



**HAL**  
open science

# Combined inorganic and isotopic signatures for the geographical discrimination of olive oil

Emna Nasr

► **To cite this version:**

Emna Nasr. Combined inorganic and isotopic signatures for the geographical discrimination of olive oil. Analytical chemistry. Université de Pau et des Pays de l'Adour, 2022. English. NNT : 2022PAUU3004 . tel-03664088

**HAL Id: tel-03664088**

**<https://theses.hal.science/tel-03664088>**

Submitted on 10 May 2022

**HAL** is a multi-disciplinary open access archive for the deposit and dissemination of scientific research documents, whether they are published or not. The documents may come from teaching and research institutions in France or abroad, or from public or private research centers.

L'archive ouverte pluridisciplinaire **HAL**, est destinée au dépôt et à la diffusion de documents scientifiques de niveau recherche, publiés ou non, émanant des établissements d'enseignement et de recherche français ou étrangers, des laboratoires publics ou privés.

# THÈSE

UNIVERSITE DE PAU ET DES PAYS DE L'ADOUR  
Ecole Doctorale des Sciences Exactes et leurs Applications  
(ED 211 SEA)

Présentée par

**Emna NASR**

pour obtenir le grade de DOCTEUR

Spécialité: Chimie Analytique et Environnement

## SIGNATURES INORGANIQUES ET ISOTOPIQUES COMBINEES POUR LA DISCRIMINATION DE L'ORIGINE GEOGRAPHIQUE DE L'HUILE D'OLIVE

Soutenue le 7 Avril 2022 à l'Institut Français de Tunisie

Après avis de :

### RAPPORTEURS

- **Nives Ogrinc** Professeur/ Jožef Stefan Institute, (Ljubljana, Slovénie)
- **Thierry Guérin** Directeur/ ANSES-DSP (France)
- **Mohamed Taieb Ben Dhia** Professeur/ Université de Tunis El Manar, UTM (Tunis, Tunisie)

### EXAMINATEURS

- **Mohamed Hammami** Directeur/ INRAP (Tunis, Tunisie)
- **Dominic Larivière** Professeur/ Université Laval (Québec, Canada)
- **Gaëtane Lespes** Professeur/Université de Pau et des Pays de l'Adour, IPREM (Pau, France)

### DIRECTEURS

- **Houyem Abderrazak** Maître de Conférence/ INRAP (Tunis, Tunisie)
- **Olivier F.X. Donard** Directeur de Recherche/ CNRS-UPPA (Pau, France)

### INVITES

- **Ekaterina N. Epova** Ingénieur/ Advanced Isotopic Analysis, AIA (Pau, France)
- **Radhia Souissi** Maître de Conférence/ INRAP (Tunis, Tunisie)
- **Mathieu Sebilo** Maître de Conférence/ Sorbonne Université -IEES (Paris, France)



## Acknowledgment

This thesis was performed in a joint supervision between the University of Tunis El Manar (UTM) in Tunisia and the University of Pau and the Adour countries (UPPA) in France. This project was funded by the European Project TunTwin from the Horizon 2020 Framework program of the European Union under grant No. 952306. It was also funded by the French ANR EquiPex MARSS project with a contribution of the METROFOOD ESFRI project and with the financial support of the Euskadi/Nouvelle Aquitaine/Navarra Euroregion through the research project ISOTOPO (with agreement no. 2020/3).

The experimental work was carried out in the facilities of the Institute of Analytical Sciences and Physical Chemistry for the Environment and Materials (IPREM) and in the laboratory of Advanced Isotopic Analysis (AIA) in France, and at the National Institute of Research and Physical-Chemical Analysis (INRAP) in Tunisia.

My sincere thanks to Pr. Gaëtane Lespes, the president of the jury and the members of the jury Dr. Nives Ogrinc, Dr. Thierry Guérin, Pr. Mohamed Hammami, Pr. Dominic Larivière, Pr. Radhia Souissi, Dr. Ekaterina Epova and Dr. Mathieu Séblío who showed their interest in my thesis and accepted to evaluate this manuscript and to participate in the defense of the thesis.

I would like to thank all those who believed in me from the beginning, but even more so those who did not believe in me and who were my source of motivation.

First, I would like to express my deepest gratitude to my supervisors Dr. Houyem Abderrazek and Dr. Olivier Donard for their help and their technical and scientific advice, the trust they have shown me, as well as for their permanent moral support. You have given me the opportunity to work in advanced laboratories to achieve this project in the best conditions.

Equally, I would like to thank Dr. Ekaterina Epova for sharing her knowledge and her time, she was a great help in the most critical moments. We shared the moments of failure as well as the moments of success, this work would never have been accomplished without you.

I am very grateful to those who actively participated in the realization of this work, from near or far: Dr. Sylvain Bérail, Dr. Julien Barre, Dr. Anne Laure Ronzani, Dr. Mathieu Sébilo, Richard Hong, Dr. Dominic Larivière, Dr. Fabienne Séby and all the UT2A team, Alberto De Diego, Dr. Radhia Souissi, Mme Beya Toumi, Mme Wiem Ayadi, Dr. Mohsen Ben Alaya, Mme Mouna Ouadhour, Marwen Gomri, Taha Chabbah, Mohamed Guesmi and all the people who helped me at IPREM and INRAP.

I am grateful to Mme Karima El Bedoui (Huile de Chorbane) for her precious help in the sampling in Tunisia, Ajmi Larbi (Olive Tree Institute of Tunis, Tunisia), Mouna Aïachi Mezghani (Olive Tree Institute of Sousse, Tunisia) as well as all the staff of the Olive Tree Institute of Tunisia for their help in the extraction of olive oil.

I would like to thank all the people who facilitated my arrival and my integration in Pau, Mohamed Ferchichi and his family, the Ben Salem family, as well as all my friends and colleagues in Pau for their endless support and the precious moments spent together, in particular Ghaya Alchoubassi, Zaied and Ahmad, Mohamed Abdelfetah Ghriga, Khouloud El Hanafi, Danielle, Wissem Khelifi, Nang...

Finally, I would like to thank my beloved parents and my brother Brahim for their support, my husband Housseem for his endless help and support, and all my family.

Emna NASR

---

## Combined inorganic and isotopic signatures for the geographical discrimination of olive oil

---

### Abstract

The globalization of the food industry has raised consumer interest in the geographical origin and the quality of food products. The global increase in food production and consumption, however, has led to fraudulent practices spreading. It threatens both the health of consumers and the economic balance of the food industry, which suffers huge financial loss every year. Olive oil is one of the most adulterated food products. As a result, a large array of analytical strategies was proposed for the geographical authentication of olive oil. The most reliable approaches that have demonstrated promising results for the geographical traceability of food products were based on the multi-elemental and isotopic fingerprinting. Nevertheless, trace elements, initially found at low to critically low concentrations in olive oil, are dissolved in a complex lipid matrix and thus the samples introduction in plasma-based instruments and the precise measurements of chemical components are challenging. This study presents a reliable analytical approach based on a three dimensional geographic information: (1) the mineral composition of the soil through the analysis of trace elements; (2) the geological background through the analysis of Sr isotopic composition; and (3) the pedo-climatic context through the determination of stable isotopes of carbon in olive oils. First, the trace elements were quantified in olive oils from Tunisia, Spain and France with high precision and accuracy by quadrupole ICP-MS following an optimized analytical procedure. The elemental concentrations combined with chemometrics allowed to classify olive oils according to their geographical provenance. Subsequently, an innovative method was developed and successfully applied for the quantitative extraction of Sr from olive oil matrix and accurate measurement of  $^{87}\text{Sr}/^{86}\text{Sr}$  isotopic ratio by MC-ICP-MS. The conservation of  $^{87}\text{Sr}/^{86}\text{Sr}$  isotopic ratios during the transfer of Sr from the soil to the plant and during olive oil extraction was demonstrated. The results were correlated with the geological characteristics of the bedrocks and thus highlighted that Sr isotopic composition of olive oil can be used as a reliable tool for fingerprinting olive oil geographic provenance. In last part of the manuscript, the stable isotopes of carbon were determined in olive oils by IRMS and allowed to trace the physiological processes of the olive tree to specific environmental characteristics. Each of the three studied single-parameter approaches provided reliable but limited geographic information. Therefore, they were combined together with chemometrics in order to establish an advanced geographical authentication tool able to overcome the most sophisticated fraudulent practices.

**Keywords:** olive oil, trace elements,  $^{87}\text{Sr}/^{86}\text{Sr}$  isotopic ratio, stable isotopes of carbon, chemometrics, geographical authentication

---

## Signatures inorganiques et isotopiques combinées pour la discrimination de l'origine géographique de l'huile d'olive

---

### Résumé

La mondialisation de l'industrie alimentaire a suscité l'intérêt des consommateurs pour l'origine géographique et la qualité des produits alimentaires. L'augmentation de la production et de la consommation mondiale de denrées alimentaires a toutefois entraîné la propagation de pratiques frauduleuses. Celles-ci menacent à la fois la santé des consommateurs et l'équilibre économique de l'industrie alimentaire, qui subit chaque année d'énormes pertes financières. L'huile d'olive est l'un des produits alimentaires les plus fraudés. En conséquence, un large éventail de stratégies analytiques a été proposé pour l'authentification géographique de l'huile d'olive. Les approches les plus fiables qui ont démontré des résultats prometteurs pour la traçabilité géographique des produits alimentaires étaient basées sur l'empreinte multi-élémentaire et isotopique. Néanmoins, éléments traces, initialement présents à des concentrations faibles à très faibles dans l'huile d'olive, sont dissous dans une matrice lipidique complexe et donc l'introduction des échantillons dans les instruments basés sur le plasma et les mesures précises des composants chimiques sont difficiles. Cette étude présente une approche analytique fiable basée sur une information géographique tridimensionnelle : (1) la composition minérale du sol à travers l'analyse des éléments traces; (2) le contexte géologique par l'analyse de la composition isotopique du Sr; et (3) le contexte pédo-climatique à travers la détermination des isotopes stables du carbone dans les huiles d'olive. Tout d'abord, les éléments traces ont été quantifiés dans des huiles d'olive de Tunisie, d'Espagne et de France avec une grande précision et exactitude par ICP-MS quadripolaire suivant une procédure analytique optimisée. Les concentrations élémentaires combinées à la chimométrie ont permis de classer les huiles d'olive en fonction de leur provenance géographique. Par la suite, une méthode innovante a été développée et appliquée avec succès pour l'extraction quantitative du Sr à partir de l'huile d'olive et la mesure précise du rapport isotopique  $^{87}\text{Sr}/^{86}\text{Sr}$  par MC-ICP-MS. La conservation des rapports isotopiques  $^{87}\text{Sr}/^{86}\text{Sr}$  pendant le transfert du Sr du sol à la plante et pendant l'extraction de l'huile d'olive a été démontrée. Les résultats ont été corrélés avec les caractéristiques géologiques des roches mères et ont ainsi mis en évidence que la composition isotopique Sr de l'huile d'olive peut être utilisée comme un outil fiable pour identifier la provenance géographique de l'huile d'olive. Dans la dernière partie du manuscrit, les isotopes stables du carbone ont été déterminés dans les huiles d'olive par IRMS et ont permis de retracer les processus physiologiques de l'olivier en fonction des caractéristiques environnementales spécifiques. Chacune des trois approches mono-paramètre étudiées a fourni des informations géographiques fiables mais limitées. C'est pourquoi elles ont été combinées avec la chimométrie afin d'établir un outil d'authentification géographique avancé capable de faire face aux pratiques frauduleuses les plus sophistiquées.

**Mots clés :** huile d'olive, éléments traces, rapport isotopique  $^{87}\text{Sr}/^{86}\text{Sr}$ , isotopes stables du carbone, chimométrie, authentification géographique.

## Table of contents

Aknowledgment .....	1
Abstract.....	iii
Résumé .....	iv
List of figures .....	ix
List of tables .....	xi
List of abbreviations .....	xiii
<b>Foreword</b> .....	<b>1</b>
<b>Chapter I State of the art</b> .....	<b>2</b>
Abstract.....	2
Introduction.....	3
1. The agri-food sector in the Maghreb and in Europe.....	6
2. Olive oil.....	9
2.1. Chemical composition.....	9
2.2. Olive oil extraction process.....	9
2.3. Types of olive oil.....	10
2.4. Worldwide economic value of olive oil .....	11
2.5. Olive oil sector in Tunisia .....	12
2.6. Olive oil sector in the European Union (EU).....	14
3. Multi-elemental and isotopic approaches for the geographical authentication of olive oil .....	15
3.1. Olive oil geographical authentication by means of trace elements.....	15
3.1.2. Analytical procedures of quantification of trace elements in olive oil .....	20
3.2. Olive oil geographical traceability by means of isotopic analysis .....	36
3.3. Statistical analysis for geographical authentication of olive oil.....	45
4. Conclusion.....	47
References.....	49
<b>Chapter II Samples description and analytical methods for the analysis of trace elements, stable isotope ratio of Carbon and Sr isotope ratio</b> .....	<b>60</b>
Introduction.....	61
1. Samples description.....	61
1.1. Samples from Tunisia.....	62
1.1.1. Olive oil samples .....	63



---

1.1.2. Samples of soil .....	65
1.1.3. Samples of roots .....	65
1.1.4. Samples of leaves .....	65
1.2. Samples from Europe .....	65
2. Analytical procedure for the analysis of trace elements in the different matrices ...	68
2.1. Samples preparation .....	68
2.2. ICP-MS analysis and quality control of the instrumental measurement.....	71
3. Analysis of stable isotope ratios of Carbon by IRMS in olive oil and leaves .....	74
4. Analysis of $^{87}\text{Sr}/^{86}\text{Sr}$ isotope ratio .....	74
4.1. Samples pretreatment .....	75
4.2. Sr purification.....	79
4.3. ICP-MS analysis.....	82
4.4. Sr isotopic analysis by MC-ICP-MS .....	83
5. Materials, reagents, standard reference materials, apparatus and instruments .....	86
References.....	90
<b>Chapter III Trace elements analysis of olive oil by ICP-MS and chemometrics for geographical discrimination .....</b>	<b>93</b>
Abstract.....	93
Introduction.....	94
2. Analytical procedure and quality control .....	96
2.1. Analytical procedure .....	96
2.2. Analytical quality control.....	96
3. Statistical data analysis.....	98
4. Results and discussion .....	99
4.1. Trace elements concentrations in olive oils .....	99
4.2. Relationship between olive oil and soil elemental content in Tunisia .....	105
4.3. Geographical classification of olive oils .....	109
5. Conclusion.....	113
References.....	114
<b>Chapter IV Determination of <math>^{87}\text{Sr}/^{86}\text{Sr}</math> in olive oil through ion extraction followed by MC-ICP-MS.....</b>	<b>120</b>
Abstract.....	120
Introduction.....	121
1. Olive oil samples and analytical strategy .....	122

---

2. Optimization of the methods .....	123
2.1. Optimization of the Method A .....	123
2.2. Optimization of the Method B .....	123
2.3. Complexation by (NH <sub>4</sub> ) <sub>2</sub> EDTA .....	124
3. Validation of the methods (method A and method B) .....	126
3.1. Validation by NIST 987 .....	126
3.2. Validation by NIST 2387 .....	128
3.3. Comparative study of both methods using olive oils .....	129
4. Application: <sup>87</sup> Sr/ <sup>86</sup> Sr isotope ratio determination in a large selection of olive oils	132
5. Application for fraud detection: case of olive oil mixtures .....	136
6. Conclusion .....	138
References .....	139
<b>Chapter V Conservation of <sup>87</sup>Sr/<sup>86</sup>Sr isotope ratio from soil to olive oil .....</b>	<b>141</b>
Abstract .....	141
Introduction .....	142
1. Samples and analytical procedure .....	143
2. Statistical analysis .....	143
3. Results and discussion .....	143
3.1. Assessment of the effect of olive oil extraction processes on <sup>87</sup> Sr/ <sup>86</sup> Sr isotope ratio	143
3.2. Concentrations and isotopic signatures of Sr of the soil, plant organs, olive oil and pomace: Intra-tree variability .....	146
3.3. Signatures of Tunisian olive oils with regards to the geological formations and ages	148
4. Conclusion .....	152
References .....	153
<b>Chapter VI Combination of isotopic and elemental approaches for the geographical authentication .....</b>	<b>155</b>
Abstract .....	155
Introduction .....	156
1. Samples and analytical procedure .....	158
2. Multivariate analysis .....	158
3. Results and discussion .....	158

---

3.1. Olive oil geographical authentication using carbon content and stable carbon isotope ratio .....	158
3.2. Olive oil geographical authentication using $^{87}\text{Sr}/^{86}\text{Sr}$ isotope ratio .....	160
3.3. Combination of the isotopic signatures with the elemental content of olive oil for the geographical authentication .....	162
4. Conclusion .....	166
References .....	167
<b>General conclusion</b> .....	171
Appendices .....	174
Scientific contribution.....	228
International conferences: oral presentations .....	228
Curriculum vitae .....	229

## List of figures

<b>Figure I.1:</b> The continuous extraction process of olive oil.....	10
<b>Figure I.2 :</b> Schematic pathways of some trace elements from the soil to the olive tree and olive oil.....	15
<b>Figure I.3:</b> Trace element concentrations in olive oil originating from: Italy, Spain, Tunisia, Spain, Portugal, Croatia, Cyprus, Turkey and Greece. (n = number of articles).....	17
<b>Figure I.4:</b> Analytical procedures for the analysis of trace elements, stable isotopes of light elements and Sr isotopic ratio in olive oil .....	19
<b>Figure I.5:</b> Percentage of articles that use atomic spectroscopic techniques to analyze trace elements in olive oil.....	32
<b>Figure II.1:</b> The sampling countries (n = number of olive oil samples). .....	62
<b>Figure II.2:</b> Sampling locations on Tunisian geological map. ....	63
<b>Figure II.3:</b> The Abencor system (OTIT). ....	64
<b>Figure II.4:</b> The sampling locations of the Spanish EVOOs.....	68
<b>Figure II.5:</b> The analytical procedure for olive oil preparation prior to ICP-MS analysis. ....	69
<b>Figure II.6:</b> Major components and Setup of PlasmaQuant MS. ....	72
<b>Figure II.7:</b> General analytical procedure for Sr isotopic analysis by MC-ICP-MS.....	75
<b>Figure II.8 :</b> Two analytical procedures applied for $^{87}\text{Sr}/^{86}\text{Sr}$ measurement in olive oil using Sr-sepc and Dowex AG50W-X8 resins.....	77
<b>Figure II.9:</b> Schematic of the experimental setup for Sr purification using Dowex AG50W-X8 resin. ....	81
<b>Figure II.10 :</b> The main components of a Nu Plasma MC-ICP-MS.....	83
<b>Figure II.11:</b> $^{87}\text{Sr}/^{86}\text{Sr}$ isotope ratios measured in NIST SRM 987 at $30 \mu\text{g kg}^{-1}$ during 2 days before olive oil analysis.....	85
<b>Figure III.1:</b> Linear correlation between Sr content in olive oil and in bioavailable Sr of soil extracts.....	106
<b>Figure III.2:</b> PCA score plot colored according to geographical origin (Tunisia, Spanish Basque country and southern France): (a) PC1 vs PC2 (b) PC1 vs PC3 (c) loadings plot for PC1 and PC3.....	110
<b>Figure IV.1:</b> The Sr extraction recoveries at different agitation times.....	123
<b>Figure IV.2:</b> The Sr complexation recoveries at different pH values.....	124

<b>Figure IV.3:</b> Elution profile of Sr and the interfering elements (Mg, Ca, K, Na, Sr and Rb) .....	125
<b>Figure IV.4:</b> Validation of the methods of a) Sr/matrix separation using resins: AG50W-X8 and Sr-Spec and the NIST SRM 987; and b) the whole analytical procedures: method A and method B using the NIST SRM 2387.....	127
<b>Figure IV.5:</b> Cross-comparison of the two methods (A and B) for NIST SRM 2387 and three samples of olive oil (a) recovery rates for extraction/complexation (white dots) and recovery rates column separation (dark dots) for different oil samples (b) Sr isotope ratios obtained by the two methods.....	130
<b>Figure IV.6:</b> Box plots of $^{87}\text{Sr}/^{86}\text{Sr}$ isotope ratio in olive oils classified according to their geographical provenance. ....	132
<b>Figure IV.7:</b> The $^{87}\text{Sr}/^{86}\text{Sr}$ isotopic ratios of the studied olive oils from Southern France and the reported values for samples from Nîmes (Medini et al., 2015).....	135
<b>Figure IV.8:</b> Theoretical mixing line between 2 olive oils and $^{87}\text{Sr}/^{86}\text{Sr}$ isotope ratio of three mixing points. ....	137
<b>Figure V.1:</b> Relationship between $^{87}\text{Sr}/^{86}\text{Sr}$ isotope ratio in olive oil and in the exchangeable fraction of the paired soil.....	144
<b>Figure V.2:</b> Comparative assessment of the $^{87}\text{Sr}/^{86}\text{Sr}$ isotope ratio measured in olive oil extracted in the OTIT (Abencor method) and in olive oil produced in oil mill .....	145
<b>Figure V.3:</b> $^{87}\text{Sr}/^{86}\text{Sr}$ isotope ratio measured in the exchangeable fraction of the soil at depth 60 cm, olive roots, leaves, olive oil and pomace from different olive orchards.....	148
<b>Figure V.4:</b> $^{87}\text{Sr}/^{86}\text{Sr}$ isotope ratios in olive oils from Tunisia grouped according to the geological period .....	150
<b>Figure VI.1:</b> Olive oil samples distribution according to $\delta^{13}\text{C} = f(\% \text{C})$ .....	159
<b>Figure VI.2:</b> $^{87}\text{Sr}/^{86}\text{Sr}$ isotope ratios in olive oils from Tunisia, France and Spain.....	160
<b>Figure VI.3:</b> The 3D score plot of the principal component analysis (PC1 vs. PC2 vs. PC3) using as variables Mn, Fe, V, Sr, Cu, Zn, Cr, $\delta^{13}\text{C}$ and $^{87}\text{Sr}/^{86}\text{Sr}$ .....	163
<b>Figure VI.4:</b> Canonical score plot of olive oils from Tunisia, France and Spain based on $\delta^{13}\text{C}$ , $^{87}\text{Sr}/^{86}\text{Sr}$ and elemental concentrations (Fe, Mn, V and Cr).....	164

## List of tables

<b>Table I.1:</b> Main products exported (in millions of Tunisian dinar) .....	13
<b>Table I.2:</b> Determination of trace elements in olive oil and other vegetable oils by means of spectrometric techniques following different sample preparation techniques .....	21
<b>Table I.3:</b> Determination of isotopic ratios of light elements in olive oil and other edible oils .....	40
<b>Table II.1:</b> Extra virgin olive oil, olive pomace, soil, roots and leaves from Tunisia: number of samples. ....	62
<b>Table II.2:</b> Olive oil samples: geographical location, cultivar, geological formation and applied agricultural practices. ....	66
<b>Table II.3:</b> The mineralization program of the microwave system (Ultrawave) for olive oil. ....	70
<b>Table II.4:</b> The mineralization program of the microwave system (Ultrawave) for plant organs. ....	71
<b>Table II.5:</b> ICP-MS operating conditions and measured isotopes. ....	73
<b>Table II.6:</b> Sr purification procedure using Sr-spec resin applied for olive oil. ....	79
<b>Table II.7:</b> Sr purification procedure using Dowex AG50W-X8 resin applied for olive oil. ....	80
<b>Table II.8 :</b> Sr purification procedure using Sr-spec resin for soil, plant organs and olive pomace. ....	82
<b>Table II.9:</b> MC ICP-MS operating conditions. ....	84
<b>Table II.10:</b> The reagents, standard reference materials, materials, apparatus and instruments used for the samples preparation and analysis .....	86
<b>Table III.1:</b> Measured concentrations of certified and non-certified elements in NIST SRM 2387 peanut butter and recoveries obtained for certified elements. ....	97
<b>Table III.2:</b> Limits of detection (LOD). limits of quantification (LOQ), linearity (R2) and precision (RSD). ....	98
<b>Table III.3:</b> Median values and ranges of concentrations ( $\mu\text{g kg}^{-1}$ ) of trace elements in olive oil samples from Tunisia, Spain (Basque country) and southern France and ranges of concentrations reported in the literature. ....	100
<b>Table III.4:</b> Median values and ranges of concentrations ( $\text{mg kg}^{-1}$ ) of trace elements in soils extracts from Tunisia. ....	105

---

<b>Table III.5:</b> Pearson correlation coefficients and significance between soil and pared olive oil elemental content.....	107
<b>Table IV.1 :</b> The Sr recovery rate of the extraction/ complexation methods and of the columns as well as the Sr concentrations and isotopic ratios of the three selected olive oils (S1, S2 and S3) and the NIST 2387.....	129
<b>Table IV.2 :</b> $^{87}\text{Sr}/^{86}\text{Sr}$ isotope ratios of olive oils from Tunisia, Spain and France. ....	133
<b>Table V.1:</b> Minimum, maximum and medium concentrations of Sr in the exchangeable fraction of soil, the roots, the leaves, olive oil and olive pomace. ....	146
<b>Table V.2:</b> The $^{87}\text{Sr}/^{86}\text{Sr}$ isotope ratio of the exchangeable fraction of soil, the roots, the leaves, olive oil (produced at OTIT and in oil mill) and olive pomace obtained from the different olive orchards in Tunisia.....	147
<b>Table VI.1:</b> Median values and ranges (in parentheses) of carbon content and $\delta^{13}\text{C}$ values of organic carbon in olive oils from Tunisia, Spain and France.....	159

---

## List of abbreviations

- ACC:** Accuracy
- AE:** Acid extraction
- ANOVA:** Analysis of variance
- BCR:** Community Bureau of Reference
- CRM:** Certified reference material
- DSN:** Desolvation nebulizer system
- EA:** Elemental analyzer
- ETA-AAS:** electrothermal atomisation - atomic absorption spectrometry
- EVOO:** Extra virgin olive oil
- FAAS:** Flame atomic absorption spectroscopy
- GFAAS:** Graphite furnace atomic absorption spectroscopy
- ICP-AES:** Atomic emission spectroscopy by inductive coupling plasma
- ICP-MS:** Inductively coupled plasma mass spectrometry
- ICP-OES:** Inductively coupled plasma atomic emission spectroscopy
- iCRC:** integrated collisional reaction cell
- IOC:** International olive council
- IRMS:** Isotope-ratio mass spectrometry
- LDA:** Linear discriminant analysis
- LOD:** Limit of detection
- LOQ:** Limit of quantification
- MC-ICP-MS:** Multicollector inductively coupled plasma mass spectrometry
- MW-AD:** Microwave assisted digestion
- NIST:** National Institute of Standards and Technology
- NMR:** Nuclear magnetic resonance
- OO:** Olive oil
- OPLS-DA:** Orthogonal Projections to Latent Structures Discriminant Analysis
- OTIT:** Olive tree institute of Tunisia
- PCA:** Principal component analysis
- PDO:** Protected designation of origin
- PGI:** Protected Geographical Indication
- QC:** Quality control
- P:** Pressure
- RF:** Radio frequency



**RR:** Recovery rate

**RSD:** Relative standard deviation

**SD:** Standard deviation

**SRM:** Standard reference material

**T:** Temperature

**TIMS:** Thermal ionization mass spectrometry

**TSG:** Traditional speciality guaranteed

## Foreword

The food industry suffers significant economic losses each year due to fraudulent practices. Olive is particularly one of the most adulterated food products. Food authenticity assessment has therefore become a major concern.

Geographical traceability of food products through advanced analytical techniques is a relevant tool to preserve food quality and to protect public health. In this context, a wide range of analytical approaches has been developed for the determination of the geographical provenance of various food products. Inorganic and isotopic approaches were successfully used as tracers of the plants growing environment.

In this study, the geographical authentication of olive oils from Tunisia, Spain and France was assessed through the analysis of trace elements as indicators of the elemental profile of the soil and isotopic ratio of C and Sr as tracers of the geo-climatic features of the plant environment.

This manuscript is divided into six chapters:

- The first chapter presents an overview on the economic situation of the agri-food industry in the Maghreb countries and in Europe. In the second part of this chapter, the analytical methods used for the geographical authentication of olive oil based on elemental and isotopic approaches were reviewed and critically discussed.
- In the second chapter, all the samples analyzed in this study were fully described. The analytical procedures developed for the determination of multi-elemental profile, stable isotope ratio of carbon and strontium isotopic ratio of the studied samples were also detailed in this chapter.
- The third chapter presents the multi-elemental approach combined with chemometrics for the geographical discrimination between olive oils samples.
- In chapter 4, an innovative method was developed and successfully applied for the determination of Sr isotopic ratio in olive oils using a MC-ICP-MS.
- Chapter 5 highlights the conservative behavior of Sr isotopic ratio when transferred from the soil the final product. The correlation between the Sr isotopic signature of the bedrock and the corresponding olive oils was then assessed.
- In the last chapter, an advanced multi-analytical approach combined with multivariate analysis was established as a reliable model for geographical authentication of olive oils.

---

# Chapter I

## State of the art

---

### **Abstract**

The food market is a key sector in the global economy. In this first chapter, the main strategic axes of agri-food industry in the Maghreb countries and in Europe were introduced. Olive oil sector is particularly of great economic importance since it is largely produced and consumed around the world. Unfortunately, olive oil displays the largest fraud actions leading to serious economic implications and potentially impacting consumer's health. As a result, a large array of analytical strategies has been developed for its geographical authentication. Among those, multi-elemental and isotopic analyses have been developed and largely described. In the first part of this chapter, the range of multi-elemental concentrations recorded in olive oil from the main producing countries have been discussed. The compilation of the data from the literature indicated that, in general, the elements are present at trace levels and can be classified in 3 groups according to the range of elemental concentrations (low, medium and high). Different practices of sample preparation, detection techniques and statistical data treatment were reviewed and discussed. Results obtained through the presented analytical approaches have demonstrated a strong correlation between the multi-elemental composition of the oil and that of the soil in which the plant grew. Subsequently, the limits of olive oil authentication using multi-elemental composition were presented. Finally, different methods based on isotopic signatures were compiled and critically assessed. Light stable isotopes have allowed, for years, an acceptable segregation of oils from different origins. More recently, the determination of stable isotopes of strontium has proven to be a reliable tool in determining geographical origin of food products. The ratio  $^{87}\text{Sr}/^{86}\text{Sr}$ , stable over time and directly related to soil geological features, opens the way to further studies on olive oils origin using a combination of different isotopic approaches and multi-elemental composition.

## Introduction

The dynamic growth of the agri-food sector accompanied by an increase in food consumption are driving global economic growth. Olive oil, particularly, is a key component of the Mediterranean diet and is largely consumed around the world. Sometimes called “liquid gold”, olive oil is mainly appreciated for its flavor and high nutritional value, along with its recognized potential in the prevention of certain diseases (Escrich, 2005; Flori et al., 2019; Harwood & Aparicio, 2000). It is also an interesting ingredient in dermo-cosmetology, as it has beneficial effects on skin (Poljšak et al., 2020; Viola et al., 2009).

The increased production of olive oil has been driven by an increasing global consumption of olive oil over the past two decades. Global consumption reached 2 970 000 metric tonnes in 2019/2020 (Statista: Olive oil consumption worldwide). This global increase in the demand has caused the price to rise, and the high economic value of olive oil has led to widespread fraudulent practices. It is now considered to be one of the most adulterated foods (Matthäus et al., 2019; Yan et al., 2020).

False declaration of geographical origin is among the most prevalent forms of olive oil fraud and is the most challenging to detect. The implications of food fraud can range from acute health effects on consumers to significant economic losses. The global financial agri-food industry loss due to olive oil fraud has been estimated to be between \$30 and \$40 billion per year (PWC 2016, available at <https://press.pwc.com/News-releases/fighting--40bn-food-fraud-to-protect-food-supply/s/44fd6210-10f7-46c7-8431-e55983286e22>, accessed on 18 January 2022). Reputable producers also suffer reputation loss when consumers lose trust in the market due to counterfeited poor-quality product (Bimbo et al., 2019).

Therefore, establishing a traceability system in the food industry, in particular in olive oil production, has become a major issue to guarantee the quality and authenticity of food products (Shears & Shears, 2010). The PDO label on olive oil has indeed become a motivating choice criterion for customers, since olive oil quality and flavor are linked to where the olives grow, and associated with specific production practices (Dekhili et al., 2011; Menapace et al., 2011). As a result, the geographical authentication of olive oil is becoming an important trend in scientific research, particularly in the field of analytical chemistry (Kalogiouri et al., 2020).

Between 1994 and 2020, the number of studies containing keywords related to the geographical authentication of olive oil has increased drastically; there were less than 30 articles in the 1990s and more than 240 in 2020 alone (Mal et al., 2020).

The choice of appropriate analytical strategies for olive oil characterization is complex. Olive oil is a particularly challenging matrix due to its high fatty composition and viscosity. Its lipid nature frequently hampers the direct traditional sample introduction strategies common for various analytical instruments. Furthermore, during the olive oil production process, which starts with olive growing and concludes with storing the extracted oil, many factors affect its overall chemical composition. First, the olive variety has a direct influence on the fatty acids, sterols, and total polyphenol composition (Essiari et al., 2014). Second, during the growth of the olive trees, the agricultural practices (irrigation and use of fertilizers) that are used can impact the final chemical composition of the olive oil (Camin, Larcher, Nicolini, et al., 2010). Third, after the harvesting of the olives and during the oil extraction process, potential contaminants and alterations can be involved in the final composition of the oil, since the olives are in direct contact with different surfaces and excipients throughout the processing.

Other key parameters that affect the chemical composition of the final product include the oil extraction method (Markhali, 2021), the type of oil obtained (virgin, extra-virgin, or lampante), (Diego, L., 2004) and the filtration of the final product (Pošćić et al., 2019). The shelf life of olive oil also affects the quality of the final product. The current industrial method extends the storage time compared to the traditional pressing method, because the industrially extracted oils have a lower percentage of total degraded polyphenols. More recently, it has been shown that the filtration process of olive oil, which mainly removes pomace residues and leftover water, can significantly alter the content of trace elements naturally present in the olive oil (Pošćić et al., 2019). Finally, the storage and transport conditions of the olive oil, if not carefully controlled, affect its oxidative stability (Cuvelier, 2012; Tekaya et al., 2005). Due to all these potential alterations during the olive oil milling process, storage, and transportation, strict analytical control is needed at every single step.

*Organic and inorganic analysis of olive oil:* The analytical methods used for the authenticity and the traceability of the olive oil should take the various possible changes into consideration in order to obtain controlled and reproducible parameters for overall quality assessment. To respond to such challenging issues, a large array of analytical strategies has been developed.

They include organoleptic approaches, biological, chemical, and elemental/ isotopic analyses (Tres et al., 2013). The usual organic analytical methods are based on the determination of organic compounds such as fatty acids and triacylglycerols (Gertz et al., 2019), phenols (Bajoub et al., 2015), sesquiterpene hydrocarbons (Quintanilla-casas et al., 2020), and sterols (Noorali & Barzegar, 2014; Youseff et al., 2014).

The current state-of-the-art methods are mostly based on the interpretation of each oil's elemental profile (as principal indicator of origin and agricultural practices), stable isotopes of light elements (whose occurrence in the final product is primarily linked to the plant growth environment), and the isotopic composition of strontium (as a direct reflection to local soil and geology) (Danezis et al., 2016; Gupta et al., 2019). Among the various elemental analysis techniques, atomic spectrometry techniques are constantly evolving. These techniques can do simultaneous multi-elemental analysis with enhanced resolution, accuracy and sensitivity, which is excellent for the discrimination of food origin (Wadood et al., 2020). However, olive oil analysis is still challenging as the oil is a fatty matrix with a rich and varied organic content, where chemical elements mainly occur at trace levels ranging from few  $\mu\text{g kg}^{-1}$  to few  $\text{mg kg}^{-1}$  (Benincasa et al., 2012). Therefore, reliable, accurate, and precise measurement of trace elements in olive oil is a key issue that requires adequate and efficient sample pretreatment and preparation methods (Pošćić et al., 2019). A wide range of olive oil preparation techniques have been proposed in the scientific literature. Some preparation methods aim to destroy the organic matter using strong acids (e.g. microwave-assisted digestion, calcination), while others are non-destructive, aiming to extract the elements without significantly altering the matrix (e.g. liquid-liquid extraction, extraction using a chelating agent, sample dilution, emulsification). Trace elements are then quantified by means of several atomic spectrometric techniques (flame atomic absorption spectroscopy: FAAS, graphite furnace atomic absorption spectroscopy: GF-AAS, inductively coupled plasma atomic emission spectroscopy: ICP-OES, inductively coupled plasma mass spectrometry: ICP-MS).

The analysis of stable isotopes, mainly H, C and O isotope ratios, by isotope ratio mass spectrometry (IRMS) and nuclear magnetic resonance (NMR) was also successfully used for geographical discrimination of olive oil, since the isotopic fractionation of these elements is correlated to geographical and climatic conditions (Camin et al., 2016; Portarena et al., 2014). More recently, the analysis of isotopes of "non-traditional" elements such as strontium allowed a reliable geographic tracing of a variety of food products. The Sr isotopic signature initially

characterizes geogenic soil formations and overlies on the geological formations (Capo et al., 1998; Voerkelius et al., 2010). Few studies have investigated  $^{87}\text{Sr}/^{86}\text{Sr}$  ratios in olive oil by means of thermal ionization mass spectrometry (TIMS) (Medini et al., 2015), as this approach is challenging, since the concentration of strontium in olive oil is in general lower than  $50 \mu\text{g kg}^{-1}$  (Benincasa et al., 2007). This critically low concentration is a major obstacle for Sr isotopic analysis. Highly sensitive detection techniques and powerful methods of sample preparation are required to eliminate the matrix and pre-concentrate the strontium.

In the first part of this chapter, an overview on the agri-food industry, particularly in the Maghreb and in Europe, was presented. Subsequently, the economic value of olive oil in the respective areas was investigated.

In the second part of this chapter, a synthetic review was performed based on the information reported in the scientific literature on (1) the occurrence of inorganic elements, and, when possible, light and non-traditional isotopes, in olive oils; (2) methods of analysis; and (3) using element analysis to determine geographical provenance. Recent analytical techniques for the authentication of olive oil are reviewed and discussed.

## **1. The agri-food sector in the Maghreb and in Europe**

The global food market is a key economic sector. It aims at the development and promotion of agricultural and fishery products. In the Euro-Mediterranean region, agri-food products represented 10.2% of the total exports in 2020 (United Nation for Environment Program, UNEP, available at <https://www.unep.org/unepmap/fr/resources/2020-edition-state-environment-and-development-mediterranean-soed>, Accessed on 07/03/2020).

The emergence of new technologies as well as the globalization of the markets have considerably developed the agri-food sector (Rigar & Bencharif, 2016.). In the Mediterranean area, a digital innovation platform, Prima Observatory on Innovation, was designed to promote new solutions and development pathways for the agri-food sector (United Nation for Environment Program, UNEP, available at <https://www.unep.org/unepmap/fr/resources/2020-edition-state-environment-and-development-mediterranean-soed>, Accessed on 07/03/2020).

*The agri-food sector in the Maghreb countries:* In the Maghreb, the agri-food industry has undergone considerable development due to a relatively high population growth rate combined with strong urbanization and improved incomes. This socio-economic transformation has generated a strong demand for processed food products in Tunisia, Algeria and Morocco (Bencharif, 1993). At the same time, liberalization and globalization of economies have created new requirements for agribusinesses in the Maghreb to reach levels of competitiveness comparable to international thresholds (Rigar & Bencharif; 2016).

In Tunisia, the food industry includes processing units of fruit, vegetables, milk, olives, meat, fish, flour, cereals, tobacco and other food products. A national strategy for the promotion of the agri-food sector (2016-2025) has been developed. It aims to strengthen the quality and safety of food, control the organization of processing campaigns, encourage production and export as well as promote partnership, technological development and networking (Ministry of Environment and Sustainable Development, 2016, available at <http://www.onagri.nat.tn/uploads/Etudes/tun169254.pdf>, Accessed on 08/03/2022). In parallel, the United Nations Industrial Development Organization (UNIDO) has implemented a phase II of the Market Access Project for Agri-Food and Terroir Products (PAMPAT) in Tunisia (2020-2024). The overall objective of this project is to contribute to the valorization of local products and their marketing, in order to promote the sale, export and employment of high quality food products (PAMPAT, Available at <https://pampat.tn/>, Accessed at 14/03/2022). Some processed products are more oriented towards the external market such as olive oil while others are intended for the domestic market such as beverages. It should be noted that the value added food and beverage industries has recorded, since the 1980s a considerable accelerated growth (Chebbi, 2016). Although Tunisia tries to provide high quality food products (ISO 22000 certification in the food industry since 2001), the competition on the global food market is increasingly accentuated. The pressure of this competition is reflected by a continuous decline in the selling prices of agri-food products (Central Bank of Tunisia, available at [https://www.bct.gov.tn/bct/siteprod/documents/RA\\_fr.pdf](https://www.bct.gov.tn/bct/siteprod/documents/RA_fr.pdf), Accessed on 08/03/2022).

As part of its strategies for upgrading the food market, Tunisia has created the Agri-food Technopole of Bizerte (AGRO'TECH) as a space for exchange and partnership between the various stakeholders of the Tunisian agri-food sector. Indeed, the agri-food technopoles are territorial economic development structures based on networking and coordination between the various agri-food stakeholders, particularly research and training institutions, industries and political decision-makers related to this sector.



To date, AGRO'TECH has 31 partners including 23 Tunisians and 8 foreigners and 102 companies in the agri-food sector (The Pole of Competitiveness of Bizerte, available at: [http://www.pole-competitivite-bizerte.com.tn /index.php?code\\_menu=4](http://www.pole-competitivite-bizerte.com.tn/index.php?code_menu=4), accessed on 03/03/2022).

Unlike the Tunisian AGROTECH model, which groups together all the country's agrifood sectors, Morocco has created 8 specialized territorial agrifood technopoles called Agropolis. Meknes Agropolis is specialized in horticulture, olive oil, milk, cereals and meat. Oriental Agropolis, Berkane, is specialized in citrus and olive oil. Souss-Massa Agropolis (Agrotech), Agadir is specialized in horticulture and local products while Tadla Agropolis is specialized in olives, vegetables, milk and meat. Gharb Agropolis, Kenitra is specialized in olives, citrus, vegetables, milk and meat. Haouz Agropolis is specialized in olives, citrus fruits, vegetables, milk and meat. Further, Haliopolis Agadir and Dakhla-Laâyoune are specialized in fish processing (Gálvez; 2014).

In Algeria, the National Land Use Plan created in 2006 aimed to enhance competitiveness with 6 integrated agricultural clusters (Rigar & Bencharif; 2016). However, the realization of agri-food technopoles remains at an early stage. The existence of an important agri-food industrial fabric in the Bejaia region has allowed the of a cluster in beverage industries. Various obstacles prevent this draft technopole from developing and meeting the standards of an agrifood technopole (Timeridjine, S.; Chitti,M.; 2021).

*The agri-food sector in Europe:* In Europe, the agri-food industry is the biggest manufacturing sector. It is considered as a strategic pillar of the economy. In France, about 70% of the agricultural, livestock and fishing products are transformed into foodstuffs (Ministry of Agriculture and Food, France, available at <https://agriculture.gouv.fr/le-panorama-des-industries-agroalimentaires>, accessed on 08/03/2022). Compared to other segments of the French economy, the agri-food industry has long been characterized by a trade surplus. However, since the mid-2000s, several reports have highlighted a decline in the French agri-food trade balance. Overall, the European Union has been running a large trade deficit in processed products for decades (Guignand et al., 2021). In fact, the intra-Community market is close to saturation, especially since new competitors have joined it as new countries have been added.

This enlargement has accentuated a competitive pressure for agri-food products already felt since the accession of Spain in 1984 (Guignand et al., 2021). The European Commission is working to improve the competitiveness of the EU food sector through creating new trade opportunities for food and drink products (European Commission website: [https://ec.europa.eu/growth/sectors/food-and-drink-industry\\_en](https://ec.europa.eu/growth/sectors/food-and-drink-industry_en), accessed on 09/03/2022)

In Europe, the priority is given to products whose quality is guaranteed by European Union schemes of geographical indications, known as Protected Designation of Origin (PDO), Protected Geographical Indications (PGI), and Traditional Specialties Guaranteed (TSG) (González & de la Guardia, 2013). Obtaining these quality labels, applied generally to all food products, is closely related to the geographical provenance and often refers to specific production processes. Therefore, origin and production schemes translate into unique taste and nutritional values. The PDO label on olive oil has indeed become a motivating choice criterion for customers (Menapace et al., 2011) since its quality and flavor are mostly linked to the origin and associated to specific production practices (Dekhili et al., 2011).

## **2. Olive oil**

### **2.1. Chemical composition**

Olive oil is a natural food product extracted from olives, the fruit of the olive tree (*Olea europaea* L.). It is a viscous liquid based on fat. This oil is composed mainly of triacylglycerols, TAG ( $\approx 99\%$ ). The minority fraction contains free fatty acids, mono- and diacylglycerols, as well as an array of lipids such as hydrocarbons, sterols, aliphatic alcohols, tocopherols and pigments (Boskou et al., 1999).

### **2.2. Olive oil extraction process**

Olive oil is obtained through a multi-stage extraction process composed of several steps. Figure I.1 illustrates the various steps of olive oil extraction.

At first, olives are washed and then crushed mechanically to obtain an olive paste. The paste is then subjected to malaxation (churning or milling to aggregate the small oil drops) at ambient temperature. Next, the mixture is centrifuged to separate the olive oil from the pomace.

The “olive pomace” is defined as the solid residue recovered during the olive oil extraction process, obtained either by pressing or centrifugation. Pomace includes pieces of skin, pulp, stone, and olive kernel.

Traditional oil extraction uses pressing followed by centrifugation/settling as a means of phase separation, whereas in modern extraction, the oil is isolated by means of centrifugation which is facilitated by the addition of a quantity of hot water (28-35°C) (Souilem et al., 2017).

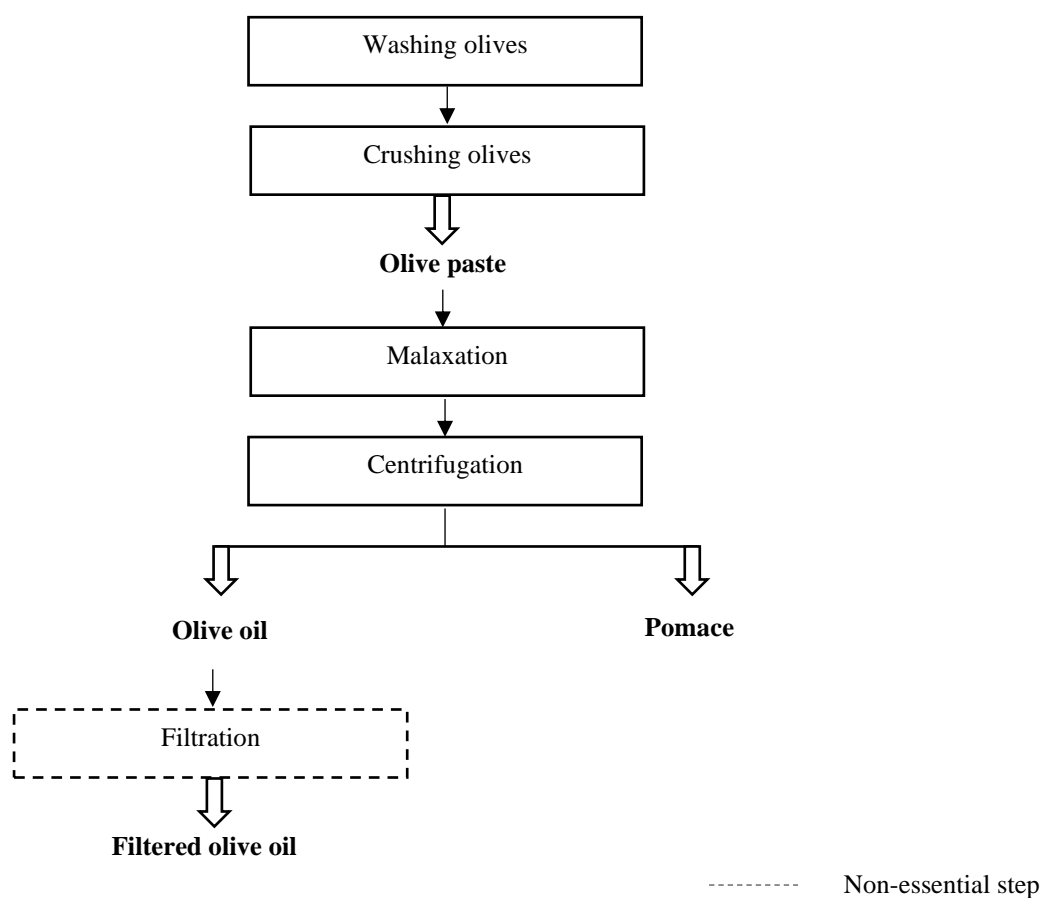

**Figure I.1:** The continuous extraction process of olive oil

### 2.3.Types of olive oil

Different designations are attributed to olive oil according to quality indicators: virgin olive oil (virgin, extra-virgin and lampante), refined olive oil and pomace oil.

Virgin olive oils are classified according to the free acidity, expressed as oleic acid, which defines the taste, smell and thus the edibility of the oil. The standard quality indicators for the classification of olive oils are set by the International Olive Oil Council (IOC). The IOC is the only international organization dedicated to the sustainable development of olive growing. It was created in Madrid, Spain, in 1959, under the auspices of the United Nations and today includes 17 member states and the European Union.

Other categories of non-virgin olive oils were defined by the IOC including refined olive oil, crude olive pomace and refined olive pomace oils.

Further, other designations may appear on the bottles of olive oil marketed, "filtered" and "unfiltered" oil. Indeed, the filtration of olive oil consists in eliminating the humidity as well as the impurities remaining in suspension in the oil. Filtration allows to extend the life of the olive oil (Goidanich, 2010).

#### **2.4. Worldwide economic value of olive oil**

Olives and olive oil are the core of the Mediterranean diet. In fact, olive oil is shown to assist people with cardiovascular issues towards their wellbeing (Roberfroid, 2014). Its use is not limited to the "kitchen" as it is also a key ingredient for dermo-cosmetics. (Gorini et al., 2019). Internationally, the constant growth of olive oil production proves the increase in demand from different companies. Indeed, multiple scientific articles emphasize the benefits and attributes of olive products leading to an increase in consumption. Large amounts of olive oil are annually produced around the Mediterranean basin and consumed worldwide. According to the International Olive Oil Council, around 10.2 million hectares of land are devoted to olive growing around the world, and the world production of olive oil from IOC member countries has tripled in the last 60 years. Production has been estimated to be almost 3 million tonnes for the period 2019/2020, with about 2 million tonnes produced in Europe, and about 1 million tonnes in non-European countries. (IOC: International Olive Council/olive oil- estimated 2019/2020 crop year). The increased production of olive oil has been driven by an increasing global consumption of olive oil over the past two decades. Global consumption reached 2 970 000 metric tonnes in 2019/2020 (Statista: Olive oil consumption worldwide, available at <https://www.statista.com/statistics/940491/olive-oil-consumption-worldwide/>, accessed on 12 March 2021). Spain provides 42.0% of world production of olive oil against 10.2% for Italy and 7.7% for Tunisia which occupies the third place worldwide.

## **2.5.Olive oil sector in Tunisia**

Olive growing is a critical sector in Tunisia's economy. In fact, Tunisia presents 309,000 growers accounting for 20% of the active population in the primary sector. Additionally, the same sector showed a positive effect towards the industrial and commercial infrastructure of the country. It presents more than 1750 oil mills, 15 refining plants, 14 olive pumice oil extractors, over 35 bottling plants and more than 200 private sector traders and exporters (Fernández-Uclés et al., 2020).

Moreover, 30% of Tunisia's agricultural land is allocated for the cultivation of olive trees. With 1.68 hectares of olive trees, olive represents 15% of the country's agricultural products. About 65.9 million feet is the estimate of the number of olive trees on the Tunisian territory (Ministry of Agriculture and Hydraulic Resources, 2006). There is a wide range of varieties of olives, among the oil varieties we can cite: Chemlali, Chétoui, Oueslati, Geboui, Zalmati, Zarazi, Barouni and Chemlali of Gafsa. The variety Chemlali is the dominant, it occupies 85% of the area intended for olive cultivation.

The Tunisian olive oil is known for its exceptional quality. It has been ranked among the 3 best olive oils in the world for several successive years.

Olive oil, on the other hand, represents 50% of the agricultural exports and 5.5% of the country's total exports. According to the IOC estimate for the 20/21 harvest year, Tunisia would produce 120,000t of olive oil, of which 100,000t would be for export. In general, olive oil represents 50% of agricultural exports and 5.5% of total exports of the country. Tunisia is also ranked 3rd producer and 1st exporter of olive oil outside the EU (IOC). The Tunisian olive oil is mainly exported to the EU, especially in bulk (98%). Less than 2% of oil is exported packaged.

At the end of January 2022, the export revenues of olive oil amounted to 620.6 million dinars, or 209.7 million U.S. dollars, recording an increase of 32% compared to the same period last year. However, only 18% of these revenues come from exports of packaged olive oil (ONAGRI: Observatoire National de l'Agriculture, Accessed on 10/03/2022).

These numbers prove that the olive growing sector and the olive oil industry, in fact, present a direct and critical impact on Tunisia's economic growth.

Table I.1 describes the value of the main products exported from Tunisia in millions of dinars between 2014 and 2018 comparing olive oil to fish, date and citrus fruit.

**Table I.1:** Main products exported (in millions of Tunisian dinar)

<b>Year</b>	<b>2014</b>	<b>2015</b>	<b>2016</b>	<b>2017</b>	<b>2018</b>
<b>Olive oil</b>	490.2	1891.9	872.4	1009.4	2125
<b>Fish, crustaceans and molluscs</b>	231.5	252.3	270.9	357.3	463.7
<b>Dates</b>	388.4	445.3	486.5	557.3	744.1
<b>Citrus fruit</b>	21.8	23	24.7	21.1	22.6

Adapted from (Tunisian National Institute of Statistics, INS, Available at <http://www.ins.tn/en/solr-search/content?keys=export>, Accessed on 28/02/2022)

To explain some of the differences noticed in Table I.1, a step back in history of the country is needed. Historically, Tunisia relied on national production of olive oil towards its domestic market. However, starting in 1962, the country adopted policies to encourage mass exports of olive oil and importing see oils with a vision to promote exports culture and offer available prices to low income families to consume the same product. These policies, encouraged investors to modernize the industrial infrastructure related to growing olives, storing and processing it. Initially, Tunisia focused on exporting olive oil to a specific set of countries such as, Italy, Spain and France, which resulted in a steady increase of the country's olive oil exports. These policies were, indeed, flexible in the face of new challenges the sector faces. For instance, with such a focused geographic focus on exports in countries within the European Union, Tunisia's exports were known for a low added value due to a lack of concern to packaging, processing or even quality labeling. In response, a national development strategy was put into action to encourage quality production by controlling adequate soils in growing areas, while also modernizing storage facilities, and putting more effort towards labels. This supported the Tunisian government gain more value towards their production of olive oils and created a unique label used in exports that glorified the Tunisian products in the international market. In general, the Tunisian national development strategy allowed various funds towards this sector. More importantly, it encouraged the growers' export activity and provided a favorable framework for investors (Fernández-Uclés et al., 2020).

Since the 80s to 90s, Tunisia has achieved an upgrade in its agricultural strategy. Laws and institutions were created in order to promote the food industry, including the production and export of olive oil. That's why today the export of olive oil has become a strategic axis for the Tunisian economy (BAKARI, 2020; Larbi & Chymes, 2010).

Tunisia has recently obtained, in 2020, a quality label, the “Appellation d’Origine Contrôlée” (AOC) olive oil of Teboursouk (3 March 2020, records of the World Intellectual Property Organization (WIPO)).

## **2.6.Olive oil sector in the European Union (EU)**

The EU produces about 67% of the world's olive oil. Approximately 4 million hectares, mainly in the Mediterranean countries of the EU, are devoted to olive cultivation, combining traditional, intensive and super intensive orchards.

Italy and Spain are the largest consumers of olive oil in the EU, about 500,000 tons are annually consumed in each of the two countries. Greece has the highest per capita consumption in the EU, with about 12 kg per person per year. In total, the EU accounts for about 53% of world consumption. ([https://ec.europa.eu/info/food-farming-fisheries/plants-and-plant-products/plant-products/olive-oil\\_en](https://ec.europa.eu/info/food-farming-fisheries/plants-and-plant-products/plant-products/olive-oil_en), accessed on 10/03/2022)

In Europe, there are a total of 132 PDO and PGI extra virgin olive oils: Italy (49), Spain (32), Greece (31), France (7), Portugal (6), Croatia (5) and Slovenia (1). The list of products that have obtained these quality labels is continuously updated. (European commission, available at <https://ec.europa.eu/info/food-farming-fisheries/food-safety-andquality/certification/quality-labels/geographical-0indications-register/#>, accessed on August 2021).

Olive oil imports into the European Union are normally subject to high tariffs ranging, currently, from 1,226 to 1,603 euros per ton. According to an association agreement signed between Tunisia and the European Union, Tunisian olive oil exports to the EU are subject to an annual duty-free quota of 56,700 tons (Food and Agriculture Organization of the United Nations, available at <https://www.fao.org/publications/card/en/c/fbe55179-ed61-427a-af6a-fb0c21bfc54e/>, accessed on 08/03/2022). The quantities exported in bulk of Tunisian extra virgin olive oil to Spain shows a significant increase in 2020 (48.6%) compared to 2019 (29%). Nevertheless, the quantities exported packaged have decreased by 93%, for the same period (NOA: National Observatory of Agriculture, available at <http://www.onagri.nat.tn/uploads/veille/marche-de-lhuile-olive.pdf>, accessed on 08/03/2022).

### 3. Multi-elemental and isotopic approaches for the geographical authentication of olive oil

#### 3.1. Olive oil geographical authentication by means of trace elements

Trace elements are widely used in the geographical authentication of food products. By definition, elements are trace elements when their concentration in the earth's crust does not exceed  $1 \text{ g kg}^{-1}$ . They are naturally present in the soil at varying concentrations and are taken up by plants through the roots. In general, it is recognized that the bioavailable elements of the soil are most easily assimilated by plants through the roots and then transferred to the upper parts by translocation (Carini & Bengtsson, 2001) (Figure I.2).

Although several factors can affect element uptake by plants (including the soil pH, the cation exchange capacity, the plant variety, and its age) the elemental composition of a plant mainly reflects soil elemental composition (Alloway & Davies, 1971; Gupta et al., 2019; A. Khan et al., 2015).

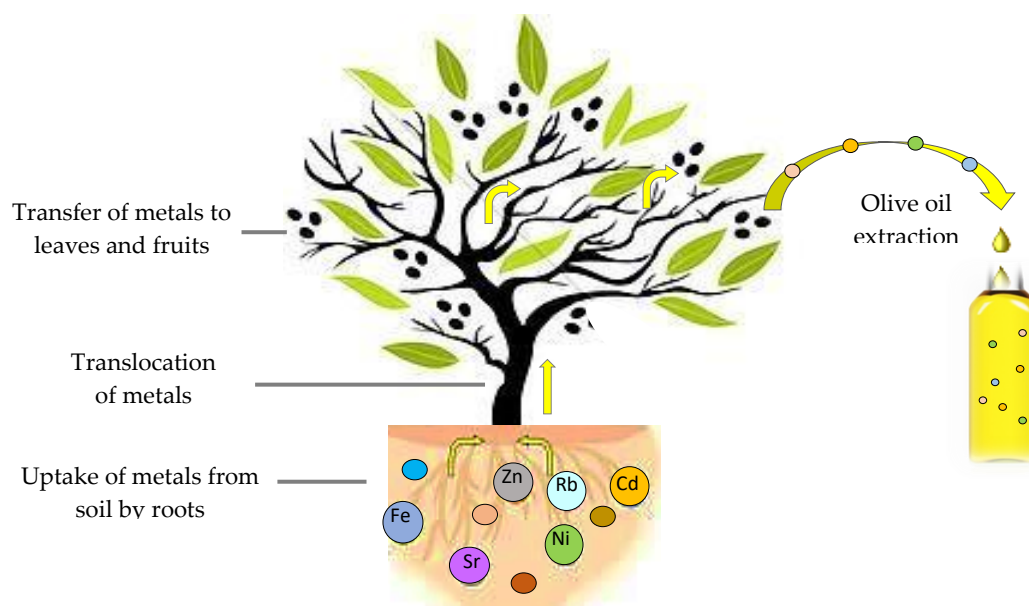

**Figure I.2** : Schematic pathways of some trace elements from the soil to the olive tree and olive oil

Elements are transferred to the soil via the biogeochemical alteration of the rocks. Therefore, the elemental composition of the soil depends mostly on the composition of the bedrock (Mathieu et al., 2008; Rachid & Misbahi, 2014). However, elements can accumulate in soil through anthropogenic activities (A. Khan et al., 2015).



Elements can be directly deposited on the soil surface by use of fertilizers and metal-containing pesticides, or result from dustfall of industrial activities and automotive traffic (brake dust and exhaust aerosols). These contaminants can be transported by irrigation water and thus can accumulate in plants. The elements assimilated by plants are therefore from lithogenic and anthropogenic origins.

Among the elements assimilated by plants, some are essential to growth and development, while others are not. Elements (both essential and nonessential) may also be toxic when present at levels exceeding a certain concentration threshold (Gupta et al., 2019). For the analysis of elements in olive oil, it is helpful to divide them into three categories: (1) Elements such as Sr, Rb and Li are found at varying concentrations in olive oils, although they are not essential for its growth and development.

Their concentrations are mainly linked to the type of soil and bedrock. Therefore, they can be used to trace the geological origin (Camin, Larcher, Perini, et al., 2010; Shahzad et al., 2017). (2) Elements like Cd, Cu and K can be added through agricultural amendments such as the Bordo Mix (mixture of copper sulphate ( $\text{CuSO}_4$ ) and quicklime ( $\text{CaO}$ )), and thus they may contribute to link to a region with specific agriculture practices (Medini, 2015). Cadmium is also a well-known food contaminant that can originate from the use of phosphate fertilizer, or it can be transferred into food through the packaging materials (Skrzydłowska et al., 2003). (3) Elements such as As, Pb, Cu, Cr and Ni can be sourced from discharges of industrial activities such as textiles and metallurgy.

As shown above, the inorganic signature of food can be an indicator of industrial activities based on a specific geographical area (A. Khan et al., 2015). These findings underline the value of using trace element content to assign geographical origins to food products, and hence of developing a reliable and trustworthy strategy for a precise determination of elemental composition.

### **3.1.1. Reported content of trace elements in olive oil**

Until now, compared to other foods, only a few studies have quantified trace elements in olive oil. This is mainly related to the complexity of the olive oil matrix, which makes it tough to develop a reliable analytical procedure.

The ranges of concentrations of the elements most commonly used for geographical classification are presented in figure I.3.

The data presented in this figure are based on the compilation and review of reported results in the scientific literature for olive oils originating from the following countries: Italy, Spain, Tunisia, Spain, Portugal, Croatia, Cyprus, Turkey and Greece. Except for Ca, trace elements in olive oils are found at varying concentrations, yet they did not exceed a few hundred micrograms per kilogram ( $\mu\text{g kg}^{-1}$ ). Figure I.3 is divided along three vertical axes to form three groups of elements at low, medium, and high concentrations. The first category of elements displaying the lower concentration includes Pb and Rb, with median concentrations around  $0.25 \mu\text{g kg}^{-1}$ .

The second group of elements at medium concentrations includes As, Ba, Mn, Ni, and Sr. The concentrations of As, Ba, Mn and Sr did not exceed  $50 \mu\text{g kg}^{-1}$ . Slightly higher values and a high variability were observed for Ni, though the highest values reported did not exceed  $200 \mu\text{g kg}^{-1}$ .

The third group of elements, including Ca, Cr, and Fe, have been classified as elements at relatively high concentrations, ranging from few hundred  $\mu\text{g kg}^{-1}$  up to tens of  $\text{mg kg}^{-1}$ ; the highest concentrations were reported for Ca.

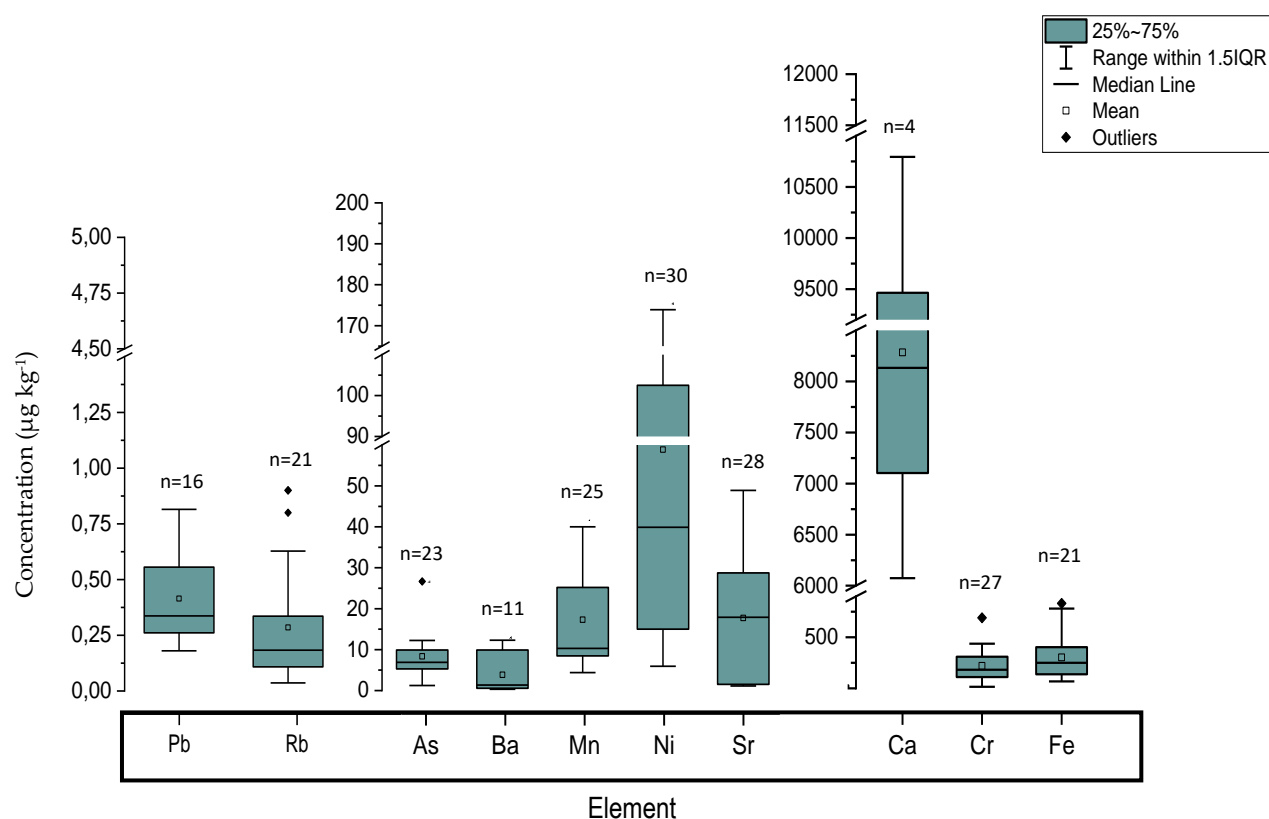

**Figure I.3:** Trace element concentrations in olive oil originating from: Italy, Spain, Tunisia, Spain, Portugal, Croatia, Cyprus, Turkey and Greece. (n = number of articles)

These elemental concentrations, mostly at critically low values, dissolved in a complex lipid matrix are thus challenging to quantify with high precision. Accordingly, an array of analytical procedures was developed. A wide variety of sample preparation methods were tested and various detection techniques were employed. The choice of an appropriate analytical strategy is crucial. Nevertheless, critical attention should be paid to the potential contamination that can occur during the sample preparation leading to high blanks and high detection limits. In case of olive oil, high blanks can be comparable to elemental concentration of the sample analyzed. Accordingly, some elements with initial critically low concentrations, such as Li and Sr (Beltrán et al., 2015), or Ni and Cd (Brkljača et al., 2013; Nasr et al., 2022), could not be detected or quantified with high precision.

This could be one of the main reasons why the concentrations of some elements recently summarized in the literature (Table 1 from Pošćić et al. 2019 (Pošćić et al., 2019)) varied enormously. For example, concentrations of Cu and Fe determined in olive oils from Croatia by Zeiner et al. (2005) (Zeiner et al., 2005) were three times higher than those reported by (Cindric et al., 2007) in oils of the same geographical origins, suggesting that contamination could have occurred during the analytical process.

Similar variability was observed for Li in oils originating from Italy. The reported concentrations ranged from 0.008 to 0.020  $\mu\text{g kg}^{-1}$  (Camin, Larcher, Nicolini, et al., 2010; Camin, Larcher, Perini, et al., 2010) while olive oils from Spain exhibited significantly higher concentration of Li, up to 6.4  $\mu\text{g kg}^{-1}$ , as reported by (Beltrán et al., 2015). This was also the case for Rb in Italian oils. The levels recorded were ranging between 0.04 and 0.39  $\mu\text{g kg}^{-1}$  in Italian olive oils (Camin, Larcher, Perini, et al., 2010) and up to 2.6  $\mu\text{g kg}^{-1}$  in Spanish oils (Beltrán et al., 2015). The concentrations of Sr were also found to vary widely between different countries, from less than 0.3  $\mu\text{g kg}^{-1}$  in European oils (Camin, Larcher, Nicolini, et al., 2010) up to 40  $\mu\text{g kg}^{-1}$  in Tunisian oils (Damak, Asano, Baba, Suda, et al., 2019). It might be supposed that such variability in concentrations of Li, Rb and Sr can be related to the elemental content of the soil of origin as these elements are mainly originating from (Camin, Larcher, Nicolini, et al., 2010; Camin, Larcher, Perini, et al., 2010).

Other element concentrations also varied widely. Co, for examples, was 1.0–5450  $\mu\text{g kg}^{-1}$  (Zeiner et al., 2005), Mg was 56–1030  $\mu\text{g kg}^{-1}$  (Benincasa et al., 2007), Mn: 3.5–150  $\mu\text{g kg}^{-1}$  (Llorent-Martínez, Ortega-Barrales, Fernández-De Córdoba, et al., 2011) and Cr: 12 - 1830  $\mu\text{g kg}^{-1}$  (Bakircioglu et al., 2013).

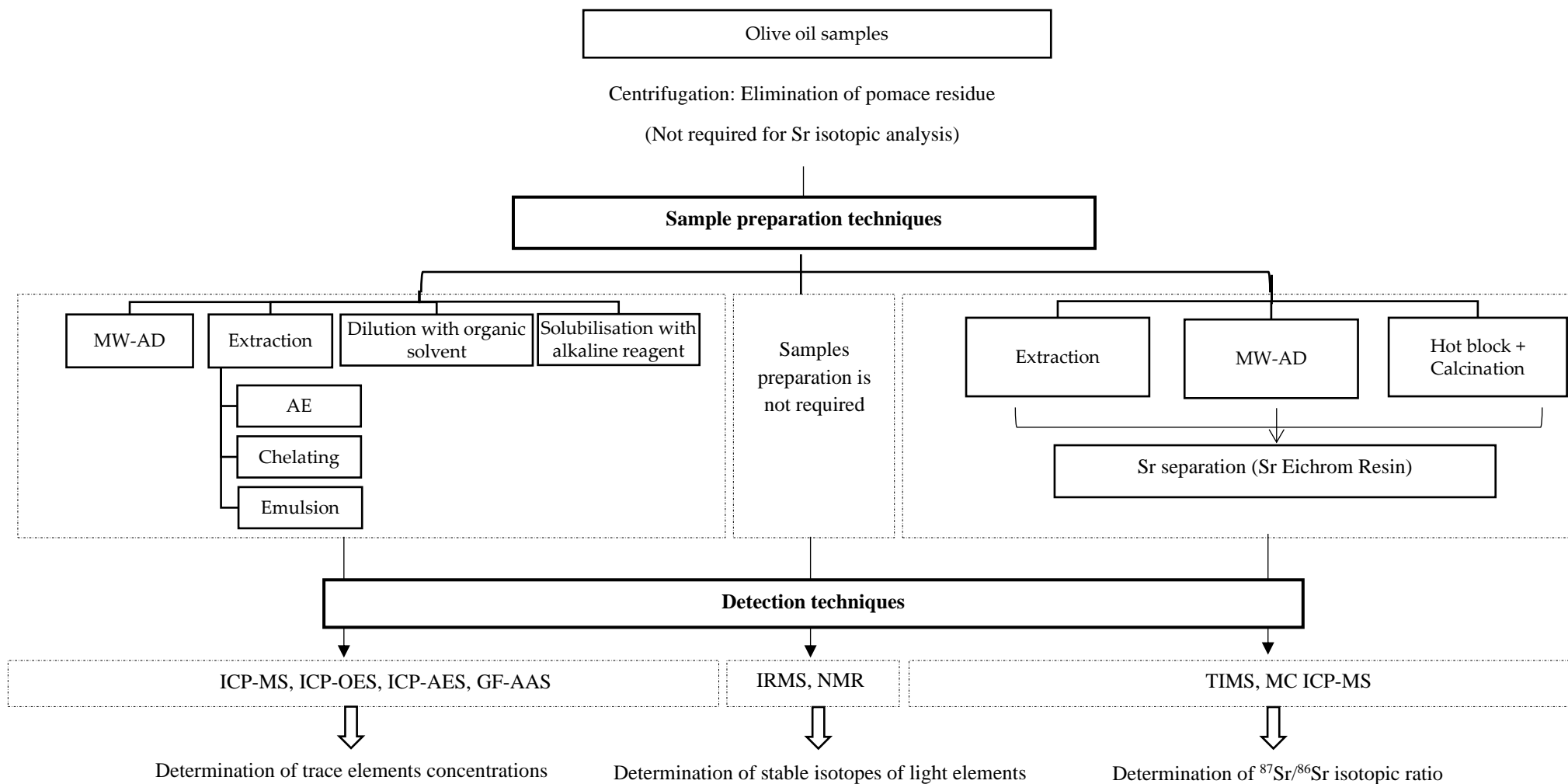

**Figure I.4:** Analytical procedures for the analysis of trace elements, stable isotopes of light elements and Sr isotopic ratio in olive oil

Such a large span of elemental concentrations has already raised doubts about the validity of some data in view of the lack of a robust and highly sensitive analytical approach to the detection of elements at critically low concentrations in one of the most complicated food matrices (Pošćić et al., 2019). The published results must be subjected to critical evaluation to avoid comparison with unreliable data, especially in the absence of certified reference materials for trace elements in olive oils. Thus, the validity of the analytical measurements has to be assessed with respect to accuracy and precision. Previously published studies will be discussed below from the general point of view of applied analytical procedures, reliability of obtained results, and their applicability for geographic authentication of olive oil.

### **3.1.2. Analytical procedures of quantification of trace elements in olive oil**

Various sample preparation approaches have been developed for the quantification of trace elements in olive oil. They each aim to release elements from the oily matrix, achieve relatively low limits of quantification (LOQ), and minimize possible contamination. Table I.2 summarizes the analytical techniques used for the trace elements analysis in olive oil classified according to the methods of sample preparation. Information about the samples analyzed, the reagents used for sample treatment, detection techniques, the limit of detection (LOD), the quality control (QC) parameters and the chemometric methods employed are also depicted in Table I.2

### **3.1.3. Sample preparation techniques**

Olive oil is a high-viscosity lipid matrix. Its viscosity makes analysis with spectrometric instruments challenging (Martínez et al., 2020). Due to the critically low concentrations of some elements in olive oil, the latest studies tended to promote the use of ICP-MS known for its high sensitivity.

When using plasma-based ionization techniques, the possible incomplete mineralization of the samples could affect the instrumental performance by forming deposits and clogging parts such as injectors, cones and lenses (Santos et al., 2007; Woods & Fryer, 2007). The presence of traces of unoxidized organic matter could also extinguish plasma sources, and thus generates spectral interferences from carbon-based polyatomic ions contributing to the spectral background (Jimenez et al., 2003). Therefore, the development of a reliable sample preparation technique is a crucial step in the process of assessing the elemental composition of olive oil.

**Table I.2:** Determination of trace elements in olive oil and other vegetable oils by means of spectrometric techniques following different sample preparation techniques

Sample preparation technique	Oil type / quality	Number of samples	Origin	Reagents	Detection technique	Analytes	Limit of detection	Material/ Method used for validation	ACC/ RR(%)	Chemometric method	Purpose	Reference	
Microwave-assisted digestion	Extra-Virgin Olive Oil (EVOO)	110	Italy	HNO <sub>3</sub> and H <sub>2</sub> O <sub>2</sub>	ICP-MS	Ti, V, Cr, Mn, Fe, Co, Ni, Cu, Rb, Sr, Cd, Sb, Ba, W, Tl, Pb, Th, U and REE	–	BCR-668 (musel tissue)		PCA, LDA	Authentication, traceability	(Aceto et al., 2019)	
	Virgin Olive Oil (VOO)	82	Spain	HNO <sub>3</sub> , H <sub>2</sub> O <sub>2</sub> and HCl	ICP-MS	Al, As, Ba, Ca, Co, Cr, Cs, Cu, Fe, Ga, Hf, K, Li, Mo, Mg, Mn, Na, Sr, Nb, Ni, Pb, Rb, Sc, Se, Sn, Ta, Th, Ti, U, V, W, Y, Zn and Zr	–	-	-	LDA		(Beltrán et al., 2015)	
	VOO	36	Italy	HNO <sub>3</sub>	ICP-MS	Be, Mg, Ca, Sc, Cr, Mn, Fe, Co, Ni, As, Se, Sr, Y, Cd, Sb, Sm, Eu and Gd	0,12; 118; 1250; 9,7; 16,3; 9,2; 152; 0,11; 21,2; 0,62; 10,2; 9,6; 0,12; 0,16; 0,14; 0,012; 0,009 and 0,012 (µg kg <sup>-1</sup> ):LOQ	-	-	LDA		(Benincasa et al., 2007)	
	Olive oil (OO)	21	Tunisia	HNO <sub>3</sub> and H <sub>2</sub> O <sub>2</sub>	ICP-MS	Na, Mg, Fe, Zn, V, Mn, As, Rb, Sr, Ba and Pb	0,35; 0,47; 0,12; 0,11 (mg kg <sup>-1</sup> ) 1,7; 6; 0,73; 0,3; 5,1; 4,6 and 6,9 (µg kg <sup>-1</sup> )	Multi-element oil standard S23-100Y	ACC: 66 - 102%			PCA	(Damak, Asano, Baba, Suda, et al., 2019)
	VOO	49	Turkey	HNO <sub>3</sub> and H <sub>2</sub> O <sub>2</sub>	ICP-MS	Fe, Ca, K, Na, Mg, As, Ba, Co, Cr,	–	-	-			PCA and HCA	(Gumus et al., 2017)

						Cu, Mn, Ni, Pb, V, Zn						
EVOO	125	Spain	HNO <sub>3</sub> , H <sub>2</sub> O <sub>2</sub> and HCl	ICP-MS for minor elements and ICP-OES for major elements	Al, Ca, Fe, Mg, Mn, K, Na, Ti, Li, Be, B, V, Cr, Co, Ni, Cu, Zn, Ga, Ge, As, Se, Rb, Sr, Zr, Nb, Mo, Cd, Sn, Sb, Cs, Ba, , Hf, Ta, W, Tl, Pb, Bi, Th, U and REE	–	Spike with a multi-element standard solution	R: 82–110%	PCA and LDA		(Sayago et al., 2018)	
EVOO and olive-pomace	16 EVOO / 10 olive-pomace	Croatia	HNO <sub>3</sub> and milli-Q water	ICP-MS	Li, Rb, Mo, Cd, Sn, Cs, Tl, Pb, Na, Mg, P, S, Ca, Ti, V, Cr, Mn, Fe, Co, Ni, Cu, Zn, Sr, Y, Sb, Ba, La, Ce; and K	–	–	–			(Pošćić et al., 2019)	
VOO, pomace-olive, corn, sunflower and soybean oils	50	Spain	HNO <sub>3</sub>	ICP-MS	Ag, As, Ba, Be, Cd, Co, Cr, Cu, Fe, Hg, Mn, Mo, Ni, Pb, Sb, Ti, Tl and V	0,8; 3,0 ;0,5; 1,5; 1,5; 1,5; 8,0; 1,5; 40; 12; 1,5; 1,5; 15; 0,8; 1,5; 15; 1,5 and 2,0 (µg kg <sup>-1</sup> )	109469 Multi-element Standard II Oil Dissolved	R: 85–115%	PCA	Quality identification of oils Discrimination between oils of different types	(Llorent-Martínez, Ortega-Barrales, Fernández-De Córdoba, et al., 2011)	
VOO	–	Italy	HNO <sub>3</sub> and H <sub>2</sub> O <sub>2</sub>	ICP-OES	Pb, Zn, Cd, and Cu	–	–	–	–	The influence of olive cultivars and period of harvest on the contents of some elements,	(Angioni et al., 2006)	

	OO	90	Tunisia	HNO <sub>3</sub>	ICP-MS	Li, B, Na, Mg, Al, K, Ca, Sc, Cr, Mn, Fe, Co, Ni, Cu, Sr, Mo, Ba and La	0,005; 0,051; 0,104; 5,118; 0,953; 0,319; 0,587; 0,000; 0,000; 0,012; 0,294; 0,005; 0,011; 0,000; 0,006; 0,028; 0,007 and 0,017 (mg kg <sup>-1</sup> )	Spike with standard solutions	R: 69 - 120%	PCA, LDA and ANOVA	The influence of the irrigation with treated waste water on the multi-elemental profile of olive oils	(Benincasa et al., 2012)
<b>Dry ashing</b>	OO	17	Croatia	HCl	ET-AAS	Cu, Ni, Pb and Fe	-	-	-	Comparison between sample preparation procedures	(Brkljača et al., 2013)	
<b>Acid extraction</b>	EVOO	539	Italy	1% HNO <sub>3</sub> / 0,2% HCl	ICP-MS	Li, Na, Mg, K, Ca, Mn, Co, Cu, Rb, Sr, Cs, Ba, La, Ce, Sm, Eu, Yb, Pb, and U	0,005; 40; 14; 60; 30; 0,01; 0,004; 0,13; 0,03; 0,04; 0,003; 0,29; 0,0017; 0,0027; 0,0009; 0,0002; 0,0004; 0,02 and 0,001 (µg kg <sup>-1</sup> )	Spike with NIST 2387 (peanut butter)	R: 82 - 101%	-	Investigation of mineral composition of authentic PDO Italian olive oils	(Camin, Larcher, Perini, et al., 2010)
	EVOO	267	Italy, France, Spain, Greece and Portugal	6,7% H <sub>2</sub> O <sub>2</sub> /1% HNO <sub>3</sub> / 0,2% HCl	ICP-MS	Li, B, Na, Mg, Al, K, Ca, V, Mn and Co	0,008; 0,17; 20; 4; 3; 20; 25; 0,007; 0,2; 0,002 and 0,0006 (µg kg <sup>-1</sup> )	Spike with NIST 2387 (peanut butter) and SPEX s-23 100z	R (NIST): 82 - 101% R (SPEX standard ): 53 - 92%	Canonical discriminant analysis	Authentication, traceability	(Camin, Larcher, Nicolini, et al., 2010)
	OO, sunflower, soybean, grape and sesame	-	-	-	3% HNO <sub>3</sub>	FAAS	Cu, Cd, Ni, Pb and Zn	0,7; 0,3; 0,5; 1,5 and 0,5 (µg kg <sup>-1</sup> )	-	-	-	Development of analytical method



	EVOO, VOO, ROO, soybean and sunflower oils	-	-	10% HNO <sub>3</sub>	GF-AAS	Cu and Fe	-	Spike with standard	ACC: 94% ±23 - 97% ±12	-	(Leonardis et al., 2000)
Extraction employing an extraction agent	Sunflower oil, OO, rapeseed oil and salmon oil	-	-	1% Lipase solution at pH 3	ICP-MS	Al, Ba, Cd, Cu, Fe, Mn, Mo, Ni, Ti, V and Zn	0.46, 0.03, 0.007, 0.028, 0.67, 0.038, 0.022, 0.14, 0.17, 0.05 and 0.07 (µg kg <sup>-1</sup> )	EnviroMAT HU- 1 Used oil diluted in sunflower oil	R: 83.3 - 117.8%	-	(Kara et al., 2015b)
	Sunflower oil, OO, rapeseed oil	-	-	0,01 M EDTA solution at pH8		Al, Ca, Cd, Cu, Mg, Mn, Ni, Ti, V and Zn,	2.47, 2.81, 0.013, 0.037, 1.37, 0.050, 0.049, 0.47, 0.032 and 0.087 (µg kg <sup>-1</sup> )	Spike of sunflower seed oil with EnviroMAT HU-1	-	-	(Kara et al., 2015a)
	Mustard oil, sunflower oil, sesame oil, groundnut oil, coconut oil, rice bran oil and corn oil	-	-	TMAH and 2% EDTA at pH 12	GF-AAS	Pb, Cd, Cr, Mn, Fe, Cu and Zn	0.6 ; 0.4; 3.1 ; 0.3 ; 0.1 ; 2.3 and 1.5 (µg kg <sup>-1</sup> )	Spike with analytes	R: 92 - 97%	-	(Manjusha et al., 2019)

Emulsification	VOO	5	-	2% Triton X-100	ICP-MS	Al, Ba, Bi, Cd, Co, Cu, Mn, Ni, Pb, Sn and V	5.31; 2.27; 0.98; 0.69; 1.09; 0.33; 0.44; 0.15; 0.02; 0.06 and 3.08 ( $\mu\text{g kg}^{-1}$ )	Spike with analytes	R: 49.6 - 176.2%	-		(Jimenez et al., 2003)
	Sunflower, hazelnut, canola, corn and OO	50	Turkey	Acidic Triton X-114 solution	ICP-OES	Cd, Cr, Cu, Fe, Mn, Ni, Pb and Zn	-	Spike with analytes	R: 96 - 109%	ANOVA	Comparison between sample preparation procedures	(Bakircioglu et al., 2013)
Solubilization with strong alkaline reagent	Almond, corn, sunflower oils and OO	17	-	TMAH and 1% HNO <sub>3</sub>	ICP-MS	Cu, Ge, Mn, Mo, Ni, Sb, Sr, Ti, V	0,02; 0,05; 0,004; 0,008; 0,012; 0,32; 0,004; 0,28 and 0,02 ( $\mu\text{g g}^{-1}$ )	-	-	-	Development of analytical method	(Savio et al., 2014)
Dilution with organic solvent	EVOO	50	Spain	Methylisobutylketone (MIBK)	electrothermal atomisation - atomic absorption spectrometry (ETA-AAS)	Cu, Cr, Fe, Mn and Ni	25; 1,5; 80; 2 and 10 (pg)	109469 Multi-element Standard II Oil Dissolved	ACC: 97.9 - 98.75%	Multivariate discriminant analysis	Authentication, traceability	(Cabrera-vique et al., 2012)
	Vegetable oils and fats	11	-	Xylene	ICP-OES equipped with HTISIS	Al, Ba, Ca, Cd, Cr, Cu, Fe, Mg, Mn, Mo, Ni, Si, Ti and V	1,6; 0,35; 0,6; 2,6; 0,59; 0,94; 0,86; 0,16; 0,2; 4,1; 2,7; 0,91; 0,21 and 0,81 ( $\mu\text{g kg}^{-1}$ )	Spike with the Conostan multi-elemental solution	Around 100%	-	Development of analytical method	(Martínez et al., 2020)

Some approaches aim to completely destroy the organic content of the sample and require the use of high-performance digestion equipment under high temperature and high pressure (Mdluli et al., 2020). Others can be implemented under relatively “soft” conditions by involving the use of various organic / inorganic solutions and chemical agents such as chelates, emulsifiers, etc. (Figure 4); they are often designed to obtain a final solution that can be rapidly and easily analyzed using various spectrometric instruments (Lepri et al., 2011; Martínez et al., 2020).

### **i) Microwave-assisted digestion**

MW-AD is one of the most frequently used sample preparation techniques used prior to element analysis for lipid matrices; it is used in approximately 2/3 of the scientific publications in this field (Table I.2). A recent review confirmed the reliability and effectiveness of MW-AD for mineralization of natural and synthetic oils and oily substances (Mdluli et al., 2020). Organic matter is induced to decompose by high temperature and high pressure (Ekezie et al., 2017).

The MW-AD method offers many advantages, such as: reducing contamination since the solutions are introduced into a closed and sealed system; and reducing time of mineralization following an optimized program specifically developed according to each type of matrix. Once mineralized, elements are released in an aqueous acidic solution and ready to be analyzed after dilution.

However, the MW-AD remains limited for olive oil applications due to the small volume allowed for processing. Generally, the maximum sample amount recommended for olive oil digestion in the most recent MW systems, such as Mars 6 (CEM, <https://cem.com>), Anton Paar Multiwave (Anton Paar, <https://www.anton-paar.com>) and Ultrawave (Milestone, <https://www.milestonesrl.com>), is around 0.5 g.

The resulting mineralized solutions, initially highly concentrated in acid, have to be diluted in order to become suitable for their introduction into an instrumental analysis in a spectrometer. Therefore, after dilution, the concentrations of some elements are likely to be below the LODs. Based on the procedure proposed by (Aceto et al., 2019), a high dilution factor of 125 (0.4 g of olive oil transferred into a final volume of 50 mL) would not be advantageous for the detection of trace and rare earth elements (REE) in olive oil, given the constraints of LODs imposed by the ICP-MS. Even with smaller dilution factor (i.e. 50; 0.5 g of olive oil transferred into the final volume of 25 mL), the overall procedure did not enable the determination of Sr in Spanish oils (Beltrán et al., 2015).

An alternative procedure was proposed to overcome this issue through the evaporation to dryness of the mineralized sample followed by a re-dissolution in the minimum volume required for analysis (Brkljača et al., 2013). Alternatively, combining samples prepared by evaporation and re-dissolving of a few independently mineralized samples can also be performed (Damak, Asano, Baba, Ksibi, et al., 2019). Under these conditions, special attention must be paid to the purity of reagents used. The solution's integrity is protected from external contamination by using closed-vessel evaporation systems.

## **ii) Ashing in a furnace**

The total combustion of olive oil in a furnace (dry ashing) is an uncommon technique and has only been applied to determine selected elements: Cd, Cu, Pb, Fe (Brkljača et al., 2013) or Sr, prior to isotopic analysis (Medini et al., 2015). The main advantage of this technique is the ability to process a relatively large amount of sample compared to the MW-AD technique, to achieve higher pre-concentration factors. Oil sample amounts ranging from 2 g (Brkljača et al., 2013) to 5 g (Medini et al., 2015) have been treated by ashing in a furnace. Nevertheless, both protocols included a preliminary oxidation step of the oils by the addition of nitric and sulfuric acids and a heating step, prior to their introduction into the furnace. All these difficult and tedious procedures may increase analytical and precision errors.

## **iii) Methods of extraction**

### **• Acid extraction (AE)**

Acid extraction procedures permit the efficient release of inorganic analytes found in olive oil (i.e. organic phase) into a slightly acidic solution (i.e. aqueous phase). The analytes are released from the oily matrix, based on the stronger affinity they have with the acidic solution. Extensive and reliable studies dedicated to the geographic origins of olive oil used this method for years as a sample preparation technique due to its efficiency and relative ease of implementation. The results obtained showed good precision (RSD: 13% - 27%) and acceptable recoveries yield (82% -101%) (Camin, Larcher, Nicolini, et al., 2010; Camin, Larcher, Perini, et al., 2010). Since then, minor modifications have been proposed, such as using a mixture of diluted acids and the addition of hydrogen peroxide (i.e. 1% HNO<sub>3</sub>, 0.2% HCl and 6.7% H<sub>2</sub>O<sub>2</sub>) (Pošćić et al.,

2019) to improve and facilitate the decomposition of the organic phase and the release of the elements.

A higher degree of acidification of the aqueous phase (up to 10%) has been found to be less efficient for metal extraction (Brkljača et al., 2013). The limitation of the AE method is the relatively low Recovery Rate (RR) compared to the destructive methods (Lepri et al., 2011). In a recent study published by (Pošćić et al., 2019), where AE was applied for the quantification of 29 elements, RR ranged from 60% up to almost 100%, which highlights that elements have different extractability characteristics. Further, it should be noted that the ratios of processed oil to the acidic mixture may vary largely among different studies. Equivalent volumes of oil and acidic mixture were used in the studies performed by (Camin, Larcher, Nicolini, et al., 2010; Camin, Larcher, Perini, et al., 2010) and (Pošćić et al., 2019) and led to high RR values, while higher oil proportion (3:1) were found to be less effective, resulting in RR of 20% and 12% respectively for Cu and Pb (Brkljača et al., 2013). On the contrary, a micro-extraction of Cu, Cd, Ni, Pb and Zn from 10 mL of olive oil by 200  $\mu$ L of aqueous solution containing 3% nitric acid, showed RR ranging between 95 and 100% (Mohebbi et al., 2018a).

Furthermore, it has been shown that the AE efficiency depends on the duration and temperature of sonication (Leonardis et al., 2000; Mohebbi et al., 2018a). High temperatures tend to reduce the surface tension between two liquids (Valasques et al., 2017) and would alter the emulsion characteristics, i.e. viscosity and droplet size (Goodarzi & Zendehboudi, 2019). Under these conditions, the phase mixing would be enhanced and yield a highly effective extraction of the trace elements from oils. Conversely, an increase of the sonication time resulted in a decrease of the extracting efficiency of approximately 15% for Cd (Mohebbi et al., 2018b).

Other parameters have been shown to affect the extraction efficiency. For example, the form and size of the extraction vessels had a significant effect on the extraction RR since they correlate with the contact surfaces between the two phases.

In conclusion, while acidic extraction-based methods have been widely described, the extraction yield cannot be assumed based on previous studies. An optimization of all significant parameters (intensity of shaking, temperature and duration of sonication, volume of extraction reagent...) is mandatory before applying this approach to the extraction of elements from olive oils.

- **Extraction using various organic/inorganic agents: chelating and emulsification**

The following methods are a slight variation of earlier ones, based on the extraction of analytes with the use of specific extraction agents. The solubilization with a strong alkaline solution (Savio et al., 2014), emulsification (Bakircioglu et al., 2013; Jimenez et al., 2003) and formation of coordination complexes (Kara et al., 2015b, 2015a; Manjusha et al., 2019) have been successfully employed for the extraction of trace elements from oils. These approaches offer advantages in terms of sample preparation time, and permit the extract to be directly introduced into the ICP. Special attention is often paid to matrix matching with the calibration standards. A summary of the various extraction techniques with their analytical characteristics is presented in Table I.2.

**iv) Dilution with organic solvent**

Methods involving dilution with organic solvents for olive oil studies (Cabrera-vique et al., 2012; Martínez et al., 2020) have the main advantage of being based on the direct analysis of diluted oily matrices (with an adjusted sample introduction system). Recently, a high temperature torch integrated sample introduction system (hTISIS) was applied for the analysis of oils and fats after dilution with xylene by ICP-OES (Martínez et al., 2020). The addition of oxygen as an auxiliary gas in ICP-OES was also investigated for that purpose (Sema Bağdat Yaşar, 2012). It is however crucial to avoid matrix effects when performing analyses with direct introduction techniques. The time saving benefit offered by this technique is attractive but the rigorousness necessary for its implementation and to achieve satisfactory results explain its limited use with respect to olive oil elemental analysis.

**v) Emulsification**

Emulsification is an alternative technique to direct introduction of oil in plasma-based instruments. Emulsifiers are added to oil to form water-soluble micelles. Stabilized "oil-in-water" emulsions can be generated using Triton X-100 and Triton X-114. These emulsifiers were successfully applied for the on-line analysis of olive oil (Bakircioglu et al., 2013; Jimenez et al., 2003). Triton X-100 was used to extract Tl and Cr, at concentrations above  $0.5 \mu\text{g kg}^{-1}$  and  $50 \mu\text{g kg}^{-1}$ , respectively, from about 3g of olive oil (Jimenez et al., 2003).

Triton X-114 allowed to extract Cd, Cr, Cu, Fe, Mn, Ni, Pb and Zn from olive oil, their concentrations were determined by ICP-OES and recoveries were ranging from 96% to 109% (Bakircioglu et al., 2013). During the sample preparation, it was difficult to maintain the stability of the emulsions formed, but stability could be achieved by a thorough control of the experimental conditions (Kara et al., 2015a)..

#### **vi) Chelation of the analytes**

The aim of chelation is to form stable complexes (metal/ligand) with higher solubility in the extraction solution. Under appropriate pH conditions, chelation enables the transfer of elements from the oily organic phase to the aqueous extraction phase. Thus, the elements extracted in the aqueous solution would be easily analyzed. The chelator can be specific to a single element (Cesur & Bati, 2002; Chem, 2008) or an agent that has the ability of complexing a wide range of elements. Examples of chelating extraction using Ethylenediaminetetraacetic acid (EDTA) (Kara et al., 2015a), lipase (Kara et al., 2015b) and a mixture of EDTA / Tetramethylammonium hydroxide (TMAH) (Manjusha et al., 2019) have been recently reported. The pH control pH during the extraction phase is of a great importance. The extraction yield has been found to be optimal when using lipase at pH =3, and the mixture of EDTA and TMAH at pH =12.

This approach is relatively rapid, sensitive, and reproducible, and it can be done without toxic chemicals, detergents and concentrated acids. However, the reagents must have a high degree of purity.

All the above-mentioned methods have shown promising results and are good choices for future experiments. Some of them are relatively rapid as no pre-treatments are required (i.e. emulsification, chelating and direct dilution), while others are simple to perform (MW-AD and acid extraction). Some of the methods require specific equipment (i.e. direct dilution). The choice of method will depend on the research targets and the availability of the apparatus and reagents. Since, in general, the concentrations of trace elements in olive oil are low, methods that allow a pre-concentration with controlled purity reagents are the most suitable.

#### **3.1.4. Comparative studies of different sample preparation methods**

As discussed before, each sample preparation technique has its advantages and limitations. The first reliable comparison between MW-AD, AE, and dry ashing for olive oil samples has demonstrated that only the latter allows the determination by ET-AAS of all elements of interest (Brkljača et al., 2013). Two recent studies have also assessed the robustness and efficiency of the most common MW-AD and acid extraction procedures (Damak, Asano, Baba, Ksibi, et al., 2019; Pošćić et al., 2019). Results published by Damak et al. (2019) showed that the ultrasound-assisted AE achieved lower LODs, the higher precision, and the better repeatability than MW-AD combined with evaporation (Damak, Asano, Baba, Ksibi, et al., 2019). However, for some unmentioned reasons, the MW-AD method was selected in their study of the geographical assessment of 21 Tunisian olive oils (Damak, Asano, Baba, Suda, et al., 2019). The advantage of the AE approach over the MW-AD was also highlighted by Pošćić et al. (2019), who stated that the MW-AD is limited for the measurement of very low concentrations, as the case of trace elements in olive oil (Pošćić et al., 2019). Nevertheless, in both studies, it was reported that there was no significant difference between concentrations found after using both techniques for the quantification of trace elements in olive oil. Therefore, on basis of these findings, it would be advantageous to perform AE in order to quantify more easily trace elements in olive oil and other matrices with similar characteristics.

The review of the current scientific literature for the quantification of trace elements in olive oil shows that the choice of an appropriate sample preparation method is crucial as it can affect the detection of analytes and the quality of the results. The choice of method should be based on the objectives of the research study, and on the analytical performance of the instrumentation to be used for the detection stage.

#### **3.1.5. Detection techniques**

The quantification of trace elements in olive oil requires sensitive detection techniques. The ICP-MS is known to be one of the most sensitive instruments available today for accurate quantification of trace elements. Accordingly, and based on our literature survey, the main analytical instrument used to determine the elemental content of olive oil for geographical traceability was the ICP-MS (almost 70% of the published studies, Figure I.5).



Other spectroscopic methods, such as ICP-OES, GF-AAS and FAAS were mostly used for the detection of alkaline metals in olive oils as they are present at higher concentrations (Pošćić et al., 2019). The plasma-based detection techniques (OES or MS) now occupy the lead position mainly when extraction (Manjusha et al., 2019), emulsification (Bakircioglu et al., 2013), liquid-liquid extraction (Mohebbi et al., 2018a) or dilution with organic solvent (Cabrera-vique et al., 2012) are used as sample preparation techniques. However, one third of studies reviewed (Table 1) did not provide the information on detection limits of analyzed elements limiting the reader's capacity to assess the validity and credibility of the results. Some authors have reported surprisingly high LODs and LOQs for ICP-MS, such as  $6 \mu\text{g kg}^{-1}$  (Mn) and  $6.9 \mu\text{g kg}^{-1}$  (Pb) (Damak, Asano, Baba, Suda, et al., 2019); or  $9.6 \mu\text{g kg}^{-1}$  (Sr) ,  $16.3 \mu\text{g kg}^{-1}$  (Cr) , and  $21.2 \mu\text{g kg}^{-1}$  (Ni)  $\mu\text{g kg}^{-1}$  (Benincasa et al., 2007).

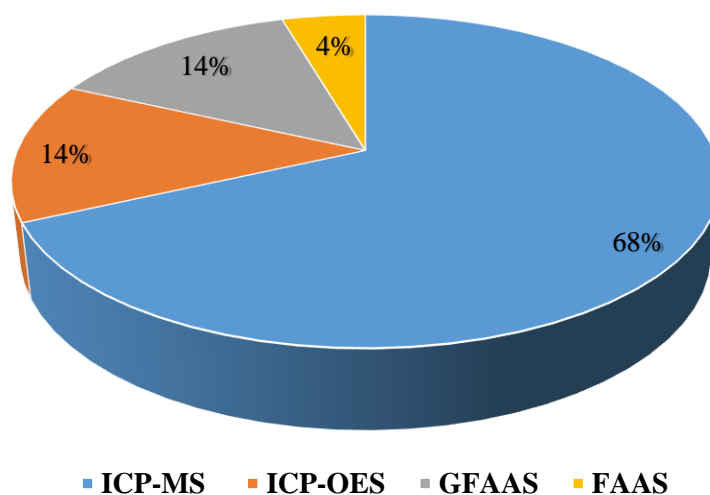

**Figure I.5:** Percentage of articles that use atomic spectroscopic techniques to analyze trace elements in olive oil

In the absence of information about the measured procedural blank, it is difficult to explain such atypical high LODs. It can only be hypothesized that these LODs are most likely due to possible contaminations during sample preparation procedures.

### 3.1.6. Analytical method validation

Both precision and accuracy are important parameters of method validation procedure. They are particularly for geographical traceability studies based on the elemental content. Indeed, a difference between the measured and the expected concentration of analyte that would be typically described as non-significant or classified as an analytical error, would distort the results in case of a geographical authentication study. Especially for olive oil authentication, as trace elements are initially at low concentrations, the difference in the elemental profile between distinct geographical origins is likely very limited. Thus, it is crucial to determine the element concentrations with a high degree of precision and accuracy to be able to perform proper assessment of the origin.

So far, there is still no certified reference material (CRM) for trace elements in olive oil despite of its growing worldwide consumption. This is the reason why a number of authors did not use CRMs in their experiments, or at least why such information was not provided (Angioni et al., 2006; Beltrán et al., 2015; Benincasa et al., 2007; Gumus et al., 2017; Mohebbi et al., 2018a; Savio et al., 2014).

However, those who have attempted to evaluate the performance of their analytical method have often aimed to use a CRM that would have physicochemical properties close to those of olive oil. The most commonly used ones are based on engine or synthetic oils, such as the multi-element organometallic oil standard on base oil (S23-100Y from SPEX CertiPrep) (Camin, Larcher, Nicolini, et al., 2010; Damak, Asano, Baba, Suda, et al., 2019) which is an oil for mechanical engines. There is also a Multi-element Standard II Oil Dissolved from Certipur® (109469) (Cabrera-vique et al., 2012; Llorent-Martínez, Ortega-Barrales, Fernández-de Córdoba, et al., 2011), and a used oil CRM (EnviroMAT HU-1) from SCP Science (Kara et al., 2015a, 2015b). It must be mentioned that these CRMs do not display the same viscosity as olive oils and the concentrations of certified elements are not comparable to those of olive oil. The closest CRM of natural edible lipid matrix available is the certified peanut butter (NIST SRM 2387). It has been seldomly used either diluted in oil or in its raw state by some researchers (Camin, Larcher, Nicolini, et al., 2010; Camin, Larcher, Perini, et al., 2010; Nasr et al., 2022). This CRM is characterized by its relatively high elemental concentrations comparing to olive oil, which makes it more suitable as a spiking standard for olive oil. Recently, Aceto et al. (2019) used an uncommon CRM, BCR-668 mussel tissue, in order to quantify lanthanides and other microelements distribution to authenticate Italian extra-virgin olive oils after microwave-assisted digestion (Aceto et al., 2019). However, the choice of such biological tissue is quite

controversial, especially in case of olive oil analyses as the levels of REE in the CRM are at least three times higher than those in olive oils. Further, the main constituents of olive oils and mussel tissue matrices are different qualitatively and quantitatively, therefore, serious discrepancies related to matrix effects could be expected. Unfortunately, the authors did not provide justifications for their choice of CRM. Indeed, the inconsistency between the calibration standard concentration range selected and the expected element concentrations in olive oil samples also tend to confirm that the results could be biased.

Furthermore, an array of studies has determined the elemental recoveries by spiking each individual oil sample with a multi-elemental standard solution. This approach is acceptable when the selected sample preparation method involves the complete destruction of the organic matter such as MW-AD (Benincasa et al., 2012; Sayago et al., 2018) or ashing in the furnace (Brkljača et al., 2013). However, despite using mono- or multi-elemental spiking solutions for validation purposes for the extraction (Leonardis et al., 2000; Manjusha et al., 2019) or the emulsification methods (Bakircioglu et al., 2013; Jimenez et al., 2003), it is very unlikely that this approach reflects the real extraction efficiency of an element initially present in the oily phase, since the elements composing the spiked solutions are already in a water-soluble form and no extraction is required. It is therefore practically impossible to define a realistic target recovery using spike of elements in aqueous solution, and it could even be misleading to do so using this approach.

In conclusion, despite the unavailability of a suitable CRM for olive oil, a wide range of alternative methods have been proposed to ensure quality assessment. The use of synthetic oils and similar lipid matrices certified for trace elements or spiking with natural oils seemed appropriate. They allowed effective control the measurement performance pending the development of an appropriate matrix-matching CRM for olive oil.

### **3.1.7. Limits of olive oil authentication by means of trace elements**

Trace element contents in plants are mainly related to the soil composition where they were grown. However, correlations between the elemental content in oil and the corresponding soil is not always valid. Many factors may influence the elemental composition of olive oil through changes in the fruit composition during its growing and ripening period or through external contamination during its extraction and packaging.

### **3.1.8. Influence of agro-climate conditions**

It has been demonstrated that several parameters such as the olive cultivar (Angioni et al., 2006), the irrigation of olive trees (Benincasa et al., 2012), the use of fertilizers (M. A. Khan et al., 2017), or fluctuations in annual climatic conditions (Greenough et al., 2010) may modify the elemental profile of olive oil. At present, no consensus has been established with regards to the possible existence of a direct and clear correlation between the concentration of trace elements in the soil and in the paired olive oils. However, interesting findings have been recently emerged. Damak et al. (2019) have sampled olives and soils from various Tunisian regions in order to investigate the correlation between the elemental content of soil and that of olives (Damak, Asano, Baba, Suda, et al., 2019). After olive oil extraction from olives, its elemental content was determined by ICP-MS after MW-AD while the soil content was analyzed by X-ray fluorescence (XRF). The XRF beads were also analyzed for trace elements by femtosecond ultraviolet Laser Ablation ICP-MS. The results of this study have demonstrated that the correlation between the composition of the soil and that of the plant is not always straightforward. The concentration of the elements analyzed (Fe, Mn, Zn, Na, and Pb) in olive oil were inversely proportional to those recorded in the soils. Based on these results, the authors concluded that the soil is not the only source of trace elements in olive oil. According to (Greenough et al., 2010), the multi-elemental composition of an agri-food product is influenced by the climatic conditions (Temperature, Precipitation, Humidity) prevailing during its growth. A recent study of Portuguese olive oils by (Gouvinhas et al., 2016) showed that trace element content could vary according to the ripeness of the olives. Another study suggested a correlation between Fe, Co, Ni, Ba, Rb, Sr and Pb in the soils and olive oils (Aceto et al., 2019), but elements such as W, Tl, Cr, Sb, Cd, and Cu exhibited a different trend; the best correlation was observed for the lanthanides. Since the lanthanides are adsorbed passively from soil and are not altered much when passing from soil to fruit, they may act as a promising tracer when analytical methods enable detection at the ultra-trace level.

### **3.1.9. Influence of the olive oil extraction process**

After harvesting, the collected fruits will undergo several steps that may alter the mineral composition of the final product (Figure I.1). During the oil extraction process, olives are in direct contact with metallic surfaces that can generate contamination in the final product.

Further, the possible addition of water after mixing and prior to centrifugation, to increase the oil extraction efficiency, may be a potential source of contamination with trace elements. These concerns have been evaluated by Sandeep Banerjee (2015) who has shown that the use of water during the oil extraction process could modify its elemental composition (Banerjee et al., 2015). He reported that the concentration of Sc, Cr, Fe, Co, and Ni in the oil increases with the addition of water. On the other hand, the use of water at the industrial-scale olive oil refining process decreases the Ca concentrations in olive oils.

Recently, it has been demonstrated that the filtration process of olive oil, frequently required to remove the pomace residues, may significantly alter the trace element content of both olive oil and pomace residues (Goidanich, 2010). In addition to the changes that will affect the sensorial and physicochemical characteristics of the oil (Bottino et al., 2008; Goidanich, 2010; Lavelli & León, 2006), Pošćić et al. (2019) have recently demonstrated that the pomace residues significantly affect the element content of the oil (Pošćić et al., 2019). In their study, 29 element concentrations were determined in centrifuged and non-centrifuged olive oils. The results were expressed as NC-to-C (non-centrifuged vs centrifuged) ratios for each element analyzed, and displayed discrepancies of up to three orders of magnitude. This fact needs to be specifically considered for an accurate quantification of trace elements in olive oil. According to Pošćić et al. (2019), a centrifugation step is mandatory prior to trace element analysis. Without centrifugation, the results are not reliable enough for comparison purposes (Pošćić et al., 2019). Finally, the storage and transportation conditions of olive oil would affect the final chemical composition. De Leonardis et al (2000) suggested the use of polypropylene containers when determining levels of Cu and Fe in edible vegetable oils (Leonardis et al., 2000).

All the above-mentioned factors can alter the inorganic signature of olive oil, and should be carefully investigated to assess the geographical origin of the oils.

### **3.2.Olive oil geographical traceability by means of isotopic analysis**

Since the inorganic oil composition does not always match that of the soil when using multi-elemental signatures, stable isotopes have long been used for traceability purposes in foods (Rossmann, 2007). The earliest uses of the stable isotope analysis technique to establish the authenticity of foods dates back to the early 1970s (Kelly, 2003).

The isotopic ratios of some light elements could change depending on the geographical origin, the climatic conditions, and finally the soil pedology and geology of the location from where the products originate (Camin et al., 2017).

### 3.2.1. Stable isotopes of light elements (C, H and O)

The use of stable isotope ratios of hydrogen, carbon and oxygen provides information on the geographical origin and the pedo-climatic context. The major elemental constituents of the olive oil (H, C, O) have different stable isotopes (i.e.  $^1\text{H}$ ,  $^2\text{H}$ ;  $^{12}\text{C}$ ,  $^{13}\text{C}$ ;  $^{16}\text{O}$ ,  $^{18}\text{O}$ ). The relative abundance of each of these stable isotopes could vary in the environment, depending on (i) the origin of the elements and (ii) the processes that will modify their concentrations.

A number of scientific studies have aimed to use the combination of the isotopic ratios of light elements for the geographical determination of the production origin of olive oils and their potential adulteration (Angerosa et al., 1999; Camin, Larcher, Nicolini, et al., 2010; Chiocchini et al., 2016; Karalis et al., 2020; Portarena et al., 2014, 2015; Tarapoulouzi et al., 2021).

Carbon and oxygen isotope data are expressed in the usual delta notation ( $\delta^{13}\text{C}$  and  $\delta^{18}\text{O}$ ), defined as:

$$\delta_{\text{sample}} (\text{‰}) = ((R_{\text{sample}} / R_{\text{standard}}) - 1) \times 1000 \quad \text{Equation 1}$$

where R is the isotopic ratio  $^2\text{H}/^1\text{H}$ ,  $^{13}\text{C}/^{12}\text{C}$  or  $^{18}\text{O}/^{16}\text{O}$ . The raw isotopic analyses of the samples are corrected with matrix-matched reference materials. The most appropriate certified reference for olive oil are NBS22, USGS84, USG85 (Banerjee et al., 2015; Schimmelmann et al., 2020). Very recently, international standards for olive oil have been proposed (Schimmelmann et al., 2020). They also propose to normalize the isotopic values, by expressing them not in per mil but in mUr (milliurey unit), which normalizes the expression of the  $\delta$  values.

In general, for the studies focused on olive oils, two main stable isotopes have been used ( $\delta^{13}\text{C}$  and  $\delta^{18}\text{O}$ ).

- $\delta^{13}\text{C}$  measurements as a tracer of physiological processes of the plant

$\delta^{13}\text{C}$  measurements have been used for decades as a tracer of the type of photosynthesis (C3, C4, CAM) (Cernusak et al., 2013). The fixation and assimilation of atmospheric  $\text{CO}_2$  during photosynthesis varies according to the metabolic pathway through the mechanism of glucose production. The ranges of  $^{13}\text{C}$  variations for C3 plants vary from  $-32$  to  $-24\%$ , from  $-16$  to  $-10\%$  for C4 plants, and from  $-30$  to  $-12\%$  for CAM (Winkler & Schmidt, 1980). These

significant differences have been used at first to reconstruct past and paleo-environments (Croft et al., 2018). Further, they can also be used to detect the adulteration of food products. A common fraudulent practice in food is sweetening products with cheap sugar by the addition of C4 sugar to C3 crops; this can be easily detected by determining  $\delta^{13}\text{C}$  values (Elflein & Raezke, 2008). More recently, it has been shown that genetic determinism is likely to influence the variation the  $\delta^{13}\text{C}$  values as well, resulting in oscillating values close to the typical photosynthetic signature (Lauteri et al., 2004; Portarena et al., 2014, 2015).

The  $\delta^{13}\text{C}$  values can also be affected by the developmental stage of the plant (Portarena et al., 2015). In the specific case of olive trees, it has been applied to evaluate the olive ripeness index. These developments using the light isotopes signatures on olive oils was further highlighted by S. Portarena (Portarena et al., 2015). The results obtained in this study demonstrated that a positive correlation between the C and the O isotopic compositions and the plant maturity stage. This is also valid to establish the evolution of the climatic changes during the fruit-ripening season and more especially during the period of maximum oil accumulation.

- $\delta^2\text{H}$  and  $\delta^{18}\text{O}$  measurements as a tracer of water dynamic

The hydrogen and oxygen isotope composition of water ( $\delta^2\text{H}$  and  $\delta^{18}\text{O}$ ) will vary depending of (i) the geographical position; the latitude, the longitude, the elevation, the distance from the sea, (ii) the type of climate; amount and type of precipitation, evaporation, (iii) type of plants which impact combining with the climate the rate of evaporation by plant transpiration.

Several studies have demonstrated that stable isotopes of light elements are good indicators of geographic origin. Table I.3 summarizes the different studies that have successfully used stable isotopes of light elements for olive oil geographical authentication. Analyses are performed using an isotope ratio mass spectrometer (IRMS) generally connected to a high temperature source for combustion or pyrolysis of olive oil typically without prior pretreatment.

Camin et al (2010) established correlation between  $\delta^2\text{H}$  and  $\delta^{18}\text{O}$  values of bulk olive oil with the same approach as developed for water:

$$\delta^2\text{H}_{\text{bulk}} = (208.1 + 2.5091) * \delta^{18}\text{O}_{\text{bulk}} \quad (R^2 < 0.46) \quad \text{Equation 2}$$

Moreover, a rapid and cost-effective pretreatment methodology for measuring C and O isotopic ratios in oil and glycerol was proposed. The glycerol was obtained with distillation after hydrolysis and extraction of the fatty acids. A correlation was found between C in oil and in glycerol extracted ( $\delta^{13}\text{C}_{\text{glycerol}} = 1.1114 * \delta^{13}\text{C}_{\text{bulk oil}} + 1.4057$ ;  $p < 0.001$ ). Moreover,  $\delta^{18}\text{O}$  of glycerol is correlated with the  $\delta^{18}\text{O}$  of leaf water. The isotopic composition of glycerol

enabling the geographical discrimination of olive oil for years (Camin, Larcher, Perini, et al., 2010). These promising results indicate that the direct measurement of isotopic ratios in glycerol would be beneficial.

The measurement of the natural stable isotopic composition of light elements allowed the tracing of several environmental conditions. However, since the plants adapt to their specific environment, the isotopic variations may be very small for the same type of the plants (photosynthesis) when the variations of environmental conditions are not significant between different study areas. Camin et al. (2016) assumed that these similarities between the different locations could result from similar climatic conditions in both regions during the pre-harvesting period. Therefore, geographically distinct regions could nonetheless display identical isotopic ratios but only if the climate is equivalent in the two different locations. To further reinforce the geographical discrimination, the combined use with  $^1\text{H}$  NMR data using a multivariate statistical approach allowed then to have reinforced the pertinence of geographical origin (Camin et al., 2016).

Recently, Tarapoulouzi et al, (2021) conducted a large scale study on a total of 100 monovarietal olive oil samples from two coastal locations in Greece (Tarapoulouzi et al., 2021). The sampling strategy aimed to avoid the effect of olive oil storage and seasonal changes. The combination of stable isotopes of light element ( $\delta^{13}\text{C}$ ,  $\delta^{18}\text{O}$ , and  $\delta^2\text{H}$ ) with a chemometric tool (OPLS-DA) enabled the separation between the samples from i) two geographical areas, ii) three cultivars where two of them were belonging to the same geographical area. Based on these results, the olive cultivar was more effective for the samples classification compared to the geographical origin.

Further, the chemometric analysis showed that the discriminating potential of stable isotopes of H and O was significantly higher compared to C isotopes since the sampling areas were sharing similar climatological and geographic characteristics. Accordingly, the choice of appropriate isotopic approaches for a geographical traceability studies should be based on the plant type and genetic determinism, the geographic, environmental and climatological characteristics of the plant growing area.

Stable isotopes of light elements are mainly related to the physiological processes in plants in response to specific climatic and environmental conditions. A large international database of the range of stable isotope ratios of light elements has been established based on the published results obtained in various geographical locations.



**Table I.3:** Determination of isotopic ratios of light elements in olive oil and other edible oils

Samples	Number of samples	Origin	Isotopes	Detection technique (manufacturer)	Statistical evaluation	Complementary analysis	Purpose of using isotopes	Reference
<b>EVOO</b>	539	Italy	$^{18}\text{O}/^{16}\text{O}$ , $^2\text{H}/^1\text{H}$ and $^{13}\text{C}/^{12}\text{C}$	IRMS (Finnigan DELTA XP, Thermo Scientific, Bremen, Germany)	The non-parametric test of Kruskal–Wallis	Multi-elemental analysis	- Discrimination capability of $^{18}\text{O}/^{16}\text{O}$ , $^2\text{H}/^1\text{H}$ and $^{13}\text{C}/^{12}\text{C}$ between olive oils from different Italian regions - The trend of these indicators over the years	(Camin, Larcher, Perini, et al., 2010)
<b>EVOO</b>	267	Italy, France, Spain, Greece and Portugal	$^{18}\text{O}/^{16}\text{O}$ , $^2\text{H}/^1\text{H}$ and $^{13}\text{C}/^{12}\text{C}$	IRMS (Delta plus XL, Delta Plus XP, Delta V, Delta S, Thermo-Finnigan, Bremen, Germany; Isoprime, AP2003, GV Instruments Ltd., Manchester, U.K.; Optima Micromass)	Kolmogorov-Smirnov test		Finding correlation between H, C and O isotope ratios in olive oil and climatic and geographical characteristics of the provenance locations.	(Camin, Larcher, Nicolini, et al., 2010)
<b>VOO</b>	49	Turkey	$^{13}\text{C}/^{12}\text{C}$	IRMS (Micro- mass, IsoPrime)	PCA and HCA		Combination of trace element concentrations and $^{13}\text{C}/^{12}\text{C}$ isotope ratio for better resolution in geographical discrimination of olive oils	(Gumus et al., 2017)
<b>VOO</b>	47	Greece	$^{18}\text{O}/^{16}\text{O}$ and $^{13}\text{C}/^{12}\text{C}$	IRMS (Finnigan Delta V Advantage, Thermo Fisher Scientific, Bremen, Germany)	Multivariate analysis	Multi-elemental analysis/ Determination of chlorophyll and carotenoid pigments	Combination of $^{18}\text{O}/^{16}\text{O}$ and $^{13}\text{C}/^{12}\text{C}$ isotope ratios and physicochemical parameters for geographical classification of olive oils from regions in proximity	(Karabagias et al., 2013)
<b>VOO</b>	387	Italy	$^{18}\text{O}/^{16}\text{O}$ and $^{13}\text{C}/^{12}\text{C}$	IRMS (Isoprime, Cheadle, UK)	Pearson coefficient and ANOVA	-	Use of stable isotope ratios as tracers for environmental conditions and geographic coordinates for olive oil geographical authentication.	(Portarena et al., 2014)

<b>Edible oils and sweeteners</b>	43	Italy, Greece and Spain	$^{18}\text{O}/^{16}\text{O}$ , $^2\text{H}/^1\text{H}$ and $^{13}\text{C}/^{12}\text{C}$	IRMS (Thermo-Finnigan Delta plus XP, Thermo Fisher Scientific Inc., Waltham, MA, USA)	-	Multi-elemental analysis	- Use of carbon isotope ratio as indication of olive oil adulteration (with corn oil). - Oxygen and hydrogen isotope fractionation between edible oils (olive oil) and local meteoric water.	(Banerjee et al., 2015)
<b>OO</b>	180	Italy	$^{18}\text{O}/^{16}\text{O}$ , $^2\text{H}/^1\text{H}$ and $^{13}\text{C}/^{12}\text{C}$	IRMS (Finnigan DELTA XP, Thermo Scientific, Bremen, Germany)	-	The acidity values, UV spectrophotometric indices (K232, K270, DK) and fatty acid composition	Measurement of Stable isotope ratios in legal applications for geographical origin of food (olive oil).	(Camin et al., 2016)
<b>OO</b>	-	Italy	$^{18}\text{O}/^{16}\text{O}$ and $^{13}\text{C}/^{12}\text{C}$	IRMS (Isoprime, GV, Cheadle, UK)	Factorial analysis of-variance (ANOVA) and Post Hoc Fisher multiple comparison test	Fatty acid composition	Effect of the cultivar and the ripening stage of olives on C and O isotope composition for traceability studies.	(Portarena et al., 2015)
<b>EVOO</b>	53	Italy and Croatia	$^{18}\text{O}/^{16}\text{O}$ and $^{13}\text{C}/^{12}\text{C}$	IRMS (Delta plus XP; ThermoFinnigan, Bremen, German)	Linear discriminant analysis	Major chemical component determination (triacylglycerols, TAG and fatty acids)/ Thermal properties	Comparison between conventional techniques, stable isotope ratio analysis and thermal properties for olive oil traceability resolution.	(Chiavaro et al., 2011)

<b>OO</b>	100	Greece	$^{18}\text{O}/^{16}\text{O}$ , $^2\text{H}/^1\text{H}$ and $^{13}\text{C}/^{12}\text{C}$	IRMS (Nu Instruments Limited, Wrexham, UK)	PCA / OPLS-DA	-	Creation of OPLS-DA model, using stable isotope ratios of C, H and O in olive oil, able to discriminate and predict origin of samples from different origins.	(Tarapoulouzi et al., 2021)
<b>EVOO</b>	210	Greece	$^{18}\text{O}/^{16}\text{O}$ and $^{13}\text{C}/^{12}\text{C}$	IRMS (not mentioned)	-	-	- C and O isotope ratios as markers of the climate regime thus of the geographical origin of olive oils. - Use of $^{13}\text{C}$ isotopic values of biophenolic extracts for geographical discrimination of olive oil.	(Karalis et al., 2020)

Nevertheless, Camin et al (2010) highlighted the significant variation in the ratios  $^{13}\text{C}/^{12}\text{C}$  and  $^{18}\text{O}/^{16}\text{O}$  of Italian olive oils sampled from 2000 to 2005. The isotope ratios of the samples collected from the same region varied among the years, characterized by different climatic conditions (rainfall and temperature) (Camin, Larcher, Perini, et al., 2010).

Therefore, the continuous evolution of the environmental and climatic conditions over the years requires a continuous update of isotopic data which evolve consistently.

### **3.2.2. Strontium isotope ratio determination for olive oil geographical traceability**

Strontium isotopic signatures are widely used for food traceability and many other applications where issues of origin are important. Strontium is relatively abundant in soil, is not metabolized by living organisms, and does not seem to undergo any detectable fractionation. This results in a fully conservative behaviour of the Sr isotopic ratio from the soils to the plants including animals feeding these plants (Coelho et al., 2017). Strontium is an alkaline earth metal naturally present in rocks, soil, and water, and has four stable isotopes ( $^{84}, ^{86}, ^{87}, ^{88}\text{Sr}$ ). The  $^{87}\text{Sr}$  isotope is radiogenic as it is partially derived from the disintegration of  $^{87}\text{Rb}$ . The isotopic ratio  $^{87}\text{Sr}/^{86}\text{Sr}$  most often considered in studies is related to the intrinsic nature of the bedrock, its age, and its geological evolution, and is therefore specific for each type of soil. The two main sources of this element in plants are the labile Sr fraction of the soil, and the Sr contained in soil pore water in the soil (Stewart et al., 1998). Strontium is absorbed by the plant and distributed into its components from the soil without undergoing isotopic fractionation (Capo et al., 1998).

Given these features, strontium has been successfully used for the geographical tracing of different food products such as wheat (Liu et al., 2016), wine (Epova et al., 2019), coffee (Liu et al., 2014) and fruits like orange (Coelho et al., 2017; Rummel et al., 2010). Recently, strontium isotopic signature was used to assess geographical traceability of olive oil. Benincasa et al. were the first to report the use of strontium isotopic ratio measurement in olive oil for traceability purposes, but the complex nature of the matrix and the low Sr content ( $<50 \mu\text{g kg}^{-1}$ ) are challenging for most analytical methods (Benincasa et al., 2007). Consequently, pre-concentration is mandatory to achieve suitable results.

S. Medini et al. (Medini et al., 2015) developed an analytical method for the measurement of  $^{87}\text{Sr}/^{86}\text{Sr}$  in olive oil toward authenticating PDO olive oil from southern France. As a pre-screening step, the elemental Sr content in the samples was determined using ICP-MS after MW-AD.

The strontium concentrations ranged between 2 and 13.9  $\mu\text{g kg}^{-1}$ , which are critically low for an accurate measurement of the isotopic ratio of Sr by mass spectrometry. Therefore, ashing of the oils in a muffle furnace was performed and allowed to increase the amount of sample that can be processed. The Sr purification were performed using Sr specific resin (Sr Eichrom resin) according to the protocol described by Pin et al. (Pin et al., 2003). Finally, the Sr isotopic ratios were determined by thermal ionization mass spectrometry (TIMS) in five olive oils from Nîmes PDO (France) and in two olive oils from Morocco. The results showed that olive oils from France and Morocco were successfully distinguished according to Sr isotopic ratios and were correlated to the bedrock geology. A good reproducibility of the extraction method used was also demonstrated. Given the unavailability of a reference material certified for the isotope ratio  $^{87}\text{Sr}/^{86}\text{Sr}$  in olive oil, a strontium carbonate isotopic CRM (NBS987) was subjected to the same procedure that olive oil samples to study the influence of pretreatments and calcination on  $^{87}\text{Sr}/^{86}\text{Sr}$  ratio. The results demonstrated that the proposed methodology did not alter the isotopic signature of Sr. However, the influence of the procedure on an oily matrix has not been demonstrated since NIST 987 is an aqueous solution with a high degree of homogeneity that doesn't reflect the complex nature of the olive oil matrix.

Techer et al., (Techer et al., 2017) studied the impact of agricultural practices on the Sr isotopic composition of olives. TIMS was used to determine the Sr isotopic compositions ( $^{87}\text{Sr}/^{86}\text{Sr}$ ) of varied parts of olives trees (branches, leaves and olives), and the Sr isotopic composition of their growing environment in two distinct agricultural contexts belonging to the same geological area. The aim of the study was to assess the impact of the irrigation and fertilization techniques on the Sr isotopic composition of olive trees. The study showed that using anthropogenic additives and irrigation water induced changes in the composition of Sr in the soil and thus in the plant. This study underscored the importance of Sr as a reliable tool for the geographical traceability of olive oil.

The different studies of light isotopes and olive oil differentiation showed that analyzing a combination of  $\delta^{13}\text{C}$  and  $\delta^{18}\text{O}$  of organic plant matter can be a powerful tool. It integrates the ecophysiological behavior, which itself is directly related to the type of photosynthesis and the pedoclimatic context. Sr isotopic signatures have been very useful to trace the geographical origin of different agricultural products, since they are usually conservatively up taken by the plants from the soils they grow in, and are stored in the plant with little to no detectable isotopic fractionation.

The use of stable isotope ratios of light elements (C, H and O) permits tracing the pedoclimatic conditions in the growing area of the plant, while the use of strontium isotopes provides information on the geological substratum. Therefore, it would be relevant to combine the two isotopic approaches to provide accurate and complementary information on the geographical origin of the production area.

### **3.3. Statistical analysis for geographical authentication of olive oil**

To summarize and better exploit the data in a study of geographical authentication of olive oil, a statistical representation is generally used. The most common statistical methods which have demonstrated discrimination between olive oils originating from different geographical origins are multivariate analyses, mainly Principal Component Analysis (PCA) and Linear Discriminant Analysis (LDA) (Granato et al., 2018). PCA is an unsupervised method, and LDA is supervised. The PCA score plot is a graphical representation of variables called principal components (Abdi & Lynne J., 2010). PCA maintains the variability of data. In most cases, a PC1 vs PC2 score plot applied to trace element content worked well to distinguish between olive oil samples of different origins (Aceto et al., 2019; Gumus et al., 2017; Sayago et al., 2018). Nevertheless, PCA applied to mineral composition is not always sufficient. For example, olive oils from 12 different geographic locations in Spain could not be distinguished only using trace elements (Sayago et al., 2018).

With PCA, graphic representation of two principal components separated the samples into two groups, either belonging to a cluster of points representing a common geographical origin (Huelva), or to one of the other regions, which were then separated into three main locations distinguished by LDA. A similar conclusion has been drawn for the geographical authentication of virgin olive oils from Western Turkey (Gumus et al., 2017): the PCA method was not able to distinguish Turkish olive oils from different locations. Only two groups of two sets of samples were successfully classified by means of score plot, each group contains samples from different locations. (Gumus et al., 2017). This study was enhanced by the use of  $\delta^{13}\text{C}$  which can further distinguish sample groups by providing additional information to resolve similarities between some element content in different samples. This study demonstrates that stable isotopes of light elements can be successfully studied with the mineral composition of the oil to better pinpoint the geographic origins of different olive oils.

As for PCA, LDA helps to summarize the main results on a two-dimensional plot while trying to maximize the discrimination between known groups. The sample classification is based on a maximum likelihood discriminant rule. To study the geographical traceability of olive oil from southwestern Spain, trace element concentrations in soils, olive pomace, and olive oils were determined (Beltrán et al., 2015). LDA was successfully applied to the concentrations of Fe, Na and W to discriminate soils from four different geographical origins. Then, since trace element concentrations are lower in the olive pomace, only eight element concentrations (i.e. W, Mg, Mn, Ca, Fe, Ba, Li and Na) were used by the LDA for an optimal classification. Despite the overlap of some points, it is still possible to discriminate between four groups of points representing the different geographic locations. This classification was less effective for olive oil using the eight aforementioned elements due to their very low concentrations in the oil. Indeed, the critically low concentrations in such a complex matrix may not be measured with high precision (problem of LOD, sensitivity, repeatability), which makes this statistical method limited for the geographical discrimination of olive oil. In this study, Mn concentration in olive oils ranged from 0.1 to 0.2  $\mu\text{g kg}^{-1}$ , while the lower concentration of calibration standard solutions used was equal to 0.2  $\mu\text{g kg}^{-1}$ . That makes the measured concentration unreliable, especially as Mn was used by LDA. Thus, if the analysis of trace elements in the soil allows for a good geographical discrimination, this does not necessarily reflect the same distribution for the corresponding olive oils.

On the other hand, in a study published in 2007, LDA applied to Italian olive oils showed a remarkable discriminating power on the basis of 18 elements. 8 groups of samples were clearly differentiated on an LDA plot with a high reliability (Benincasa et al., 2007). PCA can explain the distribution of groups of samples according to the influencing elements. It first identifies the elements, then identifies the possible interactions and combinations between them. LDA is the best alternative in the case of PCA failure to find a high enough variance among the principal components (as, for PCA, this induces a loss of information when reducing the dimensions).

#### 4. Conclusion

This review summarizes the developments in inorganic and isotopic analysis of olive oil for the purpose of geographical authentication. The first and foremost observation based on the compilation of inorganic content in olive oils is that, in general, except for elements such as Fe, Cr and Ca, elements are at trace and ultra-trace levels well below  $200 \mu\text{g kg}^{-1}$  on average. The analytical isotopic characterization of this matrix remains challenging.

Recent developments in sample preparation techniques and spectroscopic/spectrometric analysis have improved the quality of food science, however, adaptability of these methods to the olive oil matrix remains limited. Various analytical methods have been proposed in the literature to ensure the geographical traceability of olive oil, an economically important product; most of these methods operate via destructive sample preparation strategies (mainly microwave-assisted digestion), aiming to eliminate the organic matrix, which is a barrier to the introduction of samples in spectroscopic analysis instrumentation. However, the destruction of the organic matter is often incomplete, leading to unreliable results. In addition, the absence of certified reference material for olive oil remains a significant concern, limiting the reliability of the published results and hindering the validation of the proposed methods.

Non-destructive methods have also been developed to release the elements to be analyzed without totally destroying the organic matrix. These are typically extraction/complexation methods that are generally more labour-intensive, although they are performed under gentle conditions. The reproducibility of results and the extraction yield remain an analytical challenge. In general, ICP-MS is the most appropriate detection technique for quantification of elements at low concentrations. A very strict control of the blank throughout sample preparation procedures is however required. If not fully controlled, LODs can be high.

Further to the sample preparation and detection procedures, multivariate statistical models, both supervised and unsupervised, are generally applied to multi-elemental profiles of oils. They have shown that it is possible to classify olive oils according to their geographical origin on the basis of reliable data. Nevertheless, multi-elemental analysis remains limited for the identification of geographical origin of olive oil, as various external factors can alter the element concentration.

In addition to the multi-elemental profile, isotopic approaches can complete the desired information on geographic origin. Stable isotopes of light elements have provided additional information on the plant's growing environment, but alone these are not enough information



to confirm proper geographical authentication. They give information about the environmental and climate characteristics of locations and the physiology of the plant. All these aspects are likely to modify the isotopic profile of light elements. More recent developments in the analysis of the Sr isotope ratio in olive oil have enhanced the traceability studies of oils. The isotopic ratio  $^{87}\text{Sr}/^{86}\text{Sr}$  is directly and exclusively related to the geology of the soil, and does not fractionate from the soil to the final product, so it maintains the isotopic signature of the original soil. However, the critically low concentration of Sr in olive oil makes it a serious analytical challenge for its extraction from the matrix, its precise quantification, and the determination of its isotopic ratio. Further studies on the pre-concentration of Sr in olive oil are required to strengthen this approach.

## References

- Abdi, H.; Williams, L.J. Principal Component Analysis: Principal Component Analysis. *WIREs Comp Stat* **2010**, *2*, 433–459, doi:10.1002/wics.101.
- Aceto, M.; Calà, E.; Musso, D.; Regalli, N.; Oddone, M. A Preliminary Study on the Authentication and Traceability of Extra Virgin Olive Oil Made from Taggiasca Olives by Means of Trace and Ultra-Trace Elements Distribution. *Food Chemistry* **2019**, *298*, 125047, doi:10.1016/j.foodchem.2019.125047.
- Alloway, B.J.; Davies, B.E. Trace Element Content of Soils Affected by Base Metal Mining in Wales. *Geoderma* **1971**, *5*, 197–208, doi:10.1016/0016-7061(71)90009-7.
- Angerosa, F.; Bréas, O.; Contento, S.; Guillou, C.; Reniero, F.; Sada, E. Application of Stable Isotope Ratio Analysis to the Characterization of the Geographical Origin of Olive Oils. *J. Agric. Food Chem.* **1999**, *47*, 1013–1017, doi:10.1021/jf9809129.
- Angioni, A.; Cabitza, M.; Russo, M.T.; Caboni, P. Influence of Olive Cultivars and Period of Harvest on the Contents of Cu, Cd, Pb, and Zn in Virgin Olive Oils. *Food Chemistry* **2006**, *99*, 525–529, doi:10.1016/j.foodchem.2005.08.016.
- Arnaud Mathieu; Denis Baize; Christophe Raoul; Côme Daniau. Proposition de Référentiels Régionaux En Éléments Traces Métalliques Dans Les Sols : Leur Utilisation Dans Les Évaluations Des Risques Sanitaires. *Environnement, Risques & Santé* **2008**, *7*, 112–122, doi:10.1684/ers.2008.0142.
- Bajoub, A.; Hurtado-Fernández, E.; Ajal, E.A.; Ouazzani, N.; Fernández-Gutiérrez, A.; Carrasco-Pancorbo, A. Comprehensive 3-Year Study of the Phenolic Profile of Moroccan Monovarietal Virgin Olive Oils from the Meknès Region. *J. Agric. Food Chem.* **2015**, *63*, 4376–4385, doi:10.1021/jf506097u.
- Bajoub, A.; Hurtado-Fernández, E.; Ajal, E.A.; Ouazzani, N.; Fernández-Gutiérrez, A.; Carrasco-Pancorbo, A. Comprehensive 3-Year Study of the Phenolic Profile of Moroccan Monovarietal Virgin Olive Oils from the Meknès Region. *Journal of Agricultural and Food Chemistry* **2015**, *63*, 4376–4385, doi:10.1021/jf506097u.
- Bakari, S. The Impact of Olive Oil Exports on Economic Growth: Empirical Analysis from Tunisia. *BİLTÜRK Journal of Economics and Related Studies* **2020**, *2*, 441–458, doi:10.47103/bilturk.675714.
- Bakircioglu, D.; Kurtulus, Y.B.; Yurtsever, S. Comparison of Extraction Induced by Emulsion Breaking, Ultrasonic Extraction and Wet Digestion Procedures for Determination of Metals in Edible Oil Samples in Turkey Using ICP-OES. *Food Chemistry* **2013**, *138*, 770–775, doi:10.1016/j.foodchem.2012.10.089.
- Banerjee, S.; Kurtis Kyser, T.; Vuletich, A.; Leduc, E. Elemental and Stable Isotopic Study of Sweeteners and Edible Oils: Constraints on Food Authentication. *Journal of Food Composition and Analysis* **2015**, *42*, 98–116, doi:10.1016/j.jfca.2015.03.011.
- Beltrán, M.; Sánchez-Astudillo, M.; Aparicio, R.; García-González, D.L. Geographical Traceability of Virgin Olive Oils from South-Western Spain by Their Multi-Elemental Composition. *Food Chemistry* **2015**, *169*, 350–357, doi:10.1016/j.foodchem.2014.07.104.

- Bencharif A.; Les industries agro-alimentaires dans les pays du Maghreb. *Medit*, **1993**, 4 (1), 36-46
- Benincasa, C.; Gharsallaoui, M.; Perri, E.; Briccoli Bati, C.; Ayadi, M.; Khlif, M.; Gabsi, S. Quality and Trace Element Profile of Tunisian Olive Oils Obtained from Plants Irrigated with Treated Wastewater. *The Scientific World Journal* **2012**, 2012, 1–11, doi:10.1100/2012/535781.
- Benincasa, C.; Lewis, J.; Perri, E.; Sindona, G.; Tagarelli, A. Determination of Trace Element in Italian Virgin Olive Oils and Their Characterization According to Geographical Origin by Statistical Analysis. *Analytica Chimica Acta* **2007**, 585, 366–370, doi:10.1016/j.aca.2006.12.040.
- Bimbo, F.; Bonanno, A.; Viscecchia, R. An Empirical Framework to Study Food Labelling Fraud: An Application to the Italian Extra-virgin Olive Oil Market. *Aust J Agric Resour Econ* **2019**, 63, 701–725, doi:10.1111/1467-8489.12318.
- Bimbo, F.; Bonanno, A.; Viscecchia, R. An Empirical Framework to Study Food Labelling Fraud: An Application to the Italian Extra-Virgin Olive Oil Market. *Australian Journal of Agricultural and Resource Economics* **2019**, 63, 701–725, doi:10.1111/1467-8489.12318.
- Boskou, D.; Blekas, G.; Tsimidou, M. *Olive Oil Composition*; Second Edi.; AOCS Press, 1999;
- Bottino, A.; Capannelli, G.; Mattei, A.; Rovellini, P.; Zunin, P. Effect of Membrane Filtration on the Flavor of Virgin Olive Oil. *Eur. J. Lipid Sci. Technol.* **2008**, 110, 1109–1115, doi:10.1002/ejlt.200800075.
- Brkljača, M.; Giljanović, J.; Prkić, A. Determination of Metals in Olive Oil by Electrothermal Atomic Absorption Spectrometry: Validation and Uncertainty Measurements. *Analytical Letters* **2013**, 46, 2912–2926, doi:10.1080/00032719.2013.814056.
- Cabrera-Vique, C.; Bouzas, P.R.; Oliveras-López, M.J. Determination of Trace Elements in Extra Virgin Olive Oils: A Pilot Study on the Geographical Characterisation. *Food Chemistry* **2012**, 134, 434–439, doi:10.1016/j.foodchem.2012.02.088.
- Camin, F.; Boner, M.; Bontempo, L.; Fauhl-Hassek, C.; Kelly, S.D.; Riedl, J.; Rossmann, A. Stable Isotope Techniques for Verifying the Declared Geographical Origin of Food in Legal Cases. *Trends in Food Science & Technology* **2017**, 61, 176–187, doi:10.1016/j.tifs.2016.12.007.
- Camin, F.; Larcher, R.; Nicolini, G.; Bontempo, L.; Bertoldi, D.; Perini, M.; Schlicht, C.; Schellenberg, A.; Thomas, F.; Heinrich, K.; et al. Isotopic and Elemental Data for Tracing the Origin of European Olive Oils. *Journal of Agricultural and Food Chemistry* **2010**, 58, 570–577, doi:10.1021/jf902814s.
- Camin, F.; Larcher, R.; Perini, M.; Bontempo, L.; Bertoldi, D.; Gagliano, G.; Nicolini, G.; Versini, G. Characterisation of Authentic Italian Extra-Virgin Olive Oils by Stable Isotope Ratios of C , O and H and Mineral Composition. *Food Chemistry* **2010**, 118, 901–909, doi:10.1016/j.foodchem.2008.04.059.
- Camin, F.; Pavone, A.; Bontempo, L.; Wehrens, R.; Paolini, M.; Faberi, A.; Maria, R.; Capitani, D.; Vista, S.; Mannina, L. The Use of IRMS , 1 H NMR and Chemical Analysis to Characterise Italian and Imported Tunisian Olive Oils. *Food Chemistry* **2016**, 196, 98–105, doi:10.1016/j.foodchem.2015.08.132.

- Capo, R.C.; Stewart, B.W.; Chadwick, O.A. Strontium Isotopes as Tracers of Ecosystem Processes : Theory and Methods. **1998**, 197–225.
- Carini, F.; Bengtsson, G. Post-Deposition Transport of Radionuclides in Fruit. *Journal of Environmental Radioactivity* **2001**, 52, 215–236, doi:10.1016/S0265-931X(00)00034-5.
- Cernusak, L.A.; Ubierna, N.; Winter, K.; Holtum, J.A.M.; Marshall, J.D.; Farquhar, G.D. Environmental and Physiological Determinants of Carbon Isotope Discrimination in Terrestrial Plants. *New Phytol* **2013**, 200, 950–965, doi:10.1111/nph.12423.
- Cesur, H.; Bati, B. Solid-Phase Extraction of Copper with Lead 4-Benzylpiperidinedithiocarbamate on Microcrystalline Naphthalene and Its Spectrophotometric Determination. *Turk J Chem* **2002**, 26, 599-605.
- Chebbi H.; Compétences pour le Commerce et la Diversification Économique (STED) en Tunisie. Eds. *Organisation Internationale du Travail*, **2016**, Suisse; pp. 121
- Chiavaro, E.; Cerretani, L.; Di Matteo, A.; Barnaba, C.; Bendini, A.; Iacumin, P. Application of a Multidisciplinary Approach for the Evaluation of Traceability of Extra Virgin Olive Oil. *Eur. J. Lipid Sci. Technol.* **2011**, 113, 1509–1519, doi:10.1002/ejlt.201100174.
- Chiocchini, F.; Portarena, S.; Ciolfi, M.; Brugnoli, E.; Lauteri, M. Isoscapes of Carbon and Oxygen Stable Isotope Compositions in Tracing Authenticity and Geographical Origin of Italian Extra-Virgin Olive Oils. *Food Chemistry* **2016**, 202, 291–301, doi:10.1016/j.foodchem.2016.01.146.
- Cindric, I.J.; Zeiner, M.; Steffan, I. Trace Elemental Characterization of Edible Oils by ICP–AES and GFAAS. *Microchemical Journal* **2007**, 85, 136–139, doi:10.1016/j.microc.2006.04.011.
- Coelho, I.; Castanheira, I.; Bordado, J.M.; Donard, O.; Silva, J.A.L. Recent Developments and Trends in the Application of Strontium and Its Isotopes in Biological Related Fields. *TrAC Trends in Analytical Chemistry* **2017**, 90, 45–61, doi:10.1016/j.trac.2017.02.005.
- Costa, L.M.; Silva, F.V.; Gouveia, S.T.; Nogueira, A.R.A.; Nobrega, J.A. Focused Microwave-Assisted Acid Digestion of Oils: An Evaluation of the Residual Carbon Content. *Spectrochimica Acta Part B* **2001**, 56, 1981\_1985
- Cuvelier, M. QUALIT E – S Des Huiles Alimentaires Au Cours de Leur Stockage Stabilité. *OCL* **2012**, 19, 125–132.
- Dabbou, S.; Brahmi, F.; Taamali, A.; Issaoui, M.; Ouni, Y.; Braham, M.; Zarrouk, M.; Hammami, M. Extra Virgin Olive Oil Components and Oxidative Stability from Olives Grown in Tunisia. *J Am Oil Chem Soc* **2010**, 87, 1199–1209, doi:10.1007/s11746-010-1600-3.
- Damak, F.; Asano, M.; Baba, K.; Ksibi, M.; Tamura, K. Comparison of Sample Preparation Methods for Multielements Analysis of Olive Oil by ICP-MS. *Methods and protocols* **2019**, 2, 72; doi:10.3390/mps2030072,
- Damak, F.; Asano, M.; Baba, K.; Suda, A.; Araoka, D.; Wali, A.; Isoda, H.; Nakajima, M.; Ksibi, M.; Tamura, K. Interregional Traceability of Tunisian Olive Oils to the Provenance Soil by Multielemental Fingerprinting and Chemometrics. *Food Chemistry* **2019**, 283, 656–664, doi:10.1016/j.foodchem.2019.01.082.

- Danezis, G.P.; Tsagkaris, A.S.; Camin, F.; Brusic, V.; Georgiou, C.A. Food Authentication: Techniques, Trends & Emerging Approaches. *Trends in Analytical Chemistry* **2016**, *85*, 123–132, doi:10.1016/j.trac.2016.02.026.
- Danezis, G.P.; Tsagkaris, A.S.; Camin, F.; Brusic, V.; Georgiou, C.A. Food Authentication: Techniques, Trends & Emerging Approaches. *TrAC - Trends in Analytical Chemistry* **2016**, *85*, 123–132, doi:10.1016/j.trac.2016.02.026.
- De Leonardis, A.; Macciola, V.; De Felice, M. Copper and Iron Determination in Edible Vegetable Oils by Graphite Furnace Atomic Absorption Spectrometry after Extraction with Diluted Nitric Acid. *International Journal of Food Science & Technology* **2000**, *35*, 371–375, doi:10.1046/j.1365-2621.2000.00389.x.
- Dekhili, S.; Sirieix, L.; Cohen, E. How Consumers Choose Olive Oil: The Importance of Origin Cues. *Food Quality and Preference* **2011**, *22*, 757–762, doi:10.1016/j.foodqual.2011.06.005.
- Dekhili, S.; Sirieix, L.; Cohen, E. How Consumers Choose Olive Oil: The Importance of Origin Cues. *Food Quality and Preference* **2011**, *22*, 757–762, doi:10.1016/j.foodqual.2011.06.005.
- Diego L. García-González · Ramón Aparicio, D.L.; Aparicio, R. Classification of Different Quality Virgin Olive Oils by Metal-Oxide Sensors. *European Food Research and Technology* **2004**, *218*, 484–487, doi:10.1007/s00217-003-0855-4.
- dos Santos, E.J.; Herrmann, A.B.; Chaves, E.S.; Vechiatto, W.W.D.; Schoemberger, A.C.; Frescura, V.L.A.; Curtius, A.J. Simultaneous Determination of Ca, P, Mg, K and Na in Biodiesel by Axial View Inductively Coupled Plasma Optical Emission Spectrometry with Internal Standardization after Multivariate Optimization. *J. Anal. At. Spectrom.* **2007**, *22*, 1300, doi:10.1039/b702563g.
- Ekezie, F.-G.C.; Sun, D.-W.; Cheng, J.-H. Acceleration of Microwave-Assisted Extraction Processes of Food Components by Integrating Technologies and Applying Emerging Solvents: A Review of Latest Developments. *Trends in Food Science & Technology* **2017**, *67*, 160–172, doi:10.1016/j.tifs.2017.06.006.
- Elflein, L.; Ræzke, K.-P. Improved Detection of Honey Adulteration by Measuring Differences between  $^{13}\text{C}/^{12}\text{C}$  Stable Carbon Isotope Ratios of Protein and Sugar Compounds with a Combination of Elemental Analyzer - Isotope Ratio Mass Spectrometry and Liquid Chromatography - Isotope Ratio Mass Spectrometry ( $\delta^{13}\text{C}$  - EA/LC-IRMS). *Apidologie* **2008**, *39*, 574–587, doi:10.1051/apido:2008042.
- Epova, E.N.; Bérail, S.; Séby, F.; Vacchina, V.; Bareille, G.; Médina, B.; Sarthou, L.; Donard, O.F.X. Strontium Elemental and Isotopic Signatures of Bordeaux Wines for Authenticity and Geographical Origin Assessment. *Food Chemistry* **2019**, *294*, 35–45, doi:10.1016/j.foodchem.2019.04.068.
- Escrich, E. International Conference on the Healthy Effect of Virgin Olive Oil. **2005**, *35*, 421–424.
- Essiari, M.; Bachir, S.; Zouhair, R.; Chimi, H.; Misbahi, H.; Boudkhili, M. Influence de La Variété et Du Milieu de Culture Sur La Composition En Acide Gras, En Stéroïdes et En Polyphénols Totaux Pour Les Huiles Vierges de Quatre Variétés D'olives de La Région de Saïs (Maroc). *European Journal of Scientific Research* **2014**, *125*, 95–114.

Fausto L., Introduction, Handbook of Olive Oil, Harwood, J; Aparicio, R., *Aspen publishers*, Inc: ake Cook Road Riverwoods, United States, **2000**, ISBN 978-1-4419-5194-6

Fernández-Uclés, D.; Elfkih, S.; Mozas-Moral, A.; Bernal-Jurado, E.; Medina-Viruel, M.J.; Abdallah, S.B. Economic Efficiency in the Tunisian Olive Oil Sector. *Agriculture* **2020**, *10*, 391, doi:10.3390/agriculture10090391.

Flori, L.; Donnini, S.; Calderone, V.; Zinnai, A.; Taglieri, I.; Venturi, F.; Testai, L. The Nutraceutical Value of Olive Oil and Its Bioactive Constituents on the Cardiovascular System. Focusing on Main Strategies to Slow Down Its Quality Decay during Production and Storage. *Nutrients* **2019**, *11*, 1962, doi:10.3390/nu11091962.

Frankel, E.N. Chemistry of Extra Virgin Olive Oil: Adulteration, Oxidative Stability, and Antioxidants. *J. Agric. Food Chem.* **2010**, *58*, 5991–6006, doi:10.1021/jf1007677.

Gálvez E.; Technopoles agro-alimentaires : vers des systèmes innovants. *Logistique et commerce agro-alimentaires, un défi pour la Méditerranée.* **2014**, Centre international de hautes études agronomiques méditerranéennes (CIHEAM). Presses de Sciences Po, Paris. pp. 460.

Gertz, C.; Gertz, A.; Matthäus, B.; Willenberg, I. A Systematic Chemometric Approach to Identify the Geographical Origin of Olive Oils. *Eur. J. Lipid Sci. Technol.* **2019**, *121*, 1900281, doi:10.1002/ejlt.201900281.

Goidanich, P. Filtration Process of Extra Virgin Olive Oil : Effect on Minor Components , Oxidative Stability and Sensorial and Physicochemical Characteristics. *Trends in Food Science & Technology* **2010**, *21*, 201–211, doi:10.1016/j.tifs.2009.12.004.

González, A.; de la Guardia, M. Mineral Profile. *Comprehensive Analytical Chemistry*; Elsevier, **2013**; Vol. 60, pp. 51–76, <http://dx.doi.org/10.1016/B978-0-444-59562-1.00003-7>

Goodarzi, F.; Zendejboudi, S. A Comprehensive Review on Emulsions and Emulsion Stability in Chemical and Energy Industries. *Can. J. Chem. Eng.* **2019**, *97*, 281–309, doi:10.1002/cjce.23336.

Gorini, I.; Iorio, S.; Ciliberti, R.; Licata, M.; Armocida, G. Olive Oil in Pharmacological and Cosmetic Traditions. *Journal of Cosmetic Dermatology* **2019**, *18*, 1575–1579, doi:10.1111/jocd.12838.

Gouvinhas, I.; Domínguez-Perles, R.; Machado, N.; Carvalho, T.; Matos, C.; Barros, A.I.R.N.A. Effect of Agro-Environmental Factors on the Mineral Content of Olive Oils: Categorization of the Three Major Portuguese Cultivars. *J Am Oil Chem Soc* **2016**, *93*, 813–822, doi:10.1007/s11746-016-2827-4.

Granato, D.; Putnik, P.; Kovačević, D.B.; Santos, J.S.; Calado, V.; Rocha, R.S.; Cruz, A.G.D.; Jarvis, B.; Rodionova, O.Y.; Pomerantsev, A. Trends in Chemometrics: Food Authentication, Microbiology, and Effects of Processing: Trends in Chemometrics. *Comprehensive Reviews in Food Science and Food Safety* **2018**, *17*, 663–677, doi:10.1111/1541-4337.12341.

Greenough, J.D.; Fryer, B.J.; Mallory-Greenough, L. Trace Element Geochemistry of Nova Scotia (Canada) Maple Syrup. *Can. J. Earth Sci.* **2010**, *47*, 1093–1110, doi:10.1139/E10-055.

Guignand G., Caraës D., Q. Mathieu, T. Pouch & C. Rovelli. La compétitivité du secteur agricole et alimentaire français. Eds. Chambres d’agriculture de France. *Agriculture et Territoires.* **2021**, Paris; pp. 60

- Gumus, Z.P.; Celenk, V.U.; Tekin, S.; Yurdakul, O.; Ertas, H. Determination of Trace Elements and Stable Carbon Isotope Ratios in Virgin Olive Oils from Western Turkey to Authenticate Geographical Origin with a Chemometric Approach. *Eur Food Res Technol* **2017**, *243*, 1719–1727, doi:10.1007/s00217-017-2876-4.
- Gupta, N.; Yadav, K.K.; Kumar, V.; Kumar, S.; Chadd, R.P.; Kumar, A. Trace Elements in Soil-Vegetables Interface: Translocation, Bioaccumulation, Toxicity and Amelioration - A Review. *Science of the Total Environment* **2019**, *651*, 2927–2942, doi:10.1016/j.scitotenv.2018.10.047.
- Harwood, J.; Aparicio, R. *Handbook of Olive Oil : Analysis and Properties*; John, H., Ramon, A., Eds.; Aspen Publishers, **2000**; ISBN 9781475753714.
- Higgins P.. Isotope ecology from biominerals. In *Methods in Paleoecology: Reconstructing Cenozoic Terrestrial Environments and Ecological Communities*, **2018**, ed. DA Croft, DF Su, SWSimpson, Cham, Switz.: Springer Nature, pp. 99–120.
- Jimenez, M.S.; Velarte, R.; Castillo, J.R. On-Line Emulsions of Olive Oil Samples and ICP-MS Multi-Elemental Determination. *Journal of Analytical Atomic Spectrometry* **2003**, *18*, 1154–1162, doi:10.1039/b303131d.
- Kalogiouri, N.P.; Aalizadeh, R.; Dasenaki, M.E.; Thomaidis, N.S. Analytica Chimica Acta Application of High Resolution Mass Spectrometric Methods Coupled with Chemometric Techniques in Olive Oil Authenticity Studies - A Review. *Analytica Chimica Acta* **2020**, *1134*, 150–173, doi:10.1016/j.aca.2020.07.029.
- Kalogiouri, N.P.; Aalizadeh, R.; Dasenaki, M.E.; Thomaidis, N.S. Application of High Resolution Mass Spectrometric Methods Coupled with Chemometric Techniques in Olive Oil Authenticity Studies - A Review. *Analytica Chimica Acta* **2020**, *1134*, 150–173, doi:10.1016/j.aca.2020.07.029.
- Kara, D.; Fisher, A.; Hill, S. Detergentless Ultrasound-Assisted Extraction of Trace Elements from Edible Oils Using Lipase as an Extractant. *Talanta* **2015**, *144*, 219–225, doi:10.1016/j.talanta.2015.05.056.
- Kara, D.; Fisher, A.; Hill, S. Extraction of Trace Elements by Ultrasound-Assisted Emulsification from Edible Oils Producing Detergentless Microemulsions. *Food Chemistry* **2015**, *188*, 143–148, doi:10.1016/j.foodchem.2015.04.057.
- Karabagias, I.; Michos, Ch.; Badeka, A.; Kontakos, S.; Stratis, I.; Kontominas, M.G. Classification of Western Greek Virgin Olive Oils According to Geographical Origin Based on Chromatographic, Spectroscopic, Conventional and Chemometric Analyses. *Food Research International* **2013**, *54*, 1950–1958, doi:10.1016/j.foodres.2013.09.023.
- Karalis, P.; Poutouki, A.E.; Nikou, T.; Halabalaki, M.; Proestos, C.; Tsakalidou, E.; Gougoura, S.; Diamantopoulos, G.; Tassi, M.; Dotsika, E. Isotopic Traceability (<sup>13</sup>C and <sup>18</sup>O) of Greek Olive Oil. *Molecules (Basel, Switzerland)* **2020**, *25*, doi:10.3390/molecules25245816.
- Kelly, S.D. Using Stable Isotope Ratio Mass Spectrometry (IRMS) in Food Authentication and Traceability. In *Food Authenticity and Traceability*; Elsevier, **2003**; pp. 156–183 ISBN 978-1-85573-526-2.
- Khan, A.; Khan, S.; Khan, M.A.; Qamar, Z.; Waqas, M. The Uptake and Bioaccumulation of Heavy Metals by Food Plants, Their Effects on Plants Nutrients, and Associated Health Risk:

- A Review. *Environmental Science and Pollution Research* **2015**, *22*, 13772–13799, doi:10.1007/s11356-015-4881-0.
- Khan, M.A.; Khan, S.; Khan, A.; Alam, M. Soil Contamination with Cadmium, Consequences and Remediation Using Organic Amendments. *Science of The Total Environment* **2017**, *601–602*, 1591–1605, doi:10.1016/j.scitotenv.2017.06.030.
- Larbi, W.; Chymes, A. The Impact of the Government Policies and Incentives to Promote the Export of Agricultural Products in Tunisia: The Case of Olive Oil. *Food Economics - Acta Agriculturae Scandinavica, Section C* **2010**, *7*, 107–118, doi:10.1080/16507541.2010.531952.
- Lauteri, M.; Pliura, A.; Monteverdi, M.C.; Brugnoli, E.; Villani, F.; Eriksson, G. Genetic Variation in Carbon Isotope Discrimination in Six European Populations of *Castanea Sativa* Mill. Originating from Contrasting Localities. *J Evolution Biol* **2004**, *17*, 1286–1296, doi:10.1111/j.1420-9101.2004.00765.x.
- Leonardis, A. De; Macciola, V.; Felice, M. De Copper and Iron Determination in Edible Vegetable Oils by Graphite Furnace Atomic Absorption Spectrometry after Extraction with Diluted Nitric Acid. *International Journal of Food Science and Technology* **2000**, *35*, 371–375.
- Lepri, F.G.; Chaves, E.S.; Vieira, M.A. Determination of Trace Elements in Vegetable Oils and Biodiesel by Atomic Spectrometric Techniques: A Review. *Applied Spectroscopy Reviews* **2011**, *46*, 175–206, doi:10.1080/05704928.2010.529628.
- Liu, H.; Wei, Y.; Lu, H.; Wei, S.; Jiang, T.; Zhang, Y.; Guo, B. Combination of the  $^{87}\text{Sr}/^{86}\text{Sr}$  Ratio and Light Stable Isotopic Values ( $\Delta^{13}\text{C}$ ,  $\Delta^{15}\text{N}$  and  $\Delta\text{D}$ ) for Identifying the Geographical Origin of Winter Wheat in China. *Food Chemistry* **2016**, *212*, 367–373, doi:10.1016/j.foodchem.2016.06.002.
- Liu, H.-C.; You, C.-F.; Chen, C.-Y.; Liu, Y.-C.; Chung, M.-T. Geographic Determination of Coffee Beans Using Multi-Element Analysis and Isotope Ratios of Boron and Strontium. *Food Chemistry* **2014**, *142*, 439–445, doi:10.1016/j.foodchem.2013.07.082.
- Llorent-Martínez, E.J.; Ortega-Barrales, P.; Fernández-De Córdoba, M.L.; Domínguez-Vidal, A.; Ruiz-Medina, A. Investigation by ICP-MS of Trace Element Levels in Vegetable Edible Oils Produced in Spain. *Food Chemistry* **2011**, *127*, 1257–1262, doi:10.1016/j.foodchem.2011.01.064.
- Maléchaux, A.; Le Dréau, Y.; Artaud, J.; Dupuy, N. Exploring the Scientific Interest for Olive Oil Origin: A Bibliometric Study from 1991 to 2018. *Foods* **2020**, *9*, 556, doi:10.3390/foods9050556.
- Manjusha, R.; Shekhar, R.; Kumar, S.J. Ultrasound-Assisted Extraction of Pb, Cd, Cr, Mn, Fe, Cu, Zn from Edible Oils with Tetramethylammonium Hydroxide and EDTA Followed by Determination Using Graphite Furnace Atomic Absorption Spectrometer. *Food Chemistry* **2019**, *294*, 384–389, doi:10.1016/j.foodchem.2019.04.104.
- Markhali, F.S. Effect of Processing on Phenolic Composition of Olive Oil Products and Olive Mill By-Products and Possibilities for Enhancement of Sustainable Processes. *Processes* **2021**, *9*, doi:10.3390/pr9060953.
- Martínez, S.; Sánchez, R.; Lefevre, J.; Todolí, J.L. Multielemental Analysis of Vegetable Oils and Fats by Means of ICP-OES Following a Dilution and Shot Methodology. *Journal of Analytical Atomic Spectrometry* **2020**, *35*, 1897–1909, doi:10.1039/d0ja00112k.



- Matthäus, B.; Willenberg, I.; Engert, S.; Steinberg, P. The German National Reference Centre for Authentic Food (NRZ-Authent). *OCL - Oilseeds and fats, Crops and Lipids* **2019**, *26*, doi:10.1051/ocl/2019010.
- Mdluli, N.S.; Nomngongo, P.N.; Mketi, N. A Critical Review on Application of Extraction Methods Prior to Spectrometric Determination of Trace-Metals in Oily Matrices. *Critical Reviews in Analytical Chemistry* **2020**, *52*, *1*, 1–18, doi:10.1080/10408347.2020.1781591.
- Medini S. Traçage géographique des huiles d'olive par les isotopes du Sr : développement analytique et application aux huiles AOP de Nîmes, Université d'Aix-Marseille, France, 2015.
- Medini, S.; Janin, M.; Verdoux, P.; Techer, I. Methodological Development for  $^{87}\text{Sr}$  /  $^{86}\text{Sr}$  Measurement in Olive Oil and Preliminary Discussion of Its Use for Geographical Traceability of PDO Nîmes (France). *Food Chemistry* **2015**, *171*, 78–83, doi:10.1016/j.foodchem.2014.08.121.
- Menapace, L.; Colson, G.; Grebitus, C.; Facendola, M. Consumers' Preferences for Geographical Origin Labels: Evidence from the Canadian Olive Oil Market. *European Review of Agricultural Economics* **2011**, *38*, 193–212, doi:10.1093/erae/jbq051.
- Mohebbi, M.; Heydari, R.; Ramezani, M. Determination of Cu, Cd, Ni, Pb and Zn in Edible Oils Using Reversed-Phase Ultrasonic Assisted Liquid–Liquid Microextraction and Flame Atomic Absorption Spectrometry. *J Anal Chem* **2018**, *73*, 30–35, doi:10.1134/S1061934818010069.
- Nasr, E.G.; Epova, E.N.; Diego, A. De; Souissi, R.; Hammami, M.; Abderrazak, H.; Donard, O.F.X. Trace Elements Analysis of Tunisian and European Extra Virgin Olive Oils by ICP-MS and Chemometrics for Geographical Discrimination. *Foods* **2022**, *11*, 82, <https://doi.org/10.3390/foods11010082>
- Noorali, M.; Barzegar, M.; Sahari, M.A. Sterol and fatty acid compositions of olive oil as an indicator of cultivar and growing area. *J. Am. Oil Chem. Soc.* **2014**, *91*, 1571–1581, doi:10.1007/s11746-014-2497-z
- Pin, C.; Joannon, S.; Bosq, C.; Le Fèvre, B.; Gauthier, P.-J. Precise Determination of Rb, Sr, Ba, and Pb in Geological Materials by Isotope Dilution and ICP-Quadrupole Mass Spectrometry Following Selective Separation of the Analytes. *J. Anal. At. Spectrom.* **2003**, *18*, 135–141, doi:10.1039/b211832g.
- Poljšak, N.; Kreft, S.; Kočevar Glavač, N. Vegetable Butters and Oils in Skin Wound Healing: Scientific Evidence for New Opportunities in Dermatology. *Phytotherapy Research* **2020**, *34*, 254–269, doi:10.1002/ptr.6524.
- Portarena, S.; Farinelli, D.; Lauteri, M.; Famiani, F.; Esti, M.; Brugnoli, E. Stable Isotope and Fatty Acid Compositions of Monovarietal Olive Oils : Implications of Ripening Stage and Climate Effects as Determinants in Traceability Studies. *Food Control* **2015**, *57*, 129–135, doi:10.1016/j.foodcont.2015.03.052.
- Portarena, S.; Gavrichkova, O.; Lauteri, M.; Brugnoli, E. Authentication and Traceability of Italian Extra-Virgin Olive Oils by Means of Stable Isotopes Techniques. *Food Chemistry* **2014**, *164*, 12–14, doi:10.1016/j.foodchem.2014.04.115.
- Portarena, S.; Gavrichkova, O.; Lauteri, M.; Brugnoli, E. Authentication and Traceability of Italian Extra-Virgin Olive Oils by Means of Stable Isotopes Techniques. *FOOD CHEMISTRY* **2014**, doi:10.1016/j.foodchem.2014.04.115.

- Pošćić, F.; Furdek Turk, M.; Baćić, N.; Mikac, N.; Bertoldi, D.; Camin, F.; Jukić Špika, M.; Žanetić, M.; Rengel, Z.; Perica, S. Removal of Pomace Residues Is Critical in Quantification of Element Concentrations in Extra Virgin Olive Oil. *Journal of Food Composition and Analysis* **2019**, *77*, 39–46, doi:10.1016/j.jfca.2019.01.002.
- Pošćić, F.; Furdek, M.; Baćić, N.; Mikac, N.; Bertoldi, D.; Camin, F.; Jukić, M.; Žanetić, M.; Rengel, Z.; Perica, S. Journal of Food Composition and Analysis Removal of Pomace Residues Is Critical in Quantification of Element Concentrations in Extra Virgin Olive Oil. *Journal of Food Composition and Analysis* **2019**, *77*, 39–46, doi:10.1016/j.jfca.2019.01.002.
- Quintanilla-Casas, B.; Bertin, S.; Leik, K.; Bustamante, J.; Guardiola, F.; Valli, E.; Bendini, A.; Toschi, T.G.; Tres, A.; Vichi, S. Profiling versus Fingerprinting Analysis of Sesquiterpene Hydrocarbons for the Geographical Authentication of Extra Virgin Olive Oils. *Food Chemistry* **2020**, *307*, 125556, doi:10.1016/j.foodchem.2019.125556.
- Rigar S.M., Bencharif A.;. Innovations industrielles et développement territorial durable au Maghreb: une illustration à travers une étude comparative des technopôles du secteur agroalimentaire. *Reconnexion de l'Afrique à l'économie mondiale: défis de la mondialisation; Eds.* **2016**, codesria, Dakar; pp. 113-128
- Roberfroid, D. Prévention Primaire Des Maladies Cardiovasculaires Par Une Alimentation de Type Méditerranéen Question Clinique. *Minerva* **2014**, *13*, 8–9.
- Rossmann, A. Determination Of Stable Isotope Ratios In Food Analysis. *Food Reviews International* **2001**, *17*, 347–381, doi:10.1081/FRI-100104704.
- Rummel, S.; Hoelzl, S.; Horn, P.; Rossmann, A.; Schlicht, C. The Combination of Stable Isotope Abundance Ratios of H, C, N and S with  $^{87}\text{Sr}/^{86}\text{Sr}$  for Geographical Origin Assignment of Orange Juices. *Food Chemistry* **2010**, *118*, 890–900, doi:10.1016/j.foodchem.2008.05.115.
- Safarzadeh Markhali, F. Effect of Processing on Phenolic Composition of Olive Oil Products and Olive Mill By-Products and Possibilities for Enhancement of Sustainable Processes. *Processes* **2021**, *9*, 953, doi:10.3390/pr9060953.
- Savio, M.; Ortiz, M.S.; Almeida, C.A.; Olsina, R.A.; Martinez, L.D.; Gil, R.A. Multielemental Analysis in Vegetable Edible Oils by Inductively Coupled Plasma Mass Spectrometry after Solubilisation with Tetramethylammonium Hydroxide. *Food Chemistry* **2014**, *159*, 433–438, doi:10.1016/j.foodchem.2014.03.041.
- Sayago, A.; González-Domínguez, R.; Beltrán, R.; Fernández-Recamales, Á. Combination of Complementary Data Mining Methods for Geographical Characterization of Extra Virgin Olive Oils Based on Mineral Composition. *Food Chemistry* **2018**, *261*, 42–50, doi:10.1016/j.foodchem.2018.04.019.
- Schimmelmann, A.; Qi, H.; Dunn, P.J.H.; Camin, F.; Bontempo, L.; Potočnik, D.; Ogrinc, N.; Kelly, S.; Carter, J.F.; Abraham, A.; et al. Food Matrix Reference Materials for Hydrogen, Carbon, Nitrogen, Oxygen, and Sulfur Stable Isotope-Ratio Measurements: Collagens, Flours, Honeys, and Vegetable Oils. *J. Agric. Food Chem.* **2020**, *68*, 10852–10864, doi:10.1021/acs.jafc.0c02610.
- Shahzad, B.; Mughal, M.N.; Tanveer, M.; Gupta, D.; Abbas, G. Is Lithium Biologically an Important or Toxic Element to Living Organisms? An Overview. *Environ Sci Pollut Res* **2017**, *24*, 103–115, doi:10.1007/s11356-016-7898-0.

- Shears, P. Food Fraud – a Current Issue but an Old Problem. *British Food Journal* **2010**, *112*, 198–213, doi:10.1108/00070701011018879.
- Skrzydłewska, E.; Balcerzak, M.; Vanhaecke, F. Determination of Chromium, Cadmium and Lead in Food-Packaging Materials by Axial Inductively Coupled Plasma Time-of-Flight Mass Spectrometry. *Analytica Chimica Acta* **2003**, *479*, 191–202, doi:10.1016/S0003-2670(02)01527-1.
- Souilem, S.; El-Abbassi, A.; Kiai, H.; Hafidi, A.; Sayadi, S.; Galanakis, C.M. *Olive Oil Production Sector: Environmental Effects and Sustainability Challenges*; Elsevier Inc., **2017**; ISBN 9780128053140.
- Stewart, B.W.; Capo, R.C.; Chadwick, O.A. Quantitative Strontium Isotope Models for Weathering, Pedogenesis and Biogeochemical Cycling. *Geoderma* **1998**, *82*, 173–195, doi:10.1016/S0016-7061(97)00101-8.
- Tarapoulouzi, M.; Skiada, V.; Agriopoulou, S.; Psomiadis, D.; Rébufa, C.; Roussos, S.; Theocharis, C.R.; Katsaris, P.; Varzakas, T. Chemometric Discrimination of the Geographical Origin of Three Greek Cultivars of Olive Oils by Stable Isotope Ratio Analysis. *Foods* **2021**, *10*, 336, doi:10.3390/foods10020336.
- Techer, I.; Medini, S.; Janin, M.; Arregui, M. Impact of Agricultural Practice on the Sr Isotopic Composition of Food Products: Application to Discriminate the Geographic Origin of Olives and Olive Oil. *Applied Geochemistry* **2017**, *82*, 1–14, doi:10.1016/j.apgeochem.2017.05.010.
- Tekaya, I. Ben; National, I.; Tunisie, Étude de La Stabilité Oxydative de l ' Huile d ' Olive Vierge Extra Tunisienne Au Cours de Son Stockage. **2005**, *12*, 447–454.
- Timeridjine S., Chitti M.; 2021. Pôle de compétitivité en Algérie : cas du pôle agroalimentaire de Bejaia. *Revue Algérienne de Développement Economique*; **2021**, Vol 8, 1, Pages 301-310
- Tres, A.; van der Veer, G.; van Ruth, S.M. Vegetable Oils. *Comprehensive Analytical Chemistry*; Elsevier, **2013**; Vol. 60, pp. 543–572 ISBN 978-0-444-59562-1.
- Valasques, G.S.; dos Santos, A.M.P.; Teixeira, L.S.G.; da Mata Cerqueira, U.M.F.; de Souza, V.S.; Bezerra, M.A. Applications of Emulsified Systems in Elemental Analysis by Spectroanalytical Techniques. *Applied Spectroscopy Reviews* **2017**, *52*, 729–753, doi:10.1080/05704928.2017.1294599.
- Viola, P.; Viola, M.; Academy, O.N.; Libertà, P.; Pg, S. Virgin Olive Oil as a Fundamental Nutritional Component and Skin Protector. *Clinics in Dermatology* **2009**, *27*, 159–165, doi:10.1016/j.clindermatol.2008.01.008.
- Voerkelius, S.; Lorenz, G.D.; Rummel, S.; Quézel, C.R.; Heiss, G.; Baxter, M.; Brach-Papa, C.; Deters-Itzelsberger, P.; Hoelzl, S.; Hoogewerff, J.; Ponzevera E.; Van Bockstaele M., Ueckermann H. Strontium Isotopic Signatures of Natural Mineral Waters, the Reference to a Simple Geological Map and Its Potential for Authentication of Food. *Food Chemistry* **2010**, *118*, 933–940, doi:10.1016/j.foodchem.2009.04.125.
- Wadood, S.A.; Boli, G.; Xiaowen, Z.; Hussain, I.; Yimin, W. Recent Development in the Application of Analytical Techniques for the Traceability and Authenticity of Food of Plant Origin. *Microchemical Journal* **2020**, *152*, 104295, doi:10.1016/j.microc.2019.104295.
- Winkler, F.J.; Schmidt, H.-L. Einsatzmöglichkeiten der <sup>13</sup>C-Isotopen-Massenspektrometrie in der Lebensmitteluntersuchung. *Z Lebensm Unters Forsch* **1980**, *171*, 85-94

Woods, G.D.; Fryer, F.I. Direct Elemental Analysis of Biodiesel by Inductively Coupled Plasma–Mass Spectrometry. *Anal Bioanal Chem* **2007**, *389*, 753–761, doi:10.1007/s00216-007-1439-0.

Yan, J.; Erasmus, S.W.; Aguilera Toro, M.; Huang, H.; van Ruth, S.M. Food Fraud: Assessing Fraud Vulnerability in the Extra Virgin Olive Oil Supply Chain. *Food Control* **2020**, *111*, 107081, doi:10.1016/j.foodcont.2019.107081.

Yorulmaz, H.O.; Konuskan, D.B. Antioxidant Activity, Sterol and Fatty Acid Compositions of Turkish Olive Oils as an Indicator of Variety and Ripening Degree. *J Food Sci Technol* **2017**, *54*, 4067–4077, doi:10.1007/s13197-017-2879-y.

Youseff, R.; Soubh, L.; Alassaf, Z. Detection of Vegetable Oils Adulteration Using Desmethylsterols Composition. *International Journal of Pharmaceutical Sciences Review and Research* **2014**, *28*, 229–233.

Zeiner, M.; Steffan, I.; Cindric, I.J. Determination of Trace Elements in Olive Oil by ICP-AES and ETA-AAS: A Pilot Study on the Geographical Characterization. *Microchemical Journal* **2005**, *81*, 171–176, doi:10.1016/j.microc.2004.12.002.

---

# **Chapter II**

Samples description and analytical  
methods for the analysis of trace  
elements, stable isotope ratio of  
Carbon and Sr isotope ratio

---

## Introduction

Olive oil is particularly a challenging matrix due to its high fatty composition and viscosity. Its lipid nature frequently hampers direct and traditional sample introduction strategies common for various analytical instruments. Accordingly, the choice of appropriate analytical strategies for olive oil characterization is complex. A large array of analytical strategies has been developed. They include organoleptic approaches, biological, chemical, and elemental/isotopic analyses (Tres et al., 2013). Usual organic analytical methods are based on the determination of organic compounds such as fatty acids and triacylglycerols (Gertz et al., 2019), phenols (Bajoub et al., 2015; Taamalli et al., 2012), sesquiterpene hydrocarbons (Quintanilla-casas et al., 2020), sterols (Noorali & Barzegar, 2014; Youseff et al., 2014). The recent sophisticated methods are mostly based on the use of trace elemental profiles as principal indicators of origin, stable isotopes of light that are primarily linked to the plant growth environment and the isotopic composition of strontium as a direct reflection to local soil and geology (Danezis et al., 2016; Gupta et al., 2019). The continuous evolution of atomic spectrometric techniques promoted high quality analyzes for various food matrices offering new perspectives in the multi-elemental and isotopic discrimination of food origin (Wadood et al., 2020). However, olive oil is still challenging to analyze since it is composed of high and varied organic content, where chemical elements mainly occur at trace levels ranging from few ppb to few ppm (Benincasa et al., 2012). Therefore, the reliable, accurate and precise measurement of chemical elements in olive oil is a key challenge that requires adequate sample preparation methods and highly sensitive detection techniques. In this chapter, the sampling strategy as well as the analytical procedures developed for the determination of multi-elemental profile, stable isotope ratio of carbon and strontium isotopic ratio of the samples are fully described.

### 1. Samples description

The sampling was performed around the Mediterranean basin (figure II.1) where olive oil is highly produced and consumed.

A total of 42 olive oils were obtained from Tunisia (n = 25), France (n = 10) and Spain (n = 7).

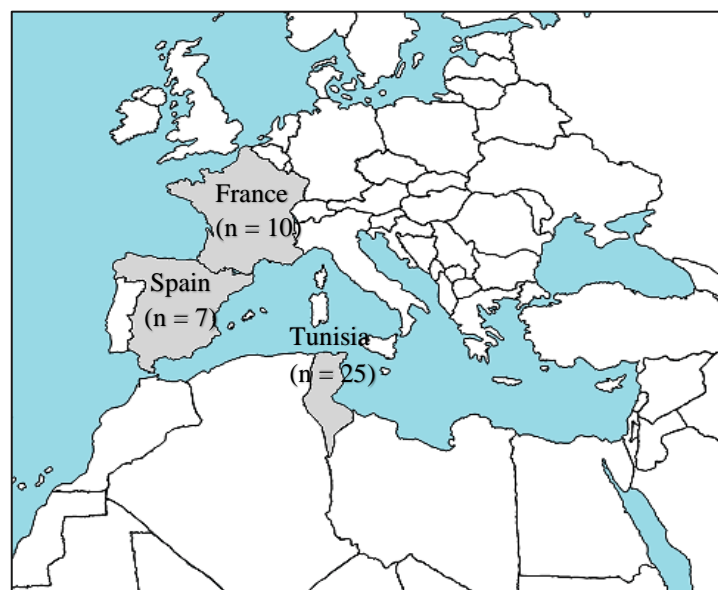

**Figure II.1:** The sampling countries (n = number of olive oil samples).

### 1.1.Samples from Tunisia

An extensive sampling campaign was conducted during the olive harvest period between 2019 and 2020 in thirteen Tunisian governorates. Samples of bottled extra virgin olive oils (EVOO) (n = 16) produced in local oil mills, samples of olives that were subjected to oil extraction in the Olive Tree Institute of Tunisia (OTIT) resulting in 9 EVOO and 9 pomace samples, soil at depth between 30 and 60 cm (n=9), olive roots (n=9) and olive leaves (n=9) were obtained (table II.1).

**Table II.1:** Extra virgin olive oil, olive pomace, soil, roots and leaves from Tunisia: number of samples.

Samples	EVOO (produced in oil mill)	EVOO (produced in OTIT / olive pomace)	Soil (30-60 cm)	Roots	Leaves
Number of samples	16	9 / 9	9	9	9

### 1.1.1. Olive oil samples

A total of 25 olive oil samples were collected from Tunisia as the following: sixteen packaged olive oils produced in oil mills were obtained from local producers based in different regions in Tunisia and nine olive oils were extracted from olives collected in different olive orchards grown on different soils. Olive oil extraction was performed at the laboratory of the olive tree institute of Tunisia (OTIT). Sampling locations are plotted on the geological map of Tunisia shown in figure II.2.

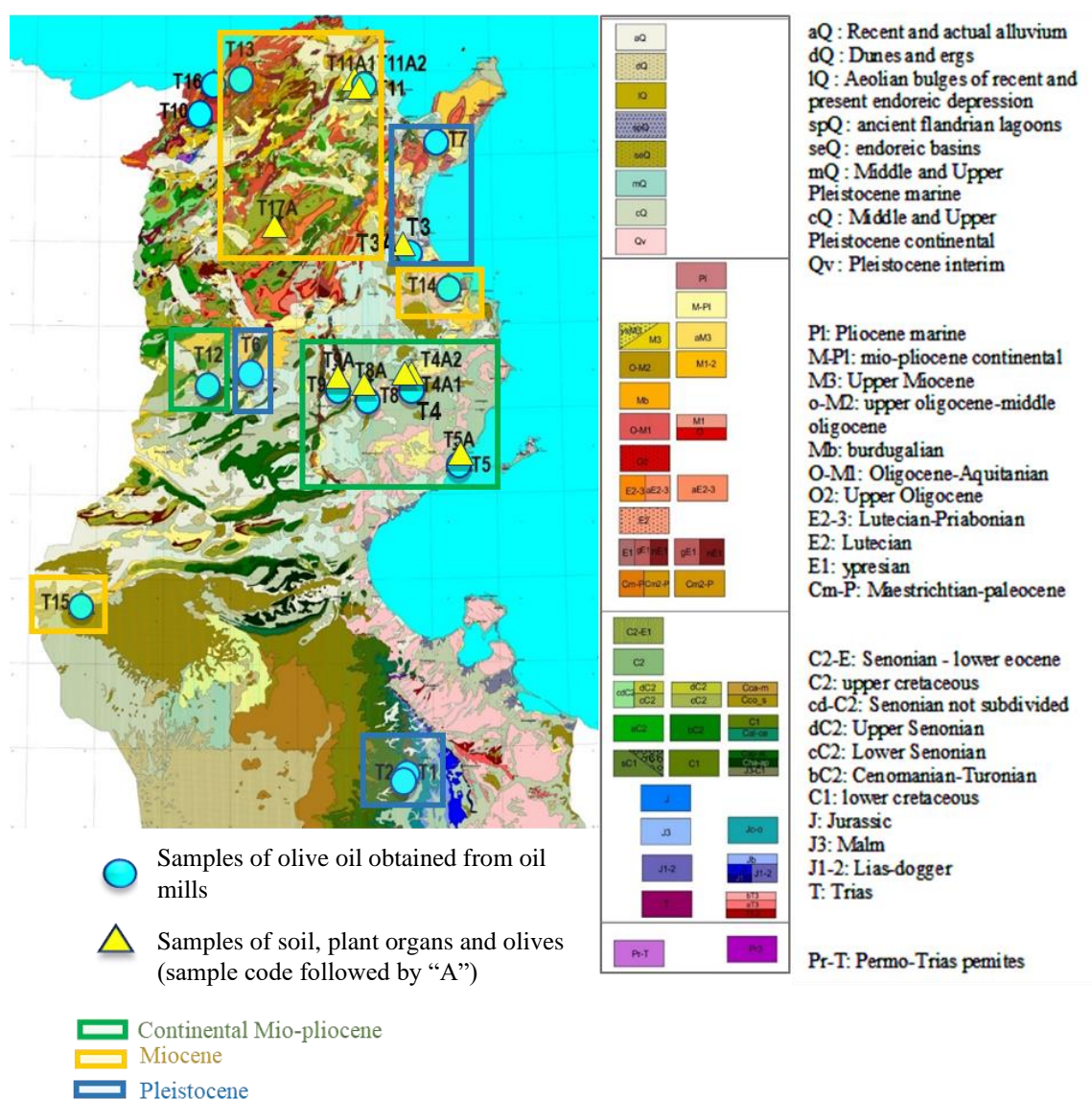

**Figure II.2:** Sampling locations on Tunisian geological map.



*Olive oil preparation:* For the extra virgin olive oil (EVOO) samples extracted from the olives collected, the following procedure was performed. About 4 to 6 kg of olives were handpicked and then kept in the refrigerator for a maximum of 24 hours before the oil was extracted. The olive oil extraction method employed was the ABENCOR method (<https://sistemaabencor.com/en/>) (figure II.3).

It includes leaf stripping and washing of the olives. Then, the grinding of the olives is performed in a hammer mill in order to obtain an olive paste. The resulting olive paste is mixed for 45 min in a mixer. During this step, a small volume of distilled water is added in order to facilitate the oil droplets release from the paste.



**Figure II.3:** The Abencor system (OTIT).

During the mixing step, the temperature is controlled not to exceed 27°C. The final step is the centrifugation. The olive paste obtained is introduced in a centrifuge system at 3500 rpm for 1 minute. This allows to separate the dry pomace from olive oil which is mixed with the wastewater. The olive oil is then separated from the water by natural decantation. All metallic surfaces in direct contact with olives, paste and olive oil are made of stainless steel and were carefully washed after each sample run.

The obtained olive oils were carefully transferred in brown glass bottles that had been previously washed with distilled water and then stored away from heat and light.

### **1.1.2. Samples of soil**

Soil sampling: Under each sampled tree from the selected orchards, paired soils have been collected. A total of 9 soil samples were collected at a depth between 30 and 60 cm using a pickaxe. This depth has been selected since it is deep enough to avoid soil with surface treatment procedures. Once collected, the soil samples were air-dried for few days and sieved through a 2 mm sieve. Then, 50 g were taken from each sample by the quartering method.

### **1.1.3. Samples of roots**

The roots of each olive tree were sampled between the depths of 30 et 60 cm. The samples were rinsed with ultrapure water to eliminate the soil particles and then sonicated with ultrapure water. After a deep rinse, the roots were dried in a forced air oven at 35°C for eight days.

### **1.1.4. Samples of leaves**

About fifty leaves were collected heterogeneously, i.e. leaves at different growing stages and on various branches. Leaves were rinsed at least five times with ultrapure water in order to eliminate atmospheric dust residues, each rinse was assisted by ultrasound. Leaves were then dried oven at 35°C for eight days. The next step was grinding in a clean agate mortar followed by a grinding in a clean agate mortar followed by an extensive grinding with a Retsch MM200 ball mill for 5 minutes at a frequency of 20 Hz until obtaining a fine powder. The samples are then homogeneous and ready to be analyzed.

## **1.2.Samples from Europe**

EVOOs from European locations were obtained and analyzed for the comparison with the Tunisian ones. Seven olive oil samples were obtained from different locations of the Spanish Basque country: Moreda, Lantziego and Oion located in the province of Araba, and Añorbe, Mendavia, Cintruenigo and Arroniz located in the province of Navarre) (figure II.4).

**Table II.2:** Olive oil samples: geographical location, cultivar, geological formation and applied agricultural practices.

Country of origin (number of samples)	Geographical location (number of samples)	Sample code	Cultivar	Bedrock (mineralization)	Agricultural practices
<b>Tunisia (n= 23)</b>	Tataouine (n=2)	T1	Zarrazi	limestones and marls	nt
		T2	Dhokkari		
	Sousse (n=2)	T3	Chemlali	calcareous and gypsum crusts	nt
		T3A	Chemlali		
	Mahdia (n=3)	T4	Chemlali	conglomerates, sand and clay	Drop irrigation and use of pomace residue as amendment
		T4A	Chemlali		
		T4A'	Chemlali		
	Sfax (n=2)	T5	Chemlali	Recent alluvium	nt
		T5A	Chemlali		
	Kasserine (n=2)	T6	Arbequina	sandstone and marl	nt
		T12	ns	limestones, dolostones, marls and gypsum (Zn)	
	Nabeul (n=1)	T7	Zarrazi	ancient limestone and gypsum alluvium	nt
		T8	Chemlali	ancient limestone and gypsum alluvium	nt
	Kairouan (n=4)	T8A	Chemlali	Recent alluvium	Drop irrigation
		T9	Chemlali		
		T9A	Chemlali		
	Jendouba (n=2)	T10	Chetoui	clay-sandstone flysch	nt
		T16	Chetoui	clay-sandstone flysch (Zn and Pb)	
	Ariana (n=3)	T11	Mixture of different varieties	Recent alluvium	nt
		T11A	Chemlali		
		T11A'	Chemlali		
	Beja (n=1)	T13	ns	ancient limestone and gypsum alluvium	nt
	Monastir (n=1)	T14	Mixture of different varieties	conglomerate, sands and clays	nt

	Tozeur (n=1)	T15	Mixture of different varieties	conglomerates, sand and clay	nt
	Siliana (n=1)	T17A	ns	Recent alluvium	nt
<b>Spain (Basque country) (n= 7)</b>	Moreda Araba (n=1)	B1	A mixture of Arroniz and Arbequina	ns	Use of fertilizer (15-15-15 NPK*; sheep and cattle manure)
	Añorbe (n=1)	B2	A mixture of Arroniz and Arbequina	ns	ns
	Mendavia (n=1)	B3	Arbequina	ns	ns
	Cintruenigo (n=1)	B4	ns	ns	ns
	Lantziego (n=1)	B5	A mixture of Arroniz and Arbequina	ns	Use of fertilizer (15-15-15 NPK; sheep and cattle manure)
	Ablitas (n=1)	B6	Arroniz	ns	ns
	Oion (n=1)	B7	A mixture of Arroniz and Arbequina	ns	Use of fertilizer (15-15-15 NPK; sheep and cattle manure)
<b>France (n=10)</b>	Nyons (n=2)	FR1	ns	ns	ns
		FR3	ns		
	Baux-de-Provence (n=1)	FR2	Mixture of different varieties	ns	ns
		FR4	ns		
	Nîmes (n=2)	FR7	ns	ns	ns
		Nice (n=2)	FR5	Cailletier	ns
			FR6	ns	
	Provence (n=3)	FR8	Mixture of different varieties		
		FR9	Aglandau	ns	ns
		FR10	ns		

nt: no treatment

ns: not specified

\*15-15-15 NPK: a fertilizer containing equal parts of Nitrogen, Phosphorous, and potassium

Further, ten protected designation of origin (PDO) EVOOs from southern of France were also obtained from supermarkets (PDO Provence, PDO Nîmes, PDO Nice and PDO Nyons).

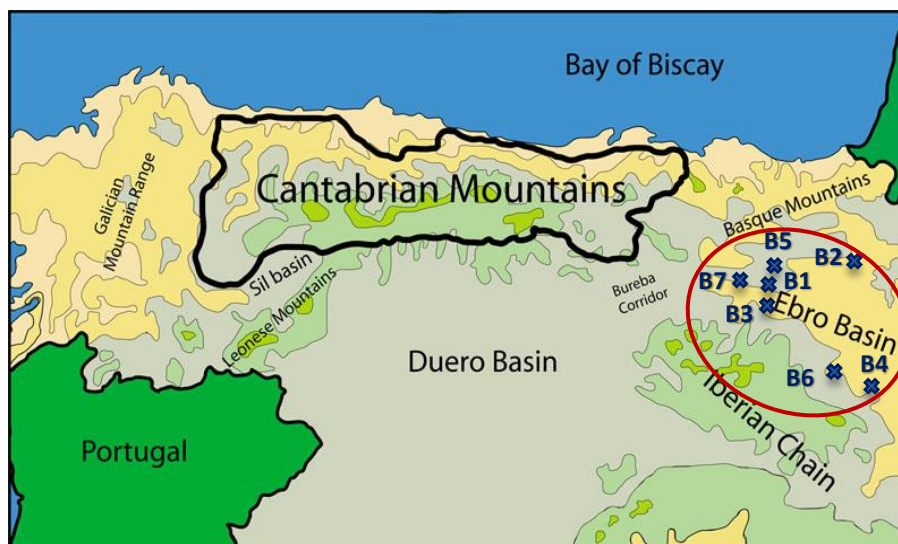

**Figure II.4:** The sampling locations of the Spanish EVOOs.

Table II.2 summarizes the olive oil samples, the geographical origins, olive cultivar, geological formation and applied agricultural practices.

## 2. Analytical procedure for the analysis of trace elements in the different matrices

### 2.1. Samples preparation

Prior to ICP-MS analysis, samples should be prepared in an aqueous solution of 2% HNO<sub>3</sub> and not containing organic matter. All the samples were prepared before analysis; the choice of the samples preparation technique depends on the matrix to be analyzed.

All labware was washed in 10% v/v HNO<sub>3</sub> and rinsed with ultra-pure water before use.

#### 2.1.1. Olive oil: Microwave assisted digestion

An array of analytical procedures was performed and tested before the choice of the most appropriate sample preparation technique. The calcination in a muffle furnace, the ultrasound assisted extraction and the mineralization in a microwave assisted digestion were tested.

The calcination yielded high blanks and the ultrasound assisted extraction resulted in low elements recoveries while the microwave assisted digestion enabled to efficiently destroy the organic matrix and resulted in high recoveries and low blanks. Indeed, in a microwave system, the samples mineralization is performed in a closed system at high temperature and high pressure. Nevertheless, olive oil is a highly reactive matrix that resulted in a drastic increase of the pressure during mineralization. Therefore, the mineralization procedure was fully optimized.

Prior to ICP-MS analysis, a multi-stage procedure was performed (Figure II.5). First, the organic matter contained in olive oils was destroyed through mineralization. Then, the obtained mineralized solutions were subjected to evaporation to dryness followed by dissolution in the minimum volume required for analysis.

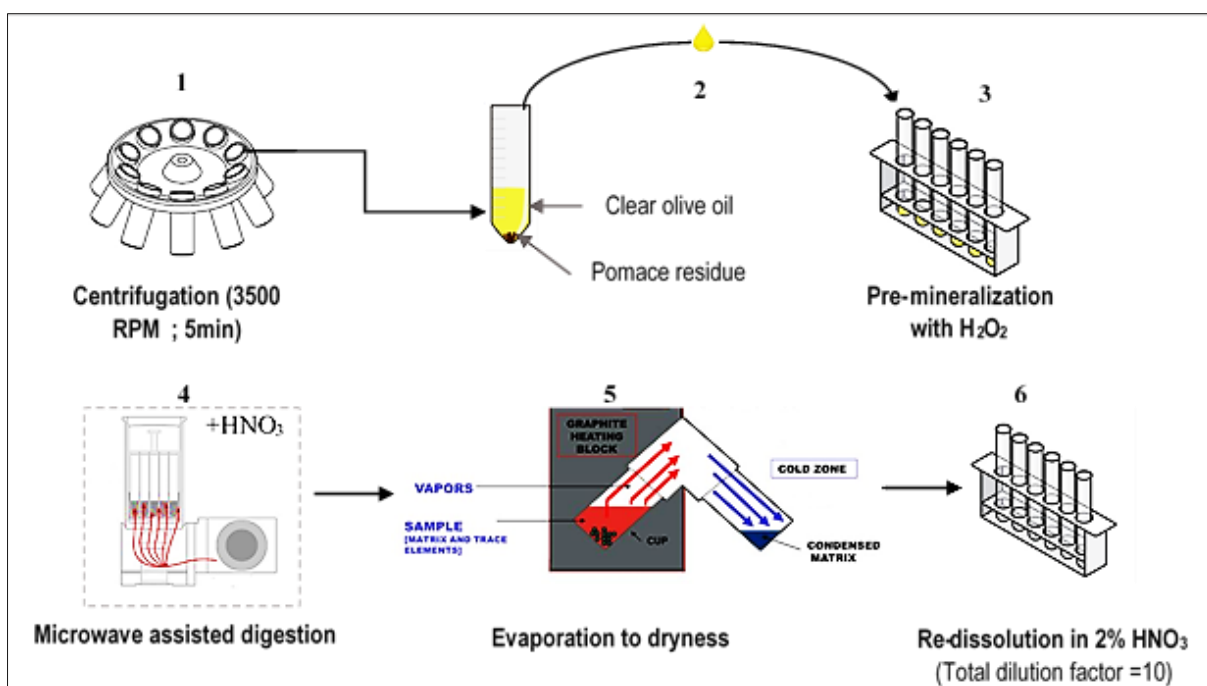

**Figure II.5:** The analytical procedure for olive oil preparation prior to ICP-MS analysis.

Prior to the mineralization, the olive oil samples were centrifuged at 3 500 rpm for 5 min using a ROTOFIX32A centrifuge system in order to eliminate any pomace residue according to previous recommendations (Pošćić et al., 2019). Then a mass of 0.5 g of olive oil from the upper oil totally clear and not containing any pomace residue was carefully transferred to quartz tubes previously cleaned following a strict cleaning protocol.

The digestion tubes containing 50% nitric acid were placed in a microwave system (Ultrawave) with a specific cleaning program. Then, the tubes were washed in 10% v/v HNO<sub>3</sub> and in 10% HCl successively and finally rinsed with ultrapure water.

For the samples digestion protocol, 0.5 mL of 30% hydrogen peroxide was added to 0.5 g of the olive oil to be mineralized. The mixture was left overnight for pre-mineralization at room temperature. The next day, 5 mL of 69% sub-boiled HNO<sub>3</sub> was gradually added since olive oil is a highly reactive matrix. The final mixture was then digested in the microwave system following an optimized gradually increasing heating program up to 250°C (table II.3).

**Table II.3:** The mineralization program of the microwave system (Ultrawave) for olive oil.

Step	Temperature (°C)	Time (min)	P max (bar)
1	100	10	110
2	100	20	110
3	170	10	110
4	170	20	110
5	250	20	110
6	250	20	110

The resulting clear solutions were then transferred to clean savillex vials and evaporated to dryness in a closed-medium sample evaporation apparatus (. The dry residue was finally re-dissolved in 5 mL of 2% sub-boiled nitric acid prior to analysis. The total dilution factor obtained is then equal to ten.

### 2.1.2. Soil: Extraction

Only elements in the exchangeable fraction of soil were extracted. A large array of analytical methods involving extraction procedures has been published at extend following the integrative work performed with the former BCR three step sequential extraction procedure on the validation of sequential extraction techniques (Rauret et al., 1999, 2000; Sahuquillo et al., 1999). In this work, the soil extraction procedure was performed following closely the method proposed by Ure et al. (2006) based on ammonium acetate extracts (Ure et al., 2006). Indeed, ammonium acetate is largely employed in soil extraction techniques as it is known for its cation exchange capacity, exchangeable bases and plant-available nutrients extraction. Briefly, a volume of 3 mL of 1M ammonium acetate at pH 7 were added to 2 g of soil sample

to release elements in exchangeable fraction. The mixture was shaken during 16 hours on a shaking plate then centrifuged at 3 500 rpm for 5 min. The supernatant aqueous phase was then carefully transferred using a pipette to a clean 50 mL vial.

### 2.1.3. Leaves, roots and pomace: Microwave assisted digestion

A mass ranging between 0.2 - 0.4 g, of each sample and a mass of 0.4 g of NIST SRM 1573a Tomato leaves in triplicate were digested with 7 mL of 69% HNO<sub>3</sub> and 0.5 mL of H<sub>2</sub>O<sub>2</sub> in a microwave system. The mineralization was carried out following a gradually increasing temperature program, up to 220°C (P<sub>max</sub> = 110 bar) (table II.4) for the plant organs (leaves and roots) while the pomace samples were mineralized following the same digestion program as olive oil (table II.3). The resulting clear solutions were diluted prior to ICP-MS analysis.

**Table II.4:** The mineralization program of the microwave system (Ultrawave) for plant organs.

Step	Temperature (°C)	Time (min)	P max (bar)
1	220	15	110
2	220	10	110

## 2.2. ICP-MS analysis and quality control of the instrumental measurement

The ICP-MS is a reliable detection technique for the determination of elements concentrations at trace levels. The argon plasma allows an effective ionization of elements at high temperature (> 6000 K) that are then selectively detected at the mass spectrometer with high sensitivity.

The PlasmaQuant MS (Analytik jena) is characterized by an unparalleled sensitivity (1500 Mcps/ppm at <2 % CeO). It is equipped with a ReflexION 90-degree ion mirror with 3D focusing to focus the ions in the mass analyzer. The major components and setups of the PlasmaQuant MS are presented in figure II.6.



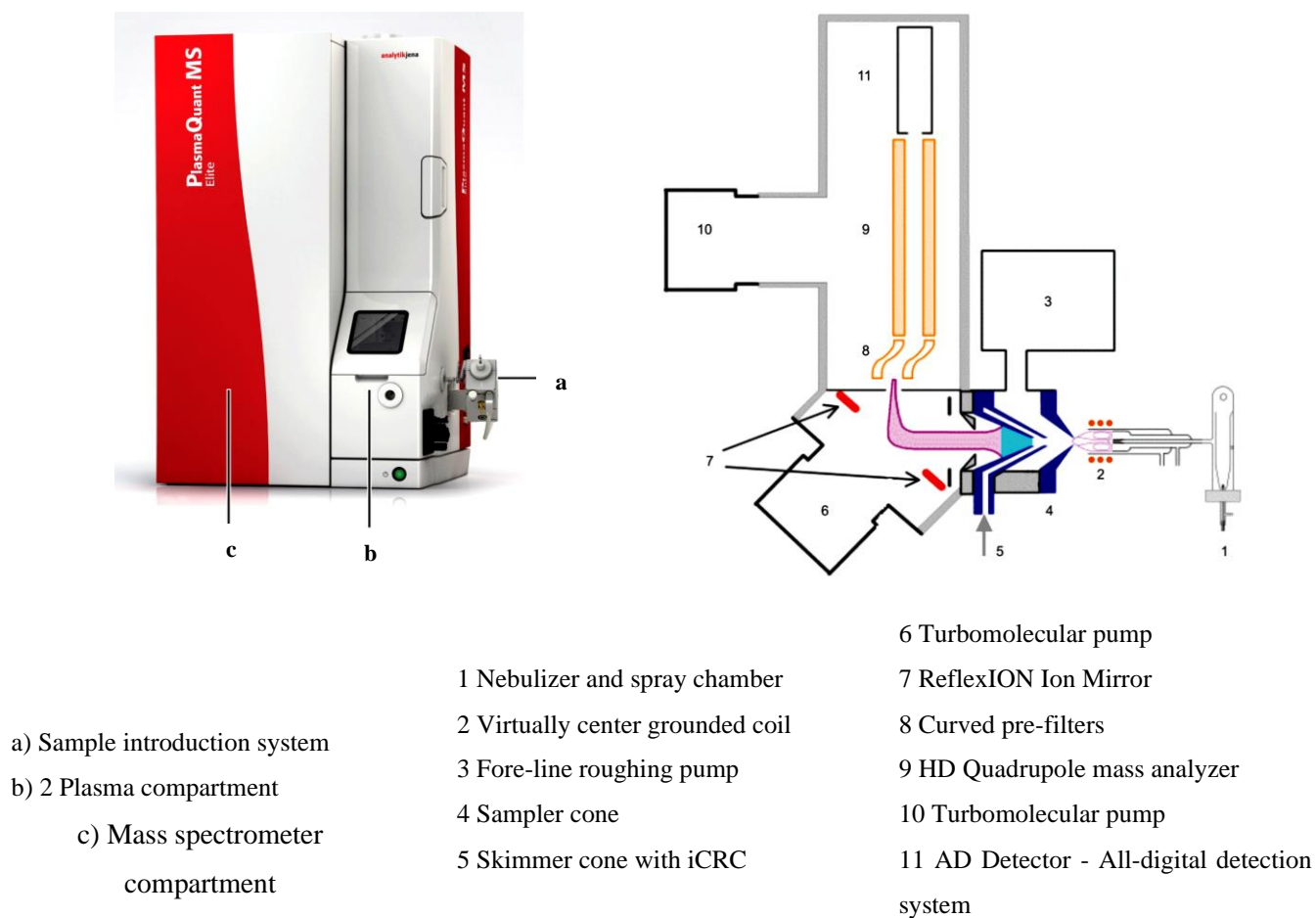

**Figure II.6:** Major components and Setup of PlasmaQuant MS.

The multi-elemental analysis of the obtained extracts from soils and oils was performed using an ICP-MS Plasma Quant Elite spectrometer. All samples were analyzed for total concentration of 17 elements: As, Ba, Ca, Cd, Co, Cr, Cu, Fe, K, Mg, Mn, Ni, Rb, Sr, Pb, V and Zn. The instrumental operating conditions and measured isotopes are presented in Table II.5.

The analysis was performed using two operating modes: the standard mode where no gas was supplied into the cell and the integrated collisional reaction cell (iCRC) in the reaction mode where He and H were used as collision gases into the cell. The iCRC mode is applied in order to reduce spectral interferences, including polyatomic interferences. The list of isotopes detected for each operating mode is detailed in table II.5.

The calibration solutions at eight different concentrations ranging from 0.01  $\mu\text{g L}^{-1}$  to 500  $\mu\text{g L}^{-1}$  were prepared by appropriate dilution of multi-elemental standard solutions CCS-4 and CCS-6. Yttrium (Y), rhodium (Rh) and iridium (Ir) at concentration of 2.5  $\mu\text{g L}^{-1}$  were used as internal standards for the low, medium and heavy masses respectively in order to correct instrumental drifts.

**Table II.5:** ICP-MS operating conditions and measured isotopes.

Component / Parameter	Specification / Value
Plasma gas flow	9.0 L min <sup>-1</sup>
Auxiliary gas flow	1.35 L min <sup>-1</sup>
Nebulizer gas flow	1.11 L min <sup>-1</sup>
Spray chamber temperature	3°C
RF power	1400 W
Sampling depth	5.5 mm
Dwell time	30 ms
Scans per replicate	20
Number replicates per sample	3
iCRC gas (flow)	He, H <sub>2</sub> (120 mL min <sup>-1</sup> )
Isotopes detected, mode “No Gas”	<sup>24</sup> Mg, <sup>85</sup> Rb, <sup>88</sup> Sr, <sup>114</sup> Cd, <sup>137</sup> Ba, <sup>208</sup> Pb, <sup>89</sup> Y, <sup>103</sup> Rh and <sup>193</sup> Ir
Isotopes detected, mode “iCRC, He”	<sup>51</sup> V, <sup>52</sup> Cr, <sup>55</sup> Mn, <sup>59</sup> Co, <sup>60</sup> Ni, <sup>63</sup> Cu, <sup>65</sup> Cu, <sup>66</sup> Zn, <sup>67</sup> Zn, <sup>68</sup> Zn, <sup>89</sup> Y, <sup>103</sup> Rh and <sup>193</sup> Ir
Isotopes detected, mode “iCRC, H <sub>2</sub> ”	<sup>39</sup> K, <sup>44</sup> Ca, <sup>56</sup> Fe, <sup>57</sup> Fe, <sup>75</sup> As, <sup>56</sup> Fe, <sup>89</sup> Y, <sup>103</sup> Rh and <sup>193</sup> Ir

Samples concentrations were calculated after applying the corrections with the blank, the internal standard and with the analytical blank. First, the calibration blank (2% HNO<sub>3</sub> spiked with the internal standard) signal was subtracted in order to ensure that the ICP-MS measurement provides a zero signal when no analyte is present. Then, the instrumental sensitivity drifts were corrected by the internal standard signal.

The standard reference material NIST SRM 1643f trace elements in water was used for quality control of the instrumental measurements.

A multi-elemental solution prepared with CCS-4 and CCS-6 standard solutions at a concentration of  $1 \mu\text{g L}^{-1}$  was analyzed at every block of 10 samples in the sequence for the quality control of the stability of the measurements.

A series of 10 blanks The limits of detection (LODs) and limits of quantification (LOQs) were calculated as three times of the standard deviation (SD) and ten times of SD on basis of 10 blanks, respectively.

### 3. Analysis of stable isotope ratios of Carbon by IRMS in olive oil and leaves

The analysis of stable carbon isotope ratio and determination of the percentage of carbon in olive oil samples was performed using an Isotope Ratio Mass Spectrometer (IRMS Delta V, ThermoFisher Scientific) connected with an Elemental analyzer (EA IsoLink, ThermoFisher Scientific). Aliquots of  $300 \mu\text{g}$  of olive oil samples were weighed into tin capsules using a microbalance (Mettler Toledo).

The international standard for  $\delta^{13}\text{C}$ , Pee Dee Belemnite (PDB), was analyzed and used to

calculate  $\delta^{13}\text{C}$  for samples as following:  $\delta_{\text{sample}} (\text{‰}) = \left( \frac{R_{\text{sample}}}{R_{\text{standard}}} - 1 \right) \times 1000$  Equation 1

where  $R_{\text{sample}}$  is the isotope ratio of the samples and  $R_{\text{standard}}$  is the isotope ratio of the international standard (PDB).

### 4. Analysis of $^{87}\text{Sr}/^{86}\text{Sr}$ isotope ratio

The general analytical procedure applied for the analysis of  $^{87}\text{Sr}/^{86}\text{Sr}$  isotope ratio by MC-ICP-MS is presented in figure II.7. The first step is the samples pretreatment with appropriate preparation techniques in order to eliminate the organic matrix and release the elements in an aqueous solution. The extract is then subjected to a column separation where Sr is separated from the matrix and the interfering elements. Before and after the Sr purification, an ICP-MS measurement is performed to determine the concentrations of Sr and the interfering elements. Finally, the  $^{87}\text{Sr}/^{86}\text{Sr}$  isotope ratio is measured by means of MC-ICP-MS.

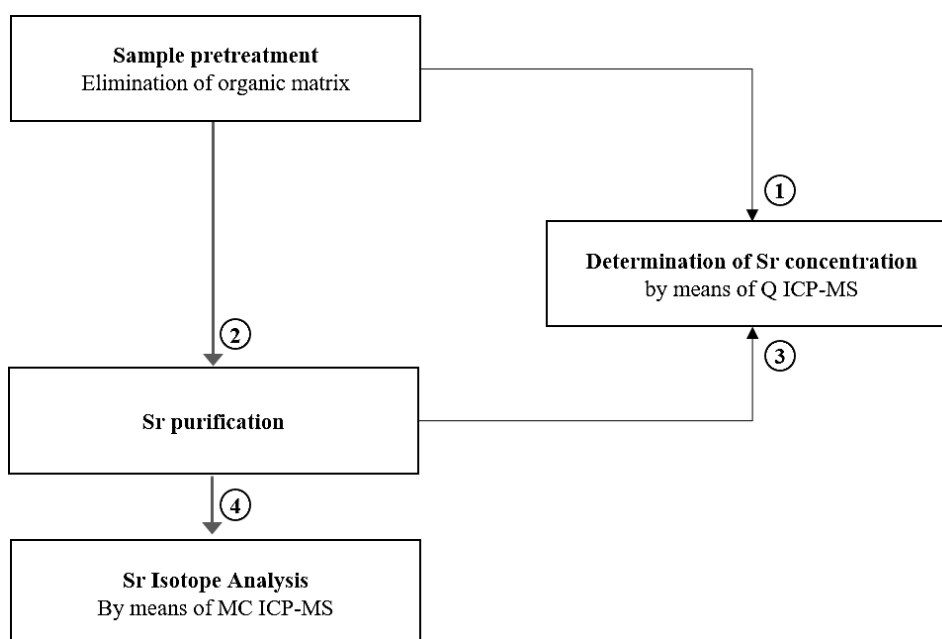

**Figure II.7:** General analytical procedure for Sr isotopic analysis by MC-ICP-MS.

## 4.1. Samples pretreatment

### 4.1.1. Olive oil

According to previous studies (Medini et al., 2015; Nasr et al., 2022), sample preparation for Sr isotopic analysis of olive oil is recognized as a challenging issue because of two givens:

1) Sr is present in olive oil at low concentration ( $1 - 50 \mu\text{g kg}^{-1}$ ) while a minimal amount of  $0.25 \mu\text{g}$  of Sr is required for a reliable isotope ratio measurement by MC-ICP-MS. Therefore, an important pre-concentration of Sr followed by an effective purification is crucial prior to Sr isotopic ratio measurement. Based on the initial concentrations of Sr in olive oil, the amount of Sr required for the isotopic analysis can be obtained from a substantial volume of olive oil: from 100 mL up to 200 mL.

2) In order to perform a precise and accurate measurement of Sr isotopic ratio by means of MC-ICP-MS, the Sr separation from the matrix and the interfering elements (Rb, Ca, K, Mg and Na) is mandatory (Vanhaecke et al., 2009). The low ionization potential elements such as K, Mg and Na produce ionization interference while ions  $^{87}\text{Rb}^+$ ,  $^{44}\text{Ca}^{2+}$  and various ArCa+

molecular ions result in isobaric interferences on masses 84, 86, 87 and 88 (De Muynck et al., 2009).

To overcome these challenges, two different sample preparation approaches were performed, validated and then compared: *Method A*) Liquid-liquid acid extraction of Sr from olive oil completed by Sr purification using the Sr-Spec resin commonly applied for such purposes prior to Sr isotopic analysis (Coelho et al., 2017); *Method B*) Extraction by complexation of Sr in olive oil using  $(\text{NH}_4)_2\text{EDTA}$ , followed by an innovative approach for the Sr purification using the Dowex AG50W-X8 resin. Both approaches are presented in figure II.8.

**i) Method A: Acid extraction prior to Sr purification using Sr-Spec resin**

The samples preparation was carried out according to the method described by (MF Turk et al, 2022, submitted) with minor modifications.

*Elements release from the olive oil matrix:* An acid extraction solution of 2%  $\text{HNO}_3$  and 0.1%  $\text{HCl}$  was prepared. A mass of 200g of olive oil was weighed into 1 L clean polyethylene bottle and an equal amount of the prepared acid solution was added. The obtained mixture was thoroughly agitated on a shaking plate (230 movement/min) for 2 hours in order to extract elements from the oil to the acid solution. The influence of the agitation time on Sr recovery was studied at 4 different values: 1h, 2h, 6h and 12h.

Subsequently, the mixture was subjected to sonication for 2 hours in an ultrasonic bath to release the elements into the emulsion formed between the olive oil and the aqueous acid phase. In order to easily separate the two phases and instead of aspirating gently the upper oil phase using a pipette, the mixture was placed at the fridge ( $4^\circ\text{C}$ ) and was kept overnight.

The next day, the oil solidifies and becomes an easily separable piece from the liquid acid phase. Therefore, the phases separation becomes easier and faster to achieve simply by recovering the clear extraction solution.

*Degradation of the residual organic matter:* Prior to Sr column separation, the potentially residual organic matter in the extract should be eliminated since the Sr-Spec resin performance decreases in presence of non-destroyed organic matter (Epova et al., 2019). Subsequently, the samples should be prepared in 4 mL of 8M  $\text{HNO}_3$  to be loaded into the column.

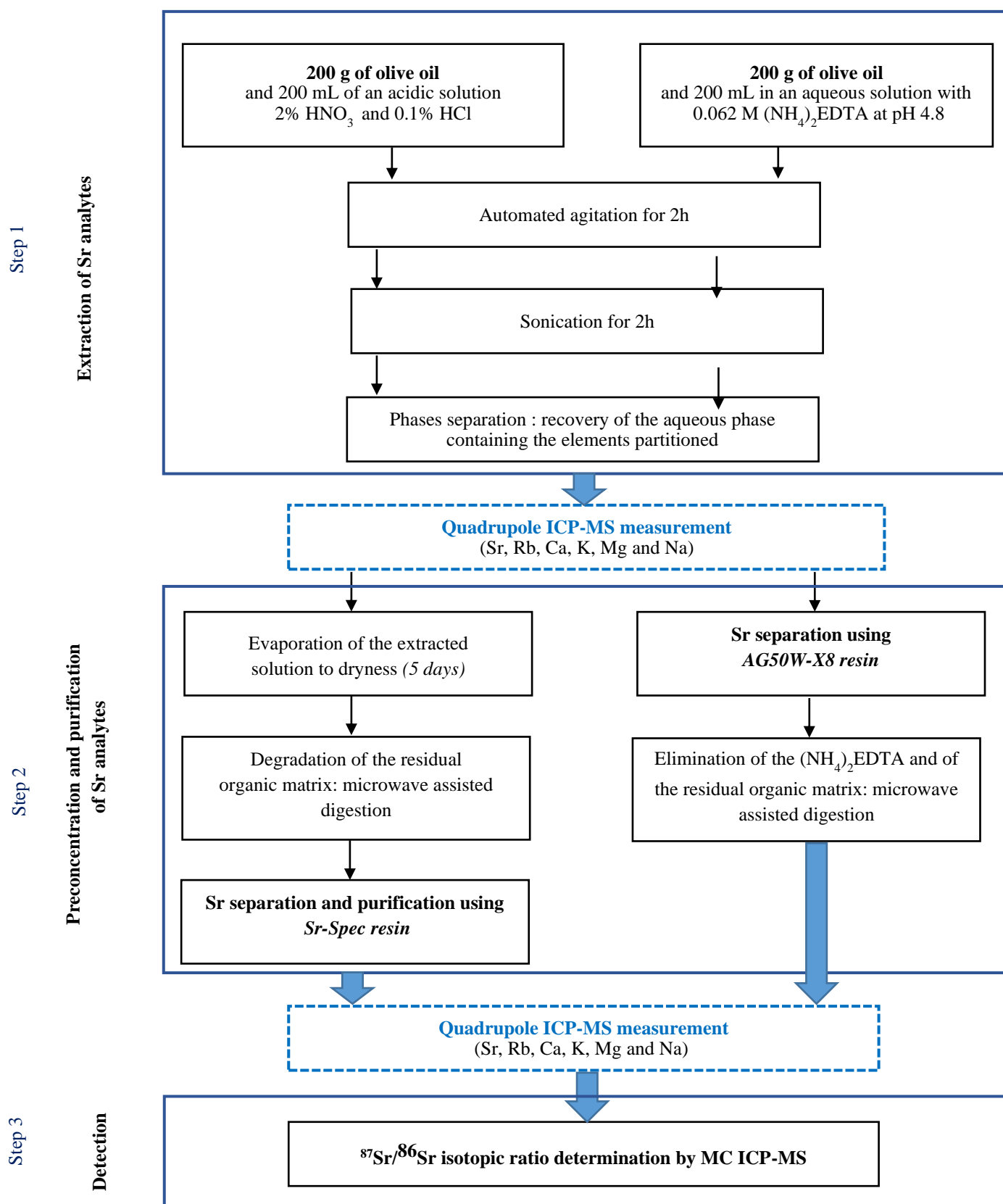

**Figure II.8** : Two analytical procedures applied for <sup>87</sup>Sr/<sup>86</sup>Sr measurement in olive oil using Sr-sepc and Dowex AG50W-X8 resins.

The extracts of 200 g of the acid mixture (2% HNO<sub>3</sub>, 0.1% HCl) were evaporated to dryness in a closed-medium sample evaporation apparatus placed in a clean room. Such a large volume was gradually evaporated by fractions of about 20 mL and the total evaporation procedure lasted 5 days. The dry residue obtained was re-dissolved in 5 mL of sub-boiled 69% HNO<sub>3</sub> and 0.5 mL of H<sub>2</sub>O<sub>2</sub> prior to microwave assisted digestion. The resulting clear solutions were evaporated to dryness and re-dissolved in 4 mL of 8M HNO<sub>3</sub>.

**ii) Method B: Complexation by EDTA prior to Sr purification using Dowex AG50W-X8 resin**

The Dowex AG50W-X8 resin is a cation exchange resin that was employed for Sr purification in large volumes of a variety of environmental and food samples (Bong et al., 2012; St-Amant et al., 2011). To the best of our knowledge, the Sr separation using the Dowex AG50W-X8 resin prior to isotopic analysis of olive oil and similar oily matrices hasn't been studied before.

*Complexation and release of the elements from the olive oil matrix:* A mixture of 200g of an aqueous solution of 0.062M (NH<sub>4</sub>)<sub>2</sub>EDTA at pH 4.8 and 200g of olive oil was prepared in a 1 L clean polyethylene bottle. The pH value of the extraction solution was selected as it is the recommended pH for the sample loading in the column. The extraction recovery of Sr was calculated at 4 different pH values: pH 4.8, pH 6, pH 8 and pH 10 for the triplicates of the three oils analyzed. The extraction recovery was calculated as the ratio:

$$R_{\text{ext}} (\%) = \frac{\text{concentration of Sr obtained after by EDTA}}{\text{Concentration of Sr obtained after microwave assisted digestion}} * 100 \quad \text{Equation 2}$$

The ultrasound assisted extraction was performed as described in paragraph 2.2.1. for the ultrasound assisted acid extraction. The pH of the extraction solution was controlled using a pH meter before and after the extraction process.

**4.1.2. Soil, plant organs and olive pomace**

Prior to Sr purification, the soil, plant organs and olive pomace were subjected to pretreatments. The sample preparation techniques were detailed in the paragraphs **2.1.2.** and **2.1.3.** The soils were extracted by 1M Ammonium acetate, the plant organs and olive pomace were subjected to microwave assisted digestion.

The extracts obtained were evaporated to dryness and then re-dissolved in 3 M HNO<sub>3</sub>.

## 4.2. Sr purification

In order to perform a precise and accurate measurement of Sr isotopic ratio by means of MC-ICP-MS, the Sr separation from the matrix and the interfering elements (Rb, Ca, K, Mg and Na) is mandatory. The low ionization potential elements such as K, Mg and Na produce ionization interference while Rb result in an isobaric interference of <sup>87</sup>Rb on <sup>87</sup>Sr. Similarly, Ca-dimer ions and ArCa<sup>+</sup> molecular ions produce isobaric interferences on Sr signals (De Muynck et al., 2009).

### 4.2.1. Olive oil

#### *i) Method A: Strontium purification using Sr-Spec resin*

The column separation was carried out using a Sr-selective resin. An amount of 200 mg of the resin was introduced into a 2 mL polypropylene column. The various steps of the separation procedure are presented in table II.6.

**Table II.6:** Sr purification procedure using Sr-spec resin applied for olive oil.

Step	Matrix	Volume (mL)
Resin washing	Milli-Q water	10
	6M HCl	1
	Milli-Q water	10
	8M HNO <sub>3</sub>	3
	Milli-Q water	10
Conditioning	8M HNO <sub>3</sub>	2
Sample loading	8M HNO <sub>3</sub>	4
Matrix removal	8M HNO <sub>3</sub>	5
Sr elution	Milli-Q water	10

First, the resin is washed respectively with 10 mL of milli-Q water, 1 mL of 6M HCl, 10 mL of milli-Q water, 3 mL of 8M HNO<sub>3</sub> and rinsed with 10 mL of milli-Q water. Subsequently, the resin is conditioned with 2 mL of 8M HNO<sub>3</sub>; it is thus prepared for the retention of Sr. Next, the sample dissolved in 4 mL of 8M HNO<sub>3</sub> was eluted.



The matrix was then washed away with 5 mL of 8M HNO<sub>3</sub> for matrix removal. Finally, a volume of 10 mL of milli-Q water was loaded for Sr elution.

*i) Method B: Strontium purification using Dowex AG50W-X8 resin*

The extracts of (NH<sub>4</sub>)<sub>2</sub>EDTA at pH 4.8 recovered were subjected to Sr purification without previous treatments. The Sr separation procedure was carried out according to the chromatographic conditions described by Dalencourt et al., (2018) with minor modifications (Dalencourt et al., 2018). The previously published study was carried out for Ra quantification in environmental samples. In the column separation procedure applied for Ra separation/ pre-concentration, one of the rinse steps was performed in order to elute Sr. Table II.7 details the various steps for Sr purification as well as the operating conditions.

**Table II.7:** Sr purification procedure using Dowex AG50W-X8 resin applied for olive oil.

Step	Matrix	Concentration (mol L <sup>-1</sup> )	pH	Volume (mL)	Elements eluted
<b>Resin wash and activation</b>	Milli-Q water	-	-	30	-
	NH <sub>4</sub> OH	12.84 (50%)	-	30	-
	Milli-Q water	-	-	200	-
<b>Conditioning</b>	(NH <sub>4</sub> ) <sub>2</sub> EDTA	0.062	4.8	20	-
	CDTA/CH <sub>3</sub> COOH	0.04/0.06	5	20	-
	NH <sub>4</sub> Cl	0.374	5	20	-
	(NH <sub>4</sub> ) <sub>2</sub> EDTA	0.062	7	15	-
	(NH <sub>4</sub> ) <sub>2</sub> EDTA	0.062	4.8	15	-
<b>Sample loading</b>	(NH <sub>4</sub> ) <sub>2</sub> EDTA	0.062	4.8	200	Ca, Na and K
<b>Rinse 1</b>	CDTA/CH <sub>3</sub> COOH	0.04/0.06	5	20	Mg
<b>Rinse 2</b>	NH <sub>4</sub> Cl	0,374	5	25	Rb, Cs
<b>Sr elution</b>	(NH <sub>4</sub> ) <sub>2</sub> EDTA	0,062	7	10	Sr

Briefly, the resin was washed with 30 mL of ultrapure water followed by 30 mL of 50% NH<sub>4</sub>OH, then rinsed with 200 mL of ultrapure water.

Once washed and activated, several conditioning steps are required (Table II.7). Then, the sample extracts were gradually loaded by fractions of 50 mL. Subsequently, two rinses were required to remove alkali and alkali-earth interfering elements. In the final step, Sr was eluted with 10 mL of 0.062M  $(\text{NH}_4)_2\text{EDTA}$  at pH 7.

Sample flow rates is one the most affecting parameters for the Sr/matrix separation efficiency. The current method required an effective loading of total volume of 300-400 mL for a single separation (Table 2). Therefore, to ensure that such considerable quantities will be passing through the column at optimal flow rate conditions, a continuous vacuum pumping supply was assembled based on the materials at the laboratory disposal. Pre-packed columns coupled to 60 mL syringes were inserted into a hermetically sealed stand of SPE vacuum connected to a diaphragm pump as shown in Figure II.9. The flow rate was adjusted at  $5 \text{ mL min}^{-1}$  by a manual valve placed at the pump inlet.

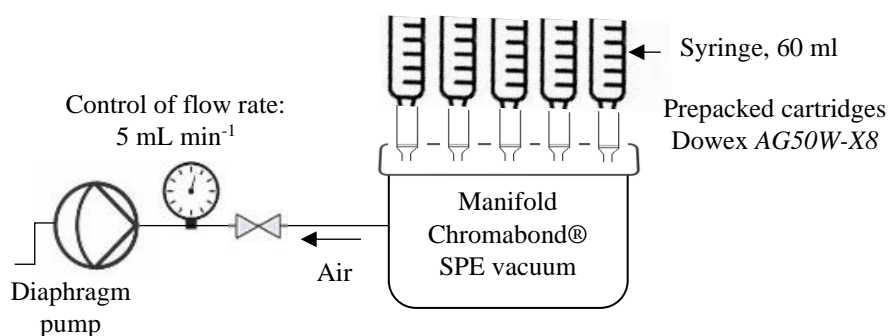

**Figure II.9:** Schematic of the experimental setup for Sr purification using Dowex AG50W-X8 resin.

*Elimination of  $(\text{NH}_4)_2\text{EDTA}$  and residual organic matter:* The extracts recovered after column separation were in the aqueous solution of 0.062M  $(\text{NH}_4)_2\text{EDTA}$  at pH 7. For the MC-ICP-MS analysis,  $(\text{NH}_4)_2\text{EDTA}$  and the potential residual organic matter should be eliminated from the final solution to be analyzed. Therefore, the Sr extracts obtained were subjected to evaporation down to dryness, a yellowish precipitate of  $(\text{NH}_4)_2\text{EDTA}$  was observed. The dry residue was re-dissolved in sub-boiled 69%  $\text{HNO}_3$  and  $\text{H}_2\text{O}_2$  was added prior to a microwave assisted digestion.

The clear solutions obtained after the mineralization were evaporated to dryness and re-dissolved in 2% HNO<sub>3</sub>. The samples were therefore ready to be analyzed.

#### 4.2.2. Soil, plant organs and olive pomace

The Sr/matrix separation was carried out with the Sr spec resin according to the procedure described in method B with minor modifications (table II.8). Briefly, 200 mg of the resin were loaded into the column. The washing steps are the following: First, the resin was washed with 10 mL of 3M HNO<sub>3</sub> and rinsed with 20 mL of ultra-pure water. Subsequently, the resin surface was conditioned for Sr complexation with 3 mL of 3 M HNO<sub>3</sub>. Then, the samples prepared in 4 mL of 3M HNO<sub>3</sub> were loaded. Subsequently, the matrix removal was carried out with 8 mL of 3 M HNO<sub>3</sub>. The final step was the Sr elution with 10 mL of ultra-pure water. The solution recovered was analyzed by MC-ICP-MS for the determination of <sup>87</sup>Sr/<sup>86</sup>Sr isotopic ratio.

**Table II.8** : Sr purification procedure using Sr-spec resin for soil, plant organs and olive pomace.

Step	Matrix	Volume (mL)
Resin washing	3 M HNO <sub>3</sub>	10
	Milli-Q water	20
Conditionning	3 M HNO <sub>3</sub>	2
Sample loading	3 M HNO <sub>3</sub>	4
Matrix removal	3 M HNO <sub>3</sub>	8
Sr elution	Milli-Q water	10

#### 4.3.ICP-MS analysis

The concentrations of Sr were measured in the extraction solution before the column separation and in the solution recovered after Sr column separation by means of an ICP-MS. The column recovery is calculated as the ratio:

$$R (\%) = \frac{\text{Sr concentration in the extract obtained after column separation}}{\text{Sr concentration in the extraction solution before column separation}} * 100 \quad \text{Equation 3}$$

The concentrations of the interfering elements (Rb, Ca, K, Mg and Na) were also determined in the extract recovered after column separation prior to MC-ICP-MS analysis.

A multi-elemental aqueous solution containing Ca, K, Mg and Na at  $2 \text{ mg L}^{-1}$  and Rb, Sr at  $4 \text{ } \mu\text{g L}^{-1}$  was prepared in  $0.062\text{M}$   $(\text{NH}_4)_2\text{EDTA}$  at pH 4.8 and subjected to Sr column separation using Dowex AG50W-X8 resin. Each fraction from the sample loading to the Sr elution was recovered and analyzed by means of quadrupole ICP-MS in order to build the elution profile of Sr and the interfering elements.

#### 4.4. Sr isotopic analysis by MC-ICP-MS

The Nu Plasma I multi-collector inductively coupled mass spectrometer (MC-ICP-MS) is capable of analyzing different masses simultaneously. Its principle is based on the physical separation of isotopes within an ion beam by the association of an energy filter and a mass filter. It is characterized by a high accuracy in the measurement of isotopes as it is equipped with several detectors (Faraday cages), all the isotopes arrive at the same time on different detectors. The main components of a Nu plasma MC-ICP-MS are presented in figure II.10.



**Figure II.10** : The main components of a Nu Plasma MC-ICP-MS.

All isotope ratio measurements were carried out using a Nu-Plasma I MC-ICP-MS. Olive oils were analyzed at  $20 \mu\text{g kg}^{-1}$  using desolvation nebulizer system DSN-100 under ‘dry plasma’ conditions while samples of soil, leaves, roots and pomace were analyzed at  $200 \mu\text{g kg}^{-1}$  at ‘wet plasma’ conditions. Solutions were self-aspirated at  $0.1 \text{ mL min}^{-1}$ . Instrumental settings and parameters resulting from daily optimizations are summarized in Tables II.9. A wash-out time of 10 min was required to ensure that the blank level was  $<1\%$  of the preceding sample or standard signal. After instrumental blank subtraction using the “On Peak Zero” approach (OPZ), the  $^{87}\text{Sr}/^{86}\text{Sr}$  ratio was corrected for mass bias using the constant ratio  $^{86}\text{Sr}/^{88}\text{Sr}$  of 0.1194, and from the potential remaining interferences from traces of  $^{87}\text{Rb}$  using the ratio  $^{85}\text{Rb}/^{87}\text{Rb}$  of 2.5926.

**Table II.9:** MC ICP-MS operating conditions.

Component / Parameter	Specification / Value
<b>General Parameters</b>	
Plasma gas flow rate ( $\text{L.min}^{-1}$ )	13
Auxiliary flow rate ( $\text{L.min}^{-1}$ )	0.8
RF power (W)	1300
Acceleration voltage (V)	6000
<b>Sr measurements</b>	
Plasma mode	Dry
Sample Introduction	DSN-100
Interface sampler cone	Ni, type B
Interface skimmer cone	Ni, type B
Typical Sensitivity ( $V_{88\text{Sr}}/\text{ppm}_{\text{Total Sr}}$ )	200
Aquisition	600 s
Uptake flow rate ( $\text{mL.min}^{-1}$ )	0.1
Blank	OPZ aquired during 60s

*Sensitivity check:* A series of measurements were performed for the NIST SRM 987 with a concentration of  $20 \mu\text{g kg}^{-1}$  before olive oils analysis and with a concentration of  $200 \mu\text{g kg}^{-1}$  for the soil, leaves, roots and pomace samples to achieve the maximum sensitivity and stability of the Sr beam. An example of  $^{87}\text{Sr}/^{86}\text{Sr}$  isotope ratios measured in NIST SRM 987 during 2 days before olive oil analysis is presented in figure II.11. Results were stable over

time and in agreement with the recommended value  $0.71026 \pm 0.00002$  (Waight et al, 2002) and the certified value  $0.71034 \pm 0.00026$ .

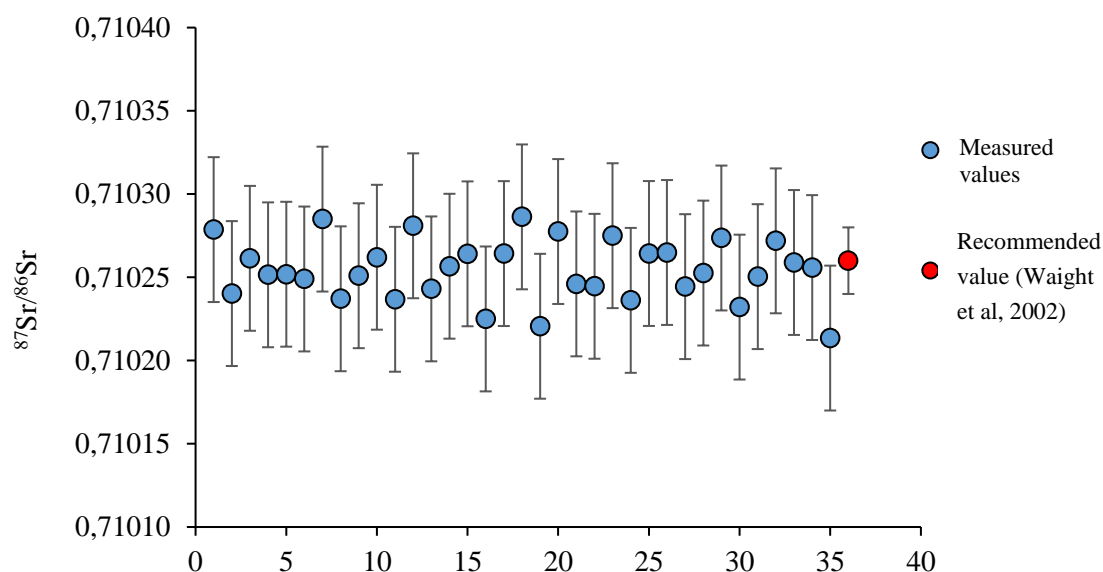

**Figure II.11:**  $^{87}\text{Sr}/^{86}\text{Sr}$  isotope ratios measured in NIST SRM 987 at  $30 \mu\text{g kg}^{-1}$  during 2 days before olive oil analysis.

*Correction of mass discrimination and mass bias:* Measurements were performed using a conventional Sample-Standard- Bracketing calibration sequence. The NIST SRM 897 was used as bracketing standard and was analyzed before and after two samples. A correction factor was calculated on the basis of the observed bias between the measured value and the true value of the  $^{87}\text{Sr}/^{86}\text{Sr}$  isotope ratio.

An Internal correction was performed to for the measured  $^{87}\text{Sr}/^{86}\text{Sr}$  ratio. A normalizing against the non-radiogenic  $^{86}\text{Sr}/^{88}\text{Sr}$  ratio with value of 0.1194 is required (Vanhaecke et al., 2009).

*Precision:* The precision was expressed as twice the standard deviation on basis of samples triplicates.

## 5. Materials, reagents, standard reference materials, apparatus and instruments

All the reagents, standard reference materials, materials, apparatus and instruments required for the samples preparation and analysis performed in the whole study are summarized in table II.10.

**Table II.10:** The reagents, standard reference materials, materials, apparatus and instruments used for the samples preparation and analysis

Name	Additional information	Company name	Purpose
<b>Reagents</b>			
Ultrapure water	Resistivity 18.2 MΩ cm	Millipore	Dilution, cleaning protocol
Nitric acid (HNO <sub>3</sub> )	69%, Instra analyzed, sub-boiled	J.T.Baker, Fisher Scientific	Samples preparation (digestion, acid extraction), Sr separation procedure (Sr-spec resin), cleaning protocol
Hydrogen peroxide (H <sub>2</sub> O <sub>2</sub> )	30–32%, Optima	Fisher scientific	Samples preparation (digestion)
Ammonium acetate	Purity > 98%	Sigma Aldrich	Samples preparation (soil extraction)
Hydrochloric acid (HCl)	32-35% Optima	Fisher Scientific	Samples preparation (acid extraction), pH adjustment, cleaning protocol
CCS-4 and CCS-6	Multi-elemental standard solutions	Inorganic ventures	Calibration curve
Sr-spec resin	Sr-selective resin	Eichrom, Triskem international	Sr / matrix separation
Dowex AG50W-X8	strong cation exchange resin (100-200 mesh)	Triskem international	Sr / matrix separation

Diammonium salt of ethylenediaminetetraacetic acid ((NH <sub>4</sub> ) <sub>2</sub> EDTA)	Extra pure	Fisher Scientific	Samples preparation (complexation)
Ammonium hydroxide (NH <sub>4</sub> OH)	20-22% ultra-trace ppt grade	Scharlau, Atlantic labo	Sr separation procedure (Dowex AG50W-X8), pH adjustment
cyclohexanediamine-N,N,N,N'-tetraacetic acid (CyDTA) monohydrate	Purity ≥ 99.0%	Honeywell Fluka	Sr separation procedure (Dowex AG50W-X8)
Acetic acid (CH <sub>3</sub> COOH)	Optima	Fisher scientific	Sr separation procedure (Dowex AG50W-X8)
Ammonium chloride (NH <sub>4</sub> Cl)	Extra pure (99.6%)	Acros Organics	Sr separation procedure (Dowex AG50W-X8)

---

**Standard Reference Materials (SRM)**

---

NIST SRM 1643f	Trace elements in water	National Institute of Standards and Technology (NIST)	Quality control of elemental analysis
NIST SRM 2387	Peanut butter	NIST	Quality control of elemental analysis
NIST SRM 987	Pure SrCO <sub>3</sub> , isotopic standard, strontium carbonate	NIST	Quality control of isotopic analysis
NIST SRM 1573a	Tomato leaves	NIST	Quality control of elemental analysis

---

**Materials**

---

Tubes	12-50 mL	Fisher Scientific	Samples preparation / analysis
Quartz vials	16-130 Ø 16 MM -136 MM X 130	ThermoFisher	Microwave digestion

---



Savillex vials	PTFE, 25 mL	Savillex corporation, Analab	Evaporation
1 L bottle	Polyethylene, 1 L	Fisher Scientific	Samples preparation (extraction)
Syringes	60 mL	Fisher Scientific	Sr purification (Dowex AG50W-X8)
2 mL cartridges	50 x 2 mL	Triskem international	Sr purification (Dowex AG50W-X8)
Polypropylene column	2 mL	Triskem international	Sr purification (Sr-spec resin)

---

#### Apparatus and instruments

---

Milli-Q system	Resistivity of 18.2 MΩ cm	Millipore	Samples preparation / analysis
ROTOFIX32A	Centrifuge	HETTICH, Atlantic Labo	Samples preparation (centrifugation)
Shaking plate	Edmund Buhler Shaker	Edmund Buhler	Samples preparation (extraction)
Ultrawave SRC technology	Microwave system	Milestones	Samples mineralization
Evapoclean	Closed medium sample evaporation apparatus, 25 mL	Analab	Evaporation
pH meter	Accumet AE150	Fisher scientific	Samples preparation
Ultrasonic cleaner	Branson 8510MT	Branson	Samples preparation / cleaning protocol
Acid distillation system		Savillex	Acid purification
Ball mill	Retsch MM200		Samples pretreatment (leaves)
ICP-MS	Plasma Quant Elite spectrometer	Analytik Jena	Elemental analysis
MC-ICP-MS	Nu plasma	Nu instruments	Isotopic analysis (Sr)
IRMS	Delta V	ThermoFisher Scientific	Isotopic analysis (C)
EA	EA IsoLink,	ThermoFisher Scientific	Isotopic analysis (C)

---

## **6. Conclusion**

In this chapter, the sampling strategy was fully described. Subsequently, the analytical methods developed for trace elements analysis and isotopic analysis (Sr and C) have been described including sample pretreatment steps and detection techniques. The sample preparation methods were developed and optimized according to the type of matrix to be analyzed ranging from simple and complex extraction procedures to destructive methods using a microwave digestion system. The multi-elemental analyses were performed using a highly sensitive ICP-MS allowing to detect with precision the concentrations of trace and ultra-trace elements while the accurate isotopic analyses were performed using a MC-ICP-MS. The determination of the carbon isotopic ratio was performed by IRMS. The quality control strategies of the whole analytical procedures were described.

## References

- Bajoub, A.; Hurtado-Fernández, E.; Ajal, E. A.; Ouazzani, N.; Fernández-Gutiérrez, A.; Carrasco-Pancorbo, A. Comprehensive 3-Year Study of the Phenolic Profile of Moroccan Monovarietal Virgin Olive Oils from the Meknès Region. *J. Agric. Food Chem.* **2015**, 63 (17), 4376–4385. <https://doi.org/10.1021/jf506097u>.
- Benincasa, C.; Gharsallaoui, M.; Perri, E.; Briccoli Bati, C.; Ayadi, M.; Khelif, M.; Gabsi, S. Quality and Trace Element Profile of Tunisian Olive Oils Obtained from Plants Irrigated with Treated Wastewater. *The Scientific World Journal* **2012**, 2012, 1–11. <https://doi.org/10.1100/2012/535781>.
- Bong, Y.-S.; Shin, W.-J.; Gautam, M. K.; Jeong, Y.-J.; Lee, A.-R.; Jang, C.-S.; Lim, Y.-P.; Chung, G.-S.; Lee, K.-S. Determining the Geographical Origin of Chinese Cabbages Using Multielement Composition and Strontium Isotope Ratio Analyses. *Food Chemistry* **2012**, 135 (4), 2666–2674. <https://doi.org/10.1016/j.foodchem.2012.07.045>.
- Coelho, I.; Castanheira, I.; Bordado, J. M.; Donard, O.; Silva, J. A. L. Recent Developments and Trends in the Application of Strontium and Its Isotopes in Biological Related Fields. *TrAC Trends in Analytical Chemistry* **2017**, 90, 45–61. <https://doi.org/10.1016/j.trac.2017.02.005>.
- Dalencourt, C.; Michaud, A.; Habibi, A.; Leblanc, A.; Larivière, D. Rapid, Versatile and Sensitive Method for the Quantification of Radium in Environmental Samples through Cationic Extraction and Inductively Coupled Plasma Mass Spectrometry. *J. Anal. At. Spectrom* **2018**, 33 (6), 1031–1040. <https://doi.org/10.1039/C8JA00060C>.
- Danezis, G. P.; Tsagkaris, A. S.; Camin, F.; Brusica, V.; Georgiou, C. A. Food Authentication: Techniques, Trends & Emerging Approaches. *TrAC Trends in Analytical Chemistry* **2016**, 85, 123–132. <https://doi.org/10.1016/j.trac.2016.02.026>.
- De Muynck, D.; Huelga-Suarez, G.; Van Heghe, L.; Degryse, P.; Vanhaecke, F. Systematic Evaluation of a Strontium-Specific Extraction Chromatographic Resin for Obtaining a Purified Sr Fraction with Quantitative Recovery from Complex and Ca-Rich Matrices. *Journal of Analytical Atomic Spectrometry* **2009**, 24 (11), 1498–1510. <https://doi.org/10.1039/b908645e>.
- Epova, E. N.; Bérail, S.; Séby, F.; Vacchina, V.; Bareille, G.; Médina, B.; Sarthou, L.; Donard, O. F. X. Strontium Elemental and Isotopic Signatures of Bordeaux Wines for Authenticity and Geographical Origin Assessment. *Food Chemistry* **2019**, 294, 35–45. <https://doi.org/10.1016/j.foodchem.2019.04.068>.
- Gertz, C.; Gertz, A.; Matthäus, B.; Willenberg, I. A Systematic Chemometric Approach to Identify the Geographical Origin of Olive Oils. *Eur. J. Lipid Sci. Technol.* **2019**, 121 (12), 1900281. <https://doi.org/10.1002/ejlt.201900281>.

Gupta, N.; Yadav, K. K.; Kumar, V.; Kumar, S.; Chadd, R. P.; Kumar, A. Trace Elements in Soil-Vegetables Interface: Translocation, Bioaccumulation, Toxicity and Amelioration - A Review. *Science of The Total Environment* **2019**, 651, 2927–2942. <https://doi.org/10.1016/j.scitotenv.2018.10.047>.

Nasr, E. G.; Epova, E. N.; de Diego, A.; Souissi, R.; Hammami, M.; Abderrazak, H.; F. X. Donard, O. Trace Elements Analysis of Tunisian and European Extra Virgin Olive Oils by ICP-MS and Chemometrics for Geographical Discrimination. *Foods* **2021**, 11 (1), 82. <https://doi.org/10.3390/foods11010082>.

Noorali, M.; Barzegar, M.; Sahari, M. A. Sterol and Fatty Acid Compositions of Olive Oil as an Indicator of Cultivar and Growing Area. *J Am Oil Chem Soc* **2014**, 91 (9), 1571–1581. <https://doi.org/10.1007/s11746-014-2497-z>.

Pošćić, F.; Furdek Turk, M.; Bačić, N.; Mikac, N.; Bertoldi, D.; Camin, F.; Jukić Špika, M.; Žanetić, M.; Rengel, Z.; Perica, S. Removal of Pomace Residues Is Critical in Quantification of Element Concentrations in Extra Virgin Olive Oil. *Journal of Food Composition and Analysis* **2019**, 77, 39–46. <https://doi.org/10.1016/j.jfca.2019.01.002>.

Quintanilla-Casas, B.; Bertin, S.; Leik, K.; Bustamante, J.; Guardiola, F.; Valli, E.; Bendini, A.; Toschi, T. G.; Tres, A.; Vichi, S. Profiling versus Fingerprinting Analysis of Sesquiterpene Hydrocarbons for the Geographical Authentication of Extra Virgin Olive Oils. *Food Chemistry* **2020**, 307, 125556. <https://doi.org/10.1016/j.foodchem.2019.125556>.

Rauret, G.; López-Sánchez, J. F.; Sahuquillo, A.; Rubio, R.; Davidson, C.; Ure, A.; Quevauviller, Ph. Improvement of the BCR Three Step Sequential Extraction Procedure Prior to the Certification of New Sediment and Soil Reference Materials. *J. Environ. Monitor.* **1999**, 1 (1), 57–61. <https://doi.org/10.1039/a807854h>.

Rauret, G.; López-Sánchez, J.-F.; Sahuquillo, A.; Barahona, E.; Lachica, M.; Ure, A. M.; Davidson, C. M.; Gomez, A.; Lück, D.; Bacon, J.; Yli-Halla, M.; Muntau, H.; Quevauviller, Ph. Application of a Modified BCR Sequential Extraction (Three-Step) Procedure for the Determination of Extractable Trace Metal Contents in a Sewage Sludge Amended Soil Reference Material (CRM 483), Complemented by a Three-Year Stability Study of Acetic Acid and EDTA Extractable Metal Content. *J. Environ. Monitor.* **2000**, 2 (3), 228–233. <https://doi.org/10.1039/b001496f>.

Sahuquillo, A.; Lopez-Sánchez, J. F.; Rubio, R.; Rauret, G.; Thomas, R. P.; Davidson, C. M.; Ure, A. M. Use of a Certified Reference Material for Extractable Trace Metals to Assess Sources of Uncertainty in the BCR Three-Stage Sequential Extraction Procedure. *Analytica Chimica Acta* **1999**, 382(3), 317–327. [https://doi.org/10.1016/S0003-2670\(98\)00754-5](https://doi.org/10.1016/S0003-2670(98)00754-5)

Medini S. Traçage géographique des huiles d'olive par les isotopes du Sr: développement analytique et application aux huiles AOP de Nîmes, Université d'Aix-Marseille, France, 2015.

St-Amant, N.; Whyte, J. C.; Rousseau, M.-E.; Lariviere, D.; Kurt Ungar, R.; Johnson, S. Radiostrontium and Radium Analysis in Low-Level Environmental Samples Following a Multi-Stage Semi-Automated Chromatographic Sequential Separation. *Applied Radiation and Isotopes* **2011**, 69 (1), 8–17. <https://doi.org/10.1016/j.apradiso.2010.08.001>.

Taamalli, A.; Arráez Román, D.; Zarrouk, M.; Segura-Carretero, A.; Fernández-Gutiérrez, A. Classification of ‘Chemlali’ Accessions According to the Geographical Area Using Chemometric Methods of Phenolic Profiles Analysed by HPLC–ESI-TOF–MS. *Food Chemistry* **2012**, 132 (1), 561–566. <https://doi.org/10.1016/j.foodchem.2011.10.070>.

Tres, A.; van der Veer, G.; van Ruth, S. M. Vegetable Oils. In *Comprehensive Analytical Chemistry*; Elsevier, **2013**; Vol. 60, pp 543–572. <https://doi.org/10.1016/B978-0-444-59562-1.00021-9>.

Ure, M.; Thomas, R.; Littlejohn, D. Ammonium Acetate Extracts and Their Analysis for the Speciation of Metal Ions in Soils and Sediments. *International Journal of Environmental Analytical Chemistry* **1993**, 51 (1–4), 65–84. <https://doi.org/10.1080/03067319308027612>.

Vanhaecke, F.; Balcaen, L.; Malinovsky, D. Use of Single-Collector and Multi-Collector ICP-Mass Spectrometry for Isotopic Analysis. *Journal of Analytical Atomic Spectrometry* **2009**, 24 (7), 863–886. <https://doi.org/10.1039/b903887f>.

Wadood, S. A.; Boli, G.; Xiaowen, Z.; Hussain, I.; Yimin, W. Recent Development in the Application of Analytical Techniques for the Traceability and Authenticity of Food of Plant Origin. *Microchemical Journal* **2020**, 152, 104295. <https://doi.org/10.1016/j.microc.2019.104295>.

Waight, T.; Baker, J.; Peate, D. Sr Isotope Ratio Measurements by Double-Focusing MC-ICPMS: Techniques, Observations and Pitfalls. *International Journal of Mass Spectrometry* **2002**, 221 (3), 229–244. [https://doi.org/10.1016/S1387-3806\(02\)01016-3](https://doi.org/10.1016/S1387-3806(02)01016-3).

Youseff, R.; Soubh, L.; Alassaf, Z. Detection of Vegetable Oils Adulteration Using Desmethylsterols Composition. *International Journal of Pharmaceutical Sciences Review and Research* **2014**, 28 (41), 229–233.

# Chapter III

## Trace elements analysis of olive oil by ICP-MS and chemometrics for geographical discrimination

---

### Abstract

The aim of this study is to investigate the levels of trace elements in olive oils from different locations and their use for geographical authentication. Concentrations of seventeen elements were determined in a total of 42 olive oils from Tunisia, Spain and France, and in 9 soil samples from Tunisia by quadrupole inductively plasma mass spectrometry. The compilation of appropriate techniques integrated in the analytical procedure allowed to achieve a satisfactory precision (RSD between 2 and 15%) and relatively low limits of detection (between 0.0001 and 0.313  $\mu\text{g kg}^{-1}$ ). The accuracy of the applied analytical method for olive oil analysis was evaluated using SRM NIST 2387 Peanut butter, recoveries obtained after microwave assisted digestion for the certified elements ranged between 86% and 102%. Concentrations of non-certified elements (V, Cr, Co, Ni, Ba, Rb, Sr, Cd, Pb, As) were also presented. Furthermore, Pearson correlation was evaluated for paired Tunisian oil / soil samples and has shown that several elements (Mg, Mn, Ni and Sr) were significantly correlated. Principal component analysis successfully discriminated three studied origins using elemental concentrations of Cu, Cr, Fe, Mn, Sr, V and Zn. This study shows the potential of applying trace elements profile for olive oil geographical discrimination.

## Introduction

trace elements represent a good geographical tracer as they are naturally present in the soil at variable concentrations. They are absorbed through the roots and transferred to the aerial parts of the plant by translocation (Carini & Bengtsson, 2001). Their distribution in the final product then reflects the elemental signature of the soil of origin. Limited interest has been given to the influence of other factors interacting with the plant or with the final product, such as the extraction process of the olive oil or agricultural practices (Benincasa et al., 2012; Gouvinhas et al., 2016). However, elements such as chromium, cadmium, and lead can be incorporated into the oil during its extraction, reflecting the manufacturing and packaging process (Skrzydłowska, Balcerzak, & Vanhaecke, 2003).

Geographical authentication studies carried out on olive oil are gradually increasing but remain limited. Indeed, olive oil is a complex lipid matrix, especially with regard to its introduction into plasma-based instruments. It is characterized by a high organic content that requires advanced conditions to destroy the matrix, and incomplete mineralization leads to inaccurate concentration determination, interferences and can induce plasma extinction. Furthermore, trace elements are present in olive oil at low concentrations, sometimes below the limits of detection (Karabagias et al., 2013; Zeiner, Steffan, & Cindric, 2005). The detection technique most often used is inductively coupled plasma mass spectrometry (ICP-MS) due to its high sensitivity (Aceto, Calà, Musso, Regalli, & Oddone, 2019; Astolfi, Marconi, Vitiello, & Massimi, 2021; Camin, Larcher, Nicolini, et al., 2010; Lepri, Chaves, & Vieira, 2011; Pošćić et al., 2019), and to a lesser extent, inductively coupled plasma atomic emission spectroscopy (ICP-OES) (Angioni, Cabitza, Teresa, & Caboni, 2006; Bakircioglu, Kurtulus, & Yurtsever, 2013), graphite furnace atomic absorption spectroscopy (ETAAS/GFAAS) (Brkljača, Giljanović, & Prkić, 2013; Leonardis, Macciola, & Felice, 2000), and flame atomic absorption spectroscopy (FAAS) (Mohebbi, Heydari, & Ramezani, 2018) are employed.

Most of the sample preparation techniques used are based on destructive methods of organic matter prior to spectroscopic analysis. Mineralization in a microwave oven has been the most used due to the ease of implementation, high recoveries, and destructive efficiency of this apparatus (Aceto et al., 2019; Beltrán, Sánchez-Astudillo, Aparicio, & García-González, 2015; Benincasa, Lewis, Perri, Sindona, & Tagarelli, 2007; Damak et al., 2019; E. J. Llorent-Martínez, Ortega-Barrales, Fernández-de Córdova, & Ruiz-Medina, 2011; Sayago, González-Domínguez, Beltrán, & Fernández-Recamales, 2018).

Several extraction methods were also developed based on the affinity of the elements with the extraction phase without having to destroy the organic matter (Camin, Larcher, Nicolini, et al., 2010; Camin, Larcher, Perini, et al., 2010; Kara, Fisher, & Hill, 2015a; Manjusha, Shekhar, & Kumar, 2019; Mohebbi et al., 2018). Nevertheless, the recovery percentages of the extraction methods remain limited due to the complex organic structure of olive oil from which metals are difficult to extract. Other studies have adopted emulsion techniques as an alternative, but these are difficult to implement, especially in terms of maintaining the stability of the emulsion (Bakircioglu et al., 2013; Jimenez, Velarte, & Castillo, 2003).

The application of multivariate statistical methods, mainly principal components analysis (PCA) and linear discriminant analysis (LDA) applied on the mineral content allowed the discrimination between food products and raw materials at different production lines (Kruszewski & Obiedziński, 2018), from different types of plants (Sakač et al., 2019) and from different geographical origins (Wakefield et al., 2019). In particular, olive oils were classified with variable resolutions according to their origin on the basis of several elements' contents (Beltrán et al., 2015; Damak et al., 2019; Gumus, Celenk, Tekin, Yurdakul, & Ertas, 2017).

In the present study, we describe a method for accurate and precise trace element concentration determination in olive oils from Tunisia, France (southern France), and Spain (region of Basque country). To the best of our knowledge, very limited studies have studied the multi-elemental composition of Tunisian olive oil so far, and these studies focused on specific and limited geographical areas in Tunisia (Benincasa et al., 2012; Damak et al., 2019; Wali et al., 2021). While it is characterized by varied and heterogeneous geology, the soil composition must vary significantly in different regions. For this reason, we have set as a first objective a sampling strategy that covers various olive oil-producing locations across the Tunisian geography, even the lowest productions for local consumption. For the samples preparation, we performed an innovative approach based on a multi-stage sample preparation procedure that allowed the destruction of the organic matter contained in olive oil in order to facilitate the analytes' introduction into the ICP-MS. The quality control of the applied analytical procedure was performed using a standard reference material (SRM) NIST 2387 peanut butter. The recoveries were calculated for the concentrations of the certified elements; the non-certified elements were quantified with high precision and exclusively presented in this paper. The results obtained in this study will allow the creation of a database for the multi-elemental profile of Tunisian olive oils that can be useful for the quality assessment and the geographical characterization.



The second objective of this work was to verify the correlation between the element concentrations in the soil and in the final product, which will allow the identification of the potential sources of elements that constitute the fingerprint of the geographical origin. Finally, the paper focused on the use of a common pattern recognition technique, the principal component analysis, as a tool for the classification of the samples according to their geographical origin.

## **2. Analytical procedure and quality control**

### **2.1. Analytical procedure**

The samples of EVOOs from Tunisia, Spain and France described in the previous chapter were analyzed for the determination of trace elements concentrations.

Olive oils were subjected to microwave assisted digestion prior to ICP-MS analysis following the analytical procedure described in chapter II.

### **2.2. Analytical quality control**

*Accuracy:* The NIST SRM 2387 peanut butter was used to evaluate the accuracy of olive oil mineralization through recoveries of the certified elements. NIST SRM 2387 peanut butter was chosen since a natural vegetable oil certified for trace elements concentrations is not available. Despite the fact that this matrix is not totally equivalent to olive oil composition and viscosity, the chemical composition of this fatty acid-rich matrix is very close to that of olive oil.

For the non-certified elements (As, Ba, Cd, Co, Cr, Ni, Pb, Rb, Sr and V), a series of microwave assisted mineralization were performed on NIST SRM 2387 prior to ICP-MS analysis. The average concentrations for inter-day and intra-day results obtained for these elements on basis of 15 replicates are presented in table III.1.

**Table III.1:** Measured concentrations of certified and non-certified elements in NIST SRM 2387 peanut butter and recoveries obtained for certified elements.

	Elements	Measured concentrations $\pm$ SD (mg kg <sup>-1</sup> )	Certified concentrations $\pm$ SD (mg kg <sup>-1</sup> )	R (%)
Certified elements (n = 3)	Ca	421 $\pm$ 6	411 $\pm$ 18	102
	Cu	4.26 $\pm$ 0.06	4.93 $\pm$ 0.15	86
	Fe	16.6 $\pm$ 0.3	16.4 $\pm$ 0.8	101
	K	6130 $\pm$ 160	6070 $\pm$ 200	101
	Mg	1696 $\pm$ 13	1680 $\pm$ 70	101
	Mn	15.5 $\pm$ 0.2	16.0 $\pm$ 0.6	97
	Zn	25.1 $\pm$ 0.3	26.3 $\pm$ 1.1	96
Non-certified elements (n = 15)	As	0.13 $\pm$ 0.07	-	-
	Ba	1.43 $\pm$ 0.13	-	-
	Cd	0.051 $\pm$ 0.002	-	-
	Co	0.024 $\pm$ 0.002	-	-
	Cr	<LOQ	-	-
	Ni	0.78 $\pm$ 0.04	-	-
	Pb	<LOQ	-	-
	Rb	5.66 $\pm$ 0.23	-	-
	Sr	2.95 $\pm$ 0.10	-	-
	V	< LOQ	-	-

In every mineralization run, a blank and a triplicate of NIST SRM 2387 were digested and then analyzed. Recoveries for six certified elements concentrations (Cu, Fe, K, Mg, Mn and Zn) in NIST SRM 2387 were calculated as the ratio: (Measured concentration / Certified concentration) \*100. The recoveries (R (%)) obtained after microwave assisted digestion were satisfactory, ranging between 86% and 102% (Table III.2).

*Precision:* precision was evaluated through the relative standard deviation (RSD) and calculated on basis of olive oil triplicates. The RSDs were satisfactory, the values obtained were low, ranging between 1% and 14% (III.2).

*LODs, LOQs and linearity:* The obtained LODs and LOQs were significantly low (Table III.2): LODs were between 0.0002 and 0.313  $\mu\text{g kg}^{-1}$  and LOQs between 0.0007 and 1.042  $\mu\text{g kg}^{-1}$ . Except for Cd in olive oil, all the measured concentrations were greater than LOD and LOQ. Linearity was satisfactory,  $R^2$  was above 0.9995 for all analyzed elements.

**Table III.2:** Limits of detection (LOD). limits of quantification (LOQ), linearity ( $R^2$ ) and precision (RSD).

Elements	LOD ( $\mu\text{g kg}^{-1}$ )	LOQ ( $\mu\text{g kg}^{-1}$ )	Linearity $R^2$	RSD (%)
As	0.004	0.014	0.9997	9 - 11
Ba	0.0003	0.0009	1.0000	4 - 9
Ca	0.227	0.758	0.9998	2 - 4
Cd	0.0002	0.0007	1.0000	-
Co	0.001	0.002	1.0000	1 - 2
Cu	0.006	0.019	0.9999	9 - 12
Cr	0.035	0.116	1.0000	10 - 14
Fe	0.015	0.049	0.9997	4 - 9
K	0.313	1.042	0.9999	1 - 2
Mn	0.010	0.033	1.0000	7 - 8
Ni	0.003	0.008	0.9998	13 - 15
Mg	0.176	0.588	0.9996	2 - 6
Rb	0.004	0.012	1.0000	1 - 3
Sr	0.001	0.004	1.0000	10 - 14
Pb	0.002	0.006	1.0000	1 - 2
V	0.011	0.037	1.0000	10 - 15
Zn	0.140	0.468	0.9999	6 - 8

### 3. Statistical data analysis

For classification of olive oil samples according to their geographical origin (Tunisia, Spain and France), a multivariate analysis was performed using SIMCA V16.0.1. The Principal Components Analysis (PCA) is an unsupervised method aiming to find new variables called dimensions calculated from a covariance matrix of the original variables while preserving as

much as possible the statistical information (variability). It allows to summarize and visualize the information in a large dataset. The samples classification was accomplished by the PCA score plot and the determination of the most discriminating elements was conducted by the loadings plot. Spearman's correlation was calculated for the trace elements concentrations in exchangeable fraction of soil and corresponding olive oils in order to verify the possible correlation between both. Spearman's correlation factors were calculated using OriginLab 2018.

## 4. Results and discussion

### 4.1. Trace elements concentrations in olive oils

The trace elements determined in the olive oils analyzed presented a wide range of concentrations ranging from less than  $1 \mu\text{g}\cdot\text{kg}^{-1}$  up to the range of  $\text{mg kg}^{-1}$ . Table III.3 presents the median and the ranges of concentration of 17 elements in olive oil samples classified according to their geographical origin (Tunisia, Spain and France). They were compared to the concentrations reported in the literature. In general, except for Fe, all the elements analyzed displayed slight but noticeable levels of concentrations in all the olive oil samples. The first group of elements includes those displaying the lowest concentration ranges. They are As, Cd, Co, Pb and Rb. These elements median concentrations were less than  $1 \mu\text{g kg}^{-1}$ . They are the most difficult to detect in a complex matrix such as olive oil due to the high organic load and viscosity for introduction in the ICP-MS with typical nebulization.

*Arsenic:* The concentration of As obtained in Tunisian, Spanish and French olive oils analyzed were low, around  $0.1 \mu\text{g kg}^{-1}$ , and were notably lower than those reported in the literature. Indeed, the concentrations of As recorded varied between  $0.05 \mu\text{g kg}^{-1}$  and  $0.16 \mu\text{g kg}^{-1}$  in European oils and were between  $0.06 \mu\text{g kg}^{-1}$  and  $0.88 \mu\text{g kg}^{-1}$  in Tunisian oils. These results are most in agreement with the concentrations previously reported in Spanish olive oils (Mirón et al., 2019) and are notably lower compared to other studies conducted on oils from Tunisia and Italy (Benincasa et al., 2007; Damak, Asano, Baba, Suda, et al., 2019).

*Cadmium:* The values obtained for Cd were below the LOD in all olive oil samples. Cadmium is one of the major contaminants that can expose humans to health risks.

**Table III.3:** Median values and ranges of concentrations ( $\mu\text{g kg}^{-1}$ ) of trace elements in olive oil samples from Tunisia, Spain (Basque country) and southern France and ranges of concentrations reported in the literature.

Element	Tunisia		Spain (Basque country)		France		Literature *
<b>Cd</b>	<LOQ		<LOQ		<LOQ		[0.001 - 0.15]
<b>Co</b>	0.09	[0.03 - 0.31]	0.07	[0.04 - 0.10]	0.07	[0.04 - 0.17]	[0.023 - 11]
<b>As</b>	0.14	[0.06 - 0.88]	0.10	[0.09 - 0.14]	0.08	[0.05 - 0.16]	[0.2 - 26.6]
<b>Rb</b>	0.35	[0.09 - 1.85]	0.55	[0.28 - 0.95]	0.66	[0.35 - 1.94]	[0.036 - 2.6]
<b>Pb</b>	0.88	[0.57 - 2.16]	0.53	[0.28 - 0.94]	0.70	[0.47 - 1.35]	[0.18 - 6.40]
<b>Ba</b>	1.21	[0.45 - 5.17]	1.28	[0.93 - 2.30]	1.61	[0.92 - 17.6]	[0.31- 12.3]
<b>Sr</b>	2.58	[1.18 - 5.04]	1.73	[1.21 - 2.11]	2.50	[1.00 - 3.55]	[1.52 - 48.9]
<b>V</b>	3.25	[2.10 - 5.45]	1.14	[0.52 - 1.56]	0.77	[0.12 - 1.53]	[4.2 - 5.8]
<b>Mn</b>	5.03	[3.58 - 17.3]	1.57	[0.96 - 2.70]	2.34	[1.08 - 3.71]	[4.4 - 40]
<b>Ni</b>	3.50	[2.02 - 11.6]	2.65	[1.86 - 3.44]	3.88	[2.22 - 6.88]	[5.95 - 173]
<b>Cu</b>	8.74	[3.62 - 23.5]	5.26	[3.10 - 11.1]	6.16	[4.40 - 6.55]	[3.35 - 66.4]
<b>Cr</b>	10.3	[7.11 - 16.8]	8.48	[3.45 - 11.2]	14.4	[11.9 - 18.2]	[15.4 - 437]
<b>Zn</b>	98	[39 - 195]	129	[100 - 152]	106	[33 - 138]	[7 - 290]
<b>Fe</b>	1240	[169 - 1310]	102	[80.7 - 117]	129	[54.7 - 190]	[67.5 - 1610]
<b>Mg</b>	208	[138 - 582]	226	[91.9 - 488]	368	[160 - 785]	[223 - 1200]
<b>K</b>	534	[128 - 3740]	601	[214 - 2970]	527	[142 - 1530]	[498 - 98000]
<b>Ca</b>	1240	[610 - 2280]	942	[607 - 1990]	1080	[580 - 1640]	[76 - 10790]

\*The literature data was collected from the previously reported results (Astolfi et al., 2021; Benincasa et al., 2007, 2012; Cabrera-vique et al., 2012; Camin, Larcher, Nicolini, et al., 2010; Camin, Larcher, Perini, et al., 2010; Damak, Asano, Baba, Suda, et al., 2019; Jimenez et al., 2003; Kara et al., 2015a, 2015b; Lendinez et al., 2001; Llorent-Martínez et al., 2014; Llorent-Martínez, Ortega-Barrales, Fernández-de Córdoba, et al., 2011; Llorent-Martínez, Ortega-Barrales, Fernández-De Córdoba, et al., 2011; Mirón et al., 2019; Pošćić et al., 2019; Wali et al., 2021)

It can be absorbed by plants from the soil and then translocated to the edible parts of the plant, and it can also be released to edible oils stored in tanks and plastic packaging (Ismael et al., 2019). In most of the published studies, cadmium was either not analyzed or was not detected in olive oil (Kara et al., 2015a; Llorent-Martínez, Ortega-Barrales, Fernández-De Córdoba, et al., 2011). Otherwise, when quantified, concentrations of Cd varied between  $0.001 \mu\text{g kg}^{-1}$  and  $0.15 \mu\text{g kg}^{-1}$  (Bakircioglu et al., 2013; Farrell & Ertan, 2019; Mendil et al., 2009; Pošćić et al., 2019).

*Cobalt:* The concentration levels of Co in Tunisian olive oils ranged from  $0.03 \mu\text{g kg}^{-1}$  to  $0.31 \mu\text{g kg}^{-1}$ . The concentrations are similar to those reported for European oils, ranging between  $0.04 \mu\text{g kg}^{-1}$  and  $0.17 \mu\text{g kg}^{-1}$ . These concentrations are in full agreement with the concentrations previously evaluated in Spanish and Italian olive oils (Beltrán et al., 2015; Benincasa et al., 2007; Sayago et al., 2018).

*Lead:* The concentrations of Pb were 10 times higher than those recorded for Co but were as well at low levels. In general, in the European oils, the concentrations of Pb did not exceed  $1.35 \mu\text{g kg}^{-1}$ . These values are in agreement with those previously reported results from Spain, Portugal and France (Camin, Larcher, Nicolini, et al., 2010). Slightly higher values were found in oils from Tunisia. The highest value was equal to  $2.16 \mu\text{g kg}^{-1}$  and this was found in olive oil from Jendouba (T16) sampled near a Pb-Zn mining deposit (Table II.2 from Chapter 2). Lead is a hazardous contaminant that can be assimilated by plants and is then accumulated at variable concentrations depending on the location of the Pb emission source (Elloumi et al., 2003). These relatively high values of Pb in the Tunisian oils were in agreement with recent results from oils originating from four geographic locations (Monastir, Medenine, Gafsa and Sfax). They also displayed relatively high concentration levels, between  $5 \mu\text{g kg}^{-1}$  and  $7.4 \mu\text{g kg}^{-1}$  (Damak, Asano, Baba, Suda, et al., 2019). In this same study, concentrations of Rb and Sr were also investigated in olive oils.

*Rubidium and Strontium:* The rubidium reported concentrations ranged between  $2.5 \mu\text{g kg}^{-1}$  and  $3.5 \mu\text{g kg}^{-1}$  and are in agreement with the concentrations found in the present study.

However, the reported concentrations of Sr were relatively high, ranging between  $33 \mu\text{g kg}^{-1}$  and  $37 \mu\text{g kg}^{-1}$  which is up to 30 times greater than the concentrations found in this study. Both Rb and Sr concentrations varied significantly in Tunisian oils.

The concentrations of Rb ranged between  $0.09 \mu\text{g kg}^{-1}$  and  $1.85 \mu\text{g kg}^{-1}$  and concentrations of Sr between  $1.18 \mu\text{g kg}^{-1}$  and  $5.04 \mu\text{g kg}^{-1}$ . This variability is related to the varied geology of Tunisian soil. Indeed, Rb and Sr contents are strongly linked to the geochemical composition of the soil of origin (Giaccio & Vicentini, 2008). This variation is less significant in the Spanish and French olive oil samples. Indeed, compared to the large geographical distribution of sampling performed in Tunisia, the samples from the Spanish Basque country and France were obtained from a limited and restricted geographical area.

The second group of elements includes the elements occurring at medium concentrations, ranging from a few  $\mu\text{g kg}^{-1}$  up to  $100 \mu\text{g kg}^{-1}$ . It includes Ba, Cr, Cu, Mn, Ni, Sr, V and Zn.

*Barium:* Ba is naturally present in the environment and is a non-essential element for plant growth. The high concentrations of Ba in soil could be related to the geological formation and also to contamination through industrial activities (paints, ceramics and glass) (Gad, 2014). Ba concentrations ranged from  $0.45 \mu\text{g kg}^{-1}$  to  $5.17 \mu\text{g kg}^{-1}$  in Tunisian oils. These values were lower than those reported by Damak et al., (2019) (Damak, Asano, Baba, Suda, et al., 2019). Similar median concentrations were obtained in Spanish and French oils, respectively equal to  $1.28 \mu\text{g kg}^{-1}$  and  $1.61 \mu\text{g kg}^{-1}$ . An outlier was recorded in the sample originating from Nîmes, concentration of Ba was equal to  $17.6 \mu\text{g kg}^{-1}$ . Such high barium concentrations had been previously recorded in Spanish olive oils (Jimenez et al., 2003; Sayago et al., 2018).

*Chromium:* Cr is also non-essential in plant growth and development but is assimilated by roots with other essential elements (Shahid et al., 2017). Concentrations of Cr in Tunisian olive oils varied between  $7.11 \mu\text{g kg}^{-1}$  and  $16.8 \mu\text{g kg}^{-1}$ . Similar levels of Cr were found in the other European oils analyzed and are all in line with the previously reported results from Spain (Cabrera-vique et al., 2012). A wide range of concentrations was reported in the literature for Cr, from a few tens of  $\mu\text{g kg}^{-1}$  levels up to hundreds of  $\mu\text{g kg}^{-1}$  (Bakircioglu et al., 2013; Beltrán et al., 2015; Benincasa et al., 2007; Cabrera-vique et al., 2012; Lendinez et al., 2001).

*Copper:* Concentrations of Cu varied between  $3.62 \mu\text{g kg}^{-1}$  and  $23.5 \mu\text{g kg}^{-1}$  in the Tunisian oil and are significantly greater than the values reported in the literature (Wali et al., 2021).

In the European oils, the concentrations of Cu ranged between  $0.04 \mu\text{g kg}^{-1}$  and  $0.17 \mu\text{g kg}^{-1}$  and were significantly low comparing to the previous findings in Italy, Spain and Turkey (Astolfi et al., 2021; Bakircioglu et al., 2013; Cabrera-vique et al., 2012; Camin, Larcher, Nicolini, et al., 2010; Erol et al., 2008; Mirón et al., 2019). The presence of Cu in the soils is necessarily related to natural geogenic background but can be altered by different cultivation processes and therefore can be found at a wide range of concentrations.

*Vanadium and Manganese:* Both, V and Mn are essential nutrients for plant growth and development at low concentrations. Although there are sources of vanadium contamination such as metallurgical industry and mining activities, its composition in soil mainly reflects that of the rocks (Chen et al., 2021; Guagliardi et al., 2018). In previous studies, vanadium was rarely analyzed in olive oil and hardly detected due to its very low concentration (Jimenez et al., 2003). In the present study, the lowest value obtained was equal to  $0.12 \mu\text{g kg}^{-1}$  and was 10 times higher than the LOD. The concentrations of V in Tunisian olive oils ranged from  $2.1 \mu\text{g kg}^{-1}$  to  $5.45 \mu\text{g kg}^{-1}$ . Mn concentrations ranged from  $3.58 \mu\text{g kg}^{-1}$  to  $17.2 \mu\text{g kg}^{-1}$ . Both ranges of concentrations are in agreement with the previously reported results for Tunisian oils (Damak, Asano, Baba, Suda, et al., 2019). Lower concentrations were found in the Spanish and the French olive oils since the concentrations detected fluctuated between  $0.12 \mu\text{g kg}^{-1}$  and  $1.56 \mu\text{g kg}^{-1}$  for V and did not exceed  $3.71 \mu\text{g kg}^{-1}$  for Mn. Both levels detected are in agreement with the previously results reported in European oils (Camin, Larcher, Nicolini, et al., 2010; Kara et al., 2015a).

*Nickel:* Median concentrations of Ni were similar in olive oils from the three different origins ranging between  $2.65 \mu\text{g kg}^{-1}$  and  $3.83 \mu\text{g kg}^{-1}$ . Very limited information is available for levels of Ni in the Tunisian olive oils, we can only refer that the values obtained from trees irrigated with treated wastewater presented higher levels of Ni (Benincasa et al., 2012). Other published results from Spain and Italy showed also high concentrations ranging between  $10 \mu\text{g kg}^{-1}$  and  $60 \mu\text{g kg}^{-1}$  (Benincasa et al., 2007; Cabrera-vique et al., 2012). In general, the presence of Ni in soil is mainly related to the parent rock composition; however, it can be accumulated in the plants as a result of agricultural and industrial practices and therefore, nickel would be found in a wide range of concentrations in soil and similarly in olive oil (Iyaka, 2011).

*Zinc:* Concentrations of Zn varied between  $39 \mu\text{g kg}^{-1}$  and  $195 \mu\text{g kg}^{-1}$  in Tunisian oils. The highest values were recorded in the sample T16, sampled close to a Zn mining site.



Thus, the high concentrations of Zn in olive oil can be related to the direct uptake of Zn from the polluted soil or to the indirect intake from dust Zn deposited on the leaves that is translocated into the olive fruits (Madejón et al., 2006). Similar ranges were obtained in European oils, ranging from 33  $\mu\text{g kg}^{-1}$  to 152  $\mu\text{g kg}^{-1}$ . These results agreed most with reported values in olive oils from Trentino, Italy (Camin, Larcher, Nicolini, et al., 2010) and from Tunisia (Damak, Asano, Baba, Suda, et al., 2019). Notably higher average concentrations were recently recorded in European olive oils, up to 492  $\mu\text{g kg}^{-1}$  (Astolfi et al., 2021).

The third group of elements includes the elements occurring at relatively high concentrations from a few hundreds of  $\mu\text{g kg}^{-1}$  to the range of  $\text{mg kg}^{-1}$ . It involves Ca, Fe, K and Mg. They are all necessary for plant growth and development.

*Calcium and potassium:* Concentrations of Ca and K in Tunisian olive oils were in agreement with those obtained from olive trees irrigated with treated wastewater (Benincasa et al., 2012). This could be related to the source of irrigation water of our sampling locations. For the European samples, concentrations of K were high in some samples from the Spanish Basque country compared to French oils. This could be due to the amendment of olive trees in Basque locations with NPK (Table 2). The concentrations of Ca in European olive oils were found in comparable concentration ranges, between 580  $\mu\text{g kg}^{-1}$  and 1990  $\mu\text{g kg}^{-1}$ . These values are lower than those previously reported in Spain (Sayago et al., 2018).

*Iron:* Concentrations of Fe in Tunisian samples ranged from 169  $\mu\text{g kg}^{-1}$  to 1310  $\mu\text{g kg}^{-1}$ . The median value is equal to 1248  $\mu\text{g kg}^{-1}$ . The highest values were obtained in olive oils produced at OTIT using the Abencor extraction method. This relatively high concentration of Fe is likely to be related to direct contamination by the extraction process of the olive oil. Indeed, Zeiner et al., (2010) pointed out that the high metals content in olive oils could be related to the production process (Zeiner et al., 2010). Levels of Fe were much lower in European oils, ranging from 54.7  $\mu\text{g kg}^{-1}$  to 160  $\mu\text{g kg}^{-1}$ . These results were more in agreement with the previously reported concentrations (Astolfi et al., 2021; Benincasa et al., 2007; Cabrera-vique et al., 2012). *Magnesium:* The concentrations of Mg in olive oils from Tunisia, ranging from 138  $\mu\text{g kg}^{-1}$  to 582  $\mu\text{g kg}^{-1}$ , were lower than those previously reported (Damak, Asano, Baba, Suda, et al., 2019).

Elemental Mg content in European olive oils was in contrast similar to concentrations reported in different Spanish locations (Sayago et al., 2018).

This wide range of concentrations and the inter/intra-country variability is certainly related to the soil geochemistry and the possible contribution from cultural processes or anthropogenic activities.

#### 4.2. Relationship between olive oil and soil elemental content in Tunisia

The multi-elemental profile of the soil samples was determined and the median as well as the range of elements concentrations are presented in table III.4.

**Table III.4:** Median values and ranges of concentrations (mg kg<sup>-1</sup>) of trace elements in soils extracts from Tunisia.

<b>Element</b>	<b>Median value</b>	<b>Minimal – Maximal concentrations</b>
Cd	0.01	[ 0.003 - 0.02 ]
Pb	0.01	[ 0.002 - 0.14 ]
Co	0.04	[ 0.02 - 0.13 ]
Cu	0.07	[ 0.0004 - 0.64 ]
As	0.07	[ 0.01 - 0.25 ]
Cr	0.14	[ 0.03 - 0.3 ]
V	0.15	[ 0.02 - 0.59 ]
Fe	0.25	[ 0.04 - 117 ]
Ni	0.25	[ 0.08 - 0.51 ]
Rb	0.39	[ 0.17 - 0.84 ]
Zn	1.86	[ 0.3 - 27.7 ]
Mn	3.23	[ 1.23 - 9.49 ]
Ba	21.5	[ 7.6 - 91.5 ]
Sr	25.6	[ 11.4 - 81.4 ]
Mg	191	[104 -772 ]
K	194	[ 51.1 - 551 ]
Ca	4580	[ 3140- 5990 ]

In order to evaluate the possible correlations between bioavailable elements contents in soil and elements concentrations recorded in the paired olive oils, we performed a correlation test. Pearson correlation coefficient was calculated for the soil exchangeable fraction extracts and corresponding olive oil elemental composition.

The correlation coefficients were evaluated in nine Tunisian sampling locations (T3A, T4A, T4A', T5A, T8A, T9A, T11A, T11A' and T17A) presenting different soils characteristics. The obtained results are presented in Table III.5 and highlight that, despite of the limited number of samples, only four elements (Mn, Ni, Mg and Sr) out of seventeen presented a statistically significant correlation between soil extracts and olive oil elemental content ( $p < 0.05$ ).

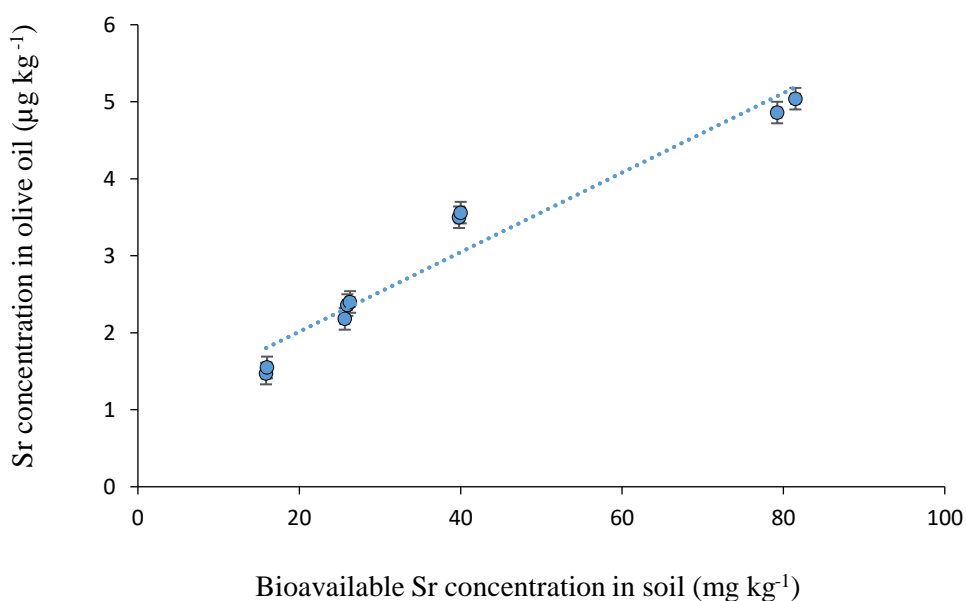

**Figure III.1:** Linear correlation between Sr content in olive oil and in bioavailable Sr of soil extracts.

Both Mg and Sr correlation coefficients, respectively equal to 0.78 and 0.85, indicate a high positive relationship between their concentration in soil and in olive oil. Figure III.1 displayed the strong correlation between the bioavailable Sr content in the soils and its concentration in olive oils. The correlation coefficient for Mn ( $r = 0.63$ ) indicates a positive correlation. It has been shown that a significant amount of Mn assimilated by the olive tree is retained in the olive leaves (Nedjimi, 2020) which could explain the moderate correlation since olive oil is obtained from the olive fruit. The Ni correlation coefficient ( $r = -0.8$ )

demonstrated a high negative correlation. This indicates that the higher the concentration of Ni in the soil, the less Ni is found in the olive oil. This might be related to the accumulation of Ni in different organs of the plant (Al-Habahbeh et al., 2021).

**Table III.5:** Pearson correlation coefficients and significance between soil and pared olive oil elemental content.

<b>Element</b>	<b>Pearson correlation coefficient (r)</b>	<b>Significance (p-value)</b>
<b>Sr</b>	0.85	0.006
<b>Ni</b>	-0.8	0.04
<b>Mg</b>	0.78	0.02
<b>Mn</b>	0.63	0.01
<b>As</b>	-0.12	0.76
<b>Ba</b>	-0.13	0.75
<b>Ca</b>	-0.08	0.85
<b>Cd</b>	ns	ns
<b>Co</b>	-0.42	0.29
<b>Cr</b>	0.03	0.93
<b>Cu</b>	-0.25	0.54
<b>Fe</b>	0.02	0.94
<b>K</b>	-0.32	0.44
<b>Pb</b>	0.08	0.84
<b>Rb</b>	0.57	0.13
<b>V</b>	-0.56	0.14
<b>Zn</b>	-0.42	0.29

Elements such As, Ba, Ca, Cd, Co, Cr, Cu, Fe, K, V, Zn and Pb and Rb are first derived from geogenic sources but most of them can also be originating from various anthropogenic activities either via the agricultural practices or during the olive oil extraction process including storage. Their concentrations did not show any significant correlation between the soils and the resulting produced olive oils ( $p > 0.05$ ).

The accumulation of Fe in the olive tree merits a special mention. In this study, we observed significantly high Fe contents in olive oils extracted in the OTIT applying the Abencor extraction method comparing to those produced in an oil mill.

These findings would suggest that the production process of olive oil could be a source of iron contamination. During the Abencor extraction, olive oil is in direct contact with metal surfaces made of stainless steel. Iron is a main constituent of stainless steel and thus it could be transferred to olive oil during the extraction process. This is also the case of chromium contents which would also indicate a direct contamination during the olive oil extraction.

In general, elements contents in the soils and their assimilation by plants can be subjected to fluctuations according the agro-climatic conditions (Gouvinhas et al., 2016). Under specific environmental conditions, the uptake and accumulation of elements from soil is affected. As a response for water stress, plants accumulate some elements in the roots that will be translocated later to satisfy their needs (Ben Mansour-Gueddes et al., 2018, 2021). Furthermore, the genetic determinism has been demonstrated to affect the elements accumulation by the olive tree. Beltrán et al. (2015) demonstrated that there are differences in some elements concentrations (Ba, Cu, Rb and Zn) between different olive cultivars (Beltrán et al., 2015). Also, competitiveness between chemically similar elements during plant water uptake can result in different levels of accumulation. For example, concentrations of Rb and K that exhibited a non-significant correlation between soil and olive oil are in competition for entry into the plant cell due to their chemical similarity (Nedjimi, 2020). When the correlation is not significant between the olive oil and soil composition, this cannot exclude the hypothesis that the correlation could be significant between the soil and other organs of the olive tree. It has been previously demonstrated that the translocation and distribution of assimilated elements in the olive tree is not homogenous and elements would be accumulated in different parts of the plant (leaves, roots and stem bark), in some cases more than in the fruit (Al-Habahbeh et al., 2021). Therefore, elements distribution in olive oils is not only related to the sources of trace elements in the plant, whether natural or anthropogenic, but also determined by intrinsic properties of the plant. Some elements such Mg, Mn, Ni and Sr have preserved the elemental signature of the soil and therefore they are reliable for geographical traceability. Other elements that did not exhibit a significant correlation can be also used for discrimination of geographical locations with different environmental conditions.

### 4.3. Geographical classification of olive oils

The multi-elemental profile of the olive oils analyzed showed a slight but noticeable variability between the samples from different origin not allowing a direct geographical discrimination based on their concentrations. In order to reduce such a large dataset without drastic loss of the information, the principal component analysis (PCA) was applied. A series of PCA were performed with different elements combinations. The elements at closely similar concentrations in all the olive oils did not contribute to the classification of the samples with respect to their geographical provenance. The most discriminating elements with notable loading factors that allowed a best separation of the samples were used as variables. The average concentrations of 7 elements (Mn, Fe, V, Cr, Sr, Zn and Cu) were used as variables to perform principal component analysis (PCA). Among these elements, we have demonstrated that only Mn and Sr contents in olive oil were correlated to that of soil. The first three PCs were extracted and explained together 71.58% of the variance. The first principal component (PC1) explained 34.6% of the variance and the second principal component (PC2) retained 21.1% of the total data variance.

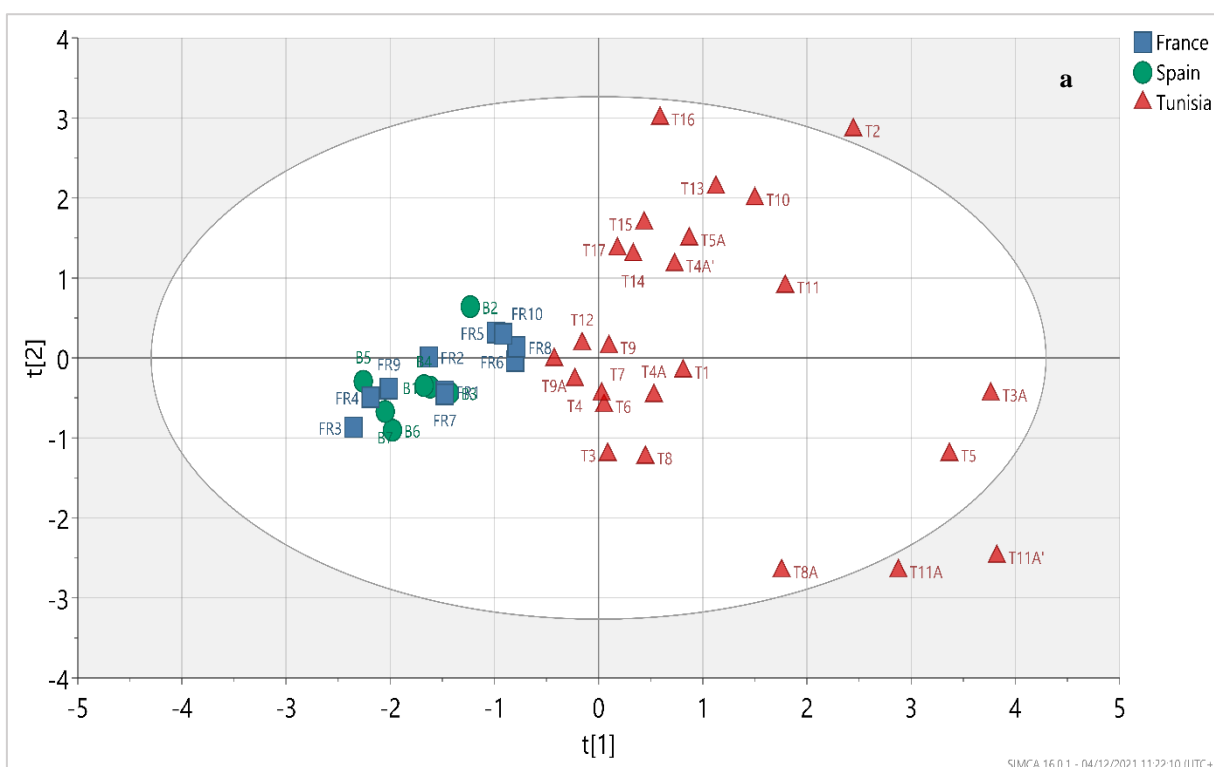

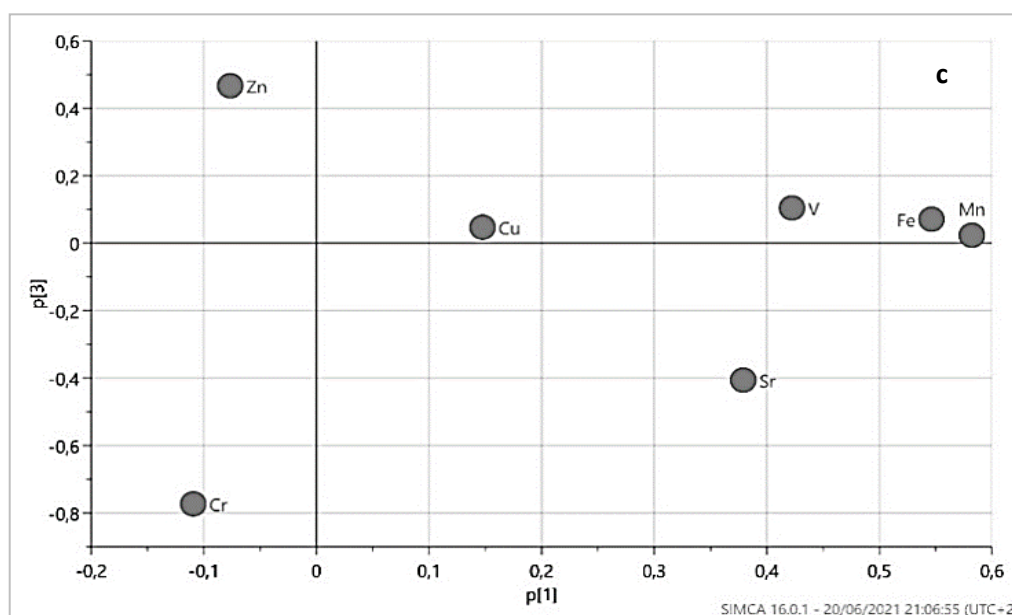
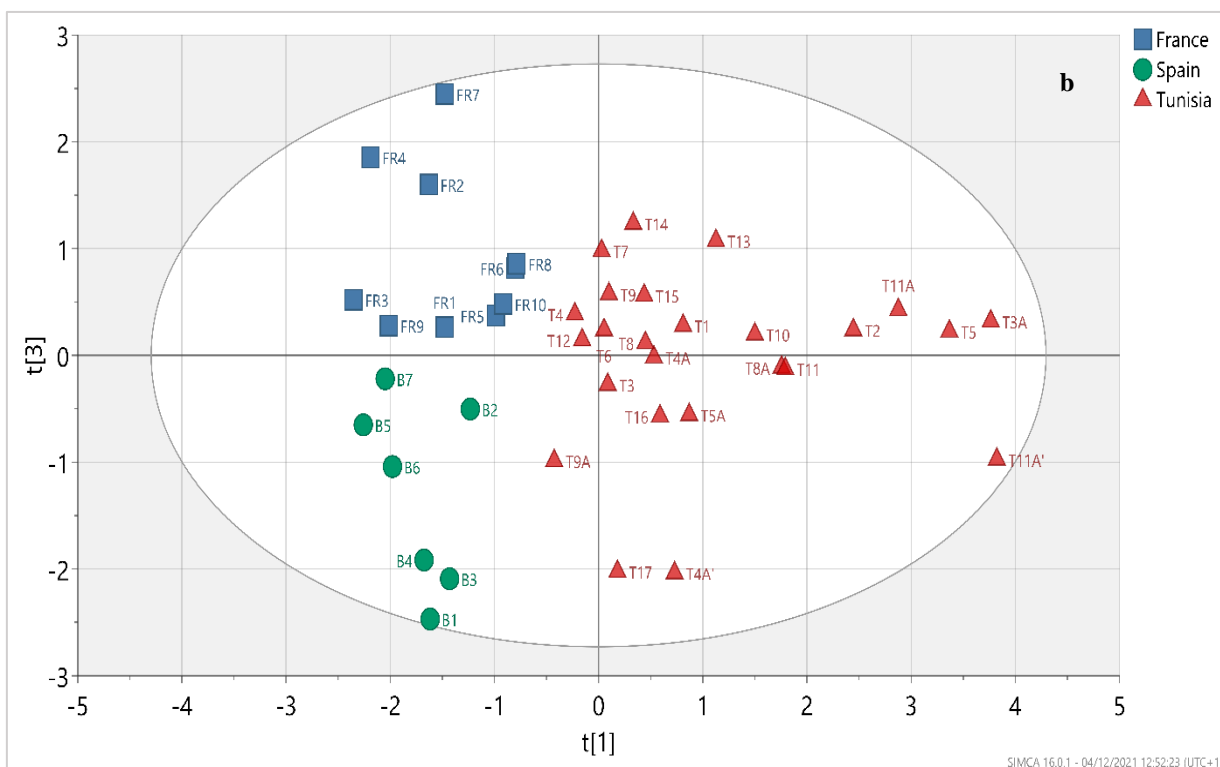

**Figure III.2:** PCA score plot colored according to geographical origin (Tunisia, Spanish Basque country and southern France): (a) PC1 vs PC2 (b) PC1 vs PC3 (c) loadings plot for PC1 and PC3.

The score plot PC1 vs PC2 (Figure III.2.a) allowed to establish a separation between two groups of samples: Tunisian and European olive oils according to PC1. Even if Tunisian oils were produced two ways, the score plot didn't show a separation according to the extraction

process. Some outliers were observed for the Tunisian samples. T2, T3A, T5, T8A, T11A and T11A' have higher scores on PC1 comparing to the cluster of samples from Tunisia. These samples are characterized by high concentrations of Fe comparing to the median value, ranging between  $4090 \pm 21 \mu\text{g kg}^{-1}$  and  $8310 \pm 76 \mu\text{g kg}^{-1}$  and most of them were produced in OTIT (Abencor extraction). PC2 did not allow any separation between samples. The score plot PC1 vs PC3 presented in Figure III.2.b was then performed and showed a clear clustering of olive oil samples according to their origin (Tunisia, Spain and France). There is a clear separation between samples with a high predictive accuracy ( $R^2X(\text{cum}) = 0.69$ ). The third principal component was effective for the separation of French and Spanish samples with 15.9% of the variation. Therefore, the PCA, which is an unsupervised method, allowed to separate olive oil samples from different geographical origin based on trace elements.

The loadings plot shown in figure III.2.c can be used to identify the elements contribution to the samples classification as well as the correlations between variables. Fe and Mn are likely to be correlated. Indeed, both elements have a similar geochemical behavior (Pohl, 2011). They present the highest loadings on PC1 (between 0.5 and 0.6). Therefore, they strongly influence the first component that separates Tunisian and European olive oils. Concentrations of Fe and Mn exhibited the highest values in olive oil samples from Tunisia (Table III.3). While concentrations of Mn in olive oil has been found to be correlated to that of soil, Fe did not show a significant correlation. Therefore, the separation between samples from Tunisia and from Europe is not only related to the soil composition. The most likely, olive oil extraction process has an important role in olive oils discrimination since Fe is highly loaded on PC1.

Slightly lower loading value was obtained for V on PC1, which was equal to 0.42. Vanadium content in olive oil was not correlated with soil thus external sources of V pollution may be responsible for the significant differences in V content. The highest values were observed in Tunisian olive oils (Table III.3).

Strontium exhibits similar absolute loading values on PC1 and PC3. Therefore, it enables to separate all the samples according to their geographical provenance.

Copper moderately influences PC1 (0.15) and poorly influences PC3 ( $\approx 0$ ). Further, the Zn loading on PC1 ( $< -0.1$ ) indicates that Zn weakly influences PC1 but it has a greater influence on PC3 with a large positive loading (0.47). Concentrations of Zn and Cu are not correlated with soil composition.



Chromium is highly loaded in PC3. Therefore, chromium content exhibits an important statistical weight for the discrimination of French and Spanish olive oils. As reported in table III.3, concentrations of Cr were higher in olive oils from France. This high discriminatory value could be related at first to the geogenic signatures of the respective areas or/and associated with the signature of the packaging and the olive oil extraction process.

Based on this exploratory chemometric analysis, it has been shown that trace elements content can be used for the geographical discrimination of olive oil. This separation is based on elements that are mainly related to the soil geochemical background and also on elements originating from anthropogenic activities and production process.

## 5. Conclusion

The presented work is one of the large-scale studies performed on Tunisian olive oils in terms of representing the production regions. The quality and the protection of olive oil sector are among the main economic priorities in Tunisia.

The findings of this study suggest that the multi-elemental composition of olive oil can be successfully used for the geographical discrimination issue. The accurate determination of 16 elements concentrations was performed with high precision in Tunisian, Spanish and French olive oils using the quadrupole ICP-MS after microwave assisted digestion. Under the optimal conditions of mineralization and analysis, relatively low values of LOD, LOQ were obtained. The RSD values obtained indicates a good precision. The SRM NIST 2387 peanut butter was used for quality control of the applied analytical procedure, analysis of the certified and non-certified elements was performed.

The trace elements levels showed a wide range of concentrations and were in agreement with the previously reported results. Among the analyzed elements, four out of seventeen elements (Mn, Sr, Mg and Ni) were found to be strongly correlated to the bioavailable soil composition. This states the transferring of the geochemical signature of the soil to the olives and then to oils. On another side, the failure to identify clear correlations for the remaining thirteen elements undoubtedly indicates that the elemental composition of olive oil could be affected either by plant elements uptake and accumulation depending on agro-climatic conditions and genetic determinism or through the production process and storage conditions. The PCA classification of olive oils according to their origins using 7 elemental concentrations (Cu, Cr, Fe, Mn, Sr, V and Zn) allowed successful discrimination with high predictive accuracy not only between European and non-European origins but also between Tunisian, French and Spanish origins. The attribution of olive oils to their origin was not hindered by the type of the production: whether manually extracted in a laboratory or pressed on a mill, the origin proved to have a more significant effect on the variation of multi-element concentrations in olive oils.

The results obtained in this study are promising and suggest a rapid and reliable method for the geographical discrimination of olive oil based on trace elements content. However, this discriminative approach is strongly linked to the composition of the soil, which can be altered by external sources of contamination and lead to false statements. In future work, isotopic compositions of several elements (O, C, N, and Sr) will be investigated and applied with the aim of enhancing the provenance discriminating ability.

## References

- Aceto, M.; Calà, E.; Musso, D.; Regalli, N.; Oddone, M. A preliminary study on the authentication and traceability of extra virgin olive oil made from Taggiasca olives by means of trace and ultra-trace elements distribution. *Food Chem.* **2019**, 298, 125047, <https://doi.org/10.1016/j.foodchem.2019.125047>.
- Al-Habahbeh, K.A.; Al-Nawaiseh, M.B.; Al-Sayaydeh, R.S.; Al-Hawadi, J.S.; Albdaiwi, R.N.; Al-Debei, H.S.; Ayad, J.Y. Long-term irrigation with treated municipal wastewater from the wadi-musa region: Soil heavy metal accumulation, uptake and partitioning in olive trees. *Horticulture* **2021**, 7, 152, <https://doi.org/10.3390/horticulturae7060152>.
- Angioni, A.; Cabitza, M.; Teresa, M.; Caboni, P. Influence of olive cultivars and period of harvest on the contents of Cu, Cd, Pb, and Zn in virgin olive oils. *Food Chem.* **2006**, 99, 525–529, <https://doi.org/10.1016/j.foodchem.2005.08.016>.
- Astolfi, M.L.; Marconi, E.; Vitiello, G.; Massimi, L. An optimized method for sample preparation and elemental analysis of extra-virgin olive oil by inductively coupled plasma mass spectrometry. *Food Chem.* **2021**, 360, 130027, <https://doi.org/10.1016/j.foodchem.2021.130027>.
- Bakircioglu, D.; Kurtulus, Y.B.; Yurtsever, S. Comparison of extraction induced by emulsion breaking, ultrasonic extraction and wet digestion procedures for determination of metals in edible oil samples in Turkey using ICP-OES. *Food Chem.* **2013**, 138, 770–775, <https://doi.org/10.1016/j.foodchem.2012.10.089>.
- Beltrán, M.; Sánchez-Astudillo, M.; Aparicio, R.; García-González, D.L. Geographical traceability of virgin olive oils from south-western Spain by their multi-elemental composition. *Food Chem.* **2015**, 169, 350–357, <https://doi.org/10.1016/j.foodchem.2014.07.104>.
- Ben Mansour-Gueddes, S.; Saidana, D.; Cheraief, I.; Dkhilali, M.; Braham, M. Biochemical, mineral and anatomical characteristics of the olive tree cv. Chetoui growing in several Tunisian areas. *Acta Sci. Pol. Hortorum Cultus* **2018**, 17, 49–70, <https://doi.org/10.24326/asphc.2018.2.5>.
- Ben Mansour-Gueddes, S.; Saidana-Naija, D.; Flamini, G.; Cheraief, I.; Braham, M. Assessment of the Climatic Condition's Impact on Volatiles, Polyphenols and Mineral Contents in Tunisian Olive Tree (*Olea europaea* L.). *Pol. J. Environ. Stud.* **2021**, 31, 219–230, <https://doi.org/10.15244/pjoes/133232>.
- Benincasa, C.; Gharsallaoui, M.; Perri, E.; Briccoli Bati, C.; Ayadi, M.; Khlif, M.; Gabsi, S. Quality and Trace Element Profile of Tunisian Olive Oils Obtained from Plants Irrigated with Treated Wastewater. *Sci. World J.* **2012**, 535781, <https://doi.org/10.1100/2012/535781>.
- Benincasa, C.; Lewis, J.; Perri, E.; Sindona, G.; Tagarelli, A. Determination of trace element in Italian virgin olive oils and their characterization according to geographical origin by statistical analysis. *Anal. Chim. Acta* **2007**, 585, 366–370, <https://doi.org/10.1016/j.aca.2006.12.040>.

Brkljača, M.; Giljanović, J.; Prkić, A. Determination of Metals in Olive Oil by Electrothermal Atomic Absorption Spectrometry: Validation and Uncertainty Measurements. *Anal. Lett.* **2013**, *46*, 2912–2926, <https://doi.org/10.1080/00032719.2013.814056>.

Cabrera-Vique, C.; Bouzas, P.R.; Oliveras-López, M.J. Determination of trace elements in extra virgin olive oils: A pilot study on the geographical characterisation. *Food Chem.* **2012**, *134*, 434–439, <https://doi.org/10.1016/j.foodchem.2012.02.088>.

Camin, F.; Larcher, R.; Nicolini, G.; Bontempo, L.; Bertoldi, D.; Perini, M.; Schlicht, C.; Schellenberg, A.; Thomas, F.; Heinrich, K.; et al. Isotopic and Elemental Data for Tracing the Origin of European Olive oils. *J. Agric. Food Chem.* **2010**, *58*, 570–577, <https://doi.org/10.1021/jf902814s>.

Camin, F.; Larcher, R.; Perini, M.; Bontempo, L.; Bertoldi, D.; Gagliano, G.; Nicolini, G.; Versini, G. Characterisation of authentic Italian extra-virgin olive oils by stable isotope ratios of C, O and H and mineral composition. *Food Chem.* **2010**, *118*, 901–909, <https://doi.org/10.1016/j.foodchem.2008.04.059>.

Carini, F.; Bengtsson, G. Post-deposition transport of radionuclides in fruit. *J. Environ. Radioact.* **2001**, *52*, 215–236.

Chen, L.; Liu, J.-R.; Hu, W.-F; Gao, J.; Yang, J.-Y. Vanadium in soil-plant system: Source, fate, toxicity, and bioremediation. *J. Hazard. Mater.* **2021**, *405*, 124200, <https://doi.org/10.1016/j.jhazmat.2020.124200>.

Damak, F.; Asano, M.; Baba, K.; Suda, A.; Araoka, D.; Wali, A.; Isoda, H.; Nakajima, M.; Ksibi, M.; Tamura, K. Interregional traceability of Tunisian olive oils to the provenance soil by multi-elemental fingerprinting and chemometrics *Food Chem.* **2019**, *283*, 656–654, <https://doi.org/10.1016/j.foodchem.2019.01.082>.

de Leonardis, A.; Macciola, V.; de Felice, M. Copper and iron determination in edible vegetable oils by graphite furnace atomic absorption spectrometry after extraction with diluted nitric acid. *Int. J. Food Sci. Technol.* **2000**, *35*, 371–375.

Elloumi, N.; Abdallah, F.B.; Mezghani, I.; Boukhris, M. Accumulation du plomb par quelques espèces végétales cultivées au voisinage d'une fonderie de plomb à Sfax Lead accumulation by some plant species cultivated in the vicinity of a lead factory in Sfax. *Pollut. Atmos.* **2003**, *178*, 285–294.

Erol, B.; Arslan, G.; Gode, F.; Altun, T.; Özcan, M.M. Determination of some inorganic metals in edible vegetable oils by inductively coupled plasma atomic emission spectroscopy (ICP-AES). *Grasas Aceites* **2008**, *59*, 239–244.

Farrell, M.; Ertan, L. Investigation of trace metals in different varieties of olive oils from Northern Cyprus and their variation in accumulation using ICP-MS and multivariate techniques. *Environ. Earth Sci.* **2019**, 78, 578, <https://doi.org/10.1007/s12665-019-8581-9>.

Gad, S.C. Barium. In *Encyclopedia of Toxicology*, 3rd ed.; Elsevier: Amsterdam, The Netherlands, **2014**; Volume 1, pp. 368–370. <https://doi.org/10.1016/B978-0-12-386454-3.00819-8>.

Giaccio, M.; Vicentini, A. Determination of the geographical origin of wines by means of the mineral content and the stable isotope ratios: A review. *J. Commod. Sci. Technol. Qual.* **2008**, 47, 267–284.

Gouvinhas, I.; Domínguez, R.; Nelson, P.; Teresa, M.; Matos, C.; Barros, A.I.R.N.A. Effect of Agro-Environmental Factors on the Mineral Content of Olive Oils: Categorization of the Three Major Portuguese Cultivars. *J. Am. Oil Chem. Soc.* **2016**, 93, 813–822, <https://doi.org/10.1007/s11746-016-2827-4>.

Guagliardi, I.; Cicchella, D.; de Rosa, R.; Ricca, N.; Buttafuoco, G. Geochemical sources of vanadium in soils: Evidences in a Southern Italy area. *J. Geochem. Explor.* **2018**, 184, 358–364, <https://doi.org/10.1016/j.gexplo.2016.11.017>.

Gumus, Z.P.; Celenk, V.U.; Tekin, S.; Yurdakul, O.; Ertas, H. Determination of trace elements and stable carbon isotope ratios in virgin olive oils from Western Turkey to authenticate geographical origin with a chemometric approach. *Eur. Food Res. Technol.* **2017**, 243, 1719–1727, <https://doi.org/10.1007/s00217-017-2876-4>.

Iyaka, Y.A. Nickel in soils: A review of its distribution and impacts. *Sci. Res. Essays* **2011**, 6, 6774–6777, <https://doi.org/10.5897/SREX11.035>.

Jimenez, M.S.; Velarte, R.; Castillo, J.R. On-line emulsions of olive oil samples and ICP-MS multi-elemental determination. *J. Anal. At. Spectrom.* **2003**, 18, 1154–1162, <https://doi.org/10.1039/b303131d>.

Kara, D.; Fisher, A.; Hill, S. Detergentless ultrasound-assisted extraction of trace elements from edible oils using lipase as an extractant. *Talanta* **2015**, 144, 219–225, <https://doi.org/10.1016/j.talanta.2015.05.056>.

Kara, D.; Fisher, A.; Hill, S. Extraction of trace elements by ultrasound-assisted emulsification from edible oils producing detergentless microemulsions. *Food Chem.* **2015**, 188, 143–148, <https://doi.org/10.1016/j.foodchem.2015.04.057>.

Kara, D.; Fisher, A.; Hill, S. Extraction of trace elements by ultrasound-assisted emulsification from edible oils producing detergentless microemulsions. *Food Chem.* **2015**, 188, 143–148, <https://doi.org/10.1016/j.foodchem.2015.04.057>.

Karabagias, I.; Michos, C.; Badeka, A.; Kontakos, S.; Stratis, I.; Kontominas, M.G. Classification of Western Greek virgin olive oils according to geographical origin based on chromatographic, spectroscopic, conventional and chemometric analyses. *Food Res. Int.* **2013**, *54*, 1950–1958, <https://doi.org/10.1016/j.foodres.2013.09.023>.

Kruszewski, B.; Obiedziński, M.W. Multivariate analysis of essential elements in raw cocoa and processed chocolate mass materials from three different manufacturers. *LWT* **2018**, *98*, 113–123, <https://doi.org/10.1016/j.lwt.2018.08.030>.

Lendinez, E.; Lorenzo, M.L.; Cabrera, C.; López, M.C. Chromium in basic foods of the Spanish diet: Seafood, cereals, vegetables, olive oils and dairy products. *Sci. Total Environ.* **2001**, *278*, 183–189, [https://doi.org/10.1016/S0048-9697\(01\)00647-7](https://doi.org/10.1016/S0048-9697(01)00647-7).

Lepri, F.G.; Chaves, E.S.; Vieira, M.A. Determination of Trace Elements in Vegetable Oils and Biodiesel by Atomic Spectrometric Techniques—A Review. *Appl. Spectrosc. Rev.* **2011**, *46*, 37–41, <https://doi.org/10.1080/05704928.2010.529628>.

Llorent-Martínez, E.J.; Fernández-De Córdoba, M.L.; Ortega-Barrales, P.; Ruiz-Medina, A. Quantitation of metals during the extraction of virgin olive oil from olives using ICP-MS after microwave-assisted acid digestion. *JAOCS J. Am. Oil Chem. Soc.* **2014**, *91*, 1823–1830, <https://doi.org/10.1007/s11746-014-2511-5>.

Llorent-Martínez, E.J.; Ortega-Barrales, P.; Fernández-De Córdoba, M.L.; Domínguez-Vidal, A.; Ruiz-Medina, A. Investigation by ICP-MS of trace element levels in vegetable edible oils produced in Spain. *Food Chem.* **2011**, *127*, 1257–1262, <https://doi.org/10.1016/j.foodchem.2011.01.064>.

Llorent-Martínez, E.J.; Ortega-Barrales, P.; Fernández-de Córdoba, M.L.; Ruiz-Medina, A. Analysis of the legislated metals in different categories of olive and olive-pomace oils. *Food Control* **2011**, *22*, 221–225, <https://doi.org/10.1016/j.foodcont.2010.07.002>.

Madejón, P.; Marañón, T.; Murillo, J.M. Biomonitoring of trace elements in the leaves and fruits of wild olive and holm oak trees. *Sci. Total Environ.* **2006**, *355*, 187–203, <https://doi.org/10.1016/j.scitotenv.2005.02.028>.

Manjusha, R.; Shekhar, R.; Kumar, S.J. Ultrasound-assisted extraction of Pb, Cd, Cr, Mn, Fe, Cu, Zn from edible oils with tetramethylammonium hydroxide and EDTA followed by determination using graphite furnace atomic absorption spectrometer. *Food Chem.* **2019**, *294*, 384–389, <https://doi.org/10.1016/j.foodchem.2019.04.104>.

Mendil, D.; Dogan, Ö.; Tüzen, M.; Soylak, M. Investigation of the levels of some element in edible oil samples produced in Turkey by atomic absorption spectrometry. *J. Hazard. Mater.* **2009**, *165*, 724–728, <https://doi.org/10.1016/j.jhazmat.2008.10.046>.

Mirón, C.; Sánchez, R.; Prats, S.; Todolí, J. Total polyphenol content and metals determination in Spanish virgin olive oils by means of a dispersive liquid-liquid aerosol phase extraction method and ICP-MS. *Anal. Chim. Acta* **2019**, 1094, 34–46, <https://doi.org/10.1016/j.aca.2019.10.009>.

Mohebbi, M.; Heydari, R.; Ramezani, M. Determination of Cu, Cd, Ni, Pb and Zn in Edible Oils Using Reversed-Phase Ultrasonic Assisted Liquid–Liquid Microextraction and Flame Atomic Absorption Spectrometry 1. *J. Anal. Chem.* **2018**, 73, 30–35, <https://doi.org/10.1134/S1061934818010069>.

Nedjimi, B. Measurement of selected trace elements in *Olea europaea* L. cv. ‘Sigoise’. *J. Trace Elem. Med. Biol.* **2020**, 62, 126595, <https://doi.org/10.1016/j.jtemb.2020.126595>.

Pohl, W.L. Economic Geology of Metals. In *Economic Geology Principles and Practice: Metals, Minerals, Coal and Hydrocarbons – Introduction to Formation and Sustainable Exploitation of Mineral Deposits*; Wiley: Hoboken, NJ, USA, **2011**; pp. 149–284. <https://doi.org/10.1002/9781444394870.ch2>.

Pošćić, F.; Furdek, M.; Bačić, N.; Mikac, N.; Bertoldi, D.; Camin, F.; Jukić, M.; Žanetić, M.; Rengel, Z.; Perica, S. Removal of pomace residues is critical in quantification of element concentrations in extra virgin olive oil. *J. Food Compos. Anal.* **2019**, 77, 39–46, <https://doi.org/10.1016/j.jfca.2019.01.002>.

Rauret, G.; Lopez-Sanchez, J.F.; Sahuquillo, A.; Barahona, E.; Lachica, M.; Ure, A.M.; Davidson, C.M.; Gomez, A.; Luck, D.; Bacon, J.; et al. Application of a modified BCR sequential extraction (three-step) procedure for the determination of extractable trace metal contents in a sewage sludge amended soil reference material (CRM 483), complemented by a three-year stability study of acetic acid. *J. Environ. Monit.* **2000**, 2, 228–233, <https://doi.org/10.1039/b001496f>.

Rauret, G.; López-Sánchez, J.F.; Sahuquillo, A.; Rubio, R.; Davidson, C.; Ure, A.; Quevauviller, P. Improvement of the BCR three step sequential extraction procedure prior to the certification of new sediment and soil reference materials. *J. Environ. Monit.* **1999**, 1, 57–61, <https://doi.org/10.1039/a807854h>.

Sahuquillo, A.; López-Sánchez, J.F.; Rubio, R.; Rauret, G.; Thomas, R.P.; Davidson, C.M.; Ure, A.M. Use of a certified reference material for extractable trace metals to assess sources of uncertainty in the BCR three-stage sequential extraction procedure. *Anal. Chim. Acta* **1999**, 382, 317–327, [https://doi.org/10.1016/S0003-2670\(98\)00754-5](https://doi.org/10.1016/S0003-2670(98)00754-5).

Sakač, M.B.; Jovanov, P.T.; Marić, A.Z.; Pezo, L.L.; Kevrešan, Ž.S.; Novaković, A.R.; Nedeljković, N.M. Physicochemical properties and mineral content of honey samples from Vojvodina (Republic of Serbia). *Food Chem.* **2019**, 276, 15–21, <https://doi.org/10.1016/j.foodchem.2018.09.149>.

Sayago, A.; González-Domínguez, R.; Beltrán, R.; Fernández-Recamales, Á. Combination of complementary data mining methods for geographical characterization of extra virgin olive oils

based on mineral composition. *Food Chem.* **2018**, 261, 42–50, <https://doi.org/10.1016/j.foodchem.2018.04.019>.

Shahid, M.; Shamshad, S.; Rafiq, M.; Khalid, S.; Bibi, I.; Niazi, N.K.; Dumat, C.; Rashid, M.I. Chromium speciation, bioavailability, uptake, toxicity and detoxification in soil-plant system: A review. *Chemosphere* **2017**, 178, 513–533, <https://doi.org/10.1016/j.chemosphere.2017.03.074>.

Skrzydłowska, E.; Balcerzak, M.; Vanhaecke, F. Determination of chromium, cadmium and lead in food-packaging materials by axial inductively coupled plasma time-of-flight mass spectrometry. *Anal. Chim. Acta* **2003**, 479, 191–202, [https://doi.org/10.1016/S0003-2670\(02\)01527-1](https://doi.org/10.1016/S0003-2670(02)01527-1).

Ure, M.U.; Thomas, R.; Littlejohn, D. Ammonium acetate extracts and their analysis for the speciation of metal ions in soils and sediments. *Int. J. Environ. Anal. Chem.* **1993**, 51, 65–84, <https://doi.org/10.1080/03067319308027612>.

Wakefield, J.; McComb, K.; Ehtesham, E.; van Hale, R.; Barr, D.; Hoogewerff, J.; Frew, R. Chemical profiling of saffron for authentication of origin. *Food Control* **2019**, 106, 106699, <https://doi.org/10.1016/j.foodcont.2019.06.025>.

Wali, A.; Damak, F.; Kawada, K.; Isoda, H.; Tamura, K.; Ksibi, M. The effects of geographic region and cultivar on oxidative stability and elemental analysis of Tunisian extra virgin olive oil. *Eur. Food Res. Technol.* **2021**, 247, 1401–1409, <https://doi.org/10.1007/s00217-021-03717-x>.

Zeiner, M.; Juranovic-Cindric, I.; Škevin, D. Characterization of extra virgin olive oils derived from the Croatian cultivar Oblica. *Eur. J. Lipid Sci. Technol.* **2010**, 112, 1248–1252, <https://doi.org/10.1002/ejlt.201000006>.

Zeiner, M.; Steffan, I.; Cindric, I.J. Determination of trace elements in olive oil by ICP-AES and ETA-AAS: A pilot study on the geographical characterization. *Microchem. J.* **2005**, 81, 171–176, <https://doi.org/10.1016/j.microc.2004.12.002>.



# Chapter IV

## Determination of $^{87}\text{Sr}/^{86}\text{Sr}$ in olive oil through ion extraction followed by MC-ICP-MS

---

### Abstract

The aim of this study was to evaluate the analytical performances of an innovative approach for Sr extraction from olive oil matrix and isotopic analysis by MC-ICP-MS. Three olive oils marketed in France were prepared and analyzed by two methods: acid extraction prior to Sr purification by Sr-spec resin and complexation by EDTA prior to Sr purification by Dowex AG50W-X8. Both extraction procedures were optimized to achieve a maximum Sr recovery and yielded recoveries greater than 65%. The NIST SRM 987 was used for the quality control of the Sr/ matrix separation and the instrumental measurement. The NIST SRM 2387 peanut butter was used for the quality control of the results and showed identical Sr isotope ratios after applying both extraction methods and microwave assisted digestion, used as a reference method. Subsequently, the developed method was applied for the determination of  $^{87}\text{Sr}/^{86}\text{Sr}$  isotope ratio of 38 olive oils from Tunisia, Spain and France and the results obtained ranged between  $0.70807 \pm 0.00003$  and  $0.70894 \pm 0.00004$ . Precision was evaluated as twice the standard deviation on basis of samples triplicates and did not exceed 110 ppm. Results obtained confirmed that the innovative approach based on the use of Dowex AG50W-X8 resin can be successfully applied as a simpler and cost-effective alternative for an accurate and sensitive Sr isotopic analysis of olive oil. The feasibility of the developed method for the detection of olive oil mixtures was demonstrated.

## Introduction

A large array of analytical methods was developed for the geographical authentication of olive oil. Nevertheless, they all present is a lack of a particularly selective criterion that would unequivocally associate oil with the provenance where olives were grown. Recently, strontium isotopic composition determined by multi-collector inductively coupled plasma mass spectrometry (MC-ICP-MS) or thermal ionization mass spectrometry (TIMS) has shown to be a good alternative and/or complementary approach for a reliable geographical authentication of various food products (Aguzzoni et al., 2020; Coelho et al., 2017; Epova et al., 2019; Liu et al., 2017). Indeed, the ratio  $^{87}\text{Sr}/^{86}\text{Sr}$  determined in plant and food derived from it reflects directly the soil of origin as it is transferred from geological bedrock to plant through soil and water retaining without isotopic fractionation (Aguzzoni et al., 2020; Bong et al., 2012; Liu et al., 2017; Marchionni et al., 2016). However, this method, well established and proved for large spectra of processed food, is still challenging to apply for olive oil (Chapter 1). First, olive oil it is a complex fatty matrix that contains Sr at critically low concentrations, generally ranging from less than  $1 \mu\text{g kg}^{-1}$  to a few tens of  $\mu\text{g kg}^{-1}$ . Therefore, the main challenging task to achieve an accurate Sr isotopic analysis is to ensure the quantitative release and pre-concentration of Sr from olive oil.

Prior to isotopic analysis, the Sr / matrix separation is required (Vanhaecke et al., 2009). The ion exchange resin commonly used for Sr purification is the Sr-selective resin from Eichrom (Sr-spec) that enables an efficient separation of the Sr over Ca and Rb. Nevertheless, the uptake of Sr decreases in the presence of traces of organic matter, even if minimal, and ends up with low amount of Sr recovered, probably insufficient for isotopic analysis. All problematics related to Sr isotopic analysis by MC-ICP-MS were widely discussed elsewhere (MF Turk et al, 2022, submitted).

To the best of our knowledge, two studies have been published so far aiming to develop a reliable method for Sr isotopic analysis of olive oil (Medini et al., 2015; MF Turk et al, 2022, submitted ). Medini et al., (2015) applied TIMS to determine the  $^{87}\text{Sr}/^{86}\text{Sr}$  ratio in seven olive oils from Nîmes (PDO) and Morocco after a long-term sample preparation that involved acid treatment followed by calcination and Sr purification using Sr-spec Eichrom resin. However, even the precision of some measurements was a bit higher than generally acceptable for this method (200 ppm), the main inconvenience of the proposed method was the long-term sample preparation, namely, calcination.

Later, the liquid-liquid extraction was proposed as an alternative approach to analyze the olive pomace instead of olive oil with low Sr concentration (MF Turk et al, 2022, submitted). This method was applied for the determination of  $^{87}\text{Sr}/^{86}\text{Sr}$  isotopic ratio in eight olive oils from Slovenia, Croatia and Tunisia and in five paired pomace samples by MC-ICP-MS with a precision of 54 ppm. The reported results confirmed that the Sr isotopic composition of olive oil was in agreement with the values obtained in the paired pomace samples. Nevertheless, sample preparation of olive oil for isotopic analysis is still a challenging issue due to potential contaminations, low extraction recovery and high sensibility of ion exchange resin to the organic matter.

The aim of the present study is to develop a sensitive and precise analytical method for determination of  $^{87}\text{Sr}/^{86}\text{Sr}$  in olive oils through quantitative extraction, efficient Sr pre-concentration and separation from the matrix, and detection by MC-ICP-MS. Two analytical approaches are compared and deeply discussed: 1) a liquid-liquid acid extraction combined with a commonly used method for Sr purification using the Sr-Spec resin; 2) an innovative approach based on complexation of Sr in oil by EDTA prior to Sr purification using a string cation exchange resin Dowex AG50W-X8. The quality control was performed at each step of the analytical procedures using the NIST SRM 2387 Peanut butter. The precision and accuracy of the isotopic measurement was assured using an isotopic reference material SRM NIST 987. The developed methods were applied on olive oil samples originating from Tunisia, France, and Spain. They allowed to investigate preliminary data in different locations.

## **1. Olive oil samples and analytical strategy**

In addition to the olive oil samples from Tunisia, Spain and France previously described in chapter II, 3 bottled olive oils were purchased from a local super market in France. They were used for the development, optimization and comparison of the analytical procedures. The samples T10 and T16 from Tunisia as well as FR8 and FR10 from France could not be analyzed due to low volume of olive oil.

The analytical strategy was described in chapter II. The samples preparation, the Sr/matrix chromatographic separation as well as the Sr isotopic measurement performed for method A and method B were fully detailed.

## 2. Optimization of the methods

### 2.1. Optimization of the Method A

Acid extraction has been recognized as a successful procedure for the release and pre-concentration of Sr prior to isotopic analysis after series of optimization (MF Turk et al, 2022, submitted). In this study, the acid mixture was prepared as reported by (MF Turk et al, 2022, submitted). However, taking into account the differences in geometry of the devices, the efficiency of agitation on shaking plate was evaluated at different times. Figure IV.1 presents the Sr extraction recoveries after agitation at 4 different times. The extraction recovery for Sr increased with 7% between 1h and 2h. Then, above 2h of agitation, there is no notable increase in the extraction efficiency. Therefore, the agitation time of 2h was selected as the optimal time. Apart from this, no any other significant optimizations for the Method A were performed.

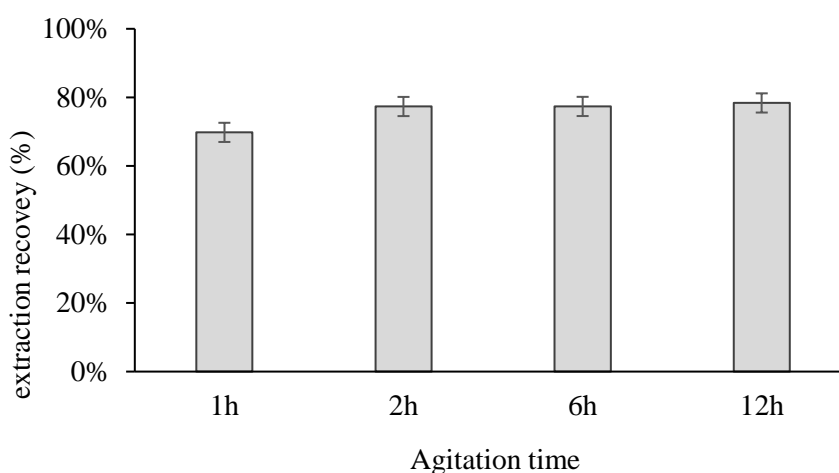

**Figure IV.1:** The Sr extraction recoveries at different agitation times

### 2.2. Optimization of the Method B

The molarity (0.062 M) as well as the pH of ((NH<sub>4</sub>)<sub>2</sub>EDTA) for loading samples into the resin chelating agent (pH 4.8) were selected as reported by (St-Amant et al., 2011) for Ra separation from milk using this resin, where Sr was eluted at one of the rinsing stages.

### 2.3.Complexation by $(\text{NH}_4)_2\text{EDTA}$

The EDTA has been used in previous studies as chelating agent of elements in olive oil samples (Chapter I). It has been shown that the pH of EDTA influenced to a large extent the extraction efficiency. The reported results showed that the extraction efficiency increased with the increase of the pH value for several elements such as Pb, Mn, Fe, Mg, Al, Ca, Ti, V, Cd, Ni, Cu and Zn (Kara et al., 2015a; Manjusha et al., 2019). At high pH conditions, EDTA is fully deprotonated ( $\text{Y}^{4-}$ ); Therefore, the metal/EDTA complexes are more stable. The extraction recovery varied also depending on the elements studied. A notable increase in the extraction efficiency at high pH values was previously observed for some elements such as Al, Ni and Pb. In contrast, the influence of the pH on the extraction rate was less important for other elements like Fe and Mn (Manjusha et al., 2019). Whereas there is no available information concerning Sr extraction efficiency with regard to the pH of EDTA.

In this study, the influence of pH of the aqueous solution of  $(\text{NH}_4)_2\text{EDTA}$  (0.062 M) on the recovery of Sr was studied on triplicates of 3 selected olive oils. The recoveries obtained are shown in Figure IV.2. The average recovery obtained at pH 4.8 was equal to 74%. It increased of 1%, 3% and 4% respectively at pH 6, pH 8 and pH10. The difference wasn't notable. For this reason, the pH 4.8 was selected as operational for complexation as an adjustment for sample loading later into the column is not required.

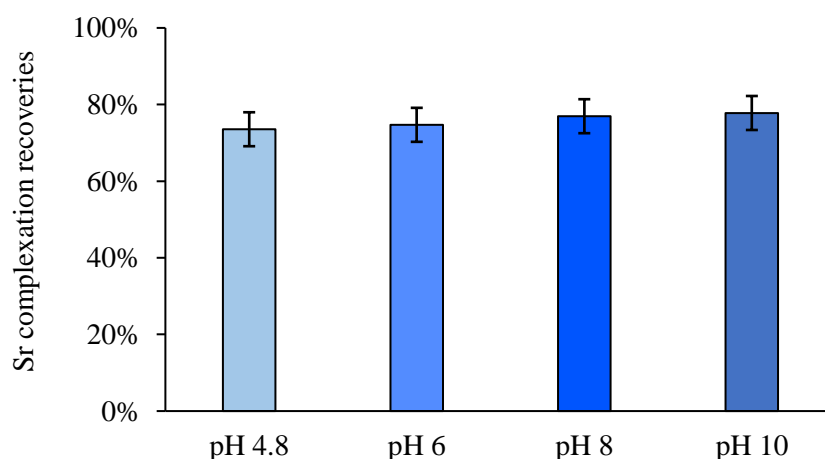

**Figure IV.2:** The Sr complexation recoveries at different pH values

The analysis of each fraction recovered from the elution steps allowed to build the elution profiles presented in figure IV.3.

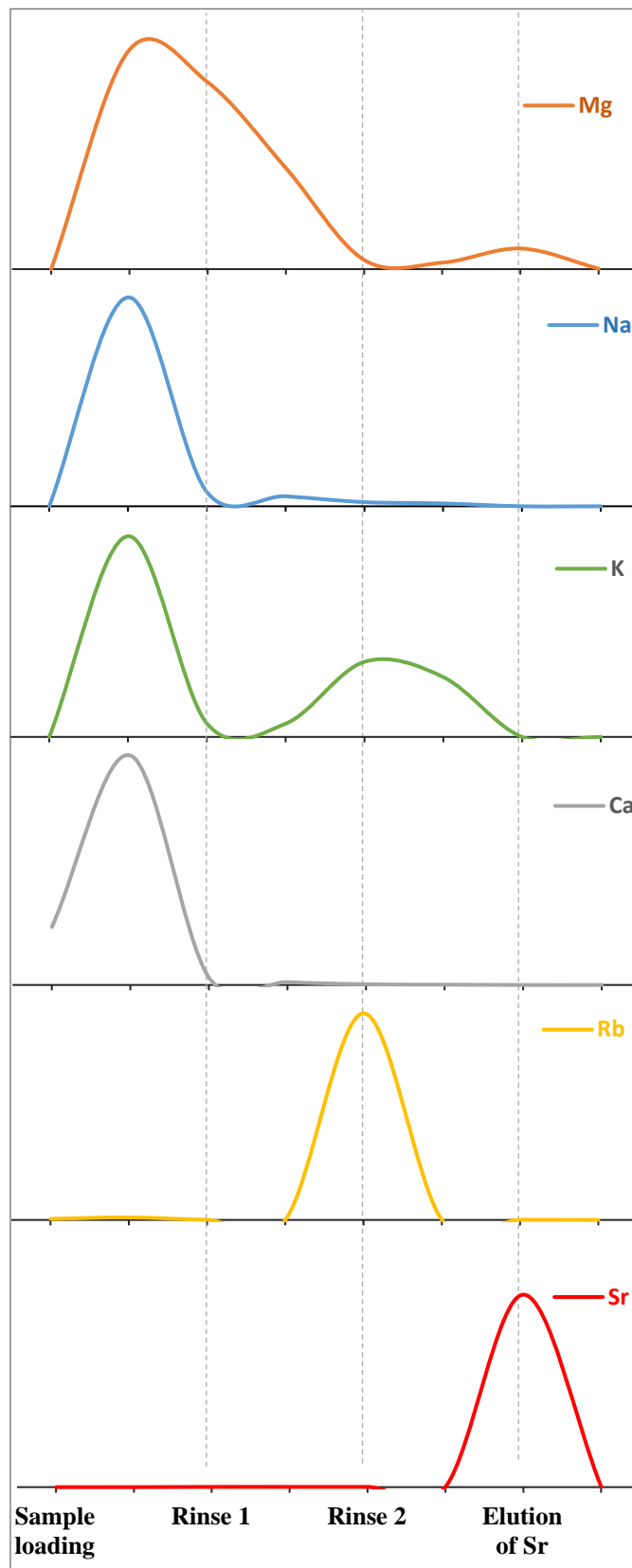

**Figure IV.3:** Elution profile of Sr and the interfering elements (Mg, Ca, K, Na, Sr and Rb)

When the samples were loaded, about 100% of Na and Ca were not retained into the column. An important fraction of Mg and K was also eluted during the sample loading. Therefore, at pH 4.8, the alkali elements were not retained.

The rinse 1 performed with CDTA/CH<sub>3</sub>COOH (0.04M/ 0.06M) allowed to elute more than 60% of the Mg. Subsequently, the rinse 2 performed with NH<sub>4</sub>Cl (0.37 M) allowed to elute about 97% of the Rb and a minor fraction of K. In the final step, the elution profile showed that 10 mL of (NH<sub>4</sub>)<sub>2</sub>EDTA (0.062 M) at pH 7 were required to ensure a quantitative recovery of Sr. The Sr fraction recovered contained only a few mg of Mg and less than 5% of Rb. The shape of the curves of Ca, Mg, and Sr are in agreement with the previously reported results by St-Amant et al. (2011) (St-Amant et al., 2011).

### **3. Validation of the methods (method A and method B)**

For the methods validation, the experiments and methodology varied according to the problematics. The main goal was to prove that proposed multi-stage sample preparation process does not lead to changes in the Sr isotopic composition. However, the practical realization was complicated due to the fact that there is no standard reference material for natural vegetable oils certified neither for Sr elemental concentration nor for Sr isotopic composition. Therefore, the validation of both methods was performed in three steps:

- i) first, the absence of meaningful isotopic fractionation during column separation using the ion exchange resins Sr-Spec and AG50W-X8 was controlled by use of the NIST SRM 987;
- ii) next, the absence of meaningful variation of the isotopic composition during the whole procedure of both methods A (extraction + Sr Spec) and B (complexation + AG50W-X8) was controlled by use of the NIST SRM 2387 peanut butter;
- iii) finally, a comparison between the analytical performance of both methods was achieved by use of three selected olive oils (S1, S2 and S3).

#### **3.1.Validation by NIST 987**

The absence of meaningful isotopic fractionation during column separation was assessed with a prepared aqueous solution containing Sr with certified isotopic composition (NIST SRM 987).

The solutions were prepared in triplicates et were loaded in the different columns with respect to the corresponding separation protocols. The elution fractions were collected and analyzed by MC-ICP-MS.

The  $^{87}\text{Sr}/^{86}\text{Sr}$  isotopic ratios measured were equal to 0.710251 (n=3; 2RSD - 37 ppm) and 0.710274 (n=3, 2RSD - 30 ppm) for the resins Sr-Spec and AG50W-X8 respectively. The results were agreement within twice the standard deviation with a recommended value of  $0.710255 \pm 0.000023$ . (Waight et al, 2002) (Figure IV.4.a).

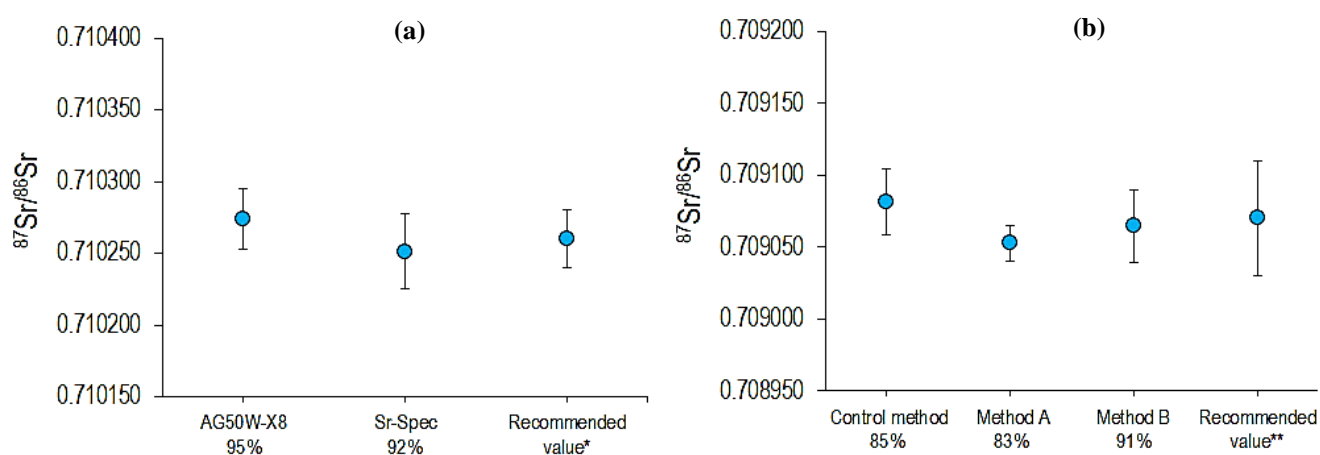

**Figure IV.4:** Validation of the methods of a) Sr/matrix separation using resins: AG50W-X8 and Sr-Spec and the NIST SRM 987; and b) the whole analytical procedures: method A and method B using the NIST SRM 2387

The control method is MW-AD / Sr-Spec, the method A (acid extraction / Sr-Spec), the method B (complexation / AG50W-X8)

Recovery rates (%) of Sr elemental concentrations are presenting with the corresponding resin or method. Values of  $^{87}\text{Sr}/^{86}\text{Sr}$  are recommended according to: \* - Waight et al, 2002, \*\* - MF Turk et al, 2022, submitted



### 3.2. Validation by NIST 2387

The NIST SRM 2387 is a peanut butter certified for several elements, but not for Sr. Recently, the Sr elemental and isotopic composition was reported based on an interlaboratory comparison:  $2.6 \text{ mg kg}^{-1}$  and  $0.70907 \pm 0.00004$  (2SD), respectively (Nasr et al., 2022) (MF Turk et al., 2022, submitted). Such relatively high concentrations of Sr in this lipid matrix allowed to determine the ratio  $^{87}\text{Sr}/^{86}\text{Sr}$  for a low sample amount of 0.3 g after microwave mineralization and Sr purification on Sr-Spec resin. Although this material does not reflect entirely the olive oil matrix in terms of the organic composition and Sr concentration (about 1000 times higher), it is still the most consistent SRM compared to the available materials. The value of  $^{87}\text{Sr}/^{86}\text{Sr}$  in NIST SRM 2387 reported by (matrina) was considered as ‘reference’ in this paper because: (i) Microwave assisted digestion is one of the most efficient techniques used for the mineralization of samples before isotopic analysis (Vanhaecke et al., 2009); (ii) Sr-Spec resin is a proved and a well-established method for Sr purification prior isotopic analysis (Coelho et al., 2017); (iii) isotopic results were confirmed by a series of 14 individual measurements in two independent laboratories. For all these reasons, the NIST SRM 2387 was selected to control the potential Sr isotopic fractionation during the extraction procedures.

*Control method:* Three aliquots of 0.3 g of NIST SRM 2387 were mineralized in a microwave oven as described by (Nasr et al., (2022)). The mineralized solutions were subjected to Sr/matrix separation using the Sr-Spec resin.

*Method A:* Three aliquots of 0.3 g of SRM NIST 2387 were prepared following the acid extraction protocol combined with chromatographic separation by Sr-Spec resin.

*Method B:* Three aliquots of 0.3 g of SRM NIST 2387 were prepared following the protocol of complexation by  $(\text{NH}_4)_2\text{EDTA}$  combined with chromatographic separation AG50W-X resin.

The obtained results and analytical uncertainties of the analytical procedures are the following: for the ‘Control method’: 0.709093 (36 ppm); for ‘Method A’ - 0.709053 (20 ppm), and for ‘Method B’ - 0.709071 (71 ppm). The measured uncertainties are in agreement with the typical uncertainty of the MC-ICP-MS measurements, therefore, the results obtained no differ significantly (Figure IV.4.b). The average Sr isotopic ratio obtained for each method was in good agreement with the recommended value of  $0.70907 \pm 0.00004$  (2SD) (MF Turk et al., 2022, submitted).

### 3.3.Comparative study of both methods using olive oils

The two analytical approaches were applied and then compared on selected olive oils S1, S2, and S3 with Sr concentrations:  $4.74 \pm 0.16 \mu\text{g kg}^{-1}$ ,  $2.44 \pm 0.09 \mu\text{g kg}^{-1}$ , and  $1.08 \pm 0.03 \mu\text{g kg}^{-1}$  respectively.

The extraction recoveries, column recoveries and the  $^{87}\text{Sr}/^{86}\text{Sr}$  isotope ratios obtained are presented in table IV.1.

**Table IV.1** : The Sr recovery rate of the extraction/ complexation methods and of the columns as well as the Sr concentrations and isotopic ratios of the three selected olive oils (S1, S2 and S3) and the NIST 2387.

Sample / SRM	Sr concentration ( $\mu\text{g kg}^{-1}$ )	Extraction recovery (%)		Column recovery (%)		$^{87}\text{Sr}/^{86}\text{Sr}$ isotope ratio $\pm$ 2SD	
		MWAD	AE	Complexation by EDTA	Sr spec	AG50W-X8	AE – Sr spec
<b>SRM NIST 2387</b>	$2950 \pm 100$	66	67	95	85	$0.70907 \pm 0.00005$	$0.70906 \pm 0.00003$
<b>S1</b>	$4.74 \pm 0.16$	82	71	93	88	$0.70850 \pm 0.00004$	$0.70847 \pm 0.00007$
<b>S2</b>	$2.44 \pm 0.09$	67	71	80	89	$0.70883 \pm 0.00004$	$0.70882 \pm 0.00004$
<b>S3</b>	$1.08 \pm 0.03$	83	79	97	85	$0.70854 \pm 0.00007$	$0.70848 \pm 0.00004$

A cross-comparison of two methods for three oils and NIST SRM 2387 is presented in figure IV.5. The rates of extraction/complexation recoveries for Sr ranged between 66-83% (Figure IV.5.a), where the lower values were observed for NIST SRM 2387, and the highest one for olive oil S3 with a relatively low Sr concentration. Such relatively low extraction/complexation rate for NIST SRM 2387 was previously observed by (MF Turk et al, 2022, submitted) and can be more likely a consequence of incomplete compliance of this organic matrix with physio-chemical characteristics of olive oil.

The recovery rates obtained after chromatographic separation of Sr from the matrix were generally higher than 80% (Figure IV.5.a), which confirmed that this step did not lead to a significant loss of the analyte.

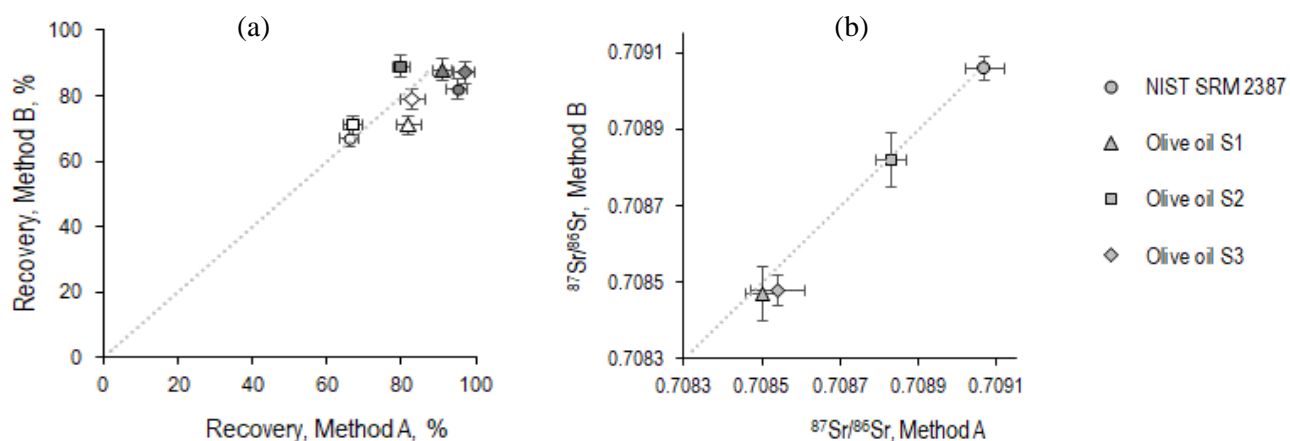

**Figure IV.5:** Cross-comparison of the two methods (A and B) for NIST SRM 2387 and three samples of olive oil (a) recovery rates for extraction/complexation (white dots) and recovery rates column separation (dark dots) for different oil samples (b) Sr isotope ratios obtained by the two methods

The cross-comparison of the  $^{87}\text{Sr}/^{86}\text{Sr}$  ratios for three olive oils and NIST SRM 2387 obtained by the two methods is presented in figure IV.5.b. The SRM 2387 yield identical Sr isotope ratios within the two methods, equal to  $0.70907 \pm 0.00005$  and  $0.70906 \pm 0.00003$ . The analytical errors were low, indicating accurate measurement of Sr isotope ratios. The  $^{87}\text{Sr}/^{86}\text{Sr}$  isotope ratios obtained in S1 were respectively equal to  $0.70850 \pm 0.00004$  and  $0.70847 \pm 0.00007$ . S2 and S3 exhibited also identical values within the analytical errors comparing the two methods, equal to  $0.70883 \pm 0.00004$  and  $0.70882 \pm 0.00004$  for S2 and equal to  $0.70854 \pm 0.00007$  and  $0.70848 \pm 0.00004$  for S3.

These results confirm that strontium was successfully retained, pre-concentrated and purified from a large volume of olive oil using both discussed methods.

In summary, method A, involving the use of a Sr-Spec resin, allowed an effective Sr extraction from olive oil, a quantitative Sr/matrix separation and a precise and accurate isotopic measurement by MC-ICP-MS. However, several notable inconveniences were noticed.

First, sample pre-treatment procedure is time-consuming. The evaporation of 200 mL of the extracted solution required before the chromatographic separation might take up 8 days and become a potential source of sample contamination. Secondly, despite all efforts to perform the phases separation thoroughly and accurately, organic matter cannot be completely removed from the extracts. Thereby, the residue obtained after evaporation may contain residual organic matter that cannot be easily destroyed by a microwave oven. Consequently, the Sr retention into the column would be hindered because the resin may be partially depleted by organic compounds present in the loading solution. As a result, careful manipulations are needed to ensure an acceptable overall Sr recovery rate for Method A.

Method B, involving the use of a strong cation exchange resin AG50W-X8, presents comparable results with method A in terms of precision and accuracy. Nevertheless, its implementation is less complicated thanks to the direct introduction of the extracted solution into the column, thereby avoiding the most time-consuming step of extracts evaporation. The whole preparation procedure lasted for 3 days. Additionally, the resin AG50W-X8 is less sensitive to the presence of traces of olive oil in loaded extracts, thereby helping to raise the highest Sr recovery rates. While these important benefits are obvious, the microwave mineralization performed in the Sr fraction to be analyzed cannot be avoided. Indeed, one of the main issues associated with this method is that the Sr eluted in 0.062 M  $(\text{NH}_4)_2\text{EDTA}$  at pH 7 is poorly suited to the MC-ICP-MS. It has been experimentally found that this solution passing through the DSN-100 desolvation system can affect the membranes, and as it goes further into the instrument, it can cause visible salting out of the ICP torch and cones, resulting in a non-negligible loss of instrumental sensitivity. Therefore,  $(\text{NH}_4)_2\text{EDTA}$  as well as possible organic residues should be removed by effective mineralization. The other inconvenience to note is that the Sr purification protocol involves the use of various high purity chemicals in large quantities.

It would be useful to add a few words about the very first published protocol for preparing oil samples for Sr isotope ratio analysis (Medini et al., 2015). A multi-step sample preparation protocol was developed: the first step was a pre-mineralization of the olive oil samples (volume less than 100 mL) on a hot plate with a mixture of  $\text{HNO}_3$  and  $\text{H}_2\text{O}_2$  for 48h, followed by calcination in a muffle furnace. The samples preparation procedure accomplished within 3 days. The Sr separation from the matrix was carried out using a Sr-Spec resin. Despite the fact that the quality control through SRM NIST 987 was satisfactory, practical experience showed a limitation related to the samples volume.

As the analytical performances of the described methods are equally satisfactory, the choice of the most appropriate method has to be made depending on the available materials and taking into account the advantages and disadvantages of each methods.

#### 4. Application: $^{87}\text{Sr}/^{86}\text{Sr}$ isotope ratio determination in a large selection of olive oils

The  $^{87}\text{Sr}/^{86}\text{Sr}$  isotope ratio is recognized as a reliable tool for the determination of geographical origin of food products since it is a key geochemical tracer. The developed method (B) described in this study was applied on a set of 38 olive oils from Tunisia, Spain and Italy. The values of  $^{87}\text{Sr}/^{86}\text{Sr}$  ratios and Sr elemental concentrations are presented in Table IV.2.

For most of the samples, a triplicate underwent the whole sample preparation procedure and measurements. Therefore, analytical errors, expressed as twice the standard deviation calculated on basis of samples triplicates accomplished by Method A were ranging between 0.000010 and 0.000040 (20 – 40 ppm), and for the triplicates accomplished by Method B reached 0.000070 (90 ppm). For each sample, independent triplicate of isotopic measurements was systematically performed and measurement.

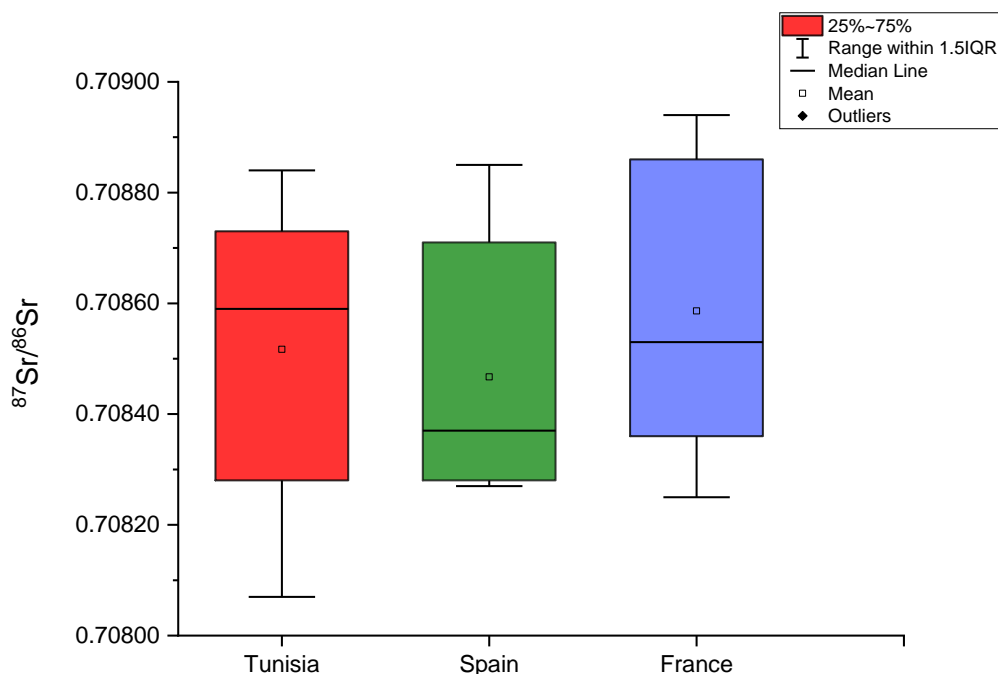

**Figure IV.6:** Box plots of  $^{87}\text{Sr}/^{86}\text{Sr}$  isotope ratio in olive oils classified according to their geographical provenance.

**Table IV.2** :  $^{87}\text{Sr}/^{86}\text{Sr}$  isotope ratios of olive oils from Tunisia, Spain and France.

Sample code	Geographical location	Country of origin	Sr concentration ( $\mu\text{g kg}^{-1}$ )	SD	$^{87}\text{Sr}/^{86}\text{Sr}$	2*SD
T1	Tataouine	<b>Tunisia</b> (n=23)	4.08	0.02	0.70881	0.00004
T2			4.16	0.02	0.70882	0.00004
T3	Sousse		2.38	0.25	0.70884	0.00004
T3A			5.04	0.25	0.70873	0.00004
T4	Chorbane		2.41	0.44	0.70862	0.00011
T4A1			3.5	0.44	0.70864	0.00006
T4A2			2.18	0.44	0.70861	0.00006
T5A	Sfax		2.53	0.14	0.70868	0.00003
T5			3.18	0.14	0.70859	0.00003
T6	Kasserine		2.73	0.02	0.70875	0.00004
T12			1.2	0.49	0.70859	0.00004
T7	Nabeul		3.89	0.49	0.70876	0.00004
T8	Kairouan		2.58	0.49	0.70857	0.00004
T8A			2.36	0.49	0.70855	0.00004
T9			4.6	0.49	0.70819	0.00004
T9A			2.47	0.49	0.70854	0.00004
T11			Chorfech	2.9	0.79	0.70828
T11A1	3.82			0.79	0.70820	0.00006
T11A2	3.86			0.79	0.70823	0.00006

<b>T13</b>	Beja		2.36	0.79	0.70831	0.00004	
<b>T14</b>	Monastir		2.62	0.79	0.70833	0.00011	
<b>T15</b>	Nefta		2.38	0.79	0.70807	0.00003	
<b>T17A</b>	Siliana		2.34	0.49	0.70818	0.00004	
<b>FR-1</b>	Nyons		1.73	0.23	0.70834	0.00004	
<b>FR-2</b>	Provence		2.07	0.23	0.70825	0.00004	
<b>FR-3</b>	Nyons		1	0.23	0.70841	0.00004	
<b>FR-4</b>	Nîmes	<b>France</b> <b>(n = 8)</b>	1.48	0.23	0.70889	0.00004	
<b>FR-5</b>	Nice		1.97	0.23	0.70865	0.00004	
<b>FR-6</b>	Nice		3.55	0.23	0.70838	0.00004	
<b>FR-7</b>	Nîmes		2.11	0.23	0.70894	0.00004	
<b>FR-9</b>	Provence		1.85	0.23	0.70883	0.00004	
<b>B1</b>	Moreda ( Alava )			1.81	0.37	0.70885	0.00004
<b>B2</b>	Anorbe (Navarre)			2.11	0.11	0.70871	0.00002
<b>B3</b>	Mendavia (Navarre)			1.32	0.11	0.70837	0.00004
<b>B4</b>	Cintruenigo (Navarre)	<b>Spain</b> <b>(n = 7)</b>	1.73	0.11	0.70848	0.00004	
<b>B5</b>	Lantziego (Araba)		1.21	0.10	0.70828	0.00004	
<b>B6</b>	Ablitas (Navarre)		2.09	0.10	0.70831	0.00004	
<b>B7</b>	Oion ( Araba )		1.69	0.02	0.70827	0.00002	

The achieved analytical precision allowed to observe a significant variability of the Sr isotopic ratios within the same region of a studied country (set of oils from Provence, France). The ranges of Sr isotope ratios in olive oils from Tunisia, Spain and France, between  $0.70807 \pm 0.0003$  and  $0.70894 \pm 0.00004$  respectively, overlapped and did not allow discrimination between the groups of samples (figure IV.6).

These similarities reflect similar geological background over different geographical locations (Burke et al., 1982).

However, a significant variability in the results was observed for the samples from southern France. Larger variability was reported in olive oils from Nîmes (France) analyzed by TIMS after calcination (Medini et al., 2015). Figure IV.7 shows the distribution of samples from Nîmes previously studied by Medini et al, (2015) and samples from Southern France according to  $^{87}\text{Sr}/^{86}\text{Sr}$  isotope ratios.

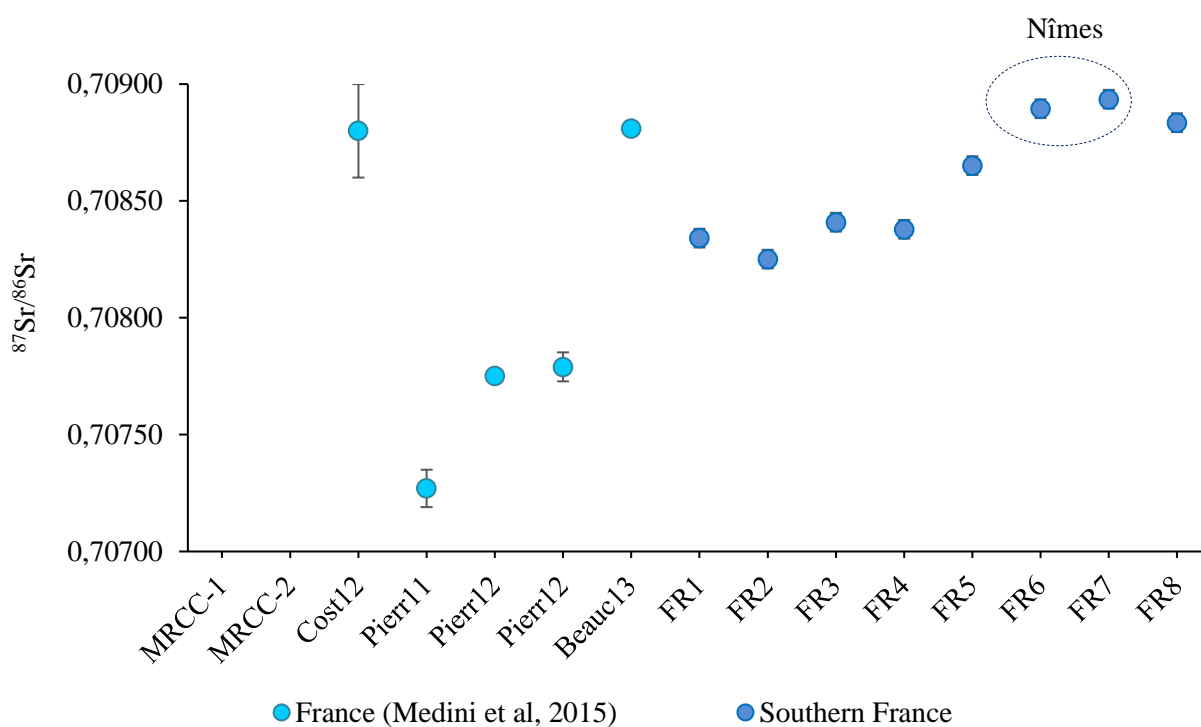

**Figure IV.7:** The  $^{87}\text{Sr}/^{86}\text{Sr}$  isotopic ratios of the studied olive oils from Southern France and the reported values for samples from Nîmes (Medini et al., 2015)



The Sr isotope ratios of the samples FR6 and FR7 originating from Nîmes are in agreement with the results previously reported for olive oils obtained from ‘Costières’ and ‘Beaucaire’ mills in Nîmes. Nevertheless, the group of samples originating from different locations in southern France (Provence, Nice, Nyons, and Nîmes) presents small variations comparing to the group of samples obtained exclusively from Nîmes. The large variability in the results could be related to the analytical procedure applied or/and correlated to the geological background of the soil of origin and suggest that even in a limited geographical area, an important variation in  $^{87}\text{Sr}/^{86}\text{Sr}$  ratios can be observed.

### 5. Application for fraud detection: case of olive oil mixtures

The above described procedure yielded unprecedented results in terms of precision, comparable to the uncertainties usually obtained for matrices considerably less complex than olive oil. This is particularly advantageous for the detection of olive oil mixtures by applying the approaches of geochemists to evaluate mixtures between 2 samples with different Sr concentration and Sr isotope ratios. Indeed, when the geochemical signature of the waters of two reservoirs has different mixing proportions, it is possible to assess the signature of the waters forming the mixture as well as the respective proportion of the mixture components (Negrel, 2011).

The Sr composition of a mixture can be calculated as the ratio:

$$(^{87}\text{Sr}/^{86}\text{Sr})_{\text{mix}} = \frac{(f * (^{87}\text{Sr}/^{86}\text{Sr})_1 * [\text{Sr}]_1) + ((1-f) * (^{87}\text{Sr}/^{86}\text{Sr})_2) * [\text{Sr}]_2}{[\text{Sr}]_{\text{mix}}}$$

Where  $f$  is the proportion (%) of the olive oil (1) in the mixture

The concentration of Sr in the mixture of olive oils is calculated as the following:

$$[\text{Sr}]_{\text{mix}} = f * [\text{Sr}]_1 + (1 - f) * [\text{Sr}]_2$$

One of the most common fraudulent practices applied in olive oil sector is the false declaration of geographical origin on bottled olive oils. Low quality olive oils are mixed with high price/quality EVOOs from different origin. It is possible to access the individual components of a such mixture through the precise measurement of  $^{87}\text{Sr}/^{86}\text{Sr}$  isotope ratios. Figure IV.8 shows a theoretical mixing line between two olive oil samples (from table IV.2) with high and low Sr isotopic ratio respectively.

The sample (1) is the olive oil with the lowest value of  $^{87}\text{Sr}/^{86}\text{Sr}$  ( $0.70807 \pm 0.00003$ ) originating from Tunisia and the sample (2) is the olive oil with the highest value ( $0.70894 \pm 0.00004$ ) from France. Three mixtures of (1) and (2) with different proportions were simulated and presented in figure IV.8, with respectively 25% of (1), 50% of (1) and 80% of (1). Theoretically, all the mixtures composed with (1) and (2) would be placed on the line that connects the two initial points and can be distinguished from the “pure” olive oils with high precision. It can be seen that due to the high precision and accuracy of the method, we can discriminate more mixing proportions. Further, this binary mixing procedure can also be extended to 3 end members systems.

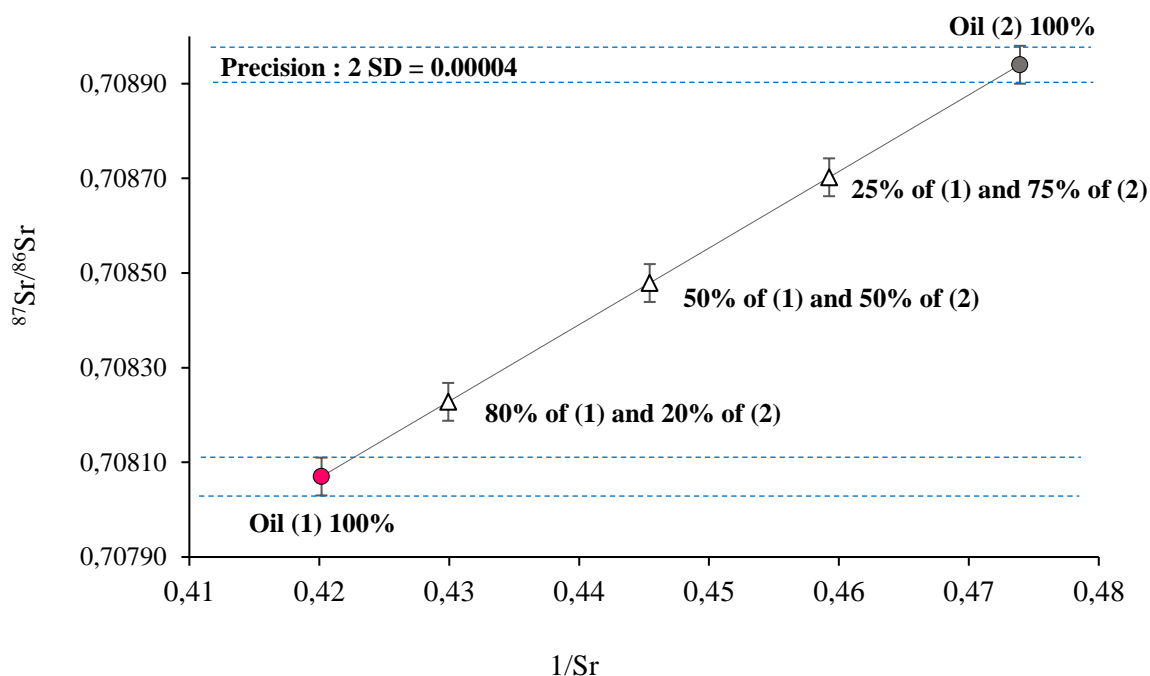

**Figure IV.8:** Theoretical mixing line between 2 olive oils and  $^{87}\text{Sr}/^{86}\text{Sr}$  isotope ratio of three mixing points.

This technique would allow in the future to evaluate the purity and the specific geographical origin of olive oil and would represent an important means to support and control the PDO, AOC or any label certifying the geographical origin.

## 6. Conclusion

In this chapter, an innovative approach for the sensitive and accurate determination of  $^{87}\text{Sr}/^{86}\text{Sr}$  isotope ratio was developed and optimized. The results obtained after a complete analytical control using standard reference materials (NIST SRM 987 and NIST SRM 2387) indicate a good accuracy and high precision. The Sr was quantitatively extracted from olive oil by complexation using EDTA and then efficiently separated from the matrix and the interfering elements by use of Dowex AG50W-X8 resin following a specific separation procedure. The analytical procedure was validated then evaluated through a comparison to a previously established method involving and acid extraction prior to Sr purification using Sr-spec resin. While findings of this study confirmed that both methods exhibited similar results in terms of Sr isotopic ratio, the developed method was advantageous in terms of time-consuming and its implementation is less complicated.

Subsequently, the developed method was successfully applied for the determination of  $^{87}\text{Sr}/^{86}\text{Sr}$  isotope ratio of 38 olive oils with high precision and thus represents a large-scale study for such analytical challenge. Finally, the precision obtained for the  $^{87}\text{Sr}/^{86}\text{Sr}$  isotope ratios measured has been shown to enable the detection of olive oil mixtures as a common fraudulent practice.

The results obtained in this study are promising for the geographical authentication of olive oil. The feasibility of this approach for the discrimination between olive oils from different origin will be investigated in the next chapters.

## References

- Aguzzoni, A.; Bassi, M.; Pignotti, E.; Robatscher, P.; Scandellari, F.; Tirler, W.; Tagliavini, M. Sr Isotope Composition of Golden Delicious Apples in Northern Italy Reflects the Soil  $^{87}\text{Sr}/^{86}\text{Sr}$  Ratio of the Cultivation Area. *J Sci Food Agric* **2020**, 100 (9), 3666–3674. <https://doi.org/10.1002/jsfa.10399>.
- Bong, Y.-S.; Shin, W.-J.; Gautam, M. K.; Jeong, Y.-J.; Lee, A.-R.; Jang, C.-S.; Lim, Y.-P.; Chung, G.-S.; Lee, K.-S. Determining the Geographical Origin of Chinese Cabbages Using Multielement Composition and Strontium Isotope Ratio Analyses. *Food Chemistry* **2012**, 135 (4), 2666–2674. <https://doi.org/10.1016/j.foodchem.2012.07.045>.
- Burke, W. H.; Denison, R. E.; Hetherington, E. A.; Koepnick, R. B.; Nelson, H. F.; Otto, J. B. Variation of Seawater  $^{87}\text{Sr}/^{86}\text{Sr}$  throughout Phanerozoic Time. *Geology* **1982**, 10 (10), 516. <https://doi.org/10.1130/0091-7613>
- Coelho, I.; Castanheira, I.; Bordado, J. M.; Donard, O.; Silva, J. A. L. Recent Developments and Trends in the Application of Strontium and Its Isotopes in Biological Related Fields. *TrAC Trends in Analytical Chemistry* **2017**, 90, 45–61. <https://doi.org/10.1016/j.trac.2017.02.005>.
- Epova, E. N.; Bérail, S.; Séby, F.; Vacchina, V.; Bareille, G.; Médina, B.; Sarthou, L.; Donard, O. F. X. Strontium Elemental and Isotopic Signatures of Bordeaux Wines for Authenticity and Geographical Origin Assessment. *Food Chemistry* **2019**, 294, 35–45. <https://doi.org/10.1016/j.foodchem.2019.04.068>.
- Kara, D.; Fisher, A.; Hill, S. Extraction of Trace Elements by Ultrasound-Assisted Emulsification from Edible Oils Producing Detergentless Microemulsions. *Food Chemistry* **2015**, 188, 143–148. <https://doi.org/10.1016/j.foodchem.2015.04.057>.
- Liu, H.; Wei, Y.; Lu, H.; Wei, S.; Jiang, T.; Zhang, Y.; Ban, J.; Guo, B. The Determination and Application of  $^{87}\text{Sr}/^{86}\text{Sr}$  Ratio in Verifying Geographical Origin of Wheat. *Journal of Mass Spectrometry* **2017**, 52 (4), 248–253. <https://doi.org/10.1002/jms.3930>.
- Manjusha, R.; Shekhar, R.; Kumar, S. J. Ultrasound-Assisted Extraction of Pb, Cd, Cr, Mn, Fe, Cu, Zn from Edible Oils with Tetramethylammonium Hydroxide and EDTA Followed by Determination Using Graphite Furnace Atomic Absorption Spectrometer. *Food Chemistry* **2019**, 294, 384–389. <https://doi.org/10.1016/j.foodchem.2019.04.104>.
- Marchionni, S.; Buccianti, A.; Bollati, A.; Braschi, E.; Cifelli, F.; Molin, P.; Parotto, M.; Mattei, M.; Tommasini, S.; Conticelli, S. Conservation of  $^{87}\text{Sr}/^{86}\text{Sr}$  Isotopic Ratios during the Winemaking Processes of ‘Red’ Wines to Validate Their Use as Geographic Tracer. *Food Chemistry* **2016**, 190, 777–785. <https://doi.org/10.1016/j.foodchem.2015.06.026>.
- Medini, S.; Janin, M.; Verdoux, P.; Techer, I. Methodological Development for  $^{87}\text{Sr}/^{86}\text{Sr}$  Measurement in Olive Oil and Preliminary Discussion of Its Use for Geographical

Traceability of PDO Nîmes (France). *Food Chemistry* **2015**, 171, 78–83. <https://doi.org/10.1016/j.foodchem.2014.08.121>.

Nasr, E. G.; Epova, E. N.; de Diego, A.; Souissi, R.; Hammami, M.; Abderrazak, H.; F. X. Donard, O. Trace Elements Analysis of Tunisian and European Extra Virgin Olive Oils by ICP-MS and Chemometrics for Geographical Discrimination. *Foods* **2021**, 11 (1), 82. <https://doi.org/10.3390/foods11010082>.

Negrel, P. Méthodes isotopiques d'identification de l'origine des polluants métalliques et organiques dans les milieux : Etat de l'art et approche critique d'application. *Rapport BRGM* **2011**, Etude N° 09 138/1A°

St-Amant, N.; Whyte, J. C.; Rousseau, M.-E.; Lariviere, D.; Kurt Ungar, R.; Johnson, S. Radiostrontium and Radium Analysis in Low-Level Environmental Samples Following a Multi-Stage Semi-Automated Chromatographic Sequential Separation. *Applied Radiation and Isotopes* **2011**, 69 (1), 8–17. <https://doi.org/10.1016/j.apradiso.2010.08.001>.

Vanhaecke, F.; Balcaen, L.; Malinovsky, D. Use of Single-Collector and Multi-Collector ICP-Mass Spectrometry for Isotopic Analysis. *Journal of Analytical Atomic Spectrometry* **2009**, 24 (7), 863–886. <https://doi.org/10.1039/b903887f>.

Waight, T.; Baker, J.; Peate, D. Sr Isotope Ratio Measurements by Double-Focusing MC-ICPMS: Techniques, Observations and Pitfalls. *International Journal of Mass Spectrometry* **2002**, 221 (3), 229–244. [https://doi.org/10.1016/S1387-3806\(02\)01016-3](https://doi.org/10.1016/S1387-3806(02)01016-3).

---

# Chapter V

## Conservation of $^{87}\text{Sr}/^{86}\text{Sr}$ isotope ratio from soil to olive oil

---

### Abstract

The ratio  $^{87}\text{Sr}/^{86}\text{Sr}$  has been successfully used for years as a geographical tracer of food products. The main goal of this study was to investigate the use of Sr isotopic ratio as a tool for the geographical authentication of olive oil. The  $^{87}\text{Sr}/^{86}\text{Sr}$  isotope ratio was determined by MC-ICP-MS in different samples (soil, olive roots, olive leaves, olive oil and olive pomace) from various Tunisian olive orchards. First, the potential influence of the oil production process on the Sr isotopic signature of olive oil was assessed. The statistical ANOVA test applied on the paired olive oils extracted in the OTIT and those obtained from oils mills showed that olive oils exhibited similar Sr isotopic ratios regardless of the production process ( $p > 0.05$ ). Moreover, Pearson correlation coefficient evaluated for paired olive oil/ soil samples showed that the  $^{87}\text{Sr}/^{86}\text{Sr}$  isotope ratios were strongly correlated ( $r = 0.99$ ;  $p < 0.001$ ). In the second part of this study, the transfer of Sr from the soil to the final products was investigated. The results showed that the ratio  $^{87}\text{Sr}/^{86}\text{Sr}$  exhibited comparable values in the bioavailable fraction of the soil, the plant organs, olive oil and olive pomace within twice the standard deviation. Hence, Sr is transferred from the soil to olive oil without isotopic fractionation. In the final part of this study, the relationship between the Sr isotopic ratio of olive oils and the isotopic signature of the bedrock was investigated. Three groups of samples were successfully distinguished on basis of Sr isotopic ratios according to the geological age of the bedrock. The results were in agreement with the  $^{87}\text{Sr}/^{86}\text{Sr}$  data over the geological time scale compiled from the literature.

The conservative behavior of Sr isotopic ratio highlighted in this study and the strong relationship between the isotopic composition of olive oils and that of the geological features suggest the possible use of  $^{87}\text{Sr}/^{86}\text{Sr}$  isotope ratio as a reliable tool for the geographical traceability of olive oil.

## Introduction

The variations of  $^{87}\text{Sr}/^{86}\text{Sr}$  isotope ratio originating from the bedrock have allowed for years its use for geographical provenance studies. In particular, food traceability studies have been demonstrated to be successfully performed when using the Sr isotope ratio (Aguzzoni et al., 2019, 2020; Baffi & Trincherini, 2016; Braschi et al., 2018; Coelho et al., 2017; Epova et al., 2019). In fact, bedrock is the main source of Sr to the global earth surface systems. The ratio  $^{87}\text{Sr}/^{86}\text{Sr}$  in geological materials is highly correlated to the age of the rock/mineral (Stewart, Capo, & Chadwick, 1998; Stille et al., 2009). Indeed, the abundance of radiogenic  $^{87}\text{Sr}$  increases over geological time as it resulting from the  $\beta$ -decay of  $^{87}\text{Rb}$  (Steiger, R.H., and Jager, 1977):

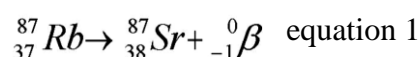

Therefore, Sr isotopic composition is a highly sensitive geochemical tracer.

Despite of the fact that strontium is a non-essential element for plant development, bioavailable Sr of the soil ( $\text{Sr}^{2+}$ ) is taken up by the plant through the roots and then transferred to the plant organs through the xylem sap (Bahadur et al., 2015). Unlike isotopes of light elements, Sr does not fractionate during the natural and analytical processes or if it does fractionate, it is normalized against  $^{86}\text{Sr}/^{88}\text{Sr}$  ratio of 0.1194 at the instrumental measurement stage (Faure, 1986). This particularity is due to the fact that the difference between the masses of the isotopes 87 and 86 of Sr is too small and the weight of these isotopes is important (Banner, 2004). Therefore, the ratio  $^{87}\text{Sr}/^{86}\text{Sr}$  measured in food products directly reflects that of the substratum.

The uptake of Sr in plants can also originate from atmospheric inputs under specific weathering conditions (bulk precipitation) and agricultural amendments directly deposited on the plant or incorporated from the soil (Graustein, 1989; Graustein & Armstrong, 1983; Techer et al., 2017).

In this study, we have investigated the potential link between the signature of Sr in the soil and the olive oil extracted from the olives collected from the trees. The effect of oil extraction process on the  $^{87}\text{Sr}/^{86}\text{Sr}$  isotope ratio of olive oil was also assessed. Indeed, during the production of olive oil, the olives are subjected to a series of steps, including extensive mechanical treatment (Figure I.1 from chapter I), in order to extract olive oil. This multi-stage process could result in Sr isotopic fractionation. Therefore, the Sr isotopic composition

of olive oils produced in local oils mills was compared to that of oils produced at the laboratory scale in the OTIT where contamination and practical conditions were thoroughly controlled. Olive oil samples obtained by different techniques were analyzed and statistically compared. Further, the intra-variability of Sr isotopic ratios between the soil, the plant organs, the resulting olive oil and olive pomace was studied and its variability within different Tunisian orchards was investigated. Finally, the isotopic signature of Sr was compared to the soil and underlying bedrock information.

### **1. Samples and analytical procedure**

The sampling strategy of soil, roots, leaves, olive oil and olive pomace from Tunisia as well as the analytical procedure applied for Sr isotopic analysis by MC-ICP-MS are described in chapter II.

### **2. Statistical analysis**

Statistical analysis was performed at different stages for a better interpretation of the results. Pearson correlation coefficient was applied using OriginLab 2018 to investigate the relationship between  $^{87}\text{Sr}/^{86}\text{Sr}$  isotope ratio of olive oil and that of the exchangeable fraction of the paired soil.

The analysis of variance (ANOVA) was performed to investigate the effect of the olive oil extraction process on the  $^{87}\text{Sr}/^{86}\text{Sr}$  isotope ratio of the final product. The statistical difference was evaluated first between the  $^{87}\text{Sr}/^{86}\text{Sr}$  isotope ratio of olive oil extracted in the OTIT and that produced in oil mill, then it was evaluated between the olive pomace and corresponding olive oil (OTIT).

### **3. Results and discussion**

#### **3.1. Assessment of the effect of olive oil extraction processes on $^{87}\text{Sr}/^{86}\text{Sr}$ isotope ratio**

At first, in order to be able later to compare the different olive oils samples collected over the different areas of Tunisia, we have first carefully evaluated the impact of olive oil extraction process on the  $^{87}\text{Sr}/^{86}\text{Sr}$  isotope ratio was investigated.



Indeed, olive oil undergoes multiple steps during its extraction from the olives and go through different processes either in a “traditional stone mill” or when been produced in a “modern oil mill” (Figure I.1 from chapter I).

The Sr isotope ratios of the olive oils were plotted against those from the paired exchangeable fraction of isotopic signatures originating from paired soils (Figure V.1).

The linear regression showed a good positive correlation between the exchangeable fraction of the soil and the paired olive oil, with  $R^2 > 0.95$ . The linear relationship was expressed as:

$$^{87}\text{Sr}/^{86}\text{Sr} \text{ olive oil} = 0.8071 \ ^{87}\text{Sr}/^{86}\text{Sr} \text{ soil (exchangeable fraction)} + 0.1367: \text{equation 2}$$

This correlation is in agreement with the results reported by (Braschi et al., 2018) about the correlation between the wine and the soil of provenance and agrees with the findings of (Aguzzoni et al., 2020) for the relationship between apples and the corresponding soils. A similar correlation was previously reported between the Sr content in olive oil and in the exchangeable fraction of the soil (Nasr et al., 2022).

Pearson correlation was applied to further investigate the correlation between the Sr isotope ratios of olive oils and the exchangeable fraction of the soils. The results obtained showed that the  $^{87}\text{Sr}/^{86}\text{Sr}$  isotope ratio of olive oils are strongly correlated with that of the soils ( $r = 0.99$ ;  $p < 0.001$ ). Hence, the correlation observed in figure V.1 is statistically consistent.

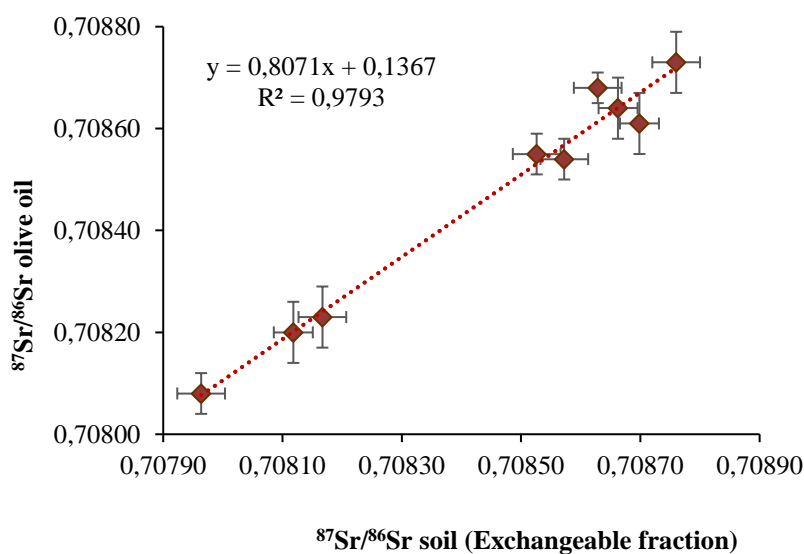
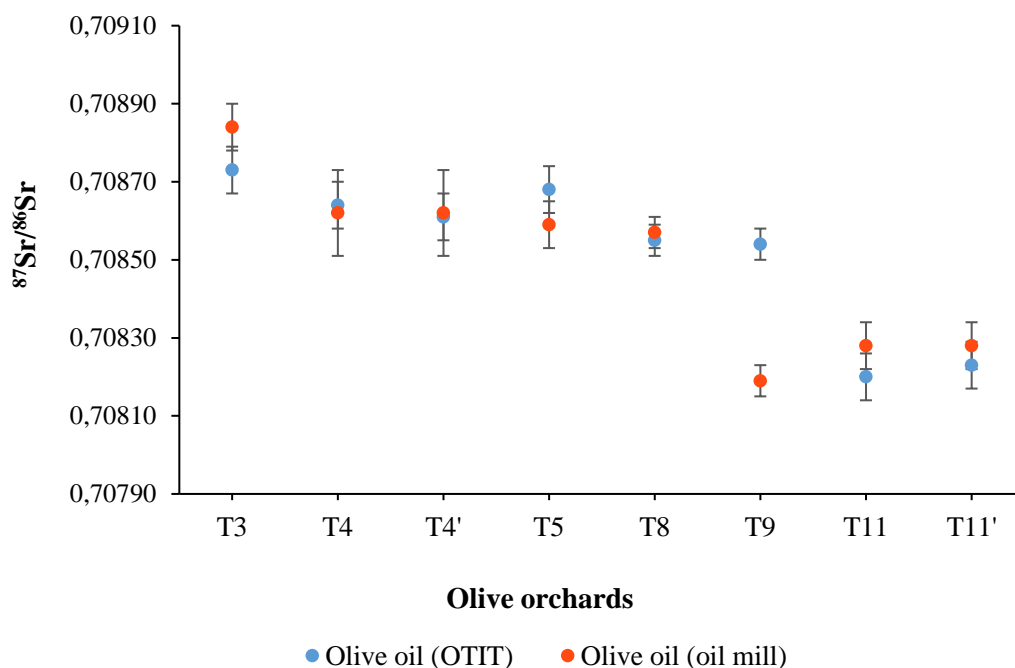

**Figure V.1:** Relationship between  $^{87}\text{Sr}/^{86}\text{Sr}$  isotope ratio in olive oil and in the exchangeable fraction of the paired soil

Further, a comparison of the  $^{87}\text{Sr}/^{86}\text{Sr}$  isotope ratio was performed between olive oils extracted in the OTIT (Abencor method) with the results obtained for oils collected from oil mills belonging to the respective olive orchards (Figure V.2). The extraction process employed in the oil mills is either the “traditional stone mill” method or the “modern mechanical mill”.

The results presented in figure V.2 clearly display that the  $^{87}\text{Sr}/^{86}\text{Sr}$  isotope ratios of olive oils obtained through the two methods were comparable on average, except for the sample T9. After investigation, it has been found that the oil mill located in S9 produces olive oil from olive crops of the neighboring regions. Accordingly, the resulting olive oil is likely a mixture of olives growing on different geological features.

The analysis of variance (ANOVA test) was performed for the olive oils (OTIT) and those produced in the oil mills. The results obtained confirm that the statistical difference between  $^{87}\text{Sr}/^{86}\text{Sr}$  isotope ratios of olive oils obtained both ways was not significant ( $p > 0.05$ ). Furthermore, the Sr isotope ratio of pomace and paired olive oils (OTIT) was subjected to ANOVA test and showed that the statistical difference between both was not significant as well ( $p > 0.05$ ). Therefore, the different olive oil extraction procedures do not affect the Sr isotopic composition of olive oil.



**Figure V.2:** Comparative assessment of the  $^{87}\text{Sr}/^{86}\text{Sr}$  isotope ratio measured in olive oil extracted in the OTIT (Abencor method) and in olive oil produced in oil mill

### 3.2. Concentrations and isotopic signatures of Sr of the soil, plant organs, olive oil and pomace: Intra-tree variability

The ranges and median concentrations of Sr measured in the different sample matrices are presented in table V.1 and the  $^{87}\text{Sr}/^{86}\text{Sr}$  isotope ratios are presented in table V.2. The results displayed in table V.1 clearly show that we can observe notable differences between the median Sr concentrations. These difference can reach up to  $10^5$  between the roots, leaves compared to the olive oil. The concentrations of Sr decrease in the order: leaves > roots > soil (exchangeable fraction) > pomace > olive oil.

The Sr concentrations of the exchangeable fraction of the soils were in wide range, between 11.4 and 81.4 mg kg<sup>-1</sup>. Higher concentrations were found in the plant organs. They varied between 273 and 370 mg kg<sup>-1</sup> in the leaves and from 94 to 132 mg kg<sup>-1</sup> in the roots.

Olive oils were depleted in Sr, with concentrations ranging from to 1.34 to 5.04  $\mu\text{g kg}^{-1}$ , while pomace samples exhibited  $10^3$  times higher concentrations, ranging between 10 and 44 mg kg<sup>-1</sup>.

**Table V.1:** Minimum, maximum and medium concentrations of Sr in the exchangeable fraction of soil, the roots, the leaves, olive oil and olive pomace.

Type of the matrix	Sr concentration		
	Minimum	Maximum	Median
Exchangeable fraction of soil (mg kg <sup>-1</sup> )	11.4	81.4	25.6
Roots (mg kg <sup>-1</sup> )	94	132	109
Leaves (mg kg <sup>-1</sup> )	273	370	299
Olive oil ( $\mu\text{g kg}^{-1}$ )	1.34	5.04	2.58
Olive pomace (mg kg <sup>-1</sup> )	10	44	15

While the variation observed for the concentrations of the Sr in the different samples was large, their respective isotopic signatures were comparable (Table V.2). Indeed, the Sr isotope ratios of the soils were in the range of  $0.70796 \pm 0.00004$  and  $0.70876 \pm 0.00004$ . The plant organs (leaves and roots) exhibited comparable ranges of Sr isotope ratios, between  $0.70797 \pm 0.00005$  and  $0.70880 \pm 0.00008$ .

The olive oils obtained from the sampled trees and the paired olive pomace samples displayed similar ranges of Sr isotope ratios with those measured in the soils, between  $0.70797 \pm 0.00002$  and  $0.70884 \pm 0.00006$ .

**Table V.2:** The  $^{87}\text{Sr}/^{86}\text{Sr}$  isotope ratio of the exchangeable fraction of soil, the roots, the leaves, olive oil (produced at OTIT and in oil mill) and olive pomace obtained from the different olive orchards in Tunisia.

Orchard	Region of origin	sample code	Soil (exchangeable fraction)	Roots	leaves	Olive oil (OTIT)	Olive Pomace	Olive oil (oil mill)
S3	Sousse	T3	$0.70876 \pm 0.00004$	$0.7088 \pm 0.00008$	$0.70878 \pm 0.00008$	$0.70873 \pm 0.00006$	$0.70871 \pm 0.00004$	$0.70884 \pm 0.00006$
			S4	Mahdia	T4	$0.70866 \pm 0.00003$	$0.70872 \pm 0.00007$	$0.70864 \pm 0.00004$
T4'	$0.70870 \pm 0.00003$	$0.70861 \pm 0.00002$			$0.70866 \pm 0.00003$	$0.70861 \pm 0.00006$	$0.70866 \pm 0.00003$	$0.70862 \pm 0.00011$
S5	Sfax	T5	$0.70863 \pm 0.00004$	$0.70859 \pm 0.00004$	$0.70863 \pm 0.00005$	$0.70868 \pm 0.00003$	$0.70868 \pm 0.00003$	$0.70859 \pm 0.00003$
S8	Kairouan	T8	$0.70853 \pm 0.00004$	$0.70854 \pm 0.00004$	$0.70852 \pm 0.00005$	$0.70855 \pm 0.00004$	$0.70853 \pm 0.00002$	$0.70857 \pm 0.00004$
S9		T9	$0.70857 \pm 0.00004$	$0.70855 \pm 0.00003$	$0.70855 \pm 0.00004$	$0.70854 \pm 0.00004$	$0.70856 \pm 0.00002$	$0.70819 \pm 0.00004$
S11	Ariana	T11	$0.70812 \pm 0.00003$	$0.70814 \pm 0.00009$	$0.70818 \pm 0.00007$	$0.7082 \pm 0.00006$	$0.70811 \pm 0.00003$	$0.70828 \pm 0.00006$
		T11'	$0.70817 \pm 0.00004$	$0.70825 \pm 0.00009$	$0.70824 \pm 0.00007$	$0.70823 \pm 0.00006$	$0.70820 \pm 0.00003$	
S17	Siliana	T17	$0.70796 \pm 0.00004$		$0.70797 \pm 0.00005$	$0.70808 \pm 0.00004$	$0.70797 \pm 0.00002$	

The values of  $^{87}\text{Sr}/^{86}\text{Sr}$  determined in the soil, the plant organs (leaves and roots) and in the paired olive oils and pomace showed a good overlap, within twice the standard deviation, for each sampled tree taken individually, as shown in figure V.3.

These results highlight the conservative behavior of Sr isotopic ratio within each sampled tree. The  $^{87}\text{Sr}/^{86}\text{Sr}$  isotope ratio does not fractionate during its transfer from the soil to the plant organs and the final products (olive oil and pomace). Accordingly, the isotopic signature of Sr extracted from the exchangeable fraction of the soil does not undergo major biological processes that could result in the fractionation of Sr within the different constituents of the olive tree and its final product. These findings are in agreement with results previously reported for various food products (Aguzzoni et al., 2019; Bong et al., 2012; Braschi et al., 2018; Liu et al., 2016; Song et al., 2014).

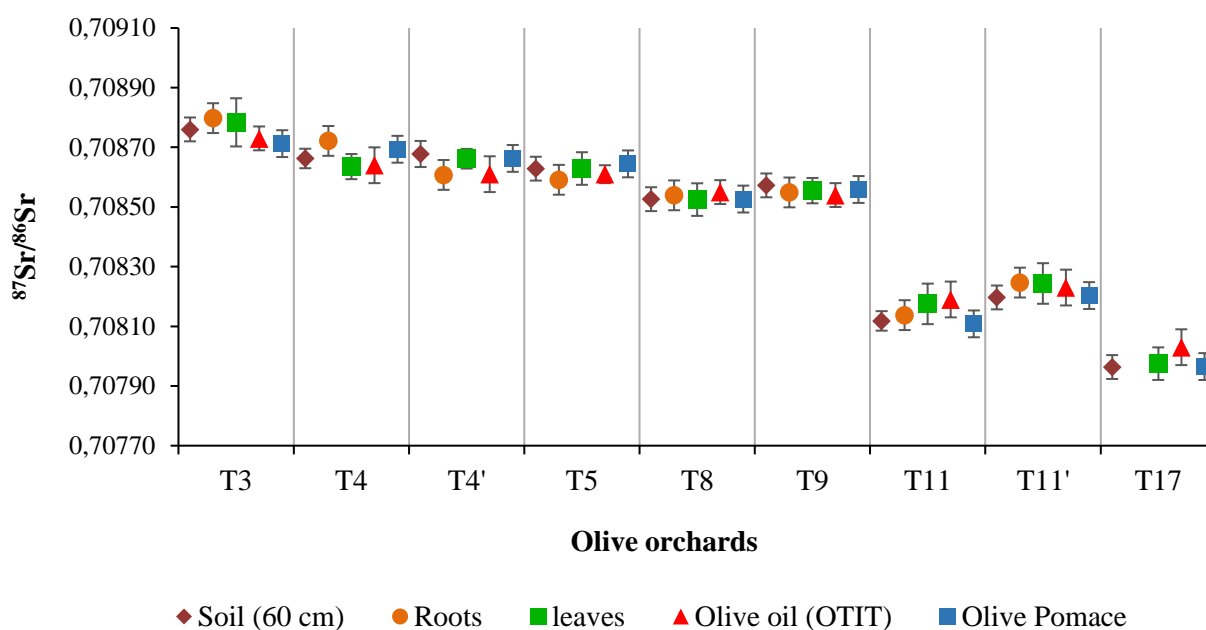

**Figure V.3:**  $^{87}\text{Sr}/^{86}\text{Sr}$  isotope ratio measured in the exchangeable fraction of the soil at depth 60 cm, olive roots, leaves, olive oil and pomace from different olive orchards

### 3.3. Signatures of Tunisian olive oils with regards to the geological formations and ages

The fact that there is a strong correlation between the Sr isotopic signature of the soil and that of olive oil have allowed us to evaluate further the relationship between olive oils and the geological formations on which the olive trees was grown.

In general, the geological settings of Tunisia are mainly characterized by sedimentary and clastic deposits during the various geological ages.

They are in majority carbonaceous and calcareous deposits such as limestone, dolomite, marles, clays and gypsum. These sedimentary formations have been redistributed and reorganized during important orogenic events that have resulted in patchwork of geologic outcrops controlled by a major faults system orientated mainly North East to South West (Templeton R.S.M 1979). In general, the different types of soils in Tunisia are dependent on climatic factors and topography. The Tunisian soils are particularly characterized by a low degree of alteration and are weakly developed (Mtimet, A. 2016). Due to the climatic characteristics of the country, arid to semi-arid climate with an irregular rainfall that is erosive and heterogeneously distributed over the territory, these soils are highly eroded (Vieillefon J., 1978). Since there is limited pedologic developments, these semi-arid conditions would prevent any evolution of the Sr isotopic signature of the soils and therefore, it would not be surprising if the Sr isotopic composition of the soil, sampled at depth 60 cm, reflects to an extent the Sr isotopic signature of the bedrock.

Based on the results presented earlier, suggesting that the isotopic signature of the labile Sr of the soil and the resulting olive oils is characterized by a conservative behavior, we have directly assessed the Sr isotope ratio of olive oil samples collected all over Tunisia. The results of the isotopic analysis are presented in figure V.4.

Three groups of samples can be well distinguished according to the geological age of the rock on which the cultivation soil is located: Miocene (tertiary), continental Mio-Pliocene (tertiary) and recent alluvium of the Pleistocene (quaternary) (Figure II.2). These 3 groups of samples present different amplitude of fluctuation of the Sr isotopic ratio, which is, in general, similar within the same group. Samples collected on Miocene outcrops present an average Sr ratio, that is lower than that of the samples collected on the Continental Mio-Pliocene outcrops and that are themselves lower than the most recent outcrops which belong to the Pleistocene.

For the group of samples originating from plots developed on a formation of the Miocene, the values of  $^{87}\text{Sr}/^{86}\text{Sr}$  isotopic ratio varied between  $0.70807 \pm 0.00003$  and  $0.70833 \pm 0.00011$ . The group of samples which orchards are developed on rocks of the continental Miocene is characterized by  $^{87}\text{Sr}/^{86}\text{Sr}$  isotopic ratio values ranging between  $0.70819 \pm 0.00004$  and  $0.70868 \pm 0.00004$  except for the sample T9.

The third group of samples located on Pleistocene display  $^{87}\text{Sr}/^{86}\text{Sr}$  isotopic ratios ranging between  $0.70875 \pm 0.00004$  and  $0.70884 \pm 0.00004$ . Accordingly, values of  $^{87}\text{Sr}/^{86}\text{Sr}$  isotopic ratios increase from the Tertiary to the Quaternary period.

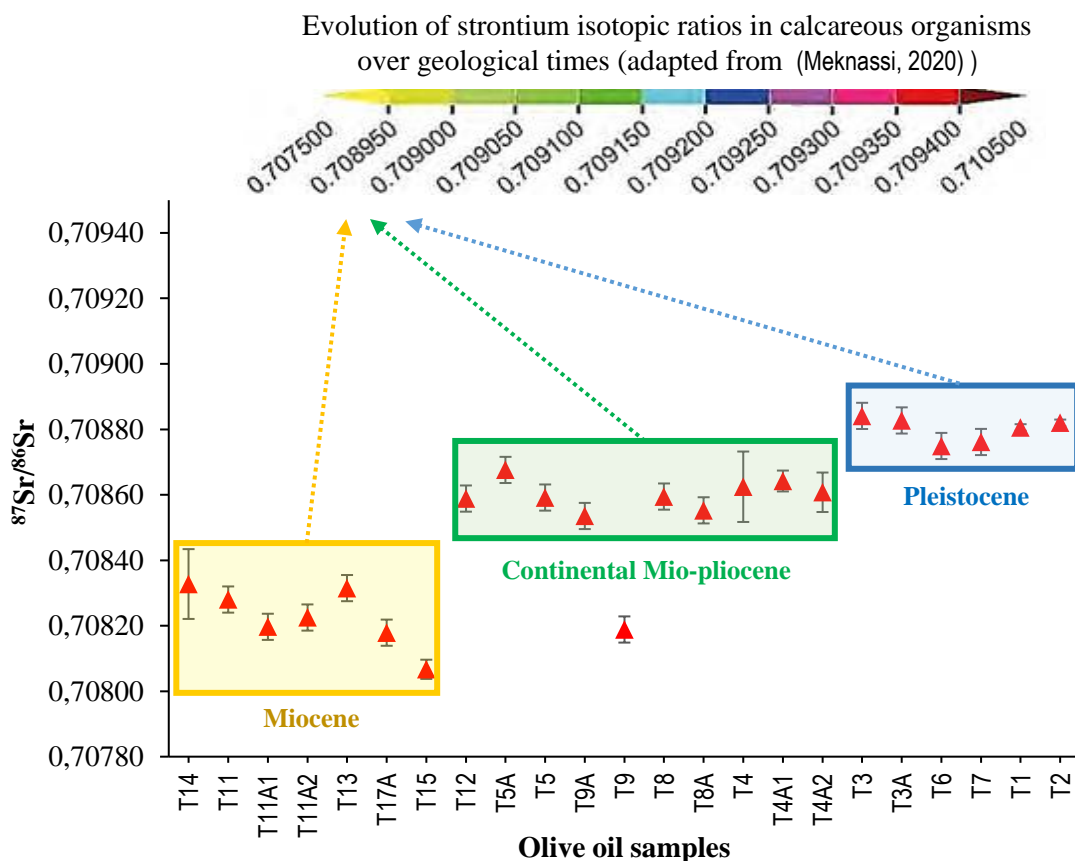

**Figure V.4:**  $^{87}\text{Sr}/^{86}\text{Sr}$  isotope ratios in olive oils from Tunisia grouped according to the geological period

For the group of samples originating from plots developed on a formation of the Miocene, the values of  $^{87}\text{Sr}/^{86}\text{Sr}$  isotopic ratio varied between  $0.70807 \pm 0.00003$  and  $0.70833 \pm 0.00011$ . The group of samples which orchards are developed on rocks of the continental Miocene is characterized by  $^{87}\text{Sr}/^{86}\text{Sr}$  isotopic ratio values ranging between  $0.70819 \pm 0.00004$  and  $0.70868 \pm 0.00004$  except for the sample T9. The third group of samples located on Pleistocene display  $^{87}\text{Sr}/^{86}\text{Sr}$  isotopic ratios ranging between  $0.70875 \pm 0.00004$  and  $0.70884 \pm 0.00004$ . Accordingly, values of  $^{87}\text{Sr}/^{86}\text{Sr}$  isotopic ratios increase from the Tertiary to the Quaternary period.

(Prokoph et al., 2008) have produced a worldwide compilation of the evolution of Sr isotope ratio through the earth history. During the Cenozoic times, they have compiled and recorded the Sr isotopic ratio in calcareous organisms and matrices which were found to present a long-term increasing trend over the geological times. The study covered the outcrops of the periods studied in this work, in which the Sr isotopic ratio was evolving from 0.70800 to 0.70900, and were shown to be in agreement with the Sr isotopic ratios recorded in the olive oils analyzed in this study.



#### 4. Conclusion

In this study, a reliable analytical approach for the geographical traceability of olive oil based on the use of  $^{87}\text{Sr}/^{86}\text{Sr}$  isotope ratio was established.

The findings of this study suggest that the bioavailable Sr is transferred from the soil to the olive tree with no isotopic fractionation of the ratio  $^{87}\text{Sr}/^{86}\text{Sr}$ . Further, the Sr isotopic composition of olive oil was found to be highly correlated to that of the bioavailable fraction of the soil of provenance independently of the oil extraction process.

The Sr isotope ratios investigated in the different samples from various olive orchards were correlated with the geological features of the bedrock. Accordingly, this study highlights the potential of  $^{87}\text{Sr}/^{86}\text{Sr}$  isotope ratio as a reliable tool for the geographical traceability of olive oil.

Nevertheless, the locations sharing similar geological features could not be distinguished on basis of this single-parameter approach. The use of a multi-analytical approach could enhance the geographical discrimination between olive oils of different origin. This perspective will be investigated in a future study.

## References

- Aguzzoni, A.; Bassi, M.; Pignotti, E.; Robatscher, P.; Scandellari, F.; Tirlor, W.; Tagliavini, M. Sr Isotope Composition of Golden Delicious Apples in Northern Italy Reflects the Soil  $^{87}\text{Sr}/^{86}\text{Sr}$  Ratio of the Cultivation Area. *Journal of the Science of Food and Agriculture* **2020**, *100*, 3666–3674, doi:10.1002/jsfa.10399.
- Aguzzoni, A.; Bassi, M.; Robatscher, P.; Scandellari, F.; Tirlor, W.; Tagliavini, M. Intra- And Inter-tree Variability of the  $^{87}\text{Sr}/^{86}\text{Sr}$  Ratio in Apple Orchards and Its Correlation with the Soil  $^{87}\text{Sr}/^{86}\text{Sr}$  Ratio. *Journal of Agricultural and Food Chemistry* **2019**, *67*, 5728–5735, doi:10.1021/acs.jafc.9b01082.
- Baffi, C.; Trincherini, P.R. Food Traceability Using the  $^{87}\text{Sr}/^{86}\text{Sr}$  Isotopic Ratio Mass Spectrometry. *European Food Research and Technology* **2016**, *242*, 1411–1439, doi:10.1007/s00217-016-2712-2.
- Bahadur, B. ; Venkat R.; Manchikatla, S.; Leela, K.; K.V.Bahadur, B.; Rajam, M.V.; Sahijram, L.; Krishnamurthy, K. V. Plant Biology and Biotechnology. *Plant Diversity, Organization, Function and Improvement*. Springer; 2015; Vol. 1; 10.1007/978-81-322-2286-6
- Banner, J.L. Radiogenic Isotopes: Systematics and Applications to Earth Surface Processes and Chemical Stratigraphy. *Earth-Science Reviews* **2004**, *65*, 141–194, doi:10.1016/S0012-8252(03)00086-2.
- Bong, Y.S.; Shin, W.J.; Gautam, M.K.; Jeong, Y.J.; Lee, A.R.; Jang, C.S.; Lim, Y.P.; Chung, G.S.; Lee, K.S. Determining the Geographical Origin of Chinese Cabbages Using Multielement Composition and Strontium Isotope Ratio Analyses. *Food Chemistry* **2012**, *135*, 2666–2674, doi:10.1016/j.foodchem.2012.07.045.
- Braschi, E.; Marchionni, S.; Priori, S.; Casalini, M.; Tommasini, S.; Ntarelli, L.; Buccianti, A.; Bucelli, P.; Costantini, E.A.C.; Conticelli, S. Tracing the  $^{87}\text{Sr}/^{86}\text{Sr}$  from Rocks and Soils to Vine and Wine: An Experimental Study on Geologic and Pedologic Characterisation of Vineyards Using Radiogenic Isotope of Heavy Elements. *Science of the Total Environment* **2018**, *628–629*, 1317–1327, doi:10.1016/j.scitotenv.2018.02.069.
- Coelho, I.; Castanheira, I.; Bordado, J.M.; Donard, O.; Silva, J.A.L. Recent Developments and Trends in the Application of Strontium and Its Isotopes in Biological Related Fields. *TrAC - Trends in Analytical Chemistry* **2017**, *90*, 45–61, doi:10.1016/j.trac.2017.02.005.
- Epova, E.N.; Bérail, S.; Séby, F.; Vacchina, V.; Bareille, G.; Médina, B.; Sarthou, L.; Donard, O.F.X. Strontium Elemental and Isotopic Signatures of Bordeaux Wines for Authenticity and Geographical Origin Assessment. *Food Chemistry* **2019**, *294*, 35–45, doi:10.1016/j.foodchem.2019.04.068.
- Graustein, W.C.,  $^{87}\text{Sr}/^{86}\text{Sr}$  ratios measure the sources and flow of strontium in terrestrial ecosystems. Rundel, p. w., Ehleringer, j. r. & Nagy, k. a. *Stable Isotopes in Ecological*

*Research: Ecological Studies*. Springer, Verlag, New York, **1989**, 491-512, doi: 10.1007/978-1-4612-3498-2\_28

Graustein, W.C.; Armstrong, R.L. The Use of  $^{87}\text{Sr}/^{86}\text{Sr}$  Ratios to Measure Atmospheric Transport into Forested Watersheds. *Science* **1983**, *219*, 289–292, doi: 10.1126/science.219.4582.289.

Liu, H.; Wei, Y.; Lu, H.; Wei, S.; Jiang, T.; Zhang, Y.; Guo, B. Combination of the  $^{87}\text{Sr}/^{86}\text{Sr}$  Ratio and Light Stable Isotopic Values ( $\delta^{13}\text{C}$ ,  $\delta^{15}\text{N}$  and  $\delta\text{D}$ ) for Identifying the Geographical Origin of Winter Wheat in China. *Food Chemistry* **2016**, *212*, 367–373, doi:10.1016/j.foodchem.2016.06.002.

Mtimet A. ; Les sols tunisiens à l'épreuve de la durabilité: de la gestion à la gouvernance; Mougou A., Ennabli, N. ; Tunis, **2016**, 104 p., ISBN 978-9938-14-730-8

Nasr, E.G.; Epova, E.N.; Diego, A. De; Souissi, R.; Hammami, M.; Abderrazak, H.; Donard, O.F.X. Trace Elements Analysis of Tunisian and European Extra Virgin Olive Oils by ICP-MS and Chemometrics for Geographical Discrimination. *Foods* **2022**, *11*, doi : 10.3390/foods11010082

Prokoph, A.; Shields, G.A.; Veizer, J. Compilation and Time-Series Analysis of a Marine Carbonate  $\delta^{18}\text{O}$ ,  $\delta^{13}\text{C}$ ,  $^{87}\text{Sr}/^{86}\text{Sr}$  and  $\delta^{34}\text{S}$  Database through Earth History. *Earth-Science Reviews* **2008**, *87*, 113–133, doi:10.1016/j.earscirev.2007.12.003.

Song, B.Y.; Ryu, J.S.; Shin, H.S.; Lee, K.S. Determination of the Source of Bioavailable Sr Using  $^{87}\text{Sr}/^{86}\text{Sr}$  Tracers: A Case Study of Hot Pepper and Rice. *Journal of Agricultural and Food Chemistry* **2014**, *62*, 9232–9238, doi:10.1021/jf503498r.

Steiger, R.H., and Jager, E. Subcommittee on Geochronology; Convention on the Use of Decay Constants in Geo- and Cosmochronology. *Earth and Planetary Science Letters* **1977**, *36*, 359-362., doi:10.3109/00016488809106418.

Techer, I.; Medini, S.; Janin, M.; Arregui, M. Applied Geochemistry Impact of Agricultural Practice on the Sr Isotopic Composition of Food Products: Application to Discriminate the Geographic Origin of Olives and Olive Oil. *Applied Geochemistry* **2017**, *82*, 1–14, doi:10.1016/j.apgeochem.2017.05.010.

Templeton R.S.M., Desprat R. C. -Bibliographie générale. *Géologie Méditerranéenne*. Tome 6, N1, **1979**. La mer pélagienne. Etude sédimentologique et écologique du Plateau tunisien et du Golfe de Gabès. pp. 337-341.

J. Vieillefon, Les sols gypseux en Tunisie. Contribution à l'amélioration de leur étude analytique, Sols de Tunisie, Vol. 10, 1978, pp. 40-105.

---

# Chapter VI

## Combination of isotopic and elemental approaches for the geographical authentication

---

### Abstract

In this study, a multi-analytical approach combined with multivariate analysis was investigated as a tool for geographical authentication of olive oils from Tunisia, Spain and France. First, stable carbon isotope ratio was determined in olive oils by IRMS. The results showed that the fractionation of carbon isotopes was mainly associated with the physiological processes of the plant and thus didn't allow to distinguish the samples of different geographical provenance. Next, the ratio  $^{87}\text{Sr}/^{86}\text{Sr}$  was successfully determined in olive oils by MC-ICP-MS with high precision. The results were in agreement with the ranges of Sr isotopic ratios that characterize the geological background of each sampling area and allowed interregional discrimination of the samples. Nevertheless, an overlap was observed in the ratios  $^{87}\text{Sr}/^{86}\text{Sr}$  of samples originating from the three studied origins that likely share similar geological features. These results suggest that the Sr isotopic ratio only cannot be used for the geographical discrimination of olive oils. Finally, a multivariate analysis combined with the isotopic approaches and elemental content of olive oils was investigated for the authentication of the olive oil samples. The unsupervised PCA allowed to classify the samples on a 3D plane according to their geographical provenance. This statistical model was reinforced through the supervised LDA that clearly displayed 3 groups of samples according to their geographical provenance through a canonical score plot. The model created on basis of  $\delta^{13}\text{C}$ ,  $^{87}\text{Sr}/^{86}\text{Sr}$  and concentrations of 4 elements (Fe, Mn, V and Cr) constitute an advanced analytical approach combines the information about the plant growing environment, the geological background and the elemental profile of the soil.

## Introduction

Therefore, the development of reliable and robust analytical methods for the geographical traceability of foodstuffs is paramount for researchers, producers and consumers. Unfortunately, there is no universal method to determine the geographical origin of foodstuffs as the choice of appropriate analytical techniques depends on the matrix to be analyzed and should account for the growing conditions of the plant and the manufacturing process of the final product.

Multi-elemental analyses, generally performed by ICP-MS and ICP-OES, have allowed to assess the geographical discrimination of olive oil with variable resolutions (Aceto et al., 2019; Beltrán et al., 2015; Damak, Asano, Baba, Suda, et al., 2019). This approach is mainly based on the link between the elemental composition of the food product and the soil on which the plant has grown (Kabata-Pendias, 2004). However, it has been shown that external factors related to anthropogenic activities can alter the composition of the soil and thus that of the plant (Benincasa et al., 2012; Chen et al., 2021; Mendil et al., 2009). Further, at each step of the fabrication process (from production to storage) of the food product, trace metal contamination can occur (Skrzydłowska et al., 2003). Thus, the multi-elemental approach has demonstrated its limitations for the optimal geo-traceability of food products, provided that all potential sources of trace elements are considered. In the case of olive oil in particular, this limitation is further exacerbated by the fact that trace elements are present at low levels which are challenging to measure even with highly sensitive instrumentation (Chapter I).

Isotopic approaches have been successfully developed and applied for the geographical authentication of food products including olive oil. Stable isotopes of light elements (C, H and O), usually performed by isotopic ratio mass spectrometry (IRMS), have enabled the discrimination between olive oils of different origins on the basis of specific geo-climatic conditions (temperature, precipitation, humidity, altitude...) (Camin, Larcher, Perini, et al., 2010; Karalis et al., 2020; Tarapoulouzi et al., 2021). As the organic carbon in plants is produced from the atmospheric fixation of CO<sub>2</sub> during the photosynthesis, the plant adapts its physiological response to specific climatic variations (sunlight, humidity and drought, temperature) in order to balance CO<sub>2</sub> assimilation and water evaporation (Driesen et al., 2020). The different photosynthetic pathways (C<sub>3</sub>, C<sub>4</sub> or CAM) with different kinetics of diffusion and fixation of CO<sub>2</sub> generates isotopic fractionation leading to fluctuations in  $\delta^{13}\text{C}$  enabling the discrimination between different types of plants.

However, this approach has a limited scope due to seasonal changes leading to variations in isotopic fractionation (Iacumin et al., 2009). Furthermore, carbon isotope ratio of plants was found to be associated with the olives ripening stage and to genetic determinism (Portarena et al., 2014, 2015).

Sr isotopic composition analysis has also been widely used to link the plant to its geological substrate. The  $^{87}\text{Sr}/^{86}\text{Sr}$  ratio is a tracer of particular interest that is strongly related to the age of the parent material (Bataille & Bowen, 2012; Coelho et al., 2017). It has been demonstrated that the Sr isotopic composition of food products is correlated with the one of the soil (Voerkelius et al., 2010). The bioavailable Sr fraction of the soil is uptaken by the plant roots without isotopic fractionation because the difference between the masses of the isotopes 87 and 86 of Sr is too small and the weight of these isotopes is important (Banner, 2004; Graustein, 1989; Graustein & Armstrong, 1983). Nevertheless, it has been shown that distinct geographical locations sharing similar geological features could not be distinguished on basis of Sr isotope ratios alone (Bong et al., 2012). The labile fraction of the Sr displays a conservative behavior between the soil up the final oil product and hence is a good proxy for assessing the geogenic signature of soil (Chapter 5).

In order to improve the geographical resolution capacity for food traceability, the use of combined inorganic and isotopic signatures can be of direct benefits since they both derived, principally, from the lithogenic signature of the soil. As an alternative to single-parameter approaches, the combination of different chemical light element and inorganic constituents was successfully performed for the authentication of several food products (Camin, Larcher, Nicolini, et al., 2010; Liu et al., 2016; Rummel et al., 2010; Zhou et al., 2018). To the best of our knowledge, the combination of multi-isotopic and elemental approaches has not been performed, so far, for the geographical authentication of olive oil.

In this study, stable isotope ratios of carbon were determined in olive oils by IRMS and its possible use for geographical discrimination between samples from Tunisia, Spain and France was investigated. Subsequently, the ratio  $^{87}\text{Sr}/^{86}\text{Sr}$  was determined by MC-ICP-MS in olive oils and was investigated for the geographical authentication of the samples. Finally, both isotopic approaches were combined with the multi-elemental profile using a statistical model (Linear discriminant analysis, LDA) to obtain a reliable and robust model for the geographical authentication of olive oil with high prediction ability.

## 1. Samples and analytical procedure

The  $\delta^{13}\text{C}$  and  $^{87}\text{Sr}/^{86}\text{Sr}$  isotope ratios were determined in the olive oil samples from Tunisia, Spain and France according to the analytical procedures described in Chapter II.

## 2. Multivariate analysis

A multivariate analysis approach was performed to create a trustworthy and predictive statistical model that combine the analytical approaches in order to classify the olive oils according to their geographical provenance.

First, the unsupervised principal component analysis (PCA) was performed using SIMCA V16.0.1 to assess the samples groupings and outliers among the three studied geographical origins by combined use of elemental and isotopic approaches.

Subsequently, the Linear discriminant analysis (LDA) was chosen as a supervised method aiming to minimize the within-group variance based on defined classification. A cross-validation was performed to evaluate the robustness of the established and to assess the prediction error rate. The canonical score plot and the cross validation were achieved using OriginLab 2018.

## 3. Results and discussion

### 3.1. Olive oil geographical authentication using carbon content and stable carbon isotope ratio

The stable carbon isotope ratio ( $^{13}\text{C}/^{12}\text{C}$ ) is useful as physiological tracer of natural processes. In table VI.1, we present the median, minimum and maximum values of carbon content (%C) and stable carbon isotope ratio ( $\delta^{13}\text{C}$ ) in olive oils from Tunisia, Spain and France.

While the average carbon content of olive oils from the three studied origins was relatively similar, the carbon content range was much broader for Tunisian (73.6 % - 85.5 %) and Spanish oils (72.9 % - 88.6 %) than those observed in French oils (76.1 % - 77.1 %). The  $\delta^{13}\text{C}$  values of olive oils were comparable within the three studied origins.

It ranged between -31.2‰ and -28‰ in the Tunisian oils and between -30.6‰ and 28‰ in both Spanish and French olive oils.

**Table VI.1:** Median values and ranges (in parentheses) of carbon content and  $\delta^{13}\text{C}$  values of organic carbon in olive oils from Tunisia, Spain and France.

Country of origin	Tunisia	Spain	France
Carbon content (%)	76.3 (73.6 ; 85.5)	75.3 (72.9 ; 88.6)	76.6 (76.1 ; 77.1)
$\delta^{13}\text{C}$ (‰)	-29.5 (-31.2 ; -28)	-29.4 (-30.6 ; -28.6)	-29.8 (-30.6 ; -28)

These results are in agreement with published results showing similar ranges of isotope ratio for olive oils from Tunisia and Europe (Angerosa et al., 1999; Camin, Larcher, Nicolini, et al., 2010; Gumus et al., 2017; Karalis et al., 2020; Tarapoulouzi et al., 2021). The  $\delta^{13}\text{C}$  values measured in olive oil are also consequent with values of  $\delta^{13}\text{C}$  usually recorded for C3 plants which oscillate between -32 and -22 ‰ (Winkler & Schmidt, 1980).

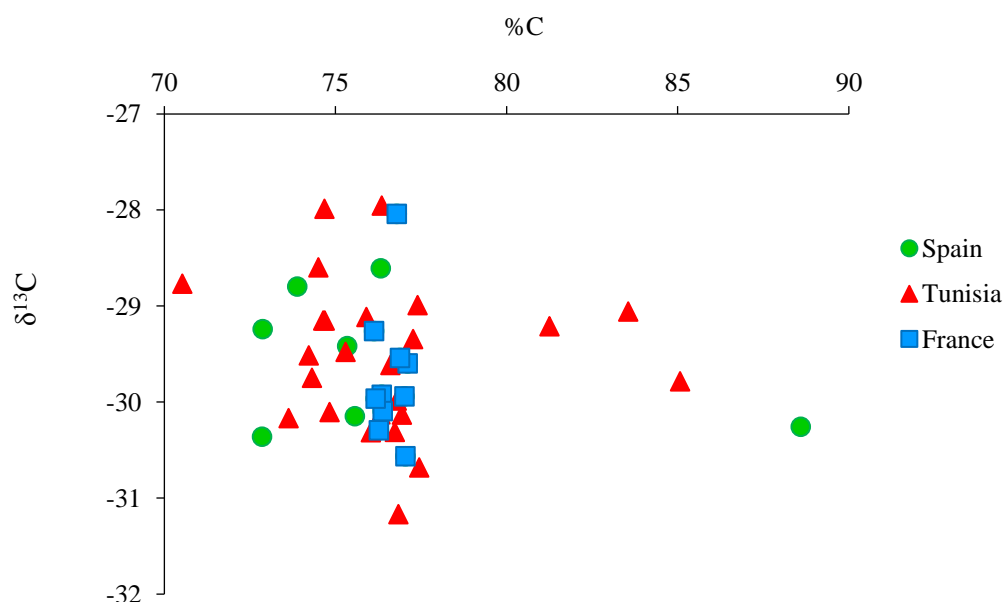

**Figure VI.1:** Olive oil samples distribution according to  $\delta^{13}\text{C} = f(\%C)$



The figure VI.1 displays the distribution of the olive oils on the plot  $\delta^{13}\text{C} = f(\%C)$ . All the samples overlapped which clearly highlights that %C and  $\delta^{13}\text{C}$  only cannot be used for geographical origin attribution. This finding was expected since the carbon isotope ratio is mostly depending on the physiological processes of the plant which is determined by the photosynthetic pathways and thus it is insufficient, alone, for the determination of the geographical origin of olive oil. However, if olive oil is diluted with other vegetable oils (corn oil for example), this approach could be successfully used to detect this type of adulteration.

### 3.2. Olive oil geographical authentication using $^{87}\text{Sr}/^{86}\text{Sr}$ isotope ratio

The concentrations of Sr as well as the  $^{87}\text{Sr}/^{86}\text{Sr}$  isotopic ratios of olive oil samples from Tunisia, southern France and the Basque country of Spain are presented in table VI.2 from chapter IV. The precision is expressed as the standard deviation calculated on basis of triplicates for the concentrations and as twice the standard deviation for the Sr isotopic ratios. The  $^{87}\text{Sr}/^{86}\text{Sr}$  IR values of olive oils originating from Tunisia ranged between  $0.70807 \pm 0.00003$  and  $0.70884 \pm 0.00004$ . The Sr isotope ratios for the samples of France displayed had slightly higher Sr isotopic ratio and were ranging between  $0.70825 \pm 0.00004$  and  $0.70894 \pm 0.00004$ .

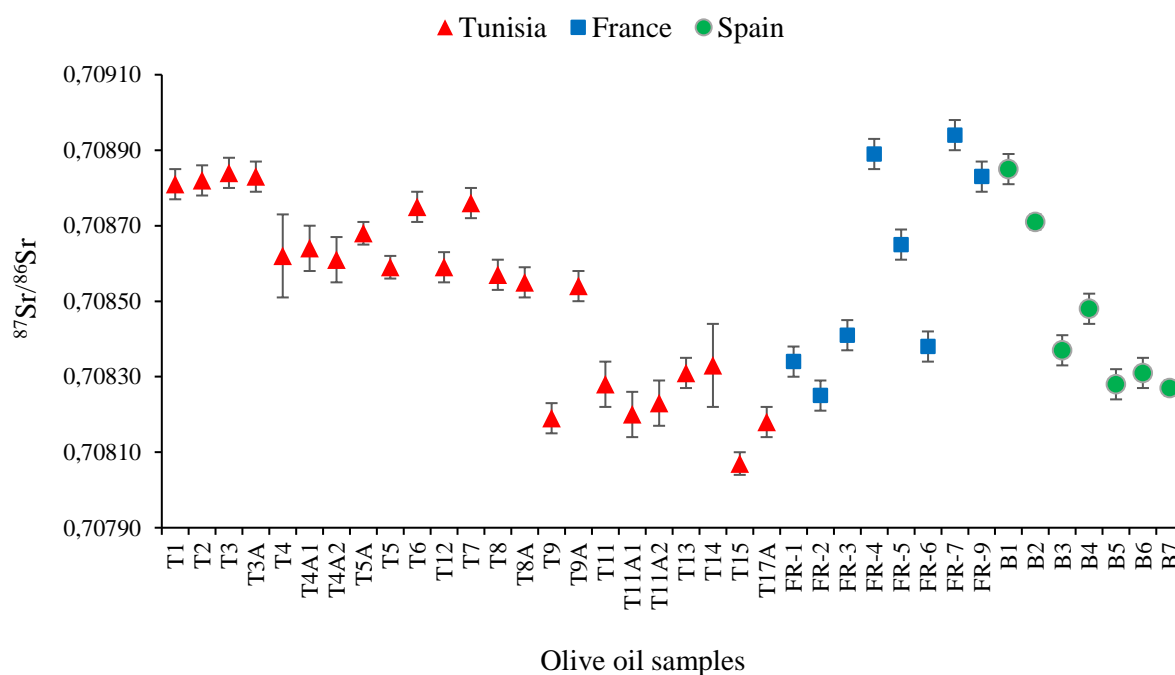

**Figure VI.2:**  $^{87}\text{Sr}/^{86}\text{Sr}$  isotope ratios in olive oils from Tunisia, France and Spain.

Finally, the olive oils from Spain exhibited similar values than for the French one ( $0.70827 \pm 0.00004$  to  $0.70885 \pm 0.00004$ ).

These results constitute the first large-scale database for  $^{87}\text{Sr}/^{86}\text{Sr}$  isotope ratio values in olive oils of different origin. Precisions on sample triplicates were relatively low, ranging from 0.00002 to 0.00011 (Nasr et al 2022).

Figure VI.2 displays the variation of the Sr isotopic ratio in the different olive oils. The lowest value determined is  $0.70807 \pm 0.00003$  and it was recorded in Tunisia whereas the highest value was detected in France ( $0.70894 \pm 0.00004$ ).

The results presented in figure VI.2 highlights the fact that there are some overlaps between the Sr isotopic ratios of olive oils originating from different countries. These results clearly demonstrate that the isotopic ratio of Sr cannot be used as a unique marker of the origin of OO on a country scale.

However, the distribution of Sr isotopic ratios within a country provides some interesting observations. In Tunisia, we can clearly identify 3 different categories of similar isotopic ratios ranging from 0.70807 and 0.70833, then 0.70819 and 0.70868 and finally 0.70875 and 0.70884. These 3 groups of isotopic signatures have been demonstrated to have the same geogenic signature in close relationship with the soil and bedrock of 3 areas of Tunisia (Chapter 5). The samples originating from France display a wide range of isotopic ratios. These values of  $^{87}\text{Sr}/^{86}\text{Sr}$  ratios were in the range 0.70825 - 0.70894; These results were found to be in agreement with the range of  $^{87}\text{Sr}/^{86}\text{Sr}$  isotope ratios previously recorded in Protected Designation of Origin (PDO) olive oils from Nîmes, southern France (0.70727 - 0.70881) (Medini et al., 2015). These values overlap with the reported data of various food products and beverages originating from France such as authentic paprika (0.7083 - 0.7087) (Brunner et al., 2010), wine (0.70829 - 0.71022) (Epova et al., 2019) and cheese Savoie (0.70827 - 0.70863) (Fortunato et al., 2004; Pillonel et al., 2005). The range of  $^{87}\text{Sr}/^{86}\text{Sr}$  isotope ratios measured in olive oils from France (0.70825-0.70894) is mostly in agreement with the typical isotopic values from soils consisting of carbonaceous sediments (0.7072 - 0.7115) and clastic sediments (0.7076 - 0.7170) which dominate the southern region of France (Willmes et al., 2018). This classification established by (Willmes et al., 2018) was based on lithology rather than ages as it allowed to better cluster  $^{87}\text{Sr}/^{86}\text{Sr}$  isotope ratios of a large number of plant samples and soil leachates.

The Spanish olive oils are originating from the province of Navarre (Anorbe, Cintruenigo, Ablitas and Mendavia) and Araba (Oion, Lantziego and Moreda). As reported by (García-Ruiz et al., 2007), geologically, Spanish locations can be classified in two groups according to the predominant geological outcrops: the Northern Spain, bordered by the Cantabrian mountains and the surrounding Areas, characterized by crystalline siliceous rocks ( $^{87}\text{Sr}/^{86}\text{Sr}$ : 0.710 – 0.750) and the Central and Eastern Spain dominated by limestone rocks ( $^{87}\text{Sr}/^{86}\text{Sr}$ : 0.706 – 0.709). The olive oil sampled in this research originate from Central and Eastern Spain areas. Accordingly, the sampling locations of the Spanish olive oils belong geologically to Central and Eastern Spain area.

This study clearly demonstrates that  $^{87}\text{Sr}/^{86}\text{Sr}$  ratio can be used as a reliable tool for fingerprinting the geological background. On a regional scale and for well-defined geological features, we can clearly discriminate the geographical and lithogenic origin of the samples. However, it cannot be used alone for geographical authentication studies since that different countries can exhibit similar lithogenic formations and, hence, will result in similar Sr isotopic ratio. This finding is only valid when the soil is not impacted by anthropogenic activities (Techer et al., 2017).

### **3.3. Combination of the isotopic signatures with the elemental content of olive oil for the geographical authentication**

To promote the full geographical information of olive oils, we integrated the elemental and isotopic signatures that reflect the geological substrate on which the olive oils are collected and the environmental characteristics. The following approaches were investigated: the trace elements concentrations, the C isotopic ratio and the Sr isotopic ratio.

The isotopic approaches (C and Sr) allowed to trace the climatic conditions and geological features of the plant origin. The results obtained for these geographical indicators individually overlapped to some extent and did not allow to distinguish the samples of different countries. Both isotopic approaches were combined together and the results, not shown here, were still overlapping. Therefore, the addition of the multi-elemental approach was investigated.

The use of trace elements contents data in combination with chemometrics has been successfully applied for the geographical discrimination of olive oils from Tunisia, France and Spain and the results obtained were previously reported by (Nasr et al., 2022).

However, the statistical model created cannot be considered to be strong and reliable enough to assess the geographical origin of olive oils. Indeed, the elemental profile of food products can be easily modified with the addition of agricultural chemicals, mixing with lower quality oils or naturally altered through contamination that can occur during the plant growth by anthropogenic activities and environmental parameters and through the olive oil production process. The combination of various geographical information (elemental and isotopic signatures) enables to create a complex geographical traceability system and thus to overcome the most sophisticated fraudulent practices. This approach was successfully applied for the authentication of several food products (Brunner et al., 2010; Liu et al., 2016; Rummel et al., 2010; Zhou et al., 2018), particularly olive oils (Camin, Larcher, Nicolini, et al., 2010).

Based on the results reported by (Nasr et al., 2022), the elements that displayed the highest contribution for the separation between the groups of samples were identified: mainly  $Mn > Fe > V > Sr > Cu$  for the separation between the Tunisian and European olive oils; Further, Cr and Zn were the most effective for separating the French and the Spanish olive oils. These elements contents combined with  $\delta^{13}C$  and  $^{87}Sr/^{86}Sr$  isotope ratios were used as variables to perform a principal component analysis.

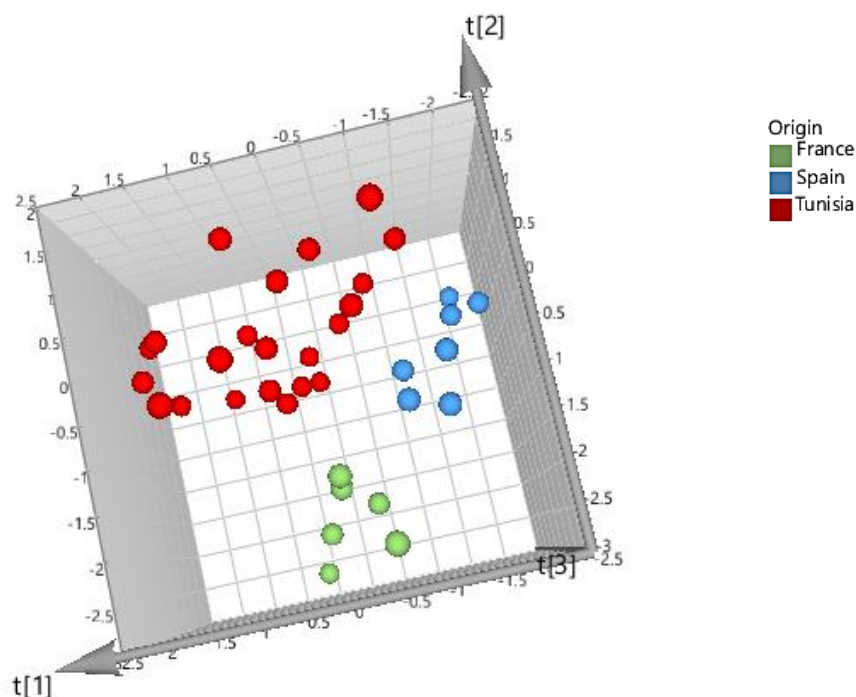
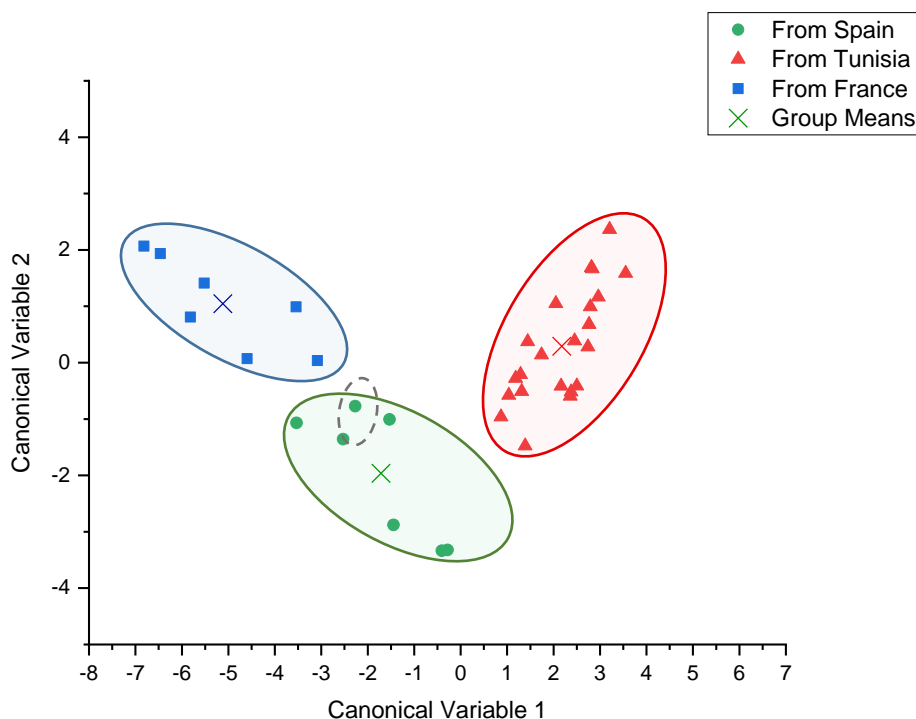

**Figure VI.3:** The 3D score plot of the principal component analysis (PC1 vs. PC2 vs. PC3) using as variables Mn, Fe, V, Sr, Cu, Zn, Cr,  $\delta^{13}C$  and  $^{87}Sr/^{86}Sr$

Three principal components (PCs) were extracted and explained together 66.79% of the whole variance. The first PC retained 25.95% of the variance while PC2 explained 21.74% of the variance. The third PC explained 19.1% of the total variance. The samples are visualized on a 3D plane corresponding to the projection on 3 axes (PC1, PC2 and PC3) (Figure VI.3).

Figure VI.3 shows a spatial distribution of olive oil samples among 3 clusters belonging to different geographical origins (Tunisia, Spain and France).

The three groups of samples are clearly distinguished suggesting that the combination of elemental and isotopic approaches is a reliable tool for the geographical discrimination of olive oils. To reinforce the statistical PCA model, a supervised LDA model was performed. Due to the samples size of olive oils from Spain ( $n=7$ ), the number of variables cannot be larger than 7. Therefore, on basis of the elements loadings, only 4 elements that displayed the highest loadings were selected as the most significant variables for the geographical discrimination of olive oils (Fe, Mn, V and Cr) and were considered with  $\delta^{13}\text{C}$  and  $^{87}\text{Sr}/^{86}\text{Sr}$  isotope ratios for LDA. Figure VI.4 displays the canonical score plot obtained. Two canonical variables explained together 100% of the variance and allowed a clear separation between the 3 geographical provenances investigated.



**Figure VI.4:** Canonical score plot of olive oils from Tunisia, France and Spain based on  $\delta^{13}\text{C}$ ,  $^{87}\text{Sr}/^{86}\text{Sr}$  and elemental concentrations (Fe, Mn, V and Cr)

The first canonical variable explained 87.25% of the variance (Wilk's Lambda = 0.072,  $X^2 = 83.99$ ,  $df = 10$  with  $p < 0.05$ ) whereas the second variable explains 10.59% (Wilk's Lambda = 0.524,  $X^2 = 20.70$ ,  $df = 4$  with  $p < 0.05$ ).

In order to evaluate the prediction and generalization powers of the discriminant model, a cross validation was performed. The olive oil samples from Tunisia and Spain were correctly classified (100% correct classification). For French olive oils, only one sample was mistakenly classified as Spanish oil (Figure VI.4). The error rate is only 1.45%.

These results highlight the fact that the model created is strong enough for conducting the geographical discrimination between the three groups of samples by the combination of the isotopic signature of C and Sr with the elemental content of 4 elements (Fe, Mn, V and Cr). It combines geographical information of climatic conditions (C isotope ratio), bedrock (Sr isotope ratio) and elemental profile of the soil (Fe, Mn, V and Cr). While the elements contents mainly trace the soil of origin chromium, some elements like Cr and Fe can be incorporated into the oil during the extraction and thus reflecting the manufacturing and packaging process (Skrzydłowska et al., 2003).

#### 4. Conclusion

In this chapter, a multi-analytical approach combined with multivariate analysis was successfully applied for the geographical classification of olive oil samples from Tunisia, Spain and France.

Initially, isotopic approaches (C and Sr) were individually investigated to evaluate their geographical discriminating potential. At first, the carbon isotope ratio was determined in olive oil samples by IRMS. The results have shown that the isotopic fractionation of carbon isotopes was mainly related to the physiological processes of the olive tree as a response to specific climatic conditions. This approach was nevertheless insufficient for the geographical discrimination of olive oils. Secondly, the  $^{87}\text{Sr}/^{86}\text{Sr}$  isotope ratio of olive oils was analyzed by MC-ICP-MS. The compilation of the results enabled to establish a first relatively large database of  $^{87}\text{Sr}/^{86}\text{Sr}$  ratio in olive oils. This second isotopic approach allowed an interregional discrimination of the samples within the same country on basis of specific geological features. However, the similarities between lithogenic formations among different countries resulted in an overlap of the Sr isotope ratios recorded in samples from different geographic provenances. Therefore, the use of this single-parameter approach is limited for geographical traceability studies. Thus, several combinations of analytical approaches were investigated. Elements contents combined with  $\delta^{13}\text{C}$  and  $^{87}\text{Sr}/^{86}\text{Sr}$  isotope ratios were used as variables to achieve a principal component analysis. The resulting score plot allowed to successfully discriminate samples of different origin. This model combines information about the geo-climatic conditions, the geological background and the elemental profile of the soil. A linear discriminant analysis was then performed to strengthen the model created. A canonical score plot was effective to clearly display three groups of samples clustered according to their geographical provenance with satisfactory prediction.

As a perspective of this work, additional authentic samples are required to further reinforce the statistical model.

## References

- Aceto, M.; Calà, E.; Musso, D.; Regalli, N.; Oddone, M. A Preliminary Study on the Authentication and Traceability of Extra Virgin Olive Oil Made from Taggiasca Olives by Means of Trace and Ultra-Trace Elements Distribution. *Food Chemistry* **2019**, 298, 125047. <https://doi.org/10.1016/j.foodchem.2019.125047>.
- Angerosa, F.; Bréas, O.; Contento, S.; Guillou, C.; Reniero, F.; Sada, E. Application of Stable Isotope Ratio Analysis to the Characterization of the Geographical Origin of Olive Oils. *Journal of Agricultural and Food Chemistry* **1999**, 47 (3), 1013–1017. <https://doi.org/10.1021/jf9809129>.
- Banner, J. L. Radiogenic Isotopes: Systematics and Applications to Earth Surface Processes and Chemical Stratigraphy. *Earth-Science Reviews* **2004**, 65 (3–4), 141–194. [https://doi.org/10.1016/S0012-8252\(03\)00086-2](https://doi.org/10.1016/S0012-8252(03)00086-2).
- Bataille, C. P.; Bowen, G. J. Mapping  $87\text{Sr}/86\text{Sr}$  Variations in Bedrock and Water for Large Scale Provenance Studies. *Chemical Geology* **2012**, 304–305, 39–52. <https://doi.org/10.1016/j.chemgeo.2012.01.028>.
- Beltrán, M.; Sánchez-Astudillo, M.; Aparicio, R.; García-González, D. L. Geographical Traceability of Virgin Olive Oils from South-Western Spain by Their Multi-Elemental Composition. *Food Chemistry* **2015**, 169, 350–357. <https://doi.org/10.1016/j.foodchem.2014.07.104>.
- Benincasa, C.; Gharsallaoui, M.; Perri, E.; Briccoli Bati, C.; Ayadi, M.; Khlif, M.; Gabsi, S. Quality and Trace Element Profile of Tunisian Olive Oils Obtained from Plants Irrigated with Treated Wastewater. *The Scientific World Journal* **2012**, 2012, 1–11. <https://doi.org/10.1100/2012/535781>.
- Bong, Y.-S.; Shin, W.-J.; Gautam, M. K.; Jeong, Y.-J.; Lee, A.-R.; Jang, C.-S.; Lim, Y.-P.; Chung, G.-S.; Lee, K.-S. Determining the Geographical Origin of Chinese Cabbages Using Multielement Composition and Strontium Isotope Ratio Analyses. *Food Chemistry* **2012**, 135 (4), 2666–2674. <https://doi.org/10.1016/j.foodchem.2012.07.045>.
- Brunner, M.; Katona, R.; Stefánka, Z.; Prohaska, T. Determination of the Geographical Origin of Processed Spice Using Multielement and Isotopic Pattern on the Example of Szegedi Paprika. *Eur Food Res Technol* **2010**, 231 (4), 623–634. <https://doi.org/10.1007/s00217-010-1314-7>.
- Camin, F.; Larcher, R.; Nicolini, G.; Bontempo, L.; Bertoldi, D.; Perini, M.; Schlicht, C.; Schellenberg, A.; Thomas, F.; Heinrich, K.; Voerkelius, S.; Horacek, M.; Ueckermann, H.; Froeschl, H.; Wimmer, B.; Heiss, G.; Baxter, M.; Rossmann, A.; Hoogewerff, J. Isotopic and Elemental Data for Tracing the Origin of European Olive Oils. *Journal of Agricultural and Food Chemistry* **2010**, 58 (1), 570–577. <https://doi.org/10.1021/jf902814s>.



Camin, F.; Larcher, R.; Perini, M.; Bontempo, L.; Bertoldi, D.; Gagliano, G.; Nicolini, G.; Versini, G. Characterisation of Authentic Italian Extra-Virgin Olive Oils by Stable Isotope Ratios of C, O and H and Mineral Composition. *Food Chemistry* **2010**, 118 (4), 901–909. <https://doi.org/10.1016/j.foodchem.2008.04.059>.

Chen, L.; Liu, J.; Hu, W.; Gao, J.; Yang, J. Vanadium in Soil-Plant System: Source, Fate, Toxicity, and Bioremediation. *Journal of Hazardous Materials* **2021**, 405, 124200. <https://doi.org/10.1016/j.jhazmat.2020.124200>.

Coelho, I.; Castanheira, I.; Bordado, J. M.; Donard, O.; Silva, J. A. L. Recent Developments and Trends in the Application of Strontium and Its Isotopes in Biological Related Fields. *TrAC Trends in Analytical Chemistry* **2017**, 90, 45–61. <https://doi.org/10.1016/j.trac.2017.02.005>.

Damak, F.; Asano, M.; Baba, K.; Suda, A.; Araoka, D.; Wali, A.; Isoda, H.; Nakajima, M.; Ksibi, M.; Tamura, K. Interregional Traceability of Tunisian Olive Oils to the Provenance Soil by Multielemental Fingerprinting and Chemometrics. *Food Chemistry* **2019**, 283, 656–664. <https://doi.org/10.1016/j.foodchem.2019.01.082>.

Driesen, E.; Van den Ende, W.; De Proft, M.; Saeys, W. Influence of Environmental Factors Light, CO<sub>2</sub>, Temperature, and Relative Humidity on Stomatal Opening and Development: A Review. *Agronomy* **2020**, 10 (12), 1975. <https://doi.org/10.3390/agronomy10121975>.

Epova, E. N.; Bérail, S.; Séby, F.; Vacchina, V.; Bareille, G.; Médina, B.; Sarthou, L.; Donard, O. F. X. Strontium Elemental and Isotopic Signatures of Bordeaux Wines for Authenticity and Geographical Origin Assessment. *Food Chemistry* **2019**, 294, 35–45. <https://doi.org/10.1016/j.foodchem.2019.04.068>.

Fortunato, G.; Mumić, K.; Wunderli, S.; Pillonel, L.; Bosset, J. O.; Gremaud, G. Application of Strontium Isotope Abundance Ratios Measured by MC-ICP-MS for Food Authentication. *J. Anal. At. Spectrom.* **2004**, 19 (2), 227. <https://doi.org/10.1039/b307068a>.

García-Ruiz, S.; Moldovan, M.; Fortunato, G.; Wunderli, S.; García Alonso, J. I. Evaluation of Strontium Isotope Abundance Ratios in Combination with Multi-Elemental Analysis as a Possible Tool to Study the Geographical Origin of Ciders. *Analytica Chimica Acta* **2007**, 590 (1), 55–66. <https://doi.org/10.1016/j.aca.2007.03.016>.

Graustein, W. C.; Armstrong, R. L. The Use of Strontium-87/Strontium-86 Ratios to Measure Atmospheric Transport into Forested Watersheds. *Science* **1983**, 219 (4582), 289–292. <https://doi.org/10.1126/science.219.4582.289>.

Graustein, W.C., <sup>87</sup>Sr/<sup>86</sup>Sr ratios measure the sources and flow of strontium in terrestrial ecosystems. Rundel, p. w., Ehleringer, j. r. & Nagy, k. a. *Stable Isotopes in Ecological Research: Ecological Studies*. Springer, Verlag, New York, **1989**, 491-512, doi: 10.1007/978-1-4612-3498-2\_28

Gumus, Z. P.; Celenk, V. U.; Tekin, S.; Yurdakul, O.; Ertas, H. Determination of Trace Elements and Stable Carbon Isotope Ratios in Virgin Olive Oils from Western Turkey to Authenticate Geographical Origin with a Chemometric Approach. *Eur Food Res Technol* **2017**, 243 (10), 1719–1727. <https://doi.org/10.1007/s00217-017-2876-4>.

Iacumin, P.; Bernini, L.; Boschetti, T. Climatic Factors Influencing the Isotope Composition of Italian Olive Oils and Geographic Characterisation. *Rapid Commun. Mass Spectrom.* **2009**, 23 (3), 448–454. <https://doi.org/10.1002/rcm.3896>.

Kabata-Pendias, A. Soil–Plant Transfer of Trace Elements, an Environmental Issue. *Geoderma* **2004**, 122 (2–4), 143–149. <https://doi.org/10.1016/j.geoderma.2004.01.004>.

Karalis, P.; Poutouki, A. E.; Nikou, T.; Halabalaki, M.; Proestos, C.; Tsakalidou, E.; Gougoura, S.; Diamantopoulos, G.; Tassi, M.; Dotsika, E. Isotopic Traceability ( $^{13}\text{C}$  and  $^{18}\text{O}$ ) of Greek Olive Oil. *Molecules* **2020**, 25 (24). <https://doi.org/10.3390/molecules25245816>.

Liu, H.; Wei, Y.; Lu, H.; Wei, S.; Jiang, T.; Zhang, Y.; Guo, B. Combination of the  $^{87}\text{Sr}/^{86}\text{Sr}$  Ratio and Light Stable Isotopic Values ( $\delta^{13}\text{C}$ ,  $\delta^{15}\text{N}$  and  $\delta\text{D}$ ) for Identifying the Geographical Origin of Winter Wheat in China. *Food Chemistry* **2016**, 212, 367–373. <https://doi.org/10.1016/j.foodchem.2016.06.002>.

Mendil, D.; Uluözlü, Ö. D.; Tüzen, M.; Soylak, M. Investigation of the Levels of Some Element in Edible Oil Samples Produced in Turkey by Atomic Absorption Spectrometry. *Journal of Hazardous Materials* **2009**, 165 (1–3), 724–728. <https://doi.org/10.1016/j.jhazmat.2008.10.046>.

Nasr, E. G.; Epova, E. N.; de Diego, A.; Souissi, R.; Hammami, M.; Abderrazak, H.; F. X. Donard, O. Trace Elements Analysis of Tunisian and European Extra Virgin Olive Oils by ICP-MS and Chemometrics for Geographical Discrimination. *Foods* **2021**, 11 (1), 82. <https://doi.org/10.3390/foods11010082>.

Pillonel, L.; Badertscher, R.; Casey, M.; Meyer, J.; Rossmann, A.; Schlichtherle-Cerny, H.; Tabacchi, R.; Bosset, J. O. Geographic Origin of European Emmental Cheese: Characterisation and Descriptive Statistics. *International Dairy Journal* **2005**, 15 (6–9), 547–556. <https://doi.org/10.1016/j.idairyj.2004.07.028>.

Portarena, S.; Farinelli, D.; Lauteri, M.; Famiani, F.; Esti, M.; Brugnoli, E. Stable Isotope and Fatty Acid Compositions of Monovarietal Olive Oils: Implications of Ripening Stage and Climate Effects as Determinants in Traceability Studies. *Food Control* **2015**, 57, 129–135. <https://doi.org/10.1016/j.foodcont.2015.03.052>.

Portarena, S.; Gavrichkova, O.; Lauteri, M.; Brugnoli, E. Authentication and Traceability of Italian Extra-Virgin Olive Oils by Means of Stable Isotopes Techniques. *Food Chemistry* **2014**, 164, 12–16. <https://doi.org/10.1016/j.foodchem.2014.04.115>.

Rummel, S.; Hoelzl, S.; Horn, P.; Rossmann, A.; Schlicht, C. The Combination of Stable Isotope Abundance Ratios of H, C, N and S with  $^{87}\text{Sr}/^{86}\text{Sr}$  for Geographical Origin Assignment of

Orange Juices. *Food Chemistry* **2010**, 118 (4), 890–900. <https://doi.org/10.1016/j.foodchem.2008.05.115>.

Medini S. Traçage géographique des huiles d'olive par les isotopes du Sr : développement analytique et application aux huiles AOP de Nîmes, Université d'Aix-Marseille, France, **2015**.

Skrzydłowska, E.; Balcerzak, M.; Vanhaecke, F. Determination of Chromium, Cadmium and Lead in Food-Packaging Materials by Axial Inductively Coupled Plasma Time-of-Flight Mass Spectrometry. *Analytica Chimica Acta* **2003**, 479 (2), 191–202. [https://doi.org/10.1016/S0003-2670\(02\)01527-1](https://doi.org/10.1016/S0003-2670(02)01527-1).

Tarapoulouzi, M.; Skiada, V.; Agriopoulou, S.; Psomiadis, D.; Rébufa, C.; Roussos, S.; Theocharis, C. R.; Katsaris, P.; Varzakas, T. Chemometric Discrimination of the Geographical Origin of Three Greek Cultivars of Olive Oils by Stable Isotope Ratio Analysis. *Foods* **2021**, 10 (2), 336. <https://doi.org/10.3390/foods10020336>.

Techer, I.; Medini, S.; Janin, M.; Arregui, M. Impact of Agricultural Practice on the Sr Isotopic Composition of Food Products: Application to Discriminate the Geographic Origin of Olives and Olive Oil. *Applied Geochemistry* **2017**, 82, 1–14. <https://doi.org/10.1016/j.apgeochem.2017.05.010>.

Voerkelius, S.; Lorenz, G. D.; Rummel, S.; Quézel, C. R.; Heiss, G.; Baxter, M.; Brach-Papa, C.; Deters-Itzelsberger, P.; Hoelzl, S.; Hoogewerff, J.; Ponzevera, E.; Van Bocxstaele, M.; Ueckermann, H. Strontium Isotopic Signatures of Natural Mineral Waters, the Reference to a Simple Geological Map and Its Potential for Authentication of Food. *Food Chemistry* **2010**, 118 (4), 933–940. <https://doi.org/10.1016/j.foodchem.2009.04.125>.

Willmes, M.; Bataille, C. P.; James, H. F.; Moffat, I.; McMorrow, L.; Kinsley, L.; Armstrong, R. A.; Eggins, S.; Grün, R. Mapping of Bioavailable Strontium Isotope Ratios in France for Archaeological Provenance Studies. *Applied Geochemistry* **2018**, 90, 75–86. <https://doi.org/10.1016/j.apgeochem.2017.12.025>.

Winkler, F. J.; Schmidt, H.-L. Einsatzmöglichkeiten der  $^{13}\text{C}$ -Isotopen-Massenspektrometrie in der Lebensmitteluntersuchung. **1980**, 10.

Zhou, X.; Taylor, M. P.; Salouros, H.; Prasad, S. Authenticity and Geographic Origin of Global Honeys Determined Using Carbon Isotope Ratios and Trace Elements. *Scientific Reports* **2018**, 8 (1), 1–11. <https://doi.org/10.1038/s41598-018-32764-w>.

## General conclusion

Olive oil is a food product of great economic importance. It is largely produced and consumed around the world which led to fraudulent practices spreading. The development of a reliable analytical approach to assess the geographical traceability of olive oil has therefore become a major concern for consumers and producers.

A wide range of analytical techniques have been developed and successfully used for the determination of the geographical origin of various food products. The most advanced methods that provide reliable information on the geographical origin of plants and food products are based on multi-elemental and isotopic approaches because they are related to the soil on which the plant was grown and they reflect the environment of the plant. However, olive oil is a complex matrix and represents an analytical challenge due to its viscosity, high organic content and very low elements concentrations hindering its introduction in the plasma based analytical instruments. Accordingly, very limited studies aiming at geographical authentication of olive oil using sophisticated techniques were published so far.

In this study, three analytical approaches were developed for the discrimination between olive oils from Tunisia, Spain and France:

- 1) The first approach was based on the analysis of trace elements in olive oil. The samples were mineralized according to a multi-stage approach using a microwave system. Each step of the analytical procedure was optimized and thoroughly controlled to avoid contamination. The concentrations of 17 elements were determined by ICP-MS with high precision and good accuracy. The quality control of the developed analytical procedure was performed using the NIST SRM 2387. Further, the elemental content of 7 elements (Cu, Cr, Fe, Mn, Sr, V and Zn) combined with multivariate analysis (PCA) allowed to discriminate samples of the three studied origins. This discrimination primarily reflects the mineral composition of the soil, which varies naturally along with lithology. However, atmospheric and anthropogenic inputs can significantly alter the multi-elemental profile of the soil, plant, and final product. Therefore, the determination of the geographic origin of foodstuffs based on elemental composition is limited and needs to be strengthened.

- 2) The second approach was based on the analysis of Sr isotopic composition. Indeed, the ratio  $^{87}\text{Sr}/^{86}\text{Sr}$  is strongly related to the geological background. The main source of Sr in

the soil is derived from the parent rock and it does not fractionate during the transfer from the soil to the plant organs. However, Sr is present in olive oil at critically low concentrations, not exceeding a few tens of  $\mu\text{g kg}^{-1}$ . The quantitative extraction of Sr from the oily matrix and the precise determination of  $^{87}\text{Sr}/^{86}\text{Sr}$  is, nevertheless, an analytical challenge. In this study, an innovative method was developed using a strong cation-exchange resin (Dowex AG50W-X8) for the Sr purification prior to isotopic analysis by MC-ICP-MS. The Sr was extracted and pre-concentrated through the complexation by EDTA of large volumes of olive oil. The method validation was performed using the NIST SRM 987 and the NIST SRM 2387 and through a comparison with the results obtained by a previously established method. Results showed that the developed analytical method was highly sensitive and allowed to determine with high precision the  $^{87}\text{Sr}/^{86}\text{Sr}$  isotope ratios in olive oil samples with low Sr content.

Before assessing the feasibility of  $^{87}\text{Sr}/^{86}\text{Sr}$  as a geographic tracer of olive oil, the conservation of  $^{87}\text{Sr}/^{86}\text{Sr}$  from soil to olive oil was studied. The Sr isotopic signature was identified in the exchangeable fraction of the soil, in the organs of the olive tree pair (roots and leaves), in the olive oil and in the olive pomace. We demonstrated that the  $^{87}\text{Sr}/^{86}\text{Sr}$  isotopic ratio was strongly correlated between the different matrices analyzed, independently of the olive oil extraction process. These results confirm the transfer of Sr from soil to olive oil without isotopic fractionation, making Sr isotopic composition a robust and reliable tool for geographic provenance issues. Subsequently, a study of the geology of each of the origins studied was carried out on the basis of information available in the literature.

The study showed that olive oil inherits its Sr isotopic composition from the geological substrate. Nevertheless, growing areas sharing similar geological characteristics are characterized by comparable Sr isotopic compositions and therefore cannot be distinguished on the basis of this single parameter approach.

3) Another isotopic approach was investigated to assess the geographical provenance of olive oil based on the analysis of stable carbon isotope ratios. Indeed, the process of assimilation of atmospheric carbon by plants through the leaves during the photosynthesis is correlated to specific agro-climatic conditions. Samples of olive oil from Tunisia and paired olive leaves were analyzed by IRMS. The results obtained suggested that the isotopic fractionation that occurs during the photosynthesis process is mostly related to the physiological processes of the plant (C3). The results obtained overlapped making it difficult to distinguish the countries of origin.

Therefore, a multi-analytical approach was investigated as a robust tool that combines complementary information about the plant growing environment. The  $^{87}\text{Sr}/^{86}\text{Sr}$  isotope ratios, the carbon stable isotope ratios and the elemental content of Fe, Mn, V and Cr, previously identified as powerful discriminating elements, were used to perform a linear discriminant analysis. The canonical plot obtained showed a good separation between 3 groups of samples from Tunisia, Spain and France. The model created should be sophisticated enough and providing complete information of the geographical characteristics for a trustworthy geographical authentication of olive oil.

In conclusion, the single-parameter approaches developed and applied in this study provided solely limited geographical information about the studied locations and didn't allow to effectively assess the geographic provenance of olive oils. The combination of the elemental and isotopic approaches was more effective in distinguishing the samples of different countries. Nevertheless, high-quality results should be ensured.

As a perspective of this work, additional authentic samples are required to reinforce further the statistical model created and to create a larger database for olive oils. Once created, this database would be beneficial for future geographical authentication studies of olive oil, the targeted analyses can be therefore reduced by the use of the available data previously provided. Indeed, the methods established in this study, based on elemental and isotopic analyses, require the use of high purity reagents and highly sensitive instruments which are not accessible to everyone.

---

# Appendices

---

---



Article

# Trace Elements Analysis of Tunisian and European Extra Virgin Olive Oils by ICP-MS and Chemometrics for Geographical Discrimination

Emna G. Nasr <sup>1,2,3</sup>, Ekaterina N. Epova <sup>4</sup>, Alberto de Diego <sup>5</sup>, Radhia Souissi <sup>2</sup>, Mohamed Hammami <sup>2</sup>, Houyem Abderrazak <sup>2</sup> and Olivier F. X. Donard <sup>1,4,\*</sup>

- <sup>1</sup> Institut des Sciences Analytiques et de Physicochimie Pour l'Environnement et les Matériaux, Université de Pau et des Pays de l'Adour, 64000 Pau, France; emna.nsr@gmail.com
  - <sup>2</sup> Laboratoire des Matériaux Utiles, Institut National de Recherche et d'Analyse Physicochimique Technopole de Sidi Thabet, Ariana 2020, Tunisia; souissiradhia@yahoo.fr (R.S.); Mohamed.Hammami@inrap.mrt.tn (M.H.); houyem.snani@yahoo.fr (H.A.)
  - <sup>3</sup> Faculty of Sciences, Farhat Hached University Campus, University of Tunis El Manar, Tunis 1068, Tunisia
  - <sup>4</sup> Advanced Isotopic Analysis, Hélioparc, 64000 Pau, France; ekaterina.epova@ai-analysis.com
  - <sup>5</sup> Department of Analytical Chemistry, Faculty of Science and Technology, University of the Basque Country, 48080 Bilbao, Spain; alberto.dediego@ehu.es
- \* Correspondence: olivier.donard@univ-pau.fr; Tel.: +33-678-789-280



**Citation:** Nasr, E.G.; Epova, E.N.; de Diego, A.; Souissi, R.; Hammami, M.; Abderrazak, H.; F. X. Donard, O. Trace Elements Analysis of Tunisian and European Extra Virgin Olive Oils by ICP-MS and Chemometrics for Geographical Discrimination. *Foods* **2022**, *11*, 82. <https://doi.org/10.3390/foods11010082>

Academic Editors: Annalisa De Girolamo and Vincenzo Lippolis

Received: 5 December 2021

Accepted: 24 December 2021

Published: 29 December 2021

**Publisher's Note:** MDPI stays neutral with regard to jurisdictional claims in published maps and institutional affiliations.



**Copyright:** © 2021 by the authors. Licensee MDPI, Basel, Switzerland. This article is an open access article distributed under the terms and conditions of the Creative Commons Attribution (CC BY) license (<https://creativecommons.org/licenses/by/4.0/>).

**Abstract:** The aim of this study was to investigate the levels of trace elements in olive oils from different locations and their use for geographical authentication. Concentrations of seventeen elements were determined in a total of 42 olive oils from Tunisia, Spain (Basque country), and southern France, and in nine soil samples from Tunisia by quadrupole inductively plasma mass spectrometry. The compilation of appropriate techniques integrated into the analytical procedure achieved a precision (RSD) between 2% and 15% and low limits of detection (between 0.0002 and 0.313  $\mu\text{g kg}^{-1}$ ). The accuracy of the analytical method applied for olive oil analysis was evaluated using SRM NIST 2387 Peanut butter. The recoveries obtained after microwave-assisted digestion for the certified elements ranged between 86% and 102%. Concentrations of non-certified elements (V, Cr, Co, Ni, Ba, Rb, Sr, Cd, Pb, and As) were presented. The use of Pearson correlation applied on paired Tunisian oil/soil samples has shown that several elements (Mg, Mn, Ni, and Sr) were significantly correlated. The multivariate statistics using principal component analysis have successfully discriminated against three studied origins. The most significant variables were the elemental concentrations of Cu, Cr, Fe, Mn, Sr, V, and Zn. This study shows the potential of applying trace elements profiles for olive oil geographical discrimination.

**Keywords:** olive oil; inductively plasma mass spectrometry; soil; trace elements; principal component analysis; geographical discrimination

## 1. Introduction

Olive oil is a natural food product largely consumed throughout the world. Its exceptional taste, its innumerable health benefits, and its nutritional value have made it a widely appreciated product [1,2]. The countries of the circum-Mediterranean basin, which are characterized by a climate favorable to olive growing, are the largest producers and exporters of olive oil, mainly Italy, Spain, Tunisia, and Greece. In Tunisia, in particular, the olive oil production sector represents a major economic resource for the country and is a strategic axis in its policy towards exportation, mainly towards the European community. Indeed, more than 75% of its olive oil production is mainly oriented towards exportation [3]. In recent years, Tunisian olive oils have been exported more and more in packaged bottles. Its policy is oriented towards the enhancement of this product and improving competitiveness in the international market. As a start, Tunisia has recently obtained a quality label, "The



Appellation d'Origine Contrôlée" (AOC) olive oil of Teboursouk (3 March 2020, records of the World Intellectual Property Organization (WIPO)). Nevertheless, the proportion of oil packaged for export remains low, and Tunisia is hoping to double its packaged oil exports in the next five years applying the Hazard Analysis and Critical Control Point (HACCP) management system [4].

Tunisian olive oil exports are largely destined for the European Union; 97% of Spain's extra-EU import of olive oil and 91% of France's are Tunisian (International Olive Council, IOC). Therefore, ensuring the authenticity of olive oil is of general concern. The exports are mainly sent out in bulk (98%), opening the prospect of fraudulent practices [5]. Indeed, olive oil is now one of the most counterfeited food products [6,7]. This seemed to prompt the country's awareness of the danger that threatens one of its flagship products. Between the early 90s and the year 2018, the number of articles that deal with the varietal or geographical origin of olive oil has increased exponentially, going from a few dozen articles to over 240 papers [8]. This increase is explained by the growing interest in this topical issue and also by the considerable development in the analytical field, allowing access to high precision and sensitive instruments. The analytical techniques used for the detection of oil adulteration are diverse. Besides organic oil components determination, trace elements analysis associated with chemometrics was successfully employed for oil geographical traceability issues.

In general, trace elements represent a good geographical tracer as they are naturally present in the soil at variable concentrations. They are absorbed through the roots and transferred to the aerial parts of the plant by translocation [9]. Their distribution in the final product then reflects the elemental signature of the soil of origin. Limited interest has been given to the influence of other factors interacting with the plant or with the final product, such as the extraction process of the olive oil or agricultural practices [10,11]. However, elements such as chromium, cadmium, and lead can be incorporated into the oil during its extraction, reflecting the manufacturing and packaging process [12].

Geographical authentication studies carried out on olive oil are gradually increasing but remain limited. Indeed, olive oil is a complex lipid matrix, especially with regard to its introduction into plasma-based instruments. It is characterized by a high organic content that requires advanced conditions to destroy the matrix, and incomplete mineralization leads to inaccurate concentration determination, interferences and can induce plasma extinction. Furthermore, trace elements are present in olive oil at low concentrations, sometimes below the limits of detection [13,14]. The detection technique most often used is inductively coupled plasma mass spectrometry (ICP-MS) due to its high sensitivity [15–19], and to a lesser extent, inductively coupled plasma atomic emission spectroscopy (ICP-OES) [20,21], graphite furnace atomic absorption spectroscopy (ETAAS/GFAAS) [22,23], and flame atomic absorption spectroscopy (FAAS) [24] are employed.

Most of the sample preparation techniques used are based on destructive methods of organic matter prior to spectroscopic analysis. Mineralization in a microwave oven has been the most used due to the ease of implementation, high recoveries, and destructive efficiency of this apparatus [17,25–29]. Several extraction methods were also developed based on the affinity of the elements with the extraction phase without having to destroy the organic matter [15,24,30–32]. Nevertheless, the recovery percentages of the extraction methods remain limited due to the complex organic structure of olive oil from which metals are difficult to extract. Other studies have adopted emulsion techniques as an alternative, but these are difficult to implement, especially in terms of maintaining the stability of the emulsion [21,33].

The application of multivariate statistical methods, mainly principal components analysis (PCA) and linear discriminant analysis (LDA) applied on the mineral content allowed the discrimination between food products and raw materials at different production lines [34], from different types of plants [35] and from different geographical origins [36]. In particular, olive oils were classified with variable resolutions according to their origin on the basis of several elements contents [25,26,37].

In the present study, we describe a method for accurate and precise trace element concentration determination in olive oils from Tunisia, France (southern France), and Spain (region of Basque country). To the best of our knowledge, very limited studies have studied the multi-elemental composition of Tunisian olive oil so far, and these studies focused on specific and limited geographical areas in Tunisia [10,26,38]. While it is characterized by varied and heterogeneous geology, the soil composition must vary significantly in different regions. For this reason, we have set as a first objective a sampling strategy that covers various olive oil-producing locations across the Tunisian geography, even the lowest productions for local consumption. For the samples preparation, we performed an innovative approach based on a multi-stage sample preparation procedure that allowed the destruction of the organic matter contained in olive oil in order to facilitate the analytes' introduction into the ICP-MS. The quality control of the applied analytical procedure was performed using a standard reference material (SRM) NIST 2387 peanut butter. The recoveries were calculated for the concentrations of the certified elements; the non-certified elements were quantified with high precision and exclusively presented in this paper. The results obtained in this study will allow the creation of a database for the multi-elemental profile of Tunisian olive oils that can be useful for the quality assessment and the geographical characterization. The second objective of this work was to verify the correlation between the element concentrations in the soil and in the final product, which will allow the identification of the potential sources of elements that constitute the fingerprint of the geographical origin. Finally, the paper focused on the use of a common pattern recognition technique, the principal component analysis, as a tool for the classification of the samples according to their geographical origin.

## 2. Materials and Methods

### 2.1. Samples Collection and Preparation

#### 2.1.1. Samples from Tunisia

*Olive oil sampling:* An extensive sampling campaign was conducted during the olive harvest period between 2019 and 2020 in thirteen Tunisian governorates. A total of 25 olive oil samples were collected as the following: sixteen packaged olive oils produced in oil mills were obtained from local producers based in different regions in Tunisia, and nine olive oils were extracted from olives collected in different olive orchards grown on different soils. Olive oil extraction was performed at the laboratory of the Olive Tree Institute of Tunisia (OTIT). Sampling locations are plotted on the geological map of Tunisia shown in Figure 1.

*Olive oil preparation:* For the extra virgin olive oil (EVOO) samples extracted from the olives collected, the following procedure was performed. About 4 to 6 kg of olives were handpicked and then kept in the refrigerator for a maximum of 24 h before the oil was extracted. The olive oil extraction method employed was the ABENCOR method (<https://sistemaabencor.com/en/>, accessed on 25 November 2021). It includes leaf stripping and washing of the olives. Then, the grinding of the olives was performed in a hammer mill in order to obtain an olive paste. The resulting olive paste was mixed for 45 min in a mixer. During this step, a small volume of distilled water was added in order to facilitate the oil droplets released from the paste.

During the mixing step, the temperature was controlled not to exceed 27 °C. The final step was centrifugation. The olive paste obtained was introduced in a centrifuge system at 3500 rpm for 1 min. This allowed the separation of the dry pomace from olive oil, which was mixed with the wastewater. The olive oil was then separated from the water by natural decantation. All metallic surfaces in direct contact with olives, paste, and olive oil were made of stainless steel and were carefully washed after each sample run. The obtained olive oils were carefully transferred in brown glass bottles that had been previously washed with distilled water and then stored away from heat and light.

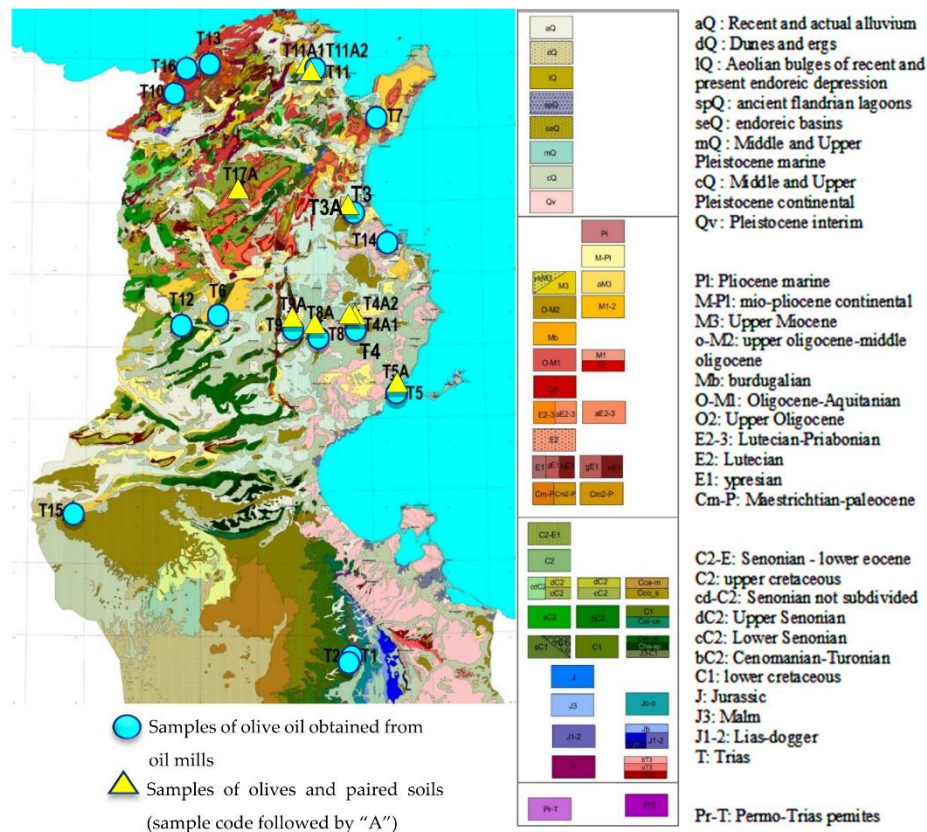

Figure 1. Sampling locations on Tunisian geological map.

Soil sampling: Under each sampled tree from the selected orchards, paired soils were collected for multi-elemental analysis as well. A total of 9 soil samples were collected at a depth of 60 cm using a pickaxe. This depth was selected since it was deep enough to avoid soil with surface treatment procedures. Once collected, the soil samples were air-dried for a few days and sieved through a 2 mm sieve. Then, 50 g were taken from each sample by the quartering method.

### 2.1.2. Samples from Europe

Apart from Tunisian olive oils, EVOOs from European locations were obtained and analyzed to compare their multi-elemental profile with that of the Tunisian ones. Seven olive oil samples were obtained from different locations of the Spanish Basque Country: Moreda, Lantziego, and Oion (province of Araba), and Añorbe, Mendavia, Cintruenigo, and Arroniz (province of Navarre). Ten protected designation of origin (AOP) EVOOs from southern France were also obtained from supermarkets (AOP Provence, AOP Nîmes, AOP Nice, and AOP Nyons).

Table 1 summarizes the olive oil and soil samples' geographical origins as well as the number of samples. Information about the geographical location, cultivar, geological formation, and applied agricultural practices are presented in Table 2.

**Table 1.** Extra virgin olive oil and soil samples: geographical origin and number of samples.

Geographical Origin	Tunisia			France (South)	Spain (Basque Country)
Samples	EVOO (produced in oil mill)	EVOO (produced in OTIT)	Soil (0–60 cm)	EVOO	EVOO
Number of samples	16	9	9	10	7

**Table 2.** Olive oil samples: geographical location, cultivar, geological formation, and applied agricultural practices.

Country of Origin (Number of Samples)	Geographical Location (Number of Samples)	Sample Code	Cultivar	Bedrock (Mineralization)	Agricultural Practices
Tunisia (n = 25)	Tataouine (n = 2)	T1	Zarrazi	limestones and marls	nt
		T2	Dhokkari		
	Sousse (n = 2)	T3	Chemlali	calcareous and gypsum crusts	nt
		T3A	Chemlali		
	Mahdia (n = 3)	T4	Chemlali	conglomerates, sand and clay	Drop irrigation and use of pomace residue as an amendment
		T4A	Chemlali		
		T4A'	Chemlali		
	Sfax (n = 2)	T5	Chemlali	Recent alluvium	nt
		T5A	Chemlali		
	Kasserine (n = 2)	T6	Arbequina	sandstone and marl	nt
		T12	ns	limestones, dolostones, marls and gypsum (Zn)	
	Nabeul (n = 1)	T7	Zarrazi	ancient limestone and gypsum alluvium	nt
	Kairouan (n = 4)	T8	Chemlali	ancient limestone and gypsum alluvium	nt
		T8A	Chemlali		
		T9	Chemlali	Recent alluvium	Drop irrigation
	Jendouba (n = 2)	T10	Chetoui	clay-sandstone flysch	nt
		T16	Chetoui	clay-sandstone flysch (Zn and Pb)	
	Ariana (n = 3)	T11	Mixture of different varieties	Recent alluvium	nt
		T11A	Chemlali		
		T11A'	Chemlali		
Beja (n = 1)	T13	ns	ancient limestone and gypsum alluvium	nt	
Monastir (n = 1)	T14	Mixture of different varieties	conglomerate, sands and clays	nt	
Tozeur (n = 1)	T15	Mixture of different varieties	conglomerates, sand and clay	nt	
Siliana (n = 1)	T17A	ns	Recent alluvium	nt	

Table 2. Cont.

Country of Origin (Number of Samples)	Geographical Location (Number of Samples)	Sample Code	Cultivar	Bedrock (Mineralization)	Agricultural Practices
Spain (Basque country) (n = 7)	Moreda Araba (n = 1)	B1	A mixture of Arroniz and Arbequina	ns	Use of fertilizer (15-15-15 NPK *; sheep and cattle manure)
	Añorbe (n = 1)	B2	A mixture of Arroniz and Arbequina	ns	ns
	Mendavia (n = 1)	B3	Arbequina	ns	ns
	Cintruenigo (n = 1)	B4	Arbequina	ns	ns
	Lantziego (n = 1)	B5	A mixture of Arroniz and Arbequina	ns	Use of fertilizer (15-15-15 NPK; sheep and cattle manure)
	Ablitas (n = 1)	B6	Arroniz	ns	ns
	Oion (n = 1)	B7	A mixture of Arroniz and Arbequina	ns	Use of fertilizer (15-15-15 NPK; sheep and cattle manure)
France (n = 10)	Nyons (n = 2)	FR1	ns	ns	ns
		FR3	ns		
	Baux-de-Provence (n = 1)	FR2	Mixture of different varieties	ns	ns
	Nîmes (n = 2)	FR4	ns	ns	ns
		FR7	ns		
	Nice (n = 2)	FR5	Caillletier	ns	ns
		FR6	ns		
	Provence (n = 3)	FR8	Mixture of different varieties	ns	ns
		FR9	Aglandau		
		FR10	ns		

nt: no treatment; ns: not specified, \* 15-15-15 NPK: a fertilizer containing equal parts of Nitrogen, Phosphorous, and potassium.

## 2.2. Multi-elemental Analysis

### 2.2.1. Reagents and Chemicals

Sub-boiled nitric acid (69% Instra analyzed JT BAKER), hydrogen peroxide (30–32% Optima, Fisher scientific, Illkirch, France), and Ammonium acetate (>98%, Sigma Aldrich, Darmstadt, Germany) was used for samples preparation. All solutions were diluted using ultrapure water (Milli-Q system, resistivity 18.2 MΩ cm, Millipore, Burlington, MA, USA). Multi-elemental standard solutions CCS-4 and CCS-6 (Inorganic ventures, Christiansburg, VA, USA) were used to build the external calibration curve. Mono-elemental solutions of Y, Rh, and Ir were used as internal standards for ICP-MS measurements.

### 2.2.2. Olive Oil Mineralization

Prior to ICP-MS analysis, a multi-stage procedure was performed (Figure 2). First, the organic matter contained in olive oils was destroyed through mineralization. Then, the obtained mineralized solutions were subjected to evaporation to dryness, followed by dissolution in the minimum volume required for analysis. Prior to the mineralization, the olive oil samples were centrifuged at 3500 rpm for 5 min using a ROTOFIX32A (HETTICH, Atlantic Labo, Bruges, France) centrifuge in order to eliminate any pomace residue according to previous recommendations [16]. Then a mass of 0.5 g of olive oil from the

upper oil totally clear and not containing any pomace residue was carefully transferred to quartz tubes previously cleaned following a strict cleaning protocol as follows: the digestion tubes containing 50% nitric acid were placed in a microwave system (Ultrawave SRC technology, Milestones, Sorisole (BG), Italy) with a specific cleaning program. Then, the tubes were washed in 10% *v/v* HNO<sub>3</sub> and in 10% HCl successively and finally rinsed with ultrapure water.

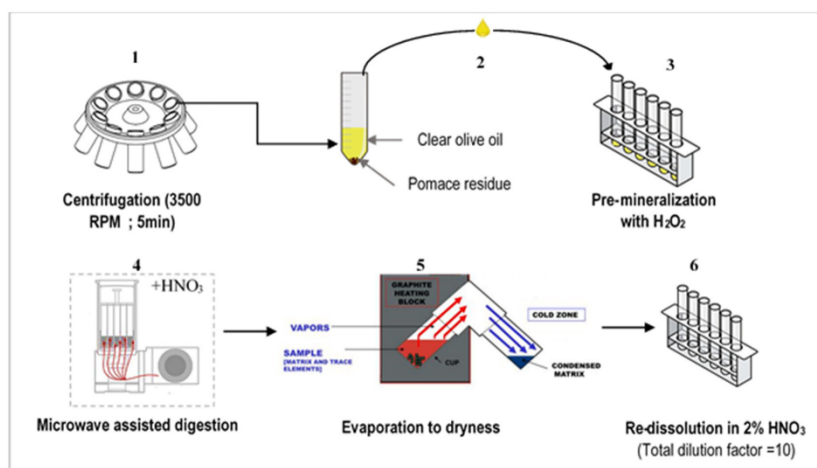

**Figure 2.** The analytical procedure for olive oil preparation prior to ICP-MS analysis: (1) Centrifugation; (2) Clear olive oil recovering; (3) Pre-digestion with H<sub>2</sub>O<sub>2</sub>; (4) Microwave assisted digestion; (5) Evaporation to dryness; (6) Re-dissolution in 2% HNO<sub>3</sub>.

For the samples digestion protocol, 0.5 mL of 30% hydrogen peroxide was added to 0.5 g of the olive oil to be mineralized. The mixture was left overnight for pre-mineralization at room temperature. The next day, 5 mL of sub-boiled nitric acid (69%, Instra Analysed Reagent, J.T.Baker, Fisher Scientific, France) was gradually added since olive oil is a highly reactive matrix. The final mixture was then digested in a microwave system (Ultrawave SRC technology, Milestones, Sorisole (BG), Italy) following an optimized gradually increasing heating program up to 250 °C where the temperature was maintained for 20 min (*P* max = 110 bar). The resulting clear solutions were then transferred to clean PFA vials (Saville Corporation, Eden Prairie, MN, USA) and evaporated to dryness in a closed-medium sample evaporation apparatus (Evapoclean 25 mL, Analab, 67,800 hoenheim, France). The dry residue was finally re-dissolved in 5 mL of 2% sub-boiled nitric acid prior to analysis. The total dilution factor obtained was then equal to ten.

### 2.3. Soil Extraction

Prior to ICP-MS analysis of the soil samples, only elements in the exchangeable fraction of soil were extracted. A large array of analytical methods involving extraction procedures has been published and extended, following the integrative work performed with the former BCR three-step sequential extraction procedure on the validation of sequential extraction techniques [39–41]. In this work, the soil extraction procedure was performed following closely the method proposed by Ure et al. (2006) based on ammonium acetate extracts [42]. Indeed, ammonium acetate is largely employed in soil extraction techniques as it is known for its cation exchange capacity, exchangeable bases, and plant-available nutrients extraction. Briefly, a volume of 3 mL of 1 M ammonium acetate at pH 7 was added to 2 g of each soil sample to release elements in exchangeable fraction. The mixture

was shaken for 16 h on a shaking plate (Edmund Buhler Shaker, D-72411 Bodelshausen, Germany) then centrifuged at 3500 rpm for 5 min. The supernatant aqueous phase was then carefully transferred using a pipette then diluted in 2% sub-boiled nitric acid prior to analysis by ICP-MS.

#### 2.4. Multielemental Analysis

The multi-elemental analysis of the obtained extracts from soils and oils was performed using an ICP-MS Plasma Quant Elite spectrometer (Analytik Jena, 07745 Jena, Germany). All samples were analyzed for a total concentration of 17 elements: As, Ba, Ca, Cd, Co, Cr, Cu, Fe, K, Mg, Mn, Ni, Rb, Sr, Pb, V, and Zn. The instrumental operating conditions and measured isotopes are presented in Table S1 (Supplementary Materials). The analysis was performed using two operating modes: The standard mode where no gas was supplied into the cell, and the integrated collisional reaction cell (iCRC) in the reaction mode where He and H were used as collision gases into the cell, and the iCRC mode was applied in order to reduce spectral interferences, including polyatomic interferences. The list of isotopes detected for each operating mode is detailed in Table S1 (Supplementary Materials).

The calibration solutions at eight different concentrations ranging from  $0.01 \mu\text{g L}^{-1}$  to  $500 \mu\text{g L}^{-1}$  were prepared by appropriate dilution of multi-elemental standard solutions CCS-4 and CCS-6. Yttrium (Y), rhodium (Rh), and iridium (Ir) at a concentration of  $2.5 \mu\text{g L}^{-1}$  were used as internal standards for the low, medium, and heavy masses, respectively, in order to correct instrumental drifts. Samples concentrations were calculated after applying the corrections with the blank, the internal standard, and the analytical blank. First, the calibration blank (2%  $\text{HNO}_3$  spiked with the internal standard) signal was subtracted in order to ensure that the ICP-MS measurement provides a zero signal when no analyte is present. Then, the instrumental sensitivity drifts were corrected by the internal standard signal. Finally, an “analytical blank” (69%  $\text{HNO}_3$ ,  $\text{H}_2\text{O}_2$ ) prepared using the whole set of reagents was mineralized and underwent the same preparation procedure as the samples under the same conditions. This blank reflects the potential contamination that occurred during the whole samples preparation protocol, and it was subtracted from the samples’ elemental concentrations in order to calculate the “true” concentration of each element.

All labware was washed in 10% *v/v*  $\text{HNO}_3$  and rinsed with ultra-pure water before use.

#### 2.5. Analytical Quality Control

The standard reference material NIST SRM 1643f (trace elements in water, National Institute of Standards and Technology, Gaithersburg, MD, USA) was used for quality control of the instrumental measurements. The NIST SRM 2387 (peanut butter, National Institute of Standards and Technology, Gaithersburg, MD, USA) was used to evaluate the accuracy of olive oil mineralization through recoveries of the certified elements. NIST SRM 2387 peanut butter was chosen since a natural vegetable oil certified for trace elements concentrations is not available. Despite the fact that this matrix is not totally equivalent to olive oil composition and viscosity, the chemical composition of this fatty acid-rich matrix is very close to that of olive oil. For the non-certified elements (As, Ba, Cd, Co, Cr, Ni, Pb, Rb, Sr, and V), a series of microwave-assisted mineralization were performed on NIST SRM 2387 prior to ICP-MS analysis. The average concentrations for inter-day and intra-day results obtained for these elements on the basis of 15 replicates are presented in Table 3.

In every mineralization run, a blank and a triplicate of NIST SRM 2387 were digested and then analyzed. Recoveries for six certified elements concentrations (Cu, Fe, K, Mg, Mn, and Zn) in NIST SRM 2387 were calculated as the ratio: (Measured concentration/Certified concentration) \* 100. The recoveries (R (%)) obtained after microwave-assisted digestion were satisfactory, ranging between 86% and 102% (Table 3).

The limits of detection (LODs) and limits of quantification (LOQs) were calculated as three times the standard deviation (SD) and ten times of SD on the basis of 10 blanks, respectively. The obtained LODs and LOQs were significantly low (Table S2: Supplementary

Materials): LODs were between 0.0002 and 0.313  $\mu\text{g kg}^{-1}$  and LOQs between 0.0007 and 1.042  $\mu\text{g kg}^{-1}$ . Except for Cd in olive oil, all the measured concentrations were greater than LOD and LOQ. Linearity was satisfactory;  $R^2$  was above 0.9995 for all analyzed elements. The precision was evaluated through the relative standard deviation (RSD) and calculated on the basis of olive oil triplicates. The RSDs were satisfactory; the values obtained were low, ranging between 1% and 14% (Table S2: Supplementary Materials).

**Table 3.** Measured concentrations of certified and non-certified elements in NIST SRM 2387 peanut butter and recoveries obtained for certified elements.

	Elements	Measured Concentrations $\pm$ SD ( $\text{mg kg}^{-1}$ )	Certified Concentrations $\pm$ SD ( $\text{mg kg}^{-1}$ )	R (%)
Certified elements ( $n = 3$ )	Ca	421 $\pm$ 6	411 $\pm$ 18	102
	Cu	4.26 $\pm$ 0.06	4.93 $\pm$ 0.15	86
	Fe	16.6 $\pm$ 0.3	16.4 $\pm$ 0.8	101
	K	6130 $\pm$ 160	6070 $\pm$ 200	101
	Mg	1696 $\pm$ 13	1680 $\pm$ 70	101
	Mn	15.5 $\pm$ 0.2	16.0 $\pm$ 0.6	97
	Zn	25.1 $\pm$ 0.3	26.3 $\pm$ 1.1	96
Non-certified elements ( $n = 15$ )	As	0.13 $\pm$ 0.07	-	-
	Ba	1.43 $\pm$ 0.13	-	-
	Cd	0.051 $\pm$ 0.002	-	-
	Co	0.024 $\pm$ 0.002	-	-
	Cr	<LOQ	-	-
	Ni	0.78 $\pm$ 0.04	-	-
	Pb	<LOQ	-	-
	Rb	5.66 $\pm$ 0.23	-	-
	Sr	2.95 $\pm$ 0.10	-	-
	V	<LOQ	-	-

## 2.6. Statistical Data Analysis

For the classification of olive oil samples according to their geographical origin (Tunisia, Spain, and France), a multivariate analysis was performed using SIMCA V16.0.1. The Principal Components Analysis (PCA) is an unsupervised method aiming to find new variables called dimensions calculated from a covariance matrix of the original variables while preserving as much as possible the statistical information (variability), allowing summary and visualization of the information in large datasets. The samples classification was accomplished by the PCA score plot, and the determination of the most discriminating elements was conducted by the loadings plot. Spearman's correlation was calculated for the trace element concentrations in an exchangeable fraction of soil and corresponding olive oils in order to verify the possible correlation between both. Spearman's correlation factors were calculated using OriginLab 2018.

## 3. Results and Discussion

### 3.1. Trace Elements Concentrations in Olive Oils

The trace elements determined in the olive oils analyzed presented a wide range of concentrations ranging from less than 1  $\mu\text{g}\cdot\text{kg}^{-1}$  up to the range of  $\text{mg kg}^{-1}$ . Table 4 presents the median and the ranges of concentration of 17 elements in olive oil samples classified according to their geographical origin (Tunisia, Spain, and France). They were compared to the concentrations reported in the literature. In general, except for Fe, all the elements analyzed displayed slight but noticeable levels of concentration in all the olive oil samples. The first group of elements includes those displaying the lowest concentration ranges. They are As, Cd, Co, Pb, and Rb. These elements' median concentrations were less than 1  $\mu\text{g kg}^{-1}$ . They are the most difficult to detect in a complex matrix such as olive oil due to the high organic load and viscosity for introduction in the ICP-MS with typical nebulization.

*Arsenic:* The concentration of As obtained in Tunisian, Spanish, and French olive oils analyzed were low, around 0.1  $\mu\text{g kg}^{-1}$ , and were notably lower than those reported in



the literature. Indeed, the concentrations of As recorded varied between 0.05  $\mu\text{g kg}^{-1}$  and 0.16  $\mu\text{g kg}^{-1}$  in European oils and were between 0.06  $\mu\text{g kg}^{-1}$  and 0.88  $\mu\text{g kg}^{-1}$  in Tunisian oils. These results were mostly in agreement with the concentrations previously reported in Spanish olive oils [43] and were notably lower compared to other studies conducted on oils from Tunisia and Italy [26,28].

**Cadmium:** The values obtained for Cd were below the LOD in all olive oil samples. Cadmium is one of the major contaminants that can expose humans to health risks. It can be absorbed by plants from the soil and then translocated to the edible parts of the plant, and it can also be released to edible oils stored in tanks and plastic packaging (Ismael et al., 2019). In most of the published studies, cadmium was either not analyzed or was not detected in olive oil [31,44]. Otherwise, when quantified, concentrations of Cd varied between 0.001  $\mu\text{g kg}^{-1}$  and 0.15  $\mu\text{g kg}^{-1}$  [16,21,45,46].

**Cobalt:** The concentration levels of Co in Tunisian olive oils ranged from 0.03  $\mu\text{g kg}^{-1}$  to 0.31  $\mu\text{g kg}^{-1}$ . The concentrations were similar to those reported for European oils, ranging between 0.04  $\mu\text{g kg}^{-1}$  and 0.17  $\mu\text{g kg}^{-1}$ . These concentrations were in full agreement with the concentrations previously evaluated in Spanish and Italian olive oils [25,28,29].

**Lead:** The concentrations of Pb were 10 times higher than those recorded for Co but were as well at low levels. In general, in the European oils, the concentrations of Pb did not exceed 1.35  $\mu\text{g kg}^{-1}$ . These values were in agreement with those previously reported results from Spain, Portugal, and France [15]. Slightly higher values were found in oils from Tunisia. The highest value was equal to 2.16  $\mu\text{g kg}^{-1}$ , and this was found in olive oil from Jendouba (T16) sampled near a Pb-Zn mining deposit (Table 2). Lead is a hazardous contaminant that can be assimilated by plants and is then accumulated at variable concentrations depending on the location of the Pb emission source [47]. These relatively high values of Pb in the Tunisian oils were in agreement with recent results from oils originating from four geographic locations (Monastir, Medenine, Gafsa, and Sfax). They also displayed relatively high concentration levels, between 5  $\mu\text{g kg}^{-1}$  and 7.4  $\mu\text{g kg}^{-1}$  [26]. In this same study, concentrations of Rb and Sr were also investigated in olive oils.

**Rubidium and Strontium:** The rubidium reported concentrations ranged between 2.5  $\mu\text{g kg}^{-1}$  and 3.5  $\mu\text{g kg}^{-1}$  and were in agreement with the concentrations found in the present study. However, the reported concentrations of Sr were relatively high, ranging between 33  $\mu\text{g kg}^{-1}$  and 37  $\mu\text{g kg}^{-1}$ , which is up to 30 times greater than the concentrations found in this study. Both Rb and Sr concentrations varied significantly in Tunisian oils.

**Table 4.** Median values and ranges of concentrations ( $\mu\text{g kg}^{-1}$ ) of trace elements in olive oil samples from Tunisia, Spain (Basque country), and southern France, and ranges of concentrations reported in the literature.

Element	Tunisia	Spain (Basque Country)	France	Literature *
Cd	<LOQ	<LOQ	<LOQ	(0.001–0.15)
Co	0.09 (0.03–0.31)	0.07 (0.04–0.10)	0.07 (0.04–0.17)	(0.023–11)
As	0.14 (0.06–0.88)	0.10 (0.09–0.14)	0.08 (0.05–0.16)	(0.2–26.6)
Rb	0.35 (0.09–1.85)	0.55 (0.28–0.95)	0.66 (0.35–1.94)	(0.036–2.6)
Pb	0.88 (0.57–2.16)	0.53 (0.28–0.94)	0.70 (0.47–1.35)	(0.18–6.40)
Ba	1.21 (0.45–5.17)	1.28 (0.93–2.30)	1.61 (0.92–17.6)	(0.31–12.3)
Sr	2.58 (1.18–5.04)	1.73 (1.21–2.11)	2.50 (1.00–3.55)	(1.52–48.9)
V	3.25 (2.10–5.45)	1.14 (0.52–1.56)	0.77 (0.12–1.53)	(4.2–5.8)
Mn	5.03 (3.58–17.3)	1.57 (0.96–2.70)	2.34 (1.08–3.71)	(4.4–40)
Ni	3.50 (2.02–11.6)	2.65 (1.86–3.44)	3.88 (2.22–6.88)	(5.95–173)
Cu	8.74 (3.62–23.5)	5.26 (3.10–11.1)	6.16 (4.40–6.55)	(3.35–66.4)
Cr	10.3 (7.11–16.8)	8.48 (3.45–11.2)	14.4 (11.9–18.2)	(15.4–437)
Zn	98 (39–195)	129 (100–152)	106 (33–138)	(7–290)
Fe	1240 (169–1310)	102 (80.7–117)	129 (54.7–190)	(67.5–1610)
Mg	208 (138–582)	226 (91.9–488)	368 (160–785)	(223–1200)
K	534 (128–3740)	601 (214–2970)	527 (142–1530)	(498–98,000)
Ca	1240 (610–2280)	942 (607–1990)	1080 (580–1640)	(76–10,790)

\* The literature data was collected from the previously reported results [10,15,16,18,26–28,30,31,33,38,43,44,48–51].

The concentrations of Rb ranged between  $0.09 \mu\text{g kg}^{-1}$  and  $1.85 \mu\text{g kg}^{-1}$  and concentrations of Sr between  $1.18 \mu\text{g kg}^{-1}$  and  $5.04 \mu\text{g kg}^{-1}$ . This variability is related to the varied geology of Tunisian soil. Indeed, Rb and Sr contents are strongly linked to the geochemical composition of the soil of origin [52]. This variation was less significant in the Spanish and French olive oil samples. Indeed, compared to the large geographical distribution of sampling performed in Tunisia, the samples from the Spanish Basque country and France were obtained from a limited and restricted geographical area.

The second group of elements includes the elements occurring at medium concentrations, ranging from a few  $\mu\text{g kg}^{-1}$  up to  $100 \mu\text{g kg}^{-1}$ . It includes Ba, Cr, Cu, Mn, Ni, Sr, V, and Zn.

*Barium:* Ba is naturally present in the environment and is a non-essential element for plant growth. The high concentrations of Ba in soil could be related to the geological formation and also to contamination through industrial activities (paints, ceramics, and glass) [53]. Ba concentrations ranged from  $0.45 \mu\text{g kg}^{-1}$  to  $5.17 \mu\text{g kg}^{-1}$  in Tunisian oils. These values were lower than those reported by Damak et al., (2019) [26]. Similar median concentrations were obtained in Spanish and French oils, respectively equal to  $1.28 \mu\text{g kg}^{-1}$  and  $1.61 \mu\text{g kg}^{-1}$ . An outlier was recorded in the sample originating from Nîmes, the concentration of Ba was equal to  $17.6 \mu\text{g kg}^{-1}$ . Such high barium concentrations had been previously recorded in Spanish olive oils [29,33].

*Chromium:* Cr is also non-essential in plant growth and development but is assimilated by roots with other essential elements [54]. Concentrations of Cr in Tunisian olive oils varied between  $7.11 \mu\text{g kg}^{-1}$  and  $16.8 \mu\text{g kg}^{-1}$ . Similar levels of Cr were found in the other European oils analyzed and were all in line with the previously reported results from Spain [50]. A wide range of concentrations was reported in the literature for Cr, from a few tens of  $\mu\text{g kg}^{-1}$  levels up to hundreds of  $\mu\text{g kg}^{-1}$  [21,25,28,50,51].

*Copper:* Concentrations of Cu varied between  $3.62 \mu\text{g kg}^{-1}$  and  $23.5 \mu\text{g kg}^{-1}$  in the Tunisian oil and were significantly greater than the values reported in the literature [38]. In the European oils, the concentrations of Cu ranged between  $0.04 \mu\text{g kg}^{-1}$  and  $0.17 \mu\text{g kg}^{-1}$  and were significantly low compared to the previous findings in Italy, Spain, and Turkey [15,18,21,43,50,55]. The presence of Cu in the soils is necessarily related to the natural geogenic background levels but could be altered by different cultivation processes and, therefore, could be found at a wide range of concentrations.

*Vanadium and Manganese:* Both V and Mn are essential nutrients for plant growth and development at low concentrations. Although there are sources of vanadium contamination, such as metallurgical industry and mining activities, its composition in soil mainly reflects that of the rocks [56,57]. In previous studies, vanadium was rarely analyzed in olive oil and hardly detected due to its very low concentration [33]. In the present study, the lowest value obtained was equal to  $0.12 \mu\text{g kg}^{-1}$  and was 10 times higher than the LOD. The concentrations of V in Tunisian olive oils ranged from  $2.1 \mu\text{g kg}^{-1}$  to  $5.45 \mu\text{g kg}^{-1}$ . Mn concentrations ranged from  $3.58 \mu\text{g kg}^{-1}$  to  $17.2 \mu\text{g kg}^{-1}$ . Both ranges of concentrations were in agreement with the previously reported results for Tunisian oils [26]. Lower concentrations were found in the Spanish and the French olive oils since the concentrations detected fluctuated between  $0.12 \mu\text{g kg}^{-1}$  and  $1.56 \mu\text{g kg}^{-1}$  for V and did not exceed  $3.71 \mu\text{g kg}^{-1}$  for Mn. Both levels detected were in agreement with the previous results reported in European oils [15,31].

*Nickel:* Median concentrations of Ni were similar in olive oils from the three different origins ranging between  $2.65 \mu\text{g kg}^{-1}$  and  $3.83 \mu\text{g kg}^{-1}$ . Very limited information is available for levels of Ni in the Tunisian olive oils; we can only refer that the values obtained from trees irrigated with treated wastewater presented higher levels of Ni [10]. Other published results from Spain and Italy also showed high concentrations ranging between  $10 \mu\text{g kg}^{-1}$  and  $60 \mu\text{g kg}^{-1}$  [28,50]. In general, the presence of Ni in the soil is mainly related to the parent rock composition; however, it can be accumulated in the plants as a result of agricultural and industrial practices, and therefore, nickel would be found in a wide range of concentrations in soil and similarly in olive oil [58].

**Zinc:** Concentrations of Zn varied between  $39 \mu\text{g kg}^{-1}$  and  $195 \mu\text{g kg}^{-1}$  in Tunisian oils. The highest values were recorded in the sample T16, sampled close to a Zn mining site. Thus, the high concentrations of Zn in olive oil can be related to the direct uptake of Zn from the polluted soil or to the indirect intake from dust Zn deposited on the leaves that are translocated into the olive fruits [59]. Similar ranges were obtained in European oils, ranging from  $33 \mu\text{g kg}^{-1}$  to  $152 \mu\text{g kg}^{-1}$ . These results agreed most with reported values in olive oils from Trentino, Italy [15] and from Tunisia [26]. Notably, higher average concentrations were recently recorded in European olive oils, up to  $492 \mu\text{g kg}^{-1}$  [18].

The third group of elements includes the elements occurring at relatively high concentrations from a few hundred  $\mu\text{g kg}^{-1}$  to the range of  $\text{mg kg}^{-1}$ . It involves Ca, Fe, K, and Mg. They are all necessary for plant growth and development.

**Calcium and Potassium:** Concentrations of Ca and K in Tunisian olive oils were in agreement with those obtained from olive trees irrigated with treated wastewater [10]. This could be related to the source of irrigation water of our sampling locations. For the European samples, concentrations of K were high in some samples from the Spanish Basque country compared to French oils. This could be due to the amendment of olive trees in Basque locations with NPK (Table 2). The concentrations of Ca in European olive oils were found in comparable concentration ranges, between  $580 \mu\text{g kg}^{-1}$  and  $1990 \mu\text{g kg}^{-1}$ . These values were lower than those previously reported in Spain [29].

**Iron:** Concentrations of Fe in Tunisian samples ranged from  $169 \mu\text{g kg}^{-1}$  to  $1310 \mu\text{g kg}^{-1}$ . The median value was equal to  $1248 \mu\text{g kg}^{-1}$ . The highest values were obtained in olive oils produced at OTIT using the Abencor extraction method. This relatively high concentration of Fe was likely to be related to direct contamination by the extraction process of the olive oil. Indeed, Zeiner et al., (2010) pointed out that the high metal content in olive oils could be related to the production process [60]. Levels of Fe were much lower in European oils, ranging from  $54.7 \mu\text{g kg}^{-1}$  to  $160 \mu\text{g kg}^{-1}$ . These results were more in agreement with the previously reported concentrations [18,28,50].

**Magnesium:** The concentrations of Mg in olive oils from Tunisia, ranging from  $138 \mu\text{g kg}^{-1}$  to  $582 \mu\text{g kg}^{-1}$ , were lower than those previously reported [26]. Elemental Mg content in European olive oils was in contrast similar to concentrations reported in different Spanish locations [29].

This wide range of concentrations and the inter/intra-country variability is certainly related to soil geochemistry and the possible contribution from cultural processes or anthropogenic activities.

### 3.2. Relationship between Olive Oil and Soil Elemental Content in Tunisia

The multi-elemental profile of the soil samples was determined, and the median, as well as the range of elements concentrations, are presented in Table S3 (Supplementary Materials). In order to evaluate the possible correlations between bioavailable elements contents in soil and elements concentrations recorded in the paired olive oils, we performed a correlation test. Pearson correlation coefficient was calculated for the soil exchangeable fraction extracts and corresponding olive oil elemental composition.

The correlation coefficients were evaluated in nine Tunisian sampling locations (T3A, T4A, T4A', T5A, T8A, T9A, T11A, T11A', and T17A), presenting different soils characteristics. The results obtained are presented in Table 5 and highlight that, despite the limited number of samples, only four elements (Mn, Ni, Mg, and Sr) out of seventeen presented a statistically significant correlation between soil extracts and olive oil elemental content ( $p < 0.05$ ).

Both Mg and Sr correlation coefficients, respectively equal to 0.78 and 0.85, indicated a high positive relationship between their concentration in soil and in olive oil. Figure 3 displayed the strong correlation between the bioavailable Sr content in the soils and its concentration in olive oils. The correlation coefficient for Mn ( $r = 0.63$ ) indicated a positive correlation. It has been shown that a significant amount of Mn assimilated by the olive tree is retained in the olive leaves [61], which could explain the moderate correlation since olive oil is obtained from the olive fruit. The Ni correlation coefficient ( $r = -0.8$ ) demonstrated

a high negative correlation. This indicates that the higher the concentration of Ni in the soil, the less Ni is found in the olive oil. This might be related to the accumulation of Ni in different organs of the plant [62].

**Table 5.** Pearson correlation coefficients and significance between soil and pared olive oil elemental content.

Element	Pearson Correlation Coefficient (r)	Significance (p-Value)
Sr	0.85	0.006
Ni	−0.8	0.04
Mg	0.78	0.02
Mn	0.63	0.01
As	−0.12	0.76
Ba	−0.13	0.75
Ca	−0.08	0.85
Cd	nd	nd
Co	−0.42	0.29
Cr	0.03	0.93
Cu	−0.25	0.54
Fe	0.02	0.94
K	−0.32	0.44
Pb	0.08	0.84
Rb	0.57	0.13
V	−0.56	0.14
Zn	−0.42	0.29

nd: not detected.

Elements such as As, Ba, Ca, Cd, Co, Cr, Cu, Fe, K, V, Zn, Pb, and Rb are first derived from geogenic sources, but most of them can also be originating from various anthropogenic activities either via agricultural practices or during the olive oil extraction process including storage. Their concentrations did not show any significant correlation between the soils and the resulting produced olive oils ( $p > 0.05$ ).

The accumulation of Fe in the olive tree merits a special mention. In this study, we observed significantly high Fe contents in olive oils extracted in the OTIT applying the Abencor extraction method compared to those produced in an oil mill. These findings would suggest that the production process of olive oil could be a source of iron contamination. During the Abencor extraction, olive oil is in direct contact with metal surfaces made of stainless steel. Iron is the main constituent of stainless steel, and thus, it could be transferred to olive oil during the extraction process. This is also the case of chromium contents which would also indicate direct contamination during the olive oil extraction.

In general, elements contents in the soils and their assimilation by plants can be subjected to fluctuations according to the agro-climatic conditions [11]. Under specific environmental conditions, the uptake and accumulation of elements from the soil are affected. As a response to water stress, plants accumulate some elements in the roots that will be translocated later to satisfy their needs [63,64]. Furthermore, genetic determinism has been demonstrated to affect the accumulation of elements by the olive tree. Beltrán et al., (2015) demonstrated that there are differences in some elements concentrations (Ba, Cu, Rb, and Zn) between different olive cultivars [25]. Competitiveness between chemically similar elements during plant water uptake can also result in different levels of accumulation. For example, concentrations of Rb and K that exhibited a non-significant correlation between soil and olive oil are in competition for entry into the plant cell due to their chemical similarity [61]. When the correlation is not significant between the olive oil and soil composition, this cannot exclude the hypothesis that the correlation could be significant between the soil and other organs of the olive tree. It has been previously demonstrated that the translocation and distribution of assimilated elements in the olive tree are not homogenous, and elements would be accumulated in different parts of the plant (leaves, roots, and stem bark), in some cases more than in the fruit [62]. Therefore, elements distribution in olive oils is not only related to the sources of trace elements in

the plant, whether natural or anthropogenic, but also determined by the intrinsic properties of the plant. Some elements such Mg, Mn, Ni, and Sr have preserved the elemental signature of the soil, and therefore, they are reliable for geographical traceability. Other elements that did not exhibit a significant correlation could also be used for discrimination of geographical locations with different environmental conditions.

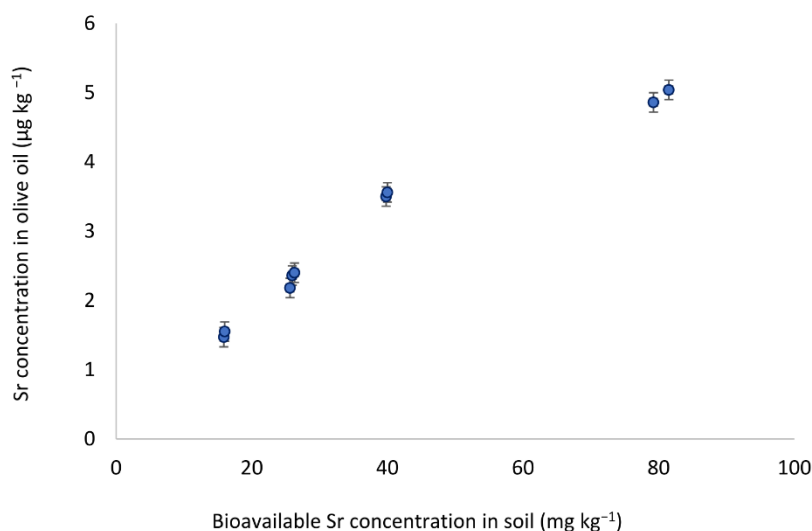

**Figure 3.** Linear correlation between Sr content in olive oil and in bioavailable Sr of soil extracts.

### 3.3. Geographical Classification of Olive Oils

The multi-elemental profile of the olive oils analyzed showed a slight but noticeable variability between the samples from different origins; however, it did not allow direct geographical discrimination based on their concentrations. In order to reduce such a large dataset without drastic loss of information, a principal component analysis (PCA) was applied. A series of PCAs were performed with different elements combinations. The elements at closely similar concentrations in all the olive oils did not contribute to the classification of the samples with respect to their geographical provenance. The most discriminating elements with notable loading factors that allowed the best separation of the samples were used as variables. The average concentrations of seven elements (Mn, Fe, V, Cr, Sr, Zn, and Cu) were used as variables to perform principal component analysis (PCA). Among these elements, we have demonstrated that only Mn and Sr contents in olive oil were correlated to that of soil. The first three PCs were extracted and explained together 71.58% of the variance. The first principal component (PC1) explained 34.6% of the variance, and the second principal component (PC2) retained 21.1% of the total data variance. The score plot PC1 vs. PC2 (Figure 3a) allowed establishing a separation between two groups of samples: Tunisian and European olive oils according to PC1. Even if Tunisian oils were produced two ways, the score plot did not show a separation according to the extraction process. Some outliers were observed for the Tunisian samples. T2, T3A, T5, T8A, T11A, and T11A' had higher scores on PC1 compared to the cluster of samples from Tunisia. These samples are characterized by high concentrations of Fe compared to the median value, ranging between  $4090 \pm 21 \mu\text{g kg}^{-1}$  and  $8310 \pm 76 \mu\text{g kg}^{-1}$ , and most of them were produced in OTIT (Abencor extraction). PC2 did not allow any separation between samples. The score plot PC1 vs. PC3 presented in Figure 3b was then performed and showed a clear clustering of olive oil samples according to their origin (Tunisia, Spain,

and France). There is a clear separation between samples with high predictive accuracy ( $R^2X(\text{cum}) = 0.69$ ). The third principal component was effective for the separation of French and Spanish samples with 15.9% of the variation. Therefore, the PCA, which is an unsupervised method, allowed to separate olive oil samples from different geographical origins based on trace elements.

The loadings plot shown in Figure 3c can be used to identify the contribution of the elements to the samples classification as well as the correlations between variables. Fe and Mn are likely to be correlated. Indeed, both elements had a similar geochemical behavior [65]. They presented the highest loadings on PC1 (between 0.5 and 0.6). Therefore, they strongly influenced the first component that separates Tunisian and European olive oils. Concentrations of Fe and Mn exhibited the highest values in olive oil samples from Tunisia (Table 4). While concentrations of Mn in olive oil were found to be correlated to that of soil, Fe did not show a significant correlation. Therefore, the separation between samples from Tunisia and from Europe is not only related to the soil composition. Most likely, the olive oil extraction process has an important role in olive oils discrimination since Fe was highly loaded on PC1.

A slightly lower loading value was obtained for V on PC1, which was equal to 0.42. Vanadium content in olive oil was not correlated with soil. Thus, external sources of V pollution may be responsible for the significant differences in V content. The highest values were observed in Tunisian olive oils (Table 4).

Strontium exhibits similar absolute loading values on PC1 and PC3. Therefore, it enables the separation of all the samples according to their geographical provenance.

Copper moderately influences PC1 (0.15) and poorly influences PC3 ( $\approx 0$ ). Furthermore, the Zn loading on PC1 ( $< -0.1$ ) indicates that Zn weakly influences PC1, but it had a greater influence on PC3 with a large positive loading (0.47). Concentrations of Zn and Cu are not correlated with soil composition.

Chromium is highly loaded in PC3. Therefore, chromium content exhibits an important statistical weight for the discrimination of French and Spanish olive oils. As reported in Table 4, concentrations of Cr were higher in olive oils from France. The high discriminatory value for Cr could be related at first to the geogenic signatures of the respective areas or/and associated with the signature of the packaging and the olive oil extraction process.

Based on this exploratory chemometric analysis, it has been shown that trace elements content can be used for the geographical discrimination of olive oil. This separation is based on elements that are mainly related to the soil geochemical background and also on elements originating from anthropogenic activities and the production process.

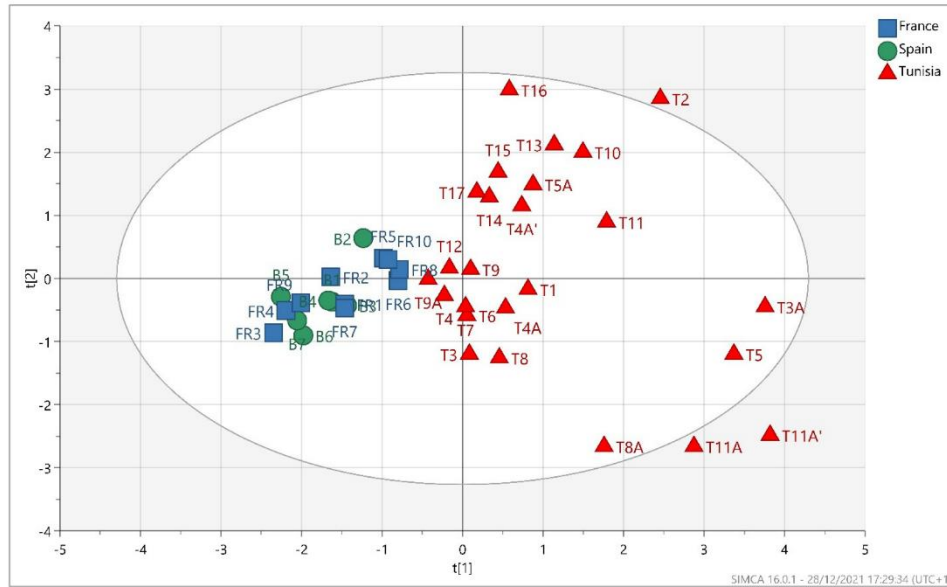

(a)

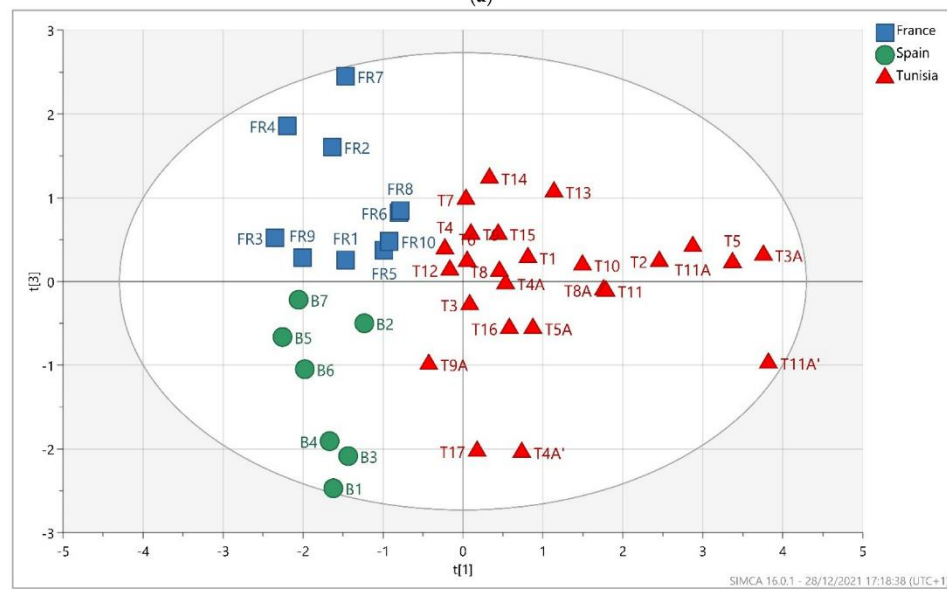

(b)

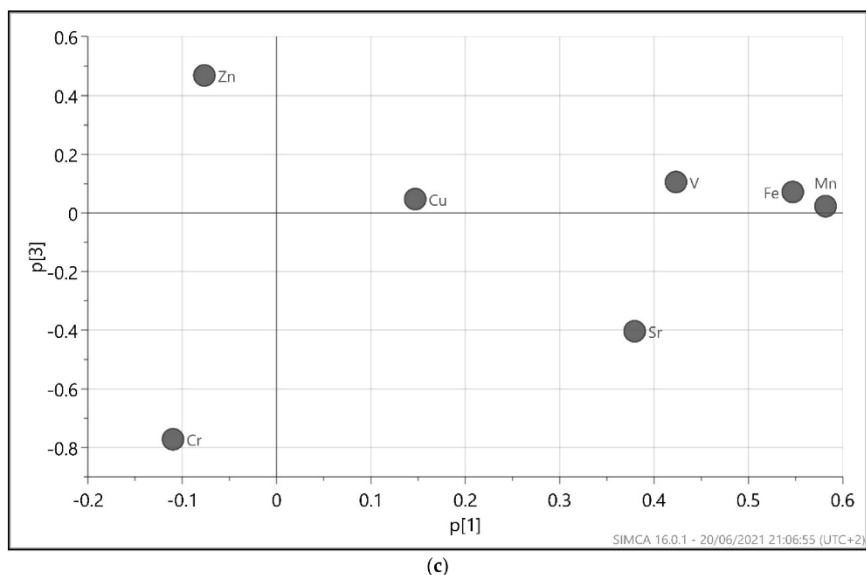

**Figure 3.** PCA score plot colored according to geographical origin (Tunisia, Spanish Basque country, and southern France): (a) PC1 vs. PC2; (b) PC1 vs. PC3; (c) loadings plot for PC1 and PC3.

#### 4. Conclusions

The presented work is one of the large-scale studies performed on Tunisian olive oils in terms of representing the production regions. The quality and the protection of the olive oil sector are among the main economic priorities in Tunisia.

The findings of this study suggest that the multi-elemental composition of olive oil can be successfully used for the geographical discrimination issue. The accurate determination of 16 elements concentrations was performed with high precision in Tunisian, Spanish, and French olive oils using the quadrupole ICP-MS after microwave-assisted digestion. Under the optimal conditions of mineralization and analysis, relatively low values of LOD, LOQ were obtained. The RSD values obtained indicate a good precision. The SRM NIST 2387 peanut butter was used for quality control of the applied analytical procedure, analysis of the certified and non-certified elements was performed.

The trace elements levels showed a wide range of concentrations and were in agreement with the previously reported results. Among the analyzed elements, four out of seventeen elements (Mn, Sr, Mg, and Ni) were found to be strongly correlated to the bioavailable soil composition. This states the transferring of the geochemical signature of the soil to the olives and then to oils. On another side, the failure to identify clear correlations for the remaining thirteen elements undoubtedly indicates that the elemental composition of olive oil could be affected either by plant elements uptake and accumulation depending on agro-climatic conditions and genetic determinism or through the production process and storage conditions. The PCA classification of olive oils according to their origins using seven elemental concentrations (Cu, Cr, Fe, Mn, Sr, V, and Zn) allowed successful discrimination with high predictive accuracy not only between European and non-European origins but also between Tunisian, French, and Spanish origins. The attribution of olive oils to their origin was not hindered by the type of the production: whether manually extracted in a laboratory or pressed on a mill, the origin proved to have a more significant effect on the variation of multi-element concentrations in olive oils.



The results obtained in this study are promising and suggest a rapid and reliable method for the geographical discrimination of olive oil based on trace elements content. In future work, isotopic compositions of several elements (O, C, N, and Sr) will be investigated and applied with the aim of enhancing the provenance discriminating ability.

**Supplementary Materials:** The following supporting information can be downloaded at <https://www.mdpi.com/article/10.3390/foods11010082/s1>. Table S1. ICP-MS operating conditions and measured isotopes; Table S2. Limits of detection (LOD). Limits of quantification (LOQ), linearity (R2), and precision (RSD); Table S3. Median values and ranges of concentrations (mg kg<sup>-1</sup>) of trace elements in soil extracts from Tunisia.

**Author Contributions:** Conceptualization, E.G.N.; Formal analysis, E.G.N.; Funding acquisition, M.H.; Investigation, E.G.N. and E.N.E.; Methodology, E.G.N.; Resources, R.S.; Software, E.G.N.; Supervision, H.A. and O.F.X.D.; Validation, E.G.N.; Writing—original draft, E.G.N.; Writing—review & editing, E.G.N., E.N.E., A.d.D., R.S., H.A. and O.F.X.D. All authors have read and agreed to the published version of the manuscript.

**Funding:** This research was funded by European Project TunTwin from the Horizon 2020 Framework program of the European Union under grant No. 952306. It was also funded by the French ANR EquiPex MARSS project with a contribution of the METROFOOD ESFRI project. This work was partially supported by the Euskadi/Nouvelle Aquitaine/Navarra Euroregion through the research project ISOTOPO (with agreement no. 2020/3). The financial support of a Ph.D. grant for Emna G. Nasr has been provided by the “Excellence Eiffel” scholarship of Campus France, the European project “TunTwin” and the scholarship “bourse d’alternance” of University Tunis El Manar, Ministry of Higher Education and Scientific Research in Tunisia.

**Data Availability Statement:** All the data are presentd in the paper and in the supplementary material.

**Acknowledgments:** The authors would like to thank all those who participated in the sampling, in particular, “Huile de Chorbane” by “Karima El Bedoui” in Tunisia and Chelo Dolado (from INTIA) and Arantzazu Pérez de Arenaza (from HAZI) for providing us with the Basque oils. We are grateful to Ajmi Larbi (Olive Tree Institute of Tunis, Tunisia) and Mouna Aiachi Mezghani (Olive Tree Institute of Sousse, Tunisia) for their help in the extraction of olive oil.

**Conflicts of Interest:** The authors declare no conflict of interest. Ekaterina Epova is a research engineer working in Advanced Iso-topic Analysis, Olivier F. X. Donard have been the co-founder of Advanced Isotopic Analysis in 2017 which is a Spin-Off from the Institute IPREM where he works. Advanced Isotopic Analysis has no conflict of interest with this study. The funders had no role in the design of the study; in the collection, analyses, or interpretation of data; in the writing of the manuscript, or in the decision to publish the results.

## References

1. Iori, L.; Donnini, S.; Calderone, V.; Zinnai, A.; Taglieri, I.; Venturi, F.; Testai, L. The Nutraceutical Value of Olive Oil and Its Bioactive Constituents on the Cardiovascular System. Focusing on Main Strategies to Slow Down Its Quality Decay during Production and Storage. *Nutrients* **2019**, *11*, 1962. [CrossRef]
2. Harwood, J.; Aparicio, R. *Handbook of Olive Oil: Analysis and Properties*; John, H., Ramon, A., Eds.; Aspen Publishers: Riverwoods, IL, USA, 2000; ISBN 9781475753714.
3. Larbi, W.; Chymes, A. The impact of the government policies and incentives to promote the export of agricultural products in Tunisia: The case of olive oil. *Food Econ.-Acta Agric. Scand. Sect. C* **2010**, *7*, 107–118. [CrossRef]
4. Keogh, J.G.; Rejeb, A. Applying HACCP in the Tunisian Olive Oil Industry: A Theoretical Background. *J. Bus. Manag. Econ. Res.* **2019**, *3*, 1–18. [CrossRef]
5. Baourakis, G.; Kalaitzis, P.; Mattas, K. *Food Chains: Quality, Safety and Efficiency in a Challenging World*; Baourakis, G., Konstadinos Mattas, P.K., Eds.; Taylor & Francis: Oxfordshire, UK, 2014; ISBN 9781317995128, 1317995120.
6. Matthäus, B.; Willenberg, I.; Engert, S.; Steinberg, P. The German National Reference Centre for Authentic Food (NRZ-Authent). *OCL-Oilseeds Fats Crop. Lipids* **2019**, *26*, 1–7. [CrossRef]
7. Yan, J.; Erasmus, S.W.; Aguilera Toro, M.; Huang, H.; van Ruth, S.M. Food fraud: Assessing fraud vulnerability in the extra virgin olive oil supply chain. *Food Control* **2020**, *111*, 107081. [CrossRef]
8. Mal, A.; Le, Y.; Artaud, J.; Dupuy, N. Exploring the Scientific Interest for Olive Oil Origin: A Bibliometric Study from 1991 to 2018. *Foods* **2020**, *9*, 556.

9. Carini, F.; Bengtsson, G. Post-deposition transport of radionuclides in fruit. *J. Environ. Radioact.* **2001**, *52*, 215–236. [[CrossRef](#)]
10. Benincasa, C.; Gharsallaoui, M.; Perri, E.; Briccoli Bati, C.; Ayadi, M.; Khlif, M.; Gabsi, S. Quality and Trace Element Profile of Tunisian Olive Oils Obtained from Plants Irrigated with Treated Wastewater. *Sci. World J.* **2012**, *2012*, 535781. [[CrossRef](#)]
11. Gouvinhas, I.; Domínguez, R.; Nelson, P.; Teresa, M.; Matos, C.; Barros, A.I.R.N.A. Effect of Agro-Environmental Factors on the Mineral Content of Olive Oils: Categorization of the Three Major Portuguese Cultivars. *J. Am. Oil Chem. Soc.* **2016**, *93*, 813–822. [[CrossRef](#)]
12. Skrzydlewska, E.; Balcerzak, M.; Vanhaecke, F. Determination of chromium, cadmium and lead in food-packaging materials by axial inductively coupled plasma time-of-flight mass spectrometry. *Anal. Chim. Acta* **2003**, *479*, 191–202. [[CrossRef](#)]
13. Zeiner, M.; Steffan, I.; Cindric, I.J. Determination of trace elements in olive oil by ICP-AES and ETA-AAS: A pilot study on the geographical characterization. *Microchem. J.* **2005**, *81*, 171–176. [[CrossRef](#)]
14. Karabagias, I.; Michos, C.; Badeka, A.; Kontakos, S.; Stratis, I.; Kontominas, M.G. Classification of Western Greek virgin olive oils according to geographical origin based on chromatographic, spectroscopic, conventional and chemometric analyses. *Food Res. Int.* **2013**, *54*, 1950–1958. [[CrossRef](#)]
15. Camin, F.; Larcher, R.; Nicolini, G.; Bontempo, L.; Bertoldi, D.; Perini, M.; Schlicht, C.; Schellenberg, A.; Thomas, F.; Heinrich, K.; et al. Isotopic and Elemental Data for Tracing the Origin of European Olive oils. *J. Agric. Food Chem.* **2010**, *58*, 570–577. [[CrossRef](#)] [[PubMed](#)]
16. Pošćić, F.; Furdek, M.; Bačić, N.; Mikac, N.; Bertoldi, D.; Camin, F.; Jukić, M.; Žanetić, M.; Rengel, Z.; Perica, S. Removal of pomace residues is critical in quantification of element concentrations in extra virgin olive oil. *J. Food Compos. Anal.* **2019**, *77*, 39–46. [[CrossRef](#)]
17. Aceto, M.; Calà, E.; Musso, D.; Regalli, N.; Oddone, M. A preliminary study on the authentication and traceability of extra virgin olive oil made from Taggiasca olives by means of trace and ultra-trace elements distribution. *Food Chem.* **2019**, *298*, 125047. [[CrossRef](#)] [[PubMed](#)]
18. Astolfi, M.L.; Marconi, E.; Vitiello, G.; Massimi, L. An optimized method for sample preparation and elemental analysis of extra-virgin olive oil by inductively coupled plasma mass spectrometry. *Food Chem.* **2021**, *360*, 130027. [[CrossRef](#)]
19. Lepri, F.G.; Chaves, E.S.; Vieira, M.A. Determination of Trace Elements in Vegetable Oils and Biodiesel by Atomic Spectrometric Techniques—A Review. *Appl. Spectrosc. Rev.* **2011**, *46*, 37–41. [[CrossRef](#)]
20. Angioni, A.; Cabitza, M.; Teresa, M.; Caboni, P. Influence of olive cultivars and period of harvest on the contents of Cu, Cd, Pb, and Zn in virgin olive oils. *Food Chem.* **2006**, *99*, 525–529. [[CrossRef](#)]
21. Bakircioglu, D.; Kurtulus, Y.B.; Yurtsever, S. Comparison of extraction induced by emulsion breaking, ultrasonic extraction and wet digestion procedures for determination of metals in edible oil samples in Turkey using ICP-OES. *Food Chem.* **2013**, *138*, 770–775. [[CrossRef](#)]
22. Brkljača, M.; Giljanović, J.; Prkić, A. Determination of Metals in Olive Oil by Electrothermal Atomic Absorption Spectrometry: Validation and Uncertainty Measurements. *Anal. Lett.* **2013**, *46*, 2912–2926. [[CrossRef](#)]
23. de Leonardis, A.; Macchiola, V.; de Felice, M. Copper and iron determination in edible vegetable oils by graphite furnace atomic absorption spectrometry after extraction with diluted nitric acid. *Int. J. Food Sci. Technol.* **2000**, *35*, 371–375. [[CrossRef](#)]
24. Mohebbi, M.; Heydari, R.; Ramezani, M. Determination of Cu, Cd, Ni, Pb and Zn in Edible Oils Using Reversed-Phase Ultrasonic Assisted Liquid—Liquid Microextraction and Flame Atomic Absorption Spectrometry 1. *J. Anal. Chem.* **2018**, *73*, 30–35. [[CrossRef](#)]
25. Beltrán, M.; Sánchez-Astudillo, M.; Aparicio, R.; García-González, D.L. Geographical traceability of virgin olive oils from south-western Spain by their multi-elemental composition. *Food Chem.* **2015**, *169*, 350–357. [[CrossRef](#)] [[PubMed](#)]
26. Damak, F.; Asano, M.; Baba, K.; Suda, A.; Araoka, D.; Wali, A.; Isoda, H.; Nakajima, M.; Ksibi, M.; Tamura, K. Environmental Soil Chemistry Laboratory, University of Tsukuba, 1-1-1 Tennodai, Tsukuba, Institute of Agro-Environmental Sciences, NARO, 3-1-3 Kannondai Tsukuba, Ibaraki 305- Geological Survey of Japan (GS), National Institute of Advanced Indust. *Food Chem.* **2019**, *283*, 654–656. [[CrossRef](#)]
27. Llorent-Martínez, E.J.; Ortega-Barrales, P.; Fernández-de Córdova, M.L.; Ruiz-Medina, A. Analysis of the legislated metals in different categories of olive and olive-pomace oils. *Food Control* **2011**, *22*, 221–225. [[CrossRef](#)]
28. Benincasa, C.; Lewis, J.; Perri, E.; Sindona, G.; Tagarelli, A. Determination of trace element in Italian virgin olive oils and their characterization according to geographical origin by statistical analysis. *Anal. Chim. Acta* **2007**, *585*, 366–370. [[CrossRef](#)] [[PubMed](#)]
29. Sayago, A.; González-Domínguez, R.; Beltrán, R.; Fernández-Recamales, Á. Combination of complementary data mining methods for geographical characterization of extra virgin olive oils based on mineral composition. *Food Chem.* **2018**, *261*, 42–50. [[CrossRef](#)] [[PubMed](#)]
30. Camin, F.; Larcher, R.; Perini, M.; Bontempo, L.; Bertoldi, D.; Gagliano, G.; Nicolini, G.; Versini, G. Characterisation of authentic Italian extra-virgin olive oils by stable isotope ratios of C, O and H and mineral composition. *Food Chem.* **2010**, *118*, 901–909. [[CrossRef](#)]
31. Kara, D.; Fisher, A.; Hill, S. Extraction of trace elements by ultrasound-assisted emulsification from edible oils producing detergentless microemulsions. *Food Chem.* **2015**, *188*, 143–148. [[CrossRef](#)] [[PubMed](#)]
32. Manjusha, R.; Shekhar, R.; Kumar, S.J. Ultrasound-assisted extraction of Pb, Cd, Cr, Mn, Fe, Cu, Zn from edible oils with tetramethylammonium hydroxide and EDTA followed by determination using graphite furnace atomic absorption spectrometer. *Food Chem.* **2019**, *294*, 384–389. [[CrossRef](#)] [[PubMed](#)]

33. Jimenez, M.S.; Velarte, R.; Castillo, J.R. On-line emulsions of olive oil samples and ICP-MS multi-elemental determination. *J. Anal. At. Spectrom.* **2003**, *18*, 1154–1162. [[CrossRef](#)]
34. Kruszewski, B.; Obiedziński, M.W. Multivariate analysis of essential elements in raw cocoa and processed chocolate mass materials from three different manufacturers. *LWT* **2018**, *98*, 113–123. [[CrossRef](#)]
35. Sakač, M.B.; Jovanov, P.T.; Marić, A.Z.; Pezo, L.L.; Kevrešan, Ž.S.; Novaković, A.R.; Nedeljković, N.M. Physicochemical properties and mineral content of honey samples from Vojvodina (Republic of Serbia). *Food Chem.* **2019**, *276*, 15–21. [[CrossRef](#)] [[PubMed](#)]
36. Wakefield, J.; McComb, K.; Ehtesham, E.; van Hale, R.; Barr, D.; Hoogewerff, J.; Frew, R. Chemical profiling of saffron for authentication of origin. *Food Control* **2019**, *106*, 106699. [[CrossRef](#)]
37. Gumus, Z.P.; Celenk, V.U.; Tekin, S.; Yurdakul, O.; Ertas, H. Determination of trace elements and stable carbon isotope ratios in virgin olive oils from Western Turkey to authenticate geographical origin with a chemometric approach. *Eur. Food Res. Technol.* **2017**, *243*, 1719–1727. [[CrossRef](#)]
38. Wali, A.; Damak, F.; Kawada, K.; Isoda, H.; Tamura, K.; Ksibi, M. The effects of geographic region and cultivar on oxidative stability and elemental analysis of Tunisian extra virgin olive oil. *Eur. Food Res. Technol.* **2021**, *247*, 1401–1409. [[CrossRef](#)]
39. Rauret, G.; Lopez-Sanchez, J.F.; Sahuquillo, A.; Barahona, E.; Lachica, M.; Ure, A.M.; Davidson, C.M.; Gomez, A.; Luck, D.; Bacon, J.; et al. Application of a modified BCR sequential extraction (three-step) procedure for the determination of extractable trace metal contents in a sewage sludge amended soil reference material (CRM 483), complemented by a three-year stability study of acetic acid. *J. Environ. Monit.* **2000**, *2*, 228–233. [[CrossRef](#)]
40. Sahuquillo, A.; López-Sánchez, J.F.; Rubio, R.; Rauret, G.; Thomas, R.P.; Davidson, C.M.; Ure, A.M. Use of a certified reference material for extractable trace metals to assess sources of uncertainty in the BCR three-stage sequential extraction procedure. *Anal. Chim. Acta* **1999**, *382*, 317–327. [[CrossRef](#)]
41. Rauret, G.; López-Sánchez, J.F.; Sahuquillo, A.; Rubio, R.; Davidson, C.; Ure, A.; Quevauviller, P. Improvement of the BCR three step sequential extraction procedure prior to the certification of new sediment and soil reference materials. *J. Environ. Monit.* **1999**, *1*, 57–61. [[CrossRef](#)] [[PubMed](#)]
42. Ure, M.U.; Thomas, R.; Littlejohn, D. Ammonium acetate extracts and their analysis for the speciation of metal ions in soils and sediments. *Int. J. Environ. Anal. Chem.* **1993**, *51*, 65–84. [[CrossRef](#)]
43. Mirón, C.; Sánchez, R.; Prats, S.; Todolí, J. Total polyphenol content and metals determination in Spanish virgin olive oils by means of a dispersive liquid-liquid aerosol phase extraction method and ICP-MS. *Anal. Chim. Acta* **2019**, *1094*, 34–46. [[CrossRef](#)] [[PubMed](#)]
44. Llorent-Martínez, E.J.; Ortega-Barrales, P.; Fernández-De Córdoba, M.L.; Domínguez-Vidal, A.; Ruiz-Medina, A. Investigation by ICP-MS of trace element levels in vegetable edible oils produced in Spain. *Food Chem.* **2011**, *127*, 1257–1262. [[CrossRef](#)]
45. Farrell, M.; Ertan, L. Investigation of trace metals in different varieties of olive oils from Northern Cyprus and their variation in accumulation using ICP-MS and multivariate techniques. *Environ. Earth Sci.* **2019**, *78*, 578. [[CrossRef](#)]
46. Mendil, D.; Dogan, Ö.; Tüzen, M.; Soylak, M. Investigation of the levels of some element in edible oil samples produced in Turkey by atomic absorption spectrometry. *J. Hazard. Mater.* **2009**, *165*, 724–728. [[CrossRef](#)] [[PubMed](#)]
47. Elloumi, N.; Abdallah, F.B.; Mezghani, I.; Boukhris, M. Accumulation du plomb par quelques espèces végétales cultivées au voisinage d'une fonderie de plomb à Sfax Lead accumulation by some plant species cultivated in the vicinity of a lead factory in Sfax. *Pollut. Atmos.* **2003**, *178*, 285–294.
48. Llorent-Martínez, E.J.; Fernández-De Córdoba, M.L.; Ortega-Barrales, P.; Ruiz-Medina, A. Quantitation of metals during the extraction of virgin olive oil from olives using ICP-MS after microwave-assisted acid digestion. *JAOCs J. Am. Oil Chem. Soc.* **2014**, *91*, 1823–1830. [[CrossRef](#)]
49. Kara, D.; Fisher, A.; Hill, S. Detergentless ultrasound-assisted extraction of trace elements from edible oils using lipase as an extractant. *Talanta* **2015**, *144*, 219–225. [[CrossRef](#)]
50. Cabrera-Vique, C.; Bouzas, P.R.; Oliveras-López, M.J. Determination of trace elements in extra virgin olive oils: A pilot study on the geographical characterisation. *Food Chem.* **2012**, *134*, 434–439. [[CrossRef](#)]
51. Lendinez, E.; Lorenzo, M.L.; Cabrera, C.; López, M.C. Chromium in basic foods of the Spanish diet: Seafood, cereals, vegetables, olive oils and dairy products. *Sci. Total Environ.* **2001**, *278*, 183–189. [[CrossRef](#)]
52. Giaccio, M.; Vicentini, A. Determination of the geographical origin of wines by means of the mineral content and the stable isotope ratios: A review. *J. Commod. Sci. Technol. Qual.* **2008**, *47*, 267–284.
53. Gad, S.C. Barium. In *Encyclopedia of Toxicology*, 3rd ed.; Elsevier: Amsterdam, The Netherlands, 2014; Volume 1, pp. 368–370. [[CrossRef](#)]
54. Shahid, M.; Shamshad, S.; Rafiq, M.; Khalid, S.; Bibi, I.; Niazi, N.K.; Dumat, C.; Rashid, M.I. Chromium speciation, bioavailability, uptake, toxicity and detoxification in soil-plant system: A review. *Chemosphere* **2017**, *178*, 513–533. [[CrossRef](#)] [[PubMed](#)]
55. Erol, B.; Arslan, G.; Code, F.; Altun, T.; Özcan, M.M. Determination of some inorganic metals in edible vegetable oils by inductively coupled plasma atomic emission spectroscopy (ICP-AES). *Grasas Aceites* **2008**, *59*, 239–244.
56. Guagliardi, I.; Cicchella, D.; de Rosa, R.; Ricca, N.; Buttafuoco, G. Geochemical sources of vanadium in soils: Evidences in a Southern Italy area. *J. Geochem. Explor.* **2018**, *184*, 358–364. [[CrossRef](#)]
57. Chen, L.; Liu, J.-R.; Hu, W.-F.; Gao, J.; Yang, J.-Y. Vanadium in soil-plant system: Source, fate, toxicity, and bioremediation. *J. Hazard. Mater.* **2021**, *405*, 124200. [[CrossRef](#)]
58. Iyaka, Y.A. Nickel in soils: A review of its distribution and impacts. *Sci. Res. Essays* **2011**, *6*, 6774–6777. [[CrossRef](#)]

59. Madejón, P.; Marañón, T.; Murillo, J.M. Biomonitoring of trace elements in the leaves and fruits of wild olive and holm oak trees. *Sci. Total Environ.* **2006**, *355*, 187–203. [[CrossRef](#)] [[PubMed](#)]
60. Zeiner, M.; Juranovic-Cindric, I.; Škevin, D. Characterization of extra virgin olive oils derived from the Croatian cultivar Oblica. *Eur. J. Lipid Sci. Technol.* **2010**, *112*, 1248–1252. [[CrossRef](#)]
61. Nedjimi, B. Measurement of selected trace elements in *Olea europaea* L. cv. 'Sigoise'. *J. Trace Elem. Med. Biol.* **2020**, *62*, 126595. [[CrossRef](#)] [[PubMed](#)]
62. Al-Habahbeh, K.A.; Al-Nawaiseh, M.B.; Al-Sayaydeh, R.S.; Al-Hawadi, J.S.; Albdaiwi, R.N.; Al-Debei, H.S.; Ayad, J.Y. Long-term irrigation with treated municipal wastewater from the wadi-musa region: Soil heavy metal accumulation, uptake and partitioning in olive trees. *Horticulturae* **2021**, *7*, 152. [[CrossRef](#)]
63. Ben Mansour-Gueddes, S.; Saidana-Naija, D.; Flamini, G.; Cheraief, I.; Braham, M. Assessment of the Climatic Condition's Impact on Volatiles, Polyphenols and Mineral Contents in Tunisian Olive Tree (*Olea europaea* L.). *Pol. J. Environ. Stud.* **2021**, *31*, 219–230. [[CrossRef](#)]
64. Ben Mansour-Gueddes, S.; Saidana, D.; Cheraief, I.; Dkhilali, M.; Braham, M. Biochemical, mineral and anatomical characteristics of the olive tree cv. Chetoui growing in several Tunisian areas. *Acta Sci. Pol. Hortorum Cultus* **2018**, *17*, 49–70. [[CrossRef](#)]
65. Pohl, W.L. Economic Geology of Metals. In *Economic Geology Principles and Practice: Metals, Minerals, Coal and Hydrocarbons—Introduction to Formation and Sustainable Exploitation of Mineral Deposits*; Wiley: Hoboken, NJ, USA, 2011; pp. 149–284. [[CrossRef](#)]

Review

# Olive Oil Traceability Studies Using Inorganic and Isotopic Signatures: A Review

Emna G. Nasr <sup>1,2,3,\*</sup>, Ekaterina N. Epova <sup>4</sup>, Mathieu Sebilo <sup>1,5</sup>, Dominic Larivière <sup>6</sup>, Mohamed Hammami <sup>2</sup>, Radhia Souissi <sup>2</sup>, Houyem Abderrazak <sup>2</sup> and Olivier F. X. Donard <sup>1</sup>

<sup>1</sup> Institut des Sciences Analytiques et de Physicochimie pour l'Environnement et les Matériaux, Université de Pau et des Pays de l'Adour, 64000 Pau, France; mathieu.sebilo@sorbonne-universite.fr (M.S.); olivier.donard@univ-pau.fr (O.F.X.D.)

<sup>2</sup> Laboratoire des Matériaux Utiles, Institut National de Recherche et d'Analyse Physicochimique Technopole de Sidi Thabet, Ariana 2020, Tunisia; mohamed.hammami@inrap.rnrt.tn (M.H.); souissiradhia@yahoo.fr (R.S.); houyem.snani@yahoo.fr (H.A.)

<sup>3</sup> Faculty of Sciences, Farhat Hached University Campus, University of Tunis El Manar, Tunis 1068, Tunisia

<sup>4</sup> Advanced Isotopic Analysis HélioParc, 64000 Pau, France; ekaterina.epova@ai-analysis.com

<sup>5</sup> Sorbonne Université, Institut d'Ecologie et des Sciences de l'Environnement de Paris (IEES Paris), CNRS, 75005 Paris, France

<sup>6</sup> Département de Chimie, Université Laval, Québec, QC G1V 0A6, Canada; dominic.lariviere@chm.ulaval.ca

\* Correspondence: emna.nsr@gmail.com

**Abstract:** The olive oil industry is subject to significant fraudulent practices that can lead to serious economic implications and even affect consumer health. Therefore, many analytical strategies have been developed for olive oil's geographic authentication, including multi-elemental and isotopic analyses. In the first part of this review, the range of multi-elemental concentrations recorded in olive oil from the main olive oil-producing countries is discussed. The compiled data from the literature indicates that the concentrations of elements are in comparable ranges overall. They can be classified into three categories, with (1) Rb and Pb well below  $1 \mu\text{g kg}^{-1}$ ; (2) elements such as As, B, Mn, Ni, and Sr ranging on average between 10 and  $100 \mu\text{g kg}^{-1}$ ; and (3) elements including Cr, Fe, and Ca ranging between 100 to  $10,000 \mu\text{g kg}^{-1}$ . Various sample preparations, detection techniques, and statistical data treatments were reviewed and discussed. Results obtained through the selected analytical approaches have demonstrated a strong correlation between the multi-elemental composition of the oil and that of the soil in which the plant grew. The review next focused on the limits of olive oil authentication using the multi-elemental composition method. Finally, different methods based on isotopic signatures were compiled and critically assessed. Stable isotopes of light elements have provided acceptable segregation of oils from different origins for years already. More recently, the determination of stable isotopes of strontium has proven to be a reliable tool in determining the geographical origin of food products. The ratio  $^{87}\text{Sr}/^{86}\text{Sr}$  is stable over time and directly related to soil geology; it merits further study and is likely to become part of the standard tool kit for olive oil origin determination, along with a combination of different isotopic approaches and multi-elemental composition.

**Keywords:** olive oil; geographical authentication; trace elements; stable isotopes of light elements;  $^{87}\text{Sr}/^{86}\text{Sr}$ ; sample preparation; detection techniques; statistical data treatment

**Citation:** Nasr, E.G.; Epova, E.N.; Sebilo, M.; Larivière, D.; Hammami, M.; Souissi, R.; Abderrazak, H.; Donard, O.F.X. Olive Oil Traceability Studies Using Inorganic and Isotopic Signatures: A Review. *Molecules* **2022**, *27*, 2014. <https://doi.org/10.3390/molecules27062014>

Academic Editor: James Barker

Received: 16 July 2021

Accepted: 20 March 2022

Published: 21 March 2022

**Publisher's Note:** MDPI stays neutral with regard to jurisdictional claims in published maps and institutional affiliations.



**Copyright:** © 2022 by the authors. Licensee MDPI, Basel, Switzerland. This article is an open access article distributed under the terms and conditions of the Creative Commons Attribution (CC BY) license (<https://creativecommons.org/licenses/by/4.0/>).

## 1. Introduction

Olive oil is a natural product obtained from olives. It is a key component of the Mediterranean diet. Sometimes called “liquid gold”, olive oil is mainly appreciated for its flavour and high nutritional value, along with its recognised potential in the prevention of certain diseases [1,2]. It is also an interesting ingredient in dermo-cosmetology, as it has beneficial effects on the skin [3,4].

Large amounts of olive oil are annually produced around the Mediterranean basin and consumed worldwide. According to the International Olive Oil Council, around 10.2 million hectares of land are devoted to olive growing around the world, and the world production of olive oil from IOC member countries has tripled in the last 60 years. Production has been estimated to be almost 3 million tonnes for the period 2019/2020, with about 2 million tonnes produced in Europe and about 1 million tonnes in non-European countries. (IOC: International Olive Council/olive oil-estimated 2019/2020 crop year). The increased production of olive oil has been driven by increasing global consumption of olive oil over the past two decades. Global consumption reached 2,970,000 metric tonnes in 2019/2020 (Statista: Olive oil consumption worldwide, available at <https://www-statista.com/statistics/940491/olive-oil-consumption-worldwide/>, accessed on 12 March 2021). This global increase in demand has caused the price to rise, and the high economic value of olive oil has led to widespread fraudulent practices. It is now considered to be one of the most adulterated foods [5,6].

False declaration of geographical origin is among the most prevalent forms of olive oil fraud and is the most challenging to detect. The implications of food fraud can range from acute health effects on consumers to significant economic losses. The global financial agri-food industry loss due to olive oil fraud has been estimated to be between \$30 and \$40 billion per year (PWC 2016, available at <https://press.pwc.com/News-releases/fighting--40bn-food-fraud-to-protect-food-supply/s/44fd6210-10f7-46c7-8431-e55983286e22>, accessed on 18 January 2022). Reputable producers also suffer reputation loss when consumers lose confidence in the market due to counterfeited poor-quality products [7].

Therefore, establishing a traceability system in the food industry, in particular in olive oil production, has become a major issue to guarantee the quality and authenticity of food products [8]. In Europe, priority is given to products whose quality is guaranteed by European Union schemes of geographical indication, known as Protected Designation of Origin (PDO), Protected Geographical Indication, and Traditional Specialties Guaranteed [9]. Whether a food product is permitted to use these quality labels is directly related to the geographical provenance and often refers to specific production processes.

The PDO label on olive oil has indeed become a motivating choice criterion for customers since olive oil quality and flavour are linked to where the olives grow and associated with specific production practices [10,11]. As a result, the geographical authentication of olive oil is becoming an important trend in scientific research, particularly in the field of analytical chemistry [12]. Between 1994 and 2020, the number of studies containing keywords related to the geographical authentication of olive oil has increased drastically; there were less than 30 articles in the 1990s and more than 240 in 2020 alone [13].

The choice of appropriate analytical strategies for olive oil characterization is complex. Olive oil is a particularly challenging matrix due to its high fatty composition and viscosity. Its lipid nature frequently hampers the traditional direct sample introduction strategies common for various analytical instruments. Furthermore, during the olive oil production process, which starts with olive growing and concludes with storing the extracted oil, many factors affect its overall chemical composition. First, the olive variety has a direct influence on the fatty acids, sterols, and total polyphenol composition [14]. Second, during the growth of the olive trees, the agricultural practices (irrigation and use of fertilisers) that are used can impact the final chemical composition of the olive oil [15]. Third, after harvesting the olives and during the oil extraction process, potential contaminants and alterations can be involved in the final composition of the oil since the olives are in direct contact with different surfaces throughout the processing.

*Effect of olive oil extraction process on its chemical composition:* olive oil is obtained through a multi-stage extraction process composed of several steps. Figure 1 illustrates the various steps of olive oil extraction.

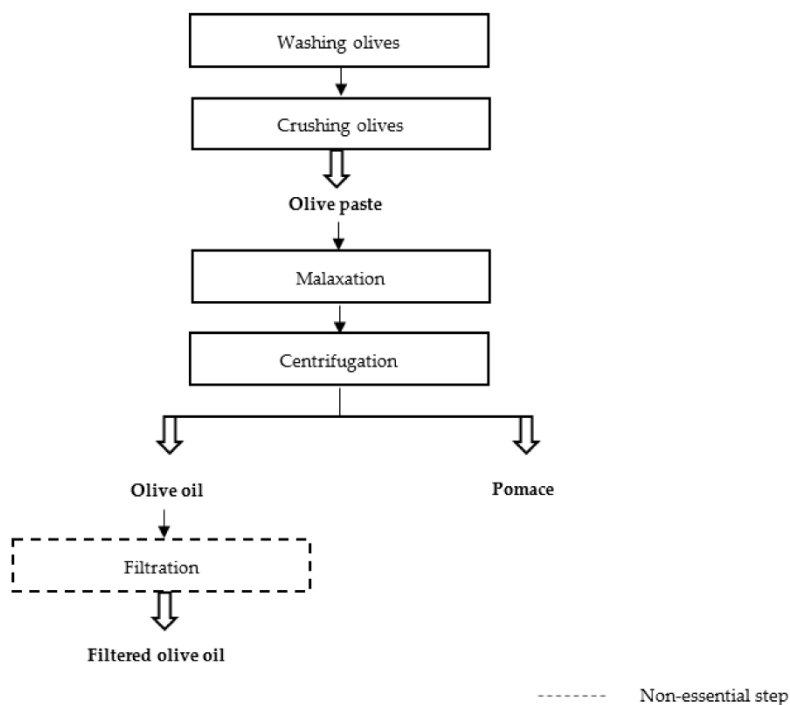

**Figure 1.** The continuous extraction process of olive oil.

At first, olives are washed and then crushed mechanically to obtain an olive paste. The paste is then subjected to malaxation (churning or milling to aggregate the small oil drops) at ambient temperature. Next, the mixture is centrifuged to separate the olive oil from the pomace. The “olive pomace” is defined as the solid residue recovered during the olive oil extraction process, obtained either by pressing or centrifugation. Pomace includes pieces of skin, pulp, stone, and olive kernel.

Other key parameters that affect the chemical composition of the final product include the oil extraction method [16], the type of oil obtained (virgin, extra-virgin, or lampante) [17], and the filtration of the final product. The shelf life of olive oil also affects the quality of the final product. The current industrial method extends the storage time compared to the traditional pressing method because the industrially extracted oils have a lower percentage of total degraded polyphenols. More recently, it has been shown that the filtration process of olive oil, which mainly removes pomace residues and leftover water, can significantly alter the content of trace elements naturally present in the olive oil [18]. Finally, the storage and transport conditions of the olive oil, if not carefully controlled, affect its oxidative stability [19,20]. Due to all these potential alterations during the olive oil milling process, storage, and transportation, strict analytical control is needed at every single step.

*Organic and inorganic analysis of olive oil:* the analytical methods used for authenticity and traceability assurance of the olive oil should take the various possible changes into consideration in order to obtain controlled and reproducible parameters for overall quality assessment. To respond to such challenging issues, a large array of analytical strategies has been developed. They include organoleptic approaches, biological, chemical, and ele-

mental/isotopic analyses [21]. The usual organic analytical methods are based on the determination of organic compounds such as fatty acids and triacylglycerols [22], phenols [23], sesquiterpene hydrocarbons [24], and sterols [25,26].

The state-of-the-art methods are mostly based on the interpretation of each oil's elemental profile (as the principal indicator of origin and agricultural practices), stable isotopes of light elements (whose ratio in the final product is primarily linked to the plant growth environment), and the isotopic composition of strontium (as a direct reflection to local soil and geology) [27,28]. Among the various elemental analysis techniques, atomic spectrometry techniques are constantly evolving. These techniques can carry out simultaneous multi-elemental analysis with enhanced resolution, accuracy and sensitivity, which is excellent for the discrimination of food origin [29]. However, olive oil analysis is still challenging as the oil is a fatty matrix with a rich and varied organic content, where chemical elements, other than C, H and O, mainly occur at trace levels ranging from few  $\mu\text{g kg}^{-1}$  to few  $\text{mg kg}^{-1}$  [30]. Therefore, reliable, accurate and precise measurement of trace elements in olive oil is a key issue that requires adequate and efficient sample pre-treatment and preparation methods [18]. A wide range of olive oil preparation techniques has been proposed in the scientific literature. Some preparation methods aim to destroy the organic matter using strong acids (e.g., microwave-assisted digestion, calcination), while others are non-destructive, aiming to extract the elements without significantly altering the matrix (e.g., liquid-liquid extraction, extraction using a chelating agent, sample dilution, emulsification). Trace elements are then quantified by means of several atomic spectrometric techniques (flame atomic absorption spectroscopy: FAAS, graphite furnace atomic absorption spectroscopy: GF-AAS, inductively coupled plasma atomic emission spectroscopy: ICP-OES, inductively coupled plasma mass spectrometry: ICP-MS).

The analysis of stable isotopes, mainly H, C and O isotope ratios, by isotope ratio mass spectrometry (IRMS) and nuclear magnetic resonance (NMR) was also successfully used for geographical discrimination of olive oil, since the isotopic fractionation of these elements is correlated to geographical and climatic parameters [31,32]. More recently, the analysis of isotopes of "non-traditional" elements such as strontium allowed a reliable geographic tracing of a variety of food products, since this isotopic signature results from geogenic soil formation that overlies on the geological substrate [33,34]. Few studies have investigated  $^{87}\text{Sr}/^{86}\text{Sr}$  ratios in olive oil by means of thermal ionization mass spectrometry (TIMS) [35], as this approach is challenging since the concentration of strontium in olive oil is generally lower than  $50 \mu\text{g kg}^{-1}$  [36]. This critically low concentration is a major obstacle for Sr isotopic analysis. Highly sensitive detection techniques and powerful methods of sample preparation are required to eliminate the matrix and pre-concentrate the strontium.

The main goal of the current review was to summarise the information reported in the literature on (1) the occurrence of inorganic elements and, when possible, light and non-traditional isotopes in olive oils; (2) methods of analysis; and (3) using element analysis to determine geographical provenance. Recent analytical techniques for the authentication of olive oil are reviewed and discussed.

Due to the very low levels of elements reported and the oily and viscous nature of the matrix, its introduction in plasma-based instrumentation is not straightforward. Sample introduction is of paramount importance to prepare for detection. Therefore, we carefully describe and critically discuss sample preparation strategies. Contaminants likely to alter the primary inorganic signatures in olive oil have been identified. Finally, the general multi-elemental and isotopic approaches are also listed. Both the effectiveness and the limitations of these analytical strategies plus detection techniques are discussed, based on the current literature.

## 2. Olive Oil Geographical Authentication by Means of Trace Elements

Trace elements are widely used in the geographical authentication of food products. By definition, elements are trace elements when their concentration in the earth's crust



does not exceed  $1 \text{ g kg}^{-1}$ . They are naturally present in the soil at varying concentrations and are taken up by plants through the roots. In general, it is recognised that the bioavailable elements of the soil are most easily assimilated by plants through the roots and then transferred to the upper parts by translocation [37] (Figure 2). Although several factors can affect element uptake by plants (including the soil pH, the cation exchange capacity, the plant variety, and its age) the elemental composition of a plant mainly reflects soil elemental composition [28,38,39].

Elements are transferred to the soil via the biogeochemical alteration of the rocks. Therefore, the elemental composition of the soil depends mostly on the composition of the bedrock [40]. However, elements can accumulate in soil through anthropogenic activities [39]. Elements can be directly deposited on the soil surface by use of fertilisers and metal-containing pesticides or result from dust fall of industrial activities and automotive traffic (brake dust and exhaust aerosols). These contaminants can be transported by irrigation water and thus can accumulate in plants. The elements assimilated by plants are, therefore, from lithogenic and anthropogenic origins.

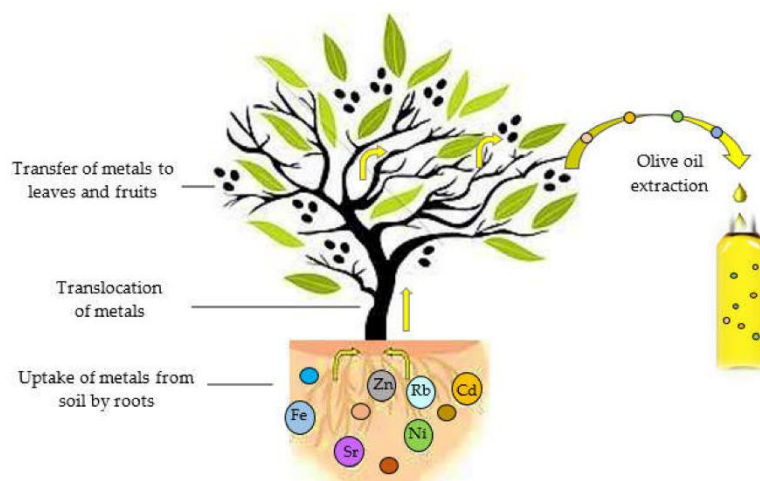

**Figure 2.** Schematic pathways of how some trace elements arrive in olive oil from the soil.

Among the elements assimilated by plants, some are essential to growth and development, while others are not. Elements (both essential and nonessential) may also be toxic when present at levels exceeding a certain concentration threshold [28]. For the analysis of elements in olive oil, it is helpful to divide them into three categories: (1) elements such as Sr, Rb and Li are found at varying concentrations in olive oils, although they are not essential for its growth and development. Their concentrations are mainly linked to the type of soil and bedrock. Therefore, they can be used to trace the geological origin [41,42]; (2) Elements such as Cd, Cu and K can be added through agricultural amendments such as the Bordo Mix (mixture of copper sulphate ( $\text{CuSO}_4$ ) and quicklime ( $\text{CaO}$ )), and thus they may contribute to link to a region with specific agriculture practices [43]. Cadmium is also a well-known food contaminant that can originate from the use of phosphate fertiliser, or it can be transferred into food through the packaging materials [44] [the composition of the bedrock]; (3) Elements such as As, Pb, Cu, Cr and Ni can be sourced from discharges of industrial activities such as textiles and metallurgy.

As shown above, the inorganic signature of food can be an indicator of industrial activities based on a specific geographical area [39]. These findings underline the value of using trace element content to assign geographical origins to food products, and hence of

developing a reliable and trustworthy strategy for a precise determination of elemental composition.

### 2.1. Reported Content of Trace Elements in Olive Oil

Until now, compared to other foods, only a few studies have quantified trace elements in olive oil. This is mainly related to the complexity of the olive oil matrix, which makes it tough to develop a reliable analytical procedure.

The ranges of concentrations of the elements most commonly used for geographical classification are presented in Figure 3. The data presented in this figure are based on the compilation and review of reported results in the scientific literature for olive oils originating from the following countries: Italy, Spain, Tunisia, Portugal, Croatia, Cyprus, Turkey and Greece. Except for Ca, trace elements in olive oils are found at varying concentrations, yet they did not exceed a few hundred micrograms per kilogram ( $\mu\text{g kg}^{-1}$ ). Figure 3 is divided along three vertical axes to form three groups of elements at low, medium and high concentrations. The first category of elements displaying the lower concentration includes Pb and Rb, with median concentrations around  $0.25 \mu\text{g kg}^{-1}$ .

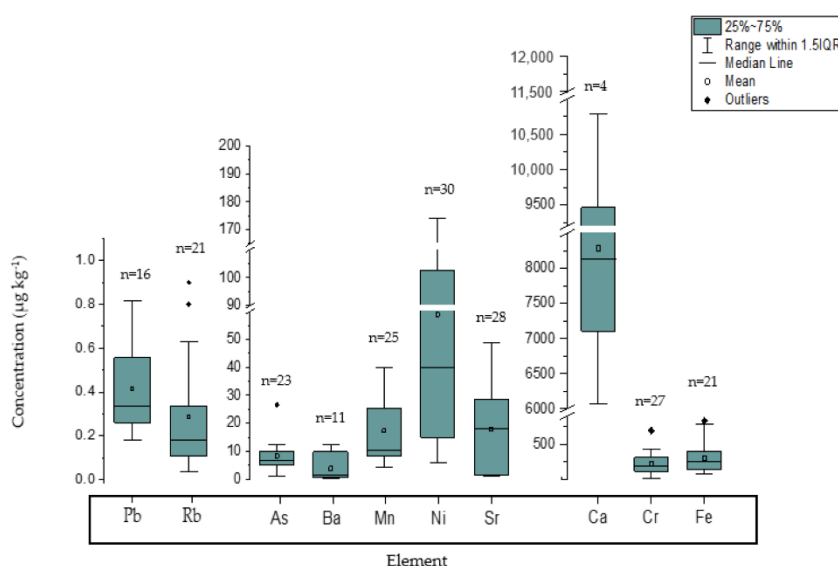

**Figure 3.** Trace element concentrations in olive oil originating from: Italy, Spain, Tunisia, Portugal, Croatia, Cyprus, Turkey and Greece. (n = number of articles).

The second category includes As, Ba, Mn, Ni and Sr, with medians between  $>0$  and  $20 \mu\text{g kg}^{-1}$ , never exceeding  $200 \mu\text{g kg}^{-1}$ . Ni shows maximum variation.

The third group of elements, including Ca, Cr and Fe, have been classified as elements at relatively high concentrations, ranging from few hundred  $\mu\text{g kg}^{-1}$  up to 10s of  $\text{mg kg}^{-1}$ ; the highest concentrations were reported for Ca.

These elemental concentrations, mostly at critically low values, dissolved in a complex lipid matrix are thus challenging to quantify with high precision. Accordingly, an array of analytical procedures was developed. A wide variety of sample preparation methods were tested, and various detection techniques were employed (Figure 4). The choice of an appropriate analytical strategy is crucial. Nevertheless, critical attention

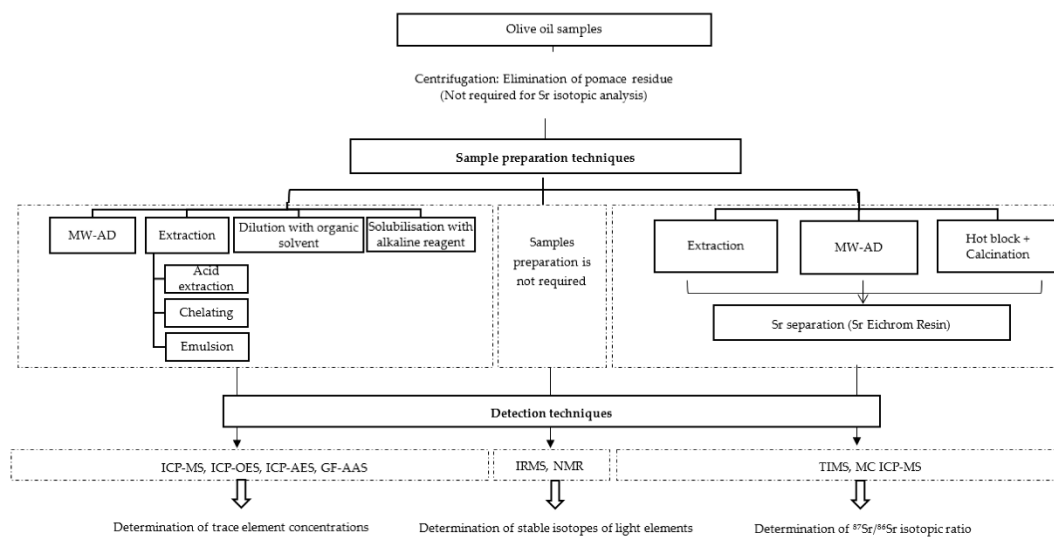

Figure 4. Analytical procedures for the analysis of trace elements, stable isotopes of light elements and Sr isotopic ratio in olive oil.

should be paid to the potential contamination that can occur during the sample preparation leading to high blanks and high detection limits. In the case of olive oil, high blanks can be comparable to the elemental concentration of the sample analysed. Accordingly, some elements with initial critically low concentrations, such as Li and Sr [45], or Ni and Cd [46,47], could not be detected or quantified with high precision. This could be one of the main reasons why the concentrations of some elements recently summarised in the literature (Table 1 from Pošćić et al. (2019) [18]) varied enormously. For example, concentrations of Cu and Fe determined in olive oils from Croatia by Zeiner et al. (2005) [48] were three times higher than those reported by Cindric et al. (2007) [49] in oils of the same geographical origins, suggesting that contamination could have occurred during the analytical process.

Similar variability was observed for Li in oils originating from Italy. The reported concentrations ranged from 0.008 to 0.020  $\mu\text{g kg}^{-1}$  [15,41] while olive oils from Spain exhibited a significantly higher concentration of Li, up to 6.4  $\mu\text{g kg}^{-1}$ , as reported by Beltran et al. (2015) [45]. This was also the case for Rb in Italian oils. The concentrations recorded were ranging between 0.04 and 0.39  $\mu\text{g kg}^{-1}$  in Italian olive oils [41] and up to 2.6  $\mu\text{g kg}^{-1}$  in Spanish oils [45]. The concentrations of Sr were also found to vary widely between different countries, from less than 0.3  $\mu\text{g kg}^{-1}$  in European oils [15] up to 40  $\mu\text{g kg}^{-1}$  in Tunisian oils [50]. It might be supposed that such variability in concentrations of Li, Rb and Sr can be related to the elemental content of the soil of origin as these elements are mainly originating from it [15,41].

Other element concentrations also varied widely. Co, for examples, was 1.0–5450  $\mu\text{g kg}^{-1}$  [48], Mg was 56–1030  $\mu\text{g kg}^{-1}$  [36], Mn: 3.5–150  $\mu\text{g kg}^{-1}$  [51] and Cr: 12–1830  $\mu\text{g kg}^{-1}$  [52]. Such a large span of elemental concentrations has already raised doubts about the validity of some data in view of the lack of a robust and highly sensitive analytical approach to the detection of elements at critically low concentrations in one of the most complicated food matrices [18]. The published results must be subjected to critical evaluation to avoid comparison with unreliable data, especially in the absence of certified reference materials for trace elements in olive oils. Thus, the validity of the analytical measurements has to be assessed with respect to accuracy and precision. Previously published studies will be discussed below from the general point of view of applied analytical procedures, reliability of obtained results, and their applicability for geographic authentication of olive oil.

## 2.2. Analytical Procedures of Quantification of Trace Elements in Olive Oil

Various sample preparation approaches have been developed for the quantification of trace elements in olive oil. They each aim to release elements from the oily matrix, achieve relatively low limits of quantification (LOQ), and minimise possible contamination. Table 1 summarises the analytical techniques used for the trace elements analysis in olive oil classified according to the methods of sample preparation. Information about the samples analysed, the reagents used for sample treatment, detection techniques, the limit of detection (LOD), the quality control (QC) parameters and the chemometric methods employed are also depicted in Table 1.

### 2.2.1. Sample Preparation Techniques

Olive oil is a high-viscosity lipid matrix. Its viscosity makes analysis with spectrometric instruments challenging [53]. Due to the critically low concentrations of some elements in olive oil, the latest studies tended to promote the use of ICP-MS known for its high sensitivity.

When using plasma-based ionization techniques, the possible incomplete mineralization of the samples could affect the instrumental performance by forming deposits and clogging parts such as injectors, cones and lenses [54,55]. The presence of traces of unoxidised organic matter could also extinguish plasma sources and thus generates spectral interferences from carbon-based polyatomic ions contributing to the spectral background [56]. Therefore, the development of a reliable sample preparation technique is a crucial step in the process of assessing the elemental composition of olive oil.

Some approaches aim to completely destroy the organic content of the sample and require the use of high-performance digestion equipment under high temperature and high pressure [57]. Others can be implemented under relatively “soft” conditions by involving the use of various organic/inorganic solutions and chemical agents such as chelates, emulsifiers, etc. (Figure 4). They are often designed to obtain a final solution that can be rapidly and easily analysed using various spectrometric instruments [53,58].

#### (i) Microwave-assisted digestion (MW-AD)

MW-AD is one of the most frequently used sample preparation techniques prior to element analysis for lipid matrices; it is used in approximately 2/3 of the scientific publications in this field (Table 1). A recent review confirmed the reliability and effectiveness of MW-AD for the mineralisation of natural and synthetic oils and oily substances [57]. Organic matter is induced to decompose by high temperature and high pressure [59].

Table 1. Determination of trace elements in olive oil and other vegetable oils by means of spectrometric techniques following different sample preparation techniques.

Sample Preparation Techniques	Oil Type/Quality	Number of Samples	Origin	Reagents	Detection Technique	Analytes	Limit of Detection	Material/Method Used for Validation	Accuracy (ACC)/Recovery (R) (%)	Chemometric Method	Purpose	References
Microwave-assisted digestion	Extra-Virgin Olive Oil (EVOO)	110	Italy	HNO <sub>3</sub> and H <sub>2</sub> O <sub>2</sub>	ICP-MS	Ti, V, Cr, Mn, Fe, Co, Ni, Cu, Rb, Sr, Cd, Sb, Ba, W, Tl, Pb, Th, U and REE	-	BCR-668 (mussel tissue)	-	PCA, LDA	-	[60]
	Virgin Olive Oil (VOO)	82	Spain	HNO <sub>3</sub> , H <sub>2</sub> O <sub>2</sub> and HCl	ICP-MS	Al, As, Ba, Ca, Co, Cr, Cs, Cu, Fe, Ga, Hf, K, Li, Mo, Mg, Mn, Na, Sr, Nb, Ni, Pb, Rb, Sc, Se, Sn, Ta, Th, Ti, U, V, W, Y, Zn and Zr	-	-	-	LDA	-	[45]
	VOO	36	Italy	HNO <sub>3</sub>	ICP-MS	Be, Mg, Ca, Sc, Cr, Mn, Fe, Co, Ni, As, Se, Sr, Y, Cd, Sb, Sm, Eu and Gd	LOQ: 0.12; 118; 1250; 9.7; 16.3; 9.2; 152; 0.11; 21.2; 0.62; 10.2; 9.6; 0.12; 0.16; 0.14; 0.012; 0.009 and 0.012 (µg kg <sup>-1</sup> )	-	-	LDA	Authentication, traceability	[36]
			21	Tunisia		ICP-MS			ACC: 66–102%		PCA	

	Olive oil (OO)			HNO <sub>3</sub> and H <sub>2</sub> O <sub>2</sub>		Na, Mg, Fe, Zn, V, Mn, As, Rb, Sr, Ba and Pb	0.35; 0.47; 0.12; 0.11 (mg kg <sup>-1</sup> )	Multi-element oil standard S23-100Y				
	VOO	49	Turkey	HNO <sub>3</sub> and H <sub>2</sub> O <sub>2</sub>	ICP-MS	Fe, Ca, K, Na, Mg, As, Ba, Co, Cr, Cu, Mn, Ni, Pb, V, Zn	-	-	-	PCA and HCA		[61]
	EVOO	125	Spain	HNO <sub>3</sub> , H <sub>2</sub> O <sub>2</sub> and HCl	ICP-MS for minor elements and ICP-OES for major elements	Al, Ca, Fe, Mg, Mn, K, Na, Ti, Li, Be, B, V, Cr, Co, Ni, Cu, Zn, Ga, Ge, As, Se, Rb, Sr, Zr, Nb, Mo, Cd, Sn, Sb, Cs, Ba, Hf, Ta, W, Tl, Pb, Bi, Th, U and REE	-	Spike with a multi-element standard solution	R: 82–110%	PCA and LDA		[62]
	EVOO and olive-pomace	16 EVOO/10 olive-pomace	Croatia	HNO <sub>3</sub> and milli-Q water	HR ICP-MS	Li, Rb, Mo, Cd, Sn, Cs, Tl, Pb, Na, Mg, P, S, Ca, Ti, V, Cr, Mn, Fe, Co, Ni, Cu, Zn, Sr, Y, Sb, Ba, La, Ce; and K	-	-	-	-	-	[18]
	VOO, pomace-olive, corn, sunflower	50	Spain	HNO <sub>3</sub>	ICP-MS	Ag, As, Ba, Be, Cd, Co, Cr, Cu, Fe, Hg, Mn, Mo, Ni, Pb, Sb, Ti, Tl and V	0.8; 3.0; 0.5; 1.5; 1.5; 1.5; 8.0; 1.5;	109469 Multi-element Standard II Oil Dissolved	R: 85–115%	PCA	Quality identification of oils	[51]

											40; 12; 1.5; 1.5; 15; 0.8; 1.5; 15; 1.5 and 2.0 ( $\mu\text{g}$ $\text{kg}^{-1}$ )	Discrimi- nation between oils of different types
	VOO	-	Italy	HNO <sub>3</sub> and H <sub>2</sub> O <sub>2</sub>	ICP-OES	Pb, Zn, Cd and Cu	-	-	-	-		The in- fluence of olive cultivars and peri- od of har- vest on the con- tents of some elements,

[63]

												0.005; 0.051; 0.104; 5.118; 0.953; 0.319; 0.587; 0.000; 0.000; 0.012; 0.294; 0.005; 0.011; 0.000; 0.006; 0.028; 0.007 and 0.017 ( $\text{mg kg}^{-1}$ )	The in- fluence of the ir- rigation with waste water on the multi-el- emental profile of olive oils
	OO	90	Tunisia	HNO <sub>3</sub>	ICP-MS	Li, B, Na, Mg, Al, K, Ca, Sc, Cr, Mn, Fe, Co, Ni, Cu, Sr, Mo, Ba and La	Spike with standard so- lutions	R: 69–120%	PCA, LDA and ANOVA				
Dry ashing	OO	17	Croatia	HCl	ElectroThermal Atomic Absorption Spectros- copy (ETAAS)	Cu, Ni, Pb and Fe	-	-	-	-		Compar- ison be- tween sample prepara- tion pro- cedures	

[30]

[46]

Acid extraction	EVOO	539	Italy	1% HNO <sub>3</sub> / 0.2% HCl	ICP-MS	Li, Na, Mg, K, Ca, Mn, Co, Cu, Rb, Sr, Cs, Ba, La, Ce, Sm, Eu, Yb, Pb and U	0.005; 40; 14; 60; 30; 0.01; 0.004; 0.13; 0.03; 0.04; 0.003; 0.29; 0.0017; 0.0027; 0.0009; 0.0002; 0.0004; 0.02 and 0.001 (µg kg <sup>-1</sup> )	Spike with NIST 2387 (peanut but- ter)	R: 82–101%	-	Investi- gation of mineral composi- tion of authentic PDO Ital- ian olive oils	[41]
	EVOO	267	Italy, France, Spain, Greece and Portu- gal	6.7% H <sub>2</sub> O <sub>2</sub> /1% HNO <sub>3</sub> /0.2 % HCl	ICP-MS	Li, B, Na, Mg, Al, K, Ca, V, Mn and Co	0.17; 20; 4; 3; 20; 25; 0.007; 0.2; 0.002 and 0.0006 (µg kg <sup>-1</sup> )	Spike with NIST 2387 (peanut but- ter) and SPEX s-23 100z	R (NIST): 82– 101% R (SPEX standard): 53– 92%	Canonical discriminant analysis	Authenti- cation, traceabil- ity	[15]
	OO, sun- flower, soybean, grape and sesame	-	-	3% HNO <sub>3</sub>	FAAS	Cu, Cd, Ni, Pb and Zn	0.7; 0.3; 0.5; 1.5 and 0.5 (µg kg <sup>-1</sup> )	-	-	-	Develop- ment of analyti- cal method	[64]

Extraction employing an extraction agent	EVOO, VOO, ROO, soy- bean and sunflower oils	-	-	10% HNO <sub>3</sub>	GF-AAS	Cu and Fe	-	Spike with standard	ACC: 94% ± 23– 97% ± 12	-	-	[65]
	Sunflower oil, OO, rapeseed oil and salmon oil	-	-	1% Lipase solution at pH 3	ICP-MS	Al, Ba, Cd, Cu, Fe, Mn, Mo, Ni, Ti, V and Zn	0.46, 0.03, 0.007, 0.028, 0.67, 0.038, 0.022, 0.14, 0.17, 0.05 and 0.07 (µg kg <sup>-1</sup> )	EnviroMAT HU-1 Used oil diluted in sunflower oil	R: 83.3–117.8%	-	-	[66]
	Sunflower oil, OO, rapeseed oil	-	-	0.01 M EDTA so- lution at pH 8	-	Al, Ca, Cd, Cu, Mg, Mn, Ni, Ti, V and Zn,	2.47, 2.81, 0.013, 0.037, 1.37, 0.050, 0.049, 0.47, 0.032 and 0.087 (µg kg <sup>-1</sup> )	Spike of sun- flower seed oil with Envi- roMAT HU-1	-	-	-	[67]



Emulsification	Mustard oil, sunflower oil, sesame oil, groundnut oil, coconut oil, rice bran oil and corn oil	-	-	TMAH and 2% EDTA at pH 12	GF-AAS	Pb, Cd, Cr, Mn, Fe, Cu and Zn	0.6; 0.4; 3.1; 0.3; 0.1; 2.3 and 1.5 ( $\mu\text{g kg}^{-1}$ )	Spike with analytes	R: 92–97%	-	[68]	
	VOO	5	-	2% Triton X-100	ICP-MS	Al, Ba, Bi, Cd, Co, Cu, Mn, Ni, Pb, Sn and V	5.31; 2.27; 0.98; 0.69; 1.09; 0.33; 0.44; 0.15; 0.02; 0.06 and 3.08 ( $\mu\text{g kg}^{-1}$ )	Spike with analytes	R: 49.6–176.2%	-	[56]	
	Sunflower, hazelnut, canola, corn and OO	50	Turkey	Acidic Triton X-114 solution	ICP-OES	Cd, Cr, Cu, Fe, Mn, Ni, Pb and Zn	-	Spike with analytes	R: 96–109%	ANOVA	Comparison between sample preparation procedures	[52]
Solubilization with strong alkaline reagent	Almond, corn, sunflower oils and OO	17	-	TMAH and 1% HNO <sub>3</sub>	ICP-MS	Cu, Ge, Mn, Mo, Ni, Sb, Sr, Ti, V	0.02; 0.05; 0.004; 0.008; 0.012; 0.32; 0.004; 0.28 and 0.02 ( $\mu\text{g g}^{-1}$ )	-	-	-	Development of analytical method	[69]

Dilution with organic solvent	EVOO	50	Spain	Methyl-isobutylketone (MIBK)	Electro-Thermal atomic absorption spectroscopy (ETAAS)	Cu, Cr, Fe, Mn and Ni	25; 1.5; 80; 2 and 10 (pg)	109469 Multi-element Standard II Oil Dissolved	ACC: 97.9–98.75%	Multivariate discriminant analysis	Authentication, traceability	[70]
	Vegetable oils and fats	11	-	Xylene	ICP-OES equipped with hTISIS	Al, Ba, Ca, Cd, Cr, Cu, Fe, Mg, Mn, Mo, Ni, Si, Ti and V	1.6; 0.35; 0.6; 2.6; 0.59; 0.94; 0.86; 0.16; 0.2; 4.1; 2.7; 0.91; 0.21 and 0.81 ( $\mu\text{g kg}^{-1}$ )	Spike with the Conostan multi-elemental solution	Around 100%	-	Development of analytical method	[53]

The MW-AD method offers many advantages, such as reducing contamination since the solutions are introduced into a closed and sealed system; and reducing the time of mineralization following an optimised program specifically developed according to each type of matrix. Once mineralised, elements are released in an aqueous acidic solution and ready to be analysed after dilution.

However, the MW-AD remains limited for olive oil applications due to the small volume allowed for processing. Generally, the maximum sample amount recommended for olive oil digestion in the most recent MW systems, such as Mars 6 (CEM, <https://cem.com>, accessed on 16 March 2021), Anton Paar Multiwave (Anton Paar, <https://www.anton-paar.com>, accessed on 16 March 2021) and Ultrawave (Milestone, <https://www.milestone.com>, accessed on 16 March 2021), is around 0.5 g.

The resulting mineralised solutions, initially highly concentrated in acid, have to be diluted in order to become suitable for their introduction into an instrumental analysis system. Therefore, after dilution, the concentrations of some elements are likely to be below the LODs. Based on the procedure proposed by Aceto et al. (2019) [60], a high dilution factor of 125 (0.4 g of olive oil transferred into a final volume of 50 mL) would not be adequate for the detection of trace and rare earth elements (REE) in olive oil, given the constraints of LODs imposed by the ICP-MS. Even with a smaller dilution factor (i.e., 50; 0.5 g of olive oil transferred into the final volume of 25 mL), the overall procedure did not allow the determination of Sr in Spanish oils [45]. An alternative procedure was proposed to overcome this issue through the evaporation to dryness of the mineralised sample followed by a re-dissolution in the minimum volume required for analysis [71]. Alternatively, combining samples prepared by evaporation and re-dissolving of a few independently mineralised samples can also be performed [72]. Under these conditions, special attention must be paid to the purity of the reagents used. The solution's integrity is protected from external contamination by using closed-vessel evaporation systems.

#### (ii) Ashing in a furnace

The total combustion of olive oil in a furnace (dry ashing) is an uncommon technique and has only been applied to determine selected elements: Cd, Cu, Pb, Fe [73] or Sr, prior to isotopic analysis [35]. The main advantage of this technique is the ability to process a relatively large amount of sample compared to the MW-AD technique, to achieve higher pre-concentration factors. Oil sample amounts ranging from 2 g [46] to 5 g [35] have been treated by ashing in a furnace. Nevertheless, both protocols included a preliminary oxidation step of the oils by the addition of nitric and sulfuric acids and a heating step prior to their introduction into the furnace. All these difficult and tedious procedures may increase analytical and precision errors.

#### (iii) Methods of extraction

- Acid extraction (AE)

Acid extraction procedures permit the efficient release of inorganic analytes found in olive oil (i.e., organic phase) into a slightly acidic solution (i.e., aqueous phase). The analytes are released from the oily matrix based on the stronger affinity they have with the acidic solution. Extensive and reliable studies dedicated to the geographic origins of olive oil used this method for years as a sample preparation technique due to its efficiency and relative ease of implementation. The results obtained showed acceptable precision (RSD: 13–27%) and good recovery yields (82–101%) [15,41]. Since then, minor modifications have been proposed, such as using a mixture of diluted acids and the addition of hydrogen peroxide (i.e., 1% HNO<sub>3</sub>, 0.2% HCl and 6.7% H<sub>2</sub>O<sub>2</sub>) [18] to improve and facilitate the decomposition of the organic phase and the release of the elements.

A higher degree of acidification of the aqueous phase (up to 10%) was found to be less efficient for metal extraction [46]. The limitation of the AE method is the relatively low Recovery Rate (RR) compared to the destructive methods [58]. In a recent study published by Poscic et al.; (2019) [18], where AE was applied for the quantification of 29 ele-

ments, RR ranged from 60% up to almost 100%, which highlights that elements have different extractability characteristics. Further, it should be noted that the ratios of processed oil to the acidic mixture may vary widely among different studies. Equivalent volumes of oil and acidic mixture were used in the studies performed by Camin et al. (2010, 2010a) [15,41] and Posic et al. (2019) [18] and led to high RR values, while higher oil proportion (3:1) was found to be less effective, resulting in RR of 20% and 12%, respectively, for Cu and Pb [46]. On the contrary, a micro-extraction of Cu, Cd, Ni, Pb and Zn from 10 mL of olive oil by 200  $\mu$ L of aqueous solution containing 3% nitric acid showed RR ranging between 95 and 100% [64].

Furthermore, it has been shown that the AE efficiency depends on the duration and temperature of sonication [64,74]. High temperatures tend to reduce the surface tension between two liquids [72] and would alter the emulsion characteristics, i.e., viscosity and droplet size [73]. Under these conditions, the phase mixing would be enhanced and yield a highly effective extraction of the trace elements from oils. Conversely, an increase of the sonication time resulted in a decrease of the extracting efficiency of approximately 15% for Cd [64].

Other parameters have been shown to affect the extraction efficiency. For example, the shape and size of the extraction vessels had a significant effect on the extraction RR since they correlate with the contact surfaces between the two phases [74].

In conclusion, while acidic extraction-based methods have been widely described, the extraction yield cannot be assumed based on previous studies. An optimization of all significant parameters (intensity of shaking, temperature and duration of sonication, volume of extraction reagent...) is mandatory before applying this approach to the extraction of elements from olive oils.

- Extraction using various organic/inorganic agents: chelating and emulsification

The following methods are a slight variation of earlier ones, based on the extraction of analytes with the use of specific extraction agents. The solubilization with a strong alkaline solution [69], emulsification [52,56] and formation of coordination complexes [70–72] have been successfully employed for the extraction of trace elements from oils. These approaches offer advantages in terms of sample preparation time and permit the extract to be directly introduced into the ICP. Special attention is often paid to matrix matching with the calibration standards. A summary of the various extraction techniques with their analytical characteristics is presented in Table 1.

(iv) Dilution with organic solvent

Methods involving dilution with organic solvents for olive oil studies [53,70] have the main advantage of being based on the direct analysis of diluted oily matrices (with an adjusted sample introduction system). Recently, a high-temperature torch integrated sample introduction system (hTISIS) was applied for the analysis of oils and fats after dilution with xylene by ICP-OES [53]. The addition of oxygen as an auxiliary gas in ICP-OES was also investigated for that purpose [75]. It is, however, crucial to avoid matrix effects when performing analyses with direct introduction techniques. The time-saving benefit offered by this technique is attractive, but the rigorousness necessary for its implementation and to achieve satisfactory results explain its limited use with respect to olive oil elemental analysis.

(v) Emulsification

Emulsification is an alternative technique to the direct introduction of oil in plasma-based instruments. Emulsifiers are added to oil to form water-soluble micelles. Stabilised “oil-in-water” emulsions can be generated using Triton X-100 and Triton X-114. These emulsifiers were successfully applied for the on-line analysis of olive oil. Triton X-100 was used to extract Tl and Cr, at concentrations above 0.5  $\mu$ g kg<sup>-1</sup> and 50  $\mu$ g kg<sup>-1</sup>, respectively, from about 3 g of olive oil [56]. Triton X-114 was allowed to extract Cd, Cr, Cu, Fe, Mn,

Ni, Pb and Zn from olive oil. Their concentrations were determined by ICP-OES, and recoveries ranged from 96% to 109% [52]. During the sample preparation, it was difficult to maintain the stability of the emulsions formed, but stability could be achieved by a thorough control of the experimental conditions [66].

(vi) Chelation of the analytes

The aim of chelation is to form stable complexes (metal/ligand) with higher solubility in the extraction solution. Under appropriate pH conditions, chelation enables the transfer of elements from the oily organic phase to the aqueous extraction phase. Thus, the elements extracted in the aqueous solution would be easily analysed. The chelator can be specific to a single element [76] or an agent that has the ability of complexing a wide range of elements. Examples of chelating extraction using Ethylenediaminetetraacetic acid (EDTA) [66], lipase [67] and a mixture of EDTA/Tetramethylammonium hydroxide (TMAH) [68] have been recently reported. The pH control pH during the extraction phase is of great importance. The extraction yield has been found to be optimal when using lipase at pH = 3, and the mixture of EDTA and TMAH at pH = 12.

This approach is relatively rapid, sensitive and reproducible, and it can be conducted without toxic chemicals, detergents and concentrated acids. However, the reagents must have a high degree of purity.

All the above-mentioned methods have shown promising results and are good choices for future experiments. Some of them are relatively rapid as no pre-treatments are required (i.e., emulsification, chelating and direct dilution), while others are simple to perform (MW-AD and acid extraction). Some of the methods require specific equipment (i.e., direct dilution). The choice of method will depend on the research targets and the availability of the apparatus and reagents. Since, in general, the concentrations of trace elements in olive oil are low, methods that allow a pre-concentration with controlled purity reagents are the most suitable.

(vii) Comparative studies of different sample preparation methods

As discussed before, each sample preparation technique has its advantages and limitations. The first reliable comparison between MW-AD, AE and dry ashing for olive oil samples has demonstrated that only the latter allows the determination by ET-AAS of all elements of interest [46]. Two recent studies have also assessed the robustness and efficiency of the most common MW-AD and acid extraction procedures [18,71]. Results published by Damak et al. (2019) showed that the ultrasound-assisted AE achieved lower LODs, higher precision and better repeatability than MW-AD combined with evaporation [71]. The advantage of the AE approach over the MW-AD was also highlighted by Poščic et al. (2019), who stated that the MW-AD is limited for the measurement of very low concentrations, as the case of trace elements in olive oil [18]. Nevertheless, in both studies, it was reported that there was no significant difference between concentrations found after using both techniques for the quantification of trace elements in olive oil. Therefore, on the basis of these findings, it would be advantageous to perform AE in order to quantify more easily trace elements in olive oil and other matrices with similar characteristics.

The review of the current scientific literature for the quantification of trace elements in olive oil shows that the choice of an appropriate sample preparation method is crucial as it can affect the detection of analytes and the quality of the results. The choice of method should be based on the objectives of the research study and on the analytical performance of the instrumentation to be used for the detection stage.

### 2.2.2. Detection Techniques

The quantification of trace elements in olive oil requires sensitive detection techniques. The ICP-MS is known to be one of the most sensitive instruments available today for the accurate quantification of trace elements. Accordingly, and based on our literature survey, the main analytical instrument used to determine the elemental content of olive

oil for geographical traceability was the ICP-MS (almost 70% of the published studies, Figure 5).

Other spectroscopic methods, such as ICP-OES, GF-AAS and FAAS were mostly used for the detection of alkaline metals in olive oils as these are present at higher concentrations [58]. The plasma-based detection techniques (OES or MS) now occupy the leading position mainly when extraction [68], emulsification [52], liquid-liquid extraction [64] or dilution with organic solvent [70] are used as sample preparation techniques. However, one-third of studies reviewed (Table 1) did not provide information on detection limits of analysed elements limiting the reader's capacity to assess the validity and credibility of the results. Some authors have reported surprisingly high LODs and LOQs for ICP-MS, such as  $6 \mu\text{g kg}^{-1}$  (Mn) and  $6.9 \mu\text{g kg}^{-1}$  (Pb) [50]; or  $9.6 \mu\text{g kg}^{-1}$  (Sr),  $16.3 \mu\text{g kg}^{-1}$  (Cr) and  $21.2 \mu\text{g kg}^{-1}$  (Ni)  $\mu\text{g kg}^{-1}$  [36].

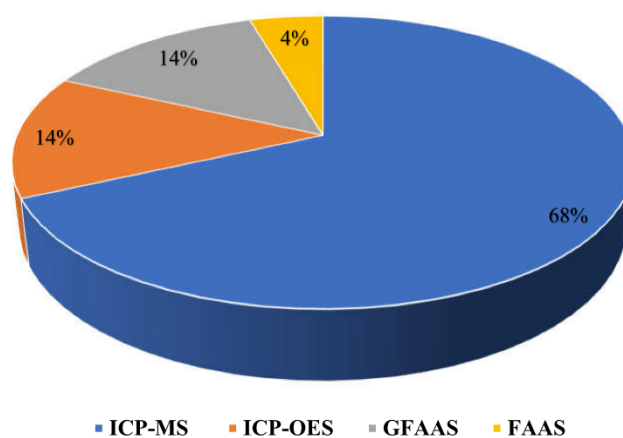

**Figure 5.** Percentage of articles that use atomic spectroscopic techniques to analyse trace elements in olive oil.

In the absence of information about the measured procedural blank, it is difficult to explain such atypical high LODs. It can only be hypothesised that these LODs are most likely due to possible contaminations during sample preparation procedures.

### 2.2.3. Analytical Method Validation

Both precision and accuracy are important parameters of the method validation procedure. For geographical traceability studies based on the elemental content, a difference between the measured and the expected concentration of analyte that would be typically described as non-significant or classified as an analytical error would distort the results and lead to false assumptions and wrong geographical classification of the studied samples. Especially for olive oil authentication, as trace elements are initially at low concentrations, the difference in the elemental profile between distinct geographical origins is likely very limited. Thus, it is crucial to determine the element concentrations with a high degree of precision and accuracy to be able to perform a proper assessment of the origin.

Thus far, there is still no certified reference material (CRM) for trace elements in olive oil despite of its growing worldwide consumption. This is the reason why a number of authors did not use CRMs in their experiments, or at least why such information was not provided [36,45,61,63,64,69].

However, those who have attempted to evaluate the performance of their analytical method have often aimed to use a CRM that would have physicochemical properties close to those of olive oil. The most commonly used ones are based on engine or synthetic oils, such as the multi-element organometallic oil standard on base oil (S23-100Y from SPEX CertiPrep) [15,50] which is an oil for mechanical engines. There is also a Multi-element Standard II Oil Dissolved from Certipur® (109469) [51,70], and a used oil CRM (EnviroMAT HU-1) from SCP Science [66,67]. It must be mentioned that these CRMs do not have the same viscosity as olive oils and the concentrations of certified elements are not comparable to those of olive oil. The closest CRM of natural edible lipid matrix available is the certified peanut butter (NIST SRM 2387). It has been seldomly used either diluted in oil or in its raw state by some researchers [15,41,47]. This CRM is characterised by its relatively high elemental concentrations compared to olive oil, which makes it more suitable as a spiking standard for olive oil. Recently, Aceto et al. (2019) used an uncommon CRM, BCR-668 muscle tissue, in order to quantify lanthanides and other microelements distribution to authenticate Italian extra-virgin olive oils after microwave-assisted digestion [60]. However, the choice of such biological tissue is quite controversial, especially in the case of olive oil analyses, as the levels of REE in the CRM are at least three times higher than those in olive oils. Further, the main constituents of olive oils and muscle tissue matrices are different qualitatively and quantitatively. Therefore, serious discrepancies related to matrix effects could be expected. Unfortunately, the authors did not provide justifications for their choice of CRM. Indeed, the inconsistency between the calibration standard concentration range selected and the concentrations of the expected elements in olive oil samples also suggests that the results could be biased.

Furthermore, an array of studies has determined the elemental recoveries by spiking each individual oil sample with a multi-elemental standard solution. This approach is acceptable when the selected sample preparation method involves the complete destruction of the organic matter such as MW-AD [30,62] or ashing in the furnace [46]. However, despite using mono- or multi-elemental spiking solutions for validation purposes for the extraction [68,74] or the emulsification methods [52,56], it is very unlikely that this approach reflects the real extraction efficiency of an element initially present in the oily phase, since the elements composing the spiked solutions are already in a water-soluble form and no extraction is required. It is, therefore, practically impossible to define a realistic target recovery using a spike of elements in an aqueous solution, and it could even be misleading to do so using this approach.

In conclusion, despite the unavailability of a suitable CRM for olive oil, a wide range of alternative methods have been proposed to ensure quality assessment. The use of synthetic oils and similar lipid matrices certified for trace elements or spiking with natural oils seemed appropriate. They allowed effective control of the measurement performance pending the development of an appropriate matrix-matched CRM for olive oil.

### 2.3. Limits of Olive Oil Authentication by Means of Trace Elements

Trace element contents in plants are mainly related to the soil composition where they were grown. However, correlations between the elemental content in oil and the corresponding soil are not always valid. Many factors may influence the elemental composition of olive oil through changes in the fruit composition during its growing and ripening period or through external contamination during its extraction and packaging.

#### 2.3.1. Influence of Agro-Climate Conditions

It has been demonstrated that several parameters such as the olive cultivar [63], irrigation of olive trees [30], use of fertilisers [77], or fluctuations in annual climatic parameters [78] may modify the elemental profile of olive oil. At present, no consensus has been reached with regard to the possible existence of a direct and clear correlation between the concentration of trace elements in the soil and in the paired olive oils. However, interesting findings have recently emerged. Damak et al. (2019) sampled olives and soils from

various Tunisian regions in order to investigate the correlation between the elemental content of soil and that of olives [50]. After olive oil extraction from olives, its elemental content was determined by ICP-MS after MW-AD, while the soil content was analysed by X-ray fluorescence (XRF). The XRF beads were also analysed for trace elements by femto-second ultraviolet Laser Ablation ICP-MS. The results of this study have demonstrated that the correlation between the composition of the soil and that of the plant is not always straightforward. The concentration of the elements analysed (Fe, Mn, Zn, Na and Pb) in olive oil were inversely proportional to those recorded in the soils. Based on these results, the authors concluded that the soil is not the only source of trace elements in olive oil. On the basis of these results, it can also be suggested that the results were influenced by the different sample treatments of oil and soils and the different analytical performances of the detection instruments used.

According to Greenough et al. (2010) [78], the multi-elemental composition of an agri-food product is influenced by the climatic conditions (temperature, precipitation, humidity) prevailing during its growth. A recent study of Portuguese olive oils by Gouvinhas et al. (2016) [79] showed that trace element content could vary according to the ripeness of the olives. Another study suggested a correlation between Fe, Co, Ni, Ba, Rb, Sr and Pb in the soils and olive oils [60], but elements such as W, Tl, Cr, Sb, Cd and Cu exhibited a different trend; the best correlation was observed for the lanthanides. Since the lanthanides are adsorbed passively from soil and are not altered much when passing from soil to fruit, they may act as a promising tracer when analytical methods enable detection at the ultra-trace level.

### 2.3.2. Influence of the Olive Oil Extraction Process

After harvesting, the collected fruits will undergo several steps that may alter the mineral composition of the final product (Figure 1). During the oil extraction process, olives are in direct contact with metallic surfaces that can generate contamination in the final product.

Further, the possible addition of water after mixing and prior to centrifugation to increase the oil extraction efficiency may be a potential source of contamination with trace elements. These concerns have been evaluated by Sandeep Banerjee (2015), who showed that the use of water during the oil extraction process could modify its elemental composition [80]. He reported that the concentration of Sc, Cr, Fe, Co and Ni in the oil increased with the addition of water. On the other hand, the use of water at the industrial-scale olive oil refining process decreased the Ca concentrations in olive oils.

Recently, it has been demonstrated that the filtration process of olive oil, frequently required to remove the pomace residues, may significantly alter the trace element content of both olive oil and pomace residues [81]. In addition to the changes that will affect the sensorial and physicochemical characteristics of the oil [82], Pošćić et al. (2019) recently demonstrated that the pomace residues significantly affected the elemental content of the oil [18]. In their study, 29 element concentrations were determined in centrifuged and non-centrifuged olive oils. The results were expressed as NC-to-C (non-centrifuged vs. centrifuged) ratios for each element analysed, and displayed discrepancies of up to three orders of magnitude. This fact needs to be specifically considered for accurate quantification of trace elements in olive oil. According to Pošćić et al. (2019), a centrifugation step is mandatory prior to trace element analysis. Without centrifugation, the results are not reliable enough for comparison purposes [18]. Finally, the storage and transportation conditions of olive oil would affect the final chemical composition. De Leonardis et al. (2000) suggested the use of polypropylene containers when determining levels of Cu and Fe in edible vegetable oils [65].

All the above-mentioned factors can alter the inorganic signature of olive oil and should be carefully investigated to assess the geographical origin of the oils.

### 3. Olive Oil Geographical Traceability by Means of Isotopic Analysis

Since the inorganic oil composition does not always match that of the soil when using multi-elemental signatures, stable isotopes have long been used for traceability purposes in foods [83]. The earliest uses of the stable isotope analysis technique to establish the authenticity of foods dates back to the early 1970s [84]. The isotopic ratios of some light elements could change depending on the geographical origin, the climatic parameters, and finally, the soil paedology and geology of the location from where the products originate [85].

#### 3.1. Stable Isotopes of Light Elements (C, H and O)

The use of stable isotope ratios of hydrogen, carbon and oxygen provides information on the geographical origin and the pedo-climatic context. The major elemental constituents of the olive oil (H, C, O) have different stable isotopes (i.e.,  $^1\text{H}$ ,  $^2\text{H}$ ;  $^{12}\text{C}$ ,  $^{13}\text{C}$ ;  $^{16}\text{O}$ ,  $^{18}\text{O}$ ). The relative abundance of each of these stable isotopes could vary in the environment, depending on (i) the origin of the elements and (ii) the processes that will modify their concentrations.

A number of scientific studies have aimed to use the combination of the isotopic ratios of light elements for the geographical determination of the production origin of olive oils and their potential adulteration [41,86–90].

Carbon and oxygen isotope data are expressed in the usual delta notation ( $\delta^{13}\text{C}$  and  $\delta^{18}\text{O}$ ), defined as:

$$\delta_{\text{sample}} (\text{‰}) = ((R_{\text{sample}}/R_{\text{standard}}) - 1) \times 1000 \quad (1)$$

where R is the isotopic ratio  $^2\text{H}/^1\text{H}$ ,  $^{13}\text{C}/^{12}\text{C}$  or  $^{18}\text{O}/^{16}\text{O}$ . The international standard for C is Pee Dee Belemnite (PDB) while the Standard Mean Ocean Water (SMOW) is used for O and H.

The raw isotopic analyses of the samples are corrected by means of internationally-accepted matrix-matching reference materials. The most appropriate certified reference for olive oil are NBS22, USGS84 and USG85 [80,91].

In general, for the studies focused on olive oils, the main stable isotopic ratios used were  $^{13}\text{C}/^{12}\text{C}$ ,  $^{18}\text{O}/^{16}\text{O}$  and  $^2\text{H}/^1\text{H}$ .

#### (i) $\delta^{13}\text{C}$ measurements as a tracer of physiological processes of the plant

$\delta^{13}\text{C}$  measurements have been used for decades as a tracer of the type of photosynthesis (C3, C4, CAM) [92]. The fixation and assimilation of atmospheric  $\text{CO}_2$  during photosynthesis varies according to the metabolic pathway through the mechanism of glucose production. The ranges of  $\delta^{13}\text{C}$  variations for C3 plants vary from  $-32$  to  $-24\%$ , from  $-16$  to  $-10\%$  for C4 plants, and from  $-30$  to  $-12\%$  for CAM [93]. These significant differences have been used at first to reconstruct past and paleo-environments [94]. Further, they can also be used to detect the adulteration of food products. A common fraudulent practice in food is sweetening products with cheap sugar by the addition of C4 sugar to C3 crops; this can be easily detected by determining  $\delta^{13}\text{C}$  values [95]. More recently, it has been shown that genetic determinism is likely to influence the variation the  $\delta^{13}\text{C}$  values as well, resulting in oscillating values close to the typical photosynthetic signature [32,89,96].

The  $\delta^{13}\text{C}$  values can also be affected by the developmental stage of the plant [89]. In the specific case of olive trees, it has been applied to evaluate the olive ripeness index. These developments using the isotopic signatures of light elements of olive oils were further highlighted by S. Portarena [89]. The results obtained in this study demonstrated a positive correlation between the C and the O isotopic compositions and the plant maturity stage. This was also valid to establish the evolution of the climatic changes during the fruit-ripening season and more especially during the period of maximum oil accumulation.

#### (ii) $\delta^2\text{H}$ and $\delta^{18}\text{O}$ measurements as a tracer of water dynamics



The hydrogen and oxygen isotope composition of water ( $\delta^2\text{H}$  and  $\delta^{18}\text{O}$ ) will vary depending on (i) the geographical position; the latitude, the longitude, the elevation, the distance from the sea, (ii) the type of climate; amount and type of precipitation, evaporation, (iii) type of plants which impact combining with the climate the rate of evaporation by plant transpiration.

Several studies have demonstrated that stable isotopes of light elements are good indicators of geographic origin. Table 2 summarises the different studies that have successfully used stable isotopes of light elements for olive oil geographical authentication. Analyses are performed using an isotope ratio mass spectrometer (IRMS) generally connected to a high-temperature source for combustion or pyrolysis of olive oil, typically without prior pre-treatment.

A rapid and cost-effective pre-treatment methodology for measuring C and O isotopic ratios in oil and glycerol was proposed. The glycerol was obtained by distillation after hydrolysis and extraction of the fatty acids. A correlation was found between C in oil and in glycerol extracted ( $\delta^{13}\text{C}$  glycerol =  $1.1114 \times \delta^{13}\text{C}$  bulk oil + 1.4057;  $p < 0.001$ ) [41]. Moreover,  $\delta^{18}\text{O}$  of glycerol is correlated with the  $\delta^{18}\text{O}$  of leaf water. These promising results indicate that the direct measurement of isotopic ratios in glycerol would be beneficial.

The measurement of the natural stable isotopic composition of light elements allowed the tracing of several environmental conditions. However, since the plants adapt to their specific environment, the isotopic variations may be very small for the same type of plants (photosynthesis) when the variations of environmental conditions are not significant between different study areas. Camin et al. (2016) [31] assumed that these similarities between the different locations could result from similar climatic conditions in both regions during the pre-harvesting period. Therefore, geographically distinct regions could nonetheless display identical isotopic ratios but only if the climate is equivalent in the two different locations. To further reinforce the geographical discrimination, the combined use with  $^1\text{H}$  NMR data using a multivariate statistical approach was investigated.

Recently, Tarapoulouzi et al. (2021) conducted a large-scale study on a total of 100 monovarietal olive oil samples from two coastal locations in Greece [90]. The sampling strategy aimed to avoid the effect of olive oil storage and seasonal changes. The combination of stable isotopes of light element ( $\delta^{13}\text{C}$ ,  $\delta^{18}\text{O}$  and  $\delta^2\text{H}$ ) with a chemometric tool (OPLS-DA) enabled the separation between the samples from (i) two geographical areas, (ii) three cultivars, two of which belonged to the same geographical area. Based on these results, the olive cultivar was more effective for the samples classification compared to the geographical origin.

Further, the chemometric analysis showed that the discriminating potential of stable isotopes of H and O was significantly higher compared to C isotopes since the sampling areas shared similar climatological and geographic characteristics. Accordingly, the choice of appropriate isotopic approaches for geographical traceability studies should be based on the plant type and genetic determinism, the geographic, environmental and climatological characteristics of the plant growing area.

A large international database of the range of stable isotope ratios of light elements was established based on the published results obtained in various geographical locations. Nevertheless, Camin et al. (2010) highlighted the significant variation in the ratios  $^{13}\text{C}/^{12}\text{C}$  and  $^{18}\text{O}/^{16}\text{O}$  of Italian olive oils sampled from 2000 to 2005. The isotope ratios of the samples collected from the same region varied among the years, characterised by different climatic conditions (rainfall and temperature) [41].

Table 2. Determination of isotopic ratios of light elements in olive oil and other edible oils.

Samples	Number of Samples	Origin	Isotopes	Detection Technique (Manufacturer)	Statistical Evaluation	Complementary Analysis	Purpose of Using Isotopes	References	
EVOO	539	Italy	$^{18}\text{O}/^{16}\text{O}$ , $^2\text{H}/^1\text{H}$ and $^{13}\text{C}/^{12}\text{C}$	IRMS (Finnigan DELTA XP, Thermo Scientific, Bremen, Germany)	The non-parametric test of Kruskal–Wallis		<ul style="list-style-type: none"> <li>Discrimination capability of <math>^{18}\text{O}/^{16}\text{O}</math>, <math>^2\text{H}/^1\text{H}</math> and <math>^{13}\text{C}/^{12}\text{C}</math> between olive oils from different Italian regions.</li> <li>The trend of these indicators over the years.</li> </ul>	[41]	
EVOO	267	Italy, France, Spain, Greece and Portugal	$^{18}\text{O}/^{16}\text{O}$ , $^2\text{H}/^1\text{H}$ and $^{13}\text{C}/^{12}\text{C}$	IRMS (Delta plus XL, Delta Plus XP, Delta V, Delta S, Thermo-Finnigan, Bremen, Germany; Isoprime, AP2003, GV Instruments Ltd., Manchester, U.K.; Optima Micromass)	Kolmogorov-Smirnov test	Multi-elemental analysis	Finding correlation between H, C and O isotope ratios in olive oil and climatic and geographical characteristics of the provenance locations.	[15]	
VOO	49	Turkey	$^{13}\text{C}/^{12}\text{C}$	IRMS (Micro-mass, Iso-Prime)	PCA and HCA		Combination of trace element concentrations and $^{13}\text{C}/^{12}\text{C}$ isotope ratio for better resolution in geographical discrimination of olive oils.	[61]	
VOO	47	Greece	$^{18}\text{O}/^{16}\text{O}$ and $^{13}\text{C}/^{12}\text{C}$	IRMS (Finnigan Delta V Advantage, Thermo Fisher Scientific, Bremen, Germany)	Multivariate analysis	Multi-elemental analysis/ Determination of chlorophyll and carotenoid pigments	Combination of $^{18}\text{O}/^{16}\text{O}$ and $^{13}\text{C}/^{12}\text{C}$ isotope ratios and physicochemical parameters for geographical classification of olive oils from regions in proximity.	[97]	
VOO	387	Italy	$^{18}\text{O}/^{16}\text{O}$ and $^{13}\text{C}/^{12}\text{C}$	IRMS (Isoprime, Cheadle, UK)	Pearson coefficient and ANOVA	-	Use of stable isotope ratios as tracers for environmental conditions and geographic coordinates for olive oil geographical authentication.	[32]	
Edible oils and sweeteners	43	Italy, Greece and Spain	$^{18}\text{O}/^{16}\text{O}$ , $^2\text{H}/^1\text{H}$ and $^{13}\text{C}/^{12}\text{C}$	IRMS (Thermo-Finnigan Delta plus XP, Thermo Fisher Scientific Inc., Waltham, MA, USA)	-	Multi-elemental analysis	<ul style="list-style-type: none"> <li>Use of carbon isotope ratio as indication of olive oil adulteration (with corn oil).</li> <li>Oxygen and hydrogen isotope fractionation between edible oils (olive oil) and local meteoric water.</li> </ul>	[80]	
OO	180	Italy	$^{18}\text{O}/^{16}\text{O}$ , $^2\text{H}/^1\text{H}$ and $^{13}\text{C}/^{12}\text{C}$	IRMS (Finnigan DELTA XP, Thermo Scientific, Bremen, Germany)	-		The acidity values, UV spectrophotometric indices (K232, K270, DK) and fatty acid composition	Measurement of Stable isotope ratios in legal applications for geographical origin of food (olive oil).	[31]
OO	-	Italy	$^{18}\text{O}/^{16}\text{O}$ and $^{13}\text{C}/^{12}\text{C}$	IRMS (Isoprime, GV, Cheadle, UK)	Factorial analysis of variance (ANOVA) and Post Hoc Fisher multiple comparison test	Fatty acid composition	Effect of the cultivar and the ripening stage of olives on C and O isotope composition for traceability studies.	[89]	

EVOO	53	Italy and Croatia	$^{18}\text{O}/^{16}\text{O}$ and $^{13}\text{C}/^{12}\text{C}$	IRMS (Delta plus XP; ThermoFinnigan, Bremen, German)	Linear discriminant analysis	Major chemical component determination (triacylglycerol and fatty acids)/Thermal properties	Comparison between conventional techniques, stable isotope ratio analysis and thermal properties for olive oil traceability resolution.	[98]
OO	100	Greece	$^{18}\text{O}/^{16}\text{O}$ , $^2\text{H}/^1\text{H}$ and $^{13}\text{C}/^{12}\text{C}$	IRMS (Nu Instruments Limited, Wrexham, UK)	PCA/OPLS-DA	-	Creation of OPLS-DA model, using stable isotope ratios of C, H and O in olive oil, able to discriminate and predict origin of samples from different origin.	[90]
EVOO	210	Greece	$^{18}\text{O}/^{16}\text{O}$ and $^{13}\text{C}/^{12}\text{C}$	IRMS (not mentioned)	-	-	<ul style="list-style-type: none"> <li>C and O isotope ratios as markers of the climate regime thus of the geographical origin of olive oils.</li> <li>Use of <math>^{13}\text{C}</math> isotopic values of biophenolic extracts for geographical discrimination of olive oil.</li> </ul>	[88]

Therefore, the variable nature of the environmental and climatic conditions over the years requires a continuous update of isotopic data that evolve consistently.

### 3.2. Strontium Isotope Ratio Determination for Olive Oil Geographical Traceability

Strontium isotopic signatures are widely used for food traceability and many other applications where issues of origin are important. Strontium is relatively abundant in soil, is not metabolised by living organisms and does not seem to undergo any detectable fractionation. This results in a fully conservative behaviour of the Sr isotopic ratio from the soils to the plants, including animals feeding these plants [99]. Strontium is an alkaline earth metal naturally present in rocks, soil and water, and has four stable isotopes ( $^{84,86,87,88}\text{Sr}$ ). The  $^{87}\text{Sr}$  isotope is radiogenic as it is derived from the disintegration of  $^{87}\text{Rb}$ . The isotopic ratio  $^{87}\text{Sr}/^{86}\text{Sr}$  most often considered in studies is related to the intrinsic nature of the bedrock, its age, and its geological evolution and is, therefore, specific for each type of soil. The two main sources of this element in plants are the labile Sr fraction of the soil, and the Sr contained in soil pore water [100]. Strontium is absorbed by the plant and distributed into its components from the soil without undergoing isotopic fractionation [34].

Given these features, strontium has been successfully used for the geographical tracing of different food products such as wheat [101], wine [102], coffee [103] and fruits such as orange [104]. Recently, strontium isotopic signature was used to assess the geographical traceability of olive oil. Benincasa et al. (2007) were the first to report the use of strontium isotopic ratio measurement in olive oil for traceability purposes, but the complex nature of the matrix and the low Sr content ( $<50 \mu\text{g kg}^{-1}$ ) are challenging for most analytical methods [36]. Consequently, pre-concentration is mandatory to achieve suitable results.

S. Medini et al. (2015) [35] developed an analytical method for the measurement of  $^{87}\text{Sr}/^{86}\text{Sr}$  in olive oil for authenticating AOP olive oil from southern France. As a pre-screening step, the elemental Sr content in the samples was determined using ICP-MS after MW-AD. The strontium concentrations ranged between 2 and  $13.9 \mu\text{g kg}^{-1}$ , which are critically low for accurate measurement of the isotopic ratio of Sr by mass spectrometry. Therefore, ashing of the oils in a muffle furnace was performed, which allowed to increase the amount of sample that can be processed. The Sr purification was performed using Sr specific resin (Sr Eichrom resin) according to the protocol described by Pin et al. (2003) [105]. Finally, the Sr isotopic ratios were determined by thermal ionization mass spectrometry (TIMS) in five olive oils from Nîmes PDO (France) and in two olive oils from Morocco. The results showed that olive oils from France and Morocco were successfully distinguished according to Sr isotopic ratios and were correlated to the bedrock geology. Good reproducibility of the extraction method used was also demonstrated. Given the unavailability of a reference material certified for the isotope ratio  $^{87}\text{Sr}/^{86}\text{Sr}$  in olive oil, a strontium carbonate isotopic CRM (NIST 987) was subjected to the same procedure that olive oil samples to study the influence of pre-treatments and calcination on  $^{87}\text{Sr}/^{86}\text{Sr}$  ratio. The results demonstrated that the proposed methodology did not alter the isotopic signature of Sr. However, the influence of the procedure on an oily matrix has not been demonstrated since NIST 987 is an aqueous solution with a high degree of homogeneity that does not reflect the complex nature of the olive oil matrix.

Techer et al. (2017) [106] studied the impact of agricultural practices on the Sr isotopic composition of olives. TIMS was used to determine the Sr isotopic compositions ( $^{87}\text{Sr}/^{86}\text{Sr}$ ) of varied parts of olives trees (branches, leaves and olives) and the Sr isotopic composition of their growing environment in two distinct agricultural contexts belonging to the same geological area. The aim of the study was to assess the impact of the irrigation and fertilisation techniques on the Sr isotopic composition of olive trees. The study showed that using anthropogenic additives and irrigation water induced changes in the composition of Sr in the soil and thus in the plant. This study underscored the importance of Sr as a reliable tool for the geographical traceability of olive oil.

The different studies based on the use of isotopes of light elements for olive oil geographical discrimination showed that analyzing a combination of  $\delta^{13}\text{C}$  and  $\delta^{18}\text{O}$  of organic plant matter can be a powerful tool. This approach integrates the ecophysiological behaviour, which itself is directly related to the type of photosynthesis and the pedoclimatic context. Sr isotopic signatures have been very useful to trace the geographical origin of different agricultural products, since they are usually conservatively up taken by the plants from the soils they grow in and are stored in the plant with little to no detectable isotopic fractionation. The use of stable isotope ratios of light elements (C, H and O) permits tracing the pedoclimatic conditions in the growing area of the plant, while the use of strontium isotopes provides information on the geological substratum. Therefore, it would be relevant to combine the two isotopic approaches to provide accurate and complementary information on the geographical location of the production area.

#### 4. Statistical Analysis for Geographical Authentication of Olive Oil

To summarise and better exploit the data in a study of geographical authentication of olive oil, a statistical representation is generally used. The most common statistical methods that have demonstrated discrimination between olive oils originating from different geographical origins are multivariate analyses, mainly Principal Component Analysis (PCA) and Linear Discriminant Analysis (LDA) [107]. PCA is an unsupervised method, and LDA is supervised. The PCA score plot is a graphical representation of variables called principal components [108]. PCA maintains the variability of data. In most cases, a PC1 vs PC2 score plot applied to trace element content worked well to distinguish between olive oil samples of different origins [60–62]. Nevertheless, PCA applied to mineral composition is not always sufficient. For example, olive oils from 12 different geographic locations in Spain could not be distinguished only using trace elements [62].

With PCA, graphic representation of two principal components separated the samples into two groups, either belonging to a cluster of points representing a common geographical origin (Huelva) or to one of the other regions, which were then separated into three main clusters distinguished by LDA. A similar conclusion has been drawn for the geographical authentication of virgin olive oils from Western Turkey [61]: the PCA method was not able to distinguish Turkish olive oils from different locations. Only two groups of two sets of samples were successfully classified by means of a score plot, each group containing samples from different locations. This study was enhanced by the use of  $\delta^{13}\text{C}$ , which can further distinguish sample groups by providing additional information to resolve similarities between some element content in different samples. It was demonstrated that stable isotopes of light elements can be successfully coupled with the mineral composition of the oil to better pinpoint the geographic origins of different olive oils.

As for PCA, LDA helps to summarise the main results on a two-dimensional plot while trying to maximise the discrimination between known groups. The sample classification is based on a maximum likelihood discriminant rule. To study the geographical traceability of olive oil from southwestern Spain, trace element concentrations in soils, olive pomace, and olive oils were determined [45]. LDA was successfully applied to the concentrations of Fe, Na and W to discriminate soils from four different geographical locations. Then, since trace element concentrations were lower in the olive pomace, only eight element concentrations (i.e., W, Mg, Mn, Ca, Fe, Ba, Li and Na) were used by the LDA for optimal classification. Despite the overlap of some points, it is still possible to discriminate between four groups of points representing the different geographic locations. This classification was less effective for olive oil using the eight aforementioned elements due to their very low concentrations in the oil. Indeed, the critically low concentrations in such a complex matrix may not be measured with high precision (problem of LOD, sensitivity, repeatability), which makes this statistical method limited for the geographical discrimination of olive oil. In this study, Mn concentration in olive oils ranged from 0.1 to 0.2  $\mu\text{g kg}^{-1}$ , while the lower concentration of calibration standard solutions

used was equal to  $0.2 \mu\text{g kg}^{-1}$ . That makes the measured concentration unreliable, especially as Mn was used by LDA. Thus, if the analysis of trace elements in the soil allows for good geographical discrimination, this does not necessarily reflect the same distribution for the corresponding olive oils.

On the other hand, in a study published in 2007, LDA applied to Italian olive oils showed a remarkable discriminating power on the basis of 18 elements. A total of 8 groups of samples were clearly differentiated on an LDA plot with high reliability [36]. PCA can explain the distribution of groups of samples according to the influencing elements. It first identifies the elements, then identifies the possible interactions and combinations between them. LDA is the best alternative in the case of PCA failure to find a high enough variance among the principal components (as, for PCA, this induces a loss of information when reducing the dimensions).

## 5. Conclusions

This review summarises the developments in inorganic and isotopic analysis for geographical authentication of olive oil. The first and foremost observation based on the compilation of inorganic content in olive oils is that, in general, except for elements such as Fe, Cr and Ca, elements are at trace and ultra-trace levels well below  $200 \mu\text{g kg}^{-1}$  on average. The analytical isotopic characterization of this matrix remains challenging.

Recent developments in sample preparation techniques and spectroscopic/spectrometric analysis have improved the quality of food science. However, the adaptability of these methods to the olive oil matrix remains limited. Various analytical methods have been proposed in the literature to ensure the geographical traceability of olive oil, an economically important product; most of these methods operate via destructive sample preparation strategies (mainly microwave-assisted digestion), aiming to eliminate the organic matrix, which is a barrier to the introduction of samples in spectroscopic analysis instrumentation. However, the destruction of organic matter is often incomplete, leading to unreliable results. In addition, the absence of certified reference material for olive oil remains a significant concern, limiting the reliability of the published results and hindering the validation of the proposed methods.

Non-destructive methods have also been developed to release the elements to be analysed without totally destroying the organic matrix. These are typically extraction/complexation methods that are generally more labour-intensive, although they are performed under gentle conditions. The reproducibility of results and the extraction yield remain an analytical challenge. In general, ICP-MS is the most appropriate detection technique for the quantification of elements at low concentrations. Very strict control of the blank throughout sample preparation procedures is, however, required. If not fully controlled, LODs can be high.

Further to the sample preparation and detection procedures, multivariate statistical models, both supervised and unsupervised, are generally applied to multi-elemental profiles of oils. They have shown that it is possible to classify olive oils according to their geographical origin on the basis of reliable data. Nevertheless, multi-elemental analysis remains limited for the identification of the geographical origin of olive oil, as various external factors can alter the element concentration.

In addition to the multi-elemental profile, isotopic approaches can complete the desired information on geographic origin. Stable isotopes of light elements have provided additional information on the plant's growing environment, but these alone are not enough to confirm proper geographical authentication. They give information about the environmental and climatic characteristics of locations and the physiology of the plant. All these aspects are likely to modify the isotopic profile of light elements. More recent developments in the analysis of the Sr isotope ratio in olive oil have enhanced the traceability studies of oils. The isotopic ratio  $^{87}\text{Sr}/^{86}\text{Sr}$  is directly and exclusively related to the geology of the soil and does not fractionate from the soil to the final product, thus, it maintains the isotopic signature of the original soil. However, the critically low concentration

of Sr in olive oil makes it a serious analytical challenge for its extraction from the matrix, its precise quantification, and the determination of its isotopic ratio. Further studies on the pre-concentration of Sr in olive oil are required to strengthen this approach.

**Author Contributions:** All the authors, E.G.N.; E.N.E.; M.S.; D.L.; M.H.; R.S.; H.A. and O.F.X.D., have contributed to evaluating the choice of the papers and the critical discussions developed in the text. All authors have read and agreed to the published version of the manuscript.

**Funding:** This research was funded by European Project TunTwin from the Horizon 2020 Framework program of the European Union under grant No. 952306. It was also funded by the French ANR EquiPex MARS5 project with a contribution of the METROFOOD ESFRI project. This work was partially supported by the Euskadi/Nouvelle Aquitaine/Navarra Euroregion through the research project ISOTOPO (with agreement no. 2020/3).

**Institutional Review Board Statement:** Not applicable.

**Informed Consent Statement:** Not applicable.

**Data Availability Statement:** All data mentioned were compiled from research articles that have been listed in the literature section.

**Acknowledgments:** The financial support of a Ph.D. grant for Emna G. Nasr has been provided by the “Excellence Eiffel” scholarship of Campus France, the European project “TunTwin” and the scholarship “bourse d’alternance” of University Tunis El Manar, Ministry of Higher Education and Scientific Research in Tunisia.

**Conflicts of Interest:** The authors declare no conflict of interest.

**Sample Availability:** Samples of the compounds are available from the authors.

## References

1. Fausto, L. Introduction. In *Handbook of Olive Oil*; Harwood, J., Aparicio, R., Eds.; Aspen Publishers, Inc.: Riverwoods, IL, USA, 2000; ISBN 978-1-4419-5194-6.
2. Flori, L.; Donnini, S.; Calderone, V.; Zinnai, A.; Taglieri, I.; Venturi, F.; Testai, L. The Nutraceutical Value of Olive Oil and Its Bioactive Constituents on the Cardiovascular System. Focusing on Main Strategies to Slow Down Its Quality Decay during Production and Storage. *Nutrients* **2019**, *11*, 1962. <https://doi.org/10.3390/nu11091962>.
3. Viola, P.; Viola, M.; Academy, O.N.; Libertà, P.; Pg, S. Virgin Olive Oil as a Fundamental Nutritional Component and Skin Protector. *Clin. Dermatol.* **2009**, *27*, 159–165. <https://doi.org/10.1016/j.clindermatol.2008.01.008>.
4. Poljšak, N.; Kreft, S.; Kočevar Glavač, N. Vegetable Butters and Oils in Skin Wound Healing: Scientific Evidence for New Opportunities in Dermatology. *Phytother. Res.* **2020**, *34*, 254–269. <https://doi.org/10.1002/ptr.6524>.
5. Matthäus, B.; Willenberg, I.; Engert, S.; Steinberg, P. The German National Reference Centre for Authentic Food (NRZ-Authent). *OCL-Oilseeds Fats Crops Lipids* **2019**, *26*, 11. <https://doi.org/10.1051/ocl/2019010>.
6. Yan, J.; Erasmus, S.W.; Aguilera Toro, M.; Huang, H.; van Ruth, S.M. Food Fraud: Assessing Fraud Vulnerability in the Extra Virgin Olive Oil Supply Chain. *Food Control* **2020**, *111*, 107081. <https://doi.org/10.1016/j.foodcont.2019.107081>.
7. Bimbo, F.; Bonanno, A.; Viscecchia, R. An Empirical Framework to Study Food Labelling Fraud: An Application to the Italian Extra-virgin Olive Oil Market. *Aust. J. Agric. Resour.* **2019**, *63*, 701–725. <https://doi.org/10.1111/1467-8489.12318>.
8. Shears, P. Food Fraud—a Current Issue but an Old Problem. *Br. Food J.* **2010**, *112*, 198–213. <https://doi.org/10.1108/000707010110118879>.
9. González, A.; de la Guardia, M. Mineral Profile. In *Comprehensive Analytical Chemistry*; Elsevier: Amsterdam, The Netherlands, 2013; Volume 60, pp. 51–76. <https://doi.org/10.1016/B978-0-444-59562-1.00003-7>.
10. Dekhili, S.; Sirieix, L.; Cohen, E. How Consumers Choose Olive Oil: The Importance of Origin Cues. *Food Qual. Prefer.* **2011**, *22*, 757–762. <https://doi.org/10.1016/j.foodqual.2011.06.005>.
11. Menapace, L.; Colson, G.; Grebitus, C.; Facendola, M. Consumers’ Preferences for Geographical Origin Labels: Evidence from the Canadian Olive Oil Market. *Eur. Rev. Agric. Econ.* **2011**, *38*, 193–212. <https://doi.org/10.1093/erae/jbq051>.
12. Kalogiouri, N.P.; Aalizadeh, R.; Dasenaki, M.E.; Thomaidis, N.S. Application of High Resolution Mass Spectrometric Methods Coupled with Chemometric Techniques in Olive Oil Authenticity Studies—A Review. *Anal. Chim. Acta* **2020**, *1134*, 150–173. <https://doi.org/10.1016/j.aca.2020.07.029>.
13. Maléchaux, A.; Le Dréau, Y.; Artaud, J.; Dupuy, N. Exploring the Scientific Interest for Olive Oil Origin: A Bibliometric Study from 1991 to 2018. *Foods* **2020**, *9*, 556. <https://doi.org/10.3390/foods9050556>.
14. Yorulmaz, H.O.; Konuskan, D.B. Antioxidant Activity, Sterol and Fatty Acid Compositions of Turkish Olive Oils as an Indicator of Variety and Ripening Degree. *J. Food Sci. Technol.* **2017**, *54*, 4067–4077. <https://doi.org/10.1007/s13197-017-2879-y>.

15. Camin, F.; Larcher, R.; Nicolini, G.; Bontempo, L.; Bertoldi, D.; Perini, M.; Schlicht, C.; Schellenberg, A.; Thomas, F.; Heinrich, K.; et al. Isotopic and Elemental Data for Tracing the Origin of European Olive Oils. *J. Agric. Food Chem.* **2010**, *58*, 570–577. <https://doi.org/10.1021/jf902814s>.
16. Safarzadeh Markhali, F. Effect of Processing on Phenolic Composition of Olive Oil Products and Olive Mill By-Products and Possibilities for Enhancement of Sustainable Processes. *Processes* **2021**, *9*, 953. <https://doi.org/10.3390/pr9060953>.
17. García-González, D.L.; Aparicio, R. Classification of Different Quality Virgin Olive Oils by Metal-Oxide Sensors. *Eur. Food Res. Technol.* **2004**, *218*, 484–487. <https://doi.org/10.1007/s00217-003-0855-4>.
18. Pošćić, F.; Furdek Turk, M.; Bačić, N.; Mikac, N.; Bertoldi, D.; Camin, F.; Jukić Špika, M.; Žanetić, M.; Rengel, Z.; Perica, S. Removal of Pomace Residues Is Critical in Quantification of Element Concentrations in Extra Virgin Olive Oil. *J. Food Compos. Anal.* **2019**, *77*, 39–46. <https://doi.org/10.1016/j.jfca.2019.01.002>.
19. Frankel, E.N. Chemistry of Extra Virgin Olive Oil: Adulteration, Oxidative Stability, and Antioxidants. *J. Agric. Food Chem.* **2010**, *58*, 5991–6006. <https://doi.org/10.1021/jf1007677>.
20. Dabbou, S.; Brahmi, F.; Taamali, A.; Issaoui, M.; Ouni, Y.; Braham, M.; Zarrouk, M.; Hammami, M. Extra Virgin Olive Oil Components and Oxidative Stability from Olives Grown in Tunisia. *J. Am. Oil Chem. Soc.* **2010**, *87*, 1199–1209. <https://doi.org/10.1007/s11746-010-1600-3>.
21. Tres, A.; van der Veer, G.; van Ruth, S.M. Vegetable Oils. In *Comprehensive Analytical Chemistry*; Elsevier: Amsterdam, The Netherlands, 2013; Volume 60, pp. 543–572, ISBN 978-0-444-59562-1.
22. Gertz, C.; Gertz, A.; Matthäus, B.; Willenberg, I. A Systematic Chemometric Approach to Identify the Geographical Origin of Olive Oils. *Eur. J. Lipid Sci. Technol.* **2019**, *121*, 1900281. <https://doi.org/10.1002/ejlt.201900281>.
23. Bajoub, A.; Hurtado-Fernández, E.; Ajal, E.A.; Ouazzani, N.; Fernández-Gutiérrez, A.; Carrasco-Pancorbo, A. Comprehensive 3-Year Study of the Phenolic Profile of Moroccan Monovarietal Virgin Olive Oils from the Meknès Region. *J. Agric. Food Chem.* **2015**, *63*, 4376–4385. <https://doi.org/10.1021/jf506097u>.
24. Quintanilla-Casas, B.; Bertin, S.; Leik, K.; Bustamante, J.; Guardiola, F.; Valli, E.; Bendini, A.; Toschi, T.G.; Tres, A.; Vichi, S. Profiling versus Fingerprinting Analysis of Sesquiterpene Hydrocarbons for the Geographical Authentication of Extra Virgin Olive Oils. *Food Chem.* **2020**, *307*, 125556. <https://doi.org/10.1016/j.foodchem.2019.125556>.
25. Youseff, R.; Soubh, L.; Alassaf, Z. Detection of Vegetable Oils Adulteration Using Desmethylsterols Composition. *Int. J. Pharm. Sci.* **2014**, *28*, 229–233.
26. Noorali, M.; Barzegar, M.; Sahari, M.A. Sterol and fatty acid compositions of olive oil as an indicator of cultivar and growing area. *J. Am. Oil Chem. Soc.* **2014**, *91*, 1571–1581. <https://doi.org/10.1007/s11746-014-2497-z>.
27. Danezis, G.P.; Tsagkaris, A.S.; Camin, F.; Brusci, V.; Georgiou, C.A. Food Authentication: Techniques, Trends & Emerging Approaches. *Trends Anal. Chem.* **2016**, *85*, 123–132. <https://doi.org/10.1016/j.trac.2016.02.026>.
28. Gupta, N.; Yadav, K.K.; Kumar, V.; Kumar, S.; Chadd, R.P.; Kumar, A. Trace Elements in Soil-Vegetables Interface: Translocation, Bioaccumulation, Toxicity and Amelioration—A Review. *Sci. Total Environ.* **2019**, *651*, 2927–2942. <https://doi.org/10.1016/j.scitotenv.2018.10.047>.
29. Wadood, S.A.; Boli, G.; Xiaowen, Z.; Hussain, I.; Yimin, W. Recent Development in the Application of Analytical Techniques for the Traceability and Authenticity of Food of Plant Origin. *Microchem. J.* **2020**, *152*, 104295. <https://doi.org/10.1016/j.microc.2019.104295>.
30. Benincasa, C.; Gharsallaoui, M.; Perri, E.; Briccoli Bati, C.; Ayadi, M.; Khelif, M.; Gabsi, S. Quality and Trace Element Profile of Tunisian Olive Oils Obtained from Plants Irrigated with Treated Wastewater. *Sci. World J.* **2012**, *2012*, 1–11. <https://doi.org/10.1100/2012/535781>.
31. Camin, F.; Pavone, A.; Bontempo, L.; Wehrens, R.; Paolini, M.; Faberi, A.; Maria, R.; Capitani, D.; Vista, S.; Mannina, L. The Use of IRMS, 1 H NMR and Chemical Analysis to Characterise Italian and Imported Tunisian Olive Oils. *Food Chem.* **2016**, *196*, 98–105. <https://doi.org/10.1016/j.foodchem.2015.08.132>.
32. Portarena, S.; Gavrichkova, O.; Lauteri, M.; Brugnoli, E. Authentication and Traceability of Italian Extra-Virgin Olive Oils by Means of Stable Isotopes Techniques. *Food Chem.* **2014**, *164*, 12–14. <https://doi.org/10.1016/j.foodchem.2014.04.115>.
33. Voerkelius, S.; Lorenz, G.D.; Rummel, S.; Quénel, C.R.; Heiss, G.; Baxter, M.; Brach-Papa, C.; Deters-Itzelsberger, P.; Hoelzl, S.; Hoogewerf, J.; et al. Strontium Isotopic Signatures of Natural Mineral Waters, the Reference to a Simple Geological Map and Its Potential for Authentication of Food. *Food Chem.* **2010**, *118*, 933–940. <https://doi.org/10.1016/j.foodchem.2009.04.125>.
34. Capo, R.C.; Stewart, B.W.; Chadwick, O.A. Strontium Isotopes as Tracers of Ecosystem Processes: Theory and Methods. *Geoderma* **1998**, *82*, 197–225. [https://doi.org/10.1016/S0016-7061\(97\)00102-X](https://doi.org/10.1016/S0016-7061(97)00102-X).
35. Medini, S.; Janin, M.; Verdoux, P.; Techer, I. Methodological Development for  $^{87}\text{Sr}/^{86}\text{Sr}$  Measurement in Olive Oil and Preliminary Discussion of Its Use for Geographical Traceability of PDO Nîmes (France). *Food Chem.* **2015**, *171*, 78–83. <https://doi.org/10.1016/j.foodchem.2014.08.121>.
36. Benincasa, C.; Lewis, J.; Perri, E.; Sindona, G.; Tagarelli, A. Determination of Trace Element in Italian Virgin Olive Oils and Their Characterization According to Geographical Origin by Statistical Analysis. *Anal. Chim. Acta* **2007**, *585*, 366–370. <https://doi.org/10.1016/j.aca.2006.12.040>.
37. Carini, F.; Bengtsson, G. Post-Deposition Transport of Radionuclides in Fruit. *J. Environ. Radioact.* **2001**, *52*, 215–236. [https://doi.org/10.1016/S0265-931X\(00\)00034-5](https://doi.org/10.1016/S0265-931X(00)00034-5).
38. Alloway, B.J.; Davies, B.E. Trace Element Content of Soils Affected by Base Metal Mining in Wales. *Geoderma* **1971**, *5*, 197–208. [https://doi.org/10.1016/0016-7061\(71\)90009-7](https://doi.org/10.1016/0016-7061(71)90009-7).



39. Khan, A.; Khan, S.; Khan, M.A.; Qamar, Z.; Waqas, M. The Uptake and Bioaccumulation of Heavy Metals by Food Plants, Their Effects on Plants Nutrients, and Associated Health Risk: A Review. *Environ. Sci. Pollut. Res.* **2015**, *22*, 13772–13799. <https://doi.org/10.1007/s11356-015-4881-0>.
40. Arnaud Mathieu; Denis Baize; Christophe Raoul; Côte Daniau. Proposition de Référentiels Régionaux En Éléments Traces Métalliques Dans Les Sols: Leur Utilisation Dans Les Évaluations Des Risques Sanitaires. *Environ. Risques St.* **2008**, *7*, 112–122. <https://doi.org/10.1684/ers.2008.0142>.
41. Camin, F.; Larcher, R.; Perini, M.; Bontempo, L.; Bertoldi, D.; Gagliano, G.; Nicolini, G.; Versini, G. Characterisation of Authentic Italian Extra-Virgin Olive Oils by Stable Isotope Ratios of C, O and H and Mineral Composition. *Food Chem.* **2010**, *118*, 901–909. <https://doi.org/10.1016/j.foodchem.2008.04.059>.
42. Shahzad, B.; Mughal, M.N.; Tanveer, M.; Gupta, D.; Abbas, G. Is Lithium Biologically an Important or Toxic Element to Living Organisms? An Overview. *Environ. Sci. Pollut. Res.* **2017**, *24*, 103–115. <https://doi.org/10.1007/s11356-016-7898-0>.
43. Medini, S. Traçage géographique des Huiles D'olive par les Isotopes du Sr: Développement Analytique et Application aux Huiles AOP de Nîmes. Ph.D. Thesis, Université d'Aix-Marseille, Marseille, France, 2015.
44. Skrzydlewska, E.; Balcerzak, M.; Vanhaecke, F. Determination of Chromium, Cadmium and Lead in Food-Packaging Materials by Axial Inductively Coupled Plasma Time-of-Flight Mass Spectrometry. *Anal. Chim. Acta* **2003**, *479*, 191–202. [https://doi.org/10.1016/S0003-2670\(02\)01527-1](https://doi.org/10.1016/S0003-2670(02)01527-1).
45. Beltrán, M.; Sánchez-Astudillo, M.; Aparicio, R.; García-González, D.L. Geographical Traceability of Virgin Olive Oils from South-Western Spain by Their Multi-Elemental Composition. *Food Chem.* **2015**, *169*, 350–357. <https://doi.org/10.1016/j.foodchem.2014.07.104>.
46. Brkljača, M.; Giljanović, J.; Prkić, A. Determination of Metals in Olive Oil by Electrothermal Atomic Absorption Spectrometry: Validation and Uncertainty Measurements. *Anal. Lett.* **2013**, *46*, 2912–2926. <https://doi.org/10.1080/00032719.2013.814056>.
47. Nasr, E.G.; Epova, E.N.; De Diego, A.; Souissi, R.; Hammami, M.; Abderrazak, H.; Donard, O.F.X. Trace Elements Analysis of Tunisian and European Extra Virgin Olive Oils by ICP-MS and Chemometrics for Geographical Discrimination. *Foods* **2022**, *11*, 82. <https://doi.org/10.3390/foods11010082>.
48. Zeiner, M.; Steffan, I.; Cindric, I.J. Determination of Trace Elements in Olive Oil by ICP-AES and ETA-AAS: A Pilot Study on the Geographical Characterization. *Microchem. J.* **2005**, *81*, 171–176. <https://doi.org/10.1016/j.microc.2004.12.002>.
49. Cindric, I.J.; Zeiner, M.; Steffan, I. Trace Elemental Characterization of Edible Oils by ICP-AES and GFAAS. *Microchem. J.* **2007**, *85*, 136–139. <https://doi.org/10.1016/j.microc.2006.04.011>.
50. Damak, F.; Asano, M.; Baba, K.; Suda, A.; Araoka, D.; Wali, A.; Isoda, H.; Nakajima, M.; Ksibi, M.; Tamura, K. Interregional Traceability of Tunisian Olive Oils to the Provenance Soil by Multielemental Fingerprinting and Chemometrics. *Food Chem.* **2019**, *283*, 656–664. <https://doi.org/10.1016/j.foodchem.2019.01.082>.
51. Llorent-Martínez, E.J.; Ortega-Barrales, P.; Fernández-De Córdoba, M.L.; Domínguez-Vidal, A.; Ruiz-Medina, A. Investigation by ICP-MS of Trace Element Levels in Vegetable Edible Oils Produced in Spain. *Food Chem.* **2011**, *127*, 1257–1262. <https://doi.org/10.1016/j.foodchem.2011.01.064>.
52. Bakircioglu, D.; Kurtulus, Y.B.; Yurtsever, S. Comparison of Extraction Induced by Emulsion Breaking, Ultrasonic Extraction and Wet Digestion Procedures for Determination of Metals in Edible Oil Samples in Turkey Using ICP-OES. *Food Chem.* **2013**, *138*, 770–775. <https://doi.org/10.1016/j.foodchem.2012.10.089>.
53. Martínez, S.; Sánchez, R.; Lefevre, J.; Todolí, J.L. Multielemental Analysis of Vegetable Oils and Fats by Means of ICP-OES Following a Dilution and Shot Methodology. *J. Anal. At. Spectrom.* **2020**, *35*, 1897–1909. <https://doi.org/10.1039/d0ja00112k>.
54. Woods, G.D.; Fryer, F.I. Direct Elemental Analysis of Biodiesel by Inductively Coupled Plasma-Mass Spectrometry. *Anal. Bioanal. Chem.* **2007**, *389*, 753–761. <https://doi.org/10.1007/s00216-007-1439-0>.
55. dos Santos, E.J.; Herrmann, A.B.; Chaves, E.S.; Vechiatto, W.W.D.; Schoemberger, A.C.; Frescura, V.L.A.; Curtius, A.J. Simultaneous Determination of Ca, P, Mg, K and Na in Biodiesel by Axial View Inductively Coupled Plasma Optical Emission Spectrometry with Internal Standardization after Multivariate Optimization. *J. Anal. At. Spectrom.* **2007**, *22*, 1300. <https://doi.org/10.1039/b702563g>.
56. Jimenez, M.S.; Velarte, R.; Castillo, J.R. On-Line Emulsions of Olive Oil Samples and ICP-MS Multi-Elemental Determination. *J. Anal. At. Spectrom.* **2003**, *18*, 1154–1162. <https://doi.org/10.1039/b303131d>.
57. Mdluli, N.S.; Nomngongo, P.N.; Mketi, N. A Critical Review on Application of Extraction Methods Prior to Spectrometric Determination of Trace-Metals in Oily Matrices. *Crit. Rev. Anal. Chem.* **2020**, *52*, 1–18. <https://doi.org/10.1080/10408347.2020.1781591>.
58. Lepri, F.G.; Chaves, E.S.; Vieira, M.A. Determination of Trace Elements in Vegetable Oils and Biodiesel by Atomic Spectrometric Techniques: A Review. *Appl. Spectrosc. Rev.* **2011**, *46*, 175–206. <https://doi.org/10.1080/05704928.2010.529628>.
59. Ekezie, F.-G.C.; Sun, D.-W.; Cheng, J.-H. Acceleration of Microwave-Assisted Extraction Processes of Food Components by Integrating Technologies and Applying Emerging Solvents: A Review of Latest Developments. *Trends Food Sci. Technol.* **2017**, *67*, 160–172. <https://doi.org/10.1016/j.tifs.2017.06.006>.
60. Aceto, M.; Calà, E.; Musso, D.; Regalli, N.; Oddone, M. A Preliminary Study on the Authentication and Traceability of Extra Virgin Olive Oil Made from Taggiasca Olives by Means of Trace and Ultra-Trace Elements Distribution. *Food Chem.* **2019**, *298*, 125047. <https://doi.org/10.1016/j.foodchem.2019.125047>.

61. Gumus, Z.P.; Celenk, V.U.; Tekin, S.; Yurdakul, O.; Ertas, H. Determination of Trace Elements and Stable Carbon Isotope Ratios in Virgin Olive Oils from Western Turkey to Authenticate Geographical Origin with a Chemometric Approach. *Eur. Food Res. Technol.* **2017**, *243*, 1719–1727. <https://doi.org/10.1007/s00217-017-2876-4>.
62. Sayago, A.; González-Domínguez, R.; Beltrán, R.; Fernández-Recamales, Á. Combination of Complementary Data Mining Methods for Geographical Characterization of Extra Virgin Olive Oils Based on Mineral Composition. *Food Chem.* **2018**, *261*, 42–50. <https://doi.org/10.1016/j.foodchem.2018.04.019>.
63. Angioni, A.; Cabitza, M.; Russo, M.T.; Caboni, P. Influence of Olive Cultivars and Period of Harvest on the Contents of Cu, Cd, Pb, and Zn in Virgin Olive Oils. *Food Chem.* **2006**, *99*, 525–529. <https://doi.org/10.1016/j.foodchem.2005.08.016>.
64. Mohebbi, M.; Heydari, R.; Ramezani, M. Determination of Cu, Cd, Ni, Pb and Zn in Edible Oils Using Reversed-Phase Ultrasonic Assisted Liquid–Liquid Microextraction and Flame Atomic Absorption Spectrometry. *J. Anal. Chem.* **2018**, *73*, 30–35. <https://doi.org/10.1134/S1061934818010069>.
65. De Leonardi, A.; Macciola, V.; De Felice, M. Copper and Iron Determination in Edible Vegetable Oils by Graphite Furnace Atomic Absorption Spectrometry after Extraction with Diluted Nitric Acid. *Int. J. Food Sci.* **2000**, *35*, 371–375. <https://doi.org/10.1046/j.1365-2621.2000.00389.x>.
66. Kara, D.; Fisher, A.; Hill, S. Extraction of Trace Elements by Ultrasound-Assisted Emulsification from Edible Oils Producing Detergentless Microemulsions. *Food Chem.* **2015**, *188*, 143–148. <https://doi.org/10.1016/j.foodchem.2015.04.057>.
67. Kara, D.; Fisher, A.; Hill, S. Detergentless Ultrasound-Assisted Extraction of Trace Elements from Edible Oils Using Lipase as an Extractant. *Talanta* **2015**, *144*, 219–225. <https://doi.org/10.1016/j.talanta.2015.05.056>.
68. Manjusha, R.; Shekhar, R.; Kumar, S.J. Ultrasound-Assisted Extraction of Pb, Cd, Cr, Mn, Fe, Cu, Zn from Edible Oils with Tetramethylammonium Hydroxide and EDTA Followed by Determination Using Graphite Furnace Atomic Absorption Spectrometry. *Food Chem.* **2019**, *294*, 384–389. <https://doi.org/10.1016/j.foodchem.2019.04.104>.
69. Savio, M.; Ortiz, M.S.; Almeida, C.A.; Olsina, R.A.; Martínez, L.D.; Gil, R.A. Multielemental Analysis in Vegetable Edible Oils by Inductively Coupled Plasma Mass Spectrometry after Solubilisation with Tetramethylammonium Hydroxide. *Food Chem.* **2014**, *159*, 433–438. <https://doi.org/10.1016/j.foodchem.2014.03.041>.
70. Cabrera-Vique, C.; Bouzas, P.R.; Oliveras-López, M.J. Determination of Trace Elements in Extra Virgin Olive Oils: A Pilot Study on the Geographical Characterisation. *Food Chem.* **2012**, *134*, 434–439. <https://doi.org/10.1016/j.foodchem.2012.02.088>.
71. Damak, F.; Asano, M.; Baba, K.; Ksibi, M.; Tamura, K. Comparison of Sample Preparation Methods for Multielements Analysis of Olive Oil by ICP-MS. *Methods Protoc.* **2019**, *2*, 72. <https://doi.org/10.3390/mps2030072>.
72. Valasques, G.S.; dos Santos, A.M.P.; Teixeira, L.S.G.; da Mata Cerqueira, U.M.F.; de Souza, V.S.; Bezerra, M.A. Applications of Emulsified Systems in Elemental Analysis by Spectroanalytical Techniques. *Appl. Spectrosc. Rev.* **2017**, *52*, 729–753. <https://doi.org/10.1080/05704928.2017.1294599>.
73. Goodarzi, F.; Zendehboudi, S. A Comprehensive Review on Emulsions and Emulsion Stability in Chemical and Energy Industries. *Can. J. Chem. Eng.* **2019**, *97*, 281–309. <https://doi.org/10.1002/cjce.23336>.
74. Rutkowska, M.; Namieśnik, J.; Konieczka, P. Ultrasound-Assisted Extraction. In *The Application of Green Solvents in Separation Processes*; Pena-Pereira, F., Tobiszewski, M., Eds.; Elsevier: Amsterdam, The Netherlands, 2017; pp. 301–324. doi:10.1016/B978-0-12-805297-6.00010-3.
75. Costa, L.M.; Silva, F.V.; Gouveia, S.T.; Nogueira, A.R.A.; Nobrega, J.A. Focused Microwave-Assisted Acid Digestion of Oils: An Evaluation of the Residual Carbon Content. *Spectrochim. Acta B* **2001**, *56*, 1981–1985.
76. Cesur, H.; Bati, B. Solid-Phase Extraction of Copper with Lead 4-Benzylpiperidinedithiocarbamate on Microcrystalline Naphthalene and Its Spectrophotometric Determination. *Turk. J. Chem.* **2002**, *26*, 599–605.
77. Khan, M.A.; Khan, S.; Khan, A.; Alam, M. Soil Contamination with Cadmium, Consequences and Remediation Using Organic Amendments. *Sci. Total Environ.* **2017**, *601–602*, 1591–1605. <https://doi.org/10.1016/j.scitotenv.2017.06.030>.
78. Greenough, J.D.; Fryer, B.J.; Mallory-Greenough, L. Trace Element Geochemistry of Nova Scotia (Canada) Maple Syrup. *Can. J. Earth Sci.* **2010**, *47*, 1093–1110. <https://doi.org/10.1139/E10-055>.
79. Gouvinhas, I.; Domínguez-Perles, R.; Machado, N.; Carvalho, T.; Matos, C.; Barros, A.I.R.N.A. Effect of Agro-Environmental Factors on the Mineral Content of Olive Oils: Categorization of the Three Major Portuguese Cultivars. *J. Am. Oil Chem. Soc.* **2016**, *93*, 813–822. <https://doi.org/10.1007/s11746-016-2827-4>.
80. Banerjee, S.; Kurtis Kyser, T.; Vuletich, A.; Leduc, E. Elemental and Stable Isotopic Study of Sweeteners and Edible Oils: Constraints on Food Authentication. *J. Food Compos. Anal.* **2015**, *42*, 98–116. <https://doi.org/10.1016/j.jfca.2015.03.011>.
81. Goidanich, P. Filtration Process of Extra Virgin Olive Oil: Effect on Minor Components, Oxidative Stability and Sensorial and Physicochemical Characteristics. *Trends Food Sci. Technol.* **2010**, *21*, 201–211. <https://doi.org/10.1016/j.tifs.2009.12.004>.
82. Bottino, A.; Capannelli, G.; Mattei, A.; Rovellini, P.; Zunin, P. Effect of Membrane Filtration on the Flavor of Virgin Olive Oil. *Eur. J. Lipid Sci. Technol.* **2008**, *110*, 1109–1115. <https://doi.org/10.1002/ejlt.200800075>.
83. Rossmann, A. Determination Of Stable Isotope Ratios In Food Analysis. *Food Rev. Int.* **2001**, *17*, 347–381. <https://doi.org/10.1081/FRI-100104704>.
84. Kelly, S.D. Using Stable Isotope Ratio Mass Spectrometry (IRMS) in Food Authentication and Traceability. In *Food Authenticity and Traceability*; Elsevier: Amsterdam, The Netherlands, 2003; pp. 156–183, ISBN 978-1-85573-526-2.
85. Camin, F.; Boner, M.; Bontempo, L.; Fauhl-Hassek, C.; Kelly, S.D.; Riedl, J.; Rossmann, A. Stable Isotope Techniques for Verifying the Declared Geographical Origin of Food in Legal Cases. *Trends Food Sci. Technol.* **2017**, *61*, 176–187. <https://doi.org/10.1016/j.tifs.2016.12.007>.

86. Angerosa, F.; Bréas, O.; Contento, S.; Guillou, C.; Reniero, F.; Sada, E. Application of Stable Isotope Ratio Analysis to the Characterization of the Geographical Origin of Olive Oils. *J. Agric. Food Chem.* **1999**, *47*, 1013–1017. <https://doi.org/10.1021/jf9809129>.
87. Chiocchini, F.; Portarena, S.; Cioffi, M.; Brugnoli, E.; Lauteri, M. Isoscapes of Carbon and Oxygen Stable Isotope Compositions in Tracing Authenticity and Geographical Origin of Italian Extra-Virgin Olive Oils. *Food Chem.* **2016**, *202*, 291–301. <https://doi.org/10.1016/j.foodchem.2016.01.146>.
88. Karalis, P.; Poutouki, A.E.; Nikou, T.; Halabalaki, M.; Proestos, C.; Tsakalidou, E.; Gougoura, S.; Diamantopoulos, G.; Tassi, M.; Dotsika, E. Isotopic Traceability ( $^{13}\text{C}$  and  $^{18}\text{O}$ ) of Greek Olive Oil. *Molecules* **2020**, *25*, 5816. <https://doi.org/10.3390/molecules25245816>.
89. Portarena, S.; Farinelli, D.; Lauteri, M.; Famiani, F.; Esti, M.; Brugnoli, E. Stable Isotope and Fatty Acid Compositions of Mono-varietal Olive Oils: Implications of Ripening Stage and Climate Effects as Determinants in Traceability Studies. *Food Control* **2015**, *57*, 129–135. <https://doi.org/10.1016/j.foodcont.2015.03.052>.
90. Tarapoulouzi, M.; Skiada, V.; Agriopoulou, S.; Psomiadis, D.; Rébufa, C.; Roussos, S.; Theocharis, C.R.; Katsaris, P.; Varzakas, T. Chemometric Discrimination of the Geographical Origin of Three Greek Cultivars of Olive Oils by Stable Isotope Ratio Analysis. *Foods* **2021**, *10*, 336. <https://doi.org/10.3390/foods10020336>.
91. Schimmelmann, A.; Qi, H.; Dunn, P.J.H.; Camin, F.; Bontempo, L.; Potočník, D.; Ogrinc, N.; Kelly, S.; Carter, J.F.; Abraham, A.; et al. Food Matrix Reference Materials for Hydrogen, Carbon, Nitrogen, Oxygen, and Sulfur Stable Isotope-Ratio Measurements: Collagens, Flours, Honeys, and Vegetable Oils. *J. Agric. Food Chem.* **2020**, *68*, 10852–10864. <https://doi.org/10.1021/acs.jafc.0c02610>.
92. Cernusak, L.A.; Ubierna, N.; Winter, K.; Holtum, J.A.M.; Marshall, J.D.; Farquhar, G.D. Environmental and Physiological Determinants of Carbon Isotope Discrimination in Terrestrial Plants. *New Phytol.* **2013**, *200*, 950–965. <https://doi.org/10.1111/nph.12423>.
93. Winkler, F.J.; Schmidt, H.-L. Einsatzmöglichkeiten der  $^{13}\text{C}$ -Isotopen-Massenspektrometrie in der Lebensmitteluntersuchung. *Z. Lebensm. Unters. Forsch.* **1980**, *171*, 85–94.
94. Higgins, P. Isotope ecology from biominerals. In *Methods in Paleoecology: Reconstructing Cenozoic Terrestrial Environments and Ecological Communities*; Croft, D.A., Su, D.F., Simpson, S.W., Eds.; Springer Nature: Berlin/Heidelberg, Germany 2018; pp. 99–120.
95. Elflein, L.; Raezke, K.-P. Improved Detection of Honey Adulteration by Measuring Differences between  $^{13}\text{C}/^{12}\text{C}$  Stable Carbon Isotope Ratios of Protein and Sugar Compounds with a Combination of Elemental Analyzer—Isotope Ratio Mass Spectrometry and Liquid Chromatography—Isotope Ratio Mass Spectrometry ( $\delta^{13}\text{C}$ —EA/LC-IRMS). *Apidologie* **2008**, *39*, 574–587. <https://doi.org/10.1051/apido:2008042>.
96. Lauteri, M.; Piura, A.; Monteverdi, M.C.; Brugnoli, E.; Villani, F.; Eriksson, G. Genetic Variation in Carbon Isotope Discrimination in Six European Populations of *Castanea Sativa* Mill. Originating from Contrasting Localities. *J. Evol. Biol.* **2004**, *17*, 1286–1296. <https://doi.org/10.1111/j.1420-9101.2004.00765.x>.
97. Karabagias, I.; Michos, Ch.; Badeka, A.; Kontakos, S.; Stratis, I.; Kontominas, M.G. Classification of Western Greek Virgin Olive Oils According to Geographical Origin Based on Chromatographic, Spectroscopic, Conventional and Chemometric Analyses. *Int. Food Res. J.* **2013**, *54*, 1950–1958. <https://doi.org/10.1016/j.foodres.2013.09.023>.
98. Chiavaro, E.; Cerretani, L.; Di Matteo, A.; Barnaba, C.; Bendini, A.; Iacumin, P. Application of a Multidisciplinary Approach for the Evaluation of Traceability of Extra Virgin Olive Oil. *Eur. J. Lipid Sci. Technol.* **2011**, *113*, 1509–1519. <https://doi.org/10.1002/ejlt.201100174>.
99. Coelho, I.; Castanheira, I.; Bordado, J.M.; Donard, O.; Silva, J.A.L. Recent Developments and Trends in the Application of Strontium and Its Isotopes in Biological Related Fields. *TrAC-Trends Anal. Chem.* **2017**, *90*, 45–61. <https://doi.org/10.1016/j.trac.2017.02.005>.
100. Stewart, B.W.; Capo, R.C.; Chadwick, O.A. Quantitative Strontium Isotope Models for Weathering, Pedogenesis and Biogeochemical Cycling. *Geoderma* **1998**, *82*, 173–195. [https://doi.org/10.1016/S0016-7061\(97\)00101-8](https://doi.org/10.1016/S0016-7061(97)00101-8).
101. Liu, H.; Wei, Y.; Lu, H.; Wei, S.; Jiang, T.; Zhang, Y.; Guo, B. Combination of the  $^{87}\text{Sr}/^{86}\text{Sr}$  Ratio and Light Stable Isotopic Values ( $\Delta^{13}\text{C}$ ,  $\Delta^{15}\text{N}$  and  $\Delta\text{D}$ ) for Identifying the Geographical Origin of Winter Wheat in China. *Food Chem.* **2016**, *212*, 367–373. <https://doi.org/10.1016/j.foodchem.2016.06.002>.
102. Epova, E.N.; Bérail, S.; Séby, F.; Vacchina, V.; Bareille, G.; Médina, B.; Sarthou, L.; Donard, O.F.X. Strontium Elemental and Isotopic Signatures of Bordeaux Wines for Authenticity and Geographical Origin Assessment. *Food Chem.* **2019**, *294*, 35–45. <https://doi.org/10.1016/j.foodchem.2019.04.068>.
103. Liu, H.-C.; You, C.-F.; Chen, C.-Y.; Liu, Y.-C.; Chung, M.-T. Geographic Determination of Coffee Beans Using Multi-Element Analysis and Isotope Ratios of Boron and Strontium. *Food Chem.* **2014**, *142*, 439–445. <https://doi.org/10.1016/j.foodchem.2013.07.082>.
104. Rummel, S.; Hoelzl, S.; Horn, P.; Rossmann, A.; Schlicht, C. The Combination of Stable Isotope Abundance Ratios of H, C, N and S with  $^{87}\text{Sr}/^{86}\text{Sr}$  for Geographical Origin Assignment of Orange Juices. *Food Chem.* **2010**, *118*, 890–900. <https://doi.org/10.1016/j.foodchem.2008.05.115>.
105. Pin, C.; Joannon, S.; Bosq, C.; Le Fèvre, B.; Gauthier, P.-J. Precise Determination of Rb, Sr, Ba, and Pb in Geological Materials by Isotope Dilution and ICP-Quadrupole Mass Spectrometry Following Selective Separation of the Analytes. *J. Anal. At. Spectrom.* **2003**, *18*, 135–141. <https://doi.org/10.1039/b211832g>.

106. Techer, I.; Medini, S.; Janin, M.; Arregui, M. Impact of Agricultural Practice on the Sr Isotopic Composition of Food Products: Application to Discriminate the Geographic Origin of Olives and Olive Oil. *Appl. Geochem.* **2017**, *82*, 1–14. <https://doi.org/10.1016/j.apgeochem.2017.05.010>.
107. Granato, D.; Putnik, P.; Kovačević, D.B.; Santos, J.S.; Calado, V.; Rocha, R.S.; Cruz, A.G.D.; Jarvis, B.; Rodionova, O.Y.; Pomerantsev, A. Trends in Chemometrics: Food Authentication, Microbiology, and Effects of Processing: Trends in Chemometrics. *Compr. Rev. Food Sci. Food Saf.* **2018**, *17*, 663–677. <https://doi.org/10.1111/1541-4337.12341>.
108. Abdi, H.; Williams, L.J. Principal Component Analysis: Principal Component Analysis. *WIREs Comp. Stat.* **2010**, *2*, 433–459. <https://doi.org/10.1002/wics.101>.

## Scientific contribution

### International conferences: oral presentations

**Emna Nasr**, Ekaterina Epova, Julien Barre, Tea Zuliani, Sylvain Bérail, Mohamed Hammami, Dominic Larivière, Houyem Abderrazek, Olivier F.X Donard

*Development of inorganic analytical strategies for the geographical authentication of olive oil*

**5th international conference on metrology in food and nutrition (IMEKOFOODS)**

Prague, 16-18 September 2020

**Emna Nasr**, Ekaterina Epova, Julien Barre, Tea Zuliani, Sylvain Bérail, Mohamed Hammami, Dominic Larivière, Houyem Abderrazek, Olivier F.X Donard

*Determination of  $^{87}\text{Sr}/^{86}\text{Sr}$  isotopic ratio in olive oil by means of multicollector-ICP MS*

**International conference on Mass Spectrometry & Analytical Techniques**

Greenville, USA (Virtual event), 05-06 August 2021

**Emna Nasr**, Ekaterina Epova, Julien Barre, Sylvain Bérail, Mohamed Hammami, Dominic Larivière, Houyem Abderrazek, Olivier F.X Donard

*Rapid and sensitive method for  $^{87}\text{Sr}/^{86}\text{Sr}$  determination in olive oil by means of MC ICP-MS*

**3rd international conference on Analytical and Bioanalytical Methods (ABC 2021)**

Plano, USA (Virtual event), 18-20 October 2021

### Articles

#### Articles published

Trace Elements Analysis of Tunisian and European Extra Virgin Olive Oils by ICP-MS and Chemometrics for Geographical Discrimination

**Emna G. Nasr**, Ekaterina N. Epova, Alberto de Diego, Radhia Souissi, Mohamed Hammami, Houyem Abderrazak and Olivier F. X. Donard

**(Foods, 2022)**

<https://doi.org/10.3390/foods11010082>

Olive oil traceability studies using inorganic and isotopic signatures: A review

**Emna G. Nasr**, Ekaterina Epova, Houyem Abderrazak, Mohamed Hammami,  
Dominic Larivière, Mathieu Sebilo, Olivier F X Donard

(*Molecules*, 2022)

<https://doi.org/10.3390/molecules27062014>

### Articles in preparation

- Analytical Strategies for a Sensitive and Precise Determination of  $^{87}\text{Sr}/^{86}\text{Sr}$  in Olive Oil through Ion Extraction, Chromatographic Separation and Multicollector Inductively-Coupled Plasma Mass-Spectrometry

**Emna G. Nasr**, Ekaterina N. Epova, Dominic Larivière, Julien Barre, Radhia Souissi,  
Mohamed Hammami, Houyem Adberrazek, Olivier F.X. Donard

- Conservative behavior of  $^{87}\text{Sr}/^{86}\text{Sr}$  isotope ratios from soil to olive oil and its by-products in Tunisia

**Emna G. Nasr**, Ekaterina N. Epova, Julien Barre, Radhia Souissi, Mohamed Hammami,  
Houyem Adberrazek, Olivier F.X. Donard

- Combined multi-elemental and isotopic signatures (C, Sr) for the geographical authentication of Tunisian and European olive oils

**Emna G. Nasr**, Mathieu Sebilo, Ekaterina N. Epova, Julien Barre, Dominic Larivière, Alberto De Diego, Radhia Souissi, Mohamed Hammami, Houyem Adberrazek, Olivier F.X. Donard

## Curriculum vitae

## Emna Nasr

✉ emna.nsr@gmail.com 📞 +33784120113 🏠 75012 Paris 🔗 [linkedin.com/in/emna-nasr-6366b5128](https://www.linkedin.com/in/emna-nasr-6366b5128)

## Formation

déc. 2018 - mars 2022

■ **Thèse de doctorat en cotutelle, spécialité Chimie analytique et environnement**

**IPREM/ UPPA, Pau (France) et INRAP/ UTM (Tunisie)**

**Signatures inorganiques et isotopiques combinées pour l'authentification géographique de l'huile d'olive**

*Expertise scientifique acquise:*

- Développement de méthode de préparation d'échantillon adaptée à chaque type matrice (sol, feuilles d'olivier, racines, huile d'olive, grignons d'olive).
- Préparation en salle blanche.
- Validation de méthode analytique et contrôle qualité.
- Analyse des éléments traces métalliques à des niveaux de concentrations bas (ppb) au moyen de l'ICP-MS quadripolaire.
- Développement de nouvelle méthode analytique pour la séparation de Sr sur colonne (Résine Dowex AG50) et analyse isotopique du  $^{87}\text{Sr}/^{86}\text{Sr}$  au moyen de l'ICP-MS à multicollecteurs.
- Analyse des isotopes stables du Carbone dans l'huile d'olive, les feuilles et le sol au moyen de l'IRMS.
- Traitement statistique des données (chimiométrie).

**Techniques analytiques et instrumentation:**

Minéralisation dans un four à microondes - Extraction liquide/liquide - Extraction par complexation (EDTA) - Séparation sur colonne (Résine Dowex AG 50 - Résine Sr spec Eichrom) - Q/ICP-MS - MC/ICP-MS - IRMS

sept. 2013 - oct. 2018

■ **Cursus d'ingénieur, spécialité Chimie industrielle**

**INSAT, Tunisie**

## Expérience professionnelle et stages

mars 2021 - août 2021

■ **Chercheur Ingénieur**

**UPPA, Pau (France)**

- Analyse isotopique du Sr pour un grand nombre d'échantillons.

févr. 2018 - juil. 2018

■ **Projet de fin d'études**

**IPREM, Pau (France)**

Développement en analyse inorganique et isotopique pour authenticité des produits agroalimentaires

- Préparation d'échantillons (Minéralisation au four à microondes, calcination dans un four à mouffles)
- Analyse des éléments traces métalliques par ICP-MS quadripolaire.
- Analyse isotopique du Strontium par ICP-MS à multicollecteurs.

juil. 2017

■ **Stage étudiant**

**SATEM, Tunisie**

Formulation de produit cosmétique.

juil. 2016

■ **Stage étudiant**

**Pierre Fabre Médicament Production, Tunisie**

Synthèse de Revue Qualité Produit.

juil. 2015

■ **Stage étudiant**

**SATEM, Tunisie**

Contribution à la formulation de produits d'hygiène et de produits cosmétiques.

août 2014

- **Stage étudiant**  
**Pharmaghreb, Tunisie**  
Réalisation de tests de contrôle qualité.

**Langues**

**Français (courant)**

**Anglais (B2 - Cambridge assessment English, Hamilton House)**

**Arabe (Langue maternelle)**

**Espagnol (Niveau scolaire)**

**Formations certifiées**

**Formation sur l'importance de la sécurité et sûreté chimique (2021), INSAT**

**Formation en Validation de méthodes analytiques (2019), Spectrum Training Center**

**Stage de formation en ICP-MS (2018), UT2A Formations et Conseil, Pau-France**

**Formation ISO/CEI 17025 (2016), Certificat: auditeur interne, African Quality Institute-AQI Tunisie**

**Logiciels maîtrisés**

- Pack Office, Mendeley, SIMCA 16, Origin, GanttProject, Minitab