



HAL
open science

Study of a new regulatory RNA involved in the virulence of *Staphylococcus aureus*

Kim Boi Le Huyen

► **To cite this version:**

Kim Boi Le Huyen. Study of a new regulatory RNA involved in the virulence of *Staphylococcus aureus*. Biochemistry, Molecular Biology. Université de Rennes, 2021. English. NNT : 2021REN1B032 . tel-03665290

HAL Id: tel-03665290

<https://theses.hal.science/tel-03665290>

Submitted on 11 May 2022

HAL is a multi-disciplinary open access archive for the deposit and dissemination of scientific research documents, whether they are published or not. The documents may come from teaching and research institutions in France or abroad, or from public or private research centers.

L'archive ouverte pluridisciplinaire **HAL**, est destinée au dépôt et à la diffusion de documents scientifiques de niveau recherche, publiés ou non, émanant des établissements d'enseignement et de recherche français ou étrangers, des laboratoires publics ou privés.

THESE DE DOCTORAT DE

L'UNIVERSITE DE RENNES 1

ECOLE DOCTORALE N° 605

Biologie Santé

Spécialité : « *Biologie Moléculaire et Structurale, Biochimie* »

Par

« **Kim Boi LE HUYEN** »

« **Etude d'un nouvel ARN régulateur impliqué dans la virulence de *Staphylococcus aureus*** »

Thèse présentée et soutenue à « L'Université de Rennes 1 », le « 26 Octobre 2021 »

Unité de recherche : INSERM U1230 – ARN régulateurs Bactériens et Médecine (BRM)

Thèse N° :

Rapporteurs avant soutenance :

REPOILA Francis Chargé de Recherche Hors Classe
GUILLIER Maude Directrice de Recherche

INRAE Micalis, Jouy-en-Josas
Université de Paris, UMR8261, CNRS, IBPC

Composition du Jury :

Président : GILLET Reynald Professeur

Université de Rennes 1, IGDR

Examineurs : LALAOUNA David Chargé de Recherche
 GUEDON Éric Directeur de Recherche
 SOUTOURINA Olga Professeur
 CATTOIR Vincent Professeur d'Université/
 Praticien Hospitalier

Université de Strasbourg, CNRS
UMR 1253 INRAE Institut Agro
Université Paris-Saclay, I2BC UMR 9198
INSERM U1230, Rennes

Dir. de thèse : CHABELSKAYA Svetlana Ingénieur de recherche

INSERM U1230, Rennes

ACKNOWLEDGMENT

Steve Jobs once said “Great things are not done by one person. They’re done by a team of people”. As I read these lines, I am realized that a thesis is far from being a solitary task. I could never have completed this journey without the support of a large number of people whose kindness, exchanges and advice have allowed me to learn and grow.

First of all, I would like to acknowledge INSERM, Region de Bretagne and Pharmacy Faculty of University of Rennes 1 for providing me with the financial means to complete this project. Next, I would like to express my gratitude to the jury members of my thesis defense: Dr. Francis Repoila, Dr. Maude Guillier, Dr. David Lalaouna, Dr. Eric Guedon, Pr. Olga Soutourina and Pr. Reynald Gillet, who so generously took time out of their schedules to supervise my work. I am also thankful to Dr. Philippe Bouloc for the constructive comments and recommendations for my paper, and to Dr. Tatiana Rochat and Pr. Olga Soutourina for being on my thesis committee and providing me invaluable feedback on my work.

Further, I wish to express my special regards to Pr. Brice Felden for believing in me and for giving me the opportunity to pursue my PhD in his laboratory. His passion for scientific research is a source of inspiration and his absence will be missed by many people.

I would also like to thank Dr. Vincent Cattoir for carrying on the responsibility of guiding the team and for supporting me throughout my last year of PhD.

I would like to express my deepest gratitude to Dr. Svetlana Chabelskaya, who has guided me positively throughout this project with your motto: “Everything will be alright!”. I could not ask for a better supervisor. Your patient support, guidance, human qualities, and overall insights in the research field have made this an inspiring experience for me.

I would like to express my appreciation to my “partner in crime”, Dr. Cintia D. Gonzalez. You have been there since the beginning of my PhD journey. I will miss all the over working hours together, our discussions and our laughter. My thesis would not be the same without you.

I am also thankful to Valérie Bordeau, Nathalie Ramage and H  l  ne Le Pabic for lending me your ear, for the comforting words you always seem to be able to find and all the laughter that have brightened up my days.

ACKNOWLEDGMENT

Many thanks to my former colleagues, Camille Riffaud, Julie Bronsard and Simon Raynaud for welcoming me into the lab and for supporting me during my thesis. All the nights out in the bars with you all and with Steven Crété and Julie Legros were memorable. I hope that we can reunite one day to reminisce our experiences together.

I would also like to acknowledge all the past and present members of the lab: Annick Lefèvre, Anita Quelavoine, Astrid Rouillon, Anne Moreau, David Luque Paz, Gaëtan Pascreau, Guillaume Ménard, Irène Nicholas, Killian Le Neindre, Lorraine Adam, Loren Desjoies, Marie-Laure Pinel-Marie, Matthieu Revest, Marc Hallier, Mohammed Sassi, Noëlla Amiot, Pierre-Yves Donnio, Régine Brielle, Sophie Reissier, Thomas Vernay, Tony Mauro, Yoann Augagneur, for their precious advice and support.

I would like to wish good luck to the new arrivals: Chloé Silard, Emiline Ostyn, Kévin Huguet, Marie Suriray, Maëliiss Germain, and Laurence Fermon. “May the Odds be ever in your favors”. And all the best for your PhD journey ending, Charlotte Oriol.

I am also thankful to Pr. Yves Le Dréan, Dr. Denis Habauzit and Dr. Christian Jaulin. Your passion and dedication in your work inspired me greatly in finding my path. A special thank you to Dr. Christophe Thiriet, who has always believed in me and encouraged me to pursue my dreams. I would not be able to challenge and push myself forwards without your guidance.

I would like to thank my friends, Anne-Laure, Mégane and Mélodie, who have always been there for me and provided stimulating discussions as well as happy distractions to rest my mind outside of my work.

I am also grateful for my family and my in-laws for always supporting me in my career as well as personal life. A warmest thank you to my husband, Cédric, for your unconditional, unequivocal, and loving support, even when I am in a bad mood.

Last but not least, I would like to dedicate this work to my parents whose constant love and support keep me motivated and confident. Ten years seem like a long time but they pass by so fast. You both have sacrificed a lot so that I would not have to face any obstacles in mine. I could never thank you enough for what you’ve done for me but I hope I made you proud.

TABLE OF CONTENT

INTRODUCTION

I. Discovery and characterization of <i>Staphylococcus aureus</i>	4
II. Genome of <i>Staphylococcus aureus</i>	6
A. The core genome.....	8
B. Mobile genetic elements.....	8
1. Plasmids.....	8
2. Staphylococcal cassette chromosome.....	10
3. ACME and COMER.....	10
4. Transposons.....	12
5. Bacteriophages.....	14
6. Staphylococcal pathogenicity islands.....	16
III. Multiple antibiotics resistance of <i>Staphylococcus aureus</i>	18
A. The discovery of antibiotics.....	18
B. Antibiotics classification.....	20
C. Antibiotic resistance in <i>S. aureus</i>	20
IV. Virulence of <i>S. aureus</i>	22
A. A commensal bacterium.....	22
B. An opportunistic pathogen.....	24
C. Virulence factors.....	28
1. Cell surface proteins.....	28
1.1. CWA/ MSCRAMMs.....	28
1.2. SERAMs.....	30
1.3. Anti-inflammatory peptides: CHIPS, SCIN, FLIPr.....	32
1.4. Capsular polysaccharides.....	32
1.5. Cell wall components and Wall components factors.....	32
2. Secreted factors.....	34
2.1. Extracellular enzymes (exoenzymes).....	34
2.2. Cytolytic toxins (pore-forming toxins).....	36
2.3. Superantigens and superantigens-like.....	38
D. Virulence regulators.....	40
1. Two-component signal transduction systems (TCS).....	40
2. Global transcriptional regulators.....	44
3. The SarA protein family.....	48
4. Sigma factors.....	50
5. Regulatory RNAs.....	50
V. Bacterial small regulatory RNAs	52
A. The discovery of small regulatory RNAs.....	52
B. Classification and modes of action.....	54
1. Riboswitches.....	54
2. sRNAs interacting with proteins.....	58
3. sRNAs interacting with DNAs.....	60
4. sRNAs interacting with RNAs.....	64
4.1. <i>Cis</i> -encoded sRNAs.....	66

4.2. <i>Trans</i> -encoded sRNAs.....	68
4.3. Other sRNAs regulation mechanisms.....	72
5. Proteins helpers of RNAs.....	74
C. Regulatory small RNAs in <i>S. aureus</i>	78
1. RNAI.....	80
2. RNAIII.....	80
3. sRNAs implicated in Metabolism.....	84
4. sRNAs implicated in Persistence.....	86
5. sRNAs implicated in Antibiotics resistance.....	86
6. sRNAs implicated in Virulence.....	88
6.1. Rsa sRNA “family”.....	88
6.2. Spr sRNA “family”.....	90
6.3. Teg sRNA “family”.....	94
6.4. Other sRNAs.....	96
MY THESIS PROJECT	98
RESULTS	102
I. Characterization of SprY	104
A. Localization of SprY in HG003 <i>S. aureus</i> strain.....	104
B. Analysis of <i>sprY</i> gene expression.....	106
II. Identification of SprY targets	108
A. Prediction <i>in silico</i> : SAOUHSC_03046 mRNA.....	108
B. Identification of SprY targets by MAPS.....	112
1. SAOUHSC_1342a mRNA.....	112
2. “A small regulatory RNA alters Staphylococcus aureus virulence by titrating RNAIII activity” (Published article).....	116
III. Regulation network between SprY and SprX2	142
A. Comparison of <i>sprY</i> and <i>sprX2</i> expressions.....	142
B. <i>In silico</i> prediction of interaction.....	144
C. Regulation mechanism of SprY and SprX2.....	144
1. Impact of SprY and SprX2 on <i>spoVG</i> expression.....	144
2. Impact of SprY and SprX2 on <i>ecb</i> expression.....	146
3. SprY and SprX2 impact on hemolysis of HG003 strain.....	146
DISCUSSIONS AND PERSPECTIVES	148
MATERIALS AND METHODS	168
REFERENCES	180
ANNEXES	222
RESUME (in French)	226

ABBREVIATIONS

Aap	Accumulation associated protein	MprF	Multiple peptide resistance factor F
Agr	Accessory gene regulator	MRSA	Methicillin-resistant <i>S. aureus</i>
AhpC	Alkyhydroxide reductase	Msa	Modulator of SarA
AIP	Auto-Inducing Peptide	MSCRAMM	Microbial Surface Components Recognizing Adhesive Matrix Molecules
Arl	Autolysis-related locus	MsrR	Methionine sulfoxide reductase
asRNAs	antisense RNAs	NO	Nitric oxide
aTc	Anhydrotetracycline	Nuc	Nucleases
Atl	Autolysin	OatA	O-acetyltransferase
ATP	Adenosine Triphosphate	ORF	Open Reading Frame
Aur	Aureolysin	PBP	Penicillin-Binding Protein
Bap	Biofilm associated protein	Plc	PtdIns-phospholipase C
CAMs	Cationic antimicrobial molecules	Pls	Plasmin-sensitive surface protein
CatA	Catalase	PSM	Phenol-Soluble Modulins
CC	Complex clonal	PVL	Panton-Valentine Leukocidin
CcpA	Catabolite control protein A	qPCR	Quantitative polymerase chain reaction
cDNA	Complementary DNA	RACE	Rapid amplification of cDNA ends
CHIPS	Chemotaxis Inhibitory Protein of <i>S. aureus</i>	RBS	Ribosome Binding Site
Clf	Clumping factor	RNA	Ribonucleic acid
Clp	Caseinolytic protease	lasRNA	antisense long RNA
Cna	Collagen-binding adhesin	rRNA	Ribosomal RNA
Coa	Staphylocoagulase	RNase	Ribonuclease
CPS	Capsular polysaccharides	Rot	Repressor of toxins
cre	catabolite-responsive element	Rsa	RNA of staphylococcus aureus
Cvf	Conserved virulence factor	Rsao	RNA <i>S. aureus</i> Orsay
DR	Direct Repeat	Sae	Staphylococcal accessory element locus
Eap	Extracellular adherence protein	Sak	Staphylokinase
EbpS	Elastin-binding protein	SAM	S-adenosylmethionine

Ecb	Extracellular complement binding protein	SaPI	<i>S. aureus</i> Pathogenicity Islands
ECM	Extracellular matrix	Sar	Staphylococcal accessory regulator
Efb	Extracellular fibrinogen binding protein	SasG	<i>S. aureus</i> surface protein G
Emp	Extracellular matrix binding protein	Sbi	Immunoglobulin-binding protein
Eno	Enolase	SCC	Staphylococcal Cassette Chromosome
Erm	Erythromycin	SCIN	Staphylococcal complement inhibitor
ETs	Exfoliative toxins	Scp	Staphopain
3' ETS	3' external transcript spacer	SD	Shine-Dalgarno
FAME	Fatty-acid-modifying enzyme	SE-I	Superantigen-like proteins
Fg	Fibrinogen	SERAM	Secretable Expanded Repertoire Adhesive Molecules
FLIPr	Formyl peptide receptor-like 1 inhibitory protein	SEs	Enterotoxins
Fn	Fibronectin	Spa	Staphylococcal protein A
FnBP	Fibronectin-Binding Protein	SplA-F	Serine-like proteases
Fur	Ferric uptake regulator	SpoVG	Stage V Sporulation Protein G
Geh	Glycerol ester hydrolase	Spr	Small pathogenicity island RNA
GlcN6P	Glutamine-fructose-6-phosphate	SrrAB	Staphylococcal respiratory regulator
Gra	Glycopeptide Resistance Associated	SSR	Small Stable RNA
Hfq	Host factor QB	ST	Sequence Type
HK	Histidine kinase	STA	System Toxin Antitoxin
Hla	Alpha hemolysin	STX	Staphyloxanthin
Hlb	Beta Hemolysin	SvrA	Staphylococcal virulence regulator
Hld	Delta Hemolysin	TCA	Tricarboxylic Acid
Htr	High temperature requirement	TcaR	Teicoplanin associated locus Regulator
hVISA	Vancomycin- Intermediate <i>Staphylococcus aureus</i>	TCS	Two-Component System
IcaABCD	Intercellular antigen	TLR2	Toll-like Receptors 2

Ig	Immunoglobulin	Tn	Transposons
IGR	Intergenic region	tRF	tRNA Fragment
Isd	Iron-regulated surface determinant	tRNA	Transfer RNA
Kd	Association Constant	TSST	Toxic Shock Syndrome Toxin
Lip	Lipase	UTR	Untranslated Region
LTA	Lipoteichoic acids	VraRS	Vancomycin-resistance associated sensor/regulator
MAPS	MS2 affinity purification coupled with RNA sequencing	VRSA	Vancomycin-Resistant Staphylococcus aureus
MGE	Mobile Genetic Element	vWbp	Von Willebrand factor binding protein
MHC	Major Histocompatibility Complex	WTA	Wall teichoic acid
MLST	Multilocus sequence typing		

INTRODUCTION

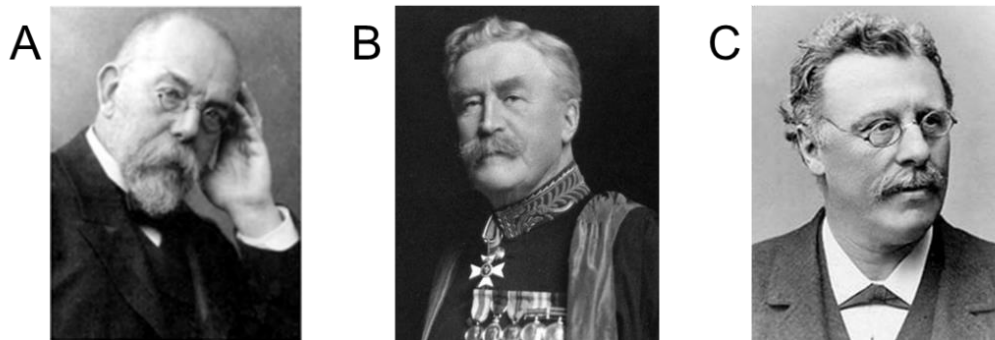

Figure 1. (A) **Sir Robert Koch** (December 11, 1843 – May 27, 1910), a German physician-scientist, well known for his pioneer studies in bacteriology, specifically in tuberculosis. (B) **Sir Alexander Ogston** (April 19, 1844- February 1, 1929), a Scottish surgeon, famous for his discover of major cause of wound infection. (C) **Sir Anton Julius Friedrich Rosenbach**, (December 16, 1842 – December 6, 1923), a German physician and microbiologist, credited for differentiating *Staphylococcus aureus* and *Staphylococcus epidermidis*.

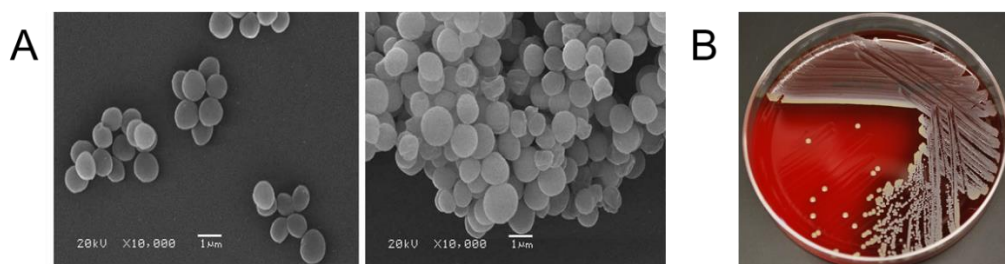

Figure 2. (A) Micrographs of scanning electron and transmission electron microscopy of *S. aureus*. characterized by grape-like clusters, intact membrane, and plentiful cytoplasmic contents. (B) *S. aureus* grows in blood agar (Z. Zhang et al. 2013).

I. Discovery and characterization of *Staphylococcus aureus*

The history of bacteriology attributes constantly the name *Staphylococcus aureus* to Anton J. Rosenbach, a German surgeon of Göttingen (Figure 1). However, it was Robert Koch, a German physician-scientist (reviewed in Blevins and Bronze 2010), who first discovered *Staphylococcus aureus* as the major cause of suppuration in 1878. Not too long after, in 1880, Alexander Ogston, a Scottish surgeon, extended the studies of these micrococci in acute abscesses and found *Streptococcus* as the other cause of wound infection (Ogston 1881). In 1882, Ogston named the clustered micrococci “*staphylococci*”, from Greek *staphyl* for “bunch of grapes”. Two years later, Anton J. Rosenbach successfully isolated two strains of staphylococci and named them based on the form and the color of their colonies: *Staphylococcus aureus*, *aurum* from Latin for “golden” and *Staphylococcus albus*, *albus* from Latin for “white” (later known as *epidermidis*) (Newsom 2008). This color was later shown to be due to the synthesis of an orange-yellow pigment, staphyloxanthin (STX), which is involved in resistance to oxidative stress, protection against lysis by host neutrophils and in animal model pathogenesis (Clauditz et al. 2006).

Staphylococcus aureus is a bacterium with a high infectious power, of the genus *Staphylococcus* and of the family of Staphylococcaceae. For more taxonomic precision, the genus *Staphylococcus* belongs to the reign of the Prokaryotes, to the division of Firmicutes, class of Bacilli, order of Bacillales. To date, there are 49 species and 27 sub species classified in the genus *Staphylococcus*.

S. aureus is characterized to be a non-motile, non-spore-forming Gram-positive coccus, which grows into round, golden-yellow and smooth colonies with a diameter of 0.8 - 1 μm , in blood agar (Merghni et al. 2017) (Figure 2). This bacterium has a relatively porous outer cell wall composed of peptidoglycans, teichoic acids, and lipoteichoic acids (Vatansever et al. 2013), which is favorable for antibiotics treatments, compared to Gram-negative bacteria (Segalla et al. 2002).

As for growth environment characterization, *S. aureus* is halophilic (well growth in medium containing high salt concentration, approximate 5 – 7% of NaCl), mesophilic (optimal growth temperature around 37°C) and neutrophil (pH ~ 7). However, these bacteria are capable to adapt to different growth conditions, such as temperature ranges from 15 to 45 °C or pH ranging from 4 to 10 (Valero et al. 2009).

S. aureus is a facultative anaerobic bacterium with the ability to reduce nitrate to nitrite and to ferment mannitol (in contrast to *S. epidermidis*). The bacterium has the capacity of producing catalase, which decomposes hydrogen peroxide to water and oxygen. It also produces coagulase that converts fibrinogen to fibrin. This process induces human plasma coagulation, inhibits the phagocytosis, in contrast to *S. epidermidis* and *S. saprophyticus* (Cheng et al. 2010), and not only help distinguish *S. aureus* from other coagulase-negative bacteria but an essential criterion to look for potential pathogen strains. Moreover, the majority of *S. aureus* strains are urease-positive (decomposes urea to ammonia); this enzyme is essential for environmental adaptation of certain bacterial pathogens by increasing pH under acid stress and nitrogen limitation (Cotter and Hill 2003; Zhou et al. 2019).

II. Genome of *Staphylococcus aureus*

The first *S. aureus* genomes to be completed were those of N315 and Mu50 in 2001 (Kuroda et al. 2001). Within the past two decade, genomes sequences of approximately 500 *Staphylococcus* strains have been completed and annotated (Gill 2009).

The genomes are presented in circular chromosomes of approximately 2.8 million base pairs with low GC composition (32%) and encode approximately 2700 coding sequences (CDSs). Most of CDSs in the *S. aureus* genome have a function assigned to them, based on significant homology with genes in other species (Lindsay and Holden 2006). To encompass the gene repertoire of a species, the concept of pan-genome has been defined as the sum of the core genome and the accessory genome (Tettelin et al. 2008). The pan-genome of *S. aureus* gathers approximately 7,500 genes of which approximately 1,500 belong to the core genome.

A. Bacterial transformation

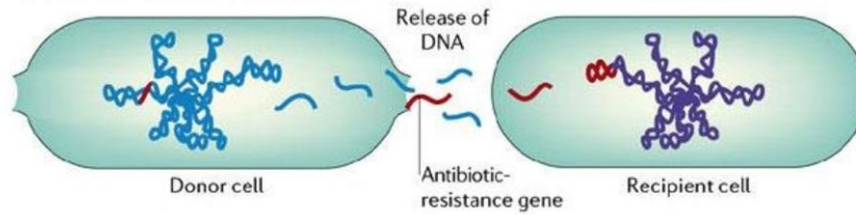

B. Bacterial transduction

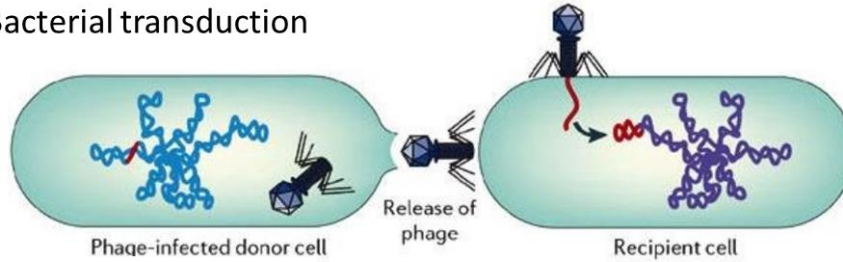

C. Bacterial conjugation

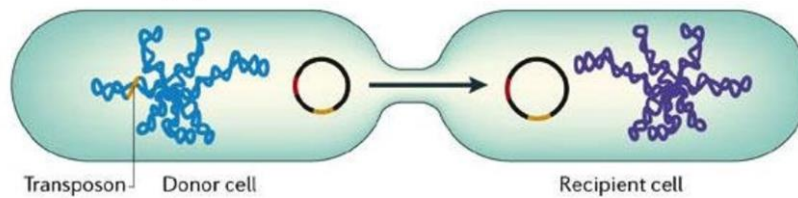

Copyright © 2006 Nature Publishing Group
Nature Reviews | Microbiology

Figure 3. Horizontal gene transfer between bacteria

(A) Transformation occurs when naked DNA is released on lysis of an organism and is taken up by another organism. (B) In transduction, genes are transferred from one bacterium to another by means of bacteriophages and can be integrated into the chromosome of the recipient cell. (C) Conjugation occurs by direct contact between two bacteria: plasmids form a mating bridge across the bacteria and DNA is exchanged (Furuya and Lowy 2006).

A. The core genome represents approximately 75% of the chromosome and is highly conservative in all strains sequenced. Thus, this brings together all the genes conserved within a species encoding the basic functions for the growth of the bacteria such as the metabolism of the bacteria, the protein synthesis, and the replication of nucleic acids (Bossi and Figueroa-bossi 2016; Lindsay and Holden 2004).

B. Mobile genetic elements (MGEs)

The rest of the genome is variable, composed of so-called accessory genes that bacteria acquire by horizontal transfer of MGEs, with a G+C content different from core genome, because they are obtained from different isolates of *S. aureus* or other low G+C bacteria (Lawrence and Ochman 1997). These genes are usually acquired from other cells or the surrounding environment in three ways: the transformation, the conjugation, and the transduction (Figure 3). Transformation was the first type of horizontal transfer discovered, by which free DNA in the environment is taken up by a competent bacterium. The conjugation is the transfer of genetic material through direct contact between the so-called donor bacteria and a receptor bacterium (Malachowa and Deleo 2010). However, these two types of transfer remain a minority in *S. aureus*. The third type of transfer is the transduction, which is probably the most used horizontal transfer by *S. aureus*. It is carried out through bacteriophages (Lindsay 2014).

MGEs account for approximately 10-20% of a *S. aureus* chromosome, including plasmids, transposons, bacteriophages, staphylococcal pathogenicity islands, and staphylococcal cassette chromosomes. They notably have a role in virulence, in resistance to antibiotics, in the pathogenicity and the adaptability in different environmental conditions of *S. aureus* (reviewed in (Lindsay and Holden 2004).

1. Plasmids

Discovered since 1960s, they are classified in three classes based on their sizes and the ability to conjugate (Richard P. Novick et al. 1989; Paulsen et al. 1996). Plasmids from class I have a size ranging between 1 and 5 kb with high copies number (15-20 copies per cell) and are classified in four subgroups based on the replication origin. They usually

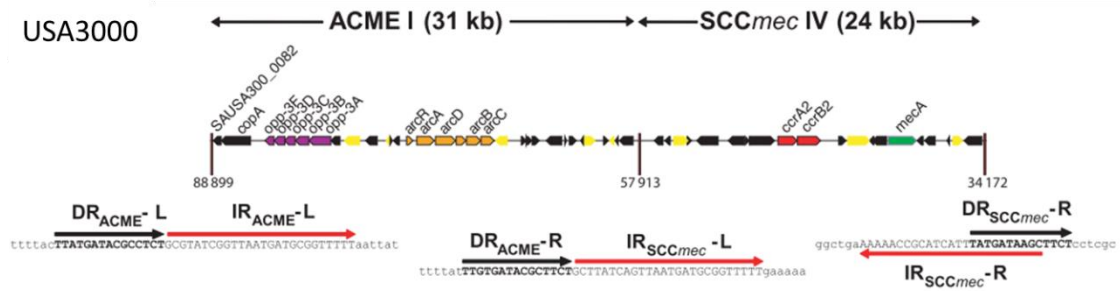

Figure 4. ACME as an element associated at the downstream of SCCmec element in USA300 strain.

Genes encoding resistance determinants shown in green, cassette chromosome recombinase in red, transposases in yellow, arginine deiminase pathway (*arc*) cluster in orange, oligopeptide permease (*opp-3*) cluster in purple, and other genes in black. In USA300, same region contains two genetic elements—type I ACME and type IV SCCmec element. Various genetic elements are demarcated by sets of direct-repeat (DR) and inverted-repeat (IR) sequences characteristic of SCC elements that integrated precisely into *orfX*. DR sequences indicated by black arrows and IR sequences by red arrows (Diep et al. 2006).

encode for single antibiotic resistance gene such as pT181, a 4.4 kb plasmid encoding for tetracycline resistance gene (Richard P. Novick et al. 1989). Class II plasmids are up to 40 kb and carry multiple resistance genes in combination with resistance to penicillin and heavy metals, aminoglycosides and/or fusidic acid. Class III plasmids are large (40-60 kb), not only multiresistant but also conjugative, due to *tra* gene which allows conjugative transfer between bacterial isolates (Thomas and Archer 1989). In addition, some virulence genes also are reported to be carried on plasmids such as exfoliate toxin B (*etb*) for scalded skin syndrome in pRW001 plasmid (Alibayov et al. 2014; Jackson and landolo 1986).

2. Staphylococcal cassette chromosome

Staphylococcal cassette chromosome (SSC) are 3-60 kb genomic cassette that usually are inserted into the *orfX* gene (T. Ito, Katayama, and Hiramatsu 1999). SCC are transferred less than other MGEs because they are more stable than other. The most well studied SSC is SCC*mec* that carry methicillin resistance gene (T. Ito, Katayama, and Hiramatsu 1999; Katayama et al. 2003). To date, eight types of SCC*mec* have been identified (A-E or I-V) based on the organization of *mec* gene and associated genes within SCC*mec* complex (Gill 2009; Teruyo Ito et al. 2001; Katayama et al. 2003; Malachowa and Deleo 2010). Another non-*mec* SCC contains fitness and/or survival determinants such as *far* for fusidic acid resistance (Holden et al. 2004) or kanamycin and erythromycin (Hiramatsu et al. 2002), etc. No SSC elements encoding for virulence genes has been found and studied until now.

3. ACME and COMER

The arginine catabolic mobile element (ACME) and the copper and mercury resistance (COMER), both have been identified first in USA300 *S. aureus* and in ATCC12228 *S. epidermidis* strains (Diep et al. 2006; Planet, Larussa, and Dana 2013) (Figure 4). They are identified as an element associated to the end of SCC*mec* element (Almebairik et al. 2020; Diep et al. 2006). Moreover, they are suggested to enhance the fitness of *S. aureus* (Almebairik et al. 2020; Diep et al. 2006; Zapotoczna et al. 2018), and to promote survival

on skin which facilitates persistence, spread, and causes skin infection (Foster and Geoghegan 2014).

4. Transposons

Transposons (Tns) are short mobile genetic elements that can be integrated into another mobile element such as plasmids or chromosomes or through bacteriophage-based transposition to move between bacterial strains and can transfer genes involved in contingency functions.

Transposons are divided into two main groups: retrotransposons often found in eukaryotes and DNA transposons found in both eukaryotes and prokaryotes. The bacterial transposons belong to the DNA transposons (DNA Tns) and the Tn family (Babakhani and Oloomi 2018). In addition, DNA Tns are also divided into four main groups: Insertion sequence (IS), composite Tns, non-composite Tns (Tn3 family) and transposable phage Mu (Babakhani and Oloomi 2018). IS are transposons that encode for only the transposase. However, they can also act as a simple transposon, which represents a transposase followed by a resistance gene; or as a composite transposon, when two IS copies flank an unrelated piece of DNA (normally resistance gene) and allow the transfer of DNA to another location.

Transposons are typically 3-60 kb of size, carry resistance determinants and usually reside in the chromosome, in plasmids or within SCC mec elements (like IS431) (Malachowa and Deleo 2010). Those MGEs represent presumably a particularly important selective advantage for the bacteria. Resistance to penicillin, erythromycin, tetracycline aminoglycoside and vancomycin have been found on transposons, such as Tn551, which is one of the first transposon found in *S. aureus* encoding for erythromycin resistance gene (S. A. Khan and Novick 1980) or Tn554 for erythromycin and streptomycin resistance (Murphy, Huwyler, and de Freire Bastos 1985). Recent reports characterized a novel transposon carrying several resistance determinants, Tn6349, which is a 48 kb composite transposon inserted into a Φ N315-like prophage (D'Andrea et al. 2019).

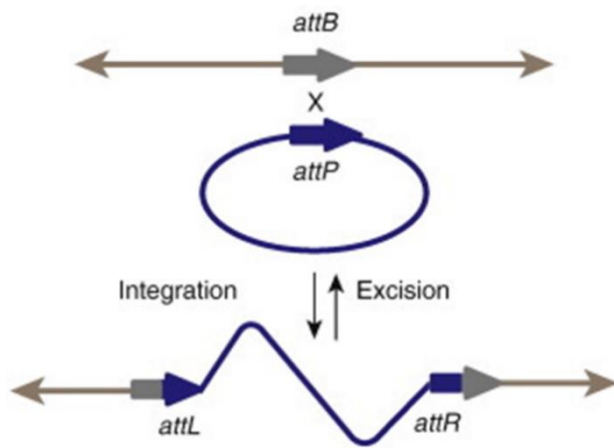

Figure 5. Overview of phage integration and excision. Phage genome is in blue and host chromosome in grey (from Fogg et al. 2014).

5. Bacteriophages

In *S. aureus*, phages are approximately 45 kb and are integrated commonly into the chromosome (called prophage) as another piece of DNA. These lysogenic phages are mostly quiescent and are replicated as part of bacterial chromosome and passed down to daughter cells during cell division. However, under certain stress conditions, they excise or replicate the phage genome and produce phage progeny, which leads to the host cell lysis (Iandolo et al. 2002; Kwan et al. 2005; Vybiral et al. 2003). Among all phages, temperate phages are the most numerous groups of the *Siphoviridae* family and belong to Cluster B phages, based on shared genes content (H. Oliveira et al. 2019). However, *S. aureus Siphoviridae* classification is a matter of discussion (reviewed in (Ingmer, Gerlach, and Wolz 2019)), some represent generalized transducing phages (Φ 11, Φ 52A...) (Fillol-Salom et al. 2019), whereas others associate with Staphylococcal pathogenicity islands (SaPIs) (Φ Sa1, Φ Sa2, Φ Sa3, Φ Sa4, Φ COL, etc.) (reviewed in (Gill 2009)).

Most *S. aureus* strains, like MW2, MSSA476, MRSA252, NCTC8325 or USA300, carry one to four prophages (Baba et al. 2002; Diep et al. 2006; Holden et al. 2004; Iandolo et al. 2002). The phage genome is circularized and can integrate into the bacterial host attachment site (*attB*) via the phage attachment site (*attP*). The integration reaction produces prophage flanked by the new attachment sites, *attL* and *attR*, which correspond to hybrid sites containing half of *attP* and half of *attB*. Excision of the prophage occurs between *attL* and *attR* to regenerate *attP* on the excised phage genome and *attB* on the host chromosome (Figure 5). Both integration and excision require integrase, the enzyme that mediates the site-specific DNA recombination (Carroll et al. 1995; Chia Yen Lee and Iandolo 1986). Since each phage carry a different integrase gene (*int*) that specifies its insertion site in the *S. aureus* chromosome, the phage immune event inside the bacteria, when two phages of the same family cannot be inserted in the same bacterial cell, is commonly observed (Fogg et al. 2014). Recent studies found that some chromosomal integration site could be heterogeneous, which means that several phages of different strains could share the same *attR* and *attL* sites sequences, but some of them also possess

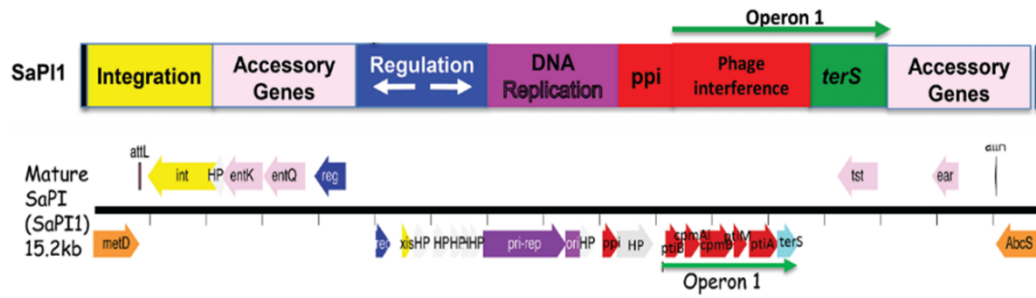

Figure 6. The SaPI1 genomic map. Colors: red represents interference genes; aqua - *terS*; orange - accessory genes; blue - regulatory genes; yellow - *int/xis*; gray - hypotheticals; purple – replication (Richard P. Novick 2019).

a unique integration-site sequence, such as the case of ϕ Sa2 in CA-MRSA strains (Coombs et al. 2020).

Many *S. aureus* bacteriophages contain virulence genes such as *sak* (staphylokinase A) (Collen 1998; Jin *et al.*, 2004), *chp* (chemotaxis inhibitory protein) (Haas *et al.*, 2004) or *lukSF-PV* (Panton-Valentine leucocidin) (Kaneko et al. 2009). Small RNAs also have been discovered in staphylococcal phages, such as SprD, a sRNA located in Φ 315 that enhances the virulence of *S. aureus* (Chabelskaya, Gaillot, and Felden 2010a; Pichon and Felden 2005); or SprX1 found in Φ 12 bacteriophage in *S. aureus* (Bohn et al. 2010; Eyraud et al. 2014). Furthermore, staphylococcal phage phi12 (or Φ 12) is also known as bacteriophage Sa2 (or Φ Sa2) and was originally isolated from NCTC8325 *S. aureus* strain beside Φ 11 and Φ 13 (Ye, Buranen, and Lee 1990). Φ 12 is demonstrated to be integrated in a specific unknown gene named *SAOUHC_01583* through its *attB* site, whereas ϕ 11 was describe by landolo et al., 2002, with an *attB* site within the intergenic region of NCTC8325 *S. aureus* chromosome (landolo et al. 2002; Xia and Wolz 2014). However, there are hardly characterization studies of Φ 12 comparing to the other two phages (Φ 11 and Φ 13) (landolo et al. 2002; Xia and Wolz 2014).

6. Staphylococcal pathogenicity islands

The staphylococcal pathogenicity islands (SaPIs) are highly mobile 15 kb genomic islands. Since they do not possess the structural genes for phage head, tail, tape measure *etc.*, they encode an integrase gene, which allow themselves to be incorporated into temperate bacteriophage (also called “helper phage”) such like Φ 11, Φ 12 and 80 α lysogens, for excision, replication, packaging and mobilizing among *S. aureus* strains (Lindsay et al. 1998; Ram et al. 2012).

In the sequenced *S. aureus* genomes, ten SaPIs have been identified: seven found in human *S. aureus* isolates (SaPI 1-5) and three from bovine isolates (SaPIbov1-3) (reviewed in (Gill 2009). SaPIs form a coherent family with highly conserved core genes including two open reading frames encoding transcriptional regulatory proteins and a region encoding integrase, Rep protein, and terminase (Figure 6). In addition, SaPIs integrate

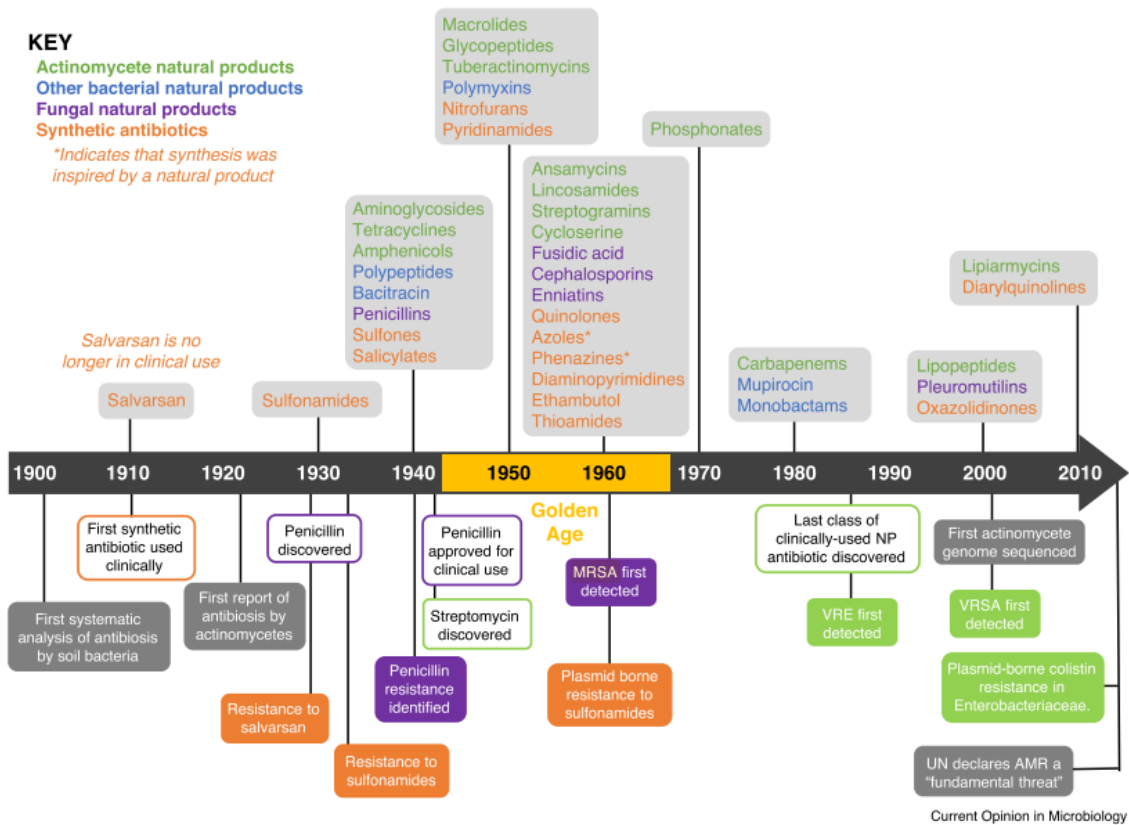

Figure 7. Timeline of antibiotics discovery and clinic applications. The antibiotics are colored per their source: green = actinomycetes, blue = other bacteria, purple = fungi and orange = synthetic. At the bottom of the timeline are key dates relating to antibiotic discovery and antimicrobial resistance, including the first reports of drug resistant strains methicillin-resistant *S. aureus* (MRSA), vancomycin-resistant enterococci (VRE), vancomycin-resistant *S. aureus* (VRSA) and plasmid-borne colistin resistance in *Enterobacteriaceae* (Hutchings, Truman, and Wilkinson 2019).

into the *S. aureus* chromosome through the chromosomal attachment site (*att*). There are five known *att* sites to date and they are specific for SaPIs and no other mobile genetic elements (Lindsay et al. 1998; Richard P. Novick, Christie, and Penadés 2010).

SaPIs encode a number of virulence determinants, which explain their important role in the pathogenesis and evolution of the bacteria. Several superantigens, toxic shock syndrome toxin (*tsst-1*) and enterotoxins are often found encoded in SaPIs (Lindsay and Holden 2004); for example, SaPI1, the first SaPI found in *S. aureus* COL strain, encodes for enterotoxin B, Q, K (*seb, seq, sek*) and putative B-lactamase protein (*ear*) (Gill et al. 2005). Moreover, recent studies discovered the presence of small regulatory RNAs (sRNAs) in SaPIs. SprC, a sRNA, was first found in SaPI_n3 (Pichon and Felden 2005) in N315 *S. aureus* strain and was shown to reduce the virulence of the bacteria and its colonization in host cells (Le Pabic et al. 2015). Another case of sRNA is SprX1, which is encoded in SaPI within Φ 12 (Bohn et al. 2010; Pichon and Felden 2005), is implicated in both antibiotic resistance (Eyraud et al. 2014) and the virulence of *S. aureus* (Buchad and Nair 2021; Kathirvel, Buchad, and Nair 2016).

III. Multiple antibiotics resistance of *Staphylococcus aureus*

A. The discovery and use of antibiotics to prevent and/or treat diseases and infections go way back from approximately 1000 years ago (Harrison et al. 2015). However, not until the 20th century that antibiotics have drastically changed the medicine field with salvarsan as the first antibiotic deployed in 1910 (reviewed in (Hutchings, Truman, and Wilkinson 2019; Kathrin I. Mohr 2016)), followed by the golden age of antibiotics with the discovery of Penicillin by Alexander Fleming (Alexander Fleming 1929). Subsequently new antibiotics have been discovered rapidly as well as the production of synthetic substances within numerous laboratories of pharmaceutical companies. The insertion of antibiotics into clinical uses was possibly the greatest medical breakthrough of the 20th century (Figure 7). To date, the term “antibiotic” was defined as a chemical substance of natural or synthetic origin that inhibits or kills pathogenic bacteria (Waksman 1947). To inactivate virulent microorganisms, these substances operate on different levels:

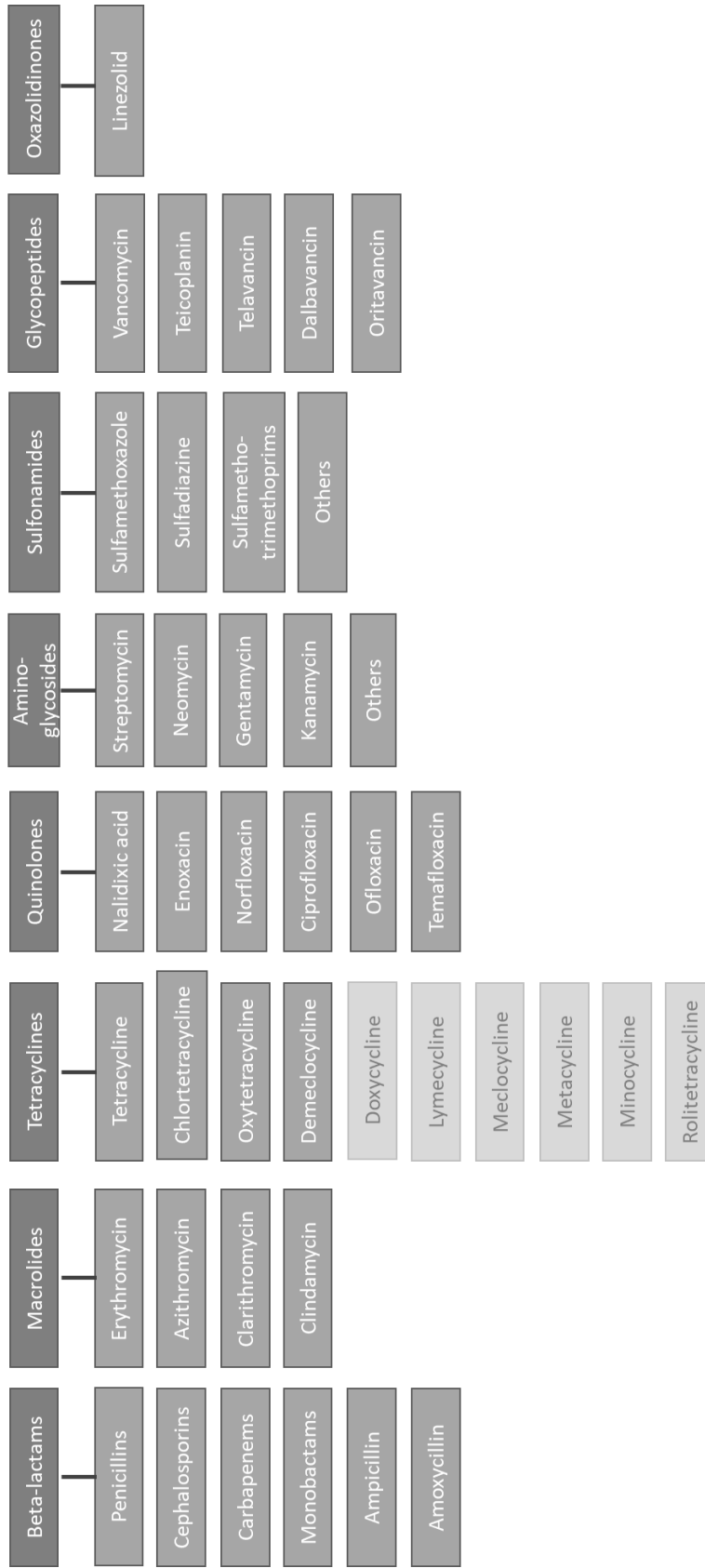

Figure 8. Antibiotics classification

(I) Inhibition of cell wall synthesis, (II) Breakdown of cell membrane structure or function, (III) Inhibition of the structure and function of nucleic acids, (IV) Inhibition of protein synthesis, (V) Blockage of key metabolic pathways (reviewed in (Begum et al. 2021)).

B. Regarding of the classification, based on different criteria such as the chemical structure, the origin, the range of activity, the effects of their activities, antibiotics are divided into eight major groups (reviewed in (Begum et al. 2021); Figure 8; Julie thesis):

- Beta-lactams, with four subgroups (Penicillins, Cephalosporins, Monobactams and Carbapenems), target the synthesis of proteins needed for bacteria cell wall (Ebimieowei Etebu; Ibemologi Ariekpar 2016).
- Macrolides aim at protein synthesis and the bacterial ribosome (Ebimieowei Etebu; Ibemologi Ariekpar 2016).
- Tetracyclines also target ribosome and disrupt the protein synthesis (Fuoco 2012).
- Quinolones interfere with DNA replication and transcription (Domagala 2018).
- Aminoglycopeptides inhibit the protein synthesis by binding to one of the sub-units of Ribosome (Ebimieowei Etebu; Ibemologi Ariekpar 2016).
- Sulfonamides target the bacterial metabolic (reviewed in (Kathrin I. Mohr, 2016)).
- Glycopeptides hinder the bacterial cell wall peptidoglycan synthesis of Gram-positive bacteria (reviewed in (Kathrin I. Mohr, 2016)).
- Oxazolidinones are synthetic substances that inhibit bacterial protein synthesis (Pandit, Singla, and Shrivastava 2012).

C. Antibiotic resistance in *S. aureus*

Although antibiotics made many medical procedures possible, the misuse of these substances has resulted in a situation where multidrug-resistant pathogens have become a severe menace to human health worldwide. Antibiotic resistance is now, one of the three most crucial community health threats of the 21st century, according to The World Health Organization (Woolhouse et al. 2016). Most pathogens are developing multi-antibiotics resistance, including *Staphylococcus aureus*, such as the case of Methicillin Resistant *Staphylococcus aureus* (MRSA) (Enright et al. 2002; Kourtis et al. 2019). N315 is

a methicillin-resistant *S aureus* (MRSA) strain isolated in 1982, and Mu50 is an MRSA strain with vancomycin resistance isolated in 1997. Statistical data demonstrated that MRSA was reported in more than 25% of cases in hospital in Europe, 34% of isolates *S. aureus* from patients in the United States, and 47% in China (Wang et al. 2014). Another example of multidrug resistance Staph is Vancomycin Resistant *Staphylococcus aureus* (VRSA) (Appelbaum 2006; Gardete and Tomasz 2014) discovered in 2002.

S. aureus is able to gain the capacity of resistance to multiple antibiotics through the horizontal transfer of MGEs, which may carry antibiotic-resistance genes (ARGs) (Felden and Cattoira 2018; Haaber, Penadés, and Ingmer 2017; Partridge et al. 2018). For instance, the genome of MRSA strains has been demonstrated to carry SSC*mec* mobile genetic elements containing the *mecA* gene that confer resistance to methicillin and all other β -lactam antibiotics (Katayama et al. 2003).

Although the rise in bacterial diseases that are resistant to almost all known antibiotics is worrying, recent research have led to the discovery of many new molecules with remarkable biological activities (Rutledge and Challis 2015).

IV. Virulence of *Staphylococcus aureus*

A. A commensal bacterium

An estimated 20% to 30% of the human population are long-term carriers *S. aureus* which can be found as part of the normal skin flora, in the nostrils, and as a normal inhabitant of the lower reproductive tract of women. According to different studies in late 1990s, three types of carriage individuals were observed between diverse human populations (Kluytmans, Van Belkum, and Verbrugh 1997; VandenBergh et al. 1999; WILLIAMS 1963). They are either non-carriers (approximately 20% of the population), persistent-carriers (20-25%) or intermittent carriers (55-60%), which have a transient *Staph* and strains vary frequently.

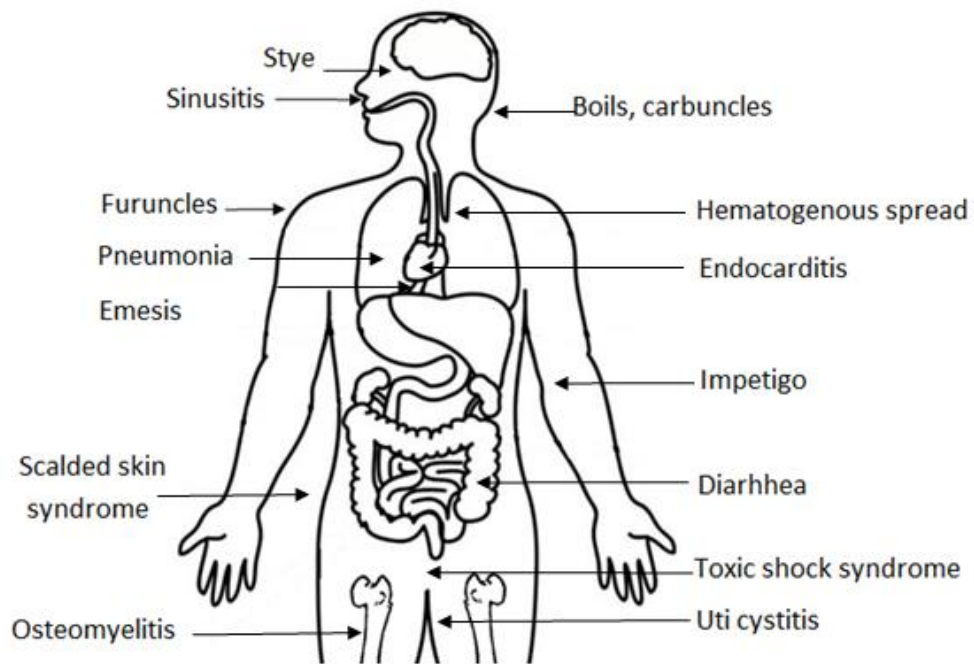

Figure 9. Overview of staphylococcal diseases

B. An opportunistic pathogen

Nevertheless, *Staphylococcus aureus* is an opportunistic pathogenic bacterium in humans and animals. The clinical infections of *S. aureus* are classified into community and nosocomial categories based on origin of infection.

- Community-acquired infections are defined as infections manifesting and diagnosed within 48 hours of admission in patients, without any previous encounter with healthcare such as pimples, boils, sties.
- Hospital-acquired infections, also known as a nosocomial infection, are diseases obtained in a hospital or other health care facility such as bacteremia or pneumonia...

For decades, *S. aureus* has been predominately a nosocomial pathogen and is a leading cause of mortality and morbidity in hospitals. It is the second most frequently isolated species during nosocomial infection in France after *Escherichia coli* (Colomb-Cotinat et al. 2016), and the second cause of Food-borne diseases (FBD) behind *Salmonella sp* (Le Loir, Baron, and Gautier 2003). However, the community *S. aureus* infections are in rise. *S. aureus* is only second to *S. epidermidis* in causing primary bacteremia in hospital patients (Otto 2009). The important clinical *S. aureus* infections cover a wide range of illnesses, from minor skin infections (pimples, abscesses), to life-threatening diseases such as pneumonia, meningitis, osteomyelitis, endocarditis, toxic shock syndrome (Archer 1998; Tong et al. 2015) (Figure 9).

Table 1_Cell surface proteins (Adapted from Chavakis, Preissner, and Herrmann 2007; Foster 2019b; Foster and Geoghegan 2014)

CELL SURFACE FACTORS	LIGAND AND BINDING MECHANISM	PUTATIVE FUNCTIONS	ROLE IN COLONIZATION OR INFECTION	REFERENCES
Microbial surface components recognizing adhesive matrix molecules (MSCRAMMs)				
Fibronectin-binding protein A (FnBPA)	Fibronectin, fibrinogen and other ECM proteins, IgG	Adhesion to different types of cells, biofilm formation, evading antibiotics and immune defense	Endocarditis, foreign body infection, mastitis, pneumonia acquired under mechanic ventilation	Martijn den Reijer et al. 2018
Fibronectin-binding protein B (FnBPB)	Fibronectin, fibrinogen and other ECM proteins	Adhesion to different types of cells, biofilm formation, inhibitor of bactericidal activity and host innate defense	Endocarditis, foreign body infection, mastitis, pneumonia acquired under mechanic ventilation	Pietrocola et al. 2019
Clumping factor A (CfA)	Fibrinogen and fibronectin, von Willebrand factor (VWF), Complement factors I and H (CFI and CFH)	Reduction of opsoniphagocytosis, tissue colonization, immune evasion, survival in blood	Endocarditis, septic shock, kidney abscess, septic arthritis, osteomyelitis	Herman-Bausier et al. 2018
Clumping factor B (CfB)	Fibrinogen, loricrin	Antiphagocytic effect, immune evasion, favors bacterial adhesion and colonization	Nasal or skin colonization, septic shock, kidney abscess, arthritis and osteomyelitis	Fiury et al. 2016; Vitry et al. 2017
Serin aspartate repeat protein C (SdrC)	Desquamated epithelial cells	Biofilm formation, favors bacterial adhesion	Nasal colonization	McDevitt et al. 1994; Josefsson et al. 1998; Wang Junchao et al. 2021
SdrD	Desquamated epithelial cells and keratinocytes	Nasal colonization, evasion innate immune response, favors bacterial adhesion	Kidney abscess following survival in blood	Askarlan et al. 2016
SdrE	Complement factors I and H (CFI and CFH)	Reduction of opsoniphagocytosis, platelet aggregation, degradation of C3b		Sharp, JA et al. 2012; Yingjie Zhang et al. 2017
Collagen-binding adhesin (Cna)	Collagenous tissues and cartilage Complement protein C1q	Tissue adhesion, prevention of complement activation	Ocular keratitis, endocarditis, septic arthritis, osteomyelitis, necrotizing pneumonia	Madani Ali et al. 2017
Elastin-binding protein (Ebps)	Elastin and soluble tropoelastin	Adhesion	Lung, skin, blood vessels adhesion (Downer et al. 2002)	
Three helical bundle				
Staphylococcal protein A (Spa)	Immunoglobulins IgG (Fc portions), TNFa and vWVF	Anti-opsonic and anti-phagocytic effect, survival in blood, inhibit complement activation	Pneumonia, endocarditis, endovascular infection, septic arthritis and osteomyelitis, pneumonia acquired under mechanic ventilation, septic shock	Ana Rita Cruz et al. 2021
The NEAT family				
Iron-regulated surface determinant A (IsdA)	ECM, heme, fibrinogen, fibronectin, cyokeratin 10, loricrin	Iron acquisition, favors bacterial adhesion, survival in neutrophils, colonization	Nasal or skin colonization, kidney abscess	Bennett et al. 2019
IsdB	Haemoglobin, heme and B3 integrins	Iron acquisition, adhesion to epithelial cells, invasion of non-phagocytic cells, colonization	Kidney abscess	Pishchany et al. 2008; Nishitani et al. 2020
IsdC	Heme, hemoglobin	Iron acquisition	Kidney abscess	Torres et al. 2006
IsdH	Heme, hemoglobin	Iron acquisition, degradation of opsonins, survival in blood	Septic death	
The G5-E motif family				
S. aureus surface protein G (SasG)	ECM	Adhesion to desquamated epithelial cells, biofilm formation	Nasal or skin colonization, septic death	Foster 2019
Adenosine synthase A (AdsA)	Converts adenosine monophosphate to adenosine	Escape host immune responses		

Table 1_Cell surface proteins (followed)

CELL SURFACE FACTORS	LIGAND AND BINDING MECHANISM	PUTATIVE FUNCTIONS	ROLE IN COLONIZATION OR INFECTION	REFERENCES
Secreted expanded repertoire adhesive molecules (SERAMs)				
Extracellular adherence protein (Eap)	ICAM-1	Inhibit neutrophils recruitment, evasion immune system, bacterial adhesion	Wound infection	Eisenbeis et al. 2017
Von Willebrand factor binding protein (vWbp)	Prothrombin and fibrinogen	Abscess formation, induce staphylococcal agglutination, bacterial dissemination	Endocarditis	
ECM binding protein (Emp)	ECM	Adhesion, immune evasion?	Abscess formation and persistence	Geraci Jennifer et al. 2017
Extracellular complement-binding protein (Ecb)	Binds to C3d domain of C3bBb	Blocking the activation pathway C3 convertase and all C5 convertases		
Extracellular fibrinogen binding protein (Efb)	Fibrinogen, platelets and C3d domain of C3bBb	Inhibit phagocytosis by neutrophils, blocking the activation pathway C3 convertase and all C5 convertases		Lawrence Y. L. Lee et al. 2004; Ya-Ping Ko et al. 2011
Second immunoglobulin-binding protein (Sbi)	Fc of IgG, C3d complement fragment and B2 glycoprotein	Evasion phagocytosis, induction of cytokines	Blood coagulation, proper abscess formation, wound healing	Cintia D. Gonzalez et al. 2019
Other anti-inflammatory peptides				
Chemotaxis inhibitory protein of <i>S. aureus</i> (CHIPS)	Complement C5a receptor (C5aR) and formyl peptide receptor (FPR)	Inhibit leukocyte ad monocyte chemotaxis, reduction of inflammation, block neutrophils activation	Purulent staphylococcal infection	Bennet Potsma et al. 2004; Rooijackers and van Strijp. 2007
Staphylococcal complement inhibitor (SCIN)	Stabilize C3 convertases C3bBb and C4bC2a	Inhibit complement activation, prevent phagocytosis	Nasal colonization	Rooijackers et al. 2005
Formyl peptide receptor-like 1 inhibitory protein (FLIPr)	Fc-gamma receptors (FcγR)	Block chemotaxis of neutrophils and monocytes		Cristina Prät et al. 2006
Capsular polysaccharides				
Capsular polysaccharides type 1, 5 and 8 (CPS 1, 5 and 8)	Masks complement deposition (C3b)	Reduce phagocytosis, favor bacterial colonization	Abscess formation, septic shock	Roghmann et al. 2005
Cell wall/ surface components				
Teichoic acids	Toll-like receptor 2 (TLR2)	Secretion of cytokines		
Lipoteichoic acids (LTA)	Toll-like receptor 2 (TLR2)	Inflammatory reaction	Pneumonia acquired under mechanic ventilation, septic shock	
Wall teichoic acid (WTA)	Toll-like receptor 2 (TLR2)	Inflammatory reaction		
Peptidoglycan	Toll-like receptor 2 (TLR2)?	Inflammation, retarded hypersensitivity	Pneumonia acquired under mechanic ventilation, septic shock	
Intercellular antigen (IcaADBC)	ECM	Biofilm formation, export and modification of adhesin polysaccharidic (PIA)		
Biofilm associated protein (Bap)	Unknown	Biofilm formation, accumulation/aggregation		
<i>S. aureus</i> surface protein G (SasG) and Plasmine sensitive surface protein (Pis)	Desquamated epithelial cells	Intercellular adhesion		Lasa and Penades (2006)
Wall components-modifying factors				
Dlt operon (DltABCD)	Incorporation of D-Alanine into teichoic acids, bind to fibronectin	Resistance to antimicrobial peptides, primitive adhesion		
Multiple peptide resistance factor F (MprF)	Lysinylate teichoic acids	Resistance to antimicrobial peptides		
Staphyloxanthin	Carotenoid	Resistance to neutrophil oxydative destruction		

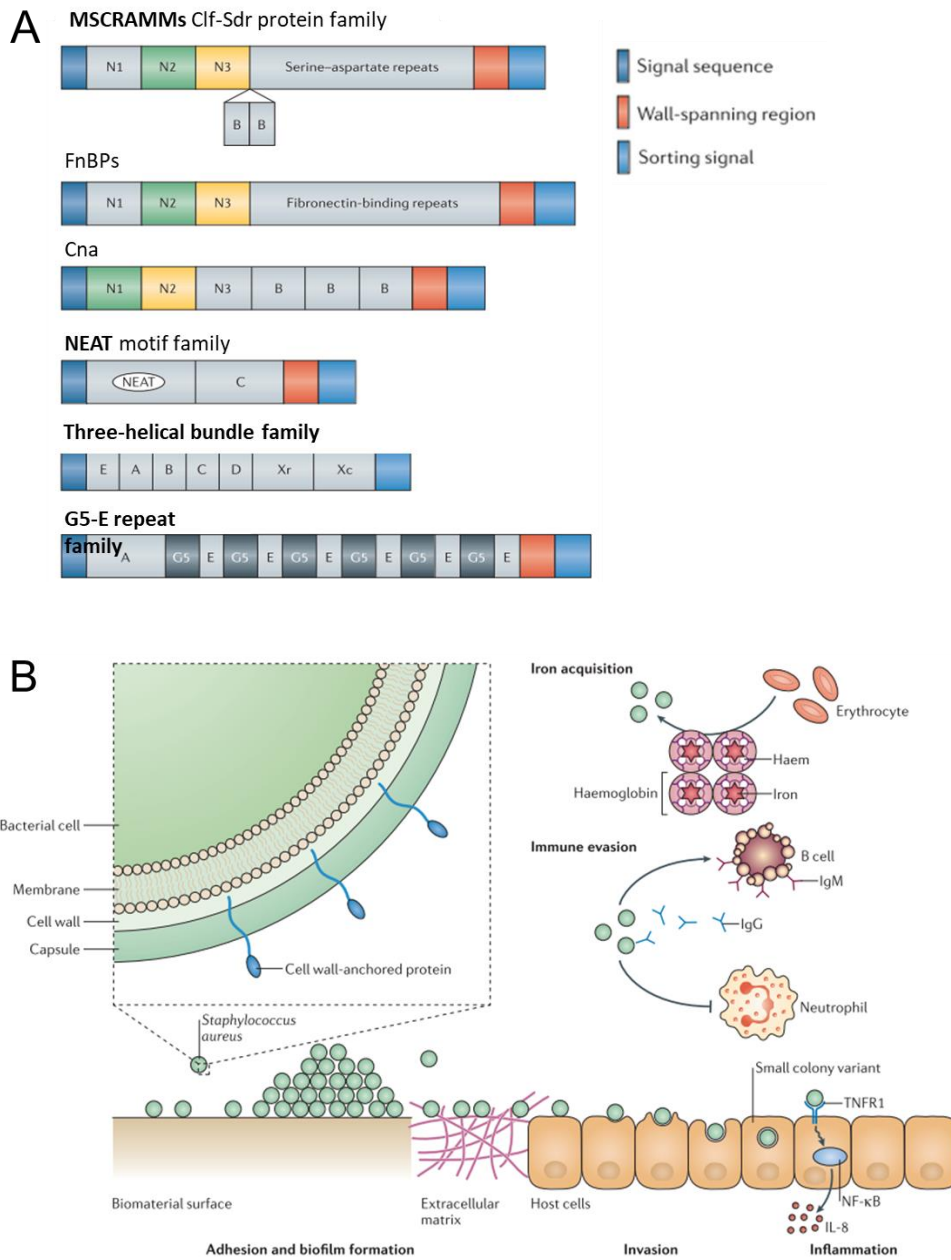

Figure 10. Cell wall-anchored proteins (CWA). (A) CWA proteins are divided into four groups (MSCRAMMs, NEAT motif family, Three-helical bundle family and G5-2 repeat family). (B) CWA proteins contribute to *Staphylococcus aureus* virulence at different levels. Iron-regulated surface determinant (Isd) binds haemoglobin and extracts and transports haem across the cell wall and membrane into the cytoplasm, where iron is released. Protein A acts as a superantigen for B lymphocytes and disrupts adaptive immune responses. Through binding to and activating tumor necrosis factor receptor 1 (TNFR1) on host epithelial cells, protein A also triggers the synthesis of cytokines (IL-6) and causes disruptive inflammation, which contributes to pathogenesis (from Foster et al. 2014).

C. Virulence factors

The process of *S. aureus* infections involves several stages: colonization, local infection, systemic dissemination and/or sepsis, metastatic infections and finally, toxinosis (Bronner, Monteil, and Prévost 2004; Foster and Geoghegan 2014; Gnanamani, Hariharan, and Paul-Satyaseela 2017). Hence, during the bacterial journey from the initial point of entry to its eventual last stop, *S. aureus* encounters different conditions changing in the host cells. To colonize and/or invade these different environments, *S. aureus* employs a wide range virulence factors that mediate attachment of the bacterium to the substrate, evasion of the host immune shield, tissue invasion, causing sepsis and elicit toxin-mediated syndromes. Although these factors can be classified based on their localizations in bacterial cell or their mechanisms, here, we organized based on their origins: cell surface factors and secreted factors (as proposed in (Chavakis, Preissner, and Herrmann 2007; Costa et al. 2013; Foster 2019b). All the proteins with their specific ligands and putative functions are described succinctly in Table 1.

1. At low density of bacteria, *Staphylococcus aureus* favors the colonization within the host cell tissues by employing various cell surface factors, which are involved in tissue adhesion and immune evasion. These surface proteins include Cell wall-anchored proteins (CWA), Secreted expanded repertoire adhesive molecules (SERAMs), capsular polysaccharides, cell wall components, and Staphyloxanthin.

1.1. CWA proteins

CWA are classified into four basic groups, based on the structural-functional motifs (Barie, Narayan, and Sawyer 2018; Foster et al. 2014): Microbial surface components recognizing adhesive matrix molecules (MSCRAMMs), NEAT motif family, G5-E repeat proteins and three-helical bundle repeats (Spa) (Figure 10). Among all CWA proteins, MSCRAMMs represent the largest member of surface proteins. They consist of Fibronectin-binding proteins (FnBPA and FnBPB) (Jonsson et al. 1991; Josse, Laurent, and Diot 2017), Clumping factors (ClfA and ClfB) (Josefsson et al. 1998), Collagen-binding

adhesin (Cna) (Switalski et al. 1993), Serin-aspartic acid rich proteins (Sdr protein) (Josefsson et al. 1998, 2001) and Elastin-binding protein (EbpS) (Ghasemian et al. 2015).

They are composed of signals typical of proteins anchored to the wall: N-terminal with a signal peptide (S) which is implicated in the transport of the cytoplasmic proteins to the cell wall; and C-terminal containing a LPXTG domain required for attaching on the cell wall (Joh et al. 1999). In addition, the shared mechanism of MSCRAMMs for ligand binding is called “Dock, Lock and Latch” or DLL (reviewed in (Foster 2019a)). The ligand of interest binds to the “opened” form of MSCRAMM and leads to a structural changing of MSCRAMM to a “closed” form to capture the ligand. They primarily target ECM such as fibronectin, fibrinogen, collagenous tissues, and other surface proteins of the host cells, resulting in their implication in adhesion and invasion of host cells, immune evasion as well as biofilm formation. Another well-studied surface protein is protein A (Spa), a protein comprising three-helical bundle repeats, which target the constant domain of Immunoglobulin IgG and is involved in protecting staphylococcus from phagocytosis (Deis et al. 2015).

1.2. SERAMs

SERAMs comprise Extracellular adherence protein (Eap) (Cheng et al. 2009; Rhem et al. 2000), von Willebrand factor binding protein (vWbp) (Nilsson et al. 2004), Coagulase (Coa) (Kang et al. 2013; Sharp et al. 2012), ECM binding protein (Emp) (Josefsson et al. 2001), Extracellular fibrinogen binding protein (Efb) (Shannon and Flock 2004), and Second immunoglobulin-binding protein (Sbi) (Wilke and Wardenburg 2010). They are structurally unrelated, unlike MSCRAMMs; however, they possess similar immunomodulatory functions. SERAMs mostly target fibrinogen, fibronectin and vitronectin and consequently contribute to host cell invasion and host colonization. Furthermore, they also target platelets and complements, which explain their importance in preventing the activation of complements and the phagocytosis during bacterial infection (reviewed in (Chavakis, Preissner, and Herrmann 2007)).

Table 2_Secreted factors (Chavakis, Preissner, and Herrmann 2007; D. Oliveira, Borges, and Simões 2018; Tam and Torres 2019)

SECRETED FACTORS	Ligand and binding mechanism	PUTATIVE FUNCTIONS	REFERENCES
Extracellular enzymes (Exoenzymes)			
Catalase (CatA)	Inactivate free hydrogen peroxide	Survival persistence and nasal colonization	Cosgrove, K. et al. 2007
Glycerol ester hydrolase (lip, geh, beh)	Inactivate fatty acids, degrade triacylglycerols, releases bactericidal lipids	Impair phagocytic killing by granulocytes	Shryock et al. 1992
Coagulases (Coa and vWbp)	Bind to prothrombin and fibrinogen	Biofilm formation , induce staphylococcal agglutination, protection against immune response; Endocarditis, Abscess formation	McAdow M et al. 2012; Zapotoczna et al. 2015
Enolase (Eno)	Catalyzes phosphoglycerate to phosphoreno pyruvate, binds to Laminin	Unknown	Carneiro, C.R. et al. 2004
Alkyhydroxide reductase (AhpC)	Residual catalase activity	Required for survival, persistence and colonization	Cosgrove, K. et al. 2007
Thioredoxin and thioredoxin reductase	Inactivates ROS	Bacterial survival, resistance to killing	Roos, G. et al. 2007
Fatty-acid-modifying enzyme (FAME)	Esterifies fatty acids	Inactivate bactericidal fatty acids, enhances bacterial survival	Long JP and Kapral FA, 1993
O-acetyltransferase (OatA)	O-acetylate peptidoglycan	Lysozyme resistance	
PtdIns-phospholipase C (Plc)	Specific lipase activity	Release cell surface proteins, bacterial survival in human blood and neutrophils	White MJ et al. 2014
Staphylokinase (Sak)	Plasminogen activator	Inactivate antimicrobial peptides, cleave complement factors, antiphagocytic effect	Foster TJ 2005
Autolysin (Alt)	Hydrolyze peptidoglycan	Biofilm formation, primitive adhesion, secretion of toxins and immunologically active wall components	Bera, A. et al. 2005
Nucleases (Nuc)	Cleave nucleic acids	Degradation of host tissue components, biofilm formation, bacterial escapes from neutrophils	Olson ME et al. 2013; Berends et al. 2010
Hyaluronidase	Degrade hyaluronic acid	Involved in bacterial dissemination and biofilm formation	Ibberson et al. 2016
Serine proteases			Sieprawska-Lupa, M. et al. 2004; Shaw, L. et al. 2004
_ Serine-like proteases (SplA-F)	Bind to Transmembrane proteins?	Induces TH2 response and production of IgE	
_ SspA (V8 protease)	Cleaves fibrinogen-binding proteins	Inactivate neutrophil activity, reduce bacterial adhesion	
_ Exfoliative toxins (ETA, ETB, ETC, ETD)	Bind to desmosomal cadherins	Staphylococcal scalded skin syndrome (SSSS): Ritter's disease, toxic epidermal necrosis, bullous impetigo	Mariutti et al. 2017; Bukowski et al. 2010
Cystein proteases			
_ Staphopain A (ScpA and ScpB)	Degrades elastin, collagen, fibrinogen, fibronectin	Block neutrophil activation and chemotaxis, biofilm formation	Laarman AJ et al. 2012; Mootz et al. 2013
_ Staphopain B (SspB)	Degrades antimicrobial peptide, cleave CD11b and CD31	Block neutrophil activation and chemotaxis, biofilm formation	Chan and Foster, 1998
Metalloprotease: aureolysin (Aur)	Catalyze and activate Serine proteases Cleaving complement C3	Inactivate antimicrobial peptides Reduction of opsonin recognition	
Cytolytic (pore-forming) toxins			
Cytolysins			
_ Hla (Hemolysin alpha)	Bind to the transmembrane protein ADAM10, Pore-forming in epithelial, endothelial and T cells, monocytes and macrophages	Cellular lysis, cytokine secretion, inflammatory response; Arthritis, osteomyelitis, pneumonia acquired under mechanic ventilation, septic shock	Song et al. 1996; Menestrina, 1986
_ Hlb (Sphingomyelinase C)	Inhibits IL-8 expression	Cytotoxic towards human keratinocytes, polymorphonuclear leukocytes, monocytes and T lymphocytes	Huseby et al. 2007; Ira and Johnston, 2008
Bicomponent toxins (Leukotoxins)			
_ Hly (HlgA, HlgC/ HlgB)	Erythrocytes and leukocytes	Lysis of erythrocytes and leukocytes; bloodstream infection	Morinaga et al. 2003
_ LukAB/ GH		Lysis of monocytes, dendritic cells, neutrophils and leukocytes; Enhancing <i>S. aureus</i> survival	Dumond et al. 2011
_ LukED	Binds to the chemokine receptor CCR5	Lysis of rabbit leukocytes, human neutrophils and mouse phagocytes	Gravet et al. 1998; Morinaga et al. 2003
_ PVL (LukS-PV, LukF-PV)	Toll-like receptors (TLR2 and TLR4), (PVL) C5a receptor on human neutrophils	Lysis of macrophages and neutrophils during severe inflammations	Zivkovic et al. 2011; Inden et al. 2009; Lofler et al. 2010; Spaan et al. 2013
Phenol-soluble modulins (Hld, PSMα 1-4, PSMβ, PSMmec)	Formyl peptide receptor (FPR)	Lysis on neutrophils and macrophages; Biofilm formation; Necrotizing pneumonia	Queck et al. 2009; Kreschmer et al. 2010
Superantigens (SAgs)			
T cell superantigens			
_ Staphylococcal enterotoxins (SEA, B, C, D, E, G and Q)	Bind to MCH II α-chain	Activate T cells and antibodies presenting cells; Food poisoning, Toxic shock syndrome (TSS), septic shock (SEA), staphylococcal purpura fulminans (SEB, SEC)	Bergdoll et al. 1981; McCormick et al. 2001
_ Toxic shock syndrome 1 (TSST-1)	Bind to MCHII α-chain, TCR and dodecapeptide	Activation T cells and antibody presenting cells; TSS, neonatal toxic shock syndrome-like, staphylococcal purpura fulminans	Davis et al. 1980; Shands et al. 1980; Schlievert PM, 1986
_ SE-I H to SE-I Y (selh to sely)	Bind to TCR	Unknown	Spaulding AR et al. 2013
_ Other superantigen-like protein (SSL-5; SSL-7; SSL-11)	Binds to neutrophil receptor PSGL-1	Blocking stimulation extravasation of neutrophils; Food poisoning, TSS	Fitzgerald et al. 2003
B cell superantigens (Spa)	(cf Table 1)		

1.3. Other anti-inflammatory peptides

Other anti-inflammatory peptides than SERAMs consist of chemotaxis inhibitory protein of *S. aureus* (CHIPS) (Chavakis et al. 2002; Clarke et al. 2009; Foster 2005), Staphylococcal complement inhibitor (SCIN) (Rooijackers et al. 2005; Silverman and Goodyear 2006) or Formyl peptide receptor-like 1 inhibitory protein (FLIPr) (Sinha et al. 1999; Stemerding et al. 2013). They are implicated in immune evasion by blocking chemotaxis and obstructing complements activation (reviewed in (Foster et al. 2014)) through binding to complements and chemoattractant receptors. Another non-proteinaceous factor is Staphyloxanthin (STX), a carotenoid pigment that contributes to the golden color of *S. aureus*. The loss of STX has been demonstrated to make *S. aureus* susceptible to killing by ROS produced by neutrophils (G. Y. Liu et al. 2005; Song et al. 2009).

1.4. Capsular polysaccharides (CPs)

CPs are produced by the majority of clinical isolates and serotypes 1, 5 and 8 are the most well studied to date (Rausch et al. 2019). The high encapsulated serotype 1 (CP1) impedes opsonophagocytic killing of staph by preventing the binding between C3b complement with receptor on phagocytic cells. The serotypes 5 and 8 (CP5 and CP8) also protect *S. aureus* from phagocytic uptake and killing by human polymorphonuclear leukocytes, by masking the complement deposition C3b (Cunnion, Zhang, and Frank 2003). Overall, their main function is to restraint phagocytosis by neutrophils, but they also involve in bacterial colonization and promote abscesses (Rausch et al. 2019) and they are the most important virulence factors under evaluation as vaccine antigens.

1.5. Cell wall components and wall components factors

Cell wall components include peptidoglycan, lipoteichoic acid (LTA), wall teichoic acid, etc., and are targets of Cationic antimicrobial molecules (CAMs), which disrupt bacterial membrane and plays a key role in innate immunity. Toll-like receptors 2 (TLR2) is a recognition receptor that recognizes Gram-positive cell wall molecules such as LTA or peptidoglycan and its activation results in the release of antimicrobial peptides (Sieling and Modlin 2002), which leads to the induction of innate immune response. It has been

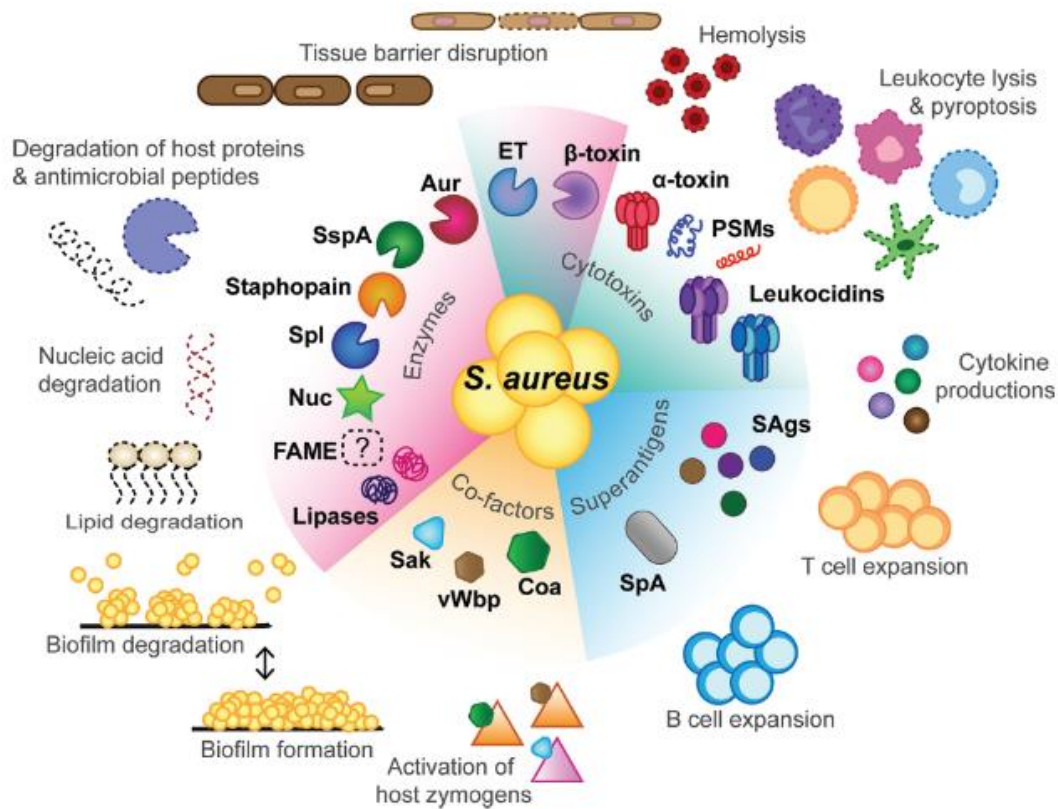

Figure 11. Overview of *S. aureus* toxins and exoenzymes. Superantigens are proteins that cause T and B cell expansions, resulting in clonal deletion and massive cytokine production. Cytotoxins (Hla and leukocidins), cause cytokine production, hemolysis, and leukocyte cell death through targeting specific cell surface receptors. PSMs mediate cytolysis by inserting into the lipid bilayer of cell membranes. Enzymes (Hlb and the Ets), cause cytotoxicity on mammalian cells, resulting in cell death, inflammation, and tissue barrier disruptions. Other enzymes, (various proteases and nucleases), mediate host protein degradation, preventing important host immune system and defense molecules. Lipases and FAME work synergistically to degrade lipids in the environment for nutrients. Cofactors (Coa, vWbp, and Sak), bind and activate host zymogens in the coagulation system for clot formation. Altogether, these toxins and enzymes provide critical nutrients (i.e., iron and carbon) that are important for the growth and survival of the bacteria. They also target different levels of host immune defense, thus contributing to the virulence of *S. aureus* during infections (from Tam and Torres 2019).

shown recently that modification of teichoic acids and phospholipids with D-alanine and L-lysine in *S. aureus* reduces binding to CAMs, therefore enhances the virulence of the bacteria (Weidenmaier et al. 2004). Moreover, wall components-modifying factors comprise Dlt operon (*dltABCD*) (Peschel et al. 1999) and multiple peptide resistance factor F (MprF) (Weidenmaier, Kristian, and Peschel 2005), have been demonstrated to be implicated in the modification of bacterial cell wall phospholipids (reviewed in (Chavakis, Preissner, and Herrmann 2007)). Their conservation in many Gram-positive pathogens besides *S. aureus* suggests that this pathway represents a common mechanism to achieve protection against CAMs.

2. At high density of Staph, the bacteria expresses a wide range of secreted factors such as extracellular enzymes, cytolytic toxins and superantigens. They play active roles in disarming host immunity by disrupting host cells and tissues and interfering with the host immune system to release nutrients and facilitate bacterial dissemination (Table 2 and Figure 11).

2.1. Extracellular enzymes or exoenzymes

Exoenzymes include catalase, hydrolases, staphylokinase (Sak), nucleases, and hyaluronidase, proteases (serine, cysteine (e.g. Staphopain) and metalloprotease (Aureolysin). Nearly all *S. aureus* strains secrete several extracellular enzymes whose functions are thought to be the disruption of host tissues and/or inactivation of host antimicrobial mechanisms, to acquire nutrients for bacterial growth and facilitate bacterial dissemination. For instance, proteases, consisting of serine- and cysteine-proteases (Singh and Phukan 2019; Tam and Torres 2019), are mainly involved in the maturation and activation of exoproteins of *S. aureus* (Rzychon et al. 2003) but also allow the degradation of immunoglobulins and plasma proteins (L. Shaw et al. 2004; Sieprawska-Lupa et al. 2004). Other enzymes such as Coagulase, Aureolysin or Staphylokinase have also been demonstrated to contribute to immune evasion of *S. aureus*, with a dual function since they allow the penetration of the bacteria through the skin (Kwiecinski et al. 2016).

A. α Hemolysin

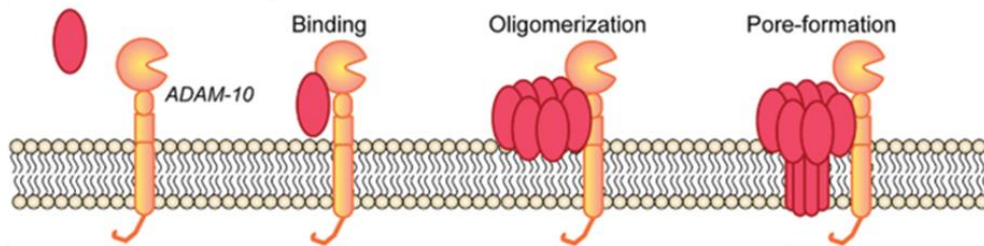

B. Bicomponents PFTs, except LukAB

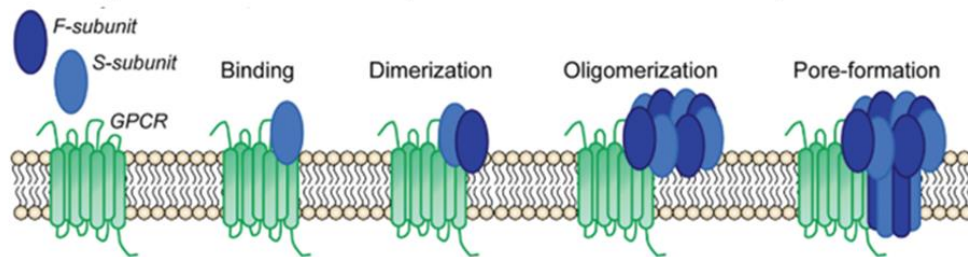

C. LukAB

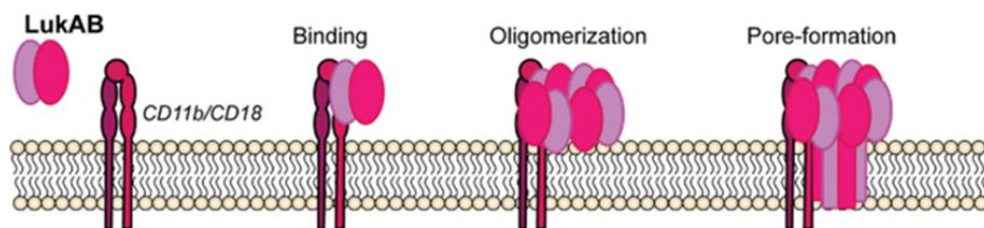

D. PSMs

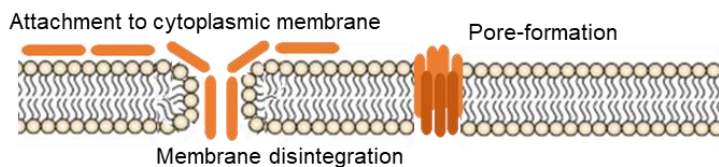

Figure 12. Overview of pore formation of several cytolytic toxins. (A) The α toxin is secreted as a monomer. By binding to the host ADAM-10 receptor, the monomers form a heptameric pre-pore. Then the pre-pore stems expand to form a pore piercing the membrane of the target cell. (B) Leukocidins are also secreted in the form of monomers. The S-subunit recognizes the target cell by binding to cellular receptors. These receptors are generally G protein-coupled receptors (GPCR). (C) LukAB, in the other hand, is secreted in the form of dimers and the S-subunit binds to the CD11b integrin. Upon binding to the receptor, the S-subunit dimerizes with the F-subunit, then this dimer oligomerizes with three other dimers to form an octameric pre-pore. Eventually, similar to the α toxin, the stems of this pre-pore expand to form a pore. (D) PSMs bind to the membrane in a nonspecific manner, leading to its disintegration, and then, PSMs aggregate to form a transient pore (Adapted from Tam and Torres 2019; D. Oliveira, Borges, and Simões 2018).

2.2. Cytolytic toxins or pore-forming toxins (PFTs)

S. aureus secretes a large number of cytolytic toxins that, although structurally diverse and with different target specificity, share a similar function on host cells (Figure 12). They are divided into two groups, based on the mechanism of regulation: receptor dependent PFTs and receptor independent PFTs.

Among receptor dependent PFTs, the toxins targeting red blood cells are hemolysins while those targeting white blood cells are leukotoxins. They include hemolysins α , β and γ and several leucocidins including Pantone-Valentine leukocidin (PVL) and leukotoxin E/D (LukE/D) (Otto 2014). The best-known PFT is α -hemolysin, produced by 80-90% of *S. aureus* strains and encoded by the *hla* gene. These toxins form β -barrel pores in the cytoplasmic membranes of target cells and cause leakage of the cell's content (when at low doses) and cell lysis (at high doses) (Foster 2005; Langzhou Song, " Michael R. Hobaugh," Christopher Shustak, Stephen Cheley, Hagan Bayley 1996). The secretion of these toxins allows the bacteria to lyse a large number of host cell types such as erythrocytes, monocytes, macrophages, platelets, leukocytes, endothelial and epithelial cells by forming pores in the plasma membrane of target cells (Bayer et al. 1997; Bhakdil 1991; Finck-Barbançon et al. 1993; Jayasinghe and Bayley 2005; Lin and Peterson 2010).

Receptor-independent PFTs include in particular the family of Phenol-Soluble Modulins (PSMs) and delta-hemolysins (Hld). Hld is encoded by *hemolysin δ* gene, which is located in the coding sequence of RNAlII, a major riboregulator of virulence of *S. aureus* (Janzon and Arvidson 1990; D. Oliveira, Borges, and Simões 2018; Tam and Torres 2019). As for PSMs, they represent a family of small protein toxins that are soluble in phenol. These are surface-active, amphipathic, and alpha-helical peptides, which are classified in different groups based on their length (Andreas Peschel; Michael Otto 2016; Donvito et al. 1997; Mehlin, Headley, and Klebanoff 1999; Watson et al. 1988): (I) PSMs type α and Hld, and (II) PSMs type β . Through their physicochemical properties, they have been shown to be essential for the structuring of biofilms formed by *S. aureus*, as well as for the detachment step allowing the dissemination of bacteria (Periasamy et al. 2012). All PSM α s have been shown to actively participate in the escape of *S. aureus* from the

Table 3_ Virulence regulators (Adapted from Jenul and Horswill, 2018)

TYPE	REGULATION SYSTEM	TARGETS REGULATION	FUCTIONS	REFERENCES
Two components system	Agr (accessory gene regulator)/ RNAIII	Activation of several exoenzymes and exotoxins Repression of surface proteins	Transition from colonisation to infection Intrecellular survival	Peng et al. 1988; Katherine Y. Le and Michael Otto, 2015; Jenul et al. 2018; Tan L. et al. 2018
	SaeRS (staphylococcal accessory element locus)	Induction of exotoxins and adhesins production	Biofilm formation; Adhesion; Immune evasion	Giraud A.T. et al. 1994; Haag A.F. et al. 2015; Liu Q. et al. 2016; Jenul et al. 2019
	SrrAB (staphylococcal respiratory regulator)	Regulation under low oxygen Induction of <i>plc</i> and <i>ica</i> expression Repression of <i>agr</i> , <i>tsst-1</i> and <i>spa</i>	Aerobie: Hydroxide resistance Anaerobie: Biofilm formation	Yarwood J.M. et al. 2001; Haag A.F. et al. 2015; Jenul et al. 2019; Pragman et al. 2020
	ArlRS (autolysis-related locus)	Autolysis and cell surface TCS Induction of <i>mgrA</i> expression Repression of <i>agr</i>	Autolysis Bacterial growth and division Bacterial adhesion	Fournier B. et al. 2000; Fournier B. et al. 2001; Haag A.F. et al. 2015; Jenul et al. 2019
	LytRS	Induction of <i>irgA</i> and <i>irgB</i> expression	Regulation of autolysis Biofilm formation Reduction of penicillin resistance	Sharma-Kuinkel B.K. et al. 2009; Haag A.F. et al. 2015
	WalkR	Regulation (direct or via SaeRS) of several of virulence genes (toxins, immune evasion)	Induction of autolysis and biofilm formation, regulation of some virulent determinants	Howden B.P. et al. 2011; Delaune A et al. 2012; Haag A.F. et al. 2015
	VraRS (vancomycin-resistance associated sensor/regulator)	Activation of <i>pbp2</i> (penicillin-binding protein 2)	Regulation of cell-wall biosynthesis pathway; Reduction of susceptibility to antibiotics	Kuroda et al. 2003; Yin S et al. 2006; Pietiainen et al. 2009
Global transcriptional factors	GraSR (Glycopeptide Resistance Associated)	Regulation of <i>mprF</i> , <i>dlt</i> and <i>vraFG</i> operons	Regulator of CAMP resistance Stress response and cell wall metabolism signal transduction pathways	Falord et al. 2011
	YycFB	Potential regulation of <i>ssaA</i> (staphylococcal secretory antigen)	Cellular permeability regulation Resistance to macrolides	Martin et al. 1999; Dubrac and Msadek, 2004
	Caseinolytic protease (ClpX, ClpP, ClpC)	ClpX induces <i>hla</i> and <i>sspA</i> expression ClpP regulates several surface proteins, exoproteins and TCS (<i>alrRS</i> , <i>mgrA</i> , <i>sigB</i>)	ClpX, ClpP required for virulence ClpC involved in biofilm formation, stress resistance	Frees et al. 2004 Michel et al. 2006 Becker et al. 2001; Chatterjee et al. 2005
	SvrA (staphylococcal virulence regulator)	Regulation of <i>agr</i> expression Upregulation of <i>hla</i> , <i>hlb</i> , <i>hld</i> , <i>spa</i> expression	Regulation of hemolysins production	Garvis et al. 2002
	MsrR (methionine sulfoxide reductase)	Repression of <i>sarA</i> expression	unknown, required for virulence?	Moskovitz et al. 2002; Rossi et al. 2003
	CvfA, CvfB (conserved virulence factors)	CvfA: represses <i>spa</i> , upregulates RNAIII and hemolysins expression CvfB: represses <i>spa</i> , upregulates RNAIII	unknown, required for virulence?	Kaito et al. 2005; Matsumoto et al. 2007; Makito Nagata et al. 2008; Matsumoto et al. 2010
	CcpA (catabolite control protein A)	Repression of <i>spa</i> expression in the presence of glucose Activation of <i>agr</i> P3	Regulation of virulence determinants and antibiotic resistance Biofilm formation	Seidl et al. 2006; Seidl et al. 2008; Ueda et al. 2011
Global transcriptional factors	Aconitase	Regulation of <i>geh</i> , <i>sec</i> , <i>plc</i> , <i>hla</i> , <i>hlb</i> , <i>agr</i> P3 expression	unknown, required for virulence?	Somerville et al. 2002b
	Msa (modulator of SarA)	Repression of <i>aur</i> , <i>sspA</i> expression Upregulation of <i>fnpA</i> , <i>sarA</i> expression	unknown, required for virulence?	Sambanthamoorthy et al. 2006
	HtrA (high temperature requirement)	Regulation of secreted factors (hemolysins)	Regulation in stress response and bacterial dissemination	Rigoulay et al. 2005
	CodY	Repression of <i>agr</i> P1, <i>hla</i> , <i>ica</i> operon	Amino acid biosynthesis, transport of macromolecules, and virulence	Majerczyk et al. 2010
	Fur (Ferric uptake regulator)	Regulate iron uptake genes (<i>fhuC</i> , <i>fhuD2</i> , <i>sirABC</i>); Upregulates <i>kata</i> transcription	Iron uptake, virulence, catalase-mediated oxidative stress resistance	Horsburgh et al. 2001

immune system by promoting its exit from the phagolysosome (Grosz et al. 2014; Münzenmayer et al. 2016). Furthermore, PSM α 1-4, encoded by the *psma* locus (especially PSM α 4), are strongly cytolytic. Recent studies have shown their contribution in the lysis of neutrophils after phagocytosis of particularly virulent strains of *S. aureus* such as isolates of community origin and resistant to methicillin (D. Oliveira, Borges, and Simões 2018; Surewaard et al. 2013); whereas hemolysin δ has moderate cytolytic activity and the PSM β peptides are non-cytolytic (Andreas Peschel; Michael Otto 2016; Otto 2014). In addition, some hospital-acquired methicillin-resistant staphylococci (HA-MRSA) express PSM-mec, which is encoded by *psm-mec* in the SSCmec cassette, and also encodes PSM α (Kaito et al. 2013; Tam and Torres 2019).

2.3. Superantigens (SAGs) and superantigens-like proteins

Superantigens are a group of potent secreted immune-stimulatory proteins capable of inducing a variety of human toxic shock associated diseases. Staphylococcal superantigens are the only toxins that can cause disease by their very presence. They comprise T cell superantigens and B cell superantigens, which are able to trigger T cell and B cell activation and proliferation, respectively. T cell superantigens include such as staphylococcal enterotoxins (SEs), toxic shock syndrome toxin-1 (TSST-1) and exfoliating toxins (Alouf and Alouf 2003; Baker and Acharya 2004; Kreiswirth et al. 1983) and many other “superantigen-like” named SSI (SE-I H to SE-I Y; or SSL-5 and SSL-7); and B cell superantigens such as Spa. Among them, the best-known Sag TSST-1 is responsible for 95% of cases of toxic shock associated with menstruation (mTSS) and 50% of TSS cases caused by nonmenstrual infective foci (nmTSS) (Bohach et al. 1990; Kreiswirth et al. 1983; Sharma et al. 2018), and also involved in the apoptosis of host cells induced by *S. aureus* (Hofer et al. 1996). By creating a non-specific interaction between T cell receptors and complex receptors major class II histocompatibility (MHC II), TSST-1 enables immune response through T cell and this activation causes the production and massive release of pro-inflammatory cytokines responsible for the onset of toxic shock (D. Oliveira, Borges, and Simões 2018). Another case of SAGs are exfoliating toxins, which belong to Serine-protease family and are responsible for a wide spectrum of symptoms,

Table 3_ Virulence regulators (followed)

TYPE	REGULATION SYSTEM	TARGETS REGULATION	FUCTIONS	REFERENCES
The SarA protein family	SarA (staphylococcal accessory regulator)	Induction of exoproteins; Repression of <i>spa</i> , <i>sarR</i> , <i>sarV</i> , <i>sigB</i> ; Activation of <i>agr</i> P2; Repression of <i>SprC</i>	Cytoplasmic regulation; Internalisation in human macrophages	Cheung A.L. et al. 1992; Cheung A.L. et al. 2008; Le Pabic et al. 2015; Jenul C. et al. 2019
	SarR	Repression of <i>agr</i> activity; Act as transcriptional factor for <i>sarA</i> and <i>sarS</i> ; Repression of proteases	Cytoplasmic regulation	Jenul C. et al. 2019
	SarT	Repression of <i>agr</i> P2, <i>hla</i> , <i>sarU</i> ; Induction of <i>sarS</i> and <i>spa</i> expression	Virulence	Schmidt K.A. et al. 2001; Cheung A.L. et al. 2008; Jenul C. et al. 2019
	SarV	Regulation of autolytic genes; Induction of <i>hla</i> , <i>splA</i> , <i>aur</i> , <i>scp</i> expression	Autolysis	Manna A.C. et al. 2004; Cheung A.L. et al. 2008
	SarX	Repression of <i>agr</i> P2 and P3 promotor activity	Stimulation of biofilm formation	Cue D. et al. 2013
	SarZ	Repression of <i>SspA</i> production; Activation of <i>agr</i> P2 and P3; Repression of <i>SarS</i>	Regulation of biofilm formation; Induction of hemolytic activity	Kaito C. et al. 2006; Cheung A.L. et al. 2008; Tamber S. et al. 2009
	SarS	Activation of <i>spa</i> transcription and other surface proteins (ETA)		Oscarsson, J. et al. 2006
	SarU	Activation of <i>agr</i> P2 and P3 promotors activity	Enhance virulence; Regulation of autolysis	Manna A.C. et al. 2004; Cheung A.L. et al. 2008; Jenul C. et al. 2019
	SarY	unknown	unknown	Cheung A.L. et al. 2008; Jenul C. et al. 2019
		MgrA/ Rat	Induction of efflux pumps (<i>NorA</i> , <i>B</i>) and capsule expression; Activation of <i>sarZ</i> , <i>sarX</i> , <i>sarS</i> ; Repression of surface proteins	Cytoplasmic regulator
	Rot (repressor of toxins)	Repression of toxins expression; Induction of extracellular proteases	Virulence	Said-Salim B. et al. 2003; Jenul et al. 2019
	TcaR (Teicoplanin associated locus Regulator)	a weak negative regulator of <i>ica</i> locus	Biofilm formation?; Modulator of resistance to teicoplanin and methicillin	Jefferson et al. 2004; Brandenberger et al. 2000
Sigma factors	sigmaA	Regulation of housekeeping genes	Adaptation to environmental changing conditions	Bischoff M. et al. 2004; Jenul C. et al. 2019
	sigmaB	Repression of <i>agr</i> activity		Bischoff M. et al. 2004; Jenul C. et al. 2019
	sigmaS	Autoregulation	Adaptation to stress response and bacterial survive	Shaw L.N. et al. 2008; Miller et al. 2012
	sigmaH	Regulation of phage integrase; Regulation of ComK regulon	Uptake of exogenes involved in virulence	Tao et al. 2010; Morikawa K. et al. 2012; Fagerlund et al. 2014

ranging from localized lesions to scalded skin syndrome (SSS) (Bukowski, Wladyka, and Dubin 2010; Ladhani 2003; Lee et al. 1987; Tam and Torres 2019).

D. Virulence regulators

Through different illustrations above, we can see that *S. aureus* possesses a large arsenal of cell wall and extracellular components involved in the virulence of the bacterium. The diverse range of these virulence factors implies that the pathogenicity of *S. aureus* is a complex process requiring an organized expression of these factors during different stages of infection (i.e. colonization, immune evasion, growth and cell division, bacterial dissemination). Indeed, *S. aureus* firstly upregulates the expression of genes coding for surface proteins involved in adhesion and defense against the host immune system; and only late in infection it starts to upregulate the production of toxins that facilitate tissue propagation. To control the production of the virulence determinants during infection, *S. aureus* employs several regulatory systems that respond to bacterial cell density (quorum sensing) and environmental signals (e.g. pH, osmolarity, and nutrient availability, temperature, and oxygen tension). These regulatory systems can be divided into five broad categories: two-component signal transduction systems, global transcriptional regulators, the SarA protein family, the sigma factors and the most recent group is regulatory RNAs (sRNAs). Here, we only describe several major regulator systems; however, all regulatory systems with their putative functions are listed concisely in Table 3.

1. Two-component signal transduction systems (TCS)

About sixteen TCS have been identified in *S. aureus* (reviewed in (Jenul and Horswill 2019)). Extracellular signal receptors are a major source of information on external environmental conditions and allow *S. aureus* to adapt to changing environmental conditions. As the name suggests, TCS works with a “sensor” molecule from the external environment and a “response” element which, when is activated, allows the bacteria to control the expression of specific RNA and/or proteins in order to respond accordingly to exposure to environmental stresses. For instance, one of the classic TCS is the

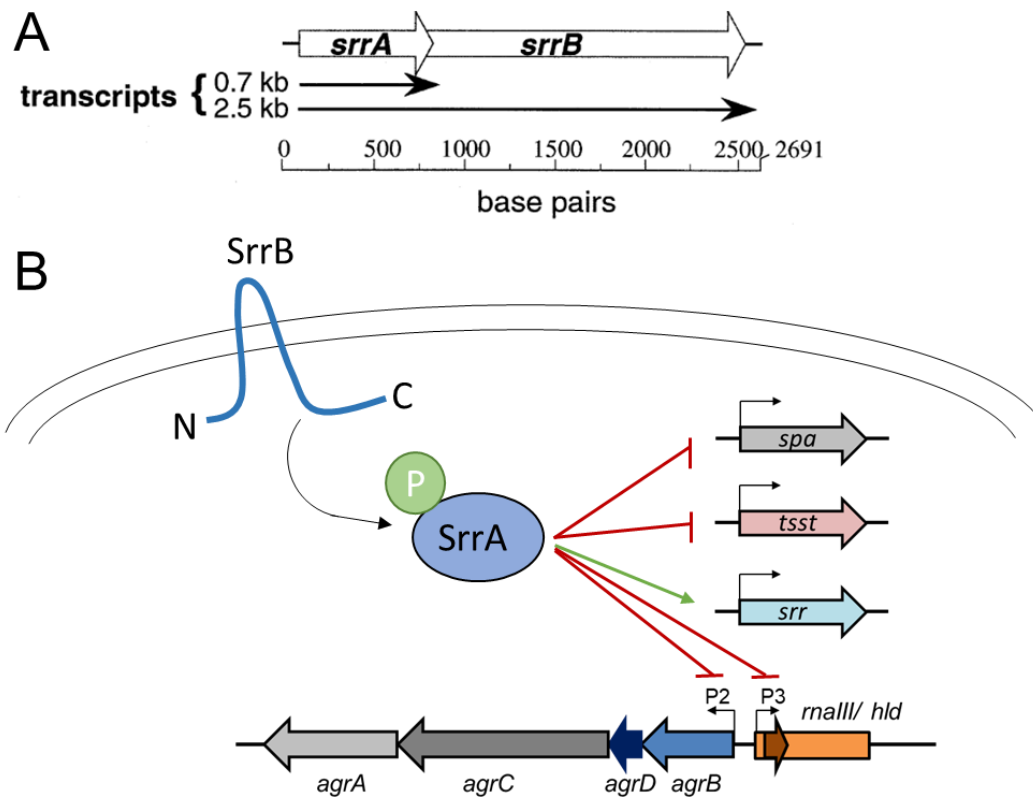

Figure 13. Two component system SrrA/ SrrB. (A) Genomic organization of *srrA* and *srrB* genes (J. M. Yarwood, McCormick, and Schlievert 2001). (B) Mode of action of SrrA/ SrrB. SrrB is found in the membrane while SrrA is in the cytoplasm. Upon signalling, SrrB is auto-phosphorylated and transfers a phosphate to SrrA. SrrA~P binds the *spa*, *srr*, *tst* and *agr* promoters. The green arrows indicate the positive regulation of SrrA, and the red one for repressive regulation (Adapted from Pragman and Schlievert 2004).

staphylococcal respiratory response AB (SrrAB) (Haag 2015; Tiwari et al. 2020; J. M. Yarwood, McCormick, and Schlievert 2001). *srrA* encodes a 28-kDa, 241-amino-acid response regulator, and *srrB* a 66-kDa, 583-amino-acid histidine kinase. The response regulator, SrrA, localizes in the cytoplasmic and SrrB, the transmembrane histidine kinase, localizes on the membrane. SrrAB seems to respond to oxygen levels. Once SrrB has received the signal, it is auto phosphorylated and associated with SrrA, allowing the phosphorylation of SrrA. This modification in SrrA alters the DNA-binding activity of this response regulator to the promoter regions of the *agr*, *spa* and *tst* loci and consequently alters the transcription of these genes (Pragman and Schlievert 2004) (Figure 13). However, among all TCS studied, two major illustrations are the accessory gene regulator system (*agr*) and the staphylococcal accessory element system (*sae*).

First, the *agr* system has been extensively studied since its discovery several decades ago by (Mallonee, Glatz, and Pattee 1982). This system is also called the quorum sensing system, due to its implication in the regulation of different virulence genes, according to the bacterial density during the infection (Richard P. Novick 2003). The *agr* locus occurs as two divergent transcription units (G. Y. C. Cheung et al. 2011; Peng et al. 1988). The first produces an RNA molecule called ARNII, which encodes four proteins, AgrA, B, C and D. The other a transcript is a sRNAs called RNAIII containing the hemolysin-delta gene (*hld*) (Morfeldt et al. 1995; R. P. Novick et al. 1993) (Figure 14A). The *agrD* transcript encodes a peptide precursor of the extracellular quorum signal of Agr, called auto-inducing peptide (AIP) (Lyon et al. 2002). The *agrB* gene product is a transmembrane endopeptidase responsible for exporting of the AIP (L. Zhang, Lin, and Ji 2004). The *agrC* and *agrA* genes encode a two-component signal transduction system with AgrC as histidine kinase sensor and AgrA as its associated response regulator (R. P. Novick et al. 1995; Queck et al. 2008). When extracellular concentration of AIP passes the threshold, AIP binds to AgrC and leads to its own auto-phosphorylation, following by the phosphorylation of AgrA (R. P. Novick et al. 1995; Queck et al. 2008; Roux et al. 2014). It can up-regulate the expressions of several exoproteins (e.g., α -, β -, γ -hemolysin, and leukotoxins), lipases, phenol-soluble modulins, and toxic shock syndrome toxins (TSST), and represses the transcription of some cell wall-associated proteins (e.g., protein A,

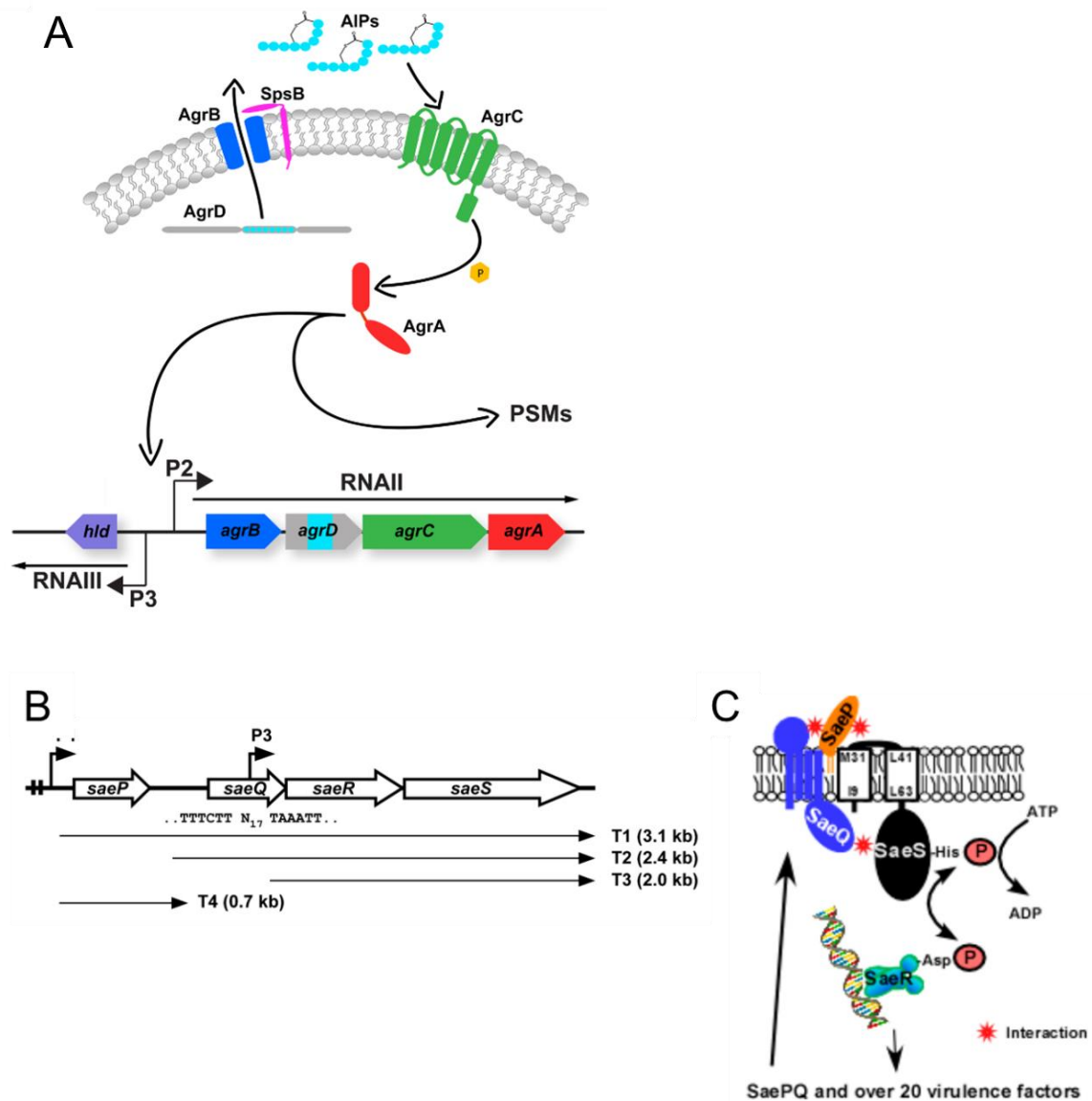

Figure 14. Two component systems. (A) The Agr system. The pro-AIP peptide is processed and secreted by AgrB, binds to an extracellular loop in the receptor-HPK (AgrC), activating autophosphorylation (or dephosphorylation), followed by phosphorylation or dephosphorylation of the response regulator, AgrA, which activates the two agr promoters, P2 and P3, leading to the production of RNA III (Jenul and Horswill 2018). (B) Organization of the sae operon. (C) The proposed mode of action of the Sae system. Upon exposure to signal(s), SaeS auto-phosphorylates and then transfers the phosphoryl group to SaeR. The phosphorylated SaeR binds to its binding sequence and activates transcription from target promoters including the saeP1 promoter. From saeP1, SaeP and SaeQ are produced and bind to SaeS in the membrane. As a lipoprotein, SaeP is expected to interact with the extracellular linker peptide of SaeS. On the other hand, SaeQ is thought to interact with the cytoplasmic domain of SaeS (Q. Liu, Yeo, and Bae 2016).

coagulase, and fibronectin binding protein) (Bronner, Monteil, and Prévost 2004; Le and Otto 2015). Through the genes it regulates, the quorum sensing Agr system is causally linked to the pathogenesis of *S. aureus* in skin and tissue infections, via the expression of toxins, but also in endocarditis, pneumonia, and osteomyelitis via its involvement in the biofilm life cycle (Boles and Horswill 2008; D. Oliveira, Borges, and Simões 2018; Vuong et al. 2004). As for the regulation of *agr* locus expression, some members of the SarA transcription factor family can regulate *agr*, including SarA and MgrA (positively) as well as other regulators like CodY (negatively). The other two-component systems also influence *agr* expression including SaeRS and SrrAB (reviewed in (Jeremy M Yarwood and Schlievert 2003)).

Next, the *sae* system is a two-component system with four elements: SaeP, SaeG, SaeR and SaeS. However, only SaeR and SaeS are identified as the response regulator and histidine kinase sensor (A. T. Giraudo et al. 1994; Rogasch et al. 2006) (Figure 14B and C). Besides its implication in biofilm formation (Haag 2015; Jenul and Horswill 2019; Q. Liu, Yeo, and Bae 2016), the system also regulate a wide range of virulence factors involved in bacterial adhesion, toxicity, and immune evasion. For instance, Sae system activates the expression of several hemolysins (*hla*, *hlb*, *hld*) and coagulase (Ana T. Giraudo, Cheung, and Nagel 1997; Goerke et al. 2005), and represses some exoenzymes (*plc*, *sspA*, *aur*) (Rogasch et al. 2006).

From then, many more TCSs have been discovered: ArIRS system potentially involved in cell division and adhesion (Fournier, Klier, and Rapoport 2001), LytRS and WalkS systems in biofilm formation (Dubrac et al. 2007; Sharma-Kuinkel et al. 2009) etc. (Table 2).

2. Global transcriptional regulators

The mechanism by which the expression of virulence factors are regulated by *S. aureus* are complex and are not completely elucidated. The regulation of *S. aureus* pathogenicity is achieved by different pathways, by the quorum-sensing accessory gene regulator, *agr* system, or by the family of winged helix DNA-binding proteins of SarA family, or the nutritionally controlled regulators. These latter global regulators act as a sensor of the

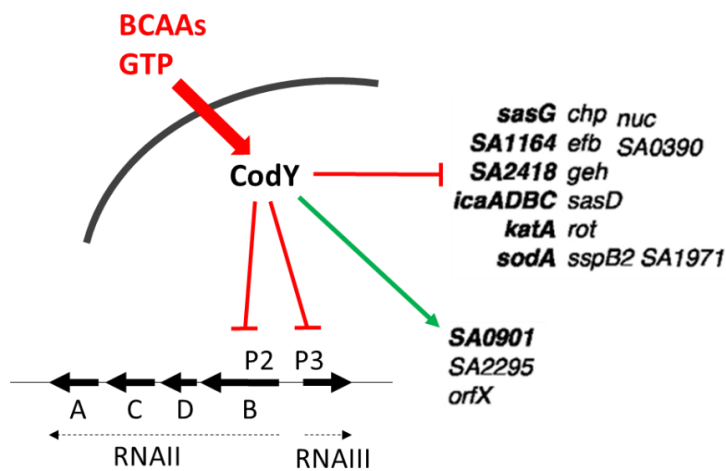

Figure 15. Model of CodY regulation. An important intracellular concentration of BCAAs and GTP activates CodY activity. Genes shown in boldface are direct targets of CodY-mediated regulation. Other genes regulated by CodY indirectly through its effect on the *agr* locus (Adapted from Boisset et al. 2007; Camargo and Gilmore 2008; Majerczyk et al. 2010).

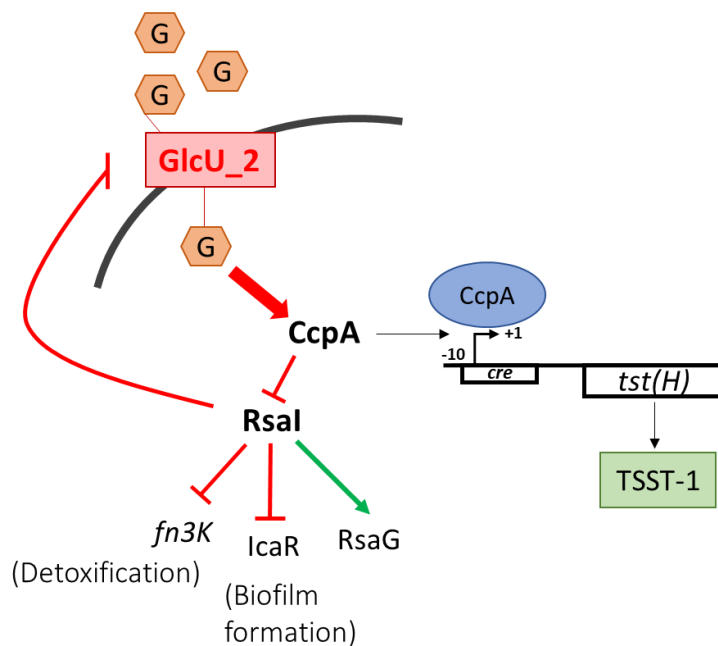

Figure 16. Model of CcpA regulation. Catabolite control protein a (CcpA) binding to its cognate cis-acting *cre* site mediates additional *tst* repression and restrains the production of TSST-1. At high concentration of glucose, CcpA also regulates another sRNA, RsaI, and its mRNA targets (Adapted from Diego O. Andrey et al. 2015; C. Caballero, 2018).

nutritional status of the bacterium, and contribute to the decision by *S. aureus* of “when and in what amounts” to express toxins, adhesins involved in biofilm formation, etc.

CodY was first discovered in *B. subtilis* and *L. lactis* as a regulator to metabolic genes involved in nitrogen and nucleotide metabolism (Molle et al. 2003; Sonenshein 2005), before being emerging as a highly conserved regulatory protein of virulence in *S. aureus* (Pohl et al. 2009) (Figure 15) According to genome-wide analysis in (Majerczyk et al. 2010), CodY regulates virulence genes through three different mechanisms: (I) *agr* expression-dependent regulation such as *cap*, *spa*, *fnbA* and *coa*; (II) direct regulation by CodY, (III) *hla* and capsule synthesis (like *ica* operon) (Majerczyk et al. 2010). One of the most well-known target of CodY is *agrBCDA* operon (Roux et al. 2014). At the exponential phase of bacterial growth, when the intracellular concentrations of branched-chain amino acids (BCAAs) and GTP are important, CodY binds to P2 and P3 promoters and represses the transcription of *agr* operon and *rnalIII* (Roux et al. 2014).

Another global regulator is CcpA encoding for catabolite control protein A that belongs to global regulatory of the carbon catabolite repression (CCR), which is involved in carbon utilization and metabolization of the preferred carbon source (i.e. glucose). In the early 1990s, CcpA was first studied in *B. subtilis* for its specific binding to DNA sequence, *cre* (for catabolite-responsive element) (Henkin 1996), and later was demonstrated on *S. xylosus* (Jankovic and Brückner 2002). However, little was known for this repressor in *S. aureus* until the 2000s. CcpA was demonstrated to involve in the virulence determinants regulation such as *RNALIII*, *hla* and *spa* (Seidl et al. 2006, 2008, 2008, 2009; Ueda et al. 2011) and recently was showed to regulate an sRNA implicated in the bacterial response to glucose consumption, RsaI (D. Bronesky et al. 2018). In addition, CcpA also represents an auxiliary factors reported to reduce methicillin resistance in *S. aureus* strain COL (De Lencastre et al. 1999) and is required for promoted colony spreading in *S. aureus* (Ueda et al. 2011) (Figure 16).

Yet another global regulator, Fur (Ferric uptake regulator), is one of the four distinct families of metallo-regulatory proteins, beside DtxR (diphtheria toxin repressor), MerR, and ArsR (Fuangthong and Helmann 2003; Troxell and Hassan 2013). Firstly purified from

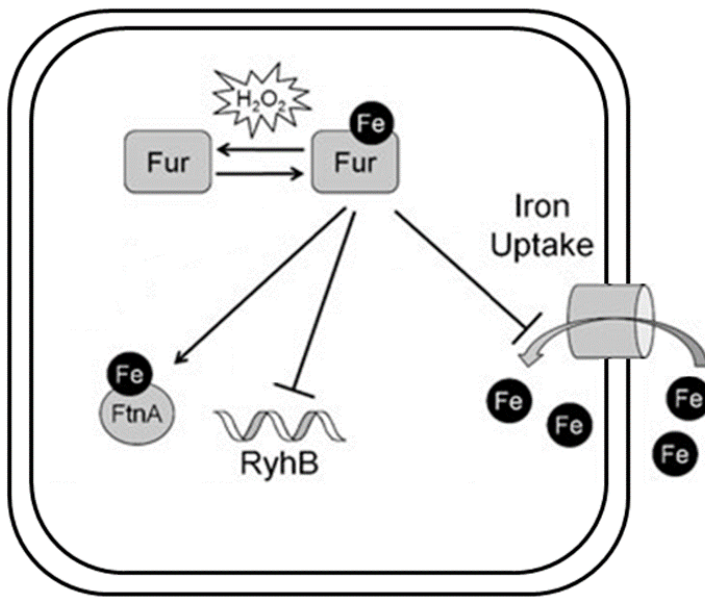

Figure 17. Model of Fur regulation in *E. coli*. In iron-rich environments, Fur functions as a dimer, bound to Fe²⁺ and represses RyhB expression, resulting in repression of target genes and in restraining the iron uptake (Adapted from Faulkner and Helmann 2011).

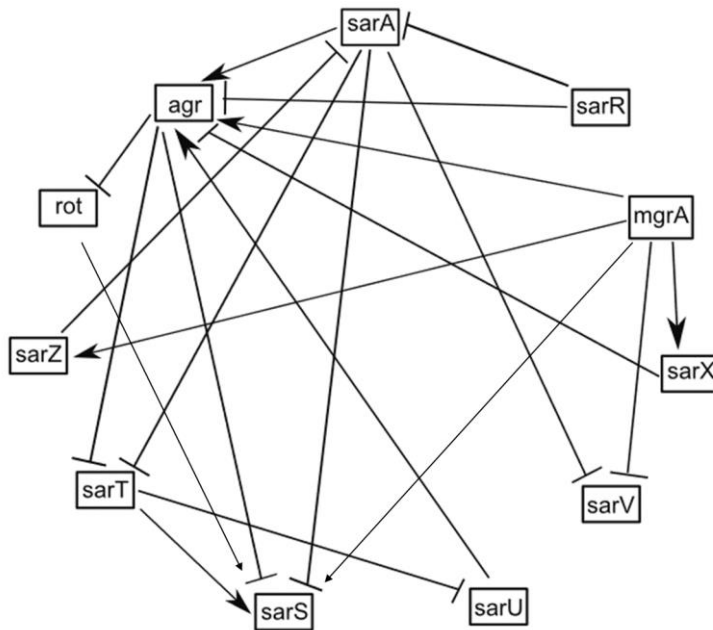

Figure 18. The SarA protein family. Inter-regulation of transcription factors of the Sar family. Arrows represent activation and barred lines interrupted arrows for repression (Adapted from Junecko J et al. 2012 and Bronner S et al. 2004).

E. coli in 1988, Fur was demonstrated to function as a dimer in the presence of iron, one of the essential elements required for the growth and the metabolism of prokaryotes (Carpenter, Whitmire, and Merrell 2009; Chandrangsu, Rensing, and Helmann 2017; Hantke 2001). Fur utilizes Fe²⁺ as a cofactor and not only represses expression of iron acquisition genes in the presence of iron (Horsburgh, Ingham, and Foster 2001), but also sRNA in *E. coli* (Massé and Gottesman 2002) (Figure 17). In many bacteria, a paradigm being RyhB in *E. coli*, an iron-sparing sRNA, negatively regulating many mRNAs encoding dispensable iron-related proteins (Chareyre and Mandin 2018) with functional homologs in many bacteria (Oglesby-Sherrouse and Murphy 2013). In *S. aureus*, however, no such iron responsive sRNA was identified until now. Furthermore, since iron and heme-iron overloads are toxic for the bacteria, most of them have developed additional regulatory mechanisms that fine-tune the acquisition and metabolism of iron and heme-iron in the absence of Fur repression (Laakso et al. 2016), as well as mechanisms to export iron excess, such as the Heme Responsible Transporter (HrtAB) (Stauff et al. 2008).

3. The SarA protein family

The SarA protein family has the particular structure of a three-dimensional “winged-helix”, composed of 3 α -helices and 3 β -sheets, allowing the protein to bind to nucleic acids (Ambrose L. Cheung et al. 2008). SarA was the first transcriptional factor discovered by (A. L. Cheung and Projan 1994). The *sarA* gene is under the control of three different promoters (P1, P2 and P3), resulting in the transcription of three transcripts but the constitutive production of a single protein (Ambrose L. Cheung et al. 2008; Jenul and Horswill 2019). SarA has been shown to regulate the expression of multiple virulence factors. For instance, SarA upregulates *tst*, *hla*, *hly* and *hld* transcription and downregulates the transcription of *sak* and *spa* (Ambrose L. Cheung et al. 2008; Ziebandt et al. 2001). In addition to SarA, there are 11 other transcriptional factors, identified as homologues of SarA, such as Rot, MgrA/Rat, SarS, SarR, SarZ, SarT, SarU, SarV, SarX, SarY and TcaR (reviewed in (Jenul and Horswill 2019)) and their regulatory networks intersect (Figure 18). For instance, MgrA plays a role in the activation of *sarZ*, *sarX* and *sarS* expression, apart from controlling the expression of several virulence factors like *hla*, *coa*,

spa (Jenul and Horswill 2019; Luong, Newell, and Lee 2003). Another example is one of the most well-known transcriptional factors of SarA-like family, Rot (Repressor of toxins), which favors the expression of SarS. Rot also upregulates the expression of several surface proteins (Spa) and inhibits the expression of some secreted factors (ETB, Hla, several proteases and toxins, which is the opposite of the Agr system (Jenul and Horswill 2019; Saïd-Salim et al. 2003).

4. Sigma factors

Sigma factors comprise major sigmaA (σ A) and three alternative sigma factors: sigmaB (σ B), sigmaH (σ H) and sigmaS (σ S) (Gruber and Gross 2003; Mittenhuber 2002; Morikawa et al. 2003; L. N. Shaw et al. 2008; Tao, Wu, and Sun 2010; Wu, De Lencastre, and Tomasz 1996). They are involved in the initiation of transcription by binding to the core RNA polymerase to form the holoenzyme that binds to specific promoters and allow the bacteria to adapt quickly to stress and express specific virulence factors when required during infection. The primary sigma factor, σ A, is responsible for the expression of housekeeping genes essential for growth. The alternative sigma factor H (σ H) has been shown to modulate the transcription of phage integrase (*int*), to stabilize the lysogens in the host cell (Tao, Wu, and Sun 2010); while σ S activation enhances the severity of infection, the immune response, and the survival of *S. aureus* in mouse infection model (Miller et al. 2012; L. N. Shaw et al. 2008). However, among alternative sigma factors, the most well-studied, σ B, has been demonstrated to control a large panel of genes involved in cellular functions (e.g. stress response). At least 30 virulence genes implicated in biofilm formation, cellular internalization, antibiotics resistance, *etc.* (Bischoff et al. 2004; Jenul and Horswill 2019), were regulated by σ B through recognizing and binding to a consensus sequence (GTTTAA-12-15-GGGTAT) located in the promoter region of its target genes (Homerova et al. 2004).

5. Regulatory RNAs

In addition to proteins that regulate virulence factors, there are RNAs that are involved in the regulation of virulence factors and in the rapid adaptation of bacteria to different

Table 4_sRNAs involved in *S. aureus* virulence

sRNAs	TARGETS REGULATION	FUCTIONS	REFERENCES
RNAIII	Repression of <i>spa</i> , <i>coa</i> , <i>rot</i> , <i>ssaA</i> , <i>ecb</i> , <i>lytM</i> , <i>sbi</i> <i>ltaS</i> expression Activation of <i>hla</i> , <i>map</i> and <i>mgrA</i> expression	Highly involved in <i>S. aureus</i> virulence	Novick et al. 1993; Boisset et al. 2007; Broneskey et al. 2016; Raina et al. 2018
Ssr42	a main effector of Rsp- <i>hla</i> regulation	Involved in hemolysis and immune evasion	Morrison et al. 2012b; Das et al. 2016; Horn et al. 2018
SprD	Repression of <i>sbi</i> mRNA translation	Involved in immune evasion	Chabelskaya et al. 2010; Chabelskaya et al. 2014
ArtR	Upregulation of <i>hla</i> mRNA Repression of <i>sarT</i> mRNA	Involved in virulence and degradation of sarT	Xue et al. 2014
RsaA	Repression of <i>mgrA</i> , hydrolases and immunomodulatory molecule (FIR) expression	Regulation of virulence, infection and biofilm formation	Romilly et al. 2014
SprC	Repression of <i>atl</i> mRNA (autolysin)	Reduction of phagocytosis and dissemination of <i>S. aureus</i>	Le Pabicet et al. 2015
SprX	Upregulation of <i>clfB</i> and <i>hld</i> expression Repression of <i>ecb</i> expression Upregulation of <i>walR</i> expression	Involved in virulence and cell wall metabolism	Kathirve et al. 2016; Ivain et al. 2017; Buchad and Nair 2021
PSM-mec	Repression of <i>agrA</i> expression	Contribution to staphylococcal pathogenesis and physiology, strain-dependent	Li Qin et al. 2016
Teg49	Repression of <i>spa</i> and <i>saeRS</i> Upregulation of <i>hla</i> and <i>sspA</i>	Involved in penicillin-mediated lysis and in virulence	Adhar C. Manna et al. 2017
Teg41	Enhances PSMa production	Enhances <i>S. aureus</i> virulence	Zaplf et al. 2019
RsaC	Repression of <i>sodA</i> mRNA and response to oxydative stress	Involved in biofilm formation and pathogenicity of <i>S. aureus</i>	Lalaouna et al. 2019
RsaI	Repression of <i>icaR</i>	Involved in biofilm formation	Broneskey et al. 2019
RsaE	Repression of <i>glcU</i> mRNA	Involved in metabolism	
RsaE	Downregulation of <i>oppB</i> and <i>opp-3A</i> , and <i>sucC</i> mRNAs	Involved in metabolism	Geissmann et al. 2009

environmental conditions (Table 4). In *Staphylococcus*, RNAIII is the most well-known riboregulator of various virulence genes. It is the effector of the *agr* system that coordinates expression of *S. aureus* genes based on bacterial density. Although RNAIII remains the most well-known, there are more sRNAs recently studied in the bacterium. Regulatory sRNAs of *S. aureus* will be described in more details in the next chapter.

V. Bacterial small regulatory RNAs

A. The discovery of small regulatory RNAs

To date, there are three main types of “classic” RNAs: messenger RNAs (mRNA), transfer RNAs (tRNA) and ribosomal RNAs (rRNA). The mRNAs are translated into proteins, while the tRNAs and the rRNAs have roles during the translation of the mRNA. tRNAs and rRNAs are non-coding RNAs, meaning that they do not have the information necessary for the synthesis of a protein. However, another type of non-coding RNA has been identified, namely regulatory RNAs (sRNAs). They allow the bacteria to regulate the expression of different factors involved in the adaptation to environmental changes.

In prokaryotes, 6S RNA was among the first regulatory RNAs identified in 1967 from *E. coli* (Hindley 1967) and rapidly sequenced (Bronwlee 1971). However, it took about thirty years to identify its function in sequestering the sigma70 subunit of RNA polymerase (Karen Montzka Wassarman and Storz 2000). Not long after, another sRNA, RNAI, was identified and demonstrated to regulate the replication of the ColE1 plasmid of *E. coli* (Stougaard, Molin, and Nordstrom 1981; Tomizawa et al. 1981) and of the plasmid pT181 in *S. aureus* (Richard P. Novick et al. 1989; Pluta and Espinosa 2018) (See Chapter V/ Section C/ 1.).

In the early 2000s, few regulatory RNAs had been identified in part due to available techniques like computational approaches, which allowed the identification of RNAs using different parameters to define sRNAs (Bronsard et al. 2017; Livny et al. 2008; Mraheil et al. 2010; Pichon and Felden 2005). From then on, more bioinformatics predictions as well as the explosion of high throughput techniques (RNA-seq, DNA micro-

arrays, clonage shotgun) have allowed the identification of many RNAs (Altuvia 2004; Hüttenhofer and Vogel 2006; Kazantsev and Pace 2006; Moore and Sauer 2007). Indeed, advances in high-throughput sequencing analysis have revealed the existence of hundreds of potential regulatory RNAs, although only a fraction of which have been validated *in vivo*. However, the lack of a consensual and fully annotated *S. aureus* genome added to the problem of sRNAs nomenclature. To overcome this matter, Sassi et al. 2015 provided a Staphylococcus Regulatory RNA Database (SRD) that gathers a list of sRNAs identified and validated experimentally throughout the years. Not long after, Bouloc and his team performed *in silico* analysis to identify sRNAs likely to act in trans and to elucidate redundancies in the literature due to the use of different nomenclatures and concluded about 50 *bona fide* sRNAs in HG003 strain, a NCTC825 derivative strain commonly used for *S. aureus* genetic regulation studies (W. Liu et al. 2018). More recently, Carroll's group created an updated *S. aureus* genome annotation report, including annotations for 303 known sRNAs in USA300, associating with publicly available RNA-Seq data sets in order to recover lost information on sRNA expression, stability, and potential to encode peptides (Sorensen et al. 2020).

B. Classification and Mode of action

The discovery and progressive characterization of bacterial sRNAs have revealed various regulatory mechanisms. They can act on different targets: nucleic acids (RNA and DNA) or proteins. According to their mechanism of action, they have been separated into several classes: riboswitches, RNAs regulating proteins, DNAs or RNAs by base-pairings. They can also act at different stages: during DNA replication or repair or gene expression, or at different levels of expression of the target: the transcriptional level, the translational level and/or the stability of the target RNA.

1. Riboswitches

Riboswitches are bacterial-specific, structured noncoding RNA commonly used by bacteria to detect a wide range of metabolites, amino acids, ions and even temperature changing (thermosensors) to regulate genes expression. The majority of the known

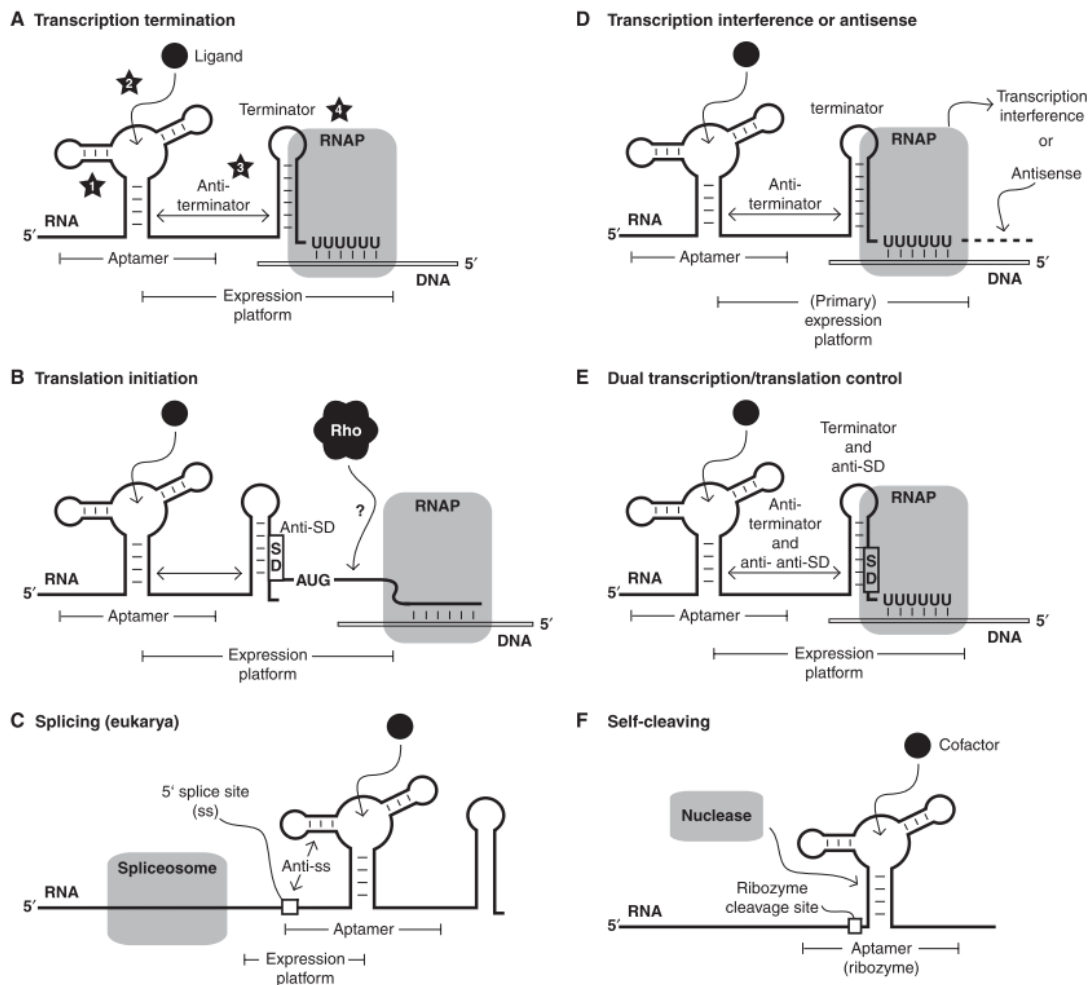

Figure 19. Riboswitches predicted mechanisms.

(A) Transcription termination, (B) Translation initiation, and (C) Splicing control (in eukaryotes) are the most common mechanisms. (D) Transcription interference or possibly antisense action, (E) Dual transcription and translation control, and (F) Ligand-dependent self-cleaving ribozyme action are more rare mechanisms observed or predicted in some bacterial species (from Breaker, 2012).

riboswitches reside in the 5' or 3' UTR of the mRNAs targets and are identified as *cis*-acting RNAs where they control transcription or translation of the targets. They are consisted of two domains: a detection domain (aptamer) which binds to a ligand molecule causing a modification of the conformation of an adjacent expression platform; and a regulatory domain (expression platform) that converts ligand binding into a change in gene expression by adopting an alternative RNA structure (Tucker and Breaker 2005).

So far, there are five established or predicted mechanisms of riboswitch-mediated gene regulation in prokaryotes (reviewed in (Breaker 2012)) (Figure 19). The most common mechanism is the modulation of transcription termination; ligand binding to the aptamer leads to secondary structural modification of mRNA and forms a competitive secondary structure or anti-terminator, which obstructs the transcription and release a nascent RNA; for example, the bacterial response to intracellular Mg^{2+} in *Salmonella enterica*. In low Mg^{2+} concentration condition, the sensor PhoQ activates the response PhoP by phosphorylation; PhoP~P then binds to the promoter of *mtgA* gene and promotes the transcription of this gene, which encodes for protein involved in internalization of Mg^{2+} . In high concentration of Mg^{2+} , Mg^{2+} fixes to the 5' UTR of *mtgA* and blocks the transcription. Another well-known mechanism is the modulation of translation initiation; ligand binding to the riboswitch aptameric provokes in conformation changing and allows the recruitment of the ribosome to the RBS of target mRNA and initiates the translation. For instance, in lactic acid bacteria, S-adenosylmethionine (SAM) has been demonstrated to bind the S_{MK} box within the 5' UTR of *metK* gene and cause a rearrangement of the RNA structure resulting in sequestration of SD and preventing the translation of MetK (SAM synthetase)(Fuchs, Grundy, and Henkin 2006).

In addition, several other interesting mechanisms for riboswitch-mediated gene regulation are ribozymes, which possess a double function: they regulates gene expression in response to a metabolite and catalyze their own cleavage (Winkler and Breaker 2005), and thermosensors that modulate gene translation dependently on the temperature such as the case of *prfA* gene in *L. monocytogenes* (Johansson et al. 2002). At low temperature (under 30°C), the 5' UTR of *prfA* forms a secondary structure that

masks the SD resulting in preventing translation, whereas at high temperature, this secondary structure enables the RBS and allows translation initiation (Johansson et al. 2002). Interestingly, in the same bacterial model, two other riboswitches (SreA and SreB) have been demonstrated to act as noncoding RNAs and to regulate in *trans* the expression of *prfA* in *L. monocytogenes* in response to the presence or the absence of S-adenosylmethionine (SAM) (Loh et al. 2009). Riboswitches of the SAM, SreA and SreB family have been shown to control the expression of the PrfA protein by binding to the 5' UTR of the *prfA* mRNA (Loh et al. 2009). This binding inhibits the translation of *prfA* mRNA which encodes a virulence regulator of *Listeria monocytogenes*.

To date, there are approximately 40 different classes of riboswitches discovered, validated, and modeled with their respective ligands (Mccown et al. 2017). Among them, some of the riboswitches, such as AdoBcl (Adenosyl cobalamin) or SAM or FMN (Flavin mononucleotide) riboswitches, occur the widest number of pathogens like *C. difficile*, *L. monocytogenes*, *S. pneumonia*, *S. aureus*, *E. faecalis* and many more (reviewed in (Bédard, Hien, and Lafontaine 2020)); therefore, they could be excellent potential targets for antibacterial drug treatments (reviewed in (Panchal and Brenk 2021)).

2. sRNAs interacting with proteins

More than a decade of intensive study of small, noncoding RNAs (sRNAs) in bacteria has identified hundreds of sRNAs. A growing and divergent group of sRNAs interact with and modify proteins. By mimicking the structures of RNA or DNA targets, these RNAs bind proteins to inhibit their activity. This is the least well-known class because only a small number of sRNAs have been identified as modulating the activity of proteins.

6S RNA, first discovered in *E. coli* in 1967 by Hindley, is found in most bacteria and its expression/ accumulation is species-specific; some species have multiple 6S RNAs such as *B. subtilis* with two copies whereas *E. coli* only has one copy (Trotochaud and Wassarman 2005). This RNA is a global regulator that downregulates transcription of multiple genes due to its interaction with the primary holoenzyme form of RNA polymerase (RNAP). Indeed, 6S has a highly conserved structure mimicking the

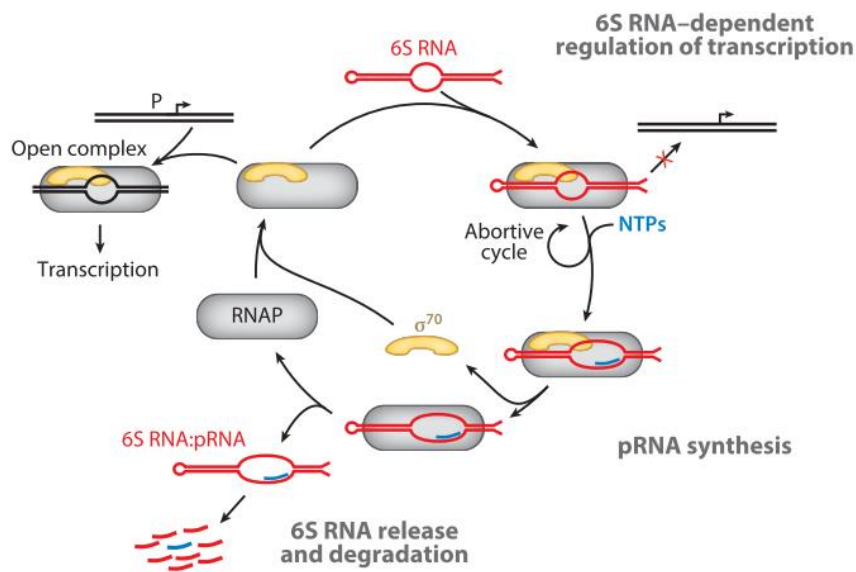

Figure 20. Model for the regulation of 6S RNA function and RNA polymerase availability by pRNA synthesis (Cavanagh and Wassarman 2014).

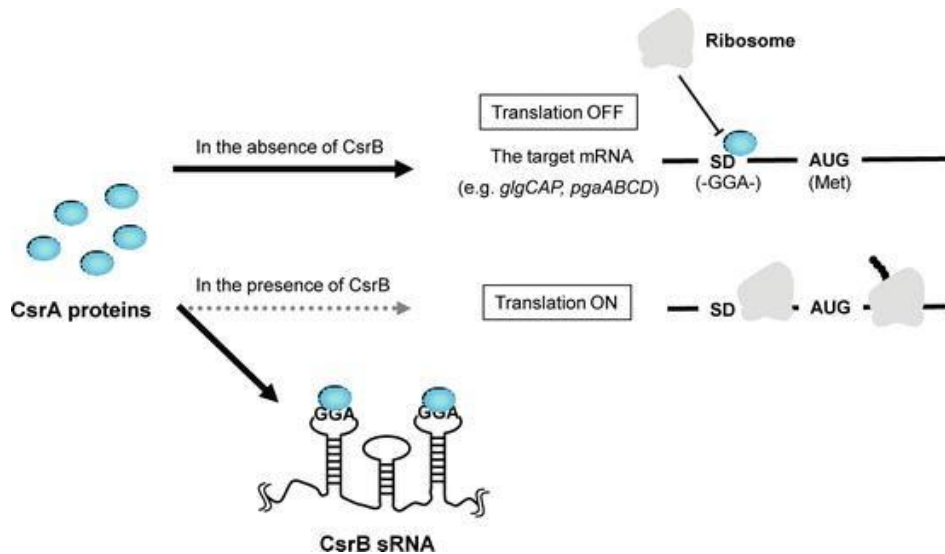

Figure 21. (A) Carbon storage regulator (CsrA) regulation mechanism. In the absence of CsrB, CsrA protein binds to GGA motifs contained in, or in the vicinity of, the Shine–Dalgarno sequence (SD) of various mRNA targets (e.g., *glgCAP* involving in glycogen metabolism, *pgaABCD* involving in biofilm attachment), leading to inhibition of translation initiation and generally to mRNA degradation. In the presence of CsrB, CsrA protein is sequestered by CsrB sRNA and allow CsrA targets to be transcript (from Nameki , Someya and Kawai, 2013) (Ranganathan, Zhao, and Simon 2013).

conformation of a DNA during transcription initiation, which allows 6S to interact with the sigma 70 subunit of RNAP (Cavanagh and Wassarman 2014; Trotochaud and Wassarman 2005) (Figure 20). Moreover, it is suggested that 6S RNA alters the competition between different sigma factors by binding to sigma 70, which might lead to an increase in activity for sigma S-dependent transcription *in vivo* (reviewed in (Cavanagh and Wassarman 2014)). Albeit *E. coli* 6S RNA is important for modulating stress and optimizing survival during nutrient limitation; however, its functions are also species-specific, just like its expression. For instance, 6S RNA has been demonstrated to be associated with bacterial extracellular vesicles (Evs) in *S. aureus* (Joshi et al. 2021). Furthermore, it has been proven *in vitro* and *in vivo*, a synthesis of a short transcript of 14 to 20 nucleotides (RNAP) encoded from 6S RNA by RNA polymerase, although no information on the specific function of this transcript is known (Svensson and Sharma 2016; Karen M. Wassarman and Saecker 2006).

CsrB and CsrC RNAs belong to the carbon storage regulator (Csr) system in *E. coli* and the homologous repressor of secondary metabolites (Rsm), found in other bacteria. CsrB and CsrC are identified as regulatory RNAs that modulate the activity of CsrA (or RsmA in other bacteria), an RNA-binding protein (RBP). This RBP is a pleiotropic regulator of carbon metabolisms and regulates gene expression post-transcriptionally at stationary growth phase. CsrA interacts with GGA sequence motif in the 5' UTR of its mRNA targets and affects ribosome binding and/or mRNA stability (M. Y. Liu et al. 1997; Weilbacher et al. 2003) (Figure 21). As for CsrB and CsrC, their structure contain multiple GGA motifs; when they are sufficiently expressed, they could isolate and antagonize CsrA protein. They have been demonstrated to regulate different metabolic pathways, biofilm formation, motility, virulence circuitry of pathogens, quorum sensing and stress response systems (Cavanagh and Wassarman 2014; Trotochaud and Wassarman 2005; Ul Haq, Müller, and Brantl 2020).

3. sRNAs interacting with DNAs

CRISPR/Cas (Clustered Regularly Interspaced Short Palindromic Repeats-CRISPR Associated Proteins) is part of a new type of prokaryotic regulatory RNAs involved in

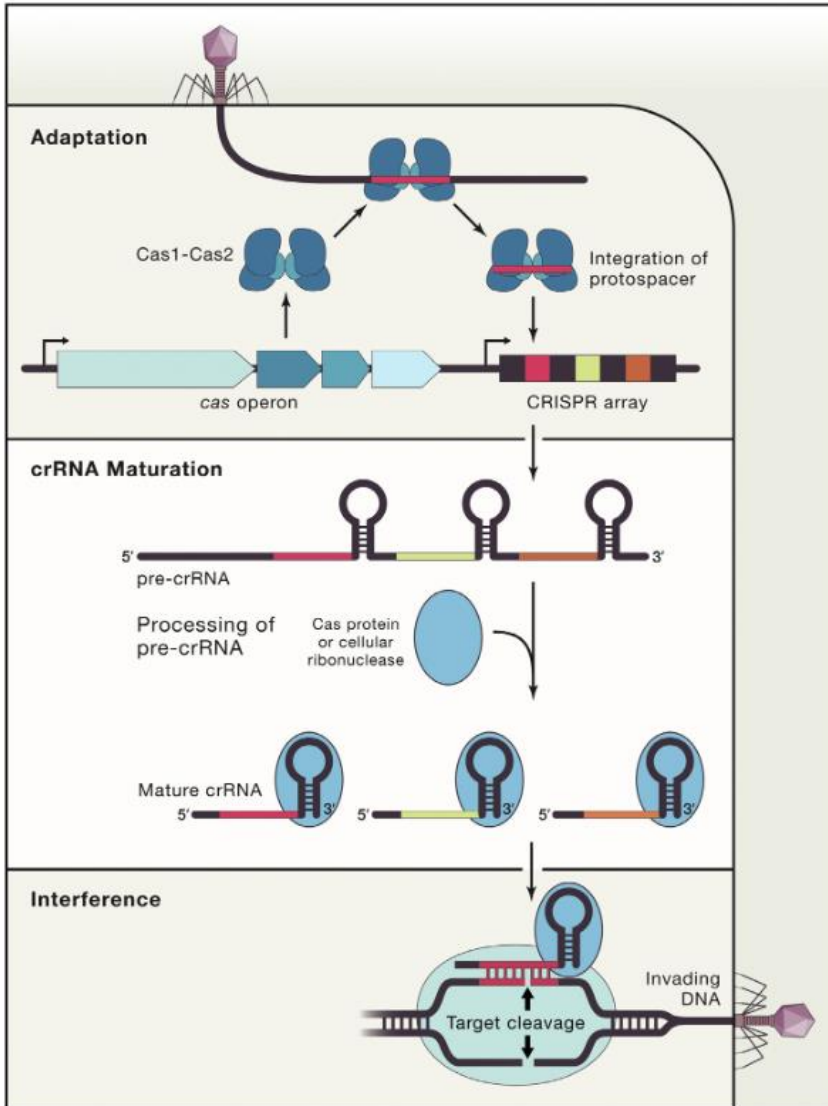

Figure 22. The three stages of CRISPR/ Cas system. During Adaptation, Cas1-Cas2 complex selects part of the foreign DNA to integrate into the host's CRISPR array. Next, for the processing stage, the CRISPR locus is transcribed into a single pre-crRNA (CRISPR RNA) which will be matured to produce a collection of small crRNA. In the interference stage, the mature crRNAs associates with Cas nucleases to cleave the foreign nucleic acid upon binding of the crRNA to the target sequence (Hille et al. 2018).

adaptative bacterial immunity. CRISPR loci represent a repeating family of DNAs found in 45 % of bacterial genomes and in 85 % of archaeal genomes and is categorized by *cas* gene into 6 types among which, type I, II and V target DNAs (McGinn and Marraffini 2018). CRISPR loci are composed of a leader RNA, "direct repeat" and spacers. The leader sequence is located at 5' end of each CRISPR, directly adjacent to the first direct repeat, and is often rich in A+T residues. These repeated sequences are sometimes partially palindromic, which allows them to form very stable secondary structures (Kunin, Sorek, and Hugenholtz 2007) and are separated by portions of variable DNA sequence called "spacers". The spacers correspond to captured viral or plasmid segments that are acquired from foreign DNA or plasmids or viruses during adaptation or immunization. Their number can reach several hundred units but most loci contain less than 50 (Horvath et al. 2009).

CRISPR/Cas mechanism is based on the acquisition of foreign genes through the recognition and specific degradation of foreign genetic elements (Makarova et al. 2006) (Figure 22). CRISPR systems work in association with genes encoding Cas proteins, which are adjacent to each CRISPR loci (Jansen et al. 2002). The *cas* genes code for a large family of proteins heterogeneous which contain functional domains typical of nucleases, helicases, and polynucleotide binding proteins (Haft et al. 2005). When phage invades a bacterium, phage nucleic acids proliferate in the cell and new phage particles are produced, leading to the death of the majority of susceptible bacteria. This immune function is executed in a three-stage process: (I) Adaptation, (II) Processing and (III) Interference. First, a small number of bacteria acquire spacers derived from these invading foreign nucleic acids giving them immunity (Adaptation). This immunity is linked to the recognition and degradation by the CRISPR-Cas system of foreign nucleic acids. Then, the CRISPR locus is transcribed into a single pre-crRNA (CRISPR RNA) which will be matured to produce a collection of small crRNA (CrRNA Biogenesis) (Processing). Each crRNA, in association with Cas proteins forms the CRISPR-Cas system. Small crRNAs recognize and interact by sequence complementarity with phage nucleic acids causing their degradation (Interference) (reviewed in (Faure et al. 2019; Samson, Magadan, and Moineau 2015)).

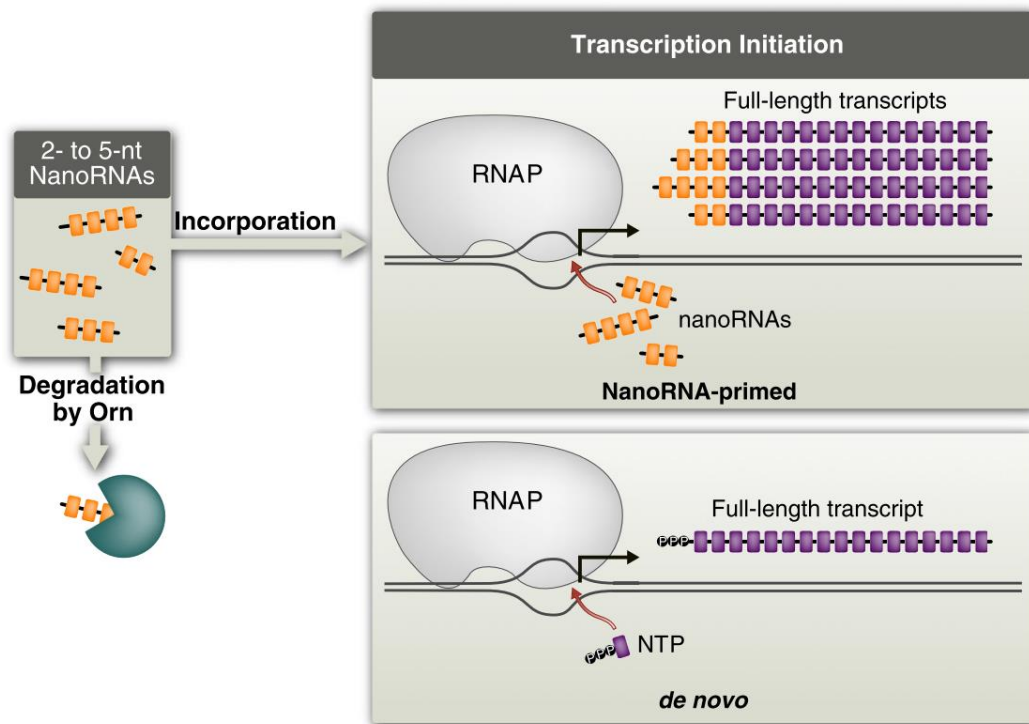

Figure 23. Mechanism of altered transcription initiation by nanoRNAs. NanoRNAs (2-5 nts) can either be degraded by Orn ribonuclease or used by RNA polymerase to initiate transcription. Compared to transcription from NTP (*i.e.*, *de novo*), initiation by nanoRNAs could potentially alter the expression of target genes by modifying the levels of transcripts, by altering the sequence of the 5' end of the transcripts, or by modifying the phosphorylation state of the 5' end of the transcripts (from Nickels and Dove 2011).

NanoRNAs are identified as another class of regulatory RNAs. The frequent transcription and rapid degradation of mRNAs are needed for bacteria to adapt to a wide range of nutritional and environmental changes. mRNA decay is initiated by a series of endo-/exoribonucleases and leaves behind 2- to 5- nts long oligoribonucleotides called “nanoRNAs”. They could also be produced from products of RNA cleavage during transcription elongation by RNAP backtracking or products of abortive transcription initiation (reviewed in (Nickels and Dove 2011)) (Figure 23). They have been demonstrated to prime transcription initiation in bacteria by being incorporated directly into a target transcript. In addition, it is believed that nanoRNAs act as activators or repressors of the transcription of target genes depending on the state of phosphorylation of their 3' end. Addition of nucleotides to the 5' end of RNAs transcribed by nanoRNAs could alter the secondary structure and thus modulate translation and / or stability of transcripts. The degradation and therefore the regulation of these nanoRNAs is effected by a 3'-5' exonuclease, oligoribonuclease (Orn). In the absence of Orn, nanoRNAs can be used as an RNA polymerase primer to initiate RNA transcription that might be harmful for cell with unknown mechanism. Goldman et al. has shown that in *E. coli*, when Orn is inactivated, the amount of nanoRNAs increases significantly, followed by the loss of viability of the bacteria (Nickels and Dove 2011). Since the use of nanoRNAs to initiate transcription could have an overall influence on gene expression, they can therefore be considered as regulators of gene expression by modulating the initiation of gene transcription and / or transcript stability (Liao, Liu, and Guo 2018; Nickels and Dove 2011).

4. sRNAs interacting with RNAs

The vast majority of sRNAs interact with RNAs, they can be classified into two categories: sRNAs encoding in *cis*, which is located on the opposite strand of the gene encoding their target mRNAs, and sRNAs encoding in *trans* that is located in a different chromosomal region than the gene for their target mRNA (Waters and Storz 2009).

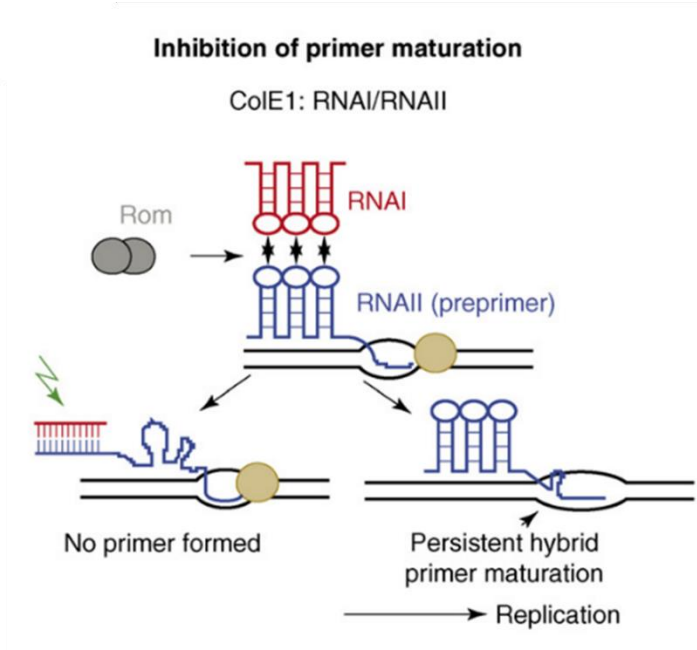

Figure 24. Schematic view of RNAI, an antisense sRNA regulation in *E. coli*. RNAI is encoded on the opposite strand of the gene encoding RNAII, has been demonstrated to inhibit primer formation and consequently prevent RNA-DNA hybrid for plasmid ColE1 replication (Brantl 2007).

4.1. *Cis*-encoded sRNAs

Cis-encoded sRNAs are expressed from the same loci as mRNA targets on the opposite strand of DNA. This results in perfect and usually extended complementarity between sRNAs and their target mRNAs. They can inhibit the expression of their targets by several mechanisms: transcriptional interference, early termination of transcription, alteration of stability or modulation of the translation of the target mRNA (Georg and Hess 2011) (reviewed in (Stork et al. 2007)).

The first type of *cis*-encoded sRNAs are RNAs antisense (asRNAs). They are generally found on plasmids or other mobile genetic elements, such as transposons or bacteriophages, but also on the chromosome (Gerhart, Wagner, and Simons 1994; Svensson and Sharma 2016; Thomason and Storz 2010; Waters et al. 2009; Westermann 2018). Thus, they control the maintenance and the stability of the mobile genetic elements by acting, for example, on the inhibition of the maturation of the primers. For instance, RNAI in *E. coli*, a 108 nucleotide RNA which is encoded on the opposite strand of the gene encoding RNAII, has been demonstrated to inhibit primer formation and consequently prevent RNA-DNA hybrid for plasmid ColE1 (Stougaard, Molin, and Nordstrom 1981; Tomizawa et al. 1981) (Figure 24). RNAI is also involved on the transcriptional reduction of *rep* mRNA (Brantl 2007; Svensson and Sharma 2016; Westermann 2018) (See Chapter V/ Section C/1.). Another sRNA discovered in bacteria that acts as asRNA and is involved in plasmid and transposon copy-number control is RNA-OUT in the case of IS10. Translation of the transposase mRNA (RNA-IN) is inhibited by the *cis*-encoded asRNA, RNA-OUT via base pairing between the 5' end of RNA-IN and the terminal loop domain of RNA-OUT (Simons and Kleckner 1983).

The next category of *cis*-encoded sRNAs is the toxin-antitoxin system (TAS). They are two-gene elements composed of a gene encoded for a stable protein toxin (less than 60 amino acids), whose expression leads to growth cessation or cell death, and a corresponding antitoxin that neutralizes the toxicity during bacterial growth. TAS are classified into six groups based on the nature of the antitoxin and mode of action since all toxins are proteins. For instance, antitoxins that are non-coding RNAs belong to type I and type III

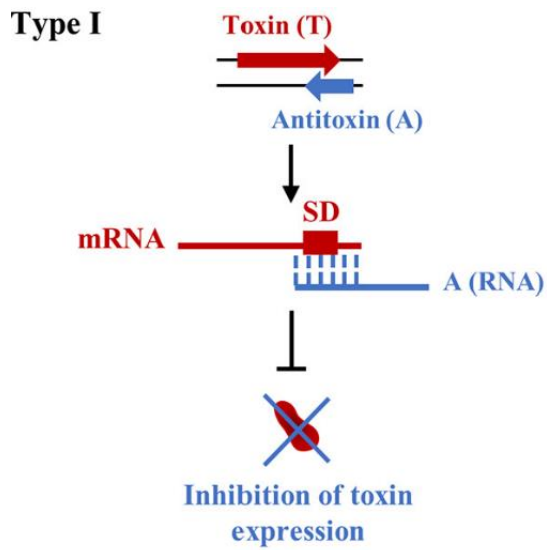

Figure 25. Type I toxin antitoxin system regulation. Type I toxin and antitoxin genes are independently transcribed from their own promoters. Their antitoxins are unstable *cis*-encoded antisense sRNAs that interact with toxin-encoding mRNAs by pairing, therefore preventing toxin mRNA translation and/or inducing its degradation (from Camille Riffaud, Pinel-Marie, and Felden 2020).

systems, and antitoxins in other types are low-molecular-weight proteins (reviewed in (Camille Riffaud, Pinel-Marie, and Felden 2020)). Here, we only show TAS type I where antitoxin is a *cis*-encoded RNA acting in *trans* (Figure 25). Binding between RNA antitoxin to the toxin gene inhibits its translation and causes the degradation of toxin gene (Svensson and Sharma 2016). For example, in *E. coli*, *ibs* gene encodes for a peptide whose overexpression provokes cell membrane disruption and Sib RNA antitoxin can repress this toxicity through base pairing in *ibs* mRNA ORF (Fozo et al. 2008; Fozo, Hemm, and Storz 2008). The function of these chromosome-encoded TA systems remains unclear; however, they might mediate stress metabolism adaptation, persistent cell formation, or antibiotic resistance (Svensson and Sharma 2016; Westermann 2018). Indeed, type I TA systems have been demonstrated to involve in the bacterial pathogens like TisB/IstR-A in *E. coli* (Edelmann et al. 2021; Vogel, Jörg; Argaman, Liron; Wagner, E. Gerhart H; Altuvia 2004) or SprA1/ SprA1-as in *S. aureus* (Beaume et al. 2010; Sayed, Jousselin, and Felden 2012).

Recently, according to transcriptomic studies of *Listeria spp.*, a new class of asRNAs has been categorized, called excludons. They are made up of long antisense RNAs (lasRNAs) that overlap multiple coding phases. LasRNA transcription is initiated from a promoter located on the complementary strand of an mRNA, generating asRNA that overlaps the entire coding phase of the opposite strand. However, transcription does not end at the end of this overlap but extends to the neighboring gene encoded on the same strand. LasRNAs inhibit the expression of one group of genes while activating the expression of a second group of genes with related physiological functions (Sesto et al. 2013).

4.2. Trans-encoded sRNAs

This is another class of sRNAs acting by base pairing, which, unlike asRNAs, are not encoded at a same genetic locus at their target mRNAs and share only limited complementarity with their target and on many occasions, requires the assistance of a chaperone protein Hfq to facilitate sRNA-mRNA interaction. The interaction between sRNAs and its target mRNA regulates gene expression through various mechanisms: this may be due to a change in translation, mRNA stability and/or transcription efficiency.

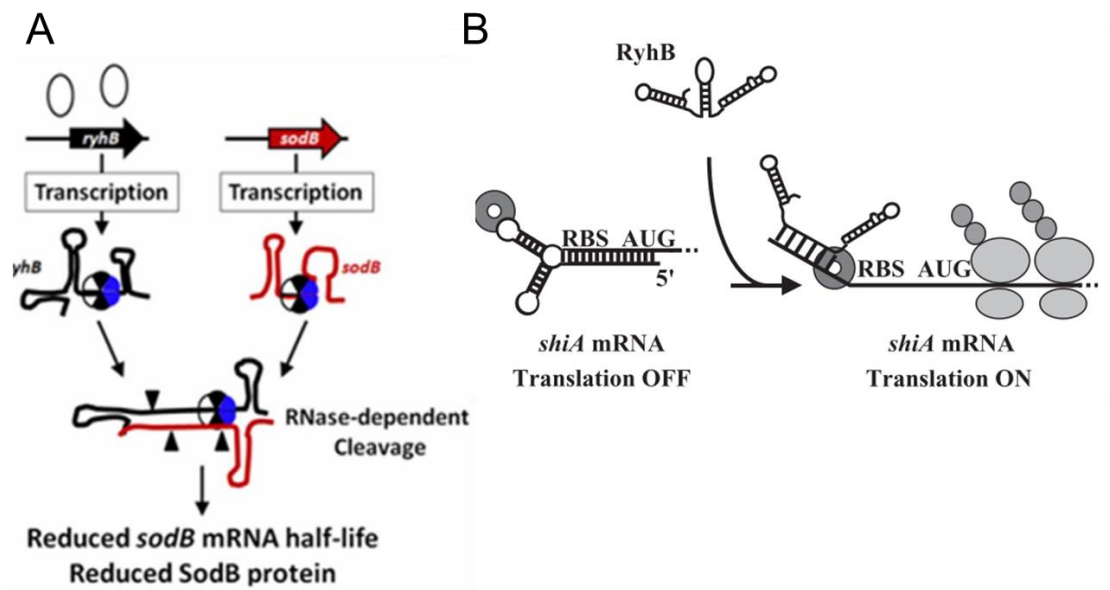

Figure 26. RyhB sRNA acts as trans-encoded sRNA in *E. coli*. (A) RyhB sRNA, with the help of Hfq chaperone protein, binds to *sodB* mRNA and prevents the translation of this mRNA target by the recruitment two RNases (Troxell and Hassan 2013). (B) RyhB sRNA also activates the translation of *shiA* mRNA by enhancing the Ribosome binding to the RBS of the mRNA (from Prévost et al. 2007).

Trans-encoded sRNAs regulate its target expression through three major mechanisms: repression of translation followed by degradation by RNases or activation of translation, or repression of transcription.

The best represented class corresponds to the sRNAs inhibiting translation of mRNA targets. They are able to bind to the translation initiation site of the mRNA and prevent the fixation of Ribosome; therefore leads to inhibition of translation, whether or not coupled with the degradation of the target mRNA. This is the case in *E. coli* with RyhB sRNAs which, with the help of the Hfq chaperone, represses translation of *sodB* mRNA that encodes for superoxide dismutase, by recruiting two RNAs by RNase E and RNase III (Massé, Escorcía, and Gottesman 2003; Morita, Mochizuki, and Aiba 2006) (Figure 26A). However, there are some cases where this interaction leads to translation activation by a conformational change in the secondary structure of the mRNA target resulting in ribosome recruitment. For instance, in *E. coli*, the same RyhB sRNA also activates the translation of *shiA* mRNA expressing a permease of shikimate, an aromatic compound which participates in the synthesis of siderophores (Prévost et al. 2007) (Figure 26B). The RyhB sRNA illustrates a situation where an sRNA can regulate several targets and in different ways. In addition, some mRNAs expression could also be regulated by multiple sRNAs; for example, in enterica bacteria, *glmS* encoding for glutamine-fructose-6-phosphate (GlcN6P) is regulated by two homologous sRNAs, GlmY and GlmZ. In depletion of GlcN6P, the two sRNAs bind to *glmS* mRNA and induce the translation to replenish GlcN6P (M. A. Khan et al. 2016).

It has been shown recently that, the interaction between a sRNAs and its target can also repress the transcription of the target mRNA. For example, in *Salmonella*, the formation of a duplex between ChiX sRNAs and *chiPQ* mRNA results in inhibition transcription (Bossi et al. 2012). sRNA allows exposure of *rut* sites normally hidden by the ribosome. These sites are used to bind the termination factor Rho which will lead to the detachment of the complex of transcription and induce the formation of a truncated mRNA (Bossi et al. 2012). Conversely, sRNAs can also suppress the Rho-dependent transcription terminator (Sedlyarova et al. 2016). This type of regulation of sRNAs at the transcriptional level

remains little described and does not represent the most common sRNA regulations on their targets.

4.3. Other sRNAs regulation mechanisms

RNAs have been proved to possess multiple functions. They could act as sRNAs and also possessing an open reading frame (ORF) coding for a peptide. These are sRNAs that interact with mRNAs and either express a protein or interact with proteins to regulate their activity such as RNAIII and PSM-mec in *S. aureus* in virulence regulation (Delphine Bronesky et al. 2016; Qin et al. 2016), SR1 in *B. subtilis* in arginine catabolism activation (Heidrich et al. 2006; Licht, Preis, and Brantl 2005) and SgrS in *E. coli* in glucose/mannose transporter and virulence (Wadler and Vanderpool 2007). It has been shown that there are currently 10 sRNAs encode short proteins, of which five have an associated function (reviewed in (Gimpel and Brantl 2017)). Another case of sRNA with multiple functions is transfer-messenger RNA (tmRNA or SsrA) that displays both tRNA and mRNA assets. TmRNA controls *trans*-translation, which is a process of rescuing the ribosomes stalled during translation of defective mRNAs, such as those lacking in-frame termination codons in all bacteria (Dulebohn et al. 2007), but also acts as an asRNA to regulate *ctrMN* operon in *S. aureus* (Y. Liu et al. 2010).

Recent discoveries suggested the existence of new sRNAs acting as RNAs sponges in gene expression regulation. The term “sponge” RNA came from eukaryotic regulatory RNA studies demonstrating that engineered RNA can compete with mRNA for miRNA interaction (Ebert, Neilson, and Sharp 2007). However, more and more RNA sponge cases have been recently studied in prokaryotes. In *Salmonella enterica*, mRNA-derived SroC sRNA acts as a sponge to sequester and trigger degradation of GcvB (Miyakoshi, Chao, and Vogel 2015) or the 3' external transcribed spacers (3' ETS) of tRNA gene can also act as sRNA sponge to absorb transcriptional noise from repressed RNAs (Lalaouna et al. 2015). In addition, the most recent case of RNA sponge in Gram-positive bacteria has been identified and validated in (Durand et al. 2021). RoxS is an sRNA implicated in oxidative stress response of *B. subtilis* and its expression and activity has been demonstrated to be affected by RoxA acting as a sponge for RoxS (Durand et al. 2021).

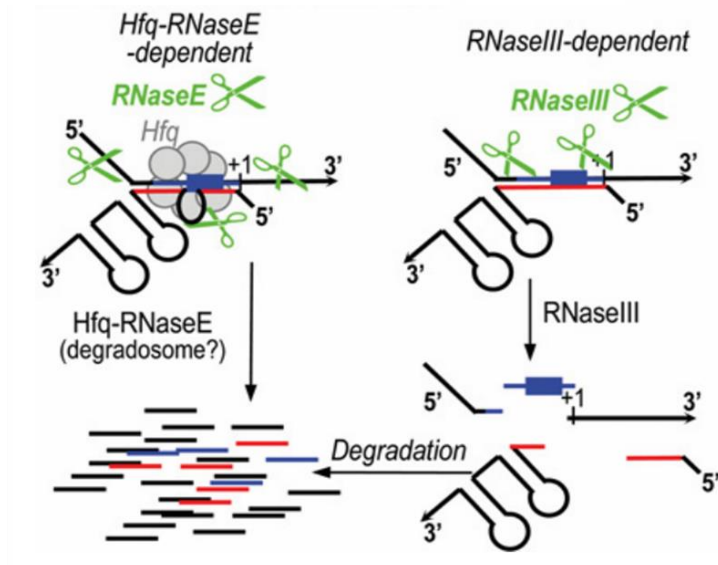

Figure 27. RNase E- and RNase III-dependent mRNA degradation mediated by ncRNAs (from Repoila and Darfeuille, 2009)

5. Proteins helpers of RNAs

Many proteins are associated with sRNAs and perform a multitude of functions such as the modification of the secondary structure of their RNA targets, the maturation of the sRNA, the promotion of the sRNA-mRNA interaction, and the degradation of the duplex formed. To date, new RNA-binding proteins were discovered such as the sequester CsrA/Rsm, the FinO/ProQ family and the CspD/E family, besides RNases and protein chaperone Hfq (reviewed in (Quendera et al. 2020; Romeo, Vakulskas, and Babitzke 2013)). Hfq (Host factor Q β) is widely identified as a global regulator and key element in sRNA-based regulation networks with ~30 % of sRNAs relying on this protein to carry out their functions in *E. coli* (Vogel and Luisi 2011). In *Salmonella*, Hfq associates with almost half of the co-immunoprecipitated sRNAs (Sittka et al. 2008). Beside involving in protein-protein interactions (Caillet et al. 2019) and in RNA degradation (reviewed in (Quendera et al. 2020)), Hfq is also implicated in remodeling sRNA secondary structure. For instance, through binding to MicA sRNA, Hfq is demonstrated to change this sRNA secondary structure, to alter its stability and to allow exposure of the *ompA* binding site for pairing that leads to translational repression (Henderson et al. 2013). Although Hfq is well documented in other bacterial species to play an important role in gene expression regulation but whose role in *S. aureus* is unclear. Recent studies suggested that Hfq might play a role in the oxidative stress response in *S. aureus*, decreasing the bacteria's ability to survive in macrophages (Bouloc and Repoila 2016; W. Liu et al. 2020). However, Hfq is not as an important regulator of gene expression as it is the case in Gram-negative bacteria, nor globally influences RNA stability.

Ribonucleases (RNases) are also classified as RBPS and play an important role in regulating the expression of target genes by sRNAs. For a very large number of sRNAs in bacteria, the interaction between sRNA and its mRNA prevents the binding of ribosomes and promotes the degradation of the mRNA by an RNase recruited during the formation of the duplex leading to an irreversible inhibition of translation of the target gene. RNases can recognize the single-stranded or double-stranded structures of RNAs (Figure 27). For instance, RNase E has been shown to act as a single-strand-specific endonuclease to

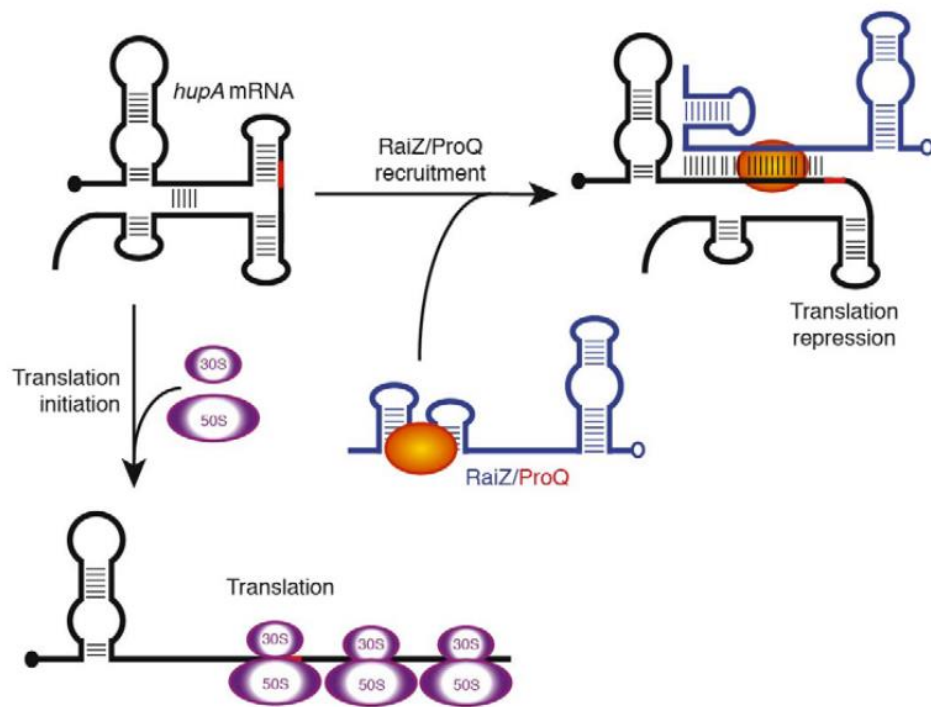

Figure 28. Molecular mechanisms of ProQ-dependent sRNA in *Salmonella Typhimurium*. *hupA* gene encodes the α -subunit of bacterial histone-like protein HU. ProQ assists the interaction between RaiZ sRNA and *hupA* mRNA to prevent the translation of the mRNA by masking the binding site of the 30S ribosome subunit (from Smirnov et al. 2017)

initiate AmgR sRNA-*mgt* operon target degradation in *Salmonella* (reviewed in (Ul Haq, Müller, and Brantl 2020)); or RNase III as the double-stranded ribonuclease in Rat sRNA-3' UTR of *txpA* mRNA in *B. subtilis* (Durand, Gilet, and Condon 2012). Moreover, certain RNases are also involved in the degradation and processing of RNAs within a multi-protein complex called a degradosome whose composition differ between Gram-positive or negative bacteria. For instance, most of the genomes of Gram-positive bacteria produce two orthologous ribonucleases, RNase J1 and RNase J2. These enzymes are part of the degradosome complex of Gram-positive bacteria consisting of a PNPase, an enolase, a DEAD box helicase (CshA), a phosphofructokinase and RNase Y. In *E. coli*, the degradosome is made up of four enzymes: RNaseE, exonuclease 3'-5' PNPase, RhlB helicase and an enolase (reviewed in (Carpousis 2007; Ul Haq, Müller, and Brantl 2020)). These RNases play an important role in post-transcriptional regulations and are, moreover, involved in the regulation of virulence factors.

Another case is ProQ of the FinO family that is commonly found in Proteobacteria (Olejniczak and Storz 2017). The majority of ProQ studies are performed in *E. coli*, *Salmonella enterica* and *Legionella pneumonia* (reviewd in Quendera et al. 2020). However, ProQ binding specificity is different from Hfq, based on RIL-seq performed by (Melamed et al. 2020), ProQ shows affinity for encoding sequences while Hfq is enriched in both sRNAs and mRNAs complex formation. One of the well-known example for ProQ role is the RaiZ sRNA – *hupA* mRNA (Smirnov et al. 2017). This complex formation ProQ/RaiZ/ *hupA* is demonstrated to prevent the translation of the mRNA by masking the binding site of the 30S ribosome subunit (Smirnov et al., 2017) (Figure 28).

In addition, Cold-shock proteins (CSPs) constitute the largest nonribosomal RBP family in Gram-negative bacteria, including *E. coli* and *S. enterica*. Out of the nine and six CSP paralogs present in *E. coli* and *S. enterica*, CspA is an RNA chaperone that accumulates during growth at low temperatures and modulates both the transcription and translation of target genes required for bacterial survival in these conditions (Bae et al. 2000; Giuliodori et al. 2010; Jiang, Hou, and Inouye 1997). Intriguingly, other family members, such as CspC and CspE, are not induced in response to cold shock but are highly expressed

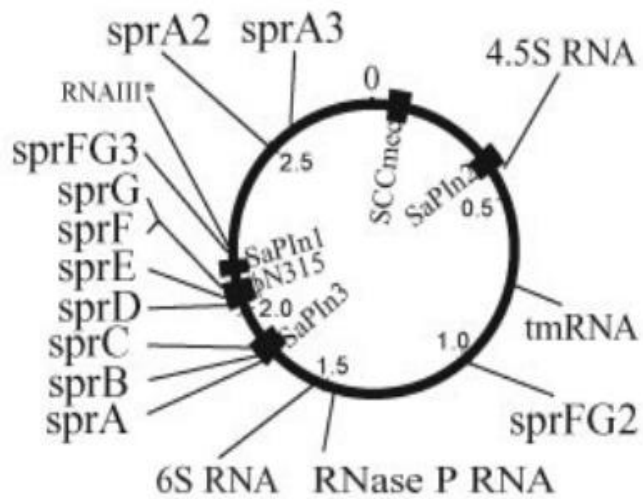

Figure 29. Overview of Spr sRNAs genomic localization. Schematic view of the genome of *S. aureus* N315 with three pathogenicity islands (SaPI1–SaPI3, in black rectangles), a staphylococcal cassette chromosome (SCC), a bacteriophage (Φ N315), and the location of the detected sRNA genes (from Pichon and Felden 2005).

at higher temperatures and suggested to be implicated in stress response and virulence of *Salmonella* pathogenicity (Michaux and Giard 2016).

C. Regulatory sRNAs in *S. aureus*

Since early 2000s, more sRNAs have been discovered in various *S. aureus* strains from computational analysis to experimental approaches like microarrays, clonage shotgun, and more recently via high-throughput RNA sequencing (RNA seq) (See Chapter V/ Section A). They are defined in general as stable molecules between 50 and 500 nts in size and their annotation depends on the approached technics and/or the localization of studied sRNAs. For example, sRNAs, whose the genes are located in pathogenicity islands of *S. aureus*, are called Spr (Small pathogenicity island RNA) (Pichon and Felden 2005) (Figure 29). Other are named RsaO sRNAs (for RNA of *S. aureus* Orsay) (Bohn et al. 2010; Marchais et al. 2009); or Rsa sRNAs (*Staphylococcus aureus* RNA) (Geissmann, Marzi, and Romby 2009). Regulatory RNAs discovered by experimental method from Geneva are named Teg sRNAs (Transcript from Experimental method from Geneva) (Beaume et al. 2010, 2011) and some other small groups of sRNAs that are still understudied such as the SSR (small stable RNAs) (Anderson et al. 2006; Retallack and Friedman 1995). Moreover, there is situation where an sRNA studied in one work was named differently in another publish, for instance, RsaOW is named Teg17 (Bohn et al. 2010; Guillet, Hallier, and Felden 2013) or SprX alias RsaOR and Teg15 (W. Liu et al. 2018). With an overflow of regulatory RNAs identified during this last decade, our lab designed a platform, called “Staphylococcal Regulatory RNA Database” with an objective to compile all published regulatory RNAs and to simplify the identification by naming them Staphylococci regulatory RNA (srn) (Sassi et al. 2015). However, many more sRNAs have been identified and it becomes a challenge to carry on the update. Indeed, Mädler and his collaborators recently provided a global analysis of transcriptional regulation and non-coding RNAs in *S. aureus* (Mädler et al. 2016) and Bouloc’s group provided a new reassessment of approximately 50 *bona fide* sRNAs in *S. aureus* by *in silico* analysis (W. Liu et al. 2018). Here, the sRNAs will be presented based on their original discovered name and their shared physiological function in *S. aureus*.

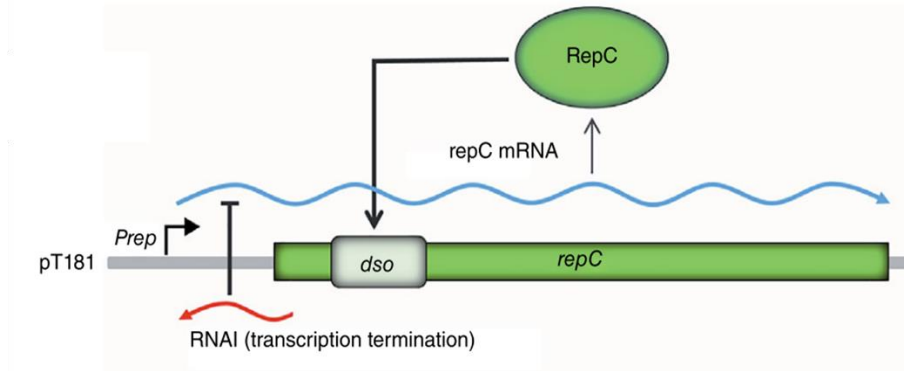

Figure 30. RNAI mechanisms in control the replication of pT181. The promoter Prep directs synthesis of the RepC initiator (green ellipse), which initiates replication by binding to its cognate *dso*. Replication of the plasmid pT181 is controlled by RNAI (red) that is complementary to the 5' UTR of the *repC* mRNA (from Pluta and Espinosa 2018).

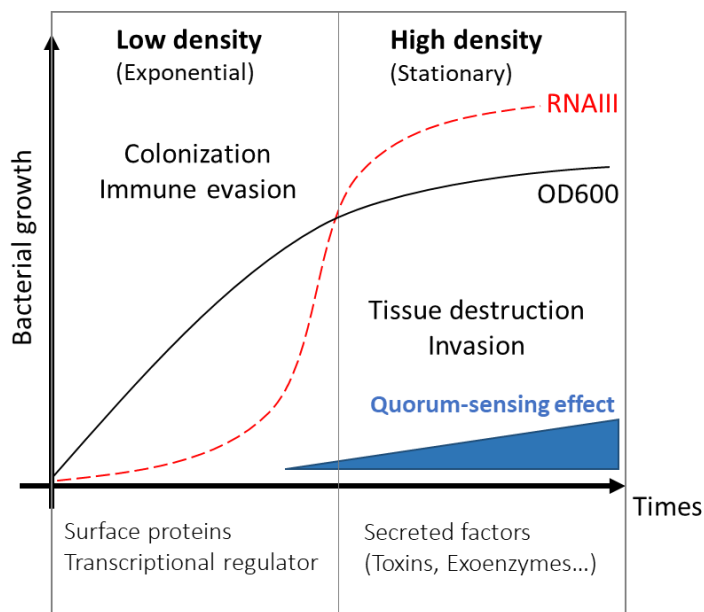

Figure 31. RNAIII activity and temporal expression of *S. aureus* virulence factors during growth. At low cell density (during the exponential phase), the *agr* system is not induced: the level of expression of RNAIII is low and the mRNAs allowing tissue colonization (*sa1000*, *spa*, *sa2353* and *rot*) are expressed. At high cell density (during the stationary phase), the *agr* system self-induces via quorum-sensing (QS). The expression of RNAIII allows the inhibition of translation of the above-mentioned target RNAs and the activation of the expression of *hla*. In addition, the coding phase of RNAIII is translated to produce hemolysin delta. Induction of the *agr* system by QS enables the coordinated response of the entire *S. aureus* population. This response allows the destruction of host tissue and promotes colonization by the bacteria (Adapted from Repoila and Darfeuille, 2009).

1. RNAI

RNAI was first studied in *E. coli* in the early 1980s for its contribution in the control of plasmid ColE1 replication (Stougaard, Molin, and Nordstrom 1981; Tomizawa et al. 1981) (See Chapter V/ Section B/3/3.1.). RNAI was later identified in *S. aureus* as a first *cis*-encoded sRNA that controls the rolling-circle replication (RCR) of plasmid pT181 by transcriptional attenuation (Richard P. Novick et al. 1989). The replication of small multiple copy plasmids carrying antibiotic resistance genes in Gram-positive bacteria generally occurs by RCR mechanism. And the most distinct trait of RCR is its initiation step by a replication initiator protein (Rep) encoded by the plasmid. For instance, pT181, a tetracycline resistant plasmid of *S. aureus*, regulates its own replication by expressing RNAI that blocks the expression of RepC. This regulation involves pairings between complementary loops in the mRNA leader (*repC*) and the asRNA (RNAI), which results in the formation of an anti-terminator at the 5' to the *repC* initiation codon that blocks the access of the Ribosome. By masking the RBS, RNAI leads to a premature termination of transcription of *repC* (Guillet, Hallier, and Felden 2013; Richard P. Novick et al. 1989; reviewed in Pluta and Espinosa 2018) (Figure 30).

2. RNAIII: A Paradigm

Discovered almost three decades ago, RNAIII is a 514 nucleotide RNA, that acts as the effector of the Agr "quorum sensing" system (R. P. Novick et al. 1993). RNAIII accumulates during growth and peaks in the post-exponential phase of growth (R. P. Novick et al. 1993). It allows the temporal regulation of the expression of virulence factors, that is to say, it controls the switch between colonization and bacterial infection of the host (Figure 31). RNAIII is a bifunctional RNA, encoding a PSM called δ -hemolysin (*hld* gene) (Janzon and Arvidson 1990) and acts as a *trans*-acting sRNA on multiple target mRNAs (Morfeldt et al. 1995) (Figure 32). This sRNA possesses an extraordinarily complex structure with 14 stem-loops (Benito et al. 2000), and three of them contribute highly to the regulation several virulence factors. Indeed, stem-loops 7, 13 and 14 with a consensus motif rich in cytosines, facilitate interactions with the guanine-rich RBS of its target mRNAs (Boisset et al. 2007). RNAIII, binding with its target mRNA, will block Ribosome to be recruited to the

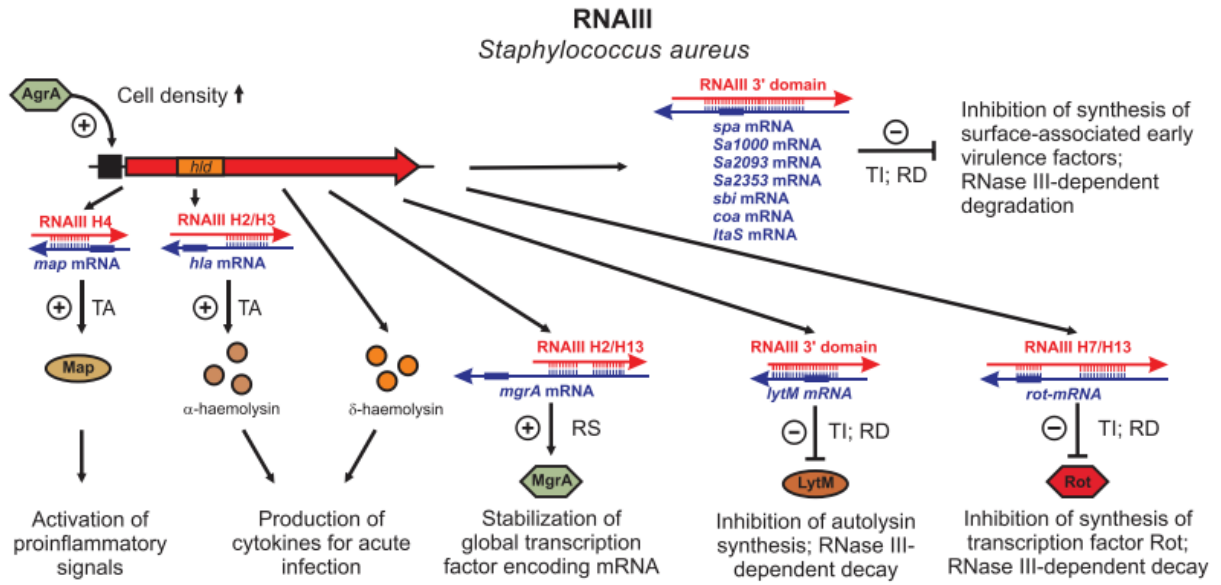

Figure 32. Regulatory activity of RNAIII. RNAIII is directly involved in the regulation of 12 mRNAs by either activating or inhibitory mechanisms (from Matthias Gimpel and Sabine Brantl, 2016).

ribosome binding site (RBS) on the mRNA, thereby prevent translation initiation and, in some cases, facilitating the degradation of mRNA by RNase III (Chevalier et al. 2010; Romilly et al. 2012). In fact, the formation of a duplex between RNAIII and the target mRNAs by loop-loop interactions creates a binding site for RNase III, which will lead to specific cleavage in the regions of the interaction (Romilly et al. 2012). These targets are particularly involved in *S. aureus* virulence such as the surface protein A (Spa), coagulase (Coa), fibrinogen binding protein (SA1000), homologs of the staphylococcal secretory antigen SsaA (SA2353 and SA2093), immunoglobulin binding protein (Sbi), lipoteichoic acid synthase (LtaS) and cell wall autolysin (LytM) (Amdahl et al. 2017; Boisset et al. 2007; Delphine Bronesky et al. 2016; Chabelskaya, Gaillot, and Felden 2010a; Geisinger et al. 2006; Huntzinger et al. 2005; Rnas et al. 2018). In addition, RNAIII inhibits initiation of translation of *rot* mRNA, encoding the repressor of toxins Rot (Mcnamara et al. 2000; Oscarsson, Tegmark-Wisell, and Arvidson 2006), which blocks the transcription of many exoproteins and toxins (Saïd-Salim et al. 2003). Therefore, by inhibiting Rot production, RNAIII indirectly activates transcription of many exotoxins and indirectly inhibits synthesis of protein A at the transcriptional level.

In addition to targets downregulation, RNAIII is also capable of activating expression of few targets: alpha hemolysin (Hla), the extracellular adhesion protein (Map) and the transcriptional regulator MgrA. The interaction of RNAIII with the 5'UTR region of *hla* and *map* mRNAs releases the SD sequence thus promoting ribosome recruitment and translation initiation (Delphine Bronesky et al. 2016; Y. Liu et al. 2011; Raina et al. 2018). Moreover, by inducing Hla production, RNAIII favors cell lysis, which is part of *S. aureus* infection process (Bramley et al. 1989; Dinges, Orwin, and Schlievert 2000; Gray and Kehoe 1984). More recently, the 3' and 5' ends of RNAIII have both been shown to interact with the 5'UTR of *mgrA* RNA, thus preventing mRNA from degradation by an unknown ribonuclease (Delphine Bronesky et al. 2016; Gupta, Luong, and Lee 2015; Raina et al. 2018).

Altogether, due to RNAIII regulatory action on multiple targets directly or indirectly via Rot and MgrA, two other global regulators of gene expression, shows the importance in

the pathogenicity of *S. aureus*. Furthermore, it also shows that RNAIII is implicated in the switch between expression of various surface proteins and synthesis of secreted toxins, which displays the level of complexity in the regulation of virulence genes.

3. sRNAs implicated in *S. aureus* Metabolism

Many sRNAs have been demonstrated to be engaged in the metabolism of *S. aureus*, however, RsaI and RsaE are the most studied so far. First, **RsaI** (alias RsaOG) (Geissmann et al. 2009) is involved in a signaling pathway responding to glucose uptake. Indeed, several direct targets of RsaI were found through MAPS approaches. Some are sRNAs, and most are mRNAs involved in glycolysis and pentose phosphate pathway (negatively regulated) and in fermentation processes (positively regulated) (D. Bronesky et al. 2018). It has been shown that RsaI regulates its mRNA targets by binding to the SD sequence and masking the RBS and consequently inhibits the translation. For instance, RsaI as a CcpA-repressed small non-coding RNA that is inhibited by high glucose concentrations. When glucose is consumed, RsaI represses translation initiation of mRNAs encoding a permease of glucose uptake (*glcU_2*) and the FN3K enzyme (*fn3K*) that protects proteins against damage caused by high glucose concentrations. This multifunctional RNA provides a signature for a metabolic switch when glucose is scarce and growth is arrested.

The second sRNA is **RsaE**, a sRNA conserved in *S. aureus* and *B. subtilis*, that controls enzymes involved in amino acid and peptide transport, cofactor synthesis, lipid metabolism, carbohydrate metabolism, the TCA cycle (Bohn et al. 2010; Geissmann et al. 2009) and in arginine degradation pathway (Rochat et al. 2018). Hence, it was suggested that RsaE repressed several enzymes of the central metabolism under non-favorable conditions and it would contribute to readjust the cellular NAD⁺/NADH balance under stress conditions (Bohn et al. 2010; Durand et al. 2017). In addition, RsaE is showed to interact with the RBS of *opp3A* mRNA, encoding an ABC transporter component, to prevent formation of the ribosomal initiation complex and to restrain its translation. Albeit RsaE functions is suggested to ensure a coordinate downregulation of the central metabolism when carbon sources become insufficient (Delphine Bronesky et al. 2019)

4. sRNAs implicated in Persistence

SprF/SprG belong to the last two regulatory RNAs of the Spr “family”, here also representing a type I toxin antitoxin system (TAS) discovered in 2014 (Pinel-Marie, Brielle, and Felden 2014). *sprG1* encodes two toxic peptides, whose translation is repressed by the antitoxin SprF1. Recently, two novel type I toxin-antitoxin systems (TAS) were found to be located in the core genome and expressed in *S. aureus*, named *sprG2/SprF2* and *sprG3/SprF3*. Identically to *sprG1/SprF1*, *sprG2* and *sprG3* encode toxins and are neutralized respectively by their antitoxin SprF2 and SprF3. In the absence of antitoxins, toxins are translated and will accumulate in the membrane, causing the death of bacteria (Pinel-Marie, Brielle, and Felden 2014). Moreover, toxins are also secreted into the extracellular environment to act against other bacteria as well as against human erythrocytes. Altogether, it has been suggested that these systems and an involvement of the *sprG/SprF* TAS in *S. aureus* adaptation to antibiotic stress or in the escape of the immune system and may have a role in the entry into persistence of bacteria (C. Riffaud et al. 2019).

5. sRNAs implicated in Antibiotic resistance

SprX was initially identified by Bohn and the collaborators in 2010 under the name of RsaOR (Bohn et al. 2010). It is a sRNA with a variable copy number depending on the strain since it is found in a single copy in the N315 strain, two copies in the HG001 strain and three copies in the Newman strain. The first data on this sRNAs showed an implication in antibiotic resistance (Eyraud et al. 2014). To better understand the mechanism by which SprX modulates antibiotic resistance, a proteomics study was performed to identify the SpoVG protein as a target of SprX. SpoVG is a protein involved in capsule formation and resistance to methicillin and glycopeptides (Schulthess et al. 2009). Thus, by inhibiting the *spoVG* translation of the *yabJ-spoVG* operon via binding at the *spoVG* translation initiation site, SprX inhibits the expression of SpoVG and thus decreases resistance to glycopeptides (Eyraud et al. 2014). In addition, SprX has been demonstrated to be involved in the virulence of *S. aureus* by regulating toxins and

autolysin, which will be described in the next section (Buchad and Nair 2021; Kathirvel, Buchad, and Nair 2016).

6. sRNAs implicated in Virulence

In *S. aureus*, many sRNAs have been identified in the last decade and many scientific reports have shown a plethora of sRNAs is implicated in the virulence of the bacteria. Like mentioned before, sRNAs identified in *S. aureus* are called by different annotations depending on the original discovery. Here, they will be divided into four main groups based on their original discovered annotations: Rsa “family”, Spr “family”, Teg “family” and other sRNAs.

6.1. Rsa sRNAs “family”

The study of **RsaA** made it possible to identify a known target, namely *mgrA* mRNA, encoding for a transcriptional factor. RsaA represses the translation of MgrA, involved in biofilm formation and capsule synthesis (Romilly et al. 2014). In addition, RsaA also represses other targets, in particular four mRNAs belonging to the family of enzymes SsaA as well as FlipR (Tomasini et al. 2017a), which interferes in opsonization *via* complements pathway. Moreover, RsaA has been shown in animal models to suppress staphylococcal virulence. These data show us a rare anti-virulent effect in bacteria and which, as suggested for RsaA (Romilly et al. 2014), could promote commensal behavior of the bacteria in order to avoid the immune system of the host.

Beside the contribution in the metabolism of *S. aureus* previously mentioned, through masking the RBS at the 3' UTR of the target, **RsaI** also represses the expression of *icaR* mRNA, the repressor of the *icaADBC* operon, which encodes for proteins involved in the synthesis of the main exopolysaccharide constituting biofilms (Delphine Bronesky et al. 2019). Hence, RsaI would contribute to PIA-PNAG synthesis by at least reducing the IcaR repressor protein levels. In addition, the authors also identified other Rsa sRNAs (RsaD, RsaE and RsaG) enriched in complexes purified through their interaction with RsaI (Delphine Bronesky et al. 2019).

RsaE is not only involved in the metabolism described earlier, but also is implicated in the synthesis of PIA in the biofilm through its negative regulation of IcaR, causing the depletion of the *icaADBC* operon (Schoenfelder et al. 2019). Moreover, a homologous of RsaE sRNA in *Bacillus subtilis*, RoxS, that has shown that RsaE expression is induced by the presence of in response to reactive oxygen species (nitric oxide (NO)) through SrrAB system. Thus, *S. aureus* RsaE may also intervene in the survival of cells against host immune reactions (Durand et al. 2015, 2017).

Recently, through MAPS approach, *sodA* mRNA was identified as one of the targets of **RsaC**. This gene encodes for a superoxide dismutase implicated in oxidative stress response (Lalaouna et al. 2019). Through binding to the RBS of *sodA* mRNA, RsaC inhibits the translation of *sodA* mRNA. In addition, RsaC also binds to *sarA* mRNA *in vitro* and therefore inhibits its translation by binding at the level of the SD sequence. SarA being a transcriptional repressor of SodM, this would accentuate the effects of RsaC on the activation of the expression of the latter (Lalaouna et al. 2019). All these data show the role of RsaC, interconnecting manganese bioavailability and ROS detoxification and suggesting a role in the resistance to oxidative burst of immune cells via SodM.

6.2. Spr sRNAs “family”

SprD is a sRNA encoded in SaPI of *S. aureus* and is involved in the virulence of the bacteria since it could be demonstrated that the expression of SprD allowed an efficient infection in a mouse model (Chabelskaya, Gaillot, and Felden 2010). Indeed, unlike the parental strain N315 which caused renal abscesses and death in mice, the deletion mutant resulted in an absence of mortality in mice (Chabelskaya, Gaillot, and Felden 2010). According to proteomic study by of extracellular proteins between the parental strain and the deletion mutant, the protein Sbi, a protein involved in immune evasion mechanisms, was identified as a target of SprD. Subsequently, SprD inhibits translation of *sbi* mRNA *in vitro* by binding to its RBS. However, this inhibition of Sbi alone does not explain the effect of SprD on the virulence of *S. aureus*. This is why studies were continued and in 2014 showed that Sbi was also repressed by RNAIII (Chabelskaya, Bordeau, and Felden 2014).

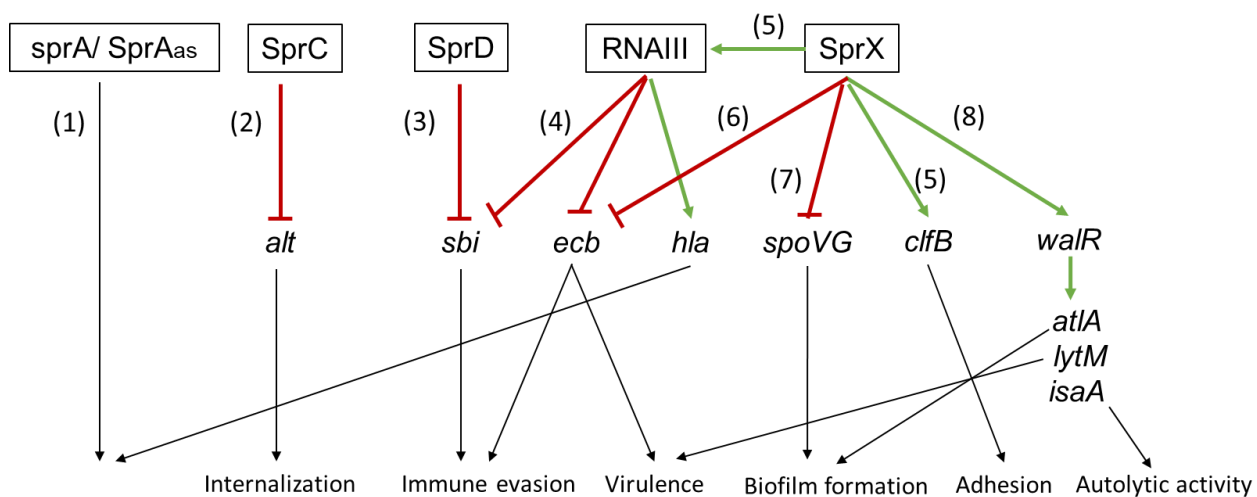

Figure 33. An overview of Spr sRNAs involved in *S. aureus* pathogenicity. All sRNAs are framed in black. The red line represents the repression regulation, and the green arrow indicates the positive regulation. (1) Germain-Amiot et al. 2019; (2) Hirschhausen et al. 2010, Le Pabic et al. 2015; (3) Chabelskaya et al. 2010; (4) Chabelskaya et al. 2014; (5) Kathirvel et al. 2016; (6) Ivain et al. 2017; (7) Eyraud et al. 2014; (8) Buchad and Nair 2021.

Thus, these two regulatory RNAs appear to act synergistically to regulate Sbi expression efficiently and is the first example of its kind (Figure 33).

SprC was studied for its targets through a comparative proteomic study (Le Pabic et al. 2015). Thus, it has been demonstrated that SprC is involved in virulence and bacterial propagation in an animal model of sepsis. In addition, a role in the internalization of bacteria by host immune cells has also been shown. The overexpression of SprC reduces the internalization of *S. aureus* by THP1 monocytes, as well as by THP1 differentiated into associated with a decrease in bacterial resistance to oxidative stress (Le Pabic et al. 2015). SprC and also interferes the internalization via epithelial cells by negatively regulates the production of autolysin (*atl*) by direct inhibition (Hirschhausen et al. 2010; Le Pabic et al. 2015) (Figure 33).

Although **SprX** (*alias* RsaOG) has been demonstrated to be involved in glycopeptides resistance, in 2014, a second study, this time on one copy of the Newman strain (SprX1), identified several other targets of SprX (Kathirvel, Buchad, and Nair 2016). The overexpression of SprX1 induced an increase in the expression of several virulence factors such as hemolysin δ (Hld) and clumping factor ClfB, which involve in the adhesion of bacteria and in the formation of biofilms as well as in virulence in mouse models, thus showing the importance of this sRNAs in the pathogenesis of *S. aureus*. In addition, in 2017, a study using an innovative double plasmid reporter system identified another SprX target, the extracellular complement-binding protein Ecb (Ivain et al. 2017). It is a secreted protein allowing the protection of bacteria against the host immune system by binding to CFH. Thus, by inhibiting the translation of *ecb* by binding to RBS, SprX decreases the expression of Ecb and therefore the protection of bacteria against the immune system (Ivain et al. 2017). Another new study of SprX contribution to *S. aureus* pathogenicity has been released by Buchad and Nair 2021. The authors have demonstrated that, through binding to the 5' region of *walR* mRNA, SprX enhances the transcription of this mRNA and consequently modulates positively the expression of several autolysins such as AtIA, IsaA and LytM (Buchad and Nair 2021), since WalR is known as a positive regulator of autolysin (Figure 33).

The study of **SprA** revealed that it is in fact a TAS type I. It is composed of an unstable SprA_{AS} antitoxin localized on the opposite strand of the toxin PepA1 (encoded by SprA1), which has hemolytic and antibacterial activities (Pichon and Felden 2005; Sayed, Jousselin, and Felden 2012). In addition, a second copy of this system has been identified, the SprA2/SprA2_{AS} system, with a similar mechanism of action and predominantly cytolytic activity (Germain-Amiot et al. 2019). Moreover, comparing to PepA1, PepA2 showed a greater toxic effect on human erythrocytes suggesting an effect of this system in the virulence of *S. aureus* (Germain-Amiot et al. 2019) (Figure 33).

6.3. Teg sRNA “family”

Recent transcriptome-sequencing (RNA-Seq) analysis indicated that one of the sRNA, **Teg49**, resides within the *sarA* P3 and P1 promoter region in SH100 *S. aureus* strain (Manna et al. 2018) and is shown to be involved in virulence regulation in *sarA*-dependent or *sarA*-independent manner. In fact, through RNA-seq analysis, Teg49 seems to affect the expression of a wide range of genes possessing different functions such as metabolism-related transcripts, cell wall-related genes production, cellular processes, and virulence factors. To further validate RNA-seq data, quantitative RT-PCR was performed and showed that Teg49 downregulates two regulatory genes, *saeR* and *lytS* among other targets, and upregulates some known virulence factors like *lukF* and *splA* (Manna et al. 2018). In addition, a mouse skin abscess model of infection revealed a modest but significant reduction in the bacterial load in the infected skin tissue, hence demonstrating that Teg49 plays a perceptible role in virulence gene regulation in *S. aureus*, although the exact mechanism has yet to be elucidated.

Another interesting Teg sRNA recently studied is called **Teg41** (alias RsaX05/srn_1080) (Beaume et al. 2010; Geissmann, Marzi, and Romby 2009; Subramanian, Bhasuran, and Natarajan 2019). In 2019, Teg41 was remarked to be located immediately downstream of the α PSM transcript (Zapf et al. 2019), suggesting that Teg41 might affect α PSMs production. Indeed, their study showed that overexpression of Teg41 leads to an increase of α PSM production and consequently, an increase in hemolytic activity of *S. aureus*. sRNA-mediated, positive gene regulation frequently occurs at the level of transcript

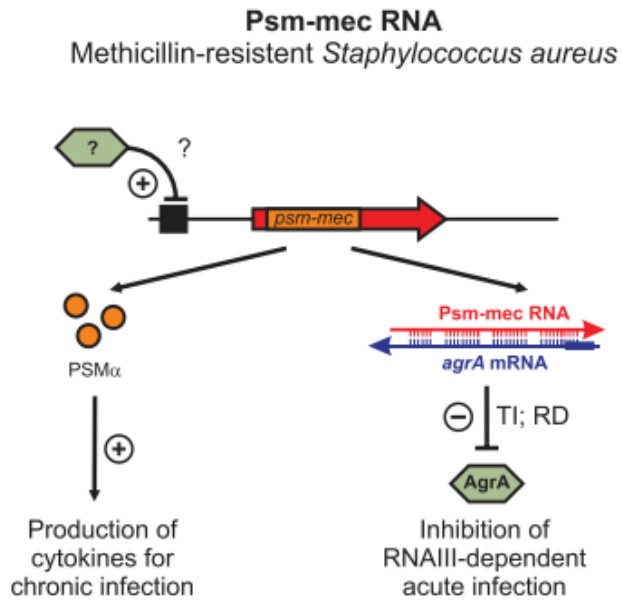

Figure 34. PSM-mec activity. Through base-pairing, sRNA Psm-mec RNA interacts with the *agrA* mRNA within the ORF region and inhibits translation of *agrA* mRNA (from Matthias Gimpel and Sabine Brantl, 2016).

stability, proposing that binding of Teg41 to the α PSM transcript stabilizes the transcript and facilitates the translation of the α PSM peptides. In conclusion, Teg41 activity definitely play a favorable role in the virulence of *S. aureus* (Zapf et al. 2019).

6.4. Other sRNAs

Other sRNAs have been identified in *S. aureus*, by different approaches at the end of the 2000s. This was made possible by the democratization of bioinformatic tools and by high-throughput RNA sequencing technologies. For instance, **ArtR** (Xue et al. 2014) upregulating *hla* expression indirectly through the degradation of *sarT*; or **SbrA-C** as σ B-dependent transcripts with unknown yet functions (Nielsen et al. 2011). Another sRNAs is identified during a study aiming to analyze by microarray the modifications of the transcriptome in response to different stresses (hot shock, cold stringent condition, and SOS responses) (Morrison et al. 2012), called **Ssr42**. Ssr42 is expressed during the stationary phase of growth and controls a multitude of virulence factors such as Hla. It is involved in the lysis of host erythrocytes, resistance to lysis by leukocytes and especially in the virulence of staphylococcus in animal models (Morrison et al. 2012).

In addition, interestingly, a new sRNAs was found in 2016, **PSM-mec** (Qin et al. 2016) (Figure 34). Among all known PSMs encoded from core genome, PSM-mec, is an exception, whose gene is found in specific sub-types of SCCmec methicillin resistance mobile genetic elements present in methicillin-resistant *Staphylococcus aureus*. While PSM-mec peptide possesses a pro-inflammatory activity (inducing calcium flux and chemotaxis) and a cytolytic activity on erythrocytes and neutrophils, the *psm-mec* RNA exerts its gene regulatory activity through its interaction with the *agrA* transcript resulting in an overall repression of *agrA* activity (Kaito et al. 2013; Qin et al. 2016). However, these effects are highly strain-dependent, which is possibly due to differences in PSM-mec peptide vs. *psm-mec* RNA-controlled effects. Albeit the *psm-mec* locus influences cytolytic capacity, methicillin resistance, biofilm formation, cell spreading, and the expression of other virulence factors, such as other PSMs, which results in a significant impact on immune evasion and diseases.

MY THESIS PROJECT

Recently, we have identified within phage Φ 12 a gene encoding for a new sRNA that is expressed in proximity of SprX2 sRNA and called it SprY. Its localization in a region of the genome containing many virulence factors suggests that this sRNA could be involved in the virulence of *S. aureus*. The objective of my thesis is to characterize SprY expression profile, to identify its targets, its mechanisms of action and the physiological roles of SprY in HG003 *S. aureus* strain.

1. Firstly, we studied SprY expression profile. For this experiment, we verified SprY expression different *S. aureus* strains such as N315, HG003, USA300 and Newman. However, for my thesis project, we mostly focused on SprY expression in HG003 wild-type strain (WT) and strains deleted for *sprX2* or *sprY* (HG003 Δ *sprX2* or HG003 Δ *sprY*). In addition, since sRNAs are known to allow bacterial adaptation to environmental changes, we also studied SprY expression in response to different stresses.

2. Secondly, since SprY (alias S629 in Madër et al. 2016), is considered *bona fide* sRNA (W. Liu et al. 2018) and sRNAs are demonstrated to be implicated in expression regulation of targeted genes, we were looking for potential direct targets of SprY. To obtain this objective, we studied SprY targets using two different approaches: one is *in silico* predictions via CopraRNA, and the other approach is a high-speed method “MS2”, based on the purification of the complexes sRNAs with its target RNA *in vivo*. Molecular biology methods and structural prediction will be used for the study of the mechanism of action of SprY sRNA.

3. Next, we studied the involvement of SprY in the virulence and the hemolytic activity of *S. aureus*. Thus, SprY function was evaluated in mouse model staphylococcal infections by the method already used to show the importance of SprD in (Chabelskaya, Gaillot, and Felden 2010).

RESULTS

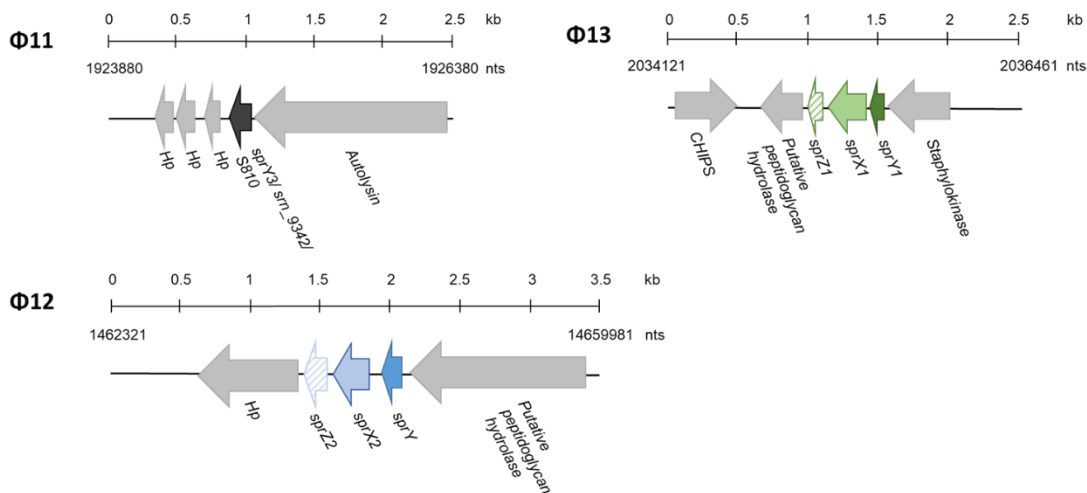

Figure 35. Genomic localization of *sprX* and *sprY* in HG003 strain. Schematic representations of the organization of the genetic loci of *sprX* and *sprY*. The coding phases, the *sprX* and *sprY* genes and the nucleotides (nts). Hp stands for hypothetical protein.

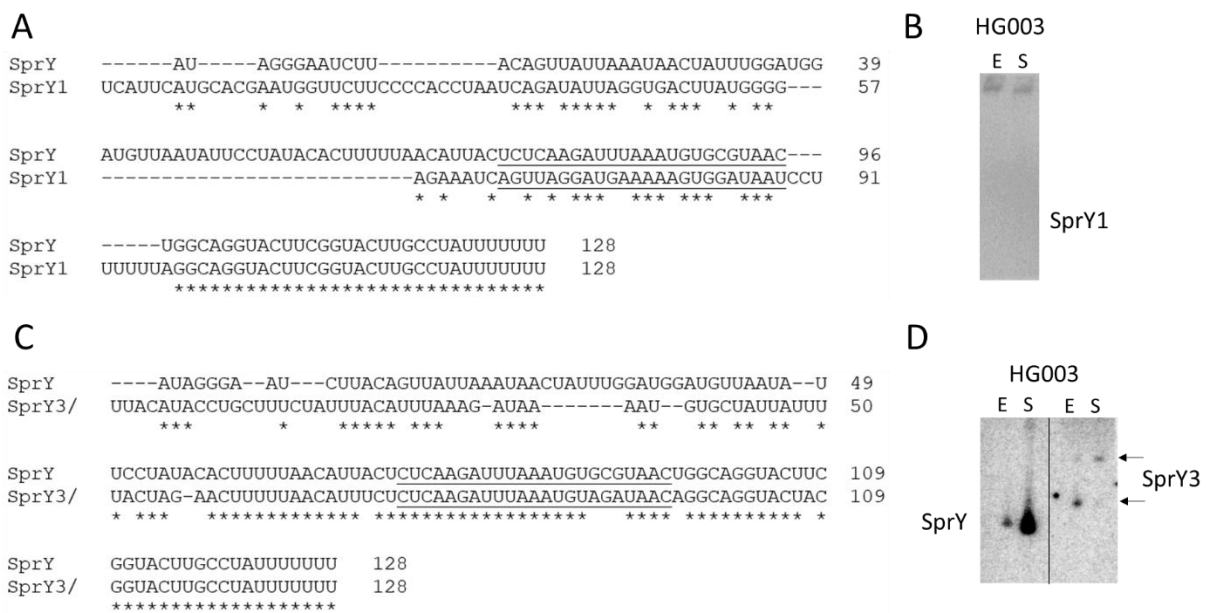

Figure 36. Analysis of *sprY1*, *sprY* and *sprY3/ srn_9342* genes. (A, C) Alignment of the *sprY* sequence of with *sprY1* sequence (A) and with *sprY3/ srn_9342* sequence (C), from 5' to 3'. Identical nucleotides between the three copies are marked with a star. The sequence of the conservative 3' end of *sprY* gene sequences is underlined. The sequences underlined correspond to sequences of primers using in Northern blots assays to detect separately the expression of 3 copies of *sprY* gene in HG003 strain. (B, D) Total RNA extraction of HG003 was performed and used for Northern Blot assay. Analysis of *sprY1* expression (B) and of *sprY* and *sprY3/srn_9342* (D) expressions in HG003 strain. Northern Blot was carried out using total RNA extraction of HG003 *S. aureus* strain at exponential phase (E) and at stationary phase (S).

I. Characterization of SprY

A. Localization of *sprY* gene in HG003 *S. aureus* strain

During studies of sRNA SprX2 and neighboring sequences, we identified by serendipity another sRNA that we called SprY. Located on phage Φ 12 between *sprX2* gene and the *SAOUHSC_01515* gene encoding for putative peptidoglycan hydrolase, *sprY* gene was also identified as a transcript of an sRNA by Mäder and his collaborators that they designated S629 (Mäder et al. 2016) (Figure 35). Not long after, Bouloc's lab performed a study in which this sRNA was validated as a *bona fide* sRNA: likely a *trans*-acting sRNA, not expressed from the opposite strand of a coding gene (W Liu et al. 2018). We determined the transcription start of *sprY* gene and the size of SprY sRNA of about 125 nucleotides (Le Huyen et al. 2021). We also showed a predicted secondary structure of SprY consisting of three stem loops and the last one being a Rho-independent transcriptional terminal site (Figure 3S in Le Huyen et al. 2021). Furthermore, during our work on *sprY* gene, we noticed two similar sequences to *sprY* located in two other phages (Φ 11 and Φ 13) of *S. aureus* HG003 strain. We named *sprY1* the first sequence, located on phage Φ 13 between *sprX1* gene and the *sak* gene (Figure 35), with 55.47% sequence identity to *sprY* according to sequence alignment analysis (Figure 36A). However, *sprY1* expression was not detected in HG003 strain by Northern Blot (Figure 36B). The second sequence with 73.4 % of identity with *sprY* gene, *sprY3*, corresponds to *srn_9342* in Newman strain (Bronsard et al. 2017). *sprY3/srn_9342* gene is located on phage Φ 11 between *SAOUHSC_02018* and *SAOUHSC_02019* genes encoding respectively for a hypothetical protein and an autolysin (Figure 35 and Figure 36C). In addition, Northern Blot showed the expression of two transcripts of SprY3 with different sizes depending on the growing phase, which is consistent with the study of Bronsard et al. 2018 (Figure 36D). In general, the three sequences seem to share a highly conserved 3' end that corresponds to a terminal transcription sequence (TTS) (Figure 36) and the rest of the sequences vary greatly from one sequence to another one. My thesis project focused only on characterizing the *sprY* gene and studying its biological contribution to *S. aureus* pathogenicity.

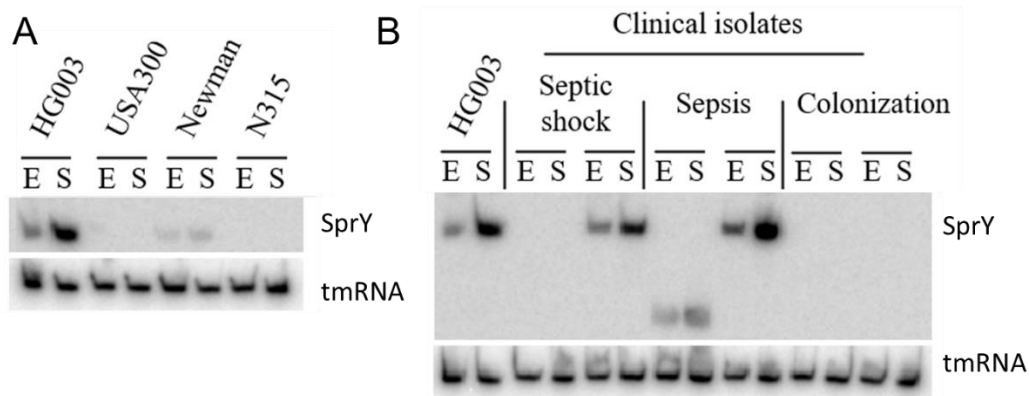

Figure 37. Analysis of *sprY* expression in different *S. aureus* strains (A) (Le Huyen et al. 2021) and clinical isolates (B). Total RNA extraction was performed at exponential phase (E) and at stationary phase (S). Northern Blot was carried out using labelled DNA probes for SprY. As loading controls, the blots were also probed for tmRNA.

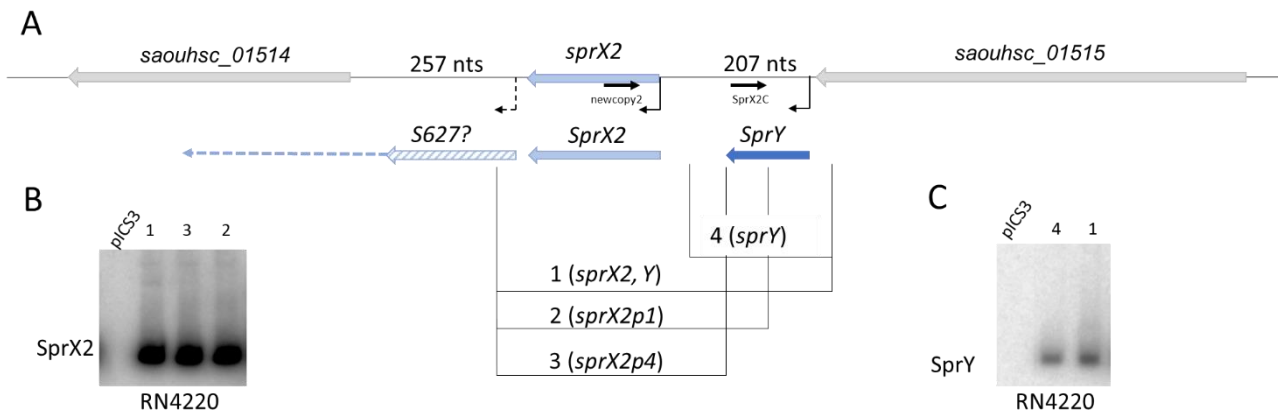

Figure 38. Expression of *sprX2* and *sprY* in RN4220 *S. aureus* strain. (A) Schematic organization of the genetic loci of *sprX2* and *sprY* in HG003 strain. Different plasmids constructions were made to overexpress *sprX2* and/ or *sprY* in RN4220 strain and are numerated from 1 to 4 ((1): pICS3-*sprY*, *sprX2*; (2): pICS3-*sprX2p1*; (3): pICS3-*sprX2p4* and (4): pICS3-*sprY*). (B) and (C) Northern Blot analysis of SprX2 and SprY expressions in RN4220 containing different plasmids. Another transcript located in the downstream of *sprX2* gene was detected by Madër et al., 2016 and named S627. newcopy2 black arrow indicates primers used in Northern Blot to detect the expression of *sprX2* and primer SprX2C for *sprY* expression.

B. Analysis of *sprY* expression

We showed previously that *sprY* is encoded on phage Φ 12 (or Sa2) that is conserved in several *S. aureus* strains other than NCTC8325 such as Newman (Herron-Olson et al. 2007) and USA300 (Diep et al. 2006) among others. However, not all Sa2 phages encode the *sprY* gene like in the case of USA300 strain; according to genomic alignment analysis by Basic Local Alignment Search Tool (BLAST) and to the conservation analysis of sRNAs in the Firmicutes phylum in (W. Liu et al. 2018). To verify this observation, we performed Northern Blot assay using total RNA extraction of different *S. aureus* strains (HG003, USA300 and Newman) at exponential phase and stationary phase of bacterial growth. In addition, total RNA extraction of N315 strain was used as control negative since it does not contain bacteriophage Sa2 (Diep et al. 2006). As expected, we only observed SprY expression in HG003 and Newman, and not in USA300 and N315 strains (Figure 37A). As for the contribution of SprY in staphylococcal infection, we tested of *sprY* expression in different clinical isolates. Our preliminary data showed the presence of SprY in septic shock and sepsis but none in colonization isolates (Figure 37B), which led us to wonder if in some infectious conditions, these features could confer advantages and might affect bacterial pathogenesis. Next, to analyze the promoter sequence of *sprY* and to test if *sprY* and *sprX2* are expressed independently, we constructed different vectors including *sprX2* gene with different portions of *sprY* gene (Figure 38A). The *S. aureus* RN4220 strain that lacks *sprY* and *sprX2* genes was transformed with these vectors and then the expression of *sprY* and *sprX2* was analyzed. RN4220 strain harboring the empty vector pICS3 was used as a negative control. Our Northern Blot results showed similar SprX2 sRNA expression levels from three first plasmids constructions (1-3) (Figure 38B). In addition, *sprY* expression was observed when the whole sequence of *sprY* is included in the plasmid designs whether the *sprX2* sequence was included or not (Figure 38C) and an approximative estimation of 35 nts upstream of *sprY* is sufficient to express *sprY*. Thus, this analysis allowed us to estimate the promoter of the *sprY* gene and to show that the two sRNAs express independently from plasmids in RN4220 strain. Next, we verified if the endogenous expression of *sprY* and *sprX2* is also independent in HG003 strain, which contains *sprX2* and *sprY* genes.

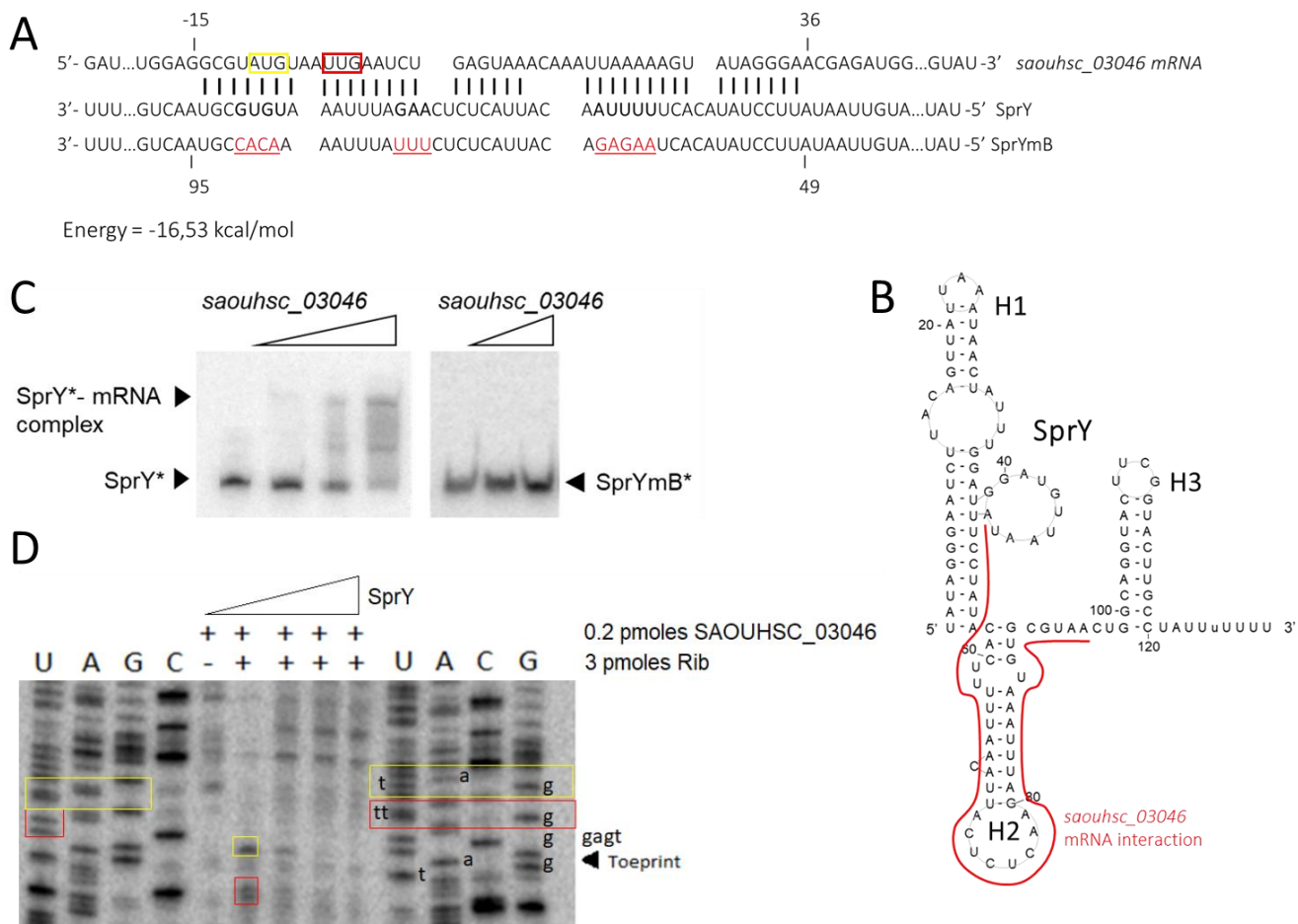

Figure 39. SprY interacts with *saouhsc_03046* mRNA. (A) Interaction between SprY and *saouhsc_03046* was predicted by IntaRNA software (Busch *et al.*, 2008). The nucleotides underlined and in red correspond to the mutations in the *sprY* and *sprYmB* sequences. (B) Schematic presentation of SprY predicted secondary structure and the region of SprY that interacts with *saouhsc_03046* mRNA (shown in red line). (C) Complex formation between SprY and *saouhsc_03046* mRNA was analyzed by native gel retardation assays of purified labelled SprY (SprY* and SprYmB*) with increasing concentrations of *saouhsc_03046* mRNA (0.1, 0.5 and 2 nM for SprY*; 2.5 and 5 μ M for SprYmB*). Complex formation between SprY and RNAlII (2.5 and 5 μ M) is used as positive control for shift assay. (D) Toeprint assay of *saouhsc_03046* mRNA. SprY specifically prevents ribosome loading on the *saouhsc_03046* translational initiation site. Here we show toeprint assays on *saouhsc_03046* mRNA in the presence of increasing concentrations of SprY (3, 15 and 75 nM). '+' indicates the presence of purified 70S ribosomes. An arrow indicates the location of the experimentally determined toeprint. U, A, G and C refer to the *saouhsc_03046* mRNA sequencing ladders. Two potentials translational initiation are framed in yellow and red.

For that, we tested their expressions in HG003 deleted for *sprX2* or *sprY* (HG003 Δ *sprX2* or HG003 Δ *sprY*) as well as in HG003 overexpressing *sprX2* or *sprY* under the control of its own promoter (HG003 pICS3-*sprX2* and HG003 pICS3-*sprY*) (Le Huyen et al. 2021). Our results showed that the absence of one sRNA or the overproduction of one does not affect the expression of the other sRNA (Figure 2C in Le Huyen et al. 2021). Taken together, regardless of the proximity of *sprX2* and *sprY* genes, their expressions are independent of each other.

II. Identification of SprY direct targets by different approaches

A. *In silico* prediction: SAOUHSC_03046 mRNA

In general, most sRNAs with known functions act by base pairing to mRNA targets. To identify SprY potential direct targets, we performed predictions *in silico* using TargetRNA2 (Kery et al. 2014) and CopraRNA (Tjaden 2008; Wright et al. 2014). Since SAOUHSC_03046 mRNA came up as the only common result from both predictions analysis (Annex 1 and Annex 2), we decided to study the impact of SprY on its expression. In addition, the analysis with IntaRNA (Busch, Richter, and Backofen 2008; Mann, Wright, and Backofen 2017) confirmed a potential base pairing between SAOUHSC_03046 mRNA and SprY involving the 2nd hairpin of SprY (49th to 95th nucleotide) and the 5'UTR and 36 nts of SAOUHSC_03046 mRNA (Figure 39A and B). Then, we verified the interaction between SprY and SAOUHSC_03046 mRNA by EMSA using synthetic RNAs. A complex between SprY and SAOUHSC_03046 mRNA was observed (Figure 39C). The predicted zone was tested furtherly by using SprYmB, an SprY allele bearing point mutations corresponding to the predicted SAOUHSC_03046 binding sequence (Figure 39A). Expectedly, SprYmB lost the ability to bind to the mRNA target, implying that the predicted zone of SprY is required for the interaction (Figure 39C). Altogether, our results confirmed the interaction between SprY and SAOUHSC_03046 mRNA *in vitro*.

Furthermore, the fact that SprY binds to the 5' UTR of SAOUHSC_03046 mRNA including the ribosome binding site (RBS), suggests the obstruction of its translation initiation. To test this hypothesis, we performed a toeprint assays. First, a ternary initiation complex made of purified 70S ribosomes, initiator tRNA^{fMet}, and SAOUHSC_03046 mRNA was

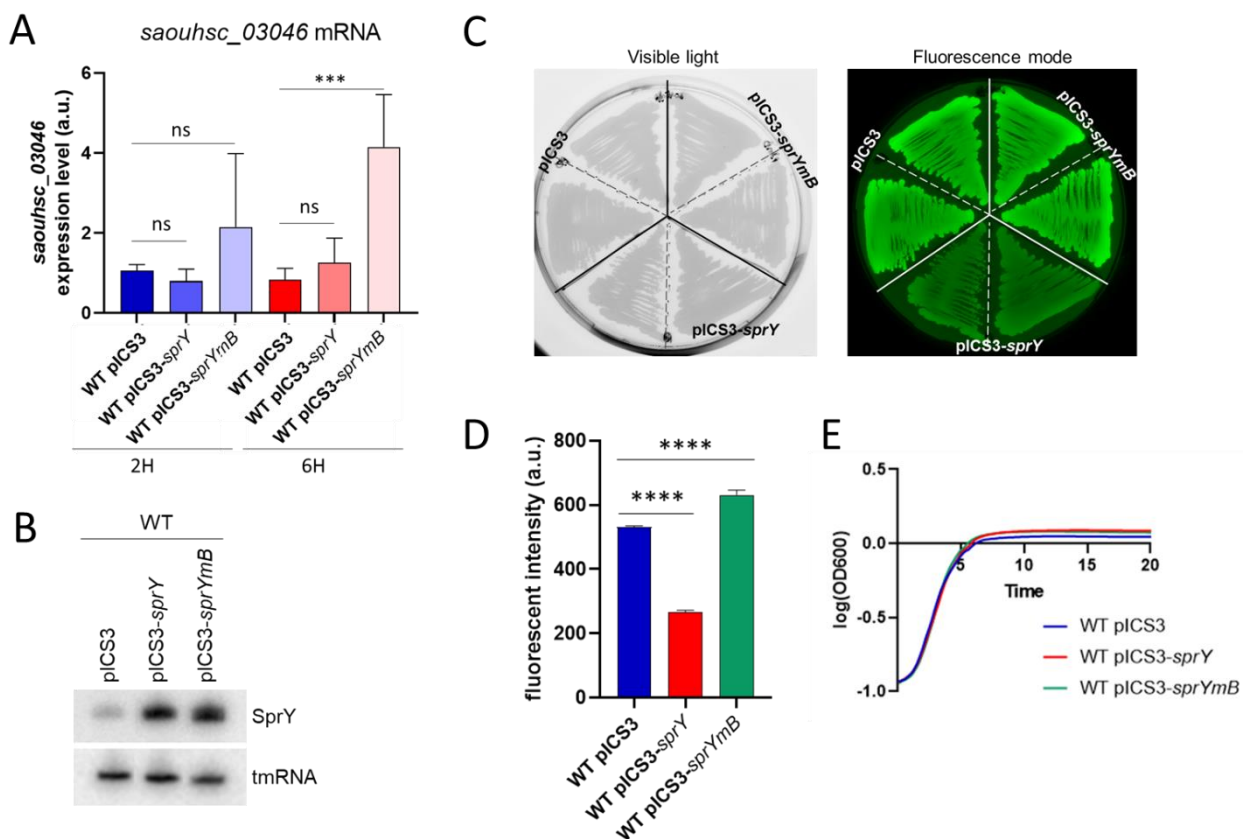

Figure 40. *saouhsc_03046* expression regulated by SprY in HG003 *S. aureus* strain. (A) Analysis of *saouhsc_03046* transcript level in HG003 (WT) strain containing empty plasmid (pICS3) or overexpressing *sprY* or *sprYmB* (pICS3-*sprY*; pICS3-*sprYmB*) by qPCR, using RNA extraction of those strains at early exponential growth phase. The mRNA expression level of *saouhsc_03046* in qPCR is normalized with the control gene (*gyrB*) and is calculated with $2^{-\Delta\Delta C_t}$ relative quantification. (B) Northern Blot analysis of *sprY* and *sprYmB* expressions in HG003 strain containing pICS3 or pICS3-*sprY* or pICS3-*sprYmB* using labelled DNA recognizing *sprY* and *sprYmB*. (C) *S. aureus* HG003 carrying the pCN33-*PtufA-03046-gfp* fusion plasmid co-transformed with pICS3 or pICS3-*sprY* or pICS3-*sprYmB* plasmids were grown on BHI agar plates. They were supplemented with chloramphenicol (10 μ g/ml) and erythromycin (10 μ g/ml). The images were obtained by scanning fluorescence on plates (right panel) and in visible light (left panel). (D) The translational initiation level of *saouhsc_03046* under SprY regulation were studied by using *gfp* gene reporter. *S. aureus* strain (WT) containing the pCN33-*PtufA-03046-gfp* fusion plasmids co-transformed with pICS3, pICS3-*sprY* or pICS3-*sprYmB*. The fluorescent intensity (D) and growth of these strains at OD600 (E) were measured every 10 minutes over 20 hours in a Biotek microplate reader.

All statistical analyses were performed using Student's t test. The error bars correspond to the average values from three independent experiments. Statistical significance is indicated by bars and asterisks as follows: *, P < 0.05; **, P < 0.01; ***, P < 0.005.

formed. A toeprint was then detected ~15 nts downstream from the AUG initiation codon of the *SAOUHSC_03046* mRNA, indicating that the ribosome fixation blocked the elongation of reverse transcription (Figure 39D). SprY significantly reduced the toeprint in a concentration-dependent manner, indicating that SprY inhibits binding of the Ribosome onto the *SAOUHSC_03046* mRNA *in vitro* (Figure 39D).

Next, we wanted to test if SprY affects *SAOUHSC_03046* expression at mRNA and/or translational level *in vivo* since SprY binds to the mRNA and masks the RBS of the mRNA. We first studied *SAOUHSC_03046* mRNA expression level by qPCR, using HG003 strain harboring empty vector pICS3 or overexpressing *sprY* or *sprYmB* (pICS3-*sprY* or pICS3-*sprYmB*). The expression of *sprY* and *sprYmB* in these strains was verified by Northern Blot (Figure 40B). Surprisingly, SprY overexpression did not affect *SAOUHSC_03046* mRNA level, whereas the overexpression of SprYmB showed a subtle increase of *SAOUHSC_03046* transcript at exponential phase and a significant increase in the target mRNA level at stationary phase (Figure 40A). We then hypothesized that SprY could affect *SAOUHSC_03046* at translational level rather than its mRNA quantity. For this, we constructed a *SAOUHSC_03046-gfp* translational gene fusion under the control of the constitutive *PtufA* promoter in pCN33 vector resulting in pCN33-*PtufA-3046-gfp*. HG003 containing empty pICS3 or pICS3-*sprY* or pICS3-*sprYmB* were co-transformed with pCN33-*PtufA-3046-gfp* in HG003 strain. Bacterial growth of all strains used for this experiment was essentially equivalent (Figure 40E). Overproduction of SprY significantly reduced *SAOUHSC_03046* translation (Figure 40C and D). Moreover, the overexpression of SprYmB increased the fluorescence intensity in strain containing construction pCN33-*PtufA-3046-gfp* (Figure 40C and D), which correlated with the increment at mRNA level. Taken together, our results showed that SprY downregulates the post-transcriptional level of *SAOUHSC_03046* but also could affects its mRNA level by an unknow mechanism not through binding to its mRNA but maybe the presence of an intermediate factor.

To further understand the physiological role of this regulation in *S. aureus*, we noticed that *SAOUHSC_03046* encodes for a protein of XRE family proteins (Xenope response element) (Ibarra et al. 2013) by genomic comparison. It also showed that *SAOUHSC_03046* gene in HG003 strain represents a homologue of 100% identity of

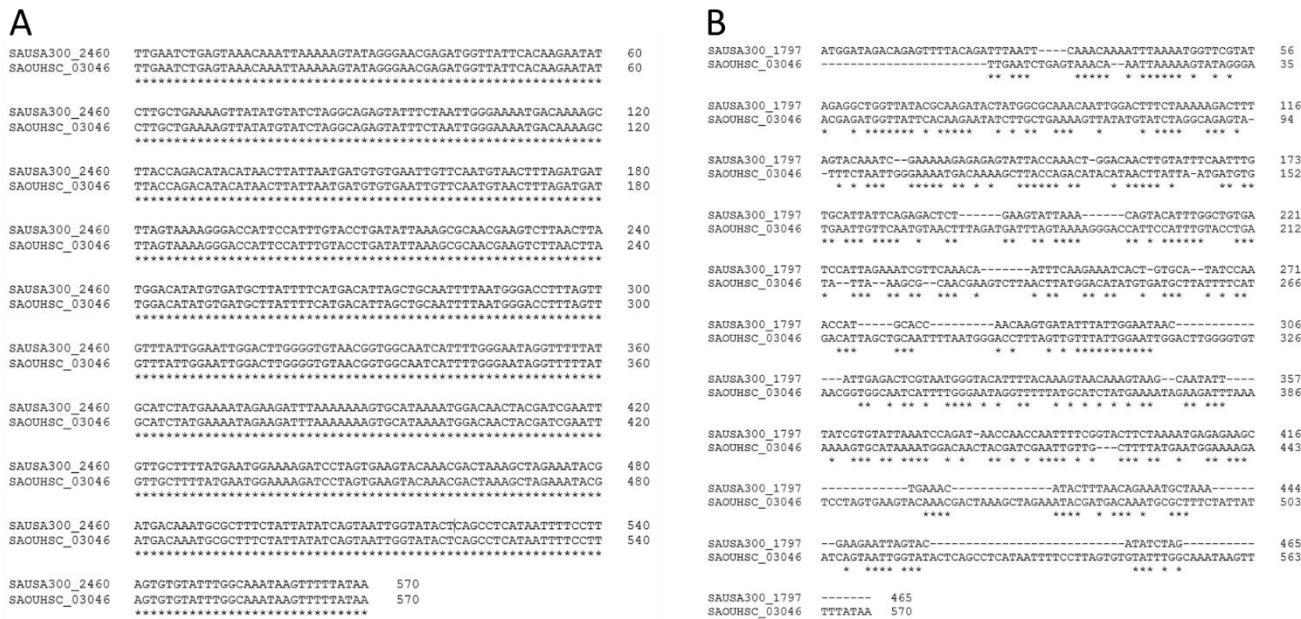

Figure 41. Predicted regulation of *spa* gene by SAOUHSC_03046 protein. Sequence alignment between *saouhsc_03046* (in HG003 strain) with *sau300_2460* (in USA300 strain) (A) and *sau300_1797* (B) using Clustal Omega (Madeira F *et al.*, 2019). The stars indicate the similarities between the two sequences.

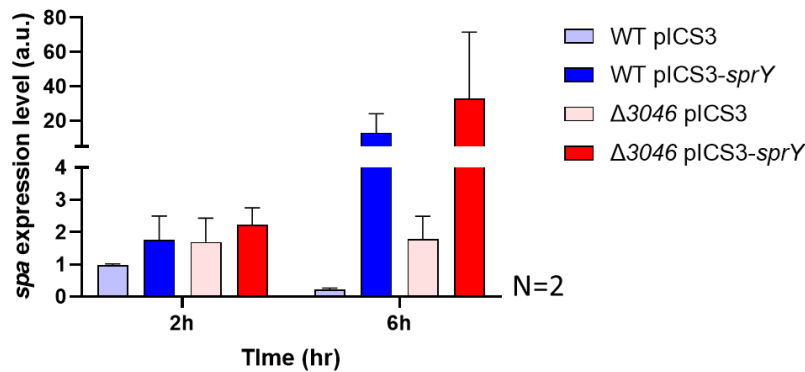

Figure 42. *spa* mRNA expression regulated by SAOUHSC_03046 in HG003 *S. aureus* strain. Analysis of *spa* transcript level in HG003 (WT) strain and strain deleted for *SAOUHSC_03046* (HG003 Δ3046) containing empty plasmid (pICS3) or overexpressing *sprY* (pICS3-*sprY*) by qPCR, using RNA extraction of those strains at early exponential phase (2h) and stationary phase (6h). The mRNA expression level of *spa* in qPCR is normalized with the control gene (*gyrB*) and is calculated with 2-ΔΔCt relative quantification.

SAUSA300_2460 and ~55% identity of SAUSA300_1797 (*xdrA* gene) in USA300 strain (Figure 41). Since XdrA is shown to activate *spa* translation in USA300 strain (McCallum et al. 2010), we suggested that SAOUHSC_03046 protein could also affect *spa* gene expression in HG003 strain. Our preliminary results showed an increase of *spa* mRNA level in HG003 deleted for SAOUHSC_03046 (HG003 Δ 3046) compared to WT strain (Figure 42). The overproduction of SprY also increased *spa* mRNA levels, which correlates with the fact that SprY overexpression reduced SAOUHSC_03046 expression at translational level (described in Figure 41). However, SprY overexpression showed similar impact on *spa* mRNA level in the presence or absence of SAOUHSC_03046, which suggests that other regulatory factors besides SAOUHSC_03046 may be involved in the regulation of SprY on *spa* mRNA.

B. Identification of SprY targets by MAPS

In addition to *in silico* approaches to identify SprY targets, we also performed *in vivo* analysis through a MS2-RNA affinity purification coupled with RNA sequencing (MAPS) (Carrier, Lalaouna, and Massé 2016; Lalaouna and Massé 2015; Tomasini et al. 2017a). MS2 tagged version of SprY was expressed under the control of an inducible promoter in HG003 strain and RNAs in complex with MS2-SprY were eluted and analyzed by RNAseq. According to bioinformatic analysis of RNAs enriched in complex with SprY-MS2 compared with MS2 alone, we identified three potential targets for SprY: (1) *rpmG1* mRNA, with an enrichment of 11.11-fold; (2) *saouhsc_1342a* mRNA, which was enriched by 7.59-fold; and (3) RNAlII, with 7.4-fold of enrichment (Le Huyen et al. 2021). However, no base pairing with a significant energy was predicted between SprY and *rpmG1* mRNA by *in silico* analysis. Hence, we focus on testing SprY impact on the expression regulation of the two other RNAs.

1. SprY affects SAOUHSC 1342a mRNA expression at translational level

IntraRNA prediction showed the binding between SprY and 20 nts around the translational start site of SAOUHSC_1342a mRNA (Figure 43A and B). We therefore confirmed SprY interactions with SAOUHSC_1342a mRNA *in vitro*. A complex formation between SprY

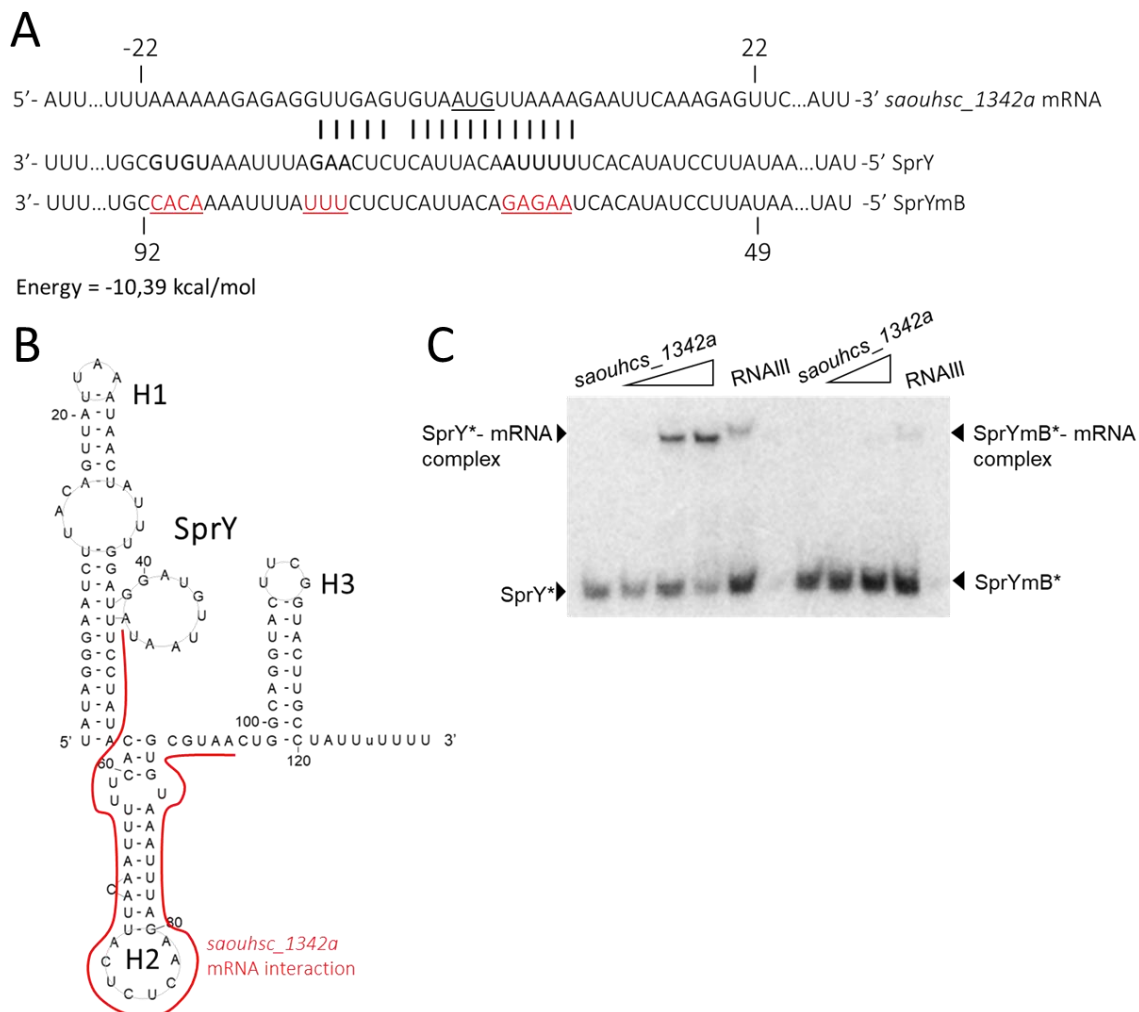

Figure 43. SprY interacts with *saouhsc_1342a* mRNA. (A) Interaction between SprY and *saouhsc_1342a* was predicted by IntaRNA software (Busch *et al.*, 2008). The nucleotides underlined and in red correspond to the mutations in the *sprY* and *sprYmB* sequences. (B) Schematic presentation of SprY predicted secondary structure and the region of SprY that interacts with *saouhsc_1342a* mRNA (shown in red line). (C) Complex formation between SprY and *saouhsc_1342a* mRNA was analyzed by native gel retardation assays of 0.025 pmoles of purified labelled SprY (SprY*) (left panel) and 0,025 pmoles of SprYmB* (right panel) with increasing concentrations of *saouhsc_03046* mRNA (0.05, 0.25 and 0.5 μ M for SprY; 0.25 and 0.5 μ M for SprYmB). Complex formation between SprY or SprYmB with RNAIII (0.5 μ M) is carried out as a positive control for the assay.

and *SAOUHSC_1342a* mRNA was observed with an increasing concentration of the mRNA (Figure 43C). We also challenged the interaction region by SprYmB (described previously in Figure 39A). As we expected, SprYmB lost its ability to bind *SAOUHSC_1342a* mRNA, which confirmed the predicted interaction zone of SprY (Figure 43C). Next, we tested the effect of SprY and SprYmB overexpression on *SAOUHSC_1342a* at post-translational level. For this, we co-transduced RN4220 *S. aureus* strain with pCN33-PtufA-1342a-gfp and pICS3 or pICS3-sprY or pICS3-sprYmB. SprY overproduction significantly reduced SAOUHSC_1342a-GFP expression, whereas the overexpression of SprYmB resulted in a similar fluorescence intensity as WT strains harboring empty plasmid (Figure 44A). In addition, bacterial growth of all strains used for this experiment was essentially comparable (Figure 44B). Taken together, we hypothesize that through binding to the 5' end of *SAOUHSC_1342a* mRNA, SprY might prevent the recruitment of the Ribosome to the RBS on the mRNA, and therefore downregulates the translation of *SAOUHSC_1342a*.

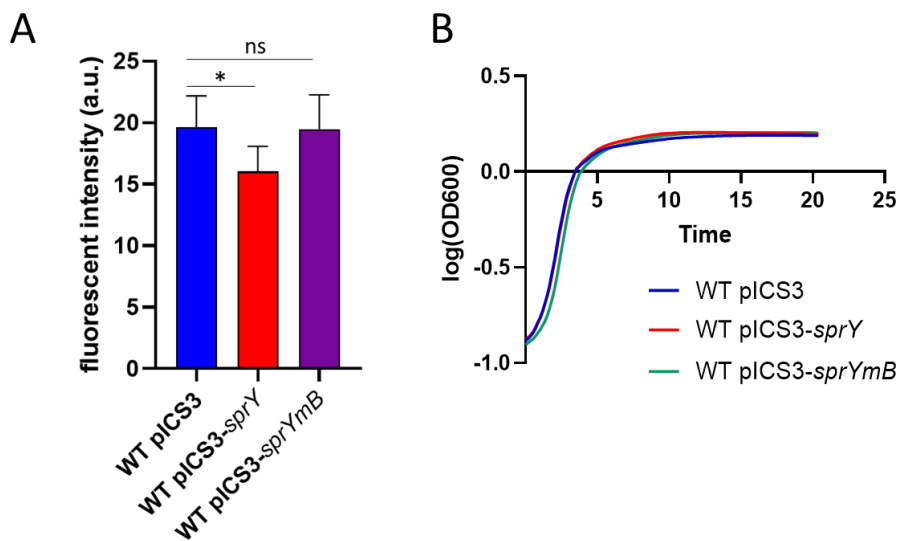

Figure 44. *saouhsc_1342a* expression-regulated by SprY in RN4220 *S. aureus* strain. (A) The translational initiation level of *saouhsc_1342a* under SprY regulation were studied using *S. aureus* RN4220 carrying the pCN33-PtufA-1342a-gfp fusion plasmid co-transformed with different plasmids (pICS3 or pICS3-sprY or pICS3-sprYmB). The fluorescent intensity (A) and the growth of these strains at OD600 (B) were measured every 10 minutes over 20 hours in a Biotek microplate reader. All statistical analyses were performed using Student's t test. The error bars correspond to the average values from three independent experiments. Statistical significance is indicated by bars and asterisks as follows: *, $P < 0.05$; **, $P < 0.01$; ***, $P < 0.005$.

2. “A small regulatory RNA alters *Staphylococcus aureus* virulence by titrating RNAIII activity” (Published article)

The second identified target for SprY is RNAIII, one of the major regulators of *S. aureus* virulence. IntaRNA prediction showed a potential base pairing between SprY and the 13th stem-loop of RNAIII. We then verified this predicted interaction between SprY and RNAIII *in vitro* by performing EMSA using synthetic RNAs. We also challenged the sequence specificity of the interaction by introducing point compensatory mutations to create SprY and RNAIII alleles (SprYmA and RNAIIImA) unable to bind the wild type sRNAs. Furthermore, the stem-loop 13 of RNAIII has been demonstrated to control the expression of several virulence factors such as *hla*, *rot*, *coa*, *lytM*, *spa*, *SA1000*, *SA2353*, *SA209*, etc. (Boisset et al. 2007; Chevalier et al. 2010; Chunhua et al. 2012; Geisinger et al. 2006; Huntzinger et al. 2005; Morfeldt et al. 1995). We suggested that through this interaction with RNAIII, SprY might affect RNAIII regulation of its targets. To verify this hypothesis, we studied the expression of two RNAIII targets: *ecb* and *rot* mRNAs. To study the mRNA level of these targets, we performed qPCR using total RNA extraction from HG003 *S. aureus* strains overexpressing SprY. We also tested *ecb* and *rot* translational expression by double plasmid system as described in Ivain et al. 2017. This experiment consists in designing a mRNA-*gfp* translational gene fusion under the control of a constitutive promoter *PtufA* in pCN33 vector resulting in pCN33-*PtufA-ecb/rot-gfp*. We then transduced these plasmids in HG003 harboring pICS3, pICS3-*sprY* and pICS3-*sprYmA* which is *sprY* mutated in the interaction zone with RNAIII. The overexpression of SprY impacts significantly the fluorescence of Ecb-GFP and Rot-GFP, while SprYmA did not affect the fluorescence intensity. Since SprYmA does not bind RNAIII, these results implied that the interaction between SprY and RNAIII is needed for the regulation of *ecb* and *rot* by SprY. Taken together, our data disclose an sRNA acting as a sponge for RNAIII and showed that SprY also impacts on the hemolytic activity and involving in the virulence of *S. aureus*. These results are presented in the article accepted for publication in NAR (Le Huyen et al. 2021).

A small regulatory RNA alters *Staphylococcus aureus* virulence by titrating RNAIII activity

Kim Boi Le Huyen¹, Cintia Daniela Gonzalez¹, Gaëtan Pascreau¹, Valérie Bordeau¹, Vincent Cattoir¹, Wenfeng Liu², Philippe Bouloc², Brice Felden^{1,†} and Svetlana Chabelskaya^{1,*}

¹Inserm, BRM [Bacterial Regulatory RNAs and Medicine] - UMR_S 1230, 35033 Rennes, France and ²Université Paris-Saclay, CEA, CNRS, Institute for Integrative Biology of the Cell (I2BC), 91198 Gif-sur-Yvette, France

Received April 06, 2021; Revised August 25, 2021; Editorial Decision August 26, 2021; Accepted September 02, 2021

ABSTRACT

Staphylococcus aureus is an opportunistic human and animal pathogen with an arsenal of virulence factors that are tightly regulated during bacterial infection. The latter is achieved through a sophisticated network of regulatory proteins and regulatory RNAs. Here, we describe the involvement of a novel prophage-carried small regulatory *S. aureus* RNA, SprY, in the control of virulence genes. An MS2-affinity purification assay reveals that SprY forms a complex *in vivo* with RNAIII, a major regulator of *S. aureus* virulence genes. SprY binds to the 13th stem-loop of RNAIII, a key functional region involved in the repression of multiple mRNA targets. mRNAs encoding the repressor of toxins Rot and the extracellular complement binding protein Ecb are among the targets whose expression is increased by SprY binding to RNAIII. Moreover, SprY decreases *S. aureus* hemolytic activity and virulence. Our results indicate that SprY titrates RNAIII activity by targeting a specific stem loop. Thus, we demonstrate that a prophage-encoded sRNA reduces the pathogenicity of *S. aureus* through RNA sponge activity.

INTRODUCTION

Staphylococcus aureus is an opportunistic human and animal pathogen that can cause a wide range of illnesses, from food poisoning and superficial abscesses to more life-threatening diseases such as pneumonia, osteomyelitis, bacteremia, endocarditis and toxic shock syndrome (1,2). The infection process requires the controlled expression of virulence factors allowing bacteria to escape the host defense system, adapt to changing environmental conditions, and attack and destroy host cells. This process involves a wide range of wall-associated proteins and extracellular fac-

tors that are expressed during the different stages of infection. Global regulatory elements including transcription factors, sigma factors, two-component systems and regulatory RNAs assure the coordinated expression of these virulence factors.

Among the regulatory RNAs, small RNAs (sRNAs) are mostly non-coding, relatively short (50–550 nucleotides), and located within core genomes or mobile genetic elements. They are usually conditionally expressed, i.e. depending upon specific stress and growth phase. sRNAs control expression of their target genes by pairing with RNAs or forming complexes with proteins; in this way they usually modulate the stability and translation of mRNAs, and modify the activity of proteins (3). Over the past decade, hundreds of putative sRNAs discovered in *S. aureus* were compiled in the *S. aureus* RNA Database SRD (4). However, a recent analysis proposes that among them, only 50 are ‘bona fide’ sRNAs (5). *Staphylococcus aureus* sRNAs were demonstrated to contribute to regulation of dozens of functions. sRNAs contribute to regulation of bacterial metabolism, such as RsaE (6–8), or to antibiotic resistance, such as SprX (9). Several sRNAs were shown to be involved in the virulence of *S. aureus* such as SprD, which regulates expression of the immune evasion protein Sbi (10).

RNAIII is a paradigm for sRNA regulation of virulence (11,12). Besides encoding the PSM δ -hemolysin (known as Hld), RNAIII also positively regulates expression of *hla*, encoding the α -hemolysin (13), which leads to cell lysis (14–16), and intervenes in the expression switch between surface proteins and secreted toxins. Through direct binding to mRNA targets, RNAIII prevents the translation of major surface proteins, such as protein A (17), Sbi (10) and Ecb (18), which play key roles in adhesion and immune evasion. In addition, RNAIII inhibits translation of *rot* mRNA, encoding the repressor of toxins Rot (19–21), which blocks the transcription of exoproteins and toxins (22). By inhibiting Rot, RNAIII indirectly activates transcription of exotoxins

*To whom correspondence should be addressed. Tel: +33 2 23 23 48 12; Email: svetlana.chabelskaia@univ-rennes1.fr

†This publication is dedicated to the memory of our colleague Prof. Brice Felden who passed away suddenly on March 2021.

© The Author(s) 2021. Published by Oxford University Press on behalf of Nucleic Acids Research.

This is an Open Access article distributed under the terms of the Creative Commons Attribution-NonCommercial License

(<http://creativecommons.org/licenses/by-nc/4.0/>), which permits non-commercial re-use, distribution, and reproduction in any medium, provided the original work is properly cited. For commercial re-use, please contact journals.permissions@oup.com

and indirectly inhibits synthesis of protein A at the transcriptional level.

In this study, we report that SprY, an sRNA expressed from prophage ϕ 12, is involved in the regulation of *S. aureus* virulence. By antisense pairing with RNAIII, SprY prevents RNAIII from regulating its targets and consequently decreases *S. aureus* hemolytic activity and virulence in a murine sepsis infection model. Together, our data reveal an sRNA acting as a sponge for RNAIII and further elucidate the regulation network controlling *S. aureus* virulence.

MATERIALS AND METHODS

Bacterial strains and growth condition

All bacterial strains and plasmids used in this work are listed in Supplementary Table S1. The DH5- α *Escherichia coli* strain was grown at 37°C in Luria-Bertani (LB) broth or LB agar plate supplemented with 50 μ g/ml ampicillin if necessary. The *S. aureus* RN4220 strains was used to prepare phage-containing vectors expressing sRNA or target-*gfp* fusions. In this study, *S. aureus* HG003 strain was used to co-transform the target-*gfp* fusions with the sRNA expressing plasmid. Cultures of these co-transformed *S. aureus* strains were grown at 37°C either in brain heart infusion broth (BHI, Oxoid) or on BHI agar plates. When necessary, media were supplemented with 10 μ g/ml of chloramphenicol and/or erythromycin. HG003 Δ rnaIII::tag004 (SaPhB618) and HG003 Δ sprY::tag112 (SaPhB980) were constructed using pMAD Δ rnaIII::tag004 and pIMsprY2::tag112, respectively, as described (23).

Plasmids constructions

Supplementary Table S2 lists all the primers used. To construct the sRNA-expressing vectors, we used pICS3 (24). To construct the pICS3-*sprY*, *sprY* with its endogenous promoter was amplified by PCR with primers 13–14 and cloned in pICS3 vector digested by PstI and NarI. To introduce mutations in *sprY*, primers 15–16 were used.

To construct the pCN33-*PtufA-rot-gfp* vector, which expresses *rot* under control of the *PtufA* promoter, we amplified 373 nucleotides *rot* with primers set 18–19. HG003 strains carrying each of the target-*gfp* fusions and the sRNA plasmids were grown on BHI agar plates supplemented with 10 μ g/ml chloramphenicol and erythromycin. The fluorescence measurements of the co-transduced HG003 strains were performed as previously described (24).

PCR products corresponding to the sequence of *ms2* tag, or *ms2* fused with *sprY* were cloned into pRMC2 digested by KpnI / SacI (see Supplementary Table S2 for primers containing MS2 tag sequence). All cloning experiments were performed with Gibson Assembly Master Mix (New England Biolabs). The reactions were then transformed into *E. coli* DH5- α by heat shock at 42°C. The plasmids were purified from overnight cultures in LB broth supplemented with Ampicillin 100 μ g/ml, extracted (Miniprep Extraction Kit, Qiagen) and Sanger sequenced by using BigDye Terminator v3.1 Cycle sequencing Kit, using a 3130 \times 1 capillary electrophoresis genetic analyzer (Applied Biosystems). The purified plasmids were used for the transformation in *S. aureus* RN4220 strain by electroporation shock. The ϕ 80

phages prepared from RN4220 were then used to transduce plasmids in HG003 strains. pMAD Δ rnaIII::tag004 is a pMAD derivative containing the PCR-amplified *rnaIII* upstream, tag004 and *rnaIII* downstream sequences cloned by Gibson assembly (using primers RNAIII UpF, RNAIII UpR, RNAIII DwF, RNAIII DwR for *rnaIII* adjacent sequences) as described. pIMsprY2::tag112 is a pIMAY derivative containing the PCR-amplified *sprY* upstream, tag004 and *sprY* downstream sequences cloned by Gibson assembly (using primers pIMAY-Up-SprY2-F, pIMAY-Up-SprY2-R, pIMAY-Down-SprY2-F and pIMAY-Down-SprY2-R for *sprY* adjacent sequences) as described (23).

Proteins extraction and Western blots

Staphylococcus aureus strains were grown until exponential phase (OD₆₀₀ = 0.8) or stationary phase (OD₆₀₀ = 10.1) in BHI at 37°C, with agitation at 160 rpm, and the cells were then pelleted for 10 min at 4°C (8000 \times g). The total proteins extractions were prepared according to (25). Rot expression was visualized by anti-Rot antibodies (Benson, 2012, JB) and anti-rabbit IgG secondary antibodies (Jackson). Western blots were revealed using the Amersham ECL Plus detection Kit. Signals were visualized using LAS 4000 (GE Healthcare).

In vitro transcription, RNA labeling and Gel-shift assays

All RNAs were transcribed from PCR-generated DNA using MEGAscript T7 kit (Ambion). The template for transcription was amplified using HG003 genomic DNA and forward primers containing T7 promoter sequences (Supplementary Table S1). RNAs were labeled at 5'-end using [γ -³²P] ATP (Amersham Biosciences) and T4 polynucleotide kinase (Invitrogen). Labeled and unlabeled RNAs were purified on a 5% acrylamide urea gel, eluted in Elution buffer (20 mM Tris-HCl pH 7.5, 250 mM NaCl, 1 mM EDTA, 1% SDS) at 37°C, eluted, ethanol precipitated, quantified by Qubit (Thermo Fisher Scientific) and stored at -80°C.

Gel-shift assays were performed as described in (26). RNAs were denatured in 50 mM Tris/HEPES pH 7–7.5, 50 mM NaCl for 2 min at 80°C, followed by refolding for 10 min at 25°C after adding MgCl₂ at final concentration of 5 mM. The binding reactions were performed in 50 mM Tris-HCl (pH 7.5), 50 mM NaCl, 5 mM MgCl₂ for 20 min at 25°C. About 0.025 pmoles of labeled SprY or SprY mutants were incubated with various concentrations of RNAIII. The samples were supplemented with 10% glycerol and were loaded on a native 4% polyacrylamide gel containing 5% glycerol. The gels were dried and visualized by Typhoon FLA 9500 scanner (GE Healthcare).

RNA extractions, northern blots, RNA half-life determination and qPCR assay

The cells were collected at exponential and at stationary phases of growth, pelleted for 10 min at 4°C (4500 \times g) and resuspended in RNA lysis buffer (0.5% SDS, 20 mM acetate of sodium, 1 mM EDTA, pH 5.5). Total RNA

was extracted as previously described (7). The Northern blot assays were carried out as previously described (9). The membranes were hybridized with specific ^{32}P -labeled probes (Supplementary Table S2) in ExpressHyb solution (Clontech) and were washed according manufacture recommendations. The membranes were then exposed and scanned with Typhoon FLA 9500 scanner (GE Healthcare). The images quantifications were realized with ImageQuant Tool 7.0.

For sRNA half-life determination, rifampicin was used as the most common treatment to stop the transcription (27). *Staphylococcus aureus* HG003 strain and its derivatives were cultured overnight, diluted to 1/100, grown for 5 h at 37°C, and incubated with 20 mg/ml rifampicin. About 8 ml of each strain was collected before and at 2, 5, 10, 20, 30, 40, 60 and 90 min after adding rifampicin. These samples were centrifuged, the pellets were frozen in liquid nitrogen then stored at -80°C. Total RNA was extracted. For the quantitative real-time PCR (qRT-PCR), total RNA extraction samples were treated with DNaseI Amplification grade Kit (Invitrogen). cDNAs preparations and qRT-PCR experiments were performed as previously described (24). The *gyrB* gene was used for normalization. As for absolute quantification by qPCR, instead of using *gyrB*, we prepared a calibration range with respective PCR products at concentrations of $10^{10/8/6/4/2/0/^{-2}}$ copies/ μl . Identification of TSS of *sprY* was performed as performed as described (28). For this reverse transcription (RT) was done on 5 μg of total RNA of HG003 strain with labeled primer 2.

Preparation of the MS2-affinity column

To prepare the 6His-MBP-MS2 protein, we used the pHMN plasmid (29) containing the 6His tag at the N-terminal and the MS2 tag at the C-terminal. The induction of protein production and bacterial lysis was performed as described by (30). The 6His tag allows a first purification on nickel resin, using an AKTÄ (GE healthcare). After being washed with water, the pumps and the column were equilibrated with lysis buffer (50 mM NaH_2PO_4 , 300 mM NaCl, 0.5% Tween 20, 10 mM Imidazole 10% glycerol). The bacterial lysate was added into the column and various fractions were recovered using the elution buffer (lysis buffer + 250 mM of imidazole). The fractions of interest were passed through a desalting column to remove traces of the elution buffer. A second purification was carried out using an amylose column washed and then equilibrated with buffer 2 (20 mM Tris-HCl, 0.2 mM NaCl, 0.5 mM EDTA). The fractions of interest were passed through the column and then eluted using a second elution buffer (buffer 2 + 10 mM maltose buffer). The fractions were also passed through a desalting column to remove all traces of maltose. For the preparation of the MS2-affinity column, 100 μl of amylose resin (NEB # E8021S) was added in a Bio-spin disposable chromatography column (Biorad # 732-6008). The column was then washed three times with 1 ml of buffer A (20 mM Tris-HCl pH 8, 150 mM KCl, 1 mM MgCl_2 , 1 mM DTT, 1 mM PSMF). A solution of 100 pmoles of 6His-MBP-MS2 protein was added to the column and was incubated for 5 min, and washed twice with 1 ml of buffer A.

Purification of bacterial lysates, RNA sequencing and Bioinformatic analysis

Staphylococcus aureus strains were grown until exponential phase ($\text{OD}_{600} = 0.8$) or stationary phase ($\text{OD}_{600} = 10.1$) in 50 ml of BHI (Oxoid). Then expressions of *ms2-sprY* and *ms2* were induced with 1 μM of anhydrotetracycline for 10 min. The bacteria were placed in ice for 10 min and centrifuged for 5 min at $4000 \times g$. The pellets were then washed with 1 ml of buffer A, centrifuged for 1 min at $16\,000 \times g$ and stored at -80°C. Frozen pellets were thawed on ice and resuspended in 2 ml of buffer A. Mechanical lysis with Fastprep (Fastprep, MP Biomedicals) in the presence of 250 μl of glass beads was carried out for 3×30 s at $6500 \times g$. The samples were centrifuged for 10 min at 4°C at $16\,000 \times g$. The bacterial lysates obtained were passed through an affinity column. Columns were washed 5 times with 1 ml of buffer A and then eluted with 1 ml of buffer A + 15 mM maltose. In order to carry out checks, we extracted the RNAs at different points in the experiment. We obtained four RNA extracts corresponding to the total RNAs taken before passage through the amylose column (input), RNA passed through a column (Flow-Through), RNA recovered after the last washing of the column (W) (Supplementary data). The RNAs from the fractions eluted from the columns are extracted with chloroform phenol as previously described (10). For MS2 and MS2-SprY, the northern blots were carried out using 5 μg of RNA according to the protocol as previously described (9). The primers used are listed in Supplementary Table S2. A bio-analyzer (2100-Agilent bio-analyzer) was used to quantify and verify the purity of the samples before being sequenced (following the manufacturer's instructions [Agilent]). RNA sequencing was carried out as previously described (31). The cDNA libraries were prepared with the NEBNext® Ultra™ II Directional RNA Library Prep Kit for Illumina®, and then sequenced as paired-end reads (2×75 bp) using an Illumina MiSeq platform and the MiSeq reagent kit version 3. The reads were mapped against the genomic sequence of *S. aureus* HG003 strain (Genbank accession no. CP000253) and then counted using the CLC Genomics Workbench software v8.1 (Qiagen). Statistical analysis was performed using the DESeq2 R package (32). Raw and processed data generated in this study have been submitted to the Gene Expression Omnibus (GEO) repository at the National Center for Biotechnology Information (NCBI) and are available under accession no. GSE166499.

Hemolysis assays

Staphylococcus aureus strains grown overnight were diluted to $\text{OD}_{600} = 0.1$ in BHI. The supernatants were taken at 2 h of bacterial growth, filtered with 0.45- μm filter and stored at -20°C. For blood sample preparation, 1 ml of human or mouse blood was centrifuged for 10 min at $4000 \times g$ at 25°C, followed by multiple washes with PBS 1X (qsp 1 ml) to eliminate the plasma and lysed red blood cells and re-suspended in 10 ml of PBS 1X. The prepared blood sample and the supernatants (diluted in 1/10) were added at a ratio 50:50 in 96 pointy wells plates to a final volume of 150 μl per well. After an incubation of 1 h at 37°C, the plate was centrifuged for 10 min at $4000 \times g$ at 25°C and 100 μl of the supernatants

were collected into a new 96 flat well plates and read at OD 540 nm. The mix of blood sample with PBS 1× or with 0.1% Triton were used respectively as negative and positive controls of hemolytic activity.

Animal infection model

HG003, HG003Δ*sprY* and complemented strains were used to study the virulence level in a murine intravenous sepsis model. All experimental protocols were approved by the Adaptive Therapeutics Animal Care and Use Committee (APAFIS#2123–2015100214568502v4). For the sepsis model, we used female Swiss mice (Janvier Labs), 6–8 weeks old and weighing ~30 g. Groups of five female mice were inoculated i.v. with 200 μl of bacterial suspensions containing 2×10^8 *S. aureus* cells in 0.9% NaCl. The survival of the mice was monitored for 12 days, and the statistical significance of differences between groups was evaluated by comparing Kaplan–Meier survival curves with the Mantel–Cox test. A *P*-value of 0.05 was considered significant.

RESULTS

SprY, a novel sRNA expressed from *S. aureus* srna cluster

A small staphylococcal RNA expressed from prophage φ12 (33) in NCTC8325 derivatives was initially described as a putative 5'UTR of a small open reading frame SAOUHSC_A01455 of 60 amino acids, and called S629 (34). However, based on in-depth analysis of the HG003 strain genome, we designated S629 as a *bona fide* sRNA (5). Because the gene S629 is adjacent to the *sprX2* sRNA gene (7,9), we renamed this sRNA SprY (Figure 1A and Supplementary Figure S1_A). Spr is an acronym coined for small pathogenicity island sRNA (35). The SprY 5'-end determined by reverse transcription (RT) (Supplementary Figure S1_B) corresponds to nucleotide position 1464380 of the NCTC8325 genome sequence (Supplementary Figure S1_A). Detection of SprY by northern blot (Figure 1B) and *in silico* identification of a Rho-independent transcriptional terminator upstream of SAOUHSC_A01455 (using ARNold; (36)) indicate that SprY is a *bona fide* sRNA of about 125 nucleotides. It is found in several *S. aureus* isolates with 95% sequence identity but is not present in other *Staphylococcaceae* (5). SprY is present only in strains containing the φ12 prophage; accordingly, it was detected by northern blot in Newman and HG003 strains but not in USA300 and N315 (Figure 1B).

SprY amounts are highest in pre-stationary phase and slowly decrease during stationary phase (Figure 2A). SprY half-life is 23.3 ± 1.45 min in pre-stationary phase (Figure 2B), implying that SprY is stable RNA, compared to most mRNAs with half-life of 2–4 min (37,38). Since *sprY* and *sprX2* are adjacent sRNA genes, we considered that their expression could be inter-dependent. For this purpose, we analyzed the amounts of both, SprY and SprX2 sRNAs in HG003 (39) and its derivatives deleted for either *sprY* (Δ*sprY*) or *sprX2* (Δ*sprX2*). Despite their proximity, deletion of one sRNA gene did not affect the expression of the other (Figure 2C). In addition, overexpression of *sprX2* (pICS3-*sprX2*) or *sprY* (pICS3-*sprY*) did not affect the expression level of the other sRNA (Figure 2C). We concluded

that *sprY* and *sprX2* are expressed independently from each other. Despite the close proximity of these genes, their expression patterns are different, since SprX2 accumulates during exponential phase while SprY accumulates in pre-stationary phase (Supplementary Figure S2, (9)).

The SprY structure predicted by RNAfold (40,41) and LocaRNA softwares (42–44) revealed three stem loops, the last one being a Rho-independent transcriptional terminator (Supplementary Figure S3). The activity of several staphylococcal sRNAs involves single-stranded C-rich regions (8,45). However, this feature is not present in SprY, suggesting that it may not target G-rich regions associated with Shine-Dalgarno sequences but other sequences.

SprY interacts directly with RNAIII, a major regulator of virulence factors of *S. aureus*

Most sRNAs act by base-pairing to RNA targets. To identify potential direct targets of SprY, we performed *in vivo* MS2-RNA affinity purification coupled with RNA sequencing (MAPS) (46). For this purpose, an MS2 tagged version of SprY was expressed under the control of an inducible promoter in HG003 (Supplementary Figure S4_A and B). After 2 and 6 h of growth, each followed by 5 min of induction, RNAs in complex with MS2-SprY were isolated by MS2 affinity chromatography, eluted, and identified by RNAseq. RNAIII, *rpmG1* mRNA and SAOUHSC_1342a mRNA were enriched 7.24-, 11.11- and 7.59-fold, respectively, with MS2-SprY compared to MS2 alone (Supplementary Figure S4_C and Supplementary Table S3). This significant enrichment suggests that these three RNAs are SprY targets. However, no base-pairing with a significant energy between SprY and *rpmG1* mRNA was predicted by *in silico* analysis suggesting that *rpmG1* mRNA enrichment with MS2 tagged SprY could be due to an indirect interaction. In contrast, IntaRNA software (47,48) indicated potential base-pairings of SprY with the 5' UTR of SAOUHSC_1342a (Supplementary Figure S4_D) and with RNAIII (Figure 3A), supporting the MAPS results. As RNAIII is the major virulence regulator and effector of quorum sensing in *S. aureus*, we focus our study on the interaction between SprY and RNAIII.

IntaRNA analysis indicates potential base-pairing between RNAIII and SprY involving the 1st hairpin of SprY (4th to 46th nucleotide) and the 13rd hairpin of RNAIII (Figure 3A and B). The predicted interaction between SprY and RNAIII was tested *in vitro* by EMSA using synthetic RNAs. A complex between SprY and RNAIII was observed (Figure 3C). Its specificity was challenged by SprY allele bearing point mutations in the 1st hairpin (SprYmA), which corresponds to the predicted RNAIII binding sequence (Figure 3A). Expectedly, SprYmA lost the ability to bind RNAIII (Figure 3C), implying that the 1st SprY hairpin is required for pairing. To bring further evidence to support the predicted pairing, an RNAIII derivative with compensatory mutations (RNAIIImA) restoring the pairing with SprYmA (Supplementary Figure S5_C) was synthesized and tested by EMSA. A gel retardation was observed between SprYmA and RNAIIImA but not between SprYmA and RNAIII (Figure 3C). In addition, RNAIII mutated in the 13th loop, which corresponds to a part of the

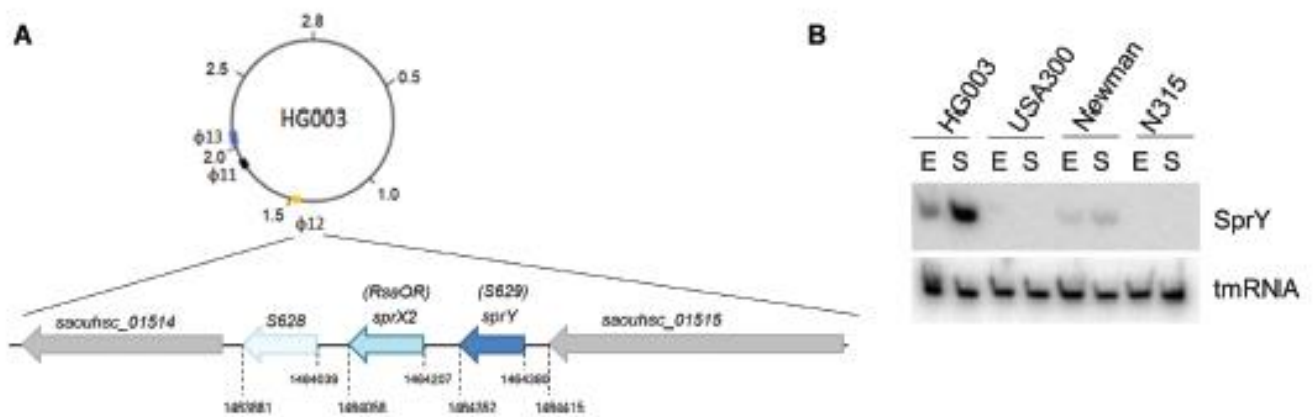

Figure 1. *sprY* and *sprX2* genomic localization and expression in *Staphylococcus aureus* HG003 strain. (A) The genomic localization of *sprY* and *sprX2* genes in *S. aureus* HG003 strain. *sprY* gene is located around 50 bp upstream of *sprX2* gene (7,9) in the staphylococcal phage $\phi 12$. (B) Expression of *SprY* in different strains of *S. aureus*. RNA extraction was performed in HG003, USA300, Newman and N315 strains at exponential phase (E) and stationary phase (S). As loading controls, the blots were also probing for *tmRNA*.

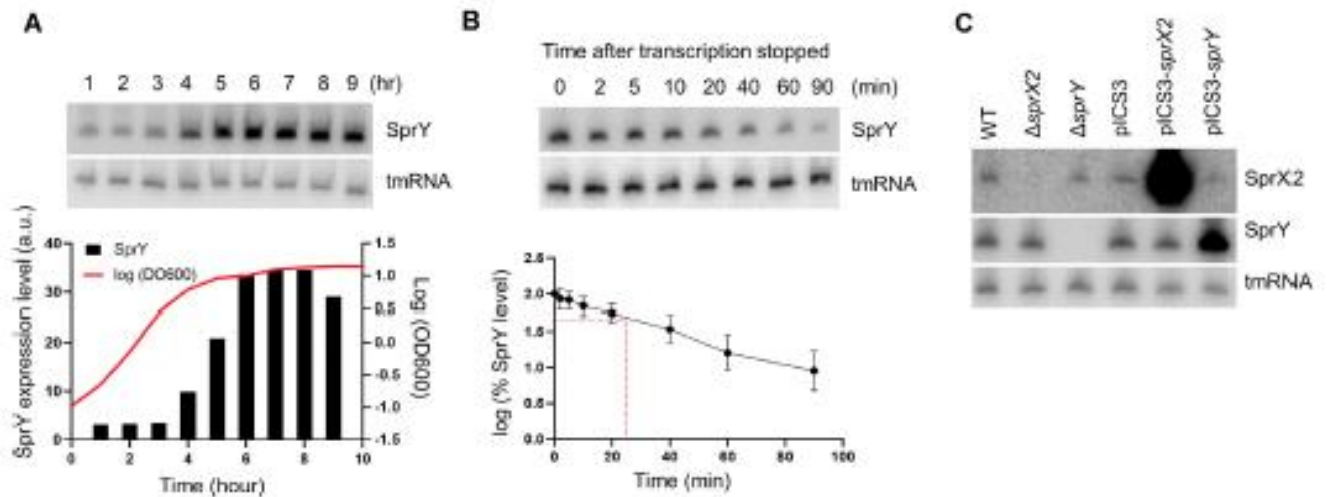

Figure 2. *SprY* expression in HG003 strain. Expression of *sprY* was determined by northern blot analysis using labeled DNA probes for *SprY*. As loading controls, the blots were also probed for *tmRNA*. (A) *SprY* expression profile during a 24 h growth of *Staphylococcus aureus* HG003 strain (WT). The growth curve of WT strain is presented by line, with the quantification of *SprY* expression level relative to the amount of *tmRNA* from the same RNA extraction in black chart (a.u., arbitrary units). (B) Stability of *SprY*. HG003 (WT) was grown until 6 h ($t = 0$) and the RNA extraction was performed at 2, 5, 10, 20, 40, 60 and 90 min after adding Rifampicin. The quantification of *SprY* stability, in semi-log plot, was performed by ImageQuant Tools 7.0. The data represent the mean of three different experiments \pm standard error. The maximum value of *rnaIII* expression at time 0 is normalized to 100% and the time at which the sRNA reaches 50% of its original level is indicated with red dotted line. (C) The expression of *sprX2* and *sprY* at 6 h of bacterial growth of HG003 wild-type strain (WT), strains deleted for *sprX2* or *sprY* ($\Delta sprX2$; $\Delta sprY$) and HG003 overexpressing *sprX2* or *sprY* (pICS3-*sprX2*, pICS3-*sprY*) by northern blots, using labeled DNA probes for *SprY* and *SprX2*. As loading control, the blots were also probing for *tmRNA*.

predicted *SprY* binding region, noticeably lost the capacity to bind *SprY* (Supplementary Figure S5_A and B). Altogether, our *in vivo* (MAPS), *in silico* and *in vitro* (EMSA) experiments revealed an interaction between the 1st *SprY* hairpin and the 13th *RNAIII* loop.

In many cases, base-pairing with sRNAs affects RNA target stability. We therefore tested if binding of *SprY* would affect the stability of *RNAIII*. The stability of *RNAIII* was compared in HG003 harboring the plasmids pICS3-*sprY*, pICS3-*sprYmA* and the control vector pICS3 (Figure 3D). No significant difference was observed in *RNAIII* stability, whether *SprY* or *SprYmA* were overexpressed (Figure 3E). This result prompted us to further analyze the role of *SprY* toward *RNAIII*.

SprY affects expression of *RNAIII* targets

RNAIII is the effector of quorum sensing and a major regulator of a plethora of virulence factors. Interestingly, the 13th *RNAIII* stem-loop is involved in the repression of several among its numerous mRNA targets. By binding to the 5' leader region of *rot* mRNA (for repressor of toxins), *RNAIII*, via the 13th stem-loop, negatively regulates the expression of this target at the translational level (49) and in consequence obstructs the expression of toxins (20,21). Another well-studied target of the 13th *RNAIII* stem-loop is *ecb* (for extracellular complement binding protein) (19,24), which is involved in blocking bacterial recognition by the host immune system (18).

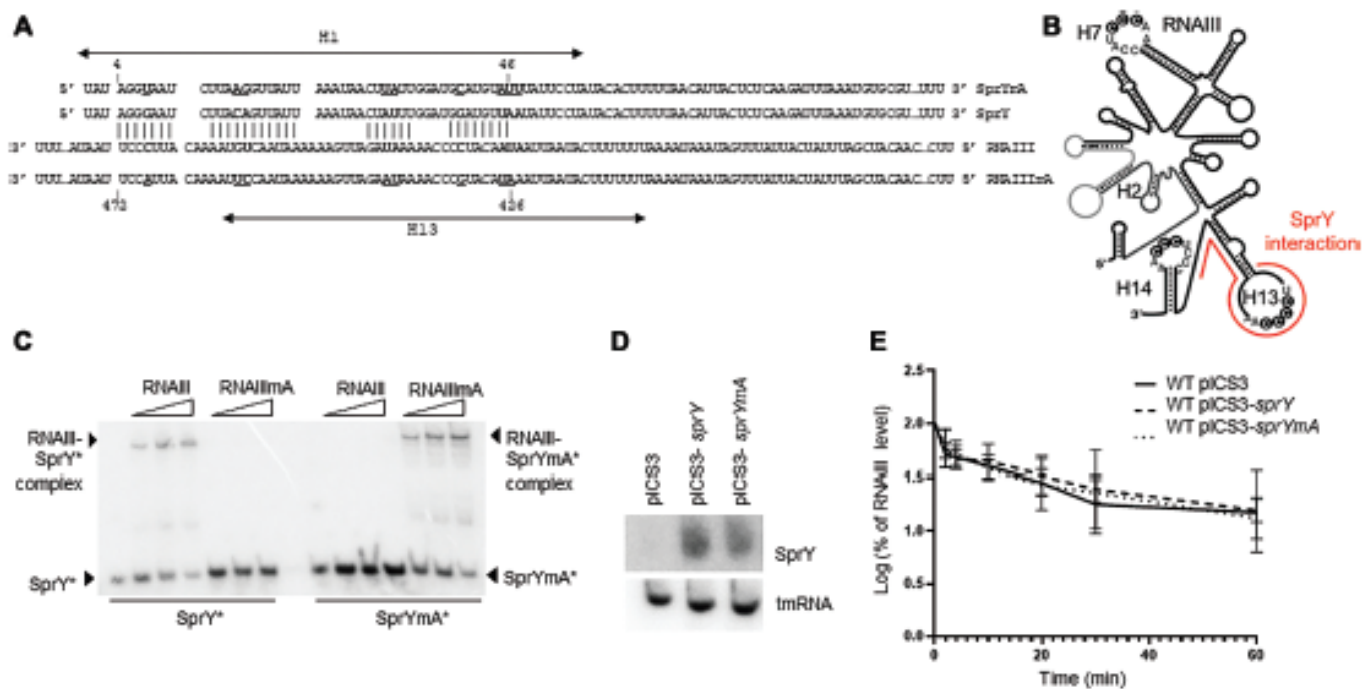

Figure 3. SprY interacts with RNAIII. (A) Interaction between SprY and RNAIII was predicted by IntaRNA software (47). Mutant of SprY and compensatory mutant RNAIII were constructed (SprYmA and RNAIII_{mA}). The nucleotides underlined and bolded correspond to the mutations in the *sprY* and *rnaIII* sequences. (B) Schematic presentation of RNAIII secondary structure and the region of RNAIII that interacts with SprY (shown by line). (C) Complex formations between SprY, SprYmA with RNAIII and RNAIII_{mA} were analysed by native gel retardation assays. Shift assays of purified labeled RNAIII and RNAIII_{mA} (SprY* and SprYmA*) were performed with increasing concentrations of RNAIII and RNAIII_{mA} (0.25, 0.5 and 1.25 μ M). (D) Verification of *sprY* expression in HG003 strain containing empty plasmid (pICCS3) or over-expressing *sprY* (pICCS3-*sprY*) or muted *sprY* (pICCS3-*sprYmA*) by northern blot using labeled DNA probes for SprY and tmRNA as control. (E) RNAIII stability was studied by northern blot using RNA total extraction in HG003 pICCS3, HG003 pICCS3-*sprY* and HG003 pICCS3-*sprYmA*, at exponential growth phase (OD = 0.8). Time (min) corresponds to the time after adding Rifampicin. The RNAIII expression levels of in each sample were normalized with the control gene (*tmRNA*). The data represent the mean of three different experiments \pm standard error for RNAIII stability. The maximum value of *rnaIII* expression at time 0 is normalized to 100% and the time at which the sRNA reaches 50% of its original level is indicated with dotted line. All statistical analyses were performed using two-way ANOVA test and Bonferroni comparison test.

We therefore questioned if the SprY binding to the 13th RNAIII stem-loop could affect the activity of RNAIII against specific targets. Surprisingly, *sprY* overexpression showed no significant impact on *rot* mRNA levels (Figure 4A). We hypothesized that SprY could affect *rot* translational initiation rather than *rot* mRNA quantity. We constructed a *rot-gfp* translational gene fusion under the control of the constitutive P_{ufpA} promoter in pCN33 resulting in pCN33- P_{ufpA} -*rot-gfp*. HG003 and HG003 Δ *rnaIII* containing empty pICCS3 or pICCS3-*sprY* were transformed with pCN33- P_{ufpA} -*rot-gfp*. In addition, a strain overexpressing *rnaIII* under constitutive promoter *amiA* (pICCS3- P_{amiA} -*rnaIII*) was used as a control. As expected, SprY overproduction significantly increased *rot* translation only in the presence of RNAIII (Figure 4B). Furthermore, the overexpression of SprYmA had no effect over the fluorescence of Rot-GFP fusion (Figure 4B), which implies that the regulation of *rot* expression by SprY involved the interaction between SprY 1st hairpin and RNAIII. In addition, deletion of *sprY* resulted in a small but significant decrease in fluorescence intensity of the Rot-GFP fusion, while strains overexpressing *sprY* showed increased fluorescence (Supplementary Figure S6). We also confirmed the effect of SprY on endogenous *rot* expression in an *rnaIII* dependent manner

by Western blot (Figure 4C). Overexpression of SprY increases Rot level in the HG003 wild-type strain but not in the absence of RNAIII.

The effect of SprY was also tested on the expression of *ech*, another target regulated by the 13th RNAIII stem-loop. Overexpression of SprY induced an increase in *ech* mRNA levels (Figure 4D). As in the case for *rot*, SprY overproduction significantly increased *ech* translation only in the presence of RNAIII (Figure 4E). Moreover, like for *rot* regulation, the overexpression of *sprYmA* had no effect on the fluorescence of Ecb-GFP (Figure 4E), which implies that the regulation of *ech* expression by SprY requires the interaction between SprY and RNAIII. In addition, as in the case for *rot*, the absence of *sprY* resulted in decreased fluorescence of the Ecb-GFP fusion (Supplementary Figure S6). Bacterial growth of all strains used for this experiment was essentially equivalent (Supplementary Figure S7). As with Rot, we observed a significant decrease in fluorescence intensity of Ecb-GFP in the absence of SprY, and an increase of fluorescence of strains overexpressing *sprY* (Figure 4). Taken together, our results indicate that SprY affects the expression of RNAIII targets likely by titrating the regulation mediated by its 13th loop.

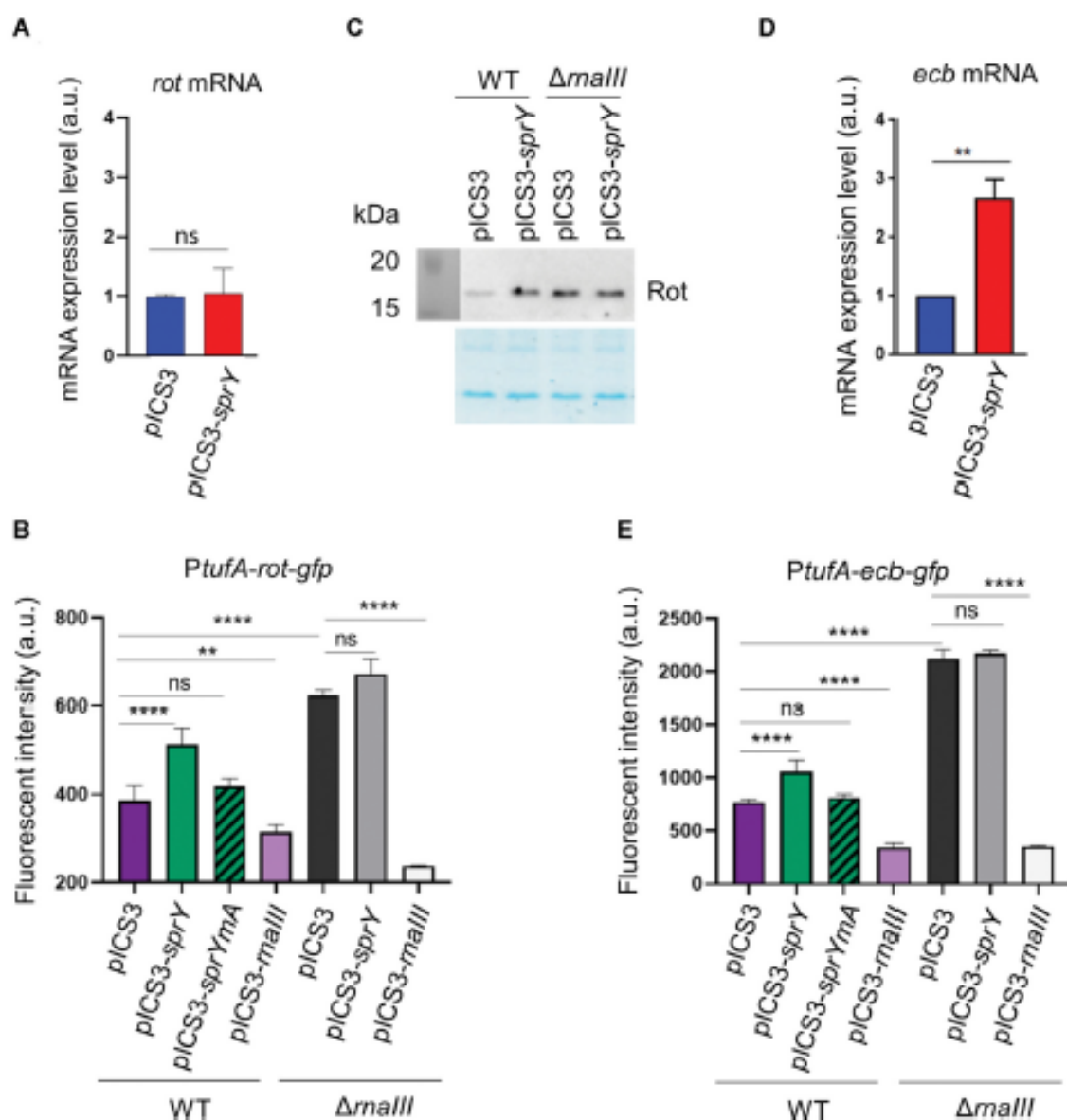

Figure 4. SprY affects the expression of RNAIII targets. Analysis of *rot* (A) and *ecb* (D) transcript levels in HG003 strain containing empty plasmid (pICS3) or overexpressing *sprY* (pICS3-*sprY*) by qPCR, using RNA extraction of those strains at early exponential growth phase. The mRNA expression level of *rot* and *ecb* in qPCR is normalized with the control gene (*gyrB*) and is calculated with $2^{-\Delta\Delta C_t}$ relative quantification. (C) Analysis of Rot protein level in HG003 strains (WT and $\Delta malIII$) containing empty plasmid (pICS3) or over-expressing *sprY* (pICS3-*sprY*) by western blot using polyclonal antibodies against Rot. The translational initiation level of *rot* (B) and *ecb* (E) under SprY regulation were studied by using *gfp* gene reporter. *Staphylococcus aureus* strains (WT and $\Delta malIII$) containing the pCN33-*PtufA-rot-gfp* or pCN33-*PtufA-ecb-gfp* fusion plasmids co-transformed with pICS3, pICS3-*sprY*, pICS3-*sprYmA* or pICS3-*PamiA-malIII*. The fluorescent intensity was measured every 10 min over 20 h in a Biotek microplate reader. Bacteria growth in different HG003 strains and GFP fluorescence intensity are shown respectively in the left panel at OD 600 and in right panel quantified by Biotek. All statistical analyses were performed using Student's *t* test. The error bars correspond to the average values from three independent experiments. Statistical significance is indicated by bars and asterisks as follows: **, $P < 0.01$; ***, $P < 0.005$; ****, $P < 0.001$.

Abundance of RNAIII and SprY depends on growth conditions

As the regulatory activity of RNAIII controlled by SprY is based on RNAIII/SprY direct binding, the endogenous ratio of each partner likely controls the biological functions of this interaction. In rich medium, both SprY and RNAIII accumulate during growth and diminish in late stationary phase (Figure 5A). The expression profiles in different media were similar for both sRNAs (Figure 5B), even

when bacterial growth rates were different (Supplementary Figure S8.A). Quantities of SprY and RNAIII were determined in different media in exponential (2 h) and stationary (6 h) phases by RT-qPCR (Supplementary Figure S8.B). Compared to RNAIII, the SprY copy number was 2-fold higher in BHI and RPMI, and 4-fold higher in TSB at 2 h of growth; however, it was significantly lower than RNAIII in NZM at 2 h (0.1-fold) (Figure 5C). The RNAIII copy number is far greater than that of SprY in all media

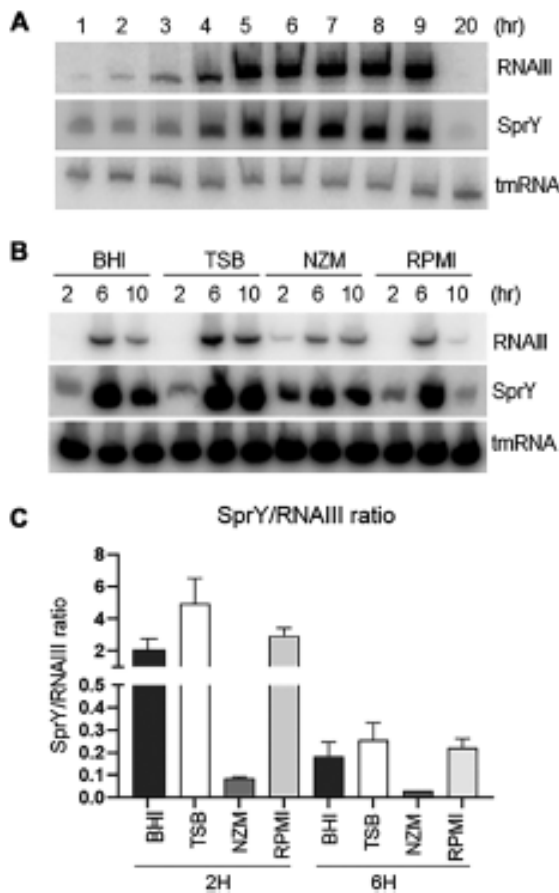

Figure 5. SprY and RNAIII ratio in different media. (A) HG003 wild-type strain was grown in BHI at 37°C. RNA was extracted at different times of growth. *sprY* and *rnaIII* expression profiles were analyzed by northern blot. (B) Analysis of *sprY* and *rnaIII* expressions in different media. HG003 wild-type strain was grown in different media (BHI, TSB, NZM and RPMI). Total RNA was extracted at 2, 6 and 10 h of growth and studied by northern blot using labeled DNA probes for SprY and RNAIII, and tmRNA as loading control. (C) The quantification of SprY and RNAIII by qPCR absolute. The RNA samples were prepared from the pellet of HG003 wild-type strain in BHI, TSB, NZM and RPMI at 2 and 6 h of growth. The chart represents the ratio SprY/RNAIII in these media. The error bars correspond to the average values from three independent experiments.

at 6 h (RNAIII: SprY ratios are 5, 3, 1000, and 5 in BHI, TSB, NZM and RPMI, respectively). These results suggest that RNAIII regulation by SprY will likely be controlled by growth conditions.

SprY limits hemolytic activity and decreases virulence of *S. aureus* in a mouse infection model

We showed above that SprY regulates the virulence factor Ecb as well as Rot through its effect on RNAIII. Moreover, Rot is known to repress toxins production (20). Since staphylococcal toxins are involved in hemolysis, the effect of SprY on *S. aureus* hemolytic activity was tested on mouse and human blood samples with HG003, HG003 Δ *sprY*, HG003 Δ *rnaIII* strains harboring either pICS3 or pICS3-*sprY* overexpressing *sprY* (Figure 6A and B). The accumulation of SprY led to a significant decrease in

the *S. aureus* hemolytic activity in all strains except for HG003 Δ *rnaIII*, indicating that RNAIII is required for SprY-mediated hemolysis.

Since SprY restricted hemolysis in mouse blood, we considered mice as a suitable model to test the role of *sprY* during staphylococcal infection. A murine intra-venous sepsis model was used with an inoculum of 2×10^8 bacteria per mouse. The survival rate of mice infected with either HG003 or HG003 Δ *sprY* was not statistically different (Figure 6C). We also tested the HG003 Δ *sprY* containing either the pICS3 (control plasmid) or overexpressing *sprY* (pICS3-*sprY*). The virulence of HG003 Δ *sprY* overexpressing *sprY* was drastically reduced compared to control the strain (pICS3) (Figure 6D). Taken together, our results show that SprY reduces *S. aureus* virulence likely by decreasing expression of virulence factors including RNAIII-activated hemolysin.

DISCUSSION

We report the function of SprY alias S629 (34), a recently identified *bona fide* sRNA (5), expressed from HG003 prophage ϕ 12 (also known as bacteriophage Sa2 or ϕ Sa2) (33). Here, we identified SprY as an sRNA tuning the sophisticated RNAIII regulation network. Co-purification of *in vivo* RNAs associated to SprY revealed that SprY binds RNAIII. RNAIII is the key effector of the accessory gene regulator (*agr*) system and the major ribonucleic staphylococcal regulator of virulence, which controls translation and stability of several mRNA targets by antisense base-pairing involving its various stem-loop structures (17,19) (Figure 7A and Supplementary Figure S9). We demonstrated that the 5' region of SprY binds to the 13th stem-loop of RNAIII. RNAIII sequence pairing with SprY is also the binding site for targets such as *rot*, *spa*, *coa*, *lytM*, *ecb*, *SA2093* and *SA2353* mRNAs (Supplementary Figure S9). SprY binding does not affect RNAIII stability but alters its function. We propose that SprY sterically prevents the formation of complexes between RNAIII and its targets, therefore affecting their expression. Indeed, SprY overproduction increases *rot* mRNA translation only when the interaction between SprY and RNAIII takes place. Moreover, SprY stimulates expression of the staphylococcal extracellular complement binding protein, Ecb (50) in an RNAIII-dependent manner. In accordance with positive regulation of *rot*, whose regulon includes genes encoding proteins with hemolytic activity such as *hla*, *psma* and *hlgACB* (22,51), SprY reduces the hemolytic activity of *S. aureus* on human and mouse blood dependently from RNAIII presence.

The interactions we uncovered between SprY and RNAIII prompt us to hypothesize that SprY acts as an RNA sponge for RNAIII to prevent RNAIII-dependent regulations. The competition between mRNA targets and the mimicry of targeted RNA by other RNAs are essential mechanisms to adjust the action of regulatory sRNAs (reviewed in (52)). RNAs with sponge-like activity were recently described in different bacterial species such as *E. coli*, *Bacillus subtilis* and *Pseudomonas aeruginosa* (53–55) and reviewed in (52,56). These sponge-like RNAs use different mechanisms to control sRNA regulators. Their binding can induce the cleavage and/or destruction of sRNA, as

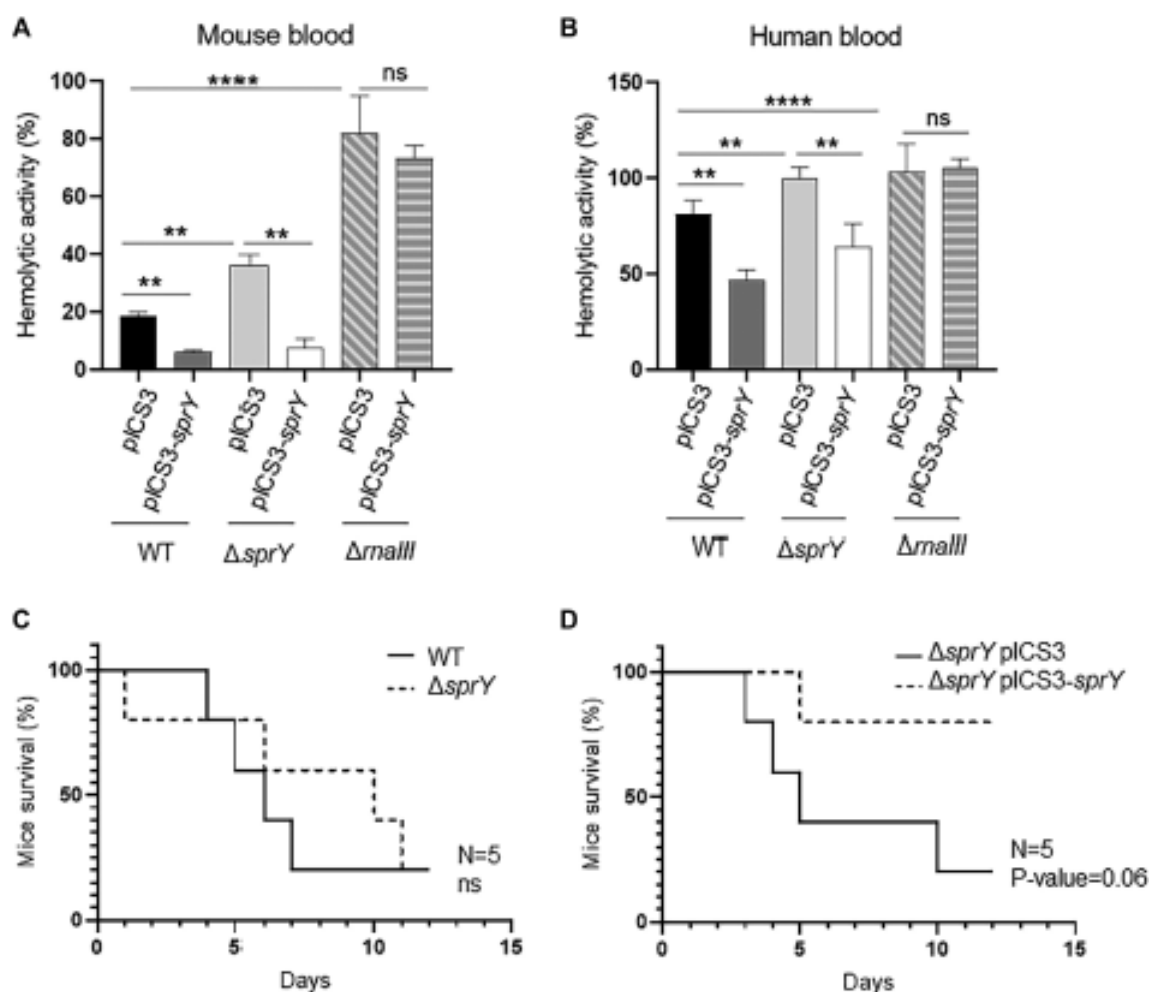

Figure 6. Impact of SprY to hemolytic activity in *Staphylococcus aureus* in different models of infection. (A and B) The supernatants of different strains of HG003 (WT, $\Delta sprY$, $\Delta rnaIII$) containing empty plasmid (pICS3) or overexpressing sprY (pICS3-sprY) were collected after 6 h of growth in BHI at 37°C. Hemolysis was performed by incubating cell culture supernatants with mouse and human blood samples at a ratio 50:50 at 37°C for 1 h. The hemolytic activity was observed in a flat-bottom 96-well microtiter plate at OD 540 nm. The blood samples prepared in PBS1X represent as negative control and in Triton 0.1% as 100% hemolysis. (C and D) Survival of mice infected with *S. aureus* wild-type strain (WT), deleted strain for sprY ($\Delta sprY$) and complemented strains for sprY ($\Delta sprY$ pICS3-sprY). Groups of 5 eight-week-old Swiss female mice were inoculated i.v. with 2×10^8 bacteria and monitored daily for 3 weeks. All statistical analyses were performed using Student's *t* test. The error bars correspond to the average values from three independent experiments. Statistical significance is indicated by bars and asterisks as follows: **, $P < 0.01$; ****, $P < 0.001$.

reported for *chb*-ChiX (57). In addition, since degradation is not an obligate outcome of duplex formation, a sponge RNA can act by titrating a regulatory sRNA and by competing with their true targets, as occurs between the tRNA spacer sequence with RybB or RyhB sRNAs (31). Until now, only few cases of base pairings between two sRNAs were identified in *S. aureus*; however, no 'sponge-like' function was shown for these interactions (58,59). Thereby, the findings presented here identify a sRNA with an original sponge activity in pathogenic bacteria.

To detectably adjust RNAIII function, SprY has to accumulate in amounts likely comparable to those of RNAIII. SprY and RNAIII expression varies according to growth conditions. The differences in sRNA stoichiometry could push the balance to different outcomes according to the growth environments. In rich media, SprY abundance is comparable to that of RNAIII during growth at low cell

density. However, in late exponential growth phase, the ratio between SprY and RNAIII reverses and amounts of RNAIII vastly dominate those of SprY. This result suggests that SprY actively interferes with RNAIII function at low cell density resulting in ablating RNAIII function and consequently allowing the production of surface proteins and inhibiting the production of extracellular toxins (Figure 7B). Early growth phase presumably represents the early stages of infection (reviewed in 60); therefore, the action of SprY is likely to be important during the beginning of infections, allowing *S. aureus* to colonize various niches without causing severe consequences for the host.

Recently, another sRNA, SprX, was also shown to modulate the pathogenicity of *S. aureus* through binding RNAIII. In contrast to SprY, SprX binds the RNAIII 5'-end near the hemolysin *hld* coding sequence (58). Although the

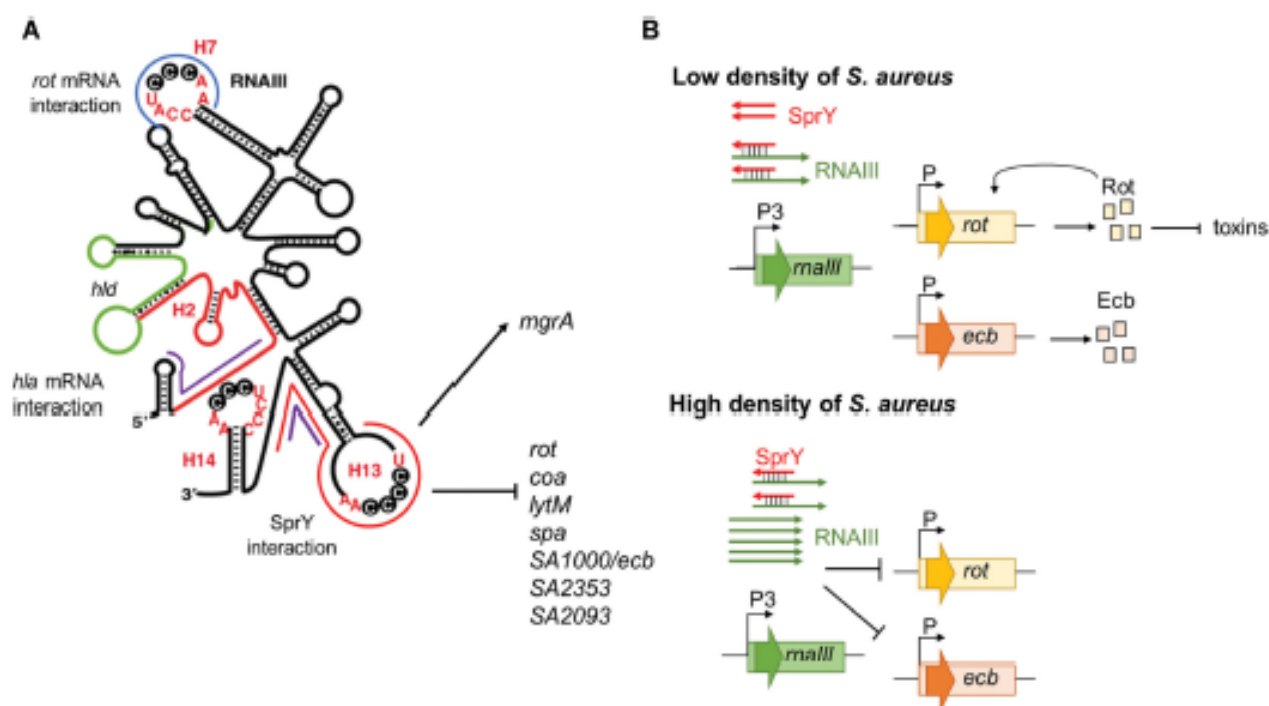

Figure 7. Schematic view of RNAIII and SprY actions. (A) Schematic view of the secondary structure of RNAIII (12) and base-pairing interaction regions with SprY and other mRNA targets. *hla* mRNA interacts with RNAIII at 2nd and 3rd hairpins (*maIII* sequence is colored in red). RNAIII encodes the delta-hemolysin (*hld*, in green). The interaction zone of RNAIII and SprY is indicated in red line and is overlapped with other RNAIII mRNA target listed here. *rot* mRNA interacts with RNAIII 7th hairpin (in blue line) and RNAIII 13rd stem-loop. *mgrA* mRNA interacts at two different sites of RNAIII (in purple line). (B) Model for SprY sponge function in RNAIII/ mRNA targets regulation. At low cell density (upper panel), SprY presents in a higher number of copies than RNAIII and bind to all RNAIII molecules produced. This interaction prevents RNAIII from binding to *rot* and *ecb* mRNA and favors the translation of Rot and Ecb proteins. At high cell density (bottom panel), RNAIII is produced in higher level than SprY and suppresses the sponge effect of SprY, therefore inhibits the translation of *rot* and *ecb*, among other targets.

significance of this pairing is unclear, the authors proposed that it might release the intramolecular base pairing between the RNAIII 5' and 3' ends, changing the secondary structure of RNAIII and facilitating the ribosomal binding for *hld* translation, resulting in an increase of Hld production and consequently a rise of hemolysis. Interestingly, SprY is expressed in immediate proximity to *sprX2* (*alias rsaOR*), one of the two copies of *sprY* in HG003 (7), but the effect of SprY on hemolysis is opposite to SprX2. SprY and SprX2 also have opposite effects on the expression of *ecb* (24). Interestingly, the adjacent *sprY* and *sprX2* genes show inverse expression profiles during growth, which might explain the contributions of sRNAs in controlling RNAIII expression and function in different points of *S. aureus* growth. Organization of genes in clusters is characteristic for genes expressing macromolecules with shared functions. In addition to protein gene clusters (61,62), sRNAs are also comprised in such clusters. For example, in *S. aureus*, an unusual condensed cluster was recently shown to contain several sRNA genes (63). Despite the discoveries of sRNAs in gene clusters, whether they possess similar or unrelated biological roles remains unclear (64). Although additional studies are needed to understand the collaboration between SprY and SprX, the current data suggest a functional relationship between these two sRNAs.

Prophages are known to have important roles in the pathogenicity of *S. aureus* either by encoding toxins and

other accessory virulence factors or by interrupting chromosomal virulence genes such as for β -hemolysin (*hlyB*) (reviewed in (65)). However, in some cases, phages not only carry virulence genes but also affect their expression. Induction of prophage was shown to also stimulate expression of some virulence determinants (66). Moreover, the presence of lysogenic phage deregulates expression of multiple genes (67). In this work, we report an example of phage encoded sRNA, acting through a novel mechanism to block an RNAIII regulatory domain. Although $\phi 12$ is present in different *S. aureus* strains such as HG003, MW2, MSSA476 and MRSA252, USA300, and RF122; however, the *sprY* gene is found in $\phi Sa2$ phage of MSSA476, MRSA252, HG003 and Newman strains but not found neither in USA300 nor in MW2 (68–71). It is possible, that the acquisition of $\phi 12$ phage carrying *sprY* would fine tune RNAIII function and give the selective advantage to certain bacterial strains in some infection conditions. This sRNA-based regulation is one of the numerous pathways acquired by *S. aureus* to modulate RNAIII activity. In the absence of $\phi 12$ -encoded *sprY*, this bacterium possesses alternative mechanisms to adjust expression and function of *agr* and its effector molecule, RNAIII, such as protein-based controls like SarA or CcpA (72–75), and RNA regulators like PSM-mec and SprX (58,76,77). Our work deciphers another layer in the multifaceted regulation of virulence factors during *S. aureus* infection and also raises a number of important

evolutionary questions regarding regulatory control provided by the prophage.

SUPPLEMENTARY DATA

Supplementary Data are available at NAR Online.

ACKNOWLEDGEMENTS

We are grateful to Dr Victor J. Torres for antibodies against Rot. We acknowledge Mr. Stéphane Dréano from IGDR UMR 6290 CNRS-UR1 for DNA sequencing assistance. We are also grateful to Dr Alexandra Gruss for the critical reading of the manuscript. We also acknowledge the 'plateform Génomique Santé' Biogenouest Génomique Biosit core facility for their technical assistance. We thank the animal core facility ARCHE (ARCHE/SFR BIOSIT, Université Rennes 1, France).

FUNDING

Agence nationale de la recherche (ANR) [ANR-15-CE12-0003-01]; Fondation pour la Recherche Médicale (FRM) [DBF20160635724]; (INSERM) Institut National de la Santé et de la Recherche Médicale, the Région Bretagne (PhD thesis) (to K.B.L.H.); School of Pharmacy and Medical Sciences of the University of Rennes 1. Funding for open access charge: FRM [DBF20160635724].

Conflict of interest statement. None declared.

REFERENCES

- FRANKLIN L, D.O.M.D. (1998) *Staphylococcus aureus* Infections. *N. Engl. J. Med.*, **339**, 520–532.
- Archer, G.L. and Climo, M.W. (2001) *Staphylococcus aureus* bacteremia - consider the source. *N. Engl. J. Med.*, **344**, 55–56.
- Wagner, E.G.H. and Romby, P. (2015) Small RNAs in Bacteria and Archaea: Who They Are, What They Do, and How They Do It. *Adv. Genet.*, **90**, 133–208.
- Sassi, M., Augagneur, Y., Mauro, T., Ivain, L., Chabelskaya, S., Hallier, M., Sallou, O. and Felden, B. (2015) SRD: A *Staphylococcus* regulatory RNA database. *RNA*, **21**, 1005–1017.
- Liu, W., Rochat, T., Toffano-Nioche, C., Le Lam, T.N., Boulouc, P. and Morvan, C. (2018) Assessment of bona fide sRNAs in *Staphylococcus aureus*. *Front. Microbiol.*, **9**, 228.
- Geissmann, T., Chevalier, C., Cros, M.J., Boisset, S., Fechter, P., Noirot, C., Schrenzel, J., François, P., Vandenesch, F., Gaspin, C. *et al.* (2009) A search for small noncoding RNAs in *Staphylococcus aureus* reveals a conserved sequence motif for regulation. *Nucleic Acids Res.*, **37**, 7239–7257.
- Bohn, C., Rigoulay, C., Chabelskaya, S., Sharma, C.M., Marchais, A., Skorski, P., Borezée-Durant, E., Barbet, R., Jacquet, E., Jacq, A. *et al.* (2010) Experimental discovery of small RNAs in *Staphylococcus aureus* reveals a riboregulator of central metabolism. *Nucleic Acids Res.*, **38**, 6620–6636.
- Rochat, T., Bohn, C., Morvan, C., Le Lam, T.N., Razi, F., Pain, A., Toffano-Nioche, C., Ponien, P., Jacq, A., Jacquet, E. *et al.* (2018) The conserved regulatory RNA RsaE down-regulates the arginine degradation pathway in *Staphylococcus aureus*. *Nucleic Acids Res.*, **46**, 8803–8816.
- Eyraud, A., Tattevin, P., Chabelskaya, S. and Felden, B. (2014) A small RNA controls a protein regulator involved in antibiotic resistance in *Staphylococcus aureus*. *Nucleic Acids Res.*, **42**, 4892–4905.
- Chabelskaya, S., Gaillot, O. and Felden, B. (2010) A *Staphylococcus aureus* small RNA is required for bacterial virulence and regulates the expression of an immune-evasion molecule. *PLoS Pathog.*, **6**, e1000927.
- Bronesky, D., Wu, Z., Marzi, S., Walter, P., Geissmann, T., Moreau, K., Vandenesch, F., Caldelari, I. and Romby, P. (2016) *Staphylococcus aureus* RNAIII and its regulon link quorum sensing, stress responses, metabolic adaptation, and regulation of virulence gene expression. *Annu. Rev. Microbiol.*, **70**, 299–316.
- Benito, Y., Kolb, F.A., Romby, P., Lina, G., Etienne, J. and Vandenesch, F. (2000) Probing the structure of RNAIII, the *Staphylococcus aureus* agr regulatory RNA, and identification of the RNA domain involved in repression of protein A expression. *RNA*, **6**, 668–679.
- Morfeldt, E., Taylor, D., Von Gabain, A. and Arvidson, S. (1995) Activation of alpha-toxin translation in *Staphylococcus aureus* by the trans-encoded antisense RNA, RNAIII. *EMBO J.*, **14**, 4569–4577.
- Gray, G.S. and Kehoe, M. (1984) Primary sequence of the alpha-toxin gene from *Staphylococcus aureus* Wood 46. *Infect. Immun.*, **46**, 615–618.
- Bramley, A.J., Patel, A.H., O'Reilly, M., Foster, R. and Foster, T.J. (1989) Roles of alpha-toxin and beta-toxin in virulence of *Staphylococcus aureus* for the mouse mammary gland. *Infect. Immun.*, **57**, 2489–2494.
- Wilke, G.A. and Wardenburg, J.B. (2010) Role of a disintegrin and metalloprotease 10 in *Staphylococcus aureus* alpha-hemolysin - Mediated cellular injury. *Proc. Natl. Acad. Sci. USA*, **107**, 13473–13478.
- Huntzinger, E., Boisset, S., Saveanu, C., Benito, Y., Geissmann, T., Namane, A., Lina, G., Etienne, J., Ehresmann, B., Ehresmann, C. *et al.* (2005) *Staphylococcus aureus* RNAIII and the endoribonuclease III coordinately regulate spa gene expression. *EMBO J.*, **24**, 824–835.
- Amdahl, H., Haapasalo, K., Tan, L., Meri, T., Kuusela, P.I., Van Strijp, J.A., Rooijackers, S. and Jokiranta, T.S. (2017) Staphylococcal protein Ecb impairs complement receptor-1 mediated recognition of opsonized bacteria. *PLoS One*, **12**, e0172675.
- Boisset, S., Geissmann, T., Huntzinger, E., Fechter, P., Bendridi, N., Possedko, M., Chevalier, C., Helfer, A.C., Benito, Y., Jacquier, A. *et al.* (2007) *Staphylococcus aureus* RNAIII coordinately represses the synthesis of virulence factors and the transcription regulator Rot by an antisense mechanism. *Genes Dev.*, **21**, 1353–1366.
- McNamara, P.J., Milligan-Monroe, K.C., Khalili, S. and Proctor, R.A. (2000) Identification, cloning, and initial characterization of rot, a locus encoding a regulator of virulence factor expression in *Staphylococcus aureus*. *J. Bacteriol.*, **182**, 3197–3203.
- Oscarsson, J., Tegmark-Wisell, K. and Arvidson, S. (2006) Coordinated and differential control of aureolysin (aur) and serine protease (sspA) transcription in *Staphylococcus aureus* by sarA, rot and agr (RNAIII). *Int. J. Med. Microbiol.*, **296**, 365–380.
- Said-Salim, B., Dunman, P.M., McAleese, F.M., Macapagal, D., Murphy, E., McNamara, P.J., Arvidson, S., Foster, T.J., Projan, S.J. and Kreiswirth, B.N. (2003) Global regulation of *Staphylococcus aureus* genes by Rot. *J. Bacteriol.*, **185**, 610–619.
- Le Lam, T.N., Morvan, C., Liu, W., Bohn, C., Jaszczyszyn, Y. and Boulouc, P. (2017) Finding sRNA-associated phenotypes by competition assays: an example with *Staphylococcus aureus*. *Methods*, **117**, 21–27.
- Ivain, L., Bordeau, V., Eyraud, A., Hallier, M., Dréano, S., Tattevin, P., Felden, B. and Chabelskaya, S. (2017) An in vivo reporter assay for sRNA-directed gene control in Gram-positive bacteria: Identifying a novel sRNA target in *Staphylococcus aureus*. *Nucleic Acids Res.*, **45**, 4994–5007.
- Chabelskaya, S., Gaillot, O. and Felden, B. (2010) A *Staphylococcus aureus* small RNA is required for bacterial virulence and regulates the expression of an immune-evasion molecule. *PLoS Pathog.*, **6**, e1000927.
- Antal, M., Bordeau, V., Douchin, V. and Felden, B. (2005) A small bacterial RNA regulates a putative ABC transporter. *J. Biol. Chem.*, **280**, 7901–7908.
- Steiner, P.A., De Corte, D., Geijo, J., Mená, C., Yokokawa, T., Rattei, T., Herndl, G.J. and Sintes, E. (2019) Highly variable mRNA half-life time within marine bacterial taxa and functional genes. *Environ. Microbiol.*, **21**, 3873–3884.
- Britton, R.A., Wen, T., Schaefer, L., Pellegrini, O., Uicker, W.C., Mathy, N., Tobin, C., Daou, R., Szyk, J. and Condon, C. (2007) Maturation of the 5' end of *Bacillus subtilis* 16S rRNA by the essential ribonuclease YkqC/RNase J1. *Mol. Microbiol.*, **63**, 127–138.
- Batey, R.T. and Kieft, J.S. (2007) Improved native affinity purification of RNA. *RNA*, **13**, 1384–1389.

30. Lalaouna, D., Desgranges, E., Caldeleri, I. and Marzi, S. (2018) MS2-Affinity Purification Coupled With RNA Sequencing Approach in the Human Pathogen *Staphylococcus aureus*. *Methods Enzymol.* **612**, 393–411.
31. Lalaouna, D., Carrier, M.C., Semsey, S., Brouard, J.S., Wang, J., Wade, J.T. and Massé, E. (2015) A 3' external transcribed spacer in a tRNA transcript acts as a sponge for small RNAs to prevent transcriptional noise. *Mol. Cell.* **58**, 393–405.
32. Love, M.I., Huber, W. and Anders, S. (2014) Moderated estimation of fold change and dispersion for RNA-seq data with DESeq2. *Genome Biol.* **15**, 550.
33. Iandolo, J.J., Worrell, V., Groicher, K.H., Qian, Y., Tian, R., Kenton, S., Dorman, A., Ji, H., Lin, S., Loh, P. et al. (2002) Comparative analysis of the genomes of the temperate bacteriophages ϕ 11, ϕ 12 and ϕ 13 of *Staphylococcus aureus* 8325. *Gene*, **289**, 109–118.
34. Mäder, U., Nicolas, P., Depke, M., Pané-Farré, J., Debarbouille, M., van der Kooij-Pol, M.M., Guérin, C., Dérozier, S., Hiron, A., Jarmer, H. et al. (2016) *Staphylococcus aureus* transcriptome architecture: from laboratory to infection-mimicking conditions. *PLoS Genet.* **12**, e1005962.
35. Pichon, C. and Felden, B. (2005) Small RNA genes expressed from *Staphylococcus aureus* genomic and pathogenicity islands with specific expression among pathogenic strains. *Proc. Natl. Acad. Sci. USA*, **102**, 14249–14254.
36. Naville, M., Ghuillot-Gaudefroy, A., Marchais, A. and Gautheret, D. (2011) ARNold: A web tool for the prediction of rho-independent transcription terminators. *RNA Biol.* **8**, 11–13.
37. Massé, E., Escorcia, F.E. and Gottesman, S. (2003) Coupled degradation of a small regulatory RNA and its mRNA targets in *Escherichia coli*. *Genes Dev.* **17**, 2374–2383.
38. Viegas, S.C., Pfeiffer, V., Sittka, A., Silva, I.J., Vogel, J. and Arraiano, C.M. (2007) Characterization of the role of ribonucleases in *Salmonella* small RNA decay. *Nucleic Acids Res.* **35**, 7651–7664.
39. Herbert, S., Ziebandt, A.K., Ohlsen, K., Schäfer, T., Hecker, M., Albrecht, D., Novick, R. and Götz, F. (2010) Repair of global regulators in *Staphylococcus aureus* 8325 and comparative analysis with other clinical isolates. *Infect. Immun.* **78**, 2877–2889.
40. Rouillard, J.M., Zuker, M. and Gulari, E. (2003) OligoArray 2.0: Design of oligonucleotide probes for DNA microarrays using a thermodynamic approach. *Nucleic Acids Res.* **31**, 3057–3062.
41. Zuker, M. (2003) Mfold web server for nucleic acid folding and hybridization prediction. *Nucleic Acids Res.* **31**, 3406–3415.
42. Raden, M., Ali, S.M., Alkhnbashi, O.S., Busch, A., Costa, F., Davis, J.A., Eggenhofer, F., Gelhausen, R., Georg, J., Heyne, S. et al. (2018) Freiburg RNA tools: A central online resource for RNA-focused research and teaching. *Nucleic Acids Res.* **46**, W25–W29.
43. Will, S., Reiche, K., Hofacker, I.L., Stadler, P.F. and Backofen, R. (2007) Inferring noncoding RNA families and classes by means of genome-scale structure-based clustering. *PLoS Comput. Biol.* **3**, 680–691.
44. Will, S., Joshi, T., Hofacker, I.L., Stadler, P.F. and Backofen, R. (2012) LocARNA-P: Accurate boundary prediction and improved detection of structural RNAs. *RNA*, **18**, 900–914.
45. Chevalier, C., Boisset, S., Romilly, C., Masquida, B., Fechter, P., Geissmann, T., Vandenesch, F. and Romby, P. (2010) *Staphylococcus aureus* RNAIII binds to two distant regions of *coa* mRNA to arrest translation and promote mRNA degradation. *PLoS Pathog.* **6**, e1000809.
46. Lalaouna, D. and Massé, E. (2015) Identification of sRNA interacting with a transcript of interest using MS2-affinity purification coupled with RNA sequencing (MAPS) technology. *Genomics Data*, **5**, 136–138.
47. Busch, A., Richter, A.S. and Backofen, R. (2008) IntaRNA: Efficient prediction of bacterial sRNA targets incorporating target site accessibility and seed regions. *Bioinformatics*, **24**, 2849–2856.
48. Mann, M., Wright, P.R. and Backofen, R. (2017) IntaRNA 2.0: Enhanced and customizable prediction of RNA-RNA interactions. *Nucleic Acids Res.* **45**, W435–W439.
49. Geisinger, E., Adhikari, R.P., Jin, R., Ross, H.F. and Novick, R.P. (2006) Inhibition of rot translation by RNAIII, a key feature of agr function. *Mol. Microbiol.* **61**, 1038–1048.
50. Amdahl, H., Jongerius, I., Meri, T., Pasanen, T., Hyvärinen, S., Haapasalo, K., van Strijp, J.A., Rooijakkers, S.H. and Jokiranta, T.S. (2013) Staphylococcal Ecb protein and host complement regulator factor H enhance functions of each other in bacterial immune evasion. *J. Immunol.* **191**, 1775–1784.
51. Tuffs, S.W., Herfst, C.A., Baroja, M.L., Podskalnyi, V.A., DeJong, E.N., Coleman, C.E.M. and McCormick, J.K. (2019) Regulation of toxic shock syndrome toxin-1 by the accessory gene regulator in *Staphylococcus aureus* is mediated by the repressor of toxins. *Mol. Microbiol.* **112**, 1163–1177.
52. Figueroa-bossi, N. and Bossi, L. (2018) Sponges and predators in the small RNA World. *Microbiol. Spectr.* **6**, <https://doi.org/10.1128/microbiolspec.rwr-0021-2018>.
53. Figueroa-Bossi, N., Valentini, M., Malleret, L. and Bossi, L. (2009) Caught at its own game: Regulatory small RNA inactivated by an inducible transcript mimicking its target. *Genes Dev.* **23**, 2004–2015.
54. Overgaard, M., Johansen, J., Møller-Jensen, J. and Valentin-Hansen, P. (2009) Switching off small RNA regulation with trap-mRNA. *Mol. Microbiol.* **73**, 790–800.
55. Miyakoshi, M., Chao, Y. and Vogel, J. (2015) Cross talk between ABC transporter mRNA via a target mRNA-derived sponge of the GcvB small RNA. *EMBO J.* **34**, 1478–1492.
56. Denham, E.L. (2020) The Sponge RNAs of bacteria – How to find them and their role in regulating the post-transcriptional network. *Biochim. Biophys. Acta - Gene Regul. Mech.* **1863**, 194565.
57. Bossi, L. and Figueroa-bossi, N. (2016) Competing endogenous RNAs: a target-centric view of small RNA regulation in bacteria. *Nat. Rev. Microbiol.* **14**, 775–784.
58. Kathirvel, M., Buchad, H. and Nair, M. (2016) Enhancement of the pathogenicity of *Staphylococcus aureus* strain Newman by a small noncoding RNA SprX1. *Med. Microbiol. Immunol.* **205**, 563–574.
59. Bronesky, D., Desgranges, E., Corvaglia, A., François, P., Caballero, C.J., Prado, L., Toledo-Arana, A., Lasa, I., Moreau, K., Vandenesch, F. et al. (2019) A multifaceted small RNA modulates gene expression upon glucose limitation in *Staphylococcus aureus*. *EMBO J.* **38**, e99363.
60. Repoila, F. and Darfeuille, F. (2009) Small regulatory non-coding RNAs in bacteria: physiology and mechanistic aspects. *Biol. Cell*, **101**, 117–131.
61. Jongerius, I., Köhl, J., Pandey, M.K., Ruyken, M., Van Kessel, K.P.M., Van Strijp, J.A.G. and Rooijakkers, S.H.M. (2007) Staphylococcal complement evasion by various convertase-blocking molecules. *J. Exp. Med.* **204**, 2461–2471.
62. McCarthy, A.J. and Lindsay, J.A. (2013) *Staphylococcus aureus* innate immune evasion is lineage-specific: a bioinformatics study. *Infect. Genet. Evol.* **19**, 7–14.
63. Bronsard, J., Pascreau, G., Sassi, M., Mauro, T., Augagneur, Y. and Felden, B. (2017) sRNA and cis-Antisense sRNA identification in *Staphylococcus aureus* highlights an unusual sRNA gene cluster with one encoding a secreted peptide. *Sci. Rep.* **7**, 4565.
64. Felden, B. and Paillard, L. (2017) When eukaryotes and prokaryotes look alike: the case of regulatory RNAs. *FEMS Microbiol. Rev.* **41**, 624–639.
65. Penadés, J.R., Chen, J., Quiles-Puchalt, N., Carpena, N. and Novick, R.P. (2015) Bacteriophage-mediated spread of bacterial virulence genes. *Curr. Opin. Microbiol.* **23**, 171–178.
66. Sumby, P. and Waldor, M.K. (2003) Transcription of the toxin genes present within the staphylococcal phage ϕ sa3ms is intimately linked with the phage's life cycle. *J. Bacteriol.* **185**, 6841–6851.
67. Fernández, L., González, S., Quiles-Puchalt, N., Gutiérrez, D., Penadés, J.R., García, P. and Rodríguez, A. (2018) Lysogenization of *Staphylococcus aureus* RN450 by phages ϕ 11 and ϕ 80 α leads to the activation of the SigB regulon. *Sci. Rep.* **8**, 12662.
68. Baba, T., Takeuchi, F., Kuroda, M., Yuzawa, H., Aoki, K.I., Oguchi, A., Nagai, Y., Iwama, N., Asano, K., Naimi, T. et al. (2002) Genome and virulence determinants of high virulence community-acquired MRSA. *Lancet*, **359**, 1819–1827.
69. Holden, M.T.G., Feil, E.J., Lindsay, J.A., Peacock, S.J., Day, N.P.J., Enright, M.C., Foster, T.J., Moore, C.E., Hurst, L., Atkin, R. et al. (2004) Complete genomes of two clinical *Staphylococcus aureus* strains: Evidence for the evolution of virulence and drug resistance. *Proc. Natl. Acad. Sci. USA*, **101**, 9786–9791.
70. Diep, B.A., Gill, S.R., Chang, R.F., Phan, T.H.V., Chen, J.H., Davidon, M.G., Lin, F., Lin, J., Carleton, H.A., Mongodin, E.F. et al. (2006) Complete genome sequence of USA300, an epidemic clone of

- community-acquired methicillin-resistant *Staphylococcus aureus*. *Lancet*, **367**, 731–739.
71. Herron-Olson, L., Fitzgerald, J.R., Musser, J.M. and Kapur, V. (2007) Molecular correlates of host specialization in *Staphylococcus aureus*. *PLoS One*, **2**, e1120.
72. Reyes, D., Andrey, D.O., Monod, A., Kelley, W.L., Zhang, G. and Cheung, A.L. (2011) Coordinated regulation by AgrA, SarA, and SarR to control agr expression in *Staphylococcus aureus*. *J. Bacteriol.*, **193**, 6020–6031.
73. Jenul, C. and Horswill, A.R. (2019) Regulation of *staphylococcus aureus* virulence. *Microbiol. Spectr.*, **7**, <https://doi.org/10.1128/microbiolspec.GPP3-0031-2018>.
74. Seidl, K., Stucki, M., Rugg, M., Goerke, C., Wolz, C., Harris, L., Berger-Bächi, B. and Bischoff, M. (2006) *Staphylococcus aureus* CcpA affects virulence determinant production and antibiotic resistance. *Antimicrob. Agents Chemother.*, **50**, 1183–1194.
75. Ueda, T., Kaito, C., Ormae, Y. and Sekimizu, K. (2011) Sugar-responsive gene expression and the agr system are required for colony spreading in *Staphylococcus aureus*. *Microb. Pathog.*, **51**, 178–185.
76. Kaito, C., Saito, Y., Ikuo, M., Ormae, Y., Mao, H., Nagano, G., Fujiyuki, T., Numata, S., Han, X., Obata, K. *et al.* (2013) Mobile Genetic Element SCCmec-encoded psm-mec RNA Suppresses Translation of agrA and Attenuates MRSA Virulence. *PLoS Pathog.*, **9**, e1003269.
77. Qin, L., McCausland, J.W., Cheung, G.Y.C. and Otto, M. (2016) PSM-Mec-A virulence determinant that connects transcriptional regulation, virulence, and antibiotic resistance in staphylococci. *Front. Microbiol.*, **7**, 1293.

Supplementary Data_ Le Huyen et al. 2021

Table Supplementary 1. Strains and plasmids

Strains	Relevant characteristics	References
<i>E. coli</i> strain		
DH5- α	F- Φ 80d <i>lacZ</i> Δ M15 <i>D(lacZA-argF)U169 deoR recA1 endA1 hsdR17 (rK- mK-)</i> <i>phoA supE44 l- thi-1 gyrA96 relA1</i>	Invitrogen; (Sambrook J <i>et al.</i> , 1989)
<i>S. aureus</i> strains		
RN4220	Restriction-defective derivative of 8325-4	(Kreiswirth <i>et al.</i> , 1983)
HG003	<i>rsbU</i> restored strain 8325, lysogenic for phages Φ 11, Φ 12, and Φ 13	(Herbert <i>et al.</i> , 2010)
USA300	Methicillin-resistant <i>S. aureus</i> (MRSA) strain, PVL; i.e. <i>lukF-PV</i> and <i>lukS-PV</i> , <i>msr(A)</i> erythromycin resistance, <i>SCCmec</i> type IV	(Fred C. Tenover and Richard V. Goering, 2009)
Newman	NCTC 8178', isolate from a secondarily infected tubercular osteomyelitis in man	(Duthie and Lorenz, 1952)
N315	Meticillin-resistant <i>S. aureus</i> (MRSA) strain isolated in 1982 from the pharyngeal smear of a Japanese patient	(Kuwahara-Arai <i>et al.</i> , 1996)
HG003 Δ <i>sprY</i>	<i>sprY</i> deleted HG003	Le Lam <i>et al.</i> , 2017
HG003 Δ <i>rnalIII</i>	<i>rnalIII</i> deleted HG003	Le Lam <i>et al.</i> , 2017
Plasmids		
pRMC2	Shuttle vector, Cm ^r (<i>cat194</i>), with tetracycline inducible promoter	(Corrigan and Foster, 2009)
pRMC2- <i>ms2</i>	pRMC2 with <i>ms2</i> tag under control of an tetracycline inducible promoter	This study
pRMC2- <i>sprY-ms2</i>	pRMC2 with <i>sprY</i> fused to <i>ms2</i> tag under control of an tetracycline inducible promoter	This study
pICS3	Shuttle vector, Cm ^r (<i>cat194</i>), pC194 replicon	(Ivain <i>et al.</i> , 2017)
pICS3- <i>sprY</i>	pICS3 with <i>sprY</i> of HG003 under control of its endogenous promoter	This study
pICS3- <i>sprYmA</i>	pICS3 with <i>sprYmA</i> of HG003 under control of its endogenous promoter	This study
pICS3- <i>PamiA-rnalIII</i>	pICS3 with <i>rnalIII</i> of HG003 under control of a constitutive promoter <i>amiA</i>	(Ivain <i>et al.</i> , 2017)
pCN33	Low-copy-number shuttle vector, Em ^r (<i>ermC</i>), pT181 <i>cop-wt</i> repC	(Charpentier <i>et al.</i> , 2004)
pCN33- <i>PtufA-ecb-gfp</i>	pCN33 with <i>ecb</i> of HG003 fused to <i>gfp</i> under control of <i>PtufA</i> promoter	(Ivain <i>et al.</i> , 2017)
pCN33- <i>PtufA-rot-gfp</i>	pCN33 with <i>rot</i> of HG003 fused to <i>gfp</i> under control of <i>PtufA</i> promoter	This study

Table Supplementary 2. Primers used in this study

N°	Name	Sequences	Utilization	References
1	T7 sprY for	TAATACGACTCACTATAGGGTATAGGGAATCTTACAGTTAT	EMSA	This study
2	T7 sprY rev	AAATAGGCAAGTACCGAAGTACC	EMSA	This study
3	T7 sprYmA for	TAATACGACTCACTATAGGGTATAGGTAATCTTAAGTTATTAATAACTTATT	EMSA	This study
4	T7 rnalIII for	TAATACGACTCACTATAGGGCCTAGATCACAGAGATGT	EMSA	(Chabelskaya et al., 2014)
5	T7 rnalIII rev	CAAAAGGCCGCGAGCTTGGGA	EMSA	(Chabelskaya et al., 2014)
6	T7 rnalIII mL13 for	CATTATTTGATAAAATAAAAACTGTAAAACATTCCTTA	EMSA	This study
7	T7 rnalIII mL13 rev	TAAGGGAATGTTTTACAGTTTTTTATTTATCAAATAATG	EMSA	This study
8	T7 rnalIII mA for	TAAGATTGAAAAATAACCTTAAAACATTACCTTAATAATAAGTATG GTCGTG	EMSA	This study
9	T7 rnalIII mA rev	AGGTTATTTTTCAATCTTATTTGGGCATGTATTTAATTGAAAAA ATTT	EMSA	This study
10	pICS2-ms2 (KpnI/ SacI) for	AAATAAGCTTGATGGTACCCGTACACCATCAGGGTACGTTTTTCAGA CACCATCAGGGTCTGGAGCTCGAATTCCTGCGCG	MAPS	This study
11	pICS2-sprY-ms2 (KpnI) for	GTATAATTAATAAAGCTTGATGGTACCTATAGGGAATCTTACAGTT ATT	MAPS	This study
12	pICS2-sprY-ms2 (EcoRI) rev	GTAAAACGACGGCCAGTGAATCCGAAGGCTAGCTATAACATAAAA AAATA	MAPS	This study
13	pICS3	AAAGCTTGATGCCTGCAGGGTACCGAATTCGGCGCCTGATGCGGTA TTT	Cloning	(Ivain et al., 2017)
14	PamiA for	GAAAAATTTGTTGATTTTTAATGGATAATGTGATATAATGG	Cloning	(Ivain et al., 2017)
15	pICS3-PstI-sprY for	GTATAATTAATAAAGCTTGATGGTACCTATAGGGAATCTTACAGTT ATT	Cloning	This study
16	pICS3-NarI-sprY rev	GACACCATCAGGGTCTGGAGCTCTATAGGGAATCTTACAGTTATT	Cloning	This study
17	pICS3-PstI-sprYmA for	AGGTAATCTTAAGTTATTAATAAATACTTATTGGATGCATGATTTATT CCTATACACTTT	Cloning	This study
18	pICS3-NarI-sprYmA rev	AATACATGCATCCAATAAGTTATTTAATAACCTTAAGATTACCTATAA TTAATGTAGCAA	Cloning	This study
19	PtufA rev	TCTCTCATGATAGTTTCTCAC	Cloning	This study
20	pCN33-rot-gfp for	GAGAAACTATCATGAGAGAAGATCTGTATATAAATTATAAAATTAAT ATG	Cloning	This study
21	pCN33-rot-gfp rev	CCTTAGTCTTCTTTGCTTCTAGAGATATCTTCTCTAGACATTTTGTAT TCG	Cloning	This study
22	SprX2	TACGGGAATGCTAAAGTCAT	Northern Blot	(Ivain et al., 2017)
23	SprY	CGAAGTACCTGCCAGTTACG	Northern Blot	This study
24	ms2	AACGTACCCTGATGGTGTACG	Northern Blot	This study
25	RNAIII	ATTATTAAGGGAATGTTTTA	Northern Blot	(Ivain et al., 2017)
26	tmRNA	ACACGCTTAATGAGCTCGGG	Northern Blot	(Ivain et al., 2017)
27	SprY qPCR for	TGGATGGATGTTAATATTCCTATACAC	RT-qPCR	This study
28	SprY qPCR rev	TACCGAAGTACCTGCCAGTTACG	RT-qPCR	This study
29	RNAIII qPCR for	GAATTTTGTCACTGTGTCGATAATCCATTT	RT-qPCR	This study
30	RNAIII qPCR rev	GAAGGAGTGATTTCAATGGCACAAGATAT	RT-qPCR	This study

N°	Name	Sequences	Utilization	References
31	ecb qPCR for	TGGGAAATCAATTTTAAGCATAGC	RT-qPCR	This study
32	ecb qPCR rev	TGTGCATGAGATTCACCGGC	RT-qPCR	This study
33	rot qPCR for	TTGGGATTGTTGGGATGTTTGTT	RT-qPCR	This study
34	rot qPCR rev	TGTATTGCTTTCAATCTCGCTG	RT-qPCR	This study
35	gyrB qPCR for	GGTGGCGACTTTGATCTAGC	RT-qPCR	This study
36	gyrB qPCR rev	TAATATGCGCTCCATCCACA	RT-qPCR	This study
37	tmRNA qPCR for	CACTCTGCATCGCTAACAG	RT-qPCR	This study
38	tmRNA qPCR rev	TCAAACGGCAGTGTTAGCA	RT-qPCR	This study

Table Supplementary 3. Whole list of RNAs co-purified with MS2-SprY (Raw data available under accession no. GSE166499)

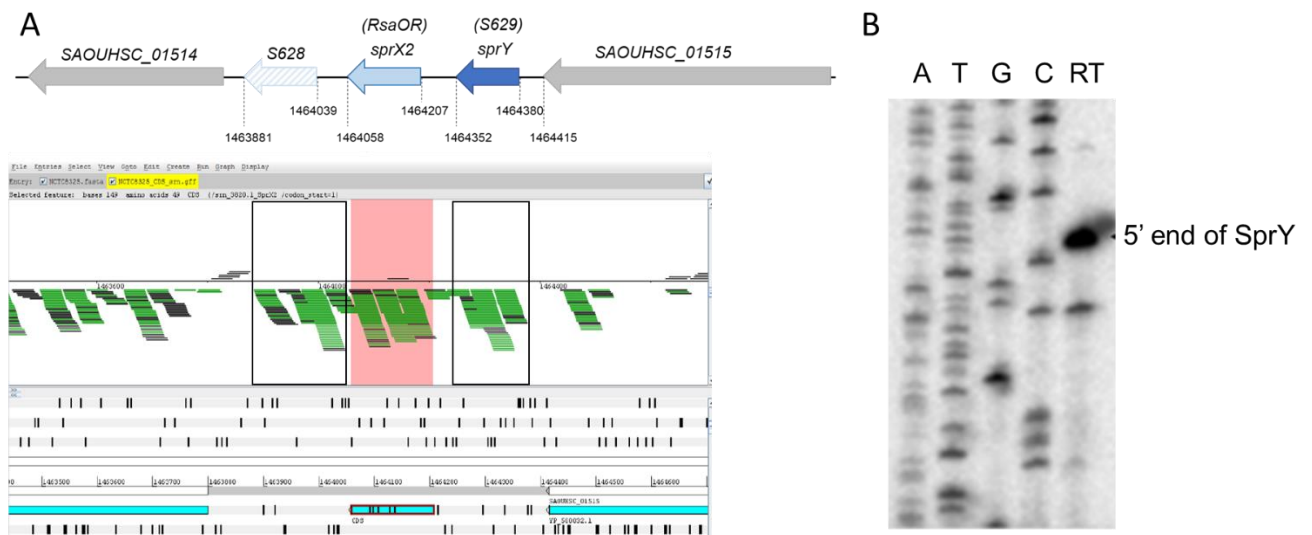

Figure 1S. *sprY* and *sprX2* localization in HG003 strain.

(A) Visualization of RNA seq data in the Artemis tool. The read alignment views in Artemis showing RNA-Seq data for NCTC8325 *S. aureus* strain (W Liu *et al.*, 2018). The framed pink reads correspond to SprX2 transcripts. The framed reads on the right of SprX2 correspond to SprY transcripts, also known as S629 (Mäder *et al.*, 2016). The framed reads on the left of SprX2 suggest a presence of another potential sRNA, which already defined as *bona fide* RNA, called S628 in W Liu *et al.*, 2018. (B) The 5' end of SprY was determined by Reverse transcription (RT). The arrow indicates the 5' end of the *sprY* gene determined experimentally. A, T, C and G refer to the sRNA sequencing ladders.

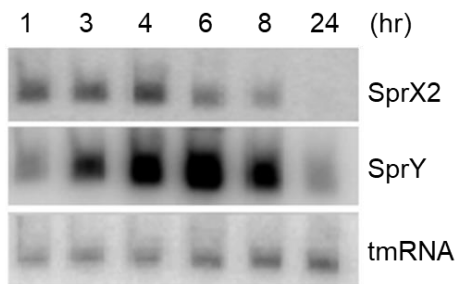

Figure 2S. *sprY* and *sprX2* expression in HG003 strain. Northern Blot analysis of *sprY* and *sprX2* expression profiles in HG003 during growth, using labelled DNA probes specific for SprY and SprX2. As loading controls, the blots were also probing for tmRNA.

A 5'
 UAUAGGGAAUCUUACAGUUUUAAAUAACUAAUUUGGAUG
 GAUGUUAAUAUCCUAUACACUUUUUAACAUUACUCUCA
 AGAUUUAAAUGUGCGUAACUGGCAGGUACUUCGGUACU
 UGCCUAUUUUUUUU 3'

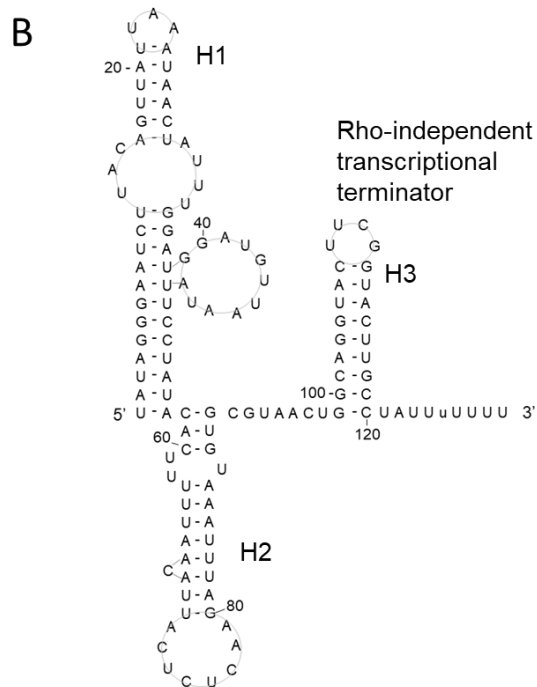

Figure 3S. SprY sequence and structure predicted.

(A) The sRNA sequence is shown with poly-U rich terminator tail (underlined). (B) Predicted secondary structure of SprY mRNA from HG003 strain is based on Mfold (Zuker *et al.*, 2003; Rouillard *et al.*, 2003) and LocaRNA (Raden *et al.*, 2018; Will, S. *et al.*, 2012; Will, S. *et al.*, 2007). The potential SprY 3'-end corresponds to the 3rd hairpin (H3) and represents a stem-loop of the Rho-independent terminator family.

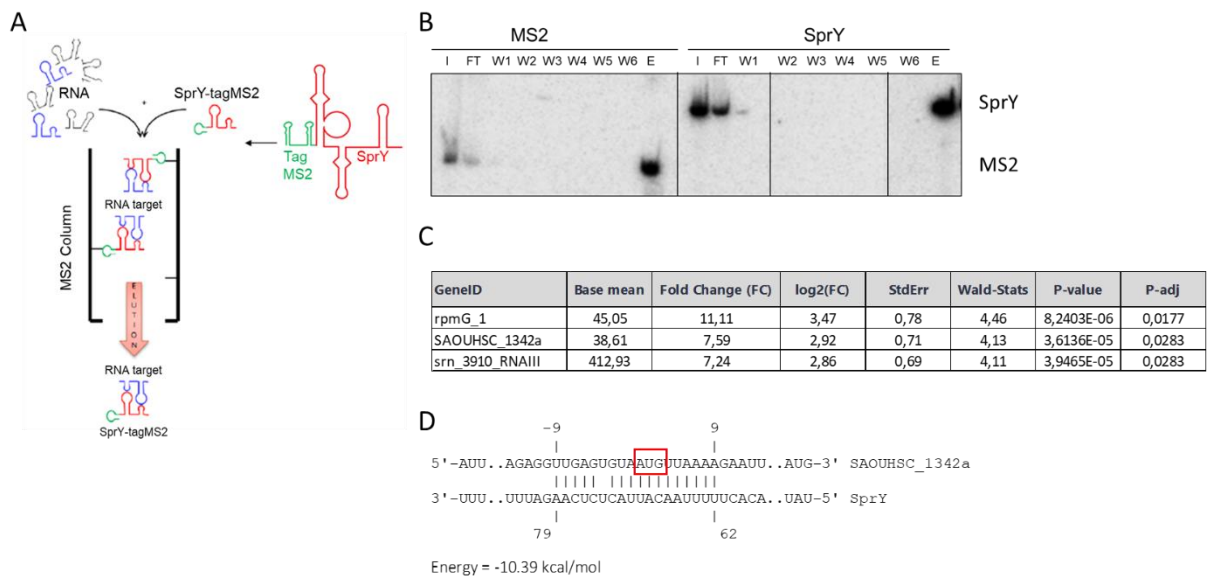

Figure 4S. Identification of potential direct targets for SprY by MS2-affinity purification.

(A) Experimental strategy to purify MS2-tagged RNA expressed *in vivo*. Green line denotes aptamer tags, red line for SprY sRNA and blue lines for potential RNA targets. The complexes formed between MS2-SprY and RNA target is retrieved by MS2 column. The complexes are eluted under native conditions.

(B) MS2 and MS2-SprY expression *in vivo*. Total RNAs was prepared at 2h and 6h of growth in BHI at 37°C. Northern Blot targeting MS2 and SprY was performed on RNAs purified from MS2 chromatography affinity: Induction (I), flow-through (FT), after Washing (W1-W6) and from Elution (E). (C) MAPS data showing enriched potential targets for MS2-SprY compared to MS2.

(D) Interaction between SprY and mRNA of *saouhsc_1342a* was predicted by IntaRNA software (Busch *et al.*, 2008). The start codon of *saouhsc_1342a* is framed in red.

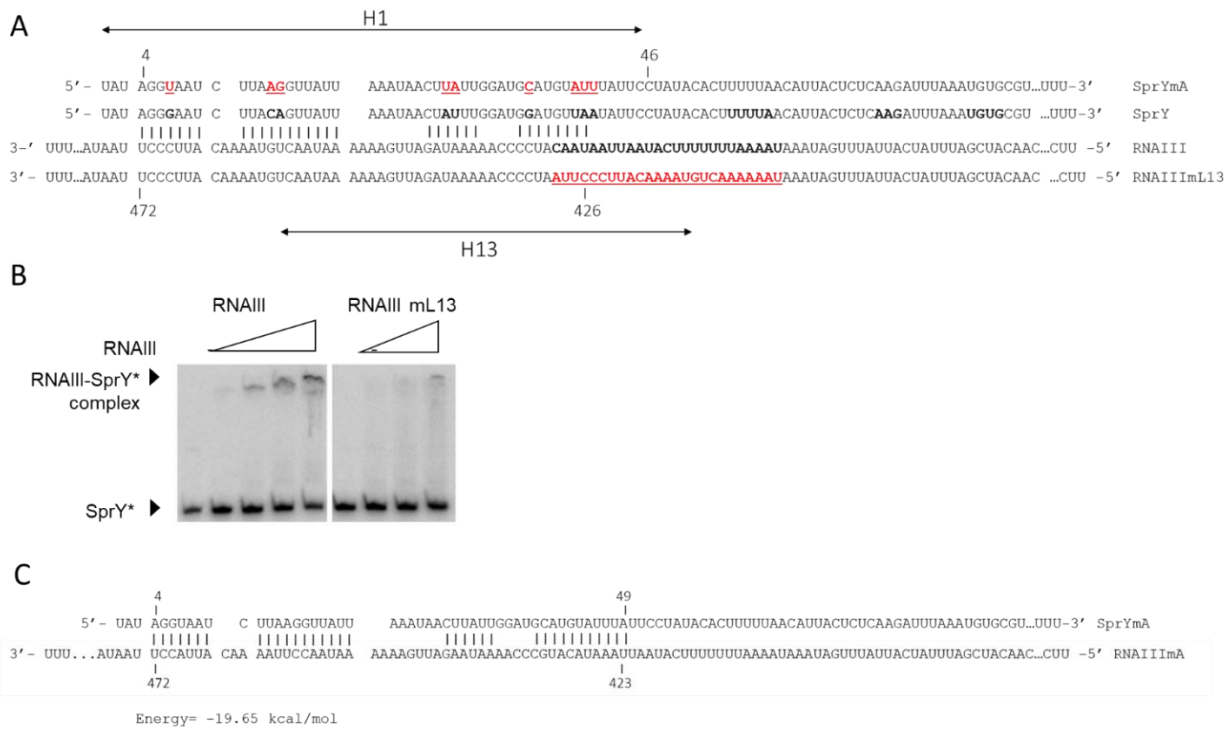

Figure 5S. (A) Interaction between SprY and RNAIII was predicted by IntaRNA software (Busch *et al.*, 2008). Different mutants of SprY and RNAIII were constructed. The nucleotides underlined and bolded in red correspond to the mutations in the *sprY* and *rnalIII* sequences.

(B) Complex formations were analysed by native gel retardation assays of purified labelled SprY (SprY*) with an increasing concentration of RNAIII wild-type (left panel) and RNAIII muted in 13rd loop (right panel) (0.08, 0.4, 0.16, 0.32 μ M).

(C) Interaction between SprYmA and RNAIII mA (compensatory mutation) was predicted by IntaRNA software (Busch *et al.*, 2008).

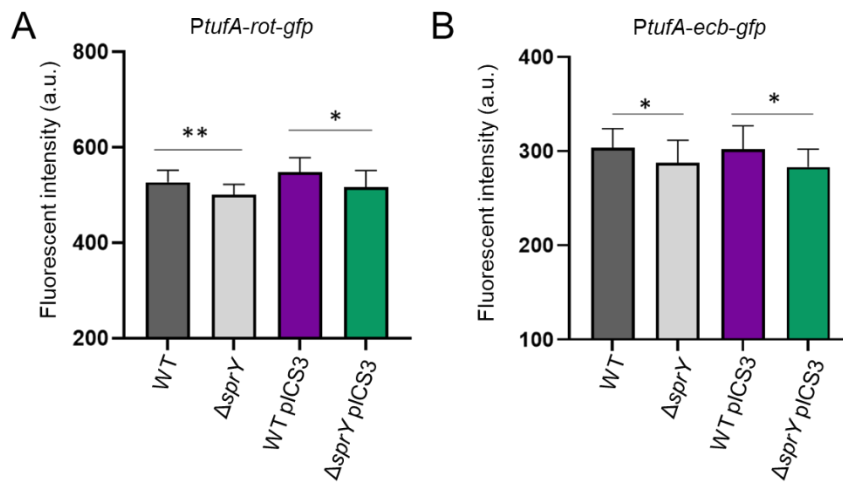

Figure 6S. WT, $\Delta sprY$ strains with or without empty plasmid (pICS3) were growth in BHI liquid in 96 wells-plate and the graphs correspond to OD 600nm measurements from Biotek. The left panel correspond to strains in double plasmid system with pCN33-*rot-gfp* (A) and the right panel with pCN33-*ecb-gfp* (B). All statistical analyses were performed using Student's t test. The error bars correspond to the average values from three independent experiments. Statistical significance is indicated by bars and asterisks as follows: *, $P < 0.05$; **, $P < 0.01$.

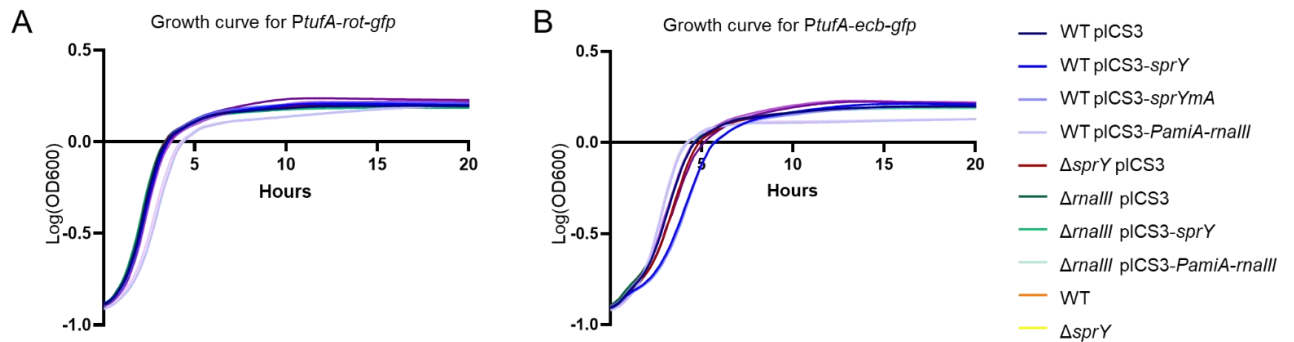
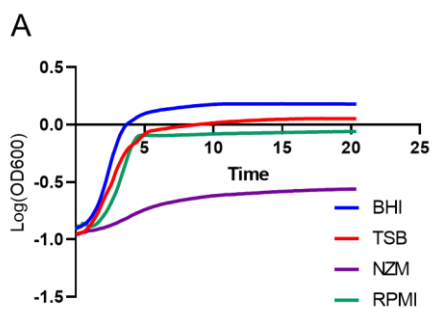

Figure 7S. WT, $\Delta sprY$ and $\Delta rnalll$ strains containing empty plasmid (pICS3), or over-expression of *sprY* or *sprYmA* (pICS3-*sprY* or pICS3-*sprYmA*) or *rnalll* (pICS3-*PamiA-rnalll*) were growth in BHI liquid in 96 wells-plate and the graphs correspond to OD 600nm measurements from Biotek. The left panel correspond to strains in double plasmid system with pCN33-*rot-gfp* (A) and the right panel with pCN33-*ecb-gfp* (B).



B

copies/ ug RNA	2H				6H			
	SprY	SD	RNAIII	SD	SprY	SD	RNAIII	SD
BHI	4,37E+06	7,31E+05	2,15E+06	3,50E+05	3,28E+07	5,49E+06	1,79E+08	2,91E+07
TSB	2,68E+06	1,11E+06	6,07E+05	4,18E+05	2,19E+07	9,12E+06	9,74E+07	6,71E+07
NZM	1,76E+06	7,23E+04	2,01E+07	3,36E+05	3,16E+06	1,30E+05	1,16E+08	1,95E+06
RPMI	3,33E+06	5,02E+05	1,17E+06	3,69E+05	1,67E+07	2,51E+06	7,76E+07	2,45E+07

Figure 8S. (A) HG003 WT strain were growth in BHI, TSB, NZM and RPMI liquid in 96 wells-plate and the graphs are presented in semi-log (OD 600) measurements from Biotek. (B) The quantification absolute was carried out using RNA extraction was performed at 2h and 6h of growth. The table represents the number of copies of SprY or RNAIII per ug of RNA extraction sample.



Figure 9S. Schematic presentation of the interaction region between RNAIII stem-loop 13 and mRNAs encoding for the transcriptional regulatory protein Rot and virulence factors : *coa* (Lebeau *et al.* 1994), *lytM* (Ramadurai *et al.* 1999), *spa* (Huntzinger *et al.* 2005), *SA1000*, *SA2093* and *SA2353* (Boisset *et al.*, 2007) and *mgrA* mRNA (Gupta *et al.*, 2015). The synthesis of Rot is regulated at the translational level by RNAIII (Geisinger *et al.* 2006; this study). The AUG codons are underlined and the interaction zone between RNAIII and SprY is colored in red.

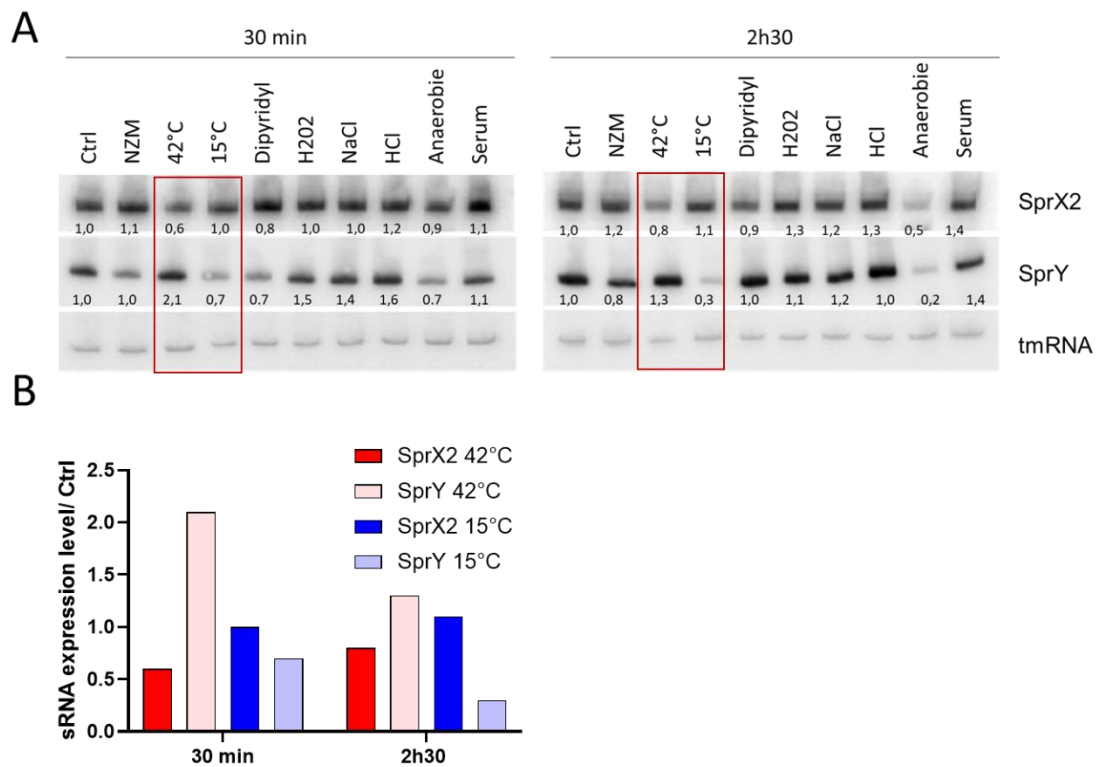

Figure 45. Analysis of the expression levels of SprX2 and SprY sRNAs under stress conditions in the strain of *S. aureus*.

(A) Analysis of the expression of *sprX* and *sprY* in strain HG001 *S. aureus* strain after 30 min and 2h30 of culture in medium depleted (NZM), under conditions at low temperature (15°C) or at high temperature (42°C), depleted in iron (Dipyridyl), oxidative stress (H2O2), in high salt concentration (NaCl), in acid medium (HCl), in 10% of human serum or in anaerobic manner compared to the expression of *sprX* and *sprY* at 37°C in LB rich medium (Ctrl). (B) The quantification of SprX2 and SprY expressions at 30 min and at 2h30 after exposing to temperature stress was performed by ImageQuant Tool 7.0 and is normalized to tmRNA.

III. Regulation network between SprY and SprX2

A. Comparison of *sprY* and *sprX2* expressions

As we mentioned before, *sprY* gene is located in immediate proximity to *sprX2* gene in phage Φ 12 of HG003 strain (Figure 35). In addition, SprX, was also defined as a *bona fide* sRNA (W. Liu et al. 2018) and studied for its contribution to virulence and antibiotics resistance of bacteria (Bohn et al. 2010; Buchad and Nair 2021; Eyraud et al. 2014; Kathirvel, Buchad, and Nair 2016). This observation insisted us to take an interest in expression of these two genes. We demonstrated that *sprX2* and *sprY* are expressed independently regardless of their proximity in a cluster of sRNAs (Figure 2C in Le Huyen et al. 2021). Interestingly, *sprY* and *sprX2* possess opposite expression profiles during growth (Figure supplementary 2S in Le Huyen et al. 2021). SprY accumulates during bacterial growth whereas SprX2 expresses early at exponential phase and decreases over time.

Next, we wonder if *sprX2* and *sprY* are also express differently in various stress conditions. For this study, HG001 strain was cultivated until the exponential growth phase (3h) and then it was subjected for 30 min and 2h30 to the following stresses: a poor environment (NZM), thermal shocks (42°C and 15°C), ionic stress (0.5 mM dipyridyl, which corresponds to iron depletion), 10 mM H₂O₂, 1M NaCl, pH 5.5 (addition of 5N HCl), anaerobic culture and serum. The expression level of both sRNAs was detected by Northern Blot and was quantified by ImageTools 7.0, compared to SprY level in LB at 37°C (Ctrl). Our data showed a clear different expression profile of SprX2 and SprY in temperature stresses. Indeed, at 42°C, SprX2 decreased by 0.6-fold after 30 min and by 0.8-fold after 2h30, while SprY levels increased 2.1-fold after 30 min and 1.3-fold after 2h30 of heat stress (Figure 45). Moreover, at 15°C, while SprX2 expression level did not showed much fluctuation after exposing to heat stress, SprY expression decreased after 2h30 of stress exposure (Figure 45). Altogether, these results showed that the expression levels of SprX and SprY2 do not undergo the same variation according to stress.

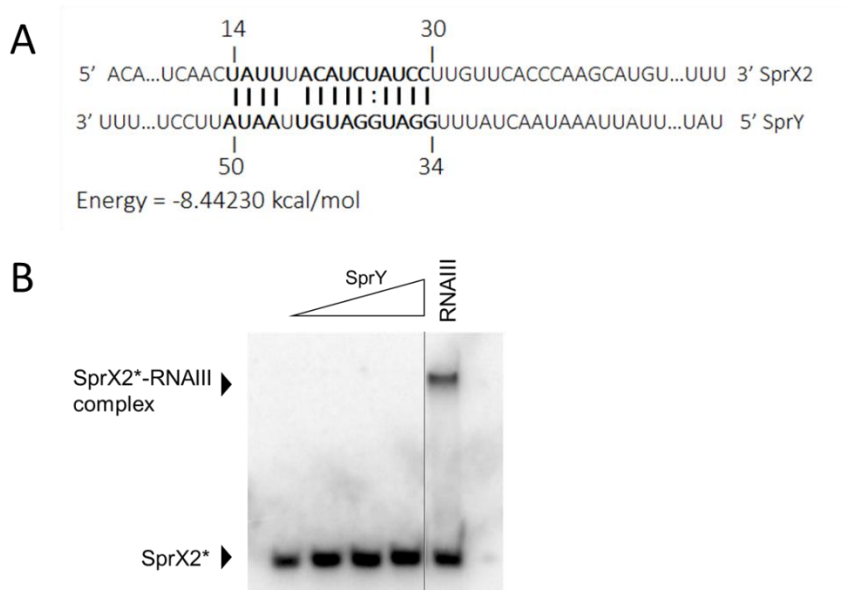

Figure 46. Analysis of predicted interaction of SprY with SprX2. (A) Interaction between SprY and SprX2 was predicted by IntaRNA software (Busch *et al.*, 2008). (B) Complex formation between SprY and SprX2 was analyzed by native gel retardation assays of purified labelled 0,025 pmoles of SprX2* with increasing concentrations of SprY (0.5, 2 and 5 μ M). Complex formation between SprX2 and RNAIII (5 nM) is used as positive control for shift assay.

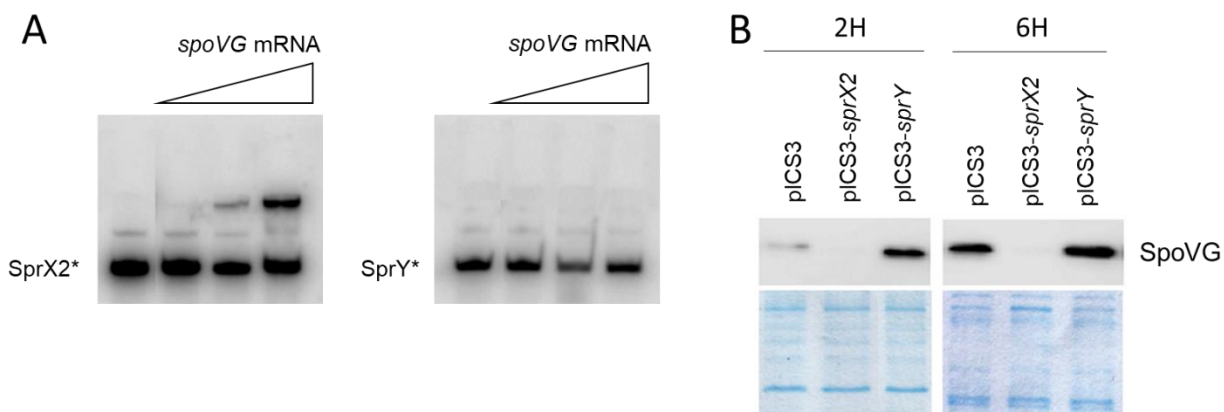

Figure 47. SpoVG expression under SprY and SprX2 regulation. (A) Complex formation between sRNA and the target mRNA was analyzed by native gel retardation assays of purified labelled 0,025 pmoles of SprX2* or SprY* with increasing concentrations of *spoVG* mRNA (0.5, 2 and 5 μ M). (B) HG003 harboring pICS3 or pICS3-*sprX2* or pICS3-*sprY* were grown in BHI at 37°C and total intracellular proteins extractions were carried out at 2h and 6h of growth. Western Blot analysis of SpoVG protein expression was performed using polyclonal antibodies against SpoVG. Coomassie stained gel was used as loading control.

B. *In silico* prediction of interaction between SprY and SprX2

The opposite expression profile of *sprX2* and *sprY* in certain conditions and close localization leads to the hypothesis that SprX2 and SprY might interact with each other. We therefore verified the potential interaction between these two sRNAs *in silico* by IntaRNA (Busch, Richter, and Backofen 2008; Mann, Wright, and Backofen 2017). The analysis indicates potential base-pairing between SprX2 and SprY involving the 5' of SprX2 (from the 14th to the 30th nts) and the 2nd hairpin of SprY (from the 34th to the 50th nts) (Figure 46A). However, we did not detect complex formation between SprX2 and SprY by EMSA (Figure 46B).

C. Regulation mechanisms of SprY and SprX2

Several targets of SprX has been identified and validated in the last decade (Eyraud et al. 2014; Ivain et al. 2017; Kathirvel, Buchad, and Nair 2016). Since *sprY* is located in immediate proximity of *sprX2* gene and is showed to possess an interesting profile of expression comparing to *sprX2*, we wonder if SprY sRNA would affect the expression of these targets of SprX2.

1. Impact of SprY and SprX2 on *spoVG* expression

In Eyraud et al. 2014, the authors have demonstrated that SprX sRNA interacts with the RBS of *yabJ-spoVG* mRNA and inhibits the translation of the second downstream gene, *spoVG*. First, to test the potential interaction of these two sRNAs with *spoVG* mRNA, we carried out EMSA using synthetic RNAs. Complex formation between SprX2 sRNA and *spoVG* mRNA was observed while no complex formation between the mRNA with SprY was detected (Figure 47A). Next, we tested the impact of SprX2 and SprY on the translational level of *spoVG* by Western blot assay. Our results showed that the overexpression of SprX2 reduced the expression of SpoVG, which is correlated with the results in Eyraud et al. 2014. On the contrary, overexpression of SprY increased the protein expression (Figure 47B) regardless of the absence of interaction between SprY and *spoVG* mRNA, which suggests that another intermediate factor may be involved.

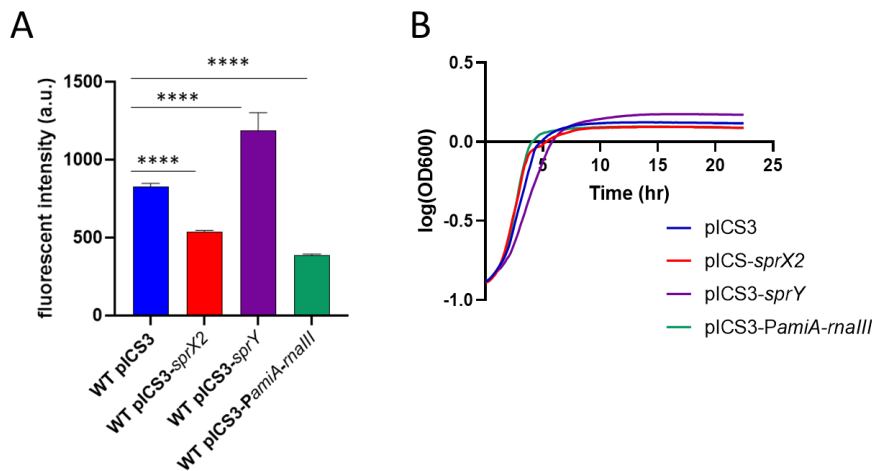

Figure 48. Expression of *ecb* under *SprY* and *SprX2* regulation. *S. aureus* HG003 (WT) carrying the pCN33-*PtufA-ecb-gfp* fusion plasmid co-transformed with different plasmids (pICS3 or pICS3-*sprX2* or pICS3-*sprY* or pICS3-*PamiA-rnallI*). The fluorescent intensity (A) and the growth of these strains at OD600 (B) were measured every 10 minutes over 20 hours in a Biotek microplate reader. All statistical analysis were performed using Student's t test. The error bars correspond to the average values from three independent experiments. Statistical significance is indicated by bars and asterisks as follows: *, $P < 0.05$; **, $P < 0.01$; ***, $P < 0.005$.

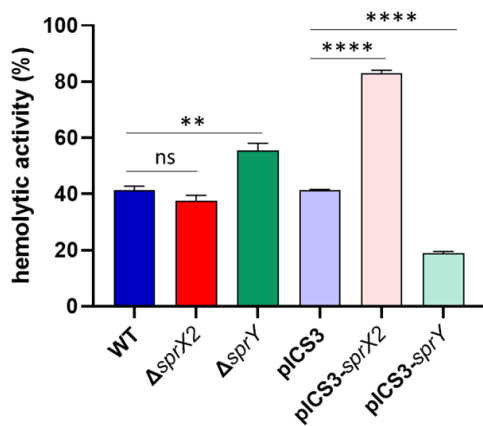

Figure 49. Hemolytic activity of *S. aureus* regulated by de *SprX2* et *SprY* in human blood. The supernatants of different strains of HG003 (WT, $\Delta sprX2$, $\Delta sprY$) and HG003 WT containing empty plasmid (pICS3) or overexpressing *sprX2* or *sprY* (pICS3-*sprX2* or pICS3-*sprY*) were collected after 6 hours of growth in BHI at 37°C. Hemolysis was performed by incubating cell culture supernatants with Human blood samples at a ratio 50:50 at 37°C for 1h. The hemolytic activity was observed in a flat-bottom 96-well microtiter plate at OD 540nm. The blood samples prepared in PBS1X represent as negative control and in Triton 0.1% as 100% hemolysis. All statistical analysis from three independent experiments were performed using Student's t test . Statistical significance is indicated by bars and asterisks as follows: *, $P < 0.05$; **, $P < 0.01$; ***, $P < 0.005$.

2. Impact of SprY and SprX2 on *ecb* expression

According to Ivain et al. 2017, SprX2 has been demonstrated to downregulate *ecb* at translational level. We showed that SprY affects *ecb* expression by impacting RNAlII function (Le Huyen et al. 2021). Here, we tested the effect of both SprY and SprX2 on *ecb* expression in the same conditions and the same genetic background. HG003 harboring pICS3 or pICS3-*sprY* were then co-transformed with pCN33-*PtufA-ecb-gfp* (Ivain et al. 2017). A co-transduction of pCN33-*PtufA-ecb-gfp* with pICS3-*PamiA-rnalll* was used as positive control of the regulation system. Bacterial growth of all strains used for this experiment was essentially equivalent (Figure 48B). Overproduction of SprX2 and RNAlII reduce the fluorescence of strain containing pCN33-*PtufA-ecb-gfp*, which represent a decrease of *ecb* translational expression levels (Figure 48A) as described in Ivain et al. 2017 and Boisset et al. 2007. On the contrary, the overexpression of SprY leads to a significant increase of the fluorescence intensity of Ecb-GFP, corresponding to the result in Le Huyen et al. 2021.

3. SprX2 and SprY affect hemolytic activity of HG003 strain

Furthermore, *sprX2*, one of the two copies of *sprX* in HG003 (*alias rsaOR*) is a homologue of *sprX* in *S. aureus* N315 strain (Bohn et al. 2010) and it has been showed that SprX affect hemolysis of *S. aureus* Newman strain (Kathirvel, Buchad, and Nair 2016). Hence, we tested the effect of SprX2 and SprY on the hemolytic activity of the bacteria in human blood. We used HG003, HG003 Δ *sprX2*, HG003 Δ *sprY* strains and HG003 WT containing either pICS3 or pICS3-*sprX2* or pICS3-*sprY*. Although the absence of *sprX2* did not affect hemolysis compared to WT, *sprY* deletion led to an increase of hemolysis in human blood (Figure 49). Moreover, overexpression of *sprX2* (HG003 pICS3-*sprX2*) led to a considerable increase the hemolytic activity of *S. aureus*, while overproduction of SprY reduced significantly the hemolytic activity (Figure 38 and Figure 6 in Le Huyen et al. 2021).

Taken together, our data showed that SprY and SprX2 possess opposite effect on common targets such as *ecb* and *spoVG* and affect differently the hemolysis induced by *S. aureus*. These results suggest that the two sRNAs might share a possible link in the regulation of *S. aureus* virulence and potential in antibiotic resistance.

DISCUSSIONS & PERSPECTIVES

NCTC8325
(Genbank: CP000253.1)

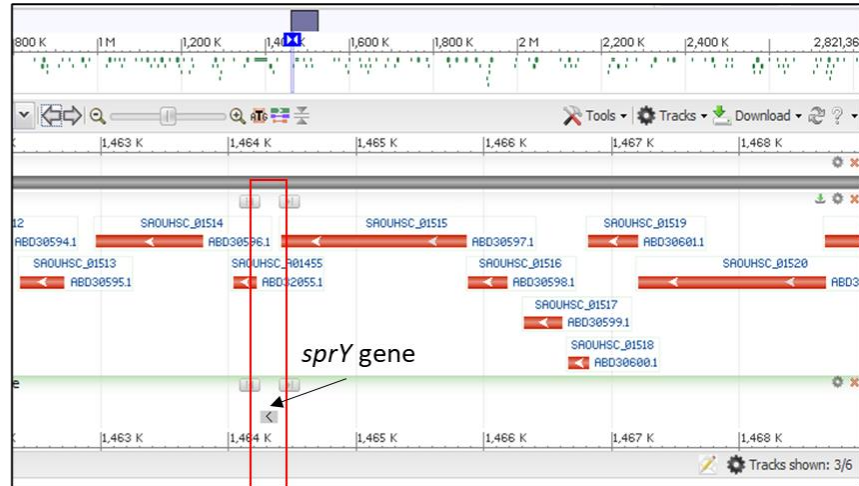

USA300
(NCBI Reference:
NC_007793.1)



Figure 50. Overview of genomic localization of *sprY* gene in NCTC8325 strain compared to *lukF/S-PV* gene in USA300 strain. The red frame indicates the corresponding zone of two genes (*sprY* and *lukF/S*) and the black arrow shows *sprY* sequence in NCTC8325 strain.

My thesis falls within an overall project of our laboratory that led to the discovery of several regulatory RNAs expressed by *S. aureus* and whose functions, for a majority of them, are unknown. My work consists in characterizing and identifying the function of a new sRNA, SprY.

I. The conservation and the genomic localization of *sprY* gene in various *S. aureus* strains

sprY gene was found in staphylococcal phage phi12 (or Φ 12), also known as bacteriophage Sa2 (or Φ Sa2) of *S. aureus* (reviewed in (Gill 2009)). As previously mentioned in Results Chapter I, this phage was originally isolated from NCTC8325 *S. aureus* strain where it resides as a prophage next to Φ 11 and Φ 13 (Ye, Buranen, and Lee 1990). Furthermore, Φ 12 (or Φ Sa2), is conserved in several other *S. aureus* strains than NCTC8325 (Iandolo et al. 2002; Pantůček et al. 2004; Sass and Bierbaum 2007), such as MW2 (Baba et al. 2002), MSSA476, MRSA252 (Holden et al. 2004), USA300 (Diep et al. 2006), Newman and RF122 strain (Herron-Olson et al. 2007). We also remark that the *lukS-PV* and *lukF-PV* genes encoding a virulence factor, PVL, were found in N315 and USA300 Φ Sa2 phage instead of *sprY* gene (Figure 50). Furthermore, bacteriophages have been demonstrated to encode different virulence factors and regulators such as genes coding for exfoliative toxin A (*eta*) (Yamaguchi et al. 2001), the cell-wall anchored protein SasX (Li et al. 2012), and the immune evasion cluster (IEC) composed of enterotoxin S (*sea*), staphylokinase (*sak*), the chemotaxis inhibitory protein (*chp*), and the staphylococcal complement inhibitor (*scn*) (Van Wamel et al. 2006) are the well-studied phage-encoded virulence factors in *S. aureus*. In addition, few sRNAs involved in the virulence regulation like SprD (Chabelskaya, Bordeau, and Felden 2014; Chabelskaya, Gaillot, and Felden 2010a) or SprF1/ SprG1 (Pinel-Marie, Brielle, and Felden 2014) were also found encoded in staphylococcal phages. Here, we have shown the presence of yet another sRNA, SprY, phage encoded that affects the pathogenicity of *S. aureus* by modulating the hemolytic activity of *S. aureus*. The differential expression of *sprY* in *S. aureus* commonly used laboratory strains and clinical isolates that we showed suggests that *sprY* could provide *S. aureus* with adaptative advantages in particular infection

environments. Further experiments in a larger scale are needed to confirm this hypothesis such as the assessment of the hemolytic activity of different *S. aureus* strains in the absence or presence of *sprY* gene.

II. Verification of *SAOUHSC_03046* expression regulated by SprY

The identification of all the potential targets of regulatory RNAs is crucial to unravel their functional roles. One of many ways to look for SprY potentially direct targets is through *in silico* predictions. By comparing results from predictions by TargetRNA2 (Kery et al. 2014) and CopraRNA (Tjaden 2008; Wright et al. 2014), we decided to study *SAOUHSC_03046* which is the only common gene coming out among the top 15 (Annex 1 and Annex 2). Our study showed the presence of base pairing between SprY and this mRNA *in vitro*, and also confirmed regulation of its expression *in vivo*. SprY interacts with the 5' UTR of *SAOUHSC_03046* mRNA masking the RBS, and consequently blocking its translation. SprY overexpression does not affect the mRNA level of *SAOUHSC_03046* but SprYmB, which does not bind the target, unexpectedly upregulates *SAOUHSC_03046* at mRNA level and at translational level. These results lead us to wonder if the regulation mechanism of SprY on *SAOUHSC_03046* involves other intermediate factors or maybe if SprYmB overexpression competes with SprY endogenous expression in the HG003 strain and biases the data. Future studies evaluating the expression of *SAOUHSC_03046* in RN4220, which is cured of phages Φ 11, Φ 12 and Φ 13 (Kreiwirth et al. 1983), might help us determine the effect of SprYmB independently from endogenous SprY.

To better understand the role of this regulation, we studied the nature of *SAOUHSC_03046* gene which encodes for a helix-turn-helix domain-containing protein belonging to XRE family protein (Xenope response element) (Ibarra et al. 2013). With a similarity in sequence with a known XRE protein (XdrA) in USA300 strain (McCallum et al. 2010), we suggested that *SAOUHSC_03046* protein might also affect the expression of the same target of XdrA, which is *spa* gene. Our preliminary results showed that the absence of *SAOUHSC_03046* provoked an increase of *spa* mRNA level compared to HG003 WT. Although more experiments are needed to reach statistical significance, our

results suggest *SAOUHSC_03046* would downregulate the expression of *spa* mRNA. Interestingly, SprY overexpression showed an increase in the levels of *spa* transcript regardless of the expression of *SAOUHSC_03046*, suggesting that the effect of SprY on *spa* is not only mediated by *SAOUHSC_03046*. Indeed, *spa* expression is regulated by several factors such as *agr*/RNAIII system and Rot (Gao and Stewart 2004; Huntzinger et al. 2005; Saïd-Salim et al. 2003); both of their expressions were affected by SprY (Le Huyen et al. 2021). The fact that *SAOUHSC_03046* might also modulate *spa* gene expression will present a new layer of regulation network of *S. aureus* virulence.

III. Identification of SprY direct targets by MAPS technique

MS2 affinity purification coupled with RNA sequencing (MAPS), developed by Lalaouna and Massé, is a technique extensible used in the last couple of years. Initially used to identify identify proteins partners for RNAs in several Gram-negative bacteria (Corcoran et al. 2012; Said et al. 2009), MAPS was adapted to study RNA-RNA interaction (Carrier, Lalaouna, and Massé 2016; Lalaouna et al. 2017; Silva et al. 2019). Recent modifications have been made to adapt this technic in Gram-positive like *S. aureus* (Lalaouna et al. 2019; Tomasini et al. 2017), which unlocks more possibilities for identification of new targets for several sRNAs of *S. aureus*. In parallel, in our lab, we also performed MAPS to study RNAs targets for several staphylococcal sRNAs using inducible plasmid pRMC2 instead of pCN51 plasmid in Tomasini et al. 2017 although the system remains the same (Ivain Lorraine thesis).

Here, in this work, we used MAPS approach to identify direct targets of SprY in normal growth condition in *S. aureus*. The analysis comparing RNAseq data from eluates of the *ms2-sprY* fusion and the control *ms2* alone, we identified three potential interesting targets for SprY: *rpmG1*, *rnall* and *SAOUHSC_1342a* mRNAs (Le Huyen et al. 2021). However, regardless of *in silico* predictions, *SAOUHSC_03046* was not found through MAPS analysis. *SAOUHSC_03046* expression profile has been studied in Madër et al. 2016 and its amount has been showed to be fairly low in most of culture conditions beside in CDM and RPMI media at exponential phase. The fact that our MAPS assay was done in LB could explain the absence of *SAOUHSC_03046* in our RNA-seq analysis.

After testing the potential interaction *in silico* by IntaRNA and *in vitro* by EMSA, SprY was only predicted to bind to RNAIII (Le Huyen et al. 2021) and *SAOUHSC_1342a* mRNA. *rpmG1* mRNA enrichment by MAPS without direct interaction with SprY suggest that *in vivo* the formation of the complex may involve other factors. In this work we were looking for direct targets that form sRNA-sRNA or sRNA-mRNA complexes, for that reason *rpmG1* was removed from the study.

RNAIII is an sRNA, thus our MAPS study revealed an sRNA-sRNA interaction *in vivo*. We then demonstrated that the binding of SprY on RNAIII prevents the latter to regulate the expression of his targets. Lalaouna and his collaborators studies using MAPS also helped them to identify RNAs acting as a sponge for sRNAs in Gram-negative bacteria. Their results showed that the 3' external transcribed spacers sequences of polycistronic transcripts (3' ETS), previously considered for a long time as “junk RNA”, binds to RyhB and RybB sRNAs to reduce sRNAs excess and to prevent them from regulating their mRNAs targets (Lalaouna et al. 2015; Ziebuhr and Vogel 2015).

IV. SprY regulates SAOUHSC_1342a expression

SAOUHSC_1342a encodes for mechanosensitive channel of large conductance (MscL), which has been mostly studied in *E. coli* (Bootha and Blount 2012; Ou et al. 1998; Wray et al. 2019, 2020) and more recently in *S. aureus* (Carniello et al. 2020). Mechanosensitive channels (MS channels) function as an emergency release valves in response to membrane tension upon low osmotic stress. For instance, when the osmotic environment decreases, water flows in and threatens bacterial cell integrity, MS channels will release cytoplasmic pressure by letting rapid efflux of cytosolic molecules from the cell (Bootha and Blount 2012; Haswell, Phillips, and Rees 2011). In bacteria, there are two families of MS channels: MS of large conductance (MscL) and MS of small conductance (MscS). Contrary to MscS, MscL are highly conserved between species, including

pathogens. MscLs have been demonstrated to protect bacterium against osmotic forces and to also participate in the transport and uptake of peptides and antibiotics in *E. coli* (Maurer and Dougherty 2001; Ou et al. 1998; Wray et al. 2020). Only recent studies has shown another role of MscL upon adhesion force in *S. aureus* (Carniello et al. 2020). MscL in *S. aureus* were shown to not only be opened by fluctuations of membrane tension due to osmotic force, but also by the adhesion force to surfaces. When the bacteria presents strong adhesion forces through adhering to substratum surface, it provokes deformation of staphylococcal cell wall and leads to opening of MscL (Carniello et al. 2020). However, the expression regulation of these MscL remains unclear. Here, we demonstrated that SprY potentially downregulates *SAOUHSC_1342a* translation, which could reveal partially the expression regulation of MscLs in *S. aureus*. The impact of SprY on *SAOUHSC_1342a* at translational level could be explained by the fact that through binding to the 5' end of *SAOUHSC_1342a* mRNA, SprY masks the RBS and prevents the Ribosome recruitment onto the mRNA. As for perspectives, we intend to test the effect of SprY on some phenotypes related to mechanosensitive channel gating in *S. aureus* by measuring the ability of uptaking fluorescent calcein or the antibiotic (dihydrostreptomycin) described in (Carniello et al. 2020). For example, the authors have demonstrated that at a high adhesion force, RN4220 wild-type strain showed more fluorescence intensity than in RN4220 deleted for *mscL* (RN4220 $\Delta mscL$), which is correlated to the uptake of the fluorescent calcein in the bacteria through these mechanosensitive channels; or RN4220 WT allows more import of the antibiotic resulting in more dead cells than in RN4220 $\Delta mscL$ (Carniello et al. 2020).

V. SprY acts as a sponge of RNAIII and alters its activity in the regulation of *S. aureus* virulence

Here, we have demonstrated that the 5' end of SprY binds directly the 13th stem-loop of RNAIII. Our study showed that SprY binding alters RNAIII function without affecting RNAIII stability and that SprY prevents the complex formation between RNAIII and its targeted mRNAs. By antisense base-pairing, RNAIII controls the translation or/and the stability of various mRNA targets. The 3' region of RNAIII is responsible for repression of multiple

mRNA targets (Boisset et al. 2007; Huntzinger et al. 2005; Lebeau et al. 1994; Ramadurai et al. 1999), and the sequence corresponding to the interaction region with SprY overlaps with sites for binding several mRNA targets, such as *rot*, *spa*, *coa*, *lytM*, *ecb*, *SA2093* and *SA2353* (reviewed in (Delphine Bronesky et al. 2016)). We showed that SprY overproduction enhances *rot* and *ecb* mRNAs translation only when the interaction between SprY and RNAIII takes place (Le Huyen et al. 2021). Taken together, we present here the case of a sRNA that acts as a sponge to fine-tune the sophisticated RNAIII regulation network (Le Huyen et al. 2021).

Recently, reports have described novel RNA functions modulating the action of sRNAs; some of them act as RNA decoys (Figuroa-Bossi et al. 2010; Overgaard et al. 2009) or as RNA sponges (reviewed in (Figuroa-bossi and Bossi 2018; Miyakoshi, Chao, and Vogel 2015)). They are identified to impact indirectly the expression of several genes without affecting the stability nor inducing the cleavage of the RNA of interest. Moreover, utilization of high-throughput technologies such as MAPS, CLIP-seq, etc. that were developed for identification of direct targets for sRNAs allow the discovery of RNA that mimic mRNA targets and bind to regulatory sRNA altering their function (reviewed in (Denham 2020)). The term “sponge” RNA came from eukaryotic regulatory RNA studies demonstrating the titration of regulatory RNA thus affecting its function. Later, it was shown that the natural eukaryotic and prokaryotic coding and noncoding RNAs could have sponge-like activity to mimic primarily targets of regulatory sRNA. The first sponge RNA in prokaryotes has been identified in *Salmonella enterica* (Figuroa-Bossi et al. 2010). ChiX sRNA represses the synthesis of ChiP, however, the presence of another mRNA transcript, chitosugars (*chb*), lead to the titration of ChiX through base pairing and as consequence allows the production of ChiP. Subsequently the mechanism of RNA sponge-like activity has been recently described in different bacteria suchlike *E. coli*, *B. subtilis*, *P. aeruginosa* (reviewed in (Denham 2020)). Since the degradation is not a necessitate aftermath of duplex formation, a sponge RNA can act by titrating a regulatory sRNA and by competing with their true targets like tRNA precursor (Lalaouna et al. 2015). Unlike *chb*-ChiX regulation, the interaction between 3'ETS tRNA spacer sequences with RybB or RyhB sRNAs does not promote the degradation of the sRNA but prevent the sRNA

from regulating its targets. Until now, in *S. aureus*, only one case of RNA has been suggested to be RNA sponge is RsaI (or RsaOG): the interaction between RsaI and RsaG was hinted to block RsaG from regulating its own targets (D. Bronesky et al. 2018). However, to our knowledges, the findings presented here are the first to identify a sRNA with a sponge activity for RNAIII in *S. aureus*. This observation suggests that SprY could reduce the toxicity of *S. aureus* by preventing the function of RNAIII and therefore, could switch the bacteria to a phenotype less virulent.

VI. How sRNAs gene cluster contribute to *S. aureus* during bacterial growth and infection?

During my thesis project, analysis of SprY and SprX2 expressions have shown some interesting remarks on these two sRNAs. Despite the immediate proximity of *sprY* and *sprX2* genes in HG003 strain, the absence or overproduction of one sRNA does not affect the expression of the other. Moreover, we showed that they possess an opposite expression profiles: SprY accumulates overtime while it is the contrary for SprX2. Not only that they express differently during bacterial growth, but they also respond oppositely under temperature stress. SprX2 was shown to decrease under 42°C and to express more at 15°C while SprY decreases at 15°C and expresses more at 42°C. Maybe the stress affect the transcription and/or the degradation of sRNA (F. Repoila and Gottesman 2001) and it would be interesting to test the stability of SprY and SprX2 in different stresses to verify this hypothesis. Furthermore, SprY affect the expression of *spoVG* in the opposite way than SprX2. While SprX2 reduces the translation of *spoVG* by direct binding to the RBS of the mRNA, SprY provokes an increase of *spoVG* amount in an unknown mechanism that does not implicate direct interaction between SprY and *spoVG* mRNA. By the same token, SprY has an opposite effect than SprX onto the expression of *ecb* (Ivain et al. 2017). SprX2 regulates *ecb* expression by direct binding (Ivain et al. 2017) whereas SprY regulates *ecb* through affecting RNAIII function (Le Huyen et al. 2021). Thus, two sRNAs located in the same cluster and regulate oppositely a common target through different mechanisms. Moreover, both sRNAs SprX2 and SprY also contribute to the virulence of *S. aureus* but in opposite way: SprX2 favors the hemolytic activity of *S. aureus* while SprY restrains it.

In general, organization of genes in clusters is trait for genes expressing macromolecules with similar functions (Vanderpool, Balasubramanian, and Lloyd 2011). In addition to protein gene clusters (Jongerius et al. 2007; McCarthy and Lindsay 2013), sRNAs have been demonstrated to be expressed from clusters such like the case of *S. aureus* in (Bronsard et al. 2017). Although several sRNAs cluster genes have been discovered, their functions are yet to be elucidated (Felden and Paillard 2017), whether they possess shared biological functions or different roles in the bacterial survival or the virulence. Interestingly, *sprY* and *sprX2*, located in a direct adjacency in a cluster and possess opposite expression profiles during growth. We wonder if this reversed profile could explain the contribution of sRNAs to control the virulence of *S. aureus* at different points of the bacterial growth. Furthermore, by developing analysis of RNAseq results, we also noticed the potential presence of another potential sRNA gene in the downstream of *sprX* gene, called *sprZ*. This latter gene has been studied in Madër et al. 2016 under the name S627 (Figure 35 and Figure 38) and defined as a *bona fide* sRNA in (W Liu et al, 2018). Although additional studies will be needed to characterize closely SprZ and to fully understand the collaboration between SprY and SprX2, the current data suggests a functional relationship between the two sRNAs and might proposes a new regulation network with a new potential sRNA SprZ.

VII. Many new regulatory sRNAs have been discovered to be involved in the virulence of *S. aureus*

Over the last decade, the biological functions and contributions of sRNAs in *S. aureus* virulence became clearer. Indeed, recent reports begin to shed some light into the regulation mechanisms of some sRNAs. For instance, SprD has been demonstrated to be involved in immune evasion (Chabelskaya et al. 2010), or RsaA in biofilm formation (Romilly et al. 2014), and SprC in phagocytosis (Le Pabic et al. 2015). Moreover, SprY as well as SprX2 were demonstrated to be implicated in the hemolytic activity of *S. aureus* (Buchad and Nair 2021; Kathirvel, Buchad, and Nair 2016; Le Huyen et al. 2021). In addition to two latter sRNAs, other staphylococcal sRNAs have been shown to be involved in the regulation of hemolysin expression and hemolysis. Teg41 enhances hemolytic

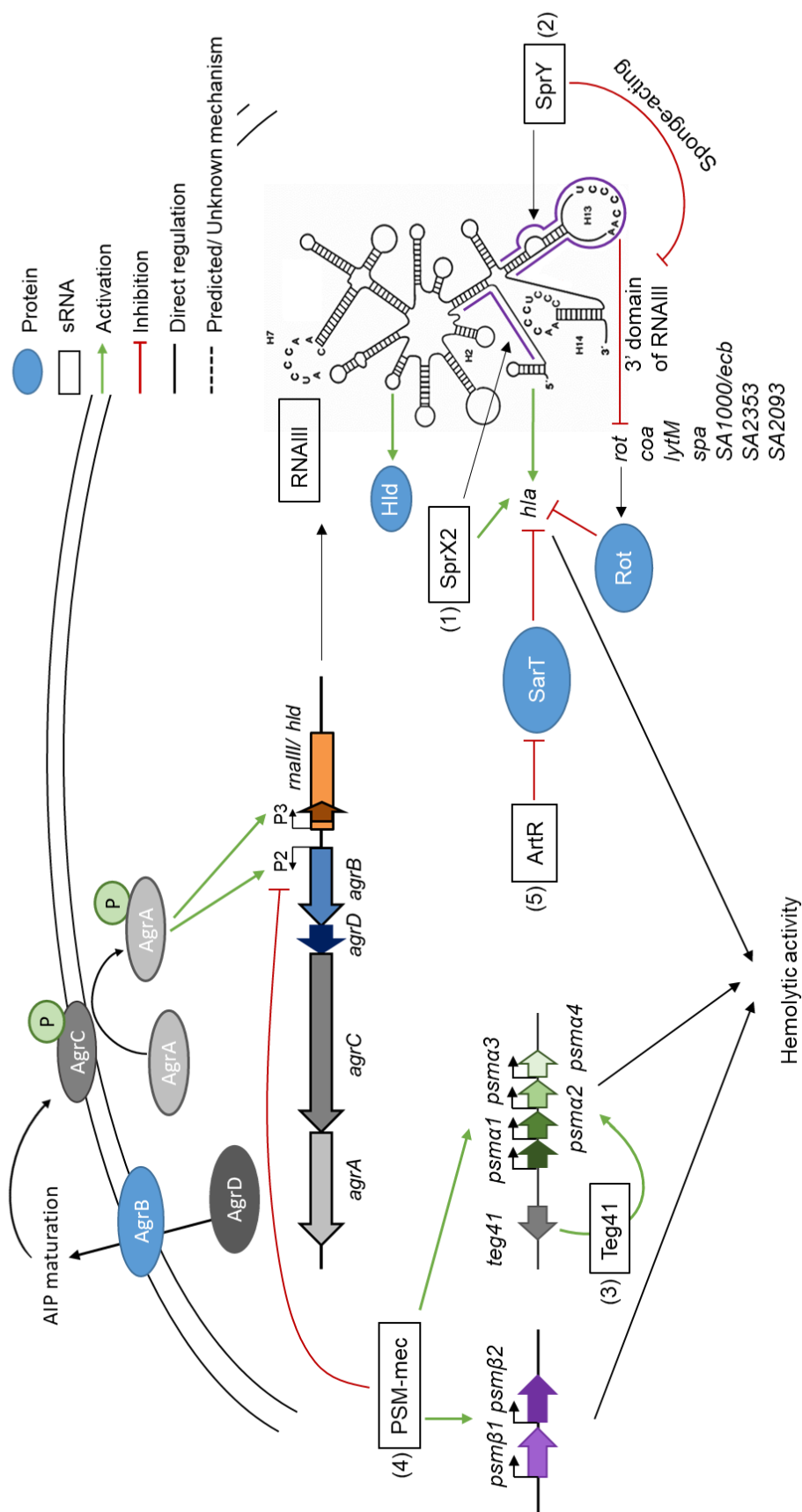

Figure 51. Overview regulation network of *S. aureus* virulence by several sRNAs. This schema represents a partial regulation network of *S. aureus* virulence involving several sRNAs: SprX2 (1), SprY (2), Teg41 (3), PSM-mec (4) and ArtR (5). The green arrow indicates positive regulation and the red arrow for negative regulation. All proteins are represented in circle and sRNA in rectangular. (1) Karthivel *et al.*, 2016, (2) Le Huyen *et al.*, 2021, (3) Zalpf *et al.*, 2020, (4) Kaito *et al.*, 2013; Li Qin *et al.*, 2017, (5) Ting Xue *et al.*, 2013

activity (Zapf et al. 2019). Teg41 locates immediately downstream of its own target, α PSMs, and enhances the production of toxins through antisense pairings between the 3' end of Teg41 with α PSM transcript. The action of two other sRNA examples is connected with *agr* function. PSM-mec is a bifunctional RNA encoded by the staphylococcal cassette chromosome mec (SCC-mec). This cassette confers the methicillin resistance to methicillin-resistant *S. aureus* (MRSA). PSM-mec RNA encodes a cytolytic phenol-soluble modulin peptide (PSM alpha), but also represses the translation of *agrA* mRNA by binding to its coding sequence of *agrA* (Kaito et al. 2013; Qin et al. 2016). The other sRNA, ArtR, was shown to regulate the expression of Hla via repressing of its regulator: ArtR binds directly to 5' untranslated region of the *sarT* mRNA and promotes its degradation (Xue et al. 2014). AgrA was shown to bind the promoter and to repress the expression of sRNA, ArtR. In an overview, *S. aureus* has developed multiple pathways to regulate its virulence by directly regulating the production of toxins or by modulating the function of *agr* and its effector, RNAIII. Thus, our work displays how multifaceted the regulation of virulence factors is during *S. aureus* infection and uncover another layer of sRNA involved in the pathogenicity of *S. aureus* (Figure 51).

MATERIALS & METHODS

Table 4_ Strains and plasmids

STRAINS	RELEVANT CHARACTERISTICS	REFERENCES
<i>E. coli</i> strain		
DH5- α	F ⁻ Φ 80d lacZ Δ M15 D(lacZA-argF)U169 deoR recA1 endA1 hsdR17 (rK- mK-) phoA supE44 l- thi-1 gyrA96 relA1	Invitrogen; (Sambrook J et al., 1989)
<i>S. aureus</i> strains		
RN4220	Restriction-defective derivative of 8325-4	Kreiswirth et al. 1983
HG003	rsbU restored strain 8325, lysogenic for phages Φ 11, Φ 12, and Φ 13	Herbert et al. 2010
HG003 Δ <i>sprY</i>	<i>sprY</i> deleted HG003	Le Lam et al. 2017
HG003 Δ <i>sprX2</i>	<i>sprX2</i> deleted HG003	Le Lam et al. 2017
HG003 Δ 3046	<i>saouhsc_03046</i> deleted HG003	This study
Plasmids		
pICS3	Shuttle vector, Cm ^r (cat194), pC194 replicon	Ivain et al. 2017
pICS3- <i>spx2</i> , <i>Y</i>	pICS3 with <i>sprX2</i> and <i>sprY</i> of HG003 under control of <i>sprX2</i> endogenous promoter	This study
pICS3- <i>spx2p1</i>	pICS3 with <i>sprX2</i> and 25 nts of 3' end of <i>sprY</i> of HG003 under control of <i>sprX2</i> endogenous promoter	This study
pICS3- <i>spx2p4</i>	pICS3 with <i>sprX2</i> of HG003 under control of its endogenous promoter	This study
pICS3- <i>sprYmB</i>	pICS3 with <i>sprYmB</i> of HG003 under control of its endogenous promoter	This study
pCN33	Low-copy-number shuttle vector, Em ^r (ermC), pT181 cop-wt repC	Charpentier et al. 2014
pCN33-PtufA- <i>saouhsc_01342a-gfp</i>	pCN33 with <i>saouhsc_01342a</i> of HG003 fused to <i>gfp</i> under control of PtufA promoter	This study
pCN33-PtufA- <i>saouhsc_03046-gfp</i>	pCN33 with <i>saouhsc_03046</i> of HG003 fused to <i>gfp</i> under control of PtufA promoter	This study

I. Materials

A. Bacterial strains and growth condition

All bacterial strains and plasmids used in this work are listed in Table 4. Mutated strain HG003 for *saouhsc_03046* (HG003 $\Delta 3046$) was made as described in Monke et al. 2015, using primers 14 to 17 in Table 5. All other mutant strains are provided by Dr. Bouloc from Institute for Integrative Biology of the Cell (I2BC), University Paris-Saclay (Le Lam et al. 2017).

Brain Heart Infusion (BHI, AES Chemunex), Luria Broth (LB, MO BIO), Tryptic Soy Broth (TSB, Oxoid), Roswell Park Memorial Institute (RPMI) 1640 medium (Gibco, Thermo Fischer Scientific) and NZM (Sigma) media were used and supplemented, if necessary, with 100 $\mu\text{g}/\text{mL}$ of ampicillin (amp) and 10 $\mu\text{g}/\text{mL}$ chloramphenicol (cat) or erythromycin (erm) unless otherwise specified. A pre-culture was inoculated with a colony isolated on a BHI dish at 37°C. The next day, the cultivation was carried out by dilution to one hundredth of this pre-culture in medium. Bacterial growth was cultivated at 37 ° C, with constant agitation at 160 rpm and followed by measuring the optical density at 600 nm (OD600).

1. DH5- α *E. coli* competent cells preparation, transformation, and plasmids purification

A culture of *E. coli* is cultivated in 400mL of SOB medium (86mM NaCl; 2.5mM KCl; 2% tryptone; 0.5% yeast extracts) and incubated for 2 to 3 days at 18°C with vigorous shaking (220 rpm) until the culture reaches an OD600 = 0.5. Once the OD600 is reached, the culture is incubated for 10 minutes on ice then centrifuged for 10 minutes at 2500g, 4 ° C and the pellets are resuspended in 80mL of cold TB buffer (10mM PIPES; 15mM CaCl₂; 250mM KCl; 55mM MnCl₂; pH 6 ,7). After a new incubation on ice for 10 minutes and a new centrifugation for 10 minutes at 2500g, 4°C, the pellets are gently resuspended in 20mL of cold TB before adding glycerol (7% final). After a final 10 minutes incubation on ice, the cells are aliquoted to 1mL/ microtube and stored at -80°C.

Table 5_ Primers

N°	NAME	SEQUENCES	UTILIZATION
1	T7 sprYmB for	GAGACATTACTCTTTTATTTAAAACACCGTAACTGGCAGGTACTTCG	EMSA
2	T7 sprYmB rev	ATGTTAATATTCTATACACTAAGAGACATTACTCTTTTATTTAAAACA	EMSA
3	T7 sprX2 for	TAATACGACTCACTATAGGGTATAGGGAATCTTACAGTTAT	EMSA
4	T7 sprX2 rev	AAATAGGCAAGTACCGAAGTACC	EMSA
5	T7 saouhsc_03046 for	TAATACGACTCACTATAGGGATAGTCTGATTGTAATGATTGTA	EMSA
6	T7 saouhsc_03046 rev	GGTCCCTTTTACTAAATCATCT	EMSA
7	T7 saouhsc_01342a for	TAATACGACTCACTATAGGCATTTAAAAAAGAGAGGTTGAG	EMSA
8	T7 saouhsc_01342a rev	ACTTTGGAATGTATAGAACAACC	EMSA
9	pICS3-PstI-sprX2, Y for	TTAAAAGCTTGCATGCCTGCAGTATTTACTTAGAATAAAAAATTTTGC	Cloning
10	pICS3-NarI-sprX2, Y rev	AGAAAATACCGCATCAGGCGCCTAAAAAGCACCCCGTA	Cloning
11	pICS3-NarI-sprX2p1 for	TTAAAAGCTTGCATGCCTGCAGAGTACTTCGGTACTTGCCTATTT	Cloning
12	pICS3-NarI-sprX2p4 for	TTAAAAGCTTGCATGCCTGCAGCCTATTTTTTATGTTATAG	Cloning
13	pCN33-PtufA-3046-gfp for	GAGAAACTATCATGAGAGAAGATCTATAGTCTGATTGTAATGATTGT	Cloning
14	pCN33-3046-gfp rev	TCTCCTTTGCTTCTAGAGATATCACTCTGCCTAGATACATATAACT	Cloning
15	pCN33-PtufA-1342a-gfp for	GAGAAACTATCATGAGAGAAGATCTACATTTAAAAAAGAGAGGTT	Cloning
16	pCN33-1342a-gfp rev	TCTTCTCCTTTGCTTCTAGAGATATCCACAACAGCAATTGCTAAA	Cloning
17	pIMAY-3046 5'for	CGACTCACTATAGGGCGAATTGGAGCTCTTCTGTCTTGTATATTAAGTGA	Cloning
18	pIMAY-3046 5'rev	ATATGAGACGATACCACGATGATAGTCAATTAGTACAATCATTACA	Cloning
19	pIMAY-3046 3'for	TGTAATGATTGTACTAATTGACTATCATCGTGGTATCGTCTCATAT	Cloning
20	pIMAY-3046 3'rev	CCTCACTAAAGGGAACAAAAGCTGGGTACCAGAACATTGCTATGACCTTTCAA	Cloning
21	saouhsc_03046 toeprint	CTTTTCAGCAAGATATTCTTGTG	Toeprint
22	spa qPCR for	GGATGAAACCATTGCGTTGTTTC	RT-qPCR
23	spa qPCR rev	AAACGAATCTCAAGCACCGAAA	RT-qPCR
24	saouhsc_03046 qPCR for	AACGGTGGCAATCATTTTGGGAAT	RT-qPCR
25	sahousc_03046 qPCR rev	TCGATCGTAGTTGTCCATTTTATGCA	RT-qPCR
26	saouhsc_01342a qPCR for	AGAAGAAGCCGAAGAAGAAGCA	RT-qPCR
27	sahousc_01342a qPCR rev	AGAACAACCTTAGCCCATCTCT	RT-qPCR
28	agrA qPCR for	CGAAGACGATCCAAAACAAAGAG	RT-qPCR
29	agrA qPCR rev	GCTCAAGCACCTCATAAGGAT	RT-qPCR
30	SprY1 (S119)	GGATTATCCACTTTTTCATCC	Northern Blot
31	SprY3/ srn_9342	AGTTCTAGTAAAATAATAGCAC	Northern Blot

All plasmids and primers used are listed in Table 4 and Table 5. Cloning experiments were carried out at 50°C for 15 minutes, using Gibson Assembly Master Mix (New England Biolabs). Then, 100µL of competent bacteria are placed in the presence of approximately 100 ng of plasmids for 15 minutes on ice before undergoing a thermal shock for 35 seconds at 42°C. After being put back on ice for 2 minutes, the bacteria are incubated for 1 hour in SOC (SOB medium + 20 mM Glucose) medium at 37 ° C. and then spread on LB dishes supplemented with 50 µg/mL ampicillin. The plasmids were purified from overnight cultures in LB broth supplemented with Ampicillin 10ug/mL and minipreparations were performed using Miniprep Extraction Kit (Qiagen). The plasmid sequence was verified by Sanger sequenced by using BigDye Terminator v3.1 Cycle sequencing Kit, using a 3130x1 capillary electrophoresis genetic analyzer (Applied Biosystems).

2. *S. aureus* RN4220 electro-competent cells preparation and transformation

A pre-culture of *S. aureus* RN4220 strain was inoculated in BHI at 37°C with agitation at 160 rpm. The next day, the bacterial culture was diluted to twentieth in 10 mL TSB (or BHI) and cultivated for 5 hours in the same condition. Then, the culture was diluted again in 100 mL TSB (or BHI) to OD600 final of 0.5 and incubated for another 30 minutes before being placed on ice for 10 minutes. The bacteria are then centrifuged at 3500 rpm, 4°C for 10 minutes. Then, the pellets were washed twice with sterile water (50mL then 5mL) and then once with 2mL of iced 0.5M sucrose. After centrifugation, the washed pellets were resuspended in 250 µL of 0.5M sucrose + 10% glycerol, were aliquoted and stocked in -80°C.

For RN4220 transformation, 50 µL of competent bacteria were incubated with 100ng of plasmids for 5 minutes at room temperature before electroporation at 2500V. 4 µL of DMSO was added into the mix for cryopreservation. The bacteria were then incubated for at least 1 hour in BHI medium at 37°C, and then spread on a BHI dish supplemented with the appropriate antibiotic.

3. Phage preparation and transduction

To prepare phage containing the plasmid of interest, a pre-culture of RN4420 transformed with the plasmid was cultivated overnight in TSB/ BHI with appropriated antibiotic at 37°C with agitation. The next day, 200 µL of the pre-culture was diluted in 500 µL of TSB/ BHI with CaCl₂ 10mM and 100 µL of that dilution was mixed with 100 µL of phage 80α and incubated for 5 hours at 28°C. Phages containing the plasmid of interest were then collected through filter of 0.45 µm. In parallel, 100µL of the dilution without phage was also incubated at 28°C as a negative control. We used RN4220 strain to prepare phage-containing vectors expressing sRNA or target-gfp fusion.

As for phage transduction, we used *S. aureus* HG003 strains to transduce sRNA expressing vector and/ or to co-transform with the target-gfp fusion. For this, 100 µL of HG003 pre-culture with 10mM CaCl₂ was incubated with 20 µL of phage 80α containing plasmid of interest for 30 minutes at 37°C, before adding 900 µL of BHI + 10mM Sodium Citrate and incubating for at least 1 hour at 37°C with agitation. The culture was then spreading on a BHI box supplemented with the appropriate antibiotic.

B. Stress conditions

The stress conditions studied and samples are from Alex Eyraud's thesis in 2014. 10 mL of the pre-cultures of strain HG001 (WT) the day before are diluted to hundredth in 600 mL of LB medium in order to obtain an OD of 0.1 then incubated at 160 rpm at 37 ° C for 3 hours until the exponential phase (OD₆₀₀ = 2). Then, 50 mL of culture are distributed in Erlenmeyer flasks to undergo the following stresses: a poor medium (NZM), thermal shocks (42°C and 15°C), ionic stress (0.5 mM dipyridyl), which corresponds to iron depletion), without agitation and anaerobic. The 50 mL of control culture and stress temperatures are directly placed at 37°C, 15°C and 42°C respectively. For ionic stress and in poor medium, the 50 mL of culture are first centrifuged for 10 minutes at 4000 rpm and at room temperature, washed with water and then respectively taken up in 50 mL of NZM medium and LB medium supplemented with dipyridyl (0.5 mM). After 30 minutes, 2h30 and 4h, the total

RNAs are extracted as described in (Bohn et al. 2010; Chabelskaya, Gaillot, and Felden 2010).

C. Plasmids constructions

Table 5 lists all the primers used. To construct the sRNA-expressing vectors, we used pICS3 (which is pRMC2 without the anhydrotetracycline inducible promoter) (described in Ivain *et al.*, 2017).

As for double plasmids system, we used pCN33 to express SprY target fused with reporter gen (*gfp*) under a constitutive promoter *PtufA* (pCN33-*PtufA-3046-gfp* and pCN33-*PtufA-1342a-gfp*). HG003 strains carrying each of the target-*gfp* fusions and the sRNA plasmids were grown on BHI agar plates supplemented with 10 µg/mL chloramphenicol and erythromycin. The fluorescence measurements of the co-transduced HG003 strains was performed as previously described (Ivain *et al.*, 2017).

II. Methods

A. Proteins extractions, Western blots and Mass Spectrometry

S. aureus strains were grown until exponential phase (2 hours) or stationary phase (6 hours) in BHI at 37°C, with agitation at 160 rpm, and the cells were then pelleted for 10 min at 4°C (8000 g). The total proteins and extracellular proteins extractions were prepared according to Chabelskaya *et al.*, 2010. Proteins samples were boiled at 95°C for 5 minutes before loading in SDS-PAGE gel 12%, following by a staining by Coomassie blue R-250. The proteins of interest were extracted from gel, trypsin digested, and the peptides were identified by MALDI MS/MS and RP-HPLC/NanoLC/ESI-MS-MS. SpoVG expression was visualized by anti-SpoVG polyclonal antibodies, and anti-rabbit IgG secondary antibodies (Jackson). Western blots were revealed using the Amersham ECL Plus detection Kit. Signals were visualized using LAS 4000 (GE Healthcare).

B. Toeprint assay

All RNAs were transcribed from PCR-generated DNA using MEGAscript T7 kit (Ambion). The template for transcription was amplified using HG003 genomic DNA and forward primers containing T7 promoter sequences (Table 5). RNAs were labelled at 5'-end using [γ -³²P] ATP (Amersham Biosciences) and T4 polynucleotide kinase (Invitrogen). Labelled and unlabeled RNAs were purified on a 5% acrylamide urea gel, eluted in Elution buffer (20mM Tris-HCl pH 7.5, 250mM NaCl, 1mM EDTA, 1% SDS) at 37°C, eluted, ethanol precipitated, quantified by Qubit (Thermo Fisher Scientific) and stored at -80°C.

For Toeprint assay, 5 pmoles of RNA target with 10 μ L of DNA probes labelled were denaturized in 50 mM Tris HCl pH 7.5, 60 mM NH₄Cl, 1 mM DTT for 2 min at 80°C, followed by refolding as described previously. The ribosomes were reactivated for 15 min at 37°C, followed by a dilution of 1/100 in 20mM Tris HCl pH 7.5, 20 mM MgCl₂, 60 mM NH₄Cl, 1 mM DTT and incubated for 15 min at 37°C. Various concentrations (0, 0.5, 1, or 2 pmoles) of purified 70S ribosomes were added to each sample and incubated for 5 minutes at 37°C. The mixture was supplemented by 10mM MgCl₂ (final concentration) and 10 pmoles of uncharged tRNA^{fMet}, followed by another incubation for 15 min at 37°C. The cDNA was synthesized with 4U of AMV RT (NEB) for 15 minutes at 37°C. Reactions were stopped by the addition of 15 μ L of loading buffer II (Ambion) and heated for 10 min at 65°C. The cDNAs were loaded and separated onto 8% polyacrylamide/8M urea gels. Sequencing ladders were generated with the same 5'-ended primer.

C. Statistical analysis

For the statistical analysis of the data, a check of the normality of the data as well as the equality of variances was carried out. Then, according to the results of these two tests, the parametric tests of Student (for paired or unpaired data) and of Welch or the nonparametric test of Mann-Whitney were carried out, on at least three independent experiments, to evaluate the significance. Data were expressed as mean \pm standard deviations.

REFERENCES

- Alexander Fleming. 1929. "On the Antibacterial Action of Culture of a Penicillium, with Special Reference to Their Use in the Isolation of B. Influenza." *British Journal of Experimental Pathology* X(3).
- Alibayov, Babek et al. 2014. "Staphylococcus Aureus Mobile Genetic Elements." *Molecular Biology Reports* 41(8): 5005–18.
- Almebairik, Nada et al. 2020. "Genomic Stability of Composite SCCmec ACME and COMER-Like Genetic Elements in Staphylococcus Epidermidis Correlates With Rate of Excision." *Frontiers in Microbiology* 11(February): 1–12.
- Alouf, Joseph E, and Heide M Alouf. 2003. "Mini-Review Staphylococcal and Streptococcal Superantigens : Molecular , Biological and Clinical Aspects." *Int. J. Med. Microbiol.* 292: 429–40.
- Altuvia, Shoshy. 2004. "Regulatory Small RNAs: The Key to Coordinating Global Regulatory Circuits." *Journal of Bacteriology* 186(20): 6679–80.
- Amdahl, Hanne et al. 2013. "Staphylococcal Ecb Protein and Host Complement Regulator Factor H Enhance Functions of Each Other in Bacterial Immune Evasion." *The Journal of Immunology* 191(4): 1775–84.
- . 2017. "Staphylococcal Protein Ecb Impairs Complement Receptor-1 Mediated Recognition of Opsonized Bacteria." *PLoS ONE* 12(3): 1–18.
- Anderson, Kelsi L. et al. 2006. "Characterization of the Staphylococcus Aureus Heat Shock, Cold Shock, Stringent, and SOS Responses and Their Effects on Log-Phase mRNA Turnover." *Journal of Bacteriology* 188(19): 6739–56.
- Andreas Peschel; Michael Otto. 2016. "Phenol-Soluble Modulins and Staphylococcal Infection." *Physiology & behavior* 176(1): 139–48.
- Antal, Maria, Valérie Bordeau, Véronique Douchin, and Brice Felden. 2005. "A Small Bacterial RNA Regulates a Putative ABC Transporter." *Journal of Biological Chemistry* 280(9): 7901–8.
- Appelbaum, P. C. 2006. "The Emergence of Vancomycin-Intermediate and Vancomycin-Resistant Staphylococcus Aureus." *Clinical Microbiology and Infection* 12(SUPPL. 1): 16–23.
- Archer, Gordon L. 1998. "Staphylococcus Aureus : A Well-Armed Pathogen." : 1179–81.

- Baba, Tadashi et al. 2002. "Genome and Virulence Determinants of High Virulence Community-Acquired MRSA." *Lancet* 359(9320): 1819–27.
- Babakhani, Sajad, and Mana Oloomi. 2018. "Transposons: The Agents of Antibiotic Resistance in Bacteria." *Journal of Basic Microbiology* 58(11): 905–17.
- Bae, Weonhye, Bing Xia, Masayori Inouye, and Konstantin Severinov. 2000. "Escherichia Coli CspA-Family RNA Chaperones Are Transcription Antiterminators." *Proceedings of the National Academy of Sciences of the United States of America* 97(14): 7784–89.
- Baker, Matthew D., and K. Ravi Acharya. 2004. "Superantigens: Structure-Function Relationships." *International Journal of Medical Microbiology* 293(7–8): 529–37.
- Barie, Philip S., Mayur Narayan, and Robert G. Sawyer. 2018. "Immunization against Staphylococcus Aureus Infections." *Surgical Infections* 19(8): 750–56.
- Batey, Robert T., and Jeffrey S. Kieft. 2007. "Improved Native Affinity Purification of RNA." *Rna* 13(8): 1384–89.
- Bayer, Arnold S. et al. 1997. "Hyperproduction of Alpha-Toxin by Staphylococcus Aureus Results in Paradoxically Reduced Virulence in Experimental Endocarditis: A Host Defense Role for Platelet Microbicidal Proteins." *Infection and Immunity* 65(11): 4652–60.
- Beaume, Marie et al. 2010. "Cartography of Methicillin-Resistant S. Aureus Transcripts: Detection, Orientation and Temporal Expression during Growth Phase and Stress Conditions." *PLoS ONE* 5(5).
- . 2011. "Orientation and Expression of Methicillin-Resistant Staphylococcus Aureus Small RNAs by Direct Multiplexed Measurements Using the NCounter of NanoString Technology." *Journal of Microbiological Methods* 84(2): 327–34. <http://dx.doi.org/10.1016/j.mimet.2010.12.025>.
- Bédard, Anne Sophie Vézina, Elsa D.M. Hien, and Daniel A. Lafontaine. 2020. "Riboswitch Regulation Mechanisms: RNA, Metabolites and Regulatory Proteins." *Biochimica et Biophysica Acta - Gene Regulatory Mechanisms* 1863(3): 194501. <https://doi.org/10.1016/j.bbagr.2020.194501>.
- Begum, Shifa, Tofa Begum, Naziza Rahman, and Ruhul A Khan. 2021. "A Review on

- Antibiotic Resistance and Way of Combating Antimicrobial Resistance.” *GSC Biological and Pharmaceutical Sciences* 14(02): 87–97.
- Benito, Yvonne et al. 2000. “Probing the Structure of RNAIII, the Staphylococcus Aureus Agr Regulatory RNA, and Identification of the RNA Domain Involved in Repression of Protein A Expression.” *Rna* 6(5): 668–79.
- Bhakdil, Sucharit. 1991. “Alpha-Toxin of Staphylococcus Aureus.” 55(4): 733–51.
- Bischoff, Markus et al. 2004. “Microarray-Based Analysis of the Staphylococcus Aureus Σ B Regulon.” *Journal of Bacteriology* 186(13): 4085–99.
- Blevins, Steve M., and Michael S. Bronze. 2010. “Robert Koch and the ‘golden Age’ of Bacteriology.” *International Journal of Infectious Diseases* 14(9): 744–51.
- Bohach, Gregory A., David J. Fast, Robert D. Nelson, and Patrick M. Schlievert. 1990. “Staphylococcal and Streptococcal Pyrogenic Toxins Involved in Toxic Shock Syndrome and Related Illnesses.” *Critical Reviews in Microbiology* 17(4): 251–72.
- Bohn, Chantal et al. 2010. “Experimental Discovery of Small RNAs in Staphylococcus Aureus Reveals a Riboregulator of Central Metabolism.” *Nucleic Acids Research* 38(19): 6620–36.
- Boisset, Sandrine et al. 2007. “Staphylococcus Aureus RNAIII Coordinately Represses the Synthesis of Virulence Factors and the Transcription Regulator Rot by an Antisense Mechanism.” *Genes and Development* 21(11): 1353–66.
- Boles, Blaise R., and Alexander R. Horswill. 2008. “Agr-Mediated Dispersal of Staphylococcus Aureus Biofilms.” *PLoS Pathogens* 4(4).
- Bootha, Ian R., and Paul Blount. 2012. “The MscS and MscL Families of Mechanosensitive Channels Act as Microbial Emergency Release Valves.” *Journal of Bacteriology* 194(18): 4802–9.
- Bossi, Lionello et al. 2012. “A Role for Rho-Dependent Polarity in Gene Regulation by a Noncoding Small RNA.” *Genes and Development* 26(16): 1864–73.
- Bossi, Lionello, and Nara Figueroa-bossi. 2016. “Competing Endogenous RNAs: A Target-Centric View of Small RNA Regulation in Bacteria.” *Natural reviews Microbiology*.
- Bouloc, Philippe, and Francis Repoila. 2016. “Fresh Layers of RNA-Mediated Regulation in Gram-Positive Bacteria.” *Current Opinion in Microbiology* 30: 30–35.

<http://dx.doi.org/10.1016/j.mib.2015.12.008>.

- Bramley, A. J. et al. 1989. "Roles of Alpha-Toxin and Beta-Toxin in Virulence of Staphylococcus Aureus for the Mouse Mammary Gland." *Infection and Immunity* 57(8): 2489–94.
- Brantl, Sabine. 2007. "Regulatory Mechanisms Employed by Cis-Encoded Antisense RNAs." *Current Opinion in Microbiology* 10(2): 102–9.
- Breaker, Ronald R. 2012. "Riboswitches and the RNA World." *Cold Spring Harbor Perspectives in Biology* 4(2).
- Britton, Robert A. et al. 2007. "Maturation of the 5' End of Bacillus Subtilis 16S rRNA by the Essential Ribonuclease YkqC/RNase J1." *Molecular Microbiology* 63(1): 127–38.
- Bronesky, D. et al. 2018. "A Dual sRNA in Staphylococcus Aureus Induces a Metabolic Switch Responding to Glucose Consumption." *bioRxiv* 33(0): 1–36.
- Bronesky, Delphine et al. 2016. "Staphylococcus Aureus RNAIII and Its Regulon Link Quorum Sensing, Stress Responses, Metabolic Adaptation, and Regulation of Virulence Gene Expression." *Annual Review of Microbiology* 70(1): 299–316.
- . 2019. "A Multifaceted Small RNA Modulates Gene Expression upon Glucose Limitation in Staphylococcus Aureus." *The EMBO Journal* 38(6): 1–18.
- Bronner, Stéphane, Henri Monteil, and Gilles Prévost. 2004. "Regulation of Virulence Determinants in Staphylococcus Aureus: Complexity and Applications." *FEMS Microbiology Reviews* 28(2): 183–200.
- Bronsard, Julie et al. 2017. "sRNA and Cis-Antisense sRNA Identification in Staphylococcus Aureus Highlights an Unusual sRNA Gene Cluster with One Encoding a Secreted Peptide." *Scientific Reports* 7(1): 1–17.
- Bronwlee. 1971. "Sequence of 6S RNA of E. Coli." *Brownlee*.
- Buchad, Hasmatbanu, and Mrinalini Nair. 2021. "The Small RNA SprX Regulates the Autolysin Regulator WalR in Staphylococcus Aureus." *Microbiological Research* 250(April): 126785. <https://doi.org/10.1016/j.micres.2021.126785>.
- Bukowski, Michał, Benedykt Wladyka, and Grzegorz Dubin. 2010. "Exfoliative Toxins of Staphylococcus Aureus." *Toxins* 2(5): 1148–65.
- Busch, Anke, Andreas S. Richter, and Rolf Backofen. 2008. "IntaRNA: Efficient Prediction

- of Bacterial SRNA Targets Incorporating Target Site Accessibility and Seed Regions.” *Bioinformatics* 24(24): 2849–56.
- Caillet, Joël et al. 2019. “Identification of Protein-Protein and Ribonucleoprotein Complexes Containing Hfq.” *Scientific Reports* 9(1): 1–12.
- Camargo, Ilana L.B.C., and Michael S. Gilmore. 2008. “Staphylococcus Aureus - Probing for Host Weakness?” *Journal of Bacteriology* 190(7): 2253–56.
- Carniello, Vera, Brandon W. Peterson, Henny C. van der Mei, and Henk J. Busscher. 2020. “Role of Adhesion Forces in Mechanosensitive Channel Gating in Staphylococcus Aureus Adhering to Surfaces.” *npj Biofilms and Microbiomes* 6(1): 23–27. <http://dx.doi.org/10.1038/s41522-020-00141-z>.
- Carpenter, Beth M., Jeannette M. Whitmire, and D. Scott Merrell. 2009. “This Is Not Your Mother’s Repressor: The Complex Role of Fur in Pathogenesis.” *Infection and Immunity* 77(7): 2590–2601.
- Carpousis, Agamemnon J. 2007. “The RNA Degradosome of Escherichia Coli: An mRNA-Degrading Machine Assembled on RNase E.” *Annual Review of Microbiology* 61: 71–87.
- Carrier, Marie Claude, David Lalaouna, and Eric Massé. 2016. “A Game of Tag: MAPS Catches up on RNA Interactomes.” *RNA Biology* 13(5): 473–76.
- Carroll, David, Michael A. Kehoe, David Cavanagh, and David C. Coleman. 1995. “Novel Organization of the Site-specific Integration and Excision Recombination Functions of the Staphylococcus Aureus Serotype F Virulence-converting Phages Φ 13 and Φ 42.” *Molecular Microbiology* 16(5): 877–93.
- Cavanagh, Amy T., and Karen M. Wassarman. 2014. “6S RNA, a Global Regulator of Transcription in Escherichia Coli, Bacillus Subtilis, and Beyond.” *Annual Review of Microbiology* 68(March): 45–60.
- Chabelskaya, Svetlana, Valérie Bordeau, and Brice Felden. 2014. “Dual RNA Regulatory Control of a Staphylococcus Aureus Virulence Factor.” *Nucleic Acids Research* 42(8): 4847–58.
- Chabelskaya, Svetlana, Olivier Gaillot, and Brice Felden. 2010. “A Staphylococcus Aureus Small RNA Is Required for Bacterial Virulence and Regulates the Expression of an

- Immune-Evasion Molecule." *PLoS Pathogens* 6(6): 1–11.
- Chandrangsu, Pete, Christopher Rensing, and John D. Helmann. 2017. "Metal Homeostasis and Resistance in Bacteria." *Nature Reviews Microbiology* 15(6): 338–50. <http://dx.doi.org/10.1038/nrmicro.2017.15>.
- Chareyre, Sylvia, and Pierre Mandin. 2018. "Bacterial Iron Homeostasis Regulation by sRNAs." *Microbiology Spectrum* 6(2).
- Chavakis, Triantafyllos et al. 2002. "Staphylococcus Aureus Extracellular Adherence Protein Serves as Anti-Inflammatory Factor by Inhibiting the Recruitment of Host Leukocytes." *Nature Medicine* 8(7): 687–93.
- Chavakis, Triantafyllos, Klaus T. Preissner, and Mathias Herrmann. 2007. "The Anti-Inflammatory Activities of Staphylococcus Aureus." *Trends in Immunology* 28(9): 408–18.
- Cheng, Alice G. et al. 2009. "Genetic Requirements for Staphylococcus Aureus Abscess Formation and Persistence in Host Tissues." *FASEB Journal* 23(10): 3393–3404.
- . 2010. "Contribution of Coagulases towards Staphylococcus Aureus Disease and Protective Immunity." *PLoS Pathogens* 6(8): 19–20.
- Cheung, A. L., and S. J. Projan. 1994. "Cloning and Sequencing of SarA of Staphylococcus Aureus, a Gene Required for the Expression of Agr." *Journal of Bacteriology* 176(13): 4168–72.
- Cheung, Ambrose L., Koren A. Nishina, Maria Pilar Trotonda, and Sandeep Tamber. 2008. "The SarA Protein Family of Staphylococcus Aureus." *International Journal of Biochemistry and Cell Biology* 40(3): 355–61.
- Cheung, Gordon Y.C. et al. 2011. "Role of the Accessory Gene Regulator Agr in Community-Associated Methicillin-Resistant Staphylococcus Aureus Pathogenesis." *Infection and Immunity* 79(5): 1927–35.
- Chevalier, Clément et al. 2010. "Staphylococcus Aureus RNAIII Binds to Two Distant Regions of Coa mRNA to Arrest Translation and Promote mRNA Degradation." *PLoS Pathogens* 6(3).
- Chia Yen Lee, and J. J. Iandolo. 1986. "Integration of Staphylococcal Phage L54a Occurs by Site-Specific Recombination: Structural Analysis of the Attachment Sites."

- Proceedings of the National Academy of Sciences of the United States of America* 83(15): 5474–78.
- Chunhua, Mu et al. 2012. “The Expression of LytM Is Down-Regulated by RNAIII in *Staphylococcus Aureus*.” *Journal of Basic Microbiology* 52(6): 636–41.
- Clarke, Simon R. et al. 2009. “Iron-Regulated Surface Determinant Protein A Mediates Adhesion of *Staphylococcus Aureus* to Human Corneocyte Envelope Proteins.” *Infection and Immunity* 77(6): 2408–16.
- Clauditz, Alexandra et al. 2006. “Staphyloxanthin Plays a Role in the Fitness of *Staphylococcus Aureus* and Its Ability to Cope with Oxidative Stress.” *Infection and Immunity* 74(8): 4950–53.
- Colomb-Cotinat, M. et al. 2016. “Estimating the Morbidity and Mortality Associated with Infections Due to Multidrug-Resistant Bacteria (MDRB), France, 2012.” *Antimicrobial Resistance and Infection Control* 5(1). <http://dx.doi.org/10.1186/s13756-016-0154-z>.
- Coombs, Geoffrey W. et al. 2020. “Diversity of Bacteriophages Encoding Panton-Valentine Leukocidin in Temporally and Geographically Related *Staphylococcus Aureus*.” *PLoS ONE* 15(2): 1–17.
- Corcoran, Colin P. et al. 2012. “Use of Aptamer Tagging to Identify in Vivo Protein Binding Partners of Small Regulatory RNAs.” *Methods in Molecular Biology* 905: 177–200.
- Costa, Ana Rita et al. 2013. “*Staphylococcus Aureus* Virulence Factors and Disease.” *Microbial pathogens and strategies for combating them: science, technology and education*: 702–10.
- Cotter, Paul D., and Colin Hill. 2003. “Surviving the Acid Test: Responses of Gram-Positive Bacteria to Low PH.” *Microbiology and Molecular Biology Reviews* 67(3): 429–53.
- Cunnion, K. M., H. M. Zhang, and M. M. Frank. 2003. “Availability of Complement Bound to *Staphylococcus Aureus* to Interact with Membrane Complement Receptors Influences Efficiency of Phagocytosis.” *Infection and Immunity* 71(2): 656–62.
- D’Andrea, Marco Maria et al. 2019. “Characterization of Tn6349, a Novel Mosaic Transposon Carrying PoxA, Cfr and Other Resistance Determinants, Inserted in the Chromosome of an ST5-MRSA-II Strain of Clinical Origin.” *Journal of Antimicrobial*

- Chemotherapy* 74(10): 2870–75.
- Deis, Lindsay N. et al. 2015. “Suppression of Conformational Heterogeneity at a Protein-Protein Interface.” *Proceedings of the National Academy of Sciences of the United States of America* 112(29): 9028–33.
- Denham, Emma L. 2020. “The Sponge RNAs of Bacteria – How to Find Them and Their Role in Regulating the Post-Transcriptional Network.” *Biochimica et Biophysica Acta - Gene Regulatory Mechanisms* 1863(8): 194565. <https://doi.org/10.1016/j.bbagr.2020.194565>.
- Diep, Binh An et al. 2006. “Complete Genome Sequence of USA300, an Epidemic Clone of Community-Acquired Methicillin-Resistant *Staphylococcus Aureus*.” *Lancet* 367(9512): 731–39.
- Dinges, Martin M., Paul M. Orwin, and Patrick M. Schlievert. 2000. “Exotoxins of *Staphylococcus Aureus*.” *Clinical Microbiology Reviews* 13(1): 16–34.
- Domagala, John M. 2018. “Antibacterials.” (June): 685–706.
- Donvito, Béatrice et al. 1997. “Synergistic Hemolytic Activity of *Staphylococcus Lugdunensis* Is Mediated by Three Peptides Encoded by a Non-Agr Genetic Locus.” *Infection and Immunity* 65(1): 95–100.
- Dubrac, Sarah, Ivo Gomperts Boneca, Olivier Poupel, and Tarek Msadek. 2007. “New Insights into the Walk/WalR (YycG/YycF) Essential Signal Transduction Pathway Reveal a Major Role in Controlling Cell Wall Metabolism and Biofilm Formation in *Staphylococcus Aureus*.” *Journal of Bacteriology* 189(22): 8257–69.
- Dulebohn, Daniel et al. 2007. “Trans-Translation: The TmRNA-Mediated Surveillance Mechanism for Ribosome Rescue, Directed Protein Degradation, and Nonstop mRNA Decay.” *Biochemistry* 46(16): 4681–93.
- Durand, Sylvain et al. 2015. “SRNA and mRNA Turnover in Gram-Positive Bacteria.” *FEMS Microbiology Reviews* 39(3): 316–30.
- . 2017. “SRNA-Mediated Activation of Gene Expression by Inhibition of 5′-3′ Exonucleolytic mRNA Degradation.” *eLife* 6: 1–23.
- . 2021. “Identification of an RNA Sponge That Controls the RoxS Riboregulator of Central Metabolism in *Bacillus Subtilis*.” *Nucleic Acids Research* 49(11): 6399–6419.

- Durand, Sylvain, Laetitia Gilet, and Ciarán Condon. 2012. "The Essential Function of *B. Subtilis* RNase III Is to Silence Foreign Toxin Genes." *PLoS Genetics* 8(12).
- Ebert, Margaret S., Joel R. Neilson, and Phillip A. Sharp. 2007. "MicroRNA Sponges: Competitive Inhibitors of Small RNAs in Mammalian Cells." *Nature Methods* 4(9): 721–26.
- Ebimiewei Etebu; Ibemologi Arikekpar. 2016. "Antibiotics: Classification and Mechanisms of Action with Emphasis on Molecular Perspectives." *BluePen* 96(4): 90–101.
- Edelmann, Daniel, Markus Oberpaul, Till F. Schäberle, and Bork A. Berghoff. 2021. "Post-Transcriptional Deregulation of the TisB/IstR-1 Toxin–Antitoxin System Promotes SOS-Independent Persister Formation in *Escherichia Coli*." *Environmental Microbiology Reports* 13(2): 159–68.
- Enright, Mark C. et al. 2002. "The Evolutionary History of Methicillin-Resistant *Staphylococcus Aureus* (MRSA)." *Proceedings of the National Academy of Sciences of the United States of America* 99(11): 7687–92.
- Eyraud, Alex, Pierre Tattevin, Svetlana Chabelskaya, and Brice Felden. 2014. "A Small RNA Controls a Protein Regulator Involved in Antibiotic Resistance in *Staphylococcus Aureus*." *Nucleic Acids Research* 42(8): 4892–4905.
- Faulkner, Melinda J., and John D. Helmann. 2011. "Peroxide Stress Elicits Adaptive Changes in Bacterial Metal Ion Homeostasis." *Antioxidants and Redox Signaling* 15(1): 175–89.
- Faure, Guilhem et al. 2019. "CRISPR–Cas in Mobile Genetic Elements: Counter-Defence and Beyond." *Nature Reviews Microbiology* (8): 513–25. <http://dx.doi.org/10.1038/s41579-019-0204-7>.
- Felden, Brice, and Vincent Cattoira. 2018. "Bacterial Adaptation to Antibiotics through Regulatory RNAs." *Antimicrobial Agents and Chemotherapy* 62(5).
- Felden, Brice, and Luc Paillard. 2017. "When Eukaryotes and Prokaryotes Look Alike: The Case of Regulatory RNAs." *FEMS microbiology reviews* 41(5): 624–39.
- Fernández, Lucía et al. 2018. "Lysogenization of *Staphylococcus Aureus* RN450 by Phages Φ 11 and Φ 80 α Leads to the Activation of the SigB Regulon." *Scientific Reports* 8(1):

1–13.

- Figueroa-bossi, Nara, and Lionello Bossi. 2018. "Sponges and Predators in the Small RNA World." *Regulating with RNA in Bacteria and Archaea*: 441–51.
- Figueroa-Bossi, Nara, Martina Valentini, Laurette Malleret, and Lionello Bossi. 2010. "Erratum: Caught at Its Own Game: Regulatory Small RNA Inactivated by an Inducible Transcript Mimicking Its Target (Genes and Development (2009) 23 (2004-2015))." *Genes and Development* 24(7): 734.
- Fillol-Salom, Alfred et al. 2019. "Bacteriophages Benefit from Generalized Transduction." *PLoS Pathogens* 15(7): 1–22.
- Finck-Barbançon, Viviane, Guy Duportail, Olivier Meunier, and Didier A. Colin. 1993. "Pore Formation by a Two-Component Leukocidin from *Staphylococcus Aureus* within the Membrane of Human Polymorphonuclear Leukocytes." *BBA - Molecular Basis of Disease* 1182(3): 275–82.
- Fogg, Paul C.M. et al. 2014. "New Applications for Phage Integrases." *Journal of Molecular Biology* 426(15): 2703–16. <http://dx.doi.org/10.1016/j.jmb.2014.05.014>.
- Foster, Timothy J. 2005. "Immune Evasion by *Staphylococci*." *Nature Reviews Microbiology* 3(12): 948–58.
- . 2019a. "Surface Proteins of *Staphylococcus Aureus*." *Microbiology Spectrum* 7(4).
- . 2019b. "The MSCRAMM Family of Cell-Wall-Anchored Surface Proteins of Gram-Positive Cocci." *Trends in Microbiology* 27(11): 927–41. <https://doi.org/10.1016/j.tim.2019.06.007>.
- Foster, Timothy J., and Joan A. Geoghegan. 2014. 2–3 Molecular Medical Microbiology: Second Edition *Staphylococcus Aureus*. Elsevier Ltd. <http://dx.doi.org/10.1016/B978-0-12-397169-2.00037-8>.
- Foster, Timothy J., Joan A. Geoghegan, Vannakambadi K. Ganesh, and Magnus Höök. 2014. "Adhesion, Invasion and Evasion: The Many Functions of the Surface Proteins of *Staphylococcus Aureus*." *Nature Reviews Microbiology* 12(1): 49–62. <http://dx.doi.org/10.1038/nrmicro3161>.
- Fournier, B., A. Klier, and G. Rapoport. 2001. "The Two-Component System ArlS-ArlR Is a Regulator of Virulence Gene Expression in *Staphylococcus Aureus*." *Molecular*

- Microbiology* 41(1): 247–61.
- Fozo, Elizabeth M. et al. 2008. "Repression of Small Toxic Protein Synthesis by the Sib and OhsC Small RNAs." *Molecular Microbiology* 70(5): 1076–93.
- Fozo, Elizabeth M., Matthew R. Hemm, and Gisela Storz. 2008. "Small Toxic Proteins and the Antisense RNAs That Repress Them." *Microbiology and Molecular Biology Reviews* 72(4): 579–89.
- FRANKLIN L, D. OWY M.D. 1998. "Staphylococcus Aureus Infections." *The New England Journal of Medicine* 339(8): 520–32.
- Fuangthong, Mayuree, and John D. Helmann. 2003. "Recognition of DNA by Three Ferric Uptake Regulator (Fur) Homologs in Bacillus Subtilis." *Journal of Bacteriology* 185(21): 6348–57.
- Fuchs, Ryan T., Frank J. Grundy, and Tina M. Henkin. 2006. "The SMK Box Is a New SAM-Binding RNA for Translational Regulation of SAM Synthetase." *Nature Structural and Molecular Biology* 13(3): 226–33.
- Fuoco, Domenico. 2012. "Classification Framework and Chemical Biology of Tetracycline-Structure-Based Drugs." *Antibiotics* 1: 1–13.
- Furuya, E. Yoko, and Franklin D. Lowy. 2006. "Antimicrobial-Resistant Bacteria in the Community Setting." *Nature Reviews Microbiology* 4(1): 36–45.
- Gao, Jinxin, and George C. Stewart. 2004. "Regulatory Elements of the Staphylococcus Aureus Protein A (Spa) Promoter." *Journal of Bacteriology* 186(12): 3738–48.
- Gardete, Susana, and Alexander Tomasz. 2014. "Mechanisms of Vancomycin Resistance in Staphylococcus Aureus." *Journal of Clinical Investigation* 124(7): 2836–40.
- Geisinger, Edward et al. 2006. "Inhibition of Rot Translation by RNAIII, a Key Feature of Agr Function." *Molecular Microbiology* 61(4): 1038–48.
- Geissmann, Thomas et al. 2009. "A Search for Small Noncoding RNAs in Staphylococcus Aureus Reveals a Conserved Sequence Motif for Regulation." *Nucleic Acids Research* 37(21): 7239–57.
- Geissmann, Thomas, Stefano Marzi, and Pascale Romby. 2009. "The Role of MRNA Structure in Translational Control in Bacteria." *RNA Biology* 6(2): 153–60.
- Georg, J., and W. R. Hess. 2011. "Cis-Antisense RNA, Another Level of Gene Regulation in

- Bacteria." *Microbiology and Molecular Biology Reviews* 75(2): 286–300.
- Gerhart, E., H. Wagner, and Robert W. Simons. 1994. "Antisense RNA Control in Bacteria, Phages, and Plasmids." *Annual Review of Microbiology* 48: 713–42.
- Germain-Amiot, Noella et al. 2019. "A Novel Staphylococcus Aureus Cis-Trans Type I Toxin-Antitoxin Module with Dual Effects on Bacteria and Host Cells." *Nucleic Acids Research* 47(4): 1759–73.
- Ghasemian, Abdolmajid, Shahin Najar Peerayeh, Bitā Bakhshi, and Mohsen Mirzaee. 2015. "The Microbial Surface Components Recognizing Adhesive Matrix Molecules (MSCRAMMs) Genes among Clinical Isolates of Staphylococcus Aureus from Hospitalized Children." 10(4): 258–64.
- Gill, Steven R. et al. 2005. "Insights on Evolution of Virulence and Resistance from the Complete Genome Analysis of an Early Methicillin-Resistant Staphylococcus Aureus Strain and a Biofilm-Producing Methicillin-Resistant Staphylococcus Epidermidis Strain." *Journal of Bacteriology* 187(7): 2426–38.
- . 2009. "Genomics of the Staphylococci." *Staphylococci in Human Disease: Second Edition* (Cv): 19–30.
- Gimpel, Matthias, and Sabine Brantl. 2017. "Dual-Function Small Regulatory RNAs in Bacteria." *Molecular Microbiology* 103(3): 387–97.
- Giraud, A. T., C. G. Raspanti, A. Calzolari, and R. Nagel. 1994. "Characterization of a Tn551-Mutant of Staphylococcus Aureus Defective in the Production of Several Exoproteins." *Canadian Journal of Microbiology* 40(8): 677–81.
- Giraud, Ana T., Ambrose L. Cheung, and Rosa Nagel. 1997. "The Sae Locus of Staphylococcus Aureus Controls Exoprotein Synthesis at the Transcriptional Level." *Archives of Microbiology* 168(1): 53–58.
- Giuliodori, Anna Maria et al. 2010. "The CspA mRNA Is a Thermosensor That Modulates Translation of the Cold-Shock Protein CspA." *Molecular Cell* 37(1): 21–33. <http://dx.doi.org/10.1016/j.molcel.2009.11.033>.
- Gnanamani, Arumugam, Periasamy Hariharan, and Maneesh Paul-Satyaseela. 2017. "Staphylococcus Aureus: Overview of Bacteriology, Clinical Diseases, Epidemiology, Antibiotic Resistance and Therapeutic Approach." *Frontiers in Staphylococcus*

aureus.

- Goerke, Christiane et al. 2005. "Role of Staphylococcus Aureus Global Regulators Sae and Σ B in Virulence Gene Expression during Device-Related Infection." *Infection and Immunity* 73(6): 3415–21.
- Gordon L. Archer; Michael W. Climo. 2001. "Staphylococcus Aureus Bacteremia - Consider the Source." 344(1): 2000–2001.
- Gray, G. S., and M. Kehoe. 1984. "Primary Sequence of the α -Toxin Gene from Staphylococcus Aureus Wood 46." *Infection and Immunity* 46(2): 615–18.
- Grosz, Magdalena et al. 2014. "Cytoplasmic Replication of Staphylococcus Aureus upon Phagosomal Escape Triggered by Phenol-Soluble Modulin α ." *Cellular Microbiology* 16(4): 451–65.
- Gruber, Tanja M., and Carol A. Gross. 2003. "Multiple Sigma Subunits and the Partitioning of Bacterial Transcription Space." *Annual Review of Microbiology* 57: 441–66.
- Guillet, Julien, Marc Hallier, and Brice Felden. 2013. "Emerging Functions for the Staphylococcus Aureus RNome." *PLoS Pathogens* 9(12): 1–13.
- Gupta, Ravi Kr, Thanh T. Luong, and Chia Y. Lee. 2015. "Erratum: RNAIII of the Staphylococcus Aureus Agr System Activates Global Regulator MgrA by Stabilizing MRNA (Proceedings of the National Academy of Sciences of the United States of America (2015) 112 (14036-14041) (DOI:10.1073/Pnas.1509251112))." *Proceedings of the National Academy of Sciences of the United States of America* 112(52): E7306.
- Haaber, Jakob, José R. Penadés, and Hanne Ingmer. 2017. "Transfer of Antibiotic Resistance in Staphylococcus Aureus." *Trends in Microbiology* 25(11): 893–905. <http://dx.doi.org/10.1016/j.tim.2017.05.011>.
- Haag, Andreas F.; Fabio Bagnoli. 2015. "The Role of Two-Component Signal Transduction Systems in Staphylococcus Aureus Virulence Regulation." *Assessment & Evaluation in Higher Education* 37(October): 435. http://books.google.com/books?id=_DDwCqx6wpcC&printsec=frontcover&dq=unwritten+rules+of+phd+research&hl=&cd=1&source=gbs_api%255Cnpapers2://publication/uuid/48967E01-55F9-4397-B941-310D9C5405FA%255Cnhttp://medcontent.metapress.com/index/A65RM03P4874

243N.p.

- Haft, Daniel H., Jeremy Selengut, Emmanuel F. Mongodin, and Karen E. Nelson. 2005. "A Guild of 45 CRISPR-Associated (Cas) Protein Families and Multiple CRISPR/Cas Subtypes Exist in Prokaryotic Genomes." *PLoS Computational Biology* 1(6): 0474–83.
- Hantke, Klaus. 2001. "Iron and Metal Regulation in Bacteria." *Current Opinion in Microbiology* 4(2): 172–77.
- Harrison, Freya et al. 2015. "A 1,000-Year-Old Antimicrobial Remedy with Antistaphylococcal Activity." *mBio* 6(4): 0–6.
- Haswell, Elizabeth S., Rob Phillips, and Douglas C. Rees. 2011. "Mechanosensitive Channels: What Can They Do and How Do They Do It?" *Structure* 19(10): 1356–69. <http://dx.doi.org/10.1016/j.str.2011.09.005>.
- Heidrich, Nadja, Alberto Chinali, Ulf Gerth, and Sabine Brantl. 2006. "The Small Untranslated RNA SR1 from the Bacillus Subtilis Genome Is Involved in the Regulation of Arginine Catabolism." *Molecular Microbiology* 62(2): 520–36.
- Henderson, Charlotte A. et al. 2013. "Characterization of MicA Interactions Suggests a Potential Novel Means of Gene Regulation by Small Non-Coding RNAs." *Nucleic Acids Research* 41(5): 3386–97.
- Henkin, Tina M. 1996. "The Role of the CcpA Transcriptional Regulator in Carbon Metabolism in Bacillus Subtilis." *FEMS Microbiology Letters* 135(1): 9–15.
- Herbert, Silvia et al. 2010. "Repair of Global Regulators in Staphylococcus Aureus 8325 and Comparative Analysis with Other Clinical Isolates." *Infection and Immunity* 78(6): 2877–89.
- Herron-Olson, Lisa, J. Ross Fitzgerald, James M. Musser, and Vivek Kapur. 2007. "Molecular Correlates of Host Specialization in Staphylococcus Aureus." *PLoS ONE* 2(10).
- Hille, Frank et al. 2018. "The Biology of CRISPR-Cas: Backward and Forward." *Cell* 172(6): 1239–59.
- Hindley, J. 1967. "Fractionation of ³²P-Labelled Ribonucleic Acids on Polyacrylamide Gels and Their Characterization by Fingerprinting." *Journal of Molecular Biology* 30(1): 125–36.

- Hiramatsu, Keiichi, Yuki Katayama, Harumi Yuzawa, and Teruyo Ito. 2002. "Molecular Genetics of Methicillin-Resistant Staphylococcus Aureus." *International Journal of Medical Microbiology* 292(2): 67–74.
- Hirschhausen, Nina et al. 2010. "A Novel Staphylococcal Internalization Mechanism Involves the Major Autolysin Atl and Heat Shock Cognate Protein Hsc70 as Host Cell Receptor." *Cellular Microbiology* 12(12): 1746–64.
- Hofer, Michaël F. et al. 1996. "Differential Effects of Staphylococcal Toxic Shock Syndrome Toxin-1 on B Cell Apoptosis." *Proceedings of the National Academy of Sciences of the United States of America* 93(11): 5425–30.
- Holden, Matthew T.G. et al. 2004. "Complete Genomes of Two Clinical Staphylococcus Aureus Strains: Evidence for the Evolution of Virulence and Drug Resistance." *Proceedings of the National Academy of Sciences of the United States of America* 101(26): 9786–91.
- Homerova, Dagmar, Markus Bischoff, Alexis Dumolin, and Jan Kormanec. 2004. "Optimization of a Two-Plasmid System for the Identification of Promoters Recognized by RNA Polymerase Containing Staphylococcus Aureus Alternative Sigma Factor ΣB ." *FEMS Microbiology Letters* 232(2): 173–79.
- Horsburgh, M. J., E. Ingham, and S. J. Foster. 2001. "In Staphylococcus Aureus, Fur Is an Interactive Regulator with PerR, Contributes to Virulence, and Is Necessary for Oxidative Stress Resistance through Positive Regulation of Catalase and Iron Homeostasis." *Journal of Bacteriology* 183(2): 468–75.
- Horvath, Philippe et al. 2009. "Comparative Analysis of CRISPR Loci in Lactic Acid Bacteria Genomes." *International Journal of Food Microbiology* 131(1): 62–70. <http://dx.doi.org/10.1016/j.ijfoodmicro.2008.05.030>.
- Huntzinger, Eric et al. 2005. "Staphylococcus Aureus RNAlII and the Endoribonuclease III Coordinately Regulate Spa Gene Expression." *EMBO Journal* 24(4): 824–35.
- Hutchings, Matt, Andrew Truman, and Barrie Wilkinson. 2019. "Antibiotics: Past, Present and Future." *Current Opinion in Microbiology* 51(Figure 1): 72–80. <https://doi.org/10.1016/j.mib.2019.10.008>.
- Hüttenhofer, Alexander, and Jörg Vogel. 2006. "Experimental Approaches to Identify

- Non-Coding RNAs." *Nucleic Acids Research* 34(2): 635–46.
- Iandolo, John J. et al. 2002. "Comparative Analysis of the Genomes of the Temperate Bacteriophages Φ 11, Φ 12 and Φ 13 of *Staphylococcus Aureus* 8325." *Gene* 289(1–2): 109–18.
- Ibarra, Jose Antonio, Ernesto Pérez-Rueda, Ronan K. Carroll, and Lindsey N. Shaw. 2013. "Global Analysis of Transcriptional Regulators in *Staphylococcus Aureus*." *BMC Genomics* 14(1).
- Ingmer, Hanne, David Gerlach, and Christiane Wolz. 2019. "Temperate Phages of *Staphylococcus Aureus*." *Microbiology Spectrum* 7(5).
- Ito, T., Y. Katayama, and K. Hiramatsu. 1999. "Cloning and Nucleotide Sequence Determination of the Entire *Mec* DNA of Pre-Methicillin-Resistant *Staphylococcus Aureus* N315." *Antimicrobial Agents and Chemotherapy* 43(6): 1449–58.
- Ito, Teruyo et al. 2001. "Structural Comparison of Three Types of Staphylococcal Cassette Chromosome." *Society* 45(5): 1323–36.
- Ivain, Lorraine et al. 2017. "An in Vivo Reporter Assay for SRNA-Directed Gene Control in Gram-Positive Bacteria: Identifying a Novel SRNA Target in *Staphylococcus Aureus*." *Nucleic Acids Research* 45(8): 4994–5007.
- Jackson, M. P., and J. J. Iandolo. 1986. "Cloning and Expression of the Exfoliative Toxin B Gene from *Staphylococcus Aureus*." *Journal of Bacteriology* 166(2): 574–80.
- Jankovic, Ivana, and Reinhold Brückner. 2002. "Carbon Catabolite Repression by the Catabolite Control Protein CcpA in *Staphylococcus Xylosus*." *Journal of Molecular Microbiology and Biotechnology* 4(3): 309–14.
- Jansen, Ruud, Jan D.A. Van Embden, Wim Gaastra, and Leo M. Schouls. 2002. "Identification of Genes That Are Associated with DNA Repeats in Prokaryotes." *Molecular Microbiology* 43(6): 1565–75.
- Janzon, L., and S. Arvidson. 1990. "The Role of the Delta-Lysin Gene (Hld) in the Regulation of Virulence Genes by the Accessory Gene Regulator (Agr) in *Staphylococcus Aureus*." *The EMBO Journal* 9(5): 1391–99.
- Jayasinghe, Lakmal, and Hagan Bayley. 2005. "The Leukocidin Pore: Evidence for an Octamer with Four LukF Subunits and Four LukS Subunits Alternating around a

- Central Axis." *Protein Science* 14(10): 2550–61.
- Jenul, Christian, and Alexander R. Horswill. 2018. "Regulation of Staphylococcus Aureus Virulence." *Microbiology Spectrum* 6(1): 1–21.
- . 2019. "Regulation of Staphylococcus Aureus Virulence." *Microbiology Spectrum* 7(2).
- Jiang, Weining, Yan Hou, and Masayori Inouye. 1997. "CspA, the Major Cold-Shock Protein of Escherichia Coli, Is an RNA Chaperone." *Journal of Biological Chemistry* 272(1): 196–202. <http://dx.doi.org/10.1074/jbc.272.1.196>.
- Joh, Danny et al. 1999. "Role of Fibronectin-Binding MSCRAMMs in Bacterial Adherence and Entry into Mammalian Cells." *Matrix Biology* 18(3): 211–23.
- Johansson, Jörgen et al. 2002. "An RNA Thermosensor Controls Expression of Virulence Genes in Listeria Monocytogenes." *Cell* 110(5): 551–61.
- Jongerius, Ilse et al. 2007. "Staphylococcal Complement Evasion by Various Convertase-Blocking Molecules." *Journal of Experimental Medicine* 204(10): 2461–71.
- Jonsson, K, C Signas, H Muller, and M Lindberg. 1991. "Two Different Genes Encode Fibronectin Binding Proteins in Staphylococcus Aureus." *European Journal of Biochemistry* 202: 1041–48.
- Josefsson, Elisabet et al. 1998. "Three New Members of the Serine-Aspartate Repeat Protein Multigene Family of Staphylococcus Aureus." *Microbiology* 144(12): 3387–95.
- . 2001. "Protection against Experimental Staphylococcus Aureus Arthritis by Vaccination with Clumping Factor A, a Novel Virulence Determinant." *Journal of Infectious Diseases* 184(12): 1572–80.
- Joshi, Bishnu et al. 2021. "Transcriptome Profiling of Staphylococcus Aureus Associated Extracellular Vesicles Reveals Presence of Small RNA-Cargo." *Frontiers in Molecular Biosciences* 7(January): 1–16.
- Josse, Jérôme, Frédéric Laurent, and Alan Diot. 2017. "Staphylococcal Adhesion and Host Cell Invasion: Fibronectin-Binding and Other Mechanisms." *Frontiers in Microbiology* 8(DEC): 1–8.
- Kaito, Chikara et al. 2013. "Mobile Genetic Element SCCmec-Encoded Psm-Mec RNA

- Suppresses Translation of AgrA and Attenuates MRSA Virulence.” *PLoS Pathogens* 9(4).
- Kaneko, Jun, Sachiko Narita-Yamada, Yukari Wakabayashi, and Yoshiyuki Kamio. 2009. “Identification of ORF636 in Phage Φ SLT Carrying Panton-Valentine Leukocidin Genes, Acting as an Adhesion Protein for a Poly(Glycerophosphate) Chain of Lipoteichoic Acid on the Cell Surface of *Staphylococcus Aureus*.” *Journal of Bacteriology* 191(14): 4674–80.
- Kang, Mingsong et al. 2013. “Collagen-Binding Microbial Surface Components Recognizing Adhesive Matrix Molecule (MSCRAMM) of Gram-Positive Bacteria Inhibit Complement Activation via the Classical Pathway.” *Journal of Biological Chemistry* 288(28): 20520–31.
- Katayama, Yuki et al. 2003. “Identification in Methicillin-Susceptible.” *Society* 185(9): 2711–22.
- Kathirvel, M., H. Buchad, and M. Nair. 2016. “Enhancement of the Pathogenicity of *Staphylococcus Aureus* Strain Newman by a Small Noncoding RNA SprX1.” *Medical Microbiology and Immunology* 205(6).
- Kathrin I. Mohr. 2016. “History of Antibiotics Research.” *Microbiology and Immunology*. http://books.google.com/books?id=_DDwCqx6wpcC&printsec=frontcover&dq=unwritten+rules+of+phd+research&hl=&cd=1&source=gbp_api%255Cnpapers2://publication/uuid/48967E01-55F9-4397-B941-310D9C5405FA%255Cnhttp://medcontent.metapress.com/index/A65RM03P4874243N.p
- Kazantsev, Alexei V., and Norman R. Pace. 2006. “Bacterial RNase P: A New View of an Ancient Enzyme.” *Nature Reviews Microbiology* 4(10): 729–40.
- Kery, Mary Beth, Monica Feldman, Jonathan Livny, and Brian Tjaden. 2014. “TargetRNA2: Identifying Targets of Small Regulatory RNAs in Bacteria.” *Nucleic Acids Research* 42(W1): 124–29.
- Khan, Muna A., Yvonne Göpel, Slawomir Milewski, and Boris Görke. 2016. “Two Small RNAs Conserved in Enterobacteriaceae Provide Intrinsic Resistance to Antibiotics Targeting the Cell Wall Biosynthesis Enzyme Glucosamine-6-Phosphate Synthase.”

Frontiers in Microbiology 7(JUN): 1–13.

- Khan, Saleem A., and Richard P. Novick. 1980. "Terminal Nucleotide Sequences of Tn551, a Transposon Specifying Erythromycin Resistance in *Staphylococcus Aureus*: Homology with Tn3." *Topics in Catalysis* 4(2): 148–54.
- Kluytmans, Jan, Alex Van Belkum, and Henri Verbrugh. 1997. "Nasal Carriage of *Staphylococcus Aureus*: Epidemiology, Underlying Mechanisms, and Associated Risks." *Clinical Microbiology Reviews* 10(3): 505–20.
- Kourtis, Athena P. et al. 2019. "Vital Signs: Epidemiology and Recent Trends in Methicillin-Resistant and in Methicillin-Susceptible *Staphylococcus Aureus* Bloodstream Infections — United States ." *MMWR. Morbidity and Mortality Weekly Report* 68(9): 214–19.
- Kreiswirth, Barry N. et al. 1983. "The Toxic Shoch Syndrome Exotoxin Structural Gene Is Not Detectably Transmitted by a Prophage." *Nature* 305(October): 709–12.
- Kunin, Victor, Rotem Sorek, and Philip Hugenholtz. 2007. "Evolutionary Conservation of Sequence and Secondary Structures in CRISPR Repeats." *Genome Biology* 8(4).
- Kuroda, Makoto et al. 2001. "Whole Genome Sequencing of Methicillin-Resistant *Staphylococcus Aureus*." *Lancet* 357(9264): 1225–40.
- Kwan, Tony et al. 2005. "The Complete Genomes and Proteomes of 27 *Staphylococcus Aureus* Bacteriophages." *Proceedings of the National Academy of Sciences of the United States of America* 102(14): 5174–79.
- Kwieceński, Jakub et al. 2016. "Staphylokinase Control of *Staphylococcus Aureus* Biofilm Formation and Detachment through Host Plasminogen Activation." *Journal of Infectious Diseases* 213(1): 139–48.
- Laakso, Holly A. et al. 2016. "A Heme-Responsive Regulator Controls Synthesis of Staphyloferrin B in *Staphylococcus Aureus*." *Journal of Biological Chemistry* 291(1): 29–40. <http://dx.doi.org/10.1074/jbc.M115.696625>.
- Ladhani, Shamez. 2003. "Understanding the Mechanism of Action of the Exfoliative Toxins of *Staphylococcus Aureus*." *FEMS Immunology and Medical Microbiology* 39(2): 181–89.
- Lalaouna, David et al. 2015. "A 3' External Transcribed Spacer in a TRNA Transcript Acts

- as a Sponge for Small RNAs to Prevent Transcriptional Noise." *Molecular Cell* 58(3): 393–405.
- . 2019. "RsaC SRNA Modulates the Oxidative Stress Response of *Staphylococcus Aureus* during Manganese Starvation." *Nucleic acids research* 47(18): 9871–87.
- Lalaouna, David, Emma Desgranges, Isabelle Caldelari, and Stefano Marzi. 2018. 612 *Methods in Enzymology MS2-Affinity Purification Coupled With RNA Sequencing Approach in the Human Pathogen Staphylococcus Aureus*. 1st ed. Elsevier Inc. <http://dx.doi.org/10.1016/bs.mie.2018.08.022>.
- Lalaouna, David, and Eric Massé. 2015. "Identification of SRNA Interacting with a Transcript of Interest Using MS2-Affinity Purification Coupled with RNA Sequencing (MAPS) Technology." *Genomics Data* 5: 136–38.
- Lalaouna, David, Karine Prévost, Alex Eyraud, and Eric Massé. 2017. "Identification of Unknown RNA Partners Using MAPS." *Methods* 117: 28–34. <http://dx.doi.org/10.1016/j.ymeth.2016.11.011>.
- Le Lam, Thao Nguyen et al. 2017. "Finding SRNA-Associated Phenotypes by Competition Assays: An Example with *Staphylococcus Aureus*." *Methods* 117: 21–27.
- Langzhou Song," Michael R. Hobaugh," Christopher Shustak, Stephen Cheley, Hagan Bayley, J. Eric Gouaux. 1996. "Structure of Staphylococcal A-Hemolysin, a Heptameric Transmembrane Pore." 30701(December).
- LASKIN;, ALLEN I. ;JOAN W. BENNETT;GEOFFREY M. GADD. 2015. *Applied Microbiology Applied Microbiology*.
- Lawrence, Jeffrey G., and Howard Ochman. 1997. "Amelioration of Bacterial Genomes: Rates of Change and Exchange." *Journal of Molecular Evolution* 44(4): 383–97.
- Le, Katherine Y., and Michael Otto. 2015. "Quorum-Sensing Regulation in Staphylococci-an Overview." *Frontiers in Microbiology* 6(OCT): 1–8.
- Lebeau, C. et al. 1994. "Coagulase Expression in *Staphylococcus Aureus* Is Positively and Negatively Modulated by an Agr-Dependent Mechanism." *Journal of Bacteriology* 176(17): 5534–36.
- Lee, C. Y. et al. 1987. "Sequence Determination and Comparison of the Exfoliative Toxin A and Toxin B Genes from *Staphylococcus Aureus*." *Journal of Bacteriology* 169(9):

3904–9.

- De Lencastre, H. et al. 1999. "Antibiotic Resistance as a Stress Response: Complete Sequencing of a Large Number of Chromosomal Loci in Staphylococcus Aureus Strain COL That Impact on the Expression of Resistance to Methicillin." *Microbial Drug Resistance* 5(3): 163–75.
- Li, Min et al. 2012. "MRSA Epidemic Linked to a Quickly Spreading Colonization and Virulence Determinant." *Nature Medicine* 18(5): 816–19. <http://dx.doi.org/10.1038/nm.2692>.
- Liao, Hebin, Mafeng Liu, and Xiaolan Guo. 2018. "The Special Existences: NanoRNA and NanoRNase." *Microbiological Research* 207(November 2017): 134–39.
- Licht, Andreas, Sven Preis, and Sabine Brantl. 2005. "Implication of CcpN in the Regulation of a Novel Untranslated RNA (SR1) in Bacillus Subtilis." *Molecular Microbiology* 58(1): 189–206.
- Lin, Ying Chi, and Marnie L. Peterson. 2010. "New Insights into the Prevention of Staphylococcal Infections and Toxic Shock Syndrome." *Expert Review of Clinical Pharmacology* 3(6): 753–67.
- Lindsay, Jodi A. et al. 1998. "The Gene for Toxic Shock Toxin Is Carried by a Family of Mobile Pathogenicity Islands in Staphylococcus Aureus." *Molecular Microbiology* 29(2): 527–43.
- . 2014. "Staphylococcus Aureus Genomics and the Impact of Horizontal Gene Transfer." *International Journal of Medical Microbiology* 304(2): 103–9. <http://dx.doi.org/10.1016/j.ijmm.2013.11.010>.
- Lindsay, Jodi A., and Matthew T.G. Holden. 2004. "Staphylococcus Aureus: Superbug, Super Genome?" *Trends in Microbiology* 12(8): 378–85.
- . 2006. "Understanding the Rise of the Superbug: Investigation of the Evolution and Genomic Variation of Staphylococcus Aureus." *Functional and Integrative Genomics* 6(3): 186–201.
- Liu, George Y. et al. 2005. "Staphylococcus Aureus Golden Pigment Impairs Neutrophil Killing and Promotes Virulence through Its Antioxidant Activity." *Journal of Experimental Medicine* 202(2): 209–15.

- Liu, Mu Ya et al. 1997. "The RNA Molecule CsrB Binds to the Global Regulatory Protein CsrA and Antagonizes Its Activity in Escherichia Coli." *Journal of Biological Chemistry* 272(28): 17502–10.
- Liu, Qian, Won Sik Yeo, and Taeok Bae. 2016. "The SaeRS Two-Component System of Staphylococcus Aureus." *Genes* 7(10).
- Liu, Wenfeng et al. 2018. "Assessment of Bona Fide SRNAs in Staphylococcus Aureus." *Frontiers in Microbiology* 9(FEB): 1–13.
- Liu, Wenfeng, Pierre Boudry, Chantal Bohn, and Philippe Bouloc. 2020. "Staphylococcus Aureus Pigmentation Is Not Controlled by Hfq." *BMC Research Notes* 13(1): 1–6. <https://doi.org/10.1186/s13104-020-4934-4>.
- Liu, Yu et al. 2010. "SsrA (TmRNA) Acts as an Antisense RNA to Regulate Staphylococcus Aureus Pigment Synthesis by Base Pairing with CrtMN mRNA." *FEBS Letters* 584(20): 4325–29.
- . 2011. "RNAlII Activates Map Expression by Forming an RNA-RNA Complex in Staphylococcus Aureus." *FEBS Letters* 585(6): 899–905.
- Livny, Jonathan, Hidayat Teonadi, Miron Livny, and Matthew K. Waldor. 2008. "High-Throughput, Kingdom-Wide Prediction and Annotation of Bacterial Non-Coding RNAs." *PLoS ONE* 3(9).
- Loh, Edmund et al. 2009. "A Trans-Acting Riboswitch Controls Expression of the Virulence Regulator PrfA in Listeria Monocytogenes." *Cell* 139(4): 770–79. <http://dx.doi.org/10.1016/j.cell.2009.08.046>.
- Le Loir, Y., F. Baron, and M. Gautier. 2003. "Staphylococcus Aureus and Food Poisoning. Genetics and Molecular Research." *Genetics and Molecular Research* 2(1): 63–76.
- Love, Michael I., Wolfgang Huber, and Simon Anders. 2014. "Moderated Estimation of Fold Change and Dispersion for RNA-Seq Data with DESeq2." *Genome Biology* 15(12): 1–21.
- Luong, Thanh T., Steven W. Newell, and Chia Y. Lee. 2003. "Mgr, a Novel Global Regulator in Staphylococcus Aureus." *Journal of Bacteriology* 185(13): 3703–10.
- Lyon, Gholson J., Jesse S. Wright, Tom W. Muir, and Richard P. Novick. 2002. "Key Determinants of Receptor Activation in the Agr Autoinducing Peptides of

- Staphylococcus Aureus." *Biochemistry* 41(31): 10095–104.
- Mäder, Ulrike et al. 2016. "Staphylococcus Aureus Transcriptome Architecture: From Laboratory to Infection-Mimicking Conditions." *PLoS Genetics* 12(4): 1–32.
- Majerczyk, Charlotte D. et al. 2010. "Direct Targets of CodY in Staphylococcus Aureus." *Journal of Bacteriology* 192(11): 2861–77.
- Makarova, Kira S. et al. 2006. "A Putative RNA-Interference-Based Immune System in Prokaryotes: Computational Analysis of the Predicted Enzymatic Machinery, Functional Analogies with Eukaryotic RNAi, and Hypothetical Mechanisms of Action." *Biology Direct* 1: 1–26.
- Malachowa, Natalia, and Frank R. Deleo. 2010. "Mobile Genetic Elements of Staphylococcus Aureus." *Cellular and Molecular Life Sciences* 67(18): 3057–71.
- Mallonee, D. H., B. A. Glatz, and P. A. Pattee. 1982. "Chromosomal Mapping of a Gene Affecting Enterotoxin A Production in Staphylococcus Aureus." *Applied and Environmental Microbiology* 43(2): 397–402.
- Mann, Martin, Patrick R. Wright, and Rolf Backofen. 2017. "IntaRNA 2.0: Enhanced and Customizable Prediction of RNA-RNA Interactions." *Nucleic Acids Research* 45(W1): W435–39.
- Manna, Adhar C. et al. 2018. "Small RNA Teg49 Is Derived from a SarA Transcript and Regulates Virulence Genes Independent of SarA in Staphylococcus Aureus." *Infection and Immunity* 86(2): 1–17.
- Marchais, Antonin et al. 2009. "Single-Pass Classification of All Noncoding Sequences in a Bacterial Genome Using Phylogenetic Profiles." *Genome Research* 19(6): 1084–92.
- Massé, Eric, Freddy E. Escorcia, and Susan Gottesman. 2003. "Coupled Degradation of a Small Regulatory RNA and Its mRNA Targets in Escherichia Coli." *Genes and Development* 17(19): 2374–83.
- Massé, Eric, and Susan Gottesman. 2002. "A Small RNA Regulates the Expression of Genes Involved in Iron Metabolism in Escherichia Coli." *Proceedings of the National Academy of Sciences of the United States of America* 99(7): 4620–25.
- Maurer, Joshua A., and Dennis A. Dougherty. 2001. "A High-Throughput Screen for MscL Channel Activity and Mutational Phenotyping." *Biochimica et Biophysica Acta* -

Biomembranes 1514(2): 165–69.

- McCallum, N. et al. 2010. “Transcriptional Profiling of XdrA, a New Regulator of Spa Transcription in *Staphylococcus Aureus*.” *Journal of Bacteriology* 192(19): 5151–64.
- McCarthy, Alex J., and Jodi A. Lindsay. 2013. “*Staphylococcus Aureus* Innate Immune Evasion Is Lineage-Specific: A Bioinformatics Study.” *Infection, Genetics and Evolution* 19: 7–14. <http://dx.doi.org/10.1016/j.meegid.2013.06.012>.
- Mccown, Phillip J. et al. 2017. “Riboswitch Diversity and Distribution.” *Rna* 23(7): 995–1011.
- McGinn, Jon, and Luciano A. Marraffini. 2018. “Molecular Mechanisms of CRISPR–Cas Spacer Acquisition.” *Nature Reviews Microbiology* (1): 7–12. <http://dx.doi.org/10.1038/s41579-018-0071-7>.
- Mcnamara, Peter J., Kathy C. Milligan-Monroe, Shirin Khalili, and Richard A. Proctor. 2000. “Identification, Cloning, and Initial Characterization of Rot, a Locus Encoding a Regulator of Virulence Factor Expression in *Staphylococcus Aureus*.” *Journal of Bacteriology* 182(11): 3197–3203.
- Mehlin, Christopher, Catherine M. Headley, and Seymour J. Klebanoff. 1999. “An Inflammatory Polypeptide Complex from *Staphylococcus Epidermidis*: Isolation and Characterization.” *Journal of Experimental Medicine* 189(6): 907–17.
- Melamed, Sahar et al. 2020. “RNA-RNA Interactomes of ProQ and Hfq Reveal Overlapping and Competing Roles.” *Molecular Cell* 77(2): 411-425.e7. <https://doi.org/10.1016/j.molcel.2019.10.022>.
- Merghni, Abderrahmen et al. 2017. “Antioxidant and Antiproliferative Potential of Biosurfactants Isolated from *Lactobacillus Casei* and Their Anti-Biofilm Effect in Oral *Staphylococcus Aureus* Strains.” *Microbial Pathogenesis* 104: 84–89. <http://dx.doi.org/10.1016/j.micpath.2017.01.017>.
- Michaux, Charlotte, and Jean Christophe Giard. 2016. “New Insight into Cold Shock Proteins: RNA-Binding Proteins Involved in Stress Response and Virulence.” *Stress and Environmental Regulation of Gene Expression and Adaptation in Bacteria* 2: 873–80.
- Miller, Halie K. et al. 2012. “The Extracytoplasmic Function Sigma Factor Σ s Protects

- against Both Intracellular and Extracytoplasmic Stresses in *Staphylococcus Aureus*.” *Journal of Bacteriology* 194(16): 4342–54.
- Mittenhuber, Gerhard. 2002. “A Phylogenomic Study of the General Stress Response Sigma Factor Σ B of *Bacillus Subtilis* and Its Regulatory Proteins.” *Journal of Molecular Microbiology and Biotechnology* 4(4): 427–52.
- Miyakoshi, Masatoshi, Yanjie Chao, and Jörg Vogel. 2015. “ Cross Talk between ABC Transporter m RNA s via a Target m RNA -derived Sponge of the G Cv B Small RNA .” *The EMBO Journal* 34(11): 1478–92.
- Molle, Virginie et al. 2003. “Additional Targets of the *Bacillus Subtilis* Global Regulator CodY Identified by Chromatin Immunoprecipitation and Genome-Wide Transcript Analysis.” *Journal of Bacteriology* 185(6): 1911–22.
- Moore, Sean D., and Robert T. Sauer. 2007. “The TmRNA System for Translational Surveillance and Ribosome Rescue.” *Annual Review of Biochemistry* 76: 101–24.
- Morfeltdt, Eva, David Taylor, Alexander Von Gabain, and Staffan Arvidson. 1995. “Activation of Alpha-Toxin Translation in *Staphylococcus Aureus* by the Trans-Encoded Antisense RNA, RNAIII.” *EMBO Journal* 14(18): 4569–77.
- Morikawa, Kazuya et al. 2003. “A New Staphylococcal Sigma Factor in the Conserved Gene Cassette: Functional Significance and Implication for the Evolutionary Processes.” *Genes to Cells* 8(8): 699–712.
- Morita, Teppei, Yukari Mochizuki, and Hiroji Aiba. 2006. “Translational Repression Is Sufficient for Gene Silencing by Bacterial Small Noncoding RNAs in the Absence of mRNA Destruction.” *Proceedings of the National Academy of Sciences of the United States of America* 103(13): 4858–63.
- Morrison, John M. et al. 2012. “Characterization of SSR42, a Novel Virulence Factor Regulatory RNA That Contributes to the Pathogenesis of a *Staphylococcus Aureus* USA300 Representative.” *Journal of Bacteriology* 194(11): 2924–38.
- Mraheil, Mobarak A. et al. 2010. “Comparative Genome-Wide Analysis of Small RNAs of Major Gram-Positive Pathogens: From Identification to Application.” *Microbial Biotechnology* 3(6): 658–76.
- Münzenmayer, Lisa et al. 2016. “Influence of Sae-Regulated and Agr-Regulated Factors

- on the Escape of *Staphylococcus Aureus* from Human Macrophages." *Cellular Microbiology* 18(8): 1172–83.
- Murphy, E., L. Huwyler, and M. do C. de Freire Bastos. 1985. "Transposon Tn554: Complete Nucleotide Sequence and Isolation of Transposition-Defective and Antibiotic-Sensitive Mutants." *The EMBO Journal* 4(12): 3357–65.
- Naville, Magali, Adrien Ghuillot-Gaudeffroy, Antonin Marchais, and Daniel Gautheret. 2011. "ARNold: A Web Tool for the Prediction of Rho-Independent Transcription Terminators." *RNA Biology* 8(1).
- Newsom, S. W.B. 2008. "Ogston's Coccus." *Journal of Hospital Infection* 70(4): 369–72. <http://dx.doi.org/10.1016/j.jhin.2008.10.001>.
- Nickels, Bryce E., and Simon L. Dove. 2011. "NanoRNAs: A Class of Small RNAs That Can Prime Transcription Initiation in Bacteria." *Journal of Molecular Biology* 412(5): 772–81. <http://dx.doi.org/10.1016/j.jmb.2011.06.015>.
- Nielsen, Jesper S. et al. 2011. "Searching for Small Σ b-Regulated Genes in *Staphylococcus Aureus*." *Archives of Microbiology* 193(1): 23–34.
- Nilsson, Martin et al. 2004. "A von Willebrand Factor-Binding Protein from *Staphylococcus Lugdunensis*." *FEMS Microbiology Letters* 234(1): 155–61.
- Novick, R. P. et al. 1993. "Synthesis of Staphylococcal Virulence Factors Is Controlled by a Regulatory RNA Molecule." *EMBO Journal* 12(10): 3967–75.
- . 1995. "The Agr P2 Operon: An Autocatalytic Sensory Transduction System in *Staphylococcus Aureus*." *MGG Molecular & General Genetics* 248(4): 446–58.
- Novick, Richard P. et al. 1989. "PT181 Plasmid Replication Is Regulated by a Countertranscript-Driven Transcriptional Attenuator." *Cell* 59(2): 395–404.
- . 2003. "Autoinduction and Signal Transduction in the Regulation of Staphylococcal Virulence." *Molecular Microbiology* 48(6): 1429–49.
- . 2019. "Pathogenicity Islands and Their Role in Staphylococcal Biology." *Microbiology Spectrum* 7(3).
- Novick, Richard P., Gail E. Christie, and Jose R. Penadés. 2010. "The Phage-Related Chromosomal Islands of Gram-Positive Bacteria." *Nature Reviews Microbiology* 8(8): 541–51.

- Oglesby-Sherrouse, Amanda G., and Erin R. Murphy. 2013. "Iron-Responsive Bacterial Small RNAs: Variations on a Theme." *Metallomics* 5(4): 276–86.
- Ogston, Alexander. 1881. "Report upon Micro-Organisms in Surgical Diseases." *British Medical Journal* 1(1054): 369–77.
- Olejniczak, Mikolaj, and Gisela Storz. 2017. "ProQ/FinO-Domain Proteins: Another Ubiquitous Family of RNA Matchmakers?" *Molecular Microbiology* 104(6): 905–15.
- Oliveira, Diana, Anabela Borges, and Manuel Simões. 2018. "Staphylococcus Aureus Toxins and Their Molecular Activity in Infectious Diseases." *Toxins* 10(6).
- Oliveira, Hugo et al. 2019. "Staphylococci Phages Display Vast Genomic Diversity and Evolutionary Relationships." *BMC Genomics* 20(1): 1–14.
- Oscarsson, Jan, Karin Tegmark-Wisell, and Staffan Arvidson. 2006. "Coordinated and Differential Control of Aureolysin (Aur) and Serine Protease (SspA) Transcription in Staphylococcus Aureus by SarA, Rot and Agr (RNAIII)." *International Journal of Medical Microbiology* 296(6): 365–80.
- Otto, Michael. 2009. "Staphylococcus Epidermidis – the 'Accidental' Pathogen." *NIH Public Access* 7(8): 555–67.
- . 2014. "Staphylococcus Aureus Toxins." *Current Opinion in Microbiology* 17(1): 32–37. <http://dx.doi.org/10.1016/j.mib.2013.11.004>.
- Ou, Xiaorong, Paul Blount, Robert J. Hoffman, and Ching Kung. 1998. "One Face of a Transmembrane Helix Is Crucial in Mechanosensitive Channel Gating." *Proceedings of the National Academy of Sciences of the United States of America* 95(19): 11471–75.
- Overgaard, Martin, Jesper Johansen, Jakob Møller-Jensen, and Poul Valentin-Hansen. 2009. "Switching off Small RNA Regulation with Trap-MRNA." *Molecular Microbiology* 73(5): 790–800.
- Le Pabic, H el ene, No ella Germain-Amiot, Val erie Bordeau, and Brice Felden. 2015. "A Bacterial Regulatory RNA Attenuates Virulence, Spread and Human Host Cell Phagocytosis." *Nucleic Acids Research* 43(19): 9232–48.
- Panchal, Vipul, and Ruth Brenk. 2021. "Riboswitches as Drug Targets for Antibiotics." *Antibiotics* 10(1): 1–22.

- Pandit, Neha, Rajeev K. Singla, and Birendra Shrivastava. 2012. "Current Updates on Oxazolidinone and Its Significance." *International Journal of Medicinal Chemistry* 2012: 1–24.
- Pantůček, R. et al. 2004. "Identification of Bacteriophage Types and Their Carriage in Staphylococcus Aureus." *Archives of Virology* 149(9): 1689–1703.
- Partridge, Sally R., Stephen M. Kwong, Neville Firth, and Slade O. Jensen. 2018. "Mobile Genetic Elements Associated with Antimicrobial Resistance." *Clinical Microbiology Reviews* 31(4): 1–61.
- Paulsen, I. T. et al. 1996. "Multidrug Resistance Proteins QacA and QacB from Staphylococcus Aureus: Membrane Topology and Identification of Residues Involved in Substrate Specificity." *Proceedings of the National Academy of Sciences of the United States of America* 93(8): 3630–35.
- Penadés, José R. et al. 2015. "Bacteriophage-Mediated Spread of Bacterial Virulence Genes." *Current Opinion in Microbiology* 23: 171–78.
- Peng, H. L. et al. 1988. "Cloning, Characterization and Sequencing of an Accessory Gene Regulator (Agr) in Staphylococcus Aureus." *Journal of Bacteriology* 170(9): 4365–72.
- Periasamy, Saravanan, Som S. Chatterjee, Gordon Y. C. Cheung, and Michael Otto. 2012. "Phenol-Soluble Modulins in Staphylococci." *Communicative & Integrative Biology* 5(3): 275–77.
- Peschel, Andreas et al. 1999. "Inactivation of the Dlt Operon in Staphylococcus Aureus Confers Sensitivity to Defensins, Protegrins, and Other Antimicrobial Peptides." *Journal of Biological Chemistry* 274(13): 8405–10.
- Pichon, Christophe, and Brice Felden. 2005. "Small RNA Genes Expressed from Staphylococcus Aureus Genomic and Pathogenicity Islands with Specific Expression among Pathogenic Strains." *Proceedings of the National Academy of Sciences of the United States of America* 102(40): 14249–54.
- Pinel-Marie, Marie Laure, Régine Brielle, and Brice Felden. 2014. "Dual Toxic-Peptide-Coding Staphylococcus Aureus RNA under Antisense Regulation Targets Host Cells and Bacterial Rivals Unequally." *Cell Reports* 7(2): 424–35. <http://dx.doi.org/10.1016/j.celrep.2014.03.012>.

- Planet, Paul J, Samuel J Larussa, and Ali Dana. 2013. "Emergence of the Epidemic Methicillin-Resistant." 4(6): 1–10.
- Pluta, Radoslaw, and Manuel Espinosa. 2018. "Antisense and yet Sensitive: Copy Number Control of Rolling Circle-Replicating Plasmids by Small RNAs." *Wiley Interdisciplinary Reviews: RNA* 9(6): 1–15.
- Pohl, Konstanze et al. 2009. "CodY in Staphylococcus Aureus: A Regulatory Link between Metabolism and Virulence Gene Expression." *Journal of Bacteriology* 191(9): 2953–63.
- Pragman, Alexa A., and Patrick M. Schlievert. 2004. "Virulence Regulation in Staphylococcus Aureus: The Need for in Vivo Analysis of Virulence Factor Regulation." *FEMS Immunology and Medical Microbiology* 42(2): 147–54.
- Prévost, Karine et al. 2007. "The Small RNA RyhB Activates the Translation of ShiA mRNA Encoding a Permease of Shikimate, a Compound Involved in Siderophore Synthesis." *Molecular Microbiology* 64(5): 1260–73.
- Qin, Li, Joshua W. McCausland, Gordon Y.C. Cheung, and Michael Otto. 2016. "PSM-MecA Virulence Determinant That Connects Transcriptional Regulation, Virulence, and Antibiotic Resistance in Staphylococci." *Frontiers in Microbiology* 7(AUG): 1–8.
- Queck, Shu Y. et al. 2008. "RNAIII-Independent Target Gene Control by the Agr Quorum-Sensing System: Insight into the Evolution of Virulence Regulation in Staphylococcus Aureus." *Molecular Cell* 32(1): 150–58.
- Quendera, Ana P. et al. 2020. "RNA-Binding Proteins Driving the Regulatory Activity of Small Non-Coding RNAs in Bacteria." *Frontiers in Molecular Biosciences* 7(May): 1–9.
- Raden, Martin et al. 2018. "Freiburg RNA Tools: A Central Online Resource for RNA-Focused Research and Teaching." *Nucleic Acids Research* 46(W1): W25–29.
- Ram, Geeta et al. 2012. "Staphylococcal Pathogenicity Island Interference with Helper Phage Reproduction Is a Paradigm of Molecular Parasitism." *Proceedings of the National Academy of Sciences of the United States of America* 109(40): 16300–305.
- Ramadurai, Lakshmi, Katherine J. Lockwood, Mathew J. Nadakavukaren, and Radheshyam K. Jayaswal. 1999. "Characterization of a Chromosomally Encoded Glycylglycine

- Endopeptidase of *Staphylococcus Aureus*." *Microbiology* 145(4): 801–8.
- Ranganathan, Shoba, Yingdong Zhao, and Richard Simon. 2013. Encyclopedia of Systems Biology *Encyclopedia of Systems Biology*.
- Rausch, Marvin et al. 2019. "Coordination of Capsule Assembly and Cell Wall Biosynthesis in *Staphylococcus Aureus*." *Nature Communications* 10(1). <http://dx.doi.org/10.1038/s41467-019-09356-x>.
- Repoila, F., and S. Gottesman. 2001. "Signal Transduction Cascade for Regulation of RpoS: Temperature Regulation of DsrA." *Journal of Bacteriology* 183(13): 4012–23.
- Repoila, Francis, and Fabien Darfeuille. 2009. "Small Regulatory Non-Coding RNAs in Bacteria: Physiology and Mechanistic Aspects." *Biology of the Cell* 101(2): 117–31.
- Retallack, Diane M., and David I. Friedman. 1995. "A Role for a Small Stable RNA in Modulating the Activity of DNA-Binding Proteins." *Cell* 83(2): 227–35.
- Reyes, Dindo et al. 2011. "Coordinated Regulation by AgrA, SarA, and SarR to Control Agr Expression in *Staphylococcus Aureus*." *Journal of Bacteriology* 193(21): 6020–31.
- Rhem, Marcus N. et al. 2000. "The Collagen-Binding Adhesin Is a Virulence Factor in *Staphylococcus Aureus* Keratitis." *Infection and Immunity* 68(6): 3776–79.
- Riffaud, C., M. Pinel-Marie, G. Pascreau, and B. Felden. 2019. "Functionality and Cross-Regulation of the Four SprG/SprF Type I Toxin-Antitoxin Systems in *Staphylococcus Aureus*." *Nucleic Acids Research* 47(4).
- Riffaud, Camille, Marie Laure Pinel-Marie, and Brice Felden. 2020. "Cross-Regulations between Bacterial Toxin–Antitoxin Systems: Evidence of an Interconnected Regulatory Network?" *Trends in Microbiology* 28(10): 851–66. <https://doi.org/10.1016/j.tim.2020.05.016>.
- Raina M et al. 2018. "Dual-Function RNAs." *Regulating with RNA in Bacteria and Archaea* (15): 471–85.
- Rochat, Tatiana et al. 2018. "The Conserved Regulatory RNA RsaE Down-Regulates the Arginine Degradation Pathway in *Staphylococcus Aureus*." *Nucleic Acids Research* 46(17): 8803–16.
- Rogasch, Kathrin et al. 2006. "Influence of the Two-Component System SaeRS on Global Gene Expression in Two Different *Staphylococcus Aureus* Strains." *Journal of*

- Bacteriology* 188(22): 7742–58.
- Romeo, Tony, Christopher A. Vakulskas, and Paul Babitzke. 2013. “Post-Transcriptional Regulation on a Global Scale: Form and Function of Csr/Rsm Systems.” *Environmental Microbiology* 15(2): 313–24.
- Romilly, Cédric et al. 2012. “Loop-Loop Interactions Involved in Antisense Regulation Are Processed by the Endoribonuclease III in *Staphylococcus Aureus*.” *RNA Biology* 9(12): 1461–72.
- . 2014. “A Non-Coding RNA Promotes Bacterial Persistence and Decreases Virulence by Regulating a Regulator in *Staphylococcus Aureus*.” *PLoS Pathogens* 10(3).
- Rooijackers, Suzan H.M. et al. 2005. “Immune Evasion by a Staphylococcal Complement Inhibitor That Acts on C3 Convertases.” *Nature Immunology* 6(9): 920–27.
- Rouillard, Jean Marie, Michael Zuker, and Erdogan Gulari. 2003. “OligoArray 2.0: Design of Oligonucleotide Probes for DNA Microarrays Using a Thermodynamic Approach.” *Nucleic Acids Research* 31(12): 3057–62.
- Roux, Agnès et al. 2014. “Cody-Mediated Regulation of the *Staphylococcus Aureus* Agr System Integrates Nutritional and Population Density Signals.” *Journal of Bacteriology* 196(6): 1184–96.
- Rutledge, Peter J., and Gregory L. Challis. 2015. “Discovery of Microbial Natural Products by Activation of Silent Biosynthetic Gene Clusters.” *Nature Reviews Microbiology* 13(8): 509–23. <http://dx.doi.org/10.1038/nrmicro3496>.
- Rzychon, Malgorzata et al. 2003. “Staphostatins: An Expanding New Group of Proteinase Inhibitors with a Unique Specificity for the Regulation of Staphopains, *Staphylococcus* Spp. Cysteine Proteinases.” *Molecular Microbiology* 49(4): 1051–66.
- Saïd-Salim, B. et al. 2003. “Global Regulation of *Staphylococcus Aureus* Genes by Rot.” *Journal of Bacteriology* 185(2): 610–19.
- Said, Nelly et al. 2009. “In Vivo Expression and Purification of Aptamer-Tagged Small RNA Regulators.” *Nucleic Acids Research* 37(20).
- Samson, Julie E., Alfonso H. Magadan, and Sylvain Moineau. 2015. “The CRISPR-Cas Immune System and Genetic Transfers: Reaching an Equilibrium.” *Plasmids: Biology*

- and Impact in Biotechnology and Discovery: 209–18.*
- Sass, Peter, and Gabriele Bierbaum. 2007. "Lytic Activity of Recombinant Bacteriophage Φ 11 and Φ 12 Endolysins on Whole Cells and Biofilms of *Staphylococcus Aureus*." *Applied and Environmental Microbiology* 73(1): 347–52.
- Sassi, Mohamed et al. 2015. "SRD: A *Staphylococcus* Regulatory RNA Database." *Rna* 21(5): 1005–17.
- Sayed, Nour, Ambre Jousselein, and Brice Felden. 2012. "A Cis-Antisense RNA Acts in Trans in *Staphylococcus Aureus* to Control Translation of a Human Cytolytic Peptide." *Nature Structural and Molecular Biology* 19(1): 105–13.
- Schoenfelder, Sonja M.K. et al. 2019. 15 PLoS Pathogens *The Small Non-Coding RNA RsaE Influences Extracellular Matrix Composition in Staphylococcus Epidermidis Biofilm Communities.*
- Schulthess, Bettina et al. 2009. "Functional Characterization of the Σ B-Dependent YabJ-SpoVG Operon in *Staphylococcus Aureus*: Role in Methicillin and Glycopeptide Resistance." *Antimicrobial Agents and Chemotherapy* 53(5): 1832–39.
- Sedlyarova, Nadezda et al. 2016. "SRNA-Mediated Control of Transcription Termination in *E. Coli*." *Cell* 167(1): 111-121.e13.
- Segalla, Anna et al. 2002. "Photophysical, Photochemical and Antibacterial Photosensitizing Properties of a Novel Octacationic Zn(II)-Phthalocyanine." *Photochemical and Photobiological Sciences* 1(9): 641–48.
- Seidl, Kati et al. 2006. "*Staphylococcus Aureus* CcpA Affects Virulence Determinant Production and Antibiotic Resistance." *Antimicrobial Agents and Chemotherapy* 50(4): 1183–94.
- . 2008. "*Staphylococcus Aureus* CcpA Affects Biofilm Formation." *Infection and Immunity* 76(5): 2044–50.
- . 2009. "Effect of a Glucose Impulse on the CcpA Regulon in *Staphylococcus Aureus*." *BMC Microbiology* 9: 1–17.
- Sesto, Nina et al. 2013. "The Excludon: A New Concept in Bacterial Antisense RNA-Mediated Gene Regulation." *Nature Reviews Microbiology* 11(2): 75–82.
- Shannon, Oonagh, and Jan Ingmar Flock. 2004. "Extracellular Fibrinogen Binding Protein,

- Efb, from *Staphylococcus Aureus* Binds to Platelets and Inhibits Platelet Aggregation." *Thrombosis and Haemostasis* 91(4): 779–89.
- Sharma-Kuinkel, Batu K. et al. 2009. "The *Staphylococcus Aureus* LytSR Two-Component Regulatory System Affects Biofilm Formation." *Journal of Bacteriology* 191(15): 4767–75.
- Sharma, Hema et al. 2018. "Clinical and Molecular Epidemiology of Staphylococcal Toxic Shock Syndrome in the United Kingdom." *Emerging Infectious Diseases* 24(2): 258–66.
- Sharp, Julia A. et al. 2012. "Staphylococcus Aureus Surface Protein SdrE Binds Complement Regulator Factor H as an Immune Evasion Tactic." *PLoS ONE* 7(5).
- Shaw, Lindsey, Ewa Golonka, Jan Potempa, and Simon J. Foster. 2004. "The Role and Regulation of the Extracellular Proteases of *Staphylococcus Aureus*." *Microbiology* 150(1): 217–28.
- Shaw, Lindsey N. et al. 2008. "Identification and Characterization of ΣS , a Novel Component of the *Staphylococcus Aureus* Stress and Virulence Responses." *PLoS ONE* 3(12).
- Sieling, Peter A., and Robert L. Modlin. 2002. "Toll-like Receptors: Mammalian 'taste Receptors' for a Smorgasbord of Microbial Invaders." *Current Opinion in Microbiology* 5(1): 70–75.
- Sieprawska-Lupa, Magdalena et al. 2004. "Degradation of Human Antimicrobial Peptide LL-37 by *Staphylococcus Aureus*-Derived Proteinases." *Antimicrobial Agents and Chemotherapy* 48(12): 4673–79.
- Silva, Inês Jesus et al. 2019. "SraL SRNA Interaction Regulates the Terminator by Preventing Premature Transcription Termination of Rho mRNA." *Proceedings of the National Academy of Sciences of the United States of America* 116(8): 3042–51.
- Silverman, Gregg J., and Carl S. Goodyear. 2006. "Confounding B-Cell Defences: Lessons from a Staphylococcal Superantigen." *Nature Reviews Immunology* 6(6): 465–75.
- Simons, Robert W., and Nancy Kleckner. 1983. "Translational Control of IS10 Transposition." *Cell* 34(2): 683–91.
- Singh, Vigyasa, and Ujjal Jyoti Phukan. 2019. "Interaction of Host and *Staphylococcus*

- Aureus Protease-System Regulates Virulence and Pathogenicity." *Medical Microbiology and Immunology* 208(5): 585–607. <http://dx.doi.org/10.1007/s00430-018-0573-y>.
- Sinha, Bhanu et al. 1999. "Fibronectin-Binding Protein Acts as Staphylococcus Aureus Invasin via Fibronectin Bridging to Integrin A5 β 1." *Cellular Microbiology* 1(2): 101–17.
- Sittka, Alexandra et al. 2008. "Deep Sequencing Analysis of Small Noncoding RNA and mRNA Targets of the Global Post-Transcriptional Regulator, Hfq." *PLoS Genetics* 4(8).
- Smirnov, Alexandre, Chuan Wang, Lisa L Drewry, and Jörg Vogel. 2017. "Molecular Mechanism of mRNA Repression in Trans by a ProQ-dependent Small RNA ." *The EMBO Journal* 36(8): 1029–45.
- Sonenshein, Abraham L. 2005. "CodY, a Global Regulator of Stationary Phase and Virulence in Gram-Positive Bacteria." *Current Opinion in Microbiology* 8(2): 203–7.
- Song, Yongcheng et al. 2009. "Inhibition of Staphyloxanthin Virulence Factor Biosynthesis in Staphylococcus Aureus: In Vitro, in Vivo, and Crystallographic Results." *Journal of Medicinal Chemistry* 52(13): 3869–80.
- Sorensen, Hailee M. et al. 2020. "Reading between the Lines: Utilizing RNA-Seq Data for Global Analysis of SRNAs in Staphylococcus Aureus." *American Society microbiology* (July).
- Stauff, Devin L. et al. 2008. "Staphylococcus Aureus HrtA Is an ATPase Required for Protection against Heme Toxicity and Prevention of a Transcriptional Heme Stress Response." *Journal of Bacteriology* 190(10): 3588–96.
- Steiner, Paul A. et al. 2019. "Highly Variable mRNA Half-Life Time within Marine Bacterial Taxa and Functional Genes." *Environmental Microbiology* 21(10): 3873–84.
- Stemerding, Annette M. et al. 2013. "Staphylococcus Aureus Formyl Peptide Receptor-like 1 Inhibitor (FLIPr) and Its Homologue FLIPr-like Are Potent Fc γ R Antagonists That Inhibit IgG-Mediated Effector Functions ." *The Journal of Immunology* 191(1): 353–62.
- Stork, Michiel, Manuela Di Lorenzo, Timothy J. Welch, and Jorge H. Crosa. 2007.

- “Transcription Termination within the Iron Transport-Biosynthesis Operon of *Vibrio Anguillarum* Requires an Antisense RNA.” *Journal of Bacteriology* 189(9): 3479–88.
- Stougaard, P., S. Molin, and K. Nordstrom. 1981. “RNAs Involved in Copy-Number Control and Incompatibility of Plasmid R1.” *Proceedings of the National Academy of Sciences of the United States of America* 78(10 I): 6008–12.
- Subramanian, Devika, Balu Bhasuran, and Jeyakumar Natarajan. 2019. “Genomic Analysis of RNA-Seq and SRNA-Seq Data Identifies Potential Regulatory SRNAs and Their Functional Roles in *Staphylococcus Aureus*.” *Genomics* 111(6): 1431–46. <https://doi.org/10.1016/j.ygeno.2018.09.016>.
- Sumby, Paul, and Matthew K. Waldor. 2003. “Transcription of the Toxin Genes Present within the Staphylococcal Phage Φ Sa3ms Is Intimately Linked with the Phage’s Life Cycle.” *Journal of Bacteriology* 185(23): 6841–51.
- Surewaard, B. G.J. et al. 2013. “Staphylococcal Alpha-Phenol Soluble Modulins Contribute to Neutrophil Lysis after Phagocytosis.” *Cellular Microbiology* 15(8): 1427–37.
- Svensson, Sarah L., and Cynthia M. Sharma. 2016. “Small RNAs in Bacterial Virulence and Communication.” *Microbiology Spectrum* 4(3): 169–212.
- Switalski, Lech M. et al. 1993. “A Collagen Receptor on *Staphylococcus Aureus* Strains Isolated from Patients with Septic Arthritis Mediates Adhesion to Cartilage.” *Molecular Microbiology* 7(1): 99–107.
- Tam, Kayan, and Victor J. Torres. 2019. “*Staphylococcus Aureus* Secreted Toxins and Extracellular Enzymes.” *Microbiology Spectrum* 7(2).
- Tao, Liang, Xiaoqian Wu, and Baolin Sun. 2010. “Alternative Sigma Factor Σ H Modulates Prophage Integration and Excision in *Staphylococcus Aureus*.” *PLoS Pathogens* 6(5): 1–11.
- Tettelin, Hervé, David Riley, Ciro Cattuto, and Duccio Medini. 2008. “Comparative Genomics: The Bacterial Pan-Genome.” *Current Opinion in Microbiology* 11(5): 472–77.
- Thomas, W. D., and G. L. Archer. 1989. “Identification and Cloning of the Conjugative Transfer Region of *Staphylococcus Aureus* Plasmid PGO1.” *Journal of Bacteriology* 171(2): 684–91.

- Thomason, Maureen Kiley, and Gisela Storz. 2010. "Bacterial Antisense RNAs: How Many Are There, and What Are They Doing?" *Annual Review of Genetics* 44: 167–88.
- Tiwari, Nitija et al. 2020. "The SrrAB Two-Component System Regulates Staphylococcus Aureus Pathogenicity through Redox Sensitive Cysteines ." *Proceedings of the National Academy of Sciences* 117(20): 10989–99.
- Tjaden, Brian. 2008. "TargetRNA: A Tool for Predicting Targets of Small RNA Action in Bacteria." *Nucleic acids research* 36(Web Server issue): 109–13.
- Tomasini, Arnaud et al. 2017a. "The RNA Targetome of Staphylococcus Aureus Non-Coding RNA RsaA: Impact on Cell Surface Properties and Defense Mechanisms." *Nucleic Acids Research* 45(11): 6746–60.
- . 2017b. "The RNA Targetome of Staphylococcus Aureus Non-Coding RNA RsaA: Impact on Cell Surface Properties and Defense Mechanisms." *Nucleic Acids Research* 45(11): 6746–60.
- Tomizawa, J., T. Itoh, G. Selzer, and T. Som. 1981. "Inhibition of ColE1 RNA Primer Formation by a Plasmid-Specified Small RNA." *Proceedings of the National Academy of Sciences of the United States of America* 78(3): 1421–25.
- Tong, Steven Y.C. et al. 2015. "Staphylococcus Aureus Infections: Epidemiology, Pathophysiology, Clinical Manifestations, and Management." *Clinical Microbiology Reviews* 28(3): 603–61.
- Trotochaud, Amy E., and Karen M. Wassarman. 2005. "A Highly Conserved 6S RNA Structure Is Required for Regulation of Transcription." *Nature Structural and Molecular Biology* 12(4): 313–19.
- Troxell, Bryan, and Hosni M. Hassan. 2013. "Transcriptional Regulation by Ferric Uptake Regulator (Fur) in Pathogenic Bacteria." *Frontiers in Cellular and Infection Microbiology* 4(OCT): 1–13.
- Tucker, Brian J., and Ronald R. Breaker. 2005. "Riboswitches as Versatile Gene Control Elements." *Current Opinion in Structural Biology* 15(3 SPEC. ISS.): 342–48.
- Tuffs, Stephen W. et al. 2019. "Regulation of Toxic Shock Syndrome Toxin-1 by the Accessory Gene Regulator in Staphylococcus Aureus Is Mediated by the Repressor of Toxins." *Molecular Microbiology* 112(4): 1163–77.

- Ueda, Tomofumi, Chikara Kaito, Yosuke Omae, and Kazuhisa Sekimizu. 2011. "Sugar-Responsive Gene Expression and the Agr System Are Required for Colony Spreading in *Staphylococcus Aureus*." *Microbial Pathogenesis* 51(3): 178–85. <http://dx.doi.org/10.1016/j.micpath.2011.04.003>.
- Ul Haq, Inam, Peter Müller, and Sabine Brantl. 2020. "Intermolecular Communication in *Bacillus Subtilis*: RNA-RNA, RNA-Protein and Small Protein-Protein Interactions." *Frontiers in Molecular Biosciences* 7(August): 1–17.
- Valero, A. et al. 2009. "Modelling the Growth Boundaries of *Staphylococcus Aureus*: Effect of Temperature, PH and Water Activity." *International Journal of Food Microbiology* 133(1–2): 186–94. <http://dx.doi.org/10.1016/j.ijfoodmicro.2009.05.023>.
- VandenBergh, Marjolein F.Q. et al. 1999. "Follow-up of *Staphylococcus Aureus* Nasal Carriage after 8 Years: Redefining the Persistent Carrier State." *Journal of Clinical Microbiology* 37(10): 3133–40.
- Vanderpool, Carin K., Divya Balasubramanian, and Chelsea R. Lloyd. 2011. "Dual-Function RNA Regulators in Bacteria." *Biochimie* 93(11): 1943–49. <http://dx.doi.org/10.1016/j.biochi.2011.07.016>.
- Varanasi, Usha et al. 1994. "Isolation of the Human Peroxisomal Acyl-CoA Oxidase Gene: Organization, Promoter Analysis, and Chromosomal Localization." *Proceedings of the National Academy of Sciences of the United States of America* 91(8): 3107–11.
- Vatansever, Fatma et al. 2013. "Antimicrobial Strategies Centered around Reactive Oxygen Species - Bactericidal Antibiotics, Photodynamic Therapy, and Beyond." *FEMS Microbiology Reviews* 37(6): 955–89.
- Viegas, Sandra C. et al. 2007. "Characterization of the Role of Ribonucleases in *Salmonella* Small RNA Decay." *Nucleic Acids Research* 35(22): 7651–64.
- Vogel, Jörg; Argaman, Liron; Wagner, E. Gerhart H; Altuvia, Shoshy. 2004. "The Small RNA IstR Inhibits Synthesis of an SOS-Induced Toxic Peptide." *Current Biology* 14: ARTMED1118.
- Vogel, Jörg, and Ben F. Luisi. 2011. "Hfq and Its Constellation of RNA." *Nature Reviews Microbiology* 9(8): 578–89.

- Vuong, Cuong et al. 2004. "A Crucial Role for Exopolysaccharide Modification in Bacterial Biofilm Formation, Immune Evasion, and Virulence." *Journal of Biological Chemistry* 279(52): 54881–86. <http://dx.doi.org/10.1074/jbc.M411374200>.
- Vybiral, Dietmar et al. 2003. "Complete Nucleotide Sequence and Molecular Characterization of Two Lytic Staphylococcus Aureus Phages: 44AHJD and P68." *FEMS Microbiology Letters* 219(2): 275–83.
- Wadler, Caryn S., and Carin K. Vanderpool. 2007. "A Dual Function for a Bacterial Small RNA: SgrS Performs Base Pairing-Dependent Regulation and Encodes a Functional Polypeptide." *Proceedings of the National Academy of Sciences of the United States of America* 104(51): 20454–59.
- Wagner, E. Gerhart H., and Pascale Romby. 2015. 90 Advances in Genetics *Small RNAs in Bacteria and Archaea: Who They Are, What They Do, and How They Do It*. Elsevier Ltd. <http://dx.doi.org/10.1016/bs.adgen.2015.05.001>.
- Waksman, Selman A. 1947. "What Is an Antibiotic or an Antibiotic Substance?" *Mycologia* 39(5): 565–69.
- Van Wamel, Willem J.B. et al. 2006. "The Innate Immune Modulators Staphylococcal Complement Inhibitor and Chemotaxis Inhibitory Protein of Staphylococcus Aureus Are Located on β -Hemolysin-Converting Bacteriophages." *Journal of Bacteriology* 188(4): 1310–15.
- Wang, Xin et al. 2014. "Antimicrobial Susceptibility and Molecular Typing of Methicillin-Resistant Staphylococcus Aureus in Retail Foods in Shaanxi, China." *Foodborne Pathogens and Disease* 11(4): 281–86.
- Wassarman, Karen M., and Ruth M. Saecker. 2006. "Synthesis-Mediated Release of a Small RNA Inhibitor of RNA Polymerase." *Science* 314(5805): 1601–3.
- Wassarman, Karen Montzka, and Gisela Storz. 2000. "6S RNA Regulates E. Coli RNA Polymerase Activity." *Cell* 101(6): 613–23.
- Waters, Lauren S. et al. 2009. "Eukaryotic Translesion Polymerases and Their Roles and Regulation in DNA Damage Tolerance." *Microbiology and Molecular Biology Reviews* 73(1): 134–54.
- Waters, Lauren S., and Gisela Storz. 2009. "Regulatory RNAs in Bacteria." *Cell* 136(4):

- 615–28. <http://dx.doi.org/10.1016/j.cell.2009.01.043>.
- Watson, D. C. et al. 1988. "The Amino Acid Sequence of a Gonococcal Growth Inhibitor from *Staphylococcus Haemolyticus*." *The Biochemical journal* 252(1): 87–93.
- Weidenmaier, Christopher et al. 2004. "Role of Teichoic Acids in *Staphylococcus Aureus* Nasal Colonization, a Major Risk Factor in Nosocomial Infections." *Nature Medicine* 10(3): 243–45.
- Weidenmaier, Christopher, Sascha Kristian, and Andreas Peschel. 2005. "Bacterial Resistance to Antimicrobial Host Defenses - An Emerging Target for Novel Antiinfective Strategies?" *Current Drug Targets* 4(8): 643–49.
- Weilbacher, Thomas et al. 2003. "A Novel SRNA Component of the Carbon Storage Regulatory System of *Escherichia Coli*." *Molecular Microbiology* 48(3): 657–70.
- Westermann, Alexander J. 2018. "Regulatory RNAs in Virulence and Host-Microbe Interactions." *Regulating with RNA in Bacteria and Archaea*: 305–37.
- Wilke, Georgia A., and Juliane Bubeck Wardenburg. 2010. "Role of a Disintegrin and Metalloprotease 10 in *Staphylococcus Aureus* α -Hemolysin - Mediated Cellular Injury." *Proceedings of the National Academy of Sciences of the United States of America* 107(30): 13473–78.
- Will, Sebastian et al. 2007. "Inferring Noncoding RNA Families and Classes by Means of Genome-Scale Structure-Based Clustering." *PLoS Computational Biology* 3(4): 680–91.
- . 2012. "LocARNA-P: Accurate Boundary Prediction and Improved Detection of Structural RNAs." *Rna* 18(5): 900–914.
- WILLIAMS, R. E. 1963. "Healthy Carriage of *Staphylococcus Aureus*: Its Prevalence and Importance." *Bacteriological reviews* 27: 56–71.
- Winkler, Wade C., and Ronald R. Breaker. 2005. "Regulation of Bacterial Gene Expression by Riboswitches." *Annual Review of Microbiology* 59: 487–517.
- Woolhouse, Mark, Catriona Waugh, Meghan Rose Perry, and Harish Nair. 2016. "Global Disease Burden Due to Antibiotic Resistance - State of the Evidence." *Journal of Global Health* 6(1): 1–5.
- Wray, Robin et al. 2019. "An Agonist of the MscL Channel Affects Multiple Bacterial

- Species and Increases Membrane Permeability and Potency of Common Antibiotics." *Molecular Microbiology* 112(3): 896–905.
- Wray, Robin, Junmei Wang, Irene Iscla, and Paul Blount. 2020. "Novel MscL Agonists That Allow Multiple Antibiotics Cytoplasmic Access Activate the Channel through a Common Binding Site." *PLoS ONE* 15(1): 1–24. <http://dx.doi.org/10.1371/journal.pone.0228153>.
- Wright, Patrick R. et al. 2014. "CopraRNA and IntaRNA: Predicting Small RNA Targets, Networks and Interaction Domains." *Nucleic Acids Research* 42(W1): 119–23.
- Wu, Shangwei, Herminia De Lencastre, and Alexander Tomasz. 1996. "Sigma-B, a Putative Operon Encoding Alternate Sigma Factor of Staphylococcus Aureus RNA Polymerase: Molecular Cloning and DNA Sequencing." *Journal of Bacteriology* 178(20): 6036–42.
- Xia, Guoqing, and Christiane Wolz. 2014. "Phages of Staphylococcus Aureus and Their Impact on Host Evolution." *Infection, Genetics and Evolution* 21: 593–601. <http://dx.doi.org/10.1016/j.meegid.2013.04.022>.
- Xue, Ting, Xu Zhang, Haipeng Sun, and Baolin Sun. 2014. "ArtR, a Novel SRNA of Staphylococcus Aureus, Regulates α -Toxin Expression by Targeting the 5' UTR of SarT mRNA." *Medical Microbiology and Immunology* 203(1): 1–12.
- Yamaguchi, T. et al. 2001. "Complete Nucleotide Sequence of a Staphylococcus Aureus Exfoliative Toxin B Plasmid and Identification of a Novel ADP-Ribosyltransferase, EDIN-C." *Infection and Immunity* 69(12): 7760–71.
- Yarwood, J. M., J. K. McCormick, and P. M. Schlievert. 2001. "Identification of a Novel Two-Component Regulatory System That Acts in Global Regulation of Virulence Factors of Staphylococcus Aureus." *Journal of Bacteriology* 183(4): 1113–23.
- Yarwood, Jeremy M, and Patrick M Schlievert. 2003. "Quorum Sensing in Staphylococcus Infections Find the Latest Version :." *The Journal of Clinical Investigation* 112(11): 1620–25.
- Ye, Z. H., S. L. Buranen, and C. Y. Lee. 1990. "Sequence Analysis and Comparison of Int and Xis Genes from Staphylococcal Bacteriophages L54a and Φ 11." *Journal of Bacteriology* 172(5): 2568–75.

- Zapf, Rachel L. et al. 2019. "The Small RNA Teg41 Regulates Expression of the Alpha Phenol-Soluble Modulins and Is Required for Virulence in Staphylococcus Aureus." *mBio* 10(1).
- Zapotoczna, Marta et al. 2018. "Mobile-Genetic-Element-Encoded Hypertolerance to Copper Phagocytes." *mBio* 9(5): 1–15.
- Zhang, Linsheng, Jianqun Lin, and Guangyong Ji. 2004. "Membrane Anchoring of the AgrD N-Terminal Amphipathic Region Is Required for Its Processing to Produce a Quorum-Sensing Pheromone in Staphylococcus Aureus." *Journal of Biological Chemistry* 279(19): 19448–56. <http://dx.doi.org/10.1074/jbc.M311349200>.
- Zhang, Zhen et al. 2013. "Activity of Antibacterial Protein from Maggots against Staphylococcus Aureus in Vitro and in Vivo." *International Journal of Molecular Medicine* 31(5): 1159–65.
- Zhou, Chunyi et al. 2019. "Urease Is an Essential Component of the Acid Response Network of Staphylococcus Aureus and Is Required for a Persistent Murine Kidney Infection." *PLoS Pathogens* 15(1): 1–23.
- Ziebandt, Anne Kathrin et al. 2001. "Extracellular Proteins of Staphylococcus Aureus and the Role of SarA and Σ B." *Proteomics* 1(4): 480–93.
- Ziebuhr, Wilma, and Jörg Vogel. 2015. "The End Is Not the End: Remnants of Trna Precursors Live on to Sponge up Small Regulatory RNAs." *Molecular Cell* 58(3): 389–90.
- Zuker, Michael. 2003. "Mfold Web Server for Nucleic Acid Folding and Hybridization Prediction." *Nucleic Acids Research* 31(13): 3406–15.

ANNEXES

Rank	Gene	Function	Synonym	Energy	Pvalue	sRNA_start	sRNA_stop	mRNA_start	mRNA_stop
1	rplI	50S ribosomal protein L9	SAOUHSC_00017	-16.68	0.000	89	122	50	85
2	-	hypothetical protein	SAOUHSC_01555	-15.45	0.000	60	106	-11	39
3	-	immunodominant antigen B	SAOUHSC_02972	-14.7	0.001	28	65	-46	-10
4	-	helix-turn-helix domain-containing protein	SAOUHSC_03046	-13.62	0.002	49	87	-1	36
5	-	hypothetical protein	SAOUHSC_01896	-12.44	0.006	75	111	-10	27
6	-	hypothetical protein	SAOUHSC_01541	-11.98	0.008	74	102	26	52
7	-	hypothetical protein	SAOUHSC_02689	-11.81	0.008	49	92	-43	-1
8	-	hypothetical protein	SAOUHSC_01519	-11.35	0.011	29	78	-38	10
9	-	hypothetical protein	SAOUHSC_02587	-10.88	0.015	97	111	-46	-33
10	-	S1 RNA-binding domain-containing protein	SAOUHSC_02297	-10.09	0.022	51	91	-49	-8
11	-	hypothetical protein	SAOUHSC_02747	-9.6	0.028	59	103	20	67
12	-	hypothetical protein	SAOUHSC_01475	-9.17	0.035	103	122	77	98
13	-	ribosomal RNA large subunit methyltransferase N	SAOUHSC_01185	-8.9	0.039	28	66	-18	19
14	rplD	50S ribosomal protein L4	SAOUHSC_02511	-8.69	0.043	40	75	-39	-1
15	-	hydroxyethylthiazole kinase	SAOUHSC_02329	-8.4	0.048	72	102	-46	-8

Annex 1. *In silico* prediction of SprY targets by TargetRNA2 (Beth Kery et al. 2014).

Rank	CopraRNA p-value	CopraRNA fdr value	Locus Tag	Gene Name	Energy [kcal/mol]	IntaRNA p-value	Position mRNA	Position sRNA	Annotation
1	8.92E-06	0.02404	saouhsc_00886	N/A	-19.61	0.000035	58 -- 92	59 -- 96	monovalent cation/H+ antiporter subunit D
2	3.009E-05	0.04054	saouhsc_02583	N/A	-13.79	0.004135	60 -- 97	28 -- 68	transcriptional regulator
3	4.844E-05	0.04352	saouhsc_01400	N/A	-15.29	0.001365	14 -- 43	64 -- 91	alanine racemase
4	0.0002266	0.08731	saouhsc_00947	N/A	-11.8	0.016013	90 -- 114	76 -- 98	enoyl-(acyl carrier protein) reductase
5	0.0002382	0.08731	saouhsc_01135	N/A	-14.69	0.002146	52 -- 95	57 -- 95	conserved hypothetical protein
6	0.0002523	0.08731	saouhsc_01475	N/A	-13.31	0.00577	51 -- 83	60 -- 95	conserved hypothetical protein
7	0.0002609	0.08731	saouhsc_01035	N/A	-16.34	0.000602	40 -- 58	76 -- 94	conserved hypothetical protein
8	0.0003038	0.08731	saouhsc_02097	N/A	-11.51	0.019258	56 -- 97	58 -- 98	conserved hypothetical protein
9	0.0003087	0.08731	saouhsc_01660	N/A	-14.64	0.002234	150 -- 191	58 -- 92	conserved hypothetical protein
10	0.0003478	0.08731	saouhsc_01771	N/A	-16.1	0.000728	174 -- 189	80 -- 95	glutamate-1-semialdehyde aminotransferase
11	0.0003564	0.08731	saouhsc_01896	N/A	-16.02	0.000775	106 -- 126	76 -- 96	conserved hypothetical protein
12	0.0004448	0.09452	saouhsc_03046	N/A	-15.6	0.001081	91 -- 135	50 -- 94	helix-turn-helix domain-containing protein
13	0.0004559	0.09452	saouhsc_02722	N/A	-16.63	0.000476	64 -- 93	59 -- 98	conserved hypothetical protein
14	0.0005159	0.09485	saouhsc_01010	N/A	-14.64	0.002223	64 -- 94	69 -- 98	phosphoribosylaminoimidazole-succinocarboxamide synthase
15	0.0005279	0.09485	saouhsc_00010	N/A	-14.85	0.001907	108 -- 144	55 -- 91	conserved hypothetical protein

Annex 2. *In silico* prediction of SprY targets by CopraRNA (Tjaden et al. 2006; Wright et al. 2013)

RESUME (in French)

I. Introduction de *Staphylococcus aureus*

Staphylococcus aureus est caractérisé comme une coque à Gram positif non mobile et non sporulée, qui se développe en colonies rondes, jaune doré et lisses avec un diamètre de 0,8 à 1 μm , dans de l'agar au sang (Merghni et al. 2017).

Les premiers génomes de *S. aureus* achevés étaient ceux de N315 et Mu50 en 2001 (Kuroda et al. 2001). Au cours des deux dernières décennies, les séquences génomiques d'environ 500 souches de *Staphylococcus* ont été complétées et annotées (Gill 2009). Les génomes sont présentés dans des chromosomes circulaires d'environ 2,8 millions de paires de bases avec une faible composition en GC (32 %) et codent pour environ 2 700 séquences codantes (CDS). La plupart des CDS du génome de *S. aureus* ont une fonction qui leur est assignée, basée sur une homologie significative avec des gènes d'autres espèces (Lindsay et Holden 2006). Le pangénome de *S. aureus* regroupe environ 7 500 gènes dont environ 1 500 appartiennent au core génome (Tettelin et al. 2008).

- Le core génome représente environ 75 % du chromosome et est très conservateur dans toutes les souches séquencées. Ainsi, celui-ci rassemble tous les gènes conservés au sein d'une espèce codant pour les fonctions de base de la croissance des bactéries telles que le métabolisme des bactéries, la synthèse des protéines et la réplication des acides nucléiques (Bossi et Figueroa-Bossi 2016 ; Lindsay et Holden 2004).
- Le reste du génome est variable, composé de gènes dits accessoires (ou MGE pour éléments génomiques mobiles) que les bactéries acquièrent par transfert horizontal, avec un % de G+C différent du génome central (Lawrence et Ochman 1997). Les MGE représentent environ 10 à 20 % d'un chromosome de *S. aureus*, y compris les plasmides, les transposons, les bactériophages, les îlots de pathogénicité des staphylocoques et les chromosomes des cassettes staphylococciques. Ils jouent notamment un rôle dans la virulence, dans la résistance aux antibiotiques, dans la pathogénicité et l'adaptabilité dans différentes conditions environnementales de *S. aureus* (revue dans (Lindsay et Holden 2004).

S. aureus est une bactérie à Gram positif fréquemment trouvée dans la flore commensale de la peau et des muqueuses de l'Homme et de l'animal (Williams, 1963). 20 à 30 % de la population humaine sont des porteurs à long terme de *S. aureus* qui peuvent être

trouvés dans le cadre de la flore cutanée normale, dans les narines. Selon différentes études menées à la fin des années 1990, trois types d'individus de transport ont été observés entre diverses populations (Kluytmans, Van Belkum et Verbrugh 1997 ; VandenBergh et al. 1999 ; WILLIAMS 1963). Ce sont soit des non-porteurs (environ 20 % de la population), des porteurs persistants (20-25 %) ou des porteurs intermittents (55-60 %), qui ont une souche transitoire et dont les souches varient fréquemment.

Depuis des décennies, *S. aureus* a été classé comme un agent pathogène et est une des causes majeures des infections nosocomiales dans les hôpitaux. C'est la deuxième espèce la plus fréquemment isolée lors d'infections nosocomiales en France après *Escherichia coli* (Colomb-Cotinat et al. 2016), et la deuxième cause de Maladies d'origine alimentaire (TBD) derrière *Salmonella* sp (Le Loir, Baron et Gautier 2003). De plus, *S. aureus* fait partie des agents pathogènes développant une résistance aux multi-antibiotiques, par exemple, le cas de la résistance à la méticilline (SARM) (Enright et al. 2002; Kourtis et al. 2019) ou à la vancomycine (VRSA) (Appelbaum 2006; Gardete et Tomasz 2014) découvert en 2002. Cette bactérie est capable d'acquérir la capacité de résistance à plusieurs antibiotiques grâce au transfert horizontal de MGE, qui peuvent porter des gènes de résistance aux antibiotiques (ARG) (Felden et Cattoir 2018; Haaber, Penadés et Ingmer 2017; Partridge et al. 2018). Bien que l'augmentation des maladies bactériennes étant résistantes à presque tous les antibiotiques connus soit préoccupante, des recherches récentes ont conduit à la découverte de nombreuses nouvelles molécules aux activités biologiques remarquables (Rutledge et Challis 2015).

En plus, les infections communautaires à *S. aureus* sont en augmentation. *S. aureus* n'arrive qu'après *S. epidermidis* en ce qui concerne la bactériémie primaire chez les patients hospitalisés (Otto 2009). Les infections cliniques importantes à *S. aureus* couvrent un large éventail de maladies, des infections cutanées mineures (boutons, abcès), aux maladies potentiellement mortelles telles que la pneumonie, la méningite, l'ostéomyélite, l'endocardite, le syndrome de choc toxique (Archer 1998; Tong et al. 2015) (Figure 2). Le processus des infections à *S. aureus* comporte plusieurs étapes : colonisation, infection locale, dissémination systémique et/ou sepsis, infections métastatiques et enfin, toxinose (Bronner, Monteil et Prévost 2004 ; Foster et Geoghegan 2014 ; Gnanamani, Hariharan et Paul- Satyaseela 2017). Pour coloniser et/ou envahir ces différents environnements, cette bactérie utilise un large choix de facteurs

de virulence qui interviennent dans l'attachement de la bactérie au substrat, l'évasion du bouclier immunitaire de l'hôte, l'invasion tissulaire, provoquant une septicémie et des syndromes toxiques.

S. aureus possède un large arsenal de facteurs de virulence, contenant de composants pariétaux et extracellulaires impliqués dans la virulence de la bactérie (Chavakis, Preissner et Herrmann 2007; Costa et al. 2013; Foster 2019). La diversité de ces facteurs de virulence implique que la pathogénicité de *S. aureus* est un processus complexe, nécessitant une expression organisée au cours des différentes étapes de l'infection (donc la colonisation, l'évasion immunitaire, la croissance et division cellulaire, et la dissémination bactérienne). En effet, *S. aureus* régule d'abord positivement l'expression de gènes codant pour des protéines de surface impliquées dans l'adhésion et la défense contre le système immunitaire de l'hôte ; et ce n'est que tardivement dans l'infection qu'il commence à réguler à la hausse la production de toxines qui facilitent la propagation des tissus. Pour contrôler la production des déterminants de la virulence pendant l'infection, *S. aureus* utilise plusieurs systèmes de régulation qui répondent à la densité cellulaire bactérienne (quorum sensing) et aux signaux environnementaux (par exemple, le pH, l'osmolarité et la disponibilité des nutriments, la température et la tension d'oxygène). Ces systèmes de régulation peuvent être divisés en cinq grandes catégories : les systèmes de transduction du signal à deux composants, les régulateurs transcriptionnels globaux, la famille de protéines SarA, les facteurs sigma et le groupe le plus récent est celui des ARN régulateurs (régARN).

II. Des ARN régulateurs chez *S. aureus*

A ce jour, il existe trois principaux types d'ARN « classiques » : les ARN messagers (ARNm), les ARN de transfert (ARNt) et les ARN ribosomiques (ARNr). Les ARNm sont traduits en protéines, tandis que les ARNt et les ARNr ont des rôles lors de la traduction de l'ARNm. Les ARNt et les ARNr sont des ARN non codants, c'est-à-dire qu'ils ne disposent pas des informations nécessaires à la synthèse d'une protéine. Cependant, un autre type d'ARN non codant a été identifié, à savoir les ARN régulateurs (régRNA). Ils permettent aux bactéries de réguler l'expression de différents facteurs impliqués dans l'adaptation aux changements environnementaux.

En général, les ARN régulateurs sont définis comme des molécules stables entre 50 et 500 nts de taille et leur annotation dépend des techniques abordées et/ou de la localisation des ARNs étudiés. Au début des années 2000, seulement quelques ARN régulateurs avaient été identifiés en partie grâce aux techniques disponibles telles que les approches computationnelles, qui permettaient l'identification d'ARN en utilisant différents paramètres pour définir les ARNs (Bronsard et al. 2017 ; Livny et al. 2008 ; Mraheil et al. 2010 ; Pichon et Felden 2005). Dès lors, de plus en plus de prédictions bio-informatiques ainsi que l'explosion des techniques à haut débit (RNA-seq, DNA micro-arrays, clonage shotgun) ont permis l'identification de nombreux ARN (Altuvia 2004 ; Hüttenhofer et Vogel 2006 ; Kazantsev et Pace 2006 ; Moore et Sauer 2007). Cependant, l'absence d'un génome consensuel et entièrement annoté de *S. aureus* a ajouté au problème de la nomenclature des ARNs. En effet, il existe des situations où un ARN étudié dans un travail a été nommé différemment dans une autre publication, par exemple, RsaOW est nommé Teg17 (Bohn et al. 2010; Guillet, Hallier et Felden 2013) ou SprX alias RsaOR et Teg15 (W. Liu et al. 2018). Pour surmonter ce problème, Sassi et al. 2015 a fourni une base de données d'ARN régulatrices de staphylocoques (SRD) qui rassemble une liste d'ARNs identifiés et validés expérimentalement au fil des années. Beaucoup plus d'ARNs ont été identifiés et il devient difficile de poursuivre la mise à jour. En effet, Mäder et ses collaborateurs ont récemment fourni une analyse globale de la régulation transcriptionnelle et des ARN non-codants chez *S. aureus* (Mäder et al. 2016) et l'équipe de Dr. Bouloc a fourni une nouvelle réévaluation d'environ 50 sRNA authentiques chez *S. aureus* par in silico. analyse (W. Liu et al. 2018). Plus récemment, l'équipe de Dr. Carroll a créé un rapport de mis à jour de l'annotation du génome de *S. aureus*, comprenant des annotations pour 303 ARNs connus dans USA300, s'associant à des ensembles de données RNA-Seq accessibles au public afin de récupérer les informations perdues sur l'expression, la stabilité et le potentiel de codage des peptides. (Sorensen et al. 2020).

La découverte et la caractérisation progressive des ARNs bactériens ont mis en évidence divers mécanismes de régulation. Ils peuvent agir sur différentes cibles : les acides nucléiques (ARN et ADN) ou les protéines. Selon leur mécanisme d'action, ils ont été séparés en plusieurs classes : riboswitchs, ARN régulant les protéines, ADN ou ARN par appariements de bases. Ils peuvent également agir à différentes étapes : lors de la réplication ou de la réparation de l'ADN ou de l'expression génique, ou à différents

niveaux d'expression de la cible: le niveau transcriptionnel, le niveau traductionnel et/ou la stabilité de l'ARN cible.

Chez *S. aureus*, découvert il y a près de trois décennies, l'ARNIII est un ARN de 514 nucléotides, qui agit comme l'effecteur du système de "quorum sensing" Agr (R. P. Novick et al. 1993). Le niveau d'ARNIII s'accumule pendant la croissance bactérienne (R.P. Novick et al. 1993). Il permet la régulation temporelle de l'expression des facteurs de virulence, c'est-à-dire qu'il contrôle le basculement entre colonisation et infection bactérienne de l'hôte. L'ARNIII est un ARN bifonctionnel, codant pour une toxine de type PSM (phénol soluble moduline) appelé - hémolysine (gène *hld*) (Janzon et Arvidson 1990) et agit comme un régARN agissant en *trans* sur plusieurs ARNm cibles (Morfeldt et al. 1995). Possédant une structure complexe de 14 tiges-boucles (Benito et al. 2000) facilite les interactions de ARNIII avec le site de fixation de ribosome (RBS) riche en guanine de ses ARNm cibles (Boisset et al. 2007). En effet, L'ARNIII, se liant à son ARNm cible, bloque le recrutement du ribosome dans le site de liaison du ribosome (RBS) sur l'ARNm, et empêche ainsi l'initiation de la traduction et, dans certains cas, facilitant la dégradation de l'ARNm par la RNase III (Chevalier et al. 2010 ; Romilly et al. 2012). Ces cibles sont particulièrement impliquées dans la virulence de *S. aureus* telles que la protéine de surface A (Spa), la coagulase (Coa), la protéine de liaison au fibrinogène (SA1000), les homologues de l'antigène sécrétoire staphylococcique SsaA (SA2353 et SA2093), la protéine de liaison aux immunoglobulines (Sbi), l'acide lipotéichoïque synthase (LtaS) et l'autolysine de la paroi cellulaire (LytM) (Amdahl et al. 2017; Boisset et al. 2007; Delphine Bronesky et al. 2016; Chabelskaya, Gaillot et Felden 2010a; Geisinger et al. 2006; Huntzinger et al. 2005, Rnas et al. 2018). De plus, ARNIII inhibe l'initiation de la traduction de l'ARNm de *rot* codant pour le répresseur des toxines (Rot) (Mcnamara et al. 2000 ; Oscarsson, Tegmark-Wisell et Arvidson 2006), qui bloque la transcription de nombreuses exoprotéines et toxines (Saïd-Salim et al. 2003). Par conséquent, en inhibant la production de pourriture, l'ARNIII active indirectement la transcription de nombreuses exotoxines et inhibe indirectement la synthèse de la protéine A au niveau transcriptionnel.

A ce jour, il a été démontré que de nombreux ARNs sont découverts d'être impliqués dans le métabolisme de *S. aureus* comme RsaI (Geissmann et al. 2009 ; D. Bronesky et al. 2018), ou dans la résistance aux antibiotiques comme SprX (Eyraud et al. 2014), ou

encore dans la virulence comme, SprD (Chabelskaya et al. 2010 ,2014), SprX (Kathirvel et al. 2016 ; Ivain et al. 2017, Buchad and Nair 2021) ou Teg41 (Zapf et al. 2019), etc.

III. Objectif de ma thèse

Récemment, nous avons identifié dans le phage Φ 12 un gène codant pour un nouvel ARN régulateur exprimé à proximité de l'ARN SprX2 et l'avons appelé SprY. Sa localisation dans une région du génome contenant de nombreux facteurs de virulence suggère que ce régARN pourrait être impliqué dans la virulence de *S. aureus*. L'objectif de ma thèse est de caractériser le profil d'expression de SprY, d'identifier ses cibles, ses mécanismes d'action et les rôles physiologiques de SprY dans la souche HG003 *S. aureus*.

1. Premièrement, nous avons étudié le profil d'expression de SprY dans la souche sauvage HG003 ainsi que des souches mutantes de HG003, dans des différentes conditions de croissance bactérienne.

2. Deuxièmement, nous recherchions des potentielles cibles directes de SprY par deux approches différentes : l'une est des prédictions *in silico* via CopraRNA, et l'autre approche est une méthode à haut débit « MS2 », basée sur la purification des complexes ARNs avec son ARN cible *in vivo*.

3. Ensuite, nous avons étudié l'implication de SprY dans la virulence et l'activité hémolytique de *S. aureus* par la méthode déjà utilisée pour montrer l'importance de SprD dans (Chabelskaya, Gaillot et Felden 2010).

IV. Expression de SprY dans des conditions de croissance bactérienne

Lors des études sur l'ARN SprX2 et les séquences voisines, nous avons identifié un autre ARN que nous avons appelé SprY. Situé sur le phage Φ 12 entre le gène *sprX2* et le gène *SAOUHSC_01515* codant pour le peptidoglycane hydrolase putative, le gène *sprY* a également été identifié comme un transcrit d'un ARN par Mäder et ses collaborateurs, désigné S629 (Mäder et al. 2016). Peu de temps après, le laboratoire de Dr. Bouloc a réalisé une étude dans laquelle cet ARN a été validé comme un véritable régARN (W Liu et al. 2018). Nous avons déterminé le début de la transcription du gène *sprY* et la taille de l'ARN SprY d'environ 125 nucléotides (Le Huyen et al. 2021). Nous avons également montré une structure secondaire prédite de SprY composée de trois boucles de tige et la

dernière étant un site terminal transcriptionnel indépendant de Rho (Le Huyen et al. 2021).

Le phage Φ 12 (ou Sa2) qui est conservé dans plusieurs souches de *S. aureus* autres que NCTC8325 telles que Newman (Herron-Olson et al. 2007) et USA300 (Diep et al. 2006). Cependant, tous les phages Sa2 ne codent pas pour le gène *sprY* comme dans le cas de la souche USA300 ; selon l'analyse d'alignement génomique par Basic Local Alignment Search Tool (BLAST) et à l'analyse de conservation des ARNs dans le phylum Firmicutes (W. Liu et al. 2018). Pour vérifier cette observation, un test Northern Blot a été effectué en utilisant l'extraction d'ARN total de différentes souches de *S. aureus* (HG003, USA300 et Newman) en phase exponentielle et en phase stationnaire de croissance bactérienne. Comme prévu, nous n'avons observé que l'expression de SprY dans les souches HG003 et Newman, et non dans les souches USA300. Quant à la contribution de SprY dans l'infection staphylococcique, nous avons testé l'expression de *sprY* dans différents isolats cliniques. Nos données préliminaires ont montré la présence de SprY dans le choc septique et la septicémie mais aucune dans les isolats de colonisation, ce qui nous a amenés à nous demander si dans certaines conditions infectieuses, ces caractéristiques pouvaient conférer des avantages et affecter la pathogénèse bactérienne.

Ensuite, nous avons analysé le profil d'expression de SprY au cours de la croissance bactérienne. Les quantités de SprY accumulent en phase pré-stationnaire et diminuent lentement pendant la phase stationnaire et sa demi-vie est de $23,3 \pm 1,45$ min en phase pré-stationnaire. Ceci implique que SprY est un ARN stable, par rapport à la plupart des ARNm avec une demi-vie de 2 à 4 min (Massé, Escorcia et Gottesman 2003 ; Viegas et al. 2007). Étant donné que *sprY* et *sprX2* sont des gènes adjacents, nous avons considéré que leur expression pouvait être interdépendante. À cette fin, nous avons analysé les quantités d'ARN SprY et SprX2 dans HG003 (Herbert et al. 2010) et ses dérivés supprimés pour *sprY* (Δ *sprY*) ou *sprX2* (Δ *sprX2*). Malgré leur proximité, la suppression d'un gène n'a pas affecté l'expression de l'autre. De plus, la surexpression de *sprX2* (pICS3-*sprX2*) ou de *sprY* (pICS3-*sprY*) n'a pas affecté le niveau d'expression de l'autre ARN. Nous avons conclu que *sprY* et *sprX2* sont exprimés indépendamment l'un de l'autre.

Ensuite, pour analyser la séquence promotrice de *sprY*, nous avons construit différents vecteurs comprenant le gène *sprX2* avec différentes portions du gène *sprY*. La souche *S.*

aureus RN4220 dépourvue des gènes *sprY* et *sprX2* a été transformée avec ces vecteurs puis l'expression de *sprY* et *sprX2* a été analysée. La souche RN4220 contenant le vecteur vide pICS3 a été utilisée comme contrôle négatif. Nos résultats de Northern Blot ont montré des niveaux d'expression d'ARNs SprX2 similaires à partir de trois premières constructions de plasmides. De plus, l'expression de *sprY* a été observée lorsque la séquence entière de *sprY* est incluse dans les conceptions de plasmide, que la séquence de *sprX2* ait été incluse ou non et une estimation approximative de 35 nts en amont de *sprY* est suffisante pour exprimer *sprY*. Ainsi, cette analyse nous a permis d'estimer le promoteur du gène *sprY* et de montrer que les deux ARNs s'expriment indépendamment des plasmides dans la souche RN4220. Nous avons également confirmé que l'expression endogène de *sprY* et *sprX2* est également indépendante dans la souche HG003, qui contient les gènes *sprX2* et *sprY*.

V. Identification de cibles potentiels de SprY par différentes techniques

1. Prédiction *in silico* : SAOUHSC_03046 ARNm

En général, la plupart des ARNs avec des fonctions connues agissent par appariement de bases à des cibles d'ARNm. Pour identifier les cibles directes potentielles de SprY, nous avons effectué des prédictions *in silico* en utilisant TargetRNA2 (Kery et al. 2014) et CopraRNA (Tjaden 2008; Wright et al. 2014). L'ARNm SAOUHSC_03046 étant apparu comme le seul résultat commun des deux analyses de prédictions, nous avons décidé d'étudier l'impact de SprY sur son expression. De plus, l'analyse avec IntaRNA (Busch, Richter et Backofen 2008 ; Mann, Wright et Backofen 2017) a confirmé un appariement de bases potentiel entre l'ARNm SAOUHSC_03046 et SprY impliquant le 2^e tige-boucle de SprY (49e à 95e nucléotide) et le 5' UTR et 36 nts d'ARNm SAOUHSC_03046. L'interaction prédite entre SprY et SAOUHSC_03064 ARNm a été vérifiée *in vitro* par EMSA en utilisant des ARN synthétiques. En plus, nous avons aussi confirmé l'interaction en utilisant SprYmB, un allèle SprY portant des mutations ponctuelles correspondant à la séquence de liaison SAOUHSC_03046 prédite. Comme prévu, SprYmB a perdu la capacité de se lier à la cible d'ARNm, ce qui implique que la zone prédite de SprY est requise pour l'interact.

De plus, le fait que SprY se lie à l'UTR 5' de l'ARNm SAOUHSC_03046 contenant RBS, suggère l'obstruction de son initiation de la traduction. Pour tester cette hypothèse, nous

avons effectué des tests d'empreintes digitales. Une empreinte a ensuite été détectée à environ 15 nts en aval du codon d'initiation AUG de l'ARNm *SAOUHSC_03046*, indiquant que la fixation du ribosome a bloqué l'élongation de la transcription inverse. Effectivement, SprY a considérablement réduit la fixation de Ribosome, indiquant que SprY inhibe la liaison du ribosome sur l'ARNm *SAOUHSC_03046 in vitro*.

Ensuite, nous avons voulu tester si SprY affecte l'expression de *SAOUHSC_03046* au niveau de l'ARNm et/ou de la traduction *in vivo* puisque SprY se lie à l'ARNm et masque le RBS de l'ARNm. Tout d'abord, nous avons montré que la surexpression de SprY n'a pas affecté le niveau d'ARNm de *SAOUHSC_03046*, alors que la surexpression de SprYmB a montré une augmentation subtile du transcrit *SAOUHSC_03046* en phase exponentielle et une augmentation significative du niveau d'ARNm cible en phase stationnaire. Nous avons ensuite émis l'hypothèse que SprY pourrait affecter *SAOUHSC_03046* au niveau traductionnel plutôt que sa quantité d'ARNm. Pour cela, nous avons construit une fusion de gènes traductionnels *SAOUHSC_03046-gfp* sous le contrôle du promoteur constitutif *PtufA* dans le vecteur pCN33 résultant en pCN33-*PtufA-3046-gfp*. HG003 contenant pICS3 ou pICS3-*sprY* ou pICS3-*sprYmB* vides ont été co-transformés avec pCN33-*PtufA-3046-gfp* dans la souche HG003. La surproduction de SprY a considérablement réduit la traduction de *SAOUHSC_03046*. De plus, la surexpression de SprYmB a augmenté l'intensité de fluorescence dans la souche contenant la construction pCN33-*PtufA-3046-gfp*, qui était en corrélation avec l'augmentation au niveau de l'ARNm. Pris ensemble, nos résultats ont montré que SprY régule négativement la traduction de *SAOUHSC_03046* mais pourrait également affecter son niveau d'ARNm par un mécanisme inconnu non pas par liaison à son ARNm mais peut-être par la présence d'un facteur intermédiaire.

Pour mieux comprendre le rôle de cette régulation, nous avons étudié la nature du gène *SAOUHSC_03046* qui code pour une protéine contenant un domaine hélice-tour-hélice appartenant à la protéine de la famille XRE (élément de réponse Xenope) (Ibarra et al. 2013). Avec une similitude de séquence avec une protéine XRE connue (XdrA) dans la souche USA300 (McCallum et al. 2010), nous avons suggéré que la protéine *SAOUHSC_03046* pourrait également affecter l'expression de la même cible de XdrA, qui est le gène *spa*. Nos résultats préliminaires ont montré que l'absence de *SAOUHSC_03046* provoquait une augmentation du niveau d'ARNm *spa* par rapport à

HG003 WT. Bien que davantage d'expériences soient nécessaires pour atteindre une signification statistique, nos résultats suggèrent que *SAOUHSC_03046* conduirait à une réduction d'expression de l'ARNm du *spa*. De plus, la surexpression de SprY induisait une augmentation de niveaux de transcription de *spa* indépendamment de l'expression de *SAOUHSC_03046*, suggérant que l'effet de SprY sur *spa* n'est pas seulement médié par *SAOUHSC_03046*. En effet, l'expression *spa* est régulée par plusieurs facteurs tels que le système agr/RNAIII et Rot (Gao et Stewart 2004 ; Huntzinger et al. 2005 ; Saïd-Salim et al. 2003); dont l'expression était affectée par SprY (Le Huyen et al. 2021). Le fait que *SAOUHSC_03046* puisse également moduler l'expression du gène *spa* présentera une nouvelle couche de réseau de régulation de la virulence de *S. aureus*.

2. In vivo par MAPS :

○ Principe de technique de MAPS

La purification par affinité MS2 couplée au séquençage d'ARN (MAPS), développée par Lalaouna et Massé, 2016, est une technique utilisée ces dernières années. La technique consiste à exprimer l'ARN d'intérêt fusionné avec un tag ms2 permettant ensuite purifier et analyser des ARN et protéines en complexe avec l'ARN d'intérêt. Initialement utilisé pour identifier des protéines partenaires d'identification pour les ARN dans plusieurs bactéries Gram-négatives (Corcoran et al. 2012 ; Saïd et al. 2009), MAPS a été adapté pour étudier l'interaction ARN-ARN (Carrier, Lalaouna et Massé 2016 ; Lalaouna et al. 2017 ; Silva et al. 2019). Des modifications récentes ont été apportées pour adapter cette technique aux Gram-positifs comme *S. aureus* (Lalaouna et al. 2019 ; Tomasini et al. 2017), ce qui ouvre plus de possibilités d'identification de nouvelles cibles pour plusieurs ARNs de *S. aureus*. En parallèle, dans notre laboratoire, nous avons également effectué MAPS pour étudier les cibles ARN de plusieurs ARNs staphylococciques en utilisant le plasmide inductible pRMC2 au lieu du plasmide pCN51 dans Tomasini et al. 2017 bien que le système reste le même (thèse Ivain Lorraine).

Dans ce travail, nous avons utilisé l'approche MAPS pour identifier des cibles directes de SprY (Figure 3). Selon l'analyse bio-informatique des ARN enrichis en complexe avec SprY-MS2 par rapport à MS2 seul, nous avons identifié trois cibles potentielles pour SprY : (1) l'ARNm rpmG1, avec un enrichissement de 11,11 fois ; (2) l'ARNm de *saouhsc_1342a*, qui a été enrichi de 7,59 fois ; et (3) RNAIII, avec un enrichissement de 7,4 fois (Le Huyen et

al. 2021). Cependant, aucun appariement de bases avec une énergie significative n'a été prédit entre l'ARNm de SprY et de *rpmG1* par analyse *in silico*. Par conséquent, nous nous concentrons sur le test de l'impact de SprY sur la régulation de l'expression des deux autres ARN.

- SAOUHSC_1342a ARNm

La prédiction de IntaRNA a montré la liaison entre SprY et 20 nts autour du site d'initiation de la traduction de l'ARNm *SAOUHSC_1342a*. Nous avons donc confirmé les interactions de SprY avec l'ARNm de *SAOUHSC_1342a* *in vitro* par EMSA. Nous avons également contesté la région d'interaction par SprYmB. Comme nous nous y attendions, SprYmB a perdu sa capacité à se lier à l'ARNm de *SAOUHSC_1342a*. Ensuite, nous avons testé l'effet de la surexpression de SprY et SprYmB sur *SAOUHSC_1342a* au niveau traductionnel. Pour cela, nous avons co-transformé la souche RN4220 *S. aureus* avec pCN33-*PtufA-1342a-gfp* et pICS3 ou pICS3-sprY ou pICS3-sprYmB. La surproduction de SprY a considérablement réduit l'expression de *SAOUHSC_1342a*-GFP, tandis que la surexpression de SprYmB a entraîné une intensité de fluorescence similaire à celle des souches WT abritant un plasmide vide. Nous émettons l'hypothèse qu'en se liant à l'extrémité 5' de l'ARNm de *SAOUHSC_1342a*, SprY pourrait empêcher le recrutement du ribosome au RBS sur l'ARNm, et donc réguler à la baisse la traduction de *SAOUHSC_1342a*.

De plus, *SAOUHSC_1342a* code pour le canal mécanosensible de grande conductance (MscL), qui a été principalement étudié chez *E. coli* (Bootha et Blount 2012 ; Ou et al. 1998 ; Wray et al. 2019, 2020) et plus récemment chez *S. aureus* (Carniello et autres 2020). Les canaux mécanosensibles (canaux MS) fonctionnent comme des valves de libération d'urgence en réponse à la tension de la membrane lors d'un faible stress osmotique. Par exemple, lorsque l'environnement osmotique diminue, que l'eau pénètre et menace l'intégrité des cellules bactériennes, les canaux MS libèrent la pression cytoplasmique en laissant s'échapper rapidement les molécules cytosoliques de la cellule (Bootha et Blount 2012 ; Haswell, Phillips et Rees 2011). Chez les bactéries, il existe deux familles de canaux MS : les MS de grande conductance (MscL) et les MS de petite conductance (MscS). Des études récentes ont montré un autre rôle de MscL sur la force d'adhésion chez *S. aureus* (Carniello et al. 2020). MscL chez *S. aureus* s'est avéré non

seulement ouvert par les fluctuations de la tension membranaire dues à la force osmotique, mais aussi par la force d'adhérence aux surfaces. Lorsque la bactérie présente de fortes forces d'adhésion en adhérant à la surface du substrat, cela provoque une déformation de la paroi cellulaire du staphylocoque et conduit à l'ouverture de MscL (Carniello et al. 2020). Cependant, la régulation de l'expression de ces MscL reste incertaine. Ici, nous avons démontré que SprY régule potentiellement à la baisse la traduction de *SAOUHSC_1342a*, ce qui pourrait révéler partiellement la régulation de l'expression de MscLs dans *S. aureus*. Nous avons l'intention de tester l'effet de SprY sur certains phénotypes liés au contrôle de canal mécanosensible chez *S. aureus* en mesurant la capacité d'absorption de la calcéine fluorescente ou de l'antibiotique (dihydrostreptomycine) décrit dans (Carniello et al. 2020). Par exemple, les auteurs ont démontré qu'à une force d'adhésion élevée, la souche de type sauvage RN4220 présentait plus d'intensité de fluorescence que dans RN4220 supprimée pour *mscL* (RN4220 Δ *mscL*), ce qui est corrélé à l'absorption de la calcéine fluorescente dans les bactéries à travers ces canaux mécanosensibles.

- ARNIII (article accepté d'être publié dans NAR)

La deuxième cible identifiée pour SprY est l'ARNIII, l'un des principaux régulateurs de la virulence de *S. aureus*. La prédiction par IntaRNA a montré un appariement de bases potentiel entre SprY et la 13^e tige-boucle de ARNIII. Nous avons ensuite vérifié cette interaction prédite entre SprY et ARNIII *in vitro* en effectuant une EMSA à l'aide des ARN synthétiques. Nous avons également analysé la spécificité de l'interaction en introduisant des mutations compensatoires ponctuelles pour créer des allèles SprY et ARNIII (SprYmA et ARNIIImA) incapables de se lier aux ARNs de type sauvage. De plus, il a été démontré que la tige-boucle 13 de ARNIII contrôle l'expression de plusieurs facteurs de virulence tels que *hla*, *rot*, *coa*, *lytM*, *spa*, *SA1000*, *SA2353*, *SA209*, etc. (Boisset et al. 2007; Chevalier et al 2010 ; Chunhua et al. 2012 ; Geisinger et al. 2006 ; Huntzinger et al. 2005 ; Morfeldt et al. 1995). Nous avons suggéré qu'à travers cette interaction avec ARNIII, SprY pourrait affecter la régulation RNAIII de ses cibles. Pour vérifier cette hypothèse, nous avons étudié l'expression de deux cibles d'ARNIII : les ARNm *ecb* et *rot*. Pour étudier le niveau d'ARNm de ces cibles, nous avons effectué une qPCR en utilisant l'extraction d'ARN total à partir de souches HG003 *S. aureus* surexprimant SprY. Nous avons également testé l'expression traductionnelle de *ecb* et *rot* par un système à double

plasmide comme décrit dans Ivain et al. 2017. Cette expérience consiste à concevoir une fusion de gène traductionnel ARNm-*gfp* sous le contrôle d'un promoteur constitutif *PtufA* dans le vecteur pCN33 résultant en pCN33-*PtufA-ecb/rot-gfp*. Nous avons ensuite transduit ces plasmides dans HG003 hébergeant pICS3, pICS3-*sprY* et pICS3-*sprYmA* qui est muté *sprY* dans la zone d'interaction avec ARNIII. La surexpression de *SprY* impacte significativement la fluorescence de *Ecb-GFP* et *Rot-GFP*, tandis que *SprYmA* n'affecte pas l'intensité de fluorescence. Étant donné que *SprYmA* ne se lie pas à l'ARNIII, ces résultats impliquent que l'interaction entre *SprY* et ARNIII est nécessaire pour la régulation de l'*ecb* et de la pourriture par *SprY*. Nos données révèlent un ARN agissant comme une éponge pour l'ARNIII et ont montré que *SprY* a également un impact sur l'activité hémolytique et impliqué dans la virulence de *S. aureus*. Ces résultats sont présentés dans l'article accepté pour publication dans le NAR (Le Huyen et al. 2021).

VI. Possible lien entre *sprX2* et *sprY*: deux gènes de ARN régulateurs localisés dans le même cluster

Au cours de mon projet de thèse, l'analyse des expressions *SprY* et *SprX2* a montré quelques remarques intéressantes sur ces deux ARNs (Figure 4). Malgré la proximité immédiate des gènes *sprY* et *sprX2* dans la souche HG003, l'absence ou la surproduction d'un ARN n'affecte pas l'expression de l'autre. De plus, nous avons montré qu'ils possèdent des profils d'expression opposés : *SprY* s'accumule dans le temps alors que c'est le contraire pour *SprX2*. Non seulement ils s'expriment différemment au cours de la croissance bactérienne, mais ils réagissent également de manière opposée sous un stress thermique. Il a été montré que *SprX2* diminuait sous 42°C et s'exprimait davantage à 15°C tandis que *SprY* diminuait à 15°C et s'exprimait davantage à 42°C. Peut-être que le stress affecte la transcription et/ou la dégradation des ARNs. De plus, *SprY* affecte l'expression de *spoVG* de manière opposée à *SprX2*. Alors que *SprX2* réduit la traduction de *spoVG* par liaison directe au RBS de l'ARNm (Eyraud et al. 2014), *SprY* provoque une augmentation de la quantité de *SpoVG* par un mécanisme inconnu qui n'implique pas d'interaction directe entre *SprY* et l'ARNm de *spoVG*. De même, *SprY* a un effet inverse de *SprX* sur l'expression de *ecb* (Ivain et al. 2017). *SprX2* régule l'expression d'*ecb* par liaison directe (Ivain et al. 2017) tandis que *SprY* régule *ecb* en affectant la fonction de l'ARNIII (Le Huyen et al. 2021). Ainsi, deux ARNs situés dans le même cluster et régulent à l'opposé une cible commune par des mécanismes différents. De plus, les deux ARNs

SprX2 et SprY contribuent également à la virulence de *S. aureus* mais de manière opposée : SprX2 favorise l'activité hémolytique de *S. aureus* (Kathirvel et al. 2016) tandis que SprY la restreint (Le Huyen et al. 2021).

Bien que plusieurs gènes de clusters d'ARNs aient été découverts, leurs fonctions restent à élucider (Felden et Paillard 2017), qu'ils possèdent des fonctions biologiques partagées ou des rôles différents dans la survie bactérienne ou la virulence. De fait intéressant, *sprY* et *sprX2*, situés dans une contiguité directe dans un cluster et possèdent des profils d'expression opposés au cours de la croissance. Nous nous demandons si ce profil inversé pourrait expliquer la contribution des ARNs au contrôle de la virulence de *S. aureus* à différents points de la croissance bactérienne.

VII. Conclusion sur les fonctions biologiques de SprY dans la virulence de *S. aureus*

Au cours de la dernière décennie, les fonctions biologiques et les contributions des ARNs dans la virulence de *S. aureus* sont devenues plus claires. En effet, des rapports récents commencent à faire la lumière sur les mécanismes de régulation de certains ARNs. Par exemple, il a été démontré que SprD est impliqué dans l'évasion immunitaire (Chabelskaya et al. 2010, 2014), ou RsaA dans la formation de biofilm (Romilly et al. 2014), et SprC dans la phagocytose (Le Pabic et al. 2015). De plus, il a été démontré que SprY ainsi que SprX2 sont impliqués dans l'activité hémolytique de *S. aureus* (Buchad et Nair 2021 ; Kathirvel, Buchad et Nair 2016 ; Le Huyen et al. 2021). En plus de deux derniers ARNs, d'autres ARNs staphylococciques se sont révélés impliqués dans la régulation de l'expression de l'hémolysine et de l'hémolyse. Teg41 améliore hémolytique activité (Zapf et al. 2019). *teg41* se localise immédiatement en aval de sa propre cible, les PSM, et améliore la production de toxines grâce à des appariements antisens entre l'extrémité 3' de Teg41 avec le transcrit α PSM. L'action de deux autres exemples d'ARNs est liée à la fonction du système *agr*. Le PSM-mec est un ARN bifonctionnel codé par le chromosome de la cassette staphylococcique mec (SCC-mec). Cette cassette confère la résistance à la pénicilline à *S. aureus* résistant à la pénicilline (SARM). L'ARN PSM-mec code pour un peptide moduline cytolitique soluble dans le phénol (PSM alpha), mais réprime également la traduction de l'ARNm *agrA* en se liant à sa séquence codante d'*agrA* (Kaito et al. 2013; Qin et al. 2016). Il a été démontré qu'un autre ARN, ArtR, régule l'expression de Hla via la répression de son régulateur : ArtR se lie directement à la région 5' non

traduite de l'ARNm *sarT* et favorise sa dégradation (Xue et al. 2014). AgrA s'est avéré se lier au promoteur et réprimer l'expression de l'ARN, ArtR. En résumé, *S. aureus* développe de multiples voies pour réguler sa virulence en modulant directement la production de toxines ou en contrôlant la fonction d'*agr* et de son effecteur, l'ARNIII. Ainsi, notre travail montre à quel point la régulation des facteurs de virulence est multiforme au cours de l'infection à *S. aureus* et découvre une autre couche d'ARNs impliquée dans la pathogénicité de *S. aureus*.

Titre : Etude de nouveaux ARN régulateurs impliqués dans la virulence de *Staphylococcus aureus*

Mots clés : *Staphylococcus aureus*, ARN régulateur, virulence, RNAlII, ARN éponge

Résumé : *Staphylococcus aureus* est une bactérie à Gram positif fréquemment trouvée dans la flore commensale de la peau. Elle est capable de s'adapter aux changements environnementaux grâce à la reprogrammation rapide de l'expression génique modulée par des ARN régulateurs, parmi d'autres facteurs. Au cours de ma thèse, mes travaux ont porté sur un nouvel ARN régulateur, appelé SprY (alias S629), avec l'objectif de comprendre sa fonction biologique. Dans un premier temps, nous avons étudié le profil d'expression de l'ARN SprY au cours de la croissance bactérienne et dans des conditions de stress. Ensuite, nous avons identifié plusieurs cibles directes pour SprY par des prédictions *in silico* et *in vivo* par MAPS (MS2-Affinity Purification Coupled With RNA Sequencing Approach). Parmi toutes les cibles identifiées, nous nous sommes intéressés au gène SAOUHSC_03046 codant pour un

régulateur transcriptionnel des protéines de la famille XRE, SAOUHCS_1342a codant pour la protéine des canaux mécanosensibles et RNAlII, qui est le riborégulateur principal de la virulence de *S. aureus*. Nous avons démontré que SprY interagit avec les ARNm de SAOUHSC_03046 et SAOUHSC_1342a au niveau de leur RBS (Ribosome Binding Site) et empêche l'initiation de la traduction de ces cibles. La caractérisation de l'interaction entre SprY et RNAlII a montré que SprY agit comme une éponge pour RNAlII et modifie la régulation de l'expression de plusieurs cibles de ce riborégulateur. SprY réduit également l'activité hémolytique de *S. aureus* pendant l'infection. L'ensemble de ces résultats ont montré que SprY joue le rôle d'éponge pour RNAlII et sa contribution dans la pathogénicité de *S. aureus*.

Title : Characterization of *novo* regulatory RNAs implicated in the virulence of *Staphylococcus aureus*

Keywords : *Staphylococcus aureus*, regulatory RNA, virulence, RNAlII, RNA sponge

Abstract : *Staphylococcus aureus* is a Gram-positive coccus frequently found in the commensal flora of the skin and possesses an adaptive ability to environmental changes. This bacteria's capacity of fast gene expression reprogramming is mediated by regulatory RNAs among other factors. During my PhD program, my work aims to characterize a new regulatory RNA, called SprY (alias S629), and to understand its cellular function. First, we studied the expression profile of SprY sRNA during bacteria growth and in stress conditions. Next, we identified a few potential direct targets for SprY by *in silico* predictions and *in vivo* by MAPS (MS2-Affinity Purification Coupled With RNA Sequencing Approach). Among all predicted targets, we are drawn into SAOUHSC_03046 encoding for a potential

transcriptional regulator of the XRE family proteins, SAOUHCS_1342a encoding for a mechanosensitive channel and RNAlII, which is the major riboregulator of *S. aureus* virulence. In addition, SprY is shown to interact with mRNA of SAOUHSC_03046 and SAOUHSC_1342a at their RBS (Ribosome Binding Site) and to prevent the translation initiation. The characterization of interaction between SprY and RNAlII showed that SprY acts as a sponge for RNAlII and alters expression regulation of several RNAlII targets. SprY also reduces the hemolytic activity of *S. aureus*. Altogether, our study showed that a regulatory RNA can act as a sponge for another regulatory RNA and contributes to the pathogenicity of *S. aureus* during infection.