

Immersive Serious Games for Learning

Physics - JeSeiPa

Jeu sérieux immersif pour l'apprentissage de la physique - JeSeiPa

Thèse de doctorat de l'université Paris-Saclay

École doctorale n°580 : sciences et technologies de l'information et de la communication (STIC)

Spécialité de doctorat : Informatique

Graduate School : Informatique et sciences du numérique

Référent : Faculté des sciences d'Orsay

Thèse préparée dans l'unité de recherche **Laboratoire Interdisciplinaire des Sciences du Numérique** (Université Paris-Saclay, CNRS), sous la direction de **Patrick BOURDOT**, Directeur de recherche, le co-encadrement de **Jeanne VÉZIEN**, Ingénieure de recherche, et le co-encadrement de **Cécile de HOSSON**, Professeure

Thèse soutenue à Paris-Saclay, le 22 mars 2022, par

Iuliia ZHURAKOVSKAIA

Composition du jury

Isabelle KERMEN Professeure, Université de Bretagne Occidentale	Présidente
Ronan QUERREC Professeur, École Nationale d'Ingénieurs de Brest	Rapporteur & Examineur
Raphael ZENDER Professeur, Humboldt-Universität zu Berlin	Rapporteur & Examineur
Julien NELSON Maître de Conférences HDR, Université Paris Cité	Examineur
Pablo A. FIGUEROA Professeur associé, Universidad des Los Andes	Examineur
Patrick BOURDOT Directeur de recherche, Université Paris-Saclay	Directeur de thèse

Titre: Jeu sérieux immersif pour l'apprentissage de la physique - JeSeiPa

Mots clés: réalité virtuelle, jeu sérieux, physique, didactique

Résumé:

Dès le plus jeune âge, la construction de notre compréhension de la réalité physique repose de manière décisive sur l'expérimentation directe. Partant du constat que l'expérimentation joue un rôle fondamental dans l'acquisition progressive de connaissances, l'objectif de ce projet doctoral est de tirer parti des technologies innovantes de la réalité virtuelle (RV), des simulations numériques et des nouvelles techniques interactives qui leur sont associées pour concevoir, développer et évaluer de nouvelles méthodes, outils et expériences dédiés à l'acquisition de connaissances dans le domaine de la physique. L'approche adoptée combine les jeux sérieux, c'est-à-dire l'utilisation des mécanismes du jeu dans un but autre que purement ludique, avec les possibilités offertes par la RV pour expérimenter de nouvelles situations physiques à la première personne. En combinant un cadre didactique clair avec une approche basée sur les jeux sérieux, l'objectif est de concevoir, d'implémenter et d'évaluer l'utilisation d'outils de simulation interactive en temps réel dans la RV, en les comparant aux approches pédagogiques traditionnelles.

Après une étude bibliographique, nous avons commencé par concevoir et mettre en œuvre un bac à sable comprenant plusieurs jeux physiques possibles afin de tester si les interactions et l'organisation générale du jeu s'avèreraient suffisamment intuitives et motivantes. Puis, sur la base des idées obtenues lors de sessions de brainstorming et d'entretiens individuels avec des étudiants, nous avons créé une liste de caractéristiques de jeu possibles.

Nos recherches se sont ensuite orientées vers des tâches d'enseignement plus pratiques, comme la question de la perception de la masse en RV. Ce travail se concentre sur le rendu pseudo-haptique d'objets ayant un poids, dans un cadre didactique d'apprentissage de la physique, notamment concernant la manipula-

tion et la comparaison de masses. Nous avons cherché à vérifier l'hypothèse selon laquelle les techniques pseudo-haptiques permettent aux utilisateurs de discriminer des objets d'aspects identiques mais de masses différentes. Nous avons donc comparé plusieurs conditions en modifiant le rapport Contrôle-Affichage en translation, en rotation, tout en conservant une métaphore visuelle explicite, la balance de Roberval.

Nous avons ensuite cherché à améliorer l'acquisition des connaissances des élèves sur le concept de densité. L'une des raisons pour lesquelles ce sujet est difficile à comprendre est que la plupart des étudiants partagent des illusions et des idées fausses, profondément ancrées, concernant le comportement des objets physiques. Nous avons comparé l'efficacité d'un jeu sérieux immersif portant sur l'enseignement du concept de densité dans 2 conditions : une version 2D dans un navigateur web, et un jeu immersif 3D en RV.

Enfin, nous avons examiné l'utilité potentielle de l'utilisation d'un compagnon à des fins pédagogiques, cette fois pour enseigner le concept de gravité. Nous avons comparé trois contextes d'accompagnement différents - un enseignant réel, une vidéo (en direct) d'un enseignant, et un avatar VR d'un enseignant. Le concept de gravité et de chute libre a été introduit dans 3 exercices : laisser tomber des objets dans différents champs de gravité ; expérimenter des trajectoires paraboliques ; expérimenter des "sandwichs" de gravitation, alternant des zones de gravité et des zones sans gravité.

Les résultats ont montré que les simulations numériques immersives et interactives en RV offrent des avantages incomparables par rapport aux approches didactiques traditionnelles, en facilitant l'apprentissage de nouvelles connaissances et en permettant l'approfondissement des connaissances existantes.

Title: Immersive Serious Games for Learning Physics - JeSeiPa

Keywords: virtual reality, serious games, physics, didactics

Abstract: From a very early age, the construction of our understanding of physical reality is based in a decisive way on direct and interactive experimentation, a link between perception and cognition. And since experimentation plays a fundamental role in the progressive acquisition of knowledge on scientific topics, including physics, the objective of this doctoral project is to leverage the innovative technologies of Virtual Reality (VR), numerical simulations, and the new interactive techniques associated with them to design, develop, and evaluate new methods, tools, and experiments dedicated to acquiring knowledge in the field of physics. The approach adopted combines serious games, i.e., using game mechanics for a purpose other than the game itself, with the possibilities offered by VR to experience new physical situations in the first person. By combining a didactic framework with a serious game-based approach, the aim is to design, implement and evaluate the use of interactive real-time simulation tools in VR, comparing them with traditional educational approaches.

In this dissertation, beyond bibliographic research, we started by designing and implementing a sandbox as a bootstrap for several possible physical games to test whether interactions and general game organisation would prove intuitive and motivating. Then, based on ideas obtained from brainstorming sessions and individual interviews with students, we created a list of possible game features. We also investigated 2 possible visualisation tools within a very frequent task in gaming: aiming and shooting at a long-distance target.

Our focus of research then shifted to more practical teaching tasks such as the question of mass perception in VR. This specific work focuses on the pseudo-haptic rendering of objects with weight within a didactic framework of learning physics, particularly when dealing with

the property of mass. We sought to verify the hypothesis that pseudo-haptic techniques allow users to discriminate objects of identical aspects but different masses. We compared several conditions by modifying the so called Control-Display ratio in translation, rotation, while keeping an explicit visual metaphor, the Roberval balance, as a baseline.

We then investigated how to improve student knowledge acquisition of the concept of density. One of the reasons why the topic is difficult to understand is that most students share deeply rooted delusions and misconceptions about the behaviour of physical objects. We compared the effectiveness of a serious immersive game in teaching the density concept in 2 conditions: a 2D version in an embedded web browser and a 3D immersive game in VR. We also developed a specific questionnaire to assess students' knowledge improvement.

Finally we considered the potential usefulness of using a companion for educational purposes, this time teaching the concept of gravity. We compared three different companion settings - a real teacher, a (live) video of a teacher, and a VR avatar of a teacher. The concept of gravity and free fall were introduced in three exercises: I - dropping objects in different gravity fields; II - experiment with parabolic trajectories; III - experimenting with gravitation "sandwiches".

Results showed that immersive and interactive digital simulations in VR offer incomparable advantages over traditional didactic approaches, by deepening and facilitating the learning of new knowledge. Recent advances in immersive interaction technologies, coupled with realistic real-time physical simulation engines, make it possible to create a credible virtual experimental space where the learner can get involved by manipulating actual objects to observe or predict their behaviour.

To my family.

Thank you!

Моей семье.

Спасибо!

Acknowledgements

As this section is written after the defence, I begin it by thanking my dissertation jury, who kindly reviewed my work. I thank my presenters, R. Querrec and R. Zender, for taking the time to read my thesis and providing invaluable feedback. These comments allowed me not only to improve the manuscript but also to complete my presentation. I thank I. Kermen, J. Nelson, P. A. Figueroa for participating in my examination committee and their insightful comments.

Many people have helped me along the way. In particular, I would like to thank my supervisor J. Vezien for her kindness and immeasurable support, and I am grateful for her patience while working on this thesis. I would like to thank P. Bourdot for helping me to see things from a different point of view. My thanks go to C. De Hosson for her help with didactics. I thank N. Ladeveze for his help with Pseudo-Haptic techniques (Chapter 4). My thanks also go to T. Bouchara for her help in introducing audio perception (Chapter 5). Thanks to N. Ferey for his genuine scientific interest in my work - I have always felt encouraged after our dialogues. My thanks go to all the staff of the VENISE team.

Of course, I would like to extend my heartfelt thanks to all the past and present PhD students from the VENISE team who have supported me, each at different stages of my development, and without whom my experience in the lab would have been much less positive. Thank you, Yiran, for your support and help throughout my work on the dissertation. Thanks to Nawel for the opportunity to talk about distracted topics and help with French. Thanks to Yujiro for his willingness to help always and with everything. Thank you, Mengchen, Valentin and Inoussa, for the interesting conversations in the office and over a cup of coffee.

I would also like to thank my parents. Grandma, thank you, I have achieved all this because of you; you have always given wise advice and effective nudges. Lena, thank you for your tireless support and encouragement. Mum, thank you for always believing in me and not letting me doubt myself. Thanks to my family for always giving me peace of mind whenever I am home. Polina, I am a doctor now - I have

achieved it, and so you can too, I believe in you! Dima, thanks for the motivation and always being there for me and supporting me. Thanks, Natasha and Sasha, you always helped and encouraged me along this challenging path. Zheka, thank you for never letting me get down and listening to all my endless worries. I couldn't have reached the level I am now without your support. And thanks, Zeus, for always wagging his tail and being madly happy when I came home, and always when I was working from home you were sleeping sweetly under the table in your cot or curled up on my lap and sniffing :)

At the end of this letter, I sincerely thank all the people who gave some of their time and energy to participate in my experiments. Without you, this thesis would not have been completed.

Contents

List of Figures	5
List of Tables	9
Acronyms	11
Synthèse en français	13
1 INTRODUCTION	17
1.1 Research approach	20
1.2 Summary of thesis contribution	20
1.2.1 Technical contributions	21
1.2.2 Empirical contributions	21
1.2.3 Theoretical contributions	22
1.3 Thesis overview	22
2 CONTEXT AND BACKGROUND	25
2.1 Introduction	25
2.2 Virtual reality	28
2.3 Serious games	35
2.4 Didactics	38
2.5 Creating the triptych: related works	41
2.5.1 ScienceSpace & NewtonWorld	41
2.5.2 At the root of the project: the EVEILS collaboration	44
2.6 Position of the thesis	46

2.7	Conclusion	48
3	DESIGN REVIEW SCENARIO & SANDBOX	49
3.1	System development: Hardware and software selection	50
3.2	General Methodology for Game Development	52
3.3	Sandbox	55
3.3.1	Global game design	56
3.3.2	Game description	60
3.3.3	Experimental procedure	68
3.3.4	Preliminary evaluation	69
3.4	Brainstorming sessions	69
3.4.1	Semi-structured Interviews	69
3.4.2	Parsing data from the interview sessions	70
3.4.3	Brainstorming solutions	70
3.4.4	Solution development	71
3.4.5	Game topic	72
3.4.6	Additional game features	74
3.5	Parabolic movement and viewpoint selection	77
3.6	Conclusion	80
4	PSEUDO-HAPTIC PERCEPTION OF MASSES	81
4.1	Introduction	82
4.2	Rationale: teaching "mass"	84
4.3	Pseudo-haptics techniques for mass evaluation in VR	85
4.4	Comparing pseudo-haptic techniques for mass comprehension in VR	87
4.4.1	Experimental setup	87
4.4.2	Experimental procedure	89
4.4.3	Preliminary tests and results	92
4.5	Conclusion	93
5	TEACHING THE CONCEPT OF DENSITY WITH IMMERSIVE TOOLS	95
5.1	Introduction	96

5.1.1	Teaching density	96
5.1.2	Clarification of the used terminology	98
5.2	Method and tasks	100
5.2.1	Design of the experimental conditions	101
5.3	Participants	102
5.4	Questionnaire	102
5.5	Visual design of density	103
5.6	Web-based 2D game	107
5.6.1	Experimental setup	107
5.6.2	Experimental procedure	111
5.7	VR Game	111
5.7.1	Experimental setup	112
5.7.2	Preliminary experiment: Using audio to provide extra information	113
5.7.3	Experimental procedure	118
5.8	Results	121
5.8.1	Online Questionnaire	121
5.8.2	2D online game	122
5.8.3	3D game - Group 1	124
5.8.4	3D game - Group 2	127
5.9	Conclusions	129
6	USING COMPANIONS: THE CASE OF GRAVITY	131
6.1	Introduction	132
6.2	Companions in the digital era	132
6.3	Teaching gravity with a companion	136
6.3.1	Why free-fall resist teaching	136
6.3.2	Teaching gravity	138
6.4	Experiments	140
6.4.1	Research question	140
6.4.2	Interviews with teachers	141
6.4.3	Experimental conditions	143

6.4.4	Experimental setup	145
6.4.5	Questionnaire	154
6.4.6	Experimental Procedure	155
6.4.7	Preliminary results	156
6.5	Conclusion	160
7	CONCLUSION AND FUTURE PERSPECTIVES	163
7.1	Contribution	164
7.2	Enhancements and future work	167
A	Appendix 1	169
A.1	Hardware selection	169
A.1.1	Lenovo controllers - Unity Input system mappings	169
A.2	Brainstorming notes	170
B	Appendix 2	173
B.1	Questionnaire "Properties of matter"	173
B.2	Post-Experiment interview questions	181
C	Appendix 3	183
C.1	Questionary "Gravity concept"	183
	Bibliography	191
	List of scientific productions	207

List of Figures

1.1	Films featuring alternative universes.	18
1.2	Page from the book [80].	19
2.1	A representation of the Earth's double core and magnetic field (Professor Kenneth R. Lang, Tufts University)	26
2.2	Methodological triptych of the JeSeiPa research framework.	28
2.3	The Geomatic Touch haptic arm [126].	29
2.4	History of VR/AR technology.	30
2.5	Data Glove and EyePhone, 1987 [149].	31
2.6	"Virtual Boy" by Nintendo, 1995 [149].	32
2.7	The relationship between Serious Games Mechanics (SGMs) and the pedagogical and game design patterns of a game [6].	36
2.8	Illustrations from the online game Mekanika.	38
2.9	Illustrations from the NewtonWorld.	43
2.10	EVEILS project - a relativistic billiard game.	46
3.1	Lenovo headset with controllers.	50
3.2	System flowchart.	51
3.3	Methodology.	52
3.4	Formative usability evaluation cycle ([63] adapted from [44]).	53
3.5	Design-Based Research [125].	54
3.6	Conceptual triptych + Game Development Cycle = Methodological triptych.	54
3.7	Open World.	56

3.8	According to the Mechanics-Dynamics-Aesthetics (MDA) methodology, designers and players look at the game from different directions [60].	58
3.9	Example of a playing chess game with Low Poly and High Poly [46].	58
3.10	NewtonVR [14].	59
3.11	Apple tree, as re-manufactured from NewtonVR [14].	60
3.12	Display of controllers in the virtual world.	61
3.13	Schematic sandbox map - Web.	62
3.14	Illustrations from the game Mecanika [11].	63
3.15	To perform the intermediate test embedded in the game, players had to click on the visual giving the correct representations of how light would propagates in the given situation - here with the fan activated [145].	63
3.16	Wind boxes - Arrows above big cubes and particles inside show the destination of wind flow. Different brightness of the cubes and size of arrows are different power.	64
3.17	Platform Wind.	65
3.18	Platform Density.	65
3.19	Density Platform - Exercise 2.	66
3.20	The Gravity Platform.	67
3.21	Gravity platform - 2 exercises.	68
3.22	List of rated ideas from brainstorm sessions.	71
3.23	Notes on brainstorming with "boxes" including various physical phenomena.	73
3.24	Notes on brainstorming on the experiment regarding Mountain Momentum.	74
3.25	Notes on brainstorming on an experiment with a drone dropping objects.	75
3.26	Game features.	76
3.27	Companion study.	77
3.28	Parabolic Trajectory [5].	78
3.29	Parabolic movement and viewpoint selection.	79
3.30	Left: Average aiming time between independent variables; Right: Shots taken (error rate) between independent variables.	80
4.1	Roberval balance.	85
4.2	Experimental setup.	88

4.3	Pseudo-haptic metaphors used in the mass evaluation experiment.	90
4.4	Interview guide.	91
4.5	Quantitative reports: RS, CT, SW, and Handedness.	93
5.1	Density & Specific mass.	99
5.2	Possible forms for representing the object.	104
5.3	Two correct ways to represent the relative sizes, weights, and densities of four objects [128].	105
5.4	Grid-and-dots representation of an object floating in a liquid with data display [128].	105
5.5	Our variations for density visualisation.	106
5.6	View of the objects in the actual experimental environment.	106
5.7	Visualisation of density in 2D and 3D.	107
5.8	Training in the 2D game.	108
5.9	Scenario 1 in the 2D game.	109
5.10	Scenario 2 in the 2D game.	109
5.11	Scenario 3 in the 2D game.	110
5.12	Prediction panel.	111
5.13	Bonus level.	112
5.14	VR game - Part 1.	114
5.15	VR game - Part 2.	115
5.16	An example of audio source in Unity, with the list of rendering variables.	116
5.17	6 valid matching patterns.	117
5.18	Two sets of cubes for Audio-tests.	118
5.19	VR game - Part 3.	120
5.20	Online questionnaire results.	122
6.1	Tangible Companion together with the participant using BCI [105].	134
6.2	The three companions in the WoZ experiment of [115].	135
6.3	The 3 types of companion in [115].	135
6.4	Angry Birds game[25].	140
6.5	Simulation of the Projectile Motion [137].	141
6.6	Condition 2 - real-time video communication with the teacher.	143
6.7	Condition 3 - Kylie, the companion robot.	144

6.8	Condition 3 - The teacher can make Kylie point at the object of interest (here the furthest cube, as indicated by the 3D yellow arrow).	144
6.9	Exercise 1: Condition "On Earth".	146
6.10	Exercise 1: Condition "On the Moon".	147
6.11	Exercise 1: Condition "In outer space - no gravitation force."	147
6.12	Exercise 1 - view with different modes.	148
6.13	Exercise 2: Condition "On Earth".	149
6.14	Exercise 2: Condition "On Moon".	150
6.15	Exercise 2: Condition - "without gravitation force".	150
6.16	Exercise 2 - complete firing procedure.	151
6.17	Different ways to project a 3D volume onto a 2D screen [101].	151
6.18	Exercise 2 - view with condition 2 (video) and condition 3 (companion mode).	151
6.19	Exercise 3: Game space.	152
6.20	Exercise 3: Game task.	153
6.21	Exercise 3: Student's game view.	153
6.22	Exercise 3 - view with different modes.	154
6.23	Question 9. Presentation variant I.	159
6.24	Question 9. Presentation variant II.	159
A.1	Windows Mixed Reality Controller buttons.	169
A.2	Brainstorming notes I.	170
A.3	Brainstorming notes II.	171

List of Tables

5.1	Time for the 2D game (unit: minutes).	123
5.2	Time for Group 1 in the 3D game (unit: minutes).	126
5.3	Time for Group 2 in the 3D game (unit: minutes).	128
6.1	Time spent in the game (in minutes).	157

Acronyms

ABLEs Agent-Based Learning Environments

AI Artificial Intelligence

AR Augmented Reality

BCI Brain-Computer Interface

C/D Control-to-Display

DBR Design-Based Research

DoF Degrees of Freedom

ECA Embodied Conversational Agents

EVE Environnement Virtuel Évolutif (Scalable Virtual Environment)

EVEILS Espaces Virtuels pour l'Enseignement et l'ILlustration Scientifiques (Virtual Spaces for Scientific Education and Illustration)

FCI Force Concept Inventory

HCI Human-Computer Interaction

HMD Head-Mounted Display

JeSeiPa Jeu Sérieux immersif Pour l'apprentissage de la physique (Serious immersive game for learning physics)

LDAR André Revuz Didactic Laboratory

LISN	Laboratoire Interdisciplinaire des Sciences du Numérique (Interdisciplinary Laboratory of Digital Sciences)
LTS	Long Term Support
MBL	Microcomputer Based Laboratory
MBT	Mechanics Baseline Test
MDA	Mechanics-Dynamics-Aesthetics
MRTK	Mixed Reality Toolkit
PC	Personal Computer
PHR	Pseudo-haptic rotation
PHT	Pseudo-haptic translation
RB	Roberval Balance
SGM	Serious Games Mechanic
STEM	Science, Technology, Engineering, and Mathematics
VENISE	Virtual & augmented ENvIronments for Simulation & Experiments
VR	Virtual Reality
WIM	World In Miniature
WMR	Windows Mixed Reality

Synthèse en français

Dès le plus jeune âge, la construction de notre compréhension de la réalité physique repose essentiellement sur l'expérimentation directe et interactive, lien entre perception et cognition. Et puisque l'expérimentation joue un rôle fondamental dans l'acquisition progressive des connaissances dans des domaines scientifiques, dont la physique, l'objectif de ce projet doctoral est d'utiliser les technologies innovantes de réalité virtuelle (RV), les simulations numériques et les nouvelles méthodes interactives qui leur sont associées, afin de concevoir, développer et évaluer de nouvelles méthodes, outils et expériences dédiés à l'acquisition de connaissances dans le domaine de la physique. L'approche adoptée combine le jeu sérieux, c'est-à-dire l'utilisation de mécanismes de jeu à d'autres fins que le jeu lui-même, avec les opportunités offertes par la réalité virtuelle pour vivre de nouvelles situations physiques à la première personne. Associant une base didactique à une approche de jeu sérieux, l'objectif est de développer, mettre en œuvre et évaluer l'utilisation d'outils de simulation interactifs temps réel en réalité virtuelle, en les comparant aux approches pédagogiques traditionnelles.

Le chapitre 1 consiste en une introduction où je motive l'utilisation de la réalité virtuelle comme technologie éducative dans le contexte de l'éducation physique. J'y formule l'hypothèse principale, les objectifs, la principale approche de recherche et les contributions techniques, empiriques et théoriques de mon travail.

Le chapitre 2 fournit le contexte de cette thèse en présentant et en passant en revue des outils méthodologiques pour mettre en évidence les avantages potentiels de l'utilisation de la réalité virtuelle, des jeux sérieux et de la didactique à des fins éducatives. De plus, je discute des travaux connexes dans une analyse bibliographique détaillée. J'examine comment, pourquoi et jusqu'où les systèmes éducatifs interactifs passés contribuent au processus d'apprentissage, et je positionne mon travail dans ce processus.

Le chapitre 3 explicite la démarche méthodologique en termes opérationnels. Le choix du matériel

et des logiciels à mettre en œuvre est analysé à la lumière de la recherche à conduire. En plus des recherches bibliographiques, nous avons commencé par concevoir et implémenter un bac à sable comme bootstrap pour plusieurs jeux physiques possibles (densité, mouvement parabolique/chute libre, gravité) afin de tester si les interactions et l'organisation globale du jeu étaient intuitives et motivantes. Ensuite, sur la base des idées issues des séances de remue-méninges et des conversations individuelles avec les étudiants, nous avons compilé une liste de 14 fonctionnalités possibles pour le jeu. Une étude préliminaire concernant le mouvement parabolique et la sélection des points de vue a été menée, où nous avons comparé 2 outils de visualisation possibles pour une tâche de jeu très courante : viser et tirer sur une cible éloignée. En conclusion, je présente les principaux résultats qualitatifs et quantitatifs de cette étude préliminaire.

L'accent de notre recherche s'est ensuite déplacé vers des tâches éducatives plus pratiques, et le **chapitre 4** présente un examen de la perception de masse dans un contexte de réalité virtuelle. J'y explique la portée de l'enseignement de la masse et le rôle que jouent les techniques pseudo-haptiques dans ce domaine. Ce travail particulier est consacré à la perception pseudo-tactile d'objets pesants dans le cadre didactique de l'étude de la physique, notamment en ce qui concerne la propriété de masse. Nous avons cherché à tester l'hypothèse selon laquelle les méthodes pseudo-haptiques permettent aux utilisateurs de distinguer des objets ayant les mêmes aspects mais des masses différentes. Nous avons comparé plusieurs conditions, en changeant le rapport contrôle-affichage en translation, en rotation, tout en conservant une métaphore visuelle explicite et un mode d'apprentissage traditionnel – la balance de Roberval – comme référence. Les résultats montrent que la métaphore de l'équilibre de Roberval s'est avérée très efficace, motivante et agréable à utiliser. Les métaphores pseudo-haptiques se sont révélées d'une efficacité minimale et étaient souvent déroutantes et frustrantes. Cela peut être dû au choix de conception (c'est-à-dire au manque d'accessoires haptiques efficaces), mais des recherches supplémentaires sur la métaphore pseudo-haptique utilisée semblent nécessaires. Le comportement des utilisateurs a également confirmé certaines idées fausses concernant la comparaison d'objets de masses différentes.

Nous avons ensuite exploré au **chapitre 5** comment améliorer la compréhension du concept de densité à l'aide d'outils immersifs. Enseigner aux élèves les concepts de base de la physique (par exemple, ceux liés à la masse, au volume ou à la densité) est beaucoup plus difficile que de simplement exposer les définitions et les lois mathématiques qui les régissent. L'une des raisons pour lesquelles ce sujet est difficile à comprendre est que la plupart des élèves partagent des idées fausses, profondément

ancrées, sur le comportement des objets physiques. Nous avons comparé l'efficacité d'un jeu sérieux immersif pour enseigner la notion de densité sous deux conditions : une version 2D dans un navigateur web embarqué et un jeu immersif 3D en réalité virtuelle. Pour cela, nous avons développé un nouveau questionnaire pour évaluer les connaissances des étudiants sur le sujet. Par ailleurs, je présente des recherches préliminaires sur l'utilisation de l'audio pour fournir des informations supplémentaires pendant la formation. Les résultats montrent une augmentation de l'efficacité de la formation utilisant la réalité virtuelle. De plus, il s'avère que la plupart des étudiants ont pu reconnaître les lacunes de leurs théories originales et les réviser, ce qui signifie qu'ils ont amélioré leur compréhension du sujet à l'étude.

Enfin, au **chapitre 6**, nous avons examiné l'utilité potentielle de l'utilisation d'un compagnon à des fins éducatives, cette fois pour enseigner le concept de gravité. Tout d'abord, on définit la notion de compagnon et l'apport d'un compagnon dans un contexte éducatif interactif. Je décris ensuite un dispositif expérimental conçu pour comparer trois contextes d'accompagnement différents : l'utilisation d'un enseignant réel physiquement présent, d'une vidéo (en direct) d'un enseignant en ligne et enfin d'un avatar d'enseignant en réalité virtuelle (avatar manipulé par l'enseignant). Le concept de gravité et de chute libre a été présenté dans trois exercices : une introduction au concept de gravité (chute d'objets dans différents champs gravitationnels), un atelier sur les trajectoires paraboliques et un exercice final combinant les deux approches (expériences avec des "sandwichs" de gravité). En raison du contexte sanitaire, seuls des essais préliminaires sont rapportés. Les résultats montrent que l'efficacité de l'utilisation des simulations de réalité virtuelle pour l'apprentissage a augmenté de 10% et que la confiance des étudiants a augmenté de 13%. Les entretiens montrent que les apprenants classent les modes d'apprentissage dans cet ordre : mode compagnon VR, communication vidéo et enseignant réel.

Le chapitre 7 présente les principales conclusions du travail de recherche effectué. Les résultats obtenus montrent que les simulations numériques immersives et interactives en réalité virtuelle offrent des avantages incomparables par rapport aux approches didactiques traditionnelles, en approfondissant et en facilitant l'apprentissage de nouvelles connaissances. Les progrès récents des technologies d'interaction immersive, associés à des mécanismes de modélisation physique réaliste en temps réel, permettent de créer un espace expérimental virtuel robuste dans lequel l'apprenant peut participer en manipulant des objets réels pour observer ou prédire leur comportement. En conclusion, j'envisage les perspectives d'avenir des systèmes d'apprentissage interactifs en réalité virtuelle à des fins éducatives et je propose des améliorations possibles à cette recherche.

Chapter 1

INTRODUCTION

Tell me and I forget.

Teach me and I remember.

Involve me and I learn.

- *Benjamin Franklin*

We all have stories from school, university or other educational institutions when some teachers could put you to sleep in seconds, regardless of your interest in a particular subject. The lesson had just started and more than half the students — some of them actually willing to learn — were already distracted or dozing off. Now imagine that Virtual Reality (VR) technology within a well-designed framework would be used on such subjects, and picture how interested the students would become. Imagine your least favourite subject (everyone has one), and now think about how your attitude towards it could change if you studied it in VR.

The division and antagonism between traditional "humanities" (philosophy, linguistics, arts) and "hard sciences" (physics, mathematics, engineering, biology), now called STEM (acronym for Science, Technology, Engineering, and Mathematics) has emerged early in the 20th century [9]. It is still very pervasive in contemporary education systems. Unfortunately, recent attempts to recognise the importance of a liberal education in partnership with STEM subjects maintain a separation of the humanities and STEM subjects instead of reclaiming a historical legacy of unity. This separation leads students to somehow

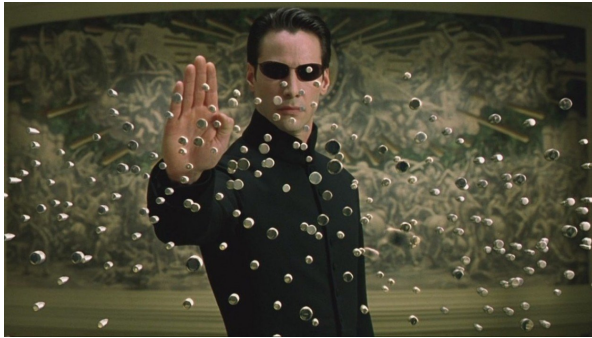

(a) The Matrix, 1999.



(b) Ready Player One, 2018.

Figure 1.1: Films featuring alternative universes.

"choose" between humanities and science, whereas "In laying the foundation of a thorough education, it is necessary that all the important mental faculties be brought into exercise. It is not sufficient that one or two be cultivated, while others are neglected. A costly edifice ought not to be left to rest upon a single pillar [100]."

As a result, modern society figuratively divides itself into "humanities" and "technologies", and it is infrequent that a person refers to oneself as belonging to the two categories. "Techies" prefer exact sciences, such as physics and mathematics, while "humanities" members prefer philosophy and literary criticism. Because they have been brought up in a system that reinforces this separation, each category has difficulties grasping the objects and concepts of the opposite group.

With this dichotomy in place, I chose to investigate how **innovative teaching methods involving digital technologies** could help teach **physics**.

From a very early age, the construction of our understanding of physical reality is based in a decisive way on direct and interactive experimentation, a link between perception and cognition. As babies, we grasp things, we drop them, throw them (much to our parents' despair), and thus get an inductive knowledge on how things behave. And since experimentation plays a fundamental role in the progressive acquisition of knowledge on basic scientific facts, beginning with physics, the objective of this doctoral project is to leverage the innovative technologies of VR, numerical simulations, and the new interactive techniques associated with them to design, develop, and evaluate new methods, tools, and experiments dedicated to acquiring knowledge in the field of physics.

Digital experiments allow us to achieve a wide range of controlled experiments; this is especially true for Virtual Reality, which can create all kinds of alternate realities for the game (Pokemon Go or Singularity). This is exactly what Facebook is proposing to do with the Meta-Universe, and that, in fact,

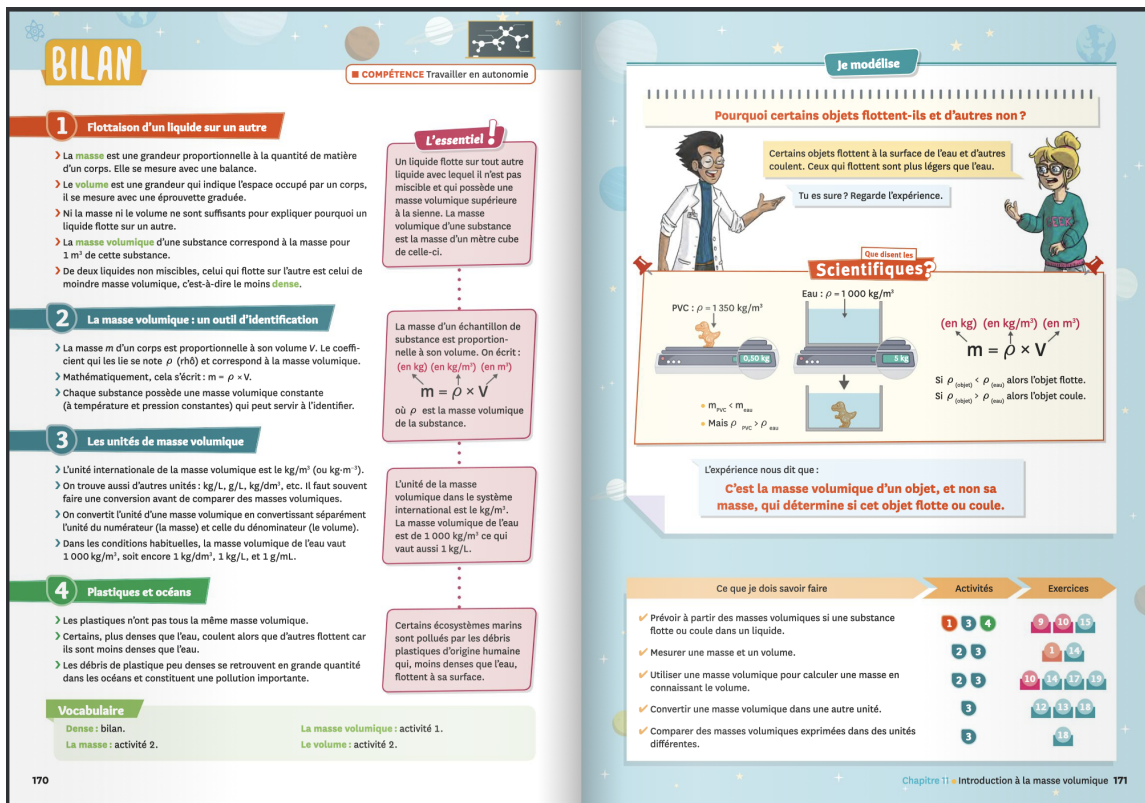

Figure 1.2: Page from the book [80].

is the promise of VR as a whole. Films such as "The Matrix" or "Ready player one" are prime examples of what an alternative universe can be (See Figure 1.1). From a pedagogical point of view, we can use this incredible power of experience to explore how people achieve real learning of concepts in a realistic framework.

In current education, physics illustrations are presented in a 2D form - textbooks, computer screen or blackboard (See Figure 1.2). With well-designed experiences and VR devices in the classroom, students could consider 3D physics from different spatial perspectives and feel the effect of being present in the studied phenomenon, through direct interactions. We want to foster a novel teaching method where it is possible to create virtual experimental laboratories where the learner can manipulate actual 3D objects to observe or predict their behaviour. Recent advances in immersive interaction technologies, coupled with realistic real-time physical simulation engines, make it possible to create such a credible virtual experimental space.

The main hypothesis of this work is that immersive and interactive digital simulations in VR offer significant advantages over traditional - text-based, oral-based - educational and media approaches .

The objective of this work is the creation of immersive systems dedicated to learning physics concepts. The dissemination of VR tools created for the didactics in physics would likely extend to other disciplines.

1.1 Research approach

Various immersive learning systems have been studied since the 90s, and previous works on teaching Newtonian physics with Virtual Reality have started around the turn of the millennium. However, no significant advancement and development of such systems were since observed. One of the difficulties of these studies comes from the availability of VR devices for everyday use for most people (ordinary people). Also, the price and general lack of practicability of such devices played an important role. For the first time, we believe most of these difficulties have now been solved.

Firstly, I thoroughly investigated previous works on immersive learning systems and the implementation of such systems in the educational process. In addition to a bibliographic study, this research consisted in four practical parts: the creation of a sandbox as a bootstrap and a pre-study about parabolic movement study and viewpoint selection; exploring the different possibilities of VR that could be used for teaching and solving the problem as mass perception in a virtual space (with an emphasis on pseudo-haptic techniques); the game design and subsequent implementation dedicated to the teaching of the concept of density with immersive tools (this work included a pre-study about using audio as an instrument to provide additional information during teaching); analysing the usefulness of a VR companion in the context of teaching gravity concepts.

1.2 Summary of thesis contribution

This dissertation provides technical contributions in the form of different games for learning, empirical findings from multiple user studies, and theoretical contributions that consider a new approach for the learning process.

1.2.1 Technical contributions

I designed and implemented:

- a sandbox to implement practical sessions in which users can experience several possible physical games to test whether interactions and general organisation of a game would prove practical, intuitive and motivating (Chapter 3);
- a VR game framework to test pseudo-haptic techniques for learning purposes (Chapter 4);
- a 2D web game in which remote users can learn the basic concept of Density (Chapter 5);
- a 3D immersive game to learn density by direct experimentation (Chapter 5);
- a VR game-based framework to study the use of a VR companion in teaching gravity concepts (Chapter 6).

1.2.2 Empirical contributions

I found that:

- Immersive serious games could, if not eradicate students' false conceptions on concepts of physics, at least shake them and help look at it from a different viewpoint, allowing students to reconsider their view on nature of the physical phenomenon;
- Benefits of immersive VR games versus 2D simulations for learning are real and quantifiable;
- The association of VR, serious games, and didactics led to an improvement in concept understanding, as proved by post-experiment tests;
- Students are more interested and motivated to learn, using digital interactive tools as opposed to traditional learning approaches (oral lectures, blackboard, face-to-face);
- Teachers also are motivated in using such technologies for their classes;
- People who completed school/university curriculum some time ago are interested in getting new knowledge or refreshing them with this educational approach (VR + serious games).

1.2.3 Theoretical contributions

I derived:

- Clues on how users achieve "learning" during traditional didactic approaches;
- Clues on how to increase the effectiveness of the learning process of concepts, in relationship to their experimentation;
- Clues in a design/implementation/evaluation process of learning games.

1.3 Thesis overview

The rest of this dissertation is organised as follows:

Chapter 2 presents the context of this thesis: methodological tools are presented and reviewed to highlight the potential benefits of using Virtual Reality, Serious Games, and Didactics for educational purposes. I discuss what, how, why, and how much previous interactive education systems contribute to the learning process and position my work within this process.

Chapter 3 explains the motivation and the targeted scenarios. I provide information about a selection of hardware and software and why it is essential for the research. Then, I describe a sandbox as a bootstrap and illustrate this with a pre-study about parabolic movement and viewpoint selection. I explicitate the main results of the study.

Chapter 4 introduces using pseudo-haptic techniques for teaching. I provide an explanation of the rationale of teaching mass and what role pseudo-haptics play in this matter. I compare two different techniques (translation and rotation techniques) with a traditional way of teaching (a Roberval balance metaphor).

Chapter 5 introduces teaching the concept of density with immersive tools. The chapter explains which misconceptions students exhibit when learning this topic; I design a novel questionnaire for evaluating basic student knowledge in the topic, explain why we created the same game in two variations: in 2D and 3D (VR), and the results of the subsequent study comparing the outcome of both games. Also,

I present a pre-study about using audio to provide additional information during teaching.

Chapter 6 reports the benefits of using a companion for educational purposes, using the example of teaching the concept of gravity. This chapter explains what a companion consists in, and how it can help in teaching. I compare three different conditions - with a real teacher, a video of the teacher, and an VR avatar of a teacher.

Chapter 7 concludes the dissertation with a summary of the main contributions and future perspectives for VR interactive learning systems for educational purposes.

Chapter 2

CONTEXT AND BACKGROUND

2.1 Introduction

The formation of a human's worldview occurs from the moment he becomes aware of himself and his place in the world surrounding him. From our very first steps in life, the construction of the way we approach the world around us, our appropriation of the common consensus that underlies it (e.g. the very notions of space and time or the persistence of objects) is based in a decisive way on continuous, direct and interactive experimentation. From this experience, which is enriched throughout our lives, we can then construct more abstract concepts relating to physical reality: the geometric properties of objects, their spatial and temporal relations, their 2D or 3D topology, temporal simultaneity, causality, etc. However, the formalisation of the transition from experience to concept during a practical session, for example, is not natural: it is the role of didactic research to link the acquisition of knowledge in a particular field (in this work, physics) to the experimental historical constitution process of this field, and to the concepts that were formed out of it.

Educational models implemented in the school education of students, in particular physics, strive to show what is hidden from the eye (for example, the phenomena and effects of wave optics, processes occurring at the level of the atomic nucleus, magnetic fields). To represent such dynamic 3D phenomena, sometimes occurring at huge or microscopic scales, teachers were mostly limited to 2D means. At present, physics education still often resorts to 2D representations, using perspective projection and pseudo-volume effect (See example on Figure 2.1). Obviously, that how unsatisfactory and partial these illustrations are to truly understand *what it is all about*.

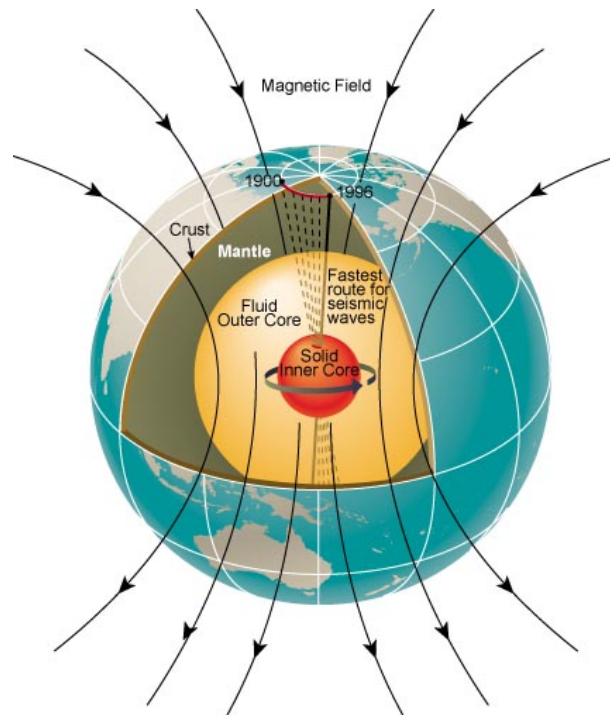

Figure 2.1: A representation of the Earth's double core and magnetic field (Professor Kenneth R. Lang, Tufts University)

How, in today's digital era, would one improve the effectiveness of learning? To answer this need, the learning process has begun to include interactive and adaptive learning systems. Such systems are part of active learning methods aimed at the independent mastery of students of the educational material through active cognitive activity. As part of the implementation of this competency-based approach, there is a need to modify the educational process, by making the student an actor and not only a spectator.

One of the major trends regarding the development of Human-Machine interfaces is Virtual Reality. VR technologies allow immersing the user in an environment simulating arbitrary 3D dynamic models. Applying VR elements in a classroom setting brings an opportunity to consider a given physical model (such as the one of Figure 2.1) from different perspectives and feel the effect of being dynamically present inside the process under study. Thanks to VR, it becomes possible to undergo a previously unavailable experience of interaction with educational content. The introduction of such technologies in the sphere of education would allow solving several important problems at once: directing the scheme of learning to an individualised, interactive study of the material (as often and as safely as required), giving the possibility of putting abstract knowledge into real-time experience, increasing the effectiveness of

learning through immersive involvement of students in the learning process.

While still recent¹, these technologies are already widespread in various media and entertainment fields, and VR devices have become available to a wide range of consumers.

The objective of this PhD research work is to take advantage of the highly innovative technologies of VR, digital simulation and the new interaction techniques associated with them to design, develop and evaluate new methods, tools and experiments dedicated to the construction of knowledge in the field of physics. The chosen approach combines *serious games*, i.e. using playful means for an objective other than the game itself (in our case, the understanding of physics), with the possibility offered by VR to experience new physical situations in the first person (e.g. Newtonian mechanics of the solid, fluid mechanics, etc.). Thus, the goal of this research is to investigate how to leverage new human-machine interfaces in order to increase student engagement into the learning process.

We thus hypothesise that to deepen and facilitate the learning of new concepts, immersive and interactive digital simulation (in VR) offers incomparable advantages compared to traditional educational and mediation approaches. To validate this hypothesis, the doctoral project intends to take advantage of recent and spectacular advances in immersive interaction technologies, which, coupled with extremely realistic real-time physical simulation engines, allow the creation of true-to-life virtual experimental laboratories where the learner can truly get involved by manipulating real objects, in order to observe, understand or predict their behaviour.

However, such a virtual workshop cannot be reduced to an "experimental sandbox" without a pedagogical drive. In science education, as in many other applications, one must never stop at the inevitable "Waow" effect produced by the introduction of VR. A VR physics simulator must therefore be exploited via a set of carefully designed interactive scenarios focusing on highlighting the fundamental concepts governing a physics simulation and enabling their elucidation. We hypothesise that leveraging serious game logic into VR simulations will achieve that goal.

Thus, this thesis is at the intersection of these three different areas, which we call a methodological triptych (see Figure 2.2): VR, Serious Games, Didactics of physics. VR and Serious Games are tools and frameworks we combine to apply to the didactics of physics. This work is code-named JeSeiPa²

To the best of our knowledge, this doctoral work is the first one to formally investigate the association

¹Except from the complete failure of the Virtual Boy by Nintendo in 1995, the first truly "democratic" VR headset geared towards consumer use was the Oculus Rift, released in 2013.

²JeSeiPa is an acronym for the French name of this project "Jeu Sérieux immersif Pour l'apprentissage de la physique". In English, JeSeiPa translates to: "I don't know". Obviously, this is a play on words, as the purpose of this study is to minimise the "I don't know" and increase the "Oh, now I know".

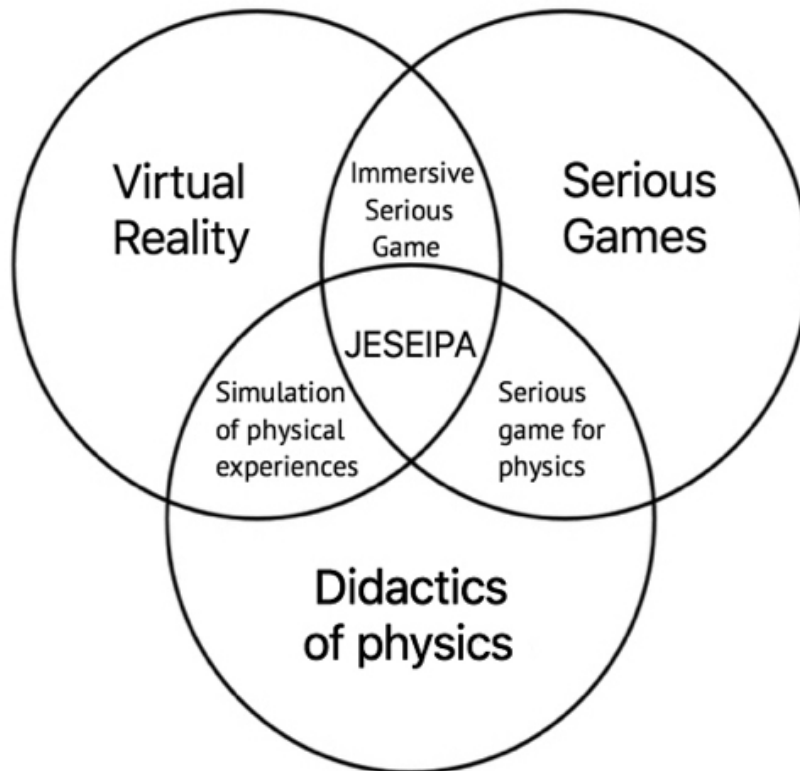

Figure 2.2: Methodological triptych of the JeSeiPa research framework.

of these three fields. Let us now introduce them in more details, with the objective of identifying how previous studies have considered their association.

2.2 Virtual reality

Virtual Reality (VR), a discipline resulting from advanced human-machine interactions, offers a coherent approach to studying interactions with digital simulations, through which the operator is immersed in a holistic experience that demands all of his sensory-motor abilities. Note that VR allows visual, audio and physical exploration, exploiting the full range of the learner's sensory feedback. For example, one can perceive the weight of an object or the viscosity of a fluid through the force feedback of a haptic device [63] (See Figure 2.3).

VR technology allows immersing the user in an environment that simulates virtually all aspects of reality [93]. Thanks to this, it is possible to generate a previously unavailable experience by interacting directly with simulated content that reproduces existing physical phenomena of all sorts. In the world of



Figure 2.3: The Geomatic Touch haptic arm [126].

VR, the learner is part of the system, autonomously being in the virtual world. Thanks to VR technology, information integration takes place to a greater extent than in traditional forms of learning, because it is possible to freely navigate through the virtual environment in three dimensions, interact with objects, monitor them, make predictions and explore the world from different perspectives.

VR - and Augmented Reality (AR) - technology has a short but complex history (see Figure 2.4). There have been successes (Data Glove and EyePhone, 1987 - see Figure 2.5) and not so successful projects ("Virtual Boy" by Nintendo, 1995 - see Figure 2.6). Beyond its recent and still spectacular technological developments (which have largely contributed to its democratisation), VR now offers a reliable methodological framework for developing realistic interactions (in the sense of ecologically valid), depending on the target application. Thus, classical cognitive ergonomics tools (task analysis, questionnaires, experiments and psycho-cognitive evaluations) are completing those specifically developed for interaction design (prototyping, participatory design), to create interaction techniques adapted to a precise context.

Focusing on our research topic, VR provides a new innovative approach to learning by increasing the cognitive activity of students, providing an alternative educational process [67]. It includes several characteristics representing significant educational potential: immersion, presence, direct participation

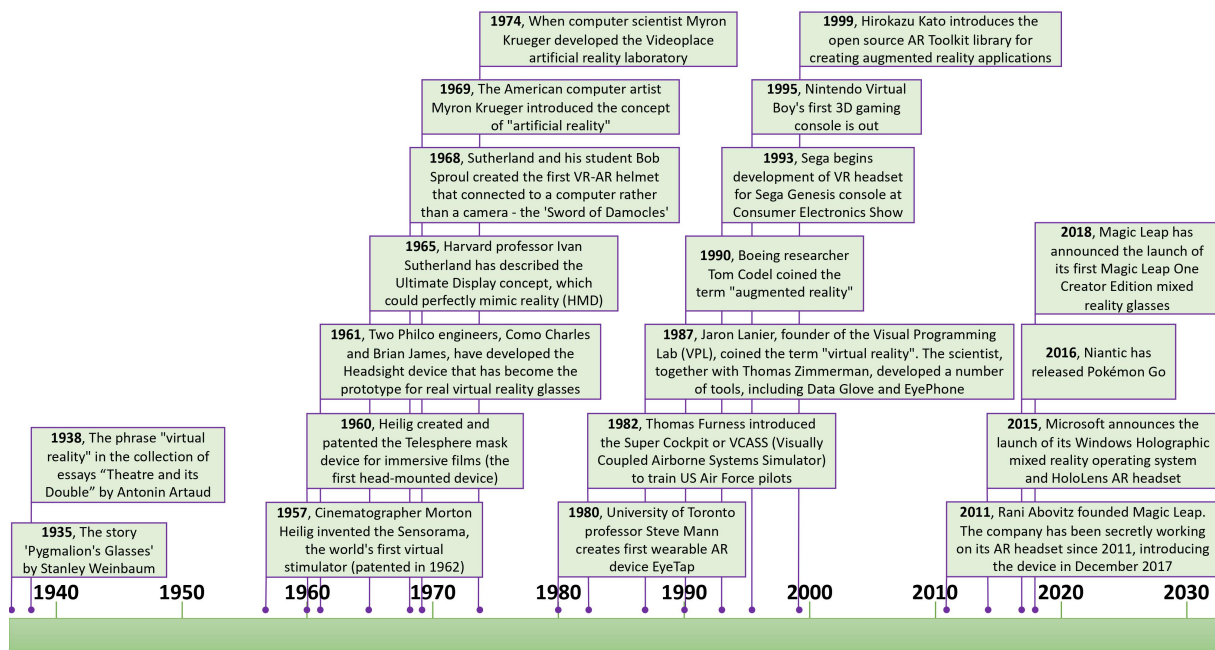

Figure 2.4: History of VR/AR technology.

(learner involvement), instant visualisation on demand, autonomy, interactivity and novelty. The major advantages of the immersive approach are multiple:

- Visibility - Virtual space allows a detailed view of objects and processes that are impossible or very difficult to observe in the real world (e.g. the anatomical features of the human body, the operation of various mechanisms, etc.). Flying into space, diving hundreds of metres underwater, travelling through the human body - VR opens up enormous possibilities [63].
- Focus - In a virtual world (especially when using personal devices) there are few external stimuli. You can concentrate fully on the material and assimilate it better [84].
- Involvement - The scenario of the learning process can be accurately programmed and controlled to help students focus on key aspects: with virtual reality, students can conduct sequenced chemical experiments, view prominent historical events and solve complex problems in a more entertaining and comprehensible play.
- Motivation - Learners are drawn in by interactions with well designed immersive environments, inducing them to spend more time and concentration on a task [31].



Figure 2.5: Data Glove and EyePhone, 1987 [149].

- Safety - In VR, you can perform complex operations, hone your driving skills, experiment and more without any risks. No matter how complex the scenario, the student will not harm themselves or others³ [84].
- Effectiveness - Based on the experiments that have already been conducted, it can be stated that the effectiveness of training with VR is at least 10% higher than with classic means [84].
- Telepresence - simultaneous presence in a virtual environment by geographically separated learners, who can exchange or collaborate [31] [84]. Teachers may also be situated remotely and join the VR session.
- High-bandwidth communication - Via high-end VR interfaces, students can interpret visual, auditory and haptic displays to gather information while using their native sensory-motor system to navigate and control objects in the synthetic environment. Such multi-sensory stimulation may prove valuable in prompting learning and recall [31].
- Multiple representations and 3D frames of reference - Spatial metaphors can enhance the meaningfulness of data and provide qualitative insights [31].

³Of course, with students anything is possible and some things will get broken, beginning with the VR devices themselves.



Figure 2.6: "Virtual Boy" by Nintendo, 1995 [149].

Furthermore, it is worth mentioning that virtual reality facilitates gamification of the learning process. Very often, information acquisition can be presented in the form of a game (see Section 2.3, below). Additionally, you can consolidate the material, conduct practical exercises and much more, using games. In this way, "dry" theory becomes alive, understandable and much more interesting, which further engages students and increases the effectiveness of education. These characteristics and the fact that VR supports three-dimensional modelling make it almost ideal a tool for specific purposes in the educational process. These goals include the development of cognitive interest in the study of a topic, the development of practical skills to work with experimental setups, a fundamental understanding of the underlying processes and phenomena in the outside world.

However, VR has its disadvantages. This includes the issue of price: despite the rapid spread and cheapening of VR equipment, buying it for personal use is still not the cheapest option. But purchasing such devices for an educational institution is now within economical reach. A wide variety of VR devices can be purchased at a variety of prices, ranging from the most affordable smartphone goggles to middle-priced Oculus Rift S or Oculus Quest to such innovative and expensive devices as Magic Leap One. Of course, the functionalities and immersion offered by the devices are different, as is the intended use, which has a direct impact on their price.

Apart from the price, there are some other essential factors:

- The cost of software development for VR - This process requires a lot of time, effort and investment. In addition, not all 3D materials can be readily transferred to VR correctly and efficiently. However,

the speedup of development of software for VR will solve this problem in the near future. For example, in Unity, in order to depict the collision of 2 physical objects, you need to add these 2 objects to the scene, add the desired physics material property to them and you are ready - this is done in a matter of minutes, a vast improvement over older APIs.

- Cybersickness - Not all people can adapt to VR in the same way. Some people experience dizziness, nausea and disorientation after just a couple of minutes. These are also individual characteristics of the body that cannot be avoided [112] [92]. However, the problem has been improved in most modern devices and may soon be eradicated completely. Companies selling VR products are aware that cybersickness can be a serious problem and they try to minimise such effects by investigating the possible cause of it and how it can be prevented. There are solutions such as including environmental manipulation, changing navigation techniques, using anti-sickness medication, providing minimal vestibular cues to minimise cue conflict or even stimulating the vestibular system directly [76].
- The need to significantly change the teaching curriculum at a national level. For now, VR is being introduced at an experimental level. In order to make technology a full part of the educational process, it is necessary to work on the curricula in schools and universities. Nevertheless, due to bureaucratic complications and user's resistance to change, this could take years.

As an illustration, the French education system has experienced countless reforms in the last decades. In particular, many ambitious plans to develop digital technology in schools and to integrate information and communication technologies in education have been proposed, not to mention the significant investments made by the regions, departments and municipalities to equip schools and promote the use of digital education.

The results are quite slow and uneven. While the issues of equipment, connection, and production of digital educational resources have generally been resolved, there is still a significant backlog in terms of teacher training and actual classroom practices and uses. Probably reformers have probably tried too hard to "add" ICT to existing teaching systems, while it is necessary to think these issues taking into account didactic and teaching frameworks [97].

- Also of great importance is the lack of media competence of users (teachers, students).
Media competence is a set of skills (motivational, contact, informational, perceptual, interpretive,

practical-operational, creative) to select, use, critically analyse, evaluate, transmit and create media data in various types and forms, and to analyse complex processes of media functioning in society [76]. In the context of the mediatisation of education, the development of teachers' professional competence is organically linked to ensuring that they are fully prepared to use the media in the learning process.

It should be emphasised that the media competence of an individual and the media competence of a teacher are fundamentally different in their specific characteristics. A teacher's professional activity is defined as pedagogical and has specific characteristics due to this activity. Students are often more media competent than teachers [7].

At this point, it is my belief that the other disadvantages such as cumbersomeness, display resolution, delays, performance and unreliability mentioned by C.Dede in 1994 [31] are no longer relevant and are a thing of the past. Now is the time for the general public to use VR technology not only for fun but also for educational purposes.

Through immersive simulation, students can learn new material in a previously inaccessible way. This technology (VR, possibly associated with serious games) has already become widespread in various training fields such as nursing education [144], evacuation training [39], learning foreign languages [1] [74], professional training courses[8], etc. Current research concludes that most users prefer to use non-traditional teaching methods, and results show the effectiveness of such approaches [93]. In the context of science education, VR technologies make it possible to envisage a radical evolution in learning methods by placing the learner at the heart of an innovative practise, which merges theoretical and practical learning into a unified (possibly collaborative) practice. With VR devices in the classroom, it becomes possible to consider 3D physics from different perspectives and feel the effect of being present in the process under study through direct interaction. The student immersed in the virtual world can move objects in space and interact with objects significantly. Ideally, the virtual world should then consist of a virtual space with all possible tools for a given set of experiments, sot that the learner has the opportunity to combine these tools and learn from the experiments [63]. Western educational institutions are starting to envisage the introduction of digital technologies that allow teaching in virtual environments [40] [24] [23].

However, despite the success of such a company, they have one major drawback - they focus on the general task of teaching something, there is no educational underpinning in them; thus, they simply

move the material into a virtual space. This study suggests the use of didactic research as the basis for such immersive learning games.

The introduction of VR technology support in online learning systems and the development of specialised content will naturally increase students' engagement in learning the material. But, as importantly, this new way of interacting with the learning material makes it possible to implement new teaching scenarios (e.g. to consolidate knowledge through hands-on activities). The advantages of VR technology (as listed above) are all arguments favouring the creation and implementation of didactic applications in the study of physics (For more on this, see Section 2.4), corresponding to the modern development of IT technology in general. In this regard, one of the tasks of a modern physics teacher is to bring together Virtual Reality and a modern educational approach in the right balance, complementing or replacing the classical educational approach. For instance, simulated reality cannot always replace real physical experiments in all situations. The right way will be a balance between new IT technologies and older, more seasoned techniques that teachers practise everyday.

It is one of the objectives of my PhD to provide meaningful hints on best practises towards the inclusion of VR into teaching practises.

2.3 Serious games

Helping students to easily and quickly develop their skills are among the most challenging learning objectives. Traditional teaching (lectures with passive students and exams with algorithmic problems) often fails to deliver a correct conceptual understanding of physics to the average student (see Chapter 5 for numbers). Interactive engagement methods - methods designed, at least in part, to promote conceptual understanding through the interactive engagement of students in activities that provide immediate feedback through discussion with peers and/or instructors - however, have been much more successful [49].

"Serious games" are learning games that have been developed for use in education in general. Far from being just games (i.e. designed for pure entertainment), they have their own clear structure, objectives and their results have practical applications in life, all distinctive characteristics. The serious games approach, as its name suggests, aims to combine play techniques with so-called "serious" objectives, such as teaching, learning, data mining or communication. Such games use pedagogy to influence the learning experience [70] [127], as opposed to a regular game's goal which is limited to its entertainment

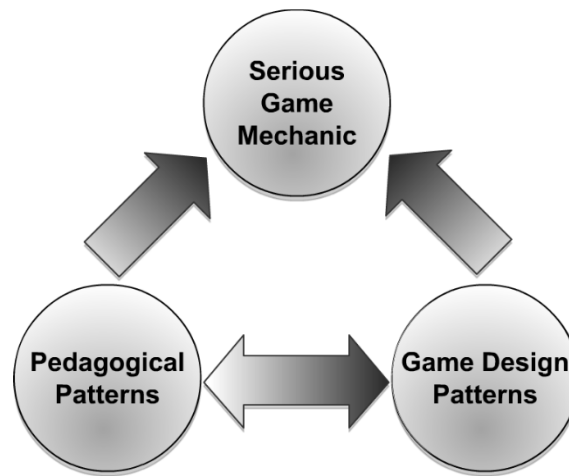

Figure 2.7: The relationship between Serious Games Mechanics (SGMs) and the pedagogical and game design patterns of a game [6].

value.

Simon Egenfeldt-Nielsen and his colleagues [38] distinguish three categories of educational computer games:

1. Games that combine entertainment and educational purposes;
2. Commercial games that can be used in the field of education;
3. Scientifically-based games that can be used in education.

We will focus on the scientifically-based games, because our goal is to study how teaching physics can be enhanced by VR techniques (no existing commercial game uses VR for education). In this category, the games establish a complex relationship between pedagogy, learning, entertainment and fun, joining educational and gaming scenarios [6] (See Figure 2.7). Mike Zida argues that serious games are born out of a combination of pedagogy and the three basic elements of computer games - story, image and software. According to him, the pedagogy should be subordinated to the story [153].

Games have a lot of advantages: they are an active way of learning, as the learning process is not just passive listening or reading. Games can be tailored to the individual needs of the user and open up opportunities for independent discovery. Games help to remember the learning material well and for a long time (linking particular game events to scientific experience). Games used in informal learning generate an increase in motivation and engagement. They are an important part of the learning process, but they should be used in conjunction with other pedagogical methods, and not replace them.

Serious games are very similar to regular games during the design phase, but project designers need to work together with people familiar with pedagogy and subject-matter experts to insert activities that educate or instruct inside the game [153], early on. Like any game, serious games attempt to leverage the instincts of cooperation, interaction, and imagination, in conjunction with instructional materials, with the hope to enhance learning by utilising the strengths of gaming [123]. Thus, when choosing serious games as a learning method, it is important to develop the right strategy and methodology for assessing the desired outcomes.

J.L. Anderson and M. Barnett assert that the combination of video games and hands-on activities will be a powerful technique to support students' scientific understanding, a claim their research on learning physics (specifically electromagnetism) with the use of computer games in secondary schools confirms [4].

This innovative approach has already shown its value in many areas. The serious games approach lends itself particularly well to a didactic and pedagogical context since it aims to stimulate and maintain the student's interest through the use of game situations. So far, key concepts of physics are generally presented by means of mathematical simulations, by which the laws governing objects (solid mechanics, fluid mechanics[147]) can be formulated, and predictions can be made about their behaviour.

Studies in such field as accounting [91], mechanical engineering [22], mathematics [69], electromagnetism [4] [47], theory of Special Relativity [16], optics [145] suggests that serious games have a real interest in enhancing the education process. But a serious game approach for didactics should combine a formal didactic analysis (identification of the hierarchy of concepts, cognitive obstacles, frequently encountered errors) with adapted game scenarios resulting from observing existing learning situations. This approach has been used recently in cases such as mechanical engineering [94] [65]. Researchers have pointed out the difficulty of evaluating such practices [29], which maybe the reason why works in this particular area remain few.

A good example of using a serious game to study Newtonian physics is the game Mekanika [11] (See Figure 2.8). The game is named a reflexive puzzle (players do not need to react to quick events, only to predict the outcome of their actions). This game is a 2D online game where the goal is to create a path for a robot to collect a series of stars, the stars indicate which path the robot must follow to get to the next level; for this the gamer needs to change the momentum, the long force area, the circular momentum and even the gravity (there are 50 levels in the game). For a formal understanding of the corresponding mechanics in a classroom, a guide is provided to the teacher in order to connect formal knowledge to

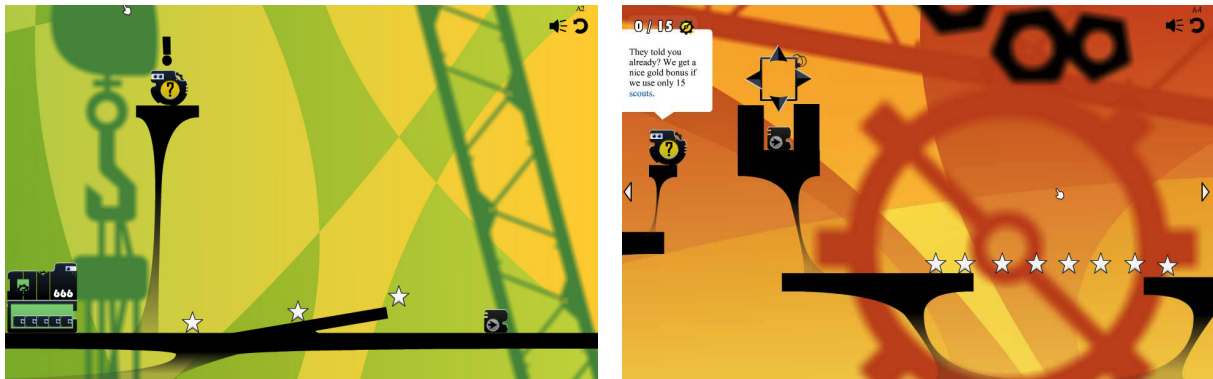

Figure 2.8: Illustrations from the online game Mekanika.

what the students intuitively learned in the course of the game. Students also have to describe why they think their own solution worked (thus describing whether their perceptions were correct or not). They noted a 7.4% increase in efficiency between the experimental and control group.

The present doctoral project aims to follow this paradigm by designing and developing several types of interactive simulations in the form of serious games in VR, exploiting both the real-time possibilities of current computers (particularly in terms of GPUs) to perform realistic simulations and the immersive multimodal interfaces that make it possible to modify the game conditions in real-time.

Thus, my approach combines serious games, i.e., using games mechanics for a purpose other than the game itself (in our case, the understanding of physics), with the possibilities offered by VR to experience new physical simulations in the first person. By combining a didactic framework (defined and detailed in Section 2.4) with a serious game-based approach, the aim is to design, implement and evaluate the use of interactive real-time simulation tools in VR, comparing them with more traditional educational approaches. The research focuses in particular on the creation and evaluation of multimodal interfaces adapted to the experimentation and learning tasks identified during the didactic analysis.

2.4 Didactics

The purpose of didactic research is to study the questions raised by teaching and the acquisition of knowledge in various scholarly disciplines. It differs from pedagogy by the central role of disciplinary content and by its epistemological dimension (how the body of knowledge was built sheds light on the educational process). Pedagogy is the science of human upbringing, training and education. Didactics is more precisely the science of learning, which investigates the laws, regularities, principles and means

of learning, reveals regularities of mastering knowledge, skills and beliefs, and determines the scope and structure of the *content of education*. Research in physics didactics, therefore, aims to study the processes of learning and teaching the different fields of physics with their specificities.

Many teachers prefer a qualitative and conceptual approach to understand Newtonian physics, starting with experiments, laboratories and demonstrations for students than with mathematical formulas [32]. Conventionally, all works can be divided into active interaction between the student and the experimental environment (being real or virtual) and passive simulation, where the student can only observe certain phenomena. Unsurprisingly student involvement in interactive learning shows better results than simple observation.

Heir to Gaston Bachelard's pioneering ideas [75], the result of Jean Piaget's work [104] is based on the identification of regularities, which can concern students' recurrent forms of reasoning, the choices of exposure of given knowledge, the consequences of these choices on the understanding of physical phenomena, etc. Knowledge of these regularities allows the development and analysis of teaching and/or training tools, tools for which VR technologies subsequently offer their advantages.

With regards to physics, more than half of the students have problems with a conceptual understanding of Newtonian physics concepts (even those who have already completed four years of relevant courses) [120]. Undergraduate students study physics in more detail at the university level, but even then, their conceptual understanding is still not effectively developed. Paradoxically, there is a lack of attention to basic concepts at university, the assumption being that the student already has the basic knowledge to get in. However, as any university physics teacher will tell you, this is not the case (our research corroborates this fact, see Chapter 5). So the students have to study more advanced material starting from shaky (even erroneous) foundations, and from that comes more misunderstandings and misconceptions [120].

Even worse, Low and Wilson [85] have shown that most students exhibit many *misconceptions* about basic concepts, particularly common is the definition of weight (see Chapter 5) and in the understanding of Newton's 3rd law (see Chapter 6). They also point out that it is too late to correct ingrained misconceptions at university; corrective actions should be taken earlier (e.g. at school level), and that hands-on activities help students consolidate their understanding of physical principles [85]. These observations confirm the validity of our approach.

As a recent example of using 'classical' didactics to understand density using classical material, Hashweh's study [53] is one example we can follow when using VR and serious games for education.

As said before, the formation of a person's worldview begins with his or her awareness of self and his or her place in the world around him or her. The natural sciences component of the general secondary education curricula plays an essential role in shaping students' future scientific outlook. Science at school should reveal to students the relationships between the physical, chemical and biological forms of matter, the commonality of the fundamental natural science concepts, laws and theories, the commonality of research methods, and to form a unified picture of the physical world.

As part of an integrated approach, there is a need to modify the educational process. The rapid computerisation of society and the availability of information and communication technologies for mass use have given impetus to the increased application of Virtual Reality, in particular in the critical field of education.

Virtual reality paired with the didactic approach provides a new and innovative teaching method, promising to increase students' cognitive engagement by providing an alternative educational process. VR encompasses several characteristics representing significant educational potential: immersion, presence, direct participation, learner involvement, instant visualisation on demand, autonomy, interactivity and novelty. These characteristics and the fact that VR supports direct, as-in-the-world three-dimensional manipulation make it almost ideal for different purposes in the educational process. Such goals include:

- the development of intellectual interest in learning physics;
- the development of practical skills in working with experimental setups [131], and
- a fundamental understanding of the processes and phenomena of the world around us.

Considering teaching physics, existing works have investigated electromagnetic [142], optics [42] (AR), fibre optics engineering [54], and nuclear physics [83]. In all cases, results were encouraging, but so far have not been widely adopted in existing curriculum.

Regardless of the field of application, introducing VR into the educational process has a number of limitations. Certainly, recent technological innovations have made it possible for virtually every learner in the western world to access VR. Major companies such as Apple, Samsung, Facebook and Microsoft are steadily increasing investments to improve and make these technologies available over the coming years. But the main hurdle to their use in the education field is that it involves considerable work to create relevant pedagogical content. Because of the associated costs, it is all the more necessary to

pay extra attention to the content that is truly needed to better the education process, as well as how to put it to the best usage. This is one of the goals of this doctoral study.

In conclusion, within the context of didactics, past research has shown that the use of VR technologies makes it possible to envisage a radical evolution in learning methods by placing the learner at the heart of an innovative device, merging theoretical and practical learning into a unified (possibly collaborative) practice. In current education in physics, illustrations are mostly presented in a 2D form because of medium limitations (computer screen). With VR devices in the classroom, it becomes possible to consider 3D physics from different perspectives and feel the effect of being present in the process under study through direct interaction. The learner can move freely inside the 3D virtual environment, interact with objects, follow them, make predictions about their behaviour, and explore the world at different scales. VR educational models, particularly regarding physics, can also show what is usually hidden from view (for example, wave optics or particle interactions).

The enormous potential of virtual technologies allows the boundaries of formal education to be crossed and paves the way for the new generation of education.

2.5 Creating the triptych: related works

Following the bibliographic studies I conducted in VR, serious games, and didactics, let me now focus on the few works that tried to connect them formally, and thus following an approach similar to the one I intend to pursue: NewtonWorld and EVEILS.

While NewtonWorld is on the border between the Immersive Serious Games section and the JeSeiPa research intersection (see Figure 2.2), this work is the closest to our concepts: to use VR to teach fundamental physics. The crucial difference is the didactics experts were not directly involved in this study.

The EVEILS project fulfils all the requirements we need: the use of a serious game in a virtual environment and the direct involvement of a didactics expert in the design/research process.

Let us now review these two works in more details.

2.5.1 ScienceSpace & NewtonWorld

In 1996, Marilyn C.Salzman et al. introduced a collection of immersive virtual environments called ScienceSpace for the study of physics [121], namely: NewtonWorld for studying the laws of motion in differ-

ent reference frames, MaxwellWorld where users could construct electric fields and manipulate multiple representation of forces and energy, and PaulingWorld where one could study molecular structures and chemical compounds.

ScienceSpace worlds managed 3D representation, multiple perspectives and frames of reference, multimodal interaction, and simultaneous visual, audio and haptic feedback. It was the first study of its kind. The authors explored how such virtual realities can nurture students' accuracy and qualitative understanding of a complex scientific phenomenon that is so remote from everyday experience.

Difficulties were noted:

1. Each student tended to have his own individual style of interaction in a virtual environment, and individual susceptibility to cybersickness;
2. The use of such technology was not appreciated by the administration because the students were as if "isolated" from the real world, and could not read instructions from the blackboard for example;
3. The head motion displays of the time were very cumbersome, uncomfortable and had limited resolution;
4. During a real lesson the teacher could monitor several students, whereas in the simulation only one subject could be represented in a virtual classroom.

Transposing to present, the current state of progress in head-mounted display technology is such that many of the problems reported (concerning hardware) no longer exist, and the modern advances of game engines permit the design and implementation of complex simulations in a fairly short period of time. Among interesting results, they noted that multimodal interactions (voice, virtual and physical controls) seemed to foster learning; even simple simulations (possible at the time of the research) could help students to properly understand physical phenomena. It was nevertheless important to calibrate the display and virtual controllers to each student individually, in addition to measuring cybersickness. Besides using questionnaires, they found protocols inducing talking-aloud behaviours to be very useful for the predict-observe-comparison cycle.

They are also noted that some interface enhancements could in some cases impair learning: for example, If two balls are the same size, students will subconsciously think that they have the same mass, but if you increase the size of one of the balls (for example to make it more visible, without changing its physical parameters), students will think that it is heavier - increasing ball size gives a false

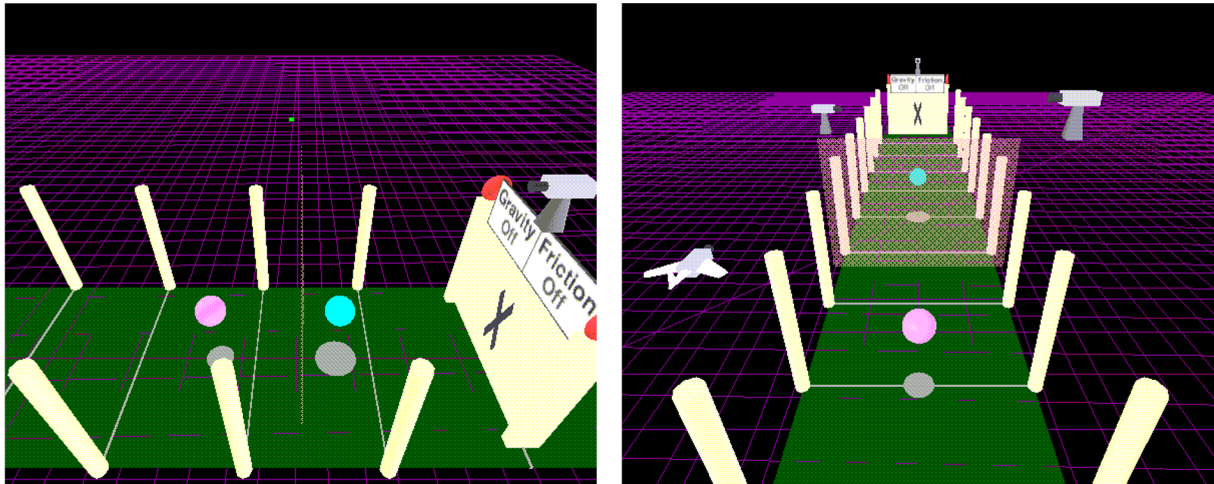

Figure 2.9: Illustrations from the NewtonWorld.

relationship between volume and mass; in such cases one needs to be as careful as possible [121]. We look at this kind of misconception in Chapter 5.

Let's take a closer look at NewtonWorld, realised by C.Dede in 1994. It was the first compelling research using immersive serious games for learning Newtonian Mechanics [31], by investigating the kinematics and dynamics of one-dimensional motion. NewtonWorld is therefore highly relevant to my research.

In NewtonWorld, a user is placed in an open "corridor", and using a "virtual hand" and a menu system, the user can launch and catch balls of various masses (See Figure 2.9). Users had the opportunity to look at this corridor from 2 different perspectives. 107 physics educators and researchers participated in this experiment, but one must note that no formal education experiments were performed in NewtonWorld.

NewtonWorld exploited the hardware available at the time, i.e. a high-power but very expensive graphics engine, a wired magnetic tracking, a custom haptic vest, and Head-Mounted Display with limited resolution (VGA). Most users mentioned challenges such as cumbersomeness, display resolution, delays, extremely limited tracking range, and cost. Indeed, at that moment, those were severe obstacles to using VR for education purposes.

Despite these hindrances, a large majority of participants felt that NewtonWorld could be an effective tool for demonstrating Newtonian physics and dynamics. Even though the device was cumbersome and with all the limitations, the educators were enthusiastic about the three-dimensional nature of this learning environment. They appreciated the ability to observe phenomena from various viewpoints.

In the 2010s, the hardware and software limitations started to alleviate, so the time came to tackle more fundamental problems, such as overcoming misconceptions regarding physics and helping proper learning.

2.5.2 At the root of the project: the EVEILS collaboration

The advent of a new generation of immersive multimodal systems, such as the "Environnement Virtuel Évolutif (Scalable Virtual Environment) (EVE)" [13] system designed by the VENISE team, enabled my advisers and their students, as part of the CoRSAIRe (Combination of sensorimotor renderings for immersive analysis of results) project, to study the contribution of multi-sensoriality (visual+audio+haptic) to scientific exploration processes in two disciplines: fluid mechanics [147], and bioinformatics [43]. At that time, the work focused on the rendering and interaction challenges in scientific visualisation, and thus was limited to experts in the studied fields, neglecting the educational value of such simulations.

A few years after, the "EVEILS" project [33] started as an interdisciplinary research project developing an innovative Virtual Reality application. Coordinated by Étienne Parizot, from the APC (Astroparticle and Cosmology) laboratory, it also involved a specialist in didactics of physics, namely Cecile De Hosson from the André Revuz Didactic Laboratory (LDAR), and the Virtual & augmented ENvIronments for Simulation & Experiments (VENISE) team at Laboratoire Interdisciplinaire des Sciences du Numérique (Interdisciplinary Laboratory of Digital Sciences) (LISN). EVEILS sought to explore advanced multimodal interaction techniques for two specific fields of physics, for which there is no direct access to experimentation: relativity and gravitational attraction. Accompanying the development of specific techniques allowing simulation and interaction with these phenomena[33], a lexical analysis in immersion users' situations validated the assimilation of key concepts in these fields [30] [90]. Let us now detail one of the two topics of EVEILS: special relativity.

Virtual Relativity: understanding relativity with new technologies

At the speed of light: Einstein dreamt it, Virtual Reality did it!

Physical sciences often resort to "thought experiments" to explore the implications of a theory or the limits of a paradigm. These fictitious experiments are particularly necessary when the phenomena examined are by nature inaccessible to direct experimentation. This is the case for 'relativistic' phenomena, which can only be correctly described within the framework of Einstein's theory of Relativity, and

only manifest themselves at speeds close to the speed of light, i.e. around roughly 300,000 km/s.

The use of Virtual Reality techniques makes it possible to simulate a world whose physical laws can, by and large, be chosen by the designer. With the spectacular development of digital technologies and the advent of Virtual Reality, it becomes possible to perform some of these thought experiments thanks to simulations that give access to a physical reality that is certainly virtual but associated with authentic sensitive visual, haptic and/or sound perceptions. The EVEILS project aimed precisely to facilitate the learning of Relativity by circumventing the main obstacle to a correct understanding of relativistic phenomena: the fact that they only appear in situations inaccessible to ordinary experience, with speeds close to the speed of light. The initial work carried out within the framework of the EVEILS project thus took advantage of VR to show, in concrete terms, the most counter-intuitive and revolutionary properties of space-time and to offer a tool to help understand them, 100 years after their discovery.

A powerful physical algorithm for real-time relativistic immersion

In previous years, various efforts tackled the challenge of generating synthetic images showing what an observer moving at close to the speed of light would see, in accordance with the theory of Relativity.

However, the objective of EVEILS was more ambitious: not only to 'show', but to 'experience' the relativistic world. This required immersing the observer in a 3D world, using VR tools, and allowing him to explore the four-dimensional nature of space-time at will. This means that the viewer should be able to move at a 'relativistic' speed but also interact with the world and observe objects that are themselves in relativistic motion. Furthermore, such an immersive experience is by definition conducted in real-time, without the help of any possible pre-calculations.

To accomplish this feat, the multidisciplinary team developed an original algorithm based on the physico-geometric properties of light rays in Relativity, coupled with an innovative visual rendering chain implementing a four-dimensional computation of the simulated physical reality⁴.

Main results of the EVEILS project

The EVEILS project's flagship achievement was the complete development of an interactive relativistic billiard game, allowing the user to immerse himself in 3D in a room to play pool at relativistic speed.

⁴Classic Newtonian renderers implicitly decouple time and space, by computing a complete 3D simulation as a function of time. EVEILS designed a 4D renderer, dynamically computing space-time events as they were needed by the visual VR output of the simulator.

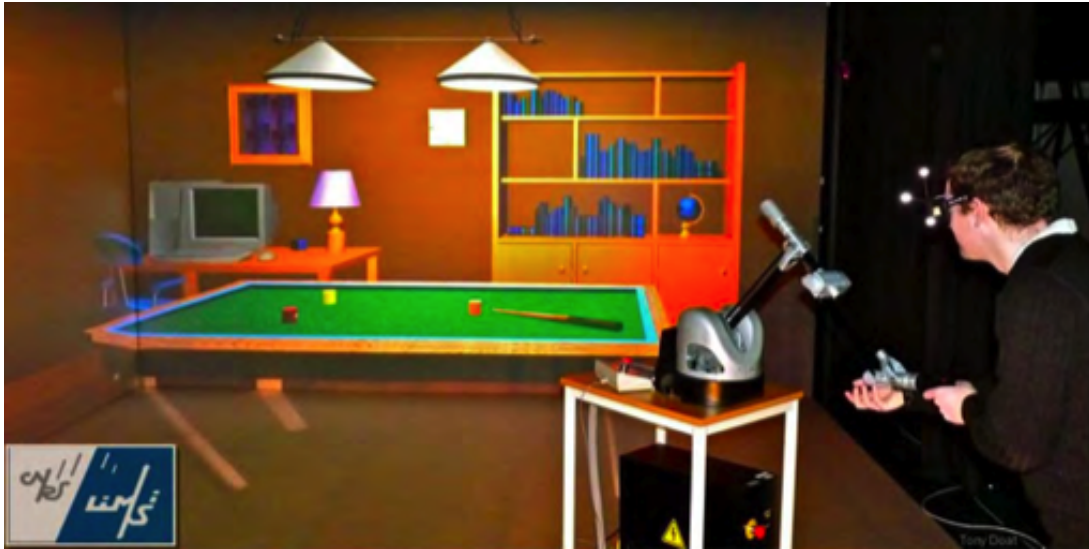

Figure 2.10: EVEILS project - a relativistic billiard game.

Figure 2.10 from [34] illustrates the corresponding simulation, implemented in the immersive Virtual Reality system "EVE" of the LISN laboratory, with two side screens and a ground screen. The operator pilots the billiard cue via a haptic arm (with force feedback), taking into account the relativistic dynamics.

This virtual space obeys the laws of Relativity, with the speed of light being reduced to an arbitrary value of 2 m/s. Thus, the user can throw the balls and also move at relativistic speeds to observe the counter-intuitive effects that result.

Simultaneously, advanced research in didactics was carried out and has led to the development of scenarios for demonstrating and learning about Relativity.

2.6 Position of the thesis

From the above bibliographic introduction, it is clear that there is a lack of researches associating the three components we seek to combine. The project JeSeiPa is at the logical intersection of these three circles: VR brings immersion and interaction; serious games are already efficiently used for learning, but not in VR settings. Thus, VR and Serious games can be combined with didactics to provide a better way to teach physics, something that, nevertheless (and somewhat surprisingly) has never been truly achieved so far.

As I mentioned previously, physics teachers typically stick to using textbooks, blackboards or computers screens. The lack of physical experiments and of interactions frequently leads to comprehension

problems. In the context of didactic research, the use of VR technologies makes it possible to envisage a radical evolution in learning methods by placing the learner at the heart of an innovative device, which merges theoretical and practical learning into a unified practice.

If the idea of using VR for educational purposes is not new in itself (ScienceSpace is 25 years old!), the main weakness of all works mentioned is the lack of a rigorous approach regarding didactics and science education. The JeSeiPa project is innovative in at least two essential aspects: its formal didactic approach and its evaluation dimensions. Both require the development of a tool with unprecedented functionalities, without which such an educational research project could not be implemented.

To summarise, our central research question is:

“Can serious games in Virtual reality be really useful for learning physics?”

while our secondary issues are:

“How can one improve the efficiency of physics teaching ?”

and:

“How can one design and evaluate immersive games in VR ?”

Teaching physics covers a very large area of possible questioning. We study such subsidiary questions as “what is teaching physics ?” and “What does it mean to understand ?”; “how we can evaluate the quality of teaching ?”; “How to design an effective learning system ?”, and others.

On a practical level, my goal is to create immersive learning systems representing virtual physics laboratories where the learner can manipulate actual 3D objects to observe and predict their behaviour. The expected benefits concern both the fundamental aspects of didactic processes, and more directly, the creation of immersive systems dedicated to learning physics concepts.

The discovery and evaluation of new paradigms and interaction techniques dedicated to virtual experimentation for learning physics should be applicable to other scientific fields: physics research, complex/massive data mining, and more generally, any other application in which Newtonian physics is strongly present: professional training/learning, assistance in the maintenance of industrial systems, video games, etc.

As part of the development of this project, the system is intended to be a usable support tool for students' reinforcement of learning material in the discipline of physics (classic Newtonian physics).

2.7 Conclusion

I described in this chapter:

- The rationale for using Virtual Reality for learning - VR is a good tool for gaining new knowledge by fostering a very large number of features that are valued in teaching.
- The benefit of using Serious Games - Interactive learning has always been more effective than dry theory.
- Advantages of didactics paired with VR and Serious Games - didactics can steer learning in the right direction and tell you what to do and what is best avoided.
- Previous state-of-the-art on the subject - this section shows that only a few works covered the three areas of interest, and none achieved a formal structured approach combining them.
- Consequently, the position of this thesis: to propose a new teaching method for teaching physics which includes the use of VR, serious games within a controlled didactic framework. The benefits gained from this research can be applied to other disciplines.

The next chapter introduces the hardware and software selection for the project, as well as the global methodology. I propose and detail a sandbox setup and the results I have been obtained from it, also, conducted brainstorming sessions.

Chapter 3

DESIGN REVIEW SCENARIO & SANDBOX

Abstract. *This chapter details the general experimental framework and the targeted scenarios of my doctoral research. Here I provide detailed information about the choices of hardware and software and justify these choices. Then, I provide more information about the methodology of the research and how I came to develop a Sandbox as a bootstrap for the subsequent work, along with a pre-study about parabolic movement and viewpoint selection. I finally explicit the first main conclusions of the study.*

3.1 System development: Hardware and software selection

The first main requirement for a VR hardware dedicated to education is that it be fully immersive, yet easy to set up. This excluded the use of screens or screen-based VR setups, such as the EVE system. Head-mounted displays were the obvious choice, given that recent hardware allow complete 6 Degrees of Freedom (DoF) tracking and excellent immersion. The second issue was a cost-efficient setup given the expected requirement for dissemination in schools. Consequently, affordable price and reasonable quality of immersion were paramount. We selected the Lenovo Explorer VR headset (Figure 3.1), which uses a 2880x1440 (1440x1440 per eye) display, has a Refresh Rate of 90 Hz, a field of view of 110°, and uses Fresnel lenses for optics. The resulting image resolution in the headset was tested with a few people with no prior VR experience, and was considered satisfactory and allowing sufficient immersion. This cheap (400 €) headset, equipped with an inside-out 6 DoF tracking system, is self sufficient and requires no external cameras or equipment, apart from a VR-compatible laptop. It comes with 2 controllers, which feature a direction pad, analog stick, Windows key, menu button, rear trigger, and a bumper style button on the inside of each (See First Appendix). The controllers communicate via Bluetooth with the controlling Personal Computer (PC), and provide 6 DoF interaction with excellent precision at arm's length.

As a development game engine, I selected Unity 3D [141]. All the necessary 3D gaming content, VR interaction and gaming organisation was implemented in Unity, with no need of external libraries or additional external programs. Unity is the most popular and widely-used game development environment. It's a cross-platform software, free for academics, with a large number of already existing assets [140] and Long Term Support (LTS)¹. The game engine provides a variety of functionalities that enables

¹Actual game contents, i.e. 3D objects, lights, etc. are not created in Unity but imported as assets in the game engine. A lot of free or cheap assets exist and can be found in a dedicated asset store.



Figure 3.1: Lenovo headset with controllers.

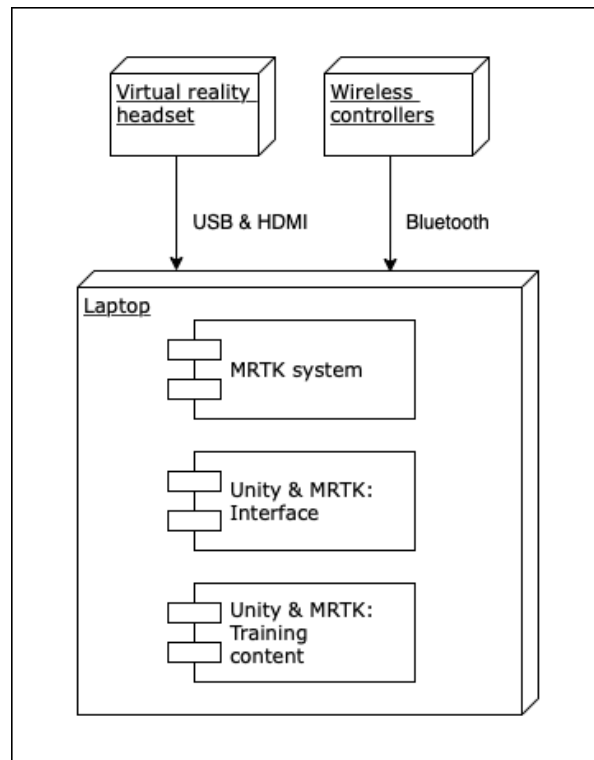

Figure 3.2: System flowchart.

the creation of a large variety of 2D or 3D games, including simulation of physical environments, normal maps, dynamic shadows, and more. Unlike many previously existing game engines, Unity has two main advantages: a visual development environment and cross-platform support. The ability to work with VR devices and great built-in functionalities were decisive factors for us as well. A vast number of tutorials exist on the Internet, making learning game development fast and fun.

The complete system layout is shown in Figure 3.2.

The Lenovo headset uses Microsoft's Windows Mixed Reality (WMR) software foundation for its core VR management, including tracking, display, device control, etc. The Windows Mixed Reality environment was initially designed for Microsoft's HoloLens AR device, but can also manage VR headsets equipped with similar hardware functionalities.

VR management of the Lenovo headset is accessible in Unity via the Mixed Reality Toolkit (MRTK) middleware library [95]. The MRTK framework offers Unity compatible plugins (to interface with the WMR core layer), as well as refactored code to be used with the latest version of compatible devices. MRTK is licensed by Microsoft as being compatible with any hardware using the Microsoft Mixed Reality software foundation (hence for the Lenovo Explorer).

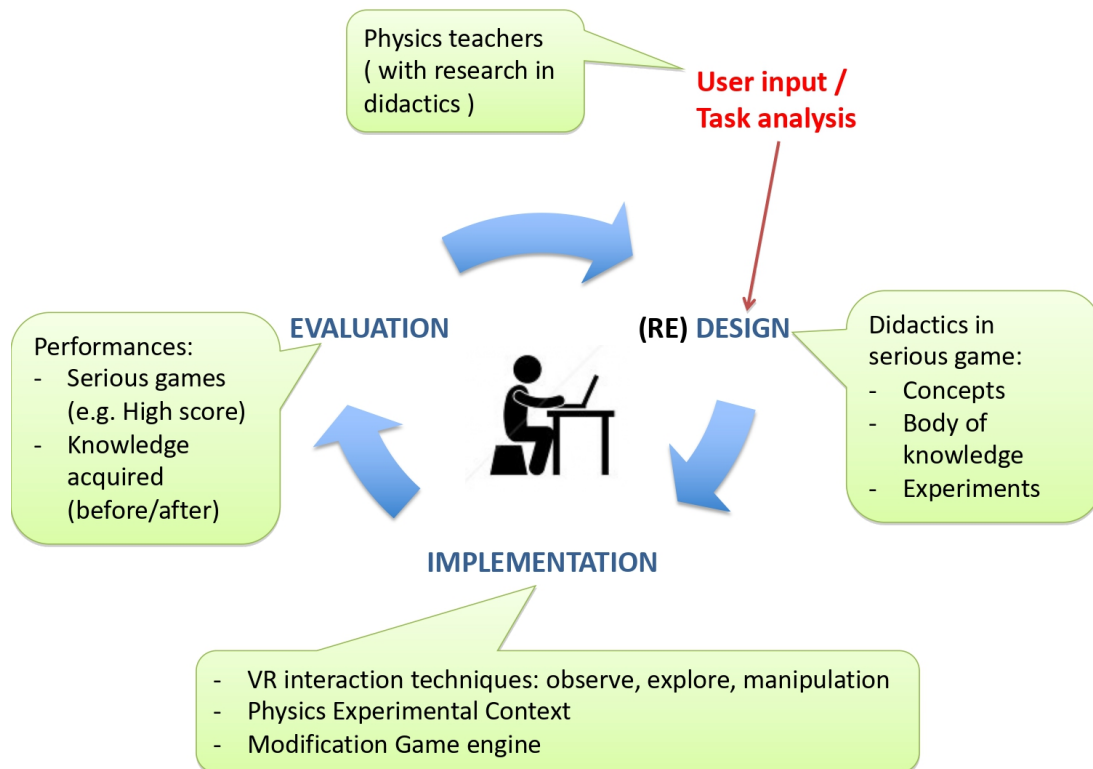

Figure 3.3: Methodology.

To create the 2D web-based games introduced in Chapter 5, we further used Unity's export facilities in WebGL. In this configuration the games is played remotely on a web client (inside an Internet navigator). A server, hosted in LISN laboratory, then collects remote data sent by the gaming client using custom scripts in PHP.

3.2 General Methodology for Game Development

The game design at the heart of our experimental methodology follows a classical cycle : Design \Rightarrow Implementation \Rightarrow Evaluation, as showed in Figure 3.3.

This cycle is very similar to Gabbard's 2014 formative usability assessment cycle [44] (see Figure 3.4). In the same way, our cycle of practice is very close to the Design-Based Research (DBR) method (see Figure 3.5). "*Design-based research is a methodological approach that aligns with research methods from the fields of engineering or applied physics, where products are designed for specific purposes*"

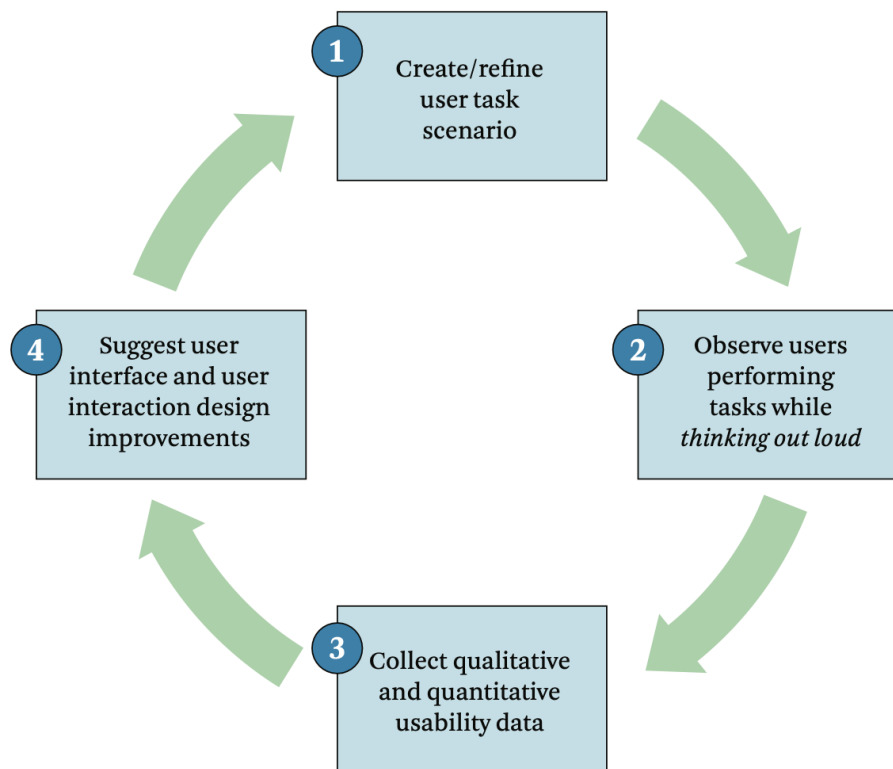

Figure 3.4: Formative usability evaluation cycle ([63] adapted from [44]).

[125]. But our cycle has been adapted to our needs, i.e. developing games for physics teachers (See Figure 3.6). Consequently this provides the effective merging of VR, Serious Games and Didactics that form ethodological triptych of the JeSeiPa research - See Figure 2.2 - Chapter 2).

To initiate the design, Physics teachers, along with researchers in didactics, provide task analysis, consisting in current practices, teaching flow, main concepts, etc. They look at questions such as “what physics topics we want to study”, “what is a didactic approach which is currently in use”, and especially identify misconceptions by the students. In our case, we work with classic Newtonian physics ($g = \text{constant}$, human scale), so that a standard Unity physics-based gaming framework is sufficient. Based on this input, we design some teaching situations, using serious games as the operative framework. For example, one can choose to study inertia, the tendency to follow a straight uniform trajectory, by making a stone-throwing game in a zero-gravity setting.

At the implementation stage, the experimental context must be connected to actual VR interactions. This generally implies the design of new, adapted interaction techniques, with respect to data observa-

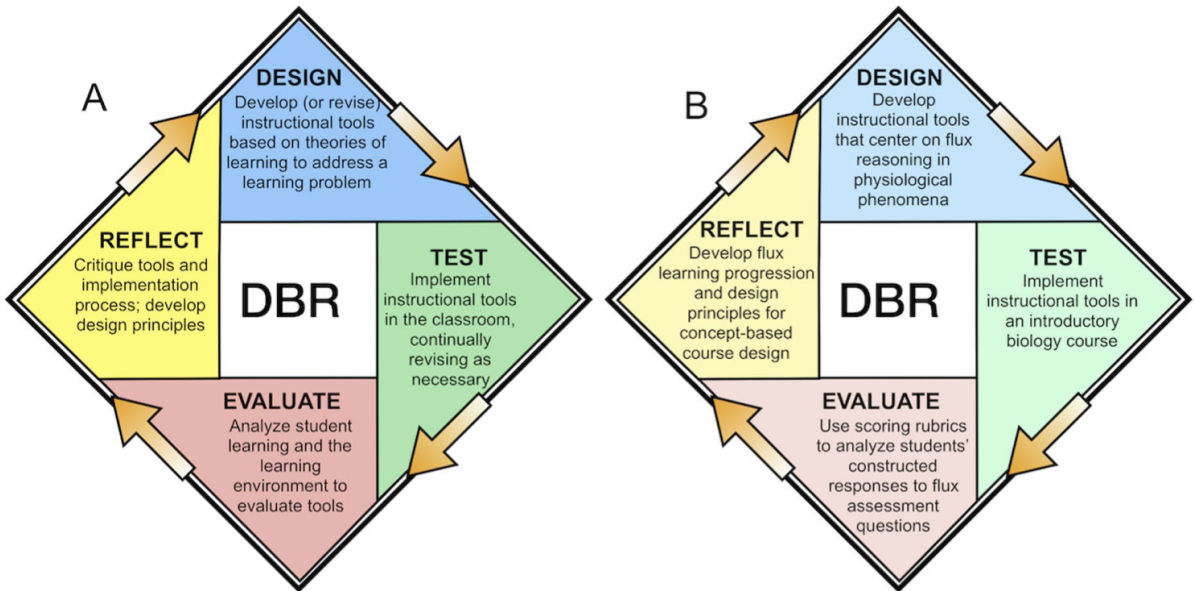

Figure 3.5: Design-Based Research [125].

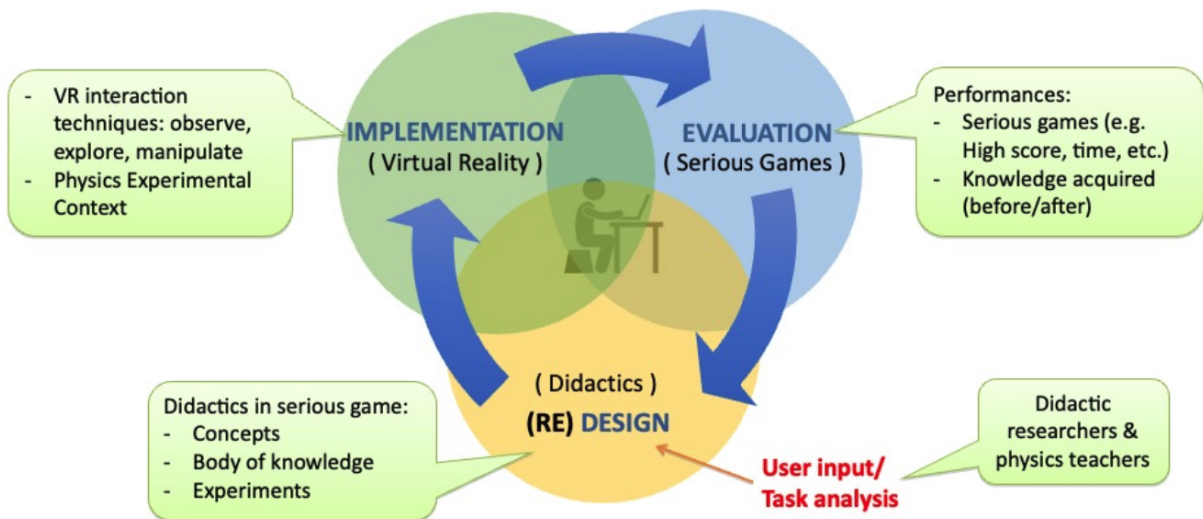

Figure 3.6: Conceptual triptych + Game Development Cycle = Methodological triptych.

tion, exploration and manipulation, inside the Unity game engine. These techniques have a big impact on the gameplay, i.e. the features of the game, such as its plot and the way it can be played smoothly and enjoyably.

The next step consists in having the game played by the target audience (in this case, students), and collect data for evaluation. Several performance indicators are possible:

- indicators collected during the game, e.g. high score, time of completion, number of errors;
- indicators collected before and after the game, e.g. questionnaires or exams measuring the knowledge acquired by students during the game.

The evaluation of the experimental scenarios is performed through activity analysis (spontaneous interaction analysis, self- and allo-confrontation interviews), in order to measure qualitatively and quantitatively the impact of this approach on the students' actual learning. In this research, I will collect both quantitative and qualitative data.

The design cycle can of course be iterated to refine the gamer's user experience and optimise the gameplay, or adapt the teaching framework according to the success of the game measured during the evaluation phase.

3.3 Sandbox

Based on our methodology, one must ideally start the design problem with a set of requirements given by the physics teacher. Nevertheless, it is a common problem that, confronted to absolute freedom, target users will not know what they want, until they see it, or at least get a glimpse of what is actually possible. Physics is such a vast field, leading to an extensive spectrum of possible experiments, so that we decided to exhibit the field of possibilities by creating a Sandbox, acting as a design bootstrap. We developed an experimental play-field containing several possible physical games to test whether interactions and the general game organisation would prove intuitive and attractive enough. This game presents itself as an Open World with a set of different tasks located on different platforms (see Figure 3.7), each dedicated to a different topic of interest. But before describing these in further detail, let us look at the game design process itself.

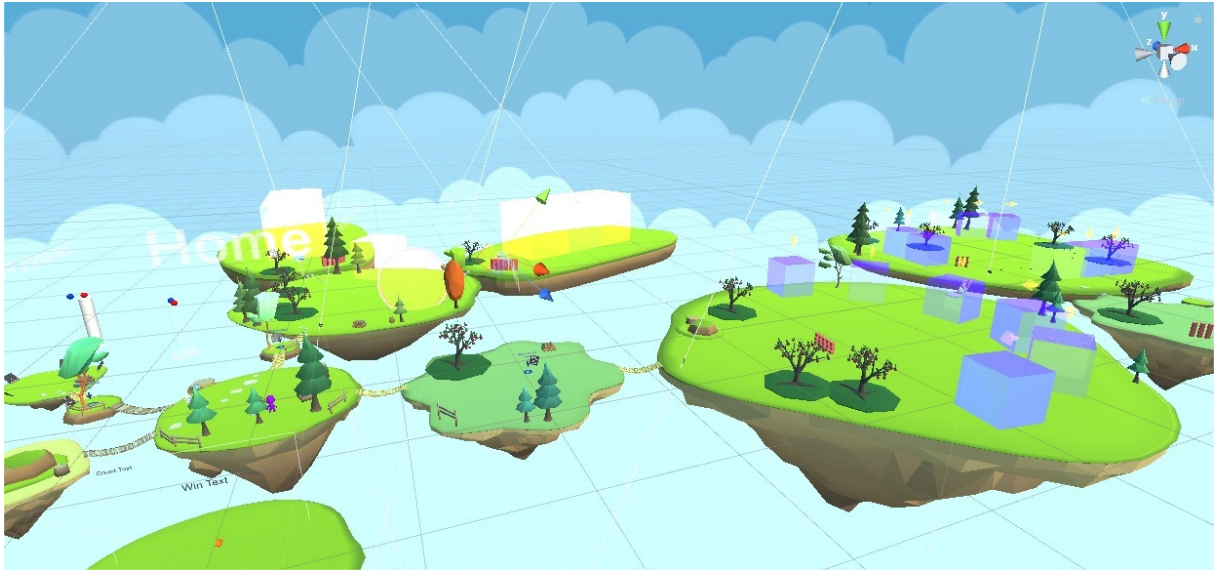

Figure 3.7: Open World.

3.3.1 Global game design

Let us now look at the process of creating games as game designers.

To begin with, let us give a definition of what a game is: In 1978, Bernard Suits stated that "A game is a voluntary attempt to overcome unnecessary obstacles" [135]. Since then, there have been many other attempts to define 'Game', but this definition still seems the best to me. Defining such concepts helps you understand what people will expect from your game. This is especially important if the game has a certain genre (in our case, a serious game) or is geared towards a certain audience. Understanding how your audience defines the term will help you create better games for them [10].

Gameology (or ludology, or game studies) is the science that studies games and game design. Over the past decades, game scientists have proposed different ways of analysing games to facilitate understanding and discussion about the structure of games and their impact on players and society as a whole. The most commonly used methods of analysis are:

1. MDA [60] - this method is best known to professional game designers. It breaks down games into 3 components: Mechanics are the base components of the game, Dynamics are the run-time behaviour of the mechanics, and finally Aesthetics are the emotional responses evoked;
2. Formal, Dramatic and Dynamic Elements [41] - this method focuses on the application of specific analytical tools to help designers create better games and promote their ideas. This method is

closely related to film history.

3. Simple Tetrad [124] - this method involves dividing a game into four main elements: mechanics, aesthetics, script and technology.

Each method has its advantages and disadvantages. We chose to base our approach on the widely used MDA framework [60]. It allows developers to decompose the overall game experience and use it to iterate through the design, research and analysis process. Thus, it is important to understand the different perspectives from which designers and players view the game and assume that designers should first approach game creation from an aesthetic perspective and then address the dynamics and finally the mechanics that generate the game's aesthetic through their dynamics.

The key elements in MDA are the definitions of Mechanics, Dynamics, and Aesthetics:

- Mechanics refers to the specific components of the game at the level of data representation and algorithms.
- Dynamics describes the (live) behaviour of elements within the game, where they are directly or indirectly triggered by the user; the outputs of elements affect the user experience and vice versa.
- Aesthetics refers to the desired emotional response of the user caused by the game or its elements (Usually aesthetics refers to philosophical notions of what is beautiful, but the meaning here is slightly different, because the emotional response can be more diverse, including surprise, nostalgia, etc.).

According to this methodology, the designer must first consider the game in terms of aesthetics - designing the players' emotions when playing the game. Having decided on the aesthetics, he can return to the dynamics that support these emotions and then go on to the mechanics that create these dynamics. Players, in turn, look at the game from the opposite end of this chain: first, they experiment with the mechanics (usually by reading the rules of the game), then they face the dynamics, trying to play the game, and finally, they experience the aesthetics the designer envisioned (see Figure 3.8).

The concept synthesises a useful vocabulary to be used in the game design process, particularly in relation to game aesthetics. The aesthetics vocabulary consists of 8 words: Sensation (game as sense-pleasure), Fantasy (game as make-believe), Narrative (game as drama), Challenge (game as obstacle course), Fellowship (game as a social framework), Discovery (game as uncharted territory), Expression (game as self-discovery) and Submission (game as a pastime). Using these words, it is possible to

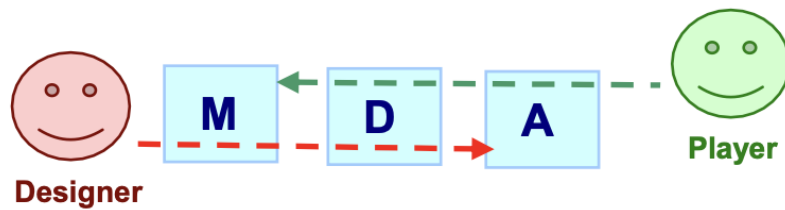

Figure 3.8: According to the MDA methodology, designers and players look at the game from different directions [60].

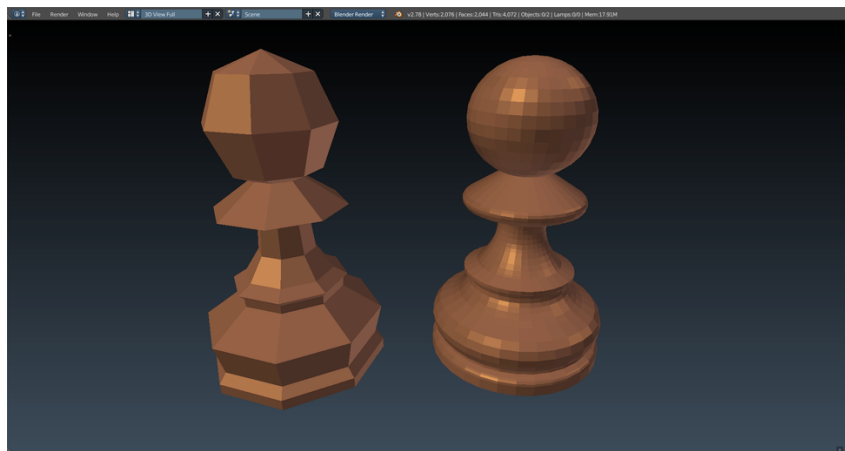

Figure 3.9: Example of a playing chess game with Low Poly and High Poly [46].

describe the general aesthetic aims of a given game. In our educative solo games, we chose to highlight *challenge, discovery, expression, and submission*, as they best correspond with what a learner would likely be motivated by in a game. As new ideas emerge, we try to assess them with these emotions in mind.

Next, it was necessary to choose the whole sandbox's style. Our choice was Low Poly. Low Poly is a polygonal mesh style in 3D computer graphics with a relatively small number of polygons. People thus identify objects by form and/or colour gamut, the fine details being absent (See Figure 3.9) [63]. This is the best choice because such graphics require less performance (guarantying real-time interaction) while trendy (it is easy to find the necessary assets, and if not available to create a model quickly). It also follows one of the basic principles of game design, "keep the project as simple as possible and focus on the task" [76].

We took as a reference the NewtonVR project [14] (see Figure 3.10). This is a free asset for the Vive/Oculus systems (because it does not use WMR, we could not use this framework for our own

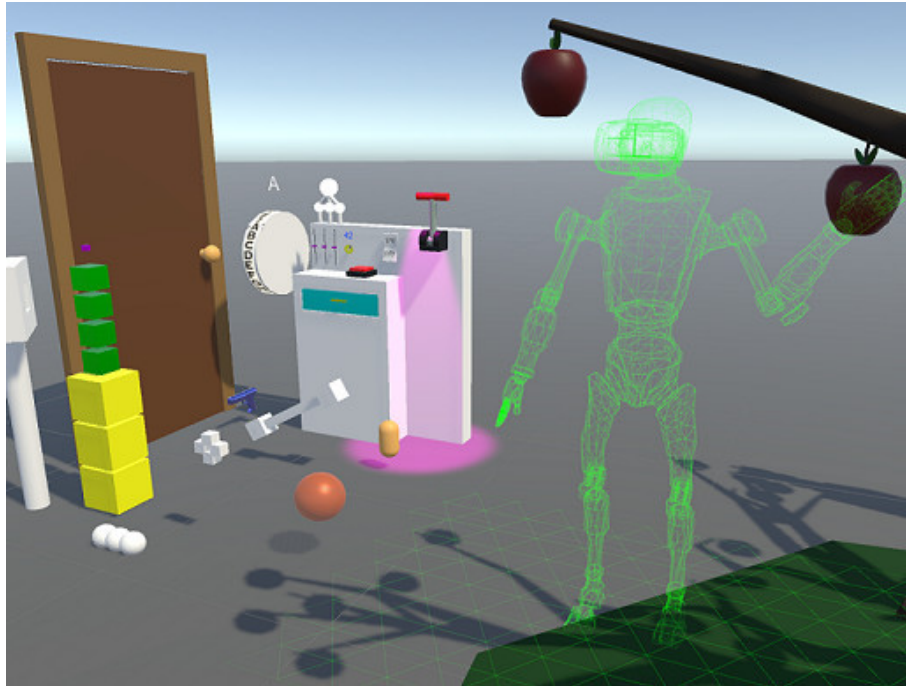

Figure 3.10: NewtonVR [14].

project). NewtonVR is a VR interactive system with improved physics, where it is possible to lift, throw, drop, and use objects. Held objects interact with other objects in the correct way: objects with the same mass can push each other equally; an object with a small mass cannot push a heavy object (in Unity, there is no such limitation without carefully calibrated scripts - you can easily move a large truck with a small rock). Also, this Asset contains a good collision sound framework: you can adjust the sound of collisions of different materials: plastic, metal, glass, wood, carpeting. We were able to use some of the sounds from this asset in our own experiments (see the audio section of chapter 5).

According to the legend, Newton realised the universal law of gravitation after an apple fell on his head². So it seemed only logical to take an apple (fallen from an apple tree - See Figure 3.11) as an object to manipulate so that the users could observe how different forces act on it, including gravity. The model was taken from the NewtonVR asset. Later it became clear that although students prefer to interact with apples, some movements are better understood and interpreted with cubes (e.g. a rotating motion).

The main colour scheme of the game is pastel blue and green (see Figure 3.7), which are relatively neutral colours. We wanted to avoid eliciting unnecessary emotions because people often associate

²There is actually some truth to this, as it was discovered in the Royal Society's archives. But the apple never actually landed on Newton's head.



Figure 3.11: Apple tree, as re-manufactured from NewtonVR [14].

colours to emotional reaction (purple with rage) and special meanings (bright red signifies danger) [63].

We replaced the default controller visualisation from the standard MRTK package with the much more realistic Oculus Virtual Hands (See Figure 3.12). These virtual hands were assessed positively in preliminary tests, so we used them for all further experiments.

3.3.2 Game description

Let's go back to the notion of Sandbox. As explained previously, any design circle has to be initiated (See 3.2: General Methodology for Game Development). We need a bootstrap, and bootstrapping is usually achieved by generating some form of a generic prototype with which people can play; that is what we call a Sandbox. Based on our bibliographic review (See Chapter 2), we chose three main exercise topics: gravity, parabolic movement/free fall, and density. These topics are of special interest from a didactic point of view, and they were not considered in any educational research involving VR.

The Sandbox consists in an open world with platforms flying in the air which are freely accessible by the player. The game space is organised according to the principle of a web (spider space) (See Figure 3.13). There are four main clusters, named "platforms" with key checkpoints on the map and interconnecting links. This is useful if the player wants to visit several places, giving him a sense of geography. The path from point to point can form either a whole journey or just a momentary move

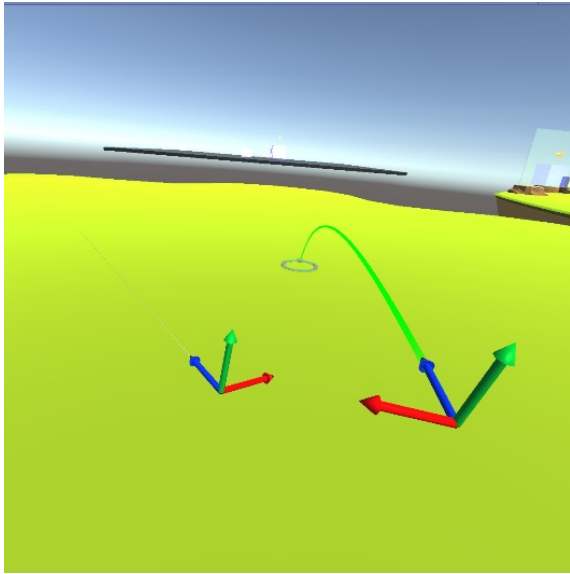

(a) Gizmo visualisation (default from MRTK package).

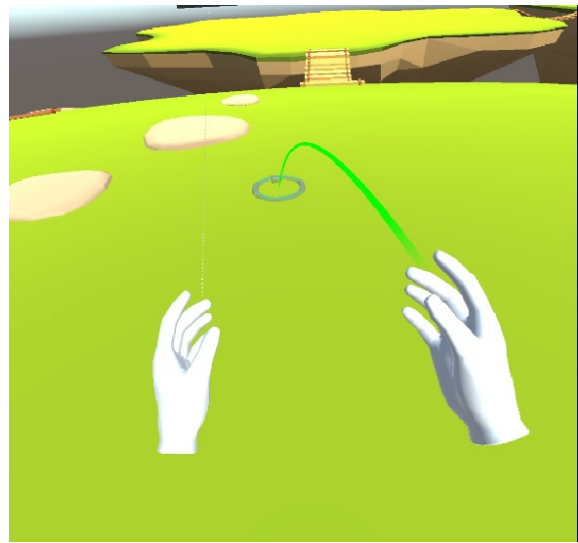

(b) Hand visualisation with Oculus Virtual Hands.

Figure 3.12: Display of controllers in the virtual world.

[124]. This kind of space organisation helped avoid unnecessary distractions for the user, restricting his travels and actions to what was actually needed, without feeling trapped in a predefined scenario.

Within the sandbox, a player is free in his movement, and there are no specific tasks. To start an exercise, the player should go to one of the 3 checkpoints, read a basic explanation panel, then select a platform where they can test some physics phenomena, and (in the most probable scenario) go the next platform exhibiting the same phenomena but with different experimental conditions (See Figure 3.13).

Experimenting with gravity immediately calls for being able to throw objects. The game designer must make a choice regarding this specific interaction, with possibilities including: shooting objects through the use of a dedicated virtual device, such as a virtual slingshot, or directly throw an object with your hand (i.e. grab an object with the virtual hand and mimick an actual throw). We chose the second option as being the closest to the real counterpart, without the need to learn how to operate a device. The clear drawback of this direct method is the inability to make precise or distant shots. We will reconsider this question in Chapter 6.

Since the Sandbox is a large space to move around, the question of how to navigate in it arose, again with two classical options: teleportation using controllers or actual walking by the participants³. Due to the impossibility of having a large physical space to experiment with in classrooms, to the complexity of

³Other possibilities for navigation control exist. See [17] for alternative solutions.

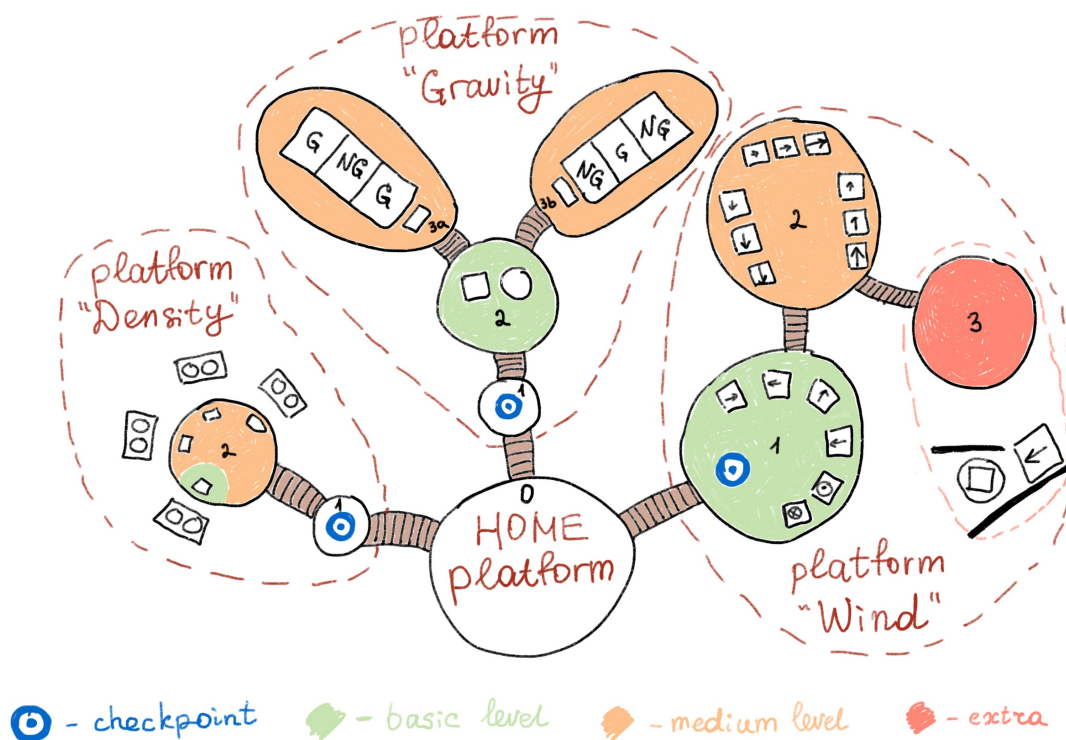

Figure 3.13: Schematic sandbox map - Web.

the map (some spaces cannot be walked through), and for the safety of the users, we chose teleportation as the method of movement. The user would press the joystick on the controller, select a location with the teleportation beam, release the button, to be instantly teleported to the selected location.

Platform 1: Wind boxes

During my bibliographic research, I became very interested in the 2D game *Mecanika* [11], specifically their wind boxes - a cube with the wind flowing inside in the direction of the arrow (See figure 3.14a). This overlapped with research on the role of quests for meta-learning in physics (optics) within serious games [145]. As an intermediate test in the game, students were asked to choose how the trajectory of light would change if a fan was on in a given situation (See Figure 3.15). I found this to be a fun and engaging activity that would attract the students' attention and thus implemented a 3D version of the wind box (See Figure 3.14a), so students could drop/place an object in such a wind box and see how the trajectory of a falling object would change depending on the direction and power of the wind box.

In my version of the game, the participant takes apples or red cubes and throws them into big

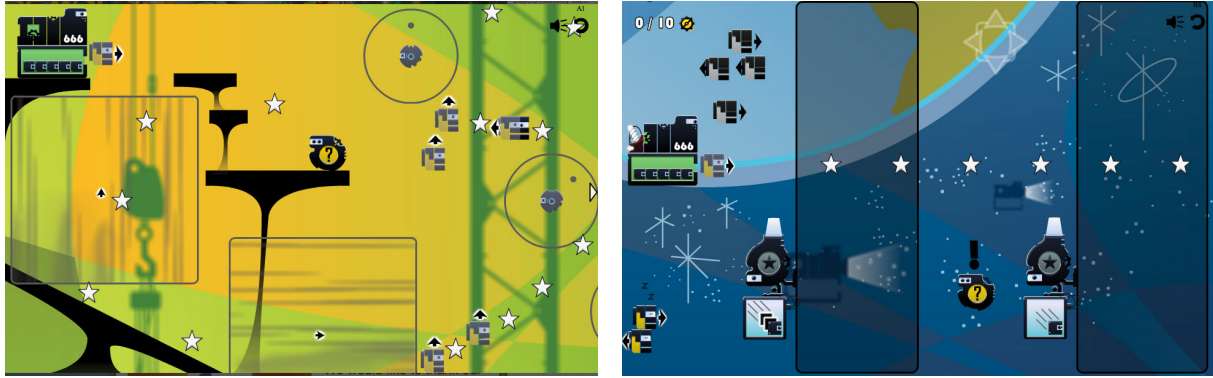

(a) Wind boxes.

(b) Gravitation boxes.

Figure 3.14: Illustrations from the game Mekanika [11].

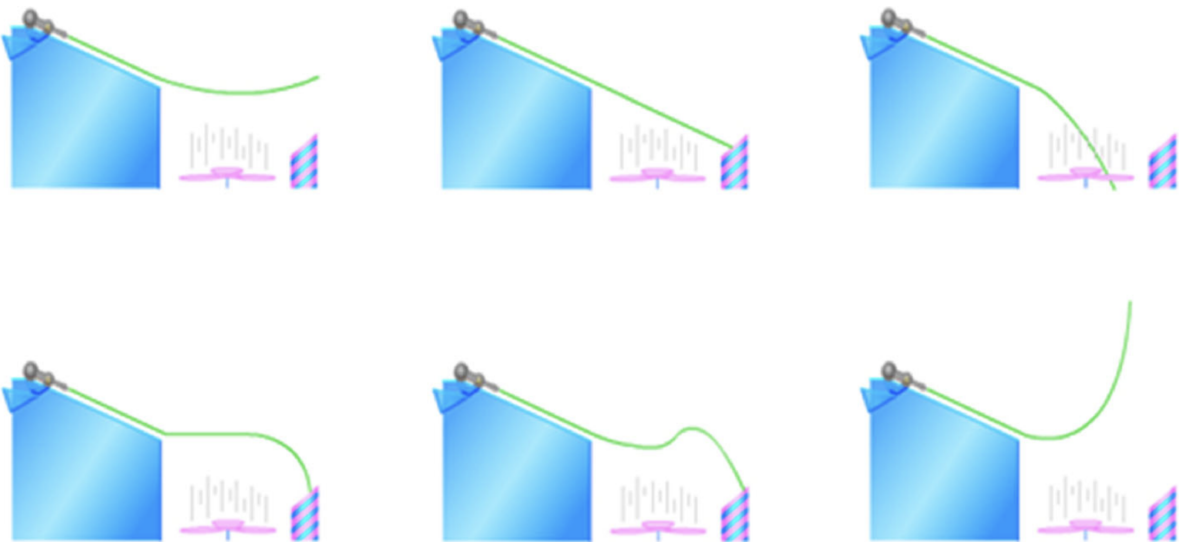

Figure 3.15: To perform the intermediate test embedded in the game, players had to click on the visual giving the correct representations of how light would propagate in the given situation - here with the fan activated [145].

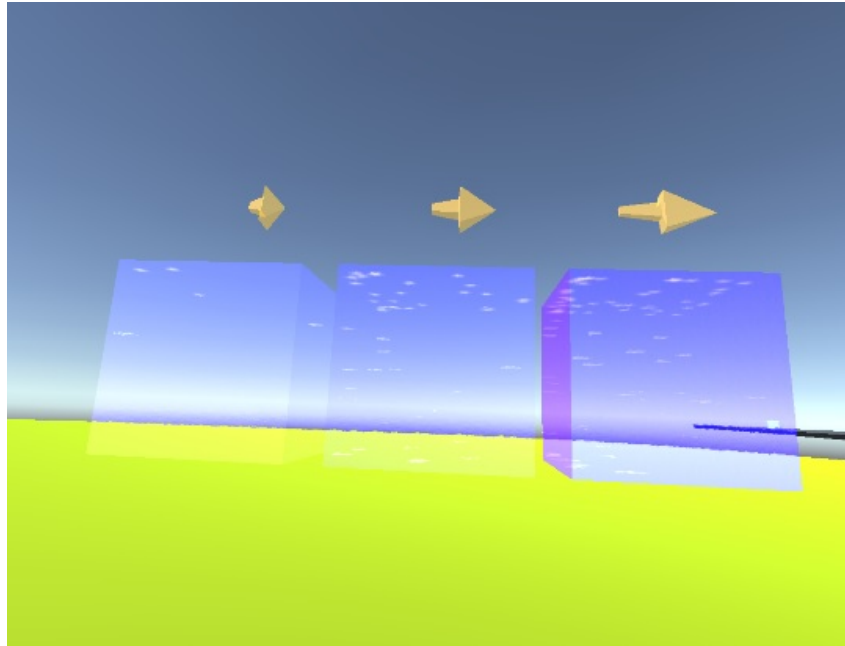

Figure 3.16: Wind boxes - Arrows above big cubes and particles inside show the destination of wind flow. Different brightness of the cubes and size of arrows are different power.

boxes with wind inside. Arrows and particles clearly indicate the direction of wind flow. Arrow size is proportional to wind power (See Figure 3.16).

The first platform has different wind directions (up, down, left, right, to and from you), while the second experimental platform exhibit various wind flow power (easy, medium and strong).

With the experience gained in the first 2 platforms, the participant is challenged by on the third platform where he shall throw a red cube into a big wind box to push a white cube from a platform (See Figure 3.17).

Platform 2: Density

The second set of platforms concerns experiments on density (see Chapter 5 for a detailed exposition on this concept). This exercise consists in a set of high cylinders containing fluids of different densities inside; it compares the falling of identical balls inside the cylinders (See Figure 3.18).

To start the exercise, the user teleports to a checkpoint materialised by a blue arrow. From this location, the user can see four similar settings, each with two balls (blue and red). The blue ball always falls in a very low density (air) cylinder. The red ball falls into fluids of varying density:

- In Ex.1: Density close to zero (air);

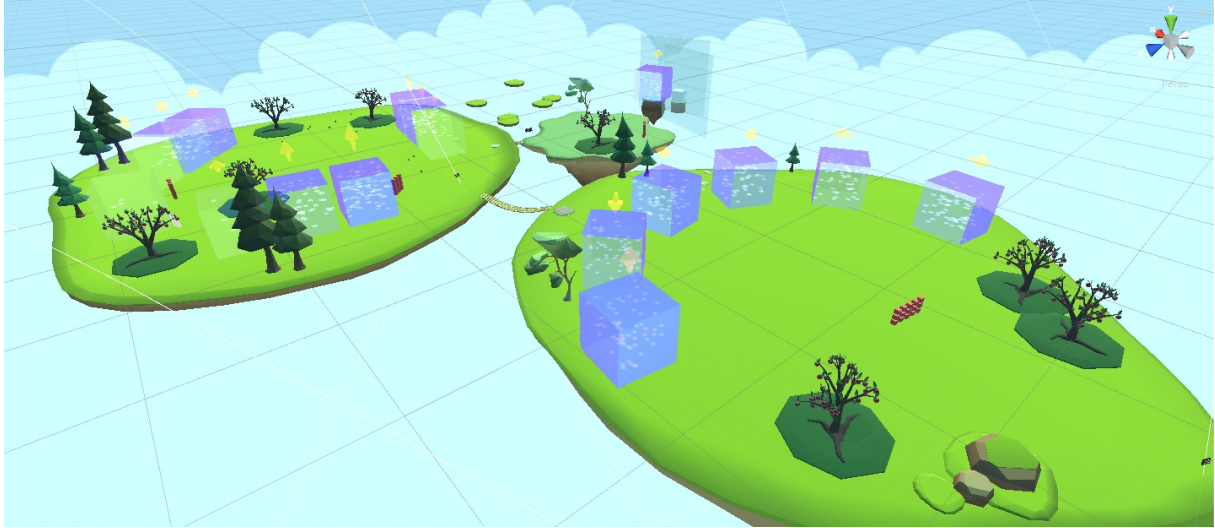

Figure 3.17: Platform Wind.

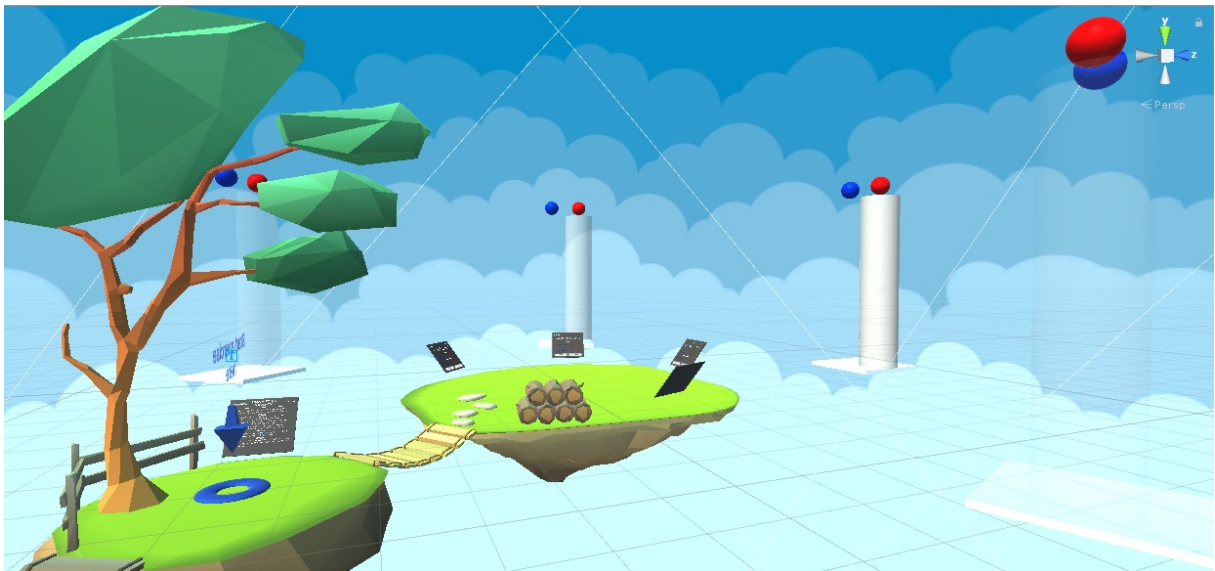

Figure 3.18: Platform Density.

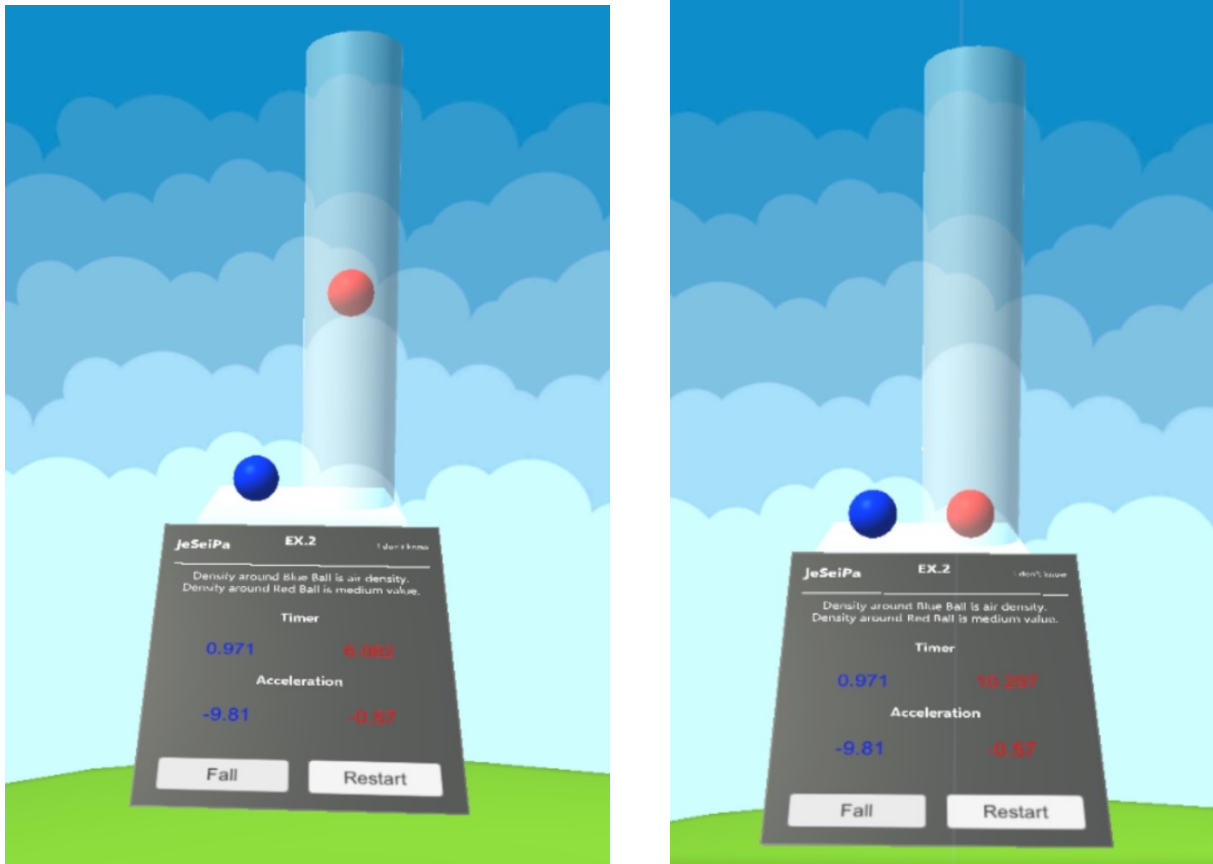

Figure 3.19: Density Platform - Exercise 2.

- In Ex.2: Density has medium value;
- In Ex.3: Density has a very high value (thick fluid);
- In Ex.4: Zero density (vacuum).

Participants trigger the simultaneous fall of the two balls, while acceleration and falling time for each ball is recorded on a front panel.

Figure 3.19 shows Exercise 2. Falling times and accelerations for the red and blue balls are quite different.

Based on didactic analysis and actual teaching experience of density, this exercise has subsequently been modified before rigorous evaluation (see Chapter 5).

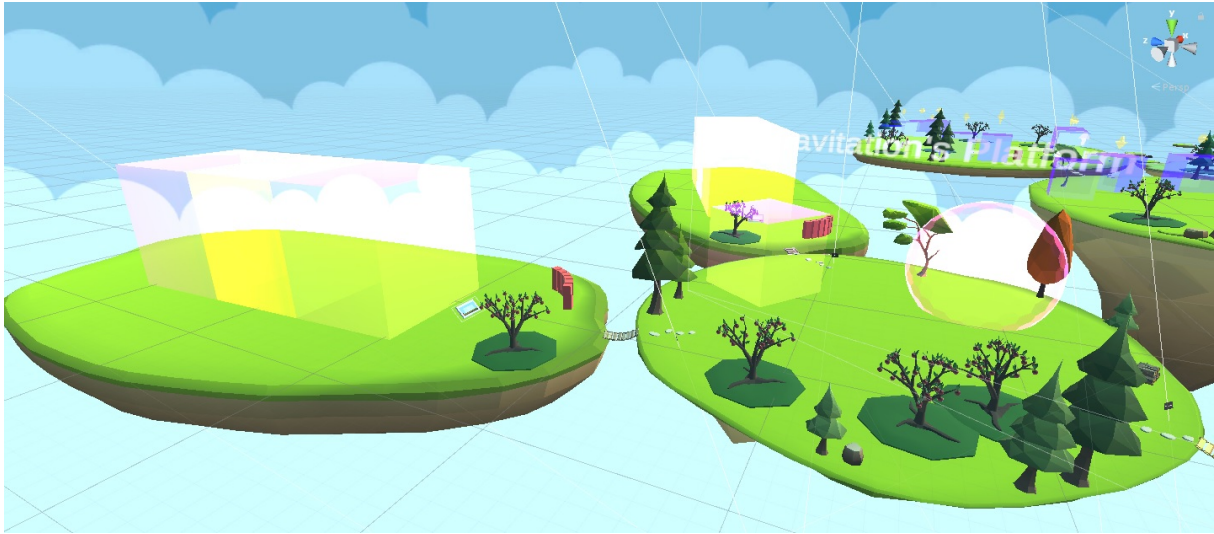

Figure 3.20: The Gravity Platform.

Platform 3: Gravitation

The second interesting feature from the 2D Mecanika game [11] was the presence of gravity-free zones (See Figure 3.14b). I implemented my personal version of this in my Sandbox (See Figure 3.20).

This platform consists in one test area and two additional platforms for actual experiments. On the test platform, participants can grab apples or cubes and place them into specific volumes. These two volumes, a big cube and a big sphere, are gravitation-free (weightlessness) zones. Experimenting the lack of gravity (and absence of falling) on this platform seeks to familiarise students with the phenomena.

Moving to the actual exercises, the participant faces 2 situations:

1. Participant face three big cubes, respectively without gravity, with gravity and without gravity inside (NG - G - NG) (See Figure 3.21a).
2. Same situation, but this time with the following conditions: with gravity, without gravity and with gravity (G - NG - G) (See Figure 3.21b).

The player can throw an apple or a small cube through the succession of cubes and observe the resulting trajectory, with the help of recording cameras.

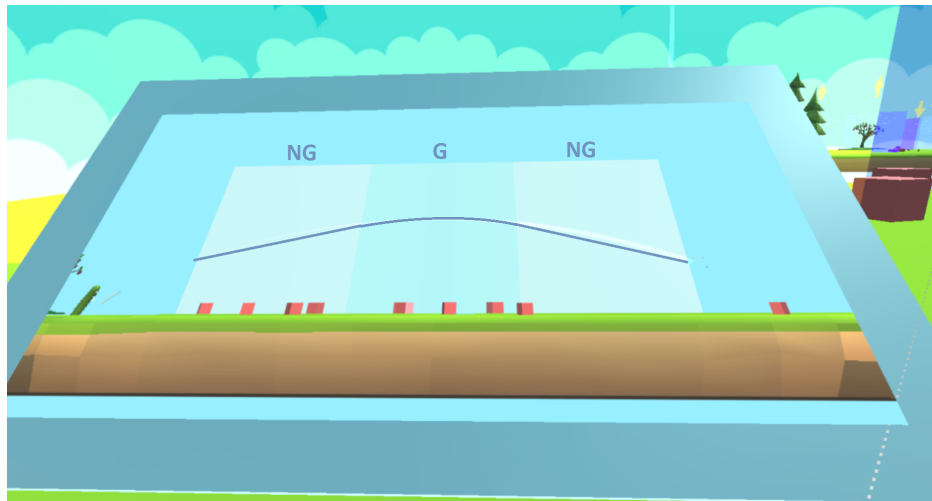

(a) Exercise NG - G - NG.

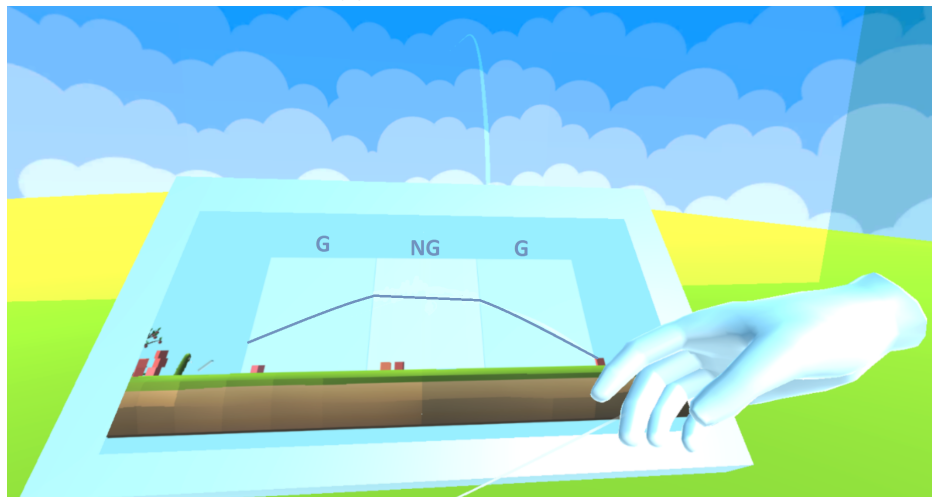

(b) Exercise G - NG - G.

Figure 3.21: Gravity platform - 2 exercises.

3.3.3 Experimental procedure

At the stage of this preliminary experiment we did not have a specific goal in mind, other than observation: we just wanted to test the interactions, the general organisation of the game, and if it was intuitive and fun. We asked all participants to describe their actions during the game following the "thinking aloud" technique.

At the beginning, each participant was briefed on how to use the VR controllers. Then the Sandbox simulation started and the students were free to choose their first exercise and generally any action in the game, the main condition being to voice their actions and opinions out loud. There was no time limit.

After the participant decided that they had completed the study of this game, a short interview session was held with them to find out what they remembered most, what they liked most (respectively least), to rank the three exercises in order of preference and other similar questions.

3.3.4 Preliminary evaluation

Five participants (Mean age = 25, SD = 3, 2 males and 3 females), selected among students and researchers of the LISN laboratory, played in this sandbox. These participants are not our target audience, but they were the closest to it - roughly the same age, with some scientific background, and immediately available. And as I said before, we did not have a specific goal in mind at this stage, therefore these participants were deemed suitable at this step.

There was no specific task for the participants to achieve, other than to explore the virtual world offered. All participants took it happily and constantly moved around the platforms; almost everyone returned to the already passed platforms and tried the tasks several times.

All participants were positive about this Sandbox game. The most positive feedback was first about the Gravity platform, then the Wind platform, and finally, the density platform which was deemed less engaging. Participants justified this by the number of interactions (in Gravity, you have to pick something up, throw it, move it; in Density, you only have to push buttons). Some commented that they found the Density exercise strange and "unnatural". Many also commented that they enjoyed playing with apples more than with cube.

In terms of movement in the game, students had no problem teleporting with the controller. However, many noted that they preferred to physically rotate on the spot rather than using the controllers to perform this motion.

Our physics didacticist counsellor, Cécile de Hosson, also praised this Sandbox idea.

3.4 Brainstorming sessions

3.4.1 Semi-structured Interviews

As part of the JeSeiPa research, I worked on the topic of viewpoint selection together with a master's student from Aalto University (Finland), Joel Gil Leon [82]. We conducted a interview session with 4 participants (Age 20-23, two males and two females). They all attended a lycée in France and took

physics courses at school, except for one who took biology classes instead. It was a semi-directed interview, and free extended answers were welcomed. Each interview lasted between 30 minutes and 1 hour.

First, we were introduced to the French educational system in high school from a student perspective. In France, physics is studied together with other subjects (e.g. chemistry). When asked about their favourite moment during their studies, they all mentioned a soap-making lesson, designed to introduce them to the chemistry lab tools. This could be justified because they enjoyed creating something with their own hands and seeing the result of their actions. The lesson consisting of making "soup" in a Petri dish was also highlighted. As a negative experience, the students mentioned lessons with simple observation without interaction (such as optics lessons). The results of these interviews support the assumption that students are highly motivated by sessions involving active intervention rather than passive lectures.

3.4.2 Parsing data from the interview sessions

As a result of the interviews we collected useful data with a lot of key ideas. We dedicated a brainstorming session to processing the raw information. We extracted all the keywords from our interviews and tried to group them into similar themes using post-it notes. We found three main themes to work on:

1. People: how people feel about learning methods;
2. Activities: level of engagement as a result of activities during classroom time;
3. Education system: practical elements regarding the learning system itself.

3.4.3 Brainstorming solutions

The best way to find good ideas is to find lots of ideas and throw out the bad ones (Linus Pauling).

We used the above three main areas for brainstorming. Understanding of problems directly from the users' point of view was key to carrying out these activities since the creativity required to complete them depends on the level of empathy of the participants towards the users and the problem.

We used a technique called brain-writing 635 [119]. Brain-writing aims to develop many ideas in a short time. We used three pages corresponding to our topics. Each person involved had three minutes to write as many ideas as possible related to a given topic. Ideas were encouraged in any way, including

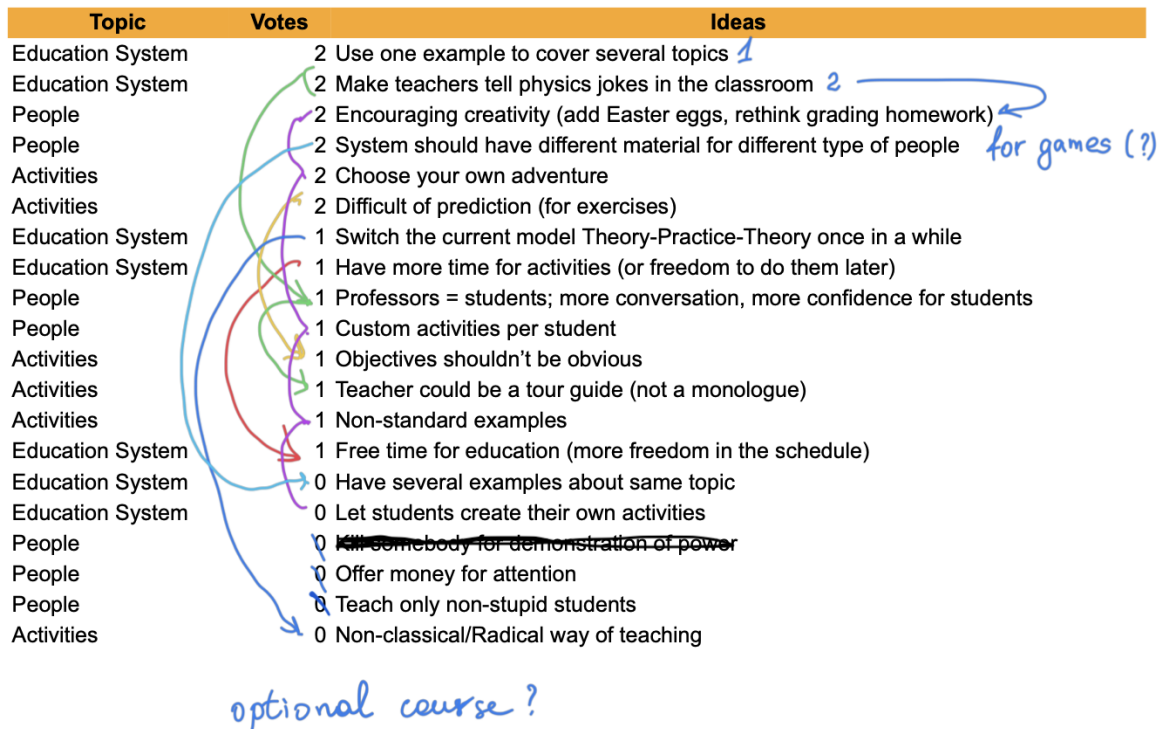

Figure 3.22: List of rated ideas from brainstorm sessions.

crazy or outrageous. After three minutes, we swapped topics, then again to complete three rounds. As a result, 20 ideas or possible solutions emerged. We kept explaining the ideas we wrote to each other, and then we rated each according to what we liked the most, or at least felt like an exciting way to explore. The final number of eligible ideas was reduced to 14 (See Figure 3.22 and First Appendix - Brainstorming notes).

3.4.4 Solution development

The next step in the design process was to discuss how these subsets of ideas could be extended and applied in a game setting. Starting with the highest-rated ones, we brainstormed each idea and how they could be applied in an education game. At this point, we used the MDA Framework to develop video games [60]. This structure provided us with the vocabulary we needed to express how a solution can be used in a game, what we can expect from it, and how it affects the overall experience. For example, when discussing one of the ideas, "different content for different people", the MDA framework suggests first thinking about aesthetics, or how we want the user to feel.

The idea for different content came from interviews with users, during which it appeared some students liked one particular exercise while others found it boring. Making content more attractive to a given user consists in designing it according to their style or mood. Given that the base material (the class topic) cannot be altered, the ability to customise different aspects of the game is related to the game's dynamics in the MDA concept. Likewise, the necessary steps a user must take for this to happen are related to the game mechanics (again we find the backwards Aesthetics-Dynamics-Mechanics logic).

3.4.5 Game topic

The last step consists in designing the game as a whole. We aimed to envisage the 14 ideas we elaborated in the light of the expected emotions of the player. In the end we came up with three possible games:

1. Using gravity blocks to observe movement of objects when they pass through them .
2. Mountain momentum - where a user would be placed on a platform which is being balanced on its centre; movable elements of different weights allow the platform to be stabilised;
3. A cargo drop - where a user needs to aim and drop object to hit a target;

The first item, gravity blocks, came up again (Mecanika style). This confirms the interest in bounded spaces with some specific conditions inside them (similar to the Gravity Platform in the Sandbox). According to this idea, boxes in the immersive environment would exhibit different laws of physics acting inside them. For example, one box could be made so that its gravity is 5 times greater than what we are used to (with objects falling through it at a higher speed). Expanding on this idea, gravity could be directed sideways, forcing an object thrown in this region to change the direction of its trajectory. The mechanism could be extended to change other physical behaviour inside this box. For example, instead of changing the value and direction of gravity, strong winds or liquids of different viscosity (water, oil, jelly) and more, could be in effect. The combination of several boxes can later be used to create a sort of three-dimensional puzzle (See Figure 3.23).

The second idea, called mountain momentum, assumes that the user will be transported on a three-dimensional platform along with other moving (or movable) objects. The platform is held in balance from its centre by weight transfer, similarly to a see-saw. This balance is upset when other weights around the platform move, forcing the user to move to keep the balance. The idea was globally appreciated, but

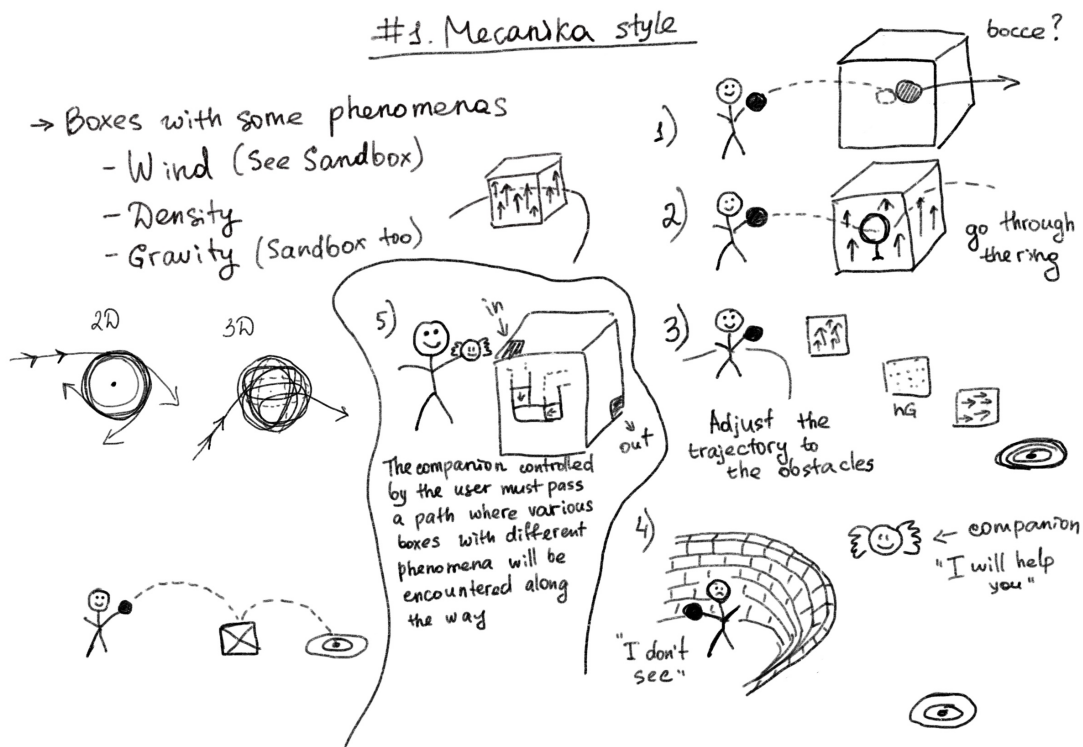

Figure 3.23: Notes on brainstorming with "boxes" including various physical phenomena.

one must be careful to consider how the navigation and interaction mechanism would work in such a situation and how extensible it would be. For example, the tipping point could be moved away from the centre, to anywhere else on the platform to increase the complexity (See Figure 3.24).

The third game topic was centred on launching or dropping an object from the ground while in motion. A 3D game would allow the falling projectile to be watched from different angles, or watched from a bird's eye view. This would be especially interesting because this type of experiment is usually explained in textbooks with side views only, and with one set of initial conditions. A 3D game would also allow to add objectives and difficulty levels in a straightforward way. The downside is that such a VR experience would involve constant visually-induced perception of one's own movement and could cause Cybersickness (see [129] for a recent view on this). After additional thoughts, these practical considerations led me to abandon this idea (See Figure 3.25).

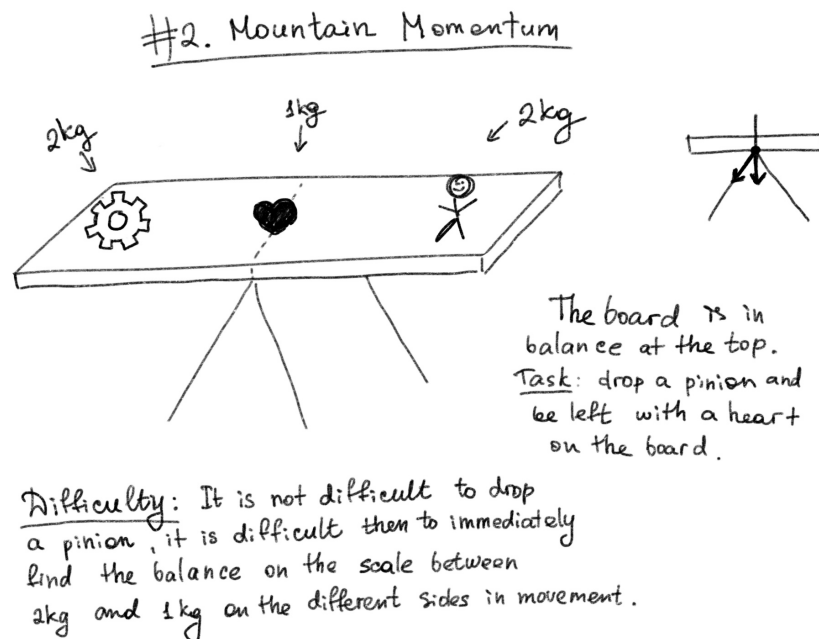

Figure 3.24: Notes on brainstorming on the experiment regarding Mountain Momentum.

3.4.6 Additional game features

Some of the 14 ideas we came up with, along with results from interviews were also combined and considered for possible implementation in the game, resulting in a new list of possible game features. I compiled the following list:

- Local & Global scores - People prefer to see their progress rather than play for nothing. A global score table will show if they are better/worse than others - extra motivation.
- Progress Bar (tasks or map%) - shows the progress within the game and allows the user to see how much is left to go.
- Access to real-time duration or countdowns - actual timing provides extra grounding to reality, and a sense of excitement.
- Companion - Many commented they would like to play the game with others. Companionship provides many benefits: confidence boosting, possibility of exchanging opinions or receiving hints and providing an external supplementary viewpoint. This elicits lots of questions regarding how

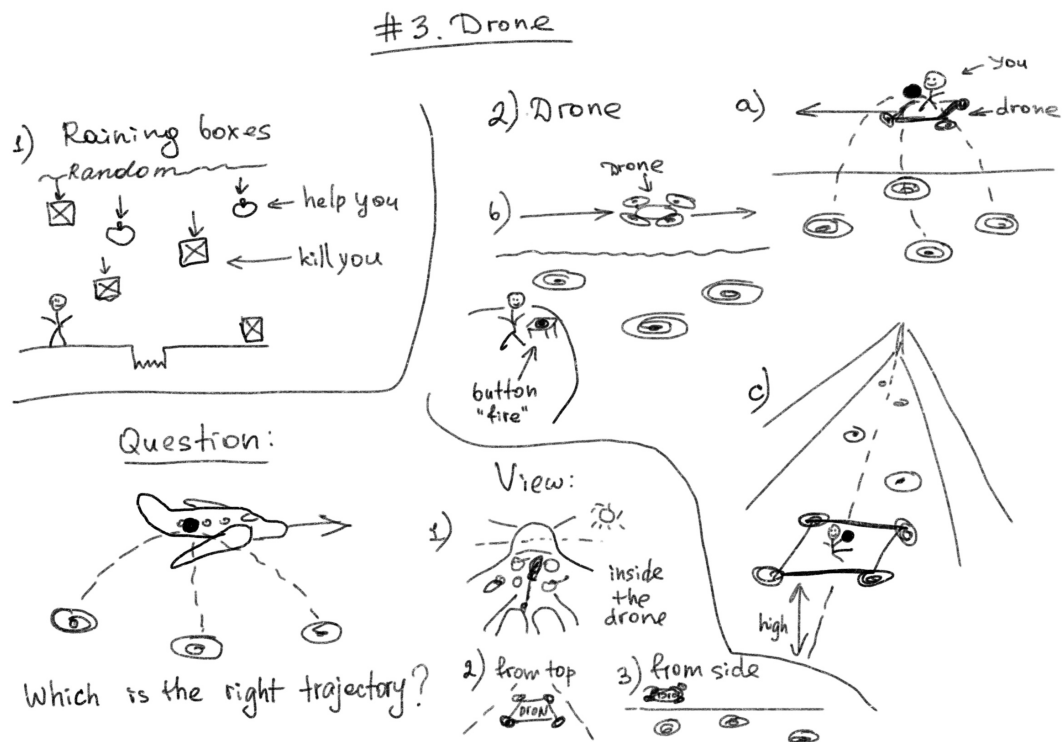

Figure 3.25: Notes on brainstorming on an experiment with a drone dropping objects.

to collaborate with fellow students or teacher while playing an immersive game. We dedicated a special chapter to this question (see Chapter 6).

- Taking selfies - The modern world has its trends and this is one of them.
- Creation in game (unpredictability) - As mentioned in the interviews, users like to create something new, and not just follow an established script (An example is [Fantastic Contraption \[26\]](#)).
- Storyline (unpredictability) - As well as creating new things, users like to feel that they can influence things (and create their own story within the game).
- Open World with restricted areas (unpredictability) - Users must feel free to roam about, not feeling trapped, while keeping focused on the subject of study. This organisation of space helps to limit the user's freedom of motion without them being aware of it.

Some of these features can be combined, e.g. Menu with clock, countdown and timer. Also, game features such as a map, the display of an object's flight path, World In Miniature (WIM) [[132](#)] (WIM is a

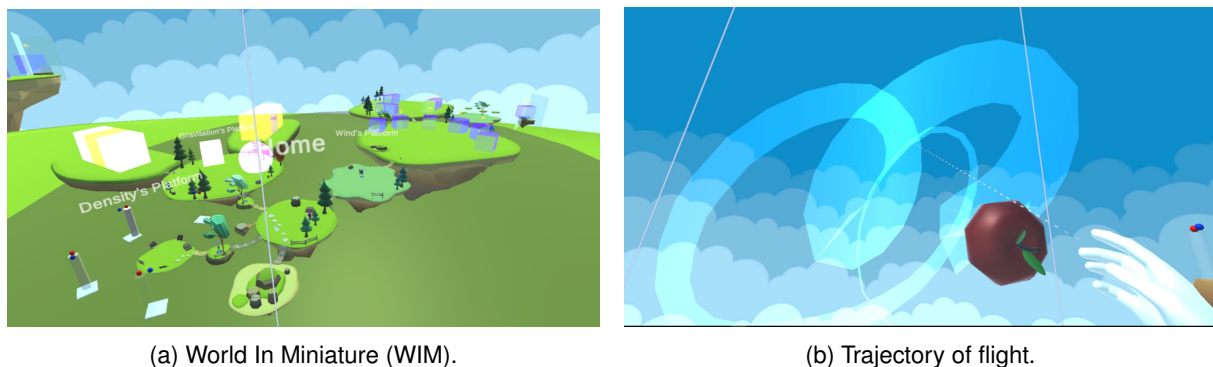

Figure 3.26: Game features.

copy of the actual virtual world at a reduced scale, see Figure 3.26a, and the presence of a companion have been considered and implemented in the Sandbox.

We thus added a flight trajectory for apples and cubes (See Figure 3.26b): when a participant throws an object, he/she can observe a trail behind it, as a memory of the flight trajectory. It is especially useful in the "Gravitation" platform.

Students who have tested these features also said they liked the map and suggested it could be used as a teleport: select a point on the map and click there to be transported to that point in the actual virtual world. For lack of time and for the purpose of teaching the students, I did not implement this feature.

WIM was considered interesting enough to justify a separate study (see below).

The last salient feature identified is the addition of a companion (See Figure 3.27), which always follows the player. To avoid unnecessary disturbance, the companion does not perform any actions without a participant's request, except following him. The player can use it as an embodied extra camera (to witness/record some phenomena from an alternate position). Also, the companion can show hints under challenging situations and allow to connect with a teacher without stopping the immersive experience (See more justifications and detailed study in Chapter 6). Several students who tested the game said they liked the companion, but would have liked it to talk⁴; they also suggested changing the chosen flying dragon model to something easier to understand visually⁵. The students finally suggested the idea of using the companion as an additional object for interactions (e.g. putting the companion in a wind box) and as an extra point of view.

⁴This preliminary version was silent.

⁵The dragon was sometimes called a "flying pig".

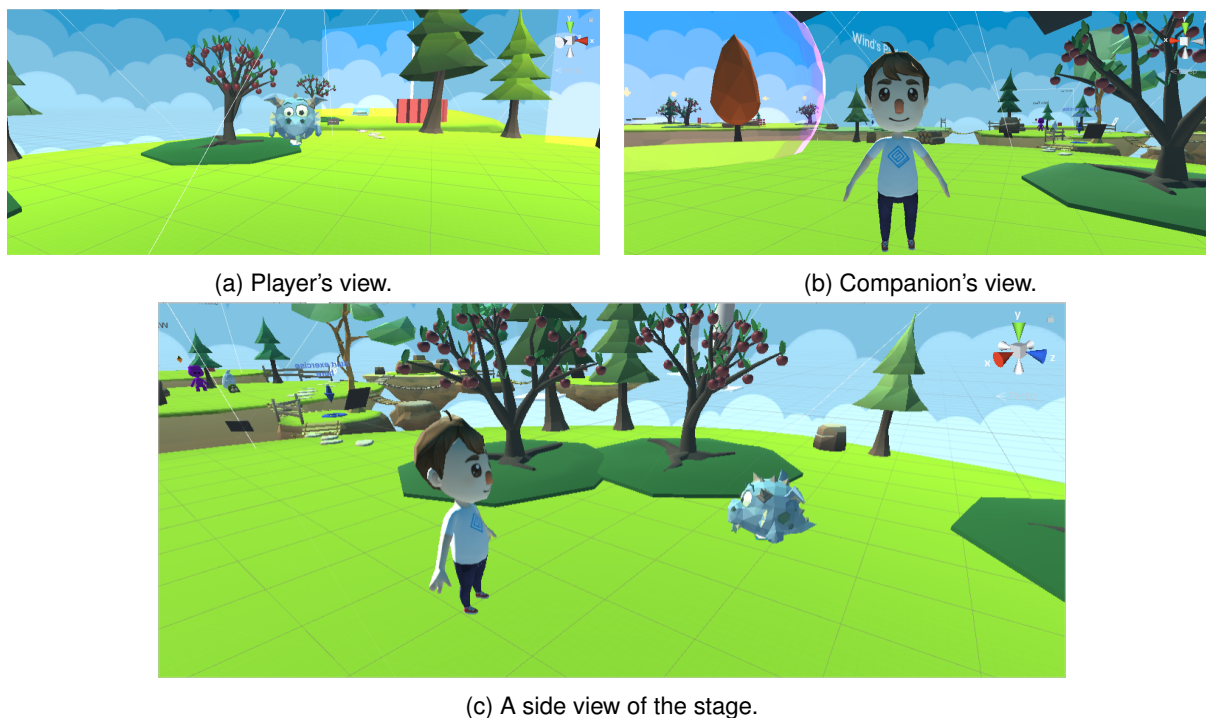

Figure 3.27: Companion study.

3.5 Parabolic movement and viewpoint selection

As I mentioned above, I worked on the topic of viewpoint selection together with a master's student and this part of the study was the main topic of his Master thesis [82]. As the supporting topic of the study, we chose "Parabolic Motion" (to which we will return in detail in Chapter 6). This classic mechanical physics topic is a common source of misunderstandings and misconceptions for many students. By throwing different objects, the student can observe how the trajectory and speed of objects change depending on the conditions of the experiment. The idea behind the exercise is that the student will better predict the object's behaviour after repeated trials and, therefore, better understand the underlying physics. This topic immediately raised the problem of the user interface for visualisation.

Our goal was to determine whether an additional perspective for visualisation would be helpful. During the development of the game, we identified immediate problems with the spatial user interface - conveying real-time information about the projectile's movement back to the user. In classic textbooks lessons, free-fall trajectories are usually presented with a side view diagram (See Figure 3.28). Advanced simulators can show a 3D trajectory in real-time with the same presentation style, but there are visualisation alternatives. We compared two widgets to present projectile movement information during

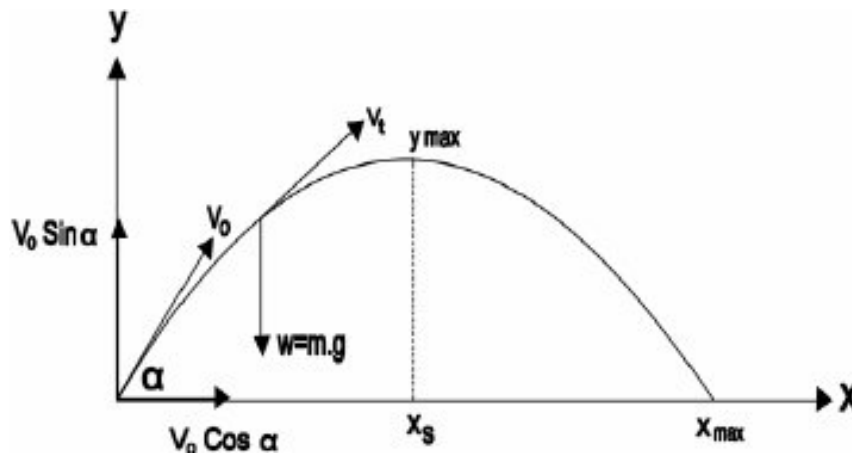

Figure 3.28: Parabolic Trajectory [5].

a classic task: aiming and firing at a long-range target. The first widget is called Camera View (see Figure 3.29c). The widget consists of a screen with a 2D live video showing an orthographic projection of the projectile's intended trajectory. The second widget is a 3D user interface (See Figure 3.29b) displaying a miniature replica of the virtual environment, called World-In-Miniature - WIM [132].

Thus, we set out to analyse two widgets (WIM and 2D Camera) in a typical task game: aiming and firing at a long-range target.

Inside a stadium-like location (chosen to provide some scale of interaction, see Figure 3.29a, the user fired a series of 5 shots from a pistol, towards a target for each condition (WIM, 2D view, no widget). After each shot, the target position was changed randomly between 3 settings: close, medium, far. The user followed instructions shown on an information panel, aimed using the touchpad and shot with the trigger.

We hypothesised that the ability to manipulate the widget might be more important than the information displayed on the widget itself. Comparing the three conditions (direct subjective view without widgets, 2D orthographic camera display and WIM), preliminary quantitative results showed that there is no significant difference between them, both in terms of average aiming time and the number of shots taken to hit a target successfully (see Figure 3.30). The qualitative results show that all participants had a very similar opinion of what was perceived as better: the WIM widget was generally found to be helpful, splitting the majority of votes between the first and second-best choices. This contrasts with the display of the orthographic camera, whose votes were mostly split between best and worst choice (given that the lack of a widget was also an option).



(a) Stadium location.

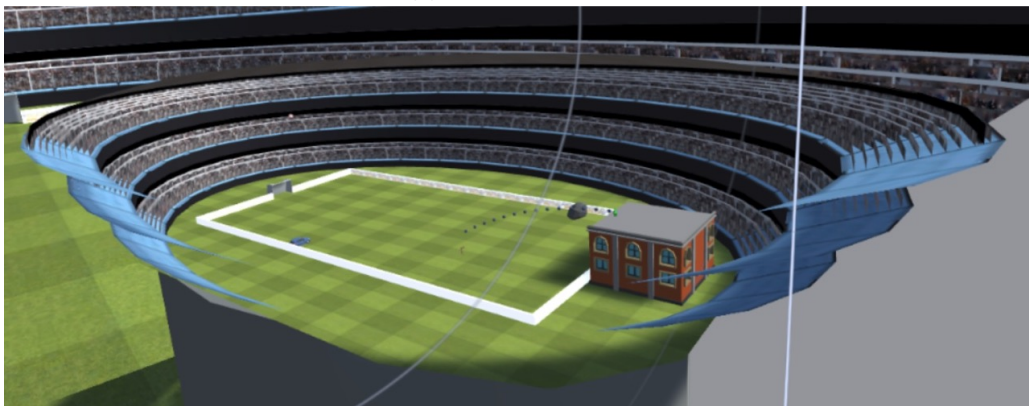

(b) World in miniature for aiming purposes.

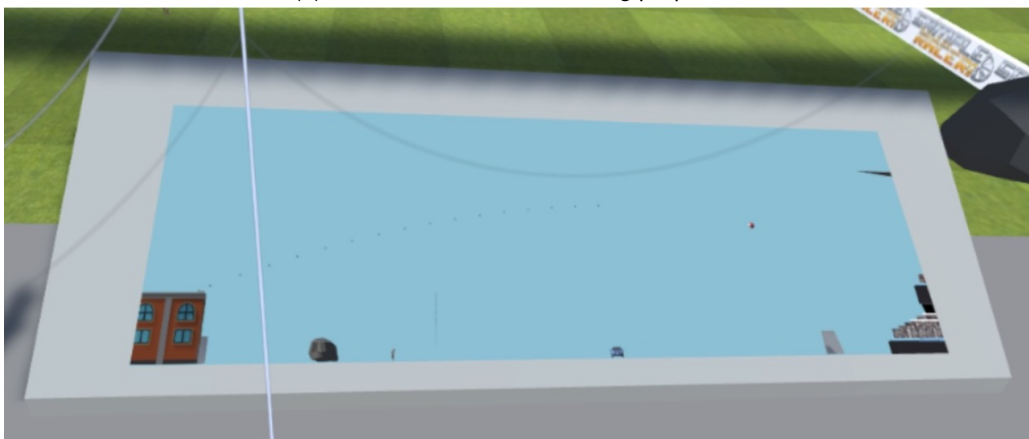

(c) 2D orthographic view for aiming purposes.

Figure 3.29: Parabolic movement and viewpoint selection.

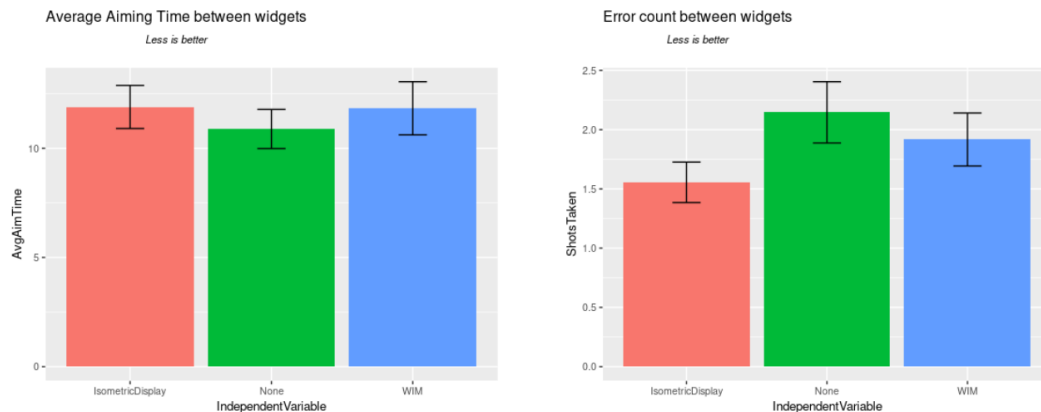

Figure 3.30: Left: Average aiming time between independent variables; Right: Shots taken (error rate) between independent variables.

3.6 Conclusion

To summarise, the chapter:

- Justified the choice of software and equipment and why it is important for our project.
- Outlined the general methodology for game development and how our path differs from the usual process of experimental design in education science (usually based on academic discussions).
- Talked about the process of designing the features of the Sandbox, then gave an insight into the specifics of implementing exercises with the Gravity, Wind and Density platforms.
- Reported the process of brainstorming, and what data we obtained from it; reviewed a few other activities that we can present in VR and gave a description of possible game features, formulated on the base of user wish.
- Focused on the specific issue of collaborative work on parabolic movement and viewpoint selection; gave the first results - we analysed how to help improve existing student activities by supplementing rather than replacing them; used elements of game design as part of development.

In the next chapter I will introduce you to the concept of pseudo-haptics, as a way to perceive mass in VR, and compare two techniques of pseudo-haptics rendering with conventional mass measurement tools in a VR teaching simulation.

Chapter 4

PSEUDO-HAPTIC PERCEPTION OF MASSES

Abstract. *Pseudo-haptics is a tactile-kinesthetic illusion where the sensory channel used to convey the haptic perception is different from the basic haptic one by way of controlled multimodal combination. This chapter focuses on the pseudo-haptic rendering of objects with weight within a didactic framework of learning physics, particularly the notion of mass. We sought to verify the hypothesis that pseudo-haptic techniques allow users to discriminate objects of identical aspects but different masses. Because we plan to deploy our final application in classes where conventional haptic devices will be absent, we focused on passive haptic feedback, and modified the visual feedback via the Control-to-Display (C/D) ratio introduced by previous authors. Several conditions were compared by respectively modifying the C/D ratio in translation, in rotation, and using an explicit metaphor (Roberval balance). Results show that the Roberval balance metaphor proved highly efficient, motivating and fun to use. Pseudo-haptics metaphors had minimal efficiency and were often confusing and frustrating. That may be due to experimental design choices (i.e. absence of effective haptic props), but further research on the metaphor of pseudo-haptic translation seems necessary. User behaviour also confirmed some previously observed misconceptions about how objects of different masses can be distinguished.*

4.1 Introduction

At the initial levels of our education, we all started by playing with cubes, looking at their colours, sizes, and weight. We evaluated the weight of the cubes first by manipulating them, in turn, feeling that some were harder to move than others. Later on, some of us were introduced to scales, either numeric (displaying the mass directly) or comparative - two cubes on opposite sides of the scale. As adults, we usually abandon such methods of determining weight and rely on actual measures. Nevertheless, when we take an object in our hands, we can usually say whether it is heavy or not, or whether it is heavier than another object. Whether we are correct or not is a different matter: it has been proven that illusions stemming from a combined weight-shape perception are easy to set up [59].

All this works in the real world. Things are different in VR because it usually makes no difference whether we move an ordinary soccer ball or a whole mountain in the virtual world: we cannot feel the weight (in the sense of: the familiar feeling of heaviness) in our hands in VR.

In addition to intrinsic mass, in VR we cannot readily feel such phenomena as the change in perceived weight under the influence of magnetic forces, frictional forces or viscosity. Haptic devices were designed towards this end: haptic technology recreates the sense of touch by applying forces, vibrations, or motions to the user through haptic devices, simulations and interfaces. Such devices can be tactile or force-feedback, depending on which receptors they focus on [86].

Thus, the visual-tactile virtual simulation of elementary physics is a tactile technique application involving hand-eye coordination and touch, design to help students understand physics concepts [66]. Such haptic technologies have been successfully used to study electrostatic and electromagnetic fields [37], surgery [148], and to teach mechanism dynamics [73]. Also, Koul et al. [73] think that an effective method for teaching and learning concepts of physics that are difficult to understand consists of enhancing education with haptics. For example, Jose et al. [66] have successfully developed basic simulation modules featuring haptic, audio and visual feedback for four basic physical concepts: gravity, viscosity, friction and magnetic forces.

An alternative to traditional kinesthetic feedback devices featuring limited work-spaces is wearable devices. Skin deformation feedback offers a user-driven feedback modality that mimics the interaction of the skin with the natural world but may suffer from a saturation of the output force due to the actuation

constraints required to achieve a small form factor. The use of such technologies in teaching inertial forces has shown the effectiveness of the tactile rendering algorithm [134].

While these works look promising from a learning perspective, representing weight in VR remains problematic: haptic devices tend to be very expensive, cumbersome, and lack robustness and longevity. Placing such devices in a classroom, in the context of a typical education curriculum, is simply not possible at this time¹.

Let us then consider the basic problem: perceiving weight without tactile or haptic feedback. There are two options: (i) changing the visual characteristics of the object, such as size (a large object will likely seem heavier than a small one) or texture (a metal-looking object will be perceived heavier than an equivalent plastic one) or (ii) changing the behaviour of the object when it is grabbed or manipulated. Changing the texture is not practical for a learning task: while it is easy to visually compare two objects, it is challenging to sort a large number of objects by weight. Also, there are light metals (lithium) and weighty pieces of wood (ebony). Resizing objects is also impractical. For example, objects with different densities and different volumes can happen to have the same mass (see Chapter 5) Object resizing can be useful, but only for simple object comparison tasks. It is only an illusion of size-weight, caused only by visual cues of size in an expanded environment. And the illusion is sensory-based and relies on integrated human perception based on multimodal sensory information [68]. Thus, changing the visual characteristics is not practical, and the object's behaviour remains to change when captured or moved.

Let us now considering option (ii). VR brings some interesting ways of "tricking" human perception: the concept of *pseudo-haptic techniques* in order to convey mass information to potential students [62] is an interesting alternative. To stimulate weight perception without kinesthetic feedback, the concept of Control-to-Display (C / D) ratio manipulation [122] is introduced. The Control-to-Display (C/D for short) ratio defines as the ratio between the amplitude of movements of the user's real hand and the amplitude of movements of its virtual counterpart (a cursor, a virtual hand, or any other form of interaction avatar). The gain of the C/D ratio should be inversely proportional to the weight of the virtual object that we want to render. For example, if an object is to be perceived as heavy, we must set the C/D ratio to less than 1 so that the rendered movements appear "compressed". The operation is applied to all three Euclidean components of the rendered movement. Control-to-Display Ratio applied to virtual objects typically cause "stiffness" or "viscosity" perception, i.e. visual/haptic illusions and pseudo-haptic effects

¹Based on the experience of my supervisors and other experts in VR who are involved in teaching.

[87]. A correct pseudo-haptic rendering based on the weight of an object could impact the perception of gravity or/and the mass of objects.

The development of the experiments presented in this chapter takes place in a general context of learning the physical quantity "mass" (learning defined as a conceptual appropriation). This approach is based on the following postulate (which we will justify below): *the construction of a physical quantity by an individual is facilitated by qualitative measurement activities through comparison tasks.*

4.2 Rationale: teaching "mass"

The mass of an object is a quantity that can be associated, as a first approximation, with the amount of matter contained in the object. It is a "locatable" magnitude, i.e. it is possible to classify objects according to their mass by defining the relations "=", "<", ">" [28]. As mentioned above, defining the magnitude "mass" of an object consists in constructing, for a variety of objects, "an equivalence class" [103], i.e. a property common to all these objects that can be accessed directly (by hand weighing, for example) or with the help of an instrument (such as a scale). While size is immediately seized by vision, a first qualitative approach to "mass", consisting of comparing and ordering the objects, seems to be a necessary precondition for learning about identifiable magnitudes in general and mass in particular. For example, when several objects are available, they can be placed two by two on the trays of a Roberval-type balance (see Figure 4.1). If the arm of the scale balances in a horizontal position, then the two objects belong to the same equivalence class (they are equivalent in terms of mass). If this is not the case, it is still possible to classify the objects by comparison. The result is an order relationship between the masses of the objects. Whether instrumented or not, these direct comparisons can be carried out using various procedures without the need to choose a unit and introduce a number and always give the same result at a given location. If this first qualitative approach to magnitudes is inadequate for not directly comparable parameters (energy, density), it nevertheless seems to be a necessary precondition for learning about identifiable magnitudes in general and mass in particular. Moreover, this approach is the one that most primary school science curricula have chosen to adopt in many countries, where the importance given to the construction of each magnitude by comparison activities before and outside any measurement activity is noted [102].

Research findings in cognitive psychology and science education support this choice. In their work on the construction of quantities, [104] showed that starting with measurement is not necessarily the

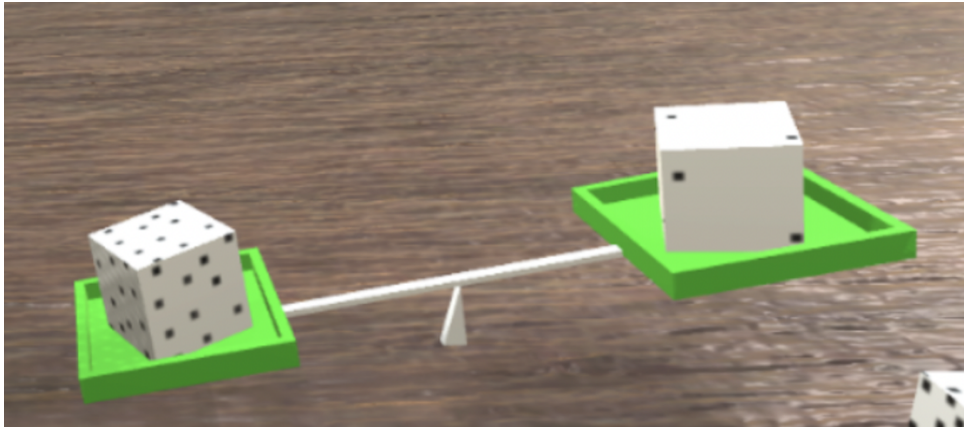

Figure 4.1: Roberval balance.

most efficient way to construct knowledge related to magnitude. Constructionist thinking, supported by Piaget, which insists on the active role that students must play in the construction of knowledge, has favoured the emergence of numerous proposals in the sense of working on magnitude prior to the introduction of measurement. Many authors stress the importance of conceptualising each magnitude before measuring it in physics and mathematics education. In a review of the literature on these issues, [88] points out that, while many sequences for learning measurement are presented in the literature, most are similar in their progression: from the identification of the magnitude and the use of arbitrary units to the use of conventional units. In the case of mass, [102] has shown that comparison activities are an aid to conceptualisation. In particular, students who have experienced a comparison situation differentiate mass from volume better than those who enter directly into measurement activities using an everyday instrument displaying the conventional reference (the gram). This result converges with those obtained by [12] and [21] on length learning.

It is based on this body of evidence that we chose this approach as a basis for our experiments.

4.3 Pseudo-haptics techniques for mass evaluation in VR

As reminded above, haptic feedback is crucial for users to interact with 3D objects inside a realistic, immersive virtual simulation. It has been demonstrated that haptics can improve task performance in a virtual environment [136], with many different applications (medical, manufacturing, teleoperation, etc.). Many studies investigated the relationship between the haptic sensory-motor channel and other sensory channels, in particular the visual one. When visual and haptic perceptions conflict occurs, the

dominance of vision over touch causes an illusion, i.e. one is likely to perceive a haptic sensation that is different from the haptic property intrinsically rendered in the real world, a phenomenon known as pseudo-haptics [77]. Researchers have found that humans perceive pseudo-haptics in terms of several physical properties, such as object stiffness [78], texture [79], or mass [36].

Having in mind the subject of our study, i.e. mass perception for learning the concept of mass in VR, several psycho-cognitive studies aimed to quantify pseudo-haptic effects in controlled situations. In such experiments, the user task is to perform a set of predefined actions (moving an object up and down, sliding an object on a surface) and then sorting the objects by weight criteria. In such experimental conditions, the Control-to-Display (C/D for short) ratio, defined as the ratio between the amplitude of movements of the user's real hand and the amplitude of movements of its virtual counterpart (a cursor, a virtual hand, or any other form of interaction avatar), has proven very effective to create beneficial pseudo-haptic effects [36]. The gain of the C/D ratio should be inversely proportional to the weight of the virtual object that we want to render. For example, if an object is to be perceived as heavy, we must set the C/D ratio to less than 1 so that the rendered movements appear "compressed". The operation is applied to all three Euclidean components of the rendered movement.

In most works, virtual haptic feedback (simulating the actual weight of a grasped object) is present but is expected to be modulated by pseudo-haptic effects. In other cases, an actual physical object provides the haptic reference feedback. For example, in [36], a 3 DoF haptic device was used to measure the relative perceived weight of two balls, with a range of different simulated masses and C/D ratios, by lifting the balls by a few centimetres. In [122], two actual wooden cubes of equal mass were first used as physical props and rendered in virtual reality within an HMD, with an alteration of the magnitude of C/D translation ratio of one of them. In a second experiment, the user was asked to lift an actual cube and a simulated one (using a haptic device) and reported the relative perceived weights. In a recent paper [151], a six DoF tracker served as a prop to rotate virtual cubes with the dominant hand. Different C/D ratios in rotation were applied to two virtual cubes that looked identical in shape but with different simulated weights. Users were able to discriminate virtual objects successfully (more than 80% of the time) even with C/D ratios close to one.

4.4 Comparing pseudo-haptic techniques for mass comprehension in VR

Because (i) active manipulation of weighting objects is crucial to the learning process of the property “mass” - see Section 4.2, (ii) deploying actual haptic feedback devices in classrooms is still not practically possible², and (iii) pseudo-haptic techniques provide satisfactory results in controlled experiments (see section 4.3), we set to compare several interacting conditions within VR simulations, in which objects of different masses (hence different weights) have to be comparatively assessed.

4.4.1 Experimental setup

We performed a VR experiment using a Lenovo Explorer Head-Mounted Display, connected to a high-end VR-compatible PC, running a Unity simulation (version 2018.4).

Before the actual experiment, we properly calibrated the interaction space for each user, aligning the virtual space with a corresponding table-top arrangement in the real space (see below).

Also, we respected special sanitary measures to avoid any possible Covid-related contamination, with adequate disinfection of all interacting devices.

All the interaction techniques in this paper are based on the typical “simple virtual hand” metaphor [58], in which a zero-order mapping maps the hand-held controller’s movement to the proxy’s movement (translation and rotation). Because we wanted the user to experience conditions as close as possible to an actual classroom experiment, no offset existed between the user’s hand and its virtual counterpart. To make the simulation more realistic, all objects were placed on a virtual desk whose horizontal surface matched the position of an actual table positioned in front of the user, acting as passive haptic feedback (Figure 4.2a).

Figure 4.2b shows the actual VR environment used in this experiment. Four cubes of similar appearance (size, shape, texture) were randomly placed side by side on a desk. Because we wanted the user to remember “which cube is which” during a particular trial, all cubes were painted with different (randomly assigned) colours, cubes could be picked up with both hands (using the trigger of VR controllers), manipulated freely, and dropped by releasing the trigger.

Based on our bibliographic review, we settled on comparing three different metaphors to experience

²Reasons range from technical setup, fragility of existing devices, to economic cost. A complete review of existing haptic solutions is out of the scope of this thesis. For a detailed analysis see [48]

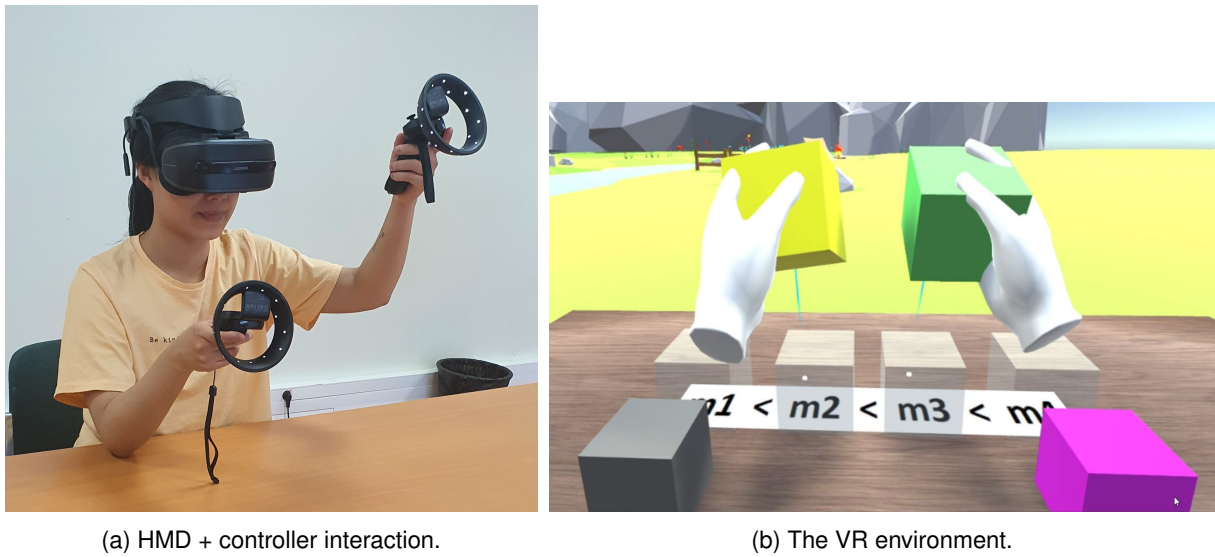

Figure 4.2: Experimental setup.

the relative mass of objects.

The first one is the Roberval Balance (RB) metaphor and is based on the visual comparison, with no pseudo-haptic feedback. By putting two cubes on each side of the scale, the user can quickly assess their relative weight (and hence, mass). The virtual balance was set up so that the test outcome was always evident. We decided against any form of direct numerical measurement, as instructed by the findings in physics education (see Section 4.2).

The second metaphor was coded in the spirit of [122], thus applying a pseudo-haptic translation C/D ratio to the manipulated object. In the initial vision of pseudo-haptics, there is a delay between the real hand and the virtual hand (a clone), so if the object is heavy, then the clone "sticks" to it, and if the object is light, then it "jumps" slightly ahead of the real position of the hand. However, Rietzler et al. [114] implemented an algorithm similar to manipulating the C / D ratio and found that if there are large differences between the position of real and virtual hands, then the quality of the user experience degraded. Thus, contrary to this previous work, by design, we made the virtual hand coincide with the real hand at all times in our experiment. Consequently, the position of the grasped object drifted from the hand as the movement progressed in a particular direction, either forward or lagging behind (as if with more inertia). When the hand stopped moving, the object "snapped back" to the hand. Early tests confirmed that users moved the cubes in short time spans (less than 2 seconds), producing reasonable drifts even with big C/D ratios and perceiving the object still attached to the hand. We will call this the

Pseudo-haptic translation (PHT) metaphor (Figure 4.3a).

The third metaphor was taken from [151], with a rotation C/D ratio applied to the grasped object (and no translation effect). The pivot point of rotation was set at the grasping position, located inside the virtual hand's palm (and thus close to the corresponding real hand location). As reported in [151], we expected that users would perceive objects rotating with smaller C/D ratios (i.e. faster than the hand) as lighter, and conversely, big C/D ratios (cube "lagging" in rotation) would lead to the perception of heavy masses. This last metaphor will be referred to as Pseudo-haptic rotation (PHR) (Figure 4.3b).

The main appeal of the pseudo-haptic techniques is to provide a principled way of creating VR experiences that simultaneously achieves two goals: to enable users to perceive the weight of virtual objects (I) and to maintain a sense of possession of virtual limbs, as well as an overall sense of presence (II).

4.4.2 Experimental procedure

It was organised in three steps in the following order:

Free exploration

The experiment's first phase consisted of presenting the setup in a sandbox configuration and allowing participants to freely manipulate a set of objects of different sizes and shapes. General instructions were given on the VR setup, grasping objects and putting them in different locations. No specific task was instructed at this stage, and users could experiment for as long as they want. Also, there was no pseudo-haptic metaphor (C/D ratio equal to 1), only direct object manipulation.

Experiment

To determine the robustness of the illusion of weight in a psycho-physical task and quantify the relation between haptic illusions and actual experimental tasks, we administered a weight discrimination task after the free exploration phase mentioned above. Participants performed a sorting task by comparing four cubes and placing them in four slots, from the lightest to the heaviest (see 4.2b). They could manipulate the cubes at will in each trial, and there was no time constraint. Choices could be revised as many times as they wanted until they attained sufficient ordering. A "next" button appeared as soon as the four slots were filled in order to validate the final decision. Each condition (RB, PHT, PHR) was

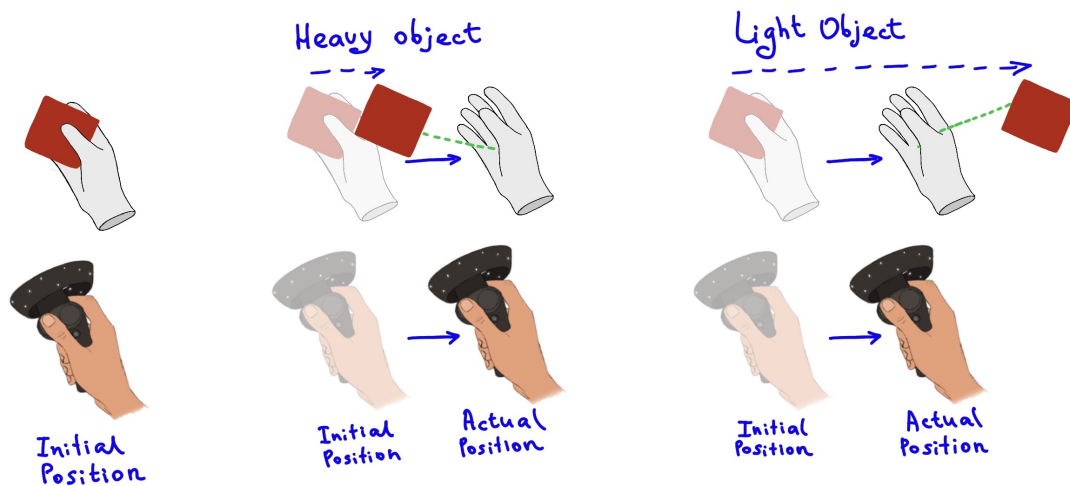

(a) PHT technique.

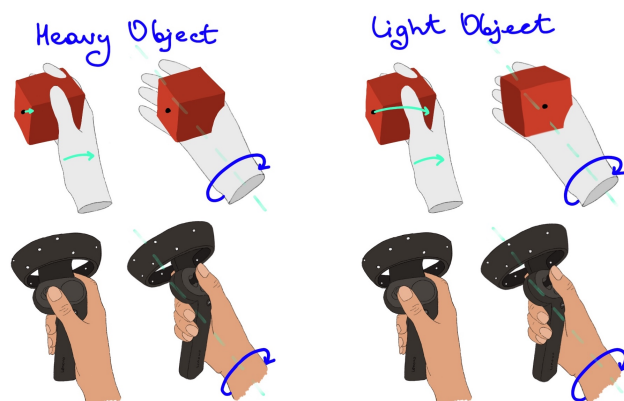

(b) PHR technique.

Figure 4.3: Pseudo-haptic metaphors used in the mass evaluation experiment.

tested, with three trials in a row. Each participant tested a different order of the conditions (RB/PHT/PHR, RB/PHR/PHT, etc.). At the end of the nine trials, the VR experiment ended.

Post-experiment interview

Following the VR experiment, participants underwent a 15-minutes semi-directed interview following the guidelines summarised in Table 1 (see Figure 4.4). The interview objective was to collect relevant data relative to subjective perceptions regarding the general quality of the environment and the interaction, the task itself, perceived object affordance, perception of weight, and general satisfaction w.r.t. the experiment. Free speech was encouraged to gather as many cues as possible on the experiment.

Experimental interview guide
<p>1. Environmental ecology</p> <p>1a Did the environment seem natural (resembling reality) or rather abstract to you? What do you think was missing?</p> <p>1b Did the interaction with the cubes seem natural to you? Difficult? Did you feel in control of the simulation?</p> <p>1c Was it awkward not seeing your real hand?</p> <p>1d Were you able to concentrate on the task and forget about the material conditions (i.e. the fact that you were in a virtual universe) ?</p> <p>1e Imagine the same task in real life, would this seem preferable?</p>
<p>2.Task</p> <p>2a Were you able to easily sort between the different cubes? (If not mentioning the different paradigms, ask: each time?)</p>
<p>3.About affordances/gestures</p> <p>Did certain gestures seem more conducive to you than others:</p> <p>3a to perform the sorting tasks?</p> <p>3b to evaluate the weight of the cubes?</p>
<p>4.About the weight of the cubes</p> <p>4a Did you perceive the cubes as having a mass/weight? Sometimes? Often? Never?</p> <p>4b Could you easily perceive that some cubes were heavier than others? Why was this? (If not mentioning the different paradigms, ask: each time?)</p>
<p>5.Involvement / Fun</p> <p>5a: Did you find the simulation interesting? Amusing? Other qualifiers?</p> <p>5b: Overall, was the task difficult? Was it easy?</p> <p>5c: Did you take the task rather seriously (compelled to get it right) or as an exercise without any consequences, a game?</p>

Figure 4.4: Interview guide.

4.4.3 Preliminary tests and results

Because of the prevailing sanitary conditions, preliminary tests were conducted on six participants (Mean age = 31, SD = 5.7) within our research group. None of the participants was involved in the design of this experiment nor involved in the research. Each participant tested a different order of the conditions (RB/PHT/PHR, RB/PHR/PHT, etc.). There were four males and two females, and all of them were right-handed with normal vision. All participants reported above-average VR expertise.

During each trial, the following dependent variables were recorded: completion time (CT), rate of success (RS), ranging from 0=no good answer to 4=perfect ordering of cubes according to weight, swaps (SW), i.e. the number of slots occupied by all cubes during the trial (SW=0 being the absolute minimum).

We reported the most salient results in Figure 4.5. The RS score was almost always the best in the RB condition, with PHR performing poorly on nearly all users. Nevertheless, all participants passed the 50% mark on RS. PHT fared well, although many users reported feeling confused (Figure 4.5a). The number of swaps SW was much lower within the RB condition than in the pseudo-haptic conditions (Figure 4.5b), revealing the users felt sure of their actions using the scale, a fact confirmed by a completion time CT being generally lower in the RB condition (Figure 4.5c). There was a small but noticeable learning effect in all conditions. It is worth noticing that 5 out of 6 participants used both their hands (exhibiting comparison behaviours), despite being all right-handed (Figure 4.5d).

We omitted the complete transcription of interviews for lack of space. The salient facts we uncovered were the following:

- General VR scene settings and manipulation procedures were considered satisfactory. One subject would have preferred to see controllers instead of hands, but it did not impede performance. Practically everyone reported they did the task seriously, despite being frustrated sometimes, and felt compelled enough to do as well as possible.
- Subjects unanimously positively valued the RB condition, finding it fun, easy, and felt confident using it as a mass assessment tool.
- Nearly all subjects overlooked rotation as a way of manipulation and never mentioned it as a way to experiment weight (even though we mentioned it explicitly as a possible action during the training phase). Most users said they used translations or dropped the cubes from a certain “constant” height.

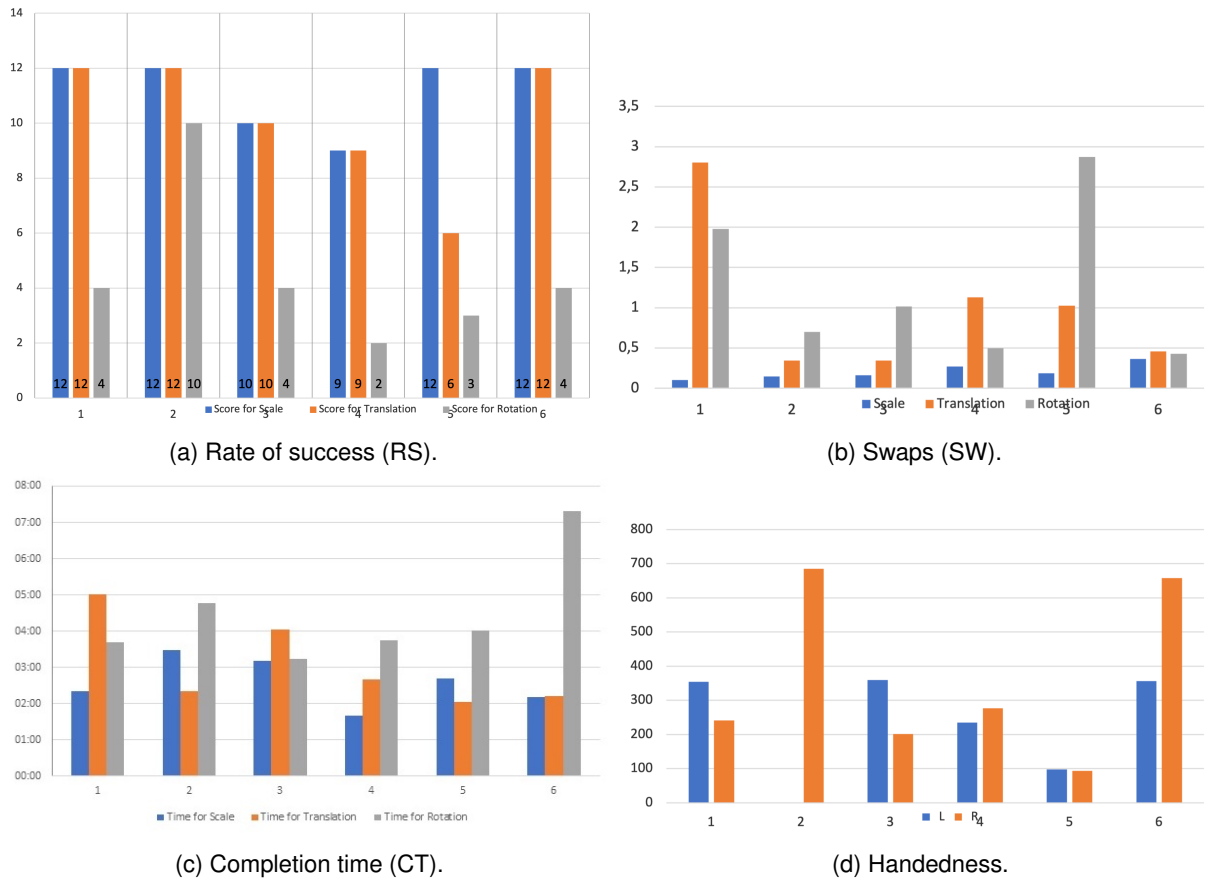

Figure 4.5: Quantitative reports: RS, CT, SW, and Handedness.

- No subject reported any actual pseudo-haptic feeling, and only a few mentioned they intellectually connected actual manipulation artefacts with weight.
- 4 subjects out of 6 explicitly used dropping as a way to assess weight, following the (false) assumption that “The heavier, the quicker” (see [51] for an analysis of this in real life experiments). One subject even complained of “weird physics” because objects would all fall the same way.

4.5 Conclusion

The conclusions of the experiment were the following:

- Condition RB was highly appreciated. Users performed nearly perfectly in RB and reported it was useful, fun and encouraged active participation. Swapping was also minimal in this condition,

reflecting that participants felt quite sure of their weight assessment.

- Unfortunately, no pseudo haptic effect was reported in the designed experiment. The most plausible cause of this is the lack of grasping of an actual tangible object. This absence of prop, which was deliberate and originated from our analysis of what future classroom conditions would be, was obviously detrimental.
- Nevertheless, condition PHT achieved nearly as well as RB, so that manipulation of translation C/D ratios may still be worth investigating. For instance, it could be interesting to limit the translation pseudo-haptic effect to the vertical direction because it is intuitively easy to assimilate with gravity.
- Misconceptions about the physics of falling objects drove many users to experiment on dropping objects as a way to mass-sort them. This belief was reported in teaching physics with real objects [51]. This led us to conclude that further investigations on dispelling such misconceptions in VR-based physics classes was needed. This will be the object of Chapter 6.

The overall conclusion is that although it is purely vision-based, the Roberval Balance tool was considered extremely valuable and, therefore, will be retained as the reference for mass evaluation in subsequent educational VR experiences of this thesis. Pseudo-haptics did not prove useful for weight perception in VR physics-based simulation geared towards education purposes. This calls for further studies on how the pseudo-haptic translation metaphor could still be useful in the absence of active haptic feedback³.

³Especially in the vertical direction, which intuitively/symbolically matches with gravity and, therefore, with mass perception.

Chapter 5

TEACHING THE CONCEPT OF DENSITY WITH IMMERSIVE TOOLS

Abstract. *Training students in basic concepts of physics (such as the ones related to mass, volume, or density) is much more complicated than just stating the underlying definitions and laws. One of the reasons for this is that most students have deeply rooted delusions and misconceptions about the behaviour of objects, sometimes close to magical thinking. Many innovative and promising technologies can be used to enhance the teaching process for students. We focus on using Virtual Reality (VR) to this effect. More specifically, this chapter investigates how to harness the combined possibilities of virtual reality and serious games in order to convey knowledge around the concept of density.*

We compared the effectiveness of a serious game in teaching the concept of density in various conditions: a 2D version in an embedded web browser and a 3D immersive game in VR. We also developed a specific questionnaire to assess students' knowledge improvement. Results show an increase in learning efficiency using VR. Also, most students were able to acknowledge the shortcomings of their initial theories and revise them, which means that they improved their understanding of the topic at hand.

5.1 Introduction

The early experiments in gravitation and how to manipulate objects with mass (and thus weight) in VR led to brainstorming discussions with my advisers and made us reconsider which concepts we should study next. Somewhat logically, we switched our focus of research to density as the next interesting topic of study. Other possibilities were considered: we initially thought to study free fall motion, as it is usually a subject of major confusion among students (see Chapter 4). Density was preferred to free fall because of practical issues and because understanding density is especially challenging, while still being related to weight perception.

Density can be designated as a scalar physical quantity, defined as the body mass ratio to the volume occupied by this body (implicitly, the body in question is homogeneous, or one will speak about average density). As mentioned in the previous chapter, defining the magnitude "mass" of an object consists of constructing, for a variety of objects, "an equivalence class" [103], i.e., a property common to all these objects that can be accessed directly or with the help of an instrument. While the size is immediately visible to the eye, the mass cannot be accessed directly; the density of an object is not always possible to determine visually. For example, knowing the material and the density of one object, it is not straightforward to tell whether it will float on the surface of a liquid (say, water) or sink. The main misconception encountered in this subject is the conflation between weight and density as quantities [128]. Thus, the study of the topic "density" using Virtual Reality and serious games is of great scientific interest.

One should note that, to the best of our knowledge, VR has never been used to teach the concept of density. Because this classic concept is addressed early in most teaching curricula all around the world, it was only logical we selected it as an excellent candidate to evaluate the efficiency of VR to comprehend physics in a classroom setting.

5.1.1 Teaching density

Successfully teaching science to school children has proven to be a challenge. Students' problems relative to science learning clearly relate to the conceptual transition from existing empirical knowledge to orthodox scientific knowledge (i.e. formal knowledge concerning natural phenomena) [57].

Of course, many factors influence the success of learning, ranging from personal factors such as cultural and religious beliefs, social and physical environment [57] to factors beyond our control, such as

the poor performance of pre-service teachers [150]. Nevertheless, many students' responses demonstrate a consistent pattern of linking each of the properties of mass, volume and density to size. These responses can be interpreted as illustrating an inability to distinguish between these interrelated concepts. R.E. Yeend et.al [150] use an alternative interpretation based on the work of Stavy and Tirosh [130], who state that most responses of students in mathematics are made according to an intuitive rule "...the rule 'More A - More B' is... the common core to many reported apparent misconceptions" ([150] from [130]).

In order to teach density, Smith [128] mentioned that it is important to show early on the correct connection between density and flotation (an object denser than water will sink while it will float if less dense) because *"it seemed entirely possible that the children might have a differentiated concept of density but not yet see how it applied to flotation"* [128]. If the learned materials do not fit students' intuitive framework, students tend to distort the learning to accommodate their beliefs. Also, they can assimilate the new material as a separate system without any relations to the real world. Consequently, they "learn" the material as it is without understanding it, pass exams, but fail to get a clear understanding of the underlying concept [128].

The main misconception encountered by students when learning on this subject is the conflation between weight and density as equivalent quantities [128]. Strike and Posner [133] argued that *"for conceptual change to occur, one must become dissatisfied with one's existing conceptions and find a new framework to be at least minimally understandable, plausible, and fruitful. ... Traditional curricula could be criticised on both counts. The curricula do not directly address the problem of making students aware of the shortcomings of their initial conceptions, and they present new conceptions, clothed in technical language and mathematical formulas, in ways that are not conceptually intelligible to students."* Therefore, it is crucial to *show* students that their current concepts are wrong and do not stand up to serious scrutiny, and based on this, provide them with an experimental path to the correct framework.

Roach [116] conclude that students should experience qualitative and quantitative approaches to density to eliminate misconceptions and achieve a proper conceptual understanding.

In France, density is first studied in middle school (école primaire et collège). An analysis of the support resources available on the website *eduscol* [96] and on the website *Fondation La main à la Pâte* [61] as well as on some French 6th grade textbooks, shows that two approaches seem to be preferred to solve the density problem:

- A qualitative experimental approach in which students are asked to compare the buoyancy or

non-buoyancy of different solids or the superposition of different liquids;

- The quantitative approach (experimental or not) by calculating the density compared to that of water.

Given a brief analysis of French physics-chemistry teachers' materials in the 6th year, and existing didactic sessions [53], these two approaches seem to be relatively prevalent in teaching practice, in France and abroad.

5.1.2 Clarification of the used terminology

It is important to remember that weight and mass are different physical quantities. Although in everyday life we often hear the question "how much do you weigh?", not everyone realises that it would be more correct to ask, for example, "what is your body mass?". For the sake of clarity, let us restate official definitions.

Formally, *mass* is a characteristic of a physical body that represents the quantity of matter contained in a body. The definition of mass is its representation in terms of inertia: The greater the mass, the more difficult it is to move or stop the movement of a body. In the international system of units, mass is expressed in kilograms (kg).

Weight is the force exerted by the Earth on an object, downwards. If the object is laid on a support, this support exerts a reaction force on this object, opposite to the weight that prevents the object from falling. Numerically, weight is the product of the mass of an object by the acceleration of gravity (on planet Earth, the acceleration of gravity is 9.8 m/s^2). Weight, contrary to popular belief, is not measured in kilograms but in newtons. In the international system of units, weight is expressed in newtons (N).

Specific weight is the ratio of the weight of a substance to the volume it occupies, while density is the ratio of the mass of a substance to the volume it occupies (see Figure 5.1). The density is also known as specific mass or volumetric mass density ¹.

On this basis, density is measured in kg/m^3 and specific weight in N/m^3 . Density is sometimes defined in reference to a given element (water). Usually, in school, we are introduced first to volume (in elementary school, sometimes before) \Rightarrow then mass (elementary school) \Rightarrow then density (secondary school, introduced as a formula) \Rightarrow then specific weight (an analytical knowledge, stated as a computa-

¹Note that the English definitions differ from the French ones. In French density is called "masse volumique", and "Densité" refers to a unitless number defined as the ratio of a density to the density of water. In this document we will use the English vocabulary.

<p><u>Density:</u></p> $\rho = \frac{m}{V}$ <p>Where m - mass, V - volume</p> <p>[kg/m³]</p>	<p><u>Specific Weight:</u></p> $\gamma = \frac{G}{V}$ <p>Where G - weight, V - volume</p> <p>[N/m³]</p>
---	--

Figure 5.1: Density & Specific mass.

tion, with no empirical understanding or interpretation) . In our research, because of the possibilities VR opened in terms of manipulation and observation, we deliberately favoured the qualitative approach by assessing density directly, by comparing different objects with a reference (a liquid in tank).

Obviously, a cube with a density that makes it sink has a higher specific weight than floats. The reference serves as a comparison device for comparing objects of different specific weights. Density, in this way, is an "experimental" unit, whereas specific weight is a scalar, a scientific measure (intrinsic to a given material) that is hard to measure by itself (you have to measure the mass, the volume, and make a computation).

So experimentally, it is much easier to "experimentally understand" density and then understand specific weight from it. So in this way, we follow the same understanding path: volume ⇒ then mass ⇒ then density ⇒ then specific weight.

Up to density, no *formal*, *numerical* knowledge is required. You can understand and predict behaviours from purely comparative experiences, which is exactly what we seek, because it is clear that, in the existing teaching process, even adults often fail to grasp the correct concept of density (especially if only confronted with quantitative approach).

Based on these considerations, our goal is to prove that:

- 3D simulations (presented in 2D or VR) help to better understand density because they give people the possibility to manipulate and make predictions (scientific empirical method);
- VR is better than a 2D game (Chapter 2).

5.2 Method and tasks

Recent STEM education research [152] reported that students who used VR for education and students using a regular desktop version exhibited similar results. Nevertheless, students experiencing immersion mentioned more motivation and feeling more present. Moreover, the results of immersion (3D) and desktop (2D) learning gave better results than actual field trips [152]. Based on these findings, and also because COVID-19 related sanitary conditions strongly promoted remote teaching, we decided to evaluate teaching the concept of density in two conditions:

1. In 2D, remotely: using keyboard/mouse interaction inside a 2D web-based simulation;
2. In 3D, in person: through an immersive VR experiment, using a run-of-the-mill Head-Mounted Display (HMD).

The first condition is similar to existing web-based physics-based simulation frameworks (such as Algodoo [2]). The second condition is set to anticipate VR setups that might exist in classrooms in a near future, given the current trend regarding the democratisation of VR devices.

Accompanying these two experimental setups, it was vital to design an evaluation questionnaire (i) to collect a priory knowledge of the participants on the subject, and (ii) to evaluate possible improvements after the teaching sequences.

I initially set to conduct this experiment in actual classrooms in the Paris area. Unfortunately, COVID-19 abruptly diverted us from this objective, and I decided to target future physics teachers in priority, but to accept also standard participants with no specific knowledge or stakes in the subject. It is nevertheless worth noting that the experimental design needed not be modified due to this situation.

Following a didactic approach introduced in Chapter 2, the main tasks we have identified are:

- To provide a good understanding of different aspects of density for participants; analyse and assess this understanding;
- To clarify the distinction between density, weight, and volume in the participants' understanding;
- To examine the effectiveness of the serious game approach in teaching density and compare the results with traditional didactic approaches.

5.2.1 Design of the experimental conditions

We chose the two conditions introduced above to compare existing digital tools to our VR-based approach, two sets of independent variables were considered: *visual rendering* (2D screen (conventional) vs HMD (immersed)) and *interaction* (2D interaction vs. 3D interaction) [117]. Thus, there are four possible experimental conditions:

- Condition 1 - 2D screen and 2D interaction;
- Condition 2 - 2D screen and 3D interaction;
- Condition 3 - HMD and 2D interaction;
- Condition 4 - HMD and 3D interaction.

C1 and C4 were actually implemented. Let us now justify why the two other conditions were rejected.

C2 would consist in a screen-based game but presented in 3D. While the setup would be attractive, there exists a question of interaction - it is not very easy to manipulate a 3D environment in a 2D view. For example, consider the following sequence:

- grabbing a cube from a table (lifting manipulation corresponding to a motion in the screen space);
- then moving the cube to a tank positioned behind (in-depth manipulation);
- then putting the cube inside the tank and into a liquid (vertical manipulation);

This simple sequence cannot be achieved with a simple mouse motion and necessitate e.g. key modifiers. Furthermore, it is difficult to apprehend relative depth motions on a 2D screen, and occlusions may occur between objects. This is just a very basic manipulation, so it was likely that people would struggle on more complex manipulations (again, one must be reminded that people would play online, with no real-time supervision). For these reasons, we decided against presenting such a condition.

C3 would consist in an immersive game with 2D interaction on a game presented in a "flat" fashion, e.g. orthographic projection. We decided against such a presentation mainly for pedagogical reasons: it would make no sense not to take advantage of the full immersive potential of a VR setup by restricting the interaction to a 2-dimensional space. Nevertheless the C3 condition is not absurd in itself and could be a subject of investigation for other types of applications.

To summarise, we defined our experimental conditions with the hypothesis that the combination of 3D interaction and immersion would help participants to better comprehend a 3D physical world setting.

5.3 Participants

Based on previous research work conducted in the VENISE team by my advisor Jeanne Vézien (see EVEILS project [33]), one of the key issues in didactics consists in identifying target users and their associated level of knowledge. Ideally, school children would be the ideal target for the study. Unfortunately, the COVID-19 sanitary crisis ruled out this primary target.

During brainstorming discussions we conducted with Cecile de Hosson, a didactics of physics researcher², we concluded that, regarding the circumstances, future physics teachers would be an appropriate audience.

Indeed, L.C. McDermott [15] found out that results in the field of education obtained at the university level, including prospective and practising teachers, apply equally well to high school students and, in some instances, to children in the elementary grades. As it appears, misconceptions and faulty reasoning occur well beyond initial cursus and follow similar patterns. Another justification for choosing this population is that if a teacher can fully grasp a topic, then he will explain it correctly to others as well, using a similar approach (and conversely a teacher with physics misconceptions will likely not provide appropriate teaching). An approach aimed at improving a teacher's knowledge will logically benefit their students. Based on this hypothesis, we selected first year university students as participants, as well as students from other disciplines and actual teachers in elementary schools.

5.4 Questionnaire

In order to establish a reliable baseline of knowledge regarding the subject of density, we set to design a dedicated online questionnaire. This questionnaire, consisting in multiple choice questions, is based on the test designed by M.Hashweh in 2015 [53]. Although recent, it was tested on 1645 students and was considered to offer reliable insight on the robustness of students' knowledge on the subject of density. The reliability (Cronbach's alpha) of the initial questionnaire of the pre-test was .82 and for the post-test was .81. The test covered the following aspects of density: spontaneous use of the density concept in an everyday context, qualitative understanding of density, quantitative understanding of density, the effect of temperature change on density at the macro level, the concept of displacement volume, conservation of density, conservation of volume, the buoyancy of simple/homogenous and complex/heterogeneous

²Cécile De Hosson is a researcher at the Laboratoire de Didactique André Revuz, in Paris. She was involved in the EVEILS project and provided informal supervision regarding the didactical aspects of my work.

objects in the water, and the use of an articulate conception of matter in explaining density-related phenomena [53].

Based on the brainstorming sessions we conducted with Cécile De Hosson [64], I extracted a selected number of questions to create a short yet significant test. Our new condensed questionnaire contains two sections: Part one addresses the density concept (as volumetric mass, i.e., a correlation between density, mass, and volume), while part two addresses the density concept through flotation (different objects with different densities are placed inside liquids). Also, we added a self-assessed level of confidence to each answer (ranging from 1 to 4), which gives us an indication of the difficulty of the questions from the student's point of view.

Thus, following strict didactic rules, we created a questionnaire containing 13 basic questions about the density concept, each with a 4-step confidence level (See Second Appendix for a complete transcription), designed not only to assess knowledge, but also to uncover misconceptions on the concept of density.

Firstly, the questionnaire was used to evaluate the baseline of student knowledge: the questionnaire was made available on a website to freshmen physics students at the Université Paris-Diderot. Secondly, we used the questionnaire to evaluate the knowledge acquired by students before and after playing the interactive serious game (pre-test and post-test). The pre-test was an exact copy of the online questionnaire, and the post-test was a copy of the pre-test but with some reordering of the questions, so that the students would not try to remember a sequence of answers.

5.5 Visual design of density

Before describing the experimental setup, I would like to describe the visualisation choices I made to represent density - i.e. what is the most appropriate way to convey all the necessary information to the student during the virtual experiment.

When we look at an object, we immediately perceive two physics-based factors: its size and visual appearance (e.g. texture). Volume is directly derived from size. Material can sometimes be inferred from visual texture, leading to an estimated density ("plastic = light = not dense", "metal = heavy = dense"), but not in a systematic way. On the other hand, mass is estimated using improvised means (see chapter 1), and combined with size can lead to an estimation of density, although this is rarely how one will perceive or estimate density.

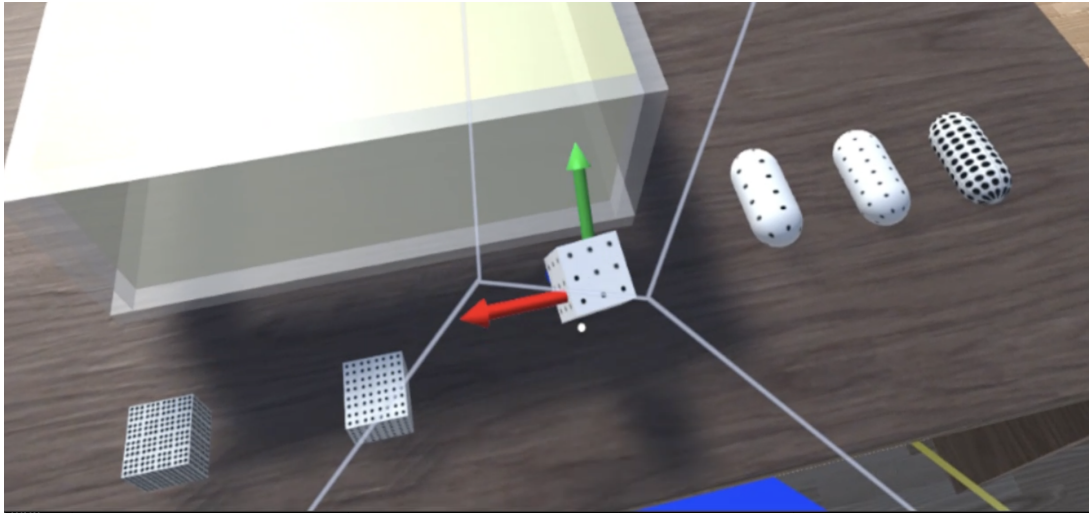

Figure 5.2: Possible forms for representing the object.

In designing our game on density, we had to choose which shape of an object to use for the presentation; several elementary shapes are available in our target software, Unity (see chapter 4): a sphere, a capsule or a cube (Figure 5.2). Complex shapes were not considered, as they could confuse the user into trying to analytically determine which object is bigger. We immediately rejected the sphere because it is impossible to tell its current orientation, and the capsule also has an obvious axis of symmetry. The cube proved to be appropriate because this shape provides accurate information about the object's dynamic pose and relative speed (a free-floating object can tumble in all directions). It is also very commonly "graspable" in the real world.

The second design choice consisted in determining the visual texture of the object. Following Smith [128], we chose to represent density using dot mapping and grayscale (Figure 5.3). Ultimately Smith selected point representation as the best representation for his symbolic mapping of density (both for object density and fluid density) (Figure 5.4). In this representation, the more points per surface unit an object exhibits, the denser the object. We decided to follow this recommendation.

However, our study had to handle both 2D and 3D representations, in order to extend visual representations to 3D objects in a VR simulation. We simulated several texturing possibilities based on Smith's finding to determine which one would convey the most significant information (Figure 5.5). Transparent texture and dice texture proved to be the most practical options, both in 2D and 3D situations (see Figure 5.6).

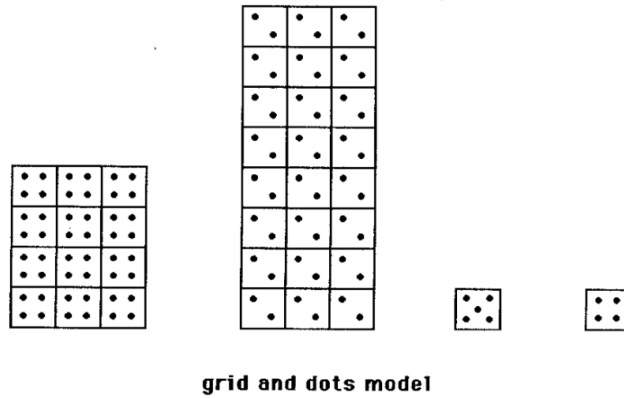
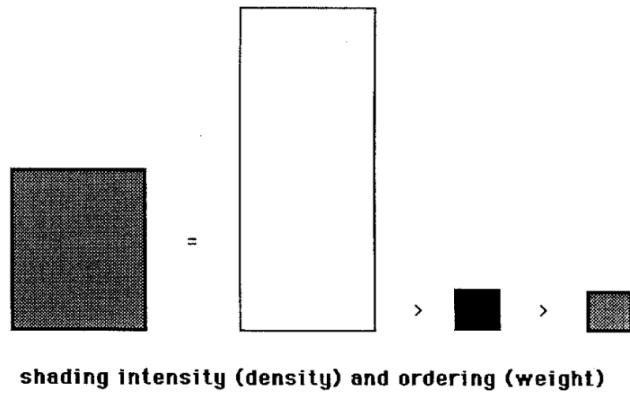

Figure 5.3: Two correct ways to represent the relative sizes, weights, and densities of four objects [128].

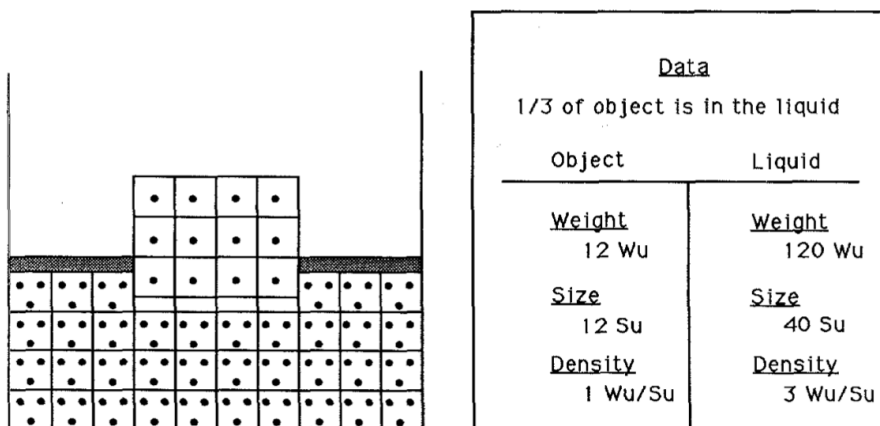
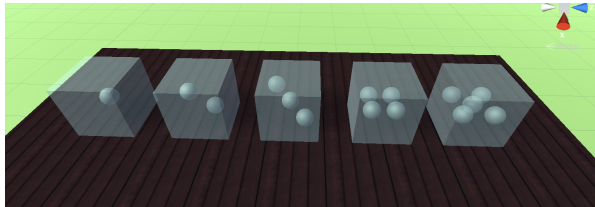
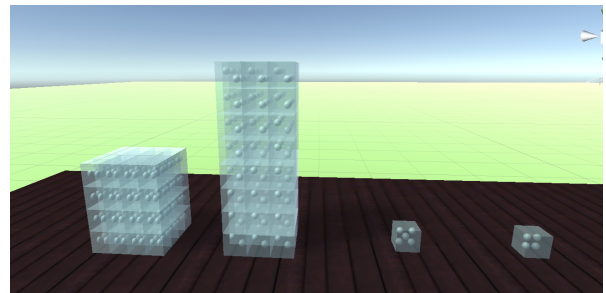

Figure 5.4: Grid-and-dots representation of an object floating in a liquid with data display [128].



(a) Transparent representation I.



(b) Transparent representation II.

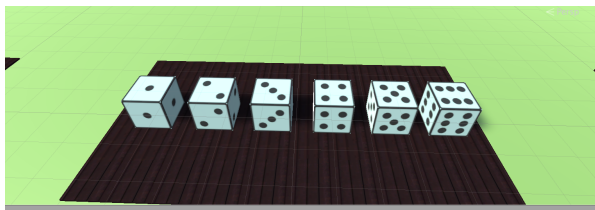

(c) Dice representation I.

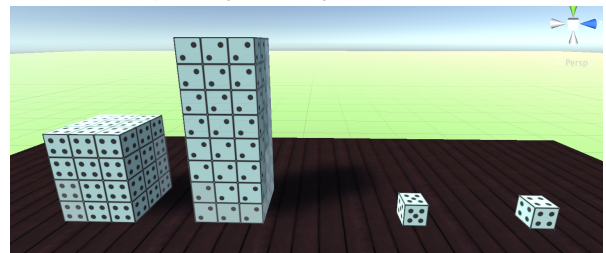

(d) Dice representation II.

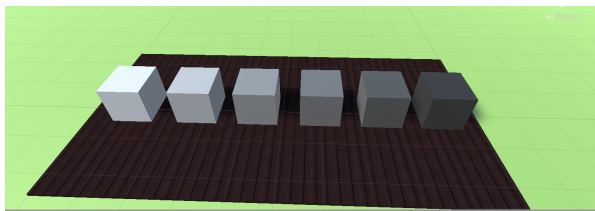

(e) Gray representation I.

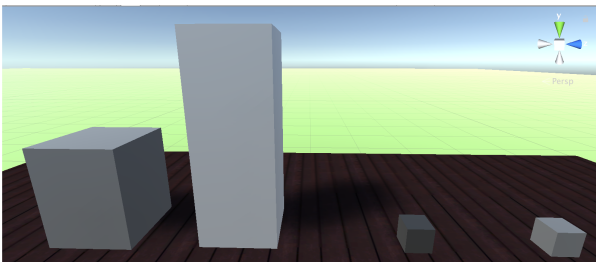

(f) Gray representation II.

Figure 5.5: Our variations for density visualisation.

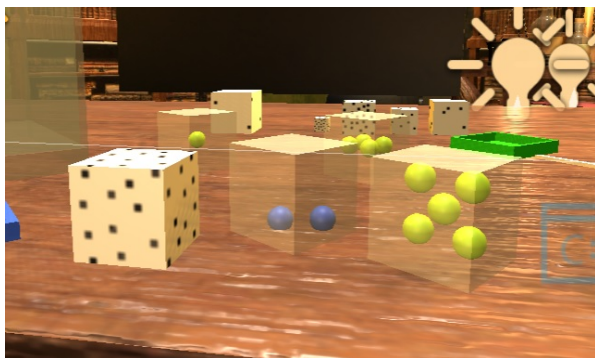

(a) 2 types of textures in an experimental environment - view 1.

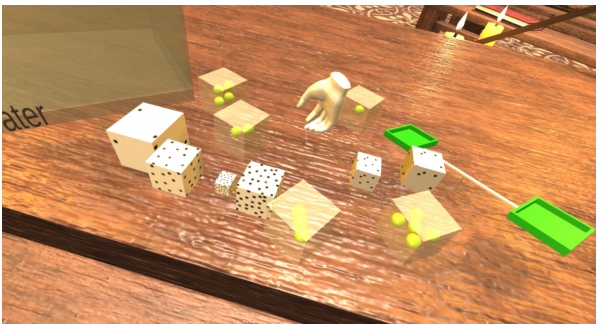

(b) 2 types of textures in an experimental environment - view 2.

Figure 5.6: View of the objects in the actual experimental environment.



Figure 5.7: Visualisation of density in 2D and 3D.

Further experimentation³ showed that:

- a transparent texture was less practical in 3D, being somewhat difficult to apprehend visually (in some preliminary tests, the material was perceived as not homogeneous, as if "beans in jello", contrary to the fundamental hypothesis);
- An organised texture (dice-like) was sometimes also misleading, as students tried to count the number of dots on the sides.

As a consequence, we finally selected the "dots on surface" texturing effect, but with a random arrangement for the dots, so that students would not try to count them but rather perceive them as "filling the object" - in a manner proportional to its density. Later interviews confirmed that most people used the correct association, while others ignored the visual cues altogether, which was still acceptable. The same visual rendering was applied in 2D and in 3D (see Figure 5.7).

In conclusion, we ended up with the visual design of Figure 5.7a and Figure 5.7b for object density. We purposely did not introduce any other additional realistic textures (e.g. wood or metal) to help students to focus on density as a concept, without the reference to some arbitrary material.

5.6 Web-based 2D game

5.6.1 Experimental setup

The second part of the research consisted in creating a 2D game designed as a web browser experience. Participants use a regular screen (connected to a laptop or PC) and mouse interaction to play within a 2D simulation, organised as a game with several "levels". This game was developed on the Unity game engine [141], as introduced in Chapter 3. The software is free and widely used for game development,

³No specific experiments were needed here. I implemented all the theoretical or 2D concepts in VR and in practice it became clear what was acceptable and "easy to read", and what was difficult to perceive. This choice confirmed its acceptability in further experiments.



Figure 5.8: Training in the 2D game.

with a large number of preexisting assets and Long Term Support. In particular, WebGL export allows for web-based target platform.

Following the general game progress outlined above, the game is decomposed into several stages: a pre-test (in the form of an online questionnaire) evaluates the current knowledge of students, then a training session (Figure 5.8), introduces the main objects and possible interactions to familiarise the user with the environment of the game, followed by three different game stages, described in detail below. A bonus level completes the game for more fun, followed by a post-test questionnaire, which consists of the same questions as the pre-test but in slightly different order.

H. Kloos [72] find out that adults are affected by the distribution of density in the set of objects presented to them, in that they could tune into density spontaneously when density was invariant, and less so when mass and volume were invariant. On the basis of the results we designed three sequential gaming conditions:

- Condition 1 – All objects have the same volume but not the same mass (Figure 5.9);
- Condition 2 - All objects are with the same mass but not the same volume (Figure 5.10);
- Condition 3 – Two tanks filled with different liquids and two sets of the objects, identical to those of Condition 1 (Figure 5.11).

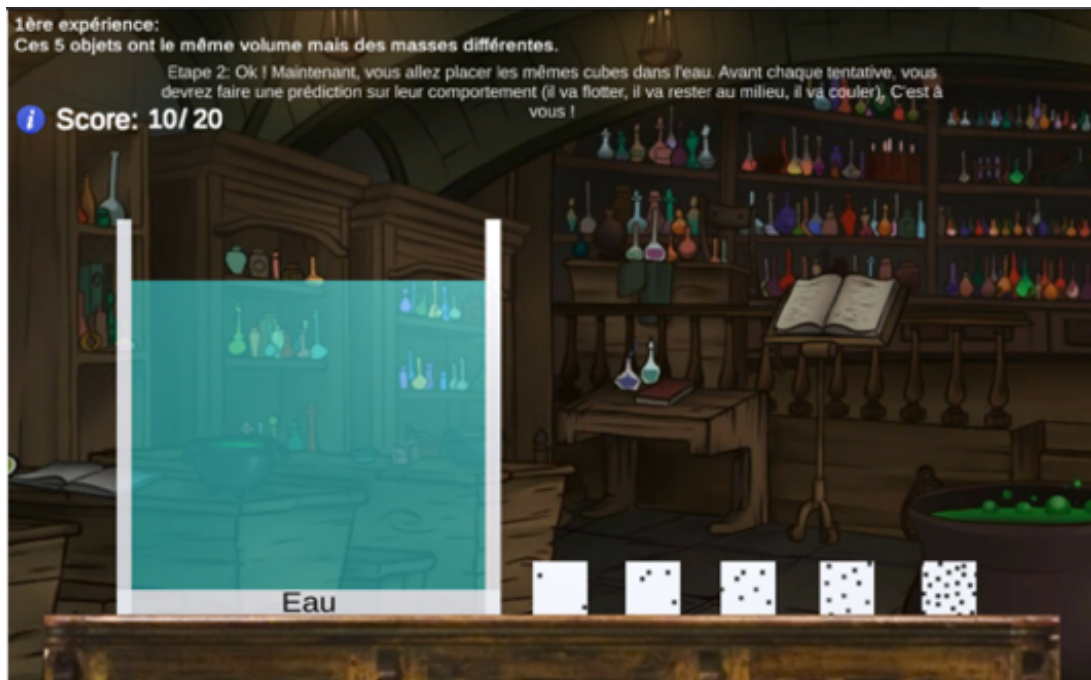

Figure 5.9: Scenario 1 in the 2D game.



Figure 5.10: Scenario 2 in the 2D game.

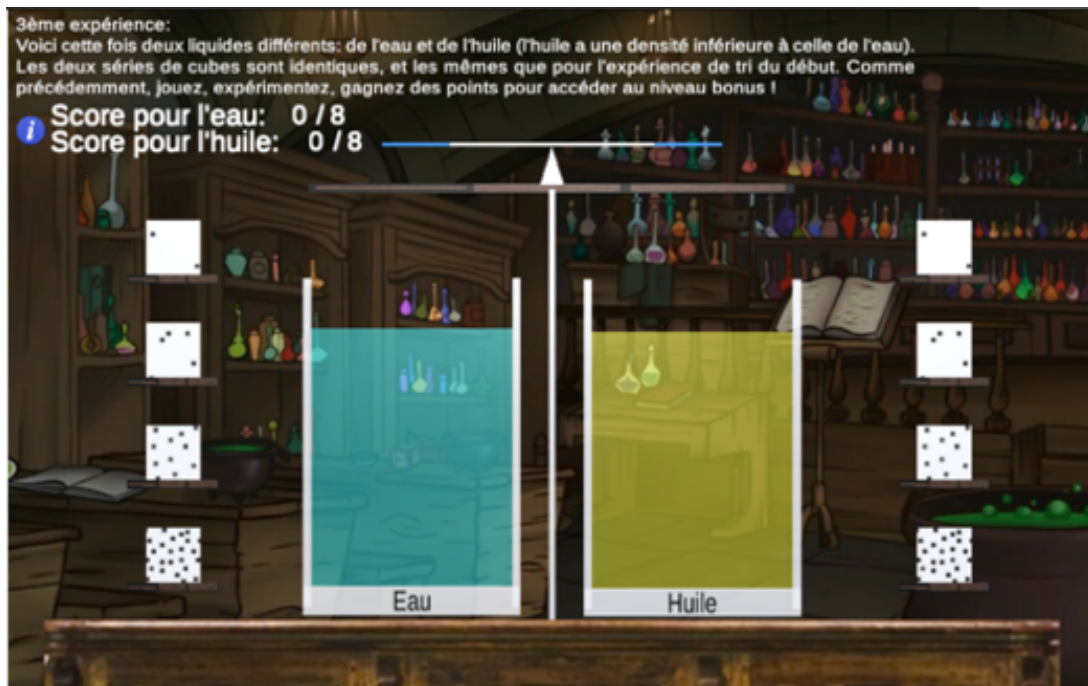

Figure 5.11: Scenario 3 in the 2D game.

Condition 1 and Condition 2 contain five cubes each, and Condition 3 has eight cubes - two identical sets of four cubes from Condition 1. All cubes have individual characteristics: size (volume), texture (dots, with varying visual density), and weight (mass). The texture is indicative of the density: the more dots, the higher the density (See Visual design of density).

Condition 1 consisted of two successive tasks: first sorting cubes according to their masses, then placing the cubes in the liquid. The sorting task used the Roberval Balance metaphor: by putting two cubes on each side of the scale, the user could quickly assess their relative weight (and hence, mass). It is, therefore, a visual metaphor with no haptic feedback. The second task consisted of placing cubes in a tank full of liquid (water); after cube selection, the user had to make a prediction (Figure 5.12) about the objects' behaviour in the water before observing the experimental outcome.

Condition 2 and Condition 3 focused only on the latter task. Condition 2 featured one single tank filled with water, while Condition 3 featured two tanks filled with liquids of different densities, namely oil and water (this was clearly stated in the presentation banner, above the game area). There was no mass sorting task in these 2 conditions, as they featured objects which were introduced in Condition 1.

Finally, a bonus level could optionally be played. It consisted in a simple version of Condition 3 but without a game score, without predictions, and with only one tank filled with mercury instead of oil.

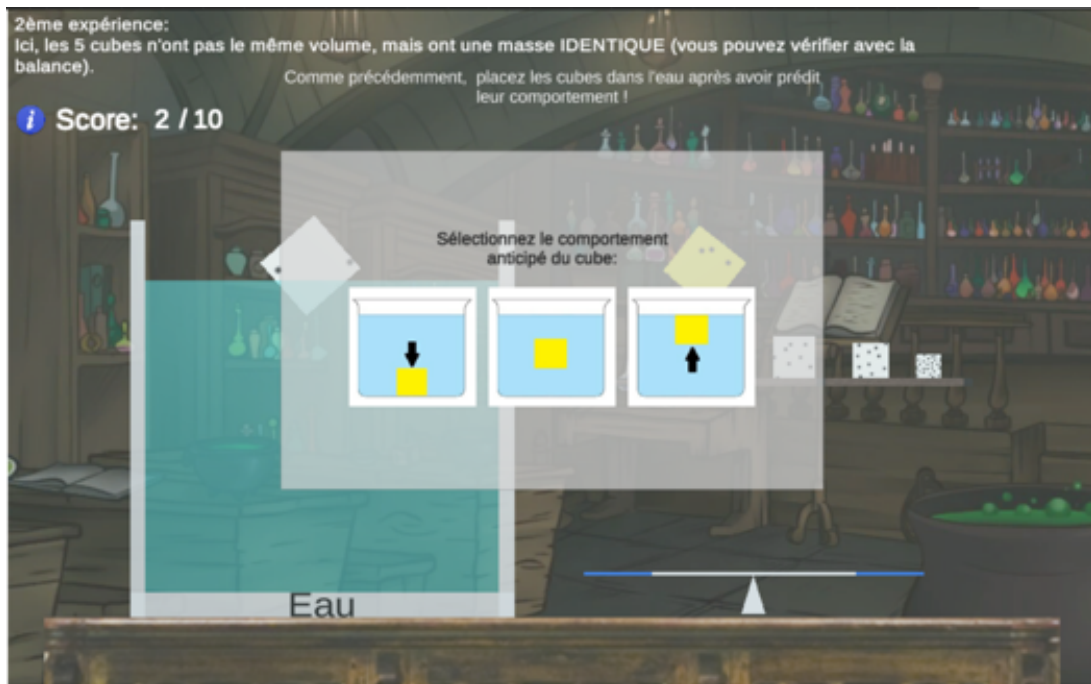

Figure 5.12: Prediction panel.

Mercury is a liquid metal of very high density, that would be impossible to test in real life due to its toxicity (Figure 5.13).

5.6.2 Experimental procedure

We placed the 2D version of the game on an institutional web server, and then we sent invitations to play by email to a group of participants along with an access link. Logs recording the players' activity (object motions, predictions, etc.) were recorded and sent to the web server hosting the online game. At the end of the experiment period, all the game logs were collected from the server for analysis.

Participants were free to spend as much time as they wanted in the 2D game and were not subjected to any additional requests.

5.7 VR Game

The third part of the experiment consisted in using the same game as in the second part, but this time interacting within an immersive VR environment.

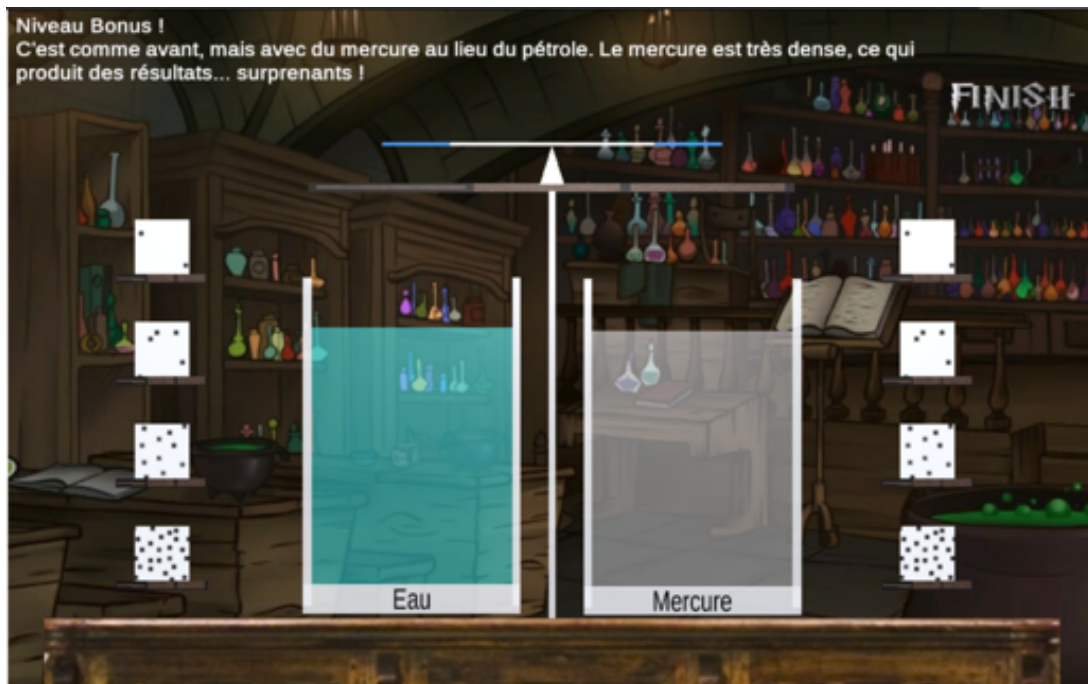

Figure 5.13: Bonus level.

5.7.1 Experimental setup

The VR serious game experiment was designed around a Lenovo Explorer Head-Mounted Display with two controllers, connected to a high-end VR-compatible PC running a Unity simulation. Each participant was equipped with standard headphones. Proper calibration of the interaction space was performed for each user before the actual experiment took place (thus making sure that each object was within comfortable reach and roughly at table level). Specific sanitary measures were taken to avoid any possible Covid-related contamination, with adequate disinfection of all interacting devices.

All the interaction techniques exploited in this setup are based on the common “simple virtual hand” metaphor already introduced in Chapter 4. The choice was justified by the fact that (i) we wanted the user to experience conditions as close as possible to an actual classroom experiment, with no offset between the user’s hand and its virtual counterpart, and (ii) experiments of chapter Chapter 4 were inconclusive regarding the use of pseudo-haptic techniques. To make the simulation even more realistic, all objects were placed on a virtual desk whose horizontal surface matched the position of an actual table positioned in front of the user, acting as passive haptic feedback. Cubes could be picked up with either hand (using the trigger of the VR controllers), manipulated freely, and dropped by releasing the trigger. Preliminary tests showed the general setup to be satisfactory for the type of experiment we considered.

Figure 5.14a shows the actual VR setup used in this experiment. As in the 2D game, the experiment consisted of a training session (Figure 5.14a), three different game conditions (Figure 5.14b, Figure 5.14c, Figure 5.15a), and a final bonus level (Figure 5.15b), all being identical in content to the ones of the 2D game. To avoid potential contamination and allow for deeper immersion, participants answered the pre- and post-tests directly in the virtual environment (Figure 5.15c).

One of the main differences between 2D and 3D games was the possibility to monitor the actual gaming conditions around participants. Aside from the dimension and interaction variables, the main difference between the two versions of the game was the availability of sound. We did not use audio in the 2D game because we could not control the audio conditions in the users' environment (a web game can be played at any convenient time and place, with no guarantee of sound fidelity or volume). In contrast, this was possible in the 3D VR experiment. To provide more immersion and convey additional information about objects (e.g., mass), each participant was equipped with headphones and binaural sound rendering was provided. We detail this addition below.

5.7.2 Preliminary experiment: Using audio to provide extra information

In our specific case, the most intuitive purpose of audio is to provide additional information about the mass of objects. Indeed, representing weight in VR (See Chapter 4) is a major problem because although force-feedback devices do exist, such haptic interactors are very expensive, cumbersome, and tend to be fragile. Placing such devices in a classroom is not practically possible. Exploiting visual modality to convey mass information also proved fruitless in this context.

Some studies [138] have already proven the ability of humans to perceive biological movements through the friction sounds produced by drawings and, in addition, the ability to reconstruct drawn shapes from the friction sounds generated. Thus, if humans can reconstruct form from sound, it may be possible to create a similar connection between mass and sound, especially as we constantly practice such a connection in real life (for example, by placing objects on a table). Using sounds as audio-induced pseudo-haptics in order to convey mass information to students seems, therefore, a promising alternative approach [89].

Moreno and Mayer [98] argue that audio can either enhance or impede learning, because it taps into distinct cognitive channels (standard media such as text and graphics use only the visual channel). Another research points towards not using background music in eLearning programs as it results in sensory overload, reducing the learning effectiveness [19]. Also, taste in music is subjective and intrusive



(a) Training in the 3D game.



(b) Scenario 1 in the 3D game.



(c) Scenario 2 in the 3D game - Part 1.

Figure 5.14: VR game - Part 1.



(a) Scenario 3 in the 3D game.



(b) Bonus level in the 3D game - Part 2.



(c) Pre-/Post-test in the 3D game.

Figure 5.15: VR game - Part 2.

to the learning experience.

We opted for event-based sound generation. Two main events are to be considered during the course of the game: objects being put on a solid surface (solid-solid collision) and objects being immersed (splashing sound followed by a bubbling effect [35], as the object sinks or surface). The resulting sounds can depend on four relevant physical parameters: mass, volume, density, and material (for a given volume, density and mass will vary with the material composing an object). We designed our game so that no material property should be investigated, and therefore this particular parameter was considered irrelevant in sound production: this means we decided against designing a "metal" sound vs. a "wood" sound or a "plastic" one.

Consequently, we will only consider mass, volume and density as the relevant physical parameters to be sonified.

Regarding rendering parameters, although there are various effective audio frameworks available for gaming [143], we chose to exclude excessively complex sound models; in the Unity engine, only two audio parameters can be easily altered while producing distinctive effects: audio level (Volume) and audio frequency (Pitch) (Figure 5.16 - left side).

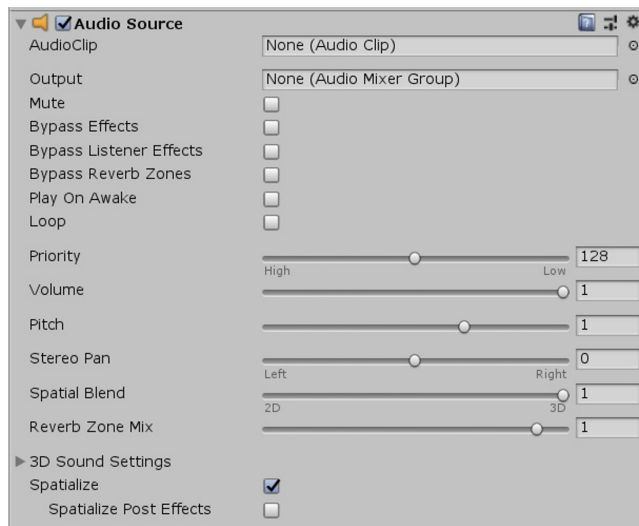

Volume: 0 .. 1
Pitch: -3 .. 3

Volume:

- Constant: 0.8 – 0.8 – 0.8
- Increase: 0.2 – 0.5 – 1

Pitch:

- Constant: 1 – 1 – 1
- Decrease: 2 – 1 – 0.2
(Before 0.1-0.2 nothing to hear, 3 is too high)

Figure 5.16: An example of audio source in Unity, with the list of rendering variables.

We must now associate two audio parameters with three physical variables, which gives six distinct physical/audio combinations. Each audio parameter can be associated with a physical variable in an increasing or decreasing way, which doubles the possibilities of matching. However, among these solu-

1) Mass (audio-level) - Volume (Pitch)					3) Volume (audio-level) - Mass (Pitch)					5) Density (audio-level) - Mass (Pitch)				
a	Volume	0.2	0.5	1	a	Volume	0.8	0.8	0.8	a	Volume	0.2	0.5	1
	Pitch	1	1	1		Pitch	2	1	0.2		Pitch	2	1	0.2
b	Volume	0.8	0.8	0.8	b	Volume	0.2	0.5	1	b	Volume	0.2	0.5	1
	Pitch	2	1	0.2		Pitch	1	1	1		Pitch	1	1	1
2) Mass (audio-level) - Density (Pitch)					4) Volume (audio-level) - Density (Pitch)					6) Density (audio-level) - Volume (Pitch)				
a	Volume	0.2	0.5	1	a	Volume	0.8	0.8	0.8	a	Volume	0.2	0.5	1
	Pitch	2	1	0.2		Pitch	2	1	0.2		Pitch	1	1	1
b	Volume	0.8	0.8	0.8	b	Volume	0.2	0.5	1	b	Volume	0.2	0.5	1
	Pitch	2	1	0.2		Pitch	2	1	0.2		Pitch	2	1	0.2

Figure 5.17: 6 valid matching patterns.

tions, some are not cognitively valid, which reduces the final choice back to six valid matching patterns (see Figure 5.17).

For "4) Volume (audio-level) - Density (Pitch)" in cubes volume decrease ($v_1 > v_2 > v_3$) but here the values for audio-level increase, why? I used inverse correlation (one goes up and the other goes down; Large object - low frequency, small object - high frequency): because if you use forward correlation (one goes up and the other goes up) it causes a conflict of understanding: a large object hits the table and makes a sound like as if it weighs several hundred kilograms, and a small one with the same weight falls almost inaudibly and it feels like one is heavy and the other is light - although the weight is the same.

In order to test which combination would provide the best perceptive outcome in VR, two sets of cubes were considered: (a) cubes with the same volume and not the same mass (Figure 5.18a); (b) cubes with the same mass and not the same volume (Figure 5.18b). We carried out this experiment with three cubes from each of the sets ((a) or (b)). For each audio variable, we selected three levels: low, medium, and high values (Figure 5.16 - right side).

The test was thus organised as follows; for each set, the participant was asked to grab cubes, lift/put them on a table, carry a cube on a scale to assess its mass, place them in water, etc. Participants did not have any restrictions on time and number of repetitions; they could also test each condition ((a) or (b)) several times. They could also ask to make the global sound level of the system louder or quieter.

We asked the participants to sort the sounds (resulting from each of the six mappings listed above) according to criteria of credibility and taste. Based on the results of a small study on 8 participants, most users did not appreciate the bubbling sound, but the collision sound and splash sound were found to be helpful. Post-test interviews showed participants preferably established a connection between the audio level and the mass of the object, as well as a connection between pitch and volume. No direct

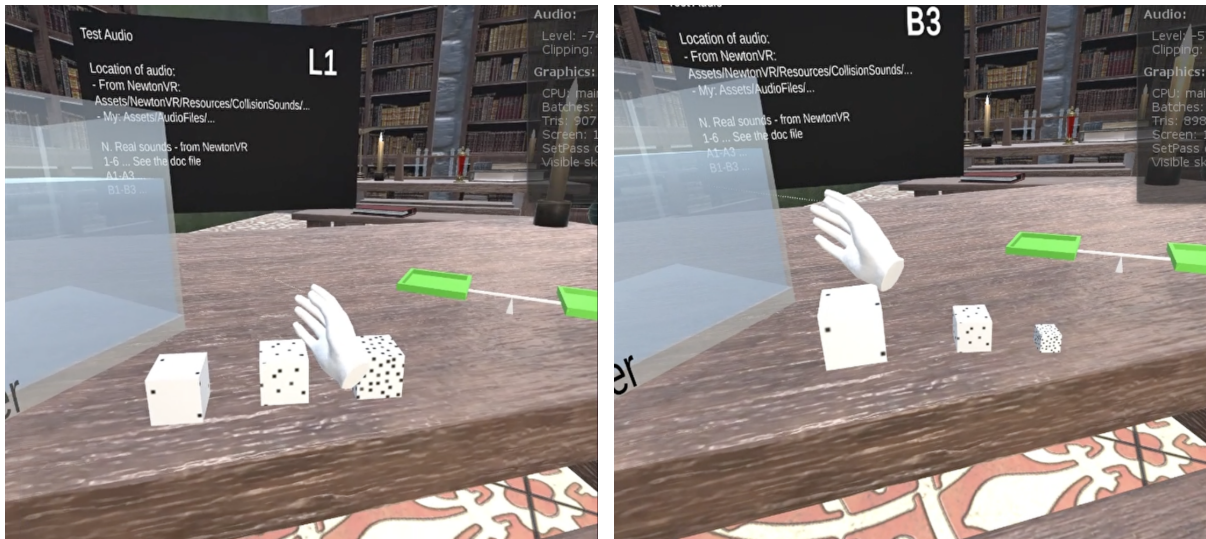

(a) Cubes with the same volume and not the same mass. (b) Cubes with the same mass and not the same volume.

Figure 5.18: Two sets of cubes for Audio-tests.

relationship was established between sounds and density, confirming that such a quantity is actually derived from volume and mass, which are perceived as "direct" properties producing actual sounds. We adopted this mapping for all stages of the 3D VR experiment. Thus, the Audio level depends on Masses, and Pitch depends on Volume and no sound relation with density.

5.7.3 Experimental procedure

The local ethical committee approved the following experiment, and proper sanitary procedures to prevent COVID-19 contamination were applied [106].

Pre-test

For better immersion and to avoid additional unnecessary exchanges of material, users passed the pre-test in the virtual environment. The test is an exact copy of the online questionnaire of Section 6.4.5. There was no time limit for completion.

Training

This initial phase consisted in presenting the setup in a sandbox configuration and allowing participants to freely manipulate a set of objects of different volumes and masses. General instructions were given

in text mode (on a virtual blackboard) about the VR setup, how to grasp cubes, and to place them in different locations (putting them on a table, in a tank with a liquid, and using the scale). No task was provided, and users could experiment for as long as they wanted. Only proper object manipulation was sought at this point.

Experiment

Participants read all instructions on a virtual blackboard situated in front of them and had to complete the proposed task. During each trial, they could manipulate the cubes at will, with no time constraint. Similarly to the web condition, participants first performed a sorting task by comparing five cubes and placing them in five slots, from the lightest to the heaviest (Figure 5.19a). In a second stage, they placed cubes in a special slot above a tank containing a liquid (water) and made a prediction on the behaviour of the cube (sink, stay in the middle, float) (Figure 5.19b). Then they were able to observe the actual behaviour. Predictions could be rechecked as many times as they wanted. Depending on their answers, a score was updated (correct answer + 2 points, wrong answer -1 point). They were asked to repeat the steps until a minimum value of the game score was reached. For the first scenario the minimum score is 20 points, for the second scenario the minimum score is 10 points, for the third scenario for water and for oil they need 8 points each. A “next” button then appeared, leading to the next experimental stage. The different game stages were identical to those of the 2D game, including the bonus level.

Post-test

As in the 2D game, a post-test was proposed in VR to the participant, as a copy of the pre-test (see Questionnaire) but with a reordering of the questions.

Post-Experiment interview

Following the VR experiment, participants were asked to undergo a 15-minutes semi-directed interview. The objective was to collect some data relative to subjective perceptions regarding the general quality of the environment and the interaction, the task itself, perceived object affordance, perception of weight, and general satisfaction of the experiment. Free speech was encouraged to gather as many cues as possible on the experiment (See Second Appendix).



(a) Stage 1 in Scenario 1.

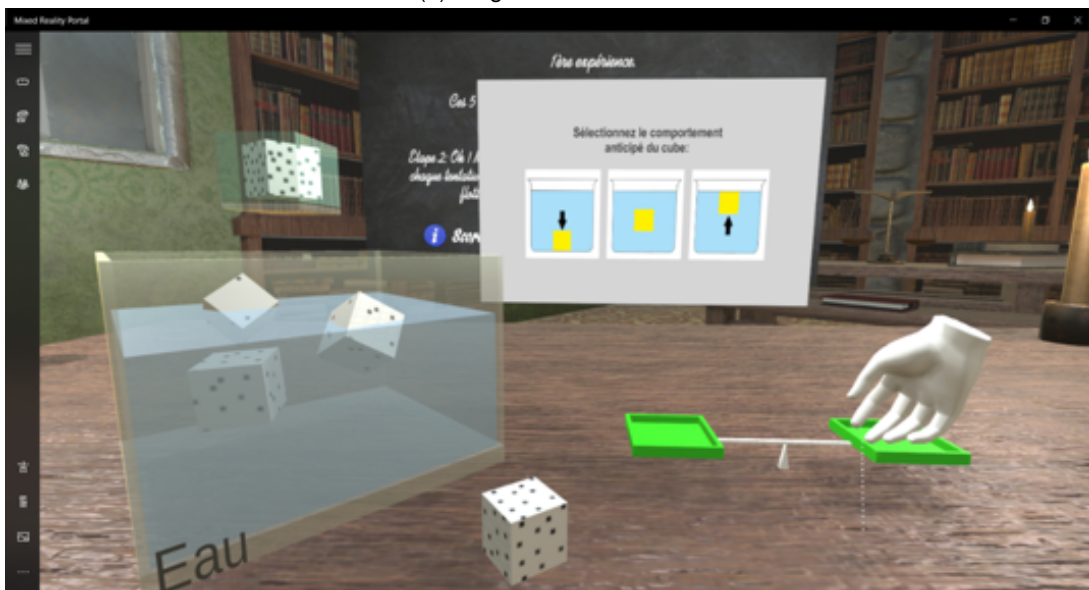

(b) Prediction panel in VR game.

Figure 5.19: VR game - Part 3.

5.8 Results

5.8.1 Online Questionnaire

The first session conducted to assess the baseline knowledge of students was targeted towards freshmen physics students. The questionnaire was made available on a website at the Université de Paris. Out of 110 logged students, 44 complete responses were gathered. Only one student answered all questions correctly. This result in itself is pretty telling: although the notion of density concerns a basic property of physical objects, it is subject to many misleading interpretations and errors.

After analysing the online questionnaire, we exploited the R factor⁴ to structure the profiles of our respondents' answers. R computes the similarity of a set of answers and group them into similarity clusters. A classification into five groups provided a rather convincing pattern (Figure 5.20a, Figure 5.20b). Two respondents stand out strongly from the rest (#7 and #33), and all the others are divided into three groups with similar misconceptions. Most students do not correctly understand how density, mass, and volume are related, to the point that some of them will consider one of these physical characteristics as independent from the others, contrary to what was taught to them during their curriculum. Surprisingly, some students perceive density as an absolutely separate parameter that does not depend on other physical parameters (mass and volume). Only one participant (#6) provided a correct answer to all the questions.

68% of the participants overcame the line of half of the correct answers. The average success rate among all participants is 60,31%.

Thus, the main conclusion was that most of the students shared identical misconceptions on the subject (e.g., most students have not integrated the idea that the density of a solid is formally defined in relationship to water, and predicts behaviour in said water) and that the knowledge regarding density was largely incomplete. At the end of the survey, We asked the students if they were interested in participating in further tests, which they answered mostly positively.

The second session of the study on a priory knowledge was informally conducted on pupils who visited the university during a "Summer School", consisting in a one-week introductory visit to the science department. Two groups were involved: the first group consisted of seven 16-year-old freshmen high school girls. All said that they had last studied the topic of density in secondary school. Their achievement rate was 79.12% with an average confidence level of 3.09. The second group consisted of seven

⁴Factors are the data objects which are used to categorise the data and store it as levels.

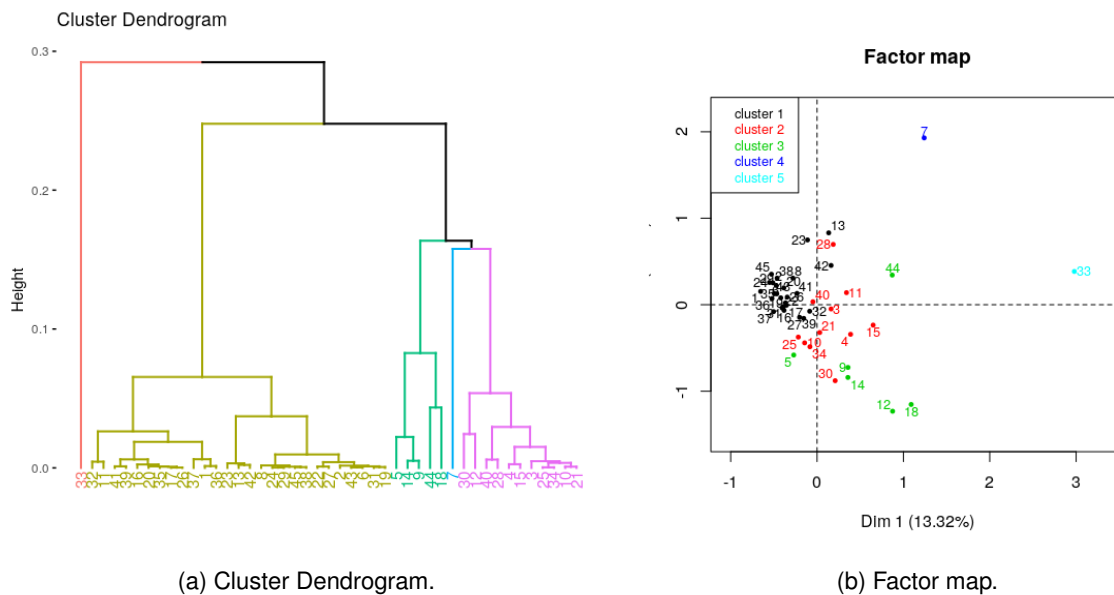

Figure 5.20: Online questionnaire results.

14 year old girls from third year of secondary level. They all said that they had last studied the topic of density during the secondary studies. Their achievement rate was 63.08% with an average confidence level of 2.61. All students participating to the summer school were selected based on their interest in science, which probably explains their relatively high success rate.

Overall, the average of all those who took the online test was close to two-third (67.5%) and the average confidence level was above half. One can conclude that, although misconceptions remain, the overall level of knowledge of the students is quite honourable.

5.8.2 2D online game

This experiment was performed on a sample of nine participants, all future physics teachers in the first year studying at the Université de Paris (Mean age = 22, 2 males and 7 females). Eight of them had a scientific background, and one of them had a background in literature. We asked them when they last studied the properties of matter: three of them answered “This year during my studies”, three others answered “During my graduate studies”, the remaining three answered “During my high school studies”.

Participants spent an average of 28 minutes on the game, with a minimum time of 11 minutes and a maximum time of 1 hour. All participants tried to achieve the minimum score required to switch to the next level, but they also did not spend more time than needed on a given task (i.e. by keeping on playing

out after achieving minimal requirements).

Looking more closely at the gameplay (Training, Scenario1, Scenario2, Scenario3, and Scenario Bonus), participants spent the most time on Condition 1 (Scenario1), then Scenario 3, and then Scenario 2. Much less time was spent at the Bonus level (see Table 5.1). Also, participants spent much less time on the post-test than on the pre-test (Average time to fill out a pre-test: 10 minutes, average time to fill out a post-test: 5 minutes).

Sections	Min t	Max t	Average t
Pre-test	3,62	33,04	10,15
Training	0,51	6,37	2,44
Scenario 1	1,15	5,59	2,86
Scenario 2	0,94	3,20	1,66
Scenario 3	0,84	3,45	2,22
Scenario Bonus	0,14	1,40	0,64
Post-test	1,98	16,65	5,31
Total game time	11,52	60,02	28,41

Table 5.1: Time for the 2D game (unit: minutes).

Regarding results of pre- and post-test, the efficiency of participants decreased by 4,27%, but the level of confidence increased by 11,5%: some participants made more mistakes after the experiment than before, but they gained subjective confidence. This shows that a self-assessed feeling of success is not always the result of successful teaching.

The participants did not step back to previously answered questions in the post-test phase, contrary to the pre-test, where five students had afterthoughts, and one student even returned three times to a single question. Participants who went back also changed their confidence levels.

The biggest challenges were raised by question p1q4⁵ ("Two balls, one larger than the other, are placed at an equal distance from the centre of a balance with equal arms. After a few moments of oscillation around the pivot point, the balance stops as in the figure below. Which of these two balls has the greatest density?") and the question p2q3⁶ ("These two objects A and B have the same density, but B has a volume 3 times greater than that of A. When you place object B in the middle of a container filled with water, it goes down to the bottom of the container. We repeat the experience with object A. What happens?"). In p1q4, students did not correctly interpret how mass, volume, and density are related,

⁵Part 1, Question 4.

⁶Part 2, Question 3.

hence their confusion. In p2q3, the problem arose from the relationship between volume and density in conjunction with a flotation situation. Thus, we see that the concept of density remains challenging to apply to certain practical cases and that initial misconceptions of students are not easily dispelled.

Of course, the fact that some questions cannot be answered unambiguously in given experimental conditions is quite confusing to a lot of students (for whom science in a classroom has to teach only truths and safe and sure answers). Despite the inefficacy of 2D games, some students commented that they positively perceived such a gaming experience in learning, and that their impressions were very good.

5.8.3 3D game - Group 1

Because of the prevailing sanitary conditions, only preliminary tests could be conducted on 11 participants (Mean age = 26, SD = 3.01). Some of the participants are from the LISN laboratory, others from Cergy Paris-Université and Institut Polytechnique de Paris. None of the participants was involved in the design of this experiment nor involved in the research. All of them were right-handed. All participants are with normal vision except one with protanopia (cannot distinguish some green shades from red shades ⁷.) All participants reported average VR expertise. Almost all of them have a scientific background and play video games every day. Finally, 5 of them mentioned that they last studied the properties of matter while in high school, and the remaining others in middle school.

The following dependent variables were recorded:

- Completion time (for each stage, for each test/question, and total)
- Data from the pre/post-tests
- Game scores
- Behaviour of the manipulated virtual objects (6D trajectories)
- Some key events such as flotation predictions, putting objects on the scale, etc.

It is worth noticing that 7 out of 11 participants used both their hands, despite being all right-handed (we also took special care in providing a symmetrical setup).

We decided not to run any statistical tests due to the small sample involved.

⁷This did not prevent the experiment since green and red colours do not predominate in the game and no ambiguity was introduced.

Playing the density games increased test accuracy from 76,22% to 82,51%, so we can assert that actual 3D manipulations, even with virtual objects, carried better meaning (with regard to 3D perception in everyday life) and provided more benefits than a more abstract observation in a 2D setting.

Similarly to the 2D game, the participants increased their confidence in their answers by 7,5% between pre- and post-test. Thus, the actual manipulations were also helpful to bring awareness of some delusions and dispel them, building a better understanding of the concept of density.

During the game, students had to reach a certain score using predictions in order to move on to the next stage. In the first and second exercise they usually had no problem making correct predictions for the heaviest and lightest cube (respectively sinking and floating). In the first exercise, the correct answer for the middle cube was (it floats in the middle) - usually answered incorrectly. After being corrected, in the second exercise nearly all made the incorrect prediction at first that it will also remain in the middle (exact answer: it will sink), which is quite logical.

More generally, many students tried to use logical reasoning: for example in the first exercise 2 cubes sink, one remains in the middle of the water, 2 cubes float. In the third exercise only 4 cubes from the first exercise are given (2 float, one remains in the middle and one sinks - for water): students often started with the lightest and heaviest cube and then just guessed, many thought they removed the cube which should have stayed in the middle of the water (minority principle). Another classic mistake was that if 3 cubes were sinking then the fourth would sink (many were surprised when it floated), thus some students made predictions based on statistics rather than knowledge of density.

Participants spent 7.67 minutes on the pre-test and 4.71 minutes on the post-test on average (See Table 5.2). The average playing time decreased compared to a 2D game. However, time increased for the Bonus level: Students were more interested because they never tested mercury in real life (being toxic, it was banned from public sales and classrooms), and the behaviour of the cubes surprised them (all objects float in this high-density liquid, and if placed in the middle of it and released, a cube seems to "shoot" out of it).

When filling the pre- and post-tests, the participants still went back to their previous answers, but to a much lesser extent than in the 2D game (here was one exception with one student who returned 4 times to one question.)

This time, only one question caused difficulties, namely p2q5a1⁸ ("To answer the following question, remember that oil is less dense than water. You place an object in the middle of a container filled with

⁸Part 2, Question 5-A1.

Sections	Min t	Max t	Average t
Pre-test	4,53	17,32	7,67
Training	0,33	2,80	1,14
Scenario 1	2,76	6,98	4,46
Scenario 2	1,02	3,95	1,78
Scenario 3	2,03	3,67	2,98
Scenario Bonus	0,28	2,91	1,32
Post-test	3,32	7,96	4,71
Total game time	16,22	39,37	25,69

Table 5.2: Time for Group 1 in the 3D game (unit: minutes).

water and see that it rises to the surface of the water. The same object is placed in a container filled with oil. What is going to happen?”). This can be explained by the fact that the participants were not focused on the type of liquid during the experiment until this was encountered, late, in Condition 3 (placing the same objects in water and in oil). The difficulty with this question shows that students have become better at understanding the ratio of density, mass, and volume, but relative flotation remains a more complex concept to grasp.

Also, when answering the questionnaire, some students admitted that they chose to guess (associating the answer with a low confidence level) because they did not feel comfortable choosing the answer "I don't know", usually associated with "failure" in a teaching environment.

We omit the complete transcription of interviews here. The salient facts we uncovered were the following:

- General VR scene settings and manipulation procedures were considered satisfactory. Participants liked the Hogwarts-style room and enjoyed the environment as a classroom.
- Subjects unanimously positively valued the different gaming conditions, finding them fun, easy; they felt confident during the games.
- Most of the participants evaluated sound effects as effective, giving them additional information and allowing them to focus on a task (lessening the cognitive load involved into remembering "which cube is which" during some comparing tasks, for example). Also, sound helped them to get involved in the game.
- Regarding learning, most users established the relationship between the number of points on

cubes and density and mass. They were able to apply this during the first part of the experiment, but the absence of a similar metaphor for the liquid was sometimes perceived negatively.

- The participants also highly appreciated the learning opportunities introduced by Virtual Reality (for example, playing with mercury) and found them helpful.
- Users did not mention feeling bored or spending excessive time in the simulation, because they felt involved. Some of them said that in school, learning was boring, but this VR experience "swallowed" them up (as one of the participant said: "I thought it was 10 minutes, but in reality, it was almost 40 minutes!").

5.8.4 3D game - Group 2

Another series of experiments were carried out, this time with teachers as participants. Part of the experiments was carried out at Collège Léon Blum in Villepreux (France). The study was conducted on six teachers (Mean age = 44, SD = 14,58) from various educational institutions. None of the participants was involved in the design of this experiment and not involved in the research. All of them were right-handed and with normal vision. All participants reported basic or no VR expertise. Furthermore, they reported they did not play video games. Except for one of them, they all had a significant teaching experience (between 10 and 30 years). Also, they came from different disciplines, i.e. sports teacher, a librarian, French and English teachers, a primary school teacher and a technology teacher. The same dependent variables were recorded as before.

Playing the density games increased test success rate from 56,41% to 67,94%, so we can again assert that actual 3D manipulations, even with virtual objects, carry more sense and provide more benefits than simple observation in 2D. Similarly, as in the 2D game and in the 3D game with Group 1, the participants increased their confidence by 5,5%. This slight change in the results compared to Group 1 may be due to the different profiles of the participants. Unsurprisingly, those participants who work in science or technology performed better than the humanities teachers.

Some of the students in the previous group showed a deterioration in performance after the game; in this group, all showed systematic improvement. This may be explained by the fact that due to their profession, teachers are more attentive and systematic in during deductive sequences.

Similarly to what was observed before, participants spent 7.89 minutes on the pre-test and 6,57 minutes on the post-test on average (See Table 5.3). The average playing time increased compared to

Sections	Min t	Max t	Average t
Pre-test	6,65	12,45	7,89
Training	0,96	3,97	1,85
Scenario 1	3,86	12,74	6,32
Scenario 2	2,48	4,99	3,23
Scenario 3	3,05	10,72	5,74
Scenario Bonus	0,10	1,27	0,58
Post-test	4,55	11,04	6,57
Total game time	32,18	37,30	42,28

Table 5.3: Time for Group 2 in the 3D game (unit: minutes).

the 3D game for a students group. However, time decreased for the Bonus level, it seems students were more interested than teachers in doing things "for fun" (not surprising given the different age groups).

When filling the pre- and post-tests, the teachers did not come back to their previous answers in comparison with students who sometimes changed their answers.

This time, three questions caused difficulties - p1q4⁹, p1q5¹⁰ and p2q2¹¹ (See Second Appendix). For questions p1q4 and p1q5 this can be explained by the fact that the participants still do not make a clear difference between density and masses of objects. Only one person improved their answers to these questions. Bad answers to question p2q2 hints to the notion that the participants think that there are some other unknown forces that affect the buoyancy of the object (that there are more than the three variables: mass, volume and density). Three participants improved their answers to this question after the test. Still, again, we see that relative flotation remains a more complex concept to grasp.

The main facts obtained from the post-interviews are the following:

- All assessed the environment positively.
- All paid attention to the sound of water splashing, but did not pay attention to the sound of solid objects hitting. This is probably because while the sound of objects dropping is very common, we don't deal with splashing water as often: people don't pay attention to obvious things like objects colliding but pay attention to something new like the sound of water splashing.
- Participants said that the game was very intuitive, and noted a pedagogical progression between experiments.

⁹Part 1, Question 4.

¹⁰Part 1, Question 5.

¹¹Part 2, Question 2.

- A primary school teacher noted that she would not be able to use such a game with her students, but specified that such an approach could be applied to older students (middle and high school, university level). Other teachers mentioned that they would like to use such technology in their subjects, especially for science learning.
- Some teachers felt unsure about their results, but found this experiment quite good. Others indicated that they were impressed by the quality of the experience.

Overall, all teachers were very positive about the experience. In conclusion I could notice that results are apparently dependent on the target audience, and may vary between student/teacher, young/adult, male/female, hard scientists/humanitarian. A more statistically significant pool of participants would help clarify these differences and identify relevant factors.

5.9 Conclusions

Students can easily understand the molecular structure of the world around them: molecules of a solid are tightly bound to each other and are very densely packed in a strictly defined order. The molecules of a liquid body are connected in a weaker way, and their arrangement is disordered. Nevertheless, students have difficulties when it is time to apply such theoretical knowledge in practice. In the case at hand, they know which mathematical formula defines density (it is easily defined and related to common properties of mass and volume) but they do not develop a deep understanding of the subject: abstract concepts are not correctly applied to practical cases, leading to incorrect or missing knowledge.

Even in a particular field or discipline, there is no "true" or "universal" teaching technique. Teachers usually resort to a combination of formal definitions and more practical illustrations to introduce concepts. The idea of using Virtual Reality for teaching is not new. Although it has never been used for the specific topic of density, Virtual Reality has already proven its ecological validity and usefulness more than once. The results presented in this study confirmed that immersive serious games could, if not eradicate students' false conceptions on this issue, at least shake them and help look at it from a different viewpoint, allowing them to reconsider their view on the physical phenomenon.

Specifically, comparison of 2D and 3D gaming conditions showed the lesser efficiency of the former and the benefits of immersive games for learning. Compared to a 2D approach, the association of Virtual Reality, serious games, and didactics lead to much better results. In particular, we have proven

that actual manipulation of virtual objects is more beneficial than just observing or interacting with a computer mouse, objectively and subjectively.

As the study was conducted on a relatively small number of participants, further experimentation on a larger number of participants is necessary. Also, further experiments with possibly splitting one VR session with three exercises into three sessions with one exercise might help to find out which elements of VR might have a more positive effect on learning and also provide a possible rationale as to why the 2D version might degrade results. Unfortunately the current protocol does not allow to identify which elements of the VR game formally justify the improvement and why the 2D game makes them worse.

As we all know and experienced, it is pretty difficult to force a student to study well without motivation. The students and the teachers highly appreciated the use of VR for teaching, leading to more motivation. The use of VR associated with traditional teaching models may be a significant impetus for better learning and in-depth understanding of certain physics phenomena. It should also be noted that the increased motivation of students may be due to the novelty effect of using VR. In order to confirm or refute this, such studies should be carried out repeatedly over the course of a much larger time frame, for example by including them in a real class course.

Chapter 6

USING COMPANIONS: THE CASE OF GRAVITY

Abstract. *This chapter reports the benefits of using a companion for educational purposes, as studied through the teaching of the concept of gravity. It first explains what a companion is and how it can help in an interactive education context. I then describe an experimental setup designed to compare three different conditions: with the help of a physically present real teacher, with a live video of the teacher (online), and with a neutral VR avatar of a teacher (the avatar being manipulated by the teacher). I designed and implemented three exercises to teach the gravitation concept: an introduction to the gravity concept, a parabolic trajectory workshop, and a final exercise combining both approaches. Due to the sanitary context, only preliminary tests are reported. The results showed that the effectiveness of using the VR simulations for learning increased by 10% and the self-confidence of the students increased by 13%. The interviews show that the students ranked the teaching modes in this order: VR companion mode, video communication and real teacher.*

6.1 Introduction

The learning environment is as important to learning as the teaching method itself. During research on inclusive design for immersive learning systems it was found that even if the teacher does not occupy the 'stage' but is present, he or she will predominantly always and in all circumstances occupy a central place in the students' expectations [27]. It is expected to remain the same in any new teaching environment, including one based on VR.

On the practical side, pre-studies and interviews (see Chapter 3) showed that students often need to ask questions during the educational process, and that, in VR, it can be complicated to switch from the virtual world to the real world and vice versa, in order to get assistance. The availability of a virtual help within the VR simulation, called a companion, can solve the problem [18] of providing help without breaking immersion. Therefore, it would be insightful to test the effectiveness of a companion, by comparing an experimental setup in VR with and without such assistant. Beyond its sheer utility, it would be fruitful to investigate the conditions in which the companion should manifest itself to maximise subjective percepts such as immersion or satisfaction. We have chosen the concept of gravity as a teaching topic, as it is one of those topics that students often have misconceptions about.

6.2 Companions in the digital era

Humans are social animals, and usually prefer to avoid being alone whenever possible. Most of the time we don't like to eat alone, sleep alone, work alone or play alone. Prisoners who break the rules are put in isolation because, as bad as it is to be locked up with dangerous criminals, it is even worse to be there alone.

Looking back a few centuries, you can see how this is reflected in the history of game design. In the past, most games were designed to be played with or against other players. Before the advent of computers, single player games such as *Solitaire* were very rare.

It is the same with the educational process. We go to school, we go to clubs, we go to classes. During our studies, we are usually surrounded by other people, students and professors.

On the other hand, VR has been democratised recently on the advent of affordable, personal devices - HMDs. These systems are very immersive, but they considerably reduce classical social interactions, which poses a problem when using them for an educational purpose.

For example, students often need to ask questions during their educational process. This may be due to a lack of attention, difficulties in understanding certain concepts, or even misconceptions: there are many opportunities that may require a break in the flow of knowledge acquisition

While wearing an HMD, it can be complicated to switch from VR to the real world in order to get assistance, then to go back to VR to resume working. The availability of a virtual help (a.k.a. a companion), can solve the problem [18]. This is the rationale for the present work.

The pre-study (See Chapter 3) helped to define potential useful functionalities of a companion, namely:

1. *Hints* - If a player is confused, he can call on the Companion and get useful tips (which can be obtained from a list of predefined FAQ list or through live help from a teacher).
2. *Extra point of view* - some situations may require a temporary view from a different perspective (i.e. see the scene through the eye of the companion).
3. *Cheerleading* - supporting the player, e.g. "That is great!", "Keep up the good work!".

To avoid unnecessary disturbance to the player, the companion should not perform any actions without a participant's request, except following him and staying available.

Companions are an evolution of Embodied Conversational Agents (ECA), who are endowed with emotional abilities that make them capable of establishing social and affective relationships with people, caring for them and providing them with companionship. The latter is recognised as a key factor in the acquisition and development of social skills in children [115].

Companions have been used in a number of studies related to education. Below I report in some details the significant works exhibiting the role and possible shape of companions in learning situations.

It has been suggested by Lea Pillette et al. [105] that users may experience difficulties or be nervous during training sessions using Mental-Imagery Brain-Computer Interfaces (MI-BCI) and that this may be partly the result of a lack of social presence and emotional support, which had been paid little attention to. One way of providing this social and emotional context is through the use of a learning companion. PEANUT (Personalised Emotional Agent for Neurotechnology User Training - See Figure 6.1)) provided social presence and emotional support depending on the performance and progress of the user through interventions combining both spoken sentences and facial expressions. Pillette et al. found desirable characteristics of their learning companion in terms of verbal content and appearance (e.g., eyebrows can increase the expressiveness of cartoon faces). They found that "*non-autonomous*



Figure 6.1: Tangible Companion together with the participant using BCI [105].

people (those who are more inclined to work in a group), who are usually at a disadvantage when using MI-BCI, benefited compared to autonomous people with PEANUT with a 3.9% increase in peak performance. In addition, in terms of user experience, PEANUT seems to have improved by 7.4% people's attitude towards their ability to learn and remember how to use MI-BCI, which is one aspect of the user experience we evaluated."

N. Roa-Seiler conducted a study regarding the presentation of companions [115] (See Figure 6.2). In this study they compared which companion the 4th grade children preferred in maths class: Samuela is a 3D screen-based character, Nao is a robot and the third embodiment was Ari, an actual person made to look like a cartoon character and projected on the screen (See Figure 6.3). The study used a Wizard of Oz setup (WoZ), where the teacher controlled the companions using a panel with predefined sets of action. The children marked Ari as the most affectionate because of her behaviour ("She smiled," "She talked nice."). Nao, not having a mouth, couldn't smile, which generated some confusion; nevertheless children found him fascinating probably because none of them had met a robot before, whereas they had already encountered screen-based characters in video games.

The use of pedagogical agents in 3D simulations can be traced to Rickel and Johnson [113] creating the STEVE (Soar Training Expert for Virtual Environments) agent. STEVE was used as a teaching assistant during procedural learning, providing verbal or direct cues to students upon requests.

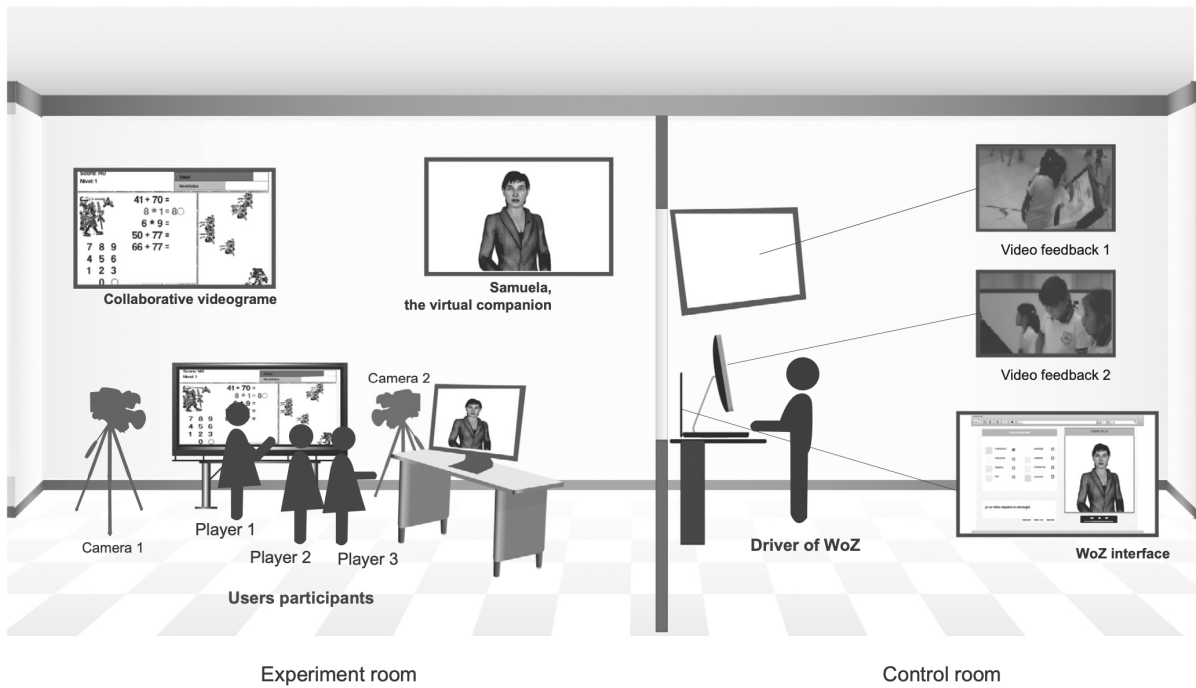

Figure 6.2: The three companions in the WoZ experiment of [115].



Figure 6.3: The 3 types of companion in [115].

This type of pedagogical agent, represented by an animated character, is now described as Agent-Based Learning Environments (ABLEs) [52]. Research has found that the visual presence of such personal assistance does not distract students from learning [99]. The presence of a digital companion has been found to have a positive effect on learners' perception of their learning experience as well as their performance outcomes with these environments [81].

The first two works show that companions can be quite effective, but their appearance and behaviour can affect this effectiveness in the teaching process. Other works do not discuss how the companion is rendered, and instead focus on the Artificial Intelligence (AI) aspect. Since these companions are designed to replace the physical teacher in a VR-based serious game, it seemed essential to investigate how to include them in our existing gaming framework. Our research is complementary to these "automated" approaches.

As a support of our work on companions (again with the Sandbox as our inspiration), we decided to focus on the topic of gravity.

6.3 Teaching gravity with a companion

6.3.1 Why free-fall resist teaching

What do an apple, a planet, a galaxy, a sandwich and an egg have in common? They are all subject to the same force that describes their movement: gravity. Of the four fundamental forces that describe all known physical phenomena, gravity is the one that we experience first, as we see it in action everywhere, all around us.

In France, the topic of gravity is dealt with in Cycle 4, but is addressed in general terms and numerical formulas [80]. Quite often, students are unable to apply their theoretical knowledge to practical tasks: unfortunately the modern education system uses quantitative calculations as a measure of learning outcomes.

The law of free-fall states that an object falling in a constant gravity field exhibits a motion as a composition of two motions, one horizontal, rectilinear and uniform, the other vertical, rectilinear and uniformly accelerated. The result of this composition is always a parabola in the Galilean frame of reference (air resistance and friction being negligible), whose exact shape will depend on the initial throwing conditions (orientation and intensity of the velocity vector at time $t = 0$).

The official teaching of free-fall is based on a progression which consists of establishing the Cartesian equation of a projectile trajectory and deducing the nature of the motion, and then demonstrating why a projectile moving in a homogeneous field of gravity is a conservative system. But this approach to parabolic motion is insufficient for a complete and consistent understanding of free-fall, especially when it comes to students' representations of projectile trajectories in a gravitational field, launched under different initial conditions (different velocity vector) [3]. This suspicion is confirmed by A. Prescott [107], who showed that the parabola is not the preferred curve for students to represent free-fall motion *even after learning*. The history of science is a confirmation to how long it took for the parabola to become a geometric model of free-fall in a gravitational field, regardless of the initial throwing conditions [3].

Halloun and Hestenes [50] note that 'students hold the pre-scientific belief that every movement has a cause'. Also A. Prescott [107] showed that students have "misconceptions when faced with a projectile movement situation". Most students do not consider the initial velocity and draw a straight line when the trajectory of motion crosses the equilibrium position (the result is not a parabola, but two upper lines of a triangle) [55]. Thus, it is clearly necessary to dispel students' misconceptions on free-fall while teaching them parabolic motion.

Where do these errors come from ?

It is generally accepted that we think the way we have been taught to think. Nevertheless, regarding physics phenomena, we all start with "intuitive physics": a kind of general explanatory scheme that represents a common and self-consistent set of concepts, and which resists attempts to change or modify it, no matter how wrong it may be. This is not taught, but comes unconsciously from our already existing knowledge and experience. These intuitive patterns are a strong obstacle to actual scientific teaching. It is precisely these "intuitive physics" that prevents us from gaining new knowledge and makes teaching less effective [146].

Elementary ideas on dynamics are a good starting point for the study of spontaneous reasoning, because many of the ideas taught in class contradict very common types of spontaneous reasoning, shared by many [146].

Spontaneous reasoning is very stable and not susceptible to learning that contradicts it. Just like delusions, they must first be destroyed before they can be replaced [133]. It is not just "a few mistakes" by students, it is a way of thinking that is found even in everyday conversations. Anyone is prone to it [146]. Thus, one must first show students the limitations of their current reasoning and only then, teach new material. Learning becomes a process in which new concepts have to displace or rearrange stable

concepts that the students have been building up for a long time.

When studying free-fall, the most common misunderstanding is the relationship between force and acceleration (force and motion) [20], and also between position, velocity and acceleration in one dimension [15]. These Newtonian concepts are often distorted or misinterpreted by students to fit their ingrained misconceptions. Students tend to memorise them separately, as formulas, with little or no connection to fundamental qualitative concepts. When Newton introduced these concepts in mechanics, the scientists of the time were just as unreceptive to new changes as today's students.

6.3.2 Teaching gravity

To shift such misconceptions, it can sometimes be useful to discuss or argue [20]. Galileo was obviously aware of such a learning strategy, for his dialogues represent a remarkable attempt to deal directly with the prevalent prejudices and prevailing theories of his time at a qualitative level. The enormous conceptual breakthroughs achieved by Galileo were not easy to convey to his peers. His writings appeal to the reader's intuition, using concrete, practical situations to illustrate his theories [20] [111] [45].

L. McDermott [15] found that results obtained with students at the university level, including prospective and practising teachers, are equally applicable to high school students and, in some cases, to primary school children. Thus we can conclude that we are pulling our delusions from our earliest years. In a survey of 6,000 high school, college and university students who took the FCI test¹ before and after learning mechanics, it was found that the largest gains in scores occurred in those students who were involved in interactive activities that provided immediate feedback through discussion with peers or instructors [110] [15].

This raises the question of how to teach students more effectively. When students have misunderstandings about the differences between instantaneous velocity and constant acceleration, a common teaching strategy to help students overcome some conceptual difficulties is to use microcomputer - based laboratory work² [15]. For example, in kinematics, students plot in real time the relationship between position, velocity and acceleration versus time for motions, including their own. Instantaneous feedback helps to explain the links between movements and their graphical representations. An introductory course should be based entirely on such laboratory work [15]. Evaluation of the syllabus by

¹The Force Concept Inventory (FCI) is a multiple-choice test designed to assess students' understanding of Newtonian dynamics [51]. The Mechanics Baseline Test (MBT) covers a wider range of topics in Newtonian mechanics than the FCI [56]

²Microcomputer Based Laboratory (MBL) tools and curricula can help students connect the physical world and the underlying principles that constitute scientific knowledge [139].

means of pre- and post-tests shows that achievement and memorisation are then significantly higher than in courses taught by traditional methods. In another type of laboratory approach, students perform simple experiments that are designed to form the basis of Socratic dialogue [108] [109].

Thus, questions that require qualitative reasoning and verbal explanation are very important. Mathematical formalism should be set aside until students have had some practice in qualitative reasoning about the phenomena being studied. Moreover, students should be asked to synthesise concepts and mathematical deductions and to formulate relationships in their own words. Likewise, learners should engage in a process of constructing qualitative models that will help them understand the relationships and differences between concepts. Persistent conceptual difficulties should be explicitly overcome by repeated challenges in different contexts. Based on all this, teaching by telling is an ineffective teaching method for most learners. Students need to be intellectually active in order to develop functional understanding.

In recent trends, there are striking examples of common parabolic games, such as Angry Birds [25]. Even if this mass-market game is not positioned as a serious game, it clearly demonstrates that whatever the initial conditions, the trajectory will always remain parabolic (see Figure 6.4) [71]. People practise shooting many times, in all sorts of initial conditions, and integrate parabolic projectile motion as the norm.

An example of a good training simulation is a serious 2D game called the Projectile Motion simulation from the PhET Interactive Simulations project at the University of Colorado Boulder (see Figure 6.5) [137]. In this simulation all the parameters of a cannon shot can be changed: shot angle, power, air resistance, projectile mass, different firing objects, force, distance measurement, and much more - this project is very visual and positively rated by students.

In conclusion, while teaching the concept of free fall in a gravity field, interaction on the one hand, and dialogue (questions and answers) on the other hand, seem to play a key role in the learning mechanism and in dispelling conceptual errors. Virtual Reality naturally responds to the interaction aspects, by creating arbitrary experimental conditions (for example, by immersing oneself in situations that are impossible to live in reality, such as going to the moon to throw objects). On the other hand, when a student is in an immersive situation via an HMD, they are cut off from the outside world, and in particular from the teacher, which tends to diminish or even interrupt the questioning and challenging mechanisms. The availability of a virtual assistant, a companion, can solve this problem.



Figure 6.4: Angry Birds game[25].

6.4 Experiments

6.4.1 Research question

The process of learning without a teacher can be difficult, so in this study our main interrogation concerns the **isolation problem** created by the use of VR systems in an educative framework and how we can **bring back the teacher** into the teaching loop while using immersive VR headsets.

To this end, we have undertaken to compare three conditions, corresponding to plausible technical scenarios in an actual classroom:

1. The teacher is physically present, but the student is alone in the virtual world (as in the experiments of Chapter 5). If he needs to talk to the teacher, he has to take off his headset, do it, and put the headset back on afterwards.
2. The student is constantly in the virtual world and can communicate with the teacher by audio/video, in the form of a live 2D window inside the simulation.
3. The student can ask assistance to a 3D virtual companion, a robot named Kylie.

To test these conditions, I designed and implemented three exercises on the chosen topic, based on observations in the Sandbox and brainstorming sessions (see Chapter 3):

1. Object dropping in a gravity field;

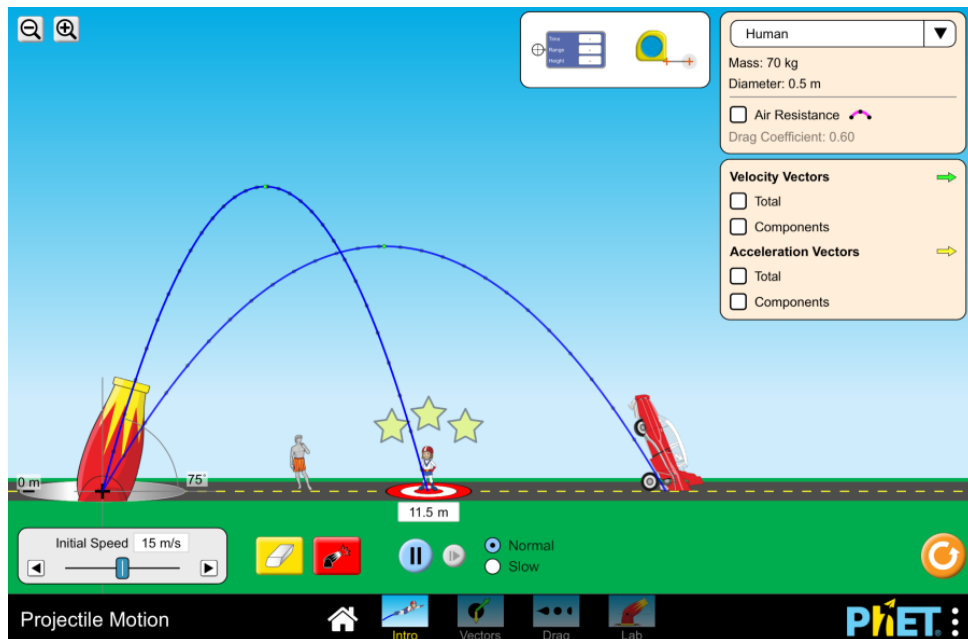

Figure 6.5: Simulation of the Projectile Motion [137].

2. Parabolic motion in a gravity field;
3. Motion in "gravitational sandwiches".

We will detail these experimental simulations below in Section 6.4.4.

Thus, several objectives can be formulated for this part of the study:

- The need to bring the teacher back into the educational process and how best to do so;
- To help students understand their mistakes in the free-fall delusion (the misconception that a heavy object falls faster than an easy one);
- To convey to students the idea of parabolic motion and how it can change in the presence or absence of gravitational fields.

6.4.2 Interviews with teachers

Prior to conducting the experiments, three interviews were conducted with teachers: two primary school teachers and an English teacher. Each of them had more than 30 years of work experience. During the interview they got descriptions of the three game conditions we had in mind, and asked to choose what

they would prefer and why. They were also asked how they generally felt about this method of teaching with VR.

- Participant 1 was a primary school teacher: she was hesitant between the second and the third option, but finally she chose the second one (video). She justified this by saying that in this case the student is doing the whole experience himself and if he needs help, face-to-face communication will be more effective in getting all the information. Indeed, children in primary school may have comprehension problems due to inattention and are more likely to listen to their teacher (and see his/her face as an authority) than to follow a robot's instructions. To the second question, she said that in her practice this method of teaching would not be useful, again because the children are still too young and lack the needed autonomy.
- Participant 2 - English teacher: She was immediately and definitely sure to choose the second condition as well. She also mentioned that personal communication plays a big role in her work and that students should not be left to independent learning. She answered positively to the second question, that she would use such a method in her teaching practice (close to the remote learning that the COVID-19 crisis has made commonplace).
- Participant 3 - primary school teacher: she chose the first option (that the student would take off the headset and communicate with her personally). She pointed out that it was necessary to combine modern technology and face-to-face communication and not to be detached from social communication in general. Our personality and social interaction skills are formed in childhood and the virtual world should not be a priority at this time. She added that she would not use such technology in mainstream classes, but perhaps as entertainment in additional courses. She suggested that this method could be applied to older students (middle and high school). Also, she and her children are already using 2D simulations on tablets (in fact in her previous lesson they had explored how penguins live in Antarctica). According to her, today's children love technology, but human interaction must remain at the forefront.

From these interviews, we can hypothesise that there will be a strong preference towards "video" or "real teacher" conditions during actual experiments. It also points out that, should this VR technology be spread in classrooms, teachers could be reluctant to use it for (reasonable) fear of losing crucial social interactions with their pupils.



Figure 6.6: Condition 2 - real-time video communication with the teacher.

6.4.3 Experimental conditions

As said above, we plan to test three playing conditions in the game:

1. The student is alone in the virtual world. In case assistance is needed, the teacher is nearby and can intervene, but immersion is interrupted (headset is removed).
2. Student plays in the virtual world but keeps in contact with the teacher with a audiovisual link (videoconferencing window inside the simulation).
3. The student is in the virtual world together with his companion, a robot named Kylie. Kylie will follow him everywhere and will provide assistance when asked for.

In the first condition, the user goes through the game by himself. As in the previous chapters, the participant is equipped with a VR headset, two controllers and headphones. If they need to talk to a teacher, they must remove their headset and talk to the teacher in person. The teacher can monitor (on an extra 2D screen) a view of what the student sees.

In the second condition the participant can communicate with the teacher via a bidirectional audio and visual link (See Figure 6.6). This way the student can see the video and hear the teacher in real time, without breaking immersion. The teacher also sees on the laptop screen what the student sees.

In the third condition the participant is in a virtual space together with the robot companion Kylie (See Figure 6.7). This companion always follows the student. When the student is at a task site, the

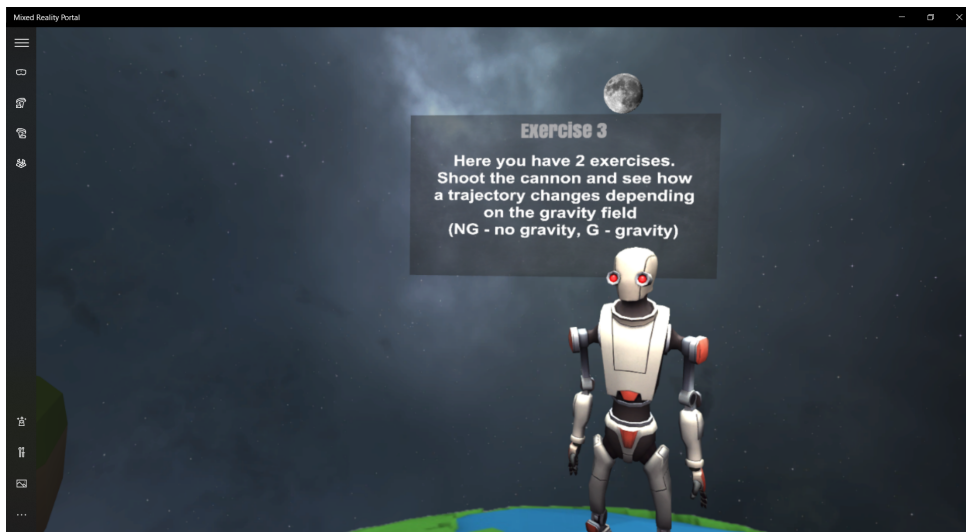

Figure 6.7: Condition 3 - Kylie, the companion robot.

companion stands in a predefined location so as not to block the view. The teacher can manage this companion as a Wizard of Oz, e.g. making the robot point to the object that the student should pay attention to (See Figure 6.8). When the teacher speaks into a microphone, the student hears the sound as coming from the robot. As in condition 2, the teacher also sees what the student sees on the monitor. We chose a robot model because it is human-like [19], and more relatable than, say, a bird or a dragon. We chose to make it gender-neutral and did not try to replicate the teacher's appearance, because a teacher maybe be unwilling or unable to create a resembling avatar in an actual classroom condition.

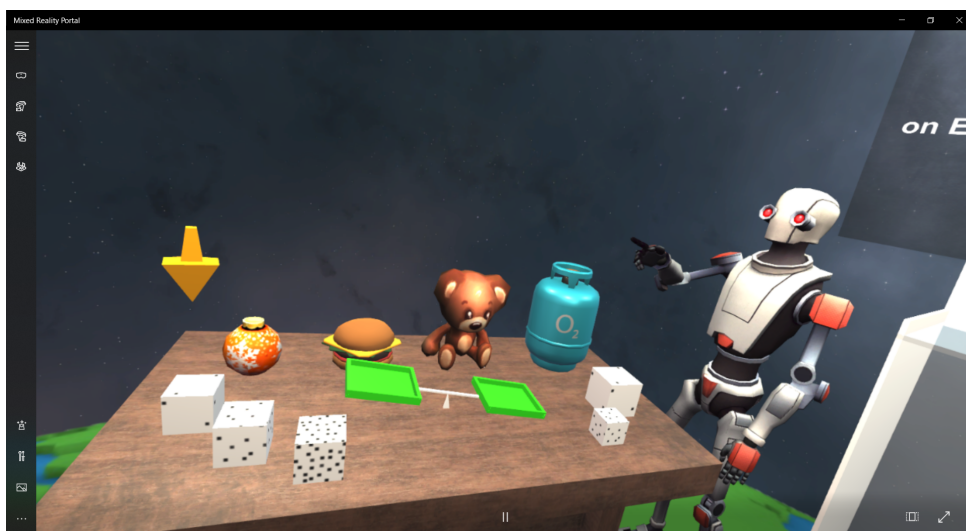

Figure 6.8: Condition 3 - The teacher can make Kylie point at the object of interest (here the furthest cube, as indicated by the 3D yellow arrow).

6.4.4 Experimental setup

There is a very long and well documented history on the understanding of motion, starting with Aristotle (4th century B.C.), throughout the middle ages (e.g. the Islamic scholar Ibn-Sina in the 11th century, Albert of Saxony in the 14th century, etc.), and up to the well-known work of Galileo and Newton, ushering the era of the analytic study of gravitational motion [107].

Many studies have been conducted to analyse how students understand the motion of objects, especially when thrown or launched with some device (e.g. a cannon). Misconceptions are universally observed, and often correspond at least partially to the historical misconceptions: a typical view, one that is hard to dispel, is that only after some impetus has been used up, can gravity start to act and the object fall towards the ground [51].

Thus, we must first introduce the concept of gravity and then consider parabolic motion. And as I mentioned earlier, this study would involve three exercises. In the first exercise I discuss the concept of gravity in the classic object-dropping experiment (on the Earth, on the Moon, and without gravity at all). The second exercise deals with parabolic motion and how the parameters of the shot change the shape of the trajectory again in three different settings (on Earth, on the Moon, in outer space). The third exercise shows how the trajectory of a projectile changes depending on the presence or absence of gravitational fields in the path of its flight. Let us now detail these three games.

Exercise 1 - Gravitation

The goal of this exercise is to show how gravity makes objects fall. This exercise is specifically designed to address the most common misconception in this regard, i.e. that heavy objects fall faster than light ones [51].

In this exercise, the student have at their disposal 9 objects of different weights, sizes and densities as well as a Roberval balance scale, just as in previous experiments (Chapters 4 and 5, see Figure 6.8). The experience goes as follows: the student grabs any two objects from the table, compares their weights on the scales (thus determining which is heavier), then places these two objects on the 2 drawn targets at the top of a dedicated platform and presses the "Start" button. The objects fall down, and a timer displays the time they each take to fall to the floor. The student then presses a "Reset" button and the objects return to their last position on the table, and a new trial can begin. 10 attempts are possible, but after the fourth attempt it is possible to move on to the next game. Note that if the student



Figure 6.9: Exercise 1: Condition "On Earth".

accidentally drops an object on the floor, it will automatically return to the table.

The game also features a blackboard with a summary table, on which the current experimental location is recalled (on Earth, on the Moon, or without gravity), as well as the number of attempts, and the fall times in all trials, allowing for comparisons.

There are three succeeding game location in this exercise: on Earth, with $g = 9.807 \text{ m/s}^2$ (See Figure 6.9); on the Moon with $g = 1.62 \text{ m/s}^2$ (See Figure 6.10); and in outer space (no gravity) (See Figure 6.11). The visuals of the background change accordingly: when the student is on Earth, the Earth is under their feet and the Moon is visible in the sky - objects fall with usual free-fall acceleration; when the student is on the Moon, the Moon is under their feet, the Earth is visible in the sky - objects fall slower than on Earth; when the student is in outer space, the student is located on a space platform, the Earth and the Moon are in the sky - objects do not fall (a slight rotation and motion in a random direction was added to the objects for a more credible visualisation - objects staying perfectly still would look unreal to a human eye³).

In video mode, the virtual screen is positioned on the side, so it does not interfere with the view, while remaining in the student's field of vision at all times. In condition 3, the companion occupies the same visual space.

³It is often the case that a mathematically exact model will look uncanny to human eyes, being accustomed to real world irregularities, such as friction, or the fact an object cannot be dropped with an absolutely zero impulse vector.



Figure 6.10: Exercise 1: Condition "On the Moon".



Figure 6.11: Exercise 1: Condition "In outer space - no gravitation force."

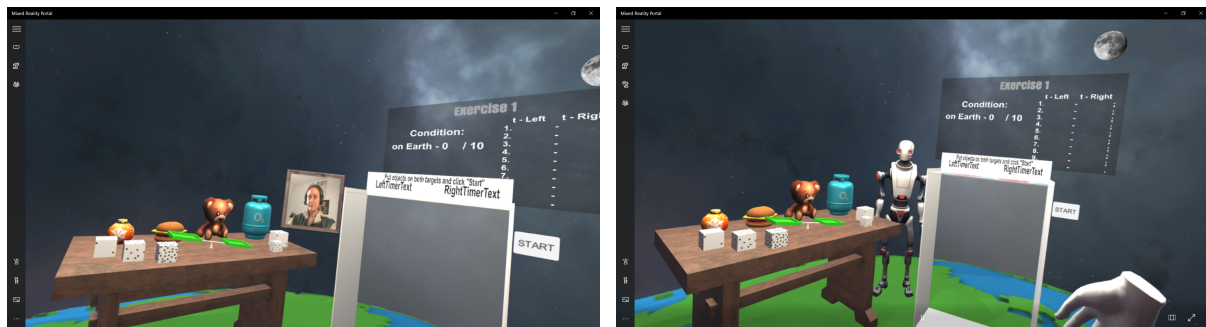

(a) Video mode.

(b) Companion.

Figure 6.12: Exercise 1 - view with different modes.

In this game, only the sounds of objects colliding are present, in addition to the audio of the teacher in video or companion mode (See Figure 6.12).

Exercise 2 - Parabolic trajectory

This exercise aims to demonstrate that regardless of the intensity of gravity, the trajectory of the projectile always remains parabolic, contrary to what many students will spontaneously express.

In this game the student can choose between two types of projectiles (a small 1 kg projectile and a big 2 kg projectile) to feed a cannon and shoot targets. Firing is triggered with a torch, and the trajectory is monitored with a 2D orthographic display. See Figure 6.13 for a global view.

A typical firing sequence goes as follows:

- The student takes any projectile, loads the cannon (by putting the projectile in contact with the cannon). A trajectory, corresponding to the current cannon orientation, is displayed in the form of a string of small balls, see Figure 6.16.
- The operator orients the cannon to aim at the target (there are two handles on the cannon for this - vertical and horizontal turns), takes the torch and lights the fuse on the cannon. After 3 seconds the cannon shoots (See Figure 6.16).
- The student can observe the flight path, both in 3D live and on the 2D orthographic monitor (See Figure 6.17).

The student can take up to 8 shots in each gravity condition (Earth, Moon, no gravity), but after the 3rd shot the student can move on to the next game, at any time. For each attempt, the target is randomly



Figure 6.13: Exercise 2: Condition "On Earth".

placed in one out of 8 positions at different distances and elevations, so that the student can experiment a variety of possible trajectories. The purpose of this exercise is to show that in the presence of gravity, the flight path will always be parabolic in a gravity field - strongly bent, bell-shaped under Earth's gravity (Figure 6.16), less so on the moon (Figure 6.14), and a straight line in the absence of gravity (Figure 6.15).

As in the previous exercise, a virtual board displays general instructions, such as the current status and the attempt number. But this time its main purpose is to show the trajectory of the cannonball from a side view, as studied in chapter 3, section 3.5.

Again, if a projectile or torch is dropped to the ground, it will automatically return to its homing position. The visual representation of the state (Earth, Moon, space) is the same as in the first exercise.

Similarly, in video mode, the virtual screen is positioned on the side, so it does not interfere with the view, while remaining in the student's field of vision at all times. In condition 3, the companion occupies the same visual space (see Figure 6.18).

The soundscape is more elaborate than in the first experiment: there are sounds of objects colliding (with each other and with the table), the sound of the wick burning (3 seconds after lighting and before the shot), the sound of the torch burning (similar to the crackle of burning wood), and the sound of the cannon firing. In video or companion mode, the teacher's voice comes from the virtual screen or companion respectively. The sound settings are tuned so that the teacher's voice, in the corresponding



Figure 6.14: Exercise 2: Condition "On Moon".



Figure 6.15: Exercise 2: Condition - "without gravitation force".



Figure 6.16: Exercise 2 - complete firing procedure.

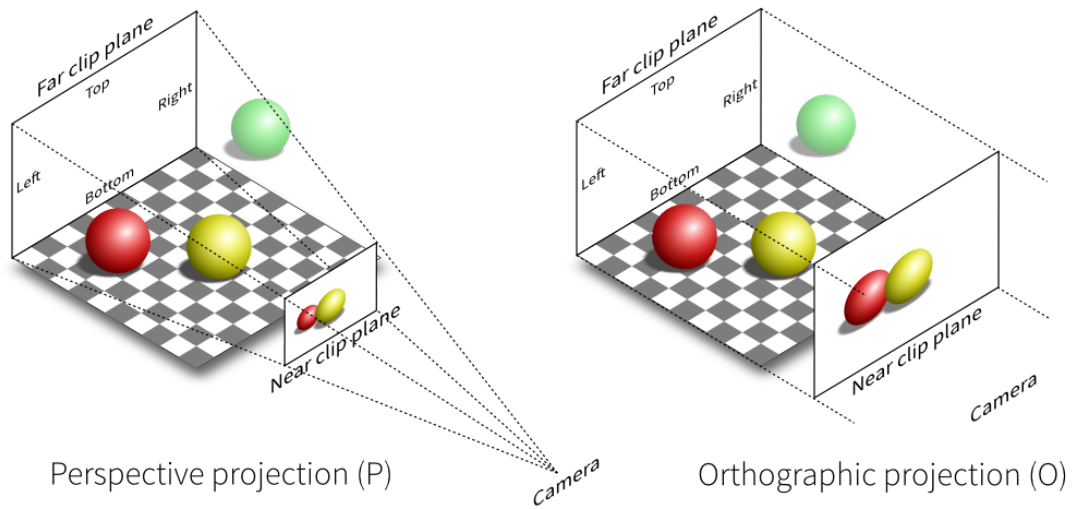

Figure 6.17: Different ways to project a 3D volume onto a 2D screen [101].

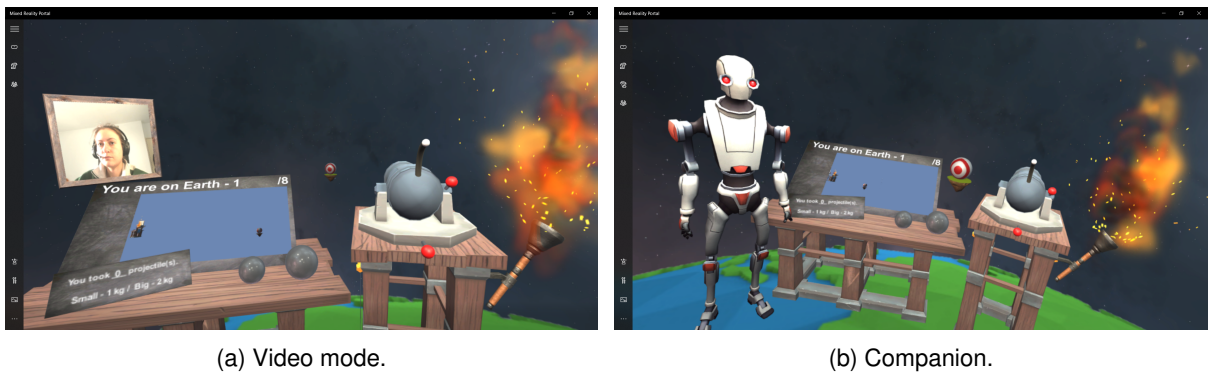

Figure 6.18: Exercise 2 - view with condition 2 (video) and condition 3 (companion mode).

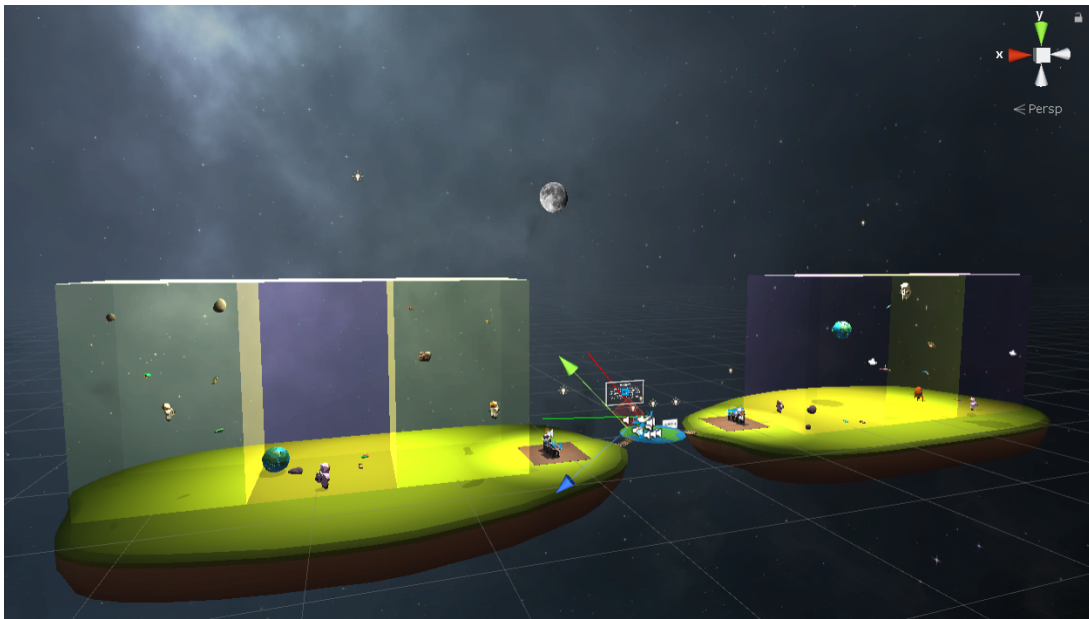

Figure 6.19: Exercise 3: Game space.

modes, will be heard everywhere at the same intensity, while virtual sounds are spatially located.

Exercise 3 - Parabolic trajectory & Gravity

In the third exercise, the student can observe how the trajectory of the projectile changes depending on the presence or absence of a gravitational field. As experimented in the sandbox of chapter 3, two kind of cubic areas, "G - gravity" and "NG - no gravity", called *boxes* are horizontally stacked in a sandwich manner: on one platform they form the sequence "G-NG-G" and on the other platform the sequence "NG-G-NG" (See Figure 6.19). "G" here stands for normal earth gravity. In each box several objects are placed to improve the legibility of the scene (i.e. if gravity is present they all lay on the ground, if there is no gravity they suspended in mid-air). Objects were chosen in the space theme: astronauts, planets, meteorites, etc. so that floating objects make sense. Again a small rotational motion was added to add believability. Again the main task consists in shooting a cannonball, but this time no target is provided, and the student is asked to focus on the shape of the trajectory as the ball traverses the "gravity sandwich". Before each shot, the student sees only the beginning of the trajectory before the gravity sandwich (see Figure 6.20). The full trajectory is visible only when the shot is fired (see Figure 6.21).

The technique is the same as in Exercise 2: the student selects a projectile (8 light 1 kg projectiles on



Figure 6.20: Exercise 3: Game task.

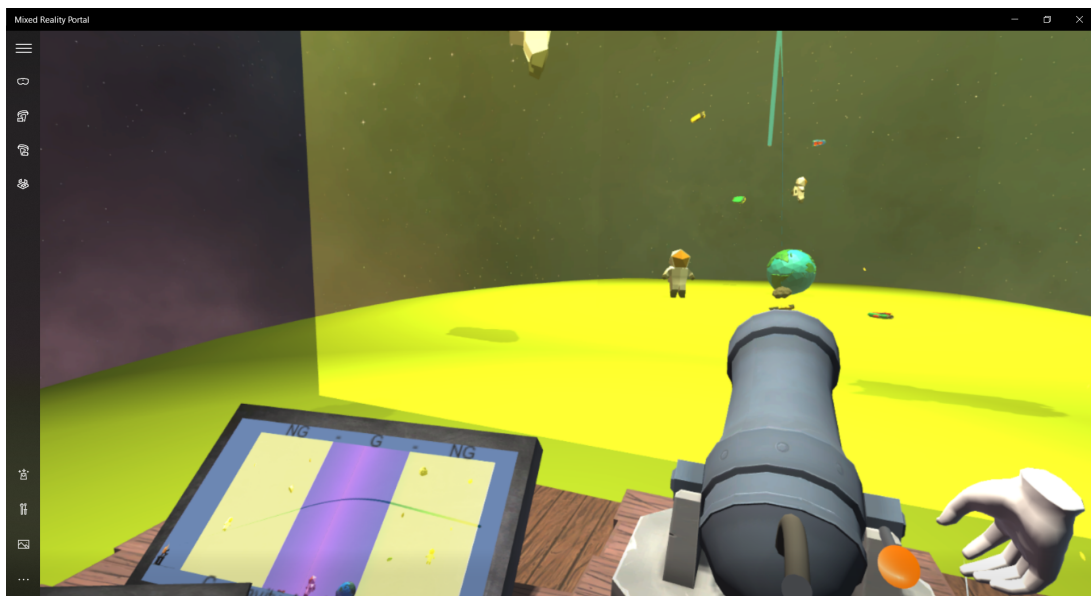
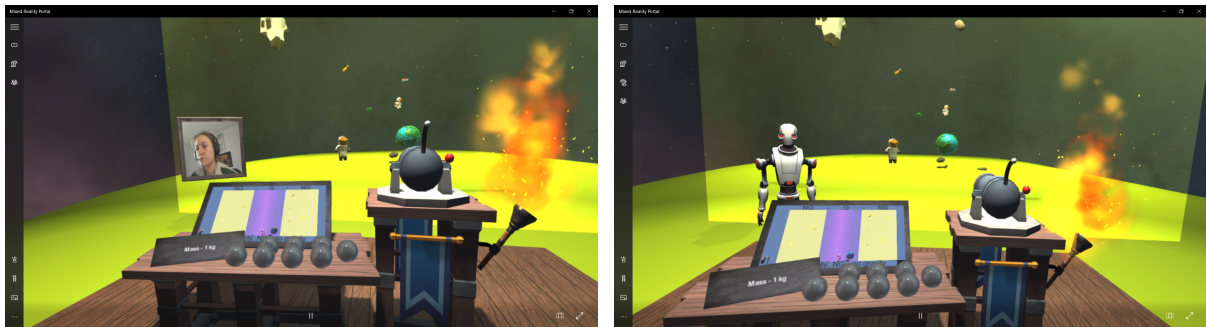

Figure 6.21: Exercise 3: Student's game view.



(a) Video mode.

(b) Companion.

Figure 6.22: Exercise 3 - view with different modes.

each platform), loads the cannon, changes the angle of elevation (in this case, only the vertical handle is present), takes a torch, fires the wick, and shoots. On a 2D orthographic video monitor, the student can watch as the trajectory unfolds (See Figure 6.21).

If the student plays with a video or companion assistance, the video or companion is in a fixed position during the exercises. Whenever the student moves (going from one platform to the other), the video is fixed in the lower left corner of the student's field of view and the companion follows the player and stops about 2 metres away (See Figure 6.22).

Sound is designed identically as in Exercise 2.

6.4.5 Questionnaire

In order to evaluate the students' comprehension around the subject of gravity and free-falling, and because I could not find an existing one, I developed my own questionnaire consisting of 9 questions (See Appendix 3). Each of the questions is accompanied a self-assessment of the level of confidence in answering the question, as in Chapter 5.

I designed the questionnaire based on my preliminary observations in the Sandbox, but also during the experiments on pseudo-haptics (4), where some participants reported their misconceptions regarding falling objects, using them to reinforce their perceptions. Indeed several students reported: "to determine whether an object was heavier than another, I dropped them from the same height simultaneously⁴ and determined which landed first."

Consequently, in this questionnaire, two questions relate to the misconception about the falling speed of objects with different masses, two questions in general about parabolic motion, four questions about

⁴using both hands.

the change in trajectory under different gravitational fields, and finally one question where the student is asked to draw possible trajectories as a function of the gravitational field. All questions except the last one are closed, multiple choice interrogations.

6.4.6 Experimental Procedure

Proper sanitary procedures to prevent COVID-19 contamination were designed and applied [106] during the preliminary experiments, described below.

Pre-test

Users passed a pre-test that we compiled specifically for this experiment (see Section 6.4.5). This questionnaire is voluntarily short and focuses on misconceptions and qualitative knowledge. There was no time limit to complete it.

Experiment

The students did not undergo a training session, because we wanted to test whether the games were playable right away. Then players received basic instructions before immersion in the virtual world, practical instructions to interact with an object (pick up / drop) were repeated during the early steps of the game (remember the teacher is close to the player and can provide assistance at any time). The objects were highlighted when grabbable as well, to simplify interactions.

In each mode (real teacher, video, companion) and for each exercise, instructions regarding the course of actions were given by the teacher by voice, but the general task description was also duplicated on the virtual board inside the simulation.

There was no game score in the game. After three trials in the first and second exercises, the student could move on at will, or could use all attempts in full. In the third exercise the student could perform any number of attempt, then finish the game.

We chose not to display a score, or force any time limit, because in this case the main task consists in realising that a particular phenomenon occurs (e.g. two objects dropped from the same height simultaneously will land at the same moment), so that the required number of attempts to do so is not important. Nevertheless we record time and number of attempts, so as to analyse these outcomes.

Post-test

Following the VR experiment, the participant was asked to complete a Post-Test questionnaire, which is the same as the Pre-Test.

Participants were then asked to undergo a 15-minutes semi-directed interview. The objective was to collect some data regarding the subjective perception of the overall quality of the environment and interaction, to justify some answers in the post-test (in misconceptions remained), and to describe how they interpreted each experiment and what they could learn from it. The students also ranked the exercises according to their preference. We were especially interested in feedback regarding the presence of the helper, and how comfortable the interaction with the teacher was, compared to a classic classroom situation. Free speech was encouraged to gather as many cues as possible on the experiment.

Finally students were given a theoretical description of each of the three game modes (real teacher, video, companion), and asked to choose which one they would ideally prefer, and why.

6.4.7 Preliminary results

Due to the sanitary situation caused by the COVID-19 crisis, a complete set of experiments could not be undertaken at the time of writing this document. However, we conducted a preliminary study which we detail below.

There were 6 participants in this pre-test (Mean age = 27, SD = 2, 2 females and 4 males), 2 per condition. All participants were right-handed, without visual problems, all have experience of using VR; two had basic knowledge of VR, two had average knowledge, and two declared a high level of expertise. All had a level equivalent to Masters in a science-related field. Four students said that they had last studied the concept of gravity in secondary school, two others in high school.

During the game I only recorded the time of completion for each condition and for each exercise, because my aim was to study knowledge acquisition, not to estimate target hitting skills. I consequently focused on test results and personal interviews.

Table 6.1 compiles the total time results for each mode, for each state, and the total playing time. The average playing time was 26.52 minutes. However, for the real time mode students spent 19.74 minutes, for the video mode it took longer at 27.36 minutes, and the longest time was obtained for the companion mode at 32.45 minutes. On average students spent the most time on the first exercise with 12.95 minutes, followed by the second exercise with 8.54 minutes and the shortest time was for the third

exercise with 5.03 minutes. The first and second exercise had 3 states (on Earth, Moon and without gravity), so there was a familiarity factor: the first exercise took the longest time, the second was shorter, and the third the shortest (for 5 out of 6 participants). For the third exercise, the same amount of time was spent on average for each platform (2.12 minutes and 2.01 minutes)⁵.

	Condition 1	Condition 2	Condition 3	Average time
Time for Exercise 1	9,33	14,07	15,45	12,95
Time for Exercise 2	6,79	8,75	10,09	8,54
Time for Exercise 3	3,62	4,53	6,92	5,03
Average Total game Time	19,74	27,36	32,45	26,52

Table 6.1: Time spent in the game (in minutes).

Based on the Pre-test and Post-test questionnaire success rate, all participants improved their performance, with average success rising from 77.56% to 87.82%. The self-confidence score increased by 13.42% as well (old - 3,41, new - 3,94). Looking at success rates for each mode, companion mode was the most effective, with an increase of 17%, followed by no-help mode with an increase of 8%, and finally video mode with 6%. However, these results need to be confirmed with a more statistically significant set of participants.

For the most part, scores increased on questions that were directly in relation to the game. In contrast, answers to question 4 (determining the flight path of a ball if dropped from an airplane, see Appendix C) remained consistently wrong in most cases. It seems the notion of initial speed is not invariant depending on how it is acquired, so that parabolic "forward" motion is not generalised easily.

During the interview, all the students noted the simplicity of Exercise 1, but one participant did not believe at first that two objects with different masses could fall the same way and concluded that the program did not work correctly, then later changed his mind⁶. In Exercise 2 half of the students commented on the usefulness of the 2D orthographic view, the other half found the exercise was obvious without it, but all enjoyed shooting at targets with a cannon. Exercise 3 was also evaluated positively, but half of the students regretted that it was not possible to shoot at specific objects. One of the suggestions was to place objects at different heights and try to predict the change in trajectory to hit the object. In this situation the 2D orthographic view was deemed useful because the transition between the gravity blocks

⁵In Exercise 3 the sum of this time is different from the total playing time because the time shown here is during the task (being on the platform) and the total time also includes time for moving between the platforms and being on the home platform to read the instructions from the blackboard.

⁶This shows the extent of misconceptions, and also the limits of a simulation which can be disbelieved at will, blaming it on the programming.

was not visible from the participant's subjective view.

When asked to rank the exercises by order of preference, half of the students put Exercise 2 in first place and the other half chose Exercise 3, but all students clearly put Exercise 1 in last place, justifying this by the over simplicity .

Regarding sounds, everyone liked the sound of the cannon firing and the crackling of the torch, but no one paid any attention to the sound of the collision between objects (probably because collisions were very predictable events, and had little importance in the context). The graphical surroundings were also rated positively, with one student saying that the moon looked very realistic.

Sounds were played in the same manner regardless of the condition, which was a deliberate decision. We feel that sometimes, rigorously realistic conditions are actually counterproductive to the transmission of knowledge. In this specific case, none of the students were confused by the presence of sounds and explosions in the "vacuum of space" condition (without gravity). Of course, the game would be different if sound transmission was the subject of study.

When asked about their preferred assisting mode, 5 students chose the companion mode, justifying that it was more interesting, that they preferred not to see the teacher in the real world because they would feel pressure, and that interacting with the companion was more useful as it could show things in a 3D context without ambiguity. One student chose video communication, saying he preferred to see the teacher, that one-to-one communication was important. One student also noted that the choice of game mode can depend on different factors: for instance, in a short simulation in VR the teacher was not required, whereas a long tutorial lesson would certainly make interacting with the teacher a necessity.

On the downside, some students noted problems with the teleportation system, especially regarding pivoting; they would have preferred a real body turn.

Students who tested the first mode (with a real teacher) noted that they had difficulty understanding what the teacher wanted from them. Being completely immersed in the VR world, an "outside" voice was hard to focus on. This effect was absent in the second and third mode subjects.

I would also like to point out that the VR equipment, as any other equipment, sometimes fails to function properly. In the course of this experiment, due to high CPU load, there were situations when the virtual controller was not displayed (physically it was present on the stage, but it was not visible). In the avatar or video communication mode, participants were quicker to perceive the procedure for making the controllers visible again (press the side button on the controller, if that did not help, then the "Windows Menu" button (Open menu), and then the "Windows Menu" button again (Close menu)). In other words,

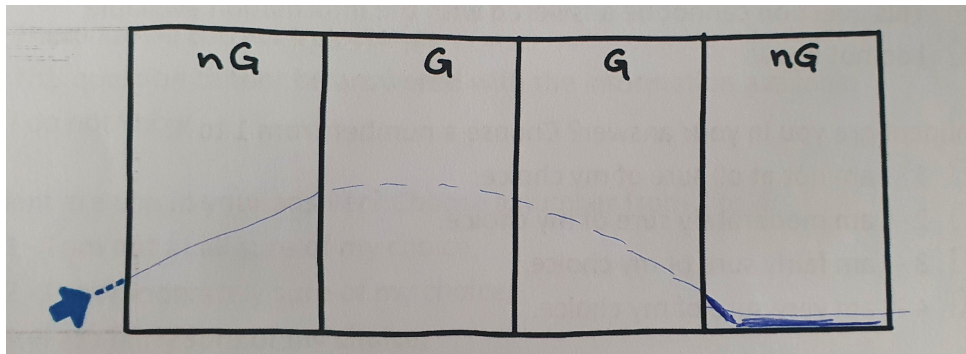

Figure 6.23: Question 9. Presentation variant I.

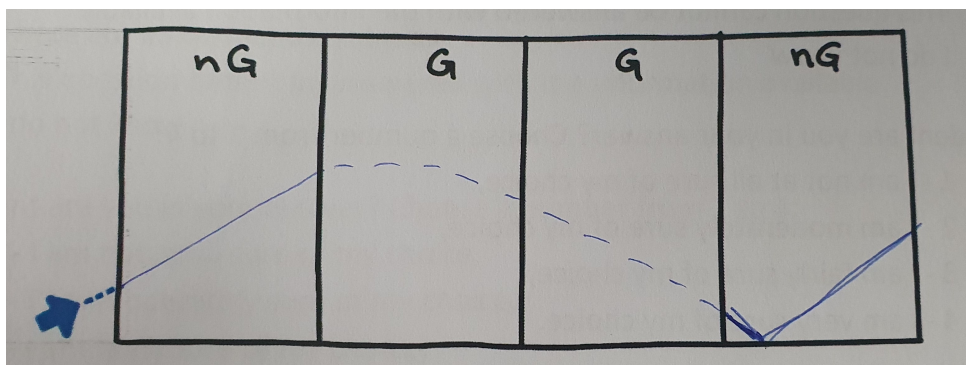

Figure 6.24: Question 9. Presentation variant II.

if there is an avatar or video of the teacher in the simulation, the student will understand the teacher's words as a call to action, whereas in single mode the student will first try to understand the teacher's speech from the real world and then try to follow the teacher's instructions. Thus, the teacher's role may not be limited to only teaching, and he may also assist the pupil during various activities.

A subject to interpretation

I would like to draw a specific attention to a point I had not anticipated when designing the questionnaire. This ambiguity arose on the subject of trajectories in the presence or absence of a gravitational field.

In question 9, we ask the student to draw a possible trajectory of a projectile within a gravitational sandwich. Initially, we expected something similar to Figure 6.23 (as presented in the virtual third experiment). All but one students did indeed draw this version, but one student drew it as in Figure 6.24.

When asked, he said that the object would likely bounce off the ground, like a rubber ball. Of course his answer also counted as correct, because we did not specify the material of the ball or any other properties of the object. By default, we assumed a completely inelastic impact, but the student still

remembered the concept of an elastic impact and applied it correctly⁷.

Thus, some questions could possibly need additional clarification, but as only one student out of six remembered such a concept, it shows that many students stuck to the most evident principles of physics (here, free-fall) and would probably be confused by more complex systems (e.g. telling them that the ground is elastic).

6.5 Conclusion

Many students have misconceptions about what could be considered the most basic concepts of physics. Although the use of VR itself for learning has proven to be effective (see chapter 5), the fact remains that the complete teaching process can be realised in a virtual environment alone. More often than not, the presence of a teacher can be a key factor. Because being immersed in a virtual world tend to isolate the student from the real world, a virtual companion or live video link with the teacher can significantly counterbalance this situation. Our goal was thus to study the effectiveness of assisting techniques in serious VR games. The increased average success rate of all participants of the preliminary tests confirms that indeed such assistance complemented the natural benefits of VR learning.

Thus, in this chapter :

- I explicated the main advantages of using a companion for educational purposes;
- I discussed the most common misconceptions students have about free fall, parabolic motion and the concept of gravity;
- I considered the concept of 'intuitive physics' and why it interferes with learning;
- I compared 3 gaming modes: with a real teacher, with a live video of the teacher, with a virtual companion controlled by the teacher;
- I explored 3 exercises: gravity, parabolic motion, and changes in parabolic motion through a gravitational "sandwich". The first two exercises were conducted in three conditions - on Earth, on the Moon, and without gravity;

Preliminary studies demonstrated, once again, the ecological validity of Virtual Reality, giving access to situations that would otherwise never be experienced. Based on success rates for each mode, We

⁷One could say an elastic rebound is actually the only correct answer from a realistic point of view.

found out that companion mode was the most effective, then was video mode, and finally no-help mode.

Unfortunately, thorough experimental sessions were not undertaken yet, due to the COVID-19 crisis.

Logically, the next step is to test these gravity games on a significant number of students.

Chapter 7

CONCLUSION AND FUTURE PERSPECTIVES

Learning is an vital process of our development that begins with our birth and continues throughout our lives. Various experts in didactics and teachers are constantly trying to improve the quality of learning and its effectiveness. Traditional teaching methods include working with 2D materials, such as drawings from textbooks and text on the blackboard, and are based on oral explanations.

Modern teaching materials, both paper and digital, still often resemble the school textbooks we are used to. Most 'innovative' textbooks have no visual enhancements or interactive features, leaving students often bored. If the teacher fails to present the material in an interesting, unusual way, students find it difficult to immerse themselves in the learning process: they do not absorb the information or do not want to learn at all.

Over the years, since technology has become an integral part of our lives, some curricula have included the use of various devices to provide more interactivity, such as tablets and computers. However, learning is still mostly a theoretical classroom activity¹, where real-world 3D experiments are mostly out of reach. This doctoral thesis explores a new approach to learning where actual observation and experimentation is at the heart of the process of education.

Today, it is increasingly common to see projects involving advanced technologies such as Virtual Reality in the learning process. Different applications will meet specific learning needs, e.g. training

¹In ancient Greece, the pedagogue was actually walking with the student, and according to the legend Aristotle used to walk while teaching.

developing personality traits (assertiveness during job interview simulation), or professional skills. But especially noteworthy is the fact that, although it involves millions of potential beneficiaries, there are still a limited number of VR projects aimed at improving the knowledge of students in schools, in disciplines such as physics, mathematics, biology and others. Often the outcome of these early trials are encouraging and highly praised by the education community. However, even if such projects use Virtual Reality in conjunction with serious games (making them more attractive) they focus on general learning problems, and do not use in-depth study of the issue of learning, the topic of didactics of science. Thus, this study logically proposed combining Virtual Reality with serious games and with physics didactics in order to design, implement and evaluate novel education pathways. More specifically, the goal of this research was to investigate how to leverage new human-machine interfaces in order to increase student engagement into the learning process.

In this thesis I argued that immersive and interactive digital simulations in VR offer significant advantages over traditional - text-based, oral-based - educational and media approaches. After this research, I still firmly believe that we can take advantage of the highly innovative technologies of VR, digital simulations and the new interaction techniques to design, develop and evaluate new methods, tools and experiments dedicated to the construction of knowledge in the field of physics.

7.1 Contribution

In order to understand the current relationships of Virtual Reality, serious games, and didactics, I began this PhD document by discussing each of the elements that constitute my methodological triptych: I considered their positive and negative sides, and which useful features they bring for educational purposes Chapter 2.

With **VR**, it is possible to gain a previously inaccessible experience of direct interaction with simulated content that replicates existing physical phenomena of various kinds. The introduction of such technologies in the field of education solves several important problems at once: directing the scheme of learning towards individual study of material, making it possible to apply the acquired knowledge in practice, and increasing the efficiency of learning through greater involvement of students in the educational process.

Serious games attempt to harness the instincts of cooperation, interaction and imagination, combined with learning materials. The resulting hypothesis is that serious games can increase the effectiveness of learning by exploiting the strengths of the gameplay process.

The aim of **didactic research** is to explore issues that arise in the process of teaching and learning in different school disciplines. It has been employed successfully throughout the last century to carefully analyse how students assimilate knowledge, highlighting the key concept of misconceptions as major obstacles to be overcome in order to gain insight in even seemingly basic scientific concepts.

Thus, in the context of didactics, the use of VR technologies and serious games can envisage a radical evolution of teaching methods, putting the learner at the centre of an innovative device that integrates theoretical and practical learning into a single practice. I have specifically identified already existing projects such as EVEILS and NewtonWorld, as cornerstones of my work. Based on this analysis, I established the requirements for hardware and software, and developed a general methodology for game development.

From the knowledge gained from the bibliographic anamnesis of Chapter 2, I implemented the first prototype of an educational game in the form of a Sandbox (Chapter 3). Within this game, I tested several game features and checked whether the interactions and the general organisation of the game would be intuitive, understandable, and fun. The first participants were very positive about this experience in the initial feedback. With this knowledge and in collaboration with a Masters student, I then conducted brainstorming sessions as well as several more structured interviews. The interviews gave an insight into the educational process from the students' point of view, suggested what the students expected and what they preferred to avoid, while providing a basis for interpreting the results of the brainstorming sessions. A pre-study on point-of-view selection in a study on parabolic movement made it clear that sometimes students' preferences can be purely preferences, and are not confirmed by objective measures (what the student prefers is not what gives the best performance).

Then I started looking at more practical applications to observe student learning, and the topic of density emerged as one of the hardest to comprehend. Immediately with density came the issue of perception of mass in virtual space, the subject of Chapter 4. I designed an VR experiment where I compared 2 different pseudo-haptic techniques with a purely visual feedback, i.e. a conventional Roberval balancing scale. Based on the results, I concluded that students prefer to work with the simplest and most obvious interaction, without the need for elaborate rendering schemes.

With a better understanding of the students' way of thinking, and breaking down students' basic misconceptions about density, I designed an experiment that should give students a step-by-step understanding of this concept (Chapter 5). To this study I also touched upon the topic of using audio for learning. I implemented and compared this experiment in two forms: 2D online and 3D in VR. The re-

sults again showed that students are looking for the easiest and most obvious option. If nothing forced the student to doubt their beliefs, in most cases they would play the "guessing game", i.e. a simple sequence of manipulation without any real interpretation.

However, those who tried to reflect on their actions showed a significant improvement in results. I came to the conclusion that "mindfulness of thinking" is also a way of thinking that can, and has been learned.

Based on the interviews conducted in Chapter 3 and also on previous works, I noticed that the perception of the teacher's involvement in the learning process can play a very important role. I designed an experiment to bring the teacher back into the VR learning process against the background of the research topic of gravity/free fall/parabolic motion (Chapter 6). Preliminary results tend to show that according to teachers, a video mode or "real teacher" would be more effective in teaching. In the opinion of students, the teacher presented as an avatar or with a video feedback is more profitable than if the teacher is being left outside the immersion system. Today's schoolchildren and students have grown up with technology; for them, technology is part of their social life. Therefore, communication with classmates/teachers in a virtual space is perfectly natural and they even aspire to more virtual communication.

The overall outcome of my work tends to demonstrate that learning with Virtual Reality technology brought significant qualitative and quantitative benefits to the students involved. Experimenting within a 3D VR simulation allowed students to fully immerse themselves in the learning process without being distracted by external factors.

Although the idea of using VR for educational purposes is not new, the main drawback of all previous works was the lack of a rigorous didactic approach. The JeSeiPa project is innovative in at least two essential aspects: didactic and educational. The overall result of my work generally demonstrates that learning with virtual reality technology has brought significant qualitative and quantitative benefits to the students. The didactic analysis of the learning process played a large role in obtaining these benefits. The identification of misconceptions and key concepts was necessary to create useful game content, and this contribution is very novel compared to previous work. Experiments within a 3D VR simulation with a didactic framework allowed students to fully immerse themselves in the learning process without being distracted by unimportant factors.

The technical outcome of this thesis is a set of serious games dedicated to VR, based on didactic research. Empirical findings have shown that these games present a definite advantage over traditional

teaching methods, but further work must now be carried out in order to validate these findings on a broader scale.

Thus, the hypothesis that immersive and interactive digital simulations in VR represent a significant advantage over traditional methods has been confirmed.

7.2 Enhancements and future work

Of course, the solutions and findings developed in this thesis have some limitations, the first one being the scale of the evaluations performed. Administrative education systems do not change overnight, and it will still take years before these tools are available in classrooms for proper tests and possible improvements. In the meantime, serious games can be used for more personal learning purposes as well as in extra curriculum sections.

The COVID-19 crisis has affected the whole world for the last few years, and this has partly impacted my work as well. Conducting all experiments on a much larger number of participants and on a more appropriate target audience (middle school children, high school students) could help to study their effectiveness much more thoroughly.

Also, this research only examined limited case studies. It did not systematically study independent variables such as learning settings, target groups, learning objects, learning goals, traditional and VR educational settings. There is obviously much to be learned in such future field experiments.

In all of the experiments conducted, we used qualitative and quantitative data to evaluate effectiveness. However, in terms of evaluating immersive interaction, subjective questionnaires are now increasingly complemented by objective biosensor data. Some biosensors, in particular Brain-Computer Interface (BCI) systems, for example, are being used in some work to analyse subjects' attention in the context of learning [118]. This will significantly help to improve the methodology of learning assessment.

It would of course be incomparably interesting to consider such an approach (combining VR, serious games and didactics) on other physics topics, or even on other disciplines as well. The approach we have adopted is indeed generalizable to most experimental sciences where theoretical concepts can be assimilated through direct experience.

Appendix A

Appendix 1

A.1 Hardware selection

A.1.1 Lenovo controllers - Unity Input system mappings

The image below shows the buttons available on Windows Mixed Reality controller.

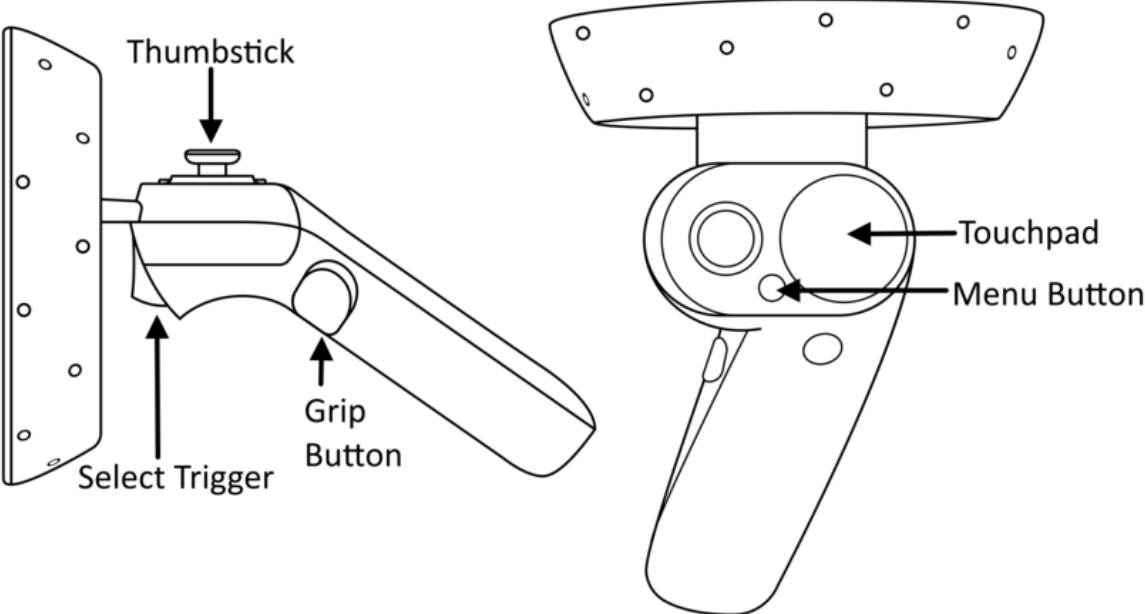
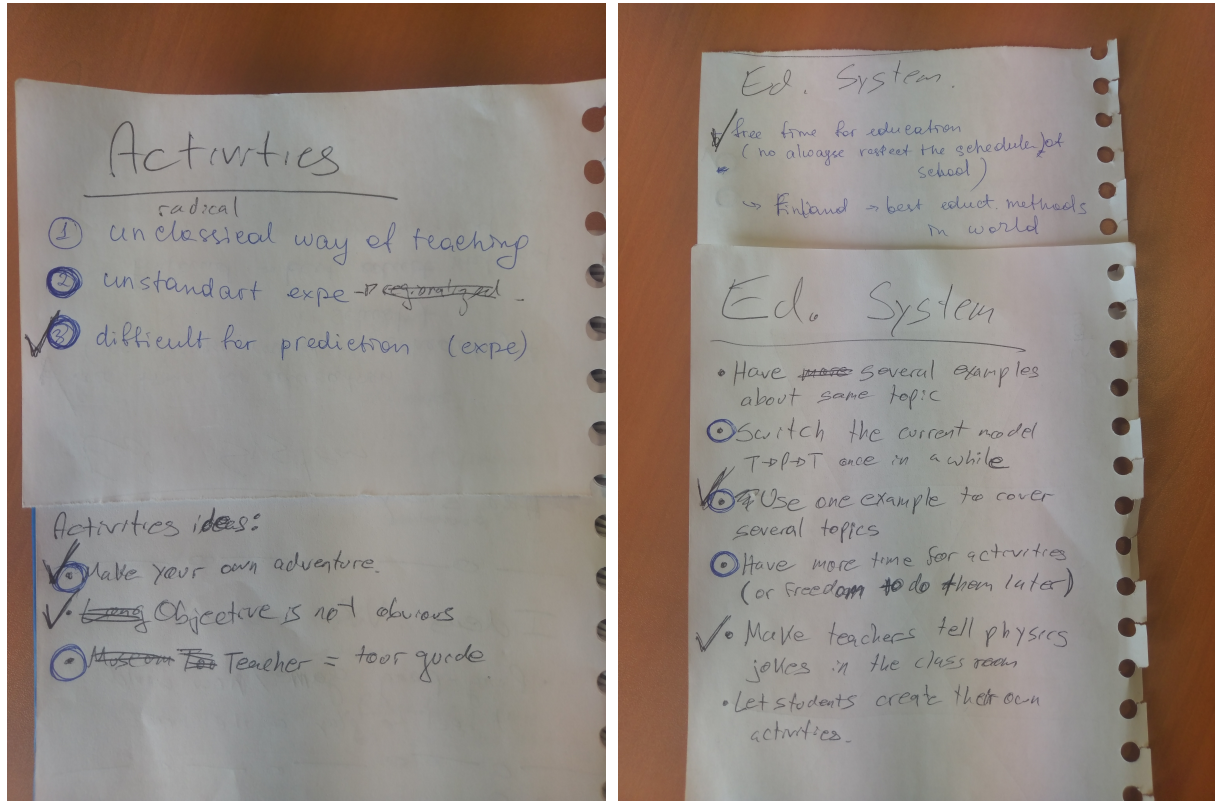

Figure A.1: Windows Mixed Reality Controller buttons.

A.2 Brainstorming notes



(a) Activities.

(b) Educational systems.

Figure A.2: Brainstorming notes I.

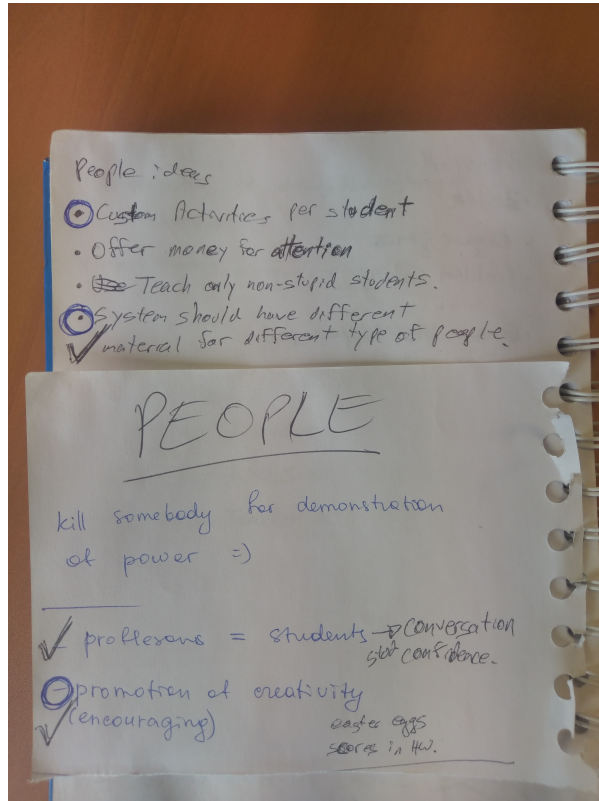

(a) Activities.

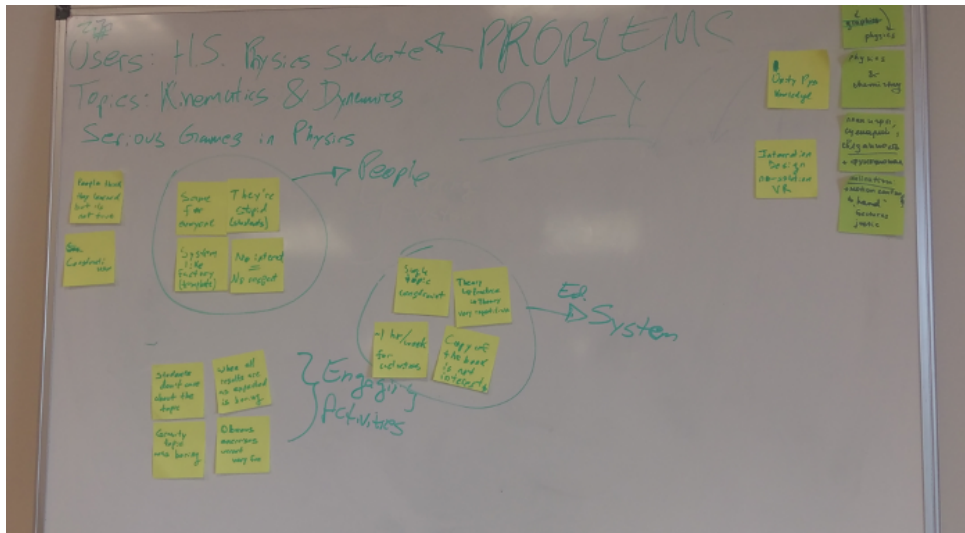

(b) Educational systems.

Figure A.3: Brainstorming notes II.

Appendix B

Appendix 2

B.1 Questionnaire "Properties of matter"

We created the questionnaire to evaluate student knowledge in topic "Properties of matter". It aims to explore how future school teachers understand certain properties of matter.

The questionnaire contains two sections: Part one addresses the density concept (as volumetric mass, i.e., a correlation between density, mass, and volume) while part two addresses the density concept through flotation (different objects with different density are placed inside liquids). Also, each answer has a self-assessed level of confidence. This gives us an indication of the difficulty of the questions from the student's point of view. Thus, we created a questionnaire containing 13 basics questions about the density concept, each with a 4-step confidence level.

We use the questionnaire in Chapter 5.

Questionnaire "Properties of matter"

Part 1.

Question 1.

A homogeneous piece of wood is cut into three pieces of different sizes, so that the sum of the lengths of the two shorter pieces is equal to the length of the longest piece. Each piece has an identical width and thickness.

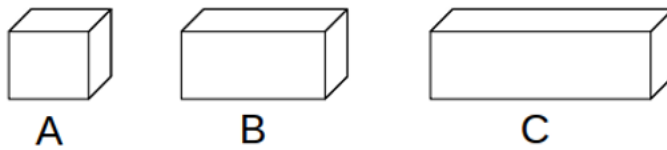

A1. Which piece has the most **volume**?

- A
- B
- C
- The three pieces have the same volume
- This question cannot be answered with the available information
- I don't know

How confident are you in your answer? Choose a number from 1 to 4:

- 1 - I am not at all sure of my choice,
- 2 - I am moderately sure of my choice,
- 3 - I am fairly sure of my choice,
- 4 - I am very sure of my choice.

A2. Which piece has the highest **density**?

- A
- B
- C
- All three pieces have the same density
- This question cannot be answered with the information available
- I don't know

How confident are you in your answer? Choose a number from 1 to 4:

- 1 - I am not at all sure of my choice,
- 2 - I am moderately sure of my choice,
- 3 - I am fairly sure of my choice,
- 4 - I am very sure of my choice.

A3. Which piece has the greatest **mass**?

- A
- B
- C
- All three pieces have the same mass
- This question cannot be answered with the information available
- I do not know

How confident are you in your answer? Choose a number from 1 to 4:

- 1 - I am not at all sure of my choice,
- 2 - I am moderately sure of my choice,
- 3 - I am fairly sure of my choice,
- 4 - I am very sure of my choice.

Question 2.

The two objects A and B in the figure below have the same mass and volume.

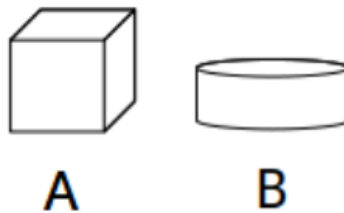

Which of these 2 objects has the greater density?

- Object A
- Object B
- Both objects A and B have the same density
- This question cannot be answered with the information available
- I do not know

How confident are you in your answer? Choose a number from 1 to 4:

- 1 - I am not at all sure of my choice,
- 2 - I am moderately sure of my choice,
- 3 - I am fairly sure of my choice,
- 4 - I am very sure of my choice.

Question 3.

The two objects A and B in the figure below are made of two different materials.

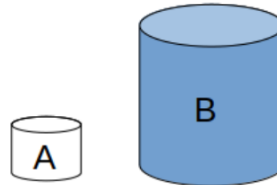

Which of these 2 objects has the greater mass?

- Object A
- Object B
- Both objects have the same mass
- This question cannot be answered with the information available
- I do not know

How confident are you in your answer? Choose a number from 1 to 4:

- 1 - I am not at all sure of my choice,
- 2 - I am moderately sure of my choice,
- 3 - I am fairly sure of my choice,
- 4 - I am very sure of my choice.

Question 4.

Two balls, one larger than the other, are placed at equal distances from the centre of a balance with equal arms. After a few moments of oscillation around the pivot point, the balance comes to rest as shown in the figure below.

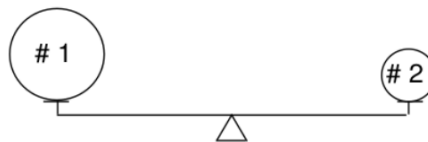

Which of these two balls has the greater density?

- The 1-ball
- The 2-ball
- The 1-ball and the 2-ball have the same density
- This question cannot be answered with the information available
- I do not know

How confident are you in your answer? Choose a number from 1 to 4:

- 1 - I am not at all sure of my choice,
- 2 - I am moderately sure of my choice,
- 3 - I am fairly sure of my choice,
- 4 - I am very sure of my choice.

Question 5.

Two balls of the same size are placed at the ends of a balance with equal arms. The balance comes to rest in the following position:

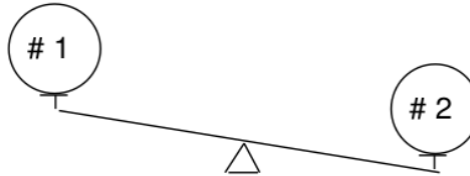

Which of these two balls has the greater density?

- The 1-ball
- The 2-ball
- The 1-ball and the 2-ball have the same density
- This question cannot be answered with the information available
- I do not know

How confident are you in your answer? Choose a number from 1 to 4:

- 1 - I am not at all sure of my choice,
- 2 - I am moderately sure of my choice,
- 3 - I am fairly sure of my choice,
- 4 - I am very sure of my choice.

Part 2.

Question 1.

The two objects A and B in the figure below have the same mass and volume. A is placed in the middle of a container filled with water and A is seen to sink to the bottom of the container.

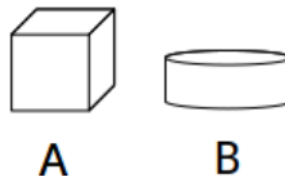

The same experiment is performed with B. What happens?

- B rises to the surface of the water
- B sinks to the bottom of the container
- This question cannot be answered with the information available
- I don't know

How confident are you in your answer? Choose a number from 1 to 4:

- 1 - I am not at all sure of my choice,
- 2 - I am moderately sure of my choice,
- 3 - I am fairly sure of my choice,
- 4 - I am very sure of my choice.

Question 2.

When the object below is placed in the middle of a container filled with water in a "vertical" position (see figure), it sinks to the bottom of the container.

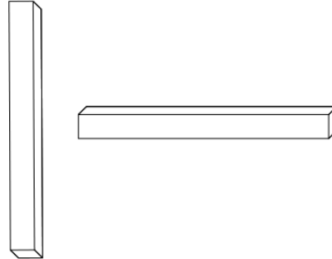

The experiment is repeated with the same object but in a "horizontal" position.

- In the horizontal position, the object rises to the surface of the water
- In the horizontal position, the object sinks to the bottom of the container
- This question cannot be answered with the information available
- I do not know

How confident are you in your answer? Choose a number from 1 to 4:

- 1 - I am not at all sure of my choice,
- 2 - I am moderately sure of my choice,
- 3 - I am fairly sure of my choice,
- 4 - I am very sure of my choice.

Question 3.

These two objects A and B have the same density but B has 3 times the volume of A. When object B is placed in the middle of a container filled with water it sinks to the bottom of the container.

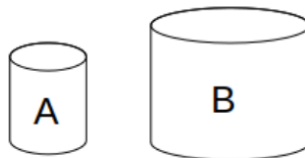

The experiment is repeated with object A. What happens?

- Object A rises to the surface of the water
- Object A sinks to the bottom of the container
- This question cannot be answered with the information available
- I don't know

How confident are you in your answer? Choose a number from 1 to 4:

- 1 - I am not at all sure of my choice,
- 2 - I am moderately sure of my choice,
- 3 - I am fairly sure of my choice,
- 4 - I am very sure of my choice.

Question 4.

The two objects below are of the same shape and volume. When object A is placed in the middle of a container filled with water, it rises to the surface; when object B is placed in the middle of a container filled with water, it rises to the surface. Now we hook A and B together to form a new cylinder C.

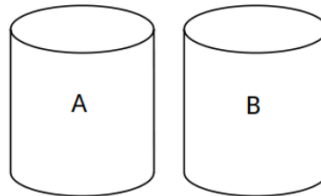

What happens now if we place this new object C in the middle of the container filled with water?

- Object C rises to the surface of the water
- Object C sinks to the bottom of the container
- This question cannot be answered with the information available
- I do not know

How confident are you in your answer? Choose a number from 1 to 4:

- 1 - I am not at all sure of my choice,
- 2 - I am moderately sure of my choice,
- 3 - I am fairly sure of my choice,
- 4 - I am very sure of my choice.

Question 5.

To answer the following questions, remember that oil is less dense than water.

A1. An object is placed in the middle of a container filled with water and found **to rise to the surface of the water**. The same object is placed in a container filled with oil. What will happen?

- The object rises to the surface of the oil
- The object sinks to the bottom of the container
- This question cannot be answered with the information available
- I don't know

How confident are you in your answer? Choose a number from 1 to 4:

- 1 - I am not at all sure of my choice,
- 2 - I am moderately sure of my choice,
- 3 - I am fairly sure of my choice,
- 4 - I am very sure of my choice.

A2. An object is placed in the middle of a container filled with water and found **to sink to the bottom of the container**. The same object is placed in a container filled with oil. What will happen?

- The object rises to the surface of the oil
- The object sinks to the bottom of the container
- This question cannot be answered with the information available
- I don't know

How confident are you in your answer? Choose a number from 1 to 4:

- 1 - I am not at all sure of my choice,
- 2 - I am moderately sure of my choice,
- 3 - I am fairly sure of my choice,
- 4 - I am very sure of my choice.

B.2 Post-Experiment interview questions

We use these questions in the post-experiment interviews after the VR game in Chapter 5.

Questions:

1. **Dots / Density:** Did you have a connection between the number of dots on cubes and the density of the cubes? Or dots are just a visual representation to remember which cube is which one? If you had this understanding, then when did you understand this?
2. During the game, you had 2 types of **sounds:** solid collision sound (2 cubes collide or a cube collide with a table) and liquid sound (splash sound). Have you noticed this? Was it useful?
3. **Environments:** Was it acceptable for you? Not too big or small things in the scene? Was it interesting for you?
4. Did you have any **difficulties** during your VR session? (Examples: Cybersickness, difficulty to grab a cube, problem to read the handwritten text from the blackboard, etc.) What did you like the most, and what was the least of all?
5. How do you think this kind of game can be **helpful** for learning? Explain your opinion.
6. **Free comments:** Do you want to say something more?

Appendix C

Appendix 3

C.1 Questionnaire "Gravity concept"

We created the questionnaire to evaluate student knowledge in the topic "Gravity concept", and it aims to explore how students understand a gravity concept.

The questionnaire contains questions with students' most common misconceptions and questions directly taken from the practical immersive exercise. Also, each answer has a self-assessed level of confidence, which gives us an indication of the difficulty of the questions from the student's point of view. Thus, we created a questionnaire containing 9 basic questions about the gravity concept, each with a 4-step confidence level.

We use the questionnaire in Chapter 6.

Questionnaire " Gravity concept"

Question 1.

On Earth you have 2 cubes with the same size. The mass of cube 1 is greater than the mass of cube 2. You drop both cubes simultaneously. Which one will land first?

- Cube 1
- Cube 2
- The cubes will fall at the same time
- This question cannot be answered with the available information
- I don't know

How confident are you in your answer? Choose a number from 1 to 4:

- 1 - I am not at all sure of my choice,
- 2 - I am moderately sure of my choice,
- 3 - I am fairly sure of my choice,
- 4 - I am very sure of my choice.

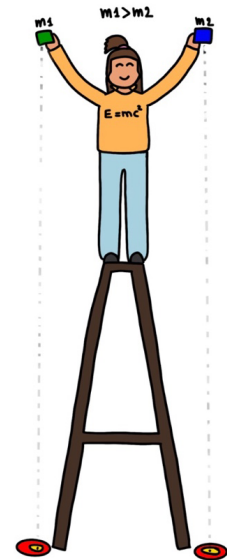

Question 2.

On Moon an astronaut has 2 cubes with the same size. The mass of cube 2 is greater than the mass of cube 1. He drops both cubes simultaneously. Which one will land first?

- Cube 1
- Cube 2
- The cubes will fall at the same time
- This question cannot be answered with the available information
- I don't know

How confident are you in your answer? Choose a number from 1 to 4:

- 1 - I am not at all sure of my choice,
- 2 - I am moderately sure of my choice,
- 3 - I am fairly sure of my choice,
- 4 - I am very sure of my choice.

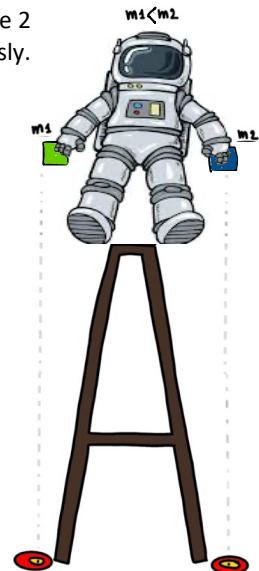

Question 3.

A cannon shoots a cannonball in 3 conditions: earth, moon, no gravitation field. All shots are fired with the same power and the same angle of inclination of the gun, the mass of all bullets is also the same. Link each trajectory (1, 2, 3) with an experimental condition.

- Trajectory 1
- Trajectory 2
- Trajectory 3
- No gravitation
- Gravitation on Earth
- Gravitation on Moon
- This question cannot be answered with the available information
- I don't know

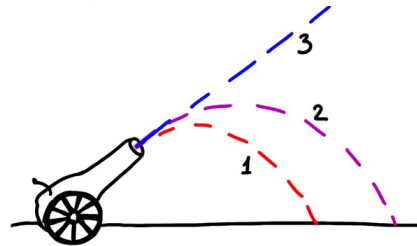

How confident are you in your answer? Choose a number from 1 to 4:

- 1 - I am not at all sure of my choice,
- 2 - I am moderately sure of my choice,
- 3 - I am fairly sure of my choice,
- 4 - I am very sure of my choice.

Question 4.

You are on an airplane. You throw a ball straight down from the plane. What will be the trajectory of this ball?

- Trajectory 1
- Trajectory 2
- Trajectory 3
- This question cannot be answered with the information available
- I do not know

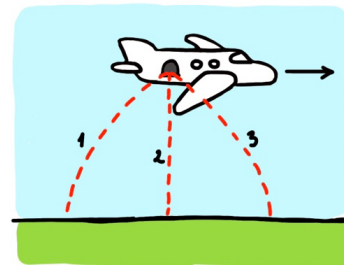

How confident are you in your answer? Choose a number from 1 to 4:

- 1 - I am not at all sure of my choice,
- 2 - I am moderately sure of my choice,
- 3 - I am fairly sure of my choice,
- 4 - I am very sure of my choice.

Question 5.

You are on the moon and shoot a cannon. What projectile will you take to hit the target?

- Small - 1 kg
- Big - 2 kg
- Both projectiles will hit the target
- This question cannot be answered with the information available
- I do not know

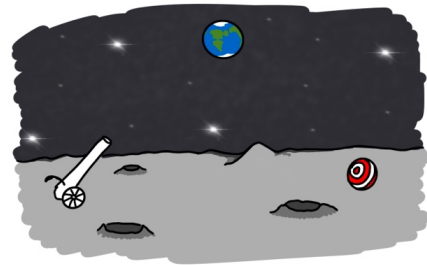

How confident are you in your answer? Choose a number from 1 to 4:

- 1 - I am not at all sure of my choice,
- 2 - I am moderately sure of my choice,
- 3 - I am fairly sure of my choice,
- 4 - I am very sure of my choice.

Question 6.

The figure shows the trajectories of the same projectile in the gravitational fields of the Earth and the Moon. Draw the flight paths of the same projectile on Mars and Jupiter. The gravity of the Earth is stronger than the gravity of the Moon, the gravity on Mars is less than the gravity of the Earth, but stronger than the gravity of the Moon. The gravity of Jupiter is stronger than the gravity of the Earth.

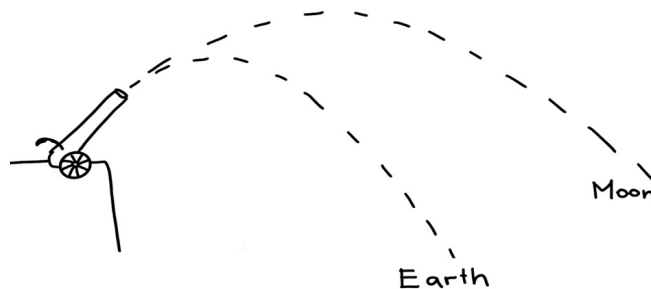

- This question cannot be answered with the information available
- I do not know

How confident are you in your answer? Choose a number from 1 to 4:

- 1 - I am not at all sure of my choice,
- 2 - I am moderately sure of my choice,
- 3 - I am fairly sure of my choice,
- 4 - I am very sure of my choice.

Question 7.

A cannon shoots a ball from the position indicated by the blue arrow, into a zone made of two sections: one with gravity (labelled G), and one without gravity (nG). Two kind of trajectories are possible: dotted lines correspond to parabolic trajectories, and solid lines correspond to straight trajectories. Among the four following situations, choose the correct ones (there can be more than one).

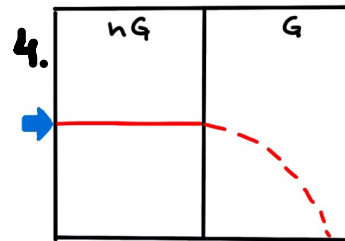
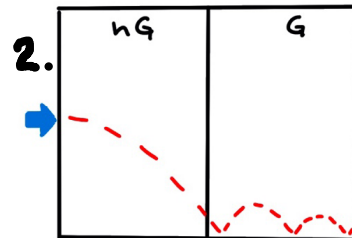
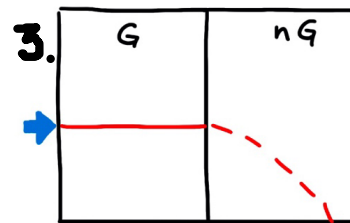
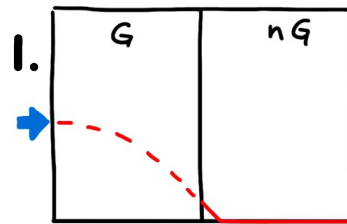

- Figure 1
- Figure 2
- Figure 3
- Figure 4
- There are no correct trajectories
- This question cannot be answered with the information available
- I do not know

How confident are you in your answer? Choose a number from 1 to 4:

- 1 - I am not at all sure of my choice,
- 2 - I am moderately sure of my choice,
- 3 - I am fairly sure of my choice,
- 4 - I am very sure of my choice.

Question 8.

The situation is the same as in the previous question, except now there are three zones. All other conditions are the same. Among the four following situations, choose the correct ones (there can be more than one).

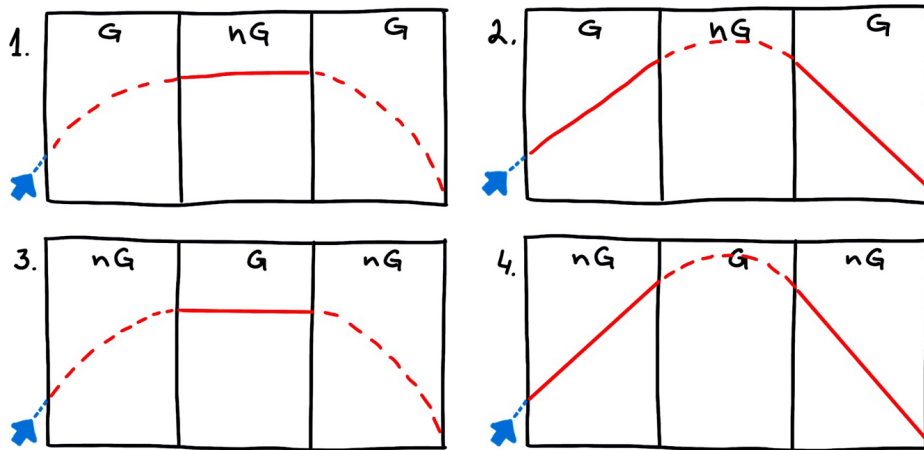

- Figure 1
- Figure 2
- Figure 3
- Figure 4
- There are no correct trajectories
- This question cannot be answered with the information available
- I do not know

How confident are you in your answer? Choose a number from 1 to 4:

- 1 - I am not at all sure of my choice,
- 2 - I am moderately sure of my choice,
- 3 - I am fairly sure of my choice,
- 4 - I am very sure of my choice.

Question 9.

Conditions are the same as in question 6 and 7. Sketch a possible trajectory depending on the presence or absence of a gravitational field.

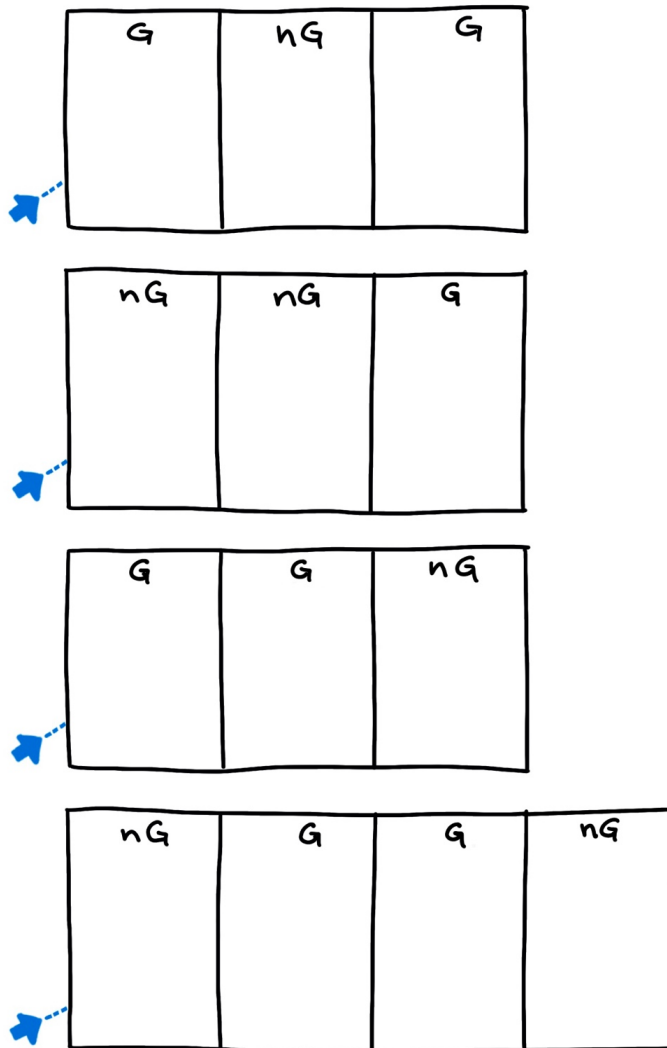

- This question cannot be answered with the information available
- I do not know

How confident are you in your answer? Choose a number from 1 to 4:

- 1 - I am not at all sure of my choice,
- 2 - I am moderately sure of my choice,
- 3 - I am fairly sure of my choice,
- 4 - I am very sure of my choice.

Bibliography

- [1] M. Alfadil. Effectiveness of virtual reality game in foreign language vocabulary acquisition. *Computers & Education*, 153:103893, 2020. ISSN 0360-1315. doi: 10.1016/j.compedu.2020.103893. URL <https://www.sciencedirect.com/science/article/pii/S0360131520300920>.
- [2] Algoryx. Algodoo. <http://www.algodoo.com/>, 2021. [Online; accessed 16-December-2021].
- [3] D. Anago, E. Oke, and C. De Hosson. Explication du mouvement parabolique par les élèves de terminale scientifique. *International Group for the Psychology of Mathematics Education - Revue de Mathématiques pour l'Ecole*, 230:7–14, 2018.
- [4] J. L. Anderson and M. Barnett. Learning physics with digital game simulations in middle school science. *Journal of Science Education and Technology*, 22(6):914–926, 12 2013. URL <https://www.learntechlib.org/p/155333>.
- [5] A. Arisetyawan. Estimation models using mathematical concepts and newton's laws for conic section trajectories on earth's surface. *Fundamental Journal of mathematical physics*, 3:33–44, 02 2013.
- [6] S. Arnab, T. Lim, M. B. Carvalho, F. Bellotti, S. de Freitas, S. Louchart, N. Suttie, R. Berta, and A. D. Gloria. Mapping learning and game mechanics for serious games analysis. *Br. J. Educ. Technol.*, 46:391–411, 2015.
- [7] V. Basilotta Gómez-Pablos, L.-A. Casado-Aranda, M. Matarranz, and A. Otto. Teachers' digital competencies in higher education: a systematic literature review. *International Journal of Educational Technology in Higher Education*, 19(8), 02 2022. doi: 10.1186/s41239-021-00312-8.
- [8] F. Bellalouna. New approach for industrial training using virtual reality technology. *Procedia CIRP*, 93:262–267, 2020. ISSN 2212-8271. doi: 10.1016/j.procir.2020.03.008. URL <https://www.sciencedirect.com/science/article/pii/S092618412030008>.

- [//www.sciencedirect.com/science/article/pii/S2212827120305539](http://www.sciencedirect.com/science/article/pii/S2212827120305539). 53rd CIRP Conference on Manufacturing Systems 2020.
- [9] J. D. Benson. Stem and the humanities. *Open Access Library Journal*, 3(5):1–5, 05 2017. doi: 10.4236/oalib.1103476.
- [10] J. G. Bond. *Introduction to Game Design, Prototyping, and Development: From Concept to Playable Game with Unity and C#*. Addison-Wesley, 2017.
- [11] F. Boucher-Genesse, M. Riopel, and P. Potvin. Research results for mecanika: a game to learn newtonian concepts. In *Proceedings of the 7th international conference on Games + Learning + Society Conference*, 2011.
- [12] G. Boulton-Lewis, L. Wilss, and S. Mutch. An analysis of young children’s strategies and use of devices of length measurement. *Journal of Mathematical Behavior*, 15:329–347, 1996.
- [13] P. Bourdot. Multimodal and multi-user interaction in caves: ongoing research on the eve system. In *Keynote talk in the 19th symposium on Virtual Reality Software and Technology (VRST103)*, 2013.
- [14] K. Bradner, N. Abel, A. Hunter, C. Wood, W. Eldridge, and J. Du Chene. Newtonvr. <https://newtonvr.readme.io/>, 2021. [Online; accessed 13-December-2021].
- [15] L. C. McDermott. *Students’ conception and problem solving in Mechanics*, chapter Section C. International Commission on Physics Education, 01 1997.
- [16] D. N. Carr and T. R. J. Bossomaier. Relativity in a rock field: A study of physics learning with a computer game. *Australasian Journal of Educational Technology*, 27:1042–1067, 2011.
- [17] W. Chen, A. Plancoulaine, N. Férey, D. Touraine, J. Nelson, and P. Bourdot. 6dof navigation in virtual worlds: Comparison of joystick-based and head-controlled paradigms. In *Proceedings of the ACM Symposium on Virtual Reality Software and Technology, VRST*, pages 111–114, 10 2013. doi: 10.1145/2503713.2503754.
- [18] C.-Y. Chou, T.-W. Chan, and C.-J. Lin. Redefining the learning companion: The past, present, and future of educational agents. *Computers & Education*, 40:255–269, 04 2003. doi: 10.1016/S0360-1315(02)00130-6.

- [19] R. C. Clark and R. E. Mayer. *E-learning and the Science of Instruction: Proven guidelines for consumers and designers of multimedia learning*. Wiley, 2016.
- [20] J. J. Clement. Students' preconceptions in introductory mechanics. *American Journal of Physics*, 50:66–71, 1982.
- [21] D. Clements and M. Stephan. *Measurement in PreK-2 Mathematics*, pages 299–320. Lawrence Erlbaum Associates, Mahwah, NJ, USA, 12 2004.
- [22] B. D. Coller and D. J. Shernoff. Video game-based education in mechanical engineering: A look at student engagement. *International Journal of Engineering Education*, 25(2):308–317, 2009.
- [23] E. Commission and E. P. ERASMUS+. Virtual reality education: Implementation of virtual reality based learning methodology in secondary school (bulgaria, croatia, cyprus, north macedonia), 2021. URL <https://www.vr-school.eu/>. [Online; accessed 29-November-2021].
- [24] E. Commission and R. N. A. for the Erasmus+ Programme. Future schools using the power of virtual and augmented reality for education and training in the classroom - vr@school (romania, italia, portugal, lithuania), 2021. URL <https://www.vr-school.eu/>. [Online; accessed 29-November-2021].
- [25] R. E. Corporation. Game angry birds. <https://www.angrybirds.com/>, 2021. [Online; accessed 15-December-2021].
- [26] S. Corporation. Game: Fantastic contraption. https://store.steampowered.com/app/386690/Fantastic_Contraption/, 2021. [Online; accessed 14-December-2021].
- [27] M. Crabb, D. Clarke, H. Alwaer, M. Heron, and R. Laing. Inclusive design for immersive spaces. *The Design Journal*, 22:2105–2118, 04 2019. doi: 10.1080/14606925.2019.1594934.
- [28] L. De Broglie. *Société Nouvelle de l'Encyclopédie Française, Tome II*. Paris, La-rousse Eds, 1955.
- [29] S. de Freitas and M. Oliver. How can exploratory learning with games and simulations within the curriculum be most effectively evaluated? *Computers & Education*, 46(3):249–264, 2006. ISSN 0360-1315. doi: 10.1016/j.compedu.2005.11.007. URL <https://www.sciencedirect.com/science/article/pii/S0360131505001600>.

- [30] C. De Hosson, T. Doat, I. Kermen, and J. Vézien. Designing learning scenarios for a 3d virtual environment: The case of special relativity. *Lat. Am. J. Phys. Educ. Vol*, 1:6, 01 2012.
- [31] C. J. Dede, M. Salzman, and R. B. Loftin. The development of a virtual world for learning newtonian mechanics. In P. Brusilovsky, P. Kommers, and N. Streitz, editors, *Multimedia, Hypermedia, and Virtual Reality Models, Systems, and Applications*, pages 87–106, Berlin, Heidelberg, 1996. Springer Berlin Heidelberg. ISBN 978-3-540-68432-9.
- [32] A. Disessa. *Changing minds: Computers, learning, and literacy*. A Bradford Book, 10 2012.
- [33] T. Doat. *Virtual spaces for scientific exploration and education: contribution to the apprehension of the Theory of Special Relativity through virtual reality*. PhD thesis, Université Paris-Sud, 09 2012.
- [34] T. Doat, E. Parizot, and J. Vézien. A carom billiard to understand special relativity. *Proceedings - IEEE Virtual Reality*, pages 201–202, 04 2011. doi: 10.1109/VR.2011.5759468.
- [35] K. v. d. Doel. Physically based models for liquid sounds. *ACM Trans. Appl. Percept.*, 2(4):534–546, 10 2005. ISSN 1544-3558. doi: 10.1145/1101530.1101554.
- [36] L. Dominjon, A. Lécuyer, J.-M. Burkhardt, P. Richard, and S. Richir. Influence of control/display ratio on the perception of mass of manipulated objects in virtual environments. *Proceedings - IEEE Virtual Reality*, pages 19–25, 04 2005. doi: 10.1109/VR.2005.1492749.
- [37] E. Dorjgotov. *The Impact of Computer Simulated Haptic Force Feedback on Physics Concept Learning: Understanding Electrostatic and Electromagnetic Fields through Haptic Feedback*. PhD thesis, Purdue University, USA, 2008. AAI3371951.
- [38] S. Egenfeldt-Nielsen, J. H. Smith, and S. P. Tosca. *Serious Games and Gamification: When Entertainment is not enough*, chapter 8, page 42. Routledge, 2019. doi: 10.4324/9780429431791.
- [39] Z. Feng, V. A. González, R. Amor, R. Lovreglio, and G. Cabrera. Immersive virtual reality serious games for evacuation training and research: A systematic literature review. *Elsevier: Computers & Education*, 127:252–266, 2018.
- [40] D.-G. for Communication of European Commission. European commission, 2021. URL <https://ati.ec.europa.eu/news/augmented-and-virtual-reality-will-change-way-educating/>. [Online; accessed 29-November-2021].

- [41] T. Fullerton. *Game Design Workshop: A Playcentric Approach to Creating Innovative Games*. A K Peters/CRC Press, 2014.
- [42] D. Furio, S. Fleck, B. Bousquet, J.-P. Guillet, L. Canioni, and M. Hachet. Hobit: Hybrid optical bench for innovative teaching. In *CHI'17 - Proceedings of the 2017 CHI Conference on Human Factors in Computing Systems*, Denver, United States, 05 2017. URL <https://hal.inria.fr/hal-01455510>.
- [43] N. Férey, J. Nelson, C. Martin, L. Picinali, G. Bouyer, A. Tek, P. Bourdot, J.-M. Burkhardt, B. Katz, M. Ammi, C. Etchebest, and L. Autin. Multisensory vr interaction for protein-docking in the corsaire project. *Vir. Real*, 13:273–293, 12 2009. doi: 10.1007/s10055-009-0136-z.
- [44] J. L. Gabbard. Usability engineering of virtual environments. In *Handbook of Virtual Environments*, 2nd ed., pages 721–747, 2014.
- [45] G. Galileo and D. Stillman. *Dialogue Concerning the Two Chief World Systems*. University of California Press, Berkeley, 1962.
- [46] GameDev.tv. Gamedev.tv: Low poly and high poly pawn comparison. <https://community.gamedev.tv/t/low-poly-and-high-poly-pawn-comparison/27901/>, 2021. [Online; accessed 13-December-2021].
- [47] R. Ghoniem, H. Abas, and H. Bdair. A novel intelligent object-oriented three-dimensional simulation system for physics experimentation. *ScienceDirect Applied Computing and Informatics*, 16 (1/2), 11 2018. doi: 10.1016/j.aci.2018.10.003.
- [48] G. S. Giri, Y. Maddahi, and K. Zareinia. An application-based review of haptics technology. *Robotics*, 10(1), 2021. ISSN 2218-6581. doi: 10.3390/robotics10010029. URL <https://www.mdpi.com/2218-6581/10/1/29>.
- [49] R. R. Hake. Interactive-engagement versus traditional methods: A six-thousand-student survey of mechanics test data for introductory physics courses. *American Journal of Physics*, 66(1):64–74, 1998. doi: 10.1119/1.18809.
- [50] I. Halloun and D. Hestenes. The initial knowledge state of college physics students. *American Journal of Physics*, 53:1043–1055, 11 1985. doi: 10.1119/1.14030.

- [51] I. A. Halloun and D. Hestenes. Common sense concepts about motion. *American Journal of Physics*, 53(11):1056–1065, 1985.
- [52] J. Harley and R. Azevedo. Toward a feature-driven understanding of students' emotions during interactions with agent-based learning environments: A selective review. *International Journal of Gaming and Computer-Mediated Simulations (IJGCMS)*, 6:17–34, 07 2014. doi: 10.4018/ijgcms.2014070102.
- [53] M. Hashweh. The complexity of teaching density in middle school. *Research in Science & Technological Education*, 34:1–24, 08 2015. doi: 10.1080/02635143.2015.1042854.
- [54] D. Hayes, C. Turczynski, J. Rice, and M. Kozhevnikov. Virtual-reality-based educational laboratories in fiber optic engineering. *Proceedings of SPIE - The International Society for Optical Engineering*, 9289, 07 2014. doi: 10.1117/12.2070779.
- [55] H. Hecht and M. Bertamini. Understanding projectile acceleration. *Journal of experimental psychology. Human perception and performance*, 26 2:730–46, 2000.
- [56] D. Hestenes, M. Wells, and G. Swackhamer. Force concept inventory. *The Physics Teacher*, 30: 141–158, 03 1992. doi: 10.1119/1.2343497.
- [57] M. G. Hewson. The acquisition of scientific knowledge: Analysis and representation of student conceptions concerning density. *Science Education*, 70(2):159–170, 1978.
- [58] H. Hrimech, L. Alem, and F. Merienne. How 3d interaction metaphors affect user experience in collaborative virtual environment. *Adv. Human-Computer Interaction*, 2011, 07 2011. doi: 10.1155/2011/172318.
- [59] E. M. Hubbard and V. S. Ramachandran. The size-weight illusion, emulation, and the cerebellum. *Behavioral and Brain Sciences*, 27(3):407–408, 2004. doi: 10.1017/S0140525X04320091.
- [60] R. Hunicke, M. Leblanc, and R. Zubek. Mda: A formal approach to game design and game research. *AAAI Workshop - Technical Report*, 1, 01 2004.
- [61] E. d. L. Institut de France, Academie des sciences. Fondation la main à la pâte, 2021. URL <https://www.fondation-lamap.org/>. [Online; accessed 09-December-2021].

- [62] P. Issartel, F. Guéniat, S. Coquillart, and M. Ammi. Perceiving Mass in Mixed Reality through Pseudo-Haptic Rendering of Newton's Third Law. In *IEEE Virtual Reality (VR)*, pages 41–46, Arles, France, Mar. 2015. IEEE. doi: 10.1109/VR.2015.7223322. URL <https://hal.archives-ouvertes.fr/hal-01264960>.
- [63] J. Jason. *The VR Book: Human-Centered Design for Virtual Reality*. ACM Books, 10 2015. ISBN 978-1-97000-112-9. doi: 10.1145/2792790.
- [64] S. Javoy, A.-A. Decroix, and C. De Hosson. La construction du concept physique de volume en cycle III : Quelles difficultés ? Quelles stratégies didactiques. In *6e colloque Espace Mathématiques Francophone*, Gennevilliers, France, 2018. URL <https://hal.archives-ouvertes.fr/hal-02198011>.
- [65] W. Johnson, H. Vilhjálmsson, and S. Marsella. Serious games for language learning: How much game, how much ai? In *Artificial Intelligence in Education - Supporting Learning through Intelligent and Socially Informed Technology, Proceedings of the 12th International Conference on Artificial Intelligence in Education, AIED 2005*, pages 306–313, 01 2005.
- [66] J. Jose, N. Akshay, and R. R. Bhavani. Learning elementary physics through haptic simulations. In *Proceedings of the 2014 International Conference on Interdisciplinary Advances in Applied Computing, ICONIAAC '14*, New York, NY, USA, 2014. Association for Computing Machinery. ISBN 9781450329088. doi: 10.1145/2660859.2660937.
- [67] D. Kamińska, T. Sapiński, S. Wiak, T. Tikk, R. Haamer, E. Avots, A. Helmi, C. Ozcinar, and G. Anbarjafari. Virtual reality and its applications in education: Survey. *Information (Switzerland)*, 10: 318, 10 2019. doi: 10.3390/info10100318.
- [68] S. Kawai, F. Henigman, C. L. MacKenzie, A. B. Kuang, and P. Faust. A reexamination of the size–weight illusion induced by visual size cues. *Experimental Brain Research*, 179:443–456, 2006.
- [69] M. Kebritchi, A. Hirumi, and H. Bai. The effects of modern mathematics computer games on mathematics achievement and class motivation. *Computers & Education*, 55:427–443, 09 2010. doi: 10.1016/j.compedu.2010.02.007.

- [70] Y. J. Kim, R. G. Almond, and V. J. Shute. Applying evidence-centered design for the development of game-based assessments in physics playground. *International Journal of Testing*, 16:142 – 163, 2016.
- [71] K. Klemetti and H. Grönberg. *IGame Designer Confessions: Insights from Finland's Top Game Designers*. Ver Sacrum Ltd., 2021.
- [72] H. Kloos. Will it float? how invariance affects children's understanding of object density. *Proceedings of the Annual Meeting of the Cognitive Science Society*, 30:687–692, 2015.
- [73] M. Koul, S. Saha, and M. Muniyandi. Teaching mechanism dynamics using a haptic device - ii. In *Proceedings of the 1st International and 16th National Conference on Machines and Mechanisms (iNaCoMM2013)*, 12 2015.
- [74] Y.-J. Lan. Chapter one - immersion into virtual reality for language learning. In K. D. Federmeier and H.-W. Huang, editors, *Adult and Second Language Learning*, volume 72 of *Psychology of Learning and Motivation*, pages 1–26. Academic Press, 2020. doi: 10.1016/bs.plm.2020.03.001. URL <https://www.sciencedirect.com/science/article/pii/S0079742120300062>.
- [75] L'Association-Internationale-Gaston-Bachelard. Gaston bachelard international association - bibliographie, 2021. URL <https://gastonbachelard.org/bibliographie/>. [Online; accessed 04-November-2021].
- [76] J. J. LaViola Jr., E. Kruijff, R. P. McMahan, D. Bowman, and I. P. Poupyrev. *3D user interfaces: theory and practice*. Addison-Wesley, 2017.
- [77] A. Lécuyer. Simulating haptic feedback using vision: A survey of research and applications of pseudo-haptic feedback. *Presence*, 18:39–53, 02 2009. doi: 10.1162/pres.18.1.39.
- [78] A. Lécuyer, S. Coquillart, A. Kheddar, P. Richard, and P. Coiffet. Pseudo-haptic feedback: can isometric input devices simulate force feedback? *VR: Virtual Reality*, pages 83–90, 03 2000. doi: 10.1109/VR.2000.840369. URL <https://hal.archives-ouvertes.fr/hal-00844954>.
- [79] A. Lécuyer, J.-M. Burkhardt, and L. Etienne. Feeling bumps and holes without a haptic interface: The perception of pseudo-haptic textures. *Proceedings of the SIGCHI Conference on Human Factors in Computing Systems*, page 239–246, 2004. doi: 10.1145/985692.985723.

- [80] Lelivrescolaire.fr. Book "physique-chimie, cycle 4". <https://fr.calameo.com/read/000596729a478266ce0b6?authid=kye07xnwkoHr/>, 2021. [Online; accessed 15-December-2021].
- [81] J. C. Lester, S. A. Converse, S. E. Kahler, S. T. Barlow, B. A. Stone, and R. S. Bhogal. The persona effect: Affective impact of animated pedagogical agents. In *Proceedings of the ACM SIGCHI Conference on Human Factors in Computing Systems*, CHI '97, page 359–366, New York, NY, USA, 1997. Association for Computing Machinery. ISBN 0897918029. doi: 10.1145/258549.258797.
- [82] J. G. León. Immersive serious games for learning physics. Master's thesis, Aalto University, School of Science, Orsay, France, 08 2019. URL https://aaltodoc.aalto.fi/bitstream/handle/123456789/41615/master_Gil_Leon_Joel_2019.pdf?sequence=1&isAllowed=y.
- [83] D. Li, B. Xiao, J. Xia, and K. Wang. Preliminary realization of immersive east system using virtual reality. *Fusion Engineering and Design*, 128:198–203, 03 2018. doi: 10.1016/j.fusengdes.2018.02.031.
- [84] K. Li and S. Wang. Development and application of vr course resources based on embedded system in open education. *Microprocessors and Microsystems*, 83:103989, 2021. ISSN 0141-9331. doi: <https://doi.org/10.1016/j.micpro.2021.103989>. URL <https://www.sciencedirect.com/science/article/pii/S0141933121001629>.
- [85] D. Low and K. Wilson. Weight, the normal force and newton's third law: dislodging a deeply embedded misconception. *Teaching Science: the Journal of the Australian Science Teachers Association*, 63:17–26, 06 2017.
- [86] A. Luciani. Haptics, haptic devices. In *Enaction and enactive interfaces : a handbook of terms*, pages 133–136. Enactive Systems Books, 2007. URL <https://hal.archives-ouvertes.fr/hal-00980020>.
- [87] A. Lécuyer. *Using Eyes, Hands and Brain for 3D Interaction with Virtual Environments: A Perception-Based Approach*. PhD thesis, Université Paris-Sud, 2010.
- [88] A. Macdonald. Young children's representations of their developing measurement understandings. In *AAMT-MERGA conference, incorporating the 23rd biennial conference of the Australian Asso-*

ciation of Mathematics Teachers and the 34th annual conference of the Mathematics Education Research Group of Australasia, pages 482–490, Adelaide, Australia, 01 2011.

- [89] C. Magnusson and K. Rasmus-Gröhn. A pilot study on audio induced pseudo-haptics. *Proceedings of the 3rd International Haptic and Auditory Interaction Design Workshop*, pages 6–7, 2008.
- [90] C. Maisch, I. Kermen, C. De Hosson, and E. Parizot. Utiliser une simulation vidéo 3D pour approcher les concepts de la cinématique relativiste : étude de cas. *RDST - Recherches en didactique des sciences et des technologies*, 12:141 – 174, Nov. 2015. doi: 10.4000/rdst.1152. URL <https://hal.archives-ouvertes.fr/hal-01663447>.
- [91] R. F. Malaquias, F. F. O. Malaquias, and Y. Hwang. Understanding technology acceptance features in learning through a serious game. *Elsevier: Computers in Human Behavior*, 87:395–402, 2018.
- [92] M. E. McCauley and T. J. Sharkey. Cybersickness: Perception of self-motion in virtual environments. *Presence: Teleoperators & Virtual Environments*, 1:311–318, 1992.
- [93] Z. Merchant, E. T. Goetz, L. Cifuentes, W. Keeney-Kennicutt, and T. J. Davis. Effectiveness of virtual reality-based instruction on students' learning outcomes in k-12 and higher education: A meta-analysis. *Elsevier: Computers & Education*, 70:29–40, 2014.
- [94] G. Michel and C. Amade-Escot. Evaluer les usages didactiques d'un serious game à partir de l'analyse de l'action conjointe: le cas mecagenius®. *STICEF*, 21, 10 2014. doi: 10.3406/stice.2014.1108.
- [95] Microsoft. What is the mixed reality toolkit, 2021. URL <https://docs.microsoft.com/en-us/windows/mixed-reality/mrkt-unity/?view=mrkunity-2021-05/>. [Online; accessed 05-November-2021].
- [96] d. l. j. e. d. s. Ministère de l'Éducation Nationale. Eduscol, 2021. URL <https://eduscol.education.fr/>. [Online; accessed 09-December-2021].
- [97] D. Moatti, B. Cornu, J.-P. Véran, and F. Bocquet. Weight, the normal force and newton's third law: dislodging a deeply embedded misconception. *Revue internationale d'éducation de Sèvres - Pédagogie et révolution numérique*, 67:103–118, 12 2014. doi: 10.4000/ries.4129.

- [98] R. Moreno and R. Mayer. A coherence effect in multimedia learning: The case for minimizing irrelevant sounds in the design of multimedia instructional messages. *Journal of Educational Psychology*, 92:117–125, 03 2000. doi: 10.1037/0022-0663.92.1.117.
- [99] R. Moreno, R. Mayer, H. Spires, and J. Lester. The case for social agency in computer-based teaching: Do students learn more deeply when they interact with animated pedagogical agents? *Cognition and Instruction - COGNITION INSTRUCT*, 19:177–213, 06 2001. doi: 10.1207/S1532690XCI1902_02.
- [100] A. C. of the Corporation and the Academical Faculty. Reports on the course of instruction in yale college. *Yale College*, pages 1–40, 09 1828. URL <http://collegiateway.org/reading/yale-report-1828/>.
- [101] N. P. Rougier. Glimpy - rendering a cube. <https://glumpy.readthedocs.io/en/latest/tutorial/cube-ugly.html?highlight=orthographic/>, 2021. [Online; accessed 17-December-2021].
- [102] D. Passelaigue. *Grandeurs et mesures à l'école élémentaire. Des activités de comparaison à la construction des concepts: le cas de la masse en CE1*. PhD thesis, Université Montpellier 2, Montpellier, France, 2011.
- [103] D. Passelaigue and V. Munier. Schoolteacher trainees' difficulties about the concepts of attribute and measurement. *Educational Studies in Mathematics*, 89(3):307–336, 2015. ISSN 00131954, 15730816. URL <http://www.jstor.org/stable/43589997>.
- [104] J. Piaget and B. Inhelder. *The Psychology of the Child*. New-York: Ingram Publisher, 1972.
- [105] L. Pillette, C. Jeunet, B. Mansencal, R. N'Kambou, B. N'Kaoua, and F. Lotte. A physical learning companion for mental-imagery bci user training. *International Journal of Human-Computer Studies*, 136:102380, 2020. ISSN 1071-5819. doi: 10.1016/j.ijhcs.2019.102380.
- [106] J. Posselt and R. Gosselin. Protocols of use for immersive platforms under covid19. In *Proceedings of the Virtual EuroVR Conference*, pages 19–21, 2020.
- [107] A. Prescott and M. C. Mitchelmore. Teaching projectile motion to eliminate misconceptions. *Proceedings of the 29th Annual Conference of the International Group for the Psychology of Mathematics Education*, 4:97–104, 2005.

- [108] R. R. Hake. Promoting student crossover to the newtonian world. *American Journal of Physics*, 55(10):878–884, 10 1987.
- [109] R. R. Hake. Socratic pedagogy in the introductory physics laboratory. *The physics teacher*, 30(9): 546–552, 12 1992.
- [110] R. R. Hake. Evaluating conceptual gains in mechanics: A six thousand student survey of test data. *AIP Conference Proceedings*, 339(1):595–604, 3/10 1997.
- [111] M. Rabinowitz. *on motion and on mechanics*. comprising *de motu* (c. 1590) (translated with introduction and notes by i. e. drabkin) and *de meccaniche* (c. 1600) (translated with introduction and notes by stillman drake). galileo galilei. university of wisconsin press, madison, 1960. 193 pp. \$5. *Science*, 132(3429):732–732, 1960. doi: 10.1126/science.132.3429.732.a.
- [112] J. T. Reason and J. J. Brand. *Motion sickness*. Academic Press, London, New York, 1975. ISBN 0125840500.
- [113] J. Rickel and W. Johnson. Integrating pedagogical capabilities in a virtual environment agent. *Proceedings of the First International Conference on Autonomous Agents*, pages 30–38, 12 1996.
- [114] M. Rietzler, F. Geiselhart, J. Gugenheimer, and E. Rukzio. *Breaking the Tracking: Enabling Weight Perception Using Perceivable Tracking Offsets*, page 1–12. Association for Computing Machinery, New York, NY, USA, 2018. ISBN 9781450356206. doi: 10.1145/3173574.3173702.
- [115] N. Roa-Seiler. *Designing Interaction Strategies for Companions Interacting with Children*, pages 129–168. Emotions and Technology. Academic Press, San Diego, 01 2016. ISBN 9780128018729. doi: 10.1016/B978-0-12-801872-9.00007-7.
- [116] L. E. Roach. Exploring students’ conceptions of density: Assessing non majors’ understanding of physics. *Journal of College Science Teaching*, 30(6):386–389, 2001.
- [117] J. Roettl and R. Terlutter. The same video game in 2d, 3d or virtual reality – how does technology impact game evaluation and brand placements? *PLOS ONE*, 13(7):1–24, 07 2018. doi: 10.1371/journal.pone.0200724.
- [118] D. Rohani and S. Puthusserypady. Bci inside a virtual reality classroomii: a potential training tool for attention. *EPJ Nonlinear Biomedical Physics*, 3, 12 2015. doi: 10.1140/epjnbp/s40366-015-0027-z.

- [119] B. Rohrbach. Kreativ nach regeln - methode 635, eine neue technik zum lösen von problemen. *Absatzwirtschaft*, 12(19):73–75, 1969.
- [120] S. Saleh. The level of b.sc.ed students' conceptual understanding of newtonian physics. *International Journal of Academic Research in Business and Social Sciences*, 01:249–256, 10 2011.
- [121] M. Salzman, C. J. Dede, D. McGlynn, and R. B. Loftin. Sceincespace: Lessons for designing immersive virtual realities. *CHI'96*, pages 89–90, 04 1996.
- [122] M. Samad, E. Gatti, A. Hermes, H. Benko, and C. Parise. *Pseudo-Haptic Weight: Changing the Perceived Weight of Virtual Objects By Manipulating Control-Display Ratio*, pages 1–13. Association for Computing Machinery, New York, NY, USA, 2019. ISBN 9781450359702. doi: 10.1145/3290605.3300550.
- [123] B. Sawyer. Serious games: Improving public policy through game-based learning and simulation. *Digitamill Inc.*, 01 2002.
- [124] J. Schell. *The art of game design: A book of Lenses*. A K Peters/CRC Press, 2014.
- [125] E. E. Scott, M. P. Wenderoth, and J. H. Doherty. Design-based research: A methodology to extend and enrich biology education research. *Cross-Disciplinary Research in Biology Education Essay*, 19(3):1–12, 2020.
- [126] C. Shop. Corner shop - geomagic touch, 2021. URL <https://cornershop.immersion.fr/produit/interaction-realite-virtuelle-3d-en/haptic-solution/geomagic-touch/?lang=en/>. [Online; accessed 16-December-2021].
- [127] V. Shute and M. Ventura. *Measuring and Supporting Learning in Games: Stealth Assessment*. The mit press, 01 2013. ISBN 9780262315210. doi: 10.7551/mitpress/9589.001.0001.
- [128] C. Smith, J. Snir, and L. Grosslight. Using conceptual models to facilitate conceptual change: The case of weight-density differentiation. *Cognition and Instruction*, 9(3):221–283, 1992. ISSN 07370008, 1532690X. URL <http://www.jstor.org/stable/3233515>.
- [129] K. Stanney, B. D. Lawson, B. Rokers, M. Dennison, C. Fidopiastis, T. Stoffregen, S. Weech, and J. M. Fulvio. Identifying causes of and solutions for cybersickness in immersive technology: Re-formulation of a research and development agenda. *International Journal of Human–Computer Interaction*, 36(19):1783–1803, 2020. doi: 10.1080/10447318.2020.1828535.

- [130] R. Stavy and D. Tirosh. *How Students (Mis-)Understand Science and Mathematics: Intuitive Rules (Ways of Knowing in Science Series)*. Teachers College Press, 2000.
- [131] C. Stern, C. A. Echeverría, and D. Porta. Teaching physics through experimental projects. *Procedia IUTAM*, 20:189–194, 2017.
- [132] R. Stoakley, M. J. Conway, and R. Pausch. Virtual reality on a wim: Interactive worlds in miniature. In *Proceedings of the SIGCHI Conference on Human Factors in Computing Systems, CHI'95*, page 265–272, USA, 1995. ACM Press/Addison-Wesley Publishing Co. ISBN 0201847051. doi: 10.1145/223904.223938.
- [133] K. A. Strike and G. Posner. *A conceptual change view of learning and understanding*, pages 211–231. L. West & L. Pines (Eds.), 1985.
- [134] J. M. Suchoski, S. Martinez, and A. M. Okamura. Scaling inertial forces to alter weight perception in virtual reality. In *2018 IEEE International Conference on Robotics and Automation (ICRA)*, pages 484–489, 2018. doi: 10.1109/ICRA.2018.8462874.
- [135] B. Suits. *The Grasshopper: Games, Life and Utopia*. Broadview Press Ltd, 2005.
- [136] D. Swapp, V. M. Pawar, and C. Loscos. Interaction with co-located haptic feedback in virtual reality. *Virtual Reality*, 10(1):24–30, 2006.
- [137] the PhET Interactive Simulations project at the University of Colorado Boulde. Projectile motion simulation. <https://phet.colorado.edu/en/simulations/projectile-motion/>, 2021. [Online; accessed 15-December-2021].
- [138] E. Thoret, M. Aramaki, R. Kronland-Martinet, j.-l. Velay, and S. Ystad. From sound to shape: Auditory perception of drawing movements. *Journal of experimental psychology. Human perception and performance*, 40:983–994, 01 2014. doi: 10.1037/a0035441.
- [139] R. Thornton and D. Sokoloff. Learning motion concepts using real-time microcomputer-based laboratory tools. *American Journal of Physics - AMER J PHYS*, 58:858–867, 09 1990. doi: 10.1119/1.16350.
- [140] Unity-Technologies. Unity assets, 2021. URL <https://assetstore.unity.com/>. [Online; accessed 05-November-2021].

- [141] Unity-Technologies. Unity homepage, 2021. URL <https://unity.com/>. [Online; accessed 04-November-2021].
- [142] M. Valdez, C. Machado Ferreira, and F. Maciel-Barbosa. *Virtual Reality Prototype as a tool in a lab environment*, pages 252–269. Poland International Center for Entrepreneurship, 10 2013. ISBN 978-83-63987-00-8.
- [143] O. Veneri, C. S. Gros, and C. S. Natkin. Procedural audio for game using gaf. In *Cedric/CNAM*, 2008.
- [144] M. Verkuyl, D. Romaniuk, and P. Mastrilli. Virtual gaming simulation of a mental health assessment: A usability study. *Elsevier: Nurse education in practice*, 31:83–87, 2018.
- [145] D. Verpoorten, J.-L. Castaigne, W. Westera, and M. Specht. A quest for meta-learning gains in a physics serious game. *Education and Information Technologies*, 19:361–374, 06 2014. doi: 10.1007/s10639-012-9219-7.
- [146] L. Viennot. Spontaneous reasoning in elementary dynamics. *European Journal of Science Education*, 1(2):205–221, 1979. doi: 10.1080/0140528790010209.
- [147] J. Vézien, B. Menelas, J. Nelson, L. Picinali, P. Bourdot, M. Ammi, B. Katz, J.-M. Burkhardt, L. Pastur, and F. Lusseyran. Multisensory vr exploration for computer fluid dynamics in the corsaire project. *Virtual Reality*, 13:257–271, 12 2009. doi: 10.1007/s10055-009-0134-1.
- [148] C. Wagner, N. Stylopoulos, and R. Howe. The role of force feedback in surgery: analysis of blunt dissection. In *Proceedings 10th Symposium on Haptic Interfaces for Virtual Environment and Teleoperator Systems. HAPTICS 2002*, pages 68–74, 2002. doi: 10.1109/HAPTIC.2002.998943.
- [149] R. Webster and A. Clark. Turn-key solutions: Virtual reality. In *ASME 2015 International Design Engineering Technical Conferences and Computers and Information in Engineering Conference*, 08 2015. doi: 10.1115/DETC2015-46174.
- [150] R. Yeend, M. Loverude, and B. L. Gonzalez. Student understanding of density: A cross-age investigation. In *Physics Education Research Conference 2001*, PER Conference, Rochester, New York, July 25-26 2001.

- [151] R. Yu and D. A. Bowman. Pseudo-haptic display of mass and mass distribution during object rotation in virtual reality. *IEEE Transactions on Visualization and Computer Graphics*, 26(5):2094–2103, 2020. doi: 10.1109/TVCG.2020.2973056.
- [152] J. Zhao, P. LaFemina, J. Carr, P. Sajjadi, J. O. Wallgrün, and A. Klippel. Learning in the field: Comparison of desktop, immersive virtual reality, and actual field trips for place-based stem education. *2020 IEEE Conference on Virtual Reality and 3D User Interfaces (VR)*, pages 893–902, 03 2020. doi: 10.1109/VR46266.2020.00012.
- [153] M. Zyda. From visual simulation to virtual reality to games. *Computer*, 38(9):25–32, 10 2005. doi: 10.1109/MC.2005.297.

List of scientific productions

1. **Presentation** in Application track of EuroVR 2020 (Chapter 4):

I. Zhurakovskaia, J. Vezien, C. de Hosson, and P. Bourdot. **Comparison of pseudo - haptic feedbacks for learning physics: the case of the mass physical parameter**. Application track of EuroVR 2020. 25-27 November 2020, Spain.

2. **Scientific poster / Short paper** in Scientific track of EuroXR 2021 [*Best Scientific Poster Award*] (Chapter 5):

I. Zhurakovskaia, J. Vezien, C. de Hosson, and P. Bourdot. **Immersive Serious Games for Learning Physics Concepts: The Case of Density**. In book: Virtual Reality and Mixed Reality, 18th EuroXR International Conference, Proceedings. 24-26 November 2021, Milan, Italy. DOI: 10.1007/978-3-030-90739-6_12

3. **Full paper** in The 22nd IEEE International Conference on Advanced Learning Technologies (Chapter 6):

I. Zhurakovskaia, J. Vezien, and P. Bourdot. **Teaching with a companion: the case of gravity**. IEEE ICALT 2022, Proceedings. 1-4 July 2022, Bucharest, Romania.

