



HAL
open science

Hominin diversity in the western Indonesian archipelago during the Quaternary: a dental record perspective

Sofwan Noerwidi

► **To cite this version:**

Sofwan Noerwidi. Hominin diversity in the western Indonesian archipelago during the Quaternary: a dental record perspective. Archaeology and Prehistory. Museum national d'histoire naturelle - MNHN PARIS; Universitat Rovira i Virgili (Tarragone, Espagne), 2020. English. NNT: 2020MNHN0018 . tel-03680512

HAL Id: tel-03680512

<https://theses.hal.science/tel-03680512v1>

Submitted on 28 May 2022

HAL is a multi-disciplinary open access archive for the deposit and dissemination of scientific research documents, whether they are published or not. The documents may come from teaching and research institutions in France or abroad, or from public or private research centers.

L'archive ouverte pluridisciplinaire **HAL**, est destinée au dépôt et à la diffusion de documents scientifiques de niveau recherche, publiés ou non, émanant des établissements d'enseignement et de recherche français ou étrangers, des laboratoires publics ou privés.



MINISTÈRE DE L'ENSEIGNEMENT SUPÉRIEUR, DE LA RECHERCHE ET DE L'INNOVATION
MINISTÈRE DE LA TRANSITION ÉCOLOGIQUE ET SOLIDAIRE

ECOLE DOCTORALE 227
SCIENCES DE LA NATURE ET DE L'HOMME : ÉCOLOGIE ET ÉVOLUTION

MUSÉUM NATIONAL D'HISTOIRE NATURELLE
DIRECTION GÉNÉRALE DÉLÉGUÉE À LA RECHERCHE, À L'EXPERTISE, À LA VALORISATION ET À L'ENSEIGNEMENT
DIRECTION DE L'ENSEIGNEMENT, DE LA PÉDAGOGIE ET DE LA FORMATION

SORBONNE UNIVERSITÉ
COLLÈGE DOCTORAL DE L'ALLIANCE SORBONNE UNIVERSITÉ



Année 2020

N° attribué par la bibliothèque
1_11_11_11_11_11_11_11_11_11_1

THÈSE

Pour obtenir le grade de
DOCTEUR DU MUSÉUM NATIONAL D'HISTOIRE NATURELLE
Discipline : Paléontologie Humaine

Présentée et soutenue publiquement par

Sofwan Noerwidi

le 27 Mai 2020

**DIVERSITÉ DES HOMININES DANS L'ARCHIPEL OUEST INDONÉSIE AU QUATERNAIRE :
UNE PERSPECTIVE DONNÉE PAR L'ÉTUDE DU REGISTRE FOSSILE DENTAIRE**

Sous la direction de M. François Sémah,
M. Carlos Lorenzo Merino, et Mme. Amélie Perrin-Vialet

JURY

M. Yves Coppens	Professeur	Rapporteur et Président du Jury	Collège de France
M. Jeffrey Schwartz	Professeur	Rapporteur et Examinateur	University of Pittsburgh
Mme. Marie-Antoinette de Lumley	Directrice de Recherche	Examinatrice	Muséum national d'Histoire naturelle
M. Harry Widianto	Professeur	Examinateur	The National Research Center for Archaeology
M. François Sémah	Professeur	Directeur de thèse et Examinateur	Muséum national d'Histoire naturelle
M. Carlos Lorenzo Merino	Professeur	Directeur de thèse et Examinateur	Universitat Rovira i Virgili
Mme. Amélie Perrin-Vialet	Maître de conférences	Encadrante de thèse et Examinatrice	Muséum national d'Histoire naturelle
M. José María Bermúdez de Castro	Directeur de Recherche	Examinateur	Centro Nacional de Investigación de La Evolución Humana



Muséum national d'Histoire naturelle



International Doctorate in
QUATERNARY AND PREHISTORY

**HOMININ DIVERSITY IN THE WESTERN INDONESIAN ARCHIPELAGO
DURING THE QUATERNARY: A DENTAL RECORD PERSPECTIVE**

Sofwan Noerwidi

Directeur/s : Dr. François Sémah
Dr. Carlos Lorenzo Merino
Dr. Amélie Vialet

Année académique 2019/2020



**Università
degli Studi
di Ferrara**



UNIVERSITAT ROVIRA I VIRGILI



ipt
Instituto
Politécnico
de Tomar



“Show me your teeth, and I will tell you who you are.”

(*Essay on the Theory of the Earth*, 1827)



Georges Cuvier (1769-1832)

for both of my parents,
who never see this manuscript.

ACKNOWLEDGMENT

Praise to Allah, God the Almighty. This work involved so many people. Therefore, I take this opportunity to thank all of them.

I am highly grateful to Prof. Marta Arzarello, Prof. François Sémah, Prof. Robert Sala, Prof. Luis Oosterbeek, the International Doctoral in Quaternary and Prehistory coordinator program, for giving me the opportunities.

I wish to acknowledge the kindness of my honorable supervisor, Prof. François Sémah, and Prof. Carlos Lorenzo, also the thesis board especially Dr. Amélie Vialet and Prof. Anne-Marie Moigne, for their highly valuable suggestion, knowledge, and dedication for their student.

Prof. José María Bermúdez de Castro and Dr. María Martín-Torres at the Centro Nacional de Investigación sobre la Evolución Humana, Spain for their sharing priceless knowledge about hominin dental studies.

I am very grateful to Prof. Marie Antoinette de Lumley at the Muséum national de Histoire naturelle, Paris, Prof. Jeffrey H. Schwartz at the University of Pittsburgh, Pennsylvania, and Prof. Yves Coppens at the College de France, Paris for their sharing precious knowledge about *Homo erectus*, inspirations, and constructive comments on my study.

My special gratitude goes to Prof. Truman Simanjuntak for gave me the opportunity to involve in the international research team which leads me to all these studies. Equally thankful to Prof. Harry Widiyanto for his strong support, motivation, advice, critic, and guidance, which are very priceless and important for me to study on paleoanthropology

I am grateful Drs. Siswanto, M.Hum (formerly) and Drs. Sugeng Riyanto, M.Hum head of Balai Arkeologi Yogyakarta, Dr. I Made Geria director of the Puslit Arkenas, Jakarta, E Wahyu Saptomo, Priyatno Hadi S, and Amelia Driwantoro (formerly) at the institution, and Dr. Harry Widiyanto (formerly) at the Directorate of Cultural Heritage Preservation and Museum for supporting me to study in Europe. And thanks to ibu Lestyani Yuniarsih and ibu Lusi (formerly) at Balitbang Kemen Dikbud Jakarta. Also thanks to ibu Destriani Nugroho at the Erasmus Plus Scholarship, Uni European Delegation for Indonesia, and Brunei Darussalam.

Prof. Dominique Grimaud-Hervé, Dr. Florent Détroit, Dr. Thomas Ingicco at the Musée de l'Homme, Prof. Anne-Marie Sémah at the Institut de Recherche pour le Développement, Prof. Anne Dambricourt-Malassé at the Institut de Paléontologie Humaine, Prof. Christophe Falguères and Prof. Jean-Jacques Bahain director of the UMR 7194 Histoire Naturelle de l'Homme Préhistorique, for their support and encouragement during my study at Paris.

I am very grateful to Prof. Robert Sala and Dr. Carlos Lorenzo Merino for their hospitality during my stay at Universitat Rovira i Virgili, Tarragona, Spain. Also grateful to Dr. Chafika Falguères and Dr. David Pleurdeau during my stay at Muséum national de Histoire naturelle, Paris.

I would like to acknowledge numbers of professor and director who gave permission and support me to study the specimens of Sangiran, Gunung Sewu, Patiayam, Wajak, Lida Ajer, Gua Harimau, Gua Pawon, Tamiang and Sukajadi used in this work;

Prof. Truman Simanjuntak (formerly) at the Puslit Arkenas and Center for Prehistory and Austronesian Studies, Jakarta.

Prof. Harry Widiyanto (formerly) Director of the Directorate of Cultural Heritage Preservation and Museum, Jakarta

Dr. Amélie Vialet at the Institut de Paléontologie Humaine, the Muséum national de Histoire naturelle, Paris

Prof. Fachroel Aziz (formerly) and Dr. Iwan Kurniawan head of the Museum of Geology, the Geological Research and Development Center, Bandung

Prof. Yahdi Zaim and Dr. Johan Arif at the Faculty of Earth Sciences and Technology, the Institute of Technology Bandung

Rusyad Adi Suriyanto, M.Hum and Dr. Neni Rahmawati at the Laboratory of Bioanthropology and Paleoanthropology, Faculty of Medicine, Public Health and Nursing, Gadjah Mada University, Yogyakarta.

Drs, Sukronedi, M.A., and Drs. M. Hidayat head of the Conservation Office of Sangiran Early Man Site, Central Java.

Dr. Natasja den Ouden, Prof. Josephine Joordens, and Prof. John de Vos (formerly) at the Naturalis Biodiversity Center, Leiden, the Netherlands.

Dr. Christine Hertler and Prof. Friedemann Schrenk at the the Naturmuseum Senckenberg, Frankfurt, Germany.

Dr. Lutfi Yondri at the Balai Arkeologi Bandung, West Java

and Dra. Indah Asikin Nurani, M.Hum at the Balai Arkeologi Yogyakarta, D.I. Yogyakarta.

Thank so much to Patricia Wills and Marta Bellato for helped me to work with CT-Scan data in the Bat. 140, Poliveau, the Muséum national de Histoire naturelle, Paris.

Houria Kacci, Germain Gomez, Sophie Ben Moussa, Priscillia Boston, Michèle Dacier, Christian Venus and Patrick Potier at the Bat. L'Institut de Paléontologie Humaine for their help during my stay in Paris.

And I thanks to my colleagues involved in the Erasmus Mundus International Doctoral in Quaternary and Prehistory also L'école doctorale 227 program MNHN & Sorbonne Université "Sciences de la nature et de l'Homme: évolution et écologie":

Lou Albessard, Jérémy Duveau, Delphine Vettese, Wanda Zinger, Lee Gocky, Isis Mesfin, Eslem Benarous, Guilhem Mauran, Raphaël Hanon, Hélèn Monod, Yudian Zhou, Corentin Biets, Sih Natalia Sukmi.

Thanks so much to all of my friends Céline E Kerfant (Paris) Madhavi Kunneirath, Laxmi Tumung, Sofian kheloufi (Tarragona), Marina Martinez de Pinillos, Ana Pantoja Pérez, Pilar Fernández Colón, Laura Martín-Francés, Mario Modesto Mata (Burgos), Eduard Pop, Sander Hilgen, Shukiato Khurniawan (Leiden), Susanne Krüger (Frankfurt), Ahmad Surya Ramadhan (Marseille), Pamela Faylona, Archie Tiauzon (Manila).

Hari Wibowo, Teddy Setiadi, Fadly Ginanjar (Yogyakarta), Dody Wiranto, Iwan Setyawan Bimas, Mbak Ari Swastika, Mbak Septina Wardhani, all friends at the development division and protection division the BPSMP also Mirza Ansyori (Sangiran), Ginarto, Slamet and Puji "the Trio Punung" (Pacitan), Unggul Prasetyo Wibowo, Mika Puspaningrum, Halmi Insani, Ifan Yoga Pratama, Anton Ferdianto, Rusiyanti (Bandung), Rolly Candra, Ferdi Nata (Baturaja), Ruly Fauzi (Palembang), Taufiqurrahman Setiawan (Medan), Kasman Setiagama,

Abi Kusno, Dyah Prastiningtyas, Adhi Agus Octaviana, Shinatrya Adhityatama (Jakarta) and also all my friends who I cannot mention one by one.

I thanks to Tulus and family at Punung, also Dodi Pabin and family at Padangbindu.

Finally, my special thanks go to my wife Evi Novita Noerwidi, both our sons Mapanji & Naraarya, and all my families at Yogyakarta Also Isnielma Nurwulan at Jakarta, for everything.

Paris, March 27th 2020



Sofwan Noerwidi

TABLE OF CONTENT

ACKNOWLEDGEMENT	iii
TABLE OF CONTENT	vii
LIST OF FIGURE	xi
LIST OF TABLE	xvii
SUMMARY	xxiii

INTRODUCTION

A. The study of hominin teeth from Indonesia	1
B. Scientific approach developed in this research	3
C. Materials and methods	5
D. The research steps	6
E. The structure of the manuscript	8
F. The milestones	9

CHAPTER 1. SUNDALAND AND ITS ENVIRONMENT

A. GEOGRAPHY AND GEOLOGY OF THE SUNDALAND

1. Human and physical geography of western Indonesia	11
2. Tectonics, volcanics, and formation of western Indonesia	13
3. Climatic cycles and physiographic dynamics	15
4. Geology and stratigraphy	16

B. PALEOENVIRONMENT

1. Variation of vegetation	20
2. Faunal migration	23

C. HUMAN REMAINS

1. The emergence of the genus <i>Homo</i> and its dispersal out of Africa	27
2. Initial human occupation in the Sundaland	30
3. Early anatomically modern humans in the Islands of Southeast Asia	33
4. Recent modern humans in the Sundaland	35

CHAPTER 2. PREHISTORIC SITES AND HUMAN DENTAL COLLECTION

A PRESENTATION OF THE SITES 39

B CENTRAL ZONE OF JAVA – Bogor-Kendeng Mountains and Central Depression

1. Trinil (Kendeng)	41
2. Kedungbrubus (Kendeng)	46
3. Sangiran Dome	48
4. Rancah (Bogor Anticlinal Zone)	64
5. Gua Pawon (Bandung Highland)	68

C	NORTHERN ZONE OF JAVA – Patiayam Dome and Northern Mountains	
1.	Patiayam Dome	73
2.	Gua Kidang (Northern Mountains)	78
D	SOUTHERN ZONE OF JAVA – Gunungsewu Mountains and Campurdarat Karst	
1.	Song Terus	83
2.	Gua Braholo	89
3.	Song Keplek	95
4.	Song Tritis	99
5.	Wajak Complex	102
E	SOUTHERN SUMATRA – Baturaja Karst	
1.	Gua Harimau	108
F	WESTERN SUMATRA – Payakumbuh Karst	
1.	Lida Ajer	119
G	NORTHERN SUMATRA – Shellmidden (<i>Kjökkenmöddinger</i>)	
1.	Sukajadi Pasar Shellmidden	123
2.	Tamiang Shellmidden	127
H	COMPARATIVE MATERIAL FROM MAINLAND ASIA	
1.	Zhoukoudian	131

CHAPTER 3. BASIC TERMINOLOGY, MATERIAL AND METHOD

A.	BASIC TERMINOLOGY	
1.	Tooth definitions and orientation	137
2.	The cusps	140
B.	MATERIAL	
1.	Upper teeth	142
2.	Lower teeth	142
3.	Summary	143
C.	ANALYTICAL APPROACHES	
1.	Wear pattern	145
2.	Morphological characters	147
3.	Measurement	169
	General Size of the teeth	169
	Crown size and cusp proportions	170
4.	Geometric-morphometric	175

CHAPTER 4. RESULT

A.	WEAR PATTERN	
	Summary of the wear pattern	183
B.	DEFINING THE HYPOTHETICAL GROUP	
1.	Background and purpose	185
2.	The procedures	186
3.	Result of the comparative study on Javan hominins	186
4.	Enlarging the comparison samples	190
5.	Result of the enlarged comparative study on second molars	192
6.	Testing the predictions	198

7. Application of the hypothetical groups	199
8. Limitations	199
C. MORPHOLOGICAL TRAIT	
1. Morphological traits of mandibular teeth	200
2. Morphological traits of maxillary teeth	215
3. Summary of morphological traits	230
D. METRICS	
1. General metrics of mandibular teeth	232
2. General metrics of maxillary teeth	239
3. Summary of general metrics	246
4. Crown size and cusps proportion of mandibular teeth	249
5. Crown size and cusps proportion of maxillary teeth	256
6. Summary of the crown size and cusps proportion analysis	262
E. GEOMETRIC-MORPHOMETRICS	
1. Geometric morphometrics of mandibular teeth	263
2. Geometric morphometrics of maxillary teeth	273
3. Summary of the geometric morphometrics analysis	283

CHAPTER 5. DENTAL DIVERSITY AND CHRONOLOGY OF HUMAN OCCUPATION IN THE SUNDALAND DURING THE QUATERNARY PERIOD

A. DENTAL DIVERSITY	
1. The dental type groups	285
2. Group 1 (<i>Meganthropus</i> type)	286
3. Group 2 (<i>Mojokertensis</i> type)	288
4. Group 3 (Sangiran type)	291
5. Group 4 (Wajak type)	293
6. Group 5 <i>Homo sapiens</i> Preneolithic (Early-Mid Holocene)	295
7. Group 6 <i>Homo sapiens</i> Neolithic-Paleometalic (Late Holocene)	297
8. Zhoukoudian <i>Homo erectus</i>	299
B. CONTEXTUALIZING THE HYPOTHETICAL GROUPS	
1. Group 1 (<i>Meganthropus</i> type)	301
2. Group 2 (<i>Mojokertensis</i> type)	304
3. Group 3 (Sangiran type)	306
4. Group 4 (Wajak type)	308
5. Group 5 <i>Homo sapiens</i> Preneolithic (Early-Mid Holocene)	309
6. Group 6 <i>Homo sapiens</i> Neolithic-Paleometalic (Late Holocene)	310
C. THE CHRONOLOGY OF HUMAN OCCUPATION	
1. Diachronic position of the hominin fossils	311
2. Origin and dispersal of early hominins into the Sundaland	313
3. Hominins variability during the late of Early to Middle Pleistocene	315
4. Extinction and emergence during the Late Pleistocene	318
5. Contact and isolation during the Early Holocene	320
6. New wave in the Late Holocene	323

CHAPTER 6. CONCLUSION AND PERSPECTIVE:

A. SOME METHODOLOGICAL PRELIMINARY REMARKS	325
B. CONCLUSION	325

1. Dental diversity vs. hominin diversity	326
2. Chronology of human occupation	327
C. SPECIFIC INTERESTS AND FUTURE PERSPECTIVES OF THE RESEARCH	331
BIBLIOGRAPHY	333
APPENDIX	
A. WEAR PATTERN	
1. Teeth on maxillary arc.	371
2. Teeth on mandibular arc.	376
3. Isolated upper teeth.	382
4. Isolated lower teeth.	386
B. MORPHOLOGICAL TRAITS	
1. Morphological traits of mandibular teeth.	391
2. Morphological traits of maxillary teeth.	405
C. GENERAL MEASUREMENTS	
1. Measurements of mandibular teeth.	421
2. Measurements traits of maxillary teeth.	434
D. CROWN SIZE AND CUSP PROPORTION	
1. Crown size and cusp proportion of LM1.	449
2. Crown size and cusp proportion of LM2.	455
3. Crown size and cusp proportion of LM3.	461
4. Crown size and cusp proportion of UM1.	467
5. Crown size and cusp proportion of UM2.	473
6. Crown size and cusp proportion of UM3.	479

LIST OF FIGURE

Chapter 1

- Fig. 1. A.1. Position of Sumatra and Java Islands in the Sundaland, western part of Indonesia (Hall and Smyth, 2008). 12
- Fig. 1. A.2. Geography of Southeast Asia and surrounding regions showing present-day tectonic boundaries and volcanic activity. Bathymetric contours at 200 m and 5 000 m (Hall, 2009). 14
- Fig. 1. A.3. Changing Sundaland palaeogeography during the time of earliest colonization by anatomically modern humans (AMH) until the Last Glacial Maximum (Wurster and Bird, 2016). 16
- Fig. 1. B.1. Distribution of distinct forest types during the Last Glacial Maximum, with two different parameters. (Right) maximum lowland evergreen rainforest (LERF) extent; “closed corridor”; (Left) minimum LERF with “open corridor” (Cannon, Morley and Bush, 2009). 21
- Fig. 1. B.2. Biostratigraphy and faunal succession of Java during Quaternary periods (De Vos and Long, 2001). 24
- Fig. 1. B.3. Two different migration routes: Siva-Malaya from South Asia and Sino-Malaya from East Asia (De Vos and Long, 2001) 26
- Fig. 1. C.1. Ancient sites of hominin presence (Kappelman, 2018). 28
- Fig. 1. C.2. Ancient sites of hominin presence in Java (Noerwidi, 2012). 31
- Fig. 1. C.3. Early anatomically modern human sites of Southeast Asia. 36

Chapter 2

- Fig. 2. A.1. Map of distribution hominin sites of Java used in this research. 39
- Fig. 2. A.2. Map of distribution hominin sites of Sumatra used in this research. 40
- Fig. 2. B.1. Geological map of Trinil area (Watanabe and Kadar, 1985). 41
- Fig. 2. B.2. Stratigraphy of Trinil HK, the type locality of *Homo erectus* (Dubois, 1895; Joordens *et al.*, 2009). 43
- Fig. 2. B.3. Left. The holotype of *Homo erectus* (Dubois, 1894). Right. The geometric pattern on *Pseudodon* found in the same layer (Joordens *et al.*, 2015). 44
- Fig. 2. B.4. Geological map of Kedungbrubus area (Watanabe and Kadar, 1985). 46
- Fig. 2. B.5. Two reconstructions of Kedungbrubus mandible, left by (Dubois, 1924) and right by (Tobias, 1966). 47
- Fig. 2. B.6. Right. Stratigraphy (Watanabe and Kadar, 1985) and cleaver from Kabuh (Bapang) Formation of Sangiran Dome (Simanjuntak, 2001). 50
- Fig. 2. B.7. Landscape of Sangiran dome (Doc. Noerwidi). 56

Fig. 2. B.8. Distribution map of main hominins found in Sangiran Dome.	57
Fig. 2. B.9. Location of Rancah hominin site, West Java (Kramer <i>et al.</i> , 2005).	64
Fig. 2. B.10. Stratigraphical section and hominin tooth of Rancah site.	65
Fig. 2. B.11. Geological map of Rajamandala ridge and pawon cave (Sudjatmiko, 2003; Maryanto, 2009).	68
Fig. 2. B.12. Plan site of Pawon cave (Yondri, 2005).	69
Fig. 2. B.13. Stratigraphy of Pawon Cave (Yondri, 2005).	70
Fig. 2. B.14. Flaxed burial of Pawon 3 individual (Yondri, 2005) and obsidian artifacts of Gua Pawon (Ferdianto, 2008).	71
Fig. 2. C.1. Map of Patiayam dome, Central Java (Siswanto, Zaim and Noerwidi, 2016).	73
Fig. 2. C.2. Geological map (left) and Acheulean handaxe from Patiayam dome (Siswanto, Zaim and Noerwidi, 2016).	76
Fig. 2. C.3. Plan and section of Gua Kidang, Rembang (Nurani <i>et al.</i> , 2019).	78
Fig. 2. C.4. Stratigraphy of Gua Kidang, Rembang (Nurani, Koesbardiati & Murti, 2014)	79
Fig. 2. C.5. Flexed burial of Gua Kidang Individual 2 (Nurani, Koesbardiati & Murti, 2014) and Shell artifact of Gua Kidang (Nurani and Hascaryo, 2010).	80
Fig. 2. D.1. Distribution map of cave habitation sites at Gunungsewu area (Borel, 2010).	82
Fig. 2. D.2. Plan of Song Terus site (Sémah <i>et al.</i> , 2004).	83
Fig. 2. D.3. Stratigraphy of Song Terus site (Sémah <i>et al.</i> , 2004).	85
Fig. 2. D.4. Flexed burial of Song Terus individual 1 (Détroit, 2002).	86
Fig. 2. D.5. Plan of Gua Braholo site, Gunungkidul (Simanjuntak, 2002).	89
Fig. 2. D.6. Stratigraphy (left) and preneolithic artifacts (right) of Gua Braholo site, Gunungkidul (Simanjuntak, 2002).	90
Fig. 2. D.7. Flexed burial of Gua Braholo individual 1 (Simanjuntak, 2002).	91
Fig. 2. D.8. Plan of Song Keplek site, Pacitan (Simanjuntak, 2002).	95
Fig. 2. D.9. Stratigraphy (left) and preneolithic artefact (right) of Song Keplek site, Pacitan (Simanjuntak, 2002).	96
Fig. 2. D.10. Flaked burial of SK4, 4500 BP (left) and extended burial of SK 5, 3200 BP (right), Pacitan (Détroit, 2002; Simanjuntak, 2002).	97
Fig. 2. D.11. Plan of Song Tritis site, Gunungkidul (Doc. Balar Yogya).	99
Fig. 2. D.12. Stratigraphy of Song Tritis site, Gunungkidul (Doc. Balar Yogya).	100
Fig. 2. D.13. Flaked burial of Song Tritis individual 1 (Doc. Détroit).	100
Fig. 2. D.14. View of the Gunung Lawa in 1890 seen from the southern edge of Tjerme village. From left to right: 1) Hoekgrot, 2) Goea Lawa, 3) Wajak, 4) cave in the steep wall, 5) Western cave (Aziz and de Vos, 1989).	102

Fig. 2. D.15. Lithic artifacts from Wajak site (Storm, 1992) and bone artifacts from Hoekgrot (Doc. Noerwidi).	103
Fig. 2. D.16. Left. Cross section of Wajak site, copy by Dubois from a sketch by van Rietschoten, 1888. The script from top to bottom: rocky wall, protruding block of marmer, clay, conglomerate with skull (Wajak 1) and bones, marble limestone (Storm, 1995). Right. Excavation boxes of Wajak site and location of Wajak 2 found in square 21 at 1.25 m dept (Aziz and de Vos, 1989).	104
Fig. 2. E.1. Map of Padang Bindu Karst and surrounding area (Simanjuntak, 2016).	108
Fig. 2. E.2. Plan of Gua Harimau site with the density of archaeological finds (Simanjuntak, 2016).	109
Fig. 2. E.3. Rock painting at Gua Harimau site (Simanjuntak, 2016).	110
Fig. 2. E.4. Stratigraphy of Gua Harimau site (Simanjuntak, 2016).	111
Fig. 2. E.5. Distribution of human skeleton remains at Gua Harimau site (Simanjuntak, 2016).	112
Fig. 2. F.1. Plan of Lida Ajer site (Westaway <i>et al.</i> , 2017).	120
Fig. 2. F.2. New dating result from Lida Ajer site (Westaway <i>et al.</i> , 2017).	120
Fig. 2. G.1. Distribution map of shelmidden sites, Northeastern Sumatra.	122
Fig. 2. G.2. Distribution map of Sukajadi shelmidden sites, North Sumatra (Setiawan <i>et al.</i> , 2011).	123
Fig. 2. G.3. Stratigraphy of Sukajadi shelmidden sites, North Sumatra (Setiawan <i>et al.</i> , 2011).	124
Fig. 2. G.4. Sumatralith artefact of Sukajadi shelmidden sites, North Sumatra (Setiawan <i>et al.</i> , 2011).	124
Fig. 2. G.5. Plan site of Tamiang shelmidden, Aceh (Wiradnyana, 2008).	127
Fig. 2. G.6. Sumatralith (left), grind stone and anvil (right) of Tamiang shelmidden, Aceh (Wiradnyana, 2008).	128
Fig. 2. G.7. Stratigraphy of Tamiang shelmidden, Aceh (Wiradnyana, 2010).	128
Fig. 2. H.1. The location of Zoukoudian Locality 1 and surrounding area (Andersson <i>et al.</i> , 1922; Yang, 2014).	131
Fig. 2. H.2. The stone artifacets of Zoukoudian Locality 1.	132
Fig. 2. H.3. Stratigraphy of Zoukoudian Locality 1 (Yang, 2014).	133

Chapter 3

Fig. 3. A.1. Anatomy and directional term for dentition (White and Folkens (2005).	138
Fig. 3. A.2. The cusps of a lower molar (White and Folkens, 2005).	140
Fig. 3. A.3. The cusps of an upper molar (White and Folkens, 2005).	141
Fig. 3. C.1. Morphological features of the incisors (White and Folkens, 2005).	148

Fig. 3. C.2. Morphological features of the canines (White and Folkens, 2005).	152
Fig. 3. C.3. Morphological features of the UP (White and Folkens, 2005).	155
Fig. 3. C.4. Morphology and landmarks of the LP (White and Folkens, 2005).	155
Fig. 3. C.5. Morphological features of the LM (White and Folkens, 2005).	159
Fig. 3. C.6. Morphological features of the UM (White and Folkens, 2005).	164
Fig. 3. C.7. Measurement variables of the UM.	171
Fig. 3. C.8. Measurement variables of the LM.	172
Fig. 3. C.9. Eight Landmarks position of the LP.	176
Fig. 3. C.10. Eight Landmarks position of the UP.	177
Fig. 3. C.11. Eighteen Landmarks position of the LP.	178
Fig. 3. C.12. twentyfour Landmarks position of the UM.	179

Chapter 4

Fig. 4. B.1. Flowchart of the research on dental comparative study;	185
Fig. 4. B.2. Cluster Analysis of morphological feature (left) and boxplot graphic of MD and BL measurements (right) on the LM2 Javan hominin specimens.	186
Fig. 4. B.3. Cluster Analysis of morphological feature (left) and boxplot graphic of MD and BL measurements (right) on the UM2 Javan hominin specimens.	187
Fig. 4. B.4. Cluster Analysis of the LM2 of all teeth based on the dental features.	192
Fig. 4. B.5. Boxplot graphic of MD and BL measurements on the LM2 of all hominin specimens.	193
Fig. 4. B.4. Cluster Analysis of the UM2 of all teeth based on the dental features.	194
Fig. 4. B.5. Boxplot graphic of MD and BL measurements on the UM2 of all hominin specimens.	195
Fig. 4. C.1. The cluster analysis based on the morphological traits on the LI1.	200
Fig. 4. C.2. The cluster analysis based on the morphological traits on the LI2.	202
Fig. 4. C.3. The cluster analysis based on the morphological traits on the LC.	204
Fig. 4. C.4. The cluster analysis based on the morphological traits on the LP3.	206
Fig. 4. C.5. The cluster analysis based on the morphological traits on the LP4.	208
Fig. 4. C.6. The cluster analysis based on the morphological traits on the LM1.	210
Fig. 4. C.7. The cluster analysis based on the morphological traits on the LM3.	213
Fig. 4. C.8. The cluster analysis based on the morphological traits on the UI1.	215
Fig. 4. C.9. The cluster analysis based on the morphological traits on the UI2.	217
Fig. 4. C.10. The cluster analysis based on the morphological traits on the UC.	219
Fig. 4. C.11. The cluster analysis based on the morphological traits on the UP3.	221

Fig. 4. C.12. The cluster analysis based on the morphological traits on the UP4.	223
Fig. 4. C.13. The cluster analysis based on the morphological traits on the UM1.	225
Fig. 4. C.14. The cluster analysis based on the morphological traits on the UM3.	227
Fig. 4. D.1. Boxplot analysis of the measurements on the LI1.	232
Fig. 4. D.2. Boxplot analysis of the measurements on the LI2.	233
Fig. 4. D.3. Boxplot analysis of the measurements on the LC.	234
Fig. 4. D.4. Boxplot analysis of the measurements on the LP3.	235
Fig. 4. D.5. Boxplot analysis of the measurements on the LP4.	236
Fig. 4. D.6. Boxplot analysis of the measurements on the LM1.	237
Fig. 4. D.7. Boxplot analysis of the measurements on the LM3.	238
Fig. 4. D.8. Boxplot analysis of the measurements on the UI1.	239
Fig. 4. D.9. Boxplot analysis of the measurements on the UI2.	240
Fig. 4. D.10. Boxplot analysis of the measurements on the UC.	241
Fig. 4. D.11. Boxplot analysis of the measurements on the UP3.	242
Fig. 4. D.12. Boxplot analysis of the measurements on the UP4.	243
Fig. 4. D.13. Boxplot analysis of the measurements on the UM1.	244
Fig. 4. D.14. Boxplot analysis of the measurements on the UM3.	245
Fig 4. D.15. LDA of crown size and cusp proportion on LM1, Axis 1 vs Axis 2.	249
Fig 4. D.16. LDA of crown size and cusp proportion on LM2, Axis 1 vs Axis 2.	252
Fig 4. D.17. LDA of crown size and cusp proportion on LM3, Axis 1 vs Axis 2.	254
Fig 4. D.18. LDA of crown size and cusp proportion on UM1, Axis 1 vs Axis 2.	256
Fig 4. D.19. LDA of crown size and cusp proportion on UM2, Axis 1 vs Axis 2.	258
Fig 4. D.20. LDA of crown size and cusp proportion on UM3, Axis 1 vs Axis 2.	260
Fig. 4. E.1. PCA Geometric-Morphometrics of lower third premolar, PC 1 vs PC2.	263
Fig. 4. E.2. PCA Geometric-Morphometrics of lower fourth premolar, PC 1 vs PC2.	265
Fig. 4. E.3. PCA Geometric-Morphometrics of lower first molar, PC 1 vs PC2.	267
Fig. 4. E.4. PCA Geometric-Morphometrics of lower second molar, PC 1 vs PC2.	269
Fig. 4. E.5. PCA Geometric-Morphometrics of lower third molar, PC 1 vs PC2.	271
Fig. 4. E.6. PCA Geometric-Morphometrics of upper third premolar, PC 1 vs PC2.	273
Fig. 4. E.7. PCA Geometric-Morphometrics of upper fourth premolar, PC 1 vs PC2.	275
Fig. 4. E.8. PCA Geometric-Morphometrics of upper first molar, PC 1 vs PC2.	277
Fig. 4. E.9. PCA Geometric-Morphometrics of upper second molar, PC 1 vs PC2.	279
Fig. 4. E.10. PCA Geometric-Morphometrics of upper third molar, PC 1 vs PC2.	281

Chapter 5

- Fig. 5. A.1. Lower teeth of Group 1 'Meganthropus', LRP3-LRM1 of Sangiran 6a (left) and LRM2-LRM3 of Arjuna 9 (right). 287
- Fig. 5. A.2. Upper teeth of Group 1 'Meganthropus', Sangiran 4 (left) and Sangiran 27 (right). 287
- Fig. 5. A.3. Lower teeth of Group 2 'Mojokertensis', Sangiran 9 (left) and Sangiran 37 (right). 289
- Fig. 5. A.4. Upper teeth of Group 2 'Mojokertensis', Tjg 1993.05 (left) and Sangiran 15a (right). 290
- Fig. 5. A.5. Lower and upper teeth of Group 3 'Sangiran', Sangiran 22b (left) and Sangiran 17 (right). 292
- Fig. 5. A.6. Lower and upper teeth of Group 4 'Wajak', mandible Wajak 2 (left) and maxilla Wajak 2 (right). 294
- Fig. 5. A.7. Isolated teeth from Sangiran Dome member of the Group 4 'Wajak', from left to right, NG D6 LRM2, Abimanyu 1 LLM2, NG G10 ULM1, Abimanyu 2 URM1. 294
- Fig. 5. A.8. Lower and upper teeth of Group 5 'Preneolithic', mandible SK 4 (left) and maxilla SK 4 (right). 296
- Fig. 5. A.9. Lower and upper teeth of Group 6 'Neolithic-Paleometallic', mandible HRM 23 (left) and maxilla HRM 36 (right). 298
- Fig. 5. C.1. Physiography of the Sundaland during Glacial Maximum (Red), Interglacial Maximum (Green), and Interstadial (Yellow). 317
- Fig. 5. C.2. Two routes of Neolithic migration into Indonesia (Simanjuntak 2017), correspond to the Austroasiatic and Austronesian migrations. 324

Chapter 6

- Fig 6. B.1. Hypothesis of the chronology of human occupation in the Sundaland during Pleistocene. 329
- Fig 6. B.2. Hypothesis of the chronology of human occupation in the Sundaland during Late Pleistocene to Holocene. Figure sources: (Platt et al. 2017). 330

LIST OF TABLE

Chapter 1

Table 1. A.1. The correlation table of Quaternary stratigraphy of Java (Zaim <i>et al.</i> , 2007)	19
--	----

Chapter 2

Table 2. B.1. Isolated teeth from Trinil site.	44
Table 2. B.2. Mandibular specimen from Kedungbrubus site.	47
Table 2. B.3. Hominin remains from Pucangan Formation of Sangiran dome.	52
Table 2. B.4. Hominin remains from Grenzbank Layer of Sangiran dome.	53
Table 2. B.5. Hominin remains from Kabuh Formation of Sangiran dome.	54
Table 2. B.6. Maxilla and mandible specimens from Sangiran dome.	58
Table 2. B.7. Isolated teeth from Sangiran dome.	60
Table 2. B.8. Hominin tooth from Rancah site.	66
Table 2. B.9. Human remains from Gua Pawon site.	72
Table 2. C.1. Isolated tooth from Patiayam dome.	77
Table 2. C.2. Human remains from Gua Kidang site.	81
Table 2. D.1. Human individual from Song Terus site.	87
Table 2. D.2. Isolated teeth from Song Terus site.	88
Table 2. D.3. Human individuals from Gua Braholo site.	92
Table 2. D.4. Isolated teeth from Gua Braholo site.	94
Table 2. D.5. Human individuals from Song Keplek site.	98
Table 2. D.6. Human individual from Song Tritis site.	101
Table 2. D.7. The difference of two archaeological assemblages from Wajak karstic area.	104
Table 2. D.8. Human individuals from Wajak complex sites.	106
Table 2. D.9. Isolated teeth from Wajak complex sites.	107
Table 2. E.1. Human individuals from Gua Harimau sites.	114
Table 2. F.1. Isolated Teeth from Lida Ajer site.	121
Table 2. G.1. Human individuals from Sukajadi Pasar shellmidden.	126
Table 2. G.2. Human individual from Tamiang Shellmidden site.	130
Table 2. H.1. Hominin mandible from Zoukoudian site.	133
Table 2. H.1. Isolated teeth from Zoukoudian site.	134

Chapter 3

Table 3. B.1. The upper teeth used in the study.	142
Table 3. B.2. The lower teeth used in the study.	142
Table 3. B.3. The summary of upper teeth used in the study.	143
Table 3. B.4. The summary of lower teeth used in the study.	143
Table 3. B.5. The summary of all teeth used in the study.	144
Table 3. C.1. The stages definition of the wear pattern used in the study.	145
Table 3. C.2. Reference of measurements on the upper molar.	171
Table 3. C.3. Reference of measurements on the lower molar.	172
Table 3. C.4. Link between the measurements and the shape - size of the tooth.	173
Table 3. C.5. Eight landmarks reference of the lower premolar.	176
Table 3. C.6. Eight landmarks reference of the upper premolar.	177
Table 3. C.7. Eighteen landmarks reference of the lower molar.	178
Table 3. C.8. Twenty-four landmarks reference of the upper premolar.	179

Chapter 4

Table 4. A.1. Summary of the tooth wear pattern by sites.	183
Table 4. A.2. Summary of the teeth used in this study.	184
Table 4. B.1. Expression of the morphological characters of four groups on the LM2.	189
Table 4. B.2. Expression of the morphological characters of four groups on the UM2.	189
Table 4. B.3. List of the Javan hominins (LM2 and UM2) splitted in 4 groups.	190
Table 4. B.4. Specimen of Group Zhoukoudian <i>Homo erectus</i> .	190
Table 4. B.5. The Early Holocene <i>Homo sapiens</i> group.	191
Table 4. B.6. The Late Holocene <i>Homo sapiens</i> group.	191
Table 4. B.7. Expression of the morphological characters of three additional groups on the lower second molar.	196
Table 4. B.8. Expression of the morphological characters of three additional groups on the upper second molar.	196
Table 4. B.9. The list of the fossil teeth belonging to the groups.	197
Table 4. B.10. Linier Discriminant Analysis Matrix on the LM2.	198
Table 4. B.11. Linier Discriminant Analysis Matrix on the UM2.	198
Table 4. B.12. Application of the hypothetical groups on the mandibular teeth class.	199
Table 4. B.13. Application of the hypothetical groups on the maxillary teeth class.	199
Table 4. C.1. Summary of morphological comparative study on lower teeth.	230

Table 4. C.2. Summary of morphological comparative study on upper teeth.	231
Table 4. D.1. Summary of morphometric on Group 1.	246
Table 4. D.2. Summary of morphometric on Group 2.	246
Table 4. D.3. Summary of morphometric on Group 3.	246
Table 4. D.4. Summary of morphometric on Group 4.	247
Table 4. D.5. Summary of morphometric on Group 5.	247
Table 4. D.6. Summary of morphometric on Group 6.	248
Table 4. D.7. Summary of morphometric on Group Zhoukoudian <i>Homo erectus</i> .	248
Table 4. D.8. Summary of crown size and cusp proportion analysis on lower teeth.	262
Table 4. D.9. Summary of crown size and cusp proportion analysis on upper teeth.	262
Table 4. E.1. Summary of GM analysis on lower teeth.	283
Table 4. E.2. Summary of GM analysis on upper teeth.	284

Chapter 5

Table 5. A.1. Morphology and morphometric characters of Group 1 'Meganthropus'.	286
Table 5. A.2. Morphology and morphometric characters of Group 2 'Mojokertensis'.	288
Table 5. A.3. Morphology and morphometric characters of Group 3 'Sangiran'.	291
Table 5. A.4. Morphology and morphometric characters of Group 4 'Wajak'.	293
Table 5. A.5. Morphology and morphometric characters of Group 5 'Preneolithic'.	295
Table 5. A.6. Morphology and morphometric characters of Group 6 'Neolithic-Paleometallic'.	297
Table 5. A.7. Morphology and morphometric characters of Group Zhoukoudian <i>Homo erectus</i> .	299
Table 5. A.8. Correlation on morphology and morphometric characters of Group Zhoukoudian <i>Homo erectus</i> to the Javan hominins.	300
Table 5. C.1. Chronology records of from Sangiran Dome and Song Terus site.	311
Table 5. C.2. Diachronic position of the hominins in the Sundaland during Quaternary.	312

Appendix A

Table A.1. Wear pattern of upper teeth from Sangiran.	371
Table A.2. Wear pattern of upper teeth from Wajak Pleistocene hominin.	371
Table A.3. Wear pattern of upper teeth from Tamiang Shellmidden.	372
Table A.4. Wear pattern of upper teeth from Sukajadi shellmidden.	372
Table A.5. Wear pattern of upper teeth from Gua Harimau.	372
Table A.6. Wear pattern of upper teeth from Gua Pawon.	373

Table A.7. Wear pattern of upper teeth from Gua Kidang.	373
Table A.8. Wear pattern of upper teeth from Song Keplek.	373
Table A.9. Wear pattern of upper teeth from Gua Braholo.	374
Table A.10. Wear pattern of upper teeth from Song Terus.	374
Table A.11. Wear pattern of upper teeth from Wajak Holocene <i>Homo sapiens</i> .	374
Table A.12. Wear pattern of lower teeth from Kedungbrubus.	376
Table A.13. Wear pattern of lower teeth from Sangiran.	376
Table A.14. Wear pattern of lower teeth from Wajak Pleistocene hominin.	377
Table A.15. Wear pattern of lower teeth from Zhoukoudian.	377
Table A.16. Wear pattern of lower teeth from Tamiang Shellmidden.	377
Table A.17. Wear pattern of lower teeth from Sukajadi Shellmidden.	378
Table A.18. Wear pattern of lower teeth from Gua Harimau.	378
Table A.19. Wear pattern of lower teeth from Gua Pawon.	379
Table A.20. Wear pattern of lower teeth from Gua Braholo.	379
Table A.21. Wear pattern of lower teeth from Song Tritis.	379
Table A.22. Wear pattern of lower teeth from Song Terus.	380
Table A.23. Wear pattern of lower teeth from Song Keplek.	380
Table A.24. Wear pattern of lower teeth from Gua Kidang.	380
Table A.25. Wear pattern of lower teeth from Wajak Holocene <i>Homo sapiens</i> .	381
Table A.26. Wear pattern of isolated upper teeth from Trinil.	382
Table A.27. Wear pattern of isolated upper teeth from Sangiran.	382
Table A.28. Wear pattern of isolated upper teeth from Lida Ajer.	383
Table A.29. Wear pattern of isolated upper teeth from Zhoukoudian.	384
Table A.30. Wear pattern of isolated upper teeth from Gua Braholo.	385
Table A.31. Wear pattern of isolated upper teeth from Song Terus.	385
Table A.32. Wear pattern of isolated upper teeth from Wajak Holocene caves.	385
Table A.33. Wear pattern of isolated lower teeth from Trinil.	386
Table A.34. Wear pattern of isolated lower teeth from Sangiran.	386
Table A.35. Wear pattern of isolated lower teeth from Patiayam.	387
Table A.36. Wear pattern of isolated lower teeth from Rancah.	387
Table A.37. Wear pattern of isolated lower teeth from Zhoukoudian.	388
Table A.38. Wear pattern of isolated lower teeth from Gua Braholo.	389
Table A.39. Wear pattern of isolated lower teeth from Song Terus.	389
Table A.40. Wear pattern of isolated lower teeth from Wajak complex.	389

Appendix B

Table B.1. Morphological character of the lower central incisor.	391
Table B.2. Morphological character of the lower lateral incisor.	392
Table B.3. Morphological character of the lower canine.	393
Table B.4. Morphological character of the lower third premolar.	394
Table B.5. Morphological character of the lower fourth premolar.	396
Table B.6. Morphological character of the lower first molar.	398
Table B.7. Morphological character of the lower second molar.	400
Table B.8. Morphological character of the lower third molar.	403
Table B.9. Morphological character of the upper central incisor.	405
Table B.10. Morphological character of the upper lateral incisor.	406
Table B.11. Morphological character of the upper canine.	407
Table B.12. Morphological character of the upper third premolar.	409
Table B.13. Morphological character of the upper fourth premolar.	411
Table B.14. Morphological character of the upper first molar.	413
Table B.15. Morphological character of the upper second molar.	415
Table B.16. Morphological character of the upper third molar.	418

Appendix C

Table C.1. Mesiodistal and Labiolingual measurements of the lower central incisor.	421
Table C.2. Mesiodistal and Labiolingual measurements of the lower lateral incisor.	422
Table C.3. Mesiodistal and Labiolingual measurements of the lower canine.	423
Table C.4. Mesiodistal and Labiolingual measurements of the lower third premolar.	424
Table C.5. Mesiodistal and Labiolingual measurements of the lower fourth premolar.	426
Table C.6. Mesiodistal and Labiolingual measurements of the lower first molar.	428
Table C.7. Mesiodistal and Labiolingual measurements of the lower second molar.	430
Table C.8. Mesiodistal and Labiolingual measurements of the lower third molar.	432
Table C.1. Mesiodistal and Labiolingual measurements of the upper central incisor.	434
Table C.2. Mesiodistal and Labiolingual measurements of the upper lateral incisor.	435
Table C.3. Mesiodistal and Labiolingual measurements of the upper canine.	436
Table C.4. Mesiodistal and Labiolingual measurements of the upper third premolar.	438
Table C.5. Mesiodistal and Labiolingual measurements of the upper fourth premolar.	440
Table C.6. Mesiodistal and Labiolingual measurements of the upper first molar.	442

Table C.7. Mesiodistal and Labiolingual measurements of the upper second molar.	444
Table C.8. Mesiodistal and Labiolingual measurements of the upper third molar.	446

Appendix D

Table D.1. Absolute and relative cusp size of LM1.	449
Table D.2. Perimetric and distance of cusp at LM1.	451
Table D.3. Absolute and relative angle of cusp at LM1.	453
Table D.4. Absolute and relative cusp size of LM2.	455
Table D.5. Perimetric and distance of cusp at LM2.	457
Table D.6. Absolute and relative angle of cusp at LM2.	459
Table D.7. Absolute and relative cusp size of LM3.	461
Table D.8. Perimetric and distance of cusp at LM3.	463
Table D.9. Absolute and relative angle of cusp at LM3.	465
Table D.10. Absolute and relative cusp size of UM1.	467
Table D.11. Perimetric and distance of cusp at UM1.	469
Table D.12. Absolute and relative angle of cusp at UM1.	471
Table D.13. Absolute and relative cusp size of UM2.	473
Table D.14. Perimetric and distance of cusp at UM2.	475
Table D.15. Absolute and relative angle of cusp at UM2.	477
Table D.16. Absolute and relative cusp size of UM3.	479
Table D.17. Perimetric and distance of cusp at UM3.	480
Table D.18. Absolute and relative angle of cusp at UM3.	481

RÉSUMÉ

Dans les îles de la partie ouest de l'archipel indonésien affectées par les changements du climat et du niveau marin, les hominines ont migré et se sont parfois trouvés isolés, au cours du Pléistocène. Le but de cette étude est de caractériser la variabilité des anciennes populations humaines dans la région de Sundaland à partir des collections dentaires qui viennent de plusieurs sites de Sumatra et de Java. Le matériel de cette étude comprend 715 dents supérieures et inférieures, dont 290 dents d'hominines pléistocènes et 425 dents d'*Homo sapiens* holocènes. Cette étude est basée sur les caractères morphologiques (n=86) et métriques (n=14). L'approche développée comprend une analyse morphologique comparative (expression des caractères discrets), une analyse en morphométrie 2D (dimensions de la couronne et proportions des cuspides), et aussi une analyse en morphométrie géométrique 2D. Les similitudes et les différences entre les spécimens (variables métriques et non métriques), testées statistiquement, ont permis leur attribution à différents groupes. Quatre groupes ont été définis pour les hominines pléistocènes et deux pour les *Homo sapiens* holocènes. Parmi les premiers (*Homo erectus*), une continuité morphologique est observée entre le Pléistocène inférieur et le début du Pléistocène moyen. D'autres groupes ne présentent pas de rupture dans l'expression des caractères jusqu'au Pléistocène supérieur. Enfin, deux groupes d'*Homo sapiens* ont été identifiés pour l'Holocène. Ainsi, cette recherche a permis de préciser les modalités des peuplements humains (continuité/rupture) en Asie du Sud-Est insulaire pendant le Quaternaire.

RESUM

Les îles de la part occidental de l'archipel d'Indonésie es van veure afectades per canvis climàtics i del nivell del mar durant el Plistocè, que podrien afectar la dispersió i / o l'aïllament dels hominins d'aquesta regió. L'objectiu d'aquest estudi és caracteritzar la diversitat de poblacions humanes antigues del Sundaland a partir de col·leccions dentals procedents de diversos jaciments de Sumatra i Java. El material d'aquest estudi està compost per 715 dents maxil·lars i mandibulars, que inclou 290 dents d'hominins del Pleistocè i 425 dents d'Holocè de l'espècie *Homo sapiens*. Aquest estudi es basa en la caracterització morfològica i mètrica dels teixits dentals. L'estudi de la morfologia externa inclourà la morfologia comparativa, la morfometria clàssica, l'anàlisi 2D geomètric-morfomètrica, la mida de la corona i les proporcions de les cúspides. Es posa a prova la similitud i les diferències mitjançant anàlisis estadístiques de dades mètriques i no mètriques, per observar agrupacions de grups entre les mostres. El resultat mostra que hi ha almenys quatre grups d'hominins durant el Plistocè. Aquest resultat suggereix que hi ha grups que semblen sobreposar-se i que apareixen cronològicament al llarg del Plistocè inferior i inicis del Plistocè mitjà, i un altre grup va sobreviure fins al Plistocè superior. La implicació d'aquest estudi ha aportat informació sobre la història de l'ocupació antiga y evolució humana a les illes del sud-est asiàtic durant el període Quaternari.

RESUMEN

En las islas de la parte occidental del archipiélago indonesio afectadas por los cambios climáticos y del nivel del mar, los homíninos emigraron y a veces se encontraron aislados durante el Pleistoceno. El objetivo de este estudio es caracterizar la variabilidad de las antiguas poblaciones humanas de la región de Sundaland a partir de las colecciones dentales de varios sitios de Sumatra y Java. El material para este estudio incluye 715 dientes superiores e inferiores, incluyendo 290 dientes de homíninos del Pleistoceno y 425 dientes de *Homo sapiens* del Holoceno. Este estudio se basa en las características morfológicas (n=86) y métricas (n=14). El enfoque desarrollado incluye un análisis morfológico comparativo (expresión de rasgos discretos), un análisis morfométrico 2D (dimensiones de la corona y proporciones de las cúspides) y también un análisis morfométrico geométrico 2D. Las similitudes y diferencias entre los especímenes (variables métricas y no métricas), probadas estadísticamente, permitieron su atribución a diferentes grupos. Se definieron cuatro grupos para los homíninos del Pleistoceno y dos para los *Homo sapiens* del Holoceno. Entre los primeros (*Homo erectus*), se observa una continuidad morfológica entre el Pleistoceno inferior y el comienzo del Pleistoceno medio. Otros grupos no muestran una ruptura en la expresión de los caracteres hasta el Pleistoceno superior. Finalmente, se identificaron dos grupos de *Homo sapiens* para el Holoceno. Así pues, esta investigación ha permitido especificar las modalidades de los asentamientos humanos (continuidad/ ruptura) en el sudeste asiático insular durante el Cuaternario.

SUMMARY

The western part islands of the Indonesian archipelago were impacted by climatic and sea-level changes during Pleistocene, which could be affecting the dispersals and/or isolation of the hominins in this region. This study aims to characterize the diversity of ancient human populations in the Sundaland based on dental collections, which came from several localities in Sumatra and Java. The material of this study is 715 teeth of maxillary and mandibular collection, consisting of 290 teeth from Pleistocene hominins and 425 teeth from Holocene *Homo sapiens*. This study based on the morphological and metric characterization of dental tissues. The study of external morphology includes comparative morphology, classical morphometry, geometric-morphometric 2D analysis, crown size, and cusp proportions. We test a similarity and differentiation by metric and non-metric statistics analysis, to observe group clustering among the samples. The result shows there are at least four groups of hominins during Pleistocene time. This result suggested there are groups that seem to be overlapping and appear chronologically throughout the Lower to the early Middle Pleistocene, another group was survived to the Late Pleistocene, and two other groups of *Homo sapiens* were present during Holocene. The implication of this study shed light on the history of ancient human occupation in the Island of Southeast Asia during the Quaternary period.

SOMMARIO

Le isole della parte occidentale dell'arcipelago indonesiano sono state colpite dai cambiamenti climatici e del livello del mare durante il Pleistocene, che potrebbero influenzare le dispersioni e / o l'isolamento degli ominidi in questa regione. Questo studio mira a caratterizzare la diversità delle antiche popolazioni umane nel Sundaland sulla base di collezioni dentali, che provenivano da diverse località di Sumatra e Java. Il materiale di questo studio è costituito da 715 denti di raccolta mascellare e mandibolare, costituiti da 290 denti di ominine pleistoceniche e 425 denti da Holocene *Homo sapiens*. Questo studio si basa sulla caratterizzazione morfologica e metrica dei tessuti dentali. Lo studio della morfologia esterna comprende la morfologia comparata, la morfometria classica, l'analisi 2D geometrico-morfometrica, la dimensione della corona e le proporzioni cuspid. Testiamo una somiglianza e una differenziazione mediante analisi statistiche metriche e non metriche, per osservare il raggruppamento di gruppi tra i campioni. Il risultato mostra che ci sono almeno quattro gruppi di ominine durante il periodo pleistocenico. Questo risultato ha suggerito che ci sono gruppi che sembrano sovrapporsi e appaiono cronologicamente in tutto il Pleistocene inferiore-medio-antico, un altro gruppo è sopravvissuto al tardo pleistocene e altri due gruppi di *Homo sapiens* erano presenti durante l'Olocene. Le implicazioni di questo studio hanno fatto luce sulla storia dell'antica occupazione umana nell'isola del sud-est asiatico durante il periodo quaternario.

RINGKASAN

Pulau-pulau di bagian barat kepulauan Indonesia terkena dampak perubahan iklim dan permukaan laut selama kala Pleistosen yang memengaruhi penyebaran dan/atau isolasi hominin di wilayah tersebut. Tujuan dari penelitian ini adalah untuk mengkarakterisasi keragaman populasi manusia di kawasan Sundaland berdasarkan koleksi gigi yang berasal dari beberapa situs di Sumatra dan Jawa. Bahan penelitian ini adalah 715 gigi koleksi rahang atas dan rahang bawah, terdiri dari 290 gigi hominin Pleistosen dan 425 gigi *Homo sapiens* Holocene. Penelitian ini didasarkan pada karakter morfologis dan metrik rancang bangun gigi. Studi tentang morfologi eksternal mencakup analisis komparasi morfologi, morfometri klasik, 2D geometri-morfometrik, ukuran mahkota dan proporsi kuspis. Kami menguji kesamaan dan perbedaan dengan analisis statistik metrik dan non-metrik, untuk mengamati pengelompokan grup di antara sampel. Hasilnya menunjukkan setidaknya ada empat kelompok hominin selama kala Pleistosen. Hasil ini juga menampilkan adanya group yang tumpang tindih dan muncul secara kronologis sejak Pleistosen Bawah hingga awal Pleistosen Tengah, sedangkan kelompok lain bertahan hingga Pleistosen Akhir, dan ada dua kelompok *Homo sapiens* yang hidup di kala Holosene. Implikasi dari penelitian ini menjelaskan sejarah penghunian manusia di Asia Tenggara Kepulauan selama periode Kuartar.

INTRODUCTION

1. The study of hominin teeth from Indonesian

Teeth are the most frequently preserved part in the skeleton. More directly affected by the forces of natural selection, teeth are a reflection of genotype changes. Moreover, they are easy to process by quantitative methods (Brace, Rosenberg and Hunt, 1987). Teeth have been the subject of numerous paleoanthropological studies for a long time. They provide a wealth of information on human, including: cultural treatment, pathology, morphological variation, and development. An understanding of dental morphological variation among living humans has proven to be important for assessing biological relationships between recent groups (for a recent review, see Bailey and Hublin, 2007).

The study hominin teeth in Indonesia began when the two molars from Trinil excavation 1891 were published by Dubois in 1924 and attributed as a human relative named *Pithecanthropus erectus* (Dubois, 1924). Subsequently, Miller (Miller, 1923), Weidenreich (1937) and von Koenigswald et al., (1940) suggested the teeth came from an orangutan. Hooijer (1948) studied the prehistoric human teeth from Padang Highland, Western Sumatra that were found by Dubois during his first exploration (1888-1890). He stated that the teeth from Lida Ajer cave near Pajakombo do not allow a definitive determination, but it is less likely they were from a European or African than Asian population (Hooijer, 1948).

Based on the analysis of several mandibular and maxillary teeth from Sangiran, von Koenigswald and Weidenreich mentioned four different taxa: *Meganthropus palaeojavanicus*, *Pithecanthropus mojokertensis*, *Pithecanthropus dubius*, *Pithecanthropus robustus* (Weidenreich, 1945; von Koenigswald, 1950). Von Koenigswald (1954; 1960) and Tobias (1967) studied the *Pithecanthropus* and *Meganthropus* dental and mandibular remains from the Sangiran dome. The latter tried to understand the evolutionary trends within hominid teeth, including *Australopithecus*, *Homo habilis*, *Sinanthropus*, and *Pithecanthropus* from Java. He concluded that four degrees of hominization could be recognized in African and Asian samples during Lower to early Middle Pleistocene (Tobias, 1967): 1) *Australopithecus*, 2) *Homo habilis* and *Meganthropus*, 3) *Telanthropus*, *Pithecanthropus mojokertensis* and *Pithecanthropus robustus*, and 4) *Atlanthropus*, *Pithecanthropus erectus* and *Sinanthropus Pekinensis*.

Korenhof studied a large number of the 'prehistoric' *Homo sapiens* teeth collected from Sangiran dome by von Koenigswald between 1935-1940. Most of the specimens lack roots, and a significant percentage of the dentine had disintegrated, probably because of the weathering factor of tropical environments. Indeed, fragile dentine can be eliminated while preserving the enamel cap. Korenhof made comparative observations of the outer and inner structures of molars, such as the primary cusps, marginal ridges, foveas, and the crista (Korenhof, 1961; 1966; 1978; 1982). His observations on the enamel-dentine partition plane laid the groundwork for present-day endostructural dental studies using high resolution techniques.

Also during this time, Jacob (1967) studied the history of Indonesian populations based on skeletal and dental remains, and stated that the last *Pithecanthropus soloensis* was going extinct while the modern populations of *Homo sapiens* were descending from *Homo wajakensis*. This paleoanthropological work was continued by Widiyanto (1991; 1993), who

studied the diversity and evolution of the hominin fossils from Java. He illustrated the evolution of Javanese hominins during the Early-to-Middle Pleistocene through examination of the robustness index. From *Homo erectus* to *Homo sapiens*, the upper canine showed reduction of robustness and upper fourth premolar showed increased of robustness, but the lower teeth did not change. Both the upper and lower second molars shows the same pattern of evolution, becoming smaller, while the first molar increased in size over time (Widianto, 1991). In another cranio-dental study, Widianto suggested that over its 1 million-year history, Indonesian *Homo erectus* could be divided into “Robust”, “Trinil-Sangiran”, and “Solo” groups. However, this hypothesis is not supported by the dental remains of the Solo group (Widianto, 1993), because there is no dental collection from this latter group.

In the context of the description of *Homo erectus* definition between Africa vs Asia, Grine (1984) compared African and Asian hominin deciduous teeth to try to understand their evolutionary history. Then, Grine and Franzen (1994) did a comprehensive morphological and metric description of the fifty-two isolated hominin permanent teeth that von Koenigswald has been found on the surface of the Sangiran dome between 1937 and 1941. These teeth are now housed in the Naturmuseum Senckenberg, Frankfurt, and were catalogued as Sangiran 7 (7.1 – 7.52) by Jacob (1975). The specimens which came from the Pucangan/Djetis bed (Lower Pleistocene) are catalogued as Sangiran 7a and those from the Kabuh/Trinil bed (Middle Pleistocene) Sangiran 7b.

Various researchers sought to catalogue Indonesian human fossil collections. Jacob (1975) did the first comprehensive catalogue of early hominins and fossil *Homo sapiens*. This work was built upon by Aziz (2001), who added the Sartono’s dental collection in the Geological Research and Development Center, Bandung. Indriati (2004) catalogued the collection of Jacob housed in the Laboratory of Paleoanthropology and Bioanthropology, Gadjah Mada University, Yogyakarta. However, except for the study of Grine and Franzen (1994), these endeavors are mostly brief descriptions of the collections lacking morphological and morphometric detail. The last catalogue with comprehensive morphological descriptions was by Schwartz and Tattersall (2003).

Kaifu and his colleagues made a comprehensive study of the mandibular (n=8) and dental (n=84) Sartono’s collection found in Java between 1952 and 1986. They examined morphological differences between the older and younger chronological groups, and also investigated their affinities with hominin African and Eurasian groups. They traced the evolutionary history, specialization and extinction in Javanese *Homo erectus*. Their results indicated that 1) there are remarkable morphological differences between the different chronological groups, 2) the older group has some primitive features shared with the early African *Homo erectus*, and 3) the younger group is morphologically advanced, showing a similar degree of dentognathic reduction to the Middle Pleistocene Chinese *Homo erectus* (Kaifu *et al.*, 2005; Kaifu, Aziz and Baba, 2005).

Zanolli (2011) explored the endostructural character of Indonesian *Homo erectus* (n=17) using a high resolution technique and compared his results to ptecontemporaneous specimens from Africa. In 2012, he studied two human deciduous molars from the Sangiran dome, attributed them to the genus *Homo* (Zanolli *et al.*, 2012). Subsequently, Zanolli *et al.* (2014) identified the Arjuna 9 specimen as a pongin based on its endostructural character, but then referred this specimen to *Meganthropus palaeojavanicus* (Zanolli *et al.*, 2019). This study actually restored Widianto’s (1993) previous identification of this specimen as a robust *Homo erectus*.

Noerwidi (2012, 2017) reconstructed the final part of population history in Java based on a comparative morphometric study of prehistoric and recent mandibular teeth. He suggested a multiple-migration hypothesis into Java during the Late Pleistocene-to-Late Holocene: An Australo-Melanesian population (Latest Pleistocene), a Southeast Asian or 'Southern *Mongoloid*' population (Neolithic Austronesian, 3000 BP), and a 'gracile' population (early AD, perhaps from India). He also identified the SK5 specimen from Gunungsewu as the first representative of the island's Austronesian language speaker.

Based on these previous studies, the human population of Indonesian archipelago shows a great diversity in temporal and spatial distribution. In fact, there are very limited studies on the variability of human populations in this region based on dental evidence. On another hand, teeth are the most common and best preserved remains in the fossil record, and supposed to be important in our understanding about human evolution. This provides an opportunity to explore the variability of human populations in Indonesia based on dental evidence. In the wide perspective, addressing questions related to that diversity is not only a taxonomical position problem, but is clearly associated with the problem of early expansion from Africa into Eurasia and within Asia, also their isolation, adaptation and local evolution even coexistence with others population.

2. Scientific approach developed in this research

Based on the research background stated in the previous part, the research question of this work is as follows:

To what extent does dental metric and morphological variability reflect human evolutionary history, adaptations and dispersals in the western part of the Indonesian archipelago (Sundaland), especially during key stages of the Quaternary Period?

This research aims to develop an original approach to the human dental evidence recovered from the western part of the Indonesian archipelago during the Quaternary Period, from the Early Pleistocene to the Holocene, to characterize variability and understand its spatio-temporal distribution. In fact, since teeth are the most abundant fossils among the hominin collection from the region, they are scattered among various collections and institutions. Some fossils were found *in situ* in prehistoric excavations, others have a more or less reliable stratigraphical context, and others are surface finds, meaning that a proper revision of the material and their chronostratigraphy is important in order to build a reference collection. Some of the teeth have been the subjects of previous studies, but this work would represent the first comprehensive study of the entire human dental sample from the Early Pleistocene to the Holocene in Sundaland. Thus, beyond the study of isolated samples, this study will provide a better understanding of the evolutionary history of Pleistocene-to-Holocene hominins from the region.

The advantages of using dental remains in hominin phylogenetic studies have been discussed elsewhere (Turner, 1969; Irish, 1993, 1997, 1998; Bailey, 2000, 2002; Irish and Guatelli-Steinberg, 2003; Martínón-Torres *et al.*, 2006; Gómez-Robles *et al.*, 2008). For example, Bailey (2002) identified autapomorphic characters of Neanderthal postcanine teeth, such as an asymmetrical lingual crown outline, presence of a transverse crest, well-developed on the lower fourth premolar, and a continuous mid-trigonid crest on lower first and second molars (Bailey, 2002). Moreover, Bailey and Wood (2007) identified as plesiomorphic the

shovel shape of the upper lateral incisor in modern human populations because it is also present in Australopithecine and early *Homo* species. The morphology of the lower second premolar of *Homo sapiens* is derived compared to *Homo heidelbergensis* and Neanderthals (Bailey and Wood, 2007).

Ungar (2017) describes how teeth could reflect dietary change, identify species, and also determine the ancestors who went extinct or survived as well as the cultural transition from forager to farmer. He argues that distinctive wear patterns provide evidence about what ancient humans actually ate. This information, combined with paleoclimatological data, could demonstrate how a changing climate altered the food available to human ancestors (Ungar, 2017). In addition, Kaifu *et al.* (2015) argue for long term isolation and endemism as leading to the emergence of *Homo floresiensis*, which is distinctive in having both primitive canine-through-premolar and advanced molar morphologies, which is a combination of dental traits unknown in any other hominin species. The primitive aspects are close to the Early Pleistocene *Homo erectus*, whereas some molar morphologies are more derived than modern humans (Kaifu *et al.*, 2015).

The paleoenvironmental reconstruction of the western part of Indonesian archipelago suggests some conditions that would promote faunal diversity, favoring dispersals, contacts or isolation of populations depending on the period. Van Den Bergh, de Vos and Sondaar (2001) showed that some endemism may be reflected in the faunal record at a subspecies level. Similarly, we can expect that dental variability in this region may reflect isolation and/or gene flow depending on specific environmental conditions.

The breadth of morphological variation exhibited by *Homo erectus* fossils in Africa, Europe, and Asia has led some researchers to divide the fossil record into multiple lineages while others defend a single polytypic species (Schwartz, 2004). Andrews (1984), Wood (1992), Stringer (1996) point to some autapomorphic characters of Asian *Homo erectus* that distinguish them from early African *Homo*, such as: sagittal keeling, thickness of cranial vault, *torus angularis*, and separation between inion and endinion. Schwartz (2005), who did a large study on the Asian hominin record, suggested that *Homo erectus* is only represented by the Trinil skullcap and various specimens from Sangiran and different from other specimens recovered in Java and China (Schwartz, 2005). Thus, it is clear that the variability of hominins fossils is not well understood, and we should aim for a better characterization as well as a better understanding of their spatio-temporal distribution.

We suggest that teeth also help to address the question of an early appearance of “modern” character in Java. Zanolli (2011) described a lower left second molar from the Pucung site in the southern part of the Sangiran dome that was discovered in stratigraphic context. The geological layer from which it comes is correlated with the Kabuh formation (Purnomo *et al.*, 2014). Tooth morphology and stratigraphic context indicate that the specimen is a hominin that is tentatively attributed to *Homo erectus* (Zanolli, 2011), but the discussion is still open. Based on our preliminary observation to the dental collection from the Kabuh Formation, we suggest a different interpretation and it is very important to identify the first appearance of modern dental morphology in Indonesia.

Anatomically modern humans might have arrived in Java in the early of Late Pleistocene, which is associated with a tropical rain forest environment. Storm *et al.* (2005) found a *Homo sapiens* upper left third premolar in von Koenigswald’s Punung collection. Westaway *et al.* (2007) relocated the Punung fauna contained in the dated breccia that was

dated to the early Last Interglacial, between 128 ± 15 and 118 ± 3 Ka. They concluded that the use of metric characters to separate *H. erectus* from *H. sapiens* is problematic (Storm *et al.*, 2005) because of the large deviation of the sample. In this study I will characterize the dental variability of the Quaternary Sundaland populations and will discuss different evolutionary scenarios, including the possibility of an early arrival of modern humans in this region.

Because of these issues and questions, it is appropriate to develop a study on **hominin diversity in the western Indonesian archipelago during the Quaternary, based on dental record perspective**. Such a study would lead to a better understanding on the history of ancient human migrations in this archipelago during the Early Pleistocene-to-Late Holocene, from the first appearance of early humans to the extinction of *Homo erectus* and the emergence of early anatomically modern *Homo sapiens*.

3. Materials and methods

This research will result in a comprehensive database of all human dental collections from Java, specimens of which are housed in 7 different institutions in Indonesia and Europe: The Sangiran Museum, Balai Arkeologi Yogyakarta, Geological Museum Bandung, Gadjah Mada University Yogyakarta, Institute of Technology Bandung, Naturmuseum Senckenberg Frankfurt, and National Museum of Natural History Leiden. The specimens represent (mostly fragmentary) 15 maxilla, 19 mandibles and 102 isolated teeth. The Pleistocene sites are Rancah (West Java), Sangiran and Patiyam (Central Java), and Trinil and Kedungbrubus (East Java).

This comparative study will also included *Sinanthropus* teeth, which are the Pleistocene hominins from the Zhoukoudian Lower Cave (China), the nearest Mainland Asia region. The Holocene *Homo sapiens* teeth are from the Insular Sundaland region (Java and Sumatra), including Tamiang and Sukajadi shellmidden sites (Northern Sumatra), Gua Harimau (South Sumatra), Gua Pawon (West Java), Gua Kidang (Central Java), Gua Braholo and Song Tritis (western part of Southern Mountains), also Song Keplek and Song Terus (eastern part of Southern Mountains). A collection of *Sinanthropus* dental casts is housed in the Institut de Paléontologie Humaine, Paris, and original Holocene *Homo sapiens* collections are housed in Museum Si Pahit Lidah (South Sumatra), Balai Arkeologi Bandung (West Java), Balai Arkeologi Yogyakarta, Gadjah Mada University Yogyakarta, and Laboratory of Gunung Sewu, Pacitan (East Java). In the end, this study will include 715 teeth, consisting of 290 teeth from Pleistocene hominins and 425 teeth from Holocene *Homo sapiens*.

The Holocene *Homo sapiens* samples used in this study are important because, in contrast to specimens referred to *Homo erectus*, and some have only been superficially studied and most are unpublished.

This study will be based on a morphological and metric characterization of the teeth to reconstruct the diversity and evolutionary history of ancient human populations in the western Indonesian archipelago. The study of external morphology will include:

- a. Comparative morphology
- b. 2D morphometry
- c. Geometric-morphometrics analysis
- d. Crown size and cusp proportions

These approaches serve different functions in achieving the goal of the proposed research. Morphological comparisons and 2D morphometry are amenable to multivariate analysis, which is important for distinguishing between fossils and characterizing groups or populations. Geometric-morphometrics analysis tests group characterizations with regard to specimens of differing size. Crown size and cusp proportions can help identify the dynamic and morphological changes in evolutionary and chronological contexts.

4. The research steps

As the preliminary step on the comparative analysis, this research will start with a case study on the second molar of Javan hominin. This very beginning step will analyze the second upper and lower molar in order to split the Pleistocene Javan hominin fossil record into different groups. Then, the study will extend the observations to comparing the groups on the other tooth class (e.g. upper and lower incisor, canine, premolar, first and third molar), also by the other analytical approaches.

The first step is morphological comparison, which will include only teeth with a wear pattern lower than Grade 5 (Molnar (1971)). Most crown morphological traits are those specified in the Arizona State University Dental Anthropology System (Turner, Nichol and Scott, 1991) [also Hrdlička (1920), Dahlberg (1956), Scott (Scott, 1973, 1979, 1980), Scott and Turner (1997), Harris and Bailit (1980), Nichol *et al.* (1984), Mizoguchi (1985), Carlsen (1987), Kanazawa *et al.* (1990), and Turner *et al.* (1991)]. Also used will be modifications of morphological trait identification for early hominins suggested by Martinon-Torres *et al.* (2008; 2012) in order to better cover the variability observed in non-*sapiens* species.

For upper and lower incisors, eight characters will be evaluated: labial convexity (Nichol, Turner and Dahlberg, 1984; Martín-Torres *et al.*, 2012), shovel shape (Hrdlička, 1920; Scott, 1973; Mizoguchi, 1985), tuberculum dentale (Scott, 1971; Carlsen, 1987), cingulum interruption groove, lingual fossa, mesial and distal marginal ridges, and marginal interruption groove. For upper and lower canines, eight characters will be evaluated: shape (Martinon-Torres *et al.*, 2012), tuberculum dentale (Scott, 1971; Carlsen, 1987; Martín-Torres *et al.*, 2012), lingual ridge or essential crest, mesial and distal accessory ridges (Martinon-Torres *et al.*, 2012), cingulum interruption groove, mesiolingual and distolingual fossae. For upper and lower premolars, 12 characters will be evaluated: shape, transverse crest, buccal and lingual essential ridges (Martinon-Torres *et al.*, 2012), mesial and distal triangular fossae, mesial and distal marginal ridges, and mesial and distal accessories cusps.

Fourteen lower molar features will be evaluated: middle and distal trigonid crests, anterior and posterior foveae (Martín-Torres *et al.*, 2012), defecting wrinkle, C5, C6, and C7 size, groove pattern, protostylid from ASUDAS (Turner, Nichol and Scott, 1991), number of cusps, crenulation, mesial and distal marginal ridges. Sixteen upper molars characters will be evaluated: crista obliqua, transverse crest, mesial marginal accessory tubercle, anterior and posterior foveae (Martín-Torres *et al.*, 2012), metacone, hypocone, and metaconule size, Carrabelli's cusp, parastyle from ASUDAS (Turner, Nichol and Scott, 1991), number of cusps, buccal and lingual accessories cusps, crenulation, mesial and distal marginal ridges.

The second step will include measurement of mesiodistal (MD) length and buccolingual (BL) width [following Wolpoff (Wolpoff, 1971)], using a standard sliding caliper and recording to the nearest 0.1 mm. MD length is the maximum distance between mesial and distal

margins, and BL width is the maximum distance between buccal and lingual margins, with the tooth in anatomical position (Martinón-Torres *et al.*, 2008).

The statistical software that will be used for both morphological comparisons and morphometric analysis is PAST (Hammer, Harper and Ryan, 2017) which is a free open source software developed for paleontologists, that provides Boxplot presentations with mean and standard error of univariate comparison for metric data, and classical clustering multivariate analyses for non-continuous and non-metric data with Manhattan distance. This method – inspired by a Manhattan city block – which is defined as the distance between two points in Euclidean space within a fixed Cartesian coordinate system (Dalfó, Comellas and Fiol, 2007; Dahal, 2015), sums the projection lengths of the segment between the points of each specimen into the coordinate axes.

Those metric and non-metric comparative study in this research will start with a case study on the upper and lower second molar of Javan hominid. The use of the tooth class for this case study is because of the most presence teeth compared to the other teeth class, and based on some significance reasons as stated previously by some researcher e.g. Widiyanto (1991; 1993), Kaifu *et al.* (2005), and Noerwidi (2012; 2017). The purpose of this case study is to propose a hypothesis about Javan hominin variability and to apply the hypothesis to more wide samples in the term of geographically and chronologically with *Homo sapiens* from the Sundaland and Zhoukoudian *Homo erectus*. The same protocol of metric and non-metric comparative study will apply on the other teeth class in order to confirm or reject the hypothesis produced by the case study.

The third step is the comparative analysis of cusp size and proportion on the occlusal surface, which is a method already employed by some researchers (Bailey, 2004; Moggi-Cecchi and Boccone, 2007; Quam, Bailey and Wood, 2009; Gómez-Robles *et al.*, 2011; Martinón-Torres *et al.*, 2013). This approach is adopted for all upper and lower premolars and molars in the same anatomical orientation (right mandibular teeth and left maxillary teeth). The protocols are to measure the absolute and relative development of primary cusp area and circumference, absolute and relative distance between cups and absolute and relative angle of primary cusp horns.

Basic descriptive statistics and Principal Component Analysis (PCA) of crown and cusp base areas will be used to investigate absolute and relative cusp size differences between hominin groups. The PCA uses correlation matrix between groups. The scatter plot only uses the first two most significant Eigenvalues with a high percentage of variance. Then, the scatterplot representation uses convex hull to limit the distribution of the groups.

The last step of the study uses Geometric-Morphometric Analysis (landmark-based GMA) to explore within- and between- taxon variation. The idea is to digitize the edge of the occlusal surface (Bae *et al.*, 2014). This approach will be used on all upper and lower premolars and molars in the same anatomical orientation. Eight landmarks will be for upper and lower premolars, and 18 and 24 landmarks applied for lower and upper molars, respectively. Geometric semi-landmark analysis will use 32 sliding points of the occlusal perimeter limit digitized clockwise from the first cusp of upper and lower premolars and molars.

5. The structure of the manuscript

This manuscript will consist of six main parts.

Chapter 1) Sundaland and its environment, and a geographical overview of western Indonesia, especially Sundaland, including Sumatra and Java. Tectonics and volcanics correlated with the formation time and factors underlying the emergence of Sundaland. Climatic and physiographic dynamic regarding glacial-interglacial cycles and landscape changes correlated with migration. Geological conditions and stratigraphy regarding primary lithological formation and chronological correlation. The palaeoenvironmental condition regarding floral variation and biostratigraphy that are correlated with faunal succession and human migration. This chapter will conclude with a brief overview of the emergence of the genus *Homo*, the initial human occupation of Sundaland during the Early Pleistocene, early anatomically modern humans of Southeast Asian islands during the Late Pleistocene, and the Holocene populations of the archipelago.

Chapter 2) The general condition of the prehistoric sites and human dental collections. The presentation of the sites will be divided into the geo-physical zones of Java and Sumatra Islands. The central zone of Java: sites along Bogor-Kendeng Mountains and great central depression, including Trinil and Kedungbrubus at Kendeng, Sangiran Dome at the Solo depression, Rancuh at the Bogor anticlinal zone, and Gua Pawon at the Bandung Highland. Northern zone of Java: Patiyam Dome at the Muria Mountain slope and Gua Kidang at the Rembang karstic mountains. The Southern Mountain of Java: sites in the Gunungsewu and Campurdarat Karstic Mountains, including Gua Braholo and Song Tritis at the western part of Gunungsewu, Song Terus and Song Kepek at the eastern part of Gunungsewu, and Wajak in the Campurdarat karstic mountains. The southern Sumatra zone: includes Gua Harimau at the Baturaja karstic region part of the Barisan Mountains, and the northern Sumatra zone consists of shellmidden sites located at the northern basin of Sumatra, including Tamiang and Sukajadi Pasar.

Chapter 3) Materials and methods of analysis, e.g. basic dental terminology, a summary of the material, and the technical analysis. Basic dental terminology: tooth definition and orientation; the cusps and occlusal landmarks. Materials: summary of upper and lower jaw teeth. The four analytical approaches: a) the scoring of non-metric or morphological characters, b) classical morphometrics, c) comparison of crown size and cusp proportions, and d) geometric-morphometric comparisons.

Chapter 4) Results following the presentation in Chapter 3.

Chapter 5) Dental type diversity, including four early hominin Early-to-Middle Pleistocene groups, and three Late Pleistocene-to-Holocene *Homo sapiens* groups. Interpretation results, including the chronology of human occupation in Sundaland, from the Early Pleistocene to the Late Holocene. Groups diversity in their faunal and floral palaeoenvironmental context, including habit and culture as adaptations. Reconstructing the origin and evolution of human populations in the archipelago, including dispersal and interaction during the glacial period; isolation, adaptation, and local evolution during the interglacial period.

Chapter 6) Conclusion and perspectives.

6. The milestones

Recent East and Southeast Asian human fossils (e.g. *Homo floresiensis* (Brown *et al.*, 2004), the Denisovans (Meyer *et al.*, 2012), and *Homo luzonensis* (Détroit *et al.*, 2019)) appear to reflect extreme variability of ancient human populations in the region. In terms of recent human genetic variation, more than 90% of East Asian (EA) haplotypes are found in Southeast Asian (SEA) or Central-South Asian (CSA) haplotypes, and with the diversity decreasing from south to north. Furthermore, 50% of EA haplotypes are found in SEA and 5% in CSA, indicating that SEA was a major geographic source of EA populations (The HUGO Pan-Asian SNP Consortium, 2009). Based on external dental characters, this study contributes to a better understanding of the history of human occupation in the Southeast Asian archipelago during the Quaternary.

CHAPTER 1. SUNDALAND AND ITS ENVIRONMENT

A. GEOGRAPHY AND GEOLOGY OF THE SUNDALAND

Sundaland, the area study of this research, is generally known as a large landmass area that would become available southwards from the Gulf of Thailand down the Malaysian Peninsula to Sumatra and Java and then north-eastwards via Borneo and fingering out towards the Philippines (Voris, 2000). Our study will be focused on Sumatra and Java, two primary islands on the west and south of Sundaland which produced a huge amount of palaeoanthropological data since almost 2 Ma to the recent times, and in geographical point of view both islands has strategic position in the history of ancient human evolution and migration, "Out of Africa".

1. Human and physical geography of western Indonesia

Indonesia is a tropical archipelago, which is covering an area of 5,000 km between 95° to 141° E, and 6° N to 11° S, and consists of 17,504 islands scattered over both sides of the equator. This archipelagic physiography condition was causing isolation and responsible to stimulates the endemic species, which makes this region as one of the richest on biodiversity. As the focus area of this study, Sumatra and Java are two of five big primary islands in the Indonesian archipelago (Fig. 1. A.1), which connected by shallow Sunda strait together with Krakatoa volcanic islands. The longest axis of Sumatra runs approximately 1,790 km northwest-southeast, crossing the equator near the center. At its widest point, the island spans 435 km (Whitten and Damanik, 2012). Java, located at the south of the equator with east-west elongated parallel to the line, has about 1,000 km long and up to 210 km wide. The island's longest river is the 600 km long Bengawan Solo River (Soeriaatmadja and Afiff, 1997), famous with Pleistocene sites along the bank. The river rises from its source in Central Java at the Lawu volcano, then flows north and eastward to its mouth in the Java Sea near the city of Surabaya, East Java.

Java is the most populated island in the world as home to 57% of the Indonesian population, with 145 million people (including Madura's 3.7 million) and over 1,100 people per km². Sumatra is not particularly densely populated by about 58.5 million people in total, with 123.46 people per km² in the 2019 census (Na'im and Syaputra, 2019). Because of its vast extent, it becomes the fifth most populous island in the world. Sumatra has over 52 ethnic groups with their languages spoken, belongs to the Malayo-Polynesian of the Austronesian language family. The language family is divide into several main sub-branches: Acehnese (Chamic), Malayic, Northwest Sumatra-Barrier Islands, Lampungic, and Rejang (Bornean). Northwest Sumatra-Barrier Islands and Lampungic branches are endemic to the island (Whitten and Damanik, 2012). In contrast to Sumatra, Java is comparatively homogeneous in ethnic composition. Only two ethnic groups are native to the island; the Javanese and Sundanese. The third group is the Madurese, which has immigrated to the east hook of Java since the 13th century. Other ethnic groups include Betawi (spoken Malay dialect), Osing, Banyumasan, and Tenggerese (Javanese), Baduy (Sundanese), Kangeanese (Madurese), and Balinese (Soeriaatmadja and Afiff, 1997).

The human occupation process in the western part of Indonesian archipelago has a long history, since the first arrival of *Homo erectus* in the Early Pleistocene, through the

emergence of the early anatomically modern human, to the Holocene occupation, and the recent Austronesian as the modern inhabitant. For more than a hundred year since the 1890s Dubois expedition in Sumatra and Java, many scholars try to find a light about the human evolution story from this region. Since those times, Java started as a famous place with its palaeoanthropological finds from the Early Pleistocene layer, mainly from the eastern part of the island. As opposite, while geologically Sumatra is the same or even older than Java but this island is poor on palaeoanthropological record, except some human remains found from the cave sites and kitchen midden from Late Pleistocene and Holocene periods

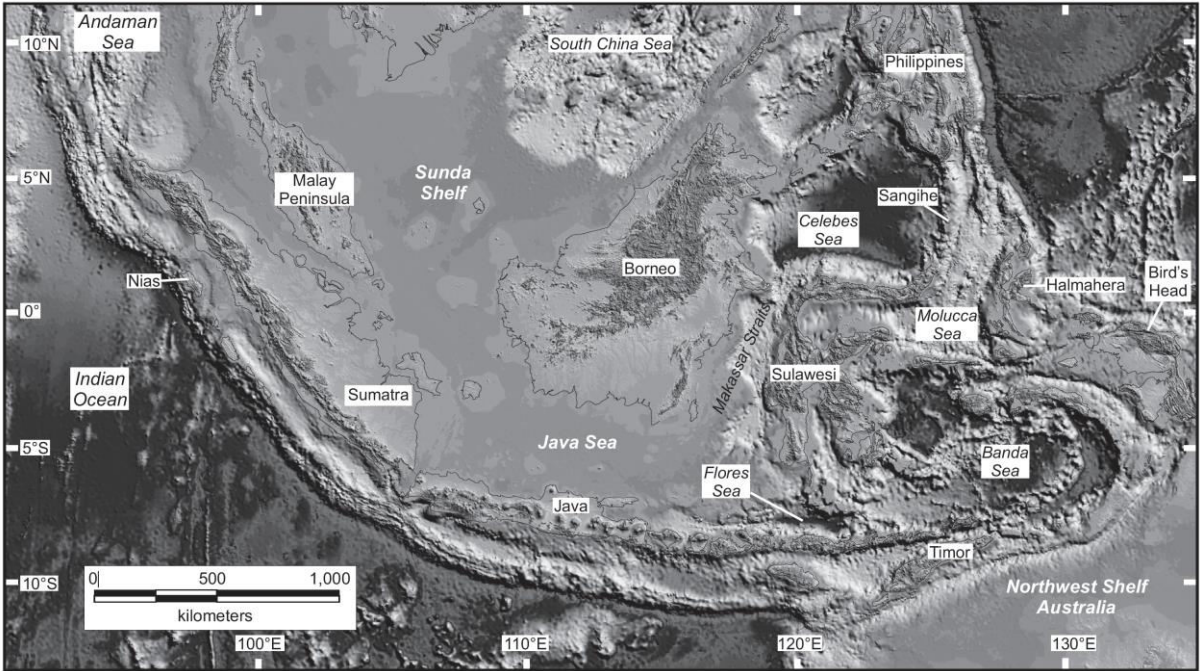

Fig. 1. A.1. Position of Sumatra and Java Islands in the Sundaland, western part of Indonesia (Hall and Smyth, 2008).

2. Tectonics, volcanics, and formation of western Indonesia

The Indonesian archipelago is constructed by three major continental plates: Eurasian on the northwest, India-Australian on the southeast, and Pacific-Philippine microplate on the northeast. This archipelago located at three different biogeographical regions, Sundaland in the west, Sahulland in the east, and Wallacea zone in between. Sundaland is the southeastern part of Eurasian continent, at the same time Sahulland is the northern part of Australian continent, and in between are Wallacean archipelagoes which separated by a deep water barrier and never connected although in the maximum glacial period when the sea level down to 125 meters below the present condition (Hall, Clements and Smyth, 2009), which make human and faunal migration in the past should across this barrier.

Sumatra and Java Island are situated on the west and south of Sundaland, located at the southeastern edge of the Eurasian continent (Hamilton, 1979). It is bordered by tectonically active zones characterized by intense seismicity and volcanism resulting from subduction (Hall, Clements and Smyth, 2009), see Fig. 1. A.2. Broadly, from north and east to south and west of the island's geology is characterized by sedimentary basins in the north and east, the Barisan mountains in Sumatra and Bogor-Serayu-Kendeng mountains in Java, the volcanic back-arc, Sumatran and Java fault, running along the length of the island near the south and west coast, the fore-arc basins, the non-volcanic fore-arc high (Simeulue-Enggano ridge and Nusakambangan-Nusabarung), the deep trench, and the subducting oceanic plate (Van Bemmelen, 1949). Those geological conditions, especially the sedimentary filling basins have recorded the history of human occupation in this region.

Study of geological profile across Sumatra and Java arc trench systems reveal that large islands of the inner volcanic arc were formed due to the subduction of an oceanic plate under a thick and old continental crust (Katili, 1975). Bellier and Sébrier (1994) show the relationship between volcanic and tectonic structures in Sumatra. They suggest the formation of huge, peculiarly shaped, volcanic calderas that have occurred in massive releasing step over fault zones, such as Ranau Lake and Toba caldera (Bellier and Sébrier, 1994). This fault zone is corresponding to the formation and development of volcanic arc in Java and Sumatra Island which affects human life.

The volcanic arc or ring of fire is a string of volcanoes composed by 400 volcanoes, around 130 are active (mostly in Java) that runs through Sumatra, Java, Bali and Nusa Tenggara, and then to the Banda Islands of Maluku to northeastern Sulawesi. Volcanic ash has made agricultural conditions unpredictable in some areas. However, it has also resulted in fertile soils, a factor in historically sustaining high population densities of Java and Bali (Lebon, 2009). The volcanic eruption also has an influence on the history of human occupation in this region. The biggest eruption of Toba supervolcano in northern Sumatra some 74 Ka was the largest explosive eruption of the past two million years, with a Volcanic Explosive Index of magnitude 8 (Chesner *et al.*, 1991). It is believed caused a global volcanic winter and cooling of the climate (Ambrose, 2000), and subsequently led to a genetic bottleneck in human evolution (Ambrose, 1998), although this impact is still in debate (e.g., Gathorne-Hardy and Harcourt-Smith, 2003; Louys, 2012).

The understanding of tectonic movement in Sundaland contributes to predicting when the landmass was possible to be occupied by early hominins and how the palaeoenvironmental condition of the places has been supporting to be the ecological niche

for the hominins. Human existence and their adaptation in the 'ring of fire' could be affected by the volcanoes, not only in the recent period which provides a fertile landscape for development of the agriculture but also in the ancient times which expected to stimulate of human migration and human population 'bottleneck' in the region, e.g., Toba supervolcano. The volcanic activities were not only vanishing the early hominins and their culture, but the sediments also could be conserved the evidence of the ancient civilization. The still ongoing tectonic process raises the ancient sediments from the lower level so that it is making possible to found and to study.

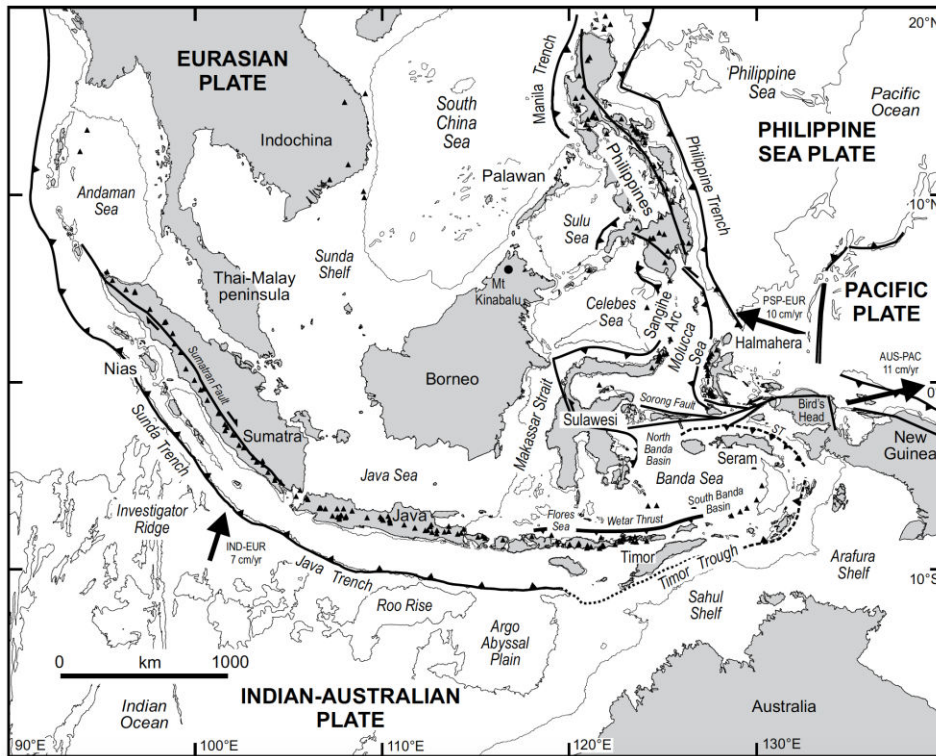

Fig. 1. A.2. Geography of Southeast Asia and surrounding regions showing present-day tectonic boundaries and volcanic activity. Bathymetric contours at 200 m and 5.000 m (Hall, 2009).

3. Climatic cycles and physiographic dynamics

The physiographical condition of western part of Indonesian archipelago or the Sundaland, now separated by shallow sea, is very sensitive to the climatic change during the Quaternary period since 2.6 Ma. Major change in global climate are manifestation of a response to some variations amount of solar radiation received at the surface of the Earth, called 'the Milankovitch cycle' (Hope, 2005). The principal components of the theory are: 1) the precession of the equinoxes (apparent movement of the seasons around the sun) with a periodicity of ~19–23 Ka, 2) the obliquity of the ecliptic (variations in the tilt of the Earth's axis) with a periodicity of ~41 Ka, and 3) the eccentricity of the orbit (changes in the shape of the Earth's orbit) with a periodicity of ~100 Ka (Lowe, Walker and Porter, 2013).

The transition of Gelasian and Calabrian stages in the Lower Pleistocene, around 1.8 Ma with magnetostratigraphically the end of the Olduvai chronozone (Cohen, Finney, and Gibbard, 2013), is a very important period in the history of human colonization in the Island Southeast Asia. Around this period, the western part of Java was already formed, but a large part of eastern Java was still below the water level, and the emersion process was started by the helped of the sea level drops during the several glacial periods in the Pleistocene times. *Homo erectus* reached Java island from the Asian continent just after this time and became one of the oldest islanders in the world (Sémah et al., 2000).

During the transition of Lower (Calabrian) to Middle Pleistocene in 0.78 Ma with the transition of Milankovitch cycle 41 Ka to 100 Ka, and the transition of Matuyama-Brunhes Magnetostratigraphy boundary, there was a terrible climatic change. Around 0.8 million years ago, sea-level fluctuations started to become more pronounced with minimum sea levels down to 120 m below the present level. During such events, migrations to Java could take place easily, because sea-level decrease to 40 m, enough to connect Java, Sumatra and Borneo with the mainland (Sathiamurthy and Voris, 2006). These contacts are documented by faunal migrations and a larger number of *Homo erectus* fossils in Java (Widianto, 1993), also the dissemination of Acheulean traditions (Simanjuntak, Sémah and Gaillard, 2010). This pronounced climate changes may have allowed the intermittent dispersals of hominins from continental Asia as far as the Flores Island (Morwood et al., 1998).

The transition of Middle and Late Pleistocene is signed by the base of the *Eemian* phase or well known as the last interglacial maximum before the final glacial episode of the Pleistocene around 126 Ka (see Fig. 1. A.3). At the beginning of the Late Pleistocene, MIS 5 characteristic climate in Java is linked with a tropical rain forest fauna (including Pongo). The Late Pleistocene correlated to the Upper Paleolithic stage of human development, including the dispersal of anatomically modern humans, Out of Africa migration, and the extinction of the last remaining archaic human species. In this chronological context, our understanding of the Late Pleistocene and the earliest *Homo sapiens* in Indonesia is very limited. On the other hand, the age of the latest appearance of *Homo erectus* is a source of hot debates (for example, see Yokoyama et al., 2008). Storm et al. (2005) describe a hominin fossil, identified as *Homo sapiens*, in association with the tropical rainforest assemblage of Punung fauna from Java. In Sumatra, Westaway et al. (2017) identified the existence of the modern human in the tropical rain forest of Sumatra between 73 and 63 Ka.

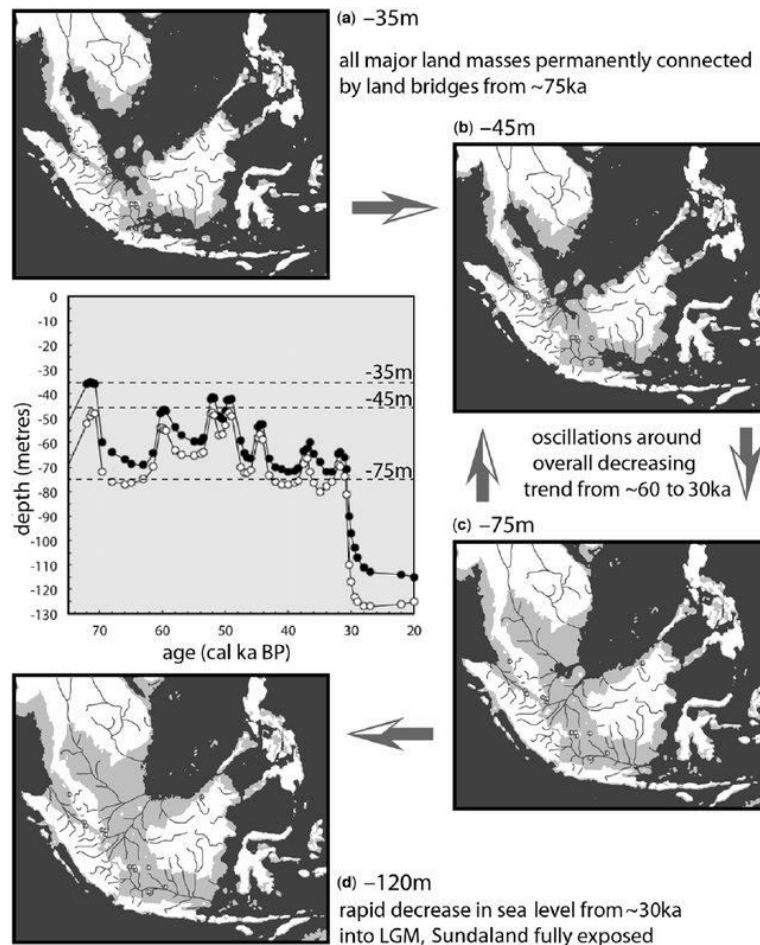

Fig. 1. A.3. Changing Sundaland palaeogeography during the time of earliest colonization by anatomically modern humans (AMH) until the Last Glacial Maximum (Wurster and Bird, 2016).

During the transition of Pleistocene to Holocene, approximately 11.7 Ka (Cohen, Finney, and Gibbard, 2013), there was the last significant climatic change, which correlated to the final melting of the ice sheet, and the glacial retreat happens after the last glacial period. The Holocene has been identified with the current warm period or interglacial period, known as the MIS 1 (Miller *et al.*, 2013). Holocene sea-level transgressions followed by submerged depressions on the Sundaland (Sathiamurthy and Voris, 2006). The configuration of the Indonesian archipelago toward this modern condition and the migration of the human population during this period should occur across the sea barrier.

The Holocene is identified as a separate epoch, not only because the climate of the present interglaciation is particularly noteworthy, but also it was the period when humans became significant agents of geological change (Miller *et al.*, 2013). The major driving force behind these postglacial adaptations was the changing environmental conditions associated with deglaciation and climatic amelioration, which created new territories for human settlement, new supplies of food and raw materials for subsistence, new technological demands for tools, shelter, and transport, and new opportunities for population growth (Bailey, 2007). In the Indonesian archipelago, the human population during this period changes their activity orientation from open-air to natural niches, such as caves and rock shelters, and they develop specific technology and subsistence in order to survive in the tropical rain forest environment (Simanjuntak and Sémah, 2005).

4. Geology and stratigraphy

The presentation of geology and stratigraphical aspect in this part aims to give a short description on the general narrative on the research area. The presentation is focused at the Sangiran dome from the central depression zone of Java, a tectonic uplift dome which recovered the most productive and long chronological human remains in Island South East Asia, and as the primary site in this research. The stratigraphical correlation between Sangiran and other hominin sites in Java will be presented with some references of the previous studies (e.g. Zaim, Rizal and Aswan, 2007). The geology and stratigraphy of Sangiran have been described since the 1930s by van Es (1931), von Koenigswald (1934), and updated by some scholars up to now.

The stratigraphy series in the Sangiran dome begins with the upper part of Kalibeng or Puren Formation dated from Upper Pliocene. However, the lower part of Kalibeng Formation is not visible on the site. Chronometric dating from the diatoms of the Upper Kalibeng suggested an age of 2.5-2.4 Ma (Ninkovich and Burckle, 1978). Kalibeng Formation is paralleled with the Kaliwungu Formation in West Java, Kalibiuk Formation in Bumiayu and Semedo, Jambe Formation in Patiayam dome, Klitik Formation in Sambungmacan, and Kalibeng Formation in Trinil and Perning in the eastern part of Kendeng Mountain (Zaim, Rizal and Aswan, 2007), see Table 1. A.1.

The main facies of Kalibeng Formation consists of blue clay and gray clay with *Turritella*, often rich in organic matter, which contains several times of silt rich in foraminifera and mollusks (Sémah F., 1984). At the top of this Formation, there is a coastal limestone bank rich with *Balanus* fossils (Van Es, 1931). This characterizes shallow marine facies corresponding to a regression phase (von Koenigswald, 1934). This limestone represents the level of transition with the following layer, a yellowish pyroclastic sandstone deposit of *Corbicula exprorecta* that suggests the first freshwater levels (Lizon-Sureau, 1979). A recent palaeoenvironmental study by Faylona (2019) suggested an alteration from a shallow marine environment into lotic aquatic vegetation with a mixture of the nearshore sublittoral environment due to regression. Palaeoclimatic evidence shows a transformation from a warm climate with the wet condition into a dry climate with reduced precipitation (Faylona, 2019). So far, there are no terrestrial vertebrate fossil, human remains, nor artifact.

The Pucangan or Sangiran Formation is dated to Lower Pleistocene, begins with volcanic breccia and lahars of variable thickness, and separated by a few meters of clay deposits with the *Corbicula* bed (Sémah F., 1984; Sémah F., Sémah A-M. and Djubiantono, 2001). These layers deposited between 1.9 Ma (Bettis III *et al.*, 2004) and 1.67 Ma (Sémah *et al.*, 2000). The Sangiran Formation is correlated with the Citalang Formation in West Java, Kaliglagah Formation, and Mengger Series in Bumiayu and Semedo, Kancilan Formation in Patiayam dome, and Pucangan Formation in Sambungmacan, Trinil and Perning in the eastern part of Kendeng Mountain (Zaim, Rizal, and Aswan, 2007). The presence of volcanic breccia and lahar in the Sangiran Formation reflects the development of volcanic activity in the region during those times. In the lahar level were found the oldest fossils of continental vertebrates of Sangiran (Van Es, 1931). Aquatic bivalve and gastropod molluscs of Pucangan lower lahar represent a basin with lagoons and near-shore environments, which shows the driest period (Faylona, 2019).

Lahar is followed by black clays of marsh and lacustrine sediment, which eleven times intersected by volcanic ash layers (Lizon-Sureau, 1979). Clay deposits are rich in organic matter, suggesting a deposit close to a lacustrine environment. Two diatomites layers have been observed, suggesting at least two marine transgressions occurred at that time (Sémah F., 1984). Palaeoenvironmental evidence from the Pucangan black clay represents a lowland habitat with mud substrate type in flowing water. The layer started with a series of wet climate and ended with dry climate periods, which represents the increased precipitations (Faylona, 2019). Vertebrate fossils have been found as well as hominin remains (von Koenigswald, 1940; Sartono, 1982; Aimi and Aziz, 1985; Widiyanto, 1993).

The transition between Pucangan and Kabuh Formations in Sangiran is a calcified conglomerate layer with mixed marine features and gravel from the erosion of the Kendeng and Southern Mountains, named as "Grenzbank" (von Koenigswald, 1940). However, this layer is not observable on all sections of the Sangiran dome (Sémah F., 1984) nor other Pleistocene sites. These facies mark a drastic change in sedimentation because the final filling of the lagoon characterizes it. After the formation of Pucangan, the marine influence disappears definitively and continued by the continental deposits (Sémah F., Sémah A-M., and Djubiantono, 2001).

The Grenzbank and Kabuh Formation consist of volcanic deposits and synorogenic deposits from the Kendeng and Southern mountains, which rising again since 0.9 Ma (Van Bemmelen, 1949; Sémah F., 1984). The volcano-sedimentary formation of Kabuh Formation is composed of clays gravel and fluvial sand with crossbedding stratification. In the coarse fraction, small translucent chalcedony pebbles that served as raw material for Sangiran flakes were observed as well as tectites and pumice (Sémah F., 1984). Kabuh or Bapang Formation in Sangiran is paralleled to the Gintung Formation in Bumiayu and Semedo, Slumprit, and Kedungmaja Formations in Patiayam, and Kabuh Formation in Sambungmacan, Trinil and Perning in the eastern part of Kendeng mountain (Zaim, Rizal and Aswan, 2007). Kabuh Formation in Sangiran dome becomes the focus of this research because of the largest number of hominin teeth in the region found together with artifacts as their cultural evidence and faunal remains a palaeoenvironmental context.

The Kabuh Formation in Sangiran is overlaid by a discordant series (Djubiantono, 1992) of volcanic breccias, namely lahars of Notopuro or Pohjajar Formation. This lower part of this formation is dated back to 0.25 Ma by fission tracks (Suzuki and Wikarno, 1982) or 0.15 Ma by Ar/Ar (Saleki, 1997). Pohjajar Formation in Sangiran is correlated to the Tambakan Formation in West Java, Linggapada Formation in Bumiayu, and Semedo, Sukabubuk Formation in Patiayam, and Notopuro Formation in Kedungbrubus and Perning (Zaim, Rizal and Aswan, 2007). In some areas above these lahar series, we find recent alluvial deposits where the fossils are very scarce and almost absent.

J A V A							
West Java Bogor Zona			Central Java North Serayu & Kendeng Zona			East Java Kendeng Zona	
Age	Subang/ Sumedang/ Majalengka	Bumiayu	Patiayam	Sangiran	Sambung macan	Trinil Ngandong	Kedungbrubus Perning
Holocene	River Terraces	River Terraces	River Terraces	Old Solo Terraces ▲●	Old Solo Terraces ●▲	Old Solo Terraces ●▲	River Terraces ●
Pleistocene	Late	Tambakan ●	Linggapada	Sukobubuk	Pohjajar (Notopuro)	 	Notopuro
				Kedungmojo ●			
	Middle	Gintung ●	Slumprit ●▲X	Bapang (Kabuh) ●▲X	Kabuh ●▲X	Kabuh X●	
Early	Citalang ●	Cisaat (Zaim, 1978)	Mangger ●	Kancilan	Sangiran (Pucangan) X●	Pucangan X●	Pucangan X●
Kali Glagah ●							
Pliocene	Late	Kaliwungu Bluish clay, shallow marine	Kalibluk Bluish clay, shallow marine	Jambe Bluish clay, shallow marine	Puren/ Kalibeng Marl, shallow marine	Klitik/ Kalibeng Limestone/ Marl, shallow marine	Kalibeng Marl, shallow marine
<ul style="list-style-type: none"> ● Vertebrate X Hominid ▲ Artifact 							

Table 1. A.1. The Correlation Table of Quaternary stratigraphy of Java (Zaim *et al.*, 2007)

B. PALAEOENVIRONMENT

The paleoenvironment part in this chapter discusses about vegetation conditions and biostratigraphy. Variation of vegetation is including the condition which stimulates animal and human migration in the Early and Middle Pleistocene, including human impact on vegetation in the Late Pleistocene and Holocene. Biostratigraphy shows the variation of ecological niche chronologically as the context of human living places in order to survive and reproduce to continue their life.

1. Variation of vegetation

Indonesian archipelago lies along the equator, and its climate tends to be relatively tropic year-round. This archipelago has two seasons, wet season and dry season, with no extremes of summer or winter. For most of the region, the dry season falls between April and October, with the wet season between November and March (Sari *et al.*, 2016). Sumatra is located on the equator line, but Java is located more southern from the equator. Almost the entire climate of Sumatra is very humid with slight differences of rainfall and temperature between the seasons, and only an abridged dry season (Whitten and Damanik, 2012). The present climatic pattern of Java is very varied and divided the island into the western part which dominated by the tropical rainforest climate, the tropical monsoon climate which predominantly lies along Java's coastal north, while the tropical savanna climate lies in isolated parts of Central Java and lowland of East Java. Such a climatic contrast leads to made shorter wet season compare to Sumatra, with only from November to around April, and shift by a long dry season from May to around October (Whitten *et al.*, 1996).

Rainforest was rare in Southeast Asia during the Tertiary period, and the climate was predominantly seasonal and dry. The climate changed to a prehumid was in the Mid Miocene, and rainforest begins to colonized this region (Morley, 2000). The forest probably dispersed to Southeast Asia and occupied all areas. Since the Early to the Late Miocene, Southeast Asia was effectively a single lowland landmass (Hall, 1998). The region remained as a single rainforest block until the transition of Late Miocene and Early Pliocene (Morley, 2000) when a few periods of increased Gramineae pollen have been found, but not enough to indicate the presence of a large area of Savannah (Gathorne-Hardy *et al.*, 2002).

Based on some evidence from geomorphology, palynology, biogeography, and vegetation/climate modelling suggest that a north-south 'savanna corridor' did exist on the continent of Sundaland through the glacial period at the times of lowered sea-level (Heaney, 1992). A study by Bird *et al.* (2005) suggested the minimum size of this corridor requires a narrow but continuous zone of open 'savanna' vegetation with around 50-150 km wide, running along the sand-covered divide between the modern South China sea and Java sea. The savanna corridor connected similar open vegetation types in the north and south of the equator and served as a barrier to the dispersal of rainforest-dependent species between Sumatra and Borneo (Bird, Taylor and Hunt, 2005). This savanna corridor may have provided a convenient route for the rapid dispersal of the human population through the Sundaland.

With the arrival of Quaternary glaciations, the savannah was formed in large parts of Southeast Asia, driving rainforest to the refugia. The large rivers draining on the Sundaland probably provided refugia along their banks. Savannah habitants, such as elephant, antelope, hippo, deer, and carnivore were flourished, along with *Homo erectus* (Whitten *et*

al., 1996). During interglacial periods, the sea level rise, the rainforest returned, and the savannah with the animals was constrained to Indochina and a few patches of eastern Java. Each of the glacial-interglacial episodes probably showed a similar pattern (Gathorne-Hardy *et al.*, 2002). Interestingly, the continuous and discontinuous of savanna and rainforest ecological niches were probably stimulate the speciation of vegetation, animal, and human (see Fig. 1. B.1). It is not only because of their fragmentation and isolation from each other but also their long-term stability, which allows organisms to survive.

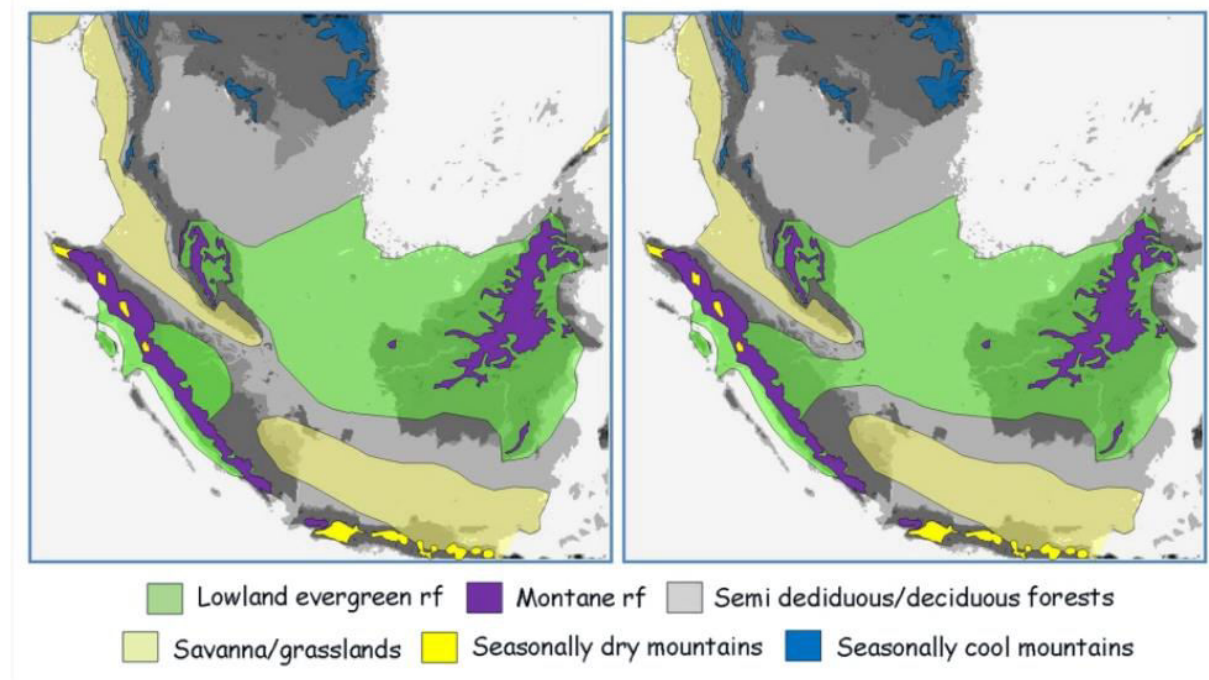

Fig. 1. B.1. Distribution of distinct forest types during the Last Glacial Maximum, with two different parameters. (Right) maximum lowland evergreen rainforest (LERF) extent; “closed corridor”; (Left) minimum LERF with “open corridor” (Cannon, Morley and Bush, 2009).

Diachronic record of palaeoenvironment condition based on pollen analysis since 2.5 Ma comes from Sangiran by the study of A.M. Sémah (A. M. Sémah, 1986). In the facies of blue clays of the Kalibeng Formation, Rhizophoraceae pollen characterizes the mangrove environment. About 2.5 Ma ago, the sea that covered the Solo region begins to retreat. At those times, the coasts present a marshy forest and the reliefs of humid tropical forest. In the Pucangan Formation, the numbers of pollen from mangrove and beach taxa in the facies of 'black' clays are dropping sharply (Sémah A. M., 1986).

Grenzbank facies shows that marine influence disappears definitively and followed by continental deposits (Sémah F., Sémah A. M., and Djubiantono, 2001). The Kabuh Formation documented an open environment of a mainly grassland landscape with rain forest gallery survived along the river (Sémah A.M. and Sémah F., 2001). The Notopuro Formation dated back to 0.15 Ma by Ar/Ar (Saleki, 1997) and 0.25 Ma by fission tracks (Suzuki and Wikarno, 1982), contains few fossils and no pollen remains (Brasseur *et al.*, 2015). During periods of the dry season, the forest is relatively open and similar to the present forest in East Java. The tropical rainforest persists and probably corresponds to the gallery along with wetter areas and higher elevations. Generally, during the wet periods, the tropical rainforest, such as that of West Java, dominates the landscape (A. M. Sémah, 1986).

The tropical rain forest seems to survive through the Pleistocene times in Sumatra. Newsome and Flenley (1988) found little evidence for forest change in the center of the montane forest zone over the last 30 Ka. During the same period, Maloney and McCormac (1995; 1996) found similar evidence for some climate changes at Pea Bullok in the highland of North Sumatra. Van der Kaars and Dam (1995; 1997) analyzed a core from the Bandung Basin, in the highland of West Java, and found evidence for cooling and periods of aridity over the past 120 Ka, but the forest cover was continued. Some charcoal as the evidence of forest disturbance by fire is present throughout the record, and the grassland may reflect drier climates. The vegetation has apparently reacted to temperature caused by a climatic change (Hope, 2005). There was apparently no significant human impact on tropical rain forest in Sundaland during the Pleistocene times.

Flenley and Butler (2001) traced indications of continuous disturbance of tropical rain forests probably by people during the last 7,000 years at Kerinci Highland, South Sumatra. Similar evidence was documented by A. M. Sémah *et al.* (2004) who traced initial evidence for the influence of prehistoric human groups on the environment around 7,000 BP at Ambarawa, Central Java. However, since 1500 BP, the evidence of rapid forest clearance, an overall pollen spectrum comparable to that of the present day, and the occurrence of charcoal in the sediment are the main indications of human activities (Sémah A. M. *et al.*, 2004). The impact of the anthropic activities on the environment was recorded from Dieng highland, Central Java. The vegetation and charcoal composition from Telaga Cebong proposes a correlation of deforestation caused by human agricultural activities in Dieng Plateau since 2,540 BP (Sajekti, 2009).

2. Faunal migration

Early quaternary faunal migration into Java likely to have occurred since 2.5 Ma (Sémah F., 1986) when only western parts of Java were emerged (van Bemmelen, 1949). Biostratigraphic schemes of Java already proposed by several previous scholars, such as von Koenigswald (1935), Badoux (1959), and de Vos (1985) based on faunal composition comes from some different Pleistocene sites in Java. The last updated version of Java biostratigraphy from one continuous locality was proposed by Ansyori (2018) based on faunal succession in Sangiran Dome. In opposite, so far, there is no biostratigraphy scheme developed from Sumatra as complete as Java. De Vos (1983) shows the correlation of faunal remains from Sumatran cave excavated by Dubois with the composition of Punung fauna of von Koenigswald collection, which indicates a similar ecology and the same age. Here is the biostratigraphy of Java:

The oldest terrestrial fauna in Java is an *Aceratherium* tooth, which comes from the Middle Pliocene Formation found at the northeast of Rancah and south of Cirebon, West Java named as Cisande fauna (Von Koenigswald, 1935) but, there is no more information about this faunal group (Ansyori, 2018). The second biozone is Cijulang fauna, which produces two proboscidians; *Stegodon* and *Elephas planifrons*, a primitive *Hexaprotodon*, anthracotheres including *Merycopotamus namus*, and a perissodactyl, *Nestoritherium*. This biozone interpreted comes from the Plio-Pleistocene boundary around 2,6 Ma, and shows a connection to the Sivalik Range, India (Moigne *et al.*, 2016). Many of these species from both levels are unknown in other Java biozones (Ansyori, 2018).

The Early Pleistocene Formation of Kaliglagah fauna (Von Koenigswald, 1934) or Satir fauna (de Vos, 1985) as the type locality produce *Sinomastodon bumiajuensis*, *Stegodon*, *Elephas planifrons*, *Sus stremmi*, *Muntiacus*, *Cervus stehlini*, large bovid, and the *Hexaprotodon simplex*, also crocodiles and a giant tortoise of *Colossochelys atlas* (van der Maarel, 1932), see Fig. 1. B.2. Satir fauna is recently also found in the Semedo site at the northern Serayu Mountain (Siswanto and Noerwidi, 2014). This faunal group is correlated to the fauna from the lower part of the Pucangan Formation in Sangiran, dating around 2.0 to 1.5 Ma (Suzuki and Wikarno, 1982; Leinders, 1985) also Pinjor from the Sivalik Range (Moigne *et al.*, 2016), see Fig. 1. B.3. The presence of *Geochelone*, *Sinomastodon*, and *Hexaprotodon* from Kaliglagah fauna represents an island environment with endemic and unbalanced fauna. The colonization mode in this period is sweepstake mode, which crossing utterly impossible for some species and very unlikely for others (Van Den Bergh, de Vos, and Sondaar, 2001). The colonization of a new island is then only the fact of luck (Simpson, 1940).

The upper part of Kaliglagah formation is associated with Cisaat fauna (de Vos, 1985) see Fig. 1. B.2. This faunal group is composed by *Stegodon trigonocephalus*, *Hexaprotodon sivalensis*, *Panthera sp.*, *Sus stremmi*, cervids, and bovids, also *Boselaphini*, the ancestor of *Duboisia santeng*. In addition, *Stegodon*, *Elephas*, a giant anteater (*Manis palaeojavanica*), porcupines, lagomorphs, small monkeys, gibbons, and a large orangutan (*Pongo*), associated with *Homo erectus* (von Koenigswald, 1934) are the member of the Djetis Fauna. The upper part of Kaliglagah formation is correlated to the upper part of the black clays at Pucangan Formation, dated back between 1.2 to 1.0 Ma. This faunal composition from this group is called Bukuran fauna which dominated by *Hexaprotodon koenigswaldi* interpreted as an isolated condition, but large felid indicates the land connection to the Asian mainland (van den Bergh, de Vos and Sondaar, 2001; Ansyori, 2018). The colonization mode in this period is

pendel mode with a migration route that can be easily crossed by some species but totally impossible for others (Simpson, 1940).

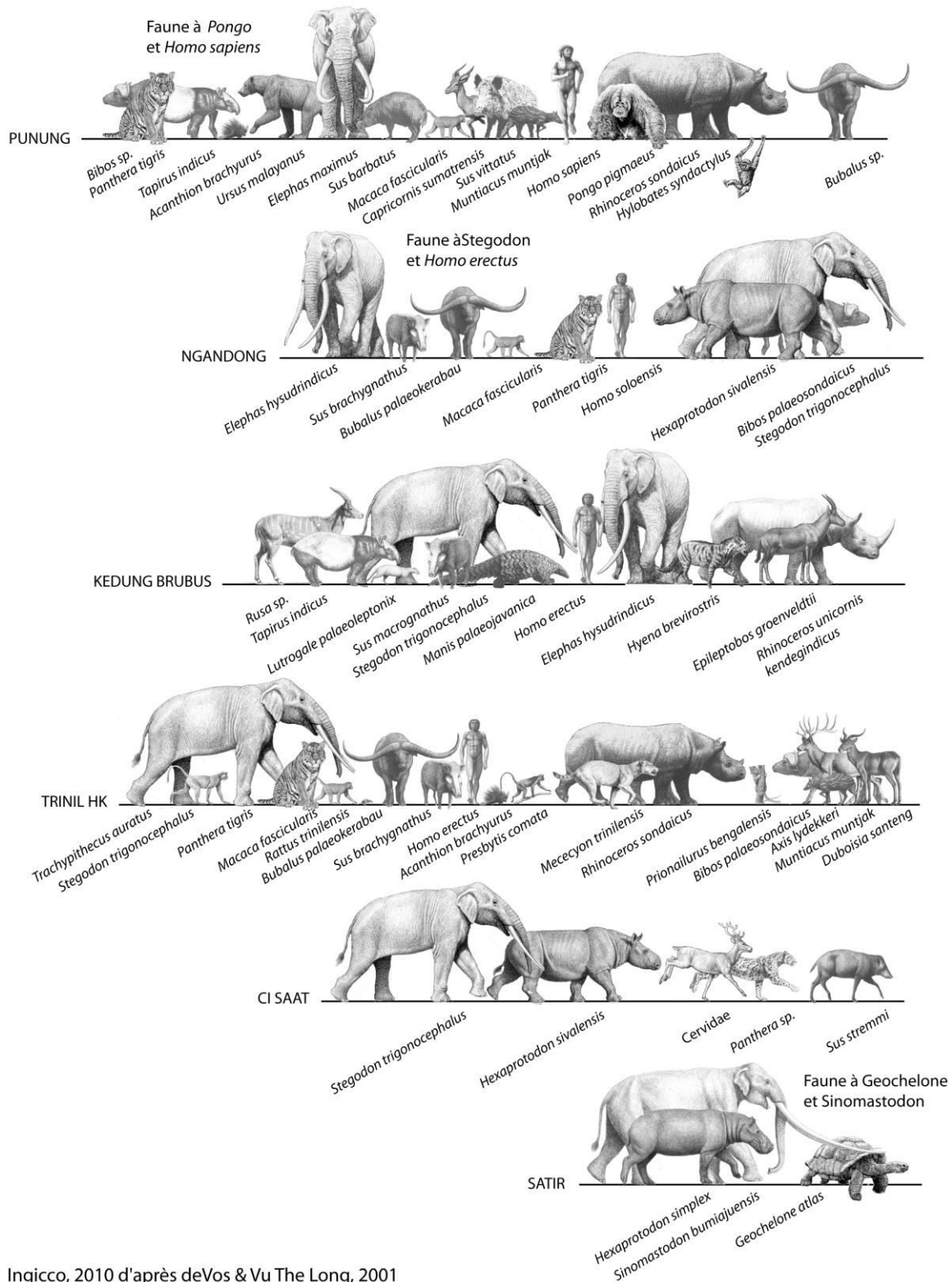

Ingicco, 2010 d'après deVos & Vu The Long, 2001

Fig. 1. B.2. Biostratigraphy and faunal succession of Java during Quaternary periods (De Vos and Long, 2001).

The Trinil Hk fauna comes from the famous locality of *Pithecanthropus erectus* found by Dubois 1890s in Ngawi. The main fauna from this group is a small deer of *Axis lydekkeri*

and a small antelope, *Duboisia kroeseni*, but *Bibos palaeosondaicus*, *Stegodon* and *Elephas namadicus* were also found (see Fig. 1. B.2). Stratigraphically, the Trinil Hk fauna is correlated to the lower part of Kabuh Formation including Grenzbank in Sangiran, and dated to 0.9 Ma (Suzuki and Wikarno, 1982; Leinders, 1985), but according to a recent study by Joordens *et al.* (2015) the age of Trinil Hk is only 0.5 Ma. This faunal group is associated with the *Pithecanthropus erectus* of Dubois and interpreted as a balance fauna (Van Den Bergh, de Vos, and Sondaar, 2001). The colonization mode in this period is filter mode with areas of land that form of bridges or archipelagos, allowing the passage of certain species but limiting that of other species (Simpson, 1940).

The Kedungbrubus fauna comes from Kedungbrubus locality in Ngawi, excavated by Dubois during his expedition in the 1890s. The faunal group is composed by *Panthera tigris oxygnatha*, *Lutrogale palaeoleplonyx*, *Hyaena brevirostris*, *Stegodon trigonocephalus*, *Elephas hysudrindicus*, *Rhinoceros sondaicus*, *Rhinoceros unicornis kendengindicus*, *Tapirus indicus*, *Muntiacus muntjak*, *Axis lydekkeri*, *Duboisia santeng*, *Bubalus palaeokerabau*, *Bibos palaeosondaicus*, *Epileplobos groeneveldii*, *Hexaprolodon sivalensis*, *Sus macrognathus*, *Manis palaeojavanica*, and *Homo erectus* (see Fig. 1. B.2). The Kedungbrubus stratigraphy is correlated to the upper part of Kabuh Formation at Sangiran, Gintung Formation at Bumiayu, and Djētis at Pening. This faunal group is interpreted as a mainland fauna with a dry climate and an open woodland environment (de Vos, 1985), and dated back around 0.8 to 0.7 Ma (Suzuki and Wikarno, 1982; Leinders, 1985). The colonization mode in this period is intermittent corridors with areas of emerged lands without barriers at certain times, allowing the passage of faunas between two regions (Van Den Bergh, de Vos, and Sondaar, 2001).

The Ngandong fauna is produced from ancient terraces at the north and west of Ngawi, East Java excavated by Oppenoorth during the 1930s. In this period, the antelopes have disappeared, but modern banteng and *Cervus Hippelaphus* are abundant. *Hippopotamus*, *Stegodon*, and *Elephas* are highly specialized. The important fossils from this group are *Cervus palaeojavanicus*, and *Sus terhaari* (von Koenigswald, 1935). This faunal group is interpreted as an open woodland environment and correlated as the habitat of the progressive group of *Homo erectus* (see Fig. 1. B.2). The age of this faunal unit could be younger than Kedungbrubus fauna (de Vos *et al.*, 1994), around the late of Middle Pleistocene 135 Ka just before the Punung fauna (Van Den Bergh, de Vos and Sondaar, 2001), but Yokoyama *et al.* (2008) estimates a minimum age around 40 Ka, an upper age limit of around 60 to 70 ka. The colonization mode in this period is intermittent corridors with areas of emerged lands without barriers at certain times, allowing the passage of faunas between two regions (Van Den Bergh, de Vos and Sondaar, 2001).

Punung fauna is associated with a wet and humid climate and associated with a closed environment. This faunal group produced some primate, such as *Pongo pygmaeus*, *Symphalangus syndactylus*, and *Macaca nemestrina*, also *Panthera tigris*, *Ursus malayanus*, *Rhinoceros sondaicus*, *Tapirus indicus*, *Muntiacus muntjak*, *Capricornis sumatrensis*, *Sus barbatus*, *Sus vittatus*, *Echinosorex sp.*, *Acanthion brachyurus*, *Bubalus sp.* and *Bibos sp.* (Badoux, 1959), see Fig. 1. B.2. The type locality is a fissure deposit at Punung, East Java, but similar composition presented by Sumatran cave deposit excavated by Dubois (de Vos, 1983). Punung fauna is interpreted as a humid tropical forest environment (Van Den Bergh, de Vos and Sondaar, 2001) with the arrival *Homo sapiens* (Storm *et al.*, 2005) at the beginning of Late Pleistocene, just before 125 Ka (Westaway *et al.*, 2007). The colonization

mode in this period is intermittent corridors with areas of emerged lands without barriers at certain times, allowing the passage of faunas between two regions (Van Den Bergh, de Vos and Sondaar, 2001).

The Wajak fauna comes from the locality of Dubois' excavation and composed by *Trachypithecus cristatus*, *Panthera tigris*, *Rhinoceros sondaicus*, *Tapirus indicus*, *Muntiacus muntjak*, *Cervus timorensis*, *Sus vittatus*, *Acanthion brachyurus*, *Manis javanica*, *Rattus tiomanicus*, *Sciurus notatus*, and *Homo sapiens*. The fauna shows a humid forest environment and dated from the Holocene period (de Vos, 1983). The last faunal group is from the Mid Holocene is Sampung fauna represented a sub recent Indo-Malayan fauna, which also found in other Mesolithic caves in East Java, including Wajak. The Sampung fauna also contains several species already extinct in Java, such as *Elephas maximus*, *Bos bubalis*, and *Rhinoceros sondaicus* (von Koenigswald, 1935). The Sampung fauna was presumed to be approximately around 5000 BP. This faunal group is interpreted as an open woodland environment (Van Den Bergh, de Vos and Sondaar, 2001).



Fig. 1. B.3. Two different migration routes: Siva-Malaya from South Asia and Sino-Malaya from East Asia (De Vos and Long, 2001)

C. HUMAN REMAINS

The discussion on human remains is divided in four parts, as follows: 1) the emergence of the genus *Homo* and its dispersal out of Africa, 2) early human occupation in the Sundaland, 3) early anatomically modern human in the Island of Southeast Asia, and 4) late anatomical modern human in the Sundaland.

1. The emergence of the genus *Homo* and its dispersal out of Africa

During a long time, the definition of hominins was related to bipedalism, but a larger locomotor repertoire across hominins than previously thought was evidence (Harcourt-Smith, 2016). The emergence of the *Hominidae* and then the genus *Homo* were marked by transformations of the nervous, masticatory, locomotor, and manipulatory systems, with accompanying functional changes. The manipulatory and locomotor systems were developed in the early phase, probably with the emergence of the hominid family. Significant changes in brain form and size occurred later, with the emergence of genus *Homo* (Tobias, 1981). The first representatives of the genus *Homo* in Africa dated to about 2.8 million years ago (Villmoare *et al.*, 2015), post-dating the first appearance of stone tools in the archaeological record (Harmand *et al.*, 2015). While once a large collection of specimens from different localities were designated as *Homo habilis*, there are now two species of early *Homo* recognized (Prat, 2004), *Homo habilis* (Leakey, Tobias and Napier, 1964) and *Homo rudolfensis* (Alexeev, 1978). In addition to a bigger brain, the early species of *Homo* had flatter faces and smaller teeth than seen in *Australopithecines*.

The radiation of genus *Homo* is involved in a reduction in jaw and tooth size, particularly in the molar teeth. In addition, brain size increased significantly, from approximately 500 cm³ to more than 640 cm³. A slight increase in body size occurred as well – although not enough to account for the larger brain size (Lewin and Foley, 2012). Antón *et al.* (2014) had rejected brain size as a defining feature of “early *Homo*” groups, but Spoor *et al.* (2015) stress on the morphological feature, while Wood and Conrad (1999) based on adaptive reason (Schwartz and Tattersall, 2015). For the first time, simple stone tools are found in Afar, Ethiopia from 2.6 Ma (Semaw *et al.*, 2003), and diet may have shifted to include more meat, procured either by scavenging, by simple hunting, or by a combination of both. The archeological evidence of a shift in subsistence patterns is often assumed to be associated with behaviors unique to the genus *Homo* (Lewin and Foley, 2012). It is generally assumed that *Homo* included more meat in their diet than did in species of *Australopithecus* (Lewin, 2005; Patterson *et al.*, 2019).

Homo erectus was long assumed to be the species intermediate between early *Homo* and *Homo sapiens*, due to the increase of paleoanthropological discoveries during the last decades, several species such as *Homo ergaster* in Africa and *Homo heidelbergensis* () in Europe seem to be present in parallel with *Homo erectus* in Asia. *Homo ergaster* represents a new species in Africa, with a very different behavioral style and the ability to expand its range beyond Africa (Lewin, 2005). Maybe as far as 1.8 Ma it had a bigger brain, a less snout-like, vertical face, and small, nearly small-sized teeth. A spectacular skeleton, of a juvenile male from Nariokotome, Kenya, dating to 1.5-1.7 Ma (Brown *et al.*, 1985), came to epitomize our view of the species as having a very modern body: tall (160-185 cm), large (50-70 kg), with long legs, and otherwise only subtly different from *Homo sapiens* body (Walker, Leakey and Leakey, 1993). *Homo ergaster* also seems to have resembled modern humans in

having low levels of sexual dimorphism, with males being about 10-20% larger than females (Lieberman, 2007).

The earliest traces of *Homo erectus-sensu lato* have been uncovered in the East Turkana basin, eastern Africa, dating around 1.9 Ma contemporary with *Homo rudolfensis* (Kimbel and Villmoare, 2016). The member of early *Homo* species begin to reached other parts of the continent and probably disperse out of Africa soon after their appearance (Rightmire, 1991), but this claim has been questioned. The discoveries of the *Homo georgicus* in the South Caucasus, Georgia, and *Homo floresiensis* from eastern Indonesia and *Homo luzonensis* from the Philippines have re-opened this question. The discovery of Dmanisi skull 5 in 2013, dated back to 1.8 Ma BP, is evidence of *Homo erectus-sensu lato* in Eurasia. Then, the discovery of *Homo floresiensis* estimated as an endemically dwarfed *Homo erectus* or maybe an endemically dwarfed version of a more primitive *Homo habilis*-grade hominin (Prat, 2005; Wood, 2011; Détroit *et al.*, 2013; Argue *et al.*, 2017). Therefore, it is unclear if the speciation of *Homo erectus* or *Homo ergaster* from *Homo habilis* took place in Africa or Asia.

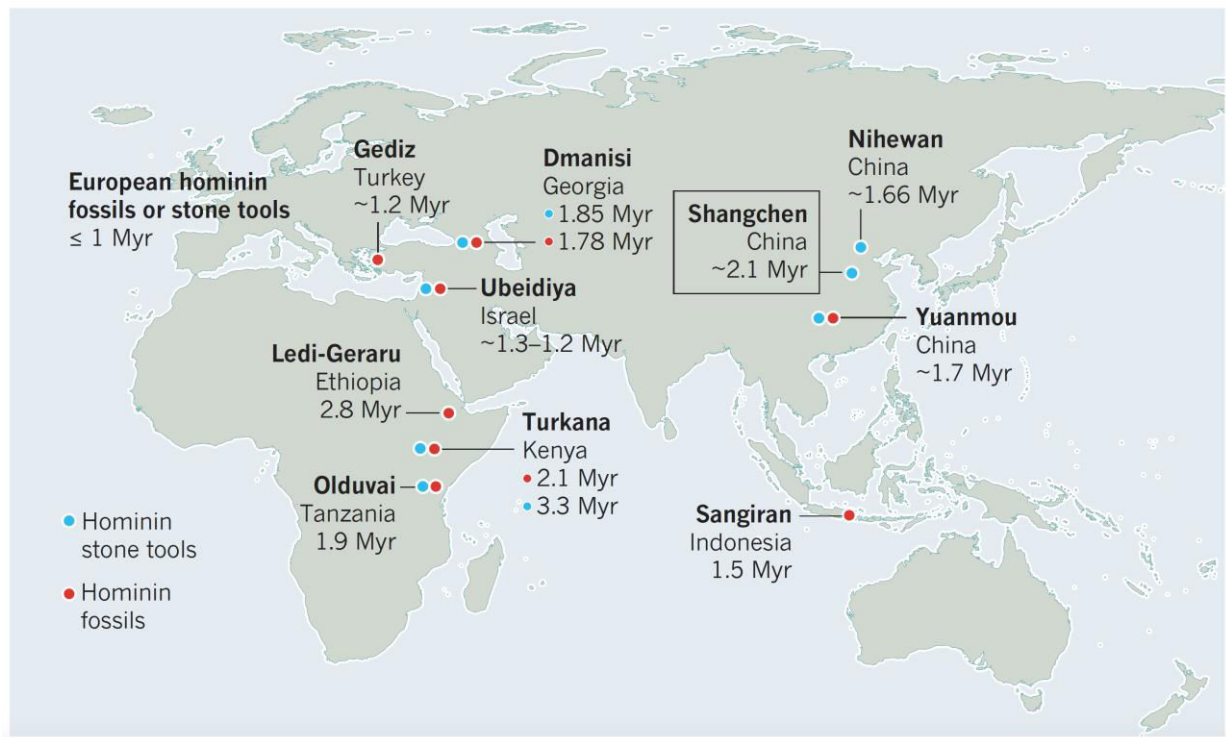

Fig. 1. C.1. Ancient sites of hominin presence (Kappelman, 2018).

The spread of *Homo erectus* eastward into Asia is fragmentary documented, but it is clear they were present in Island Southeast Asia and East Asia Mainland (see Fig. 1. C.1). In Southeast Asia, a date of 1.8 Ma was claimed for *Homo erectus* in Java (Swisher *et al.*, 1994), but the palaeomagnetic and $^{40}\text{Ar}/^{39}\text{Ar}$ dating of the "lower lahar", a layer located at the base of the fossil-bearing series of the Sangiran dome, marking the emergence of the first dryland at Sangiran, took place at the end and just after the Olduvai sub chron. Therefore 1.7 Ma can be considered as a maximal theoretical age for the arrival of the first hominins in Sangiran (Sémah *et al.*, 2000). The earliest human remains attributed to the genus *Homo* in eastern Asia Mainland currently consist of two incisors that may belong to *Homo erectus* from Yuanmou, south China, dated back to 1.7 Ma (Zhu *et al.*, 2008). The next-oldest

evidence is *Homo erectus* cranium from Lantian (Gongwangling), dated at least at 1.15 Ma (Zhu *et al.*, 2015).

Another route from Africa could have been taken by hominins, to the eastern Mediterranean, and western Europe (Rightmire, 1991). Isolated teeth have been from 'Ubeidiya in Israel dated to ~1.5 Ma, attributed to *Homo erectus* or *Homo ergaster* (Belmaker *et al.*, 2002). In western Europe, a hominin mandible from Sima del Elefante at Atapuerca, is dated to between 1.2–1.1 Ma (de Castro *et al.*, 2011). Another earliest Eurasian archaeological remains come from Barranco-Leon 5, Fuente-Nueva 3, and lowest levels of Gran Dolina in Spain (Carbonell *et al.*, 2008; Moyano *et al.*, 2011), at Pirro Nord in Italy at 1.6-1.3 Ma (Arzarello *et al.*, 2012) and in Turkey: a partial skull from Kocabas in the Denizli Basin at 1.6-1.2 My (Kappelman *et al.*, 2008; Vialet *et al.*, 2018) and a lithic flake in the Gediz Valley securely dated to 1.2 My (Maddy *et al.*, 2015). Some from Asia Mainland are Riwat and Pabbi Hills in northern Pakistan ~1.9 Ma (Dennell, 2007), and Majuangou in northeastern China dated to 1.66 Ma (Zhu *et al.*, 2004). Flake tools at Dayu locality, Sangiran from the upper part of Pucangan Formation, probably between 1.6 and 1.2 Ma, could be the oldest stone industry in Island Southeast Asia (Stone, 2006; Widiyanto, 2006). Afterward, the lithic artifacts found in Mata Menge (Brumm *et al.*, 2016) and Luzon (Ingicco *et al.*, 2018) dated back to 700 Ka were become the oldest evidence of archaic hominins availability to crossing the sea barrier.

2. Initial human occupation in the Sundaland

Research on human paleontology in Indonesia started when Eugene Dubois discovered the fossil skullcap and femur of the first 'Java Man', the holotype of *Pithecanthropus erectus* (now named as *Homo erectus*), in an excavation on the riverbank of Bengawan Solo near Trinil, East Java in 1891 (Dubois, 1896). Since that time, research on this hominin species has progressed. Based on current palaeoanthropological evidence, *Homo erectus* was the first human population who colonized the Indonesian archipelago, especially on the western side of the Wallace Line or the Sundaland, and probably across into Wallace zone (Van Den Bergh *et al.*, 2016).

The oldest *erectus*-like fossil found so far is believed to be the child's skullcap from at Perning Village, near Brantas River, around 10 Km north of Mojokerto, East Java, found by Andoyo a fossil collector of Geological Survey of the Netherland Indies in February 13, 1939 (Huffman *et al.*, 2006), it was attributed to *Homo erectus* archaic or *Pithecanthropus Mojokertensis* according to Jacob (1975). Lithology and paleogeographical evidence from the local equivalent of the Pucangan formation that contained the fossil indicates that the Perning hominin is likely to date from 1.8 Ma, by absolute dating on pumice pebbles and hornblende sand coming from the same site, but from the underlying horizon (Swisher *et al.*, 1994; Huffman, 2001). Some scholars disagree and suggest the Mojokerto child could be slightly younger in age because the dating sample location has not been relocated, so the stratigraphic relationship between the sample and the fossil cannot be confirmed. The recent study and redating of two pumice horizons at the site indicate that the age of the Mojokerto cranial vault is younger than 1.49 Ma (Morwood *et al.*, 2003).

The most productive hominin locality site in Island Southeast Asia is Sangiran, Central Java (see Fig. 1. C.2), located in a wide sedimentary basin of the Solo depression, which is filled by volcanic deposit. Sangiran dome was created millions of years ago by tectonic uplift, then eroded by the tributary of the Bengawan Solo river, exposing their beds, which is rich in archaeological finds. Sangiran site records a thick sedimentary layer since 1,6 Ma (Early Pleistocene) of Pucangan formation to 0,5 Ma (Mid Pleistocene) of Kabuh formation. This lithological formation produces almost more than one hundred hominin fossils, including a dozens of well-preserved crania, around forty fragments of mandible and maxilla, also a huge number of isolated teeth. So far, there are no hominin fossils yielded from Kalibeng of Pliocene underlying the Pucangan formation, and Notopuro of late Pleistocene overlying the Kabuh formations.

In the early times, Dubois (1894) proposed *Pithecanthropus erectus* for Trinil find. And then, one genus and three species named *Meganthropus palaeojavanicus*, *Pithecanthropus modjokertensis*, *Pithecanthropus robustus*, and *Pithecanthropus dubius* have been proposed by von Koenigswald (1940; 1950; 1967) and Weidenreich (1945; 1951). In 1932, the term *Homo soloensis* was proposed for the human fossils of Ngandong from the late of Middle Pleistocene found by ter Haar (Oppenoorth, 1932). In 1922, Dubois proposed *Homo wajakensis* for a modern human fossil from the Late Pleistocene, which was found in the marble quarry of Campurdarat, East Java (Dubois, 1922). This species classification of the early Indonesian human remains was subsequently modified by other researchers (Jacob, 1976; Sartono, 1982; Widiyanto, 1993). Until now, we do not have enough explanation to understand the origin of these various groups of Javanese hominins.

Homo erectus of Indonesia is believed to have evolved within three stages, which cover a period of evolution for more than one million year. Widiyanto (2001), based on cranial and mandibular morphology and morphometric studies, suggests that the oldest archaic *Homo erectus* (the robust group including *Pithecanthropus mojokertensis*, *Pithecanthropus robustus*, *Pithecanthropus dubius*, and *Meganthropus palaeojavanicus*) evolves into classical *Homo erectus* (Trinil-Sangiran group, including Patiayam and Semedo) and progressive form of *Homo erectus* (the youngest group such as Ngandong-Ngawi-Sambungmacan or Solo group) (Widiyanto, 2001; 2016). Radiometric combination by Ar/Ar and ESR proposes an age of 0.8-0.6 Ma for the Sangiran group hominid from Kabuh formation (Saleki, 1997; Falguères, 2001). This long chronological context of *Homo erectus* occupation in Java generates a question about the environmental impact on their evolutionary history and their adaptative strategy to survive through the environmental changes.

The more recent and progressive form of Javanese *Homo erectus* is termed as *Pithecanthropus* or *Homo erectus soloensis*, or Solo Man (Jacob, 1976; Sartono, 1982; Widiyanto, 1993). Hominin fossils from Ngandong, Ngawi, and Sambungmacan, found in the fluvial terraces of Bengawan Solo, Central Java, are considered to be the most anatomically derived and youngest representatives of *Homo erectus* (Widiyanto, 1993). Non-destructive gamma-ray spectrometric dating of the three hominin calvaria Ngandong 1 (Ng 1), Ngandong 7 (Ng 7), and Sambungmacan 1 (Sm 1) have given a minimum age at around 40 ka, with an upper age limit at around 60 to 70 ka. That means that the *Homo erectus* of Java very likely survived the Toba eruption and may have been coexisted with the earliest *Homo sapiens* in Southeast Asia and Australasia (Yokoyama *et al.*, 2008). This was very recently confirmed by chronostratigraphical work done by (Rizal *et al.*, 2019) which gave the minimum age of 108-117 Ka to the hominin layer in Ngandong.

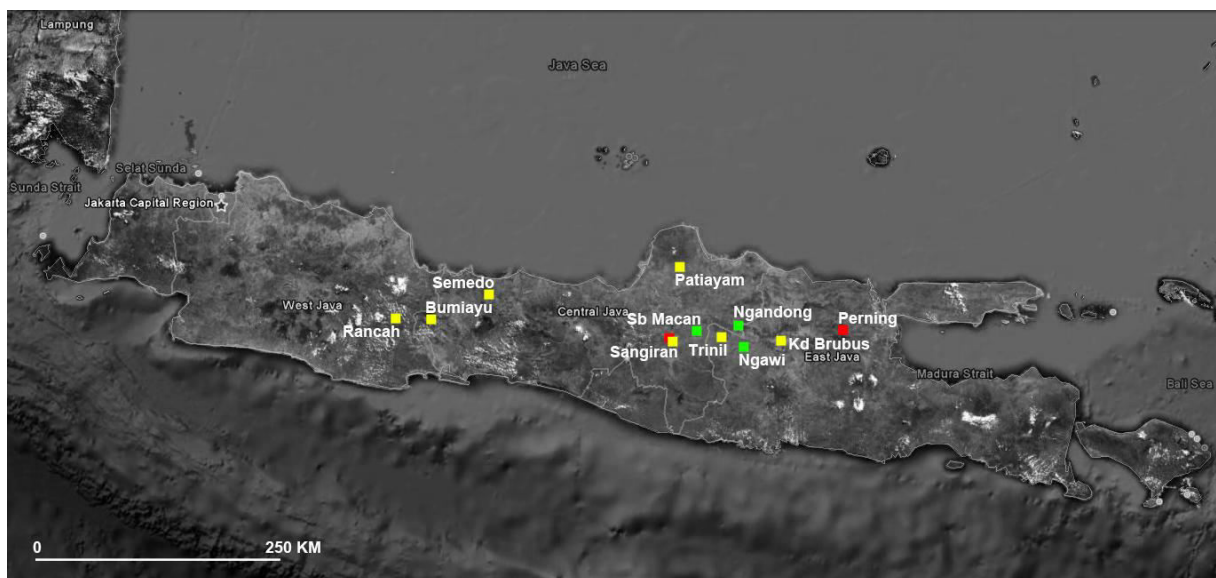

Fig. 1. C.2. Ancient sites of hominin presence in Java (Noerwidi, 2012).

Kaifu *et al.* (2005) analyzed a dentognathic sample from the Early Pleistocene of Sangiran and examined morphological differences between chronological groups, and investigated their affinities with other hominin groups from Africa and Eurasia. The results indicated the Bapang Formation group is showing a similar degree of reduction to that of Middle Pleistocene Chinese *Homo erectus*, and the Sangiran Formation group exhibits some

features that are equal to the *Homo ergaster* of Africa (Kaifu *et al.*, 2005; Kaifu, 2006). Afterwards, Kaifu *et al.* (2008) describe the cranial morphological changes of *Homo erectus* in Java using geometric morphometrics. He proposed that Bapang groups developed distinct morphological changes related to brain size expansion, and other changes are apparently unique specializations restricted in Javanese *Homo erectus*. He suggests the continuous, gradual morphological evolution of Javanese *Homo erectus* from the Mid-Pleistocene of Sangiran to the Late Pleistocene of Ngandong groups. The development of some unique features in Solo Javanese *Homo erectus* supports the hypothesis that this Javanese lineage went extinct without making significant contributions to the ancestry of modern humans in this region (Kaifu *et al.*, 2008).

3. Early anatomically modern human in the Island of Southeast Asia

The debate about the origins of modern humans has traditionally focused on two contrasting views with its variants (Finlayson, 2005). Multi-regional evolution (Out-of-Africa 1) proposes that present-day populations worldwide are the descendants of *in situ* evolution after an initial dispersal of *Homo erectus* from Africa during the Early Pleistocene (Thorne and Wolpoff, 1992). The alternative hypothesis, Out-of-Africa 2, proposes that all present-day populations are descended from a recent common ancestor that lived in East Africa ~150 000 years ago, the population of which replaced all regional populations (Stringer, 2000). And the origin of modern humans in Island Southeast Asia still unclear.

The initial anatomically modern human was estimated to come to the Island of Southeast Asia as early in the last Interglacial maximum. Badoux (1959) referred to five human teeth in the Punung fauna, but Storm *et al.* (Storm *et al.*, 2005) did not find these teeth in the von Koenigswald collection in Frankfurt, Germany, but found another *Homo sapiens* tooth of upper left P3, labeled PU-198. They suggested the climate was primarily humid and warm between 126 ka and 81 ka, but the level of Java Sea was 40-60 meters below present condition between 120 ka and 90 ka during the stadials of MIS-5b and MIS-5d. That means that the tropical rainforest and its inhabitants, including *Homo sapiens*, reached Java across a land bridge from Mainland Asia during this period at least 80 ka (Storm *et al.*, 2005).

Westaway *et al.* (2007) dated the fossiliferous Punung breccia and indicated it was deposited no earlier than 143 ka and no later than 115 ka. This is the chronometric age for the 'Punung Fauna' and a minimum age for the appearance of a fully modern fauna of tropical rain forest in Java also corresponds to the timing of the first *Homo sapiens* arrival in the Island Southeast Asia. Many scholars doubt this hypothesis because it is challenging to agree on an important claim based on only one tooth of uncertain origin and its taxonomical attribution still needs to be confirmed. Polanski *et al.* (2016) demonstrate the tooth of PU-198 to be slightly larger than previously suggested, and overlap in between *Homo erectus* and *Homo sapiens* size distribution. He doubts on the assignment of PU-198 to *Homo sapiens*, and the appearance of *Homo sapiens* on Java between 143 and 115 ka (Polanski, Marsh, and Maddux, 2016).

The timing of modern human emergence and occupation in Southeast Asia is uncertain. Genetic evidence for anatomically modern humans out of Africa is before 75 ka and in Island Southeast Asia before 60 ka (Fu *et al.*, 2013; Pagani *et al.*, 2016). Although genetic data indicate a rapid migration out of Africa and into Southeast Asia by at least 60 ka, this region is rare for fossil evidence for early modern human occupation. New evidence came from Tam Pa Ling, Laos in Mainland, and Lida Ajer, Sumatra in Island Southeast Asia. A modern human cranium from Tam Pa Ling recovered from 51-46 ka, and direct dating of the bone indicates a maximum age of ~63 ka (Demeter *et al.*, 2012). Fossil of human teeth from Lida Ajer places modern humans in Sumatra between 73 and 63 ka (Westaway *et al.*, 2017). Lida Ajer and Tam Pa Ling represents the earliest evidence of anatomically modern human occupation in Southeast Asia, and support the genetic timing of the dispersal of modern humans Out of Africa (Demeter *et al.*, 2012; Westaway *et al.*, 2017).

Two skulls of Wajak (East Java), skull cap of Niah Cave (Serawak), frontal bone and limb bones of Tabon Cave (Palawan), and skeleton of Moh Khiew (Thailand) are more robust paleoanthropological evidence for the appearance of anatomically modern human in Island

Southeast Asia from the Late Pleistocene. New dates by Barker *et al.* (2007) for the West Mouth of Niah Cave, which related to the 'Deep Skull' is range from 46 to 34 ka (Barker *et al.*, 2007). Recently, U-series direct dating has been carried out on several human fossils from Tabon Cave, with dates ranging from 16 to 58 ka BP (Dizon *et al.*, 2002; Détroit *et al.*, 2004). An AMS radiocarbon date on the charcoal sample gathered from the burial of Moh Khiew gave a result of 25 ka (Matsumura and Pookajorn, 2005). Recent U-series dating results on the human bone from Wajak indicate a minimum age of between 37.4 and 28.5 ka (Storm *et al.*, 2013).

4. Recent modern human in the Sundaland

Recent anatomically modern humans appeared in the Late Pleistocene to Early Holocene, which is a crucial period in the prehistoric chronology of the Island Southeast Asia. Chronologically it is a transition between the Paleolithic and Pre-Neolithic culture (see Fig. 1. C.3.). This period was marked by a dramatic climate and sea-level fluctuations, which brought changes to paleogeography and paleoenvironment conditions. Simanjuntak and Sémah (2005) identified three cultural characteristics in this period, such as 1) the exploration of wider geographical area in the archipelago, even crossing the sea barrier, 2) the change of activity orientation from open-air to natural niches, such as caves and rock shelters, and 3) the development in technology and subsistence (Simanjuntak and Sémah, 2005).

Before World War II, the Archaeological Service of the Netherland Indies made some finds at Sampung in East Java which represents a "Mesolithic" cultural context with some human remains. The first discovery was reported by van Es (1930), who excavated an *in situ* skeleton at Gua Lawa in 1926. Mijsberg (1932), in his study based on the excavation by van Stein Callenfels in 1928-1931, notes there were three specimens from Sampung and three from Bojonegoro that indicated a population of predominantly "Melanesian" affinity (Jacob, 1967). A large number of isolated teeth have also been reported from Prajekan and Tuban. Van Heekeren discovered a human skeleton in 1935 in Petpuruh Cave which was examined by Mijsberg, who concluded the specimen revealed the "Australoid" or "Papuan" affinities (Van Heekeren, 1972). In Sodong Cave, van Heekeren (1936) found a "pygmoid" skeleton which was almost complete, except for the skull. This fascinating specimen was lost during the Japanese occupation before it could be studied completely. Finally, in Marjan Cave, van Heekeren (1957) discovered many skeletons with mesocranic skulls, robust mandibles, and large teeth that closed to Australo-Melanesian affinities (Jacob, 1967).

During the same period in Sumatra, some prehistoric human remains were recorded in 1913 by the Swiss geologist August Tobler from the Ulu Tjanko cave in the karst hills between the Merangin and Batang Tabir Rivers in Jambi (Sarasin, 1914) and by P. V. van Stein Callenfels in 1920 who excavated a kitchen midden at Binjai Tamiang, at a distance of 50 km from the mouth of the Tamiang river in North Sumatra (Schürmann, 1931). The remains examined by Sarasin were associated with a culture that used almost exclusively obsidian as material for its tools and belonged to a gracile variety of man with small teeth, perhaps a Veddah-form. Those from the Binjai Tamiang kitchen midden consist of a few skull fragments associated with Hoabinhian artefacts such as monofacial pebble tools of an oval shape as well as pestles and mortars, also faunal remains of elephant, rhino, bear, deer, tortoise, crab, and fish. Wastl concluded that they were deriving from a short-statured individual, with a dolichocranic skull, belonging to the Papua-Melanesoid characters (Wastl, 1939; Heine-Geldern, 1945).

After the Indonesian independence, recent discovery from Java is caves and rock shelters yielded some skeleton in the Gunungsewu and surrounding area limestone range in East Java, recovered by the National Research Center of Archaeology (Pusat Penelitian Arkeologi Nasional), since the 1990s. Two specimens come from Gua Lawa (Sampung), eight from Gua Braholo (Wonosari), five from Song Keplek, and one from Song Terus (Détroit, 2002; Simanjuntak, 2002). Most have been analyzed in detail by Widiyanto (2002), Détroit (2002), and Noerwidi (Noerwidi, 2012). The majority of these specimens are stated to have affinities with existing Australo-Melanesian populations in eastern Indonesia and Australia.

Radiocarbon dating indicates that they date from the late Pleistocene and early Holocene, between 13.500 and 4.500 BP (Simanjuntak, 2002), except one Neolithic burial extended of SK5 which dated to 3200 BP (Noerwidi, 2012). From West Java, seven specimens have been discovered in Pawon Cave, on the southern edge of the Bandung Basin between 2003-2018. The excavation also produced obsidian tools, bone tools, animal bones, and shells. Radiocarbon dates for the Gua Pawon population fall between 5.660 ± 170 BP, 7320 ± 180 BP and 9.520 ± 200 BP (Yondri, 2005). Five from seven individuals of Gua Pawon already analyzed and belonged to the Australo-Melanesian population (Noerwidi, 2012).

Briefly, there were three cultural complexes during the Terminal Pleistocene to Early Holocene in the western part of the Indonesian archipelago, they are: 1) Hoabinhian industry of shell midden, 2) Obsidian flakes industry, 3) Keplek chert industry, and 4) Sampung shell bone industry. The influence of Hoabinhian culture from the Mainland to Island Southeast Asia also traced in the northern Sumatra. Two famous Hoabinhian shell midden sites in this region are Tamiang, Aceh, and Sukajadi, North Sumatra. Some human remains in the context of flexed burial are dated back to the early Holocene, between 9000 to 6000 BP (Wiradnyana, 2016). Cave habitation with human burial in a flexed position of the cave found in the southern Sumatra to western Java, such as Gua Harimau (South Sumatra) and Gua Pawon (West Java). Obsidian blade culture is the character of these sites, which dated back between 7000 to 4500 BP (Chia, Yondri and Simanjuntak, 2010; Matsumura *et al.*, 2018). The eastern part of Java is characterized by the human population with two different techno-complex, they are Keplek chert flakes industry and Sampung shell bone industry which develop in a similar period, between 9000 to 4500 BP. Song Keplek and Song Terus are two sites in the eastern part of Gunungsewu, which represent the Keplek culture. Gua Braholo and Song Tritis in the western part of Gunungsewu, also Gua Kidang in the Northern Mountain of Java are represent the Sampung culture (Simanjuntak, 2004; Nurani, Koesbardiati and Murti, 2014).

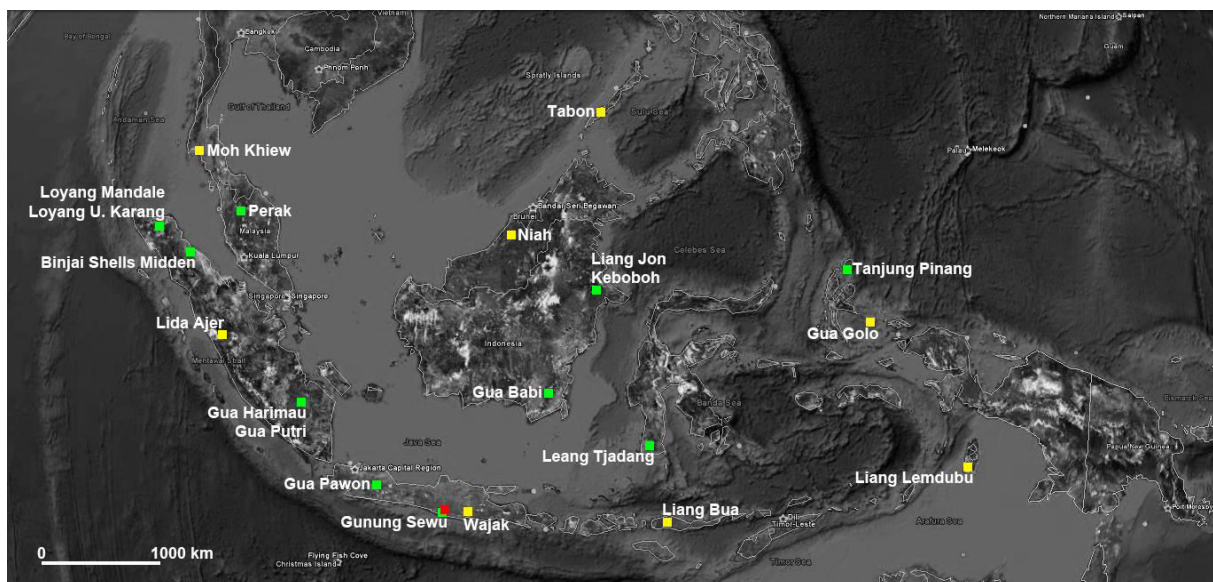

Fig. 1. C.3. Early anatomically modern human sites of Southeast Asia (Noerwidi, 2012). Red & Yellow = Late Pleistocene, Green = Holocene

In the Late Holocene, the linguistic evidence suggests settlement by a Malayo-Polynesian population ancestral to the present Malayan and Sundanese/Javanese, expanding southwards from eastern Borneo and possible arriving between 1500 and 1300

BC (Blust, 1984). Physiographical of Indonesian during this period is entirely archipelago similar to the present condition, and the migrant population has to adapted and developed marine subsistence to cross the sea barrier. This migration wave would appear to belong to the eastern movement which accompanied by a massive flow of Neolithic material culture, especially red-slipped plainware pottery, from Taiwan into the Philippines and southwards into Island Southeast Asia (Bellwood, 2017). Several sites in central and western Indonesia with early red-slipped plain ware, such as: Kamassi and Minanga Sipakko in West Sulawesi (3.500-2.500 BP), Punung in central Java (2.100-1.100 BP), and Kendenglembu in East Java (1.350 BP) (Simanjuntak, 2002, 2015b; Noerwidi, 2009). Unfortunately, so far, the Neolithic horizon has no produced paleoanthropological data. As opposite, there are a lot of human remains from later Metal Age contexts, for instance, from jar burial sites distributed on the north coast of Java and the eastern coast of Sumatra.

Our understanding of Neolithic to Early Metal Age in Sumatra has much progress with the recent excavation of Gua Harimau, South Sumatra. The pottery from this site is mostly cord-marked and carved-paddle-impressed. Red-slipped plain ware is rare and it appears that the Eastern Neolithic stream never penetrated this far west in Indonesia. However, there are also some rare incised and punctate sherds in Gua Harimau (Simanjuntak, 2015a), and from nearby site Gua Pondok Selabe (Widianto 2011). This fact provides a possibility about the Austroasiatic migration model into western Island Southeast Asia along with the Austronesian speaking peoples. Bellwood shows that incised and impressed pottery were similar to that from those sites in Mainland Southeast Asia around 2000-1500 BC (Bellwood, 2007). Matsumura *et al.* (Matsumura *et al.*, 2018) show the burials reveal a change from an older Australo-Papuan cranial morphology to a new Neolithic immigrant of Asian morphology at around 1000-600 BC. The Pre-Neolithic burials were all folded and sloping position, whereas the late Neolithic and Early Metal Age burials, some directly dated to between 750-200 BC, were mostly extended and supine position. Many of the supine burials contain bronze and iron artifacts, and it is not yet clear if they are actually from the Neolithic period. One of the Australo-Papuan burials is directly dated to only 600 BC, so Bellwood (2017) suggesting that the arrival of the Asian newcomers could have been at the end of the Neolithic or even in the Early Metal Age.

CHAPTER 2. SITES AND THEIR DENTAL COLLECTION

A. PRESENTATION OF THE SITES

This part is talking about the general condition of the prehistoric sites and human dental collection which used in this research. The presentation of the sites will be divided by a physiological zone of Java and Sumatra Islands based on the previous study by Van Bemmelen (1949). Java island consisted of three main physiological zones from north to south; the Northern Mountains zone, Central Mountains and Depression, and the Southern Mountains zone (Fig. 2. A.1). Sumatra island comprised of only two main physiological zones from east to west; the Sumatra Basins and Bukit Barisan Mountains (Fig. 2. A.2).

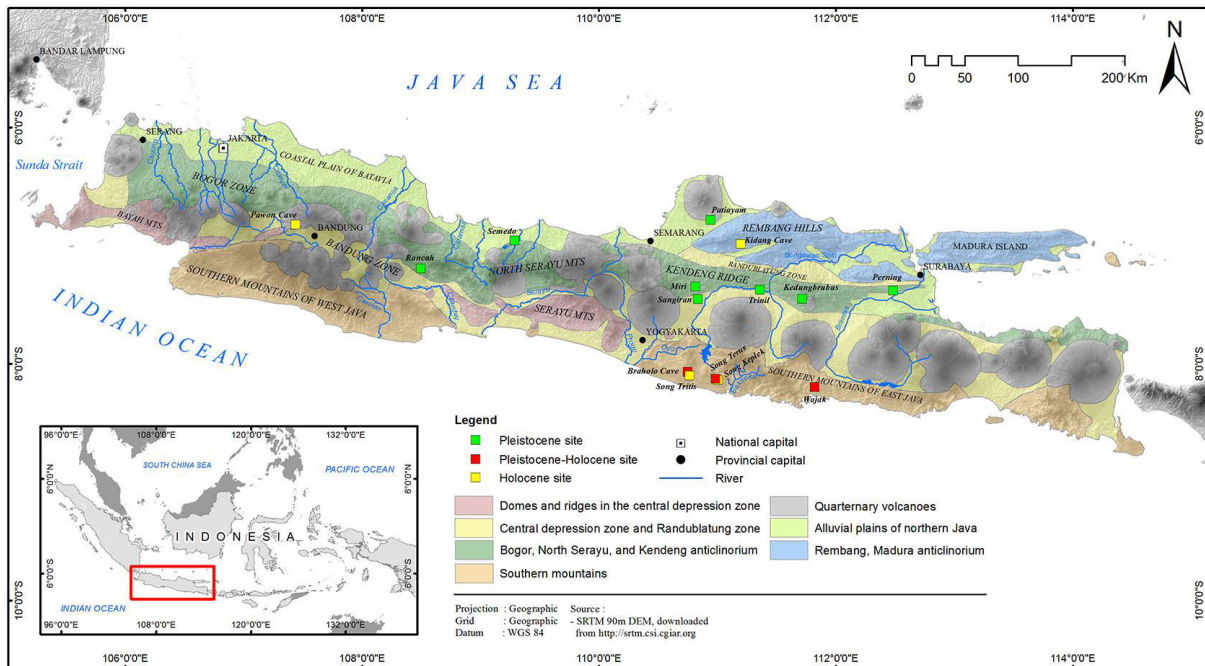

Fig. 2. A.1. Map of distribution hominin sites of Java used in this research.

The central zone of Java presents prehistoric sites along Bogor-Kendeng Mountains and great central depression, including;

- Trinil and
- Kedungbrubus at Kendeng,
- Sangiran Dome at Solo depression,
- Rancah at Bogor anticlinal zone, and
- Gua Pawon at the Bandung Highland.

Prehistoric sites in the northern zone of Java is including:

- Patiayam Dome at the Muria Mountain slope and
- Gua Kidang at the Rembang karstic mountains.

The southern zone is the sites which located at the Gunungsewu and Campurdarat Karstic Mountains, including:

- Gua Braholo and
- Song Tritis at the western part of Gunungsewu,

- Song Terus and
- Song Keplek at the eastern part of Gunungsewu, also
- Wajak complex located on the Campurdarat karstic mountains.

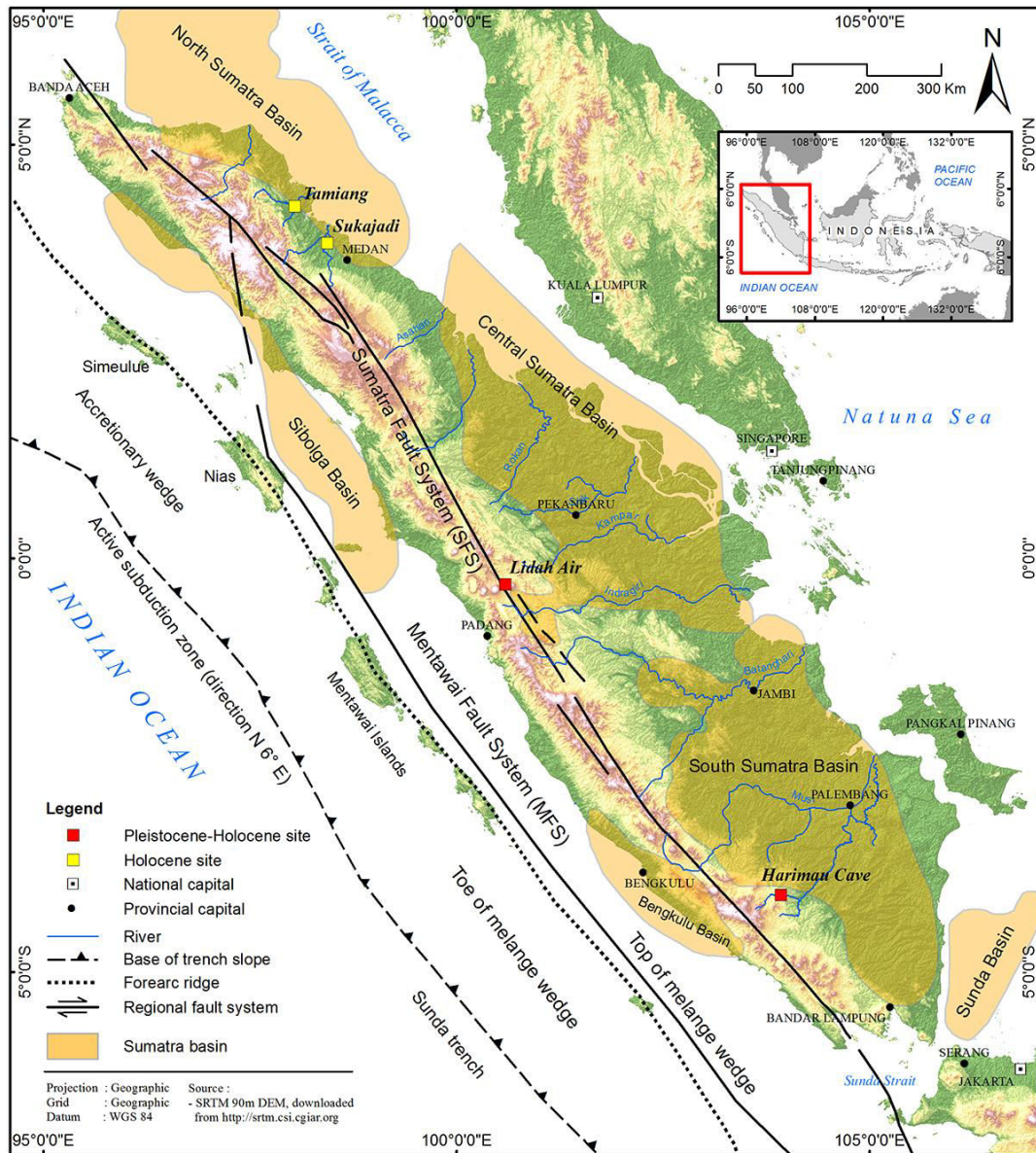

Fig. 2. A.2. Map of distribution hominin sites of Sumatra used in this research.

The southern Sumatra zone is prehistoric cave site of

- Gua Harimau at Baturaja karstic region part on the eastern slope of Barisan Mountains.

The western Sumatra zone is prehistoric cave site of

- Lida Ajer Cave at Payakumbuh karstic region part on the western slope of Barisan Mountains.

The northern Sumatra zone is shellmidden sites which located at the northern basin of Sumatra, including:

- Tamiang, Aceh and
- Sukajadi Pasar, North Sumatra.

B. CENTRAL ZONE OF JAVA (BOGOR-KENDENG MOUNTAINS AND CENTRAL DEPRESSION)

1. TRINIL

Location

Trinil site is located $7^{\circ} 22' S$ and $111^{\circ} 21' E$ around the Trinil hamlet near the Bengawan Solo River. This site is administratively located at Kawu Village, Kedunggalar District, Ngawi Regency, East Java and 10 km west of Ngawi city. The position of Trinil site is located near a large narrow meander of the Bengawan Solo River (Fig. 2. B.1), causing the outcrops of Miocene, Pliocene, and Pleistocene Formations between Pengkol to Trinil and produced a huge amount of marine and terrestrial vertebrate fossils (Van Es 1931).

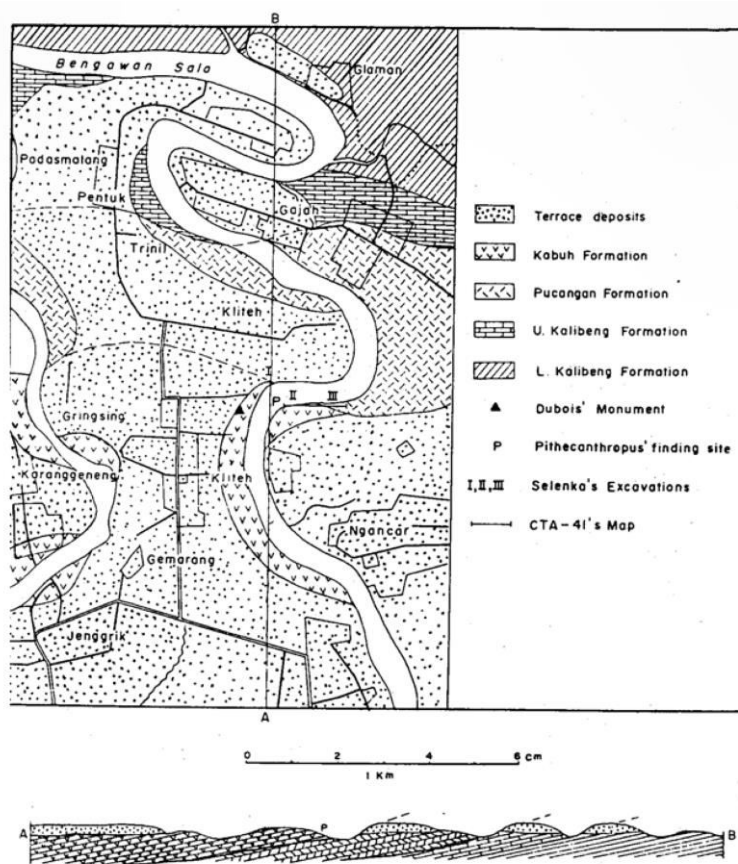

from Watanabe & Kadar 1985

Fig. 2. B.1. Geological map of Trinil area (Watanabe and Kadar 1985).

Research History

The history of paleontological research in Java began when two naturalists were starting to collect fossils in the area. A German-Dutch botanist/geologist, Frans Wilhelm Junghuhn started collecting fossils in 1857 and an Arab-Javanese painter, Raden Saleh Syarif Bustaman did the same during 1865-1866 in the area of Kendeng mountains (Leakey and Slikkerveer 1995). Local people would then refer the finding from these naturalists as "*balung buto*", which means bones of giants.

In the 1890s, a young military doctor named Eugene Dubois, assigned two officers of KNIL, Corporal Anthonie de Winter and Gerardus Kriele, to collect fossils from the Kendeng hills. Between 1891-1894 Dubois led the research in Trinil, found calotte, femur, and teeth assigned to *Pithecanthropus erectus* (now *Homo erectus*) (Dubois 1894). In 1895, Dubois went back to Netherland with reptile and mammal fossils, also the specimens of *Pithecanthropus* and never go back again to the Netherland Indies. He gave the position of the expedition leader to the two military officers of KNIL, corporal Anthonie de Winter and Gerardus Kriele until they finished the fieldwork in 1900 (Albers and de Vos 2010; Theunissen 1989).

After Kriele and de Winter finished his excavations at Trinil, from 1906-1908 the fieldwork to search for more new *Pithecanthropus* bone was continued by Lenore Selenka near the location of Dubois' excavation (Selenka and Blanckenhorn 1911). Although the Selenka expedition did not find new hominin remains, it yielded important contextual data through a systematic and multidisciplinary approaches (Alink, Roebroeks, and Simanjuntak 2016). There was no paleontological fieldwork in Trinil some decades following the Selenka expedition, but there were some paleontological collection studies in the 1930s e.g., *Carnivore* by Brongersma (1935; 1937; 1941), vertebrates fauna by Von Koenigswald (1933), and *Bovidae* by Hooijer, 1958).

In 1976 and 1977 new geological observations were made by an Indonesian-Japanese team (Soeradi et al. 1985), but no paleoanthropological fieldwork has been published since the Selenka expedition in the 1900s, except a new collaboration between Naturalis, Leiden and The National Research Center of Archaeology, Jakarta managed by Joordens and Simanjuntak since 2017. The Dubois' archives and collections have been extensively studied such as by (Van Den Bergh 1999; van der Geer, Lyras, and Volmer 2018; Hooijer 1958; Hooijer and Kurtén 1984; Meulen 1999; de Vos and Aziz 1989; de Vos, Hardjasmita, and Sondaar 1982). The application of new technique and method on his collection also contributing to our knowledge of *Homo erectus* and their paleoenvironmental setting in Java (Alink et al. 2016; Joordens et al. 2009, 2015; Ruff et al. 2015; de Vos 2004).

Formations / Archaeological Layers

The stratigraphy of Trinil site is overall presenting the Kabuh Formation but also the Pucangan Formation. Kalibeng Formation should outcrop in some parts of Trinil site. The sediments exposed in the Trinil area are black clays belonging to the Late Pleistocene Pucangan Formation. Above the Pucangan Formation lies the Kabuh Formation, which consists of medium to very coarse cross-bedded and conglomeratic sandstones. The border between Pucangan and Kabuh Formations is composed of a thin bed of lapilli containing a lot of vertebrate remains, so-called *Grenslaag* or border layer. This bed is also called *Hauptknochenschicht* means the main bone layer. This layer contains of Middle Pleistocene vertebrate fauna of Trinil H.K., including *Pithecanthropus (Homo) erectus* (Fig. 2. B.2). The main fossiliferous layer is covered by fine-grained cross-bedded sandstone, sometimes containing plant remains (Van Es 1931; Selenka and Blanckenhorn 1911; Soeradi et al. 1985).

The faunal remains in this layer include numerous artiodactyls. We notice *Muntiacus* and *Axis*, *Duboisia santeng* (small antelope), and also large bovids such as *Bibos palaeosondaicus*, and *Bubalus palaeokarabau*. Suidae is only represented by *Sus brachygnathus*; *Stegodon trigonocephalus* and *Rhinoceros sondaicus* are also found.

Primates are *Semnopithecus auratus*, *Macaca fascicularis* and *Hylobatidae* (Ingicco, De Vos, and Huffman 2014; de Vos et al. 1982). The carnivores include *Panthera tigris*, *Prionailurus bengalensis*, and *Mececyon trinilensis* (Hooijer and Kurtén 1984). Two micromammals are included, *Hystrix brachyura* and *Rattus trinilensis* (de Vos et al. 1982).

The age of the hominin fossils in the *Hauptknochenschicht* (HK) is still debatable. Soeradi *et al.* (1985) assume that the HK layer is comparable with the 'Grenzbank' of the Sangiran dome, which is dated between 0.9 and 0.7 Ma (Widianto and Simanjuntak 2009). However, recent dating on sediments preserved in the Dubois collection suggests that the age of the *Hauptknochenschicht* might be younger as predicted before, between 0.43 ± 0.05 Ma and 0.54 ± 0.1 Ma (Joordens *et al.* 2015).

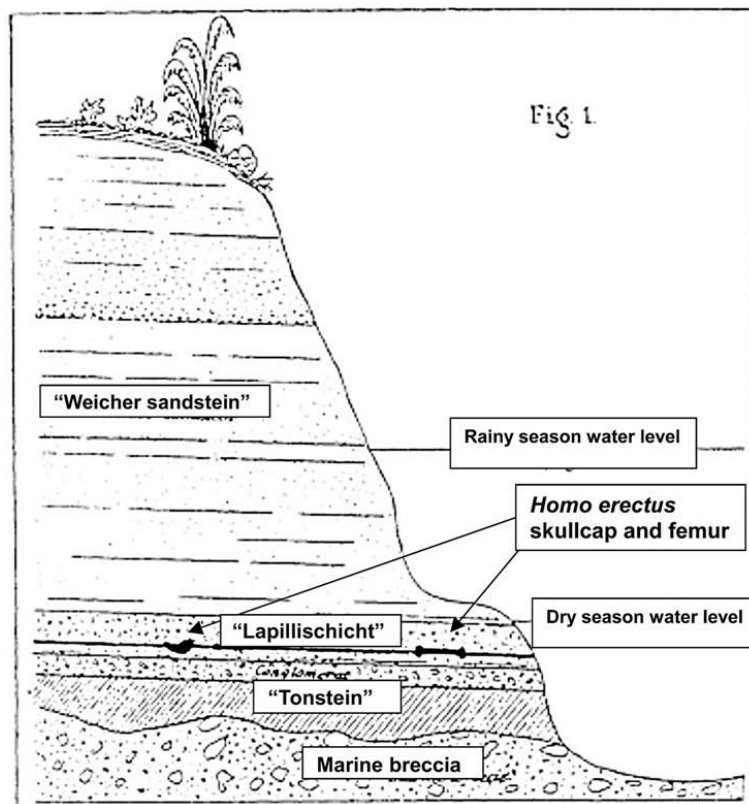

Fig. 2. B.2. Stratigraphy of Trinil HK, the type locality of *Homo erectus* (Dubois 1895; Joordens *et al.* 2009).

Human remains

The Trinil specimen composed as a skull cap and a femur which found between 1891 to 1894 by Eugene Dubois, to the 1899 by Kriel and de Winter. In September 1891, Dubois found the right upper third molar of hominin, and a month later found a spectacular hominin skullcap at a distance about 1 m from the first finding. In August 1892, a hominin femur was found about 12 m downstream of the skullcap, and in the same month also an upper left second molar, and then a lower left third premolar also found. Finally, from 1895 to 1900, the total of four incomplete hominin femora were found by his successor (Ruff *et al.* 2015).

With the reference of Ernest Haeckel, who suggests an ancestral human should be a species between apes and humans, Dubois decided to the Trinil specimen to the species of *Pithecanthropus erectus*, literally translated as the upright walking ape-man. Through the

generic name has been changed later, Dubois' description is the reference (holotype) for the *Homo erectus* (Dubois 1894, 1896). The character of Trinil skull cap is low, with a low forehead and markedly protruding supraorbital ridge. In occipital view, a pronounced occipital torus is present. A series of torus structures encircle the skull, separating the upper cranial vault from the basalt part below (Fig. 2. B.3). The Trinil femur is actually quite similar to the modern human femora. Its morphology indicates a fully developed upright posture and body proportions comparable to those in the modern human population. The specimen shows a remarkable ossification of the iliofemoral ligament, a bony outgrowth at the upper interior margin of the thigh bone (Puymerail et al. 2012; Ruff et al. 2015). Recent analysis on the Dubois' collection by Joordens *et al.* (2015) found geometric pattern on the Pseudodon shell claimed from the same layer of *Pithecanthropus erectus*.

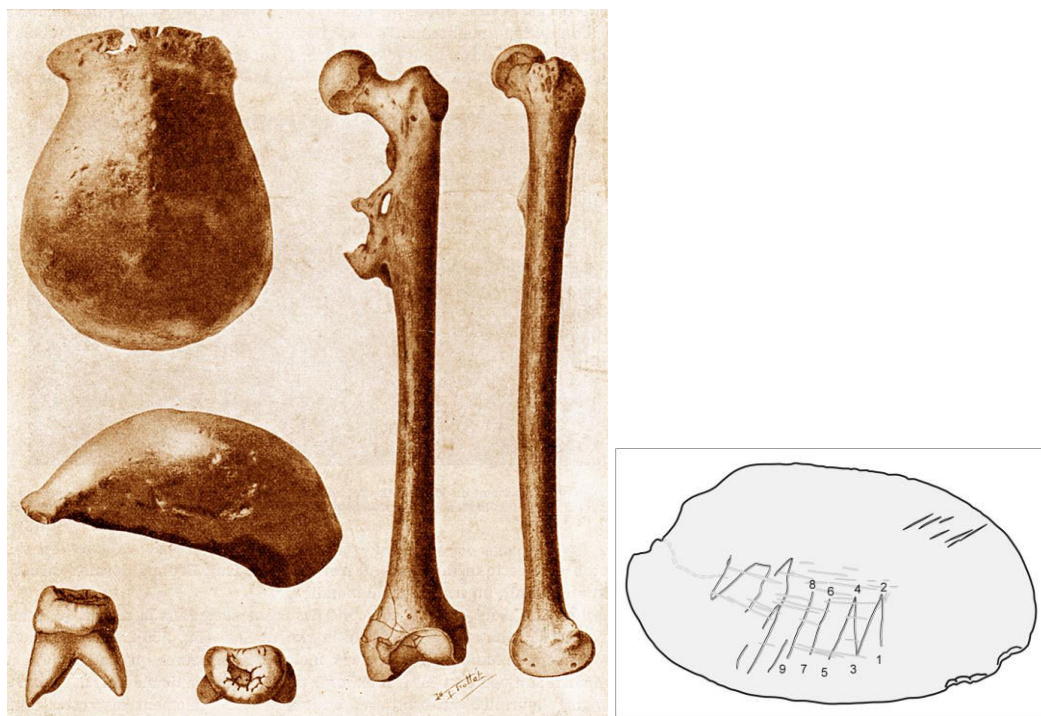

Fig. 2. B.3. Left. The holotype of *Homo erectus* (Dubois 1894). Right. The geometric pattern on Pseudodon found in the same layer (Joordens et al. 2015).

Here is the table of dental remains from Trinil site (Table 2. B.1), found by the expedition of Dubois during 1890s:

NO	LOCALITY	NO. COL	CATEGORY	GRADE	AGE	TAXA	STRATIGRAPHY	LITHOLOGY	STORAGE
1	Trinil	Trinil 1	URM3	B1/B2	16-20	<i>H. erectus</i>	Kabuh	Fluviatile deposit	RNH
2	Trinil	Trinil 4	ULM2	C	20-25	<i>H. erectus</i>	Kabuh	Fluviatile deposit	RNH
3	Trinil	Trinil 5	LLP3	D	25-30	<i>H. erectus</i>	Kabuh	Fluviatile deposit	RNH

Table 2. B.1. Isolated teeth from Trinil site. Abv: RNH = Rijksmuseum van Natuurlijke Historie, the Netherlands.

The Significance

The Dubois' description on Trinil specimens is the reference (holotype) for the species of *Homo erectus*. However, a recent study by Ruff *et al.* (2015), on Trinil Femur I suggests that specimens could be from a more recent period than the skull cap, while the incomplete Femora II–V may represent the *Homo erectus*. This hypothesis is so challenging if we consider the recent dating made by Joordens *et al.* (2015) who suggest an age younger around 0.5 Ma.

So far, there is no lithic artifact has been found from a huge excavation box made by Dubois and Salenka in Trinil site, besides the shell artifact described by Joordens *et al.* (2015). This condition is so problematic if we compare to other Pleistocene sites of Java, which produces core and flake lithic tools as Sangiran dome dated back to 1.2 and 0.8 Ma (Simanjuntak and Sémah 1996; Widiyanto 2006). Further systematic research could answer this question regarding the cultural aspect of Trinil hominin.

2. KEDUNGBRUBUS

Location

Kedungbrubus is located about 30 km southeast of Ngawi and about 30 km northeast of Madiun at the southern margin of Kendeng hills (Fig. 2. B.4), which covered by teak forest and limited population. On November 24, 1890, Dubois found a fragment of right mandibular symphysis in river sediments near Kedungbrubus and wrote a publication about it lately in 1924. This specimen was belonging to the first *Pithecanthropus* find in Java and named as *Pithecanthropus* A or Mandible A (Albers and de Vos 2010; Dubois 1924).

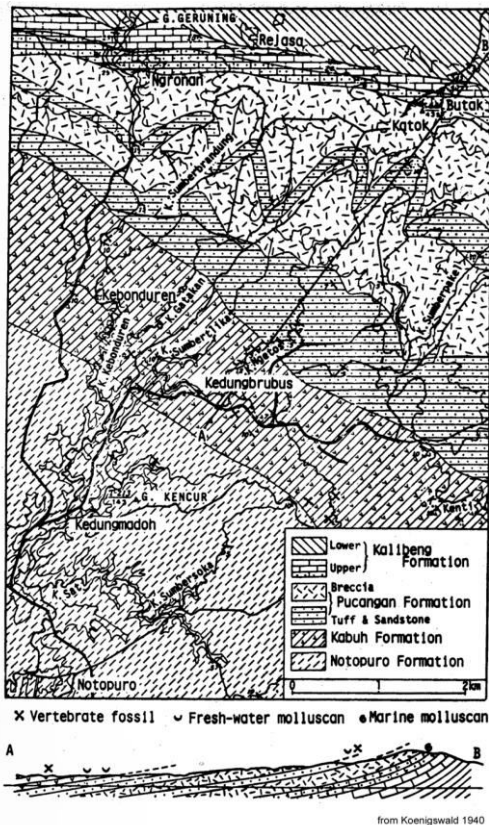

Fig. 11: Geological map of the Kedung Brubus area (after Duyfjes 1936 in Koenigswald 1940, p. 45)

Fig. 2. B.4. Geological map of Kedungbrubus area (Watanabe and Kadar 1985).

Research History

Von Koenigswald (1940) reported the stratigraphy of Kedungbrubus site consists of a series of tuff and tuffaceous sandstone alternating with tuffaceous breccias. He noted two mammal fossil-bearing horizons represented by fluvial deposits: an older zone which was interpreted as the Pucangan Formation and a younger zone interpreted as Kabuh Formation (von Koenigswald 1940).

A recent study by Watanabe and Kadar (1985) reported seven places around Kedungbrubus composed of medium-fine grained sand, coarse-grained sand, and sandstone with pebbles. A pebble-bearing calcareous sandstone layer which exists in the upper part of

the sequence is closely resembling the boundary layer in the Sangiran area and contains fragments of mollusks but without mammal fossils (Watanabe and Kadar 1985).

Formations / Archaeological Layers

Duyfjes (1936) reported four main lithological formations around the Kedungbrubus site consisting of the marine sediment of Pliocene to terrestrial sediment of Late Pleistocene. The Formations in sequences are from Kalibeng Formation in Gunungbutak hill, Pucangan Formation in between Sumberbandung river and Sumberpakel river, Kabuh Formation around Kedungbrubus village, and Notopuro Formation around Notopuro village.

The Dubois' discovery of a fragmentary mandible found near Kedungbrubus, but the exact provenance is unknown. Mammalian fossils from the same general locality suggest that the Kendeng sediments from where the mandible founded is correlated to Kabuh Formation (von Koenigswald 1934). The age of Kedungbrubus site is problematic around the Middle Pleistocene. De Vos, Hardjasmita and Sondaar (1982) put the Kedungbrubus Fauna younger than Trinil Fauna, based on the presence of *Elephas*. Although, Hooijer and Kurtén (1984) found no reason to consider the Kedungbrubus Fauna to be younger compared to that from Trinil as had been suggested by the previous author.

Human remains

The Kedungbrubus 1 mandible is a fragment of the anterior part of right mandibular corpus (Table 2. B.2). There is only one canine preserved with a broken of the third premolar and an alveolar of fourth premolar. The mandible is generally attributed to the classical *Homo erectus* but has a gracile character. Tobias (1966) suggests that the gracility of the mandible caused by the mandible belongs to a juvenile individual.

NO	LOCALITY	NO. COL	REMAINS	AGE	TAXA	STRATIGRAPHY	FAUNA	DATING	STORAGE
1	Kedungbrubus	Kedungbrubus 1	Fr. Mandible	Adolescent	<i>H erectus</i>	Kabuh	Trinil	0.5 Ma	RNH

Table 2. B.2. Mandibular specimen from Kedungbrubus site.

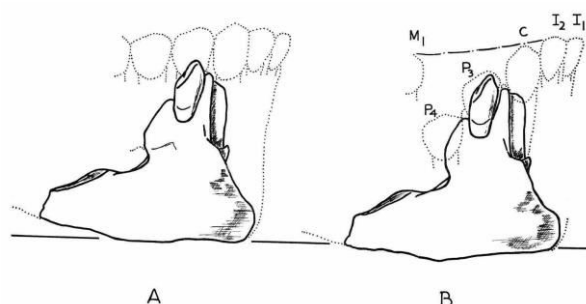

Fig. 2. B.5. Two reconstructions of Kedungbrubus mandible, left by (Dubois 1924) and right by (Tobias 1966).

The Significance

As the type locality of Kedengbrubus fauna, this site is potentially to provide an overview of the paleoenvironmental condition in Java during the Mid-Pleistocene. Nevertheless, it seems a main part of the site has been drowned as a reservoir since 2008.

3. SANGIRAN DOME

Location

Sangiran site is located in two regencies, Sragen and Karanganyar (Central Java), around 15 km north of the city of Surakarta. Sangiran is a quaternary anticlinal dome which eroded by Cemara river, a tributary of Bengawan Solo river (Fig. 2. B.7). The dome covered approximately 8 km length and 4 km width and located on a variety of altitudes between 183 meters and 100 meters above the modern sea level.

The Sangiran Dome is located in a wide sedimentary depression of the Solo basin. This depression is surrounded by the quaternary stratovolcanoes of Merapi, Merbabu, and Lawu, also within the boundaries of the Southern Mountains in the south and the Kendeng Hills in the north, which were formed and began to lift during the Miocene (Sémah et al. 2004). Products of the erosion from these mountains can be found in the Middle Pleistocene of Kabuh Formation in Sangiran, such as chalcedony silicified wood and quartz (Van Bemmelen 1949; Brasseur et al. 2015; Sartono 1964).

Research History

In 1893 Dubois visited the Sangiran Dome because of his interest on the report of huge amount of fossils found, though at that time, his activity was limited only on observation and did not carry out any excavation (Bartstra 1985). In late 1930, a young German-Dutch geologist joined the Geological Survey of the Netherland Indies in Java as a paleontologist to help Van Es (1931) in the identification of mollusk to determine the ages of *Pithecanthropus*. He also participated in the excavation of Ngandong in 1931 with Ter Haar - Oppenoorth (1932) and realized the significance of the geology and paleontological study in Java.

Von Koenigswald began a systematic survey of the Java Island and initiated the first research in Sangiran in 1931. Besides, finding a huge amount of faunal fossils, he also found flake tools from chalcedony and jasper in Ngebung Hill in 1934 (Von Koenigswald, 1934; 1935). He argued that the raw material is not originally found in Sangiran, but should have come from the Southern Mountains. This hypothesis leads him to found Baksoka Paleolithic site of the Pacitanian culture in the following year (Von Koenigswald, 1936; 1939).

Between 1931 and 1941, von Koenigswald made the most significant finds in this area. He proposed the first biostratigraphy of Java in 1934 based on some Pleistocene sites of Kaliglagah, Cijulang, Jetis, Trinil, and Ngandong. He announced the discovery of a juvenile calvarium from Pening and assigned to *Pithecanthropus Mojokertensis* in 1935 (von Koenigswald 1935). In 1937, a local assistant in Sangiran brought him a skull specimen of *Pithecanthropus* in several pieces because they expected to get more payment by the number of fossil pieces. This specimen was later named as the Sangiran 2, an exact duplicate of Dubois' *Pithecanthropus* calvarium from Trinil (von Koenigswald and Weidenreich 1938).

Other von Koenigswald's important findings are the Sangiran B mandible or the Sangiran 1b and a maxilla with the diastema of the Sangiran 4. He invited Franz Weidenreich, a paleontologist, to visit Java in 1937 to examine his recent discovery. Both of them then announced in 1938 of the discovery of the *Pithecanthropus robustus* based on a skull cap of

Sangiran 3 and maxilla of Sangiran 4 (von Koenigswald and Weidenreich 1938). In the 1939 and 1945, Koenigswald and Weidenreich published the lower jaws of Sangiran 5 as a new species of *Pithecanthropus dubius*, and Sangiran 6 belong to a new genus of *Meganthropus paleojavanicus* (von Koenigswald 1939, 1948; Weidenreich 1945).

All paleontological research in Javanese sites stopped during the Japanese occupation of the Second World War between 1942 and 1945. After the Independence of Indonesia, starting around the 1960s, Van Heekeren (1972) started a new archaeological research in Sangiran, also paleontological collections study of Sangiran fauna by Hooijer (1964). By the period between 1960s and 1970s research in Sangiran entered a new phase lead by Indonesian researcher, the tripartite of Sartono, a geologist from the Institute Technology Bandung; Soejono, a prehistorian from the National Research Center for Archaeology; and Jacob, a paleoanthropologist from the Laboratory of Bio- and Palaeoanthropology, Gadjah Mada University.

Between the 1970s and 1980s the first comprehensive geological and paleontological research was held in collaboration between University of Tokyo and Geological Research and Development Bandung, lead by Watanabe and Kadar (1985). During this period, Bartstra did an archaeological research in Sangiran regarding to answer the question on artifact of *Homo erectus* or Java Man (Bartstra 1982, 1983). Bartstra (1985); and Basoeki (1989) localized the Sangiran industries for the first time in the stratigraphical context of the Ngebung terraces. In the 1990s, a collaboration was made between The Institute of Technology Bandung and the University of Iowa lead by Zaim and Bettis on Geochronology and palaeoenvironmental development of Sangiran Dome during the occupation period of *Homo erectus* (Bettis et al. 2004; Larick et al. 2001).

In the early of 1990, MNHN (France) in collaboration with the National Research Center of Archaeology lead by Sémah, Djubiantono and Simanjuntak started an intensive excavation in Ngebung locality and found the first occupation layer in Sangiran which dated back to 0.8 Ma (Sémah et al. 1992, 1993; Simanjuntak and Sémah 1996). This collaboration is still continued until recently in the framework of Mission Quaternaire et Préhistoire en Indonésie (MQPI), with activities including excavation in Pucung locality, in the close proximity of the location where the famous Sangiran 17 was found.

Genesis

Volcanic activity played an important role in the formation of Sangiran dome, sedimentation filling of the basin, and marine regression, which caused Sangiran to be completely isolated from the marine environment (Brasseur et al. 2015; Djubiantono 1992; Sémah, Sémah, and Djubiantono 2001). These ancient volcanoes were close to the great recent volcanoes such as Mount Lawu which belongs to the inner arc of the Sunda. The volcanoes were already present about 2 Ma at the end of the Pliocene and formed important deposits such as lahars and breccias in Sangiran (Van Bemmelen 1949).

The regression event in Solo Depression started at the Gauss-Matuyama limit around 2.6 Ma causing Sangiran environment transition from an open sea to a lagoon (Djubiantono and Sémah F., 1993). At the Early Pleistocene around 1.8 Ma, a large volcanic activity happened and marked as a huge lahars deposit in Sangiran. These deposits partially filled the lagoon and allowed the deposition of coastal marsh clays (Djubiantono and Sémah F.,

1993). At the early of the Middle Pleistocene around 0.8 Ma, the marine environment totally disappeared from Sangiran and started the deposition of the continental environment through the Middle Pleistocene of Kabuh Formation which contains terrestrial faunal and human remains. The last huge volcanic activity recorded in Sangiran was the upper lahar of the Notopuro Formation about 0.2 Ma (Sémah 1984a).

During the Upper Pleistocene, a regional tectonic stage triggered the development of several dome structures, such as Gesi, Bringinan, Onto, Klego, Gemolong, and Sangiran itself on the northwestern flanks of Lawu volcano. Their positions around the base of this volcano might indicate the collapse of its northern side, causing the folding of local plastic layers (Van Bemmelen 1949). Following the dome uplift, dome structures were eroded by the Cemoro river and exposing the older Quaternary formations. The monsoon seasons are responsible for the rain's seasonal distribution with the mean of annual precipitation is 1600 mm and causes heavy erosion (Brasseur et al. 2015).

Formations / Archaeological Layers

Sangiran Dome holds records long range of occupation layers, which exhibits shallow marine level to terrestrial succession with a total thickness of 250 m and spanning from the Early Pleistocene ca 2.1-2.2 Ma (Hyodo 2001) to the upper Middle Pleistocene around 0.15 Ma (Falguères 2001), see Fig. 2. B.6 left. Sangiran Dome is an area of about 50 km², progressively showing the oldest to the younger units which are exposed from the central to the external part of the dome structure. Several main units are classically described as chronostratigraphic formation, named as Kalibeng (Puren), Pucangan (Sangiran), Kabuh (Bapang), and Notopuro (Pohजार) Formations (Van Es 1931; von Koenigswald 1934; Saleki 1997; Sémah 1984a; Suzuki and Wikarno 1982; Watanabe and Kadar 1985) Sémah *et al.*, 2000; Larick *et al.*, 2001; Bettis III *et al.*, 2004).

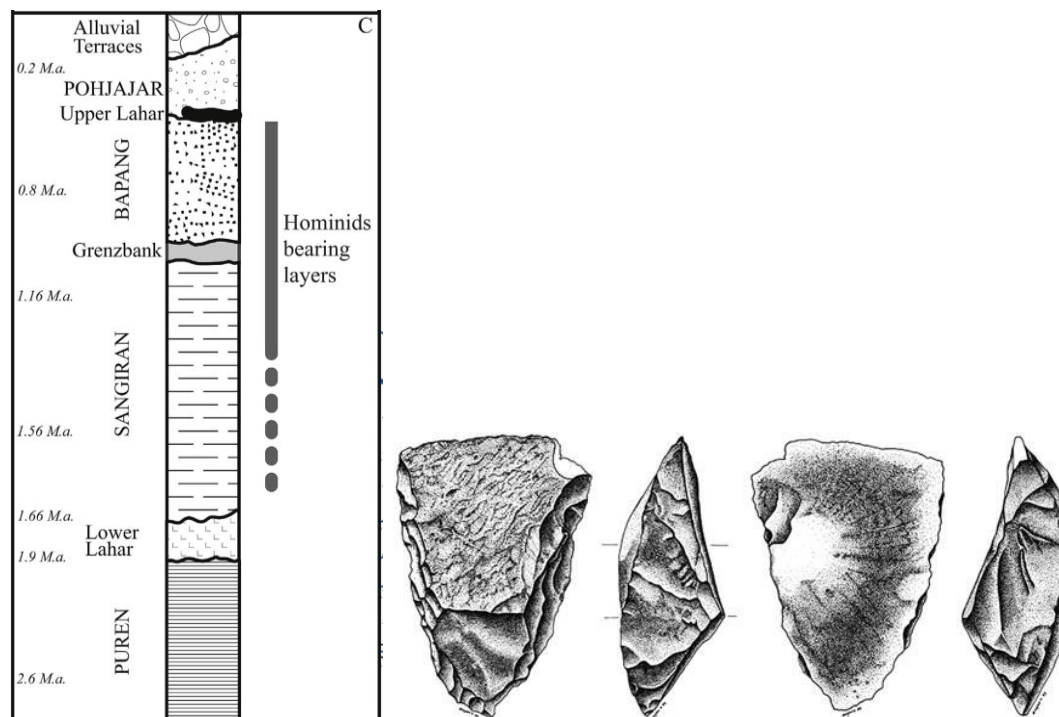

Fig. 2. B.6. Stratigraphy (Watanabe and Kadar 1985) and cleaver from Kabuh (Bapang) Formation of Sangiran Dome (Simanjuntak 2001).

Kalibeng (Puren) Formation

The Kalibeng (or Puren) Formation from the Upper Pliocene period is the oldest sediments in Sangiran Dome. The main facies consists of blue and gray clays with *Turritella* and often rich in organic matter which contains, at times, sandy clay-rich of foraminifera and mollusks (Van Es, 1931; Von Koenigswald, 1934; Sémah F., 1984a). During Pliocene about 2.5 Ma ago, the sea that covered the Solo region begins to retreat. The *Rhizophoraceae* pollen content in the facies of blue clays of the Kalibeng Formation allows us to observe the slight oscillations of the shoreline and suggests that the coastline of the lagoon was occupied by large mangrove forest. At this time, the coasts present a marshy forest and reliefs of humid tropical forest (Sémah A.M., 1986).

At the top of the Kalibeng Formation there was a coastal limestone bank with *Balanus* fossils. This characterizes shallow marine facies representing a regression phase. This limestone represents the level of transition which was followed by a yellowish pyroclastic sandstone deposit containing *Corbicula* that suggests the first freshwater levels (Van Es 1931; von Koenigswald 1934; Lizon-Sureau 1979). This first *Corbicula* bed in the upper part of the formation is the initial beginning of brackish or freshwater continental sedimentation (von Koenigswald 1940; Watanabe and Kadar 1985). Chronometric dating from the diatoms of the Upper Kalibeng suggested an age of 2.5-2.1 Ma (Ninkovich and Burckle 1978), based on the comparative study of marine diatoms from Upper Kalibeng and marine intercalation in the Pucangan, compare to the central Pacific core. The upper limit of the Kalibeng Formation is a diachronic erosive unconformity covered by a series of lahars deposited.

Pucangan (Sangiran) Formation

The Pucangan layers (lower Pleistocene) begin with a level of volcanic breccia and lahars of variable thickness which deposited between 1.9 Ma (Bettis et al. 2004) and 1.67 Ma (Sémah F. *et al.*, 2000). The presence of these lahars is the reflection of volcanic activity development in the region at that time. The continental environment developed around the Sangiran region at this stage, as the oldest continental vertebrates remain was found reworked in those lahars (Ansyori 2018; Brasseur et al. 2015; Van Es 1931; von Koenigswald 1940). They are corresponding to the Satir fauna colonization of Java Island (Van Den Bergh, de Vos, and Sondaar 2001; Sondaar 1984).

The lahar is followed by black clays with sometimes intercalated by layers of volcanic ash or diatomites (Van Es 1931; von Koenigswald 1934; Lizon-Sureau 1979). Fossils of terrestrial vertebrate were found in the lower lahar near the Sangiran museum contain of primitive cervids (*Cervus stehlini*) and bovids (antelope) (Ansyori 2018). Clay deposits are rich in organic material suggesting deposited close to a lacustrine environment. Two layers of diatomites have been observed suggesting that at least two marine transgressions occurred at that time in Sangiran (Sémah F., 1984a). The pollen record indicates regular shifts between the tropical rain forest and more open vegetation, linked to the major climatic changes which occurred during that period (Sémah A.M., 1986; Brasseur *et al.*, 2015).

Vertebrate fossils of Bukuran fauna together with hominin remains have been found in the black clay layers of Pucangan Formation of Early Pleistocene called (Von Koenigswald,

1940; Aimi and Aziz, 1985; Widiyanto, 1993; Ansyori 2018) (Fig. 2. B.8). Here is the table of human remains from Pucangan Formation (Table 2. B.3), including:

NO	ID	FRAGMENT	LOCALITY	DATE	FOUNDER
1	Sangiran 1a	Left Maxilla	Sangiran Dome	09/1936	Von Koenigswald
2	Sangiran 5	Right Mandible	Ngebung	1939	Von Koenigswald
3	Sangiran 6b	Left Mandible	Bukuran	1936	Von Koenigswald
4	Sangiran 7-35	Left Maxilla	Sangiran Dome	1937-1941	Von Koenigswald
5	Sangiran 7-36	Maxilla	Sangiran Dome	1937-1941	Von Koenigswald
6	Sangiran 7-37	Right Maxilla	Sangiran Dome	1937-1941	Von Koenigswald
7	Sangiran 7-70	Left Mandible	Sangiran Dome	1937-1941	Von Koenigswald
8	Sangiran 9	Right Mandible	Bojong	11/1960	Kerto
9	Sangiran 15a	Left Maxilla	Ngrejeng	20/07/1969	S. Sartono
10	Sangiran 22a	Fr. Occipital	Sangiran	08/02/1974	Wagimin
	Sangiran 22b	Mandible	Sangiran	08/02/1974	Wagimin
11	Sangiran 27	Maxilla	Sangiran	1978	Suherman
12	Sangiran 31	Fr. Cranium	Sangiran	1979	S. Sartono
13	Hanoman 1	Fr. Cranium	Ngebung	1988	Indonesian-French Team
14	Arjuna 13	Fr. Cranium	Ngebung	1988	Idem
15	Hanoman 13	Left Mandible	Ngebung	1988	Idem
16	Bu 9404	Fr. Occipital	Bukuran	04/1994	Ngatimin

Table 2. B.3. Hominin remains from Pucangan Formation of Sangiran dome.

(Sources: Von Koenigswald, 1939; Weidenreich, 1945; von Koenigswald, 1950, 1968; Sartono, 1974, 1978, 1991, 1961; Jacob, 1973; Krantz, 1975; Oakley, Campbell and Molleson, 1976; Sartono and Grimaud-Hervé, 1983; Procureur and Orban-Segebarth, 1983; Widiyanto, 1993a; Grine and Franzen, 1994; Tyler, Sartono and Krantz, 1995; Tyler, 2001; Schwartz and Tattersall, 2003; Indriati, 2004; Kaifu, Aziz and Baba, 2005; Durband, 2008; Indriati and Antón, 2008; Wood, 2011; Zanolli, 2011)

The earliest hominin fossils from Sangiran dome were found in the clays layer of Pucangan (Sangiran) Formation (Jacob 1981; von Koenigswald 1954; Watanabe and Kadar 1985; Widiyanto 2001b), Early Pleistocene ca. 1.6 and ca. 1 Ma (Nishimura 1981; Saleki 1997; Suzuki and Wikarno 1982), but their stratigraphic position is poorly known (Brasseur et al. 2015).

The existence of Lithic tools in Sangiran is represented by “Sangiran flakes” industry as defined by Von Koenigswald (1936; 1939), made of allochthonous rocks probably the raw material originally from the southern mountains of Gunungsewu. Although Von Koenigswald confused about the stratigraphical position of Ngebung artefact and as to be the tools of *Homo erectus*, Soejono (1975) and Sartono (1980) suggest that artifact come from the older stratigraphical position. Bartstra (1983; 1985) in his excavation found two layers of industries from the river terraces of the Ngebung Hill. The “Old River Gravel” layer of middle Late Pleistocene mainly contains flakes artifact, equal to the Ngandong terrace tools, and the “Young River Gravel” of upper Late Pleistocene to Holocene produced big core tools similar to Pacitanian industries and Sambungmacan implements.

Simanjuntak and Sémah (1996) have evidence that the “Sangiran flakes” industry is contemporary with the Kabuh hominid-bearing layers. They found a total of 20 Ngebung artefact *in situ* throughout the Kabuh Formation in Ngebung of Middle Pleistocene. Widiyanto, Toha and Simanjuntak (2001) found “Sangiran flakes” industry directly associated with the Grenzbank layer, which dated back older than 0.8 Ma (Sémah 1984b; Watanabe and Kadir 1985). Around the 2000s, several “Sangiran flakes” were discovered in conglomerate lenses at the Dayu locality, on the upper part near the end of Pucangan Formation, and estimated dated back to 1.2 Ma as the oldest lithic artifacts known in Java today (Widiyanto and Simanjuntak 2009). The discovery of Dayu artifact confirmed the hypothesis mentioned above and closed the debate on the age of the “Sangiran flakes” as the work of *Homo erectus* (Sémah et al. 2014).

Grenzbank Layer

The transition horizon in Sangiran Dome is a level named "Grenzbank" by Von Koenigswald (1934) as calcified conglomerate with mixed of marine features and gravel from erosion of the Kendeng Hills and the Southern Mountains. This level is not observable in all sections of the Sangiran Dome (Sémah F., 1984). These facies mark a drastic change in sedimentation because it is characteristic of the final filling of the lagoon, the marine influence disappears definitively and gives way to continental deposits (Sémah F., Sémah A.M. and Djubiantono, 2001).

Hominins fossil fragments which found from the early of Middle Pleistocene of Grenzbank layer (Table 2. B.4) are including:

NO	ID	FRAGMENT	LOCALITY	DATE	FOUNDER
1	Sangiran 1b	Right Mandible	Bukuran	09/1936	Atmowidjojo
2	Sangiran 4a	Fr. Maxilla	Glagah Ombo	12/1939	Von Koenigswald
3	Sangiran 6a	Right Mandible	Glagah Ombo	1941	Kromopawiro
4	Sangiran 8	Right Mandible	Glagah Ombo	09/1952	P. Mark & S. Sartono
5	Sangiran 33	Right Mandible	Blimbengkulon	05/1979	Sutanto
6	Bk 8606	Right Mandible	Blimbengkulon	06/1986	Sutanto
7	Sangiran XX	Left Mandible		1993	S. Sartono
8	Arjuna 9	Right Mandible	Ngebung	1988	Indonesian-French Team
9	Arjuna 18	Isolated Tooth	Ngebung	1988	Idem
10	Brahmana 13	Isolated Tooth	Ngebung	1988	Idem
11	Kresna 11	Femur	Ngebung	1988	Idem
12	Bp 9408	Fr. Frontal	Kali Brangkal	08/1994	Sutanto
13	Bpg 2001.04	Maxilla	Bapang	04/2001	Samingan

Table 2. B.4. Hominin remains from Grenzbank Layer of Sangiran dome.

(Sources: Marks, 1953; von Koenigswald, 1968; Jacob, 1973; Widiyanto, 1993a; Schwartz and Tattersall, 2003; Indriati, 2004; Kaifu *et al.*, 2005; Zanolli, 2011).

The Grenzbank consists of synorogenic deposits from the Kendeng Hills and the Southern mountains as well as volcanic deposits (Van Bemmelen 1949; von Koenigswald 1934; Sémah 1984a). Observing an angular unconformity in sub-contemporaneous layers near Kaliuter (15 km north of Sangiran), Djubiantono (1992) proposed that tectonic erosion increased at the end of the Early Pleistocene in the Kendeng zone. He hypothesized that the break in the sedimentation dynamics marked by the Grenzbank conglomerate could be linked with the uplift and subsequent erosion of the Kendeng and Southern Mountains surrounding the Solo depression around 0.9 Ma (Brasseur et al. 2015; Djubiantono and Sémah 1993; Sémah et al. 2010, 2001).

Kabuh (Bapang) Formation

The volcano-sedimentary formation of Kabuh or Bapang (Middle Pleistocene) is composed of clays gravel and fluvial sand with crossbedding stratification. In the coarse fraction small translucent chalcedony pebbles that served as raw material for Sangiran shards were observed as well as tectites and pumice (Van Es 1931; von Koenigswald 1934; Sémah 1984a). The basal part of Bapang (or Kabuh) Formation dated to the Early-Middle Pleistocene boundary around 0.8 Ma (Nishimura, 1981; Suzuki and Wikarno, 1982; Sémah, 1984b; Saleki, 1997; Hyodo *et al.*, 2011).

Kabuh Formation together with underlying Grenzbank as the transition between Pucangan and Kabuh Formations, sometimes yield small-sized lithic artifacts called “Sangiran flakes”, made from jasper, silicified limestone, quartzite, and chalcedony where the raw materials coming from the southern mountains (von Koenigswald 1936; Simanjuntak and Sémah 1996). Acheulean lithic artifacts were found together with in situ mammal fossils and hominin remains, on an occupation floor excavated by Sémah *et al.* (1992) in Ngebung locality in the Northwestern part of the Sangiran dome (Fig. 2. B.6 right).

Pollen analysis supported by paleoenvironmental studies documented an open environment of a mainly grassland landscape with rain forest gallery survived along the river (Sémah A-M. and Sémah F., 2001; Bettis *et al.*, 2009; Bouteaux and Moigne, 2010). The landscape change could be correlated to the climatic evolution around 0.8 Ma, represented by the Trinil HK to Kedungbrubus faunal turnover (de Vos 1985; de Vos et al. 1994).

Kabuh formation mainly the focus of the archaeological study in the Sangiran dome because it yields a large number of faunal remains as well as most of the Sangiran fossil hominids (Fig. 2. B.8) together with their artifacts. Some localities with Kabuh formation in the Sangiran dome provide a large quantity of faunal remains with a great number of taxons: cervids, bovids, rhino, carnivores and elephants. So, its means a marker of an open and dry environment, also a strong connection with the mainland Asia (Ansyori 2018).

Human remains recovered from Middle Pleistocene of Kabuh (Bapang) Formation in the Sangiran dome are presented at Table 2. B.5. Some isolated teeth were also found in Kabuh formation during survey and excavation by some researcher from Japan, French and Indonesia in some locality, such as Ngebung, Sendangbusik, Bukuran, Pucung, Ngrejeng and Padas (Jacob, 1973; Sartono, 1974; Aziz, 1981; Widiyanto, 1993; Aziz, Baba and Narasaki, 1994; Sartono, Tyler and Krantz, 1995; Tyler, Sartono and Krantz, 1995; Grimaud-Hervé and Widiyanto, 2001; Schwartz and Tattersall, 2003; Kaifu, Aziz and Baba, 2005; Zanolli, 2011). See

the table for complete maxillary and mandibular dental remains from the Middle Pleistocene Kabuh Formation.

NO	ID	FRAGMENT	LOCALITY	DATE	FOUNDER
1	Sangiran 2	Calotte	Bapang	1937	Von Koenigswald
2	Sangiran 3	Fr. Cranium	Tanjung	1938	Von Koenigswald
3	Sangiran 7b	23 Isol. Teeth	Sangiran Dome	1937-1941	Von Koenigswald
4	Sangiran 7-70	Fr. Mandible	Sangiran Dome	1937-1941	Von Koenigswald
5	Sangiran 10	Calotte	Tanjung	07-08/1963	Teuku Jacob
6	Sangiran 12	Calotte	Pucung	01/1965	S. Sartono
7	Sangiran 13	Fr. Parietal	Sangiran	1965	Teuku Jacob
8	Sangiran 14	Basal & Mastoid		1968	Teuku Jacob
9	Sangiran 15b	Right Maxilla	Sangiran	1969	Teuku Jacob
10	Sangiran 16a	LM2		1969	Teuku Jacob
11	Sangiran 16b	ULP		1969	Teuku Jacob
12	Sangiran 17	Cranium	Pucung	13/09/1969	Toekimin
13	Sangiran 18	Fr. Calotte		1970	Teuku Jacob
14	Sangiran 19a	Occipital		1970	Teuku Jacob
15	Sangiran 19b	Fr. Tibia	Ngebung	1970	Teuku Jacob
16	Sangiran 20	Right Parietal		1971	Teuku Jacob
17	Sangiran 21	Right Mandible	Ngebung	11/1973	S. Sartono
18	Sangiran 25	Right Parietal		1978	Teuku Jacob
19	Sangiran 26	Left Temporal		1978	Teuku Jacob
20	Sangiran 37	Right Mandible	Sendangbusik	03/1981	Djoko
21	Sangiran 38	Calvaria	Sendangbusik	1981	Teuku Jacob
22	Sangiran 40a	Occipital			
23	Sangiran 40b	Right Parietal			
24	Ng 8503	Right Mandible	Ngrejeng	03/1985	S. Sartono
25	Sangiran 46	Teeth	Ngebung	1988	Indonesian-French Team
26	Tjg 1993.05	Cranium	Tanjung	18/05/1993	Sugeng
27	Grogolan Wetan	Calotte	Grogolanwetan	1993	Sugimin
28	Brahmana 3	Occipital	Ngebung	1988	Indonesian-French Team
29	Cranium 0132	Calotte	Bojong	06/02/2016	Setu Wiryorejo

Table 2. B.5. Hominin remains from Kabuh Formation of Sangiran dome.

(Sources: Von Koenigswald, 1940; Weidenreich, 1945; Sartono, 1971; Widiyanto, 1993; Widiyanto and Grimaud-hervé, 2000; Arif *et al.*, 2002; Indriati, 2004; Kaifu *et al.*, 2011).

Notopuro (Pohjajar) Formation

The Kabuh Formation is covered by a discordant series (Djubiantono 1992) of volcanic breccias and so-called lahars of Notopuro or Pohjajar Formation. The Lahar constitutes the base, and the following layers are mainly coarse fluvio-volcanic sands alternating with tuffs, only interrupted by a further lahar. This unit, dated back to 0.15 Ma by Ar/Ar (Saleki 1997) and 0.25 Ma by fission tracks (Suzuki and Wikarno 1982), contains few fossils and no pollen remains (Brasseur et al. 2015). At some areas above these series are found recent alluvial deposits contain sand, gravel, and boulders with intercalated silty levels. Those terraces deposits are postdating dome folding which not locally dated, and also very few contain fossils (Brasseur et al. 2015). So far, there is no hominin fossils produced from Kalibeng and Notopuro Formations (Fig. 2. B.8).



Fig. 2. B.7. Landscape of Sangiran dome (Doc. Noerwidi).

The Significance

Sangiran dome records the longest evidence of human occupation in the Insular of Southeast Asia, from 1.6 Ma to 500 Ka BP. This site rich in human remains with the artifact as their cultural evidence, and faunal remains as their ecological context. Not less than 140 individuals have been recovered from Sangiran dome, caused as the most productive hominin site in this region. The Sangiran dome also recorded the evolution steps of *Homo erectus* in a range of 1 million years as stated by Widiyanto (1993). The huge amount of human remains which produced in a climatic change of one million years also rises a question about hominin diversity that might happen during those periods.

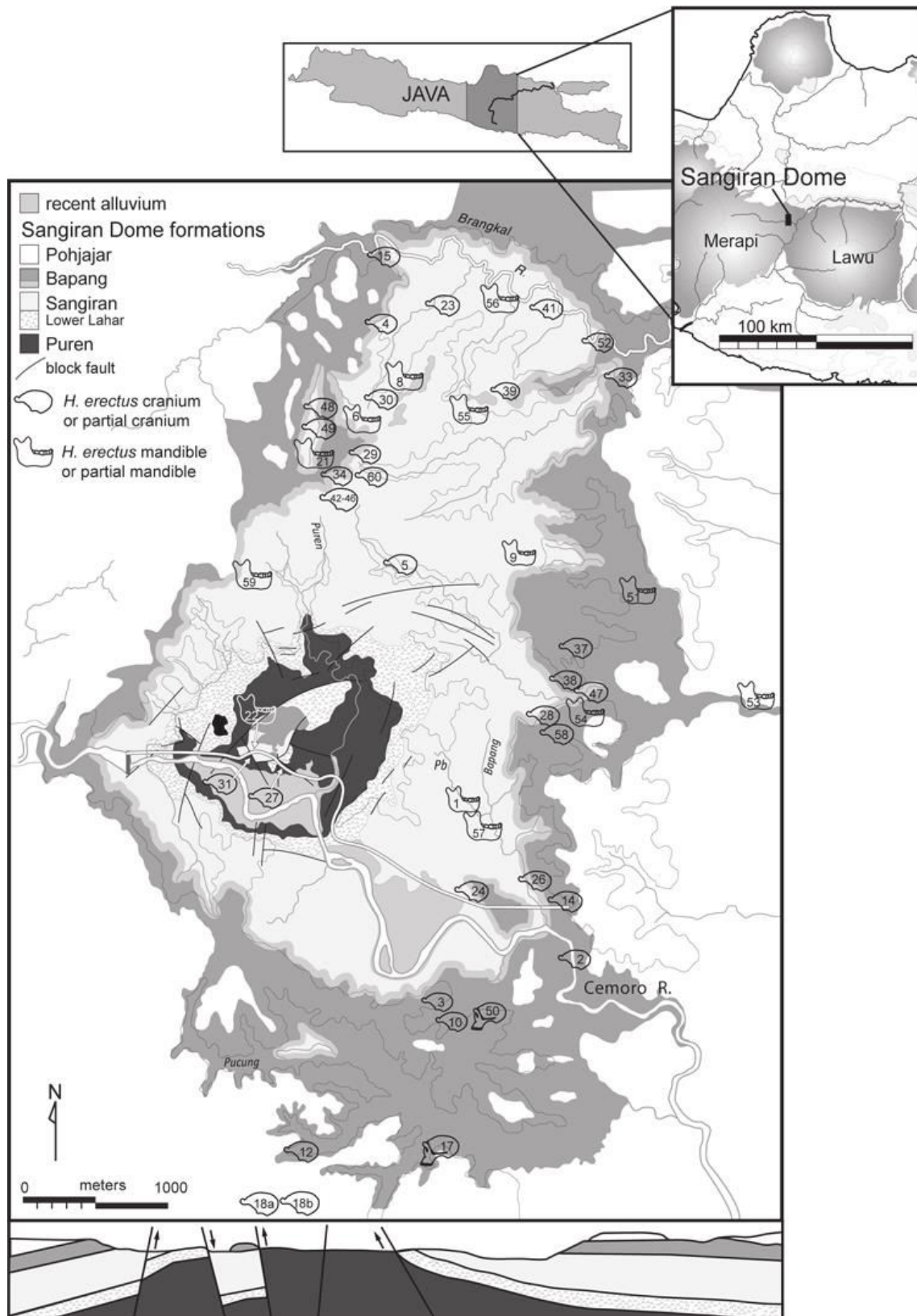

Fig. 2. B.8. Distribution map of main hominins found in Sangiran Dome (Ciochon 2010).

Maxillary and Mandibular Dental Remains

Here is the table of mandible and maxilla specimens from the Sangiran Dome (Table 2. B.6):

NO	LOCALITY	NO. COL	REMAINS	SIDING	TEETH	GRADE	AGE (YO)	STRATIGRAPHY	LITHOLOGY	STORAGE	NOTE
1	Sangiran Dome	Sangiran 1a	Fr. Maxilla	Left	M1-3	H	40-50	Pucangan	Lacustrine deposit	SFN	
2	Bukuran	Sangiran 1b	Mandible	Right	P4-M3	E	24-30	Grenzbank		SFN	
3	Glagah Ombo	Sangiran 4	Fr. Maxilla	Left-Right	LC1-M1 RC1-M3	F	30-35	Grenzbank		SFN	
4	Ngebung	Sangiran 5	Fr. Mandible	Right	M1-2	G	35-40	Pucangan / Grenzbank	Lacustrine deposit	SFN	
5	Glagah Ombo	Sangiran 6a	Fr. Mandible	Right	P3-M1	G	35-40	Pucangan / Grenzbank		SFN	
6	Bukuran	Sangiran 6b	Fr. Mandible	Left	M2-M3	H	40-45	Pucangan		SFN	
7	Sangiran Dome	Sangiran 7-3abcd	Upper Teeth	Right	P4-M3	E	24-30	Pucangan	Jetis Beds	SFN	
8	Sangiran Dome	Sangiran 7-35	Fr. Maxilla	Left	C-P3	C	18-22	Pucangan	Jetis Beds	SFN	
9	Sangiran Dome	Sangiran 7-36	Fr. Maxilla		C-P3	C	18-22	Pucangan	Jetis Beds	SFN	
10	Sangiran Dome	Sangiran 7-37	Fr. Maxilla	Right	P4-M1	E	24-30	Pucangan	Jetis Beds	SFN	
11	Sangiran Dome	Sangiran 7-70	Fr. Mandible	Left	M1-M3	I	45-55	Pucangan	Jetis Beds	SFN	
12	Glagah Ombo	Sangiran 8	Fr. Mandible	Right	C1-M3	F	30-35	Grenzbank	Conglomeratic Layer	GRDC	
13	Bojong	Sangiran 9	Fr. Mandible	Right	C1-M3	F	30-35	Pucangan / Grenzbank	Boundary	GRDC	
14	Ngrejeng	Sangiran 15a	Fr. Maxilla	Left	P3-4	E	24-30	Pucangan	Grey claystone	GRDC	
15	Sangiran Dome	Sangiran 15b	Fr. Maxilla	Right	P3	G	35-40	Kabuh		UGM	
16	Pucung	Sangiran 17	Fr. Maxilla	Left-Right	RC1 M1-3 LP3	G	35-40	Kabuh	Low-Mid Tuff	GRDC	
17	Ngebung	Sangiran 21	Fr. Mandible	Right	M3	E	24-30	Kabuh	AG	GRDC	

18	Sangiran	Sangiran 22b	Fr. Mandible	Left-Right	LC1-M3 RI1-M3	G	35-40	Pucangan	Black Clay	GRDC
19	Sangiran Dome	Sangiran 27	Fr. Maxilla	Left-Right	RP3-M2 LP4-M2	F	30-35	Pucangan		UGM
20	Blimbingskulon	Sangiran 33	Fr. Mandible	Right	M2	E	24-30	Grenzbank / Kabuh		GRDC
21	Sendangbusik	Sangiran 37	Fr. Mandible	Right	P4-M3	E	24-30	Kabuh	Low-Mid Tuff	GRDC
22	Ngrejeng	Ng 8503	Fr. Mandible	Right	M1-M2	B1/B2	16-20	Kabuh	Low-Mid Tuff	GRDC
23	Blimbingskulon	Sangiran 39	Fr. Mandible	Right	M1-3	F	30-35	Pucangan / Grenzbank		GRDC
24	Ngebung 1	Ardjuna 9	Fr. Mandible	Right	M2-M3	F	30-35	Grenzbank / Kabuh		BPSMP
25	Ngebung	Sangiran 46			4 Teeths in matrix			Grenzbank / Kabuh		Arkenas
26	Ngebung	Hanoman 13	Fr. Mandible	Left	M3	?		Pucangan		BPSMP
27	Sangiran Dome	Sangiran XX	Fr. Mandible	Left	M1-3	F	30-35	Grenzbank		UGM
28	Tanjung	Tjg 1993.05	Fr. Maxilla	Left-Right	P3-M3	E	24-30	Kabuh	Low-Mid Tuff	ITB
29	Grogolwetan	Grogolwetan	Fr. Maxilla	Left-Right	RI1-M3 LM1, LM3	G	35-40	Kabuh	Low-Mid Tuff	BPSMP
30	Bapang	Bpg 2001.04	Fr. Maxilla	Left	P3-M2	F	30-35	Grenzbank		ITB
31	Bapang	Fr. Rahang	Fr. Mandible	?	?	?		Kabuh	Fluvio-volcanic	BPSMP

Table 2. B.6. Mandible and maxilla specimens from Sangiran dome.

Abbreviation: SFN = Senckenberg Frankfurt Naturmuseum (Germany), GRDC = Geological Research and Development Center, Bandung (Indonesia), UGM = Gadjah Mada University, Yogyakarta (Indonesia), BPSMP = Conservation Office of Sangiran Early Man Site (Indonesia), Arkenas = The National Research Center for Archaeology, Jakarta (Indonesia), ITB = Institut of Technology Bandung (Indonesia).

Table of Isolated teeth

Here is the table of isolated teeth (Table 2. B.7) found in the Sangiran Dome:

NO	LOCALITY	NO. COL	CATEGORY	GRADE	AGE (YO)	STRATIGRAPHY	LITHOLOGY	STORAGE
1	Sangiran Dome	Sangiran 7-1	URI1	H	40-50	Kabuh	Trinil Beds	SFN
2	Sangiran Dome	Sangiran 7-2	ULI2	G	35-40	Kabuh	Trinil Beds	SFN
3	Sangiran Dome	Sangiran 7-3a	URP4	E	24-30	Kabuh	Trinil Beds	SFN
4	Sangiran Dome	Sangiran 7-3b	URM1	E	24-30	Kabuh	Trinil Beds	SFN
5	Sangiran Dome	Sangiran 7-3c	URM2	E	24-30	Kabuh	Trinil Beds	SFN
6	Sangiran Dome	Sangiran 7-3d	URM3	E	24-30	Kabuh	Trinil Beds	SFN
7	Sangiran Dome	Sangiran 7-6	ULM3	H	40-50	Kabuh	Trinil Beds	SFN
8	Sangiran Dome	Sangiran 7-8	ULM1	E	24-30	Kabuh	Trinil Beds	SFN
9	Sangiran Dome	Sangiran 7-9	URM1	D	20-24	Kabuh	Trinil Beds	SFN
10	Sangiran Dome	Sangiran 7-10	URM1	E	24-30	Kabuh	Trinil Beds	SFN
11	Sangiran Dome	Sangiran 7-13	ULm2			Kabuh	Trinil Beds	SFN
12	Sangiran Dome	Sangiran 7-14	URM1/2	G	35-40	Kabuh	Trinil Beds	SFN
13	Sangiran Dome	Sangiran 7-17	URM3	H	40-50	Kabuh	Trinil Beds	SFN
14	Sangiran Dome	Sangiran 7-18	LRI2	B1/B2	16-20	Kabuh	Trinil Beds	SFN
15	Sangiran Dome	Sangiran 7-20	LLM1/2	E	24-30	Kabuh	Trinil Beds	SFN
16	Sangiran Dome	Sangiran 7-25	LRP3	H	40-45	Kabuh	Trinil Beds	SFN
17	Sangiran Dome	Sangiran 7-26	LRP3	A	12-18	Kabuh	Trinil Beds	SFN
18	Sangiran Dome	Sangiran 7-27	ULP3	E	24-30	Kabuh	Trinil Beds	SFN
19	Sangiran Dome	Sangiran 7-29	URP4	G	35-40	Kabuh	Trinil Beds	SFN
20	Sangiran Dome	Sangiran 7-30	URP4	C	18-22	Kabuh	Trinil Beds	SFN
21	Sangiran Dome	Sangiran 7-31	ULP3	B1/B2	16-20	Kabuh	Trinil Beds	SFN
22	Sangiran Dome	Sangiran 7-32	URP3	D	20-24	Kabuh	Trinil Beds	SFN
23	Sangiran Dome	Sangiran 7-34	ULP3	A	12-18	Kabuh	Trinil Beds	SFN
24	Sangiran Dome	Sangiran 7-38	ULM1	G	35-40	Pucangan	Jetis Beds	SFN
25	Sangiran Dome	Sangiran 7-40	URM1	D	20-24	Pucangan	Jetis Beds	SFN
26	Sangiran Dome	Sangiran 7-42	LRM1	E	24-30	Pucangan	Jetis Beds	SFN
27	Sangiran Dome	Sangiran 7-43	LLM1	E	24-30	Pucangan	Jetis Beds	SFN
28	Sangiran Dome	Sangiran 7-45	URC	F	30-35	Pucangan	Jetis Beds	SFN

29	Sangiran Dome	Sangiran 7-46	UR/LC	G	35-40	Pucangan	Jetis Beds	SFN
30	Sangiran Dome	Sangiran 7-47	ULC	C	18-22	Pucangan	Jetis Beds	SFN
31	Sangiran Dome	Sangiran 7-48	URI1	F	30-35	Pucangan	Jetis Beds	SFN
32	Sangiran Dome	Sangiran 7-50	ULI2/LRI2	D	20-24	Pucangan	Jetis Beds	SFN
33	Sangiran Dome	Sangiran 7-53	ULM2	E	24-30	Pucangan	Jetis Beds	SFN
34	Sangiran Dome	Sangiran 7-56	ULI2	D	20-24	Pucangan	Jetis Beds	SFN
35	Sangiran Dome	Sangiran 7-57	LLI2	A	12-18	Pucangan	Jetis Beds	SFN
36	Sangiran Dome	Sangiran 7-58	ULP3	D	20-24	Pucangan	Jetis Beds	SFN
37	Sangiran Dome	Sangiran 7-59	LLC	E	24-30	Pucangan	Jetis Beds	SFN
38	Sangiran Dome	Sangiran 7-61	LRM1	F	30-35	Pucangan	Jetis Beds	SFN
39	Sangiran Dome	Sangiran 7-62	LRM1/2	D	20-24	Pucangan	Jetis Beds	SFN
40	Sangiran Dome	Sangiran 7-64	LRM2	D	20-24	Pucangan	Jetis Beds	SFN
41	Sangiran Dome	Sangiran 7-65	LRM2	A	12-18	Pucangan	Jetis Beds	SFN
42	Sangiran Dome	Sangiran 7-67	LRm1			Pucangan	Jetis Beds	SFN
43	Sangiran Dome	Sangiran 7-69	LRP3	C	18-22	Pucangan	Jetis Beds	SFN
44	Sangiran Dome	Sangiran 7-72	LRm2			Pucangan	Jetis Beds	SFN
45	Sangiran Dome	Sangiran 7-73	ULM3	D	20-24	Pucangan	Jetis Beds	SFN
46	Sangiran Dome	Sangiran 7-75	LLI1	D	20-24	Pucangan	Jetis Beds	SFN
47	Sangiran Dome	Sangiran 7-76	LRM1	E	24-30	Pucangan	Jetis Beds	SFN
48	Sangiran Dome	Sangiran 7-78	LLM1/2	F	24-30	Pucangan	Jetis Beds	SFN
49	Sangiran Dome	Sangiran 7-83	ULc			Pucangan	Jetis Beds	SFN
50	Sangiran Dome	Sangiran 7-84	LRM2	F	24-30	Pucangan	Jetis Beds	SFN
51	Sangiran Dome	Sangiran 7-85	URI1	E	24-30	Pucangan	Jetis Beds	SFN
52	Sangiran Dome	Sangiran 7-86	URI1	D	20-24	Pucangan	Jetis Beds	SFN
53	Sangiran Dome	Sangiran 7-88	LLI2	B1/B2	16-20	Pucangan	Jetis Beds	SFN
54	Sangiran Dome	Sangiran 7-89	URM2	D	20-24	Pucangan	Jetis Beds	SFN
55	Sangiran Dome	Sangiran 11a	LRI1			Kabuh		UGM
56	Sangiran Dome	Sangiran 11b	ULM3			Kabuh		UGM
57	Sangiran Dome	Sangiran 16a	LL/RM2			Kabuh		UGM
58	Sangiran Dome	Sangiran 16b	ULP3/4			Kabuh		UGM
59	Sangiran Dome	Sangiran 24	LLM2, ULM1, URM1, ULM3, LLM2, LLM3, LRM3, LRM3,					ITB

	LRP4, and LRP4 (Pongo?)						
60	Sangiran Dome	Sangiran 28	?				ITB
61	Sangiran Dome	Sangiran 32	?				ITB
62	Sangiran Dome	Sangiran 35	URM2				?
63	Sangiran Dome	Sangiran 36	?				?
64	Sangiran Dome	Sangiran 42	?				?
65	Ngebung	Ardjuna 1a	URM2				BPSMP
66	Ngebung	Ardjuna 1b	ULM2				BPSMP
67	Ngebung	Ardjuna 1c	URM1				BPSMP
68	Ngebung	Ardjuna 5	LRM3				BPSMP
69	Ngebung	Ardjuna 8	LRM2			Notopuro	BPSMP
70	Ngebung	Ardjuna 10	LLM2			Pucangan	Upper Layer BPSMP
71	Ngebung	Ardjuna 12	ULM2			Pucangan	Upper Layer BPSMP
72	Sangiran Dome	Brahmana 13	LRI1	?		Grenzbank	BPSMP
73	Ngebung	Sangiran 48	ULM2	D	20-24	Kabuh	BPSMP
74	Ngebung	NG 9107.1	URM3	F	30-35		BPSMP
75	Ngebung	NG 9107.2	LLM3	E	24-30		BPSMP
76	Ngebung	NG 92.1	LLM3	G	35-40		BPSMP
77	Ngebung	NG 92.2	LLM1	F	30-35		BPSMP
78	Ngebung	NG 92.3	URM1	D	20-24		BPSMP
79	Ngebung	NG 92.4	LRM2	H	40-45		BPSMP
80	Ngebung	NG 92 D6	LRM2	E	24-30	Kabuh	BPSMP
81	Ngebung	NG 9505	URP3/4	F	30-35	Kabuh	Ensemble B or C BPSMP
82	Ngrejeng	Ng 9603	URM1	F	30-35	Pucangan	GRDC
83	Sendangklampok	Nk 9603	LRM2	E	24-30	Pucangan	White Clay GRDC
84	Sendangbusik	Sangiran 58	LLI1			Kabuh	Low-Mid Tuff GRDC
85	Bukuran	Bs 9706	LLI1	C	18-22	Kabuh	Low-Mid Tuff GRDC
86	Pucung	PCG.1	ULm1			Kabuh	BPSMP
87	Pucung	PCG.2	LLm2			Kabuh	BPSMP
88	Ngejeng	Njg 2005.05	ULM3			Kabuh	Above Grenzbank ITB
89	Padas	PDS 0712	URM2/3	C	18-22	Kabuh	BPSMP

90	Ngebung	NG 0802.1	URM2	E	24-30	Kabuh	BPSMP
91	Ngebung	NG 0802.2	LLM2/3	E	24-30	Kabuh	BPSMP
92	Ngebung	NG 0802.3	LLM3	G	35-40	Kabuh	BPSMP
93	Pancuran	MI 92.1	LRM1	H	40-45	Kabuh	BPSMP
94	Pancuran	MI 92.2	URM2	H	40-45	Kabuh	BPSMP
95	Pucung	Abimanyu 1	LLM2	E	24-30	Kabuh	BPSMP
96	Pucung	Abimanyu 2	URM1	D	20-24	Kabuh	BPSMP
97	Pucung	Abimanyu 4	LLM1	B1/B2	16-20	Kabuh	BPSMP

Table 2. B.7. Isolated teeth from Sangiran dome.

Abbreviation: SFN = Senckenberg Frankfurt Naturmuseum (Germany), GRDC = Geological Research and Development Center, Bandung (Indonesia), UGM = Gadjah Mada University, Yogyakarta (Indonesia), BPSMP = Conservation Office of Sangiran Early Man Site (Indonesia), Arkenas = The National Research Center for Archaeology, Jakarta (Indonesia), ITB = Institut of Technology Bandung (Indonesia).

4. RANCAH (BOGOR ANTICLINAL ZONE)

Location

Physiographically, the Pleistocene sites in the western part of Java are located in the Bogor Zone anticlinorium mountains. This mountain is connected to the North Serayu in Central Java, Kendeng in East Java. The physiographic zone reflects a deposit of basin area, and geometrically extends almost west-east orientation Van Bemmelen, (1949). This mountain should be raised during the late Pliocene when at the same time the rest of central and eastern part Java still submerged.

Tambaksari and Rancah are districts in the Ciamis regency, West Java. Two rivers flow in this area, named Cipasang and Cisanca, are tributaries belong to the Cijulang river (Fig. 2. B.9). Tambaksari site located in a sedimentary basin named as "Cijulang" by Von Koenigswald (1934), based on his faunal finding of archaic terrestrial faunal remains characterized by the presence of *Merycopotamus nanus* Lydekker an archaic hippo.

Research History

Paleontological research in this area began in the early 20th century when J van Houten found vertebrata fossils in the northeastern of Rancah in the 1920s. Further studies were conducted by Van Es (1931), Von Koenigswald (1934), and Hetzel (1935). Tambaksari produced several kinds of terrestrial faunal remains including *Bibos*, *Bubalus*, *Cervus*, *Crocodylus*, *Proboscidae*, *Hypopotamidae*, *Celonidae*, and *Rhinocerotidae*. Some localities in Tambaksari area which produced those faunal fossils are including Urugkasang, Cisanca, Cicalincing, Cibabut, Cihonje, Ciloa, Cibabut, and Cipasang localities.

Some prehistoric research in this area also conducted by Soejono, (1975), Sartono (1987), Djubiantono (1997; 1999; 2001), Simanjuntak (1986), Zaim (2004), Kramer *et al.* (2005), and Yondri (1995; 1996; 2001) which produced some information and evidence of prehistoric human existence in West Java. These studies provide a preliminary data on Pleistocene fossil remains and Paleolithic tools.

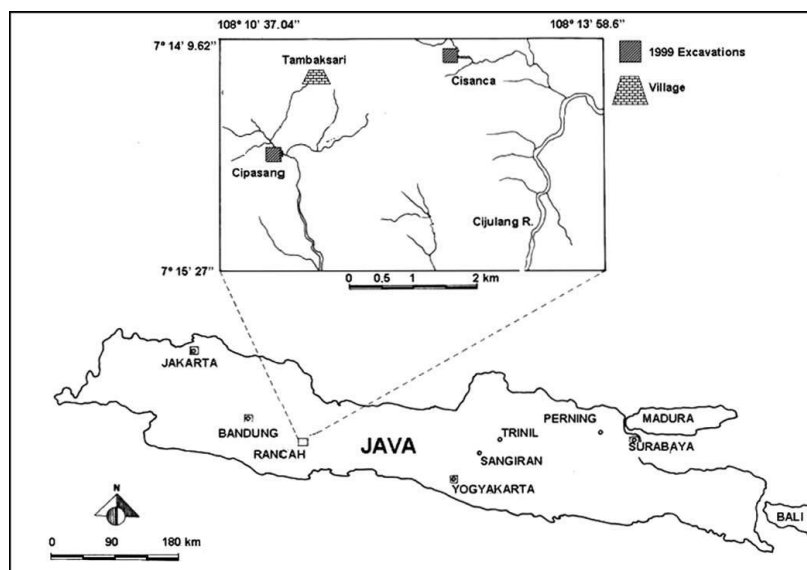

Fig. 2. B.9. Location of Rancah hominin site, West Java (Kramer et al. 2005).

The most impressive finding from Tambaksari site is a hominin incisor in July 1999 by Balai Arkeologi Bandung, STTNas Yogyakarta, Laboratory of Quaternary Geology of the GRDC Bandung, University of Tennessee and Auburn University. They found the tooth in an excavation of Cisanca locality in 333 cm depth below the surface in the bluish sandstone layer containing terrestrial faunal remains (Kramer et al. 2005).

Zaim (2004), Hertler, Rizal and Zaim (2007), also Ferdianto (2018) in their research in Cariang area, Sumedang, in the Bogor anticlinal zone, found several vertebrate fossils of the Mid Pleistocene period. They found some remains of *Bovidae*, *Stegodon*, *Rhinocerotidae*, *Suidae* and *Cervidae*. The most interesting finding by Ferdianto et al., (in press) are Rhino's teeth probably belong to *Ascentherium boschi*, archaic of small *Suidae* and *Cervidae*, which could be the member of Sande fauna as proposed by Von Koenigswald (1935). So far, there are no human remains have been found in this area.

Formations / Archaeological Layers

The stratigraphy of Rancah area from the oldest to the youngest as proposed by Kastowo and Suwarna (1996) are Halang Formation and Tapak Formation, from Miocene to Pliocene periods and covered by undifferentiated volcanics of Slamet volcano. However, Quaternary terrestrial vertebrates and hominin teeth found by Kramer *et al.* (2005) and other previous researcher have represented the existence of younger lithological formation in Rancah site (Fig. 2. B.10).

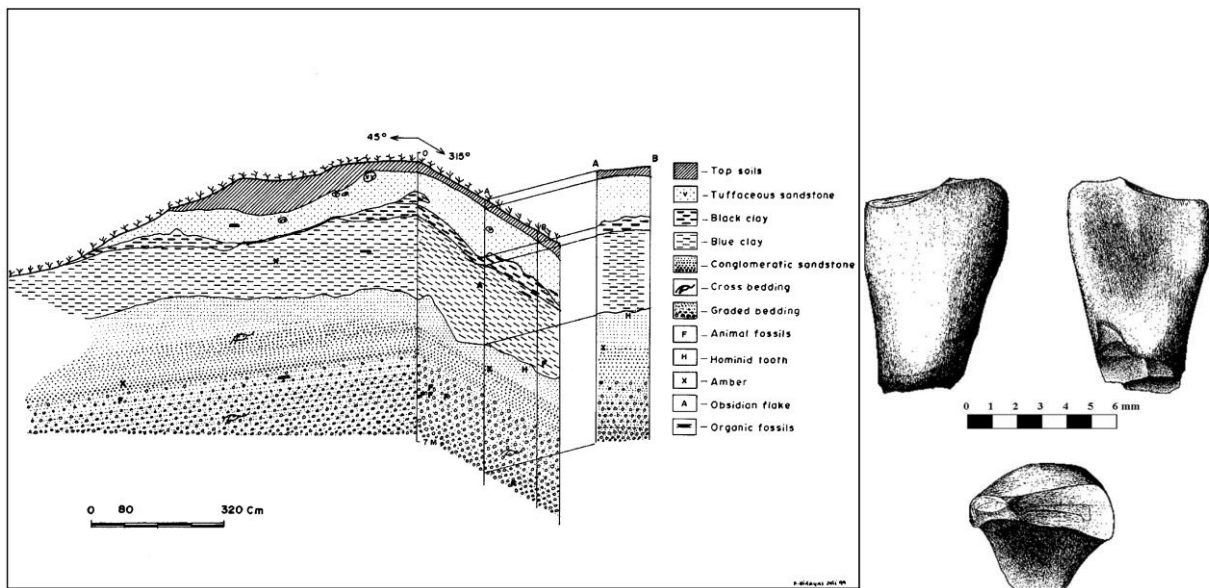

Fig. 2. B.10. Stratigraphical section and hominin tooth of Rancah site (Kramer et al. 2005).

The two main lithological formation of Rancah area are:

Halang

Halang Formation is characterized by tuffaceous sandstone, conglomerate, marl, and claystone. This formation presumably deposited during Middle to Early Pliocene, in an open marine environment by a turbidity current. Halang Formation is overlain unconformably by Tapak Formation, interfingering with the Gununghurim member of Halang Formation, and is underlain conformably by Lawak Formation.

Tapak

Tapak Formation is characterized by greenish-grey coarse-grained sandstone in the lower part, gradually grading upward into finer greenish-grey sandstone with some grey to yellowish sandy marl intercalations. At the upper part, alternating calcareous sandstone and marl contain brackish of marine molluscs, tending to show an Early to Middle Pliocene. The depositional environment is assumed to be a tidal zone. The conglomerate of Tapak Formation contains *Merycopotamus nannus*, a Middle Pliocene mammal, is found to occupy the lower part of the sequence, as well as calcareous sandstone being rich in molluscs. Locally, the upper part contains lignite layers. The environment of deposition is presumed to be a coastline, where the fluctuation of the sea level occurred frequently.

Human remains

Kramer *et al.* (2005) found a hominin tooth at Cisanca and named as specimen RH1. It is a permanent, lower, right, lateral incisor without root preserved. He compared to four isolated lower lateral hominid incisors from the von Koenigswald collection of Sangiran (Grine and Franzen 1994). He notes very similar of lingual surfaces in their “faint” marginal ridges and median vertical swellings below the incisal edge. Although Sangiran specimen display slight “double-shoveling” (labial marginal ridges), but resemble in their smoothly convex labial surfaces (Kramer *et al.* 2005).

In the metrical point of view, the RH1 specimen is too large to be *Macaca* and too small to be *Pongo*, but most similar in size to *Homo sapiens* and most similar in shape to *H. erectus*. A series of bovid teeth found about 2 meters below RH1 were dated with EPR techniques suggesting an age between 516-606 Ka BP.

NO	LOCALITY	NO. COL	REMAINS	GRADE	AGE	STRATIGRAPHY	FAUNA	DATING	STORAGE
1	Tambaksari	Rancah Hominid 1	LRI2	D ?	20-24	Sandstone	Mid Pleistocene	0.5-0.6 Ma	Dit PCBM

Table 2. B.8. Hominin tooth from Rancah site. Abv: Dit. PCBM = Directorate of Heritage Preservation and Museum, Jakarta (Indonesia).

The Significance

The evidence for the existence of early hominins in the western part of Java is still problematic and debatable today, because almost all the *Homo erectus* findings is come from the Central and Eastern parts of Java. This condition arises the theory of migration routes which connected directly to the Mainland of Asia to the central and eastern part of Java by a savannah corridor. In the Pleistocene glacial period when sea levels dropped dozens of meters below the actual surface, the Sundaland are connected by a land bridge and allow the migration flow from the mainland to the archipelago.

The western part of Java was firstly emerge compared to the eastern part of this island in the Plio-Pleistocene transition around 2 Ma ago. This region should be firstly occupied as hypothesized by Cisande and Cijulang fauna proposed by Von Koenigswald (1934), but later revised by Sondaar (1984) and De Vos (1985). Recent findings of archaic faunal remains by Ferdianto (2018) in Sumedang area could be compatible with the previous

hypothesis. During the Pleistocene period, the western part of Java was supposed to be almost tropical rain forested (van der Kaars and Dam 1997; Stuijts 1993) and avoided occupied by human. But, recent findings of hominin tooth by Kramer *et al.*, (2005) dated from the Mid Pleistocene 0.5-0.6 Ma open a possibility about human occupation in this region.

5. GUA PAWON (BANDUNG HIGHLAND)

The greater Bandung highland area, West Java, is a large intramontane basin surrounded by volcanic highlands (Dam et al. 1996). This zone tectonically the equivalent of the Solo Zone in eastern Java. It represents the axial part of the Pleistocene Java geanticline, which broke off from its south flank (the southern mountains) and slipped northward. In some places, the tertiary formations form mountains and ridges which rise like islands above the quaternary plain and plateaus, such as Rajamandala Range south of Bandung (Van Bemmelen 1949).

The Rajamandala ridge forms a step anticlinorium overturned to the north. Based on a geological study by Sudjatmiko (2003), stated some lithological formation in the Rajamandala range from Oligocene to Miocene periods, they are Rajamandala Formation, Citarum Formation, Jatiluhur Formation, Cantayan Formation, and volcanic quaternary breccia and lahar of Gunung Gede Mt (Fig. 2. B.11). The age of Rajamandala limestone comes from the Late Oligocene and Early Miocene (Siregar 2005), and this 650 m thick of limestone formation is the main lithological unit which produce some karstic cavities, such as Gua Pawon in the Gunung Pawon near Gunung Masigit.

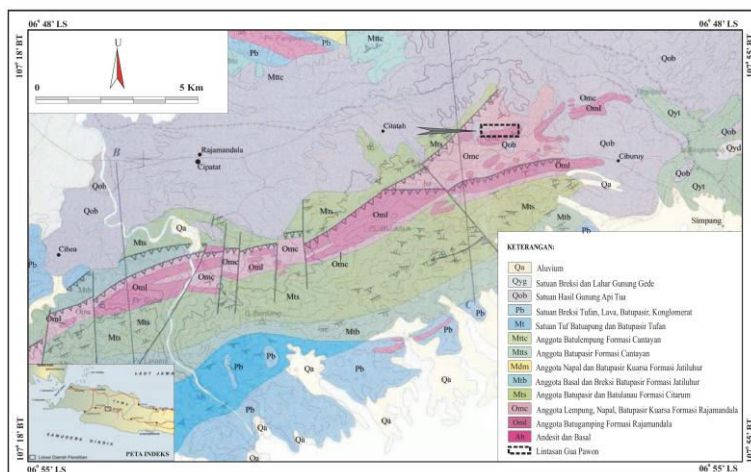

Fig. 2. B.11. Geological map of Rajamandala ridge and pawon cave (Maryanto 2009; Sudjatmiko 2003).

General condition of Gua Pawon

Gua Pawon or Pawon cave is located in Gunung Masigit village, Cipatat District, Bandung Regency, West Java and around 25 Km far to the west of Bandung city. Geologically, this site is located on the western part of the Gunung Masigit karstic area of Rajamandala Formation from Late Oligocene and early Miocene around 30 Mya. Geographically, Pawon cave located on the offshore of Bandung paleo-lake and located about 716 meters above actual sea level. Gua Pawon was found by KRCB in the May of 1999, in damage condition on the western part caused by phosphate mining of local people around 4-5 m depth (Yondri 2005).

Pawon cave has an east-west orientation with an entrance in the northern part (Fig. 2. B.12). The cave has 16 meters wide of the entrance, 38 meters of total length, and 8,5 meters high from the actual surface floor. The Archaeological excavation conducted by Balar Bandung, a regional office for archaeological research of West Java, was starting from 2003

up to now. Six excavation boxes have been opened, which are distributed on the southern and middle parts of the cave. Excavation has reached more than two m depths and the archaeological layer still continuing.

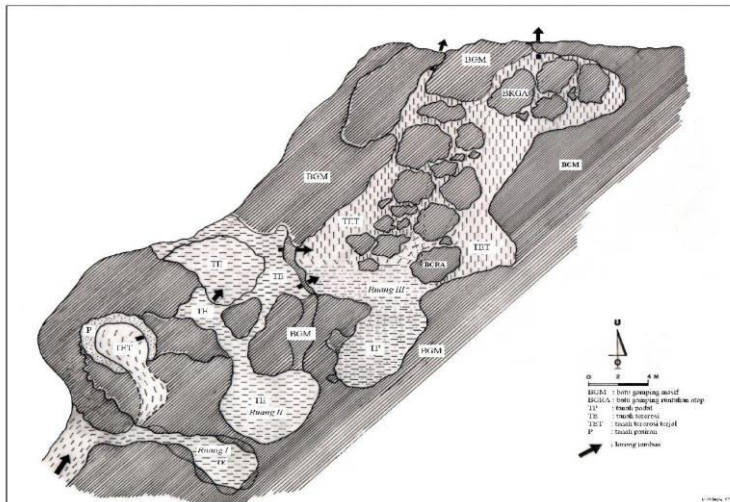

Fig. 2. B.12. Plan site of Pawon cave (Yondri 2005).

Archaeological Layer

Archaeological excavation since 2003 in Pawon Cave successfully recovered fragments of pottery, flake tools, bone point, spatula, percutor, accessories from mammal and shark teeth, moluscs, and the most important finds are human remains. So far, there are four stratigraphical units in the Pawon Cave, named layer D from the bottom to layer A on the upper part (Fig. 2. B.13).

Layer A is the most upper part in Pawon Cave with 20 to 35 cm below the surface. This layer came from a recent period with the disturbed conditions. Layer A produced some archaeological finds such as; obsidian and chalsedony flake tools, bone tools, faunal remains, pottery, shell, but also mixed with modern materials such as glass, iron nail, and bottle cap.

Layer B is located below Layer A about 35 to 70 depth from surface, and produce animal bones, bole tools, obsidian, chert, and jasper flake tools, percutor, shell, and very rare fragment of pottery. The human remains of two individuals were recovered from this layer. One individual in flexed primary burial and another individual was probably found as a secondary burial. One chronometric dating based on human remains gives date about 5660 170 BP.

Layer C is located between 65 to 100 cm below the surface and contains many fragmented of limestone mixed with phosphate. This layer produces similar archaeological finds compare to the previous layer, but without pottery. The human remains of one individual were recovered from this layer and dated back to 7320 180 BP.

Layer D is the lowest archaeological layer in Pawon Cave. The archaeological finds from this layer are faunal remains, bone tools, flake tools from obsidian (Fig. 2. B.14 right), chert and jasper, percutor from andesite, shell, and accessories from canine and shark teeth which perforated on the root part. Two individuals were found in this layer, and the first one gave a chronometric date to 9525 200 BP, and another individual should be older than this dates.

Based on a palaeoenvironmental study by Stuijts (1993) also van der Kaars and Dam (1995), we know that the highland of the western part of Java always covered by dense tropical rain forests during the Late Pleistocene and Holocene. There was no clear evidence of dry condition during the last glacial maximum, even the temperature was decreased to 3°C lower, but no lower rainfall compared to the present condition.

In the transition of Pleistocene to Holocene around 12 to 8 Kya BP there was vegetation dynamic in this region, but since 8000 BP, the climate is similar to the present condition. A slightly drier condition and human impact were recorded around 5000 BP (Stuijts, 1993), but according to the Pawon Cave, the highland of West Java was already occupied by the Preneolithic population at least since the boundary of Pleistocene Holocene around 10 Ka BP.

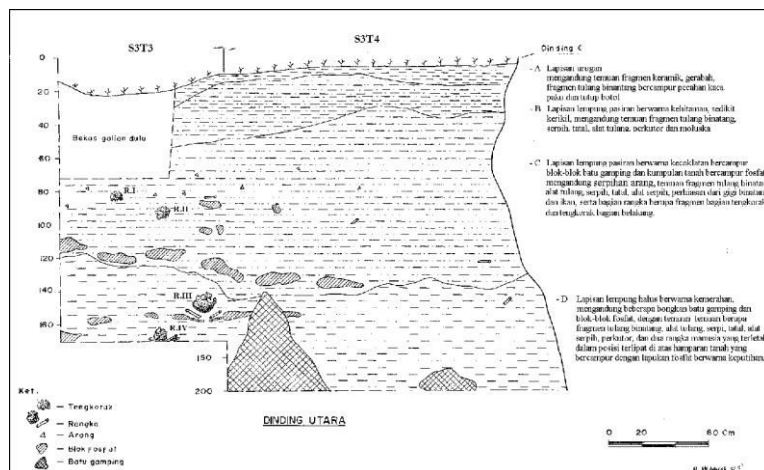

Fig. 2. B.13. Stratigraphy of Pawon Cave (Yondri 2005).

Human Remains

The human remains found in Pawon cave belonged to seven individuals (see Table 2. B.9) and were discovered for the first time in an archaeological research in 2003. Several studies have been done on the human remains from Pawon Cave. Analysis of the burial has been done by Yondri (2005), the lower teeth by Noerwidi (2012; 2017), and the mandibular cortical bone by Rizquillah *et al.* (2016).

The first individual, named as Pawon 1, belongs to a male above 55 years old. The individual was found in very fragmented conditions but still possible to identified the flexed position, with the face oriented to the south direction. Another cultural traces on this individual is red painted on the surface of the bones. Next to the first individual, there is a fragment of occipital bone belong to the second individual (Pawon 2) from an adult female. Both individuals are dated back to 5660 170 BP.

The third individual (Pawon 3) is belongs to an adult male. This individual was buried in a flexed position, sideways in the right direction, with north-south orientation, and the head located on the southern part, with face heading to the east direction (Fig. 2. B.14 left). The parallel position of the upper and lower legs is indicated a hyperflexion of the body, which probably caused by wrap treatment during the burial procession. One chronometric 14C dating from this individual gave a date to 7320 180 BP.

The fourth individual or Pawon 4 is located below the third individual. This individual traces a flexed primary burial with completed only by cranium and rib bones. The individual was buried in north-south orientation but inverted position compared to the previous third individual above. The individual was placed sideways to the left direction, with the face heading to the east direction. This skeleton should have the same age as the previous individual, around 7320 180 BP.

The fifth individual (Pawon 5) contains the maxilla and mandibular fragments. This individual was found in the deepest layer of Pawon cave and should come from around 9525-200 BP. The last two individuals of Pawon 6 and Pawon 7 were just discovered during the excavation campaign in 2017 and 2018. These individuals are still in the conservation process and could not be analyzed.



Fig. 2. B.14. Flexed burial of Pawon 3 individual (Yondri 2005) and obsidian artifacts of Gua Pawon (Ferdianto 2008).

The Significance

Until recently, Pawon Cave is considered to be the oldest cave habitation in the western part of Java, which occupied at least since the transition of Pleistocene and Holocene around 10 Kya. Pawon Cave habitant also represents the human population group who adapted to the highland tropical rain forest environment. This environmental condition could be different from their cousins living in the Gunungsewu karstic region in the eastern part of Java who adapted to an open environment.

A bioanthropological study should be very important to compare the Pawon population to Gunungsewu or other Pre-Neolithic populations. Beside of the difference in the environmental context and cultural adaptation, Pawon man also has similarities to other Preneolithic populations in the term of burial practice. The skeleton of Pawon 1 was buried in a flexed position with red-painted-skeleton, similar to the tradition in the Hoekgroot, Sampung, and Braholo, the western part of Gunungsewu. The skeleton of Pawon 3 which was buried in the hyperflexed position, has a similarity to the individual from Song Terus site, the eastern part of Gunungsewu.

Human Remains

NO	NO. IDV	REMAINS	SEX	GRADE	AGE	AFFINITY	DATING	BURIAL	POSITION	ORIENTATION	SKULL	CULTURAL	STRATIGRAPHY
1	PWN 1	Fr. Skeleton	Male	H	40 - 50	Australo-Melanesian	5660 170	Primary	Flexed	E - W		Red Painted	Mid Holocene
2	PWN 2	Fr. Cranium	Female		Adult	Australo-Melanesian	5661 170	Secondary					Mid Holocene
3	PWN 3	Almost complete skeleton	Male	H	40 - 50	Australo-Melanesian	7320 180	Primary	Flexed	N - S	South	Stone tools	Mid Holocene
4	PWN 4	Almost complete skeleton	Female	G	35 - 40	Australo-Melanesian	7320 180	Primary	Flexed	N - S	North		Mid Holocene
5	PWN 5	Fr. Mandible and Maxilla	Male	D	20 -24	Australo-Melanesian	9525 200	Primary (?)					Early Holocene
6	PWN 6	Fr. Skeleton											
7	PWN 7	Ft. Skeleton											

Table 2. B.9. Human remains from Gua Pawon site.

C. NORTHERN ZONE OF JAVA (PATIAYAM DOME AND NORTHERN MOUNTAINS)

1. PATIAYAM DOME

Location

Patiayam site located in between Kudus and Pati Regency, Central Java, covers around 5 x 7 km, and about 12 km east of Kudus city. Patiayam is a structural uplift mountain with the highest point about 350 above sea level on the northern coast of Java. Patiayam is administratively located in the Jekulo district of Kudus regency and Margorejo, Gembong, also Tlogowungu of Pati regency (Fig. 2. C.1).

There are several hypotheses about the process of forming the Patiayam Dome. Van Bemmelen (1949) argues that the volcano-tectonic process of Mount Muria causes the formation of the Patiayam Dome. It happens due to the collapsing of the body part of Mount Muria to the southeast direction, pushing all the rock in the path of collapse, and stopping on the foot of Mount Muria. It causes the entire of collapsed rock to fold and form hills, then eroded, with denudational force caused a series of Patiayam hills as today.

Another hypothesis came from Verbeek and Fennema in 1896 as quoted by Van Es (1931), Sartono *et al.* (1978), also by Zaim (1989) and Mulyaningsih *et al.* (2008) who believe that Patiayam Dome is formed by an independent volcanic formation and activity process in the Patiayam site, and no correlation with the volcanic activity of Mount Muria.

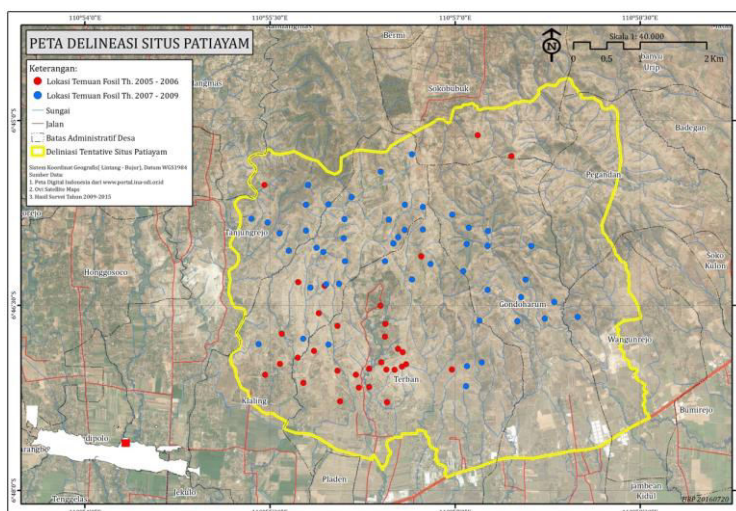

Fig. 2. C.1. Map of Patiayam dome, Central Java (Siswanto, Zaim, and Noerwidi 2016).

Research History

In the 1890s Eugene Dubois assigned two military officers of KNIL, corporal Anthonie de Winter and Gerardus Kriele, to collect fossils and spotted the distribution in the Kendeng hills including Patiayam. However, this expedition was unsuccessful because the hills were covered by dense shrubs that block out the lithological observation. Finally, de Winter and his team did not satisfy result for the expedition, so they went back to Madiun in August of 1891 (Leakey and Slikkerveer 1995). Van Es (1931) has been identified nine species of

vertebrate fossils from the Patiayam site. After this earliest period, the paleontological research was stop during the second world war and continuing after the Indonesian independence.

In 1978, Sartono and Zaim conducted a study to complete van Es' findings and found 17 vertebrate species also human remains, including a premolar and skull fragments of *Homo erectus*. They made detailed geological map of the Patiayam region, and found that the lithological formation of Patiayam Site is not much different from the rocks of the Sangiran Dome (Sangiran Dome). Their statement was based on observation results of the lithological units on both regions, and the findings of the vertebrate fossils were also not much difference between the Patiayam and Sangiran sites (Sartono et al. 1978). Zaim (1989) also Zaim and Delaune (1988; 1990) made detail studies on sedimentology, stratigraphy, palaeogeography and formation of Patiayam dome.

Archeological research was carried out by Truman Simanjuntak between 1981 to 1983. This study was including surveys and excavations along the Balong River and Ampo River on the eastern part of Patiayam. He found many vertebrate fossils but no human remains and artifact. Around the early 2000s, there was many fossils lost from Patiayam site, and Balai Arkeologi Yogyakarta started to conduct an archaeological research since 2005 lead by Siswanto. The purpose of the study is to know the diversity of faunal species, traces the human and cultural remains, to clear the stratigraphical position of the fossils, and to know the lateral position (distribution) of fauna fossils in the Patiayam site (Siswanto et al. 2016).

Formations / Archaeological Layers

Sartono *et al.* (1978) did a detailed geological study to produce a geological map and compiled a stratigraphy of the Patiayam Dome, classifying the various types of rocks and naming these lithological groups in several official units commonly called formations, which are based on their age from old to young is as follows (Fig. 2. C.2):

Jambe

Jambe Formation is originally coming from Kali Jambe, which means Jambe river, the name of a river located in the eastern part of the Patiayam site. This formation consists of clay, greenish-gray, carbonate. This formation contains fossils of foraminifera and marine mollusks, also glauconite minerals that are formed in the ocean. Based on the analysis of the foraminifera, it could be concluded that the age of the clay layer of Jambe Formation was deposited during the Plio-Pleistocene boundary in the litoral to shallow neritic environments. Zaim (1989) found the evidence of volcanic activities on the lower and upper part of the Jambe Formation, which represents by two conglomerate or breccia rock layers, with floating embedded volcanic rock fragments in the clay layers.

Kancilan

Kancilan Formation comes from the name of an intermittent river in the center of the Patiayam Dome, namely Kali Kancilan means Kancilan river. Breccia outcrops of the Kancilan Formation are found on the cliff of the river and the bottom of Slumprit hill. The relationship between the Kancilan Formation and the Jambe Formation is unclear because there is no direct contact in the field. However, from the depositional environment and their ages, Zaim

(1989) believes that there is a hiatus between the Kancilan Formation and the Jambe Formation, or the relationship is unconformity.

Volcanic breccia of Kancilan Formation consisting of volcanic origin rock fragments such as basalt-absarokite and shoshonit, embedded in tuffaceous sand, angular-subangular grains, with clast-supported, but sometimes floating in the matrix-supported. The laharic breccia is the result of deposition process from volcanic activity (Zaim 1989). There are no fossils and artifacts were found in the Kancilan Formation.

In the volcanic breccia, there is two intrusions of magmatic rocks, located at the bottom and top of the Kancilan Formation. The radiometric dating with the Potassium-Argon method (K/Ar) has been carried out by Bellon *et al.* (1988) and Bandet *et al.* (1989) performed on the breccia and the intrusion rocks produce 0.85 ± 0.02 Ma and 0.97 ± 0.07 Ma for the breccia, and 0.50 ± 0.08 mya for the intrusion rock. So, we can conclude that there were two main volcanic activities in the Patiayam dome during Middle Pleistocene; around 0.97 - 0.85 and 0.5 Ma.

Slumprit

The Slumprit Formation inspired by the name of a hill in the center part of the Patiayam Dome, just in the south of the peak of Patiayam mountains, namely the Slumprit hill. On the slope of this hill revealed a very well Slumprit Formation consisting of alternating layers of medium-fine sandstone, light-colored tuffaceous clay, brownish-white tufa, and dark gray-black clay, located unconformity above the Kancilan Formation.

In the dark gray clay, there is a layer about 40 cm thick rich of freshwater mollusks fossils called Coquina limestone. The Freshwater molluscs consist of *Viviparus sp.*, *Corbicula sp.*, *Paludina javanica*, *Brotia sp.*, *Sulcospira sp.*, and *Melanooides sp.* There are also many vertebrate fossils found in the fine sandstone and tuffaceous layers of Slumprit Formation, such as *Stegodon*, *Bovidae*, *Cervidae*, *Suidae*, *Cervidae*, and *Homo erectus*. This lithological group of the Slumprit Formation is referred to the fine volcanic sediment rock (Zaim 1989).

The age determination of Slumprit Formation is based on paleontological study and chronometric dating. Paleontological study on fossils from Slumprit Formation shows the faunal group belonging to the Middle Pleistocene. Then, Sémah (1984) based on a paleomagnetic study with samples taken from the tuffaceous clay layer of this formation states that the Slumprit Formation entered the positive period of Brunhes or Middle Pleistocene. So, the age of Slumprit Formation could be determined from Middle Pleistocene based on both studies.

Kedungmojo

The Kedungmojo Formation named based on the name of Kedungmojo village, which is located on the western part of Patiayam Dome. The Kedungmojo Formation deposited in conformity above the Slumprit Formation, consisting of tuffaceous sandstone, very coarse-grained with small conglomerate lenses, with planar sedimentary structures and parallel laminates, inserted by a thin layer of fine sand and silt, showing a cross-bedding structure, flaser, and wavy lamination. The granular fragments of the conglomerate layer are rounded to subrounded, around 2 - 5 cm diameter and originally from basaltic rocks. Sometimes the orientation of the granules shows the direction of the cross-bedding structure.

Kedungmojo Formation contains many vertebrate fossils, but so far, no human fossils and artifacts were found. The vertebrate fossils found in the Kedungmojo Formation are

similar to Slumprit Formation consist of the faunal group from the Middle Pleistocene. By Zaim (1989) lithological layers in the Kedungmojo Formation are grouped in the coarse volcanic of sediment rock series, above the fine volcanic of sediment rock series.

Sukobubuk

The uppermost of lithological formation in the Patiayam Dome is Sukobubuk Formation originally from the Sukobubuk village, located on the southeast slope of Mount Muria to the north of the dome. The Sukobubuk Formation covers the entire older formation below, consisting of debris avalanche of lahar called agglomerate from Mount Muria. Sukobubuk Formation contains andesite-leucistic rocks, embedded in a very rough and un-compact sandstone. The age of this agglomerate cannot be determined certainty because it covers the entire older formations below and it is assumed to be deposited in the Holocene Period.

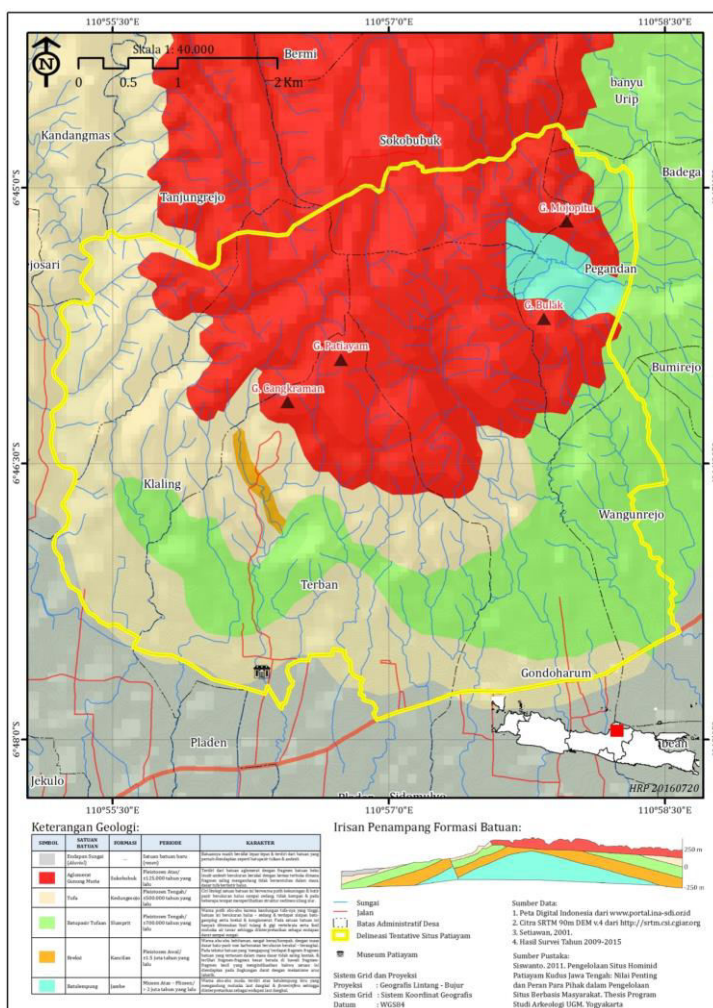

Fig. 2. C.2. Geological map (left) and Acheulean handaxe from Patiayam dome (right) (Siswanto et al. 2016).

Human remains

One of the most important finds by S. Sartono and Y. Zaim in 1977 from the Patiayam Site is some fragments of *Homo erectus* remains. The fossil found in the sandstone layer of Slumprit Formation of the early Middle Pleistocene, which consists of tuffaceous silt and clays alternating with tuffaceous sandstones with lenses of conglomerates. Freshwater

mollusk occurred in the black clays indicated that this formation was deposited in the non-marine condition of swamps environment (Zaim and Ardan 1998).

On Slumprit hill, there is a deposit of volcanic breccia layer which followed by tens meter of tuffaceous clay and sandstone, which is associated with the eruption of the ancient Patiayam volcano. Skull fragments and human teeth (Table 2. C.1) were found among fossils of mammals and reptiles from the tuffaceous clay and sandstone layer. Von Koenigswald (1968) dates volcanic rock from the Muria which has stratigraphic relation with vertebrate fauna of Patiayam Dome giving range between 0.59-0.43 Ma. Through the Potassium-Argon dating method, the maximum age for the fossils of Patiayam show an age around 0.85 ± 0.02 Ma. According to Widiyanto (1993), the similarity of stratigraphical characters and chronological positions makes it possible to correlated the fossils from Patiayam with similar findings from the Kabuh Formation in the Sangiran Site.

NO	LOCALITY	NO. COL	REMAINS	GRADE	AGE	STRATIGRAPHY	LITHOLOGY	STORAGE
1	Slumprit	Patiayam 1	LLP3	H	40-45	Slumprit	Tuffaceous Sandstone	ITB

Table 2. C.1. Isolated tooth from Patiayam dome. Abv: ITB = Institute of Technology, Bandung (Indonesia).

Artefact

Some Paleolithic artifacts have been found in Patiayam site. In 2007 Balai Arkeologi Yogyakarta discovered several flake artifacts made from silicified limestone during a survey on the banks of Kancilan River. The raw material of silicified limestone is not found in the Patiayam dome, but may be imported from outside areas, such as the Kendeng Mountains. In opposite, the andesite raw material of hand axe (Fig. 2. C.2 right) and polyhedral were found in the Patiayam Dome (Siswanto et al. 2016).

The Significance

Patiayam is an island during the Pleistocene interglacial period, and now located on the northern coast of Java. The geographical position is different compare to other Pleistocene sites in the Solo Basin and along the Bengawan Solo river. On the other hand, the lithic artifacts from Patiayam Dome are made from volcanic andesite, chert, and silicified limestone. The volcanic andesite is produced in Patiayam Dome, but the raw material of chert and silicified limestone should come from another region, the closest is Kendeng mountain. This condition raises a question regarding the relationship between the Patiayam inhabitant to the Kendeng mountain.

Patiayam is a potential quaternary site which not yet studied optimally, however it has produced faunal and human remains also their artifact. Patiayam site also preserved their remains in a very good condition. Archaeological excavation by Balai Arkeologi Yogyakarta between 2017-2019 in the Slumprit Formation always found faunal remains in the primary context of their original anatomically position covered by tuffaceous layer which probably produced by ancient volcano near the Patiayam area. This taphonomical phenomenon is challenging to find the animal and/or human remains with their complete anatomical member.

2. GUA KIDANG (NORTHERN MOUNTAINS)

The northern mountain of Java is an anticlinorium mountain which extending from Rembang in the west to Madura Island in the east and approximately spreading around 350 km length. The North-west Java basin restricts this region in the west, Semarang-Rembang Basin, Muria complex, Bawean basin, and North Madura basin in the north, and Randublatung depression in the south. The Northern mountain is also better known as Rembang - Madura Mountain structural unit. The Rembang zone which is located on the western part of the mountain can be separated into two main parts, they are the Northern Rembang Anticlinorium in the north and Middle Rembang Anticlinorium in the south (Eisar 2008).

There are several major lithostratigraphic units developed in the Rembang zone since the Middle Eocene to Quaternary periods, they are from the oldest to the youngest; Ngimbang Formation; Kujung Formation, Prupuh Formation, Tuban Formation, Tawun Formation with Ngrayong horizon on the upper part, Bulu Formation, Wonocolo Formation, Ledok Formation, Paciran Formation, Mundu and Lidah Formation (Pringgoprawiro 1983). The Middle Miocene limestones of Bulu Formation is the main lithological unit which plays an important role in the karstification process in this region and produced many caves and caverns. Some archaeological cave sites that have been discovered and studied by Balai Arkeologi Yogyakarta since the 2000s, and the most important is Gua Kidang.

General condition of Gua Kidang

Karst of Blora is located on the western part of the Northern Mountains of Rembang-Madura anticlinal zone in the Rembang zone. This region is bordered by Semarang-Rembang alluvial plain of the north coast of Java, also Muria volcanic complex, and synclinal zone of Randublatung Depression in the south (Pannekoek 1949). This region performed by limestone of Bulu Formation as the base and siltstone of Wonocolo Formation above which occurred from karstification process and generated karstic caves.

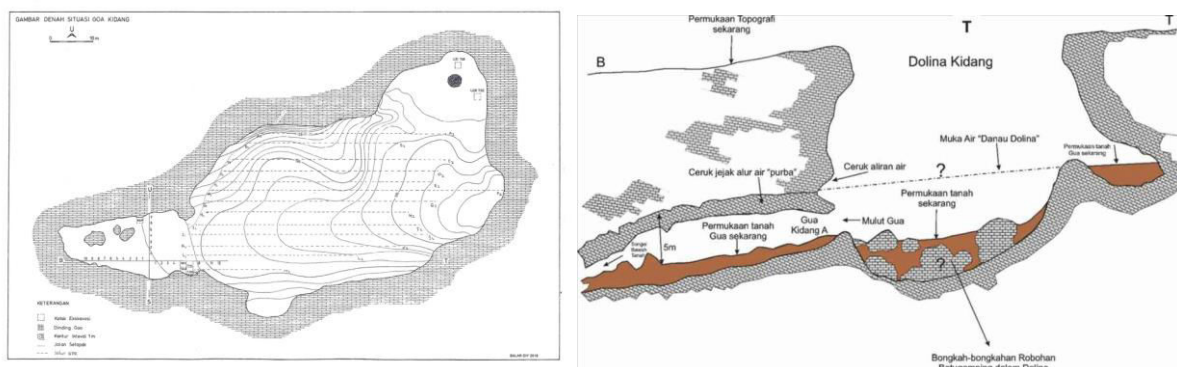

Fig. 2. C.3. Plan and section of Gua Kidang, Rembang (Nurani et al. 2019).

Balai Arkeologi Yogyakarta (Balas Yogya) did an archaeological survey in the Karst Blora during 2005-2006 and found 17 caves which only Gua Kidang has archaeological potencies (Nurani and Yuwono 2008). Gua Kidang administratively located in Tinapan village, Todanan district, Blora regency, Central Java. This cave is actually a collapsed sinkhole of dried underground channel river in the karstic zone (Fig. 2. C.3). Gua Kidang has a big

chamber measured as 36 m length by 36 m width, and 18 m height with good air circulation and good light intensity, also dry floor with thick archaeological deposit (Nurani and Hascaryo 2010; Nurani and Yuwono 2008).

Archaeological Layer

Intensive excavation in Gua Kidang by Balar Yogya began from 2009 to 2019 lead by Nurani. There are three main archaeological layers in this site: the historical layer, Neolithic layer, and Preneolithic layer (Fig. 2. C.4). The historical layer contains metal, Chinese coins, and porcelain. Neolithic layer produces earthenware,

Some artefacts have been recovered from Preneolithic period are dominantly made from animal bones and shells such as scrapers (Fig. 2. C.5 right), point, knife, spatula, sharpener, and beads (accessories). Two stone tools are recovered as percutor from andesite and sharpener from chert (Nurani 2016).

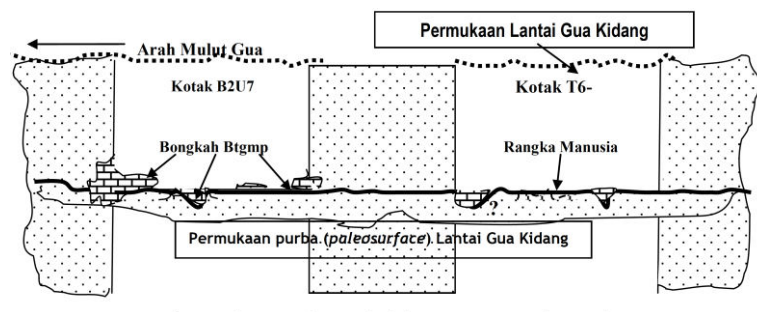

Fig. 2. C.4. Stratigraphy of Gua Kidang, Rembang (Nurani, Koesbardiati, and Murti 2014).

Human Remains

So far, there are three individual of human remains found in Gua Kidang site (Table 2. C.2) and has been analysed by Nurani, Koesbardiati and Murti (2014). The first individual is a juvenile around 13-20 years old with stature around 160-170 cm. The individual recovered from a primary burial context with extended position of southeast-northwest orientation. The sex determination is unknown so far caused by very limited remains which only conserved on the lower part of post-cranial.

The second individual is an adult male around 25-35 years old which recovered from a primary burial context in a flexed position (Fig. 2. C.5 left). The skeleton lying on the left side with east-west orientation and the head part located on the east direction. The stature and population group analysis on this individual suggest Australomelanesian affinities with the stature of individu around 153 cm height.

The last individual is an adult female with 153-156 cm height. This individual was recovered from primary burial context with the squatted position. The cranio-dental remains of this individual are very limited, so it is impossible to know her population affinities.

Based on stratigraphical and archaeological context suggested that the age of second and third burial in Gua Kidang site approximately came from the Preneolithic period of the Mid-Holocene, while the first burial suggested from the Early Holocene (Nurani et al. 2014).



Fig. 2. C.5. Flexed burial of Gua Kidang Individual 2 (Nurani et al. 2014) and Shell artifact of Gua Kidang (Nurani and Hascaryo 2010).

The Significance

Gua Kidang site provides information about human occupation in the Northern Mountains of Java. These finds are very important because the eastern part of the karstic mountains between Gresik and Tuban regency are mostly lost due to the mining activity of the national cement industry. Gua Kidang site records the Holocene human occupation in this area and could be parallel with the human occupation of the same period in the Southern Mountains, such as Kepek period and Sampung bones culture.

Table of Individuals

NO	NO. IDV	REMAINS	SEX	GRADE	AGE	AFFINITY	BURIAL	POSITION	ORIENTATION	SKULL	CULTURAL	STRATIGRAPHY	DATING
1	GKD 1	Fr. Leg bones			13 - 20	Mongoloid (?)	Primary	Extended				Holocene	9.440 ± 220 BP
2	GKD 2	Almost complete skeleton	Male	E/F	24 - 35	Negrito	Primary	Flaxed	E - W	East	Shell	Mid. Holocene	
2	GKD 3	Almost complete skeleton without skull	Female		40-59	Australomelanesian (?)	Primary	Squatted		Lost		Mid. Holocene	
4	GKD	Fr. Long bone (not fully excavated)											

Table 2. C.2. Human remains from Gua Kidang site.

D. SOUTHERN ZONE OF JAVA (GUNUNGSEWU MOUNTAINS AND CAMPURDARAT KARST)

GUNUNGSEWU MOUNTAIN, EASTERN JAVA

The Southern Mountain or so-called 'Thousand Mountains' (Gunung Sewu in the Javanese language) of eastern Java is a mountainous region located in the southeastern part of Central and East Java. It is surrounded by depressions in the west, north and east, which are the Bantul graben, Solo depression and Wonogiri-Baturetno depressions respectively. The mountain is restricted by the Indian Ocean in the south.

The age of the lithological formation in Southern mountain ranges from Eocene to Early Pliocene, comprising from the oldest to the youngest are: Wungkal-Gamping Formation, Kebo-Butak Formation, Semilir Formation, Nglanggran Formation, Sambipitu Formation, Oyo Formation, Wonosari Formation, and Kepek Formation (Van Bemmelen 1949). The Miocene limestones of Wonosari Formation underwent deep karstification after the last main uplift of the hills. This process presents a unique landscape and shapes many hills which contain karstic cavities. Many of these great cavities were used by human as shelters during prehistoric times (Sémah et al. 2004). Some famous archaeological sites that have been studied are; Gua Braholo and Song Tritis in Yogyakarta, also Song Keplek, Gua Tabuhan and Song Terus (Fig. 2. D.1), in Pacitan, East Java.

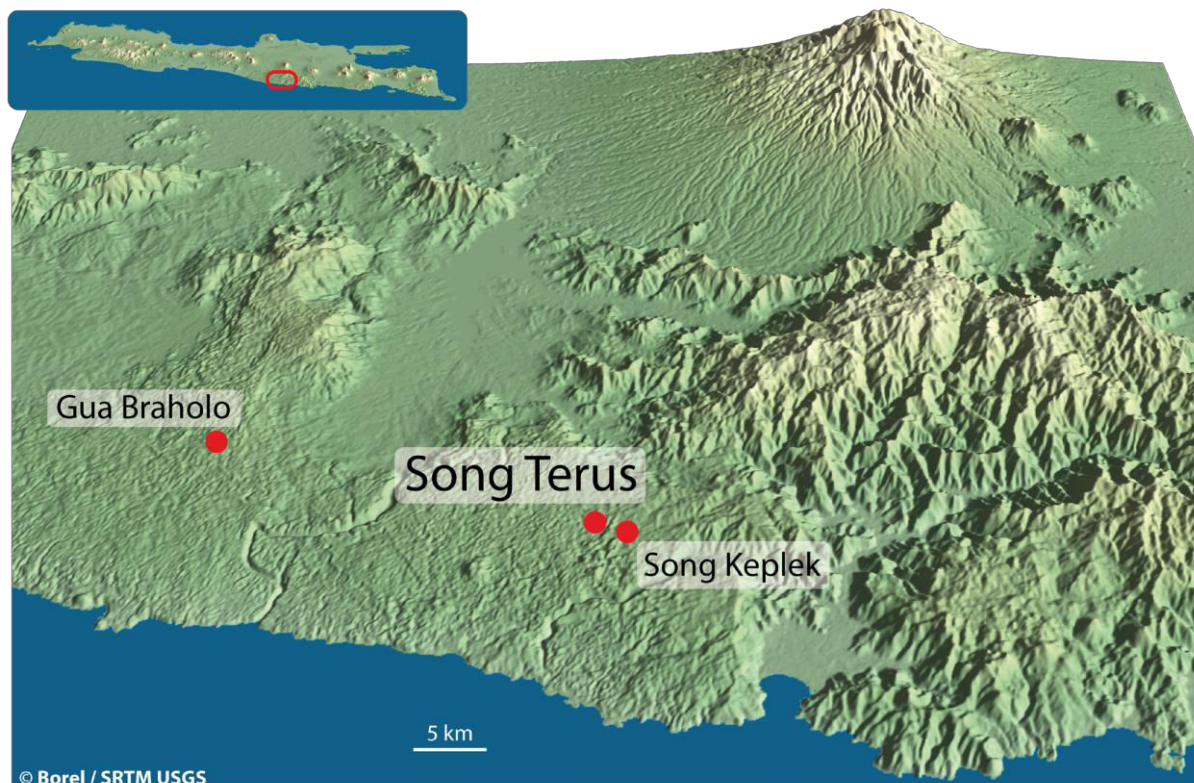

Fig. 2. D.1. Distribution map of cave habitation sites at Gunungsewu area (Borel 2010).

1. SONG TERUS

General condition of Song Terus

Song Terus site is located in Wareng village, Punung District, Pacitan Regency, East Java. This site located around 3 km from Song Keplek and not far from Tabuhan cave. Song terus is a cave which perforated (*Terus* in Javanese) a small karstic hill. The cave orientation is east-west, with 10 to 20 meters wide. Now, the eastern part of the cave is closed by a big limestone block, but the western entrance is indicated used for a shelter for prehistoric people (Fig. 2. D.2).

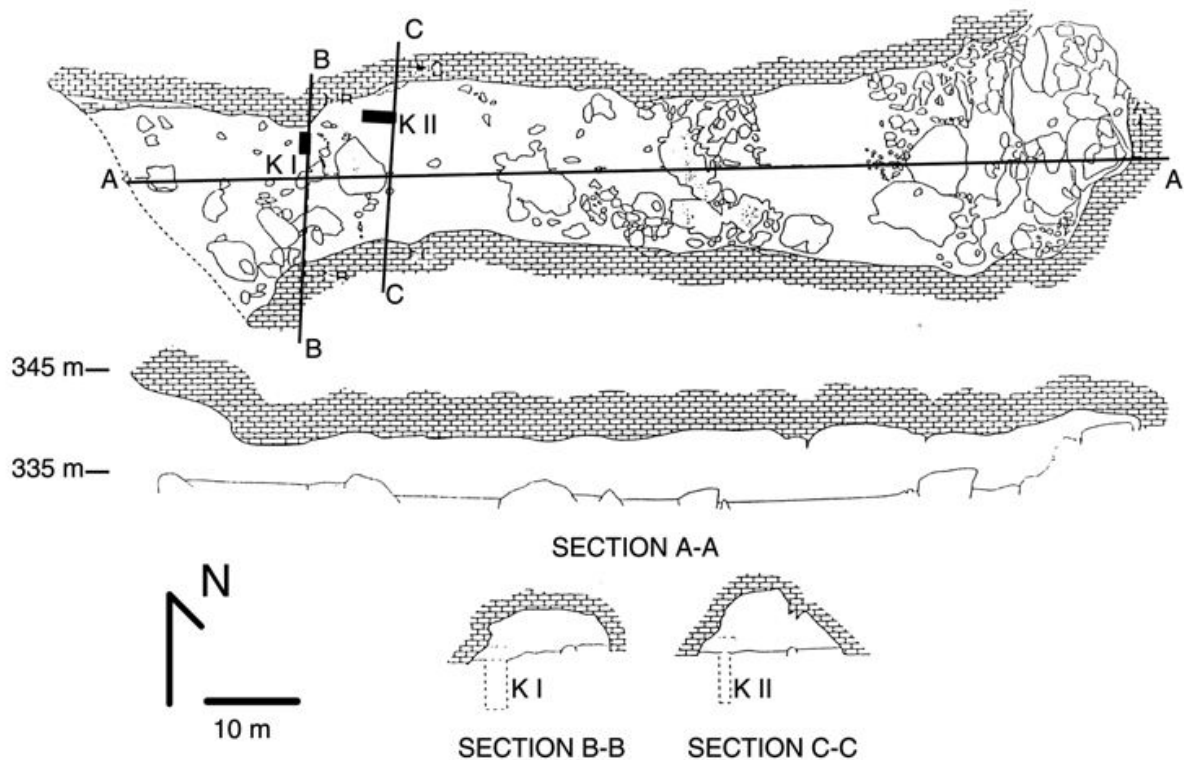

Fig. 2. D.2. Plan of Song Terus site (Sémah et al. 2004).

Song Terus site has been excavated by R.P. Soejono and Basoeki for the first time in 1953 and recovered the neolithic cultural layer together with animal remains from *Elephas* and *Primates* (Soejono 1993). A Recent excavation in this site was starting in 1994 by a Franco-Indonesian team lead by Sémah and Simanjuntak in the framework of Indonesian Mission for Quaternary and Prehistory. The deepest square is coming from two test pits; K I 16 meters and K II 8 m depth.

Archaeological Layer

The archaeological layer which represented in Song Terus site from the bottom up are Terus, Tabuhan, and Keplek layers (Sémah et al. 2004), see Fig. 2. D.3, and here is the description of those layers:

Terus Layer

The lowest cultural layer in Song Terus site is called as Terus layer, named after the site. The U-series and ESR dating put this layer into the Middle to the early of the Late Pleistocene period 341 to 80 ka have (Hameau 2004; Sémah et al. 2004; Tu 2012). This layer consists of alluvial deposits produced by a river (Gallet 2004) and produced abundant lithic artifacts made from chert, such as nucleus, flakes and scrapers also denticulates. This assemblage mixes quite fresh artefacts which probably made close to the cave, also patinated, rounded, and transformed lithic tools (Tiauzon 2011). So far, there are no human remains and scarce faunal remains produced by this lower part of Terus layer.

The upper part of the Terus layer shows the traces of the oldest cave occupation floor date which back to early of Late Pleistocene 125 to 80 ka (Ansyori 2010; Fauzi 2008; Tu 2012). These very ancient cave occupation layers has been characterized from the archaeological perspective by Fauzi (2008) which found fresh artefact and the zooarchaeological point of view by Ansyori (2010) who found micro mammal and large mammal fauna, such as *Cervidae*, *Bovidae*, *Tapiridae* and *Rhinoceros*, which could be correlated to the "Punung" fauna (Ansyori 2010; Badoux 1959). So far a very important human remains from this layer is one lower left deciduous molar identified as a human remain from this upper part of Terus layer, which dated back to 80 ka BP. Above the Terus layer there is a 30 cm thick layer of black volcanic ashes which produce during a flood (Gallet 2004) and make this layer as a boundary between the Terus layer below and Tabuhan layer above.

Tabuhan Layer

The middle cultural layer in Song Terus is Tabuhan layer, named based on Gua Tabuhan site not far from Song Terus. This occupation layer dated back to the Late Pleistocene around 60 to 30 ka (Hameau 2004; Sémah et al. 2004). Taphonomical study by Kusno (2009) has divide this layer into three subdivisions based on the characteristic of the accumulation of the archaeological filling (Kusno 2009). Different from the previous layer which rich on lithic artefact, the Tabuhan layer is very rare on lithic industry that mainly produced from the limestones. The animal remains from Tabuhan layer are dominantly by large mammals, such as *Cervidae*, *Bovidae*, and carnivores, *Suidae* are present but very rare. Large number of bones presents many cut marks, burnt traces, and intentionally fractured (Ansyori 2010; Fadjar 2006; Kusno 2009).

This layer also very rare on human remains, and so far the most important is one upper left deciduous first molar which recovered from the lower part of the Tabuhan layer and dated back to 60 ka. The pollen content of the Upper Tabuhan layer reflects dry conditions, and many burnt stones are found including several zones which could be interpreted as fireplaces.

Keplek Layer

The upper part of the cultural layer in the Song Terus is known as Keplek layer, and some chronometric dating from the ¹⁴C samples gives date between 9.400 to 5.700 BP. Below this layer is a carbonate laminations filling, which separates the Tabuhan and Keplek layers and seems to be the boundary transition between Pleistocene and Holocene periods.

The Keplek layer characterized by rich flake industry, abundance of *Cercopithecidae*, which consisted of *Trachypithecus* and *Macaca*, together with an almost completed human remains and big mammals such as *Bovidae*, *Suidae*, *Cervidae*, *Oursidae*, *Rhinocerotidae* and *Elephas*. This layer also contains the aquatic fauna from mollusk and turtle (Amano et al. 2016; Ansyori 2010; Ingicco 2012).

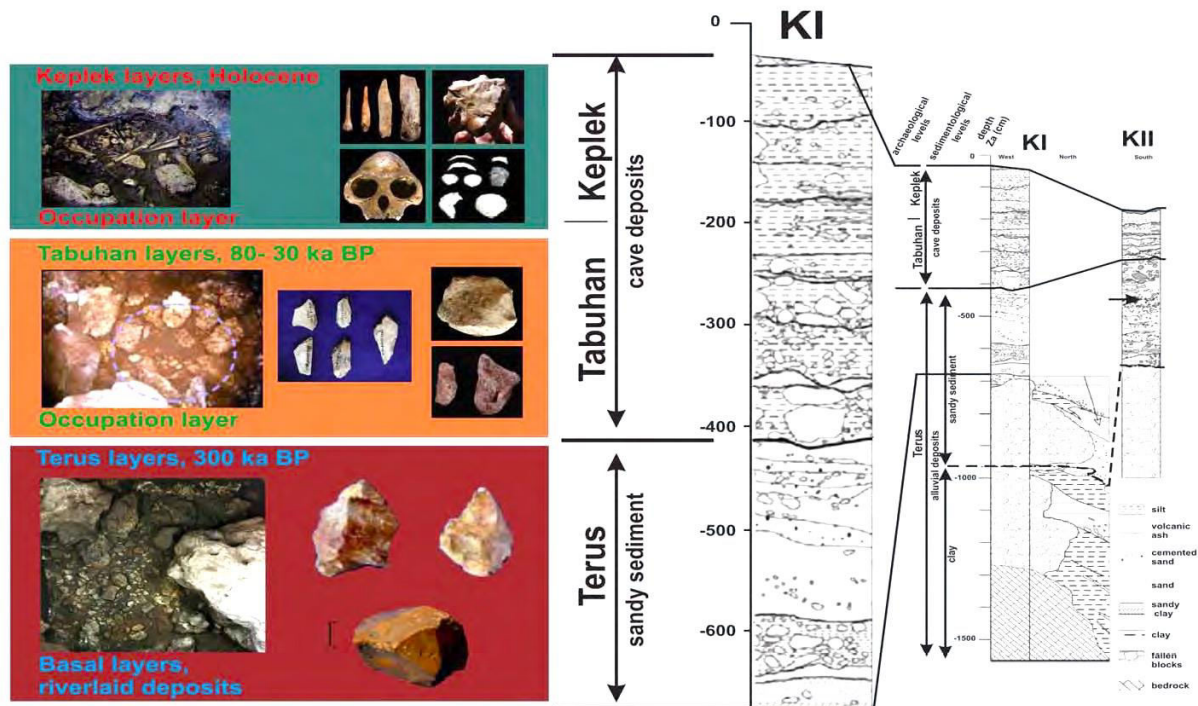

Fig. 2. D.3. Stratigraphy of Song Terus site (Sémah et al. 2004).

Human Remains

Human remains from Song Terus identified as one almost complete skeleton (Table 2. D.1), one parietal, one temporal, and 14 isolated teeth from at least 10 individuals (Table 2. D.2), including 3 adolescents. One almost-complete skeleton recovered from Song Terus site was identified for the first time in 1999 in square J9 on the northern part of the cave. The skeleton belongs to a male individual above 45 years old and. This individual called “Mbah Sayem” by local people and named as ST 1 in this study. The biological aspect of this individual was already described completely by Détróit (2002), and the burial aspect by Budiman Budiman (2008).

ST 1 individual buried in a flexed position, sideways to the right direction, north-south orientation, with the head on the northern part, and face heading to the south direction (Fig. 2. D.4). There is a feature made of limestone block laid out around the skeleton. The parallel position of both upper and lower legs indicates a hyperflexion of the skeleton that probably caused by wrap treatment during burial procession. A burn left tibia with broken in its proximal part and rotate to 90° directions from its anatomical position could be caused by fire when the muscle still attached on the bone (Détróit 2002).

Détróit (2002) notes a paleoenvironmental study by A.M. Sémah which was found many fern spores around the skeleton. There are also a chert flake tool near face, bone point and retouch flake on the left hand of the skeleton. Many face bones of *Cercopithecidae*,

from *Macaca* and *Trachypithecus* are found around the individual. Others faunal remains are *Elephas* molar, *Suidae* teeth, porcupine, small carnivore, also mollusc shells. All of artefact and ecofact which found together with the skeleton is interpreted as burial goods for the death. A chronometric dating based on shell give the burial datation from 9330 +/- 90 BP, which make it as one of the oldest flexed burial has been found in Southeast Asia (Sémah et al. 2004).



Fig. 2. D.4. Flexed burial of Song Terus individual 1 (Détroit 2002).

The Significance

Song Terus is most important site in the eastern part of Gunungsewu karstic region, because it records the long term human activity in the area, at least since Middle Pleistocene dated back to 300 ka BP. Song Terus has complete three archaeological layer of Gunungsewu as described above; Terus, Tabuhan, and Keplek layers. Moreover, the upper part of Terus layer is representing as the oldest evidence of cave occupation in Southeast Asia, between 125 to 80 Ka. Falling down of deciduous teeth which recovered from Upper Terus, Lower Tabuhan and Keplek layers are the evidence of intensive cave occupation in the different periods of climatic changes, from the last interglacial maximum of early Late Pleistocene, through last glacial maximum of MIS 2, to the recent period in Holocene last 10 ka BP.

Table of Individual

NO	NO. IDV	REMAINS	SEX	GRADE	AGE	AFFINITY	BURIAL	POSITION	ORIENTATION	SKULL	CULTURAL	STRATIGRAPHY	DATING
1	ST 1	Almost complete skeleton	Male	>I	> 55	Australo-Melanesian	Primary	Flexed	E - W	West	Stone and bone tools	Kepek Layer	9330+-90

Table 2. D.1. Human individual from Song Terus site.

NO	NO. COL	CATEGORY	GRADE	AGE	STRATIGRAPHY	DATING
1	ST 96-KI-ZA95-100	LRM2	B1	16 - 20	Keplek layer	Holocene
2	ST 96-M10-457a	URM2	G	35 - 40	Keplek layer	Holocene
3	ST 96-M11-299	ULM1	A	12 - 18	Keplek layer	Holocene
4	ST 96-M11-1802	URM2	G	35 - 40	Keplek layer	Holocene
5	ST 97-M10-2528	LRC	D	20 - 24	Keplek layer	Holocene
6	ST 97-M10-2882	URI2	A	12 - 18	Keplek layer	Holocene
7	ST 97-M11-3011	LRdm2	Juvenile	11 ± 2.5	Keplek layer	Holocene
8	ST 98-L8-919	LLI2	E	24 - 40	Keplek layer	Holocene
9	ST 99-N12-581	LLC	D	20 - 24	Keplek layer	Holocene
10	ST 99-O12-457	ULdm1	Juvenile	10 ± 2.5	Keplek layer	Holocene
11	ST 04 M10 13JU2	ULdm1	Juvenile	10 ± 2.5	Tabuhan layer	> 60 Ka
12	ST 04-K9-7848	LLI2	D	20 – 24	Tabuhan layer	Late Pleistocene
13	ST 04-K9-8638	URM2	G	35 – 40	Tabuhan layer	Late Pleistocene
14	ST 06 M10 13121	LLdm1	Juvenile	10 ± 2.5	Terus layer	> 80 Ka

Table of Isolated Teeth

Table 2. D.2. Isolated teeth from Song Terus site.

Based on the archaeological excavation in Braholo cave, there is at least five cultural layers in this site (Fig. 2. D.6 left), they are; Layer 1 produces many neolithic finds, such as fragments of pottery, polished stone adze, and shell. Layer 2 is the transition between the Neolithic and Pre-Neolithic cultural layer, with rare of Neolithic artifacts. Layer 3 is very thick Preneolithic layer, with many foyer traces of human activity and volcanic ashes which probably correlated with environmental changes which was occurred for 6000 years between around 10 and 4 Kya. There are many archaeological finds (Fig. 2. D.6 right) and human remains in this Preneolithic cultural layer. Layer 4 is the boundary of Pleistocene - Holocene, which dated back to 12 ka BP. Layer 5 and the layer bellow have a limited number of stone and bone artifact, and so far there is no human remains in this layer.

Beside of more than 50,000 flakes and stone tool fragments, Amano *et al.*, (2016) notes approximately 425,000 total bone fragments were recovered from Braholo site. Most of the faunal remains were from squares O8, G8 and G7 have been sorted and identified to its taxon by Due Awe and Amano. Several faunal remains successfully identified as fish, birds, reptile, and dominated by mammals, such as; primate, lemur, rodent, insectivore, bats, carnivore, artiodactyla, perisodactyla, and elephas (Amano et al. 2016).

The artifacts found in Braholo site shows dissimilarities to other Preneolithic sites. For example, utilized limestone flakes, modified *Tridacna* shells, and double point bone needles are all found in Braholo but not in the eastern Gunung Sewu sites. In contrast, there is a relatively lacking presence of chert flakes in Braholo. Likewise, the polishing tools manufactured from mollusk shells and the type of shell beads recovered from eastern Gunung Sewu region are different from those were found in Braholo (Amano et al. 2016; Détróit et al. 2006; Simanjuntak 2004). A series of prehistoric burials already recovered and analyzed by Widiyanto (2002), Détróit *et al.*, (2006) and Noerwidi (*in prep*) showed that the individuals in these burials belong to the Australomelanesian population.

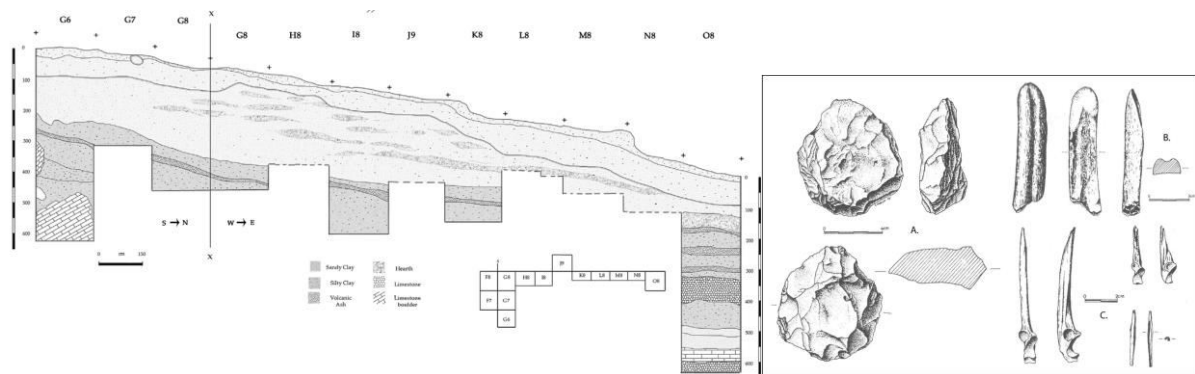

Fig. 2. D.6. Stratigraphy (left) and preneolithic artifacts (right) of Gua Braholo site, Gunungkidul (Simanjuntak 2002).

Human Remains

Human remains from Braholo Cave are represented by eight individuals in primary and secondary burial contexts (Widiyanto 2002). Most of the primary burials were predominantly buried in a flexed position (Fig. 2. D.7), while only one skeleton was buried in a circular position. Since the burial contexts were associated with the hearth layers, it is possible to determine that this burial activity occurred over a time span of 5000 years from 9 to 4 Ka BP (Widiyanto 2002). Recent work by Noerwidi in 2014 could identified totally of 24

minimum number of individuals which have been recovered from this site (Noerwidi, *in prep*), and only ten individuals have their dental remains preserved (Table 2. D.3) and several isolated teeth (Table 2. D.4).



Fig. 2. D.7. Flexed burial of Gua Braholo individual 1 (Simanjuntak 2002).

The Significance

Until recently, Braholo Cave is known as the longest occupation site in the western part of Gunung Sewu, which dated back to 33 Ka BP in the last glacial maximum period. Recent research in Braholo site by Puslit Arkenas since 2016 is challenging to recover older occupation layer from the most lower level (Sutikna, *pers comm*).

Moreover, Braholo is the most productive cave site in Gunungsewu area, which produced at least 24 individual of human remains. The cultural context of the burial shows similarities to their cousins in the eastern part of Gunungsewu and Pawon Cave in the West Java. The cultural characteristics which predominantly showed by the bones industry is close to their relative in the Sampung region (East Java) but different to the Keplek cultural complex in the eastern part of Gunungsewu. The phenomenon was indicated similarities and difference cultural adaptation process in Java during Holocene.

The Individuals

NO	NO. IDV	REMAINS	SEX	TEETH	GRADE	AGE	AFFINITY	BURIAL	POSITION	ORIENTATION	SKULL	CULTURAL TRACES	STRATIGRAPHY	DATING
1	BHL 1	Almost complete skeleton	Male	Lower and upper teeth	G	35 - 40	Australo-Melanesian	Primary	Flexed	E - W	West		Keplek Layer	9780+-230
2	BHL 2	Almost complete skeleton	Female	-		> 50	Australo-Melanesian	Secondary	-	-			Keplek Layer	8760+-170
3	BHL 3	Skeleton without teeth		-		Adult	Australo-Melanesian	Secondary	-	-		Red painted	Neolithic Layer	4120+-100
4	BHL 4	Almost complete skeleton		Upper teeth	F	30 - 35	Australo-Melanesian	Primary						Mid Holocene
5	BHL 5	Almost complete skeleton	Female	Lower teeth	D	20 - 24	Australo-Melanesian	Secondary	-	-			Keplek Layer	9780+-230
6	BHL 6	Fr. cranial and post cranial	Female	-		> 18	Australo-Melanesian	Primary	Flexed	E - W	East		Keplek Layer	9780+-231
7	BHL 7	Almost complete skeleton		Upper teeth	B1/2	16 - 20		Primary					Tabuhan Layer	11940+-160
8	BHL 8	Post cranial		-		Adult		Secondary	-	-			Tabuhan Layer	12200+-160
9	BHL-D5-3	Fr. cranial and post cranial	Female	-		Adult	Australo-Melanesian	Secondary				Red painted		8760+-170
10	BHL-F4-1	Post cranial and teeth		Upper and lower teeth	B1	16 - 20							Neolithic Layer	4120+-100
11	BHL-F4-3	Post cranial and teeth	Female	Upper teeth	G	35 - 40							Keplek Layer	9780+-230
12	BHL-F4-4	Post cranial		-		Adult							Tabuhan Layer	11940+-160
13	BHL-F7	Mandible	Female	Lower teeth	F	30-35	Mongoloid (?)	Secondary					Neolithic Layer	4120+-100

14	BHL-F8-1	Post cranial	Male	-		Adult		Secondary		Neolithic Layer	4120+-100
15	BHL-F8-2	Post cranial and teeth	Female			Adult		Primary			Mid Holocene
16	BHL-F8-3	Post cranial	Male	-		Adult			Red painted	Keplek Layer	9780+-230
17	BHL-G6-3	Post cranial	Female	-		Adult				Keplek Layer	9780+-230
18	BHL-H8-2	Post cranial and teeth	Male			Adult	Australo-Melanesian	Primary	Red painted	Neolithic Layer	4120+-100
19	BHL-H8-3	Post cranial and teeth	Female			Adult		Primary		Keplek Layer	9780+-230
20	BHL-H8-4	Fr. cranial and post cranial	Female	-		Adult		Secondary		Tabuhan Layer	11940+-160
21	BHL-I7-1	Post cranial and mandible		Lower teeth	B1	16 - 20				Neolithic Layer	4120+-100
22	BHL-I7-2	Fr. cranial	Male	-		Adult					Mid Holocene
23	BHL-I8-3	Fr. cranial and post cranial	Male	-		Adult				Keplek Layer	9780+-230
24	BHL-L8-2	Post cranial		-		Adult				Keplek Layer	Mid Holocene

Table 2. D.3. Human individuals from Gua Braholo site.

Table of Isolated Teeth

NO	NO. COL	CATEGORY	GRADE	AGE	STRATIGRAPHY	DATING
1	BHL 97-F4-12	URC	B1	16 - 20	Neolithic Layer	4120+-100
2	BHL 97-F4-17	LRM2	G	35 - 40	Neolithic Layer	4120+-100
3	BHL 97-F4-20	URC	C	18 - 22	Keplek Layer	9780+-230
4	BHL 98-I7-19	LRP4	B1	16 - 20	Neolithic Layer	4120+-100
5	BHL H8 410	URM2	H	40 - 50	Neolithic Layer	4120+-100
6	BHL H8 411	LRM3	H	40 - 50	Neolithic Layer	4120+-100
7	BHL H8 412	URM3	H	40 - 50	Keplek Layer	9780+-230

Table 2. D.4. Isolated teeth from Gua Braholo site.

3. SONG KEPLEK

General condition of Song Keplek

Song Keplek is located in the Gunungsewu karstic region. Keplek refers to as *keplek* in the Javanese language, which means card gambling by domino, because before the archaeological research conducted on the site, local people use Song Keplek as an arena for card gambling. This site located at the bottom of a hill and lies at 333 m above sea level. In front of the cave there is a seasonal channel tributary of Pasang River at about 200 meters on the southeast direction. The entrance is 20 meters wide with the main chamber is oriented northeast-southeast, and most of the deep part of the cave space is filled by huge boulders of fallen roof (Noerwidi 2012; Simanjuntak 2002), see Fig. 2. D.8.

Twelve boxes have been excavated by the National Center for Archaeological Research (Arkenas); six boxes are 2 x 2 m and another six boxes are with various measurements. The deepest excavations are B6 and A5 which reached around 6 m depth. Other excavation boxes were opened only in the upper part of the sedimentary filling because of the presence of big limestone boulder which blocked the excavation (Noerwidi 2012; Simanjuntak 2002).

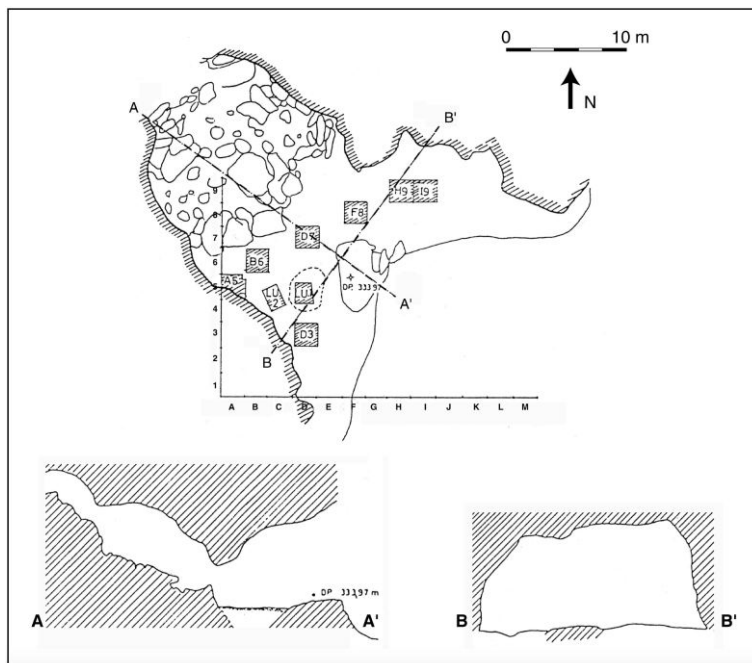

Fig. 2. D.8. Plan of Song Keplek site, Pacitan (Simanjuntak 2002).

Archaeological Layer

The archaeological layers in Song Keplek could be divided into two main layers; Preneolithic (layer 4-2) in the lower part and the Neolithic (layer 1) in the upper part (Fig. 2. D.9 left). The upper part of cultural layers in the Song Keplek site is composed by layers 1a, 1b, and 1c, which contain of Neolithic artifacts, such as; fragments of pottery and polished stone adzes which is dated between 700 and 3000 BP.

Archaeological layers below the neolithic phase are layers of 2, 3, and 4 which is rich in flakes and bones tools, dated back from 4500 to 8000 BP and locally named as the “Keplek period”, based on the name of Song Keplek site. Layer 5 is the deepest human occupation layer. It produces stone flakes and faunal remains which correlated with the “Tabuhan layer” (locally known from Gua Tabuhan site in Punung area). The dates for the Tabuhan period from this site are extend between 15.880 to 24.420 BP (Simanjuntak 2002).

The Keplek period is characterized by a very dense and varied archaeological remains, particularly faunal remains, as well as lithic and bone industries (Fig. 2. D.9 right). “Keplek people” used to practice flexed burials, have intensive hearth activities in the cave, extended catchment area reaching coastal area to exploit marine biota, hunting various game, especially Cercopithecids, and also exploit seeds such as candlenut (Ind. Kemiri) and canarium (Ind. Kenari). They also exploited another fauna including Bovidae, Suidae, Elephantidae, Cervidae, Cercopithecidae, Chelonidae (marine turtle), Testudinidae (terrestrial turtle), Cypraeidae (marine gastropoda), and Pelidae (terrestrial gastropoda). In the other hand, the neolithic layer found above the Keplek horizons is characterized by the appearance of potteries and rectangular polished stone adzes (Simanjuntak 2002).

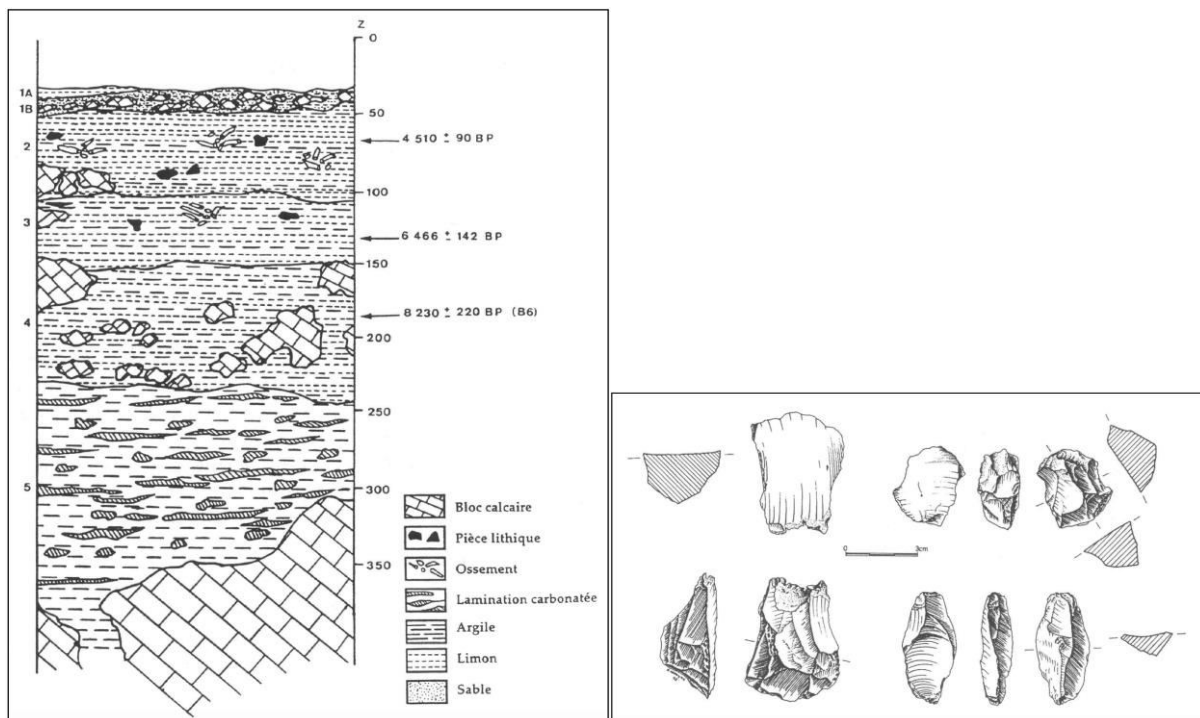

Fig. 2. D.9. Stratigraphy (left) and preneolithic artefact (right) of Song Keplek site, Pacitan (Simanjuntak 2002).

Human Remains

The human remains found in Song Keplek during the earliest excavation in 1992 belong to three individuals. Two additional specimens were found during subsequent excavations (Table 2. D.5). The first three individuals, which are named SK1, SK2 and SK3, are documented only by cranio-dental fragments. These three sets of human remains were found in squares D3 and B6, in level 2, which corresponds to the youngest part of the Keplek cultural period. The two skeletons found in the following years, named SK4 and SK5 (Fig. 2. D.10), were fortunately in better conservation condition than the first three, and represent almost complete skeletons. All of these specimens, including SK5, have been analyzed

morphologically by Widiyanto (2002), morphology and upper face morphometrics by Détroit (2002), and also Noerwidi (2012).

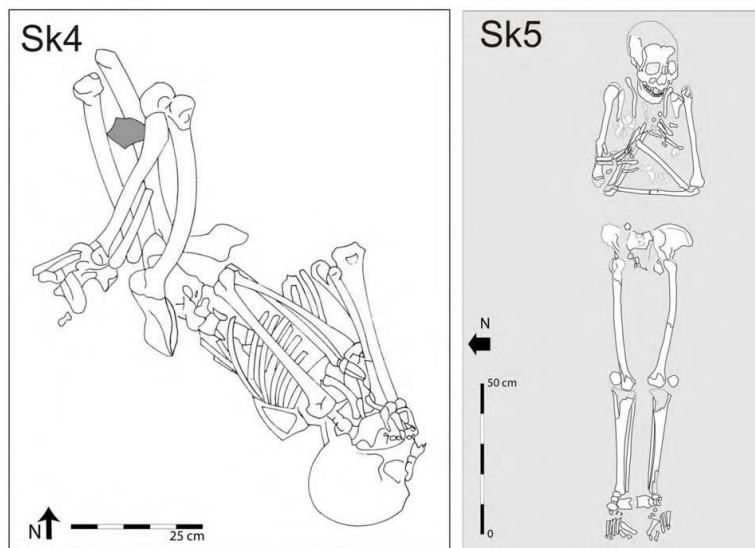

Fig. 2. D.10. Flaked burial of SK4, 4500 BP (left) and extended burial of SK 5, 3200 BP (right), Pacitan (Détroit 2002; Simanjuntak 2002).

The Significance

Based on previous studies we, can conclude that the Song Keplek is known as one of the very rare site which occupied by two different population groups in Java. The human remains from the first half of the Holocene are identified as Australomelanesian affinities and correlated to the Preneolithic cultural tradition, which showed by individuals of SK 1 and SK 4. In another hand, the late Holocene of SK 5 individual represents as Southeast Asian affinities, which correspond to the Austronesian language speaker and correlated to the Neolithic tradition (Noerwidi 2012). Therefore, the Song Keplek site records a transition period of occupation between two different human groups. Among five individuals of Song Keplek site, there are only three individuals which have dental remains, they are Song Keplek (SK) 1, SK 4, and SK 5. The following are dental description from the site:

Table of Human Remains

NO	NO. IDV	REMAINS	SEX	TEETH	GRADE	AGE	AFFINITY	BURIAL	POSITION	ORIENTATION	SKULL	STRATIGRAPHY	DATING
1	SK 1	Frag. Maxilla	Male	Upper right	D	35 - 50	Australo-Melanesian	Secondary	-	-		Keplek Layer	Mid Holocene
2	SK 2	Frag. Cranium	Male	-		Adult	Australo-Melanesian	Secondary	-	-		Keplek Layer	Mid Holocene
3	SK 3	Frag. Cranium	Adolescent	-		7 - 9	Australo-Melanesian	Secondary	-	-		Keplek Layer	Mid Holocene
4	SK 4	Almost complete skeleton	Female	Upper and lower	G	35 - 40	Australo-Melanesian	Primary	Flexed	NW - SE	Southeast	Keplek Layer	5900+-180 BP
5	SK 5	Almost complete skeleton	Female	Upper and lower	H	40 - 50	Mongoloid	Primary	Extended	E - W	East	Neolithic Layer	3053+-65 BP

Table 2. D.5. Human individuals from Song Keplek site.

4. SONG TRITIS

General condition

Song Tritis site located in Semampir hamlet, Semugih village, Rongkop district, Gunung Kidul regency, Yogyakarta. Geographically, the site is located in the same area with Gua Braholo, around 5 km south of Braholo site, in the western part of Gunungsewu karstic region. Song Tritis is located around 9 km inland from the coastal of the Southern Ocean, around 2 km north of Rongkop district, also 150 m east of street which connected Baran and Sadang. Song Tritis is located on the western slope of a karstic hill, facing the south direction, and located on 356 m above sea level. The mouth of the cave is 30 m width, and 7 m height, but the room is 50 m length, 20 m width, and 9 m height (Fig. 2. D.11).

Balai Arkeologi (Balar) Yogyakarta, led by Harry Widiyanto did six years of archaeological excavation from 2000 to 2005 in the southeastern part of the cave. There is a water container on the northeastern part of the cave not far from the entrance which built by the local people long time before the archaeological research by Balar Yogyakarta had begun. Recent condition of the cave is difficult to reach because of the dense shrubs and some big teak (*Tectona grandis*) trees in front of the cavity.

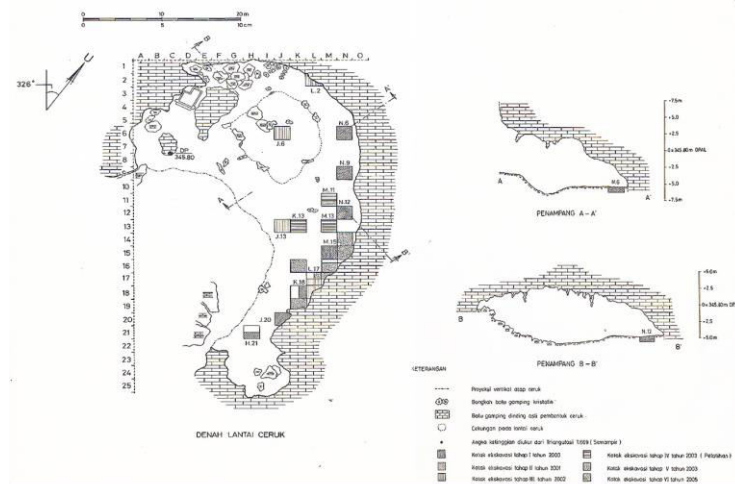

Fig. 2. D.11. Plan of Song Tritis site, Gunungkidul (Doc. Balar Yogya).

Archaeological context

The excavation of Balar Yogyakarta in Song Tritis has been recovered 3 meters thick of archaeological deposit which dated back to around 8.000 BP (Fig. 2. D.12). They found traces of human activity inside the cave including lithic artefact, bone artefact, Bovidae, Cervidae, and a huge number of *Macaca* bones. There are three archaeological layers that have been found in Song Tritis. The upper layer comes from Neolithic after 3.000 BP, characterized by pottery, mixed with lithic and bone tools, also a burial feature (Widiyanto 2001a).

The layer below is Preneolithic period between 6.000-3.000 BP, characterized by a dense of hearth with 1.5 m thick which shows intensive human activity inside the cave during 3.000 years through Mid-Holocene. Flake tool, bone point, and spatula dominated this period which related to the hunting activity. Monkey is the most favorite taxa to be

hunted, but also a small number of Bovidae and Cervidae. The oldest layer below is the earliest occupation period as early to 8.000 BP with non-intensive activities (Widianto 2001a).

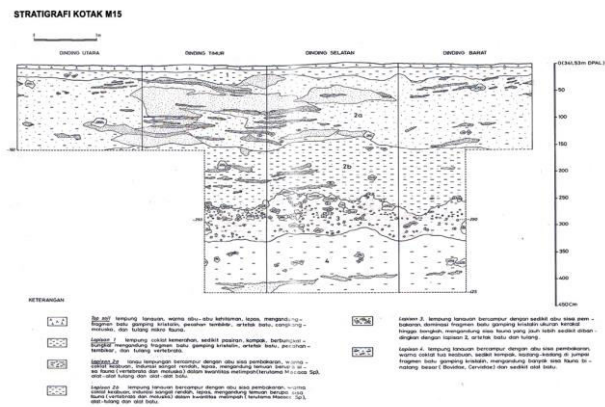

Fig. 2. D.12. Stratigraphy of Song Tritis site, Gunungkidul (Doc. Balar Yoga).

Human remain

One flexed burial feature (Fig. 2. D.13) has been found in the square L17-18 in the upper part layer of Song Tritis (Table 2. D.6). The remain belong to a female individual buried in a primary flexed position. Based on preliminary observation by Widianto (2001), the individual is closed to the Mongoloid affinity rather than Australomelanesian population. So far, only the mandible was recovered and conserved in Balar Yoga, but the rest of the remains were still in situ and was difficult to identified.



Fig. 2. D.13. Flaked burial of Song Tritis individual 1 (Doc. Détroit)

The Significance

Similar to Braholo cave, the Song Tritis cave represents the cave occupation in the western part of Gunungsewu area during Holocene, especially in the Preneolithic period. The cultural context of Song Tritis resembled Braholo cave which dominantly filled by bone tools and related to Sampung cultural complex. The existence of a female Mongoloid individual in a primary flexed burial context is unusual in Gunungsewu area. Detail analysis should be done to explains this phenomenon.

Table of Human Remains

NO	NO. IDV	REMAINS	SEX	GRADE	AGE	AFFINITY	BURIAL	POSITION	ORIENTATION	SKULL	CULTURAL	STRATIGRAPHY	DATING
1	STR 1	Almost complete skeleton	Female	> I	> 55	Australo-Melanesian (?)	Primary	Flexed	N - S	North	Sampungian	Keplek Layer	6-3 Ka

Table 2. D.6. Human individual from Song Tritis site.

5. WAJAK COMPLEX

General condition of Wajak Site

Wajak site is located on a mountain slope of the Gunung Lawa mountains, at the Tjerme village, near Campurdarat, Tulungagung Regency, East Java. This site was discovered by B.D. Van Rietschoten who found a skull fragment (known as Wajak 1) when exploring a marble mining on October 24, 1888. According to van Rietschoten, the Wajak skull was found about one meter of clay, beneath a conglomerate of small marble stone, mixed with a limestone like clay (Storm 1976), see Fig. 2. D.16 left.

In 1889, the specimen of Wajak 1 was sent to Eugène Dubois in Sumatra. Dubois (1890) impressed that the Wajak Man is greatly deviated from the 'Malay type' and that it rather resembled the 'Papuan type'. Furthermore, Dubois said it was better not to continue the excavation at the Wajak site by the people who were no experts and then instructed van Rietschoten to stop the excavation (Dubois 1922; Storm 1976).

Later in 1890, Dubois moved from Sumatra to Java to excavate some sites at the Gunung Lawa area and some caves at nearby karstic area with the help of De Winter, such as Goea Ketjil (means small cave), Hoekgrot (corner cave) at Gunung Lawa near Tjerme (Fig. 2. D.14), also Goea Djimbe near Kates, Goea Mendjangan at Trenggalek, Goea Roto near Redjotangan, Goea Song Kentong near Besole. During the excavation campaign at Wajak complex, he found the second specimen (known as Wajak 2) along with fragments of various mammals in the rock-fissure sediments (Fig. 2. D.16). Although Dubois (1922) described the exact location of the Wajak site, later it was believed to be lost or totally destroyed by marble mining activity (Van den Brink 1982; Coon 1962; Jacob 1967; van Stein Callenfels 1936) until the site was rediscovered in 1985 by Aziz and de Vos (1989).



Fig. 2. D.14. View of the Gunung Lawa in 1890 seen from the southern edge of Tjerme village. From left to right: 1) Hoekgrot, 2) Goea Lawa, 3) Wajak, 4) cave in the steep wall, 5) Western cave (Aziz and de Vos 1989).

Archaeological Assemblages

The result of Dubois' survey and excavation at Gunung Lawa karstic region could be summarized as follow:

- Site 1: Hoekgrot or the Eastern Corner Cave, which produced the red-painted human skeleton remains from the Holocene sediment.
- Site 2: The Goea Lawa, which produced no bones.
- Site 3: The locality of Wajak site where the Wajak 1 found by Van Rietschoten and Wajak 2 found by the excavation of De Winter in the rock-fissure deposit.

- Site 4: The cave in the steep wall, which could be reached only by rope and which contained only tough lava.
- Site 5: Goea Ketjil, the western corner cave, which produced human bones in the Holocene sediment.

Beside five previous sites, Dubois also did an excavation at the Goea Djimbe near Kates, northeast direction from Wajak complex. He found human remains, together with animal bones and bone artifacts. In the other East Java cave sites, Dubois only found animal bones and no human remains so far.

So far, unfortunately there is only limited archaeological context on those both Wajak fossils. Storm (1992) during his re-study of the Wajak Man, he was found two artifacts and interpreted as small blades (Fig. 2. D.15 left). Together with the artifacts, he also indicates the presence of a possible cut marks on the distal part of metacarpus from a large deer, signs of burning, and remains of marine origin (Storm 1992). Based on his observation, Storm conclude that Wajak site was a habitation site, a burial site, or both function (Storm 1995). During re-observation on the 'Dubois collection' for this research, He found various bone tools similar to 'Sampungian industry', as stated for the first time by van Stein Callenfels (1932), in the Goea Djimbe, Goea Ketjil and Hoekgrot assemblages (Fig. 2. D.15 right), such as: needle, point, spatula, and propulser (?) also earthenware (?), but no lithic tools have been found so far.



Fig. 2. D.15. Lithic artifacts from Wajak site (Storm 1992) and bone artifacts from Hoekgrot (Doc. Noerwidi).

The faunal remains from Gunung Lawa cave sites are consisted of *Rusa timorensis*, *Muntjacus muntjac*, *Sus scrofa*, *Tapirus indicus*, *Rhinoceros sondaicus*, *Hystrix javanica*, *Panthera tigris* and *Presbytis cristatus* (Van den Brink 1982; Storm 1995). Almost all mammals which found in this site are still survive in Java, but tapir is now extinct, rhino is in restricted area, and tiger probably disappeared in the last century (Whitten et al. 1996). The animal bone assemblages is named as Wajak Fauna and could be interpreted as an open woodland fauna (de Vos 1983, 1985). In the other hand, Dubois on his monthly report only noted a few bone fragment of animals, probably deer, were found in the breccia which filled the fissure (Aziz and de Vos 1989). Those both faunal assemblages should come from different archaeological layers.

Human Remains

So far, there are two individuals from Wajak site, which came from cranial and post-cranial bones. Wajak 1 consists of almost complete skull and fragment of right mandibular ramus with molars, then Wajak 2 consist of skull fragments and post-cranial fragments as stated by Jacob (1967) and Storm (1976). Recent laser ablation U-series dating results by Storm *et al.* (2013) on human and faunal bone fragments from Wajak, indicates a minimum age of between 37.4 and 28.5 ka BP. Other sites, such as Hoekgrot, Goea Ketjil, and Goea Djimbe, produced some human remains including cranial and post-cranial fragments (Table 2. D.8), also isolated teeth (Table 2. D.9.). The age of this remains probably correspond to between 6.560±140 BP and 10.560±75 BP as suggested by Shutler Jr *et al.* (2004) based on AMS radiocarbon dating on the faunal bones.

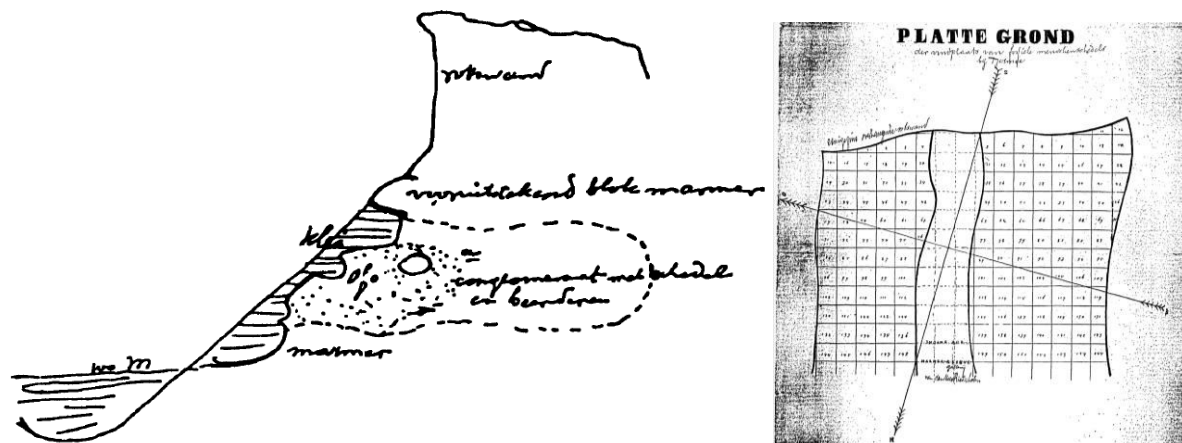

Fig. 2. D.16. Left. Cross section of Wajak site, copy by Dubois from a sketch by van Rietschoten, 1888. The script from top to bottom: rocky wall, protruding block of marmer, clay, conglomerate with skull (Wajak 1) and bones, marble limestone (Storm 1995). Right. Excavation boxes of Wajak site and location of Wajak 2 found in square 21 at 1.25 m dept (Aziz and de Vos 1989).

The Significance

Actually, there are two different archaeological assemblages in the Wajak karstic area (Table 2. D.7), which could be separated as follows:

	HUMAN REMAINS	FAUNAL REMAINS	ARTIFACT	SEDIMENT	AGE
HOLOCENE					
HOEKGROT	Red painted skeleton	Wajak fauna	Sampungian Bone tools	Holocene	10.500-6.500 BP
GOEA KETJIL	Fr. skeleton	Wajak fauna	Sampungian Bone tools	Holocene	10.500-6.500 BP
PLEISTOCENE					
WAJAK	Fr. skull and mandible	A few of fr. deer	Microlith	Breccia in rock-fissure	38 Ka BP

Table 2. D.7. The difference of two archaeological assemblages from Wajak karstic area.

The Holocene remains, especially the red-painted skeleton from Hoekgrot, could be correlated to their cousin, Preneolithic populations in Java, such as Gua Pawon in Bandung Highlands and Gua Braholo in the western part of Gunungsewu area. This hypothesis confirmed by the archaeological assemblages which show similarity between Sampungian bone industry techno-complex that also found in Gua Lawa Sampung karstic area, Gua Kidang in the Northern Mountains, and Gua Braholo.

There are two views of the Wajak skulls that generally followed by the scientists. First of all, it is clear that Wajak Man are representing the *Homo sapiens* with their large and very robust characters (Storm 1995). The robustness of the skull is the main reason why the Wajak remains were linked with other previous robust skulls in Asia-Australia region, such as Ngandong (Solo Man) and the late Pleistocene – early Holocene from Australia; Keilor, Kow Swamp, and Cohuna (Coon 1962; Thorne and Wolpoff 1992; Weidenreich 1945). However, other scientists also noticed difficulties in the assumption of a direct evolutionary link between Ngandong and Wajak (Jacob 1967; Santa Luca 1980; Storm 1995, 2001; Stringer 1992).

Table of Individuals

NO	LOCALITY	NO. COL	REMAINS	SEX	GRADE	AGE	STRATIGRAPHY	FAUNA	ARCHAEOLOGY	DATING	STORAGE
1	Wajak	Wajak 1	Cranium and fr. right mandible	Female	C	18 - 22	?	Wajak	?	38 Ka	RNH
2	Wajak	Wajak 2	Mandible and fr. maxilla	Male	F	30 - 35	Pleistocene-Holocene	Wajak	Flake and Blade	38 Ka	RNH
3	Djimbe	Djimbe 17321	Maxilla	Female	G	35-40	Holocene	Wajak	Sampung	Holocene	RNH
4	Djimbe	Djimbe 17322	Right Maxilla	Male	I	45-55	Holocene	Wajak	Sampung	Holocene	RNH
5	Djimbe	Djimbe 17324	Mandible	Female	G	35-40	Holocene	Wajak	Sampung	Holocene	RNH
6	Ketjil	Ketjil 17796	Maxilla	Female	H	40-50	Holocene	Wajak	Sampung	Holocene	RNH
7	Ketjil	Ketjil 17797	Right Mandible	Male	H	40-45	Holocene	Wajak	Sampung	Holocene	RNH
8	Ketjil	Ketjil 17798	Left Mandible	Male	H	40-45	Holocene	Wajak	Sampung	Holocene	RNH
9	Hoekgrot	Hoekgrot 17410	Left Maxilla (red painted)	Male	E	24-30	Holocene	Wajak	Sampung	Holocene	RNH
10	Hoekgrot	Hoekgrot 17411	Right Maxilla (red painted)	Male	E	24-30	Holocene	Wajak	Sampung	Holocene	RNH
11	Hoekgrot	Hoekgrot 17463	Right Mandible	Juvenile		7 +- 2	Holocene	Wajak	Sampung	Holocene	RNH
12	Hoekgrot	Hoekgrot 17474	Left Maxilla	Female	C	18-22	Holocene	Wajak	Sampung	Holocene	RNH

Table 2. D.8. Human individuals from Wajak complex sites. Abv. RNH = Rijksmuseum van Natuurlijke Historie, the Netherlands.

Table of Isolated Teeth

NO	NO. COL	CATEGORY	GRADE	AGE	STRATIGRAPHY	DATING
1	Wajak 1457-12	LLC	D	20-24	Holocene	Holocene
2	Wajak 1457-13	ULP3	E	24-30	Holocene	Holocene
3	Wajak 1457-14	LLP4	F	30-35	Holocene	Holocene
4	Djimbe 17323	ULC	H	40-55	Holocene	Holocene
5	Hoekgrot 17465	URI1	F	30-35	Holocene	Holocene
6	Hoekgrot 17466	URI1	F	30-35	Holocene	Holocene
7	Hoekgrot 17467	URI2	E	24-30	Holocene	Holocene
8	Hoekgrot 17468	URI2	E	24-30	Holocene	Holocene
9	Hoekgrot 17469	LLI2	F	30-35	Holocene	Holocene
10	Hoekgrot 17470	LRI2	F	30-35	Holocene	Holocene
11	Hoekgrot 17471	URC	D	20-24	Holocene	Holocene
12	Hoekgrot 17472	URC	H	40-50	Holocene	Holocene
13	Hoekgrot 17473	ULC	F	30-35	Holocene	Holocene
14	Hoekgrot 17475	URP3	B2	16-20	Holocene	Holocene
15	Hoekgrot 17476	URP4	F	30-35	Holocene	Holocene
16	Hoekgrot 17477	LRP4	E	24-30	Holocene	Holocene
17	Hoekgrot 17478	LRP4	H	40-45	Holocene	Holocene
18	Hoekgrot 17479	LLP4	H	40-45	Holocene	Holocene
19	Hoekgrot 17480	LLM2	H	40-45	Holocene	Holocene
20	Hoekgrot 17481	LRM1	H	40-46	Holocene	Holocene
21	Hoekgrot 17482	LRM2	H	40-47	Holocene	Holocene

Table 2. D.9. Isolated teeth from Wajak complex sites.

E. SOUTHERN SUMATRA GUA HARIMAU (BATURAJA KARST)

Baturaja karstic region consists of Padang Bindu, Muara Dua-Simpang Saga, West OKU, East OKU, and Pematang Karang karstic areas. This karstic region is located on the eastern slope of Bukit Barisan Mountains anticlinal zone with land elevation up to 300 meters above sea level. Lithological formation of this region consisted by sedimentary rock of Baturaja limestone formation aged of Early Miocene between 16-23 Ma, when the territory was still a shallow sea. Entering the Quaternary age, the limestones of the Baturaja Formation started to rise and exposed to the surface (Van Bemmelen 1949; Gafoer, Amin, and Pardede 1993). Furthermore, the limestones unit of Baturaja Formation underwent a karstification process resulting in a morphology typical of karst which we can find out today, such as caves and karst ornamentation (Wibowo et al. 2016).

Padang Bindu karst is one and the most important karst region in the Baturaja karstic region extending east-west direction approximately parallel to the flow of Ogan River between Pangandonan Anyar in the west and Ulak Pandan in the east. Limestone outcrops are found in Sayak Hill, Karang Batubelah Hill, Padang Bindu Cave site, Semuhun River, and Muara Cawang River (Negeri Sindang) (Wibowo et al. 2016), see Fig. 2. E.1. There are some archaeological cave sites in the Padang Bindu karst area, such as Gua Harimau, Gua Pandan, Gua Akar, Gua Putri, Karang Pelaluan, Karang Beringin, also Pondok Selabe, and one of the most important sites is Gua Harimau.

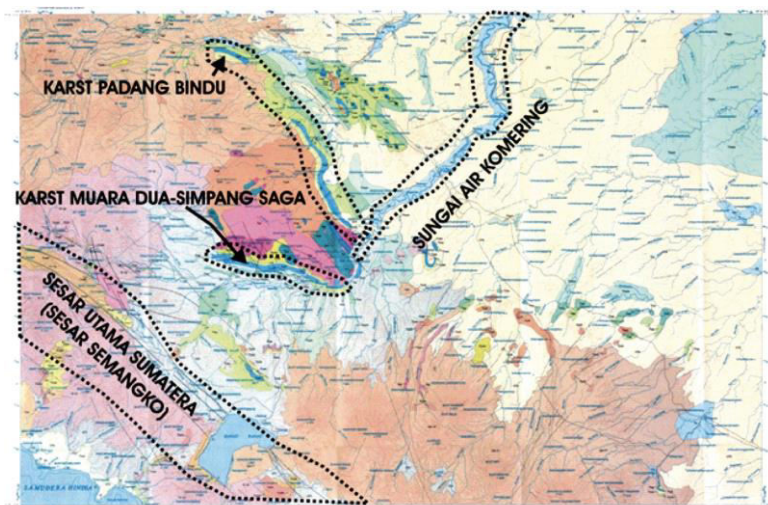

Fig. 2. E.1. Map of Padang Bindu Karst and surrounding area (Simanjuntak 2016).

General condition of Gua Harimau

The Indonesian National Center for Archaeological Research (Puslit Arkenas) conducted their first exploration in the Baturaja area in 1995, who was led by Jatmiko. They found a dense spread of lithic artifacts in the upstream part of Ogan river, especially in the Districts of Pangandonan and Semidang Aji, particularly in Padang Bindu village (Jatmiko 1995). The study was continued in 2001 by the collaboration between Puslit Arkenas and IRD (French Research Institute). This time the research was more focussed on the area around Padang Bindu Village, District of Semidang Aji. Besides excavating the Selabe Cave, they also

conducted a follow-up research on several tributaries of Ogan River, among which are Semuhun River, Air Tawar River, Air Haman Basah River (Aek Haman) and Dayang Rindu River (Jatmiko and Forestier 2002).

Advance researches were conducted in 2003 and 2004 by excavating Pondok Selabe 1 site. The results of the researches revealed the existence of Preneolithic occupation up to 5.700 BP (Forestier et al. 2006). Several years later in 2007, Puslit Arkenas began an advance research in Baturaja region. The excavations were continued in several caves, including Karang Beringin Cave and Karang Pelaluan Cave. The survey activities were also continued to find new cave sites, and one of them was the discovery of Harimau Cave in 2008 (Simanjuntak 2016).

Administratively, Gua Harimau site is a cave located in the Padang Bindu village, Semidang Aji district, and Ogan Komering Ulu regency, South Sumatra. Geographically, this cave located on the southeastern part of Karang Sialang Hill around ± 164 m above sea level. Gua Harimau is located around ± 20 meters above the Aek Haman Basah river with 38° of sloping. The cavity of Gua Harimau is facing to the southeast direction with 43 m width, 32 m length, the average horizontal depth is around 15 m, and about $\pm 16,5$ m height. The type of the cave extending to the side (32 m) with moderate air circulation as well as good-moderate intensity of the light. Ornaments found in this cave is a flow stones, pillars, stalactites and stalagmites (Simanjuntak, Oktaviana, and Handini 2016).

Gua Harimau was found in the archaeological survey of 2008 conducted by the Puslit Arkenas based on an information from Pak Fendi, a local resident of Padang Bindu Village. Through an intensive excavation held by Puslit Arkenas since 2010 and since 2012, a substantial area of the floor of the cave has been excavated, recovering a huge number of individuals in the context of the grave with a variety of positions and burial goods. A large number of archaeological findings such as stone tools, fauna remains, pottery, and metal artifacts reflect the evidence of prehistoric life (Matsumura et al. 2018; Simanjuntak 2016), see Fig. 2. E.2.

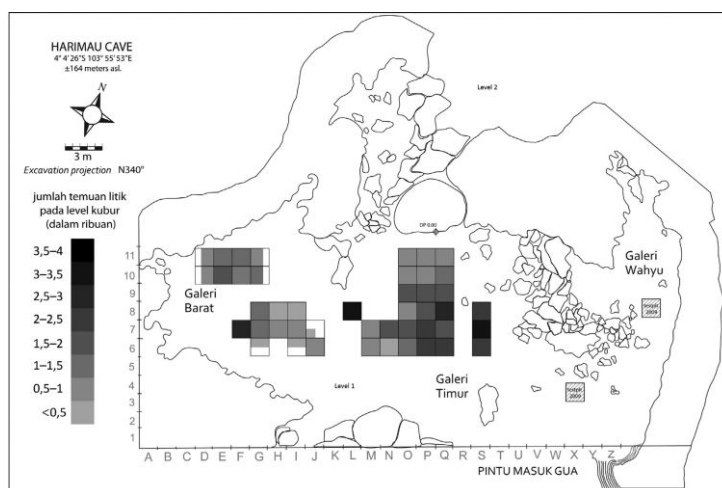

Fig. 2. E.2. Plan of Gua Harimau site with the density of archaeological finds (Simanjuntak 2016).

One of the most interesting findings in Gua Harimau site is the presence of rock painting (Fig. 2. E.3) in this cave which also became the first findings on the island of Sumatra. The rock paintings depicted geometric patterns and were supposedly painted using hematite. The existence of the cave paintings confirmed the existence of prehistoric rock art,

especially rock painting in the western part of Indonesian archipelago (Oktaviana, Setiawan, and Saptomo 2016; Simanjuntak and Octaviana 2012).



Fig. 2. E.3. Rock painting at Gua Harimau site (Simanjuntak 2016).

Archaeological Layer

Archaeological remains have been recovered from Gua Harimau consist of lithic artifacts, metal artifacts, artifacts from organic materials (bones, teeth, and shells of mollusks), potteries, faunal remains, microscopic organic remains (soil, charcoal, pollen), hematite, and cave paintings (Simanjuntak 2016).

Based on archaeological remains found in Gua Harimau, there are at least two cultural layers have been developed in the site (Fig. 2. E.4). The upper layer is Neolithic-Paleometallic period which dated around between 3.000 and 1.000 BP. This period is characterized by a huge number of extended burial, potteries and metal artifacts. This cultural layer shows a significant accumulation of freshwater mollusks, which represent the main diet of the people at that time. In addition, the type of terrestrial fauna that widely consumed was *Varanus* (large lizards) and *Testudines* (turtles), also *Suidae*, *Bovidae*, *Cervidae*, and *Cercopithecidae*, but in less quantity. Significant number of *Cercopithecidae* primates signaled an enclosed forest environment (with canopy), which is also not much different from the situation today. The existence of *Pisces* and *Trionyx* allows the assumptions about the closeness between the location of the cave with the flow of river water (see Ansyori and Due Awe, 2016; Fauzi, Oktaviana and Budiman, 2016; Noerwidi *et al.*, 2016; Simanjuntak, 2016).

Many type of potteries have been discovered from the upper layer of Gua Harimau. Some types clearly have a function as a burial gift, based on an intact small jar associated with the extended primary burials. The main technique of pottery production in Gua Harimau is dominated by paddle-anvil technique while the wheel technique was quite scarce. The motif pattern consists of rhombus, chevron, corded-mark, ellipse, line, circle, dense circles (patterned), square, triangle, fish bones, and crescent motif. The technique used to apply this motif such as engraving, pressing, levering, and attaching. There is also the possibility of a relationship between the decorative motifs appear on the pottery with rock-art in the Harimau Cave (Ansyori 2016).

Since 2009 to 2013 several metal artifacts have been found from the upper layer of Gua Harimau. They are containing of axes, bracelets, spatula, knife, and other unidentified type. Several artifacts are closely associated with human burial as burial gifts, and relate its function to the symbolic meaning. A direct dating on human remain associated with bronze

axes resulted an age of 2.588 ± 88 calBP. This date is presumably older than the estimated age of Dong Son culture diffusion to the archipelago, which is a few centuries BC (Fauzi et al. 2016; Soejono 1993).

The lower layer is related to the lithic artifacts industry and some flexed primary burial, were estimated developed between 14.000 to 5.000 BP. Based on faunal remains observation known this older period is dominantly by the exploitation of large terrestrial fauna. In this period, the amount of fish remains finding was insignificant and there is no longer indication of the utilization of freshwater mollusks as part of the diet (see Ansyori and Due Awe, 2016; Fauzi, Oktaviana and Budiman, 2016; Noerwidi *et al.*, 2016; Simanjuntak, 2016).

Rock art in Harimau Cave site was firstly discovered in 2009 by E. Wahyu Saptomo a Puslit Arkenas researcher, when he discovered seven motifs on the eastern wall of the cave. In 2010, Pindi Setiawan identified 25 rock art from the eastern and western walls of Gua Harimau, which generally have geometric pattern, by finger painted and using pointy tools with dark red or dark brown color. Between 2011 and 2014, A.A. Octaviana added six geometric motifs in the Wahyu Gallery niche, 18 rock art on the southern panels of Wahyu Gallery and on the upper part of the West Gallery (Oktaviana et al. 2016; Simanjuntak, Fauzi, and Oktaviana 2014). So far there is no direct dating regarding on this rock painting, but it could be probably come from the Preneolithic period of Mid Holocene correspond to the hematit finding in the lower layer of Gua Harimau occupation.

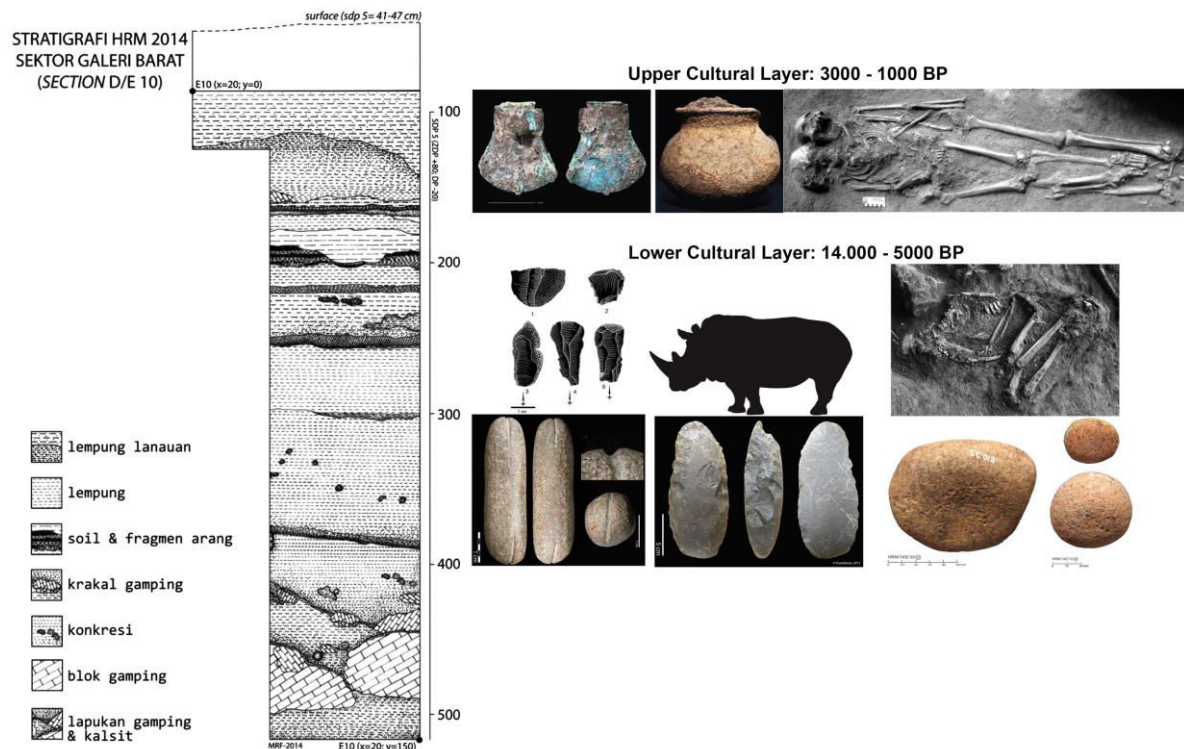

Fig. 2. E.4. Stratigraphy of Gua Harimau site (Simanjuntak 2016).

Human Remains

Since the excavation season of 2010 to 2016, so far there are already recovered at least 81 individuals of human remains from Gua Harimau (Table 2. E.1). Those remains are

dated back from the preneolithic around 5.712-5.591 cal BP through to the Neolithic, and Bronze-iron ages or 1.864-1.719 cal BP. Some level represents the continuity of artefact and floral/faunal remains from the Neolithic through to Bronze-iron ages suggests continuity in occupation over this time period (Matsumura et al. 2018; Simanjuntak 2016).

Based on the human remains in their grave context, there are some type of burial in Gua Harimau, they are single, double, and collective burial (Fig. 2. E.5). 10 individuals are buried as single burial in the flexed position of Preneolithic period and the extended position of Neolithic-Paleometallic period. 7 graves of 14 individuals identified as double burial and 9 graves which contain around 27 individuals were buried in collective burial system. The rest of the individuals were buried in another primary or secondary systems. The secondary burial is mostly containing fragments of cranium, mandible, and the long bones (updated from Noerwidi *et al.*, 2016).

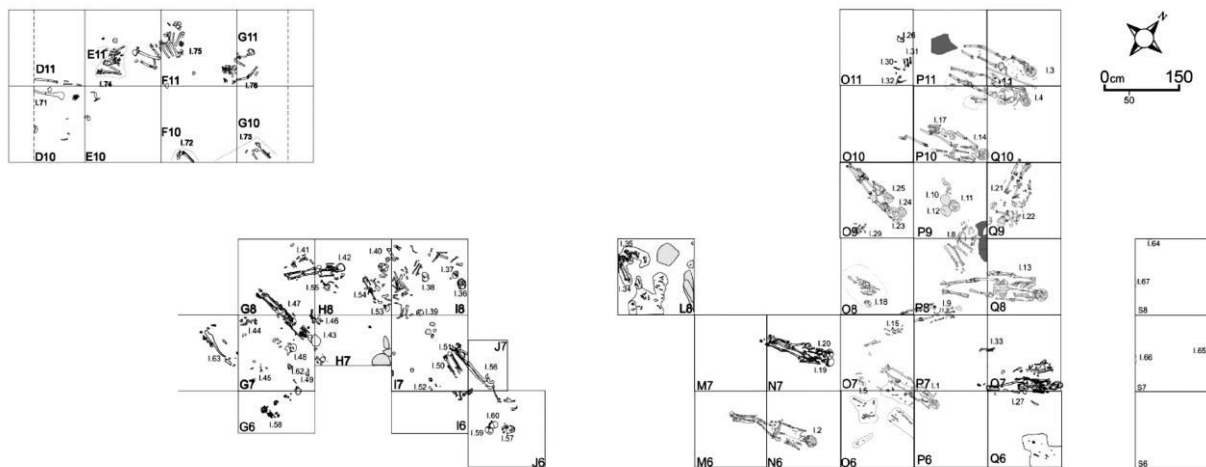

Fig. 2. E.5. Distribution of human skeleton remains at Gua Harimau site (Simanjuntak 2016).

In double and collective burial which involve more than one individual in a single grave, there are two variations of skeletal position, i.e. parallel side-by-side and piled up position. From 7 double burial, 5 graves were buried side-by-side; whereas in the remaining 2 graves were buried piled up. In 9 collective burial context, side by side position is present in 11 graves while in the other 6 graves were buried in a piled-up position (updated from Noerwidi *et al.*, 2016).

A flexed burial position from the Preneolithic layer is a representation of the condition of a fetus inside a womb. In some traditional societies in the region, especially from the Eastern part of Indonesia, this position represents the belief that said the death is a return process to the “womb” of the “mother earth”, and the rebirth of the soul into the next life. The Gua Harimau graves indicates the burial tradition performed by the prehistoric society, with the graves completed by the burial gifts contain pottery, bronze axe, bronze bracelet, iron spatula, adze and others stone artifacts (Noerwidi et al. 2016).

The taphonomical study suggested that the burial procession at Gua Harimau uses grave marks for connected the genealogically of the people who died in a different time in order to be buried together. The absence of any remains of these grave marks could be caused by the use of non-permanent material. The grave marks hypothesis is supported by the traces of graves which were reopened and reburied in the case of double and collective burials. According to palynology analysis of the collective burial, there are some interesting pollens found such as *Ephedraceae* (bush plant), *Fagaceae* (flower shrub), and *Leguminosae*

(woody plant). The presence of *Fagaceae* and *Leguminosae* pollens indicates the use of flowers in a burial ritual and hard wood for coffin or burial container (Noerwidi et al. 2016; Vita, Sayekti, and Octina 2016).

The Significance

The oldest human occupation in Sumatra is presented by Lida Ajer, Sibrambang, and Djambu which show the similarity of tropical rainforest fauna to the Punung about 128-118 Ka BP. Hooijer (1948) noted *Homo sapiens* tooth as well as fossils of *Pongo pygmaeus*, *Hylobates sp.*, *Elephas sp.*, and *Rhinoceros sp.* from Dubois' collection of Lida Ajer (Hooijer 1948; de Vos 1983). The chronology of the site based on a recent study by Westaway *et al.*, (2017) shows of upper Pleistocene between 73-63 Ka BP.

The excavations at the Gua Harimau by the Puslit Arkenas which reached 4 m depth below the modern floor, indicates a long period of cave occupation in the site dated back more than 14 Ka BP. The discovery of some lithic artifacts from layers under the age of 14.825 ± 336 calBP with *Rhinocerotidae* remains makes Gua Harimau is very significant to reveal the initial occupation of Sumatra Island (Simanjuntak 2016).

The existence of two different human groups, Australomelanesian from the first half part of Holocene and Southeast Asian Austronesian speaker in the last part of Holocene arise of a question about the history of human occupation in Sumatra during this period. Detail analysis on the human remains from Gua Harimau could show the replacement or coexist those both human groups.

Table of Human Remains

NO	NO. IDV	REMAINS	SEX	GRADE	AGE	AFFINITY	BURIAL	POSITION	ORIENTATION	SKULL	CULTURAL	STRATIGRAPHY	DATING
1	HRM 1	Almost complete skeleton	Female	D	20 - 24	Mongoloid	Primary	Extended	E - W	E		Late Holocene	
2	HRM 2	Almost complete skeleton	Male			Mongoloid	Primary	Extended	E - W	E		Late Holocene	2196 ± 84
3	HRM 3	Almost complete skeleton	Female			Mongoloid	Primary	Extended	E - W	E		Late Holocene	1840 ± 23
4	HRM 4	Almost complete skeleton	Male			Mongoloid	Primary	Extended	E - W	E		Late Holocene	1872 ± 24
5	HRM 5	Fr. Long bones					?						
6	HRM 6	Fr. Bones											
7	HRM 7	Fr. Bones											
8	HRM 8	Almost complete skeleton	Male	G	35 - 40	Australo-Melanesian	Primary	Flexed	N - S	N			1951 ± 28
9	HRM 9	Almost complete skeleton	Male	I	45 - 55	Mongoloid	Primary	Extended	NE - SW	NE		Late Holocene	
10	HRM 10	Cranium	Female	B1/2	16 - 20	Mongoloid	Secondary						
11	HRM 11	Cranium	Male			Mongoloid	Secondary						2588 ± 88
12	HRM 12	Cranium and partially post-cranium	Male	G	35 - 40	Mongoloid	Secondary				Red stained		
13	HRM 13	Almost complete skeleton	Female	I	45 - 55	Mongoloid	Primary	Extended	NE - SW	NE		Late Holocene	2014 ± 30
14	HRM 14	Almost complete skeleton	Female		> 55	Mongoloid	Primary	Extended	E - W	E		Late Holocene	
15	HRM 15	Fr. Post cranial				Mongoloid	Primary	Extended	NE - SW	NE			
16	HRM 16	Fr. Bones									Red stained		
17	HRM 17	Cranium and long bones	Male	B1/2	16 - 20		Secondary						

18	HRM 18	Fr. Long bones					Secondary						2354 ± 5
19	HRM 19	Almost complete skeleton	Male			Mongoloid	Primary	Extended	E - W	E			Late Holocene
20	HRM 20	Almost complete skeleton	Female			Mongoloid	Primary	Extended	E - W	E			Late Holocene
21	HRM 21	Almost complete skeleton	Female	E	24 - 30	Mongoloid	Primary	Extended	N - S	S	Red stained		
22	HRM 22	Fr. Cranium, costae, and long bones		E	24 - 30		Primary	Extended	N - S	S			
23	HRM 23	Almost complete skeleton		B1/2	16 - 20	Mongoloid	Primary	Extended	E - W	E	Red stained		Late Holocene
24	HRM 24	Almost complete skeleton		I	45 - 55	Mongoloid	Primary	Extended	E - W	E	Red stained		Late Holocene
25	HRM 25	Almost complete skeleton		B1/2	16 - 20	Mongoloid	Primary	Extended	E - W	E			Late Holocene
26	HRM 26	Fr. Cranium					Secondary						
27	HRM 27	Almost complete skeleton				Mongoloid	Primary	Extended	E - W	E			Late Holocene 1786 ± 36
28	HRM 28	Fr. Bones											
29	HRM 29	Fr. Long bones					?						
30	HRM 30	Fr. Long bones					Secondary						
31	HRM 31	Fr. Long bones					Secondary						
32	HRM 32	Fr. Long bones					Secondary						
33	HRM 33	Fr. Long bones					?						
34	HRM 34	Fr. Post cranial					Not clear						
35	HRM 35	Almost complete skeleton					Primary						
36	HRM 36	Fr. Cranium and long bones		F	30 - 35	Australo-	Disturbed				Red		Mid. Holocene

					Melanesian					stained	
37	HRM 37	Fr. Cranium and long bones	G	35 - 40	Australo-Melanesian	Disturbed				Red stained	Mid. Holocene
38	HRM 38	Fr. Cranium and long bones			Australo-Melanesian	Disturbed					Mid. Holocene
39	HRM 39	Fr. Cranium and long bones			Australo-Melanesian	Disturbed					Mid. Holocene
40	HRM 40	Fr. Long bones			Australo-Melanesian	Disturbed					Late Holocene 2339 ± 9
41	HRM 41	Fr. Cranium				Secondary					
42	HRM 42	Almost complete skeleton	Male		Mongoloid	Primary	Extended	NE - SW	NE		Late Holocene
43	HRM 43	Almost complete skeleton	Female		Mongoloid	Primary	Extended	E - W	E		2335 ± 9
44	HRM 44	Fr. Vertebrae and costae				Secondary					2691 ± 56
45	HRM 45	Fr. Post cranial				?					
46	HRM 46	Almost complete skeleton			Mongoloid	Primary	Extended	E - W	E		
47	HRM 47	Almost complete skeleton			Mongoloid	Primary	Extended	E - W	E		Late Holocene
48	HRM 48	Cranium and coxae	Female			Secondary					
49	HRM 49	Fr. Bones				?					
50	HRM 50	Fr. Post cranial				Primary	Extended	E - W	E		Late Holocene
51	HRM 51	Fr. Post cranial	Female			Primary	Extended	E - W	E		Late Holocene
52	HRM 52	Fr. Bones				Secondary					
53	HRM 53	Cranium	Male			Secondary					
54	HRM 54	Fr. Long bones			Australo-	Primary	Flexed				2230 ± 63

Melanesian									
55	HRM 55	Fr. Cranium, clavicle and vertebrae	Female				?		
56	HRM 56	Fr. Post cranial	Male		Mongoloid	Primary	Extended		1860 ± 21
57	HRM 57	Cranium	Female			Secondary			
58	HRM 58	Fr. Post cranial					?		2261 ± 64
59	HRM 59	Cranium	Female		Mongoloid	Secondary			Late Holocene
60	HRM 60	Cranium	Male	F	30 - 35	Mongoloid	Secondary	Red stained	Late Holocene
61	HRM 61	Fr. Bones							
62	HRM 62	Pelvis							
63	HRM 63	Almost complete skeleton			Mongoloid	Primary	Extended		
64	HRM 64	Fr. Bones				Not fully excavated			
65	HRM 65	Fr. Bones				Not fully excavated			
66	HRM 66	Fr. Bones				Not fully excavated			
67	HRM 67	Fr. Bones				Not fully excavated			
68	HRM 68	Fr. Long bones					?		
69	HRM 69	Fr. Post cranial				Primary	Extended		
70	HRM 70	Fr. Bones							
71	HRM 71	Almost complete skeleton			Mongoloid	Primary	Extended	NE - SW	NE
72	HRM 72	Fr. Long bones				Not fully excavated			
73	HRM 73	Fr. Long bones				Not fully excavated			

74	HRM 74	Almost complete skeleton	Male	I	45 - 55	Australo-Melanesian	Primary	Flexed	N - S	N	Mid. Holocene	4572 - 4514 BP
75	HRM 75	Almost complete skeleton				Australo-Melanesian	Primary	Flexed	N - S	N	Mid. Holocene	
76	HRM 76	Almost complete skeleton	Male			Australo-Melanesian	Primary	Flexed	N - S	N	Mid. Holocene	
77	HRM 77	Fr. Bones										
78	HRM 78	Fr. Bones										
79	HRM 79	Almost complete skeleton	Male	I	45 - 55	Australo-Melanesian	Primary	Flexed	NE - SW	SW	Mid. Holocene	4514 - 5565 BP
80	HRM 80	Fr. Long bones					?					
81	HRM B1	Fr. Post cranial	Male			Mongoloid	Primary	Extended	E - W	E		

Table 2. E.1. Human individuals from Gua Harimau sites.

F. WESTERN SUMATRA LIDA AJER (PAYAKUMBUH KARST)

The landscape of Padang Highland about 930 m asl in the western Sumatra is characterized by the influences of volcanic and tectonic origins, as well as by geological processes such as weathering, erosion, sedimentation, and solution. The volcanic landscape is built up by the product of Marapi and Malintang volcanoes in the central of the region. This landscape was then affected by tectonic activities producing lineaments that are assumed as active faults. These faults which are in NW-SE direction, seem to have the same direction as the Takung River Fault Zone. Based on its morphogenetic characteristics and process, the landform of the area can be distinguished into the exogen factors such as denudational, fluvial, and karst origin, while the endogen factors produced the structural and volcanic origins (Lumbanbatu 2008).

Payakumbuh sub-basin is located in the Padang Highland which administratively included in three sub-districts of Lima Puluh Kota Regency, namely Luak District, Harau District, Lareh Sago Halaban District, and Payakumbuh City. The geomorphological aspects of this region are characterized by a basin surrounded by steep cliffs. The base of Payakumbuh basin is formed by alluvial plain in the middle, where rivers flow such as Batang Sinamar, Batang Agam, Batang Bungo, and Batang Lampasi (Setiawan 2012). A Lower carboniferous limestone belt runs in a northeast-southwest trajectory between Padang to the west and Pekanbaru to the east, through the Payakumbuh sub-Basin, and the limestone tower hills existed in the middle of the plain are contained of caves and shelters. The limestone cave site of Lida Ajer is located close to a large rounded karst hill of Gunung Sago (Westaway et al. 2017).

General condition of Lida Ajer

Dubois, with his wife and young child, was sailed to the Dutch East Indies in 1887 by the S.S. Amalia, and Payakumbuh is the first place of his stationed as a medical doctor in the Dutch Indies Army (Theunissen 1989). Between his busy life as a doctor, Dubois visited caves as suggested by Wallace to find 'Diluvial Man', the missing link in the tropical place. Three important caves are Lida Ajer (Lidah Air in modern spelling) cave, Sibrambang cave, and Djamboe (Jambu) cave (Hooijer 1948; de Vos 1983). Lida Ajer was observed by Dubois for the first time in between 1887 to 1890 (Dubois 1888, 1891), and was recently reinvestigated and excavated by Westaway et al. (2017).

Sibrambang and Djamboe are located near Tapisello, but the exact locations remain unknown, and Lida Ajer is situated in a limestone deposit, south of the Situduh Batu village and located at 00° 19 06.7 S, 100° 35 37.6 E. The cave is about 150 m above the valley carved by Batang Babuwe River (de Vos 1983). The cave entrance is 4.8 m wide and 2.1 m high, facing an easterly direction (Fig. 2. F.1). Lida Ajer comprises a small solution cave with two main chambers and a rear sinkhole. The front chamber has some speleothem decorations and columns, while the rear chamber contains the fossil breccia deposit. This breccia is composed of large-bodied mammal teeth within a sandy clay matrix, has been heavily eroded by natural or anthropogenic factors. Dubois originally attributed the fossils to the

Holocene (Dubois 1891) but later indicated that they might be significantly older (de Vos 1983).

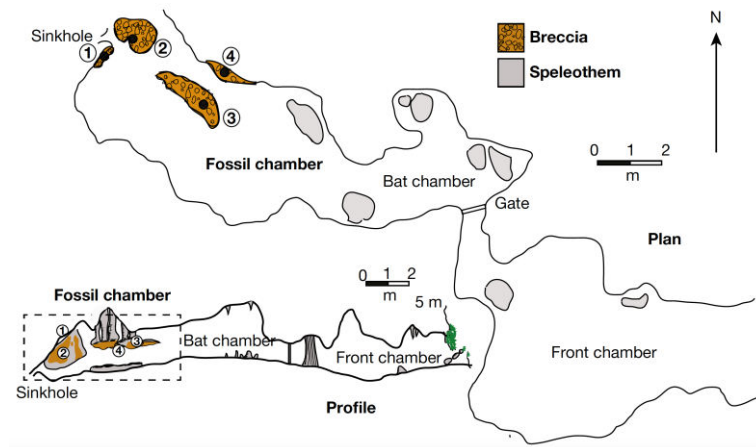

Fig. 2. F.1. Plan of Lida Ajer site (Westaway et al. 2017).

Archaeological Layer

The assemblages from the three cave sites consist of isolated teeth from medium to large size mammals, while small microvertebrates are completely absent (Bacon et al. 2015; de Vos 1983). Almost all teeth show the gnawing of porcupines, thus interpreted as the result of this animal as collecting agents (Bacon et al. 2015; Louys 2012). The samples of Sibrambang and Djamboe consist of animal remains only, but Lida Ajer yielded two modern human teeth (Brongersma 1941; Dubois 1888; Hooijer 1948; de Vos 1983), see Fig. 2. F.2 left.

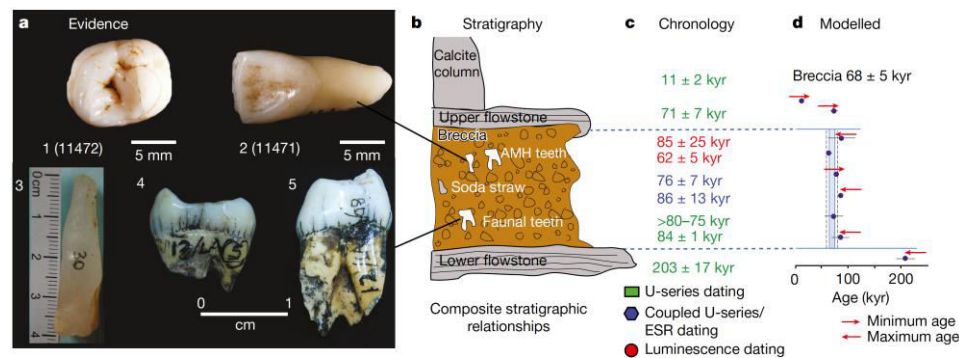

Fig. 2. F.2. New dating result from Lida Ajer site (Westaway et al. 2017).

The faunal composition includes several primates such as *Pongo*, *Hylobates*, *Presbytis*, and *Macaca*. Medium size mammals are *Rusa*, *Muntiacus muntjac*, *Bibos javanicus*, *Capricornis sumatrensis*, *Sus vittatus*, and *Sus barbatus*. Large herbivores are including *Dicerorhinus sumatrensis*, and *Elephas maximus*. Among the carnivores are *Panthera tigris*, *Panthera pardus*, *Neofelis sp.*, *Catopuma temminckii*, *Prionailurus bengalensis*, *Cuon sp.*, *Ursus malayanus*, *Paguma sp.* *Arctonyx sp.* Small mammals lack in the samples due to taphonomic biases (Bacon et al. 2015; Volmer et al. 2017; de Vos 1983).

The first estimations for the age of the ‘Sumatran cave fossils’ was made by de Vos (1983), who predicted the assemblage of Lida Ajer to be correlated to the Punung fauna from the Late Pleistocene, based on of the similarities of the taxonomical composition (de

Vos 1983). The assemblage of Sibrambang was dated to 81 ka-70 Ka BP (Drawhorn 1994) and estimated to be of the same age for Lida Ajer and Djamboe (Bacon et al. 2015). Westaway et al. (2017) recently revealed an age between 73 to 63 ka for Lida Ajer remains and proved the presence of modern humans in Sumatra during this time.

So far, no archaeological evidence was found from those caves as the evidence of human habitation in the caves (Hooijer 1948). Traces of human activities, such as cut marks, could not be recognized on the specimens and were not stated by the taphonomic analyses (Bacon et al. 2015). Nevertheless, the assemblage reflects that the faunal and human remains were represented on the landscape during Late Pleistocene (Westaway et al. 2017). Forest-dependent species such as *Neofelis* sp., as well as *Pongo pygmaeus*, indicate closed forests similar to the tropical rainforest in Sumatra today (Louys and Meijaard 2010).

Human Remains

The two Lida Ajer teeth (Table 2. F.1), which were isolated finds without any associated bone were fully described by Hooijer (1948) and Westaway et al. (2017).

NO	NO. COL	CATEGORY	GRADE	AGE	STRATIGRAPHY	DATING
1	Lida Ajer 11471	URI1	F	30-35	Pleistocene-Holocene	73-63 Ka
2	Lida Ajer 11472	ULM2	E	24-30	Pleistocene-Holocene	73-63 Ka

Table 2. F.1. Isolated Teeth from Lida Ajer site.

The Significance

The assemblage from Lida Ajer reflects the presence of anatomically modern human in the tropical rainforest of Sundaland who survive from the catastrophic events such as the Toba volcano super-eruption or the climatic changes of the LGM during the Late Pleistocene.

G. NORTHERN SUMATRA SHELLMIDDEN (*Kjökkenmöddinger*)

The East coast of the island of Sumatra has a distribution of Hoabinhian sites both in the lowlands and in the highlands. There are two watershed areas that are the center of the distribution of Hoabinhian sites on the East coast of Sumatra, namely the Wampu watershed, which flows in Langkat District, North Sumatra and the Tamiang watershed, which flows in Aceh Tamiang regency and East Aceh regency (Wiradnyana 2010), see Fig. 2. G.1.

The terminology of Hoabinhian was formally established at the First Congress of the Far East Prehistoric Association in Hanoi in 1932. The term was used to give a description of a prehistoric civilization especially in the Southeast Asia. As quoted by Forestier (2007), Hoabinhian is "a civilization consisting of tools that are generally trimmed with a fairly diverse type and using a fairly simple formation style. This culture is characterized by equipment that is often trimmed on one side, stone adzes, large sub-triangle shaped artifacts, discs, short axes, ellips-shaped tools, and a large number of bone tools" (Forestier 2007).

The Hoabinhian site in the lowlands is on an altitude around 5 meters above sea level and ranges between 10 - 20 km from the coastline. Environmental conditions are usually flooded and located closed to the river compared to the coastline. The remaining artifacts characterize Hoabinhian culture with faunal remains dominated by shells of mollusks. Some of the Hoabinhian sites in the lowlands are located in tidal areas (Wiradnyana 2010).

The Hoabinhian site of the highlands is only found in the Wampu watershed, on the slopes of Bukit Barisan mountains. The sites condition is different compared to the lowlands sites which are classified as open sites, on the highland sites are only found in the caves and rock-shelters, but also closed to the river flow. The artifacts found morphologically and technologically have similarities to the Hoabinhian sites in the lowlands except that the faunal remains found is dominated by terrestrial mammal bones (Wiradnyana 2010).



Fig. 2. G.1. Distribution map of shellmidden sites, Northeastern Sumatra.

several kinds of small mammals as well. So far, there are no pottery has been found (Van Heekeren 1972).



Fig. 2. G.3. Stratigraphy of Sukajadi shellmidden sites, North Sumatra (Setiawan et al. 2011)

The shells from Sukajadi Pasar VIII shellmidden site composed by the estuarine species from classes of *Pivalvia* of *Archidae*, *Veneridae*, and *Mytilidae*. These types of shellfish living habitat is in shallow water areas by immersing themselves in the sand or mud. *Mytilidae* is considered to be the most consumed type of shellfish. This shellfish is a type which life in the tidal areas and brush on the wood or coral (Setiawan et al. 2011).

The occupation period of Sukajadi Pasar III shellmidden site ranges between 7000 to 5000 BP. This hypothesis is supported by two radiocarbon dating based on remains of wood from swamp plant found by Miksic (1980) from a test pit dated to 5.055 ± 65 BP and based on charcoal from the hearth dated back to 7.340 ± 360 BP (Bronson and Glover 1984).



Fig. 2. G.4. Sumatralith artefact of Sukajadi shellmidden sites, North Sumatra (Setiawan et al. 2011).

Human Remains

In 1974, McKinnon transferred some human remains found originally from Sukajadi Pasar shell-midden site to the Laboratory of Paleoanthropology and Bioanthropology in Gadjah Mada University, Yogyakarta (Table 2. G.1). He saved the remains from the looting of the shell-midden site by the local people for cement quarry. McKinnon noted that the human remains were found 1,2 – 4 m below the surface (Boedhisampurno 1983).

Boedhisampurno (1983) did an osteological analysis and determined the human remains were at least 12 individuals, composed by four males and eight females, aged between 20-40 years old. Generally, the individuals of Sukajadi Pasar have hyperdolichocrane and hypsicrane (high skull) with big cranial capacity. They have pronounced on frontal and torus occipital, but less pronounced on torus supraorbital and nuchal line. They also have narrow and high face but not flat face, with a narrow nose, and high eye.

The mandible shows *dolicognath* or narrow and elongated, but the symphysis not pointed. Teeth morphology shows the absence of shovel shape, incisive rotation, tricuspid of the fourth premolar, and premolar cone. The molar has no carabelli's cusp and protostylid, absence of sixth and seventh cusps, also no hypocone reduction. All of those characters are closed to the Australomelanesian affinities and this hypothesis supported by the mesiodistal and buccolingual measurement. There are not many character which could be observed based on the post cranial aspect, except showing a less robust on the femoral bones (Boedhisampurno 1983).

The Significance

The Sukajadi Pasar shellmidden complex represents early human occupation in the northern part of Sumatra since Early Holocene, which is the 'mysterious' episode of the prehistory of this region. Their cultural aspect shows connection to the Hoabinhian cultural complex in the Mainland Southeast Asia characterized by the Sumatralith. Detailed in-depth analysis on human remains from shellmidden sites could open our perspective to the history of human occupation in Sumatra.

Table of Human Remains

NO	NO. IDV	REMAINS	SEX	GRADE	AGE	AFFINITY
1	SKJ 1	Post Cranial	Male		Adult	
2	SKJ 2a	Fr. Cranium	Male		Adult	
3	SKJ 2b	Post Cranial	Female		Adult	
4	SKJ 2c	Post Cranial	Female		Adult	
5	SKJ 2d	Cranium			Adult	
6	SKJ 2e	Post Cranial	Female		Adult	
7	SKJ 2f	Post Cranial	Male		Adult	
8	SKJ 3	Fr. Cranium and post cranium	Male	H	40 - 50	Australo-Melanesian
9	SKJ 4a	Fr. Cranium	Female	F	30 - 35	Australo-Melanesian
10	SKJ 4b	Fr. Cranium	Female	F	30 - 35	Australo-Melanesian
11	SKJ 4c	Fr. Maxilla	Male		Adult	
12	SKJ 5	Fr. Cranium			Adult	
13	SKJ 6a	Fr. Maxilla	Female	I	45 - 55	Australo-Melanesian
14	SKJ 6b	Fr. Maxilla	Male	I	45 - 55	Australo-Melanesian
15	SKJ X	Skull	Male	G	35 - 40	Australo-Melanesian

Table 2. G.1. Human individuals from Sukajadi Pasar shellmidden.

Archaeological Layer

Based on archaeological research by Balar Medan, there are some artifact found in Pangkalan shellmidden site, including grindstone and mortar, chert flake tool, silicified limestone scraper, Sumatralith, percutor, shell tools, a limited amount of pottery fragments, red ochre, and charcoal (Fig. 2. G.6). They also note several terrestrial faunal bones recovered from the site, including *Suidae* (pig) and *Ophidia* (snake) (Wiradnyana *et al.*, 2008).



Fig. 2. G.6. Sumatralith (left), grind stone and anvil (right) of Tamiang shel midden, Aceh (Wiradnyana 2008)

Shellfish from Pangkalan shellmidden site are dominantly of *Corbicula* (a freshwater species), brackish water species of *Neritidae* from *Gastropode*, and also *Arcticidae*, *Tridacnidae* from *Pelecypode*. Pollen analysis from the site suggested that the Hoabinhian people consumed a high portion of plants that lived around the site, including *Papilionaceae* (beans), *Rubiaceae* (coffee-beans) and *Convolvulaceae* (water spinach) (Wiradnyana 2008).

The Pangkalan Shellmidden site has three cultural layers (Fig. 2. G.7). The lowest layer is dated back to 12.550 ± 290 BP with the context of charcoal (traces of burning activities) and hand-axes. The technology and morphology of this layer is similar to the Paleolithic period. This finding led to a hypothesis about the end of the Paleolithic period and the beginning of the Preneolithic period in the northern part of Sumatra or distinctive technologies which were developed in the Preneolithic period (Wiradnyana 2016).

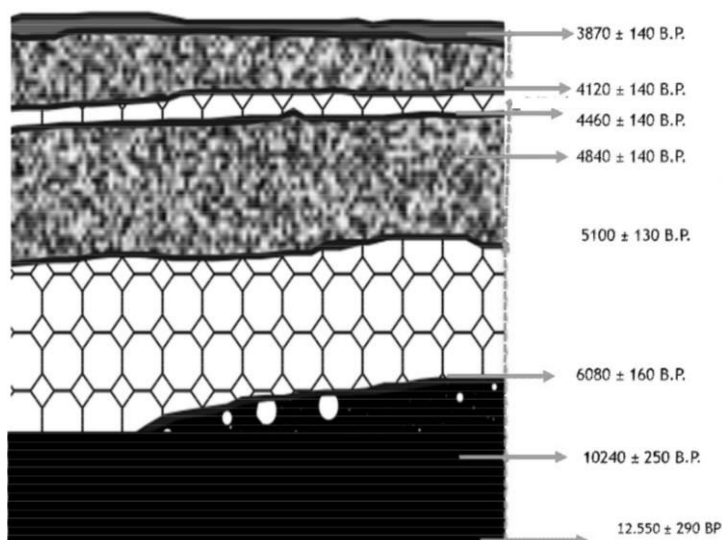

Fig. 2. G.7. Stratigraphy of Tamiang shel midden, Aceh (Wiradnyana 2010).

The middle cultural layer is associated with the Hoabinhian cultural characteristics, which came from the Middle Holocene period and dated between 5.100 ± 130 BP to 4.460 ± 140 BP. In this cultural layer was found various stone tools with Hoabinhian morphology and technology as well as flexed human burial. The uppermost layer is Neolithic period, which developed around 3.870 ± 140 BP with the context of pottery fragments and short axes with polished sharpening edge (Wiradnyana 2016).

Human Remains

There is one individual of human remain (Table 2. G.2) from Tamiang shell-midden conserved in the Laboratory of Paleoanthropology and Bioanthropology, Gadjah Mada University, Yogyakarta. This remains were recovered in June 1965 and including of a cranium with dolichocephalic character, a fragment of right maxilla, and a robust mandible which probably come from a male individual. There is no burial context noted from this remains. Wiradnyana in his recent excavation on the 2007 noted several fragments of human cranium from three individual with red paint (Wiradnyana 2008). So far, there are no detailed analysis on this human remains.

The Significance

Similar to Sukajadi Pasar, Pangkalan shellmidden site also represents early human occupation in the most northern part of Sumatra at least since the boundary of the Late Pleistocene to Early Holocene. Their cultural aspect shows connection to the Hoabinhian cultural complex in the Mainland Southeast Asia as characterized by the Sumatralith. Detail analysis on human remains from this shellmidden sites could open our perspective to the history of human occupation in the northern part of this area.

Table of Human Remains

NO	NO. IDV	REMAINS	SEX	GRADE	AGE	AFFINITY	BURIAL	CULTURAL	STRATIGRAPHY	DATING
1	TMG A1C	Cranium and post cranium	Male	G	35 - 40	Australo-Melanesian	Flaxed (?)	Hoabinhian	Mid Holocene	5.100 ± 130 BP - 4.460 ± 140 BP

Table 2. G.2. Human individual from Tamiang Shellmidden site.

H. COMPARATIVE MATERIAL FROM ASIA MAINLAND

General condition of Zhoukoudian

Zhoukoudian is a series of cavities located at 39° 41' N, 115° 51' E about 128 m above sea level, in the Fangshan District, 55 km southwest of downtown Beijing (Fig. 2. H.1 left). This location was known by local farmers in the early twentieth century for Ordovician limestone quarrying. This site was first visited by the Swedish geologist Johan Gunnar Andersson as a potential location of quaternary mammalian fossils at Chicken Bone Hill, now termed as Zhoukoudian Locality 6 in 1918 (Andersson 1919). The American paleontologist Walter Granger later identified fossils at “Longgushan” the Dragon Bone Hill in 1921 (Andersson, Granger, and Zdansky 1922). Austrian paleontologist Otto Zdansky then discovered two human teeth at the Locality 1 cave in 1926, the same year Canadian anthropologist Davidson Black named the teeth as a new species *Sinanthropus pekinensis* (Black 1927).

Long-term fieldwork was undertaken from 1921 to 1937, and many important discoveries were recovered in the Dragon Bone Hill, especially at Locality 1 (Fig. 2. H.1 right). The first excavation was undertaken by Zdansky in 1921 and 1923, and three isolated hominid teeth were recovered (Black 1926; Weidenreich 1937; Zdansky 1927). During this period, Black started the official international collaboration with the Cenozoic Research Laboratory in 1927. Both Davidson Black and Chinese paleontologist Yang Zhongjian led excavations at the site, and five complete *Homo erectus* skulls and a number of mandibular and dental remains were discovered from 1929 to 1936 (Weidenreich, 1937; 1943). The first identified and also the well-preserved recovery skull (skulls E), discovered in 1929 by Pei Wenzhong (Black 1930; Black et al. 1933; Pei 1929). Hominid were found each field season, but the richest discoveries was the excavation of skulls LI, LII, and LIII during 11 days in November 1936 by Jia Lanpo (Jia 1999). The sixth complete skull was discovered during fieldwork from the 1950s to 1970s (Zhang and Shen 2014).

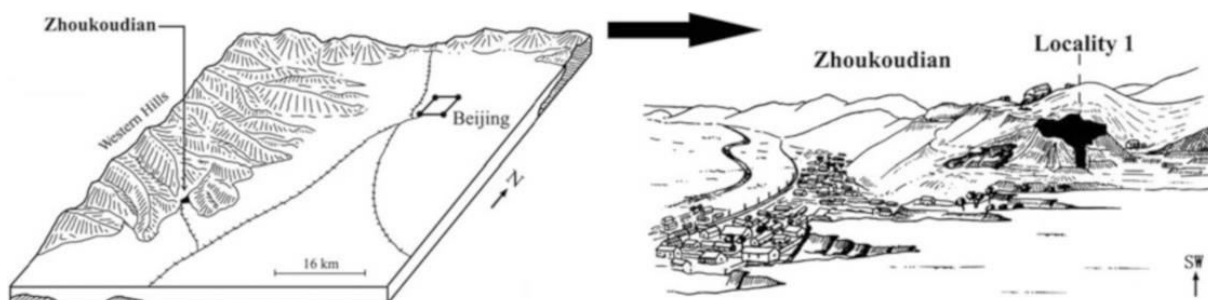

Fig. 2. H.1. The location of Zoukoudian Locality 1 and surrounding area (Andersson et al. 1922; Yang 2014).

Archaeological Layer

Up to now, at least 27 fossil localities have been systematically studied and numbered. These are known not only for the discoveries of human remains but also for the long sequence of lithic and animal bone assemblages produced through several excavations in the various localities (Erickson 1990). Over hundred thousand pieces of stone artifacts have been recovered from Locality 1 with the main raw materials used including quartz, flint,

and sandstone. The type of stone tools (Fig. 2. H.2) is including; scrapers, points, choppers, burins, and borers, produced using different production techniques mainly by bipolar striking. Changes in tool size, raw materials used and the flake-producing techniques over time demonstrate that the lithic technology of Peking Man progressively evolved (Pei and Zhang 1985). Nearly a hundred species of mammalian fossils have been found in Locality 1, including thick-jaw deer (*Megaloceros pachyosteus*), sika deer (*Cervus grayi*), gazelle (*Gazella*), saber-toothed tiger (*Machairodus*), striped hyena (*Pachycrocuta sinensis*), and cave bear (*Ursus spelaeus*). Some of these were clearly part of the diet of Peking Man (de Chardin 1943; Yang 2014).

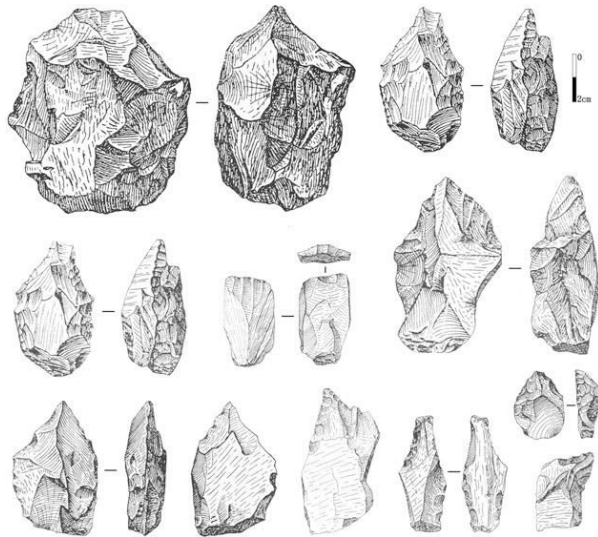

Fig. 2. H.2. The stone artifacts of Zoukoudian Locality 1 (Pei and Zhang 1985; Yang 2014).

The Zoukoudian cave sediment has more than 40 m thick and divided into 17 layers (Fig. 2. H.3). Human remains were found in nearly all layers (1–10). The lithic assemblages were concentrated in several horizons (layers 1, 3, 4, top of 8 and 10), and some artifacts were found scattered throughout the thick brecciated layers (layers 5–9) (Pei and Zhang 1985). The sediments also record much information regarding paleoclimatic change (Yang et al. 1985). They are characterized by breccia layers interbedded with non-breccia layers. The breccia layers imply a cold climate and the non-breccia layers imply a warm climate. There are many sedimentary cycles composed of subdivided beds in each layer, which may reflect paleoclimatic variations of different scales (Liu 1985).

Several ash layers are scattered relatively widely within the 40 m of deposits, and ash residue in the fourth layer was quite thick with the thickest part is over 6 m. Inside these layers, there were large quantities of burnt stones, charred bones, and burnt seeds. The analysis of black layer samples and associated charred bone fragments confirms the traces of fire use by Peking Man (Weiner et al. 1998; Wu 1999).

A chronological sequence has been proposed by Zhao *et al.*, (1985) are: c. 700 ka for the lowest fossiliferous horizon (layer 13), based mainly on paleomagnetic stratigraphy; c. 500 ka for the lowest stone artifact-containing layer (layer 10), based on fission track dating of sphere grains extracted from ash deposits; and c. 230 ka for the uppermost strata (layers 1–3) based on $^{230}\text{Th}/^{234}\text{U}$ dating of fossils (Zhao et al. 1985). Recent chronological studies of Locality 1 places the age of the hominid remains in the range between 230–500 ka. A new result indicates the date of the oldest human fossils is about 770 ka and that *Homo erectus* at Zhoukoudian lived during a relatively mild glacial period (Shen et al. 2009).

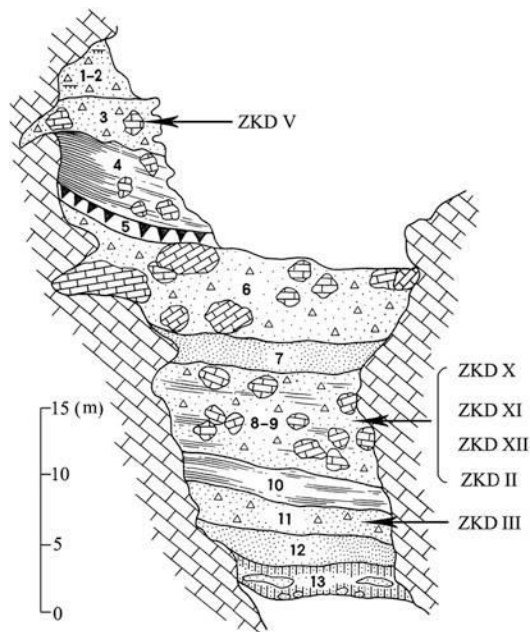

Fig. 2. H.3. Stratigraphy of Zoukoudian Locality 1 (Yang 2014).

Human Remains

The inventory of all of the Peking Man fossils from Locality 1 is as follows: 6 complete or nearly complete skulls, 12 large skull fragments, 15 incomplete mandibles (Table 2. H.1), 157 teeth (Table 2. H.2), three humeral fragments, one clavicle, seven femur fragments, one tibia fragment, and a lunate bone. The specimens represent materials from more than 40 male and female individuals of different ages (Yang 2014). The material used in this research is teeth cast collection of the Institut de Paléontologie Humaine, Paris assigned as *Sinanthropus pekinensis* or Zhoukoudian *Homo erectus*. The collection number used by the institution is the number given by (Weidenreich 1937) in his monography from the excavation before 1937. Unfortunately, the teeth collection from that period were lack of stratigraphical record (Weidenreich 1937). The human teeth used in this research are including:

NO	LOCALITY	NO. COL	REMAINS	TEETH	GRADE	AGE
1	B1	Sp B1	Right mandibular corpus	LLI1-LLC LRI1-LRM1		9 +- 3
2	B2	Sp B2	Right mandibular corpus	LLI1-LLC LRI1-LRM1		9 +- 3
3	F1	Sp F1.5	Right mandibular corpus	LRM2-LRM3	B1/B2	16-20
4	G1	Sp G1	Left mandibular corpus	LLI1-LLM3	H	40-45
5	G2	Sp G2	Right mandibular corpus	LRM2-LRM3	I	45-55
6	H4	Sp H4	Right mandibular corpus	LRI2-LRM1	I	45-55
7	R2	Sp R2	Right mandibular corpus	LRM1-LRM3	H	40-45

Table 2. H.1. Hominin mandible from Zoukoudian site.

NO	NO. COL	CATEGORY	GRADE	AGE
1	Sp 2	URI1	F	30-35
2	Sp 4	ULI1	F	30-35
3	Sp 6	URI2	E	24-30
4	Sp 8	LLI2	B1/B2	16-20
5	Sp 10	LRI2	B1/B2	16-20
6	Sp 13	ULC	B1/B2	16-20
7	Sp 14	URC	D	20-24
8	Sp 15	URC	C	18-22
9	Sp 17	LLC	H	40-45
10	Sp 19	URP3	D	20-24
11	Sp 20	LRP3	B1/B2	16-20
12	Sp 25	ULP4	B1/B2	16-20
13	Sp 28	URP4	G	35-40
14	Sp 29	LRP4	B1/B2	16-20
15	Sp 33	ULM1	D	20-24
16	Sp 36	LLM1	C	18-22
17	Sp 38	LLM1	H	40-45
18	Sp 40	LLM2	B1/B2	16-20
19	Sp 41	ULM2	E	24-30
20	Sp 43	LLM2	G	35-40
21	Sp 44	LLM2	B1/B2	16-20
22	Sp 45	LRM2	G	35-40
23	Sp 46	URM3	E	24-30
24	Sp 51	LRM3	B1/B2	16-20
25	Sp 52	LLM3	B1/B2	16-20
26	Sp 70	LLC	D	20-24
27	Sp 80	LRP3	C	18-22
28	Sp 82	LRP3	B1/B2	16-20
29	Sp 89	LRP4	C	18-22
30	Sp 90	LRP4	B1/B2	16-20
31	Sp 131	LRM3	G	35-40
32	Sp 137	LLM1	E	24-30
33	Sp 139	LLM2	G	35-40
34	Sp 140	ULM1	C	18-22
35	Sp 185	LRI1	F	24-30

Table 2. H.1. Isolated teeth from Zoukoudian site.

Signification

Early human settlement in Mainland Asia is a hot topic on which many subsequent studies have focused. Zhoukoudian is the richest *Homo erectus* cave site in Eastern Asia and contributes to our understanding of the history of human evolution in this region. The hot topic concerning Peking Man whether this hominid species was a direct ancestor of later East Asian populations or a side branch in human evolution impacts on the two principal current hypotheses about the origin of modern *Homo sapiens* (e.g., Wolpoff, 1984).

CHAPTER 3. BASIC TERMINOLOGY, MATERIAL, AND METHOD

In pre-Darwinian times, anthropologists and naturalists mainly focused on variation and classification based on externally visible physical characteristics, such as skin, hair, eye color and form, and skull types. Teeth have almost played no position in the early studies of Blumenbach, Cuvier, and others. In the nineteenth century, Broca, Mummery, and Flower started exploring the teeth and their role in understanding human health and behavior. The substantive developments were taking place in paleontology when Owen, Cope, and Osborn were putting the foundations of comparative odontology by proposed the detailed terminology of the dental part (Irish and Scott, 2016).

In the early Twenty century, with the post-Darwinian acceptance that humans were primates and their closest relationship was to the apes, Hrdlička (1920) and Gregory (1927) started paying attention to the teeth size and morphology in primates, also their correlation to the recent human populations. Dahlberg (1956) determined the systematic study of human dental variation with a standardization. He developed the first series of plaster plaques that showed ranked expressions for key morphological traits of the occlusal region, such as primary and accessories cusps. The standards for the study of the tooth crown and root morphology than continued developing by Turner, Nichol, and Scott (1991) and crown wear by Molnar (1971), Molnar *et al.*, (1972), Scott (1979), and Lovejoy (1985) (Irish and Scott, 2016).

The studies of fossil hominin teeth were starting by Weidenreich (1937) for *Sinanthropus pekinensis* and Robinson (1955) on the *Australopithecinae*. Odontometric studies on hominin teeth improved by the contribution of Brace and his colleagues (Brace, 1967; Brace and Mahler, 1971), Wolpoff (1971), and Frayer (1978), who focused on metric trends in hominin dental evolution from the *Australopithecines* to the European *Homo sapiens* from the Mesolithic period. In the 1980s, Wood and his colleagues made the first systematic comparative morphological studies between *Australopithecines* and early *Homo*. This study followed by Bermúdez de Castro (1986; 1988), who initiated comparison research on the dentition of Middle Pleistocene hominins from Western Europe.

For the last two decades, along with technological development, there are some publication on teeth that can be used as textbooks and serve as scientific references in dental anthropology, such as Dental Anthropology (Hillson, 1996), The Anthropology of Modern Human Teeth (Scott and Turner, 1997), Technique and Application in Dental Anthropology (Irish and Nelson, 2008), Anthropological Perspectives on Tooth Morphology (Scott and Irish, 2013), and Tooth Development in Human Evolution and Bioarchaeology (Hillson, 2014). Although dental anthropology has a long history in physical anthropology, the recent years brought a number of new discoveries, with new analysis technique and methods, which make the teeth more interesting to answer the questions on human evolution (Bailey and Hublin, 2007).

A. BASIC TERMINOLOGY

The dental terminology represented here is a basic lexicon used in this research, including 1) tooth definition and orientation (Fig. 3. A.1.), also 2) the cusps (Fig. 3. A.2.). The first part provides the basic terminology and abbreviation of tooth identity, position, ordinal, siding also the direction of the tooth in the context of the maxilla or mandibular arc. The second part provides the definition of the primary and accessories cusps on the lower and upper molar. The last part provides some specific morphological character and feature on the tooth crown or occlusal surfaces of lower and upper teeth used and referred into this research.

1. Tooth definition and orientation

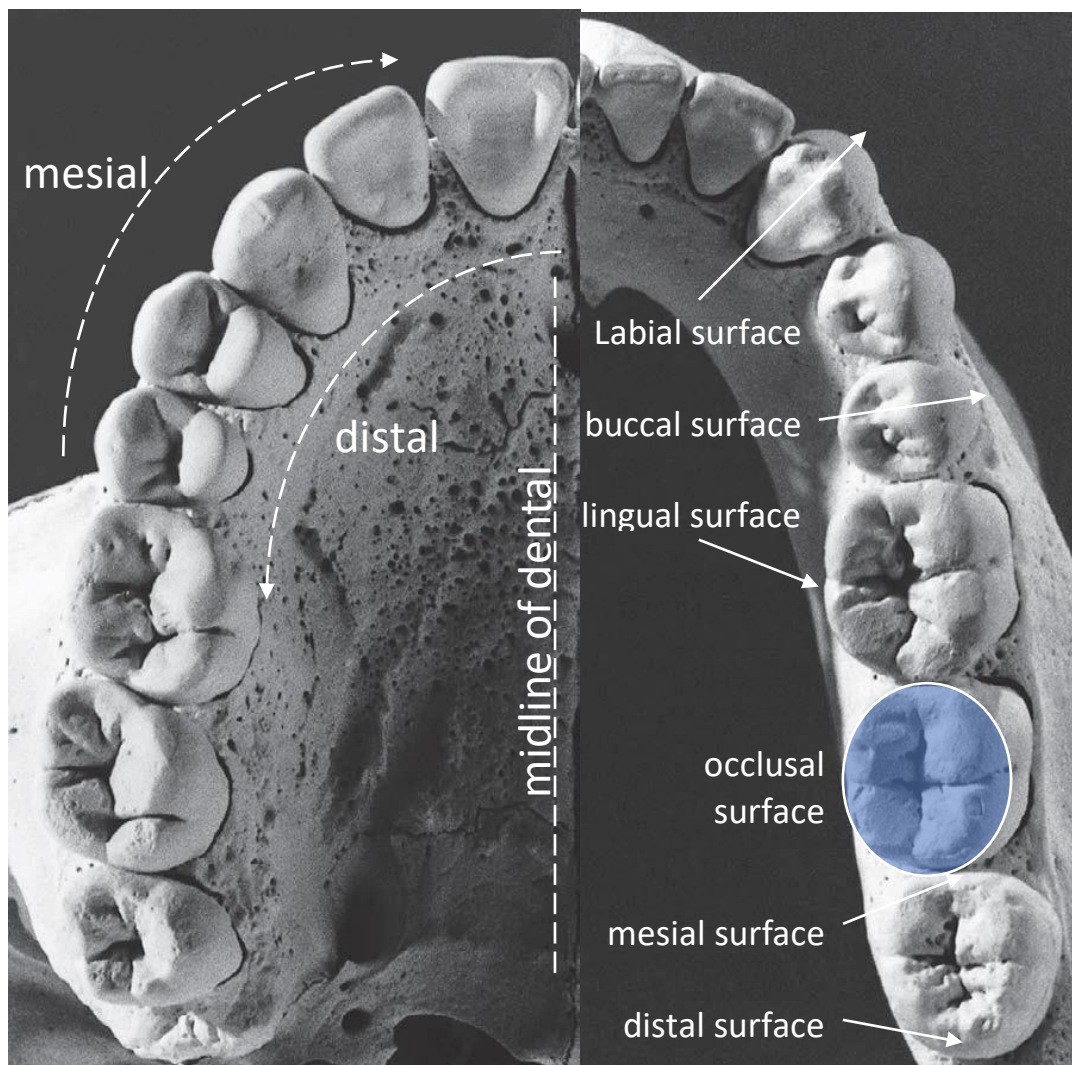

Fig. 3. A.1. Anatomy and directional term for dentition, adapted from White and Folkens (2005)
Example: left = maxilla, right = mandible

Tooth position:

- U : upper teeth
- L : lower teeth

Tooth siding:

- R : right side
- L : left side

Tooth identity:

- I : permanent incisor
- C : permanent canine
- P : permanent premolar
- M : permanent molar
- di : deciduous incisor
- dc : deciduous canine
- dm : deciduous molar

Tooth ordinal:

- 1 : used for central incisor and first molar
- 2 : used for lateral incisor and second molar
- 3 : used for first premolar and third molar
- 4 : used for second premolar

e.g. ULI1 means upper left first permanent incisor, LRdm2 means lower right second deciduous molar

Teeth direction:

- a. Mesial : the portion of the tooth which closest to the point where the central incisors contact each other
- b. Distal : the opposite of mesial
- c. Lingual: the part of the tooth crown in contact with the tongue
- d. Labial : the opposite of lingual but usually reserved for the incisors and canines
- e. Buccal : the opposite of lingual but usually reserved for the premolars and molars

2. The cusps

Osborn (1892) employed the original cusp terminology as the basis for a nomenclature of maxillary and mandibular molar cusps, which is still used today. He chose terms that had been used for the description of cusp tips of the protodont tooth type: protoconus (maxilla) and protoconid (mandible) for the main cusps, and paraconus and metaconus (maxilla) as well as paraconid and metaconid (mandible) for the two marginal projections (Osborn, 1895).

As for the basic rules of naming tooth structures, each cusp is called a cone. Different cones are identified by different prefixes, the major ones being proto-, para-, meta-, hypo-, and ento-. An -id added to the name of a cusp indicates that it is part of a tooth in the mandible; for example, a protocone is a major cusp on a maxillary molar, while a protoconid is on a mandibular molar. Minor cusps may have the suffix -ule added to the name (e.g., hypoconule). A cingulum is a shelf-like ridge around the outside of a maxillary molar, cingulid on a mandibular tooth.

- **Lower molar**

Here is the definition of the cusps for lower molar (Fig. 3. A.2.):

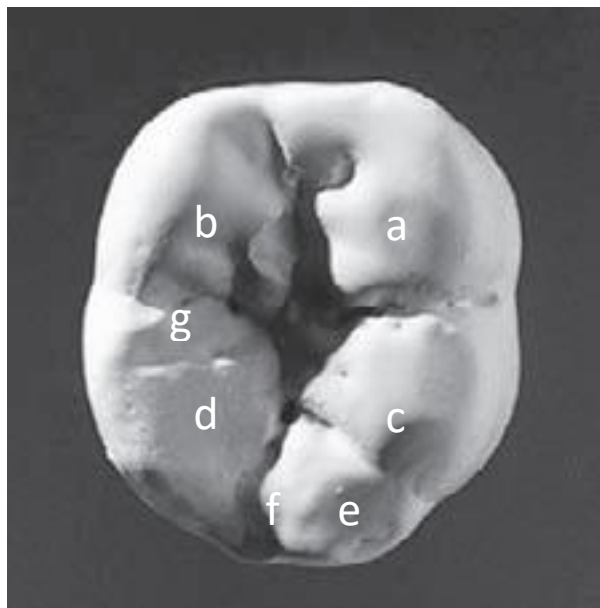

Fig. 3. A.2. The cusps of a lower molar (source White and Folkens, 2005):
(a) Protoconid, (b) Metaconid, (c) Hypoconid, (d) Entoconid, (e) Hypoconulid, (f) Entoconulid (if exist, supposed to be there), and (g) Metaconulid (if exist, supposed to be there).
Model: LRM1. Occlusal surface.

- a. Protoconid (Cusp 1) : the mesiobuccal cusp.
- b. Metaconid (Cusp 2) : the mesiolingual cusp.
- c. Hypoconid (Cusp 3) : the distobuccal cusp.
- d. Entoconid (Cusp 4) : the distolingual cusp.
- e. Hypoconulid (Cusp 5) : the distal cusp.
- f. Entoconulid (Cusp 6) : the accessory cusp between hypoconulid and entoconid.
- g. Metaconulid (Cusp 7) : the lingual accessory cusp between metaconid and entoconid.

- **Upper molar**

Here is the definition of the cusps for upper molar (Fig. 3. A.3.):

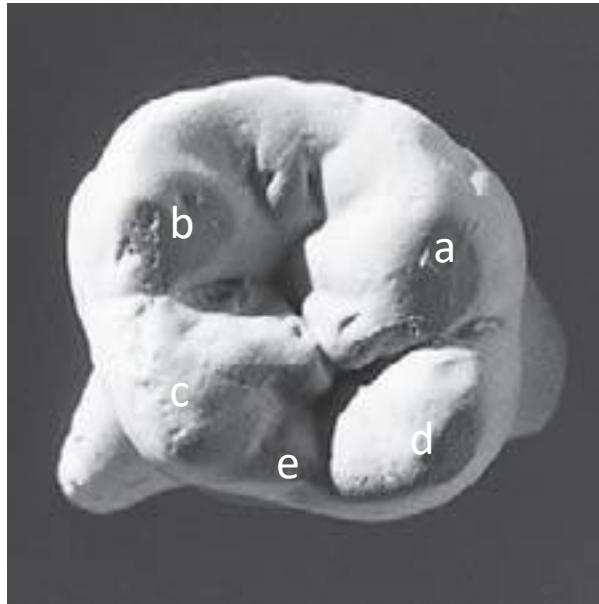

Fig. 3. A.2. The cusps of an upper molar (source White and Folkens, 2005):
(a) Protocone, (b) Paracone, (c) Metacone, (d) Hypocone, (e) Metaconule
Model: URM1. Occlusal surface.

- a. Protocone (Cusp 1) : the mesiolingual cusp.
- b. Paracone (Cusp 2) : the mesiobuccal cusp.
- c. Metacone (Cusp 3) : the distobuccal cusp.
- d. Hypocone (Cusp 4) : the distolingual cusp.
- e. Metaconule (Cusp 5) : the distal accessory cusp.

B. MATERIAL

Observations on this study were made on the original fossils, casts, and documentation specimens from Pleistocene to Holocene hominin teeth from Sundaland (western part of Indonesia) and Zhoukoudian site mainland Asia.

Here is the summary table of the total number of material used in this study (Table 3. B.1. and Table 3. B.2.).

1. Upper Teeth

No	Site	UI1	UI2	UC	UP3	UP4	UM1	UM2	UM3
Pleistocene Hominin									
1	Trinil							1	1
2	Sangiran	5	3	10	17	14	24	21	15
3	Wajak	1	2	2	2	2	2	2	2
4	Lida Ajer	1						1	
Holocene <i>Homo sapiens</i>									
1	Song Keplek	3	2	2	3	3	3	3	3
2	Song Terus	1	2	1	1	1	3	3	1
3	Gua Braholo	3	3	5	4	4	5	2	3
4	Gua Pawon	2	2	1	1	1	1	1	1
5	Wajak				1				
6	Goea Djimbe		1	4	3	3	3	3	
7	Goea Ketjil						2	2	2
8	Hoekgrot	2	2	4	2	1			
9	Gua Kidang	2	2	2	2	2	2	2	2
10	Gua Harimau	5	6	8	11	9	11	6	5
11	Sukajadi	1		1	2	3	3	3	2
12	Tamiang	1			1		1	1	
Other Comparative Material									
1	Zhoukoudian	7	9	9	8	8	8	9	7

Table 3. B.1. The upper teeth used in the study

2. Lower Teeth

No	Site	LI1	LI2	LC	LP3	LP4	LM1	LM2	LM3
Pleistocene Hominin									
1	Trinil				1				
2	Kedungbrubus			1					
3	Sangiran	5	4	4	7	6	22	28	17
4	Patiayam				1				
5	Rancah		1						
6	Wajak	1	1	1	1	1	2	2	2
Holocene <i>Homo sapiens</i>									
1	Song Keplek	2	2	2	2	2	2	2	2
2	Song Terus	1	3	3	1	1	2	2	1
3	Gua Braholo	2	2	2	2	3	3	4	4

4	Song Tritis	1	1	1	1	1	1	1	1
5	Gua Pawon		1	2	2	2	2	4	4
6	Gua Kidang	2	2	2	2	2	2	2	2
7	Wajak			1		1			
8	Goea Djimbe	2	2	3	2	2	2	2	2
9	Goea Ketjil				1	1	2	2	1
10	Hoekgrot		3		1	4	1	2	
11	Gua Harimau	5	7	7	9	9	12	8	6
12	Sukajadi	1	1	2	2	2	4	3	2
13	Tamiang		1	1	1	1	1	1	
Other Comparative Material									
1	Zhoukoudian	2	1	3	1	2	2	1	1

Table 3. B.2. The lower teeth used in the study

3. Summary

We summarized below the material used in this study based on the chronological point of view (Table 3. B.3. and Table 3. B.4.) divided into three groups: Early Hominins (EH), *Homo sapiens* Preneolithic (HSP), and *Homo sapiens* Neolithic-Paleometalic (HSN-P). EH group consists of Pleistocene *Homo erectus* and Pleistocene *Homo sapiens*. HSP consist of Early Holocene *Homo sapiens* with preneolithic cultural context from cave sites and shellmiddens. HSN-P consists of Late Holocene *Homo sapiens* with Neolithic (and/or paleometalic) cultural context from the burial sites in caves.

Upper Teeth Group	UI1	UI2	UC	UP3	UP4	UM1	UM2	UM3	TOTAL
EH	10	7	13	17	16	27	28	27	145
HSP	14	13	23	21	20	25	24	19	159
HSN-P	4	3	5	9	9	9	5	4	48
TOTAL	28	23	41	47	45	61	57	50	352

Table 3. B.3. Summary of the upper teeth used in the study. (Note: EH = Early Hominins, HSP = *Homo sapiens* Preneolithic, HSN-P = *Homo sapiens* Neolithic-Paleometalic)

Lower Teeth Group	LI1	LI2	LC	LP3	LP4	LM1	LM2	LM3	TOTAL
EH	6	10	7	16	17	27	35	27	145
HSP	9	16	20	19	23	26	28	21	162
HSN-P	4	6	6	8	9	11	6	6	56
TOTAL	19	32	33	43	49	64	69	54	363

Table 3. B.4. Summary of the lower teeth used in the study. (Note: EH = Early Hominins, HSP = *Homo sapiens* Preneolithic, HSN-P = *Homo sapiens* Neolithic-Paleometalic)

To end, we calculated the total number of teeth by group used in this study (Table 3. B.5.).

No	Taxa	TOTAL
1	EH	290
2	HSP	321
3	HSN-P	104
	TOTAL	715

Table 3. B.5. Total number of the teeth used in the study. (Note: EH = Early Hominins, HSP = *Homo sapiens* Preneolithic, HSN-P = *Homo sapiens* Neolithic-Paleometalic)

C. ANALYTICAL APPROACHES

1. Wear Pattern

As soon as the teeth erupted, they started to wear out. Rate and pattern of wear depend on tooth (developmental sequences, morphology, size, internal crown structure), angulation, non-dietary use, biomechanics of chewing, and diet (White and Folkens, 2005). Because wear will have an impact on the analyses we will conduct (morphological features on occlusal face of the teeth, size of the cusps as well as measurements and geometric morphometrics), we must first study the stages of wear of each tooth in our sample.

To score the dental wear in this study, we used the categories proposed by Molnar (1971). The scoring method is summarized as follows (Table 3. C.1.):

Category of Wear	Incisor and Canine	Premolar	Molar
1	Unworn.	Unworn.	Unworn.
2	Wear facets minimal in size.	Wear facets, no observable dentine.	Wear facets, no observable dentine.
3	Cusp pattern obliterated, enamel dentine patches may be present.	Cusp pattern partially or completely obliterated. Small dentine patches.	Cusp pattern partially or completely obliterated. Small dentine patches.
4	Dentine patch (Minimal).	Two or more dentine patches, one of large size.	Three or more small dentine patches.
5	Dentine patch (Extensive).	Two or more dentine patches, secondary dentine may be slight.	Three or more large dentine patches, secondary dentine, none to slight.
6	Secondary dentine (Moderate to Extensive).	Entire tooth still surrounded by enamel, secondary dentine moderate to heavy.	Secondary dentine moderate to extensive, entire tooth completely surrounded by enamel.
7	Crown (enamel) worn away on at least one side, extensive secondary dentine.	Crown (enamel) worn away, on at least one side, extensive secondary dentine.	Crown (enamel) worn away, on at least one side, extensive secondary dentine.
8	Roots functioning in occlusal surface.	Roots functioning in occlusal surface.	Roots functioning in occlusal surface.

Table 3. C.1. The stages definition of the wear pattern used in the study. Sources: Molnar (1971)

Based on the wear category of Molnar (1971), we decided to keep in our study the teeth which show a wear grade of less and/or equal to 4. This one corresponds to a minimal patch on the incisor and canine, two or more dentine patches on premolar, and three or more small dentine patches on molar. So, it makes it possible to observe the morphological characters, the size and proportion of the cusps and the landmarks used for geometric morphometrics studies.

2. Morphological Characters

The description of dental characters will be mainly focused on the crown morphology. It requires that the crown is almost complete with low to moderate wear category, i.e. lower than grade 5 of Molnar (1971) as stated before. There are two different approaches to describe the dental morphology as used in the previous studies (Martinón-Torres *et al.*, 2008):

- The detailed description of each tooth in the sample provides information on every morphological character of each specimen in each tooth class (e.g., Johanson, White and Coppens, 1982; Grine, 1989; Moggi-Cecchi, Grine and Tobias, 2006).
- Divides the sample by tooth class, provides a summary of overall morphology of each tooth type and then draws attention to individual specimens that show any distinctive morphological features (e.g., Weidenreich, 1937; Bermudez de Castro, 1988; Tobias, 1991; Bailey, 2002; Martinón-Torres *et al.*, 2008).

This study will use both approaches. Chapter 4 will provide the summary description based on teeth categories of all the samples from all the sites studied in this research, presenting a summary of the overall morphology of each tooth type. The detail description of each tooth from all the sites gives information on every morphological character of each specimen in each tooth class, which will be presented in the Appendix.

The summary description will be used for the comparative studies with paying attention to individual specimens that showed any distinctive features. The detail descriptions in the Annex will be made based on the assumption that teeth were in their original anatomical position. The general crown shape and morphological traits description are observed from the labial and lingual aspects for incisors and canines, and the occlusal aspect for premolars and molars.

The majority of the crown morphological traits used in this study came from the Arizona State University Dental Anthropology System (Turner, Nichol and Scott, 1991), also Hrdlička (1920), Dahlberg (1956), Scott (Scott, 1973, 1979, 1980), Scott and Turner (1997), Harris and Bailit (1980), Nichol *et al.* (1984), Mizoguchi (1985), Carlsen (1987), Kanazawa *et al.* (1990), also Turner *et al.* (1991). Some modifications of some morphological traits used in this study were previously suggested by Martinon-Torres *et al.* (2008; 2012) to be more suitable for the early hominins which variability is greater than in *Homo sapiens*. We proposed additional modifications needed in the context of this study.

Indeed, the ASUDAS was originally developed to observe the dental morphological variability in modern *Homo sapiens*. That's why it cannot cover the morphological expression within the early or extinct hominin fossils. Moreover, the phylogenetic implication of the expression of dental features is discussed (Carter, Worthington and Smith, 2014) and the ASUDAS scales and plaques are confusing or too subjective since hominin species present their own anatomical variations, therefore Martinón-Torres *et al.*, (2012) did simplification of the grade-scales and add more variable for them.

Here we present in details the morphological traits considered in this study by tooth type.

a. Incisor

We describe the features observed on the incisors, mentioning when it is necessary, the specific scoring for the upper or the lower incisors (Fig. 3. C.1.)

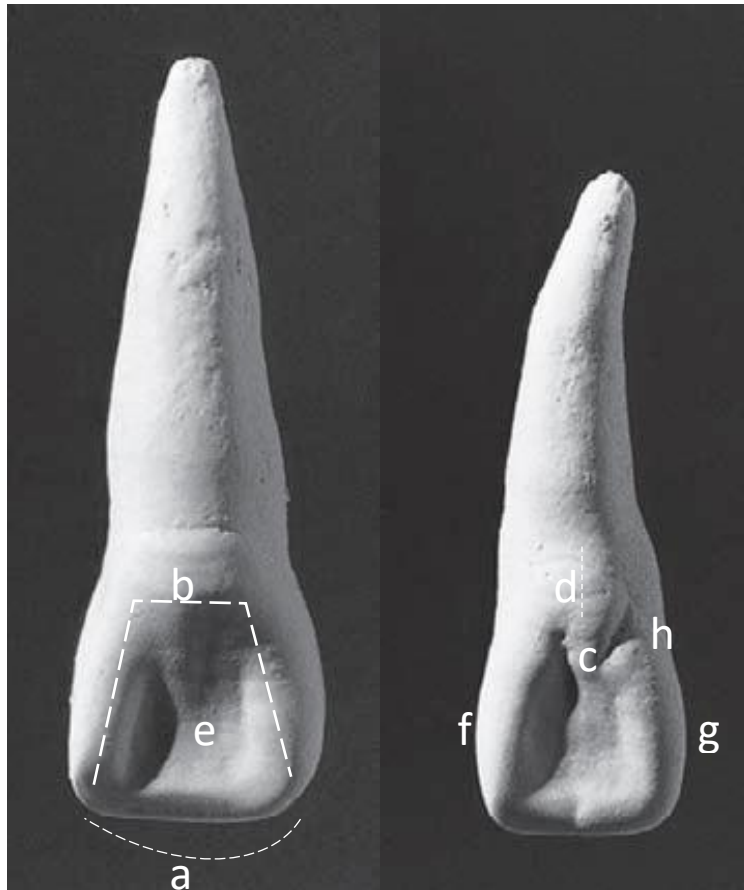

Fig. 3. C.1. Morphological features of the incisors (source White and Folkens, 2005): (a) Labial convexity, (b) Shovel shape, (c) Tuberculum dental, (d) Cingulum interruption groove, (e) Lingual fossa, (f) Mesial marginal ridge, (g) Distal marginal ridge, and (h) Marginal interruption groove Model: URI1 (left) and URI2 (right). Lingual face.

- **Labial convexity**

It is defined as the convexity of the labial surface when viewed from the occlusal aspect (Nichol, Turner and Dahlberg, 1984; Martín-Torres *et al.*, 2012). On **the lower incisors, five grades** are defined:

Grade 0: the labial surface is flat.

Grade 1: the labial surface exhibits a trace of convexity.

Grade 2: the labial surface exhibits a weak convexity.

Grade 3: the labial surface exhibits a moderate convexity.

Grade 4: the labial surface exhibits a pronounced convexity.

On the upper incisors, a supplementary grade is observed:

Grade 5 the labial surface exhibits a very strong convexity.

- **Shovel shape**

It is defined as the presence of lingual margin ridges. The degree of expression is also scored (Hrdlička, 1920b; Scott, 1973; Mizoguchi, 1985). On the lower incisors, five grades are defined:

Grade 0: No shovel shape. The marginal ridges are not expressed.

Grade 1: Faint shovel shape. The mesial and distal aspects of the lingual surface can be seen and palpated.

Grade 2: Trace of shovel shape. Elevations of the marginal ridges are easily seen.

Grade 3: Moderate shovel shape. The marginal ridges are more pronounced and there is a tendency for ridge convergence.

Grade 4: Pronounced shovel shape. The marginal ridges are clearly pronounced.

On the upper central incisors, the scoring is slightly different and eight grades are defined:

Grade 0 (absence): it is rare for UI1 to express the complete absence of marginal ridges. For this reason, grade 0 on the UI1 shoveling plaque actually shows very slight marginal ridge expression.

Grade 1 (trace): Marginal ridges can be discerned, but expression is slight, with mesial marginal ridge not extending to the basal eminence.

Grade 2 (low moderate): Ridges more pronounced, with mesial marginal ridge extending further down on basal eminence.

Grade 3 (high moderate): Ridges more pronounced, almost coalescing at basal eminence.

Grade 4 (low pronounced): Well-developed ridges that converge at basal eminence.

Grade 5 (medium pronounced): More pronounced marginal ridges meeting at basal eminence.

Grade 6 (high pronounced): Pronounced ridges that meet at basal eminence, almost folding in on themselves.

Grade 7 (extreme pronounced): Any expression that exceeds grade 6 can be placed in grade 7. It is a rare expression, so much so that a good example for the plaque was never found. This grade would involve marginal ridges that folded around on themselves, similar to grade 6 on the UI2 shoveling plaque.

On **the upper lateral incisors**, the scoring is **slightly different** and **eight grades** are defined:

Grade 0 (absence): As for UI1, complete absence of marginal ridges is rare on UI2. There are slight marginal ridges on the plaque for grade 0.

Grade 1 (trace): Characterized by the presence of faint mesial and distal marginal ridges.

Grade 2 (low moderate): Moderate marginal ridges with little fossa formation.

Grade 3 (high moderate): Distinct marginal ridges but only moderate lingual fossa.

Grade 4 (low pronounced): Well-developed marginal ridges that come in contact at the lingual base of the crown.

Grade 5 (medium pronounced): Well-developed marginal ridges, forming a distinct lingual fossa.

Grade 6 (semi-barreled): The marginal ridges wrap around and contact at a low point on the basal eminence.

Grade 7 (barreled): The marginal ridges are so pronounced that they contact at almost the incisal surface of the basal eminence, assuming a full barrel shape.

- **Tuberculum dental**

It is defined as tubercles, ridges, or cups-like features expressed in the cingular region of the lingual surface (Scott, 1971; Carlsen, 1987). On **the lower incisors**, **five grades** are defined:

Grade 0: No expression. Cingular region of the lingual surface is smooth.

Grade 1: Faint ridging.

Grade 2: Trace ridging.

Grade 3: Strong ridging.

Grade 4: Pronounced ridging.

On **the upper incisors**, **two supplementary grades** are observed:

Grade 5: Weakly developed cuspule with a free apex.

Grade 6: Strong cusp with a free apex.

- **Cingulum interruption groove**

It is defined as an interruption groove of the cingulum or tuberculum dental (this study). On **the lower and upper incisors**, **three grades** are defined:

Grade 0: Absence of an interruption groove on the tuberculum dental.

Grade 1: Presence of an interruption groove on the tuberculum dental.

Grade 2: Presence of an extension of interruption groove on the tuberculum dental from the crown to the root.

- **Lingual fossa**

It is defined as a pit, groove, or depression on the lingual surface of the crown (this study). On **the lower and upper incisors, two grades** are defined:

Grade 0: Absent.

Grade 1: Present.

- **Mesial marginal ridge**

It is defined as an elevation of enamel which forms the mesial margin of the lingual surface (this study). On **the lower and upper incisors, two grades** are defined:

Grade 0: Absent.

Grade 1: Present.

- **Distal marginal ridge**

It is defined as an elevation of enamel which forms the distal margin of the lingual surface ridge (this study). On **the lower and upper incisors, two grades** are defined:

Grade 0: Absent.

Grade 1: Present.

- **Marginal Interruption groove**

It is defined as an interruption located on the marginal ridge (this study). On **the lower and upper incisors, three grades** are defined:

Grade 0: Absence of an interruption groove on the marginal ridge.

Grade 1: Presence of an interruption groove on mesial or distal marginal ridges.

Grade 2: Presence of an interruption groove on both mesial and distal marginal ridges.

b. Canine

Here is morphological feature of the canine (Fig. 3. C.2.)

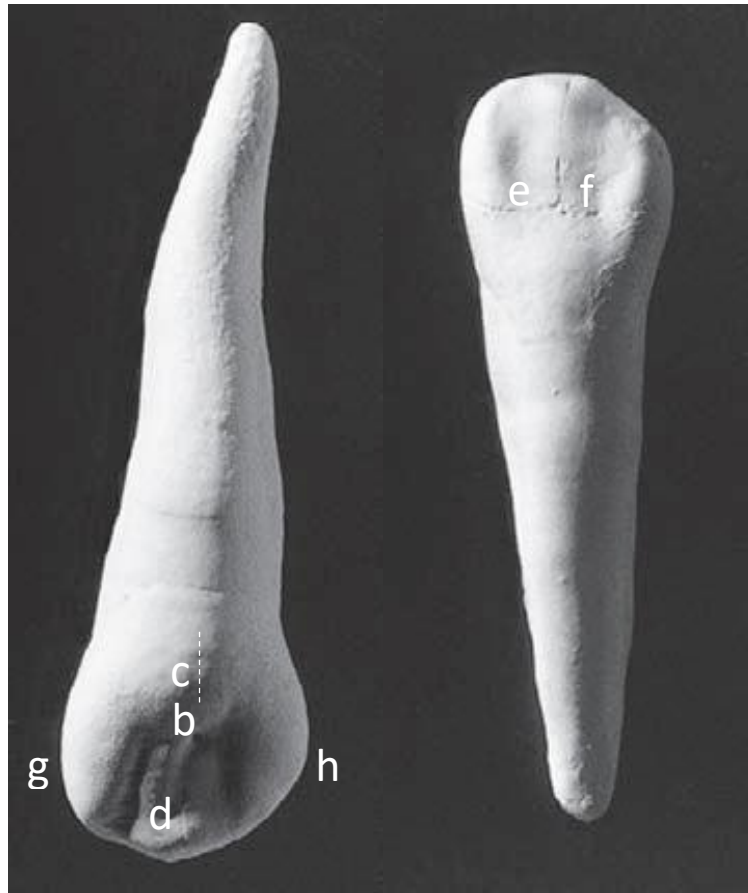

Fig. 3. C.2. Morphological feature of the canines (source White and Folkens, 2005):
(a) Shape, (b) Tuberculum dental, (c) Cingulum interruption groove, (d) Lingual ridge or essential crest, (e) Mesiolingual fossa, (f) Distolingual Fossa, (g) Mesial accessory ridge, and (h) Distal accessory ridge.
Model: URC (left) and LRC (right). Lingual face.

- **Shape of canine**

It is defined as the general shape of the canine when viewed from buccal or lingual aspects (Martinon-Torres *et al.*, 2012). On **the lower and upper canines, two grades** are defined:

Grade 0: Flared, asymmetrical and with talonid-like distal margin ridge.

Grade 1: Incisor-like or symmetrical.

- **Tuberculum dental**

It is defined as the tubercles, ridges, or cups-like features expressed in the cingular region of the lingual surface (Scott, 1971; Carlsen, 1987; Martín-Torres *et al.*, 2012). On **the lower canine, five grades** are defined:

Grade 0: No expression. Cingular region of the lingual surface is smooth.

Grade 1: Faint ridging.

Grade 2: Trace ridging.

Grade 3: Strong ridging.

Grade 4: Pronounced ridging.

On **the upper canine**, the scoring is **slightly different** and **eight grades** are defined:

Grade 0: Absence of any ridge or tubercle formation.

Grade 1: Very slight tubercle, characterized by a single groove.

Grade 2: Slight tubercle, outlined by two grooves.

Grade 3: Moderate tubercle.

Grade 4: Medium tubercle with no free apex.

Grade 5: Large tubercle with free apex.

Grade 6: Pronounced tubercle with free apex.

Grade 7: Hyper-pronounced tubercle with free apex.

- **Cingulum interruption groove**

It is defined as a depression or groove that interrupt the normal course of the basal cingulum (personal observation). On **the lower and upper canines**, **three grades** are defined:

Grade 0: Absent.

Grade 1: Present.

Grade 2: Presence of the groove and continuing to the root.

- **Lingual ridge or essential crest**

It is defined as the ridge or crest that located on the central part of lingual face (personal observation). On **the lower and upper canines**, **two grades** are defined:

Grade 0: Attenuated or flat.

Grade 1: Swollen.

- **Mesiolingual fossa**

It is defined as a depression located in the mesiolingual part between mesial ridge and essential lingual ridge (personal observation). On **the lower and upper canines**, **two grades** are defined:

Grade 0: Absent.

Grade 1: Present.

- **Distolingual Fossa**

It is defined as a depression located in the distolingual part between distal ridge and essential lingual ridge (personal observation). On **the lower and upper canines, two grades** are defined:

Grade 0: Absent.

Grade 1: Present.

- **Mesial accessory ridge**

It is defined as the developmental ridge in the mesiolingual fossa between the tooth apex and the mesiolingual margin ridge (Martinon-Torres *et al.*, 2012). On **the lower and upper canines, three grades** are defined:

Grade 0: Mesial and distal lingual ridges have the same size. Neither is attached to the tuberculum dental if present.

Grade 1: Mesial marginal ridge is larger than the distolingual and it may be weakly attached to the tuberculum dental.

Grade 2: Mesiolingual ridge is much larger and incorporates the tuberculum dental (In the upper canines this is called Morris' type).

- **Distal accessory ridge**

It is defined as the developmental ridge in the distolingual fossa between the tooth apex and the distolingual margin ridge (Martinon-Torres *et al.*, 2012). On **the lower and upper canines, three grades** are defined:

Grade 0: The ridge is absent.

Grade 1: The ridge is weakly developed.

Grade 2: The ridge is pronounced.

c. Premolar

Here is morphological feature of the premolar (Fig. 3. C.3. and Fig. 3. C.4.)

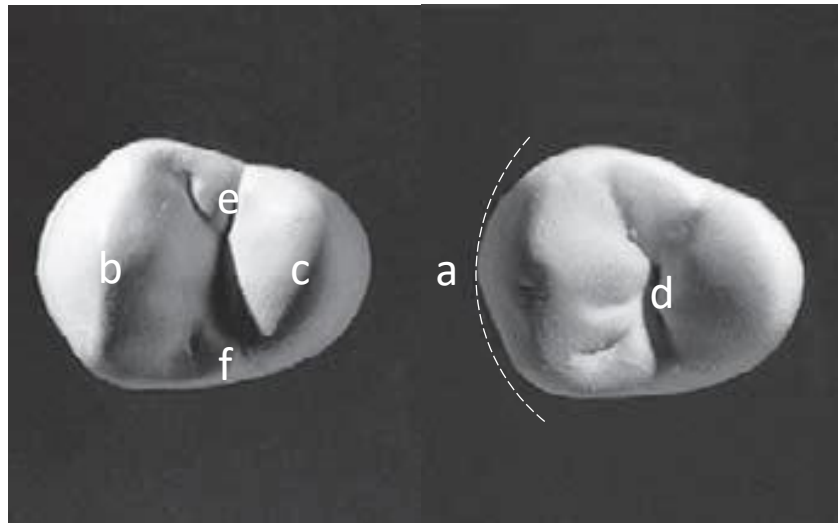

Fig. 3. C.3. Morphology of the upper premolars (source White and Folkens, 2005): (a) Shape, (b) Buccal essential ridge, (c) Lingual essential ridge, (d) Transverse crest, (e) Mesial triangular fossa, and (f) Distal triangular fossa. Model: URP3 (left) and URP4 (right). Occlusal Surface.

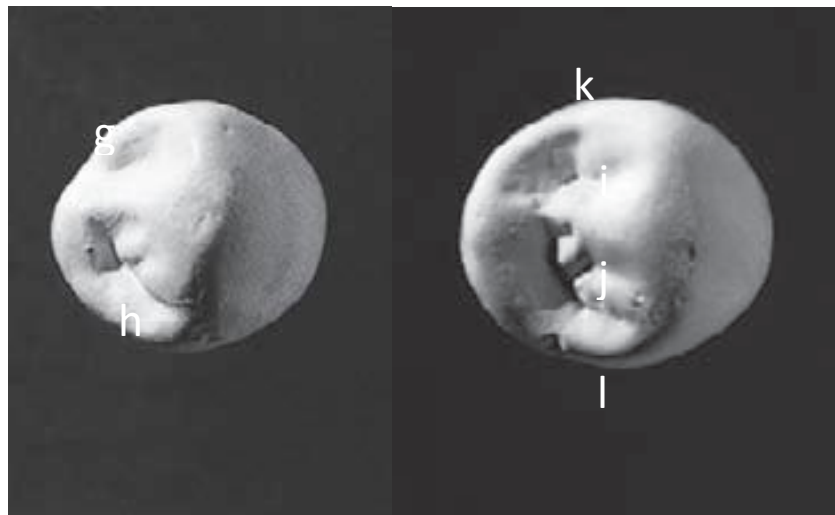

Fig. 3. C.4. Morphology of the lower premolars (source White and Folkens, 2005): (g) Mesial marginal ridge, (h) Distal marginal ridge, (i) Mesial accessory ridge, (j) Distal accessory ridge, (k) Mesial accessory cusp (if exist, supposed to be there), and (l) Distal accessory cusp (if exist, supposed to be there). Model: LRP3 (left) and LRP4 (right). Occlusal Surface.

- **Shape of Premolar**

It is defined as the general shape of the premolar in occlusal view (Martinon-Torres *et al.*, 2012). On **the lower third premolar, three grades** are defined:

Grade 0: Strongly asymmetrical and conspicuous talonid.

Grade 1: Moderately symmetrical.

Grade 2: Symmetrical.

On **the lower fourth premolar**, the scoring is **slightly different** and **three grades** are defined:

Grade 0: Asymmetrical with expanded, occlusal polygon.

Grade 1: Symmetrical with reduced occlusal polygon.

Grade 2: Symmetrical.

On **the upper premolar**, the scoring is **slightly different** and **two grades** are defined:

Grade 0: Strongly asymmetrical and conspicuous talonid.

Grade 1: Symmetrical or moderately symmetrical.

- **Buccal essential ridge**

It is defined as the degree of expression and possible bifurcation of essential ridge on the buccal cusp (Martinon-Torres *et al.*, 2012). On **the lower and upper premolar**, **three grades** are defined:

Grade 0: The crest is absent.

Grade 1: The crest is single.

Grade 2: The crest is bifurcated.

- **Lingual essential ridge**

It is defined as the degree of expression and possible bifurcation of essential ridge on the lingual cusp (Martinon-Torres *et al.*, 2012). On **the lower and upper premolar**, **three grades** are defined:

Grade 0: The crest is absent.

Grade 1: The crest is single.

Grade 2: The crest is bifurcated.

- **Transverse crest**

It is defined as the development of a crest connecting the buccal and lingual cusp (Martinon-Torres *et al.*, 2012). On **the lower and upper premolar**, **three grades** are defined:

Grade 0: The crest is absent. The sagittal fissure is continuous.

Grade 1: The crest is weak or it is interrupted by the sagittal fissure.

Grade 2: The crest is pronounced or the sagittal fissure is erased.

- **Mesial triangular fossa**

It is defined as a triangle-like depression located on the mesial side (personal observation). On **the lower and upper premolar, four grades** are defined:

Grade 0: Mesial triangular fossa is absent, interrupted by the sagittal fissure continuous to mesial margin.

Grade 1: Mesial triangular fossa is not clear, discontinuous of the sagittal fissure to mesial margin.

Grade 2: Mesial triangular fossa is not complete, with one edge is missing.

Grade 3: Mesial triangular fossa is complete.

- **Distal triangular fossa**

It is defined as a triangle-like depression located on the distal side (personal observation). On **the lower and upper premolar, four grades** are defined:

Grade 0: Distal triangular fossa is absent, interrupted by the sagittal fissure continuous to distal margin.

Grade 1: Distal triangular fossa is not clear, discontinuous of the sagittal fissure to distal margin.

Grade 2: Distal triangular fossa is not complete, with one edge is missing.

Grade 3: Distal triangular fossa is complete.

- **Mesial marginal ridge**

It is defined as the margin expressed on the mesial side (personal observation). On **the lower and upper premolar, three grades** are defined:

Grade 0: Absent.

Grade 1: Slight linear ridge marked as a mesial margin.

Grade 2: Pronounced linear or mountain-like ridge on the mesial margin.

- **Distal marginal ridge**

It is defined as the margin expressed on the distal side (personal observation). On **the lower and upper premolar, three grades** are defined:

Grade 0: Absent.

Grade 1: Slight linear ridge marked as a distal margin.

Grade 2: Pronounced linear or mountain-like ridge on the distal margin.

- **Mesial accessory ridge**

It is defined as the developmental ridge in the mesiolingual fossa between apex of the tooth and the mesiolingual marginal ridge (Kanazawa, Sekikawa and Ozaki, 1990). On **the lower and upper premolar, two grades** are defined:

Grade 0: The accessory ridge is absent.

Grade 1: The accessory ridge is present.

- **Distal accessory ridge**

It is defined as the developmental ridge in the distolingual fossa between apex of the tooth and the distolingual marginal ridge (Kanazawa, Sekikawa and Ozaki, 1990). On **the lower and upper premolar, two grades** are defined:

Grade 0: The accessory ridge is absent.

Grade 1: The accessory ridge is present.

- **Mesial accessory cusp / tubercle**

It is defined as the tubercle or extra cusp which developed on the mesial aspect (Carlsen, 1987). On **the lower and upper premolar, two grades** are defined:

Grade 0: Absent.

Grade 1: Present.

- **Distal accessory cusp / tubercle**

It is defined as the tubercle or extra cusp which developed on the distal aspect (Carlsen, 1987). On **the lower and upper premolar, two grades** are defined:

Grade 0: Absent.

Grade 1: Present.

d. Lower molar

Here is morphological feature of the lower molar (Fig. 3. C.5.)

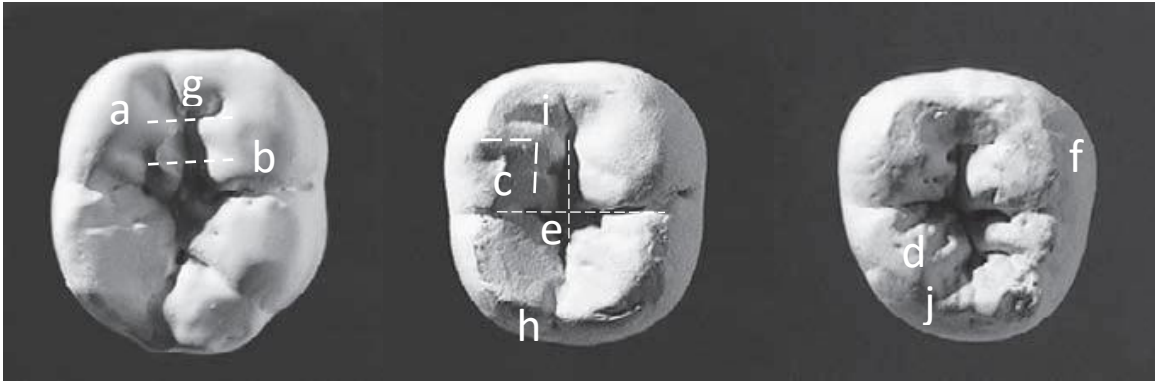

Fig. 3. C.5. Morphology of the lower molars (source White and Folkens, 2005)

(a) Middle trigonid crest, (b) Distal trigonid crest, (c) Deflecting wrinkle, (d) Crenulation (example), (e) Groove pattern, (f) Protostylid (if exist, supposed to be there), (g) Mesial marginal ridge, (h) Distal marginal ridge, (i) Anterior fovea, (j) Posterior fovea

Model: LRM1 (left), LRM2 (center), and LRM3 (right). Occlusal Surface.

- **Number of cusps**

It is defined as the total number of cusps observed on **the lower molar** (personal observation). **Four grades** are defined:

Grade 0: Composed by 4 cusps, without any accessories cusps.

Grade 1: Composed by 5 cusps, with Hypoconulid.

Grade 2: Composed by 6 cusps, with Hypoconulid and Entoconulid.

Grade 3: Composed by 7 cusps, with Hypoconulid, Entoconulid, and Metaconulid.

- **Hypoconulid (C5)**

It is defined as the size of Hypoconulid (C5) presented on the distal and occupies buccal part of **the lower molar** (Turner *et al.*, 1991). **Six grades** are defined:

Grade 0: Hypoconulid is absent (four-cusped tooth).

Grade 1: Trace expression.

Grade 2: Slight.

Grade 3: Moderate.

Grade 4: Strong.

Grade 5: Pronounced.

- **Entoconulid (C6)**

It is defined as the size of C6 (Entoconulid) presented on the distal and occupies lingual part of **the lower molar** (Turner *et al.*, 1991). **Six grades** are defined:

Grade 0: Entoconulid is absent.

Grade 1: Cusp 5 is more than twice the size of cusp 6.

Grade 2: Cusp 5 is about twice as large as cusp 6.

Grade 3: Cusps 5 and 6 are about equal in size.

Grade 4: Cusp 6 is slightly larger than cusp 5.

Grade 5: Cusp 6 is markedly larger than cusp 5.

- **Metaconulid (C7)**

It is defined as the accessory cusp expressed between cusps 2 (Metaconid) and 4 (Entoconid) on the lingual part of **the lower molar**; hence the synonym *tuberculum intermedium* (Turner *et al.*, 1991). **Six grades** are defined:

Grade 0: No accessory cusp between cusps 2 and 4.

Grade 1: Small, wedge-shaped cusp between cusps 2 and 4.

Grade 1.5: This expression does not assume the typical wedge-shaped form of a cusp 7 but is marked by a groove on the lingual surface of the metaconid

Grade 2: Distinct but small cusp.

Grade 3: Moderate cusp.

Grade 4: Large cusp.

- **Middle trigonid crest**

It is defined as the expression of a crest connecting the mesial aspects of the Protoconid and the Metaconid of **the lower molar** (Martinon-Torres *et al.*, 2012). **Three grades** are defined:

Grade 0: The crest is absent.

Grade 1: There is a weak crest but interrupted by the central groove.

Grade 2: There is a continuous bridge-like crest connecting the mesial aspects of the Protoconid and the Metaconid.

- **Distal trigonid crest**

It is defined as the expression of a crest connecting the distal aspects of the Protoconid and the Metaconid of **the lower molar** (Martinon-Torres *et al.*, 2012). **Three grades** are defined:

Grade 0: The crest is absent.

Grade 1: There is a weak crest but interrupted by the central groove.

Grade 2: There is a continuous bridge-like crest connecting the distal aspects of the Protoconid and the Metaconid.

- **Deflecting wrinkle**

It is defined as the deflecting wrinkle is expressed on the occlusal surface of the mesiolingual cusp (Metaconid) of **the lower molar** (Turner *et al.*, 1991). **Four grades** are defined:

Grade 0: Deflecting wrinkle absent; essential ridge of metaconid runs a straight course from cusp tip to central occlusal fossa.

Grade 1: Essential ridge is straight but with midpoint constriction.

Grade 2: Essential ridge deflects at halfway point toward central occlusal fossa but does not contact hypoconid.

Grade 3: Essential ridge shows strong deflection at midpoint and connect with the hypoconid.

- **Crenulation**

It is defined as the degree of crenulation on **the lower molar** cusps area (personal observation). **Five grades** are defined:

Grade 0: No crenulation.

Grade 1: Crenulation on one cusp area.

Grade 2: Crenulation cusps on two cusps area.

Grade 3: Crenulation cusps on three cusps area.

Grade 4: Crenulation cusps on all cusps area.

- **Groove pattern**

It is defined as the groove system contacting between **the lower molar** cusps (Gregory and Hellman, 1926; Jorgensen, 1956; Turner, Nichol and Scott, 1991). **Three grades** are defined:

Grade 0: Y pattern: contact between cusps 2 (Metaconid) and 3 (Hypoconid).

Grade 1: X pattern: contact between cusps 1 (Protoconid) and 4 (Entoconid).

Grade 2: + pattern: contact between cusps 1 (Protoconid), 2 (Metaconid), 3 (Hypoconid), and 4 (Entoconid) at central sulcus.

- **Protostylid**

It is defined as the supernumerary or accessory cusp located on the mesiobuccal surface of **the lower molar** (Dahlberg, 1956). **Eight grades** are defined:

Grade 0: No pit or positive expression on buccal surface of lower molar.

Grade 1: Buccal pit (a pit of varying sizes, situated around the midpoint of the crown in the protoconid-hypoconid inter-lobe groove).

Grade 2: A very slight swelling and associated groove coursing mesially from buccal groove

Grade 3: Slight positive expression on mesiobuccal cusp.

Grade 4: moderate positive expression.

Grade 5: Strong positive expression.

Grade 6: Pronounced positive expression.

Grade 7: Most distinctive form of protostylid, expressed as tubercle.

- **Mesial marginal ridge**

It is defined as the margin expressed on the mesial side of **the lower molar** (personal observation). **Three grades** are defined:

Grade 0: Absent.

Grade 1: Slight linear ridge marked as a mesial margin.

Grade 2: Pronounced linear or mountain-like ridge on the mesial margin.

- **Distal marginal ridge**

It is defined as the margin expressed on the distal side of **the lower molar** (personal observation). **Three grades** are defined:

Grade 0: Absent.

Grade 1: Slight linear ridge marked as a distal margin.

Grade 2: Pronounced linear or mountain-like ridge on the distal margin.

- **Anterior fovea**

It is defined as the expression of a fovea or groove on the anterior occlusal surface, posterior to the mesial marginal ridge of **the lower molar** (Turner and Nichol, 1991; Martinon-Torres *et al.*, 2012). **Five grades** are defined:

Grade 0: Absent.

Grade 1: Trace, with slight development of mesial marginal ridge.

Grade 2: Essential ridges on trigonid better developed, as is marginal ridge.

Grade 3: Essential ridges pronounced and marginal ridge well developed, producing a distinctive fovea on the anterior portion of the trigonid.

Grade 4: Pronounced essential ridges and marginal ridge produce a well-defined fovea.

- **Posterior fovea**

It is defined as the expression of a fovea or groove on the posterior occlusal surface, anterior to the distal marginal ridge of **the lower molar** (developed from (Wood, Abbott and Graham, 1983; Martín-Torres *et al.*, 2012)). **Three grades** are defined:

Grade 0: Absent.

Grade 1: Slight linear depression in the distal marginal complex.

Grade 2: Pronounced linear or pit-like depression in the distal marginal complex.

e. Upper molar

Here is morphological feature of the upper molar (Fig. 3. C.6.)

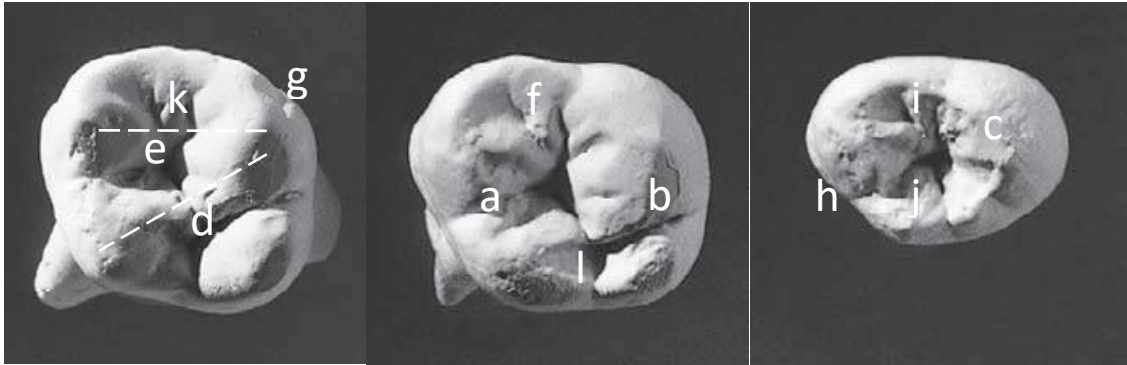

Fig. 3. C.6. Morphology of the upper molars (source White and Folkens, 2005)

(a) Buccal accessory tubercle (if exist, supposed to be there), (b) Lingual accessory tubercle (if exist, supposed to be there), (c) Crenulation (example), (d) Crista obliqua, (e) Transversal crest, (f) Mesial marginal accessory tubercle, (g) Carabelli's cusp (if exist, supposed to be there), (h) Parastyle (if exist, supposed to be there), (i) Mesial marginal ridge, (j) Distal marginal ridge, (k) Anterior fovea, and (l) Posterior fovea.

Example: URM1 (left), URM2 (center), and URM3 (right). Occlusal Surface.

- **Number of cusps**

It is defined as the total number of cusps observed on **the upper molar** (personal observation). **Three grades** are defined:

Grade 0: Composed by 3 cusps, without Hypocone.

Grade 1: Composed by 4 cusps.

Grade 2: Composed by 5 cusps, with Metaconule.

- **Metacone (C3)**

It is defined as the size of metacone (C3) presented on the distobuccal part of **the upper molar** (Turner *et al.*, 1991). **Seven grades** are defined:

Grade 0: Metacone absent.

Grade 1: There is a ridge at the metacone site but no free apex.

Grade 2: Metacone expressed as faint cuspule with a free apex.

Grade 3: Weak cusp.

Grade 3.5: intermediate-sized cusp that falls between grades 3 and 4 (interpolation necessary).

Grade 4: Metacone is large.

Grade 5: Metacone is pronounced, equal in size to a large UM1 hypocone.

- **Hypocone (C4)**

It is defined as the size of hypocone (C4) presented on the distolingual part of **the upper molar** (Larson, 1978; Turner *et al.*, 1991). **Seven grades** are defined:

Grade 0: No hypocone expression of any form; a true three-cusped tooth.

Grade 1: For this grade, there is a low-level expression of the hypocone, often expressed as no more than an outline on the distolingual aspect of the trigon. In Dahlberg's original classification, this would be scored as a three cusped upper molar along with grade 0.

Grade 2: In the Dahlberg classification, 3+ was equivalent to a small conical hypocone on the distolingual border of the trigon; grade 2 reflects this phenotype, where there is basically a conical cusp, or tubercle, with a free apex.

Grade 3: The hypocone is reduced in size but assumes a normal ovate shape along with a distinct free apex.

Grade 4: This grade would be equivalent to 3.5 on the modified hypocone plaque; the hypocone is reduced in size but is moderate rather than slight in expression.

Grade 5: Hypocone is well developed, a step beyond grade 4.

Grade 6: Pronounced expression of the hypocone; often equals or exceeds the size of the major cusps of the trigon.

- **Metaconule (C5)**

It is defined as the accessory cusp expressed between the hypocone and metacone of **the upper molar** (Harris and Bailit, 1980). **Six grades** are defined:

Grade 0: Trait is absent, only one vertical groove on distal surface of upper molar between hypocone and metacone.

Grade 1: Slight conule.

Grade 2: Trace conule.

Grade 3: Small cuspule.

Grade 4: Small cusp.

Grade 5: Medium cusp.

- **Buccal accessory tubercle**

It is defined as the accessory cusp expressed on the buccal part between paracone and metacone of **the upper molar** (personal observation). **Three grades** are defined:

Grade 0: Absent.

Grade 1: Slight, small, weak and not individualized tubercle.

Grade 2: Pronounced, strong, and individualized tubercle.

- **Lingual accessory tubercle**

It is defined as the accessory cusp expressed on the lingual part between protocone and hypocone of **the upper molar** (personal observation). **Three grades** are defined:

Grade 0: Absent.

Grade 1: Slight, small, weak and unindividualized tubercle.

Grade 2: Pronounced, strong, and individualized tubercle.

- **Crenulation**

It is defined as the degree of crenulation on the cusps area of **the upper molar** (personal observation). **Five grades** are defined:

Grade 0: No crenulation.

Grade 1: Crenulation on one cusp area.

Grade 2: Crenulation cusps on two cusps area.

Grade 3: Crenulation cusps on three cusps area.

Grade 4: Crenulation cusps on all cusps area.

- **Crista obliqua**

It is defined as the expression of an enamel crest connecting the protocone and the metacone of **the upper molar** (Martinon-Torres *et al.*, 2012). **Three grades** are defined:

Grade 0: The crest is absent.

Grade 1: There is a crest but interrupted between the protocone and the metacone.

Grade 2: There is a continuous crest connecting the protocone and the metacone.

- **Transversal crest**

It is defined as the crest connecting the mesial aspect of the protocone and the paracone of **the upper molar** (Martinon-Torres *et al.*, 2012). **Three grades** are defined:

Grade 0: The crest is absent.

Grade 1: There is a crest but interrupted between the protocone and the paracone.

Grade 2: There is a continuous crest connecting the protocone and the paracone.

- **Mesial marginal accessories tubercle**

It is defined as the presence of tubercles in the mesial marginal ridge of **the upper molar**. Their expression is easily affected by wear (developed from Martinon-Torres *et al.*, 2012). **Three grades** are defined:

Grade 0: Tubercles are absent.

Grade 1: Tubercles are present.

Grade 2: Tubercles are pronounced, mountain-like elongated buccolingually orientation.

- **Carabelli's cusp**

It is defined as a cingular derivative expressed on the lingual surface of the protocone on **the upper molar** (Dahlberg, 1956). **Eight grades** are defined:

Grade 0. Mesiolingual cusp does not exhibit any grooves or pits on the lingual surface

Grade 1: A vertical groove separates the protocone from the mesial marginal ridge complex; Grade 1 expression occurs when there is a slight eminence that deflects distally from this groove.

Grade 2: When expression goes beyond a slight groove or eminence and takes the form of a pit.

Grade 3: Expression is still slight but takes on a more distinct form than shown by grades 1 and 2

Grade 4: The most pronounced expression of Carabelli's trait that does not involve a tubercle with a free apex; grade 4 takes the classic bird-wing form.

Grade 5: Small tubercle with a free apex.

Grade 6: Moderate tubercle with a free apex.

Grade 7: Pronounced tubercle with a free apex.

- **Parastyle**

It is defined as a small cusp lying anterior to the paracone on the cingulum of **the upper molar** (Turner *et al.*, 1991). **Seven grades** are defined:

Grade 0: Buccal surfaces of paracone and metacone cusps are smooth.

Grade 1: A small pit near the buccal groove between paracone and metacone cusps.

Grade 2: Small cusp but no free apex.

Grade 3: Medium cusp with free apex.

Grade 4: Large cusp with free apex.

Grade 5: Very large cusp with free apex that may extend to the surfaces of cusps 2 and 3.

Grade 6: Peg-shaped crown attached to root of second or third molar.

- **Mesial marginal ridge**

It is defined as the margin expressed on the mesial side of **the upper molar** (personal observation). **Three grades** are defined:

Grade 0. Absent.

Grade 1: Slight linear ridge marked as a mesial margin.

Grade 2: Pronounced linear or mountain-like ridge on the mesial margin.

- **Distal marginal ridge**

It is defined as the margin expressed on the distal side of **the upper molar** (personal observation). **Three grades** are defined:

Grade 0: Absent.

Grade 1: Slight linear ridge marked as a distal margin.

Grade 2: Pronounced linear or mountain-like ridge on the distal margin.

- **Anterior fovea**

It is defined as the expression of a fovea or groove on the anterior occlusal surface, posterior to the mesial marginal ridge of **the upper molar** (Turner, Nichol and Scott, 1991; Martínón-Torres *et al.*, 2012). **Five grades** are defined:

Grade 0: Absent.

Grade 1: Trace, with slight development of mesial marginal ridge.

Grade 2: Essential ridges on trigonid better developed, as is marginal ridge.

Grade 3: Essential ridges pronounced and marginal ridge well developed, producing a distinctive fovea on the anterior portion of the trigonid.

Grade 4: Pronounced essential ridges and marginal ridge produce a well-defined fovea.

- **Posterior fovea**

It is defined as the expression of a fovea or groove on the posterior occlusal surface, anterior to the distal marginal ridge of **the upper molar** (Wood, Abbott and Graham, 1983; Martínón-Torres *et al.*, 2012). **Three grades** are defined:

Grade 0: Absent.

Grade 1: Slight linear depression in the distal marginal complex.

Grade 2: Pronounced linear or pit-like depression in the distal marginal complex.

3. Measurement

a. General size of the teeth

The dental measurements used in this study are the classical mesiodistal (MD) and buccolingual (BL) dimensions of the crown following the methods of Lefèvre (1973), measured with a standard sliding caliper and recorded to the nearest 0.1 mm.

The measurement protocol was following Martinon-Torres *et al.* (2008). The MD diameter for incisors, canines, and premolars was measured as the maximum distance between the mesial and distal faces, parallel to the incisal/occlusal surface. For the BL diameter of incisors, canines and premolars, we measured the maximum width between the buccal and the lingual surfaces of the tooth in a plane that is perpendicular to the MD diameter.

For molars, the MD diameter is the maximum distance between the mesial and the distal faces, parallel to the occlusal surface. The reference plane for placement of the fixed caliper tip is the mesial surface since it is usually flatter than the distal surface. For the BL diameter of molars, we measured the maximum width between the buccal and the lingual surfaces, parallel to the occlusal surface. The reference plane for this measurement is usually the lingual surface for the lower molars and the buccal surface for the upper molars (Martinón-Torres *et al.*, 2008). This protocol was used both for isolated teeth and teeth still in the alveolar arcade.

b. Crown size and cusp proportion

Previous researches have highlighted the evolutionary significance of the size of the dental crown and the proportions of the cusps. The dimensions of the crown and cusp areas enabled to differentiate species within Plio-Pleistocene hominins in both Africa and Eurasia (e.g. Wood and Abbott, 1983; Wood, Abbott and Graham, 1983; Wood and Engleman, 1988; Bailey, 2004; Moggi-Cecchi and Boccone, 2007; Quam, Bailey and Wood, 2009; Gómez-Robles *et al.*, 2011; Martínón-Torres *et al.*, 2013).

Measurements

In this study, the measurement of the crown and the cusp proportions are following the previous works by Bailey (2002), Quam *et al.* (2009), Gomez-Robles *et al.* (2011), Martinon-Torres *et al.* (2013). Moreover, we have adapted additional variables to the aim of this research. Were considered (Fig. 3. C.7. and Fig. 3. C.8.):

- a. The cusp area: absolute and relative development of the area of the four main cusps (Bailey, 2004; Gómez-Robles *et al.*, 2011; Martínón-Torres *et al.*, 2013).
- b. The cusp circumference: absolute and relative development of the circumference of the four main cusps
- c. The cusp distance: absolute and relative distance between the horn of the four main cusps (Bailey, 2004; Gómez-Robles *et al.*, 2011; Martínón-Torres *et al.*, 2013).
- d. The cusp angle: absolute and relative angle of the horn of the four main cusps (Bailey, 2004; Gómez-Robles *et al.*, 2011; Martínón-Torres *et al.*, 2013).

The description of those measurement presented on the following figures and tables:

Upper molar

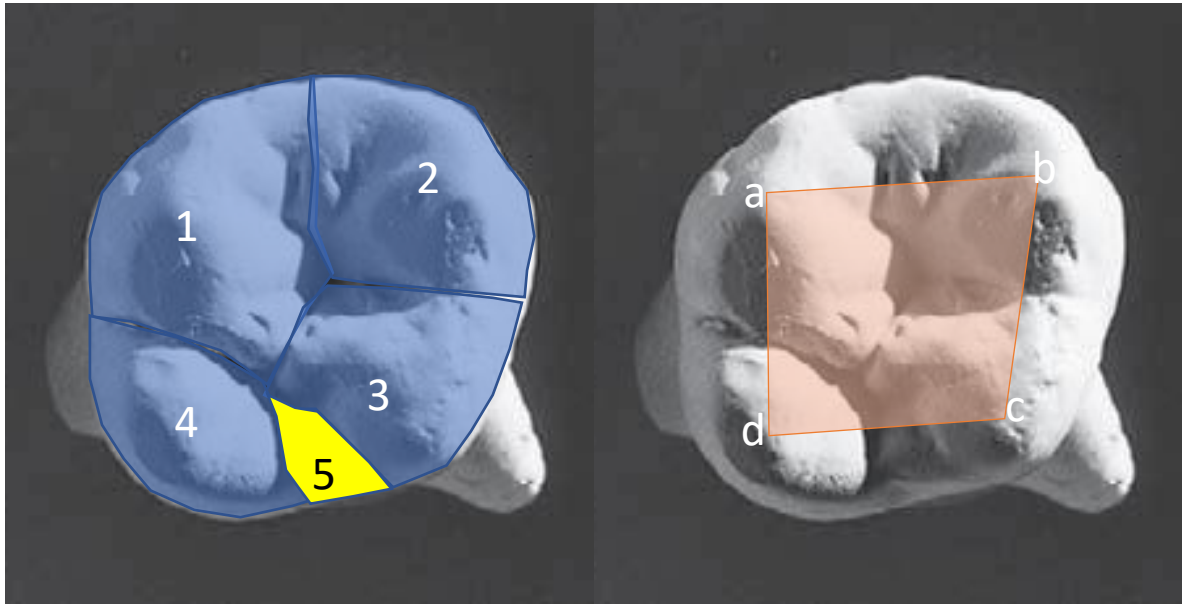

Fig. 3. C.7. Measurements on the upper molar:
Size and circumference measurement (left), cusp distance and angle (right)
Model: ULM1. Occlusal surface.

The measurement definition which presented on the Fig. 3. C.7. are described in the following table 3. C.2.:

NO	MEASUREMENT	REFERENCE
1	Size and circumference of protocone	1
2	Size and circumference of paracone	2
3	Size and circumference of metacone	3
4	Size and circumference of hypocone	4
5	Size and circumference of accessory cusp*	5
6	protocone-paracone distance	a-b
7	paracone-metacone distance	b-c
8	metacone-hypocone distance	c-d
9	hypocone-protocone distance	d-a
10	Angle of protocone	a
11	Angle of paracone	b
12	Angle of metacone	c
13	Angle of hypocone	d

Table 3. C.2. Reference of measurements on the upper molar.

*Note: The size and circumference of the accessory cusp and tubercle were divided and added for two closest cusps.

Lower molar

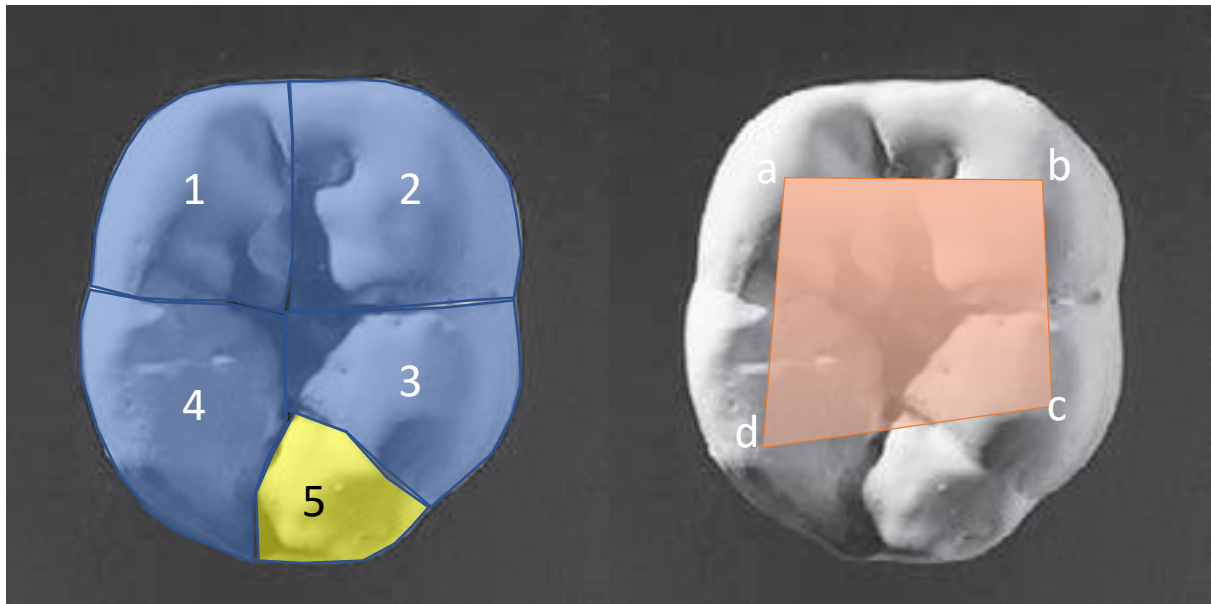

Fig. 3. C.8. Measurement on the lower molar:
Size and circumference measurement (left), cusp distance and angle (right)
Model: ULM1. Occlusal surface.

The measurement definition which presented on the Fig. 3. C.8. are described in the following table 3. C.3:

NO	MEASUREMENT	REFERENCE
1	Size and circumference of metaconid	1
2	Size and circumference of protoconid	2
3	Size and circumference of hypoconid	3
4	Size and circumference of entoconid	4
5	Size and circumference of accessory cusp*	5
6	metaconid-protoconid distance	a-b
7	protoconid-hypoconid distance	b-c
8	hypoconid-entoconid distance	c-d
9	entoconid-metaconid distance	d-a
10	Angle of metaconid	a
11	Angle of protoconid	b
12	Angle of hypoconid	c
13	Angle of entoconid	d

Table 3. C.3. Reference of measurement on the lower molar.

*Note: The size and circumference of the accessory cusp and tubercle were divided and added for two closest cusps.

The total crown base area (TCBA) was calculated as the sum of the absolute cusp base areas. The relative size of each cusp was determined by dividing the absolute cusp area by the TCBA (Bailey, 2004; Quam, Bailey and Wood, 2009).

Those four morphometric variables could be linking to the size, shape, or size-shape of the teeth (Table 3. C.4), as listed in the chart below:

Size-linked	Size-shape	Size-free / Shape
Cusp Area	Cusp Distance	Cusp Angle
Cusp Circumference		

Table 3. C.4. Link between the measurements and the shape - size of the tooth.

Limitations

Following the procedure of Quam *et al.* (2009) and Gomez-Robles *et al.*, (2011), we have selected for our analysis the teeth corresponding to the following conditions:

- Only molars that preserves the four main cusps or more.
- Only teeth in good condition. Teeth that were suffering from crown wear higher than grade 4 of Molnar (1971), or damage that has erased the fissure pattern or breakage that has disturbed an accurate assessment of the crown area, are excluded from the analysis.
- Preferably the right lower molar and the left upper molar (when both teeth for the same individual are preserved). Otherwise, the tooth best preserved and/or with the least worn condition was used.

Measurement protocol

To take such measurements, a picture of the occlusal surface of the tooth is required. The protocol used is adapted from the procedure of Bailey (2002), as follow:

- A Nikon™ D70S digital camera with AF-S Nikkor DX 18-70 mm lens f/3.5-4.5G ED was used to capture images of the occlusal surface of the tooth. The camera was attached to a tripod and was leveled horizontally and vertically. The pictures were taken with a manual setting using 50 mm (standard) magnification, 200 ISO, with a narrow aperture and low speed, which supposed to be provided a natural and sharp picture.
- For the isolated tooth: it is mounted on plastiline and positioned in anatomical position so that its occlusal plane was vertical to the visual axis of the camera lens. For tooth in situ, the cranium or mandible was manipulated so that the occlusal surface of the particular tooth was vertical to the optical axis of the camera. A millimeter-scale was included in each picture for calibration, placed parallel to and at the same distance from the lens as the occlusal plane.

Captured images were measured automatically with the FIJI image analysis software (Schindelin *et al.*, 2012), following the procedures of Wood and Abbott (1983), (Wood, Abbott and Graham (1983), Wood and Engleman (1988), Bailey (2004), Quam *et al.* (2009), Gomez-Robles *et al.* (2011), and Martinon-Torres *et al.* (2013):

- The Picture was cropped and rotated to orientate the tooth in a mesiodistal axis parallel to the base of the photograph (the x-axis).
- Teeth from the different sides were mirrored to obtain a constant orientation of lower right molar and upper left molar before performing the analysis.
- Each cusp area was measured by tracing the outline of the cusp, following the main fissures in the occlusal surface.
- Sometimes, wear obscured the path of the major cracks to the edge of the tooth. In these cases, the course of the crack was estimated by extrapolating a line from where the main fissure was eroded to the edge of the crown.
- When necessary, the corrections of interproximal wear were made to estimate the original mesial or distal limits based on the buccolingual extent of the wear facet and shape of the tooth.
- Where part of the dentine has been exposed for a particular cusp, the intercuspal distances have been taken from the center of the exposed dentine.
- Where additional cusps were present (e.g., Cusp 5 and marginal tubercles), the primary fissure was extended to the edge of the tooth and the appropriate proportions of the area of any additional cusps were added to the areas of the adjacent main cusps. When necessary, it was divided between the adjacent main cusps [e.g. the area of the metaconule (cusp 5) was divided between the metacone and the hypocone].
- All measurements were rounded to 0.00 millimeter.

4. Geometric Morphometrics (GM)

General considerations

The geometric morphometrics (GM) method is becoming one of the most useful approaches in morphological studies (Adams, Rohlf and Slice, 2004). GM captures the spatial aspects of morphological variation of biological structures. Shape variation in morphological structures is captured by configurations of landmarks, which are points of correspondence between different objects that match between and within populations (Bookstein, 1991; O'Higgins, 2000; Zelditch *et al.*, 2004).

GM techniques may offer a promising methodological approach to analyze evolution in dental pattern in a quantitative framework. (Gómez-Robles *et al.*, 2011). The study of dental morphology by the GM methods allows for a detailed comparison of hominin species and useful for taxonomic assignment and phylogenetic reconstruction (Gómez-Robles *et al.*, 2012). Numerous recent studies have demonstrated the presence of GM differences among the dentitions of several hominin species, for example see Martinón-Torres *et al.* (Martinón-Torres *et al.*, 2006), Gomez-Robles *et al.* (Gómez-Robles *et al.*, 2007, 2008, 2011, 2012), Bae *et al.* (Bae *et al.*, 2014), Xiao *et al.* (Xiao *et al.*, 2014).

The landmark

A landmark is a recognizable natural or artificial feature used for navigation, a feature that stands out from its near environment and is often visible from long distances. From the biological point of view, a landmark is an object with a comparatively small area and specific location, which is interesting due to its biological characteristics. Landmarks are defined by geometric characteristics of the hard and soft tissues (Bookstein, 1991). A landmark in one specimen corresponds to geometrically and biologically to the same landmark in other specimens within and between populations (Zelditch *et al.*, 2004). In 2D documentation, landmarks have two well-defined coordinates, and because of defined by the biological properties of their location, they carry relevant morphological information in their coordinate system (Martinón-Torres *et al.*, 2006).

Landmarks are point locations that are biologically homologous between specimens, but many anatomical structures cannot be quantified using traditional landmarks. Two or three-dimensional curves (outlines) or surfaces are difficult to represent by landmarks because positions along the curve or surface cannot be homologous between different individuals. Semi-landmarks make it possible to quantify two- or three-dimensional homologous curves and surfaces and to analyze them together with traditional landmarks (Gunz and Mitteroecker, 2013). For the assessment of occlusal outlines, no landmarks are available. However, semi-landmarks can be used for this purpose (Martinón-Torres *et al.*, 2006).

Landmarks were chosen because of their significance in assessing teeth variability (Biggerstaff, 1969), and they are easy to locate on the images of the occlusal surface of the teeth (Martinón-Torres *et al.*, 2006). Eight landmarks for lower as well as upper premolars (Fig. 3. C.9. and Fig. 3. C.10.), eighteen landmarks for lower molar (Fig. 3. C.11), twenty-four landmarks for an upper molar (Fig. 3. C.12.) were digitized with TpsDig2 software (Rohlf, 2005) to analyze the occlusal morphology of those teeth.

- a. Premolar
 - Lower premolar:

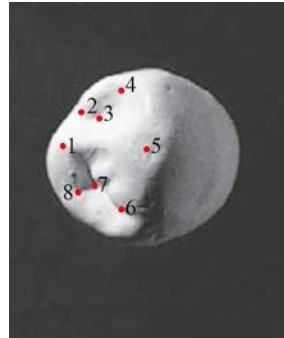

Fig. 3. C.9. Eight Landmarks position on the lower premolar.
Model: LRP3

The landmark position which presented on the Fig. 3. C.9. are described in the following table 3. C.5:

NO	LANDMARK	REFERENCE
1	Peak of lingual cusp	1
2	Lingual end of mesial triangular fossa	2
3	Distal end of mesial triangular fossa	3
4	Buccal end of mesial triangular fossa	4
5	Peak of buccal cusp	5
6	Buccal end of distal triangular fossa	6
7	Mesial end of distal triangular fossa	7
8	Distal end of distal triangular fossa	8

Table 3. C.5. Eight landmarks reference of the lower premolar

- **Upper premolar:**

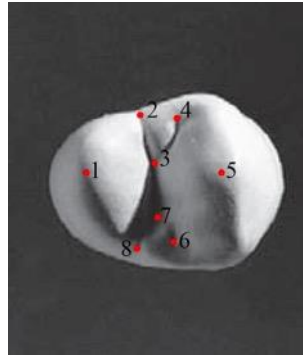

Fig. 3. C.10. Eight Landmarks position of the upper premolar.
Model: ULP3

The landmark position which presented on the Fig. 3. C.10. are described in the following table 3. C.6:

NO	LANDMARK	REFERENCE
1	Peak of lingual cusp	1
2	Lingual end of mesial triangular fossa	2
3	Distal end of mesial triangular fossa	3
4	Buccal end of mesial triangular fossa	4
5	Peak of buccal cusp	5
6	Buccal end of distal triangular fossa	6
7	Mesial end of distal triangular fossa	7
8	Distal end of distal triangular fossa	8

Table 3. C.6. Eight landmarks reference of the upper premolar

- b. Molar**
- **Lower molar:**

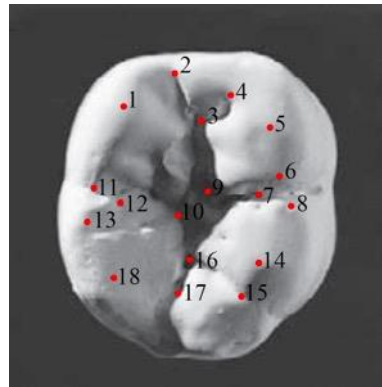

Fig. 3. C.11. Eighteen Landmarks position of the lower molar.
Model: LRM1

The landmark position which presented on the Fig. 3. C.11. are described in the following table 3. C.7:

NO	LANDMARK	REFERENCE
1	Peak of Metaconid (C2)	1
2	Lingual end of anterior fovea	2
3	Central intersection of anterior fovea	3
4	Buccal end of anterior fovea	4
5	Peak of Protoconid (C1)	5
6	Mesial end of Protoconulid (buccal accessories cusp)	6
7	Lingual end of Protoconulid (buccal accessories cusp)	7
8	Distal end of Protoconulid (buccal accessories cusp)	8
9	Mesial end of the contact between Metaconid/Protoconid with Hypoconid/Entoconid	9
10	Distal end of the contact between Metaconid/Protoconid with Hypoconid/Entoconid	10
11	Mesial end of Metaconulid (C7)	11
12	Buccal end of Metaconulid (C7)	12
13	Distal end of Metaconulid (C7)	13
14	Peak of Hypoconid (C3)	14
15	Buccal end of Hypoconulid (C5)	15
16	Mesial end of Hypoconulid (C5)	16
17	Lingual end of Hypoconulid (C5)	17
18	Peak of Entoconid (C4)	18

Table 3. C.7. Eighteen landmarks reference of the lower molar

- **Upper molar:**

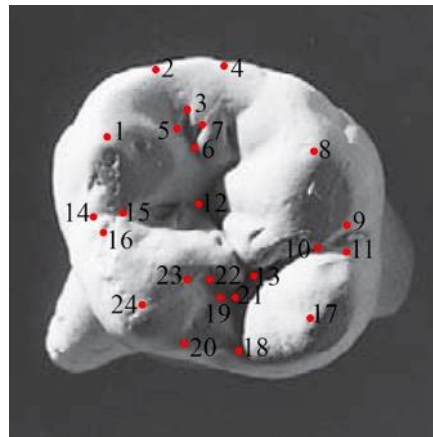

Fig. 3. C.12. Twenty-four Landmarks position of the upper molar.
Model: URM1;

The landmark position which presented on the Fig. 3. C.12. are described in the following table 3. C.8:

NO	LANDMARK	REFERENCE
1	Peak of Protocone (C1)	1
2	Lingual end of mesial accessories tubercle	2
3	Distal end of mesial accessories tubercle	3
4	Buccal end of mesial accessories tubercle	4
5	Lingual end of anterior fovea	5
6	Intersection of anterior fovea	6
7	Buccal end of anterior fovea	7
8	Peak of Paracone (C2)	8
9	Mesial end of buccal accessories cusp	9
10	Lingual end of buccal accessories cusp	10
11	Distal end of buccal accessories cusp	11
12	Central fossa	12
13	Distal triangular fossa	13
14	Mesial end of lingual accessories cusp	14
15	Buccal end of lingual accessories cusp	15
16	Distal end of lingual accessories cusp	16
17	Peak of Metacone (C3)	17
18	Buccal end of Metaconule (C5)	18
19	Mesial end of Metaconule (C5)	19
20	Lingual end of Metaconule (C5)	20
21	Buccal end of posterior fovea	21
22	Intersection of posterior fovea	22
23	Lingual end of posterior fovea	23
24	Peak of Hypocone (C4)	24

Table 3. C.8. Twenty-four Landmarks position of the upper molar.

Protocol of the analysis

The protocol of documentation and the condition of the teeth which used for GM analysis is following and adapted from Bailey (Bailey, 2004), Quam *et al.*, (2009) and Gomez-Robles *et al.*, (2011). The used of upper and lower premolar also molar mare more well known or more establish. So this study uses lower right and upper left teeth orientation, as did by previous metric approach of crown size and cusp proportion.

Some additional information come from the protocol of Martinon-Torres *et al.* (2006), Gomez-Robles *et al.* (2007, 2008, 2011, 2012), Bae *et al.* (2014), Xiao *et al.* (2014). We observed the following conditions:

- The landmarks located on the tips of the main cusps were visually located in the images by examining the original fossil when permission to mark was denied.
- When the tip of the main cusp showed little wear, the landmarks were located on the center of the wear facet.
- On the casts, landmarks were marked with a soft pencil before the documentation process.
- Landmarks on the groove and fovea were marked at the deepest part of the fissure. The specimen was excluded of the analysis in case of unclear location of the landmarks.
- The original shape was estimated by reference to the overall crown shape and the buccolingual extent of the wear facets following the protocol of Bailey and Lynch (2005), for the mesial and/or distal borders of the teeth which affected by interproximal wear.

Digitizing landmark

At the beginning of the digitizing process, each tooth has to be oriented in the same direction with the mesial and distal sides horizontally parallel to the x-axis, and the buccal and lingual sides vertically parallel to the y-axis, with the buccal side toward to the right. Similar to the protocol of crown size and cusp proportion, we use lower right teeth and upper left teeth.

The program MakeFan8 (Sheets, 2001) was used to create the centroid necessary to generate a series of equiangular fans. Two cusps on premolar and four cusps on molar were digitized on the occlusal surface in order to create the centroid. They are lingual cusp (red) and buccal cusp (blue) for the premolar. Potocone (red), paracone (blue), metacone (green), hypocone (yellow) for upper molar and metaconid (red), protoconid (blue), hypoconid (green), entoconid (yellow) for lower molar.

Some conditions to create the centroid point are following the protocol of Martinon-Torres *et al.* (2006), Gomez-Robles *et al.* (2007, 2008, 2011, 2012), Bae *et al.* (2014), Xiao *et al.* (2014), as follow:

- Centroid was generated from the location of the main cusps; if an accessory cusp is present, it was not included in the analyses (e.g. metaconule on upper molar and hypoconulid on a lower molar).
- Molars are included if they present at least four cusps. For example, we have excluded the upper molar if the hypocone was absent.
- The center of each cusp was chosen as the landmark location. The highest point of the cusp was used if it's not located on dentinal facet.

The centroid was calculated automatically by MakeFan8 and 30 equiangular fan lines were created in with 2-point thickness and an exaggeration of 3 to ensure that the fan lines crossed the edge of the occlusal surface of the tooth.

TpsDig2 version 2.16 (Rohlf, 2010) was used to digitize the landmarks and semi-landmarks created from the 30 equiangular fan lines at the point where the line crossed the edge of the occlusal surface. Indeed, the landmarks were digitalized first followed by the 30 semi-landmarks. They were always digitized in the same clockwise direction starting with the first point being the buccal cusp for premolar, the protocone for the upper molar and the metaconid of the lower molar. In order to minimize the bending energy between each landmark and target form (Bookstein, 1991; Gunz, Mitteroecker and Bookstein, 2006) each of the 30 semi-landmarks were then slid and connected using TpsUtil and tpsRelw (Rohlf, 2010).

Then, Generalized Procrustes Analysis (GPA) was performed in tpsRelw (Rohlf, 2010). The resultant shapes (residual Procrustes) were analyzed using the Relative Warps Analysis function in tpsRelw. The relative warp output is the same as the Principal Component output. TPS-grids were also evaluated to observe better the degree of variation at the edges of the different principal components (Bookstein, 1997). The TPS-grids and principal components plots were generated in tpsRelw (see Martínón-Torres *et al.*, 2006; Gómez-Robles *et al.*, 2007, 2008, 2011, 2012; Bae *et al.*, 2014; Xiao *et al.*, 2014).

CHAPTER 4. RESULTS

A. WEAR PATTERN

Observation on the wear category based on Molnar (1971) is the first step of the analysis. Only teeth that have the wear pattern of less and/or equal to the grade 4 will be included in the further analysis, as explained in in the previous chapter; under grade 4, the condition shows eventually a minimal dentine patch on the incisor and canine, two patches on the premolar, three or more small dentine patches on the molar. Detail observation of the wear pattern is presented in the Appendix A. Wear Pattern (Table. A.1 to Table. A.40).

Summary of the Wear Pattern

Our observations of the tooth wear pattern on the upper and lower teeth from an individual or isolated specimens of Pleistocene hominins and Holocene *Homo sapiens* are summarized in the following table (Table 4. A.1):

Taxa	Grade 0	Grade 1	Grade 2	Grade 3	Grade 4	Grade 5	Grade 6	Grade 7	Grade 8	Total
Early Hominins										
Trinil		1	1	1						3
Kedungbrubus									1	1
Sangiran	1	13	64	65	22	5	2		1	173
Patiayam				1						1
Rancah				1						1
Wajak		4	10	16	2					32
Lida Ajer			1	2						3
Zhoukoudian		8	25	20	9	5	2	1	1	71
<i>Homo sapiens</i>										
Tamiang			5	7	1					13
Sukajadi			5	23	11	8		1	5	53
Harimau PreN			5	16	24	11	2			58
Harimau Neo	6	12	19	27	12	8	2	1		87
Gua Pawon		3	8	12	9	4	1			37
Gua Kidang			1	3	11	5	11	1		32
SK PreN		2	13	28						43
SK Neo			3	16	8					27
Gua Braholo		6	26	23		1				56
Song Tritis				5	2	4	3	2		16
Song Terus		4	4	6	7	6	5	4	7	43
Wajak		1	16	24	13	10	2			66
Holocene										

Table 4. A.1. Summary of the tooth wear pattern by sites
Abv: PreN = Preneolithic layer, Neo = Neolithic layer

We have to excluded the teeth which correspond to grade 5 and above. Under those category, the condition only shows a minimal dentine patch on the incisor and canine, two patches on the premolar, three or more small dentine patches on the molar. So, the summary of the teeth used in this study, as follow (Table 4. A.2):

Taxa	Total	Used	% Used
EH	290	238	82,07
HSP	321	248	77,26
HSN-P	104	77	74,04

Table 4. A.2. Summary of the teeth used in this study. Abv: EH = Early Hominins, HSP = *Homo sapiens* Preneolithic, HSN-P = *Homo sapiens* Neolithic-Paleometallic.

B. DEFINING THE HYPOTHETICAL GROUPS

1. Background and purpose

This whole study will include a total amount of 715 teeth of early hominin and *Homo sapiens* from prehistoric sites of the Sundaland and Mainland East Asia. Based on wear pattern analysis in the previous part, there are only 563 teeth which could be included in the comparative studies, including 176 teeth of Pleistocene Javan hominin, 62 teeth of Zoukoudian *Homo erectus*, 248 teeth of early Holocene *Homo sapiens*, and 77 teeth of Late Holocene *Homo sapiens*. This research will start those whole comparative analyses with a case study on the second molar of Javan hominin. The first step will consider the second molar in order to split the Pleistocene Javan hominin fossil record into different groups. Then, the study will extend the observations to comparing the groups on the other tooth class (anterior teeth, premolars, first and third molar).

This study has chosen the M2 because this tooth class is the most abundant in the sample available and based on some significant reasons compared to the other tooth class on the mandibular or maxillary arc. Moreover, the significance of the second molar on the study of human diversity and evolution was highlighted previously by some studies e.g., Widiyanto (1991; 1993) and Kaifu *et al.* (2005). They noted that the Pleistocene Javan hominin teeth, especially the second molar, reflected evolutionary changes through time. Furthermore, a study by Noerwidi (2012) added more about the significance of the second molar on the identification of the difference between populations in Island Southeast Asia during the Holocene.

The purpose of this case study is to propose a hypothesis about the Javan hominin variability based on specific tooth classes (the upper and lower M2). In a second step, we will apply the hypothesis produced by this case study on a geographically and chronologically enlarged sample. The use of the Zhoukoudian *Homo erectus* into this comparison is to identify the possibility of genetic contact between the island and mainland Asia. In the same way, the aim of a comparative study between Javan hominins and groups of *Homo sapiens* from the Sundaland is to identify the possibility of inheritance characters through time, that is to say, biological continuity or discontinuity in this area from the Lower Pleistocene (Fig. 4. B.1.).

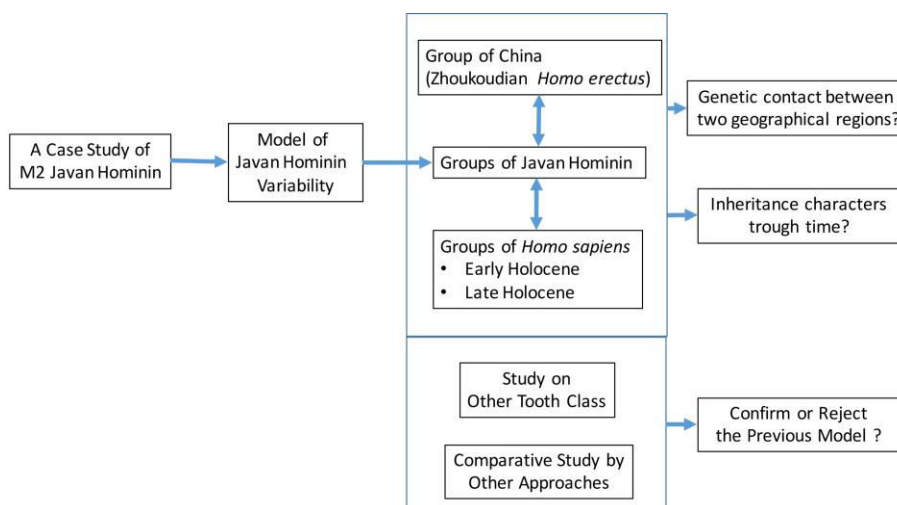

Fig. 4. B.1. Flowchart of the research on dental comparative study

2. The procedures

The sample used in this case study includes 25 permanent lower second molars (LM2) and 19 upper second molars (UM2) of Javan Pleistocene hominins. These 44 M2 are from a mandibular or a maxillary arcades, together with 22 additional teeth. So, they represent a total of 66 teeth from the 176 Javan hominin teeth or 37,5 % of the total sample.

The dental comparisons were conducted following the terminologies employed in Weidenreich, (1937), Bermudez de Castro, (1988), Bailey (2002), and Martín-Torres *et al.* (2008). Some morphological features are scored using the ASUDAS (Turner *et al.*, 1991) and adjusted for the early Atapuerca hominins by Martín-Torres *et al.* (2012) and for the Indonesian specimens by the author of the present study.

As explain in chapter 3, 14 characters were considered on the lower M2 and 16 on the upper M2 (put exact pages). As measurements, we retained the Mesiodistal (MD) and buccolingual (BL) dimensions. We visualized the metrics via boxplots and for the non-metric data, we used the classical clustering multivariate analyses with Manhattan distance generated by PAST version 3.20 (Hammer 2018). This later method inspired by Manhattan city block- is defined as the distance of two points in Euclidean space with a fixed Cartesian coordinate system (Dalfó *et al.* 2007; Dahal 2015). So, it sums the projection lengths of the segment between the points of each sample specimen into the coordinate axes.

3. Results of the comparative study on Javan Hominins

The cluster analysis on morphological characters of the LM2 splits the sample into four main hominin groups (Fig. 4. B.2. left), and the measurements added to complete the characterization of the groups (Fig. 4. B.2. right). Thus, based on metric and non-metric features, they are described as follows:

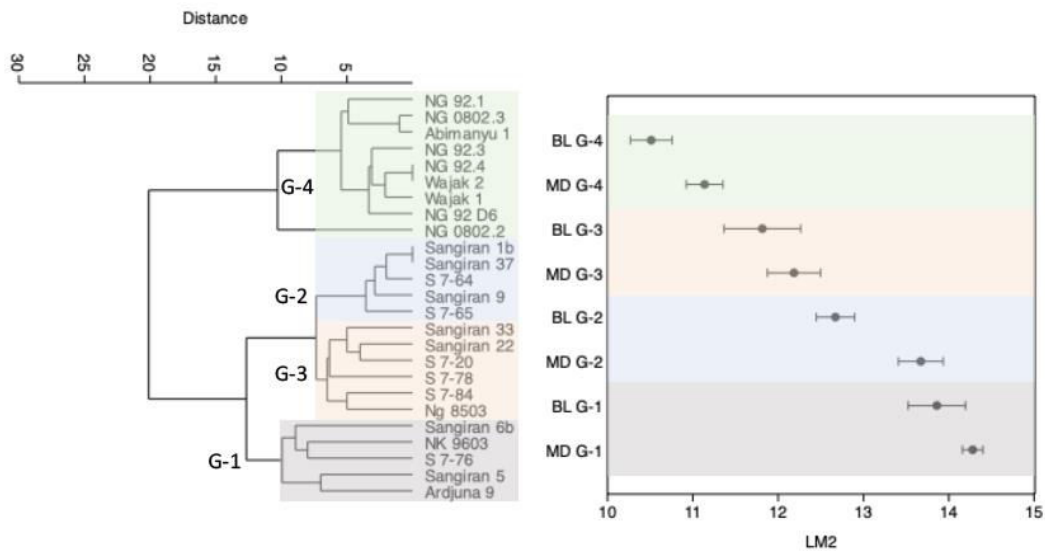

Fig. 4. B.2. Cluster Analysis of morphological feature (left) and boxplot graphic of MD and BL measurements (right) on the LM2 of Javan hominin specimens.

- Group 1 (grey box) has **very large size** of teeth (MD and BL), with **square shape** tendency, six to seven cusps, presence of C5, C6 and/or C7, with **large** distal accessories cusps and **moderate** lingual accessory cusp, **presence** of mesial and distal

marginal ridges, Y groove pattern, and **markedly pronounced** of deflecting wrinkle, middle and distal trigonid crest, crenulation, protostylid, anterior and posterior fovea.

- Group 2 (blue box) has **medium size** of teeth and an **elongated shape** of MD orientation, six to seven cusps, presence of C5, C6 and/or C7, with **moderate** distal accessories cusps and **small** lingual accessory cusp, presence of mesial and distal marginal ridges, Y groove pattern and **moderately presence** of deflecting wrinkle, middle and distal trigonid crest, crenulation, protostylid, anterior and posterior fovea.
- Group 3 (red box) has **medium size** of teeth (MD and BL), with **square shape** relatively, six to seven cusps, presence of C5, C6 and/or C7, with **weak** distal accessories cusps and **small or absent** lingual accessory cusp, **weak presence** of deflecting wrinkle, middle and distal trigonid crest, crenulation, protostylid, Y groove pattern, mesial marginal ridge and anterior fovea, **weak presence or absent** of distal marginal ridge and posterior fovea.
- Group 4 (green box) shows reduced and **small size of teeth** (MD and BL), **square shape** relatively, **four cusps** with **plus (+) groove pattern**, **absent** of deflecting wrinkle, middle and distal trigonid crest, crenulation, protostylid, and distal marginal ridge, **present but less pronounced** or **absent** of mesial marginal ridge and anterior fovea.

We could conclude that there is a tendency but not strict distribution of individuals in groups that follows a chronological trend from oldest to younger with Early Pleistocene fossils differing from those of the Middle and Late Pleistocene.

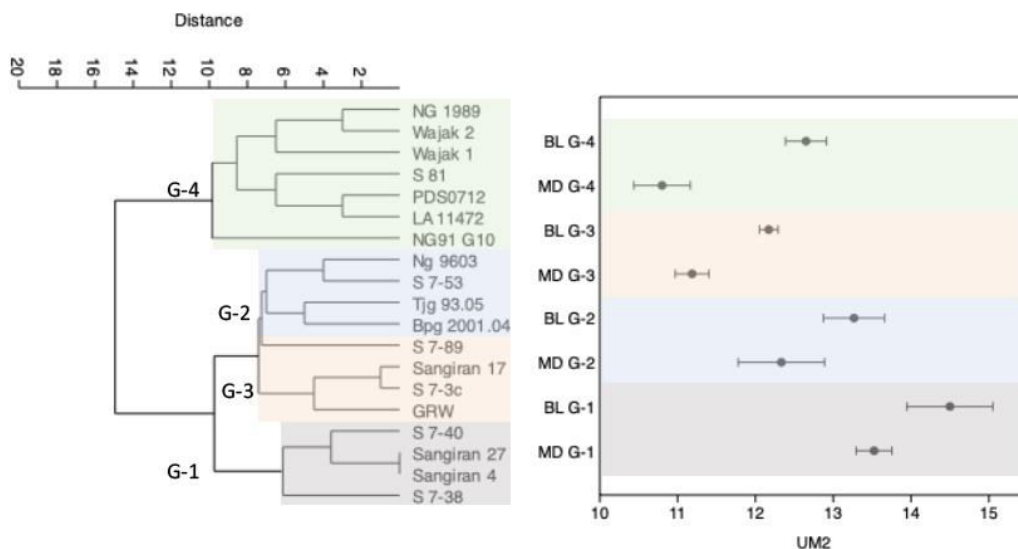

Fig. 4. B.3. Cluster Analysis of morphological feature (left) and boxplot graphic of MD and BL measurements (right) on the UM2 of Javan hominin specimens.

Again we obtained 4 groups on the UM2 on non-metric features (Fig. 4. B.3. left) and metric measurements (Fig. 4. B.3. right) as follows:

- Group 1 (grey box) has **large size** of teeth (MD and BL) with relatively **rhombus shape**, five cusps, with **no reduction** on C3 and C4, **moderately present** of C5, presence of buccal and lingual accessories tubercle, transversal crest and crista

obliqua, crenulation, mesial marginal accessory tubercle, mesial and distal marginal ridge, anterior and posterior fovea, present of parastyle, but **no** Carabelli.

- Group 2 (blue box) has **moderately size** of MD and BL with **rhombus shape** relatively, five cusps, with **reduction** on C4, and **moderately or small present** of C5, weak presence of buccal and lingual accessories tubercle, transversal crest and crista obliqua, crenulation, mesial marginal accessory tubercle, mesial and distal marginal ridge, anterior and posterior fovea, **present** of parastyle, and **significant present** of Carabelli cusp.
- Group 3 (red box) has **small size** of MD and BL with slightly elongated BL or **rhomboid shape**, five cusps, with **reduction** on C3 and C4, and small present of C5, **weak presence** of buccal accessories tubercle, crista obliqua, mesial marginal ridge, and anterior fovea, **weak present or absent** of transversal crest, crenulation, mesial marginal accessory tubercle, parastyle, distal marginal ridge, and posterior fovea. **Absent** lingual accessory tubercle and Carabelli.
- Group 4 (green box) shows reduced and **small size** of MD with **elongated** shape with BL orientation or **rhomboid** shape, **four to five** cusps, with **significant reduction** on C3 and C4, and **weak present or absent** of C5, buccal accessory tubercle, crista obliqua, mesial marginal accessory tubercle, mesial and distal marginal ridges, also anterior and posterior fovea. **Absent** lingual accessory tubercle, transversal crest, crenulation, Carabelli, and parastyle.

There is a tendency of size reduction through the time of UM2 fossils, but not strictly as expressed on the LM2 records.

The summary of the characters of LM2 (Table 4. B.1) and UM2 (Table 4. B.2) from each group could be presented on the following table:

	Size	Shape	NC	C5	C6	C7	DW	MdTC	DTC	Cr	GP	Prd	MMR	DMR	AF	PF
G-1	Large	square	6/7	***	**	**	***	**	**	**	Y	***	*	*	**	**
G-2	Med	MD	6/7	**/*	*	*	**	*	*	*	Y	**/*	*	*	*	*
G-3	Med	square	5/7	**/*	*/-	*	*	*	*/-	*	Y	**/*	*	*/-	*	*/-
G-4	Small	square	4	-	-	-	-	-	-	-	+	-	*/-	-	*/-	-

Table 4. B.1. Expression of the morphological characters of four groups on the LM2.

Note: NC = Number of Cusps, C5 = Size of Hypoconulid, C6 = Size of Entoconulid, C7 = Size of Metaconulid, MdTC = Middle Trigonid Crest, DTC = Distal Trigonid Crest, DW = Deflecting Wrinkle, Cr = Crenulation, GP = Groove Pattern, Posd = Protostylid, MMR = Mesial Marginal Ridge, DMR = Distal Marginal Ridge, AF = Anterior Fovea, PF = Posterior Fovea. Presence: *** = Pronounced, ** = Moderate, * = Faint. MD = elongated shape with mesiodistal orientation.

	Size	Shape	NC	C3	C4	C5	BAT	LAT	CO	TC	Cr	MMAT	CC	Pasl	MMR	DMR	AF	PF
G-1	Large	Rhombus	5	***	***	**	**	*	**	**	**	*	-	*	*	*	**	**
G-2	Med	Rhombus	5	***	**	**/*	**/*	*	**/*	*	*	*	*	*	*	*	*	*
G-3	Small	Slightly BL	5	**	**	*	*	-	*	*/-	*/-	*/-	-	*/-	*	*/-	*	*/-
G-4	Small	BL	4/5	**	*	*/-	*/-	-	*/-	-	-	*/-	-	-	*/-	*/-	*/-	*/-

Table 4. B.2. Expression of the morphological characters of four groups on the UM2.

Note: NC = Number of Cusps, C3 = Size of Metacone, C4 = Size of Hypocone, C5 = Size of Metaconule, BAT = Buccal Accessory Tubercle, LAT = Lingual Accessory Tubercle, Cr = Crenulation, CO = Crista Obliqua, TC = Transversal Crest, MMAT = Mesial Marginal Accessory Tubercle, CC = Carrabelli's Cusp, Pasl = Parastyle, MMR = Mesial Marginal Ridge, DMR = Distal Marginal Ridge, AF = Anterior Fovea, PF = Posterior Fovea. Presence: *** = Pronounced, ** = Moderate, * = Faint. BL = elongated shape with bucolingual orientation or Rhomboid shape

Here is the list of Javan hominin specimens belonging to the groups :

GROUP	LM2	UM2
G 1	Sangiran 5, Sangiran 6b, Arjuna 9, S 7-76, NK 9603	Sangiran 4, Sangiran 27, S 7-38, S 7-40
G 2	Sangiran 1b, Sangiran 9, Sangiran 37, S 7-64, S 7-65	Bpg 2001.04, Tjg 1993.05, Ng 9603, S 7-53
G 3	Sangiran 22, Sangiran 33, S 7-20, S 7-78, S 7-84, NG8503	Sangiran 17, GRW, S 7-3c, S 7-89
G 4	Wajak 1, Wajak 2, NG 92 D6, NG 92.1, NG 92.3, NG 92.4, Abimanyu 1, NG 0802.2	Wajak 1, Wajak 2, LA 11472, NG 91 G10, NG 1986, S 81, PDS 0712

Table 4. B.3. List of the Javan hominins (LM2 and UM2) splitted in 4 groups.

4. Enlarging the comparison samples

The next step of comparative studies will include some sample teeth from Pleistocene of Mainland Asia and Holocene of Island Southeast Asia.

a. The Zhoukoudian *Homo erectus*

The Zhoukoudian *Homo erectus* consist of hominins (Table 4. B.4) from Zoukoudian site, Locality 1 named as *Sinanthropus pekinensis* by previous researcher e.g., Black (1927). The reason to include the Group of Zoukoudian *Homo erectus* in the comparative studies is based on a question regarding spatial perspective, viz. Is there any genetic contact between both regions, Island Southeast Asia and Mainland Asia ? If yes, what are the characters in common ?

NO.	CLASS	TOTAL
1	Mandibular teeth	38
2	Isolated lower teeth	22
3	Isolated upper teeth	12

Table 4. B.4. Specimen of Group Zhoukoudian *Homo erectus*

b. The *Homo sapiens*

We have considered Preneolithic and Neolithic populations of the Island Southeast Asia (Table 4. B.5). The reason to include the Groups of *Homo sapiens* in the comparative studies is based on a question regarding chronological perspective, viz. Are there any characters' inheritance that survives through both different times; from the Pleistocene to the Holocene. If yes, what are the characters in common?

The use of Holocene *Homo sapiens* sample in this study is also helpful in the comparison with the Pleistocene hominins. It is meaningful to identify the apomorphies in *Homo sapiens* compared to the *Homo erectus* as well as to observe the variability among the populations of *Homo sapiens*.

c. Early Holocene *Homo sapiens*

The Group of the Early Holocene *Homo sapiens* (Table 4. B.5) consists of Preneolithic population from Late Pleistocene to Middle Holocene from several cave and shellmidden sites in Sumatra and Java.

NO.	SITE	CHRONOLOGY
1	Tamiang Shellmidden	12.000-4.000 BP
2	Sukajadi Shellmidden	7.000-5.000 BP
3	Gua Harimau (Lower Level)	14.000-5.000 BP
4	Gua Pawon	9.500-5.500 BP
5	Gua Braholo	12.000-4000 BP
6	Song Tritis	6.000-3.000 BP
7	Song Terus (Holocene)	9.400-5.700 BP
8	Song Keplek (Preneolithic)	8.000-4.500 BP
9	Gua Kidang	9.500 BP to Mid Holocene
10	Hoekgroot	10.500-6.500 BP
11	Gua Kecil	10.500-6.500 BP
12	Gua Djimbe	10.500-6.500 BP

Table 4. B.5. The early Holocene *Homo sapiens* group.

d. Late Holocene *Homo sapiens*

The Group of the Late Holocene *Homo sapiens* (Table 4. B.6) consists of the Late Holocene Neolithic and Paleometallic populations from two sites in Sumatra and Java. So far, there are very rare human remains from the context of the Neolithic cultural complex from the Late Holocene in Indonesia, and the two sites included in this research have significant value to represent such period.

NO.	SITE	CHRONOLOGY
1	Song Keplek (Neolithic)	3.200 BP
2	Gua Harimau (Upper Level)	2.800-1.800 BP

Table 4. B.6. The Late Holocene *Homo sapiens* group.

5. Result of the enlarged comparative study on second molars

a. Lower second molar

The morphological analysis of LM2 consists of 66 teeth (Appendix B Table B.7): 35 Pleistocene hominins (25 from Sangiran, 8 from Zhoukoudian, 2 from Wajak) and 31 Holocene *Homo sapiens* (5 from Northern Sumatra, 8 from Gua Harimau, 4 from Gua Pawon, 8 from Gunungsewu, 5 from Wajak Holocene caves, 1 from Gua Kidang).

Then, metric measurement on LM2 consists of 69 teeth (Appendix C Table C.7). Indeed 3 teeth were added: one from Zhoukoudian, one from Gunungsewu, and one from Wajak Holocene cave.

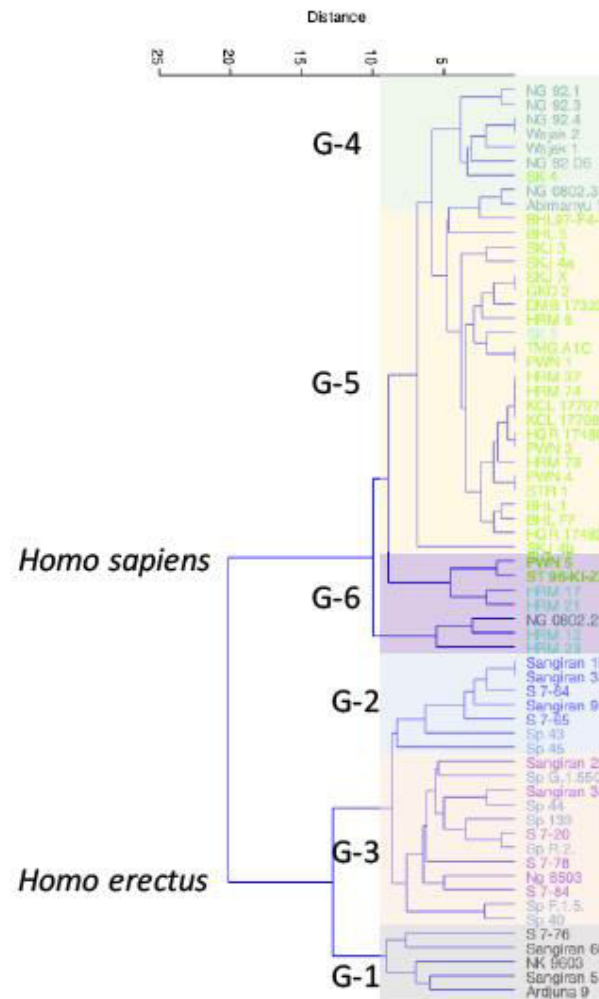

Fig. 4. B.4. Cluster Analysis of the LM2 of all teeth based on the dental features.

The cluster analysis on all of LM2 split the sample in 6 groups adding 2 new ones (Fig. 4. B.4.). The metric measurement helps to characterize the groups (Fig. 4. B.5.). They are described as follows:

- Members of Zhoukoudian *Homo erectus* splitted into two groups: G 2 and G 3, has medium size of MD and BL, with **square shape** relatively, six to seven cusps, **presence** of C5, C6 and/or C7, with **weak** distal accessories cusps and **small or absent** lingual accessory cusp, **weak presence** of deflecting wrinkle, middle and distal trigonid crest, crenulation, protostylid, Y groove pattern, mesial marginal ridge and anterior fovea, **weak presence or absent** of distal marginal ridge and posterior fovea.

- Group 5 (yellow box) shows **reduced** and **small size** of MD and BL, **square shape** relatively, **four cusps with plus (+) groove pattern**, **absent** of deflecting wrinkle, middle and distal trigonid crest, crenulation, protostylid, **absent** of mesial and distal marginal ridge, also anterior and posterior fovea.
- Group 6 (purple box) shows **reduced** and **small size** of MD and BL, **elongated MD shape** relatively, **four to five cusps with Y groove pattern**, **presence or absent** of C5, middle and distal trigonid crest, **weak or absent** mesial marginal ridge and anterior fovea, absent of deflecting wrinkle, crenulation, protostylid, distal marginal ridge and posterior fovea.

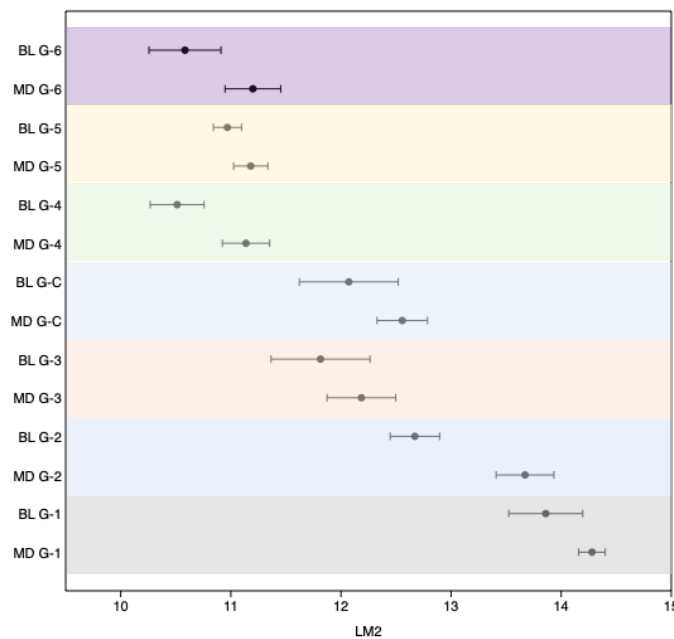

Fig. 4. B.5. Boxplot graphic of MD and BL measurements on the LM2 of all hominin specimens.
(G-C = Zhoukoudian *Homo erectus*)

The boxplot analysis of lower second molar (Fig. 4. B.5.) highlights that the size of the Pleistocene hominins is generally bigger than that of *Homo sapiens*. Within the Pleistocene hominins, the proportions are different: MD is clearly larger than BL in G-2 while values for both measurements overlap for G-1, G-3, and G-C (with a tendency for MD to be larger than BL).

The G-4 has smaller dimensions with values close to the G-5 and G-6, smaller compared to the *Homo erectus* but has a slightly similar composition with a tendency for MD to be larger than BL. The G-5 has an equal size of mesiodistal and buccolingual, different to the G-4 and G-6, which show elongated teeth (MD>BL) which means both group occurred the reduction of buccolingual size.

b. Upper second molar

The Morphological analysis of UM2 consists of 53 teeth (Appendix B Table B.15): 26 Pleistocene hominins (21 from Sangiran, 2 from Zhoukoudian, 1 from Lida Ajer, 2 from

Wajak) and 27 Holocene *Homo sapiens* (4 from Northern Sumatra, 6 from Gua Harimau, 3 from Gua Pawon, 9 from Gunungsewu, 4 from Wajak Holocene caves, 1 from Gua Kidang).

Then, metric measurement on UM2 consists of 57 teeth (Appendix C Table C.15). Indeed 4 teeth were added: two from Sangiran, one from Gunungsewu, and one from Wajak Holocene cave.

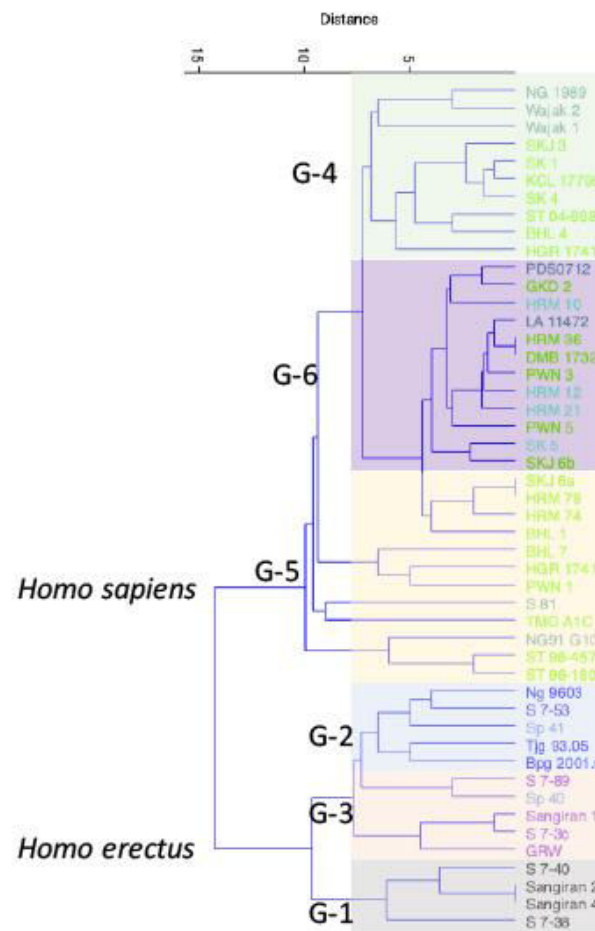

Fig. 4. B.6. Cluster Analysis of the UM2 of all teeth based on the dental features.

The same groups as the result of LM2 analysis were obtained on all of UM2 specimens based on non-metric features (Fig. 4. B.6.) and metric measurements (Fig. 4. B.7.), as follows:

- Members of Zhoukoudian *Homo erectus* splitted into two groups: G 2 and G 3, has **moderate size** of MD and BL with **rhombus shape**, five cusps, with **reduction** on C3 and C4, and **small present** of C5, **weak presence** of buccal accessories tubercle, crista obliqua, mesial marginal ridge, and anterior fovea, **weak present** or **absent** of transversal crest, crenulation, mesial marginal accessory tubercle, parastyle, distal marginal ridge, and posterior fovea. **Absent** lingual accessory tubercle and Carabelli.
- Group 5 (yellow box) shows **reduced** and **small size** of MD with elongated BL or **rhomboid shape**, **four cusps**, with **significant reduction** on C3 and C4, **weak present** of crista obliqua, mesial marginal accessory tubercle, **weak present** or **absent** of Carabelli, parastyle, mesial and distal marginal ridges, also anterior and posterior fovea. **Absent** of buccal and lingual accessory tubercle, transversal crest, crenulation.

- Group 6 (purple box) shows reduced and **small size** of MD with elongated BL or **rhomboid** shape, **four to five cusps**, with **significant reduction** on C3 and C4, and **weak present** or **absent** of C5, transversal crest, crista obliqua, mesial marginal accessory tubercle. **Absent** of buccal and lingual accessory tubercle, crenulation, Carabelli, parastyle, mesial and distal marginal ridges, also anterior and posterior fovea.

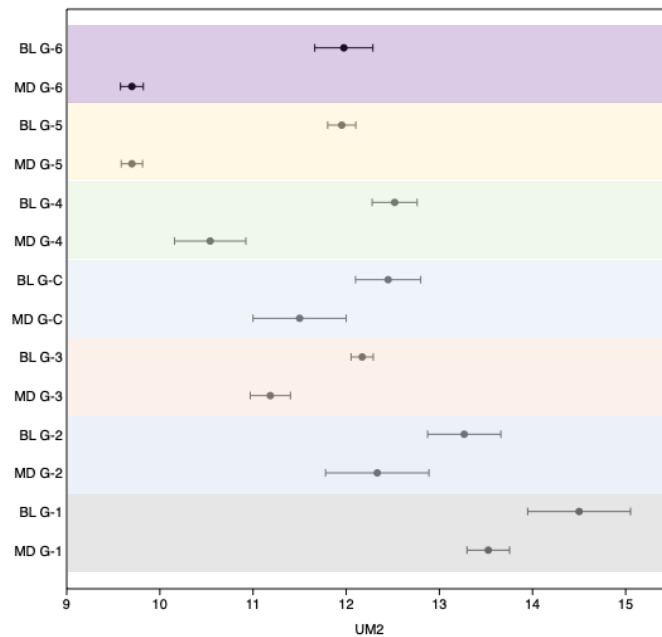

Fig. 4. B.7. Boxplot graphic of MD and BL measurements on the UM2 of all hominin specimens.
(G-C = Zhoukoudian *Homo erectus*)

The boxplot analysis of upper second molar (Fig. 4. B.7.) highlights that the size of the Pleistocene hominins is generally bigger than that of *Homo sapiens*, except G-3 and G-C Zhoukoudian *Homo erectus*. Within the Pleistocene hominins, the proportions are different: BL is clearly larger than MD in G-1 and G-2, while values for both measurements almost closed for G-2 and G-C (with a tendency for BL to be larger than MD).

The G-4 has smaller dimensions with values close to the G-5 and G-6, smaller compared to the *Homo erectus*. They have a clearly similar composition with the BL to be larger than MD. This composition means both the G-5 and G-6 have elongated shapes with buccolingual orientation.

Here are the summary of the characters from the hypothetical groups (Table. 4. B.10. and Table. 4. B.11.):

	Size	Shape	NC	C5	C6	C7	DW	MdTC	DTC	Cr	GP	Prd	MMR	DMR	AF	PF
ZKD	Med	MD	6/7	**/*	*	*	**	*	*	*	Y	**/*	*	*	*	*
G-5	Small	square	4	-	-	-	-	-	-	-	+	-	*/-	-	*/-	-
G-6	Med	square	4/5	*/-	-	-	-	*/-	*/-	-	Y	-	*/-	-	*/-	-

Table 4. B.7. Expression of the morphological characters of three additional groups on the LM2.

Note: NC = Number of Cusps, C5 = Size of Hypoconulid, C6 = Size of Entoconulid, C7 = Size of Metaconulid, MdTC = Middle Trigonid Crest, DTC = Distal Trigonid Crest, DW = Deflecting Wrinkle, Cr = Crenulation, GP = Groove Pattern, Posd = Protostylid, MMR = Mesial Marginal Ridge, DMR = Distal Marginal Ridge, AF = Anterior Fovea, PF = Posterior Fovea. Presence: *** = Pronounced, ** = Moderate, * = Faint. MD = elongated shape with mesiodistal orientation.

	Size	Shape	NC	C3	C4	C5	BAT	LAT	CO	TC	Cr	MMAT	CC	PasI	MMR	DMR	AF	PF
ZKD	Med	Rhombus	5	***	**	**/*	**/*	*	**/*	*	*	*	*	*	*	*	*	**
G-5	Small	BL	4	**	**	-	-	-	*	*/-	-	*/-	*/-	-	*/-	*/-	*/-	*/-
G-6	Small	BL	4/5	**	**	*/-	-	-	*/-	*/-	-	*/-	-	-	-	-	-	*/-

Table 4. B.8. Expression of the morphological characters of three additional groups on the UM2.

Note: NC = Number of Cusps, C3 = Size of Metacone, C4 = Size of Hypocone, C5 = Size of Metaconule, BAT = Buccal Accessory Tubercle, LAT = Lingual Accessory Tubercle, Cr = Crenulation, CO = Crista Obliqua, TC = Transversal Crest, MMAT = Mesial Marginal Accessory Tubercle, CC = Carrabelli's Cusp, PasI = Parastyle, MMR = Mesial Marginal Ridge, DMR = Distal Marginal Ridge, AF = Anterior Fovea, PF = Posterior Fovea. Presence: *** = Pronounced, ** = Moderate, * = Faint. BL = elongated shape with buccolingual orientation or Rhomboid shape.

Here is the list of Javan hominin specimens belonging to the groups

GROUP	LM2	UM2
G 1	Sangiran 5, Sangiran 6b, Arjuna 9, S 7-76, NK 9603	Sangiran 4, Sangiran 27, S 7-38, S 7-40
G 2	Sangiran 1b, Sangiran 9, Sangiran 37, S 7-64, S 7-65	Bpg 2001.04, Tjg 1993.05, Ng 9603, S 7-53
G 3	Sangiran 22, Sangiran 33, S 7-20, S 7-78, S 7-84, NG8503	Sangiran 17, GRW, S 7-3c, S 7-89
G 4	Wajak 1, Wajak 2, NG 92 D6, NG 92.1, NG 92.3, NG 92.4, Abimanyu 1, NG 0802.2	Wajak 1, Wajak 2, LA 11472, NG 91 G10, NG 1986, S 81, PDS 0712
G 5	Tamiang, Sukajadi, Gua Harimau lower layer, Gua Pawon, Gua Braholo, Song Tritis, Song Terus, Song Keplek preneolithic, Gua Kidang, Wajak Holocene caves	Tamiang, Sukajadi, Gua Harimau lower layer, Gua Pawon, Gua Braholo, Song Tritis, Song Terus, Song Keplek preneolithic, Gua Kidang, Wajak Holocene caves
G 6	Gua Harimau upper layer and SK 5	Gua Harimau upper layer and SK 5
ZKD	Zhoukoudian <i>Homo erectus</i>	Zhoukoudian <i>Homo erectus</i>

Table. 4. B.9. The list of the fossil teeth belonging to the groups.

6. Testing the predictions

Correlation between the dental groups based on morphological characters could be shown on the Linear Discriminant Analysis (LDA) by the jackknifed method. The 'given group' designed by the researcher are presented on the rows, and the 'predicted group' given by the LDA presented on the column, as follow:

	G-1	G-2	G-3	G-4	G-C	G-5	G-6	TOTAL
G-1	4	0	0	0	1	0	0	5
G-2	0	5	0	0	0	0	0	5
G-3	0	1	5	0	0	0	0	6
G-4	0	0	0	7	0	1	1	9
G-C	0	2	2	0	4	0	0	8
G-5	0	0	0	0	0	26	0	26
G-6	0	0	0	0	0	1	4	5
TOTAL	4	8	7	7	5	28	5	64

Table. 4. B.10. Linier Discriminant Analysis Matrix on the LM2. (G-C = Zhoukoudian *Homo erectus*).

The Discriminant matrix shows that the Zhoukoudian *Homo erectus* shares morphological character with G-2 (2 individuals) and G-3 (2 individuals) *Homo erectus* Java. The Pleistocene hominin of G-1 shares morphological characters with Zhoukoudian *Homo erectus* (1 individual) and the G-3 share with G-2 (1 individual). The *Homo sapiens* of G 4 shares morphological character with G-5 (1 individual), and G-6 (1 individual) *Homo sapiens*, also the G-6 shares with G-5 (1 individual) *Homo sapiens*.

Similar result showed on the LDA of upper second molar, as follow:

	G-1	G-2	G-3	G-4	G-C	G-5	G-6	TOTAL
G-1	4	0	0	0	0	0	0	4
G-2	0	2	1	0	1	0	0	4
G-3	0	0	3	0	1	0	0	4
G-4	0	0	0	4	0	2	1	7
G-C	0	1	1	0	0	0	0	2
G-5	0	0	0	4	0	13	6	23
G-6	0	0	0	0	0	2	2	4
TOTAL	4	3	5	8	2	17	9	48

Table. 4. B.11. Linier Discriminant Analysis Matrix on the UM2. (G-C = Zhoukoudian *Homo erectus*).

The discriminant matrix shows that the Zhoukoudian *Homo erectus* shares morphological character with G-2 (1 individual) and G-3 (1 individual) *Homo erectus* Java. The Pleistocene hominin of G-3 shares morphological character with Zhoukoudian *Homo erectus* (1 individual). The *Homo sapiens* of G-4 shares morphological characters with G-5 (2 individuals) and G-6 (1 individual) *Homo sapiens*, the G-5 shares with G-4 (4 individuals), and G-6 (6 individuals) *Homo sapiens*, also the G-6 shares with G-5 (2 individuals) *Homo sapiens*.

7. Application of the hypothetical groups

The approach developed for the M2, which has made it possible to distinguish several groups among the fossils studied, will be applied to the other tooth class and to the different comparison approaches. The aim is to test if it is possible to perform the same groups, which would reinforce the initial results. At the same time, this approach will allow us to test the ability of different teeth to discriminate between groups.

The application of the hypothetical groups produced from this case study will use the teeth located in the mandibular and maxillary arc context. The application aims to define the group identity of isolated teeth specimens, where are they belong to place. Here are the individual specimens :

	LI1	LI2	LC	LP3	LP4	LM1	LM2	LM3
G 1				S6a	S5, S6a	S5, S6a	S5, S6b, Arjuna 9	S6b, Arjuna 9
G 2			S9	S9	S1b, S9, S37	S1b, S37	S1b, S9, S37	S1b, S9, S37
G 3		S22b	S22b	S22b	S22b	S22b	S22b, NG 8503	S22b, NG 8503
G 4	Wajak 2	Wajak 2	Wajak 2	Wajak 2	Wajak 2	Wajak 2	Wajak 2	Wajak 2

Table 4. B.12. Application of the hypothetical groups on the mandibular teeth class.

	UI1	UI2	UC	UP3	UP4	UM1	UM2	UM3
G 1			S4	S4, S27	S4, S27	S4, S27	S4, S27	S4, S27
G 2				S15a, Tjg 9305	S15a, Tjg 9305	Tjg 9305, Bpg 2001.04	Tjg 9305, Bpg 2001.04	Tjg 9305, Bpg 2001.04
G 3	GRW	GRW	GRW, S17	GRW, S17	S7-3	S7-3, S17	GRW, S7- 3, S17	GRW, S7-3, S17
G 4			Wajak 2	Wajak 2	Wajak 2	Wajak 2	Wajak 2	Wajak 2

Table 4. B.13. Application of the hypothetical groups on the maxillary teeth class.

8. Limitations

The hypothesis has several limitations for certain tooth class, as there are not all members of the groups hypothesized in the case study have representation all of the tooth classes. Some limitations are :

- There is no sample of canine and incisor from the Group 1, also incisor of the Group 2 of the lower teeth.
- There is no sample of canine and incisor from the Group 2, also incisor of the Group 1 and Group 4 of the upper teeth.

C. MORPHOLOGICAL TRAITS

1. Morphological Traits of Mandibular Teeth

a. Lower Central Incisor

We observed the expression of the morphological features on 19 lower central incisors (Appendix B Table B.1): 6 Pleistocene hominins (2 from Sangiran, 3 from Zhoukoudian, 1 from Wajak) and 13 Holocene *Homo sapiens* (1 from Northern Sumatra, 5 from Gua Harimau, 5 from Gunungsewu, 1 from Wajak Holocene caves, 1 from Gua Kidang).

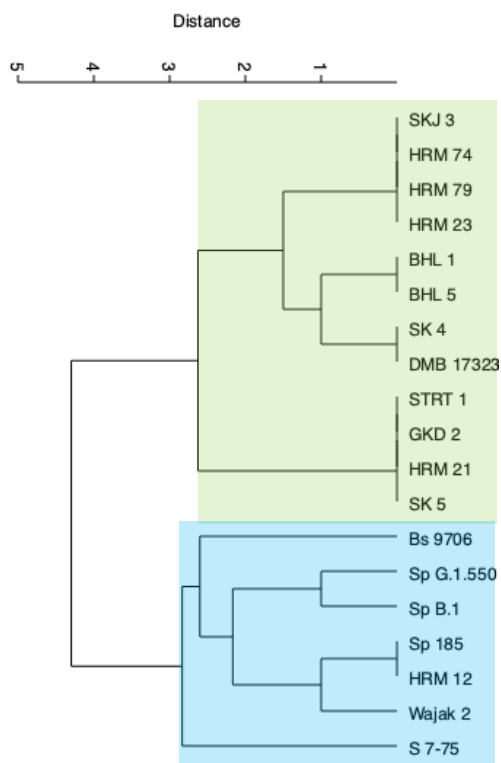

Fig. 4. C.1. The cluster analysis based on the morphological traits on the lower central incisors.

The cluster analysis based on the non-metric features of the lower central incisors (Fig. 4. C.1) separates them in two groups: one that includes the majority of *Homo sapiens* and the other dominated by Pleistocene hominins.

The group of *Homo sapiens* (green box) consists of:

- Dominated by Early Holocene *Homo sapiens* from Sukajadi, Gua Harimau lower layer, Gua Braholo, Song Keplek, Song Tritis, Gua Kidang, and Djimbe
- Late Holocene *Homo sapiens* from Gua Harimau upper layer and Song Keplek

The group dominated by Pleistocene hominins (blue box) consists of:

- Bs 9706 and S 7-75 of Javan *Homo erectus*
- Sp B1, Sp G1, and Sp 185 of Zhoukoudian *Homo erectus*
- Wajak 2 of Late Pleistocene *Homo sapiens*
- HRM 12 of Late Holocene *Homo sapiens*

Due to the small size of the sample, the analysis did not reveal the 6 groups as highlighted by the analysis done on M2 but it was effective in separating the oldest fossils from the most recent ones. This condition is probably due to the size of the sample (N=19 for the lower central incisor).

The split between the Pleistocene hominins and the *Homo sapiens* is caused by the presence of mesial and distal marginal ridges on the previous group with the expression of the lingual fovea of the lower central incisor. On the contrary, the last group has a simple shape.

We explained the presence of two *Homo sapiens* teeth (**Wajak 2** and **HRM 2**) within the Pleistocene hominins cluster is caused by the appearance of the lingual fovea and the marginal ridge characters of the lower central incisor on those specimens, which generally absent in the *Homo sapiens* groups.

b. Lower Lateral Incisor

We observed the expression of the morphological features on 30 lower lateral incisors (Appendix B Table B.2): 10 Pleistocene hominins (4 from Sangiran, 5 from Zhoukoudian, 1 from Wajak) and 20 Holocene *Homo sapiens* (2 from Northern Sumatra, 7 from Gua Harimau, 1 from Gua Pawon, 7 from Gunungsewu, 3 from Wajak Holocene caves, 1 from Gua Kidang).

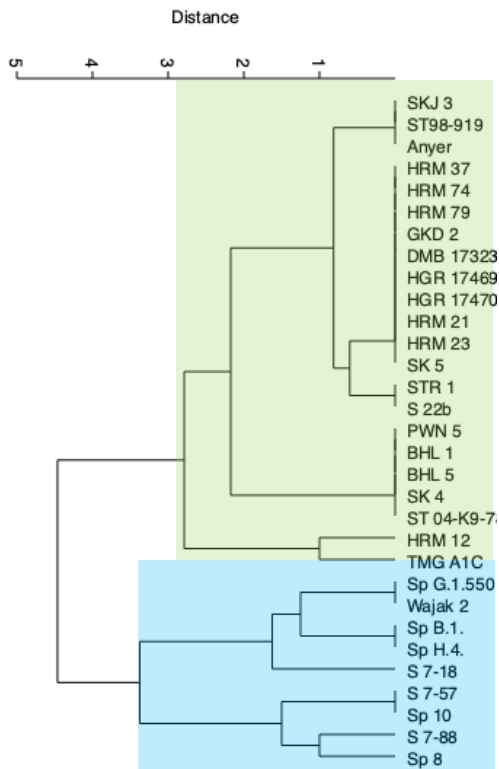

Fig. 4. C.2. The cluster analysis based on the morphological traits on the lower lateral incisors.

The cluster analysis based on the non-metric features of the lower lateral incisors (Fig. 4. C.2) separates them in two groups: one dominated by *Homo sapiens* and the other by Pleistocene hominins.

The group of *Homo sapiens* (green box) consists of:

- Early Holocene *Homo sapiens* from Tamiang, Sukajadi, Gua Harimau, Gua Pawon, Gua Braholo, Song Keplek, Song Terus, Song Tritis, Gua Kidang, Hoekgrot, and Djimbe
- Late Holocene *Homo sapiens* from Gua Harimau and Song Keplek
- Sangiran 22b of Javan *Homo erectus*

The group dominated by Pleistocene hominins (blue box) consists of:

- S 7-18, S 7-57, and S 7-88 of Javan *Homo erectus*
- Sp B1, Sp G1, Sp H4, Sp 8, and Sp 10 of Zhoukoudian *Homo erectus*
- Wajak 2 of Late Pleistocene *Homo sapiens*

Due to the small size of the sample, the analysis did not reveal the 6 groups as highlighted by the analysis done on M2 but it was effective in separating the oldest fossils from the most recent ones.

The split of the Pleistocene hominins and *Homo sapiens* groups are caused by the presence of mesial and distal marginal ridges on the previous group with the expression of the lingual fovea of the lower lateral incisor. On the contrary, the last group has a simple shape.

We explained the presence of **Wajak 2** from the *Homo sapiens* specimen in the cluster of Pleistocene hominins is caused by the appearance of the lingual fovea and the marginal ridge characters on the specimen which generally absent in the *Homo sapiens* groups. In contrary, the presence of **Sangiran 22b** from the *Homo erectus* specimen in the cluster of early *Homo sapiens* is caused by the absence of the lingual fovea character of the lower lateral incisor.

c. Lower Canine

We observed the expression of the morphological features on 29 lower canines (Appendix B Table B.3): 7 Pleistocene hominins (2 from Sangiran, 4 from Zhoukoudian, 1 from Wajak) and 22 Holocene *Homo sapiens* (3 from Northern Sumatra, 7 from Gua Harimau, 2 from Gua Pawon, 7 from Gunungsewu, 2 from Wajak Holocene caves, 1 from Gua Kidang).



Fig. 4. C.3. The cluster analysis based on the morphological traits on the lower canines.

The cluster analysis based on the non-metric features of the lower canine (Fig. 4. C.3) separates them in three groups: a group of *Homo sapiens*, a mixed group between *Homo sapiens* and Pleistocene hominin, and a group of Pleistocene hominins.

The group of *Homo sapiens* (dark green box) consists of:

- Wajak 2 of Late Pleistocene *Homo sapiens*
- Early Holocene *Homo sapiens* from Tamiang, Sukajadi, Gua Harimau, Gua Pawon, Song Terus, Song Tritis, Wajak, and Djimbe

The group of Pleistocene hominins (blue box) consists of:

- S 7 59 and Sangiran 22b of Javan *Homo erectus*
- Sp H4 and Sp 17 of Zhoukoudian *Homo erectus*

The mixed group of Early and Late Holocene *Homo sapiens* (green box) consists of:

- Early Holocene *Homo sapiens* from Sukajadi, Gua Harimau, Gua Braholo, Song Keplek, and Gua Kidang
- Late Holocene *Homo sapiens* from Gua Harimau and Song Keplek
- Sp B.1 and Sp G.1 of Zhoukoudian *Homo erectus*

The cluster analysis on lower canine is only split the samples into three groups which dominated by *Homo sapiens*, or Pleistocene hominins, and a group which mixed between *Homo sapiens* and Pleistocene hominins. The cluster analysis could not present the hypothesis of six groups.

The cluster analysis on lower canine is only split the samples into three groups which dominated by *Homo sapiens*, or Pleistocene hominins, and a group which mixed between *Homo sapiens* and Pleistocene hominins. The cluster analysis could not present the hypothesis of six groups but it succeed in separating the oldest fossils.

The split of the Pleistocene hominins and *Homo sapiens* groups on the lower canine are caused by the presence of asymmetric or less symmetric shape on the previous group with the extension of the mesiobuccal and distolingual corner of the lower canine. On the contrary, the last group has a symmetric shape. The split among the group of *Homo sapiens* is caused by the presence or absence of the lingual fovea and the marginal ridge characters. This split is correlated to the chronological difference.

d. Lower Third Premolar

We observed the expression of the morphological features on 33 lower third premolars (Appendix B Table B.4): 14 Pleistocene hominins (6 from Sangiran, 1 from Patiayam, 1 from Trinil, 7 from Zhoukoudian, 1 from Wajak) and 19 Holocene *Homo sapiens* (3 from Northern Sumatra, 7 from Gua Harimau, 1 from Gua Pawon, 5 from Gunungsewu, 3 from Wajak Holocene caves).

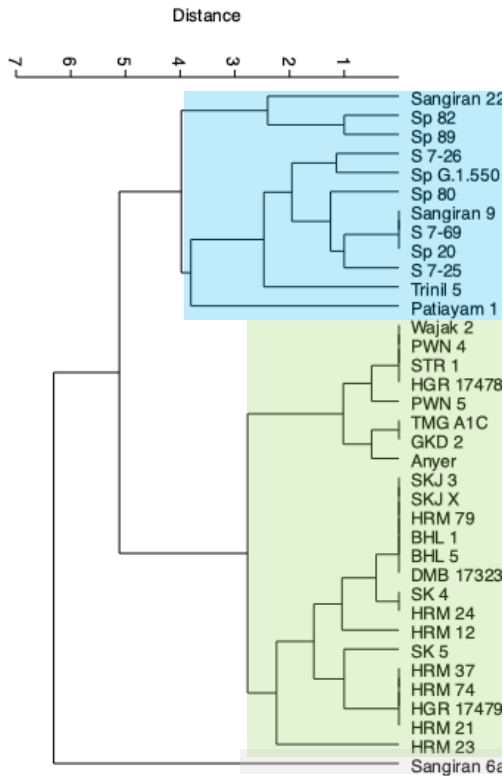

Fig. 4. C.4. The cluster analysis based on the morphological traits on the lower third premolars.

The cluster analysis based on the non-metric features of the lower third premolar (Fig. 4. C.4) separates them in three groups: a group of robust *Homo erectus*, a mixed group between Javan *Homo erectus* and Zhoukoudian *Homo erectus*, and a group mixed between Late Pleistocene, Early and Late Holocene *Homo sapiens*.

The group which mixed between Javan and Zhoukoudian *Homo erectus* (blue box) consists of:

- S 7-69, Trinil 5 and Sangiran 9 of G 2 Javan *Homo erectus*
- S 7-25, S 7-26, Patiayam 1 and Sangiran 22b of G 3 Javan *Homo erectus*
- Sp 20, Sp 80, Sp 82, and Sp 89 of Zhoukoudian *Homo erectus*

The group dominated by *Homo sapiens* (green box), could be split into two sub groups:

- A sub group consists of Wajak of Late Pleistocene *Homo sapiens* and Early Holocene *Homo sapiens* from Tamiang, Sukajadi, Gua Harimau, Gua Pawon, Gua Braholo, Song Keplek, Song Tritis, Gua Kidang, Hoekgrot, and Djimbe
- A sub group consists of Early Holocene *Homo sapiens* and Late Holocene *Homo sapiens* from Gua Harimau and Song Keplek

The robust *Homo erectus* (grey box) consists of:

- Sangiran 6a of robust *Homo erectus*.

The cluster analysis on lower third premolar is split the samples into three groups which consist of robust *Homo erectus*, a group which mixed between *Homo erectus* Java and China, also a mixed group of Late Pleistocene, Early Holocene and Late Holocene *Homo sapiens*. The cluster analysis partially confirms the hypothesis of six groups.

The split of the Pleistocene hominins and *Homo sapiens* groups are caused by the presence of asymmetric or less symmetric shape on the previous group with the extension of the mesiobuccal and distolingual corner of the lower third premolar. On the contrary, the last group has a symmetric shape. The **Sangiran 6a** specimen, which located far from both previous groups, is caused by an unusual asymmetric shape of the specimen. The split among the group of *Homo sapiens* is caused by the difference shape of the mesial and distal triangular fossa also by the presence or absence of the marginal ridge and accessories ridge characters. This split is correlated to the chronological difference.

e. Lower Fourth Premolar

We observed the expression of the morphological features on 36 lower fourth premolars (Appendix B Table B.5): 13 Pleistocene hominins (9 from Sangiran, 7 from Zhoukoudian, 1 from Wajak) and 23 Holocene *Homo sapiens* (3 from Northern Sumatra, 10 from Gua Harimau, 2 from Gua Pawon, 6 from Gunungsewu, 3 from Wajak Holocene caves, 1 from Gua Kidang).

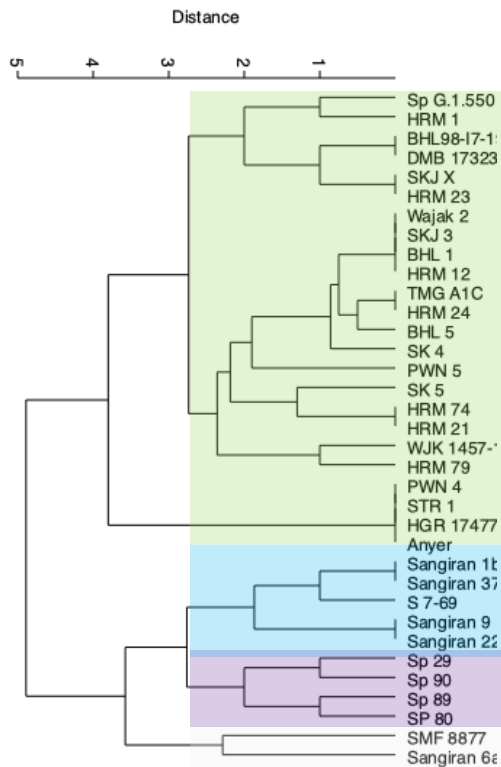

Fig. 4. C.5. The cluster analysis based on the morphological traits on the lower fourth premolars.

The cluster analysis based on the non-metric features of the lower fourth premolar (Fig. 4. C.5) separates them in two main groups: one with *Homo erectus* and the other with *Homo sapiens*, except one tooth from Zhoukoudian. Lower fourth premolar seems efficient to discriminate between *Homo erectus* and *Homo sapiens*.

The group of *Homo erectus* could be divided into three subgroups: a group of robust *Homo erectus*, a group of Zhoukoudian *Homo erectus*, a mixed group between Javan *Homo erectus*. The group of *Homo sapiens* also could be divided into three subgroups which consist of Late Pleistocene, Early and Late Holocene *Homo sapiens*.

The group dominated by *Homo sapiens* (green box), could be splitted into three sub groups:

- A sub group consists of Sp G.1 from Zhoukoudian *Homo erectus*, Early Holocene *Homo sapiens* and G 6 Late Holocene *Homo sapiens*
- A sub group consists of Wajak from Late Pleistocene *Homo sapiens*, Early Holocene *Homo sapiens*, and Late Holocene *Homo sapiens* from Tamiang, Sukajadi, Gua Harimau, Gua Pawon, Gua Braholo, Song Keplek, Wajak, and Djimbe
- A sub group consists of Early Holocene *Homo sapiens* and Late Holocene *Homo sapiens* from Song Tritis and Hoekgrot

The group which mixed of Javan *Homo erectus* (blue box) consists of:

- Sangiran 1b, Sangiran 9, and Sangiran 37 of G 2 Javan *Homo erectus*
- S 7-69 and Sangiran 22b of G 3 Javan *Homo erectus*

The group of Zhoukoudian *Homo erectus* (purple box) consists of:

- Sp 29, Sp 80, Sp 89, and Sp 90 of Zhoukoudian *Homo erectus*

The group of robust *Homo erectus* (grey box) consists of:

- SMF 8877 and Sangiran 6a of robust *Homo erectus*

The split of the Pleistocene hominins and *Homo sapiens* groups are caused by the presence of asymmetric or less symmetric shape on the previous group with the extension of the mesiobuccal and distolingual corner of the lower fourth premolar. On the contrary, the last group has a symmetric shape.

The **Sangiran 6a** and **SMF 8877** specimens of *robust Homo erectus*, which located far from other *Homo erectus* groups, is caused by an unusual asymmetric shape of the specimen.

The split among the group of *Homo erectus* is caused by a double of lingual essential ridge and a pronounced of mesial triangular fossa characters which presented on the Zhoukoudian *Homo erectus*. On the contrary, the Javan *Homo erectus* shows a single of lingual essential ridge and a less pronounced of mesial triangular fossa characters.

The split among the group of *Homo sapiens* is caused by the difference shape of the mesial and distal triangular fossa also by the presence or absence of the marginal ridge and accessories ridge characters. This split is not correlated to the chronological difference.

f. Lower First Molar

We observed the expression of the morphological features on 46 lower first molars (Appendix B Table B.6): 21 Pleistocene hominins (14 from Sangiran, 1 from Miri, 4 from Zhoukoudian, 2 from Wajak) and 25 Holocene *Homo sapiens* (5 from Northern Sumatra, 6 from Gua Harimau, 2 from Gua Pawon, 6 from Gunungsewu, 3 from Wajak Holocene caves).

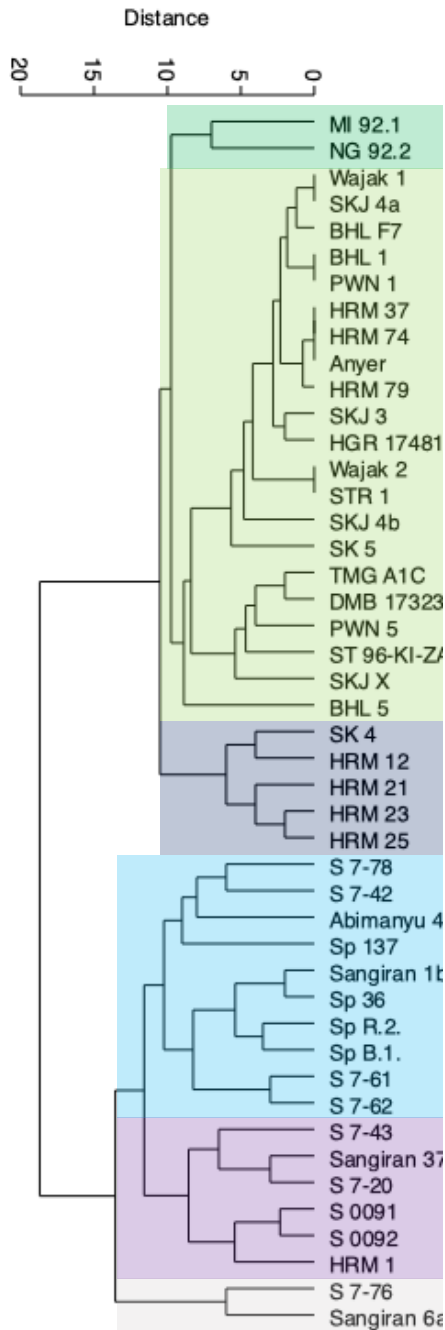

Fig. 4. C.6. The cluster analysis based on the morphological traits on the lower first molars.

The cluster analysis based on the non-metric features of the lower first molar (Fig. 4. C.6) separates them in two main groups: one with *Homo erectus* and the other with *Homo sapiens*. Lower first molar seems efficient to discriminate between *Homo erectus* and *Homo sapiens*.

The group of *Homo erectus* could be divided into three subgroups: a group of robust *Homo erectus*, a mixed group between Javan *Homo erectus* and Zhoukoudian *Homo erectus*, a group of Javan *Homo erectus*.

The group of *Homo sapiens* also could be divided into three subgroups: a group of Pleistocene hominins, a group which dominated by Early Holocene *Homo sapiens*, and a group which dominated by Late Holocene *Homo sapiens*.

The Pleistocene hominin (dark green box) consists of:

- MI 92.1 and NG 92.2 of Pleistocene hominin from Miri and Ngebung

The group which dominated by Early Holocene *Homo sapiens* (green box) consists of:

- Wajak 1 of Late Pleistocene *Homo sapiens*
- Early Holocene *Homo sapiens* from Tamiang, Sukajadi, Gua Harimau, Gua Pawon, Gua Braholo, Song Terus, Song Keplek, Song Tritis, Hoekgrot, and Djimbe
- Late Holocene *Homo sapiens* from Gua Harimau

The group which dominated by Late Holocene *Homo sapiens* (dark grey box) consists of:

- Late Holocene *Homo sapiens* from Gua Harimau
- SK 4 of Early Holocene *Homo sapiens*

The group which mixed between Javan and Zhoukoudian *Homo erectus* (blue box) consists of:

- S 7-42, S 7-61, S 7-62, S 7-78, Abimanyu 4, and Sangiran 1b of G 2 Javan *Homo erectus*
- Sp B1, Sp R2, Sp 36, and Sp 137 of Zhoukoudian *Homo erectus*

The Javan *Homo erectus* (purple box) consists of:

- S 7-20, S 7-43, S 0091, S 0092, and Sangiran 37 of G 3 Javan *Homo erectus*
- An exceptional of HRM 1 from Late Holocene *Homo sapiens*

The robust *Homo erectus* (grey box) consists of:

- Sangiran 6a and S 7-76 of robust *Homo erectus*

The cluster analysis on lower first molar is split the samples into six groups which consist of robust *Homo erectus*, a group which mixed between Javan and Zhoukoudian *Homo erectus*, Javan *Homo erectus*, Pleistocene hominins, a group which dominated by Early Holocene *Homo sapiens*, and a group which dominated by Late Holocene *Homo sapiens*. The cluster analysis confirms the hypothesis of six groups.

The split of the Pleistocene hominins and *Homo sapiens* groups in the lower first molar are caused by the presence of crenulation, deflecting wrinkle, middle and distal trigonid crest, also distal marginal ridge and posterior fovea on the previous group. On the contrary, the last group has the absence of those characters.

The split among the group of *Homo erectus* is caused by the difference of the expression of C5-C6-C7 accessories cusps and the crenulation. Zhoukoudian *Homo erectus* are spread in the cluster together with G 2 and G 3 Javan *Homo erectus*. The **Sangiran 6a** and **S 7-76** specimens of robust *Homo erectus*, which located far from *Homo erectus* groups, is caused by the presence of a pronounced protostylid and middle trigonid crest characters.

The Pleistocene Hominin of **MI 92.1** and **NG 92.2**. which included in the cluster of *Homo sapiens* are caused the absent of crenulation, deflecting wrinkle, middle and distal trigonid crest, also distal marginal ridge and posterior fovea.

The split among the group of *Homo sapiens* in the lower first molar is caused by the different number of the cusps, the expression of the C5 accessory cusp, the groove pattern, deflecting wrinkle, middle and distal trigonid crest. This split is correlated to the chronological difference. The Early Holocene *Homo sapiens* show an absence of those characters means they have a simple occlusal morphology. On the contrary, the Late Holocene *Homo sapiens* from **Gua Harimau** upper level show the presence of such characters means they have more complicated occlusal morphology compared to the previous group.

g. Lower Third Molar

We observed the expression of the morphological features on 45 lower third molars (Appendix B Table B.8): 23 Pleistocene hominins (13 from Sangiran, 8 from Zhoukoudian, 2 from Wajak) and 22 Holocene *Homo sapiens* (2 from Northern Sumatra, 6 from Gua Harimau, 4 from Gua Pawon, 8 from Gunungsewu, 2 from Wajak Holocene caves, 1 from Gua Kidang).

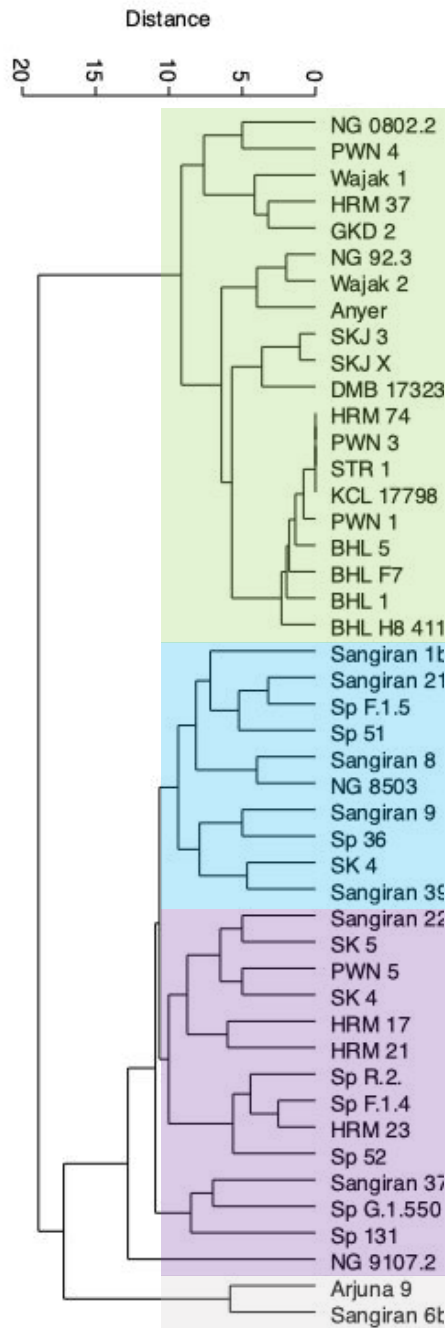

Fig. 4. C.7. The cluster analysis based on the morphological traits on the lower third molars.

The cluster analysis based on the non-metric features of the lower third molar (Fig. 4. C.7) separates them in four groups: a group of robust *Homo erectus*, a mixed group between G 2 Javan and Zhoukoudian *Homo erectus*, a group which mixed between G 3 Javan and

Zhoukoudian *Homo erectus*, and a mixed group between Late Pleistocene, Early and Late Holocene *Homo sapiens*.

The group of dominated by *Homo sapiens* (green box) consists of:

- NG 0802.2, NG 92.3 Middle Pleistocene hominin and Wajak 2 of Late Pleistocene *Homo sapiens*
- Early Holocene *Homo sapiens* and Late Holocene *Homo sapiens* from Gua Harimau, Gua Pawon, Gua Braholo, Song Tritis, Gua Kidang, Goea Ketjil, and Djimbe
- Late Holocene *Homo sapiens* from Gua Harimau

The group which mixed between G 2 Javan and Zhoukoudian *Homo erectus* (blue box) consists of:

- Sangiran 1b, Sangiran 21, Sangiran 8, Sangiran 9, Sangiran 39 and NG 8503 of G 2 Javan *Homo erectus*
- Sp F1, Sp 36, and Sp 51 of Zhoukoudian *Homo erectus*
- SK 4 of G 5 Early Holocene *Homo sapiens*

The group which mixed between G 3 Javan and Zhoukoudian *Homo erectus* (purple box) consists of:

- NG 9107.2, Sangiran 22b and Sangiran 37 of G 3 *Homo erectus* Java
- Sp R2, Sp F1, Sp 52, and Sp 131 of Zhoukoudian *Homo erectus*
- G 6 Late Holocene *Homo sapiens* from Gua Harimau and Song Keplek

The robust *Homo erectus* (grey box) consists of:

- Sangiran 6b and Arjuna 9 of robust *Homo erectus*

The cluster analysis on lower third molar is split the samples into four groups which consist of robust *Homo erectus*, a group which mixed between G 2 Javan and Zhoukoudian *Homo erectus*, a group which mixed between G 3 Javan and Zhoukoudian *Homo erectus*, and a group which dominated by *Homo sapiens*. The cluster analysis confirms the first three hypothesized groups, and present a mixed of the last three hypothesized groups.

The split of the Pleistocene hominins and *Homo sapiens* groups in the lower third molar are caused by the presence of crenulation, deflecting wrinkle, middle and distal trigonid crest, also distal marginal ridge and posterior fovea on the previous group. On the contrary, the last group has the absence of those characters.

The split among the group of *Homo erectus* is caused by the difference of the expression of C5-C6-C7 accessories cusps and the crenulation. Zhoukoudian *Homo erectus* are spread in the cluster together with G 2 and G 3 Javan *Homo erectus*. The **Arjuna 9** and **Sangiran 6b** specimens of robust *Homo erectus*, which located far from *Homo erectus* groups, is caused by the presence of a pronounced protostylid and middle trigonid crest characters.

The split among the group of *Homo sapiens* in the lower third molar is caused by the different number of the cusps, the expression of the C5 accessory cusp, the groove pattern, deflecting wrinkle, middle and distal trigonid crest. There is a tendency that the split correlated to the chronological difference, but not strict because the archaic character reappear in the Late Holocene *Homo sapiens* specimens.

2. Morphological Traits of Maxillary Teeth

a. Upper Central Incisor

We observed the expression of the morphological features on 27 upper central incisors (Appendix B Table B.9): 10 Pleistocene hominins (6 from Sangiran, 1 from Miri, 1 from Lida Ajer, 2 from Zhoukoudian) and 17 Holocene *Homo sapiens* (2 from Northern Sumatra, 5 from Gua Harimau, 2 from Gua Pawon, 5 from Gunungsewu, 2 from Wajak Holocene caves, 1 from Gua Kidang).

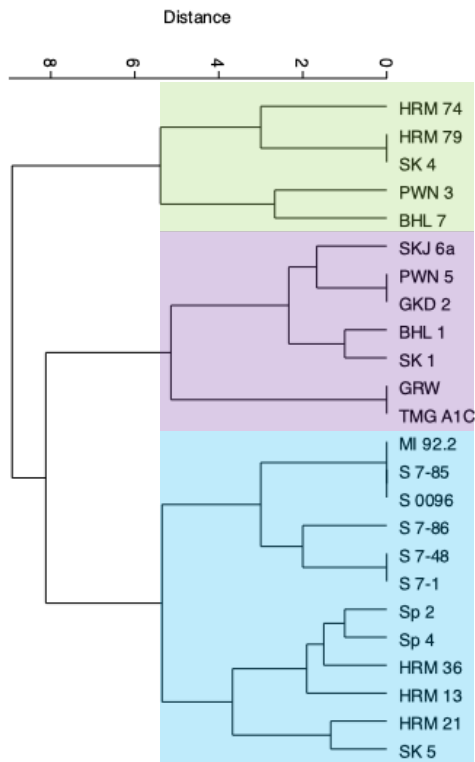

Fig. 4. C.8. The cluster analysis based on the morphological traits on the upper central incisors.

The cluster analysis based on the non-metric features of the upper central incisors (Fig. 4. C.8) separates them in three groups: two groups dominated by *Homo sapiens* and a mixed group between Pleistocene hominins and *Homo sapiens*.

The group of Early Holocene *Homo sapiens* (green box) consists of:

- Early Holocene *Homo sapiens* from Gua Harimau, Gua Pawon, Gua Braholo and Song Kepek

The group mixed between Early Holocene *Homo sapiens* and early hominin (purple box) consists of:

- Early Holocene *Homo sapiens* from Tamiang, Sukajadi, Gua Pawon, Gua Braholo, Song Kepek, and Gua Kidang
- An exceptional of GRW member of Javan *Homo erectus*

The group mixed between Pleistocene hominin and *Homo sapiens* (blue box) which could be divided into two sub groups consists of:

- A subgroup of Javan *Homo erectus* consists of MI 92.2, S 0096, S 7-1, S 7-48, S 7-85, and S 7-86
- A subgroup mixed of Zhoukoudian *Homo erectus* and Late Holocene *Homo sapiens* consists of Sp 2 and Sp 4 also *Homo sapiens* from Gua Harimau and Song Kepek

The cluster analysis on upper central incisor is only split the samples into three groups which consist of two groups dominated by *Homo sapiens*, and a group mixed between Pleistocene hominins and *Homo sapiens*. The cluster analysis could not present the hypothesis of six groups.

The split between those groups in the upper central incisor is represented by the different expressions of the labial convexity, shovel shape, lingual fovea, also mesial and distal marginal ridges. The Pleistocene hominins, especially the Zhoukoudian *Homo erectus*, has low expression of the labial convexity but a pronounced expression of the shovel shape, and the presence of the lingual fovea with mesial and distal marginal ridges. On the contrary, Early Holocene *Homo sapiens* has pronounced expression of the labial convexity but absent of the shovel shape, lingual fovea, and the marginal ridges, which means they have simple morphological shape compared to the *Homo erectus* group.

The presence of **Grogolanwetan** from the *Homo erectus* specimen in the cluster of Early Holocene *Homo sapiens* is caused by the absence of the shovel shape, lingual fovea, and the marginal ridges. In contrary, the presence of **SK 4, HRM 13, HRM 21, HRM 36** from the Late Holocene *Homo sapiens* specimen in the cluster of Zhoukoudian *Homo erectus* is caused by low expression of the labial convexity but pronounced expression of the shovel shape, and the presence of the lingual fovea with mesial and distal marginal ridges.

b. Upper Lateral Incisor

We observed the expression of the morphological features on 22 upper lateral incisors (Appendix B Table 4. C.10): 7 Pleistocene hominins (5 from Sangiran, 1 from Miri, 2 from Zhoukoudian) and 15 Holocene *Homo sapiens* (1 from Northern Sumatra, 5 from Gua Harimau, 2 from Gua Pawon, 3 from Gunungsewu, 3 from Wajak Holocene caves, 1 from Gua Kidang).

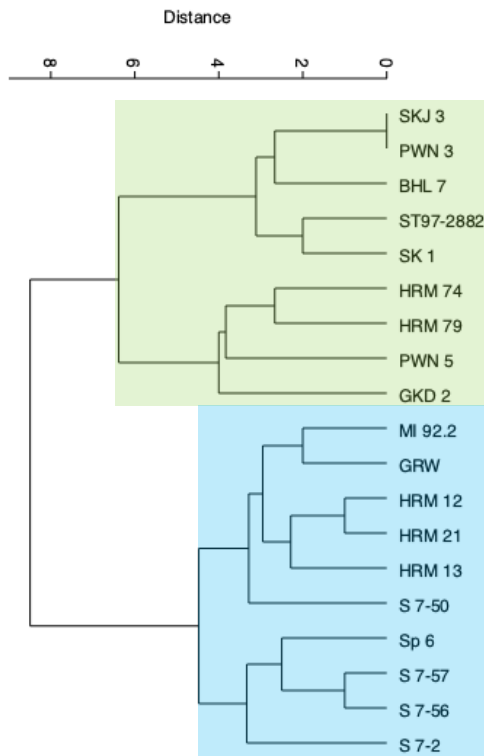

Fig. 4. C.9. The cluster analysis based on the morphological traits on the upper lateral incisors.

The cluster analysis based on the non-metric features of the upper lateral incisors (Fig. 4. C.9) separates them in two groups: one dominated by *Homo sapiens* and the other a mixed group between Pleistocene hominins and *Homo sapiens*.

The group of Early Holocene *Homo sapiens* (green box) consists of:

- Early Holocene *Homo sapiens* from Sukajadi, Gua harimau, Gua Pawon, Gua Braholo, Song Terus, Song Keplek, and Gua Kidang

The group mixed between Pleistocene hominin and *Homo sapiens* (blue box) which could be divided into two sub groups consists of:

- A subgroup mixed of Javan *Homo erectus* and Late Holocene *Homo sapiens* consists of MI 92.2, Grogolanwetan, S 7-50 and *Homo sapiens* from Gua Harimau
- A subgroup mixed of Javan *Homo erectus* and Zhoukoudian *Homo erectus* consists of Sp 6, S 7-2, S 7-56, and S 7-57

The cluster analysis on upper lateral incisor is only split the samples into two groups which consist of a group of *Homo sapiens*, and a group mixed between Pleistocene hominins and *Homo sapiens*. The cluster analysis could not present the hypothesis of six groups.

The split between those groups in the upper lateral incisor is represented by the different expressions of the labial convexity, shovel shape, lingual fovea, also mesial and distal marginal ridges. The Pleistocene hominins, especially the Zhoukoudian *Homo erectus*, has low expression of the labial convexity but a pronounced expression of the shovel shape, and the presence of the lingual fovea with mesial and distal marginal ridges. On the contrary, Early Holocene *Homo sapiens* has pronounced expression of the labial convexity but absent of the shovel shape, lingual fovea, and the marginal ridges, which means they have simple morphological shape compared to the *Homo erectus* group.

The presence of **HRM 12**, **HRM 21**, **HRM 36** from the Late Holocene *Homo sapiens* specimen in the cluster of *Homo erectus* is caused by low expression of the labial convexity but pronounced expression of the shovel shape, and the presence of the lingual fovea with mesial and distal marginal ridges.

c. Upper Canine

We observed the expression of the morphological features on 37 upper canines (Appendix B Table B.11): 13 Pleistocene hominins (8 from Sangiran, 4 from Zhoukoudian, 1 from Wajak) and 24 Holocene *Homo sapiens* (1 from Northern Sumatra, 7 from Gua Harimau, 2 from Gua Pawon, 6 from Gunungsewu, 7 from Wajak Holocene caves, 1 from Gua Kidang).

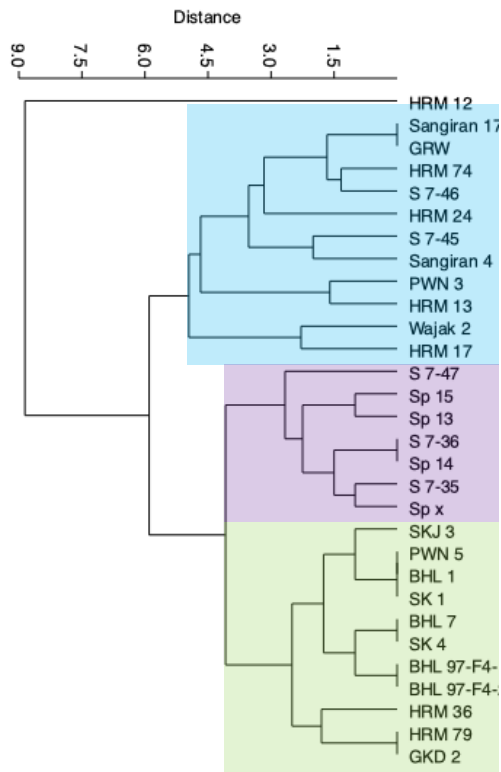

Fig. 4. C.10. The cluster analysis based on the morphological traits on the upper canines.

The cluster analysis based on the non-metric features of the upper canine (Fig. 4. C.10) separates them in three groups: one dominated by *Homo sapiens*, one dominated by Pleistocene hominins, and the other a mixed group between Pleistocene hominins and *Homo sapiens*.

The group mixed between Pleistocene hominin and *Homo sapiens* (blue box) which could be divided into two sub groups consists of:

- A subgroup mixed of Javan *Homo erectus* with Early and Late Holocene *Homo sapiens* consists of Sangiran 4, Sangiran 17, Grogolanwetan, S 7-45, S 7-46, and *Homo sapiens* from Gua Harimau lower level, Gua Pawon also Wajak 2
- A subgroup mixed Late Pleistocene, Early and Holocene *Homo sapiens* from Wajak, Gua Harimau, and Gua Pawon

The group of Pleistocene hominin (purple box) consists of:

- S 7-35, S 7-36, and S 7-47 of *Homo erectus* Java
- Sp x, Sp 13, Sp 14, and Sp 15 of Zhoukoudian *Homo erectus*

The group of *Homo sapiens* (green box) consists of:

- Early Holocene *Homo sapiens* from Sukajadi, Gua Harimau, Gua Pawon, Gua Braholo, Song Keplek, and Gua Kidang

The cluster analysis on upper canine is only split the samples into three groups which consist of a group of *Homo sapiens*, a group of Pleistocene Hominins and a group mixed between Pleistocene hominins and *Homo sapiens*. The cluster analysis could not present the hypothesis of six groups.

The split of the Pleistocene hominins and *Homo sapiens* groups on the upper canine are caused by the presence of asymmetric or less symmetric shape on the previous group with the extension of the mesiobuccal and distolingual corner of the upper canine. On the contrary, the last group has a symmetric shape. The split among the group of *Homo sapiens* is caused by the presence or absence of the lingual fovea and the marginal ridges characters. This split is not correlated to the chronological difference.

The presence of **Sangiran 4**, **Sangiran 17**, **Grogolanwetan, S 7-45**, and **S 7-46** in the cluster of *Homo sapiens* together with Gua Harimau lower level, Gua Pawon also Wajak 2 is caused by the absence of the shovel shape, lingual fovea, and the marginal ridges.

One exception is the individu of **HRM 12** which located far from others groups, caused by the extreme presence of dental tubercle, also pronounced of sentral marginal ridge dan distal accessory ridge. We do not have yet any explanation why this individual has such different morphological characters.

d. Upper Third Premolar

We observed the expression of the morphological features on 40 upper third premolars (Appendix B Table B.12): 17 Pleistocene hominins (14 from Sangiran, 1 from Zhoukoudian, 2 from Wajak) and 23 Holocene *Homo sapiens* (3 from Northern Sumatra, 8 from Gua Harimau, 3 from Gua Pawon, 5 from Gunungsewu, 3 from Wajak Holocene caves, 1 from Gua Kidang).

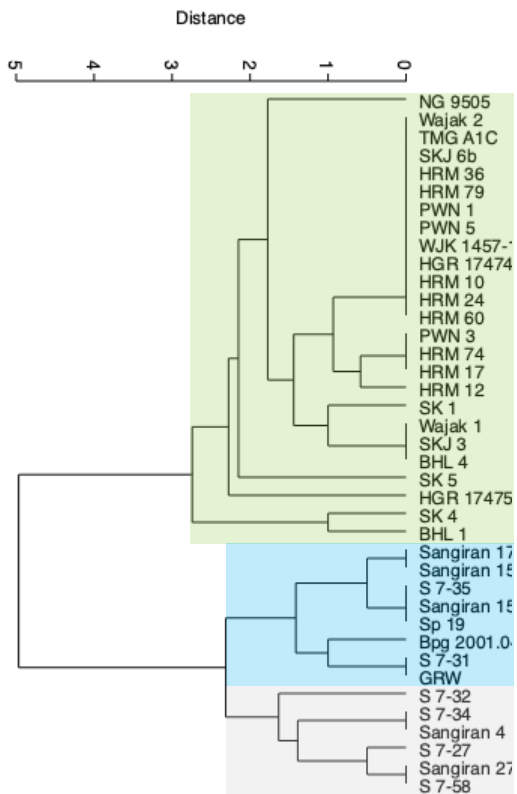

Fig. 4. C.11. The cluster analysis based on the morphological traits on the upper third premolars.

The cluster analysis based on the non-metric features of the upper third premolar (Fig. 4. C.11) separates them in two main groups: one dominated by *Homo sapiens*, and the other is early hominins, which could be divided into two sub groups.

The group of *Homo sapiens* (green box) consists of:

- NG 9505 and Wajak 2 of Pleistocene hominins
- Early Holocene *Homo sapiens* from Tamiang, Sukajadi, Gua Harimau, Gua Pawon, Gua Braholo, Song Keplek, Wajak, and Hoekgrot
- Late Holocene *Homo sapiens* from Gua Harimau and Song Keplek

The group of Pleistocene (blue box) which could be divided into two sub groups consists of:

- S 7-27, S 7-32, S 7-34, S 7-58, Sangiran 4, and Sangiran 27 of robust *Homo erectus*
- A subgroup mixed of Zhoukoudian and Javan *Homo erectus* consists of Sangiran 17, Sangiran 15b, S 7-35, Sangiran 15a, Sp 19, Bpg 2001.03, S 7-31 and Grogolanwetan

The cluster analysis on upper third premolar is only split the samples into two groups which consist of a group which dominated by *Homo sapiens* and a group of Pleistocene hominins. The cluster analysis could not present the hypothesis of six groups.

The split of the Pleistocene hominins and *Homo sapiens* groups on the upper third premolar are caused by the presence of transversal crest also mesial and distal accessories ridge on the previous group. On the contrary, the last group has absent those characters, means they have more simple occlusal shape compare to the previous group. The split among the group of *Homo erectus* is caused by the different expression of the mesial and distal triangular fossae. This condition also happens in the upper premolar of the *Homo sapiens* groups.

e. Upper Fourth Premolar

We observed the expression of the morphological features on 40 upper fourth premolars (Appendix B Table B.13): 16 Pleistocene hominins (12 from Sangiran, 2 from Zhoukoudian, 2 from Wajak) and 24 Holocene *Homo sapiens* (2 from Northern Sumatra, 9 from Gua Harimau, 3 from Gua Pawon, 6 from Gunungsewu, 3 from Wajak Holocene caves).

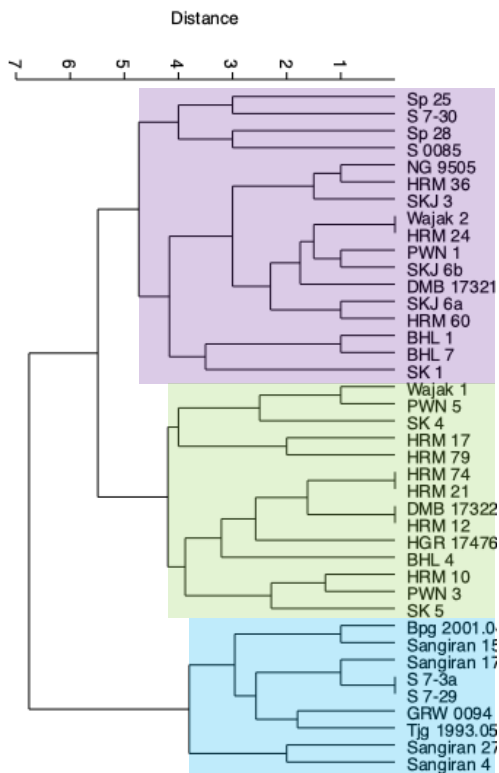

Fig. 4. C.12. The cluster analysis based on the morphological traits on the upper fourth premolars.

The cluster analysis based on the non-metric features of the upper fourth premolar (Fig. 4. C.12) separates them in three groups: a group of *Homo sapiens*, a group of Pleistocene hominins, and the other a mixed group between Pleistocene hominin and *Homo sapiens*.

The mixed group between Pleistocene hominins and *Homo sapiens* (purple box) which could be divided into two sub groups consists of:

- A subgroup mixed of Javan with Zhoukoudian *Homo erectus* consists of S 7-30, S 0085, Sp 25 and Sp 28
- A subgroup mixed of Wajak 2 of Late Pleistocene *Homo sapiens*, with Early Holocene *Homo sapiens* and Late Holocene *Homo sapiens* from Sukajadi, Gua Harimau, Gua Pawon, Gua Braholo, Song Keplek, and Djimbe

The group of *Homo sapiens* (green box) consists of:

- Wajak 1 of Late Pleistocene *Homo sapiens*
- Early Holocene *Homo sapiens* from Gua Harimau, Gua Pawon, Gua Braholo, Song Keplek, Hoekgrot, and Djimbe
- Late Holocene *Homo sapiens* from Gua Harimau and Song Keplek

The group of Pleistocene hominin (blue box) could be divided into two sub groups consists of:

- A subgroup of robust *Homo erectus* consists of Sangiran 4 and Sangiran 27
- A subgroup mixed of Javan *Homo erectus* Java consists of Bpg 2001.03, Sangiran 15a, Sangiran 17, S 7-3a, S 7-29, Grogolanwetan and Tjg 1993.05

The cluster analysis on upper fourth premolar is only split the samples into three groups which consist of a group of *Homo sapiens*, a group of Pleistocene hominins and a group mixed between Pleistocene hominins and *Homo sapiens*. The cluster analysis could not present the hypothesis of six groups.

The split of the Pleistocene hominins and *Homo sapiens* groups on the upper fourth premolar are caused by the presence of transversal crest also mesial and distal accessories ridge on the previous group. On the contrary, the last group has absent those characters, means they have more simple occlusal shape compare to the previous group. The split among the group of *Homo erectus* is caused by the different expression of the mesial and distal triangular fossae. This condition also happens in the upper fourth premolar of *Homo sapiens* groups.

The **S 7-30**, **S 0085**, **Sp 25** and **Sp 28** specimens of the Pleistocene hominins from Java and China are located in the cluster of *Homo sapiens* groups, together with Wajak 2 of Late Pleistocene *Homo sapiens*, also Early and Late Holocene *Homo sapiens* from Sukajadi, Gua Harimau lower level, Gua Pawon, Gua Braholo, Song Keplek, and Djimbe. This condition is represented by the absent of the transversal crest on those specimens.

f. Upper First Molar

We observed the expression of the morphological features on 47 upper first molars (Appendix B Table B.14): 21 Pleistocene hominins (16 from Sangiran, 3 from Zhoukoudian, 2 from Wajak) and 26 Holocene *Homo sapiens* (4 from Northern Sumatra, 9 from Gua Harimau, 3 from Gua Pawon, 8 from Gunungsewu, 2 from Wajak Holocene caves).

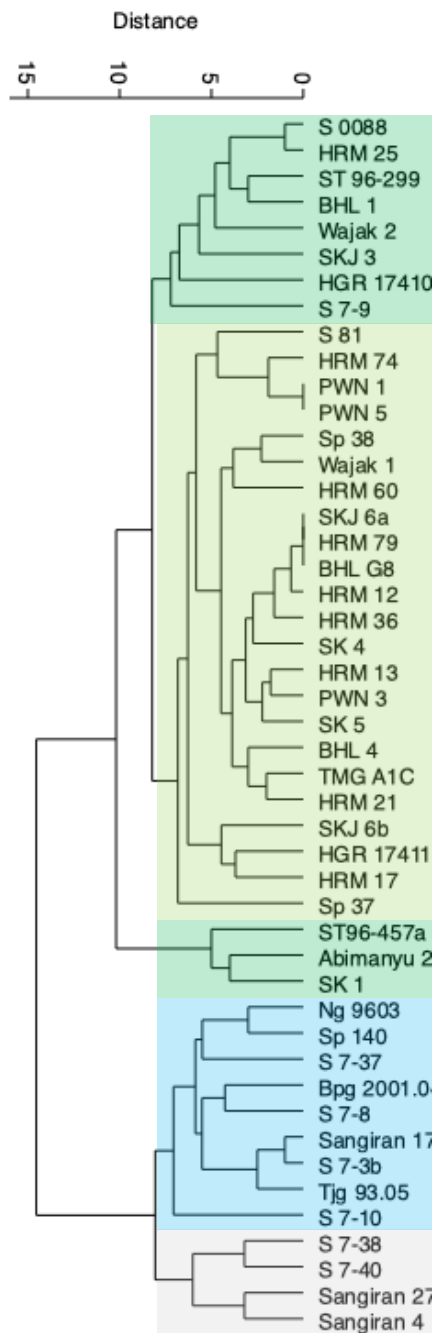

Fig. 4. C.13. The cluster analysis based on the morphological traits on the upper first molars.

The cluster analysis based on the non-metric features of the upper first molar (Fig. 4. C.13) separates them in five groups: a group of robust *Homo erectus*, a mixed group between Javan with Zhoukoudian *Homo erectus*, a mixed group between Pleistocene hominin and Early Holocene *Homo sapiens*, and a mixed group between Late Pleistocene, Early and Late Holocene *Homo sapiens*.

The robust *Homo erectus* (grey box) consists of:

- S 7-38, S 7-40, Sangiran 4 and Sangiran 27 of robust *Homo erectus*

The group which mixed between Javan and Zhoukoudian *Homo erectus* (blue box) consists of:

- NG 9603, S 7-8, S 7-37, Bpg 2001.03, and Tjg 1993.05 of G 2 *Homo erectus* Java
- S 7-3b, S 7-10, and Sangiran 17 of G 3 *Homo erectus* Java
- Sp 140 of Zhoukoudian *Homo erectus* China

The group which mixed between Pleistocene hominins and *Homo sapiens* (dark green box) which could be divided into two subgroups:

- S 0088, S 7-9, Abimanyu 2, and Wajak 2 of Late Pleistocene *Homo sapiens*
- Early Holocene *Homo sapiens* from Sukajadi, Song Terus, Gua Braholo, Song Keplek, and Hoekgrot, also HRM 25 of Late Holocene *Homo sapiens*

The group mixed group of *Homo sapiens* (green box) consists of:

- S 81 and Wajak 1 of Late Pleistocene *Homo sapiens*
- Early Holocene *Homo sapiens* from Tamiang, Sukajadi, Gua Harimau, Gua Pawon, Gua Braholo, Song Keplek, and Hoekgrot
- Late Holocene *Homo sapiens* from Gua Harimau and Song Keplek
- Sp 37 and Sp 38 of Zhoukoudian *Homo erectus*

The cluster analysis on upper first molar is split the samples into four groups which consist of robust *Homo erectus*, a group mixed between Javan *Homo erectus* with Zhoukoudian *Homo erectus*, a group mixed between Pleistocene hominin and Early Holocene *Homo sapiens*, and a group which mixed between Late Pleistocene, Early and Late Holocene *Homo sapiens*. The cluster analysis confirms the first three hypothesized groups, and present a mixed of the last three hypothesized groups.

The split of the Pleistocene hominins and *Homo sapiens* groups in the upper first molar are represented by the presence of buccal and lingual accessories tubercle, crenulation, parastyle, distal marginal ridge, and posterior fovea on the previous group. On the contrary, the last group has the absence of those characters, means they have simple occlusal morphology compared to the previous group.

The split among the group of *Homo erectus* is caused by the difference of the expression of crenulation, parastyle, carabelli's cusp, parastyle, and posterior fovea. The **Sp 140** of Zhoukoudian *Homo erectus* is located in the cluster together with Javan *Homo erectus*. The **S 81** and **Wajak 1** of Late Pleistocene *Homo sapiens* also **Sp 37** and **Sp 38** of Zhoukoudian *Homo erectus* specimens are located in the cluster of *Homo sapiens* groups, caused by the number of the cusps, also the absent of the parastyle and posterior fovea.

The split among the group of *Homo sapiens* in the upper first molar is presented by the different reduction of the C3 and C4 cusps, also different expression of the transversal crest. This split is correlated to the chronological difference.

g. Upper Third Molar

We observed the expression of the morphological features on 39 upper third molars (Appendix B Table B.16): 21 Pleistocene hominins (16 from Sangiran, 1 from Trinil, 2 from Zhoukoudian, 2 from Wajak) and 18 Holocene *Homo sapiens* (1 from Northern Sumatra, 4 from Gua Harimau, 1 from Gua Pawon, 8 from Gunungsewu, 2 from Wajak Holocene caves, 1 from Gua Kidang).

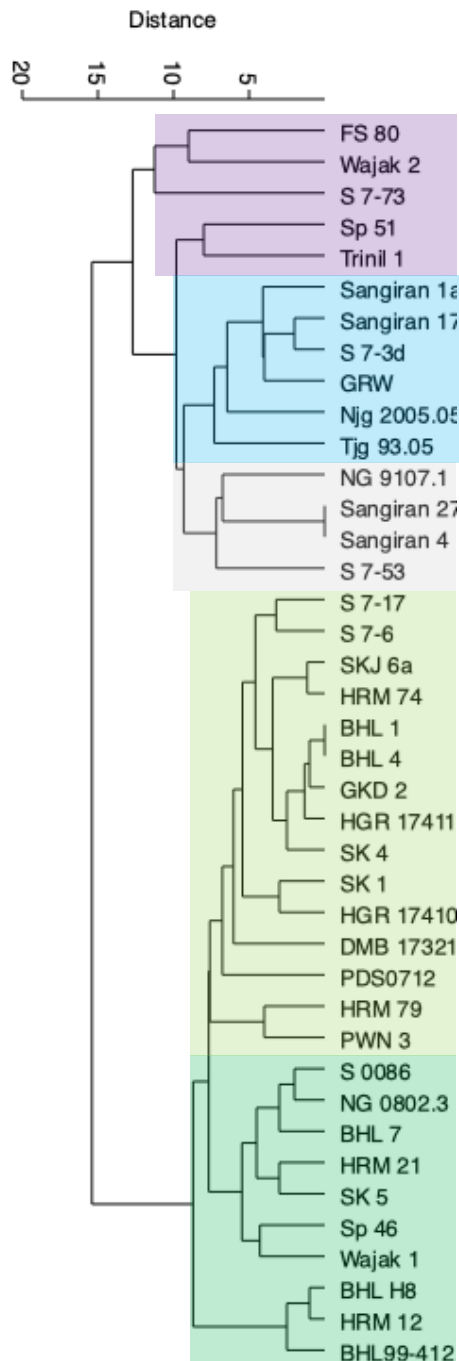

Fig. 4. C.14. The cluster analysis based on the morphological traits on the upper third molars.

The cluster analysis based on the non-metric features of the upper third molar (Fig. 4. C.14) separates them in five groups: a mixed group between Javan hominins and

Zhoukoudian *Homo erectus*, G 3 Javan *Homo erectus*, and a group mixed between Late Pleistocene *Homo sapiens*, Early Holocene *Homo sapiens* also Late Holocene *Homo sapiens*.

The group which mixed between Javan hominins and Zhoukoudian *Homo erectus* consists of:

- FS 80, S 7-73, and Trinil 1 of Javan *Homo erectus*
- Wajak 2 of Late Pleistocene *Homo sapiens*
- Sp 51 of Zhoukoudian *Homo erectus*

The Javan *Homo erectus* consists of:

- Njg 2005.05, Sangiran 1a, Sangiran 17, Sangiran 7-3d, and Grogolanwetan of G 3 Javan *Homo erectus*
- Tjg 1993.05 of G 2 Javan *Homo erectus*

The robust *Homo erectus* consists of:

- Sangiran 4, Sangiran 27, S 7-53, and NG 9107.01 of Pleistocene hominins

The group dominated by Early Holocene *Homo sapiens* consists of:

- S 7-6, S 7-17, and PDS 0712 of Pleistocene hominin
- Early Holocene *Homo sapiens* from Sukajadi, Gua Harimau, Gua Pawon, Gua Braholo, Song Keplek, Gua Kidang, Hoekgrot, and Djimbe

The mixed group of *Homo sapiens* consists of:

- S 0086, NG 0802.3, and Wajak 1 of Late Pleistocene *Homo sapiens*
- Sp 46 of Zhoukoudian *Homo erectus*
- Early Holocene *Homo sapiens* from Gua Braholo
- Late Holocene *Homo sapiens* from Gua Harimau and Song Keplek

The cluster analysis on upper third molar is split the samples into four main groups which consist of robust *Homo erectus*, a group which mixed between Javan and Zhoukoudian *Homo erectus*, Javan *Homo erectus*, and a group mixed between Late Pleistocene *Homo sapiens*, Early Holocene *Homo sapiens* also Late Holocene *Homo sapiens*. The cluster analysis confirms the the first three hypothesized groups, and present a mixed of the last three hypothesized groups.

The split of the Pleistocene hominins and *Homo sapiens* groups in the upper first molar are represented by the presence of buccal and lingual accessories tubercle, crenulation, parastyle, distal marginal ridge, and posterior fovea on the previous group. On the contrary, the last group has the absence of those characters, means they have simple occlusal morphology compared to the previous group.

The split among the group of *Homo erectus* is caused by the difference of the expression of crenulation, parastyle, carabelli's cusp, parastyle, and posterior fovea. The **Sp 51** of Zhoukoudian *Homo erectus* and **Wajak 2** of Late Pleistocene *Homo sapiens* are located in the cluster together with Javan *Homo erectus*. The S 7-6, S 7-17, PDS 0712, S 0086, NG 0802.3, and Wajak 1 of Late Pleistocene *Homo sapiens* also **Sp 46** of Zhoukoudian *Homo erectus* specimens are located in the cluster of *Homo sapiens* groups, caused by the number of the cusps, also the absent of the parastyle and posterior fovea.

The split among the group of *Homo sapiens* in the upper third molar is presented by the different reduction of the C3 and C4 cusps, also different expression of the transversal crest. This split is not correlated to the chronological difference.

3. Summary of morphological traits

The summary of morphological traits on upper and lower teeth of the individual or isolated specimen could be presented on the following table:

Tooth	Groups	Separation between early hominin and <i>Homo sapiens</i>	Separation among early hominin	Separation among <i>Homo sapiens</i>
LI1	2 groups: <i>Homo sapiens</i> and Pleistocene hominin	Confirms separation between <i>Homo sapiens</i> and Pleistocene hominin, except HRM 12	No, limited sample	Yes, tendency separation between G-5 and G-6
LI2	2 groups: <i>Homo sapiens</i> and Pleistocene hominin	Confirms separation between <i>Homo sapiens</i> and Pleistocene hominin, except Sangiran 22b	No, limited sample	No separation between G-5 and G-6
LC	3 groups: <i>Homo sapiens</i> , Pleistocene hominin, and mixed group	A tendency to separate between <i>Homo sapiens</i> and Pleistocene hominin, except Sp B.1 and Sp G.1	No, limited sample	No separation between G-4, G-5 and G-6
LP3	3 groups: G 1, mixed group of G 2-3 and ZKD, and G 4-5-6	Confirms separation between <i>Homo sapiens</i> and Pleistocene hominin	Clear separation of G-1 Yes, tendency separation between G-2 and G-3	Yes, tendency separation between G-5 and G-6
LP4	4 groups: G 1, ZKD, mixed group of G 2-3 and ZKD, and G 4-5-6	Confirms separation between <i>Homo sapiens</i> and Pleistocene hominin, except Sp G.1	Clear separation of G-1, ZKD and Javan <i>Homo erectus</i>	No separation between G-4, G-5 and G-6
LM1	6 groups: G 1, mixed group of G 2 and ZKD, G 3, G 4, G 5, and G 6	Confirms separation between <i>Homo sapiens</i> and Pleistocene hominin, except HRM 1	Clear separation of G-1, G-2 and G-3	Yes, tendency separation between G-4, G-5 and G-6
LM3	4 groups: G 1, mixed group of G 2 and ZKD, mixed group of G 3 and ZKD, and G 4-5-6	Confirms separation between <i>Homo sapiens</i> and Pleistocene hominin, except HRM 17 and HRM 21	Clear separation of G-1, G-2 and G-3	No separation between G-4, G-5 and G-6

Table 4. C.1. Summary of morphological comparative study on lower teeth.

Tooth	Groups	Separation between early hominin and <i>Homo sapiens</i>	Separation among early hominin	Separation among <i>Homo sapiens</i>
UI1	2 groups: <i>Homo sapiens</i> , and mixed group between <i>Homo sapiens</i> and Pleistocene hominin	A tendency to separate between <i>Homo sapiens</i> and Pleistocene hominin, except GRW and HRM	Yes, tendency separation between Zhoukoudian and Javan <i>Homo erectus</i>	Yes, tendency separation between G-5 and G-6
UI2	2 groups: <i>Homo sapiens</i> and Pleistocene hominin	A tendency to separate between <i>Homo sapiens</i> and Pleistocene hominin, except HRM	No, limited sample	Yes, tendency separation between G-5 and G-6
UC	3 groups: <i>Homo sapiens</i> , Pleistocene hominin, and mixed group	A tendency to separate between <i>Homo sapiens</i> and Pleistocene hominin, except HRM 12	No separation among early hominins	No separation between G-4, G-5 and G-6
UP3	3 groups: <i>Homo sapiens</i> and Pleistocene hominin	Confirms the difference between <i>Homo sapiens</i> and Pleistocene hominin	Yes, tendency separation between G-1 and mixed G-2 & G-3	No separation between G-4, G-5 and G-6
UP4	3 groups: <i>Homo sapiens</i> , Pleistocene hominin, and mixed group	Confirms the difference between <i>Homo sapiens</i> and Pleistocene hominin, except Sp 25 and Sp 28	Clear separation of G-1 Yes, tendency separation between G-2 and G-3	Yes, tendency separation between G-5 and G-6
UM1	4 groups: G 1, mixed group of G 2-3 and ZKD, G 4-5, and G 4-5-6	Confirms the difference between <i>Homo sapiens</i> and Pleistocene hominin, except Sp 37 and Sp 38	Clear separation of G-1 Yes, tendency separation between G-2 and G-3	Yes, tendency separation between G-4 and mixed G-5 and G-6
UM3	5 groups: G 1, mixed group of G 2 and ZKD, G 3, G 5, and G 4-5-6	Confirms the difference between <i>Homo sapiens</i> and Pleistocene hominin, except S-7	Clear separation of G-1, G-2 and G-3	Yes, tendency separation between G-5 and G-6

Table 4. C.2. Summary of morphological comparative study on upper teeth.

D. METRICS

1. General Metrics of Mandibular Teeth

a. Lower Central Incisor

We have measured 19 lower central incisors (Appendix C Table C.1): each G-2 and G-3 *Homo erectus* Java also G-4 Late Pleistocene *Homo sapiens* only have 1 sample, 3 of G-C Zhoukoudian *Homo erectus*, 9 of G-5 Early Holocene and 4 of G-6 Late Holocene *Homo sapiens*, but G-1 robust *Homo erectus* has no sample.

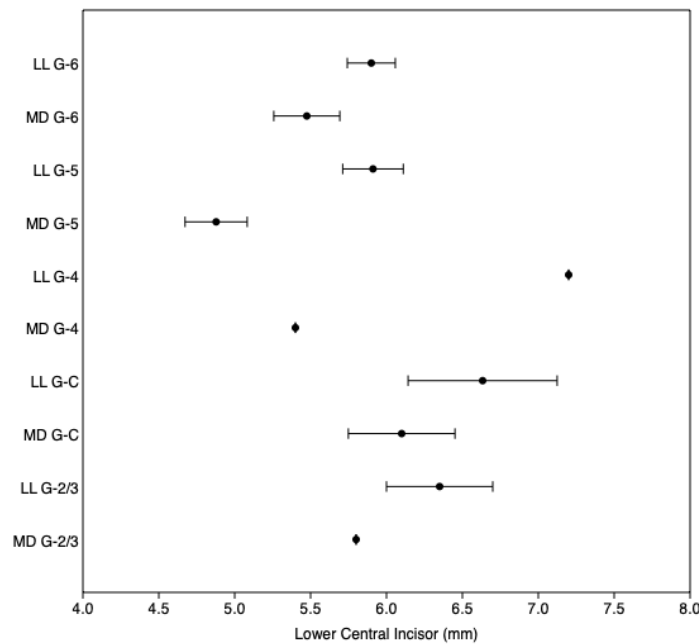

Fig. 4. D.1. Boxplot analysis of the measurements on the lower central incisor.

Note: LL = Labiolingual, MD = Mesiodistal. G-2/3 = Javan *Homo erectus*, G-C = Zhoukoudian *Homo erectus*, G-4 = Late Pleistocene *Homo sapiens*, G-5 = Early Holocene *Homo sapiens*, and G-6 = Late Holocene *Homo sapiens*.

Based on boxplot analysis of lower central incisor, we could see that the size of early hominin relatively bigger compared to the *Homo sapiens*. Ours measurements on the lower central incisor shows that in all hominins the LL dimension is bigger than the MD one (Fig. 4. D.1.). G-2/3 Javan *Homo erectus* and Zhoukoudian *Homo erectus* have similar composition of MD and LL size.

The biggest difference between the two measurements is observed in G-4 and, to a lesser extent in G-5. G-6 Late Holocene *Homo sapiens* relatively has more equal in size between MD and LL compared to both previous groups. Through time the size of the lower central incisor is decreasing from the early hominins to Early Holocene. Interestingly, it is not happening for the G-6 Late Holocene *Homo sapiens* whose MD size is as big as in G-4 Late Pleistocene *Homo sapiens*.

b. Lower Lateral Incisor

Metric measurement on lower lateral incisor consists of 31 teeth (Appendix Table 4. C.2): each G-2 and G-3 *Homo erectus* Java have two sample, five of Zhoukoudian *Homo erectus*, one of G-4 Pleistocene *Homo sapiens*, eleven of G-5 Early Holocene and four of G-6 Late Holocene *Homo sapiens*, but G-1 *Homo erectus* has no sample.

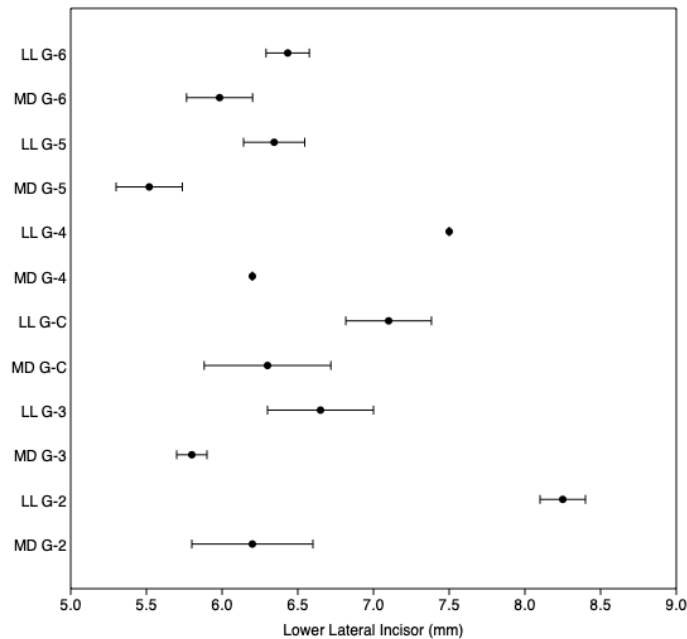

Fig. 4. D.2. Boxplot analysis of the measurements on the lower lateral incisor.

Note: LL = Labiolingual, MD = Mesiodistal. G-2 and G-3 = Javan *Homo erectus*, G-C = Zhoukoudian *Homo erectus*, G-4 = Late Pleistocene *Homo sapiens*, G-5 = Early Holocene *Homo sapiens*, and G-6 = Late Holocene *Homo sapiens*.

Ours measurements on the lower lateral incisor shows that the Pleistocene hominins has relatively bigger size compared to the *Homo sapiens*. G-2 Javan *Homo erectus* has very big LL size compared to all hominins. G-3 Javan *Homo erectus* shows similar size of MD and LL to the *Homo sapiens*.

Interestingly, the Zhoukoudian *Homo erectus* has similar size and composition to the G-4 Late Pleistocene *Homo sapiens*, but relatively bigger size to the Holocene *Homo sapiens*. The G-2 Javan *Homo erectus* and G-4 Late Pleistocene *Homo sapiens* has very wide distance between MD and LL size, and this composition similar to the G-5 Early Holocene *Homo sapiens*.

Through time the size of the lower lateral incisor is decreasing from the early hominins to Early Holocene. Interestingly, it is not happening for the G-4 Late Pleistocene *Homo sapiens* whose MD size is big as early hominins. Also, the G-6 Late Holocene *Homo sapiens* has MD size bigger compared to the G-5 Early Holocene *Homo sapiens*.

c. Lower Canine

Metric measurement on lower canine consists of 32 teeth (Appendix Table 4. C.3): G-2/3 *Homo erectus* Java has two sample, four of Zhoukoudian *Homo erectus*, one of G-4 Late Pleistocene *Homo sapiens*, nineteen of G-5 Early Holocene and six of G-6 Late Holocene *Homo sapiens*, but G-1 *Homo erectus* has no sample.

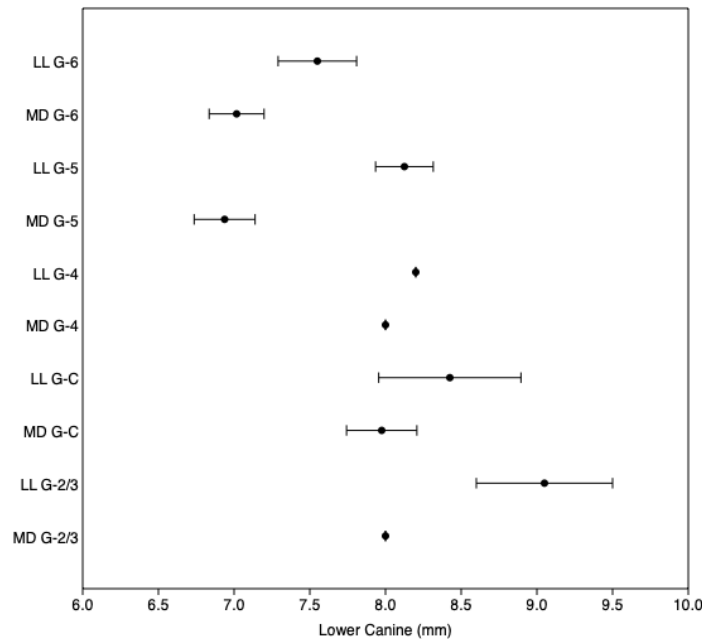

Fig. 4. D.3. Boxplot analysis of the measurements on the lower canine.

Note: LL = Labiolingual, MD = Mesiodistal. G-2/3 = Javan *Homo erectus*, G-C = Zhoukoudian *Homo erectus*, G-4 = Late Pleistocene *Homo sapiens*, G-5 = Early Holocene *Homo sapiens*, and G-6 = Late Holocene *Homo sapiens*.

Ours measurements on the lower canine shows that the Pleistocene hominins generally have bigger size compared to the *Homo sapiens*. The G-3 Javan *Homo erectus* has the biggest size of LL compared to all hominins, and has wider distance between MD and LL size compared to the Zhoukoudian *Homo erectus* and G-4 Late Pleistocene *Homo sapiens*. The G-3 Javan *Homo erectus* relatively has more elongated shape of LL, compared to the Zhoukoudian *Homo erectus* which have more square shape of MD and LL size.

Similar to the lower incisor, the G-4 Late Pleistocene *Homo sapiens* has bigger of size compared to G-5 Early Holocene and G-6 Late Holocene *Homo sapiens*, but similar to the Pleistocene hominin. G-5 Early Holocene *Homo sapiens* has MD size smaller and LL size bigger compared to the G-6 Late Holocene *Homo sapiens*. The G-6 Late Holocene *Homo sapiens* relatively has more square shape in size between MD and LL size, compared to the G-5 Early Holocene *Homo sapiens* which have more elongated shape of LL.

Through time the size of the lower canine is decreasing from the early hominins to the Holocene. Interestingly, the smallest MD size is in the G-5 Early Holocene *Homo sapiens* and the smallest LL size is in the G-6 Late Holocene *Homo sapiens*.

d. Lower Third Premolar

Metric measurement on lower third premolar consists of 43 teeth (Appendix Table 4. C.4): each G-1 *Homo erectus* and G-4 Late Pleistocene *Homo sapiens* has only one sample. The G-2 *Homo erectus* Java has two sample, five of G-3 *Homo erectus* Java, seven of Zhoukoudian *Homo erectus*, nineteen of G-5 Early Holocene and eight of G-6 Late Holocene *Homo sapiens*.

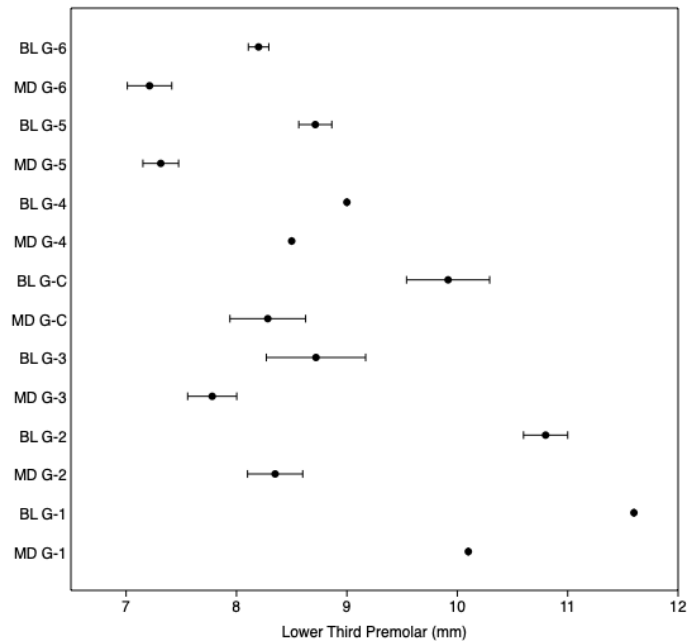

Fig. 4. D.4. Boxplot analysis of the measurements on the lower third premolar.

Note: BL = Buccolingual, MD = Mesiodistal. G-1 = robust *Homo erectus*, G-2 and G-3 = Javan *Homo erectus*, G-C = Zhoukoudian *Homo erectus*, G-4 = Late Pleistocene *Homo sapiens*, G-5 = Early Holocene *Homo sapiens*, and G-6 = Late Holocene *Homo sapiens*.

Ours measurements on the lower third premolar shows that the Pleistocene hominin generally have bigger size compared to the *Homo sapiens*. The G-1 robust *Homo erectus* has the biggest size compared to all hominins. G-2 Javan *Homo erectus* and Zhoukoudian *Homo erectus* have wide distance of MD and BL size compared to G-3 Javan *Homo erectus* and G-4 Late Pleistocene *Homo sapiens* with the reduction of BL size. This composition means the G-2 Javan and Zhoukoudian *Homo erectus* has more elongated shape of BL size compared to the G-3 *Homo erectus* Java and G-4 Late Pleistocene *Homo sapiens* which have more square shape of MD and BL.

The G-4 Late Pleistocene *Homo sapiens* relatively has bigger size of MD and MD compared to the G-5 Early Holocene and G-6 Late Holocene *Homo sapiens*, and with slightly similar composition to the G-3 Javan *Homo erectus*. The G-5 Early Holocene *Homo sapiens* relatively has BL size bigger compared to the G-6 Late Holocene *Homo sapiens*, means the G-6 Late Holocene *Homo sapiens* has more square shape with the reduction of BL size.

Through time the size of the lower third premolar is decreasing from the early hominins to the Late Holocene.

e. Lower Fourth Premolar

Metric measurement on lower fourth premolar consists of 47 teeth (Appendix Table 4. C.5): G-1 *Homo erectus* Java and G-4 Late Pleistocene *Homo sapiens* has only one sample. G-2 *Homo erectus* has two sample, three of G-3 *Homo erectus*, seven of Zhoukoudian *Homo erectus*, twentyone of G-5 Early Holocene and nine of G-6 Late Holocene *Homo sapiens*.

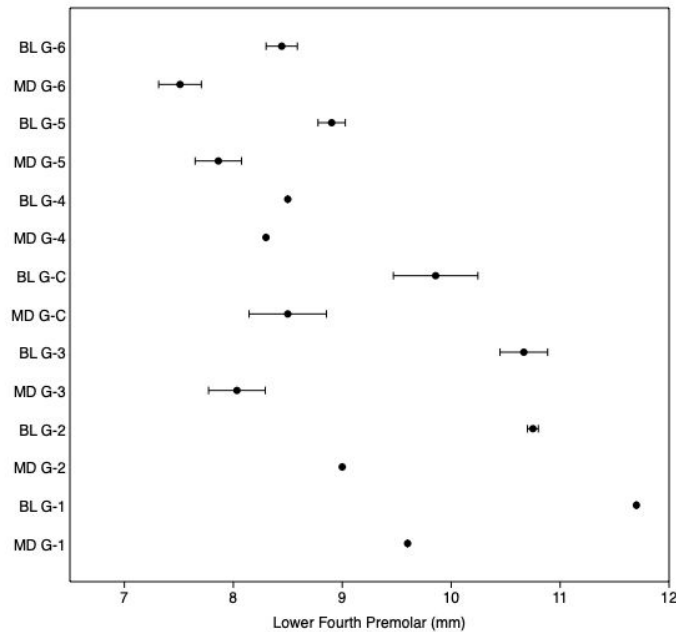

Fig. 4. D.5. Boxplot analysis of the measurements on the lower fourth premolar.

Note: BL = Buccolingual, MD = Mesiodistal. G-1 = robust *Homo erectus*, G-2 and G-3 = Javan *Homo erectus*, G-C = Zhoukoudian *Homo erectus*, G-4 = Late Pleistocene *Homo sapiens*, G-5 = Early Holocene *Homo sapiens*, and G-6 = Late Holocene *Homo sapiens*.

Ours measurements on the lower fourth premolar shows that the Pleistocene hominins generally have bigger compared to the *Homo sapiens*. The G-1 robust *Homo erectus* has the biggest compared to all hominins. The G-3 Javan *Homo erectus* have wide distance of MD and BL size compared to G-2 Javan *Homo erectus* and Zhoukoudian *Homo erectus* also G-4 Late Pleistocene *Homo sapiens* with the reduction of BL size. This condition is in contrary with the previous composition of lower third premolar, means the G-3 Javan *Homo erectus* has more elongated shape of BL size compared to the G-2 Javan *Homo erectus* and G-4 Late Pleistocene *Homo sapiens* which have more square shape of MD and BL.

The G-4 Late Pleistocene *Homo sapiens* relatively has bigger size of MD compared to the G-5 Early Holocene and G-6 Late Holocene *Homo sapiens*, with more square shape of MD and BL size. The G-5 Early Holocene *Homo sapiens* relatively has BL size bigger compared to the G-6 Late Holocene *Homo sapiens*, means the G-6 Late Holocene *Homo sapiens* has more square shape with the reduction of BL size.

Through time the size of the lower fourth premolar is decreasing from the early hominins to the Late Holocene.

f. Lower First Molar

Metric measurement on lower first molar consists of 64 teeth (Appendix Table 4. C.6): G-1 *Homo erectus* has five sample, three of G-2 *Homo erectus* Java, nine of G-3 *Homo erectus* Java, six of Zhoukoudian *Homo erectus*, four of G-4 Pleistocene *Homo sapiens*, twenty-six of G-5 Early Holocene and eleven of G-6 Late Holocene *Homo sapiens*.

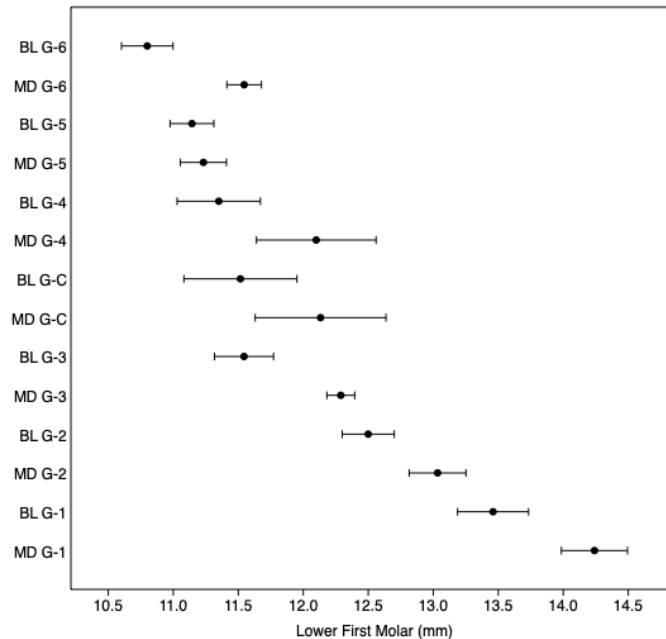

Fig. 4. D.6. Boxplot analysis of the measurements on the lower first molar.

Note: BL = Buccolingual, MD = Mesiodistal. G-1 = robust *Homo erectus*, G-2 and G-3 = Javan *Homo erectus*, G-C = Zhoukoudian *Homo erectus*, G-4 = Late Pleistocene *Homo sapiens*, G-5 = Early Holocene *Homo sapiens*, and G-6 = Late Holocene *Homo sapiens*.

Ours measurements on the lower first molars shows that the Pleistocene hominins generally have bigger size compared to the *Homo sapiens*. The composition size of the Zhoukoudian *Homo erectus* is relatively different compared to the G-1, G-2, and G-3 Javan *Homo erectus*, with the MD size bigger than the BL size. In contrary, the Zhoukoudian *Homo erectus* relatively has square shape with the similar size of MD and BL.

Similar to the previous groups, the G-4 Pleistocene *Homo sapiens* relatively has bigger size of MD compared to the G-5 Early and G-6 Late Holocene *Homo sapiens*, and with the slightly similar composition to the Zhoukoudian *Homo erectus*. G-5 Early Holocene *Homo sapiens* relatively has equal size of MD and BL, different to the G-6 Late Holocene *Homo sapiens* which has the BL size smaller compared to the MD size, means the G-6 Late Holocene *Homo sapiens* occurred the reduction of BL size.

Through time the size of the lower first molar is decreasing from the early hominins to the Holocene. Interestingly, the G-4 Late Pleistocene *Homo sapiens* whose MD size has similar size to the early hominins.

g. Lower Third Molar

Metric measurement on lower third molar consists of 54 teeth (Appendix Table 4. C.8): each G-2, and G-3 *Homo erectus* have four sample. G-1 *Homo erectus* has three sample, nine of Zhoukoudian *Homo erectus*, seven of G-4 Pleistocene *Homo sapiens*, twentyone of G-5 Early Holocene and six of G-6 Late Holocene *Homo sapiens*.

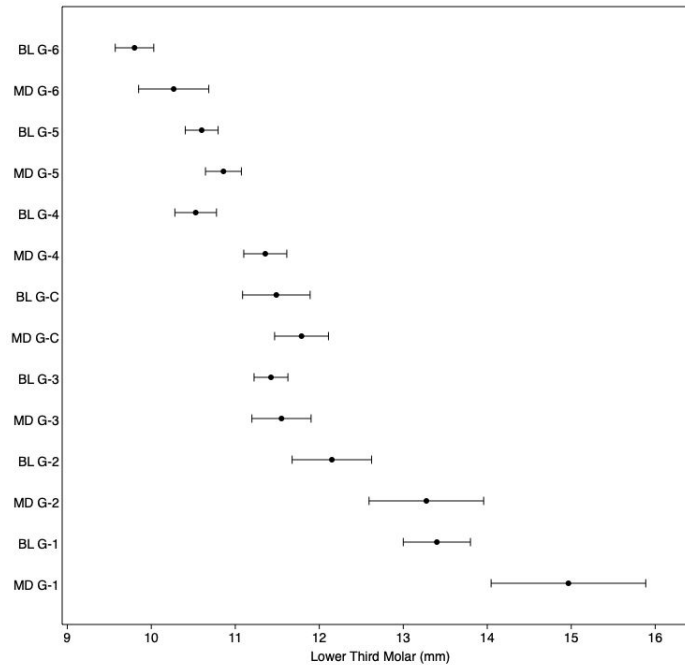

Fig. 4. D.7. Boxplot analysis of the measurements on the lower third molar.

Note: BL = Buccolingual, MD = Mesiodistal. G-1 = robust *Homo erectus*, G-2 and G-3 = Javan *Homo erectus*, G-C = Zhoukoudian *Homo erectus*, G-4 = Late Pleistocene *Homo sapiens*, G-5 = Early Holocene *Homo sapiens*, and G-6 = Late Holocene *Homo sapiens*.

Ours measurements on the lower third molar shows that the Pleistocene hominins generally have bigger size compared to the *Homo sapiens*. The composition size of G-1 robust *Homo erectus* is the biggest among the Pleistocene hominins. The composition size of G-1 and G-2 Javan *Homo erectus* are different compared to the G-3 Javan *Homo erectus* and Zhoukoudian *Homo erectus*, with the MD size bigger than the BL size. In contrary, the G-3 Javan *Homo erectus* and Zhoukoudian *Homo erectus* relatively has the similar size of MD and BL. This means the G-1 and G-2 javan *Homo erectus* have elongated shape of MD orientation, compared to the more square shape of G-3 Javan *Homo erectus* and Zhoukoudian *Homo erectus*, with the reduction of MD size.

The G-4 Pleistocene *Homo sapiens* relatively has bigger size of MD compared to the G-5 Early and G-6 Late *Homo sapiens*, and with the slightly similar composition to the Zhoukoudian *Homo erectus*. The G-5 Early Holocene *Homo sapiens* relatively has equal size of MD and BL, different to the G-4 Pleistocene *Homo sapiens* and G-6 Late Holocene *Homo sapiens* which has the MD size bigger compared to the BL size. This composition means the G-4 Pleistocene *Homo sapiens* and G-6 Late Holocene *Homo sapiens* has elongated shape of MD orientation and occurred the reduction of BL size.

Through time the size of the lower third molar is decreasing from the early hominins to the Holocene.

2. General Metrics of Maxillary Teeth

a. Upper Central Incisor

Metric measurement on upper central incisor consists of 26 teeth (Appendix Table 4. C.9): each G-3 and Zhoukoudian *Homo erectus* also G-4 Pleistocene *Homo sapiens* have three sample. G-2 *Homo erectus* has three sample, twelve of G-5 Early Holocene and four of G-6 Late Holocene *Homo sapiens*.

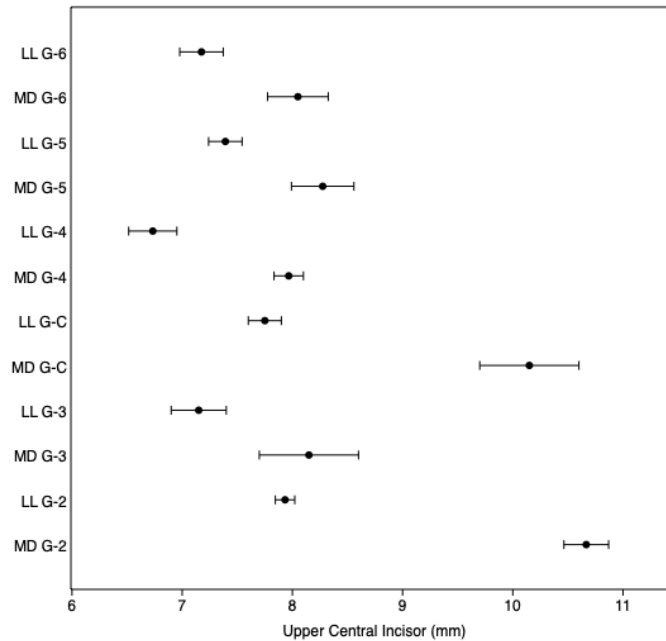

Fig. 4. D.8. Boxplot analysis of the measurements on the upper central incisor.

Note: BL = Buccolingual, MD = Mesiodistal. G-2 and G-3 = Javan *Homo erectus*, G-C = Zhoukoudian *Homo erectus*, G-4 = Late Pleistocene *Homo sapiens*, G-5 = Early Holocene *Homo sapiens*, and G-6 = Late Holocene *Homo sapiens*.

Ours measurements on the lower central incisor shows that the size of Pleistocene hominins, except G-3 *Homo erectus* Java, are bigger compared to all the *Homo sapiens*. The G-2 Javan *Homo erectus* and Zhoukoudian *Homo erectus* have extremely bigger MD size compared to the LL size. This composition is different compared to the G-3 Javan *Homo erectus* and G-4 Pleistocene *Homo sapiens* which have slightly bigger MD size compared to the LL size, means both groups have reduced in the LL size.

Interestingly, the composition of G-4 Pleistocene *Homo sapiens* is similar to the G-3 Javan *Homo erectus* and the G-6 Late Holocene *Homo sapiens*. In the Holocene *Homo sapiens*, the G-5 Early Holocene *Homo sapiens* has relatively equal size of MD and LL. This condition is different compared to the G-6 Late Holocene *Homo sapiens* which has LL size smaller compared to the MD size, means this group has reduced in the LL size.

Through time there is a tendency the size (especially MD size) of the upper central incisor is decreasing from the early hominins to the Holocene, except for the G-3 Javan *Homo erectus* which has the same size to the *Homo sapiens*.

b. Upper Lateral Incisor

Metric measurement on upper lateral incisor consists of 23 teeth (Appendix Table 4. C.10): each G-1 *Homo erectus* Java and Zhoukoudian *Homo erectus* also G-4 Pleistocene *Homo sapiens* have only one sample. G-2 and G-3 *Homo erectus* Java have two sample, twelve of G-5 Early Holocene and three of G-6 Late Holocene *Homo sapiens*.

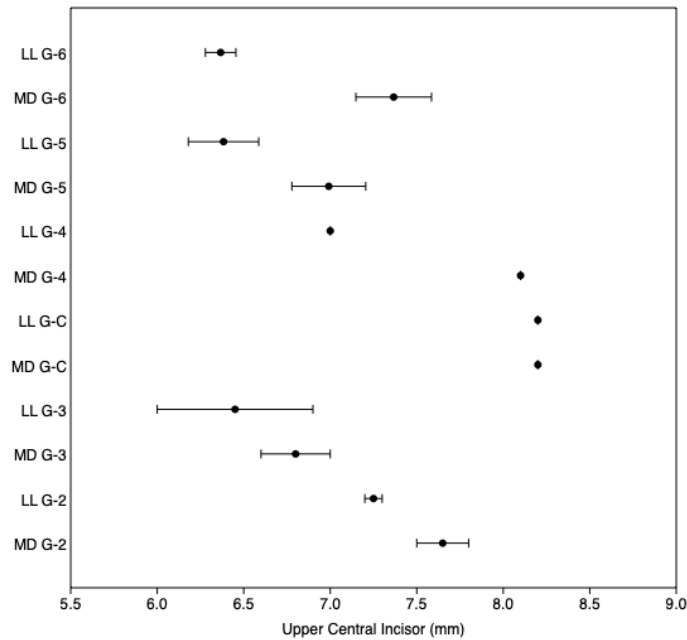

Fig. 4. D.9. Boxplot analysis of the measurements on the upper lateral incisor.

Note: BL = Buccolingual, MD = Mesiodistal. G-2 and G-3 = Javan *Homo erectus*, G-C = Zhoukoudian *Homo erectus*, G-4 = Late Pleistocene *Homo sapiens*, G-5 = Early Holocene *Homo sapiens*, and G-6 = Late Holocene *Homo sapiens*.

Ours measurements on the upper lateral incisor shows that the size of early hominins, except G-3 *Homo erectus*, is bigger compared to the *Homo sapiens*. The Zhoukoudian *Homo erectus* has similar size of MD and LL, but different composition compared to the G-3 Javan *Homo erectus* and G-4 Pleistocene *Homo sapiens*. In contrary, G-3 Javan *Homo erectus* Java and G-4 Late Pleistocene *Homo sapiens* has bigger MD size compared to the labiolingual size, means this group has reduced in the LL size.

The composition size of G-4 Pleistocene *Homo sapiens* is similar to the G-6 Late Holocene *Homo sapiens*, but different to G-5 Early Holocene *Homo sapiens*. In the Holocene *Homo sapiens*, the G-5 Early Holocene *Homo sapiens* relatively has equal size of MD and LL. This condition is different compared to the G-6 Late Holocene *Homo sapiens* which has LL size smaller compared to the MD size, means this grup has reduced in the LL size. We note, there are no trend of evolution through time in the size of the upper lateral incisor.

c. Upper Canine

Metric measurement on upper canine consists of 39 teeth (Appendix Table 4. C.11): each G-1, G-2 *Homo erectus* Java and Zhoukoudian *Homo erectus* have three sample. G-3 *Homo erectus* Java has two sample, one of G-4 Pleistocene *Homo sapiens*, twentythree of G-5 Early Holocene and five of G-6 Late Holocene *Homo sapiens*.

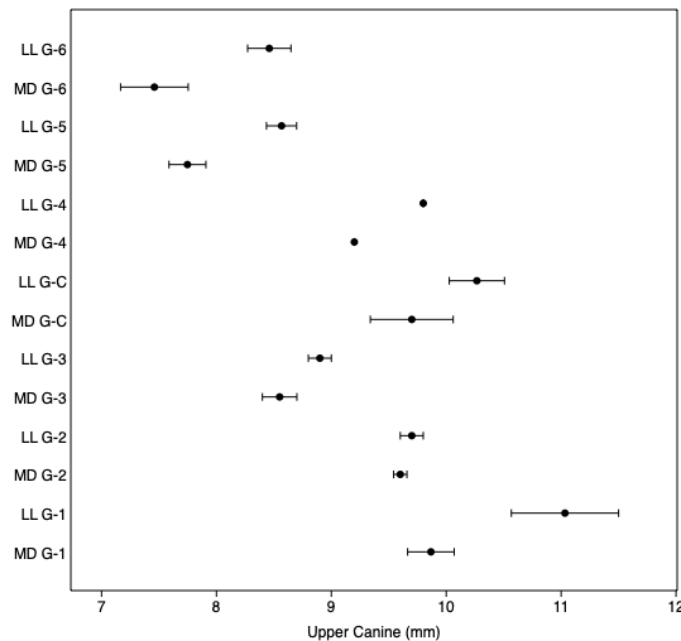

Fig. 4. D.10. Boxplot analysis of the measurements on the upper canine.

Note: BL = Buccolingual, MD = Mesiodistal. G-1 = robust *Homo erectus*, G-2 and G-3 = Javan *Homo erectus*, G-C = Zhoukoudian *Homo erectus*, G-4 = Late Pleistocene *Homo sapiens*, G-5 = Early Holocene *Homo sapiens*, and G-6 = Late Holocene *Homo sapiens*.

Ours measurements on the upper canine shows that the size of Pleistocene hominins has bigger size compared to the *Homo sapiens*. The G-1 robust *Homo erectus* Java has extremely bigger LL size compared to the MD size, and has different composition compared to the G-2 and G-3 Javan *Homo erectus*. In contrary, both latter groups have equal size of LL and MD size, means this group has reduced in the LL size. The Zhoukoudian *Homo erectus* has similar size to the G-2 Javan *Homo erectus*, with different composition but similar to the G-3 Javan *Homo erectus*.

The composition size of G-4 Pleistocene *Homo sapiens* is similar to Pleistocene hominins, and bigger compared to the G-5 Early Holocene and G-6 Late Holocene *Homo sapiens*. In the Holocene *Homo sapiens*, the G-6 Late Holocene *Homo sapiens* relatively has equal size of MD and LL. This condition is different compared to the G-5 Early Holocene *Homo sapiens* which has LL size bigger compared to the MD size, means this group has reduced in the LL size.

Through time the size of the upper canine is decreasing from the early hominins to the Holocene, except for the Zhoukoudian *Homo erectus* and G-4 Late Pleistocene *Homo sapiens* which have similar size between the G-1 robust and G-2 Javan *Homo erectus*.

d. Upper Third Premolar

Metric measurement on upper third premolar consists of 47 teeth (Appendix Table 4. C.12): each G-1 and G-2 *Homo erectus* Java have four sample. G-3 *Homo erectus* Java has six sample, one of Zhoukoudian *Homo erectus*, two of G-4 Pleistocene *Homo sapiens*, twentyone of G-5 Early Holocene and nine of G-6 Late Holocene *Homo sapiens*.

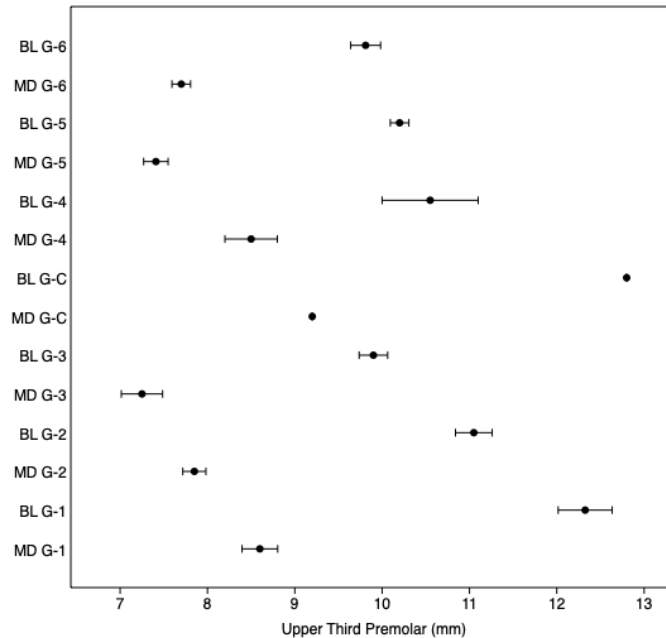

Fig. 4. D.11. Boxplot analysis of the measurements on the upper third premolar.

Note: BL = Buccolingual, MD = Mesiodistal. G-1 = robust *Homo erectus*, G-2 and G-3 = Javan *Homo erectus*, G-C = Zhoukoudian *Homo erectus*, G-4 = Late Pleistocene *Homo sapiens*, G-5 = Early Holocene *Homo sapiens*, and G-6 = Late Holocene *Homo sapiens*.

Ours measurements on the upper third premolar shows that the BL size of early hominins, except G-3 *Homo erectus* Java, are bigger compared to the *Homo sapiens*. The Zhoukoudian *Homo erectus* has the biggest composition size of MD and BL, slightly similar to the G-1 robust *Homo erectus* size. Interestingly, the G-3 Javan *Homo erectus* has smaller size compared to the G-4 Late Pleistocene *Homo sapiens* and similar to the G-5 Early Holocene *Homo sapiens*.

In the *Homo sapiens* population, the size of G-4 Pleistocene *Homo sapiens* is bigger but the composition is similar to the G-5 Early Holocene and G-6 Late Holocene *Homo sapiens*. The distance between the size of MD and BL is wider in the G-5 Early Holocene *Homo sapiens*, compared to the G-6 Late Holocene *Homo sapiens*, which reduced in the BL size. This composition means the G-5 Early Holocene *Homo sapiens* has more elongated shape of BL orientation compared to the G-6 Late Holocene *Homo sapiens* which has more square shape.

Through time there is a tendency the size (especially BL size) of the upper third premolar is decreasing from the early hominins to the Holocene, except for the Zhoukoudian *Homo erectus* and which has the same size to the robust *Homo erectus*.

e. Upper Fourth Premolar

Metric measurement on upper fourth premolar consists of 45 teeth (Appendix C Table C.13): each G-1 *Homo erectus* Java and Zhoukoudian *Homo erectus* have two sample. G-2 *Homo erectus* has only one sample, four of G-3 *Homo erectus* Java, six of G-4 Pleistocene *Homo sapiens*, twenty of G-5 Early Holocene and nine of G-6 Late Holocene *Homo sapiens*.

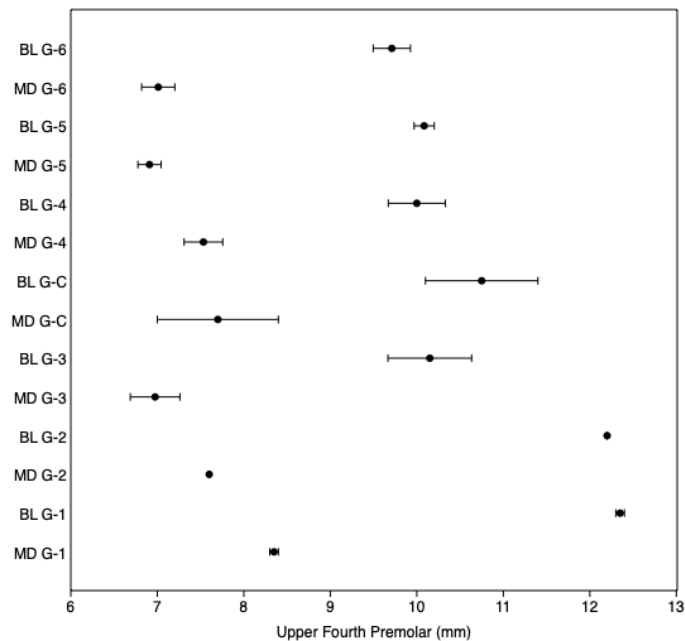

Fig. 4. D.12. Boxplot analysis of the measurements on the upper fourth premolar.

Note: BL = Buccolingual, MD = Mesiodistal. G-1 = robust *Homo erectus*, G-2 and G-3 = Javan *Homo erectus*, G-C = Zhoukoudian *Homo erectus*, G-4 = Late Pleistocene *Homo sapiens*, G-5 = Early Holocene *Homo sapiens*, and G-6 = Late Holocene *Homo sapiens*.

Ours measurements on the upper fourth premolar shows that the the BL size of Pleistocene hominins, except G-3 Javan *Homo erectus*, is bigger compared to the *Homo sapiens*. The G-1 robust and G-2 Javan *Homo erectus* has the biggest size of BL compared to G-3 Javan and Zhoukoudian *Homo erectus*. Interestingly, the G-3 Javan *Homo erectus* Java has the smallest size compared to the other early hominin groups and similar to the G-4, G-5 Early Holocene, and G-6 late Holocene *Homo sapiens*.

In the *Homo sapiens* population, the composition size of BL and MD is quite similar between the G-4 Pleistocene *Homo sapiens*, G-5 Early Holocene and G-6 Late Holocene *Homo sapiens*. The distance between the size of MD and BL is wider in the G-5 Early Holocene *Homo sapiens*, compared to the G-6 Late Holocene *Homo sapiens* which has shorter and reduced in the BL size. This composition means the G-5 Early Holocene *Homo sapiens* has more elongated shape of BL orientation compared to the G-6 Late Holocene *Homo sapiens* which has more square shape.

Through time there is a tendency the size (especially BL size) of the upper third premolar is decreasing from the early hominins to the Holocene, except for the G-3 Javan *Homo erectus* and which has the same size to the *Homo sapiens*.

f. Upper First Molar

Metric measurement on upper first premolar consists of 60 teeth (Appendix Table 4. C.14): each G-1 and G-2 *Homo erectus* Java have three sample. G-3 *Homo erectus* Java has nine sample, two of Zhoukoudian *Homo erectus*, eight of G-4 Pleistocene *Homo sapiens*, twentyfive of G-5 Early Holocene and nine of G-6 Late Holocene *Homo sapiens*.

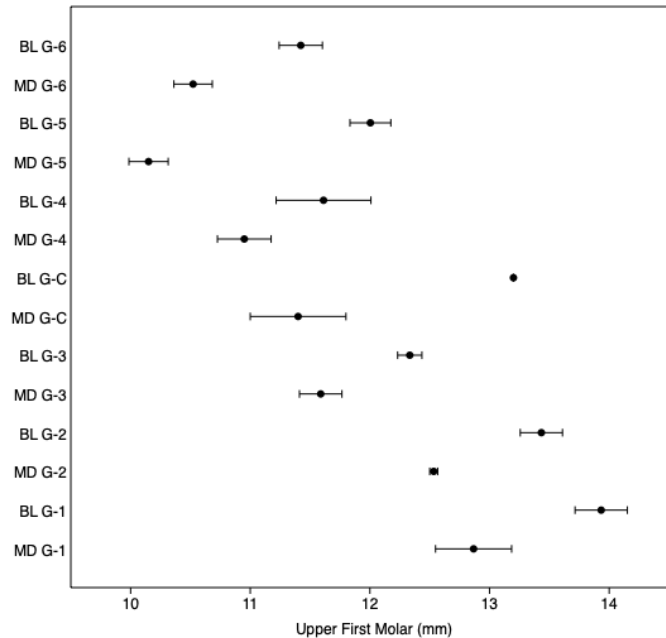

Fig. 4. D.13. Boxplot analysis of the measurements on the upper first molar.

Note: BL = Buccolingual, MD = Mesiodistal. G-1 = robust *Homo erectus*, G-2 and G-3 = Javan *Homo erectus*, G-C = Zhoukoudian *Homo erectus*, G-4 = Late Pleistocene *Homo sapiens*, G-5 = Early Holocene *Homo sapiens*, and G-6 = Late Holocene *Homo sapiens*.

Ours measurements on the upper first molar shows that the composition size of all Pleistocene hominins are relatively bigger compared to the *Homo sapiens*. The G-1 robust and G-2 Javan *Homo erectus* have the biggest size of BL compared to the G-3 Javan and Zhoukoudian *Homo erectus*. The G-1 robust *Homo erectus* Java has diverse size of mesiodistal. Interestingly, the G-3 *Homo erectus* Java has smaller size compared to the other early hominin groups and slightly bigger compared to the G-4 Pleistocene *Homo sapiens*.

In the *Homo sapiens* population, the composition size of BL and MD of the G-4 Pleistocene *Homo sapiens* is relatively similar, means this group has rhombus shape. The MD size of G-5 Early Holocene *Homo sapiens* is smaller compare to the G-6 Late Holocene *Homo sapiens*, but the BL size of G-5 Early Holocene *Homo sapiens* is bigger compare to the G-6 Late Holocene *Homo sapiens*. This composition means the G-5 Early Holocene *Homo sapiens* has more rhomboid shape of BL orientation compared to the G-6 Late Holocene *Homo sapiens* which has more rhombus shape.

Through time the size of the upper first molar is decreasing from the early hominins to the Holocene, except for the G-3 Javan *Homo erectus* which have similar size to the *Homo sapiens*.

g. Upper Third Molar

Metric measurement on upper third molar consists of 49 teeth (Appendix C Table C.16): G-1 *Homo erectus* Java have three sample, six of G-2 *Homo erectus* Java, ten of G-3 *Homo erectus* Java, two of Zhoukoudian *Homo erectus*, six of G-4 Pleistocene *Homo sapiens*, sixteen of G-5 Early Holocene and four of G-6 Late Holocene *Homo sapiens*.

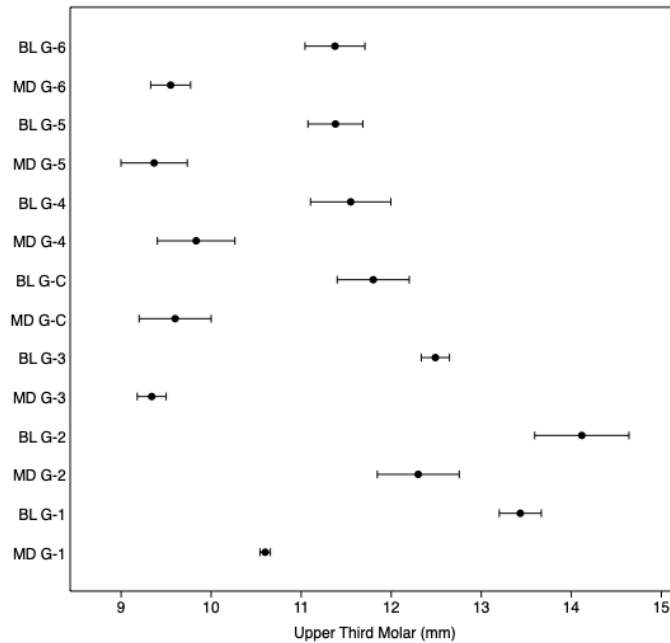

Fig. 4. D.14. Boxplot analysis of the measurements on the upper third molar.

Note: BL = Buccolingual, MD = Mesiodistal. G-1 = robust *Homo erectus*, G-2 and G-3 = Javan *Homo erectus*, G-C = Zhoukoudian *Homo erectus*, G-4 = Late Pleistocene *Homo sapiens*, G-5 = Early Holocene *Homo sapiens*, and G-6 = Late Holocene *Homo sapiens*.

Ours measurements on the upper first molar shows that the BL size of all early hominins, except G-3 *Homo erectus* Java and G-C *Homo erectus* China, are relatively bigger compared to the *Homo sapiens*. The G-2 *Homo erectus* Java has the biggest size in the early hominins. The G-1 and G-3 Javan *Homo erectus* has wide distance between the size of MD and BL, in contrary the G-2 Javan *Homo erectus* and Zhoukoudian *Homo erectus* has short distance. This composition means the G-3 Javan and Zhoukoudian *Homo erectus* have more rhomboid shape of BL orientation, compared to the G-2 Javan and Zhoukoudian *Homo erectus* which have rhombus shape. The G-3 Javan and Zhoukoudian *Homo erectus* has smaller size compared to the other early Hominin group and slightly similar to the G-4.

In the *Homo sapiens* population, the composition size of BL and MD of the G-4 Pleistocene *Homo sapiens* is relatively similar, means this group has rhombus shape. The MD size of G-5 Early Holocene *Homo sapiens* is smaller compare to the G-6 Late Holocene *Homo sapiens*, but the BL size of G-5 Early Holocene *Homo sapiens* is bigger compare to the G-6 Late Holocene *Homo sapiens*. This composition means the G-5 Early Holocene *Homo sapiens* has rhomboid shape of BL compared to the G-6 Late Holocene *Homo sapiens* which has rhombus shape.

Through time there is a tendency the size (especially BL size) of the upper third molar is decreasing from the early hominins to the Holocene, except for the G-2 Javan *Homo erectus* and which has the biggest size.

3. Summary of general metric

Group 1

	Upper	Lower
Incisor	NA	NA
Canine	<ul style="list-style-type: none"> • Large size of UC • Thick of LL 	NA
Premolar	<ul style="list-style-type: none"> • Large size of UP • Elongated BL 	<ul style="list-style-type: none"> • Very large size • Elongated mesiobuccal – distolingual
Molar	<ul style="list-style-type: none"> • Large size of UM • Elongated BL on UM3 	<ul style="list-style-type: none"> • Very large size and square shape • Elongated MD on LM3

Table 4. D.1. Summary of morphometric on Group 1.

Group 2

	Upper	Lower
Incisor	<ul style="list-style-type: none"> • Large size of UI • Elongated MD 	<ul style="list-style-type: none"> • Medium size of LL on LI1 • Large size of LL on LI2
Canine	<ul style="list-style-type: none"> • Medium size of UC • Almost equal size of MD & LL 	NA
Premolar	<ul style="list-style-type: none"> • Medium size of UP • Elongated BL • Large distance between MD & BL 	<ul style="list-style-type: none"> • Medium size of LP • Elongated BL • Large distance between MD & BL on LP3
Molar	<ul style="list-style-type: none"> • Large size and rhombus shape except rhomboid shape on UM3 • Almost equal size of MD & BL on UM1 and UM2, except elongated BL on UM3 	<ul style="list-style-type: none"> • Large size and rectangular shape • Elongated MD

Table 4. D.2. Summary of morphometric on Group 2.

Group 3

	Upper	Lower
Incisor	<ul style="list-style-type: none"> • Small size of UI • Almost equal size of MD & LL 	<ul style="list-style-type: none"> • Medium size of LI1 and small size of LI2 • Almost equal size of MD & LL on LI1, but elongated LL on LI2
Canine	<ul style="list-style-type: none"> • Medium size of UC • Almost equal size of MD and LL 	<ul style="list-style-type: none"> • Medium size of LC • Thick of LL

Premolar	<ul style="list-style-type: none"> • Small size and square shape • Elongated BL 	<ul style="list-style-type: none"> • Medium size and square shape • Almost equal size of MD & BL on LP3 but elongated BL on LP4
Molar	<ul style="list-style-type: none"> • Medium size • Almost equal size of MD & BL or rhombus shape on UM1 & UM2, • Elongated BL or rhomboid shape on UM3 	<ul style="list-style-type: none"> • Medium size and rectangular of LM1 & square of LM2-LM3 • Almost equal between MD and BL dimension on LM2 & LM3

Table 4. D.3. Summary of morphometric on Group 3.

Group 4

	Upper	Lower
Incisor	<ul style="list-style-type: none"> • Medium size of UI • Elongated MD on UI1, but almost equal size of MD & LL on UI2 	<ul style="list-style-type: none"> • Medium size of LI • Large distance between LL & MD • Thick LL
Canine	<ul style="list-style-type: none"> • Medium size of LC • Elongated LL 	<ul style="list-style-type: none"> • Medium size of LC • Almost equal size of MD & LL
Premolar	<ul style="list-style-type: none"> • Medium size and square shape • Elongated BL 	<ul style="list-style-type: none"> • Medium size of LP3 but small size of LP4, with square shape • Almost equal size of MD and BL
Molar	<ul style="list-style-type: none"> • Medium size and rhomboid shape • Almost equal size of MD and BL or rhombus shape on UM1 • Elongated BL or rhomboid shape on UM2 and UM3 	<ul style="list-style-type: none"> • Medium size • Elongated MD or rectangular shape of LM1 and LM3 • Almost equal size of MD & BL or square shape on LM2

Table 4. D.4. Summary of morphometric on Group 4.

Group 5

	Upper	Lower
Incisor	<ul style="list-style-type: none"> • Medium size of UI • Almost equal size of MD & LL 	<ul style="list-style-type: none"> • Small size with thick of LL • Large distance between MD and LL
Canine	<ul style="list-style-type: none"> • Small size with thick of LL • Large distance between MD and LL 	<ul style="list-style-type: none"> • Small size with thick of LL • Large distance between MD and LL
Premolar	<ul style="list-style-type: none"> • Small size and oval shape • Elongated BL 	<ul style="list-style-type: none"> • Small size and oval shape • Elongated BL
Molar	<ul style="list-style-type: none"> • Small size and rhomboid shape • Elongated BL • Large distance size of MD and BL 	<ul style="list-style-type: none"> • Small size and square shape • Almost equal size of MD & BL

Table 4. D.5. Summary of morphometric on Group 5.

Group 6

	Upper	Lower
Incisor	<ul style="list-style-type: none"> • Small size of UI • Elongated MD 	<ul style="list-style-type: none"> • Small size of LI • Almost equal size of MD & LL
Canine	<ul style="list-style-type: none"> • Small size of UC • Elongated LL 	<ul style="list-style-type: none"> • Small size of LC • Almost equal size of MD & LL
Premolar	<ul style="list-style-type: none"> • Small size and circular shape • Elongated BL 	<ul style="list-style-type: none"> • Small size and circular shape • Elongated BL
Molar	<ul style="list-style-type: none"> • Small size • Almost equal size of MD & BL or rhombus shape on UM1 and UM2 • Elongated BL or rhomboid shape on UM3 	<ul style="list-style-type: none"> • Small size and rectangular shape • Elongated MD

Table 4. D.6. Summary of morphometric on Group 6.

Zhoukoudian *Homo erectus*

	Upper	Lower
Incisor	<ul style="list-style-type: none"> • Large size of UI • Elongated MD on UI1 • Almost equal size of MD & LL on UI2 	<ul style="list-style-type: none"> • Large size of LI • Almost equal size of MD & LL on LI1, but thick of LL on LI2
Canine	<ul style="list-style-type: none"> • Medium size of UC • Slightly elongated LL 	<ul style="list-style-type: none"> • Large size of LC • Almost equal size of MD & LL
Premolar	<ul style="list-style-type: none"> • Large size and rectangular shape • Elongated BL 	<ul style="list-style-type: none"> • Medium size and rectangular shape • Elongated BL
Molar	<ul style="list-style-type: none"> • Medium size and rhomboid shape • Elongated BL 	<ul style="list-style-type: none"> • Medium size and rectangular shape • MD and BL reduction • Slightly elongated MD on LM1 and LM2, but almost equal size of MD & BL on LM3

Table 4. D.7. Summary of morphometric on Group Zhoukoudian *Homo erectus*.

4. Crown Size and Cusp Proportions of Mandibular Teeth

In this part, we will perform comparative study by the crown size and cusp proportions approach of the occlusal surface on hominins teeth. The aim of this comparative study is test our previous hypothesis produced by the non-metric features (See Chapter 4. B.). We will see if the metrics on molars support our 6 groups hypothesis. In this approach we will use some measurements (see Chapter 3. C.3.b.): the development of primary cusp area and circumference, distance between cups, and and relative angle of primary cusp horns.

We use Linear Discriminant Analysis (LDA), a method used in statistics to find a linear combination of features that characterizes or separates two or more classes of objects (Abdi 2007). LDA is used when groups are known a priori (unlike in cluster analysis) (Büyüköztürk and Çokluk-Bökeoğlu 2008). There are two graphics to presents the analysis result; the left graphic is the distribution of the specimens and the groups, the right graphic is the distribution of the factors with the stronger factors represented by longer lines.

a. Lower First Molar

Crown size and cusp proportion analysis on LM1 consists of 45 teeth: 22 Pleistocene hominins (16 from Sangiran, 1 from Miri, 4 from Zhoukoudian, 1 from Wajak) and 23 Holocene *Homo sapiens* (5 from Northern Sumatra, 8 from Gua Harimau, 2 from Gua Pawon, 6 from Gunungsewu, 1 from Wajak Holocene caves).

Crown size and cusp proportion analysis on LM1 has 16 variables (see Appendix 3. 1.A) with 16 possible underlying factors. The first two factors have eigenvalue of 4,40 and 1,49 or 56,19 % and 19,04 % with the total amount 75,23 %.

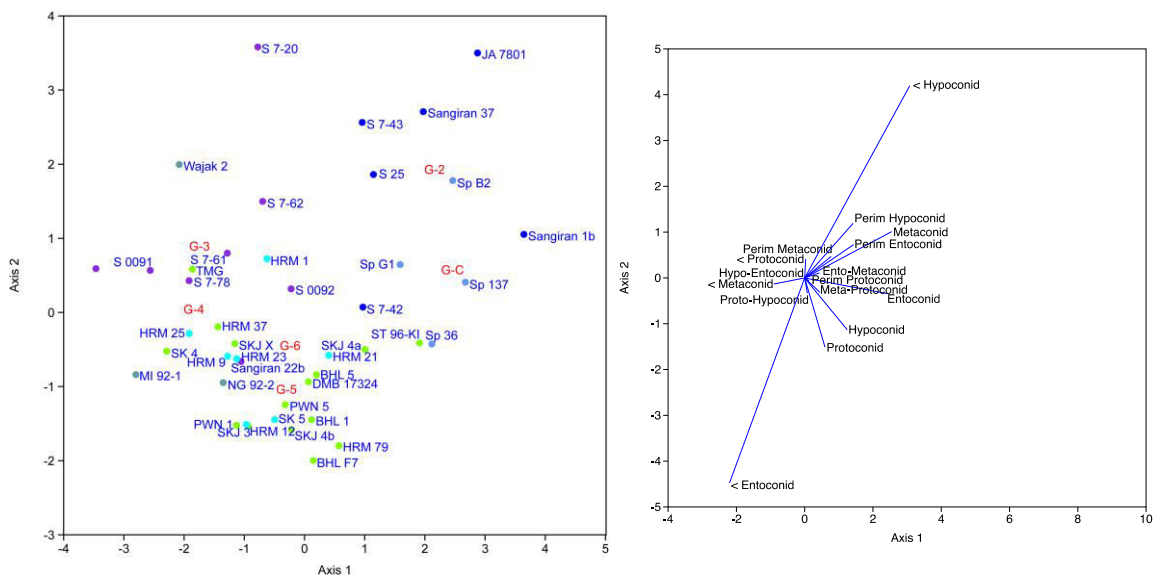

Fig 4. D.15. LDA of crown size and cusp proportion on lower first molar, Axis 1 vs Axis 2.

G-1 = robust *Homo erectus*, G-2 and G-3 = Javan *Homo erectus*, G-C = Zhoukoudian *Homo erectus*, G-4 = Late Pleistocene *Homo sapiens*, G-5 = Early Holocene *Homo sapiens*, and G-6 = Late Holocene *Homo sapiens*.

Protoconid = size of protoconid, Perim Protoconid = protoconid circumference, Proto-Hypoconid = protoconid-hypoconid distance, < Protoconid = angle of protoconid

The LDA based on crown size and cusp proportion variables of the LM1 (Fig. 4. E.1) shows a tendency of the grouping for early hominins (especially G-1, G-2, and Zhoukoudian *Homo erectus*) separate to *Homo sapiens*. The most significant variables to characterize the groups are: area and angle of the cusp. Other variables are not significant in this analysis: circumference and distance of the cusp.

Area of the cusp

- Groups with large area of the cups located on the right side: G 1-2 *Homo erectus* Java and Zhoukoudian *Homo erectus*
- Groups with narrow area of the cups located on the right side: G 3 *Homo erectus* Java and G 4-5-6 Late Pleistocene, Early and Late Holocene *Homo sapiens*

Angle of the cusp

- Groups with large angle of hypoconid located on the upper side: G 2 *Homo erectus* Java, and followed by G 3 *Homo erectus* Java and Zhoukoudian *Homo erectus*
- Groups with large angle of entoconid located on the lower side: G 5 *Homo sapiens* Early Holocene and followed by G 6 *Homo sapiens* Late Holocene, and G 4 Pleistocene hominins

G 1 Pleistocene hominin has specific shape (located outside of the graph) with very large cusp area and large angle of entoconid.

LM1 Summary

General summary:

- The G-1 robust, G-2 Javan and G-C Zhoukoudian *Homo erectus* are located on the right side of the axis 1, in contrary the G-3 Javan *Homo erectus*, G-4-5-6 *Homo sapiens* located on the left side.
- All early hominins located on upper side of the axis 2, in contrary all the *Homo sapiens* located on the bottom side, with the G-4 located between them.
- Some specimens which closed to other groups are; Sp B.2 closed to G-2, TMG, HRM 1, and Wajak 2 closed to G-3, S 7-42 and ST 96-KI closed to G-C, and Sangiran 22b closed to G-6.

And the detail summary of the crown size and cusp proportion comparative study on the LM1 are:

- G 1 has very large cusp area and wide entoconid angle, means **Sangiran 6a** has very large size with square shape relatively represented by blunt entoconid angle.
- G 2 has large cusp area and large hypoconid angle, means G 2 *Homo erectus* Java has large size with elongated mesiodistal shape represented by blunt hypoconid angle, except **S 7-42** which closed to Zhoukoudian *Homo erectus* with large size but less elongated mesiodistal shape, represented by moderately hypoconid angle.
- G 3 has small cusp area and moderately hypoconid angle, means G 3 *Homo erectus* Java has small size with less elongated mesiodistal shape, represented by moderately

hypoconid angle, except **Sangiran 22b** which closed to G 5-6 *Homo sapiens* with small size and more square shape relatively, represented by blunt entoconid angle.

- Zhoukoudian *Homo erectus* has large cusp area and moderately hypoconid angle, means G 2 *Homo erectus* Java has large size with less elongated mesiodistal shape represented by moderately hypoconid angle, except **Sp B2** which closed to G 2 *Homo erectus* Java with large size and elongated mesiodistal shape represented by blunt hypoconid angle.
- G 4-5-6 have small cusp area and wide entoconid angle, means those groups have small size with square shape, represented by blunt entoconid angle, except **Wajak 2** of G 4 Pleistocene hominin, **TMG** and **HRM 1** of G 5-6 Early and Late Holocene *Homo sapiens* which closed to G 3 *Homo erectus* Java with small size but less elongated mesiodistal shape, represented by moderately hypoconid angle, also **ST 96 KI** which closed to Zhoukoudian *Homo erectus* with large size but less elongated mesiodistal shape, represented by moderately hypoconid angle.

b. Lower Second Molar

Crown size and cusp proportion analysis on LM2 consists of 67 teeth: 36 Pleistocene hominins (26 from of Sangiran, 8 from Zhoukoudian, 2 from Wajak) and 31 Holocene *Homo sapiens* (5 from Northern Sumatra, 8 from Gua Harimau, 4 from Gua Pawon, 9 from Gunungsewu, 3 from Wajak Holocene caves, 1 from Gua Kidang).

Crown size and cusp proportion analysis on LM2 (Table 4. E.3) has 16 variables (see Appendix 3. 1.B) with 16 possible underlying factors. The first two factors have eigenvalue of 5,01 and 1,54 or 61,19 % and 18,77 % with the total amount 79,96 %.

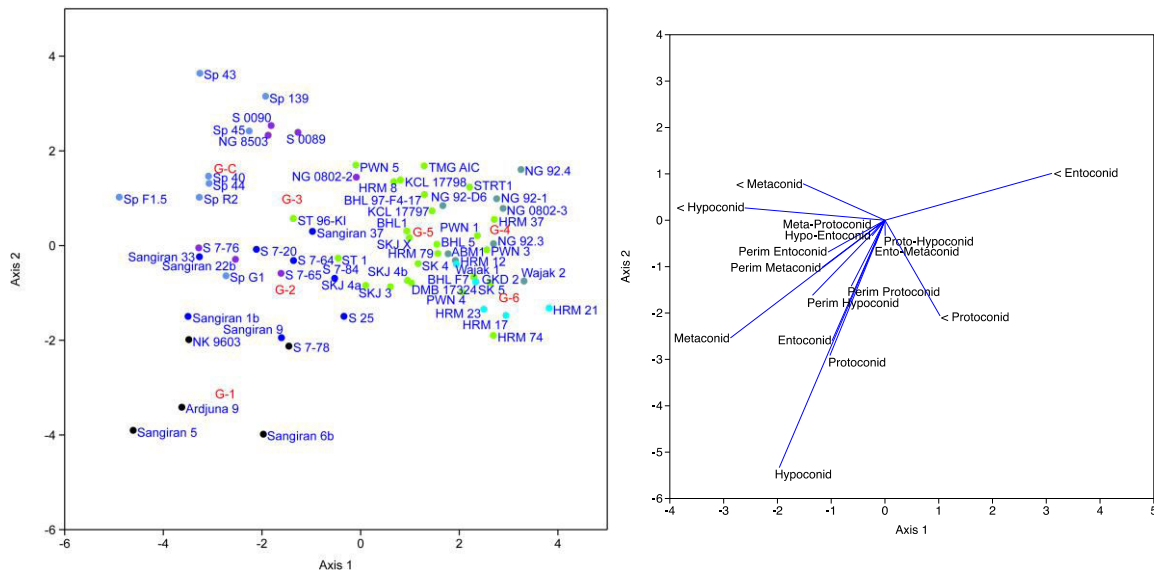

Fig 4. D.16. LDA of crown size and cusp proportion on lower second molar, Axis 1 vs Axis 2.

G-1 = robust *Homo erectus*, G-2 and G-3 = Javan *Homo erectus*, G-C = Zhoukoudian *Homo erectus*, G-4 = Late Pleistocene *Homo sapiens*, G-5 = Early Holocene *Homo sapiens*, and G-6 = Late Holocene *Homo sapiens*.

Protoconid = size of protoconid, Perim Protoconid = protoconid circumference, Proto-Hypoconid = protoconid-hypoconid distance, < Protoconid = angle of protoconid

The linier discriminant analysis based on crown size and cusp proportion variables of LM2 (Fig. 4. E.2) shows a tendency of the grouping for early hominins (especially G-1) and *Homo sapiens*, even more detail. The most significant variables to characterize the groups are: area and angle of the cusp. Other variables are not significant in this analysis: circumference and distance of the cusp

Angle of the cusp

- Groups with large angle of entoconid located on the right side: G 4-5-6 Late Pleistocene, Early and Late Holocene *Homo sapiens*
- Groups with large angle of hypoconid located on the left side: G 1-2-3 *Homo erectus* Java and Zhoukoudian *Homo erectus*

Area of the cusp

- Groups with narrow area of the cups located on the upper side: G 4-5 Late Pleistocene and Early Holocene *Homo sapiens*, also G 3 *Homo erectus* Java and Zhoukoudian *Homo erectus*

- Groups with large area of the cups located on the lower side: G 1-2 *Homo erectus* Java, also G 6 Late Holocene *Homo sapiens*

- **LM2 Summary**

General summary:

- All *Homo sapiens* groups are located on the right side of the axis 1, in contrary all early hominins groups are located on the left side.
- The G-3 Javan and G-C Zhoukoudian *Homo erectus* are located on upper side of the axis 2, in contrary G-1 robust *Homo erectus* located on the bottom side, with the G-2 Javan *Homo erectus* and all *Homo sapiens* are located between them.

Here is the summary of the crown size and cusp proportion comparative study on the LM2:

- G 1 has very large cusp area and wide protoconid angle, means Sangiran 5, Sangiran 6b, and Arjuna 9 have very large size with developed hypoconid cusp represented by blunt protoconid angle, except **S 7-78** and **NK 9603** which have large cusp size but less developed hypoconid cusps represented by less blunt protoconid angle.
- G 2 has large cusp area and wide hypoconid angle, means G 2 *Homo erectus* Java has large cusp size with elongated mesiodistal shape represented by blunt hypoconid angle, except **S 25** and **S 7-84** which closed to G 4-5-6 *Homo sapiens* with small cusp size and less elongated mesiodistal shape, represented by less blunt hypoconid angle.
- G 3 *Homo erectus* Java and Zhoukoudian *Homo erectus* have small cusp area with wide metaconid angle and moderately hypoconid angle, means G 3 *Homo erectus* Java has small size with less elongated mesiodistal shape represented by moderately hypoconid angle and developed entoconid cusp represented by blunt metaconid angle, except **Sangiran 22b**, **S 7-65**, and **S 7-76** which closed to G 2 *Homo erectus* Java with moderately cusp size, also **NG 0802.2** which closed to the G 5-6 *Homo sapiens* with small size and more square shape relatively, represented by blunt entoconid angle.
- G 4-5-6 have small cusp area and wide entoconid angle, means those groups have small size with square shape, represented by blunt entoconid angle, except **ST 96 KI** which closed to G 3 *Homo erectus* Java and Zhoukoudian *Homo erectus* with large size but less elongated mesiodistal shape, represented by moderately hypoconid angle.

c. Lower Third Molar

Crown size and cusp proportion analysis on LM3 consists of 39 teeth: 21 Pleistocene hominins (12 from of Sangiran, 7 from Zhoukoudian, 1 from Wajak) and 15 Holocene *Homo sapiens* (2 from Northern Sumatra, 3 from Gua Harimau, 4 from Gua Pawon, 6 from Gunungsewu, 2 from Wajak Holocene caves, 1 from Gua Kidang).

Crown size and cusp proportion analysis on LM3 has 16 variables (see Appendix 3. 1.C) with 16 possible underlying factors. The first two factors have eigenvalue of 12,81 and 1,95 or 71,36 % and 10,91 % with the total amount 82,27 %.

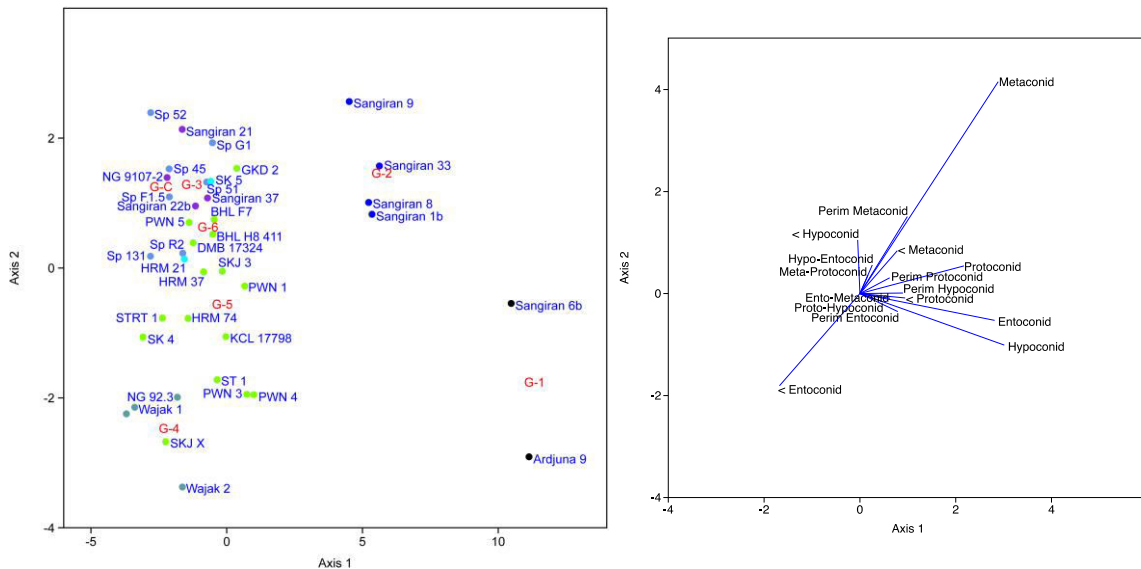

Fig 4. D.17. LDA of crown size and cusp proportion on lower third molar, Axis 1 vs Axis 2.

G-1 = robust *Homo erectus*, G-2 and G-3 = Javan *Homo erectus*, G-C = Zhoukoudian *Homo erectus*, G-4 = Late Pleistocene *Homo sapiens*, G-5 = Early Holocene *Homo sapiens*, and G-6 = Late Holocene *Homo sapiens*.

Protoconid = size of protoconid, Perim Protoconid = protoconid circumference, Proto-Hypoconid = protoconid-hypoconid distance, < Protoconid = angle of protoconid

The linier discriminant analysis based on crown size and cusp proportion variables of LM3 (Fig. 4. E.2) shows a tendency of the grouping for early hominins (especially for the G-1, G-2, and G-4) also *Homo sapiens*. The most significant variables to characterize the groups are: area and angle of the cusp. Other variables are not significant in this analysis: circumference and distance of the cusp

Area of the cusp

- Groups with large area of the cups located on the right side: G 1-2 *Homo erectus* Java
- Groups with narrow area of the cups located on the left side: G 4-5-6 Late Pleistocene, Early and Late Holocene *Homo sapiens*, also G 3 *Homo erectus* Java and Zhoukoudian *Homo erectus*

Angle of the cusp

- Groups with large angle of hypoconid located on the upper side: G 3 *Homo erectus* Java and Zhoukoudian *Homo erectus*, also G 6 Late Holocene *Homo sapiens* and some G 5 Early Holocene *Homo sapiens*

- Groups with large angle of entoconid located on the right side: G 4-5 Late Pleistocene and Early Holocene *Homo sapiens*
- G 1 large angle of protoconid and entoconid
- G-2 large angle of metaconid and hypoconid

- **LM3 Summary**

General summary:

- The G-1 robust and G-2 Javan *Homo erectus* are located on the right side of the axis 1, in contrary the G-3 Javan G-C Zhoukoudian *Homo erectus*, and all *Homo sapiens* located on the left side.
- The G-2-3 Javan and G-C Zhoukoudian *Homo erectus* are located on upper side of the axis 2, in contrary G-1 robust *Homo erectus* and G-4 Late Pleistocene *Homo sapiens* are located on the bottom side, with the G-5-6 Early and Late Holocene *Homo sapiens* are located between them.

Here is the summary of the crown size and cusp proportion comparative study on the LM3:

- G 1 has very large cusp area with wide protoconid and entoconid angle, means **Sangiran 6b** and **Arjuna 9** have very large size with square shape relatively represented by blunt entoconid angle, and developed hypoconid cusp represented by blunt protoconid angle.
- G 2 has large cusp area with large protoconid and hypoconid angle, means G 2 *Homo erectus* Java consists of **Sangiran 1b**, **Sangiran 8**, **Sangiran 9**, and **Sangiran 33** have large size with elongated mesiodistal shape represented by blunt hypoconid angle, and developed hypoconid cusp represented by blunt protoconid angle.
- G 3 *Homo erectus* Java, Zhoukoudian *Homo erectus*, and G 6 Late Holocene also some G 5 Early Holocene *Homo sapiens* Java have small cusp area and wide hypoconid angle, means G 3 *Homo erectus* Java has small size with less elongated mesiodistal shape, represented by blunt hypoconid angle. Some member of G 5 Early Holocene *Homo sapiens* included in this group are **GKD 2**, **BHL F7**, **PWN 5**, **BHL H8**, **DMB 17324**, **SKJ 3**, **HRM 37** and **PWN 1**.
- G 4 Pleistocene hominins and some G 5 Early Holocene *Homo sapiens* have small cusp area and wide entoconid angle, means those groups have small size with square shape, represented by blunt entoconid angle. Some member of G 5 Early Holocene *Homo sapiens* included in this group are **SKJ X**, **PWN 3**, **PWN 4**, **ST 1**, **SK 4**, **HRM 74** and **KCL 17798**.

5. Crown Size and Cusp Proportions of Maxillary Teeth

a. Upper First Molar

Crown size and cusp proportion analysis on UM1 consists of 47 teeth: 24 Pleistocene hominins (19 from of Sangiran, 3 from Zhoukoudian, 2 from Wajak) and 23 Holocene *Homo sapiens* (4 from Northern Sumatra, 9 from Gua Harimau, 2 from Gua Pawon, 7 from Gunungsewu, 31 from Wajak Holocene caves).

Crown size and cusp proportion analysis on UM1 has 16 variables (see Appendix 3. 2.A) with 16 possible underlying factors. The first two factors have eigenvalue of 11,70 and 2,32 or 67,32 % and 13,37 % with the total amount 80,69 %.

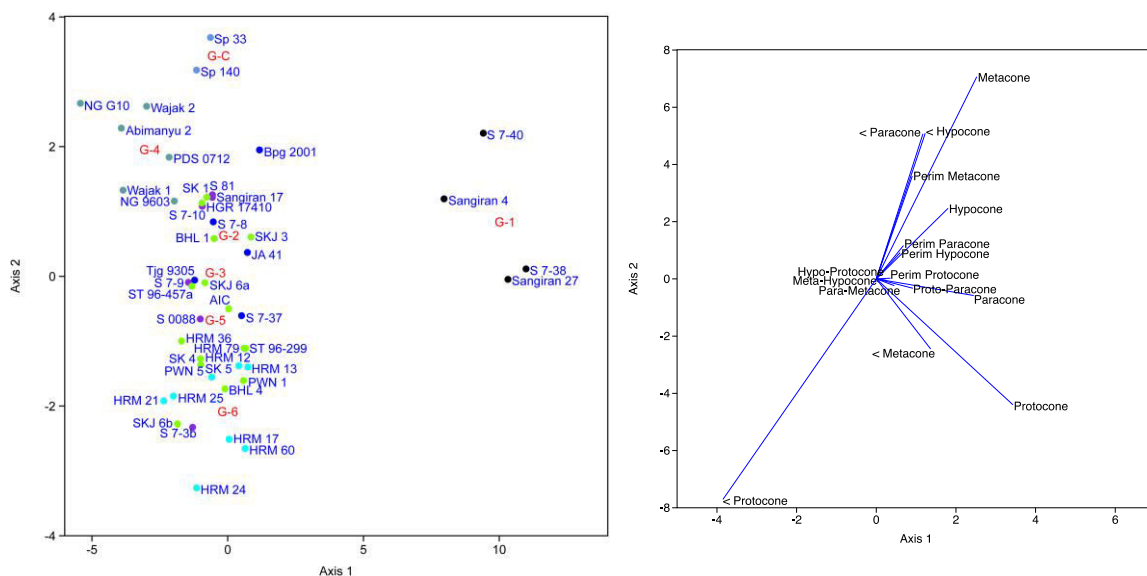

Fig 4. D.18. LDA of crown size and cusp proportion on upper first molar, Axis 1 vs Axis 2.

G-1 = robust *Homo erectus*, G-2 and G-3 = Javan *Homo erectus*, G-C = Zhoukoudian *Homo erectus*, G-4 = Late Pleistocene *Homo sapiens*, G-5 = Early Holocene *Homo sapiens*, and G-6 = Late Holocene *Homo sapiens*.

Protoconid = size of protoconid, Perim Protoconid = protoconid circumference, Proto-Hypoconid = protoconid-hypoconid distance, < Protoconid = angle of protoconid

The linier discriminant analysis based on crown size and cusp proportion variables of UM1 (Fig. 4. E.4) shows a tendency of the grouping for early hominins (especially G-1, G-4, and Zhoukoudian *Homo erectus*) also *Homo sapiens*. The most significant variables to characterize the groups are: area and angle of the cusp. Other variables are not significant in this analysis: circumference and distance of the cusp.

Area of the cusp

- Groups with large area of the cups located on the right side: G 1 Pleistocene hominin
- Groups with narrow area of the cups located on the left side: G 2-3 *Homo erectus* Java and Zhoukoudian *Homo erectus*, also G 4-5-6 Late Pleistocene, Early and Late Holocene *Homo sapiens*.

- Groups with large area of metacone and hypocone located on the upper side: Zhoukoudian *Homo erectus* and G 4 Late Pleistocene hominin, also G 2-3 *Homo erectus* Java

Angle of the cusp

- Groups with large angle of paracone and hypocone located on the upper side: G 2-3 *Homo erectus* Java and Zhoukoudian *Homo erectus*, also G 4 Late Pleistocene hominin.
- Groups with large angle of protocone and metacone located on the lower side: G 5-6 Early and Late Holocene *Homo sapiens*

- **UM1 Summary**

General summary:

- The G-1 robust *Homo erectus* located on the right side of the axis 1, in contrary all the rest hominins are located on the left side.
- There is a tendency the early hominins located on upper side of the axis 2, in contrary all the *Homo sapiens* located on the bottom side, with the G-3 Javan *Homo erectus* located between them.

Here is the summary of the crown size and cusp proportion comparative study on the UM1:

- G 1 has very large cusp area with wide paracone and hypocone angle, means **Sangiran 4**, and **S 7-40** have very large cusp size with developed metacone cusp represented by blunt paracone and hypocone angle, but **Sangiran 27** and **S 7-38** presents very large cusp area with less wide paracone and hypocone angle or less developed metacone cusp.
- G 2 *Homo erectus* Java, G 4 Pleistocene hominins, Zhoukoudian *Homo erectus* also some member of G 3 *Homo erectus* Java and G 5 Early Holocene *Homo sapiens* have moderately cusp area with wide paracone and hypocone angle or developed metacone cusp, except **Tjg 1993.05** and **S 7-37** which closed to G 3 *Homo erectus* Java with moderately cusp area with less wide paracone and hypocone angle or less developed metacone cusp. Some member of G 3 *Homo erectus* Java included in this group consists of **Sangiran 17**, **Sangiran 7-10** and G 5 Early Holocene *Homo sapiens* included consists of **SK 1**, **HGR 17410**, **ST 96-457a**, and **SKJ 6a**.
- G 5-6 Early and Late Holocene *Homo sapiens* and some member of G 3 *Homo erectus* Java have small cusp area with wide protocone and metacone angle or rhomboid shape. Some member of G 3 *Homo erectus* Java included in this group consists of **S 7-3b**, **S 7-9**, and **S 0088**.

b. Upper Second Molar

Crown size and cusp proportion analysis on UM2 consists of 46 teeth: 21 Pleistocene hominins (16 from of Sangiran, 2 from Zhoukoudian, 2 from Wajak) and 25 Holocene *Homo sapiens* (4 from Northern Sumatra, 6 from Gua Harimau, 2 from Gua Pawon, 9 from Gunungsewu, 2 from Wajak Holocene caves, 1 from Gua Kidang).

Crown size and cusp proportion analysis on UM2 has 16 variables (see Appendix 3. 2.B) with 16 possible underlying factors. The first two factors have eigenvalue of 3,20 and 2,45 or 35,72 % and 27,39 % with the total amount 63,11 %.

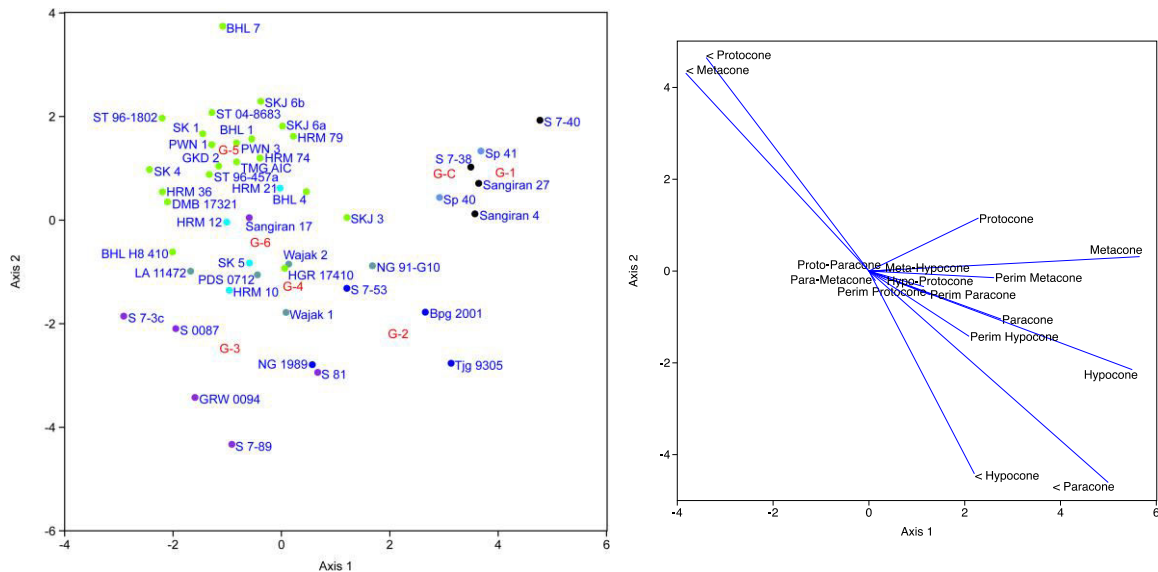

Fig 4. D.19. LDA of crown size and cusp proportion on upper second molar, Axis 1 vs Axis 2.

G-1 = robust *Homo erectus*, G-2 and G-3 = Javan *Homo erectus*, G-C = Zhoukoudian *Homo erectus*, G-4 = Late Pleistocene *Homo sapiens*, G-5 = Early Holocene *Homo sapiens*, and G-6 = Late Holocene *Homo sapiens*.

Protoconid = size of protoconid, Perim Protoconid = protoconid circumference, Proto-Hypoconid = protoconid-hypoconid distance, < Protoconid = angle of protoconid

The linier discriminant analysis based on crown size and cusp proportion variables of UM2 (Fig. 4. E.5) shows a tendency of the grouping for early hominins (especially G-1 to G-4 and Zhoukoudian *Homo erectus*) also *Homo sapiens*. The most significant variables to characterize the groups are: area and angle of the cusp. Other variables are not significant in this analysis: circumference and distance of the cusp.

Area of the cusp

- Groups with large area of the cups located on the right side: G 1-2 *Homo erectus* Java and Zhoukoudian *Homo erectus*,
- Groups with narrow area of the cups located on the left side: G 3 *Homo erectus* Java, G 4 Pleistocene hominin also G 5-6 Early and Late Holocene *Homo sapiens*.

Angle of the cusp

- Groups with large angle of protocone and metacone located on the lower side: G 5 Early Holocene *Homo sapiens* and some member of G 6 Late Holocene *Homo sapiens*

- Groups with large angle of paracone and hypocone located on the lower side: G 2-3 *Homo erectus* Java G 4 Pleistocene hominins and some member of G 6 Late Holocene *Homo sapiens*.
- G 1 Pleistocene hominins and Zhoukoudian *Homo erectus* located separated from both groups

- **UM2 Summary**

General summary:

- All the early hominins, except G-3 Javan *Homo erectus*, are located on the right side of the axis 1, in contrary all *Homo sapiens* including G-3 are located on the left side.
- The G-5 Early Holocene *Homo sapiens*, G-1 robust and Zhoukoudian *Homo erectus* are located on upper side of the axis 2, in contrary G-4 Pleistocene *Homo sapiens*, G-2 and G-3 Javan *Homo erectus* are located on the bottom side, with the G-6 Late Holocene *Homo sapiens* located between them.

Here is the summary of the crown size and cusp proportion comparative study on the UM2:

- G 1 Pleistocene hominins and Zhoukoudian *Homo erectus* have very large cusp area with moderately wide paracone and hypocone angle, means **Sangiran 4**, **Sangiran 27**, **S 7-38**, and **S 7-40** of G 1 Pleistocene hominins, also **Sp 40** and **Sp 41** of Zhoukoudian *Homo erectus* China, have very large cusp area with moderately developed metacone cusp represented by moderately blunt paracone and hypocone angle.
- G 2-3 *Homo erectus* Java, G 4 Pleistocene hominins, also some member of G 5-6 Early and Late Holocene *Homo sapiens* have moderately cusp area with wide paracone and hypocone angle or developed metacone cusp. Some member of G 5 Early Holocene *Homo sapiens* included in this group consists of **BHL H8**, **HGR 17410**, and **SKJ 3**, and then G 6 Late Holocene *Homo sapiens* included consists of **SK 5**, and **HRM 10**.
- G 5 Early Holocene *Homo sapiens* and some member of G 3 *Homo erectus* Java and G 6 Late Holocene *Homo sapiens* have small cusp area with wide protocone and metacone angle or rhomboid shape. Some member of G 3 *Homo erectus* Java included in this group included **Sangiran 17** and G 5 Early Holocene *Homo sapiens* consists of **HRM 12** and **HRM 21**.

c. Upper Third Molar

Crown size and cusp proportion analysis on UM3 consists of 29 teeth: 19 Pleistocene hominins (26 from of Sangiran, 8 from Zhoukoudian, 2 from Wajak) and 10 Holocene *Homo sapiens* (2 from Gua Harimau, 6 from Gunungsewu, 1 from Wajak Holocene caves, 1 from Gua Kidang).

Crown size and cusp proportion analysis on UM3 has 16 variables (see Appendix 3. 2.C) with 16 possible underlying factors. The first two factors have eigenvalue of 12,58 and 3,61 or 64,17 % and 18,43 % with the total amount 82,60 %.

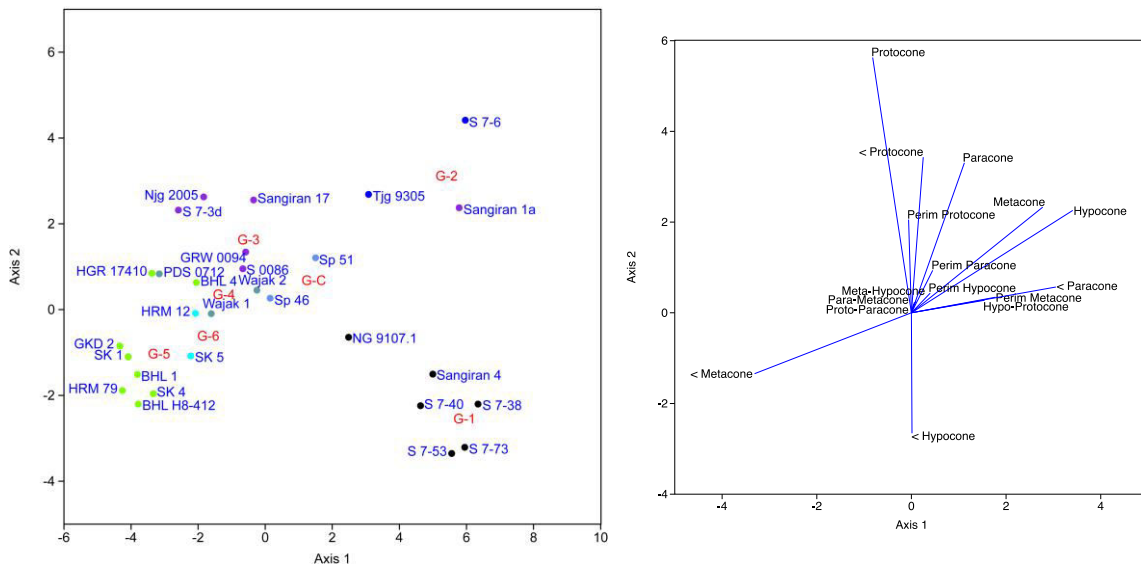

Fig 4. D.20. LDA of crown size and cusp proportion on upper third molar, Axis 1 vs Axis 2.

G-1 = robust *Homo erectus*, G-2 and G-3 = Javan *Homo erectus*, G-C = Zhoukoudian *Homo erectus*, G-4 = Late Pleistocene *Homo sapiens*, G-5 = Early Holocene *Homo sapiens*, and G-6 = Late Holocene *Homo sapiens*.

Protoconid = size of protoconid, Perim Protoconid = protoconid circumference, Proto-Hypoconid = protoconid-hypoconid distance, < Protoconid = angle of protoconid

The linier discriminant analysis based on crown size and cusp proportion variables of UM3 (Fig. 4. E.6) shows a tendency of the grouping for early hominins (especially G-1 and G-2) also *Homo sapiens*. The most significant variables to characterize the groups are: area and angle of the cusp. Other variables are not significant in this analysis: circumference and distance of the cusp.

Area of the cusp

- Groups with large area of the cups located on the right side: G 1-2 *Homo erectus* Java
- Groups with narrow area of the cups located on the left side: G 5-6 Early and Late Holocene *Homo sapiens*.
- G 4 Late Pleistocene hominin, also G 3 *Homo erectus* Java and Zhoukoudian *Homo erectus* located in the middle

Angle of the cusp

- G 1 Pleistocene hominins with large angle of paracone and hypocone located on the lower right side

- G 2 *Homo erectus* Java with large angle of protocone and paracone located on the upper right side
- G 3 *Homo erectus* Java, G 4 Pleistocene hominins, and Zhoukoudian *Homo erectus* with large angle of protocone and metacone located on the upper left side.
- G 5-6 Early and Late Holocene *Homo sapiens* with large angle of metacone and hypocone located on the lower left side.

- **UM3 Summary**

General summary:

- All the early hominins, except G-3 Javan *Homo erectus*, are located on the right side of the axis 1, in contrary all *Homo sapiens* including G-3 are located on the left side.
- The G-1 robust *Homo erectus*, G-5 Early Holocene and G-6 Late Holocene *Homo sapiens* are located on upper side of the axis 2, in contrary G-2 and G-3 Javan *Homo erectus* are located on the bottom side, with the G-4 Pleistocene *Homo sapiens* and Zhoukoudian *Homo erectus* are located between them.

Here is the summary of the crown size and cusp proportion comparative study on the UM3:

- G 1 Pleistocene hominins has very large cusp area with wide paracone and hypocone angle, means **Sangiran 4**, **S 7-38**, **S 7-40** and **NG 9107.1** of G 1 Pleistocene hominins, also **Sp 40** and **Sp 41** of Zhoukoudian *Homo erectus*, have very large size with moderately developed metacone cusp represented by moderately blunt paracone and hypocone angle.
- G 2 *Homo erectus* Java has large cusp area with wide protocone and paracone angle, means **Tjg 1993.05** and **S 7-6**, have large cusp area with developed distal cusps represented by blunt protocone and paracone angle. **Sangiran 1a** of G 3 *Homo erectus* Java and **Sp 51** of Zhoukoudian *Homo erectus* located close to this group.
- G 3 *Homo erectus* Java and G 4 Pleistocene hominins have moderately cusp area with wide protocone and metacone angle or rhomboid shape. **HRM 12** of G 6 Late Holocene *Homo sapiens* and **Sp 46** of Zhoukoudian *Homo erectus* located close to this group.
- G 5 Early Holocene *Homo sapiens* has small cusp area with wide protocone and metacone angle or rhomboid shape. **SK 5** of G 6 Late Holocene *Homo sapiens*.

Summary of the crown size and cusp proportion analysis

Here is the summary of the crown size and cusp proportion analysis on the lower teeth (Table 4. D.8.) and upper teeth (Table 4. D.9.):

Tooth	Separation between early hominin and <i>Homo sapiens</i>	Separation among early hominin	Separation among <i>Homo sapiens</i>
LM1	Yes, tendency separation between <i>Homo sapiens</i> and Pleistocene hominin	Clear separation for G-1 Yes, tendency separation between G-2 and Zhoukoudian <i>Homo erectus</i> with G-3	No separation between G-4, G-5 and G-6
LM2	Yes, almost clear separation between <i>Homo sapiens</i> and Pleistocene hominin	Yes, tendency separation between G-1 and G-2 with G-3 and Zhoukoudian <i>Homo erectus</i>	Yes, tendency separation between G-5 with G-6
LM3	Yes, tendency separation between <i>Homo sapiens</i> and Pleistocene hominin	Yes, tendency separation between G-1, G-2 with G-3 and Zhoukoudian <i>Homo erectus</i>	No separation between G-4, G-5 and G-6

Table 4. D.8. Summary of crown size and cusp proportion analysis on lower teeth.

Tooth	Separation between early hominin and <i>Homo sapiens</i>	Separation among early hominin	Separation among <i>Homo sapiens</i>
UM1	No clear separation between <i>Homo sapiens</i> and Pleistocene hominin	Yes, tendency separation between G-1, Zhoukoudian <i>Homo erectus</i> with G-2 and G-3	Yes, tendency separation between G-4, G-5, and G-6
UM2	Yes, tendency separation between <i>Homo sapiens</i> and Pleistocene hominin	Yes, tendency separation between G-1 and Zhoukoudian <i>Homo erectus</i> with G-2 and G-3	Yes, tendency separation between G-4 and G-6 with G-5
UM3	Yes, tendency separation between <i>Homo sapiens</i> and Pleistocene hominin	Yes, tendency separation between G-1, G-2 with Zhoukoudian <i>Homo erectus</i> and G-3	Yes, tendency separation between G-4 and G-6 with G-5

Table 4. D.9. Summary of crown size and cusp proportion analysis on upper teeth.

E. GEOMETRIC MORPHOMETRICS

We will consider the conformation of the occlusal surface of the premolars and molars in order to complete our comparative study, putting apart the size effect, using geometric morphometrics (GM). We will see if the GM analyses support our 6 groups hypothesis. In this approach, we can assess the weight of each variable. The characters are also helpful to see the dynamic of morphological change between the groups. This approach will be used on all upper and lower premolars and molars in the same anatomical orientation. We have digitized landmarks on the occlusal surface: 8 landmarks for the premolars, 18 and 24 landmarks for lower and upper molars (see protocol in chapter 3.C.5).

1. Geometric Morphometrics of Mandibular Teeth

a. Lower Third Premolar

GM analysis on LP3 consists of 29 teeth: 12 Pleistocene hominins (5 from of Sangiran, 1 from Patiayam, 1 from Trinil, 4 from Zhoukoudian, 1 from Wajak) and 17 Holocene *Homo sapiens* (3 from Northern Sumatra, 5 from Gua Harimau, 1 from Gua Pawon, 5 from Gunungsewu, 3 from Wajak Holocene caves).

We use 8 landmarks for 2D of GM, so we have totally 16 point of X and Y coordinates which used as 16 factors for Principal Component Analysis (The most important is that the PCA will be generated from the co-variance matrix of the residuals of the Procrustes superimposition). The first two factors of the PCA between-groups have eigenvalue value bigger than 10 %, which are 12,98 and 2,74 or 64,42 % and 13,50 % which totally is 77,92 % of cumulative value.

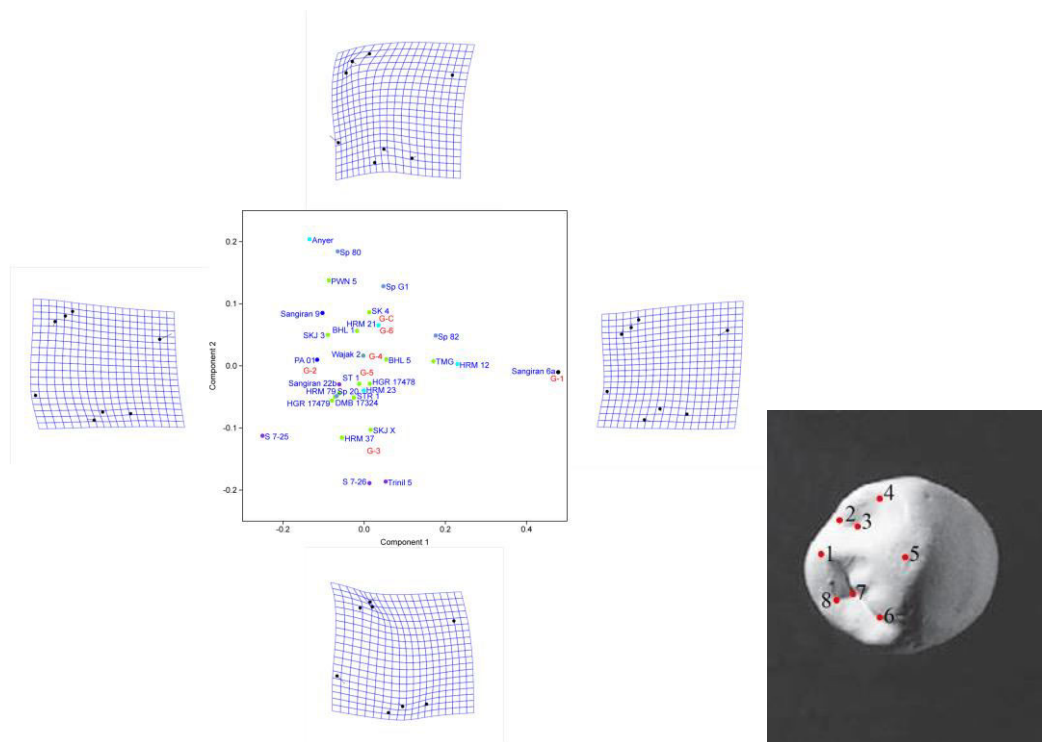

Fig. 4. E.1. PCA Geometric-Morphometric of lower third premolar, PC 1 vs PC2.

Note: Up = Mesial direction, Right = Buccal direction

G-1 = robust *Homo erectus*, G-2 and G-3 = Javan *Homo erectus*, G-C = Zhoukoudian *Homo erectus*, G-4 = Late Pleistocene *Homo sapiens*, G-5 = Early Holocene *Homo sapiens*, and G-6 = Late Holocene *Homo sapiens*.

The PCA based on the GM study of the LP3 (Fig. 4. F.1) shows a tendency to separate G-1 robust and G-3 Javan *Homo erectus*, also some specimens to the rest hominins. The main tendency separation is four shapes: far distance between buccal and lingual cusps located on the right side, closed distance between buccal and lingual cusps located on the left side, developed mesial and distal triangular fossa located on the upper side, and reduced mesial and distal triangular fossa located on the lower side.

LP3 Summary

Here is the summary of GM comparative study on the LP3:

- **Sangiran 6a** of G 1 Pleistocene hominin, **Sp 82** of Zhoukoudian *Homo erectus*, also **TMG** of G 5 Early Holocene *Homo sapiens* and **HRM 12** of G 6 Late Holocene *Homo sapiens* have far distance between buccal and lingual cusps.
- All of *Homo sapiens* and Zhoukoudian *Homo erectus*, including **Sangiran 9** and **PA 01** of G 2 *Homo erectus* Java, also **Sangiran 22b**, **S 7-26**, **S 7-26**, and **Trinil 5** of G 3 *Homo erectus* Java, have closed distance between buccal and lingual cusps.
- All of G 2 *Homo erectus* Java, including **Sp G1** and **Sp 82** of Zhoukoudian *Homo erectus* **Wajak 2** of G 4 Late Pleistocene *Homo sapiens*, also **HRM 21** of G 6 Late Holocene *Homo sapiens*, have mesial and distal triangular fossa development with mesial and distal region expansion
- All of G 3 *Homo erectus* Java, including **Sp 20** of Zhoukoudian *Homo erectus*, also **HRM 23** of G 6 Late Holocene *Homo sapiens*, have mesial and distal triangular fossa reduction with mesial and distal region diminution
- G 5 Early Holocene *Homo sapiens* specimens are splitted into developed and reduced mesial and distal triangular fossa

b. Lower Fourth Premolar

GM analysis on LP4 consists of 32 teeth: 11 Pleistocene hominins (6 from of Sangiran, 4 from Zhoukoudian, 1 from Wajak) and 21 Holocene *Homo sapiens* (3 from Northern Sumatra, 6 from Gua Harimau, 1 from Gua Pawon, 7 from Gunungsewu, 3 from Wajak Holocene caves).

We use 8 landmarks for 2D of GM, so we have totally 16 point of X and Y coordinates which used as 16 factors for Principal Component Analysis. The first two factors of the PCA between-groups have eigenvalue value bigger than 15 %, which are 7,45 and 3,97 or 46,76 % and 24,91 % which totally about 71,67 % of cumulative value.

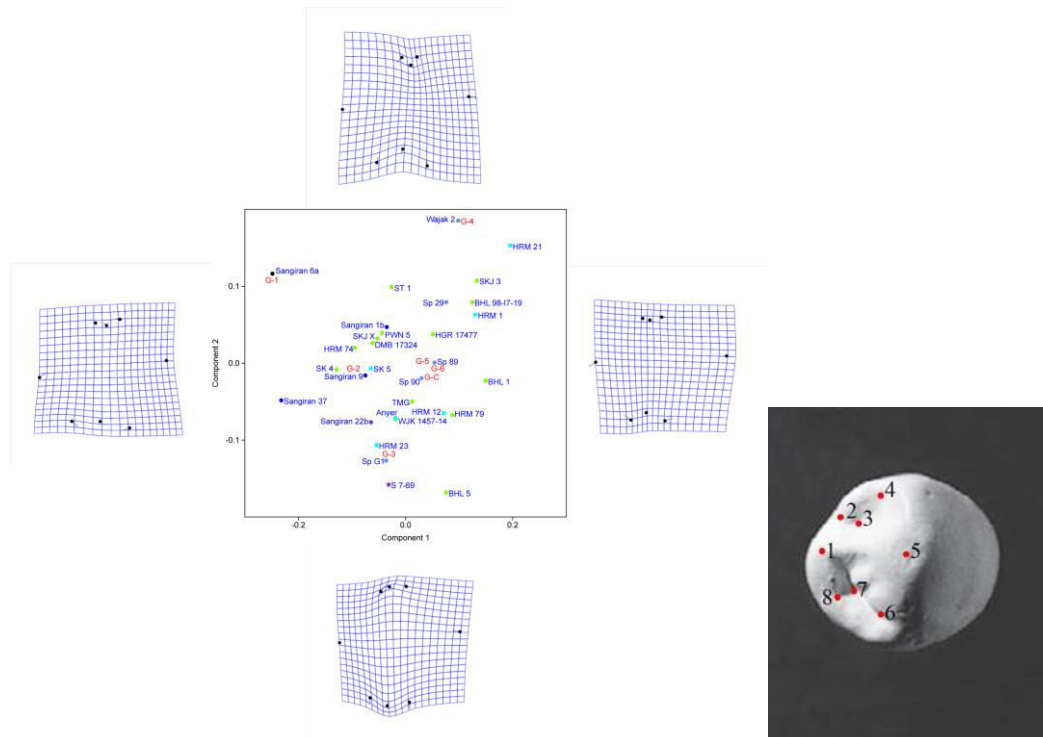

Fig. 4. E.2. PCA Geometric-Morphometric of lower fourth premolar, PC 1 vs PC2.

Note: Up = Mesial direction, Right = Buccal direction

G-1 = robust *Homo erectus*, G-2 and G-3 = Javan *Homo erectus*, G-C = Zhoukoudian *Homo erectus*, G-4 = Late Pleistocene *Homo sapiens*, G-5 = Early Holocene *Homo sapiens*, and G-6 = Late Holocene *Homo sapiens*.

The PCA based on the GM study of the LP4 (Fig. 4. F.2) shows a tendency to separate G-1, robust and G-3 Javan *Homo erectus*, G-4 Late Pleistocene *Homo sapiens*, also some specimens to the rest hominins. The main tendency separation is four shapes: closed distance between buccal and lingual cusps located on the right side, far distance between buccal and lingual cusps located on the left side, developed mesial and distal triangular fossa located on the upper side, and reduced mesial and distal triangular fossa located on the lower side.

LP4 Summary

Here is the summary of GM comparative study on the LP4:

- All of G 1-3 Pleistocene hominin, including **Sp G1** of Zhoukoudian *Homo erectus*, also **HRM 23** and **SK 5** of G 6 Late Holocene *Homo sapiens*, have far distance between buccal and lingual cusps.
- All of *Homo sapiens* and Zhoukoudian *Homo erectus*, including **Wajak 2** of G 4 Late Pleistocene *Homo sapiens*, have closed distance between buccal and lingual cusps.
- **Sangiran 6a** of G 1 Pleistocene hominin, **Sangiran 1b** of G 2 *Homo erectus* Java, **Wajak 2** of G 4 Late Pleistocene *Homo sapiens*, also **Sp 29** and **Sp 89** of Zhoukoudian *Homo erectus* have mesial and distal triangular fossa development with mesial and distal region expansion
- **Sangiran 9** and **Sangiran 37** of G 2 *Homo erectus* Java, **Sangiran 22b** and **S 7-69** of G 3 *Homo erectus* Java also **Sp G1** and **Sp 90** of Zhoukoudian *Homo erectus*, have mesial and distal triangular fossa reduction with mesial and distal region diminution
- G 5-6 Early and Late Holocene *Homo sapiens* specimens are splitted into far and closed distance of buccal and lingual cusps, also developed and reduced mesial and distal triangular fossa.

c. Lower First Molar

GM analysis on LM1 consists of 42 teeth: 22 Pleistocene hominins (18 from of Sangiran, 3 from Zhoukoudian, 1 from Wajak) and 20 Holocene *Homo sapiens* (4 from Northern Sumatra, 7 from Gua Harimau, 2 from Gua Pawon, 6 from Gunungsewu, 1 from Wajak Holocene caves).

We use 18 landmarks for 2D of GM, so we have totally 32 point of X and Y coordinates which used as 32 factors for Principal Component Analysis. The first two factors of the PCA between-groups have eigenvalue value bigger than 15 %, which are 72,04 and 18,10 or 68,36 % and 17,18 % which totally for 85,54 % of cumulative value.

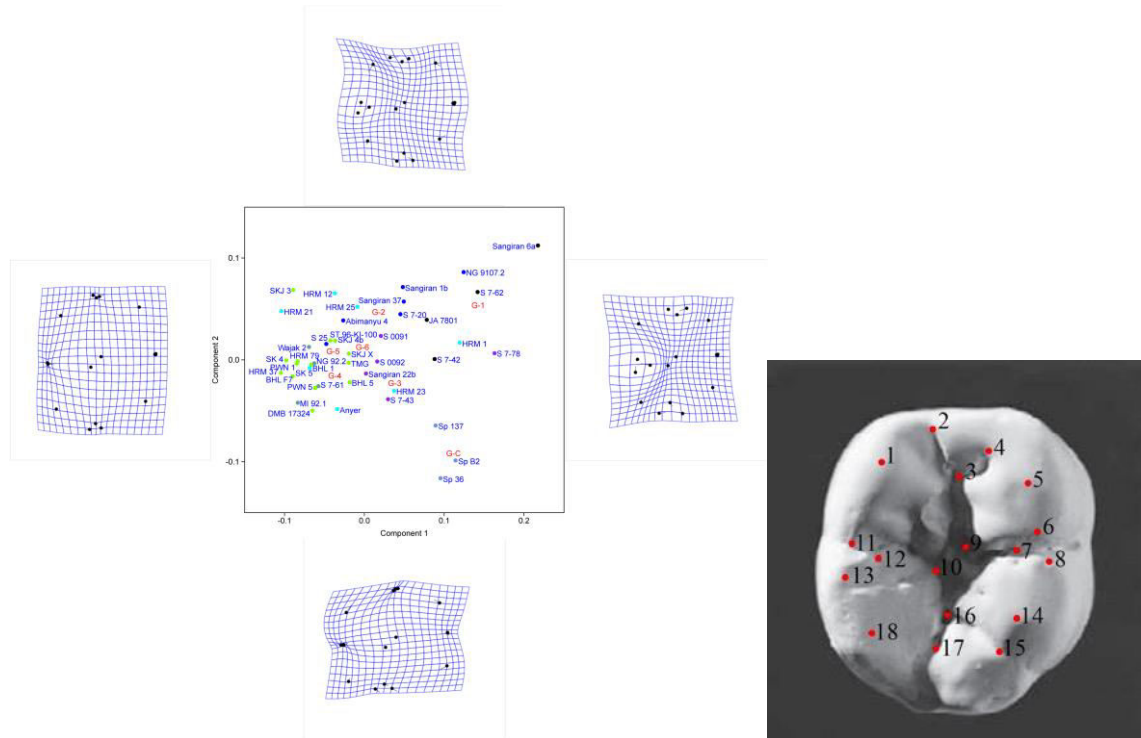

Fig. 4. E.3. PCA Geometric-Morphometric of lower first molar, PC 1 vs PC2.

Note: Up = Mesial direction, Right = Buccal direction

G-1 = robust *Homo erectus*, G-2 and G-3 = Javan *Homo erectus*, G-C = Zhoukoudian *Homo erectus*, G-4 = Late Pleistocene *Homo sapiens*, G-5 = Early Holocene *Homo sapiens*, and G-6 = Late Holocene *Homo sapiens*.

The PCA based on the GM study of the LM1 (Fig. 4. F.3) shows a tendency to separate between *Homo erectus* and *Homo sapiens*. The main tendency separation is four shapes: complicated occlusal formation located on the right side, simple occlusal formation located on the left side, elongated mesiodistal shape located on the upper side, and square shape located on the lower side.

LM1 Summary

Here is the summary of GM comparative study on the LM1:

- All of Pleistocene hominins from Java and Zhoukoudian, including **HRM 1** and **HRM 23** of G 6 Late Holocene *Homo sapiens*, have complicated occlusal formation with large anterior and posterior fovea, also lingual accessory tubercle.

- All of *Homo sapiens*, including **Abimanyu 4** and **S 25** of G 2 *Homo erectus* Java and G 4 Pleistocene hominins, have simple occlusal formation with narrow to absent anterior and posterior fovea, also lingual accessory tubercle.
- G 1-2 Pleistocene hominins, including **S 0091** of G 3 *Homo erectus* Java, **Wajak 2** of G 4 Late Pleistocene *Homo sapiens*, **SKJ X**, **SKJ 3**, **SKJ 4b**, and **ST KI** of G 5 Early Holocene *Homo sapiens*, also **HRM 1**, **HRM 12**, **HRM 21**, and **HRM 25** of G 6 Late Holocene *Homo sapiens* have mesiodistal elongated shape
- G 3 *Homo erectus* Java, Zhoukoudian *Homo erectus*, G 4 Pleistocene hominins, G 5 Early Holocene *Homo sapiens*, 6 Late Holocene *Homo sapiens*, including **S 7-42** of G 1 Pleistocene hominins, have square shape

d. Lower Second Molar

GM analysis on LM2 consists of 64 teeth: 34 Pleistocene hominins (26 from of Sangiran, 6 from Zhoukoudian, 2 from Wajak) and 30 Holocene *Homo sapiens* (4 from Northern Sumatra, 9 from Gua Harimau, 4 from Gua Pawon, 9 from Gunungsewu, 3 from Wajak Holocene caves, 1 from Gua Kidang).

We use 18 landmarks for 2D of GM, so we have totally 32 point of X and Y coordinates which used as 32 factors for Principal Component Analysis. The first two factors of the PCA between-groups have eigenvalue value bigger than 15 %, which are 10,55 and 7,21 or 43,39 % and 29,64 % which totally for 73,03 % of cumulative value.

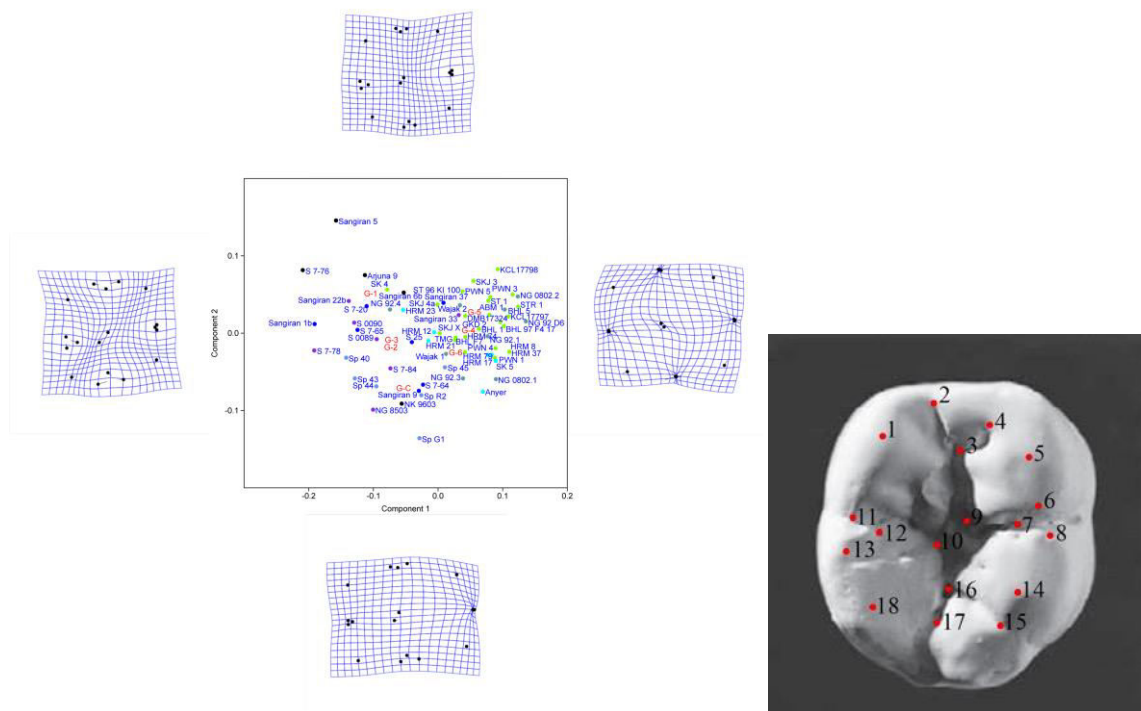

Fig. 4. E.4. PCA Geometric-Morphometric of lower second molar, PC 1 vs PC2.

Note: Up = Mesial direction, Right = Buccal direction

G-1 = robust *Homo erectus*, G-2 and G-3 = Javan *Homo erectus*, G-C = Zhoukoudian *Homo erectus*, G-4 = Late Pleistocene *Homo sapiens*, G-5 = Early Holocene *Homo sapiens*, and G-6 = Late Holocene *Homo sapiens*.

The PCA based on the GM study of the LM2 (Fig. 4. F.4) shows a tendency to separate between *Homo erectus* and *Homo sapiens*. The main tendency separation is four shapes: simple occlusal formation located on the right side, complicated occlusal formation located on the left side, elongated mesiodistal shape located on the upper side, and square shape located on the lower side.

LM2 Summary

Here is the summary of GM comparative study on the LM2:

- All of Pleistocene hominins from Java and Zhoukoudian, including **SKJ X**, **SKJ 4a**, and **SK 4** of G 5 Early Holocene *Homo sapiens* also **HRM 12**, **HRM 21**, and **HRM 23** of G 6

Late Holocene *Homo sapiens*, have complicated occlusal formation with large anterior and posterior fovea, also lingual accessory tubercle.

- All of G 4 Pleistocene hominins and *Homo sapiens*, including **Sangiran 37** of G 3 *Homo erectus* Java and **Sangiran 33** of G 3 *Homo erectus* Java also **Sp 45** of Zhoukoudian *Homo erectus*, have simple occlusal formation with narrow to absent anterior and posterior fovea, also lingual accessory tubercle.
- G 1-2 Pleistocene hominins, including **Wajak 2**, **Abimanyu 1**, **NG 92 D6**, **NG 92.4**, and **NG 0802.2** of G 4 Pleistocene hominins, also **HRM 23** of G 6 Late Holocene *Homo sapiens* have mesiodistal elongated shape
- 6 Late Holocene *Homo sapiens*, Zhoukoudian *Homo erectus*, including **Sangiran 9**, **S 25**, **S 7-64** of G 2 *Homo erectus* Java, **NG 8503**, **S 0089**, **S 7-78**, and **S 7-84** of G 3 *Homo erectus* Java, also **Wajak 1**, **NG 92.1**, **NG 92.3**, and **NG 0802.1** of G 4 Pleistocene hominins, have square shape
- G 5 Early Holocene *Homo sapiens* from Sukajadi, Gua Braholo, Song Keplek, Song Terus, Song Tritis, Goea Ketjil and Djimbe have mesiodistal elongated shape, but other specimens from Tamiang, Gua Harimau lower level, Gua Pawon, and Gua Braholo have square shape.

Late Holocene *Homo sapiens*, have complicated occlusal formation with large anterior and posterior fovea, also lingual accessory tubercle.

- All of *Homo sapiens*, including **Wajak 1**, **Wajak 2**, **NG 0802.2**, and **NG 9107.1** of G 4 Pleistocene hominins also **Sp 45** of Zhoukoudian *Homo erectus*, have simple occlusal formation with narrow to absent anterior and posterior fovea, also lingual accessory tubercle.
- G 1, 3, and 4 Pleistocene hominins, including **Sangiran 8** of G 2 *Homo erectus* Java, also **HRM 21** of 6 Late Holocene *Homo sapiens*, have square shape
- G 2 *Homo erectus* Java and Zhoukoudian *Homo erectus*, including **SA 7600** of G 1 Pleistocene hominins, **Sangiran 22b** of G 3 *Homo erectus* Java, **Wajak 1** of G 4 Pleistocene hominins, also **HRM 17** and **SK 5** of G 6 Late Holocene *Homo sapiens* have mesiodistal elongated shape
- Specimens of G 5 Early Holocene *Homo sapiens* are shared into elongated and square shape

2. Geometric-Morphometric of Maxillary Teeth

a. Upper Third Premolar

GM analysis on UP3 consists of 35 teeth: 14 Pleistocene hominins (11 from of Sangiran, 1 from Zhoukoudian, 2 from Wajak) and 21 Holocene *Homo sapiens* (3 from Northern Sumatra, 7 from Gua Harimau, 2 from Gua Pawon, 4 from Gunungsewu, 5 from Wajak Holocene caves).

We use 8 landmarks for 2D of GM, so we have totally 16 point of X and Y coordinates which used as 16 factors for Principal Component Analysis. The first two factors of the PCA between-groups have eigenvalue value bigger than 10 %, which are 3,09 and 1,57 or 46,69 % and 23,72 % which totally for 70,41 % of cumulative value.

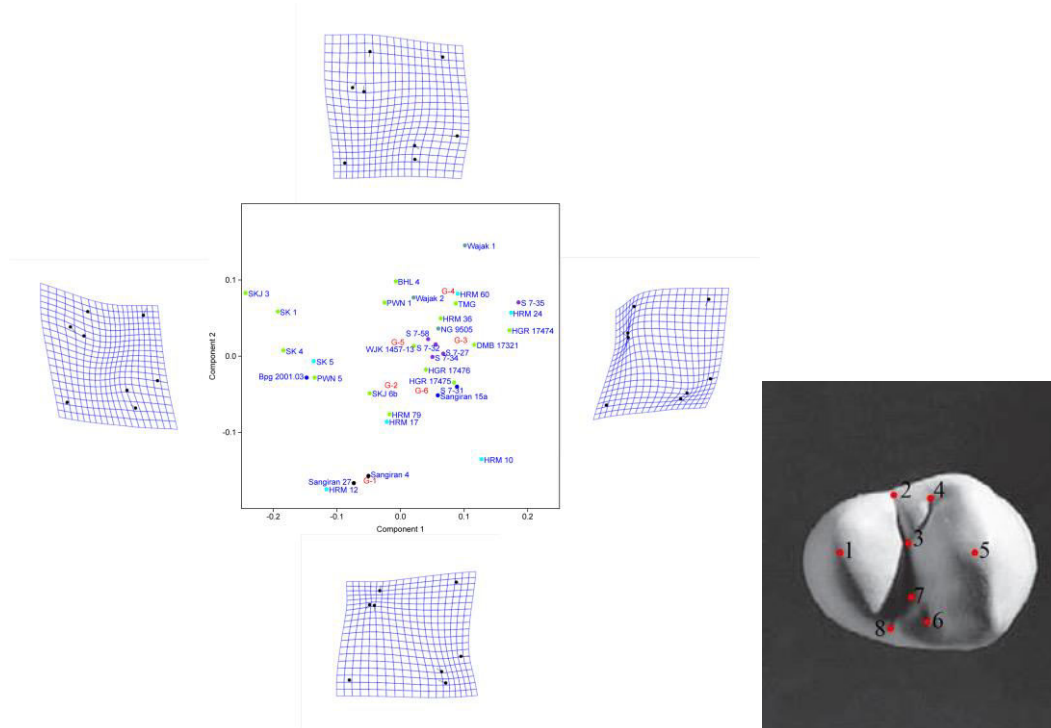

Fig. 4. E.6. PCA Geometric-Morphometric of upper third premolar, PC 1 vs PC2.

Note: Up = Mesial direction, Right = Buccal direction

G-1 = robust *Homo erectus*, G-2 and G-3 = Javan *Homo erectus*, G-C = Zhoukoudian *Homo erectus*, G-4 = Late Pleistocene *Homo sapiens*, G-5 = Early Holocene *Homo sapiens*, and G-6 = Late Holocene *Homo sapiens*.

The PCA based on the GM study of the UP3 (Fig. 4. F.6) shows a tendency to separate G-1 robust *Homo erectus* and some specimens to the rest hominins. The main tendency separation is four shapes: reduced mesial and distal triangular fossa located on the right side, developed mesial and distal triangular fossa located on the left side, closed distance between buccal and lingual cusps located on the upper side, and far distance between buccal and lingual cusps located on the lower side.

UP3 Summary

Here is the summary of GM comparative study on the UP3:

- G 1-2 Pleistocene hominin, including **HRM 10**, **HRM 12**, **HRM 17**, and **SK 5** of G 6 Late Holocene *Homo sapiens*, have far distance between buccal and lingual cusps.
- G 3-4 Pleistocene hominin, including **HRM 24** and **HRM 60** of G 6 Late Holocene *Homo sapiens*, have closed distance between buccal and lingual cusps.
- All of G 1 Pleistocene hominins, including **Bpg 2001.04** of G 2 *Homo erectus* Java, also **HRM 12** and **SK 5** of G 6 Late Holocene *Homo sapiens*, have mesial and distal triangular fossa development with mesial and distal region expansion
- All of G 3-4 Pleistocene hominins also G 6 Late Holocene *Homo sapiens*, including **Sangiran 15a** and **S 7-31** of G 2 *Homo erectus* Java, have mesial and distal triangular fossa reduction with mesial and distal region diminution
- G 5 Early Holocene *Homo sapiens* specimens are splitted into far and closed buccal and lingual cusps, also developed and reduced mesial and distal triangular fossa

UP4 Summary

Here is the summary of GM comparative study on the UP4:

- G 1-2 Pleistocene hominin, including **Wajak 2** of G 4 Late Pleistocene *Homo sapiens*, have far distance between buccal and lingual cusps.
- G 3-4 Pleistocene hominin and Zhoukoudian *Homo erectus*, including **S 0086** of G 2 *Homo erectus* Java, SK 5 of G 6 Late Holocene *Homo sapiens*, have closed distance between buccal and lingual cusps.
- All of G 1, 2, 3 Pleistocene hominins, including **SKJ 3**, **SKJ 6b**, and **SK 1** of G 5 Early Holocene *Homo sapiens*, have mesial and distal triangular fossa development with mesial and distal region expansion
- All of G 4 Pleistocene hominins also G 5-6 Early and Late Holocene *Homo sapiens*, including **S 7-3a** of G 3 *Homo erectus* Java, have mesial and distal triangular fossa reduction with mesial and distal region diminution
- G 5 Early Holocene *Homo sapiens* specimens are splitted into far and closed buccal and lingual cusps

c. Upper First Molar

GM analysis on UM1 consists of 50 teeth: 25 Pleistocene hominins (20 from of Sangiran, 3 from Zhoukoudian, 2 from Wajak) and 25 Holocene *Homo sapiens* (5 from Northern Sumatra, 8 from Gua Harimau, 2 from Gua Pawon, 8 from Gunungsewu, 2 from Wajak Holocene caves).

We use 24 landmarks for 2D of GM, so we have totally 48 point of X and Y coordinates which used as 32 factors for Principal Component Analysis. The first two factors of the PCA between-groups have eigenvalue value bigger than 15 %, which are 20,06 and 7,90 or 58,90 % and 23,19 % which totally for 82,09 % of cumulative value.

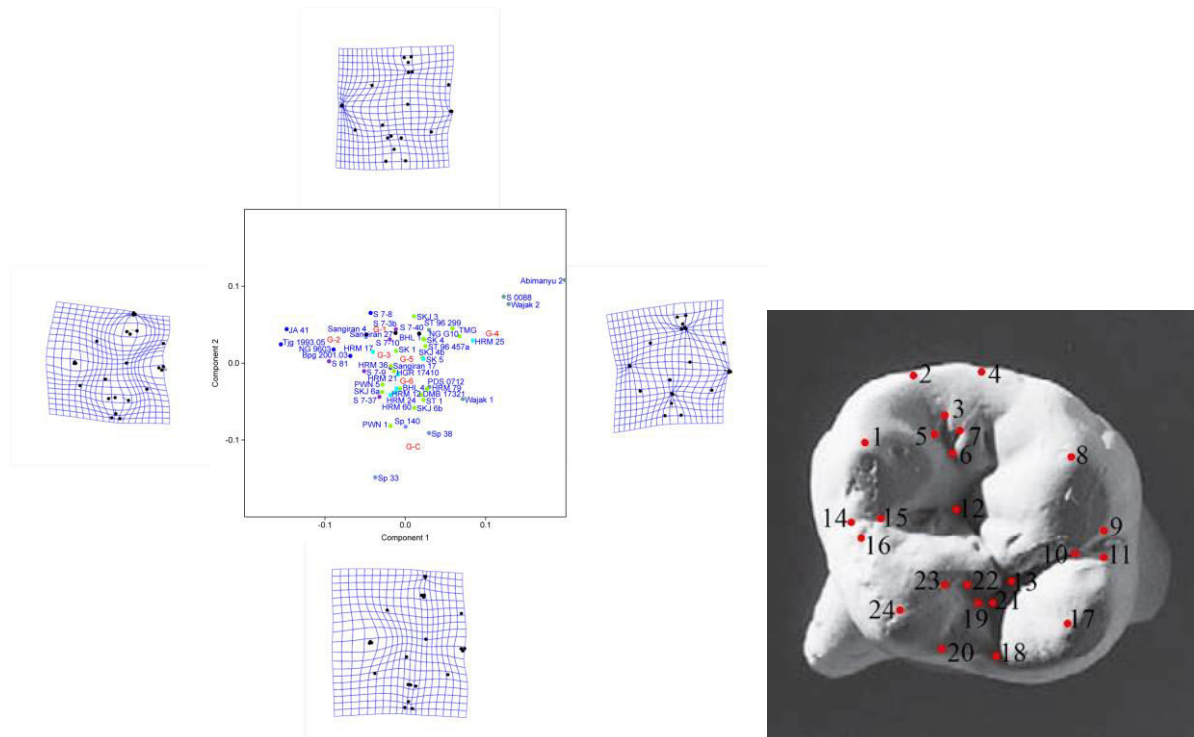

Fig. 4. E.8. PCA Geometric-Morphometric of upper first molar, PC 1 vs PC2.

Note: Up = Mesial direction, Right = Buccal direction

G-1 = robust *Homo erectus*, G-2 and G-3 = Javan *Homo erectus*, G-C = Zhoukoudian *Homo erectus*, G-4 = Late Pleistocene *Homo sapiens*, G-5 = Early Holocene *Homo sapiens*, and G-6 = Late Holocene *Homo sapiens*.

The PCA based on the GM study of the UM1 (Fig. 4. F.8) shows a tendency to separate G-1 robust *Homo erectus*, G-2 Javan and Zhoukoudian *Homo erectus* to *Homo sapiens*. The main tendency separation is four shapes: simple occlusal formation located on the right side, complicated occlusal formation located on the left side, developed MMAT and distal cusp located on the upper side, and reduced MMAT and distal cusp located on the lower side.

UM1 Summary

Here is the summary of GM comparative study on the UM1:

- All of Pleistocene hominins from Java and Zhoukoudian, including **HRM 12**, **HRM 17**, **HRM 21**, **HRM 24**, and **HRM 60** of G 6 Late Holocene *Homo sapiens*, have

complicated occlusal formation with large anterior and posterior fovea, also buccal accessory tubercle.

- All of *Homo sapiens* and G 4 Pleistocene hominins, including **Sp 38** of Zhoukoudian *Homo erectus*, have simple occlusal formation with narrow to absent anterior and posterior fovea, also buccal accessory tubercle.
- G 1, 2, and 4 Pleistocene hominins, including **S 7-10** and **S 7-3b** of G 3 *Homo erectus* Java, also **HRM 17**, **HRM 25**, and **SK 5** of G 6 Late Holocene *Homo sapiens*, have developed MMAT and distal cusp
- G 2 *Homo erectus* Java and Zhoukoudian *Homo erectus*, including **HRM 12**, **HRM 21**, **HRM 24**, and **HRM 60** of G 6 Late Holocene *Homo sapiens*, have reduced MMAT and distal cusp
- Specimens of G 5 Early Holocene *Homo sapiens* are splitted into complicated and simple shape, also developed and reduced MMAT and distal cusp.

d. Upper Second Molar

GM analysis on upper second molar consists of 47 teeth: 22 Pleistocene hominins (17 from of Sangiran, 2 from Zhoukoudian, 1 from Lida Ajer, 2 from Wajak) and 25 Holocene *Homo sapiens* (4 from Northern Sumatra, 6 from Gua Harimau, 3 from Gua Pawon, 9 from Gunungsewu, 2 from Wajak Holocene caves, 1 from Gua Kidang).

We use 24 landmarks for 2D of GM, so we have totally 48 point of X and Y coordinates which used as 32 factors for Principal Component Analysis (PCA). The first two factors of the PCA between-groups have eigenvalue value bigger than 10 %, which are 44,22 and 22,35 or 47,97 % and 24,24 % which totally for 72,21 % of cumulative value.

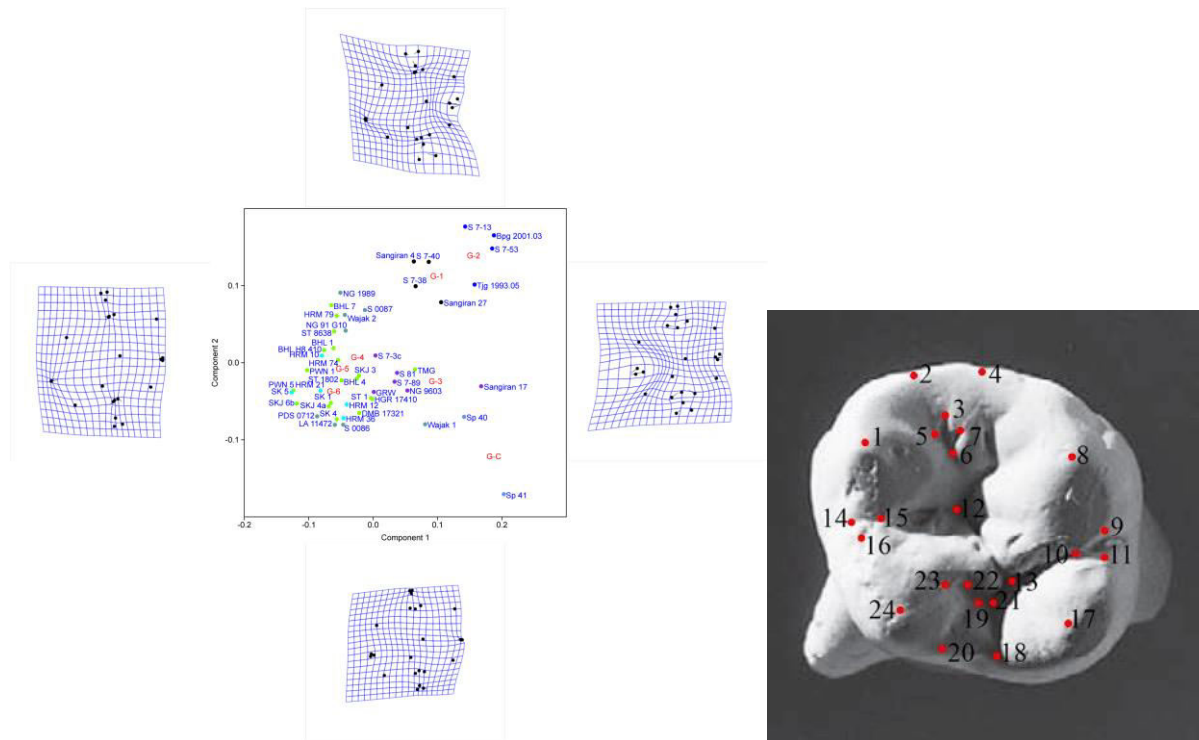

Fig. 4. E.9. PCA Geometric-Morphometric of upper second molar, PC 1 vs PC2.

Note: Up = Mesial direction, Right = Buccal direction

G-1 = robust *Homo erectus*, G-2 and G-3 = Javan *Homo erectus*, G-C = Zhoukoudian *Homo erectus*, G-4 = Late Pleistocene *Homo sapiens*, G-5 = Early Holocene *Homo sapiens*, and G-6 = Late Holocene *Homo sapiens*.

The PCA based on the GM study of the UM2 (Fig. 4. F.8) shows a tendency to separate between Javan *Homo erectus* and *Homo sapiens*, including separation the Zhoukoudian *Homo erectus* from both previous hominins. The main tendency separation is four shapes: complicated occlusal formation located on the right side, simple occlusal formation located on the left side, developed MMAT and distal cusp located on the upper side, and reduced MMAT and distal cusp located on the lower side.

UM2 Summary

Here is the summary of GM comparative study on the UM2:

- All of Pleistocene hominins from Java and Zhoukoudian, including **Wajak 1** of G 4 Late Pleistocene *Homo sapiens*, have complicated occlusal formation with large anterior and posterior fovea, also buccal accessory tubercle.
- All of *Homo sapiens* and G 4 Pleistocene hominins, have simple occlusal formation with narrow to absent anterior and posterior fovea, also buccal accessory tubercle.
- G 1-2 Pleistocene hominins, including **S 7-3c** of G 3 *Homo erectus* Java, **Wajak 2**, **NG 91 G 10**, **NG 1989**, and **S 0087** of G 4 Pleistocene hominins, also **HRM 10** of G 6 Late Holocene *Homo sapiens*, have developed MMAT and distal cusp
- G 3 *Homo erectus* Java, Zhoukoudian *Homo erectus*, and G 6 G 6 Late Holocene *Homo sapiens* including **PDS 0712**, **LA 11472**, and **S 0086** of G 4 Pleistocene hominins, have reduced MMAT and distal cusp
- Specimens of G 5 Early Holocene *Homo sapiens* are splitted into developed and reduced MMAT and distal cusp.

e. Upper Third Molar

GM analysis on UM3 consists of 36 teeth: 22 Pleistocene hominins (18 from of Sangiran, 2 from Zhoukoudian, 2 from Wajak) and 14 Holocene *Homo sapiens* (1 from Northern Sumatra, 3 from Gua Harimau, 2 from Gua Pawon, 6 from Gunungsewu, 2 from Wajak Holocene caves).

We use 24 landmarks for 2D of GM, so we have totally 48 point of X and Y coordinates which used as 32 factors for Principal Component Analysis. The first two factors of the PCA between-groups have eigenvalue value bigger than 15 %, which are 36,12 and 11,46 or 59,29 % and 18,81 % which totally for 78,10 % of cumulative value.

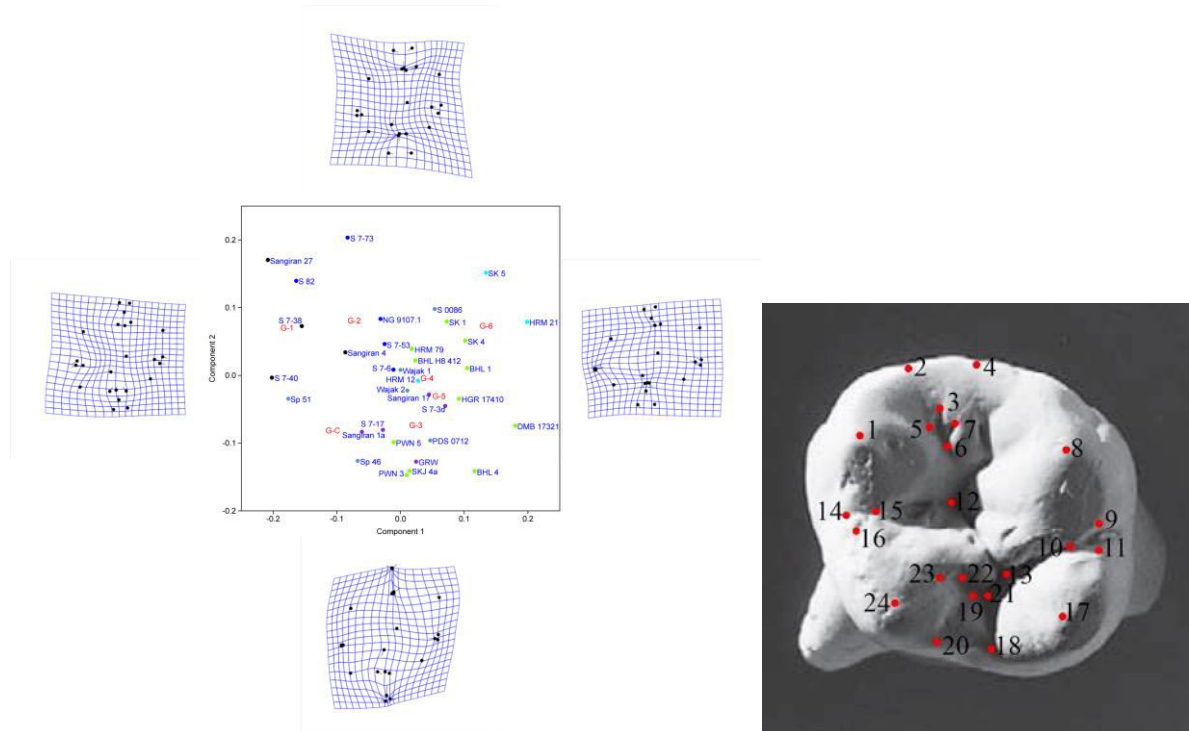

Fig. 4. E.10. PCA Geometric-Morphometric of upper third molar, PC 1 vs PC2.

Note: Up = Mesial direction, Right = Buccal direction

G-1 = robust *Homo erectus*, G-2 and G-3 = Javan *Homo erectus*, G-C = Zhoukoudian *Homo erectus*, G-4 = Late Pleistocene *Homo sapiens*, G-5 = Early Holocene *Homo sapiens*, and G-6 = Late Holocene *Homo sapiens*.

The PCA based on the GM study of the UM3 (Fig. 4. F.9) shows a tendency to separate G-1 robust *Homo erectus*, G-2 Javan and Zhoukoudian *Homo erectus* to *Homo sapiens*. The main tendency separation is four shapes: simple occlusal formation located on the right side, complicated occlusal formation located on the left side, developed MMAT and distal cusp located on the upper side, and reduced MMAT and distal cusp located on the lower side.

UM3 Summary

Here is the summary of GM comparative study on the UM3:

- All of Pleistocene hominins from Java and Zhoukoudian, including **PWN 5** of G 5 Early Holocene *Homo sapiens*, have complicated occlusal formation with large anterior and posterior fovea, also buccal accessory tubercle.
- All of *Homo sapiens* and G 4 Pleistocene hominins, including **Sangiran 17**, **S 7-3d**, and **Grogolwetan** of G 3 *Homo erectus* Java, have simple occlusal formation with narrow to absent anterior and posterior fovea, also buccal accessory tubercle.
- G 1-2 Pleistocene hominins, including **Wajak 1** and **S 0086** of G 4 Pleistocene hominins, also **HRM 21** and **SK 5** of G 6 Late Holocene *Homo sapiens*, have developed MMAT and distal cusp
- G 3 *Homo erectus* Java, Zhoukoudian *Homo erectus*, and G 6 G 6 Late Holocene *Homo sapiens* including **S 7-40** of G 1 Pleistocene hominins, **Wajak 2** and **PDS 0712** of G 4 Pleistocene hominins, also **HRM 12** of G 6 Late Holocene *Homo sapiens*, have reduced MMAT and distal cusp
- Specimens of G 5 Early Holocene *Homo sapiens* are splitted into developed and reduced MMAT and distal cusp.

Summary of the GM analysis

Here is the summary of GM analysis on the lower teeth (Table 4. E.1.) and upper teeth (Table 4. E.2.):

Tooth	Separation between early hominin and <i>Homo sapiens</i>	Separation among early hominin	Separation among <i>Homo sapiens</i>
LP3	No clear separation between <i>Homo sapiens</i> and Pleistocene hominin	Clear separation for G-1 Yes, tendency separation between G-2, G-3, with Zhoukoudian <i>Homo erectus</i>	No separation between G-4, G-5 and G-6
LP4	No clear separation between <i>Homo sapiens</i> and Pleistocene hominin	Clear separation for G-1 Clear separation between G-2, G-3, with Zhoukoudian <i>Homo erectus</i>	Clear separation between G-4 with G-5 and G-6
LM1	Yes, almost clear separation between <i>Homo sapiens</i> and Pleistocene hominin	Yes, tendency separation between G-1, G-2 and G-3 Clear separation of Zhoukoudian <i>Homo erectus</i>	Yes, tendency separation between G-4 and G-5 with G-6
LM2	Yes, almost clear separation between <i>Homo sapiens</i> and Pleistocene hominin	Yes, tendency separation between G-1, G-2 with G-3, also with Zhoukoudian <i>Homo erectus</i>	Yes, tendency separation between G-5 with G-6
LM3	Yes, almost clear separation between <i>Homo sapiens</i> and Pleistocene hominin	Yes, tendency separation between G-1, G-2, and G-3 Clear separation of Zhoukoudian <i>Homo erectus</i>	Yes, tendency separation between G-5 with G-6

Table 4. E.1. Summary of GM analysis on lower teeth.

Tooth	Separation between early hominin and <i>Homo sapiens</i>	Separation among early hominin	Separation among <i>Homo sapiens</i>
UP3	No clear separation between <i>Homo sapiens</i> and Pleistocene hominin	Clear separation for G-1 No tendency separation for the rest early hominins	No tendency separation between G-4, G-5 and G-6
UP4	Yes, tendency separation between <i>Homo sapiens</i> and Pleistocene hominin	Yes, tendency separation between G-1, G-2, G-3, and Zhoukoudian <i>Homo erectus</i>	Yes, tendency separation between G-5 and G-6
UM1	No clear separation between <i>Homo sapiens</i> and Pleistocene hominin	Yes, tendency separation between Javan <i>Homo erectus</i> , and Zhoukoudian <i>Homo erectus</i>	No tendency separation between G-4, G-5 and G-6
UM2	Yes, almost clear separation between <i>Homo sapiens</i> and Pleistocene hominin	Yes, tendency separation between G-1, G-2, G-3, and Zhoukoudian <i>Homo erectus</i>	No tendency separation between G-4, G-5 and G-6
UM3	Yes, tendency separation between <i>Homo sapiens</i> and Pleistocene hominin	Yes, tendency separation between G-1 and G-2 with G-3 and Zhoukoudian <i>Homo erectus</i>	Yes, tendency separation between G-5 and G-6

Table 4. E.2. Summary of GM analysis on upper teeth.

CHAPTER 5. DENTAL DIVERSITY AND CHRONOLOGY OF HUMAN OCCUPATION IN THE SUNDALAND DURING THE QUATERNARY PERIOD

A. DENTAL DIVERSITY

1. The dental type groups

Based on four approaches used in Chapter 4, we have identified six dental type groups within the hominins from the western part of the Indonesian archipelago during the Quaternary periods. These dental type groups are not automatically correlated to the hominin population groups, but more to the group of dental character. These six groups include:

- Group 1: e.g., including maxilla of Sangiran 4 (*Pithecanthropus robustus*), the mandible of Sangiran 5 (*Pithecanthropus dubius*), and mandible of Sangiran 6 (*Meganthropus palaeojavanicus*)
- Group 2: e.g., including the mandible of Sangiran 1b and maxilla of Sangiran 15a (*Pithecanthropus mojokertensis*)
- Group 3: e.g., including maxilla of Sangiran 17 and mandible of Sangiran 22b (*Pithecanthropus erectus*)
- Group 4: Wajak 1 & 2 (*Homo wajakensis*)
- Group 5: *Homo sapiens* from Preneolithic period
- Group 6: *Homo sapiens* from Neolithic-Paleometallic period

Considering the earliest name attributed previously to these hominin fossils, we decide to call Group 1 as '*Meganthropus*' type, Group 2 as '*Mojokertensis*' type, Group 3 as 'Sangiran' type, Group 4 as 'Wajak' type, Group 5 as 'Preneolithic' type, Group 6 as 'Neolithic-Paleometallic' type, and Zhoukoudian *Homo erectus*.

2. Group 1 ('*Meganthropus*' type)

Group 1 ' <i>Meganthropus</i> ' Type	
Morphology	<ul style="list-style-type: none"> Asymmetrical shape on UC and UP, strongly asymmetrical with the expanded mesiobuccal and distolingual corner on LP Very complex occlusal formation with pronounced developed accessories of LM and UM
Classical Metric	<ul style="list-style-type: none"> UI: NA UC: Large size with thick LL size UP: Large size with elongated BL UM: Large size of UM with elongated BL on UM3 LI: NA LC: NA LP: Very large size LM: Very large size with elongated MD on LM3
Cusp Size and Proportion	<ul style="list-style-type: none"> UM: Very large cusp area with moderately wide Pa and Hy angle, and rhombus shape, except rhomboid shape on UM3. LM: Very large size with developed Hyd cusp represented by blunt Prd angle
Geometric-Morphometric	<ul style="list-style-type: none"> UP: Asymmetric oval shape with far distance cusps, elongated BL and developed MTF and DTF UM: Complicated occlusal formation, with developed AF and PF, LAT and BAT, also MMAT. LP: Asymmetric oval shape with far distance cusps, elongated mesiobuccal-distolingual orientation and developed MTF and DTF LM: Complicated occlusal formation, with developed AF and PF, LAT and BAT, also Med and Hyd.

Table 5. A.1. Morphological and morphometric characters of Group 1 '*Meganthropus*' type

Abbreviation: MD = Mesiodistal, LL = Labiolingual, BL = Buccolingual, MTF = Mesial Triangular Fossa, DTF = Distal Triangular Fossa, AF = Anterior Fovea, PF = Posterior Fovea, LAT = Lingual Accessory Tubercle, BAT = Buccal Accessory Tubercle, Pr = Protocone, Pa = Paracone, Me = Metacone, Hy = Hypocone, Prd = Protoconid, Med = Metaconid, Hyd = Hypoconid, End = Entoconid

Group 1 '*Meganthropus*' type has some characters from previous early hominin of Africa, such as: big size teeth, asymmetric shape of canine and premolar, rectangular shape and very complex occlusal formation of molar, especially pronounced metaconulid (C7) accessory cusp, continuous trigonid crest, deflecting wrinkle, high degree of crenulation, large space of contact between metaconid (C2) and hypoconid (C3) main cusps, pronounced protostylid, mesial and distal marginal cusps, also anterior and posterior fovea (Table 5. A.1).

The specimens which were identified as the member of the Group 1 '*Meganthropus*' type (Fig. 5. A.1. and Fig. 5. A.2.), consist of:

Upper Teeth of Group 1	Maxilla: Sangiran 4, Sangiran 27 Isolated teeth: S 7-35, S 7-38, S 7-40
Lower Teeth of Group 1	Mandible: Sangiran 5, Sangiran 6a & 6b, Arjuna 9 Isolated teeth: S 7-42, S 7-62, JA 7801, S 7-76, NK 9603, SA 7600, SA 1982, JA 7801, SMF 8858



Fig. 5. A.1. Lower teeth of Group 1 '*Meganthropus*', LRP3-LRM1 of Sangiran 6a (left) and LRM2-LRM3 of Arjuna 9 (right)



Fig. 5. A.2. Upper teeth of Group 1 '*Meganthropus*', Sangiran 4 (left) and Sangiran 27 (right)

3. Group 2 ('Mojokertensis' type)

Group 2 'Mojokertensis' type	
Morphology	<ul style="list-style-type: none"> • Moderately complex shape of incisor • Asymmetrical shape on canine and premolar, with expanded mesiobuccal and distolingual corner on LP • Complex occlusal formation with developed accessories of UM and LM
Classical Metric	<ul style="list-style-type: none"> • UI: Large size with elongated MD • UC: Medium size with almost equal MD & LL size • UP: Medium size with elongated BL • UM: Large size and rhombus shape except for rhomboid shape on UM3 • LI: Medium LL on LI1, and large LL on LI2 • LC: NA • LP: Medium size with elongated BL • LM: large size with rectangular shape with elongated MD
Cusp Size and Proportion	<ul style="list-style-type: none"> • UM: Large cusp area with wide Pa and Hy angle or developed Me cusp, but wide Pr and Pa angle or developed distal cusps on UM3. • LM: Large size with blunt Hyd angle or elongated MD shape, but blunt Prd angle or developed Hyd cusp on the LM3.
Geometric-Morphometric	<ul style="list-style-type: none"> • UP: Less symmetric oval shape with elongated BL orientation presented by far distance cusps with large MTF and DTF • UM: less complicated occlusal formation, moderate developed AF and PF, LAT and BAT, also MMAT. • LP: Less symmetric oval shape with far distance cusps, elongated BL orientation, also large MTF and DTF • LM: Less complicated occlusal formation, moderate developed AF and PF, LAT, and BAT. Less developed Med and Hyd.

Table 5. A.2. Morphological and morphometric characters of Group 2 'Mojokertensis' type

Abbreviation: MD = Mesiodistal, LL = Labiolingual, BL = Buccolingual, MTF = Mesial Triangular Fossa, DTF = Distal Triangular Fossa, AF = Anterior Fovea, PF = Posterior Fovea, LAT = Lingual Accessory Tubercle, BAT = Buccal Accessory Tubercle, Pr = Protocone, Pa = Paracone, Me = Metacone, Hy = Hypocone, Prd = Protoconid, Med = Metaconid, Hyd = Hypoconid, End = Entoconid

The Group 2 'Mojokertensis' type has several characters from the previous hominin, probably they has common ancestor with the Group 1 'Meganthropus' type, such as: asymmetric shape of canine and premolar and very complex occlusal formation of molar, especially the presence of metaconulid (C7) accessory cusp, presence of trigonid crest, deflecting wrinkle, moderately degree of crenulation, moderately space of contact between metaconid (C2) and hypoconid (C3) main cusps, presence of protostylid, mesial marginal cusp, and anterior fovea.

Some specific characters in Group 2 are derived in this group, such as a reduction in size and rectangular shape of the molar, which differ compared to the previous group type. The reduction of metaconulid (C7) accessory cusp, presence but discontinuous of trigonid crest, reduction of crenulation degree, reduction of contact space between metaconid (C2) and hypoconid (C3) main cusps, reduction of protostylid, mesial marginal cusp, and anterior fovea also happen in this group (Table 5. A.2).

The Group 2 also shared characters with other Javan hominins, the Group 3, relatively to the complexity of occlusal formation, such as: the presence but discontinuous of trigonid crest, reduction of contact space between metaconid (C2) and hypoconid (C3) main cusps, mesial marginal cusp, and anterior fovea.

The specimens identified as the member of the Group 2 '*Mojokertensis*' type (Fig. 5. A.3 and Fig. 5. A.4), consist of:

Upper Teeth of Group 2	Maxilla: Bpg 2001.04, Tjg 1993.05, Sangiran 15a, Isolated teeth: NG 9107.1, S 7-6, S 7-8, S 7-13, S 7-30, S 7-31, S 7-27, S 7-53, S 7-73, S 82, JA 41, S 0085
Lower Teeth of Group 2	Mandible: Sangiran 1b, Sangiran 8, Sangiran 9, Sangiran 21, Sangiran 37, S 25 Isolated teeth: Abimanyu 4, PA 01, S 7-20, S 7-25, S 7-64, S 7-65, NG 9107.1, NG 9107.2



Fig. 5. A.3. Lower teeth of Group 2 '*Mojokertensis*', Sangiran 9 (left) and Sangiran 37 (right)



Fig. 5. A.4. Upper teeth of Group 2 '*Mojokertensis*', Tjg 1993.05 (left) and Sangiran 15a (right)

4. Group 3 ('Sangiran' type)

Group 3 'Sangiran' type	
Morphology	<ul style="list-style-type: none"> • Simple shape of incisor • Asymmetrical shape on canine and premolar, with expanded mesiobuccal corner on LP • Complex occlusal formation with less developed accessories of UM and LM
Classical Metric	<ul style="list-style-type: none"> • UI: Small size with almost equal MD & LL size • UC: Medium size with almost equal MD & LL size • UP: Medium size with square shape • UM: Medium size with rhombus shape on UM 1 & UM2, but elongated BL or rhomboid shape on UM3 • LI: Medium size of LI1, and small size of LI2, with almost equal size of MD & LL on LI1, but elongated LL on LI2 • LC: Medium size with thick LL • LP: Medium size with almost equal size of MD & BL on LP3 but elongated BL on LP4 • LM: Medium size and rectangular shape of LM1, but square shape of LM2 & LM3
Cusp Size and Proportion	<ul style="list-style-type: none"> • UM: Large cusp area with wide Pa and Hy angle or developed Me cusp, but moderately cusp area with wide Pr and Me angle or rhomboid shape on UM3. • LM: moderate size with square shape represented by moderately Hyd angle and developed End cusp represented by blunt Med angle, but small size with less elongated MD shape, represented by blunt Hyd angle on the LM3.
Geometric-Morphometric	<ul style="list-style-type: none"> • UP: Less symmetric circular shape with moderate distance cusps also moderate MTF and DTF • UM: less complicated occlusal formation, with moderate to narrow AF and PF, LAT and BAT, also MMAT. • LP: Less symmetric circular shape with moderate MTF and DTF • LM: Less complicated occlusal formation, with moderate to narrow of AF and PF, LAT and BAT. Less developed Med and Hyd.

Table 5. A.3. Morphological and morphometric characters of Group 3 'Sangiran' type

Abbreviation: MD = Mesiodistal, LL = Labiolingual, BL = Buccolingual, MTF = Mesial Triangular Fossa, DTF = Distal Triangular Fossa, AF = Anterior Fovea, PF = Posterior Fovea, LAT = Lingual Accessory Tubercle, BAT = Buccal Accessory Tubercle, Pr = Protocone, Pa = Paracone, Me = Metacone, Hy = Hypocone, Prd = Protoconid, Med = Metaconid, Hyd = Hypoconid, End = Entoconid

The Group 3 'Sangiran' has some characters similar with Javan hominins from the Group 1 '*Meganthropus*' and the Group 2 '*Mojokertensis*', such as: asymmetric shape of canine and premolar and very complex occlusal formation of molar, presence of trigonid crest, deflecting wrinkle, moderately degree of crenulation, moderately space of contact between metaconid (C2) and hypoconid (C3) main cusps, presence of protostylid, mesial marginal cusp, and anterior fovea.

Some other characters are derived in the Group 3 'Sangiran', such as a reduction in size and square shape of molar compared to the Group 2 type. The lost of entoconulid (C6) or metaconulid (C7) accessory cusps, presence but discontinuous of trigonid crest, reduction of crenulation degree, reduction of contact space between metaconid (C2) and hypoconid (C3) main cusps, reduction of protostylid, mesial marginal cusp, and anterior fovea also happen in the Group 3 'Sangiran' type (Table 5. A.3).

The Group 3 also shared character with other Javan hominins from the Group 2, concerning the complexity of occlusal formation, such as: the presence but discontinuous of trigonid crest, reduction of contact space between metaconid (C2) and hypoconid (C3) main cusps, mesial marginal cusp, and anterior fovea.

The specimens identified as the member of the Group 3 'Sangiran' type (Fig. 5. A.5), consist of:

Upper Teeth of Group 3	Maxilla: Sangiran 17, Sangiran 1a, Sangiran 15b, GRW, S 7-3, Isolated teeth: S 7-9, S 7-10, S 7-14, S 7-17, S 7-27, S 7-29, S 7-32, S 7-34, S 7-35, S 7-37, S 7-58, S 7-89, S 0088, S 0087, S 81, NG 9603
Lower Teeth of Group 3	Mandible: Sangiran 22, Sangiran 33, Sangiran 39, NG 8503 Isolated teeth: Trinil 5, S 7-25, S 7-26, S 7-43, S 7-61, S 7-62, S 7-69; S 7-78, S 7-84, S 7-89, NG 9107.1, S 0089, S 0090, S 0091, S 0092



Fig. 5. A.5. Lower and upper teeth of Group 3 'Sangiran', Sangiran 22b (left) and Sangiran 17 (right)

5. Group 4 ('Wajak' type)

Group 4 Wajak type	
Morphology	<ul style="list-style-type: none"> • Moderately complex shape of incisor • Symmetrical with an oval shape and elongated buccolingual on canine and premolar • Simple occlusal formation represented by the reduction of accessories characters, with the square shape of LM and rhombus shape of UM
Classical Metric	<ul style="list-style-type: none"> • UI: Medium size with elongated MD of UI1, but almost equal MD & LL size of UI2 • UC: Medium size with almost equal MD & LL size • UP: Small size with elongated BL • UM: Medium size with rhombus shape on UM 1, but elongated BL or rhomboid shape on UM 2 & UM3 • LI: Medium size of LI1, with thick LL • LC: Medium size, with an oval shape and almost equal size of MD & LL • LP: Medium size of LP3 but small size of LP4, with an oval shape and almost equal size of MD & BL • LM: Medium size with elongated MD or rectangular shape of LM1 and LM3, but almost equal size of MD & BL or square shape on LM2
Cusp Size and Proportion	<ul style="list-style-type: none"> • UM: Moderately cusp area with wide Pa and Hy angle or developed Me cusp, but wide Pr and Me angle or rhomboid shape on UM3. • LM: Small size with a square shape, represented by blunt End angle.
Geometric-Morphometric	<ul style="list-style-type: none"> • UP: Symmetric oval shape with moderate distance cusps with narrow MTF and moderate to narrow DTF • UM: Simple occlusal formation, relatively moderate to narrow AF and PF, LAT and BAT, also MMAT. • LP: Symmetric oval shape with narrow MTF and moderate to narrow DTF • LM: Simple occlusal formation, relatively moderate to narrow of AF and PF, LAT and BAT. Less developed Med and Hyd.

Table 5. A.4. Morphological and morphometric characters of Group 4 'Wajak' type

Abbreviation: MD = Mesiodistal, LL = Labiolingual, BL = Buccolingual, MTF = Mesial Triangular Fossa, DTF = Distal Triangular Fossa, AF = Anterior Fovea, PF = Posterior Fovea, LAT = Lingual Accessory Tubercle, BAT = Buccal Accessory Tubercle, Pr = Protocone, Pa = Paracone, Me = Metacone, Hy = Hypocone, Prd = Protoconid, Med = Metaconid, Hyd = Hypoconid, End = Entoconid

There are many different characters in the Group 4 'Wajak' type, which are only found in this group. The characters are symmetrical with ellipse shape and elongated buccolingual on canine and premolar, also simple occlusal formation compared to the previous hominins, with square shape of LM and rhombus shape of UM. A simple occlusal formation of molar expressed on the absent of hypoconulid (C5), entoconulid (C6), and metaconulid (C7) accessory cusp, absent of trigonid crest, no crenulation, + groove pattern, absent of protostylid, absent of mesial and distal marginal cusp, also absent of anterior and posterior fovea (Table 5. A.4).

The Group 4 'Wajak' type has only limited characters in common with other groups, such as: relatively similar size of anterior teeth compared to the *Homo sapiens* group and the accessory tubercle on upper molar also present at the previous group's type.

The specimens identified as the member of the Group 4 'Wajak' type (Fig. 5. A.6 and Fig. 5. A.7), consists of:

Upper Teeth of Group 4	Maxilla: Wajak 1 and Wajak 2 Isolated teeth: LA 11472, NG 91 G10, NG 1989, NG 9505, NG 9603, S 81, PDS 0712, Abimanyu 2, S 0086, S 0087, S 0088
Lower Teeth of Group 4	Mandible: Wajak 1 and Wajak 2 Isolated teeth: Abimanyu 1, NG 92 D6, NG 92.1, NG 92.2, NG 92.3, NG 92.4, MI 92.1, NG 0802.2, NG 0802.1



Fig. 5. A.6. Lower and upper teeth of Group 4 'Wajak', mandible Wajak 2 (left) and maxilla Wajak 2 (right)

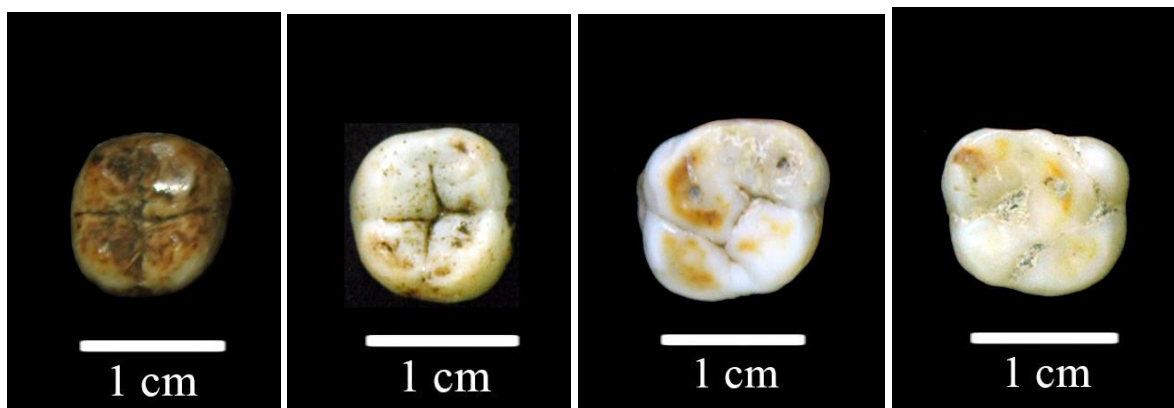

Fig. 5. A.7. Isolated teeth from Sangiran Dome member of the Group 4 'Wajak', from left to right, NG D6 LRM2, Abimanyu 1 LLM2, NG G10 ULM1, Abimanyu 2 URM1

6. Group 5 ('Preneolithic' type)

Group 5 'Preneolithic' type	
Morphology	<ul style="list-style-type: none"> • Simple shape of incisor • Symmetrical with ellipse shape and elongated buccolingual on canine and premolar • Simple occlusal formation with the absent of accessories characters, also square shape of LM and rhomboid shape of UM,
Classical Metric	<ul style="list-style-type: none"> • UI: Medium size with almost equal MD & LL size • UC: Small size with thick of LL • UP: Small size and oval shape with elongated BL • UM: Small size and rhomboid shape with elongated BL • LI: Small size with thick of LL • LC: Small size with thick of LL • LP: Small size and oval shape with elongated BL • LM: Small size and square shape with almost equal size of MD & BL
Cusp Size and Proportion	<ul style="list-style-type: none"> • UM: Small cusp area with wide Pr and Me angle or rhomboid shape. • LM: Small size with a square shape, represented by blunt End angle.
Geometric-Morphometric	<ul style="list-style-type: none"> • UP: Symmetric circular shape with moderate to short distance cusps with narrow MTF and moderate to narrow DTF • UM: Simple occlusal formation, relatively narrow to absent AF and PF, LAT and BAT, also MMAT. • LP: Symmetric oval shape, elongated BL with narrow MTF and moderate to narrow DTF • LM: Very simple occlusal formation with narrow or absent AF and PF, also LAT and BAT. Reduced Med and Hyd.

Table 5. A.5. Morphology and morphometric characters of Group 5 'Preneolithic' type

Abbreviation: MD = Mesiodistal, LL = Labiolingual, BL = Buccolingual, MTF = Mesial Triangular Fossa, DTF = Distal Triangular Fossa, AF = Anterior Fovea, PF = Posterior Fovea, LAT = Lingual Accessory Tubercle, BAT = Buccal Accessory Tubercle, Pr = Protocone, Pa = Paracone, Me = Metacone, Hy = Hypocone, Prd = Protoconid, Med = Metaconid, Hyd = Hypoconid, End = Entoconid

The Group 5 'Preneolithic' type has many similarities with the previous Group 4 'Wajak' type, such as: symmetrical shape of canine and premolar, and also simple occlusal formation compared to the previous hominins, with square shape of the lower molar. A simple occlusal formation of molar expressed on the absent of hypoconulid (C5), entoconulid (C6), and metaconulid (C7) accessory cusp, absent of trigonid crest, no crenulation, + groove pattern, absent of protostylid, absent of mesial and distal marginal cusp, also absent of anterior and posterior fovea expressed in this group as well as in the Group 4 'Wajak' type.

The specific characters only present in Group 5 'Preneolithic' type are a reduction in size and oval shape of canine and premolar, also rhomboid shape of UM with buccolingual elongated orientation, and reduction of mesiodistal size compared to the previous hominins. There are some characters of Group 5 which shared among the preneolithic populations of Sumatra and Java. The following features: symmetrical shape, size reduction, and simple composition of occlusal formation of the molar (Table 5. A.5).

The specimens identified as the member of the Group 5 'Preneolithic' type (Fig. 5. A.8), consist of:

Upper Teeth of Group 5	Maxilla: Tamiang, Sukajadi, Gua Harimau lower layer, Gua Pawon, Gua Braholo, Song Tritis, Song Terus, Song Keplek preneolithic, Gua Kidang, Wajak Holocene caves Isolated teeth: Some isolated teeth from Gua Braholo and Song Terus
Lower Teeth of Group 5	Mandible: Tamiang, Sukajadi, Gua Harimau lower layer, Gua Pawon, Gua Braholo, Song Tritis, Song Terus, Song Keplek preneolithic, Gua Kidang, Wajak Holocene caves Isolated teeth: Some isolated teeth from Gua Braholo and Song Terus



Fig. 5. A.8. Lower and upper teeth of Group 5 'Preneolithic', mandible SK 4 (left) and maxilla SK 4 (right)

7. Group 6 ('Neolithic-Paleometallic' type)

Group 6 'Neolithic-Paleometallic' type	
Morphology	<ul style="list-style-type: none"> Moderately complex shape of incisor Symmetrical shape with circular shape on canine and premolar Less simple occlusal formation with lightly developed of accessories characters on LM and UM
Classical Metric	<ul style="list-style-type: none"> UI: Small size with elongated MD UC: Small size with thick of LL UP: Small size and circular shape with elongated BL UM: Small size with rhombus shape, except rhomboid shape on UM3 LI: Small size with almost equal size of MD & LL LC: Small size with almost equal size of MD & LL LP: Small size and circular shape with elongated BL LM: Small size and rectangular shape with elongated MD
Cusp Size and Proportion	<ul style="list-style-type: none"> UM: Small cusp area with wide protocone and metacone angle or rhomboid shape. LM: Small size with a rectangle shape, represented by blunt Hyd angle.
Geometric-Morphometric	<ul style="list-style-type: none"> UP: Symmetric circular shape with moderate to short distance cusps with narrow MTF and moderate to narrow DTF UM: Simple occlusal formation, with moderate to narrow AF and PF, LAT and BAT, also MMAT. LP: Symmetric circular shape, elongated BL with narrow MTF and moderate to narrow DTF LM: Simple occlusal formation with moderate or narrow AF and PF, also LAT and BAT. Reduced Med and Hyd.

Table 5. A.6. Morphological and morphometric characters of Group 6 'Neolithic-Paleometallic' type

Abbreviation: MD = Mesiodistal, LL = Labiolingual, BL = Buccolingual, MTF = Mesial Triangular Fossa, DTF = Distal Triangular Fossa, AF = Anterior Fovea, PF = Posterior Fovea, LAT = Lingual Accessory Tubercle, BAT = Buccal Accessory Tubercle, Pr = Protocone, Pa = Paracone, Me = Metacone, Hy = Hypocone, Prd = Protoconid, Med = Metaconid, Hyd = Hypoconid, End = Entoconid

The Group 6 'Neolithic-Paleometallic' has characters in common with other previous Group 3 'Sangiran' type and Group 4 'Wajak' type. The characters which similar to the Group 3 are rectangular shape and complexities of the occlusal formation of the molar, and the characters similar to the Group 4 are symmetrical shape of canine and premolar. The occlusal surface of molar shows: the presence of hypoconulid (C5), trigonid crest, moderately space of contact between metaconid (C2), and hypoconid (C3) main cusps, presence of protostylid, mesial marginal cusp, and anterior fovea.

The specific characters of the Group 6 'Neolithic-Paleometallic' type are the reduction in size compared to the previous group's types, circular shape of canine and premolar, also the reduction or absence of triangular fossa, especially the mesial triangular fossa. There are some characters of the Group 6 which shared among the 'Neolithic-Paleometallic' populations of Sumatra and Java. The following features: symmetrical shape, size reduction, and complexities of the occlusal formation of the molar (Table 5. A.6).

The specimens identified as the member of the Group 6 'Neolithic-Paleometallic' type (Fig. 5. A.9), consist of:

Upper Teeth of Group 6	Maxilla: Gua Harimau upper layer and SK 5 Isolated teeth: -
Lower Teeth of Group 6	Mandible: Gua Harimau upper layer and SK 5 Isolated teeth: -

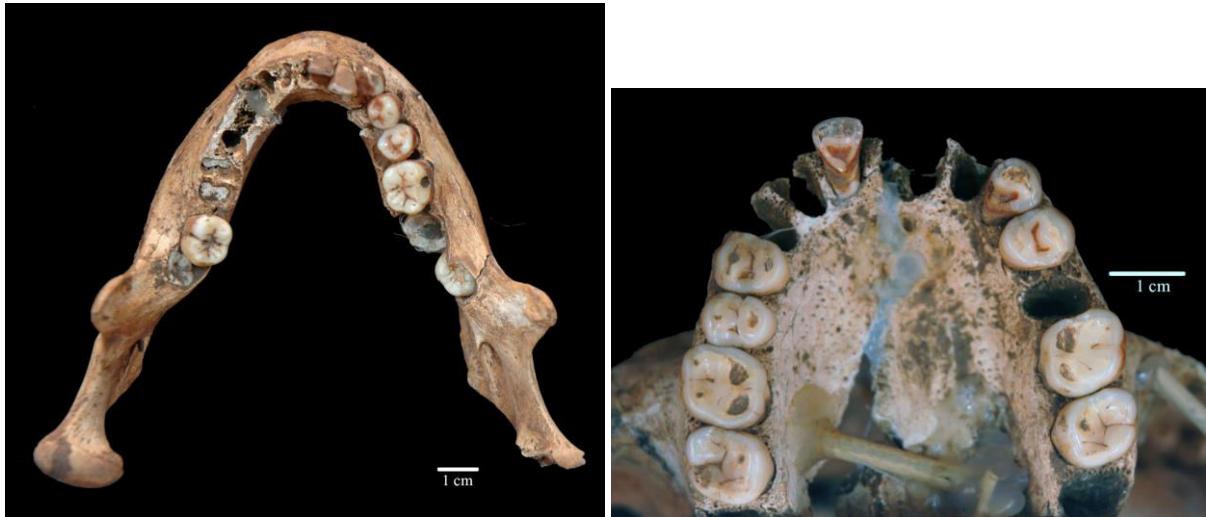

Fig. 5. A.9. Lower and upper teeth of Group 6 'Neolithic-Paleometallic', mandible HRM 23 (left) and maxilla HRM 36 (right)

8. Zhoukoudian *Homo erectus* type

Zhoukoudian <i>Homo erectus</i> type	
Morphology	<ul style="list-style-type: none"> • Moderately complex shape of incisor • Asymmetrical shape on canine and premolar, with expanded mesiobuccal corner • Complex occlusal formation with developed accessories and rectangular shape of molar
Classical Metric	<ul style="list-style-type: none"> • UI: Large size with elongated MD on UI1, but almost equal MD & LL size • UC: Medium size with slightly elongated LL • UP: Large size with rectangular shape, elongated BL • UM: Medium size with elongated BL or rhomboid shape • LI: Large size of LI1, and moderate size of LI2, with almost equal size of MD and LL on LI1, but thick of LL on LI2 • LC: Large size with almost equal size of MD & LL • LP: Medium size rectangular shape with elongated BL • LM: Medium size and rectangular to square shape with slightly elongated MD on LM1 & LM2, but almost equal size of MD & BL on LM3
Cusp Size and Proportion	<ul style="list-style-type: none"> • UM: Large cusp area with wide Pa and Hy angle or developed Me cusp, but moderately cusp area with wide Pr and Me angle or rhomboid shape on UM3. • LM: moderate size with square shape represented by moderately Hyd angle and developed End cusp represented by blunt Med angle.
Geometric-Morphometric	<ul style="list-style-type: none"> • UP: Symmetric oval shape with moderate distance cusps with moderate to narrow MTF and large to moderate DTF • UM: less complicated occlusal formation, relatively moderate to narrow AF and PF, LAT and BAT, also MMAT. • LP: Less symmetric circular shape with moderate MTF and DTF • LM: Less complicated occlusal formation, relatively moderate to narrow of AF and PF, LAT and BAT. Less developed Med and Hyd.

Table 5. A.7. Morphology and morphometric characters of Group Zhoukoudian *Homo erectus* type

Abbreviation: MD = Mesiodistal, LL = Labiolingual, BL = Buccolingual, MTF = Mesial Triangular Fossa, DTF = Distal Triangular Fossa, AF = Anterior Fovea, PF = Posterior Fovea, LAT = Lingual Accessory Tubercle, BAT = Buccal Accessory Tubercle, Pr = Protocone, Pa = Paracone, Me = Metacone, Hy = Hypocone, Prd = Protoconid, Med = Metaconid, Hyd = Hypoconid, End = Entoconid

Zhoukoudian *Homo erectus* has some character, such as: asymmetric shape of canine and premolar and very complex occlusal formation of molar, especially the presence of metaconulid (C7) accessory cusp, presence of trigonid crest, deflecting wrinkle, moderately degree of crenulation, moderately space of contact between metaconid (C2) and hypoconid (C3) main cusps, presence of protostylid, mesial marginal cusp, and anterior fovea.

Zhoukoudian *Homo erectus* also has share character with Javan hominin, the Group 2 'Mojokertensis' and Group 3 'Sangiran type', on the complexities of occlusal formation, such as: the presence but discontinuous of trigonid crest, reduction of contact space between metaconid (C2) and hypoconid (C3) main cusps, mesial marginal cusp, and anterior fovea which share with those Javan hominin groups.

We summarize the correlation between Zhoukoudian and Javan hominins (*Homo erectus* and *Homo sapiens*) as follow in the Table 5. A.8:

Tooth Class	Morphology	Metric
LI	Closed to Javan <i>Homo erectus</i> and <i>Homo sapiens</i>	Closed to G-2 and G-3 Javan <i>Homo erectus</i>
LC	Closed to Javan <i>Homo erectus</i> and <i>Homo sapiens</i>	Between Javan <i>Homo erectus</i> and G-4 Late Pleistocene <i>Homo sapiens</i>
LP	Closed to Javan <i>Homo erectus</i>	Between G-2 and G-3 Javan <i>Homo erectus</i>
LM	Closed to G-2 and G-3 Javan <i>Homo erectus</i>	Between G-2 and G-3 Javan <i>Homo erectus</i>
UI	Mainly closed to the <i>Homo sapiens</i> , but also to the <i>Homo erectus</i> for the UI2	Closed to G-2 and G-3 Javan <i>Homo erectus</i>
UC	Closed to Javan <i>Homo erectus</i>	Between Javan <i>Homo erectus</i> and G-4 Late Pleistocene <i>Homo sapiens</i>
UP	Closed to Javan <i>Homo erectus</i>	Between Javan <i>Homo erectus</i> and G-4 Late Pleistocene <i>Homo sapiens</i>
UM	Closed to G-2 and G-3 Javan <i>Homo erectus</i>	Between G-2 and G-3 Javan <i>Homo erectus</i>

Table 5. A.8. Correlation on morphology and morphometric characters of Group Zhoukoudian *Homo erectus* to the Javan hominins

Then we could conclude that the different correlation on morphology and metric characters between Zhoukoudian *Homo erectus* with Javan *Homo erectus* and *Homo sapiens* shows a mosaic character in the Zhoukoudian *Homo erectus*. Others, it could be caused by different layer stratigraphy of dental remains from Zhoukoudian site.

B. CONTEXTUALIZING THE HYPOTHETICAL GROUPS

1. Group 1 '*Meganthropus*' type

The name of *Meganthropus* was attributed to several robust mandibles and cranium fragments found in the Sangiran dome, such as mandible of Sangiran 6a and 6b, maxilla Sangiran 27, and cranium Sangiran 31. Sangiran 6a is the holotype of a new species of *Meganthropus palaeojavanicus*. It was firstly found in 1941 by Von Koenigswald, who described, as the largest hominid mandible known. It is the same height as a gorilla, but morphologically different. The maximum height of the mandible is at the symphysis in anthropoids, while in Sangiran 6, it is at the level of the first molar.

Robinson (1953; 1955) proposed that *Meganthropus* could be a Southeast Asian representative of the Australopithecine, especially the robust group, based on a comparative study of teeth and mandible. A similar hypothesis was suggested by Krantz (1975), who argued that Sangiran 6 should be grouped as *Australopithecus africanus*, a gracile group as of Australopithecine. Von Koenigswald (1957) did not regard the species *palaeojavanicus*, but considered the genus as ancestral to *Pithecanthropus*, sharing a common ancestor with the Australopithecine in the Upper or Mid Pliocene. He shows combined characteristics of *Australopithecus africanus* and *Australopithecus robustus* on premolars (von Koenigswald 1973). This view later supported by Procureur and Orban-Segebarth (1983), who suggested that the *Meganthropus* represents the existence of *Australopithecus* outside Africa.

Tobias and von Koenigswald (1965) suggested the taxonomical position of *Meganthropus* is between *Australopithecus* and *Homo habilis* so that Jacob (1973) and Sartono (1991) suggested that two genera exist within the early Javanese hominins: *Meganthropus* and *Homo*. Kramer and Konigsberg (1994) challenged this view and proposed that the *Meganthropus* should be located between *Homo habilis* and *Homo erectus*. In the later trend, the majority of paleoanthropologists consider the *Meganthropus* as a variation of *Homo erectus*. It was proposed that the *Meganthropus*, together with all the hominins from the Early and Middle Pleistocene belong to *Homo erectus* (Mayr 1950; Rightmire 1984).

Widianto (1993), with Arjuna 9 as the additional specimen of *Meganthropus* found in 1988, considered them as the robust group of *Homo erectus*. This view was more recently supported by Kaifu, *et al.* (2005), who put all together the Grenzbank/Sangiran hominins group in the primitive group of *Homo erectus*. However, Tyler (2001) argues that the *Meganthropus* is a separate species or an *Homo erectus* subspecies, proposing the names *Homo palaeojavanicus* or *Homo erectus palaeojavanicus* based on their overall primitiveness. In extreme contradiction of this view, Wolpoff (1999) argues for strong similarities between earlier and later Javanese fossils and no species nor subspecies distinction.

On the cranio-maxillary part, Tyler (1996) described the Sangiran 27 specimen as a nearly complete but deformed cranium of *Meganthropus*. Sangiran 31 fragmentary skull was also described as *Meganthropus* by Sartono (1983). Tyler (1996) concluded that the specimens were out of the normal range of *Homo erectus* shape. The cranium was deeper, lower vaulted, and wider than any *Homo erectus* specimen recovered. The specimens have an unusual character of the same double sagittal crest or double temporal ridge, which almost join at the sagittal of the cranium, with a heavily thickened nuchal ridge, and a low

cranial capacity (Tyler 1996). However, he did not agree with the hypothesis of Krantz (1975), who suggested the Sangiran 31 as a giant of *Homo habilis*. Grimaud-Hervé (2001) did not agree with Tyler (1996), as she identifies the position of temporal lines on the middle of parietal bones, and included this specimen in the robust group of *Homo erectus*.

Zanolli *et al.* (2019) reevaluated the *Meganthropus* and *Pithecanthropus dubius* or a robust group of *Homo erectus* based on the internal structure of the teeth and he has shown that Arjuna 9 was apart from the human pattern, notably from *Homo erectus*, and more closely fit to the Pongine. Later, he confirmed the presence of *Meganthropus* as a Pleistocene Indonesian hominid genera but distinct from *Pongo*, *Gigantopithecus*, and *Homo*. Further, he showed that *Meganthropus* has the greatest affinity with *Lufengpithecus*, and hypothesized that these taxa are phylogenetically closely related. He also concluded molar used by Dubois as the paratype of *Homo erectus* (1891) did not belong to hominin (human lineage) but instead were more likely belong to *Meganthropus*.

We consider that the group 1 'Meganthropus' type has plesiomorphies from previous African hominins especially *Australopithecus*, such as: big size teeth, asymmetric shape of canine and premolar, rectangular shape and very complex occlusal formation of molar, such as: pronounced metaconulid (C7) accessory cusp, continuous trigonid crest, deflecting wrinkle, high degree of crenulation, large space of contact between metaconid (C2) and hypoconid (C3) main cusps, pronounced protostylid, mesial and distal marginal cusps, also anterior and posterior fovea. On the contrary, early *Hominid* (e.g., *Pongo*), has pronounced and buccolingually elongated mesial marginal ridge, pronounced buccal and lingual accessories tubercle, very complex crenulation degree on the surface of all cusps, large-deep anterior and posterior fovea, but no presence of protostylid.

In our opinion, the claim of the new taxonomical position for *Meganthropus* as an early hominid as suggested by Zanolli *et al.* (2019) could not be accepted because the *Meganthropus* including *Pithecanthropus dubius* has less pronounced mesial marginal ridge, no buccal accessory tubercle, reduction of crenulation degree on the surface of all cusps, short-narrow anterior and posterior fovea, but pronounced protostylid. This character shows that the Group 1 *Meganthropus* type is closer to the early African hominins, especially the Australopithecine, as suggested previously by Robinson (1953; 1955), Tobias and von Koenigswald (1965), followed by Jacob (1973) and Sartono (1983).

Our result in the maxillary teeth, *Pithecanthropus robustus* Sangiran 4 and *Meganthropus* C of Sangiran 27 are classified in the Group 1 *Meganthropus* type, based on some archaic characters such as diastema pre canine (especially in Sangiran 4), asymmetric shape of premolar with accessory cingulum, large size and rectangular elongated mesiodistally orientation of the molar, presence of lingual accessory tubercle, posterior fovea (similar to the lower molars). The presence and continuous of transversal crest and oblique crista on the maxillary molars of Sangiran 4 and Sangiran 27 correspond to the presence and continuous of middle and distal trigonid crest in the mandibular teeth of Group 1 *Meganthropus* type.

Another specimen member of the Group 1 *Meganthropus* type is a fragment of the right mandible of *Meganthropus* D published by Sartono in 1993 from the lower Kabuh Formation of Middle Pleistocene and has been dated to between 0.73 Ma (Hyodo, Watanabe, and Sunata 1993). The ramus is severely damaged, the corpus appears relatively saved, but the teeth have been damaged, so the specimen could not be included in this

comparative study. Sartono *et al.* (1995) agreed that the *Meganthropus* A Sangiran 6 and *Meganthropus* D were very likely to be representations of the same species, as they have a very similar shape, although a slightly bigger on the previous specimen.

2. Group 2 '*Mojokertensis*' type

The name *Pithecanthropus modjokertensis* was created to characterize a fossilized juvenile skull discovered in February 1936 by Andojo at Pening, near Mojokerto in the southern slope of Kendeng Mountains, East Java. The skull, together with the Sangiran 1b mandible were attributed to this species mainly due to the stratigraphical correlation between both original sites in the Djetis beds, proposed as one of the earliest hominin occupation in Java in the Early Pleistocene (von Koenigswald 1937, 1940, 1950). In our work, the use of *Mojokertensis* name is not linked to the skullcap, which was found without any dental remains, but refers to a fragment of right mandible (Sangiran 1b) from the Pucangan Formation of the Sangiran dome.

Eugène Dubois was arguing the attribution of the Mojokerto fossil to the genus *Homo* instead of *Pithecanthropus*. Consequently, Von Koenigswald renamed his fossil as *Homo modjokertensis* (von Koenigswald and Weidenreich 1939). The name of *Pithecanthropus modjokertensis* was still maintained by Jacob (1980) for the robust group of Early Pleistocene *Homo erectus*, besides the existence of the *Meganthropus* group. After the trend towards simplification, the fate of *Pithecanthropus modjokertensis* was similar to that of *Meganthropus*, regarded as variations of *Homo erectus*, and clustered together with all the Lower and Middle Pleistocene hominins (Mayr 1950; Rightmire 1984). Following this influence, Sartono (1986, 1991) used the name of *Homo robustus* to define the previous fossils of *Pithecanthropus modjokertensis*.

Widianto (1993) classified as the robust group of *Homo erectus* all the early Pleistocene forms: *Meganthropus palaeojavanicus*, *Pithecanthropus modjokertensis*, *Pithecanthropus robustus* and *Pithecanthropus dubius*. A same view was more recently defended by Kaifu, *et al.* (2005), who put all together the Grenzbank/Sangiran hominins allocated as a primitive group of *Homo erectus*. Zanolli (2011), in his study based on internal dental characters, did not revise the taxonomical position of the *Mojokertensis* group.

In this study, the *Mojokertensis* type refers to the Sangiran 1b mandible and the maxillary bones Bpg 2001.04 and Tjg 1993.05. We retained as the main dental characters of the *Mojokertensis* type: the reduction in buccolingual dimension and an oval-rectangular shape of the molars compared to the early hominins with the presence but discontinuous of a trigonid crest. Other reductions are including metaconulid (C7) accessory cusp, crenulation degree, contact space between metaconid (C2), and hypoconid (C3) main cusps, protostylid, mesial marginal cusp, and anterior fovea.

We have also showed that the Group 2 has archaic characters such as an asymmetric shape of canines and premolars, a very complex occlusal formation of the molar, the presence of trigonid crest, deflecting wrinkle, accessories cusps, moderately crenulation, the presence of protostylid, mesial marginal cusp and anterior fovea. These characters, shared with the group 1, are considered primitive. This suggests that both groups, *Meganthropus* and *Mojokertensis* had common ancestors, from other previous hominin.

We noted that the Group 2 *Mojokertensis* type has shared some characters to the following Group 3 Sangiran, in the complexity of occlusal formation, such as: the presence but discontinuous of trigonid crest, reduction of contact space metaconid (C2) and hypoconid (C3) main cusps, mesial marginal accessory cusp, and anterior fovea. The similarities and differences between the Group 2 *Mojokertensis* to the Group 3 Sangiran suggested there was a contact between both groups. The specimens included in the Group 2

Mojokertensis type are mandibles of Sangiran 1b, Sangiran 37, Sangiran 8, and Sangiran 9, also the maxilla Sangiran 15a, Bpg 2001.04, and Tjg 1993.05.

Sangiran 8 is a damaged fragment of mandible from the Grenzbank layer and described as a *Meganthropus* mandible by Marks (1953) and Jacob (1973) based on the great size of the corpus. Von Koenigswald (1968) interpreted that the deformation was caused by the crocodile bite, although later it was criticized by Baba and Aziz (2001). Widiyanto (1993) classified Sangiran 8 in the robust group of *Homo erectus*, together with Sangiran 5 and Sangiran 9. Kaifu *et al.* (2005) made restoration and measured the undamaged part on the left corpus of Sangiran 8 which turned to be smaller than that of Sangiran 5 and 9, in the thickness and height of corpus. Based on the results of our study, we placed this tooth with that of Sangiran 9 and the others belonging to group 2 *Mojokertensis* type. This hypothesis is supported by the lateral corpus morphology of Sangiran 8, which is similar to Sangiran 9, although the mandibular symphysis junction is more posteriorly in the Sangiran 8 (Kaifu *et al.* 2005; Schwartz 2016).

Sangiran 9 is a fragment of right mandible from upper clay of Pucangan Formation and assigned to *Pithecanthropus C* by Sartono (1961; 1974). Von Koenigswald (1968) thought it came from the lower part of Black Clay Pucangan Formation, and considered this specimen together with Sangiran 5, as the oldest human fossils found in Java. Later, Sartono (1970) assigned this specimen to the end of the Lower Pleistocene and attributed it to *Pithecanthropus dubius*. Itihara (1985) corrected the possible occurrence level of Sangiran 9 and placed around the boundary of the Grenzbank Layer and Pucangan Formation. Widiyanto (1993) classified the mandible of Sangiran 9 in the robust group of *Homo erectus*, together with Sangiran 5 and Sangiran 8. For Kaifu *et al.* (2005), these specimens belong to a primitive group of *Homo erectus* from Grenzbank/Sangiran Formation. Schwartz (2016) assigned Sangiran 9 as the basic morphology and reassembled it with Sangiran 5, Sangiran 6, Sangiran 8, and some isolated teeth. We have argued that Sangiran 8 and Sangiran 9 belong to the same group, in agreement with Schwartz's proposal, but in our opinion, Sangiran 5 and Sangiran 6 should be distinguished and placed in the Group 1 *Meganthropus* type.

Sangiran 15a is assigned as the member of Group 2 *Mojokertensis* type. This specimen, found by Sartono in 1963 in the Pucangan Formation, is from the Lower Pleistocene. It was classified as *Pithecanthropus Modjokertensis* by Sartono (1974) in agreement with von Koenigswald, based on the size of the teeth and more particularly the development of the occlusal surface (C-P4). Sangiran 15a is as large as Sangiran 1b (*Pithecanthropus modjokertensis*) and smaller than Sangiran 6 (*Meganthropus palaeojavanicus*). Moreover, the teeth of Sangiran 15b are smaller than Sangiran 4 (*Pithecanthropus robustus*) and larger than *Pithecanthropus VIII*-Sangiran 17 (*Pithecanthropus erectus* type).

Sangiran 15a, Bpg 2001.04, and Tjg 1993.05 have similar premolar patterns, such as the presence of accessories and marginal ridges, so they are reassembled in the Group 2 *Mojokertensis* type. Note that Bpg 2001.04 is from Grenzbank Layer and Tjg 1993.05 is from Kabuh Layer. They also show a basic pattern of the molars (oval-rectangular mesiodistally elongated orientation) and the presence of lingual accessory tubercle and a posterior fovea. The presence of transversal crest and oblique crista on the maxillary molars of Bpg 2001.04 and Tjg 1993.05 should correspond to the presence of middle and distal trigonid crest in the mandibular teeth of Group 2 *Mojokertensis* type.

3. Group 3 'Sangiran' type

The name of Sangiran does not refer to any taxonomical taxa, but have been used by Widiyanto (1993) as a name of Sangiran-Trinil group for the *Homo erectus* remains from lower and middle Kabuh Formation of Middle Pleistocene at Sangiran and Trinil. This group corresponds to the previous taxa of *Pithecanthropus erectus* as proposed for the first time by Dubois (1894) followed by von Koenigswald and Weidenreich (1939), and Jacob (1966). Sartono (1986) used *Homo erectus erectus* or *Homo erectus trinilensis* for the same group. In contemporary, Widiyanto and Simanjuntak (2009) used the terminology of typical or classical groups of *Homo erectus* for the remains of Sangiran and Trinil. Kaifu *et al.* (2005) assigned as a gracile group of *Homo erectus* for the remains from Kabuh Formation, above Grenzbank Layer.

The Group 3 Sangiran type shares some characters with the Group 2 *Mojokertensis*, in the complexity of occlusal formation, such as: the presence but discontinuous of trigonid crest, reduction of contact space between metaconid and hypoconid, mesial marginal accessory cusp, and anterior fovea. The characters only found in the Group 2 Sangiran are: reduction mesiodistally size and square shape of molar compared to the previous hominins, absence of accessory cusp, also the reduction crenulation degree, and protostylid. The similarities and differences between the Group 3 Sangiran to the Group 2 *Mojokertensis* suggested there was contact between both groups.

Since there are no teeth associated with the calotte of Trinil 2 and Sangiran 2, the name of Sangiran type in this study is not correlated to both skullcap, but to the teeth found in the Sangiran dome, such as mandible of Sangiran 22b from the late of Early Pleistocene and cranium of Sangiran 17 from the Middle Pleistocene. Based on cranial morphology, Schwartz (2016) distinguished Sangiran 17 from Trinil 2, as the holotype of *Homo erectus*, also with Sangiran 2, Sangiran 4, Sangiran 10 and Sangiran 12. Unfortunately, there are no teeth on the Trinil 2 specimen and the three molars from Trinil are not directly associated to the skullcap. So we were not able to compare the teeth from both specimens.

While Sangiran 17 has robust cranial characters different from others typical group of *Homo erectus* from Sangiran as suggested by Schwartz (2016), this study shows that the specimen has derived characters such as the reduction of the upper third molar. From the dental point of view, Sangiran 17 has a similar character to other Sangiran specimens, such as Sangiran 1a (S71), Sangiran 7-3, Sangiran 7-17, and Sangiran 15b, even similar to the isolated teeth of Trinil 11620 and Trinil 11621. Zanolli *et al.* (2019) show that both isolated teeth from Trinil have robust kinematic apparatus based on the root morphology, which should be owned by a robust species, *Meganthropus*. However, they only compared the upper molar of Trinil with the lower molar of *Meganthropus* of Sangiran 6a and Arjuna 9 and did not compare to the same series of *Meganthropus* upper molar. This claim could not be accepted because the upper molar of *Meganthropus*, such as Sangiran 4 and Sangiran 27, have different characters to the Trinil teeth and also Sangiran 17, with elongated mesiodistally shape and without metacone reduction.

The robustness of cranial morphology of Sangiran 17 as presented previously by Jacob (1976) and then by Schwartz (2016), also the robustness of the masticatory apparatus assessed on the Trinil molar as presented by Zanolli *et al.* (2019) could be correlated to the local evolution of Javanese *Homo erectus* from the Trinil-Sangiran stage to the Ngandong stage as proposed by Widiyanto (1993; 2001). Kaifu *et al.* (2008) showed that the Sangiran 17

and also Sambungmacan specimens exhibit characteristics that potentially indicate an evolution from the Sangiran group toward the unique specialization of the Ngandong stage. It corresponds to the late robust group of *Pithecanthropus soloensis* as indicated by Jacob (1976). However, there was an objection to this evolutionary view, as stated by Baab and Zaim (2017). Unfortunately, there are no dental remains so far that have been found in the last group of *Homo erectus* from Ngandong, Ngawi, and Sambungmacan. So, the Group 3 Sangiran dental type could not be able automatically applied to the skull of Solo Man.

Mandible Sangiran 22b, Sangiran 33, Sangiran 39, and NG 8503 are classified as member of the Group 3 Sangiran type because of their similarities on dental characters, such as: reduction mesiodistally size and square shape of molar compared to the previous hominins, absence of accessory cusp, also the reduction crenulation degree, and protostylid. Sangiran 22b was found in 1974 at the upper part of the Pucangan Formation. This specimen was classified as a robust *Homo erectus* by Widiyanto (1993), together with other Early Pleistocene fossils such as Sangiran 5, Sangiran 8, Sangiran 9, Sangiran 33, and Ardjuna 9, although they show a great variability. This classification is then different from Tyler, Sartono, and Krantz (1995), who assigned the Sangiran 22b as a typical group of *Homo erectus*. Kaifu *et al.* (2005) considered this specimen as a gracile member of the archaic group *Grenzbank-Sangiran* (Pucangan) Layers, together with Sangiran 1b. In our study, the two specimens came out in different groups: Group 2 *Mojokertensis* type, as discussed previously, and Group 3 Sangiran type, as discussed in this part.

Sangiran 33 is a fragment of the right mandible, discovered in 1979 from the Grenzbank layer, and identified as *Meganthropus C* by Aziz (1983). Widiyanto (1993), as discussed above, also placed this specimen in the robust group of *Homo erectus*. Both claims are mostly based on the stratigraphical correlation. Although, Kaifu *et al.* (2005) classified Sangiran 33 as the member of archaic group *Grenzbank-Sangiran* (Pucangan) Layers, but showed similar characteristics to common previous mandible finds, especially Sangiran 8 and Sangiran 9, which are the member of Group 2 *Mojokertensis* type in our study. As we previously argued, Group 2 *Mojokertensis* and Group 3 Sangiran share some morphological characters. As Sangiran 33 shows a reduction of mesiodistal size with square shape, it seems closer to the Group 3 Sangiran. So, in our opinion, it is better to consider this specimen as the member of this later group and the attribution of Sangiran 33 as a *Meganthropus* should be revised.

The assignment of Sangiran 39 and NG 8503 as the member of Group 3 Sangiran type is in accordance with the previous classification. Aziz *et al.* (1994) and Kaifu *et al.* (2005) were previously reassembled both specimens as a typical group of *Homo erectus* from Bapang/AG Layers of Middle Pleistocene, so it's in agreement with the result of our research.

4. Group 4 'Wajak' type

The name of *Wajakensis* is originally coming from an almost complete cranium found by van Riestchoten at the end of 1888, at Gunung Lawa Mountains near Tulungagung, East Java. Based on the study of these skulls, Dubois coined the species *Homo wajakensis* which he is considered to be the ancestor of Proto-Australians (Dubois 1920, 1922). Weidenreich (1945) used the terminology of "Wajak Type" to refer to morphological similarities between the Keilor skull, a proto-Australian, and the Wajak hominins. Later, Jacob (1967) proposed the Wajak skulls as the ancestor of both recent 'Mongoloid' and 'Australo-Melanesian' populations, playing an essential role in the reconstruction of human migration routes in the Sundaland and Sahulland.

To consider Wajak as "robust" *Homo sapiens* is consensual (Storm 1995). However, there are two views regarding the *Homo wajakensis* generally followed by scientists. Some argued, based on the robustness of the Wajak remains, with other previous robust skulls in Asia-Australia region such as Ngandong, Ngawi, and Sambungmacan (Solo Man), and the Late Pleistocene - Early Holocene from Australia; Keilor, Kow Swamp, and Cohuna (Coon 1962; Thorne and Wolpoff 1992; Weidenreich 1945). Others noticed difficulties in the assumption of a direct evolutionary link between the Solo group and the Wajak Man (Jacob 1967; Santa Luca 1980; Storm 1995, 2001; Stringer 1992).

In our study, we highlighted the peculiar features of the Group 4 Wajak type absent in the previous Group 1-3. Those derived characters include symmetrical shape and simple occlusal formation of postcanine teeth with + groove pattern and some absence of accessories cusps, trigonid crest, crenulation, protostylid, mesial and distal marginal cusp, also anterior and posterior fovea. Interestingly, there are several specimens included in Group 4 Wajak type, which come from Middle Pleistocene localities such as Ngebung and Pucung from Sangiran.

The expression of a such specific character, as shown by the member of the Group 4 Wajak type in the teeth from the Middle Pleistocene localities of Sangiran were never discussed by previous authors (e.g., Widiyanto 1993; Kaifu 2006, Zanolli 2011). The emergence of the Group 4 Wajak type, which completely different compared to the previous Group 1 *Meganthropus*, Group 2 *Mojokertensis*, and Group 3 Sangiran, from Early to Middle Pleistocene could be suggested as the appearance of a new arrival or genetic drift of human group in this region.

Unfortunately, no cranial or mandibular remains have been found so far together with the dental remains of Middle Pleistocene Group 4 Wajak type from Sangiran. So, it is impossible to compare those specimens from Sangiran with the Wajak skull, and to consider the teeth of Group 4 Wajak as the type for the last *Homo erectus* of Ngandong (from the early of Late Pleistocene as claimed with a new datation recently by Rizal *et al.* (2019)), is very speculative. Nevertheless, some claims put the Wajak Man as the transition between the Solo Man and the Proto-Australians (e.g., Weidenreich, 1945; Coon, 1962; Thorne and Wolpoff, 1992).

5. Group 5 'Preneolithic' type (Early-Mid Holocene)

Group 5 Preneolithic type is referred to as the *Homo sapiens* remains from the Early-Middle Holocene period. It corresponds to the last hunter-gatherer populations in a preneolithic cultural context, from shell midden open-air sites and cave habitation sites. There were several terminologies to define the populations from this period, such as palaeo-Melanesian for Gua Kepah (Mijsberg 1932), Wadjakoid for characters found in the Wajak remains and the recent populations (Snell 1938), Melanesoid for Shell midden of Sumatra (Hooijer 1950; van Stein Callenfels 1936; Wastl 1939), and Australomelanesian for Mesolithic, Epipaleolithic, or Preneolithic population (Jacob 1967; von Koenigswald 1952a; Mijsberg 1932; Widianto 2002), or Australo-Papuan (Matsumura *et al.* 2017) which are different from the Melanesian Islanders who receive significant genetic input by the East Asian (Austronesian speakers) during the Late Holocene.

In our study, the Group 5 Preneolithic shows strong connection with the previous Group 4 Wajak type from the Late Pleistocene. Indeed, some characters are maintained in Group 5 such as: symmetrical shape and simple occlusal formation with + groove pattern and absence of accessories cusps, trigonid crest, crenulation, protostylid, mesial and distal marginal cusp, also anterior and posterior fovea. The Group 5 Preneolithic also has derived characters which are not present in the previous group, such as reduction of mesiodistal dimension. The similarities between those groups attest to an ancestor-descendant relationship between Group 4 Wajak and 5 Preneolithic, and the difference shows a local development of the Group 5.

Our observation on the lower second molar on the previous chapter shows there are three poles of dental characters of Group 5 Preneolithic and Group 6 Neolithic-Paleometallic, they are: Group 5 from Java-South Sumatra, Group 5 from North Sumatra, and Group 6 from Java-Sumatra. Group 4 Wajak as the parent specimens are located in the middle of those groups, especially specimen Wajak 2.

Observation on the upper second molar shows similar result that presents three poles of dental characters, they are: Group 5 from Java, Group 5 from Sumatra, and Group 4 Wajak Late Pleistocene. Group 6 from Gua Harimau shows correlation to the previous Group 5 North Sumatra, means there and the Group 5 from Gua Pawon is located to the same populations.

6. Group 6 'Neolithic-Paleometallic' type (Late Holocene)

Neolithic-Paleometallic type group is referred to the *Homo sapiens* remains from the Late Holocene period. Their subsistence was based on agriculture and animal domestication in a Neolithic-Paleometallic cultural context. Mostly the archaeological sites correspond to caves used to bury the dead. There were some terminologies to define the populations from this period such as: Malayan (Snell 1938; van Stein Callenfels 1936), Mongoloid (Jacob 1967; von Koenigswald 1952a; Mijsberg 1932; Widiyanto 2002), Southern Mongoloid to distinguish with the Northern Mongoloid (Bellwood 2007; Coon 1962), Southeast Asian population, based on genetic studies (Lipson *et al.* 2014; Melton *et al.* 1998), and Asian Neolithic affinity (Matsumura *et al.* 2017). Some previous scholars also divided this population into two more specific groups. Proto-Malay refers to the Neolithic group, and Deutro-Malay refers to the Paleometallic group (Huxley 1860; Wallace 1869).

In our study, the dental characters of Group 6 Neolithic-Paleometallic type present a reduction in size compared to the previous population, circular shape of canine and premolar, also reduction or even absent of mesial triangular fossa. This group shares features with the previous Javanese hominins (Group 3 Sangiran type and Group 4 Wajak type). With Group 3, we noted the following features: square shape and complexities of the occlusal formation of the molar and the following with group 4: symmetrical shape of canine and premolar. The complexity of the occlusal formation of molar include: the presence of hypoconulid (C5), trigonid crest, moderately space of contact between metaconid (C2), and hypoconid (C3) main cusps, presence of protostylid, mesial marginal cusp, and anterior fovea. We considered such characters as plesiomorphic in Group 6 Neolithic-Paleometallic.

C. THE CHRONOLOGY OF HUMAN OCCUPATION

1. Diachronic Position of Hominin Fossils

In order to reconstruct the chronology of human occupation in the western part of Indonesian archipelago, two stratigraphical records from Java are considered as they represent long term human occupation in this region: Sangiran site at the Solo Basin which records between Early Pleistocene to the late Middle Pleistocene and Song Terus site at Gunungsewu karstic region which records between the late Middle Pleistocene to the Late Holocene.

We summarized the correspondence between the stratigraphy record and the chronometric dating from Solo Basin and Gunungsewu area (Table 5. C.1) suggested from previous studies:

Stratigraphy/Level	Period	Chronometric	Method	Reference
Pucangan (Sangiran)				
Lower Lahar	Early Pleistocene	1,67 Ma	$^{40}\text{Ar}/^{39}\text{Ar}$ and Paleomag	(Sémah et al. 2000)
Tuff 1 (1)	Early Pleistocene	1.51 Ma	Fission Track	(Suzuki, Saefudin, and Itihara 1985)
Tuff 6/5	Early Pleistocene	1.49 Ma	Fission Track	(Suzuki et al. 1985)
Tuff 8	Early Pleistocene	1.35 Ma	U/Pb	(Matsu'ura et al. 2020)
Tuff 11/10	Early Pleistocene	1.16 Ma	Fission Track	(Suzuki et al. 1985)
Kabuh (Bapang)				
Grenzbank	Late Early Pleistocene	0.90 Ma	Paleomag	(Hyodo et al. 1993)
Grenzbank	Late Early Pleistocene	0.97 Ma	U/Pb	(Matsu'ura et al. 2020)
Middle Tuff	Early Mid Pleistocene	0.78 Ma	Fission Track	(Suzuki et al. 1985)
High Pumice	Early Mid Pleistocene	0.70 Ma	$^{40}\text{Ar}/^{39}\text{Ar}$	(Falgüeres 2001)
Tektites	Early Mid Pleistocene	0.78 Ma	$^{40}\text{Ar}/^{39}\text{Ar}$	(Swisher et al. 1994)
Notopuro (Pohjajar)				
Upper Lahar	Mid-Pleistocene	0.49 Ma	Fission Track	(Hyodo et al. 1993)
Middle Tuff	Late Middle Pleistocene	0.25 Ma	Fission Track	(Suzuki et al. 1985)
Terus				
Lower Terus	Mid-Pleistocene	350 Ka	U-series	(Sémah et al. 2004)
Upper Terus	Early Late Pleistocene	115 Ka	U-series	(Sémah et al. 2004)
Tabuhan				
Lower Tabuhan	Late Pleistocene	71 Ka	U-series	(Sémah et al. 2004)
Upper Tabuhan	Terminal Pleistocene	18 Ka	U-series	(Sémah et al. 2004)
Keplek				
Lower Keplek	Early Holocene	9330 ± 90 BP	Radiocarbon	(Sémah et al. 2004)
Mid Keplek	Mid-Holocene	8130 ± 100 BP	Radiocarbon	(Sémah et al. 2004)
Upper Keplek	Late Holocene	5770 ± 60 BP	Radiocarbon	(Sémah et al. 2004)
	Neolithic	3053 ± 65 BP	AMS	(Noerwidi 2012)

Table 5. C.1. Chronology records of from Sangiran Dome and Song Terus site

Then we summarized the hominin fossil groups found in the Sundaland with their chronological context (Table 5. C.2).

Chronology	Hominin Fossils
Early Pleistocene (1.6 to 1.2 Ma)	<ul style="list-style-type: none"> Group 1: Sangiran 4, Sangiran 5, Sangiran 6a, Sangiran 6b, Sangiran 27 Group 2: Sangiran 1b, Sangiran 9, Sangiran 15a Group 3: Sangiran 1a, Sangiran 22b
Late of Early Pleistocene (0.9 Ma)	<ul style="list-style-type: none"> Group 1: Arjuna 9 Group 2: Sangiran 8, Bpg. 2001.04 Group 3: Sangiran 33
Mid Pleistocene (0.78 to 0.5 Ma)	<ul style="list-style-type: none"> Group 2: Sangiran 37, Tjg 93.05 Group 3: Sangiran 15b, Sangiran 17, Sangiran 33, Sangiran 39, NG 8503 Group 4: Isolated teeth of NG 91 610, NG 92.01, NG 92.03, NG 92.04, NG 92 D6, PDS 0712, NG 0802.3, Abimanyu 1
Late Pleistocene to Early Holocene (125 to 12 Ka)	<ul style="list-style-type: none"> Group 4: Wajak 1 & 2, Lida Ajer Group 5: Braholo 4
Early to Mid-Holocene (10 to 5 Ka)	<ul style="list-style-type: none"> Group 5: Song Terus from Keplek Layer, Song Keplek 1 & 4, Braholo (except BHL 4), Song Tritis, Wajak Holocene caves, Gua Kidang, Gua Harimau lower layer, Northern Sumatra Shellmidden
Late Holocene (3 Ka)	<ul style="list-style-type: none"> Group 6: Song Keplek 5 and Gua Harimau upper layer

Table 5. C.2. Diachronic position of the hominins in Sundaland during Quaternary

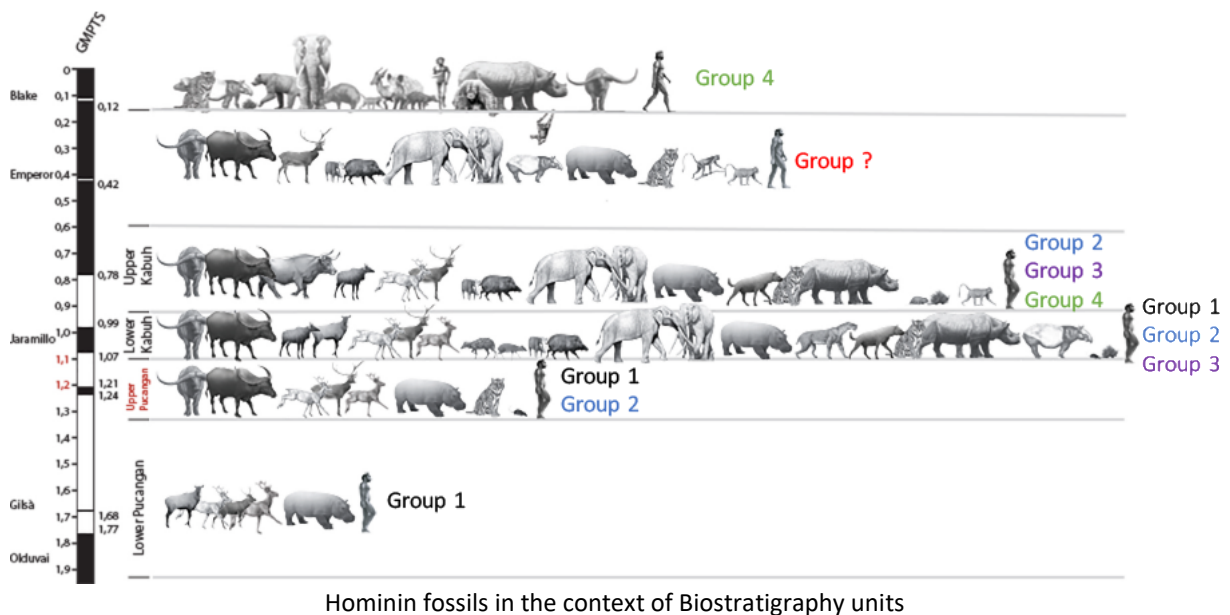

Note:

Early to Mid Pleistocene faunal units from Sangiran Dome were adapted from Ansyori, 2018

Late of Mid Pleistocene to Late Pleistocene faunal units of Ngandong and Punung were adapted from Sondaar, 1984

2. Origin and dispersal of early hominins into Sundaland

The departure of *Homo erectus* from Africa occurred slightly before 1.8 Ma and arrived in Island Southeast Asia not long thereafter (Fleagle *et al.* 2010). However, some argued that the early hominin pre-erectus migrate out of Africa before this event (e.g., Barras 2013). During a rather brief period, from 1.98 to 1.79 Ma, the northern hemisphere glaciation produced the drop of sea level, and the Tethys sea corridor between Africa and Eurasia became intermittently accessible to moved out of Africa (Ciochon 2010).

Sumatra and Java were part of the Sundaland subcontinent, and the early phase of human occupation in this western Indonesia archipelago has occurred in the Early Pleistocene. Considering the age of early hominin fossils on Java and the sea level record, it is most likely that hominins made their first crossing into Sundaland between 1.8 - 1.74 Ma during glaciations, when the sea level was at least 50 m lower than the present level (Bettis *et al.* 2009). The drop of low-sea level during this period opened land bridges connecting the islands with the mainland Southeast Asia and favouring faunal also human migrations into the archipelago (Van Den Bergh, de Vos, and Sondaar 2001).

The first hominins arrived in the Solo Basin during the sedimentation periods of the Pucangan Formation at least 1.6 Ma. The area at these times was a low relief landscape along the upper reaches of a shallow estuary (Sémah 1986). Freshwater marshes and marsh-edge environments supported aquatic and semiaquatic vertebrates such as small hippos, cervids, bovids, and crocodiles (Bettis *et al.* 2009). From the chronological point of view, the Group 1 *Meganthropus* type and the Group 2 *Mojokertensis* type from the Lower Pleistocene correspond to the earliest hominins who settled in Java. The Group 1 type includes Lower Pleistocene fossils as Sangiran 5 or *Pithecanthropus dubius* (von Koenigswald 1950) and Sangiran 6b or *Meganthropus* II (Grine and Franzen 1994), also maxilla of Sangiran 27 of *Meganthropus* C (Indriati and Antón 2008) from the Pucangan Formation. The Group 2 *Mojokertensis* type found in the Pucangan formation is the mandible of Sangiran 1b called '*Pithecanthropus modjokertensis*' (von Koenigswald 1940), also some isolated teeth of Sangiran 7a (Grine and Franzen 1994).

Based on the chemical study, Von Koenigswald (1973) showed that the second *Meganthropus* jaw has the same state of preservation and the same fluorine content as the mandible of *Pithecanthropus modjokertensis*. This suggests that both specimens came from the same layer so that the Group 1 *Meganthropus* type and the Group 2 *Mojokertensis* type probably were living together side by side in the same period. These conditions of Java could be similar to Olduvai, East Africa, with the coexisted of *Homo habilis* and Australopithecines in the Plio-Pleistocene boundary.

On the upper Pucangan Formation around 1.2 Ma (Suzuki and Wikarno 1982), the Group 1 *Meganthropus* type still existed, represented by the mandible of Sangiran 6a or *Meganthropus palaeojavanicus* and the maxilla of Sangiran 4 or *Pithecanthropus robustus* (von Koenigswald 1950). The Group 2 *Mojokertensis* type found in the upper Pucangan Formation consists of the mandible of Sangiran 9 or *Pithecanthropus (dubius)* C (Sartono 1961b) and the maxilla of Sangiran 15a or *Pithecanthropus (modjokertensis)* D (Sartono 1974a). Other fossils belong to the same lithological series but show the character of Group 3 Sangiran type, including the mandible of Sangiran 22b or *Pithecanthropus* F (Sartono 1978) and the maxilla of Sangiran 1a (Schwartz and Tattersall 2003).

During the Early Pleistocene, the evolution of the landscape in Java was mainly driven by the development of volcanic activity and major climatic cycles (Sémah *et al.* 2010). The palaeoenvironmental reconstructions suggested that the lowland rain forest appears and dominates the main part landscapes of Central Java. Pollen studies by A.M. Sémah (1984b; 1986) on fossil-bearing stratigraphical sections from Bumiayu, Gemolong, and Sangiran in the Solo Basin show that rainforest was the dominant vegetation type between 2.6 and 1 Ma (Sémah 1984a; Sémah, *et al.* 2001). Palaeoenvironmental analysis of aquatic fossils demonstrates that Trinil at 1.5 Ma was near-coastal rivers, lakes, swamp forests, lagoons, and marshes with minor marine influence (Joordens *et al.* 2009). During this period, the humid forest-covered emerged lands behind immense coastal mangroves and back mangrove formations, often along with extensive swamp forests (Sémah and Sémah 2012).

Knowledge about the dietary niche is key to understanding hominin adaptation because diet influenced by habitat preference (Joordens *et al.* 2009). Peters and Vogel (2005) have analyzed the carbon isotope ratio of tooth enamel of African *Homo erectus*, and found evidence that early *Homo erectus* either was eating C4 (warm season) grasses, sedges and broad-leafed herbs, or was eating the small animals that had eaten these same plants. This links *Homo erectus* with wetland and marsh habitats, which commonly occur around coastal areas. Evidence both in Africa and in Asia at Java is consistent with the hypothesis that there was a prolonged temporal and spatial association of *Homo erectus* with wetland and coastal habitats (Bettis *et al.* 2009). Terrestrial paleoenvironments include lakes, rivers, deltas, and marshes that provide drinking water and potential sources of plant and animal foods for hominins (Joordens *et al.* 2009).

The association between *Homo erectus* with wetland and coastal habitats showed by Choi and Driwantoro (2007) who did cut-mark analysis of Pleistocene mammalian fossils, found 18 cut-marks inflicted by tools of thick clamshell flakes on two bovid bones created during butchery at the Pucangan Formation in Sangiran between 1.6 and 1.5 Ma. This documented the use of the first tools in Sangiran and the oldest evidence of shell tools in the world. Other evidence comes from Trinil environments, which yield at least eleven edible mollusc species and four edible fish species that could be procured with no or minimal technology. From an ecological point of view, Joordens *et al.* (2009) demonstrate that the omnivorous hominins in coastal habitats with catchable aquatic fauna could have consumed aquatic resources. The hypothesis of aquatic exploitation was tested with a taphonomic analysis of aquatic fossils associated with hominin fossils. They show shell midden-like characteristics of large bivalve shell assemblages containing *Pseudodon* and *Elongaria* from Trinil HK indicate deliberate collection by a selective agent, possibly hominin (Joordens *et al.* 2009).

The discovery of some “Sangiran flake” artifacts in conglomerate lenses at Dayu locality, on the upper part of the Pucangan Formation, dated back to 1.2 Ma, make it as the evidence of the real hominin oldest artifacts known in Java today (Widianto and Simanjuntak 2009). Unfortunately, we do not know yet precisely who is the owner of the artifact, the Group 1 *Meganthropus* type, Group 2 *Mojokertensis* type, Group 3 Sangiran type or all of them.

3. Hominins variability during the late Early to Middle Pleistocene

A major sedimentary rupture occurs at Sangiran during the late Lower Pleistocene, resulting in the deposition of Grenzbank ('the boundary bed') layer, followed by the Kabuh series (von Koenigswald 1940; Leinders 1985; Sémah *et al.* 2001). Contrasting with the Pucangan underlying series, they reflect at least two major events, tectonic and climatic, which are clearly documented in both the regional stratigraphic and palaeobiological records (Sémah *et al.* 2010). With the arrival of Quaternary glaciations around 0.9 and 0.8 Ma, between the MIS 19 and 22, the savannah formed in large parts of Southeast Asia, driving fragmentation and reduction of the rainforest. The replacement of the rain forest by drier and more open vegetation, which appeared at the end of Early Pleistocene, can't be attributed to the environmental reconquest after volcanic eruptions, but as a response to climatic trends. The rain forest underwent severe fragmentation, restricting to locally humid spots among an open landscape with extensive grasslands (Sémah and Sémah 2012)

At the transition of Early to Middle Pleistocene around 0.9 Ma, some fossil specimens from the Grenzbank layer of Sangiran Dome were the representatives of the hominin during this period. The last survivors of Group 1 *Meganthropus* type was represented by the mandible of Arjuna 9, identified as the robust *Homo erectus* (see Widiyanto 1993), from Ngebung locality, Sangiran. Two other groups were also survived in this period by the presence: mandible of Sangiran 8 (Marks 1953) and the maxilla of Bpg 2001.04 (Zaim *et al.* 2011) from the Group 2 *Mojokertensis* type, also Sangiran 33 called 'mandible of *Pithecanthropus H*' by Aziz (1983) from the Group 3 Sangiran type.

During the accumulation of the Kabuh Formation in the Middle Pleistocene since 0.78 Ma, the local environmental conditions have changed. Braided streams draining nearby volcanic highlands provided intermittent floods of sandy, silty and clayey sediment (Brasseur *et al.* 2015), forming a dynamic and diverse riverine landscape characterized by open woodland, savanna and tree-lined channels (Bettis *et al.* 2009). The large rivers draining on the Sundaland probably provided refugia along their banks. Savannah habitants, such as elephant, antelopes, hippo, deer, and carnivore, were flourished, along with the hominins (Whitten *et al.* 1996).

Three type groups were found in this period. There are the last survivors of Group 2 *Mojokertensis* type which represented by Sangiran 37 '*Pithecanthropus G*' (Aziz 1981) and Tjg 1993.05 (Sartono 1993) from Kabuh formation. Representatives of the Group 3 Sangiran type are the most abundant, including NG 8503 and Sangiran 39 or BK 8606 (Aziz *et al.* 1994), also the maxilla of Sangiran 7-3, Sangiran 7-17 (Grine and Franzen 1994), Sangiran 15b (Jacob 1973), and Sangiran 17 (Sartono 1971) are from the same lithological series. Others individuals are belonging from a new type of the Group 4 Wajak, including: NG 91 G10 and NG 92 D6 from lower Kabuh, also Abimanyu 1 from the middle of Kabuh Formations.

The faunal turnovers and human recolonization in the Pleistocene times seem to be correlated with extreme global cooling event and sea level decline during the hardest glacial period such as MIS 22 (Hantoro 1997; Sémah *et al.* 2010). It could have been stimulated by the oldest Toba Tuff volcanic eruption at Northern Sumatra (Lee *et al.* 2004) and a meteorite impact of Australasian tektite at Southern Laos (Sieh *et al.* 2019). On the other hand, global warming in the interglacial maximum, when the climate is warmer and humid, caused the sea-level rise. This condition created an insular environment, causing isolation from

continental Asia. Based on the dental characters, we have demonstrated that the Group 3 Sangiran type shared some characters with the previous Group 2 *Mojokertensis* type, and also with the Zhoukoudian *Homo erectus*. Some dental similarities including size reduction in Sangiran type compared to *Mojokertensis* type could be the result of isolation and adaptation to an insular environmental context caused by dramatic climatic changes during the Mid-Pleistocene. This study presumes genetic continuity between hominins from the Early to Middle Pleistocene *Pithecanthropus* (*Homo erectus*), but probably not with *Meganthropus*.

On the other hand, the Group 4 Wajak type might be identified as a newcomer because it seems that there is no gradual evolution from the previous Group 1 *Meganthropus* type or Group 2 *Mojokerto* type. The discovery of specimens of the group 4 associated with Acheulian artifacts in Ngebung 2 occupation layer in the Sangiran dome suggests that the Wajak type migrated to Java on the boundary of Lower to Middle Pleistocene around 0.8 Ma (Sémah *et al.* 1992; Simanjuntak, Sémah, and Gaillard 2010). This event could be the reflection of the 'mid-Pleistocene revolution' as proposed by Sémah *et al.* (2010), which could be caused by the formation of new geographical territories of the archipelago. In this context, a new genetic flow from mainland may have reached Java represented by the Group 4 Wajak type. Finally, this group, including '*Homo wajakensis*', survived, despite the dramatic climatic change, from the Middle Pleistocene to the Late Pleistocene.

This study, therefore, suggests a complex diversity among hominins of Java that could be identified by dental records with at least three groups that co-existed around the boundary of Lower to Middle Pleistocene. This result does not contradict the proposals published by von Koenigswald (1950), Jacob (1973), and Sartono (1991). It is also compatible with the hypothesis of gradual evolution from Early to Middle Pleistocene as proposed by Widiyanto (1993) and Kaifu *et al.*, (2005), especially between Group 2 *Mojokertensis* and 3 Sangiran type. However, we have to consider the possibilities scenario of what happen on the Group 1 *Meganthropus* type which was extinct in the Middle Pleistocene. Also for the Group 4 Wajak type which appeared in these period and survived to the Late Pleistocene.

The variability of hominins in Java during the Middle Pleistocene also supported by the diversity of Non-Human Primate (NHP) and other vertebrate mammal fossils. The Kedungbrubus faunal unit shows maximum species richness, originating from both an influx of new species from the Southeast Asian mainland and local evolution of endemic taxa (van den Bergh *et al.* 2001). Several NHP fossils also found in Java from this period, such as; *Gigantopithecus* at Semedo (Noerwidi *et al.* 2016), Pongo in von Koenigswald's collection in Frankfurt from Sangiran (Kaifu, Aziz, and Baba 2000; Zanolli 2011), *Hylobate* at Trinil (Ingicco *et al.* 2014), *Macaca*, *Presbytis* and *Tracipithecus* from Trinil and Sangiran in the von Koenigswald's collection in Bandung (Larick *et al.* 2000; De Vos *et al.* 1994).

The existence of those forest-dependent species is the evidence that a forest habitat survived from the glacial climatic changing event in Java during Middle Pleistocene, and this island has been a refuge for several large extinct primates. Moreover, the palaeoenvironmental study by Louys and Meijaard (2010) suggested that the Sundaland was dominated by a heterogeneous vegetation complex throughout the Early to Middle Pleistocene, as indicated by the large-bodied mammals found in palaeontological sites (Louys and Turner 2012). Those ecological conditions are ideal for stimulated the variability of early hominin biological aspects and the subsistence of primitive features.

The hominin variability pattern in Java perhaps reflected the model proposed by Dennell *et al.* (2010) who suggested that the most important driving force behind the pattern of hominin settlement during the Early and Middle Pleistocene was climatic factors, so regional discontinuity and local extinction were indicating that long-term refugia must have existed to enable populations to survive during critical periods. They suggest that the pattern of repeated colonization and extinction may help explain the morphological variability of Middle Pleistocene hominins (Dennell *et al.* 2010). Furthermore, Dennell *et al.* (2011) propose a population pattern for Middle Pleistocene Europe based on demographic “sources” and “sinks” model. The sources were a small number of “core” or populations in glacial refugia from which hominins expanded wider in interstadial and interglacial periods.

In the Sundaland context as an archipelago, it could be a reverse mechanism: hominins expanded wider during the glacial period from the sources of interglacial refugia. Populations in South Asia and north of Mainland Southeast Asia would have been "sink" populations in that they depended upon employment from source populations in Island Southeast Asia (see Fig. 5. C.1.). So that, the Sundaland hominins would have been a likely source of refugia immigrant or source populations, but Northern India and Northern China hominins could be the sink population. The movement of the Pleistocene hominins could be correlated with the faunal migration routes of 'Siva-Malayan' and 'Sino-Malayan' fauna from South and East Asia to the Island Southeast Asia as suggested by the previous study (e.g., de Vos and Long 2001).

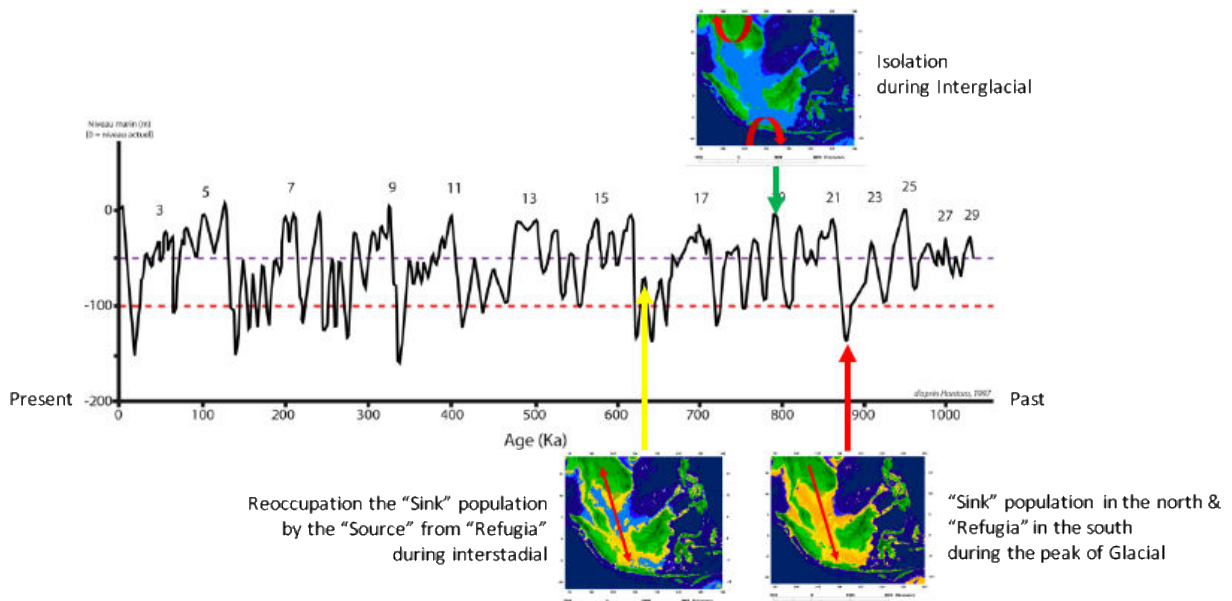

Fig. 5. C.1. Physiography of the Sundaland during Glacial Maximum (Red), Interglacial Maximum (Green), and Interstadial (Yellow)

4. Extinction and Emergence during the Late Pleistocene

The dramatic climatic change which occurred during the early Late Pleistocene represents by the faunal turnover around 125 Ka. The domination of big mammals from the dry and open environment of Ngandong fauna in the late Middle Pleistocene has changed to the closed tropical rain forest of Punung fauna in the early of Late Pleistocene (de Vos, Hardjasmita, and Sondaar 1982). Although around 81 ka, the vegetation changed from closed freshwater swamp forest to open herbaceous swamp, dominated by grasses and sedges as showed by vegetation record of Bandung highland (van der Kaars and Dam 1995, 1997). However, between 74 and 47 ka, slightly warmer, and wetter conditions existed again (Louys and Meijaard 2010).

The only fossils which represent this period are the Lida Ajer specimens from Payakumbuh karstic area, Western Sumatra, and the Wajak fossils from Campurdarat karstic area, East Java. The Lida Ajer specimens were recently dated between 73 to 63 Ka BP, and the Wajak hominins between 37.4 to 28.5 Ka BP (Storm *et al.* 2013; Westaway *et al.* 2017). Another human remain from this period is Punung Hominin, claimed as a *Homo sapiens* premolar from Gunung Dawung locality of Punung, East Java dated back to 115 Ka (Storm *et al.* 2005; Westaway *et al.* 2007). These fossils sorted as members of the Group 4 Wajak type in our study.

The signification of chronological position of the two deciduous molars from Song Terus, East Java, could fill the chronological gap from the Late Pleistocene period. Indeed, the two teeth are from different archaeological layers, ST06 dated to at least 80 Ka and ST04 dated to 60 Ka. Our analysis led to promising preliminary results. The comparison of ST06 with specimens from Early and Middle Pleistocene, shows some similarities on the OES and EDJ features making the ST06 specimen close to this archaic hominins group. On the other hand, the summary of metric and morphological comparisons between ST04 and the early mid-Pleistocene hominins, Neanderthal and *Homo sapiens*, suggests that ST04 belongs to *Homo sapiens* (Noerwidi *et al.* 2018).

Thus, the two deciduous human teeth from Song Terus could represent a transitional model in the Late Pleistocene period between archaic hominins and anatomically modern humans. This hypothesis is supported by archaeological data from the site that shows the Pleistocene flake industry of Song Terus, which appeared since 230 Ka, stopped at 80 Ka just below the thick volcanic ash sediment (Tiauzon 2011). The overlying archaeological level reflected new behaviors with the exploitation of a large number of cervids and bovinds (Kusno 2009). However, it lacks of lithic artifact, only several chert flakes and a big andesitic hammer-stone with fresh scars were found in the same level associated with the faunal bone dated to 39 Ka (Sémah *et al.* 2004). Probably human in this period prefer to use wood, bamboo, or other organic material for tools as *Homo sapiens* do.

The disappearance of the previous archaic hominin type from the Mid-Pleistocene was probably correlated with the climatic change in the early Late Pleistocene. The previous Group 2 *Mojokertensis* and Group 3 Sangiran types who lived in the open ecological niche probably could not survived in the tropical rain forest as shows by palaeoenvironmental data (see e.g., Tu 2012). This hypothesis is supported by the chronological study of the last *Homo erectus* from Ngandong which placed them between 117 and 108 Ka BP (Rizal *et al.* 2019). However, this result contradicts the previous study by Yokoyama *et al.* (2008), who established a minimum around 40 Ka and a maximum around 60 to 70 ka for the *Homo*

erectus from Sambungmacan, which probably survived after the Toba super-eruption and may have coexisted with the earliest *Homo sapiens* in the Island Southeast Asia.

There are two main hypotheses regarding the origin of anatomically modern human population in Island Southeast Asia during the Late Pleistocene; 'the multiregional continuity' and 'replacement' model. The former is the first formulated. It proposed that the Australo-Papuan and the East Asian populations, as two separate phenotypes of recent Southeast Asian populations, are the descendants of Javanese and Chinese *Homo erectus*. It was supported by numerous palaeoanthropologists, as early as the pioneering works of Weidenreich (1945) and Coon (1962), and later by several scholars (e.g., Thorne and Wolpoff 1992; Wolpoff 1985; Wolpoff et al. 1994).

The other model, the 'replacement' hypothesis, is the dominant model for the geographic origin and early migration of anatomically modern humans, supported by genetic and palaeoanthropological data (e.g., Stringer 2003). The model proposes a "single origin" of *Homo sapiens* in Africa, refuting a parallel evolution process leading to anatomically modern humans in other regions (Wolpoff, Hawks, and Caspari 2000), but arguing for multiple admixtures between *Homo sapiens* and early hominins in Eurasia (Villanea et al. 2019). This model suggests that *Homo sapiens* most likely developed in Africa between 300,000 (Hublin et al. 2017) and 200,000 years ago (White et al. 2003), and all modern non-African populations are largely descended from these populations who came out of Africa and replaced the previous hominins: *Homo erectus* and *Homo neanderthalensis* (Stringer 2012).

The presence of some isolated teeth in Ngebung locality of Sangiran dome as early as 0.8 Ma, belonging to Group 4 Wajak type, is an opportunity to test the 'multiregional continuity' mechanism for the hominin evolution in Island Southeast Asia. Remember that teeth from Mid-Middle Pleistocene at Pucung locality belong also to the Group 4, were found together with other gracile human postcranial bones. Exotic bolas artifact made of allochthonous raw material probably imported from the Southern mountains (Sémah, *pers. comm*) were found in association. The engraving shell artifact from Trinil dated to 0.5 Ma was made by *Homo erectus* evidencing the cognitive development and the neuromotor control of the Asian *Homo erectus* (Joordens et al. 2015). Unfortunately, there has not yet found evidence of fire domestication, which reflect diet change and technological advance as found in the Zhoukoudian cave inhabited by *Homo erectus*, cousins of those from Mainland Asia.

The presence of two deciduous teeth attributed to two different species (Noerwidi et al. 2018) at the Song Terus site probably evidences the 'replacement' mechanism for the history of hominin occupation in Island Southeast Asia. However, this model should not be considered as the final conclusion for the discourse of initial presence of anatomically modern human in the Island Southeast Asia, as this area is a refugia place for archaic hominin species, such as *Homo soloensis* (Rizal et al. 2019), *Homo floresiensis* (Sutikna et al. 2016) and recently found *Homo luzonensis* (Détroit et al. 2019). Furthermore, the genetic evidence from the Denisovans suggested there were interbreeding between archaic hominin with the ancestor of the Australomelanesian population (Jacobs et al. 2019), based on fossils previously found in Siberia (Reich et al. 2010) and Tibet (Chen et al. 2019). This hypothesis opens a challenge about the possibility to traces the 'southern Denisovans' evidence, which probably located somewhere in the Solo basin or Southern mountains sites.

5. Contact and Isolation during the Early Holocene

During the Late Glacial Maximum and the transition of the Pleistocene-Holocene, there was a fluctuating record of environmental changes (Voris 2000). The drop in the sea level during MIS 2 is correlated to the emergence of a vast area on the Sundaland, which stimulated modern human migration during this period. These human groups would be faced and adapted to the climatic and environmental changes from the terminal Pleistocene to the Holocene, including temperature and sea-level fluctuations. The environmental changes may imply to the distribution of human groups through the lands that became a dense forested, or by seafaring between the islands (Sémah and Sémah 2012). This new physiographical formation also could stimulate the human population groups to adapt to the isolated forest or islands environment.

There are two main hypotheses regarding the origin of the population in Island Southeast Asia during the terminal Pleistocene and Holocene periods; the 'regional continuity' and the 'two-layer' hypotheses with some variations. The regional continuity model suggests the previous Late Pleistocene anatomically modern human migration as the single source of demographic expansion in the Island Southeast Asia and eliminates the significant influence of later dispersals. This model was first proposed by Weidenreich (1945) and Coon (1962). In a way, it is supported by later cranio-dental studies (Hanihara 1993, 2013; Pietrusewsky 2008, 2010; Turner 1987, 1992) which argued for a local evolution of the present-day Southeast Asian populations mainly driven by local adaptation.

The second model is the 'two-layer' hypothesis, which suggests that the human occupation of the Island Southeast Asia occurred over two distinct periods by two separate population groups or 'layers'. This model hypothesized that 'the first layer' of Southeast Asia was initially occupied by indigenous populations, affiliated to the modern population of Australo-Papuans or Austro-Melanesians (Jacob 1967). Later a genetic input occurred in the Late Holocene by newcomers of 'the second layer' from North and/or East Asia which led to the formation of the present-day Southeast Asian or "Mongoloid" populations (Jacob 1967; Matsumura and Oxenham 2014).

The debate about the two models began when Hooijer (1950) proposed a hypothesis that the large teeth (macrodont) population have been found in various Malaysian cave deposits also Sumatran kitchen middens, usually identified to Melanesoids, were the populations on the way to evolve to their present of small teeth (microdont) population. Von Koenigswald (1952) did not agree and argued that the macrodont population of Australo-Melanesian was replaced or was pushed to the eastern part of Indonesia by the Neolithic population who brought the quadrangular axe. Dealing with two different populations, the Australo-Melanesian and the Malayan (Snell 1938), von Koenigswald (1952) was against a local microevolution as suggested by Hooijer (1950). Hooijer (1952) insisted given the cases of microevolution on vertebrate fossils caused by environmental adaptation factor in the archipelago context.

The variation of the 'two-layer' hypothesis was developed by Howells (1973) who suggested the previous existence of 'Old Melanesia', in Sundaland, Sahulland, and that the Wallacea region was colonized by Australo-Melanesian populations with preneolithic techno-complex. The human remains from Wajak, Niah, and Tabon were considered to be ancestral to the Australo-Melanesians who have occupied the archipelago since at least ~~in~~

the late Pleistocene. During Neolithic times, with the emergence of food production, the population in the western part of Indonesia began to be dominated by Austronesian speaking populations (Bellwood 2017), leading to an eastward movement of the western boundary of 'New Melanesia' increasingly towards New Guinea.

Jacob (1974) also suggested the hypothesis of two populations: the Mongoloids, in the north and western part of Indonesia and the Australo-Melanesians in the south and eastern part of this archipelago. Widiyanto (2002; and Widiyanto *et al.*, 1997) supported the two populations model by human remains found at Gua Babi, Kalimantan, and Gunungsewu, East Java. This 'two-layer' model is strongly supported by recent works e.g., by Matsumura *et al.* (2017, 2018). A variation of this model developed by Noerwidi (2012, 2017) suggests a multiple migrations hypothesis into Java during Terminal Pleistocene to Late Holocene: Australo-Melanesian population (Latest Pleistocene), Southeast Asian or 'Southern Mongoloid' (Neolithic Austronesian, 3000 BP), and 'gracile' population (early AD, perhaps from India). This view is also supported by Corny *et al.* (2017), who suggested a significant Late Glacial Maximum anatomically modern human expansion and a strong biological impact of the spread of Neolithic farmers into SEA during the Holocene.

Another hypothesis was proposed by Déroit (2002) suggested an "Inter-Populations Hybridisation Zone" model with intensive contacts between populations inside the Island Southeast Asia, in between the two major geographical poles of Australia and Mainland Asia. This model is supported by the large variability of regional funeral practices and the mosaic morphologies of prehistoric Southeast Asian *Homo sapiens* during Holocene (Déroit *et al.* 2006).

In our study, we show that the western part of the Indonesian archipelago in the terminal Pleistocene and Early Holocene period was occupied by several populations of Group 5 Preneolithic type who lived in open-air sites near the water or caves. This group was represented by human fossils from shell midden sites of Northern Sumatra with the Hoabinhian cultural context between 9-6 Ka BP, and Gua Harimau cave in the South Sumatra with the flake-blade obsidian culture dated back to 14 Ka BP. Contemporary populations occupied Java Island as evidenced by Gua Pawon with the flake-blade obsidian culture in the West Java dated back to 9 Ka BP, eastern part of Gunungsewu caves with Keplek flake cultural complex between 10-4.5 Ka BP, also Sampung bones industry in the western part of Gunungsewu caves between 13-4 Ka BP, Gua Kidang in the Northern Mountains dated back to 9 Ka BP, and the Wajak caves complex of Gunung Lawa mountain, East Java from the first part of Holocene period.

We concluded that the population of Group 5 Preneolithic type should have evolved from the previous Group 4 Wajak type lineage. Some dental character similarities with occlusal pattern simplification and size reduction in Preneolithic type compared to Wajak type could be the result of isolation and adaptation to an insular environment caused by the maximum of the interglacial event since 8.5 Ka BP (Sathiamurthy and Voris 2006). The dental discriminant analysis shows that the Preneolithic type shares their characters with each other, between populations from Sumatra and Java. The Lida Ajer specimen seems to represent an isolated population, but the Wajak Late Pleistocene fossils share characters with the Gunungsewu Preneolithic group which is close to Gua Pawon, Wajak Preneolithic, and Gua Kidang in Java. Gua Pawon also shares characters with Gua Harimau lower layer and the last group share with the Shellmidden site in the northern Sumatra.

This hypothesis, based on our results obtained on dental pattern, shows a relationship between the preneolithic population in the northern and southern Sumatra, supported by archaeological evidence with the presence of the Hoabinhian element, as the main cultural character of Shellmidden site of northern Sumatra and in Gua Harimau, South Sumatra. Gua Harimau and Gua Pawon, which share dental characters, also have a similar cultural context with flake blade obsidian techno-complex. Gua Pawon in western Java and cave sites at Gunungsewu, Wajak complex, and Gua Kidang in eastern Java, have dental features in common and also share Sampungian bone and shell industry elements.

6. New maritime wave in the Late Holocene

The western part of Indonesian region in the Late Holocene is characterized by a full archipelago environment caused by the temperate conditions started with the beginning of Holocene and its maximum event around 8500 BP (Sathiamurthy and Voris 2006) when the climatic optimum was reached, and the conditions became almost ever-wet. At this time, the rain forest would have reached its maximal extent (Sémah and Sémah 2012). The human population occupied in the Late Holocene period has the character of Group 6 Neolithic-Paleometallic type and corresponds to the Neolithic and Paleometallic cultural context. This type of group is represented by the Gua Harimau upper layer from 2.800 BP and Neolithic burial of Song Keplek 5 from 3.200 BP. This new gene flow should arrive together with the dispersal of the Neolithic cultural complex by the maritime migration, which brought polished stone tools, ceramics, rice agriculture, also chicken, pig, and dog domestication to the Island Southeast Asia.

Human migration events in the Late Holocene period could be divided into neolithic and paleometallic migrations from chronologically perspective, also into Austronesian and Austroasiatic migration by the populations. The two-period of neolithic and paleometallic migrations could be equal to Proto-Malay (old Malay) and Deutro-Malay (young Malay) migrations events which were firstly proposed by Wallace (1869), and supported by an archaeological model of the 'old and young megalithic' hypothesis of Van der Hoop (1932). Proto-Malay of many inland populations on the larger island of Indonesia shows a greater degree of Australo-Papuan inheritance. As opposed, the Deutro-Malay that inhabit the more accessible area simply had more contact with the 'Asian Mongoloid' is represented as the late migration in this region (Bellwood 2007; Glinka 1978, 1981).

The Proto-Malay and Deutro-Malay migrations events could be equal to the Sinodont and Sundadont hypothesis based on dental studies. The pioneer of this study is Hanihara (1966), who defined the Mongoloid dental complex. Turner (1990) separated the Mongoloid dental complex into the Sinodont and Sundadont and defined that both later groups are, in contrast, different from a broader Mongoloid dental complex. This hypothesis was latterly supported by several scholars, e.g., Hamada *et al.* (1997) and Scott *et al.* (2018). The Sinodont occupied the East Asian mainland, the Australoid in the Sahuland, and between both groups is the Sundadont of the Island Southeast Asia. Distinct to the Proto-Malay hypothesis on the degree of Australo-Papuan inheritance, the Sundadont is regarded as having a more generalized, proto-Mongoloid morphology and having a longer ancestry than its offspring, the Sinodont (Scott and Turner 1997).

Simanjuntak (2017) discussed two sources of origin and development of the Neolithic culture in Indonesia, called as the 'Eastern Route Migration' (ERM) by Austronesian from Taiwan about 4500 BP (Bellwood 2007; Blust 1984) and the 'Western Route Migration' (WRM) by Austroasiatic population about the same period, which possibly originated in Indochina, specifically northern Vietnam, and migrated through Kalimantan (Blench 2010), and Malay Peninsula to the western Indonesia (Sidwell 2010). The WMR and EMR migrations could be equal to the distribution of backed adze in the western part of Island Southeast Asia and pick adze in the eastern part of the region as proposed firstly by Heine-Geldern (1932) and supported by Duff (1970). Both models also could be equal to the 'Bau-Malaya' of cord-marked also paddle-impressed pottery, and 'Sa Huynh-Kalanay' of red-slipped also incised pottery, the two different area of ceramic techno complex in the western and eastern of Island Southeast Asia as suggested by Solheim (1975).

Based on the 'two-layer' model, the Late Holocene expansion of language families, specifically the Austronesian and Austroasiatic linguistic families, can be correlated with the Neolithic dispersal of food-producing populations (Matsumura *et al.* 2017). However, (Noerwidi 2017), with a 'multiple-layer' model, suggested the multiple migrations events of the 'Mongoloid' newcomers did not totally replace previous 'Australo-Melanesian' indigenous populations. Based on the dental characters considered in this study, we think that the previous indigenous Group 5 Preneolithic type were mixed with the Group 6 Neolithic newcomers from Mainland Southeast Asia. Some similarities and differences in dental characters on the occlusal surface of the teeth in Neolithic type compared to Preneolithic type could be the result of new genetic flow and interbreeding between both populations in the Late Holocene period. Some differences between Song Kepek neolithic skeleton and Gua Harimau upper layer, as shown in the previous discussion, could represent two genetic intrusion waves from the west and north of Island Southeast Asia, probably correspond to the Austroasiatic and Austronesian migrations.

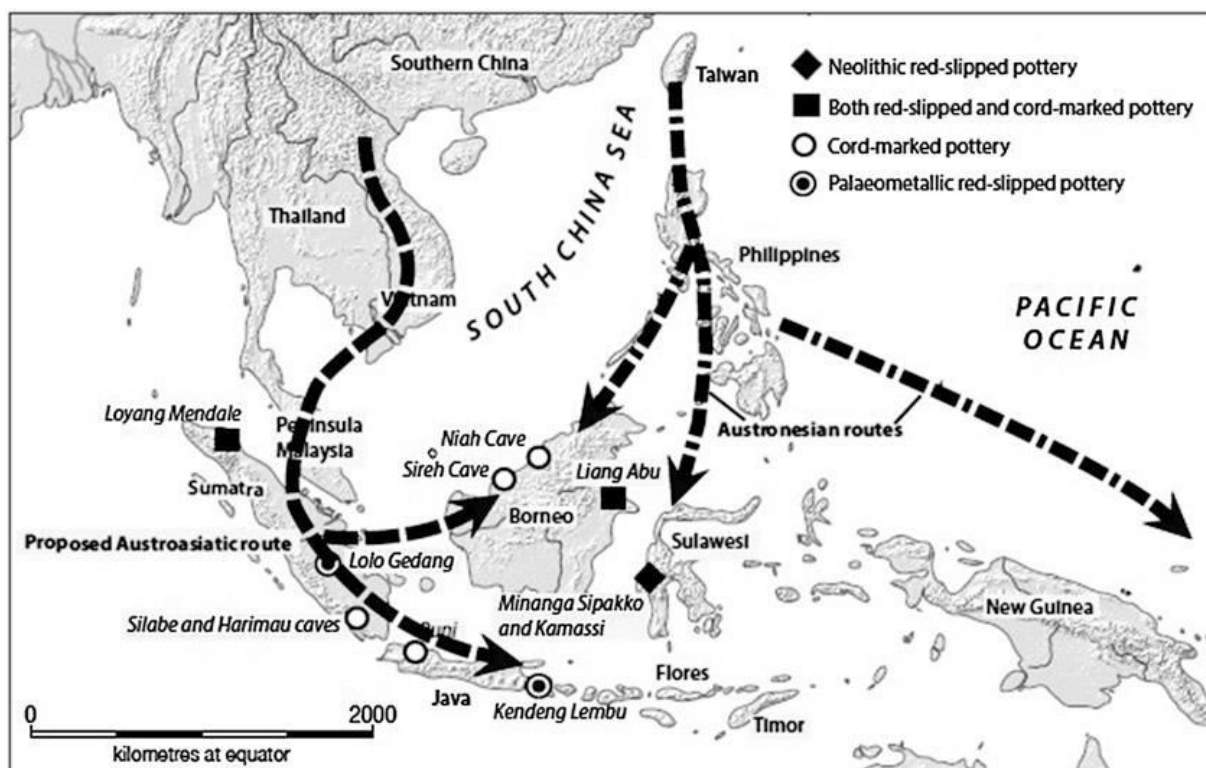

Fig. 5. C.2. Two routes of Neolithic migration into Indonesia (Simanjuntak 2017), correspond to the Austroasiatic and Austronesian migrations.

CHAPTER 6. CONCLUSION AND PERSPECTIVES

A. SOME METHODOLOGICAL PRELIMINARY REMARKS

This research focused on the potential of external dental characters used in a paleoanthropological perspective. Observations carried out on the sample part showing minimal wear proved to be a useful approach in order to identify dental types and provide information regarding hominins variability and, in some cases, phylogeny. Such approaches are not invasive in terms of conservation. They must be conducted prior to any other cutting edge analysis such as CT-Scan acquisition (which can hamper some other analyses such as ESR/U series dating).

The use of ASUDAS protocol in the dental comparative study is very common, but the method meets some limitations for scoring the early hominin specimens as it was designed for *Homo sapiens* reference collection and specimens. The present study used a modified version of ASUDAS previously suggested by Martinon-Torres *et al.* (2008; 2012). Other modifications were added as proposed in the Chapter 3 for this research.

In the metric approach of conventional measurements on BL and MD (size of the teeth) is appear efficient to highlight evolutionary trends, in generally speaking we could see size reduction through time from early hominins to the Holocene *Homo sapiens*. In advance metric approach of crown size and cusp proportion, we proposed to count the cusp circumference besides cusp size, cusp distance, and cusp angle as mentioned in Bailey (2004), Gómez-Robles *et al.* (2011) and Martínón-Torres *et al.* (2013). The result doesn't point to a significant difference between the use of cusp area and cusp circumference. On the contrary, the cusp area and the cusp angle appear as the most significant variables to characterize hominin groups and to understand the pattern change in an evolutionary perspective.

In the geometric morphometrics approach, it appears interesting to use some complementary landmarks on premolar and molar teeth beside those commonly used, I order to better characterize dental shapes of hominins: mesial and distal triangular fossae of the premolar, mesial and distal marginal ridges, buccal and lingual accessories tubercle of the molar. But, in our observation, the 2D geometric morphometrics approach has limitations which is less efficient than non-metric approach to discriminate the fossil following their dental pattern.

B. CONCLUSION

Sumatra and Java on the western part of Indonesian Archipelago are part of the Sundaland continental shelf. The biogeography of this region, including dispersals and/or isolation of hominins, was impacted by Quaternary climatic changes and sea-level fluctuations. This study was intended to characterize the variability of these hominins through the Pleistocene and the Holocene grounding on the dental record perspective, hence providing a new insight about their spatio-temporal distribution and the history of settlements. The comparative approach used metric and non-metric assessment of the external dental characters. Due to their high component of genetic relatedness and their frequency in the fossil record, teeth are particularly useful to explore the evolutionary

scenario (Turner 1969; Irish 1993, 1997, 1998; Bailey 2000, 2002; Irish and Guatelli-Steinberg 2003; Martín-Torres *et al.* 2006; Gómez-Robles *et al.* 2008).

This research started with the case study of the Javan hominins M2, this tooth class being the most abundant in the fossil sample, and also quite significant compared to other teeth (Widianto, 1991; 1993; Kaifu *et al.*, 2005). Indeed, we succeed in splitting our dental sample into several groups by their morphological and metric characters. It suggested us a way to interpret the Javan hominins' variability. Subsequently, we have enlarged our sample, geographically and chronologically, notably including Zhoukoudian fossils and *Homo sapiens* fossils from Java and Sumatra. Eventually, the hypothesis was tested on other teeth classes by means of several approaches including: morphological traits, classical measurements, crown size and cusps proportion, and geometric-morphometrics comparison studies.

The two main results are:

1. Dental diversity vs. hominin diversity

The four approaches (metric and non-metric comparative analysis) of the western Indonesian dental record allow to distinguish six groups. Such groups represent the dental record diversity and are not directly correlated to the hominin population diversity. However, we could observe that the diversity of the dental type groups overlaps chronologically. Dental diversity is not strictly following the chronology, which means that the variability is higher than expected:

- Group 1 (named here “Meganthropus” type) includes Early Pleistocene hominins formerly named Sangiran 4, Sangiran 5, Sangiran 6a & b, Sangiran 27, Arjuna 9, and other isolated teeth of S-7a from Early Pleistocene layers of the Sangiran Dome. The main feature: large size teeth, asymmetric shape of canine and premolar, square shape of LM and rhombus shape of UM, also a complicated occlusal morphology with pronounced developed accessories of LM and UM.
- Group 2 (named here “Mojokertensis” type) includes specimens such as Sangiran 1b, Sangiran 8, Sangiran 9, Sangiran 15a, Sangiran 37, Tjg 1993.05, Bpg 2001.04 and other hominins found in Early to Mid-Pleistocene layers in the Sangiran Dome. The main feature: medium size teeth, less symmetric shape of canine and premolar, rectangular shape of LM and rhombus shape of UM, also a less complicated occlusal morphology with developed accessories of UM and LM.
- Group 3 (named here “Sangiran” type) consists of Sangiran 1a, Sangiran 7-3, Sangiran 7-17, Sangiran 15b, Sangiran 17, Sangiran 22b, Sangiran 33, Sangiran 39, and NG 8503 also hominins from Early to Mid-Pleistocene from Sangiran. The main feature: small size teeth, less symmetric shape of canine and premolar, square shape of LM and rhombus and rhomboid shape of UM, also a less complicated occlusal morphology with less developed accessories of UM and LM.

The comparative sample from mainland Asia (Zhoukoudian) is distributed between Groups 2 Mojokertensis and 3 Sangiran type. This condition is probably caused by different stratigraphic distribution of the fossils (in different levels) and/or represent the high variability of the group.

- Group 4 (named here “Wajak” type) includes several hominins from Mid-Pleistocene in Sangiran and *Homo sapiens* ‘wajakensis’ from the Late Pleistocene. The main feature: moderate size teeth, symmetric shape of canine and premolar, square shape

of LM and rhomboid shape of UM, also simple occlusal morphology represented by the reduction of accessories characters.

- Group 5 (named “Preneolithic” type) includes the *H. sapiens* fossils from Early to Mid-Holocene. The main feature: small size teeth, symmetric shape of canine and premolar, square shape of LM and rhomboid shape of UM, also simple occlusal morphology represented by the absent of accessories characters.
- Group 6 (named here “Neolithic-Paleometallic” type) groups the Late Holocene *H. sapiens* in the sample. The main feature: small size teeth, symmetric shape of canine and premolar, rectangular shape of LM and rhomboid shape of UM, also less complicated occlusal morphology with lightly developed of accessories characters.

2. Chronology of human occupation

The earliest hominin occupation in Island Southeast Asia occurred during the Early Pleistocene at least 1.6 Ma (e.g. Sémah et al., 2000). This period yields fossils Group 1 “Meganthropus” type, including Sangiran 5 (*Pithecanthropus dubius*, von Koenigswald, 1950), Sangiran 6b or ‘Meganthropus’ II (Grine and Franzen 1994), or the Sangiran 27 maxilla ‘Meganthropus’ C (Indriati and Antón 2008) from the Lower Pleistocene Pucangan layers. The Group 2 “Mojokertensis” type is also found in the Pucangan series: the mandible Sangiran 1b fossil called *Pithecanthropus modjokertensis* (von Koenigswald, 1940), also some isolated teeth (Sangiran 7a, Grine and Franzen, 1994).

In a higher part of the Pucangan series, around 1.2 Ma (Suzuki and Wikarno, 1982), are found fossils belonging to Group 1 “Meganthropus” type like the Sangiran 6a fragmentary mandible *Meganthropus palaeojavanicus* and the Sangiran 4 maxilla *Pithecanthropus robustus* (von Koenigswald, 1950). Group 2 “Mojokertensis” type is also found in upper Pucangan levels with the Sangiran 9 mandible *Pithecanthropus (dubius)* C (Sartono, 1961) and the Sangiran 15a maxilla *Pithecanthropus (modjokertensis)* D (Sartono, 1974). Other fossils show characters of Group 3 “Sangiran” type, including the Sangiran 22b mandible *Pithecanthropus* F (Sartono, 1978) and the maxilla Sangiran 1a (Schwartz and Tattersall, 2003).

Near the boundary between Early and Middle Pleistocene (around 0.9 Ma), the Grenzbank layer also yields hominin fossils. We find here the last specimens belonging to Group 1 “Meganthropus” with the Arjuna 9 mandibular fragment described as robust *Homo erectus* (Widianto 1993) from Ngebung locality. Group 2 “Mojokertensis” at this level is represented by the Sangiran 8 mandible (Marks, 1953) and the Bpg 2001.04 maxilla (Zaim et al., 2011). Other fossils from the Grenzbank show Group 3 “Sangiran” type characters, including Sangiran 33 (“mandible of *Pithecanthropus H*”, Aziz, 1983).

In the early Middle Pleistocene Kabuh series (c. 0.8 Ma), Group 2 “Mojokertensis” type is documented by the Sangiran 37 mandible of *Pithecanthropus G* (Aziz, 1981) and the maxilla Tjg 1993.05 (Sartono, 1993). Fossils from Group 3 “Sangiran” type are more frequent, such as the mandible NG 8503, Sangiran 39 or BK 8606 (Aziz et al., 1994), also the maxilla of Sangiran 7-3, Sangiran 7-17 (Grine and Franzen, 1994), Sangiran 15b (Jacob 1973), and Sangiran 17 (Sartono 1971). New dental characters of Group 4 “Wajak” type appear in the Kabuh layers at the time, represented by some isolated teeth of NG 91 G10 and NG 92 D6 from Ngebung locality, and also Abimanyu 1 from Pucung locality.

The Late Pleistocene (since 125 ka) dental record in the western Indonesian archipelago is still poor. We studied here the Lida Ajer one, recently claimed to date back c. 73-63 Ka (Westaway *et al.*, 2017), and the Wajak hominins (37.4 to 28.5 ka, Storm *et al.* 2013). Another human remain from this period and stated as *Homo sapiens* is the premolar from Gunung Dawung locality of Punung, East Java, dated to 115 Ka (Storm *et al.* 2005; Westaway *et al.* 2007). The first two specimens included in this research belong to the Group 4 “Wajak” type, while the last one has to be characterized in the future.

At the very end of the Pleistocene and during the first part of the Holocene, the western part of Indonesian archipelago was occupied by *Homo sapiens* of Group 5 “Preneolithic” type. This group is represented by a huge amount of specimens coming from shellmidden sites of the east coast of northern Sumatra, Gua Harimau cave in Baturaja karst in south Sumatra, Gua Pawon at Rajamandala karst in Western Java, some caves of Gunung Sewu mountains (East Java), Gua Kidang in Rembang karst (East Java), and Wajak complex at Campur Darat karst (East Java).

The Group 6 “Neolithic-Paleometallic” type is only documented during the Late Holocene, including specimens of the communal burial from Gua Harimau upper layer, and the Neolithic extended burial of Song Keplek 5 individual.

The dental analyses show that four groups of dental type (1 to 4) were represented in Java during Early to Middle Pleistocene times (see Fig 6. B.1). The robust characters noticed for groups 1 and 2 might point to an adaptation to the lowland rain forest environment which prevailed during the Early Pleistocene (Sémah, A-M and Sémah, F, 2012). The “Sangiran flakes” industry, as the oldest lithic artifacts known in Java today, estimated to 1.2 Ma (Widianto and Simanjuntak 2009), could be the trace of the cultural adaptation of the early hominins during this period.

During the transition from Early to Middle Pleistocene, the overlapping of Groups 1, 2 and 3 is clear in the Grenzbank layer. Based on some similarities on the dental characters, those Javan hominins might belong to the same lineage. The consistency of Group 1 metric and morphological characters, such as very robust size and occlusal morphological complexity might even be related to some early African hominins, opening the way to further studies including a comparison with African and other Eurasian fossils.

Early Middle Pleistocene layers document an overlapping of Groups 2, 3 and the emergence of Group 4. Some dental character similarities with size reduction in Group 3 compared to Group 2 could represent the intraspecific biological variability caused by ‘local evolution’ of the Javan hominins, maybe in relation with the dramatic climatic changes during the Middle Pleistocene (see A. M. Sémah *et al.* 2010). This study presumes biological continuity between the Early to Middle Pleistocene *Pithecanthropus* (*Homo erectus*) as previously stated by Sartono (1986); Widianto (1993); Kaifu *et al.* (2005).

The Zhoukoudian *Homo erectus* who lived at the same period in Mainland Asia share some metric and morphological characters with Group 2 and Group 3. Based on these records, there might be a genetic contact between Island Southeast Asia and Mainland Asia during the Middle Pleistocene. Previous studies based on cranial anatomy show a relationship between Zhoukoudian and Javan *Homo erectus*, especially the Solo progressive group (Weidenreich 1943, 1951; Santa Luca 1980; Jacob 1981). Unfortunately, so far there is no dental record from the fossils of the Solo group. Dental discoveries in the future from this fossil group will be expected to give a new perspective.

On the other hand, Group 4 presents significantly different characters and no sign of gradual change when compared to other groups 1, 2, 3. Specimens belonging to this type found in Kabuh layers in Sangiran might be identified as representatives of a new dispersal to Java, an hypothesis which is not in contradiction with the discovery, in related archaeological horizons (e.g. at Ngebung) of Acheulean artifact around 0.8 Ma (Sémah *et al.* 1992; Simanjuntak *et al.*, 2010). Such observations reflect the severe environmental and palaeogeographical changes which occurred during the Middle Pleistocene, including the possibility of a new genetic flow from mainland Asia represented by the Group 4 “Wajak” type.

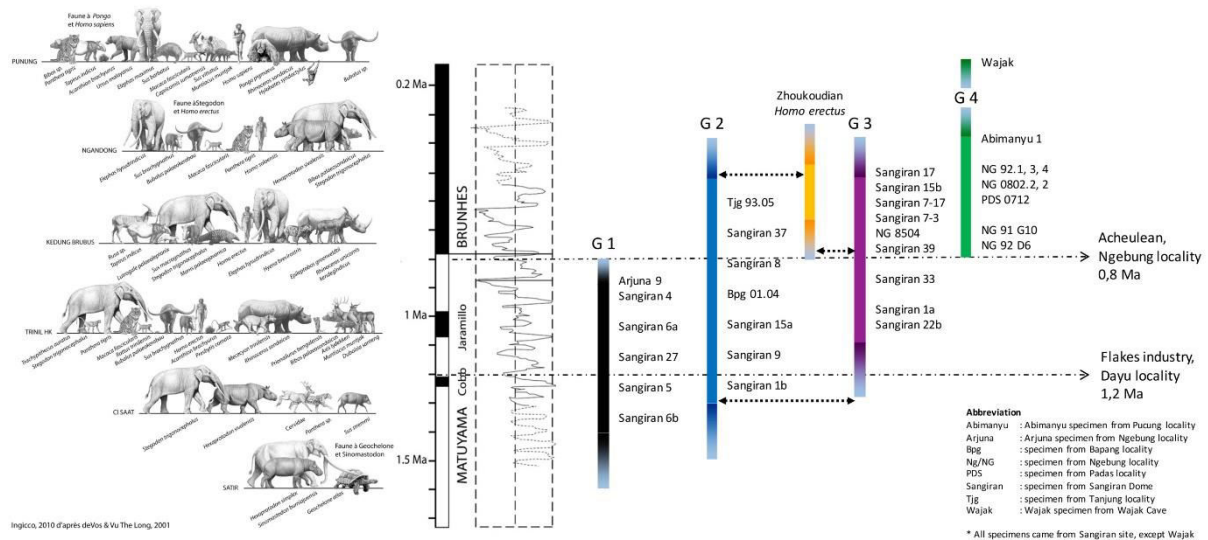

Fig 6. B.1. Hypothesis of the chronology of human occupation in the Sundaland during Pleistocene. Note: the ‘dental type groups’ present in this hypothesis are different from the terminology of the ‘population’

The Group 4 “Wajak” type also includes several *Homo sapiens* fossils, such as Wajak and Lida Ajer specimens. Together with the Punung tooth, they might be related to the earliest occurrences of *H. sapiens* in Island Southeast Asia. There are not many hominin dental remains related to this still partly hypothetical event, hence it will be very significant to undertake in-depth study on two deciduous human molar recovered from Song Terus site in East Java (see Sémah *et al.*, 2004; Noerwidi *et al.*, 2018), whose chronological distribution (between 110 and 50 ka) might cross the replacement event of *H. erectus* by *H. sapiens*.

Dental discriminant analysis shows the Group 5 “Preneolithic” type is widely shared among Preneolithic populations as reflected by the dental record. Some are shared with Wajak 1 and 2, especially for early Holocene fossils from Gunung Sewu, and Sumatra shellmidden e.g., SK 4, BHL F4, and ST 96 KI to Wajak 2, also SKJ specimens to Wajak 1. Gua Pawon of West Java also shares characters with Gua Harimau and the fossils found in Sumatran Shellmidden e.g., PWN 1 to TMG and HRM 8, also BHL F7, GKD 2 and DMB 17323 to HRM 79.

Some resemblances therefore raise the question of a possible lineage relationship with Lida Ajer and Wajak Late Pleistocene specimens of the Group 4 “Wajak” dental type. On the other hand, several dental character similarities are accompanied with size reduction in Group 5 vs. Group 4, and might be related to an adaptation to an insular environment during early Holocene (e.g. climatic optimum c. 8500 BP, see Sathiamurthy and Voris 2006).

Eventually, Group 6 “Neolithic-Paleometallic” dental types are found on teeth from Neolithic and Paleometallic cultural contexts. The conspicuous difference in dental characters is likely to lead to the hypothesis of newcomers from mainland Asia. Such a pattern of human dispersals can be accompanied here by two important remarks:

- Some dental characters’ similarities and differences re. the occlusal surface between the indigenous Group 5 and the newcomer Group 6 could be the result of interbreeding between two populations.
- Among Group 6 specimens, some differences between Song Keplek 5 individual (East Java) and Gua Harimau upper layer (South Sumatra) that were highlighted in Chapter 5 could represent the trace of two genetic flows, respectively, from the northern and western Southeast Asia, corresponding to late Holocene Austroasiatic and Austronesian dispersals.

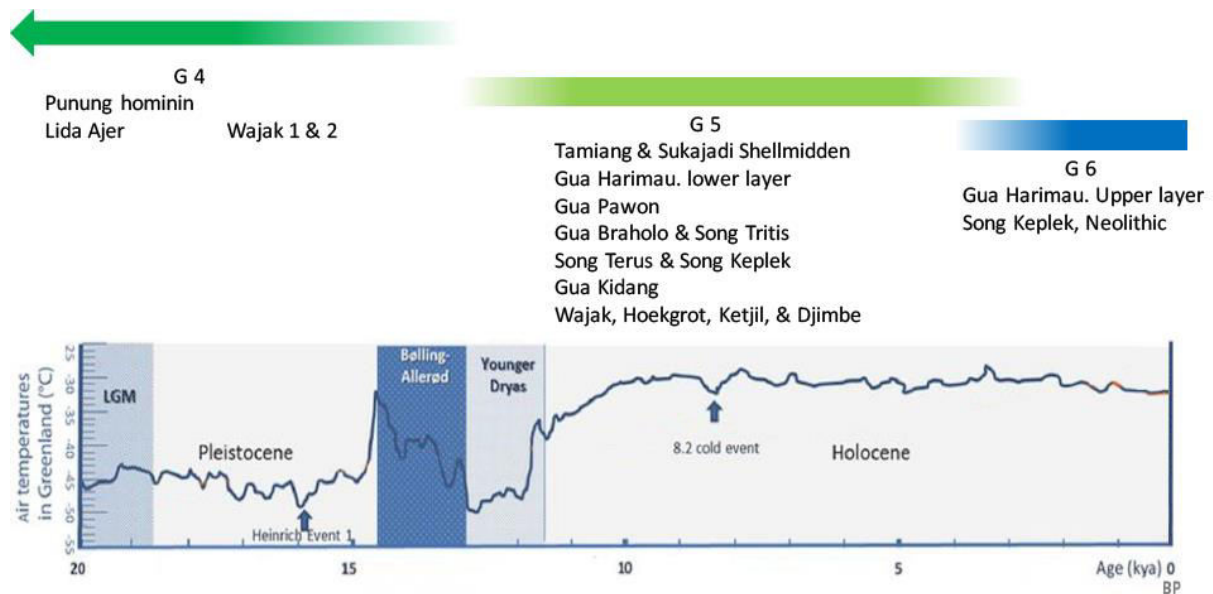

Fig 6. B.2. Hypothesis of the chronology of human occupation in the Sundaland during Late Pleistocene to Holocene. Figure sources: (Platt et al. 2017)

Fig 6. B.2 summarizes the dental characters variability (Groups 4 to 6 of dental types) observed in the *Homo sapiens* record since the Late Pleistocene. We notice a simplification of the dental pattern in Group 4 *H. sapiens* (compared to earlier hominins), phenomenon that continues in Group 5, accompanied by a clear size reduction. However, younger fossils from Group 6 clearly show a more complex occlusal pattern compared to the previous record. As for example, the 5 cusps with ‘Y’ pattern of LM2 which dominates dental types during the Early and Middle Pleistocene almost disappears in the Late Pleistocene and Early Holocene records. However, this character is observed significantly on specimens dating back to the late Holocene, especially in Gua Harimau upper layer. This questions the evolutionary significance of such cusps distribution patterns and highlights the complexity of dental types in Island Southeast Asia during the Quaternary.

C. SPECIFIC INTERESTS AND FUTURE PERSPECTIVES OF THE RESEARCH

Teeth are the most abundant anatomical parts represented among hominin fossils collections, especially from Indonesia. Some fossils were found *in situ* in archaeological or palaeontological excavations, others have a more or less reliable stratigraphical context, and others are surface finds. That means that the identification of the material and the documentation of their chrono-stratigraphical context is not always possible. It has to be taken into account in any attempt to study.

The present study tried to compile quite scattered data and to build an updated comprehensive reference collection: some of the analyzed teeth have been subject of detailed previous studies, some were only partly or not studied; a large part of the *Homo sapiens* collection included in this study were never studied in detail before. The latter collection had therefore a twofold role in our research: using the fossils as reference collection (i.e. comparing quite recent *H. sapiens* sample with older hominins) and also describing the diversity of late Pleistocene to late Holocene populations in Western Indonesia in the light of the dental record, in order to present a comprehensive and updated approach of Quaternary prehistoric human remains in the area.

The conclusions propose to discriminate 6 groups (= dental types) and to correlate, partly or as a whole, each of them with the hominin groups which occupied the western part of the Indonesian archipelago. This approach, both regarding dental type diversity and chronology must be deepened and enlarged in the future in several important ways: the exploration of teeth internal characters by CT-Scan acquisition (which has begun on several fossils); the inclusion of deciduous teeth in the study (as mentioned before, such an approach can be critical for several sites, e.g. in Gunung Sewu area); the comparative approach between the dental material and other anatomical cranial and post-cranial characters.

BIBLIOGRAPHY

- Adams, Dean C., F. James Rohlf, and Dennis E. Slice. 2004. "Geometric Morphometrics: Ten Years of Progress Following the 'Revolution.'" *Italian Journal of Zoology* 71(1):5–16.
- Aimi, M. and Fachroel Aziz. 1985. "Quaternary Geology of the Hominid Fossil Bearing Formations in Java."
- Albers, P. C. H. and J. de Vos. 2010. *Through Eugène Dubois' Eyes*. Leiden: Brill.
- Alexeev, V. 1978. "Palaeoanthropology of the Globe and Formation of Human Races. The Paleolithic."
- Alink, Gerrit, Wil Roebroeks, and Truman Simanjuntak. 2016. "The *Homo erectus* Site of Trinil: Past, Present and Future of a Historic Place." *AMERTA* 34(2):99–114.
- Amano, Noel, Anne Marie Moigne, Thomas Ingicco, François Sémah, Rokus Due Awe, and Truman Simanjuntak. 2016. "Subsistence Strategies and Environment in Late Pleistocene–Early Holocene Eastern Java: Evidence from Braholo Cave." *Quaternary International* 416:46–63.
- Ambrose, Stanley H. 1998. "Late Pleistocene Human Population Bottlenecks, Volcanic Winter, and Differentiation of Modern Humans." *Journal of Human Evolution* 34(6):623–51.
- Ambrose, Stanley H. 2000. "Volcanic Winter in the Garden of Eden: The Toba Supereruption and the Late Pleistocene Human Population Crash." *Volcanic Hazards and Disasters in Human Antiquity* 345:71.
- Andersson, Johan Gunnar. 1919. "Preliminary Description of a Bone-Deposit at Chow-Kou-Tien in Fang-Shan-Hsien, Chili Province." *Geografiska Annaler* 1(3–4):265–68.
- Andersson, Johan Gunnar, Walter Granger, and Otto Zdansky. 1922. "Current Palaeontological Research in China. Bulletin of the AMNH; v. 46, Article 13." (51).
- Andrews, Peter. 1984. "An Alternative Interpretation of the Characters Used to Define *Homo erectus*." *Courier Forschungsinstitut Senckenberg* 69:167–75.
- Ansyori, Mohammad Mirza. 2010. "Fauna from the Oldest Occupation Layer in Song Terus Cave , Eastern Java, Indonesia. Biochronological Significance of Terus Layer." Muséum national d'Histoire naturelle.
- . 2016. "Pottery from Harimau Cave." Pp. 226–46 in *Harimau Cave and the Long Journey of OKU Civilization*, edited by T. Simanjuntak. Yogyakarta: Gadjah Mada University Press.
- . 2018. "Biostratigraphic Significance of Sangiran Dome, Central Java, Indonesia: An Insight on Animal Succession of Java during the Lower and Middle Pleistocene." Muséum national d'Histoire naturelle.
- Ansyori, Mohammad Mirza and Rokhus Due Awe. 2016. "Traces of Fauna Utilization in Harimau Cave Site." Pp. 212–25 in *Harimau Cave and the Long Journey of OKU Civilization*, edited by T. Simanjuntak. Yogyakarta: Gadjah Mada University Press.

- Antón, Susan C., Richard Potts, and Leslie C. Aiello. 2014. "Evolution of Early Homo: An Integrated Biological Perspective." *Science* 345(6192):1236828.
- Argue, Debbie, Colin P. Groves, Michael S. Y. Lee, and William L. Jungers. 2017. "The Affinities of *Homo floresiensis* Based on Phylogenetic Analyses of Cranial, Dental, and Postcranial Characters." *Journal of Human Evolution* 107:107–33.
- Arif, Johan, Yousuke Kaifu, Yahdi Zaim, Takeshi Made Setoguchi, Emmy Suparka, Technology Bandung, National Science Museum, and Received October. 2002. "Preliminary Observation (Tjg-1993.05) of a New Cranium of *Homo erectus* from Sangiran." *Anthropological Science* 110(2):165–77.
- Arzarello, Marta, Giulio Pavia, Carlo Peretto, Carmelo Petronio, and Raffaele Sardella. 2012. "Evidence of an Early Pleistocene Hominin Presence at Pirro Nord (Apricena, Foggia, Southern Italy): P13 Site." *Quaternary International* 267:56–61.
- Aziz, Fachroel. 1981. "Temuan Baru Rahang Bawah *Pithecanthropus*." Pp. 94–97 in *Proc PIT X IAGI Indonesia*. Bandung.
- . 1983. "Notes on a New *Meganthropus* S. 33 from the Sangirian Dome Area, Central Java." *Publ. Geol. Res. Dev. Cent., Paleontol. Ser.* 4:56–60.
- . 2001. "Hominid Fossils Housed at the Geological Research and Development Center, Bandung, Indonesia." *A Scientific Life: Papers in Honor of Prof. Dr. T. Jacob*. Yogyakarta: Bigraf Publishing 53–66.
- Aziz, Fachroel, H. Baba, and S. Narasaki. 1994. "Preliminary Report on Recent Discoveries of Fossil Hominids from the Sangiran Area, Jawa." *Jurnal Geologi Dan Sumberdaya Mineral* 29:11–16.
- Aziz, Fachroel and John de Vos. 1989. "Rediscovery of the Wadjak Site (Java, Indonesia)." *Journal of the Anthropological Society of Nippon* 97(1):133–44.
- Baab, Karen L. and Yahdi Zaim. 2017. "Global and Local Perspectives on Cranial Shape Variation in Indonesian *Homo erectus*." *Anthropological Science* 125(2):67–83.
- Baba, Hisao and Fachroel Aziz. 2001. "Comments on the Breakage of the *Meganthropus* B Mandible." *A Scientific Life: Papers in Honour of Prof Dr T Jacob*. Yogyakarta: Bigraf Publishing 67–74.
- Bacon, Anne-Marie, Kira Westaway, Pierre-Olivier Antoine, Philippe Durringer, Amandine Blin, Fabrice Demeter, Jean-Luc Ponche, Jian-Xin Zhao, Lani Minnie Barnes, and Thongsa Sayavonkhamdy. 2015. "Late Pleistocene Mammalian Assemblages of Southeast Asia: New Dating, Mortality Profiles and Evolution of the Predator–Prey Relationships in an Environmental Context." *Palaeogeography, Palaeoclimatology, Palaeoecology* 422:101–27.
- Badoux, D. M. 1959. "Fossil Mammals from Two Fissure Deposits at Punung (Java)(Ph. D. Dissertation)." *University of Utrecht*.
- Bae, Christopher J., Wei Wang, Jianxin Zhao, Shengming Huang, Feng Tian, and Guanjun Shen. 2014. "Modern Human Teeth from Late Pleistocene Luna Cave (Guangxi, China)." *Quaternary International* 354:169–83.

- Bailey, Geoff. 2007. *Time Perspectives, Palimpsests and the Archaeology of Time*. Vol. 26.
- Bailey, Shara E. 2000. "Dental Morphological Affinities among Late Pleistocene and Recent Humans." *Dental Anthropology* 14(2):1–8.
- . 2002. "Neandertal Dental Morphology: Implications for Modern Human Origins." *The Anatomical Record (New Anat.)* 269(December):256.
- . 2004. "A Morphometric Analysis of Maxillary Molar Crowns of Middle-Late Pleistocene Hominins." *Journal of Human Evolution* 47(3):183–98.
- Bailey, Shara E. and Jean-Jacques Hublin. 2007. "Abstract Dental Perspectives on Human Evolution: State-of-the-Art Research in Dental Paleoanthropology." *Chemistry & Biodiversity* 1(March):1–434.
- Bailey, Shara E. and John M. Lynch. 2005. "Diagnostic Differences in Mandibular P4 Shape between Neandertals and Anatomically Modern Humans." *American Journal of Physical Anthropology* 126(3):268–77.
- Bailey, Shara E. and Bernard A. Wood. 2007. "Trends in Postcanine Occlusal Morphology within the Hominin Clade: The Case of Paranthropus." Pp. 33–52 in *Dental perspectives on human evolution: state of the art research in dental paleoanthropology*. Springer.
- Bandet, Y., François Sémah, S. Sartono, and T. Djubiantono. 1989. "Premier Peuplement Par Les Mammifères d'une Région de Java Est, à La Fin Du Pliocène: Âge de La Faune Du Gunung Butak, Près de Kedungbrubus (Indonésie)." *Comptes Rendus de l'Académie Des Sciences. Série 2: Mécanique...* 308(9):867–70.
- Barker, Graeme, Huw Barton, Michael Bird, Patrick Daly, Ipoi Datan, Alan Dykes, Lucy Farr, David Gilbertson, Barbara Harrison, Chris Hunt, Tom Higham, Lisa Kealhofer, John Krigbaum, Helen Lewis, Sue McLaren, Victor Paz, Alistair Pike, Phil Piper, Brian Pyatt, Ryan Rabett, Tim Reynolds, Jim Rose, Garry Rushworth, Mark Stephens, Chris Stringer, Jill Thompson, and Chris Turney. 2007. "The 'human Revolution' in Lowland Tropical Southeast Asia: The Antiquity and Behavior of Anatomically Modern Humans at Niah Cave (Sarawak, Borneo)." *Journal of Human Evolution* 52(3):243–61.
- Barras, Colin. 2013. "Outside of Africa: Our Surprising Origins." *New Scientist* 218(2916):40–43.
- Bartstra, Gert-Jan. 1982. "*Homo erectus erectus* : The Search for His Artifacts." *Current Anthropology* 23(3):318–20.
- . 1983. "Some Remarks upon: Fossil Man from Java, His Age, and His Tools." *Bijdragen Tot de Taal-, Land- En Volkenkunde* 139(4):421–34.
- . 1985. "Sangiran, the Stone Implements of Ngebung, and the Palaeolithic of Java." *Modern Quaternary Research in Southeast Asia* 9:99–113.
- Bartstra, Gert-Jan and Basoeki. 1989. "Recent Work on the Pleistocene and the Palaeolithic of Java." *Current Anthropology* 30(2):241–44.
- Bellier, Olivier and Michel Sébrier. 1994. "Relationship between Tectonism and Volcanism along the Great Sumatran Fault Zone Deduced by SPOT Image Analyses." *Tectonophysics* 233(3–4):215–31.

- Bellon, H., R. Soeria-Atmadja, R. C. Maury, E. Suparka, and Y. S. Yuwono. 1988. "Chronology and Petrology of Back Arc Volcanism in Java." Pp. 245–57 in *Proc. Reg. Conf. Geol. Min. Hyd. Res. SE Asia*. Gauthier-Villars.
- Bellwood, Peter. 2007. *Prehistory of the Indo-Malaysian Archipelago: Revised Edition*. Canberra: ANU E Press.
- . 2017. *First Islanders: Prehistory and Human Migration in Island Southeast Asia*. John Wiley & Sons.
- Belmaker, Miriam, Eitan Tchernov, Silvana Condemi, and Ofer Bar-Yosef. 2002. "New Evidence for Hominid Presence in the Lower Pleistocene of the Southern Levant." *Journal of Human Evolution* 43(1):43–56.
- Van Bemmelen, R. W. van. 1949. *The Geology of Indonesia, Vol IA: General Geology of Indonesia and Adjacent Archipelagoes*. Vol. 1. The Hague, Martinus Nijhoff.
- Van Den Bergh, Gerrit D. 1999. "The Late Neogene Elephantoid-Bearing Faunas of Indonesia and Their Palaeozoogeographic Implications." *Scripta Geologica* 117:1–419.
- Van Den Bergh, Gerrit D., Yousuke Kaifu, Iwan Kurniawan, Reiko T. Kono, Adam Brumm, Erick Setiyabudi, Fachroel Aziz, and Michael J. Morwood. 2016. "*Homo floresiensis*-like Fossils from the Early Middle Pleistocene of Flores." *Nature* 534(7606):245–48.
- Van Den Bergh, Gerrit D., John de Vos, and Paul Y. Sondaar. 2001. "The Late Quaternary Palaeogeography of Mammal Evolution in the Indonesian Archipelago." *Palaeogeography, Palaeoclimatology, Palaeoecology* 171:385–408.
- Bermudez de Castro, J. M. 1988. "Dental Remains from Atapuerca/Lbeas (Spain) II. Morphology." *Journal of Human Evolution* 17:279–304.
- Bettis, E. Arthur, Adrienne K. Milius, Scott J. Carpenter, Roy Larick, Yahdi Zaim, Yan Rizal, Russell L. Ciochon, Stephanie A. Tassier-Surine, Daniel Murray, Suminto, and Sutinko Bronto. 2009. "Way out of Africa: Early Pleistocene Palaeoenvironments Inhabited by *Homo erectus* in Sangiran, Java." *Journal of Human Evolution* 56(1):11–24.
- Bettis, E. Arthur, Yahdi Zaim, Roy R. Larick, Russell L. Ciochon, Suminto, Yan Rizal, Mark Reagan, and Matthew Heizler. 2004. "Landscape Development Preceding *Homo erectus* Immigration into Central Java, Indonesia: The Sangiran Formation Lower Lahar." *Palaeogeography, Palaeoclimatology, Palaeoecology* 206(1–2):115–31.
- Biggerstaff, Robert H. 1969. "The Basal Area of Posterior Tooth Crown Components: The Assessment of within Tooth Variations of Premolars and Molars." *American Journal of Physical Anthropology* 31(2):163–70.
- Bird, Michael I., David Taylor, and Chris Hunt. 2005. "Palaeoenvironments of Insular Southeast Asia during the Last Glacial Period: A Savanna Corridor in Sundaland?" *Quaternary Science Reviews* 24(20–21):2228–42.
- Black, Davidson. 1926. "Tertiary Man in Asia: The Chou Kou Tien Discovery." *Nature* 118(2977):733.
- . 1927. "On a Lower Molar Hominid Tooth from the Chou Kou Tien Deposit." *Palaeont. Sinica, Ser. D* 7:1–29.

- — —. 1930. *On an Adolescent Skull of Sinanthropus Pekinensis in Comparison with an Adult Skull of the Same Species and with Other Hominid Skulls, Recent and Fossil*. Vol. 7. geological survey of China.
- Black, Davidson, Pierre Teilhard De Chardin, Chung-chien Yang, and Wenzhong Pei. 1933. *Fossil Man in China: The Choukoutien Cave Deposits with a Synopsis of Our Present Knowledge of the Late Cenozoic in China...* Geological Survey of China, and the Section of Geology of the National
- Blench, Roger. 2010. "Was There an Austroasiatic Presence in Island Southeast Asia Prior to the Austronesian Expansion?" *Bulletin of the Indo-Pacific Prehistory Association* 30:133–44.
- — —. 1984. "The Austronesian Homeland: A Linguistic Perspective." *Asian Perspectives* 26(1):45–67.
- Boedhisampurno, S. 1983. "Kerangka Manusia Dari Bukit Kelambai, Stabat, Sumatra Utara." Pp. 955–84 in *Pertemuan Ilmiah Arkeologi Ke III*. Jakarta: Puslit Arkenas.
- Bookstein, Fred L. 1991. "Thin-Plate Splines and the Atlas Problem for Biomedical Images." Pp. 326–42 in *Biennial International Conference on Information Processing in Medical Imaging*. Springer.
- — —. 1997. "Landmark Methods for Forms without Landmarks: Morphometrics of Group Differences in Outline Shape." *Medical Image Analysis* 1(3):225–43.
- Borel, Antony. 2010. "Formes et Fonctions Au Sein Des Industries Lithiques de La Fin Du Pléistocène et Du Début de l' Holocène En Asie Du Sud-Est : Un Nouvel Apport à La Compréhension Des Comportements Humains." (Ed 227).
- Bouteaux, Anne and Anne Marie Moigne. 2010. "New Taphonomical Approaches: The Javanese Pleistocene Open-Air Sites (Sangiran, Central Java)." *Quaternary International* 223–224:220–25.
- Brace, C. Loring. 1967. "Environment, Tooth Form, and Size in the Pleistocene." *Journal of Dental Research* 46(5):809–16.
- Brace, C. Loring and Paul E. Mahler. 1971. "Post-Pleistocene Changes in the Human Dentition." *American Journal of Physical Anthropology* 34(2):191–203.
- Brace, C. Loring, Karen R. Rosenberg, and Kevin D. Hunt. 1987. "Gradual Change in Human Tooth Size in the Late Pleistocene and Post- Pleistocene." *Evolution* 41(4):705.
- Brasseur, Boris, François Sémah, Anne Marie Sémah, and Tony Djubiantono. 2015. "Pedo-Sedimentary Dynamics of the Sangiran Dome Hominid Bearing Layers (Early to Middle Pleistocene, Central Java, Indonesia): A Palaeopedological Approach for Reconstructing 'Pithecanthropus' (Javanese *Homo erectus*) Palaeoenvironment." *Quaternary International* 376:84–100.
- Van den Brink, L. M. 1982. "On the Mammal Fauna of the Wajak Cave, Java (Indonesia)." *Mod. Quatern. Res. SE Asia* 7:177–93.
- Brongersma, L. D. 1935. "Notes on Some Recent and Fossil Cats, Chiefly from the Malay Archipelago." *Zoologische Mededelingen* 18(1):1–89.

- . 1937. "On Fossil Remains of a Hyaenid from Java." *Zoologische Mededelingen, Rijksmuseum van Natuurlijke Historie Te Leiden*, 20:186–202.
- . 1941. "On the Remains of Carnivora from Cave Deposits in Java and Sumatra, with Notes on Recent Specimens." *Zoologische Mededelingen, Rijksmuseum van Natuurlijke Historie Te Leiden*, 23:114–48.
- Bronson, Bennet and Ian Glover. 1984. "Archaeological Radiocarbon Dates from Indonesia: A First List." *Indonesia Circle* 12(34):37–44.
- Brown, Frank, John Harris, Richard Leakey, and Alan Walker. 1985. "Early *Homo erectus* Skeleton from West Lake Turkana, Kenya." *Nature* 316(6031):788–92.
- Brown, P., T. Sutikna, M. J. Morwood, R. P. Soejono, Jatmiko, E. Wayhu Saptomo, and Rokus Awe Due. 2004. "A New Small-Bodied Hominin from the Late Pleistocene of Flores, Indonesia." *Nature* 431(7012):1055–61.
- Brumm, Adam, Gerrit D. Van Den Bergh, Michael Storey, Iwan Kurniawan, Brent V. Alloway, Ruly Setiawan, Erick Setiyabudi, Rainer Grün, Mark W. Moore, Dida Yurnaldi, Mika R. Puspaningrum, Unggul P. Wibowo, Halmi Insani, Indra Sutisna, John A. Westgate, Nick J. G. Pearce, Mathieu Duval, Hanneke J. M. Meijer, Fachroel Aziz, Thomas Sutikna, Sander Van Der Kaars, Stephanie Flude, and Michael J. Morwood. 2016. "Age and Context of the Oldest Known Hominin Fossils from Flores." *Nature* 534(7606):249–53.
- Budiman. 2008. "3D Profile Analysis on Human Burial from Song Terus Site , Punung , East Java , Indonesia."
- Cannon, Charles H., Robert J. Morley, and Andrew B. G. Bush. 2009. "The Current Refugial Rainforests of Sundaland Are Unrepresentative of Their Biogeographic Past and Highly Vulnerable to Disturbance." *Proceedings of the National Academy of Sciences of the United States of America* 106(27):11188–93.
- Carbonell, Eudald, José M. Bermúdez De Castro, Josep M. Parés, Alfredo Pérez-González, Gloria Cuenca-Bescós, Andreu Ollé, Marina Mosquera, Rosa Huguet, Jan Van Der Made, Antonio Rosas, Robert Sala, Josep Vallverdú, Nuria García, Darryl E. Granger, María Martínón-Torres, Xosé P. Rodríguez, Greg M. Stock, Josep M. Vergès, Ethel Allué, Francesc Burjachs, Isabel Cáceres, Antoni Canals, Alfonso Benito, Carlos Díez, Marina Lozano, Ana Mateos, Marta Navazo, Jesús Rodríguez, Jordi Rosell, and Juan L. Arsuaga. 2008. "The First Hominin of Europe." *Nature* 452(7186):465–69.
- Carlsen, Ole. 1987. *Dental Morphology*. Munksgaard.
- Carter, Katherine, Steven Worthington, and Tanya M. Smith. 2014. "News and Views: Non-Metric Dental Traits and Hominin Phylogeny." *Journal of Human Evolution* 69(1):123–28.
- de Castro, José María Bermúdez. 1986. "Dental Remains from Atapuerca (Spain) I. Metrics." *Journal of Human Evolution* 15(4):265–87.
- de Castro, José María Bermúdez, María Martínón-Torres, Aida Gómez-Robles, Leyre Prado-Simón, Laura Martín-Francés, María Lapresa, Anthony Olejniczak, and Eudald Carbonell. 2011. "Early Pleistocene Human Mandible from Sima Del Elefante (TE) Cave Site in Sierra de Atapuerca (Spain): A Comparative Morphological Study." *Journal of Human Evolution* 61(1):12–25.

- de Chardin, Pierre Teilhard. 1943. *Fossil Men: Recent Discoveries and Present Problems*. Henri Vetch.
- Chen, Fahu, Frido Welker, Chuan Chou Shen, Shara E. Bailey, Inga Bergmann, Simon Davis, Huan Xia, Hui Wang, Roman Fischer, Sarah E. Freidline, Tsai Luen Yu, Matthew M. Skinner, Stefanie Stelzer, Guangrong Dong, Qiaomei Fu, Guanghui Dong, Jian Wang, Dongju Zhang, and Jean Jacques Hublin. 2019. "A Late Middle Pleistocene Denisovan Mandible from the Tibetan Plateau." *Nature* 569(7756):409–12.
- Chesner, C_A, William I. Rose, A. L. Deino, R. Drake, and J. A. Westgate. 1991. "Eruptive History of Earth's Largest Quaternary Caldera (Toba, Indonesia) Clarified." *Geology* 19(3):200–203.
- Chia, Stephen, Lufti Yondri, and Truman Simanjuntak. 2010. "Obsidian Sourcing in Bandung, Indonesia." *Asian Perspectives* 148–56.
- Choi, Kildo and Dubel Driwantoro. 2007. "Shell Tool Use by Early Members of *Homo erectus* in Sangiran, Central Java, Indonesia: Cut Mark Evidence." *Journal of Archaeological Science* 34(1):48–58.
- Ciochon, Russell L. 2010. "Divorcing Hominins from the Stegodon-Ailuropoda Fauna: New Views on the Antiquity of Hominins in Asia." Pp. 111–26 in *Out of Africa I*. Springer.
- Cohen, K. M., S. Finney, and P. L. Gibbard. 2013. "International Chronostratigraphic Chart." *International Commission on Stratigraphy*.
- Consortium, The HUGO Pan-Asian S. N. P. 2009. "Mapping Human Genetic Diversity in Asia." *Science* 326(5959):1541–45.
- Coon, Carleton Stevens. 1962. "The Origin of Races."
- Corny, Julien, Manon Galland, Marta Arzarello, Anne Marie Bacon, Fabrice Demeter, Dominique Grimaud-Hervé, Charles Higham, Hirofumi Matsumura, Lan Cuong Nguyen, Thi Kim Thuy Nguyen, Viet Nguyen, Marc Oxenham, Thongsa Sayavongkhamdy, François Sémah, Laura L. Shackelford, and Florent Détroit. 2017. "Dental Phenotypic Shape Variation Supports a Multiple Dispersal Model for Anatomically Modern Humans in Southeast Asia." *Journal of Human Evolution* 112:41–56.
- Dahal, Sujan. 2015. "Effect of Different Distance Measures in Result of Cluster Analysis." Aalto University School of Engineering.
- Dahlberg, Albert A. 1956. "Materials for the Establishment of Standards for Classifications of Tooth Characters, Attributes and Techniques in Morphological Studies of the Dentition." *Zollar Laboratory of Dental Anthropology, University of Chicago*.
- Dalfó, C., F. Comellas, and M. A. Fiol. 2007. "The Multidimensional Manhattan Network." *Electronic Notes in Discrete Mathematics* 29(SPEC. ISS.):383–87.
- Dam, M. A. C., P. Suparan, Jan J. Nossin, and RPGA Voskuil. 1996. "A Chronology for Geomorphological Developments in the Greater Bandung Area, West-Java, Indonesia." *Journal of Southeast Asian Earth Sciences* 14(1–2):101–15.
- Demeter, Fabrice, Laura L. Shackelford, Anne-Marie Bacon, Philippe Durringer, Kira Westaway, Thongsa Sayavongkhamdy, José Braga, Phonphanh Sichanthongtip, Phimmasaeng Khamdalavong, Jean-Luc Ponche, Hong Wang, Craig Lundstrom, Elise Patole-Edoumba, and Anne-Marie Karpoff. 2012. "Anatomically Modern Human in

- Southeast Asia (Laos) by 46 Ka." *Proceedings of the National Academy of Sciences of the United States of America* 109(36):14375–80.
- Dennell, Robin W. 2007. "Use in Large River Systems of Northern India and Pakistan." *The Evolution and History of Human Populations in South Asia* 41–68.
- Dennell, Robin W., M. Martínón-Torres, and J. M. Bermúdez de Castro. 2010. "Out of Asia: The Initial Colonisation of Europe in the Early and Middle Pleistocene." *Quaternary International* 223–224:439.
- Dennell, Robin W., Maria Martinon-Torres, and Jose M. Bermudez de Castro. 2011. "Hominin Variability, Climatic Instability and Population Demography in Middle Pleistocene Europe." *Quaternary Science Reviews* 30(11–12):1511–24.
- Détroit, Florent. 2002. "Origine et Évolution des *Homo sapiens* en Asie du Sud-Est: Descriptions et Analyses Morphométriques de Nouveaux Fossiles." 444.
- Détroit, Florent, Julien Corny, Eusebio Z. Dizon, and Armand S. Mijares. 2013. "'Small Size' in the Philippine Human Fossil Record: Is It Meaningful for a Better Understanding of the Evolutionary History of the Negritos?" *Human Biology* 85(1–3):45–65.
- Détroit, Florent, Eusebio Dizon, Christophe Falguères, Sébastien Hameau, Wilfredo Ronquillo, and François Sémah. 2004. "Upper Pleistocene *Homo sapiens* from the Tabon Cave (Palawan, The Philippines): Description and Dating of New Discoveries." *Comptes Rendus - Palevol* 3(8):705–12.
- Détroit, Florent, Armand Salvador Mijares, Julien Corny, Guillaume Daver, Clément Zanolli, Eusebio Dizon, Emil Robles, Rainer Grün, and Philip J. Piper. 2019. "A New Species of *Homo* from the Late Pleistocene of the Philippines." *Nature* 568(7751):181.
- Détroit, Florent, T. Simanjuntak, I. Pojoh, and M. Hisyam. 2006. "*Homo sapiens* in Southeast Asian Archipelagos: The Holocene Fossil Evidence with Special Reference to Funerary Practices in East Java." *Austronesian Diaspora and the Ethnogeneses of the People in Indonesian Archipelago*. LIPI Press, Jakarta.
- Dizon, Eusebio, Florent Détroit, François Sémah, Christophe Falguères, Sébastien Hameau, Wilfredo Ronquillo, and Emmanuel Cabanis. 2002. "Notes on the Morphology and Age of the Tabon Cave Fossil *Homo sapiens*." *Current Anthropology* 43(4):660–66.
- Djubiantono, Tony. 1992. "Les Derniers Dépôts Marins de La Dépression de Solo (Java Central, Indonésie)-Stratigraphie et Paléogéographie." *PhD.. Muséum National d'Histoire Naturelle, Paris*.
- Djubiantono, Tony. 1997. *Geologi Daerah Karangnunggal, Kabupaten Tasikmalaya, Jawa Barat. Laporan Hasil Penelitian Arkeologi*. Bandung.
- . 1999. *Penelitian Geologi Kwartir Di Situs Rancah, Kabupaten Ciamis, Jawa Barat. Laporan Hasil Penelitian Arkeologi*. Bandung.
- . 2001. *Penelitian Arkeometri Di Situs Tambaksari, Kabupaten Ciamis, Jawa Barat. Laporan Hasil Penelitian Arkeologi*. Bandung.
- Djubiantono, Tony and F. Sémah. 1993. "L'évolution de La Région de Solo Au Quaternaire." *Les Dossiers D'archéologie* (184):46–47.

- Drawhorn, G. M. 1994. "The Systematics and Paleodemography of Fossil Orangutans." *Unpublished PhD Thesis, University of California.*
- Dubois, Eugène. 1888. "Over de Wenschelijkheid van Een Onderzoek Naar de Diluviale Fauna van Nederlandsch-Indie, in Het Bijzonder van Sumatra." *Natuurkundl. Tijdschr. Nederl. Indie* 48:158–65.
- . 1891. *Voorloopig Bericht Omtrent Het Onderzoek Naar de Pleistocene En Tertiaire Vertebraten-Fauna van Sumatra En Java, Gedurende Het Jaar 1890.* Ernst.
- . 1894. *Pithecanthropus erectus Eine Menschenaehnliche Uebergangsform Aus Java.* Batavia: Landesdruckerei.
- . 1895. "Pithecanthropus erectus Du Pliocène de Java." *Bulletin de La Société Belge de Géologie* IX:151–60.
- . 1896. "On *Pithecanthropus erectus*: A Transitional Form between Man and the Apes." *The Journal of the Anthropological Institute of Great Britain and Ireland* 25:240–55.
- . 1920. "De Proto-Australische Fossiele Mensch van Wadjak (Java)." *Koninklijke Akademie van Wetenschappen, Amsterdam* 19:88–105.
- . 1922. "The Proto-Australian Fossil Man of Wadjak, Java." *Kon. Akad. Wet., Amsterdam* 23(7):1013–51.
- . 1924. "On the Principal Characters of the Cranium and the Brain, the Mandible and the Teeth of *Pithecanthropus erectus*." *Kon. Ak. v. Wet. A'dam, Proceedings* 27(3):265–78.
- Duff, Roger. 1970. *Stone Adzes of Southeast Asia: An Illustrated Typology.* Canterbury Museum Trust Board.
- Durband, Arthur C. 2008. "The Enigma of the Sangiran 4 Palate Revisited." *HOMO- Journal of Comparative Human Biology* 59(2):111–22.
- Duyfjes, J. 1936. "Zur Geologie Und Stratigraphie Des Kendenggebietes Zwischen Trinil Und Soerabaja (Java)." *De Ingenieur Ned.-Indie* 4:136–49.
- Eisar, Michael. 2008. "Geology of Sitimulyo, Puncakwangi-Todanan District, Pati-Blora Regency, Central Java Province."
- Erickson, Paul A. 1990. "The Story of Peking Man: From Archaeology to Mystery." *Science* 250(4986):1456–57.
- Van Es, L. J. C. 1931. "The Age of Pithecanthropus." Thesis, M. Nijhof, The Hague: 1-142, 2 pis, 1 chart.
- Fadjar, Kasman Setiagama. 2006. "L'industrie Osseuse de l'horizon Keplek Holocène de La Grotte de Song Terus, Punung, Java Est (Indonésie)." *Muséum national d'Histoire naturelle, Paris.*
- Falguères, Christophe. 2001. "Dating Layers and Fossils in Sangiran Dome: Methods and Results." Pp. 309–19 in *Sangiran: Man, Culture, and Environment in Pleistocene Times*, edited by T. Simanjuntak, B. Prasetyo, and R. Handini. Jakarta: Yayasan Obor Indonesia.

- Fauzi, Mohammad Ruly. 2008. "Okupasi Manusia Pada Lapisan Budaya Terus Di Situs Song Terus, Pacitan, Jawa Timur." Universitas Indonesia.
- Fauzi, Mohammad Ruly, Adhi Agus Oktaviana, and Budiman. 2016. "Traces of Paleometalik Culture and Its Chronology in Harimau Cave." Pp. 247–66 in *Harimau Cave and the Long Journey of OKU Civilization*, edited by T. Simanjuntak. Yogyakarta: Gadjah Mada University Press.
- Faylona, Marie Grace Pamela Garong. 2019. "The Early Pleistocene Aquatic Palaeoecology and Palaeoclimate in Central Java, Indonesia as Recorded in Mollusc Assemblages from the Kalibeng and Pucangan Layers of Sangiran Dome." *Muséum national d'Histoire naturelle*.
- Ferdianto, Anton. 2008. "Artefak Obsidian Dari Gua Pawon, Kabupaten Bandung.[Skripsi]." *Depok: Universitas Indonesia, H 10*.
- . 2018. *Penelusuran Migrasi Awal Di Jawa Bagian Barat: Sumedang, Jawa Barat. Laporan Hasil Penelitian Arkeologi*. Bandung.
- Finlayson, Clive. 2005. "Biogeography and Evolution of the Genus *Homo*." *Trends in Ecology and Evolution* 20(8):457–63.
- Fleagle, John G., John J. Shea, Frederick E. Grine, Andrea L. Baden, and Richard E. Leakey. 2010. *Out of Africa I: The First Hominin Colonization of Eurasia*. Springer Science & Business Media.
- Flenley, John R. and Kevin Butler. 2001. "Evidence for Continued Disturbance of Upland Rain Forest in Sumatra for the Last 7000 Years of an 11,000 Year Record." *Palaeogeography, Palaeoclimatology, Palaeoecology* 171(3–4):289–305.
- Forestier, Hubert. 2007. "Les Éclats Du Passé Préhistorique de Sumatra: Une Très Longue Histoire Des Techniques." *Archipel* 74(1):15–44.
- Forestier, Hubert, Dubel Driwantoro, Dominique Guillaud, and D. Siregar. 2006. "New Data for the Prehistoric Chronology of South Sumatra." *Archaeology: Indonesian Perspective. RP Soejono's Festschrift. LIPI Press, Jakarta* 177–92.
- Frazer, David W. 1978. *The Evolution of the Dentition in Upper Paleolithic and Mesolithic Europe*. University of Kansas.
- Fu, Qiaomei, Alissa Mittnik, Philip L. F. Johnson, Kirsten Bos, Martina Lari, Ruth Bollongino, Chengkai Sun, Liane Giemsch, Ralf Schmitz, and Joachim Burger. 2013. "A Revised Timescale for Human Evolution Based on Ancient Mitochondrial Genomes." *Current Biology* 23(7):553–59.
- Gafoer, S., T. C. Amin, and R. Pardede. 1993. "Geology of the Bengkulu Quadrangle, Sumatra, Scale 1: 250.000." *Geological Research and Development Centre, Bandung*.
- Gallet, Xavier. 2004. "Dynamique de La Sédimentation Dans Les Grottes Du Karst de Punung (Pacitan, Java): Relations Avec Les Occupations Paléolithiques." *Muséum national d'Histoire naturelle*.
- Gathorne-Hardy, F. J. and W. E. H. Harcourt-Smith. 2003. "The Super-Eruption of Toba, Did It Cause a Human Bottleneck?" *Journal of Human Evolution* 45(3):227–30.

- Gathorne-Hardy, F. J., Syaukani, R. G. Davies, P. Eggleton, and D. T. Jones. 2002. "Quaternary Rainforest Refugia in South-East Asia: Using Termites as Indicators." *Biological Journal of the Linnean Society* 75(4):453–66.
- van der Geer, Alexandra A. E., George A. Lyras, and Rebekka Volmer. 2018. "Insular Dwarfism in Canids on Java (Indonesia) and Its Implication for the Environment of *Homo erectus* during the Early and Earliest Middle Pleistocene." *Palaeogeography, Palaeoclimatology, Palaeoecology* 507(July):168–79.
- Glinka, Josef. 1978. "Gestalt Und Herkunft. Beitrag Zur Anthropologischen Gliederung Indonesiens.(Morphologie et Origine. Contribution à Une Comparaison Anthropologique Des Indonésiens)." *Studia Instituti Anthropos* 35:1–176.
- . 1981. "Racial History of Indonesia." *Rassengeschichte Der Menschheit* 97–113.
- Gómez-Robles, A., M. Martínón-Torres, J. M. Bermúdez de Castro, A. Margvelashvili, M. Bastir, J. L. Arsuaga, A. Pérez-Pérez, F. Estebarez, and L. M. Martínez. 2007. "A Geometric Morphometric Analysis of Hominin Upper First Molar Shape." *Journal of Human Evolution* 53(3):272–85.
- Gómez-Robles, Aida, José María Bermúdez de Castro, María Martínón-Torres, Leyre Prado-Simón, and Juan Luis Arsuaga. 2012. "A Geometric Morphometric Analysis of Hominin Upper Second and Third Molars, with Particular Emphasis on European Pleistocene Populations." *Journal of Human Evolution* 63(3):512–26.
- Gómez-Robles, Aida, José María Bermúdez De Castro, María Martínón-Torres, and Leyre Prado-Simón. 2011. "Crown Size and Cusp Proportions in *Homo antecessor* Upper First Molars. A Comment on Quam et Al. 2009." *Journal of Anatomy* 218(2):258–62.
- Gómez-Robles, Aida, María Martínón-Torres, José María Bermúdez de Castro, Leyre Prado-Simón, and Juan Luis Arsuaga. 2011. "A Geometric Morphometric Analysis of Hominin Upper Premolars. Shape Variation and Morphological Integration." *Journal of Human Evolution* 61(6):688–702.
- Gómez-Robles, Aida, María Martínón-Torres, José María Bermúdez de Castro, Leyre Prado, Susana Sarmiento, and Juan Luis Arsuaga. 2008. "Geometric Morphometric Analysis of the Crown Morphology of the Lower First Premolar of Hominins, with Special Attention to Pleistocene *Homo*." *Journal of Human Evolution* 55(4):627–38.
- Gregory, William K. 1927. "Hesperopithecus Apparently Not an Ape nor a Man." *Science* 66(1720):579–81.
- Gregory, William K. and M. Hellman. 1926. "The Dentition of Dryopithecus and the Origin of Man." *Am. Mus. Anthropol. Pap.* 28, 1 123.
- Grimaud-Hervé, Dominique. 2001. "Taxonomic Position of the Sangiran 31 Hominid." See *Simanjuntak et Al* 46–53.
- Grimaud-Hervé, Dominique and Harry Widianto. 2001. "Grimaud-Hervé et Widianto 2001 Les Fossiles Humains Découverts à Java Depuis Les Années 1980.Pdf."
- Grine, Frederick E. 1984. "Comparison of the Deciduous Dentitions of African and Asian Hominids." *Courier Forschungsinstitut Senckenberg* 69:69–82.

- . 1989. "New Hominid Fossils from the Swartkrans Formation (1979–1986 Excavations): Craniodental Specimens." *American Journal of Physical Anthropology* 79(4):409–49.
- Grine, Frederick E. and J. L. Franzen. 1994. "Fossil Hominid Teeth from the Sangiran Dome (Java, Indonesia)." *Courier Forschungsinstitut Senckenberg* 171:75–103.
- Gunz, Philipp and Philipp Mitteroecker. 2013. "Semilandmarks: A Method for Quantifying Curves and Surfaces." *Hystrix* 24(1).
- Gunz, Philipp, Philipp Mitteroecker, and Fred L. Bookstein. 2006. "Semilandmarks in Three Dimensions." *Modern Morphometrics in Physical Anthropology* 73–98.
- Hall, Robert. 1998. "The Plate Tectonics of Cenozoic SE Asia and the Distribution of Land and Sea." *Biogeography and Geological Evolution of SE Asia* 99–131.
- . 2009. "Southeast Asia's Changing Palaeogeography." *Blumea: Journal of Plant Taxonomy and Plant Geography* 54(1–3):148–61.
- Hall, Robert, Benjamin Clements, and Helen R. Smyth. 2009. "Sundaland: Basement Character, Structure and Plate Tectonic Development."
- Hall, Robert and Helen R. Smyth. 2008. "Cenozoic Arc Processes in Indonesia: Identification of the Key Influences on the Stratigraphic Record in Active Volcanic Arcs." *Special Paper of the Geological Society of America* 436(03):27–54.
- Hamada, Ryuta, Shintaro Kondo, and Eizo Wakatsuki. 1997. "Odontometrical Analysis of Filipino Dentition." *The Journal of Showa University Dental Society* 17(3):197–207.
- Hameau, S. 2004. "Datation Des Sites Paleolithiques Du Pleistocene Moyen et Superieur de Punung (Pacitan, Java). Applications Des Methodes ESR et U-Th Aux Grottes de Song Terus et Goa Tabuhan." *Paris: Museum National d'Histoire Naturelle* 20.
- Hamilton, Warren Bell. 1979. *Tectonics of the Indonesian Region*. US Govt. Print. Off.
- Hammer, Ø., D. A. T. Harper, and P. D. Ryan. 2017. "PAST: Paleontological Statistics Software Package for Education."
- Hanihara, Kazuro. 1966. "Mongoloid Dental Complex in the Deciduous Dentition." *Journal of the Anthropological Society of Nippon* 74(2):61–72.
- Hanihara, Tsunehiko. 1993. "Dental Affinities among Polynesian and Circum-Polynesian Populations." *Nichibunken Japan Review* 59–82.
- Hanihara, Tsunehiko. 2013. "Geographic Structure of Dental Variation in the Major Human Populations of the World." Pp. 479–509 in *Anthropological perspectives on tooth morphology: Genetics, evolution, variation*. Cambridge University Press.
- Hantoro, W. S. 1997. "Quaternary Sea Level Variations in the Pacific-Indian Ocean Gateways: Response and Impact." *Quaternary International* 37:73–80.
- Harcourt-Smith, William. 2016. "Early Hominin Diversity and the Emergence of the Genus *Homo*." *J Anthropol Sci* 94:19–27.
- Harmand, Sonia, Jason E. Lewis, Craig S. Feibel, Christopher J. Lepre, Sandrine Prat, Arnaud Lenoble, Xavier Boës, Rhonda L. Quinn, Michel Brenet, and Adrian Arroyo. 2015. "3.3-Million-Year-Old Stone Tools from Lomekwi 3, West Turkana, Kenya." *Nature*

- 521(7552):310–15.
- Harris, E. F. and H. L. Bailit. 1980. "The Metaconule: A Morphologic and Familial Analysis of a Molar Cusp in Humans." *American Journal of Physical Anthropology* 53:349–358.
- Heaney, L. R. 1992. "A Synopsis of Climatic and Vegetational Change in Southeast Asia." *Tropical Forests and Climate* 53–61.
- van Heekeren, H. R. 1936. "Megalithische Overblijfselen in Besœeki." *Dalam Djawa, Jaargang XI, Hlm* 1–18.
- . 1957. "The Stone Age of Indonesia. 2nd Rev."
- . 1972. "The Stone Age of Indonesia, with a Contribution by RP Soejono." *Nijhoff, The Hague*.
- von Heine-Geldern, Robert. 1932. "Urheimat Und Früheste Wanderungen Der Austronesier in Anthropos, T." *Band XXVII*.
- . 1945. "Science and Scientists in the Netherlands Indies."
- Hertler, Christine, Yan Rizal, and Yahdi Zaim. 2007. "Habitat Differentiation in the Pleistocene of Jawa-Introduction of the New Pleistocene Fossil Locality Majalengka." Pp. 165–74 in *Late neogene and quaternary biodiversity and evolution (regional developments and interregional correlations: proceedings of the 18th International Senckenberg Conference. volume II)*. Vol. 259.
- Hetzl, W. H. 1935. *Toelichting Bij Blad 54 (Madjenang), Geologische Kaart van Java, Schaal 1:100,000*. Bandung.
- Hillson, Simon. 1996. *Dental Anthropology*. Cambridge University Press.
- . 2014. *Tooth Development in Human Evolution and Bioarchaeology*. Cambridge University Press.
- Hooijer, Dirk Albert. 1948. "Prehistoric Teeth of Man and of the Orang-Utan from Central Sumatra, with Notes on the Fossil Orang-Utan from Java and Southern China." *Zoologische Mededelingen, Rijksmuseum van Natuurlijke Historie Te Leiden* 29:175–301.
- . 1950. "Fossil Evidence of Austromelanesian Migrations in Malaysia?" *Southwestern Journal of Anthropology* 6(4):416–22.
- . 1952. "Austromelanesian Migrations Once More." *Southwestern Journal of Anthropology* 8(4):472–77.
- . 1958. "Fossil Bovidae from the Malay Archipelago and the Punjab." *Zoologische Verhandelingen* 38(1):1–112.
- . 1964. "New Records of Mammals from the Middle Pleistocene of Sangiran, Central Java." *Zoologische Mededelingen, Rijksmuseum van Natuurlijke Historie Te Leiden*, 40(10).
- Hooijer, Dirk Albert and Bjorn Kurtén. 1984. "Trinil and Kedungbrubus: The Pithecanthropus-Bearing Fossil Faunas of Java and Their Relative Age." *Annales Zoologici Fennici* 21(2):135–41.
- van der Hoop, A. N. J. 1932. *Megalithic Remains in South-Sumatra*. WJ Thieme.

- Hope, Geoffrey. 2005. "The Quaternary in Southeast Asia." *The Physical Geography of Southeast Asia* 24–37.
- Howells, William White. 1973. "Cranial Variation in Man: A Study by Multivariate Analysis of Patterns of Difference among Recent Human Populations." *Peabody Museum of Archaeology and Ethnology, Harvard Univ.*
- Hrdlička, Aleš. 1920a. *Anthropometry*. Wistar institute of anatomy and biology.
- . 1920b. "Shovel-shaped Teeth." *American Journal of Physical Anthropology* 3(4):429–65.
- Hublin, Jean Jacques, Abdelouahed Ben-Ncer, Shara E. Bailey, Sarah E. Freidline, Simon Neubauer, Matthew M. Skinner, Inga Bergmann, Adeline Le Cabec, Stefano Benazzi, Katerina Harvati, and Philipp Gunz. 2017. "New Fossils from Jebel Irhoud, Morocco and the Pan-African Origin of *Homo sapiens*." *Nature* 546(7657):289–92.
- Huffman, O. F. 2001. "Geologic Context and Age of the Parning/Mojokerto *Homo erectus*, East Java." *Journal of Human Evolution* 40(4):353–62.
- Huffman, O. F., Y. Zaim, J. Kappelman, D. R. Ruez, J. de Vos, Y. Rizal, F. Aziz, and C. Hertler. 2006. "Relocation of the 1936 Mojokerto Skull Discovery Site near Parning, East Java." *Journal of Human Evolution* 50(4):431–51.
- Huxley, Thomas Henry. 1860. "On Species, Races and Their Origin." *Journal Proceedings of the Royal Institution of Great Britain* 3(February).
- Hyodo, Masayuki. 2001. "The Sangiran Geomagnetic Excursion and Its Chronological Contribution to the Quaternary Geology of Java." *Sangiran: Man, Culture and Environment in Pleistocene Times. Jakarta: Yayasan Obor Indonesia* 320–35.
- Hyodo, Masayuki, Shuji Matsu'ura, Yuko Kamishima, Megumi Kondo, Yoshihiro Takeshita, Ikuko Kitaba, Tohru Danhara, Fachroel Aziz, Iwan Kurniawan, and Hisao Kumai. 2011. "High-Resolution Record of the Matuyama–Brunhes Transition Constrains the Age of Javanese *Homo erectus* in the Sangiran Dome, Indonesia." *Proceedings of the National Academy of Sciences* 108(49):19563–68.
- Hyodo, Masayuki, Naotune Watanabe, and Wahyu Sunata. 1993. "Magnetostatigraphy of Hominid Fossil Bearing Formations in Sangiran and Mojokerto, Java." *Anthropological Science* 101(2):157–86.
- Indriati, Ety. 2004. "Indonesian Fossil Hominid Discoveries from 1889 to 2003: Catalogue and Problems (Part One Collection Building)." *National Science Museum Monographs* 24:163–77.
- Indriati, Ety and Susan C. Antón. 2008. "Earliest Indonesian Facial and Dental Remains from Sangiran, Java: A Description of Sangiran 27." *Anthropological Science* 116(3):219–29.
- Ingicco, Thomas. 2012. "Les Primates Quaternaires de Song Terus (Java Est, Indonésie): Implications Paléobiogéographiques et Archéozoologiques Pour l'Asie Du Sud-Est." *Bulletins et Memoires de La Societe d'Anthropologie de Paris* 24(3–4):199–203.
- Ingicco, Thomas, Noel Amano, Hubert Forestier, Carlos King, K. Manalo, Sebastien Nomade, A. Pereira, M. C. Reyes, Q. Shao, M. Lising, G. Lyras, D. Yurnaldi, A. Bautista, J. De Vos, Gerrit D. van den Bergh, C. Jago-On, J. J. Bahain, Maria Gema Chacón, Noel Amano, Hubert Forestier, Carlos King, K. Manalo, and Sebastien Nomade. 2018. "Earliest Known

- Hominin Activity in the Philippines by 709 Thousand Years Ago." *Nature* 557(7704):233–37.
- Ingicco, Thomas, John De Vos, and O. Frank Huffman. 2014. "The Oldest Gibbon Fossil (Hylobatidae) from Insular Southeast Asia: Evidence from Trinil, (East Java, Indonesia), Lower/Middle Pleistocene." *PLoS ONE* 9(6).
- Irish, Joel D. 1993. "Biological Affinities of Late Pleistocene through Modern African Aboriginal Populations." *The Dental Evidence. PhD Diss, Tempe AR.*
- . 1997. "Characteristic High- and Low-Frequency Dental Traits in Sub-Saharan African Populations." *American Journal of Physical Anthropology* 102(4):455–67.
- . 1998. "Ancestral Dental Traits in Recent Sub-Saharan Africans and the Origins of Modern Humans." *Journal of Human Evolution* 34(1):81–98.
- Irish, Joel D. and Debbie Guatelli-Steinberg. 2003. "Ancient Teeth and Modern Human Origins: An Expanded Comparison of African Plio-Pleistocene and Recent World Dental Samples." *Journal of Human Evolution* 45(2):113–44.
- Irish, Joel D. and Greg C. Nelson. 2008. *Technic and Application in Dental Anthropology.*
- Irish, Joel D. and G. Richard Scott. 2016. *A Companion to Dental Anthropology.* West Sussex: Wiley Blackwell.
- Itihara, M. 1985. "Geology and Stratigraphy of the Sangiran Area." *Quaternary Geology of the Hominid Fossil Bearing Formations in Java* 11–43.
- Jacob, Teuku. 1966. "The Sixth Skull Cap of *Pithecanthropus erectus*." *American Journal of Physical Anthropology* 25(3):243–50.
- . 1967. "Some Problems Pertaining to the Racial History of the Indonesian Region." University of Utrecht, Netherland.
- . 1973. "Palaeoanthropological Discoveries in Indonesia with Special Reference to the Finds of the Last Two Decades." *Human Evolution* 1900(Kedungbrubus 2):473–85.
- . 1974. "Studies on Human Variation in Indonesia." *Journal of the National Medical Association* 66(5):389–99.
- . 1975. "Indonesia." Pp. 103–16 in *Catalogue of Fossil Hominids.*
- . 1976. "Early Populations in the Indonesia Region." Pp. 81–93 in *The Origin of the Australian*, edited by R. L. Kirk and A. G. Thorne. Canberra: Australian Institute of Aboriginal Studies.
- . 1980. "*Pithecanthropus* of Indonesia Phenotype Genetics and Ecology."
- . 1981a. "*Meganthropus*, *Pithecanthropus*, and *Homo sapiens* in Indonesia: Evidence and Problems." Pp. 81–84 in *Colloque Int CNRS Process Hominisation*. Vol. 599.
- . 1981b. "Solo Man and Peking Man." Pp. 87–104 in *Homo erectus: Papers in Honor of Davidson Black.*
- Jacobs, Guy S., Georgi Hudjashov, Lauri Saag, Pradiptajati Kusuma, Chelzie C. Darusallam, Daniel J. Lawson, Mayukh Mondal, Luca Pagani, François Xavier Ricaut, Mark Stoneking, Mait Metspalu, Herawati Sudoyo, J. Stephen Lansing, and Murray P. Cox. 2019. "Multiple Deeply Divergent Denisovan Ancestries in Papuans." *Cell* 177(4):1010–

1021.e32.

- Jatmiko. 1995. *Laporan Penelitian Arkeologi Di Situs Martapura and Baturaja, Kabupaten OKU, Provinsi Sumatra Selatan*. Jakarta.
- Jatmiko and Hubert Forestier. 2002. *Laporan Survey Prasejarah Padang Bindu, Kabupaten OKU, Sumatra Selatan*. Jakarta.
- Jia, L. 1999. "Chronicle of Zhoukoudian (1927–1937)." *Shanghai Scientific and Technical Publishers, Shanghai* 152.
- Johanson, Donald C., Tim D. White, and Yves Coppens. 1982. "Dental Remains from the Hadar Formation, Ethiopia: 1974–1977 Collections." *American Journal of Physical Anthropology* 57(4):545–603.
- Joordens, Josephine C A, Francesco d’Errico, Frank P. Wesselingh, Stephen Munro, John de Vos, Jakob Wallinga, Christina Ankjærgaard, Tony Reimann, Jan R. Wijbrans, and Klaudia F. Kuiper. 2015. "*Homo erectus* at Trinil on Java Used Shells for Tool Production and Engraving." *Nature* 518(7538):228.
- Joordens, Josephine C. A., Francesco D’Errico, Frank P. Wesselingh, Stephen Munro, John de Vos, Jakob Wallinga, Christina Ankjærgaard, Tony Reimann, Jan R. Wijbrans, Klaudia F. Kuiper, Francesco D’Errico, Frank P. Wesselingh, Stephen Munro, John de Vos, Jakob Wallinga, Christina Ankjærgaard, Tony Reimann, Jan R. Wijbrans, Klaudia F. Kuiper, Herman J. Mûcher, Hélène Coqueugniot, Vincent Prié, Ineke Joosten, Bertil Van Os, Anne S. Schulp, Michel Panuel, Victoria Van Der Haas, Wim Lustenhouwer, John J. G. Reijmer, and Wil Roebroeks. 2015. "*Homo erectus* at Trinil on Java Used Shells for Tool Production and Engraving." *Nature* 518(7538):228.
- Joordens, Josephine C. A., F. P. Wesselingh, J. de Vos, H. B. Vonhof, and D. Kroon. 2009. "Relevance of Aquatic Environments for Hominins: A Case Study from Trinil (Java, Indonesia)." *Journal of Human Evolution* 57(6):656–71.
- Jorgensen, K. D. 1956. "The Deciduous Dentition; A Descriptive and Comparative Anatomical Study." *Acta Odontol Scand* 14:1–202.
- van der Kaars, W. A. and M. A. C. Dam. 1995. "A 135,000-Year Record of Vegetational and Climatic Change from the Bandung Area, West-Java, Indonesia." *Palaeogeography, Palaeoclimatology, Palaeoecology* 117(1–2):55–72.
- . 1997. "Vegetation and Climate Change in West-Java, Indonesia during the Last 135,000 Years." *Quaternary International* 37(96):67–71.
- Kaifu, Yousuke. 2006. "Advanced Dental Reduction in Javanese *Homo erectus*." *Anthropological Science* 114(1):35–43.
- Kaifu, Yousuke, Fachroel Aziz, and H. Baba. 2000. "New Evidence for the Existence of Pongo in Early/Middle Pleistocene Java." Pp. 55–60 in *Towards ahead: geological museum in a changing world. Papers presented in the International Symposium on Geological Museum*.
- Kaifu, Yousuke, Fachroel Aziz, and Hisao Baba. 2005. "Hominid Mandibular Remains from Sangiran: 1952-1986 Collection." *American Journal of Physical Anthropology* 128(3):497–519.

- Kaifu, Yousuke, Fachroel Aziz, Ety Indriati, Teuku Jacob, Iwan Kurniawan, and Hisao Baba. 2008. "Cranial Morphology of Javanese *Homo erectus*: New Evidence for Continuous Evolution, Specialization, and Terminal Extinction." *Journal of Human Evolution* 55(4):551–80.
- Kaifu, Yousuke, Hisao Baba, Fachroel Aziz, Ety Indriati, Friedemann Schrenk, and Teuku Jacob. 2005. "Taxonomic Affinities and Evolutionary History of the Early Pleistocene Hominids of Java: Dentognathic Evidence." *American Journal of Physical Anthropology* 128(4):709–26.
- Kaifu, Yousuke, Reiko T. Kono, Thomas Sutikna, and Emanuel Wahyu Saptomo. 2015. "Unique Dental Morphology of *Homo floresiensis* and Its Evolutionary Implications." 1–27.
- Kaifu, Yousuke, Yahdi Zaim, Hisao Baba, Iwan Kurniawan, Daisuke Kubo, Yan Rizal, Johan Arif, and Fachroel Aziz. 2011. "New Reconstruction and Morphological Description of a *Homo erectus* Cranium: Skull IX (Tjg-1993.05) from Sangiran, Central Java." *Journal of Human Evolution* 61(3):270–94.
- Kanazawa, Eisaku, Mitsuo Sekikawa, and Tadashi Ozaki. 1990. "A Quantitative Investigation of Irregular Cuspules in Human Maxillary Permanent Molars." *American Journal of Physical Anthropology* 83(2):173–80.
- Kappelman, John. 2018. "An Early Hominin Arrival in Asia." *Nature* 559(7715):480–81.
- Kappelman, John, Mehmet Cihat Alçiçek, Nizamettin Kazancı, Michael Schultz, Mehmet Özkul, and Şevket Şen. 2008. "First *Homo erectus* from Turkey and Implications for Migrations into Temperate Eurasia." *American Journal of Physical Anthropology* 135(1):110–16.
- Kastowo and N. Suwarna. 1996. "Geologic Map of the Majenang Quadrangle, Java."
- Katili, John A. 1975. "Volcanism and Plate Tectonics in the Indonesian Island Arcs." *Tectonophysics* 26(3–4):165–88.
- Kimbel, William H. and Brian Villmoare. 2016. "From *Australopithecus* to *Homo*: The Transition That Wasn't." *Philosophical Transactions of the Royal Society B: Biological Sciences* 371(1698).
- von Koenigswald, G. H. R. 1933. "Beitrag Zur Kenntnis Der Fossilen Wirbeltiere Javas." *Wetensch. Med. Dienst Mijnb. Ned. Indie*. 23(1):1–187.
- . "Zur Stratigraphie Des Javanischen Pleistocän." *De Ingenieur in Nederlands-Indië* 1:185–201.
- . 1935. "Die Fossilen Säugetierfaunen Javas." *Kon. Akad. Wet., Amsterdam* XXXVIII(2):188–98.
- . 1936. "Early Palaeolithic Stone Implements from Java." *Bull. Raffles Mus. Singapore* 1:52–60.
- . 1937. "Ein Unterkieferfragment Des Pithecanthropus Aus Den Trinil-Schichten Mitteljavas." *Koninkl. Nederl. Akademie van Wetenschappen* 40:883–93.
- . 1939. "Das Pleistocän Java." *Quartar* 2:28–53.

- . 1940. "Neue Pithecanthropus-Funde 1936-1938: Ein Beitrag Zur Kenntnis Der Praehominiden." *Wetensch. Med. Dienst Mijnb. Ned. Indie.* 28:1–233.
- . 1948. "Fossil Hominids from the Lower Pleistocene of Java." *Rep18th Internat Geol Congr* 59–61.
- . 1950. "Fossil Hominids from the Lower Pleistocene of Java." Pp. 59–61 in *Proceedings of the International Geological Congress of Great Britain*. London.
- . 1952. "Evidence of a Prehistoric Australomelanesoid Population in Malaya and Indonesia." *Southwestern Journal of Anthropology* 8(1):92–96.
- . 1954. "Pithecanthropus, Meganthropus and the Australopithecinae." *Nature* 173(4409):795–97.
- . 1957. "Meganthropus and the Australopithecinae." in *Proceedings of the third Pan-African congress on prehistory*, D. Clark, ed., Chotto and Windus, London.
- . 1960. "Meganthropus palaeojavanicus vK a New Fossil Hominid from Java." *Cong Intl Anthropol Ethnol. Brussels* 271–72.
- . 1967. "Evolutionary Trends in the Deciduous Molars of the Hominidea." *Journal of Dental Research* 46(5):777–86.
- . 1968a. "Das Absolute Alter Des Pithecanthropus erectus Dubois." *Evolution Und Hominization. Stuttgart: Gustav Fischer* 195–203.
- . 1968b. "Observations of Pithecanthropus Mandibles from Sangiran." *Central Java Koninklijke Akademie van Wetenschappen, Amsterdam, Series B* 71:1–9.
- . 1973. "Australopithecus, Meganthropus and Ramapithecus." *Journal of Human Evolution* 2(6):487–91.
- von Koenigswald, G. H. R. and Franz Weidenreich. 1938. "Discovery of an Additional Pithecanthropus Skull." *Nature* 142(3598):715.
- . 1939. "The Relationship between Pithecanthropus and Sinanthropus." *Nature*.
- Korenhof, C. A. W. 1961. "The Enamel-Dentine Border: A New Morphological Factor in the Study of the (Human) Molar Pattern." *Proc. Koninkl. Nederl. Acad. Wetensch.* 64:639–64.
- . 1966. "A Comparative Study of Evolutionary Trends in the Upper Molar Pattern of Recent Kodiak Island Inhabitants and Subrecent Javanese Malaysians." *Journal of Dental Research* 45(6):1687–95.
- . 1978. "Remnants of the Trigonid Crests in Medieval Molars of Man of Java." *Development, Function, and Evolution of Teeth. Academic Press, New York* 157–70.
- . 1982. "Evolutionary Trends of the Inner Enamel Anatomy of Deciduous Molars from Sangiran (Java, Indonesia)." *Teeth; From, Function and Evolution* 350–65.
- Kramer, Andrew, Tony Djubiantono, Fachroel Aziz, James S. Bogard, Robert A. Weeks, Daniel C. Weinard, Willis E. Hames, Michael Elam, Arthur C. Durband, and Agus. 2005. "The First Hominid Fossil Recovered from West Java, Indonesia." *Journal of Human Evolution* 48(6):661–67.

- Kramer, Andrew and Lyle W. Konigsberg. 1994. "The Phyletic Position of Sangiran 6 as Determined by Multivariate Analysis." *Courier Forsch Senckenberg* 171:105–14.
- Krantz, G. S. 1975. "An Explanation for the Diastema of Javan Erectus Skull IV." *Paleoanthropology, Morphology and Paleoecology* 361–72.
- Kusno, Abi. 2009. "Archaeozoological Contribution to the Characterization of the Stratigraphy of the Upper Pleistocene in Tabuhan Layers (Song Terus Cave , Eastern Java , Indonesia)." Muséum national d'Histoire naturelle.
- Larick, R., R. L. Ciochon, Y. Zaim, Sudijono, Suminto, Y. Rizal, Fachroel Aziz, M. Reagan, and M. Heizler. 2001. "Early Pleistocene $^{40}\text{Ar}/^{39}\text{Ar}$ Ages for Bapang Formation Hominins, Central Jawa, Indonesia." *Proceedings of the National Academy of Sciences of the United States of America* 98(9):4866–71.
- Larick, Roy, Russell L. Ciochon, Yahdi Zaim, Sudijono, Suminto, Yan Rizal, and Fachroel Aziz. 2000. "Lithostratigraphic Context for Kln-1993.05-SNJ, a Fossil Colobine Maxilla from Jokotingkir, Sangiran Dome." *International Journal of Primatology* 21(4):731–59.
- Larson, M. A. 1978. "Dental Morphology of the Gran Quivira Indians." Arizona State University.
- Leakey, Louis S. B., Phillip V Tobias, and John Russell Napier. 1964. "A New Species of the Genus *Homo* from Olduvai Gorge." *Nature* 202(4927):7–9.
- Leakey, Richard E. and L. J. Slikkerveer. 1995. *Pithecanthropus : Kisah Manusia Purba Dari Indonesia, Penemunya Dubois Dan Arti Penemuan Itu Bagi Asal-Usul Manusia*. Richard Leakey Foundation for Anthropological Research.
- Lebon, Sylviane L. G. 2009. *Volcanic Activity and Environment: Impacts on Agriculture and Use of Geological Data to Improve Recovery Processes*.
- Lee, Meng Yang, Chang Hwa Chen, Kuo Yen Wei, Yoshiyuki Iizuka, and Steven Carey. 2004. "First Toba Supereruption Revival." *Geology* 32(1):61–64.
- Lefèvre, J. 1973. "Etude Odontologique Des Hommes de Muge." *Bulletins et Mémoires de La Société d'Anthropologie de Paris* 10(3):301–33.
- Leinders, J. J. M. 1985. "The Age of the Hominid-Bearing Deposits of Java: State of the Art. Geol." *Mijnbouw* 64:167–73.
- Lewin, Hoger. 2005. *Human Evolution: An Illustrated Introduction*.
- Lewin, R. and R. A. Foley. 2012. *Principles of Human Evolution*.
- Lieberman, Daniel E. 2007. "Homing in on Early *Homo* Raising the Gold Standard." *Nature* 449(September):291–92.
- Lipson, Mark, Po Ru Loh, Nick Patterson, Priya Moorjani, Ying Chin Ko, Mark Stoneking, Bonnie Berger, and David Reich. 2014. "Reconstructing Austronesian Population History in Island Southeast Asia." *Nature Communications* 5.
- Liu, ZeChun. 1985. "Sequence of Sediments at Locality 1 in Zhoukoudian and Correlation with Loess Stratigraphy in Northern China and with the Chronology of Deep-Sea Cores." *Quaternary Research* 23(2):139–53.

- Lizon-Sureau, Bénédicte. 1979. "Essai de Reconstitution Du Paléoenvironnement Du Pithécantrophe de Java, Au Pléistocène Moyen, Dans La Région de Sangiran (Java Central), Par Les Méthodes d'analyse En Sédimentologie Classique et Moderne."
- Louys, Julien. 2012. "Mammal Community Structure of Sundanese Fossil Assemblages from the Late Pleistocene, and a Discussion on the Ecological Effects of the Toba Eruption." *Quaternary International* 258:80–87.
- Louys, Julien and Erik Meijaard. 2010. "Palaeoecology of Southeast Asian Megafauna-Bearing Sites from the Pleistocene and a Review of Environmental Changes in the Region." *Journal of Biogeography* 37(8):1432–49.
- Louys, Julien and Alan Turner. 2012. "Environment, Preferred Habitats and Potential Refugia for Pleistocene *Homo* in Southeast Asia." *Comptes Rendus - Palevol* 11(2–3):203–11.
- Lovejoy, C. Owen, Richard S. Meindl, Robert P. Mensforth, and Thomas J. Barton. 1985. "Multifactorial Determination of Skeletal Age at Death: A Method and Blind Tests of Its Accuracy." *American Journal of Physical Anthropology* 68(1):1–14.
- Lowe, J. J., M. J. C. Walker, and S. C. Porter. 2013. "Understanding Quaternary Climatic Change." *Encyclopedia of Quaternary Science. 2st Ed. Oxford: Elsevier* 28–39.
- Lumbanbatu, Ungkap M. 2008. "Karakteristik Bentang Alam Daerah Payakumbuh, Sumatra Barat." *Jurnal Geologi Dan Sumberdaya Mineral* 18(2):65–79.
- van der Maarel, F. H. 1932. "Contributions to the Knowledge of the Fossil Mammalian Fauna of Java." *Wet. Med. Dienst. Mijnb. Ned. Indie* 15:1–208.
- Maddy, D., D. Schreve, T. Demir, A. Veldkamp, J. R. Wijbrans, W. van Gorp, D. J. J. van Hinsbergen, M. J. Dekkers, R. Scaife, J. M. Schoorl, C. Stemerink, and T. van der Schriek. 2015. "The Earliest Securely-Dated Hominin Artefact in Anatolia?" *Quaternary Science Reviews* 109:68–75.
- Maloney, B. K. and F. G. McCormac. 1995. "A 30,000-Year Pollen and Radiocarbon Record from Highland Sumatra as Evidence for Climatic Change." *Radiocarbon* 37(2):181–90.
- . 1996. "Palaeoenvironments of North Sumatra: A 30,000 Year Old Pollen Record from Pea Bullok." *Bulletin of the Indo-Pacific Prehistory Association* 14:73–82.
- Marks, P. 1953. "Preliminary Note on the Discovery of a New Jaw of *Meganthropus von Koenigswald* in the Lower Middle Pleistocene of Sangiran, Central Java." *Indonesian Journal of Natural Science* 1(2):3.
- Martinón-Torres, M., M. Bastir, J. M. Bermúdez de Castro, A. Gómez, S. Sarmiento, A. Muela, and J. L. Arsuaga. 2006. "Hominin Lower Second Premolar Morphology: Evolutionary Inferences through Geometric Morphometric Analysis." *Journal of Human Evolution* 50(5):523–33.
- Martinón-Torres, María, José María Bermúdez de Castro, Aida Gómez-Robles, Ann Margvelashvili, Leyre Prado, David Lordkipanidze, and Abessalom Vekua. 2008. "Dental Remains from Dmanisi (Republic of Georgia): Morphological Analysis and Comparative Study." *Journal of Human Evolution* 55(2):249–73.
- Martinón-Torres, María, José María Bermúdez De Castro, Aida Gómez-Robles, Leyre Prado-Simón, and Juan Luis Arsuaga. 2012. "Morphological Description and Comparison of the Dental Remains from Atapuerca-Sima de Los Huesos Site (Spain)." *Journal of Human*

Evolution 62(1):7–58.

- Martinón-Torres, María, Petra Spěváčková, Ana Gracia-Téllez, Ignacio Martínez, Emiliano Bruner, Juan Luis Arsuaga, and José María Bermúdez de Castro. 2013. “Morphometric Analysis of Molars in a Middle Pleistocene Population Shows a Mosaic of ‘modern’ and Neanderthal Features.” *Journal of Anatomy* 223(4):353–63.
- Maryanto, S. 2009. “Pendolomitan Batugamping Formasi Rajamandala Di Lintasan Gua Pawon , Bandung Barat.” *Indonesian Journal on Geoscience* 4(3):203–13.
- Matsu’ura, Shuji, Megumi Kondo, Tohru Danhara, Shuhei Sakata, Hideki Iwano, Takafumi Hirata, Iwan Kurniawan, Erick Setiyabudi, Yoshihiro Takeshita, Masayuki Hyodo, Ikuko Kitaba, Masafumi Sudo, Yugo Danhara, and Fachroel Aziz. 2020. “Age Control of the First Appearance Datum for Javanese *Homo erectus* in the Sangiran Area.” *Science* 367(6474):210–14.
- Matsumura, H., M. Oxenham, T. Simanjuntak, and M. Yamagata. 2017. “The Biological History of Southeast Asian Populations from Late Pleistocene and Holocene Cemetery Data.” *First Islanders: Prehistory and Human Migration in Island Southeast Asia*. Wiley Blackwell, Oxford.
- Matsumura, Hirofumi and Marc F. Oxenham. 2014. “Demographic Transitions and Migration in Prehistoric East/Southeast Asia through the Lens of Nonmetric Dental Traits.” *American Journal of Physical Anthropology* 155(1):45–65.
- Matsumura, Hirofumi and Surin Pookajorn. 2005. “A Morphometric Analysis of the Late Pleistocene Human Skeleton from the Moh Khiew Cave in Thailand.” *HOMO- Journal of Comparative Human Biology* 56(2):93–118.
- Matsumura, Hirofumi, Ken-ichi Shinoda, Truman Simanjuntak, Adhi Agus Oktaviana, Sofwan Noerwidi, Harry Octavianus Sofian, Dyah Prastiningtyas, Lan Cuong Nguyen, Tsuneo Kakuda, and Hideaki Kanzawa-Kiriyama. 2018. “Cranio-Morphometric and ADNA Corroboration of the Austronesian Dispersal Model in Ancient Island Southeast Asia: Support from Gua Harimau, Indonesia.” *PloS One* 13(6):e0198689.
- Mayr, E. 1950. “Taxonomic Categories in Fossil Hominids.” *Cold Spring Harbor Symposia on Quantitative Biology* 15:109–18.
- McKinnon, E. Edwards. 1991. “The Hoabinhian in the Wampu/Lau Biang Valley of Northeastern Sumatra: An Update.” *Bulletin of the Indo-Pacific Prehistory Association* 10([TRANSITIONS TO AGRICULTURE IN THE EASTERN OLD WORLD]):132–42.
- Melton, Terry, Stephanie Clifford, Jeremy Martinson, Mark Batzer, and Mark Stoneking. 1998. “Genetic Evidence for the Proto-Austronesian Homeland in Asia: MtDNA and Nuclear DNA Variation in Taiwanese Aboriginal Tribes.” *The American Journal of Human Genetics* 63(6):1807–23.
- Meulen, A. J. Van Der. 1999. “New Paleontological Data from the Continental Plio-Pleistocene of Java.”
- Meyer, Matthias, Martin Kircher, Marie-Theres Gansauge, Heng Li, Fernando Racimo, Swapn Mallick, Joshua G. Schraiber, Flora Jay, Kay Prüfer, and Cesare De Filippo. 2012. “A High-Coverage Genome Sequence from an Archaic Denisovan Individual.” *Science* 338(6104):222–26.

- Mijsberg, W. A. 1932. "Recherches Sur Les Restes Humains Troubes Dans Les Fouilles de l'abris-Sous-Roche Du Guwa Lawa a Sampoeng et Des Sites Prehistoriques a Bodjonegoro (Java)." Pp. 39–54 in *Hommage, Premier Congres des Prehistoriens d'Extreme-Orient a Hanoi*. Societe Royale des Arts et des Sciences de Batavia.
- Miller, G. H., J. Brigham-Grette, Richard B. Alley, L. Anderson, H. A. Bauch, M. S. V Douglas, M. E. Edwards, S. A. Elias, B. P. Finney, and J. J. Fitzpatrick. 2013. "Paleoclimate History of the Arctic." Pp. 113–25 in *Encyclopedia of Quaternary Science: Second Edition*. Elsevier Inc.
- Miller, G. S. 1923. "Notes on the Cast of the Pithecanthropus Molars." *Bull. Amer. Mus. Nat. Hist.* 48:527–30.
- Mizoguchi, Yuji. 1985. "Shovelling: A Statistical Analysis of Its Morphology." *University Museum Bulletin* 26.
- Moggi-Cecchi, J. and S. Boccone. 2007. "Maxillary Molars Cusp Morphology of South African *Australopithecines*." Pp. 53–64 in *Dental perspectives on human evolution: state of the art research in dental paleoanthropology*. Springer.
- Moggi-Cecchi, Jacopo, Frederick E. Grine, and Phillip V Tobias. 2006. "Early Hominid Dental Remains from Members 4 and 5 of the Sterkfontein Formation (1966–1996 Excavations): Catalogue, Individual Associations, Morphological Descriptions and Initial Metrical Analysis." *Journal of Human Evolution* 50(3):239–328.
- Moigne, Anne-Marie, Anne Dambricourt Malassé, Mukesh Singh, Amandeep Kaur, Claire Gaillard, Baldev Karir, Surinder Pal, Vipnesh Bhardwaj, Salah Abdessadok, and Cécile Chapon Sao. 2016. "The Faunal Assemblage of the Paleonto-Archeological Localities of the Late Pliocene Quranwala Zone, Masol Formation, Siwalik Range, NW India." *Comptes Rendus Palevol* 15(3–4):359–78.
- Molnar, Stephen. 1971. "Human Tooth Wear, Tooth Function and Cultural Variability." *American Journal of Physical Anthropology* 34(2):175–89.
- Molnar, Stephen, M. J. Barrett, Luigi Brian, C. Loring Brace, David S. Brose, J. R. Dewey, Jean E. Frisch, Pranab Ganguly, Nils-Gustaf Gejvall, and David Lee Greene. 1972. "Tooth Wear and Culture: A Survey of Tooth Functions among Some Prehistoric Populations [and Comments and Reply]." *Current Anthropology* 13(5):511–26.
- Morley, Robert J. 2000. *Origin and Evolution of Tropical Rain Forests*. John Wiley & Sons.
- Morwood, M. J., P. B. O'Sullivan, F. Aziz, and A. Raza. 1998. "Fission-Track Ages of Stone Tools and Fossils on the East Indonesian Island of Flores." *Nature* 392(6672):173–76.
- Morwood, M. J., P. O'Sullivan, E. E. Susanto, and F. Aziz. 2003. "Revised Age for Mojokerto 1, an Early *Homo erectus* Cranium from East Java, Indonesia." *Australian Archaeology* 57(July):1–4.
- Moyano, Isidro Toro, Deborah Barsky, Dominique Cauche, Vincenzo Celiberti, Sophie Grégoire, Frédéric Lebegue, Marie Hélène Moncel, and Henry de Lumley. 2011. "The Archaic Stone Tool Industry from Barranco León and Fuente Nueva 3, (Orce, Spain): Evidence of the Earliest Hominin Presence in Southern Europe." *Quaternary International* 243(1):80–91.

- Na'im, Akhsan and Hendry Syaputra. 2019. *Nationality, Ethnicity, Religion, and Language of Indonesians*.
- Nashruddin. 1997. *Laporan Penelitian Situs Bukit Kerang Di Pesisir Timur Sumatera Utara Dan Aceh Timur*. Jakarta.
- Newsome, J. and J. R. Flenley. 1988. "Late Quaternary Vegetational History of the Central Highlands of Sumatra. II. Palaeopalynology and Vegetational History." *Journal of Biogeography* 555–78.
- Nichol, Christian R., Christy G. Turner, and Albert A. Dahlberg. 1984. "Variation in the Convexity of the Human Maxillary Incisor Labial Surface." *American Journal of Physical Anthropology* 63(4):361–70.
- Ninkovich, D. and L. H. Burckle. 1978. "Absolute Age of the Base of the Hominid-Bearing Beds in Eastern Java." *Nature* 275(5678):306.
- Nishimura, Susumu. 1981. "On the Fission-Track Dating of Tuffs and Volcanic Ashes." *Nuclear Tracks* 5(1–2):157–67.
- Noerwidi, Sofwan. 2009. "Archaeological Research at Kendeng Lembu, East Java, Indonesia." *Bulletin of the Indo-Pacific Prehistory Association* 29(174):26–32.
- . 2012. "The Significance of the Holocene Human Skeleton Song Keplek 5 in the History of Human Colonization of Java: A Comprehensive Morphological and Morphometric Study." Muséum national d'Histoire naturelle, Paris.
- . 2017. "Using Dental Metrical Analysis to Determine the Terminal Pleistocene and Holocene Population History of Java." Pp. 79–96 in *terra australis 45*, edited by P. Piper and D. Bulbeck. Canberra: ANU E Press.
- Noerwidi, Sofwan, Anne-Marie Moigne, María Martín-Torres, Mirza Ansyori, Abi Kusno, Ruly Fauzi, Archie Tiauzon, Hua Tu, Xavier Gallet, and Christophe Falguères. 2018. "Identification on Two Deciduous Human Molars from Pleistocene Layers of Song Terus Site, East Java."
- Noerwidi, Sofwan, Dyah Prastiningtyas, Harry Widiyanto, Fadhilla A. Aziz, Adhyanti Putri, Taufiq Senjaya, and Rokhus D. Awe. 2016. "The Graves of The Harimau Cave: A Biocultural Study." Pp. 152–78 in *Harimau Cave and the Long Journey of OKU Civilization*, edited by T. Simanjuntak. Yogyakarta: Gadjah Mada University Press.
- Noerwidi, Sofwan, Siswanto, and Harry Widiyanto. 2016. "Giant Primate of Java: A New Gigantopithecus Specimen from Semedo." *Berkala Arkeologi* 36(2):141–60.
- Nurani, Indah Asikin. 2016. "The Technology of Tools and Ornaments Production At Gua Kidang, Blora." *Berkala Arkeologi* 36(1):1.
- Nurani, Indah Asikin and Agus Tri Hascaryo. 2010. "Pola Hidup Komunitas Gua Hunian Prasejarah Kawasan Karst Blora." *Berkala Arkeologi* 30(1):23–38.
- Nurani, Indah Asikin, Agus Tri Hascaryo, Toetik Koesbardiati, Delta Bayu Murti, Hari Wibowo, and Ferry Rahman Aries. 2019. *Okupasi Dolina Kidang: Hunian Prasejarah Akhir Plestosen - Awal Holosen Kawasan Karst Blora*. edited by Y. Zaim. Yogyakarta: Balai Arkeologi DIY.

- Nurani, Indah Asikin, Toetik Koesbardiati, and Delta Bayu Murti. 2014. "Sistem Kubur Penghuni Gua Kidang, Blora." *Berkala Arkeologi* 34(1):17–36.
- Nurani, Indah Asikin and J. S. Edy Yuwono. 2008. "Gua Kidang, Pilihan Manusia Prasejarah Di Kawasan Karst Blora." *Berkala Arkeologi* XXVIII(1):1–20.
- O'Higgins, Paul. 2000. "The Study of Morphological Variation in the Hominid Fossil Record: Biology, Landmarks and Geometry." *Journal of Anatomy* 197(1):103–20.
- Oakley, Kenneth P., Bernard G. Campbell, and Theya I. Molleson. 1976. "Catalogue of Fossil Hominids, Part III: Americas, Asia, Australasia." *Asian Perspectives* 19(2):324.
- Oktaviana, Adhi Agus, Pindi Setiawan, and E. Wahyu Saptomo. 2016. "Rock Art Pattern in Harimau Cave Site in South Sumatra." Pp. 267–86 in *Harimau Cave and the Long Journey of OKU Civilization*, edited by T. Simanjuntak. Yogyakarta: Gadjah Mada University Press.
- Oppenoorth, W. F. F. 1932. "*Homo (Javanthropus) soloensis* Een Pleistocene Mensch van Java." *Wetensch. Med. Dienst Mijnb. Ned. Indie.* 20:49–74.
- Osborn, Henry Fairfield. 1892. *The History and Homologies of Human Molar Cusps*.
 ———. 1895. *The History of the Cusps of the Human Molar Teeth...*
- Pagani, Luca, Daniel John Lawson, Evelyn Jagoda, Alexander Mörseburg, Anders Eriksson, Mario Mitt, Florian Clemente, Georgi Hudjashov, Michael DeGiorgio, and Lauri Saag. 2016. "Genomic Analyses Inform on Migration Events during the Peopling of Eurasia." *Nature* 538(7624):238.
- Pannekoek, Antonie Johannes. 1949. *Outline of the Geomorphology of Java*.
- Patterson, David B., David R. Braun, Kayla Allen, W. Andrew Barr, Anna K. Behrensmeier, Maryse Biernat, Sophie B. Lehmann, Tom Maddox, Fredrick K. Manthi, Stephen R. Merritt, Sarah E. Morris, Kaedan O'Brien, Jonathan S. Reeves, Bernard A. Wood, and René Bobe. 2019. "Comparative Isotopic Evidence from East Turkana Supports a Dietary Shift within the Genus *Homo*." *Nature Ecology and Evolution* 3(July).
- Pei, W. Z. and S. S. Zhang. 1985. "A Study on the Lithic Artifacts of *Sinanthropus*." *Palaeontol. Sin. New Ser. D* 12:1–277.
- Pei, Wen Chung. 1929. "An Account of the Discovery of an Adult *Sinanthropus* Skull in the Chou Kou Tien Deposit 1." *Bulletin of the Geological Society of China* 8(3):203–5.
- Peters, Charles R. and John C. Vogel. 2005. "Africa's Wild C 4 Plant Foods and Possible Early Hominid Diets." *Journal of Human Evolution* 48(3):219–36.
- Pietrusewsky, M. 2008. "Cranio-metric Variation in Southeast Asia and Neighboring Regions: A Multivariate Analysis of Cranial Measurements." *Human Evolution* 23(1–2):49–86.
 ———. 2010. "A Multivariate Analysis of Measurements Recorded in Early and More Modern Crania from East Asia and Southeast Asia." *Quaternary International* 211(1–2):42–54.
- Platt, Daniel E., Marc Haber, Magda Bou Dagher-Kharrat, Bouchra Douaihy, Georges Khazen, Maziar Ashrafian Bonab, Angélique Salloum, Francis Mouzaya, Donata Luiselli, Chris Tyler-Smith, Colin Renfrew, Elizabeth Matisoo-Smith, and Pierre A. Zalloua. 2017. "Mapping Post-Glacial Expansions: The Peopling of Southwest Asia." *Scientific Reports*

7(December 2016):1–10.

- Polanski, Joshua M., Hannah E. Marsh, and Scott D. Maddux. 2016. "Dental Size Reduction in Indonesian *Homo erectus*: Implications for the PU-198 Premolar and the Appearance of *Homo sapiens* on Java." *Journal of Human Evolution* 90:49–54.
- Prat, S. 2004. "Les Premiers Représentants Du Genre *Homo*, En Quête d'une Identité. Apports de l'étude Morphologique et de l'analyse Cladistique." *Bulletins et Mémoires de La Société d'Anthropologie de Paris* 16(16 (1-2)):17–35.
- Prat, Sandrine. 2005. "Characterising Early *Homo*: Cladistic, Morphological and Metrical Analyses of the Original Plio-Pleistocene Specimens." *From Tools to Symbols, from Early Hominids to Modern Humans* (1):198–228.
- Pringgoprawiro, Harsono. 1983. "Biostratigrafi Dan Paleogeografi Cekungan Jawa Timur Utara Suatu Pendekatan Baru." *Disertasi Doktor, Institut Teknologi Bandung*.
- Procureur, F. and R. Orban-Segebarth. 1983. "Odontometric Arguments for the Phyletic Position of *Meganthropus Palaeojavanicus*." *Journal of Human Evolution* 12(8):692–93.
- Purnomo, Andri, Anne-Marie Semah, Francois Semah, and Truman Simanjuntak. 2014. "Geological Structure, Sedimentation Dynamic and Prehistory in the Southeastern Part of the Sangiran Dome (Java-Indonesia): Research and Conservation Strategies." Pp. 94–99 in *XVIIIth Congress of the International Union for Prehistoric and Protohistoric Science*.
- Puymeraill, Laurent, Christopher B. Ruff, Luca Bondioli, Harry Widiyanto, Erik Trinkaus, and Roberto Macchiarelli. 2012. "Structural Analysis of the Kresna 11 *Homo erectus* Femoral Shaft (Sangiran , Java)." *Journal of Human Evolution* 63(5):741–49.
- Quam, Rolf, Shara Bailey, and Bernard Wood. 2009. "Evolution of M1 Crown Size and Cusp Proportions in the Genus *Homo*." *Journal of Anatomy* 214(5):655–70.
- Reich, David, Richard E. Green, Martin Kircher, Johannes Krause, Nick Patterson, Eric Y. Durand, Bence Viola, Adrian W. Briggs, Udo Stenzel, Philip L. F. Johnson, Tomislav Maricic, Jeffrey M. Good, Tomas Marques-Bonet, Can Alkan, Qiaomei Fu, Swapan Mallick, Heng Li, Matthias Meyer, Evan E. Eichler, Mark Stoneking, Michael Richards, Sahra Talamo, Michael V. Shunkov, Anatoli P. Derevianko, Jean Jacques Hublin, Janet Kelso, Montgomery Slatkin, and Svante Pääbo. 2010. "Genetic History of an Archaic Hominin Group from Denisova Cave in Siberia." *Nature* 468(7327):1053–60.
- Rightmire, G. P. 1984. "Comparisons of *Homo erectus* from Africa and Southeast Asia." *Cour. Forsch. Inst. Senckenberg* 69:83–98.
- . 1991. "The Dispersal of *Homo erectus* from Africa and the Emergence of More Modern Humans." *Journal of Anthropological Research* 47(2):177–91.
- Rizal, Yan, Kira E. Westaway, Yahdi Zaim, Gerrit D. van den Bergh, E. Arthur Bettis, Michael J. Morwood, O. Frank Huffman, Rainer Grün, Renaud Joannes-Boyau, Richard M. Bailey, Michael C. Westaway, Iwan Kurniawan, Mark W. Moore, Michael Storey, Fachroel Aziz, Jian xin Zhao, Aswan, Maija E. Sipola, Roy Larick, John Paul Zonneveld, Robert Scott, Shelby Putt, and Russell L. Ciochon. 2019. "Last Appearance of *Homo erectus* at Ngandong, Java, 117,000–108,000 Years Ago." *Nature* (May).

- Rizqullah, Wisam, Azhari Azhari, Lusi Epsilawati, Lutfi Yondri, Fahmi Oscandar, and Yuti Malinda. 2016. "Gambaran Ketebalan Dan Densitas Tulang Kortikal Maksila Dan Mandibula Manusia Pawon Dengan Pencitraan Cone Beam Computed Tomography 3D." *PURBAWIDYA: Jurnal Penelitian Dan Pengembangan Arkeologi* 5(2):79–88.
- Robinson, John Talbot. 1953. "Meganthropus, Australopithecines and Hominids." *American Journal of Physical Anthropology* 11(1):1–38.
- . 1955a. "Further Remarks on the Relationship between 'Meganthropus' and Australopithecines." *American Journal of Physical Anthropology* 13(3):429–45.
- . 1955b. "The Dentition of the Australopithecinae."
- Rohlf, Fred J. 2010. "TpsRelw, Relative Warps Analysis, Version 2.16." *Department of Ecology and Evolution, State University of New York at Stony Brook*.
- Ruff, Christopher B., Laurent Puymeryl, Roberto Macchiarelli, Justin Sipla, and Russell L. Ciochon. 2015. "Structure and Composition of the Trinil Femora: Functional and Taxonomic Implications." *Journal of Human Evolution* 80:147–58.
- Sajekti, Andjarwati Sri. 2009. "An Indication of Holocene Environmental Change Based on the Palynological Research in Telaga Cebong, Dieng Plateau, Central Java, Indonesia." *Muséum national d'Histoire naturelle, Paris*.
- Saleki, Hassane. 1997. "Apport d'une Intercomparaison de Méthodes Nucléaires (230Th/234U, ESR et 40Ar/39Ar) à La Datation de Couches Fossifères Pléistocènes Dans Le Dôme de Sangiran (Java, Indonésie)."
- Santa Luca, A. P. 1980. *The Ngandong Fossil Hominids: A Comparative Study of a Far Eastern Homo erectus Group*. Vol. 78. Yale Univ Peabody Museum.
- Sarasin, Paul. 1914. *Neue Lithochrone Funde Im Innern von Sumatra*. Birkhäuser.
- Sari, Agus P., Rizka Elyza Sari, Ria N. Butarbutar, Martha Maulidya, and Wisnu Rusmantoro. 2016. *Indonesia and Climate Change: Current Status and Policies*.
- Sartono, S. 1961. "Notes on a New Find on a Pithecanthropus Mandible C." *Publikasi Teknik Seri Paleontologi* 2.
- . 1964. *Stratigraphy and Sedimentation of the Easternmost Part of Gunung Sewu, East Djawa*. Departemen Perindustrian Dasar/Pertambangan, Direktorat Geologi.
- . 1970. *The Discovery of a Hominid Skull at Sangiran, Central Java: An Announcement*. Direktorat Geologi.
- . 1971. "Observations on a New Skull of Pithecanthropus erectus VIII from Sangiran Central Java." *Proc. Konink L. Nedel. Acad. van Wetens* 74(2):185–94.
- . 1974. "Observations on a Newly Discovered Jaw of Pithecanthropus Modjokertensis from the Lower Pleistocene of Sangiran, Central Java." *Proceedings of the Koninklijke Nederlandse Akademie van Wetenschappen (Geology)* 77(1):26–31.
- . 1978. "The Site of Homo erectus Mandible F." *Modern Quaternary Research in Southeast Asia* 4:19–24.
- . 1980. "Homo erectus ngandongensis The Possible Maker of the Sangiran Flakes." *Anthropologie (1962-),* 18(2/3), 121-131.

- . 1982. "Characteristics and Chronology of Early Man in Java." Pp. 491–533 in *Proceedings, Premier Congres International de Paléontologie Humaine*.
- . 1986. "New Lights on Human Evolution in Southeast Asia." *Bulletin of the Geological Society of Malaysia* 20(August):269–88.
- . 1991. "Homo - *Pithecanthropus erectus* Le Débat sans Fin." *L'Anthropologie* 1:123–36.
- . 1993. "A New *Homo erectus* Skull from Sangiran: An Announcement." in *Proceedings of the International Conference on Human Paleoeology: Ecological Context of the Evolution of Man*.
- Sartono, S. and Dominique Grimaud-Hervé. 1983. "Les Pariétaux de l'hominidé Sangiran 31." *Anthropologie (L')(Paris)*, 87(4), 465-468.
- Sartono, S., S. Hardjasmita, Y. Zaim, U. P. Nababan, and T. Djubiantono. 1978. "Sedimentasi Daerah Patiayam, Jawa Tengah." *Berita Pusat Penelitian Arkeologi* 19:1–21.
- Sartono, S., D. E. Tyler, and G. S. Krantz. 1995. "A New '*Meganthropus*' Mandible from Sangiran, Java: An Announcement." *Human Evolution in Its Ecological Context* 1:225–28.
- Sathiamurthy, E. and H. K. Voris. 2006. *Maps of Holocene Sea Level Transgression and Submerged Lakes on the Sunda Shelf*. Vol. 2.
- Schindelin, Johannes, Ignacio Arganda-Carreras, Erwin Frise, Verena Kaynig, Mark Longair, Tobias Pietzsch, Stephan Preibisch, Curtis Rueden, Stephan Saalfeld, and Benjamin Schmid. 2012. "Fiji: An Open-Source Platform for Biological-Image Analysis." *Nature Methods* 9(7):676.
- Schürmann, Heinrich M. E. 1931. *Kjökkenmöddinger Und Paläolithicum in Nord-Sumatra*. na.
- Schwartz, Jeffrey H. 2004. "Getting to Know *Homo erectus*." *Science* (July):53–54.
- . 2005. *The Red Ape: Orangutans and Human Origins*. 2nd Revise. edited by Basic Books. USA: Westview Press.
- . 2016. "Beyond *Homo erectus*: Sangiran Is Key to Deciphering the Asian Human Fossil Record and Re-Evaluating Homo." Pp. 93–110 in *Ribot Trafí F, coord. Homenaje al Dr. José Gibert Clols. Una vida dedicada a la ciencia y al conocimiento de los primeros europeos*. Granada, Spain: Publicaciones Diputación de Granada.
- Schwartz, Jeffrey H. and Ian Tattersall. 2003. *The Human Fossil Record, Volume Two: Craniodental Morphology of Genus Homo (Africa and Asia)*. Vol. 2. New Jersey: John Wiley & Sons Publication.
- . 2015. "Defining the Genus *Homo*." *Science* 349(6251):931–32.
- Scott, Eugenie C. 1979. "Dental Wear Scoring Technique." *American Journal of Physical Anthropology* 51(2):213–17.
- Scott, G. Richard. 1971. "Canine Tuberculum-Dentale." P. 294 in *American Journal of Physical Anthropology*. Vol. 35. Wiley-Liss Div John Wiley & Sons Inc, 605 Third Ave, New York, Ny 10158-0012.

- . 1973. "An Analysis of Family and Population Data on Carabelli's Trait and Shovel-Shaped Incisors." in *41st annual meeting of the American Association of Physical Anthropologists, Lawrence, Kansas*.
- . 1980. "Population Variation of Carabelli's Trait." *Human Biology* 52(1):63–78.
- Scott, G. Richard and Joel D. Irish. 2013. *Anthropological Perspectives on Tooth Morphology*.
- Scott, G. Richard, Kirk Schmitz, Kelly N. Heim, Kathleen S. Paul, Roman Schomberg, and Marin A. Pilloud. 2018. "Sinodonty, Sundadonty, and the Beringian Standstill Model: Issues of Timing and Migrations into the New World." *Quaternary International* 466:233–46.
- Scott, G. Richard and Christy G. Turner. 1997. *Anthropology of Modern Human Teeth*. Cambridge University Press Cambridge.
- Selenka, Margarethe Lenore and Max Ludwig Paul Blanckenhorn. 1911. *Die Pithecanthropus-Schichten Auf Java: Geologische Und Paläontologische Ergebnisse Der Trinil-Expedition (1907 Und 1908), Ausgeführt Mit Unterstützung Der Akademischen Jubiläumsstiftung Der Stadt Berlin Und Der Königlich Bayerischen Akademi Der Wissensch.* Vol. 39. Wilhelm Engelmann.
- Sémah, A. M. 1986. "Le Milieu Naturel Lors Du Premier Peuplement de Java." *These de Doctorat d'Etat Es Sciences, Université de Provence* 3.
- Sémah, A. M. and F. Sémah. 2001. "La Signification Paléoécologique Des Couches à Hominidés de l'île de Java." *Origine Des Peuplements et Chronologie Des Cultures Paléolithiques Dans Le Sud-Est Asiatique. Paris: Artcom* 251–78.
- . 2012. "The Rain Forest in Java through the Quaternary and Its Relationships with Humans (Adaptation, Exploitation and Impact on the Forest)." *Quaternary International* 249:120–28.
- Sémah, Anne-Marie, Francois Sémah, Rachid Moudrikah, Francois Frohlich, and Tony Djubiantono. 2004. "A Late Pleistocene and Holocene Sedimentary Record in Central Java and Its Palaeoclimatic Significance." *Modern Quaternary Research in Southeast Asia* 18 63–88.
- Sémah, Anne Marie, François Sémah, Tony Djubiantono, and Boris Brasseur. 2010. "Landscapes and Hominids' Environments: Changes between the Lower and the Early Middle Pleistocene in Java (Indonesia)." *Quaternary International* 223–224:451–54.
- Sémah, F., A. M. Sémah, T. Djubiantono, and H. T. Simanjuntak. 1992. "Did They Also Make Stone Tools?" *Journal of Human Evolution* 23(5):439–46.
- Sémah, F., Anne-Marie Sémah, Tony Djubiantono, and D. Driwantoro. 1993. "La Fouille Du Site de Ngebung." *Les Dossiers d'Archéologie* (184):68–74.
- Sémah, François. 1984a. "Stratigraphie et Paléomagnétisme du Pliocène Supérieur et du Pléistocène de l'île de Java (Indonésie)." *These de Doctorat Es Sciences. Université de Provence Aix-Marseille I*.
- . 1984b. "The Sangiran Dome in the Javanese Plio-Pleistocene Chronology." *Courier Forschungsinstitut Senckenberg* 69:245–52.

- . 1986. "Le Peuplement Ancien de Java. Ebauche d'un Cadre Chronologique." *L'anthropologie* 90(3):359–400.
- Sémah, François, Hassane Saleki, Christophe Falguères, Gilbert Féraud, and Tony Djubiantono. 2000. "Did Early Man Reach Java during the Late Pliocene?" *Journal of Archaeological Science* 27(9):763–69.
- Sémah, François, A. M. Sémah, C. Falgueres, F. Detroit, X. Gallet, S. Hameau, A. M. Moinge, and H. .. Simanjuntak. 2004. "The Significance of the Punung Karstic Area (Eastern Java) for the Chronology of the Javanese Palaeolithic, with Special Reference to the Song Terus Cave." *Modern Quaternary Research of Southeast Asia* 18:45–62.
- Sémah, François, Anne-Marie Sémah, and Tony Djubiantono. 2001. "From the Shoreline to the Slopes of the Volcanoes: The Long Pithecanthropus Trek." *Sangiran: Man, Culture and Environment in Pleistocene Times* 195–219.
- Sémah, François, Truman Simanjuntak, Eusebio Dizon, Claire Gaillard, and Anne-Marie Sémah. 2014. "Insular Southeast Asia in the Lower Paleolithic." *Encyclopedia of Global Archaeology* 3904–18.
- Semaw, Sileshi, Michael J. Rogers, Jay Quade, Paul R. Renne, Robert F. Butler, Manuel Dominguez-Rodrigo, Dietrich Stout, William S. Hart, Travis Pickering, and Scott W. Simpson. 2003. "2.6-Million-Year-Old Stone Tools and Associated Bones from OGS-6 and OGS-7, Gona, Afar, Ethiopia." *Journal of Human Evolution* 45(2):169–77.
- Setiawan, Taufiqurrahman. 2012. "Permukiman Gua Di Sub-Cekungan Payakumbuh." *Sangkhakala: Berkala Arkeologi* 15(2):224–42.
- Setiawan, Taufiqurrahman, Nenggih Susilowati, Andri Restyadi, Marseria Sebayang, and Ater Budiman Sinaga. 2011. *Penelitian Situs Dunia Di Sumatra Utara: Situs Bukit Kerang*. Medan.
- Sheets, H. D. 2001. "Principal Components Analysis Generator: Integrated Morphometrics Package." *Canisius College, Buffalo, New York*.
- Shen, Guanjun, Xing Gao, Bin Gao, and Darryl E. Granger. 2009. "Age of Zhoukoudian *Homo erectus* Determined with 26 Al/10 Be Burial Dating." *Nature* 458(7235):198.
- Shutler Jr, R., J. M. Head, D. J. Donahue, A. J. T. Jull, M. F. Barbetti, S. Matsu'ura, John de Vos, and P. Storm. 2004. "AMS Radiocarbon Dates on Bone from Cave Sites in Southeast Java, Indonesia, Including Wajak." *Modern Quaternary Research in Southeast Asia* 18:89–93.
- Sidwell, Paul. 2010. "The Austroasiatic Central Riverine Hypothesis." *Вопросы Языкового Подства* 4(16 (59)):117–34.
- Sieh, Kerry, Jason Herrin, Brian Jicha, Dayana Schonwalder Angel, James D. P. Moore, Paramesh Banerjee, Weerachat Wiwegwin, Vanpheng Sihavong, Brad Singer, Tawachai Chualaowanich, and Punya Charusiri. 2019. "Australasian Impact Crater Buried under the Bolaven Volcanic Field, Southern Laos." *Proceedings of the National Academy of Sciences*.
- Simanjuntak, Truman. 2001. "New Insights on the Tools of Pithecanthropus." *Sangiran: Man, Culture and Environment in Pleistocene Times. The National Research Centre of Archaeology, Yayasan Obor* 154–70.

- . 2002. *Gunung Sewu in Prehistoric Times*. Gajah Mada University Press.
- . 2004. "New Insight on the Prehistoric Chronology of Gunung Sewu, Java, Indonesia." *Modern Quaternary Research in Southeast Asia* 18:9–30.
- . 2015a. *Gua Harimau Dan Perjalanan Panjang Peradaban OKU*. Gajah Mada University Press.
- . 2015b. "Progres Penelitian Austronesia Di Nusantara." *Amerta* 33(1):25–44.
- . 2016. *Harimau Cave and the Long Journey of OKU Civilization*. edited by T. Simanjuntak. Yogyakarta: Gajah Mada University Press.
- . 2017. "The Western Route Migration: A Second Probable Neolithic Diffusion to Indonesia." *Terra Australis* 45:201–12.
- Simanjuntak, Truman, M. Ruly Fauzi, and Adhi Agus Oktaviana. 2014. *Laporan Penelitian Arkeologi: Peradaban Di Lingkungan Karst Kabupaten OKU, Sumatra Selatan*. Jakarta.
- Simanjuntak, Truman and Adhi Agus Octaviana. 2012. *Perjalanan Panjang Peradaban OKU*. Jakarta.
- Simanjuntak, Truman, Adhi Agus Oktaviana, and Retno Handini. 2016. "Updated Views on the Austronesian Studies in Indonesia." *Austronesian Diaspora: A New Perspective* 207–22.
- Simanjuntak, Truman and François Sémah. 1996. "A New Insight into the Sangiran Flake Industry." *Bulletin of the Indo-Pacific Prehistory Association* 14:22–26.
- . 2005. "Indonesia-Southeast Asia: Climates, Settlements, and Cultures in Late Pleistocene." *Comptes Rendus - Palevol* 5(1–2):371–79.
- Simanjuntak, Truman, François Sémah, and Claire Gaillard. 2010. "The Palaeolithic in Indonesia: Nature and Chronology." *Quaternary International* 223–224:418–21.
- Simpson, George Gaylord. 1940. "Mammals and Land Bridges." *Journal of the Washington Academy of Sciences* 30(4):137–63.
- Siregar, M. Safei. 2005. "Sedimentasi Dan Model Terumbu Formasi Rajamandala Di Daerah Padalarang-Jawa Barat." *RISSET Geologi Dan Pertambangan* 15(1):61–81.
- Siswanto and Sofwan Noerwidi. 2014. "Fosil Probocidea Dari Situs Semedo: Hubungannya Dengan Biostratigrafi Dan Kehadiran Manusia Di Jawa." *Berkala Arkeologi* 34(2):115–30.
- Siswanto, Yahdi Zaim, and Sofwan Noerwidi. 2016. *Melacak Jejak Kehidupan Purba Di Patiayam*. edited by Bagyo Prasetyo. Yogyakarta: Kepel.
- Snell, Christiaan Alfred Raoul Diederik. 1938. "Menschelijke Skeletresten Uit de Duinformatie van Java's Zuidkust Nabij Poeger (Z.-Banjoewangi)."
- Soejono, R. P. 1975. *Jaman Prasejarah Di Indonesia*. Departemen Pendidikan dan Kebudayaan.
- . 1993. *Sejarah Nasional Indonesia I: Jaman Prasejarah*. edited by M. D. Poesponegoro and N. Notosusanto. Jakarta: Balai Pustaka.
- Soeradi, T., T. Shibasahi, D. Kadar, M. Sudijonolthara, H. Kumai, T. Hayashi, K. Fuyama, F. Aziz, H. Siagian, and M. Furutani. 1985. "Geology and Stratigraphy of the Trinil Area." *Quaternary Geology of the Hominid Fossil Bearing Formations in Java* (4):49–53.

- Soeriaatmadja, Roehayat Emon and Suraya A. Afiff. 1997. *The Ecology of Java and Bali*. Oxford University Press.
- Solheim, Wilhelm G. 1975. "Reflections on the New Data of Southeast Asian Prehistory: Austronesian Origin and Consequence." *Asian Perspectives* 18(2):146–60.
- Sondaar, Paul Y. 1984. "Faunal Evolution and the Mammalian Biostratigraphy of Java." *Cour. Forsch. Inst. Senckenberg* 69:219–35.
- Spoor, Fred, Philipp Gunz, Simon Neubauer, Stefanie Stelzer, Nadia Scott, Amandus Kwekason, and M. Christopher Dean. 2015. "Reconstructed *Homo habilis* Type OH 7 Suggests Deep-Rooted Species Diversity in Early *Homo*." *Nature* 519(7541):83.
- Sri, Mulyaningsih, Bronto Sutikno, Kusnaedi Ari, Simon I., and Prasetyanto W. I. 2008. "Vulkanisme Kompleks Gunung Patiayam Di Kecamatan Jekulo , Kabupaten Kudus , Provinsi Jawa Tengah." *Indonesian Journal on Geoscience* 3(2):75–88.
- van Stein Callenfels, P. V. 1932. "Note Preliminaire Sur Les Fouilles Dans L'abri-Sous-Roche Du Guwa Lawa a Sampung." Pp. 16–29 in *Hommage, Premier Congres des Prehistoriens d'Extreme-Orient a Hanoi*. Societe Royale des Arts et des Sciences de Batavia.
- . 1936. "The Melanesoid Civilizations of Eastern Asia." *Bulletin of the Raffles Museum* 1:41–51.
- Stone, Richard. 2006. "Java Man's First Tools."
- Storm, Paul. 1976. "The Evolutionary Significance of the Wajak Skulls." *Scripta Geologica* (September):591.
- . 1992. "Two Microliths from Javanese Wadjak Man." *J. Anthropol. Soc. Nippon* 100 (2):191-203.
- . 1995. *The Evolutionary Significance of the Wajak Skulls*. Nationaal Natuurhistorisch Museum.
- . 2001. "The Evolution of Humans in Australasia from an Environmental Perspective." *Palaeogeography, Palaeoclimatology, Palaeoecology* 171(3–4):363–83.
- Storm, Paul, Fachroel Aziz, John de Vos, Dikdik Kosasih, Sinung Baskoro, Ngaliiman, and Lars W. van de Hoek Ostende. 2005. "Late Pleistocene *Homo sapiens* in a Tropical Rainforest Fauna in East Java." *Journal of Human Evolution* 49(4):536–45.
- Storm, Paul, Rachel Wood, Chris Stringer, Antonis Bartsiokas, John de Vos, Maxime Aubert, Les Kinsley, and Rainer Grün. 2013. "U-Series and Radiocarbon Analyses of Human and Faunal Remains from Wajak, Indonesia." *Journal of Human Evolution* 64(5):356–65.
- Storm, Paul, Rachel Wood, Chris Stringer, Antonis Bartsiokas, John De Vos, Maxime Aubert, Les Kinsley, and Rainer Grün. 2013. "U-Series and Radiocarbon Analyses of Human and Faunal Remains from Wajak, Indonesia." *Journal of Human Evolution* 64(5):356–65.
- Stringer, C. B. 1992. "Replacement, Continuity and the Origin of *Homo sapiens*." *Continuity or Replacement: Controversies in Homo sapiens Evolution* 9–24.
- . 1996. "Current Issues in Modern Human Origins." Pp. 115–34 in *Contemporary issues in human evolution*. Vol. 21. California Academy of Sciences San Francisco.
- . 2000. "Coasting out of Africa." *Nature* 405(May):53.

- . 2003. "Out of Ethiopia." *Nature* 423(6941):692–95.
- . 2012. *Lone Survivors: How We Came to Be the Only Humans on Earth*. Macmillan.
- Stuijts, Inge-Lise Maria. 1993. *Late Pleistocene and Holocene Vegetation of West Java, Indonesia*. Balkema Rotterdam.
- Sudjatmiko. 2003. *Peta Geologi Lembar Cianjur, Jawa, Skala 1 : 100.000*. Bandung.
- Sutikna, Thomas, Matthew W. Tocheri, Michael J. Morwood, E. Wahyu Saptomo, Jatmiko, Rokus Due Awe, Sri Wasisto, Kira E. Westaway, Maxime Aubert, Bo Li, Jian Xin Zhao, Michael Storey, Brent V. Alloway, Mike W. Morley, Hanneke J. M. Meijer, Gerrit D. Van Den Bergh, Rainer Grün, Anthony Dosseto, Adam Brumm, William L. Jungers, and Richard G. Roberts. 2016. "Revised Stratigraphy and Chronology for *Homo floresiensis* at Liang Bua in Indonesia." *Nature* 532(7599):366–69.
- Suzuki, M., I. Saefudin, and M. Itihara. 1985. "Fission Track Ages of Pumice Tuff, Tuff Layers and Javites of Hominid Fossil Bearing Formations in Sangiran Area, Central Java."
- Suzuki, M. and B. Wikarno. 1982. "Fission-Track Ages of Pumice Tuff Layers and Javites of Hominid Bearing Formations in Sangiran, Central Java." *Comm. XI Int. Congr. INQUA* 2:322.
- Swisher, Carl C., Garniss H. Curtis, Teuku Jacob, A. G. Getty, and A. Suprijo. 1994. "Age of the Earliest Known Hominids in Java, Indonesia." *Science* 263(5150):1118–21.
- Theunissen, Bert. 1989. *Eugene Dubois and the Ape-Man from Java*.
- Thorne, Alan G and Milford H. Wolpoff. 1992. "The Multiregional Evolution of Humans." *Scientific American* 266(4):76–83.
- Tiauzon, Archie. 2011. "Lithic Technology in Song Terus during the Late Middle Pleistocene and the Early Upper Pleistocene." *Muséum national d'Histoire naturelle*.
- Tobias, Phillip V. 1966. "A Re-Examination of the Kedung Brubus Mandible." *Zoologische Mededelingen, Rijksmuseum van Natuurlijke Historie Te Leiden*, 41(22):307–21.
- . 1981. "The Emergence of Man in Africa and Beyond [and Discussion]." *Philosophical Transactions of the Royal Society B: Biological Sciences* 292(1057):43–56.
- . 1991. "The Skulls, Endocasts and Teeth of *Homo habilis*. Olduvai Gorge." *Cambridge Univ Press, Cambridge, UK* 4:1–921.
- Tobias, Phillip V. and G. H. R. von Koenigswald. 1965. "A Comparison Between the Olduvai Hominines and Those of Java and Some Implications for Hominid Phylogeny." *Current* 6(4):427–31.
- . 1967. "A Comparison Between the Olduvai Hominines and Those of Java and Some Implications for Hominid Phylogeny." *Nature* 204(4958):515–18.
- Tu, Hua. 2012. "Contextualizing Faunal Dispersals and Early Cave Hominid Bearing Occupations in SE Asia during MIS5 : Chronologic and Palaeoclimatic Approaches on Speleothems and Fossil Tooth." *Muséum national d'Histoire naturelle*.
- Turner, Christy G. 1969. "Microevolutionary Interpretations from the Dentition." *American Journal of Physical Anthropology* 30(3):421–26.

- . 1987. "Late Pleistocene and Holocene Population History of East Asia Based on Dental Variation." *American Journal of Physical Anthropology* 73(3):305–21.
- . 1990. "Major Features of Sundadonty and Sinodonty, Including Suggestions about East Asian Microevolution, Population History, and Late Pleistocene Relationships with Australian Aboriginals." *American Journal of Physical Anthropology* 82(3):295–317.
- . 1992. "The Dental Bridge between Australia and Asia: Following Macintosh into the East Asian Hearth of Humanity." *Archaeology in Oceania* 27(3):143–52.
- Turner, Christy G., C. R. Nichol, and G. R. Scott. 1991. "Scoring Procedures for Key Morphological Traits of the Permanent Dentition : The Arizona State University Dental Anthropology System." *Advances in Dental Anthropology* (JANUARY 1991):13–31.
- Tyler, D. E. 1996. "The Taxonomic Status of the " *Meganthropus* " Cranium Sangiran 31 and the " *Meganthropus* " Occipital Fragment III." *Bulletin of the Indo-Pacific Prehistory Association* 15:235–41.
- . 2001. "Two New " *Meganthropus* " Mandibles." 4.
- Tyler, D. E., S. Sartono, and G. S. Krantz. 1995. " *Homo erectus* Mandible F (Sangiran 22) from Java: An Announcement." *Palaeo-Anthropology: Evolution and Ecology of Homo Erectus, Pithecanthropus Centennial Foundation* 203–6.
- Ungar, Peter S. 2017. *Evolution's Bite: A Story of Teeth, Diet, and Human Origins*. Princeton University Press.
- Vialet, Amélie, Sandrine Prat, Patricia Wils, and Mehmet Cihat Alçiçek. 2018. "The Kocabaş Hominin (Denizli Basin, Turkey) at the Crossroads of Eurasia: New Insights from Morphometric and Cladistic Analyses." *Comptes Rendus - Palevol* 17(1–2):17–32.
- Villanea, Fernando A., Joshua G. Schraiber, Temple University, and Evolutionary Medicine. 2019. "Multiple Episodes of Interbreeding between Neanderthal and Modern Humans." *Nature Ecology & Evolution* 3(1):39.
- Villmoare, Brian, William H. Kimbel, Chalachew Seyoum, Christopher J. Campisano, Erin N. DiMaggio, John Rowan, David R. Braun, J. Ramón Arrowsmith, and Kaye E. Reed. 2015. "Early *Homo* at 2.8 Ma from Ledi-Geraru, Afar, Ethiopia." *Science* 347(6228):1352–55.
- Vita, Anjarwati Sayekti, and Linda Octina. 2016. "Vita Anjarwati Sayekti Linda Octina." Pp. 74–84 in *Harimau Cave and the Long Journey of OKU Civilization*, edited by T. Simanjuntak. Yogyakarta: Gadjah Mada University Press.
- Volmer, Rebekka, Ericson Hölzchen, Alexia Wurster, Maria Rebecca Ferreras, and Christine Hertler. 2017. "Did *Panthera Pardus* (Linnaeus, 1758) Become Extinct in Sumatra Because of Competition for Prey? Modeling Interspecific Competition within the Late Pleistocene Carnivore Guild of the Padang Highlands, Sumatra." *Palaeogeography, Palaeoclimatology, Palaeoecology* 487:175–86.
- Voris, Harold K. 2000. "Maps of Pleistocene Sea Levels in Southeast Asia: Shorelines, River Systems and Time Durations." *Journal of Biogeography* 27(5):1153–67.
- de Vos, J. 1983. "The Pongo Faunas from Java and Sumatra and Their Significance for Biostratigraphical and Paleo-Ecological Interpretations." Pp. 417–25 in *Paleontology*.

- . 1985. "Faunal Stratigraphy and Correlation of the Indonesian Hominid Sites." Pp. 215–20 in *Ancestors: The Hard Evidence*.
- . 2004. "The Dubois Collection: A New Look at an Old Collection." *Scripta Geologica* (4):267–85.
- de Vos, J. and Fachroel Aziz. 1989. "The Excavations by Dubois (1891-1900), Selenka (1906-1908) and the Geological Survey by the Indonesian-Japanese Team (1976-1977) at Trinil (Java, Indonesia)." *Journal of the Anthropological Society of Nippon* 97(3):407–20.
- de Vos, J., S. Hardjasmita, and P. Y. Sondaar. 1982. "The Fauna from Trinil, Type Locality of *Homo erectus*; A Reinterpretation." *Geologie En Mijnbouw* 16:207–16.
- de Vos, J. and V. T. Long. 2001. "First Settlements: Relations between Continental and Insular Southeast Asia." *Origine Des Peuplements et Chronologie Des Cultures Paléolithiques Dans Le Sud-Est Asiatique. Semenanjung, Paris* 225–49.
- de Vos, J., P. Y. Sondaar, Gerrit D. Van Den Bergh, and F. Aziz. 1994. "The *Homo* Bearing Deposits of Java and Its Ecological Context." *Cour. Forsch. Inst. Senckenberg* 171(1):129–40.
- Walker, Alan, Richard Leakey, and Richard E. Leakey. 1993. *The Nariokotome Homo erectus Skeleton*. Harvard University Press.
- Wallace, Alfred Russel. 1869. *The Malay Archipelago: The Land of the Orang-Utan, and the Bird of Paradise*.
- Wastl, J. 1939. "Prähistorische Menschenreste Aus Dem Muschelhügel von Bindjai-Tamiang in Nord-Sumatra." *Kultur Und Rasse* 237–43.
- Watanabe, Naotune and Darwin Kadar. 1985. *Quaternary Geology of the Hominid Fossil Bearing Formations in Java: Report of the Indonesian-Japan Joint Research Project CTA-41, 1976-1979*. Geological Research and Development Centre.
- Weidenreich, Franz. 1937. "The Dentition of *Sinanthropus Pekinensis*. A Comparative Odontography of the Hominids." *Paleont. Sinica, NsD, No. 1, Whole S.* 101:1–180.
- . 1943. "The Skull of *Sinanthropus Pekinensis*: A Comparative Study on a Primitive Hominid Skull." *Palaeontol. Sin. New Ser. D* 10(127).
- . 1945. "Giant Early Man from Java and South China." *Anthropological Papers of the American Museum of Natural History* 40:5-134.
- . 1951. "Morphology of Solo Man." *The American Museum of National History* 43(3):201–90.
- Weiner, Steve, Qinqi Xu, Paul Goldberg, Jinyi Liu, and Ofer Bar-Yosef. 1998. "Evidence for the Use of Fire at Zhoukoudian, China." *Science* 281(5374):251–53.
- Westaway, K. E., J. Louys, R. Due Awe, M. J. Morwood, G. J. Price, J. X. Zhao, M. Aubert, R. Joannes-Boyau, T. M. Smith, M. M. Skinner, T. Compton, R. M. Bailey, G. D. Van Den Bergh, J. De Vos, A. W. G. Pike, C. Stringer, E. W. Saptomo, Y. Rizal, J. Zaim, W. D. Santoso, A. Trihascaryo, L. Kinsley, and B. Sulistyanto. 2017. "An Early Modern Human Presence in Sumatra 73,000-63,000 Years Ago." *Nature* 548(7667):322–25.
- Westaway, K. E., M. J. Morwood, R. G. Roberts, A. D. Rokus, J. x. Zhao, P. Storm, F. Aziz, G. van den Bergh, P. Hadi, Jatmiko, and J. de Vos. 2007. "Age and Biostratigraphic

- Significance of the Punung Rainforest Fauna, East Java, Indonesia, and Implications for Pongo and *Homo*." *Journal of Human Evolution* 53(6):709–17.
- White, Tim D., Berhane Asfaw, David DeGusta, Henry Gilbert, Gary D. Richards, Gen Suwa, and F. Clark Howell. 2003. "Pleistocene *Homo sapiens* from Middle Awash, Ethiopia." *Nature* 423(6941):742–47.
- White, Tim D. and Pieter A. Folkens. 2005. *The Human Bone Manual*. Academic Press.
- Whitten, Anthony J., Tony Whitten, R. S. Soeriaatmadja, Roehayat Emon Soeriaatmadja, and Suraya A. Afiff. 1996. *Ecology of Java & Bali*. Vol. 2. Oxford University Press.
- Whitten, Tony and Sengli J. Damanik. 2012. *The Ecology of Sumatra*. Tuttle Publishing.
- Wibowo, U. P., Fadhlan. S. Intan, Ruly Fauzi, and Erlangga E.L. 2016. "Unggul Prasetyo Wibowo Fadhlan. S. Intan Ruly Fauzi Erlangga E. L." Pp. 46–73 in *Harimau Cave and the Long Journey of OKU Civilization*, edited by T. Simanjuntak. Yogyakarta: Gadjah Mada University Press.
- Widianto, Harry. 1991. "The Hominid Dental Remains of Java: A Metrical Study." *Bulletin of the Indo-Pacific Prehistory Association* 11:23–35.
- . 1993. "Unité et Diversité Des Hominides Fossiles de Java: Presentation de Restes Humaines Fossiles Inédits." Paris, Muséum national d'histoire naturelle.
- . 2001a. *Laporan Penelitian Song Tritis. Laporan Penelitian Arkeologi*. Yogyakarta.
- . 2001b. "The Perspective on the Evolution of Javanese *Homo erectus* Based on Morphological and Stratigraphic Characteristics." Pp. 24–45 in *Sangiran: Man, Culture, and Environment in Pleistocene Times*, edited by T. Simanjuntak, B. Prasetyo, and R. Handini. Jakarta: Yayasan Obor Indonesia.
- . 2002. "Prehistoric Inhabitants of Gunung Sewu." *Gunung Sewu in Prehistoric Times* 227–48.
- . 2006. "The Discovery of Pucangan Flakes in Sangiran." in *Paper presented at the 11th Congress of the European Association of Southeast Asian Archaeologists*. Bougon.
- . 2016. *Nafas Sangiran, Nafas Situs-Situs Hominid*. Kementerian Pendidikan dan Kebudayaan, Direktorat Jenderal Kebudayaan, Balai
- Widianto, Harry and Dominique Grimaud-hervé. 2000. "Un Nouveau Crâne Humain Fossile Dans Le Dôme de Sangiran (Java , Indonésie)." 330:883–88.
- Widianto, Harry and Truman Simanjuntak. 2009. *Sangiran Answering the World*. Ministry of Culture and Tourism.
- Widianto, Harry, Truman Simanjuntak, and Budianto Toha. 1997. *Ekskavasi Situs Gua Babi, Kabupaten Tabalong, Provinsi Kalimantan Selatan*. Pusat Penelitian Arkeologi Nasional, Balai Arkeologi Banjarmasin.
- Widianto, Harry, Budianto Toha, and Truman Simanjuntak. 2001. "The Discovery of Stone Implements in the Grenzbank: New Insights into the Chronology of the Sangiran Flake Industry." *Bulletin of the Indo-Pacific Prehistory Association [PLEISTOCENE ARCHAEOLOGY IN EAST ASIA]* 21:157–61.

- Wiradnyana, Ketut. 2008. "Laporan Hasil Penelitian Arkeologi Ekskavasi Situs Bukit Kerang Pangkalan." *Aceh Tamiang, NAD (Belum Diterbitkan)*.
- . 2010. "Pentarikhan Baru Situs Hoabinhian Dan Berbagai Kemungkinannya." (26):222–33.
- . 2016. "Hoabinhian and Austronesia: The Root of Diversity in the Western Part of Indonesia." *Eur. Sci. J.* 12:131–45.
- Wolpoff, Milford H. 1971a. "A Functional Measure of Tooth Size." *Southwestern Journal of Anthropology* 27(3):279–86.
- . 1971b. "Interstitial Wear." *Journal of Human Evolution* 69(April):123–28.
- . 1984. "Modern *Homo sapiens* Origins: A General Theory of Hominid Evolution Involving the Fossil Evidence from East Asia." *The Origins of Modern Humans* 411–84.
- . 1985. "Human Evolution at the Peripheries: The Pattern at the Eastern Edge." Pp. 355–65 in *Hominid evolution: past, present and future. In Proceedings of the Taung Diamond Jubilee International Symposium, Johannesburg and Mmabatho, South Africa, 27th January-4th February. New York: Alan R Liss. p.*
- . 1999. *Paleoanthropology*. McGraw-Hill Humanities, Social Sciences & World Languages.
- Wolpoff, Milford H., Ann Arbor U. S. A, Alan G. Thorne, Jan Jelinek, and Brno Czech Republic. 1994. "The Case for Sinking *Homo erectus* . 100 Years of Pithecanthropus Is Enough !" 341–61.
- Wolpoff, Milford H., John Hawks, and Rachel Caspari. 2000. "Multiregional, Not Multiple Origins." *American Journal of Physical Anthropology: The Official Publication of the American Association of Physical Anthropologists* 112(1):129–36.
- Wood, Bernard. 1992. "Early Hominid Species and Speciation." *Journal of Human Evolution* 22(4–5):351–65.
- . 2011a. "Did Early *Homo* Migrate "out of " or 'in to' Africa?" *Proceedings of the National Academy of Sciences of the United States of America* 108(26):10375–76.
- . 2011b. *Wiley-Blackwell Encyclopedia of Human Evolution*. John Wiley & Sons.
- Wood, B. A. and S. A. Abbott. 1983a. "Analysis of the Dental Morphology of Plio-Pleistocene Hominids. I. Mandibular Molars: Crown Area Measurements and Morphological Traits." *Journal of Anatomy* 136(Pt 1):197.
- . 1983b. "Analysis of the Dental Morphology of Plio-Pleistocene Hominids. I. Mandibular Molars: Crown Area Measurements and Morphological Traits." *Journal of Anatomy* 136(Pt 1):197–219.
- Wood, B. A., S. A. Abbott, and S. H. Graham. 1983. "Analysis of the Dental Morphology of Plio-Pleistocene Hominids. II. Mandibular Molars--Study of Cusp Areas, Fissure Pattern and Cross Sectional Shape of the Crown." *Journal of Anatomy* 137 (Pt 2)(2):287–314.
- Wood, B. A. and C. A. Engleman. 1988. "Analysis of the Dental Morphology of Plio-Pleistocene Hominids. V. Maxillary Postcanine Tooth Morphology." *Journal of Anatomy* 161:1.

- Wood, Bernard and Mark Collard. 1999. "The Human Genus." *Science* 284(5411):65–71.
- Wu, Xinzhi. 1999. "Investigating the Possible Use of Fire at Zhoukoudian, China." *Science* 283(5400):299.
- Wurster, Christopher M. and Michael I. Bird. 2016. "Barriers and Bridges: Early Human Dispersals in Equatorial SE Asia." *Geological Society Special Publication* 411(1):235–50.
- Xiao, Dongfang, Christopher J. Bae, Guanjun Shen, Eric Delson, Jennie J. H. Jin, Nicole M. Webb, and Licheng Qiu. 2014. "Metric and Geometric Morphometric Analysis of New Hominin Fossils from Maba (Guangdong, China)." *Journal of Human Evolution* 74:1–20.
- Yang, Liu. 2014. "Zhoukoudian: Geography and Culture." *Encyclopedia of Global Archaeology* 7961–65.
- Yang, Z. G., J. Z. Mou, F. Qian, X. Y. Wang, P. S. Liu, H. L. Chen, W. D. Yin, and X. S. Wei. 1985. "Study of the Late Cenozoic Strata at Zhoukoudian. In (RK Wu, ME Ren, XM Zhu, ZG Yang, CK Hu, ZC Kong, YY Xie & SS Zhao, Eds) Multi-Disciplinary Study of the Peking Man Site at Zhoukoudian."
- Yokoyama, Yuji, Christophe Falguères, François Sémah, Teuku Jacob, and Rainer Grun. 2008. "Gamma-Ray Spectrometric Dating of Late *Homo erectus* Skulls from Ngandong and Sambungmacan, Central Java, Indonesia." *Journal of Human Evolution* 55(2):274–77.
- Yondri, Lutfi. 1995. *Alat-Alat Batu Temuan Dari Daerah Tambaksari Dan Sekitarnya, Ciamis, Jawa Barat". Laporan Penelitian Prasejarah Di Daerah Tambaksari, Kabupaten Ciamis, Jawa Barat.* Bandung.
- . 1996. "Keprasejarah Tambaksari, Ciamis: Sebuah Penjajakan Berdasarkan Jejak-Jejak Arkeologisnya." in *Evaluasi Hasil Penelitian Arkeologi.* Ujungpandang.
- . 2001. "Keprasejarah Tambaksari, Ciamis: Sebuah Penjajakan Berdasarkan Jejak-Jejak Arkeologisnya." in *Ciamis: Arkeologi dan Budayanya*, edited by Endang Sri Hardiati. Bandung: Ikatan Ahli Arkeologi Indonesia.
- . 2005. "Kubur Prasejarah Temuan Dari Gua Pawon Desa Gunung Masigit, Kabupaten Bandung, Provinsi Jawa Barat, Sumbangan Data Bagi Kehidupan Prasejarah Di Sekitar Tepian Danau Bandung Purba."
- Zaim, Yahdi. 1989. "Les Formations 'Volcano-Sédimentaires' Quaternaires de La Région de Patiayam (Central Java, Indonesia)." *Theses Doktorat L'Institut de Paleontologie Humaine, Perancis, Tidak Dipublikasikan* 264.
- Zaim, Yahdi and Mireille Delaune. 1988. "La Sédimentation Du" Volcano-Sédimentaire" Quaternaire de La Région de Patiayam (Java Central-Indonésie)."
- . 1990. "Nouvelles Données Sur La Stratigraphie et Le Milieu de Sédimentation Des Formations Volcano-Sédimentaires Quaternaires de La Région de Patiayam (Java - Indonésie)." *Géodynamique* 5(2):135–50.
- Zaim, Yahdi and Rachman Ardan. 1998. "A Premolar of *Homo erectus* from Patiayam Region Central Java, Indonesia." *Buletin Geologi* 28(1–36).
- Zaim, Yahdi, Russell L. Ciochon, Joshua M. Polanski, Frederick E. Grine, E. Arthur Bettis, Yan Rizal, Robert G. Franciscus, Roy R. Larick, Matthew Heizler, Aswan, K. Lindsay Eaves, and Hannah E. Marsh. 2011. "New 1.5 Million-Year-Old *Homo erectus* Maxilla from Sangiran

- (Central Java, Indonesia).” *Journal of Human Evolution* 61(4):363–76.
- Zaim, Yahdi, Yan Rizal, and Aswan. 2007. “The Geological Background of Hominid Colonization of Java.” Pp. 92–98 in *First Islanders – Human Origins Patrimony in Southeast Asia*, edited by A.-M. Sémah and K. Setiagama. HopSea.
- Zanolli, Clément. 2011. “L’organisation Endostructurale de Restes Dentaires Humains Du Pléistocène Inférieur Final-Moyen Initial d’Indonésie et d’Afrique, Avec Une Attention Particulière à *Homo erectus* s.s. Caractérisation Comparative à Haute Résolution et Problématiques Taxinomi.” Muséum National d’Histoire Naturelle, France.
- Zanolli, Clement, Anne-marie Bacon, Luca Bondioli, Jose Braga, and Fabrice Demeter. 2014. “Lower Pleistocene Hominid Paleobiodiversity in Southeast Asia : Evidence for a Javanese Pongine Taxon Lower Pleistocene Hominid Paleobiodiversity in Southeast Asia : Evidence.” 153:67233.
- Zanolli, Clément, Luca Bondioli, Lucia Mancini, Arnaud Mazurier, Harry Widiyanto, and Roberto MacChiarelli. 2012. “Brief Communication: Two Human Fossil Deciduous Molars from the Sangiran Dome (Java, Indonesia): Outer and Inner Morphology.” *American Journal of Physical Anthropology* 147(3):472–81.
- Zanolli, Clément, Ottmar Kullmer, Jay Kelley, Anne-Marie Bacon, Fabrice Demeter, Jean Dumoncel, Luca Fiorenza, Frederick E. Grine, Jean-Jacques Hublin, Anh Tuan Nguyen, Thi Mai Huong Nguyen, Lei Pan, Burkhard Schillinger, Friedemann Schrenk, Matthew M. Skinner, Xueping Ji, and Roberto Macchiarelli. 2019. “Evidence for Increased Hominid Diversity in the Early to Middle Pleistocene of Indonesia.” *Nature Ecology & Evolution*.
- Zdansky, O. 1927. “Preliminary Notice on Two Teeth of a Hominid from a Cave in Chihli (China).” *Bull. Geol. Soc. China* 5:281–84.
- Zelditch, Miriam Leah, Jason Mezey, H. David Sheets, Barbara L. Lundrigan, and Theodore Garland. 2004. “Developmental Regulation of Skull Morphology II: Ontogenetic Dynamics of Covariance.” *Evolution and Development* 8(1):46–60.
- Zhang, Xiaoling and Chen Shen. 2014. “Zhoukoudian, Archaeology Of.” *Encyclopedia of Global Archaeology* 7958–61.
- Zhao, S. S., J. X. Pei, S. L. Guo, S. S. Liu, F. Qian, S. H. Chou, and X. G. Li. 1985. “Study of Chronology of Peking Man Site. Multi-Disciplinary Study of the Peking Man Site at Zhoukoudian: 239-240.”
- Zhu, R. X., R. Potts, Y. X. Pan, H. T. Yao, L. Q. L, X. Zhao, X. Gao, L. W. Chen, F. Gao, and C. L. Deng. 2008. “Early Evidence of the Genus *Homo* in East Asia.” *Journal of Human Evolution* 55(6):1075–85.
- Zhu, R. X., Richard Potts, Fei Xie, Kenneth A. Hoffman, Chenglong L. Deng, C. D. Shi, Yongxin X. Pan, Hui Qiu Wang, Rui Ping Shi, and Y. C. Wang. 2004. “New Evidence on the Earliest Human Presence at High Northern Latitudes in Northeast Asia.” *Nature* 431(7008):559–62.
- Zhu, Zhao-Yu, Robin Dennell, Wei-Wen Huang, Yi Wu, Zhi-Guo Rao, Shi-Fan Qiu, Jiu-Bing Xie, Wu Liu, Shu-Qing Fu, and Jiang-Wei Han. 2015. “New Dating of the *Homo erectus* Cranium from Lantian (Gongwangling), China.” *Journal of Human Evolution* 78:144–57.

APPENDIX A. WEAR PATTERN

1. Teeth on the Maxillary Arc a. Pleistocene Hominin

Sangiran

NO	LOCALITY	NO. COL	SIDING	UI1	UI2	UC	UP3	UP4	UM1	UM2	UM3
1	Sangiran Dome	Sangiran 1a	Left	-	-	-	-	-	-	?	3
2	Glagah Ombo	Sangiran 4	Left	-	-	3	2	2	3	-	-
			Right	-	-	3	2	2	3	2	1
3	Sangiran Dome	Sangiran 7-3abc	Right	-	-	-	-	3	3	2	2
4	Sangiran Dome	Sangiran 7-35	Left	-	-	2	2	-	-	-	-
5	Sangiran Dome	Sangiran 7-36	Right	-	-	3	-	-	-	-	-
6	Sangiran Dome	Sangiran 7-37	Right	-	-	-	-	?	3	-	-
7	Ngrejeng	Sangiran 15a	Left	-	-	-	3	2	-	-	-
8	Sangiran Dome	Sangiran 15b	Right	-	-	-	?	4	-	-	-
9	Pucung	Sangiran 17	Left	-	-	-	3	-	-	-	-
			Right	-	-	3	-	-	3	2	2
10	Sangiran Dome	Sangiran 27	Left	-	-	-	-	?	4	3	2
			Right	-	-	-	?	?	3	3	
11	Tanjung	Tjg 1993.05	Right	-	-	-	?	3	3	2	2
12	Grogolwetan	Grogolwetan	Left	3	3	3	-	-	-	-	-
			Right	-	-	3	4	4	-	2	2
13	Bapang	Bpg 2001.04	Left	-	-	-	3	2	3	2	-

Table A.1. Wear pattern of upper teeth from Sangiran. Note: (-) the tooth does not exist, (?) the tooth exists but not complete, so it is difficult to do a proper observation.

The observation shows that all of 48 teeth preserved from the maxillary fragments of Sangiran dome could be included in the further analysis. The rest of the seven uncomplete teeth could not be included (Table A.1).

Wajak

NO	LOCALITY	NO. COL	SIDING	UI1	UI2	UC	UP3	UP4	UM1	UM2	UM3
1	Wajak	Wajak 1	Left	-	-	-	-	-	-	2	1
			Right	-	-	-	3	2	3	2	1
2	Wajak	Wajak 2	Left	-	-	3	3	3	3	2	2
			Right	-	-	3	3	3	-	2	2

Table A.2. Wear pattern of upper teeth from Wajak Pleistocene hominin. Note: (-) the tooth does not exist.

The observation shows that all of the 18 teeth preserved from the maxillary fragments of Wajak Pleistocene hominin could be included in the further analysis (Table A.2).

b. Holocene *Homo sapiens*

Tamiang Shellmidden

NO	LOCALITY	NO. IDV	SIDING	UI1	UI2	UC	UP3	UP4	UM1	UM2	UM3
1	Tamiang	TMG A1C	Right	3	-	-	3	-	3	2	-

Table A.3. Wear pattern of upper teeth from Tamiang Shellmidden. Note: (-) the tooth does not exist.

The observation shows that all of the 4 teeth preserved from the maxillary fragments of Tamiang site could be included in the further analysis (Table A.3).

Sukajadi Shellmidden

NO	LOCALITY	NO. IDV	SIDING	UI1	UI2	UC	UP3	UP4	UM1	UM2	UM3
1	Sukajadi	SKJ 3	Left	-	8	5	3	3	3	3	-
			Right	-	7	4	4	3	-	-	-
2	Sukajadi	SKJ 6a	Left	3	-	-	-	3	4	-	-
			Right	-	-	-	-	3	5	4	3
3	Sukajadi	SKJ 6b	Left	-	-	-	3	2	4	4	-
			Right	-	8	-	-	-	4	-	-

Table A.4. Wear pattern of upper teeth from Sukajadi shellmidden. Note: (-) the tooth does not exist.

The observation shows 18 of 23 teeth preserved from the maxillary fragments of Sukajadi site could be included in the further analysis. The rest of 5 heavy worn teeth could not be included in the analysis (Table A.4).

Gua Harimau

NO	LOCALITY	NO. IDV	SIDING	UI1	UI2	UC	UP3	UP4	UM1	UM2	UM3
1	Harimau	HRM 10	Right	-	-	-	2	2	-	1	-
2	Harimau	HRM 12	Left	-	4	4	3	-	3	2	2
3	Harimau	HRM 13	Left	5	6	5	6	-	5	?	-
			Right	5	7	5	-	-	6	-	-
4	Harimau	HRM 17	Right	-	-	3	2	2	1	-	-
5	Harimau	HRM 21	Left	3	3	-	-	2	3	2	1
			Right	-	-	-	-	3	3	2	1
6	Harimau	HRM 22	Left	-	-	-	2	-	-	-	-
7	Harimau	HRM 24	Left	-	-	-	2	-	-	-	-
			Right	-	-	3	3	3	4	-	-
8	Harimau	HRM 25	Left	-	-	-	-	-	1	-	-
9	Harimau	HRM 36	Left	-	-	3	2	-	4	3	-
			Right	3	-	-	3	3	4	3	-
10	Harimau	HRM 60	Left	-	-	-	2	2	-	-	-
			Right	-	-	-	-	2	4	-	-
11	Harimau	HRM 74	Left	5	4	4	5	5	6	4	

			Right	4	4	4	4	3	?	5	5
12	Harimau	HRM 79	Left	4	3	3	4	3	5	4	?
			Right	4	3	3	4	3	6	-	-

Table A.5. Wear pattern of upper teeth from Gua Harimau. Note: (-) the tooth does not exist, (?) the tooth exists but not complete, so it is difficult to do a proper observation.

The observation shows 62 of 82 teeth preserved from the maxillary fragments of Gua Harimau site could be included in the further analysis. The rest of 20 heavy worn and incomplete teeth could not be included in the analysis (Table A.5).

Gua Pawon

NO	LOCALITY	NO. IDV	SIDING	UI1	UI2	UC	UP3	UP4	UM1	UM2	UM3
1	Gua Pawon	PWN 1	Left	-	-	-	3	3	4	3	-
2	Gua Pawon	PWN 3	Left	4	4	4	4	4	6	4	2
			Right	-	-	3	4	-	-	-	-
3	Gua Pawon	PWN 5	Left	3	3	-	-	-	-	-	-

Table A.6. Wear pattern of upper teeth from Gua Pawon. Note: (-) the tooth does not exist.

The observation shows 15 of 16 teeth preserved from the maxillary fragments of Gua Pawon site could be included in the further analysis. The rest of 1 heavy worn tooth could not be included in the analysis (Table A.6).

Gua Kidang

NO	LOCALITY	NO. COL	SIDING	UI1	UI2	UC	UPM3	UPM4	UM1	UM2	UM3
1	Gua Kidang	GKD 3	Left	4	4	5	6	6	6	4	3
			Right	4	4	5	6	6	6	4	3

Table A.7. Wear pattern of upper teeth from Gua Kidang.

The observation shows 8 of 16 teeth preserved from the maxillary fragments of Gua Kidang site could be included in the further analysis. The rest of 8 heavy worn teeth could not be included in the analysis (Table A.7).

Song Keplek

NO	LOCALITY	NO. COL	SIDING	UI1	UI2	UC	UP3	UP4	UM1	UM2	UM3
1	Song Keplek	SK 1	Left	3	3	3	3	2	3	2	1
			Right	-	-	-	-	-	3	2	1
2	Song Keplek	SK 4	Left	3	3	3	3	2	3	2	2
			Right	3	3	3	3	2	3	2	2
3	Song Keplek	SK 5	Left	4	-	-	-	3	4	3	2
			Right	4	-	-	3	3	4	3	2

Table A.8. Wear pattern of upper teeth from Song Keplek. Note: (-) the tooth does not exist.

The observation shows all of 38 teeth preserved from the maxillary fragments of Song Keplek site could be included in the further analysis (Table A.8).

Gua Braholo

NO	LOCALITY	NO. COL	SIDING	UI1	UI2	UC	UP3	UP4	UM1	UM2	UM3
1	Gua Braholo	BHL 1	Left	3	-	-	-	-	3	2	-
			Right	3	-	3	3	2	3	2	2
2	Gua Braholo	BHL 4	Left	-	-	-	3	3	3	2	-
			Right	-	-	-	-	-	-	-	1
3	Gua Braholo	BHL 7	Left	3	2	-	-	1	-	-	-
			Right	3	2	2	-	1	-	1	-

Table A.9. Wear pattern of upper teeth from Gua Braholo. Note: (-) the tooth does not exist.

The observation shows all of 23 teeth preserved from the maxillary fragments of Gua Braholo site could be included in the further analysis (Table A.9).

Song Terus

NO	LOCALITY	NO. COL	SIDING	UI1	UI2	UC	UP3	UP4	UM1	UM2	UM3
1	Song Terus	ST 1	Left	-	7	8	6	5	5	4	6
			Right	8	6	6	7	-	8	4	2

Table A.10. Wear pattern of upper teeth from Song Terus. Note: (-) the tooth does not exist.

The observation shows only 3 of 14 teeth preserved from the maxillary fragment of Song Terus site could be included in the further analysis. The rest of 11 heavy worn teeth could not be included in the analysis (Table A.10).

Wajak Complex

NO	LOCALITY	NO. IDV	SIDING	UI1	UI2	UC	UPM3	UPM4	UM1	UM2	UM3
1	Goea Djimbe	Djimbe 17321	Left	-	-	3	4	4	5	2	-
2	Goea Djimbe	Djimbe 17321	Right	-	3	3	5	5	5	2	-
3	Goea Djimbe	Djimbe 17322	Right	-	-	3	4	4	5	4	-
4	Goea Ketjil	Ketjil 17796	Left	-	-	5	6	5	6	-	-
5	Goea Ketjil	Ketjil 17796	Right	-	-	5	6	5	6	5	-
6	Hoekgrot	Hoekgrot 17410	Left	-	-	-	-	-	3	2	2
7	Hoekgrot	Hoekgrot 17411	Right	-	-	-	-	-	3	2	2
8	Hoekgrot	Hoekgrot 17474	Left	-	-	2	1	-	-	-	-

Table A.11. Wear pattern of upper teeth from Wajak Holocene *Homo sapiens*. Note: (-) the tooth does not exist.

The observation shows 19 of 33 teeth preserved from the maxillary fragments of Wajak complex site could be included in the further analysis. The rest of 14 heavy worn teeth could not be included in the analysis (Table A.11).

2. Teeth on the Mandible Arc

a. Pleistocene Hominin

Kedungbrubus

NO	LOCALITY	NO. COL	SIDING	LI1	LI2	LC	LP3	LP4	LM1	LM2	LM3
1	Kedungbrubus	Kedungbrubus 1	Right	-	-	8	-	-	-	-	-

Table A.12. Wear pattern of lower teeth from Kedungbrubus. Note: (-) the tooth does not exist.

The observation shows there is no tooth preserved from the mandible fragment of Kedungbrubus site could be included in the further analysis (Table A.12).

Sangiran

NO	LOCALITY	NO. COL	SIDING	LI1	LI2	LC	LP3	LP4	LM1	LM2	LM3
1	Bukuran	Sangiran 1b	Right	-	-	-	-	3	3	2	1
2	Ngebung	Sangiran 5	Right	-	-	-	-	-	5	3	-
3	Glagah Ombo	Sangiran 6a	Right	-	-	-	2	3	3	-	-
4	Bukuran	Sangiran 6b	Left	-	-	-	-	-	-	5	4
5	Sangiran Dome	Sangiran 7-70	Left	-	-	-	-	-	?	4	3
6	Glagah Ombo	Sangiran 8	Right	-	-	-	-	-	-	-	2
7	Bojong	Sangiran 9	Right	-	-	3	3	3	-	2	2
8	Ngebung	Sangiran 21	Right	-	-	-	-	-	-	-	2
9	Sangiran	Sangiran 22b	Left	-	4	3	3	3	4	3	2
			Right	-	-	4	3	3	5	3	2
10	Blimbinkulon	Sangiran 33	Right	-	-	-	-	-	-	2	-
11	Sendangbusik	Sangiran 37	Right	-	-	-	-	3	3	2	1
12	Ngrejeng	Ng 8503	Right	-	-	-	-	-	1	0	-
13	Blimbinkulon	Sangiran 39	Right	-	-	-	-	-	-	-	2
14	Ngebung 1	Ardjuna 9	Right	-	-	-	-	-	-	2	2
15	Ngebung	Hanoman 13	Left	-	-	-	-	-	-	-	8
16	Sangiran Dome	Sangiran XX	Left	-	-	-	-	-	3	?	?

Table A.13. Wear pattern of lower teeth from Sangiran. Note: (-) the tooth does not exist, (?) the tooth exists but not complete, so it is difficult to do a proper observation.

The observation shows 41 of 48 teeth preserved from the mandible fragments of Sangiran site could be included in the further analysis. The rest of 7 heavy worn and uncomplete teeth could not be included in the analysis (Table A.13).

Wajak

NO	LOCALITY	NO. COL	SIDING	LI1	LI2	LC	LP3	LP4	LM1	LM2	LM3
1	Wajak	Wajak 1	Right	-	-	-	-	-	3	2	1
2	Wajak	Wajak 2	Left	3	3	3	3	-	4	2	1
			Right	3	3	-	-	3	4	2	-

Table A.14. Wear pattern of lower teeth from Wajak Pleistocene hominin. Note: (-) the tooth does not exist.

The observation shows all of 15 teeth preserved from the mandible fragments of Wajak Pleistocene hominin could be included in the further analysis (Table A.14).

Zhoukoudian

NO	LOCALITY	NO. COL	SIDING	LI1	LI2	LC	LP3	LP4	LM1	LM2	LM3
1	Zhoukoudian	Sp B1	Left	3	3	4	-	-	-	-	-
			Right	3	2	3	2	?	-	-	-
2	Zhoukoudian	Sp B2	Left	3	2	4	-	-	-	-	-
			Right	3	3	3	4	3	1	-	-
3	Zhoukoudian	Sp F1.5	Right	-	-	-	-	-	-	2	1
4	Zhoukoudian	Sp G1	Left	4	4	4	3	2	5	2	1
5	Zhoukoudian	Sp G2	Right	-	-	-	-	-	-	6	6
6	Zhoukoudian	Sp H4	Right	-	5	5	8	7	5	-	-
7	Zhoukoudian	Sp R2	Right	-	-	-	-	-	4	3	2

Table A.15. Wear pattern of lower teeth from Zhoukoudian. Note: (-) the tooth does not exist, (?) the tooth exists but not complete, so it is difficult to do a proper observation.

The observation shows 28 of 37 teeth preserved from the mandible fragments of Zhoukoudian site could be included in the further analysis. The rest of 9 heavy worn and incomplete teeth could not be included in the analysis (Table A.15).

b. Holocene *Homo sapiens*

Tamiang Shellmidden

NO	LOCALITY	NO. COL	SIDING	LI1	LI2	LC	LP3	LP4	LM1	LM2	LM3
1	Tamiang	TMG A1C	Left	-	3	-	2	2	2	2	-
			Right	-	-	3	3	3	4	-	-

Table A.16. Wear pattern of lower teeth from Tamiang Shellmidden. Note: (-) the tooth does not exist.

The observation shows all of 9 teeth preserved from the mandible fragments of Tamiang site could be included in the further analysis (Table A.16).

Sukajadi Shellmidden

NO	LOCALITY	NO. COL	SIDING	LI1	LI2	LC	LP3	LP4	LM1	LM2	LM3
1	Sukajadi	SKJ 3	Left	5	5	5	3	3	3	4	-
			Right	5	5	5	3	3	3	4	3
2	Sukajadi	SKJ 4a	Left	-	8	8	-	8	3	2	-
3	Sukajadi	SKJ 4b	Right	-	-	-	-	-	-	2	-
4	Sukajadi	SKJ X	Left	-	-	4	3	3	4	-	3
			Right	-	-	-	3	2	3	3	2

Table A.17. Wear pattern of lower teeth from Sukajadi Shellmidden. Note: (-) the tooth does not exist.

The observation shows 22 of 31 teeth preserved from the mandible fragments of Sukajadi site could be included in the further analysis. The rest of 9 heavy worn teeth could not be included in the analysis (Table A.17).

Gua Harimau

NO	LOCALITY	NO. COL	SIDING	LI1	LI2	LC	LP3	LP4	LM1	LM2	LM3
1	Gua Harimau	HRM 1	Left	-	-	0	0	1	1	0	0
2	Gua Harimau	HRM 8	Right	-	-	-	-	-	-	4	-
3	Gua Harimau	HRM 9	Right	-	-	-	-	-	5	-	-
4	Gua Harimau	HRM 12	Left	3	4	4	4	-	-	2	-
			Right	3	3	3	3	4	5	2	-
5	Gua Harimau	HRM 17	Left	-	-	-	-	-	1	1	-
6	Gua Harimau	HRM 21	Left	3	3	3	-	-	4	-	1
			Right	3	3	-	3	3	3	2	1
7	Gua Harimau	HRM 22	Left	-	-	-	2	-	-	-	-
8	Gua Harimau	HRM 23	Left	-	-	-	-	-	-	2	0
			Right	3	3	3	2	2	2	-	0
9	Gua Harimau	HRM 24	Right	-	4	4	4	5	-	-	-
10	Gua Harimau	HRM 25	Left	-	-	-	-	-	1	-	-
11	Gua Harimau	HRM 37	Left	-	3	3	3	-	4	3	-
			Right	-	-	3	3	-	4	3	2
12	Gua Harimau	HRM 74	Left	-	3	-	-	4	6	5	5
			Right	-	3	4	4	4	6	5	-
13	Gua Harimau	HRM 79	Left	3	3	3	3	4	5	-	-
			Right	3	-	3	3	4	5	3	-

Table A.18. Wear pattern of lower teeth from Gua Harimau. Note: (-) the tooth does not exist.

The observation shows 72 of 82 teeth preserved from the mandible fragments of Gua Harimau site could be included in the further analysis. The rest of 10 heavy worn teeth could not be included in the analysis (Table A.18).

Gua Pawon

NO	LOCALITY	NO. COL	SIDING	LI1	LI2	LC	LP3	LP4	LM1	LM2	LM3
1	Gua Pawon	PWN 1	Left	-	-	-	-	-	4	2	1
2	Gua Pawon	PWN 3	Left	-	-	-	-	-	-	5	2
3	Gua Pawon	PWN 4	Left	-	-	-	-	5	-	3	2
			Right	-	-	3	5	5	-	-	-
4	Gua Pawon	PWN 5	Left	-	-	3	2	2	3	?	1
			Right	-	2	3	2	-	3	?	1

Table A.19. Wear pattern of lower teeth from Gua Pawon. Note: (-) the tooth does not exist, (?) the tooth exists but not complete, so it is difficult to do a proper observation.

The observation shows 17 of 23 teeth preserved from the mandible fragments of Gua Pawon site could be included in the further analysis. The rest of 6 heavy worn and incomplete teeth could not be included in the analysis (Table A.19).

Gua Braholo

NO	LOCALITY	NO. COL	SIDING	LI1	LI2	LC	LP3	LP4	LM1	LM2	LM3
1	Gua Braholo	BHL 1	Left	-	-	-	-	-	3	2	-
			Right	3	3	3	3	3	3	-	-
2	Gua Braholo	BHL 5	Left	2	2	2	2	2	3	2	?
			Right	2	2	2	2	2	2	2	-
3	Gua Braholo	BHL F7	Left	-	-	-	-	-	2	-	-
			Right	-	-	-	-	-	3	2	1

Table A.20. Wear pattern of lower teeth from Gua Braholo. Note: (-) the tooth does not exist, (?) the tooth exists but not complete, so it is difficult to do a proper observation.

The observation shows 26 of 27 teeth preserved from the mandible fragments of Gua Braholo site could be included in the further analysis. The rest of 1 incomplete teeth could not be included in the analysis (Table A.20).

Song Tritis

NO	LOCALITY	NO. COL	SIDING	LI1	LI2	LC	LP3	LP4	LM1	LM2	LM3
1	Song Tritis	STR 1	Left	7	7	6	6	5	5	3	4
			Right	6	5	5	3	3	4	3	3

Table A.21. Wear pattern of lower teeth from Song Tritis.

The observation shows only 7 of 16 teeth preserved from the mandible fragment of Song Tritis site could be included in the further analysis. The rest of 9 heavy worn teeth could not be included in the analysis (Table A.21).

Song Terus

NO	LOCALITY	NO. COL	SIDING	LI1	LI2	LC	LP3	LP4	LM1	LM2	LM3
1	Song Terus	ST 1	Left	-	-	3	5	5	6	4	5
			Right	8	7	7	8	8	8	4	4

Table A.22. Wear pattern of lower teeth from Song Terus. Note: (-) the tooth does not exist.

The observation shows only 4 of 14 teeth preserved from the mandible fragment of Song Terus site could be included in the further analysis. The rest of 10 heavy worn teeth could not be included in the analysis (Table A.22).

Song Keplek

NO	LOCALITY	NO. COL	SIDING	LI1	LI2	LC	LP3	LP4	LM1	LM2	LM3
1	Song Keplek	SK 4	Left	3	3	3	3	3	3	2	2
			Right	3	3	3	3	3	3	2	2
2	Song Keplek	SK 5	Left	3	3	3	3	3	4	4	3
			Right	3	3	3	3	2	4	4	3

Table A.23. Wear pattern of lower teeth from Song Keplek.

The observation shows all of 32 teeth preserved from the mandible fragments of Song Keplek site could be included in the further analysis (Table A.23).

Gua Kidang

NO	LOCALITY	NO. COL	SIDING	LI1	LI2	LC	LP3	LP4	LM1	LM2	LM3
1	Gua Kidang	GKD 3	Left	4	4	5	6	6	6	5	3
			Right	4	4	5	6	6	7	4	2

Table A.24. Wear pattern of lower teeth from Gua Kidang.

The observation shows only 7 of 16 teeth preserved from the mandible fragments of Gua Kidang site could be included in the further analysis. The rest of 9 heavy worn teeth could not be included in the analysis (Table A.24).

Wajak Complex

NO	LOCALITY	NO. COL	SIDING	LI1	LI2	LC	LPM3	LPM4	LM1	LM2	LM3
1	Goea Djimbe	Djimbe 17324	Left	3	3	3	3	3	4	3	2
2	Goea Djimbe	Djimbe 17324	Right	3	3	3	3	3	4	2	2
3	Goea Ketjil	Ketjil 17797	Right	-	-	-	5	6	6	4	-
4	Goea Ketjil	Ketjil 17798	Left	-	-	-	-	-	6	5	2

Table A.25. Wear pattern of lower teeth from Wajak Holocene *Homo sapiens*. Note: (-) the tooth does not exist.

The observation shows 18 of 23 teeth preserved from the mandible fragments of Wajak complex site could be included in the further analysis. The rest of 5 heavy worn teeth could not be included in the analysis (Table A.25).

3. Isolated Upper Teeth

a. Pleistocene Hominin

Trinil

NO	LOCALITY	NO. COL	SIDING	GRADE
1	Trinil	Trinil 1	URM3	1
2	Trinil	Trinil 4	ULM2/3	2

Table A.26. Wear pattern of isolated upper teeth from Trinil.

The observation shows all of 2 isolated upper teeth from the Trinil site could be included in the further analysis (Table A.26).

Sangiran

NO	LOCALITY	NO. COL	CATEGORY	GRADE
1	Sangiran Dome	Sangiran 7-1	URI1	4
2	Sangiran Dome	Sangiran 7-2	ULI2	4
3	Sangiran Dome	Sangiran 7-3a	URP4	3
4	Sangiran Dome	Sangiran 7-3b	URM1	3
5	Sangiran Dome	Sangiran 7-3c	URM2	2
6	Sangiran Dome	Sangiran 7-3d	URM3	2
7	Sangiran Dome	Sangiran 7-6	ULM3	2
8	Sangiran Dome	Sangiran 7-8	ULM1	4
9	Sangiran Dome	Sangiran 7-9	URM1	2
10	Sangiran Dome	Sangiran 7-10	URM1	3
11	Sangiran Dome	Sangiran 7-13	ULm2	1
12	Sangiran Dome	Sangiran 7-14	URM1/2	3
13	Sangiran Dome	Sangiran 7-17	URM3	3
14	Sangiran Dome	Sangiran 7-27	ULP3	3
15	Sangiran Dome	Sangiran 7-29	URP4	3
16	Sangiran Dome	Sangiran 7-30	URP4	3
17	Sangiran Dome	Sangiran 7-31	ULP3	2
18	Sangiran Dome	Sangiran 7-32	URP3	3
19	Sangiran Dome	Sangiran 7-34	ULP3	1
20	Sangiran Dome	Sangiran 7-38	ULM1	4
21	Sangiran Dome	Sangiran 7-40	URM1	2
22	Sangiran Dome	Sangiran 7-45	URC	4
23	Sangiran Dome	Sangiran 7-46	UR/LC	5
24	Sangiran Dome	Sangiran 7-47	ULC	3
25	Sangiran Dome	Sangiran 7-48	URI1	6
26	Sangiran Dome	Sangiran 7-50	ULI2/LRI2	4
27	Sangiran Dome	Sangiran 7-53	ULM2	2
28	Sangiran Dome	Sangiran 7-56	ULI2	5
29	Sangiran Dome	Sangiran 7-58	ULP3	2
30	Sangiran Dome	Sangiran 7-73	ULM3	2

31	Sangiran Dome	Sangiran 7-83	ULdc	?
32	Sangiran Dome	Sangiran 7-85	URI1	4
33	Sangiran Dome	Sangiran 7-86	URI1	4
34	Sangiran Dome	Sangiran 7-89	URM2	2
35	Sangiran Dome	Sangiran 11b	ULM3	?
36	Sangiran Dome	Sangiran 16b	ULP3/4	stone
37	Sangiran Dome	Sangiran 35	URM2	?
38	Ngebung	Ardjuna 1a	URM2	Lost ?
39	Ngebung	Ardjuna 1b	ULM2	Lost ?
40	Ngebung	Ardjuna 1c	URM1	Lost ?
41	Ngebung	Ardjuna 12	ULM2	Lost ?
42	Ngebung	Sangiran 48	ULM2	3
43	Ngebung	NG 9107.1	URM3	1
44	Ngebung	NG 92.3	URM1	2
45	Ngebung	NG 9505	URP3/4	3
46	Ngrejeng	Ng 9603	URM1	3
47	Pucung	PCG.1	ULdm1	2
48	Ngrejeng	Njg 2005.05	ULM3	2
49	Padas	PDS 0712	URM2/3	2
50	Ngebung	NG 0802.1	URM2	2
51	Pancuran	MI 92.2	URM2	6
52	Pucung	Abimanyu 2	URM1	2

Table A.27. Wear pattern of isolated upper teeth from Sangiran. Note: (?) the tooth exists but not complete, so it is difficult to do a proper observation.

The observation shows 40 of 52 isolated upper teeth from Sangiran site could be included in the further analysis. The rest of 12 heavy worn, lost, uncomplete and missed identification teeth could not be included in the analysis (Table A.27).

Lida Ajer

NO	LOCALITY	NO. COL	CATEGORY	GRADE
1	Lida Ajer	Lida Ajer 11471	URI1	3
2	Lida Ajer	Lida Ajer 11472	ULM2	2

Table A.28. Wear pattern of isolated upper teeth from Lida Ajer

The observation shows all of 2 isolated upper teeth from the Lida Ajer site could be included in the further analysis (Table A.28).

Zhoukoudian

NO	LOCALITY	NO. COL	CATEGORY	GRADE
1	Zhoukoudian	Sp 2	URI1	4
2	Zhoukoudian	Sp 4	ULI1	3
3	Zhoukoudian	Sp 6	URI2	2
4	Zhoukoudian	Sp 13	ULC	1
5	Zhoukoudian	Sp 14	URC	2
6	Zhoukoudian	Sp 15	URC	2
7	Zhoukoudian	Sp 19	URP3	2
8	Zhoukoudian	Sp 25	ULP4	1
9	Zhoukoudian	Sp 28	URP4	2
10	Zhoukoudian	Sp 33	ULM1	3
11	Zhoukoudian	Sp 41	ULM2	3
12	Zhoukoudian	Sp 46	URM3	3
13	Zhoukoudian	Sp 140	ULM1	1

Table A.29. Wear pattern of isolated upper teeth from Zhoukoudian

The observation shows all of 13 isolated upper teeth from the Zhoukoudian site could be included in the further analysis (Table A.29).

b. Holocene *Homo sapiens*

Gua Braholo

NO	LOCALITY	NO. COL	CATEGORY	GRADE
1	Gua Braholo	BHL 97-F4-12	URC	2
2	Gua Braholo	BHL 97-F4-20	URC	3
3	Gua Braholo	BHL H8 410	URM2	5
4	Gua Braholo	BHL H8 412	URM3	2

Table A.30. Wear pattern of isolated upper teeth from Gua Braholo

The observation shows 3 of 4 isolated upper teeth from Gua Braholo site could be included in the further analysis. The rest of 1 heavy worn tooth could not be included in the analysis (Table A.30).

Song Terus

NO	LOCALITY	NO. COL	CATEGORY	GRADE
1	Song Terus	ST 96-M10-457a	URM2	2
2	Song Terus	ST 96-M11-299	ULM1	1
3	Song Terus	ST 96-M11-1802	URM2	2
4	Song Terus	ST 97-M10-2882	URI2	1
5	Song Terus	ST 99-O12-457	ULdm1	4
6	Song Terus	ST 04 M10 13JU2	ULdm1	5
7	Song Terus	ST 04-K9-8638	URM2	3

Table A.31. Wear pattern of isolated upper teeth from Song Terus

The observation shows 6 of 7 isolated upper teeth from Song Terus site could be included in the further analysis. The rest of 1 heavy worn tooth could not be included in the analysis (Table A.31).

Wajak Complex

NO	LOCALITY	NO. COL	CATEGORY	GRADE
1	Goea Djimbe	Djimbe 17323	ULC	3
2	Hoekgrot	Hoekgrot 17465	URI1	3
3	Hoekgrot	Hoekgrot 17466	URI1	3
4	Hoekgrot	Hoekgrot 17467	URI2	2
5	Hoekgrot	Hoekgrot 17468	URI2	2
6	Hoekgrot	Hoekgrot 17471	URC	2
7	Hoekgrot	Hoekgrot 17472	URC	3
8	Hoekgrot	Hoekgrot 17473	ULC	3
9	Hoekgrot	Hoekgrot 17475	URP3	2
10	Hoekgrot	Hoekgrot 17476	UP4	3

Table A.32. Wear pattern of isolated upper teeth from Wajak Holocene caves

The observation shows all of 10 isolated upper teeth from the Wajak complex site could be included in the further analysis (Table A.32).

4. Isolated Lower Teeth

a. Pleistocene Hominin

Trinil

NO	LOCALITY	NO. COL	SIDING	GRADE
1	Trinil	Trinil 5	LLP3	3

Table A.33. Wear pattern of isolated lower teeth from Trinil.

The observation shows 1 isolated lower tooth from the Trinil site could be included in the further analysis (Table A.33).

Sangiran

NO	LOCALITY	NO. COL	CATEGORY	GRADE
1	Sangiran Dome	Sangiran 7-18	LRI2	2
2	Sangiran Dome	Sangiran 7-20	LLM1/2	2
3	Sangiran Dome	Sangiran 7-25	LRP3	3
4	Sangiran Dome	Sangiran 7-26	LRP3	1
5	Sangiran Dome	Sangiran 7-42	LRM1	3
6	Sangiran Dome	Sangiran 7-43	LLM1	2
7	Sangiran Dome	Sangiran 7-57	LLI2	2
8	Sangiran Dome	Sangiran 7-59	LLC	4
9	Sangiran Dome	Sangiran 7-61	LRM1	3
10	Sangiran Dome	Sangiran 7-62	LRM1/2	2
11	Sangiran Dome	Sangiran 7-64	LRM2	2
12	Sangiran Dome	Sangiran 7-65	LRM2	1
13	Sangiran Dome	Sangiran 7-67	LRdm1	4
14	Sangiran Dome	Sangiran 7-69	LRP3	2
15	Sangiran Dome	Sangiran 7-72	LRdm2	1
16	Sangiran Dome	Sangiran 7-75	LLI1	4
17	Sangiran Dome	Sangiran 7-76	LRM1	2
18	Sangiran Dome	Sangiran 7-78	LLM1/2	2
19	Sangiran Dome	Sangiran 7-84	LRM2	3
20	Sangiran Dome	Sangiran 7-88	LLI2	2
21	Sangiran Dome	Sangiran 11a	LRI1	?
22	Sangiran Dome	Sangiran 16a	LL/RM2	stone
23	Sangiran Dome	Sangiran 35	URM2	?
24	Sangiran Dome	SA 7600	LLM3	3
25	Sangiran Dome	JA 7801	LRM1	3
26	Sangiran Dome	Sangiran 1982	LLM3	1
27	Ngebung	Ardjuna 5	LRM3	Lost ?
28	Ngebung	Ardjuna 8	LRM2	Lost ?
29	Ngebung	Ardjuna 10	LLM2	Lost ?
30	Sangiran Dome	Brahmana 13	LRI1	Lost ?
31	Ngebung	NG 9107.2	LLM3	2

32	Ngebung	NG 92.1	LLM3	3
33	Ngebung	NG 92.2	LLM1	3
34	Ngebung	NG 92.4	LRM2	4
35	Ngebung	NG 92 D6	LRM2	2
36	Sendangklampok	Nk 9603	LRM2	2
37	Sendangbusik	Sangiran 58	LLI1	?
38	Bukuran	Bs 9706	LLI1	2
39	Pucung	PCG.2	LLdm2	3
40	Ngebung	NG 0802.2	LLM2/3	1
41	Ngebung	NG 0802.3	LLM3	2
42	Pancuran	MI 92.1	LRM1	4
43	Pucung	Abimanyu 1	LLM2	2
44	Pucung	Abimanyu 4	LLM1	1

Table A.34. Wear pattern of isolated lower teeth from Sangiran. Note: (?) the tooth exists but not complete, so it is difficult to do a proper observation.

The observation shows 36 of 44 isolated lower teeth from Sangiran site could be included in the further analysis. The rest of 8 heavy worn, lost, uncomplete and missed identification teeth could not be included in the analysis (Table A.34).

Patiayam

NO	LOCALITY	NO. COL	CATEGORY	GRADE
1	Slumprit	Patiayam 1	LLP3	3

Table A.35. Wear pattern of isolated lower teeth from Patiayam.

The observation shows 1 isolated lower tooth from the Patiayam site could be included in the further analysis (Table A.33).

Rancah

NO	LOCALITY	NO. COL	CATEGORY	GRADE
1	Tambaksari	Rancah Hominid 1	LRI2	3

Table A.36. Wear pattern of isolated lower teeth from Rancah

The observation shows 1 isolated lower tooth from the Rancah site could be included in the further analysis (Table A.36).

Zhoukoudian

NO	LOCALITY	NO. COL	CATEGORY	GRADE
1	Zhoukoudian	Sp 8	LLI2	1
2	Zhoukoudian	Sp 10	LRI2	1
3	Zhoukoudian	Sp 17	LLC	5
4	Zhoukoudian	Sp 20	LRP3	2
5	Zhoukoudian	Sp 29	LRP4	2
6	Zhoukoudian	Sp 36	LLM1	2
7	Zhoukoudian	Sp 38	LLM1	4
8	Zhoukoudian	Sp 40	LLM2	2
9	Zhoukoudian	Sp 43	LLM2	2
10	Zhoukoudian	Sp 44	LLM2	2
11	Zhoukoudian	Sp 45	LRM2	3
12	Zhoukoudian	Sp 51	LRM3	2
13	Zhoukoudian	Sp 52	LLM3	2
14	Zhoukoudian	Sp 70	LLC	3
15	Zhoukoudian	Sp 80	LRP3	2
16	Zhoukoudian	Sp 82	LRP3	2
17	Zhoukoudian	Sp 89	LRP4	2
18	Zhoukoudian	Sp 90	LRP4	2
19	Zhoukoudian	Sp 131	LRM3	3
20	Zhoukoudian	Sp 137	LLM1	2
21	Zhoukoudian	Sp 139	LLM2	3
22	Zhoukoudian	Sp 185	LRI1	3

Table A.37. Wear pattern of isolated lower teeth from Zhoukoudian

The observation shows 21 of 22 isolated lower teeth from Zhoukoudian site could be included in the further analysis. The rest of 1 heavy worn tooth could not be included in the analysis (Table A.37).

b. Holocene *Homo sapiens*

Gua Braholo

NO	LOCALITY	NO. COL	CATEGORY	GRADE
1	Gua Braholo	BHL 97-F4-17	LRM2	3
2	Gua Braholo	BHL 98-I7-19	LRP4	1
3	Gua Braholo	BHL H8 411	LRM3	3

Table A.38. Wear pattern of isolated lower teeth from Gua Braholo.

The observation shows all of 3 isolated lower teeth from the Gua Harimau site could be included in the further analysis (Table A.38).

Song Terus

NO	LOCALITY	NO. COL	CATEGORY	GRADE
1	Song Terus	ST 96-KI-ZA95-100	LRM2	1
2	Song Terus	ST 97-M10-2528	LRC	3
3	Song Terus	ST 97-M10-2882	URI2	1
4	Song Terus	ST 97-M11-3011	LRdm2	3
5	Song Terus	ST 98-L8-919	LLI2	4
6	Song Terus	ST 99-N12-581	LLC	2
7	Song Terus	ST 04-K9-7848	LLI2	3
8	Song Terus	ST 06 M10 13121	LLdm1	3

Table A.39. Wear pattern of isolated lower teeth from Song Terus

The observation shows all of 8 isolated lower teeth from the Song Terus site could be included in the further analysis (Table A.39).

Wajak Complex

NO	LOCALITY	NO. COL	CATEGORY	GRADE
1	Hoekgrot	Hoekgrot 17469	LLI2	3
2	Hoekgrot	Hoekgrot 17470	LRI2	3
3	Hoekgrot	Hoekgrot 17477	LRP4	2
4	Hoekgrot	Hoekgrot 17478	LRP4	4
5	Hoekgrot	Hoekgrot 17479	LLP4	4
6	Hoekgrot	Hoekgrot 17480	LLM2	4
7	Hoekgrot	Hoekgrot 17481	LRM1	4
8	Hoekgrot	Hoekgrot 17482	LRM2	4

Table A.40. Wear pattern of isolated lower teeth from Wajak complex.

The observation shows all of 8 isolated lower teeth from the Wajak complex site could be included in the further analysis (Table A.40).

APPENDIX B. MORPHOLOGICAL TRAITS

1. Morphological Traits of Mandibular Teeth

a. Lower Central Incisor

No.	Site	Code	LC	SS	TD	CIG	LF	MMR	DMR	MIG
Pleistocene Hominin										
1	Sangiran	S 7-75	1	1	0	0	1	0	1	1
2	Sangiran	Bs 9706	2	0	0	0	1	0	1	0
3	Zhoukoudian	Sp G.1.550	2	1	0	0	1	0	0	0
4	Zhoukoudian	Sp B.1.	2	1	0	0	1	1	0	0
5	Zhoukoudian	Sp 185	1	1	0	0	1	1	1	0
6	Wajak	Wajak 2	2	1	0	0	1	1	1	0
Holocene <i>Homo sapiens</i>										
7	Sukajadi	SKJ 3	2	0	0	0	0	0	0	0
8	Gua Harimau	HRM 74	2	0	0	0	0	0	0	0
9	Gua Harimau	HRM 79	2	0	0	0	0	0	0	0
10	Gua Braholo	BHL 1	4	0	0	0	0	0	0	0
11	Gua Braholo	BHL 5	4	0	0	0	0	0	0	0
12	Song Keplek	SK 4	3	0	0	0	0	0	0	0
13	Song Tritis	STRT 1	1	0	0	0	?	?	?	?
14	Gua Kidang	GKD 2	1	0	0	0	0	0	0	0
15	Goea Djimbe	DMB 17323	3	0	0	0	0	0	0	0
16	Gua Harimau	HRM 12	1	1	1	0	1	1	1	0
17	Gua Harimau	HRM 21	1	0	0	0	0	0	0	0
18	Gua Harimau	HRM 23	2	0	0	0	0	0	0	0
19	Song Keplek	SK 5	1	0	0	0	0	0	0	0

Table B.1. Morphological character of the lower central incisor.

Note: LC = Labial Convexity, SS = Shovel Shape, TD = Tuberculum Dental, CIG = Cingulum Interruption Groove, LF = Lingual Fossa, MMR = Mesial Marginal Ridge, DMR = Distal Marginal Ridge, MIG = Marginal Interruption Groove.

b. Lower Lateral Incisor

No.	Site	Code	LC	SS	TD	CIG	LF	MMR	DMR	MIG
Pleistocene Hominin										
1	Sangiran	Sangiran 22b	2	?	0	0	?	0	0	?
2	Sangiran	S 7-18	2	1	0	0	1	1	0	0
3	Sangiran	S 7-57	2	1	?	?	0	1	1	1
4	Sangiran	S 7-88	2	1	1	0	1	0	1	1
5	Zhoukoudian	Sp G.1.550	3	1	0	0	1	1	1	0
6	Zhoukoudian	Sp B.1.	3	1	0	0	1	1	0	0
7	Zhoukoudian	Sp H.4.	?	0	0	0	?	0	0	0
8	Zhoukoudian	Sp 10	2	1	0	0	0	1	1	1
9	Zhoukoudian	Sp 8	2	1	0	0	1	1	1	1
10	Wajak	Wajak 2	3	1	0	0	1	1	1	0
Holocene <i>Homo sapiens</i>										
11	Tamiang	TMG A1C	1	0	0	0	1	0	0	0
12	Sukajadi	SKJ 3	1	0	0	0	0	0	0	0
13	Gua Harimau	HRM 37	2	0	0	0	0	0	0	0
14	Gua Harimau	HRM 74	2	0	2	0	0	0	0	0
15	Gua Harimau	HRM 79	2	0	0	0	0	0	0	0
16	Gua Pawon	PWN 5	4	0	0	0	0	0	0	0
17	Gua Braholo	BHL 1	4	0	0	0	0	0	0	0
18	Gua Braholo	BHL 5	4	0	0	0	0	0	0	0
19	Song Keplek	SK 4	4	0	0	0	0	0	0	0
20	Song Terus	ST04-K9-7848	4	0	0	0	0	0	0	0
21	Song Terus	ST98-919	?	0	0	0	0	0	0	0
22	Song Tritis	STR 1	2	0	0	0	?	0	0	?
23	Gua Kidang	GKD 2	2	0	0	0	0	0	0	0
24	Goea Djimbe	DMB 17323	2	0	0	0	0	0	0	0
25	Hoekgrot	HGR 17469	2	0	0	0	0	0	0	0
26	Hoekgrot	HGR 17470	2	0	0	0	0	0	0	0
27	Gua Harimau	HRM 12	1	1	1	0	1	0	0	0
28	Gua Harimau	HRM 21	2	0	1	0	0	0	0	0
29	Gua Harimau	HRM 23	2	0	0	0	0	0	0	0
30	Song Keplek	SK 5	2	0	0	0	0	0	0	0

Table B.2. Morphological character of the lower lateral incisor.

Note: LC = Labial Convexity, SS = Shovel Shape, TD = Tuberculum Dental, CIG = Cingulum Interruption Groove, LF = Lingual Fossa, MMR = Mesial Marginal Ridge, DMR = Distal Marginal Ridge, MIG = Marginal Interruption Groove.

c. Lower Canine

No.	Site	Code	SH	TD	CIG	LR	MLF	DLF	CMR	DAR
Pleistocene Hominin										
1	Sangiran	Sangiran 22	0	2	0	1	1	1	0	?
2	Sangiran	S 7-59	0	0	0	0	0	1	1	0
3	Zhoukoudian	Sp G.1.550	0	0	0	1	1	1	1	1
4	Zhoukoudian	Sp B.1.	0	0	0	1	1	1	1	1
5	Zhoukoudian	Sp H.4.	0	0	0	?	?	?	0	0
6	Zhoukoudian	Sp 17	0	0	0	?	?	?	0	0
7	Wajak	Wajak 2	1	0	0	0	0	0	0	0
Holocene <i>Homo sapiens</i>										
8	Tamiang	TMG A1C	1	0	0	0	0	0	0	0
9	Sukajadi	SKJ 3	1	0	0	1	0	0	0	0
10	Sukajadi	SKJ X	1	0	0	1	1	1	0	0
11	Gua Harimau	HRM 37	1	0	0	0	0	0	0	0
12	Gua Harimau	HRM 74	1	0	0	0	1	1	0	0
13	Gua Harimau	HRM 79	1	0	0	1	1	1	1	?
14	Gua Pawon	PWN 4	1	0	0	1	0	0	0	0
15	Gua Pawon	PWN 5	1	0	0	0	0	0	0	0
16	Gua Braholo	BHL 1	1	0	0	1	1	1	1	0
17	Gua Braholo	BHL 5	1	0	0	1	1	1	1	0
18	Song Tritis	STRT 1	1	0	0	0	0	0	0	0
19	Song Keplek	SK 4	1	0	0	1	1	1	1	0
20	Song Terus	ST97-2528	1	0	0	0	0	0	0	0
21	Song Terus	ST99-581	1	0	0	0	0	0	0	0
22	Gua Kidang	GKD 2	1	0	0	1	1	1	0	0
23	Wajak	WJK 1457-12	1	0	0	0	0	0	0	0
24	Goea Djimbe	DMB 17323	1	0	0	0	0	0	0	0
25	Gua Harimau	HRM 12	1	0	0	1	1	1	1	0
26	Gua Harimau	HRM 21	1	0	0	1	1	1	1	0
27	Gua Harimau	HRM 23	1	2	0	0	0	0	1	0
28	Gua Harimau	HRM 24	1	0	0	0	0	0	1	0
29	Song Keplek	SK 5	1	0	0	1	1	1	1	0

Table B.3. Morphological character of the lower canine.

Note: SH = Shape, TD = Tuberculum Dental, CIG = Cingulum Interruption Groove, LR = Lingual Ridge, MLF = Mesiolingual Fossa, DLF = Distolingual Fossa, CMR = Canine Mesial Ridge, DAR = Distal Accessory Ridge.

d. Lower Third Premolar

No.	Site	Code	Sh	BER	LER	TC	MTF	DTF	MAR	DAR	MMR	DMR	MAC	DAC
Pleistocene Hominin														
1	Trinil	Trinil 5	1	1	1	2	1	3	1	0	1	1	0	0
2	Sangiran	Sangiran 6a	0	2	2	2	1	3	0	1	1	0	0	1
3	Sangiran	Sangiran 9	1	2	1	2	1	3	1	1	1	1	0	0
4	Sangiran	Sangiran 22	1	?	2	0	1	1	?	?	1	1	0	0
5	Sangiran	S 7-25	1	2	1	2	3	2	1	1	0	1	0	0
6	Sangiran	S 7-26	1	2	1	1	2	3	1	1	1	1	0	0
7	Sangiran	S 7-69	1	2	1	2	1	1	1	1	1	1	0	0
8	Patiayam	Patiayam 1	1	2	1	1	2	2	0	0	0	1	0	0
9	Wajak	Wajak 2	2	1	1	2	0	3	0	1	1	1	0	0
10	Zhoukoudian	Sp G.1.550	1	1	1	1	?	?	1	1	?	1	0	0
11	Zhoukoudian	Sp 20	1	2	1	2	2	3	1	1	1	1	0	0
12	Zhoukoudian	Sp 80	1	2	1	2	2	1	1	1	1	0	0	0
13	Zhoukoudian	Sp 82	1	1	1	0	3	2	1	1	1	1	0	0
14	Zhoukoudian	Sp 89	1	1	1	0	1	1	1	1	1	0	0	0
Holocene <i>Homo sapiens</i>														
15	Tamiang	TMG A1C	2	1	1	2	1	3	1	1	1	0	0	0
16	Sukajadi	SKJ 3	2	1	1	2	1	1	?	?	0	0	0	0
17	Sukajadi	SKJ X	2	1	1	2	1	2	0	0	0	0	0	0
18	Gua Harimau	HRM 37	2	1	1	2	1	3	0	0	0	1	0	0
19	Gua Harimau	HRM 74	2	1	1	2	1	3	0	0	0	1	0	1
20	Gua Harimau	HRM 79	2	1	1	2	1	1	0	0	0	0	0	0
21	Gua Pawon	PWN 5	2	1	1	2	2	3	0	0	1	1	0	0
22	Gua Braholo	BHL 1	2	1	1	2	0	3	0	0	0	0	0	0
23	Gua Braholo	BHL 5	2	1	1	2	1	1	0	0	0	0	0	0

24	Song Tritis	STR 1	2	1	1	?	1	3	?	?	1	1	0	0
25	Song Keplek	SK 4	2	1	1	2	2	3	1	0	0	0	0	0
26	Goea Djimbe	DMB 17323	2	1	1	2	1	1	0	0	0	0	0	0
27	Hoekgrot	HGR 17478	2	1	1	2	?	1	0	1	1	1	0	0
28	Hoekgrot	HGR 17479	2	1	1	2	?	1	0	0	0	1	0	0
29	Gua Harimau	HRM 12	2	2	1	2	0	3	0	0	0	0	0	0
30	Gua Harimau	HRM 21	2	1	1	2	1	3	0	0	0	1	0	0
31	Gua Harimau	HRM 23	2	1	1	1	0	3	0	1	0	0	0	0
32	Gua Harimau	HRM 24	2	?	1	?	2	3	?	?	0	0	0	0
33	Song Keplek	SK 5	2	1	1	1	1	1	0	0	0	1	0	0

Table B.4. Morphological character of the lower third premolar.

Note: SH = Shape, BER = Buccal Essential Ridge, LER = Lingual Essential Ridge, TC = Transversal Crest, MTF = Mesial Triangular Fossa, DTF = Distal Triangular Fossa, MMR = Mesial Marginal Ridge, DMR = Distal Marginal Ridge, MAR = Mesial Accessory Ridge, DAR = Distal Accessory Ridge, MAC = Mesial Accessory Cusp, DAC = Distal Accessory Cusp.

e. Lower Fourth Premolar

No.	Site	Code	Sh	BER	LER	TC	MTF	DTF	MAR	DAR	MMR	DMR	MAC	DAC
Pleistocene Hominin														
3	Sangiran	Sangiran 1b	1	2	1	1	2	3	1	1	1	1	0	0
1	Sangiran	Sangiran 6a	0	2	1	2	1	3	0	1	1	?	0	1
4	Sangiran	Sangiran 9	1	2	1	2	1	3	0	0	1	1	0	0
5	Sangiran	Sangiran 22	1	?	1	2	?	2	?	?	1	1	0	0
6	Sangiran	Sangiran 37	1	2	1	1	2	3	1	1	1	1	0	0
7	Sangiran	S 7-69	1	2	1	2	1	2	1	1	1	1	0	0
2	Sangiran	SMF 8877	0	1	1	1	1	3	0	1	1	1	0	0
8	Wajak	Wajak 2	2	1	1	2	0	3	0	0	0	0	0	0
9	Zhoukoudian	Sp G.1.550	1	1	1	1	3	2	1	1	0	1	0	0
10	Zhoukoudian	Sp 29	1	2	2	1	3	3	1	1	1	0	0	0
11	Zhoukoudian	SP 80	1	2	1	2	2	1	1	1	1	0	0	0
12	Zhoukoudian	Sp 89	1	1	1	2	1	1	1	1	1	0	0	0
13	Zhoukoudian	Sp 90	1	2	2	2	2	3	1	1	1	0	0	0
Holocene <i>Homo sapiens</i>														
14	Tamiang	TMG A1C	2	1	1	2	2	3	1	1	0	0	0	0
15	Sukajadi	SKJ 3	?	1	1	2	?	3	?	?	0	0	0	0
16	Sukajadi	SKJ X	2	1	1	1	0	2	0	1	0	0	0	0
17	Gua Harimau	HRM 74	2	?	1	2	1	1	?	?	0	1	0	0
18	Gua Harimau	HRM 79	2	1	1	1	0	2	0	0	0	0	0	0
19	Gua Pawon	PWN 4	2	?	?	?	?	?	?	?	1	1	0	0
20	Gua Pawon	PWN 5	2	1	1	2	2	3	0	1	1	0	0	0
22	Gua Braholo	BHL 1	2	1	1	2	1	2	0	0	0	0	0	0
23	Gua Braholo	BHL 5	2	1	1	2	1	3	0	1	0	0	0	0
24	Song Tritis	STR 1	2	?	1	1	1	2	?	?	1	1	0	0

25	Gua Braholo	BHL98-I7-19	2	1	1	1	1	1	1	1	0	0	0	0
26	Song Keplek	SK 4	2	1	1	2	2	3	1	0	0	0	0	0
27	Gua Kidang	GKD 2	2	?	?	?	?	?	?	?	?	?	0	0
28	Wajak	WJK 1457-14	2	1	1	1	3	1	0	0	1	0	0	0
29	Goea Djimbe	DMB 17323	2	1	1	1	3	3	1	1	0	0	0	0
30	Hoekgrot	HGR 17477	2	1	1	1	3	3	1	1	1	1	0	0
31	Gua Harimau	HRM 1	2	1	1	1	1	3	1	1	0	1	0	1
32	Gua Harimau	HRM 12	2	1	1	2	1	3	0	0	0	0	0	0
33	Gua Harimau	HRM 21	2	1	1	2	0	1	0	0	0	1	0	0
34	Gua Harimau	HRM 23	2	1	1	1	3	0	0	1	0	0	0	0
35	Gua Harimau	HRM 24	2	?	1	2	?	3	?	?	0	0	0	0
36	Song Keplek	SK 5	2	1	1	1	3	3	0	0	0	1	0	0

Table B.5. Morphological character of the lower fourth premolar.

Note: SH = Shape, BER = Buccal Essential Ridge, LER = Lingual Essential Ridge, TC = Transversal Crest, MTF = Mesial Triangular Fossa, DTF = Distal Triangular Fossa, MMR = Mesial Marginal Ridge, DMR = Distal Marginal Ridge, MAR = Mesial Accessory Ridge, DAR = Distal Accessory Ridge, MAC = Mesial Accessory Cusp, DAC = Distal Accessory Cusp.

f. Lower First Molar

No.	Site	Code	NC	C5	C6	C7	MdTC	DTC	DW	Cr	GP	Posd	MMR	DMR	AF	PF
Pleistocene Hominin																
1	Sangiran	Sangiran 1b	6	3	0	2	1	1	3	2	1	1	1	1	3	3
2	Sangiran	Sangiran 6a	7	4	2	3	2	2	2	3	1	6	1	1	3	2
3	Sangiran	Sangiran 37	7	4	2	2	2	1	3	1	1	2	1	0	3	0
4	Sangiran	S 7-20	7	4	2	2	1	1	3	1	1	1	1	0	2	0
5	Sangiran	S 7-42	6	3	0	2	1	1	2	3	1	2	1	0	3	0
6	Sangiran	S 7-43	7	4	2	1	1	1	3	3	1	1	2	0	4	0
7	Sangiran	S 7-61	7	4	1	2	1	1	3	1	1	4	1	1	4	2
8	Sangiran	S 7-62	7	4	1	2	1	1	2	1	1	3	2	1	4	2
9	Sangiran	S 7-76	7	4	2	2	2	2	3	2	1	4	1	1	2	2
10	Sangiran	S 7-78	6	2	1	0	1	1	2	2	1	2	1	0	2	0
11	Sangiran	S 0091	7	3	2	1	1	0	0	0	1	1	1	0	2	0
12	Sangiran	S 0092	7	3	2	1	?	1	0	0	2	1	1	0	?	0
13	Miri	MI 92.1	5	1	0	0	0	0	0	1	1	1	0	1	0	1
14	Sangiran	NG 92.2	5	4	0	0	0	0	0	1	2	2	0	0	0	0
15	Sangiran	Abimanyu 4	6	3	0	3	1	1	0	1	1	1	1	0	2	0
16	Wajak	Wajak 1	4	0	0	0	?	0	0	0	1	1	?	0	?	1
17	Wajak	Wajak 2	4	0	0	0	1	1	2	?	2	1	1	0	3	0
18	Zhoukoudian	Sp R.2.	6	4	0	2	1	1	3	2	1	3	1	1	?	2
19	Zhoukoudian	Sp B.1.	6	4	0	2	1	1	3	?	1	2	1	1	2	0
20	Zhoukoudian	Sp 36	6	3	0	1	1	1	3	2	1	1	1	1	3	2
21	Zhoukoudian	Sp 137	6	3	0	1	1	0	3	2	1	5	1	0	2	0
Holocene <i>Homo sapiens</i>																
22	Tamias	TMG A1C	5	3	0	0	0	0	0	0	1	1	1	0	2	0
23	Sukajadi	SKJ 3	4	0	0	0	0	0	0	0	2	1	0	0	1	1

24	Sukajadi	SKJ 4a	4	0	0	0	1	0	0	0	1	?	0	0	1	?
25	Sukajadi	SKJ 4b	4	0	0	0	0	0	0	0	2	2	1	1	1	1
26	Sukajadi	SKJ X	5	2	0	0	0	0	0	0	2	0	1	?	1	1
27	Gua Harimau	HRM 37	4	0	0	0	0	0	0	0	2	0	?	0	1	0
30	Pawon	PWN 1	4	0	0	0	0	0	0	0	1	1	1	0	?	?
31	Pawon	PWN 5	5	3	0	0	0	0	0	0	2	2	1	0	3	0
32	Gua Braholo	BHL 1	4	0	0	0	0	0	?	0	1	1	1	0	2	0
33	Gua Braholo	BHL 5	5	0	0	1	1	0	2	0	3	1	1	0	3	0
34	Gua Braholo	BHL F7	4	0	0	0	0	0	0	0	1	1	0	0	1	0
36	Song Terus	ST 96-KI-ZA95-100	5	2	0	0	1	0	0	0	3	1	1	0	3	0
37	Song Keplek	SK 4	5	3	0	0	1	1	2	0	1	1	0	0	2	0
39	Goea Djimbe	DMB 17323	5	2	0	0	0	0	0	0	1	0	1	0	2	0
40	Hoekgrot	HGR 17481	4	0	0	0	0	0	0	0	2	1	0	0	0	0
41	Gua Harimau	HRM 1	7	4	2	1	0	0	2	0	1	1	1	0	3	0
42	Gua Harimau	HRM 12	5	3	0	0	1	0	3	0	1	0	0	0	3	0
43	Gua Harimau	HRM 21	5	2	0	0	0	1	3	0	?	1	0	0	1	0
44	Gua Harimau	HRM 23	5	3	0	0	1	1	3	0	2	1	1	0	1	0
45	Gua Harimau	HRM 25	5	3	0	0	1	1	3	0	1	1	0	0	0	0
46	Song Keplek	SK 5	4	0	0	0	1	1	2	0	?	0	1	?	1	?

Table B.6. Morphological character of the lower first molar.

Note: NC = Number of Cusps, C5 = Size of Hypoconulid, C6 = Size of Entoconulid, C7 = Size of Metaconulid, MdTC = Middle Trigonid Crest, DTC = Distal Trigonid Crest, DW = Deflecting Wrinkle, Cr = Crenulation, GP = Groove Pattern, Posd = Protostylid, MMR = Mesial Marginal Ridge, DMR = Distal Marginal Ridge, AF = Anterior Fovea, PF = Posterior Fovea.

g. Lower Second Molar

No.	Site	Code	NC	C5	C6	C7	MdTC	DTC	DW	Cr	GP	Prd	MMR	DMR	AF	PF
Pleistocene Hominin																
1	Sangiran	Sangiran 1b	7	3	2	2	1	1	3	2	1	2	1	1	3	1
2	Sangiran	Sangiran 5	7	2	2	3	2	2	3	3	1	6	1	1	3	2
3	Sangiran	Sangiran 6b	6	4	0	2	1	1	?	?	?	5	1	1	2	2
4	Sangiran	Sangiran 9	7	2	2	3	1	1	3	?	1	2	1	1	2	1
5	Sangiran	Sangiran 22	7	3	1	1	1	0	2	1	1	2	1	1	3	0
6	Sangiran	Sangiran 33	7	3	1	1	1	1	3	2	1	3	2	0	3	0
7	Sangiran	Sangiran 37	7	3	2	2	1	1	3	2	1	2	1	1	3	1
8	Sangiran	S 7-20	7	3	1	1	1	1	3	1	1	2	1	0	2	0
9	Sangiran	S 7-64	7	3	2	2	1	1	3	1	1	2	1	1	2	1
10	Sangiran	S 7-65	7	2	2	2	1	1	2	3	1	2	1	1	3	1
11	Sangiran	S 7-76	7	4	2	2	2	2	3	2	1	4	1	1	2	2
12	Sangiran	S 7-78	6	2	1	0	1	1	2	2	1	2	1	0	2	0
13	Sangiran	S 7-84	6	2	0	1	1	1	3	0	1	2	1	0	2	1
14	Sangiran	Ng 8503	7	2	1	1	1	1	3	1	1	2	0	0	3	1
15	Sangiran	Ardjuna 9	6	3	0	3	1	2	3	3	1	6	2	1	3	2
16	Sangiran	NG 92.1	4	0	0	0	1	0	?	0	2	0	?	?	1	?
17	Sangiran	NG 92.3	4	0	0	0	1	1	0	0	2	0	1	0	3	0
18	Sangiran	NG 92.4	4	0	0	0	1	1	?	?	2	1	1	0	2	0
19	Sangiran	NG 92 D6	4	0	0	0	2	1	0	0	3	1	1	0	2	0
20	Sangiran	NK 9603	6	3	0	3	2	2	3	2	1	4	1	1	3	1
21	Sangiran	NG 0802.2	6	1	0	2	1	1	0	1	3	0	0	0	0	0
22	Sangiran	NG 0802.3	4	0	0	0	1	1	0	0	3	1	0	0	0	0
23	Sangiran	Abimanyu 1	4	0	0	0	1	1	0	0	3	0	0	0	0	0
24	Wajak	Wajak 1	4	0	0	0	1	1	0	0	2	1	1	1	2	0

25	Wajak	Wajak 2	4	0	0	0	1	1	0	2	2	1	1	0	2	0
26	Zhoukoudian	Sp G.1.550	6	3	2	0	1	1	3	1	1	2	1	?	3	0
27	Zhoukoudian	Sp R.2.	7	3	1	2	1	1	3	1	1	2	1	0	2	0
28	Zhoukoudian	Sp F.1.5.	5	4	0	0	1	1	3	?	1	2	2	0	3	0
29	Zhoukoudian	Sp 40	4	0	0	0	1	1	3	1	2	3	1	0	1	0
30	Zhoukoudian	Sp 43	6	3	0	2	1	1	2	2	1	1	1	1	3	3
31	Zhoukoudian	Sp 44	7	3	1	2	1	1	3	2	1	3	1	0	3	0
32	Zhoukoudian	Sp 45	7	3	3	2	1	1	3	2	2	2	1	0	0	0
33	Zhoukoudian	Sp 139	6	3	0	1	2	1	3	1	1	2	1	0	2	0
Holocene <i>Homo sapiens</i>																
34	Tamiang	TMG A1C	4	0	0	0	0	0	0	0	1	1	1	0	2	0
35	Sukajadi	SKJ 3	4	0	0	0	0	0	0	0	2	1	0	1	1	1
36	Sukajadi	SKJ 4a	4	0	0	0	0	0	0	0	1	1	0	0	1	1
37	Sukajadi	SKJ 4b	5	0	0	0	0	0	0	0	2	1	1	1	0	2
38	Sukajadi	SKJ X	4	0	0	0	0	0	0	0	2	0	1	1	1	1
39	Gua Harimau	HRM 8	4	0	0	0	0	0	?	0	2	1	1	0	2	1
40	Gua Harimau	HRM 37	4	0	0	0	0	0	0	0	2	0	0	0	0	0
41	Gua Harimau	HRM 74	4	0	0	0	0	0	?	0	1	0	0	0	0	0
42	Gua Harimau	HRM 79	4	0	0	0	0	0	0	0	1	0	0	0	0	0
43	Pawon	PWN 1	4	0	0	0	0	0	0	0	1	1	1	0	2	0
44	Pawon	PWN 3	4	0	0	0	0	0	?	0	2	?	0	0	0	0
45	Pawon	PWN 4	4	0	0	0	?	0	0	0	3	0	?	0	?	0
46	Pawon	PWN 5	5	2	0	0	0	0	0	?	3	1	1	0	?	?
47	Gua Braholo	BHL 1	4	0	0	0	0	0	0	0	2	1	1	0	1	0
48	Gua Braholo	BHL 5	4	0	0	0	0	0	0	0	3	3	0	0	1	0
49	Gua Braholo	BHL F7	4	0	0	0	0	0	0	0	2	1	0	0	1	0
50	Gua Braholo	BHL97-F4-17	4	0	0	0	1	0	0	0	3	1	0	0	1	0

51	Song Tritis	STR 1	4	0	0	0	0	0	0	0	3	0	0	0	0	0
52	Song Keplek	SK 4	4	0	0	0	1	0	0	0	2	2	1	0	2	0
53	Song Terus	ST 96-KI-ZA95-100	5	2	0	0	1	0	0	0	3	1	1	0	3	0
54	Gua Kidang	GKD 2	4	0	0	0	0	0	0	0	2	0	?	?	?	?
55	Goea Djimbe	DMB 17323	4	0	0	0	0	0	0	0	2	0	1	0	2	0
56	Goea Ketjil	KCL 17797	4	0	0	0	0	0	0	0	2	0	0	0	0	0
57	Goea Ketjil	KCL 17798	4	0	0	0	0	0	0	0	2	0	0	0	0	0
58	Hoekgrot	HGR 17480	4	0	0	0	0	0	0	0	2	1	0	0	0	0
59	Hoekgrot	HGR 17482	4	0	0	0	0	0	0	0	2	1	1	0	0	0
60	Gua Harimau	HRM 12	6	2	0	2	1	1	0	0	1	1	0	0	0	0
61	Gua Harimau	HRM 17	6	3	0	1	1	1	0	0	3	1	1	0	2	0
62	Gua Harimau	HRM 21	5	3	0	0	1	1	0	0	3	1	1	0	2	0
63	Gua Harimau	HRM 23	5	3	0	0	1	1	0	0	1	0	0	0	0	0
64	Anyer	Anyer	4	0	0	0	1	0	0	0	2	1	1	0	1	0
65	Song Keplek	SK 5	4	0	0	0	0	0	0	0	1	0	1	0	1	0

Table B.7. Morphological character of the lower second molar.

Note: NC = Number of Cusps, C5 = Size of Hypoconulid, C6 = Size of Entoconulid, C7 = Size of Metaconulid, MdTC = Middle Trigonid Crest, DTC = Distal Trigonid Crest, DW = Deflecting Wrinkle, Cr = Crenulation, GP = Groove Pattern, Prd = Protostylid, MMR = Mesial Marginal Ridge, DMR = Distal Marginal Ridge, AF = Anterior Fovea, PF = Posterior Fovea.

h. Lower Third Molar

No.	Site	Code	NC	C5	C6	C7	MdTC	DTC	DW	Cr	GP	Posd	MMR	DMR	AF	PF
Pleistocene Hominin																
1	Sangiran	Sangiran 1b	6	4	2	0	1	1	3	2	1	1	1	0	3	0
2	Sangiran	Sangiran 6b	6	4	0	3	1	2	2	3	1	5	1	?	2	?
3	Sangiran	Sangiran 8	7	3	2	2	1	1	2	2	2	2	1	0	2	3
4	Sangiran	Sangiran 9	6	3	0	3	1	1	3	2	1	2	1	1	3	3
5	Sangiran	Sangiran 21	7	3	2	2	1	1	3	3	1	1	1	0	3	1
6	Sangiran	Sangiran 22b	7	3	1	2	2	1	2	1	1	0	1	0	3	0
7	Sangiran	Sangiran 37	7	3	3	1	1	1	3	1	1	2	2	0	4	0
8	Sangiran	Sangiran 39	7	2	2	1	1	1	2	1	1	1	?	1	?	2
9	Sangiran	NG 8503	7	3	2	2	1	1	2	1	1	2	1	0	3	2
10	Sangiran	Arjuna 9	6	4	0	3	2	2	3	3	1	6	2	2	3	3
11	Sangiran	NG 9107.2	6	4	0	3	1	1	3	1	1	0	0	0	0	0
12	Sangiran	NG 92.3	4	0	0	0	1	1	0	0	1	0	1	0	3	0
13	Sangiran	NG 0802.2	5	1	0	0	1	0	0	1	3	0	0	0	0	0
14	Zhoukoudian	Sp G.1.550	7	2	3	2	1	1	3	1	1	1	2	1	1	0
15	Zhoukoudian	Sp R.2.	6	3	0	1	1	1	3	2	1	2	2	0	3	0
16	Zhoukoudian	Sp F.1.4	6	2	0	1	1	1	3	?	1	5	2	0	2	0
17	Zhoukoudian	Sp F.1.5	7	3	2	2	1	1	3	5	1	?	1	0	3	0
18	Zhoukoudian	Sp 51	7	3	2	1	1	1	3	3	1	0	1	1	3	2
19	Zhoukoudian	Sp 52	6	2	0	1	1	1	3	2	2	5	1	0	3	2
20	Zhoukoudian	Sp 36	6	3	0	1	1	1	3	2	1	1	1	1	2	2
21	Zhoukoudian	Sp 131	7	3	3	1	1	1	3	2	3	1	0	0	1	0
22	Wajak	Wajak 1	5	2	0	0	1	1	2	0	1	1	1	0	1	0
23	Wajak	Wajak 2	4	0	0	0	1	1	0	0	1	1	1	0	2	0
Holocene <i>Homo sapiens</i>																

24	Sukajadi	SKJ 3	4	0	0	0	1	0	0	0	2	0	?	1	1	1
25	Sukajadi	SKJ X	4	0	0	0	0	0	0	0	2	0	1	1	1	1
26	Gua Harimau	HRM 37	5	3	0	0	1	1	3	0	2	1	0	0	1	0
27	Gua Harimau	HRM 74	4	0	0	0	?	?	?	0	2	0	0	0	0	0
28	Gua Pawon	PWN 1	4	0	0	0	0	0	0	0	2	1	0	0	0	0
29	Gua Pawon	PWN 3	4	0	0	0	0	0	0	0	2	?	0	0	0	0
30	Gua Pawon	PWN 4	5	4	0	0	1	0	0	0	2	0	0	0	0	0
31	Gua Pawon	PWN 5	7	3	1	1	1	1	2	0	1	1	0	0	2	0
32	Gua Braholo	BHL 1	4	0	0	0	0	0	0	0	2	1	0	0	1	0
33	Gua Braholo	BHL 5	4	0	0	0	0	0	0	0	?	0	1	0	0	0
34	Gua Braholo	BHL H8 411	4	0	0	0	1	0	0	0	1	0	0	0	0	0
35	Gua Braholo	BHL F7	4	0	0	0	0	0	0	0	1	1	0	0	0	0
36	Song Tritis	STR 1	4	0	0	0	0	0	0	0	2	0	0	0	0	0
37	Song Keplek	SK 4	6	2	0	1	1	1	2	0	1	1	1	1	3	2
38	Song Keplek	SK 4	7	2	1	1	1	1	2	0	3	0	1	0	2	0
39	Gua Kidang	GKD 2	5	3	0	0	1	1	?	0	1	0	0	0	0	0
40	Goea Djimbe	DMB 17323	4	0	0	0	0	0	0	0	2	0	1	1	2	3
41	Goea Ketjil	KCL 17798	4	0	0	0	0	0	0	0	2	0	0	0	0	0
42	Gua Harimau	HRM 17	6	2	0	2	1	1	2	1	3	1	1	0	2	0
43	Gua Harimau	HRM 21	5	2	0	0	1	1	2	0	3	2	1	0	3	0
44	Gua Harimau	HRM 23	6	2	0	1	1	1	3	1	2	?	?	0	3	0
45	Song Keplek	SK 5	7	1	1	1	1	1	3	1	1	0	1	0	3	0

Table B.8. Morphological character of the lower third molar.

Note: NC = Number of Cusps, C5 = Size of Hypoconulid, C6 = Size of Entoconulid, C7 = Size of Metaconulid, MdTC = Middle Trigonid Crest, DTC = Distal Trigonid Crest, DW = Deflecting Wrinkle, Cr = Crenulation, GP = Groove Pattern, Posd = Protostylid, MMR = Mesial Marginal Ridge, DMR = Distal Marginal Ridge, AF = Anterior Fovea, PF = Posterior Fovea.

2. Morphological Traits of Maxillary Teeth

a. Upper Central Incisor

No.	Site	Code	LC	SS	TD	CIG	LF	MMR	DMR	MIG
Pleistocene Hominin										
1	Sangiran	S 7-1	1	1	0	0	1	1	1	0
2	Sangiran	S 7-48	1	1	0	0	1	1	1	0
3	Sangiran	S 7-85	2	2	0	0	1	1	1	1
4	Sangiran	S 7-86	2	1	0	0	1	0	1	0
5	Sangiran	GRW	0	1	0	0	0	?	0	?
6	Sangiran	S 0096	2	2	0	0	1	1	1	1
7	Miri	MI 92.2	2	2	0	0	1	1	1	1
8	Lidah Air	LA 11471	1	3	0	0	1	1	1	0
9	Zhoukoudian	Sp 2	1	3	1	1	1	1	1	1
10	Zhoukoudian	Sp 4	1	3	1	0	1	1	1	1
Holocene <i>Homo sapiens</i>										
11	Tamiang	TMG A1C	0	1	0	0	0	0	0	0
12	Sukajadi	SKJ 6a	2	0	0	0	0	0	0	0
13	Gua Harimau	HRM 36	1	3	1	0	0	1	1	1
14	Gua Harimau	HRM 74	3	1	3	1	?	1	1	?
15	Gua Harimau	HRM 79	3	1	2	1	?	?	?	?
16	Gua Pawon	PWN 3	4	?	1	1	?	?	?	?
17	Gua Pawon	PWN 5	3	0	0	0	1	0	0	0
18	Gua Braholo	BHL 1	4	0	0	0	0	0	0	0
19	Gua Braholo	BHL 7	3	0	1	1	1	0	0	1
20	Song Keplek	SK 1	4	1	0	0	0	0	0	0
21	Song Keplek	SK 4	3	1	2	1	1	0	0	0
22	Gua Kidang	GKD 2	3	0	0	0	?	0	0	?
23	Hoekgrot	HGR 17465	3	1	0	0	1	0	0	0
24	Hoekgrot	HGR 17466	2	1	0	0	1	0	0	0
25	Gua Harimau	HRM 13	1	3	0	0	1	1	1	?
26	Gua Harimau	HRM 21	1	3	3	1	0	1	1	2
27	Song Keplek	SK 5	1	3	2	1	?	1	1	?

Table B.9. Morphological character of the upper central incisor.

Note: LC = Labial Convexity, SS = Shovel Shape, TD = Tuberculum Dental, CIG = Cingulum Interruption Groove, LF = Lingual Fossa, MMR = Mesial Marginal Ridge, DMR = Distal Marginal Ridge, MIG = Marginal Interruption Groove.

b. Upper Lateral Incisor

No.	Site	Code	LC	SS	TD	CIG	LF	MMR	DMR	MIG
Pleistocene Hominin										
1	Sangiran	S 7-2	2	2	2	0	1	1	1	0
2	Sangiran	S 7-50	1	1	0	0	1	1	1	0
3	Sangiran	S 7-56	2	2	1	1	1	1	1	0
4	Sangiran	S 7-57	2	3	1	1	1	1	1	0
5	Sangiran	GRW	2	3	0	0	1	1	1	0
6	Miri	MI 92.2	2	2	0	0	1	1	1	1
7	Zhoukoudian	Sp 6	2	4	1	1	1	1	1	1
Holocene <i>Homo sapiens</i>										
8	Sukajadi	SKJ 3	3	?	?	?	?	?	?	?
9	Gua Harimau	HRM 74	2	1	2	0	?	0	0	?
10	Gua Harimau	HRM 79	2	1	2	1	1	1	0	1
11	Gua Pawon	PWN 3	3	?	1	1	?	?	?	?
12	Gua Pawon	PWN 5	2	0	3	0	1	0	0	0
13	Gua Braholo	BHL 7	3	0	2	0	0	0	0	1
14	Song Terus	ST97-2882	3	0	0	0	1	0	0	0
15	Song Keplek	SK 1	3	1	0	0	0	0	0	0
16	Gua Kidang	GKD 2	2	0	2	2	?	0	0	?
17	Goea Djimbe	DMB 17321	3	1	0	0	1	0	1	1
18	Hoekgrot	HGR 17467	2	0	0	0	1	0	0	0
19	Hoekgrot	HGR 17468	2	0	0	0	1	0	0	0
20	Gua Harimau	HRM 12	1	3	0	0	0	1	1	1
21	Gua Harimau	HRM 13	1	4	0	0	1	1	1	?
22	Gua Harimau	HRM 21	1	3	0	0	0	1	1	0

Table B.10. Morphological character of the upper lateral incisor.

Note: LC = Labial Convexity, SS = Shovel Shape, TD = Tuberculum Dental, CIG = Cingulum Interruption Groove, LF = Lingual Fossa, MMR = Mesial Marginal Ridge, DMR = Distal Marginal Ridge, MIG = Marginal Interruption Groove.

c. Upper Canine

No.	Site	Code	Sh	TD	CIG	LR	MLF	DLF	CMR	DAR
Pleistocene Hominin										
1	Sangiran	Sangiran 4	0	0	0	0	0	0	1	1
7	Sangiran	Sangiran 17	0	1	0	0	0	0	0	0
2	Sangiran	S 7-35	0	2	0	1	1	1	2	0
3	Sangiran	S 7-36	0	1	0	1	1	1	1	0
4	Sangiran	S 7-45	0	1	1	0	0	0	1	1
5	Sangiran	S 7-46	0	2	0	0	0	0	?	?
6	Sangiran	S 7-47	0	2	1	1	1	1	1	?
8	Sangiran	GRW	0	1	0	0	0	0	0	0
13	Wajak	Wajak 2	1	4	0	0	0	0	0	0
9	Zhoukoudian	Sp 13	0	0	0	1	1	1	1	0
10	Zhoukoudian	Sp 14	0	1	0	1	1	1	1	0
11	Zhoukoudian	Sp 15	0	0	1	1	1	1	1	0
12	Zhoukoudian	Sp x	0	1	0	1	1	1	2	0
Holocene <i>Homo sapiens</i>										
14	Sukajadi	SKJ 3	1	1	0	1	1	1	0	0
15	Gua Harimau	HRM 36	1	1	0	0	0	1	0	0
16	Gua Harimau	HRM 74	1	2	0	0	0	0	0	0
17	Gua Harimau	HRM 79	1	0	0	0	0	0	0	0
18	Gua Pawon	PWN 3	1	2	0	0	?	?	2	1
19	Gua Pawon	PWN 5	1	0	0	1	1	1	0	0
20	Gua Braholo	BHL 1	1	0	0	1	1	1	0	0
21	Gua Braholo	BHL 7	1	0	0	0	1	1	1	0
22	Gua Braholo	BHL 97-F4-12	1	0	0	1	1	1	1	0
23	Gua Braholo	BHL 97-F4-20	1	0	0	1	1	1	1	0
24	Song Keplek	SK 1	1	0	0	1	1	1	0	0
25	Song Keplek	SK 4	1	0	0	0	1	1	1	0
26	Gua Kidang	GKD 2	1	0	0	?	?	?	0	0
27	Goea Djimbe	DMB 17321	1	0	0	0	0	0	0	0
28	Goea Djimbe	DMB 17322	1	0	0	0	0	0	0	0
29	Goea Djimbe	DMB 17323	1	0	0	0	0	0	0	0
30	Hoekgrot	HGR 17471	1	0	0	0	0	0	0	0
31	Hoekgrot	HGR 17472	1	0	0	0	0	0	0	0
32	Hoekgrot	HGR 17473	1	0	0	0	0	0	0	0
33	Hoekgrot	HGR 17474	1	0	0	1	1	1	1	0
34	Gua Harimau	HRM 12	1	4	1	1	1	1	2	2
35	Gua Harimau	HRM 13	1	2	0	?	?	?	1	1
36	Gua Harimau	HRM 17	1	3	0	1	0	0	0	?
37	Gua Harimau	HRM 24	1	2	1	0	0	0	1	0

Table B.11. Morphological character of the upper canine.

Note: SH = Shape, TD = Tuberculum Dental, CIG = Cingulum Interruption Groove, LR = Lingual Ridge, MLF = Mesiolingual Fossa, DLF = Distolingual Fossa, CMR = Canine Mesial Ridge, DAR = Distal Accessory Ridge.

d. Upper Third Premolar

No.	Site	Code	Sh	BER	LER	TC	MTF	DTF	MMR	DMR	MAR	DAR	MAC	DAC
Pleistocene Hominin														
1	Sangiran	Sangiran 4	1	2	2	1	1	0	1	0	1	1	0	0
2	Sangiran	Sangiran 15a	1	1	2	1	1	0	1	0	1	1	0	0
3	Sangiran	Sangiran 15b	1	1	1	1	2	3	1	0	?	?	0	0
4	Sangiran	Sangiran 17	1	1	1	1	1	1	1	0	0	1	0	0
5	Sangiran	Sangiran 27	1	?	1	1	1	1	1	1	1	1	0	0
6	Sangiran	S 7-27	1	2	1	1	2	2	1	1	1	1	0	0
7	Sangiran	S 7-31	1	1	2	1	3	3	0	0	1	1	0	0
8	Sangiran	S 7-32	1	0	2	1	3	3	1	1	0	1	0	0
9	Sangiran	S 7-34	1	2	2	1	2	2	1	1	1	1	0	0
10	Sangiran	S 7-35	1	1	1	0	3	3	1	0	1	1	0	0
11	Sangiran	S 7-58	1	1	1	1	1	2	1	1	1	1	0	0
12	Sangiran	NG 9505	1	1	1	1	3	2	0	0	0	0	0	0
13	Sangiran	Bpg 2001.04	1	1	2	1	3	3	0	0	0	1	0	0
14	Sangiran	GRW	1	1	2	1	3	1	0	0	1	1	0	0
15	Wajak	Wajak 1	1	1	1	0	2	1	1	0	0	0	0	0
16	Wajak	Wajak 2	1	1	1	0	3	2	0	0	0	0	1	0
17	Zhoukoudian	Sp 19	1	1	2	0	2	3	0	0	1	0	0	0
Holocene <i>Homo sapiens</i>														
18	Tamiang	TMG A1C	1	1	1	0	2	2	0	0	0	0	0	0
19	Sukajadi	SKJ 3	1	1	1	0	3	3	1	0	0	0	0	0
20	Sukajadi	SKJ 6b	1	1	1	0	2	3	0	0	0	0	0	0
21	Gua Harimau	HRM 36	1	1	1	0	3	3	0	0	0	0	0	0
22	Gua Harimau	HRM 74	1	?	?	0	1	2	?	?	?	?	0	0
23	Gua Harimau	HRM 79	1	1	1	0	0	3	0	0	0	0	0	0

24	Gua Pawon	PWN 1	1	1	1	0	3	3	0	0	0	0	0	1
25	Gua Pawon	PWN 3	1	?	?	0	2	2	0	0	1	0	0	0
26	Gua Pawon	PWN 5	1	1	1	0	3	2	0	0	0	0	0	0
27	Gua Braholo	BHL 1	1	1	1	0	3	2	1	1	0	0	0	0
28	Gua Braholo	BHL 4	1	1	1	0	2	2	1	0	0	0	0	0
29	Song Keplek	SK 1	1	0	1	0	3	3	1	0	0	0	1	0
30	Song Keplek	SK 4	1	1	1	1	3	2	1	1	0	0	1	0
31	Gua Kidang	GKD 2	1	?	?	?	?	?	?	?	?	?	?	?
32	Wajak	WJK 1457-13	1	1	1	0	3	2	0	0	0	0	0	0
33	Hoekgrot	HGR 17474	1	1	1	0	3	3	0	0	0	0	0	0
34	Hoekgrot	HGR 17475	1	1	1	0	3	3	0	0	1	1	0	0
35	Gua Harimau	HRM 10	1	1	1	0	1	0	0	0	0	0	0	0
36	Gua Harimau	HRM 12	1	1	0	0	0	3	0	0	0	?	0	0
37	Gua Harimau	HRM 17	1	1	0	0	?	1	0	0	?	0	0	0
38	Gua Harimau	HRM 24	1	1	1	0	2	1	0	0	0	0	0	0
39	Gua Harimau	HRM 60	1	1	1	0	2	2	0	0	0	0	0	0
40	Song Keplek	SK 5	1	1	0	0	3	2	0	1	0	0	0	0

Table B.12. Morphological character of the upper third premolar.

Note: SH = Shape, BER = Buccal Essential Ridge, LER = Lingual Essential Ridge, TC = Transversal Crest, MTF = Mesial Triangular Fossa, DTF = Distal Triangular Fossa, MMR = Mesial Marginal Ridge, DMR = Distal Marginal Ridge, MAR = Mesial Accessory Ridge, DAR = Distal Accessory Ridge, MAC = Mesial Accessory Cusp, DAC = Distal Accessory Cusp.

e. Upper Fourth Premolar

No.	Site	Code	Sh	BEC	LEC	TC	MTF	DTF	MMR	DMR	MAR	DAR	MAC	DAC
Pleistocene Hominin														
1	Sangiran	Sangiran 4	1	2	2	1	1	0	1	0	1	1	0	0
2	Sangiran	Sangiran 15a	1	1	2	1	1	0	0	0	1	1	0	0
3	Sangiran	Sangiran 17	1	1	1	1	1	1	1	0	0	1	0	0
4	Sangiran	Sangiran 27	1	2	1	1	1	1	1	1	1	1	0	0
5	Sangiran	Bpg 2001.04	1	1	2	1	1	0	1	0	1	1	0	0
6	Sangiran	Tjg 1993.05	1	?	1	1	?	0	?	0	?	1	?	0
7	Sangiran	GRW	1	1	1	1	3	1	0	0	1	1	0	0
8	Sangiran	S 7-3a	1	1	1	1	1	1	1	0	1	1	0	0
9	Sangiran	S 7-29	1	1	1	1	1	1	1	0	1	1	0	0
10	Sangiran	S 7-30	1	1	2	1	3	3	1	0	1	1	0	0
11	Sangiran	NG 9505	1	1	1	1	2	3	0	0	0	0	0	0
12	Sangiran	S 0085	1	1	1	0	3	3	1	1	1	1	0	0
13	Wajak	Wajak 1	1	1	1	0	1	2	0	1	0	0	0	0
14	Wajak	Wajak 2	1	1	1	0	2	3	0	0	1	0	0	0
15	Zhoukoudian	Sp 25	1	1	2	0	1	3	1	0	1	1	0	0
16	Zhoukoudian	Sp 28	1	1	1	0	3	1	1	0	1	1	0	0
Holocene <i>Homo sapiens</i>														
17	Sukajadi	SKJ 3	1	1	1	0	3	3	0	0	0	0	0	0
18	Sukajadi	SKJ 6a	1	1	1	0	1	3	0	0	0	1	0	0
19	Sukajadi	SKJ 6b	1	1	1	0	2	3	0	0	1	1	0	0
20	Gua Harimau	HRM 74	1	?	?	0	1	1	?	0	?	0	0	0
21	Gua Harimau	HRM 79	1	1	1	0	0	3	0	0	0	0	0	0
22	Gua Pawon	PWN 1	1	1	1	0	3	3	0	0	1	1	0	0
23	Gua Pawon	PWN 3	1	?	?	0	3	2	0	0	0	0	0	0

24	Gua Pawon	PWN 5	1	1	1	0	1	2	1	1	0	0	0	0
25	Gua Braholo	BHL 1	1	1	1	0	2	3	1	1	0	0	0	0
26	Gua Braholo	BHL 4	1	1	1	0	2	1	1	0	0	0	0	0
27	Gua Braholo	BHL 7	1	1	0	0	2	3	1	1	0	0	0	0
28	Song Keplek	SK 1	1	0	1	0	3	3	1	0	0	0	0	0
29	Song Keplek	SK 4	1	0	1	0	1	2	0	1	1	0	0	0
30	Goea Djimbe	DMB 17321	1	1	1	0	2	2	0	0	1	1	0	0
31	Goea Djimbe	DMB 17322	1	1	?	1	1	1	0	0	0	0	0	0
32	Hoekgrot	HGR 17476	1	1	0	1	1	2	0	0	0	0	0	0
33	Gua Harimau	HRM 10	1	1	0	0	2	2	0	0	0	0	0	0
34	Gua Harimau	HRM 12	1	1	1	1	1	1	0	0	?	?	0	0
35	Gua Harimau	HRM 17	1	1	0	0	0	2	0	0	0	0	0	0
36	Gua Harimau	HRM 21	1	1	1	0	1	1	0	0	0	0	1	0
37	Gua Harimau	HRM 24	1	1	1	0	2	3	0	0	1	0	0	0
38	Gua Harimau	HRM 36	1	1	1	1	3	3	0	0	0	0	1	0
39	Gua Harimau	HRM 60	1	1	1	0	2	3	0	0	0	1	0	0
40	Song Keplek	SK 5	1	0	0	0	2	1	0	0	0	0	0	0

Table B.13. Morphological character of the upper fourth premolar.

Note: SH = Shape, BER = Buccal Essential Ridge, LER = Lingual Essential Ridge, TC = Transversal Crest, MTF = Mesial Triangular Fossa, DTF = Distal Triangular Fossa, MMR = Mesial Marginal Ridge, DMR = Distal Marginal Ridge, MAR = Mesial Accessory Ridge, DAR = Distal Accessory Ridge, MAC = Mesial Accessory Cusp, DAC = Distal Accessory Cusp.

f. Upper First Molar

No.	Site	Code	CN	C3	C4	C5	BAT	LAT	Cr	CO	TC	MMAT	CC	Pasl	MMR	DMR	AF	PF
Pleistocene Hominin																		
1	Sangiran	Sangiran 4	5	5	4	2	2	0	3	2	1	1	1	2	1	1	3	3
2	Sangiran	Sangiran 17	5	5	4	1	1	0	1	1	1	1	1	2	1	1	2	2
3	Sangiran	Sangiran 27	5	5	4	2	2	0	3	1	1	?	0	1	1	1	3	3
4	Sangiran	S 7-3b	5	5	4	2	1	0	1	1	1	1	1	2	1	1	2	2
5	Sangiran	S 7-8	5	5	4	1	0	0	2	1	1	?	2	1	1	1	1	2
6	Sangiran	S 7-9	5	4	4	3	1	0	1	1	0	?	1	1	0	0	0	1
7	Sangiran	S 7-10	5	4	4	1	1	1	1	1	1	?	1	1	0	1	1	2
8	Sangiran	S 7-37	5	5	4	2	1	0	2	1	0	1	3	1	1	1	2	3
9	Sangiran	S 7-38	5	5	4	2	1	0	3	1	0	?	0	1	1	1	2	2
10	Sangiran	S 7-40	5	5	4	2	1	0	3	2	1	0	0	0	1	1	2	2
11	Sangiran	S 81	4	5	4	0	0	0	0	0	0	1	0	0	0	1	3	1
12	Sangiran	Tjg 93.05	5	5	4	1	1	0	1	1	1	1	2	2	1	1	2	3
13	Sangiran	Ng 9603	5	4	4	1	0	0	2	1	1	1	1	1	1	1	2	3
14	Sangiran	Bpg 2001.04	5	5	4	1	1	0	2	1	1	1	2	1	0	1	3	2
15	Sangiran	S 0088	5	5	4	3	0	0	0	1	0	1	0	0	0	0	0	0
16	Sangiran	Abimanyu 2	5	5	4	3	0	0	0	1	0	1	3	1	0	0	1	0
17	Wajak	Wajak 1	4	5	4	0	0	0	0	2	?	?	0	1	0	0	0	0
18	Wajak	Wajak 2	5	4	4	2	0	0	1	2	?	1	0	1	0	0	0	0
19	Chokoutien	Sp 37	4	5	4	0	1	0	1	1	1	?	0	0	?	0	2	0
20	Chokoutien	Sp 38	4	5	4	0	0	0	1	2	1	?	0	1	1	0	0	0
21	Chokoutien	Sp 140	5	4	4	2	1	0	2	1	1	1	1	0	1	1	2	3
Holocene <i>Homo sapiens</i>																		
22	Tamiang	TMG A1C	4	4	3	0	0	0	0	1	0	0	0	1	0	0	0	0
23	Sukajadi	SKJ 3	5	4	4	1	0	0	0	0	0	1	0	1	0	0	1	1

24	Sukajadi	SKJ 6a	4	5	4	0	0	0	0	1	1	0	0	0	0	0	0	0
25	Sukajadi	SKJ 6b	4	4	3	0	0	0	0	0	0	1	0	0	0	0	0	1
26	Gua Harimau	HRM 36	4	5	3	0	0	0	0	1	1	1	0	0	0	0	0	0
27	Gua Harimau	HRM 74	4	5	4	0	0	0	0	1	?	0	0	0	0	1	?	?
28	Gua Harimau	HRM 79	4	5	4	0	0	0	0	1	1	?	0	0	?	0	?	?
29	Gua Pawon	PWN 1	4	5	4	0	0	0	0	2	1	1	0	0	0	1	0	2
30	Gua Pawon	PWN 3	4	4	4	0	0	0	?	?	?	0	0	0	?	?	?	?
31	Gua Pawon	PWN 5	4	5	4	0	0	0	0	2	1	?	0	0	0	1	?	2
32	Gua Braholo	BHL 1	5	4	4	1	0	0	0	1	0	0	0	1	0	0	0	0
33	Gua Braholo	BHL 4	4	5	4	0	0	0	0	1	0	0	1	1	0	0	0	0
34	Gua Braholo	BHL G8	4	5	4	0	0	0	0	1	1	0	0	0	0	0	0	0
35	Song Keplek	SK 1	5	5	4	1	0	0	0	1	0	1	6	0	0	0	0	0
36	Song Keplek	SK 4	5	5	4	1	0	0	0	1	1	0	0	0	0	0	0	0
37	Song Terus	ST 96-299	5	4	3	1	0	0	0	1	0	1	0	0	0	0	0	0
38	Song Terus	ST 96-457a	5	5	3	1	0	0	0	1	0	1	3	0	1	1	1	0
39	Hoekgrot	HGR 17410	5	4	3	1	0	0	0	1	0	0	0	1	0	1	0	2
40	Hoekgrot	HGR 17411	4	4	3	0	0	0	0	1	0	?	0	0	1	?	2	?
41	Gua Harimau	HRM 12	4	5	4	0	0	0	0	1	1	1	0	0	0	0	0	0
42	Gua Harimau	HRM 13	4	4	4	0	0	0	0	1	1	0	0	1	0	?	0	?
43	Gua Harimau	HRM 17	4	4	3	0	0	0	0	2	0	1	0	0	1	0	0	0
44	Gua Harimau	HRM 21	4	5	3	0	0	0	0	1	0	0	0	0	0	0	0	0
45	Gua Harimau	HRM 25	5	5	4	2	0	0	0	1	0	1	0	0	0	0	0	0
46	Gua Harimau	HRM 60	4	4	3	0	0	0	0	2	2	0	0	1	0	0	0	0
47	Song Keplek	SK 5	4	4	5	0	0	0	0	1	1	NA	0	0	0	0	0	0

Table B.14. Morphological character of the upper first molar. Note: NC = Number of Cusps, C3 = Size of Metacone, C4 = Size of Hypocone, C5 = Size of Metaconule, BAT = Buccal Accessory Tubercle, LAT = Lingual Accessory Tubercle, Cr = Crenulation, CO = Crista Obliqua, TC = Transversal Crest, MMAT = Mesial Marginal Accessory Tubercle, CC = Carrabelli's Cusp, Pasl = Parastyle, MMR = Mesial Marginal Ridge, DMR = Distal Marginal Ridge, AF = Anterior Fovea, PF = Posterior Fovea.

g. Upper Second Molar

No.	Site	Code	CN	C3	C4	C5	BAT	LAT	Cr	CO	TC	MMAT	CC	Pasl	MMR	DMR	AF	PF
Pleistocene Hominin																		
1	Sangiran	Sangiran 4	5	5	4	1	1	0	3	2	1	1	0	0	1	1	3	3
2	Sangiran	Sangiran 17	5	4	4	1	0	0	1	2	1	1	1	2	1	1	2	3
3	Sangiran	Sangiran 27	5	5	4	1	1	0	3	2	1	?	0	0	1	1	3	3
4	Sangiran	S 7-3c	5	4	4	1	0	0	1	2	1	1	1	1	1	1	2	3
5	Sangiran	S 7-38	5	5	4	1	2	0	3	1	0	0	0	1	1	1	2	2
6	Sangiran	S 7-40	5	5	4	2	1	0	3	1	1	0	0	0	1	1	2	3
7	Sangiran	S 7-53	5	4	3	2	1	1	2	2	1	1	0	2	1	1	3	3
8	Sangiran	S 7-89	5	4	3	1	1	0	1	1	1	1	1	1	1	1	3	1
9	Sangiran	S 81	4	5	4	0	0	0	0	0	0	1	0	0	0	1	3	1
10	Sangiran	Tjg 93.05	5	4	4	2	1	1	1	1	1	1	3	2	1	1	2	3
11	Sangiran	Bpg 2001.04	5	4	4	2	1	1	2	1	1	1	1	1	1	1	3	3
12	Sangiran	GRW	4	4	4	0	0	0	1	1	1	0	1	2	1	1	2	3
13	Sangiran	NG 1989	5	4	4	1	0	0	0	2	0	1	0	0	0	0	2	0
14	Sangiran	NG91 G10	5	5	4	1	0	0	0	1	0	1	3	1	0	0	0	0
15	Sangiran	Ng 9603	5	4	3	2	0	0	1	2	1	1	0	2	1	1	3	2
16	Sangiran	PDS0712	4	5	4	0	0	0	0	0	0	1	0	0	0	0	0	0
17	Sangiran	Wajak 1	4	4	5	0	1	0	0	1	1	1	0	0	1	0	2	0
18	Sangiran	Wajak 2	5	4	4	1	1	0	0	2	1	1	0	0	0	0	1	0
19	Lida Ajer	LA 11472	4	4	3	0	0	0	0	0	0	0	0	0	0	0	0	0
20	Chokoutien	Sp 40	5	4	4	1	1	0	1	0	1	1	0	0	1	1	3	1
21	Chokoutien	Sp 41	5	4	3	2	0	1	1	1	0	1	0	0	1	1	2	2
Holocene <i>Homo sapiens</i>																		
22	Tamiang	TMG A1C	4	3	1	0	0	0	0	0	0	0	0	1	1	0	2	1
23	Sukajadi	SKJ 3	5	4	4	1	0	0	0	1	0	1	0	0	1	0	1	1

24	Sukajadi	SKJ 6a	4	5	4	0	0	0	0	1	1	0	0	0	0	0	0	0
25	Sukajadi	SKJ 6b	4	4	3	0	0	0	0	1	0	1	0	?	0	1	0	1
26	Gua Harimau	HRM 36	4	4	3	0	0	0	0	1	0	0	0	0	0	0	0	0
27	Gua Harimau	HRM 74	4	5	4	0	0	0	0	1	1	0	0	2	0	0	0	0
28	Gua Harimau	HRM 79	4	5	4	0	0	0	0	1	1	0	0	0	0	0	0	0
29	Gua Pawon	PWN 1	4	4	3	0	0	0	0	2	1	1	0	0	1	1	1	2
30	Gua Pawon	PWN 3	4	4	3	0	0	0	0	1	1	0	0	0	0	0	0	0
31	Gua Pawon	PWN 5	4	4	3	0	0	0	0	1	1	1	0	1	0	0	0	0
32	Gua Braholo	BHL 1	4	4	4	1	0	0	0	1	0	0	0	1	0	0	0	0
33	Gua Braholo	BHL 4	4	4	3	0	0	0	0	1	0	0	0	1	1	0	1	0
34	Gua Braholo	BHL 7	5	3	2	1	1	0	0	1	1	1	0	0	1	1	2	2
35	Song Kepek	SK 1	5	4	3	1	0	0	0	1	0	1	0	0	1	0	1	0
36	Song Kepek	SK 4	5	4	3	1	0	0	0	1	0	1	0	0	1	1	1	1
37	Song Terus	ST 96-457a	5	5	3	1	0	0	0	1	0	1	3	0	1	1	1	0
38	Song Terus	ST 96-1802	5	4	3	1	0	0	0	1	0	1	3	0	1	1	2	0
39	Song Terus	ST 04-8683	4	4	3	0	0	0	0	1	0	1	0	0	1	0	2	0
40	Gua Kidang	GKD 2	4	4	4	0	0	0	?	?	0	?	0	0	?	?	?	0
41	Goea Djimbe	DMB 17321	4	4	3	0	0	0	0	1	0	0	0	0	0	0	0	0
42	Goea Ketjil	KCL 17796	5	4	3	1	0	0	0	1	0	1	0	0	1	1	1	0
43	Hoekgrot	HGR 17410	5	4	3	1	0	0	0	1	0	0	0	1	1	1	2	2
44	Hoekgrot	HGR 17411	4	3	3	0	0	0	0	1	0	1	0	0	1	1	2	3
45	Gua Harimau	HRM 10	4	3	3	0	0	0	0	0	0	1	0	0	0	0	0	0
46	Gua Harimau	HRM 12	4	4	2	0	0	0	0	1	0	0	0	0	0	0	0	0
47	Gua Harimau	HRM 21	4	4	3	0	0	0	0	1	0	1	0	0	0	0	0	0
48	Song Kepek	SK 5	4	4	3	0	0	0	0	1	1	0	0	0	0	1	0	1

Table B.15. Morphological character of the upper second molar.

Note: NC = Number of Cusps, C3 = Size of Metacone, C4 = Size of Hypocone, C5 = Size of Metaconule, BAT = Buccal Accessory Tubercle, LAT = Lingual Accessory Tubercle, Cr = Crenulation, CO = Crista Obliqua, TC = Transversal Crest, MMAT = Mesial Marginal Accessory Tubercle, CC = Carrabelli's Cusp, Pasl = Parastyle, MMR = Mesial Marginal Ridge, DMR = Distal Marginal Ridge, AF = Anterior Fovea, PF = Posterior Fovea.

a. Upper Third Molar

No.	Site	Code	CN	C3	C4	C5	BAT	LAT	Cr	CO	TC	MMAT	CC	Pasl	MMR	DMR	AF	PF
Pleistocene Hominin																		
1	Trinil	Trinil 1	4	3	4	0	2	2	2	1	1	1	0	0	1	1	3	3
2	Sangiran	Sangiran 1a	5	3	5	1	0	0	2	1	?	?	3	1	?	1	?	3
3	Sangiran	Sangiran 4	5	5	5	2	1	0	3	1	1	1	3	0	0	1	3	3
4	Sangiran	Sangiran 17	5	3	4	1	0	0	2	1	1	1	1	0	0	1	1	2
5	Sangiran	Sangiran 27	5	5	5	2	1	0	3	1	1	?	1	0	?	1	?	3
6	Sangiran	S 7-3d	5	3	4	1	1	0	2	1	1	1	0	0	0	1	1	3
7	Sangiran	S 7-6	5	2	2	1	0	0	1	1	0	0	0	0	0	0	0	0
8	Sangiran	S 7-17	4	2	2	0	0	0	1	1	1	?	0	0	0	0	0	0
9	Sangiran	S 7-53	5	4	4	2	1	0	2	1	1	1	0	2	0	1	2	4
10	Sangiran	S 7-73	5	3	4	5	1	1	3	1	1	1	0	0	1	1	2	1
11	Sangiran	NG 9107.1	5	4	4	4	1	1	2	1	1	1	1	0	0	1	3	3
12	Sangiran	Tjg 93.05	4	4	4	0	1	1	1	1	1	1	0	0	1	1	1	2
13	Sangiran	GRW	5	3	4	1	0	0	1	1	1	0	0	1	0	1	1	2
14	Sangiran	Njg 2005.05	5	3	4	1	1	0	2	2	1	0	1	0	1	1	3	2
15	Sangiran	S 0086	5	4	3	2	0	0	0	1	1	1	0	0	0	0	1	0
16	Sangiran	PDS 0712	4	5	4	0	0	0	0	0	0	0	1	0	0	0	1	1
17	Sangiran	NG 0802.3	5	4	3	2	0	0	0	0	1	0	0	0	0	0	1	0
18	Wajak	Wajak 1	5	3	3	1	1	0	0	0	0	1	0	0	1	0	2	0
19	Wajak	Wajak 2	5	4	5	2	2	0	1	1	1	1	0	0	0	0	1	0
20	Zhoukoudian	Sp 46	5	4	3	1	0	1	2	1	1	?	0	0	0	0	2	0
21	Zhoukoudian	Sp 51	5	4	3	2	0	2	2	1	1	1	0	0	1	1	3	2
Holocene <i>Homo sapiens</i>																		
22	Sukajadi	SKJ 6a	4	4	2	0	0	0	0	1	1	0	0	0	0	0	0	0
23	Gua Harimau	HRM 74	4	4	3	0	0	0	0	?	?	0	0	0	0	0	0	0

24	Gua Harimau	HRM 79	4	4	3	0	1	0	0	1	1	1	1	0	1	0	2	0
25	Gua Pawon	PWN 3	4	3	2	0	0	0	0	1	1	0	0	0	1	0	2	0
26	Gua Braholo	BHL 1	4	3	3	0	0	0	0	0	0	0	0	0	0	0	0	0
27	Gua Braholo	BHL 4	4	3	3	0	0	0	0	0	0	0	2	0	0	0	0	0
28	Gua Braholo	BHL 7	5	4	3	1	1	0	0	0	1	1	0	0	0	0	1	0
29	Gua Braholo	BHL H8	3	4	0	0	0	0	0	0	0	1	0	0	0	0	1	0
30	Gua Braholo	BHL99-412	3	3	0	0	0	0	0	0	0	1	0	1	0	0	0	0
31	Song Keplek	SK 1	4	4	3	0	2	0	0	0	0	1	2	0	0	0	0	0
32	Song Keplek	SK 4	4	3	3	0	0	0	0	0	0	1	2	0	0	0	0	1
33	Gua Kidang	GKD 2	4	3	3	1	0	0	0	0	0	0	0	0	0	0	0	0
34	Goea Djimbe	DMB 17321	5	3	2	1	0	0	0	0	1	0	0	1	0	0	0	0
35	Hoekgrot	HGR 17410	4	4	3	0	1	0	0	0	1	1	0	1	0	0	0	0
36	Hoekgrot	HGR 17411	4	3	3	0	0	0	0	0	0	0	0	0	1	0	0	0
37	Gua Harimau	HRM 12	3	4	0	0	0	0	0	0	0	1	0	0	0	0	0	0
38	Gua Harimau	HRM 21	5	4	3	2	0	0	0	0	0	1	0	0	1	1	1	1
39	Song Keplek	SK 5	5	4	3	2	1	0	0	0	0	1	0	0	0	0	1	1

Table B.16. Morphological character of the upper third molar.

Note: NC = Number of Cusps, C3 = Size of Metacone, C4 = Size of Hypocone, C5 = Size of Metaconule, BAT = Buccal Accessory Tubercle, LAT = Lingual Accessory Tubercle, Cr = Crenulation, CO = Crista Obliqua, TC = Transversal Crest, MMAT = Mesial Marginal Accessory Tubercle, CC = Carrabelli's Cusp, Pasl = Parastyle, MMR = Mesial Marginal Ridge, DMR = Distal Marginal Ridge, AF = Anterior Fovea, PF = Posterior Fovea.

APPENDIX C. GENERAL METRIC

1. Measurements of mandibular teeth

a. Lower Central Incisor

No.	Site	Code	MD	LL
Pleistocene Hominin				
1	Sangiran	S 7-75	5,8	6,7
2	Sendang Busik	BS 9706	5,8	6
3	Zhoukoudian	Sp G.1.550	6,4	7,5
4	Zhoukoudian	Sp B.1.	5,4	5,8
5	Zhoukoudian	Sp 185	6,5	5,6
6	Wajak	Wajak 2	5,4	7,2
Holocene <i>Homo sapiens</i>				
7	Sukajadi	SKJ 3	5	6
8	Gua Harimau	HRM 74	4,6	5,5
9	Gua Harimau	HRM 79	4,6	5,2
10	Gua Braholo	BHL 1	5,3	6,4
11	Gua Braholo	BHL 5	5,8	6,8
12	Song Keplek	SK 4	5,5	6,4
13	Song Tritis	STRT 1	3,9	5,4
14	Gua Kidang	GKD 2	4,2	5,2
15	Goea Djimbe	DMB 17324	5	6,3
16	Gua Harimau	HRM 12	5,1	6
17	Gua Harimau	HRM 21	6,1	5,7
18	Gua Harimau	HRM 23	5,3	6,3
19	Song Keplek	SK 5	5,4	5,6

Table C.1. Mesiodistal and Labiolingual measurements of the lower central incisor.

Note: MD = Mesiodistal (in mm), LL = Labiolingual (in mm).

b. Lower Lateral Incisor

No.	Site	Code	MD	LL
Pleistocene Hominin				
1	Sangiran	S 7-57	5,8	8,4
2	Sangiran	S 7-88	6,6	8,1
3	Sangiran	Sangiran 22b	5,7	7
4	Sangiran	S 7-18	5,9	6,3
5	Zhoukoudian	Sp G.1.550	6,7	8,1
6	Zhoukoudian	Sp B.1.	6	6,8
7	Zhoukoudian	Sp H.4.	4,8	7
8	Zhoukoudian	Sp 10	6,9	7,2
9	Zhoukoudian	Sp 8	7,1	6,4
10	Wajak	Wajak 2	6,2	7,5
Holocene <i>Homo sapiens</i>				
11	Tamiang	TMG A1C	5,3	6,3
12	Sukajadi	SKJ 3	5	6,4
13	Gua Harimau	HRM 37	5,5	6,2
14	Gua Harimau	HRM 74	5,5	6
15	Gua Harimau	HRM 79	5,2	5,4
16	Gua Pawon	PWN 5	6,5	7,5
17	Gua Braholo	BHL 1	6,2	6,8
18	Gua Braholo	BHL 5	5,4	6,6
19	Song Keplek	SK 4	6,2	6,8
20	Song Terus	ST04-7848	4,4	4,2
21	Song Terus	ST98-919	6,5	7,2
22	Song Tritis	STR 1	3,6	5,9
23	Gua Kidang	GDK 2	4,4	5,6
24	Goae Djimbe	DMB 17324	5,7	6,9
25	Hoekgrot	HGR 17469	6,1	6,7
26	Hoekgrot	HGR 17470	6,8	7
27	Song Keplek	SK 5	5,7	6
28	Gua Harimau	HRM 10	6,4	6,8
29	Gua Harimau	HRM 12	5,1	6
30	Gua Harimau	HRM 21	6,6	6,7
31	Gua Harimau	HRM 23	6,1	6,6

Table C.2. Mesiodistal and Labiolingual measurements of the lower lateral incisor.

Note: MD = Mesiodistal (in mm), LL = Labiolingual (in mm).

c. Lower Canine

No.	Site	Code	MD	LL
Pleistocene Hominin				
1	Sangiran	Sangiran 22b	8	9,5
2	Sangiran	S 7-59	8	8,6
3	Zhoukoudian	Sp G.1.550	8	10,2
4	Zhoukoudian	Sp B.1.	6,1	5,5
5	Zhoukoudian	Sp H.4.	7,5	7,7
6	Zhoukoudian	Sp 17	8,6	9,8
7	Wajak	Wajak 2	8,2	8
Holocene <i>Homo sapiens</i>				
8	Tamiang	TMG A1C	6,2	7,2
9	Sukajadi	SKJ 3	8,8	9
10	Sukajadi	SKJ X	7	7,2
11	Gua Harimau	HRM 37	6,2	7,4
12	Gua Harimau	HRM 74	6,4	7,7
13	Gua Harimau	HRM 79	6,2	7,4
14	Gua Pawon	PWN 4	6,93	7,29
15	Gua Pawon	PWN 5	7,1	9,1
16	Gua Braholo	BHL 5	7,4	9,2
17	Song Tritis	STRT 1	6,6	7,4
18	Song Keplek	SK 4	7,2	8,2
19	Song Terus	ST 1	6	8,5
20	Song Terus	ST97-2528	8	9
21	Song Terus	ST99-581	7,9	8,2
22	Gua Kidang	GKD 2	6	7,2
23	Wajak	WJK 1457-12	6,9	7,8
24	Goea Djimbe	DMB 17323	8,5	8,2
25	Goea Djimbe	DMB 17324	7,8	9
26	Goea Djimbe	DMB 17324	7,6	9
27	Gua Harimau	HRM 12	7,5	7,8
28	Gua Harimau	HRM 21	6,8	7,8
29	Gua Harimau	HRM 23	6,6	7,3
30	Gua Harimau	HRM 24	6,5	6,5
31	Song Keplek	SK 5	7,2	8,4

Table C.3. Mesiodistal and Labiolingual measurements of the lower canine.

Note: MD = Mesiodistal (in mm), LL = Labiolingual (in mm).

d. Lower Third Premolar

No.	Site	Code	MD	BL
Pleistocene Hominin				
1	Glagah Ombo	Sangiran 6a	10,1	11,6
2	Bojong	Sangiran 9	8,6	11
3	Sangiran	S 7-69	8,1	10,6
4	Sangiran	Sangiran 22b	8,5	10,4
5	Sangiran	S 7-25	7,8	8,4
6	Sangiran Dome	S 7-26	7,7	7,8
7	Patiayam	Patiayam 1	7,8	8,8
8	Trinil	Trinil 5	7,1	8,2
9	Zhoukoudian	Sp G.1.550	8,8	11,3
10	Zhoukoudian	Sp B.1.	7,2	6,7
11	Zhoukoudian	Sp H.4.	7,3	8,8
12	Zhoukoudian	Sp 20	9,2	10
13	Zhoukoudian	Sp 80	8,4	9
14	Zhoukoudian	Sp 82	8,8	10,4
15	Zhoukoudian	Sp 89	7,2	10
16	Wajak	Wajak 2	8,5	9
Holocene <i>Homo sapiens</i>				
17	Tamiang	TMG A1C	6,6	8,2
18	Sukajadi	SKJ 3	7,4	8,6
19	Sukajadi	SKJ X	7,7	8,2
20	Gua Harimau	HRM 8	8,3	9,1
21	Gua Harimau	HRM 37	7,8	9
22	Gua Harimau	HRM 74	7,6	9
23	Gua Harimau	HRM 79	7	7,8
24	Gua Pawon	PWN 4	8,9	9,8
25	Gua Pawon	PWN 5	8,6	9,7
26	Gua Braholo	BHL 1	7,5	9,4
27	Gua Braholo	BHL 5	8,1	9,9
28	Song Tritis	STR 1	6,4	7,5
29	Song Keplek	SK 4	8	9
30	Song Terus	ST 1	7,5	9
31	Gua Kidang	GKD 2	6	7,8
32	Goea Djimbe	DMB 17324	7,6	8,8
33	Goea Djimbe	DMB 17324	7,8	8,9

34	Goea Ketjil	KCL 17797	6,8	8,8
35	Hoekgrot	HGR 17463	6,8	9,2
36	Gua Harimau	HRM 2	8	8,8
37	Gua Harimau	HRM 10	7,3	8,2
38	Gua Harimau	HRM 12	7,5	8
39	Gua Harimau	HRM 21	7,4	8,2
40	Gua Harimau	HRM 23	7,3	8
41	Gua Harimau	HRM 24	6	8,2
42	Song Keplek	SK 5	7,2	8,2
43	Anyer	Anyer	7	8

Table C.4. Mesiodistal and Buccolingual measurements of the lower third premolar.

Note: MD = Mesiodistal (in mm), BL = Buccolingual (in mm).

e. Lower Fourth Premolar

No.	Site	Code	MD	BL
Pleistocene Hominin				
1	Glagah Ombo	Sangiran 6a	9,6	11,7
2	Sangiran Dome	SMF 8877	11,8	12
3	Sangiran Dome	Sangiran 1b	9	10,8
4	Bojong	Sangiran 9	8,5	11,1
5	Sangiran	Sangiran 22b	8,5	10,7
6	Sendang Busik	Sangiran 37	8,5	10,5
7	Sangiran	S 7-69	8,1	10,6
8	Zhoukoudian	Sp G.1.550	8,6	11,8
9	Zhoukoudian	Sp B.1.	10	9,1
10	Zhoukoudian	Sp H.4.	7,5	9
11	Zhoukoudian	Sp 29	9	10,5
12	Zhoukoudian	SP 80	8,4	9
13	Zhoukoudian	Sp 89	7,2	10
14	Zhoukoudian	Sp 90	8,8	9,6
15	Wajak	Wajak 2	8,3	8,5
Holocene <i>Homo sapiens</i>				
16	Tamiang	TMG A1C	6,4	8,5
17	Sukajadi	SKJ 3	7,6	9,4
18	Sukajadi	SKJ X	8,4	8,6
19	Gua Harimau	HRM 8	8,2	8,7
20	Gua Harimau	HRM 74	8	9,2
21	Gua Harimau	HRM 79	7,6	8,5
22	Gua Pawon	PWN 4	6,9	8,9
23	Gua Pawon	PWN 5	7,9	9,3
24	Gua Braholo	BHL 1	8,8	9,9
25	Gua Braholo	BHL 5	8,2	9,8
26	Song Tritis	STR 1	6,7	7,8
27	Gua Braholo	BHL98-I7-19	7,4	7,6
28	Song Keplek	SK 4	7	9
29	Song Terus	ST 1	7,8	9,2
30	Gua Kidang	GKD 2	7,5	8,6
31	Wajak	WJK 1457-14	7,5	8,4
32	Goea Djimbe	DMB 17324	7,8	9,2
33	Goea Djimbe	DMB 17324	7,6	9,5
34	Goea Ketjil	KCL 17797	7	8,8
35	Hoekgrot	HGR 17463	11,4	9,6
36	Hoekgrot	HGR 17477	8,4	9,1
37	Hoekgrot	HGR 17478	8,1	9
38	Hoekgrot	HGR 17479	8	8,6

39	Gua Harimau	HRM 1	6,9	7,6
40	Gua Harimau	HRM 2	7,5	8,8
41	Gua Harimau	HRM 10	7,6	8,4
42	Gua Harimau	HRM 12	8	9
43	Gua Harimau	HRM 21	7,2	8,8
44	Gua Harimau	HRM 23	8,6	8,5
45	Gua Harimau	HRM 24	6,6	8,4
46	Song Keplek	SK 5	7,7	8,5
47	Anyer	Anyer	7,5	8

Table C.5. Mesiodistal and Buccolingual measurements of the lower fourth premolar.

Note: MD = Mesiodistal (in mm), BL = Buccolingual (in mm).

f. Lower First Molar

No.	Site	Code	MD	BL
Pleistocene Hominin				
1	Ngebung	Sangiran 5	13,4	12,9
2	Glagah Ombo	Sangiran 6a	14,8	13,3
3	Sangiran	Meganthropus D	14	14
4	Sangiran	S 7-76	14,7	12,9
5	Sangiran	S 7-78	14,3	14,2
6	Sangiran	Sangiran 1b	12,6	12,9
7	Sangiran	S 7-42	13,2	12,3
8	Sangiran	S 7-43	13,3	12,3
9	Sangiran	Sangiran 22b	12,6	12,6
10	Sendang Busik	Sangiran 37	12,2	11,6
11	Ngrejeng	Sangiran 39	12,7	11,6
12	Sangiran	S 7-20	12,5	11,6
13	Sangiran	S 7-61	12,2	12
14	Sangiran	S 7-62	12,6	12,2
15	Sangiran	Abimanyu 4	11,8	10,8
16	Sangiran	S 0091	12	10,5
17	Sangiran	S 0092	12	11
18	Zhoukoudian	Sp G.1.550	12,2	13,4
19	Zhoukoudian	Sp R.2.	11	11
20	Zhoukoudian	Sp B.1.	11	10,5
21	Zhoukoudian	Sp H.4.	11,5	10,9
22	Zhoukoudian	Sp 36	14,1	12,1
23	Zhoukoudian	Sp 137	13	11,2
24	Miri	MI 92.1	12	11,6
25	Ngebung	NG 92.2	10,9	10,4
26	Wajak	Wajak 1	13,1	11,8
27	Wajak	Wajak 2	12,4	11,6
Holocene <i>Homo sapiens</i>				
28	Tamiang	TMG A1C	11	10
29	Sukajadi	SKJ 3	12	11,5
30	Sukajadi	SKJ 4.a	10,5	10
31	Sukajadi	SKJ 4.b	11	10
32	Sukajadi	SKJ X	11	10
33	Gua Harimau	HRM 8	12,5	11,6
34	Gua Harimau	HRM 37	10,5	11
35	Gua Harimau	HRM 74	11	10,6
36	Gua Harimau	HRM 79	11	11
37	Pawon	PWN 1	11,8	11,5
38	Pawon	PWN 3	10,6	11,2

39	Pawon	PWN 5	12,5	12,4
40	Gua Braholo	BHL 1	11	10,8
41	Gua Braholo	BHL 5	12,1	11,8
42	Gua Braholo	BHL F7	11,4	11,2
43	Song Tritis	STR 1	10,3	10,5
44	Song Terus	ST 1	11,2	11,8
45	Song Terus	ST94-KI-95-100	13	11,6
46	Song Keplek	SK 4	11,8	12,2
47	Gua Kidang	GKD 2	9,2	10,5
48	Goea Djimbe	DMB 17324	12	12
49	Goea Djimbe	DMB 17324	11,5	11,8
50	Goea Ketjil	KCL 17797	11,7	11,4
51	Goea Ketjil	KCL 17798	10,8	11,9
52	Hoekgrot	HGR 17414	9,4	9,8
53	Hoekgrot	HGR 17481	11,4	10,3
54	Gua Harimau	HRM 1	11,8	10
55	Gua Harimau	HRM 9	11,5	11
56	Gua Harimau	HRM 10	12	10,8
57	Gua Harimau	HRM 12	11,5	12,5
58	Gua Harimau	HRM 21	11,5	10,8
59	Gua Harimau	HRM 23	11,9	10,7
60	Gua Harimau	HRM 24	10,4	10,6
61	Gua Harimau	HRM 25	12	10,2
62	Gua Harimau	HRM 36	11,5	10,5
63	Song Keplek	SK 5	11,4	11,2
64	Anyer	Anyer	11,5	10,5

Table C.6. Mesiodistal and Buccolingual measurements of the lower first molar.

Note: MD = Mesiodistal (in mm), BL = Buccolingual (in mm).

g. Lower Second Molar

No.	Site	Code	MD	BL
Pleistocene Hominin				
1	Ngebung	Arjuna 9	14,3	13,5
2	Ngebung	Sangiran 5	14	14,9
3	Bukuran	Sangiran 6b	14,1	13,8
4	Sangiran	S 7-76	14,7	12,9
5	Sangiran	S 7-78	14,3	14,2
6	Sendang Klampok	NK 9603	14,4	13
7	Sangiran	Sangiran 1b	13,5	12,5
8	Bojong	Sangiran 9	14	12,6
9	Blimbing Kulon	Sangiran 33	14,5	13,5
10	Sangiran	S 7-20	12,5	11,6
11	Sangiran	S 7-64	13,3	12,5
12	Sangiran	S 7-84	13,5	13
13	Sangiran	Sangiran 22b	12,8	12,9
14	Sendang Busik	Sangiran 37	12,3	11,8
15	Ngebung	Sangiran 39	12,5	12,5
16	Sangiran	S 7-65	13,5	13,5
17	Ngebung	NG 0802.2	11,3	10,7
18	Sangiran	S 0089	11,4	10,5
19	Sangiran	S 0090	11,5	10,8
20	Zhoukoudian	Sp G.1.550	12,2	13,7
21	Zhoukoudian	Sp R.2.	11,7	12
22	Zhoukoudian	Sp F.1.5	13	11
23	Zhoukoudian	Sp G.2.	12,8	13,6
24	Zhoukoudian	Sp 40	12	12,1
25	Zhoukoudian	Sp 43	12,8	10,7
26	Zhoukoudian	Sp 44	13,4	11,4
27	Zhoukoudian	Sp 139	10,7	9,2
28	Ngebung	NG 92.1	11,7	11
29	Ngebung	NG 92.3	11,8	11
30	Ngebung	NG 92.4	10	9,2
31	Ngebung	NG 92 D6	11	10,8
32	Ngebung	NG 0802.1	10,8	10,1
33	Pucung	Abimanyu 1	10,1	10
34	Wajak	Wajak 1	11,6	11,4
35	Wajak	Wajak 2	11,4	10,2
Holocene <i>Homo sapiens</i>				
36	Tamiang	TMG A1C	10	9,2
37	Sukajadi	SKJ 3	12,5	11,4
38	Sukajadi	SKJ 4a	11	10,5

39	Sukajadi	SKJ 4b	12,6	11,7
40	Sukajadi	SKJ X	11,5	11,5
41	Gua Harimau	HRM 8	11,9	10,8
42	Gua Harimau	HRM 37	10	10,6
43	Gua Harimau	HRM 74	11,5	10,7
44	Gua Harimau	HRM 79	10,5	10,2
45	Gua Pawon	PWN 1	11,6	11,2
46	Gua Pawon	PWN 3	10,8	11,0
47	Gua Pawon	PWN 4	11,0	11,9
48	Gua Pawon	PWN 5	12,1	11,8
49	Gua Braholo	BHL 1	10,4	10,8
50	Gua Braholo	BHL 5	10	10,6
51	Gua Braholo	BHL F7	10,5	10,5
52	Gua Braholo	BHL97-F4-17	11	10,8
53	Song Tritis	STR 1	12	11,5
54	Song Keplek	SK 4	12	11,6
55	Song Terus	ST 1	12	11,5
56	Song Terus	ST 96-KI-ZA95-100	13	11,6
57	Gua Kidang	GKD 2	10	11
58	Goea Djimbe	DMB 17324	11	11
59	Goea Djimbe	DMB 17324	10,5	10,2
60	Goea Ketjil	DMB 17797	11,1	10,6
61	Goea Ketjil	KCL 17798	10	11,4
62	Hoekgrot	HGR 17480	11	10,2
63	Hoekgrot	HGR 17482	11,6	10,7
64	Gua Harimau	HRM 12	11,5	12
65	Gua Harimau	HRM 17	11,1	10
66	Gua Harimau	HRM 21	11,5	10,5
67	Gua Harimau	HRM 23	11,7	10
68	Song Keplek	SK 5	11,4	11
69	Anyer	Anyer	10	10

Table C.7. Mesiodistal and Buccolingual measurements of the lower second molar.

Note: MD = Mesiodistal (in mm), BL = Buccolingual (in mm).

h. Lower Third Molar

No.	Site	Code	MD	BL
Pleistocene Hominin				
1	Bukuran	Sangiran 6b	14,2	14,2
2	Sangiran Dome	Meganthropus D	16,8	13
3	Ngebung	Arjuna 9	13,9	13
4	Sangiran Dome	Sangiran 1b	14,3	12,5
5	Glagah Ombo	Sangiran 8	14,6	13
6	Bojong	Sangiran 9	12,2	12,3
7	Ngebung	Sangiran 21	12	10,8
8	Sangiran	Sangiran 22b	12,3	12
9	Sangiran	Sangiran 24	11,7	11,2
10	Sendang Busik	Sangiran 37	10,6	11,1
11	Sangiran	Arjuna 5	11,6	11,4
12	Ngebung	NG 9107.2	10,7	9,7
13	Ngebung	NG 0802.2	11,2	10,6
14	Zhoukoudian	Sp G.1.550	12,5	12,6
15	Zhoukoudian	Sp R.2.	9,8	9,9
16	Zhoukoudian	Sp.F.1.4	10,8	12
17	Zhoukoudian	Sp F.1.5	11,5	9,5
18	Zhoukoudian	Sp G.2.	12,5	13
19	Zhoukoudian	Sp 45	11,8	12
20	Zhoukoudian	Sp 51	12	12,2
21	Zhoukoudian	Sp 52	12,5	11,5
22	Zhoukoudian	Sp 131	12,7	10,7
23	Sangiran Dome	Sangiran 24	11,6	10,4
24	Sangiran Dome	Sangiran 24	10,6	9,2
25	Ngebung	NG 92.3	11,8	11
26	Wajak	Wajak 1	12,5	11
27	Wajak	Wajak 2	11,2	10,4
Holocene <i>Homo sapiens</i>				
28	Gua Harimau	HRM 74	11,5	10,5
29	Sukajadi	SKJ 3	10,8	10,4
30	Sukajadi	SKJ X	11,5	10
31	Gua Harimau	HRM 37	9,8	9,4
32	Gua Harimau	HRM 74	11,5	10,5
33	Gua Pawon	PWN 1	10,5	10,4
34	Gua Pawon	PWN 3	10,8	10,6
35	Gua Pawon	PWN 4	11,7	10,6
36	Gua Pawon	PWN 5	10,5	11,2
37	Gua Braholo	BHL 1	10,4	12
38	Gua Braholo	BHL 5	10,7	10,7

39	Gua Braholo	BHL H8 411	11	12,5
40	Gua Braholo	BHL F7	9,5	10
41	Song Tritis	STR 1	9,5	9,4
42	Song Keplek	SK 4	12	11,1
43	Song Terus	ST 1	11,1	10,9
44	Gua Kidang	GKD 2	10	10,5
46	Goea Djimbe	Djimbe 17324	11	10,8
47	Goea Djimbe	Djimbe 17324	11,2	10,6
48	Goea Ketjil	Ketjil 17798	11	10,6
49	Gua Harimau	HRM 10	9,5	9,5
50	Gua Harimau	HRM 17	9,6	9,2
51	Gua Harimau	HRM 21	10	9,5
52	Gua Harimau	HRM 23	11	9,8
53	Song Keplek	SK 5	12	10,8
54	Anyer	Anyer	9,5	10

Table C.8. Mesiodistal and Buccolingual measurements of the lower third molar.

Note: MD = Mesiodistal (in mm), BL = Buccolingual (in mm).

2. Measurements of maxillary teeth

a. Upper Central Incisor

No.	Site	Code	MD	LL
Pleistocene Hominin				
1	Sangiran	S 7-1	10,3	7,9
2	Sangiran	S 7-85	11	8,1
3	Sangiran	S 7-86	10,7	7,8
4	Grogolan Wetan	GRW 0095	7,7	6,9
5	Sangiran	S 7-48	8,6	7,4
6	Zhoukoudian	Sp 2	9,7	7,6
7	Zhoukoudian	Sp 4	10,6	7,9
8	Sangiran	S 0096	7,7	6,9
9	Miri	MI 92.2	8,1	7
10	Lida Ajer	LA 11471	8,1	6,3
Holocene <i>Homo sapiens</i>				
11	Tamiang	TMG A1C	6,8	6,2
12	Sukajadi	SKJ 6a	9,2	6,9
13	Gua Harimau	HRM 74	6,8	7
14	Gua Harimau	HRM 79	7,5	7,2
15	Gua Pawon	PWN 5	9,4	7,8
16	Gua Braholo	BHL 1	9	8
17	Gua Braholo	BHL 7	7,8	7,2
18	Song Keplek	SK 1	8,6	7,8
19	Song Keplek	SK 4	9,5	8
20	Gua Kidang	GKD 2	7,4	7,4
21	Hoekgrot	HGR 17465	8,9	7,6
22	Hoekgrot	HGR 17466	8,4	7,6
23	Gua Harimau	HRM 10	7,7	7,3
24	Gua Harimau	HRM 13	7,5	7,3
25	Gua Harimau	HRM 21	8,7	7,5
26	Song Keplek	SK 5	8,3	6,6

Table C.9. Mesiodistal and Labiolingual measurements of the upper central incisor.

Note: MD = Mesiodistal (in mm), LL = Labiolingual (in mm).

b. Upper Lateral Incisor

No.	Site	Code	MD	LL
Pleistocene Hominin				
1	Sangiran	S 7-57	8,4	5,8
2	Sangiran	S 7-50	7,8	7,2
3	Sangiran	S 7-56	7,5	7,3
4	Sangiran	S 7-2	7	6,9
5	Grogolan Wetan	GRW 0095	6,6	6
6	Zhoukoudian	Sp 6	8,2	8,2
7	Miri	MI 92.2	8,1	7
Holocene <i>Homo sapiens</i>				
8	Gua Harimau	HRM 36	6,2	6,3
9	Gua Harimau	HRM 74	6,4	6,5
10	Gua Harimau	HRM 79	6	6,3
11	Gua Pawon	PWN 5	7,4	7
12	Gua Braholo	BHL 7	6,5	6,8
13	Song Terus	ST97-2882	5,2	6,4
14	Song Keplek	SK 1	6,4	5,8
15	Gua Kidang	GKD 2	5,2	6,4
16	Goea Djimbe	DMB 17321	7,4	7,4
17	Goea Djimbe	DMB 17322	6,6	5,8
18	Hoekgrot	HGR 17467	7,7	6,4
19	Hoekgrot	HGR 17468	7,4	6,2
20	Gua Harimau	HRM 12	7,2	6,2
21	Gua Harimau	HRM 13	6,5	7,1
22	Gua Harimau	HRM 21	7,8	6,4

Table C.10. Mesiodistal and Labiolingual measurements of the upper lateral incisor.

Note: MD = Mesiodistal (in mm), LL = Labiolingual (in mm).

c. Upper Canine

No.	Site	Code	MD	LL
Pleistocene Hominins				
1	Glagah Ombo	Sangiran 4	9,5	11,9
2	Sangiran	S 7-36	10,2	10,3
3	Sangiran	S 7-47	9,9	10,9
4	Sangiran	S 7-35	9,6	9,6
5	Sangiran	S 7-45	9,7	9,9
6	Sangiran	S 7-46	9,5	9,6
7	Pucung	Sangiran 17	8,8	8,4
8	Grogolan Wetan	GRW	8,7	9
9	Zhoukoudian	Sp 13	9,2	9,8
10	Zhoukoudian	Sp 14	9,5	10,4
11	Zhoukoudian	Sp 15	10,4	10,6
12	Wajak	Wajak 2	9,2	9,8
Holocene <i>Homo sapiens</i>				
13	Sukajadi	SKJ 3	8,8	9,2
14	Gua Harimau	HRM 36	6,4	8
15	Gua Harimau	HRM 74	7,6	8,3
16	Gua Harimau	HRM 79	7,6	8,3
17	Gua Pawon	PWN 3	7	8,6
18	Gua Pawon	PWN 5	8,2	8,8
19	Gua Braholo	BHL 1	8,5	9,2
20	Gua Braholo	BHL 7	7,2	8
21	Gua Braholo	BHL97-F4-12	7,7	8,2
22	Gua Braholo	BHL97-F4-20	7,1	8,5
23	Song Keplek	SK 1	8,8	9
24	Song Keplek	SK 4	7,3	9,8
25	Gua Kidang	GKD 2	6,2	7,5
26	Goea Djimbe	DMB 17321	8,6	9,8
27	Goea Djimbe	DMB 17322	7,8	8
28	Goea Djimbe	DMB 17323	8,4	7,9
29	Goea Ketjil	KCL 17796	7,2	8
30	Hoekgrot	HGR 17471	8,2	8,6
31	Hoekgrot	HGR 17472	7,8	8,1
32	Hoekgrot	HGR 17473	8,4	9
33	Hoekgrot	HGR 17474	8,4	8,6
34	Gua Harimau	HRM 10	8,2	8,8
35	Gua Harimau	HRM 12	7,5	8,8
36	Gua Harimau	HRM 13	6,5	8,7
37	Gua Harimau	HRM 17	7,9	8
38	Gua Harimau	HRM 24	7,2	8

Table C.11. Mesiodistal and Labiolingual measurements of the upper canine.

Note: MD = Mesiodistal (in mm), LL = Labiolingual (in mm).

d. Upper Third Premolar

No.	Site	Code	MD	BL
Pleistocene Hominin				
1	Glagah Ombo	Sangiran 4	8,3	12,8
2	Sangiran	Sangiran 27	8,9	12,8
3	Sangiran	S 7-35	8,2	12,2
4	Sangiran	S 7-58	9	11,5
5	Bapang	Bpg 2001.04	8,1	11,3
6	Ngrejeng	Sangiran 15a	7,5	11,5
7	Sangiran	S 7-31	8	10,6
8	Sangiran	S 7-32	7,8	10,8
9	Sangiran	Sangiran 15b	7,2	10
10	Pucung	Sangiran 17	6,3	10,4
11	Grogolan Wetan	GRW 0094	7,4	8,8
12	Sangiran Dome	S 7-27	7,6	10,3
13	Sangiran Dome	S 7-34	8	9,6
14	Ngebung	NG 9505	7,4	9,4
15	Zhoukoudian	Sp 19	9,2	12,8
16	Wajak	Wajak 1	8,2	9,9
17	Wajak	Wajak 2	8	10,8
Holocene <i>Homo sapiens</i>				
18	Tamias	TMG A1C	6,5	9,6
19	Sukajadi	SKJ 3	7,2	10,4
20	Sukajadi	SKJ 6b	6,7	9,2
21	Gua Harimau	HRM 36	7,2	9,8
22	Gua Harimau	HRM 74	7	9,8
23	Gua Harimau	HRM 79	7	10
24	Gua Pawon	PWN 1	6,8	10
25	Gua Pawon	PWN 3	7,4	10,2
26	Gua Pawon	PWN 5	7,8	11
27	Gua Braholo	BHL 1	8,2	10,2
28	Gua Braholo	BHL 4	7,2	10,5
29	Song Keplek	SK 1	8,4	10,5
30	Song Keplek	SK 4	8	10,5
31	Gua Kidang	GKD 2	6,5	9,4
32	Goea Djimbe	DMB 17321	8	10,6
33	Goea Djimbe	DMB 17321	8,4	10,9
34	Goea Djimbe	DMB 17322	7,6	10,6
35	Goea Ketjil	KCL 17796	6,6	9,8

36	Goea Ketjil	KCL 17796	7	10
37	Hoekgrot	HGR 17474	8,3	10,8
38	Hoekgrot	HGR 17475	7,8	10,4
39	Gua Harimau	HRM 2	7,3	10,3
40	Gua Harimau	HRM 10	7,9	9,5
41	Gua Harimau	HRM 12	8	10,8
42	Gua Harimau	HRM 13	7,7	9,7
43	Gua Harimau	HRM 17	8,2	9,6
44	Gua Harimau	HRM 21	7,8	9,8
45	Gua Harimau	HRM 24	7,2	9
46	Gua Harimau	HRM 60	7,6	10
47	Song Keplek	SK 5	7,6	9,6

Table C.12. Mesiodistal and Buccolingual measurements of the upper third premolar.

Note: MD = Mesiodistal (in mm), BL = Buccolingual (in mm).

e. Upper Fourth Premolar

No.	Site	Code	MD	BL
Pleistocene Hominin				
1	Glagah Ombo	Sangiran 4	8,4	12,3
2	Sangiran	Sangiran 27	8,3	12,4
3	Bapang	Bpg 2001.04	7,6	12,2
4	Ngrejeng	Sangiran 15a	7,5	11,1
5	Sangiran	Sangiran 17	6,3	10,4
6	Sangiran	Tjg 1993.05	?	?
7	Sangiran	GRW 0094	7,4	8,8
8	Sangiran	S 7-3a	6,7	10,3
9	Zhoukoudian	Sp 25	8,4	11,4
10	Zhoukoudian	Sp 28	7	10,1
11	Sangiran	S 7-29	7,9	10,2
12	Sangiran	S 7-30	7,7	10,2
13	Ngebung	NG 9505	7,4	9,4
14	Sangiran	S 0085	6,5	8,7
15	Wajak	Wajak 1	7,7	10,8
16	Wajak	Wajak 2	8	10,7
Holocene <i>Homo sapiens</i>				
17	Sukajadi	SKJ 3	6,5	10
18	Sukajadi	SKJ 6.a	6,8	10,2
19	Sukajadi	SKJ 6.b	6,4	9,4
20	Gua Harimau	HRM 74	6,7	10
21	Gua Harimau	HRM 79	6	9,8
22	Gua Pawon	PWN 1	6,4	10
23	Gua Pawon	PWN 3	7,2	10,4
24	Gua Pawon	PWN 5	7	11
25	Gua Braholo	BHL 1	7,6	10,8
26	Gua Braholo	BHL 4	7,6	10,5
27	Gua Braholo	BHL 7	7,8	9,9
28	Song Keplek	SK 1	8,2	10,2
29	Song Keplek	SK 4	6,8	10,2
30	Gua Kidang	GKD 2	6	9,2
31	Goea Djimbe	DMB 17321	7	10,3
32	Goea Djimbe	DMB 17321	6,6	10,3
33	Goea Djimbe	DMB 17322	6,6	8,8
34	Goea Ketjil	KCL 17796	6,4	10,4
35	Goea Ketjil	KCL 17796	7	10,5
36	Hoekgrot	HGR 17476	7,6	9,8
37	Gua Harimau	HRM 2	6,3	10,5
38	Gua Harimau	HRM 10	7	9,6

39	Gua Harimau	HRM 12	8	10,8
40	Gua Harimau	HRM 17	7,2	9,2
41	Gua Harimau	HRM 21	7,6	9,5
42	Gua Harimau	HRM 24	6,8	8,9
43	Gua Harimau	HRM 36	6,2	9,5
44	Gua Harimau	HRM 60	6,8	10,2
45	Song Keplek	SK 5	7,2	9,2

Table C.13. Mesiodistal and Buccolingual measurements of the upper fourth premolar.

Note: MD = Mesiodistal (in mm), BL = Buccolingual (in mm).

f. Upper First Molar

No.	Site	Code	MD	BL
Pleistocene Hominin				
1	Glagah Ombo	Sangiran 4	12,3	13,5
2	Sangiran	Sangiran 27	12	14,2
3	Sangiran	S 7-40	13,4	14,1
4	Bapang	Bpg 2001.04	12,5	13,5
5	Sangiran	S 7-9	12,5	13,1
6	Sangiran	S 7-38	12,6	13,7
7	Sangiran	Sangiran 17	10,8	12,6
8	Tanjung	Tjg-1993.05	11,8	12,5
9	Sangiran	S 7-3b	12,5	12,3
10	Sangiran	S 7-8	11,3	12,5
11	Sangiran	S 7-10	12	11,7
12	Sangiran	S 7-14	11,3	12,5
13	Sangiran	S 7-37	11,8	12,6
14	Ngebung	Ng 9603	11	12
15	Sangiran	S 81	11,8	12,3
16	Zhoukoudian	Sp 37	11,8	13,2
17	Zhoukoudian	Sp 38	9,8	10
18	Zhoukoudian	Sp 140	11	13,2
19	Sangiran	Sangiran 24	11,7	11,5
20	Sangiran	Sangiran 24	10,1	11
21	Ngebung	NG 92.3	10,5	10,2
22	Sangiran	S 0088	11	11,4
23	Sangiran	S 0091	12	10,5
24	Pucung	Abimanyu 2	10,5	10,2
25	Wajak	Wajak 1	10,8	13,5
26	Wajak	Wajak 2	11	12,8
Holocene <i>Homo sapiens</i>				
27	Tamias	TMG A1C	9,3	11
28	Sukajadi	SKJ 3	11	12
29	Sukajadi	SKJ 6a	10,6	12,2
30	Sukajadi	SKJ 6b	9,4	11,4
31	Gua Harimau	HRM 36	9,7	11
32	Gua Harimau	HRM 74	9,4	11,5
33	Gua Harimau	HRM 79	9,8	11,5
34	Gua Pawon	PWN 1	10	12,6
35	Gua Pawon	PWN 3	9,8	12,5
36	Gua Pawon	PWN 5	11,8	13,1
37	Gua Braholo	BHL 1	10,6	12,4
38	Gua Braholo	BHL 4	11	13,2

39	Gua Braholo	BHL 7	8,8	10,8
40	Song Keplek	SK 1	11	13,8
41	Song Keplek	SK 4	11	12,8
42	Song Terus	ST96-299	11,2	11,8
43	Song Terus	ST96-457a	10	10,7
44	Gua Kidang	GKD 2	8,8	11,1
45	Goea Djimbe	DMB 17321	9,8	12,8
46	Goea Djimbe	DMB 17322	9,3	11,5
47	Goea Ketjil	KCL 17796	9,6	12,3
48	Hoekgrot	HGR 17410	10,4	11,5
49	Hoekgrot	HGR 17411	10,5	11,8
50	Goea Djimbe	DMB 17321	10,8	12,8
51	Gua Harimau	HRM 10	10,5	11,5
52	Gua Harimau	HRM 12	11,2	12,5
53	Gua Harimau	HRM 13	9,8	11,5
54	Gua Harimau	HRM 17	10,5	11,2
55	Gua Harimau	HRM 21	10,6	11,8
56	Gua Harimau	HRM 24	9,8	10,6
57	Gua Harimau	HRM 25	10,6	11
58	Gua Harimau	HRM 60	11,1	11,1
59	Song Keplek	SK 5	10,6	11,6

Table C.14. Mesiodistal and Buccolingual measurements of the upper first molar.

Note: MD = Mesiodistal (in mm), BL = Buccolingual (in mm).

g. Upper Second Molar

No.	Site	Code	MD	BL
Pleistocene Hominin				
1	Glagah Ombo	Sangiran 4	13,4	15,4
2	Sangiran	Sangiran 27	13	15,5
3	Sangiran	S 7-38	13,6	13,7
4	Sangiran	S 7-40	14,1	13,4
5	Bapang	Bpg 2001.04	12,5	13,8
6	Sangiran	S 7-53	13,2	13,5
7	Sangiran	FS 80	12,3	13
8	Tanjung	Tjg 93.05	11,7	12,8
9	Pucung	Sangiran 17	10,7	12
10	Ngebung	Ng 9603	11	12
11	Grogolan Wetan	GRW 0094	10,6	12,6
12	Grogolan Wetan	GRW 0096	10,6	12
13	Sangiran	S 7-3c	12,6	12,3
14	Sangiran	S 7-14	11,3	12,5
15	Sangiran	S 7-89	12	12,1
16	Sangiran	NG 1989	11,3	12,1
17	Sangiran	S 81	11,8	12,3
18	Zhoukoudian	Sp 40	12	12,1
19	Zhoukoudian	Sp 41	11	12,8
20	Sangiran	S 0069	9,8	12,2
21	Sangiran	S 0086	11	11,4
22	Sangiran	S 0087	10,2	12,2
23	Sangiran	S 0088	11	11,4
24	Ngebung	NG91 G10-1	11,7	12,2
25	Padas	PDS0712	10	12,2
26	Wajak	Wajak 1	10,5	13,2
27	Wajak	Wajak 2	11	13
28	Lida Ajer	LA 11472	9,5	12
Holocene <i>Homo sapiens</i>				
29	Tamiang	TMG A1C	8,5	10,6
30	Sukajadi	SKJ 3	11	12,8
31	Sukajadi	SKJ 6a	10	12,6
32	Sukajadi	SKJ 6b	9,8	12,8
33	Gua Harimau	HRM 36	9	10,8
34	Gua Harimau	HRM 74	9,8	12
35	Gua Harimau	HRM 79	10	11,5
36	Gua Pawon	PWN 1	9	12
37	Gua Pawon	PWN 3	9,8	12
38	Gua Pawon	PWN 5	10	13

39	Gua Braholo	BHL 1	10,5	12
40	Gua Braholo	BHL 4	9,8	12,8
41	Gua Braholo	BHL 99-410	9,5	12
42	Song Keplek	SK 1	10	12,2
43	Song Keplek	SK 4	9,8	12,4
44	Song Terus	ST 96-457a	10	10,7
45	Song Terus	ST 96-1802	9,2	11,2
46	Song Terus	ST 04-8683	9,6	10,8
47	Gua Kidang	GKD 2	9,2	11,4
48	Goea Djimbe	DMB 17321	9,2	12,8
49	Goea Djimbe	DMB 17322	9,2	11,2
50	Goea Ketjil	KCL 17796	9,5	12,2
51	Hoekgrot	HGR 17410	10,2	11,7
52	Hoekgrot	HGR 17411	10,7	12,3
53	Song Keplek	SK 5	9,5	11,8
54	Gua Harimau	HRM 10	9,5	11,3
55	Gua Harimau	HRM 12	10	12,8
56	Gua Harimau	HRM 21	9,8	12

Table C.15. Mesiodistal and Buccolingual measurements of the upper second molar.

Note: MD = Mesiodistal (in mm), BL = Buccolingual (in mm).

h. Upper Third Molar

No.	Site	Code	MD	BL
Pleistocene Hominin				
1	Glagah Ombo	Sangiran 4	10,7	13,8
2	Sangiran	Sangiran 24	10,6	13
3	Sangiran	Sangiran 27	10,5	14,5
4	Sangiran	S 7-53	13,2	13,5
5	Sangiran	Sangiran 1a	13,6	15,2
6	Trinil	Trinil 1	12	15,6
7	Sangiran	S 7-73	12,3	14,9
8	Sangiran	FS 80	12,3	13
9	Ngebung	NG 9107.1	10,4	12,5
10	Tanjung	Tjg-1993.05	9,5	12,8
11	Pucung	Sangiran 17	8,5	12,5
12	Grogolan Wetan	GRW 0094	9,8	12,6
13	Grogolan Wetan	GRW 0097	9,8	12,9
14	Sangiran	Sangiran 11b	9,4	12,8
15	Ngrejeng	Njg 2005.05	9,7	12,8
16	Sangiran	S 7-3d	9	12,3
17	Sangiran	S 7-17	9,4	11,9
18	Sangiran	S 0086	8,5	11,4
19	Sangiran	S 0097	9,8	12,9
20	Zhoukoudian	Sp 46	9,2	11,4
21	Zhoukoudian	Sp 51	10	12,2
22	Sangiran	Sangiran 24	8,3	10,8
23	Padas	PDS 0712	9,9	12,2
24	Sangiran	NG 0802.3	10,8	10,1
25	Sangiran	S 7-6	10,7	10,9
26	Wajak	Wajak 1	8,8	12,8
27	Wajak	Wajak 2	10,5	12,5
Holocene <i>Homo sapiens</i>				
28	Sukajadi	SKJ 3	11,4	12,6
29	Sukajadi	SKJ 6a	7,6	10
30	Gua Harimau	HRM 74	9,6	12,2
31	Gua Harimau	HRM 79	9,8	12
32	Gua Pawon	PWN 3	7,8	12,5
33	Gua Braholo	BHL 1	8,8	11,8
34	Gua Braholo	BHL 4	8,4	12,2
35	Gua Braholo	BHL99-411	11	12,5
36	Gua Braholo	BHL99-412	10	12
37	Song Keplek	SK 1	9,5	12
38	Song Keplek	SK 4	8,5	12,6

39	Gua Kidang	GKD 2	8,2	10,6
40	Goea Djimbe	DMB 17321	8,4	12,6
41	Goea Djimbe	DMB 17322	8,8	11,1
42	Hoekgrot	HGR 17410	8,8	10,7
43	Hoekgrot	HGR 17411	9,7	11
44	Gua Harimau	HRM 10	9,4	11,2
45	Gua Harimau	HRM 12	9,8	12,2
46	Gua Harimau	HRM 21	9	10,6
47	Song Keplek	SK 5	10	11,5

Table C.16. Mesiodistal and Buccolingual measurements of the upper third molar.

Note: MD = Mesiodistal (in mm), BL = Buccolingual (in mm).

APPENDIX D. CROWN SIZE AND CUSP PROPORTION

1. Crown size and cusp proportion of LM1

a. Cusp size of LM1

Code	TA	Med	Prd	Hyd	End	% Med	% Prd	% Hyd	% End
Sangiran 6a	147,33	38,37	27,93	37,25	43,79	26,04	18,96	25,28	29,72
Sangiran 1b	140,58	33,20	33,02	42,55	31,81	23,62	23,49	30,27	22,63
Sangiran 22b	123,22	28,48	32,40	30,49	31,86	23,11	26,29	24,74	25,85
Sangiran 37	117,95	32,67	23,66	31,16	30,46	27,70	20,06	26,42	25,82
S 25	126,04	26,82	26,68	34,88	37,67	21,28	21,17	27,67	29,88
S 7-42	125,97	30,17	32,09	36,10	27,61	23,95	25,47	28,66	21,92
S 7-43	125,87	29,57	29,20	34,80	32,30	23,49	23,20	27,65	25,66
JA 7801	132,93	35,11	30,03	34,66	33,13	26,41	22,59	26,07	24,92
MI 92-1	109,05	22,64	26,65	32,57	27,19	20,76	24,44	29,87	24,93
NG 92-2	101,21	21,03	25,11	31,03	24,04	20,78	24,81	30,66	23,75
S 7-20	112,42	26,90	29,42	31,20	24,91	23,93	26,17	27,75	22,15
S 7-61	111,26	28,61	29,32	27,20	26,13	25,71	26,35	24,45	23,49
S 7-62	123,20	32,52	27,53	33,82	29,33	26,40	22,35	27,45	23,81
S 7-78	110,88	29,27	24,78	30,44	26,40	21,72	27,72	29,83	20,73
S 0091	115,09	26,00	25,85	32,68	30,57	22,59	22,46	28,39	26,56
S 0092	117,32	25,17	25,14	34,60	32,42	21,45	21,43	29,49	27,63
Abimanyu 4	102,56	27,69	21,85	23,16	29,86	27,00	21,30	22,58	29,11
Wajak 2	116,84	34,48	29,54	28,10	24,72	29,51	25,28	24,05	21,16
Sp 36	139,75	33,80	36,78	38,36	30,81	24,19	26,32	27,45	22,05
Sp 137	139,93	43,11	35,20	33,42	28,20	30,81	25,16	23,88	20,15
Sp B2	121,82	32,86	25,20	30,20	33,56	26,97	20,69	24,79	27,55
Sp G1	139,00	33,63	38,12	35,70	31,55	24,19	27,42	25,68	22,70
AIC	109,94	25,28	28,22	30,19	26,26	22,99	25,67	27,46	23,88
SKJ 3	122,86	25,39	36,09	38,22	23,16	20,67	29,38	31,11	18,85
SKJ 4a	128,27	26,15	29,00	40,00	33,12	20,39	22,61	31,18	25,82
SKJ 4b	123,98	25,57	32,28	38,69	27,44	20,63	26,04	31,21	22,13
SKJ X	118,92	28,98	24,84	32,92	32,18	24,37	20,89	27,68	27,06
HRM 37	126,06	29,03	32,85	38,33	25,85	23,03	26,06	30,41	20,51
HRM 79	126,44	31,93	27,33	32,09	35,09	25,25	21,61	25,38	27,75
PWN 1	124,19	25,44	36,26	34,62	27,87	20,48	29,20	27,87	22,44
PWN 5	125,78	30,42	33,10	34,52	27,73	24,19	26,32	27,45	22,05
BHL 1	126,04	30,55	34,50	35,22	25,76	24,24	27,38	27,94	20,44
BHL 5	120,76	29,59	29,04	31,55	30,58	24,50	24,05	26,12	25,32
BHL F7	128,10	30,57	31,61	32,47	33,45	23,86	24,68	25,35	26,11
SK 4	122,59	23,88	33,90	38,03	26,78	19,48	27,66	31,03	21,84
ST 96-KI	139,34	30,20	35,91	36,31	36,93	21,67	25,77	26,05	26,50
DMB 17324	131,81	31,50	36,12	33,55	30,65	23,90	27,40	25,45	23,25

HRM 1	124,12	26,78	27,93	35,22	34,20	21,58	22,50	28,37	27,55
HRM 9	128,83	27,05	35,57	42,28	23,93	21,00	27,61	32,82	18,57
HRM 12	121,86	23,42	30,45	33,10	34,89	19,22	24,99	27,16	28,63
HRM 21	113,30	28,37	23,42	32,21	29,30	25,04	20,67	28,43	25,86
HRM 23	123,58	26,44	35,22	34,15	27,78	21,40	28,50	27,63	22,48
HRM 25	107,64	23,48	24,11	33,15	26,90	21,81	22,40	30,80	24,99
SK 5	120,99	31,26	28,73	32,31	28,69	25,84	23,74	26,71	23,71

Table D.1. Absolute and relative cusp size of LM1.

Abbreviation: TA = Total Area, Med = Absolute size of Metaconid, Prd = Absolute size of Protoconid, Hyd = Absolute size of Hypoconid, End = Absolute size of Entoconid, % Med = Relative size of Metaconid, % Prd = Relative size of Protoconid, % Hyd = Relative size of Hypoconid, % End = Relative size of Entoconid.

b. Perimetric and distance of cusps at LM1

Code	C Med	C Prd	C Hyd	C End	Med-Prd	Prd-Hyd	Hyd-End	End-Med
Sangiran 6a	23,89	22,34	30,93	32,19	5,70	6,13	6,14	7,83
Sangiran 1b	22,89	22,66	32,34	27,92	5,82	5,51	6,63	6,68
Sangiran 22b	20,98	23,92	27,15	27,49	5,36	5,50	5,47	5,83
Sangiran 37	21,30	20,03	22,34	23,09	5,27	5,13	5,82	7,29
S 25	20,50	21,16	31,48	29,40	5,43	5,69	5,64	6,36
S 7-42	21,55	22,78	24,47	21,60	5,23	5,08	5,48	6,00
S 7-43	21,42	21,48	27,33	18,42	5,80	5,52	6,64	6,10
JA 7801	22,43	21,08	29,91	27,89	5,32	5,19	6,08	6,85
MI 92-1	19,80	20,13	22,17	21,22	4,56	4,68	5,29	4,50
NG 92-2	17,93	20,84	22,44	19,35	4,34	4,49	4,42	4,79
S 7-20	20,17	21,62	28,98	24,79	4,83	4,47	5,37	5,77
S 7-61	20,51	22,31	26,68	25,35	4,98	4,74	5,77	5,52
S 7-62	22,26	20,74	23,57	22,67	5,43	4,62	5,92	5,30
S 7-78	20,03	18,67	21,21	20,40	5,82	5,78	5,97	6,11
S 0091	20,61	20,38	28,02	26,83	5,84	6,14	6,67	6,03
S 0092	19,82	20,46	28,76	27,61	6,22	5,49	7,13	6,16
Abimanyu 4	22,56	18,08	22,72	27,31	4,45	5,02	5,15	5,27
Wajak 2	23,26	21,25	21,59	19,62	5,63	5,06	5,78	5,79
Sp 36	22,36	23,10	30,67	27,29	6,70	5,97	7,15	6,66
Sp 137	25,31	23,50	29,54	26,55	6,61	5,14	6,31	6,13
Sp B2	22,90	23,22	28,46	29,01	5,96	4,33	5,74	6,44
Sp G1	22,57	24,71	23,88	22,20	5,40	4,85	5,63	6,06
AIC	19,42	21,20	26,89	26,32	4,93	4,57	5,49	5,13
SKJ 3	19,14	23,08	24,39	18,68	5,60	6,98	5,56	6,91
SKJ 4a	20,09	20,79	25,88	22,34	5,25	7,24	5,12	7,30
SKJ 4b	19,10	21,89	24,24	20,79	5,37	5,61	5,33	5,54
SKJ X	21,07	20,38	23,25	22,50	5,69	6,54	6,13	6,46
HRM 37	21,39	22,85	25,10	20,75	6,08	4,77	6,25	4,86
HRM 79	22,25	20,89	22,63	23,85	5,92	6,53	6,19	6,73
PWN 1	19,10	22,79	23,39	20,59	5,75	5,79	6,10	5,89
PWN 5	19,43	21,82	27,91	28,25	5,13	5,01	5,79	5,05
BHL 1	21,06	22,99	23,09	19,85	5,04	4,82	5,03	4,90
BHL 5	20,56	19,72	21,67	20,84	5,22	5,15	5,65	5,45
BHL F7	21,74	22,17	22,53	23,29	5,27	5,64	5,69	5,72
SK 4	18,62	21,76	23,35	20,09	5,25	5,25	6,10	5,01
ST 96-KI	21,89	23,21	29,15	28,61	5,73	6,29	6,20	6,96
DMB 17324	23,31	24,80	25,09	23,85	6,50	5,17	6,70	6,06
HRM 1	21,07	21,26	29,34	27,98	6,09	5,08	7,02	5,49
HRM 9	20,39	23,75	25,94	19,39	6,05	6,05	7,15	5,97
HRM 12	18,38	20,60	23,32	23,13	6,44	5,32	6,54	5,40

HRM 21	21,66	20,16	24,45	20,90	4,99	4,89	6,07	5,28
HRM 23	20,27	23,48	28,69	25,18	5,84	5,80	5,71	5,87
HRM 25	19,86	19,62	26,90	25,26	5,45	6,29	5,70	6,34
SK 5	20,76	20,69	21,23	20,77	5,72	5,63	6,24	5,78

Table D.2. Perimetric and distance of cusp at LM1.

Abbreviation: C Med = Circumference of Metaconid, C Prd = Circumference of Protoconid, C Hyd = Circumference of Hypoconid, C End = Circumference of Entoconid, Med-Prd = Distance between Metaconid and Protoconid, Prd-Hyd = Distance between Protoconid and Hypoconid, Hyd-End = Distance between Hypoconid and Entoconid, End-Med = Distance between Entoconid and Metaconid.

c. Angle of cusp at LM1

Code	< Med	< Prd	< Hyd	< End	% < Med	% < Prd	% < Hyd	% < End
Sangiran 6a	91,10	92,00	101,70	75,20	25,31	25,56	28,25	20,89
Sangiran 1b	94,00	93,50	96,50	76,00	26,11	25,97	26,81	21,11
Sangiran 22b	99,14	81,57	102,00	77,29	27,54	22,66	28,33	21,47
Sangiran 37	91,00	90,10	111,50	67,40	25,28	25,03	30,97	18,72
S 25	96,45	84,45	101,50	77,60	26,79	23,46	28,19	21,56
S 7-42	89,40	93,50	96,50	80,60	24,83	25,97	26,81	22,39
S 7-43	95,90	92,40	92,45	79,25	26,64	25,67	25,68	22,01
JA 7801	91,73	92,88	103,15	72,24	25,48	25,80	28,65	20,07
MI 92-1	98,70	90,50	87,10	83,70	27,42	25,14	24,19	23,25
NG 92-2	88,73	92,14	90,85	88,28	24,65	25,59	25,24	24,52
S 7-20	89,50	95,50	98,50	76,50	24,86	26,53	27,36	21,25
S 7-61	91,90	96,10	92,35	79,65	25,53	26,69	25,65	22,13
S 7-62	99,00	85,00	101,00	75,00	27,50	23,61	28,06	20,83
S 7-78	95,20	85,80	97,00	82,00	26,44	23,83	26,94	22,78
S 0091	98,50	89,70	88,70	83,10	27,36	24,92	24,64	23,08
S 0092	95,54	92,67	92,42	79,37	26,54	25,74	25,67	22,05
Abimanyu 4	95,38	92,51	89,91	82,20	26,49	25,70	24,98	22,83
Wajak 2	91,95	88,55	99,55	79,95	25,54	24,60	27,65	22,21
Sp 36	92,70	90,50	94,50	82,30	25,75	25,14	26,25	22,86
Sp 137	89,25	86,87	101,72	82,16	24,79	24,13	28,26	22,82
Sp B2	86,50	87,70	113,25	72,55	24,03	24,36	31,46	20,15
Sp G1	94,74	84,82	107,46	72,98	26,32	23,56	29,85	20,27
AIC	96,40	89,49	95,70	78,41	26,78	24,86	26,58	21,78
SKJ 3	93,80	85,80	94,00	86,40	26,06	23,83	26,11	24,00
SKJ 4a	97,00	82,50	98,30	82,20	26,94	22,92	27,31	22,83
SKJ 4b	91,16	88,89	90,45	89,50	25,32	24,69	25,13	24,86
SKJ X	92,50	90,80	89,00	87,70	25,69	25,22	24,72	24,36
HRM 37	95,56	87,09	93,40	83,95	26,54	24,19	25,94	23,32
HRM 79	91,60	90,50	91,50	86,40	25,44	25,14	25,42	24,00
PWN 1	94,00	90,20	91,10	84,70	26,11	25,06	25,31	23,53
PWN 5	95,40	92,65	87,60	84,35	26,50	25,74	24,33	23,43
BHL 1	86,98	91,80	89,02	92,20	24,16	25,50	24,73	25,61
BHL 5	91,50	93,10	89,10	86,30	25,42	25,86	24,75	23,97
BHL F7	95,25	88,25	92,10	84,40	26,46	24,51	25,58	23,44
SK 4	99,60	89,40	88,00	83,00	27,67	24,83	24,44	23,06
ST 96-KI	97,29	85,75	99,95	77,01	27,03	23,82	27,76	21,39
DMB 17324	98,22	81,82	105,53	74,43	27,28	22,73	29,31	20,68
HRM 1	96,13	93,90	89,37	80,60	26,70	26,08	24,83	22,39
HRM 9	97,45	92,05	86,50	84,00	27,07	25,57	24,03	23,33
HRM 12	88,95	93,05	87,81	90,19	24,71	25,85	24,39	25,05

HRM 21	97,68	95,60	86,57	80,15	27,13	26,56	24,05	22,26
HRM 23	90,75	88,19	92,87	88,19	25,21	24,50	25,80	24,50
HRM 25	91,50	90,76	89,30	88,44	25,42	25,21	24,81	24,57
SK 5	92,55	92,15	89,00	86,30	25,71	25,60	24,72	23,97

Table D.3. Absolute and relative angle of cusp at LM1.

Abbreviation: < Med = Absolute angle of Metaconid, < Prd = Absolute angle of Protoconid, < Hyd = Absolute angle of Hypoconid, < End = Absolute angle of Entoconid, % < Med = Relative angle of Metaconid, % < Prd = Relative angle of Protoconid, % < Hyd = Relative angle of Hypoconid, % < End = Relative angle of Entoconid

2. Crown size and cusp proportion of LM2

a. Cusp size of LM2

Code	TA	Med	Prd	Hyd	End	% Med	% Prd	% Hyd	% End
Ardjuna 9	158,55	39,71	38,33	52,08	28,44	25,05	24,18	32,84	17,93
Sangiran 5	175,30	41,38	49,35	49,58	34,99	23,61	28,15	28,28	19,96
Sangiran 6b	167,71	41,68	38,33	53,04	34,66	24,85	22,85	31,63	20,67
NK 9603	161,39	37,45	40,16	44,69	39,09	23,20	24,88	27,69	24,22
S 7-78	157,32	34,17	43,61	46,93	32,61	21,72	27,72	29,83	20,73
Sangiran 1b	155,31	39,22	38,33	49,30	28,47	25,25	24,68	31,74	18,33
Sangiran 9	149,15	34,48	35,79	45,67	33,21	23,12	24,00	30,62	22,27
Sangiran 33	149,42	34,71	38,57	38,05	29,09	29,25	25,81	25,47	19,47
S Box 25	134,91	32,77	28,39	37,38	36,37	24,17	20,36	28,18	27,30
S 7-20	121,34	31,55	38,33	31,20	20,27	26,00	31,59	25,71	16,70
S 7-64	132,03	30,16	36,16	37,80	27,91	22,84	27,39	28,63	21,14
S 7-84	139,71	31,74	40,33	36,14	31,50	22,72	28,87	25,87	22,55
NG 8503	109,59	31,98	26,42	22,11	29,08	29,18	24,11	20,18	26,54
Sangiran 22	138,13	33,75	38,33	32,36	33,70	24,43	27,75	23,42	24,39
Sangiran 37	125,01	30,63	31,53	32,88	29,97	24,50	25,22	26,30	23,97
S 0089	108,40	26,18	28,01	28,75	25,47	24,15	25,84	26,52	23,49
S 0090	111,73	24,83	31,83	31,95	23,13	22,22	28,49	28,59	20,70
NG 0802-2	101,31	23,63	30,13	25,85	21,70	23,32	29,74	25,52	21,42
S 7-65	138,56	35,03	42,07	35,74	25,72	25,28	30,36	25,79	18,56
S 7-76	132,54	33,30	28,60	41,04	29,60	25,12	21,58	30,96	22,33
Abimanyu 1	119,24	26,68	36,80	32,31	23,45	22,38	30,86	27,10	19,67
NG 92-1	89,58	20,49	25,35	23,67	20,07	22,87	28,30	26,42	22,40
NG 92.3	104,88	22,73	25,10	31,49	25,56	21,67	23,93	30,02	24,37
NG 92.4	78,91	17,09	22,00	21,64	18,18	21,66	27,88	27,42	23,04
NG 92-D6	101,11	21,58	30,42	25,37	23,74	21,34	30,09	25,09	23,48
NG 0802-3	90,21	19,27	25,02	17,50	28,42	21,36	27,74	19,40	31,50
Wajak 1	132,20	28,87	38,08	35,86	29,39	21,84	28,80	27,13	22,23
Wajak 2	118,21	23,20	32,22	33,34	29,45	19,63	27,26	28,20	24,91
Sp 40	124,52	29,75	38,39	28,41	27,97	23,89	30,83	22,82	22,46
Sp 43	118,92	28,77	32,78	31,29	26,09	24,19	27,56	26,31	21,93
Sp 44	124,07	33,28	34,10	34,44	22,25	26,82	27,48	27,76	17,93
Sp 45	128,73	36,76	32,98	32,11	26,88	28,56	25,62	24,94	20,88
Sp 139	87,27	21,70	20,86	25,62	19,10	24,87	23,90	29,35	21,88
Sp F1.5	133,31	35,69	31,76	31,15	34,72	26,77	23,82	23,36	26,04
Sp G1	136,71	29,65	42,82	38,59	25,65	21,69	31,32	28,23	18,76
Sp R2	136,87	33,61	34,13	42,65	26,48	24,56	24,94	31,16	19,35
BHL1	119,34	26,68	36,80	32,31	23,55	22,36	30,84	27,07	19,73
BHL 5	126,61	28,80	36,61	33,84	27,36	22,75	28,92	26,73	21,61
BHL 97-F4-17	109,52	27,08	34,02	23,31	25,11	24,73	31,06	21,28	22,93

BHL F7	122,12	23,07	37,28	39,01	22,76	18,89	30,53	31,94	18,64
SK 4	123,67	23,48	37,27	44,29	18,63	18,99	30,14	35,81	15,06
ST 1	124,85	28,59	34,97	37,26	24,04	22,90	28,01	29,84	19,25
ST 96-KI	125,41	27,18	32,32	32,67	33,23	21,67	25,77	26,05	26,50
STRT1	96,13	18,56	33,96	24,94	18,67	19,31	35,33	25,94	19,42
PWN 1	123,62	27,49	38,60	35,45	22,09	22,23	31,22	28,68	17,87
PWN 3	123,56	27,07	31,73	34,71	30,05	21,91	25,68	28,09	24,32
PWN 4	124,77	26,42	33,71	29,96	34,68	21,17	27,02	24,01	27,80
PWN 5	125,98	30,30	31,06	31,87	32,76	24,05	24,65	25,30	26,00
SKJ 3	128,62	29,69	31,38	42,34	25,21	23,08	24,40	32,92	19,60
SKJ 4a	128,46	27,89	34,13	40,80	25,64	21,71	26,57	31,76	19,96
SKJ 4b	127,45	27,08	32,10	39,52	28,75	21,25	25,19	31,01	22,56
SKJ X	122,30	27,26	30,06	39,78	25,20	22,29	24,58	32,53	20,60
AIC	94,21	21,94	28,55	27,58	16,14	23,29	30,30	29,28	17,13
HRM 8	115,02	26,85	31,64	31,56	24,97	23,34	27,51	27,44	21,71
HRM 37	103,35	19,19	36,13	29,75	18,28	18,57	34,96	28,79	17,69
HRM 74	126,47	23,65	34,29	35,65	32,88	18,70	27,11	28,19	26,00
HRM 79	113,45	24,20	32,34	35,16	21,75	21,33	28,51	30,99	19,17
GKD 2	124,72	28,07	31,05	37,75	27,85	22,51	24,90	30,27	22,33
DMB 17324	129,37	30,85	43,72	31,55	23,25	23,85	33,79	24,39	17,97
KCL 17797	128,69	24,12	45,73	34,51	24,33	18,74	35,54	26,82	18,91
KCL 17798	107,74	23,27	30,67	27,24	26,56	21,60	28,47	25,28	24,65
SK 5	122,12	24,79	32,80	36,05	28,48	20,30	26,86	29,52	23,32
HRM 12	123,09	27,74	35,04	36,24	24,07	22,54	28,47	29,44	19,55
HRM 17	126,78	29,60	28,54	36,02	32,62	23,35	22,51	28,41	25,73
HRM 21	120,61	20,41	34,50	30,52	35,18	16,92	28,60	25,31	29,17
HRM 23	111,46	22,49	38,33	25,63	25,02	20,18	34,39	22,99	22,44

Table D.4. Absolute and relative cusp size of LM2.

Abbreviation: TA = Total Area, Med = Absolute size of Metaconid, Prd = Absolute size of Protoconid, Hyd = Absolute size of Hypoconid, End = Absolute size of Entoconid, % Med = Relative size of Metaconid, % Prd = Relative size of Protoconid, % Hyd = Relative size of Hypoconid, % End = Relative size of Entoconid.

b. Perimetric and distance of cusp at LM2

Code	C Med	C Prd	C Hyd	C End	Med-Prd	Prd-Hyd	Hyd-End	End-Med
Ardjuna 9	24,61	28,33	35,30	26,55	6,66	5,87	7,71	7,55
Sangiran 5	25,28	28,89	28,28	23,85	6,17	6,26	7,02	7,60
Sangiran 6b	25,53	28,33	32,51	25,34	6,53	7,10	7,10	7,95
NK 9603	25,31	23,77	26,34	25,38	6,26	5,83	6,60	6,88
S 7-78	23,91	26,61	27,67	22,66	6,47	6,42	6,63	6,79
Sangiran 1b	24,98	28,33	33,86	25,46	6,29	6,50	6,58	7,05
Sangiran 9	23,68	23,92	30,28	24,00	6,07	7,05	6,60	7,80
Sangiran 33	25,38	24,92	25,66	21,38	5,47	5,49	5,68	6,24
S Box 25	24,57	22,68	26,02	26,54	4,16	5,38	4,97	5,96
S 7-20	21,60	28,33	28,98	23,05	4,83	4,47	5,37	5,77
S 7-64	21,29	24,48	25,45	21,41	5,09	4,91	5,61	5,19
S 7-84	22,20	25,31	24,45	23,75	6,19	6,26	6,34	6,51
NG 8503	21,57	21,98	20,26	22,97	5,36	5,76	5,79	5,64
Sangiran 22	22,53	28,33	28,48	28,14	6,07	5,92	6,29	6,45
Sangiran 37	21,69	22,02	24,71	22,22	5,30	5,95	5,65	6,45
S 0089	19,86	21,19	27,95	24,30	4,62	4,20	5,14	4,70
S 0090	19,78	22,19	29,25	24,99	6,17	4,98	6,43	5,23
NG 0802-2	18,86	21,65	19,18	19,94	5,04	5,36	5,09	5,50
S 7-65	23,23	26,64	24,42	20,82	6,35	5,63	6,91	6,17
S 7-76	25,62	24,89	28,30	25,82	3,92	4,16	4,77	4,40
Abimanyu 1	20,42	24,16	22,64	19,14	5,26	5,67	5,26	5,87
NG 92-1	17,63	20,60	20,23	17,43	5,10	5,00	5,00	5,20
NG 92.3	18,19	20,43	23,17	20,45	4,34	5,15	4,58	5,26
NG 92.4	16,31	18,60	18,46	17,40	3,94	4,85	3,84	4,94
NG 92-D6	18,35	22,89	19,74	19,33	5,23	5,75	5,09	5,64
NG 0802-3	17,02	19,95	16,56	20,55	4,94	5,22	5,28	5,36
Wajak 1	20,69	24,03	25,14	21,03	6,94	6,08	5,94	6,27
Wajak 2	20,80	23,13	25,06	22,62	5,55	6,57	6,19	6,17
Sp 40	21,75	25,70	22,66	21,09	6,14	4,71	6,02	4,87
Sp 43	20,75	22,49	27,29	25,51	5,91	5,54	5,62	5,32
Sp 44	22,86	22,94	23,73	19,36	5,27	5,10	5,40	5,66
Sp 45	22,90	23,69	23,53	22,53	6,35	5,84	6,44	5,20
Sp 139	19,03	18,76	24,68	21,82	5,05	4,57	5,04	5,36
Sp F1.5	23,45	21,54	28,16	29,46	5,50	5,64	6,01	7,16
Sp G1	21,17	26,36	25,02	20,83	6,71	5,25	6,29	6,31
Sp R2	22,77	23,35	33,36	26,81	6,09	5,77	7,03	6,31
BHL1	20,42	24,16	22,73	19,33	5,35	5,42	5,26	5,26
BHL 5	21,25	23,41	22,78	20,61	5,74	5,51	5,78	5,54
BHL 97-F4-17	21,25	23,41	22,78	20,61	4,93	5,44	5,06	5,83
BHL F7	18,89	23,95	24,25	18,97	5,57	5,72	5,66	5,49

SK 4	18,60	23,06	24,80	16,75	5,35	5,70	5,31	5,35
ST 1	20,60	23,07	23,54	19,46	5,56	5,31	5,59	5,58
ST 96-KI	19,70	20,89	26,24	25,75	5,43	5,96	5,88	6,60
STRT1	16,91	22,27	19,57	17,55	5,26	5,29	4,98	5,36
PWN 1	19,20	22,09	24,28	17,96	5,81	5,99	5,73	6,20
PWN 3	20,33	21,70	24,25	21,83	4,96	6,62	5,54	5,94
PWN 4	19,68	23,57	21,62	23,04	6,18	6,12	6,10	6,10
PWN 5	21,22	22,23	22,07	24,47	6,18	5,39	6,51	4,31
SKJ 3	21,83	22,06	25,55	20,14	5,44	6,25	6,06	6,16
SKJ 4a	20,82	22,77	25,80	19,69	5,63	5,48	5,97	5,75
SKJ 4b	20,29	22,31	24,86	21,71	5,57	5,64	5,52	5,77
SKJ X	19,08	20,54	24,41	18,84	5,19	5,04	5,38	4,94
AIC	18,10	20,44	20,77	16,34	4,74	4,56	4,39	4,65
HRM 8	21,59	23,66	22,88	20,05	5,83	5,38	5,75	4,96
HRM 37	17,13	23,24	22,21	17,44	5,25	5,02	4,98	4,80
HRM 74	19,42	23,20	23,57	23,30	5,47	5,74	5,61	6,02
HRM 79	19,22	22,87	23,44	18,34	5,23	5,17	5,24	5,34
GKD 2	20,03	21,48	24,90	22,28	5,17	5,71	5,38	5,60
DMB 17324	21,52	25,56	22,71	18,64	5,00	5,66	5,54	6,33
KCL 17797	19,11	25,90	23,66	19,37	6,27	5,82	5,07	5,43
KCL 17798	18,65	21,54	20,65	19,82	5,55	5,46	4,98	5,37
SK 5	19,43	23,11	25,37	21,55	5,65	5,74	5,58	5,87
HRM 12	21,04	23,23	24,07	23,40	6,29	6,93	6,84	7,02
HRM 17	20,81	22,08	25,44	22,09	5,02	6,35	5,48	6,56
HRM 21	17,20	24,50	26,28	26,58	4,11	4,76	5,14	4,80
HRM 23	18,35	28,33	26,31	24,51	4,97	5,33	5,98	6,06

Table D.5. Perimetric and distance of cusp at LM2.

Abbreviation: C Med = Circumference of Metaconid, C Prd = Circumference of Protoconid, C Hyd = Circumference of Hypoconid, C End = Circumference of Entoconid, Med-Prd = Distance between Metaconid and Protoconid, Prd-Hyd = Distance between Protoconid and Hypoconid, Hyd-End = Distance between Hypoconid and Entoconid, End-Med = Distance between Entoconid and Metaconid.

c. Angle of cusp at LM2

Code	< Med	< Prd	< Hyd	< End	% < Med	% < Prd	% < Hyd	% < End
Ardjuna 9	88,05	98,30	99,70	73,95	24,46	27,31	27,69	20,54
Sangiran 5	98,05	87,47	101,90	72,58	27,24	24,30	28,31	20,16
Sangiran 6b	92,23	91,88	94,92	80,97	25,62	25,52	26,37	22,49
NK 9603	92,57	89,38	99,66	78,39	25,71	24,83	27,68	21,78
S 7-78	95,20	85,80	97,00	82,00	26,44	23,83	26,94	22,78
Sangiran 1b	95,27	86,27	98,53	79,93	26,46	23,96	27,37	22,20
Sangiran 9	95,50	87,50	98,00	79,00	26,53	24,31	27,22	21,94
Sangiran 33	96,83	84,34	103,10	75,73	26,90	23,43	28,64	21,04
S Box 25	91,00	97,00	91,00	81,00	25,28	26,94	25,28	22,50
S 7-20	89,50	95,50	98,50	76,50	24,86	26,53	27,36	21,25
S 7-64	97,50	88,10	94,00	80,40	27,08	24,47	26,11	22,33
S 7-84	93,00	88,15	94,35	84,50	25,83	24,49	26,21	23,47
NG 8503	101,00	83,50	94,70	80,80	28,06	23,19	26,31	22,44
Sangiran 22	94,52	87,64	97,08	80,76	26,26	24,34	26,97	22,43
Sangiran 37	96,60	86,10	98,30	79,00	26,83	23,92	27,31	21,94
S 0089	92,10	94,40	91,40	82,10	25,58	26,22	25,39	22,81
S 0090	89,35	93,45	88,65	88,55	24,82	25,96	24,63	24,60
NG 0802-2	95,60	84,80	96,50	83,10	26,56	23,56	26,81	23,08
S 7-65	92,10	93,10	91,50	83,30	25,58	25,86	25,42	23,14
S 7-76	96,30	95,45	87,70	80,55	26,75	26,51	24,36	22,38
Abimanyu 1	90,33	90,14	92,91	86,62	25,09	25,04	25,81	24,06
NG 92-1	85,70	92,57	89,36	92,37	23,81	25,71	24,82	25,66
NG 92.3	90,80	91,50	91,20	86,50	25,22	25,42	25,33	24,03
NG 92.4	88,78	90,00	91,57	89,65	24,66	25,00	25,44	24,90
NG 92-D6	96,08	82,79	96,58	84,55	26,69	23,00	26,83	23,49
NG 0802-3	91,10	92,10	89,30	87,50	25,31	25,58	24,81	24,31
Wajak 1	80,55	89,95	91,55	97,95	22,38	24,99	25,43	27,21
Wajak 2	93,77	88,73	92,72	84,78	26,05	24,65	25,76	23,55
Sp 40	99,00	79,00	102,35	79,65	27,50	21,94	28,43	22,13
Sp 43	100,35	77,40	101,50	80,75	27,88	21,50	28,19	22,43
Sp 44	97,80	82,60	103,40	76,20	27,17	22,94	28,72	21,17
Sp 45	98,56	82,54	91,90	87,00	27,38	22,93	25,53	24,17
Sp 139	91,45	88,55	99,50	80,50	25,40	24,60	27,64	22,36
Sp F1.5	92,10	90,80	103,55	73,55	25,58	25,22	28,76	20,43
Sp G1	93,00	81,55	109,00	76,45	25,83	22,65	30,28	21,24
Sp R2	94,15	95,45	89,50	80,90	26,15	26,51	24,86	22,47
BHL1	90,65	88,00	90,08	91,27	25,18	24,44	25,02	25,35
BHL 5	88,60	93,00	88,80	89,60	24,61	25,83	24,67	24,89
BHL 97-F4-17	88,00	94,00	90,00	88,00	24,44	26,11	25,00	24,44
BHL F7	92,30	88,90	89,40	89,40	25,64	24,69	24,83	24,83

SK 4	95,30	85,00	89,40	90,30	26,47	23,61	24,83	25,08
ST 1	91,10	87,95	93,60	87,35	25,31	24,43	26,00	24,26
ST 96-KI	97,29	85,75	99,95	77,01	27,03	23,82	27,76	21,39
STRT1	90,30	87,60	92,30	89,80	25,08	24,33	25,64	24,94
PWN 1	87,20	91,60	90,60	90,60	24,22	25,44	25,17	25,17
PWN 3	95,90	89,80	82,80	91,50	26,64	24,94	23,00	25,42
PWN 4	88,80	89,60	89,60	92,00	24,67	24,89	24,89	25,56
PWN 5	96,11	87,77	83,25	92,87	26,70	24,38	23,13	25,80
SKJ 3	93,40	92,05	86,00	88,55	25,94	25,57	23,89	24,60
SKJ 4a	92,00	90,00	92,00	86,00	25,56	25,00	25,56	23,89
SKJ 4b	90,41	88,74	93,25	87,60	25,11	24,65	25,90	24,33
SKJ X	93,20	89,10	89,60	88,10	25,89	24,75	24,89	24,47
AIC	86,90	88,35	92,40	92,35	24,14	24,54	25,67	25,65
HRM 8	95,80	84,20	95,40	84,60	26,61	23,39	26,50	23,50
HRM 37	86,40	89,50	87,90	96,20	24,00	24,86	24,42	26,72
HRM 74	86,20	95,30	87,50	91,00	23,94	26,47	24,31	25,28
HRM 79	90,20	90,20	91,80	87,80	25,06	25,06	25,50	24,39
GKD 2	83,20	98,30	80,70	97,80	23,11	27,31	22,42	27,17
DMB 17324	90,73	94,20	92,67	82,40	25,20	26,17	25,74	22,89
KCL 17797	90,35	77,90	98,90	92,85	25,10	21,64	27,47	25,79
KCL 17798	94,20	79,60	100,00	86,20	26,17	22,11	27,78	23,94
SK 5	87,20	93,12	87,75	91,93	24,22	25,87	24,38	25,54
HRM 12	88,00	98,00	85,00	89,00	24,44	27,22	23,61	24,72
HRM 17	90,60	94,20	88,60	86,60	25,17	26,17	24,61	24,06
HRM 21	91,50	101,10	81,20	86,20	25,42	28,08	22,56	23,94
HRM 23	88,00	102,50	86,00	83,50	24,44	28,47	23,89	23,19

Table D.6. Absolute and relative angle of cusp at LM2.

Abbreviation: < Med = Absolute angle of Metaconid, < Prd = Absolute angle of Protoconid, < Hyd = Absolute angle of Hypoconid, < End = Absolute angle of Entoconid, % < Med = Relative angle of Metaconid, % < Prd = Relative angle of Protoconid, % < Hyd = Relative angle of Hypoconid, % < End = Relative angle of Entoconid

3. Crown size and cusp proportion of LM3

a. Cusp size of LM3

Code	TA	Med	Prd	Hyd	End	% Med	% Prd	% Hyd	% End
Ardjuna 9	153,16	34,21	42,15	45,14	31,66	22,34	27,52	29,47	20,67
Sangiran 6b	171,06	44,45	42,88	41,35	42,38	25,99	25,07	24,17	24,77
Sangiran 8	161,34	39,43	40,13	49,55	32,23	24,44	24,87	30,71	19,98
Sangiran 1b	148,99	34,51	36,37	40,13	37,99	23,16	24,41	26,93	25,49
Sangiran 9	132,80	38,23	33,64	30,77	30,16	28,79	25,33	23,17	22,71
Sangiran 21	103,57	33,00	28,57	23,00	19,00	31,86	27,59	22,21	18,35
Sangiran 22b	116,11	32,63	31,04	28,61	23,83	28,10	26,73	24,64	20,52
Sangiran 33	164,65	47,03	42,53	42,33	32,76	28,56	25,83	25,71	19,90
Sangiran 37	104,62	28,34	31,45	23,94	20,89	28,56	25,83	25,71	19,90
NG 9107-2	92,72	24,83	21,93	23,71	22,25	26,78	23,65	25,57	24,00
NG 92.3	104,88	22,73	25,10	31,49	25,56	21,67	23,93	30,02	24,37
NG 0802-2	101,31	23,63	30,13	25,85	21,70	23,32	29,74	25,52	21,42
Wajak 1	121,11	31,45	31,71	32,34	25,62	25,96	26,18	26,70	21,16
Wajak 2	117,59	23,76	32,00	35,83	26,00	20,21	27,22	30,47	22,11
Sp 45	128,73	36,76	32,98	32,11	26,88	28,56	25,62	24,94	20,88
Sp 51	119,92	27,39	25,33	34,97	32,23	22,84	21,12	29,16	26,88
Sp 52	119,10	29,28	32,07	34,95	22,80	24,58	26,93	29,35	19,14
Sp 131	120,07	29,40	38,81	27,75	24,11	24,49	32,32	23,11	20,08
Sp F1.5	96,57	28,87	24,52	21,82	21,36	29,90	25,39	22,60	22,12
Sp G1	128,09	35,45	38,55	33,36	20,73	27,68	30,10	26,04	16,18
Sp R2	100,38	27,07	35,38	21,06	16,87	26,97	35,25	20,98	16,81
SKJ 3	110,52	25,67	34,08	30,07	20,70	23,23	30,84	27,21	18,73
SKJ X	95,58	20,18	26,63	25,90	22,87	21,11	27,86	27,10	23,93
HRM 37	91,13	14,94	38,83	25,30	12,06	16,39	42,61	27,76	13,23
HRM 74	117,31	22,35	31,44	36,28	27,24	19,05	26,80	30,93	23,22
PWN 1	117,91	24,35	36,94	30,55	26,07	20,65	31,33	25,91	22,11
PWN 3	115,35	24,40	30,16	33,07	27,72	21,15	26,15	28,67	24,03
PWN 4	118,00	26,38	30,33	36,59	24,70	22,36	25,70	31,01	20,93
PWN 5	111,59	25,80	27,77	33,66	24,36	23,12	24,89	30,16	21,83
BHL F7	110,48	23,22	35,61	36,20	15,45	21,02	32,23	32,77	13,98
BHL H8 411	108,94	30,93	33,40	14,98	29,63	28,39	30,66	13,75	27,20
SK 4	102,04	21,25	32,02	31,68	17,09	20,83	31,38	31,05	16,75
ST 1	111,02	24,80	29,22	27,54	29,46	22,34	26,32	24,81	26,54
STRT 1	91,78	21,05	25,45	22,60	22,68	22,94	27,73	24,62	24,71
GKD 2	112,69	31,23	32,87	25,55	23,04	27,71	29,17	22,67	20,45
DMB 17324	110,13	25,89	27,59	33,60	23,05	23,51	25,05	30,51	20,93
KCL 17798	110,37	28,26	32,42	26,02	23,67	25,60	29,37	23,58	21,45
HRM 21	96,95	19,40	38,30	25,05	14,20	20,01	39,50	25,84	14,65
SK 5	115,27	30,50	32,36	29,15	23,26	26,46	28,07	25,29	20,18

Table D.7. Absolute and relative cusp size of LM3.

Abbreviation: TA = Total Area, Med = Absolute size of Metaconid, Prd = Absolute size of Protoconid, Hyd = Absolute size of Hypoconid, End = Absolute size of Entoconid, % Med = Relative size of Metaconid, % Prd = Relative size of Protoconid, % Hyd = Relative size of Hypoconid, % End = Relative size of Entoconid.

b. Perimetric and distance of cusp at LM3

Code	C Med	C Prd	C Hyd	C End	Med-Prd	Prd-Hyd	Hyd-End	End-Med
Ardjuna 9	23,70	25,83	26,78	22,07	5,86	7,29	5,86	8,56
Sangiran 6b	26,19	25,53	25,95	25,49	5,32	7,63	5,76	8,46
Sangiran 8	25,39	25,59	28,75	24,71	6,43	7,70	6,81	8,55
Sangiran 1b	23,85	24,30	27,79	26,06	7,16	7,13	7,25	7,89
Sangiran 9	25,33	23,45	23,08	21,89	5,32	5,83	5,97	6,92
Sangiran 21	22,42	21,10	20,38	18,92	5,07	4,51	5,22	5,27
Sangiran 22b	22,52	23,20	22,20	20,06	5,20	5,20	5,64	6,36
Sangiran 33	22,52	23,20	22,20	20,06	6,43	7,24	7,11	8,22
Sangiran 37	22,15	22,55	19,26	19,01	4,31	4,95	4,80	5,32
NG 9107-2	19,78	18,26	20,02	19,02	4,44	5,76	4,72	5,00
NG 92.3	18,19	20,43	23,17	20,45	4,34	5,15	4,58	5,26
NG 0802-2	18,86	21,65	19,18	19,94	5,04	5,36	5,09	5,50
Wajak 1	20,35	23,59	24,99	21,60	5,44	4,64	5,10	6,41
Wajak 2	18,90	21,40	22,05	23,98	5,29	5,68	5,11	5,89
Sp 45	22,90	23,69	23,53	22,53	6,35	5,84	6,44	5,20
Sp 51	20,90	20,37	23,93	22,40	6,69	4,69	6,91	4,78
Sp 52	21,21	23,31	23,55	19,57	5,93	4,32	6,12	4,89
Sp 131	20,85	25,38	21,58	19,55	5,19	3,71	5,09	4,29
Sp F1.5	20,61	20,38	23,69	22,73	5,74	5,33	6,01	6,13
Sp G1	22,82	25,06	24,66	18,46	5,80	5,05	5,66	6,05
Sp R2	20,78	22,91	19,08	17,10	4,95	4,91	4,16	5,51
SKJ 3	20,31	22,88	22,22	18,27	5,64	6,71	5,16	6,68
SKJ X	18,00	19,90	20,12	19,87	4,58	5,32	4,21	5,67
HRM 37	16,62	23,87	25,17	18,22	4,72	5,29	4,14	4,80
HRM 74	19,04	22,28	24,07	21,28	5,95	4,95	6,16	5,10
PWN 1	19,21	23,51	22,52	21,07	6,16	7,27	6,26	7,10
PWN 3	19,65	22,10	23,64	20,07	4,08	4,69	3,82	4,60
PWN 4	20,39	22,17	24,07	20,08	4,59	6,49	4,65	6,92
PWN 5	20,15	20,99	23,12	21,15	5,63	5,30	6,26	5,19
BHL F7	19,20	23,66	23,99	15,33	4,39	6,00	4,83	5,95
BHL H8 411	24,39	22,66	15,71	21,86	7,24	5,57	4,81	6,17
SK 4	19,10	22,79	23,05	16,96	4,71	4,93	3,79	4,90
ST 1	19,78	21,76	20,90	21,58	4,70	5,50	4,90	5,57
STRT 1	18,38	19,80	18,78	18,98	4,74	5,40	4,88	5,35
GKD 2	22,17	22,58	20,98	19,42	4,81	4,48	5,28	5,25
DMB 17324	19,75	21,13	22,69	19,15	4,92	5,86	4,98	5,64
KCL 17798	20,61	22,22	20,44	19,28	5,02	5,91	4,43	6,07
HRM 21	17,54	24,00	20,30	15,50	4,52	5,85	4,39	5,35
SK 5	23,05	23,61	22,24	19,31	4,98	4,40	4,71	5,39

Table D.8. Perimetric and distance of cusp at LM3.

Abbreviation: C Med = Circumference of Metaconid, C Prd = Circumference of Protoconid, C Hyd = Circumference of Hypoconid, C End = Circumference of Entoconid, Med-Prd = Distance between Metaconid and Protoconid, Prd-Hyd = Distance between Protoconid and Hypoconid, Hyd-End = Distance between Hypoconid and Entoconid, End-Med = Distance between Entoconid and Metaconid.

c. Angle of cusp at LM3

Code	< Med	< Prd	< Hyd	< End	% < Med	% < Prd	% < Hyd	% < End
Ardjuna 9	99,90	96,05	92,00	72,05	27,75	26,68	25,56	20,01
Sangiran 6b	91,70	91,30	97,20	79,80	25,47	25,36	27,00	22,17
Sangiran 8	90,98	91,05	96,33	81,64	25,27	25,29	26,76	22,68
Sangiran 1b	94,91	84,81	101,46	78,82	26,36	23,56	28,18	21,89
Sangiran 9	90,85	95,70	94,55	78,90	25,24	26,58	26,26	21,92
Sangiran 21	91,40	89,50	98,80	80,30	25,39	24,86	27,44	22,31
Sangiran 22b	91,23	91,75	99,56	77,46	25,34	25,49	27,66	21,52
Sangiran 33	96,40	87,50	100,10	76,00	26,78	24,31	27,81	21,11
Sangiran 37	89,84	96,04	89,32	84,80	24,96	26,68	24,81	23,56
NG 9107-2	88,30	93,43	87,34	90,93	24,53	25,95	21,48	28,04
NG 92.3	90,80	91,50	91,20	86,50	25,22	25,42	25,33	24,03
NG 0802-2	95,60	84,80	96,50	83,10	26,56	23,56	26,81	23,08
Wajak 1	85,41	88,51	112,23	73,85	23,73	24,59	31,18	20,51
Wajak 2	87,70	90,15	92,00	90,15	24,36	25,04	25,56	25,04
Sp 45	98,56	82,54	91,90	87,00	27,38	22,93	25,53	24,17
Sp 51	103,65	78,50	101,95	75,90	28,79	21,81	28,32	21,08
Sp 52	91,55	89,70	95,45	83,30	25,43	24,92	26,51	23,14
Sp 131	93,24	83,45	103,41	79,90	25,90	23,18	28,73	22,19
Sp F1.5	90,30	92,12	96,00	81,58	25,08	25,59	26,67	22,66
Sp G1	94,10	81,90	108,50	75,50	26,14	22,75	30,14	20,97
Sp R2	85,20	86,55	101,15	87,10	23,67	24,04	28,10	24,19
SKJ 3	91,18	84,46	95,61	88,75	25,33	23,46	26,56	24,65
SKJ X	86,94	88,51	96,84	87,71	24,15	24,59	26,90	24,36
HRM 37	89,24	83,73	89,10	97,93	24,79	23,26	24,75	27,20
HRM 74	101,80	80,05	101,10	77,05	28,28	22,24	28,08	21,40
PWN 1	93,50	87,40	91,75	87,35	25,97	24,28	25,49	24,26
PWN 3	91,05	86,08	91,90	90,97	25,29	23,91	25,53	25,27
PWN 4	89,05	92,50	92,35	86,10	24,74	25,69	25,65	23,92
PWN 5	100,68	86,51	92,08	80,73	27,97	24,03	25,58	22,43
BHL F7	95,50	88,50	91,20	84,80	26,53	24,58	25,33	23,56
BHL H8 411	74,15	82,15	103,50	100,20	20,60	22,82	28,75	27,83
SK 4	87,85	81,75	97,95	92,45	24,40	22,71	27,21	25,68
ST 1	92,00	89,00	91,00	88,00	25,56	24,72	25,28	24,44
STRT 1	91,90	89,20	90,40	88,50	25,53	24,78	25,11	24,58
GKD 2	94,57	89,30	98,45	77,68	26,27	24,81	27,35	21,58
DMB 17324	87,90	92,50	84,70	94,90	24,42	25,69	23,53	26,36
KCL 17798	87,15	87,55	94,30	91,00	24,21	24,32	26,19	25,28
HRM 21	90,60	88,00	84,35	97,05	25,17	24,44	23,43	26,96
SK 5	84,04	93,75	98,00	84,21	23,34	26,04	27,22	23,39

Table D.9. Absolute and relative angle of cusp at LM3.

Abbreviation: < Med = Absolute angle of Metaconid, < Prd = Absolute angle of Protoconid, < Hyd = Absolute angle of Hypoconid, < End = Absolute angle of Entoconid, % < Med = Relative angle of Metaconid, % < Prd = Relative angle of Protoconid, % < Hyd = Relative angle of Hypoconid, % < End = Relative angle of Entoconid

4. Crown size and cusp proportion of UM1

a. Cusp size of UM1

Code	TA	Pr	Pa	Me	Hy	% Pr	% Pa	% Me	% Hy
Sangiran 4	134,47	40,75	40,39	34,17	29,16	26,59	26,32	25,41	21,69
Sangiran 27	146,69	41,95	39,20	32,06	33,48	28,60	26,72	21,86	22,82
S 7-38	141,18	49,47	31,61	29,69	30,41	35,04	22,39	21,03	21,54
S 7-40	142,29	46,61	34,41	36,39	24,88	32,76	24,18	25,57	17,49
S 7-37	125,26	39,35	32,04	28,78	25,08	31,42	25,58	22,98	20,02
Tjg 9305	130,16	42,60	30,14	32,62	24,80	32,73	23,16	25,06	19,05
Bpg 2001	137,47	41,06	31,46	35,27	29,67	29,87	22,89	25,66	21,58
S 7-8	126,36	31,64	37,46	27,70	29,57	25,04	29,64	21,92	23,40
JA 41	130,18	45,00	32,18	25,60	27,40	34,57	24,72	19,66	21,05
S 7-9	116,15	32,96	31,02	28,13	24,04	28,38	26,71	24,22	20,70
S 7-10	106,33	33,42	25,58	26,68	20,65	31,43	24,06	25,09	19,42
Sangiran 17	114,79	41,21	25,97	26,05	21,56	35,90	22,62	22,69	18,78
S 7-3b	110,56	33,38	31,05	23,50	22,63	30,19	28,08	21,26	20,47
S 81	122,31	37,79	25,83	26,72	31,97	30,90	21,12	21,85	26,14
S 0088	111,90	35,50	28,65	27,25	20,50	31,72	25,60	24,35	18,32
Abimanyu 2	115,37	39,91	27,61	21,77	26,08	34,59	23,93	18,87	22,61
NG 9603	113,48	32,10	28,47	28,71	24,20	28,29	25,09	25,30	21,33
NG G10	119,67	35,41	30,52	26,93	26,81	29,59	25,50	22,50	22,40
PDS 0712	98,33	31,99	31,57	20,47	14,30	32,53	32,11	20,82	14,54
Wajak 1	123,52	40,92	28,96	27,58	26,06	33,13	23,45	22,33	21,09
Wajak 2	126,62	37,93	27,15	28,76	32,79	29,95	21,44	22,71	25,89
Sp 33	121,65	27,35	32,43	35,62	26,25	22,48	26,66	29,28	21,58
Sp 38	115,53	26,76	26,64	36,13	26,00	28,01	27,89	27,35	16,75
Sp 140	130,51	29,14	28,60	38,83	33,94	22,33	21,91	29,75	26,01
BHL 1	128,54	35,58	31,27	31,30	30,39	27,68	24,33	24,35	23,64
BHL 4	127,24	31,24	35,26	33,90	26,85	24,55	27,71	26,64	21,10
SK 1	129,41	43,04	33,11	28,59	24,67	33,26	25,59	22,09	19,06
SK 4	126,39	43,54	28,77	25,54	28,54	34,45	22,76	20,21	22,58
SK 5	119,75	29,11	32,41	28,51	29,72	24,31	27,06	23,81	24,82
ST 96-299	112,87	31,96	33,87	28,18	18,86	28,32	30,01	24,97	16,71
ST 96-457a	92,37	25,58	25,41	23,74	17,64	27,69	27,51	25,70	19,10
SKJ 3	119,32	36,16	28,99	29,88	24,29	30,31	24,30	25,04	20,36
SKJ 6a	122,02	32,16	28,70	29,11	32,05	26,36	23,52	23,86	26,27
SKJ 6b	100,47	32,62	28,45	21,70	17,70	32,47	28,32	21,60	17,62
AIC	122,59	36,36	32,01	31,11	23,11	29,66	26,11	25,38	18,85
PWN 1	122,21	38,89	31,46	25,64	26,22	31,82	25,74	20,98	21,45
PWN 5	126,17	40,71	31,57	26,68	27,21	32,27	25,02	21,15	21,57
HRM 36	101,72	29,53	23,03	21,51	27,65	29,03	22,64	21,15	27,18
HRM 79	125,68	35,58	29,62	32,24	28,24	28,31	23,57	25,65	22,47

HGR 17410	122,01	36,59	37,10	27,73	20,59	29,99	30,41	22,73	16,88
HRM 12	114,42	32,05	29,81	29,39	23,17	28,01	26,05	25,69	20,25
HRM 13	116,45	33,91	31,36	21,98	29,20	29,12	26,93	18,88	25,08
HRM 17	116,41	32,31	34,14	26,66	23,30	27,76	29,33	22,90	20,02
HRM 21	119,01	34,74	29,91	28,58	25,78	29,19	25,13	24,01	21,66
HRM 24	100,25	35,03	23,29	20,38	21,55	34,94	23,23	20,33	21,50
HRM 25	107,38	32,83	29,35	23,76	21,44	30,57	27,33	22,13	19,97
HRM 60	123,59	36,02	30,21	26,94	30,42	29,14	24,44	21,80	24,61

Table D.10. Absolute and relative cusp size of UM1.

Abbreviation: TA = Total Area, Pr = Absolute size of Protocone, Pa = Absolute size of Paracone, Me = Absolute size of Metacone, Hy = Absolute size of Hypocone, % Pr = Relative size of Protocone, % Pa = Relative size of Paracone, % Me = Relative size of Metacone, % Hy = Relative size of Hypocone.

b. Perimetric and distance of cusps at UM1

Code	C Pr	C Pa	C Me	C Hy	Pr-Pa	Pa-Me	Me-Hy	Hy-Pr
Sangiran 4	23,31	24,49	22,58	21,46	6,46	6,27	6,00	6,16
Sangiran 27	25,86	24,44	23,02	24,60	6,70	6,10	6,54	6,30
S 7-38	27,08	22,10	21,45	22,67	6,92	6,26	5,95	5,71
S 7-40	27,93	22,24	25,22	19,63	6,79	6,07	6,04	5,80
S 7-37	23,85	21,86	21,53	22,47	6,70	6,10	6,73	6,21
Tjg 9305	26,81	21,43	22,23	19,25	6,51	5,17	6,37	5,17
Bpg 2001	25,98	23,41	23,12	21,88	6,34	5,22	6,32	5,10
S 7-8	25,52	24,25	20,18	20,27	6,90	5,33	6,83	5,30
JA 41	25,88	23,28	21,70	21,20	6,50	6,00	6,95	6,40
S 7-9	22,98	21,57	21,67	19,24	6,40	5,21	6,30	5,27
S 7-10	23,69	20,45	20,51	17,55	6,36	5,20	6,49	5,25
Sangiran 17	24,62	20,10	20,23	19,00	6,06	4,90	6,20	4,90
S 7-3b	23,37	21,82	18,90	19,40	5,70	5,28	5,81	5,14
S 81	24,45	20,82	19,63	23,11	5,34	5,07	6,00	5,41
S 0088	23,35	20,62	20,15	18,60	5,77	5,16	5,48	5,17
Abimanyu 2	25,50	19,65	18,05	21,50	5,86	4,96	5,76	4,70
NG 9603	22,55	21,98	21,37	20,16	5,55	4,88	6,26	4,96
NG G10	22,99	23,02	19,99	20,94	6,40	5,20	5,77	5,86
PDS 0712	23,16	22,46	19,29	16,55	6,76	5,35	5,51	5,11
Wajak 1	26,49	21,69	22,20	22,30	6,31	4,60	5,96	4,44
Wajak 2	25,64	21,40	22,45	24,46	6,13	4,97	6,62	5,13
Sp 33	20,48	22,45	25,18	20,20	6,06	4,83	6,34	5,83
Sp 38	24,72	25,57	25,01	20,92	6,29	5,03	5,34	4,93
Sp 140	22,53	21,70	26,54	23,56	5,98	4,96	6,17	5,13
BHL 1	23,72	22,21	22,09	22,21	5,91	5,11	6,03	5,12
BHL 4	20,96	24,25	22,31	20,47	6,06	4,78	5,98	4,72
SK 1	25,92	22,90	24,55	23,45	6,86	5,66	6,93	5,23
SK 4	26,86	20,35	20,40	20,70	6,17	5,30	6,39	5,59
SK 5	20,81	22,24	22,30	22,14	5,74	5,28	5,44	5,20
ST 96-299	22,74	22,63	21,03	17,66	6,60	5,55	5,84	5,57
ST 96-457a	20,27	20,48	19,13	17,34	5,67	5,37	5,96	5,18
SKJ 3	23,66	20,85	21,59	19,74	5,75	5,44	5,78	5,67
SKJ 6a	22,27	20,80	20,58	22,45	6,12	4,86	6,47	5,14
SKJ 6b	22,07	20,61	18,66	17,07	6,05	5,00	5,80	4,84
AIC	23,71	22,91	20,98	19,33	6,10	5,17	6,39	5,41
PWN 1	24,46	21,44	19,64	21,13	5,93	5,92	6,31	6,20
PWN 5	25,05	21,37	20,54	22,20	6,81	5,40	6,77	5,24
HRM 36	21,68	19,47	17,83	19,81	5,68	4,28	5,35	4,61
HRM 79	23,20	21,07	21,73	20,52	6,43	5,49	6,33	5,21
HGR 17410	23,98	23,67	21,66	18,90	5,39	4,82	5,28	5,54

HRM 12	22,82	21,07	21,23	18,95	7,12	5,15	6,34	5,14
HRM 13	23,57	22,12	17,96	21,56	6,68	5,62	5,87	5,29
HRM 17	22,01	22,83	19,82	19,50	5,54	5,02	5,31	5,28
HRM 21	23,08	21,75	22,20	20,58	6,12	5,00	6,36	5,18
HRM 24	22,33	19,45	18,28	18,70	5,78	5,50	5,78	4,66
HRM 25	22,47	21,15	18,59	21,44	6,39	5,77	6,71	5,55
HRM 60	24,16	21,51	20,50	21,24	6,52	5,60	6,20	5,60

Table D.11. Perimetric and distance of cusp at UM1.

Abbreviation: C Pr = Circumference of Protocone, C Pa = Circumference of Paracone, C Me = Circumference of Metacone, C Hy = Circumference of Hypocone, Pr-Pa = Distance between Protocone and Paracone, Pa-Me = Distance between Paracone and Metacone, Me-Hy = Distance between Metacone and Hypocone, Hy-Pr = Distance between Hypocone and Protocone.

c. Angle of cusp at UM1

Code	< Pr	< Pa	< Me	< Hy	% < Pr	% < Pa	% < Me	% < Hy
Sangiran 4	95,90	80,10	104,30	79,70	28,03	20,86	28,97	22,14
Sangiran 27	95,30	82,84	109,40	72,46	29,25	20,23	30,39	20,13
S 7-38	89,80	79,60	105,30	85,30	24,94	22,11	29,25	23,69
S 7-40	85,65	85,55	100,90	87,90	23,79	23,76	28,03	24,42
S 7-37	101,87	78,60	102,38	77,15	28,30	21,83	28,44	21,43
Tjg 9305	101,10	77,30	101,90	79,70	28,08	21,47	28,31	22,14
Bpg 2001	100,20	79,55	100,10	80,15	27,83	22,10	27,81	22,26
S 7-8	97,65	81,55	97,95	82,85	24,35	25,43	24,43	25,79
JA 41	103,00	80,84	101,50	74,66	28,61	22,46	28,19	20,74
S 7-9	99,60	79,51	100,50	80,39	27,67	22,09	27,92	22,33
S 7-10	105,40	75,45	105,00	74,15	29,28	20,96	29,17	20,60
Sangiran 17	105,16	75,80	108,16	71,88	29,13	21,00	29,96	19,91
S 7-3b	106,70	75,10	103,70	74,50	29,64	20,86	28,81	20,69
S 81	101,10	85,85	96,75	76,30	28,08	23,85	26,88	21,19
S 0088	99,05	78,35	102,15	80,45	27,51	21,76	28,38	22,35
Abimanyu 2	101,80	80,00	102,30	77,90	30,50	19,44	29,81	20,25
NG 9603	104,30	80,25	98,80	76,65	30,36	22,29	27,44	19,90
NG G10	95,55	84,20	97,15	83,10	26,54	23,39	26,99	23,08
PDS 0712	97,00	80,30	100,20	82,50	26,94	19,53	30,61	22,92
Wajak 1	101,68	74,20	105,04	79,08	28,24	20,61	29,18	21,97
Wajak 2	104,05	83,30	97,65	75,00	28,90	23,14	27,13	20,83
Sp 33	92,50	88,50	100,50	78,50	25,69	24,58	27,92	21,81
Sp 38	89,00	79,08	101,44	90,48	24,72	21,97	28,18	25,13
Sp 140	98,82	78,72	102,04	80,42	28,84	21,87	28,34	20,95
BHL 1	97,40	83,89	95,79	82,92	27,06	23,30	26,61	23,03
BHL 4	104,30	75,10	104,40	76,20	28,97	20,86	29,00	21,17
SK 1	101,94	79,20	98,40	80,46	28,32	22,00	27,33	22,35
SK 4	101,30	80,50	101,74	76,46	28,14	22,36	28,26	21,24
SK 5	99,49	76,85	102,63	81,03	27,64	21,35	28,51	22,51
ST 96-299	101,43	70,15	112,02	76,40	28,18	19,49	31,12	21,22
ST 96-457a	108,43	75,23	102,46	73,88	30,12	20,90	28,46	20,52
SKJ 3	97,16	83,92	99,13	79,79	26,99	23,31	27,54	22,16
SKJ 6a	99,40	83,80	98,40	78,40	27,61	23,28	27,33	21,78
SKJ 6b	104,14	73,16	105,70	77,00	28,93	20,32	29,36	21,39
AIC	106,00	76,00	106,00	72,00	29,44	21,11	29,44	20,00
PWN 1	101,40	81,35	100,45	76,80	28,17	22,60	27,90	21,33
PWN 5	100,50	79,40	99,20	80,90	27,92	22,06	27,56	22,47
HRM 36	104,56	69,32	115,43	70,69	29,04	19,26	32,06	19,64
HRM 79	100,00	79,84	97,00	83,16	27,78	22,18	26,94	23,10
HGR 17410	90,03	88,03	99,71	82,23	25,01	24,45	27,70	22,84

HRM 12	105,00	65,33	117,35	72,32	29,17	18,15	32,60	20,09
HRM 13	99,38	74,10	104,70	81,82	27,61	20,58	29,08	22,73
HRM 17	102,25	75,05	108,90	73,80	28,40	20,85	30,25	20,50
HRM 21	111,35	71,21	109,90	67,54	30,93	19,78	30,53	18,76
HRM 24	110,85	72,40	99,50	77,25	30,79	20,11	27,64	21,46
HRM 25	110,64	73,28	103,67	72,41	30,73	20,36	28,80	20,11
HRM 60	107,30	69,45	111,50	71,75	29,81	19,29	30,97	19,93

Table D.12. Absolute and relative angle of cusp at UM1.

Abbreviation: < Pr = Absolute angle of Protocone, < Pa = Absolute angle of Paracone, < Me = Absolute angle of Metacone, < Hy = Absolute angle of Hypocone, % < Pr = Relative angle of Protocone, % < Pa = Relative angle of Paracone, % < Me = Relative angle of Metacone, % < Hy = Relative angle of Hypocone

5. Crown size and cusp proportion of UM2

a. Cusp size of UM2

Code	TA	Pr	Pa	Me	Hy	% Pr	% Pa	% Me	% Hy
Sangiran 4	144,63	43,89	38,88	34,34	27,52	30,35	26,88	23,74	19,03
Sangiran 27	163,36	49,76	41,75	29,79	25,72	33,85	28,40	20,26	17,50
S 7-38	141,18	49,47	31,61	29,69	30,41	35,04	22,39	21,03	21,54
S 7-40	142,29	46,61	34,41	36,39	24,88	32,76	24,18	25,57	17,49
S 7-53	147,64	48,59	38,83	28,95	31,27	32,91	26,30	19,61	21,18
Bpg 2001	143,02	40,45	42,71	32,60	27,26	28,28	29,86	22,79	19,06
NG 1989	114,43	38,39	34,14	26,28	27,06	30,50	27,13	20,88	21,50
Tjg 9305	141,33	43,05	33,32	30,52	34,44	30,46	23,58	21,59	24,37
Sangiran 17	114,45	43,73	35,54	17,92	17,26	38,21	31,05	15,66	15,08
GRW 0094	122,32	38,53	37,73	23,60	22,46	31,50	30,85	19,29	18,36
S 7-3c	98,34	34,00	27,89	17,90	18,55	34,57	28,36	18,20	18,86
S 7-89	105,93	35,24	27,08	21,26	22,35	33,27	25,56	20,07	21,10
S 81	122,31	34,01	23,25	24,05	28,77	30,90	21,12	21,85	26,14
S 0087	102,14	37,88	32,17	19,31	12,78	37,09	31,50	18,91	12,51
NG 91-G10	119,24	35,29	30,41	26,83	26,71	29,60	25,50	22,50	22,40
PDS 0712	98,33	35,19	34,73	22,52	15,73	32,53	32,11	20,82	14,54
Wajak 1	123,86	42,15	41,78	22,34	17,59	34,03	33,73	18,04	14,20
Wajak 2	127,85	39,65	32,03	27,80	28,37	31,01	25,05	21,74	22,19
LA 11472	103,24	40,00	30,09	16,64	16,51	38,74	29,15	16,12	15,99
Sp 40	123,02	29,23	38,56	27,77	27,46	23,76	31,34	22,57	22,32
Sp 41	125,39	32,97	28,39	32,40	31,63	26,29	22,64	25,84	25,23
BHL 1	126,31	49,42	32,99	25,35	18,55	39,13	26,12	20,07	14,69
BHL 4	128,74	49,06	34,41	23,98	21,29	38,11	26,73	18,63	16,54
BHL 7	95,56	34,81	25,09	23,80	11,86	36,43	26,26	24,91	12,41
BHL H8 410	103,57	36,29	29,71	19,93	17,64	35,04	28,69	19,24	17,03
SK 1	118,25	39,94	34,18	23,47	20,66	33,78	28,90	19,85	17,47
SK 4	120,79	56,23	31,10	18,76	14,70	46,55	25,75	15,53	12,17
ST 96-1802	88,26	30,31	23,18	18,57	16,20	34,34	26,26	21,04	18,35
ST 04-8683	93,38	29,40	28,29	19,88	15,81	31,48	30,30	21,29	16,93
ST 96-457a	92,37	25,58	25,41	23,74	17,64	27,69	27,51	25,70	19,10
AIC	113,24	51,14	29,00	20,59	12,51	45,16	25,61	18,18	11,05
SKJ 3	127,28	38,01	37,75	27,60	23,92	29,86	29,66	21,68	18,79
SKJ 6a	127,42	39,71	38,97	24,73	24,02	31,16	30,58	19,41	18,85
SKJ 6b	129,37	40,04	36,57	24,60	28,16	30,95	28,27	19,01	21,77
HRM 36	87,54	31,36	23,58	15,43	17,17	35,82	26,94	17,63	19,61
HRM 74	119,87	46,77	31,74	23,38	17,98	39,02	26,48	19,50	15,00
HRM 79	119,24	42,62	32,27	26,52	17,83	35,74	27,06	22,24	14,95
PWN 1	121,40	44,00	34,06	22,86	20,48	36,24	28,06	18,83	16,87
PWN 3	120,07	44,55	28,27	22,10	25,16	37,10	23,54	18,40	20,95

GKD 2	99,22	27,07	27,80	24,24	20,11	27,28	28,02	24,43	20,27
DMB 17321	117,08	42,70	35,57	20,59	18,22	36,47	30,38	17,59	15,56
HGR 17410	118,88	38,51	38,44	22,31	19,62	32,39	32,34	18,77	16,50
SK 5	112,35	37,34	33,64	20,80	20,57	33,24	29,94	18,51	18,31
HRM 10	113,56	36,23	31,81	22,80	22,72	31,90	28,01	20,08	20,01
HRM 12	121,24	26,92	44,14	28,17	22,02	22,21	36,40	23,23	18,16
HRM 21	118,62	42,96	36,87	21,05	17,74	36,22	31,08	17,75	14,96

Table D.13. Absolute and relative cusp size of UM2.

Abbreviation: TA = Total Area, Pr = Absolute size of Protocone, Pa = Absolute size of Paracone, Me = Absolute size of Metacone, Hy = Absolute size of Hypocone, % Pr = Relative size of Protocone, % Pa = Relative size of Paracone, % Me = Relative size of Metacone, % Hy = Relative size of Hypocone.

b. Perimetric and distance of cusps at UM2

Code	C Pr	C Pa	C Me	C Hy	Pr-Pa	Pa-Me	Me-Hy	Hy-Pr
Sangiran 4	26,58	24,33	22,59	20,57	7,20	5,46	6,85	7,40
Sangiran 27	29,03	25,72	24,00	20,05	7,44	5,51	5,92	6,19
S 7-38	27,08	22,10	21,45	22,67	6,92	5,26	5,95	5,71
S 7-40	27,93	22,24	25,22	19,63	6,79	5,07	6,04	5,80
S 7-53	28,35	23,62	21,60	23,36	6,91	5,77	6,46	5,70
Bpg 2001	25,50	25,05	23,21	21,00	6,52	5,59	6,38	5,78
NG 1989	26,29	23,47	20,65	21,85	6,42	5,79	5,98	5,28
Tjg 9305	28,52	23,03	23,19	24,48	6,65	5,40	6,64	5,20
Sangiran 17	26,38	23,22	18,50	16,15	5,89	4,71	5,12	5,18
GRW 0094	24,38	23,57	20,21	20,68	6,80	5,05	5,60	4,68
S 7-3c	24,00	19,86	16,96	18,29	6,73	5,33	6,43	5,51
S 7-89	23,15	20,13	18,41	19,23	6,23	4,95	5,24	5,69
S 81	24,45	20,82	19,63	23,11	5,34	5,57	6,00	5,91
S 0087	24,10	21,46	17,38	16,62	6,30	5,31	5,20	6,73
NG 91-G10	22,95	22,97	19,95	20,90	5,89	5,69	5,77	5,86
PDS 0712	24,06	24,39	20,37	18,76	6,76	5,35	5,51	5,11
Wajak 1	25,07	25,15	19,43	18,00	6,82	5,45	5,16	3,73
Wajak 2	26,86	21,64	21,45	21,08	8,16	5,74	7,49	5,13
LA 11472	24,37	21,68	16,60	17,45	7,03	4,95	4,44	5,17
Sp 40	21,58	25,68	22,30	20,88	6,40	4,61	6,64	5,08
Sp 41	21,93	21,49	22,99	22,48	7,12	5,06	7,26	5,15
BHL 1	27,09	22,29	19,37	18,50	5,62	5,55	6,05	5,50
BHL 4	28,96	22,69	20,06	19,18	7,93	5,30	6,60	5,80
BHL 7	22,43	19,44	20,26	14,71	7,08	4,99	6,60	4,66
BHL H8 410	24,34	20,76	17,50	16,90	6,65	5,00	6,23	4,63
SK 1	24,76	23,30	18,85	17,85	6,79	5,73	6,25	5,18
SK 4	29,03	21,16	17,35	16,88	6,19	5,44	5,34	6,07
ST 96-1802	21,65	18,54	16,97	16,43	6,07	4,11	6,01	4,14
ST 04-8683	21,54	21,24	18,20	16,85	5,63	3,98	5,63	4,55
ST 96-457a	20,27	20,48	19,13	17,34	5,67	5,37	5,96	5,18
AIC	27,68	21,24	17,60	15,43	6,23	4,98	5,01	6,56
SKJ 3	24,94	23,20	22,15	18,69	7,68	5,67	6,53	5,98
SKJ 6a	25,03	23,69	18,45	19,11	7,10	4,11	6,81	4,28
SKJ 6b	23,99	22,71	18,80	19,80	7,16	4,84	5,87	3,80
HRM 36	22,21	18,76	15,52	16,41	6,27	3,99	5,19	4,07
HRM 74	26,44	21,55	18,61	17,83	6,95	5,34	5,35	5,64
HRM 79	25,39	22,21	19,79	17,97	6,47	5,30	5,12	5,50
PWN 1	25,13	22,57	19,68	18,03	6,19	6,11	4,97	5,40
PWN 3	23,51	18,59	17,95	19,32	4,79	4,56	4,50	5,43
GKD 2	20,23	20,56	19,03	18,17	5,62	5,54	4,62	4,71

DMB 17321	25,56	22,97	18,20	17,17	5,26	5,70	5,78	4,43
HGR 17410	24,80	23,46	20,39	19,37	6,57	4,55	5,72	4,74
SK 5	24,34	22,11	18,65	19,50	6,63	4,78	6,13	5,25
HRM 10	24,26	21,53	18,74	18,46	6,90	5,73	5,73	5,88
HRM 12	18,26	21,88	17,12	15,74	5,59	4,42	3,81	4,33
HRM 21	24,89	23,65	18,02	17,83	7,88	5,01	5,97	5,70

Table D.14. Perimetric and distance of cusp at UM2.

Abbreviation: C Pr = Circumference of Protocone, C Pa = Circumference of Paracone, C Me = Circumference of Metacone, C Hy = Circumference of Hypocone, Pr-Pa = Distance between Protocone and Paracone, Pa-Me = Distance between Paracone and Metacone, Me-Hy = Distance between Metacone and Hypocone, Hy-Pr = Distance between Hypocone and Protocone.

c. Angle of cusp at UM2

Code	< Pr	< Pa	< Me	< Hy	% < Pr	% < Pa	% < Me	% < Hy
Sangiran 4	86,95	87,60	111,00	74,45	24,15	24,33	30,83	20,68
Sangiran 27	90,92	71,70	117,38	80,00	25,26	19,92	32,61	22,22
S 7-38	89,80	79,60	105,30	85,30	24,94	22,11	29,25	23,69
S 7-40	85,65	85,55	100,90	87,90	23,79	23,76	28,03	24,42
S 7-53	101,60	73,50	107,40	77,50	28,22	20,42	29,83	21,53
Bpg 2001	89,50	90,05	91,45	89,00	24,86	25,01	25,40	24,72
NG 1989	96,75	80,40	95,60	87,25	29,65	19,56	29,33	21,46
Tjg 9305	95,40	83,60	94,70	86,30	26,50	23,22	26,31	23,97
Sangiran 17	94,72	74,60	112,45	78,23	26,31	20,72	31,24	21,73
GRW 0094	99,00	70,45	110,60	80,85	27,43	19,52	30,65	22,40
S 7-3c	99,65	77,10	104,90	78,35	27,68	21,42	29,14	21,76
S 7-89	82,50	86,50	109,50	81,50	22,92	24,03	30,42	22,64
S 81	101,10	85,85	96,75	76,30	28,08	23,85	26,88	21,19
S 0087	82,90	85,00	110,75	81,35	23,03	23,61	30,76	22,60
NG 91-G10	95,60	84,15	97,15	83,10	26,56	23,38	26,99	23,08
PDS 0712	92,00	75,30	105,20	87,50	26,94	19,53	30,61	22,92
Wajak 1	82,97	74,90	87,80	114,33	23,05	20,81	24,39	31,76
Wajak 2	104,70	70,00	107,30	78,00	29,08	19,44	29,81	21,67
LA 11472	85,20	63,92	125,20	85,68	23,67	17,76	34,78	23,80
Sp 40	98,70	83,80	100,20	77,30	27,42	23,28	27,83	21,47
Sp 41	98,85	83,15	97,30	80,70	27,46	23,10	27,03	22,42
BHL 1	104,50	79,70	98,05	77,75	29,03	22,14	27,24	21,60
BHL 4	92,44	72,45	113,89	81,22	25,68	20,13	31,64	22,56
BHL 7	104,00	71,00	107,00	78,00	28,89	19,72	29,72	21,67
BHL H8 410	96,50	79,50	98,00	86,00	26,81	22,08	27,22	23,89
SK 1	112,15	63,65	113,70	70,50	31,15	17,68	31,58	19,58
SK 4	100,70	67,25	123,20	68,85	27,97	18,68	34,22	19,13
ST 96-1802	103,10	75,90	105,10	75,90	28,64	21,08	29,19	21,08
ST 04-8683	103,86	73,10	113,31	69,73	28,85	20,31	31,48	19,37
ST 96-457a	108,43	75,23	102,46	73,88	30,12	20,90	28,46	20,52
AIC	86,00	78,90	120,80	74,30	23,89	21,92	33,56	20,64
SKJ 3	96,90	70,70	114,30	78,10	26,92	19,64	31,75	21,69
SKJ 6a	98,40	78,04	103,75	79,81	27,33	21,68	28,82	22,17
SKJ 6b	109,00	58,35	116,60	76,05	30,28	16,21	32,39	21,13
HRM 36	94,40	69,00	114,00	82,60	26,22	19,17	31,67	22,94
HRM 74	91,30	71,30	114,20	83,20	25,36	19,81	31,72	23,11
HRM 79	93,50	71,70	112,30	82,50	25,97	19,92	31,19	22,92
PWN 1	111,00	60,00	118,00	71,00	30,83	16,67	32,78	19,72
PWN 3	106,10	65,00	127,90	61,00	29,47	18,06	35,53	16,94
GKD 2	106,50	65,25	108,50	79,75	29,58	18,13	30,14	22,15

DMB 17321	110,80	77,58	88,18	83,44	30,78	21,55	24,49	23,18
HGR 17410	90,20	78,60	104,40	86,80	25,06	21,83	29,00	24,11
SK 5	93,09	80,17	104,00	82,74	25,86	22,27	28,89	22,98
HRM 10	97,60	69,70	115,20	77,50	27,11	19,36	32,00	21,53
HRM 12	85,60	70,60	111,50	92,30	23,78	19,61	30,97	25,64
HRM 21	84,15	72,65	115,75	87,45	23,38	20,18	32,15	24,29

Table D.15. Absolute and relative angle of cusp at UM2.

Abbreviation: < Pr = Absolute angle of Protocone, < Pa = Absolute angle of Paracone, < Me = Absolute angle of Metacone, < Hy = Absolute angle of Hypocone, % < Pr = Relative angle of Protocone, % < Pa = Relative angle of Paracone, % < Me = Relative angle of Metacone, % < Hy = Relative angle of Hypocone

6. Crown size and cusp proportion of UM3

a. Cusp size of UM3

Code	TA	Pr	Pa	Me	Hy	% Pr	% Pa	% Me	% Hy
Sangiran 4	138,06	44,13	36,98	26,11	30,84	27,73	25,99	21,22	25,06
S 7-53	147,64	48,59	38,83	28,95	31,27	32,91	26,30	19,61	21,18
S 7-38	141,18	49,47	31,61	29,69	30,41	35,04	22,39	21,03	21,54
S 7-40	142,29	46,61	34,41	36,39	24,88	32,76	24,18	25,57	17,49
S 7-73	136,41	48,29	44,42	20,40	23,30	35,40	32,56	14,95	17,08
Sangiran 1a	141,34	31,81	32,94	23,42	24,90	28,13	29,14	20,71	22,02
S 7-6	82,15	36,70	26,39	19,30	19,76	44,67	32,12	11,32	11,88
Tjg 9305	101,65	30,32	26,80	19,08	25,45	29,83	26,36	18,77	25,04
Sangiran 17	95,39	29,39	30,21	16,45	19,34	30,81	31,67	17,24	20,27
GRW 0094	110,57	42,55	23,06	22,99	21,97	38,48	20,86	20,79	19,87
S 7-3d	83,51	30,07	22,19	16,94	14,31	36,01	26,57	20,28	17,14
Njg 2005	95,44	34,23	28,92	14,87	17,42	35,87	30,30	15,58	18,25
NG 9107-1	103,60	32,32	30,89	21,88	18,51	31,20	29,82	21,12	17,87
S 0086	107,17	45,52	26,15	20,90	14,60	42,47	24,40	19,50	13,62
PDS 0712	98,33	31,99	31,57	20,47	14,30	32,53	32,11	20,82	14,54
Wajak 1	90,99	37,72	22,71	12,50	18,06	41,46	24,96	13,74	19,85
Wajak 2	120,18	35,75	31,76	25,51	27,16	29,75	26,43	21,23	22,60
Sp 46	100,28	30,56	33,64	18,58	17,50	30,47	33,55	18,53	17,45
Sp 51	119,12	25,99	28,26	37,08	27,79	21,82	23,72	31,13	23,33
BHL 1	104,38	54,12	33,64	11,21	5,41	51,85	32,23	10,74	5,18
BHL 4	92,04	28,02	28,22	16,33	19,47	30,44	30,66	17,74	21,15
BHL H8-412	110,74	50,40	32,60	20,10	7,64	45,51	29,44	18,15	6,90
SK 1	114,96	55,04	26,27	19,10	14,54	47,88	22,85	16,61	12,65
SK 4	106,81	46,10	29,63	13,07	18,01	43,16	27,74	12,24	16,86
SK 5	111,45	43,63	31,54	22,53	13,75	39,15	28,30	20,22	12,34
GKD 2	80,52	27,75	23,24	13,40	16,13	34,46	28,86	16,64	20,03
HGR 17410	87,42	41,74	27,85	9,88	7,95	47,75	31,86	11,30	9,09
HRM 12	93,29	42,82	28,44	14,30	7,73	45,90	30,49	15,33	8,29
HRM 79	112,90	43,44	31,84	12,61	25,00	38,48	28,20	11,17	22,15

Table D.16. Absolute and relative cusp size of UM1.

Abbreviation: TA = Total Area, Pr = Absolute size of Protocone, Pa = Absolute size of Paracone, Me = Absolute size of Metacone, Hy = Absolute size of Hypocone, % Pr = Relative size of Protocone, % Pa = Relative size of Paracone, % Me = Relative size of Metacone, % Hy = Relative size of Hypocone.

b. Perimetric and distance of cusps at UM3

Code	C Pr	C Pa	C Me	C Hy	Pr-Pa	Pa-Me	Me-Hy	Hy-Pr
Sangiran 4	24,14	22,46	21,50	22,61	6,03	5,50	5,90	5,73
S 7-53	28,35	23,62	21,60	23,36	6,91	5,77	6,46	5,70
S 7-38	27,08	22,10	21,45	22,67	6,92	5,26	5,95	5,71
S 7-40	27,93	22,24	25,22	19,63	6,79	5,07	6,04	5,80
S 7-73	28,03	27,50	18,20	19,63	7,50	5,50	7,67	5,38
Sangiran 1a	21,67	21,77	21,01	20,12	6,54	4,58	5,46	5,97
S 7-6	23,12	19,72	22,37	23,45	6,08	5,10	4,75	5,11
Tjg 9305	21,92	21,17	18,91	21,56	6,05	5,10	5,20	4,73
Sangiran 17	20,85	22,33	19,25	18,85	5,61	4,95	4,07	4,51
GRW 0094	25,31	21,70	18,95	19,55	7,42	4,97	4,10	4,74
S 7-3d	22,06	20,32	16,81	16,51	5,29	4,65	4,64	4,96
Njg 2005	24,05	21,47	17,11	17,34	7,29	4,59	5,23	4,75
NG 9107-1	22,36	20,72	19,05	17,36	5,77	4,38	5,55	4,21
S 0086	25,93	19,73	18,05	15,76	6,46	4,78	5,78	5,62
PDS 0712	22,06	21,39	18,37	15,76	6,76	5,35	5,51	5,11
Wajak 1	24,78	19,07	14,65	19,48	5,95	3,99	4,28	2,55
Wajak 2	24,82	21,74	20,42	20,50	6,03	6,53	5,66	6,28
Sp 46	21,36	22,24	17,44	17,80	6,71	5,14	5,04	4,78
Sp 51	20,46	22,58	24,87	20,58	6,65	4,66	6,70	4,87
BHL 1	27,68	22,60	14,03	9,56	7,65	4,97	3,29	5,23
BHL 4	20,99	21,36	16,24	18,28	5,88	4,53	5,85	4,17
BHL H8-412	27,15	22,10	18,87	11,62	7,98	5,00	2,99	7,77
SK 1	27,61	18,99	17,25	14,29	7,27	6,21	4,65	5,65
SK 4	26,90	20,90	14,93	18,17	5,60	5,57	5,14	5,17
SK 5	25,08	21,82	18,84	16,55	8,10	6,33	6,44	4,90
GKD 2	20,73	18,59	15,24	17,14	5,24	3,94	5,75	3,37
HGR 17410	25,83	20,27	13,20	13,27	6,77	4,37	3,25	5,34
HRM 12	24,56	20,44	15,44	11,18	6,40	4,62	3,01	5,72
HRM 79	25,25	21,74	13,91	21,02	3,92	4,42	4,01	4,87

Table D.17. Perimetric and distance of cusp at UM1.

Abbreviation: C Pr = Circumference of Protocone, C Pa = Circumference of Paracone, C Me = Circumference of Metacone, C Hy = Circumference of Hypocone, Pr-Pa = Distance between Protocone and Paracone, Pa-Me = Distance between Paracone and Metacone, Me-Hy = Distance between Metacone and Hypocone, Hy-Pr = Distance between Hypocone and Protocone.

c. Angle of cusp at UM3

Code	< Pr	< Pa	< Me	< Hy	% < Pr	% < Pa	% < Me	% < Hy
Sangiran 4	103,67	75,83	101,60	78,90	28,80	21,06	28,22	21,92
S 7-53	101,60	73,50	107,40	77,50	28,22	20,42	29,83	21,53
S 7-38	89,80	79,60	105,30	85,30	24,94	22,11	29,25	23,69
S 7-40	85,65	85,55	100,90	87,90	23,79	23,76	28,03	24,42
S 7-73	103,30	79,25	99,35	78,10	28,69	22,01	27,60	21,69
Sangiran 1a	81,27	85,47	108,74	84,52	22,58	23,74	30,21	23,48
S 7-6	83,20	77,90	103,20	95,70	23,11	21,64	28,67	26,58
Tjg 9305	94,05	73,60	103,85	88,50	26,13	20,44	28,85	24,58
Sangiran 17	99,20	62,74	117,80	80,26	27,56	17,43	32,72	22,29
GRW 0094	77,70	61,30	121,00	100,00	21,58	17,03	33,61	27,78
S 7-3d	95,10	76,60	108,95	79,35	26,42	21,28	30,26	22,04
Njg 2005	88,30	66,05	120,05	85,60	24,53	18,35	33,35	23,78
NG 9107-1	98,53	77,76	100,61	83,10	27,37	21,60	27,95	23,08
S 0086	89,68	80,66	108,66	81,00	24,91	22,41	30,18	22,50
PDS 0712	97,00	70,30	110,20	82,50	26,94	19,53	30,61	22,92
Wajak 1	92,95	61,39	105,84	99,82	25,82	17,05	29,40	27,73
Wajak 2	106,50	70,15	109,50	73,85	29,58	19,49	30,42	20,51
Sp 46	91,29	69,91	110,39	88,41	25,36	19,42	30,66	24,56
Sp 51	100,85	80,46	101,44	77,25	28,01	22,35	28,18	21,46
BHL 1	61,34	67,31	112,30	119,05	17,04	18,70	31,19	33,07
BHL 4	108,70	71,81	105,18	74,31	30,19	19,95	29,22	20,64
BHL H8-412	54,30	80,55	126,10	99,05	15,08	22,38	35,03	27,51
SK 1	94,70	60,25	123,00	82,05	26,31	16,74	34,17	22,79
SK 4	111,78	65,36	112,00	70,86	31,05	18,16	31,11	19,68
SK 5	99,40	66,40	104,55	89,65	27,61	18,44	29,04	24,90
GKD 2	115,60	76,00	96,40	72,00	32,11	21,11	26,78	20,00
HGR 17410	66,95	69,00	125,65	98,40	18,60	19,17	34,90	27,33
HRM 12	64,70	77,50	115,40	102,40	17,97	21,53	32,06	28,44
HRM 79	124,40	52,20	135,00	48,40	34,56	14,50	37,50	13,44

Table D.18. Absolute and relative angle of cusp at UM3.

Abbreviation: < Pr = Absolute angle of Protocone, < Pa = Absolute angle of Paracone, < Me = Absolute angle of Metacone, < Hy = Absolute angle of Hypocone, % < Pr = Relative angle of Protocone, % < Pa = Relative angle of Paracone, % < Me = Relative angle of Metacone, % < Hy = Relative angle of Hypocone



MUSEUM GEOLOGI



Università degli Studi di Ferrara



UNIVERSITAT ROVIRA I VIRGILI



ipt Instituto Politécnico de Tomar

