



**HAL**  
open science

# Neurophysiological and theoretical study of cellular and synaptic mechanisms underlying aberrant thalamocortical oscillations in a rodent model of psychotic transition

Ali Mahdavi Omaselan Olya

► **To cite this version:**

Ali Mahdavi Omaselan Olya. Neurophysiological and theoretical study of cellular and synaptic mechanisms underlying aberrant thalamocortical oscillations in a rodent model of psychotic transition. *Neurons and Cognition [q-bio.NC]*. Université de Strasbourg; Albert-Ludwigs-Universität (Freiburg im Breisgau, Allemagne), 2021. English. NNT : 2021STRAJ024 . tel-03698462

**HAL Id: tel-03698462**

**<https://theses.hal.science/tel-03698462>**

Submitted on 18 Jun 2022

**HAL** is a multi-disciplinary open access archive for the deposit and dissemination of scientific research documents, whether they are published or not. The documents may come from teaching and research institutions in France or abroad, or from public or private research centers.

L'archive ouverte pluridisciplinaire **HAL**, est destinée au dépôt et à la diffusion de documents scientifiques de niveau recherche, publiés ou non, émanant des établissements d'enseignement et de recherche français ou étrangers, des laboratoires publics ou privés.

École Doctorale Des Sciences De La Vie Et De La Santé

**THESE** présentée par :

**Ali MAHDAVI OMASELAN OLYA**

Soutenue le : 19 July 2021

pour obtenir le grade de: **Docteur de l'université de Strasbourg**

Discipline/ Spécialité: Neurosciences

**Etude neurophysiologique et théorique des  
mécanismes cellulaires et synaptiques sous-tendant  
les oscillations thalamocorticales aberrantes dans un  
modèle murin de transition psychotique**

**THÈSE dirigée par :**

**PINAULT Didier**, Chargé de recherches INSERM, Université de Strasbourg

**CODIRECTEUR DE THÈSE :**

**ROTTER Stefan**, Professor of Computational Neuroscience, Bernstein Center Freiburg  
& Faculty of Biology, University of Freiburg, Germany

**RAPPORTEURS :**

**PRATT Judith**, Research Professor, University of Strathclyde, Glasgow  
**HILL Sean**, Director of the Krembil Centre for Neuroinformatics at CAMH,  
University of Toronto

---

**AUTRES MEMBRES DU JURY :**

**ISOPE Philippe**, Directeur de recherches CNRS, Université de Strasbourg  
**DESTEXHE Alain**, Directeur de recherche de L'Institut Européen de Neurosciences  
Théoriques (EITN), Institut de Neurosciences de Paris-Saclay  
(NeuroPSI)



**Neurophysiological and theoretical study of cellular  
and synaptic mechanisms underlying aberrant  
thalamocortical oscillations in a rodent model of  
psychotic transition**

**Ali MAHDAVI**

Directors:

**Didier PINAULT**

**Stefan ROTTER**

**University of Strasbourg**

**University of Freiburg**

**19 July 2021**

## Abstract

**Background and hypothesis:** Sleep disturbances are observed in patients with early-course schizophrenia and individuals at-risk mental state to develop psychotic disorders. Cortical EEG investigations have revealed a deficit in sleep-related, thalamocortical (TC) spindles in first-episode schizophrenia patients and young nonpsychiatric first-degree relatives, suggesting it as a potential early electro-biomarker of the disease. Sleep spindles have a thalamic origin with the GABAergic thalamic reticular nucleus (TRN) being a core structure in their generation. The TRN is innervated by two major glutamatergic inputs, TC and layer VI corticothalamic (CT) axon collaterals. Sleep spindle deficit supports the hypothesis that the thalamus and glutamate receptors play a crucial etio-pathophysiological role, the underlying mechanisms of which remain unknown. We hypothesized that a reduced function of NMDA receptors is involved in the sleep spindle deficit observed in patients having or about to have psychotic disorders.

**Methods:** A joint experimental-theoretical approach was used to test the hypothesis. An electrophysiological multisite cell-to-network exploration was used to investigate the effects of a single psychotomimetic dose of the NMDA glutamate receptor antagonist ketamine in the sensorimotor TC system of rats sedated with pentobarbital, a non-REM sleep model associated with a spindle-like activity. The computational spiking network model of the 3-stage CT-TRN-TC loop circuit working in the non-REM sleep state was simulated using NEST, a simulator for spiking neural network models. In the simulated network, all neurons are conceived as single-compartment spiking neurons incorporating Hodgkin-Huxley style currents. Simulated synapses include two excitatory glutamatergic synapses mediated by AMPA and NMDA receptors and two inhibitory GABAergic synapses mediated by GABA<sub>A</sub> and GABA<sub>B</sub> receptors. The single-cell and LFP recordings were obtained from the CT, TRN, and TC neurons to assess their firing and oscillatory activities before and after the implementation of ketamine-related changes.

**Results:** Spontaneously occurring oscillations were recorded in the frontoparietal cortical EEG, in thalamic extracellular recordings, in dual juxtacellularly recorded TRN and TC neurons. The TRN cells rhythmically exhibited robust high-frequency bursts of action potentials (7 to 15 APs at 200–700 Hz). A single administration of low-dose ketamine fleetingly reduced TC delta- (1-4 Hz), theta- (5-9 Hz) and sigma-frequency



(10-17 Hz) oscillations, amplified beta (17-29 Hz), gamma (30–80 Hz) and higher frequency oscillations, and switched the firing pattern of both TC and TRN neurons from a burst mode to a single AP mode. The antipsychotic clozapine consistently prevented the emergence of the ketamine effect. To know whether or not the ketamine effects are due to the specific blockade of NMDA receptors, some experiments were performed administrating other drugs. Only MK-801, a more specific NMDA receptor antagonist, could mimic the ketamine's fleeting psychosis-relevant effects better than the cholinesterase inhibitor physostigmine, and the dopamine receptor agonist apomorphine.

In the CT, TRN, and TC neurons of the simulated network, a set of combined ketamine-related changes including the reduced activity of NMDA receptors and the increased activity of AMPA and GABA<sub>A</sub> receptors led to a change in the baseline of the membrane potential from Up-state-Down-state transitions to a persistent Up state. This occurred concomitantly with a conversion from the burst mode to the single AP mode, and from the synchronized sleep-like state to the desynchronized arousal-like state. The computational findings were fully consistent with our experimental data. In addition, CT, TRN, and TC neurons exhibited similar ketamine-induced effects in terms of oscillatory and firing behaviors, indicating that the simulated CT-TRN-TC network works in a proper regime as a loop circuit. Without involving the reduced function of NMDA receptors, none of the other plausible scenarios designed based on the multiple mechanisms of ketamine action could alone mimic the ketamine-like effects, indicating the very specific and leading role of NMDA receptors relative to the role of non-NMDA receptors in revealing the effects of a ketamine-induced psychosis-relevant transition state.

**Conclusion:** Our analysis of the rodent model suggests that the ketamine-induced swift conversion of ongoing TC-TRN activities may have involved highly distributed brain networks including at least the ascending reticular activating system and the corticothalamic pathway. Our analysis of the computational model suggests that a combination of changes including the reduced activity of NMDA receptors, and potentiated activity of AMPA and GABA<sub>A</sub> receptors may contribute to the emergence of psychosis-related effects of ketamine. Both our experimental and computational observations strongly support the hypothesis that the transition to a psychosis-relevant state and the schizophrenia-related deficit in sleep spindles and slow oscillations involve a hypofunction of NMDA receptors, a potential therapeutic target.

## Résumé de la thèse en français

**Introduction:** La schizophrénie, une maladie psychotique chronique débilante, touche environ 1% de la population mondiale (Wittchen et al, 2011). Ses causes sont encore inconnues. Dans la schizophrénie, des troubles du sommeil sont observés (Monti et Monti, 2005 ; Wamsley et al, 2012 ; Ferrarelli et Tononi, 2016 ; Manoach et al, 2016). Ils sont également observés chez des personnes présentant un état mental à haut risque de développer un trouble psychotique ou bipolaire (Zanini et al., 2015). L'investigation EEG corticale révèle un déficit des fuseaux thalamocorticaux (TC) liés au sommeil, une oscillation comprenant un ensemble de 10-16 cycles par seconde (Ferrarelli et al, 2007 ; Manoach, 2014). En tant qu'électro-biomarqueur précoce potentiel de la maladie, la compréhension des mécanismes neuronaux sous-jacents au déficit des fuseaux du sommeil peut aider au développement à la fois du pronostic et de la thérapie. Il a été démontré que les déficits des fuseaux sont corrélés à une hyperconnectivité sensorimotrice-thalamique (Baran et al., 2019) et à une altération de la mémoire et des fonctions cognitives dépendantes du sommeil, qui sont toutes deux rapportées dans la schizophrénie (Ferrarelli et al. 2007, 2010 ; Manoach et al. 2010 ; Pinhong et al., 2019). Dans le système CT-TRN-TC (corticothalamique-TRN-thalamocortical), le thalamus est une structure critique pour les processus sensorimoteurs et cognitifs liés à l'attention. Il relaie les informations sensorielles, motrices et cognitives au cortex par le biais de connexions réciproques TC et CT avec les différentes couches du néocortex (Sherman et Guillery, 2000). Le thalamus est également fortement connecté avec les neurones inhibiteurs GABAergiques du noyau réticulaire thalamique (TRN), qui sont situés stratégiquement entre le cortex et le thalamus. Le TRN module les activités thalamiques par le biais de l'inhibition latérale (Steriade et al., 1993 ; Pinault, 2004) et peut être considéré comme un aiguilleur fonctionnel au sein des système TC (Pratt et Morris, 2015).

Notre objectif est de disséquer les mécanismes cellulaires et synaptiques d'une transition psychotique aiguë afin d'aider au développement thérapeutique visant à prévenir les troubles psychotiques tels que la schizophrénie. Notre stratégie est de considérer et de comparer une simulation expérimentale et une simulation computationnelle d'une telle transition au sein du système TC, d'un état physiologique à un état psychotique. La partie expérimentale a été réalisée à l'Université de Strasbourg (INSERM, U1114), et la partie théorique à l'Université de Freiburg au Bernstein Center Freiburg (BCF).

**Hypothèse:** Plusieurs études cliniques ont permis d'étayer l'hypothèse d'un hypofonctionnement des récepteurs au glutamate de type N-Méthyl-d-aspartate (NMDA) dans la schizophrénie (Luby et al., 1959 ; Javitt et al., 1991, Olney et al., 1999 ; Cohen et al., 2015). Les récepteurs NMDA sont, entre autres, impliqués dans la genèse des fuseaux thalamiques (Jacobsen et al, 2001 ; Deleuze et Huguenard, 2016). Il a été montré que des oscillations similaires à des fuseaux peuvent être générées dans le circuit en boucle CT-TRN-TC, au sein duquel les récepteurs NMDA des neurones TRN sont essentiels pour la génération de tirs rythmiques en rafale à haute fréquence de potentiels d'action, laquelle rafale est sous-tendue par un potentiel calcique bas seuil et qui hyperpolarise de façon rythmique, via l'activation de récepteur GABA<sub>A</sub>, les neurones TC postsynaptiques (McCormick et al, 1997 ; Pinault et al, 2006 ; Huguenard et al, 2007 ; Bonjean et al, 2011 ; Astori et al, 2014). De plus, dans une étude in vitro, le blocage sélectif des récepteurs NMDA diminue significativement la durée des oscillations fusiformes (Jacobsen et al, 2001). De plus, la kétamine, un antagoniste des récepteurs NMDA, simule une transition vers un état psychotique chez l'homme sain (Anticevic et al., 2011 ; Hoflich et al., 2015 ; Baran et al., 2019) et chez les rongeurs (Pinault, 2008 ; Ehrlichman et al., 2009 ; Kocsis, 2012). Par conséquent, nous avons émis l'hypothèse selon laquelle le déficit des fuseaux de sommeil enregistrés chez les patients ayant ou sur le point d'avoir des troubles psychotiques implique une réduction de la fonction des récepteurs NMDA. Pour tenter de vérifier cette hypothèse, nous avons étudié expérimentalement et mathématiquement les effets d'une dose subanesthésique de kétamine sur les fuseaux et les oscillations lentes enregistrés dans le système CT-TRN-TC.

### **La partie expérimentale**

Toutes les procédures ont été effectuées sous l'approbation du Ministère de l'Enseignement Supérieur, de la Recherche et de l'Innovation.

**Stratégie:** Pour vérifier l'hypothèse, nous avons utilisé des rats mâles sédatisés au pentobarbital (n=70), un modèle de sommeil non-REM auquel sont associées des oscillations de type fuseau (bande de fréquence sigma : 10-17 Hz) ainsi que des ondes plus lentes dans les bandes de fréquence thêta (5-9 Hz) et delta (1-4 Hz) (Pinault et coll., 2006). Ces ondes sont qualitativement similaires à celles enregistrées chez le rat vigile (Pinault et coll., 2001). Dans ces conditions expérimentales, nous avons utilisé une approche électrophysiologique multisite, combinant des enregistrements cellulaires, des potentiels extracellulaires et un EEG cortical au sein du système TC

somatosensoriel afin d'étudier les effets d'une administration sous-cutanée de kétamine à une dose subanesthésique. A cette dose, la kétamine est connue pour induire un état psychotique chez l'homme sain (Krystal et al., 1994 ; Hetem et al., 2000) et, chez le rat vigile, un comportement anormal associé à une diminution des performances cognitives et une perturbation des oscillations EEG corticales rappelant un trouble psychotique observé en clinique (Pinault, 2008 ; Hakami et coll., 2009 ; Pitsikas et coll., 2008). Trois séries d'expériences ont été menées sous sédation induite par le pentobarbital combinée avec une analgésie multimodale (générale et locale) : (1) Enregistrements EEG corticaux somatosensoriels (46 rats), (2) enregistrements TRN juxtacellulaires et TC extracellulaires (16 rats), (3) enregistrements TRN-TC juxtacellulaires appariés (8 rats). Les enregistrements intrathalamiques ont été obtenus en même temps que l'EEG cortical somatosensoriel.

**Résultats:** Dans la condition de contrôle, l'EEG cortical et les enregistrements extracellulaires de neurones TC étaient caractérisés par une dominance d'épisodes synchronisés semblables à ceux enregistrés durant le sommeil naturel. Ils comprennent des oscillations delta, thêta et de brèves oscillations de type fuseau. Toutes les cellules TRN et TC enregistrées par dérivation juxtacellulaire présentaient de manière rythmique de robustes salves de potentiels d'action à haute fréquence (200-500 PA/s). De manière significative, une administration systémique de kétamine rapidement et transitoirement (effet maximal à environ 15 minutes) réduisait la puissance des fuseaux et celle des oscillations plus lentes dans le potentiel de champ extracellulaire (EFP) des neurones TC et dans l'EEG cortical, augmentait la puissance des oscillations dans les bandes de fréquence bêta (18-29 Hz), gamma (30-80 Hz) et de plus haute fréquence (81-200 Hz). Parallèlement, la kétamine changeait le patron de décharge des neurones TC et TRN, enregistrées par dérivation juxtacellulaire, du mode rafale au mode tonique. Une récupération partielle des effets de la kétamine a été observée 60 à 80 minutes après l'administration de la kétamine.

Afin de savoir si les effets de la kétamine sont dus ou non au blocage spécifique des récepteurs NMDA, nous avons réalisé des expériences en utilisant d'autres molécules. Seule la dizocilpine (MK-801, 0,1 mg/kg, 5 rats), un antagoniste plus spécifique des récepteurs NMDA, a mieux imité les effets fugaces de la kétamine que la physostigmine, un inhibiteur de la cholinestérase (0,5 mg/kg, 4 rats) et l'apomorphine, un agoniste des récepteurs de la dopamine (1 mg/kg, 4 rats). Une injection systémique de clozapine (5 mg/kg, 10 rats), qui module l'activité de plusieurs

récepteurs dont les récepteurs NMDA via le site de la glycine (Schwieler et al., 2008), prévient de façon remarquable les effets de la kétamine. Ces résultats expérimentaux sont publiés dans le journal Schizophrenia Research (Mahdavi et coll., Schizophr Res, 2020).

## **La partie théorique**

**Stratégie:** Le modèle computationnel en mode d'émission de PAs du circuit en boucle à 3 étages CT-TRN-TC a été simulé à l'aide de NEST, un simulateur de modèles de réseaux neuronaux en mode d'émission de PAs, afin d'élucider les interactions fonctionnelles entre les différentes composantes du système somatosensoriel CT-TRN-TC dans un état de sommeil NREM normal (NNSS) et dans un état de sommeil NREM pathologique (PNSS) en fonction des effets induits par la kétamine, notamment en modifiant systématiquement les paramètres des récepteurs NMDA. Le modèle contient des populations de neurones excitateurs et inhibiteurs, avec des connexions organisées en régions et en voies. Le système neuronal étudié ici se compose d'une zone du cortex somatosensoriel, de la région correspondante du thalamus dorsal et du noyau réticulaire thalamique (TRN), ce dernier étant un réservoir de neurones GABAergique. Le cortex et le thalamus sont composés de neurones excitateurs et inhibiteurs. Tous les neurones sont modélisés comme des neurones à un compartiment en mode d'émission de PAs incorporant des courants de style Hodgkin-Huxley. Les canaux synaptiques simulés assurent une excitation voltage-dépendante (de type NMDA) et voltage-indépendante (de type AMPA), ainsi qu'une inhibition rapide (de type GABA<sub>A</sub>) et lente (de type GABA<sub>B</sub>). Dans notre modèle, les paramètres et leurs valeurs pour les profils de connectivité pour construire le réseau CT-TRN-TC et les paramètres impliqués dans la transition de l'état de veille à l'état de sommeil NREM ont été influencés par des modèles de réseaux TC précédemment publiés (Bazhenov et coll., 2000 ; Hill et Tononi, 2005 ; Landisman et coll., 2007 ; Krishnan et coll., 2016) ou ont été fixés pour être cohérents avec les observations expérimentales (Mahdavi et coll., 2020). Au cours des simulations réalisées avec ce modèle, nous enregistrons simultanément l'activité des neurones uniques et les LFP de trois régions comprenant les populations CT, TRN et TC afin d'analyser le patron de leur émission de PAs et leur comportement oscillatoire, en particulier l'activité du fuseau de sommeil. Un ensemble de changements combinés incluant la réduction du gain des récepteurs NMDA, l'augmentation du gain des récepteurs AMPA et l'accélération des récepteurs GABA<sub>A</sub> a été implémenté dans notre modèle pour le faire passer à l'état pathologique

(PNSS), selon les mécanismes connus de l'action de la kétamine. Nous avons appliqué tous ces changements en tenant compte des résultats d'études antérieures sur la kétamine et ses effets au-delà du " simple " fait d'être un antagoniste des récepteurs NMDA. La kétamine affecte l'activité des récepteurs AMPA et GABA<sub>A</sub> en plus des récepteurs NMDA (Llamosas et coll., 2019 ; Wang et coll., 2017 ; Irifune et coll. 2000 ; Sleight et coll., 2014).

**Résultats:** Lorsque le modèle de réseau passe de l'état de veille à l'état de sommeil, le comportement oscillatoire des LFP des neurones CT, TRN et TC passe des ondes rapides désynchrones de faible amplitude aux ondes lentes plus synchrones de plus grande amplitude, ce qui montre que le modèle peut simuler avec succès les caractéristiques de l'état de sommeil d'une manière cohérente à la fois avec les études précédentes et avec nos propres résultats expérimentaux.

En tant qu'analyses qualitatives, les enregistrements de type intracellulaire et leurs tracés matriciels correspondants obtenus à partir du modèle de réseau proposé du système CT-TRN-TC ont révélé que les neurones CT, TRN et TC émettent des PAs en mode rafale pendant le NNSS. Dans le PNSS, les changements combinés, y compris l'inactivation des récepteurs NMDA et d'autres changements liés à la kétamine, entraînent un changement dans le patron de décharge des neurones CT, TRN et TC, qui passent du mode rafale au mode PA unique. En outre, les LFP des CT, TRN et TC ont considérablement changé, passant d'une activité synchrone de type sommeil à un état plus désynchrone. L'analyse spectrale de ces LFP a montré une augmentation significative de la puissance des oscillations de haute fréquence (HO), y compris les oscillations bêta, gamma et de haute fréquence, et une réduction des oscillations de fréquence lente (LO), y compris les oscillations delta et thêta et les activités fusiformes. Ces résultats sont également parfaitement cohérents avec nos données expérimentales.

Le fait de régler la conductance des récepteurs NMDA, ou la probabilité de connexion aux récepteurs NMDA, à des valeurs inférieures à celles du NNSS entraîne une réduction de l'activité des rafales et une augmentation du taux de PA uniques. En d'autres termes, la réduction progressive de l'activité des récepteurs NMDA conduit progressivement à réduire la robustesse (durée de la rafale et événements par rafale) et la quantité de rafales et à augmenter la quantité d'événements uniques. Le résultat de l'atténuation progressive des récepteurs NMDA est cohérent avec l'augmentation

de l'effet de la kétamine jusqu'à ce qu'il atteigne son pic (environ 10-15 minutes après l'administration unique de kétamine), puis la diminution de son effet jusqu'à une récupération partielle (environ 40-60 minutes après le pic de l'effet de la kétamine). Les histogrammes de l'intervalle inter-pic des signaux d'enregistrement corticaux, TRN et thalamiques montrent qu'en raison de l'inactivation des récepteurs NMDA, la quantité maximale à l'intervalle de 2-5 ms, un marqueur de l'occurrence abondante de salves de PA, a disparu presque complètement et, au lieu de cela, les intervalles inter-pic plus longs (ISI entre 10 et 250 ms) ont augmenté, indiquant le passage du mode rafale au mode tonique.

Les changements combinés liés à la kétamine affectent la ligne de base des potentiels membranaires cellulaires dans les trois régions du système CT-TRN-TC, de sorte que les neurones CT, TRN et TC génèrent davantage d'oscillations de potentiel membranaire proches du seuil, et que la ligne de base bimodale (états ascendant et descendant) du potentiel membranaire dans le NNSS passe à l'état ascendant persistant dans le PNSS, ce qui augmente la probabilité d'émission d'un seul PA.

Afin de savoir si les effets induits par la kétamine sont spécifiquement dus à la combinaison simultanée de changements de paramètres, y compris la réduction de l'activité des récepteurs NMDA et la potentialisation des courants AMPA et GABA<sub>A</sub>, nous avons évalué plusieurs autres scénarios possibles concernant les multiples mécanismes d'action de la kétamine, comme l'ont montré des études précédentes. Par exemple, nous avons testé si d'autres scénarios, tels que des changements dans les récepteurs AMPA et/ou GABA<sub>A</sub> seuls sans manipulation des récepteurs NMDA, pouvaient conduire à la transition vers la psychose induite par la kétamine, comme le reflète le changement du patron d'émission, la réduction des oscillations lentes et l'augmentation des oscillations élevées. L'inactivation des récepteurs NMDA a permis à elle seule de faire passer le patron d'émission de PAs du mode rafale au mode tonique, mais n'a pas permis de réduire significativement les fuseaux, ce qui indique la nécessité d'une combinaison de changements pour imiter les effets complets de la kétamine. Nous avons également constaté qu'aucun des autres scénarios ne pouvait à lui seul imiter les effets de la kétamine. Les changements simultanés et combinés impliquant les récepteurs NMDA, AMPA et GABA<sub>A</sub> doivent être mis en œuvre pour révéler les effets complets de la kétamine.

**Conclusion:** D'un point de vue pharmacologique, il est prématuré de tirer des conclusions fortes, car toutes les expériences visant à évaluer les effets de l'un des médicaments testés ont été menées chez le rat sédaté au pentobarbital. Bien que le pentobarbital ait pu involontairement interagir avec certains des médicaments testés, le modèle de sommeil offre l'avantage d'évaluer simultanément les effets aigus de la kétamine sur tout le spectre des oscillations neurales, qui sont considérées comme des électro-biomarqueurs translationnels et des endophénotypes potentiels d'un état de transition vers la psychose. De plus, dans la condition de sommeil modélisée par le calcul, dans laquelle il n'y a pas d'ambiguïté pharmacologique potentielle, nous avons obtenu des résultats soutenant nos résultats expérimentaux. Nous concluons que les effets pharmacologiques induits par le pentobarbital ne compromettent pas la pertinence et la fiabilité des conclusions tirées des résultats expérimentaux.

D'un point de vue théorique et translationnel, il est intrigant de constater que les changements induits par la kétamine dans les oscillations EEG des rongeurs et les LFP corticaux obtenus par calcul sont comparables à ceux enregistrés chez des rats éveillés au comportement naturel (Hakami et al., 2009 ; Hiyoshi et al., 2014 ; Pinault, 2008). Ils rappellent également ceux observés chez les individus à risque d'état mental (Fleming et al., 2019 ; Ramyeed et al., 2015) et le premier épisode de schizophrénie (Andreou et al., 2015 ; Flynn et al., 2008).

La présente étude expérimentale et théorique conjointe démontre que les effets aigus de la kétamine ont un effet transitoire de promotion de l'éveil, suggérant qu'elle agit comme un inducteur rapide des processus cognitifs associés au sommeil paradoxal, ce qui rappelle sa capacité à induire des symptômes hallucinatoires et délirants (Baldeweg et al., 1998 ; Becker et al., 2009 ; Behrendt, 2003 ; Ffytche, 2008 ; Spencer et al., 2004). La kétamine à faible dose perturbe non seulement les rythmes cérébraux, mais aussi les processus sensorimoteurs et cognitifs liés à l'attention (Grent-'t-Jong et al., 2018 ; Höflich et al., 2015 ; Hong et al., 2010), soutenant l'idée que la schizophrénie est un trouble cognitif avec la psychose comme conséquence ultérieure (Cohen et Insel, 2008 ; Huang et al., 2019 ; Woodward et Heckers, 2016).

Qu'est-ce que la préparation aiguë à la kétamine modèle en effet ? Tout d'abord, ce modèle ne couvre pas les dimensions génétiques-neurodéveloppementales et anatomiques, ni les mécanismes de décompensation des troubles psychotiques. Le modèle rongeur, humain et computationnel de la kétamine aiguë est censé imiter les



formes aiguës de psychose et de schizophrénie précoce plutôt que chronique (Anticevic et al., 2015b). Dans la présente enquête électrophysiologique-computationnelle, la kétamine aiguë, principalement par des mécanismes de cascade liés aux récepteurs NMDA, a suscité une transition d'un état physiologiquement " normal " à un état pertinent pour la psychose. Dans le système CT-TRN-TC, dans des conditions de sommeil non-REM, la kétamine a converti de manière transitoire et significative le modèle d'activité de tir d'un mode rafale à un mode AP unique, a réduit les fuseaux corticaux et thalamiques et les oscillations de fréquence plus lente, et a augmenté les oscillations de haute fréquence dans les bandes bêta, gamma et de fréquence plus élevée. Une réduction des fuseaux de sommeil et des oscillations delta a été signalée dans l'évolution précoce de la schizophrénie (Manoach et al., 2014 ; Kaskie et al., 2019). Par conséquent, nous pouvons conclure que dans la condition de sommeil, notre modèle de kétamine aiguë simule un état qui rappelle électrophysiologiquement une transition vers un état psychotique, car la kétamine reproduit les perturbations des oscillations cérébrales liées à la psychose, et l'antipsychotique clozapine, qui se lie aux récepteurs de la sérotonine et de la dopamine ainsi qu'au récepteur NMDA par son site glycine, les empêche. D'autre part, chez l'homme, le passage naturel à la psychose se fait à partir d'un état déjà perturbé (ou état mental à risque). Ceci implique des mécanismes étio-pathophysiologiques interactifs multifactoriels impliquant l'environnement, la socio-culture, les gènes, la pro-inflammation, les facteurs de risque, les neurotransmissions dopaminergiques, GABAergiques et glutamatergiques, et la dysconnectivité fonctionnelle entre les systèmes corticaux et sous-corticaux hautement distribués, y compris les circuits liés au thalamus.

Malgré la difficulté d'interprétation du modèle de kétamine aiguë, la présente étude peut aider à comprendre, au moins pour les systèmes TC hautement distribués, les perturbations entre cellules et réseaux qui se produisent lors de la conversion d'un état physiologique à un état pathologique lié à la psychose. Les oscillations EEG corticales sont des biomarqueurs fiables des activités thalamiques car le cortex et le thalamus travaillent ensemble. La présente étude montre qu'il est possible, sur la base des connaissances disponibles et de nos résultats informatiques, de prédire les corrélations probables entre les cellules thalamiques et le réseau.

Les changements induits par la kétamine peuvent perturber à la fois le flux d'informations " ascendant " et " descendant " (Mahdavi et al., Schizophr Res, 2020),

en référence au rôle du système d'activation réticulaire (RAS) dans la conduite des rythmes EEG corticaux (Garcia-Rill et al, 2015) et à la contribution de la voie CT dans les oscillations thalamiques (Anderson et al, 2017), respectivement. Dans le système somatosensoriel CTC, le rôle des neurones CT qui innervent massivement les neurones TC et TRN a été déterminé par des enregistrements unicellulaires et LFP des neurones CT à l'aide de simulations informatiques du circuit à 3 étages CT-TRN-TC.

Nous avons développé un modèle computationnel du réseau CT-TRN-TC fonctionnant dans l'état de sommeil non-REM et proposé un mécanisme neuronal qui pourrait servir de modèle de transition vers la psychose induite par la kétamine. Nos observations informatiques ont non seulement étayé nos résultats expérimentaux, mais ont également indiqué le schéma de tir et le comportement oscillatoire des neurones CT dans des états normaux et pathologiques. Elles ont également confirmé certaines de nos prédictions expérimentales, telles que le changement induit par la kétamine dans la ligne de base du potentiel de membrane, des transitions état haut-état-état bas à l'état haut persistant. Ce changement est associé à une transition du mode rafale au mode PA unique, et à une transition de l'état de sommeil synchronisé à l'état d'éveil désynchronisé. En raison de la fonction réduite des récepteurs NMDA, le modèle d'activité de tir des neurones CT passe du mode rafale au mode AP unique. De plus, en raison de la désinhibition des interneurones GABAergiques et de l'excitation accrue des neurones TC, la fréquence d'allumage des neurones CT augmente. Les neurones CT, à leur tour, excitent fortement les neurones TRN et TC. Cependant, en l'absence ou en faible présence de récepteurs NMDA, ces neurones ne tirent pas de salves et ne subissent ensuite aucune transition entre l'état haut et l'état bas. Au contraire, ils agissent dans un état Up persistant et se déchargent en mode AP unique par une activation élevée des récepteurs AMPA médiée par le cortex. Les différentes populations neuronales du réseau simulé présentent des comportements similaires et concomitants en termes d'oscillations et de modèles d'activité de tir, ce qui indique que le modèle de calcul du réseau CT-TRN-TC fonctionne dans un régime approprié en tant que circuit en boucle.

Les résultats de calcul ont mis en évidence le rôle important des récepteurs NMDA pour la transition du mode rafale vers le mode de piquage unique et la réduction de l'activité du fuseau. Cependant, ils n'ont pas pu confirmer la suffisance d'une modification isolée des récepteurs NMDA. Au contraire, en considérant les résultats

d'études antérieures sur la kétamine et ses effets au-delà du " simple " antagoniste des récepteurs NMDA (Sleigh et al., 2014), une combinaison de changements a été mise en œuvre impliquant des récepteurs non NMDA en plus des récepteurs NMDA. Ces changements combinés constituent l'ensemble des effets induits par la kétamine. En d'autres termes, un ensemble de changements coordonnés comprenant la réduction de l'activité des récepteurs NMDA et l'augmentation de l'activité des récepteurs AMPA et GABA<sub>A</sub> se produisant ensemble s'est avéré être responsable du changement du schéma d'activité de tir et des déficits du fuseau, résultant en l'état de psychose. Nous avons également montré que, sans tenir compte de la fonction réduite des récepteurs NMDA, aucun des autres scénarios plausibles basés sur les multiples mécanismes d'action de la kétamine ne pouvait à lui seul imiter les effets de type kétamine, ce qui indique le rôle très spécifique et prépondérant des récepteurs NMDA par rapport aux récepteurs non NMDA dans le réseau CT-TRN-TC. Les modifications de l'activité des synapses AMPA et GABA<sub>A</sub> liées à la kétamine peuvent être dues à l'action directe de la kétamine sur celles-ci (Irifune et al., 2000 ; Iskandrani et al., 2015 ; Wang et al., 2017 ; Ghosal et al., 2020) ou être secondaires à l'hypofonctionnement des récepteurs NMDA induit par la kétamine (Homayoun et Moghaddam, 2007 ; Ren et al., 2016 ; Weckman et al., 2019). Il n'existe pas de preuves convergentes pour ces mécanismes d'action de la kétamine. Cependant, notre modèle computationnel soutient l'hypothèse selon laquelle les changements liés à la kétamine conduisent à la conversion vers un état relevant de la psychose.

Nos résultats actuels apportent une valeur ajoutée théorique et translationnelle à l'approche conceptuelle actuelle avec une certaine validité de construction. Il existe également une validité prédictive en raison de l'action préventive de la clozapine (Mahdavi et al, 2020) et du fait que la tDCS frontopariétale réduit les effets induits par la kétamine au moins sur les oscillations de fréquence delta, sigma et gamma (Lahogue and Pinault, 2021, *Transl Neurosci*, In press). Cependant, il faut également mentionner que, chez les patients atteints de psychose, les perturbations naturelles de l'EEG (réduction de l'activité du fuseau, augmentation de la puissance gamma, etc.) sont plus subtiles que les changements induits par la kétamine. Dans l'ensemble, nos observations expérimentales et informatiques soutiennent fortement l'hypothèse selon laquelle la transition vers un état de psychose et le déficit lié à la schizophrénie dans les fuseaux de sommeil et les oscillations lentes impliquent une hypofonction des récepteurs NMDA. Nos résultats actuels mettent en évidence l'implication de multiples

systèmes de neurotransmetteurs et l'hypothèse de réseaux cérébraux entiers, plutôt que la théorie du circuit cérébral isolé de la schizophrénie (Kambeitz et al., 2016). Les mécanismes neuronaux qui sous-tendent l'effet de type éveil fugace induit par la kétamine peuvent être, en partie, similaires à ceux responsables de la phase initiale de l'action antidépressive à action rapide de la kétamine chez les patients souffrant de troubles dépressifs majeurs résistants aux médicaments (Duncan Jr. et al., 2019 ; Krystal et al., 2019 ; Nugent et al., 2019). Cela nous amène à penser que les effets de la kétamine sont dépendants de l'état. En outre, les présents résultats suggèrent que les modèles combinés de sommeil et de kétamine ont une certaine validité prédictive pour la première étape du développement de thérapies innovantes contre les troubles psychotiques, bipolaires et dépressifs.

## Acknowledgments

First, I would like to thank the NeuroTime Erasmus+ program of the European Commission and the Bernstein Center Freiburg for providing the funding support for this project.

I would also thank my committee members, Prof. Judith Pratt, Prof. Sean Hill, Prof. Philippe Isope and Prof. Alain Destexhe for their participation and their brilliant and effective comments and suggestions.

Further, I would like to express my everlasting gratitude to both of my fantastic and inspiring supervisors, Prof. Didier Pinault and Prof. Stefan Rotter, who guided me throughout this project and helped me finalize it by their insightful feedback, valuable advice and unwavering support.

Thank you, all of the unforgettable and knowledgeable colleagues, professors, and students, for exciting and helpful discussions, for scientific and motivational support I was given to further my research.

Last but not least, I would like to thank my family and friends from the bottom of my heart for their endless love and unconditional support. This thesis would not have been possible without you.



## **ABBREVIATIONS**

AMPA	$\alpha$ -Amino-3-hydroxy-5-methyl-4-isoxazolepropionic acid
ARMS	At risk mental state for developing psychosis
CT	Corticothalamic
EC-SCZ	Early-course schizophrenia
EEG	Electroencephalogram
EFP	Extracellular field potential
FFT	Fast Fourier transform
fMRI	Functional magnetic resonance imaging
GABA	Gamma-Aminobutyric Acidx
hfBursts	High-frequency bursts
HFO	Higher-frequency oscillations
HO	High-frequency oscillations
LFP	Local field potential
LO	Low-frequency oscillations
NMDA	N-Methyl-D-aspartate
NNSS	Normal non-REM sleep state
Non-REM	Non-rapid eye movement
NRG1	Neuregulin 1
PCP	Phencyclidine
PNSS	Pathological non-REM sleep state
PPI	Prepulse inhibition
PV	Parvalbumin
REM	Rapid eye movement
SWS	Slow wave sleep
TC	Thalamocortical
tDCS	Transcranial direct current stimulation
TRN	Thalamic reticular nucleus
VPI	Ventral posterolateral nucleus
VPm	Ventral posteromedial nucleus

## Table of contents

---

List of figures .....	vii
List of tables .....	ix
<b>PART 1</b> .....	<b>1</b>
Neurophysiological Study .....	1
<b>Chapter 1</b> .....	<b>2</b>
1. Introduction and Literature review .....	2
1.1. Schizophrenia – An overview .....	2
1.1.1. Schizophrenia.....	2
1.1.2. Schizophrenia prodrome.....	3
1.1.3. Neurobiology of schizophrenia .....	4
1.1.3.1. Environment.....	4
1.1.3.2. Genetics.....	5
1.1.3.3. Dopamine hypothesis .....	6
1.1.3.4. Glutamate NMDA receptor hypofunction hypothesis .....	7
1.1.3.5. Hypothesis of GABAergic dysfunction .....	9
1.2. Sleep disturbances and aberrant brain rhythms in ARMS and EC-SCZ .....	10
1.2.1. Sleep disturbances in psychiatric disorders .....	10
1.2.2. Sleep disturbances in ARMS and EC-SCZ according to polysomnographic findings	12
1.2.3. Aberrant neural oscillations in schizophrenia .....	15
1.2.4. Abnormal brain rhythms in EC-SCZ and ARMS during sleep.....	15
1.2.5. Sleep spindle deficit in EC-SCZ.....	17
1.2.6. Abnormal gamma rhythm in EC-SCZ and ARMS in wake state .....	18
1.2.7. Abnormal theta and delta rhythms in EC-SCZ and ARMS in wake state.....	19
1.3. Dysfunction of thalamus-related networks in EC-SCZ and ARMS .....	20
1.3.1. The 3-neuron CT-TRN-TC system.....	20
1.3.2. Abnormal thalamus-related connectivity in EC-SCZ and ARMS .....	22
1.3.3. Abnormal thalamus-related oscillations in EC-SCZ and ARMS.....	23
1.3.4. Role of dysfunctional TRN-related networks in transition to psychosis.....	23
1.4. NMDA receptor hypofunction-related alterations in neural oscillations .....	25
1.4.1. NMDA receptor hypofunction-related alterations in gamma and other neural oscillations.....	26



1.4.2. NMDA receptor hypofunction-related alterations in delta- and theta-frequency oscillations.....	28
1.4.3. NMDA receptor hypofunction-related spindle reduction .....	29
1.5. Model of transition to psychosis .....	29
1.5.1. Neurodevelopmental models of schizophrenia .....	30
1.5.2. Genetic Models of schizophrenia.....	31
1.5.3. Dopamine-based models of psychosis .....	33
1.5.4. The NMDA receptor-related models of EC-SCZ .....	33
1.5.4.1. PCP model.....	33
1.5.4.2. MK-801 model.....	34
1.5.4.3. Role of NMDA receptor subunits in transition to psychosis.....	35
1.5.4.4. Ketamine model .....	36
1.6. The low-dose ketamine-induced model of psychosis transition .....	39
1.6.1. Ketamine model of transition to psychosis in human studies .....	39
1.6.2. Ketamine model of transition to psychosis in animal studies.....	42
1.6.3. Acute low-dose ketamine model mimics EC-SCZ but not chronic schizophrenia .....	43
1.6.4. Implications and limitations related to low-dose ketamine models .....	44
1.7. Aims.....	44
<b>Chapter 2 .....</b>	<b>47</b>
2. Materials and Methods.....	47
2.1. Animals and drugs .....	47
2.2. Surgery under general anesthesia .....	47
2.3. The analgesic pentobarbital-induced sedation .....	48
2.4. The rat somatosensory CT-TRN-TC system .....	49
2.5 Cell-to-network recordings .....	50
2.6. Cortical EEG recordings (21 rats) .....	51
2.7. Preparation for intrathalamic recordings.....	51
2.8. Thalamic juxtacellular TRN and extracellular TC recordings (16 rats) .....	52
2.9. Paired juxtacellular TRN-TC recordings (8 rats).....	53
2.10. Administration of ketamine and other drugs .....	54
2.11. Identification of recording sites.....	56
2.12. Data analysis .....	57
<b>Chapter 3 .....</b>	<b>59</b>
3. Results.....	59

3.1. The analgesic pentobarbital-induced sedation as a model of non-REM sleep .....	59
3.2. Ketamine reduces sleep-like activity patterns and amplifies high-frequency oscillations in both cortex and thalamus.....	62
3.3. The psychotomimetic ketamine switches the firing pattern of both TC and TRN neurons from burst mode to tonic mode .....	66
3.4. MK-801 mimics the ketamine effects better than physostigmine and apomorphine .....	74
3.5. Firing pattern of apomorphine and physostigmine in TRN neurons .....	80
3.6. Clozapine prevents the emergence of ketamine's effects.....	81
3.7. High dosage of Ketamine does not mimic the effects of MK-801 and psychotomimetic ketamine .....	84
<b>Chapter 4</b> .....	<b>87</b>
4. Discussion .....	87
4.1. The arousal promoting effect of low-dose ketamine .....	88
4.2. Contribution of the corticothalamic pathway .....	92
4.3. Contribution of the ascending reticular activating system and basal forebrain.....	94
<b>PART 2</b> .....	<b>97</b>
Theoretical & Computational Study.....	97
<b>Chapter 1</b> .....	<b>98</b>
1. Introduction and Literature review .....	98
1.1. Computational model of ketamine-induced effects in the thalamo-cortical loop.....	98
1.2. Computational model of non-REM sleep in the thalamocortical system.....	99
1.3. Computational model to scrutinize the glutamate hypothesis of schizophrenia .....	102
1.4. Effect of ketamine on non-NMDA synaptic receptors .....	105
1.4.1. Effect of ketamine on AMPA receptors .....	105
1.4.2. Effect of ketamine on GABA receptors .....	106
1.5. NMDA receptors on inhibitory neurons are more sensitive to antagonism.....	108
1.6. Aims and objectives .....	111
<b>Chapter 2</b> .....	<b>114</b>
2. Materials and methods.....	114
2.1. The computational network model of the CT-TRN-TC loop circuit.....	114
2.2. Topological and probabilistic connectivity between neural populations .....	115
2.3. Further aspects of constructing the CT-TRN-TC network.....	117
2.4. Model neurons .....	121
2.5. Intrinsic currents.....	123

2.6. Synaptic currents .....	126
2.7. Modeling of LFP.....	130
2.8. Power spectrum of simulated LFPs.....	130
2.9. Analysis of firing activity through event detection .....	131
2.10. Investigating transient and progressive effect of ketamine .....	132
<b>Chapter 3 .....</b>	<b>133</b>
3. Results and discussion .....	133
3.1. Transition from the waking-like state to the non-REM sleep-like state.....	133
3.2. Occurrence of bursts and spindles in the NNSS.....	137
3.3. Transition from the NNSS to the PNSS.....	140
3.4. The firing pattern of the simulated CT-TRN-TC network switches from the burst mode in the NNSS to the tonic mode in the PNSS due to the combination of changes: a candidate mechanism of ketamine action.....	144
3.5. The reduced LO including spindles, and the increased HO in the PNSS compared to the NNSS .....	147
3.6. The reduced activity of NMDA receptors reduces robustness and number of bursts, and increases the number of single-spike events .....	150
3.7. The IAPIH analysis of single-cell recordings indicates a reduced bursting and increased single-spike events in the PNSS relative to the NNSS .....	154
3.8. Membrane potentials reflect Up-State-Down state transitions in the NNSS and a persistent Up state in the PNSS.....	155
3.9. The reduced activity of NMDA receptors alone can switch the firing pattern from the burst mode to the tonic mode, but it cannot decrease the spindle activity. This indicates that a combination of changes is necessary to mimic the full effects of ketamine. ....	157
<b>PART 3.....</b>	<b>169</b>
Conclusions.....	169
<b>PART 4.....</b>	<b>175</b>
References.....	175
Résumé .....	214

## List of figures

---

### Part1

#### Chapter 2

Figure 2-1. Structure of the somatosensory CT-TRN-TC system and experimental design. .... 49

Figure 2-2. Coronal plane of rat brain illustrating cortical EEG and intrathalamic recording sites.53

#### Chapter 3

Figure 3-1. Sleep-like activity patterns under the analgesic pentobarbital-induced sedation. .... 61

Figure 3-2. ketamine transiently prevented the occurrence of natural sleep in the somatosensory CT-TRN-TC system..... 63

Figure 3-3. Ketamine significantly decreases the power of sleep-like oscillations including spindles and slower oscillations, and increases that of high-frequency oscillations including gamma oscillations in the somatosensory thalamocortical system..... 64

Figure 3-4. Ketamine reduces sleep-related oscillations including spindles in the thalamocortical system..... 65

Figure 3-5. Ketamine decreases the hfBurst density and increases the single AP (sAP) density in extracellularly recorded thalamocortical (TC) neurons. .... 67

Figure 3-6. Ketamine switches the firing pattern from a burst mode to a single action potential mode in thalamic relay (glutamatergic) and reticular (GABAergic) neurons. .... 69

Figure 3-7. Thalamocortical (TC) firing related to gamma-frequency oscillations. .... 72

Figure 3-8. Thalamic reticular nucleus (TRN) firing related to gamma-frequency oscillations. ... 73

Figure 3-9. MK-801 mimicked the transient effect of ketamine on the cortical EEG oscillations except on the delta- and beta-frequency oscillations. .... 76

Figure 3-10. Apomorphine decreased the powers of all frequency bands in the somatosensory cortical EEG and could not mimic the ketamine effect. .... 77

Figure 3-11. Physostigmine decreased the powers of all frequency bands in the somatosensory cortical EEG and could not mimic the ketamine effect. .... 78

Figure 3-12. MK-801 mimics the ketamine effects better than physostigmine and apomorphine.79

Figure 3-13. Kinetics of effects of different experimented drugs. .... 80

Figure 3-14. Physostigmine or apomorphine decreases the hfBurst density in juxtacellularly recorded thalamic reticular nucleus neurons. .... 81

Figure 3-15. Under the clozapine condition, ketamine does not exhibit its effects on sleep TC oscillations..... 82

Figure 3-16. Clozapine prevents the emergence of ketamine's effects on the somatosensory cortical oscillations. .... 83

Figure 3-17. High dosage of ketamine (80 mg/kg) does not mimic the effects of psychotomimetic ketamine (2.5 mg/kg)..... 85

#### Chapter 4

Figure 4-1. Theoretical prediction of the ketamine action in both the ascending reticular activating system and the corticothalamic pathway ..... 91

### Part 2

## Chapter 2

Figure 2-1. Computational spiking network model of the three-stage CT-TRN-TC loop circuit. ....	115
Figure 2-2. Topological and probabilistic connectivity between the neural populations of the simulated CT-TRN-TC system through synaptic receptors. ....	118
Figure 2-3. Detection method to identify single spikes and bursts. ....	131

## Chapter 3

Figure 3-1. Transition from the WS to the NNSS in the simulated CT-TRN-TC network. ....	135
Figure 3-2. LFP-like recordings in the WS and sleep-like state acquired from the cortical, TRN and thalamic populations of the simulated CT-TRN-TC network. ....	139
Figure 3-3. The firing and oscillatory activity of the simulated CT-TRN-TC network dramatically changes due to the ketamine-related parameter changes. ....	146
Figure 3-4. Transition from NNSS to PNSS in the simulated CT-TRN-TC network. ....	148
Figure 3-5. The reduction of LO and increase of HO due to the inactivation of NMDA receptors and changes of ketamine-related parameters in the simulated CT-TRN-TC system during sleep-like state. ....	149
Figure 3-6. Bursting decreases by reducing either the connection probability to NMDA synapses ( $P_{max}$ ) or the peak conductance of NMDA receptors ( $g_{peak}$ ). ....	151
Figure 3-7. Reduction of the connection probability to NMDA synapses significantly affects the firing behaviour of simulated CT-TRN-TC system in the sleep-like state. ....	152
Figure 3-8. Reduction of the peak conductance of NMDA receptors affects the firing behaviour of the CT-TRN-TC system in the sleep-like state. ....	153
Figure 3-9. High-frequency bursts are reduced and single APs are increased in PNSS relative to NNSS. ....	154
Figure 3-10. Neuronal membrane potentials in the simulated CT-TRN-TC system reflect Up-state-Down-state transitions in the NNSS and a persistent Up-state in the PNSS. ....	156
Figure 3-11. Ketamine-like effect in switching the firing pattern from the burst mode to the tonic mode is specifically due to the attenuation of NMDA receptors. ....	162
Figure 3-12. A combined change of several parameters is essential to mimic the ketamine-induced reduction in spindles and theta oscillations. ....	165

# List of tables

---

## Part1

### Chapter 2

Table 2-1. The requirements of signal conditioning, tip diameter and resistance of micropipettes for different recording signals with their approximate recording locations.....	54
Table 2-2. Description of different substances used in this study under the pentobarbital-induced sedation.....	55
Table 2-3. Number of experiments with the type and location of recordings performed using different substances administered under the pentobarbital-induced sedation. ....	56

## Part2

### Chapter 2

Table 2-1. The topological properties of different areas involved in the CT-TRN-TC network model.....	116
Table 2-2. Parameters of the connectivity profiles used to construct the CT-TRN-TCI network. ....	119
Table 2-3. Parameter values for each neuron type in the NNSS.....	128
Table 2-4. Parameters for intrinsic and synaptic currents in the NNSS.....	129

### Chapter 3

Table 3-1. Parameters involved in the transition from the WS to the NNSS.....	136
Table 3-2. Parameter changes that lead to a transition from the NNSS to the PNSS (Scenario A), similar to ketamine-induced effects.....	143
Table 3-3. Parameter changes that bring the NNSS to a new state including Scenarios B to F.....	160
Table 3-4. The effect of different alternative scenarios in comparison with the ketamine effect on the firing and oscillatory activities of the simulated CT-TRN-TC network in the non-REM sleep-like state. ....	167

# **PART 1**

---

## **Neurophysiological Study**

# Chapter 1

---

## 1. Introduction and Literature review

### 1.1. Schizophrenia – An overview

#### 1.1.1. Schizophrenia

Schizophrenia is a neurodevelopmental, debilitating mental illness (Lewis and Levitt, 2002; Haaro-Peled et al, 2009) affecting about 1% of the world's population (Karayiorgou and Gogos, 1997; Insel, 2010). Early stage or onset of schizophrenia occurs in late adolescence, although it may also emerge rarely in childhood or adulthood (Sadock et al., 2014). It is characterized by the manifestation of the clinical disorganization such as changes in mood, affect, thought, memory, attention and language associated with the cognitive deficits (Cornblatt et al 1985; Saykin et al 1994; Rund, 1998; McGurk et al 2004; Bowie and Harvey, 2006) and the impairments in the sensorimotor skills which involve processes of receiving sensory information from our bodies and environment (sensory input) and producing a response (motor output) (Leitman et al, 2005; Leitman et al, 2008; Turetsky et al, 2009; Javitt, 2009a; Javitt, 2009b; Berman et al., 2016).

Schizophrenia was identified by Kraepelin and Bleuler in the early 1900's. But even after a century, the main causes of schizophrenia are not fully known and there is no full success to treat schizophrenia patients. In schizophrenia, a number of factors such as the heterogeneity of the disease and the lack of clear pathological lesions make it a complex phenomenon. To better understand the underlying neurobiological mechanisms of schizophrenia more research is needed (Insel, 2010). Schizophrenia is a multifarious and multifactorial disease with a heterogeneous constellation of symptoms. The inherent heterogeneity of schizophrenia has resulted in a lack of consensus regarding the disorder's diagnostic criteria. The symptoms of schizophrenia are broken down into three key domains – positive, negative and cognitive symptoms (van Os and Kapur, 2009).



Positive symptoms include the psychotic symptoms and represent traits, behaviors and actions that schizophrenia patients possess that are not seen in healthy individuals. Positive symptoms consist of hallucinations, delusions, suspiciousness, thought disorder and motor symptoms. Negative symptoms are characterized by a number of abnormalities in normal behaviours, functions and actions that are missing or absent in patients. Negative Symptoms include social withdrawal, affective flattening, self-neglect, loss of motivation and initiative, emotional blunting, and paucity of speech.

Cognitive symptoms include reductions in working memory, attention, executive functions, verbal and visual learning and memory, reasoning and problem solving, speed of processing and social cognition which is ultimately impairing the individual's ability to communicate (Green et al., 2004; Keefe and Harvey, 2012).

### **1.1.2. Schizophrenia prodrome**

In schizophrenia and related psychotic disorders, the course of the prodrome is identified as a phase that precedes the onset of psychosis. Indeed, schizophrenia onset may occur much before the manifestation of psychotic symptoms. The prodromal phase is often experienced by adolescents and youth and is characterized by a series of negative and nonspecific subclinical symptoms before the psychosis onset lasting from weeks to several years. The prodromal phase begins with the symptoms such as social withdrawal, anxiety, and depression. Then, it is commonly followed by moderate, short-lasting, or intermittent positive symptoms, speech problems, and sleep disturbances. After this, near to conversion to psychosis, prodromal individuals at this high-risk period, experience more serious attenuated positive symptoms but the duration, intensity, and frequency of these symptoms are still less than the threshold for meeting the criteria and being identified as full-blown psychosis with its manifest clinical symptoms. To distinguish these prodromal persons (i.e., individuals at-risk mental state for developing psychosis or schizophrenia (ARMS)) from patients with psychosis, some basic symptoms have been defined to design assessment scales, for example, Comprehensive Assessment of At-Risk Mental State (CAARMS). These prodromal basic symptoms include a wide range of abnormalities such as impaired perception, thought, sensation, motion, emotion, language, attention, memory, etc. Most of the schizophrenia patients (about 75 %) experience the prodromal phase. The prodromal phase extends over several years from ARMS to the early course

of psychosis or schizophrenia. Symptoms of psychosis (hallucinations, delusions, thought disorders, sleep problems, etc.) are common but not unique to schizophrenia. They may also occur in other psychotic disorders such as bipolar disorder. Early-course schizophrenia (EC-SCZ) describes patients who are recently diagnosed with schizophrenia and enter their first episode of the illness. After first episode, symptoms decline and reach a plateau at later stages (chronic schizophrenia) (Larson et al., 2010; Insel, 2010; Newton et al., 2018; Häfner, 2019). Understanding the specific neurophysiological features of the schizophrenia prodrome may help research targeting the main causes of schizophrenia and in improving the prevention/intervention strategies.

### **1.1.3. Neurobiology of schizophrenia**

Schizophrenia has various types of symptoms that may be referred to a heterogeneous collection of disorders, suggesting that the pathophysiology of schizophrenia may not be simply attributed to a single brain dysfunction (Lewis and Lieberman, 2000).

Although some genetic factors, as well as the environmental triggers which are in significant interaction with the genetic factors, are identified from a number of twin and familial studies, there is no consensual view and established etio-pathology of schizophrenia due to its complexity and heterogeneity resulting from the various phenotypes of the disease arising from multiple factors (Tsuang et al., 2001; Sullivan et al., 2003; Sullivan, 2005). Neurobiology of schizophrenia involves multifactorial, multiple interactive etio-pathophysiological mechanisms, involving genes, environment, socio-culture, pro-inflammation, risk factors, dopaminergic, glutamatergic and/or GABAergic neurotransmissions, etc (Ross et al., 2006; Kahn and Sommer, 2015).

#### **1.1.3.1. Environment**

Environmental factors may play a considerable role in the development of schizophrenia, especially in individuals who are in a vulnerable position to develop the disorder. Environmental stressors linked to schizophrenia include childhood trauma, minority ethnicity, residence in an urban area (Krabbendam and Van Os, 2005), and social isolation. In addition, social stressors, such as discrimination or economic adversity, may predispose individuals toward delusional or paranoid thinking. Twin studies have indicated that in patients with schizophrenia, genes contribute no more than 50% to aetiology

suggesting that environmental factors may also play a considerable role in schizophrenia (Bromet and Fennig, 1999; Sullivan et al., 2003; Moran et al., 2016). Children born in winter and spring also display an increased risk of developing schizophrenia (Bradbury and Miller, 1985), as do children born at higher latitudes (Kinney et al., 2009).

### **1.1.3.2. Genetics**

Large body of evidence provides support for the idea that genetic factors play a significant role in the etiology of schizophrenia. Twin and familial studies have shown an increased risk of schizophrenia in the relatives of patients. These studies have shown that the risk of illness is approximately 10% for a first-degree relative including parents, siblings or children, and 3% for a second-degree relative such as uncles and aunts. In monozygotic twins who share the same genetic material, the risk of developing schizophrenia is 48% if the other has the disorder, whereas the risk is 12% to 14% in dizygotic twins. If both parents have schizophrenia, the risk of the illness in child born is approximately 40%. Another strong evidence supporting the genetic basis for schizophrenia is this finding that siblings with schizophrenia often experience onset of the disorder at the same age. All these findings indicate that schizophrenia may emerge as a result of a genetic predisposition (Gottesman, 1991; Tsuang, 2000).

There is no single gene identified for schizophrenia. Many studies have recently identified a series of genetic loci associated with schizophrenia. It has been shown by genome-wide association studies that a large number (>108) of single nucleotide polymorphisms (SNPs) such as DISC1, SYN2, TPH1, NRG1, COMT, ZNF804A and ERBB4 may contribute to the increased risk of schizophrenia. The combined effects of multiple common SNPs may lead to a significant increase in the risk of schizophrenia. Each SNP may have a small impact on the disease risk. These genetic studies suggest many predisposing mutations, indicating that schizophrenia is highly heterogeneous genetically (Purcell et al., 2009; Girard et al., 2012; Ripke et al., 2013; Ripke et al., 2014; Falola et al., 2017; Bergen et al., 2019). Several genetic studies have shown that various copy number variants (CNVs) such as 22q11.2 (Cleyngen et al., 2020), APBA2 and NRXN1 (Kirov et al., 2008) may be associated with the schizophrenia. These CNVs are rare. They contribute to the schizophrenia risk much more significantly than common SNPs. However, genetic studies have not found an identical genomic causation to be shared by the schizophrenia patients (Need et al., 2009; Rees et al., 2014; Bergen et al., 2019).

There are several genetic studies highlighting that both schizophrenia-related genetic risk factors, common SNPs and rare CNVs, affect the glutamatergic system including the postsynaptic activity of NMDA receptors (Demontis et al., 2011; Pratt et al., 2012; Ripke et al., 2014; Morris and Pratt, 2014; Harrison, 2015; Hall et al., 2015; Pratt et al., 2018). The function of NMDA receptors is associated with the glutamate hypothesis of schizophrenia as presented in the following sections.

There is highly supported evidence for a candidate gene called DISC1 in increasing the risk of major mental illnesses (Hennah et al., 2006; Ishizuka et al., 2006; Porteous and Millar, 2006; Dawson et al., 2015; Pratt et al., 2018). DISC1 plays a role in neuronal migration, neuronal maturation, synaptic transmission, and neural plasticity (Ross et al., 2006). Although DISC1 has been shown to be a SNP (i.e. very low increase in risk of developing schizophrenia), the main findings of DISC1 stem from cytogenetics studies which showed a balanced translocation between chromosomes 1 and 11 in several families and an increased risk of developing a major psychotic disease such as schizophrenia by about 50 fold in comparison to the general population (Brandon et al., 2009). Furthermore, there is considerable evidence that CNVs of the 16p11.2 genetic locus confer substantially increased risk of developing schizophrenia between 8 and 24-fold (McCarthy et al., 2009). Some of the candidate schizophrenia susceptibility genes which are supported by multiple evidence and have been manipulated in animal studies to generate a genetic model of schizophrenia are described in the section 1.5.

### **1.1.3.3. Dopamine hypothesis**

The dopamine D2 receptor antagonists such as chlorpromazine alleviate psychosis. This observation led to the dopamine hypothesis of schizophrenia, developed during the 1960s and 70s (Howes and Kapur, 2009). The dopamine hypothesis postulates that hyperdopaminergia originated in the pars compacta, and the ventral tegmental area and stretched from them through the dopamine pathways into striatal regions is responsible for positive symptoms of schizophrenia (Lau et al., 2013). Later findings modified this hypothesis. While the hyperdopaminergia has been shown in the striatal regions, hypodopaminergia has been reported in prefrontal cortical regions (Lau et al., 2013; Howes and Kapur, 2009)

The weakness of the dopamine hypothesis is that administration of dopamine receptor antagonists does not lead to alleviate the negative and cognitive symptoms of

schizophrenia (Javitt, 2007; Javitt et al., 2012). Some studies have shown that some of the patients with schizophrenia does not respond to non-clozapine antipsychotics (Mortimer et al., 2010) despite using the dopamine antagonists and the high levels of D2 occupancy (Kapur et al., 2002). These findings reveal the limitations of dopamine hypothesis suggesting that the pathophysiological basis of schizophrenia may be unrelated to dopaminergic dysfunction and that there may be a 'non-dopaminergic' subtype of schizophrenia (Howes and Kapur, 2014). Despite this large body of evidence against the dopamine hypothesis, still there are some studies supporting that by indicating the involvement of dopamine D1 and D2 receptors in working memory and psychosis, respectively (Goldman-Rakic et al., 2004) and that subcortical striatal dopaminergic dysfunction may contribute to the negative symptoms and cognitive impairments (Simpson et al., 2010; Howes et al., 2015).

#### **1.1.3.4. Glutamate NMDA receptor hypofunction hypothesis**

##### **1.1.3.4.1 NMDA receptors**

Glutamate, an amino acid, is most abundant excitatory neurotransmitter in the vertebrate nervous system. NMDA receptor is one of three ligand-gated ionotropic glutamate receptors. Two others are AMPA and kainate receptor. A NMDA receptor is made of several subunits including NR1, NR2 or NR3. Each subunit may have several subtypes. NMDA receptor is a complex receptor with some unique properties. NMDA receptor is both ligand-dependent and voltage-dependent and requires simultaneous changes in membrane voltage and binding of a ligand for its complex opening and closing processes. The ligand gating requires co-activation by the binding of two different ligands: glutamate and either D-serine or glycine. NR1 and NR2 subunits contain a glycine-binding site and a glutamate binding site, respectively (Cohen et al., 2015). The glycine site is an allosteric modulatory site regulating the time constant and desensitization rate of the channel (Javitt, 2007) that its activation is necessary for channel opening, however, it is not sufficient. NMDA receptor antagonists that block the glutamate or glycine binding sites are competitive antagonists, such as 2-amino-7-phosphonoheptanoic acid (AP7) (Frohlich and Van Horn, 2014). Uncompetitive NMDA receptor antagonists including dizocilpine (MK-801), phencyclidine (PCP), and ketamine bind to a PCP binding site within the pore of the ion channel. The voltage-dependence of current through the channel is mainly due to binding of  $Mg^{2+}$  or  $Zn^{2+}$  ions. It means that the binding of ligands is not sufficient and

the magnesium blockade must be removed to activate the channel. Depolarization removes this blockage, thus allowing a voltage-dependent flow of sodium and small amounts of calcium ions into the cell and potassium out of the cell. Uncompetitive NMDA receptor antagonists block within the ion channel at the  $Mg^{2+}$  site and in that way prevent influx of  $Ca^{2+}$  (Frohlich and Van Horn, 2014).

These unique properties of NMDA receptors allows them to play a crucial role in the brain functions (Javitt, 2000). Open channels of NMDA receptors are permeable to  $Ca^{2+}$ , unlike most other ligand gated ion channels.  $Ca^{2+}$  flux through NMDA receptors is thought to be critical in synaptic plasticity including the processes of long term potentiation and depression, which is a cellular mechanism for learning and memory. It is thought that NMDA receptors contribute to cognitive functions and abnormal NMDA receptor, therefore, may play a crucial role in the memory deficit and other cognitive impairments associated with schizophrenia (Malhorta et al., 1996; Manoach et al., 2014).

#### **1.1.3.4.2. NMDA receptor hypofunction hypothesis**

The glutamate hypothesis of schizophrenia that first emerged in the 1980s implies the dysfunction of glutamatergic system as a neurobiological mechanism underlying positive and negative symptoms as well as cognitive impairments (Anis et al., 1983; Olney and Farber, 1995; Tsai and Coyle, 2002; Coyle et al., 2003). This clinical observation that a single subanesthetic dose of glutamate NMDA receptor antagonists such as phencyclidine (PCP) or ketamine may transiently induce abnormalities associated with not only positive symptoms but also negative symptoms and cognitive impairments in healthy and non-schizophrenia individuals, emulating those present in schizophrenia patients, led to a fundamental shift in the path of search for the pathophysiological causes of schizophrenia from the dopamine hypothesis to the glutamate NMDA receptor hypofunction hypothesis (Luby et al., 1959; Thornberg and Saklad, 1996; Olney et al., 1999; Morris et al., 2005, Stone et al., 2007; Moghaddam and Javitt, 2012; Howes et al., 2015).

The glutamate hypothesis is more comprehensive than the dopamine hypothesis and is able to account for the full range of schizophrenia symptoms. The accumulating evidence support the hypothesis of reduced function of NMDA receptors in schizophrenia, in addition to the elevated activity of dopaminergic system in subcortical brain regions (Krystal et al., 1994,

Olney and Farber, 1995; Pilowsky et al., 2006; Javitt, 2010; Moghaddam and Javitt, 2012). Consistent with this finding, highly supporting evidence from pharmacological, genetic and theoretical studies have highlighted the critical role of NMDA receptor hypofunction in the etio-pathophysiology of schizophrenia (Moghaddam, 2003; Coyle, 2004; Jones et al., 2011; Schwartz et al., 2012; Bergeron and Coyle, 2012; Pocklington et al., 2014; Snyder and Gao, 2019). Moreover, a reduced expression or binding of NMDA receptors in cortex and thalamus has been reported by postmortem studies in schizophrenia brain (Pakkenberg et al., 2009).

The interaction between the dopamine and glutamate hypotheses has also been raised because of interactions between dopamine D1 receptors and NMDA receptors and the role of dopamine and glutamate in the dysfunctional cortico-limbocortico-thalamic circuitry observed in schizophrenia (Tsai and Coyle, 2002). It was shown that the dopaminergic dysfunction is secondary and occurs at a later step in a longer pathway rooted in glutamatergic dysfunction including NMDA receptor hypofunction (Roberts et al., 2010). In spite of these studies, there is no consensual view that which one of these two systems, glutamate or dopamine, exerts influence over the other at first step (Olney et al., 1999; Kehrer et al., 2008).

#### **1.1.3.5. Hypothesis of GABAergic dysfunction**

There is growing evidence strongly highlighting the important role of GABAergic dysfunction in the context of decreased function of NMDA receptors in the pathophysiology of schizophrenia (For review, see: de Jonge et al., 2017; Nakazawa and Sapkota, 2020; Jahangir et al., 2021).

NMDA receptors are excitatory. Therefore, it is expected to observe a reduced resting brain activity due to the reduced excitation caused by hypofunction of NMDA receptors. But surprisingly, the increased resting brain activity (for example, hyperconnectivity, increased high-frequency oscillations, elevated level of glutamate transmission, overexcitability) have widely been reported in schizophrenia patients relative to healthy people. Such an observation suggests possible existence of a disinhibition of excitatory neurons. This disinhibition occurs because it has been shown that NMDA receptor antagonists selectively and preferentially influence the GABAergic neurons. Taken together, reduced inhibition from the GABAergic projections leads to the

increased excitation. Such a hypothesis grants a crucial role to the dysfunctional GABAergic signaling in the pathophysiology of schizophrenia (Lewis and Mogaddam, 2006; Forrest et al., 2014; Pratt et al., 2017; Baran et al., 2019).

## **1.2. Sleep disturbances and aberrant brain rhythms in ARMS and EC-SCZ**

### **1.2.1. Sleep disturbances in psychiatric disorders**

The circadian rhythm of the sleep/wake cycle is transition between sleep and wakefulness occurring across a 24-h period. Sleep is traditionally divided into rapid eye movement (REM) sleep in which dreams actually occur and non-rapid eye movement (non-REM) sleep or dreamless sleep (Monti et al., 2013). Individual sleep stages have specific neurophysiological characteristics. For examples, their electrophysiological brain activity differs in pattern, amplitude, and frequency.

During REM sleep, theta (5–10 Hz) activity is dominant in the hippocampus and is hypothesized to facilitate the transfer of information from the hippocampus to the neocortex (Gardner et al., 2014; Poe et al. 2000). It can occupy approximately 20–25% of the person's overall sleep. The brain waves in this stage are low-voltage, fast frequency waves similar to those occurring during wakefulness. REM sleep plays an important role in learning and memory. REM sleep is not a deep sleep and awakening may occur easily.

The non-REM sleep is commonly subdivided into three stages: N1, N2, and N3 which are characterized by progressively deeper sleep (Iber et al. 2007). However, it may be seen that non-REM sleep is divided to 4 stages in some studies. Non-REM sleep, on average, exhibits reduced neural firing activity and slower EEG oscillations compared to REM sleep and wakefulness (Vyazovskiy et al., 2009).

Stage 1 (N1) of non-REM sleep: In stage 1 sleep, the person falls asleep and engages in light sleep. The person is still alert to sensory stimulation in the environment, and brain activity is mixed. N1 is characterized by both alpha (~8–12 Hz) and Theta (~4–7 Hz) waves. Stage 2 (N2) of non-REM sleep: This stage is moderately light sleep and consists of slowing of heart rate and dropping of body temperature. This stage is characterized by slower brain waves which are intermittently mixed with faster waves, called sleep spindles (explained in next paragraph with more detail) and K-complexes. About half of the sleep time is spent at this stage. It is believed that sleep disturbances in schizophrenia are associated with the stage 2 (Ferrarelli and Tononi, 2017). Stage 3 (N3)



of non-REM: This stage is also known as slow wave sleep (SWS) or deep sleep. N3 is characterized by high-voltage slow waves occurring at the range of delta band (0.2–4 Hz) (Iber et al. 2007; Amzica and Steriade, 1998).

In the sleeping human brain, spindles appear within a frequency range of approximately 9–15 Hz with the pattern of waxing and waning over a timescale of roughly 0.5–3 seconds. Spindle activity is a signature of the light stage 2 of non-REM sleep during which they occur often once every 3–10 s in conjunction with other EEG rhythms between 0.5 and 16 Hz, but they are also found during deeper sleep in stage N3 (Ferrarelli & Tononi, 2017).

It is assessed that spindle activity during sleep, in order to protect sleep from disruption and provide good sleep quality, partly inhibits transmission of external sensory stimuli through the thalamus to the cortex. Some experimental evidence support this hypothesis that, in addition to sleep time, thalamic circuits through the generation of spindles have important roles in gating and filtering prethalamic and peripheral sensory input during waking, thus allowing the brain to focus on the most relevant stimuli (Crick F., 1984; Dang-Vu et al. 2010; Ferrarelli & Tononi, 2017).

That is well established that slow oscillations including spindles play an important role in learning and memory (Huber and Born, 2014; Manoach et al., 2019). Spindle-like activity triggers the intracellular mechanisms in thalamus and cortex that are involved in synaptic plasticity including long-term potentiation and therefore in learning, memory consolidation, neuronal development and pathophysiology of psychiatric disorders such as schizophrenia (Sejnowski and Destexhe 2000; Diekelmann and Born, 2010; Astori et al., 2011; Luthi, 2013; Astori et al., 2013). Both animals and human studies have indicated that there is a significant correlation between learning a task and increase in the sleep-spindle activity during non-REM sleep, highlighting the sleep spindle-dependent memory consolidation (Clemens et al. 2006, Nishida and Walker 2007; Johnson et al., 2012; Tamaki et al., 2013; Bang et al., 2014). Sleep spindles have been implicated as a neurobiological marker of human intelligence because of their correlation with the learning ability and IQ (Fang et al. 2017; Fogel and Smith, 2011). Spindle activity and cognitive functions are significantly and positively correlated with one another (For a systematic review, see: Hung Au and Harvey, 2020; Manoach and Stickgold, 2019). In spite of growing body of research on spindles, the contribution of sleep spindles in brain functions

and diseases remains a fascinating target of inquiry and a hot topic of discussion.

Abnormal sleep may play a critical role in psychosis and may even be a primary cause of a range of neuropsychiatric disorders. Many studies examined sleep abnormalities in schizophrenia (for a systematic review, see: Chan et al. 2017). Sleep complaints and disturbances in schizophrenia patients have been reported since Bleuler (1919) and Kraepelin (1950). Sleep and mood reciprocally affect one another. There is an interrelationship between sleep disturbances and emotional problems (Thayer, 1987; Boivin et al., 1997; Murray et al., 2009). Sleep quality is impaired in the patients with schizophrenia similar to impaired sleep architecture observed in the individuals with major depression or primary insomnia (Doi et al., 2000; Cohrs, 2008; Kamath et al., 2015). Schizophrenia patients suffer from fragmented and little restful sleep so that they have difficulty reaching a persistent sleep (Benson, 2006; Benson, 2015). Schizophrenia patients suffer from abnormalities in the circadian organization of sleep-wake cycles and experience difficulties with sleep initiation and maintenance so that prolonged sleep onset, maintenance insomnia, and the reduced N3 sleep and REM sleep onset latency are frequently reported (Cohrs, 2008; Bromundt et al., 2011; Wulff et al., 2012 ;Monti et al., 2013; Benson et al., 2015). Now, the question is that whether sleep disturbances are side effects and secondary problems or they must be taken into account as a primary and specific characteristic of psychotic disorders such as schizophrenia? This question may be addressed by studies investigating the presence of sleep disturbances in the prodromal phase of the psychosis. Whether sleep disturbances are associated with the conversion to psychosis and emergence of psychotic symptoms? In the following, we review some of these studies that have assessed sleep disturbances in the ARMS individuals and schizophrenia patients in their early course of the illness.

### **1.2.2. Sleep disturbances in ARMS and EC-SCZ according to polysomnographic findings**

Sleep disturbances are one of the most common characteristics and frequent symptoms of the prodromal phase of psychotic disorders before the development of manifest clinical symptomatology of psychosis (Cohrs, 2008; Correll et al., 2014; Zanini et al., 2015). Numerous investigations have reported a strong association between sleep disturbances and the susceptibility of transition to psychosis (Yung and McGorry, 1996a;

Yung and McGorry, 1996b; Tan and Ang, 2001; Ruhrmann et al., 2010). Assessments on the individuals at genetic or clinical high-risk state for the development of psychosis (CHR) have shown that sleep disturbances precede the psychosis onset. Retrospective studies have also shown that schizophrenia patients have suffered from sleep disturbances before the disease onset (Lunsford-Avery and Mittal, 2013). A study showed that patients at ultra-high risk for psychosis experience longer sleep onset latency and highly impaired continuity of sleep relative to healthy people (Lunsford-Avery et al., 2013). In another study, circadian rhythms of the sleep/wake cycle were assessed in CHR youth in comparison with healthy subjects. CHR adolescents showed considerable circadian disruptions. Notably, one year after the first assessment, the CHR individuals had increased positive and negative symptoms, suggesting circadian rhythm disturbances in the prodromal phase as a potential vulnerability marker of transition to psychosis (Lunsford et al., 2017).

A recent study has investigated the sleep disturbances in large population of CHR patients (N=194) and shown that these patients experience sleep disturbances significantly more than healthy individuals. It has also been shown that sleep disturbances in the CHR individuals were associated with greater positive and negative symptoms and functional impairments. Thus, it may be suggested that more focus on the sleep disturbances in the CHR as an important clinical factor may be helpful to better understand the disease and prevent the transition to psychosis (Poe et al., 2017).

There is strong relationship between experiencing sleep disturbances and suffering from psychotic-like symptoms. Lee et al. (2012) have shown this relationship in a cross sectional study assessing more than 7000 adolescents. In another study, Fisher et al. (2014) have assessed sleep disturbances in about 7000 children and suggested that REM and non-REM arousal sleep disorders may be an early predictor/indicator of susceptibility to psychotic disorders in adolescence. Parasomnias, especially frequent nightmares and night terrors in children aged between 2.5 and 9 years were associated with psychotic experiences at age 12 years (Fisher et al., 2014).

Overall, sleep disturbances trigger the initial onset of psychosis. Changes in sleep patterns or abnormalities in the sleep-wake cycle can serve as a predictor of forthcoming psychosis or imply a transition to a major psychotic disorder such as schizophrenia (Chemerinski et al., 2002; Zanini et al., 2015). Therefore, studying the sleep disturbances

in individuals with ARMS and during pre-psychotic periods, and search for understanding their neurobiological basis may help improving prevention/treatment strategies (Zanini et al., 2013; Lustford-Avery et al., 2013).

Schizophrenia patients in their first psychotic episode have experienced reduced total sleep time, increased latency of stage 2 of non-REM sleep, decreased time of stage 2 of non-REM sleep, short latency of REM sleep and increased total awake time. Circadian rhythm sleep disruptions have most frequently been detected in the prodromal phase or prior to psychotic relapse (Chouinard et al., 2004; Monti et al., 2013; Kamath et al., 2015). There are a number of studies reporting a reduced sleep slow wave (SWS, ie., stage 3 of non-REM sleep) time in early-course and neuroleptic-naïve patients with schizophrenia and their nonpsychotic first degree young relatives at risk for schizophrenia (Keshavan et al., 1990; Poulin et al., 2003; Keshavan et al., 2004a; Keshavan et al., 2004b). Presence of SWS inhibits the initiation of REM sleep. It has been proposed that there might be a relationship between the reduced duration of SWS and the changes in the properties of REM sleep (Benson, 2003), a brain state considered as a natural model of psychosis (Scarone et al., 2008; Mason and Wakerley, 2012; Mota-rolim et al., 2021). It has been demonstrated that patients with acute schizophrenia experience greater sleep disturbances compared to the patients with chronic psychosis. It has been highlighted that sleep difficulties and psychotic experiences co-occur and sleep disturbances even can serve as predictor of later psychotic experiences (Reeve et al., 2015; Kamath et al., 2015).

Taken together, sleep disturbances have most frequently been reported in the early stages of schizophrenia (Kamath et al., 2015; Monti and Monti, 2005; Wamsley et al., 2012) and the individuals having a high-risk mental state for developing a transition to psychotic and bipolar disorders (Lunsford-Avery et al., 2013; Zanini et al., 2015). However, they have also been observed in chronic patients (Hofstetter et al., 2003; Monti and Monti, 2004). Indeed, sleep abnormalities are a common problem and always present in a patient with schizophrenia during the whole course of illness regardless of the phase of disorder (acute or chronic) and independent of the medication status (medicated or unmedicated) (Monti and Monti, 2005; Monti et al., 2013). Based on such evidence, it may be concluded that sleep disturbances imply a specific characteristic of schizophrenia, especially one of the key features of its prodromal phase, and must not be considered as a side effect of

antipsychotic medications or sleep disruption (Ritsner et al., 2004; Chouinard et al. 2004; Manoach et al., 2014; Schilling et al., 2017).

### **1.2.3. Aberrant neural oscillations in schizophrenia**

Schizophrenia may be considered as a disease characterised by abnormalities in the expression of coordinated activity in the brain, resulting from abnormality of neural oscillations, an abnormal synchronization and dysconnection between functional networks and breakdown in communication which let us to define schizophrenia as a disease of dysfunctional oscillations through which the core symptoms of schizophrenia may arise (Uhlhaas and Singer, 2010).

Many known brain functions are associated with electrical activities occurring synchronously at specific frequency oscillations. Patients with schizophrenia exhibit impaired neural oscillatory activities during sensory and cognitive tasks. Among the different frequency bands, gamma and spindle have most frequently been highlighted by the schizophrenia studies (Gonzalez-Burgos and Lewis, 2008; Williams and Boksa, 2010; Uhlhaas and Singer, 2010; Ferrarelli et al., 2010; Manoach et al., 2014). However, it has been documented that aberrant neural oscillations observed in schizophrenia are essentially related to all frequency bands (e.g., delta band) and provide key markers linking neural mechanisms of the disease to the clinical dysfunctions and manifestations in schizophrenia (Moran and Hong, 2011).

In recent decades, the growing body of research has been investigating the underlying neural mechanisms of sleep and sleep rhythms involved in learning, memory consolidation, cognitive functions and impairments and psychiatric diseases (Ferrarelli et al, 2007; Manoach et al., 2015). In addition, recording sleep EEG minimizes the possible confounding factors frequently occurring during wakefulness, providing a suitable condition for investigating brain function in patients and healthy people (Ferrarelli et al., 2007). There are a number of studies that have examined the patterns of sleep EEG in addition to the sleep architecture in the EC-SCZ and ARMS.

### **1.2.4. Abnormal brain rhythms in EC-SCZ and ARMS during sleep**

We could not find any human study investigating gamma-frequency band during sleep in EC-SCZ or ARMS. Only handful of studies have assessed the changes in the neural oscillatory activity at the range of delta-, theta-frequency oscillations during sleep

in patients with EC-SCZ.

Only one sleep EEG study has assessed the gamma band during sleep in the established schizophrenia patients who have been kept unmedicated for a few weeks. The mentioned study revealed that unmedicated schizophrenia patients exhibit a significant increase in gamma power relative to healthy individuals and major depressive disorder in all sleep stages, suggesting elevated gamma activity as one of the key features of schizophrenia. Increased gamma power was significantly associated with the positive symptoms. An increase in beta power has also been reported in these unmedicated schizophrenia patients in all sleep stages (Tekell et al., 2005). These findings have not been consolidated by further studies.

Based on a recent study, the density of slow waves (0.5-4 Hz) during non-REM sleep is significantly reduced in the early course of the psychosis (Kaskie et al., 2019). Reduced amplitude and slope of the slow waves have been reported in first-degree relatives of schizophrenia patients (D'Agostino et al., 2018). Manoach et al. (2014) showed that delta- and theta-frequency oscillations are decreased in antipsychotic-naïve, EC-SCZ, and in non-psychotic first-degree relatives during stage 2 of non-REM sleep relative to healthy subjects. Ganguli et al. (1987) have shown that young, never-medicated, non-schizoaffective schizophrenics had decreased delta counts per minute during all stages of non-REM sleep compared to healthy individuals (Ganguli et al., 1987). Keshavan et al. (1998) have shown significant reduction in delta and theta power during sleep in medication-naïve schizophrenia patients. Sleep delta deficit has also been reported in the unmedicated, first-stage schizophrenia patients, suggesting that the sleep delta deficit is one of the primary signs of the schizophrenia and not secondary induced by the medication effect (Keshavan et al., 1998). Sekimoto et al. (2007 and 2011) have shown sleep delta deficit during the whole night in schizophrenia patients but these patients were not in the early course of their illness (Sekimoto et al., 2007; Sekimoto et al., 2011). Several other sleep EEG studies showing the reduction in number, amplitude, and power of delta frequency oscillations in schizophrenia patients compared to control subjects (Kajimura et al., 1995; Goder et al., 2006; Hoffmann et al., 2000; Manoach et al., 2010). These studies did not assess the delta band in the prodromal phase of psychosis. In addition, conflicting results have also been reported in the study on delta frequency oscillations in schizophrenia (For a meta-analysis, see: Chan et al., 2017).

### **1.2.5. Sleep spindle deficit in EC-SCZ**

In recent years, there have been growing studies focusing on spindle deficits in schizophrenia as a major biological marker of the illness. Manoach et al. (2014) demonstrated that there is a significant reduction in density, amplitude, and duration of sleep spindles in early course antipsychotic-naïve patients with schizophrenia relative to the healthy individuals. Spindles were recorded during stage 2 of non-REM sleep in which spindles occur abundantly. The EC-SCZ patients also showed reduced sleep spindle activity compared to the patients with other psychotic disorders. The reduced sleep spindle activity also was reported in the young nonpsychiatric first-degree relatives of the early course patients. Tesler et al. (2015) also found a significant reduction in sleep spindle density over the temporal and centroparietal brain regions in adolescent patients with early onset course of schizophrenia. Kaskie et al. (2019) have highlighted reduced density and duration of sleep spindles in the frontal brain regions of the first-episode psychosis patients. The sleep spindle parameters were recorded during stage 2 and 3 of non-REM sleep. The reduced sleep spindle was associated with the severity of negative symptoms in these patients.

Moreover, a study has shown that sleep spindle density is negatively correlated with schizotypy (schizophrenia-like experiences) in healthy individuals. This finding indicates that the decreased sleep spindles lead to an increased risk of psychosis not only in schizophrenia patients but also in healthy subjects. It also shows that schizophrenia and schizotypy may share a common neurobiological basis and provides support for the sleep spindle deficit in schizophrenia as a major neurobiological marker of the disease (Lustenberger et al. 2015). Sleep spindle deficit may occur at a date earlier than the onset of schizophrenia. Therefore, spindle deficit can serve as a sign of impending schizophrenia (Manoach et al., 2014). The significant presence of sleep spindle deficit at the onset of psychosis suggests sleep spindles as an appropriate target for early therapeutic strategies in schizophrenia and psychotic disorders (Kaskie et al., 2019; Zhang et al., 2020).

Also, a significant reduction in sleep spindles has widely been reported in chronic medicated patients with schizophrenia by numerous studies (Ferrarelli et al. 2007, Ferrarelli et al., 2010; Manoach et al. 2010; Seeck-Hirschner et al., 2010; Wamsley et al., 2012; Bartsch et al., 2013; Castelnuovo et al., 2018; Schilling et al., 2017). Given that

spindle deficit exists throughout the disease irrespective of the phase of disorder (early course or chronic), the age (adolescent or adult), and the medication status (medicated or neuroleptic-naïve), it may be suggested that sleep spindle deficit must be implicated as one of the major biological markers and specific features of schizophrenia. Sleep spindle deficit is not a side effect of antipsychotic medications or a consequence of several years of suffering from psychotic symptoms (Manoach et al., 2014; Zhang et al., 2020).

Sleep spindle deficit is significantly associated with positive (Manoach et al., 2014), negative (Kaskie et al., 2019) and cognitive (Forest et al., 2007; keshavan et al., 2011) symptoms seen in the EC-SCZ. Spindle deficit contributes to the impaired memory consolidation and is negatively related to positive symptoms in either chronic or antipsychotic-naïve, first-episode patients with schizophrenia (Wamsley et al., 2012; Manoach et al., 2014; Goder et al., 2015). Keshavan et al. (2011) showed a significant association of the reduced sleep spindle density with impaired attention and reasoning in the EC-SCZ patients.

Future studies, especially EEG studies, are required to investigate the sleep spindles in ARMS individuals. It is now well established that sleep spindle deficit is present in EC-SCZ. However, to know when the spindle deficit first occurs and how it contributes to the development of schizophrenia, further investigations targeting sleep spindles in ARMS individuals are required (Zhang et al., 2020).

#### **1.2.6. Abnormal gamma rhythm in EC-SCZ and ARMS in wake state**

Given that gamma frequency oscillations have been associated with a wide range of cognitive functions and impairments, many research studies in recent decades have focused on the role of this frequency band in schizophrenia (Hermann et al., 2004; Williams and Boksa, 2010). Based on the available evidence, both reduction and increase in gamma-band power and synchronization have frequently been reported either at rest or during cognitive task performance (Rutter et al., 2009; Moran and Hong, 2011). However, most of them have reported increased power in baseline gamma oscillations at resting state and reduced power during the cognitive task performance in schizophrenia patients compared to healthy subjects (Venables et al., 2009; Spencer, 2012; Uhlhaas and Singer, 2013). There are considerable discrepancies between the observations of different studies investigating gamma power in schizophrenia (For review, see: Başar, 2013; Perrottelli et al., 2021). We do not find converging evidence because it depends on



the fact that gamma power is measured at resting state or task-related condition, and is obtained from spontaneously occurring or evoked EEG. This equivocality may also depend on the fact that gamma power is measured at which stage of the illness. For example, results from ARMS individuals or EC-SCZ are different from those reported in chronic schizophrenia (Grent-'t-Jong et al., 2018). In a study (Grent-'t-Jong et al., 2018), resting-state gamma-band activity was assessed across the different stages of schizophrenia. CHR Individuals exhibited increased gamma-band power compared to both first-episode and chronic schizophrenia in frontal and temporal cortical networks. AMRS individuals who transitioned to psychosis showed increased medial prefrontal gamma activity relative to healthy people (Ramyead et al., 2015). Chronic patients showed a reduction of gamma-band power in widespread regions including frontal, temporal, and sensorimotor regions. Andreou et al. (2015) found increased resting-state gamma-band connectivity in first-episode schizophrenia patients compared to the healthy group. First-episode psychosis patients showed increased gamma-band activity not only at resting state but also under the attention task (Flynn et al., 2008), indicating the elevation of gamma activity as one of the specific characteristics of early course psychosis. Reports on the gamma oscillations in schizophrenia are highly state- or stage-dependent, however, the most frequent observation has been an increase in gamma band power in both ARMS and EC-SCZ as indicated in a systematic review by Perrotelli and colleagues (2021). These observations show that increased gamma power can be implicated as a sign of psychosis transition or illness onset.

### **1.2.7. Abnormal theta and delta rhythms in EC-SCZ and ARMS in wake state**

Reduced event-related low-frequency EEG activity at the range of delta band has been observed in EC-SCZ patients and their unaffected siblings (Simmonite et al., 2015). In a quantitative EEG study, CHR patients with transition to psychosis (CHR-T) at follow-up exhibited significantly higher frontal delta power relative to the healthy controls and CHR patients without transition to psychosis (CHR-NT). CHR-T showed higher parietal delta power compared to CHR-NT. CHR-T showed higher theta power on central and frontal areas compared to CHR-NT, and healthy controls. Van Tricht et al. (2014) suggested that these differences in EEG measures between CHR-T, CHR-NT and control group show that higher delta and theta powers may be implicated as a prediction model for future transition to the first episode of psychosis. Excess delta and theta power in CHR-

T has also been reported in other studies (Gschwandtner et al., 2009; Zimmermann et al., 2010). However, there is equivocal evidence from the studies assessing delta and theta frequency oscillations in chronic schizophrenia patients. During wake state, either reduction or increase in both delta and theta powers have frequently been reported in chronic schizophrenia (Donkers et al., 2013; Frantseva et al., 2014; Lehmann et al., 2014; Kim et al., 2015; Garakh et al., 2015).

### **1.3. Dysfunction of thalamus-related networks in EC-SCZ and ARMS**

#### **1.3.1. The 3-neuron CT-TRN-TC system**

In the cortico-thalamo-cortical (CTC) system, the thalamus, a critical structure for attention-related sensorimotor and cognitive processes, relays the sensory, motor and cognitive information to the cortex (Sherman and Guillery, 2006) and is an important neuronal oscillator (Steriade and Deschênes, 1984). In the CTC system, the thalamus plays a crucial role in filtering or gating information and has extensive interconnectivity with other brain regions including the strong glutamatergic reciprocal connections with the different layers of the neocortex through the thalamocortical and corticothalamic pathways (Pinault, 2004).

Thalamus is also in interconnection with thalamic reticular nucleus (TRN) which is located strategically between the cortex and thalamus. TRN is a thin net-like layer of GABAergic neurons that forms a shell surrounding the lateral and ventral aspects of the thalamus (Mitrofanis and Guillery, 1993). The TRN is a modulator of TC activities through lateral inhibition, an initiator of rhythmic TC activities and mediator of selective attention (Pinault, 2004). It is the principal inhibitory nucleus of the thalamus through the GABAergic neurotransmission. TRN is innervated by two major glutamatergic inputs, TC and layer VI corticothalamic (CT) axon collaterals, which mediate most of their excitatory effects through the activation of glutamate receptors (Crandall et al., 2015; Deschênes and Hu, 1990; Gentet and Ulrich, 2003). TRN actively contributes to the neuronal activities during both sleep and wakefulness. TRN plays a crucial role in the inhibition of sensory processing during sleep. During wake, TRN regulates the flow of information and enhances the sensory processing during the attentional tasks (Pinault, 2004).

The sensory and motor TC regions are innervated by cortical inputs only from layer VI CT neurons (Guillery and Sherman, 2002). Importantly, layer VI CT axons innervate

simultaneously TC and TRN neurons (Bourassa et al., 1995), together forming a 3- neuron circuit robustly involved in the bottom-up and top-down processing as well as in the generation of sleep spindles (Bal et al., 2000; Ferrarelli and Tononi, 2011; Bonjean et al., 2011).

Sleep spindles originate from the thalamus in which the TRN is a leading structure in their generation by exerting a powerful rhythmic inhibitory modulation of TC activities (Guillery and Harting, 2003; Pinault, 2004; Steriade et al., 1985; Steriade et al., 1993). Inside the TRN, low-threshold T-type calcium channels and small conductance calcium activated potassium (SK2) channels contribute to the generation of spindles (Astori et al., 2013). The CT inputs excite TRN neurons. TRN, by generating spindle rhythmic burst firing, rhythmically hyperpolarizes the postsynaptic TC neurons through the activation of GABA receptors. The long and strong TRN-mediated inhibition causes TC neurons to fire in short bursts of action potentials, leading to appearance of spindle activity in cortical EEG (Contreras & Steriade 1996 ;Steriade 2003; Pinault 2004 ;Astori et al., 2013).

It has been shown that spindles can be autonomously generated in TRN, without necessarily requiring TC and CT inputs. In contrast, cortex alone is unable to produce spindles (Steriade et al., 1987; Steriade et al., 1993; Steriade, 2005; Fuentealba and Steriade, 2005). These findings indicate the thalamic origin of spindles. However, CT feedback is essential for the synchronized spindle activity within the thalamus (Bal et al., 2000; Blumenfeld and McCormick, 2000; Astori et al., 2013). Sleep spindles are sustained and synchronously propagated across the thalamus and cortex through the CT and TC feedback loops (von Krosigk et al., 1993; Contreras and Steriade, 1996; Steriade and Llina's 1988; Pinault, 2004; Huguenard and McCormick, 2007; Astori et al., 2013). Taken together, CT, TRN and TC neurons together form a 3-neuron CT-TRN-TC circuit robustly involved in the generation, propagation and maintenance of sleep spindles (Bal et al., 2000; Bonjean et al., 2011).

There is accumulating evidence highlighting the contribution of anatomical and functional abnormalities of the thalamus and abnormal thalamocortical interactions in pathophysiology of schizophrenia and the manifestation of its psychotic symptoms (for review, see: Celada et al., 2013; Pratt et al., 2017).

### **1.3.2. Abnormal thalamus-related connectivity in EC-SCZ and ARMS**

The dysconnection hypothesis indicates a functional or structural connection abnormality observed in the schizophrenia brain that is different from a non-schizophrenia brain. Both decreased and increased connectivity are reported in schizophrenia. In many recent studies, dysfunctional connectivity in thalamocortical networks has been investigated in order to better understand the pathophysiology of schizophrenia (Clinton and Meador-Woodruff, 2004; Ferrarelli and Tononi, 2011; Pinault, 2011; Woodward et al., 2012; Uhlhaas, 2013; Anticevic et al., 2015b; Woodward and Heckers, 2016). These findings are consistent with clinical reports about the dysfunction of neuronal oscillations in schizophrenia patients (Maharajh et al., 2010; Spencer et al., 2003; Herrmann and Demiralp, 2005). However, linking these neurobiological markers to underlying neural mechanisms remains a challenge.

With the rise of the thalamus in the pathophysiology of schizophrenia, research in this area is no longer limited to the cortex (Andreasen et al., 1997, Ferrarelli and Tononi, 2017). In other words, by revealing the essential role of TC circuits in brain functions, including attention and memory, which are commonly impaired in schizophrenia patients, it could open up new perspectives for a better understanding of the disorder.

Aberrant structural and functional couplings have been reported in EC-SCZ, as well as in ARMS individuals. Several studies have shown the increased structural connectivity between the thalamus and sensorimotor and somatosensory cortices and the decreased structural connectivity between the thalamus and prefrontal cortex in first-episode psychosis and CHR (Cho et al., 2016).

The thalamic functional dysconnectivity may occur at the prodromal phase prior to the psychosis onset and become more pronounced in early course psychosis. The resting-state fMRI studies have highlighted reduced functional connectivity between the thalamus and regions of prefrontal and cingulate cortices, striatum and cerebellum and, in contrast, the increased functional connectivity between the thalamus and motor and somatosensory cortices in EC-SCZ (Anticevic et al., 2015b; Woodward and Heckers, 2016; Fryer et al., 2021) and in individuals at high risk for transition to psychotic disorders like schizophrenia (Anticevic et al., 2014a; Anticevic et al., 2014b; Anticevic et al., 2015c, 2017; Dandash et al., 2014 ;Ferri et al. 2018; Fryer et al., 2021).

A fMRI data has demonstrated that CHR individuals for psychosis exhibited

cerebello–thalamo–cortical hyperconnectivity relative to the healthy individuals. The increased connectivity among converters (CHRs who convert to psychosis) was more pronounced than that among non-converters. The hyperconnectivity was also significant in chronic schizophrenia patients. These observations strongly suggest the cerebello–thalamo–cortical hyperconnectivity as robust state-independent neural signature of transition to psychosis (Cao et al., 2018).

### **1.3.3. Abnormal thalamus-related oscillations in EC-SCZ and ARMS**

EEG can reflect not only cortical activities but also thalamic influence on cortex and how cortex and thalamus communicate with one another. For example, thalamus-TRN principally contribute to the generation of sleep spindles which appear in EEG recordings (Steriade, 2003). A study has shown that the TC functional hyperconnectivity in schizophrenia significantly correlates with reduced sleep spindle density (Baran et al., 2019).

A number of studies have shown that abnormalities in TC functional connectivity are correlated with cognitive deficits in schizophrenia (Wang et al., 2015; Woodward 2017; Baran et al., 2019; Manoach et al., 2019). Findings of many studies have highlighted the deficit in TC-TRN-related spindle activity is negatively correlated with severity of both positive and negative symptoms (Ferrarelli et al., 2007, 2010; Ferrarelli and Tononi, 2011). Not only in schizophrenia subjects but also in healthy individuals, reduced spindle density correlates with the increased thalamic excitation through the increased thalamic glutamate levels and the higher risk of psychosis (Lustenberger et al. 2015).

There is accumulating evidence that dysfunction of thalamus-related spindle-generating systems is a core neuropathophysiological hallmark for psychosis-related disorders such as schizophrenia (Andreasen, 1997; Clinton and Meador-Woodruff, 2004; Cronenwett and Csernansky, 2010; Pinault, 2011; Steullet, 2020).

### **1.3.4. Role of dysfunctional TRN-related networks in transition to psychosis**

The abnormality of the TRN-modulated TC information flow may provide an explanation for the association between the sleep spindle deficit and cognitive impairments observed in schizophrenia (Keshavan et al., 2011; Fogel and Smith, 2011; Halassa et al., 2014).

A set of human postmortem and rodent studies has reported reduced level of the

calcium binding protein parvalbumin (PV) neurons, a predominant TRN neuronal population, in schizophrenia patients and has revealed that significant reduction of the PV neurons in TRN along with altered firing patterns of these neurons occurs during the early course of the disease (Steullet et al., 2018). A mouse study has revealed that the mutation in schizophrenia-associated gene the crystallin  $\beta$ 2 led to a significant reduction of TRN-PV neurons, resulting in the impaired prepulse inhibition associated with cognitive impairment in schizophrenia (Heermann et al., 2018). There are several other genetic studies that have revealed the importance of TRN in the pathophysiology of schizophrenia (Gulsuner et al., 2013; Ahrens et al., 2015; Andrade et al., 2016). Based on these genetic findings, it has been suggested that a genetic abnormality that impairs TRN in early developmental period may, in turn, lead to the impaired TC circuitry, resulting in the increased risk of psychosis (Baran et al., 2019).

TRN neurons discharge at gamma frequencies during wake state and modulate the thalamus-cortex communication (Marks and Roffwarg, 1993; Pinault and Deschenes, 1992a; Pinault and Deschenes, 1992b). Therefore, reduced activity of TRN neurons may account for the abnormal gamma-frequency oscillations (Thuné et al., 2016). In support of previous clinical findings (Ferrarelli and Tononi, 2011; Manoach et al., 2016), an optogenetic and pharmacological study using optogenetic stimulation has highlighted that the reduced activity of Parvalbumin TRN neurons may lead to increased wakefulness and abnormal cortical delta, gamma, and spindle activity consistent with abnormal cortical oscillations observed in schizophrenia (Thankachan et al. 2019).

TRN has been proposed to be a key functional communication hub between thalamic nuclei and the cortex (Pinault, 2004; Pratt and Morris, 2015). TRN-mediated TC circuit abnormalities may contribute to the pathophysiology of schizophrenia and manifestations of schizophrenia symptoms (Ferrarelli et al., 2010; Pinault, 2011; Halassa et al., 2014; Pratt et al., 2017; Young and Wimmer, 2017).

Pratt et al. (2017), in a review work, have highlighted that the thalamus plays a crucial role in coordination of large-scale brain networks so that NMDA receptor hypofunction-mediated disinhibition in TC networks may lead to behavioral and cognitive abnormalities as seen in the early stages of schizophrenia. Under the effect of NMDA receptor antagonist, the inhibited TRN cannot inhibit thalamus. Therefore, TRN-mediated disinhibition may exert a profound impact on TC interactions leading to increased gamma-

band oscillations and TC connectivity. This provides a neurobiological mechanism underlying the TC hyperconnectivity and elevated excitability between thalamus and cortex observed in EC-SCZ (Troyano-Rodriguez et al., 2014; Pratt et al., 2017).

Baran et al. (2019) suggested reduced TRN-mediated inhibition of thalamus as an underlying mechanism linking the increased sensorimotor-thalamic connectivity and sleep spindle deficits. The reduced activity of TRN neurons may lead to less occurrence of bursts necessary for producing spindles during stage 2 of non-REM sleep. These findings provide strong support for the contribution of abnormal TRN-mediated TC interactions in increasing risk for developing psychosis (Baran et al., 2019).

NMDA receptor subunits including NR1 and NR2A/B/C/D are differentially expressed in different cell types and regions. Excitatory pyramidal neurons of cortex express high levels of NR2B subunit (Wang et al., 2008; Xi et al., 2009), whereas the inhibitory GABAergic neurons of TRN express NR2C subunit more than other subunits (Xi et al., 2009; Zhang et al., 2012a). Ketamine, which induces schizophrenia-like abnormalities, preferentially acts on NR2C subunits of NMDA receptors located on TRN neurons, partially because of the higher baseline activity of TRN neurons compared to excitatory neurons, which lessens  $Mg^{2+}$  dependent block of TRN NMDA receptors (Homayoun and Moghaddam, 2007; Kotermanski and Johnson, 2009). Zhang et al. (2012) have highlighted the NR2C subunit of NMDA receptors in TRN as a potential target for studying the pathophysiology of schizophrenia. Moreover, administration of PCP results in inhibition of TRN activity (Troyano-Rodriguez et al., 2014), and acute ketamine administration leads to increased TC activity (Dawson et al., 2013). Based on this evidence, it appears that TRN is one of the primary sites of ketamine action. Ketamine-induced blockade of NMDA receptors affects the activity of TRN neurons leading to the disinhibition of TC neurons. This finding not only supports the NMDA receptor hypofunction but also offers the thalamus/TRN as a key site vulnerable to NMDA receptor hypofunction (Vukadinovic, 2014; Pratt and Morris, 2015; Pratt et al., 2017).

#### **1.4. NMDA receptor hypofunction-related alterations in neural oscillations**

There is a growing body of evidence highlighting both NMDA receptor hypofunction and aberrant oscillatory activities in schizophrenia, especially in EC-SCZ, as reviewed in previous chapters. The question that arises is whether there is a link between these two

dysfunctions. Several studies have examined the role of NMDA receptors on the different frequency oscillations including spindles, delta-, theta-, gamma- and higher-frequency oscillations in the cortex and thalamus using the NMDA receptor antagonists (For review of in vivo studies, see: Hunt and Kasicki, 2013). However, there are a handful of studies that have examined the effect of NMDA receptor antagonists on brain oscillations during sleep. Further inquiry in this domain in future studies seems imperative given the importance of sleep oscillations in cognitive functions, memory consolidation, and pathology of psychotic diseases, as well as given the high capability of NMDA receptor antagonists to affect the brain oscillations and simulate features of psychosis. In the following, we reviewed some of the studies that have highlighted the association between NMDA receptor hypofunction and the aberrant oscillatory activities, reminiscent of those observed in schizophrenia, especially EC-SCZ, and ARMS.

#### **1.4.1. NMDA receptor hypofunction-related alterations in gamma and other neural oscillations**

Aberrant gamma band oscillations have been reported in schizophrenia patients. Whether such abnormality can be due to the NMDA receptor hypofunction or not? If yes, whether the NMDA receptor hypofunction-induced aberrant gamma oscillations can be correlated with a psychotic-like state? In an attempt to address these questions, several studies have been conducted so far.

The acute subanesthetic ketamine-induced NMDA receptor hypofunction led to the significant increase of gamma-frequency oscillations and the significant reduction of delta-frequency oscillations in the healthy subjects compared to the placebo group. The theta-alpha (5–12 Hz) frequency oscillations were also decreased to some extent. Acute administration of ketamine in healthy individuals induced several schizophrenia-relevant symptoms and mimicked some of the aberrant oscillations observed in EC-SCZ patients and their first-degree relatives (Hong et al., 2010).

Electrophysiological data has revealed that a single relatively low-dose non-anesthetic administration of NMDA receptor antagonists, MK-801 or ketamine, leads to a significant increase in the power and frequency of gamma-frequency oscillations in different rat brain regions including cortical, intracortical, subcortical, sensorimotor and cognitive structures in anesthetized, sedated and freely moving rats (Pinault, 2008; Hakami et al., 2009). These findings show that the increased gamma activity induced by



NMDA receptor antagonists are not related to the conscious sensorimotor processing or hyperlocomotion-related brain state and therefore suggest a possible link between the gamma hyperactivity and the psychotic-like state associated with the positive symptoms and cognitive impairments as observed in schizophrenia (Hakami et al., 2009).

To model psychosis in freely-moving rats using NMA receptor antagonist MK-801, Lee et al. (2017) have assessed the effect of localized NMDA receptor hypofunction on the gamma-(30-80 Hz) and higher-frequency oscillations (HFO: 130-180 Hz) in multiple brain regions including the prefrontal cortex, dorsal hippocampus, and nucleus accumbens (NAcc). The effect of systemic administration of MK801 was also assessed. MK-801 administration could significantly increase the gamma oscillations and HFOs in all three regions regardless of the location of infusion. The local infusion of MK-801 in a small region affected the oscillatory activity of major brain networks so that similar effects or even, in several cases, greater effects obtained from the distant regions, indicating the inherent quality of regions and networks to generate specific oscillations. Systemic administrations also led to similar results. The rats' behaviors identified as the endophenotypes of the psychosis were also measured. MK-801-treated rats exhibited schizophrenia-associated behavioral phenotypes such as locomotor activity, stereotypies, and ataxic behaviors regardless of the local or systemic administration. Interestingly, LFP recording from the ventrolateral thalamus exhibited increased power of gamma and HFOs after local NAcc and systemic administration of MK-801, suggesting the connections between these regions likely through the glutamatergic projections or/and thalamic relay neurons. Overall, NMDA receptor hypofunction-induced behavioral and electrophysiological effects are associated with the behavioral and neuronal features of psychosis and consistent with those observed in schizophrenia (Uhlhaas and Singer, 2010). Like Hakami et al. (2009), Lee and colleagues found that the aberrant oscillatory activities induced by localized or systemic MK-801 infusion occurred independently from the behavioral state of the animal and were not a consequence of hyperlocomotion, supporting the association between the NMDA receptor-hypofunction-induced phenotypes and psychotic-like state (Lee et al., 2017).

NMDA receptor antagonists increase gamma power. NR2A and NR2B subunits of NMDA receptors are highly expressed in inhibitory GABAergic neurons. Lack of NR2A or NR2B subunits of NMDA receptors on inhibitory GABAergic neurons increases gamma

power, possibly due to the disinhibition (Xi et al., 2009; Kocsis, 2012a; Kocsis, 2012b). Therefore, NMDA receptor antagonists strongly and preferentially influence the NR2A- and NR2B-containing GABAergic neurons. Both NMDA receptors and inhibitory parvalbumin neurons play an important role in the features of gamma frequency oscillations. In awake mice, lack of NMDA receptors on parvalbumin-positive neurons leads to the increased power of spontaneous gamma oscillations in the somatosensory cortex (Carlen et al., 2012).

Based on the collection of evidence, it may be highlighted that ketamine-induced NMDA receptor hypofunction selectively and primarily occurs in GABAergic neurons. This leads to the disinhibition of TC circuits, resulting in the elevation of gamma-band oscillations and connectivity in CT-TRN-TC network including somatosensory and prefrontal cortex. These findings are associated with the EC-SCZ and ARMS rather than chronic schizophrenia (Dawson et al., 2013; Rivolta et al., 2015; Anticevic et al., 2015a; Anticevic et al., 2015b; Pratt et al., 2017). However, there are evidence for opposite results (Woodward et al., 2012). Further studies are required to reach more consensual view.

#### **1.4.2. NMDA receptor hypofunction-related alterations in delta- and theta-frequency oscillations**

Several in vivo studies have shown that the administration of NMDA receptor antagonists in freely moving rats increases the power of delta-(1-4 Hz) frequency oscillations in cortical regions such as prefrontal and somatosensory cortices (Sebban et al., 2002; Páleníček et al., 2011). High doses of ketamine, MK-801, and PCP increase the delta power in various brain regions. However, low doses of these drugs induce an initial reduction in the delta power which is followed by an increase about two hours after injection (Dimpfel and Spuler, 1990). The effect of NMDA receptor antagonists on the delta oscillations is highly dose-dependent, especially at the range of low subanesthetic doses. In high doses, NMDA receptor antagonists are used for anesthesia due to their dissociative effects and it is expected to see the large-amplitude slow oscillations after their administration in high doses (Fu et al., 2008; Sharma et al., 2010). Mechanisms of action of NMDA receptor antagonists like PCP and ketamine in low subanesthetic doses may be different from their mechanisms of action in high doses. In rats anesthetized with chloral hydrate, administration of low dose ketamine decreases the delta power in the cortex and thalamus (Kargieman et al., 2007, 2008; Santana et al., 2011).

A number of rodent studies have reported reduction in the hippocampal theta-frequency oscillations after administration of NMDA receptor antagonists. However, there is also opposite findings (Guadagna et al., 2012; Kittelberger et al., 2012). Most of the rodent studies have reported the increased theta power in the cortical regions induced by the NMDA receptor antagonists (Ehrlichman et al., 2009; Saunders et al., 2012).

### **1.4.3. NMDA receptor hypofunction-related spindle reduction**

Jacobsen et al. (2001) have acquired in vitro extracellular multiunit recordings from the slice preparation comprising thalamic relay nuclei and TRN. They indicated that the selective blockade of NMDA receptors in thalamic slices leads to a significant reduction in power, density, duration and frequency of spindles. These significant reductions in properties of spindle activity were not due to the reduced excitation. Increasing the intensity of the stimulus could not compensate for the decreased spindles due to the NMDA receptor inactivation, consolidating the major contribution of NMDA receptors on the spindle activities and their maintenance. Moreover, blockade of AMPA receptors could not affect the spindle-like oscillations in terms of their occurrence and persistence, but using a NMDA receptor antagonist APV led to a dramatic suppression of spindles, providing a convincing argument for the major and specific role of NMDA receptors on the spindle activities (Jacobsen et al., 2001).

## **1.5. Model of transition to psychosis**

There are different approaches to model psychosis, including neurodevelopmental, genetic, and pharmacological. These modeling approaches commonly target glutamate or dopamine systems. Due to the limitations of human models, animal models are significantly and undeniably useful tools for assessing neural mechanisms and seeking treatments or preventive strategies for a variety of human disorders.

One of the advantages of animal models is that they have fewer ethical concerns relative to human models and allow chronic, perinatal, repeated, and high-dose administration of drugs. In addition, animal models allow recordings from deep and specific brain regions. However, interpretation of animal models is difficult because we cannot know how relevant drug-induced changes are to the psychotic symptoms in human patients. Different drugs with different mechanisms of action can represent some aspects

and symptoms of schizophrenia, making it difficult to relate them to the pathophysiology of the disease. The multifaceted nature of schizophrenia makes it exceedingly difficult to be represented in a single model (Jones et al. 2011).

### **1.5.1. Neurodevelopmental models of schizophrenia**

Neurodevelopmental models of schizophrenia are based on the hypothesis that the symptoms and abnormalities that appear in late adolescence or early adulthood are related to a disorder in the pre- or postnatal development of the brain. In other words, the developmental hypothesis relates schizophrenia to prenatal or postnatal events such as maternal infection occurred during pregnancy or obstetric circumstances (Brown and Derkits, 2010; Brown, 2012). The developmental animal models of schizophrenia apply specific drugs or neonatal lesions or make specific circumstances (e.g., postweaning stress) during the prenatal or postnatal period to see whether they lead to the emergence of schizophrenia-like disorders in early adolescence or a time after puberty. For example, postnatal social isolation leads to abnormal behaviors in early adulthood, including hyperlocomotion, increased anxiety, sensorimotor and cognitive impairments (Jones et al., 2011). Acute and chronic administration of ketamine, MK801 and phencyclidine (PCP) as NMDA receptor antagonists in early postnatal period in animals increased the rate of neuronal death by apoptosis during the early phase of central nervous system development (Ikonomidou et al. 1999; Stefani and Moghaddam, 2005). This inhibition of NMDA receptors in early postnatal period resulted in schizophrenia-like behavioural and structural disorders in rats in their adulthood (Harris et al., 2003; Bubeníková-Valesová et al., 2008). The behavioural changes, including increase in locomotor activity, impaired social interaction (reduced contacts with unfamiliar partners), a perseveration of behaviour (sniffing, face washing etc.), stereotypy (e.g., excessive grooming), deficiency in information processing, impairment of cognitive functions (working memory and attention), may be correlated with neurobiological markers of schizophrenia and the symptoms observed in schizophrenia patients (Lipska and Weinberger, 2000; Wang et al., 2004). These findings supported both the neurodevelopmental and glutamate NMDA receptor hypofunction hypotheses in schizophrenia, and highlighted the manipulation of NMDA receptors during neonatal period as a method in creating a neurodevelopmental model of schizophrenia (for review, see: Bubeníková-Valesová et al., 2008).

Moreover, it has been shown that the maternal immune activation (MIA) may be related to psychotic disorders such as schizophrenia. Neurodevelopmental animal models have been developed based on intrauterine stressors such as maternal viral infections occurring during pregnancy. For example, in MIA rodent models, a pregnant rodent is infected by administration of immunogenic substances such as specific bacterial or viral pathogens or pro-inflammatory cytokines. This early fetal infection impacts the processes of postnatal brain development. The viral infection-induced neurophysiological and behavioral abnormalities are evaluated in offspring. In animal models, one of the most common approaches to mimic the gestational viral infection is administration of a viral mimic polyriboinosinic-polyribocytidilic acid (PolyI:C), which is able to induce a set of schizophrenia-like behavioral and cognitive abnormalities (Resinger et al., 2015).

### **1.5.2. Genetic Models of schizophrenia**

Genetic studies have highlighted contribution of some genes in schizophrenia. Some of these candidate genes that their association with schizophrenia has been supported by strong evidence are DISC1, Neuregulin 1 (NRG1), dysbindin, COMT (Brandon et al., 2011; O'Tuathaigh et al., 2013; Dawson et al., 2015; Harrison, 2015; Winship et al., 2019). The genetic models of schizophrenia have been generated based on mutations in these candidate genes that lead to the schizophrenia-like disorders. Mutations in dysbindin and NRG1 result in the cognitive impairments in humans and lead to increased risk for developing schizophrenia (Stefansson et al., 2003; Weickert et al., 2004; Benzel et al., 2007; Weickert et al., 2008). Some schizophrenia risk genes may affect the glutamate signaling and the function of NMDA receptors (Pratt et al., 2012; Pocklington et al., 2014; Harrison, 2015; Pratt et al., 2018). Genetic animal models have indicated that manipulations of NRG1 or dysbindin in mice are able to affect function of NMDA receptors and lead to abnormal behaviors consistent with schizophrenia-like phenotypes, including hyperactivity, elevated anxiety-like behavior, impaired working memory performance and deficits in cognitive abilities and social interactions (Karl et al., 2008; Mei and Xiong, 2008; Karlsgodt et al., 2011 ;Jones et al., 2011).

Changes in the mouse DISC1 gene affect several neurotransmission systems such as serotonin, glutamate and dopamine systems. Mutations in DISC1 in mice lead to alterations in brain morphology, including decreased brain volume and cortical thickness, and disorders such as changes in locomotor activity, decreased sociability, impairments

in working memory, cognitive abilities and volitional behavior associated with neuropathology and symptoms of schizophrenia (Jaaro-Peled et al., 2009; Kvaajo et al., 2008). The DISC1 truncation exert impact on the function of NMDA receptors. The transgenic mice expressing truncated DISC1 showed an abnormally increased PFC-thalamic connectivity and the dysfunction of glutamate system (Dawson et al., 2015).

There are several schizophrenia-associated genes which are related to D-serine, a co-agonist of the NMDA receptor. One of these genes is D-amino acid oxidase (DAO), an enzyme that contributes to degradation of D-serine. Genetic manipulation of DAO in mice leads to behavioral and cognitive abnormalities consistent with schizophrenia (Labrie et al., 2008). Postmortem studies have reported increase in expression and activity of DAO in schizophrenia patients. Increased DAO activity leads to reduced level of D-serine which, in turn, results in the reduced activity of NMDA receptors (Ayhan et al., 2016; Winship et al., 2019).

Several genetic models have proposed a model for schizophrenia by inducing NMDA receptor hypofunction. It has been documented that mutations of the NMDA receptors subunit genes such as NR1, NR2A, and NR2B lead to a significant increase of risk for developing schizophrenia (Tang et al., 2006). These findings have been supported by postmortem and genetic studies from schizophrenia patients (Coyle, 2004). For example, mutation of the NR1 gene in mice that reduces the expression of NR1 subunit of NMDA receptors results in a series of schizophrenia-like phenotypes including abnormal selective attention, deficits in social and sexual interactions, increased motor activity, and impairments in sensorimotor gating and cognitive abilities (Ballard et al., 2002 ;Dzirasa et al., 2009).

Moreover, there are several genetic models that have targeted dopaminergic neurotransmission. The catechol-O-methyltransferase (COMT) is a gene that encodes the enzyme that contributes to the elimination of dopamine in the prefrontal cortex (Tunbridge et al., 2006). Knockout of COMT in mice may lead to increased anxiety and increased aggression (Gogos et al., 1998). A polymorphism in COMT may result in abnormal working memory in human subjects and may impair the prefrontal cognition, leading to slightly increased risk of schizophrenia (Egan et al., 2001).

### **1.5.3. Dopamine-based models of psychosis**

Dopamine and glutamate hypotheses are two major hypotheses of the pathoetiology of schizophrenia. Based on these two hypotheses, two categories of drugs have widely been used in the animal and human studies to serve as pharmacological models of schizophrenia by inducing schizophrenia-like behavioral or neurophysiological manifestations. Drugs such as amphetamine and Apomorphine acting as dopamine agonists target the dopaminergic system. Drugs including phencyclidine (PCP), dizocilpine (MK-801) and ketamine acting as non-competitive NMDA receptor antagonists target the glutamatergic system (for review, see: Feifel and Schilling, 2013; Steeds et al., 2015). To review drug-based animal models of schizophrenia that have targeted NMDA receptor hypofunction hypothesis, see Lee and Zhou, 2019.

Dopamine models of psychosis have been proposed based the dopamine hypothesis. In this hypothesis, it is believed that dopamine system is impaired due to the increased release of dopamine or the increased activity of dopamine receptors. It has been shown that amphetamine, an indirect dopamine agonist, induces psychotic-like state associated with schizophrenia symptoms in healthy individuals and leads to exacerbation of the psychotic-like symptoms in patients. These induced symptoms were more associated with the positive symptoms of schizophrenia. Amphetamine could not significantly induce changes associated with negative and cognitive symptoms (Yui et al., 1999; Srisurapanont et al., 2001; Featherstone et al., 2007; Forrest et al., 2014; Winship et al., 2019). In this section, we review the literature with more concentration on the models of EC-SCZ based on the hypothesis of NMDA receptor hypofunction.

### **1.5.4. The NMDA receptor-related models of EC-SCZ**

#### **1.5.4.1. PCP model**

It has been found that the phencyclidine (PCP), a non-competitive NMDA receptor antagonist, leads to induce hallucinations, delusions, social withdrawal, stereotyped speech, and impairment in cognitive abilities in healthy human individuals. Numerous human and animal studies have used PCP as a schizophrenomimetic drug to investigate the contribution of NMDA receptors in the pathophysiology of schizophrenia (Carlsson and Svensson, 1990; Johnson and Jones, 1990; Javitt and Zukin, 1991).

In animals, acute administration of PCP can lead to a variety of behavioral abnormalities associated with symptoms of schizophrenia. Animal models have indicated that the acute administration of PCP may lead to an exhibition of ataxia, increased stereotypies, and impaired locomotor activity which have translational relevance to the positive symptoms of schizophrenia in humans (Sturgeon et al., 1979; Kalinichev et al., 2007). Acute PCP administration decreased the social interaction which is associated with negative symptoms of schizophrenia (Sams-Dodd, 1995). Moreover, acute PCP administration led to variety of cognitive impairments such as impaired sensorimotor gating, learning and attention (Mansbach and Geyer, 1989; Martinez et al., 1999; Noda et al., 2001; Egerton et al., 2005; Egerton et al., 2008), which are reminiscent of sensorimotor gating, attention and learning impairments observed in EC-SCZ patients (Hammer et al., 2013; Mohn and Torgalsbøen, 2017).

Acute administration of PCP increased the brain metabolism in cortical areas and thalamus and decreased it in the dorsal thalamic reticular nucleus (Martinez et al., 1999; Egerton et al., 2005). Acute PCP administration during the early postnatal period leads to the loss of parvalbumin-containing neurons from the motor and somatosensory cortices (Wang et al., 2008). These findings support the hypothesis of an increased level of glutamate (for meta-analysis, see: Knopf, 2021) and consequently increased activity of both somatosensory cortex and thalamus mediated by the reduced inhibition from the inhibitory GABAergic neurons. These findings are consistent with the neurobiological features of EC-SCZ (Anticevic et al., 2015b). However, there are conflicting findings of the PCP-induced effects on the dopamine systems from the animal models which are inconsistent with the increased activity of the dopamine system in subcortical regions and the decreased activity of the dopamine system in the cortical areas as observed in schizophrenia patients (Slifstein et al., 2015).

#### **1.5.4.2. MK-801 model**

MK-801 is more specific NMDA receptor antagonist than ketamine and has longer action of NMDA receptor antagonism (Pinault, 2008). Because of such a feature, it is thought that MK-801 may induce a “full” range of schizophrenia-associated abnormalities. Rodent models have shown that acute administration of MK-801 induces locomotor hyperactivity, increased ataxia and stereotypy (Rung et al., 2005; Manahan-Vaughan et al., 2008). Single acute administration of MK-801 (0.1, 0.2 and 0.3 mg/kg) leads to the



significant inhibition of social interaction (Rung et al., 2005; Zou et al., 2008), which is associated with negative symptoms including social withdrawal as one of the highly prevalent symptoms in first-episode schizophrenia (Bambole et al., 2013) and as one of early signs of psychosis at the prodromal phase (Mäki et al., 2014). Acute MK-801 serves as a model of psychosis and induces a set of cognitive impairments in sensorimotor gating, latent learning, and working memory and spatial and object recognition memory (Yamada et al., 1996; Bast et al., 2000; Manahan-Vaughan et al., 2008; Wiescholleck and Manahan-Vaughan, 2012). All these cognitive deficiencies are reminiscent of those detected in EC-SCZ patients (Hammer et al., 2013; Mohn and Torgalsbøen, 2017).

The acute MK-801 administration leads to impaired long-term potentiation (LTP) which is associated with cognitive deficits (Kulikova et al., 2012; Wiescholleck and Manahan-Vaughan, 2012). Administration of MK-801 decreases the expression of NMDA receptor subunits including NR1, NR2C, and NR2B, leading to reduced activity of NMDA receptors (Linden et al., 2001; Liu et al., 2017). Increased gamma power has been reported in EC-SCZ patients (Theberge et al., 2002). This observation has been mimicked in animal models by the administration of NMDA receptor antagonists such as MK-801. For example, it has been shown that administration of MK-801 dose-dependently leads to a significant increase in the power of gamma-frequency oscillations in the neocortex (Pinault, 2008). There is also evidence that acute MK-801 administration increases gamma power in the hippocampus (Kittelberger et al., 2012). It has also been shown that MK-801 affects inhibitory GABAergic interneurons more than excitatory pyramidal neurons. MK-801-induced NMDA receptor hypofunction leads to the disinhibition of excitatory PFC neurons that, in turn, results in the increased activity of PFC-related circuits (Yonezawa et al., 1998; Homayoun and Moghaddam, 2007). These results are consistent with the emerging observations that imply the elevated PFC glutamate and PFC hyperconnectivity in EC-SCZ patients (Anticevic et al., 2015b), suggesting acute MK-801 as an appropriate model to investigate the NMDA receptor hypofunction hypothesis in EC-SCZ.

#### **1.5.4.3. Role of NMDA receptor subunits in transition to psychosis**

Manipulation of NMDA receptor subunits is another approach to investigate the NMDA receptor hypofunction and its role in the pathophysiology of schizophrenia. The deletion of NR1 subunit from the mice forebrain leads to the increased gamma band

power. Mouse models have shown that the lack of NR1 in the sensory cortex and medial PFC may induce a range of schizophrenia-like changes such as decreased self-care, impaired social interaction and cognitive impairments in prepulse inhibition and short-term memory (Kehrer et al., 2008; Tatard-Leitman et al., 2015).

Belforte et al. (2010) have highlighted the contribution of NMDA receptor hypofunction in the pathophysiology of schizophrenia by indicating that selective deletion of NR1 from 40-50% of GABAergic interneurons of cortex and hippocampus during early postnatal development leads to the emergence of a wide range of schizophrenia-associated behavioral changes in mice in their pubertal age. These mice exhibited novelty-induced hyperlocomotion, anhedonia-like and anxiety-like behaviors, mating and nest-building deficits, and impairments in spatial and social memory, and prepulse inhibition. These mice, like most schizophrenia patients, experienced the transition to a psychotic-like state after their adolescence. Early postnatal deletion of NR1 from the GABAergic neurons leads to the disinhibition of excitatory pyramidal neurons and decreased cortical synchronization. Deletion of NR1 after adolescence did not induce schizophrenia-related changes. These findings provide support for several hypotheses known in schizophrenia, and link them together. These hypotheses include NMDA receptor hypofunction, dysfunction of GABAergic neurons (Lewis et al., 2005) and neurodevelopmental origin of schizophrenia (Bora, 2015).

Both NR2A and NR2B subunits of NMDA receptors significantly contribute to the synaptic plasticity associated with cognitive functions (Kiyama et al., 1998; Moriya et al., 2000). NR2B knockout mice exhibited the enhanced startle reflex to acoustic stimulus, reduced excitatory postsynaptic currents (EPSCs) mediated by NMDA receptors and reduced LTP in the hippocampus (Ito et al., 1997; von Engelhardt et al., 2008). Deletion of NR2B from the pyramidal neurons of mouse forebrain at early postnatal period leads to the schizophrenia-relevant abnormalities such as hyperlocomotion, exaggerated stimulant response, impaired spatial learning and object recognition memory (Badanich et al., 2011). In mice, the NR2A knockout led to almost similar effects as NR2B knockout (Sprengel et al., 1998; Brigman et al., 2008).

#### **1.5.4.4. Ketamine model**

##### **1.5.5.4.1. Ketamine**

Ketamine (2-chlorophenyl-2-methylamino-cyclohexanone) was synthesized in the

1960s as a PCP derivative in an attempt to reduce the side effects of PCP as a dissociative anesthetic. Ketamine relative to PCP has short duration of action, reduced neurotoxicity and much less side effects even with repeated administration (Lee and Zhou, 2019). These features made ketamine safer and more favorable to be used as a clinical anesthetic and as a pharmacological challenge of human subjects in neuroimaging or neuropsychological studies (Rowland, 2005). In addition to be used as a dissociative anesthetic, ketamine dose-dependently has several medical applications including analgesic, amnesic, an effective rapid-acting antidepressant and postoperative pain management (Niesters et al., 2012; Rowland, 2005; Molero et al. 2018).

In low doses, ketamine's effect emerges within about 10 minutes and its hallucinogenic effects last about one hour by injection and up to two hours by ingestion orally. At high subanesthetic doses, users may experience visual and auditory hallucinations and an extreme dissociative state characterized by a sense of detachment from the external world. These users experience abnormal physical and emotional states which are called derealization and depersonalization, respectively. Given that ketamine induces a psychotic-like state, it has widely been used in preclinical studies to test the effectiveness of antipsychotic drugs and new compounds. Ketamine noncompetitively acts on the NMDA receptor and blocks it by binding to a site near the channel pore. However, ketamine acts on other kinds of receptors such as dopamine D2 and serotonin receptors (Frohlich et al., 2014).

#### **1.5.5.4.2 Acute ketamine models**

Several human studies have proposed ketamine-induced NMDA receptor hypofunction as an appropriate model for recreating a psychosis-like state (Newcomer et al., 1999; Höflich et al., 2015). Ketamine application in healthy human individuals induces multiple schizophrenia-like psychotic symptoms, reminiscent of positive, negative, and cognitive symptoms in schizophrenia patients (Newcomer et al., 1999).

In animal studies, acute administration of ketamine (2.5-30 mg/kg) leads to the cognitive impairments including impaired spatial learning and working memory and reduced sensorimotor gating (Verma and Moghaddam, 1996; de Bruin et al., 1999). These acute ketamine-induced cognitive impairments are reminiscent of the impaired spatial working memory in first-episode schizophrenia patients (Eckfeld et al., 2017) and adolescents with psychosis (Zanello et al., 2009). As a prodromal symptom, impaired

spatial working memory has also been detected in ARMS individuals (Fusar-Poli et al., 2010). Significant sensorimotor gating deficit has been shown in young adolescents with EC-SCZ (Rydkjaer et al., 2020).

Acute ketamine-induced effects can be blocked by clozapine (Szlachta et al., 2017) which acts on the NMDA receptors like an agonist (Lipina et al., 2005; Schwieler et al., 2008). It has been shown that acute ketamine increases basal power in the gamma band and decreases evoked power in the theta band. Therefore, acute ketamine-induced frequency oscillations in mice could mimic the abnormal oscillatory activities observed in EC-SCZ (Ehrlichman et al., 2009). A study has indicated that prenatal application of acute ketamine (60 mg/kg and 20 mg/kg every 20 min for 3 h) in pregnant rats resulted in a disinhibition of the exploratory activity, increased stereotypic behavior, increased locomotor activity, and agitation in the prenatally treated rats in the pubertal stage. In the adult stage, these rats experienced deficits in social interaction, depressive-, anxiety- and aggressive-like behavior, and cognitive deficits. These observations suggest a pharmacological animal model in which ketamine-induced prenatal inhibition of NMDA receptors may lead to the transition to a psychotic-like state in the juvenile stage which is followed by more severe schizophrenia-like behavioral phenotypes in the adult stage (Coronel-Oliveros and Pacheco-Calderon, 2018).

Effects of ketamine are highly dose-dependent. Acute administration of ketamine may lead to abnormal behavior such as hyperlocomotion activity associated with positive symptoms. However, there are inconsistent results in the behavioral changes associated with negative symptoms. This inconsistency may be due to the fact that low-dose ketamine has the antidepressant effect that may prevent the exhibition of behavioral changes corresponding to the negative symptoms. Unlike the acute administration of ketamine, subchronic administration of ketamine produced more persistent behavioral changes associated with positive, negative, and cognitive symptoms (Lahti et al., 2001; Featherstone et al., 2012; Chatterjee et al., 2012; Szlachta et al., 2017). However, the subchronic ketamine administration (30 mg/kg for days) led to a steady decline in the gamma oscillations over 2-4 weeks after ketamine treatment, showing that subchronic ketamine model is more fit to the chronic schizophrenia in which reduced gamma-band activity has been reported (Flynn et al., 2008; Kittelberger et al., 2012). Acute low-dose

ketamine models correspond better to the EC-SCZ and are further reviewed in the following section.

## **1.6. The low-dose ketamine-induced model of psychosis transition**

### **1.6.1. Ketamine model of transition to psychosis in human studies**

Can ketamine provide a model for transition to psychosis or EC-SCZ? Which stage of schizophrenia does ketamine provide a better model for? Beck et al. (2020), in a systematic review and meta-analysis, answered the question: What psychiatric symptoms are associated with ketamine-induced changes? They found that acute administration of ketamine was associated with significant induction of positive and negative symptoms of psychosis in healthy individuals and a significant increase of these symptoms in schizophrenia patients. Ketamine-induced psychosis-like symptoms are more associated with positive than negative symptoms and were greater when ketamine infusion was followed by a bolus (Beck et al., 2020).

Anticevic et al. (2015b) have examined effect of ketamine on healthy individuals to study the PFC functional connectivity. The results revealed that ketamine leads to robust PFC hyperconnectivity in healthy individuals similar to that observed in EC-SCZ patients and individuals at high risk for developing psychosis. Reduced PFC connectivity has been reported in chronic schizophrenia (Cole et al., 2011). Other studies have also suggested increased PFC connectivity and activation during the schizophrenia onset (Marsman et al., 2013; Schobel et al., 2013). In addition, ketamine induces high visual disturbances which is rarely observed in chronic schizophrenia. As another example, however, auditory hallucinations are common in established schizophrenia, they are rarely induced by ketamine administration. Based on such evidence, low-dose ketamine administration appears to be an appropriate model to mimic the EC-SCZ rather than the chronic schizophrenia (Anticevic et al., 2015b).

It has been shown that administration of ketamine in multiple subanesthetic dosages including low, moderate, and high doses in healthy male participants leads to the progressive dose-dependent increases in the severity of multiple schizophrenia-like symptoms including alogia, avolition-apathy, anhedonia-asociality, and impairments in memory and attention. These symptoms significantly appeared in healthy individuals even after low dose administration of ketamine, indicating the high capability of low dose

ketamine in leading healthy people to develop a psychotic-like state in which a series of hallmark features of EC-SCZ has been exhibited. The results of the ketamine model show that progression of the illness and the increasing severity of the symptoms after illness onset may be attributed to a progressive increase of NMDA receptor hypofunction (Newcomer et al., 1999).

Lahti et al. (1995) showed that subanesthetic administration of ketamine in schizophrenia patients at multiple low doses (0.1, 0.3, and 0.5 mg/kg) induced a dose-dependent, short lasting worsening of psychotic symptoms including positive symptoms such as visual hallucinations, delusions and thought disorder. These ketamine-induced psychotic symptoms were considerably reminiscent of the symptoms that these patients had already experienced during active or acute phase of their illness. Positive symptoms are highly present during early stages and acute exacerbations of the disease. Ketamine reinstated the acute or early phase of the psychosis in the schizophrenia patients and failed to exacerbate the negative symptoms in these patients. These data suggest that increasing the NMDA receptor hypofunction exacerbates symptoms of schizophrenia and reproduce the early or acute phase of the disease (Lahti et al., 1995). This provides another evidence supporting ketamine as a model of psychosis transition.

Hong et al. (2010) have shown that subanesthetic administration of ketamine in healthy human subjects leads to the emergence of thought disorder, withdrawal-retardation, and dissociative symptoms. This human study has developed a ketamine model of psychosis and suggested the ketamine-induced hypofunction of NMDA receptors as one of the key mechanisms for schizophrenia-associated aberrant neural oscillations. Ketamine administration led to the significant reduction of delta-frequency oscillations (1–5 Hz) and significant augmentation of gamma-frequency oscillations (40–85 Hz) in healthy individuals. Ketamine also slightly reduced slow oscillations at the theta-alpha (5–12 Hz) range. Results of this low-dose ketamine model mimicked some abnormalities observed in schizophrenia patients (Newcomer et al, 1999; Lahti et al, 2001) and are also similar to those obtained from animal models (Bland et al, 2007; Hunt et al, 2009; Ehrlichman et al, 2009; Lazarewicz et al, 2009).

Several resting-state fMRI studies have highlighted the increased functional connectivity between the thalamus and motor/somatosensory cortex in all stages of schizophrenia (Woodward et al., 2012; Anticevic et al., 2014; Woodward and Heckers,

2015; Anticevic et al., 2017). Such an abnormality appears early in the disease and persists, although it is more pronounced early in the disease than in the chronic period (Woodward et al., 2012). Can ketamine induce such a dysconnectivity? Höflich et al. (2015) have proposed a low-dose ketamine model of psychosis by highlighting that the intravenous application of low-dose ketamine can transiently induce the increased somatosensory-thalamic connectivity in healthy individuals similar to those observed in EC-SCZ patients and ARMS individuals. Therefore, the low-dose ketamine may provide a link between the NMDA receptor hypofunction hypothesis and abnormal functional connectivity in thalamus-related systems. However, neurophysiological mechanisms that underlie the link between these two are not fully deciphered. It has been hypothesized that the suppression of NMDA receptors on inhibitory GABAergic neurons causes disinhibition of the excitatory neurons that consequently leads to an increased release of glutamate, resulting in over-connected regions (Lopez-Gil et al., 2007; Höflich et al., 2015).

Both TC connectivity and gamma frequency oscillations are correlated with the information processing and cognitive functions (Colgin and Moser, 2010; Fries et al., 2007). Abnormality in both of them has been reported in early stages of schizophrenia and in ARMS individuals and is associated with the cognitive impairments like attentional deficits and positive symptoms like hallucinations (Spencer et al., 2003; Spencer, 2011; Venables et al., 2009). Therefore, if a drug could induce these core abnormalities, it may be implicated as an appropriate model for transition to psychosis. In a resting-state MEG study (Rivolta et al., 2015), effects of ketamine administration transiently resembled oscillatory and connectivity patterns of schizophrenia in healthy participants. In other words, low-dose ketamine led to the increased power of gamma band (30-90 Hz) in cortex and thalamus, and increased functional TC connectivity in healthy individuals, consistent with data from EEG and fMRI recordings in EC-SCZ patients and ARMS individuals (Kikuchi et al., 2011; Anticevic et al., 2015b; Hirano et al., 2015) and preclinical observations on the ketamine effects on the gamma oscillations (Pinault, 2008; Hakami et al., 2009). Based on these results, Rivolta et al. (2015) suggested the disinhibition of TC circuits in EC-SCZ as a consequence of NMDA receptor hypofunction.

Moreover, there is evidence from human and rodent studies indicating the increase of glutamate release after ketamine administration (Chowdhury et al., 2017; Abdallah et al.,

2018). There is evidence for the NMDA receptor hypofunction-mediated disinhibition and consequent elevated glutamate level in the schizophrenia onset (Kim et al., 2011). Elevated glutamate is progressively declined with the disease duration, meaning that it is the feature of psychosis onset (Marsman et al., 2013; Rivolta et al., 2014). These findings pronounce the capability of ketamine in simulating the schizophrenia onset and in serving as an appropriate model of conversion to psychosis (Rivolta et al., 2015).

### **1.6.2. Ketamine model of transition to psychosis in animal studies**

In addition to the human studies investigating the association of ketamine with schizophrenia symptoms in healthy individuals and patients (for a systematic review and meta-analysis, see: Beck et al., 2020), there are a growing number of preclinical animal studies indicating that the application of ketamine in rodents impairs cognitive functioning such as attention and memory (Verma and Moghaddam, 1996; Imre et al., 2006) and induces schizophrenia-like symptoms including hyperactivity, stereotypies and ataxia (Tricklebank et al., 1989 ;Pitsikas et al., 2008). Ketamine-induced memory deficits have been highlighted by several animal studies. For example, Chrobak et al., (2008) showed that ketamine (3-10 mg/kg) leads to the increase of number of errors during the performance of a memory task in rats. Another animal study revealed that subanesthetic low dose of ketamine (0.3, 1 and 3 mg/kg) impairs the spatial memory (object location) and non-spatial memory (object recognition) in rodents (Pitsikas et al., 2008). These animal findings are reminiscent of non-spatial working memory problems observed in first-episode schizophrenia patients (Liu et al., 2021) and impaired spatial working memory abilities in ARMS patients (Wood et al., 2003).

Dawson et al. (2014) showed that acute administration of ketamine in mice led to an increased functional thalamic connectivity with the motor and somatosensory cortex as well as to the prefrontal cortex. It has been shown that sustained NMDA receptor hypofunction in mice may lead to hypoconnectivity in PFC-related networks which is a result consistent with chronic schizophrenia. Based on these observations, it was suggested that acute subanesthetic administration of ketamine may have greater translational relevance to the abnormalities observed in the early course than chronic schizophrenia. The suggestion has also been supported by other investigation (Hauser et al, 2011).



Ehrlichman et al., (2009) have shown that ketamine administration in mice led to induce changes in the EEG power spectra including the reduced evoked power of theta-frequency oscillations and increased basal power of gamma-frequency oscillations which are results consistent with those obtained in other animal models as well as studies in patients with schizophrenia (Yamamoto, 1997; Koukkou et al., 2000).

In an electrophysiological study (Pinault, 2008), ketamine was administered in a subanesthetic dose in freely-moving awake rats. The dose of ketamine administered was almost equivalent to the dose that induces cognitive impairments, schizophrenia-like psychotic behaviors, and exacerbates symptoms in schizophrenia patients. This dose was much less than doses used in the previous animal studies for modeling schizophrenia. Ketamine significantly increased the power of ongoing gamma oscillations in the neocortex of awake rats. Ketamine also remarkably induced an increased gamma synchronization which is associated with abnormal motor activity (ataxia). To validate that ketamine-induced gamma hyperactivity was not the consequence of hyperlocomotion or motor activity, ketamine was administered in sedated rats and similar observations were obtained (Hakami et al., 2009). The same results were obtained by the administration of MK-801, a more specific antagonist of NMDA receptors. To address this question that whether ketamine-induced gamma hyperactivity is specifically due to the blockade of NMDA receptors, other kinds of drugs including apomorphine and d-amphetamine were tested. Both of them increased the gamma activity but much less than that ketamine did. Effects of apomorphine and d-amphetamine on the gamma oscillations were not dose-dependent, indicating that dopaminergic receptors are much less involved in the occurrence of gamma hyperactivity relative to glutamatergic receptors.

### **1.6.3. Acute low-dose ketamine model mimics EC-SCZ but not chronic schizophrenia**

Acute ketamine administration leads to significant increase in glutamate level, gamma band activity and PFC-related connectivity in both animals (Moghaddam et al., 1997; Hakami et al., 2009; Dawson et al., 2014) and humans (Rowland et al., 2005; Rivolta et al., 2015; Anticevic et al., 2015a). Reduction in these three indexes have been found in chronic schizophrenia (Theberge et al., 2003; Ohrmann et al., 2007; Cole et al., 2011) but increase in early course psychosis and ARMS (Theberge et al., 2002; Flynn et al., 2008; Anticevic et al., 2015b). According to the animal and human models reviewed

here, we may conclude that acute administration of ketamine appears to provide a model of schizophrenia that corresponds to its early course rather than chronic phase. In the present study, we have concentrated on the prodromal phase of schizophrenia (from ARMS to EC-SCZ), not on the chronic phase.

#### **1.6.4. Implications and limitations related to low-dose ketamine models**

As reviewed in this section, a large body of evidence indicates that ketamine appears to be an appropriate model for emulating abnormal oscillatory activities observed in EC-SCZ in wakefulness. But what about ketamine effects on sleep oscillations? Only a handful of studies have examined the effects of ketamine on oscillatory activities during the sleep state. Sleep spindle deficit is one of the major signatures of schizophrenia and has been reported in the late and early stages of schizophrenia. Therefore, sleep spindle deficit may serve as a sign of transition to psychosis. The mechanisms that underlie sleep spindle deficit are unknown. Now, this is an important question that how ketamine affects sleep spindles as one of the major signs of the disease? Can low-dose administration of ketamine also lead to a reduction of sleep spindles? The current animal study is an attempt to address these questions.

In addition to glutamatergic system, ketamine acts on other systems such as dopaminergic, serotonergic and GABAergic systems (Kapur and Seeman, 2002; Li and Vlisides, 2016). This fact makes the interpretation of observations obtained from ketamine models intricate so that ketamine effects cannot simply be attributed to the glutamatergic system. However, it may be suggested that a combination of disturbed systems is involved in the pathophysiology of schizophrenia and ketamine model may have this potential to combine the competing hypotheses (Frohlich and Van Horn, 2014).

#### **1.7. Aims**

Schizophrenia, a chronic debilitating psychotic disease, affects about 1% of the population worldwide (Wittchen et al, 2011). Its causes are still unknown. Sleep abnormalities have been observed not only in chronic and early course of complex mental health diseases, such as schizophrenia (Kamath et al., 2015; Monti and Monti, 2005; Wamsley et al., 2012) but also in individuals having a high-risk mental state for developing a transition to psychotic disorders (Zanini et al., 2015), suggesting sleep disturbances as one of the major characteristics of schizophrenia.

Cortical EEG studies have revealed a reduction in sleep spindles throughout schizophrenia regardless of the phase of disorder (early course or chronic), the age (adolescent or adult), and the medication status (medicated or unmedicated). Sleep spindle deficit has even been detected in the first psychotic episode and in first-degree relatives of the patients (Ferrarelli et al., 2007; Ferrarelli et al., 2010; Manoach et al., 2014; Manoach et al., 2016; Castelnovo et al., 2017). Therefore, sleep spindle deficit may be implicated as an early electro-biomarker of impending psychosis. Significant reduction in sleep delta-frequency oscillations has also been reported in unmedicated, first-stage schizophrenia patients (Keshavan et al., 1998; Kaskie and Ferrarelli, 2017). The neural mechanisms underlying the reduction in sleep spindles and slow oscillations remain to be elucidated.

Sleep spindles have a thalamic origin with the GABAergic TRN being a leading structure in their generation by exerting a powerful rhythmic inhibitory modulation of thalamocortical (TC) activities (Pinault, 2004; Steriade et al., 1985; Steriade et al., 1993). The TRN, the principal inhibitory structure of the dorsal thalamus, is innervated by two major glutamatergic inputs, TC and layer VI corticothalamic (CT) axon collaterals, which mediate most of their excitatory effects through the activation of glutamate receptors (Deschênes and Hu, 1990; Gentet and Ulrich, 2003; Crandall et al., 2015). Importantly, layer VI CT axons innervate simultaneously TC and TRN neurons (Bourassa et al., 1995), together forming a 3-neuron circuit robustly involved in the generation, propagation, and maintenance of sleep spindles (Bal et al., 2000; Bonjean et al., 2011).

There is accumulating evidence that dysfunction of thalamus-related systems is a core pathophysiological hallmark for psychosis-related disorders (Andreasen, 1997; Clinton and Meador-Woodruff, 2004a; Cronenwett and Csernansky, 2010; Pinault, 2011; Pratt et al., 2017; Steullet, 2019). In the CT-TRN-TC system, NMDA receptors are also essential in the generation of thalamic spindles (Deleuze and Huguenard, 2016; Jacobsen et al., 2001), and there is an increasing number of clinical and preclinical evidence supporting the hypothesis of NMDA receptor hypofunction involved in the etio-pathophysiology of schizophrenia (Krystal et al., 1994; Olney et al., 1999; Clinton and Meador-Woodruff, 2004b; Coyle, 2012; Lin et al., 2012; Morris and Pratt, 2014; Snyder and Gao, 2020).

Furthermore, the NMDA receptor antagonist ketamine models a transition to a psychosis-relevant state in both healthy humans (Anticevic et al., 2015; Baran et al., 2019; Höflich et al., 2015; Rivolta et al., 2015) and rodents (Chrobak et al., 2008; Ehrlichman et al., 2009; Hakami et al., 2009; Kocsis, 2012a; Pinault, 2008; Pitsikas et al., 2008).

Therefore, we hypothesized that a reduced function of NMDA receptors contributes to the reduction of sleep spindles observed in patients having or about to have psychotic disorders. In an attempt to test this hypothesis, the effects of a single low-dose administration of ketamine on sleep oscillations were investigated using network and cellular recordings in the dorsal thalamus and TRN along with the cortical EEG in the rat sedated with pentobarbital, a productive of sleep-like oscillations (Pinault, et al., 2006).

## Chapter 2

---

### 2. Materials and Methods

#### 2.1. Animals and drugs

Seventy-three adult male Wistar rats, aged 3-6 months old and weighing 260-390g were utilized. All experiments were done in accordance with European Union Guidelines (UE 2010/63) and were approved by the regional ethics committee regarding animal experimentation, University of Strasbourg (Comité Régional d'Ethique en Matière d'Expérimentation Animale de Strasbourg) and by the Ministère de l'Education Nationale, de l'Enseignement Supérieur et de la Recherche under the reference number: APAFIS#3413-2015122809432649v2. Animals were housed and kept under controlled environmental conditions (temperature:  $22\pm 1$ °C; humidity:  $55\pm 10\%$ ; 12/12 h light/dark cycle; lights on at 7:00 am) with food and water available *ad libitum*. Every precaution was taken to minimize stress and the number of animals used for each series of experiments.

Ketamine was provided from Merial (Lyon, France); MK-801, apomorphine, and physostigmine, from Sigma-Aldrich (Saint-Quentin Fallavier, France), pentobarbital from Sanofi (Libourne, France), and Fentanyl from Janssen-CILAG (Issy-Les-Moulineaux, France). All drugs were dissolved and diluted in sodium chloride (NaCl, 0.9%).

#### 2.2. Surgery under general anesthesia

Deep general anesthesia was initiated with an intraperitoneal injection of pentobarbital (60 mg/kg). Analgesia was achieved with a subcutaneous injection of fentanyl (5 mg/kg) every 30 minutes. An additional small dose (10-15 mg/kg) of pentobarbital was administered, when necessary, that is, to maintain a constant level of surgical anesthesia. The rectal temperature was maintained at 36.5 °C (moderate peroperative and protective hypothermia) using a thermoregulated pad. Each deeply anesthetized rat was installed in a stereotaxic apparatus, its trachea cannulated and connected to a ventilator. Artificial ventilation was kept at 60 breaths per minute with an equal mixture of air and oxygen (50% air–50% O<sub>2</sub>) for the rest of the experiment. The

depth of the anesthesia was continuously monitored using an electrocardiogram, watching the rhythm and depth of the breathing, and measuring the withdrawal reflex (pinching the hindpaw). At the end of the surgery, the rectal temperature was set to and maintained at 37.5°C using a thermoregulated pad. The ear bars had a foam tip and the inter-auricular pressure was relaxed to minimize stress. The anesthesia lasted about 2 hours, the time necessary to perform the stereotaxic implantation of the electrodes (Pinault, 2005). Under deep anesthesia, the EEG exhibited an alternation of high-amplitude ( $> 0.2$  mV) low-frequency ( $< 5$  Hz) waves, spikes ( $>1$ mV), and flat traces.

### **2.3. The analgesic pentobarbital-induced sedation**

At the end of the surgical procedures and about 2 h after the induction of the general anesthesia, the analgesic pentobarbital-induced sedation was initiated once the rat showed first signs of recovery from the deep anesthesia. These signs are a reflective response to pinching the animal's paws and EEG bouts of a desynchronized state. The analgesia was assured with fentanyl, a well-recognized powerful analgesic (Colpaert FC et al., 1980).

The analgesic pentobarbital-induced sedation solution was prepared by the mixture of pentobarbital ( $4.21 \pm 0.07$  mg), fentanyl ( $2.41 \pm 0.15$   $\mu$ g), glucose ( $48.7 \pm 1.2$  mg), and d-tubocurarine chloride (2 mg/ml). Pentobarbital-induced sedation was maintained by the continuous intravenous injection of the solution with a constant perfusion rate ( $\sim 0.2$ - $0.5$  ml/h). A neuromuscular blocking agent was used (d-tubocurarine chloride:  $0.64 \pm 0.04$  mg/kg/h, i.v.) to prevent muscle rigidity and tremors and help maintain stable mechanical ventilation.

The general condition of the animal and the state of the sedation were continuously monitored through the EEG and ECG recordings and also for the analgesic effect, lidocaine regularly was dropped to the surgical areas. Before starting the recordings, we needed to wait at least two hours to have the stable condition of sedation after the continuous intravenous infusion of the pentobarbital solution began, that is, when the cortical EEG exhibited a stationary state associated with a cycle of synchronized and desynchronized states. The intravenous infusion rate could be increased or decreased to maintain the sedation state stationary. A stable sleep-like pattern assessed using an online spectral analysis.

To promote the incidence of sleep activity episodes including spindles, we used a pentobarbital sedation solution at a subanaesthetic dose. When all of the recordings reach the stable condition under the pentobarbital-induced sedation (which usually lasts about 2 hours), the single subcutaneous injection of the saline as control condition was done and then after 20 minutes, the ketamine was subcutaneously administered as the pathological condition (Figure 2-1B).

#### 2.4. The rat somatosensory CT-TRN-TC system

The principal anatomical features and interconnected structures of the rat somatosensory cortico-reticulo-thalamocortical (CT-TRN-TC) system is shown in Figure 2-1A. The layer VI CT-TRN-TC system is a 3-neuron circuit involving the layer VI of neocortex, the GABAergic thalamic reticular nucleus (TRN) and the thalamocortical neurons of first-order thalamus (VPM and VPL cells). The cortical inputs of the first-order thalamic nuclei like the ventral posterior, VP (somatosensory), and the ventral lateral, VL (motor) originate from layer VI of the neocortex. Both the CT and the TC neurons which are reciprocally connected are glutamatergic and their principal axon crosses the TRN where it gives rise to axon collaterals. The TRN neuron is GABAergic and projects into the TC neurons of the dorsal thalamus principally through lateral inhibition. The locations of the intrathalamic recordings including the extracellular and juxtacellular recordings are in the medial part of the somatosensory ventral posterior nucleus (VPM) and TRN neurons (Figure 2-1A).

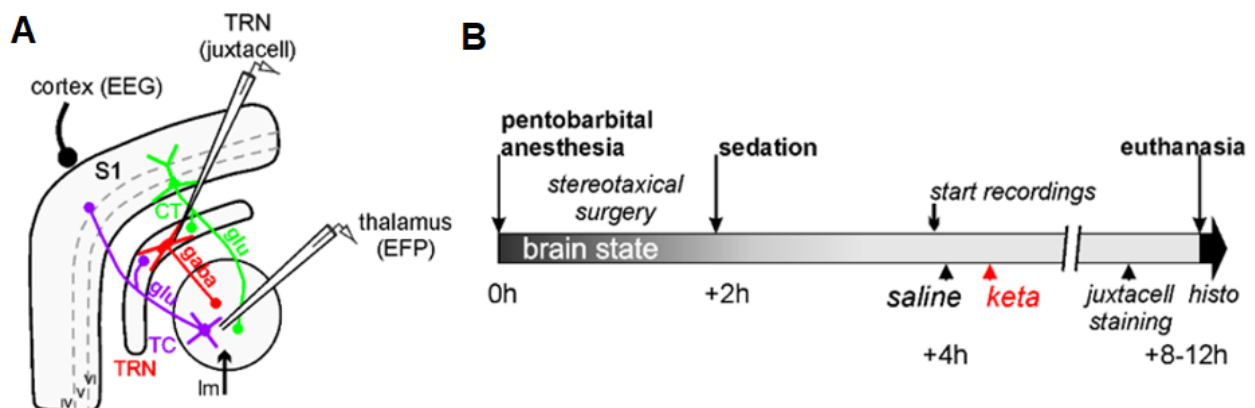

**Figure 2-1. Structure of the somatosensory CT-TRN-TC system and experimental design.** (A) Experimental design: The principal interconnected structures and anatomical features of the rat somatosensory cortico-reticulo-thalamocortical (CT-TRN-TC) system of pentobarbital sedated

rats showing the location of the intrathalamic recordings using the glass micropipettes, a sharp one (tip diameter ~ 1µm) to record juxtacellular activities in the thalamic reticular nucleus (TRN), another micropipette (tip-diameter ~5-7 µm) to record extracellular activities (field and action potentials) in a dorsal thalamic nucleus along with the EEG of the frontal cortex (s1). The extracellular and juxtacellular recording glass micropipettes contained a neuronal tracer to label the recorded neurons. Both the CT (in green) and the TC (in purple) neurons are glutamatergic (glu) and their principal axon crosses the TRN where it gives rise to axon collaterals. The TRN neuron is GABAergic (gaba) and project only into the TC neurons of the dorsal thalamus principally through lateral inhibition. **(B)** Design timeline illustrating the principal steps of the acute experiment. After anesthetizing the rat and doing the surgery, the pentobarbital-induced sedation was initiated once the rat displays first sign of recovery (reflex response to pinching the paws and EEG bouts of desynchronized state) from the deep anesthesia. The recording session started about 2 hours after the beginning of the pentobarbital-induced sedation, that is when the cortical EEG exhibits a stationary state characterized by a cycle of synchronized and desynchronized states in which the synchronized one is characterized by the recurrent long-lasting sleep-like episodes (>6 s). The color code of the brain state is dark gray for anesthesia, light gray for sedation and dark for death. keta: ketamine; histo: histology.

## 2.5. Cell-to-network recordings

To understand how a subanesthetic administration of ketamine (2.5 mg/kg) could affect ongoing sleep oscillations, in vivo electrophysiological experiments on adult male rats were performed under the pentobarbital-induced sedation. Multisite cell-to-network recordings were simultaneously performed in the somatosensory TC-TRN system along with the surface EEG of the related cortex of the pentobarbital-sedated rats, a rodent model of slow-wave sleep with spindles (Connor et al., 2003; Ganes and Andersen, 1975; Pinault et al., 2006). Three different series of experiments were conducted under the analgesic pentobarbital-induced sedation: 1- Somatosensory cortical EEG recordings (21 rats), 2- The juxtacellular TRN and extracellular TC recordings (16 rats), 3- The paired juxtacellular TRN-TC recordings (8 rats). The intrathalamic recordings were obtained along with the somatosensory cortical EEG. In addition, in an attempt to understand the cellular membrane potential oscillations underlying the firing patterns, a few experiments (3 rats) were carried out to record intracellularly TC neurons. The diameter of the micropipette tip was inferior to 1 µm (30–70 MΩ). The intracellular signal (0–6000 Hz) was acquired using an intracellular recording amplifier (NeuroData IR-283; Cygnus Technology Inc.).

The ongoing recordings were acquired for two hours which includes two 20-minute sessions before the subcutaneous single injection of ketamine (the pre-control and control



(saline) conditions) and four 20-minute sessions after the subcutaneous single injection of ketamine. All ongoing recording signals were digitized at a sampling rate of 20kHz 16-bit (Digidata 1440A with pCLAMP10 Software, Molecular Devices). To verify the location of the cell-to-network recordings performed in the somatosensory system, during the recording session, the natural-like mechanical sensory stimulation of the vibrissae was done to observe the evoked activities following the stimulation of the receptive field expecting that it activates the lemniscal (lm) inputs of the somatosensory part of the thalamus and also post-mortem histology was done after the recording session.

## **2.6. Cortical EEG recordings (21 rats)**

For the implantation of the electroencephalograph (EEG) electrodes, four small openings were drilled on the surface of the skull. Two active electrodes (recording silver wires with the diameter of 200  $\mu\text{m}$  sheathed with Teflon) were placed in contact of the internal plate of the skull, without touching and rupturing the dura, at the right and left parietal bones over the bilateral primary somatosensory cortex (from bregma: 2.3 mm posterior and 5 mm lateral) and two reference electrodes into the back cortical holes (2 mm posterior and 5 mm lateral to the lambda bilaterally). Ongoing EEG signals were processed with the band pass of 0.1-800 Hz (Cyber-Amp 380, Axon Instruments, Foster City, CA, US).

## **2.7. Preparation for intrathalamic recordings**

For deep brain recordings from the intrathalamic target regions, we used a stabilizing craniotomy and duratomy technique (developed by Pinault, 2005). A micro-cranioduratomy was performed under deep anesthesia above the somatosensory parietal cortex so that a square window (5mm x 5mm approximately) was drilled through the skull until revealing the cortical surface in order to insert the sharp recording-labelling glass micropipettes filled with a saline solution (potassium acetate, 0.5 M) and a neuronal tracer (neurobiotin, 1.5%). Since the opened area undergoes the dehydration, we used surgical sponges soaked with saline (0.9% NaCl) to keep the cranium openings hydrated (Figure 2-2). The micropipettes were clamped to the holders attached to micro-drivers (Linear piezoactuator, PI France) to move the pipettes up and down with controllable step size into the brain to reach the intrathalamic target regions. EEG electrodes made from Ag-AgCl wire were inserted into the micropipettes to have contact with the solution. These

wires were connected to an intracellular amplifier, an oscilloscope, a signal conditioner and an analog to digital converter. Then, by using these electrophysiological instruments, the recorded voltage signals were monitored and stored in a computer for being analyzed.

A stereotaxic atlas (Paxinos and Watson, 1998) was used to specify the locations of micropipettes and EEG electrodes. The accurate stereotaxic sites of the recording glass electrodes were marked on the drilled region and then small openings (< 0.8 mm in diameter) were made until the brain surface was revealed without touching the brain. The approximate locations of the intrathalamic recordings are 2.8 mm posterior to bregma, 4.2 mm lateral to bregma, 4.5 mm ventral to the dura for the recordings from TRN neurons, and 2.8 mm posterior to bregma, 2.8 mm lateral to bregma, 5 mm ventral to the dura for the recordings from the somatosensory TC neurons (the medial part of VPM cells).

## **2.8. Thalamic juxtacellular TRN and extracellular TC recordings (16 rats)**

These series of experiments (16 rats) were designed to perform juxtacellular recordings in TRN region and extracellular (field potential and single/multiunit) recordings in first-order (specific, sensory and motor circuits) thalamic nuclei, more specifically of the midline (medial dorsal), in the medial part of the ventral posterior nucleus (specific/somatosensory). The cell-to-network recordings in the first-order thalamic nuclei were done along with the EEG of the frontoparietal cortex.

To record from the intrathalamic regions, we used the glass micropipettes with different tip diameters depending on the type of recording, a sharp one (tip diameter ~ 1  $\mu\text{m}$ , resistance: 25-50 M $\Omega$ ) to record juxtacellular activities, another micropipette (semi-microelectrode, tip-diameter ~5-7  $\mu\text{m}$ , resistance: <10 M $\Omega$ ) for the extracellular recording type which can include multiunit firings (Table 2-1, Figure 2-2). The extracellular and juxtacellular signals were processed with band passes of 0.1-6000 Hz and acquired using a low-noise differential amplifier (DPA-2FL, npi electronic, GmbH).

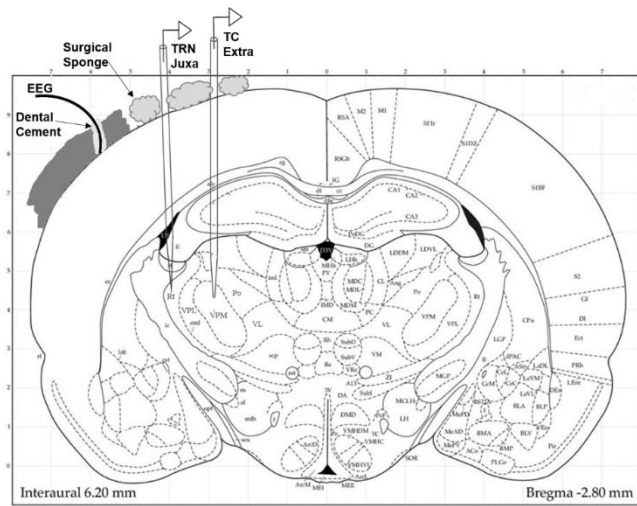

**Figure 2-2. Coronal plane of rat brain illustrating the cortical EEG and intrathalamic recording sites.**

The figure illustrates the two glass micropipettes recording from the extracellular TC neurons (a subpopulation of VPM region) and the juxtacellular TRN neuron (Rt) along with the cortical EEG. surgical sponges soaked with saline (NaCl 0.9%) are laid down on the cranium opening to keep the surgical opened area hydrated and clean. The EEG hole is surrounded by the dental cement to have the good quality of fixation and connection between the EEG electrode and the drilled hole.

## **2.9. Paired juxtacellular TRN-TC recordings (8 rats)**

Extracellular recordings of TC neurons reveal multiunit activities making it difficult to identify the firing pattern of the single TC neuron and distinguish the activity of each cell from another using the spike-sorting method. Therefore, to consolidate the ketamine-induced effects on the extracellular recordings (population activities), a third series of experiments (8 rats) consisting of paired juxtacellular TRN-TC recordings were performed in the somatosensory system. The diameter of the micropipette tip was about 1  $\mu\text{m}$  (15–30 M $\Omega$ ) (Pinault, 1996) (Table 2-1).

**Table 2-1.** The requirements of signal conditioning, tip diameter and resistance of micropipettes for different recording signals with their approximate recording locations. LparCx: Left parietal cortex; RparCx: Right parietal cortex; Juxta: Juxtacellular; Extra: Extracellular; Intra: Intracellular; L: lateral to bregma; V: Ventral to the dura.

Type & location of recording	Approximate Location (mm)	Signal conditioning (bandpass, Hz)	Tip diameter ( $\mu\text{m}$ )	Resistance ( $\text{M}\Omega$ )
LparCx EEG	2.3 P, 5 L, bilaterally	0.1-800	-	-
RparCx EEG	2.3 P, 5 L, bilaterally	0.1-800	-	-
Juxta TRN	2.8 P, 4.2 L, 4.5 V	0-6000	~ 1 – 1.5	15-30
Extra TC	2.8 P, 2.8 L, 5 V	0.1-1200	5 – 7	<10
Juxta TC	2.8 P, 2.8 L, 5 V	0-6000	~1 – 1.5	15-30
Intra TC	2.8 P, 2.8 L, 5 V	0-6000	< 1	30-70

## 2.10. Administration of ketamine and other drugs

The spontaneously-occurring activities of somatosensory CT-TRN-TC system were challenged following a single subcutaneous administration of the NMDA receptor antagonist ketamine at a psychosis-relevant dose (2.5 mg/kg).

There is accumulating evidence that ketamine acts at not only NMDA receptors but also other kinds of receptors such as dopaminergic and cholinergic receptors (Kapur and Seeman, 2002; Sleight et al., 2014). In an attempt to know whether or not the ketamine effects are due to the specific blockade of the NMDA receptors, we carried out some experiments to record the sleep-related cortical EEG oscillations following the administration of MK-801 (dizocilpine, 0.1 mg/kg, 4 rats), a more specific non-competitive antagonist of NMDA receptors, the cholinesterase inhibitor physostigmine (0.5 mg/kg, 4 rats), or the competitive dopamine D2 receptor agonist apomorphine (1 mg/kg, 4 rats) (Table 2-2). We tried to figure out which of these drugs are able to mimic the ketamine's effects. They were injected 20 minutes after saline (control) injection. In addition to the cortical EEG, the intrathalamic data were juxtacellularly recorded from TRN neurons following the administration of apomorphine and physostigmine.

Moreover, we tested clozapine which is an antipsychotic medication that is used to treat severe schizophrenia symptoms in people who have not responded to other medications. It is thought that clozapine involves a variety of receptors including dopamine and serotonin receptors (Meltzer, 1991; Meltzer, 1994; Deutch, 1995; Seeman, 2002;

Nucifora et al., 2017; Haidary and Padhy, 2020) .It has also been shown that clozapine may involve NMDA receptors via the glycine site (Lipina et al., 2005; Schwieler et al., 2008). Moreover, clozapine is well-known to modulate sleep spindles (Tsekou et al., 2015). Therefore, we performed experiments to investigate how ketamine acts under the clozapine condition.

Each drug was administered based on the purpose of each experiment that was unique to that animal. The drugs used in the present study are briefly described in Table 2-2 in terms of their brain targets, applications and effects. Each drug was subcutaneously administered only once at a certain dosage (Table 2-3).

**Table 2-2.** Description of different substances used in this study under the pentobarbital-induced sedation.

Substance	Description
<b>Ketamine</b>	NMDA receptor antagonists; producing transient psychotic symptoms in healthy adults (Krystal et al., 1994); as a model for schizophrenia (review: Frohlich et al., 2014); starting and maintaining anesthesia; dissociative hallucinogens (Kohrs et al., 1998); analgesics; antidepressants (Browne et al., 2013), a trance-like state while providing pain relief, sedation, and memory loss; As an agonist of dopamine D2 receptors (Kapur et al., 2002).
<b>Mk801</b> (Dizocilpine)	A noncompetitive antagonist of the NMDA receptor (Huettner et al., 1988); preventing the flow of ions, including calcium (Ca <sup>2+</sup> ), through the channel of NMDARs; a potent anti-convulsant; inhibition of the induction of long term potentiation (Coan et al., 1987); used in research in creating animal models of schizophrenia (Rung et al., 2005; Eyjolfsson et al., 2006)
<b>Apomorphine</b>	A non-selective dopamine agonist which activates both D2-like and, to a much lesser extent, D1-like receptors (Youdim et al., 2000); used in the treatment of Parkinson's disease (Chaudhuri et al., 1998)
<b>Physostigmine</b>	A covalent inhibitor of acetylcholinesterase, the enzyme responsible for the breakdown of acetylcholine in the synaptic cleft of the neuromuscular junction; enhancement of the transmission of acetylcholine signals; used to treat glaucoma and delayed gastric emptying (Scheindlin S, 2010).
<b>Clozapine</b>	An atypical second generation antipsychotic medication; an antagonist at the 5-HT <sub>2A</sub> subunit of the serotonin receptor, putatively improving depression, anxiety, and the negative cognitive symptoms associated with schizophrenia (Essali et al., 2009); it binds to serotonin as well as dopamine receptors; Clozapine induces the release of glutamate and D-serine, an agonist at the glycine site of the NMDA receptor, from astrocytes (Tanahashi et al., 2012). Clozapine prevents impaired NMDA receptor expression caused by NMDA receptor antagonists (Xi et al., 2011); A direct interaction of clozapine with the GABA <sub>B</sub> receptor has also been shown (Wu et al., 2011).

**Table 2-3.** Number of experiments with the type and location of recordings performed using different substances administered under the pentobarbital-induced sedation. Cx EEG: Cortical EEG; Juxta: Juxtacellular, Extra: Extracellular; Intra: Intracellular.

<b>Substance (dosage)</b>	<b>Number of experiments</b>	<b>Type and location of recordings</b>
Ketamine (2.5 mg/kg)	21	Cx EEG
Ketamine (2.5 mg/kg)	16	Cx EEG Juxta TRN, Extra TC
Ketamine (2.5 mg/kg)	8	Cx EEG Paired juxta TC-TRN
Ketamine (2.5 mg/kg)	3	Cx EEG Intra TC
Ketamine (80 mg/kg)	3	Cx EEG
Mk801 (0.1 mg/kg)	4	Cx EEG
Apomorphine (1 mg/kg)	2	Cx EEG
Apomorphine (1 mg/kg)	2	Cx EEG Juxta TRN
Physostigmine (0.5 mg/kg)	2	Cx EEG
Physostigmine (0.5 mg/kg)	2	Cx EEG Juxta TRN
Clozapine (5 mg/kg)	5	Cx EEG
Ketamine (2.5 mg/kg) under clozapine (5 mg/kg)	5	Cx EEG

## 2.11. Identification of recording sites

We used a single-cell labeling method to identify the anatomical location and morphology of the extracellularly and juxtacellularly recorded thalamic neurons. Neurobiotin as a histochemical marker was electrophysiologically used in this method (Pinault, 1996). At the end of recording sessions, to identify formally both the location of recording regions and the structure of the recorded neurons, histologically, the target neurons were individually labeled with Neurobiotin using the extracellular or juxtacellular

tracer nano-iontophoresis technique (Pinault, 1996). This technique was applied only in the last recorded neurons. After the juxtacellular labeling of the recording regions, the rat was humanely killed with an intravenous overdose of pentobarbital. At this point, the process of histology was started according to the standard histological techniques.

The rat was then transferred from the stereotaxic frame to the fume hood and was transcardially perfused with a fixative containing 4% paraformaldehyde in 10 mM phosphate buffer saline. Then, the brain tissue was processed using standard histological techniques for anatomical documentation. For identifying the recording sites and for retrieving the tracer-filled neurons, the coronal brain slices were examined with a light microscope (E600, Nikon France). Finally, the anatomical location of the labeled regions was verified by referring to a stereotaxic rat brain atlas (Paxinos and Watson, 1998).

## **2.12. Data analysis**

After data acquisition and being sure that the recordings were done from desired regions (subpopulations and neurons), we then applied three different ways to analyze the obtained data consisting the qualitative, quantitative, and statistical analyses. For qualitative analysis, we were able to scrutinize the in vivo electrophysiological recorded data over the 120-minute recording session using the Axon software (Clampex, AxonInstruments). Slow oscillations including sleep spindles could easily be identified by visual inspection of the recorded EEG and network signals. For quantitative investigation, data analyses were performed with the software packages Clampfit v10 (Molecular Devices) and SciWorks v10 (Datawave Technologies).

For the quantitative analysis, spectral analysis of EEG and network oscillations was performed with fast Fourier transformation (FFT, 2-Hz resolution). The power of baseline activity was analyzed in 6 frequency bands: delta-(1–4 Hz), theta-(5-9 Hz), sigma-(10–16 Hz, spindles), beta-(17-29 Hz), gamma-(30–80 Hz), and higher-(81–200 Hz) frequency oscillations. For each band, the total power was the sum of all FFT values. The time course of the power of ongoing activity was measured over two-hour recording including the pre-control and control 20-minute sessions before the drug injection and four 20-minute sessions after the drug injection. The time course of the power was used to obtain the power histograms which are illustrating the drug-induced percent changes at the mean power of 10-min duration of post-injection condition relative to that of the 10-min duration

of saline (control) condition. Mean power histograms were separately obtained for each of the six frequency bands.

To investigate the firing pattern of the juxtacellularly-recorded TC and TRN cells, the density (number per minute) of high-frequency bursts (hfBursts) and single action potentials (sAPs) were obtained for the duration of two-hour recordings including before and after the drug injection. The density is the sum of bursts or sum of single APs occurring in one minute of recording. By detecting the sum of bursts and single APs per minute over two-hour recording, we were capable of monitoring and comparing the firing pattern of the juxtacellularly recorded cell before and after the single administration of a drug, e.g. the ketamine. To calculate the density, a procedure of spike detection and Inter-AP interval analysis were used. In single-unit juxtacellular recordings, high-frequency bursts (hfBursts) were identified based on a voltage threshold and an inter-AP interval inferior to 4 ms. Single action potentials (APs) were detected using a voltage threshold and an inter-AP interval superior to 10 ms. A TC or TRN burst had a minimum of 1 inter-AP interval. In addition to the density of single APs and of hfBursts, Standard inter-AP interval (resolution 1 ms) histograms (IAPH) and autocorrelogram histograms were computed. To apprehend the time relationship between the network or cellular gamma waves and the cellular firing of a single TC or TRN neuron, gamma waves were detected using a 25-55 Hz filter to create a peri-event (gamma wave) time histogram (PETH) of the TC or TRN firing.

The density of hfBursts and single APs were also obtained from the extracellular recordings. Given that the extracellular recording reflects multiunit activities, to identify clusters of APs based on of their waveform attributes including the amplitude of the spike and valley components, a multi-dimensional clustering analysis was applied using an automatic spike sorting tool from SciWorks.

Each drug effect was measured relative to the vehicle condition with each rat being its control. For statistical analysis, the Student's paired t-test (significant when P-value  $\leq 0.05$ ) was measured to evaluate the statistical significance of the observed effects, specifically to know how significant is the difference between two conditions before and after injection of a certain substance, e.g. the ketamine.



## Chapter 3

---

### 3. Results

#### 3.1. The analgesic pentobarbital-induced sedation as a model of non-REM sleep

The pentobarbital containing regimen at a light anesthetic dose promoted the incidence of sleep-like activities including spindles and slower oscillations in both cortex and thalamus. About two hours after the onset of the continuous infusion of the pentobarbital containing regimen, when all of the signals reach to a stable condition so that the on-line spectral analysis revealed a stationary amount of spindles and slower oscillations, the recordings started (Figure 3-1). They were qualitatively similar to those recorded during the natural non-REM sleep (Ahnaou et al., 2017; Hakami et al., 2009; Pinault, 2008).

In the pentobarbital-sedated rat, the spontaneously-occurring recording signals under the control (saline) condition revealed that the frontoparietal cortical EEG and the extracellular field potential (EFP) of a thalamic subpopulation of TC neurons are associated with sleep activity patterns which are characterized by theta-frequency (5-9 Hz) oscillations and spindles (intra-frequency: 10-16 waves/s) (Figure 3-1). Juxtacellular recordings of TRN cells rhythmically exhibited a series of robust high-frequency bursts of action potentials (7 to 15 APs at 200-700 Hz) (Figure 3-1B, E). The burst mode of TRN neuron usually starts with 2-3 bursts at the theta-frequency band and then they are followed by several bursts (5-8 bursts) at the spindle-frequency band (Figure 3-1). This result is consistent with the previous experimental studies showing that in TRN cells, a typical intracellular spindle is characterized by a series of rhythmic (10-16 Hz) high-frequency bursts (hfBursts;  $n = 7-13$  APs) superimposed on a depolarizing envelope (Mulle et al, 1986; Steriade et al, 1993; Pinault et al, 2006).

Sleep activity patterns of the ongoing EEG and thalamic EFP are concomitant with the rhythmic high-frequency burst activity in juxtacellularly-recorded TRN cell (Figure 3-1), which may be an indication of the synchrony and strong connectivity of these somatosensory regions as a loop circuit.

Time-Frequency spectral analysis of the 32-second representative traces of cortical EEG and of extracellular thalamic recording shows the presence of the sleep-like episodes in which sleep oscillations were identifiable as soon as the traces contained rhythmic, medium- to high-amplitude (>0.1 mV) EEG/network waves occurring in a frequency band of 1-16 Hz, including delta, theta- and sigma-frequency oscillations (spindles) which appear concomitantly in both the cortex and the thalamus (Figure 3-1C). The mean power spectra under the control condition indicates the high appearance of sleep-like activity patterns under the analgesic pentobarbital-induced sedation (Figure 3-1D).

Overall, the qualitative and quantitative analyses of the multisite cell-to-network spontaneously-occurring recordings revealed that the analgesic pentobarbital-induced sedation set the somatosensory CT-TRN-TC system in a state that sleep-like activities are remarkably produced and electrophysiologically corresponds to the non-REM sleep in which delta- and theta-frequency oscillations and spindles significantly occur (Figure 3-1). This result is also consistent with previous studies indicating the somatosensory 3-neuron layer VI CT-TRN-TC circuit as the principal leading circuit in the generation of spindles (Pinault, 2004; Steriade et al., 1985; Steriade et al., 1993). Therefore, we propose that the pentobarbital-induced sedation may be considered as a rodent model of non-REM sleep that provides an appropriate experimental condition for being challenged by the NMDA receptor antagonist ketamine in order to investigate its effect on the firing and oscillatory behavior of the somatosensory CT-TRN-TC system of the sedated rat.

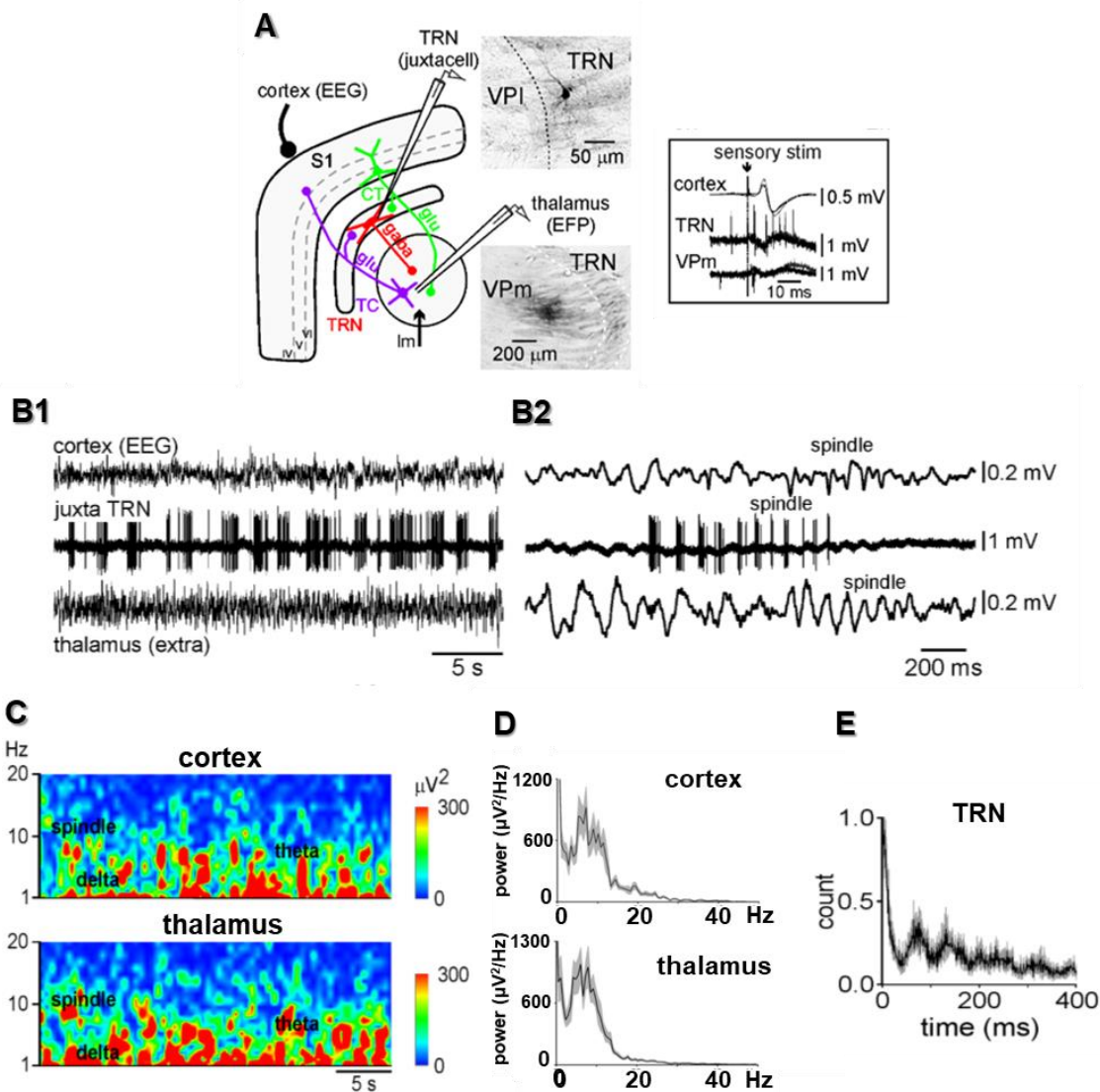

**Figure 3-1. Sleep-like activity patterns under the analgesic pentobarbital-induced sedation.**

(A) The principal interconnected structures and anatomical features of the rat somatosensory cortico-reticulo-thalamocortical (CT-TRN-TC) system of pentobarbital sedated rats showing the location of the intrathalamic recordings using the glass micropipettes, a sharp one (tip diameter ~ 1  $\mu\text{m}$ ) to record juxtacellular activities in the thalamic reticular nucleus (TRN), another micropipette (tip-diameter ~5-7  $\mu\text{m}$ ) to record extracellular activities (field and action potentials) in a dorsal thalamic nucleus along with the EEG of the frontal cortex (s1). The hodology of the somatosensory 3-neuron CT-TRN-TC circuit is also shown. The extracellular and juxtacellular recording glass micropipettes contained a neuronal tracer to label the recorded neurons. The identity of the recorded neurons was established following juxtacellular labeling (Pinault, 1996). The natural-like mechanical sensory stimulation of the vibrissae was used to identify the receptive field which activates the lemniscal (Im) inputs of the somatosensory part of the thalamus (medial part of the VPm). In the frame is shown the functional identification of the recorded somatosensory neurons at the beginning of the recording session, that is, short-latency sensory-evoked activities simultaneously recorded in the cortical EEG and in thalamic relay (VPm) and reticular (TRN) neurons. (B1-B2) A 32-s trace recorded in a pentobarbital sedated rat. Both the cortical EEG and

the thalamic extracellular activities are prominently synchronized. During this synchronized state, the TRN cell fires rhythmic high-frequency bursts of APs at the delta- (1-4 Hz), theta- (5-9 Hz) and spindle- (10-16 Hz) frequency bands. **(B2)** A short-lasting trace showing spindle network (Cx EEG and thalamus extracellular) and cellular (TRN) activities. **(C)** Time-frequency spectral analysis of the 32-s cortical and thalamic records (resolution: 1 Hz, hamming, 50% overlap) of the B1 trace. This analysis shows that the recordings are associated with the sleep-like episodes which are characterized by theta-frequency (5-9 Hz) oscillations and spindles which appear almost simultaneously in both the cortex and the thalamus. **(D)** Spectral analysis of the cortical EEG (top) and of the thalamic extracellular activities (bottom) recorded under the saline conditions, indicating pentobarbital sedation as a producer of low-frequency sleep-like activities, reminiscent of non-REM sleep. Each value is a grand average ( $\pm$ SEM) from 6 rats, each rat being its own control (per value: 23 epochs of 2 s/rat (hamming, resolution: 0.5 Hz)). **(E)** Averaged autocorrelogram (resolution: 1 ms, from ten 2-s traces  $\pm$ SEM in grey) of the firing of a representative juxtacellularly-recorded TRN neuron. The autocorrelation analysis reveals the 9-16 Hz rhythmicity during the saline condition, confirming the highly rhythmic nature of the bursty discharge of juxtacellularly recorded TRN. S1= The primary somatosensory cortex, juxtacell = juxtacellular recording, EFP: extracellular field potential, VPm: the medial part of the somatosensory ventral posterior nucleus; TRN= Thalamic reticular nucleus, keta= ketamine, extra= extracellular, histo = histology.

### **3.2. Ketamine reduces sleep-like activity patterns and amplifies high-frequency oscillations in both cortex and thalamus**

After a single subcutaneous administration of ketamine (2.5 mg/kg), not a single slow-wave sleep episode was observed during the recording session in all ketamine-treated rats (Figures 3-2 and 3-3). From about 5 minutes after the single injection of ketamine at the psychosis-relevant dose (2.5 mg/kg), the pattern of the cortical and thalamic baseline sleep activities was dramatically reduced in amplitude so as the synchronized state in the control condition was supplanted by a more desynchronized pattern (Figure 3-2).

The exclusive advantage of analyzing the time course of the power of neural oscillations (Figure 3-3) is that it enables us to follow precisely the variations of power of each distinct frequency band over time for two-hour recording period before and after the subcutaneous administrations of ketamine. We can observe how long the effect of ketamine lasts and how its effect rises and decays during the recording time. The ketamine effects, observed in all recorded regions ( $n \geq 5$  rats/region), were transient (peaking at 15–20 min) and a partial recovery appeared at ~60-80 minutes after the systemic administration of ketamine (Figures 3-2 and 3-3). Statistical analysis using T.TEST (Figure 3-3, right) showed the significance of the ketamine's effect, the transience and partial recovery of its effect as well (Figure 3-2 and 3-3). Indeed, ketamine transiently and significantly decreased the power (synchronization index) of pentobarbital-induced

sleep-like low-frequency oscillations including spindles and delta-frequency oscillations in both cortex and thalamus (Figures 3-3 and 3-4). It also decreased the amount of theta-frequency (5–9 Hz) oscillations (Figures 3-3 and 3-4), a CT theta activity that is a hallmark of drowsiness (Pinault et al., 2001). Concomitantly, ketamine transiently and significantly increased the power of ongoing high frequency oscillations including beta-, gamma- and higher-frequency oscillations in both cortical EEG and thalamic EFP recorded from the sedated rat. These findings show that ketamine prevented the occurrence of natural sleep during at least the 80-min recording sessions. The arousal promoting effect of a single psychotomimetic dose of ketamine has already been well documented in awake, free-behaving rats, indicating that they were abnormally hyperactive with stereotypies and ataxia, and their cortex transiently displayed a remarkable increase in the power of high frequency oscillations (Ahnaou et al., 2017; Hakami et al., 2009; Pinault, 2008). This validates and supports our current results.

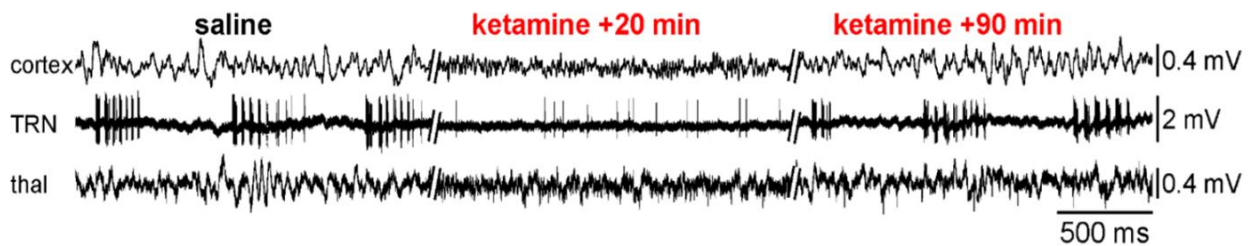

**Figure 3-2. ketamine transiently prevented the occurrence of natural sleep in the somatosensory CT-TRN-TC system.**

Typical simultaneous recordings of the S1 cortex (EEG), the somatosensory TRN (single-unit juxtacellular configuration) and related thalamus (extracellular configuration). Under the saline (control) condition, both the cortex and the thalamus (thal) exhibit a synchronized state, characterized by the occurrence of low-frequency (1-16 Hz) oscillations, including spindles, and the TRN cell exhibits three series of rhythmic robust hfBursts of action potentials (300-500 APs/s). Under the ketamine condition (here, 20 minutes post-ketamine injection), the TC system displays a more desynchronized state, characterized by the prominent occurrence of faster activities (>16 Hz), which include gamma-frequency oscillations, and the TRN cell fires more in the single AP mode than in the burst mode. Ninety minutes after the subcutaneous administration of low-dose ketamine, the sleep state of the TC system is back in the CT-TRN-TC system.

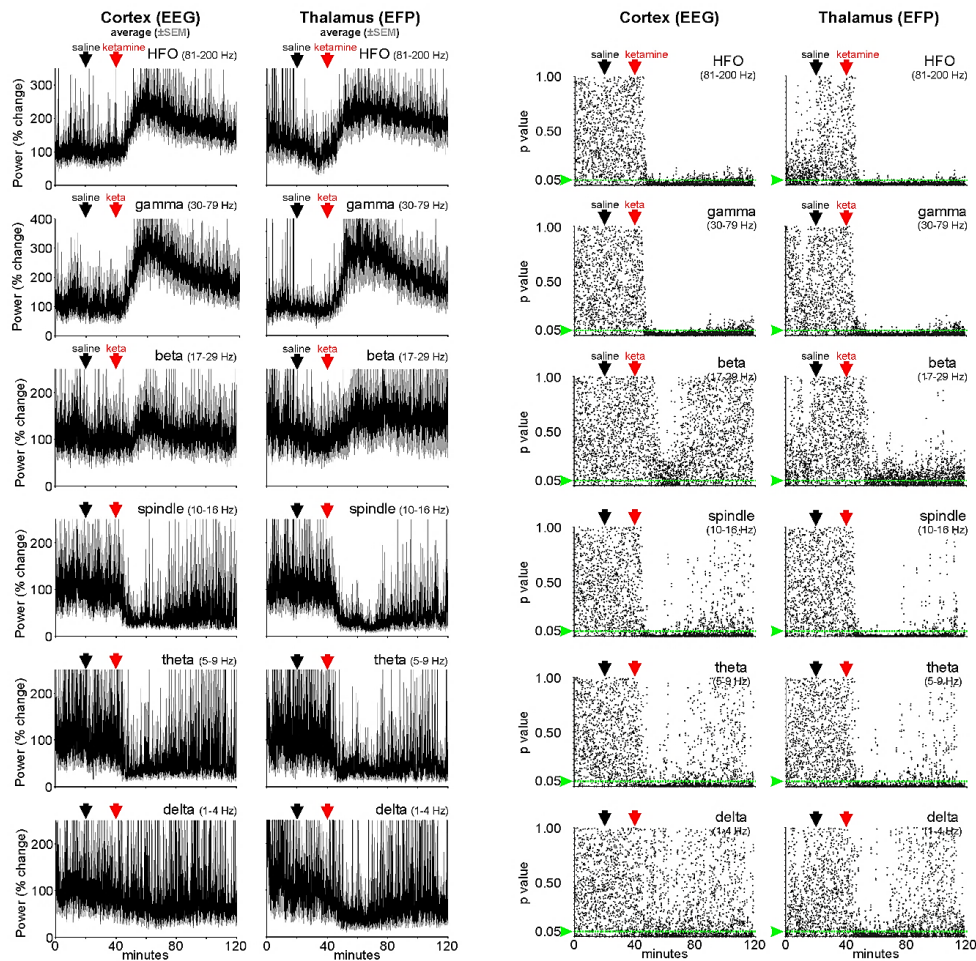

**Figure 3-3. Ketamine significantly decreases the power of sleep-like oscillations including spindles and slower oscillations, and increases that of high-frequency oscillations including gamma oscillations in the somatosensory thalamocortical system.**

**(Left)** Time course of the power (% change relative to the saline condition, grand average from 7 rats with simultaneous cortical and thalamic recordings) of neural oscillations before and after the subcutaneous administrations of saline (at 20 min) and ketamine (at 40 min), showing that the ketamine transiently reduces low-frequency oscillations including delta, theta and spindle oscillations and conversely, amplifies the high-frequency oscillations, including beta, gamma and higher oscillations. **(Right)** Each dot is a Student's paired t-Test (one test ketamine relative to saline (100%) every 2 seconds). The 100% corresponds to the average of all the values ( $n=300$  per rat) obtained during the 10 min period that precedes the ketamine administration. The p-value 0.05 is indicated by the green line. The smaller the p-value, the higher the significance. The slight recovery starts at ~50-80 minutes after the systemic single administration of ketamine. HFO, higher-frequency oscillations; EFP: Extracellular field potential.



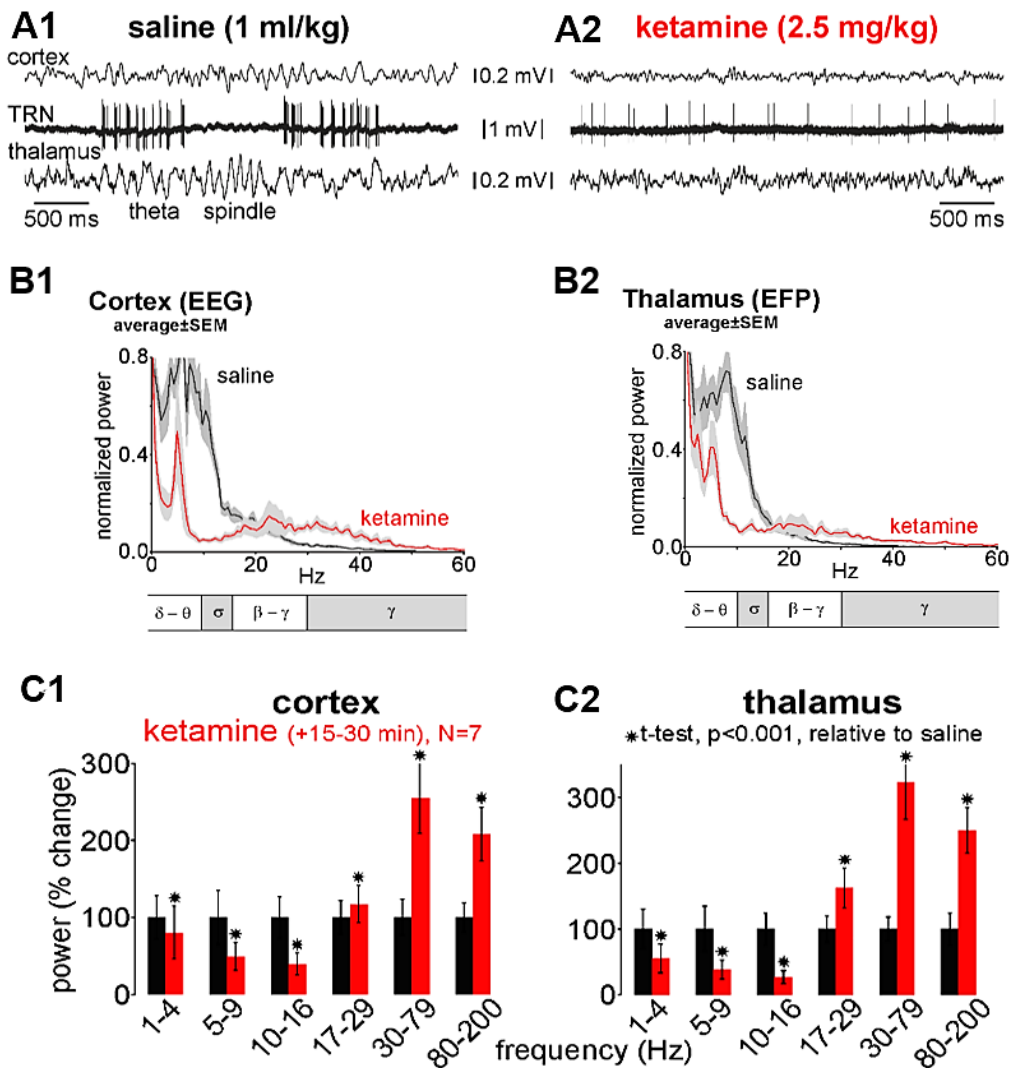

**Figure 3-4. Ketamine reduces sleep-related oscillations including spindles in the thalamocortical system.**

**(A1)** Under the saline (control) condition, the cortex and the dorsal thalamic nuclei exhibit a synchronized state, characterized by the occurrence of low-frequency (1–16 Hz) oscillations, including spindles. **(A2)** Under the ketamine condition, the TC system displays a more desynchronized state, characterized by the prominent occurrence of fast activities (>16 Hz), which include gamma-frequency oscillations. And the TRN cell fires more in the single AP (sAP) mode than in the hfBurst mode. Spectral analysis of the cortical EEG **(B1)** and of the thalamic extracellular activities **(B2)** recorded under the saline (black) then the ketamine (red) conditions. Each value is a grand average ( $\pm$ SEM) from 6 rats, each rat being its control (per value: 23 epochs of 2 s/rat (hamming, resolution: 0.5 Hz)). This shows that under the ketamine effect, the power of low frequency oscillations including spindles is decreased and the power of the high frequency oscillations including gamma is increased. The power spectrum histograms of the ketamine effect on the whole spectrum of the cortical **(C1)** and thalamic **(C2)** oscillations show that ketamine significantly decreases the power of low frequency oscillations including delta, theta and spindles and significantly increases the high frequency oscillations including beta, gamma and higher frequency oscillations in both cortex and thalamus. Each column is the average power of period

of 10 minutes in both saline and ketamine conditions (N=7). In the ketamine condition, this 10-min period was taken from the time course between 15 to 30 minutes after the beginning of ketamine administration. EFP: extracellular field potential, keta= ketamine.  $\delta$ = delta,  $\theta$ = theta,  $\sigma$ = sigma,  $\beta$ = beta,  $\gamma$ = gamma.

### **3.3. The psychotomimetic ketamine switches the firing pattern of both TC and TRN neurons from burst mode to tonic mode**

#### **3.3.1. Thalamic relay**

The extracellular recordings performed in the somatosensory thalamus revealed the field potential oscillations and, in most instances, multiunit activities (Figure 3-5). From 11 extracellular thalamic recordings, 6 (from 6 rats) contained at least two TC units that were identified using an automated spike sorting procedure (Figure 3-5). During the sedation, the extracellularly recorded TC units presented an irregular firing pattern consisting in hfBursts and single APs (Figure 3-5A).

The firing density in the extracellularly recorded TC neurons is much smaller than that of the juxtacellularly recorded TRN cells and it was extremely rare to see series of rhythmic hfBursts at the spindle frequency, making it difficult to identify the TC spindle-frequency firing patterns. Therefore, we predicted that the AP-free periods in the TC extracellular field potential recordings contained subthreshold membrane potential oscillations in the spindle frequency range (Pinault et al., 2006). This was demonstrated by the dual juxtacellular TRN-TC recordings (Figure 3-6A1) and by the intracellular recordings of TC neurons (Figure 3-6D).

By calculating the density (the sum of bursts per minute or the sum of single APs per minute) over two-hour recording, we were capable of monitoring and comparing the firing pattern of the extra- or juxtacellularly recorded cells before and after the single administration of the ketamine. From ~5 min after the ketamine administration (16 TC units from 6 rats), the density of hfBursts significantly decreased whereas that of single APs increased for at least 60 min (Figure 3-5B), meaning that ketamine switches the firing pattern of multiunit recording TC cells from burst mode to tonic mode. Although in this type of recording the data comes from the total activity of several neurons, its result might reflect the general behavior of thalamic relay neurons.

The spike sorting method may not be precise and reliable as the amplitude and shape of the APs might not be stationary over time (Lewicki, 1998) making it difficult to identify the firing pattern of each single TC neuron and distinguish its activity from another.



For instance, in TC hfBursts, the AP amplitude became progressively smaller (Figure 3-5A). In addition, extracellular TC recordings sometimes detected the firing of TRN axons passing close to the electrode, the TRN Bursts being well distinguishable from the TC bursts (Pinault et al, 2001). Therefore, to better validate the ketamine effects observed in the extracellular TC recordings, we performed dual juxtacellular recordings of thalamic relay and reticular neurons.

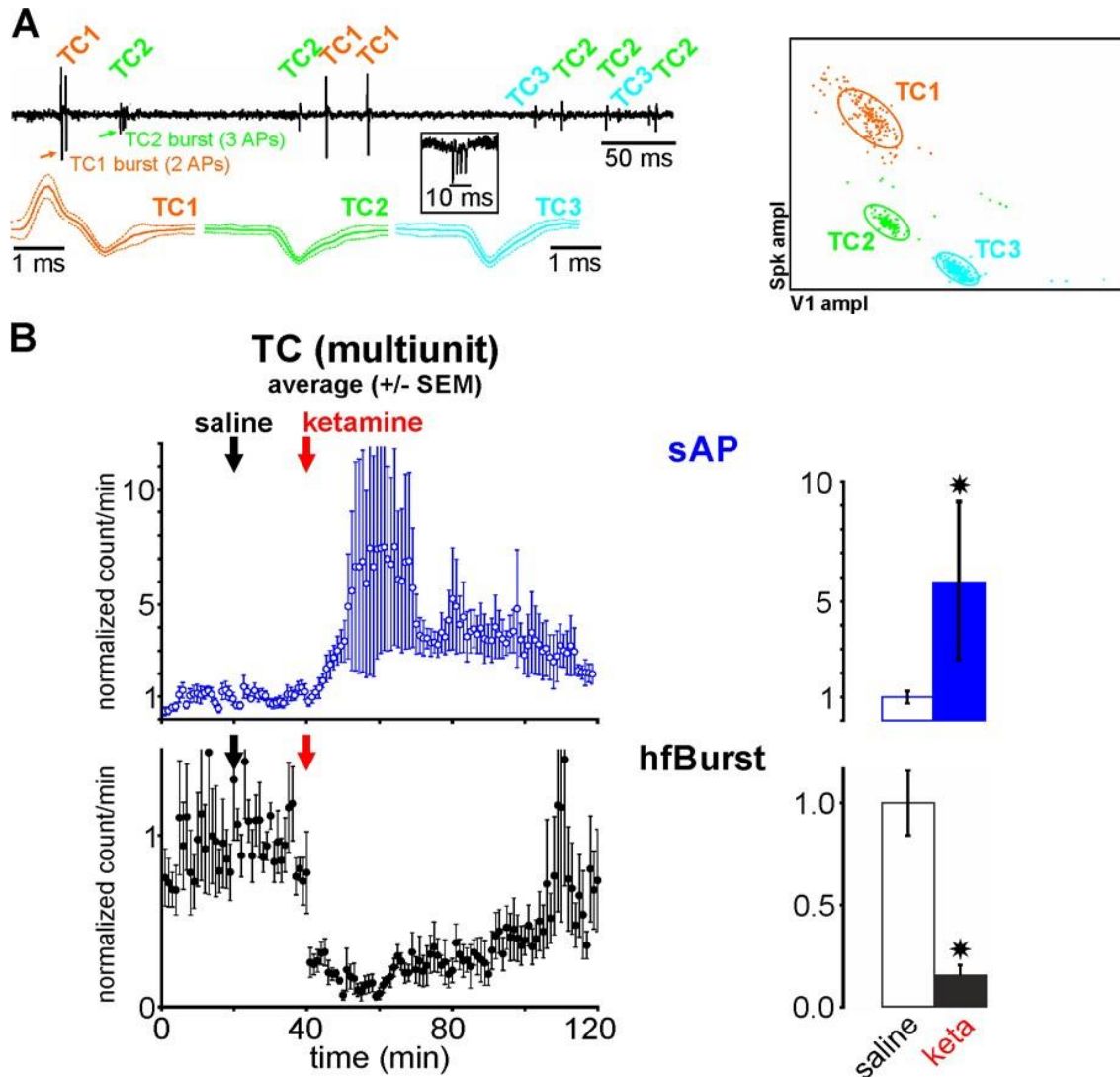

**Figure 3-5. Ketamine decreases the hfBurst density and increases the single AP (sAP) density in extracellularly recorded thalamocortical (TC) neurons.**

(A) A typical example of a spike sorting of 3 TC cells (TC1, TC2 and TC3) from an extracellular multiunit recording. In the recording bout (high-pass filter cut at 100 Hz), the three TC cells are visually well distinguishable, TC1 exhibiting a hfBurst of 2 APs then sAPs, TC2 a hfBurst of 3 APs then sAPs, and TC3 only sAPs. A typical extracellular hfBurst is shown in the frame. The mean $\pm$ SD of 50 APs of the three detected TC neurons are shown. Three clusters are well identified on the basis of the amplitude of the spike and valley components (spk ampl and V1 ampl, respectively) of the APs. (B) Grand average ( $\pm$ SEM, N=16, from 6 rats) of the relative changes of the density

(normalized count per minute, 1 being the control value under the saline condition) of the sAPs and of the hfBursts. Ketamine administration at the psychosis-relevant dose (2.5 mg/kg, red arrow at 40 min) significantly led to a transient increase in the density of sAPs (blue) and a transient reduction in the density of hfBursts (black) relative to the saline condition (N=5). On the right, the histograms show the average values corresponding to 20-40 minutes ketamine postinjection. The histograms illustrate that the decrease of hfBursts and the increase of sAPs in the multiunit ongoing recordings of TC neurons are largely significant. Asterisk when significant (paired t-test,  $p < 0.01$ ).

The juxtacellular single-unit recording-labeling technique allows the formal identification of the recorded neuron (Figure 3-6A1, B1, C1) (Pinault, 1996). Five out of 8 dual juxtacellular TC-TRN recordings (5 rats) had a duration long enough for data analyses under control and ketamine conditions.

Occurrence of hfBursts in the juxtacellular recordings of TC neurons is many less than TRN's. In spite of this, even in TC neuron, ketamine, transiently and significantly, decreased the density of TC hfBursts and increased that of single APs. The single APs are explosively increased so that they occur about 6 times more than their occurrences in the control (saline) condition (Figure 3-6 and 3-3A1, A2 and B3). However, the hfBurst density was reduced about 50%, meaning that AP bursts still occurred under the ketamine condition. These remaining AP bursts under the ketamine condition were not as robust as typical hfBursts under the control condition, meaning that the number of APs per burst and the inter-AP interval are reduced and increased, respectively (Figure 3-7A). These remaining bursts which are embedded in the irregular tonic AP trains, a lot of them were doublets and triplets, whose intrafrequency was lower (inter-AP interval peak at 5–6 ms, Figure 3-7A1, A2) than that of typical hfBursts (interval peak at 2–3ms, Figure 3-7A1). A partial recovery was noticeable 60–80 min after the ketamine administration (Figure 3-5B and Figure 3-6B3). Of importance, ketamine increased the firing frequency band of TC neurons from, on average, 5–20 Hz ( $10.8 \pm 2.9$  Hz, N = 5 from 5 rats) to 15–30 Hz ( $21.7 \pm 3.5$  Hz, N = 5) (Figure 3-6E).

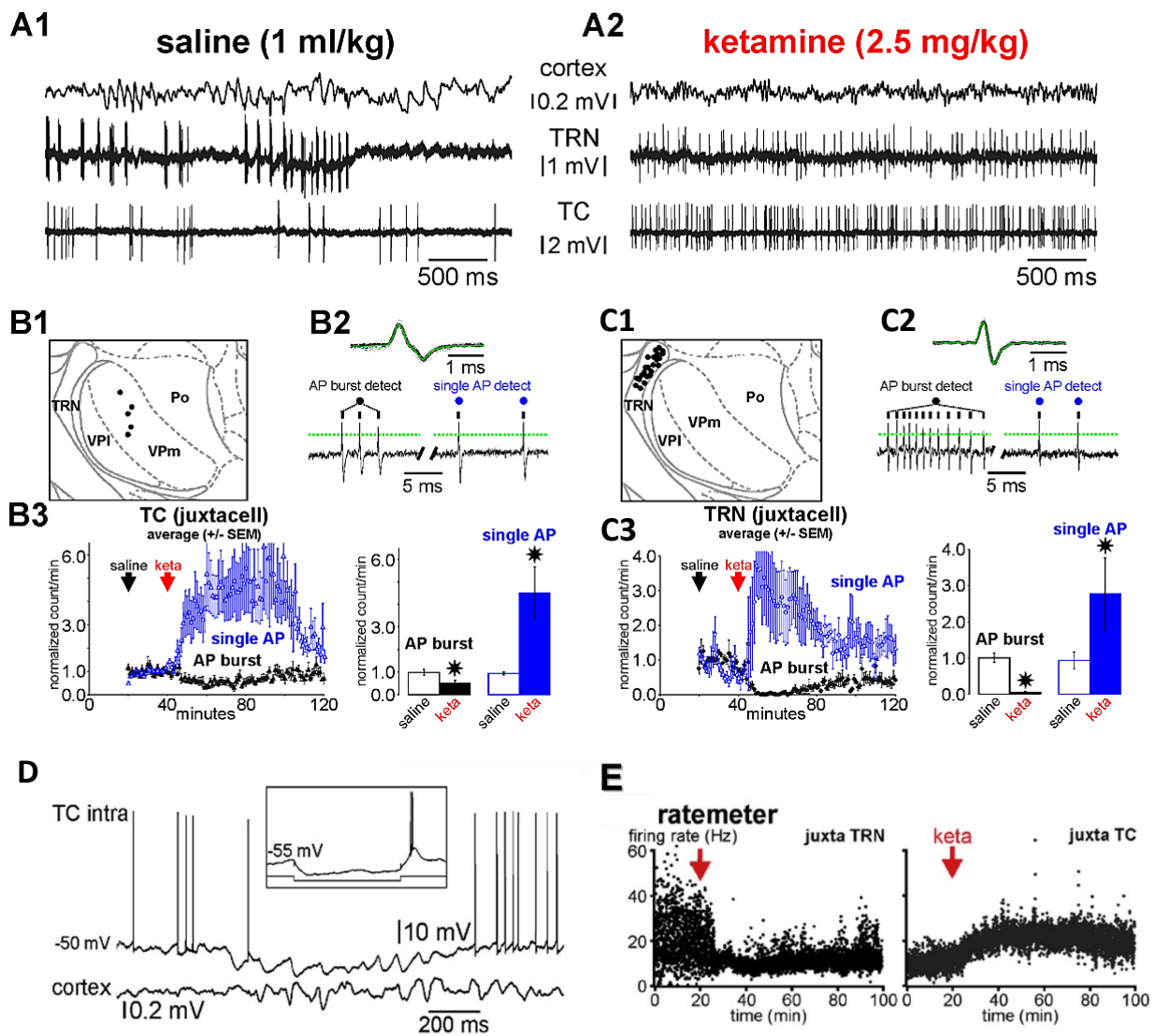

**Figure 3-6. Ketamine switches the firing pattern from a burst mode to a single action potential mode in thalamic relay (glutamatergic) and reticular (GABAergic) neurons.**

**(A1, A2)** Typical simultaneous recordings of the cortex (EEG), and of two single TRN and TC neurons (juxtacellular configuration) of the somatosensory system. Under the saline (A1, control) condition, the cortex displays a synchronized state, characterized by the occurrence of medium-voltage ( $>0.1$  mV) low-frequency (1–16 Hz) oscillations, the TRN cell exhibits a typical series of rhythmic robust hfBursts of action potentials (hfBursts, 300–500 APs/s), and the TC neuron exhibits single action potentials (sAPs) and, during the TRN burst series, a few bursts. A few minutes after the systemic administration of ketamine (A2, here: +20 min), the cortex displays a more desynchronized state, characterized by the prominent occurrence of lower voltage ( $<0.1$  mV) and faster activities ( $>16$  Hz), which include gamma-frequency oscillations. Under the ketamine condition, both the TC and the TRN cells exhibit much more sAPs than hfBursts. **(B1, C1)** The stereotaxic location of intrathalamic recordings. The black dots show the anatomical locations of juxtacellularly recorded TC of the somatosensory thalamus and TRN neurons. **(B2, top)** Average and superimposition of 50 action potentials. **(B2, below):** Detection (from a voltage threshold, indicated by a green dotted line) of a typical hfBurst of 3 APs and of 2 successive single APs.

Detected as a burst (black dot) if interval is less than 5 ms, otherwise as a single APs (blue dots). **(B3)** The density (number per minute,  $\pm$ SEM, 5 TC cells from 5 rats) of hfBursts and of sAPs under the saline and ketamine conditions. Paired t-test (star when  $p < 0.05$ ). **(C2, below):** Detection (from a voltage threshold, indicated by a green dotted line) of a typical hfBurst of 12 APs and of 2 successive single APs. **(C3)** The density (number per minute,  $\pm$ SEM, 5 TRN cells from 5 rats) of hfBursts and of sAPs under the saline and ketamine conditions. Paired t-test (star when  $p < 0.05$ ). **(D)** Representative trace of an intracellularly recorded TC neuron showing the occurrence of subthreshold oscillations, including spindle-frequency rhythmic waves, which are concomitant with a synchronized EEG state in the related cortex. Note that the subthreshold oscillations occur during the through of a long-lasting hyperpolarization. In the frame is shown the occurrence of a low-threshold potential topped by a high-frequency burst of APs (hfBurst) at the offset of a 200-ms hyperpolarizing pulse. **(E)** Ratemeter of simultaneously juxtacellularly recorded TRN and TC neurons under saline then ketamine conditions. Each dot is the average ( $n = 5$  neurons from 5 rats) of the number of inter-AP intervals per second.

Curiously, under the ketamine condition, the mean firing frequency of TC neurons ( $< 30$  Hz) was lower than the network gamma-frequency oscillations (frequency at maximal power:  $33.6 \pm 1.1$  Hz,  $n = 7$ ), raising the question whether or not TC single APs were related to the juxta- and extracellular gamma oscillations. In an attempt to address this question, we first looked at the raw juxtacellular recordings, in which we notice that TC neurons did not emit an AP at every wave of the gamma oscillations, which were not perfectly regular in waveform and timing (Figure 3-7B1), suggesting that the juxtacellular field potential variations reflected more membrane potential oscillations than APs.

Secondly, a substantial number of single APs were phase-related to both the juxtacellular and the extracellular gamma waves (Figure 3-7B2). However, the temporal link was stronger with the juxtacellular (cellular activity) than the extracellular (nearby network activity) wave. In contrast to layer-organized cortical structures, the weak relation between the juxtacellular APs and the extracellular gamma waves seen in the somatosensory thalamus might have been due to an anarchic overlap of the current sinks and sources generated by the neural activities. On the other hand, there was no apparent relation between the TC firing and the cortical gamma waves (Figure 3-7B2), which is not surprising as the EEG integrates the activities of interweaved large-scale networks.

### 3.3.2. TRN

During sedation, all juxtacellularly recorded TRN cells exhibited sequences of rhythmic hfBursts in relation to the sleep TC oscillations (Figure 3-6A1). The burst sequence naturally recurred at a low frequency ( $< 1$  Hz) (Figure 3-1B1 and Figure 3-6A1),

during which rhythmic hfBursts occurred at the sigma (spindle)- and lower-frequency bands, including the theta and delta bands. The rhythmic character of spindle burst patterns was identifiable with an autocorrelation histogram (Figure 3-1E). In TRN neurons, such sustained rhythmic burst activity involves the activation of NMDA receptors (Jacobsen et al., 2001). From ~5min after a single ketamine administration, all juxtacellularly recorded TRN cells suddenly and transiently switched their ongoing rhythmic burst firing pattern to a sustained tonic, single AP firing pattern (Figure 3-6A2, C3). Furthermore, ketamine decreased their firing frequency band from 0 to 60 Hz ( $16.5 \pm 2.5$  Hz) to 5–25 Hz ( $8.1 \pm 1.8$  Hz;  $n = 5$  from 5 rats) (Figure 3-6E). Remarkably and significantly, the single AP density increased whereas the hfBurst density decreased (Figures 3-6C3 and 3-8A2, B1, B2). The autocorrelation histograms of the juxtacellular TRN recordings show that the probability of the occurrence of AP bursts dramatically decreased under the ketamine effect relative to saline condition. The autocorrelation analysis revealed the 9-16 Hz rhythmicity during the saline condition, confirming the highly rhythmic nature of the bursty discharge of juxtacellularly recorded TRN, and in contrast, it revealed no rhythmicity under the ketamine effect, showing the ketamine administration dramatically abolishes the normal strong synchronization and the periodicity of the series of rhythmic AP bursts occurring at the spindle frequency range (Figure 3-8A). In the inter AP interval histograms (IAPIH) for the juxtacellular recordings of TRN neurons, under the saline condition (Figure 3-8B1), the first peak shows the large count ( $1840 \pm 469$ ) of successive spikes occurring within an interval less than 2-4 ms which is a marker for abundant occurrences of high-frequency (300-600 Hz) APs of bursts. This peak disappeared almost completely after ketamine administration (Figure 3-8B2), meaning that hfBursts no longer occur. Under the ketamine condition, the first peak (3–6 ms) reflects longer inter-AP intervals which, like in TC neurons, are the signature of doublets and triplets embedded in the irregular tonic AP trains (Figure 3-8B2).

Interestingly, the interval histogram reveals a second peak at ~30–50 ms. We predicted that the 30–50-ms peak represents a marker of juxtacellular gamma oscillations. Indeed, when looking closely at the juxtacellular recordings, it is obvious that the TRN cells fired at a certain proportion of gamma waves during their positive-going component (Figure 3-8C1), meaning that the juxtacellular oscillations reflected threshold/suprathreshold and subthreshold membrane potential gamma oscillations. This

observation is supported by a peri-gamma wave time histogram of the AP distribution (Figure 3-8C2), which shows that the probability of firing reached a maximum at (virtually 0 ms) the positive going component of the gamma wave. Furthermore, a substantial number of TRN APs was also phase-related to gamma waves recorded extracellularly in the related somatosensory thalamic nucleus, suggesting a certain degree of functional connectivity. In the same way as TC neurons, there was no apparent relation between the TRN firing and the cortical gamma waves (Figure 3-8C2).

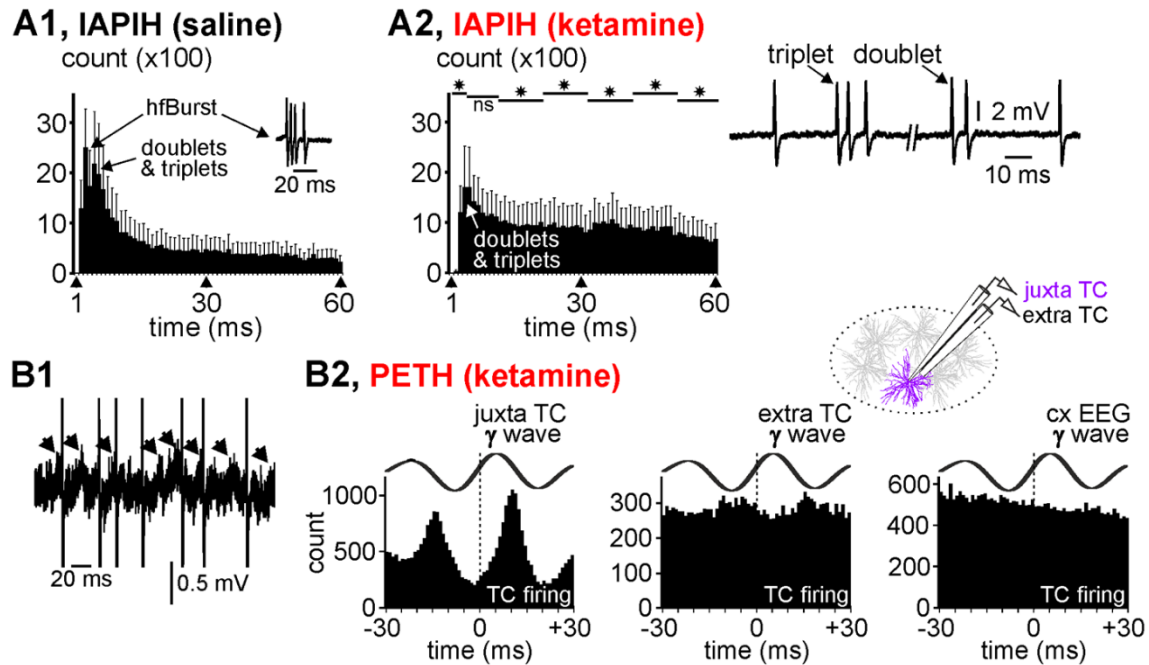

**Figure 3-7. Thalamocortical (TC) firing related to gamma-frequency oscillations.**

**(A1, A2)** Averaged cumulated inter-AP interval histograms (IAPIH) from 5 juxtacellularly recorded TC cells (from 5 rats) under the control (A1) then the ketamine (A2) conditions (keta +15-25 min). Note the ketamine-induced diminution in the number of the short-lasting IAPIs, especially those composing high-frequency bursts of APs (IAP I = 2-10 ms). A typical TC hfBurst (IAP I at 2-3 ms) is shown in the control histogram. The remaining bursts were slower (IAP I at 5-6 ms) and shorter (e.g, especially doublets and triplets, like those shown on the right). Star when significant (paired t-test,  $p < 0.05$ ). **(B1)** A typical short-lasting trace of a juxtacellularly recorded TC cell showing low-amplitude gamma-frequency oscillations in the field potential and the AP occurrence at some cycles of the gamma oscillation. Each arrow indicates a juxtacellular gamma wave. The APs are truncated. **(B2)** Peri-event (gamma wave) time histogram (PETH, resolution of 1 ms) of the TC firing (cumulative count) under the ketamine condition (5 TC cells from 5 rats). Every gamma wave (juxta TC, extra TC (inter-tip distance = 100  $\mu$ m, see drawing), and cxEEG) is an average of 100 filtered (25-55 Hz) individual gamma ( $\gamma$ ) waves. Time "0" corresponds to the time at which gamma waves were detected.

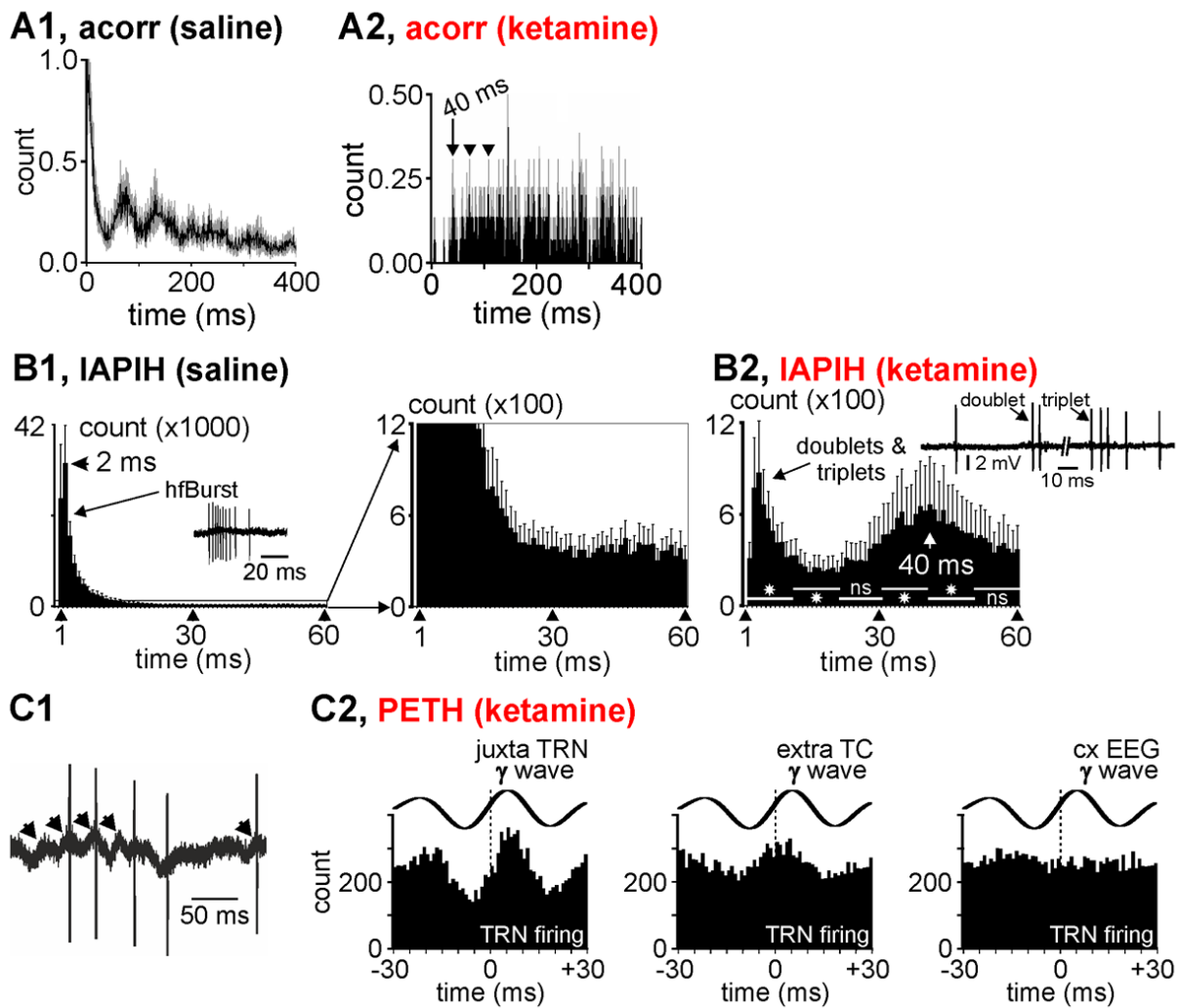

**Figure 3-8. TRN firing related to gamma-frequency oscillations.**

**(A1, A2)** Averaged autocorrelograms (acorr, resolution: 1 ms, from ten 2-s traces  $\pm$ SEM in grey) of the firing of a representative juxtacellularly-recorded TRN neuron under the saline (A1) and ketamine (A2) conditions. Under the ketamine condition, 2 to 3 successive APs (arrow and arrowheads) have a probability of about 0.20-0.25 (relative to the reference AP at time 0 ms) to be separated by an interval of 40 ms. The units of the Y axis are normalized counts. **(B1, B2)** Averaged cumulated inter-AP interval histograms (IAPH) from 5 juxtacellularly recorded TRN cells (from 5 rats) under the control (B1) then the ketamine (B2) conditions (keta +15-25 min). In (B1), are shown the control (saline) IAPH in full (left) and partial (right) Y scales. Note the ketamine-induced dramatic diminution in the number of the short-lasting IAPs, especially those composing high-frequency bursts of APs (IAP = 2-10 ms). A typical TRN hfBurst is shown in the control histogram. The remaining bursts were slower (increase in IAPs) and shorter (e.g, especially doublets and triplets, like those shown). Star when significant (paired t-test,  $p < 0.05$ ). **(C1)** A typical short-lasting trace of a juxtacellularly recorded TRN cell showing low-amplitude gamma-frequency oscillations in the field potential and that the AP occurrence at some cycles of the gamma oscillation. Each arrow indicates a juxtacellular gamma wave. **(C2)** Peri-event (gamma wave) time histogram of the TRN firing (cumulative count) under the ketamine condition (5 TRN cells from 5 rats). Every gamma wave (juxta TRN, extra TC, and cxEEG) is an average of 100



filtered (25-55 Hz) individual gamma ( $\gamma$ ) waves. Time “0” corresponds to the time at which gamma waves were detected.

### **3.4. MK-801 mimics the ketamine effects better than physostigmine and apomorphine**

There is accumulating evidence that ketamine affects the activity of diverse receptors other than NMDA receptors, including dopamine, serotonin, acetylcholine, AMPA and GABA<sub>A</sub> receptors (Irifune et al., 2000; Yamakura et al., 2000; Kapur and Seeman, 2002; Frohlich et al., 2014; Sleight et al., 2014; Li and Vlisides, 2016). Therefore, one may wonder whether the acute ketamine effects, observed under our experimental conditions, were specifically due to a blockade of NMDA receptors. In an attempt to address this issue, the sleep-related cortical EEG oscillations were recorded following the subcutaneous administration of either MK-801 (dizocilpine, 0.1 mg/kg), a more specific non-competitive antagonist of NMDA receptors, the cholinesterase inhibitor physostigmine (0.5 mg/kg), or the competitive dopamine D2 receptor agonist apomorphine (1 mg/kg). MK-801 was expected to reproduce the ketamine effect (Pinault, 2008), physostigmine to promote REM sleep (Sitaram et al., 1976) and a desynchronized cortical EEG (Kenny et al., 2016; Roy and Stullken, 1981), and apomorphine to affect the EEG oscillations (Jang et al., 2009; Shvaloff et al., 1988). We tried out to know which of them were able to mimic the ketamine’s transient effects on six distinct frequency bands of sleep-like cortical oscillations. They were administered 20 minutes after the saline condition and then the ongoing recordings were obtained for 80 minutes.

Like ketamine, MK-801 consistently decreased the power of ongoing spindles and theta-frequency oscillation and substantially increased that of gamma- and higher-frequency TC network oscillations (Figures 3-9 and 3-12). There were some differences between the effect of ketamine and that of MK-801. The effect of MK-801 starts at about 15-20 minutes after its injection (Figure 3-9), whereas the ketamine acts faster in about 5 minutes. The effect of ketamine is transient so that the partial recovery starts after about 50-80 minutes, whereas the effect of MK801 persists longer and does not exhibit the recovery during the recording sessions up to 80 minutes after injection (Figure 3-9). In contrast to ketamine, MK-801 did not significantly change the power of delta-and beta-frequency oscillations (Figures 3-9 and 3-12), very likely the result of a dose effect (Hiyoshi et al., 2014).



Both the physostigmine and apomorphine simulated the ketamine effects on slow frequency oscillation including spindles and delta- and theta-frequency oscillations. They were not able to mimic the effect of ketamine on the high-frequency oscillations including the beta-, gamma- and higher-frequency oscillations (Figures 3-10, 3-11 and 3-12). Unlike ketamine, physostigmine or apomorphine significantly decreased the power of all frequency bands in TC network oscillations (Figure 3-12). The pharmacokinetics of these two drugs present a plateau-like curve, beginning at about 10 and 20 minutes and starting to recover at the end of the recording session. Overall, in contrast to drugs modulating dopaminergic and cholinergic transmitter systems, dizocilpine (MK-801), a more specific NMDA receptor antagonist, well mimicked the ketamine effects on spindles and higher-frequency oscillations (Figures 3-9 and 3-12), supporting the hypothesis that the ketamine effects are due to the specific blockade of the NMDA receptors. These results suggest that the ketamine may be an eligible candidate to investigate the disturbed oscillations especially sleep spindles associated with the reduced function of NMDA receptors.

Kinetics of different tested drugs have been presented all together at the same image (Figure 3-13) making it easier to compare their effects with one another and with ketamine in particular. Kinetics show how each of drugs differently or similarly acts on the discrete sleep-related cortical frequency oscillations over 120 minutes of ongoing recordings (Figure 3-13).

## Cortex (EEG) average ( $\pm$ SEM)

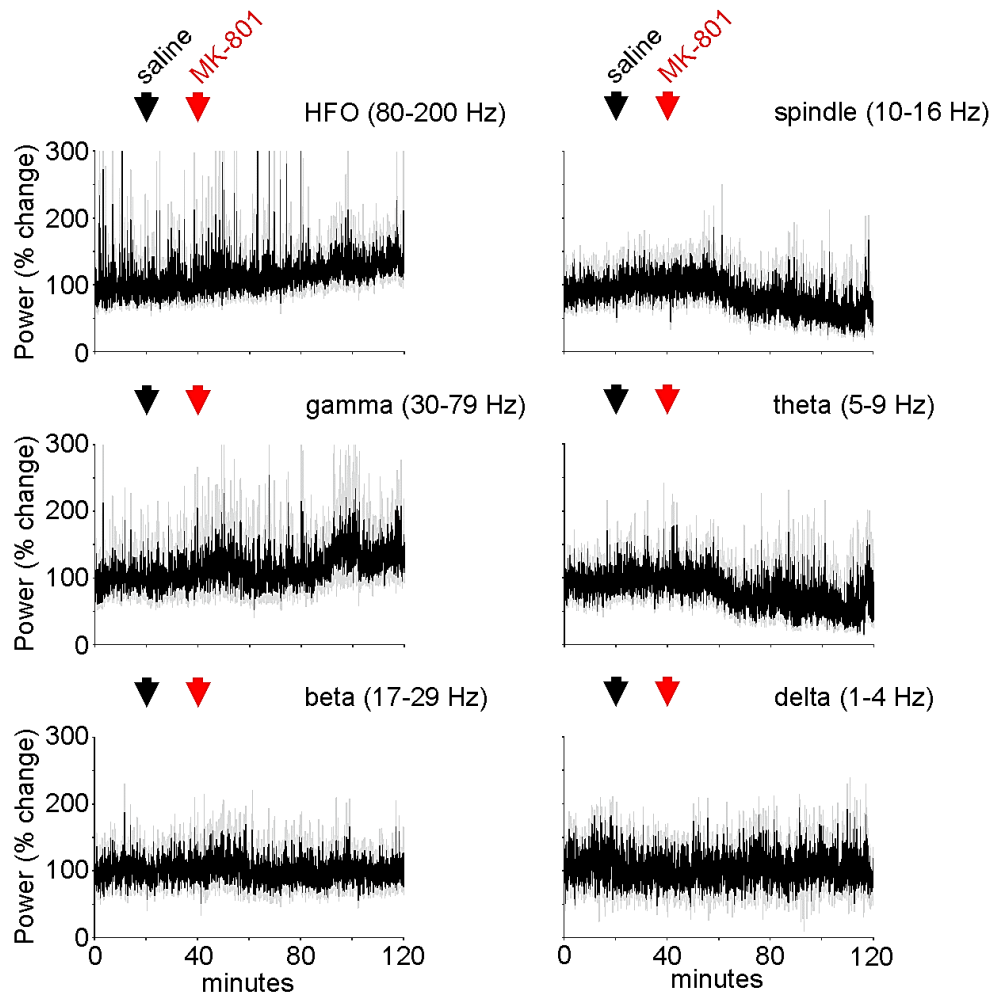

**Figure 3-9. MK-801 mimicked the transient effect of ketamine on the cortical EEG oscillations except on the delta- and beta-frequency oscillations.**

Time course of the power (% change relative to the saline condition, mean (in black)  $\pm$ SEM (in grey), 4 rats per condition, each rat being its own control) of cortical EEG oscillations (all frequency bands) before and after the subcutaneous administrations of saline (at 20 min) and MK-801 (0.1 mg/kg) (at 40 min). MK-801 decreased the powers of theta oscillations and spindles, increased the powers of gamma- and higher-frequency oscillations and had no considerable effect on the powers of delta- and beta-frequency oscillations.

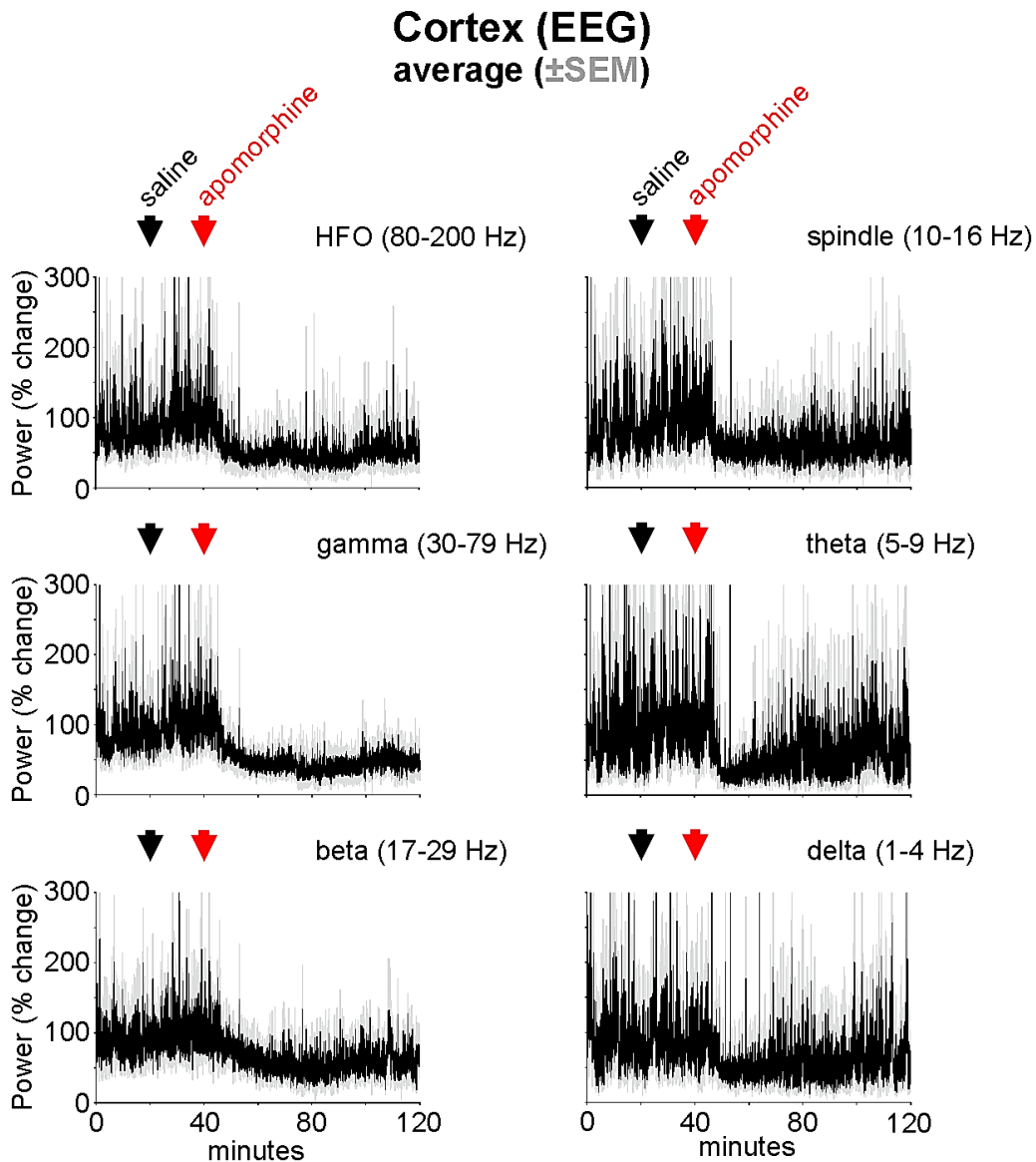

**Figure 3-10. Apomorphine decreased the powers of all frequency bands in the somatosensory cortical EEG and could not mimic the ketamine effect.**

Time course of the power (% change relative to the saline condition, mean (in black)  $\pm$ SEM (in grey), 4 rats per condition, each rat being its own control) of cortical EEG oscillations (all frequency bands) before and after the subcutaneous administrations of saline (at 20 min) and apomorphine (1 mg/kg) (at 40 min). Apomorphine administration (red arrow) leads to a remarkable reduction in the power of all frequency bands of TC network oscillations including spindles, delta-, theta-, beta-, gamma- and higher-frequency oscillations (HFO). A slight recovery starts at ~40-70 minutes after the systemic administration of Apomorphine.

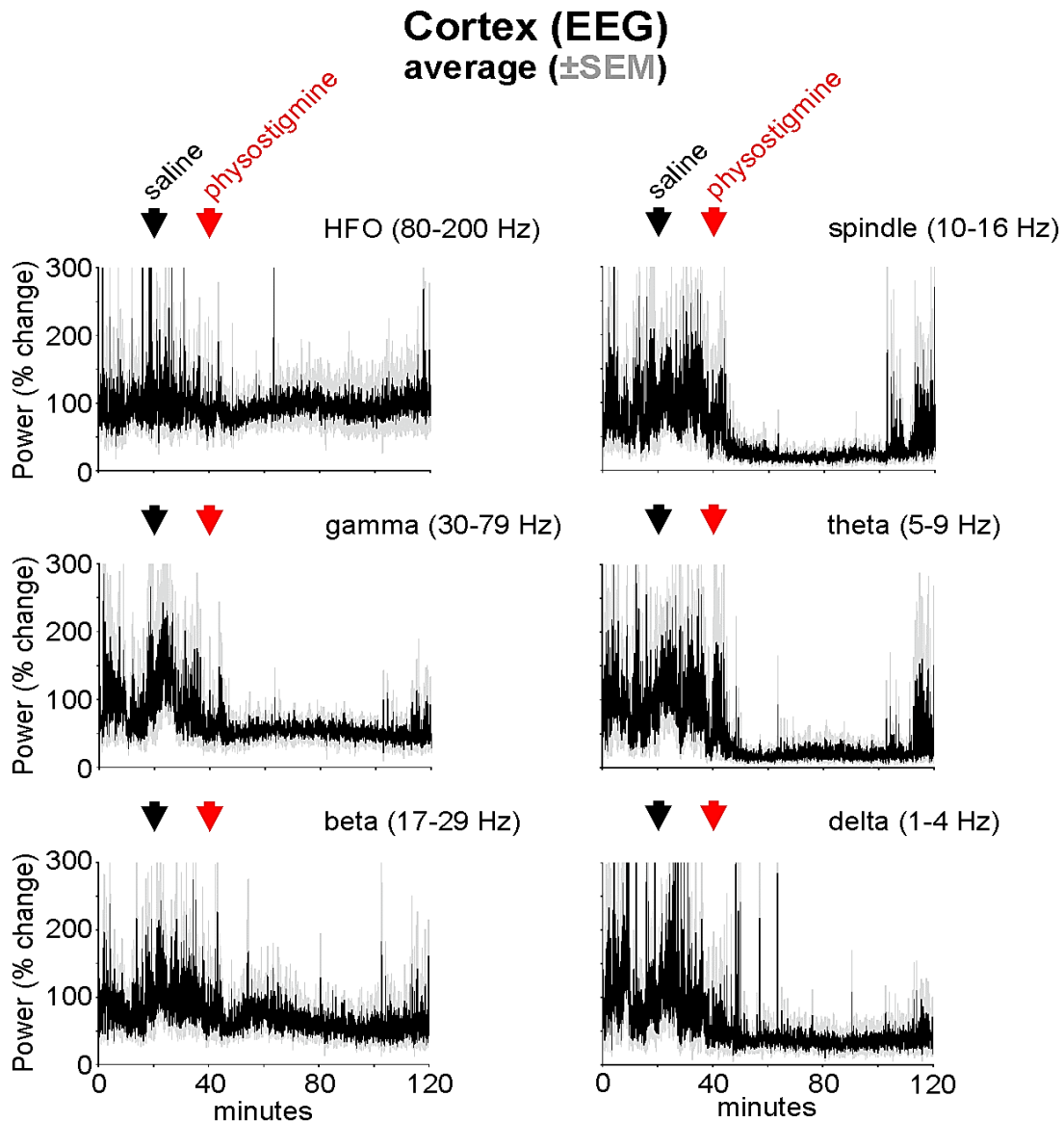

**Figure 3-11. Physostigmine decreased the powers of all frequency bands in the somatosensory cortical EEG and could not mimic the ketamine effect.**

Time course of the power (% change relative to the saline condition, mean (in black)  $\pm$ SEM (in grey), 4 rats per condition, each rat being its own control) of cortical EEG oscillations (all frequency bands) before and after the subcutaneous administrations of saline (at 20 min) and physostigmine (0.5 mg/kg) (at 40 min). Physostigmine administration (red arrow) leads to a remarkable reduction in the power of all frequency bands of TC network oscillations including spindles, delta-, theta-, beta- and gamma-frequency oscillations except the higher-frequency oscillation (HFO).

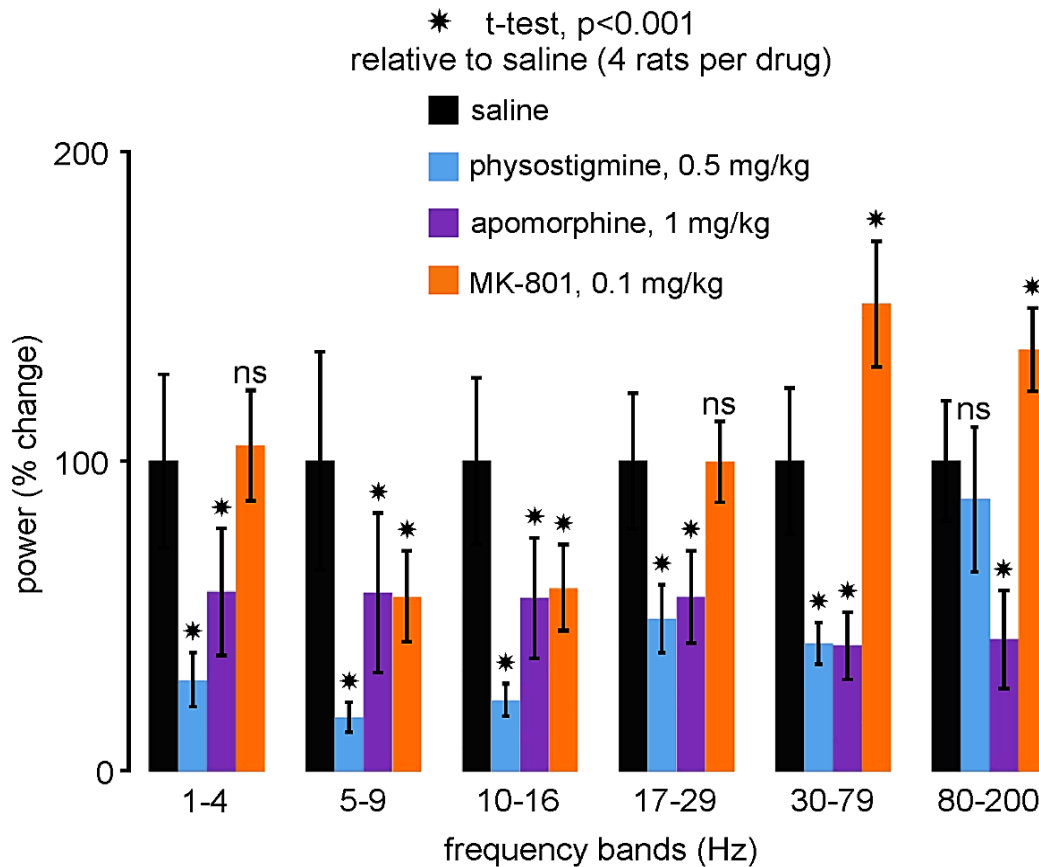

**Figure 3-12. MK-801 mimics the ketamine effects better than physostigmine and apomorphine.**

The histogram illustrates the drug-induced percent changes (at 20-60 min postinjection, relative to the saline condition, each animal being its own control) in power of the six frequency bands including delta (1-4 Hz), theta (5-9 Hz), spindle (10-16 Hz), beta (17-29 Hz), gamma (30-79 Hz) and high-frequency oscillations (HFO, 80-200 Hz) in the cortical EEG (4 rats per drug; mean $\pm$ SEM). Unlike ketamine effects, both apomorphine and physostigmine reduce the power of high-frequency oscillations including beta, gamma-frequency oscillations and HFOs. MK-801 could mimic the ketamine effects on all frequency bands except on the delta and beta. Student t-test: (\*)  $p < 0.001$ ; ns, not significant.

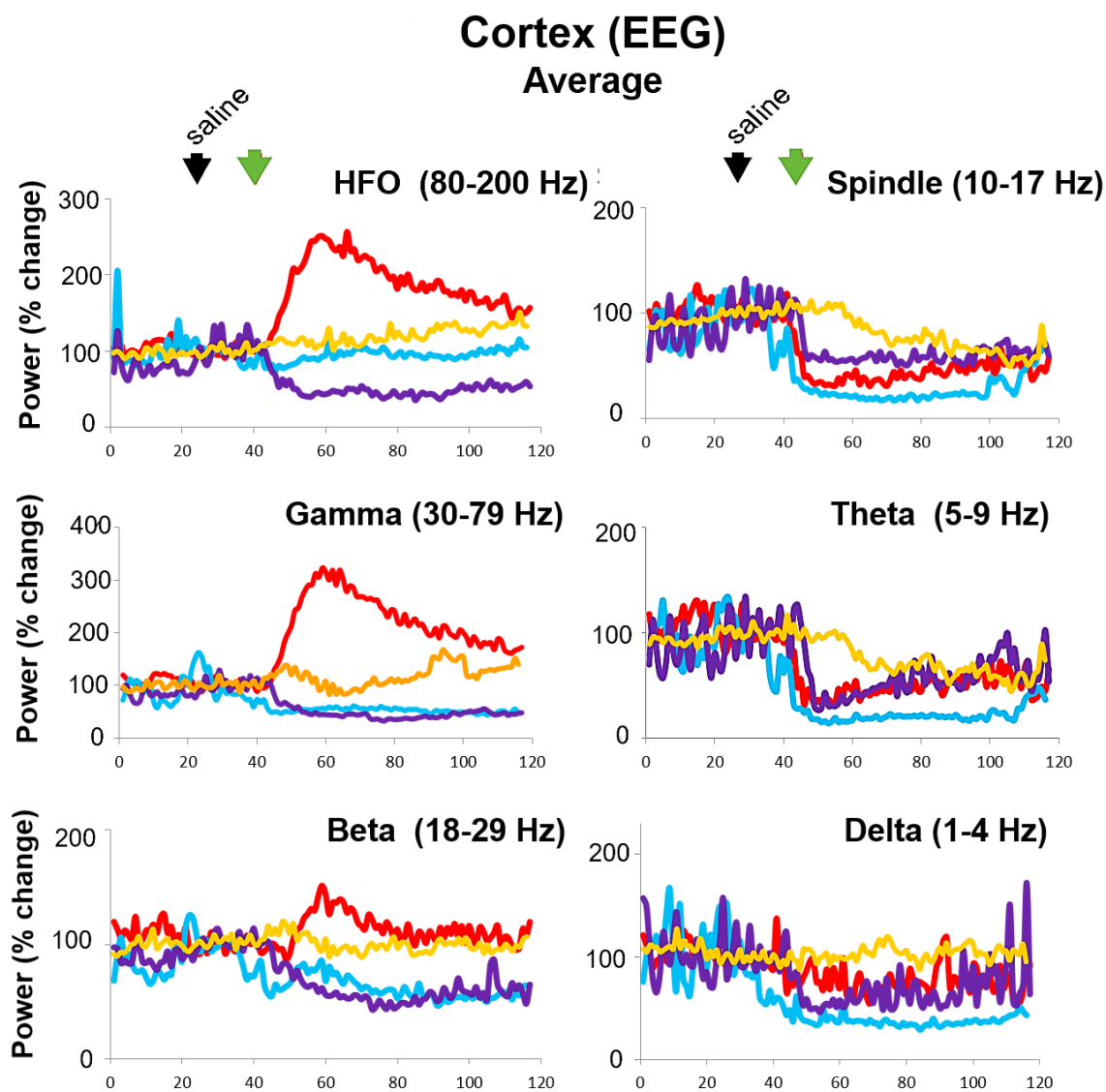

**Figure 3-13. Kinetics of effects of different experimented drugs on sleep TC oscillations.**

Kinetics of effects of different experimented substances including ketamine (red, 2.5 mg/kg, N=7), MK-801 (yellow, 0.1 mg/kg, N=4), Apomorphine (purple, 1 mg/kg, N=4) and Physostigmine (blue, 0.5 mg/kg, N=4) on the power of six different frequency oscillations obtained from the ongoing EEG of left parietal cortex (green arrows indicate injection times of substances). MK-801 mimics the ketamine effects on all frequency bands except delta and beta. Effects of MK-801 last longer compared to the transient effects of ketamine. Like ketamine, both apomorphine and physostigmine reduce the power of low-frequency oscillations at the range of delta, theta and spindle. Unlike ketamine, both apomorphine and physostigmine reduce the power of high-frequency oscillations at the range of beta-, gamma- and higher-frequency oscillations (HFP). Effect of Physostigmine on the HFO is not considerable. Power = average power over a period of a minute of recording. All data is normalized to the saline condition.

### **3.5. Firing pattern of apomorphine and physostigmine in TRN neurons**

In addition to the cortical EEG, we also carried out some experiments to record the

intrathalamic data juxtacellularly from TRN neurons by the administration of apomorphine and physostigmine. In juxtacellularly recorded TRN neurons, physostigmine (n = 2 TRN cells from 2 rats) decreased the density of hfBursts and increased that of single APs. Therefore, physostigmine switched the firing pattern of TRN neurons from the burst mode to the tonic mode like ketamine, although its effect on cortical oscillations was not similar to the ketamine effect. Apomorphine (n = 2 TRN cells from 2 rats) significantly decreased the density of both hfBursts and single APs (Figure 3-14). These results indicate that the underlying mechanisms of action of both apomorphine and physostigmine may be different from that of the ketamine (Figure 3-14).

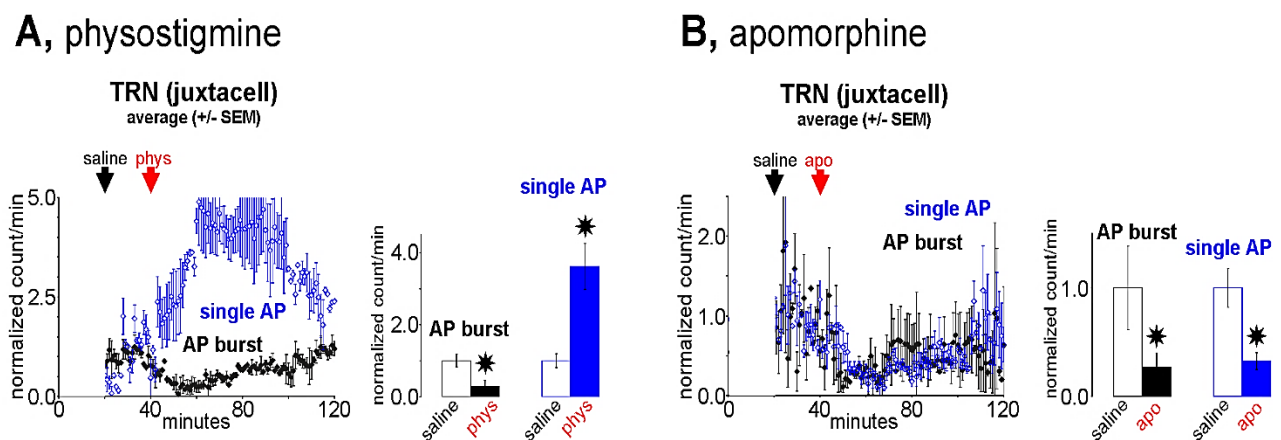

**Figure 3-14. Physostigmine or apomorphine decreases the hfBurst density in juxtacellularly recorded thalamic reticular nucleus neurons.**

The density (number per minute,  $\pm$ SEM, 2 TRN cells from 2 rats) of hfBursts and of sAPs under the saline (A or B), physostigmine (A) or apomorphine (B) conditions. In the histograms, the normalized values are from the time period of 20-60 min postinjection (phys or apo), that is, 40-80 min in the charts. Note that, like ketamine, physostigmine increases the sAP density and decreases the hfBurst density. Unlike ketamine, apomorphine decreased the density of both hfBursts and sAPs. The changes observed in firing patterns are largely significant (t-test, P-value < 0.001).

### 3.6. Clozapine prevents the emergence of ketamine's effects

Clozapine is one of the most effective antipsychotic drugs against treatment-resistant schizophrenia (Kane et al., 1988). Its clinical effects are thought to be related to interactions with a variety of receptors (Meltzer, 1991; Meltzer, 1994; Deutch, 1995; Seeman, 2002; Nucifora et al., 2017; Haidary and Padhy, 2020), including the glutamatergic receptors and more specifically NMDA receptors via the glycine site (Lipina et al., 2005; Schwieler et al., 2008; Hunt et al., 2013). Also, clozapine is well-known to

modulate sleep spindles (Tsekou et al., 2015), possibly due to the activation of GABAergic TRN neurons via a specific action on D4 dopamine receptors (Mrzljak et al., 1996), which would exert a tonic influence on the TRN activity (Barrientos et al., 2019). Therefore, it was interesting to probe whether a single systemic administration of clozapine could prevent the ketamine effects on TC oscillations. To address this issue, clozapine was subcutaneously administered at a dose (5 mg/kg) that durably decreases the power of spontaneously-occurring cortical gamma oscillations in the naturally-behaving rat (Jones et al., 2012) 20 or 120 min before the ketamine challenges. In all rats ( $n = 5$ ), clozapine consistently prevented the emergence of ketamine peak (at ~15–20 min) effect on spindles, delta- and gamma-/higher-frequency oscillations. When administered alone, clozapine significantly increased the power of delta oscillations. Its effect on the other frequency oscillations was not significant (Figures 3-15 and 3-16). Under the clozapine condition, almost the same results were obtained with and without the interference of ketamine, demonstrating the strong preventive effect of clozapine on ketamine action. These findings indicate the strong impact of clozapine on the brain, although it is not appeared directly on the somatosensory TC oscillations, suggesting the other regional targets or different neuronal mechanisms of clozapine action.

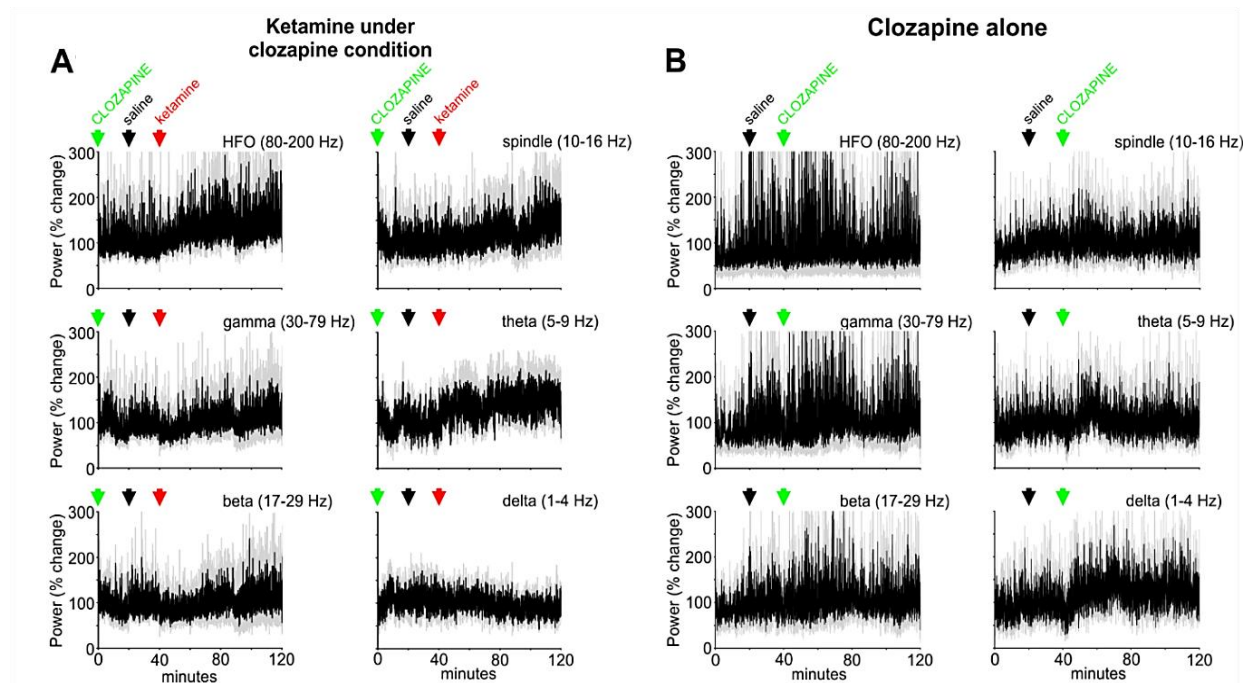

**Figure 3-15. Under the clozapine condition, ketamine does not exhibit its effects on sleep TC oscillations.**



Each chart shows, for a given frequency band oscillation, the time course (1 FFT value/2 seconds) of the drug effects (% change in power) on the cortical EEG during a 120 min recording session. **(A)** The ketamine (2.5 mg/kg) was administered under the clozapine condition at 40 minutes. Note that, under the clozapine condition, the ketamine led to an increase in the power of low frequency oscillations instead of decrease. **(B)** The clozapine (5 mg/kg) alone was administered under control condition at 40 minutes. Clozapine alone did not lead to a considerable effect on the power of sleep TC oscillations. In spite of this, ketamine could not exhibit its effects under the clozapine condition (A), indicating the different regional targets or different mechanisms of action of these two drugs. All analysed data was normalized to percentage of the mean power of the 10-min period of control (saline) condition. N(ketamine under clozapine) = 5, N(clozapine alone) = 5. HFO, high-frequency oscillations (81-200 Hz).

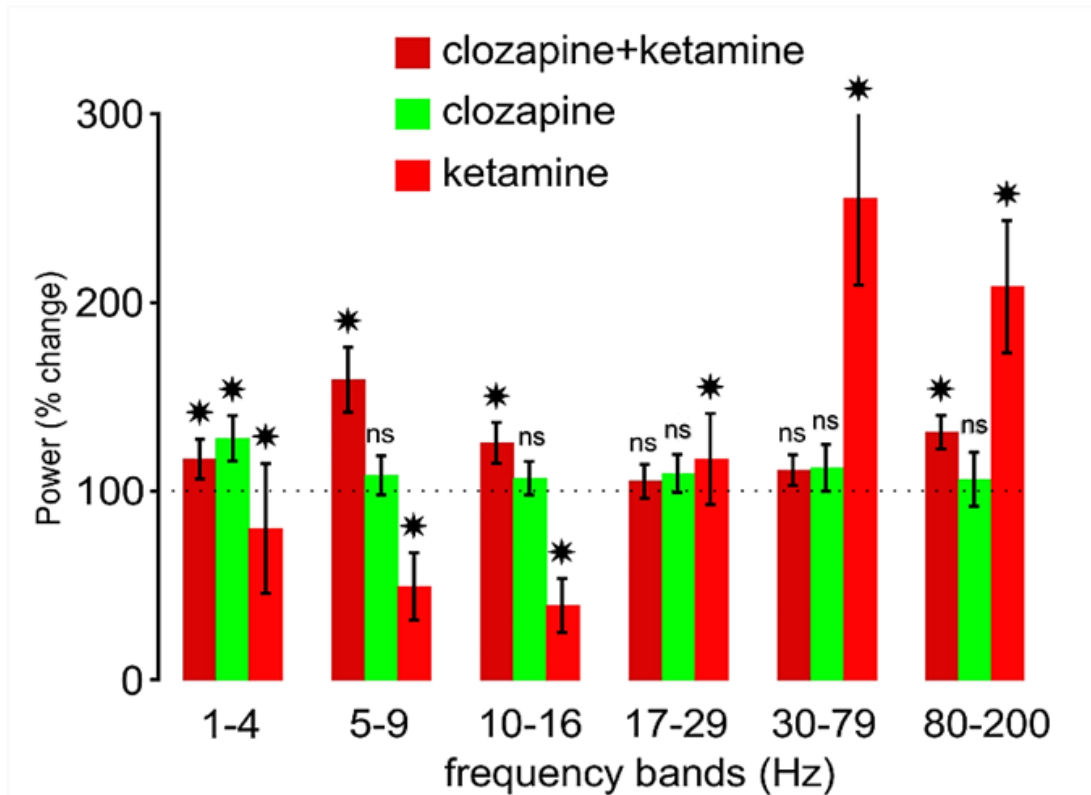

**Figure 3-16. Clozapine prevents the emergence of ketamine's effects on the somatosensory cortical oscillations.**

The histogram illustrates the drug induced percent changes (mean  $\pm$  SEM; relative to the saline (control) condition (100%, indicated by dotted line)) in power of all frequency bands in the cortical EEG. In the clozapine+ketamine condition (dark red), ketamine (2.5 mg/kg) was administered 40 min after the clozapine (5 mg/kg) administration. In the clozapine+ketamine condition, the power of low-frequency oscillations at the ranges of delta (1-4 Hz), theta (5-9 Hz) and spindle (10-16 Hz) were increased relative to the control condition. It means that ketamine effects under the clozapine condition (dark red) were even reversed in comparison with its effects under the saline condition (red). Ketamine under the clozapine condition (dark red) could not affect the high-frequency oscillations at the ranges of beta and gamma bands and could significantly increase the power of higher-frequency oscillations (HFO, 80-200 Hz) but this effect was much less significant than

ketamine effect under the saline condition (red). N(clozapine+ketamine) = 5, N(clozapine) = 5, N(ketamine) = 7. Student paired t-test: (\*)  $p < 0.05$ ; ns, not significant.

### **3.7. High dosage of Ketamine does not mimic the effects of MK-801 and psychotomimetic ketamine**

MK-801 could mimic the effects of ketamine (2.5 mg/kg) on all frequency oscillations but delta- and beta-frequency oscillations (Figure 3-12 and 13). As an attempt to explain the non-significant effects of MK-801 on delta- and beta-frequency oscillations, we tested higher dose of ketamine (80 mg/kg). We guessed that its high dose might lead to the similar effects as MK801 which is a more specific antagonist of NMDA receptors. High dose of ketamine (80 mg/kg) could not resemble the effect of MK-801 (Figure 3-17). There might be several likely reasons for this discrepancy. First, it is difficult to find a proper dose for each of ketamine and MK-801 so that both reveal the same effects. Second, ketamine may have different mechanisms of action at low and high doses. Hiyoshi et al. (2014) have shown that NMDA receptor antagonists such as ketamine and MK-801 at higher and lower doses reveal differential effects on the rat cortical EEG oscillations.

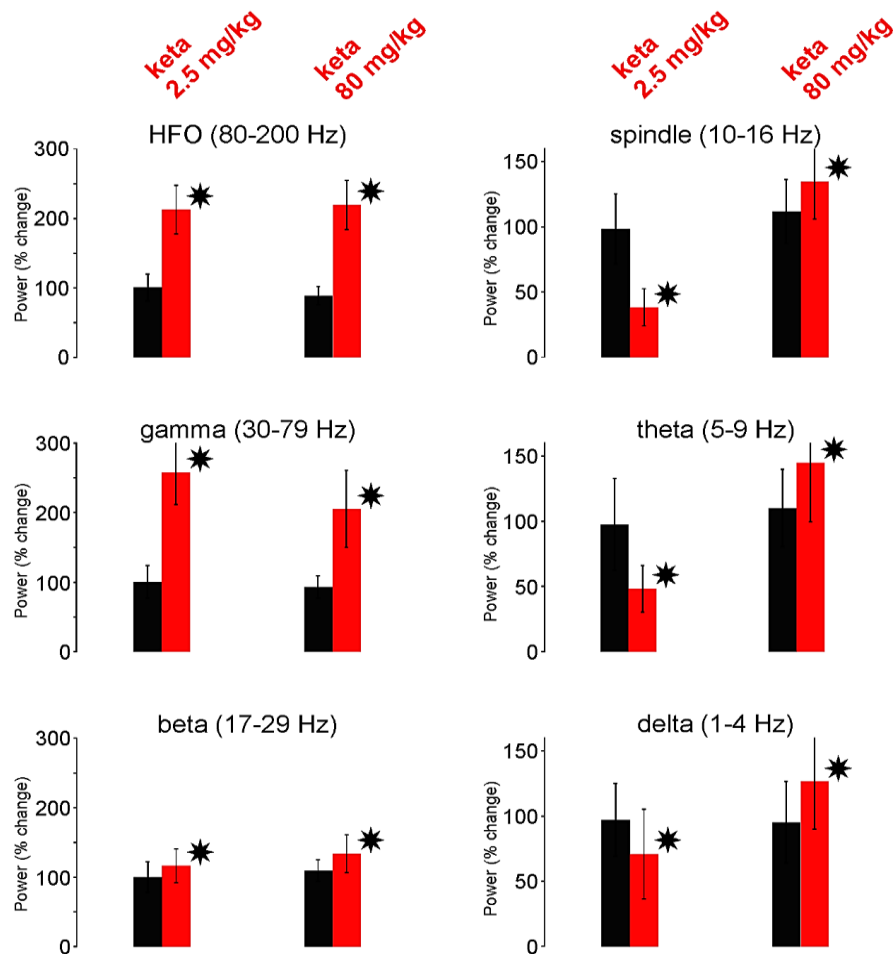

**Figure 3-17. High dosage of ketamine (80 mg/kg) does not mimic the effects of psychotomimetic ketamine (2.5 mg/kg).**

The histograms illustrate the drug induced percent changes (mean  $\pm$  SEM; relative to the saline (control) condition (black histograms)) in powers of six different frequency bands in the cortical EEG. Unlike keta 2.5 mg/kg that reduced the powers of low-frequency oscillations at the ranges of delta, theta and spindle, and increased the powers of high-frequency oscillations at the ranges of beta, gamma and higher frequency bands, keta 80 mg/kg significantly increased the powers of sleep TC oscillations in all frequency bands. The comparison between the ketamine effects at the low dose (2.5 mg/kg) and high dose (80 mg/kg) indicates the highly dose-dependent effect of ketamine on the sleep TC oscillations. keta = ketamine. N(keta 80 mg/kg) = 3, N(keta 2.5 mg/kg) = 7. Student paired t-test: (\*)  $p < 0.05$ .

Moreover, ketamine at the higher dose (80 mg/kg) did not even mimic its own effect at the psychotomimetic dose (2.5 mg/kg), indicating its effect is varied depending on the dose. High dosage of ketamine (80 mg/kg) increased the powers of all frequency oscillations in the somatosensory cortex. Higher dose (80 mg/kg) of ketamine, unlike the dose of 2.5 mg/kg, increased the power of sleep-like oscillations including delta- and theta-

frequency oscillations and spindles (Figure 3-17). Hiyoshi et al. (2014) have also obtained the results similar to us. They showed that ketamine at high doses increases the powers of both delta and gamma bands. Some human studies have shown elevated delta in unmedicated and first-episode schizophrenia patients (Sponheim et al., 1994; Harris et al., 2006; Kirino et al., 2007; John et al., 2009). There are animal studies showing the increased delta band activity due to the administration of NMDA receptor antagonists (Sebban et al., 2002; Sharma et al., 2010; Páleníček et al., 2011; Zhang et al., 2012). There is optogenetic study showing the increase in the cortical delta activity during the wakefulness due to direct optogenetic inhibition of parvalbumin neurons of TRN (Tankachan et al., 2019). There are other optogenetic studies showing that the elevated delta frequency oscillations during the wakefulness may lead to the impaired working memory as observed in schizophrenia (Duan et al., 2015; Rahman et al., 2021). There are several reasons for the difference between the results of these studies and ours. In the present study, we administered ketamine at the low psychotomimetic dose and proposed a combined sleep-ketamine model for the psychosis transition. Those human studies that have shown an elevated activity of delta frequency band in schizophrenia have not been performed during the sleep condition, whereas those studies that have been investigated delta frequency oscillations during sleep in first-episode schizophrenia patients indicated a reduction in the activity of delta frequency band (Ganguli et al., 1987; Keshavan et al., 1998; Manoach et al., 2014; D'Agostino et al., 2018; Kaskie et al., 2019), highly supporting our observation in the present study. Those animal studies that have shown an increase in the delta activity due to the NMDA receptor antagonists have not been conducted in the sleep condition as well and have administered very high doses of NMDA receptor antagonists relative to the present study. In the support of our observation, there are animal studies showing that the administration of ketamine at the low dose results in the reduction of delta power in the cortex and thalamus (Kargieman et al., 2007, 2008; Santana et al., 2011). The above-mentioned optogenetic studies (Duan et al., 2015; Tankachan et al., 2019; Rahman et al., 2021) have also obtained their results during the wakefulness. Therefore, we may conclude that the effect of ketamine is highly dose-dependent and state-dependent. High dosage of ketamine could not offer a suitable model for the psychosis transition and for the sleep-spindle deficits observed in schizophrenia and early stages of psychosis (Figure 3-17).

## Chapter 4

---

### 4. Discussion

In the present study, the single low-dose administration of psychotomimetic ketamine, conducted in the pentobarbital sedated rat, induced a transient dramatic decrease in ongoing thalamic and cortical spindles and slower oscillations, and a concomitant increase in beta-, gamma- and higher-frequency oscillations, which is reminiscent of an arousal effect. These new preclinical findings support the critical role of a reduced function of NMDA receptors in the reduction of spindles and slow waves in schizophrenia. They also support the hypothesis that the deficient TRN inhibition contributes to the spindle reduction observed in patients with schizophrenia (Baran et al., 2019; Ferrarelli and Tononi, 2011; Manoach and Stickgold, 2019; Pratt and Morris, 2015; Young and Wimmer, 2017).

There are many neurodevelopmental and genetic studies that have shown the schizophrenia-like behavioral and neurophysiological phenotypes due to the manipulation of the NMDA receptors (in Chapter 1, see 1.5.1 and 1.5.2). Our combined sleep-ketamine model does not cover the genetic-neurodevelopmental dimensions and was not designed to be compared with them. However, the present study showed that the NMDA receptor antagonist ketamine at the psychotomimetic dose leads to the arousal-like and psychosis-relevant state which is consistent with that observed in those neurodevelopmental and genetic studies that have targeted the glutamate neurotransmission and NMDA receptors (Harris et al., 2003; Stefani and Moghaddam, 2005; Bubeníková-Valesová et al., 2008; Karl et al., 2008; Mei and Xiong, 2008; Karlsgodt et al., 2011; Jones et al., 2011; Dawson et al., 2015; Ayhan et al., 2016; Pratt et al., 2018; Winship et al., 2019).

The present study showed that low-dose ketamine induces simultaneous and similar effects on the cellular and network activity patterns of both GABAergic TRN and glutamatergic TC neurons. Previous studies have shown that ketamine disrupts the function of CT pathways (Anderson et al., 2017) and leads to the generation of persistent and generalized abnormal gamma-frequency oscillations in cortical and subcortical

regions (Hakami et al., 2009; Slovik et al., 2017). In an attempt to understand the neural mechanisms underlying these observations, the multiple plausible alternative theories are discussed in the following.

#### **4.1. The arousal promoting effect of low-dose ketamine**

A previous study has shown that NMDA receptor hypofunction, in the awake rat, leads to a sustained increase in the firing rate (single AP mode) and concomitantly the reduced burst activity associated with a psychosis-relevant behavior (Jackson et al., 2004). These findings are consistent with our observations.

It is well illustrated that a single administration of ketamine at the psychotomimetic dose transiently induces the arousal-promoting effect in awake, freely-moving rats (Pinault, 2008; Ahnaou et al., 2017). Such an effect is characterized by a series of behavioral and electrophysiological abnormalities including hyperlocomotion, ataxias, and stereotypies associated with deficits in cognitive performances (Chrobak et al., 2008; Pitsikas et al., 2008), and a significant augmentation of gamma-frequency oscillations (Pinault, 2008; Ehrlichman et al., 2009; Hakami et al., 2009).

These transient abnormalities are reminiscent of a psychosis-relevant behavior, during which not a single sleep episode was observed during the time dedicated to sleep in the ketamine-treated freely-behaving rats (Hakami et al., 2009). Moreover, a comprehensive study demonstrated that ketamine delays the sleep onset latency (Ahnaou et al., 2017). Clinical investigation showed that patients with psychosis have difficulties initiating sleep (Poulin et al., 2003). Abnormal levels of arousal may be a predictor of psychotic disorders (Lee et al., 2012; Tieges et al., 2013).

In the present study, psychotomimetic ketamine induced a fleeting arousal-like effect in the TC-TRN system of the sedated rat. Such an effect is the reminiscent of REM sleep, a sleep stage that is implicated as a natural model of psychosis (Dresler et al., 2015; Hobson, 1997; Mason and Wakerley, 2012; Mota et al., 2016; Scarone et al., 2008).

Moreover, in the sedated rat, ketamine led to a desynchronized state characterized by a significant increase in the power of beta-, gamma-, and higher-frequency oscillations. These elevated high oscillations are similar to those recorded during the natural REM sleep (Kocsis, 2012b). This ketamine-induced desynchronized state may be interpreted

as uncharacteristic REM-like sleep phenomena or a pathological persistent Up state (Figure 4-1). During the ketamine-induced pathological Up state, expected to occur within diverse cortical and subcortical structures (Hakami et al., 2009), cortical and thalamic neurons would be more depolarized than during the Down state to generate more threshold (for AP initiation) and supra-threshold membrane potential oscillations (Destexhe and Pare, 1999).

TRN neurons consist of the synaptic receptors and specific ion channels including T-type  $\text{Ca}^{2+}$  channels (T channels) that play essential role in occurring and sustaining the burst activity pattern. T-type  $\text{Ca}^{2+}$  currents contribute to the enhancement of calcium entry, synaptic potentiation, and for the generation of low-threshold spikes, which lead to the firing at the burst mode (Huguenard, 1996). At the onset of non-REM sleep, the altered activity in modulatory afferents and in glutamatergic input leads to a membrane hyperpolarization of TRN neurons that fundamentally alters their firing properties (Steriade et al. 1986). This hyperpolarization, in turn, leads to the deinactivation of low-threshold T channels resulting in the rapid and transient depolarization and occurrence of AP bursts (Coulter et al. 1989; Crunelli et al. 1989; Hernandez-Cruz and Pape 1989; Huguenard J.R., 1996; Crunelli et al., 2006).

Both TC-TRN interactions and the intrinsic pacemaker properties of TRN neurons play leading roles in the generation of thalamic spindles (Steriade et al., 1985; Steriade et al., 1993). Given that the T channels play crucial role in the ionic mechanisms underlying the burst activity of thalamic neurons, manipulation of T channels may impact their firing patterns (Astori et al., 2011; Wimmer et al., 2012) and consequently sleep spindle activity. For example, it has been shown that the genetic knock-out of  $\text{Cav}3.3 \text{Ca}^{2+}$  channels, which encodes the low-threshold T channels, prevent the occurrence of low-threshold rhythmic AP bursts through and after hyperpolarization (Huguenard and Pince, 1992).

A ketamine-induced significant increase in the density of single APs suggests that TC and TRN neurons often have more depolarized membrane potential, meaning that they spend longer time at the Up state and their membrane potential often is near the threshold to generate a single AP. This is supported by the occurrence of gamma oscillations and single AP firing pattern in our juxtacellular TC and TRN recordings. The single AP mode is usually recorded when T channels are inactivated via membrane depolarization ( $>-60\text{mV}$ ) (Mulle et al., 1986).

T channels relieve the magnesium block of synaptic NMDA receptors which lead to calcium entry through these receptors and a  $Ca^{2+}$  rise in dendritic spines. It has been shown that, in the transgenic mice, NMDA receptors and T channels synergistically contribute to the long-term potentiation in the thalamus at the glutamatergic synapse between TC and TRN neurons (Leresche and Lambert, 2017). Based on such evidence, it may be so interpreted that the ketamine-induced NMDA receptor hypofunction may mediate the abnormal activity of T channels resulting in the switch from the burst to the single AP mode in both TRN and TC neurons.

Based on these observations and speculations, we suggest that disruption of the Cav3.3  $Ca^{2+}$  channels may be involved in the etio-pathophysiology of schizophrenia (Andrade et al., 2016). Furthermore, T channels as an essential mechanism for the generation of AP bursts may be an appropriate target for manipulating the TC and TRN discharge patterns and thereby modifying sleep spindle activity.

Now, the question that could be raised here is that why the firing frequency band of TRN and TC reduced and increased, respectively, under the ketamine condition. Indeed, why did the NMDA receptor hypofunction impact TC and TRN neurons differently? Under the ketamine condition, both TRN and TC neurons fired in the single AP mode, and the TRN cells on average 2.7 times less than TC neurons. Based on this observation, the likely answer that comes to mind is that ketamine appears to exert a stronger effect on TRN neurons than on the TC neurons. This is consistent with previous studies indicating that administration of PCP, another NMDA receptor antagonist, results in inhibition of TRN activity (Troyano-Rodriguez et al., 2014) and acute ketamine administration leads to the increased TC activity (Dawson et al., 2013). Based on these previous and our observations, it appears that TRN is one of the primary sites of action for ketamine. Ketamine-induced hypofunction of NMDA receptors reduces the activity of TRN neurons leading to the disinhibition (overexcitation) of TC neurons. Furthermore, it has already been indicated that TRN neurons highly express NMDA receptors, especially its NR2C subunit. Only a few regions express this subunit. TRN is one of the major regions expressing NR2C subunit. The NR2C-containing TRN neurons are highly sensitive to NMDA receptor antagonists (Zhang et al., 2012). Ketamine selectively and effectively acts on TRN neurons and reduces their firing rate, converts their firing pattern, and consequently disrupts the responsibility of these neurons for the generation of sleep



spindles. Given that sleep spindles originate from the thalamus in which TRN has a leading role and that the sleep spindle deficit is one of the main signatures of schizophrenia, we highlight the NMDA receptors, especially their NR2C subunit in TRN, as a potential target for investigating the pathophysiology of schizophrenia.

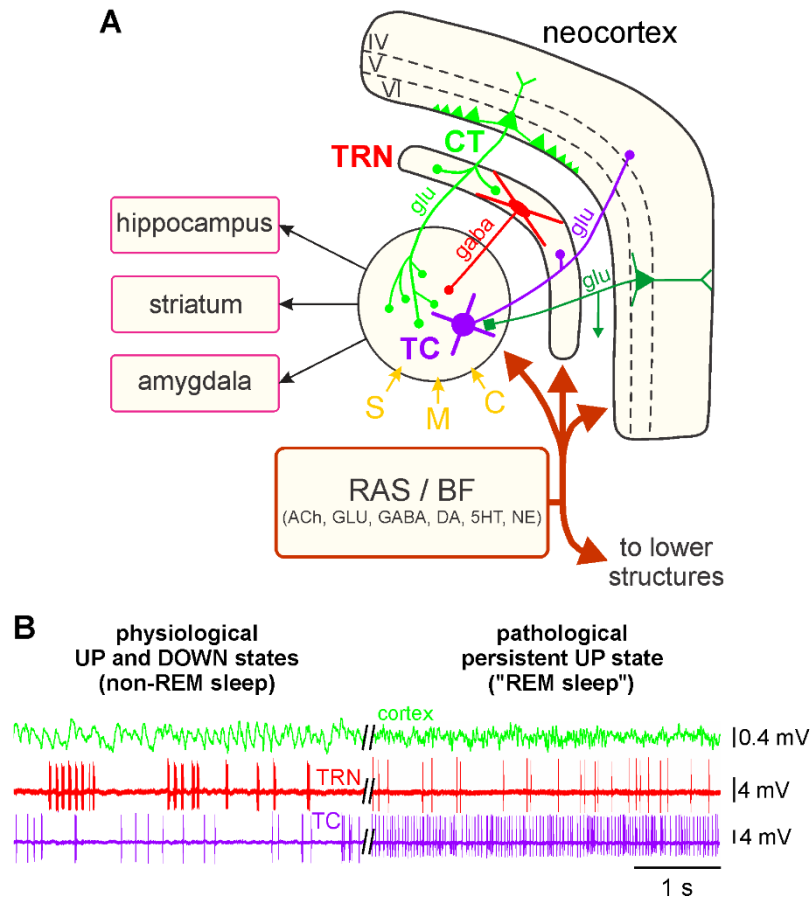

**Figure 4-1. Theoretical prediction of the ketamine action in both the ascending reticular activating system and the corticothalamic pathway**

**(A)** Simplified drawing of the hodology of the 3-neuron CT-TRN-TC circuit, which is considered as being the upper part of the ascending reticular activating system (RAS). See chapter 2 and Figure 2-1A legend for detailed description of the circuit, which receives sensory (S), motor (M) and cognitive/associative (C) inputs. It is important to specify that the layer VI CT neurons outnumber by a factor of about 10 the TC neurons. The thalamic nuclei are under the neuromodulatory influence of the various inputs from the ascending RAS and the basal forebrain (BF). **(B, left)** Physiological UP and DOWN states: During the non-REM sleep, the TC system displays principally a synchronized state, characterized by the occurrence of delta oscillations and spindles; the TRN cell exhibits mainly rhythmic (at the delta-, theta- and spindle-frequency bands) hfBursts of action potentials. The synchronized state includes two sub-states, UP and DOWN, which are usually associated with active and quiescent cellular firings, respectively. **(B, right)** Pathological

persistent UP state: This ketamine-induced persistent UP state is assumed to be an abnormal REM sleep. After a single systemic administration of a subanesthetizing low-dose of ketamine, the TC system displays a more desynchronized state (peak effect at about +15–20 min) characterized by the prominent occurrence of lower voltage and faster activities (>16 Hz), which include beta-, gamma- and higher-frequency oscillations. Under the ketamine condition, both the TC and the TRN neurons exhibit a persistent irregular and tonic firing containing more single APs than hfBursts. ACh, acetylcholine; GLU, glutamate; 5HT, serotonin; DA, dopamine; NE, norepinephrine.

#### **4.2. Contribution of the corticothalamic pathway**

In the sedated rat, the psychotomimetic ketamine simultaneously affected both the glutamatergic TC and the GABAergic TRN neurons by converting their firing pattern from burst to single AP mode. How did ketamine do this? What can be the possible underlying mechanisms of this ketamine-induced conversion?

During sleep, sustained hyperpolarization would be the result of either powerful and prolonged inhibition or disfacilitation. Ketamine would likely exert a sustained excitation on both TC and TRN neurons by common afferent input. In addition to the influence of neuromodulatory inputs (see 4.3), the CT pathway seems an excellent candidate (Lam and Sherman, 2010; Landisman and Connors, 2007). The CT axons simultaneously project into both TRN and TC neurons. Indeed, the primary axon of the CT neurons splits into two branches, one innervating TRN neurons, the other TC neurons (Bourassa et al., 1995; Golshani et al., 2001). Furthermore, it has been shown that NMDA receptor antagonists preferentially affect GABAergic interneurons (Grunze et al., 1996; Lewis and Moghaddam, 2006). The effect of ketamine-induced NMDA receptor hypofunction in such a selective manner would lead to the excitation rather than inhibition in excitatory neurons. Therefore, the ketamine-induced NMDA receptor-mediated inhibition (disfacilitation) of the cortical GABAergic interneurons may contribute to the disinhibition (or excitation) of glutamatergic pyramidal neurons (Homayoun and Moghaddam, 2007), including CT neurons. So, the disinhibition of CT neurons would lead to the generation of a sustained thalamic AMPA-mediated gamma hyperactivity (Anderson et al., 2017; Crandall et al., 2015; Golshani et al., 2001). And the ketamine-induced hyperactivation of layer VI CT neurons could in addition promote the gamma-frequency pacemaker properties of the GABAergic TRN cells (Pinault and Deschênes, 1992a, 1992b).

Such an interpretation of our results assigns a significant role to the CT pathway. Due to the NMDA receptor hypofunction-mediated disinhibition of CT neurons, these neurons would be highly excited. These highly active CT neurons exert impact on the TRN and TC neurons and force them to fire in the single AP mode through the excessively activated AMPA receptors and in the inactive or feeble presence of NMDA receptors, which are essential for producing bursts. Further explanation is presented in the following.

NMDA receptors are more critical for the CT-mediated excitation of TRN than TC neurons (Deleuze and Huguenard, 2016). Furthermore, the long-lasting kinetics of NMDA receptors in the GABAergic TRN neurons are essential to promote rhythmic  $\text{Ca}^{2+}$ -mediated burst firing, which then cyclically hyperpolarizes the postsynaptic TC neurons through the activation of GABA receptors. Importantly, in TRN neurons, the NMDA-mediated effects of CT transmission can work across a wide range of voltages so as the voltage-dependent blockade by  $\text{Mg}^{2+}$  is incomplete and that NMDA receptors can be activated by synaptically released glutamate even in the absence of AMPA receptor-mediated activation (Deleuze and Huguenard, 2016). Thus, because CT neurons outnumber by a factor of  $\sim 10$  TC neurons (Sherman and Koch, 1986), the ketamine-induced NMDA receptor hypofunction-related effects are expected to be stronger on TRN than on TC neurons in reducing burst activity, which was indeed observed in the present study (Figure 3-6B3, C3).

There is a growing body of evidence for both increased functional TC connectivity (Avram et al. 2018, Ferri et al. 2018) and reduced sleep spindle activity in schizophrenia (Manoach et al. 2014, Wamsley et al. 2012). It has been shown that there is a significant correlation between these two biomarkers of schizophrenia (Baran et al., 2019). But what are the mechanisms underlying this correlation? Based on our results, we suggest NMDA receptor hypofunction-mediated disinhibition. The NMDA receptor hypofunction-related spindle reduction and gamma increase in the TRN-TC system may help to understand the increased TC connectivity correlated with spindle deficits in schizophrenia.

Ketamine, at a psychotomimetic dose, is expected to affect almost, if not all, brain neurons. In the thalamus, it would impact at least TC and TRN neurons, which work together because of reciprocal connections through open and closed-loop circuits (Pinault and Deschenes, 1998).

The present study showed that psychotomimetic ketamine exerts a stronger impact on GABAergic TRN neurons than on the glutamatergic TC neurons, as explained in more detail in section 4.1. This finding may also be generalized to the cortex. This finding is in line with an intra-cortical study showing that NMDA receptor hypofunction decreases the firing of GABAergic neurons and increases that of glutamatergic neurons (Homayoun and Moghaddam, 2007). Thus, NMDA receptor hypofunction would lead to TC and cortical excitations through the disinhibition of their glutamatergic neurons, which would lead to an excessive accumulation of synaptic glutamate and subsequently to activation of AMPA receptors (Moghaddam et al., 1997), resulting in the electrophysiological abnormalities associated with the psychotic-like state. Such a psychosis-relevant state may be the source for the generation of abnormal internally generated information (Hakami et al., 2009; Gandal et al., 2012).

#### **4.3. Contribution of the ascending reticular activating system and basal forebrain**

The mechanisms of action of ketamine would not be limited to the glutamatergic system and NMDA receptors. The likely mechanisms underlying the effects of ketamine remain controversial as it acts in all brain structures and at many receptors (Dorandeu, 2013; Sleight et al., 2014; Zanos et al., 2018). The ketamine-induced acute arousal promoting effect may involve, among many others, cholinergic, monoaminergic, and orexinergic arousal systems (Ahnaou et al., 2017; Dawson et al., 2013; Lu et al., 2008). Moreover, a single acute administration of physostigmine significantly decreased the power of spindles and slower waves similar to ketamine effects. Therefore, we should not exclude that the observed physostigmine effects suggest that ketamine could also have acted at acetylcholine receptors.

Interestingly, the fact that a single low dose of ketamine simultaneously affected, in an opposite manner, spindle-/delta-frequency and gamma-/higher-frequency TC oscillations are reminiscent of the seminal finding of Moruzzi and Magoun (Moruzzi and Magoun, 1949). Indeed, these pioneering investigators demonstrated that electrical stimulation of the reticular formation, a complex set of interconnected circuits within the brainstem, evokes in the TC system a switch of the EEG pattern from a synchronized to a desynchronized state. Such an effect may be interpreted as an EEG arousal reaction.

Moreover, activation of the mesencephalic reticular formation efficaciously leads to the desynchronized cortical EEG in lightly anesthetized animals (Munk et al., 1996).

Thus, the present findings provide further support for the hypothesis of a dysregulation of the ascending reticular activating system, which includes the pedunculo-pontine nucleus, the basal forebrain, and the thalamus, in the etiopathophysiology of psychotic disorders (Dawson et al., 2013; Garcia-Rill et al., 2015; Heimer, 2000; Howland, 1997). Besides this, it has been demonstrated that NMDA receptor hypofunction leads to a persistent increase in gamma oscillations in the basal ganglia, a cholinergic structure with widespread axonal projections well-known to modulate the neocortex and the TC-TRN system (Hakami et al., 2009; Pinault and Deschenes, 1992). Also, for the observed ketamine effects, we should not exclude a contribution of the ascending GABAergic pathways (originating from the brainstem, midbrain, ventral tegmental area, zona incerta, basal ganglia, and from the basal forebrain), which play a critical role in promoting TC activation, arousal and REM sleep (Brown and McKenna, 2015; Kim et al., 2015).

In the present study, interestingly, physostigmine, known to promote REM sleep (Sitaram et al., 1976) and a cortical EEG arousal (Kenny et al., 2016; Roy and Stullken, 1981), exhibited a ketamine-like effect on delta-, theta-frequency oscillations and spindles (Figure 3-11) and the firing pattern of TRN neurons (Figure 3-14). However, physostigmine did not mimic the ketamine effects on the high-frequency oscillations. These observations show that ketamine and physostigmine likely have similar mechanisms of action, to some extent, suggesting that the ketamine effect should not be confined to the CT-TRN-TC network or glutamatergic system.

The atypical antipsychotic clozapine consistently prevented the foremost ketamine-induced acute effects on sleep oscillations. The fact that clozapine alone increased delta oscillations, but did not enhance sleep spindles or reduce gamma activity may indicate a general slowing of the EEG power, which may counteract the arousal effects of ketamine and help to keep the rats in the slow-wave sleep (Hinze-Selch et al., 1997). The fact that, in contrast to ketamine, clozapine alone did not affect the cortical gamma power suggests that ketamine and clozapine exerted their action via distinct neural/molecular targets, which does not discredit the hypothesis of a dysregulation of the reticular activating

system (Dawson et al., 2013; Garcia-Rill et al., 2015; Heimer, 2000; Howland, 1997), the TC system being nothing but its downstream part (Figure 4-1).

Further investigation is required to better understand, in the thalamus, the mechanisms underlying the relative contribution of the top-down and bottom-up effects of low-dose ketamine.

## **PART 2**

---

### **Theoretical & Computational Study**

# Chapter 1

---

## 1. Introduction and Literature review

### 1.1. Computational model of ketamine-induced effects in the thalamo-cortical loop circuit

In a previously published experimental model for the transition to psychosis, we have administered the NMDA receptor antagonist ketamine in a subanesthetic and psychotomimetic dose to assess its effect on single-neuron and network activity of the somatosensory CT-TRN-TC system of sedated rats. We performed a series of experiments to elucidate the neuronal mechanisms underlying the reduced sleep spindles observed in the patients with schizophrenia. In the experiments, rats were kept sedated using a continuous infusion of pentobarbital to produce sleep-like slow frequency oscillations including spindles. This state was then challenged by low-dose ketamine leading to increased gamma-frequency oscillations and reduced sleep spindles, which are the signs of a transition to psychosis. In order to establish a computational model for the ketamine-induced transition to psychosis, a scenario was required to transform the activity of the CT-TRN-TC network from the normal wake state to the normal non-REM sleep state (NNSS), specifically stage N2 of non-REM sleep during which spindles are considerably generated. Another scenario was required to induce a transition from NNSS to the pathological non-REM sleep state (PNSS) featuring the known effects of ketamine.

In the following sections, first, previously published computational thalamocortical (TC) models of sleep and its different stages are described. Next, we briefly review computational studies that provide an implementation of the glutamate hypothesis of schizophrenia. Then, we outline some important implications of the previous research for the design of our computational model of ketamine-induced transition to psychosis. Next to the straightforward antagonistic effect of ketamin on NMDA recptors, we discuss the



effect of ketamine on non-NMDA receptors and the increased sensitivity of GABAergic TRN neurons to NMDA receptor antagonists like ketamine.

## **1.2. Computational model of non-REM sleep in the thalamocortical system**

To construct the TC network model and adjust the neural properties of its different components, we used our electrophysiological data (Mahdavi et al., 2020) and other experimental observations (Landisman and Connors, 2007). In addition, we also used existing computational models so that the overall structure of the TC network model proposed in the present study is similar to previous models investigating oscillations during sleep (Bazhenov et al., 2000; Hill and Tononi, 2005; Esser et al., 2009; Bonjean et al., 2011; Chen et al., 2012; Wei et al., 2016, Krishnan et al., 2016; Krishnan et al., 2018). It comprises cortical pyramidal neurons, cortical inhibitory interneurons, thalamic relay (TC) neurons and thalamic reticular nucleus (TRN) neurons, which are interconnected through glutamatergic and GABAergic synaptic projections.

Previous computational studies have proposed neuronal mechanisms for the transition between wake state and sleep state that is characterized by sleep spindles and slow oscillations (Destexhe et al., 1996; Bazhenov et al., 1998; Timofeev et al., 2000; Hill and Tononi, 2005; Bonjean et al., 2011). For example, Hill and Tononi (2005) suggested a large-scale network model for wakefulness and sleep based on the TC system. Their model comprises the primary visual cortex with different layers, some thalamic nuclei, and TRN. These areas are connected via thalamocortical, corticothalamic and corticocortical projections. In a modified model (Esser et al., 2009), it was shown that the transition from the wake mode to the sleep mode could occur by changing the peak conductance of AMPA and NMDA synapses and intrinsic channels such as the sodium leak current  $I_{NaL}$  and low-threshold calcium current  $I_T$ , but primarily by increasing the peak conductance of the potassium leak current  $I_{KL}$ . Others had before identified the potassium leak current as a critical component for the switch between wake states and sleep states (Bazhenov et al., 2002; Hill and Tononi, 2005).

Different kinds of neuromodulators, such as acetylcholine (ACh), GABA, histamine (HA), serotonin (5-HT) and norepinephrine also contribute to wake-sleep transitions. Different levels and proportions of these neuromodulators determine whether the brain is waking or whether it is in one of the sleep stages. For example, the levels of ACh, HA and

norepinephrine are reduced and the level of GABA as an inhibitory neurotransmitter is increased in non-REM sleep stages, compared to the waking state (Léna et al., 2005; McCormick, 1992; Vanini et al., 2011; Krishnan et al., 2016). Previous computational work (Krishnan et al., 2016), which has investigated the cellular mechanisms underlying sleep stages in the TC network, has indicated how the orchestrated and combined action of several neuromodulators and their specific intrinsic and synaptic targets are associated with specific types of brain rhythms in wake and sleep states. Already a slight change in the levels of these neuromodulators may affect the properties of sleep spindles, delta and sleep slow oscillations that induce a transition between N2 and N3 stages in non-REM sleep.

It has been shown that there is a relation between these neuromodulators and intrinsic currents, including potassium and sodium currents, as well as synaptic currents, such as AMPA current. However, all these neuromodulators were not explicitly included in the previous studies, and also not in ours. Rather, the effects of them have been indirectly reconstructed through different intrinsic and synaptic currents such as potassium, sodium and AMPA currents, which were indeed part of the models. These relations and the corresponding changes in the intrinsic and synaptic currents are explained in more detail in the following.

The wake state is characterized by the irregular firing in spontaneous single-cell activity and associated low-amplitude fast oscillations in the EEG and LFP. During the waking state, neurons are mostly in Up states, highly desynchronized. Different mechanisms have been proposed to be involved in the transition from wake to sleep, which is a transition from a desynchronized to a synchronized state. It corresponds to the termination of the persistent Up state and an initiation of periodic Up and Down states. The non-REM sleep state is characterized by sleep-like slow oscillations that consist of Down and Up states. In the Down state, neurons are hyperpolarized and silent, whereas in the Up state, neurons fire at high rates with many bursts where the firing rate is even higher than in the wake mode (Steriade et al., 2001; Timofeev et al., 2000). Several previous studies of slow oscillations based on recordings from isolated cortical slabs (Timofeev et al., 2000; Bazhenov et al., 2002) have revealed that the calcium dependent potassium current  $I_{KCa}$  and synaptic depression may be responsible for the termination of Up states. In other studies, it has been proposed that activation of the sodium-dependent

potassium current  $I_{KNa}$  (Compte et al., 2003) and the activation of inhibitory neurons (Chen et al., 2012) may be involved in the termination of Up states. It has been proposed that slow oscillations may be initiated and maintained by the activation of persistent sodium currents, possibly triggered by synaptic input from the thalamus. The results of Hill and Tononi obtained by computational modeling are consistent with experimental studies (Azouz and Gray, 1999; Contreras et al., 1996; Steriade et al. 2001; Massimini et al. 2004).

In a number of previous models, single-compartment spiking neurons (Hill and Tononi, 2005; Esser et al., 2009; Krishnan et al., 2016) or model neurons with dendritic and axo-somatic compartments (Timofeev et al., 2000; Bazhenov et al., 2002; Chen et al., 2012; Krishnan et al., 2016), include various kinds of intrinsic and synaptic currents. The model neuron that we have used in our study to construct the neural populations of the CT-TRN-TC network has been proposed by Hill and Tononi (2005). It is a single-compartment spiking neuron, described in detail in the Materials and Methods section.

There are several computational studies that have addressed the role of neuromodulators for the sleep-wake cycle (Robinson et al., 2011; Costa et al., 2016). Only the model by Krishnan et al. (2016), however, has precisely examined not only the transition from wake to sleep state, but also the transitions between all different sleep stages including REM sleep and stage N2 and N3 of non-REM sleep. Krishnan et al. (2016) have proposed a cellular and neurochemical basis of sleep stages in the TC network. Using a biophysically realistic computational model of the TC network, their study has identified the critical intrinsic and synaptic neuronal mechanisms involving the simultaneous and combined action of different neuromodulators. This includes acetylcholine (ACh), Histamine (HA), GABA and monoamines, which may lead to transitions between wake state and different sleep states. They have indicated that the differences in the level of neuromodulators acting in combination may be responsible for the differences in the temporal dynamics of delta-frequency oscillations and spindles. In other words, their study revealed that even minor changes in the levels of neuromodulators may affect the properties of non-REM sleep oscillations including delta-frequency oscillations and spindles, likely resulting in the impaired dynamics of memory consolidation.

These combined changes of ACh, HA, and GABA work together to initiate firing patterns and oscillatory activities specific to the wake state or one of the sleep stages. In the TC network model, a transition from the wake-like state to stage N2 of the non-REM sleep-like state occurs by reducing the levels of ACh and HA, and increasing GABA transmission (Krishnan et al., 2016). They also proposed a model for REM sleep by increasing the level of ACh and decreasing the levels of HA and GABA relative to the wake state. They implemented these combined changes in these neuromodulators based on the findings of different previous studies (McCormick, 1992; Vazquez and Baghdoyan, 2001; Lena et al., 2005; Vanini et al., 2011). In the model proposed by Krishnan et al. (2016), ACh, HA and GABA were not explicitly modelled, but their effects were implemented through a set of related intrinsic and synaptic mechanisms. The effect of ACh on sleep oscillations can indirectly be modelled through the potassium leak current. Given that ACh is decreased in non-REM sleep, this may be implemented by increasing the conductance of the potassium leak current in excitatory and inhibitory cortical and thalamic neurons and decreasing it in TRN neurons (Krishnan et al., 2016). Experimental studies have shown that the reduced ACh causes an increased activity of AMPA receptors (Gil et al., 1997; Hsieh et al., 2000). Therefore, the ACh effect may be mediated through AMPA and potassium leak currents. Another neuromodulator that plays an important role in the switch to non-REM sleep is histamine (HA). Its effect may indirectly be accounted for through the hyperpolarization-activated cation current,  $I_h$ , in thalamic neurons (McCormick and Williamson, 1991; McCormick, 1992) and the potassium leak currents in all regions (Krishnan et al., 2016). The increase in the level of GABA may be implemented through an increase in the peak conductance of GABAergic receptors.

We draw the conclusion that the reduced thalamic ACh and HA along with the reduced cortical ACh and the increased GABA may lead to the occurrence of spindles, a signature of stage N2 of non-REM sleep. To switch from wake to sleep, these combined changes in these neuromodulators have indirectly been considered in our model through related intrinsic and synaptic currents as explained above.

### **1.3. Computational model to scrutinize the glutamate hypothesis of schizophrenia**

The glutamate hypothesis addresses positive, negative as well as cognitive schizophrenia symptoms. This hypothesis was formulated after analyzing the effect of

administration of drugs such as ketamine and phencyclidine (PCP) which interfere with the glutamatergic system and lead to the aforementioned categories of symptoms in healthy subjects (Javitt, 1987; Javitt and Zukin, 1991; Jentsch and Roth, 1999). This characteristic makes the glutamate hypothesis a promising candidate to explain the neuro-etiology of schizophrenia. A small number of studies have indeed investigated this hypothesis by using a computational model. For example, Murray et al. (2012) have devised an integrate-and-fire neural network model to simulate working-memory storage and memory retrieval. The network consists of pyramidal neurons and inhibitory interneurons which are interconnected through excitatory synaptic currents mediated by AMPA and NMDA receptors, and inhibitory synaptic currents mediated by GABA<sub>A</sub> receptors. In order to investigate the link between a disruption of cortical excitation/inhibition (E/I) balance and deficits of working memory observed in schizophrenia, synaptic disinhibition was implemented through a reduced strength of NMDA connections from excitatory neurons to interneurons. They found that cortical disinhibition may lead to a degradation of the stored information and a reduced ability to filter out distracting inputs. Both aspects clearly affect the maintainability of working memory. To test the model's predictions, ketamine injections were given to human subjects who then performed a working memory task. The expectation was that ketamine would induce disinhibition, leading to impaired inhibitory interneurons. It was, consequently, considered as a pharmacological model of schizophrenia. There are indeed several studies indicating a significant contribution of inhibitory dysfunction in the pathology of schizophrenia (Lewis et al. 2005; Daskalakis et al., 2007; Marin, 2012). In conclusion, the above-mentioned biology-inspired neural network model proposed that the hypofunction of NMDA receptors on interneurons leads to cortical disinhibition and, therefore, to a disruption of E/I balance. This was viewed as a candidate neural mechanism of the working memory deficits observed in early course schizophrenia. However, other computational models have indicated that NMDA receptors on pyramidal neurons may also play an important role for persistent activity during working memory by causing strong recurrent excitation (Wang 1999; Durstewitz et al. 2000).

In addition to the study by Murray et al. (2012), there are a number of other computational studies that have focused on the glutamate hypothesis. Their research suggests that the NMDA receptor hypofunction may also make important contributions to the negative and cognitive effects observed in schizophrenia (Wang, 2006; Siekmeier et al.,

2007; Diwadkar et al., 2008). For example, Wang (2006) proposed a prefrontal microcircuit model for cognitive deficits in schizophrenia. He used a biophysically-inspired computational approach, in which NMDA receptors play a critical role in modulating excitatory pyramidal neurons and inhibitory interneurons. This study showed that how a compromised balance between excitation and inhibition in the prefrontal cortex, caused by the hypofunction of NMDA receptors, may lead to the inability to filter out distracting stimuli. The behavior of the model was similar to the increased distractibility observed in schizophrenic patients, associated with cognitive deficits like impaired working memory and decision making (Wang, 2006). Another computational study has assessed the NMDA receptor hypofunction in hippocampus indicating that the reduced input from the entorhinal cortex to the hippocampal region CA1 due to the reduced efficacy of NMDA receptors may underly the problems in memory retrieval observed in schizophrenia patients and ketamine-treated normal individuals (Siekmeier et al., 2007)

Other biophysically inspired computational models have pointed out a possible contribution of NMDA receptor hypofunction to the pathology of schizophrenia by emphasizing the altered balance between the excitation (glutamatergic AMPA and NMDA currents) and inhibition (GABAergic currents) leading to a destabilization of the whole network (Loh et al., 2007; Rolls et al., 2008). For example, Wolf et al. (2005) included various kinds of intrinsic and synaptic currents, including AMPA, NMDA and GABA currents. They could show that the NMDA/AMPA ratio affects the transition between the Up- and Down-state in medium spiny neurons (MSNs) of the Nucleus Accumbens (NAcc). The model predicted that an inability of NAcc MSNs to maintain the transition between Up-states and Down-states may be caused by an NMDA receptor hypofunction. This model has thus proposed a link between the abnormal integration of information and the NMDA receptor hypofunction, which is thought to contribute to the pathology of schizophrenia (Wolf et al., 2005).

Another computational study that provides support for the glutamate hypothesis was performed by Loh et al. (2007). They proposed a dynamical system hypothesis of schizophrenia that encompasses all three categories of schizophrenia symptoms by relating them to the instabilities in attractor neural networks. They simulated an integrate-and-fire network model in which NMDA, AMPA and GABA currents were matched by their

contribution to exponentially decaying currents in the postsynaptic neuron. The rise times of AMPA and GABA currents were not considered because they are very short. The NMDA current includes both rise and decay terms leading to an alpha function. Their study aimed to investigate the effects of synaptic currents on the network because evidence points to a strong relation between altered synaptic currents, the symptoms of schizophrenia and channel-specific pharmacologic treatment of schizophrenia (Coyle et al., 2003; Lewis et al., 2005). Their results showed that a reduced conductance of NMDA receptors leads to a reduced stability and an increased distractibility of the attractor states in relation to the cognitive symptoms of schizophrenia. In other words, a decrease in the excitatory glutamatergic activity mediated by NMDA receptors may cause transitions from one attractor to another one. The reasons are an increase in the irregular firing of neurons in conjunction with shallower attractor states, resulting less stable memories. In their model, reduced activity of NMDA receptors also leads to lower firing rates in the anterior cingulate cortex, which is related to negative symptoms. Positive symptoms, in contrast, were related to an instability of the attractor states caused by decreasing the conductance of both the NMDA and GABA receptors. These results not only supported the glutamate hypothesis, but also indirectly linked it to the dopamine hypothesis. It has been shown that an increased activity of D1 receptors leads to an increase of NMDA currents, whereas an increased activity of D2 receptors has opposite effect on it (Durstewitz et al., 2002; Seamans et al., 2004; Trantham-Davidson et al., 2004). Durstewitz et al. (2008) have reviewed biophysically realistic computational models proposing how alterations of D1 and D2 receptors may lead to the emergence of cognitive, negative, and positive symptoms of schizophrenia. The underlying idea is that dopamine affects cognitive functions through its effects on synaptic currents including NMDA and GABA<sub>A</sub> currents and intrinsic currents such as the persistent sodium current, various types of calcium currents and the slowly inactivating potassium current.

#### **1.4. Effect of ketamine on non-NMDA synaptic receptors**

##### **1.4.1. Effect of ketamine on AMPA receptors**

The rapid antidepressant effect of ketamine is usually explained by an alteration of the AMPA to NMDA receptor ratio. An explanation is that ketamine inactivates NMDA receptors on GABAergic interneurons, leading to an increase in glutamate through disinhibition and a subsequently increased activity of AMPA receptors (Homayoun and

Moghaddam, 2007; Aleksandrova et al., 2017). There are other studies, however, showing that the effect of ketamine on AMPA receptors is not secondary and ketamine may have a direct impact on them. An *in vivo* electrophysiological study (Iskandrani et al., 2015) has investigated the effect of subanesthetic doses of ketamine on AMPA-mediated responses in male rats. Their findings proposed that administration of acute ketamine leads to a significant amplification of AMPA transmission, resulting in a rapid enhancement of firing activity in catecholaminergic neurons. Interestingly, they showed that ketamine administration may exert a direct effect on AMPA receptors since ketamine led to an enhancement of AMPA- but not NMDA-evoked responses in the hippocampal pyramidal neurons. Moreover, they showed that the ketamine-induced changes in neurons' activities may be prevented by the administration of DNQX, an AMPA antagonist, revealing the considerable effect of ketamine on the function of AMPA receptors. By these observations, they have also provided a possible additional mechanism for the elevated activity of dopamine neurons in the ventral tegmental area. Subanesthetic doses of ketamine potentiate the activity of AMPA receptors not only in hippocampus but also in pyramidal neurons of prefrontal cortex (Moghaddam et al., 1997; Koike et al., 2011; Chowdhury et al., 2012; Björkholm et al., 2015; Aleksandrova et al., 2017).

There are other studies investigating ketamine-based mechanisms beyond NMDA receptor antagonism (Aleksandrova et al., 2017). In particular, there is accumulating evidence that supports the crucial role of AMPA receptors for the rapid antidepressant effects of ketamine (Maeng et al., 2008; Machado-Vieira et al., 2015; Koike et al., 2014). It was shown that ketamine increases the surface expression of both GluA1 and GluA2 subunits of AMPA receptors leading to a synaptic potentiation and behavioral antidepressant effects. Administration of ketamine could not reveal its effects in the GluA2 knock-out mice, indicating the direct impact of ketamine on AMPA receptors (Nosyreva et al., 2013). Taken together, all these findings suggest to take not only NMDA receptors into consideration, but also the AMPA receptors and their role in ketamine-induced effects, including the emergence of schizophrenia symptoms.

#### **1.4.2. Effect of ketamine on GABA receptors**

The effect profile of ketamine is usually attributed to NMDA receptors, but there is ample evidence for the involvement of other kinds of synaptic receptors. The administration of ketamine, for example, affects the function of GABA<sub>A</sub> receptors. A study



using convulsive and anesthetic behavioral models in mice demonstrated that the GABA<sub>A</sub> receptor agonist muscimol potentiates ketamine-induced anesthesia (Irifune et al., 2000). Also, ketamine was able to inhibit tonic convulsions induced by the GABA<sub>A</sub> receptor antagonist bicuculline, demonstrating an agonistic impact of ketamine on GABA<sub>A</sub> receptors. As a result, ketamine has also an anticonvulsant effect. These findings suggest that ketamine-induced anesthesia and anticonvulsion may, in fact, be mediated by GABA<sub>A</sub> receptors. Irifune et al. suggested that the effect of ketamine on GABA<sub>A</sub> receptors may not be secondary to its effect on NMDA receptors. It has been shown that an increased activity of NMDA receptors significantly increases the GABA release, and that the administration of a very specific NMDA receptor antagonist significantly blocks GABA release. Therefore, an NMDA receptor antagonist like ketamine would also be expected to decrease the activation of GABA<sub>A</sub> receptors. The opposite result has been obtained, and ketamine enhances GABA<sub>A</sub> receptor-mediated neurotransmission. Therefore, the increased activity of GABA<sub>A</sub> receptors caused by ketamine might not be indirectly be mediated by NMDA receptors, but should be considered as a direct effect of ketamine on GABA<sub>A</sub> receptors. However, ketamine acts on different kinds of receptors (such as NMDA, AMPA, muscarinic cholinergic, and opioid receptors), Irifune et al. (2000) have shown that ketamine-induced anesthesia may be mediated concomitantly by both the increased activity of GABAergic neurons and the decreased activity of excitatory glutamatergic and muscarinic cholinergic neurons.

Another study by Wang et al. (2017) has investigated the role of GABA<sub>A</sub> receptors in ketamine anesthesia. They showed that ketamine has a significant subtype-specific effect on the GABA<sub>A</sub> receptors. Clinically relevant dosages of ketamine potentiated the activity of extrasynaptic GABA<sub>A</sub> receptors, resulting in increased tonic inhibitory currents in mouse hippocampal and cortical neurons. An electrophysiological study (Ghosal et al., 2020) showed that a single dose of ketamine may rapidly reverse the stress-induced deficits in GABAergic transmission in rat prefrontal cortex, leading to a reversal of depressive-like behaviors. The mechanisms underlying the ketamine-induced increase in GABA function are unclear. Ghosal et al. (2020) suggested that the increased GABA function may be the result of an initial ketamine-induced increase in the glutamatergic neurotransmission (Ren et al., 2016), likely through the disinhibition of glutamate signaling (Widman and McMahon, 2018). A second possibility is that ketamine directly affects

GABA function, independent of glutamatergic transmission. However, an underlying mechanism of this is still unknown. Taken together, we conclude that ketamine directly or indirectly affects GABA<sub>A</sub> receptors. Therefore, we decided to include them in our computer simulations of ketamine-induced psychotic-like transitions in a CT-TRN-TC network.

### **1.5. NMDA receptors on inhibitory neurons are more sensitive to antagonism**

One consequence of NMDA receptor hypofunction may be disinhibition, which can occur through the effect of NMDA receptor antagonists on inhibitory GABAergic neurons rather than excitatory neurons (Lisman et al., 2008; Nakazawa et al., 2012). Electrophysiological findings show that this NMDA receptor-mediated disinhibition may result in an increased excitability that is characteristic of schizophrenia (Wobrock et al., 2007). In animal models, the administration of ketamine increases excitability of the PFC (Moghaddam et al., 1997). This is a surprising observation, as using ketamine as a blocker of excitatory neurotransmission should actually lead to reduced excitability. It has been proposed that NMDA receptor antagonists preferentially affect inhibitory interneurons, partially because of their higher baseline activity relative to pyramidal neurons, which reduces the Mg<sup>2+</sup> dependent block of their NMDA receptors (Homayoun and Moghaddam, 2007). In other words, NMDA receptors on inhibitory neurons have a larger impact on neuronal activity because, as researchers have proposed, the average or baseline membrane potential of inhibitory neurons is more depolarized than that of pyramidal neurons (Lewis and Moghaddam, 2006). This property makes the inhibitory neurons more vulnerable to a removal of the voltage-dependent magnesium block. This finding provides a mechanism for the higher sensitivity of inhibitory neurons to NMDA receptor antagonists. It may also answer the question why and how NMDA receptor blockade can lead to excitation instead of inhibition (Su et al., 2018). Less activated inhibitory neurons lead to a disinhibition, which subsequently results in the increased activity of excitatory neurons of the whole network.

It is important to know about the role of various subunits of NMDA receptors and take them into consideration in our simulation of CT-TRN-TC network. Doing so can help to better understand the mechanisms underlying ketamine-induced effects and NMDA receptor hypofunction. NMDA receptor subunits including NR1 and NR2A/B/C/D are differentially expressed in different cell types and regions. Excitatory pyramidal neurons of cortex express high levels of the NR2B subunit (Wang et al., 2008; Xi et al., 2009), whereas inhibitory

GABAergic neurons of TRN express the NR2C (GluN2C) subunit more than other subunits (Xi et al., 2009; Zhang et al., 2012). The GluN2C subunit is highly expressed not only in TRN, but also in inhibitory neurons of thalamus and cortex (Gupta et al., 2016). It has been shown that the GluN2C-containing NMDA receptors may significantly affect the TC and cortical oscillations. The lower expression of GluN2C in patients with schizophrenia has been reported by previous post-mortem studies (Meador-Woodruff et al., 2003; Akbarian et al., 1996; Ibrahim et al., 2000). Also, knockout and reduction of GluN2C have been shown to lead to abnormal neuronal oscillations and cortical excitatory-inhibitory imbalance, resulting in cognitive deficits as observed in schizophrenia (Gupta et al., 2016). Interestingly, NR2C subunits of NMDA receptors localized at TRN neurons exhibit a greater sensitivity to the ketamine as compared to NR2A/B/D receptors (Kotermanski and Johnson, 2009). This interesting finding may underlie NMDA receptor hypofunction through a dysfunctional TRN, leading to the disinhibition of TC neurons that have frequently been reported by several different studies of schizophrenia. Of interest here is especially the TRN-mediated disinhibition observed under subanesthetic administration of NMDA receptor antagonists such as the ketamine (Homayoun and Moghaddam, 2007, Anticevic et al., 2012; Pratt et al., 2017). This finding does not only support the NMDA receptor hypofunction theory, but it also highlights that thalamus is particularly vulnerable by NMDA receptor hypofunction.

Kinney et al. (2006) have proposed an answer to the question why inhibitory neurons are more sensitive to ketamine as compared to excitatory neurons. They showed that ketamine reduces the expression of GAD67, which is a GABA synthesizing enzyme existing in most inhibitory interneurons (Kinney et al., 2006). It also has been shown that NMDA receptors on inhibitory neurons regulate the expression of the calcium binding protein parvalbumin (Kinney et al., 2006) which, in turn, modulates the firing properties of TRN bursting neurons (Albéri et al., 2013). Moreover, it has been shown that a knockout of the NMDA receptor GluN1 subunit in inhibitory neurons leads to cortical disinhibition and results in schizophrenia-like symptoms (Korotkova et al, 2010; Belforte et al., 2010; Su et al., 2018).

Given that both excitatory and inhibitory neurons express NMDA receptors, it seems that both of them contribute to the emergence of schizophrenia symptoms. As NMDA receptors on inhibitory neurons are more sensitive to NMDA receptor antagonists, it may be expected that inhibitory GABAergic neurons contribute more to NMDA receptor hypofunction in schizophrenia than excitatory glutamatergic neurons. For example, Cohen et al. (2015) have

shown how NMDA-mediated inhibitory dysfunction may lead to reduced GABAergic transmission and reduced inhibition, leading to an increase of TC and CT excitation. These are the unique molecular properties of NMDA receptors that make their hypofunction particularly relevant for the pathophysiology of schizophrenia (Cohen, 2015).

Both the reduced activity of NMDA receptors in inhibitory GABAergic neurons and NMDA receptor antagonists such as ketamine lead to cognitive impairments and behavioral abnormalities reminiscent of schizophrenia. This suggests that NMDA receptor antagonists affect the NMDA receptors in the inhibitory GABAergic neurons more than in the excitatory glutamatergic neurons. Given that NMDA receptors on inhibitory neurons are more vulnerable for being affected by ketamine than NMDA receptors on excitatory neurons, ketamine reduces the activity of inhibitory neurons more than excitatory neurons. These findings revealed the importance of NMDA receptors on inhibitory neurons, such as GABAergic TRN neurons, on the emergence of ketamine-induced effects. This higher sensitivity of NMDA receptors in GABAergic inhibitory neurons to NMDA receptor antagonists is one of the specific properties of inhibitory GABAergic neurons like TRN neurons that is also implemented in our model. We have accounted for this property in our simulated CT-TRN-TC network by adjusting the parameters of NMDA receptors including magnesium blockade, gating variables, conductance and connection probability as described in the chapter of methods and materials.

## 1.6. Aims

The neural mechanisms underlying the schizophrenia-related thalamocortical spindle deficit are unknown. We have used a joint experimental-computational approach to investigate the hypothesis that the deficit in sleep spindles and slower oscillations recorded in early course schizophrenia involves a reduced function of NMDA receptors. To this aim, we first carried out a series of in vivo electrophysiological experiments, the results of which are presented in a paper published in the journal *Schizophrenia Research*. Then, addressing the same hypothesis theoretically, a computational model of the CT-TRN-TC network was developed. The goal was to elucidate the neuronal mechanisms underlying the transition from NNSS to PNSS that is induced by ketamine as indicated in our experimental observations.

The analysis of electrophysiological recordings revealed that administration of the NMDA receptor antagonist ketamine at a psychotomimetic dose transiently and significantly results in a reduction of cortical and thalamic spindles and lower-frequency oscillations and switches the firing pattern of TC and TRN neurons from a burst mode to a tonic mode (Mahdavi et al., 2020). In view of these experimental results, we hypothesized that the acute ketamine model may also be a model of the transition to psychosis. We found that, in the sleep-like condition, acute ketamine leads to psychosis-related disturbances of brain oscillations including spindle deficits, whereas the antipsychotic clozapine, that binds to the serotonin and dopamine receptors (Meltzer, 1991; Meltzer, 1994; Deutch, 1995; Seeman, 2002; Nucifora et al., 2017; Haidary and Padhy, 2020) as well as to the NMDA receptor through its glycine site (Lipina et al., 2005; Schwieler et al., 2008), prevents them. The objective of the computational part of the project was to provide additional support for our interpretation of the experimental findings

What can the computational model suggest as a possible underlying mechanism for the transition to psychosis caused by administration of ketamine at the subanesthetic dose? What happens to the neuronal activity of the simulated CT-TRN-TC network after the transition, given that the non-REM sleep-like state is characterized by slow oscillations and transitions between up and down states? Is the computational model able to mimic the ketamine effects by inactivating or attenuating the NMDA receptors alone? Can the simulation results confirm that the ketamine effects are specifically due to a reduced efficacy

of NMDA receptors, as the experimental data have already indicated? A number of previous studies have shown that ketamine affects not only NMDA receptors, but also other synaptic receptors including AMPA and GABA<sub>A</sub> receptors (Irifune et al., 2000; Sleight et al., 2014; Wang et al., 2017; Aleksandrova et al., 2017; Llamosas et al., 2019). Using our model of non-REM sleep state in the CT-TRN-TC network, we aim at assessing the role of NMDA receptors in conjunction with a possible contribution of AMPA and GABA<sub>A</sub> receptors for the transition from the NNSS to the PNSS. To investigate how the CT-TRN-TC network functions before and after ketamine application, we analyze the firing patterns of individual neurons in CT, TRN and TC populations by recording membrane potentials and detecting action potentials. In addition, we also analyze the oscillatory activity of the same populations by recording local field potentials (LFPs) and extracting activity in 6 distinct frequency bands including delta- (1-4 Hz) and theta- (5-8 Hz) frequency oscillations, spindles (9-16 Hz), as well as beta- (17-30), gamma- (31-80 Hz) and higher- (81-200 Hz) frequency oscillations.

In our experiments, we did not acquire electrophysiological recordings directly from corticothalamic (CT) neurons of layer VI. In the computational model of the 3-stage CT-TRN-TC loop circuit, we directly obtain the LFP-like and intracellular-like recordings from simulated CT neurons. We assess the action potential firing and oscillatory activity of CT neurons.

We hypothesized that a combination of changes in parameters of AMPA, NMDA and GABA<sub>A</sub> receptors with a primary contribution of NMDA receptors is required to obtain a good account of the full ketamine-induced effects. The balanced and combined ketamine-related changes in NMDA and non-NMDA receptors may contribute to the transition to psychosis-relevant state and the schizophrenia-related deficit in sleep oscillations. However, the reduced efficacy of NMDA receptors still plays more important role than changes in other synaptic receptors. In view of our electrophysiological observations, we predict that, in the simulated model of non-REM sleep state in the CT-TRN-TC system, inactivation or attenuation of NMDA receptors together with other ketamine-related changes in AMPA and GABA<sub>A</sub> receptors may lead to a reduction of spindles and switch the firing activity from the burst mode in NNSS to irregular non-burst single-spiking mode in PNSS.

To assess the role each of the synaptic receptors has in the ketamine-induced transition to psychosis, we test different possible mechanisms. Such an assessment may

indicate how NMDA receptors compared to the other synaptic non-NMDA receptors are essential in causing the psychotic transition upon ketamine administration. First, each synaptic receptor is alone manipulated, without changing any other receptors along with that. By this assessment, we may better understand whether or not the manipulation of each receptor alone or combination of them may exhibit the ketamine-like effects, and which of these possibilities gives a good account of the ketamine-induced effects. We will also test which combination of changes involving AMPA, NMDA and GABA<sub>A</sub> receptors offers the best mechanism to accounting for the ketamine-induced transition to psychosis.

In summary, the computational approach addresses the same question as our experiments. We expect that this combination helps us to find out what neural mechanisms underlie the schizophrenia-related sleep spindle deficit, and whether the deficit in sleep spindles and slower oscillations recorded in schizophrenia involves a reduced function of NMDA receptors.

## Chapter 2

---

### 2. Materials and methods

In this chapter, we will outline how the computational network model of the somatosensory CT-TRN-TC loop circuit was constructed, simulated and analyzed. First, we describe the structure of the model, the connectivity between neural populations, the conductance-based neuron model and its specific properties. Then, we describe the methods used to acquire and analyse cell level and network level activities.

The statistical significance of the obtained results was evaluated with the Student's paired t-test (significant when  $P \leq 0.05$ ).

#### 2.1. The computational network model of the CT-TRN-TC loop circuit

The computational model of the three-stage CT-TRN-TC loop circuit was simulated using NEST, a simulator for spiking neural network models. We used NEST 2.18.0 (Jordan et al., 2019) and Python 3.7.3. All simulations and data analyses were performed on the bwForCluster NEMO ([https://wiki.bwhpc.de/e/Category:BwForCluster\\_NEMO](https://wiki.bwhpc.de/e/Category:BwForCluster_NEMO)).

The network is comprised of several populations of spiking neurons in cortical and subcortical regions connected by either glutamatergic or GABAergic pathways. The neuronal system studied here consists of a primary area of somatosensory cortex, the corresponding region of the thalamus including somatosensory thalamocortical (TC) neurons, and the inhibitory GABAergic region of the thalamic reticular nucleus (TRN). Both the somatosensory cortical and thalamic regions consist of excitatory and inhibitory neurons. The connections between neurons and regions are based on AMPA and NMDA



receptors for glutamatergic excitation, and on GABA<sub>A</sub> and GABA<sub>B</sub> receptors for GABAergic inhibition. Figure 2-1 shows a schematic representation of the regions and their connections involved in the modelling of the CT-TRN-TC network. The connectivity pattern is presented in more detail in the next section.

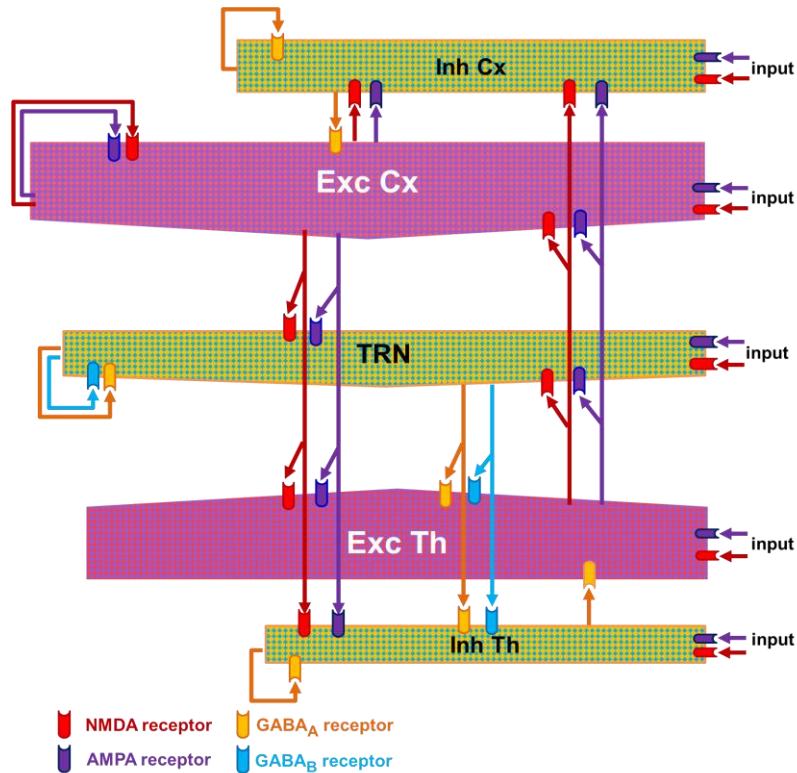

**Figure 2-1. Computational spiking network model of the three-stage CT-TRN-TC loop circuit.**

The model network consists of five neuronal populations including excitatory cortex (Exc Cx), inhibitory cortex (Inh Cx), inhibitory neurons of thalamic reticular nucleus (TRN), excitatory thalamus (Exc Th) and inhibitory thalamus (Inh Th). The connections between the neurons of these populations are based on different types of synapses (indicated by the arrows) in the target area. NMDA (red arrows) and AMPA (violet arrows) synapses are both excitatory, GABA<sub>A</sub> (orange arrows) and GABA<sub>B</sub> (blue arrows) synapses are both inhibitory. Each population has its private excitatory input, summarizing the effect of other brain regions.

## 2.2. Topological and probabilistic connectivity between neural populations

We used the topology library of NEST to construct the structured network model of the CT-TRN-TC loop circuit. This allowed us to create populations of point neurons with defined connectivity profiles between populations. The procedure involved two steps:

**1. Defining areas:** The model network is comprised of five different neural populations: the excitatory glutamatergic cortex, inhibitory GABAergic cortex, excitatory glutamatergic thalamus, inhibitory GABAergic thalamus, and inhibitory GABAergic neurons of the TRN. Neurons of each population are uniformly distributed on a bounded rectangular grid. Each grid has an extent (size of the bounded area) and includes rows and columns. Number of rows multiplied by the number of columns determines how many point neurons (elements) belong to the corresponding population. Table 2-1 shows the layout of different areas involved in the network. Each neuron receives additional external excitatory input reflecting the effect of other brain areas which are not explicitly represented in the simulated network.

**Table 2-1.** The topological properties of different areas involved in the CT-TRN-TC network model. Exc Cx: excitatory cortical neuron, Inh Cx: inhibitory cortical neuron, TRN: TRN neuron, Exc Th: excitatory thalamic neuron, Inh Th: inhibitory thalamic neuron

elements	extent	rows	columns	Number of neurons
Exc Cx	20 × 20 mm <sup>2</sup>	48	48	2304
Inh Cx	20 × 20 mm <sup>2</sup>	20	20	400
TRN	20 × 20 mm <sup>2</sup>	24	24	576
Exc Th	20 × 20 mm <sup>2</sup>	27	27	729
Inh Th	20 × 20 mm <sup>2</sup>	12	12	144

**2. Defining connectivity profiles:** We define the dictionary that specifies the properties of a synaptic connection. This includes connection type, the synapse model, the location-dependent likelihood of choosing a target, weights and delays.

The connection type used in all the connection dictionaries is “divergent”. When creating a divergent connection, Topology visits each node (i.e., neuron) in the source layer and selects target nodes from the target layer. Masks and kernels are applied in the target layer. In a divergent connection, a mask describes which area of the pool (target) layer shall be searched for nodes to connect by any individual node in the driver (source) layer. Only neurons within the mask are considered as potential targets that have a

chance to be selected (i.e., stimulated) by the source neuron. The type of mask used in the model is circular. A circular mask is a part of target layer that is specified by its radius within which the projections from a single source cell diverge. Topology is based on probabilistic connections through kernels. The kernel is a function returning a probability for creating a connection between a driver (source neuron) and a pool node (postsynaptic neuron in target region). Topology then generates a connection according to this probability. Figure 2-2 (right) shows a divergent connection between excitatory thalamic population (source layer) and excitatory cortical population (target layer) via NMDA synapse. In this case, connection probability to NMDA receptors ( $P_{\max}$ ) falls off with a “standard deviation” of  $\sigma$ . Figure 2-2 illustrates a red circular mask with a certain radius and a Gaussian kernel in which green dashed lines show  $\sigma$ ,  $2\sigma$ ,  $3\sigma$ . Overall, all connections follow this general manner: a source (presynaptic) neuron projects to several postsynaptic neurons in a circular mask in the target area. Some of the neurons are selected probabilistically according to Gaussian spatial profile, with a maximum probability of connection  $P_{\max}$  and width  $\sigma$ .

Target (postsynaptic) neurons are stimulated by the synaptic currents including NMDA, AMPA, GABA<sub>A</sub> and GABA<sub>B</sub> currents. Parameters of the connectivity profiles such as type of synaptic channel activated by the connection, style of the connection pattern, maximum probability of the connection, and strength of the connections were inspired by previous TC network models proposed by computational (Bazhenov et al., 2002; Hill and Tononi, 2005; Krishnan et al., 2016) and experimental studies (Landisman et al, 2007). However, all parameters had to be tuned to account for the new properties of the current model. More importantly, however, the values of all model parameters were set to be consistent with our experimental observations (Mahdavi et al., 2020). All connection profiles for all model connections are listed in Table 2-2. One population is connected to itself and to other populations using a specified connection dictionary. All connections between populations are shown in Figure 2-1 and Figure 2-2.

### **2.3. Further aspects of constructing the CT-TRN-TC network**

We used Python’s random module to change the random seed in order to create different network realizations. Specifically, we used the random.seed(x) function to initialize the random number generator in a controlled way. Each time we executed the

simulation, we chose a different seed value  $x$ . This enabled us to also account for the variability of simulations across independent realizations.

In the model, each population has its private excitatory input to account for the top-down influence of other brain regions. This private input is implemented by a Poisson generator, which makes sure that each neuron gets independent input. To model the neurons of the CT-TRN-TC network, we used a specific neuron model proposed by Hill and Tononi. In NEST, it is called “ht\_neuron”. Due to a known issue in the software, it was not possible to connect the Poisson generator directly to these neurons if they are connected to each other in a topological manner. For that reason, we had to use so-called “parrot neurons” as an interface to the Poisson generator.

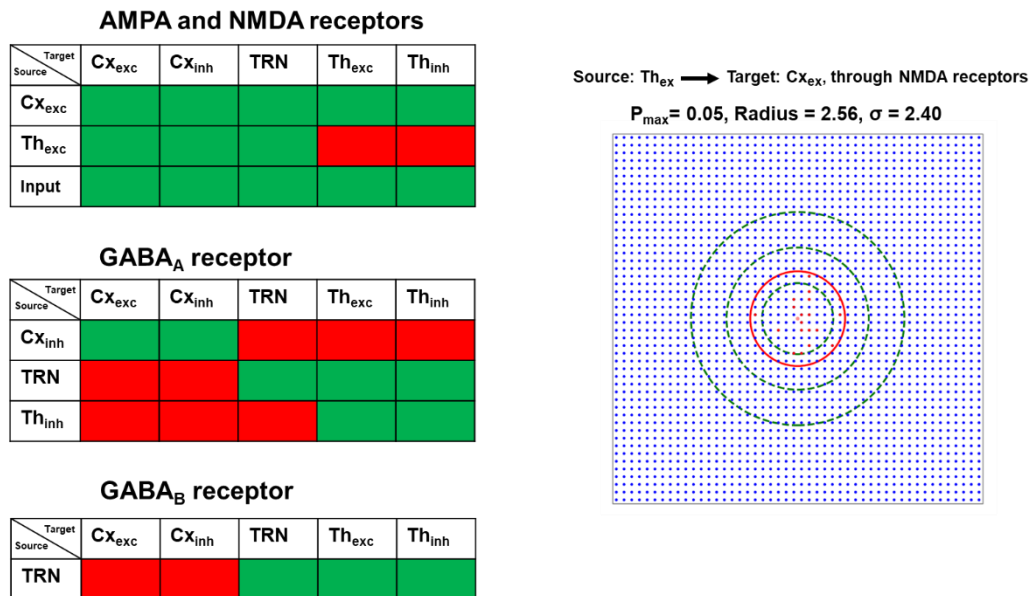

**Figure 2-2. Topological and probabilistic connectivity between the neural populations of the simulated CT-TRN-TC system through synaptic receptors.**

**A.** Connectivity patterns are specified as follows: source area as a layer of origin, target area as a layer of termination, cell type (exc: excitatory, inh: inhibitory) and type of synaptic currents (AMPA, NMDA, GABA<sub>A</sub> and GABA<sub>B</sub>). If a source (presynaptic) neuron is connected to a target (postsynaptic) neuron, the entry is green, otherwise red. **B.** Example of a topologically and probabilistically defined connectivity profile. A grid with divergent Gaussian projections from a single excitatory TC neuron (marked by a light-red dot at the center) into the cortical layer (blue and red dots), in which some of the cortical neurons (red dots) are randomly selected according to a Gaussian profile with a peak of  $P_{max}$  (maximum probability of connection) and a width of  $\sigma$  (standard deviation, green circles). The red circle illustrates a circular mask. Only neurons within this mask have a chance to be selected by the source neuron. The dashed green circles mark  $\sigma$ ,  $2\sigma$  and  $3\sigma$  of the

Gaussian kernel (description with more detail in the text).  $Cx_{inh}$  = inhibitory cortex,  $Cx_{exc}$  = excitatory cortex,  $Th_{inh}$  = inhibitory thalamus,  $Th_{exc}$  = excitatory thalamus.

**Table 2-2. Parameters of the connectivity profiles used to construct the CT-TRN-TC network.**

Each profile comprises kind of synapse (AMPA, NMDA, GABA<sub>A</sub> and GABA<sub>B</sub>), the maximum probability of connection ( $P_{max}$ ), the standard deviation of the target area to which the projections from a single source neuron diverge ( $\sigma$ ), strength of the connections (weight) and the mean $\pm$ SD of the conduction delay from the source neuron to the target neurons. Each neuron receives private background input from a Poisson source. Exc Cx: excitatory cortex, Inh Cx Inhibitory cortex, TRN: thalamic reticular nucleus, Exc Th: excitatory thalamus, Inh Th: inhibitory thalamus.

Source Region	Target Region	Receptor	$P_{max}$	$\sigma$	Radius	Weight	Delay
Exc Cx	Exc Cx	AMPA	0.0624	2.08	2.56	1.26	1 $\pm$ 0.25
Exc Cx	Exc Cx	NMDA	0.0624	2.08	2.56	1.35	1 $\pm$ 0.25
Exc Cx	Inh Cx	AMPA	0.16	1.76	2.24	1.5	1 $\pm$ 0.25
Exc Cx	Inh Cx	NMDA	0.16	1.76	2.24	1.6	1 $\pm$ 0.25
Exc Cx	Exc Th	AMPA	0.096	2.72	2.88	1.02	9 $\pm$ 3
Exc Cx	Exc Th	NMDA	0.096	2.4	2.88	1.02	9 $\pm$ 3
Exc Cx	Inh Th	AMPA	0.12	5.28	5.76	1.2	11 $\pm$ 3
Exc Cx	Inh Th	NMDA	0.12	5.28	5.76	1.2	11 $\pm$ 3
Exc Cx	TRN	AMPA	0.102	2.24	3.2	1.5	8 $\pm$ 3
Exc Cx	TRN	NMDA	0.112	2.56	3.2	1.65	8 $\pm$ 3
Inh Cx	Exc Cx	GABA <sub>A</sub>	0.104	2.08	3.2	2.5	0.75 $\pm$ 0.1
Inh Cx	Inh Cx	GABA <sub>A</sub>	0.12	3.68	4.48	1.625	0.75 $\pm$ 0.1
Exc Th	Exc Cx	AMPA	0.078	2.08	2.56	1.65	7 $\pm$ 0.5
Exc Th	Exc Cx	NMDA	0.078	2.4	2.88	1.65	7 $\pm$ 0.5
Exc Th	Inh Cx	AMPA	0.16	2.4	2.56	1.8	7 $\pm$ 0.5
Exc Th	Inh Cx	NMDA	0.18	2.4	2.56	1.9	7 $\pm$ 0.5

Exc Th	TRN	AMPA	0.08	1.76	2.24	1.2	2±0.25
Exc Th	TRN	NMDA	0.1	1.76	2.24	1.5	2±0.25
TRN	Exc Th	GABA <sub>A</sub>	0.11	2.72	2.88	1.375	1.5±0.25
TRN	Exc Th	GABA <sub>B</sub>	0.06	1.76	2.88	0.6	1.5±0.25
TRN	Inh Th	GABA <sub>A</sub>	0.102	2.72	2.88	1.25	1.5±0.25
TRN	Inh Th	GABA <sub>B</sub>	0.075	1.76	2.88	0.75	1.5±0.25
TRN	TRN	GABA <sub>A</sub>	0.0765	2,72	4	1.125	2±0.25
TRN	TRN	GABA <sub>B</sub>	0.06	1.76	4	0.6	2±0.25
Inh Th	Exc Th	GABA <sub>A</sub>	0.15	2.08	2.24	1.25	1±0.25
Inh Th	Inh Th	GABA <sub>A</sub>	0.15	3.68	7.04	1.25	1±0.25
Input to exc Cx	Exc Cx	AMPA	1	-	0.35	0.52	6±2
Input to exc Cx	Exc Cx	NMDA	1	-	0.35	0.585	6±2
Input to inh Cx	inh Cx	AMPA	1	-	0.5	0.5	6±2
Input to inh Cx	inh Cx	NMDA	1	-	0.5	0.5	6±2
Input to exc Th	Exc Th	AMPA	1	-	0.5	0.6	4±0.25
Input to exc Th	Exc Th	NMDA	1	-	0.5	0.6	4±0.25
Input to inh Th	Inh Th	AMPA	1	-	1	0.7	3±0.25
Input to inh Th	Inh Th	NMDA	1	-	1	0.75	3±0.25
Input to TRN	TRN	AMPA	1	-	0.65	0.6	3±0.25
Input to TRN	TRN	NMDA	1	-	0.65	0.75	3±0.25
Poisson generator	Input to exc Cx	-	1	-	-	280	2±0.25
Poisson generator	Input to inh Cx	-	1	-	-	245	2±0.25
Poisson generator	Input to exc Th	-	1	-	-	280	2±0.25
Poisson generator	Input to inh Th	-	1	-	-	245	2±0.25

## 2.4. Model neurons

All neurons are modeled as single-compartment (point) spiking neurons using Hodgkin–Huxley style currents. The spiking dynamics is simplified for computational efficiency reasons. The Hodgkin–Huxley paradigm is used to model changes in the subthreshold membrane potential. A simple firing threshold is employed to describe the generation of action potentials (APs). The main advantage of the integrate-and-fire approach is that it is computationally more efficient than the Hodgkin–Huxley model and is therefore a good candidate for large-scale network modeling. Thus, our model neurons are a hybrid between Hodgkin–Huxley and integrate-and-fire neuron models. The neuron model used to construct the CT-TRN-TC network in our study is derived from the neuron model described by Hill and Tononi (2005). It is one of the neuron models implemented in NEST. We selected this model because of its specific properties that are important to construct the CT-TRN-TC network model. These features are: (1) AMPA, NMDA, GABA<sub>A</sub>, and GABA<sub>B</sub> conductance-based synaptic channels with separate rise time and decay time constants of the conductance transients, (2) voltage dependence of the NMDA receptor conductance unblocking to model the Magnesium blockage in addition to ligand-gating, (3) dynamics for the post-spike repolarizing potassium current instead of instantaneous reset to the reversal potential of the leak potassium current. The dynamic equation for the membrane potential  $V$  of a neuron is as follows

$$\begin{aligned} \frac{dV}{dt} &= [-I_{NaL} - I_{KL} - I_{int} - I_{syn}]/\tau_m - I_K \\ I_{NaL} &= g_{NaL}(V - E_{Na}), \quad I_{KL} = g_{KL}(V - E_K), \\ I_K &= g_{spike}(V - E_K)/\tau_{spike} \\ I_{int} &= I_{Na(p)} + I_{KCa} + I_{DK} + I_h + I_T \\ I_{syn} &= I_{AMPA} + I_{NMDA} + I_{GABA_A} + I_{GABA_B} \end{aligned}$$

where  $\tau_m$  is the membrane time constant as derived from experimental data for excitatory and inhibitory cells (Mason et al. 1991, Baranyi et al. 1993).  $I_{NaL}$  and  $I_{KL}$  are the sodium and potassium leak currents, respectively. The conductances for the sodium leak ( $g_{NaL} =$

0.2  $\mu\text{S}$ ) and potassium leak ( $g_{KL} = 1.0 \mu\text{S}$ ) are the primary determinants of the resting membrane potential. Manipulation of  $g_{KL}$  has been considered as one of the main parameters involved in the transition from wake to sleep by sleep models (Hill and Tononi, 2005, 2009; Bazhenov et al., 2002; Krishnan et al., 2016) as explained with more detail in the next chapter. Reversal potentials are  $E_{Na} = 30 \text{ mV}$  and  $E_K = -90 \text{ mV}$ . Two types of input contribute to the membrane potential, the synaptic currents ( $I_{syn}$ ) and intrinsic currents ( $I_{int}$ ) which are described next. During the simulations performed with this model, we simultaneously record all relevant variables from a sample of neurons in the network (membrane potentials, intrinsic and synaptic conductances and currents), from all regions.

When  $V$  exceeds the firing threshold  $\theta$ , a spike is generated by setting  $V$  and  $\theta$  instantaneously to  $E_{Na}$ , modeling the contribution of the fast  $I_{NaL}$  current. The activation of a fast potassium current  $I_K$  during a spike is represented by a brief pulse with amplitude of  $g_{KL} = 1 \text{ mS}$  and width  $\tau_{spike}$ , which is the time constant for the post-spike repolarizing potassium current. This current drives the membrane potential toward  $E_K$ , while continuing to integrate intrinsic and synaptic currents. These dynamics replace the instantaneous reset to resting potential of simpler models. The threshold  $\theta$  is also dynamic, reflecting adaptivity caused by sodium channel inactivation, and determines at which membrane potential a neuron should fire

$$\frac{d\theta}{dt} = -(\theta - \theta_{eq})/\tau_\theta$$

The resting threshold  $\theta_{eq}$  determines the equilibrium threshold potential ( $\theta_{eq} = -51 \text{ mV}$  for excitatory cortical neurons, otherwise  $-53 \text{ mV}$ ). The threshold time constant  $\tau_\theta$  determines the time to return to the equilibrium threshold. The parameters of  $\theta$  and  $I_K$ , including  $\tau_\theta$ ,  $\tau_{spike}$  and  $\theta_{eq}$ , provide a model of neuronal spiking deviates from the integrate-and-fire model, in which a spike occurs when the membrane potential reaches a threshold and then is instantaneously reset to a resting potential. The two models differ by the mechanisms for fast sodium and fast potassium conductances that model the rising and decaying periods of action potentials, respectively. In the current model, using  $\theta$  and  $I_K$  allowed us to model the key characteristics of spike generation including action potential width, repolarization and refractory periods (Hill and Tononi, 2005, 2009).



## 2.5. Intrinsic currents

The Hodgkin-Huxley framework was used to model the intrinsic ion channel currents

$$I_{int} = g_{peak} m^M h^N (V - E_{int})$$

where  $g_{peak}$  and  $E_{int}$  are the peak conductance and the reversal potential, respectively. The activation and inactivation variables are determined by  $m$  and  $h$ , respectively. The factors  $M$  and  $N$  account for the (effective) number of activation and inactivation particles of the channel. The equation for the gating of activation and inactivation is

$$\frac{dx}{dt} = \frac{x_{\infty}(V) - x}{\tau_x(V)}$$

where  $x$  is either  $m$  or  $n$ , and  $x_{\infty}$  is the steady-state activation or inactivation value for the ion channel. The intrinsic currents considered in this model were modeled using details of the intracellular channel dynamics. These currents include the persistent sodium current  $I_{Na(p)}$ , the potassium leak current  $I_{KL}$ , depolarization-activated potassium current  $I_{DK}$ , the calcium-activated potassium current  $I_{KCa}$  which is only present in TRN neurons, the low-threshold T-type calcium current  $I_T$ , and the pacemaker current  $I_h$ , which is a noninactivating hyperpolarization-activated cation current. The parameter values for the gating variables, peak conductances and reversal potentials were borrowed from the previous studies (Hill and Tononi 2005, Bazhenov 2014). The values were tuned according to the model if needed. All parameter values are shown in Table 2-3 and Table 2-4.

**The persistent sodium current  $I_{Na(p)}$ :** This current is called “persistent” because its inactivation time course is very slow. It exists in all neurons in the model. Its behavior has been described in previous studies (Compte et al. 2003; Hill and Tononi, 2005). Its activation is quick ( $< 1$  ms) and occurs near the resting potential. Due to this rapid time course, the steady-state values are used for the activation. The inactivation of the  $I_{Na(p)}$  was not modelled because of its very slow time course (on the order of seconds). This current and its steady-state activation  $m_{\infty}$  are given by

$$I_{Na(P)} = g_{Nap}^{peak} m_{\infty}^3 (V - E_{Na})$$

$$m_{\infty} = 1/[1 + \exp((-V + 55.7)/7.7)]$$

Where  $g_{Nap}^{peak}$  and  $E_{Na}$  are the peak conductance and the reversal potential, respectively, and their values are shown in Table 2-4.

**Depolarization-activated potassium current  $I_{DK}$ :** This current is a sodium- and calcium-activated potassium current that exists in all cortical layers including somatosensory cortex of layer VI. It has been proposed that it contributes to the termination of the depolarized phase of slow oscillations (Sanchez-Vives and McCormick 2000; Steriade et al. 2001). In the depolarization phase, both sodium and calcium currents are activated by the influx of ions after which the potassium current begins to be activated. The depolarization-dependent activation of the current  $I_{DK} = g_{DK} m_{\infty} (V - E_{DK})$  is as follows:

$$m_{\infty} = 1/[1 + (0.25D)^{3.5}]$$

$g_{DK}$  and  $E_{DK}$  are the peak conductance and the reversal potential, respectively, and their values are shown in Table 2-3 and Table 2-4. The factor D accumulates with depolarization and decays to an internal equilibrium concentration.  $I_{DK}$  is described with more detail in the previous modeling work (Hill and Tononi, 2005)

**The noninactivating hyperpolarization-activated cation current  $I_h$ :** This current is observed in both cortex and thalamus (Huguenard and McCormick 1992; McCormick and Bal 1997; Robinson and Siegelbaum 2003). Combined and simultaneous changes in the levels of histamine (HA), acetylcholine (Ach) and GABA are thought to be involved in the transition from wake to sleep state or between different sleep stages (Vanini et al., 2012; Krishnan et al., 2016). One of the ways to implement changes in the level of HA is through the parameters of  $I_h$  as explained in the next chapter. The voltage-dependent activation variable  $m_h$  for  $I_h$  is modeled by the equation

$$m_h = 1/\{1 + \exp[(V - V_{threshold})/5.5]\}$$

where  $V_{threshold}$  is -75 mV. The activation time constant for the  $I_h$  is:

$$\tau_m = 1/[\exp(-14.59 - 0.086V) + \exp(-1.87 + 0.0701V)]$$

**The low-threshold T-type calcium current  $I_T$ :** This current is a low-threshold fast activating calcium current which plays essential role in occurring and sustaining the burst activity pattern in the thalamus and TRN (Huguenard and Prince 1992; McCormick and Bal 1997). Indeed,  $I_T$  contributes to the generation of low-threshold spikes, which lead to the firing at the burst mode (Huguenard, 1996). It has also been proposed that some cortical neurons contain T-type calcium currents (Paré and Lang 1998). At the onset of non-REM sleep, the altered inputs to the TRN neurons lead to a membrane hyperpolarization in these neurons (Steriade et al. 1986). This hyperpolarization, in turn, leads to the deinactivation of low-threshold T-type calcium channels resulting in the rapid depolarization and consequent occurrence of AP bursts (Huguenard J.R., 1996; Crunelli et al., 2006). Also, it seems that T-type calcium channels interact with NMDA receptors (Wang et al., 2015; Nocholson and Kullman, 2017). These features of  $I_T$  make it as one of the appropriate candidates for being manipulated in order to transition between wake and sleep state, and as one of the likely candidates involved in the transition to psychosis. Its role is further discussed in the next chapters. The description of  $I_T$  is based on previous work (Destexhe et al. 1996; Huguenard and McCormick 1992). The steady-state activation variable and the voltage-dependent time constant of activation for  $I_T$  are as follows:

$$m_{\infty} = 1/\{1 + \exp[-(V + 52)/7.2]\}$$

$$\tau_m = 0.15/\{\exp[(V + 27)/10] + \exp[-(V + 102)/15]\} + 0.44$$

The steady-state inactivation variable and the voltage-dependent time constant of inactivation for  $I_T$  are as follows:

$$h_{\infty} = 1/\{1 + \exp[(V + 80)/5]\}$$

$$\tau_h = 22.7 + 0.27/\{\exp[(V + 48)/4] + \exp[-(V + 407)/50]\}$$

**The calcium-activated potassium current  $I_{KCa}$ :** TRN neurons contain this kind of current. The characterization of  $I_{KCa}$  was performed in previous work (Destexhe et al. 1996; Huguenard and McCormick 1992). The neuron model ht\_neuron does not include

this current and we added it to the model. The differential equation of intracellular calcium level is as follows

$$\frac{dCa}{dt} = -5.18 * 10^{-6} I_T + (Ca_{eq} - Ca)/\tau_{Ca}$$

where the calcium equilibrium level  $Ca_{eq} = 0.00024$  and  $\tau_{Ca} = 160 \text{ ms}$  is the time constant to return to  $Ca_{eq}$ . The equation of  $I_{KCa}$  and its activation variable are as follows

$$I_{KCa} = g_{KCa} m^2 (V - E_{KCa})$$

$$\frac{dm}{dt} = 48 Ca^2 (1 - m) - 0.03m$$

where  $g_{KCa}$  and  $E_{KCa}$  are peak conductance and reversal potential for  $I_{KCa}$ , respectively. The inactivation variable of  $I_{KCa}$  are not included here due to its slow time course.

## 2.6. Synaptic currents

Simulated synaptic currents consist of the excitatory currents including NMDA (voltage-dependent due to the Magnesium blockade) and AMPA (voltage-independent) currents, as well as inhibitory currents including GABA<sub>A</sub> (fast kinetics) and GABA<sub>B</sub> (slow kinetics) currents. The synaptic current and its underlying conductance are defined by the following equations

$$I_{syn} = \sum_{ij} g_j^{(i)} (V - E_j) \quad ,$$

$$g_j(t) = g_{peak} \frac{e^{-t/\tau_{rise}} - e^{-t/\tau_{decay}}}{e^{-\frac{t_{peak}}{\tau_{rise}}} - e^{-\frac{t_{peak}}{\tau_{decay}}}} \quad , \quad t_{peak} = \frac{\tau_{rise} \tau_{decay}}{\tau_{decay} - \tau_{rise}} \ln\left(\frac{\tau_{decay}}{\tau_{rise}}\right)$$

where  $I_{syn}$  is the sum of all synaptic currents.  $E_j$  is the reversal potential for each channel and if it is above the spike threshold, the current is excitatory, otherwise inhibitory. The channel conductance  $g_j(t)$  is time-dependent, characterizing the synaptic activation for each channel. The conductance  $g_j$  for each afferent  $i$ , on each channel  $j$ , determines the amplitude and time course of the post synaptic potentials (PSPs).  $g_{peak}$  is the peak conductance for each synapse, and  $\tau_{rise}$  and  $\tau_{decay}$  are the rise and decay time constants

of each synaptic conductance, respectively. The time to peak is  $t_{peak}$ . The values of parameters for all synaptic currents for different kinds of cell types associated with different model regions are provided in Table 2-3 and Table 2-4. In addition to be ligand-gated, NMDA receptors are voltage dependent because of the magnesium blockade. For this reason, the simulated NMDA current has an additional factor to account for the voltage dependence of NMDA receptors

$$\tilde{g}_{NMDA} = m(V) g_{NMDA}(t)$$

$$m(V) = A_1(V)m_{fast} + A_2(V)m_{slow}$$

$$A_1(V) + A_2(V) = 1, \quad A_1(V) = 0.51 - 0.0028V$$

$$\frac{dm_{fast}}{dt} = \frac{m_{eq}(V) - m_{fast}}{\tau_{Mg_{fast}}}$$

$$\frac{dm_{slow}}{dt} = \frac{m_{eq}(V) - m_{slow}}{\tau_{Mg_{slow}}}$$

$$m_{eq}(V) = 1 / \{1 + \exp[(V - V_{act})/\sigma_{act}]\}$$

where  $g_{NMDA}(t)$  is the conductance transient of NMDA synapses, similar to the other cases described in the previous section. The voltage dependent gating  $m(V)$  of NMDA receptors depends on fast and slow unblocking variables  $m_{fast}$  and  $m_{slow}$ , respectively. Although the blocking of NMDA channels by  $Mg^{2+}$  occurs instantaneously ( $<0.06$  ms), the unblocking is slower and happens at two times scales (Vargas-Caballero and Robinson 2003). Therefore, the unblocking of the NMDA receptor is modelled as a two-stage process with one component unblocking quickly ( $\tau_{Mg_{fast}} = 0.68$  ms) and another component unblocking slowly ( $\tau_{Mg_{slow}} = 22.7$  ms).  $m_{eq}(V)$  as a voltage-dependent sigmoid function is an equilibrium variable for the conductance of NMDA receptors with  $V_{act} = -25.57$  mV and  $\sigma_{act} = 12$  mV.

**Table 2-3. Parameter values for each neuron type in the NNSS.**

Description of parameters is in the text. Units for conductance, time constant ( $\tau$ ) and reversal potential ( $E$ ) are microsiemens ( $\mu\text{S}$ ), millisecond ( $\text{ms}$ ) and millivolt ( $\text{mV}$ ), respectively.

Parameters	Cell Type				
	Exc Cx	Inh Cx	Exc Th	Inh Th	TRN
$g_{Kl}$	0.88	0.88	0.88	0.88	0.80
$g_{KCa}^{peak}$	0.0	0.0	0.0	0.0	30
$g_T^{peak}$	0.0	3.0	6.0	0.0	8.0
$g_h^{peak}$	0.4	0.0	0.5	0.0	0.0
$g_{DK}$	0.75	0.75	0.75	0.0	0.0
$\tau_m$	8	7	7	6	6
$\tau_{spike}$	0.65	0.55	0.5	0.5	0.53
$\theta_{eq}(\text{mV})$	-51	-53	-53	-53	-53
$g_{NMDA}^{peak}$	0.11	0.125	0.115	0.12	0.135
$g_{AMPA}^{peak}$	0.11	0.11	0.115	0.115	0.115
$E_{GABA_A}$	-70	-70	-80	-80	-80

**Table 2-4. Parameters for intrinsic and synaptic currents in the NNSS.**  
Parameters are described in the text. Units for conductance, time constant ( $\tau$ ) and reversal potential ( $E$ ) are microsiemens ( $\mu\text{S}$ ), millisecond ( $ms$ ) and millivolt ( $mV$ ), respectively.

Parameters of intrinsic currents		Parameters of synaptic currents	
Parameters	value	Parameters	value
$E_{KL}$	-90	$E_{AMPA}$	0
$E_{DK}$	-95	$E_{NMDA}$	0
$E_{Na}$	30	$E_{GABA_B}$	-90
$E_{KCa}$	-120	$g_{GABA_A}^{peak}$	0.14
$E_h$	-40	$g_{GABA_B}^{peak}$	1
$E_T$	0	$\tau_{AMPA}^{rise}$	0.5
$g_{Nap}^{peak}$	2	$\tau_{AMPA}^{decay}$	2.4
$g_{NaL}$	0.05	$\tau_{NMDA}^{rise}$	4
$\tau_{DK}$	800	$\tau_{NMDA}^{decay}$	40
$\tau_{Ca}$	160	$\tau_{GABA_A}^{rise}$	1
$Ca_{eq}$	0.00024	$\tau_{GABA_A}^{decay}$	7
		$\tau_{GABA_B}^{rise}$	60
		$\tau_{GABA_B}^{decay}$	200
		$\tau_{NMDA}^{Mg-fast}$	0.68
		$\tau_{NMDA}^{Mg-slow}$	22.7
		$V_{NMDA}^{act} (mV)$	-25.5

## 2.7. Modeling of LFP

The local field potential (LFP) refers to the electric potential in the extracellular space caused by a set of active neurons. With regard to in vivo extracellular recordings, the LFP can be considered as a reflection of synaptic activity within a local volume around a measuring electrode. The LFP results from the activity of a network of neurons and is generated by electric currents and charges in neurons. As a consequence, all ionic currents in neurons including synaptic and intrinsic currents contribute to the LFP. It is believed that synaptic currents make the main contribution to the LFP, however, intrinsic currents and even spikes also contribute (Niedermeyer and Lopes da Silva, 1998; Nunez and Srinivasan, 2005).

In our model, the LFPs were recorded from three regions including the CT, TRN and TC populations to analyse their dynamics in different frequency bands, in particular, spindles. These LFP recordings will then be used for comparison with our experimental EEG and extracellular recordings. It should be noted, however, that the number of model neurons in populations is much smaller than in biological reality. The equation to account for the LFP as an extracellular voltage is given by

$$V_{ext} = \frac{R_e}{4\pi} \sum_j \frac{I_j}{r_j}$$

where  $V_{ext}$  is the extracellular potential,  $R_e$  (230 cm) is the extracellular resistivity,  $I_j$  is intrinsic and synaptic current sources, and  $r_j$  is the distance from the source  $I_j$  to the recording site. This equation is the standard model of the LFP, and it was used in both older (Rall and Shepherd, 1968; Protopapas et al., 1998; Destexhe, 1998) and newer (Nunez and Srinivasan, 2005; Gold et al., 2006; Hill and Tononi, 2007; Pettersen and Einevoll, 2008) work.

## 2.8. Power spectrum of simulated LFPs

The recoded LFP was first standardized using the Excel function `STANDARDIZE(x,  $\mu$ ,  $\sigma$ )` which has the following arguments:

- $x$  is the value to normalize.
- $\mu$  is the mean of the distribution.



- $\sigma$  is the standard deviation of the distribution.

The equation for the normalized value  $z$  is  $z = (x - \mu) / \sigma$ . The normalized LFP was transferred to the electrophysiological tool Clampfit10 for being analysed. The power spectrum was measured for the 40-second LFPs. The window type was Hamming and the sampling frequency was 10 kHz. The spectral power was measured for the frequency range from 0 Hz to 200 Hz, which covers the six distinct frequency bands delta (1-5 Hz), theta (5-9 Hz), spindle (9-16 Hz), beta (16-30 Hz), gamma (30-80 Hz) and high-frequency oscillations (HFO, 80-200 Hz).

## 2.9. Analysis of firing activity through event detection

The firing activity of a 40 second intracellular recording of the membrane potential in model neurons was analysed in Clampfit10 by an event detection method in order to identify bursts and single spike events. High-frequency bursts were detected based on a voltage threshold and an inter-AP interval less than 6 ms. In intracellular recordings, action potentials (APs) were detected using a voltage threshold and an inter-AP interval greater than 10 ms. At least 2 successive events (1 inter-spike interval less than 6 ms) were required to identify them as a burst (Figure 2-3). In addition to the count of single spikes and bursts occurring in 40 seconds, the different properties of burst activity were obtained including the mean duration of burst, the mean events per burst, and events in bursts.

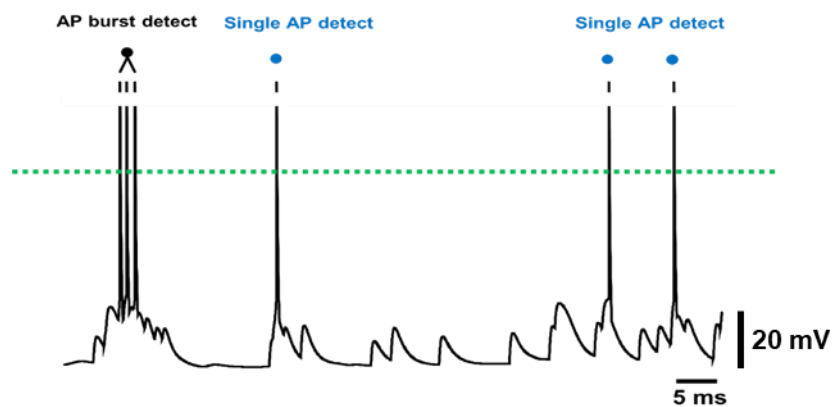

**Figure 2-3. Detection method to identify single spikes and bursts.**

A representative trace of a single-cell cortical recording from a model neuron illustrating the detection (from a voltage threshold, indicated by a green dotted line) of a burst of 3 APs (black dot) and of 3 successive single APs (blue dots).

## 2.10. Investigating transient and progressive effect of ketamine

Our experimental finding revealed that the ketamine effect increases progressively over time until it reaches its peak about 20 minutes after a single subcutaneous injection in subanaesthetic dose. Then, its effect gradually declines until slight recovery. The transient effect of ketamine lasts about one hour, including rising and decaying periods. To consider these graded effects of ketamine, we changed the parameters of NMDA receptors in 9 steps between zero and the standard value. This allowed us to investigate their effects on the firing behaviour in terms of numbers of single spikes and bursts, mean burst duration and mean number of spikes per burst in neurons of the different areas of the CT-TRN-TC model network. Along with the parameters of NMDA receptors, we had to adjust other things like the parameters of AMPA and GABAA receptors to new values.

All these manipulated parameters are listed in the next chapter, Table 3-1. However, in this table, values are shown only for normal and pathological (peak effect of ketamine) conditions. The other 7 values are between these two numbers with the same step size from the start value (the NNSS or recovered state) to the end value (the PNSS, i.e., peak effect of psychotomimetic dose of ketamine).

## Chapter 3

---

### 3. Results and discussion

#### 3.1. Transition from the waking-like state to the non-REM sleep-like state

In the waking-like state (WS), neurons in all brain regions fire in tonic irregular spiking (non-bursting) mode. Typical mean firing rates are 20, 25 and 10 spikes per second in cortex, thalamus and TRN, respectively. This indicates that the excitatory glutamatergic CT and TC neurons are more active than inhibitory GABAergic TRN neurons in the WS. Activity looks like a persistent Up-state (Figure 3-1).

The transition from the WS to the NNSS is assumed to be caused by simultaneous changes in the conductances for various intrinsic and synaptic channels as listed in Table 3-1. These parameters are taken from previous in vitro observations (McCormick, 1992; Bazhenov et al., 2002; Krishnan et al., 2016) and computational models of the transition from wakefulness to slow-wave sleep in the thalamocortical network (Hill and Tononi, 2005, 2007). Previous studies of slow oscillations obtained from cortical recordings (Timofeev et al., 2000; Bazhenov et al., 2002) revealed that the calcium dependent potassium current  $I_{KCa}$  and synaptic depression are responsible for the termination of Up states. In other studies, it has been proposed that activation of the sodium-dependent potassium current  $I_{DK}$  (Compte et al., 2003) and the activation of inhibitory neurons (Chen et al., 2012) may be responsible for the termination of Up-states. In our model of NNSS, in addition to the changes in  $I_{KCa}$  and  $I_{DK}$ , we assume that the peak conductance of NMDA receptors in inhibitory neurons is higher than in excitatory neurons (Table 3-1).

In a previous computational model (Esser et al., 2007), the conductances of both AMPA and NMDA synapses were increased in sleep state. This was supposed to reflect the fact that the activation of muscarinic receptors reduces intracortical EPSPs (Gil et al. 1997), suggesting that excitatory synapses are depressed during wakefulness relative to

sleep. In our model, the same changes in AMPA and NMDA receptors were implemented in the NNSS (Table 3-1).

Moreover, histamine (HA) and acetylcholine (ACh) are reduced in non-REM sleep relative to the wake state. HA and ACh affect the AMPA and potassium leak currents (Krishnan et al., 2016). In our model, the effect of HA and ACh was indirectly imposed on the AMPA and potassium leak currents. Krishnan et al. (2016) have proposed that the simultaneous manipulation of AMPA, GABA<sub>A</sub> and potassium leak currents determines the dynamic state of the TC network. Adjusting these conductances to specific values may lead to a switch between the wake mode and different sleep stages. In our model, inspired by the study of Krishnan et al. (2016), the conductances of these three synapse types were set to specific values in order to induce the switch from the wake mode to the N2 stage of non-REM sleep. To this aim, the conductances of AMPA and GABA<sub>A</sub> receptors were increased in cortical and thalamic neurons (Table 3-1).

In our model, the transition from the WS to the NNSS occurred primarily by increasing the potassium leak conductance  $g_{KL}$  from 0.4 to 0.88 in excitatory cortical and thalamic neurons. In contrast,  $g_{KL}$  was decreased from 0.75 to 0.65 in inhibitory TRN neurons. These are the main changes that different computational studies have implemented to induce a transition to sleep in the TC network (Bazhenov et al., 2002; Hill and Tononi, 2007; Krishnan et al., 2016). None of the other changes played a role as significant as the increase in  $g_{KL}$  of excitatory neurons for the transition to the sleep state. This increased conductance of potassium leak channels is due to the reduced action of neuromodulators such as ACh and HA during non-REM sleep (Vanini et al., 2012; Krishnan et al., 2016). However, previous studies have shown that the increased conductance of various kinds of potassium channels also make a contribution to the transition to the sleep state. The in vitro observations have already indicated that the reduced activity of acetylcholine leads to unblock potassium leak channels (McCormick 1992) and noninactivating potassium channels (Madison et al. 1987). Decreasing acetylcholine and norepinephrine unblocks slow potassium currents (McCormick 1992). To account for this change in our model, the conductance for the depolarization-activated potassium current  $I_{DK}$  was increased (Table 3-1).

In addition, some of the remaining parameters were also changed to support the transition to the non-REM sleep state. In our model, the persistent sodium conductance

$g_{Na(p)}$  was increased, as it has been shown that deactivated muscarinic acetylcholine receptors lead to an increase of  $g_{Na(p)}$  (Hill and Tononi 2005, Mittmann and Alzheimer 1998). It has also been shown that both ACh and HA affect  $I_h$  (McCormick et al. 1993; Krishnan et al., 2016) and ACh affects  $I_T$  (McCormick 1992). We modelled these effects by increasing the conductance for both  $I_h$  and  $I_T$  (Table 3-1).

In summary, to transition from the WS to the NNSS, the peak conductances of various kinds of intrinsic and synaptic channels including  $g_{KL}$ ,  $g_{DK}$ ,  $g_{NaP}$ ,  $g_T$ ,  $g_h$ ,  $g_{KCa}$ ,  $g_{NMDA}$ ,  $g_{AMPA}$  and  $g_{GABAA}$  were increased to different extents in all involved regions. Only  $g_{KL}$  in TRN was decreased (Table 3-1). These changes are required to generate the subthreshold slow oscillations characterized by a periodic transition between Up and Down states in single-cell recordings and the occurrence of spindles and slow oscillations in LFP-like recordings, associated with the non-REM sleep state.

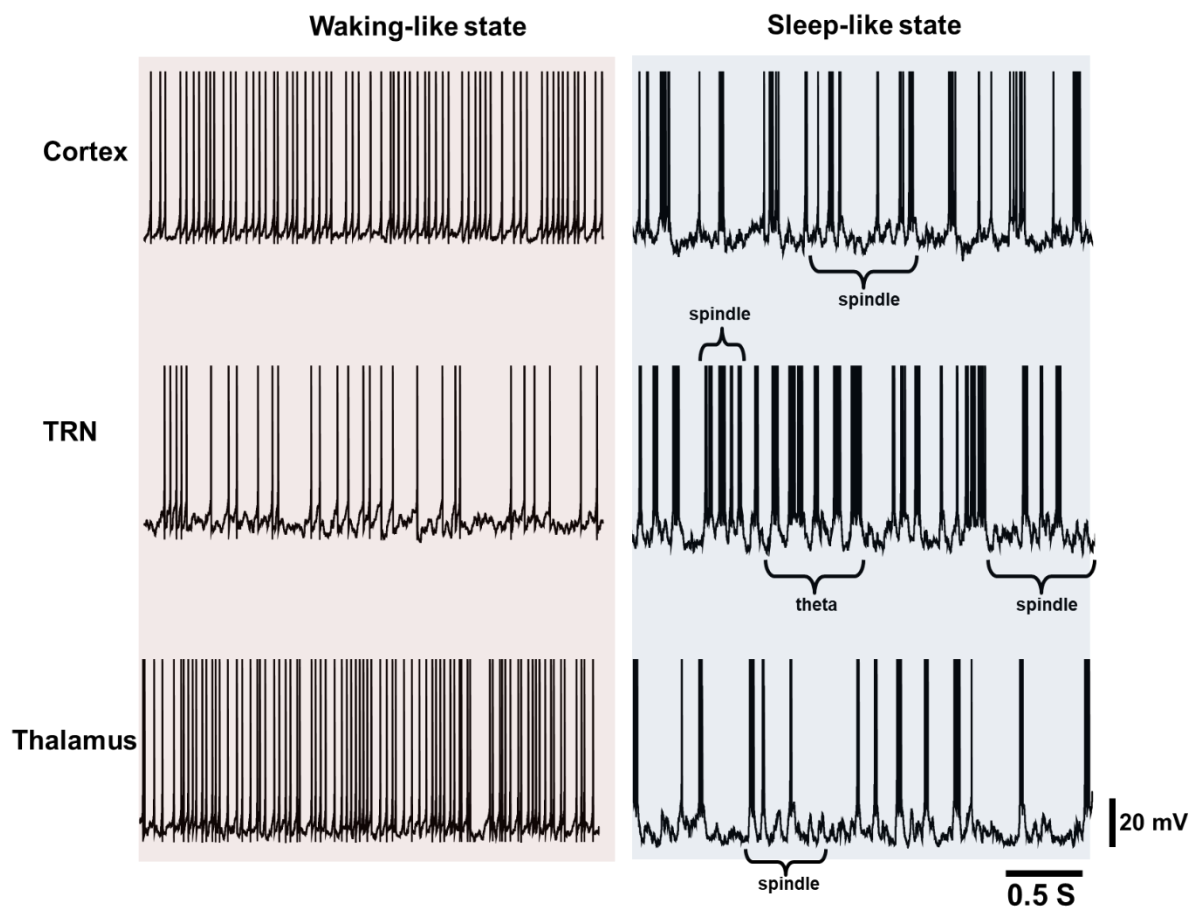

**Figure 3-1. Transition from the WS to the NNSS in the simulated CT-TRN-TC network.**

The three second representative intracellular-like recordings are characterized by irregular single spikes in the WS, and by an abundant occurrence of bursts in the NNSS. The subthreshold activity

changes from a persistent up-state in the WS to frequent Up-state-Down-state transitions in the sleep-like state. Subthreshold activities in the sleep mode exhibit subthreshold slow oscillations in the theta (5-9 Hz) and spindle (9-16 Hz) frequency range. This is a signature of stage N2 of non-REM sleep.

**Table 3-1. Parameters involved in the transition from the WS to the NNSS.**

Values are given for different cell types in different regions including excitatory cortex (exc Cx), inhibitory cortex (inh Cx), TRN, excitatory thalamus (exc Th) and inhibitory thalamus (inh Th). The unit of conductance is micro-siemens ( $\mu\text{S}$ ).

Parameter	Region	Waking value	Sleep value
$g_{KL}$	exc Cx, inh Cx, exc Th, inh Th	0.4	0.88
$g_{KL}$	TRN	0.75	0.65
$g_{DK}$	exc Cx	0.25	0.75
$g_{DK}$	inh Cx	0.25	0.75
$g_{DK}$	exc Th	0.15	0.75
$g_{NaP}$	All regions	1	2
$g_T$	exc Th	3	6
$g_T$	TRN	4	8
$g_h$	exc Th	0.4	0.5
$g_{KCa}$	TRN	12	30
$g_{peak}^{NMDA}$	exc Cx	0.09	0.11
$g_{peak}^{NMDA}$	inh Cx	0.1	0.12
$g_{peak}^{NMDA}$	exc Th	0.09	0.115
$g_{peak}^{NMDA}$	TRN	0.1	0.135
$g_{peak}^{AMPA}$	All	0.1	0.115
$g_{peak}^{GABAA}$	All	0.11	0.14

### 3.2. Occurrence of bursts and spindles in the NNSS

In the NNSS, the simulated CT-TRN-TC network model spontaneously produced low-frequency oscillations (LO) characterized by periodic transitions between Up and Down states. These transitions were also shown in previous in vivo recordings and computational models (Steriade et al., 2001; Hill and Tononi, 2004; Krishnan et al., 2016; Wei Y. et al., 2018; Mahdavi A. et al., 2020). The subthreshold activity of neurons changes from the persistent Up state in WS to the Up-state-Down-state transitions in the NNSS. Subthreshold activities in the simulated wake state mostly contain low-amplitude high-frequency oscillations (HO) at the range of beta (16-30 Hz) and gamma (30-80 Hz) frequencies, whereas in the simulated non-REM sleep-like state, the Up-state period is usually preceded or followed by subthreshold slow oscillations in the theta (5-9) and spindle (9-16) range (Figure 3-1). This subthreshold spindle activity was consistently demonstrated in experimental recordings from cats and rats (Timofeev and Steriade, 1996; Mahdavi et al. 2020).

The combined effect of excitatory postsynaptic currents (EPSCs) and intrinsic currents in the target neurons initiates the Up states of subthreshold slow oscillations during sleep. Termination of Up states was caused by the slow activation of potassium currents. Their conductances are increased in the sleep state leading to hyperpolarization, inhibition and transition to the (silent) Down state. The mechanisms of Up-state initiation and its termination have been explained in previous studies (Timofeev et al., 2000; Bazhenov et al., 2002; Chen et al., 2012; Bazhenov et al., 2016).

In the NNSS, and in TC, TRN and CT neurons alike, the Up state consists of a series of single APs, irregular bursts or several rhythmic and consecutive bursts or combination of these events (Figure 3-1). The bursts occur predominantly in the NNSS.

When the model network switches from the WS to the NNSS, the oscillatory behavior of the CT, TRN and TC local field potentials (LFPs) changes from desynchronized low-amplitude fast waves to the more synchronized higher-amplitude slow waves. Our model can successfully recapitulate the characteristics of non-REM sleep state in a way consistent with previous studies and with our own experimental results. Power spectrum analysis of the LFPs in all regions revealed that by transition from the WS to the NNSS, sleep-like LO (1-16 Hz) significantly increase and the HO (17-200 Hz) significantly decrease (Figure 3-2).

In contrast with the WS, TRN neurons in the NNSS are highly active (firing rate:  $26 \pm 14$  Hz), firing in the burst mode. They are more bursty and active than TC and CT neurons, which have average firing rates of  $14 \pm 3$  Hz and  $15 \pm 3$  Hz, respectively. The representative traces of single-cell recordings (Figure 3-1) show that the number of bursts, and the number of spikes occurring in each burst, are larger in TRN neurons compared to TC and CT neurons. In other words, during the NNSS, the quantity and robustness of bursts occurring in TRN neurons are higher as compared to the TC and CT neurons. Quantity of bursts implies the number of bursts occurring over 40 seconds. Robustness of bursts implies both the number of events per burst and the duration of burst.

Our computational model is in line with previous experimental studies with regard to many properties of neural activity in TRN and TC cells, but there are also some differences. Experimental studies have shown that in TRN cells, a typical intracellular spindle is characterized by a series of rhythmic (10-16 Hz) high-frequency bursts (hf bursts;  $n = 7-13$  APs) superimposed on a depolarizing envelope (Mulle et al, 1986; Steriade et al, 1993; Pinault et al, 2006). In TRN neurons of the simulated model of the CT-TRN-TC network, the consecutive hf bursts in the NNSS occur often in the spindle or theta range, but not always and not in regular series. Such an activity of TRN neurons in hybrid theta-spindle rhythmic hf bursts is reminiscent of the activity of juxtacellularly recorded TRN neurons obtained from sedated rats (Mahdavi et al., 2020). In simulated TRN neurons, rhythmic hf bursts do occur but, in contrast to experimental observations, a regular, repetitive and periodic series of rhythmic hf bursts is rare.

In TC neurons, the Up-state occurs after a hyperpolarization period attributed to the inhibition caused by GABAergic TRN neurons (Timofeev and Steriade, 1996; Wei et al., 2016). In the sedated rat, an intracellularly recorded TC neuron exhibits subthreshold oscillations that include spindle-frequency rhythmic waves occur during a long-lasting hyperpolarization (Mahdavi et al., 2020). In the NNSS, the simulated TC neurons are firing in the burst mode and subthreshold membrane potential oscillations sometimes occur in the spindle frequency range (Figure 3-1). Therefore, computational and experimental recordings from the TC neurons are consistent with one another to a large extent.

Since the computational model has its own limitations (e.g. the relatively small number of neurons, the biophysical detail of the neuron models, missing features), it must



be expected that its behavior cannot be perfectly consistent with the experimental data in every respect.

In our model, burst mode firing and spindles occurred not only in TRN, but also in TC and CT neurons. This indicates a great degree of coherence of different regions of the somatosensory CT-TRN-TC loop circuit. Overall, the simulated CT-TRN-TC network is successfully able to model the NNSS. It features Up-state-Down-state transitions, the bursting activity of neurons and the occurrence of LO, such as spindles both in LFPs and subthreshold membrane potentials.

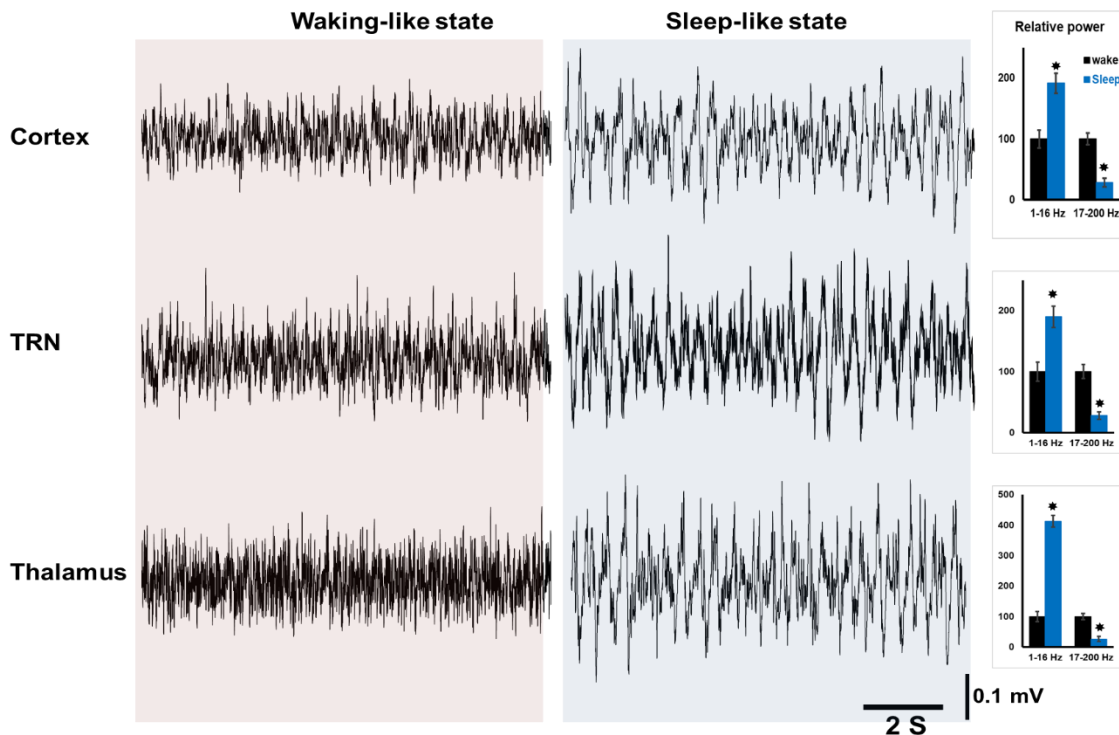

**Figure 3-2. LFP-like recordings in the WS and sleep-like state acquired from the cortical, TRN and thalamic populations of the simulated CT-TRN-TC network.**

Ten seconds representative LFP-like recordings in the WS are characterized by desynchronized fast oscillations. In a sleep-like state (NNSS) the signals are characterized by more synchronized higher-amplitude slow oscillations. The frequency band specific histograms (right) of the simulated cortical, TRN and thalamic LFPs show the significant reduction in power of LO (1-16 Hz) and the significant increase in the power of HO (17-200 Hz). Average of 5 forty seconds recording traces (Hamming window, resolution: 0.5 Hz, \*: t-test,  $p < 0.05$ ).

### **3.3. Transition from the NNSS to the PNSS**

In order to bring the model into a condition similar to the ketamine-induced state studied in experiments, the values of some parameters were changed as listed in Table 3-2. After applying these changes, the spike activity and LFP frequency bands of the CT-TRN-TC loop circuit model were investigated to compare and elucidate the functional interactions between different components of the network in the NNSS and the PNSS configuration. After transition from the NNSS to the PNSS, we expect to observe the effects on the oscillatory and firing activity of the network consistent with the neurophysiological abnormalities recorded in the previous acute psychotomimetic ketamine experiments conducted in the sleep or sedated condition (Hakami et al., 2009; Mahdavi et al., 2020), early course schizophrenia patients as well as in the individuals at risk mental state for transition to psychosis (Flynn et al., 2008; Manoach et al., 2014; Andreou et al., 2015; Ramyeed et al., 2015). If our expectations come true, we may offer the suggested ketamine-related changes as neural mechanisms that underlie the transition to psychosis.

Two alternative strategies were used to create the pathological condition in accordance with the action of NMDA receptor antagonist ketamine. The first strategy was based on the assumption that ketamine blocks individual NMDA synapses randomly and independently. To this end, we simply reduced the probability of a functional NMDA synapse located on postsynaptic neurons. The second strategy was based on the idea that ketamine blocks individual receptors, but not necessarily entire synapses. To reflect this, we reduced the peak conductance of NMDA synapses but left their number intact. As a result, either the connection probability or the peak conductance of NMDA synapses were set to smaller values (Table 3-2).

As NMDA synapses are excitatory glutamatergic synapses, blocking NMDA receptors, or reducing their activity, leads to a change of the balance between excitation and inhibition. The network faces a slight reduction in overall excitation, and firing rates go down. To compensate for the reduced excitation, increasing the activity of AMPA receptors may be an appropriate compensatory mechanism. An increase of the activity of AMPA receptors is also in accordance with ketamine based experiments (Moghaddam et al., 1997; Nosyreva et al., 2013; Iskandrani et al., 2015; Björkholm et al., 2015; Chowdhury

et al., 2015). Reduced activity of NMDA receptors did not lead to a dramatic E/I imbalance, because GABAergic neurons, TRN neurons among them, express NMDA receptors intensely. Also, these neurons exhibit more sensitivity to NMDA receptor antagonists (Homayoun and Moghaddam, 2007). For example, the NMDA receptor subunit GluN2C (i.e., NR2C), which is sensitive to NMDA receptor antagonists, is more expressed in inhibitory neurons than in excitatory neurons (Homayoun and Moghaddam, 2006; Zhang et al., 2012; Gupta et al., 2016). Moreover, there is evidence indicating that NMDA receptors of the TRN neurons have greater conductance and weaker magnesium block relative to neurons of other regions. Also, the strength of connection between TRN and cortex mediate by NMDA receptors is stronger relative to strength of connections between other regions (Deleuze and Huguenard, 2016). These features reveal how NMDA receptors are critical for the excitation of TRN neurons, especially excitation by corticothalamic inputs. This feature was implemented in the model by assigning higher value to the conductance of NMDA receptors in inhibitory neurons as compared to excitatory neurons NMDA conductance of TRN neurons was set to the highest value. Connection strengths were also adjusted by considering the mentioned features (Table 3-1 and Table 3-2).

Ketamine affects some subunits of NMDA receptors more than others. The NR2C subunit is highly expressed in the TRN compared to other regions. It has been shown that the NR2C subunits of NMDA receptors in TRN are more sensitive to ketamine as compared to NR2A/B/D subunits (Kotermanski and Johnson, 2009). Moreover, a weaker expression of NR2C in patients with schizophrenia has been reported in previous post-mortem studies (Meador-Woodruff et al., 2003; Akbarian et al., 1996; Ibrahim et al., 2000). This is why ketamine may be a good candidate to model schizophrenia, and why TRN may be a key region that deserves the attention of researchers. Ketamine affects NMDA receptors in TRN more than in other regions. This specific feature of TRN is implemented in our model as follows. In TRN relative to other regions, the probability of connection to NMDA receptors and the leak conductance of NMDA receptors were set to lower values in the PNSS (Table 3-2). These parameters in inhibitory interneurons relative to excitatory neurons were also set to lower values, but they were set to the lowest values in TRN (Table 3-2).

In addition to changes in NMDA synapses, parameters of other types of synapses were also changed in order to mimic ketamine-like effects. These changes were applied in view of experimental studies showing an effect of ketamine not only for the NMDA synapse but also for other types of synapses such as AMPA or GABA<sub>A</sub> (Irifune et al. 2000; Sleigh et al., 2014; Wang et al., 2017; Llamosas et al., 2019). In any case, however, the effect of ketamine on NMDA synapses was dominant in all studies. To reflect the ketamine-induced potentiation of AMPA and GABA<sub>A</sub> currents, parameters of these two currents have been changed as shown in Table 3-2. In summary, a set of combined changes including the reduced gain of NMDA receptors, the increased gain of AMPA receptors and faster GABA<sub>A</sub> receptors was implemented in our model to bring it close to the pathological state (PNSS), according to the known mechanisms of ketamine action. We found it important to consider these findings from previous studies about ketamine and its effects beyond “just” being an NMDA receptor antagonist (Sleight et al., 2014).

In addition to the parameters of synaptic transmission, the peak conductance for the intrinsic T-type calcium current  $I_T$  was decreased because of its role in the generation of bursts (Cain and Snutch, 2010, 2013; Vickstrom et al., 2020) and its relation with the NMDA receptors (Wang et al., 2015; Nicholson and Kullman, 2017).

To switch from the NNSS to the PNSS in the simulated CT-TRN-TC network, we implemented several changes (Table 3-2), attributed to the multiple mechanisms of ketamine action suggested by several separate studies. All of these changes together (Scenario A) contribute to the transition to psychosis-relevant state, as shown in the following qualitative and quantitative results.

**Table 3-2. Parameter changes that lead to a transition from the NNSS to the PNSS (Scenario A), similar to ketamine-induced effects.**

$pr_{pop}$  is a connection probability specified for each population involved in the model. The unit of time constants is milliseconds. TC: Thalamocortical neurons, Cx: Cortical neurons, exc: excitatory, inh: inhibitory, NMDARs: NMDA receptors, AMPARs: AMPA receptors.

Parameter changes in first method	Region	NNSS	PNSS
Probability of connection to NMDARs	exc Cx, exc TC	$pr_{pop}$	$0.02 * pr_{pop}$
Probability of connection to NMDARs	TRN, inh TC, inh Cx	$pr_{pop}$	$0.0 * pr_{pop}$
Probability of connection to AMPARs	exc Cx, inh Cx	$pr_{pop}$	$1.5 * pr_{pop}$
Probability of connection to AMPARs	exc TC, inh TC, TRN	$pr_{pop}$	$2 * pr_{pop}$
Parameter changes in second method	Region	NNSS	PNSS
$g_{NMDA}^{peak}$ (peak conductance of NMDARs)	exc Cx	0.11	0.05
$g_{NMDA}^{peak}$ (peak conductance of NMDARs)	inh Cx, inh TC	0.12	0.02
$g_{NMDA}^{peak}$ (peak conductance of NMDARs)	exc TC	0.115	0.05
$g_{NMDA}^{peak}$ (peak conductance of NMDARs)	TRN	0.135	0.0
$g_{AMPA}^{peak}$ (peak conductance of AMPARs)	Exc Cx, inh Cx	0.11	0.22
$g_{AMPA}^{peak}$ (peak conductance of AMPARs)	TRN, exc TC, inh TC	0.115	0.21
$g_{GABAA}^{peak}$ (peak conductance of GABA <sub>A</sub> Rs)	All	0.14	0.155
Parameter changes in both methods	Region	NNSS	PNSS
$\tau_{NMDA}^{rise}$ (Rise time constant of NMDARs)	All	4	1
$\tau_{NMDA}^{decay}$ (Decay time constant of NMDARs)	All	40	10
$\tau_{AMPA}^{rise}$ (Rise time constant of AMPARs)	All	2.4	1.2
$\tau_{AMPA}^{decay}$ (Decay time constant of AMPARs)	All	0.5	0.12
$\tau_{GABAA}^{rise}$ (Rise time constant of GABA <sub>A</sub> receptors)	All	7	3.5
$\tau_{GABAA}^{decay}$ (Decay time constant of GABA <sub>A</sub> receptors)	All	1	0.5
$g_T^{peak}$ (Peak conductance of T-type calcium channel)	Exc Cx	3	1
$g_T^{peak}$ (Peak conductance of T-type calcium channel)	Exc TC	6	3
$g_T^{peak}$ (Peak conductance of T-type calcium channel)	TRN	8	4

### **3.4. The firing pattern of the simulated CT-TRN-TC network switches from the burst mode in the NNSS to the tonic mode in the PNSS due to the combination of changes: a candidate mechanism of ketamine action**

Inactivating the NMDA receptors along with other ketamine-related changes (Table 3-2) remarkably affected the firing pattern and oscillatory activity of the simulated CT-TRN-TC network. The single-cell and LFP-like recordings explicitly revealed these effects (Figure 3-3). The changes in the ketamine-related parameters induce a switch of the firing pattern of neurons from the burst mode in the NNSS to the irregular single spiking mode in the PNSS (Figure 3-3 and 3-4).

Both strategies (Table 3-2) that we used to transition from the NNSS to the PNSS revealed essentially the same results. This means that regardless how the activity of NMDA receptors is decreased by ketamine, either via the connection probability or via the peak conductance, the same results were obtained. In both cases, the reduced activity of NMDA receptors led to a transition from the dominant burst mode in NNSS to the irregular single spiking mode in the PNSS (Figure 3-3 and 3-4).

The LFP-like recordings obtained from the cortex, TRN and thalamus showed that after applying the ketamine-related changes in all related parameters, the slow and high-amplitude waves occurring in the NNSS disappeared and instead, faster and lower-amplitude waves appeared in the PNSS. The raster plot analysis shows that the synchronous and regular activity of neurons in the NNSS changes to the asynchronous and irregular activity in the PNSS (Figure 3-3).

The activity of neurons in the PNSS is similar to the waking mode, however, the mechanisms underlying the transition from the wake state to the NNSS are different from the transition from the NNSS to the PNSS, as described in Methods and Materials. This similarity was expected because it is known that low-dose ketamine leads to an arousal promoting effect. This effect is characterized by an increase of HO including gamma-frequency oscillations in both the awake freely-moving rats (Pinault D, 2008; Hakami T et al., 2009; Ahnaou A et al., 2017) and the sedated rats (Mahdavi A et al., 2020). Therefore, the similarity between the simulated wake mode and the simulated PNSS did not come as a surprise, and it further supports our results about the PNSS.

Ketamine-related effects reduced the average firing rate of neurons in the TRN from  $26 \pm 14$  Hz in the NNSS to  $10 \pm 7$  Hz in the PNSS. The firing frequencies of TC and CT

neurons were increased, on average, from  $14\pm 3$  Hz and  $15\pm 3$  Hz in the NNSS to  $25\pm 7$  Hz and  $19\pm 5$  Hz in the PNSS, respectively. Relative to TC and CT neurons, TRN neurons exhibit higher firing rates in the NNSS and smaller firing rate in the PNSS (Figure 3-3). This behavior is also consistent with our experimental observations. Why are bursts more pronounced in TRN during NNSS as compared to TC and CT neurons? Why do ketamine-related changes impact the firing rate of these neurons differently? This may be interpreted as follows.

Given that NMDA receptors are highly critical for the cortical excitation of TRN neurons (Deleuze and Huguenard, 2016), these neurons, relative to CT and TC neurons, face a more pronounced NMDA receptor hypofunction, leading to reduced firing rates. Consequently, the TRN-mediated disinhibition may lead to the increased activity of excitatory thalamus which, in turn, lead to high activity in excitatory cortical neurons (Figure 3-3). Indeed, the reason for highly excited CT neurons may be the increased excitation from TC neurons and also a reduced inhibition from cortical GABAergic interneurons. As explained, NMDA receptors play a crucial role in the neural activity of TRN neurons so that, in absence or feeble presence of NMDA receptors, even highly excited CT neurons that strongly innervate TRN neurons, cannot force TRN neurons to fire in a higher rate. This result indicates the critical impact that different components of the CT-TRN-TC loop circuit have on one another.

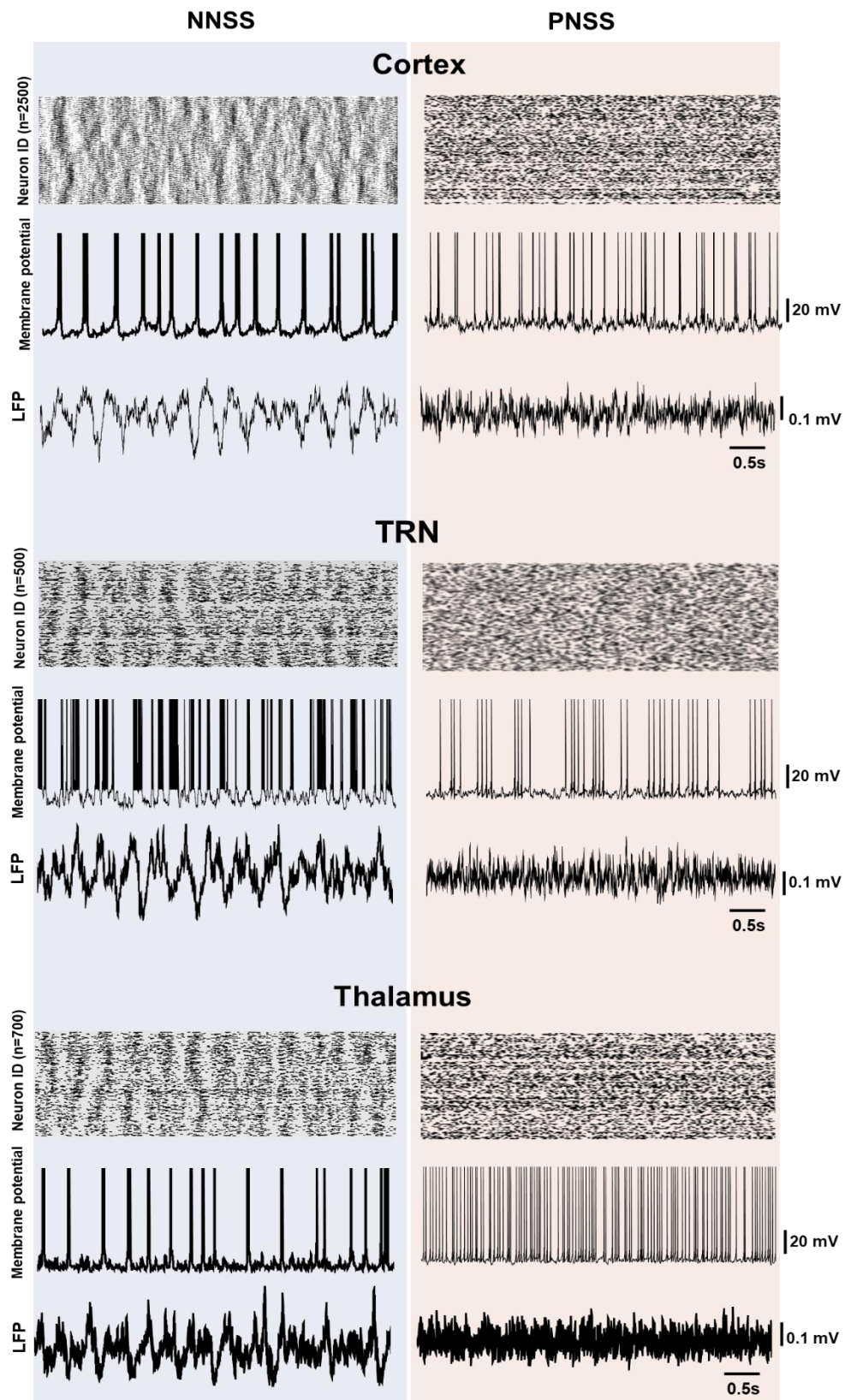

**Figure 3-3. The firing and oscillatory activity of the simulated CT-TRN-TC network dramatically changes due to the ketamine-related parameter changes.**



Raster plots and 5 second representative single-cell recordings reveal that due to the blockade of NMDARs along with the other ketamine-related changes, the firing activity of neurons changes from the burst mode (left) to the irregular single-spike mode (right) in cortex, thalamus and TRN. The ten seconds representative LFP-like recording traces indicate the dramatic change from the sleep-like slow waves in the NNSS (left) to the desynchronized low-amplitude high-frequency oscillations in the PNSS (right).

### **3.5. The reduced LO including spindles, and the increased HO in the PNSS compared to the NNSS**

In the NNSS, spindles occur in both the single-cell activities (Figure 3-4) and LFPs (Figure 3-5). They almost disappear in the PNSS (Figure 3-4 and 3-5). As qualitatively shown (Figure 3-3), single-cell activity of CT, TRN and TC neurons is characterized by the abundant occurrence of bursts in the NNSS and irregular single -spikes in the PNSS. These characteristics correspond to subthreshold activity of the membrane potential (MP) in both the NNSS and PNSS. The subthreshold MP activity changes from the Up-state-Down-state transition in the NNSS to an almost persistent Up-state in the PNSS. A quantitative underpinning of this is shown in section 3.8. We analyzed slow frequency oscillations, including theta oscillations (5-9 Hz) and spindles (9-16 Hz), which are the major signature of stage N2 of non-REM sleep. In the PNSS, as a result of ketamine-related changes, these subthreshold slow oscillations disappear and are replaced by faster oscillations (Figure 3-4).

The subthreshold MP activities of individual neurons contribute to the LFP, however, simultaneous spindles in both signals occur rarely or are difficult to detect. Representative traces of the LFP show that spindle-like activity occurring during NNSS is markedly reduced in the PNSS (Figure 3-5). In fact, the power spectrum analysis was applied to the LFP-like recordings from the simulated network and included six disjoint frequency bands. This analysis revealed that the sleep-like LO including delta- and theta-frequency oscillations and spindles were significantly reduced and the HO including beta-, gamma- and higher-frequency oscillations (HFO) were significantly increased (except cortical beta power) in PNSS in comparison with NNSS (Figure 3-5). These findings are also fully consistent with our experimental data. In the simulated CT-TRN-TC network, the combination of changes including the blockade of NMDA receptors along with other ketamine-related manipulations led to a reduced power of spindles. This finding is

reminiscent of the ketamine-induced effect on the spindles, as shown in our electrophysiological experiments.

Under the influence of ketamin, TRN does no longer work in burst mode and its firing activity is reduced. As a result, the TC and CT neurons are more active and exhibit less slow oscillations, in particular spindles (Figure 3-5). This result is consistent with previous experimental studies, demonstrating that TRN is critical for the generation of sleep spindles (Steriade et al., 1985; Steriade et al., 1993; Pinault, 2004; Mahdavi et al., 2020).

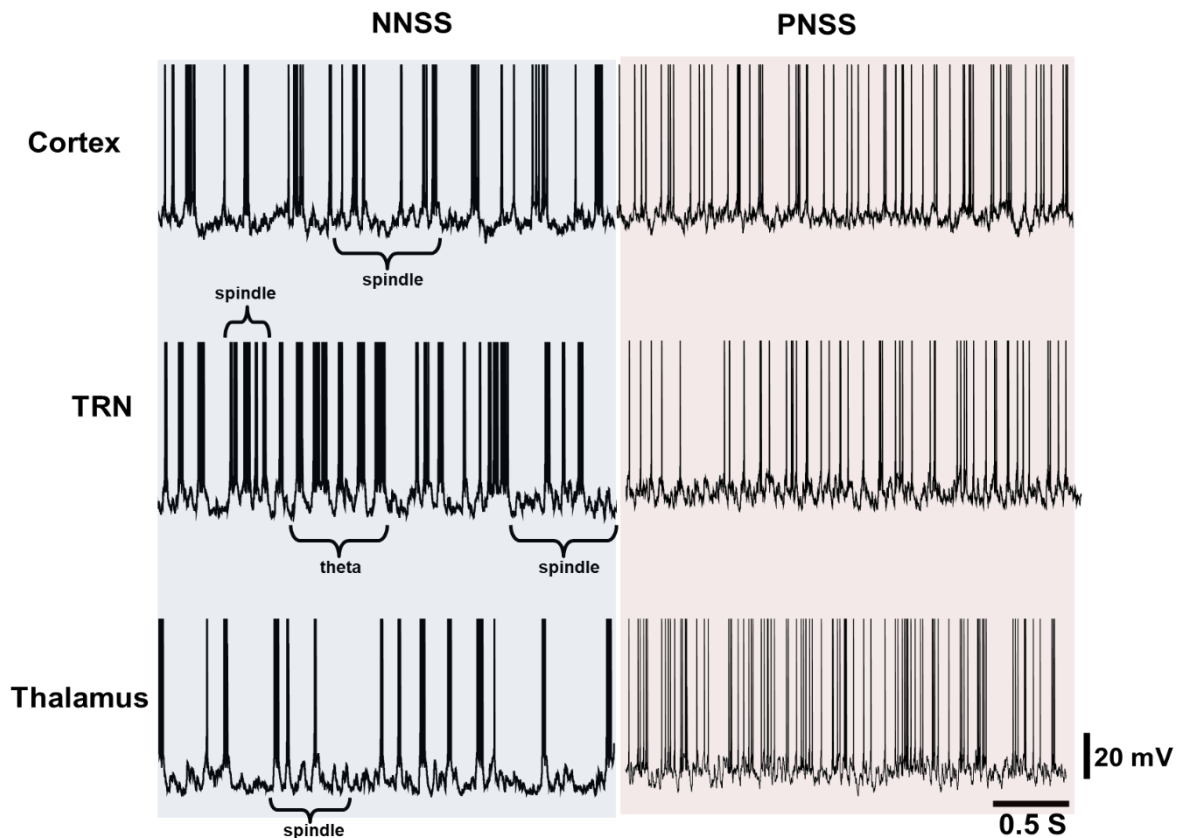

**Figure 3-4. Transition from NNSS to PNSS in the simulated CT-TRN-TC network.**

The three second representative intracellular-like recordings in the NNSS shown here are characterized by abundant bursts, whereas in the PNSS they are characterized by irregular single-spikes. The subthreshold activity changes from Up-state-Down-state transitions in the NNSS to a persistent Up-state in the PNSS. Subthreshold activities in the NNSS show that subthreshold slow oscillations occur abundantly in the frequency range of theta (5-9 Hz) and spindle (9-16 Hz). This profile is a signature of the N2 stage of non-REM sleep. In the PNSS, in contrast, these subthreshold slow oscillations disappear and faster oscillations appear instead.

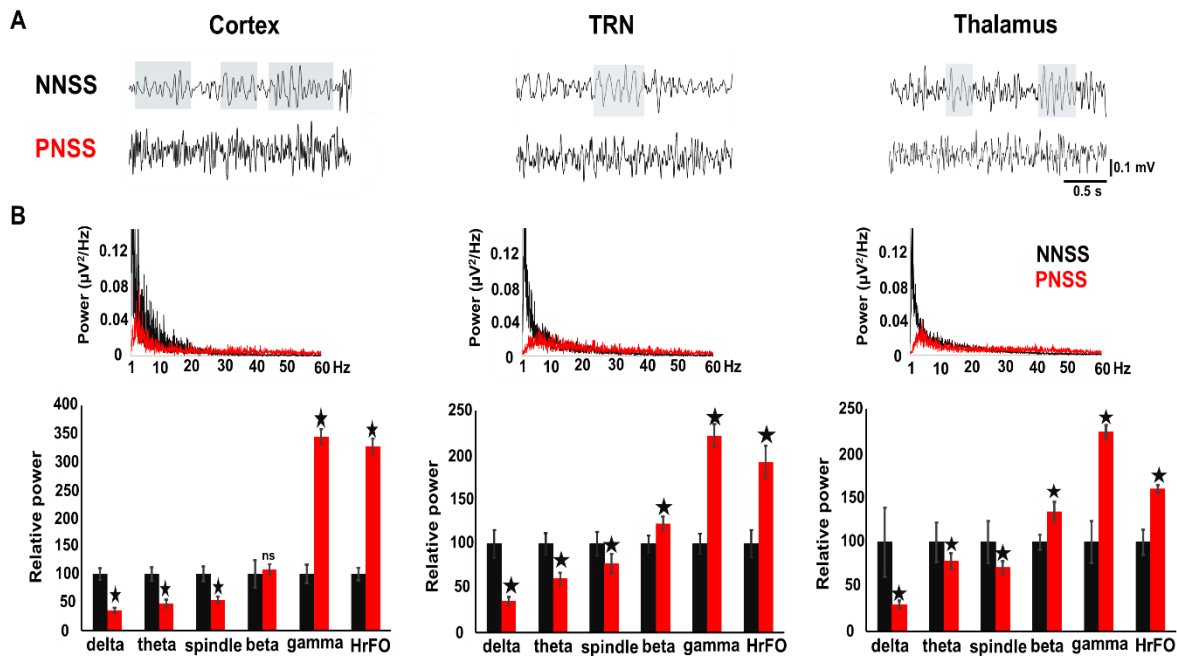

**Figure 3-5. The reduction of LO and increase of HO due to the inactivation of NMDA receptors and changes of ketamine-related parameters in the simulated CT-TRN-TC system during sleep-like state.**

**A.** Representative traces of the cortical, TRN and thalamic LFPs (3 seconds, frequency band 5-35 Hz) in physiological and pathological states show that spindle activity occurs in abundance during NNSS (rectangular shaded areas). Spindles are abolished after the inactivation of NMDA receptors and ketamine-related parameter changes. High-frequency oscillations appear instead. **B.** High-resolution power spectra (top) and frequency band specific histograms (bottom) of the simulated cortical, TRN and thalamic LFPs show a significant increase in the power of HO, including beta (18-29 Hz), gamma (30-80Hz) and higher-frequency (81-200 Hz, HrFO) oscillations. They also show a significant reduction in power of LO, including delta (1-4Hz) and theta (5-8 Hz) oscillations, as well as spindles (9-16 Hz), except cortical beta, specifically due to the lack of NMDA receptors in the PNSS (red) compared to the NNSS (mean of five 40 s recording traces, Hamming window, resolution: 0.5 Hz, \*: t-test,  $p < 0.05$ ).

In our electrophysiological experiments, we recorded frontoparietal cortical EEG but we did not record from CT neurons. In our computer simulations, we obtained single-cell and LFP recordings from CT neurons. These recordings revealed that, before and after virtual ketamine administration, cortical neurons behave similar to TRN and TC neurons in several aspects. Due to the ketamine-related changes, the firing pattern of CT neurons changed from burst mode to single AP mode (quantitative analysis in the next sections), and their oscillatory behavior changed from synchronized slow oscillations to more desynchronized faster oscillations (Figures 3-4 and 3-5). The difference was that CT

neurons, in the NNSS, showed a smaller number of bursts ( $81 \pm 27$  in 40 seconds) relative to TRN neurons ( $112 \pm 35$  in 40 seconds). The robustness of CT bursts (burst duration  $\approx 12 \pm 9$  ms, number of events per burst  $\approx 5 \pm 3$ ) was also less than that of TRN bursts (burst duration  $\approx 21 \pm 15$  ms, number of events per burst  $\approx 9 \pm 6$ ).

In the PNSS, CT neurons were highly excited similar to an arousal-like state. LFP recordings from cortical neurons (and thalamus) showed a significant increase in HO and a significant reduction in sleep-like slow oscillations, including spindles and delta- and theta-frequency oscillations. These LFP observations are consistent with the EEG observations including our in vivo electrophysiological findings (Mahdavi et al., 2020), and other preclinical studies showing ketamine-induced hyperactivity in cortical regions (Hakami et al., 2009; Anderson et al., 2017; Mahdavi et al., 2020). These elevated high oscillations are also similar to those recorded during the natural REM sleep (Kocsis, 2012b). The ketamine-related changes bring the model to a pathological sleep state, reminiscent of REM sleep state, known as a natural psychotic state in which dreams occur. Moreover, our computationally obtained results are also consistent with the findings in human studies showing an increased gamma band activity and sleep spindle deficit in the EC-SCZ patients and ARMS individuals (Flynn et al., 2008; Manoach et al., 2014; Andreou et al., 2015; Ramyeed et al., 2015). At the cellular level, virtually induced ketamine effects revealed in the single-cell recordings from the simulated cortical neurons are also consistent with those observed in an animal study indicating that administration of NMDA receptor antagonist MK801 concomitantly leads to potentiation of firing rate, increased number of irregular single spikes and reduction of bursts in the prefrontal cortical neurons, which were correlated with the impaired working memory and behavioral stereotypy, reminiscent of cognitive and motor abnormalities observed in schizophrenia (Jackson et al., 2004).

### **3.6. The reduced activity of NMDA receptors reduces robustness and number of bursts, and increases the number of single-spike events**

Different kinds of quantitative analyses were performed to account for the change in the firing activity of the CT, TRN and TC neurons from the burst mode to the tonic mode as a result of the reduced activity of NMDA receptors and other ketamine-related changes. In addition to the extreme cases of NNSS (normal or recovered state) and PNSS (peak

effect of psychotomimetic dose of ketamine), we also considered several states between them, with parameters obtained by linear interpolation. All parameters are listed in Table 3-2, however, in this table, values are shown only for normal and pathological condition. Figure 3-7 and Figure 3-8 show a fingerprint of these states in terms of the number of events in bursts, single events, duration of bursts, and events per burst. The states are parametrized by the changes in connection probability to NMDA receptors and by changes in the conductance of NMDA receptors, respectively.

Low values for the peak conductance of NMDA receptors or the connection probability for NMDA synapses result in a reduced burst activity and more single APs (Figure 3-7 and 3-8). The result of a gradual attenuation of NMDA receptors is consistent with an increased effect of ketamine until reaching its peak (~10-15 minutes after a single administration of ketamine) and then decaying its effect until partial recovery (~40-60 minutes after peak effect of ketamine). These results show a strong and monotonic relationship between the parameters of NMDA receptors and the quantity and robustness of bursts. The gradually decreased activity of NMDA receptors results in fewer spikes per burst and more single events in ongoing single-cell recordings (Figure 3-7 and 3-8). The number of spikes per burst and the duration of bursts gradually decreases with decreasing peak conductance and connection probability of the NMDA receptors, indicating that bursting becomes less pronounced in all respects (Figure 3-6). By applying these gradual changes to NMDA receptors, we could model the smooth and gradual rising and decaying effect of a psychotomimetic dose of ketamine. The manipulation of NMDA receptors significantly affects burst activity in the simulated CT-TRN-TC network.

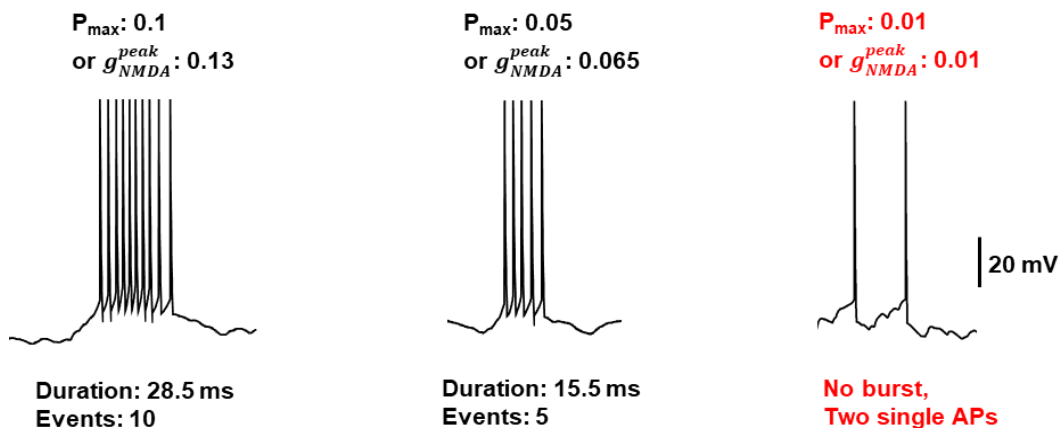

**Figure 3-6. Bursting decreases by reducing either the connection probability to NMDA synapses ( $P_{max}$ ) or the peak conductance of NMDA receptors ( $g_{NMDA}^{peak}$ ).**

Reduction of  $P_{\max}$  from 0.075 to 0.015 or  $g_{NMDA}^{peak}$  from 0.13 to 0.065 results in a reduction of both the duration of bursts (from 28.5 ms to 15.5 ms) and the number of spikes per burst (from 10 to 5), indicating the occurrence of less robust burst due to the NMDA receptor hypofunction. Further reduction of  $P_{\max}$  or  $g_{NMDA}^{peak}$  to a value near zero (0.01) leads to the abolition of burst and occurrence of two single APs, indicating the switch from burst mode to the tonic mode due to the intense hypofunction of NMDA receptors. These two bursts and single APs shown are samples from a TRN neuron recorded in three different conditions.

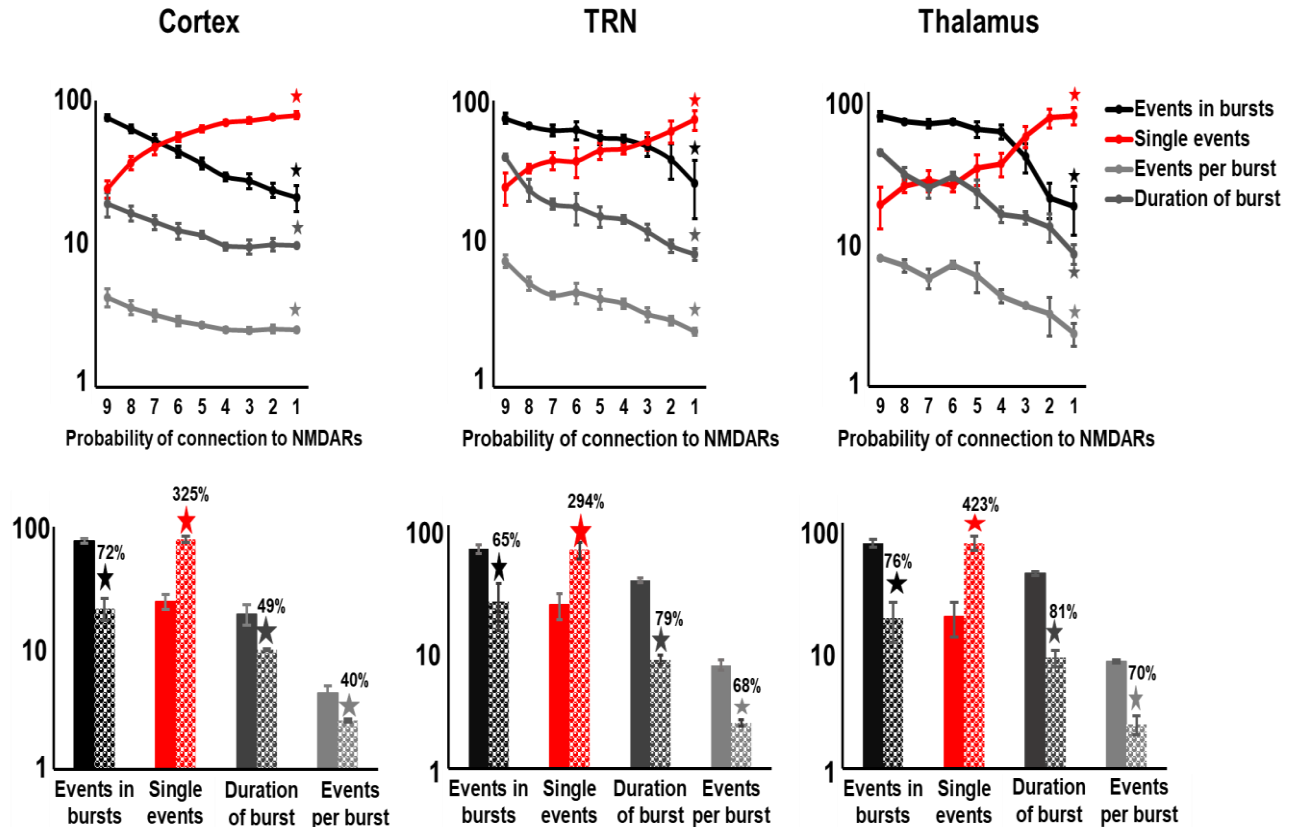

**Figure 3-7. Reduction of the connection probability to NMDA synapses significantly affects the firing behaviour of simulated CT-TRN-TC system in the sleep-like state.**

In all of the three regions including cortex, TRN and thalamus, the average number of events in bursts (black) is significantly reduced, the average number of single-spike events (red) is significantly increased, both the burst duration (light black) and number of events per burst (lighter black) are significantly reduced after reducing the connection probability to NMDA synapses. Histograms show the results for the maximum (solid fill) and minimum (sphere pattern fill) connection probability to NMDA synapses. Results are the average ( $\pm$ SEM) of 5 recordings obtained from 5 different individual neurons, each 40 seconds long. Vertical axis has a logarithmic scale. In the horizontal axis, 9 represents the  $P_{\max}$  in the NNSS and 1 represents the  $P_{\max}$  in the PNSS (Table 3-2). Other values are between these two numbers with the same step size from the start value (the NNSS) to the end value (the PNSS). Along with  $P_{\max}$ , rising and decaying time constants of NMDA receptors were also changed in the same manner. The number of events in bursts and the number of single-spike events are expressed as a percentage of all events. Numbers in percentages on the histograms (sphere pattern fill) show what percentages these

histograms have changed relative to the histograms (solid fill) just next to them on their left sides. NMDARs: NMDA receptors. \*: t-test,  $p < 0.05$ .

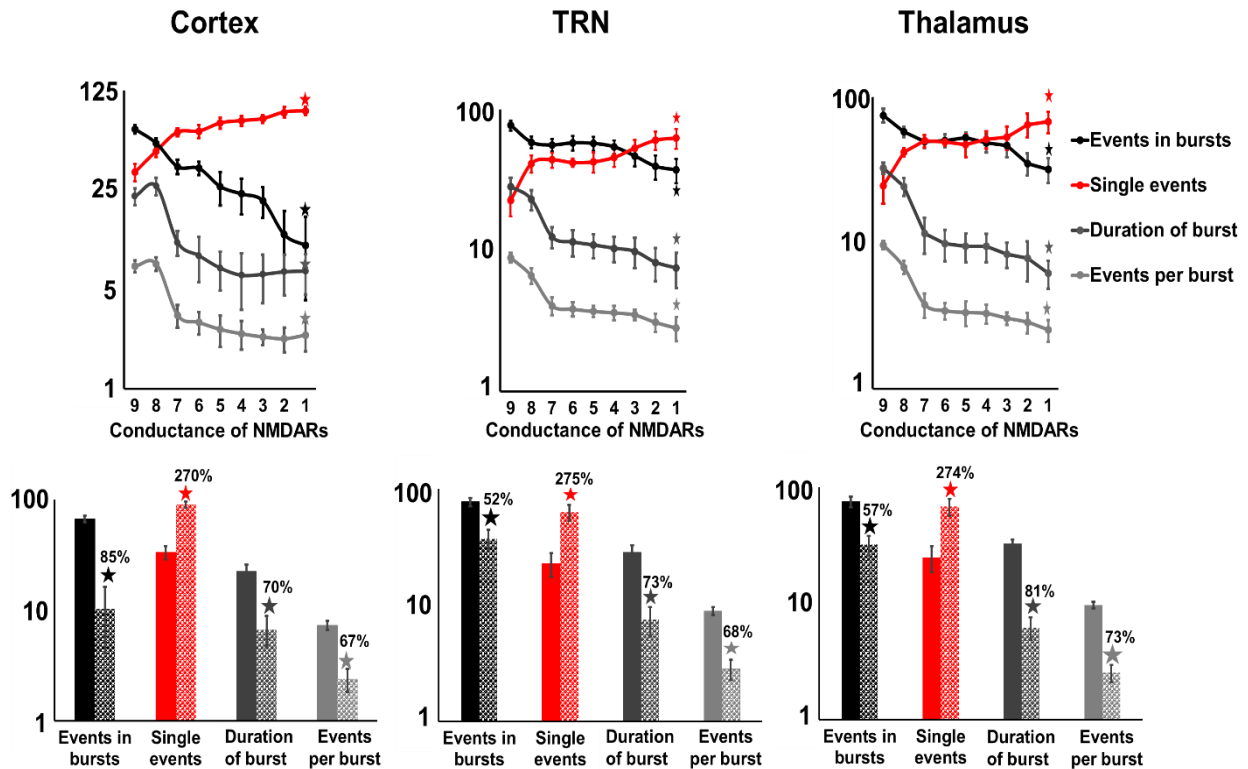
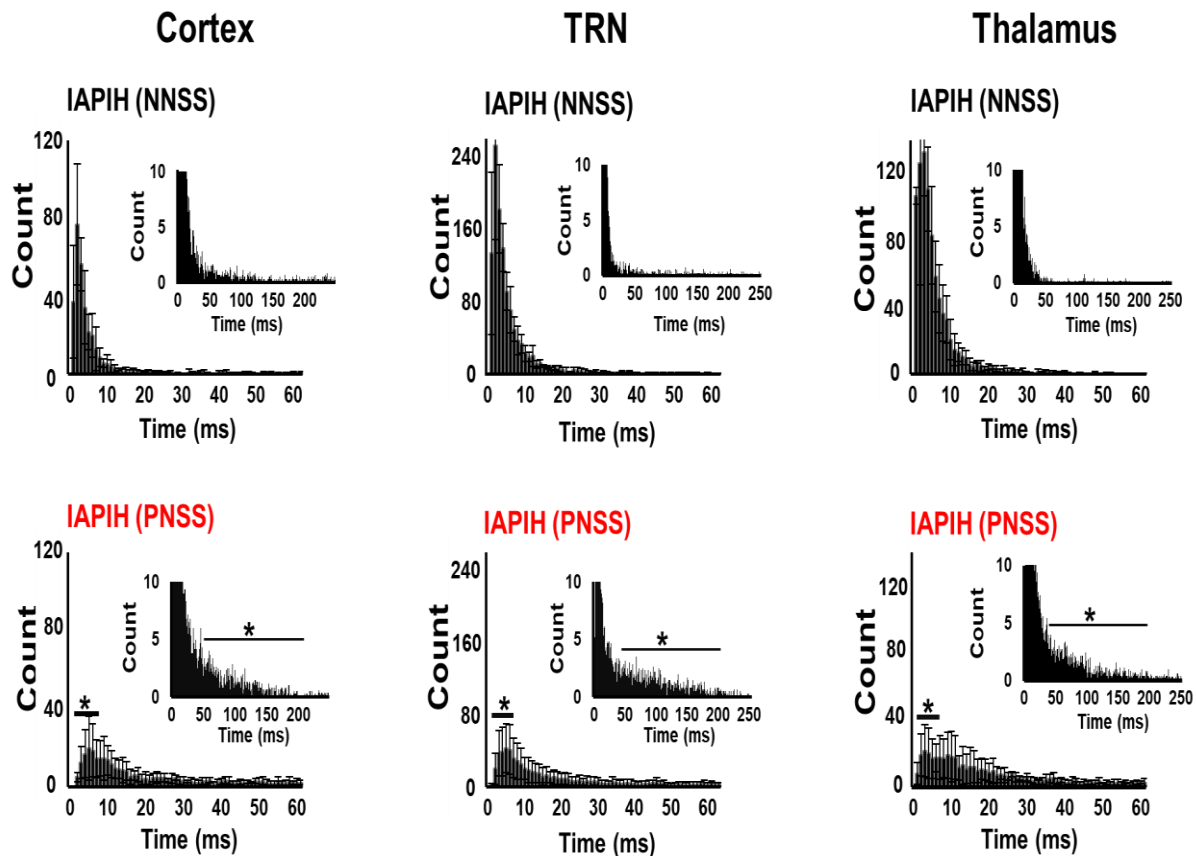

**Figure 3-8. Reduction of the peak conductance of NMDA receptors affects the firing behaviour of the CT-TRN-TC system in the sleep-like state.**

In all of the three regions including the cortex, the TRN and the thalamus, the average number of events in bursts (black) gets significantly reduced, the average number of single events (red) gets significantly increased, both the duration of bursts (light black) and the number of events per burst (lighter black) get significantly reduced due to the reduction of the peak conductance of NMDA receptors. Histograms show the results for the largest (solid fill) and smallest (sphere pattern fill) conductance of NMDA receptors considered. Results are obtained from 40 seconds long recordings. Vertical axis has a logarithmic scale. In the horizontal axis, 9 represents the peak conductance of NMDA receptors ( $g_{NMDA}^{peak}$ ) in the NNSS and 1 represents  $g_{NMDA}^{peak}$  in the PNSS (Table 3-2). Other values are between these two numbers with the same step size from the start value (the NNSS) to the end value (the PNSS). Along with  $g_{max}$ , rising and decaying time constants of NMDA receptors were also changed in the same manner. The number of events in bursts and of single-spike events are given relative to the total number of events. Numbers in percentages on the histograms (sphere pattern fill) show what percentages these histograms have changed relative to the histograms (solid fill) just next to them on their left sides. NMDARs: NMDA receptors. \*: t-test,  $p < 0.05$ .

### 3.7. The IAPIH analysis of single-cell recordings indicates a reduced bursting and increased single-spike events in the PNSS relative to the NNSS

The inter-AP interval histograms (IAPIH) of cortical, TRN and thalamic signals show that in the PNSS relative to the NNSS, the peak at an interval length of 2-5 ms, a marker of abundant occurrence of hf bursts, disappeared almost completely and instead, longer inter-spike intervals (between 10 and 250 ms) are more represented. This indicates a switch from the burst mode to the tonic mode (Figure 3-9).



**Figure 3-9. High-frequency bursts are reduced and single APs are increased in PNSS relative to NNSS.**

Average cumulated inter-AP interval histograms (IAPIH) of intracellularly recorded traces obtained from cortical, TRN and thalamic cells during NNSS (top) and PNSS (down) conditions. Note a highly significant reduction in the number of short IAPIs, especially those comprising the bursts (IAPI = 2-6 ms) and a significant increase of long IAPIs (IAPI = 10-200 ms, see smaller IAPIHs) showing the abundant occurrence of single APs in the PNSS (down) in comparison with the NNSS (top) due to the blockade of NMDA receptors. Average of 5 recordings, each 40 seconds long, \*: t-test,  $p < 0.05$ .



### **3.8. Membrane potentials reflect Up-State-Down state transitions in the NNSS and a persistent Up state in the PNSS**

Another important difference between the normal and the pathological state is a different baseline of neuronal membrane potentials in all three regions of the CT-TRN-TC network, as shown in Figure 3-10. The intracellular-like recordings in all regions showed that, in the pathological sleep state, CT, TRN and TC neurons generate more near-threshold membrane potential oscillations. This means that the bimodal baseline (Up and Down states) of membrane potentials in the NNSS changes to the persistent Up state in the PNSS, which also increases the possibility of AP initiation. The analysis of membrane potentials showed that in the PNSS, the baseline of the membrane potential dramatically shifts in all regions to about 10-15 mV more positive potentials in the PNSS relative to the NNSS (Figure 3-10). This keeps the activity of most CT-TRN-TC neurons in a persistent Up state. TRN and TC neurons due to the NMDA receptor hypofunction, do not fire bursts and do not consequently act in the Up-state-Down-state transitions. Rather, they undergo a persistent Up state and discharge in the single AP mode through a cortex-mediated elevated activation of AMPA receptors.

During persistent Up states, the long-lasting hyperpolarization ( $< -60$  mV, Down state), which is essential for the occurrence of bursts, does not occur. Bursting, however, is essential for sleep LO, such as spindles. Therefore, when the hf bursts are absent and replaced by single intermittent spikes, the network enters an arousal-like state, in which spindles and slower oscillations are dramatically reduced.

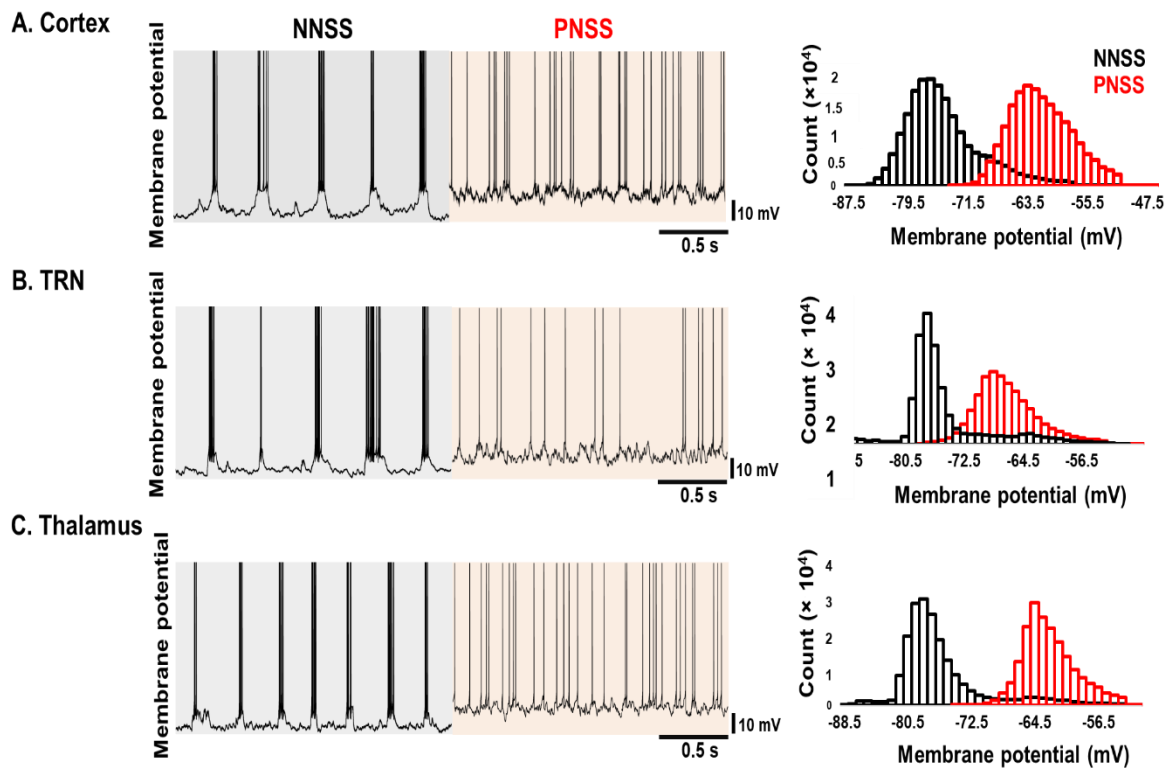

**Figure 3-10. Neuronal membrane potentials in the simulated CT-TRN-TC system reflect Up-state-Down-state transitions in the NNSS and a persistent Up-state in the PNSS.**

**A, B and C:** Two-second-long membrane potential traces (left) and membrane potential histograms (right, 1 kHz sampling rate, 1 mV bin width, average of 4 intracellular-like recordings of 4 individual cells, 40 s duration) show that due to the inactivated NMDA receptors, the cortical, TRN and thalamic neurons generate more membrane potential oscillations close to threshold (-51 mV in cortical cells, -53 mV in thalamic cells). As a result, the bimodal distribution (Up states and Down states) of the membrane potential in the normal sleep mode changes to a persistent Up-state in the pathological sleep mode.

From our experimental findings, we know that the juxtacellularly recorded TC and TRN neurons undergo a ketamine-induced switch from a non-REM sleep state to the arousal abnormal REM-like sleep state, in which neurons fire intermittently in the single AP mode and bursts occur rarely. At that time, based on the extra- and juxtacellular observations, we predicted this switch to the Up state at the intracellular level. Now, our computational model confirmed it and revealed the neuronal mechanisms underlying our experiments. Single-cell recordings from model neurons showed that ketamine-induced transformation from burst mode to single AP mode is associated with the transformation from Up-state-Down-state transitions to the persistent Up-state. The latter is also associated with decreased LO and increased HO, which reflect the oscillatory activities

similar to those recorded during REM sleep or in ketamine-treated freely behaving rats (Pinault, 2008; Hakami et al., 2009; Kocsis, 2012b).

### **3.9. The reduced activity of NMDA receptors alone can switch the firing pattern from the burst mode to the tonic mode, but it cannot decrease the spindle activity. This indicates that a combination of changes is necessary to mimic the full effects of ketamine.**

The PNSS is a neuronal mechanism that may lead to a psychosis transition, according to the ketamine-induced effects. Since ketamine affects neurons and synapses through different mechanisms involving various synaptic receptors beyond NMDA receptors, it is important to know whether the manipulation of each receptor alone, or combinations of them, would also be able to induce ketamine-like effects in the simulated CT-TRN-TC network. We wanted to find out whether the specific combination of changes (i.e., the PNSS) is the only mechanism that leads to ketamine-like effects, or whether there are other possibilities. Table 3-3 shows which changes have been applied to the parameter values in each of these scenarios. We call the main mechanism leading to the pathological condition (PNSS) **Scenario A**. It includes a reduced activity of NMDA synapses in combination with changes in other ketamine-related parameters (as listed in Table 3-2). To better understand the role of NMDA receptors for the emergence of ketamine effects, five additional scenarios were implemented, as described below.

**Scenario B** (Figure 3-11, orange bar): Only NMDA receptors were changed without affecting other ketamine-related parameters. We expected similar results as for highly specific antagonists of NMDA receptors, such as MK801. We indeed obtained a significant decrease in the number of bursts, the number of spikes in bursts, the burst duration and a significant increase in the number of single APs. The firing pattern of neurons is significantly affected, including a switch from the burst mode to the tonic mode. Although the transition is not as robust as in Scenario A, we find that the inactivation of NMDA receptors alone is sufficient to change the firing pattern as ketamine does.

**Scenario C** (Figure 3-11, yellow bar): Only the AMPA receptor activity was increased. The result was expected to be consistent with the effect of AMPA receptor agonists. In this scenario, only the peak conductance of AMPA receptors or the connection probability to AMPA receptors, was increased and their time constants were reduced to make these

receptors faster (table 3-3). All other parameters were unchanged relative to the NNSS. This scenario was considered, because it has been shown that ketamine facilitates the function of AMPA receptors and makes the AMPA channels faster (Llamosas et al., 2019; Wang et al., 2017). However, this aspect of ketamine action alone was not able to induce full ketamine-like effects. We observed even more robust bursts of longer duration and an increased number of APs in each burst, both in thalamic and in TRN neurons. This indicates that AMPA receptors cannot be the only receptors affected by ketamine.

**Scenario D** (Figure 3-11, blue bar): Only the AMPA receptor activity was decreased. The question was whether the reduced function of another type of excitatory receptor would induce a similar behavior as ketamine with its broader action. We expected that the outcome would fit well with the application of AMPA receptor antagonists. In this scenario, only the connection probability, or the peak conductance, of AMPA receptors was decreased and their time constants were reduced (Table 3-3). Comparing the blue bars (Scenario D) with black bars (Scenario A) in Figure 3-11 indicate that the reduced activity of AMPA receptors did not change the firing pattern of the network in any of the involved regions, whereas the reduced activity of NMDA receptors (red and orange bars) was able to switch the firing pattern in all regions from the burst to the single-spike mode. This shows that only a reduced activity of NMDA receptors is able to mimic the ketamine-like effects, and that a reduced activity of AMPA receptors does not lead to a comparable outcome. These results show that changes of different kinds of excitatory receptors affect the firing behavior of the simulated CT-TRN-TC network differently, and each of them has specific effects.

**Scenario E** (Figure 3-11, green bar): Only GABA<sub>A</sub> receptor activity was increased. We expected features of deep sleep and general effects in accordance with GABA<sub>A</sub> receptor agonists. Several studies reported an impact of ketamine on GABA<sub>A</sub> receptors and inhibitory synaptic transmission. It was specifically shown that ketamine augments the activity of these receptors (Irifune et al. 2000; Sleight et al., 2014). In line with these findings, the activity of GABA<sub>A</sub> receptors was potentiated. These changes in GABAergic transmission alone, however, could not mimic the ketamine effects. We found more robust bursts, with more spikes in each burst and extended burst duration. However, the firing pattern was not affected in any of the regions considered. Long and robust bursts come with delta- and slower-frequency oscillations, as well as long-lasting Up-states and Down-

states, which are characteristics of deep sleep (stage N3 of non-REM sleep). Scenario A promotes a general arousal and leads to a switch from the N2 stage to a lighter sleep (REM sleep; a natural psychotic state occurring during sleep) or even to waking state. Scenario E, in contrast, has a sleep-promoting effect and leads to a switch from the N2 stage to the deeper sleep (stage N3 of non-REM sleep).

**Scenario F** (Figure 3-11, purple bar): All parameters listed in table 3-2 were changed, except the properties of NMDA receptors. This setting emphasizes the essential role of NMDA receptors for the emergence of ketamine effects. We found that this scenario is not able to switch the firing pattern of neurons from the burst mode to the tonic mode. This shows that even the joint potentiation of both AMPA and GABA<sub>A</sub> receptors is insufficient to mimic the psychotomimetic effect of ketamine, and a change of NMDA receptors is indispensable to achieve this effect (Figure 3-11 and Table 3-4).

**Table 3-3. Parameter changes that bring the NNSS to a new state including Scenarios B to F.**

$pr_{pop}$  is a connection probability specified for each of the populations involved in the model (see Table 2-2). Units of peak conductance and time constants are micro-Siemens and milliseconds, respectively. TC: Thalamocortical neurons, Cx: Cortical neurons, exc: excitatory, inh: inhibitory, NMDARs: NMDA receptors, AMPARs: AMPA receptors;  $GABA_A$ Rs:  $GABA_A$  receptors.

Parameter changes in first method	Region	NNSS	Scenario B
Probability of connection to NMDARs	exc Cx, exc TC	$pr_{pop}$	$0.02 * pr_{pop}$
Probability of connection to NMDARs	TRN, inh TC, inh Cx	$pr_{pop}$	$0.0 * pr_{pop}$
Parameter changes in second method	Region	NNSS	Scenario B
$g_{NMDA}^{peak}$ (peak conductance of NMDARs)	exc Cx	0.11	0.05
$g_{NMDA}^{peak}$ (peak conductance of NMDARs)	inh Cx, inh TC	0.12	0.02
$g_{NMDA}^{peak}$ (peak conductance of NMDARs)	exc TC	0.115	0.05
$g_{NMDA}^{peak}$ (peak conductance of NMDARs)	TRN	0.135	0.0
Parameter changes in both methods	Region	NNSS	Scenario B
$\tau_{NMDA}^{rise}$ (Rise time constant of NMDARs)	All	4	1
$\tau_{NMDA}^{decay}$ (Decay time constant of NMDARs)	All	40	10

Parameter changes in first method	Region	NNSS	Scenario C
Probability of connection to AMPARs	exc Cx, inh Cx	$pr_{pop}$	$1.5 * pr_{pop}$
Probability of connection to AMPARs	exc TC, inh TC, TRN	$pr_{pop}$	$2 * pr_{pop}$
Parameter changes in second method	Region	NNSS	Scenario C
$g_{AMPA}^{peak}$ (peak conductance of AMPARs)	Exc Cx, inh Cx	0.11	0.22
$g_{AMPA}^{peak}$ (peak conductance of AMPARs)	TRN, exc TC, inh TC	0.115	0.21
Parameter changes in both methods	Region	NNSS	Scenario C
$\tau_{AMPA}^{rise}$ (Rise time constant of AMPARs)	All	2.4	1.2
$\tau_{AMPA}^{decay}$ (Decay time constant of AMPARs)	All	0.5	0.12

Parameter changes in first method	Region	NNSS	Scenario D
Probability of connection to AMPARs	exc Cx, inh Cx	$pr_{pop}$	$0.05 * pr_{pop}$
Probability of connection to AMPARs	exc TC, inh TC, TRN	$pr_{pop}$	$0.03 * pr_{pop}$
Parameter changes in second method	Region	NNSS	Scenario D
$g_{AMPA}^{peak}$ (peak conductance of AMPARs)	Exc Cx, inh Cx	0.11	0.05
$g_{AMPA}^{peak}$ (peak conductance of AMPARs)	TRN, exc TC, inh TC	0.115	0.05

Parameter changes in both methods	Region	NNSS	Scenario D
$\tau_{AMPA}^{rise}$ (Rise time constant of AMPARs)	All	2.4	1.2
$\tau_{AMPA}^{decay}$ (Decay time constant of AMPARs)	All	0.5	0.12
Parameter changes in first method	Region	NNSS	Scenario E
Probability of connection to GABA <sub>A</sub> Rs	All	$pr_{pop}$	$2 * pr_{pop}$
Parameter changes in second method	Region	NNSS	Scenario E
$g_{GABAA}^{peak}$ (peak conductance of GABA <sub>A</sub> Rs)	All	0.14	0.22
Parameter changes in both methods	Region	NNSS	Scenario E
$\tau_{GABAA}^{rise}$ (Rise time constant of GABA <sub>A</sub> receptors)	All	7	3.5
$\tau_{GABAA}^{decay}$ (Decay time constant of GABA <sub>A</sub> receptors)	All	1	0.5
Parameter changes in first method	Region	NNSS	Scenario F
Probability of connection to AMPARs	exc Cx, inh Cx	$pr_{pop}$	$1.5 * pr_{pop}$
Probability of connection to AMPARs	exc TC, inh TC, TRN	$pr_{pop}$	$2 * pr_{pop}$
Parameter changes in second method	Region	NNSS	Scenario F
$g_{AMPA}^{peak}$ (peak conductance of AMPARs)	Exc Cx, inh Cx	0.11	0.22
$g_{AMPA}^{peak}$ (peak conductance of AMPARs)	TRN, exc TC, inh TC	0.115	0.21
$g_{GABAA}^{peak}$ (peak conductance of GABA <sub>A</sub> Rs)	All	0.14	0.155
Parameter changes in both methods	Region	NNSS	Scenario F
$\tau_{AMPA}^{rise}$ (Rise time constant of AMPARs)	All	2.4	1.2
$\tau_{AMPA}^{decay}$ (Decay time constant of AMPARs)	All	0.5	0.12
$\tau_{GABAA}^{rise}$ (Rise time constant of GABA <sub>A</sub> receptors)	All	7	3.5
$\tau_{GABAA}^{decay}$ (Decay time constant of GABA <sub>A</sub> receptors)	All	1	0.5
$g_T^{peak}$ (Peak conductance of T-type calcium current)	Exc Cx	3	1
$g_T^{peak}$ (Peak conductance of T-type calcium current)	Exc TC	6	3
$g_T^{peak}$ (Peak conductance of T-type calcium current)	TRN	8	4

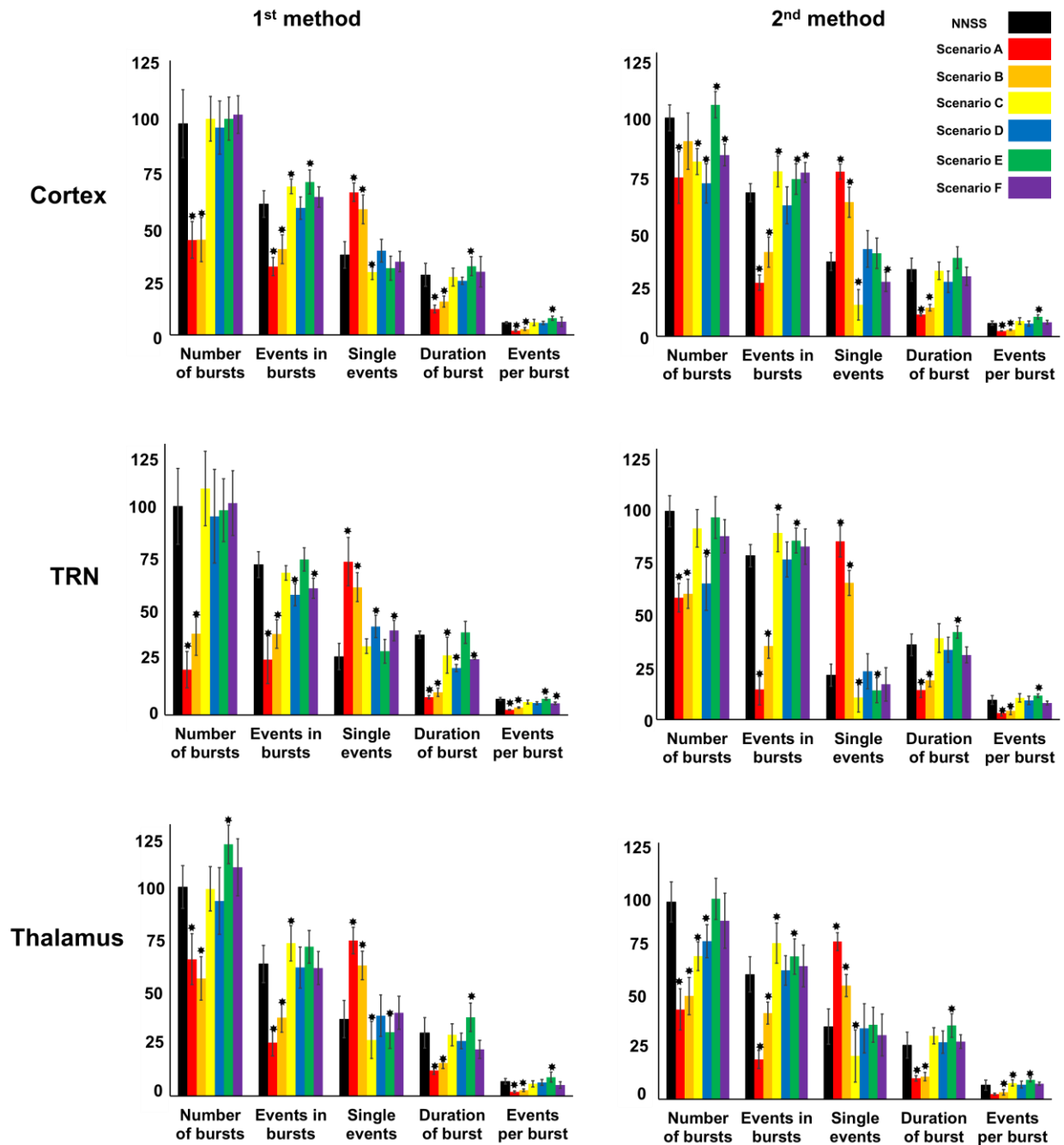

**Figure 3-11. Ketamine-like effect in switching the firing pattern from the burst mode to the tonic mode is specifically due to the attenuation of NMDA receptors.**

In addition to the scenario that brings the simulated CT-TRN-TC network to the pathological condition induced by ketamine (PNSS, **Scenario A**, red), five other, more selective scenarios were implemented to test whether the switch in the firing pattern is specifically due to the reduced function of NMDA receptors. These scenarios include a reduced activity of NMDA receptors (**Scenario B**, orange), an increased activity of AMPA receptors (**Scenario C**, yellow), a decreased activity of AMPA receptors (**Scenario D**, blue), an increased activity of GABA<sub>A</sub> receptors (**Scenario E**, green), and parameter changes as scenario B except NMDA receptors (**Scenario F**, purple). All five scenarios are described in the text in more detail. None of them could switch



the firing pattern from the burst mode to the tonic mode and fully recapitulate the ketamine-like effects (**Scenario A**, red), except Scenario B (orange). Only Scenario A (red) and Scenario B (orange) could significantly increase the number of single-spikes and significantly decrease the number of bursts, the number of spikes in bursts, the burst duration, and the number of spikes per burst. This is a clear indication that this kind of switch in the firing pattern is specifically due to the reduced activity of NMDA receptors. The black bars refer to the NNSS. The number of spikes in bursts and of single-spikes are given in relative terms. Results are the average ( $\pm$ SEM) of 5 recordings (each of 40 s duration) obtained from 5 individual neurons. \*: t-test,  $p < 0.05$ .

In addition to the spiking characteristics, the oscillatory activity of the various populations was investigated by analyzing the spectral power of LFPs for 6 distinct frequency bands. This kind of analysis was done in three conditions: the NNSS, the PNSS (Scenario A) and Scenario B. The analysis of LFP power shows that Scenario B has a significantly increased power of HO including beta-, gamma- and higher-frequency oscillations, and a significantly decreased power of LO only in the delta band. Therefore, Scenario B could successfully mimic the ketamine-like effects of Scenario A (PNSS) on the delta-, beta-, gamma- and higher-frequency oscillations. In contrast to Scenario A, Scenario B could not mimic the ketamine-like effects on the theta-frequency oscillations and spindles. One of the main effects of ketamine, as indicated in our experimental results, is a reduction in the power of spindles. Figure 3-12 shows that only inactivating the NMDA receptors (Scenario B) is insufficient to decrease the power of spindles. The reduced activity of NMDA receptors alone (Scenario B) could affect the firing activity according to the ketamine effects (Figures 3-11), but it could not reduce the power of spindles (Figures 3-12). This shows that the reduced activity of NMDA receptors is necessary, but not sufficient, to unfold the full effects of ketamine. That is why we also manipulated the parameters of non-NMDA receptors, including AMPA and GABA<sub>A</sub> receptors. Only if the ketamine-related changes were imposed on the other kinds of receptors (AMPA and GABA<sub>A</sub>), all systemic effects of ketamine were fully emerged.

None of the scenarios B to F alone could mimic the complete set of ketamine effects. This shows that without including the hypofunction of NMDA receptors it is impossible to mimic the ketamine effects, indicating the crucial and specific role of NMDA receptors relative to non-NMDA receptors in generating the ketamine-like effects, which eventually results in a psychosis-like transition.

Selectively inactivating NMDA receptors (Scenario B), we expected to obtain the results similar to the application of MK801, an NMDA receptor antagonist that is more specific than ketamine. Our experimental results of surface EEG recordings showed that MK801 significantly reduced the power of theta oscillations and spindles, increased the power of gamma- and higher-frequency oscillations, and did not lead to significant changes in the delta- and beta-frequency oscillations (Mahdavi et al., 2020). The analysis of our computational model could confirm these results only for the power of gamma- and higher-frequency oscillations. Selectively blocking the NMDA receptors led to a significantly reduced power of delta oscillations, but did not lead to significant changes in the power of theta oscillations and spindles. This discrepancy between the experimental and computational results may be either due to a highly dose-dependent effect of MK-801 (Hiyoshi et al., 2014), or to its unknown mechanisms of action, or to a shortcoming of the computational model. In the experiments, we administered MK-801 in a certain dose (0.1 mg/kg) that led to reduction of spindles, but we did not try other dosages and also did not acquire the extracellular recordings from the subcortical regions. Therefore, in order to validate the results of Scenario B, further experiments are required.

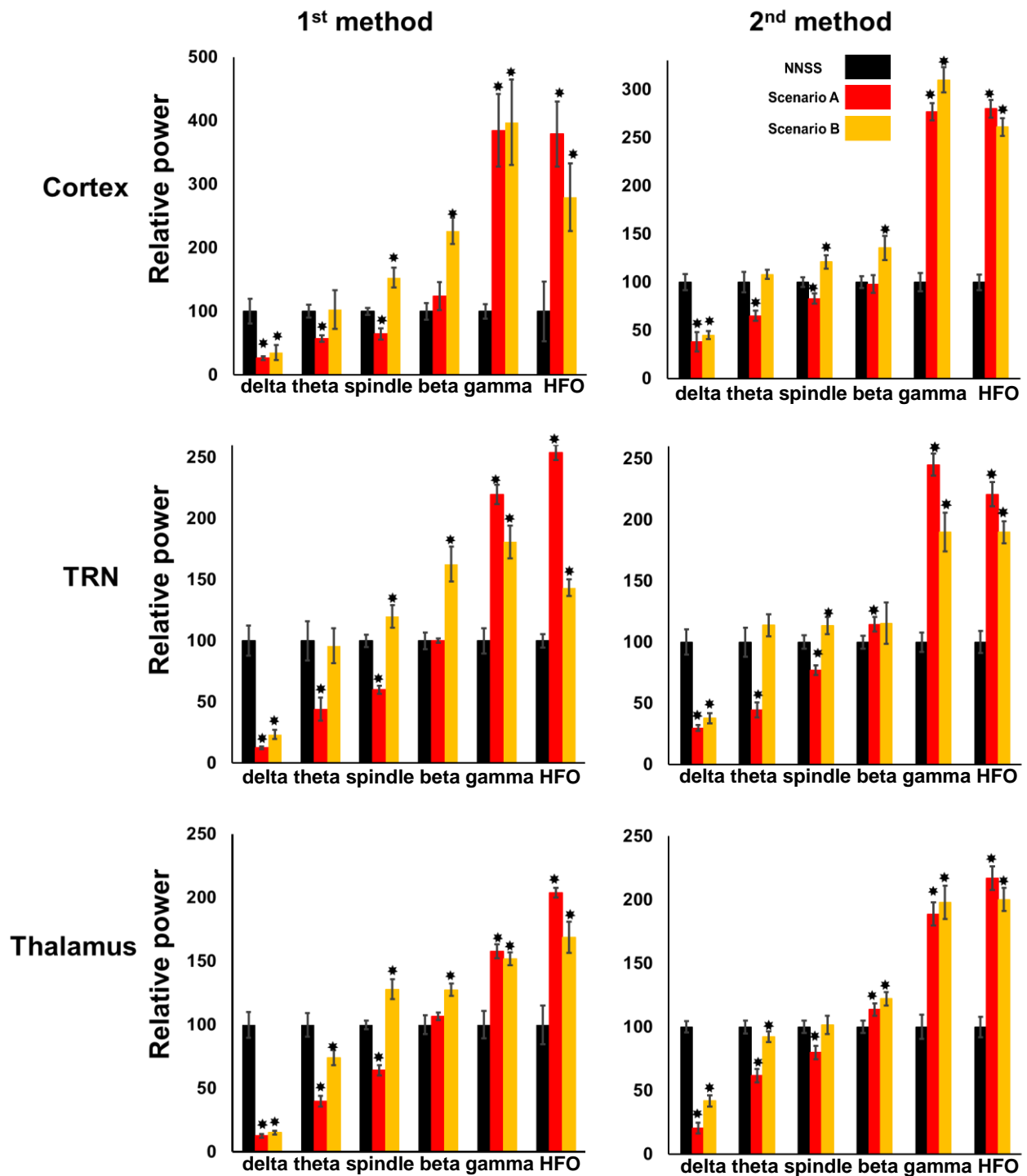

**Figure 3-12. A combined change of several parameters is essential to mimic the ketamine-induced reduction in spindles and theta oscillations.**

The power spectral analysis applied to both approaches to bring the model network to a pathological state revealed that the effects of inactivated NMDA receptors alone (yellow bars, Scenario B) mimicked the ketamine-like effects (red bars, Scenario A) and significantly reduced the power of delta oscillations and significantly increased the power of high frequency oscillations including the beta-, gamma- and higher-frequency oscillations. It did not mimic, however, the ketamine-like effects on theta oscillations and spindles. This indicates that NMDA receptors

cannot alone be made responsible for the ketamine effects. The black bars represent the power acquired from the LFPs of the normal non-REM sleep state. Results are the average ( $\pm$ SEM) of 5 LFP recordings (40 s long) acquired from 5 individual neurons. \*: t-test,  $p < 0.05$ .

The effect of all the scenarios A to F has been compared with the ketamine effect on spiking activities and field potentials, as briefly shown in Table 3-4. Such a comparison helps to elucidate, which of the scenarios matches the effect of ketamine better than others. There are additional untested parameter combinations (e.g., a combination of scenario B and C, or a combination of scenario C and D) to assess whether they can lead to switch the firing pattern of the simulated network. We were not able to consider them all in this study and cannot rule out that their effect resembles that of ketamin. A brief motivation why the 6 scenarios were chosen is presented in the text where they and the result of their analysis are explained. Scenario A comprises most of the known mechanisms of ketamine action on the different kinds of synaptic receptors including NMDA, AMPA and GABA<sub>A</sub> receptors. An exception are dopamine and acetylcholine receptors, which are not considered in our simulations of the CT-TRN-TC network.

Amongst these 6 scenarios, only Scenario A (PNSS) was able to recapitulate all ketamine effects on both the firing pattern and neural oscillations, resembling our experimental results. By investigating the partial effects of several different scenarios, we conclude that the reduced activity of NMDA receptors in combination with the increased activity of both AMPA and GABA<sub>A</sub> receptors is necessary and sufficient to make the model pathological in accordance with the psychotomimetic effects of ketamine. Therefore, we suggest Scenario A as an appropriate model of the underlying mechanism for the transition to psychosis.

We have manipulated the activity of AMPA and GABA<sub>A</sub> receptors in addition to NMDA receptors to model the multiple mechanisms of ketamine action. These additional effects question the hypothesis that ketamine effects emerge specifically as a result of NMDA receptor hypofunction. Note, however, that the altered activity of AMPA and GABA<sub>A</sub> receptors may be secondary, occurring as a consequence of reduced activity of NMDA receptors (Homayoun and Moghaddam, 2007; Ren et al., 2016), or may be caused by the direct impact of ketamine on these receptors (Irifune et al., 2000; Nosyreva et al., 2013; Iskandrani et al., 2015; Ghosal et al., 2020), independently of NMDA receptor hypofunction. If we accept the former, we can still consider NMDA receptor hypofunction

as the main cause of ketamine effects. Our results indeed strongly support the NMDA receptor hypofunction hypothesis. Otherwise, NMDA receptor hypofunction alone cannot account for all the ketamine effects. Instead, a combination of changes involving NMDA, AMPA and GABA<sub>A</sub> receptors can account for them. Our results thus reveal that the suppression of NMDA receptors is essential, but insufficient to explain all the psychotomimetic effects of ketamine on the CT-TRN-TC network. We suggest that the ketamine-induced transition to psychosis may be mediated not only by NMDA receptors but also, at least in part, by AMPA and GABA<sub>A</sub> receptors. This suggestion is corroborated by the fact that ketamine can be used as an anesthetic, but unlike most other anesthetics, it does not appear to activate the sleep-promoting areas like hypothalamus. Rather, ketamine activates thalamic wake-promoting nuclei (Lu et al., 2008).

**Table 3-4. The effect of different alternative scenarios in comparison with the ketamine effect on the firing and oscillatory activities of the simulated CT-TRN-TC network in the non-REM sleep-like state.**

If outcome of a perturbation scenario is consistent with the ketamine effect, the table cell is green, otherwise it is red. Only Scenario A (PNSS) is fully consistent with the known effects of ketamine. Among scenarios from B to C, Scenario B mimics the ketamine effect better than others, indicating the crucial role of NMDA receptors. An analysis of distinct frequency bands was not performed for the scenarios C, D, E and F, because they failed to show the correspondence with the ketamine effects on the spiking activity including bursts and single APs. ↑: increased activity, ↓: decreased activity. NMDARs: NMDA receptors, AMPARs: AMPA receptors, GABA<sub>A</sub>Rs: GABA<sub>A</sub> receptors.

Scenario	Changes	Effect on							
		Burst	Single AP	Delta	Theta	Spindle	Beta	Gamma	HFO
Scenario A	NMDARs ↓, AMPARs ↑ GABA <sub>A</sub> Rs ↑	Green	Green	Green	Green	Green	Green	Green	Green
Scenario B	NMDARs ↓	Green	Green	Green	Red	Red	Green	Green	Green
Scenario C	AMPARs ↑	Red	Red						
Scenario D	AMPARs ↓	Red	Red						
Scenario E	GABA <sub>A</sub> Rs ↑	Red	Red						
Scenario F	AMPARs ↑, GABA <sub>A</sub> Rs ↑	Red	Red						

In summary, in the present theoretical study, we developed a computational model of the CT-TRN-TC network in both WS and NNSS. This simulated network works in a proper regime as a loop circuit because its multiple neural populations show similar behaviors in terms of oscillations and firing activity patterns. Then, based on our electrophysiological findings and other evidence, we proposed the PNSS (Scenario A), a neural mechanism in the CT-TRN-TC network that may serve as a model of ketamine-induced transition to psychosis. We highlighted that the combined ketamine-related changes involving AMPA and GABA<sub>A</sub> receptors with the leading role of NMDA receptor hypofunction may underlie the transition to a psychosis-relevant state and the schizophrenia-related deficit in sleep spindles.

## **PART 3**

---

### **Conclusions**

From a pharmacological viewpoint, it is premature to draw strong conclusions, as all experiments designed to assess the effects of any tested drug were conducted in the pentobarbital-sedated rat. Although pentobarbital may unwillingly have interacted with some of the drugs tested, the sleep model offers the advantage to assess acute ketamine effects simultaneously on the whole spectrum of neural oscillations, which are considered translational electro-biomarkers and potential endophenotypes of a psychosis transition state. Also, under the computationally modeled sleep condition, in which there is no potential pharmacological ambiguity, we obtained results supporting our experimental findings. We conclude that the pharmacological effects induced by pentobarbital do not compromise the cogency and reliability of the conclusions drawn from experimental results.

From a theoretical and translational point of view, it is intriguing to see that the ketamine-induced changes in rodent EEG oscillations and computationally obtained cortical LFPs are comparable to those recorded in awake, naturally behaving rats (Hakami et al., 2009; Hiyoshi et al., 2014; Pinault, 2008). They are also reminiscent of those observed in at-risk mental state individuals (Fleming et al., 2019; Ramyeed et al., 2015) and the first episode of schizophrenia (Andreou et al., 2015; Flynn et al., 2008).

The present joint experimental-theoretical investigation demonstrates that the acute effects of ketamine have a transient arousal-promoting effect, suggesting that it acts as a rapid inducer of REM sleep-associated cognitive processes, which is reminiscent of its ability to induce hallucinatory and delusional symptoms (Baldeweg et al., 1998; Becker et al., 2009; Behrendt, 2003; Ffytche, 2008; Spencer et al., 2004). Low-dose ketamine not only disturbs brain rhythms but also disrupts attention-related sensorimotor and cognitive processes (Grent-'t-Jong et al., 2018; Höflich et al., 2015; Hong et al., 2010), supporting the notion that schizophrenia is a cognitive disorder with psychosis as a subsequent consequence (Cohen and Insel, 2008; Huang et al., 2019; Woodward and Heckers, 2016).

What does the acute ketamine preparation indeed model? First of all, this model does not cover the genetic-neurodevelopmental and anatomical dimensions, and neither the decompensatory mechanisms of psychotic disorders. The acute ketamine rodent, human and computational model is thought to mimic acute forms of psychosis and early rather than chronic schizophrenia (Anticevic et al., 2015b). In the present electrophysiological-computational investigation, acute ketamine, primarily through



NMDA receptor-related cascade mechanisms, elicited a transition from a physiologically “normal” state to a psychosis-relevant state. In the CT-TRN-TC system, under the non-REM sleep condition, ketamine transiently and significantly converted the firing activity pattern from a burst mode to a single AP mode, reduced cortical and thalamic spindles and slower-frequency oscillations, and increased high-frequency oscillations in beta, gamma, and higher frequency bands. A reduction in sleep spindles and delta oscillations has been reported in the early course of schizophrenia (Manoach et al., 2014; Kaskie et al., 2019). Therefore, we may conclude that in the sleep condition, our acute ketamine model simulates a state that is electrophysiologically reminiscent of a transitioning to a psychotic state, as ketamine reproduces psychosis-related disturbances of brain oscillations, and the antipsychotic clozapine, that binds to the serotonin and dopamine receptors (Meltzer, 1991; Meltzer, 1994; Deutch, 1995; Seeman, 2002; Nucifora et al., 2017; Haidary and Padhy, 2020) as well as to the NMDA receptor through its glycine site (Lipina et al., 2005; Schwieler et al., 2008), prevents them. On the other hand, in humans, the natural transition to psychosis emerges from an already disturbed state (or at-risk mental state). This implicates multifactorial, interactive etio-pathophysiological mechanisms involving the environment, socio-culture, genes, pro-inflammation, risk factors, dopaminergic, GABAergic, and glutamatergic neurotransmissions, and functional dysconnectivity between cortical and subcortical highly-distributed systems, including thalamus-related circuits.

Despite the difficult interpretation of the acute ketamine model, the present study may help to understand, at least for the highly-distributed TC systems, the cell-to-network disturbances occurring during the conversion from a physiological to a pathological, psychosis-relevant state. Cortical EEG oscillations are reliable biomarkers of thalamic activities as both the cortex and the thalamus work together. In the present study, it is shown that it is possible, based on the available knowledge and our computational findings, to predict the likely thalamic cell-to-network correlates.

Ketamine-induced changes may disturb both the “bottom-up” and the “top-down” information flow (Mahdavi et al., 2020), referring to the role of the reticular activating system (RAS) in driving the cortical EEG rhythms (Garcia-Rill et al, 2015) and the contribution of the CT pathway in thalamic oscillations (Anderson et al., 2017), respectively. In the somatosensory CTC system, the role of CT neurons that massively

innervate both TC and TRN neurons was determined by single-cell and LFP recordings from CT neurons using computer simulations of the 3-stage CT-TRN-TC circuit.

We developed a computational model of the CT-TRN-TC network working in the non-REM sleep state and proposed a neural mechanism that may serve as a model of ketamine-induced transition to psychosis. Our computational observations not only supported our experimental findings but also indicated the firing pattern and oscillatory behavior of CT neurons under both normal and pathological states. They also confirmed some of our experimental predictions such as the ketamine-induced change in the baseline of the membrane potential from the Up-state-Down-state transitions to the persistent Up state. This change is associated with a transition from the burst mode to the single AP mode, and a transition from the synchronized sleep-like state to the desynchronized arousal-like state. Due to the reduced function of NMDA receptors, the firing activity pattern of CT neurons changes from burst to single AP mode. In addition, due to the disinhibition from GABAergic interneurons and increased excitation from the TC neurons, the firing rate of CT neurons increases. CT neurons, in turn, highly excite the TRN and TC neurons. However, in the absence or feeble presence of NMDA receptors, these neurons do not fire bursts and do not subsequently undergo any Up-state-Down-state transitions. Rather, they act in a persistent Up state and discharge in the single AP mode through a cortex-mediated elevated activation of AMPA receptors. Different neural populations of the simulated network show similar and concomitant behaviors in terms of oscillations and firing activity patterns, indicating that the computational model of the CT-TRN-TC network works in a proper regime as a loop circuit.

The computational results emphasized the important role of NMDA receptors for the transition from the burst mode to the single spiking mode and the reduction of spindle activity. However, they could not confirm the sufficiency of an isolated change in the NMDA receptors. Rather, by considering the findings from previous studies about ketamine and its effects beyond “just” being an NMDA receptor antagonist (Sleigh et al., 2014), a combination of changes was implemented involving non-NMDA receptors in addition to the NMDA receptors. These combined changes together constitute the full ketamine-induced effects. In other words, a set of coordinated changes including the reduced activity of NMDA receptors and the augmented activity of AMPA and GABA<sub>A</sub> receptors occurring together was found to be responsible for the change of firing activity

pattern and spindle deficits, resulting in the psychosis-relevant state. We also showed that, without considering the reduced function of NMDA receptors, none of the other plausible scenarios based on the multiple mechanisms of ketamine action could alone mimic the ketamine-like effects, indicating the very specific and prominent role of NMDA receptors relative to non-NMDA receptors in the CT-TRN-TC network. Ketamine-related changes in the activity of AMPA and GABA<sub>A</sub> synapses may be due to the direct action of ketamine on them (Irifune et al., 2000; Iskandrani et al., 2015; Wang et al., 2017; Ghosal et al., 2020) or may be secondary to the ketamine-induced NMDA receptor hypofunction (Homayoun and Moghaddam, 2007; Ren et al., 2016; Weckman et al., 2019). There is no converging evidence for these mechanisms of ketamine action. However, our computational model supports the hypothesis that ketamine-related changes lead to the conversion to a psychosis-relevant state.

Our present findings provide a theoretical and translational added value to the present conceptual approach with some construct validity. There is also predictive validity because of clozapine preventive action (Mahdavi et al., 2020) and that frontoparietal tDCS reduces the ketamine-induced effects at least on delta, sigma and gamma-frequency oscillations (Lahogue and Pinault, 2021, *Transl Neurosci*, In press). However, it should also be mentioned that, in patients with psychosis, the natural EEG disturbances (reduction in spindle activity, increase in gamma power, etc.) are subtler than the ketamine-induced changes. Taken together, both our experimental and computational observations strongly support the hypothesis that the transition to a psychosis-relevant state and the schizophrenia-related deficit in sleep spindles and slow oscillations involve a hypofunction of NMDA receptors. Our present findings highlight the involvement of multiple neurotransmitter systems and the whole brain-networks hypothesis, rather than the isolated brain circuit theory of schizophrenia (Kambeitz et al., 2016). The neural mechanisms underlying the ketamine-induced fleeting arousal-like effect may be, in part, similar to those responsible for the initial stage of the rapidly-acting antidepressant action of ketamine in patients with drug-resistant major depressive disorders (Duncan Jr. et al., 2019; Krystal et al., 2019; Nugent et al., 2019). This leads us to think that the ketamine effects are state-dependent. In addition, the present results suggest that the combined sleep and ketamine models have some predictive validity for the first-stage development of innovative therapies against psychotic, bipolar, and depressive disorders.



## **PART 4**

---

### **References**

- Abdallah, C. G., De Feyter, H. M., Averill, L. A., Jiang, L., Averill, C. L., Chowdhury, G., Purohit, P., de Graaf, R. A., Esterlis, I., Juchem, C., Pittman, B. P., Krystal, J. H., Rothman, D. L., Sanacora, G., & Mason, G. F. (2018). The effects of ketamine on prefrontal glutamate neurotransmission in healthy and depressed subjects. *Neuropsychopharmacology : official publication of the American College of Neuropsychopharmacology*, *43*(10), 2154–2160.
- Ahnaou, A., Huysmans, H., Biermans, R., Manyakov, N. V., & Drinkenburg, W. (2017). Ketamine: differential neurophysiological dynamics in functional networks in the rat brain. *Translational psychiatry*, *7*(9), e1237.
- Ahrens, S., Jaramillo, S., Yu, K., Ghosh, S., Hwang, G. R., Paik, R., Lai, C., He, M., Huang, Z. J., & Li, B. (2015). ErbB4 regulation of a thalamic reticular nucleus circuit for sensory selection. *Nature neuroscience*, *18*(1), 104–111.
- Akbarian, S., Sucher, N. J., Bradley, D., Tafazzoli, A., Trinh, D., Hetrick, W. P., Potkin, S. G., Sandman, C. A., Bunney, W. E., Jr, & Jones, E. G. (1996). Selective alterations in gene expression for NMDA receptor subunits in prefrontal cortex of schizophrenics. *The Journal of neuroscience : the official journal of the Society for Neuroscience*, *16*(1), 19–30.
- Albéri, L., Lintas, A., Kretz, R., Schwaller, B., & Villa, A. E. (2013). The calcium-binding protein parvalbumin modulates the firing 1 properties of the reticular thalamic nucleus bursting neurons. *Journal of neurophysiology*, *109*(11), 2827–2841.
- Aleksandrova, L. R., Phillips, A. G., & Wang, Y. T. (2017). Antidepressant effects of ketamine and the roles of AMPA glutamate receptors and other mechanisms beyond NMDA receptor antagonism. *Journal of psychiatry & neuroscience : JPN*, *42*(4), 222–229.
- Amzica, F., & Steriade, M. (1998). Electrophysiological correlates of sleep delta waves. *Electroencephalography and clinical neurophysiology*, *107*(2), 69–83.
- Anderson, P. M., Jones, N. C., O'Brien, T. J., & Pinault, D. (2017). The N-Methyl d-Aspartate Glutamate Receptor Antagonist Ketamine Disrupts the Functional State of the Corticothalamic Pathway. *Cerebral cortex (New York, N.Y. : 1991)*, *27*(6), 3172–3185.
- Andrade, A., Hope, J., Allen, A., Yorgan, V., Lipscombe, D., & Pan, J. Q. (2016). A rare schizophrenia risk variant of CACNA1L disrupts Cav3.3 channel activity. *Scientific reports*, *6*, 34233.
- Andreasen, N. C. (1997). The role of the thalamus in schizophrenia. *Canadian journal of psychiatry. Revue canadienne de psychiatrie*, *42*(1), 27–33.
- Andreou, C., Nolte, G., Leicht, G., Polomac, N., Hanganu-Opatz, I. L., Lambert, M., Engel, A. K., & Mulert, C. (2015). Increased Resting-State Gamma-Band Connectivity in First-Episode Schizophrenia. *Schizophrenia bulletin*, *41*(4), 930–939.
- Anis, N. A., Berry, S. C., Burton, N. R., & Lodge, D. (1983). The dissociative anaesthetics, ketamine and phencyclidine, selectively reduce excitation of central mammalian neurones by N-methyl-aspartate. *British journal of pharmacology*, *79*(2), 565–575.
- Anticevic, A., Corlett, P. R., Cole, M. W., Savic, A., Gancsos, M., Tang, Y., Repovs, G., Murray, J. D., Driesen, N. R., Morgan, P. T., Xu, K., Wang, F., & Krystal, J. H. (2015a). N-methyl-D-aspartate receptor antagonist effects on prefrontal cortical connectivity better model early than chronic schizophrenia. *Biological psychiatry*, *77*(6), 569–580.
- Anticevic, A., Gancsos, M., Murray, J. D., Repovs, G., Driesen, N. R., Ennis, D. J., Niciu, M. J., Morgan, P. T., Surti, T. S., Bloch, M. H., Ramani, R., Smith, M. A., Wang, X. J., Krystal, J. H., & Corlett, P. R. (2012). NMDA receptor function in large-scale anticorrelated neural systems with implications for cognition and schizophrenia. *Proceedings of the National Academy of Sciences of the United States of America*, *109*(41), 16720–16725.

- Anticevic, A., Haut, K., Murray, J. D., Repovs, G., Yang, G. J., Diehl, C., McEwen, S. C., Bearden, C. E., Addington, J., Goodyear, B., Cadenhead, K. S., Mirzakhani, H., Cornblatt, B. A., Olvet, D., Mathalon, D. H., McGlashan, T. H., Perkins, D. O., Belger, A., Seidman, L. J., Tsuang, M. T., ... Cannon, T. D. (2015c). Association of Thalamic Dysconnectivity and Conversion to Psychosis in Youth and Young Adults at Elevated Clinical Risk. *JAMA psychiatry*, *72*(9), 882–891.
- Anticevic, A., Hu, X., Xiao, Y., Hu, J., Li, F., Bi, F., Cole, M. W., Savic, A., Yang, G. J., Repovs, G., Murray, J. D., Wang, X. J., Huang, X., Lui, S., Krystal, J. H., & Gong, Q. (2015b). Early-course unmedicated schizophrenia patients exhibit elevated prefrontal connectivity associated with longitudinal change. *The Journal of neuroscience : the official journal of the Society for Neuroscience*, *35*(1), 267–286.
- Anticevic, A., Tang, Y., Cho, Y. T., Repovs, G., Cole, M. W., Savic, A., Wang, F., Krystal, J. H., & Xu, K. (2014b). Amygdala connectivity differs among chronic, early course, and individuals at risk for developing schizophrenia. *Schizophrenia bulletin*, *40*(5), 1105–1116.
- Anticevic, A., Yang, G., Savic, A., Murray, J. D., Cole, M. W., Repovs, G., Pearlson, G. D., & Glahn, D. C. (2014a). Mediodorsal and visual thalamic connectivity differ in schizophrenia and bipolar disorder with and without psychosis history. *Schizophrenia bulletin*, *40*(6), 1227–1243.
- Astori, S., Wimmer, R. D., & Lüthi, A. (2013). Manipulating sleep spindles--expanding views on sleep, memory, and disease. *Trends in neurosciences*, *36*(12), 738–748.
- Astori, S., Wimmer, R. D., Prosser, H. M., Corti, C., Corsi, M., Liaudet, N., Volterra, A., Franken, P., Adelman, J. P., & Lüthi, A. (2011). The Ca(V)3.3 calcium channel is the major sleep spindle pacemaker in thalamus. *Proceedings of the National Academy of Sciences of the United States of America*, *108*(33), 13823–13828.
- Au, C. H., & Harvey, C. J. (2020). Systematic review: the relationship between sleep spindle activity with cognitive functions, positive and negative symptoms in psychosis. *Sleep medicine: X*, *2*, 100025.
- Ayhan, Y., Abazyan, B., Nomura, J., Kim, R., Ladenheim, B., Krasnova, I. N., Sawa, A., Margolis, R. L., Cadet, J. L., Mori, S., Vogel, M. W., Ross, C. A., & Pletnikov, M. V. (2011). Differential effects of prenatal and postnatal expressions of mutant human DISC1 on neurobehavioral phenotypes in transgenic mice: evidence for neurodevelopmental origin of major psychiatric disorders. *Molecular psychiatry*, *16*(3), 293–306.
- Azouz, R., & Gray, C. M. (1999). Cellular mechanisms contributing to response variability of cortical neurons in vivo. *The Journal of neuroscience : the official journal of the Society for Neuroscience*, *19*(6), 2209–2223.
- Badanich, K. A., Doremus-Fitzwater, T. L., Mulholland, P. J., Randall, P. K., Delpire, E., & Becker, H. C. (2011). NR2B-deficient mice are more sensitive to the locomotor stimulant and depressant effects of ethanol. *Genes, brain, and behavior*, *10*(7), 805–816.
- Bal, T., Debay, D., & Destexhe, A. (2000). Cortical feedback controls the frequency and synchrony of oscillations in the visual thalamus. *The Journal of neuroscience : the official journal of the Society for Neuroscience*, *20*(19), 7478–7488.
- Baldeweg, T., Spence, S., Hirsch, S. R., & Gruzelier, J. (1998). Gamma-band electroencephalographic oscillations in a patient with somatic hallucinations. *Lancet (London, England)*, *352*(9128), 620–621.
- Ballard, T. M., Pauly-Evers, M., Higgins, G. A., Ouagazzal, A. M., Mutel, V., Borroni, E., Kemp, J. A., Bluethmann, H., & Kew, J. N. (2002). Severe impairment of NMDA receptor function in mice carrying targeted point mutations in the glycine binding site results in drug-resistant nonhabituating hyperactivity. *The Journal of neuroscience : the official journal of the Society for Neuroscience*, *22*(15), 6713–6723.
- Bambole, V., Shah, N., Sonavane, S., Johnston, M., and Shrivastava, A. (2013) Study of negatives symptoms in first episode schizophrenia. *Open Journal of Psychiatry*, *3*, 323-328.

- Bang, J. W., Khalilzadeh, O., Hämäläinen, M., Watanabe, T., & Sasaki, Y. (2014). Location specific sleep spindle activity in the early visual areas and perceptual learning. *Vision research*, 99, 162–171.
- Baran, B., Karahanoğlu, F. I., Mylonas, D., Demanuele, C., Vangel, M., Stickgold, R., Anticevic, A., & Manoach, D. S. (2019). Increased Thalamocortical Connectivity in Schizophrenia Correlates With Sleep Spindle Deficits: Evidence for a Common Pathophysiology. *Biological psychiatry. Cognitive neuroscience and neuroimaging*, 4(8), 706–714.
- Barrientos, R., Alatorre, A., Martínez-Escudero, J., García-Ramírez, M., Oviedo-Chávez, A., Delgado, A., & Querejeta, E. (2019). Effects of local activation and blockade of dopamine D4 receptors in the spiking activity of the reticular thalamic nucleus in normal and in ipsilateral dopamine-depleted rats. *Brain research*, 1712, 34–46.
- Bartsch, U., Simpkin, A. J., Demanuele, C., Wamsley, E., Marston, H. M., & Jones, M. W. (2019). Distributed slow-wave dynamics during sleep predict memory consolidation and its impairment in schizophrenia. *NPJ schizophrenia*, 5(1), 18.
- Başar E. (2013). A review of gamma oscillations in healthy subjects and in cognitive impairment. *International journal of psychophysiology : official journal of the International Organization of Psychophysiology*, 90(2), 99–117.
- Bast, T., Zhang, W., Feldon, J., & White, I. M. (2000). Effects of MK801 and neuroleptics on prepulse inhibition: re-examination in two strains of rats. *Pharmacology, biochemistry, and behavior*, 67(3), 647–658.
- Bazhenov, M., Timofeev, I., Steriade, M., & Sejnowski, T. (2000). Spiking-bursting activity in the thalamic reticular nucleus initiates sequences of spindle oscillations in thalamic networks. *Journal of neurophysiology*, 84(2), 1076–1087.
- Bazhenov, M., Timofeev, I., Steriade, M., & Sejnowski, T. J. (1998). Computational models of thalamocortical augmenting responses. *The Journal of neuroscience : the official journal of the Society for Neuroscience*, 18(16), 6444–6465.
- Bazhenov, M., Timofeev, I., Steriade, M., & Sejnowski, T. J. (2002). Model of thalamocortical slow-wave sleep oscillations and transitions to activated States. *The Journal of neuroscience : the official journal of the Society for Neuroscience*, 22(19), 8691–8704.
- Beck, K., Hindley, G., Borgan, F., Ginestet, C., McCutcheon, R., Brugger, S., Driesen, N., Ranganathan, M., D'Souza, D. C., Taylor, M., Krystal, J. H., & Howes, O. D. (2020). Association of Ketamine With Psychiatric Symptoms and Implications for Its Therapeutic Use and for Understanding Schizophrenia: A Systematic Review and Meta-analysis. *JAMA network open*, 3(5), e204693.
- Becker, C., Gramann, K., Müller, H. J., & Elliott, M. A. (2009). Electrophysiological correlates of flicker-induced color hallucinations. *Consciousness and cognition*, 18(1), 266–276.
- Behrendt R. P. (2003). Hallucinations: synchronisation of thalamocortical gamma oscillations underconstrained by sensory input. *Consciousness and cognition*, 12(3), 413–451.
- Belforte, J. E., Zsiros, V., Sklar, E. R., Jiang, Z., Yu, G., Li, Y., Quinlan, E. M., & Nakazawa, K. (2010). Postnatal NMDA receptor ablation in corticolimbic interneurons confers schizophrenia-like phenotypes. *Nature neuroscience*, 13(1), 76–83.
- Benson K. L. (2015). Sleep in Schizophrenia: Pathology and Treatment. *Sleep medicine clinics*, 10(1), 49–55.
- Benson K. L. (2006). Sleep in schizophrenia: impairments, correlates, and treatment. *The Psychiatric clinics of North America*, 29(4), 1033–x.
- Bergen, S. E., Ploner, A., Howrigan, D., CNV Analysis Group and the Schizophrenia Working Group of the Psychiatric Genomics Consortium, O'Donovan, M. C., Smoller, J. W., Sullivan, P. F., Sebat, J., Neale,



- B., & Kendler, K. S. (2019). Joint Contributions of Rare Copy Number Variants and Common SNPs to Risk for Schizophrenia. *The American journal of psychiatry*, 176(1), 29–35.
- Bergeron, R., & Coyle, J. T. (2012). NAAG, NMDA receptor and psychosis. *Current medicinal chemistry*, 19(9), 1360–1364.
- Berman, R. A., Gotts, S. J., McAdams, H. M., Greenstein, D., Lalonde, F., Clasen, L., Watsky, R. E., Shora, L., Ordonez, A. E., Raznahan, A., Martin, A., Gogtay, N., & Rapoport, J. (2016). Disrupted sensorimotor and social-cognitive networks underlie symptoms in childhood-onset schizophrenia. *Brain : a journal of neurology*, 139(Pt 1), 276–291.
- Björkholm, C., Jardemark, K., Schilström, B., & Svensson, T. H. (2015). Ketamine-like effects of a combination of olanzapine and fluoxetine on AMPA and NMDA receptor-mediated transmission in the medial prefrontal cortex of the rat. *European neuropsychopharmacology : the journal of the European College of Neuropsychopharmacology*, 25(10), 1842–1847.
- Bland, B. H., Declerck, S., Jackson, J., Glasgow, S., & Oddie, S. (2007). Septohippocampal properties of N-methyl-D-aspartate-induced theta-band oscillation and synchrony. *Synapse (New York, N.Y.)*, 61(3), 185–197.
- Blumenfeld, H., & McCormick, D. A. (2000). Corticothalamic inputs control the pattern of activity generated in thalamocortical networks. *The Journal of neuroscience : the official journal of the Society for Neuroscience*, 20(13), 5153–5162.
- Boivin, D. B., Czeisler, C. A., Dijk, D. J., Duffy, J. F., Folkard, S., Minors, D. S., Totterdell, P., & Waterhouse, J. M. (1997). Complex interaction of the sleep-wake cycle and circadian phase modulates mood in healthy subjects. *Archives of general psychiatry*, 54(2), 145–152.
- Bonjean, M., Baker, T., Lemieux, M., Timofeev, I., Sejnowski, T., & Bazhenov, M. (2011). Corticothalamic feedback controls sleep spindle duration in vivo. *The Journal of neuroscience : the official journal of the Society for Neuroscience*, 31(25), 9124–9134.
- Bora E. (2015). Neurodevelopmental origin of cognitive impairment in schizophrenia. *Psychological medicine*, 45(1), 1–9.
- Bourassa, J., Pinault, D., & Deschênes, M. (1995). Corticothalamic projections from the cortical barrel field to the somatosensory thalamus in rats: a single-fibre study using biocytin as an anterograde tracer. *The European journal of neuroscience*, 7(1), 19–30.
- Bowie, C. R., & Harvey, P. D. (2006). Cognitive deficits and functional outcome in schizophrenia. *Neuropsychiatric disease and treatment*, 2(4), 531–536.
- Bradbury, T. N., & Miller, G. A. (1985). Season of birth in schizophrenia: a review of evidence, methodology, and etiology. *Psychological bulletin*, 98(3), 569–594.
- Brandon, N. J., Millar, J. K., Korth, C., Sive, H., Singh, K. K., & Sawa, A. (2009). Understanding the role of DISC1 in psychiatric disease and during normal development. *The Journal of neuroscience : the official journal of the Society for Neuroscience*, 29(41), 12768–12775.
- Brigman, J. L., Feyder, M., Saksida, L. M., Bussey, T. J., Mishina, M., and Holmes, A. (2008). Impaired discrimination learning in mice lacking the NMDA receptor NR2A subunit. *Learn. Mem.* 15, 50–54.
- Bromet, E. J., & Fennig, S. (1999). Epidemiology and natural history of schizophrenia. *Biological psychiatry*, 46(7), 871–881.
- Bromundt, V., Köster, M., Georgiev-Kill, A., Opwis, K., Wirz-Justice, A., Stoppe, G., & Cajochen, C. (2011). Sleep-wake cycles and cognitive functioning in schizophrenia. *The British journal of psychiatry : the journal of mental science*, 198(4), 269–276.

- Brown, A. S., & Derkits, E. J. (2010). Prenatal infection and schizophrenia: a review of epidemiologic and translational studies. *The American journal of psychiatry*, *167*(3), 261–280.
- Brown, P. L., Shepard, P. D., Elmer, G. I., Stockman, S., McFarland, R., Mayo, C. L., Cadet, J. L., Krasnova, I. N., Greenwald, M., Schoonover, C., & Vogel, M. W. (2012). Altered spatial learning, cortical plasticity and hippocampal anatomy in a neurodevelopmental model of schizophrenia-related endophenotypes. *The European journal of neuroscience*, *36*(6), 2773–2781.
- Brown, R. E., & McKenna, J. T. (2015). Turning a Negative into a Positive: Ascending GABAergic Control of Cortical Activation and Arousal. *Frontiers in neurology*, *6*, 135.
- Browne, C. A., & Lucki, I. (2013). Antidepressant effects of ketamine: mechanisms underlying fast-acting novel antidepressants. *Frontiers in pharmacology*, *4*, 161.
- Bubeníková-Valesová, V., Horáček, J., Vrajová, M., & Höschl, C. (2008). Models of schizophrenia in humans and animals based on inhibition of NMDA receptors. *Neuroscience and biobehavioral reviews*, *32*(5), 1014–1023.
- Cain, S. M., & Snutch, T. P. (2010). Contributions of T-type calcium channel isoforms to neuronal firing. *Channels (Austin, Tex.)*, *4*(6), 475–482.
- Cao, H., Chén, O. Y., Chung, Y., Forsyth, J. K., McEwen, S. C., Gee, D. G., Bearden, C. E., Addington, J., Goodyear, B., Cadenhead, K. S., Mirzakhani, H., Cornblatt, B. A., Carrión, R. E., Mathalon, D. H., McGlashan, T. H., Perkins, D. O., Belger, A., Seidman, L. J., Thermenos, H., Tsuang, M. T., ... Cannon, T. D. (2018). Cerebello-thalamo-cortical hyperconnectivity as a state-independent functional neural signature for psychosis prediction and characterization. *Nature communications*, *9*(1), 3836.
- Carlén, M., Meletis, K., Siegle, J. H., Cardin, J. A., Futai, K., Vierling-Claassen, D., Rühlmann, C., Jones, S. R., Deisseroth, K., Sheng, M., Moore, C. I., & Tsai, L. H. (2012). A critical role for NMDA receptors in parvalbumin interneurons for gamma rhythm induction and behavior. *Molecular psychiatry*, *17*(5), 537–548.
- Carlsson, M., & Svensson, A. (1990). The non-competitive NMDA antagonists MK-801 and PCP, as well as the competitive NMDA antagonist SDZ EAA494 (D-CPPene), interact synergistically with clonidine to promote locomotion in monoamine-depleted mice. *Life sciences*, *47*(19), 1729–1736.
- Castelnovo, A., Graziano, B., Ferrarelli, F., & D'Agostino, A. (2018). Sleep spindles and slow waves in schizophrenia and related disorders: main findings, challenges and future perspectives. *The European journal of neuroscience*, *48*(8), 2738–2758.
- Celada, P., Lladó-Pelfort, L., Santana, N., Kargieman, L., Troyano-Rodríguez, E., Riga, M. S., & Artigas, F. (2013). Disruption of thalamocortical activity in schizophrenia models: relevance to antipsychotic drug action. *The international journal of neuropsychopharmacology*, *16*(10), 2145–2163.
- Chan, M. S., Chung, K. F., Yung, K. P., & Yeung, W. F. (2017). Sleep in schizophrenia: A systematic review and meta-analysis of polysomnographic findings in case-control studies. *Sleep medicine reviews*, *32*, 69–84.
- Chatterjee, M., Verma, R., Ganguly, S., & Palit, G. (2012). Neurochemical and molecular characterization of ketamine-induced experimental psychosis model in mice. *Neuropharmacology*, *63*(6), 1161–1171.
- Chaudhuri, K. R., & Clough, C. (1998). Subcutaneous apomorphine in Parkinson's disease. *BMJ (Clinical research ed.)*, *316*(7132), 641.
- Chemerinski, E., Ho, B. C., Flaum, M., Arndt, S., Fleming, F., & Andreasen, N. C. (2002). Insomnia as a predictor for symptom worsening following antipsychotic withdrawal in schizophrenia. *Comprehensive psychiatry*, *43*(5), 393–396.

- Chen, J. Y., Chauvette, S., Skorheim, S., Timofeev, I., & Bazhenov, M. (2012). Interneuron-mediated inhibition synchronizes neuronal activity during slow oscillation. *The Journal of physiology*, *590*(16), 3987–4010.
- Cho, K. I., Shenton, M. E., Kubicki, M., Jung, W. H., Lee, T. Y., Yun, J. Y., Kim, S. N., & Kwon, J. S. (2016). Altered Thalamo-Cortical White Matter Connectivity: Probabilistic Tractography Study in Clinical-High Risk for Psychosis and First-Episode Psychosis. *Schizophrenia bulletin*, *42*(3), 723–731.
- Chouinard, S., Poulin, J., Stip, E., & Godbout, R. (2004). Sleep in untreated patients with schizophrenia: a meta-analysis. *Schizophrenia bulletin*, *30*(4), 957–967.
- Chowdhury, G. M., Behar, K. L., Cho, W., Thomas, M. A., Rothman, D. L., & Sanacora, G. (2012). <sup>1</sup>H-[<sup>13</sup>C]-nuclear magnetic resonance spectroscopy measures of ketamine's effect on amino acid neurotransmitter metabolism. *Biological psychiatry*, *71*(11), 1022–1025.
- Chowdhury, G. M., Zhang, J., Thomas, M., Banasr, M., Ma, X., Pittman, B., Bristow, L., Schaeffer, E., Duman, R. S., Rothman, D. L., Behar, K. L., & Sanacora, G. (2017). Transiently increased glutamate cycling in rat PFC is associated with rapid onset of antidepressant-like effects. *Molecular psychiatry*, *22*(1), 120–126.
- Chrobak, J. J., Hinman, J. R., & Sabolek, H. R. (2008). Revealing past memories: proactive interference and ketamine-induced memory deficits. *The Journal of neuroscience : the official journal of the Society for Neuroscience*, *28*(17), 4512–4520.
- Clemens, Z., Fabó, D., & Halász, P. (2006). Twenty-four hours retention of visuospatial memory correlates with the number of parietal sleep spindles. *Neuroscience letters*, *403*(1-2), 52–56.
- Cleynen, I., Engchuan, W., Hestand, M. S., Heung, T., Holleman, A. M., Johnston, H. R., Monfeuga, T., McDonald-McGinn, D. M., Gur, R. E., Morrow, B. E., Swillen, A., Vorstman, J., Bearden, C. E., Chow, E., van den Bree, M., Emanuel, B. S., Vermeesch, J. R., Warren, S. T., Owen, M. J., Chopra, P., ... Bassett, A. S. (2020). Genetic contributors to risk of schizophrenia in the presence of a 22q11.2 deletion. *Molecular psychiatry*, 10.1038/s41380-020-0654-3.
- Clinton, S. M., & Meador-Woodruff, J. H. (2004a). Thalamic dysfunction in schizophrenia: neurochemical, neuropathological, and in vivo imaging abnormalities. *Schizophrenia research*, *69*(2-3), 237–253.
- Clinton, S. M., & Meador-Woodruff, J. H. (2004b). Abnormalities of the NMDA Receptor and Associated Intracellular Molecules in the Thalamus in Schizophrenia and Bipolar Disorder. *Neuropsychopharmacology : official publication of the American College of Neuropsychopharmacology*, *29*(7), 1353–1362.
- Coan, E. J., Saywood, W., & Collingridge, G. L. (1987). MK-801 blocks NMDA receptor-mediated synaptic transmission and long term potentiation in rat hippocampal slices. *Neuroscience letters*, *80*(1), 111–114.
- Cohen, J. D., & Insel, T. R. (2008). Cognitive neuroscience and schizophrenia: translational research in need of a translator. *Biological psychiatry*, *64*(1), 2–3.
- Cohen, S. M., Tsien, R. W., Goff, D. C., & Halassa, M. M. (2015). The impact of NMDA receptor hypofunction on GABAergic neurons in the pathophysiology of schizophrenia. *Schizophrenia research*, *167*(1-3), 98–107.
- Cohrs S. (2008). Sleep disturbances in patients with schizophrenia : impact and effect of antipsychotics. *CNS drugs*, *22*(11), 939–962.
- Cole, M. W., Anticevic, A., Repovs, G., & Barch, D. (2011). Variable global dysconnectivity and individual differences in schizophrenia. *Biological psychiatry*, *70*(1), 43–50.
- Colgin, L. L., & Moser, E. I. (2010). Gamma oscillations in the hippocampus. *Physiology (Bethesda, Md.)*, *25*(5), 319–329.

- Colpaert, F. C., Niemegeers, C. J., Janssen, P. A., & Maroli, A. N. (1980). The effects of prior fentanyl administration and of pain on fentanyl analgesia: tolerance to and enhancement of narcotic analgesia. *The Journal of pharmacology and experimental therapeutics*, *213*(2), 418–424.
- Compte, A., Sanchez-Vives, M. V., McCormick, D. A., & Wang, X. J. (2003). Cellular and network mechanisms of slow oscillatory activity (<1 Hz) and wave propagations in a cortical network model. *Journal of neurophysiology*, *89*(5), 2707–2725.
- Contreras, D., & Steriade, M. (1996). Spindle oscillation in cats: the role of corticothalamic feedback in a thalamically generated rhythm. *The Journal of physiology*, *490* ( Pt 1)(Pt 1), 159–179.
- Contreras, D., Timofeev, I., & Steriade, M. (1996). Mechanisms of long-lasting hyperpolarizations underlying slow sleep oscillations in cat corticothalamic networks. *The Journal of physiology*, *494* ( Pt 1)(Pt 1), 251–264.
- Cornblatt, B. A., Lenzenweger, M. F., Dworkin, R. H., & Erlenmeyer-Kimling, L. (1985). Positive and negative schizophrenic symptoms, attention, and information processing. *Schizophrenia bulletin*, *11*(3), 397–408.
- Coronel-Oliveros, C. M., & Pacheco-Calderón, R. (2018). Prenatal exposure to ketamine in rats: Implications on animal models of schizophrenia. *Developmental psychobiology*, *60*(1), 30–42.
- Correll, C. U., Hauser, M., Penzner, J. B., Auther, A. M., Kafantaris, V., Saito, E., Olvet, D., Carrión, R. E., Birmaher, B., Chang, K. D., DelBello, M. P., Singh, M. K., Pavuluri, M., & Cornblatt, B. A. (2014). Type and duration of subsyndromal symptoms in youth with bipolar I disorder prior to their first manic episode. *Bipolar disorders*, *16*(5), 478–492.
- Coyle J. T. (2004). The GABA-glutamate connection in schizophrenia: which is the proximate cause?. *Biochemical pharmacology*, *68*(8), 1507–1514.
- Coyle J. T. (2012). NMDA receptor and schizophrenia: a brief history. *Schizophrenia bulletin*, *38*(5), 920–926.
- Coyle, J. T., Tsai, G., & Goff, D. (2003). Converging evidence of NMDA receptor hypofunction in the pathophysiology of schizophrenia. *Annals of the New York Academy of Sciences*, *1003*, 318–327.
- Crandall, S. R., Cruikshank, S. J., & Connors, B. W. (2015). A corticothalamic switch: controlling the thalamus with dynamic synapses. *Neuron*, *86*(3), 768–782.
- Crick F. (1984). Memory and molecular turnover. *Nature*, *312*(5990), 101.
- Cronenwett, W. J., & Csernansky, J. (2010). Thalamic pathology in schizophrenia. *Current topics in behavioral neurosciences*, *4*, 509–528.
- Crunelli, V., Cope, D. W., & Hughes, S. W. (2006). Thalamic T-type Ca<sup>2+</sup> channels and NREM sleep. *Cell calcium*, *40*(2), 175–190.
- D'Agostino, A., Castelnovo, A., Cavallotti, S., Casetta, C., Marcatili, M., Gambini, O., Canevini, M., Tononi, G., Riedner, B., Ferrarelli, F., & Sarasso, S. (2018). Sleep endophenotypes of schizophrenia: slow waves and sleep spindles in unaffected first-degree relatives. *NPJ schizophrenia*, *4*(1), 2.
- Dandash, O., Fornito, A., Lee, J., Keefe, R. S., Chee, M. W., Adcock, R. A., Pantelis, C., Wood, S. J., & Harrison, B. J. (2014). Altered striatal functional connectivity in subjects with an at-risk mental state for psychosis. *Schizophrenia bulletin*, *40*(4), 904–913.
- Dang-Vu, T. T., Schabus, M., Desseilles, M., Sterpenich, V., Bonjean, M., & Maquet, P. (2010). Functional neuroimaging insights into the physiology of human sleep. *Sleep*, *33*(12), 1589–1603.
- Daskalakis, Z. J., Fitzgerald, P. B., & Christensen, B. K. (2007). The role of cortical inhibition in the pathophysiology and treatment of schizophrenia. *Brain research reviews*, *56*(2), 427–442.

- Dawson, N., McDonald, M., Higham, D. J., Morris, B. J., & Pratt, J. A. (2014). Subanesthetic ketamine treatment promotes abnormal interactions between neural subsystems and alters the properties of functional brain networks. *Neuropsychopharmacology : official publication of the American College of Neuropsychopharmacology*, 39(7), 1786–1798.
- Dawson, N., Kurihara, M., Thomson, D. M., Winchester, C. L., McVie, A., Hedde, J. R., Randall, A. D., Shen, S., Seymour, P. A., Hughes, Z. A., Dunlop, J., Brown, J. T., Brandon, N. J., Morris, B. J., & Pratt, J. A. (2015). Altered functional brain network connectivity and glutamate system function in transgenic mice expressing truncated Disrupted-in-Schizophrenia 1. *Translational psychiatry*, 5(5), e569.
- Dawson, N., Morris, B. J., & Pratt, J. A. (2013). Subanaesthetic ketamine treatment alters prefrontal cortex connectivity with thalamus and ascending subcortical systems. *Schizophrenia bulletin*, 39(2), 366–377.
- de Bruin, N. M., Ellenbroek, B. A., Cools, A. R., Coenen, A. M., & van Luijtelaar, E. L. (1999). Differential effects of ketamine on gating of auditory evoked potentials and prepulse inhibition in rats. *Psychopharmacology*, 142(1), 9–17.
- de Jonge, J. C., Vinkers, C. H., Hulshoff Pol, H. E., & Marsman, A. (2017). GABAergic Mechanisms in Schizophrenia: Linking Postmortem and *In Vivo* Studies. *Frontiers in psychiatry*, 8, 118.
- Deleuze, C., & Huguenard, J. R. (2016). Two classes of excitatory synaptic responses in rat thalamic reticular neurons. *Journal of neurophysiology*, 116(3), 995–1011.
- Demontis, D., Nyegaard, M., Buttenschøn, H. N., Hedemand, A., Pedersen, C. B., Grove, J., Flint, T. J., Nordentoft, M., Werge, T., Hougaard, D. M., Sørensen, K. M., Yolken, R. H., Mors, O., Børglum, A. D., & Mortensen, P. B. (2011). Association of GRIN1 and GRIN2A-D with schizophrenia and genetic interaction with maternal herpes simplex virus-2 infection affecting disease risk. *American journal of medical genetics. Part B, Neuropsychiatric genetics : the official publication of the International Society of Psychiatric Genetics*, 156B(8), 913–922.
- Deschênes, M., & Hu, B. (1990). Membrane resistance increase induced in thalamic neurons by stimulation of brainstem cholinergic afferents. *Brain research*, 513(2), 339–342.
- Destexhe A. (1998). Spike-and-wave oscillations based on the properties of GABAB receptors. *The Journal of neuroscience : the official journal of the Society for Neuroscience*, 18(21), 9099–9111.
- Destexhe, A., & Paré, D. (1999). Impact of network activity on the integrative properties of neocortical pyramidal neurons in vivo. *Journal of neurophysiology*, 81(4), 1531–1547.
- Destexhe, A., Bal, T., McCormick, D. A., & Sejnowski, T. J. (1996). Ionic mechanisms underlying synchronized oscillations and propagating waves in a model of ferret thalamic slices. *Journal of neurophysiology*, 76(3), 2049–2070.
- Deutch A. (1995). Mechanisms of action of clozapine in the treatment of neuroleptic-resistant and neuroleptic-intolerant schizophrenia. *European psychiatry : the journal of the Association of European Psychiatrists*, 10 Suppl 1, 39s–46s.
- Diekelmann, S., & Born, J. (2010). The memory function of sleep. *Nature reviews. Neuroscience*, 11(2), 114–126.
- Dimpfel, W., & Spüler, M. (1990). Dizocilpine (MK-801), ketamine and phencyclidine: low doses affect brain field potentials in the freely moving rat in the same way as activation of dopaminergic transmission. *Psychopharmacology*, 101(3), 317–323.
- Diwadkar, V. A., Flaugh, B., Jones, T., Zalányi, L., Ujfalussy, B., Keshavan, M. S., & Erdi, P. (2008). Impaired associative learning in schizophrenia: behavioral and computational studies. *Cognitive neurodynamics*, 2(3), 207–219.

- Doi, Y., Minowa, M., Uchiyama, M., Okawa, M., Kim, K., Shibui, K., & Kamei, Y. (2000). Psychometric assessment of subjective sleep quality using the Japanese version of the Pittsburgh Sleep Quality Index (PSQI-J) in psychiatric disordered and control subjects. *Psychiatry research*, *97*(2-3), 165–172.
- Donkers, F. C., Englander, Z. A., Tiesinga, P. H., Cleary, K. M., Gu, H., & Belger, A. (2013). Reduced delta power and synchrony and increased gamma power during the P3 time window in schizophrenia. *Schizophrenia research*, *150*(1), 266–268.
- Dresler, M., Wehrle, R., Spoormaker, V. I., Steiger, A., Holsboer, F., Czisch, M., & Hobson, J. A. (2015). Neural correlates of insight in dreaming and psychosis. *Sleep medicine reviews*, *20*, 92–99.
- Duan, A. R., Varela, C., Zhang, Y., Shen, Y., Xiong, L., Wilson, M. A., & Lisman, J. (2015). Delta frequency optogenetic stimulation of the thalamic nucleus reuniens is sufficient to produce working memory deficits: relevance to schizophrenia. *Biological psychiatry*, *77*(12), 1098–1107.
- Duncan, W. C., Jr, Ballard, E. D., & Zarate, C. A. (2019). Ketamine-Induced Glutamatergic Mechanisms of Sleep and Wakefulness: Insights for Developing Novel Treatments for Disturbed Sleep and Mood. *Handbook of experimental pharmacology*, *253*, 337–358.
- Durstewitz, D., & Seamans, J. K. (2002). The computational role of dopamine D1 receptors in working memory. *Neural networks : the official journal of the International Neural Network Society*, *15*(4-6), 561–572.
- Durstewitz, D., & Seamans, J. K. (2008). The dual-state theory of prefrontal cortex dopamine function with relevance to catechol-o-methyltransferase genotypes and schizophrenia. *Biological psychiatry*, *64*(9), 739–749.
- Dzirasa, K., Ramsey, A. J., Takahashi, D. Y., Stapleton, J., Potes, J. M., Williams, J. K., Gainetdinov, R. R., Sameshima, K., Caron, M. G., & Nicolelis, M. A. (2009). Hyperdopaminergia and NMDA receptor hypofunction disrupt neural phase signaling. *The Journal of neuroscience : the official journal of the Society for Neuroscience*, *29*(25), 8215–8224.
- Eckfeld, A., Karlsgodt, K. H., Haut, K. M., Bachman, P., Jalbrzikowski, M., Zinberg, J., van Erp, T., Cannon, T. D., & Bearden, C. E. (2017). Disrupted Working Memory Circuitry in Adolescent Psychosis. *Frontiers in human neuroscience*, *11*, 394.
- Egan, M. F., Goldberg, T. E., Kolachana, B. S., Callicott, J. H., Mazzanti, C. M., Straub, R. E., Goldman, D., & Weinberger, D. R. (2001). Effect of COMT Val108/158 Met genotype on frontal lobe function and risk for schizophrenia. *Proceedings of the National Academy of Sciences of the United States of America*, *98*(12), 6917–6922.
- Egerton, A., Reid, L., McGregor, S., Cochran, S. M., Morris, B. J., & Pratt, J. A. (2008). Subchronic and chronic PCP treatment produces temporally distinct deficits in attentional set shifting and prepulse inhibition in rats. *Psychopharmacology*, *198*(1), 37–49.
- Egerton, A., Reid, L., McKechar, C. E., Morris, B. J., & Pratt, J. A. (2005). Impairment in perceptual attentional set-shifting following PCP administration: a rodent model of set-shifting deficits in schizophrenia. *Psychopharmacology*, *179*(1), 77–84.
- Ehrlichman, R. S., Gandal, M. J., Maxwell, C. R., Lazarewicz, M. T., Finkel, L. H., Contreras, D., Turetsky, B. I., & Siegel, S. J. (2009). N-methyl-d-aspartic acid receptor antagonist-induced frequency oscillations in mice recreate pattern of electrophysiological deficits in schizophrenia. *Neuroscience*, *158*(2), 705–712.
- El Iskandrani, K. S., Oosterhof, C. A., El Mansari, M., & Blier, P. (2015). Impact of subanesthetic doses of ketamine on AMPA-mediated responses in rats: An in vivo electrophysiological study on monoaminergic and glutamatergic neurons. *Journal of psychopharmacology (Oxford, England)*, *29*(7), 792–801.

- Essali, A., Al-Haj Haasan, N., Li, C., & Rathbone, J. (2009). Clozapine versus typical neuroleptic medication for schizophrenia. *The Cochrane database of systematic reviews*, 2009(1), CD000059.
- Esser, S. K., Hill, S. L., & Tononi, G. (2007). Sleep homeostasis and cortical synchronization: I. Modeling the effects of synaptic strength on sleep slow waves. *Sleep*, 30(12), 1617–1630.
- Esser, S. K., Hill, S., & Tononi, G. (2009). Breakdown of effective connectivity during slow wave sleep: investigating the mechanism underlying a cortical gate using large-scale modeling. *Journal of neurophysiology*, 102(4), 2096–2111.
- Eyolfsson, E. M., Brenner, E., Kondziella, D., & Sonnewald, U. (2006). Repeated injection of MK801: an animal model of schizophrenia?. *Neurochemistry international*, 48(6-7), 541–546.
- Falola, O., Osamor, V. C., Adebisi, M., & Adebisi, E. (2017). Analyzing a single nucleotide polymorphism in schizophrenia: a meta-analysis approach. *Neuropsychiatric disease and treatment*, 13, 2243–2250.
- Fang, Z., Ray, LB, Owen, A.M., Fogel, S.M. (2017). Neural Correlates of human cognitive abilities during sleep. *bioRxiv*.
- Featherstone, R. E., Kapur, S., & Fletcher, P. J. (2007). The amphetamine-induced sensitized state as a model of schizophrenia. *Progress in neuro-psychopharmacology & biological psychiatry*, 31(8), 1556–1571.
- Featherstone, R. E., Liang, Y., Saunders, J. A., Tatar-Leitman, V. M., Ehrlichman, R. S., & Siegel, S. J. (2012). Subchronic ketamine treatment leads to permanent changes in EEG, cognition and the astrocytic glutamate transporter EAAT2 in mice. *Neurobiology of disease*, 47(3), 338–346.
- Feifel, D., & Shilling, P. (2013). Chapter 30 – Modeling Schizophrenia in Animals.
- Ferrarelli, F., & Tononi, G. (2011). The thalamic reticular nucleus and schizophrenia. *Schizophrenia bulletin*, 37(2), 306–315.
- Ferrarelli, F., & Tononi, G. (2017). Reduced sleep spindle activity point to a TRN-MD thalamus-PFC circuit dysfunction in schizophrenia. *Schizophrenia research*, 180, 36–43.
- Ferrarelli, F., Huber, R., Peterson, M. J., Massimini, M., Murphy, M., Riedner, B. A., Watson, A., Bria, P., & Tononi, G. (2007). Reduced sleep spindle activity in schizophrenia patients. *The American journal of psychiatry*, 164(3), 483–492.
- Ferrarelli, F., Peterson, M. J., Sarasso, S., Riedner, B. A., Murphy, M. J., Benca, R. M., Bria, P., Kalin, N. H., & Tononi, G. (2010). Thalamic dysfunction in schizophrenia suggested by whole-night deficits in slow and fast spindles. *The American journal of psychiatry*, 167(11), 1339–1348.
- Ferri, F., Venskus, A., Fotia, F., Cooke, J., & Romei, V. (2018). Higher proneness to multisensory illusions is driven by reduced temporal sensitivity in people with high schizotypal traits. *Consciousness and cognition*, 65, 263–270.
- Fytche D. H. (2008). The hodology of hallucinations. *Cortex; a journal devoted to the study of the nervous system and behavior*, 44(8), 1067–1083.
- Fisher, H. L., Lereya, S. T., Thompson, A., Lewis, G., Zammit, S., & Wolke, D. (2014). Childhood parasomnias and psychotic experiences at age 12 years in a United Kingdom birth cohort. *Sleep*, 37(3), 475–482.
- Flynn, G., Alexander, D., Harris, A., Whitford, T., Wong, W., Galletly, C., Silverstein, S., Gordon, E., & Williams, L. M. (2008). Increased absolute magnitude of gamma synchrony in first-episode psychosis. *Schizophrenia research*, 105(1-3), 262–271.
- Fogel, S. M., & Smith, C. T. (2011). The function of the sleep spindle: a physiological index of intelligence and a mechanism for sleep-dependent memory consolidation. *Neuroscience and biobehavioral reviews*, 35(5), 1154–1165.

- Forest, G., Poulin, J., Daoust, A. M., Lussier, I., Stip, E., & Godbout, R. (2007). Attention and non-REM sleep in neuroleptic-naive persons with schizophrenia and control participants. *Psychiatry research, 149*(1-3), 33–40.
- Forrest, A. D., Coto, C. A., & Siegel, S. J. (2014). Animal Models of Psychosis: Current State and Future Directions. *Current behavioral neuroscience reports, 1*(2), 100–116.
- Frantseva, M., Cui, J., Farzan, F., Chinta, L. V., Perez Velazquez, J. L., & Daskalakis, Z. J. (2014). Disrupted cortical conductivity in schizophrenia: TMS-EEG study. *Cerebral cortex (New York, N.Y. : 1991), 24*(1), 211–221.
- Fries, P., Nikolić, D., & Singer, W. (2007). The gamma cycle. *Trends in neurosciences, 30*(7), 309–316.
- Frohlich, J., & Van Horn, J. D. (2014). Reviewing the ketamine model for schizophrenia. *Journal of Psychopharmacology, 28*(4), 287–302.
- Frohlich, J., & Van Horn, J. D. (2014). Reviewing the ketamine model for schizophrenia. *Journal of psychopharmacology (Oxford, England), 28*(4), 287–302.
- Fryer, S. L., Ferri, J. M., Roach, B. J., Loewy, R. L., Stuart, B. K., Anticevic, A., Ford, J. M., & Mathalon, D. H. (2021). Thalamic dysconnectivity in the psychosis risk syndrome and early illness schizophrenia. *Psychological medicine, 1*–9. Advance online publication.
- Fu, Y., Guo, L., Zhang, J., Chen, Y., Wang, X., Zeng, T., Tian, S., & Ma, Y. (2008). Differential effects of ageing on the EEG during pentobarbital and ketamine anaesthesia. *European journal of anaesthesiology, 25*(10), 826–833.
- Fuentealba, P., & Steriade, M. (2005). The reticular nucleus revisited: intrinsic and network properties of a thalamic pacemaker. *Progress in neurobiology, 75*(2), 125–141.
- Fusar-Poli, P., Broome, M. R., Matthiasson, P., Woolley, J. B., Johns, L. C., Tabraham, P., Bramon, E., Valmaggia, L., Williams, S. C., & McGuire, P. (2010). Spatial working memory in individuals at high risk for psychosis: longitudinal fMRI study. *Schizophrenia research, 123*(1), 45–52.
- Gandal, M. J., Edgar, J. C., Klook, K., & Siegel, S. J. (2012). Gamma synchrony: towards a translational biomarker for the treatment-resistant symptoms of schizophrenia. *Neuropharmacology, 62*(3), 1504–1518.
- Ganes, T., & Andersen, P. (1975). Barbiturate spindle activity in functionally corresponding thalamic and cortical somato-sensory areas in the cat. *Brain research, 98*(3), 457–472.
- Ganguli, R., Rabin, B. S., Kelly, R. H., Lyte, M., & Ragu, U. (1987). Clinical and laboratory evidence of autoimmunity in acute schizophrenia. *Annals of the New York Academy of Sciences, 496*, 676–685.
- Garakh, Z., Zaytseva, Y., Kapranova, A., Fiala, O., Horacek, J., Shmukler, A., Gurovich, I. Y., & Strelets, V. B. (2015). EEG correlates of a mental arithmetic task in patients with first episode schizophrenia and schizoaffective disorder. *Clinical neurophysiology : official journal of the International Federation of Clinical Neurophysiology, 126*(11), 2090–2098.
- Garcia-Rill, E., D'Onofrio, S., Mahaffey, S., Bisagno, V., & Urbano, F. J. (2015). Pedunculopontine arousal system physiology-Implications for schizophrenia. *Sleep science (Sao Paulo, Brazil), 8*(2), 82–91.
- Gardner, R. J., Kersanté, F., Jones, M. W., & Bartsch, U. (2014). Neural oscillations during non-rapid eye movement sleep as biomarkers of circuit dysfunction in schizophrenia. *The European journal of neuroscience, 39*(7), 1091–1106.
- Gentet, L. J., & Ulrich, D. (2003). Strong, reliable and precise synaptic connections between thalamic relay cells and neurones of the nucleus reticularis in juvenile rats. *The Journal of physiology, 546*(Pt 3), 801–811.



- Gentet, L. J., & Ulrich, D. (2003). Strong, reliable and precise synaptic connections between thalamic relay cells and neurones of the nucleus reticularis in juvenile rats. *The Journal of physiology*, 546(Pt 3), 801–811.
- Ghosal, S., Duman, C. H., Liu, R. J., Wu, M., Terwilliger, R., Girgenti, M. J., Wohleb, E., Fogaca, M. V., Teichman, E. M., Hare, B., & Duman, R. S. (2020). Ketamine rapidly reverses stress-induced impairments in GABAergic transmission in the prefrontal cortex in male rodents. *Neurobiology of disease*, 134, 104669.
- Gil, Z., Connors, B. W., & Amitai, Y. (1997). Differential regulation of neocortical synapses by neuromodulators and activity. *Neuron*, 19(3), 679–686.
- Girard, S. L., Dion, P. A., Bourassa, C. V., Geoffroy, S., Lachance-Touchette, P., Barhdadi, A., Langlois, M., Joober, R., Krebs, M. O., Dubé, M. P., & Rouleau, G. A. (2015). Mutation burden of rare variants in schizophrenia candidate genes. *PloS one*, 10(6), e0128988.
- Göder, R., Aldenhoff, J. B., Boigs, M., Braun, S., Koch, J., & Fritzer, G. (2006). Delta power in sleep in relation to neuropsychological performance in healthy subjects and schizophrenia patients. *The Journal of neuropsychiatry and clinical neurosciences*, 18(4), 529–535.
- Gogos, J. A., Morgan, M., Luine, V., Santha, M., Ogawa, S., Pfaff, D., & Karayiorgou, M. (1998). Catechol-O-methyltransferase-deficient mice exhibit sexually dimorphic changes in catecholamine levels and behavior. *Proceedings of the National Academy of Sciences of the United States of America*, 95(17), 9991–9996.
- Gold, C., Henze, D. A., Koch, C., & Buzsáki, G. (2006). On the origin of the extracellular action potential waveform: A modeling study. *Journal of neurophysiology*, 95(5), 3113–3128.
- Goldman-Rakic, P. S., Castner, S. A., Svensson, T. H., Siever, L. J., & Williams, G. V. (2004). Targeting the dopamine D1 receptor in schizophrenia: insights for cognitive dysfunction. *Psychopharmacology*, 174(1), 3–16.
- Golshani, P., Liu, X. B., & Jones, E. G. (2001). Differences in quantal amplitude reflect GluR4- subunit number at corticothalamic synapses on two populations of thalamic neurons. *Proceedings of the National Academy of Sciences of the United States of America*, 98(7), 4172–4177.
- Gonzalez-Burgos, G., & Lewis, D. A. (2008). GABA neurons and the mechanisms of network oscillations: implications for understanding cortical dysfunction in schizophrenia. *Schizophrenia bulletin*, 34(5), 944–961.
- Gottesman, I. I. (1991). A series of books in psychology. Schizophrenia genesis: The origins of madness. W H Freeman/Times Books/ Henry Holt & Co.
- Green, M. F., Kern, R. S., & Heaton, R. K. (2004). Longitudinal studies of cognition and functional outcome in schizophrenia: implications for MATRICS. *Schizophrenia research*, 72(1), 41–51.
- Grent-'t-Jong, T., Gross, J., Goense, J., Wibrál, M., Gajwani, R., Gumley, A. I., Lawrie, S. M., Schwannauer, M., Schultze-Lutter, F., Navarro Schröder, T., Koethe, D., Leweke, F. M., Singer, W., & Uhlhaas, P. J. (2018). Resting-state gamma-band power alterations in schizophrenia reveal E/I-balance abnormalities across illness-stages. *eLife*, 7, e37799.
- Grunze, H. C., Rainnie, D. G., Hasselmo, M. E., Barkai, E., Hearn, E. F., McCarley, R. W., & Greene, R. W. (1996). NMDA-dependent modulation of CA1 local circuit inhibition. *The Journal of neuroscience : the official journal of the Society for Neuroscience*, 16(6), 2034–2043.
- Gschwandtner, U., Pflueger, M. O., Semenín, V., Gaggiotti, M., Riecher-Rössler, A., & Fuhr, P. (2009). EEG: a helpful tool in the prediction of psychosis. *European archives of psychiatry and clinical neuroscience*, 259(5), 257–262.

- Guadagna, S., Bundgaard, C., Hovelsø, N., Volbracht, C., Francis, P. T., Egebjerg, J., & Sotty, F. (2012). Memantine potentiates hippocampal  $\theta$  oscillations at a therapeutic dose in anesthetized mice: a mechanistic link to its cognitive-enhancing properties. *Neuropharmacology*, *62*(7), 2208–2218.
- Guillery, R. W., & Harting, J. K. (2003). Structure and connections of the thalamic reticular nucleus: Advancing views over half a century. *The Journal of comparative neurology*, *463*(4), 360–371.
- Guillery, R. W., & Sherman, S. M. (2002). Thalamic relay functions and their role in corticocortical communication: Generalizations from the visual system. *Neuron*, *33*, 163–175.
- Gulsuner, S., Walsh, T., Watts, A. C., Lee, M. K., Thornton, A. M., Casadei, S., Rippey, C., Shahin, H., Consortium on the Genetics of Schizophrenia (COGS), PAARTNERS Study Group, Nimgaonkar, V. L., Go, R. C., Savage, R. M., Swerdlow, N. R., Gur, R. E., Braff, D. L., King, M. C., & McClellan, J. M. (2013). Spatial and temporal mapping of de novo mutations in schizophrenia to a fetal prefrontal cortical network. *Cell*, *154*(3), 518–529.
- Gupta, S. C., Ravikrishnan, A., Liu, J., Mao, Z., Pavuluri, R., Hillman, B. G., Gandhi, P. J., Stairs, D. J., Li, M., Ugale, R. R., Monaghan, D. T., & Druvid, S. M. (2016). The NMDA receptor GluN2C subunit controls cortical excitatory-inhibitory balance, neuronal oscillations and cognitive function. *Scientific reports*, *6*, 38321.
- Häfner H. (2019). From Onset and Prodromal Stage to a Life-Long Course of Schizophrenia and Its Symptom Dimensions: How Sex, Age, and Other Risk Factors Influence Incidence and Course of Illness. *Psychiatry journal*, *2019*, 9804836.
- Haidary, H. A., & Padhy, R. K. (2020). Clozapine. *In StatPearls*. StatPearls Publishing.
- Hakami, T., Jones, N. C., Tolmacheva, E. A., Gaudias, J., Chaumont, J., Salzberg, M., O'Brien, T. J., & Pinault, D. (2009). NMDA receptor hypofunction leads to generalized and persistent aberrant gamma oscillations independent of hyperlocomotion and the state of consciousness. *PloS one*, *4*(8), e6755.
- Halassa, M. M., Chen, Z., Wimmer, R. D., Brunetti, P. M., Zhao, S., Zikopoulos, B., Wang, F., Brown, E. N., & Wilson, M. A. (2014). State-dependent architecture of thalamic reticular subnetworks. *Cell*, *158*(4), 808–821.
- Hall, J., Trent, S., Thomas, K. L., O'Donovan, M. C., & Owen, M. J. (2015). Genetic risk for schizophrenia: convergence on synaptic pathways involved in plasticity. *Biological psychiatry*, *77*(1), 52–58.
- Hammer, T. B., Oranje, B., Skimminge, A., Aggernæs, B., Ebdrup, B. H., Glenthøj, B., & Baaré, W. (2013). Structural brain correlates of sensorimotor gating in antipsychotic-naïve men with first-episode schizophrenia. *Journal of psychiatry & neuroscience : JPN*, *38*(1), 34–42.
- Harris, L. W., Sharp, T., Gartlon, J., Jones, D. N., & Harrison, P. J. (2003). Long-term behavioural, molecular and morphological effects of neonatal NMDA receptor antagonism. *The European journal of neuroscience*, *18*(6), 1706–1710.
- Harris, A., Melkonian, D., Williams, L., & Gordon, E. (2006). Dynamic spectral analysis findings in first episode and chronic schizophrenia. *The International journal of neuroscience*, *116*(3), 223–246.
- Harrison P. J. (2015). Recent genetic findings in schizophrenia and their therapeutic relevance. *Journal of psychopharmacology* (Oxford, England), *29*(2), 85–96.
- Hauser, M., Moore, J. W., de Millas, W., Gallinat, J., Heinz, A., Haggard, P., & Voss, M. (2011). Sense of agency is altered in patients with a putative psychotic prodrome. *Schizophrenia research*, *126*(1-3), 20–27.
- Heermann, T., Garrett, L., Wurst, W., Fuchs, H., Gailus-Durner, V., Hrabě de Angelis, M., Graw, J., & Hölter, S. M. (2019). Crybb2 Mutations Consistently Affect Schizophrenia Endophenotypes in Mice. *Molecular neurobiology*, *56*(6), 4215–4230.

- Heimer L. (2000). Basal forebrain in the context of schizophrenia. *Brain research. Brain research reviews*, 31(2-3), 205–235.
- Hennah, W., Thomson, P., Peltonen, L., & Porteous, D. (2006). Genes and schizophrenia: beyond schizophrenia: the role of DISC1 in major mental illness. *Schizophrenia bulletin*, 32(3), 409–416.
- Herrmann, C. S., & Demiralp, T. (2005). Human EEG gamma oscillations in neuropsychiatric disorders. *Clinical neurophysiology : official journal of the International Federation of Clinical Neurophysiology*, 116(12), 2719–2733.
- Herrmann, C. S., Munk, M. H., & Engel, A. K. (2004). Cognitive functions of gamma-band activity: memory match and utilization. *Trends in cognitive sciences*, 8(8), 347–355.
- Hill, S., & Tononi, G. (2005). Modeling sleep and wakefulness in the thalamocortical system. *Journal of neurophysiology*, 93(3), 1671–1698.
- Hinze-Selch, D., Mullington, J., Orth, A., Lauer, C. J., & Pollmächer, T. (1997). Effects of clozapine on sleep: a longitudinal study. *Biological psychiatry*, 42(4), 260–266.
- Hirano, Y., Oribe, N., Kanba, S., Onitsuka, T., Nestor, P. G., & Spencer, K. M. (2015). Spontaneous Gamma Activity in Schizophrenia. *JAMA psychiatry*, 72(8), 813–821.
- Hiyoshi, T., Kambe, D., Karasawa, J., & Chaki, S. (2014). Differential effects of NMDA receptor antagonists at lower and higher doses on basal gamma band oscillation power in rat cortical electroencephalograms. *Neuropharmacology*, 85, 384–396.
- Hobson J. A. (1997). Dreaming as delirium: a mental status analysis of our nightly madness. *Seminars in neurology*, 17(2), 121–128.
- Hoffmann, R., Hendrickse, W., Rush, A. J., & Armitage, R. (2000). Slow-wave activity during non-REM sleep in men with schizophrenia and major depressive disorders. *Psychiatry research*, 95(3), 215–225.
- Höflich, A., Hahn, A., Küblböck, M., Kranz, G. S., Vanicek, T., Windischberger, C., Saria, A., Kasper, S., Winkler, D., & Lanzenberger, R. (2015). Ketamine-Induced Modulation of the Thalamo-Cortical Network in Healthy Volunteers As a Model for Schizophrenia. *The international journal of neuropsychopharmacology*, 18(9), pyv040.
- Hofstetter, J. R., Mayeda, A. R., Happel, C. G., & Lysaker, P. H. (2003). Sleep and daily activity preferences in schizophrenia: associations with neurocognition and symptoms. *The Journal of nervous and mental disease*, 191(6), 408–410.
- Homayoun, H., & Moghaddam, B. (2007). NMDA receptor hypofunction produces opposite effects on prefrontal cortex interneurons and pyramidal neurons. *The Journal of neuroscience : the official journal of the Society for Neuroscience*, 27(43), 11496–11500.
- Hong, L. E., Summerfelt, A., Buchanan, R. W., O'Donnell, P., Thaker, G. K., Weiler, M. A., & Lahti, A. C. (2010). Gamma and delta neural oscillations and association with clinical symptoms under subanesthetic ketamine. *Neuropsychopharmacology : official publication of the American College of Neuropsychopharmacology*, 35(3), 632–640.
- Howes, O. D., & Kapur, S. (2009). The dopamine hypothesis of schizophrenia: version III--the final common pathway. *Schizophrenia bulletin*, 35(3), 549–562.
- Howes, O. D., & Kapur, S. (2014). A neurobiological hypothesis for the classification of schizophrenia: type A (hyperdopaminergic) and type B (normodopaminergic). *The British journal of psychiatry : the journal of mental science*, 205(1), 1–3.
- Howes, O., McCutcheon, R., & Stone, J. (2015). Glutamate and dopamine in schizophrenia: an update for the 21st century. *Journal of psychopharmacology (Oxford, England)*, 29(2), 97–115.

- Howes, O., McCutcheon, R., & Stone, J. (2015). Glutamate and dopamine in schizophrenia: an update for the 21st century. *Journal of psychopharmacology (Oxford, England)*, 29(2), 97–115.
- Howland R. H. (1997). Sleep-onset rapid eye movement periods in neuropsychiatric disorders: implications for the pathophysiology of psychosis. *The Journal of nervous and mental disease*, 185(12), 730–738.
- Hsieh, C. Y., Cruikshank, S. J., & Metherate, R. (2000). Differential modulation of auditory thalamocortical and intracortical synaptic transmission by cholinergic agonist. *Brain research*, 880(1-2), 51–64.
- Huang, A. S., Rogers, B. P., & Woodward, N. D. (2019). Disrupted modulation of thalamus activation and thalamocortical connectivity during dual task performance in schizophrenia. *Schizophrenia research*, 210, 270–277.
- Huber, R., & Born, J. (2014). Sleep, synaptic connectivity, and hippocampal memory during early development. *Trends in cognitive sciences*, 18(3), 141–152.
- Huettner, J. E., & Bean, B. P. (1988). Block of N-methyl-D-aspartate-activated current by the anticonvulsant MK-801: selective binding to open channels. *Proceedings of the National Academy of Sciences of the United States of America*, 85(4), 1307–1311.
- Huguenard J. R. (1996). Low-threshold calcium currents in central nervous system neurons. *Annual review of physiology*, 58, 329–348.
- Huguenard, J. R., & McCormick, D. A. (2007). Thalamic synchrony and dynamic regulation of global forebrain oscillations. *Trends in neurosciences*, 30(7), 350–356.
- Huguenard, J. R., & Prince, D. A. (1992). A novel T-type current underlies prolonged Ca(2+)-dependent burst firing in GABAergic neurons of rat thalamic reticular nucleus. *The Journal of neuroscience : the official journal of the Society for Neuroscience*, 12(10), 3804–3817.
- Hunt, M. J., & Kasicki, S. (2013). A systematic review of the effects of NMDA receptor antagonists on oscillatory activity recorded in vivo. *Journal of psychopharmacology (Oxford, England)*, 27(11), 972–986.
- Iber, C., Ancoli-Israel, S., Chesson, A.L., Quan, S.F. (2007). The AASM Manual for the Scoring of Sleep and Associated Events: Rules, Terminology, and Technical Specifications. Westchester, Ill: American Academy of Sleep Medicine.
- Ibrahim, H. M., Hogg, A. J., Jr, Healy, D. J., Haroutunian, V., Davis, K. L., & Meador-Woodruff, J. H. (2000). Ionotropic glutamate receptor binding and subunit mRNA expression in thalamic nuclei in schizophrenia. *The American journal of psychiatry*, 157(11), 1811–1823.
- Ikonomidou, C., Bosch, F., Miksa, M., Bittigau, P., Vöckler, J., Dikranian, K., Tenkova, T. I., Stefovskaja, V., Turski, L., & Olney, J. W. (1999). Blockade of NMDA receptors and apoptotic neurodegeneration in the developing brain. *Science (New York, N.Y.)*, 283(5398), 70–74.
- Imre, G., Fokkema, D. S., Den Boer, J. A., & Ter Horst, G. J. (2006). Dose-response characteristics of ketamine effect on locomotion, cognitive function and central neuronal activity. *Brain research bulletin*, 69(3), 338–345.
- Insel T. R. (2010). Rethinking schizophrenia. *Nature*, 468(7321), 187–193.
- International Schizophrenia Consortium, Purcell, S. M., Wray, N. R., Stone, J. L., Visscher, P. M., O'Donovan, M. C., Sullivan, P. F., & Sklar, P. (2009). Common polygenic variation contributes to risk of schizophrenia and bipolar disorder. *Nature*, 460(7256), 748–752.
- Irifune, M., Sato, T., Kamata, Y., Nishikawa, T., Dohi, T., & Kawahara, M. (2000). Evidence for GABA(A) receptor agonistic properties of ketamine: convulsive and anesthetic behavioral models in mice. *Anesthesia and analgesia*, 91(1), 230–236.

- Ishizuka, K., Paek, M., Kamiya, A., & Sawa, A. (2006). A review of Disrupted-In-Schizophrenia-1 (DISC1): neurodevelopment, cognition, and mental conditions. *Biological psychiatry*, 59(12), 1189–1197.
- Ito, I., Futai, K., Katagiri, H., Watanabe, M., Sakimura, K., Mishina, M., & Sugiyama, H. (1997). Synapse-selective impairment of NMDA receptor functions in mice lacking NMDA receptor epsilon 1 or epsilon 2 subunit. *The Journal of physiology*, 500 ( Pt 2)(Pt 2), 401–408.
- Jaaro-Peled, H., Hayashi-Takagi, A., Seshadri, S., Kamiya, A., Brandon, N. J., & Sawa, A. (2009). Neurodevelopmental mechanisms of schizophrenia: understanding disturbed postnatal brain maturation through neuregulin-1-ErbB4 and DISC1. *Trends in neurosciences*, 32(9), 485–495.
- Jackson, M. E., Homayoun, H., & Moghaddam, B. (2004). NMDA receptor hypofunction produces concomitant firing rate potentiation and burst activity reduction in the prefrontal cortex. *Proceedings of the National Academy of Sciences of the United States of America*, 101(22), 8467–8472.
- Jacobsen, R. B., Ulrich, D., & Huguenard, J. R. (2001). GABA(B) and NMDA receptors contribute to spindle-like oscillations in rat thalamus in vitro. *Journal of neurophysiology*, 86(3), 1365–1375.
- Jahangir, M., Zhou, J. S., Lang, B., & Wang, X. P. (2021). GABAergic System Dysfunction and Challenges in Schizophrenia Research. *Frontiers in cell and developmental biology*, 9, 663854.
- Jang, H. S., Kim, J. Y., Kim, S. H., & Lee, M. G. (2009). Role of dopamine receptors on electroencephalographic changes produced by repetitive apomorphine treatments in rats. *The Korean journal of physiology & pharmacology : official journal of the Korean Physiological Society and the Korean Society of Pharmacology*, 13(3), 147–151.
- Javitt D. C. (2000). Intracortical mechanisms of mismatch negativity dysfunction in schizophrenia. *Audiology & neuro-otology*, 5(3-4), 207–215.
- Javitt D. C. (2007). Glutamate and schizophrenia: phencyclidine, N-methyl-D-aspartate receptors, and dopamine-glutamate interactions. *International review of neurobiology*, 78, 69–108.
- Javitt D. C. (2009a). Sensory processing in schizophrenia: neither simple nor intact. *Schizophrenia bulletin*, 35(6), 1059–1064.
- Javitt D. C. (2009b). When doors of perception close: bottom-up models of disrupted cognition in schizophrenia. *Annual review of clinical psychology*, 5, 249–275.
- Javitt D. C. (2010). Glutamatergic theories of schizophrenia. *The Israel journal of psychiatry and related sciences*, 47(1), 4–16.
- Javitt D. C. (2012). Twenty-five years of glutamate in schizophrenia: are we there yet?. *Schizophrenia bulletin*, 38(5), 911–913.
- Javitt, D. C., & Zukin, S. R. (1991). Recent advances in the phencyclidine model of schizophrenia. *The American journal of psychiatry*, 148(10), 1301–1308.
- Jentsch, J. D., & Roth, R. H. (1999). The neuropsychopharmacology of phencyclidine: from NMDA receptor hypofunction to the dopamine hypothesis of schizophrenia. *Neuropsychopharmacology: official publication of the American College of Neuropsychopharmacology*, 20(3), 201–225.
- John, J. P., Rangaswamy, M., Thennarasu, K., Khanna, S., Nagaraj, R. B., Mukundan, C. R., & Pradhan, N. (2009). EEG power spectra differentiate positive and negative subgroups in neuroleptic-naive schizophrenia patients. *The Journal of neuropsychiatry and clinical neurosciences*, 21(2), 160–172.
- Johnson, K. M., & Jones, S. M. (1990). Neuropharmacology of phencyclidine: basic mechanisms and therapeutic potential. *Annual review of pharmacology and toxicology*, 30, 707–750.
- Johnson, L. A., Blakely, T., Hermes, D., Hakimian, S., Ramsey, N. F., & Ojemann, J. G. (2012). Sleep spindles are locally modulated by training on a brain-computer interface. *Proceedings of the National Academy of Sciences of the United States of America*, 109(45), 18583–18588.

- Jones, C. A., Watson, D. J., & Fone, K. C. (2011). Animal models of schizophrenia. *British journal of pharmacology*, 164(4), 1162–1194.
- Jordan, J. et al. (2019). NEST 2.18.0. *Zenodo*. <https://doi.org/10.5281/zenodo.2605422>
- Kahn, R. S., & Sommer, I. E. (2015). The neurobiology and treatment of first-episode schizophrenia. *Molecular psychiatry*, 20(1), 84–97.
- Kajimura, N., Kato, M., Okuma, T., Sekimoto, M., Watanabe, T., & Takahashi, K. (1995). A quantitative sleep-EEG study on the effects of benzodiazepine and zopiclone in schizophrenic patients. *Schizophrenia research*, 15(3), 303–312.
- Kalinichev, M., Robbins, M. J., Hartfield, E. M., Maycox, P. R., Moore, S. H., Savage, K. M., Austin, N. E., & Jones, D. N. (2008). Comparison between intraperitoneal and subcutaneous phencyclidine administration in Sprague-Dawley rats: a locomotor activity and gene induction study. *Progress in neuro-psychopharmacology & biological psychiatry*, 32(2), 414–422.
- Kamath, J., Virdi, S., & Winokur, A. (2015). Sleep Disturbances in Schizophrenia. *The Psychiatric clinics of North America*, 38(4), 777–792.
- Kambeitz, J., Kambeitz-Ilankovic, L., Cabral, C., Dwyer, D. B., Calhoun, V. D., van den Heuvel, M. P., Falkai, P., Koutsouleris, N., & Malchow, B. (2016). Aberrant Functional Whole-Brain Network Architecture in Patients With Schizophrenia: A Meta-analysis. *Schizophrenia bulletin*, 42 Suppl 1(Suppl 1), S13–S21.
- Kapur, S., & Seeman, P. (2002). NMDA receptor antagonists ketamine and PCP have direct effects on the dopamine D(2) and serotonin 5-HT(2)receptors-implications for models of schizophrenia. *Molecular psychiatry*, 7(8), 837–844.
- Kapur, S., McClelland, R. A., VanderSpek, S. C., Wadenberg, M. L., Baker, G., Nobrega, J., Zipursky, R. B., & Seeman, P. (2002). Increasing D2 affinity results in the loss of clozapine's atypical antipsychotic action. *Neuroreport*, 13(6), 831–835.
- Karayiorou, M., & Gogos, J. A. (1997). A turning point in schizophrenia genetics. *Neuron*, 19(5), 967–979.
- Kargieman, L., Santana, N., Mengod, G., Celada, P., & Artigas, F. (2007). Antipsychotic drugs reverse the disruption in prefrontal cortex function produced by NMDA receptor blockade with phencyclidine. *Proceedings of the National Academy of Sciences of the United States of America*, 104(37), 14843–14848.
- Karl, T., Duffy, L., Scimone, A., Harvey, R. P., & Schofield, P. R. (2007). Altered motor activity, exploration and anxiety in heterozygous neuregulin 1 mutant mice: implications for understanding schizophrenia. *Genes, brain, and behavior*, 6(7), 677–687.
- Karlsgodt, K. H., Robleto, K., Trantham-Davidson, H., Jairl, C., Cannon, T. D., Lavin, A., & Jentsch, J. D. (2011). Reduced dysbindin expression mediates N-methyl-D-aspartate receptor hypofunction and impaired working memory performance. *Biological psychiatry*, 69(1), 28–34.
- Kaskie, R. E., Graziano, B., & Ferrarelli, F. (2019). Topographic deficits in sleep spindle density and duration point to frontal thalamo-cortical dysfunctions in first-episode psychosis. *Journal of psychiatric research*, 113, 39–44.
- Keefe, R. S., & Harvey, P. D. (2012). Cognitive impairment in schizophrenia. *Handbook of experimental pharmacology*, (213), 11–37.
- Kehrer, C., Maziashvili, N., Dugladze, T., & Gloveli, T. (2008). Altered Excitatory-Inhibitory Balance in the NMDA-Hypofunction Model of Schizophrenia. *Frontiers in molecular neuroscience*, 1, 6.
- Kenny, J. D., Chemali, J. J., Cotten, J. F., Van Dort, C. J., Kim, S. E., Ba, D., Taylor, N. E., Brown, E. N., & Solt, K. (2016). Physostigmine and Methylphenidate Induce Distinct Arousal States During Isoflurane General Anesthesia in Rats. *Anesthesia and analgesia*, 123(5), 1210–1219.

- Keshavan, M. S., Cashmere, J. D., Miewald, J., & Yeragani, V. K. (2004). Decreased nonlinear complexity and chaos during sleep in first episode schizophrenia: a preliminary report. *Schizophrenia research*, 71(2-3), 263–272.
- Keshavan, M. S., Diwadkar, V. A., Montrose, D. M., Stanley, J. A., & Pettegrew, J. W. (2004). Premorbid characterization in schizophrenia: the Pittsburgh High Risk Study. *World psychiatry : official journal of the World Psychiatric Association (WPA)*, 3(3), 163–168.
- Keshavan, M. S., Montrose, D. M., Miewald, J. M., & Jindal, R. D. (2011). Sleep correlates of cognition in early course psychotic disorders. *Schizophrenia research*, 131(1-3), 231–234.
- Keshavan, M. S., Reynolds, C. F., & Kupfer, D. J. (1990). Electroencephalographic sleep in schizophrenia: a critical review. *Comprehensive psychiatry*, 31(1), 34–47.
- Keshavan, M. S., Reynolds, C. F., 3rd, Miewald, M. J., Montrose, D. M., Sweeney, J. A., Vasko, R. C., Jr, & Kupfer, D. J. (1998). Delta sleep deficits in schizophrenia: evidence from automated analyses of sleep data. *Archives of general psychiatry*, 55(5), 443–448.
- Kikuchi, M., Hashimoto, T., Nagasawa, T., Hirose, T., Minabe, Y., Yoshimura, M., Strik, W., Dierks, T., & Koenig, T. (2011). Frontal areas contribute to reduced global coordination of resting-state gamma activities in drug-naïve patients with schizophrenia. *Schizophrenia research*, 130(1-3), 187–194.
- Kim, J. W., Lee, Y. S., Han, D. H., Min, K. J., Lee, J., & Lee, K. (2015). Diagnostic utility of quantitative EEG in un-medicated schizophrenia. *Neuroscience letters*, 589, 126–131.
- Kim, T., Thankachan, S., McKenna, J. T., McNally, J. M., Yang, C., Choi, J. H., Chen, L., Kocsis, B., Deisseroth, K., Strecker, R. E., Basheer, R., Brown, R. E., & McCarley, R. W. (2015). Cortically projecting basal forebrain parvalbumin neurons regulate cortical gamma band oscillations. *Proceedings of the National Academy of Sciences of the United States of America*, 112(11), 3535–3540.
- Kinney, D. K., Teixeira, P., Hsu, D., Napoleon, S. C., Crowley, D. J., Miller, A., Hyman, W., & Huang, E. (2009). Relation of schizophrenia prevalence to latitude, climate, fish consumption, infant mortality, and skin color: a role for prenatal vitamin d deficiency and infections?. *Schizophrenia bulletin*, 35(3), 582–595.
- Kinney, J. W., Davis, C. N., Tabarean, I., Conti, B., Bartfai, T., & Behrens, M. M. (2006). A specific role for NR2A-containing NMDA receptors in the maintenance of parvalbumin and GAD67 immunoreactivity in cultured interneurons. *The Journal of neuroscience : the official journal of the Society for Neuroscience*, 26(5), 1604–1615.
- Kirino E. (2007). Mismatch negativity correlates with delta and theta EEG power in schizophrenia. *The International journal of neuroscience*, 117(9), 1257–1279.
- Kirov, G., Gumus, D., Chen, W., Norton, N., Georgieva, L., Sari, M., O'Donovan, M. C., Erdogan, F., Owen, M. J., Ropers, H. H., & Ullmann, R. (2008). Comparative genome hybridization suggests a role for NRXN1 and APBA2 in schizophrenia. *Human molecular genetics*, 17(3), 458–465.
- Kittelberger, K., Hur, E. E., Sazegar, S., Keshavan, V., & Kocsis, B. (2012). Comparison of the effects of acute and chronic administration of ketamine on hippocampal oscillations: relevance for the NMDA receptor hypofunction model of schizophrenia. *Brain structure & function*, 217(2), 395–409.
- Kiyama, Y., Manabe, T., Sakimura, K., Kawakami, F., Mori, H., & Mishina, M. (1998). Increased thresholds for long-term potentiation and contextual learning in mice lacking the NMDA-type glutamate receptor epsilon1 subunit. *The Journal of neuroscience : the official journal of the Society for Neuroscience*, 18(17), 6704–6712.

- Knopf, A. (2021), Schizophrenia: Lower brain Glutamate levels could be linked to antipsychotics; higher could be biomarker for disease severity. *The Brown University Child & Adolescent Psychopharmacology Update*, 23: 5-5.
- Kocsis B. (2012a). Differential role of NR2A and NR2B subunits in N-methyl-D-aspartate receptor antagonist-induced aberrant cortical gamma oscillations. *Biological psychiatry*, 71(11), 987–995.
- Kocsis B. (2012b). State-dependent increase of cortical gamma activity during REM sleep after selective blockade of NR2B subunit containing NMDA receptors. *Sleep*, 35(7), 1011–1016.
- Kohrs, R., & Durieux, M. E. (1998). Ketamine: teaching an old drug new tricks. *Anesthesia and analgesia*, 87(5), 1186–1193.
- Koike, H., & Chaki, S. (2014). Requirement of AMPA receptor stimulation for the sustained antidepressant activity of ketamine and LY341495 during the forced swim test in rats. *Behavioural brain research*, 271, 111–115.
- Koike, H., Iijima, M., & Chaki, S. (2011). Involvement of AMPA receptor in both the rapid and sustained antidepressant-like effects of ketamine in animal models of depression. *Behavioural brain research*, 224(1), 107–111.
- Korotkova, T., Fuchs, E. C., Ponomarenko, A., von Engelhardt, J., & Monyer, H. (2010). NMDA receptor ablation on parvalbumin-positive interneurons impairs hippocampal synchrony, spatial representations, and working memory. *Neuron*, 68(3), 557–569.
- Kotermanski, S. E., & Johnson, J. W. (2009). Mg<sup>2+</sup> imparts NMDA receptor subtype selectivity to the Alzheimer's drug memantine. *The Journal of neuroscience : the official journal of the Society for Neuroscience*, 29(9), 2774–2779.
- Koukkou, M., Federspiel, A., Bräker, E., Hug, C., Kleinlogel, H., Merlo, M. C., & Lehmann, D. (2000). An EEG approach to the neurodevelopmental hypothesis of schizophrenia studying schizophrenics, normal controls and adolescents. *Journal of psychiatric research*, 34(1), 57–73.
- Krabbendam, L., & van Os, J. (2005). Schizophrenia and urbanicity: a major environmental influence--conditional on genetic risk. *Schizophrenia bulletin*, 31(4), 795–799.
- Krishnan, G. P., Chauvette, S., Shamie, I., Soltani, S., Timofeev, I., Cash, S. S., Halgren, E., & Bazhenov, M. (2016). Cellular and neurochemical basis of sleep stages in the thalamocortical network. *eLife*, 5, e18607.
- Krishnan, G. P., Rosen, B. Q., Chen, J. Y., Muller, L., Sejnowski, T. J., Cash, S. S., Halgren, E., & Bazhenov, M. (2018). Thalamocortical and intracortical laminar connectivity determines sleep spindle properties. *PLoS computational biology*, 14(6), e1006171.
- Krystal, J. H., Abdallah, C. G., Sanacora, G., Charney, D. S., & Duman, R. S. (2019). Ketamine: A Paradigm Shift for Depression Research and Treatment. *Neuron*, 101(5), 774–778.
- Krystal, J. H., Karper, L. P., Seibyl, J. P., Freeman, G. K., Delaney, R., Bremner, J. D., Heninger, G. R., Bowers, M. B., Jr, & Charney, D. S. (1994). Subanesthetic effects of the noncompetitive NMDA antagonist, ketamine, in humans. Psychotomimetic, perceptual, cognitive, and neuroendocrine responses. *Archives of general psychiatry*, 51(3), 199–214.
- Kulikova, S. P., Tolmacheva, E. A., Anderson, P., Gaudias, J., Adams, B. E., Zheng, T., & Pinault, D. (2012). Opposite effects of ketamine and deep brain stimulation on rat thalamocortical information processing. *The European journal of neuroscience*, 36(10), 3407–3419.
- Kvajo, M., McKellar, H., Arguello, P. A., Drew, L. J., Moore, H., MacDermott, A. B., Karayiorgou, M., & Gogos, J. A. (2008). A mutation in mouse *Disc1* that models a schizophrenia risk allele leads to specific alterations in neuronal architecture and cognition. *Proceedings of the National Academy of Sciences of the United States of America*, 105(19), 7076–7081.



- Labrie, V., Wong, A. H., & Roder, J. C. (2012). Contributions of the D-serine pathway to schizophrenia. *Neuropharmacology*, 62(3), 1484–1503.
- Lahogue, C., Pinault, D. (2021). Frontoparietal anodal tDCS reduces ketamine-induced oscillopathies. *Translational Neuroscience*, In press. hal-02964379v2.
- Lahti, A. C., Koffel, B., LaPorte, D., & Tamminga, C. A. (1995). Subanesthetic doses of ketamine stimulate psychosis in schizophrenia. *Neuropsychopharmacology : official publication of the American College of Neuropsychopharmacology*, 13(1), 9–19.
- Lahti, A. C., Weiler, M. A., Tamara Michaelidis, B. A., Parwani, A., and Tamminga, C. A. (2001). Effects of ketamine in normal and schizophrenic volunteers. *Neuropsychopharmacology* 25, 455–467.
- Lam, Y. W., & Sherman, S. M. (2010). Functional organization of the somatosensory cortical layer 6 feedback to the thalamus. *Cerebral cortex (New York, N.Y. : 1991)*, 20(1), 13–24.
- Landisman, C. E., & Connors, B. W. (2007). VPM and PoM nuclei of the rat somatosensory thalamus: intrinsic neuronal properties and corticothalamic feedback. *Cerebral cortex (New York, N.Y. : 1991)*, 17(12), 2853–2865.
- Larson, M. K., Walker, E. F., & Compton, M. T. (2010). Early signs, diagnosis and therapeutics of the prodromal phase of schizophrenia and related psychotic disorders. *Expert review of neurotherapeutics*, 10(8), 1347–1359.
- Lau, C. I., Wang, H. C., Hsu, J. L., & Liu, M. E. (2013). Does the dopamine hypothesis explain schizophrenia?. *Reviews in the neurosciences*, 24(4), 389–400.
- Lazarewicz, M. T., Ehrlichman, R. S., Maxwell, C. R., Gandal, M. J., Finkel, L. H., & Siegel, S. J. (2010). Ketamine modulates theta and gamma oscillations. *Journal of cognitive neuroscience*, 22(7), 1452–1464.
- Lee, G., & Zhou, Y. (2019). NMDAR Hypofunction Animal Models of Schizophrenia. *Frontiers in molecular neuroscience*, 12, 185.
- Lee, J., Hudson, M. R., O'Brien, T. J., Nithianantharajah, J., & Jones, N. C. (2017). Local NMDA receptor hypofunction evokes generalized effects on gamma and high-frequency oscillations and behavior. *Neuroscience*, 358, 124–136.
- Lee, Y. J., Cho, S. J., Cho, I. H., Jang, J. H., & Kim, S. J. (2012). The relationship between psychotic-like experiences and sleep disturbances in adolescents. *Sleep medicine*, 13(8), 1021–1027.
- Lehmann, D., Faber, P. L., Pascual-Marqui, R. D., Milz, P., Herrmann, W. M., Koukkou, M., Saito, N., Winterer, G., & Kochi, K. (2014). Functionally aberrant electrophysiological cortical connectivities in first episode medication-naive schizophrenics from three psychiatry centers. *Frontiers in human neuroscience*, 8, 635.
- Leitman, D. I., Foxe, J. J., Butler, P. D., Saperstein, A., Revheim, N., & Javitt, D. C. (2005). Sensory contributions to impaired prosodic processing in schizophrenia. *Biological psychiatry*, 58(1), 56–61.
- Leitman, D. I., Loughhead, J., Wolf, D. H., Ruparel, K., Kohler, C. G., Elliott, M. A., Bilker, W. B., Gur, R. E., & Gur, R. C. (2008). Abnormal superior temporal connectivity during fear perception in schizophrenia. *Schizophrenia bulletin*, 34(4), 673–678.
- Léna, I., Parrot, S., Deschaux, O., Muffat-Joly, S., Sauvinet, V., Renaud, B., Suaud-Chagny, M. F., & Gottesmann, C. (2005). Variations in extracellular levels of dopamine, noradrenaline, glutamate, and aspartate across the sleep-wake cycle in the medial prefrontal cortex and nucleus accumbens of freely moving rats. *Journal of neuroscience research*, 81(6), 891–899.
- Leresche, N., & Lambert, R. C. (2017). T-type calcium channels in synaptic plasticity. *Channels (Austin, Tex.)*, 11(2), 121–139.

- Lewicki M. S. (1998). A review of methods for spike sorting: the detection and classification of neural action potentials. *Network (Bristol, England)*, 9(4), R53–R78.
- Lewis, D. A., & Levitt, P. (2002). Schizophrenia as a disorder of neurodevelopment. *Annual review of neuroscience*, 25, 409–432.
- Lewis, D. A., & Lieberman, J. A. (2000). Catching up on schizophrenia: natural history and neurobiology. *Neuron*, 28(2), 325–334.
- Lewis, D. A., & Moghaddam, B. (2006). Cognitive dysfunction in schizophrenia: convergence of gamma-aminobutyric acid and glutamate alterations. *Archives of neurology*, 63(10), 1372–1376.
- Lewis, D. A., Hashimoto, T., & Volk, D. W. (2005). Cortical inhibitory neurons and schizophrenia. *Nature reviews. Neuroscience*, 6(4), 312–324.
- Li, L., & Vlisides, P. E. (2016). Ketamine: 50 Years of Modulating the Mind. *Frontiers in human neuroscience*, 10, 612.
- Lin, C. H., Lane, H. Y., & Tsai, G. E. (2012). Glutamate signaling in the pathophysiology and therapy of schizophrenia. *Pharmacology, biochemistry, and behavior*, 100(4), 665–677.
- Lindén, A. M., Väsänen, J., Storvik, M., Lakso, M., Korpi, E. R., Wong, G., & Castrén, E. (2001). Uncompetitive antagonists of the N-methyl-D-aspartate (NMDA) receptors alter the mRNA expression of proteins associated with the NMDA receptor complex. *Pharmacology & toxicology*, 88(2), 98–105.
- Lipina, T., Labrie, V., Weiner, I., & Roder, J. (2005). Modulators of the glycine site on NMDA receptors, D-serine and ALX 5407, display similar beneficial effects to clozapine in mouse models of schizophrenia. *Psychopharmacology*, 179(1), 54–67.
- Lipska, B. K., & Weinberger, D. R. (2000). To model a psychiatric disorder in animals: schizophrenia as a reality test. *Neuropsychopharmacology : official publication of the American College of Neuropsychopharmacology*, 23(3), 223–239.
- Lisman, J. E., Coyle, J. T., Green, R. W., Javitt, D. C., Benes, F. M., Heckers, S., & Grace, A. A. (2008). Circuit-based framework for understanding neurotransmitter and risk gene interactions in schizophrenia. *Trends in neurosciences*, 31(5), 234–242.
- Liu, X., Li, J., Guo, C., Wang, H., Sun, Y., Wang, H., Su, Y. A., Li, K., & Si, T. (2018). Olanzapine Reverses MK-801-Induced Cognitive Deficits and Region-Specific Alterations of NMDA Receptor Subunits. *Frontiers in behavioral neuroscience*, 11, 260.
- Liu, Y., Bi, T., Zhang, B., Kuang, Q., Li, H., Zong, K., Zhao, J., Ning, Y., She, S., & Zheng, Y. (2021). Face and object visual working memory deficits in first-episode schizophrenia correlate with multiple neurocognitive performances. *General psychiatry*, 34(1), e100338.
- Llamosas, N., Perez-Caballero, L., Berrocoso, E., Bruzos-Cidon, C., Ugedo, L., & Torrecilla, M. (2019). Ketamine promotes rapid and transient activation of AMPA receptor-mediated synaptic transmission in the dorsal raphe nucleus. *Progress in neuro-psychopharmacology & biological psychiatry*, 88, 243–252.
- Loh, M., Rolls, E. T., & Deco, G. (2007). A dynamical systems hypothesis of schizophrenia. *PLoS computational biology*, 3(11), e228.
- López-Gil, X., Babot, Z., Amargós-Bosch, M., Suñol, C., Artigas, F., & Adell, A. (2007). Clozapine and haloperidol differently suppress the MK-801-increased glutamatergic and serotonergic transmission in the medial prefrontal cortex of the rat. *Neuropsychopharmacology : official publication of the American College of Neuropsychopharmacology*, 32(10), 2087–2097.

- Lu, J., Nelson, L. E., Franks, N., Maze, M., Chamberlin, N. L., & Saper, C. B. (2008). Role of endogenous sleep-wake and analgesic systems in anesthesia. *The Journal of comparative neurology*, *508*(4), 648–662.
- Luby, E. D., Cohen, B. D., Rosenbaum, G., Gottlieb, J. S., & Kelley, R. (1959). Study of a new schizophrenomimetic drug; sernyl. *A.M.A. archives of neurology and psychiatry*, *81*(3), 363–369.
- Lunsford-Avery, J. R., & Mittal, V. A. (2013). Sleep dysfunction prior to the onset of schizophrenia: A review and neurodevelopmental diathesis–stress conceptualization. *Clinical Psychology: Science and Practice*, *20*(3), 291–320.
- Lunsford-Avery, J. R., Dean, D. J., & Mittal, V. A. (2017). Self-reported sleep disturbances associated with procedural learning impairment in adolescents at ultra-high risk for psychosis. *Schizophrenia research*, *190*, 160–163.
- Lunsford-Avery, J. R., Orr, J. M., Gupta, T., Pelletier-Baldelli, A., Dean, D. J., Smith Watts, A. K., Bernard, J., Millman, Z. B., & Mittal, V. A. (2013). Sleep dysfunction and thalamic abnormalities in adolescents at ultra high-risk for psychosis. *Schizophrenia research*, *151*(1-3), 148–153.
- Lustenberger, C., O'Gorman, R. L., Pugin, F., Tüshaus, L., Wehrle, F., Achermann, P., & Huber, R. (2015). Sleep spindles are related to schizotypal personality traits and thalamic glutamine/glutamate in healthy subjects. *Schizophrenia bulletin*, *41*(2), 522–531.
- Lüthi A. (2014). Sleep Spindles: Where They Come From, What They Do. *The Neuroscientist : a review journal bringing neurobiology, neurology and psychiatry*, *20*(3), 243–256.
- Machado-Vieira, R., Henter, I. D., & Zarate, C. A., Jr (2017). New targets for rapid antidepressant action. *Progress in neurobiology*, *152*, 21–37.
- Madison, D. V., Lancaster, B., & Nicoll, R. A. (1987). Voltage clamp analysis of cholinergic action in the hippocampus. *The Journal of neuroscience : the official journal of the Society for Neuroscience*, *7*(3), 733–741.
- Maeng, S., Zarate, C. A., Jr, Du, J., Schloesser, R. J., McCammon, J., Chen, G., & Manji, H. K. (2008). Cellular mechanisms underlying the antidepressant effects of ketamine: role of alpha-amino-3-hydroxy-5-methylisoxazole-4-propionic acid receptors. *Biological psychiatry*, *63*(4), 349–352.
- Maharajh, K., Teale, P., Rojas, D. C., & Reite, M. L. (2010). Fluctuation of gamma-band phase synchronization within the auditory cortex in schizophrenia. *Clinical neurophysiology : official journal of the International Federation of Clinical Neurophysiology*, *121*(4), 542–548.
- Mahdavi, A., Qin, Y., Aubry, A. S., Cornec, D., Kulikova, S., & Pinault, D. (2020). A single psychotomimetic dose of ketamine decreases thalamocortical spindles and delta oscillations in the sedated rat. *Schizophrenia research*, *222*, 362–374.
- Mäki P, Koskela S, Murray GK, Nordström T, Miettunen J, Jääskeläinen E, Veijola JM. Difficulty in making contact with others and social withdrawal as early signs of psychosis in adolescents--the Northern Finland Birth Cohort 1986. *Eur Psychiatry*. 2014 Aug;29(6):345-51.
- Malhotra, A., Pinals, D., Weingartner, H. *et al.* (1996). NMDA Receptor Function and Human Cognition: The Effects of Ketamine in Healthy Volunteers. *Neuropsychopharmacol* *14*, 301–307.
- Manahan-Vaughan, D., von Haebler, D., Winter, C., Juckel, G., & Heinemann, U. (2008). A single application of MK801 causes symptoms of acute psychosis, deficits in spatial memory, and impairment of synaptic plasticity in rats. *Hippocampus*, *18*(2), 125–134.
- Manoach, D. S., & Stickgold, R. (2019). Abnormal Sleep Spindles, Memory Consolidation, and Schizophrenia. *Annual review of clinical psychology*, *15*, 451–479.

- Manoach, D. S., Demanuele, C., Wamsley, E. J., Vangel, M., Montrose, D. M., Miewald, J., Kupfer, D., Buysse, D., Stickgold, R., & Keshavan, M. S. (2014). Sleep spindle deficits in antipsychotic-naïve early course schizophrenia and in non-psychotic first-degree relatives. *Frontiers in human neuroscience*, *8*, 762.
- Manoach, D. S., Pan, J. Q., Purcell, S. M., & Stickgold, R. (2016). Reduced Sleep Spindles in Schizophrenia: A Treatable Endophenotype That Links Risk Genes to Impaired Cognition?. *Biological psychiatry*, *80*(8), 599–608.
- Manoach, D. S., Thakkar, K. N., Stroynowski, E., Ely, A., McKinley, S. K., Wamsley, E., Djonlagic, I., Vangel, M. G., Goff, D. C., & Stickgold, R. (2010). Reduced overnight consolidation of procedural learning in chronic medicated schizophrenia is related to specific sleep stages. *Journal of psychiatric research*, *44*(2), 112–120.
- Mansbach, R. S., & Geyer, M. A. (1989). Effects of phencyclidine and phencyclidine biologs on sensorimotor gating in the rat. *Neuropsychopharmacology : official publication of the American College of Neuropsychopharmacology*, *2*(4), 299–308.
- Marín O. (2012). Interneuron dysfunction in psychiatric disorders. *Nature reviews. Neuroscience*, *13*(2), 107–120.
- Marks, G. A., & Roffwarg, H. P. (1993). Spontaneous activity in the thalamic reticular nucleus during the sleep/wake cycle of the freely-moving rat. *Brain research*, *623*(2), 241–248.
- Marsman, A., van den Heuvel, M. P., Klomp, D. W., Kahn, R. S., Luijten, P. R., & Hulshoff Pol, H. E. (2013). Glutamate in schizophrenia: a focused review and meta-analysis of <sup>1</sup>H-MRS studies. *Schizophrenia bulletin*, *39*(1), 120–129.
- Martinez, Z. A., Ellison, G. D., Geyer, M. A., & Swerdlow, N. R. (1999). Effects of sustained phencyclidine exposure on sensorimotor gating of startle in rats. *Neuropsychopharmacology : official publication of the American College of Neuropsychopharmacology*, *21*(1), 28–39.
- Mason, O., & Wakerley, D. (2012). The psychotomimetic nature of dreams: an experimental study. *Schizophrenia research and treatment*, *2012*, 872307.
- Massimini, M., Huber, R., Ferrarelli, F., Hill, S., & Tononi, G. (2004). The sleep slow oscillation as a traveling wave. *The Journal of neuroscience : the official journal of the Society for Neuroscience*, *24*(31), 6862–6870.
- McCarthy, S. E., Makarov, V., Kirov, G., Addington, A. M., McClellan, J., Yoon, S., Perkins, D. O., Dickel, D. E., Kusenda, M., Krastoshevsky, O., Krause, V., Kumar, R. A., Grozeva, D., Malhotra, D., Walsh, T., Zackai, E. H., Kaplan, P., Ganesh, J., Krantz, I. D., Spinner, N. B., ... Sebat, J. (2009). Microduplications of 16p11.2 are associated with schizophrenia. *Nature genetics*, *41*(11), 1223–1227.
- McCormick D. A. (1992). Neurotransmitter actions in the thalamus and cerebral cortex and their role in neuromodulation of thalamocortical activity. *Progress in neurobiology*, *39*(4), 337–388.
- McCormick, D. A., & Bal, T. (1997). Sleep and arousal: thalamocortical mechanisms. *Annual review of neuroscience*, *20*, 185–215.
- McCormick, D. A., & Williamson, A. (1991). Modulation of neuronal firing mode in cat and guinea pig LGNd by histamine: possible cellular mechanisms of histaminergic control of arousal. *The Journal of neuroscience : the official journal of the Society for Neuroscience*, *11*(10), 3188–3199.
- McCormick, D. A., Wang, Z., & Huguenard, J. (1993). Neurotransmitter control of neocortical neuronal activity and excitability. *Cerebral cortex (New York, N.Y. : 1991)*, *3*(5), 387–398.
- McGurk, S. R., & Mueser, K. T. (2004). Cognitive functioning, symptoms, and work in supported employment: a review and heuristic model. *Schizophrenia research*, *70*(2-3), 147–173.

- Meador-Woodruff, J. H., Clinton, S. M., Beneyto, M., & McCullumsmith, R. E. (2003). Molecular abnormalities of the glutamate synapse in the thalamus in schizophrenia. *Annals of the New York Academy of Sciences*, 1003, 75–93.
- Mei, L., & Xiong, W. C. (2008). Neuregulin 1 in neural development, synaptic plasticity and schizophrenia. *Nature reviews. Neuroscience*, 9(6), 437–452.
- Meltzer H. Y. (1994). An overview of the mechanism of action of clozapine. *The Journal of clinical psychiatry*, 55 Suppl B, 47–52.
- Meltzer H. Y. (1991). The mechanism of action of novel antipsychotic drugs. *Schizophrenia bulletin*, 17(2), 263–287.
- Minzenberg, M. J., Firl, A. J., Yoon, J. H., Gomes, G. C., Reinking, C., & Carter, C. S. (2010). Gamma oscillatory power is impaired during cognitive control independent of medication status in first-episode schizophrenia. *Neuropsychopharmacology : official publication of the American College of Neuropsychopharmacology*, 35(13), 2590–2599.
- Mitrofanis, J., & Guillery, R. W. (1993). New views of the thalamic reticular nucleus in the adult and the developing brain. *Trends in neurosciences*, 16(6), 240–245.
- Moghaddam B. (2003). Bringing order to the glutamate chaos in schizophrenia. *Neuron*, 40(5), 881–884.
- Moghaddam, B., & Javitt, D. (2012). From revolution to evolution: the glutamate hypothesis of schizophrenia and its implication for treatment. *Neuropsychopharmacology : official publication of the American College of Neuropsychopharmacology*, 37(1), 4–15.
- Moghaddam, B., Adams, B., Verma, A., & Daly, D. (1997). Activation of glutamatergic neurotransmission by ketamine: a novel step in the pathway from NMDA receptor blockade to dopaminergic and cognitive disruptions associated with the prefrontal cortex. *The Journal of neuroscience : the official journal of the Society for Neuroscience*, 17(8), 2921–2927.
- Mohn, C., & Torgalsbøen, A. K. (2018). Details of attention and learning change in first-episode schizophrenia. *Psychiatry research*, 260, 324–330.
- Molero, P., Ramos-Quiroga, J. A., Martin-Santos, R., Calvo-Sánchez, E., Gutiérrez-Rojas, L., & Meana, J. J. (2018). Antidepressant Efficacy and Tolerability of Ketamine and Esketamine: A Critical Review. *CNS drugs*, 32(5), 411–420.
- Monti, J. M., & Monti, D. (2004). Sleep in schizophrenia patients and the effects of antipsychotic drugs. *Sleep medicine reviews*, 8(2), 133–148.
- Monti, J. M., & Monti, D. (2005). Sleep disturbance in schizophrenia. *International Review of Psychiatry*, 17(4), 247–253.
- Monti, J. M., BaHammam, A. S., Pandi-Perumal, S. R., Bromundt, V., Spence, D. W., Cardinali, D. P., & Brown, G. M. (2013). Sleep and circadian rhythm dysregulation in schizophrenia. *Progress in neuro-psychopharmacology & biological psychiatry*, 43, 209–216.
- Moran, L. V., & Hong, L. E. (2011). High vs low frequency neural oscillations in schizophrenia. *Schizophrenia bulletin*, 37(4), 659–663.
- Moran, P., Stokes, J., Marr, J., Bock, G., Desbonnet, L., Waddington, J., & O'Tuathaigh, C. (2016). Gene x Environment Interactions in Schizophrenia: Evidence from Genetic Mouse Models. *Neural plasticity*, 2016, 2173748.
- Moriya, T., Kouzu, Y., Shibata, S., Kadotani, H., Fukunaga, K., Miyamoto, E., & Yoshioka, T. (2000). Close linkage between calcium/calmodulin kinase II alpha/beta and NMDA-2A receptors in the lateral amygdala and significance for retrieval of auditory fear conditioning. *The European journal of neuroscience*, 12(9), 3307–3314.

- Morris, B. J., Cochran, S. M., & Pratt, J. A. (2005). PCP: from pharmacology to modelling schizophrenia. *Current opinion in pharmacology*, 5(1), 101–106.
- Morris, B. J., & Pratt, J. A. (2014). Novel treatment strategies for schizophrenia from improved understanding of genetic risk. *Clinical genetics*, 86(5), 401–411.
- Mortimer, A. M., Singh, P., Shepherd, C. J., & Puthirackal, J. (2010). Clozapine for treatment-resistant schizophrenia: National Institute of Clinical Excellence (NICE) guidance in the real world. *Clinical schizophrenia & related psychoses*, 4(1), 49–55.
- Moruzzi, G., & Magoun, H. W. (1949). Brain stem reticular formation and activation of the EEG. *Electroencephalography and clinical neurophysiology*, 1(4), 455–473.
- Mota, N. B., Resende, A., Mota-Rolim, S. A., Copelli, M., & Ribeiro, S. (2016). Psychosis and the Control of Lucid Dreaming. *Frontiers in psychology*, 7, 294.
- Mota-Rolim, S. A., de Almondes, K. M., & Kirov, R. (2021). Editorial: "Is this a Dream?" - Evolutionary, Neurobiological and Psychopathological Perspectives on Lucid Dreaming. *Frontiers in psychology*, 12, 635183.
- Mrzljak, L., Bergson, C., Pappy, M., Huff, R., Levenson, R., & Goldman-Rakic, P. S. (1996). Localization of dopamine D4 receptors in GABAergic neurons of the primate brain. *Nature*, 381(6579), 245–248.
- Mulle, C., Madariaga, A., & Deschênes, M. (1986). Morphology and electrophysiological properties of reticularis thalami neurons in cat: in vivo study of a thalamic pacemaker. *The Journal of neuroscience : the official journal of the Society for Neuroscience*, 6(8), 2134–2145.
- Munk, M. H., Roelfsema, P. R., König, P., Engel, A. K., & Singer, W. (1996). Role of reticular activation in the modulation of intracortical synchronization. *Science (New York, N.Y.)*, 272(5259), 271–274.
- Murray, G., Nicholas, C. L., Kleiman, J., Dwyer, R., Carrington, M. J., Allen, N. B., et al. (2009). Nature's clocks and human mood: the circadian system modulates reward motivation. *Emotion* 9, 705–716.
- Murray, J. D., Anticevic, A., Gancsos, M., Ichinose, M., Corlett, P. R., Krystal, J. H., & Wang, X. J. (2014). Linking microcircuit dysfunction to cognitive impairment: effects of disinhibition associated with schizophrenia in a cortical working memory model. *Cerebral cortex (New York, N.Y. : 1991)*, 24(4), 859–872.
- Nakazawa, K., & Sapkota, K. (2020). The origin of NMDA receptor hypofunction in schizophrenia. *Pharmacology & therapeutics*, 205, 107426.
- Nakazawa, K., Zsiros, V., Jiang, Z., Nakao, K., Kolata, S., Zhang, S., & Belforte, J. E. (2012). GABAergic interneuron origin of schizophrenia pathophysiology. *Neuropharmacology*, 62(3), 1574–1583.
- Need, A. C., Ge, D., Weale, M. E., Maia, J., Feng, S., Heinzen, E. L., Shianna, K. V., Yoon, W., Kasperaviciute, D., Gennarelli, M., Strittmatter, W. J., Bonvicini, C., Rossi, G., Jayathilake, K., Cola, P. A., McEvoy, J. P., Keefe, R. S., Fisher, E. M., St Jean, P. L., Giegling, I., ... Goldstein, D. B. (2009). A genome-wide investigation of SNPs and CNVs in schizophrenia. *PLoS genetics*, 5(2), e1000373.
- Newcomer, J. W., Farber, N. B., Jevtovic-Todorovic, V., Selke, G., Melson, A. K., Hershey, T., Craft, S., & Olney, J. W. (1999). Ketamine-induced NMDA receptor hypofunction as a model of memory impairment and psychosis.
- Newton, R., Rouleau, A., Nylander, A. G., Loze, J. Y., Resemann, H. K., Steeves, S., & Crespo-Facorro, B. (2018). Diverse definitions of the early course of schizophrenia—a targeted literature review. *NPJ schizophrenia*, 4(1), 21.
- Nicholson, E., & Kullmann, D. M. (2017). T-type calcium channels contribute to NMDA receptor independent synaptic plasticity in hippocampal regular-spiking oriens-alveus interneurons. *The Journal of physiology*, 595(11), 3449–3458.

- Niedermeyer, E. (2003). The Clinical Relevance of EEG Interpretation. *Clinical Electroencephalography*, 34(3), 93–98.
- Niesters, M., & Dahan, A. (2012). Pharmacokinetic and pharmacodynamic considerations for NMDA receptor antagonists in the treatment of chronic neuropathic pain. *Expert opinion on drug metabolism & toxicology*, 8(11), 1409–1417.
- Nishida, M., & Walker, M. P. (2007). Daytime naps, motor memory consolidation and regionally specific sleep spindles. *PloS one*, 2(4), e341.
- Noda, A., Noda, Y., Kamei, H., Ichihara, K., Mamiya, T., Nagai, T., Sugiura, S., Furukawa, H., & Nabeshima, T. (2001). Phencyclidine impairs latent learning in mice: interaction between glutamatergic systems and sigma(1) receptors. *Neuropsychopharmacology : official publication of the American College of Neuropsychopharmacology*, 24(4), 451–460.
- Nosyreva, E., Szabla, K., Autry, A. E., Ryazanov, A. G., Monteggia, L. M., & Kavalali, E. T. (2013). Acute suppression of spontaneous neurotransmission drives synaptic potentiation. *The Journal of neuroscience : the official journal of the Society for Neuroscience*, 33(16), 6990–7002.
- Nucifora, F. C., Jr, Mihaljevic, M., Lee, B. J., & Sawa, A. (2017). Clozapine as a Model for Antipsychotic Development. *Neurotherapeutics: the journal of the American Society for Experimental NeuroTherapeutics*, 14(3), 750–761.
- Nugent, A. C., Ballard, E. D., Gould, T. D., Park, L. T., Moaddel, R., Brutsche, N. E., & Zarate, C. A., Jr (2019). Ketamine has distinct electrophysiological and behavioral effects in depressed and healthy subjects. *Molecular psychiatry*, 24(7), 1040–1052.
- Nunez, P.L., Srinivasan, R. (2006). *Electric Fields of the Brain: The Neurophysics of EEG*. Second Edition. New York: Oxford University Press.
- Ohrmann, P., Siegmund, A., Suslow, T., Pedersen, A., Spitzberg, K., Kersting, A., Rothermundt, M., Arolt, V., Heindel, W., & Pfeleiderer, B. (2007). Cognitive impairment and in vivo metabolites in first-episode neuroleptic-naive and chronic medicated schizophrenic patients: a proton magnetic resonance spectroscopy study. *Journal of psychiatric research*, 41(8), 625–634.
- Olney, J. W., & Farber, N. B. (1995). Glutamate receptor dysfunction and schizophrenia. *Archives of general psychiatry*, 52(12), 998–1007.
- Olney, J. W., Newcomer, J. W., & Farber, N. B. (1999). NMDA receptor hypofunction model of schizophrenia. *Journal of psychiatric research*, 33(6), 523–533.
- O'Tuathaigh, C. M., Babovic, D., O'Meara, G., Clifford, J. J., Croke, D. T., & Waddington, J. L. (2007). Susceptibility genes for schizophrenia: characterisation of mutant mouse models at the level of phenotypic behaviour. *Neuroscience and biobehavioral reviews*, 31(1), 60–78.
- Pakkenberg, B., Scheel-Krüger, J., & Kristiansen, L. V. (2009). Schizophrenia; from structure to function with special focus on the mediodorsal thalamic prefrontal loop. *Acta psychiatrica Scandinavica*, 120(5), 345–354.
- Páleníček, T., Fujáková, M., Brunovský, M., Balíková, M., Horáček, J., Gorman, I., Tylš, F., Tišlerová, B., Soš, P., Bubeníková-Valešová, V., Höschl, C., & Krajča, V. (2011). Electroencephalographic spectral and coherence analysis of ketamine in rats: correlation with behavioral effects and pharmacokinetics. *Neuropsychobiology*, 63(4), 202–218.
- Paré, D., & Lang, E. J. (1998). Calcium electrogenesis in neocortical pyramidal neurons in vivo. *The European journal of neuroscience*, 10(10), 3164–3170.
- Paxinos, G., Watson, C. (1998). *The Rat Brain in Stereotaxic Coordinates*. Comprehensive. 4. Academic Press; San Diego.

- Perrottelli, A., Giordano, G. M., Brando, F., Giuliani, L., & Mucci, A. (2021). EEG-Based Measures in At-Risk Mental State and Early Stages of Schizophrenia: A Systematic Review. *Frontiers in psychiatry*, *12*, 653642.
- Pettersen, K. H., & Einevoll, G. T. (2008). Amplitude variability and extracellular low-pass filtering of neuronal spikes. *Biophysical journal*, *94*(3), 784–802.
- Pilowsky, L. S., Bressan, R. A., Stone, J. M., Erlandsson, K., Mulligan, R. S., Krystal, J. H., & Ell, P. J. (2006). First in vivo evidence of an NMDA receptor deficit in medication-free schizophrenic patients. *Molecular psychiatry*, *11*(2), 118–119.
- Pinault D. (1996). A novel single-cell staining procedure performed in vivo under electrophysiological control: morpho-functional features of juxtacellularly labeled thalamic cells and other central neurons with biocytin or Neurobiotin. *Journal of neuroscience methods*, *65*(2), 113–136.
- Pinault D. (2004). The thalamic reticular nucleus: structure, function and concept. *Brain research. Brain research reviews*, *46*(1), 1–31.
- Pinault D. (2008). N-methyl d-aspartate receptor antagonists ketamine and MK-801 induce wake-related aberrant gamma oscillations in the rat neocortex. *Biological psychiatry*, *63*(8), 730–735.
- Pinault D. (2011). Dysfunctional thalamus-related networks in schizophrenia. *Schizophrenia bulletin*, *37*(2), 238–243.
- Pinault, D., & Deschênes, M. (1998). Anatomical evidence for a mechanism of lateral inhibition in the rat thalamus. *The European journal of neuroscience*, *10*(11), 3462–3469.
- Pinault, D., Deschênes, M., 1992a. Control of 40-Hz firing of reticular thalamic cells by neurotransmitters. *Neuroscience*, *51* (2), 259–268.
- Pinault, D., Deschênes, M., 1992b. Voltage-dependent 40-Hz oscillations in rat reticular thalamic neurons in vivo. *Neuroscience*, *51* (2), 245–258.
- Pinault, D., Slézia, A., & Acsády, L. (2006). Corticothalamic 5-9 Hz oscillations are more pro-epileptogenic than sleep spindles in rats. *The Journal of physiology*, *574*(Pt 1), 209–227.
- Pinault, D., Vergnes, M., & Marescaux, C. (2001). Medium-voltage 5-9-Hz oscillations give rise to spike-and-wave discharges in a genetic model of absence epilepsy: in vivo dual extracellular recording of thalamic relay and reticular neurons. *Neuroscience*, *105*(1), 181–201.
- Pitsikas, N., Boultsadakis, A., & Sakellaris, N. (2008). Effects of sub-anesthetic doses of ketamine on rats' spatial and non-spatial recognition memory. *Neuroscience*, *154*(2), 454–460.
- Pocklington, A. J., O'Donovan, M., & Owen, M. J. (2014). The synapse in schizophrenia. *The European journal of neuroscience*, *39*(7), 1059–1067.
- Poe, G. R., Nitz, D. A., McNaughton, B. L., & Barnes, C. A. (2000). Experience-dependent phase-reversal of hippocampal neuron firing during REM sleep. *Brain research*, *855*(1), 176–180.
- Poe, S. L., Brucato, G., Bruno, N., Arndt, L. Y., Ben-David, S., Gill, K. E., Colibazzi, T., Kantrowitz, J. T., Corcoran, C. M., & Girgis, R. R. (2017). Sleep disturbances in individuals at clinical high risk for psychosis. *Psychiatry research*, *249*, 240–243.
- Poulin, J., Daoust, A. M., Forest, G., Stip, E., & Godbout, R. (2003). Sleep architecture and its clinical correlates in first episode and neuroleptic-naive patients with schizophrenia. *Schizophrenia research*, *62*(1-2), 147–153.
- Pratt, J. A., & Morris, B. J. (2015). The thalamic reticular nucleus: a functional hub for thalamocortical network dysfunction in schizophrenia and a target for drug discovery. *Journal of psychopharmacology (Oxford, England)*, *29*(2), 127–137.



- Pratt, J. A., Morris, B., & Dawson, N. (2018). Deconstructing Schizophrenia: Advances in Preclinical Models for Biomarker Identification. *Current topics in behavioral neurosciences*, 40, 295–323.
- Pratt, J., Dawson, N., Morris, B. J., Grent-'t-Jong, T., Roux, F., & Uhlhaas, P. J. (2017). Thalamo-cortical communication, glutamatergic neurotransmission and neural oscillations: A unique window into the origins of ScZ?. *Schizophrenia research*, 180, 4–12.
- Pratt, J., Winchester, C., Dawson, N., & Morris, B. (2012). Advancing schizophrenia drug discovery: optimizing rodent models to bridge the translational gap. *Nature reviews. Drug discovery*, 11(7), 560–579.
- Protopapas, A.D., Vanier, M., Bower, J.M. (1998). Simulating large networks of neurons. In: C Koch and I Segev eds. *Methods in Neuronal Modeling*. MIT Press, Cambridge, MA, pp. 461–498.
- Rahman, F., Nanu, R., Schneider, N. A., Katz, D., Lisman, J., & Pi, H. J. (2021). Optogenetic perturbation of projections from thalamic nucleus reuniens to hippocampus disrupts spatial working memory retrieval more than encoding. *Neurobiology of learning and memory*, 179, 107396.
- Rall, W., & Shepherd, G. M. (1968). Theoretical reconstruction of field potentials and dendrodendritic synaptic interactions in olfactory bulb. *Journal of neurophysiology*, 31(6), 884–915.
- Ramyead, A., Kometer, M., Studerus, E., Koranyi, S., Ittig, S., Gschwandtner, U., Fuhr, P., & Riecher-Rössler, A. (2015). Aberrant Current Source-Density and Lagged Phase Synchronization of Neural Oscillations as Markers for Emerging Psychosis. *Schizophrenia bulletin*, 41(4), 919–929.
- Rees, E., Walters, J. T., Georgieva, L., Isles, A. R., Chambert, K. D., Richards, A. L., Mahoney-Davies, G., Legge, S. E., Moran, J. L., McCarroll, S. A., O'Donovan, M. C., Owen, M. J., & Kirov, G. (2014). Analysis of copy number variations at 15 schizophrenia-associated loci. *The British journal of psychiatry : the journal of mental science*, 204(2), 108–114.
- Reeve, S., Sheaves, B., & Freeman, D. (2015). The role of sleep dysfunction in the occurrence of delusions and hallucinations: A systematic review. *Clinical psychology review*, 42, 96–115.
- Reisinger, S., Khan, D., Kong, E., Berger, A., Pollak, A., & Pollak, D. D. (2015). The poly(I:C)-induced maternal immune activation model in preclinical neuropsychiatric drug discovery. *Pharmacology & therapeutics*, 149, 213–226.
- Ren, Z., Pribiag, H., Jefferson, S. J., Shorey, M., Fuchs, T., Stellwagen, D., & Luscher, B. (2016). Bidirectional Homeostatic Regulation of a Depression-Related Brain State by Gamma-Aminobutyric Acidergic Deficits and Ketamine Treatment. *Biological psychiatry*, 80(6), 457–468.
- Ripke, S., Neale, B.M., Corvin, A., Walters, J.T.R., et al. (2014). Biological insights from 108 schizophrenia-associated genetic loci. *Nature*, 511(7510), 421–427.
- Ripke, S., O'Dushlaine, C., Chambert, K., Moran, J. L., Kähler, A. K., Akterin, S., Bergen, S. E., Collins, A. L., Crowley, J. J., Fromer, M., Kim, Y., Lee, S. H., Magnusson, P. K., Sanchez, N., Stahl, E. A., Williams, S., Wray, N. R., Xia, K., Bettella, F., Borglum, A. D., ... Sullivan, P. F. (2013). Genome-wide association analysis identifies 13 new risk loci for schizophrenia. *Nature genetics*, 45(10), 1150–1159.
- Ritsner, M., Kurs, R., Ponizovsky, A., & Hadjez, J. (2004). Perceived quality of life in schizophrenia: relationships to sleep quality. *Quality of life research : an international journal of quality of life aspects of treatment, care and rehabilitation*, 13(4), 783–791.
- Rivolta, D., Castellanos, N. P., Stawowsky, C., Helbling, S., Wibral, M., Grützner, C., Koethe, D., Birkner, K., Kranaster, L., Enning, F., Singer, W., Leweke, F. M., & Uhlhaas, P. J. (2014). Source-reconstruction of event-related fields reveals hyperfunction and hypofunction of cortical circuits in antipsychotic-naive, first-episode schizophrenia patients during Mooney face processing. *The Journal of neuroscience : the official journal of the Society for Neuroscience*, 34(17), 5909–5917.

- Rivolta, D., Heidegger, T., Scheller, B., Sauer, A., Schaum, M., Birkner, K., Singer, W., Wibral, M., & Uhlhaas, P. J. (2015). Ketamine Dysregulates the Amplitude and Connectivity of High-Frequency Oscillations in Cortical-Subcortical Networks in Humans: Evidence From Resting-State Magnetoencephalography-Recordings. *Schizophrenia bulletin*, *41*(5), 1105–1114.
- Roberts, B. M., Seymour, P. A., Schmidt, C. J., Williams, G. V., & Castner, S. A. (2010). Amelioration of ketamine-induced working memory deficits by dopamine D1 receptor agonists. *Psychopharmacology*, *210*(3), 407–418.
- Robinson, P. A., Phillips, A. J., Fulcher, B. D., Puckeridge, M., & Roberts, J. A. (2011). Quantitative modelling of sleep dynamics. *Philosophical transactions. Series A, Mathematical, physical, and engineering sciences*, *369*(1952), 3840–3854.
- Rolls, E. T., Loh, M., Deco, G., & Winterer, G. (2008). Computational models of schizophrenia and dopamine modulation in the prefrontal cortex. *Nature reviews. Neuroscience*, *9*(9), 696–709.
- Ross, C. A., Margolis, R. L., Reading, S. A., Pletnikov, M., & Coyle, J. T. (2006). Neurobiology of schizophrenia. *Neuron*, *52*(1), 139–153.
- Rowland, L. M., Bustillo, J. R., Mullins, P. G., Jung, R. E., Lenroot, R., Landgraf, E., Barrow, R., Yeo, R., Lauriello, J., & Brooks, W. M. (2005). Effects of ketamine on anterior cingulate glutamate metabolism in healthy humans: a 4-T proton MRS study. *The American journal of psychiatry*, *162*(2), 394–396.
- Roy, R. C., & Stullken, E. H. (1981). Electroencephalographic evidence of arousal in dogs from halothane after doxapram, physostigmine, or naloxone. *Anesthesiology*, *55*(4), 392–397.
- Ruhrmann, S., Schultze-Lutter, F., Salokangas, R. K., Heinimaa, M., Linszen, D., Dingemans, P., Birchwood, M., Patterson, P., Juckel, G., Heinz, A., Morrison, A., Lewis, S., von Reventlow, H. G., & Klosterkötter, J. (2010). Prediction of psychosis in adolescents and young adults at high risk: results from the prospective European prediction of psychosis study. *Archives of general psychiatry*, *67*(3), 241–251.
- Rund B. R. (1998). A review of longitudinal studies of cognitive functions in schizophrenia patients. *Schizophrenia bulletin*, *24*(3), 425–435.
- Rung, J. P., Carlsson, A., Rydén Markinhuhta, K., & Carlsson, M. L. (2005). (+)-MK-801 induced social withdrawal in rats; a model for negative symptoms of schizophrenia. *Progress in neuro-psychopharmacology & biological psychiatry*, *29*(5), 827–832.
- Rutter, L., Carver, F. W., Holroyd, T., Nadar, S. R., Mitchell-Francis, J., Apud, J., Weinberger, D. R., & Coppola, R. (2009). Magnetoencephalographic gamma power reduction in patients with schizophrenia during resting condition. *Human brain mapping*, *30*(10), 3254–3264.
- Rydkjaer, J., Jepsen, J., Pagsberg, A. K., Fagerlund, B., Glenthøj, B. Y., & Oranje, B. (2020). Do young adolescents with first-episode psychosis or ADHD show sensorimotor gating deficits?. *Psychological medicine*, *50*(4), 607–615.
- Sadock, E., Auerbach, S. M., Rybarczyk, B., & Aggarwal, A. (2014). Evaluation of integrated psychological services in a university-based primary care clinic. *Journal of clinical psychology in medical settings*, *21*(1), 19–32.
- Sams-Dodd F. (1995). Distinct effects of d-amphetamine and phencyclidine on the social behaviour of rats. *Behavioural pharmacology*, *6*(1), 55–65.
- Sanchez-Vives, M. V., & McCormick, D. A. (2000). Cellular and network mechanisms of rhythmic recurrent activity in neocortex. *Nature neuroscience*, *3*(10), 1027–1034.
- Santana, N., Troyano-Rodríguez, E., Mengod, G., Celada, P., & Artigas, F. (2011). Activation of thalamocortical networks by the N-methyl-D-aspartate receptor antagonist phencyclidine: reversal by clozapine. *Biological psychiatry*, *69*(10), 918–927.

- Saunders, J. A., Gandal, M. J., & Siegel, S. J. (2012). NMDA antagonists recreate signal-to-noise ratio and timing perturbations present in schizophrenia. *Neurobiology of disease*, *46*(1), 93–100.
- Saykin, A. J., Shtasel, D. L., Gur, R. E., Kester, D. B., Mozley, L. H., Stafiniak, P., & Gur, R. C. (1994). Neuropsychological deficits in neuroleptic naive patients with first-episode schizophrenia. *Archives of general psychiatry*, *51*(2), 124–131.
- Scarone, S., Manzone, M. L., Gambini, O., Kantzas, I., Limosani, I., D'Agostino, A., & Hobson, J. A. (2008). The dream as a model for psychosis: an experimental approach using bizarreness as a cognitive marker. *Schizophrenia bulletin*, *34*(3), 515–522.
- Scheindlin S. (2010). Episodes in the story of physostigmine. *Molecular interventions*, *10*(1), 4–10.
- Schellenberger Costa, M., Weigenand, A., Ngo, H. V., Marshall, L., Born, J., Martinetz, T., & Claussen, J. C. (2016). A Thalamocortical Neural Mass Model of the EEG during NREM Sleep and Its Response to Auditory Stimulation. *PLoS computational biology*, *12*(9), e1005022.
- Schilling, C., Schlipf, M., Spietzack, S., Rausch, F., Eisenacher, S., Englisch, S., Reinhard, I., Haller, L., Grimm, O., Deuschle, M., Tost, H., Zink, M., Meyer-Lindenberg, A., & Schredl, M. (2017). Fast sleep spindle reduction in schizophrenia and healthy first-degree relatives: association with impaired cognitive function and potential intermediate phenotype. *European archives of psychiatry and clinical neuroscience*, *267*(3), 213–224.
- Schobel, S. A., Chaudhury, N. H., Khan, U. A., Paniagua, B., Styner, M. A., Asllani, I., Inbar, B. P., Corcoran, C. M., Lieberman, J. A., Moore, H., & Small, S. A. (2013). Imaging patients with psychosis and a mouse model establishes a spreading pattern of hippocampal dysfunction and implicates glutamate as a driver. *Neuron*, *78*(1), 81–93.
- Schwartz, T. L., Sachdeva, S., & Stahl, S. M. (2012). Glutamate neurocircuitry: theoretical underpinnings in schizophrenia. *Frontiers in pharmacology*, *3*, 195.
- Schwieler, L., Linderholm, K. R., Nilsson-Todd, L. K., Erhardt, S., & Engberg, G. (2008). Clozapine interacts with the glycine site of the NMDA receptor: electrophysiological studies of dopamine neurons in the rat ventral tegmental area. *Life sciences*, *83*(5-6), 170–175.
- Seamans, J. K., & Yang, C. R. (2004). The principal features and mechanisms of dopamine modulation in the prefrontal cortex. *Progress in neurobiology*, *74*(1), 1–58.
- Sebban, C., Tesolin-Decros, B., Ciprian-Ollivier, J., Perret, L., & Spedding, M. (2002). Effects of phencyclidine (PCP) and MK 801 on the EEGq in the prefrontal cortex of conscious rats; antagonism by clozapine, and antagonists of AMPA-, alpha(1)- and 5-HT(2A)-receptors. *British journal of pharmacology*, *135*(1), 65–78.
- Seeck-Hirschner, M., Baier, P. C., Sever, S., Buschbacher, A., Aldenhoff, J. B., & Göder, R. (2010). Effects of daytime naps on procedural and declarative memory in patients with schizophrenia. *Journal of psychiatric research*, *44*(1), 42–47.
- Seeman P. (2002). Atypical antipsychotics: mechanism of action. *Canadian journal of psychiatry. Revue canadienne de psychiatrie*, *47*(1), 27–38.
- Sejnowski, T. J., & Destexhe, A. (2000). Why do we sleep?. *Brain research*, *886*(1-2), 208–223.
- Sekimoto, M., Kato, M., Watanabe, T., Kajimura, N., & Takahashi, K. (2007). Reduced frontal asymmetry of delta waves during all-night sleep in schizophrenia. *Schizophrenia bulletin*, *33*(6), 1307–1311.
- Sekimoto, M., Kato, M., Watanabe, T., Kajimura, N., & Takahashi, K. (2011). Cortical regional differences of delta waves during all-night sleep in schizophrenia. *Schizophrenia research*, *126*(1-3), 284–290.
- Sharma, A. V., Wolansky, T., & Dickson, C. T. (2010). A comparison of sleeplike slow oscillations in the hippocampus under ketamine and urethane anesthesia. *Journal of neurophysiology*, *104*(2), 932–939.

- Sherman, S. M., & Guillery, R. W. (2006). Exploring the thalamus and its role in cortical function. *Cambridge, MA: MIT Press.*
- Sherman, S. M., & Koch, C. (1986). The control of retinogeniculate transmission in the mammalian lateral geniculate nucleus. *Experimental brain research*, 63(1), 1–20.
- Shvaloff, A., Tesolin, B., & Sebban, C. (1988). Effects of apomorphine in quantified electroencephalography in the frontal cortex: changes with dose and time. *Neuropharmacology*, 27(12), 1313–1317.
- Siekmeier, P. J., Hasselmo, M. E., Howard, M. W., & Coyle, J. (2007). Modeling of context-dependent retrieval in hippocampal region CA1: implications for cognitive function in schizophrenia. *Schizophrenia research*, 89(1-3), 177–190.
- Simmonite, M., Bates, A. T., Groom, M., Hollis, C., & Liddle, P. F. (2015). Reduced event-related low frequency EEG activity in patients with early onset schizophrenia and their unaffected siblings. *Psychiatry research*, 232(1), 51–57.
- Simpson, E. H., Kellendonk, C., & Kandel, E. (2010). A possible role for the striatum in the pathogenesis of the cognitive symptoms of schizophrenia. *Neuron*, 65(5), 585–596.
- Sitaram, N., Wyatt, R. J., Dawson, S., & Gillin, J. C. (1976). REM sleep induction by physostigmine infusion during sleep. *Science (New York, N.Y.)*, 191(4233), 1281–1283.
- Sleigh, J., Harvey, M., Voss, L., denny, B., (2014). Ketamine - more mechanisms of action than just NMDA blockade. *Trends in Anaesthesia and Critical Care*, 4, 76–81.
- Slifstein, M., van de Giessen, E., Van Snellenberg, J., Thompson, J. L., Narendran, R., Gil, R., Hackett, E., Girgis, R., Ojeil, N., Moore, H., D'Souza, D., Malison, R. T., Huang, Y., Lim, K., Nabulsi, N., Carson, R. E., Lieberman, J. A., & Abi-Dargham, A. (2015). Deficits in prefrontal cortical and extrastriatal dopamine release in schizophrenia: a positron emission tomographic functional magnetic resonance imaging study. *JAMA psychiatry*, 72(4), 316–324.
- Slovik, M., Rosin, B., Moshel, S., Mitelman, R., Schechtman, E., Eitan, R., Raz, A., & Bergman, H. (2017). Ketamine induced converged synchronous gamma oscillations in the cortico-basal ganglia network of nonhuman primates. *Journal of neurophysiology*, 118(2), 917–931.
- Snyder, M. A., & Gao, W. J. (2020). NMDA receptor hypofunction for schizophrenia revisited: Perspectives from epigenetic mechanisms. *Schizophrenia research*, 217, 60–70.
- Sponheim, S. R., Clementz, B. A., Iacono, W. G., & Beiser, M. (1994). Resting EEG in first-episode and chronic schizophrenia. *Psychophysiology*, 31(1), 37–43.
- Spencer, K. M. (2012). Baseline gamma power during auditory steady-state stimulation in schizophrenia. *Frontiers in human neuroscience*, 5, 190.
- Spencer, K. M., Nestor, P. G., Niznikiewicz, M. A., Salisbury, D. F., Shenton, M. E., & McCarley, R. W. (2003). Abnormal neural synchrony in schizophrenia. *The Journal of neuroscience : the official journal of the Society for Neuroscience*, 23(19), 7407–7411.
- Spencer, K. M., Nestor, P. G., Perlmutter, R., Niznikiewicz, M. A., Klump, M. C., Frumin, M., Shenton, M. E., & McCarley, R. W. (2004). Neural synchrony indexes disordered perception and cognition in schizophrenia. *Proceedings of the National Academy of Sciences of the United States of America*, 101(49), 17288–17293.
- Sprengel, R., Suchanek, B., Amico, C., Brusa, R., Burnashev, N., Rozov, A., Hvalby, O., Jensen, V., Paulsen, O., Andersen, P., Kim, J. J., Thompson, R. F., Sun, W., Webster, L. C., Grant, S. G., Eilers, J., Konnerth, A., Li, J., McNamara, J. O., & Seeburg, P. H. (1998). Importance of the intracellular domain of NR2 subunits for NMDA receptor function in vivo. *Cell*, 92(2), 279–289.

- Srisurapanont, M., Kittiratanapaiboon, P., & Jarusuraisin, N. (2001). Treatment for amphetamine psychosis. *The Cochrane database of systematic reviews*, (4), CD003026.
- Steeds, H., Carhart-Harris, R. L., & Stone, J. M. (2015). Drug models of schizophrenia. *Therapeutic advances in psychopharmacology*, 5(1), 43–58.
- Stefani, M. R., & Moghaddam, B. (2005). Transient N-methyl-D-aspartate receptor blockade in early development causes lasting cognitive deficits relevant to schizophrenia. *Biological psychiatry*, 57(4), 433–436.
- Stępnicki, P., Kondej, M., & Kaczor, A. A. (2018). Current Concepts and Treatments of Schizophrenia. *Molecules (Basel, Switzerland)*, 23(8), 2087.
- Steriade M. (2003). The corticothalamic system in sleep. *Frontiers in bioscience : a journal and virtual library*, 8, d878–d899.
- Steriade M. (2005). Sleep, epilepsy and thalamic reticular inhibitory neurons. *Trends in neurosciences*, 28(6), 317–324.
- Steriade, M., & Deschenes, M. (1984). The thalamus as a neuronal oscillator. *Brain research*, 320(1), 1–63.
- Steriade, M., Deschênes, M., Domich, L., & Mulle, C. (1985). Abolition of spindle oscillations in thalamic neurons disconnected from nucleus reticularis thalami. *Journal of neurophysiology*, 54(6), 1473–1497.
- Steriade, M., Domich, L., Oakson, G., & Deschênes, M. (1987). The deafferented reticular thalamic nucleus generates spindle rhythmicity. *Journal of neurophysiology*, 57(1), 260–273.
- Steriade, M., McCormick, D. A., & Sejnowski, T. J. (1993). Thalamocortical oscillations in the sleeping and aroused brain. *Science (New York, N.Y.)*, 262(5134), 679–685.
- Steriade, M., Timofeev, I., & Grenier, F. (2001). Natural waking and sleep states: a view from inside neocortical neurons. *Journal of neurophysiology*, 85(5), 1969–1985.
- Steullet P. (2020). Thalamus-related anomalies as candidate mechanism-based biomarkers for psychosis. *Schizophrenia research*, 226, 147–157.
- Steullet, P., Cabungcal, J. H., Bukhari, S. A., Ardelt, M. I., Pantazopoulos, H., Hamati, F., Salt, T. E., Cuenod, M., Do, K. Q., & Berretta, S. (2018). The thalamic reticular nucleus in schizophrenia and bipolar disorder: role of parvalbumin-expressing neuron networks and oxidative stress. *Molecular psychiatry*, 23(10), 2057–2065.
- Stone, J. M., Morrison, P. D., & Pilowsky, L. S. (2007). Glutamate and dopamine dysregulation in schizophrenia--a synthesis and selective review. *Journal of psychopharmacology (Oxford, England)*, 21(4), 440–452.
- Sturgeon, R. D., Fessler, R. G., & Meltzer, H. Y. (1979). Behavioral rating scales for assessing phencyclidine-induced locomotor activity, stereotyped behavior and ataxia in rats. *European journal of pharmacology*, 59(3-4), 169–179.
- Su, T., Lu, Y., Geng, Y., Lu, W., & Chen, Y. (2018). How could N-Methyl-D-Aspartate Receptor Antagonists Lead to Excitation Instead of Inhibition? *Brain Science Advances*, 4(2), 73–98.
- Sullivan, P. F., Kendler, K. S., & Neale, M. C. (2003). Schizophrenia as a complex trait: evidence from a meta-analysis of twin studies. *Archives of general psychiatry*, 60(12), 1187–1192.
- Szlachta, M., Pabian, P., Kusmider, M., Solich, J., Kolasa, M., Zurawek, D., et al. (2017). Effect of clozapine on ketamine-induced deficits in attentional set shift task in mice. *Psychopharmacology*, 234, 2103–2112.
- Tamaki, M., Huang, T. R., Yotsumoto, Y., Hämäläinen, M., Lin, F. H., Náñez, J. E., Sr, Watanabe, T., & Sasaki, Y. (2013). Enhanced spontaneous oscillations in the supplementary motor area are associated

with sleep-dependent offline learning of finger-tapping motor-sequence task. *The Journal of neuroscience : the official journal of the Society for Neuroscience*, 33(34), 13894–13902.

- Tan, H. Y., & Ang, Y. G. (2001). First-episode psychosis in the military: a comparative study of prodromal symptoms. *The Australian and New Zealand journal of psychiatry*, 35(4), 512–519.
- Tanahashi, S., Yamamura, S., Nakagawa, M., Motomura, E., & Okada, M. (2012). Clozapine, but not haloperidol, enhances glial D-serine and L-glutamate release in rat frontal cortex and primary cultured astrocytes. *British journal of pharmacology*, 165(5), 1543–1555.
- Tang, J., LeGros, R. P., Louneva, N., Yeh, L., Cohen, J. W., Hahn, C. G., Blake, D. J., Arnold, S. E., & Talbot, K. (2009). Dysbindin-1 in dorsolateral prefrontal cortex of schizophrenia cases is reduced in an isoform-specific manner unrelated to dysbindin-1 mRNA expression. *Human molecular genetics*, 18(20), 3851–3863.
- Tatard-Leitman, V. M., Jutzeler, C. R., Suh, J., Saunders, J. A., Billingslea, E. N., Morita, S., White, R., Featherstone, R. E., Ray, R., Ortinski, P. I., Banerjee, A., Gandal, M. J., Lin, R., Alexandrescu, A., Liang, Y., Gur, R. E., Borgmann-Winter, K. E., Carlson, G. C., Hahn, C. G., & Siegel, S. J. (2015). Pyramidal cell selective ablation of N-methyl-D-aspartate receptor 1 causes increase in cellular and network excitability. *Biological psychiatry*, 77(6), 556–568.
- Tekell, J. L., Hoffmann, R., Hendrickse, W., Greene, R. W., Rush, A. J., & Armitage, R. (2005). High frequency EEG activity during sleep: characteristics in schizophrenia and depression. *Clinical EEG and neuroscience*, 36(1), 25–35.
- Tesler, N., Gerstenberg, M., Franscini, M., Jenni, O. G., Walitza, S., & Huber, R. (2015). Reduced sleep spindle density in early onset schizophrenia: a preliminary finding. *Schizophrenia research*, 166(1-3), 355–357.
- Thankachan, S., Katsuki, F., McKenna, J. T., Yang, C., Shukla, C., Deisseroth, K., Uygun, D. S., Strecker, R. E., Brown, R. E., McNally, J. M., & Basheer, R. (2019). Thalamic Reticular Nucleus Parvalbumin Neurons Regulate Sleep Spindles and Electrophysiological Aspects of Schizophrenia in Mice. *Scientific reports*, 9(1), 3607.
- Thayer R. E. (1987). Energy, tiredness, and tension effects of a sugar snack versus moderate exercise. *Journal of personality and social psychology*, 52(1), 119–125.
- Théberge, J., Bartha, R., Drost, D. J., Menon, R. S., Malla, A., Takhar, J., Neufeld, R. W., Rogers, J., Pavlosky, W., Schaefer, B., Densmore, M., Al-Semaan, Y., & Williamson, P. C. (2002). Glutamate and glutamine measured with 4.0 T proton MRS in never-treated patients with schizophrenia and healthy volunteers. *The American journal of psychiatry*, 159(11), 1944–1946.
- Thornberg, S. A., & Saklad, S. R. (1996). A review of NMDA receptors and the phencyclidine model of schizophrenia. *Pharmacotherapy*, 16(1), 82–93.
- Thuné, H., Recasens, M., & Uhlhaas, P. J. (2016). The 40-Hz Auditory Steady-State Response in Patients With Schizophrenia: A Meta-analysis. *JAMA psychiatry*, 73(11), 1145–1153.
- Tieges, Z., McGrath, A., Hall, R. J., & Maclullich, A. M. (2013). Abnormal level of arousal as a predictor of delirium and inattention: an exploratory study. *The American journal of geriatric psychiatry : official journal of the American Association for Geriatric Psychiatry*, 21(12), 1244–1253.
- Timofeev, I., & Steriade, M. (1996). Low-frequency rhythms in the thalamus of intact-cortex and decorticated cats. *Journal of neurophysiology*, 76(6), 4152–4168.
- Timofeev, I., Grenier, F., Bazhenov, M., Sejnowski, T. J., & Steriade, M. (2000). Origin of slow cortical oscillations in deafferented cortical slabs. *Cerebral cortex (New York, N.Y. : 1991)*, 10(12), 1185–1199.

- Trantham-Davidson, H., Neely, L. C., Lavin, A., & Seamans, J. K. (2004). Mechanisms underlying differential D1 versus D2 dopamine receptor regulation of inhibition in prefrontal cortex. *The Journal of neuroscience : the official journal of the Society for Neuroscience*, 24(47), 10652–10659.
- Tricklebank, M. D., Singh, L., Oles, R. J., Preston, C., & Iversen, S. D. (1989). The behavioural effects of MK-801: a comparison with antagonists acting non-competitively and competitively at the NMDA receptor. *European journal of pharmacology*, 167(1), 127–135.
- Troyano-Rodriguez, E., Lladó-Pelfort, L., Santana, N., Teruel-Martí, V., Celada, P., & Artigas, F. (2014). Phencyclidine inhibits the activity of thalamic reticular gamma-aminobutyric acidergic neurons in rat brain. *Biological psychiatry*, 76(12), 937–945.
- Tsai, G., & Coyle, J. T. (2002). Glutamatergic mechanisms in schizophrenia. *Annual review of pharmacology and toxicology*, 42, 165–179.
- Tsekou, H., Angelopoulos, E., Paparrigopoulos, T., Golemati, S., Soldatos, C. R., Papadimitriou, G. N., & Ktonas, P. Y. (2015). Sleep EEG and spindle characteristics after combination treatment with clozapine in drug-resistant schizophrenia: a pilot study. *Journal of clinical neurophysiology : official publication of the American Electroencephalographic Society*, 32(2), 159–163.
- Tsuang, M. (2000). Schizophrenia: genes and environment. *Biological psychiatry*, 47(3), 210–220.
- Tsuang, M. T., Stone, W. S., & Faraone, S. V. (2001). Genes, environment and schizophrenia. *The British journal of psychiatry. Supplement*, 40, s18–s24.
- Tunbridge, E. M., Weinberger, D. R., & Harrison, P. J. (2006). A novel protein isoform of catechol O-methyltransferase (COMT): brain expression analysis in schizophrenia and bipolar disorder and effect of Val158Met genotype. *Molecular psychiatry*, 11(2), 116–117.
- Turetsky, B. I., Bilker, W. B., Siegel, S. J., Kohler, C. G., & Gur, R. E. (2009). Profile of auditory information-processing deficits in schizophrenia. *Psychiatry research*, 165(1-2), 27–37.
- Uhlhaas P. J. (2013). Dysconnectivity, large-scale networks and neuronal dynamics in schizophrenia. *Current opinion in neurobiology*, 23(2), 283–290.
- Uhlhaas, P. J., & Singer, W. (2010). Abnormal neural oscillations and synchrony in schizophrenia. *Nature reviews. Neuroscience*, 11(2), 100–113.
- Uhlhaas, P. J., & Singer, W. (2013). High-frequency oscillations and the neurobiology of schizophrenia. *Dialogues in clinical neuroscience*, 15(3), 301–313.
- van Os, J., & Kapur, S. (2009). Schizophrenia. *Lancet (London, England)*, 374(9690), 635–645.
- van Tricht, M. J., Ruhrmann, S., Arns, M., Müller, R., Bodatsch, M., Velthorst, E., Koelman, J. H., Bour, L. J., Zurek, K., Schultze-Lutter, F., Klosterkötter, J., Linszen, D. H., de Haan, L., Brockhaus-Dumke, A., & Nieman, D. H. (2014). Can quantitative EEG measures predict clinical outcome in subjects at Clinical High Risk for psychosis? A prospective multicenter study. *Schizophrenia research*, 153(1-3), 42–47.
- Vanini, G., Wathen, B. L., Lydic, R., & Baghdoyan, H. A. (2011). Endogenous GABA levels in the pontine reticular formation are greater during wakefulness than during rapid eye movement sleep. *The Journal of neuroscience : the official journal of the Society for Neuroscience*, 31(7), 2649–2656.
- Vazquez, J., & Baghdoyan, H. A. (2001). Basal forebrain acetylcholine release during REM sleep is significantly greater than during waking. *American journal of physiology. Regulatory, integrative and comparative physiology*, 280(2), R598–R601.
- Venables, N. C., Bernat, E. M., & Sponheim, S. R. (2009). Genetic and disorder-specific aspects of resting state EEG abnormalities in schizophrenia. *Schizophrenia bulletin*, 35(4), 826–839.

- Verma, A., and Moghaddam, B. (1996). NMDA receptor antagonists impair prefrontal cortex function as assessed via spatial delayed alternation performance in rats: modulation by dopamine. *J. Neurosci.* 16, 373–379.
- Vickstrom, C. R., Liu, X., Zhang, Y., Mu, L., Kelly, T. J., Yan, X., Hu, M. M., Snarrenberg, S. T., & Liu, Q. S. (2020). T-Type Calcium Channels Contribute to Burst Firing in a Subpopulation of Medial Habenula Neurons. *eNeuro*, 7(4), ENEURO.0201-20.2020.
- von Engelhardt, J., Doganci, B., Jensen, V., Hvalby, Ø., Göngrich, C., Taylor, A., Barkus, C., Sanderson, D. J., Rawlins, J. N., Seeburg, P. H., Bannerman, D. M., & Monyer, H. (2008). Contribution of hippocampal and extra-hippocampal NR2B-containing NMDA receptors to performance on spatial learning tasks. *Neuron*, 60(5), 846–860.
- von Krosigk, M., Bal, T., & McCormick, D. A. (1993). Cellular mechanisms of a synchronized oscillation in the thalamus. *Science (New York, N.Y.)*, 261(5119), 361–364.
- Vukadinovic Z. (2014). NMDA receptor hypofunction and the thalamus in schizophrenia. *Physiology & behavior*, 131, 156–159.
- Vyazovskiy, V. V., Olcese, U., Lazimy, Y. M., Faraguna, U., Esser, S. K., Williams, J. C., Cirelli, C., & Tononi, G. (2009). Cortical firing and sleep homeostasis. *Neuron*, 63(6), 865–878.
- Walton, K. D., & Llinás, R. R. (2010). Central Pain as a Thalamocortical Dysrhythmia: A Thalamic Efference Disconnection?. In L. Kruger (Eds.) et. al., *Translational Pain Research: From Mouse to Man*. CRC Press/Taylor & Francis.
- Wamsley, E. J., Tucker, M. A., Shinn, A. K., Ono, K. E., McKinley, S. K., Ely, A. V., Goff, D. C., Stickgold, R., & Manoach, D. S. (2012). Reduced sleep spindles and spindle coherence in schizophrenia: mechanisms of impaired memory consolidation?. *Biological psychiatry*, 71(2), 154–161.
- Wang X. J. (1999). Synaptic basis of cortical persistent activity: the importance of NMDA receptors to working memory. *The Journal of neuroscience : the official journal of the Society for Neuroscience*, 19(21), 9587–9603.
- Wang X. J. (2006). Toward a prefrontal microcircuit model for cognitive deficits in schizophrenia. *Pharmacopsychiatry*, 39 Suppl 1, S80–S87.
- Wang, C., Anastasio, N., Popov, V., Leday, A., & Johnson, K. M. (2004). Blockade of N-methyl-D aspartate receptors by phencyclidine causes the loss of corticostriatal neurons. *Neuroscience*, 125(2,) 473–483.
- Wang, D. S., Penna, A., & Orser, B. A. (2017). Ketamine Increases the Function of  $\gamma$ -Aminobutyric Acid Type A Receptors in Hippocampal and Cortical Neurons. *Anesthesiology*, 126(4), 666–677.
- Wang, G., Bochorishvili, G., Chen, Y., Salvati, K. A., Zhang, P., Dubel, S. J., Perez-Reyes, E., Snutch, T. P., Stornetta, R. L., Deisseroth, K., Erisir, A., Todorovic, S. M., Luo, J. H., Kapur, J., Beenhakker, M. P., & Zhu, J. J. (2015). CaV3.2 calcium channels control NMDA receptor-mediated transmission: a new mechanism for absence epilepsy. *Genes & development*, 29(14), 1535–1551.
- Wang, H. L., Rau, C. L., Li, Y. M., Chen, Y. P., & Yu, R. (2015). Disrupted thalamic resting-state functional networks in schizophrenia. *Frontiers in behavioral neuroscience*, 9, 45.
- Wang, H., Stradtman, G. G., 3rd, Wang, X. J., & Gao, W. J. (2008). A specialized NMDA receptor function in layer 5 recurrent microcircuitry of the adult rat prefrontal cortex. *Proceedings of the National Academy of Sciences of the United States of America*, 105(43), 16791–16796.
- Weckmann, K., Deery, M. J., Howard, J. A., Feret, R., Asara, J. M., Dethloff, F., Filiou, M. D., Labermaier, C., Maccarrone, G., Lilley, K. S., Mueller, M., & Turck, C. W. (2019). Ketamine's Effects on the Glutamatergic and GABAergic Systems: A Proteomics and Metabolomics Study in Mice. *Molecular neuropsychiatry*, 5(1), 42–51.



- Wei, Y., Krishnan, G. P., Komarov, M., & Bazhenov, M. (2018). Differential roles of sleep spindles and sleep slow oscillations in memory consolidation. *PLoS computational biology*, *14*(7), e1006322.
- Widman, A. J., & McMahon, L. L. (2018). Disinhibition of CA1 pyramidal cells by low-dose ketamine and other antagonists with rapid antidepressant efficacy. *Proceedings of the National Academy of Sciences of the United States of America*, *115*(13), E3007–E3016.
- Wiescholleck, V., & Manahan-Vaughan, D. (2012). PDE4 inhibition enhances hippocampal synaptic plasticity in vivo and rescues MK801-induced impairment of long-term potentiation and object recognition memory in an animal model of psychosis. *Translational psychiatry*, *2*(3), e89.
- Williams, S., & Boksa, P. (2010). Gamma oscillations and schizophrenia. *Journal of psychiatry & neuroscience : JPN*, *35*(2), 75–77.
- Winship, I. R., Dursun, S. M., Baker, G. B., Balista, P. A., Kandratavicius, L., Maia-de-Oliveira, J. P., Hallak, J., & Howland, J. G. (2019). An Overview of Animal Models Related to Schizophrenia. *Canadian journal of psychiatry. Revue canadienne de psychiatrie*, *64*(1), 5–17.
- Wittchen, H. U., Jacobi, F., Rehm, J., Gustavsson, A., Svensson, M., Jönsson, B., Olesen, J., Allgulander, C., Alonso, J., Faravelli, C., Fratiglioni, L., Jennum, P., Lieb, R., Maercker, A., van Os, J., Preisig, M., Salvador-Carulla, L., Simon, R., & Steinhausen, H. C. (2011). The size and burden of mental disorders and other disorders of the brain in Europe 2010. *European neuropsychopharmacology: the journal of the European College of Neuropsychopharmacology*, *21*(9), 655–679.
- Wobrock, T., Kadovic, D., & Falkai, P. (2007). Kortikale Erregbarkeit bei Schizophrenie. Untersuchungen mit der transkraniellen Magnetstimulation (TMS) [Cortical excitability in schizophrenia. Studies using transcranial magnetic stimulation]. *Der Nervenarzt*, *78*(7), 753–763.
- Wolf, J. A., Moyer, J. T., Lazarewicz, M. T., Contreras, D., Benoit-Marand, M., O'Donnell, P., & Finkel, L. H. (2005). NMDA/AMPA ratio impacts state transitions and entrainment to oscillations in a computational model of the nucleus accumbens medium spiny projection neuron. *The Journal of neuroscience : the official journal of the Society for Neuroscience*, *25*(40), 9080–9095.
- Wood, S. J., Pantelis, C., Proffitt, T., Phillips, L. J., Stuart, G. W., Buchanan, J. A., Mahony, K., Brewer, W., Smith, D. J., & McGorry, P. D. (2003). Spatial working memory ability is a marker of risk-for-psychosis. *Psychological medicine*, *33*(7), 1239–1247.
- Woodward N. D. (2017). Thalamocortical Functional Connectivity, Cognitive Impairment, and Cognitive Remediation in Schizophrenia. *Biological psychiatry. Cognitive neuroscience and neuroimaging*, *2*(4), 307–309.
- Woodward, N. D., & Heckers, S. (2016). Mapping Thalamocortical Functional Connectivity in Chronic and Early Stages of Psychotic Disorders. *Biological psychiatry*, *79*(12), 1016–1025.
- Woodward, N. D., Karbasforoushan, H., & Heckers, S. (2012). Thalamocortical dysconnectivity in schizophrenia. *The American journal of psychiatry*, *169*(10), 1092–1099.
- Wu, Y., Blichowski, M., Daskalakis, Z. J., Wu, Z., Liu, C. C., Cortez, M. A., & Snead, O. C., 3rd (2011). Evidence that clozapine directly interacts on the GABAB receptor. *Neuroreport*, *22*(13), 637–641.
- Wulff, K., Dijk, D. J., Middleton, B., Foster, R. G., & Joyce, E. M. (2012). Sleep and circadian rhythm disruption in schizophrenia. *The British journal of psychiatry : the journal of mental science*, *200*(4), 308–316.
- Xi, D., Keeler, B., Zhang, W., Houle, J. D., & Gao, W. J. (2009). NMDA receptor subunit expression in GABAergic interneurons in the prefrontal cortex: application of laser microdissection technique. *Journal of neuroscience methods*, *176*(2), 172–181.
- Xi, D., Li, Y. C., Snyder, M. A., Gao, R. Y., Adelman, A. E., Zhang, W., Shumsky, J. S., & Gao, W. J. (2011). Group II metabotropic glutamate receptor agonist ameliorates MK801-induced dysfunction of NMDA

receptors via the Akt/GSK-3 $\beta$  pathway in adult rat prefrontal cortex. *Neuropsychopharmacology : official publication of the American College of Neuropsychopharmacology*, 36(6), 1260–1274.

- Xi, D., Zhang, W., Wang, H. X., Stradtman, G. G., & Gao, W. J. (2009). Dizocilpine (MK-801) induces distinct changes of N-methyl-D-aspartic acid receptor subunits in parvalbumin-containing interneurons in young adult rat prefrontal cortex. *The international journal of neuropsychopharmacology*, 12(10), 1395–1408.
- Yamada, K., Noda, Y., Hasegawa, T., Komori, Y., Nikai, T., Sugihara, H., & Nabeshima, T. (1996). The role of nitric oxide in dizocilpine-induced impairment of spontaneous alternation behavior in mice. *The Journal of pharmacology and experimental therapeutics*, 276(2), 460–466.
- Yamamoto, M., Mizuki, Y., Suetsugi, M., Ozawa, Y., Ooyama, M., & Suzuki, M. (1997). Effects of dopamine antagonists on changes in spontaneous EEG and locomotor activity in ketamine-treated rats. *Pharmacology, biochemistry, and behavior*, 57(1-2), 361–365.
- Yonezawa, Y., Kuroki, T., Kawahara, T., Tashiro, N., & Uchimura, H. (1998). Involvement of gamma-aminobutyric acid neurotransmission in phencyclidine-induced dopamine release in the medial prefrontal cortex. *European journal of pharmacology*, 341(1), 45–56.
- Youdim, M. B., Gassen, M., Gross, A., Mandel, S., & Grünblatt, E. (2000). Iron chelating, antioxidant and cytoprotective properties of dopamine receptor agonist; apomorphine. *Journal of neural transmission. Supplementum*, (58), 83–96.
- Young, A., & Wimmer, R. D. (2017). Implications for the thalamic reticular nucleus in impaired attention and sleep in schizophrenia. *Schizophrenia research*, 180, 44–47.
- Yui, K., Goto, K., Ikemoto, S., Ishiguro, T., Angrist, B., Duncan, G. E., Sheitman, B. B., Lieberman, J. A., Bracha, S. H., & Ali, S. F. (1999). Neurobiological basis of relapse prediction in stimulant-induced psychosis and schizophrenia: the role of sensitization. *Molecular psychiatry*, 4(6), 512–523.
- Yung, A. R., & McGorry, P. D. (1996a). The initial prodrome in psychosis: descriptive and qualitative aspects. *The Australian and New Zealand journal of psychiatry*, 30(5), 587–599.
- Yung, A. R., & McGorry, P. D. (1996b). The prodromal phase of first-episode psychosis: past and current conceptualizations. *Schizophrenia bulletin*, 22(2), 353–370.
- Zanello, A., Curtis, L., Badan Bâ, M., & Merlo, M. C. (2009). Working memory impairments in first-episode psychosis and chronic schizophrenia. *Psychiatry research*, 165(1-2), 10–18.
- Zanini, M. A., Castro, J., Cunha, G. R., Asevedo, E., Pan, P. M., Bittencourt, L., Coelho, F. M., Tufik, S., Gadelha, A., Bressan, R. A., & Brietzke, E. (2015). Abnormalities in sleep patterns in individuals at risk for psychosis and bipolar disorder. *Schizophrenia research*, 169(1-3), 262–267.
- Zanini, M., Castro, J., Coelho, F. M., Bittencourt, L., Bressan, R. A., Tufik, S., & Brietzke, E. (2013). Do sleep abnormalities and misaligned sleep/circadian rhythm patterns represent early clinical characteristics for developing psychosis in high risk populations?. *Neuroscience and biobehavioral reviews*, 37(10 Pt 2), 2631–2637.
- Zhang, Y., Buonanno, A., Vertes, R. P., Hoover, W. B., & Lisman, J. E. (2012). NR2C in the thalamic reticular nucleus; effects of the NR2C knockout. *PLoS one*, 7(7), e41908.
- Zhang, Y., Quiñones, G. M., & Ferrarelli, F. (2020). Sleep spindle and slow wave abnormalities in schizophrenia and other psychotic disorders: Recent findings and future directions. *Schizophrenia research*, 221, 29–36.
- Zhang, Y., Yoshida, T., Katz, D. B., & Lisman, J. E. (2012). NMDAR antagonist action in thalamus imposes  $\delta$  oscillations on the hippocampus. *Journal of neurophysiology*, 107(11), 3181–3189.

- Zimmermann, R., Gschwandtner, U., Wilhelm, F. H., Pflueger, M. O., Riecher-Rössler, A., & Fuhr, P. (2010). EEG spectral power and negative symptoms in at-risk individuals predict transition to psychosis. *Schizophrenia research*, 123(2-3), 208–216.
- Zou, H., Zhang, C., Xie, Q., Zhang, M., Shi, J., Jin, M., & Yu, L. (2008). Low dose MK-801 reduces social investigation in mice. *Pharmacology, biochemistry, and behavior*, 90(4), 753–757.

**Etude neurophysiologique et théorique des  
mécanismes cellulaires et synaptiques sous-  
tendant les oscillations thalamocorticales  
aberrantes dans un modèle murin de  
transition psychotique**

**Résumé**

La schizophrénie est une maladie chronique invalidante. Des troubles cognitifs et de la qualité du sommeil sont observés pendant la transition psychotique. Les oscillations cérébrales, identifiables dans un électroencéphalogramme, sont également perturbées lors de la transition. Elles sont impliquées dans la cognition et représentent un marqueur de la qualité du sommeil. Les oscillations sont générées au sein du système corticothalamique et impliquent une transmission excitatrice glutamatergique. Nous avons donc testé l'hypothèse selon laquelle leur perturbation associée au passage à la psychose implique un hypofonctionnement des récepteurs du glutamate. En utilisant des approches neurophysiologiques, nous avons démontré, chez des rats endormis, que la kétamine, un antagoniste des récepteurs du glutamate, simule les perturbations liées à la psychose. Cet effet est prévenu par la clozapine, un antipsychotique largement utilisé en psychiatrie. Des outils mathématiques ont été utilisés pour développer un modèle neuronal de la transition psychotique. Les résultats de cette étude offrent une cible thérapeutique potentielle visant à prévenir la schizophrénie.

Mots-clés : Schizophrénie, Transition vers la psychose, Troubles du sommeil, Thalamus, Récepteur du glutamate, Kétamine, Clozapine

**Résumé en anglais**

Schizophrenia is an invalidating chronic disease. Warning cognitive signs and sleep disorders are seen during the psychotic transition. Brain oscillations, identifiable in an electroencephalogram, are also disturbed during the transitioning. They are involved in cognition and represent a marker of sleep quality. Oscillations are generated within the corticothalamic system and involve glutamatergic excitatory transmission. So, we tested the hypothesis that their disturbance associated with the transitioning to psychosis involves the hypofunction of glutamate receptors. Using neurophysiological approaches, we demonstrated, in sleeping rats, that ketamine, a glutamate receptor antagonist, simulates the psychosis-related disturbances. This effect was prevented by clozapine, an antipsychotic widely used in psychiatry. Mathematical tools were used to develop a neural model of psychotic transition. The present findings offer a potential therapeutic target aimed at preventing schizophrenia.

Keywords: Schizophrenia, Transition to psychosis, Sleep disturbances, Thalamus, Glutamate receptor, Ketamine, Clozapine