



**HAL**  
open science

# Valorization of plastic non-woven sheets of polyethylene terephthalate (PET) for the development of environmental friendly concrete

Sifatullah Bahij

► **To cite this version:**

Sifatullah Bahij. Valorization of plastic non-woven sheets of polyethylene terephthalate (PET) for the development of environmental friendly concrete. Materials. Université de Strasbourg, 2021. English. NNT : 2021STRAD020 . tel-03700988

**HAL Id: tel-03700988**

**<https://theses.hal.science/tel-03700988>**

Submitted on 21 Jun 2022

**HAL** is a multi-disciplinary open access archive for the deposit and dissemination of scientific research documents, whether they are published or not. The documents may come from teaching and research institutions in France or abroad, or from public or private research centers.

L'archive ouverte pluridisciplinaire **HAL**, est destinée au dépôt et à la diffusion de documents scientifiques de niveau recherche, publiés ou non, émanant des établissements d'enseignement et de recherche français ou étrangers, des laboratoires publics ou privés.

*ÉCOLE DOCTORALE 269 MATHÉMATIQUES, SCIENCES DE  
L'INFORMATION ET DE L'INGÉNIEUR (MSII)*

ICube UMR 7357

# THÈSE

présenté par :

**Sifatullah BAHIJ**

Soutenu le : 06 Décembre 2021

pour obtenir le grade de : **Docteur de l'Université de Strasbourg**

Discipline/ Spécialité : **Science de l'Ingénierie / Génie Civil – Matériaux**

**Valorization of Plastic Non-Woven Sheets of  
Polyethylene Terephthalate (PET) for the  
Development of Environmental Friendly Concrete**

**THÈSE dirigée par :**

[Mm. FEUGEAS Françoise]

Professeur, INSA Strasbourg (directrice)

[M. FAQIRI Amanullah]

Professeur, Université Polytechnique de Kaboul

(co-directeur)

**RAPPORTEURS :**

[M. LAFHAJ Zoubeir]

Professeur, l'Ecole Centrale de Lille

[M. WAIZY Hamidullah]

Professeur, Université Polytechnique de Kaboul

**AUTRES MEMBRES DU JURY :**

[Mm. GHORBEL Elhem]

Professeur, Cergy Paris Université

[M. SHNIZAI Zakeria]

Professeur, Université Polytechnique de Kaboul

**INVITE :**

[M. OMARY Safiullah]

MCF, INSA Strasbourg (co-encadrant)



UNIVERSITY OF STRASBOURG



*DOCTORAL SCHOOL OF MATHEMATICS, INFORMATION SCIENCES  
AND ENGINEERING – ED 269*

ICube UMR 7357

# THESIS

Presented by:

**Sifatullah BAHIJ**

Defended on: 06 December 2021

to obtain the degree of: **Ph.D. from the University of Strasbourg**

Discipline/Specialty: **Engineering Science / Civil Engineering – Materials**

**Valorization of Plastic Non-Woven Sheets of  
Polyethylene Terephthalate (PET) for the  
Development of Environmental Friendly Concrete**

**THESIS directed by:**

[Ms. FEUGEAS Françoise]

Professor, INSA Strasbourg (Director)

[Mr. FAQIRI Amanullah]

Professor, Kabul Polytechnic University (Co-director)

director)

**REPORTERS:**

[Mr. LAFHAJ Zoubeir]

Professor, l'Ecole Centrale de Lille

[Mr. WAIZY Hamidullah]

Professor, Kabul Polytechnic University

**OTHER MEMBERS OF THE JURY:**

[Ms. GHORBEL Elhem]

Professor, University of Cergy Paris

[Mr. SHNIZAI Zakeria]

Professor, Kabul Polytechnic University

**INVITED:**

[Mr. OMARY Safiullah]

MCF, INSA Strasbourg (Co-advisor)

---

Dedicated  
to  
my beloved parents, sisters, brothers, and wife  
for their love, sacrifices and prayers



## ACKNOWLEDGMENTS

All praise is due to Almighty Allah for granting me the knowledge, health, strength, patience, and endurance to complete this study with success.

I appreciate the moral and educational guidance of my dear parents, sisters, and brothers through whom Allah had made me climb the ladder of success, the great support, sacrifice, encouragement, and eternal love of my blessed wife, who maintained her tender loving care with patience in the course of my studies. Special words of thanks are due to my father Engr. Rahmatullah ZAHID for his encouragement, financial and unfailing support throughout these years of demanding studies. Moreover, a particular thank to my childhood teacher and Uncle Dr. Muhibullah ZAHIDY for his unforgettable support and encouragement for my future success.

I would like to express my sincerest gratitude to both Kabul Polytechnic University (KPU), Afghanistan, and Institut National des Sciences Appliquées-Strasbourg (INSA Strasbourg), France for supporting this research work, and providing me with the necessary resources to complete the program. I would also sincerely like to acknowledge the support of the French Embassy in Kabul and CAMPUS FRANCE for supporting and organizing the financial phase of this degree and research work.

I am highly indebted to express my deepest appreciation to my thesis directors, Prof. Dr. Françoise FEUGEAS and Prof. Dr. Amanullah FAQIRI, who have supported me throughout my research work with their patience, knowledge, and personal involvement. I would like to thank you for encouraging my research and for allowing me to grow as a research scientist. Your advice on both research as well as on my career have been invaluable.

I would like to express my special thanks to my thesis co-advisor, Dr. Safiullah OMARY, for unforgettable supporting me during these past four years. OMARY is someone you will instantly love and never forget once you meet him. He's a supportive, friendly, social person and one of the smartest people I know. I hope that I could be as lively, enthusiastic, and energetic as Mr. OMARY. He was and will be my primary resource for getting my science questions answered, insightful discussions about the research, and was instrumental in helping me crank out this thesis.

Moreover, it is a moral responsibility on my part to acknowledge the contribution of the Jury of thesis defense Prof. Elhem GHORBEL, Prof. Zoubeir LAFHAJ, Prof. Hamidullah WAIZY, and Prof. Zakeria SHNIZAI for their valuable contributions, guidance, moral support, and encouragement. Their valuable suggestions greatly helped me to complete this research work.

Furthermore, the research work would be a mess, if not for the immense support of our departmental personals: Dr. Vincent STEINER, Engr. Damien KAELBEL, and Eng. Naqibullah WAHIDY for their tireless efforts during the experimental phase.

Finally, I have to thank my Afghan friends: Sayed Bashir HASHMI, Sayed Hashim MOHSENI, Sayed Mudasser SHOBAIR, Manzoor SADAT, Omran AMERKHIL, Khisraw HABIB, Khanullah FULAD ARAB, Ali Ahmad FAIZY, Naseer SAHIL, and Amran MOHAMMADKHEL living in Strasbourg, France. Their care and support helped me a lot throughout my graduate studies.

## ABSTRACT

It is a fact that plastic packages are widely used over the world. This large-scale consumption has resulted in the decrease of initial resources used to manufacture the packages and has made it more of a challenge to dispose of the increased amount of solid plastic wastes. Plastic waste is one of the most significant types of waste materials in the world, owing to its non-degradation and low biodegradability. The presence of large quantities of plastic wastes has resulted in a variety of environmental issues. Therefore, various researches have already been conducted to find a safe and environmentally friendly solution for the disposal of plastic wastes. Recently, the researchers have explored that one possible solution is the incorporation of plastic wastes into cementitious materials due to their long service life and lower weight.

This study intends to investigate the effect of non-woven polyethylene terephthalate (PET) waste plastic tissue on the fresh, physical, mechanical, acoustic, thermal, and microstructural behaviors of mortar and concrete. Including reference specimens, non-woven fabrics were considered in two ways: a) as a layer with 5 various configurations of 1-Layer, 2-Layers, 2-Sides, 3-Sides, and full wrapping to strengthen specimens, and b) as cut pieces (10×10) mm with four different incorporated ratios of 0%, 0.25%, 0.50%, and 0.75%. Lastly, the bond properties between non-woven sheets and cementitious materials were investigated as well.

The results indicate that the mechanical properties (compressive, split tensile, and flexural strengths) were remarkably improved while applying non-woven sheets as a layer. Even though SEM analysis observed excellent distribution of cut pieces and good bonding between cementitious materials and PET fabrics, but mechanical properties were decreased with the incorporation of non-woven tissue as cut pieces. Moreover, the control specimens showed brittle behaviors and were damaged to many fragments after mechanical testing. While samples strengthened or containing cut pieces of non-woven tissue had improved ductility, were maintained together, and not separated into many small parts.

On the other hand, the incorporation of cut pieces of non-woven sheets resulted in the reduction of workability, fresh and dry densities and these reductions were more significant for higher percentages. Additionally, the porosity and water absorption were enhanced with the incorporation of cut pieces and increased further for higher volume fractions of cut

pieces. Also, the attachment of non-woven tissue as a layer to strengthened concrete samples or incorporation of cut pieces in concrete mixtures resulted in remarkable improvements in acoustic and thermal properties.

Furthermore, it was found that non-woven tissue has a very good bond with cementitious materials without using any adhesive materials. However, the bond behaviors enhanced with the increase of w/c ratio and reduction of superplasticizer content. This is because of the microstructure of non-woven sheet that is made of hairlines microfilaments that interacted inside the cement paste after mortar casting. This phenomenon was verified by interferometry and microscopic analysis as well.

Finally, the correlations between different properties of concrete have plotted between each other, the trend of lines and  $R^2$  coefficient clearly prove the excellent accuracies. It means that certain properties of such type of concrete could be predicted from other already known behaviors. In addition, the current research data was checked by previously developed models and shows great accuracy as well.

## RESUME

Les emballages en plastique sont largement utilisés dans le monde. Leur consommation a un impact sur la diminution des ressources initiales pour leur fabrication. De plus, l'élimination de ce type de déchets est plus difficile en raison de la quantité accrue de la production quotidienne. Les déchets plastiques sont quantitativement les plus importants parmi les déchets solides en raison de leur non dégradabilité ou de leur faible caractéristique de biodégradabilité. La présence de grandes quantités de déchets plastiques a donc des impacts environnementaux importants. Diverses recherches expérimentales ont été effectuées pour trouver des solutions respectueuses pour l'environnement concernant l'élimination de ces déchets solides. Récemment, pour réduire l'impact environnemental, différents types de déchets plastiques ont été incorporés dans les formulations de matériaux cimentaires [1–6].

Cette étude vise à lever certains verrous scientifiques afin de rendre possible l'utilisation des déchets de polyéthylène téréphtalate (PET) intissé pour élaborer de nouveaux mortiers ou bétons et d'étudier leurs effets sur les propriétés à l'état frais, propriétés physiques, propriétés mécaniques, propriétés acoustiques, propriétés thermiques et microstructurales des matériaux cimentaires. Le PET intissé a été utilisé en faisant varier le type d'incorporation : a) comme une couche et b) sous forme de pièces découpées. Dans le cadre d'utilisation en tant qu'une couche, 5 différentes configurations ont été réalisées : 1 couche, 2 couches, 2 faces, 3 faces et enveloppement complet pour renforcer des échantillons. De plus, sous forme de morceau avec une dimension de (10×10) mm, trois différents taux d'incorporation de 0,25%, 0,50% et 0,75% ont été incorporés dans le mortier/béton. Enfin, le phénomène d'adhésion entre intissé et matériaux cimentaire a été également analysé.

Dans un premier temps, la caractérisation des matériaux utilisés a été réalisée pour assurer leur qualité en accord avec les normes. Les propriétés physiques et mécaniques des granulats (gravillons et sable) ont été étudiées. Les résultats montrent une conformité de ces matériaux selon les normes européennes. De plus, deux types de ciment : CEM I 52,5 N (ciment européen) et GHORI (ciment Afghan) ont été utilisés pour l'élaboration de mortier et béton. Les ciments utilisés ont été caractérisés par l'analyse granulométrie laser, les mesures de masse volumique, module de finesse et temps de prise.

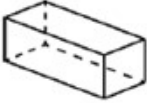
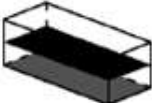
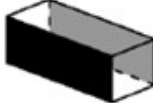


Les propriétés caractérisées des deux ciments (CEM I et GHORI) ont été récapitulées dans le **Tableau 1**. En général, le ciment GHORI présente des caractéristiques plus faibles que le CEM I. De plus, dans certains cas, le ciment GHORI ne répond pas aux recommandations et exigences des normes internationales.

**Tableau 1:** Caractéristiques des ciments CEM I 52.5 N et GHORI

Propriétés	CEM I 52,5 N	GHORI
Masse volumique (gr/cm <sup>3</sup> )	3,104 ±0,002	3,003 ±0,009
Surface massique (cm <sup>2</sup> /gr)	4509 ±257	2764 ±303
Rapport Eau sur Ciment (E/C) pour la consistance normalisée	0,330	0,266
Temps de début de prise (min)	127 ±1,6	97 ±2,5
Temps de fin de prise (min)	273 ±1,6	182 ±2,2

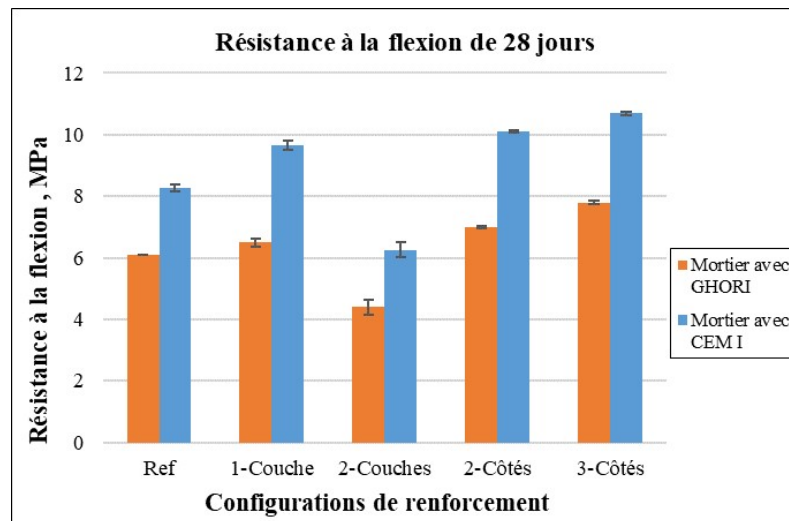
Dans un deuxième temps, l'utilisation de PET intissé en tant que couche et morceau dans le mortier/béton a été analysée. Les propriétés mécaniques (résistances à la compression, à la traction par fendage et à la flexion), de transferts (conductivité thermique et acoustique) ainsi que le phénomène d'adhésion ont été étudiées. Le **Tableau 2** donne une synthèse des observations post-rupture réalisées pour chaque d'éprouvette soumis à l'essai de flexion et compression.

**Tableau 2:** Synthèse des observations post-rupture des éprouvettes

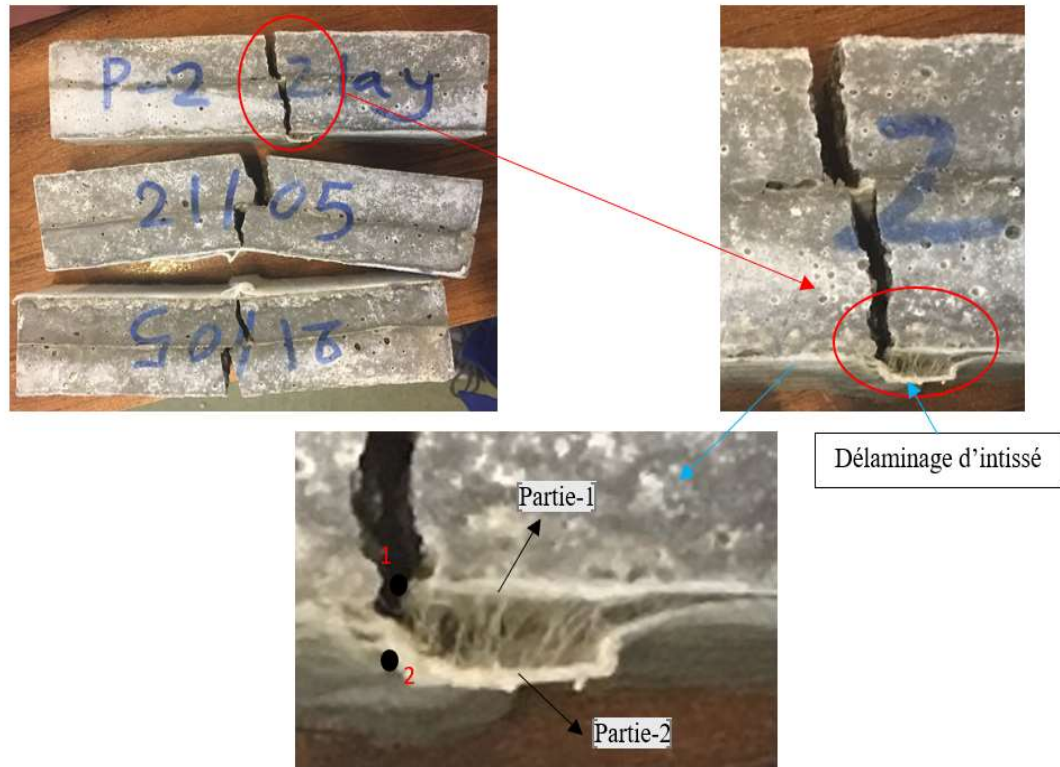
Type	Référence	2a	2b	3	4
					
Position de l'intissé	-	Milieu dessous	Deux cotés	Deux cotés et dessous	Intérieur
Forme du béton	Oui, droite au centre	Feuilles 16×4 cm	Feuilles 16×4 cm	U 16×12 cm	Morceaux 1×1 cm
Rupture de l'intissé	-	Oui, au centre	Oui, au centre	Oui, au centre	Oui, au centre
Décollement du textile	-	Partielle	Partielle	non	Partielle
Décollement béton-textile	-	non	non	non	non
Délaminage du textile	-	Oui, type I	non	Oui, type I	non

Force maintien des deux parties par l'intissé	-	Moyenne	Forte	Très forte	Faible
--	---	---------	-------	------------	--------

Les résultats expérimentaux indiquent une amélioration significative de ces propriétés en fonction du placement de ces couches. Par ailleurs, les échantillons renforcés avec ces couches d'intissé ont montré des comportements ductiles et ont montré un bon comportement après charge ultime à celles des échantillons de référence (sans intissé) qui présentent un mode d'endommagement typique en se séparant en plusieurs parties. Les résultats obtenus pour l'essai de flexion au 3-point ont été illustrés dans la **Figure 1** et **Figure 2**.



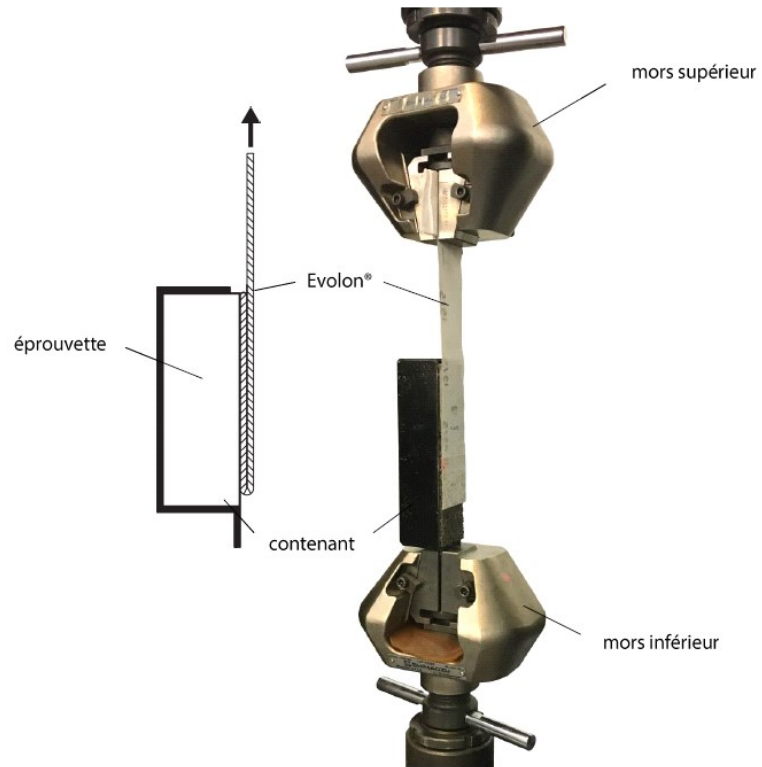
**Figure 1:** Résistance à la flexion des mortiers avec les différents configurations de couche d'intissé



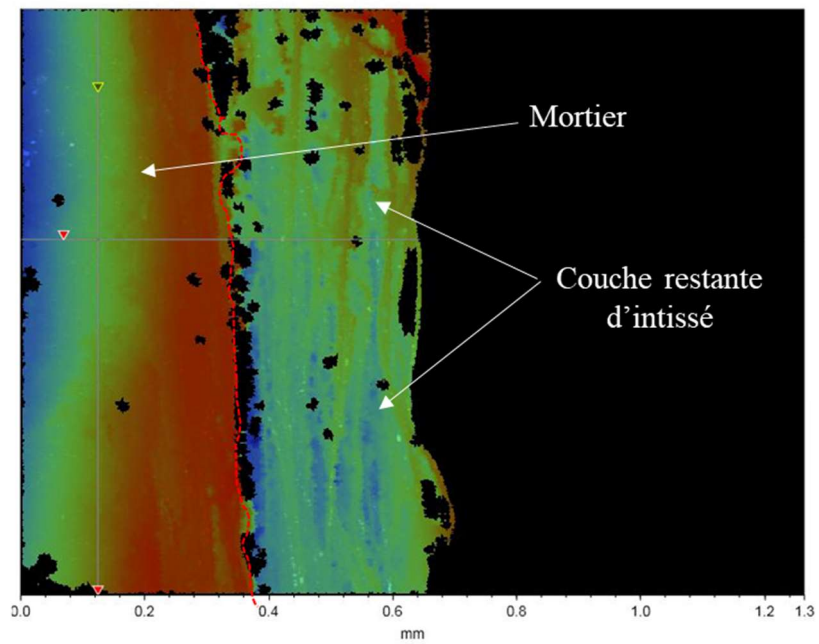
**Figure 2:** Rupture de l'éprouvette avec une seule couche d'intissé

De plus, un essai d'arrachement à 180° a été effectué pour analyser l'adhésion entre l'intissé et mortier (**Figure 3**). Les résultats expérimentaux montrent qu'une bonne adhésion a été enregistrée entre l'intissé et le mortier. Les analyses microscopiques (interférométrie, optique, électronique) montrent qu'une couche d'environ 0,6 mm d'intissé reste sur la surface de l'éprouvette après le test d'arrachage, ce qui démontre une très bonne adhésion (**Figure 4**). Les essais d'arrachement ont été réalisés sous deux conditions : augmentation du rapport E/C sans et avec maintien de classe de consistance. Les résultats soulignent que l'augmentation du rapport E/C et la diminution de superplastifiant permettent une amélioration de l'adhésion (**Figure 5**).

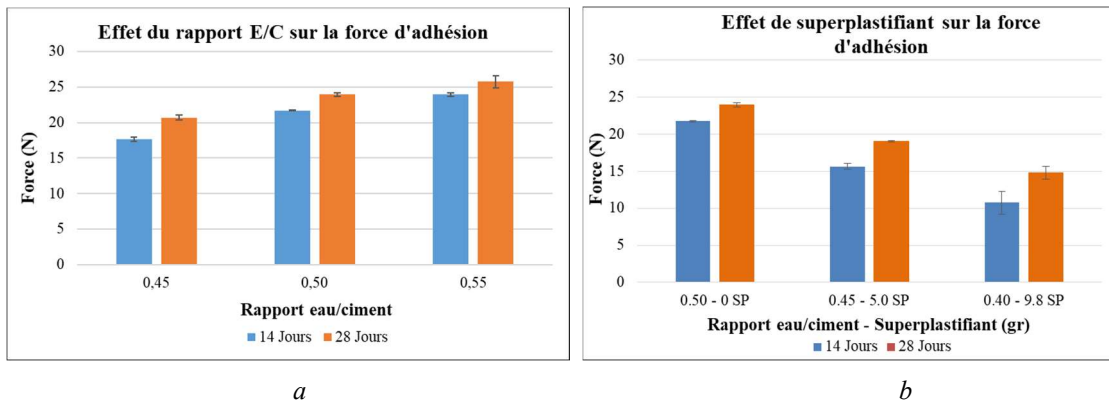




*Figure 3: Montage expérimental pour les essais d'arrachement*

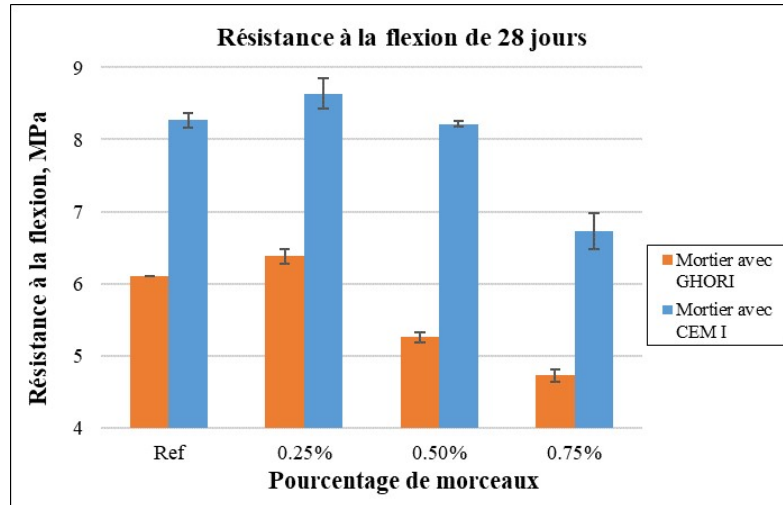


*Figure 4: Epaisseur de la couche d'intissé restante après l'essai d'arrachement*



**Figure 5:** Effet de a) rapport E/C et b) superplastifiant sur la force d'adhésion

Dans un troisième temps, l'effet de l'incorporation de PET tissé en tant que morceaux dans les formulations de mortier ou béton a été étudié. Les propriétés des formulations à l'état frais, les propriétés physiques (masse volumique et porosité), les propriétés mécaniques (résistances à la compression, à la traction par fendage et à la flexion), de transferts (conductivité thermique et acoustique) ainsi que la microstructure ont été étudiées. Les résultats obtenus indiquent une réduction significative de la maniabilité des mortiers et/ou bétons où une corrélation inverse existe entre la maniabilité et le taux d'incorporation de morceau d'intissé qui est liée à la capacité d'absorption élevée de l'intissé. Les résultats obtenus sont en accord avec ceux de la littérature [7]. En raison de la faible masse volumique d'intissé, la masse volumique apparente à l'état frais des mélanges diminue avec l'augmentation du taux d'intissé incorporé. Par contre, à l'état durci, la porosité accessible à l'eau augmente et la densité diminue avec l'augmentation de quantité d'intissé dans les formulations. De plus, les propriétés mécaniques ont été significativement diminuées avec l'augmentation du pourcentage de morceaux d'intissé (**Figure 6** et **Figure 7**). Les résultats obtenus sont en accord avec ceux de la littérature [8].



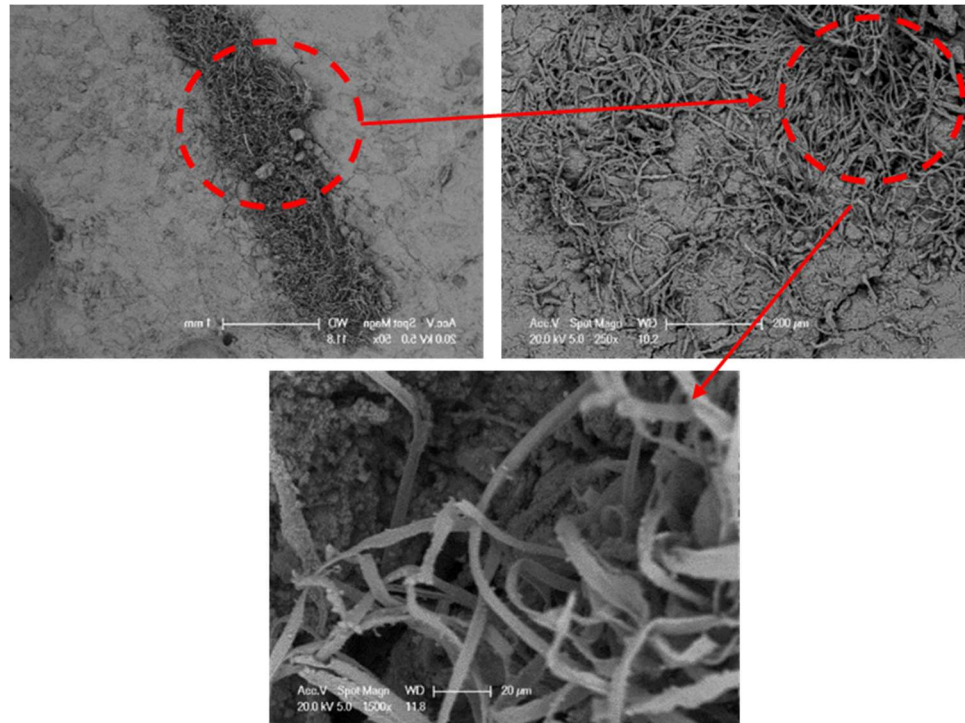
*Figure 6: Résistance à la flexion des mortiers avec l'incorporation d'intissé en tant que morceaux*



*Figure 7: Rupture des échantillons de mortier avec l'incorporation d'intissé en tant que morceaux*

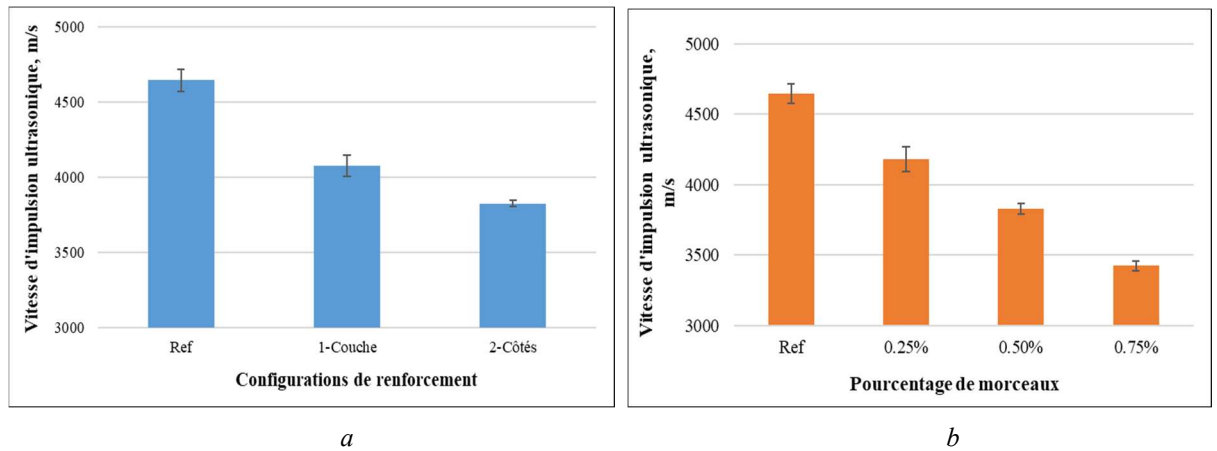
Les mortiers incorporés des morceaux d'intissé pourraient être présentés comme un matériau tri-phasique composé d'une matrice cimentaire et de sable avec des morceaux d'intissé (PET) séparés par une zone de transition (ITZ). L'analyse d'image microstructurales de Microscopie Electronique à Balayage (MEB) sur des surfaces polies indique une faible liaison d'ITZ entre morceau incorporé d'intissé et pâte cimentaire en comparant avec celle entre pâte cimentaire et sable. De plus, les images en microscopie électronique montrent une augmentation de la quantité des pores dans les mélanges avec morceaux d'intissé comme illustré dans les images de **Figure 8**. Ainsi, l'augmentation de porosité et la diminution des propriétés mécaniques pourraient être liées avec la faiblesse des zones de transition interfaciale. Par ailleurs, de la même façon que les échantillons avec couche d'intissé, la rupture des échantillons avec morceaux d'intissé présente un comportement ductile et les éprouvettes restent en une seule partie après charge ultime par

comparaison avec les échantillons de référence (sans intissé) qui présentent un mode d'endommagement typique en se séparant en plusieurs parties (*Figure 7*).



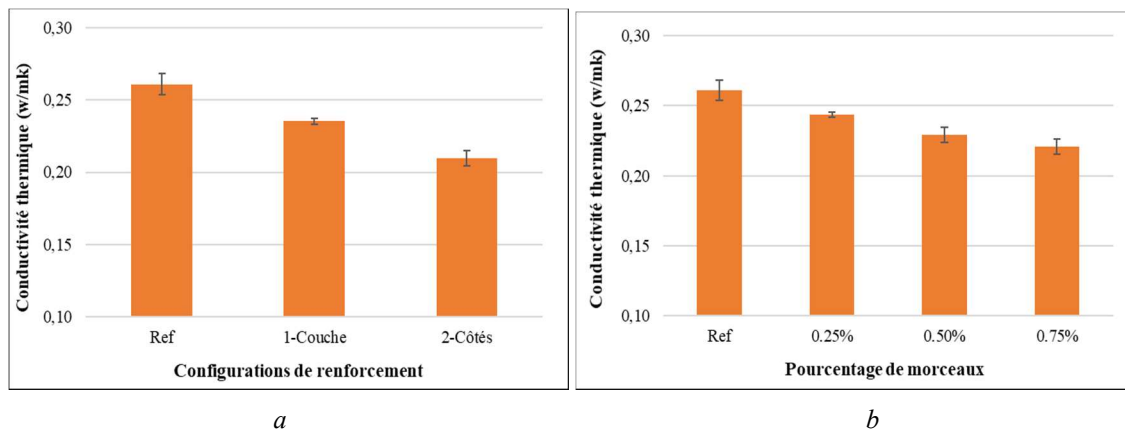
*Figure 8: Analyses des images par MEB sur les mortiers avec des morceaux d'intissé*

Les propriétés acoustiques des échantillons contenant du PET intissé, quel que soit leur mode d'incorporation : en couche ou en morceau, ont considérablement diminué par rapport à celles des échantillons de référence. Ceci peut être expliqué par l'importante porosité de l'intissé qui augmente la porosité interne de la structure en étant incorporé comme des morceaux ou la porosité de surface de la structure lorsque l'intissé est en couche. De plus, l'intissé a une valeur de vitesse d'impulsion ultrasonore inférieure à celle du matériau cimentaire (*Figure 9*). Les résultats obtenus sont également en accord avec ceux de la littérature [9].



**Figure 9:** Effet de d'intissé en tant que a) couche et b) morceaux sur la propriété acoustique

De la même façon, indépendamment du type d'incorporation d'intissé, les conductivités thermiques des échantillons avec intissé sont plus faibles que celles des échantillons de référence (**Figure 10**). Cela est dû à la conductivité thermique inférieure d'intissé par rapport aux autres composants du mélange. Ces résultats sont aussi en accord avec ceux de la littérature [10].



**Figure 10:** Effet de d'intissé en tant que a) couche et b) morceaux sur la propriété thermique

Les corrélations entre les propriétés étudiées des mortiers ou bétons ont été établies à travers des résultats expérimentaux de cette étude et ceux issus de la littérature. Les modèles empiriques ont été proposés (**Figure 11**).

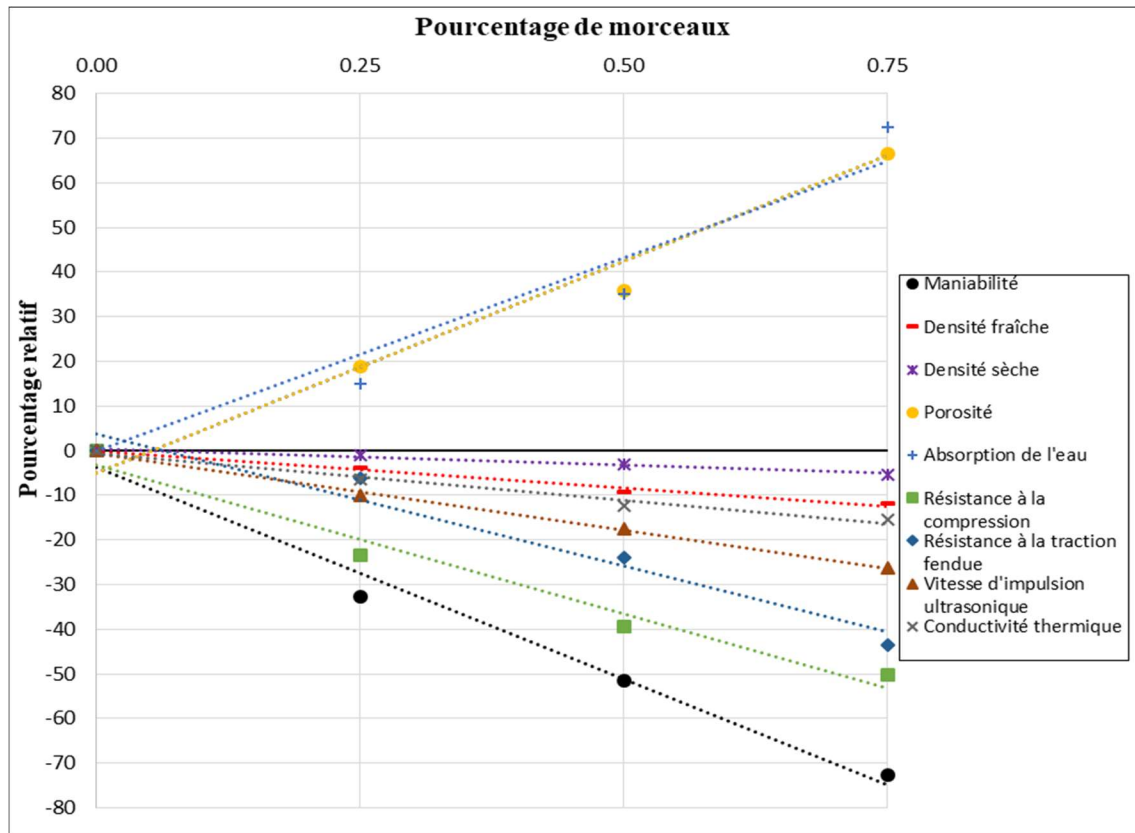


Figure 11: Effet d'intissé en tant que morceaux sur les propriétés béton

Finally, the experimental results obtained in the framework of this work allow the highlighting of the incorporation of recycled polyethylene terephthalate (PET) waste in cementitious materials. The use of PET waste as a layer shows a significant improvement of mechanical properties with a ductile behavior under mechanical stress. On the contrary, these properties decrease when incorporating PET waste in the form of pieces. Independently of the use of PET waste, the properties of transfers: acoustic and thermal of cementitious materials improve. Finally, the use of this kind of waste (recycled PET) can be recommended as a layer for the improvement of mechanical properties and transfers.

### Valorisation de la recherche

#### ❖ Publications dans les revues internationales avec comité de lecture

- 1) **Sifatullah Bahij**, S. Omary, F. Feugeas, A. Faqiri, Fresh and hardened properties of concrete containing different forms of plastic waste – a review, *Waste Management*. 113 (2020) 157–175. <https://doi.org/10.1016/j.wasman.2020.05.048>

- 2) **Sifatullah Bahij**, Safiullah Omary, Françoise Feugeas and Amanullah Faqiri, Structural Strengthening/Repair of Reinforced Concrete (RC) Beams by Different Fibre-Reinforced Cementitious Materials - A State-of-the-Art Review. *Civil Environ Eng* 10 (2020): 354 <https://doi: 10.37421/jcce.2020.10.354>
- 3) **Sifatullah Bahij**, Safiullah Omary, Vincent Steiner, Françoise Feugeas, Amanullah Faqiri “Experimental study on concrete specimens strengthened with non-woven sheets, *International Journal of Civil Infrastructure*, 4(2021): 128-137. DOI: [10.11159/ijci.2021.016](https://doi: 10.11159/ijci.2021.016)
- 4) **Sifatullah Bahij**, Safiullah Omary, Vincent Steiner, Françoise Feugeas and Amanullah Faqiri “Structural behaviors of reinforced concrete (RC) beams strengthened with different types and methods of fiber reinforced polymers (FRP) - A critical review”, *Peer Review* in the *Journal of Practice Periodical on Structural Design and Construction*.

❖ **Communications en conférences internationales avec comité de lecture**

- 1) **Sifatullah Bahij**, Safiullah Omary, Françoise Feugeas and Amanullah Faqiri. “Use of Non-Woven Polyethylene Terephthalate (PET) Tissue to improve Certain Properties of the Concrete” *Proceedings of the 6<sup>th</sup> International Conference on Civil, Structural and Transportation Engineering (ICCSTE'21)* Niagara Falls, Canada – May 17-19, 2021. DOI: [10.11159/iccste21.157](https://doi: 10.11159/iccste21.157)
- 2) **Sifatullah Bahij**, Safiullah Omary, Vincent Steiner, Françoise Feugeas and Amanullah Faqiri. “Strengthening of Mortar Specimens with Non-Woven Plastic Sheets”, *Proceedings of Fib Symposium 2021*, Lisbon, June 14-16, 2021
- 3) **Sifatullah Bahij**, Safiullah Omary, Vincent Steiner, Françoise Feugeas, Amanullah Faqiri “Effect of PET Plastic Cut Pieces’ Aspect Ratio on Fresh and Mechanical Properties of Cement Mortar” **accepted** to *7<sup>th</sup> International Conference on Civil, Structural and Transportation Engineering (ICCSTE'22)*.

**Prix**

- Prix du meilleur article et présentation lors de la 6<sup>ème</sup> Conférence internationale sur le génie civil, structurel et des transports (*International Conference on Civil, Structural, and Transportation Engineering*) Niagara Falls, Canada – 17-19 mai 2021.



# TABLE OF CONTENTS

<b>ACKNOWLEDGMENTS</b> .....	<b>I</b>
<b>ABSTRACT</b> .....	<b>III</b>
<b>RESUME</b> .....	<b>V</b>
<b>TABLE OF CONTENTS</b> .....	<b>XVI</b>
<b>LIST OF FIGURES</b> .....	<b>XXI</b>
<b>LIST OF TABLES</b> .....	<b>XXV</b>
<b>LIST OF ABBREVIATIONS</b> .....	<b>XXVI</b>
<b>GENERAL INTRODUCTION</b> .....	<b>1</b>
<b>CHAPTER # 1</b> .....	<b>7</b>
<b>BIBLIOGRAPHIC RESEARCH</b> .....	<b>7</b>
<b>1. USE OF PLASTIC WASTE AS FIBERS IN CEMENTITIOUS MATERIALS</b> .....	<b>7</b>
<b>1.1. Fresh state: workability and density</b> .....	<b>8</b>
<b>1.2. Physical properties: density and water absorption</b> .....	<b>12</b>
<b>1.3. Mechanical properties</b> .....	<b>15</b>
1.3.1. <i>Compressive strength</i> .....	15
1.3.2. <i>Flexural strength</i> .....	18
1.3.3. <i>Split tensile strength</i> .....	19
<b>1.4. Transfer properties</b> .....	<b>25</b>
1.4.1. <i>Thermal conductivity</i> .....	25
1.4.2. <i>Ultrasonic pulse velocity (UPV)</i> .....	26
<b>2. CONCLUSIONS</b> .....	<b>26</b>
<b>3. RESEARCH OBJECTIVES</b> .....	<b>28</b>
<b>CHAPTER # 2</b> .....	<b>29</b>
<b>MATERIALS AND METHODS</b> .....	<b>29</b>
<b>1. MATERIALS</b> .....	<b>29</b>
<b>1.1. Cement</b> .....	<b>29</b>
<b>1.2. Aggregates</b> .....	<b>30</b>
<b>1.3. Water</b> .....	<b>31</b>
<b>1.4. Superplasticizer</b> .....	<b>32</b>



1.5.	Non-woven PET plastic tissue .....	32
<b>2.</b>	<b>EXPERIMENTAL METHODS FOR THE CHARACTERIZATION OF MORTAR/CONCRETE COMPONENTS .....</b>	<b>34</b>
<b>2.1.</b>	<b>Cement.....</b>	<b>35</b>
2.1.1.	<i>Specific gravity and bulk density .....</i>	35
2.1.2.	<i>Normal consistency and setting times (initial and final setting time) .....</i>	35
2.1.3.	<i>Laser Granulometry .....</i>	35
<b>2.2.</b>	<b>Aggregates.....</b>	<b>36</b>
2.2.1.	<i>Specific gravity, bulk density, and water absorption .....</i>	36
2.2.2.	<i>Size distribution .....</i>	37
2.2.3.	<i>Los Angeles .....</i>	37
<b>2.3.</b>	<b>Water .....</b>	<b>38</b>
2.3.1.	<i>pH value.....</i>	38
<b>2.4.</b>	<b>Non-woven sheets .....</b>	<b>38</b>
2.4.1.	<i>Traction force .....</i>	38
<b>3.</b>	<b>EXPERIMENTAL METHODS FOR MORTAR/CONCRETE .....</b>	<b>39</b>
<b>3.1.</b>	<b>Mix design and mixing procedure of mortar .....</b>	<b>39</b>
<b>3.2.</b>	<b>Mix design and mixing procedure of concrete.....</b>	<b>41</b>
<b>3.3.</b>	<b>Casting and curing of mortar/concrete .....</b>	<b>44</b>
<b>3.4.</b>	<b>Fresh properties.....</b>	<b>45</b>
3.4.1.	<i>Workability .....</i>	45
3.4.2.	<i>Fresh density.....</i>	45
<b>3.5.</b>	<b>Physical properties.....</b>	<b>46</b>
<b>3.6.</b>	<b>Mechanical properties .....</b>	<b>47</b>
3.6.1.	<i>Flexural strength .....</i>	47
3.6.2.	<i>Compressive strength .....</i>	48
3.6.3.	<i>Split tensile strength.....</i>	48
<b>3.7.</b>	<b>Transfer properties .....</b>	<b>49</b>
3.7.1.	<i>Ultrasonic pulse velocity (UPV).....</i>	49
3.7.2.	<i>Thermal conductivity .....</i>	49
<b>3.8.</b>	<b>Microstructure imaging analysis by Scanning Electron Microscopy (SEM) .....</b>	<b>50</b>
<b>3.9.</b>	<b>Bond properties.....</b>	<b>51</b>
<b>4.</b>	<b>CONCLUSIONS .....</b>	<b>54</b>

<b>CHAPTER # 3 .....</b>	<b>56</b>
<b>CHARACTERIZATION OF CONCRETE/MORTAR COMPONENTS.....</b>	<b>56</b>
<b>1. CHARACTERIZATION OF CEMENT.....</b>	<b>56</b>
1.1. Laser granulometry .....	56
1.2. Specific gravity and bulk density.....	59
1.3. Normal consistency and setting times .....	59
<b>2. CHARACTERIZATION OF AGGREGATES .....</b>	<b>61</b>
2.1. Size distribution .....	61
2.2. Specific gravity and water absorption.....	62
2.3. Bulk density.....	63
2.4. Los Angeles.....	64
<b>3. CHARACTERIZATION OF WATER .....</b>	<b>65</b>
3.1. pH value .....	65
<b>4. CHARACTERIZATION OF NON-WOVEN TISSUE .....</b>	<b>65</b>
4.1. Traction force .....	65
<b>5. CONCLUSIONS .....</b>	<b>66</b>
<b>CHAPTER # 4 USE OF NON-WOVEN TISSUE IN MORTAR .....</b>	<b>68</b>
<b>1. USE OF NON-WOVEN SHEETS AS A LAYER IN MORTAR WITH CEM I AND GHORI CEMENT .....</b>	<b>69</b>
1.1. Effect of layer on fresh properties of mortar .....	71
1.2. Effect of layer on mechanical properties of mortar .....	72
1.2.1. Flexural strength .....	72
1.2.2. Compressive strength.....	78
1.2.3. Split tensile strength.....	81
1.3. Effect of layer on ultrasonic pulse velocity (UPV) of mortar .....	82
<b>2. USE OF NON-WOVEN SHEETS INCORPORATED AS CUT PIECES IN MORTAR</b>	<b>84</b>
2.1. Effect of cut pieces on fresh properties of mortar .....	84
2.1.1. Workability.....	84
2.1.2. Fresh density.....	85
2.2. Effect of cut pieces on physical properties .....	86
2.2.1. Dry density.....	86

2.2.2.	<i>Porosity and water absorption</i> .....	87
<b>2.3.</b>	<b>Effect of cut pieces on mechanical properties</b> .....	<b>88</b>
2.3.1.	<i>Flexural Strength</i> .....	88
2.3.2.	<i>Compressive strength</i> .....	91
2.3.3.	<i>Split tensile strength</i> .....	95
<b>2.4.</b>	<b>Effect of cut pieces on ultrasonic pulse velocity (UPV)</b> .....	<b>97</b>
<b>4.</b>	<b>EFFECT OF ASPECT RATIO (<math>L/W</math>) OF NON-WOVEN TISSUE ON CERTAIN PROPERTIES OF MORTAR</b> .....	<b>99</b>
<b>4.1.</b>	<b>Effect of aspect ratio on fresh properties of mortar</b> .....	<b>100</b>
4.1.1.	<i>Workability</i> .....	100
<b>4.2.</b>	<b>Effect of aspect ratio on physical properties</b> .....	<b>102</b>
4.2.1.	<i>Bulk density</i> .....	102
4.2.2.	<i>Porosity</i> .....	103
<b>4.3.</b>	<b>Effect of aspect ratio on mechanical properties</b> .....	<b>105</b>
4.3.1.	<i>Flexural strength</i> .....	105
4.3.2.	<i>Compressive strength</i> .....	106
<b>5.</b>	<b>BOND PROPERTIES BETWEEN NON-WOVEN SHEETS AND MORTAR</b> .....	<b>108</b>
<b>5.1.</b>	<b>Effect of water content (w/c ratio) on adhesion force</b> .....	<b>109</b>
5.1.1.	<i>Interferometry analysis</i> .....	111
5.1.2.	<i>Microscopic analysis</i> .....	113
5.1.3.	<i>Mechanical strengths</i> .....	116
<b>5.2.</b>	<b>Effect of superplasticizer content on adhesion force</b> .....	<b>118</b>
5.2.1.	<i>Interferometry analysis</i> .....	120
5.2.2.	<i>Microscopic analysis</i> .....	121
<b>6.</b>	<b>CONCLUSIONS</b> .....	<b>124</b>
<b>CHAPTER # 5</b>	<b>USE OF NON-WOVEN TISSUE IN CONCRETE</b> .....	<b>127</b>
<b>1.</b>	<b>USE OF NON-WOVEN SHEET AS A LAYER IN CONCRETE</b> .....	<b>128</b>
<b>1.1.</b>	<b>Effect of layer on fresh properties of concrete</b> .....	<b>129</b>
<b>1.2.</b>	<b>Effect of layer on mechanical properties of concrete</b> .....	<b>130</b>
1.2.1.	<i>Compressive strength</i> .....	130
1.2.2.	<i>Flexural strength</i> .....	133
1.2.3.	<i>Split tensile strength</i> .....	136
<b>1.3.</b>	<b>Effect of layer on ultrasonic pulse velocity (UPV) of concrete</b> .....	<b>137</b>

1.4.	Effect of layer on thermal properties of concrete .....	138
<b>2.</b>	<b>USE OF NON-WOVEN SHEETS AS CUT PIECES INCORPORATED IN CONCRETE</b>	<b>140</b>
2.1.	Effect of cut pieces on fresh properties of concrete.....	141
2.1.1.	Workability .....	141
2.1.2.	Fresh density.....	142
2.2.	Effect of cut pieces on physical properties of concrete .....	143
2.2.1.	Dry density.....	143
2.2.2.	Porosity and water absorption .....	144
2.3.	Effect of cut pieces on mechanical properties of concrete .....	145
2.3.1.	Compressive strength .....	145
2.3.2.	Split tensile strength.....	147
2.4.	Effect of cut pieces on ultrasonic pulse velocity (UPV) of concrete.....	152
2.5.	Effect of cut pieces on thermal properties of concrete .....	152
<b>3.</b>	<b>CONCLUSIONS .....</b>	<b>157</b>
	<b>GENERAL CONCLUSIONS AND PERSPECTIVES.....</b>	<b>159</b>
	<b>REFERENCES .....</b>	<b>163</b>
	<b>ANNEXES.....</b>	<b>172</b>

## LIST OF FIGURES

Figure 1- 1: Slump values versus volume fraction of MPW [37].....	9
Figure 1- 2: Wet density for all SCCs mixtures containing plastic fibers [8].....	12
Figure 1- 3: Density of hardened mortar as a function of percentages of fibers [27].....	13
Figure 1- 4: Water absorption of the concrete mixtures containing PP fibers [29].....	14
Figure 1- 5: Compressive strength of concrete mixtures [34].....	15
Figure 1- 6: Compressive strength of concrete mixtures with plastic fibers [29].....	17
Figure 1- 7: Compressive strength versus plastic fiber ratio [8].....	17
Figure 1- 8: Flexural strength of different fiber-reinforced concrete [29].....	18
Figure 1- 9: Flexural strength versus percentage of plastic fibers [30].....	19
Figure 1- 10: Split tensile strength versus percentage of PET plastic fibers [30].....	20
Figure 1- 11: Relative percentage for the effect of plastic fibers on mechanical properties [38].	24
Figure 2- 1: Compressive strength of CEM I 52.5 N [48].....	30
Figure 2- 2: Types of aggregates; a) fine aggregates (sand), b) fine coarse aggregates, and c) coarse aggregates used in INSA Strasbourg.....	31
Figure 2- 3: Types of aggregates; a) fine aggregates (sand), b) fine coarse aggregates, and c) coarse aggregates used in Kabul Polytechnic University (KPU).....	31
Figure 2- 4: Types of bi-component fiber cross-sections [53,54].....	33
Figure 2- 5: Evolon® non-woven plastic tissue.....	33
Figure 2- 6: Principle of hydro entangling [57].....	34
Figure 2- 7: Equipment of the laser diffraction test.....	36
Figure 2- 8: Equipment for applying traction force on non-woven tissue.....	39
Figure 2- 9: Mortar mixers: a) INSA and b) KPU.....	41
Figure 2- 10: Mix of non-woven cut pieces within the sand.....	41
Figure 2- 11: Casting of samples.....	44
Figure 2- 12: Forms of slumps [71].....	45
Figure 2- 13: Flexural testing machine: a) INSA and b) KPU.....	47
Figure 2- 14: Arrangement of spacing between loading points and supports.....	47
Figure 2- 15: Compressive strength machine used in KPU.....	48
Figure 2- 16: Ultrasonic pulse velocity test equipment.....	49
Figure 2- 17: ISOMET 2104 equipment for thermal conductivity.....	50
Figure 2- 18: Equipment for SEM analysis.....	51
Figure 2- 19: Placement of non-woven sheets in prisms.....	52
Figure 2- 20: Shimadzu 100 kN machine.....	52
Figure 2- 21: Metal container.....	53
Figure 2- 22: Complete setup of the bond test and samples under testing.....	54
Figure 3- 1: Size distribution, a) CEM I 52.5 N and b) GHORI.....	57
Figure 3- 2: Size distribution of CEM I and GHORI cements.....	58
Figure 3- 3: SEM observations of a) CEM I 52.5 N b) GHORI cement.....	59
Figure 3- 4: Size distribution curve for fine and coarse aggregates in INSA.....	61
Figure 3- 5: Size distribution curve for fine and coarse aggregates in KPU.....	62
Figure 3- 6: Standard size distribution curve [88].....	62
Figure 3- 7: Force-displacement curve for the traction of non-woven tissue in INSA.....	66
Figure 4- 1: Non-woven fabrics as a layer.....	69
Figure 4- 2: Flexural strength of mortar prisms with CEM I cement and different configurations of non-woven sheets.....	72
Figure 4- 3: Flexural strength of mortar prisms with GHORI cement and different configurations of non-woven sheets.....	73
Figure 4- 4: Flexural strength of mortars with different configurations of non-woven sheets after 28 days of curing.....	74

Figure 4- 5: Cracking patterns of mortar prisms (Ref) .....	75
Figure 4- 6: Cracking patterns of mortar prisms (1-Layer) .....	75
Figure 4- 7: Cracking patterns of mortar prisms (2-Layers) .....	76
Figure 4- 8: Delamination of non-woven sheet by hand.....	77
Figure 4- 9: Cracking patterns of mortar prisms (2-Sides) .....	77
Figure 4- 10: Cracking patterns of mortar prisms (3-Sides) .....	78
Figure 4- 11: Compressive strength of mortar samples with CEM I cement with different configurations of non-woven sheets .....	79
Figure 4- 12: Compressive strength of mortar samples with GHORI cement with different configurations of non-woven sheets .....	79
Figure 4- 13: Compressive strength after 28 days of curing.....	80
Figure 4- 14: Cracking pattern of mortar samples a) Ref, b) 1-Layer, c) 2-Layers, d) 2-Sides, and e) 3-Sides.....	81
Figure 4- 15: Detachment of sheets from the mortar samples.....	81
Figure 4- 16: Split tensile strength of mortar with GHORI cement, and with or without non-woven sheets .....	82
Figure 4- 17: Cracking pattern of mortar samples a) Ref and b) covered .....	82
Figure 4- 18: Ultrasonic pulse velocity of mortar with GHORI cement, and with or without non-woven sheets .....	83
Figure 4- 19: Cut pieces of the non-woven plastic fabric .....	84
Figure 4- 20: Slump value versus percentage of non-woven fabrics with samples of GHORI and CEM I cement mortar .....	85
Figure 4- 21: Fresh density of mortar specimens with GHORI cement .....	86
Figure 4- 22: Dry density of mortar specimens with GHORI cement .....	87
Figure 4- 23: Porosity and water absorption of mortar specimens with GHORI cement .....	88
Figure 4- 24: Flexural strength of mortar specimens with CEM I cement .....	89
Figure 4- 25: Flexural strength of mortar specimens with GHORI cement .....	89
Figure 4- 26: Flexural strength of mortar specimens after 28 days of curing with CEM I and GHORI .....	90
Figure 4- 27: Cracking pattern of mortar prisms with CEM I: a) Ref, b) 0.25%, c) 0.50%, and d) 0.75%.....	91
Figure 4- 28: Cut pieces inside the prism.....	91
Figure 4- 29: Compressive strength of mortar specimens with CEM I cement .....	92
Figure 4- 30: Compressive strength of mortar specimens with GHORI cement .....	92
Figure 4- 31: Compressive strength of mortar specimens after 28 days of curing with CEM I and GHORI cements .....	93
Figure 4- 32: Cracking pattern of mortar samples with CEM I: a) Ref, b) 0.25%, c) 0.50%, and d) 0.75%.....	94
Figure 4- 33: Cut pieces inside the sample.....	94
Figure 4- 34: Split tensile strength of mortar specimens with GHORI cement .....	95
Figure 4- 35: Cracking pattern of mortar cylinders with GHORI cement a) Ref, b) 0.25%, c) 0.50%, and d) 0.75%.....	96
Figure 4- 36: SEM images of mortar containing cut pieces of fabrics with CEM I .....	97
Figure 4- 37: UPV values of mortar specimens with GHORI cement .....	97
Figure 4- 38: Cu pieces of non-woven tissue with different aspect ratios .....	100
Figure 4- 39: Average slump value versus percentage of plastic incorporation .....	101
Figure 4- 40: Average slump value versus aspect ratio .....	101
Figure 4- 41: Average bulk density versus percentage of plastic incorporation .....	102
Figure 4- 42: Average bulk density versus aspect ratio .....	103
Figure 4- 43: Average porosity versus percentage of plastic incorporation .....	104
Figure 4- 44: Average porosity versus aspect ratio .....	104

Figure 4- 45: Average flexural strength versus percentage of plastic incorporation .....	105
Figure 4- 46: Average flexural strength versus plastic aspect ratio .....	106
Figure 4- 47: Average compressive strength versus percentage of plastic incorporation .....	106
Figure 4- 48: Average compressive strength versus plastic aspect ratio .....	107
Figure 4- 49: Effect of w/c ratio on the adhesion force .....	109
Figure 4- 50: Surface textures of specimens with a) w/c=0.45, b) w/c=0.50, and c) w/c=0.55 ..	110
Figure 4- 51: Density of the remaining microfilaments on the surface of specimens with a) w/c=0.45, b) w/c=0.50, and c) w/c=0.55 .....	111
Figure 4- 52: Surface irregularities and concentration of remaining fibers on prisms' surfaces; a) w/c=0.45, b) w/c=0.50, and c) w/c=0.55 .....	113
Figure 4- 53: Microscopic analysis of specimens with various w/c ratios; a) w/c=0.45, b) w/c=0.50, and w/c=0.55 .....	115
Figure 4- 54: Non-woven fabric on mortar specimen surface after bond test (w/c of 0.50) .....	115
Figure 4- 55: The closer view of non-woven fabric on mortar specimen surface after bond test (w/c of 0.50) .....	116
Figure 4- 56: Flexural strength test of samples after bond test.....	116
Figure 4- 57: Flexural strength of reference samples and prisms after bond test.....	117
Figure 4- 58: Compressive strength test of samples after bond test.....	117
Figure 4- 59: Compressive strength of reference samples and prisms after bond test.....	118
Figure 4- 60: Effect of superplasticizer content on bond force .....	118
Figure 4- 61: Surface textures of mortar specimens containing various amount of SP and a) w/c=0.4, b) w/c=0.45, and c) w/c=0.50 .....	119
Figure 4- 62: Density of the microfilaments on the specimens' surfaces a) w/c=0.40+SP, b) w/c=0.45+SP, and c) w/c=0.50.....	120
Figure 4- 63: Surface irregularities and density of remained fibers; a) w/c=0.40+SP, b) w/c=0.45+SP, and w/c=0.50.....	121
Figure 4- 64: Microscopic analysis of specimens with various w/c ratios; a) w/c=0.40+SP, b) w/c=0.45+SP, and w/c=0.50.....	122
Figure 4- 65: Flexural strength of reference samples and prisms after bond test.....	123
Figure 4- 66: Compressive strength of reference samples and prisms after bond test.....	124
Figure 5- 1: Cube compressive strength of concrete specimens.....	130
Figure 5- 2: Cylindrical compressive strength of concrete specimens .....	130
Figure 5- 3: Compressive strength of concrete specimens after 28 days a) cubic and b) cylindrical .....	131
Figure 5- 4: Cracking patterns after compressive strength a) Ref, b) 1-Layer, c) 2-Sides, and d) full wrapped .....	132
Figure 5- 5: Cracking patterns after compressive strength a) Ref and b) full wrapped samples	132
Figure 5- 6: Flexural strength of concrete specimens .....	133
Figure 5- 7: Flexural strength of concrete specimens after 28 days of curing.....	134
Figure 5- 8: Cracking pattern of beam (reference) .....	134
Figure 5- 9: Cracking patterns of beam (1-Layer) .....	135
Figure 5- 10: Cracking patterns of beam (2-Sides) .....	135
Figure 5- 11: Cracking patterns of beam (3-Sides) .....	136
Figure 5- 12: Split tensile strength of concrete specimens .....	137
Figure 5- 13: Cracking pattern after tensile splitting testing a) Ref and b) covered samples.....	137
Figure 5- 14: Ultrasonic pulse velocity of concrete specimens .....	138
Figure 5- 15: Thermal conductivity of concrete specimens.....	139
Figure 5- 16: Relations between percentages of non-woven cut pieces and various properties of concrete.....	139
Figure 5- 17: Slump values of concrete mixtures .....	142
Figure 5- 18: Fresh density of concrete mixtures .....	143

<i>Figure 5- 19: Dry density of concrete specimens .....</i>	144
<i>Figure 5- 20: Porosity and water absorption of concrete specimens .....</i>	145
<i>Figure 5- 21: Cube compressive strength of concrete specimens .....</i>	146
<i>Figure 5- 22: Cube compressive strength of concrete specimens after 28 days .....</i>	146
<i>Figure 5- 23: Cracking pattern a) Ref, b) 0.25%, c) 0.50%, and d) 0.75% .....</i>	147
<i>Figure 5- 24: Split tensile strength of concrete specimens .....</i>	147
<i>Figure 5- 25: Split tensile strength of concrete specimens after 28 days .....</i>	148
<i>Figure 5- 26: Cracking patterns after splitting tensile testing a) Ref, b) 0.25%, c) 0.50%, and d) 0.75% .....</i>	148
<i>Figure 5- 27: Relations between dry density, compressive and split tensile strengths .....</i>	149
<i>Figure 5- 28: Relations between porosity, compressive and split tensile strengths .....</i>	150
<i>Figure 5- 29: Relations between porosity and dry density .....</i>	151
<i>Figure 5- 30: Relations between compressive and split tensile strengths .....</i>	151
<i>Figure 5- 31: UPV of concrete specimens .....</i>	152
<i>Figure 5- 32: Thermal conductivity of concrete specimens .....</i>	153
<i>Figure 5- 33: Relations between UPV, thermal conductivity, and dry density .....</i>	154
<i>Figure 5- 34: Relations between UPV, thermal conductivity, and porosity .....</i>	154
<i>Figure 5- 35: Relations between UPV, thermal conductivity, and compressive strength .....</i>	155
<i>Figure 5- 36: Relations between UPV and compressive strength .....</i>	156
<i>Figure 5- 37: Relations between percentages of non-woven cut pieces and various properties of concrete .....</i>	156



## LIST OF TABLES

<i>Table 1- 1: Workability of concrete mixtures containing plastic fibers [26]</i> .....	8
<i>Table 1- 2: Relative percentage for the effect of plastic fibers on concrete workability [38]</i> .....	10
<i>Table 1- 3: Splitting tensile strength of PET-based concrete [42]</i> .....	20
<i>Table 1- 4: Relative percentage for the effect of plastic fibers on compressive strength, flexural strength, splitting tensile strength, and modulus of elasticity [38]</i> .....	21
<i>Table 1- 5: Thermal conductivity of various concrete mixtures [31]</i> .....	25
<i>Table 2- 1: Chemical composition of CEM I 52.5 N [48]</i> .....	30
<i>Table 2- 2: Chemical composition of GHORI cement</i> .....	30
<i>Table 2- 3: Physical and chemical properties of superplasticizer</i> .....	32
<i>Table 2- 4: Physical and mechanical properties of non-woven sheets [33]</i> .....	34
<i>Table 2- 5: Mix proportion a) standard mortar with CEM I in INSA b) mortar with GHORI cement in KPU</i> .....	39
<i>Table 2- 6: Mix proportion of mortar samples with cut pieces and CEM I in INSA</i> .....	40
<i>Table 2- 7: Mix proportion of mortar samples with cut pieces and GHORI cement in KPU</i> .....	40
<i>Table 2- 8: Mix proportion of concrete with GHORI cement in KPU (kg/m<sup>3</sup>) [68]</i> .....	42
<i>Table 2- 9: Mix proportion of concrete with cut pieces and GHORI cement in KPU (kg/m<sup>3</sup>)</i> .....	42
<i>Table 2- 10: Used mix designs and non-woven configuration</i> .....	43
<i>Table 2- 11: Experimental procedure for thermal conductivity of concrete</i> .....	50
<i>Table 2- 12: Conducted tests and their methods</i> .....	54
<i>Table 3- 1: Specific gravities and bulk densities of both type of cement</i> .....	59
<i>Table 3- 2: water/cement ratio for normal consistency of CEM I 52.5 N and GHORI cement paste</i> .....	59
<i>Table 3- 3: Setting times of CEM I 52.5 N and GHORI cement</i> .....	60
<i>Table 3- 4: Summary for the characterized properties of CEM I 52.5 N and GHORI cement</i> .....	60
<i>Table 3- 5: Specific gravity and water absorption (WA) values of fine aggregates, fine coarse aggregates, and coarse aggregates in INSA</i> .....	63
<i>Table 3- 6: Specific gravity and water absorption (WA) values of fine aggregates, fine coarse aggregates, and coarse aggregates in KPU</i> .....	63
<i>Table 3- 7: Bulk and compacted bulk densities of fine aggregates, of fine aggregates, fine coarse aggregates, and coarse aggregates in INSA</i> .....	63
<i>Table 3- 8: Bulk and compacted bulk densities of fine aggregates, of fine aggregates, fine coarse aggregates, and coarse aggregates in KPU</i> .....	64
<i>Table 3- 9: Abrasion values of aggregates in KPU</i> .....	64
<i>Table 3- 10: pH value of water</i> .....	65
<i>Table 3- 11: Tensile strength of non-woven sheet in INSA</i> .....	65
<i>Table 4- 1: Summary of tests for chapter # 4</i> .....	68
<i>Table 4- 2: Type of samples and their descriptions</i> .....	69
<i>Table 4- 3: Amount of cut pieces of non-woven fabrics</i> .....	100
<i>Table 4- 4: Types of mixtures prepared for bond properties analysis in INSA</i> .....	108
<i>Table 5- 1: Overall flow of chapter # 5</i> .....	127
<i>Table 5- 2: Description of concrete samples strengthened with non-woven sheets</i> .....	128
<i>Table 5- 3: Description of samples containing cut pieces of non-woven sheet</i> .....	140

## **LIST OF ABBREVIATIONS**

<b>PET</b>	:	Polyethylene Terephthalate
<b>PP</b>	:	Polypropylene
<b>PVC</b>	:	Poly Vinyl Chloride
<b>PA</b>	:	Plastic Aggregates
<b>PF</b>	:	Plastic Fibers
<b>NA</b>	:	Natural Aggregates
<b>CA</b>	:	Coarse Aggregates
<b>FA</b>	:	Fine Aggregates
<b>SP</b>	:	Superplasticizer
<b>EN</b>	:	European Standards
<b>ASTM</b>	:	American Society for Testing and Materials
<b>ACI</b>	:	American Concrete Institute
<b>UPV</b>	:	Ultrasonic Pulse Velocity
<b>SD</b>	:	Standard Division

## General Introduction

The term plastic comes from the Greek word “plastikos”, which means “fit for molding”. This term refers to the plasticity and malleability of a material, which allows it to cast, extrude, or press into many shapes. Plastics are the compound of a wide range of materials, whereas the mix proportion of these materials is arranged to obtain different products and to fulfill the needs of the industry [11,12]. It is mostly derived from petrochemicals or oil and is considered a non-renewable resource, but most of them are partially natural [13].

It is a fact that plastic packages are widely used over the world. Therefore, the consumption of plastics in our daily life is increasing every year. A total of 322 million tons of plastic were produced all around the world in 2015, while 58 million tons of plastic were produced only in Europe in the year just reported. In 2016, this production was increased to 335 million tons worldwide and 60 million tons in Europe. In addition, in the mentioned year, china was the largest producer of plastic followed by Europe and NAFTA. From the mentioned statistical data, 31.1% of these wastes were recycled, 41.6% were used for energy recovery, and 27.3% were landfilled worldwide in 2016. Besides, the six largest European countries (Germany, Italy, France, Spain, UK, and Poland) cover almost 80% (49.9 tons) of the European demand in 2016. Specifically, the plastics demand in France reached 5.6 million tons in 2016, which represents 9.6% of the European plastics demand after Germany (24.5%) and Italy (14.2%).

In 2011, the US Environmental Protection reported that the total solid waste production was 251 million tons in the USA and 10.37 million tons in Iran. From the mentioned data, 84% of the solid waste was buried and only 6.0% were recycled in Iran, while in the USA, 53.8% were buried and 34.5% were recycled. From mentioned solid wastes, 12.7% and 8.0% were composed of plastic in the USA and Iran, respectively [14–17].

On the other hand, PET is a kind of plastic that is used in many applications like blown bottles, soft drink bottles, packing and food containers and etc. A few common characteristics of the PET plastic are: tough and clear, high strength and stiffness, resistance against heat and chemical attacks, the best barrier against oxygen and carbon dioxide (CO<sub>2</sub>). In the year 2007, PET consumption was about 10 million tons all over the world, which was equivalent to 250 billion bottles, and this figure rises about 15% per year [18,19].

Thus, this large quantity of non-degradable wastes, especially plastic waste has caused many environmental challenges. Besides, these wastes are considered to be one of the most hazardous sources of pollution [1–6]. Recycling and reuse of plastic wastes play an important role in sustainable waste management. The aim of waste management is to save natural resources, decrease pollution of the environment, and reduce embodied energy [20]. Therefore, plastic waste management is one of the crucial issues to decrease disposal challenges and environmental problems. Generally, plastic waste management for their treatment involves recycling, landfilling, and incineration [12,21].

**Recycling:** The recycling of plastics should be conducted in such a way to minimize the pollution level and to increase the efficiency level for the conservation of energy. The recycling of plastics is divided into the following four general types:

- Primary: this type of recycling includes the process of scrap or waste into products, which is similar to the original one.
- Secondary: with the process of secondary recycling, the plastic product will be produced that has completely different properties than the original product.
- Tertiary: basic chemicals and fuels are produced from plastic scrap as part of the municipal waste stream or as a segregated waste.
- Quaternary: this recycling reclaims the energy content of the scrap plastics by burning or incineration.

**Landfilling:** The landfill is a traditional and least preferable method for waste management because such a method needs a large space and causes persistent pollution. The main drawback of the landfill is that none of the material resources used for the production of plastic are recovered. In the UK, the tax for landfills is increasing every year to motivate people for turning away wastes from landfills to other recovery actions.

**Incineration:** This process decreases the need for landfills but will enhance worries about the release of hazardous materials to the environment. This process of recycling is applicable in some developed countries because of the high combustible value of plastics and low moisture content. Besides, the incineration cost is considered to be the highest. However, the new technology of incineration can utilize heavily contaminated plastic waste for energy recovery by incineration waste plants.

Since, the annual consumption of plastics has been increasing gradually all over the world. The inadequate disposal of plastic has been resulted in major environmental problems due to the shortage of space for landfilling, not easily degradable, and low biodegradability. Therefore, various researches have already been conducted to find a safe and environmentally friendly solution for the disposal of plastic wastes. Recently, researchers have realized to utilize waste plastics in cementitious materials because of their long service life and lower weight to eliminate or reduce environmental problems. Thus, the reuse of plastic wastes as construction materials provides a remarkable future market for waste recycling. In this regard, many studies have been performed and they considered plastic wastes as aggregates or fibers to study their effect on different properties of cementitious materials [1,22–26].

For instance, experimental work was performed to study the incorporation of high-density polyethylene plastic fibers into concrete mixtures with 0%, 0.4%, 0.75%, and 1.25% by volume. The findings have illustrated that the workability dropped considerably with the increase of volume fraction of fibers [7]. Besides, waste plastics were incorporated into concrete mixtures as an aggregate replacement. Including a reference mixture, 10%, 15%, and 20% of fine aggregates were replaced by plastic waste. It was reported that the fresh density tends to decrease with the increase of plastic waste ratio, due to the lower density of plastic aggregates [1].

In the same manner, research work was performed on physical and mechanical behaviors of recycled PET fiber-reinforced mortar and considered 0.5%, 1.0%, and 1.5% of PET fibers by volume. It was underlined that the addition of PET fibers resulted in a small reduction in density [27]. Moreover, experimental work was carried out to study certain properties of the concrete with plastic aggregates derived from shredded PVC sheets. This study considered 5.0%, 15%, 30%, 45%, 65%, and 85% of sand replaced by PVC aggregates. The results highlighted a considerable enhancement of water absorption with the increase of plastic waste content. This may be attributed to the flakiness of plastic aggregates, resulting in reduced concrete mass packing, poor transition zone, and macro cracks [28].

Furthermore, research work was carried out on self-compacting concrete containing 0.25%, 0.5%, 0.75%, 1.0%, 1.25%, 1.5%, 1.75%, and 2.0% of plastic fibers by volume. The

findings underlined that the compressive strength improved up to 1.5% of plastic fibers and thereafter, this strength decreased back [8]. In addition, the flexural strength was improved by 10-13%, while 0.15%, 0.30%, and 0.45% of 12 mm long polypropylene fibers were incorporated into concrete mixtures [29]. Similar results were documented that the tensile splitting strength enhanced for concrete mixtures with PET fibers up to 10% and then reduced back for 15% and 20% of PET fibers [30].

In the same token, it was found that the speed of ultrasound remarkably decreased, while PET plastic aggregates were substituted by fine aggregates. This can be attributed to the difference in the speed of ultrasound in plastic particles and concrete aggregates [9]. Besides, a research study was conducted on concrete containing three different types of plastic fibers at 1.0% volume fraction. It was explored that thermal conductivity remarkably decreased for the fiber-reinforced specimens compared to the references ones. As a comparison, this reduction was 18% and 22% for PET and PP fiber-reinforced specimens, respectively. This can be due to the lower thermal conductivity of plastic fibers than cement and aggregates [31].

On the other hand, researchers partially replaced cement and fly ash with PET fibers and used 5.51 Kg of PET fibers in one cubic meter of concrete. Since 5 grams of fibers can be extracted from one bottle, this makes the total number of bottles collected from the environment to produce one cubic meter of concrete is equal to 1102. Moreover, the cost of concrete was decreased by 19 percent as a result of this substitution. These outcomes show both environmental and economic benefits of PET fibers in cementitious materials [32].

It has been summarized from the previous researches that enough work has been conducted on plastic wastes that were substituted by aggregates or added into concrete mixtures. However, none of the researchers considered such recycled plastic waste as non-woven sheets to strengthen specimens or incorporate in cementitious materials. Therefore, this work as a joint project between Kabul Polytechnic University and the University of Strasbourg aims to investigate certain properties of cementitious materials containing non-woven tissue as a layer or as cut pieces. In the present study, the product of **FREUDENBERG** Company named Evolon<sup>®</sup> microfilaments textile made from a combination of short and long fibers, and bounded together by chemical, mechanical, heat,

or solvent treatment was used. This product offers many possibilities for tapping into new markets and developing applications. They are used for technical packaging for the automotive and electronics industry, anti-allergy encasings, or as cleaning cloths and sports towels, and etc. [33]. In addition, the chosen product was made from PET plastics, which is a type of plastic with a wide range of applications, strong mechanical properties, long durability, and etc.

Overall, this study intends to investigate the effect of non-woven plastic sheets on the fresh, physical, mechanical, acoustic, thermal, bond, and microstructural behaviors of concrete and mortar. Therefore, non-woven sheets were considered in two ways: a) as a layer with five various configurations of 1-Layer, 2-Layers, 2-Sides, 3-Sides, and full wrapping to strengthen specimens, and b) as cut pieces of (10×10) mm with four different incorporated percentages of 0%, 0.25%, 0.50%, and 0.75% by weight. This document is divided into five chapters.

The first chapter is specified to bibliographic synthesis of the previous work on the incorporation of waste plastic in cementitious materials. Firstly, general information regarding properties and production of plastic, and their wastes data globally and particularly in Europe were presented. Then, a state-of-the-art of previous studies focusing on the incorporation and effect of waste plastics on the fresh, physical, mechanical, acoustic, thermal, and microstructural behaviors of cementitious materials is explored.

The second chapter concerns the presentation of materials (cement, aggregates, water, superplasticizer, and non-woven sheets) that were used in the elaboration of mortar and concrete. In addition, the experimental methods used for the characterization of materials as well as for the measurement of the fresh, physical, mechanical, transfer, microstructural, and bond properties of mortar/concrete are detailed.

The third chapter covers the results of materials characterization to ensure their quality in accordance with the standards. Firstly, cement was characterized by laser granulometry, density, specific gravity, modulus of fineness, and setting times. Following that the physical and mechanical properties of fine and coarse aggregates were studied.

The fourth chapter aims to underline the effect of non-woven sheets on various properties of mortar. Firstly, non-woven tissue was considered as a layer to investigate its effect on mechanical (compressive, flexural, and split tensile strengths) and sound properties of

mortar. Then, cut pieces of such sheets were incorporated into mortar mixtures to study their effect on the fresh, physical, mechanical, acoustic, and microstructural properties of mortar. Finally, the adhesion between non-woven sheets and mortar specimens was analyzed.

The fifth chapter covers the effect of non-woven sheets as a layer and cut pieces on different behaviors of concrete. In the first step, such sheet was utilized to strengthen concrete samples and evaluate its influence on the mechanical, thermal, and acoustic properties. In the second step, cut pieces of tissue with various percentages were incorporated in concrete mixtures to explore their effect on the fresh, physical, mechanical, and transfer properties (sound and thermal) of concrete. Then, the correlations between the different properties of concrete were established that are based on the experimental results of this study and those of the literature.

Finally, general conclusions and perspectives close to this research work are presented.



# CHAPTER # 1

## BIBLIOGRAPHIC RESEARCH

The purpose of this chapter is to establish a state of art concerning the use of waste plastics in cementitious materials.

As previously mentioned that the plastic wastes have already been recycled and used inside cementitious materials as aggregates or fibers. The use of non-woven sheets waste is novel but this kind of waste can be compared with fibers effect when incorporated in cementitious material. Therefore, in this chapter, different studies have been cited to describe the effect of waste plastics fibers on the fresh, physical, mechanical, thermal, sound, and microstructural properties of cementitious materials. In addition, at the end of each part concerning a property, a comprehensive discussion was presented to explore the trends, optimum values, and major effects of plastic fibers on different properties of cementitious materials.

### **1. Use of plastic waste as fibers in cementitious materials**

Several materials such as recycled plastic, glass wood, carpet, tire cord, cellulose, present good durability, chemical resistance, thermal and electrical resistance, versatility, and lightweight properties during utilization. Therefore, these improved properties will enable innovation and the production of sustainable composite materials like concrete reinforced with fibers made of recycled materials is to improve tensile strength, structural ductility, and thermo-electrical insulation of concrete matrix. Four main types of fibers are manufactured to prepare fiber-reinforced concrete: steel fibers, glass fibers, natural fibers, and synthetic fibers. Plastic fibers are part of synthetic fibers and can be found in different compositions such as PP, HDPE, PET, nylon, PE, PVC, PVA, or hybrid fibers (compound of steel and plastic fibers) that can replace steel fibers in cementitious matrixes. Plastic fibers can be produced freshly or recycled [34].

Waste plastic fibers could be incorporated in cementitious materials with varying percentages and have significant effects on different properties of mortar/concrete such as fresh, physical, mechanical, thermal, acoustic, and etc. In the following sections, the effect

of waste plastic fibers on certain properties of cementitious materials has been discussed in detail.

### **1.1. Fresh state: workability and density**

Research work was conducted on the applications of concrete mixtures reinforced with 0.1%, and 0.3% of fibers manufactured from recycled PET bottles. The results state that the slump values have been decreased noticeably as PET fibers increased in concrete mixtures. This means that the workability of concrete mixtures became worse with the addition of PET fibers. Thus, fibers more than 0.3% resulting in serious homogeneity and workability problems in concrete mixtures [35].

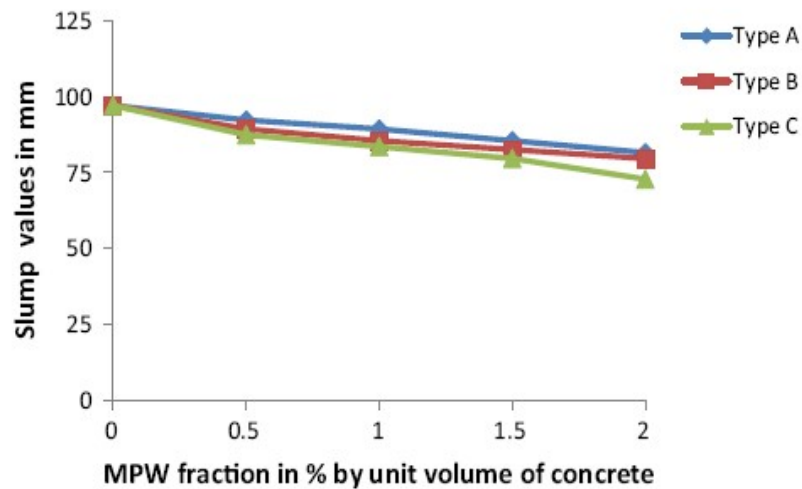
In the same manner, experimental work was conducted on concrete containing recycled PET bottle fibers with the percentages of 0.5%, 1.0%, 1.5%, and 2.0% by volume of concrete. The authors revealed that slump values declined with the introduction of fibers into concrete mixtures. This can be explained by the fact that there is more friction between the pieces of plastic fibers. On the other hand, the large surface area of plastic fibers is able to absorb cement paste in a mixture that will enhance concrete viscosity [22]. Similarly, authors found through the experimental work performed on concrete having PET bars (CRP) and steel bars (CRS) that slump values slightly decreased as PET fibers were applied into concrete mixtures. Oppositely, this value increased for concrete containing steel fibers [36].

Likewise, a research investigation was performed on mechanical properties of concrete with 0%, 0.05%, 0.18%, and 0.3% of recycled PET fibers by volume. The findings illustrate that the workability has reduced as percentages of PET fibers have increased. However, PET fiber-reinforced concrete still has adequate workability and concrete mixtures were able to compact without excessive vibration as presented in **Table 1- 1** [26].

*Table 1- 1: Workability of concrete mixtures containing plastic fibers [26]*

Mix codification	Fiber content, volume %	Slump, mm
1	0	100
2	0.05	155
3	0.18	70
4	0.30	50

Also, an experimental study was performed to examine the fresh and hardened properties of concrete reinforced with metalized plastic waste (MPW) fibers from 0% to 2.0% by volume. Thus, MPWs were shredded into 5.0 mm, 10 mm, and 20 mm long fibers. This was underscored that concrete workability was affected by both test parameters namely the fraction and type of MPWs. It means that concrete containing Type A fibers from 0.5% to 2.0% showed slump reduction by 5.0%, 8.0%, 12%, and 16%, respectively as shown in **Figure 1- 1**. Such fibers affect concrete viscosity, interrupt matrix consistency, and occupy a large proportion of cement paste due to its greater surface area. It is due to the presence of fibers, which form a mesh like structure adhering to fine and coarse fragments of the matrix. Furthermore, it was well documented that long fibers decreased the workability more than short fibers at the same volume fraction [37].



**Figure 1- 1:** Slump values versus volume fraction of MPW [37]

Likewise, research work was carried out in order to analyze mechanical and durability properties of high-strength concrete containing steel and polypropylene fibers and considered 0.15%, 0.3%, and 0.45% of polypropylene fibers with 12 mm length. The outputs illustrate that slump values decreased with the increase of fiber content [29].

Finally, the mechanical properties of concrete reinforced with recycled HDPE plastic fibers were evaluated and fibers were incorporated containing two diameters and three percentages of 0.4%, 0.75%, and 1.25% by volume. The authors found that slump values have dropped considerably as fiber content increased [7].

The relative percentages for the effect of plastic fibers on concrete workability as investigated by various authors are presented in *Table 1- 2*.

*Table 1- 2: Relative percentage for the effect of plastic fibers on concrete workability [38]*

Substitution Type	Studied Properties	Percentage of Plastic Fibers (%)										Authors
		0.1	0.15	0.3	0.45	0.5	0.75	1.0	1.25	1.5	2	
Volume of concrete	Workability, compressive, tensile and flexural strengths	-50	-	-90	-	-	-	-	-	-	-	[35]
Volume of concrete	Workability, compressive and split tensile strengths	-	-	-	-	-39	-	-43	-	-47	-58	[22]
Volume of concrete	Workability and flexural strength	-	-	-	-	-	-	-3	-	-	-	[36]
Volume of mix	Workability, compressive, split tensile and flexural strengths	-	-	-	-	-5	-	-8	-	-12	-16	[37]
Volume of concrete	Workability, compressive,	-	-24	-32	-53	-	-	-	-	-	-	[29]

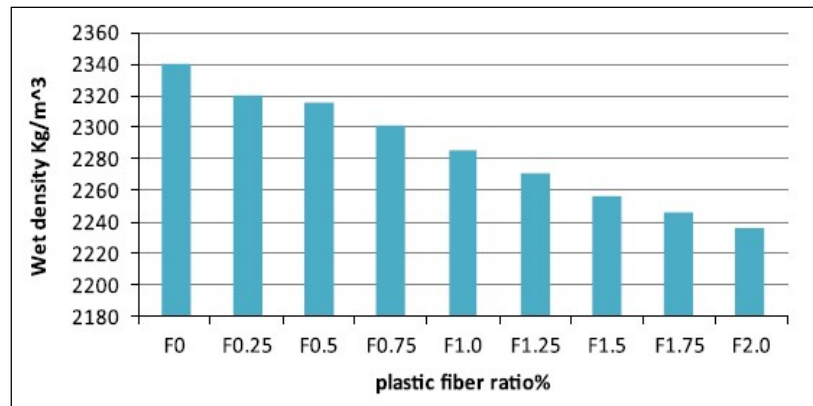
	<i>split tensile and flexural strengths and electrical resistivity</i>											
<b>Volume of concrete</b>	<b>Workability</b> , <i>compressive, split tensile and flexural strengths and water permeability</i>	-	-	-	-45	-	-66	-	-74	-	-	[7]

*Minus (-) sign represents decreasing the property of concrete calculated regarding the reference specimens of each study. In addition, the total studied properties by authors are written in gray italic font and the concern studied property of section is in black bold font.*

**Table 1- 2** summarizes the outcomes of various authors that the workability of concrete reinforced with plastic fibers reduced with the rise of fibers content. This is due to the higher friction between plastic fibers and the presence of fibers forming a mesh like structure adhering to fine and coarse fragments of the matrix. Furthermore, it is clearly detected from the literature that the level of drop in workability is proportional to the percentage of plastic fibers. It means that for a higher percentage of plastic fibers, more reduction was underlined. It is clearly indicated in **Table 1- 2** that long fibers reduced the workability more than short ones. It means that [Daniel et al., 2016 \[35\]](#) and [Ninoslav et al., 2016 \[7\]](#) introduced longer fibers into concrete mixtures compared to other researchers, therefore, they reported more reduction compared to [Bhogayata and Arora, 2017 \[37\]](#).

Furthermore, a research study was carried out to outline the possibility of enhancing some properties of self-compacting concrete with the incorporation of waste plastic fibers from beverage bottles. The study considered a control mixture and concrete with 0.25%, 0.5%, 0.75%, 1.0%, 1.25%, 1.5%, 1.75%, and 2.0 % of plastic fibers by volume. Concrete was mixed with the following procedures: 1) plastic fiber, fine and coarse aggregates were mixed for 30 seconds, 2) half of the water was added into the mixer and mixing continued

for one more minute, 3) plastic waste and aggregates were remained for 60 seconds to absorb water, 4) cement and fly ash were added into a mixer and mixed for another 60 seconds, and 5) SP and remaining water were added and concrete was mixed for 180 seconds. The results illustrate that the fresh density ranged between 2340 kg/m<sup>3</sup> and 2235 kg/m<sup>3</sup> as waste plastic fibers were applied to concrete mixtures as shown in **Figure 1- 2**. The reason behind this can be the lower specific gravity of plastic fibers (1.12) compared to cement (3.15) and aggregate (2.65) [8].

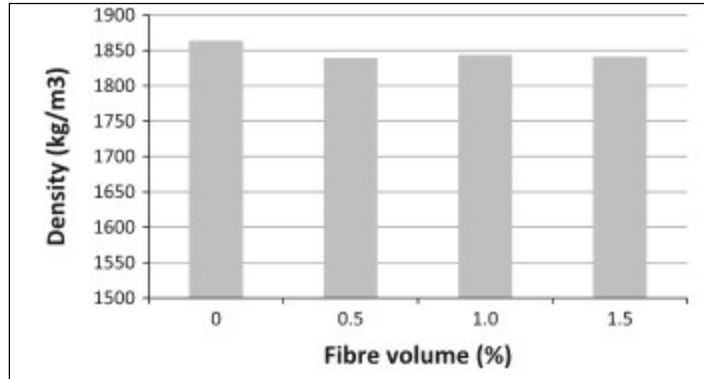


*Figure 1- 2: Wet density for all SCCs mixtures containing plastic fibers [8]*

## 1.2. Physical properties: density and water absorption

Density is a characteristic property of materials and means mass per unit volume. The density of concrete differs from mixture to mixture, it vastly depends upon the mix design and other characteristics like specific gravity of aggregates, etc.

A research work was performed on physical and mechanical behaviors of recycled PET fiber-reinforced mortar and considered 0.5%, 1.0%, and 1.5% of PET fibers by volume. It was underlined that PET fibers addition resulted in a small decrease in density as shown in **Figure 1- 3 [27]**.



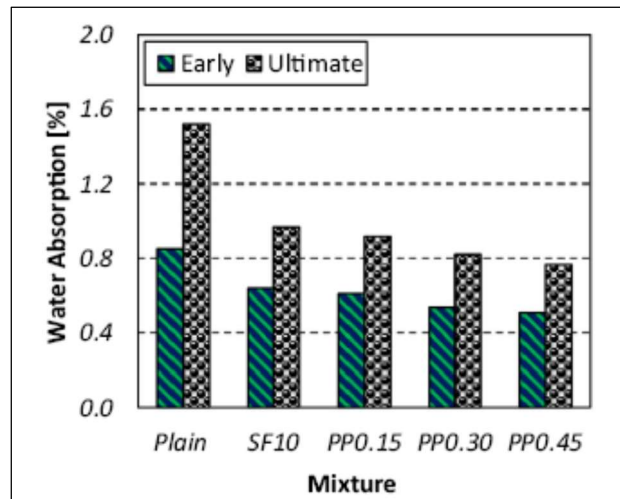
*Figure 1- 3: Density of hardened mortar as a function of percentages of fibers [27]*

Similarly, a research study was conducted to investigate the durability of polypropylene fiber-reinforced concrete and incorporated 0%, 0.05%, 0.1%, and 0.2% of fibers by volume. The findings show that unit weights of fiber-reinforced concrete were slightly lower than that of concrete without fibers for each group. It was also reported, while the amount of fly ash and polypropylene fiber increased in concrete mixtures the unit weight has reduced [39].

It can be pointed out from the above mentioned literature that all authors highlighted similar findings showing a reduction in the density of plastic fiber-reinforced concrete compared to the conventional one. In addition, it is obviously pointed out by [Al-hadithi and Hilal, 2016 \[8\]](#) that the level of drop in density is proportional to the percentage of plastic fibers. Incorporation of 0.25%, 0.5%, 0.75%, 1.0%, 1.25%, 1.5%, 1.75%, and 2.0% of waste plastic fibers resulted in 1.0%, 2.0%, 3.0%, 3.5%, 4.0%, 4.5%, 5.0% reduction of fresh density, respectively, compare to the reference one. Moreover, a similar approach has been indicated by [Karahan and Atis, 2011](#); [Pereira De Oliveira and Castro-Gomes, 2011 \[27,39\]](#) that the higher amount of plastic fibers, the lower concrete density due to the lower density of plastic fibers.

Besides, many factors effect concrete water absorption such as: type of materials, additives, temperature, length of exposure, etc. In this regard, an experimental study was carried out on 12 mm long polypropylene fibers with contents of 0.15%, 0.30%, and 0.45% in order to analyze the mechanical and durability properties of high-strength concrete containing both steel and polypropylene fibers. The outcomes demonstrated that polypropylene fibers play a positive role in water absorption of fiber-reinforced concrete that is a reduction in water absorption capacity. The authors pointed out that the water absorption has been

decreased by 40%, 46%, and 49% of the concrete containing 0.15%, 0.30%, and 0.45% of plastic fibers, respectively, compared to the reference one as shown in **Figure 1- 4**. In the present study, the lower water absorption is due to the limited pore connectivity and reduced concrete porosity. Furthermore, based on water absorption classification, all of concrete matrixes presented a low water absorption that illustrated a good quality of concrete [29].



**Figure 1- 4:** Water absorption of the concrete mixtures containing PP fibers [29]

Similarly, experimental work has been carried out and considered 0%, 0.5%, 1.0%, and 1.5% of PET fibers by volume to examine the physical and mechanical behaviors of recycled PET fiber-reinforced mortar. It was well documented that water absorption has been decreased by 48%, 55%, and 48%, while 0.5%, 1.0%, and 1.5% of PET fibers were incorporated into the mortar, respectively. It can be attributed to the fact that the addition of PET fibers alters mortar porosity especially around the fibers' contact zone and reduces the number of capillary pores [27].

Although fewer studies have been conducted to explore water absorption and porosity of fiber-reinforced concrete, it can be concluded from all authors that water absorption decreased with the rise of plastic fiber content. In addition, both authors clearly pointed out that a decrease in water absorption is related to the amount of plastic fibers. Therefore, the higher amount of plastic fibers provides a greater degree of decrease in water absorption of concrete specimens.

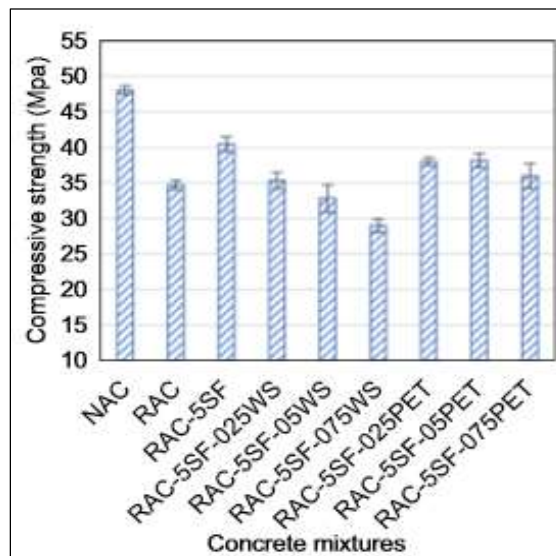


### 1.3. Mechanical properties

#### 1.3.1. Compressive strength

An experimental study was performed in order to examine the thermo-mechanical properties of recycled PET fiber-reinforced concrete. The research study considered three different types of 1.0% PET plastic fibers: 1) straight and 40 mm long (PET/a), 2) straight and 52 mm long (PET/b), and 3) crimped and 52 mm long (PET/c). It was clearly highlighted that concrete with PET/a, b, c fibers had higher compressive strength than normal concrete and this improvement was more significant for shorter fibers compared to longer and crimped ones [31].

In the same manner, researchers studied recycled woven plastic sack and PET bottle wastes as fibers in concrete mixtures containing recycled aggregates. They incorporated 0.25%, 0.5%, and 0.75% of PET fibers with (50-60) mm length and (2-3.5) mm width, and 0.25%, 0.5%, and 0.75% of woven plastic sack fibers into concrete mixtures. The findings stated that the compressive strength has been decreased with the increase of PET and woven plastic sack fibers compared to the concrete without fibers. This reduction was more significant for concrete that contains woven plastic sack fiber than mixtures with PET fibers as shown in *Figure 1- 5*. However, this result is different from other studies, which is because of aggregate strength, cement paste strength, and adhesion properties between concrete ingredients [34].



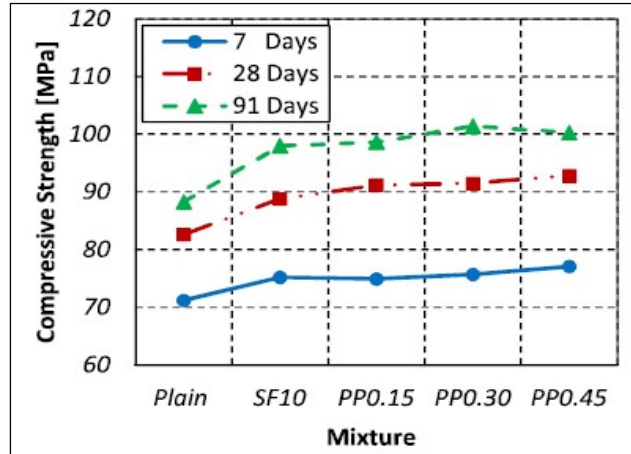
*Figure 1- 5: Compressive strength of concrete mixtures [34]*

Also, research work has been performed and concentrated on 0%, 0.1%, and 0.3% of fibers from recycled PET bottles in order to investigate the applications of PET fiber-reinforced concrete. It has been reported that the incorporation of 0.1% PET fibers by volume into concrete marginally enhanced the compressive strength compared to the normal one, but this strength slightly decreased for concrete containing 0.3% of PET fibers [35].

Similarly, an experiment was performed on concrete mixtures containing 0.5%, 1.0%, 1.5%, and 2.0% of PET fibers by volume of concrete. It was underlined that the compressive strength for each batch of concrete mixtures exceeded the targeted strength of 35 MPa, and concrete with 1.0% of PET fibers reported the best value of compressive strength among the other fiber-reinforced concrete. However, the concrete compressive strength declined with the rise of PET fibers content and this reduction was more remarkable for longer fibers than shorter ones. This is due to fibers bundling during mixing and pouring and the area between fiber surfaces is the weakest point in concrete, therefore early cracks were detected by compression loading [22].

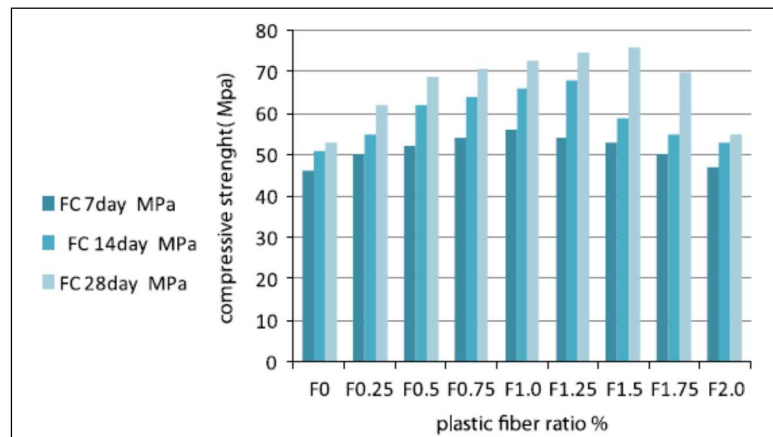
In the same context, concrete mixtures containing 2.0%, 3.0%, 4.0%, and 5.0% of PET fibers by weight of cement have been experimentally studied to find the effect of PET fibers on various performances of concrete. The outcomes have been demonstrated that the compressive strength improved for concrete with PET fibers up to 3.0%, and thereafter, this strength has been decreased back [40].

The study carried out by Afroughsabet and Ozbakkaloglu, 2015 [29] highlighted a remarkable enhancement in the compressive strength by 5.0% to 15% due to the incorporation of polypropylene fibers into concrete mixtures as shown in *Figure 1- 6*. This is because of fibers' ability to restrain cracks extension, decrease the extent of stress concentration, alter cracking direction, and delay cracking growth rate.



**Figure 1- 6:** Compressive strength of concrete mixtures with plastic fibers [29]

Finally, an experimental study has been carried out in order to improve certain properties of self-compacting concrete that contains waste plastic fibers. Therefore, the research study considered waste plastic fibers with 0.25%, 0.5%, 0.75%, 1.0%, 1.25%, 1.5%, 1.75%, and 2.0% by volume, including a reference mixture. The results underlined a growth in the compressive strength when plastic fibers were added into concrete up to 1.5%, but this strength reduced back for concrete that contains more than 1.5% of waste fibers as shown in **Figure 1- 7**. This is attributed to the fact, while fibers were introduced into concrete mixtures, micro-cracks try to arrest and prevent further cracking propagation, therefore, more energy is required for the propagation of cracks inside samples [8].



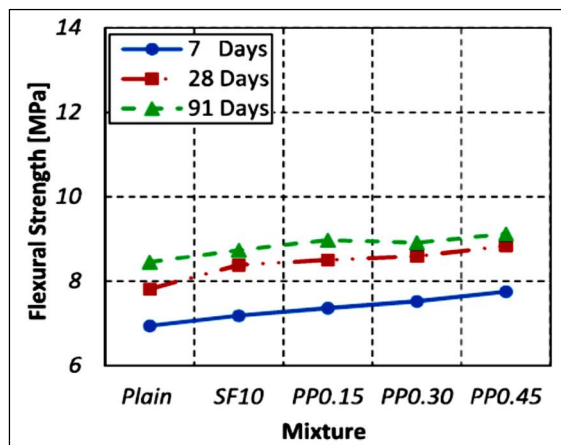
**Figure 1- 7:** Compressive strength versus plastic fiber ratio [8]

### 1.3.2. Flexural strength

In order to examine the flexural strength of cementitious materials, experimental research work was carried out and considered concrete mixtures with 0.1% and 0.3% of fibers from recycled PET bottles, including a control mixture. The findings reported a slight decrease in the flexural strength of the fiber-reinforced concrete compared to the reference samples [35].

In the same manner, a research study was performed in order to examine certain properties of concrete including reference specimens and concrete with 0.05%, 0.18%, and 0.3% of PET fibers by volume. A remarkable enhancement in the flexural strength, toughness, and energy absorption was observed for those concrete mixtures that contain 20 mm long fibers. It was also detected that the toughness index of fiber-reinforced concrete enhanced with the increase of fibers length. In addition, concrete mixtures containing fibers showed ductile behavior with improved deflection than control specimens [26].

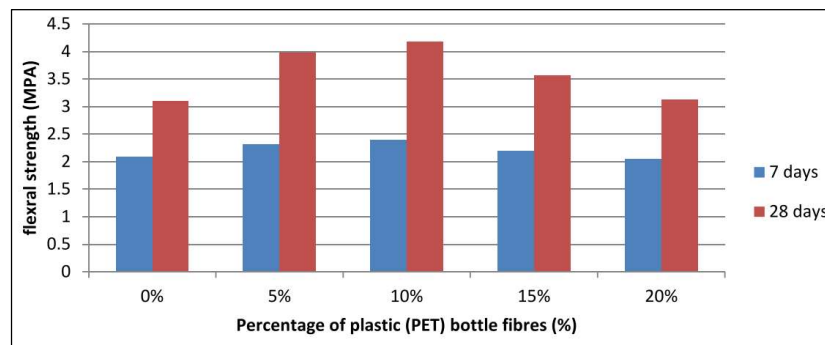
Similarly, a research investigation was carried out on concrete that contains 0.15%, 0.30%, and 0.45% of 12 mm long polypropylene fibers. The results illustrate that the flexural strength gradually increased from 5.0% to 14% as polypropylene fibers were introduced into concrete mixtures. The percentage of improvement depends on the fiber content and test age as shown in **Figure 1- 8**. Furthermore, since steel fibers have higher tensile strength and elastic modulus than plastic fibers, therefore, steel fibers improve flexural strength three times more than plastic fibers [29].



**Figure 1- 8:** Flexural strength of different fiber-reinforced concrete [29]

In the same token, it was reported through the experimental work conducted on concrete having 0.5%, 1.0%, 1.5%, and 2.0% of PET fibers that the flexural strength increased as the volume fraction of PET fibers increased up to 1.5%. Afterward, this strength was slightly decreased but still, the strength was more than control specimens [41].

Lastly, the experimental work conducted on concrete with 5.0%, 10%, 15%, and 20% of PET plastic bottle fibers replacing sand observed that the flexural strength increased up to 10% of PET fibers and then gradually decreased for 15% and 20% substitutions as shown in *Figure 1- 9*. Therefore, a 10% substitution was verified as an optimum value [30].



*Figure 1- 9: Flexural strength versus percentage of plastic fibres [30]*

### ***1.3.3. Split tensile strength***

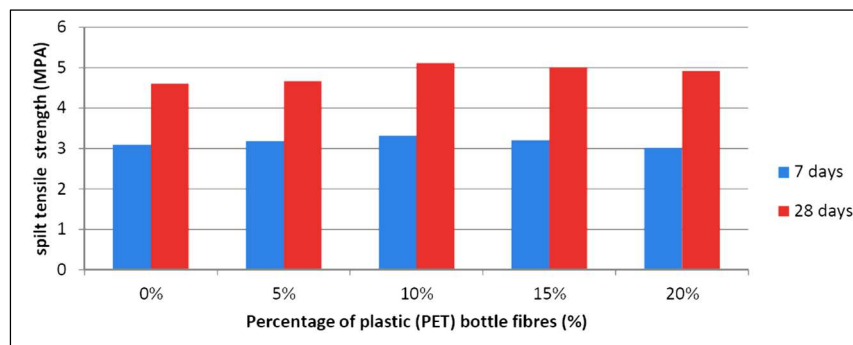
In order to evaluate tensile splitting strength, experimental work was conducted on concrete that contains 0.5%, 1.0%, 1.5%, and 2.0% of PET fibers by volume of concrete. The findings have highlighted that the split tensile strength improved only with the addition of fibers up to 1.0%, thereafter, a reduction was recorded for PET more than 1.0%. This is because of the bridging mechanism of PET fibers up to some percentages, while for higher percentages the bond strength between fibers and cement paste has been decreased. On the other hand, while the stress reaches the tensile strength of concrete, then stress is transferred to PET fibers, and fibers can delay the propagation of cracks which finally improves the split tensile strength. In addition, control specimens failed suddenly and separated into many parts, while fiber-reinforced samples could retain their shapes after concrete cracks [22].

Similarly, experimental work was carried out on concrete containing 12 mm long polypropylene fibers with percentages of 0.15%, 0.30%, and 0.45%. It was found that due

to the incorporation of polypropylene fibers into concrete mixtures the split tensile strength has been enhanced from 13% to 20% [29].

It has been detected from the experiments performed on concrete having 0.5%, 1.0%, 1.5%, and 2.0% of PET fibers that split tensile strength greatly improved, while percentages of PET fibers has raised to 1.5%, thereafter, such strength slightly decreased [41].

Also, researchers focused on concrete specimens that contain PET plastic bottle fibers replaced by fine aggregates. The outcomes showed that the split tensile strength gradually enhanced up to 10% PET fibers substitution and then the specimens experienced a reduction for 15% and 20% replacement as shown in *Figure 1- 10*. Therefore, a 10% substitution appeared to be the optimum value and useful for further purposes [30].



*Figure 1- 10: Spilt tensile strength versus percentage of PET plastic fibers [30]*

Finally, it was found through a research study carried out on concrete containing 0.5%, 1.0%, and 1.5% of PET fibers that split tensile strength was enhanced, while the percentage of PET fibers increased from 0% to 1.5% as presented in *Table 1- 3*. It is attributed to the fact that incorporated fibers bridge the cracks and improve bond properties between concrete ingredients. Therefore, PET fibers improve bending and tensile strengths [42].

*Table 1- 3: Splitting tensile strength of PET-based concrete [42]*

PET content [%]	Splitting tensile strength [Mpa]		
	7 days	14 days	28 days
0	1.98	2.34	2.97
0.5	2.10	2.87	3.24
1.0	2.15	2.95	3.43
1.5	2.27	3.08	3.67

The relative percentages for the effect of plastic fibers on the mentioned mechanical properties; compressive strength, flexural strength, and splitting tensile strength are summarized in **Table 1- 4**.

**Table 1- 4:** Relative percentage for the effect of plastic fibers on compressive strength, flexural strength, splitting tensile strength, and modulus of elasticity [38]

Substitution Type	Studied Properties	Percentage of Plastic Fibers (%)											Authors
		0.1	0.15	0.3	0.45	0.5	0.75	1	1.5	5	10	15	
Volume of concrete	Density, compressive, split tensile strengths, modulus of elasticity, Poisson's ratio and pulse velocity	-	-	-23	-	-23	-25	-	-	-	-	-	[34]
Volume of concrete	Workability, compressive, tensile and flexural strengths	+2	-	-2	-	-	-	-	-	-	-	-	[35]
Volume of concrete	Workability, compressive and split tensile strengths	-	-	-	-	-20	-	+2 2	-20	-	-	-	[22]
Volume of concrete	Workability, compressive, split tensile and flexural strengths and electrical resistivity	-	+10	+11	+13	-	-	-	-	-	-	-	[29]

Volume of concrete	<i>Workability, density, compressive and flexural strengths and pulse velocity</i>	+1	+1	+2.5	+3	+4	-	+4	+5	-	-	-	[8]
Weight of cement	<i>Compressive strength</i>	-	-	-	-	-	-	-	-	+2	-	-	[40]
Volume of concrete	<i>Workability, compressive, tensile and flexural strengths</i>	-3	-	-3	-	-	-	-	-	-	-	-	[35]
Volume of concrete	<i>Density, porosity, compressive and flexural strengths</i>	-	-	+16	-	-	-	-	-	-	-	-	[26]
Volume of concrete	<i>Workability, compressive, split tensile and flexural strengths and electrical resistivity</i>	-	+9	+10	+13	-	-	-	-	-	-	-	[29]
Volume of concrete	<i>Compressive, split tensile and flexural strengths</i>	-	-	-	-	+16	-	+27	+37	-	-	-	[41]
Replaced with sand	<i>compressive, split tensile and flexural strengths</i>	-	-	-	-	-	-	-	-	+22	+28	+12	[30]
Volume of concrete	<i>Workability, compressive and split</i>	-	-	-	-	-2	-	+9	-15	-	-	-	[22]



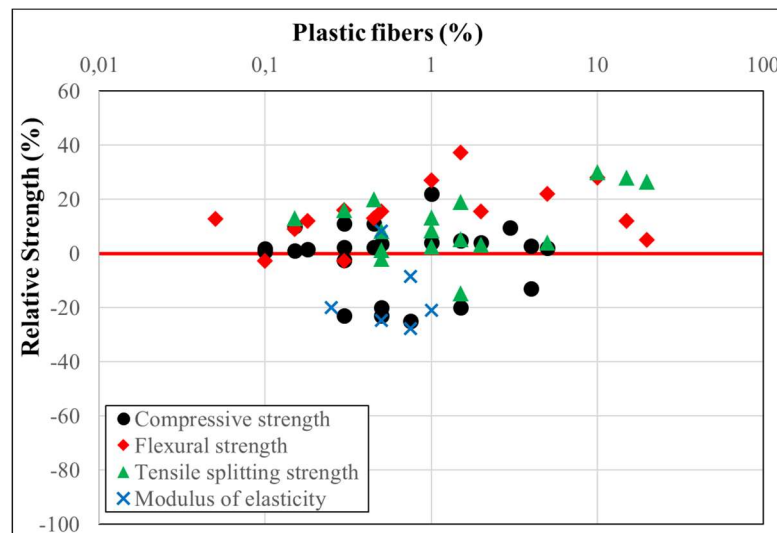
	<b>tensile strengths</b>												
Volume of concrete	<i>Workability, compressive, and flexural strengths and electrical resistivity</i> <b>split tensile</b>	-	+13	+16	+20	-	-	-	-	-	-	-	[29]
Volume of concrete	<i>Compressive, and flexural strengths</i> <b>split tensile</b>	-	-	-	-	+2	-	+3	+5	-	-	-	[41]
Replaced with sand	<i>compressive, and flexural strengths</i> <b>split tensile</b>	-	-	-	-	-	-	-	-	+4	+3	+28	[30]
Volume of concrete	<i>Compressive strengths and modulus of elasticity</i> <b>and split tensile</b>	-	-	-	-	+8	-	+13	+19	-	-	-	[42]

*Minus (-) and plus (+) signs represent decreasing and increasing the property of concrete calculated regarding the reference specimens of each study, respectively. In addition, the total studied properties by authors are written in gray italic font and the concern studied property of section is in black bold font.*

The discussion is based on studies carried out regarding the effect of plastic fibers on mechanical properties (compressive, flexural, and tensile splitting strengths) of cementitious materials.

The outcomes concerning the effect of plastic fibers on the compressive strength of concrete are summarized in **Figure 1- 11**. The majority of authors highlighted an enhancement in the compressive strength of concrete that contains plastic fibers compared to ordinary concrete. This is due to the fact that the incorporation of fibers arrests micro-cracks and prevents cracking propagation, whereas, more energy is needed for the propagation of cracks inside samples. However, it is clearly documented that some

researchers recorded opposite results, which is a decrease in the compressive strength with the increase of plastic fibers. This is because of aggregate strength, cement paste strength, and adhesion properties between concrete ingredients. In addition, fibers bundle during mixing and pouring that causes the weakest points between fiber surfaces, and finally resulting in early cracks under compressive loading and decreasing compressive strength. **Figure 1- 11** also summarizes the effect of plastic fibers on the flexural strength of concrete. The flexural strength, toughness, and energy absorption have been enhanced, while plastic fibers were added into concrete mixtures. Moreover, it can be observed from **Figure 1- 11** that the majority of authors reported similar findings which are an improvement in the flexural strength. But still, some authors like [Daniel et al., 2016 \[35\]](#) detected opposite results, which was a small reduction in the flexural strength when applying plastic fibers into concrete mixtures. This is linked to aggregate strength, cement paste strength, types of ingredient materials including plastic fibers, and adhesion properties within a concrete matrix. In addition, concrete mixtures that contain plastic fibers showed significant ductile behavior and improved deflection than control specimens.



**Figure 1- 11:** Relative percentage for the effect of plastic fibers on mechanical properties [38]

Finally, the effect of plastic fibers on the splitting tensile strength of concrete has been also summarized in **Figure 1- 11** and stated that almost all authors agreed on the enhancement of such strength, while plastic fibers were incorporated into concrete mixtures. This improvement was up to some percentages and after that, the strength decreased back

because fibers bridge cracking up to some percentages, but for higher percentages, the bond strength between fibers and cement paste has been decreased. Besides, specimens without fibers failed abruptly and separated into many pieces, whereas, fiber-reinforced samples have retained their shapes after concrete cracks. However, only a research study conducted by [Shahidan et al., 2018 \[22\]](#) has recorded converse results and this is due to the effect of aggregate strength, cement paste strength, types of ingredient materials including plastic fibers, and adhesion properties between concrete ingredients.

## 1.4. Transfer properties

### 1.4.1. Thermal conductivity

Experimental work was performed on concrete that contains three different types of plastic fibers at 1.0% volume fraction and reference specimens without fibers. The results underline that thermal conductivity ( $k$ ) significantly decreased for the specimens having PET fibers compared to control specimens. The outcomes illustrated that thermal conductivity has decreased by 18% for PET and 22% for PP compared to the control one as shown in [Table 1- 5](#). This can be due to the lower thermal conductivity of plastic fibers than cement and aggregates [\[31\]](#).

*Table 1- 5: Thermal conductivity of various concrete mixtures [31]*

Mixture	$\bar{k}$ (W/mK)	95% CI (W/mK)	FRR (%)
UNRC	0.967	0.284	0.0
RPETFRC/a	0.793	0.251	-18.0
PPFRC	0.756	0.139	-21.8

Similarly, an attempt was performed to use plastic fibers for the production of low thermal conductivity concrete. In this study, four types of plastic fibers were used as part of ingredients for concrete production, including high-density polyethylene (HDPE), low-density polyethylene (LDPE), polypropylene (PP), and polyethylene terephthalate (PET). The outputs demonstrate that thermal conductivity depends on the material property, surface area, thickness, and temperature gradient in steady-state heat transfer conditions. Moreover, thermal conductivities of HDPE, LDPE, and PP were reported to be about 0.43, 0.35, and 0.23 W/(m·K), while this property of ordinary concrete was about 1.34–2.92 W/(m·K) [\[43\]](#).

Overall, it can be underlined that investigation about thermal conductivity of concrete is pointed out by a few authors in the literature. However, it can be mentioned that thermal conductivity is proportional to the amount and types of plastic fibers, surface area, thickness, and temperature gradients. Finally, the authors stated that this property has been decreased, while plastic fibers were incorporated into concrete mixtures.

#### ***1.4.2. Ultrasonic pulse velocity (UPV)***

The ultrasonic pulse velocity test means to assist the transit time of ultrasonic pulses with 50-58 kHz, created by an electro-acoustical transducer and passing from one surface of the element to the other. The transit time of ultrasonic pulses depends on the density and elastic properties of the material being tested.

In this regard, an experimental work was carried out to study the UPV value of PET fiber reinforced concrete on prismatic specimens. The results present that the UPV values of both fiber-reinforced and reference concrete were in the range of 3.5–4.5 km/s, which shows a good quality of concrete. But, the incorporation of PET fibers resulted in 8–11% reduction of UPV values because of lower specific gravity and sound transfer properties of fibers [44].

In addition, an experimental study was conducted on concrete containing 0%, 0.5%, 1.0%, 1.5%, 2.0%, and 3.0% of PET plastic fibers. The authors observed that UPV value has decreased with the addition of PET fibers and this reduction was more significant for higher percentages of fibers. As a comparison, specimens with short fibers had slightly higher UPV values compared to the samples containing longer fibers [45,46].

Almost all authors agreed that the UPV value decreased with the incorporation of plastic fibers and such reduction was more significant for a higher volume fraction of fibers. This is due to the lower sound transfer properties of PET fibers compared to concrete ingredients.

## **2. Conclusions**

The conducted literature review has mainly focused on the effect of waste plastic fibers on the fresh, physical, mechanical, acoustic, and thermal properties of cementitious materials. Some of the concluding points are as follow:

- The workability of concrete mixtures has decreased remarkably with the incorporation of waste plastic fibers and this reduction was more significant for higher percentages. It was explained that the increased surface area, impervious nature, and high capacity of water absorption of plastic wastes at the fresh state and latterly the release of absorbed water to the hydrated state [22,35,36].
- Fresh and dry densities of concrete containing waste plastic fibers have been decreased as the percentage of plastic wastes increased. This can be attributed to the lower density of the incorporated plastic wastes and such reduction is directly related to the amount of waste plastic quantity [27,39].
- Most of the researchers reported an improvement in the compressive, flexural, and split tensile strengths of fiber-reinforced concrete compared to ordinary concrete. The researchers indicate that the introduction of fibers into concrete mixtures bridge cracking, try to arrest micro-cracks, and prevent further cracking propagation [22,26,29,40,41].

The transfer properties (acoustic and thermal) have been decreased as plastic wastes were introduced into concrete mixtures. It was related to the lower transfer properties of plastic compared to concrete ingredients. Moreover, the degree of the drop was related to the percentage of plastic waste [31,43,45].

It appears that researchers have conducted many works on plastic wastes that were incorporated into cementitious materials. However, the use of non-woven sheets as recycled plastic waste in cementitious materials is not referenced in the literature. Therefore, this research study aims to investigate the fresh, physical, mechanical, and microstructural properties of concrete and mortar containing PET non-woven sheet as a layer with different configurations or as cut pieces with various incorporation ratio. In addition, a part of this experimental work is concentrated to evaluate the effect of PET non-woven on acoustic and thermal properties as well. Moreover, the bond behaviors between non-woven sheets and cementitious materials are studied. This project is a joint program between Kabul Polytechnic University, Afghanistan, and the INSA Strasbourg, France. Therefore, parts of the present research work were conducted on locally available material in France and some parts in Afghanistan.

### 3. Research objectives

The main objective of this research study is the introduction of non-woven plastic tissue as a layer or cut pieces for the development of environmentally friendly mortar/concrete. The specific objectives are considering non-woven fabrics in cementitious materials in two ways: a) as a layer with 5 various configurations of 1-Layer, 2-Layers, 2-Sides, 3-Sides, and full wrapping to strengthen specimens, and b) as cut pieces (10×10) mm with four different incorporated percentages of 0%, 0.25%, 0.50%, and 0.75% by weight. Thereafter, for each considered method of non-woven sheets, the following properties of mortar/concrete are studied:

- Fresh properties: consistency, density
- Physical properties: dry density, porosity, and water absorption
- Mechanical properties: compressive, flexural, and tensile splitting strengths
- Thermal properties
- Acoustic properties
- Microstructure and surface analysis
- Bond properties between non-woven fabrics and mortar specimens and the effect of w/c ratio and amount of superplasticizer on such properties.

#### *Scientific Valorization*

- 1) **Sifatullah Bahij**, S. Omary, F. Feugeas, A. Faqiri, Fresh and hardened properties of concrete containing different forms of plastic waste – a review, *Waste Management*. 113 (2020) 157–175. <https://doi.org/10.1016/j.wasman.2020.05.048>
- 2) **Sifatullah Bahij**, Safiullah Omary, Françoise Feugeas and Amanullah Faqiri, Structural Strengthening/Repair of Reinforced Concrete (RC) Beams by Different Fibre-Reinforced Cementitious Materials - A State-of-the-Art Review. *Civil Environ Eng* 10 (2020): 354 <https://doi: 10.37421/jcce.2020.10.354>
- 3) **Sifatullah Bahij**, Safiullah Omary, Vincent Steiner, Françoise Feugeas and Amanullah Faqiri “Structural behaviors of reinforced concrete (RC) beams strengthened with different types and methods of fiber reinforced polymers (FRP) - A critical review”, *Peer Review* in the *Journal of Practice Periodical on Structural Design and Construction*.

## CHAPTER # 2

### MATERIALS AND METHODS

This chapter mainly focuses on the materials used for the elaboration of mortar/concrete, as well as the testing procedures for materials characterization, mortar and concrete samples.

Firstly, the materials (cement, aggregates, water, superplasticizer, and non-woven plastic tissue) used for the preparation of mortar or concrete mixtures have been introduced in detail.

In the second part, the experimental methods for material characterization are discussed. The cement was characterized based on specific gravity, bulk density, normal consistency and setting times, SEM analysis, and laser granulometry. While the aggregates were studied based on bulk density, specific gravity, water absorption, sieve analysis, and Los Angeles. Finally, the pH value of water used for mortar/concrete specimens' preparation and curing process was measured.

Thereafter, the experimental methods for mix design, mixing procedure, casting, and curing of mortar mixtures were explained. Following that, the testing methods for the fresh, physical, mechanical, microstructure, and bond properties of mortar have been detailed.

Finally, the experimental methods for mix design, mixing procedure, casting, and curing of concrete mixtures were explained in detail. Besides, the testing methods for the fresh, physical, mechanical, acoustic, and thermal properties of concrete have been exposed.

It must be noted that the procedure of standardized tests and used apparatus were explained in detail in Annex due to pedagogical and accessibility problems to standards in Afghanistan.

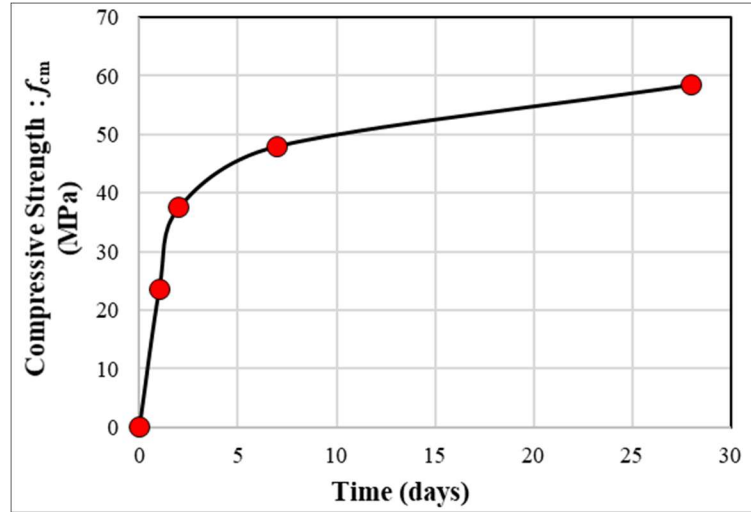
#### **1. Materials**

The following materials have been used to prepare and cast mortar and concrete specimens.

##### **1.1. Cement**

An Ordinary Portland Cement (OPC) of CEM I 52.5 N produced by HEMING according to the standard NF EN 197-1/A1 [47] was used for the preparation of specimens. The evolution of compressive strength and chemical composition of cement, mentioned in the

technical file provided by the producer company, are presented in **Figure 2- 1** and **Table 2- 1**. It is mentioned that the cement contains 95% of clinker and 5.0% of secondary materials.



**Figure 2- 1:** Compressive strength of CEM I 52.5 N [48]

**Table 2- 1:** Chemical composition of CEM I 52.5 N [48]

Components	CaO	SiO <sub>2</sub>	Al <sub>2</sub> O <sub>3</sub>	Fe <sub>2</sub> O <sub>3</sub>	K <sub>2</sub> O	MgO	Na <sub>2</sub> O	S--	Cl-	CO <sub>2</sub>	SO <sub>3</sub>	PAF	INS	CaO <sub>Free</sub>	Na <sub>2</sub> O <sub>e</sub> q active
Weight (%)	61.3	20	4.8	3.1	1.12	4.9	0.26	0.03	0.07	0.7	3.7	0.8	0.2	1.6	1
Phases	C <sub>3</sub> S				C <sub>2</sub> S				C <sub>3</sub> A				C <sub>4</sub> AF		
Weight (%)	63				20				7				10		

Besides, for the preparation of mortar specimens in the laboratory of Kabul Polytechnic University (KPU), an Ordinary Portland Cement (OPC) of GHORI brand, conforming to ASTM C150 [49] and locally produced in Afghanistan was used. The chemical composition of GHORI cement was found with the help of SPECTRO X-labPro machine in the Ministry of Mines and Petroleum and the results are presented in **Table 2- 2**.

**Table 2- 2:** Chemical composition of GHORI cement

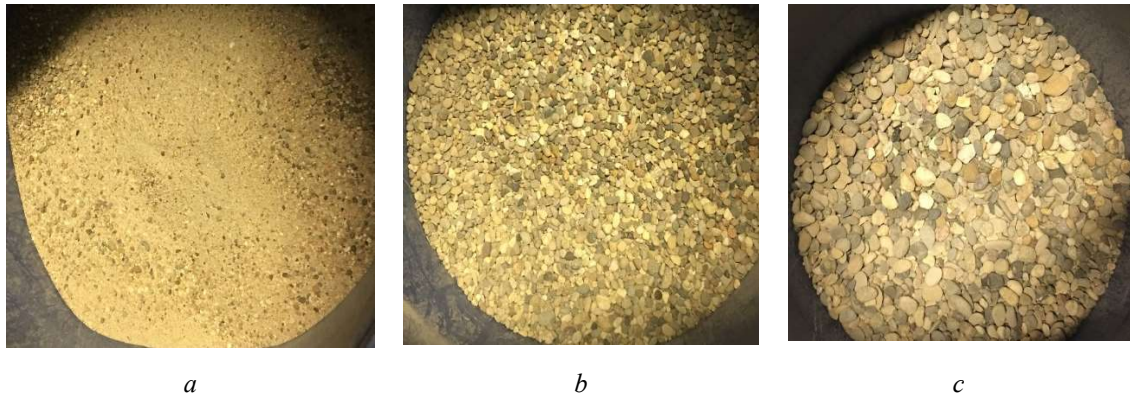
Components	CaO	SiO <sub>2</sub>	Al <sub>2</sub> O <sub>3</sub>	Fe <sub>2</sub> O <sub>3</sub>	K <sub>2</sub> O	MgO	Na <sub>2</sub> O	S--	Cl-	SO <sub>3</sub>
Weight (%)	63.44	17.63	4.892	2.016	0.5656	1.327	1.374	1.688	0.013	4.215

## 1.2. Aggregates

Locally available aggregates with three different sizes were used as fine and coarse aggregates in INSA Strasbourg. Fine aggregates (sand) had the size of (0-4) mm, and

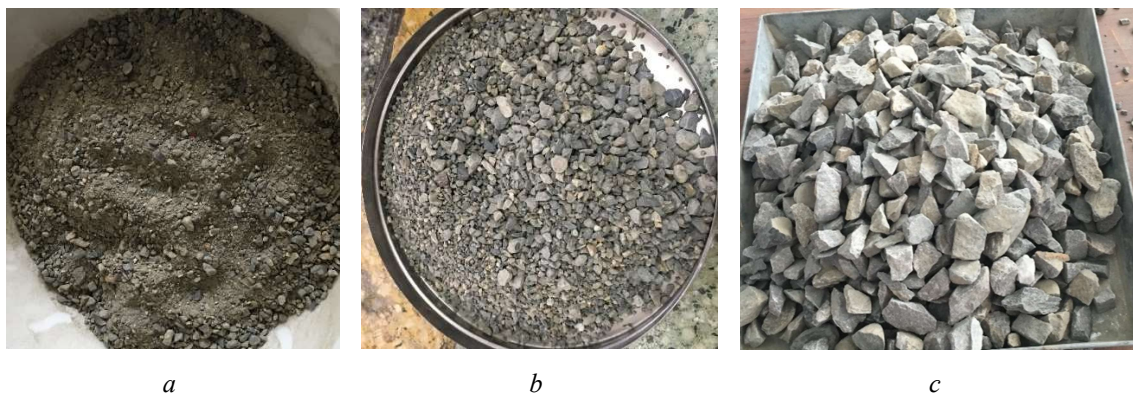


coarse aggregates containing two types; *a*) fine coarse aggregates (4-8) mm and *b*) coarse aggregates (8-16) mm as shown in **Figure 2- 2**.



**Figure 2- 2:** Types of aggregates; *a*) fine aggregates (sand), *b*) fine coarse aggregates, and *c*) coarse aggregates used in INSA Strasbourg

In addition, for the experiments performed in Kabul Polytechnic University (KPU), coarse aggregates with two different maximum sizes of 10 mm and 25 mm, crushed from mountain rocks, and fine aggregates with 6.3 mm maximum size collected from the local river were used to produce concrete and mortar mixtures (**Figure 2- 3**).



**Figure 2- 3:** Types of aggregates; *a*) fine aggregates (sand), *b*) fine coarse aggregates, and *c*) coarse aggregates used in Kabul Polytechnic University (KPU)

### 1.3. Water

Tap water available inside laboratories was used for mixing and curing of mortar and concrete specimens.

#### 1.4. Superplasticizer

In order to improve the workability of concrete and mortar mixtures, a superplasticizer from its newest generation was used, which is certified by EN 934-2 [50], and was sourced from a local supplier (SIKA) in France. **Table 2- 3** shows the physical and chemical properties of the mentioned superplasticizer.

Moreover, in the KPU-Lab, a new generation of polycarboxylate-based superplasticizer named ADIUM 150 certified by EN 934-2 [50] was used to improve the workability of concrete and mortar mixtures. It was sourced from the local branch of the Isomat Company. **Table 2- 3** presents the physical and chemical properties of the mentioned superplasticizer.

*Table 2- 3: Physical and chemical properties of superplasticizer*

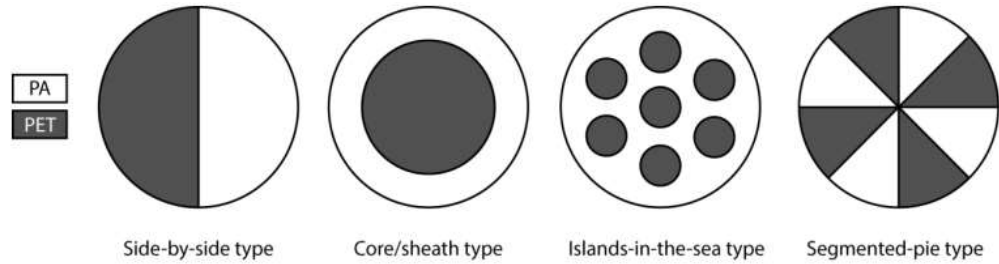
Properties	Value/type	
	SIKA used in INSA [51]	ADIUM 150 used in KPU [52]
Color	Dark brown	Brown
State	Liquid	Liquid
Density, kg/lit	1.15±0.03	1.03 - 1.07
pH	7.5 ± 1.0	5.0 ± 0.5
Chloride content	≤0.1%	Free
Recommended dosage:	5 L for 1 m <sup>3</sup> of concrete	≤ 2.0% by weight

#### 1.5. Non-woven PET plastic tissue

Non-woven PET plastic fabrics are widely defined as sheets or web structures and made from a combination of short and long fibers, and bounded together by chemical, mechanical, heat, or solvent treatment. Such fabrics are flat, porous, and do not require converting the fibers to yarn. The process for the production of non-woven fabrics is shorter, therefore, such fabrics are economic compared to knitted or woven fabrics. The raw materials for the production of this type of fabric are natural, synthetic, or half-synthetic (e.g. PLA, PP, PES, PE, PET, etc.).

The production of non-woven microfilaments includes two steps:

The first step involves the manufacture of bi-compound fibers. The formation of typical bi-component fibers or filaments involves co-extruding two polymers from a single spinneret with a desired cross-sectional arrangement. The bi-component fibers can be classified according to the distribution of each component within the cross-sectional area. Typical cross-section configurations include side-by-side, core/sheath type, islands-in-the-sea, segmented-pie type, etc. as shown in **Figure 2- 4** [53,54].



**Figure 2- 4:** Types of bi-component fiber cross-sections [53,54]

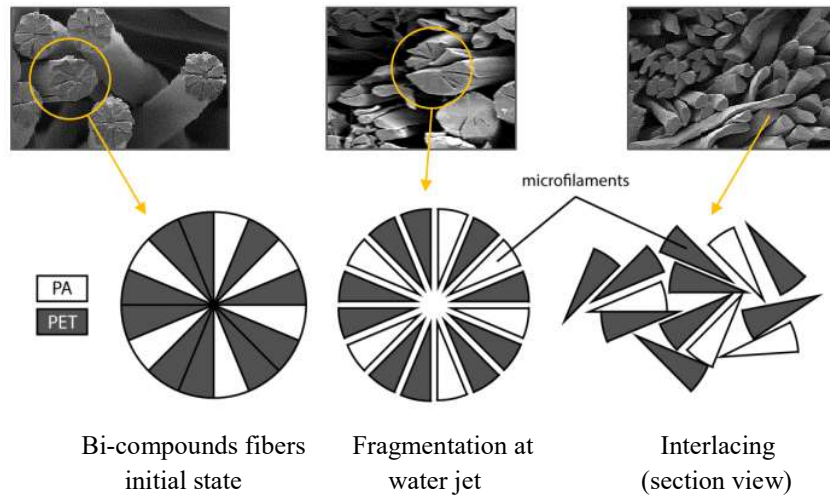
In the present study, the product of Freudenberg Company named Evolon<sup>®</sup> microfilaments textile was used as a layer or cut pieces in concrete or mortar mixtures as shown in **Figure 2- 5** [33]. This company has used segmented-pie type of bi-compound fibers to obtain the non-woven sheets. In addition, the number of segments in a segmented-pie ranges from 4 to 18, whereas the Evolon<sup>®</sup> textile has 16 bi-compounds segments and Polyethylene Terephthalate (PET)-Polyamide (PA) ratios of 70-30% [55–57].



**Figure 2- 5:** Evolon<sup>®</sup> non-woven plastic tissue

In the second step, the bi-compound fibers are subjected to mechanical (needling and fluid jet), thermal (pressurized stream and hot air), or chemical (acrylic, resin, and hydrogen chloride) treatments. This process could divide the single fiber into microfibers and form a coherent structure in total. The effectiveness of the separation is controlled by the quality of the interface between the different components. The low affinity between PET and PA weakens the bond between the segments and makes the separation possible [58–60]. In order to manufacture Evolon<sup>®</sup>, the Freudenberg Company uses the hydro entangling process: a high pressure water jet applied on both sides of the sheets, transforms the fibers in microfilaments by de-segmentation, and entangle them with each other as shown in

**Figure 2- 6.** This process was first introduced by DuPont in 1970 and is widely used in the production of non-woven sheets [58,61].



**Figure 2- 6:** Principle of hydro entangling [57]

The physical and mechanical properties of the non-woven sheet are presented in **Table 2- 4**.

**Table 2- 4:** Physical and mechanical properties of non-woven sheets [33]

Properties	Unit	Test Method	Values
Web bonding	-	EN 29092	Hydrolace
Mas per unit area	gr/m <sup>2</sup>	EN 9073-1	Target 100
Thickness	mm	ISO 9073-2	Target 0.37
Tensile strength (Machine direction)	N	EN 13934-1	Target 300
Tensile strength (Cross direction)	N	EN 13934-1	Target 290
Tear strength (Machine direction)	N	EN 13937	Target 8
Tear strength (Cross direction)	N	EN 13937	Target 8
Elongation at break (Machine direction)	%	EN 139374-1	Target 45
Elongation at break (Cross direction)	%	EN 139374-1	Target 50
Water absorption	ml/m <sup>2</sup>	DIN53923-78	Target 430 (Washed product)

## 2. Experimental methods for the characterization of mortar/concrete components

In order to select a proper mix design, adequate mixing sequence and duration, and curing condition, it is vital to characterize the used materials. Therefore, this part includes the testing procedures for characterizing the mortar/concrete ingredient materials.

## **2.1. Cement**

For the characterization of cement, the following properties are investigated.

### ***2.1.1. Specific gravity and bulk density***

Specific gravity is the property of materials to compare densities of a particular material to the water at a specified temperature. Specific gravity is calculating whether the material is able to sink or float on water.

On the other hand, bulk density is the behavior of materials which is defined as the mass divided by the total occupied volume. The total volume is equal to the volume of particles, the volume of inter-particles, and the volume of internal pores.

The specific gravity and bulk density of cement were conducted according to the ASTM C188-17 standard considerations [62]. The tests procedures and used apparatus are explained in detail in *Annex 1*.

### ***2.1.2. Normal consistency and setting times (initial and final setting time)***

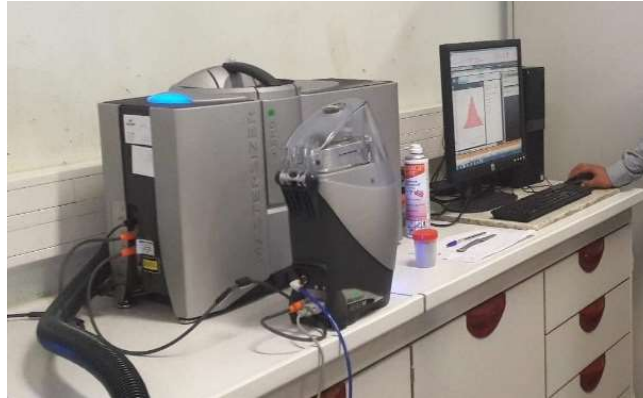
The normal consistency of cement represents the percentage of required water for the cement paste at which the viscosity of cement paste becomes that vacant plunger penetrates to a depth of  $(6 \pm 1)$  mm from the bottom of the mold. The time at which cement begins hardening and completely loses its plasticity is called the initial setting time of cement. The time required for the cement to achieve its complete strength is called the final setting time. These behaviors of cement were measured in compliance with the EN NF 196-3 [63] standard considerations. The test procedure is given in detail in *Annex 1*.

### ***2.1.3. Laser Granulometry***

For measuring and controlling the particle size distribution and surface area of cement, many techniques can be used such as; sieve analysis, air permeability, etc., but laser diffraction is the most popular and accurate method. Because the laser diffraction method is quick, easy, and provides a complete picture of the full-size distribution. In this method, a laser beam passes through spread particles of the sample, and angular variation in the intensity of scattered light is calculated. For large particles, the relative angle of the light scattering is smaller compared to small particles. Such data for angular scattering intensity is then analyzed to measure the size of particles, which is reported as a volume equivalent to sphere diameter.



Using the Mastersizer 3000E, it was possible to measure particle size range from 10 nm up to 3.5 mm using a single optical measurement path (*Figure 2- 7*). Ten samples of cement were examined. The tested samples, equivalent of one tea spoon, present a mix of cement powder taken from different depths of the cement bag.



*Figure 2- 7: Equipment of the laser diffraction test*

## **2.2. Aggregates**

The aggregates were characterized based on the following properties.

### **2.2.1. Specific gravity, bulk density, and water absorption**

The specific gravity, bulk density, and water absorption of aggregates are important properties for the preparation of concrete with a proper mix design. Specific gravity is the ratio between the masses of material and an equal volume of water at a specified temperature. Since aggregates have water permeable voids, therefore, it is necessary to measure two types of specific gravity: bulk specific gravity and apparent specific gravity. Moreover, the bulk density is the mass of aggregates needed to fill the cylinder of a unit volume after aggregates are batched according to the volume. Moreover, water absorption is defined as the difference in weights of aggregate samples at oven-dried and saturated conditions. Thus, these properties were measured according to the NF EN 1097-6 [64] standard considerations. The tests procedures were explained in detail in *Annex 2*.

Three samples for each type of aggregates were tested, the specific gravities, apparent specific gravity, and water absorption were calculated throughout the following equations.

$$\text{Specific gravity} = \frac{W_4}{W_3 - (W_1 - W_2)}$$

$$\text{Apparent specific gravity} = \frac{W_4}{W_4 - (W_1 - W_2)}$$

$$\text{Water absorption} = \frac{W_3 - W_4}{W_4} \times 100$$

Where,

$W_1$ : weight of aggregates + water + pycnometer.

$W_2$ : weight of pycnometer + water.

$W_3$ : weight of surface dried aggregates after 24 hours immersed in water.

$W_4$ : weight of oven-dried aggregates.

Furthermore, the bulk densities was obtained throughout the following formulas:

$$\text{Loose bulk density} = \frac{W_2 - W_1}{V}$$

$$\text{Compacted bulk density} = \frac{W_3 - W_1}{V}$$

Where,

$W_1$ : weight of the empty cylinder.

$V$ : volume of the selected cylinder.

$W_2$ : weight of cylinder and aggregates.

$W_3$ : weight of the cylinder and rodded aggregates in three layers.

### 2.2.2. *Size distribution*

Grading or size distribution states the process to determine the particle size distribution of a typical sample of aggregates. This property was measured based on NF EN 933-1 [65] standard considerations. The test procedure was explained in detail in *Annex 2*.

After taking the weights of retained aggregates in each sieve, a curve of aggregate grading is plotted, where the x-axis represents the size of aggregates, and the y-axis indicates the percentage of passing.

### 2.2.3. *Los Angeles*

The Los Angeles test is conducted to measure the hardness characteristics of aggregates. Therefore, the aim of such property is to observe the percentage of wear due to relative rubbing action between aggregates and steel balls used as abrasive charges. This test was

performed based on ASTM M C131 [66] standard considerations. The test procedure was explained in detail in *Annex 2*.

### **2.3. Water**

Tap water available inside the laboratories was used for the production of concrete and mortar. The pH test was performed using PHM 210 standard pH meter to analyze the acidity of water.

#### **2.3.1. pH value**

pH is a scale used to identify how acidic or basic a water-based solution is. pH value was measured as an average of 3 samples with the procedure mentioned in detail in *Annex 3*.

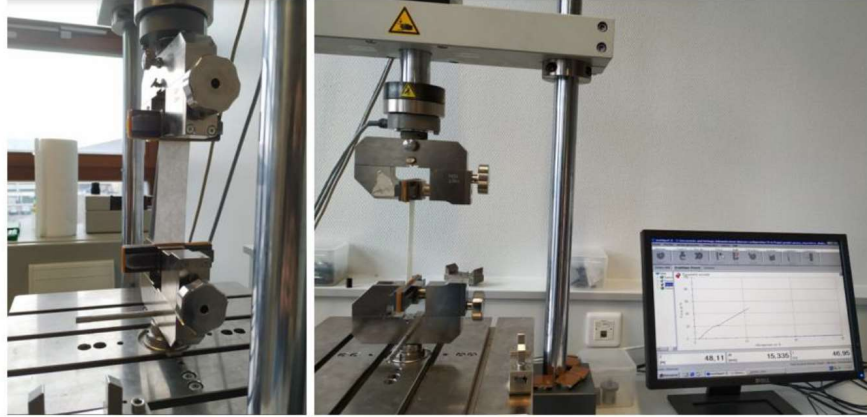
### **2.4. Non-woven sheets**

It was already mentioned that the product of Freudenberg Company named Evolon<sup>®</sup> microfilaments textile has been used as a layer or cut pieces in mortar/concrete mixtures. Even though, the technical file lists all of the properties of non-woven tissue, only the strength of such tissue against traction force was discovered here.

#### **2.4.1. Traction force**

The objective of this test is to find the resistance of non-woven sheets against traction force. Therefore, 3 samples of non-woven tissue were cut into (40×160) mm strips and were tested using Zwick/Roell Z2.0 traction machine as shown in *Figure 2- 8*. Once the strip is correctly positioned, the traction force was applied up to the breakage of strips. In addition, the displacement rate for testing the strips was 2 mm/min. Finally, the curve to record the traction force and displacement were obtained from the machine.





*Figure 2- 8: Equipment for applying traction force on non-woven tissue*

### 3. Experimental methods for mortar/concrete

#### 3.1. Mix design and mixing procedure of mortar

Based on two types of cement (CEM I in INSA and GHORI in KPU), different types of mortar samples were prepared to analyze the fresh, physical, mechanical, microstructural, and bond properties.

Overall, two types of mortar were cast as follows:

- 1) Samples with non-woven sheets as a layer.
- 2) Specimens containing non-woven fabrics as (10×10) mm cut pieces.

For samples with non-woven sheets as a layer, the mix proportion in compliance with EN NF 196-1 [67] standard was used as presented in *Table 2- 5*.

*Table 2- 5: Mix proportion a) standard mortar with CEM I in INSA b) mortar with GHORI cement in KPU*

<i>a</i>		<i>b</i>	
Materials	Weight of materials (gr)	Materials	Weight of materials (gr)
Fine aggregates (sand 0-4 mm)	1350	Fine aggregates (sand 0-6.3 mm)	1350
CEM I	450	GHORI cement	450
Water	225	Water	225
w/c ratio	0.5	w/c ratio	0.5

While for mortar mixtures containing various percentages of non-woven sheets as cut pieces, the mix design was modified with the addition of cut pieces and superplasticizer in function of the lower consistency. The mix proportion of standardized mortar based on CEM I in INSA is tabulated in *Table 2- 6*. The proportion of mortar with GHORI cement

is presented in **Table 2- 7**. It must be noted that the amount of fabrics for one batch is calculated by taking the mass of solid ingredients (cement + sand) as 1800 gr for both types of mortar. Moreover, the amount of cut pieces and superplasticizer were selected based on previous and present experimental works.

**Table 2- 6:** Mix proportion of mortar samples with cut pieces and CEM I in INSA

Materials	Weight of materials for different percentage of non-woven fabrics (gr)		
	0.25%	0.50%	0.75%
Fine aggregates (sand 0-4 mm)	1350	1350	1350
CEM I	450	450	450
Water	225	225	225
Non-woven sheets	4.5	9.0	13.5
Superplasticizer (SIKA)	4.5	9.8	14.3
w/c ratio	0.5	0.5	0.5

**Table 2- 7:** Mix proportion of mortar samples with cut pieces and GHORI cement in KPU

Materials	Weight of materials for different percentage of non-woven fabrics (gr)		
	0.25%	0.50%	0.75%
Fine aggregates (sand 0-6.3 mm)	1350	1350	1350
GHORI cement	450	450	450
Water	225	225	225
Non-woven sheets	4.5	9.0	13.5
Superplasticizer (ADUIM 150)	3.2	7.4	10.3
w/c ratio	0.5	0.5	0.5

For the preparation of mortars, standard mixers inside the laboratories of INSA Strasbourg (with CEM I) and KPU (with GHORI cement) were used as shown in **Figure 2- 9**. Since the specimens with non-woven plastic fabrics as a layer induce no change in mix design, the following standard mixing procedure was used NF EN 196-1, 2016 [67].

- Cement + water were added to the mixer and were mixed for 30 seconds at a slow speed.
- Then, sand were added in 30 seconds, and were mixed for another 30 seconds at a slow speed and then 30 seconds at a fast speed.

- Mixer was stopped for 60 seconds and mortar stuck to the bottom and sides of the mold were removed and mixed with the mortar inside the mold.
- Finally, the mixture was mixed for 60 seconds at a fast speed.



*a*



*b*

**Figure 2- 9:** Mortar mixers: a) INSA and b) KPU

On the other hand, for the preparation of specimens containing cut pieces of non-woven tissue, a standard mixing procedure was slightly modified. It means that the cut pieces were mixed within the sand in a dry state out of the mixer before the start of mixing as shown in **Figure 2- 10**. Then, a similar procedure was followed as for standard mortar mixing.



**Figure 2- 10:** Mix of non-woven cut pieces within the sand

### **3.2. Mix design and mixing procedure of concrete**

The concrete samples were fabricated only with GHORI cement in KPU. The mix proportion of concrete ingredients is designed based on the ACI Standard Practice [ACI 291.1 \[68\]](#) (volume basis) that contains a constant w/c ratio of 0.45 and a total binder content of 455 kg/m<sup>3</sup>.

Similar to the mortar mixtures, non-woven sheets are used in concrete mixtures with two various methods: 1) as a layer to strengthen samples, and 2) as cut pieces having (10×10) mm sizes and incorporated with various percentages of 0%, 0.25%, 0.50%, and 0.75%. The detailed amount of concrete components for specimens containing non-woven sheets as a layer are summarized in **Table 2- 8**.

**Table 2- 8:** Mix proportion of concrete with GHORI cement in KPU (kg/m<sup>3</sup>) [68]

<b>Materials</b>	<b>Weight of Materials (kg)</b>
Fine aggregates (sand 0-6.3 mm)	782
Fine coarse aggregates (2-10 mm)	358
Coarse aggregates (6.3-25 mm)	538
GHORI cement	455
Water	205
Superplasticizer	2.5
w/c ratio	0.45

For concrete mixtures containing cut pieces of non-woven sheets, the mix proportions were slightly modified with the addition of cut pieces and superplasticizer in function of lower consistency. In this case, the content of fabrics for one cubic meter is calculated taking the mass of solid ingredients of concrete as 2133 kg. It must be noted that the concrete mixtures containing cut pieces were either prepared with GHORI Cement in KPU. The amounts of ingredients of concrete mixtures containing cut pieces are summarized in **Table 2- 9**.

**Table 2- 9:** Mix proportion of concrete with cut pieces and GHORI cement in KPU (kg/m<sup>3</sup>)

<b>Materials</b>	<b>Weight of materials for different percentage of non-woven fabrics (kg)</b>		
	<b>0.25%</b>	<b>0.50%</b>	<b>0.75%</b>
Fine aggregates (sand 0-6.3 mm)	782	782	782
Fine coarse aggregates (2-10 mm)	358	358	358
Coarse aggregates (6.3-25 mm)	538	538	538
GHORI cement	455	455	455
Water	205	205	205
Non-woven sheets	5.33	10.66	15.99
Superplasticizer	3.6	5.0	6.1
w/c ratio	0.45	0.45	0.45

For the production of concrete mixtures, a tilting drum mixer was used, the following mixing methods were applied to produce the concrete mixtures:

- The mixer was charged by introducing ingredients of concrete in a proper sequence. There are no general rules on the order of feeding ingredients into the mixer, as this depends on properties of the mixer and of the mix.
- Then a small amount of water (normally 10% of the mixing water) was first fed to prevent the dust during the mixing.
- After that, the mixer was started and concrete ingredients containing 10% water was mixed for 90 seconds.
- Thereafter, the remaining water was added uniformly to the mixer, and mixing was continued for another 60 seconds.
- Finally, all the materials were mixed for a minimum of 120 seconds.

However, for the preparation of concrete mixtures containing cut pieces, before adding water, cut pieces were added uniformly into the mixer while sand + cement + aggregates + 10% of water were mixed in a dry state for 90 seconds. Then, a similar mixing procedure was followed as was used for the concrete mixtures with non-woven sheets as a layer.

The **Table 2-10** summarizes the different types of mix designs and incorporation of non-woven sheets:

*Table 2- 10: Used mix designs and non-woven configuration*

Mix design	Cement	w/c ratio	Non-woven sheets	Configurations	Superplasticizer	Lab
Mortar	CEM I	0.50	As a layer	Detailed in chapter # 4	Not used	INSA
Mortar	GHORI	0.50	As a layer	Detailed in chapter # 4	Not used	KPU
Mortar	CEM I	0.50	As cut pieces of 10×10 mm	Incorporation of 0.25%, 0.50 & 0.75% by mass of solid components	Used to maintain the consistency	INSA
Mortar	GHORI	0.50	As cut pieces of 10×10 mm	Incorporation of 0.25%, 0.50 & 0.75% by mass of solid components	Used to maintain the consistency	KPU
Concrete	GHORI	0.45	As a layer	Detailed in chapter # 5	Not used	KPU
Concrete	GHORI	0.45	As cut pieces of 10×10 mm	Incorporation of 0.25%, 0.50 &	Used to maintain the consistency	KPU

				0.75% by mass of solid components		
--	--	--	--	--------------------------------------	--	--

### 3.3. Casting and curing of mortar/concrete

For mortar specimens, the non-woven plastic tissues were placed in the oiled molds according to their strengthening configurations as shown in *Figure 2- 11*. The molds were then fully filled with mortar mixtures and fixed in an automated jolting machine, where the table, mold, hopper, and clamping mechanism were lifted and dropped 60 times. In the case of specimens with 2-Layers, one layer was placed at the bottom of the mold, and mortar mixture was poured to fill half of the molds, then the molds were lifted and dropped freely 30 times. Thereafter, the 2<sup>nd</sup> layer was placed and the molds were filled completely with the mixture before being lifted and dropped another 30 times.



*Figure 2- 11: Casting of samples*

Moreover, for each strengthening configuration, 24 prisms (40×40×160) mm, 24 cubes (50 mm), and 12 cylinders (75×150) mm were cast to be tested for the physical, mechanical, and microstructural behaviors of mortar.

Similar to the mortar samples, concrete specimens were prepared by placing the non-woven plastic tissue in the molds according to their configurations. After mixing completion, the concrete mixtures were poured into the molds and were vibrated with the help of a vibrating machine. In addition, for each strengthening configuration and type of test, 18 specimens were prepared to measure the considered properties after 7, 14, and 28 days of curing. The elaborated samples were 100 mm cubes, (100×200) mm cylinders, (100×70) mm cylinders, and (100×100×500) mm beams.

Immediately after casting, mortar and concrete samples were transferred to the curing room and were cured inside molds at (20 ±2) C° temperature, and 95 ±3% humidity for 24 hours.

Moreover, the prepared specimens were demolded after 24 hours and then cured inside the curing tank for a maximum of 28 days according to the standard.

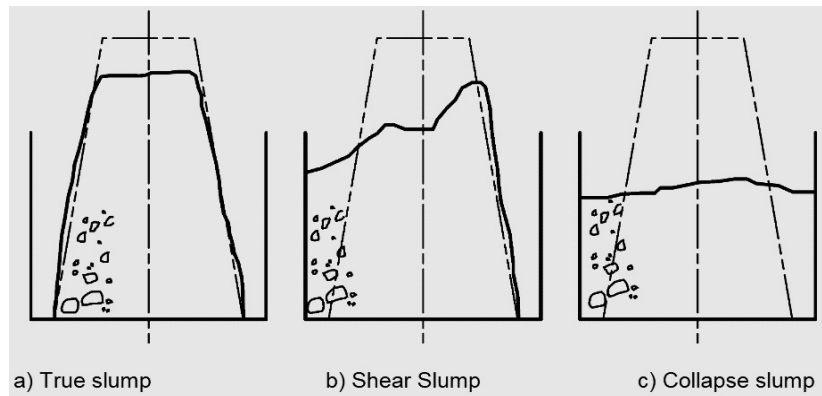
### 3.4. Fresh properties

#### 3.4.1. Workability

This test was performed for mortar mixtures according to the EN 1015-3 [69] standard considerations as an average of 3 samples. Moreover, the slump test for concrete mixtures was conducted according to EN 12350-2 [70] standard considerations. This test was conducted to know the consistency of mortar/concrete mixtures with cut pieces and required amount of superplasticizer to maintain the slump value similar to the reference ones. The test procedure is explained in detail in *Annex 4*.

The slump test is only acceptable in the following conditions:

- ✓ A slump in which concrete remains almost undamaged and symmetrical as shown in *Figure 2- 12a*.
- ✓ If the specimen shears, as shown in *Figure 2- 12b*, the test should be repeated.
- ✓ If two consecutive tests show similar shear or collapse shapes, the concrete does not have a required consistency for the slump test to be suitable.



*Figure 2- 12: Forms of slumps [71]*

#### 3.4.2. Fresh density

The fresh density of mortar mixtures was carried out based on EN 1015-6/A1 [72] standard considerations on 3 samples. While for concrete, it was measured based on EN 12350-6 [73] standard considerations. The tests procedures for mortar and concrete mixtures are explained in detail in *Annex 4*.

Finally, the fresh density of mortar/concrete was calculated as below:

$$D = \frac{m_2 - m_1}{V}$$

Where,

$D$ : is the density of the fresh mortar/concrete, in  $\text{kg/m}^3$

$m_1$ : is the mass of the empty vessel, in  $\text{kg}$

$m_2$ : is the mass of the vessel completely filled with compacted mortar/concrete, in  $\text{kg}$

$V$ : is volume of the vessel, in  $\text{m}^3$

### 3.5. Physical properties

Physical properties are to explore the density, porosity, and amount of water that could be absorbed by mortar/concrete specimens and were conducted based on NF P18-459 [74] standard considerations. Besides, the final result was considered as an average of 3 samples. The test procedure and used apparatus are explained in detail in *Annex 4*.

The properties were calculated by the following equations:

$$\text{Apparent bulk density } \rho_{app} = \frac{M_3}{M_2 - M_1} \cdot \rho_{wat}$$

$$\text{Water absorption } WA = \frac{M_2}{M_3 - M_2} \cdot 100$$

$$\text{Porosity } n = \frac{M_2 - M_3}{M_3 - M_1} \cdot 100$$

$M_1$  : The mass of samples in water through hydrostatic measurement.

$M_2$  : The masse of surface dry saturated samples after 24 hours of immersing in water.

$M_3$  : The mass of oven-dried samples at a temperature of  $105 \pm 5$  °C.

Besides, the procedure for measuring the physical properties of concrete specimens was similar to the ones for mortar. However, the used concrete samples were (100×70) mm cylinders instead of 50 mm cubes for mortar.



### 3.6. Mechanical properties

#### 3.6.1. Flexural strength

The flexural test was conducted according to EN 1015-11 [75] standard consideration on 3 specimens of (40×40×160) mm mortar prisms.

The 3R flexural and compressive automatic and ADR-Auto 250/25 cement machines were used in the INSA and KPU, respectively. These machines had two steel supporting rollers that have  $10 \pm 0.5$  mm diameter, 45 to 50 mm length, and spaced at  $100 \pm 0.5$  mm apart is shown in *Figure 2- 13*.



*Figure 2- 13: Flexural testing machine: a) INSA and b) KPU*

Besides, a loading rate of 50 N/s was applied on mortar prisms according to the standard and the maximum load in kN and stress in MPa was recorded.

Furthermore, the flexural strength of concrete specimens was measured according to EN 12390-5 [76] standard consideration on 3 specimens of (100×100×500) mm beams. The flexural tests on concrete samples were carried out as 4-Points bending test with a loading rate of 0.05 MPa/s using ELE<sup>®</sup> 50 kN Mini-Flexural machine conforming to EN 12390-5 [76] standard consideration. Moreover, regarding to the force application, the spacing between loading points and supports was arranged as shown in *Figure 2- 14*.



*Figure 2- 14: Arrangement of spacing between loading points and supports*

### 3.6.2. Compressive strength

The compressive strength was conducted on 40 mm mortar cubes based on EN 1015-11 [75] standard considerations. The 3R machine with the option of compressive strength and conforming EN-1015-11 [75] standard considerations with a loading rate of 0.5 MPa/s was used that contains two steel plates of  $40 \pm 0.1$  mm long and  $40 \pm 0.1$  mm wide apart. The final results were based on the average of three samples tested for each curing time (3, 7, 14, 28 days).

While considering concrete specimens, the compressive strength was conducted on 100 mm cubes and (100×200) mm cylinders according to the EN 12390-3 [77] standard considerations. In addition, the surface of cylindrical samples was polished before the compression test in order to obtain a flat surface. The compressive strengths were obtained using ADR 1500 ELE<sup>®</sup> Compression machine conforming to EN 12390-4 [78], with a constant rate of loading 0.6 MPa/s (*Figure 2- 15*).



*Figure 2- 15: Compressive strength machine used in KPU*

### 3.6.3. Split tensile strength

The tensile splitting test was conducted on 3 specimens of (75×150) mm cylinder using ADR 1500 ELE<sup>®</sup> Compression machine according to the EN 12390-6 [79] standard considerations for mortar. The loading rate for this test was taken according to the standard as 0.05 MPa/s.

Besides, the procedure for measuring the split tensile strength of concrete specimens was similar to the ones for mortar with the same machine and loading rate. However, the used concrete cylinders were (100×200) mm instead of (75×150) mm for the mortar.

The test procedures for mechanical properties (flexural, compressive, and tensile splitting strengths) of mortar and concrete are presented in detail in *Annex 4*.

### 3.7. Transfer properties

#### 3.7.1. Ultrasonic pulse velocity (UPV)

The ultrasonic pulse velocity (UPV) test means to assist the transit time of ultrasonic pulses with 50-58 kHz, created by an electro-acoustical transducer and passing from one surface of the element to the other. An ultrasonic pulse velocity test was carried out using ELE® Pundit Plus equipment by direct method on 100 mm concrete cubes in accordance with ASTM C597 [80] standards as shown in *Figure 2- 16*. Besides, 3 samples were considered for each type of sample. The pulse velocity values were computed by dividing the cube dimension by the transit time.

$$V = \frac{l}{t}$$

Where,

$V$ : is the velocity in *km/sec*

$l$ : is the cube dimension in *km*

$t$ : is time in seconds



*Figure 2- 16: Ultrasonic pulse velocity test equipment*

#### 3.7.2. Thermal conductivity

The amount of heat transfer or thermal conductivity was measured using the equipment of the ISOMET 2104 heat transfer analyzer according to EN 12667 [81] as shown in *Figure 2- 17*. The ISOMET 2104 is a portable measuring instrument for the direct measurement

of thermo-physical properties of a wide range of isotropic materials. In addition, this equipment is a multifunction instrument for the measurement of thermal conductivity ( $\lambda$ ), thermal diffusivity ( $a$ ), volume heat capacity ( $c\rho$ ), and temperature ( $^{\circ}\text{C}$ ).



*Figure 2-17: ISOMET 2104 equipment for thermal conductivity*

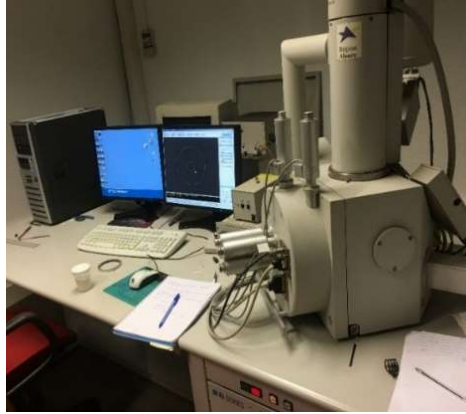
In order to measure the effect of non-woven PET plastic tissue on thermal properties of concrete, the tissue was considered as a layer or cut pieces incorporated into concrete samples. For the calculation of such properties, (100×70) mm cylindrical specimens were cast and the experimental program of thermal conductivity is presented in *Table 2- 11*. Moreover, the results were measured as an average of 3 samples.

*Table 2- 11: Experimental procedure for thermal conductivity of concrete*

Name	Description
Ref	No sheet
1-layer	A layer of a non-woven sheet at the bottom
2-sides	Non-woven sheets at two vertical opposite sides
0.25%	0.25% of non-woven cut pieces
0.50%	0.50% of non-woven cut pieces
0.75%	0.75% of non-woven cut pieces

### **3.8. Microstructure imaging analysis by Scanning Electron Microscopy (SEM)**

Scanning Electron Microscopy (SEM) analysis using Philips XL30<sup>®</sup> equipment was conducted to investigate the microstructure of cement powder in initial state and mortar containing cut pieces of non-woven sheets. Moreover, the SEM analysis were carried out to observe the interfacial transition zone (ITZ) between incorporated cut pieces of non-woven sheets and cement paste. The SEM analysis will help to establish correlation between the microstructure, physical, mechanical, and transfer properties of mortar at the hardened state (*Figure 2- 18*).



*Figure 2- 18: Equipment for SEM analysis*

### **3.9. Bond properties**

The adhesion properties of non-woven sheets with mortar specimens and the influencing parameters such as: 1) w/c ratio and 2) amount of superplasticizer are investigated. In order to measure the adhesive behaviors, bond test using a special setup by extracting certain tissue from the surface of prisms with 180° pull-out was performed. A metal container has been manufactured locally inside the laboratory of INSA Strasbourg, which had sufficient space for proper insertion or removal of the specimens.

Since 40×40×160 mm prisms were used for such test, thus, non-woven tissues were cut to 40 mm width as the width of prisms and 400 mm long (160 mm length of prisms and 240 mm for pulling). Then, the cut sheets were placed in the mold as shown in *Figure 2- 19*. For each variable parameter, 6 prisms were cast to be tested after 14 and 28 days of standard curing. It could be mentioned that the mix design, mixing, casting, and curing processes were the same as for standard mortar.



*Figure 2- 19: Placement of non-woven sheets in prisms*

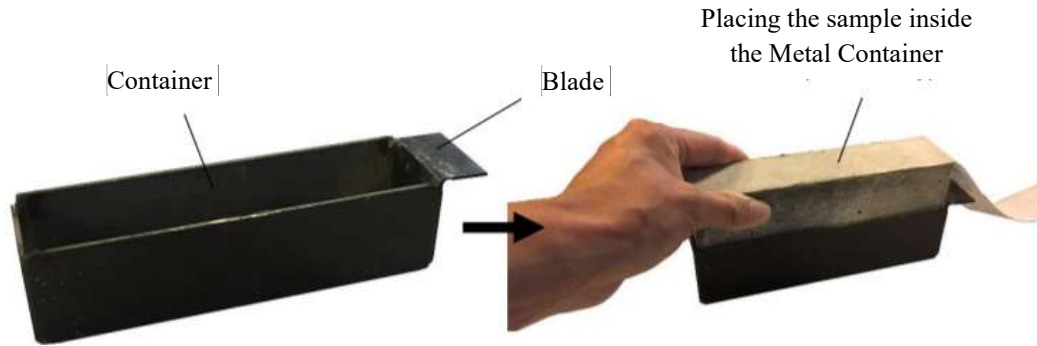
**a) Apparatus**

- Shimadzu 100 kN direct tensile testing equipment was used as shown in *Figure 2- 20*.



*Figure 2- 20: Shimadzu 100 kN machine*

- Metal container with a blade at one end to fix the container in the testing machine. While the other end was free and the non-woven sheet was bent from the bottom of the specimens to the top that the sheets will be fixed in the top of the machine as shown in *Figure 2- 21*.
- Prisms (40×40×160) mm



*Figure 2- 21: Metal container*

***b) Testing procedure***

In order to measure the bond properties of prisms, the following procedure is carried out:

- The specimens were removed from the water and were dried in the air for 2 hours before the test.
- Then, specimens were placed in the metal container (*Figure 2- 22*) and the blade of the metal container was fixed at the lower jaw. The free end of the sheet was caught in the upper jaw using a rubber piece in order to avoid the sliding of non-woven sheets during the test.
- After fixing the metal container, the test was started and the machine gradually pulled the sheets from the prims with a displacement rate of 2 mm/min.
- The readings were taken at  $\Delta t = 0.1s$  interval of time, whereas an average of 80,000 values was recorded for each specimen.



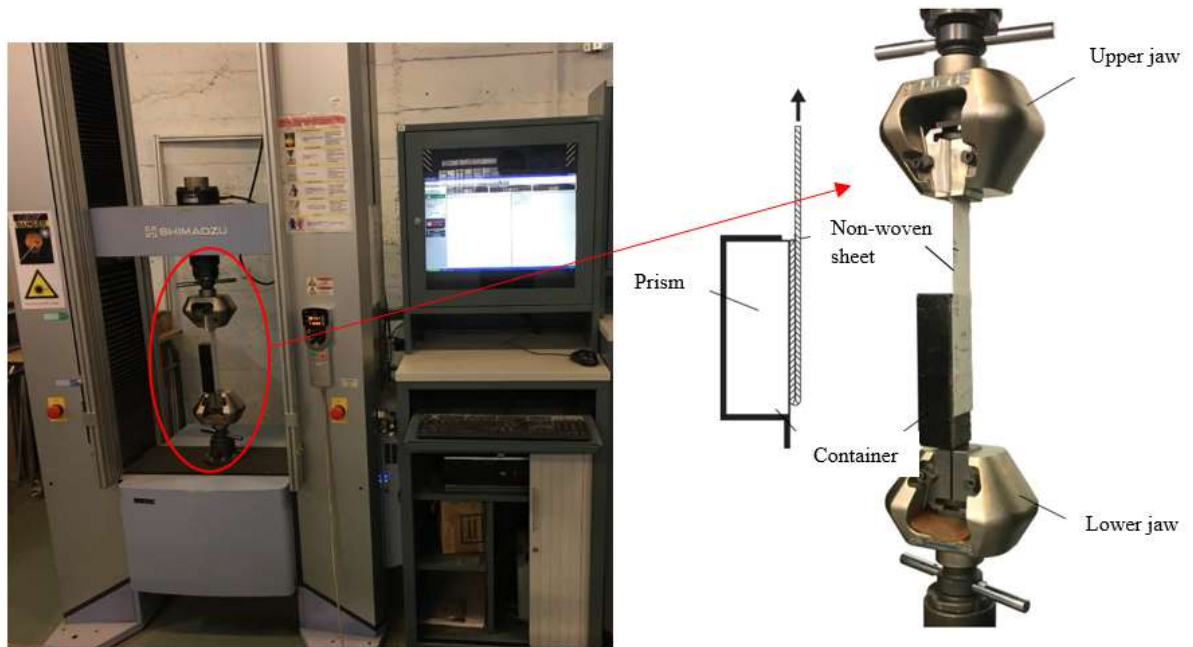


Figure 2- 22: Complete setup of the bond test and samples under testing

#### 4. Conclusions

The experimental methods carried out as part of this work have been grouped together in the *Table 2-12*.

The used methods for the characterization of materials, mortar, and concrete were conducted in accordance with the standards. However, the bond properties were measured using a prepared setup in INSA for the well understanding of adhesion between non-woven sheets as a layer and mortar mix design.

Table 2- 12: Conducted tests and their methods

Type of property		Standard/equipment	
Materials characterization	Cement	Specific gravity	ASTM C188-17 [62]
		Bulk density	
		Laser granulometry	Mastersizer 3000E
		Normal consistency and setting times	NF EN 196-3 [63]
		SEM analysis	E-SEM based Philips XL30
	Aggregates	Bulk density	NF EN 1097-6 [64]
		Specific gravity and water absorption	
		Size distribution	NF EN 933-1 [65]



		Los Angeles	ASTM M C131 [66]
	Water	pH value	pHM210
	Non-woven sheet	Traction force	Zwick/Roell Z2.0
<b>Mortar characterization</b>	Fresh properties	Workability	EN 1015-3 [69]
		Fresh density	EN 1015-6/A1 [72]
	Physical properties	Dry density	NF P18-459 [74]
		Porosity and water absorption	
	Mechanical properties	Compressive strength	EN 1015-11 [75]
		Flexural strength	
Split tensile strength		EN 12390-6 [79]	
<b>Bond properties of mortar</b>	Adhesion between non-woven sheets and mortar	SEM analysis	E-SEM based Philips XL30
		Bond property	Shimadzu 100 kN machine
<b>Concrete characterization</b>	Fresh properties	Workability	EN 12350-2 [71]
		Fresh density	EN 12350-6 [73]
	Physical properties	Dry density	NF P18-459 [74]
		Porosity and water absorption	
	Mechanical properties	Compressive strength	EN 12390-3 [77]
		Flexural strength	EN 12390-5 [76]
		Split tensile strength	EN 12390-6 [79]
	Transfer properties	Acoustic	ASTM C597 [80]
Thermal conductivity		EN 12667 [81]	

# CHAPTER # 3

## CHARACTERIZATION OF CONCRETE/MORTAR COMPONENTS

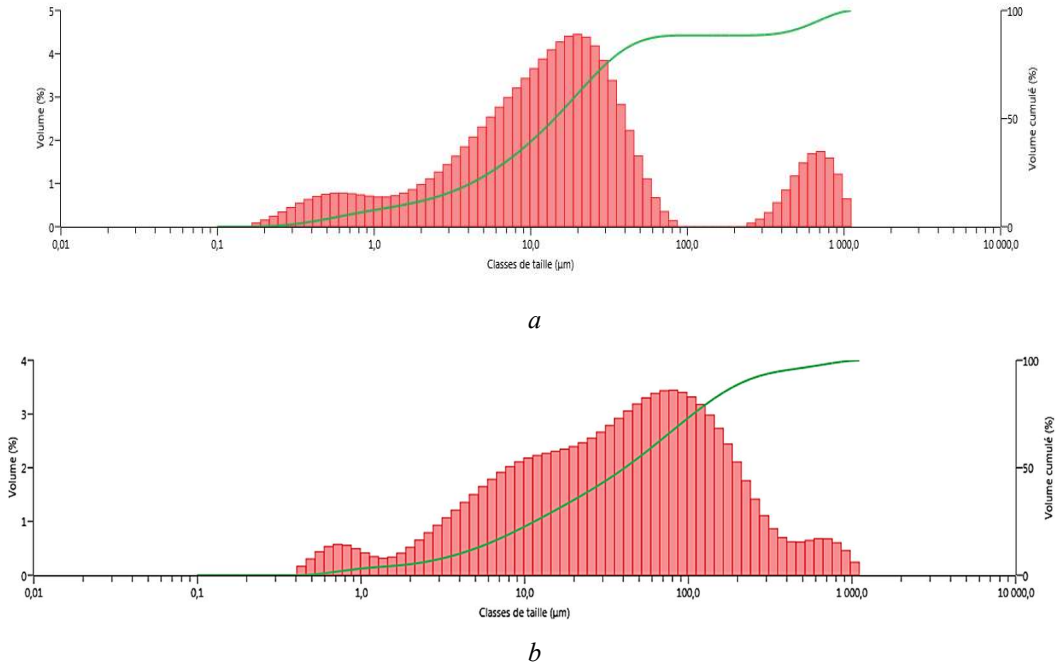
This chapter describes the results for the characterization of cement, sand, coarse aggregates, and water. Firstly, cement is characterized by bulk density, specific gravity, modulus of fineness, normal consistency and setting times, scanning electronic microscopy (SEM), and laser granulometry. Thereafter, the bulk density, specific gravity, water absorption, sieve analysis, and Los Angeles of both fine and coarse aggregates are studied. The pH value of water used for the preparation and curing of mortar/concrete specimens is checked to ensure their quality.

### 1. Characterization of cement

An Ordinary Portland Cement of CEM I 52.5 N produced by HEMING [82] according to the standard of NF EN 197-1/A1 [47] was used for the preparation of specimens in INSA Strasbourg. Besides, for the preparation of concrete or mortar specimens in the laboratory of KPU, an Ordinary Portland Cement of GHORI brand, conforming to ASTM C150 [49] and locally produced in Afghanistan were used. The following tests were carried out to characterize the behaviors of cement.

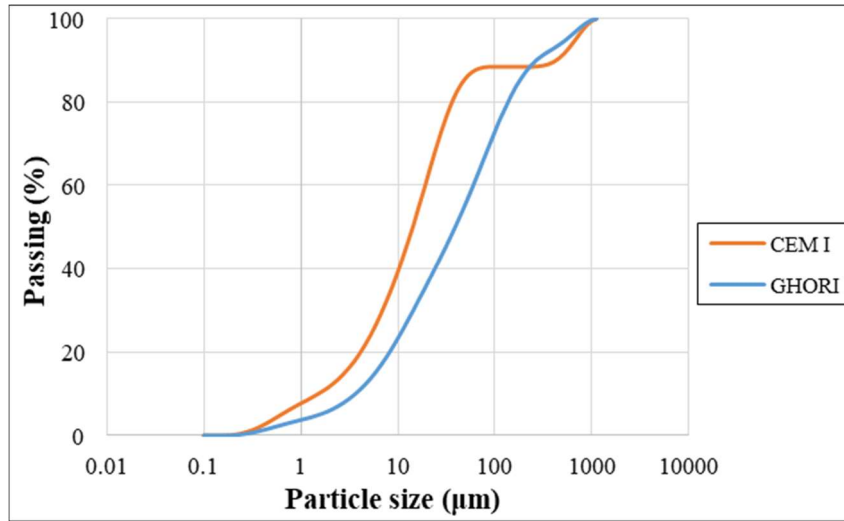
#### 1.1. Laser granulometry

In order to measure the particle size and surface area of the cement, 10 samples of CEM I 52.5 N and GHORI was tested using laser granulometry equipment. The surface area and size distribution of CEM I 52.5 N and GHORI are shown in *Figure 3- 1*.



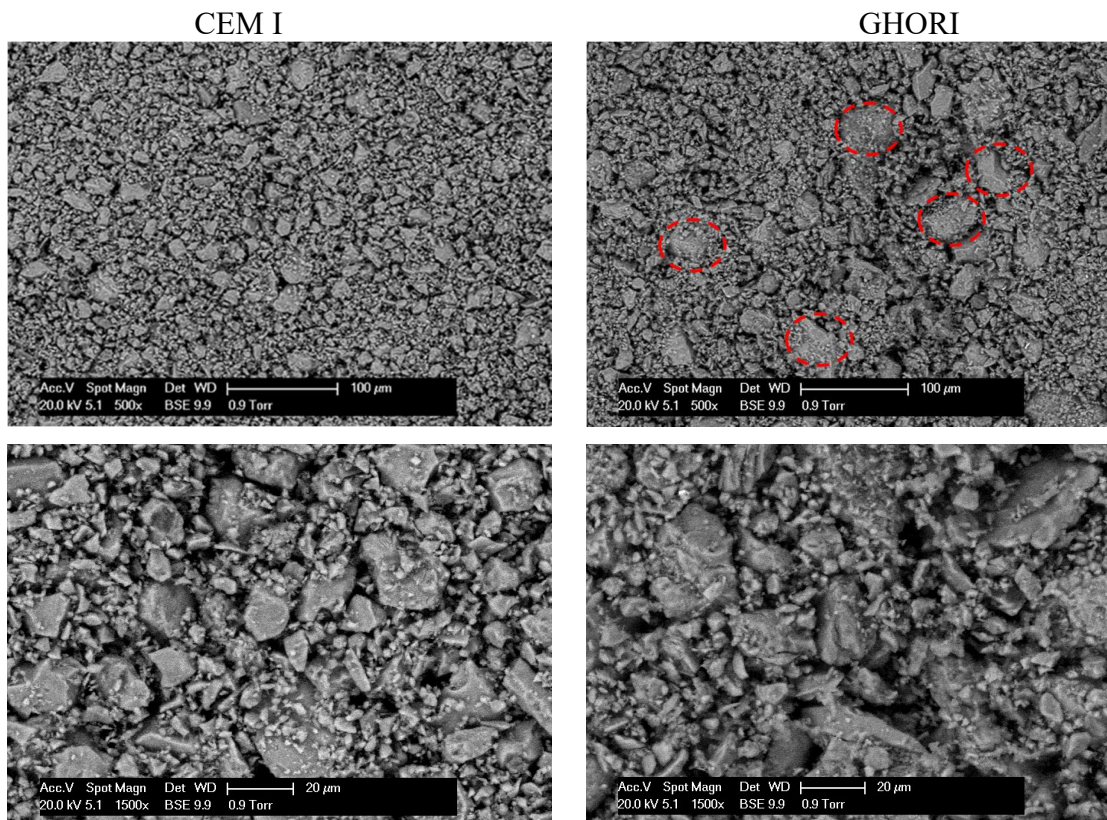
**Figure 3- 1:** Size distribution, a) CEM I 52.5 N and b) GHORI

The obtained results from laser granulometry analysis present that the surface area of CEM I 52.5 N is  $4509 \pm 257$  (cm<sup>2</sup>/gr) and that of GHORI cement is  $2764 \pm 303$  (cm<sup>2</sup>/gr). It can be seen that the surface area of CEM I is higher than that of GHORI cement. Besides, the obtained surface area of CEM I 52.5 N is in accordance with the technical form of the producer company, HEMING [82] and is in good accordance with the literature [83]. On the other hand, the technical form of GHORI cement doesn't present the surface area of the produced cement. However, the Portland Cement Association (PCA) and ASO Cement [84,85] recommend cement with the surface area of more than 2500 cm<sup>2</sup>/gr. While the IS 8041 [86] recommends the usage of ordinary Portland cement with the surface area not less than 2250 cm<sup>2</sup>/gr. Even though, GHORI cement has a lower surface area compared to CEM I, it can be still used for the production of cementitious materials as per recommendations and standards. In addition, the difference between the surface area of CEM I and GHORI cements was clearly verified by the size distribution curve shown in **Figure 3- 2**. The curves point out that almost 90% of CEM I particles are finer than that of GHORI cement.



**Figure 3- 2:** Size distribution of CEM I and GHORI cements

The SEM image analysis was conducted on CEM I 52.5 N and GHORI cements, in order to analyze the microstructure of cement particles. The images were shown in **Figure 3- 3** and reveal that the GHORI cement contains bigger particles of grains compared to those of CEM I 52.5 N. Therefore, the SEM analysis confirms the obtained results of surface area for both type of cement.



a

b

**Figure 3- 3:** SEM observations of a) CEM I 52.5 N b) GHORI cement

### 1.2. Specific gravity and bulk density

In order to measure the specific gravity and bulk density of cements, 3 samples of each cement, CEM I 52.5 N and GHORI, were tested. The obtained results were presented in **Table 3- 1**.

**Table 3- 1:** Specific gravities and bulk densities of both type of cement

Cement type	Specific gravity	Bulk density (gr/cm <sup>3</sup> )
<b>CEM I</b>	3.127 ±0.002	3.104 ±0.002
<b>GHORI</b>	3.041 ±0.011	3.003 ±0.009

The average specific gravities of CEM I and GHORI are 3.127 and 3.041, respectively. It can be seen that the GHORI cement presents a lower specific gravity than the CEM I. Moreover, the same trend was observed for the bulk density, whereas, the CEM I present a higher bulk density than GHORI one. It can be explained through the lower detected surface area and bigger grains of GHORI cement. Moreover, the specific gravity and bulk density of Portland Cement ranges from 3.10 to 3.25 as per Portland Cement Association [84]. Therefore, the CEM I answer properly to the recommendation while the GHORI cement doesn't fulfill the requirement proposed by PCA [84].

### 1.3. Normal consistency and setting times

In order to observe the normal consistency of cement, the test has been repeated on the cement paste containing various amounts of water until the paste found viscosity that vacant plunger penetrates to a depth of 6 ±1 mm from the bottom of the mold according to EN 196-3 standard [63]. The tests were realized in two different labs, but the temperature was maintained according to the requirement of the mentioned standard (20 ±2 °C) and the relative humidity was about 60%. The results of normal consistency on cement paste for both CEM I 52.5 N and GHORI cement are shown in **Table 3- 2**.

**Table 3- 2:** water/cement ratio for normal consistency of CEM I 52.5 N and GHORI cement paste

Cement type	w/c ratio	Plunger Penetration (mm)
<b>CEM I</b>	0.330	6.0
<b>GHORI</b>	0.266	5.5

As shown in **Table 3- 2** that the CEM I answer to the normal consistency with a higher w/c ratio compared to the GHORI one. The lower amount of mixing water needed by GHORI cement for the normal consistency can be attributed to its coarser ground fineness. Besides, the normal consistency of CEM I is in accordance with the literature [83].

After finding the normal consistency, the initial and final setting times were measured and their results are shown in **Table 3- 3**.

**Table 3- 3: Setting times of CEM I 52.5 N and GHORI cement**

Sample	CEM I 52.5 N		GHORI	
	Initial (min)	Final (min)	Initial (min)	Final (min)
1	127	271	100	180
2	129	275	97	185
3	125	273	94	181
<b>Average</b>	<b>127 ±1.6</b>	<b>273 ±1.6</b>	<b>97 ±2.5</b>	<b>182 ±2.2</b>

The obtained results present that the initial setting time for CEM I and GHORI cement is 127 and 97 minutes. Besides, the final setting time of CEM I and GHORI cement is 273 and 182 minutes, respectively. These values were confirmed by previous studies which reveal that the initial setting time of Portland cement should not be earlier than 45 min and the final setting time should not exceed 6.5 hours [87]. On the other hand, a remarkable difference was observed between the outcomes of setting times of GHORI and CEM I Portland cements. This is attributed to the coarser behaviors of GHORI cement compared to the CEM I and the higher amount of CaO in GHORI cement than that of CEM I (**Table 2- 2**).

The characterized properties of both cements (CEM I and GHORI) were summarized in **Table 3- 4**. Globally, it can be seen that GHORI cement presents weaker values compare to the CEM I. It is why, in some cases the GHORI cement doesn't fulfil the recommendations and requirements of international standards.

**Table 3- 4: Summary for the characterized properties of CEM I 52.5 N and GHORI cement**

Properties	CEM I	GHORI
<b>Specific gravity</b>	3.127 ±0.002	3.041 ±0.011
<b>Bulk density (gr/cm<sup>3</sup>)</b>	3.104 ±0.002	3.003 ±0.009
<b>Surface area (cm<sup>2</sup>/gr)</b>	4509 ±257	2764 ±303
<b>w/c ratio of normal consistency</b>	0.330	0.266
<b>Initial setting time (min)</b>	127 ±1.6	97 ±2.5

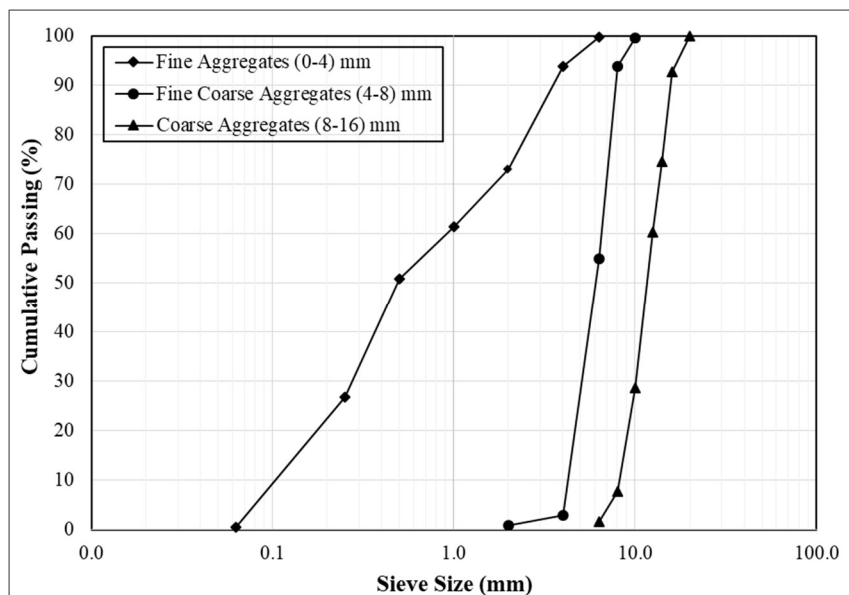
Final setting time (min)	273 ±1.6	182 ±2.2
--------------------------	----------	----------

## 2. Characterization of aggregates

Three different sizes of aggregates were used as fine and coarse aggregates. The following tests were performed to characterize the behaviors of both fine and coarse aggregates.

### 2.1. Size distribution

The results of the sieve analysis and distribution curves of aggregates tested in INSA Strasbourg are shown in *Figure 3- 4*.



*Figure 3- 4: Size distribution curve for fine and coarse aggregates in INSA*

In the same manner, 3 samples were tested and their results for the sieve analysis and distribution curves in the laboratory of KPU are shown in *Figure 3- 5*.



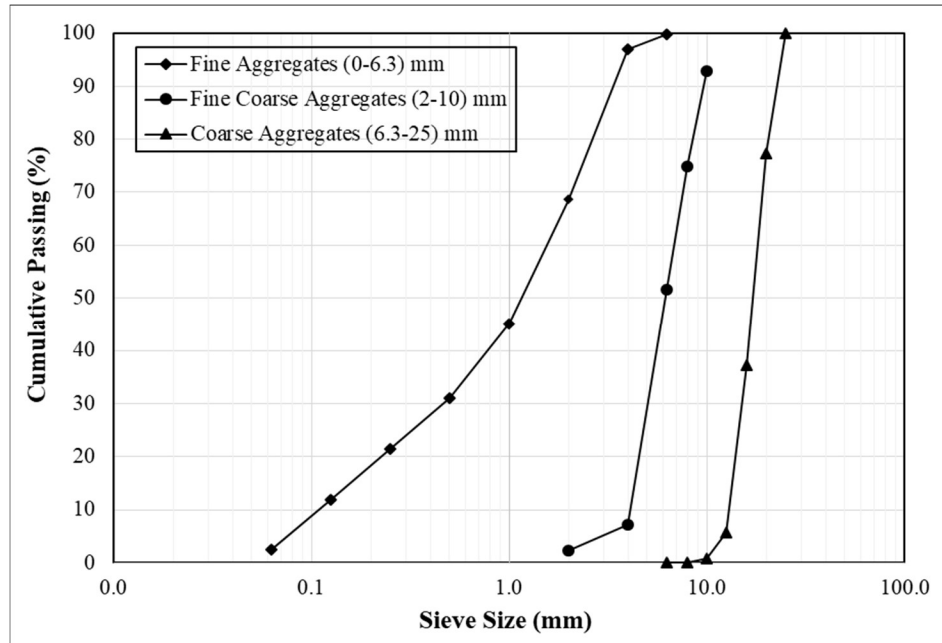


Figure 3- 5: Size distribution curve for fine and coarse aggregates in KPU

The size distributions clearly present that the curves are uniform and no gaps were seen for the aggregates used in KPU and INSA. In addition, this phenomenon was confirmed by the ASTM C33 [88] standards as shown in *Figure 3- 6*. It can be confirmed that both types of aggregates can be used for the production of concrete/mortar.

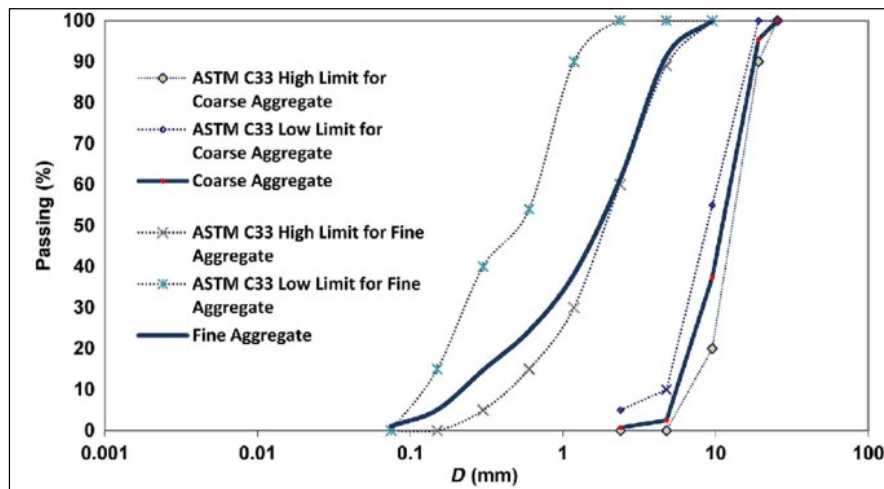


Figure 3- 6: Standard size distribution curve [88]

## 2.2. Specific gravity and water absorption

Three samples for each type of aggregate were tested and their results obtained in INSA Strasbourg are shown in *Table 3- 5*.



*Table 3- 5: Specific gravity and water absorption (WA) values of fine aggregates, fine coarse aggregates, and coarse aggregates in INSA*

Aggregates	Specific gravity	SD	Apparent specific gravity	SD	WA (%)	SD
Fine aggregates (0-4 mm)	2.589	0.004	2.660	0.014	1.07	0.20
Fine coarse aggregates (4-8 mm)	2.504	0.004	2.617	0.008	1.72	0.15
Coarse aggregates (8-16 mm)	2.566	0.015	2.639	0.012	1.09	0.01

In the same context, three samples for each type of aggregates were tested in the laboratory of KPU and their results are shown in *Table 3- 6*.

*Table 3- 6: Specific gravity and water absorption (WA) values of fine aggregates, fine coarse aggregates, and coarse aggregates in KPU*

Aggregates	Specific gravity	SD	Apparent specific gravity	SD	WA (%)	SD
Fine aggregates (0-6.3 mm)	2.653	0.004	2.729	0.007	1.28	0.10
Fine coarse aggregates (2-10 mm)	2.634	0.017	2.738	0.001	1.44	0.20
Coarse aggregates (6.3-25 mm)	2.586	0.014	2.664	0.011	1.13	0.07

The aggregates used in France were calcareous limestone with round surfaces, but the aggregates utilized in Afghanistan were calcareous crushed stone. In addition, the aggregates used in Afghanistan had slightly higher specific gravity compared to the ones in France. On the other hand, both types of aggregates present almost the similar coefficient of water absorption.

### 2.3. Bulk density

Three samples for each type of aggregates were tested and the results obtained in INSA Strasbourg are shown in *Table 3- 7*.

*Table 3- 7: Bulk and compacted bulk densities of fine aggregates, of fine aggregates, fine coarse aggregates, and coarse aggregates in INSA*

Aggregates	Bulk density (kg/m <sup>3</sup> )	SD	Compacted bulk density (kg/m <sup>3</sup> )	SD
Fine aggregates (0-4 mm)	1734.72	11.72	1820.86	7.04
Fine coarse aggregates (4-8 mm)	1495.43	21.10	1574.22	2.23
Coarse aggregates	1516.16	2.20	1611.54	0.97

(8-16 mm)				
-----------	--	--	--	--

In the same context, three samples for each type of aggregates were tested in the laboratory of Kabul Polytechnic University and the results are shown in **Table 3- 8**.

**Table 3- 8:** Bulk and compacted bulk densities of fine aggregates, of fine aggregates, fine coarse aggregates, and coarse aggregates in KPU

Aggregates	Bulk density (kg/m <sup>3</sup> )	SD	Compacted bulk density (kg/m <sup>3</sup> )	SD
Fine aggregates (0-6.3 mm)	1624.51	20.6	1784.20	19.74
Fine coarse aggregates (2-10 mm)	1288.90	14.00	1441.48	9.21
Coarse aggregates (6.3-25 mm)	1299.97	7.67	1496.98	2.95

The obtained results reveal that there is a difference between the bulk densities of aggregates used in both laboratories. The aggregates used in Afghanistan have lower bulk densities compared to the ones used in France. This is due to the microstructure, maximum sizes, and size distribution of aggregates.

#### 2.4. Los Angeles

The Los Angeles (LA) test was only conducted in the laboratory of KPU for all four grades of aggregates and their results are shown in **Table 3- 9**.

**Table 3- 9:** Abrasion values of aggregates in KPU

Weights (gr)	Grades			
	A (9.5-37.5) mm	B (6.3-9.5) mm	C (4.75-6.3) mm	D (2.36-4.75) mm
Original sample of aggregate ( $W_1$ )	5011	5000	5000	5000
Retained sample of aggregate ( $W_2$ )	3810	3507	3557	3642
Coefficient of LA	24%	30%	29%	27%

The outcomes of the Los Angeles test show that both fine and coarse aggregates have appropriate hardness and their results are within the range (maximum abrasion value of 45%) ASTM M C131 [66].

### 3. Characterization of water

Tap water available inside the laboratory of INSA and KPU was used for the preparation and curing of samples. The following test was performed to analyze the quality of the water.

#### 3.1. pH value

Three samples were tested to find the pH value of water and the recorded results in INSA Strasbourg and in Kabul Polytechnic University (KPU) were shown in *Table 3- 10*.

*Table 3- 10: pH value of water*

Sample #	INSA	KPU
1	7.24	7.54
2	7.21	7.55
3	7.23	7.54
<b>Average</b>	7.23 ±0.012	7.54 ±0.005

The pH values in both laboratories indicate that water is neither acidic and nor alkaline. Thus the pH of the water complies with the standard and could be used for both preparation and curing of mortar/concrete samples.

### 4. Characterization of non-woven tissue

#### 4.1. Traction force

Three strips of non-woven tissue of 40 mm width were tested to evaluate their strengths against traction force and the recorded results are shown in *Table 3- 11*.

*Table 3- 11: Tensile strength of non-woven sheet in INSA*

Sample #	Ultimate load capacity (N)	Maximum elongation (mm)
1	205.0	66.6
2	191.5	74.3
3	191.1	76.5
<b>Average</b>	195.9 ±6.5	72.5 ±4.2

The results indicate that the non-woven sheets present three phases of linear deformation versus force with a final elongation around 45%. The force versus displacement curves are shown in *Figure 3- 7*. The curves present elastic behavior up to ① point and then the load remained constant up to ② point because of slightly sliding in non-woven tissue. Finally,

the curves followed elastic-plastic behaviors between points ② and ③, and the non-woven tissue was torn at the ultimate load capacity of point ③.

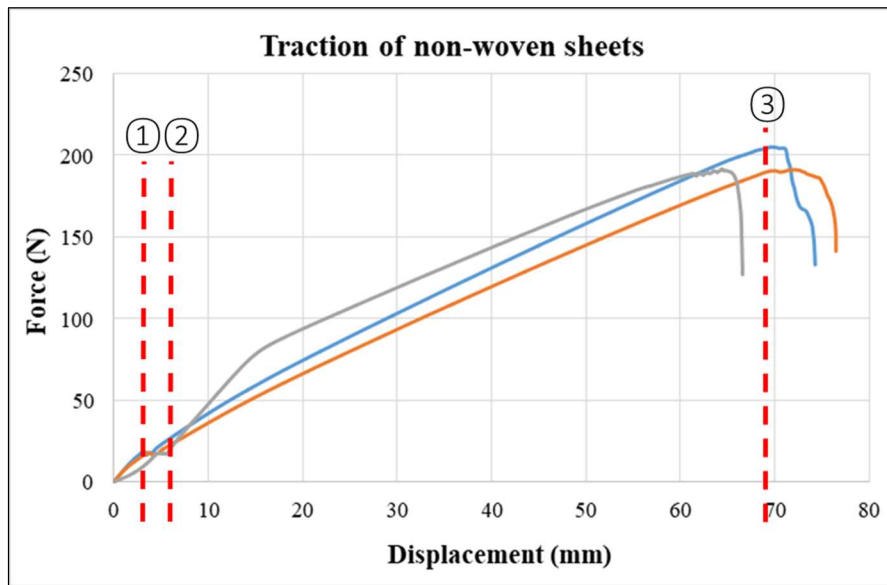


Figure 3- 7: Force-displacement curve for the traction of non-woven tissue in INSA

The maximum average value obtained is about 196 N whereas **Table 2- 4** gives a “target” of 300 N for the tensile strength (machine direction) or 290 N (cross direction). This can be explained by the fact that the procedure used in this work is not standardized and that the target value is the maximum possible depending on the manufacturing. Here, the samples were extracted from a waste: the edge of the fabric roll has been used. Nevertheless, it appears that the three samples cut in different parts of the fabric have similar behavior and evidence the homogeneity of the product.

## 5. Conclusions

Overall, the results of material characterization present that cements, aggregates, and water used in both laboratories meet the required standards and are suitable for having proper mix designs. However, some of the properties of materials used in Afghanistan differ from those utilized in France.

- Although, GHORI cement meets the needed specifications, some properties differ significantly from CEM I 52.5. For example, the GHORI cement is substantially coarser (with a surface area of  $2764 \pm 303 \text{ cm}^2/\text{gr}$ ) than CEM I 52.5 (with a surface

area of  $4509 \pm 257 \text{ cm}^2/\text{gr}$ ). It explains the amount of water used for the normal consistency of GHORI cement that is significantly less compared to CEM I 52.5.

- On the other hand, the physical and mechanical properties of sand and aggregates are in accordance with the aforementioned standards. However, the aggregates used in Afghanistan has a lower bulk density and are somewhat coarser than the ones in France.
- The results of fineness modulus for fine aggregates (sand) used in INSA and KPU are according to the EN 12620+A1 [89] standard with the range of (2.4 - 4.0). However, the fine aggregates used in KPU had higher capacity of water absorption (WA), fineness modulus and fine content retained at the pan compared to the ones used in INSA.

It is for these reasons that, for the preparation of the samples, it was decided to use the same mix design and the same proportions for the mortar prepared in the KPU and INSA laboratories thus a similar workability was obtained for both mortars.

## CHAPTER # 4

### USE OF NON-WOVEN TISSUE IN MORTAR

This chapter mainly focused on the effect of non-woven sheets as a layer or cut pieces on various properties of mortar.

In the first step, non-woven tissue was applied as a layer with CEM I and GHORI cement with various configurations (1-Layer, 2-Layers, 2-Sides, 3-Sides, and full wrapping) to explore its effect on mechanical (compressive, flexural, and split tensile strengths) and acoustic properties of mortar. Besides, the cracking mechanism was also discussed in detail for each mechanical property.

In the second step, (10×10) mm cut pieces of non-woven sheets were incorporated with 0%, 0.25%, 0.50%, and 0.75% by mass of solid components into mortar mixtures, and their effect on the fresh, physical, mechanical, microstructural, and acoustic properties was investigated.

In the third step, non-woven sheets were cut into various dimensions (5×7, 5×10, and 5×20) mm to study the effect of their aspect ratio on the fresh, physical, and mechanical properties of mortar.

Finally, the parameter linked to the adhesion between non-woven sheets and mortar specimens was explored with the help of traction force, interferometry, and microscopic analysis. Moreover, the effect of w/c ratio and superplasticizer content on bond properties between tissue and mortar specimens was studied as well.

**Table 4- 1** presents the overall flow of this chapter, which presents the mix design, used cement type, incorporation of non-woven sheet and the number of conducted tests.

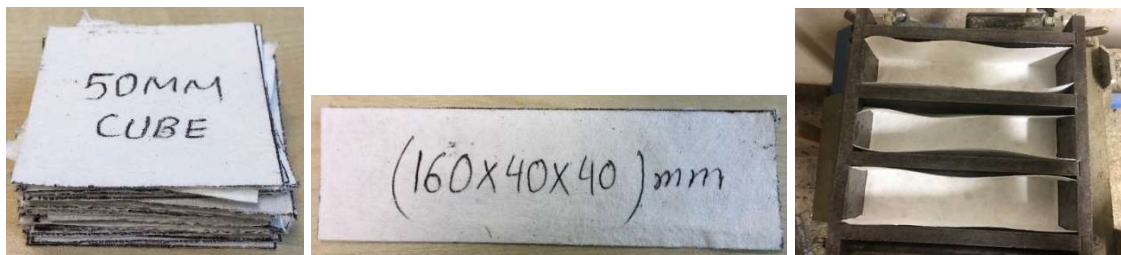
*Table 4- 1: Summary of tests for chapter # 4*

Mix design	Cement	Non-woven sheets	Configurations	Tests	Lab
Mortar	CEM I	As a layer	Detailed in chapter # 4	<ul style="list-style-type: none"><li>• Workability</li><li>• Flexural Strength</li><li>• Compressive Strength</li></ul>	INSA
Mortar	GHORI	As a layer	Detailed in chapter # 4	<ul style="list-style-type: none"><li>• Flexural Strength</li><li>• Compressive Strength</li><li>• Tensile splitting Strength</li><li>• Ultrasonic Pulse Velocity</li></ul>	KPU

Mortar	CEM I	As cut pieces of 10×10 mm	Incorporation of 0%, 0.25%, 0.50 & 0.75% by mass of solid components	<ul style="list-style-type: none"> <li>• Flexural Strength</li> <li>• Compressive Strength</li> </ul>	INSA
Mortar	GHORI	As cut pieces of 10×10 mm	Incorporation of 0%, 0.25%, 0.50 & 0.75% by mass of solid components	<ul style="list-style-type: none"> <li>• Workability</li> <li>• Density and Porosity</li> <li>• Flexural Strength</li> <li>• Compressive Strength</li> <li>• Tensile splitting Strength</li> <li>• Ultrasonic Pulse Velocity</li> </ul>	KPU
Mortar	CEM I	As cut pieces with different aspect ratio	Incorporation of 0%, 0.25%, 0.50 & 0.75% by mass of solid components	<ul style="list-style-type: none"> <li>• Workability</li> <li>• Density and Porosity</li> <li>• Flexural Strength</li> <li>• Compressive Strength</li> </ul>	INSA
Mortar	CEM I	As a layer	Detailed in chapter # 4	<ul style="list-style-type: none"> <li>• Effect of w/c ratio and SP content on adhesion behavior</li> </ul>	INSA

## 1. Use of non-woven sheets as a layer in mortar with CEM I and GHORI cement

As previously described non-woven tissue was applied as a layer in mortar samples as shown in *Figure 4- 1*.











*Figure 4- 1: Non-woven fabrics as a layer*





Therefore, the experimental program and various strengthening configurations of mortar samples are presented in *Table 4- 2*.

*Table 4- 2: Type of samples and their descriptions*

Type of samples and their dimensions	Name	Description	Conducted tests	Image
--------------------------------------	------	-------------	-----------------	-------

Prisms (40×40×160) mm	Ref	No sheet	Flexural and compressive strengths	
	1-Layer	One layer at the bottom of specimens		
	2-Layers	One layer at the bottom and a layer at the middle of prisms		
	2-Sides	Non-woven sheets at two vertical opposite sides		
	3-Sides	Non-woven sheets at the bottom and two vertical opposite sides		
Cylinders (75×150) mm	Ref	No sheet	Split tensile strength	
	Layer	Completely covered with non-woven sheets		
Cubes (50 mm)	Ref	No sheet	Compressive strength and UPV	



	1-Layer	A layer of non-woven sheet at the bottom		
	2-Layers	One layer at the bottom and a layer at the middle	Compressive strength	
	2-Sides	Non-woven sheets at two vertical opposite sides	Compressive strength and UPV	
	4-Sides	Non-woven sheets at all four vertical sides	Compressive strength	

### 1.1. Effect of layer on fresh properties of mortar

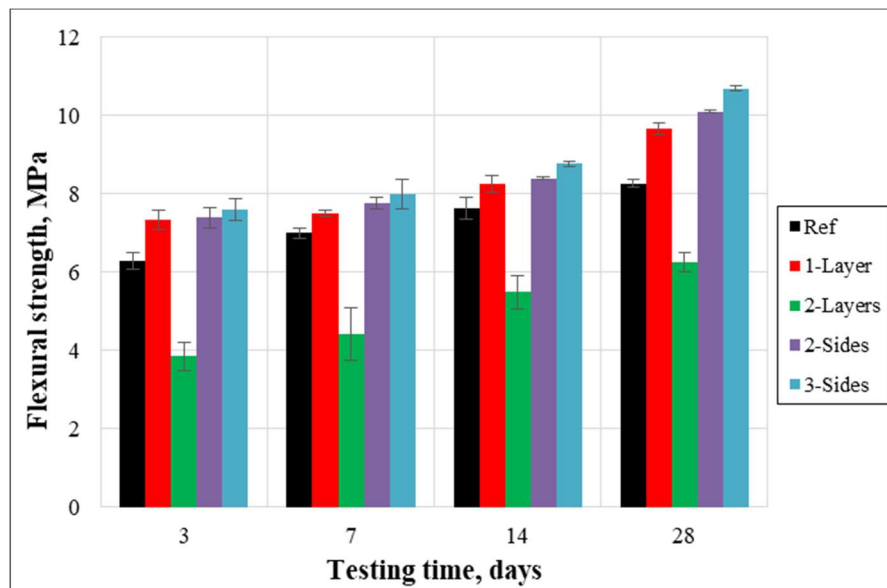
Since non-woven sheets as a layer were used in the outer faces of samples, therefore, similar standard mix design was used for all reference and strengthened specimens. Here, the workability of mortar mixtures remained constant and no effect was underlined on the slump value of mortar mixtures. However, in order to know the consistency of standard mortar mixtures, the slump test was conducted on three samples and their average was  $18.2 \pm 2.3$  mm, and  $19.3 \pm 2.5$  mm for mixtures with GHORI and CEM I, respectively. Therefore, the same mix proportion of mortar were used for both type of cement.

Furthermore, the fresh density of mortar mixtures used for the preparation of samples with various strengthening configurations was similar to that of the reference samples ( $2533 \pm 13$  kg/m<sup>3</sup> and  $2581 \pm 9$  kg/m<sup>3</sup> for the mixtures tested in KPU and INSA, respectively). The difference in fresh density is related to the higher bulk density of cement and sand used in INSA compared to the ones in KPU.

## 1.2. Effect of layer on mechanical properties of mortar

### 1.2.1. Flexural strength

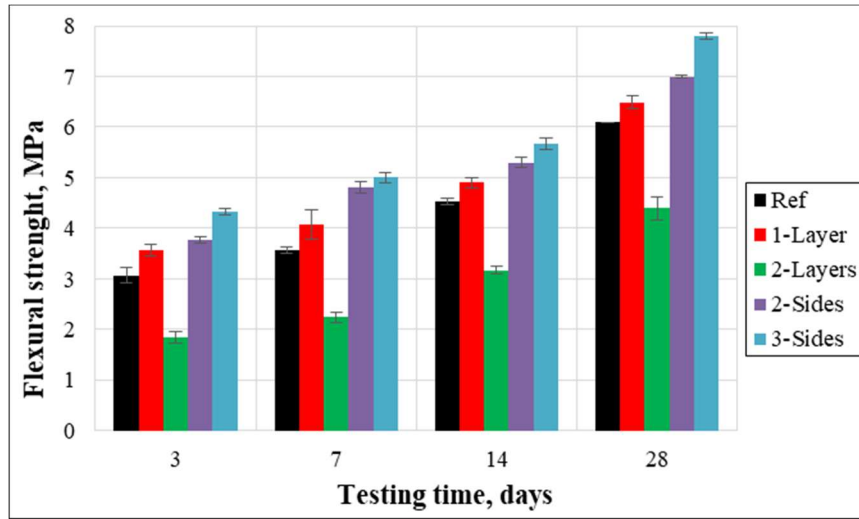
The findings of flexural strength obtained with CEM I are shown in *Figure 4- 2*. The results indicate that the flexural load capacity has enhanced remarkably for the prisms strengthened with 1-Layer, 2-Sides, and 3-Sides of non-woven sheets compared to the reference samples. This enhancement was evidenced at all curing times. Prisms strengthened with U-wrapping (3-Sides) show the highest flexural strength followed by those with 2-Sides and with 1-Layer. This can be attributed to the fact that attachment of sheets leads to delay the crack propagation and more load is required to damage the prisms because non-woven sheets act as strengthen materials. However, the flexural strength was decreased significantly for the specimens containing 2-Layers of non-woven sheets because the middle layer divides prisms into two separate parts. Therefore, under the applied loadings, the samples will behave as two distinct cross-sections. Furthermore, as usual, the flexural strength improved with the increase of curing time.



*Figure 4- 2: Flexural strength of mortar prisms with CEM I cement and different configurations of non-woven sheets*

In addition, the same non-woven tissue from **FREUDENBERG** Company was transferred to Afghanistan and used for strengthening purposes or mortar specimens with GHORI cement. Similar results with the same trends were recorded, which is the improvement of

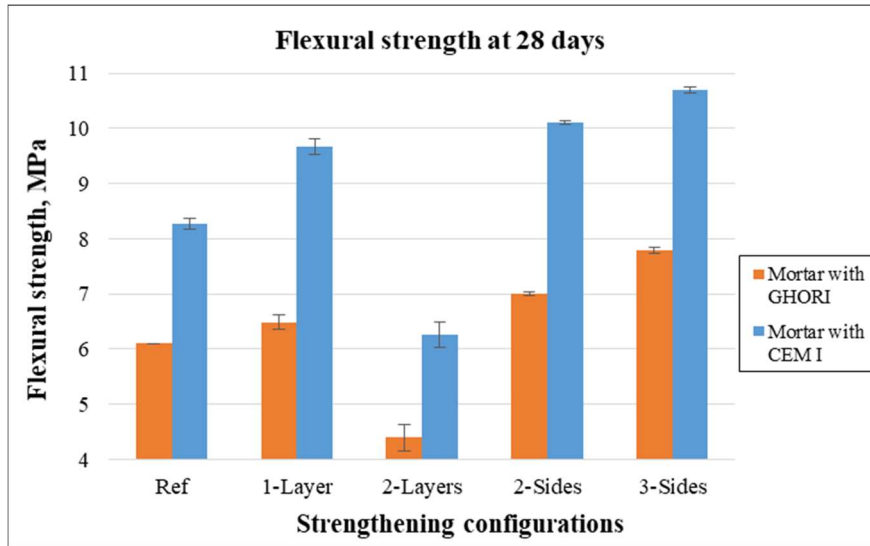
flexural strength of samples strengthened by 1-Layer, 2-Sides, and 3-Sides compared to control ones as shown in *Figure 4- 3*.



*Figure 4- 3: Flexural strength of mortar prisms with GHORI cement and different configurations of non-woven sheets*

After 28 days of curing, it was found that the flexural strength of prisms with CEM I has increased by 14.5%, 18.2%, and 22.7% for 1-Layer, 2-Sides, and 3-Sides specimens, respectively, compared to the reference ones. However, the flexural strength has decreased significantly by 32.1% for the samples containing one layer at the bottom and the other at the middle of prisms. While the flexural strength of prisms using GHORI cement has improved by 6.4%, 20.5%, and 24.2% for 1-Layer, 2-Sides, and 3-Sides prisms, respectively, compared to the reference ones. However, this property has decreased by 26.3% for the samples of 2-Layers. This data highlight that the non-woven tissue improves the flexural strength of the prisms with the two types of mortar composition when used in external configuration as sheets of same dimensions than the faces of samples.

The flexural strengths of samples with GHORI cement is lower than the ones obtained with CEM I as shown in *Figure 4- 4*. This is due to the lower performance of GHORI cement compared to the CEM I 52.5N as described in third chapter: such cement is much coarser and not grinded well which has a great effect on its mechanical strength.



*Figure 4- 4: Flexural strength of mortars with different configurations of non-woven sheets after 28 days of curing*

Since no one has considered non-woven sheets as a strengthening material for mortar or concrete specimens till now, still, the improvement in flexural behaviors of strengthened prisms could be compared with the outcomes of previously conducted studies concerning use of woven sheets reinforcement. Some authors considered fiber-reinforced polymer (FRP) with various configurations to strengthen concrete beams. They found that the flexural strength has increased with the introduction of strengthening materials. In addition, this improvement was more significant for 3-Sides, followed by 2-Sides and then 1-Layer beams compared to the reference ones [90–93].

➤ **Crack pattern**

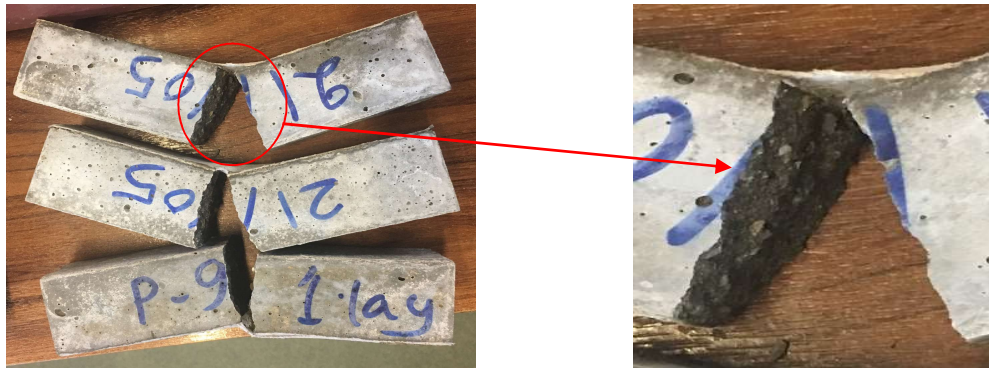
Overall the failure mechanism indicates that the reference specimens were separated completely into two parts after ultimate loading. While samples containing non-woven tissue as 1-Layer, 2-Layers, 2-Sides, and 3-Sides were cracked but not separated into two parts and were linked by layers of non-woven sheets. The crack patterns observed for samples based on their strengthening configurations and tested in INSA are described as follows.

- a) **Reference:** The reference samples were completely divided into two separate parts as shown in *Figure 4- 5*.



*Figure 4- 5: Cracking patterns of mortar prisms (Ref)*

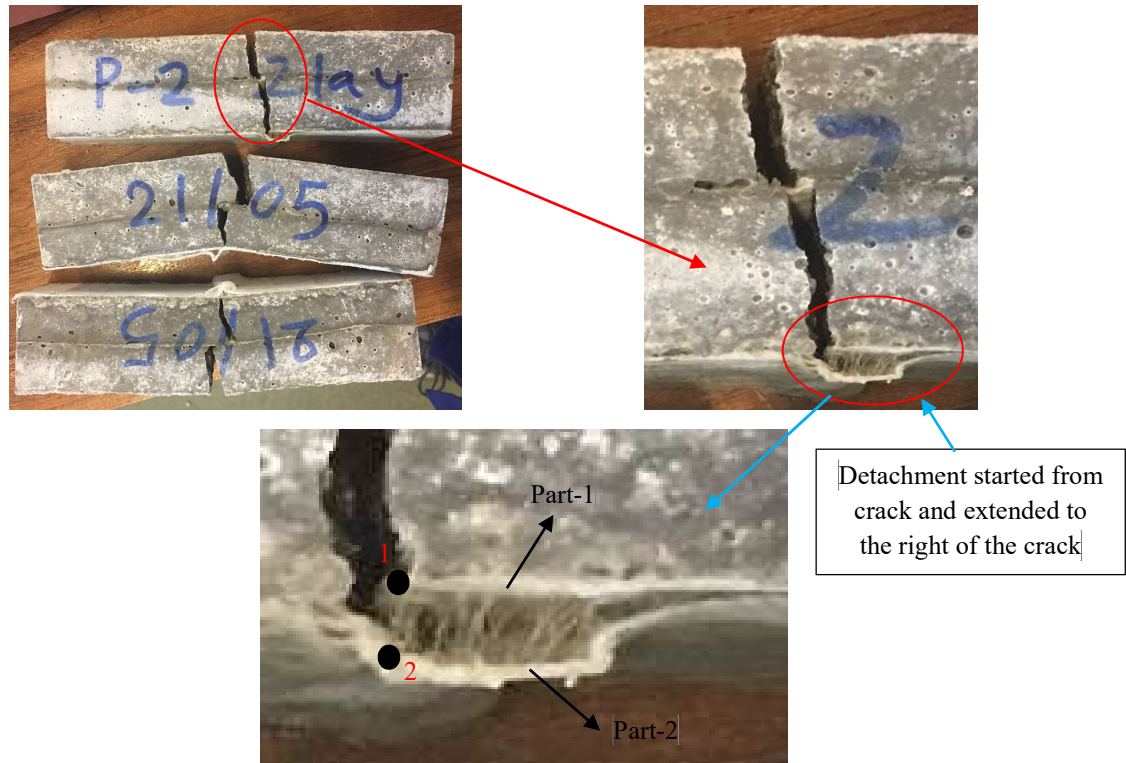
- b) **1-Layer:** After ultimate loading, the bottom layer was locally detached at one or both sides of the crack but not broken. This detachment was started from the crack and extended to the edges of prisms over a distance of (10-20) mm. Moreover, while analyzing the detachment more closely, it was observed that such detachment was not between mortar and sheets but it was due to the separation of sheets into two parts. It means that after detachment, still, part of the non-woven sheets remained on the surface of samples as shown in *Figure 4- 6*. The fracture behavior is less brittle compare to the reference one.



*Figure 4- 6: Cracking patterns of mortar prisms (1-Layer)*

- c) **2-Layers:** In the case of samples containing two layers, the middle layer was remarkably weakened and partially broken, and could be fully fragmented with a little more load. In addition, the bottom layer is locally detached at one or both sides of the crack. This detachment was started from the crack and extended to the edges of the specimen over a distance of (5-10) mm as shown in *Figure 4- 7*. Moreover, while analyzing the detachment more closely, it was observed that such detachment

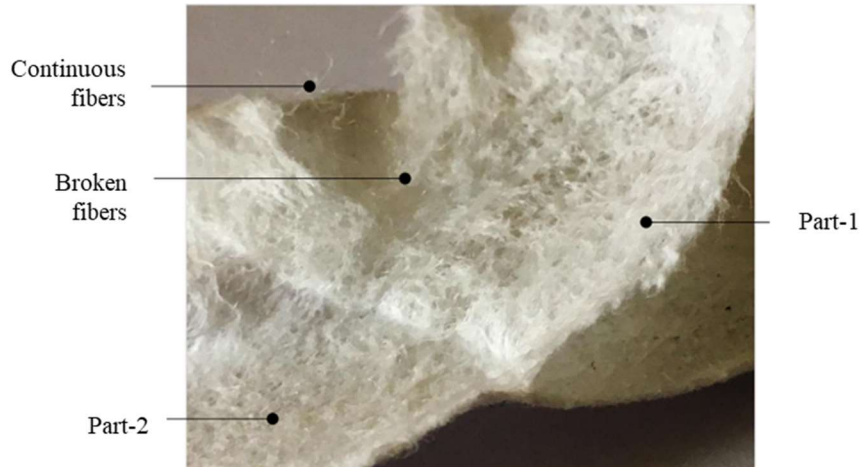
was not mortar-textile but it was textile-textile. This is attributed to the fact that two parts of non-woven sheets were separated from each other. After the separation, Part-1 has completely deteriorated at point 1 but Part-2 is partially broken as can be seen in point 2.



*Figure 4- 7: Cracking patterns of mortar prisms (2-Layers)*

In order to observe the separation of non-woven sheets into two parts, a 20 cm strip of such sheet was delaminated by hand with pulling the two parts. It was observed that some microfilaments were totally split, while others were still continuous, as shown in *Figure 4- 8*.





*Figure 4- 8: Delamination of non-woven sheet by hand*

- d) **2-Sides:** The samples strengthened at two vertical opposite sides were broken at the bottom where the tensile forces are the strongest. Here, the textile breakage is distributed along with the failure of a prism. However, the textile held both parts together at the area where it is not broken as shown in *Figure 4- 9*.



*Figure 4- 9: Cracking patterns of mortar prisms (2-Sides)*

- e) **3-Sides:** The 3-Sides samples were damaged over the entire cross-section of the prism under the non-woven sheets. Here, the textile was not broken but detachment was underlined at the tension zone along the crack. In addition, a slight detachment was observed as well on the sides of prisms along the crack. Moreover, the prism was completely confined by non-woven sheets and was not able to be separated into two parts as shown in *Figure 4- 10*.

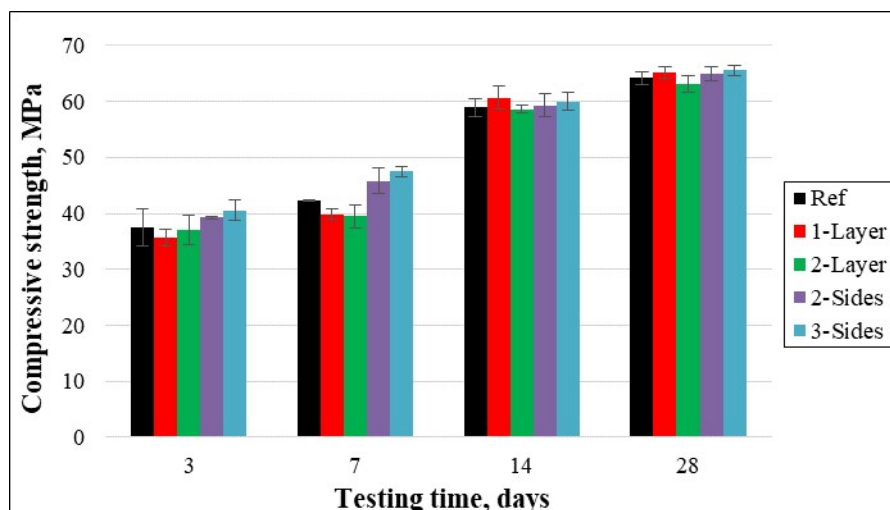


**Figure 4- 10:** Cracking patterns of mortar prisms (3-Sides)

In addition, the crack patterns of prisms with GHORI cement tested in KPU were similar to the ones obtained in INSA.

### 1.2.2. Compressive strength

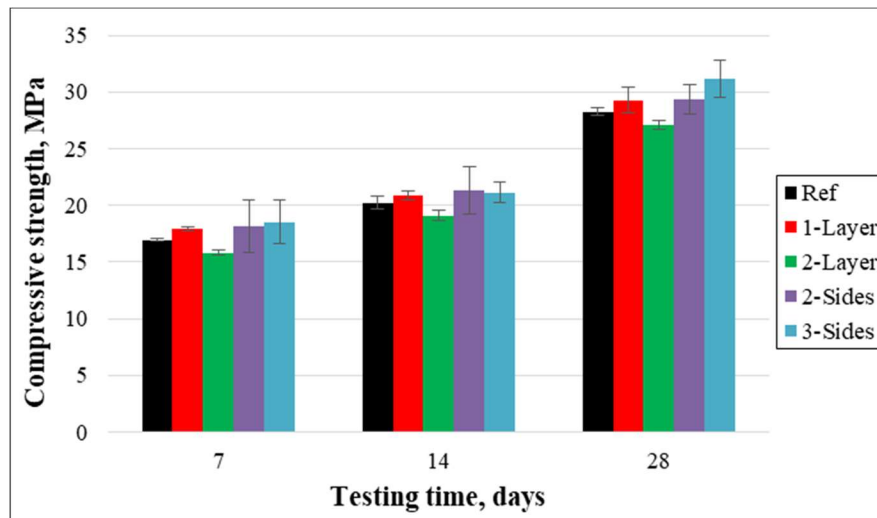
The compressive strength was performed on the same prisms after flexural testing and the results obtained for CEM I are shown in **Figure 4- 11**. The outcomes clearly illustrate that the compressive strength was not much affected while the specimens were strengthened by non-woven sheets. This could be the higher load during compression compared to the flexural loading which non-woven tissue cannot withstand. Moreover, as usual, the compressive strength was enhanced with the increase of curing time for all strengthening configurations.





*Figure 4- 11: Compressive strength of mortar samples with CEM I cement with different configurations of non-woven sheets*

In addition, results with the same trends were recorded for the compressive strength using GHORI cement instead of CEM I. It means that the compressive strength was not affected while the specimens were strengthened by non-woven sheets as shown in *Figure 4- 12*.



*Figure 4- 12: Compressive strength of mortar samples with GHORI cement with different configurations of non-woven sheets*

As already mentioned that the introduction of non-woven sheets as a layer has a negligible effect on the compressive strength of mortar. After 28 days, the compressive strength, based on average values, has slightly increased only by 1.5%, 1.6%, and 2.2% for 1-Layer, 2-Sides, and 3-Sides samples, respectively, compared to the reference ones, but, the compressive strength has decreased by 1.6% for the samples containing one layer at the bottom and the other at the middle. While considering the outcomes of the compressive strength using GHORI cement, they have similar trends. Similar to the flexural strength, the compressive strengths measured for all types of configurations using GHORI cement are lower than the ones with CEM I (*Figure 4- 13*). This is once again linked to the lower quality of GHORI cement compared to the CEM I 52.5N.

No one studied non-woven tissue to strengthen structural element, the improvement of the compressive strength has been verified by previous experimental works, which strengthened samples by fiber-reinforced polymer (FRP) sheets using various

configurations. The obtained results in literature indicate that the compressive strength was increased with the use of FRP sheets. However, there is a difference between the outcomes of the current study and the previous ones due to great difference between materials strengths, adhesive materials and etc. [94–96].

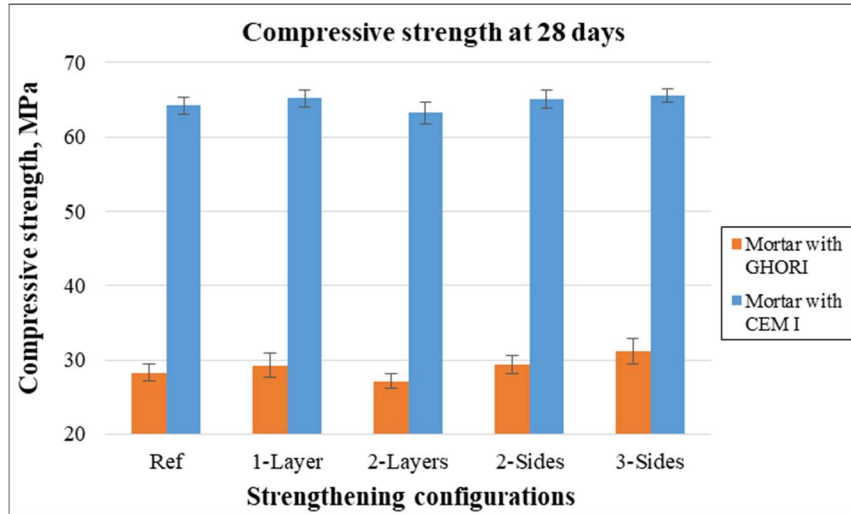


Figure 4- 13: Compressive strength after 28 days of curing

The cracking patterns for reference and strengthened specimens observed in INSA are shown in **Figure 4- 14**. The specimens without non-woven sheets failed in a brittle manner and separated into many small portions. However, the strengthened samples were not separated into many fragments and they maintained their shapes after the ultimate load, especially, the face strengthened by non-woven fabrics. The photos clearly indicate that the specimens strengthened at 2-Sides and 3-Sides were completely confined by such sheets, and the tissue maintains their shapes very strongly. This behavior of non-woven tissue could be beneficial in the case of sudden failure, particularly earthquake damages.



a

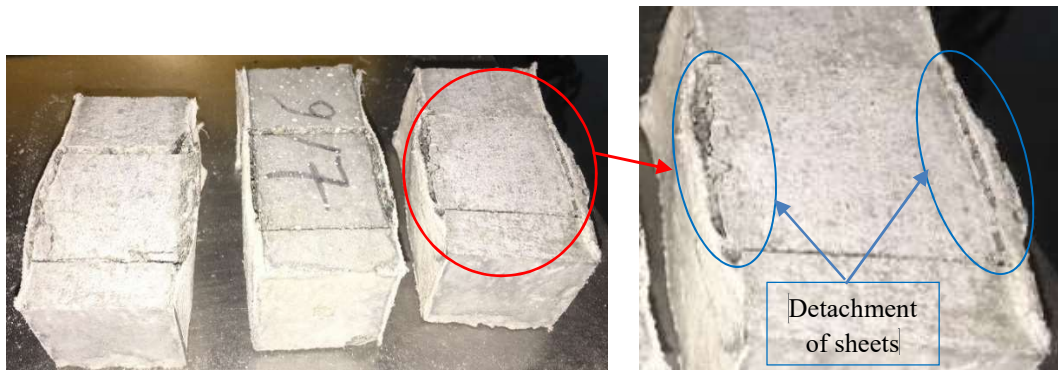
b

c



**Figure 4- 14:** Cracking pattern of mortar samples a) Ref, b) 1-Layer, c) 2-Layers, d) 2-Sides, and e) 3-Sides

It was clearly observed that non-woven sheets in the loading area were detached from the specimens but still, the samples were taken by sheets as shown in **Figure 4- 15**.



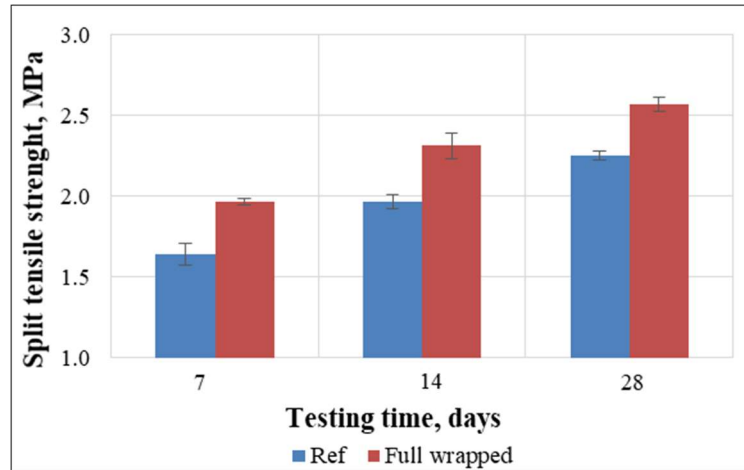
**Figure 4- 15:** Detachment of sheets from the mortar samples

Furthermore, the crack patterns after compressive strength of specimens with GHORI cement and tested in KPU were similar to the ones obtained in INSA.

### 1.2.3. Split tensile strength

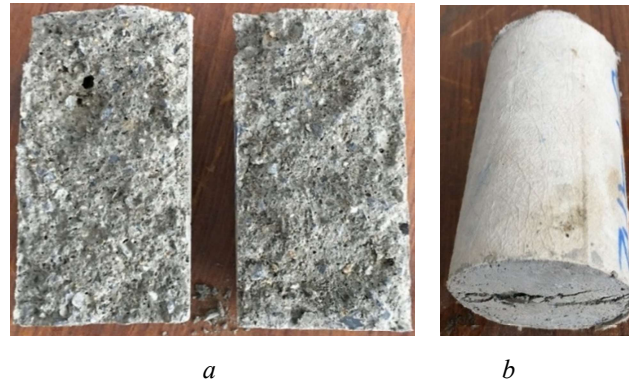
The splitting tensile test was performed to find the indirect tensile strength of mortar samples and their findings observed in KPU are shown in **Figure 4- 16**. The results clearly indicate that the split tensile strength has remarkably improved at all curing times, while cylinders were covered by non-woven sheets compared to the reference samples.

After 28 days of curing, reference cylinders had a split tensile strength of 2.25 MPa, and this strength was increased by 14.25% to 2.57 MPa for covered samples. This is attributed to the fact that non-woven sheets bridge the cracks and prevent the samples from early damage, therefore, more energy was needed to split the samples.



*Figure 4- 16: Split tensile strength of mortar with GHORI cement, and with or without non-woven sheets*

Besides, the control specimens failed with brittle fracture and were separated into two completely separated fragments. On the opposite, covered cylinders were not separated and taken by such fabrics. This means that the attachment of plastic sheets makes the samples sustain more splitting loads and the final fracture will be without brittle behaviors as shown in *Figure 4- 17*.

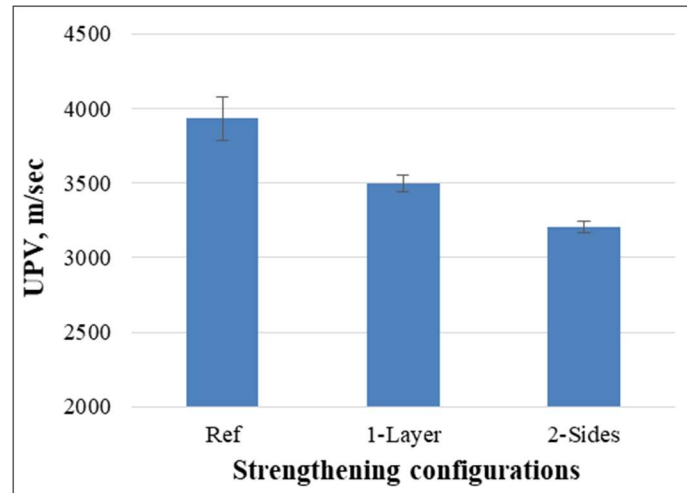


*Figure 4- 17: Cracking pattern of mortar samples a) Ref and b) covered*

### **1.3. Effect of layer on ultrasonic pulse velocity (UPV) of mortar**

The UPV test was conducted to observe the sound transfer properties of mortar specimens and their findings for specimens tested in KPU are shown in *Figure 4- 18*. The results indicate that the UPV value has been notably decreased, while mortar cubes were strengthened by non-woven tissues compared to the reference ones. This is due to the lower UPV value of plastic compared to mortar and sound-absorbing properties of Evolon ® fabric. After 28 days of curing, the average UPV value for reference specimens was

3933.89 m/s, while this value has decreased by 11.31% to 3495.76 m/s for the specimens having non-woven fabrics at one side. Moreover, the UPV has further decreased by 18.54% to 3204.34 m/s for the samples strengthened by non-woven sheets at two opposite sides. Therefore, the usage of such sheets in structural elements could be beneficial to reduce their sound transfer properties. For example, non-woven sheets could be used as layers in slabs or partition walls to improve their acoustic properties.



*Figure 4- 18: Ultrasonic pulse velocity of mortar with GHORI cement, and with or without non-woven sheets*

## Conclusion

The attachment of non-woven sheets as a layer did not have any effect on the fresh properties (workability and fresh density) of mortar because such tissue was used at the outer faces of samples. However, the introduction of such sheets resulted in a significant enhancement of mechanical properties of strengthened specimens compared to the reference ones, particularly, flexural and split tensile strengths. This is due to a delay in the crack propagation and more load is required to destroy the specimens because non-woven sheets play strengthening functions. Besides, the improvement in flexural strength was more significant for the samples strengthened at 2-Sides and 3-Sides compared to others. On the other hand, the strengthened specimens showed more ductile behaviors and were not separated in broken parts thanks to the PET non-woven sheets that maintained those parts of mortar sticking to the plastic fabric after ultimate load. For example, the 3-Sides



samples were damaged over the entire cross-section of the prism under the non-woven sheets but the tissue was not torn and the prisms were entirely confined by the tissue. Furthermore, the UPV value has decreased remarkably for the samples containing non-woven sheets as a layer compared to the reference ones. The reason behind this is the lower UPV value of non-woven tissue compared to the sand and cement. Finally, it was clearly observed that the results obtained with GHORI cement and CEM I presented the same trends.

## **2. Use of non-woven sheets incorporated as cut pieces in mortar**

Non-woven sheets were used as (10×10) mm cut pieces with four various percentages of 0% 0.25%, 0.50%, and 0.75% by mass of solid components (sand + cement) as shown in *Figure 4- 19*.

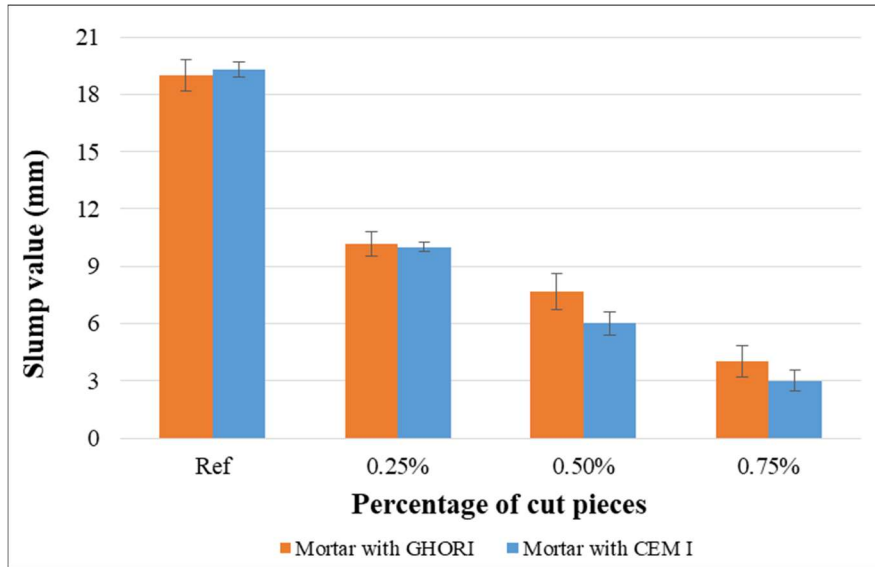


*Figure 4- 19: Cut pieces of the non-woven plastic fabric*

### **2.1. Effect of cut pieces on fresh properties of mortar**

#### **2.1.1. Workability**

The outcomes of the slump test obtained from mixtures containing various percentages of cut pieces of non-woven sheets and tested in INSA and KPU are shown in *Figure 4- 20*. The findings highlight that the consistency of mortar mixtures containing cut pieces with GHORI or CEM I cements decreased significantly compared to the ones without cut pieces. This is attributed to the fact that the incorporation of cut pieces modifies the viscosity of the cementitious matrix, they absorb a large amount of water and they trapped cement. Besides, the slump value has decreased further with the increase of percentage of non-woven fabrics. It appears that 0.75% of non-woven sheets result in serious homogeneity and workability problems in mortar mixtures.



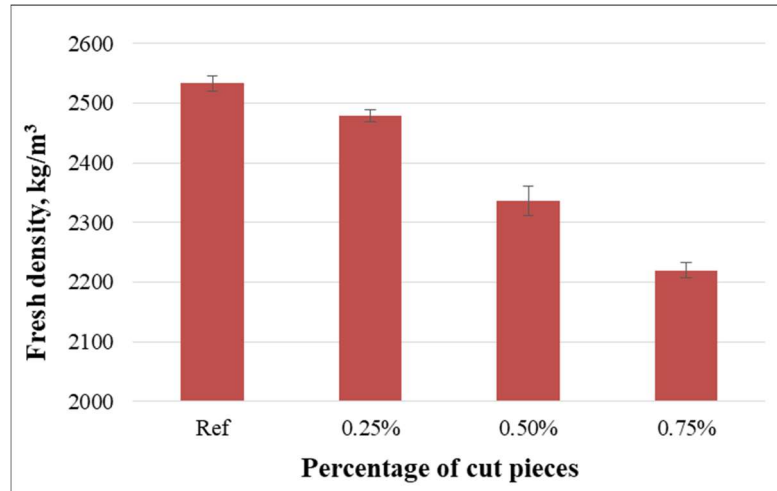
**Figure 4- 20:** Slump value versus percentage of non-woven fabrics with samples of GHORI and CEM I cement mortar

The above graph indicates that the workability of mortar containing plastic cut pieces decreased significantly, while percentages of non-woven fabrics have increased. Therefore, for maintaining the slump value similar to the one obtained for standard mortar (without non-woven tissue), a superplasticizer was added with different percentages.

The reduction of workability was confirmed by the previous research works conducted on the polypropylene/polyethylene (PP/PE) blended fibers incorporated in mortar mixtures. The outcomes have highlighted that the slump value has decreased remarkably for fiber-based mortar compared to the control ones and this reduction was more significant for higher percentages [97].

### **2.1.2. Fresh density**

The fresh density of mortar was measured and their results are presented in **Figure 4- 21**. The outcomes clearly demonstrate that the fresh density has decreased with the incorporation of non-woven plastic tissue compared to the mixtures without them. Such reduction was more significant for higher percentages of cut pieces. This is because of the lower specific gravity of plastic fabrics compared to cement and aggregates.



*Figure 4- 21: Fresh density of mortar specimens with GHORI cement*

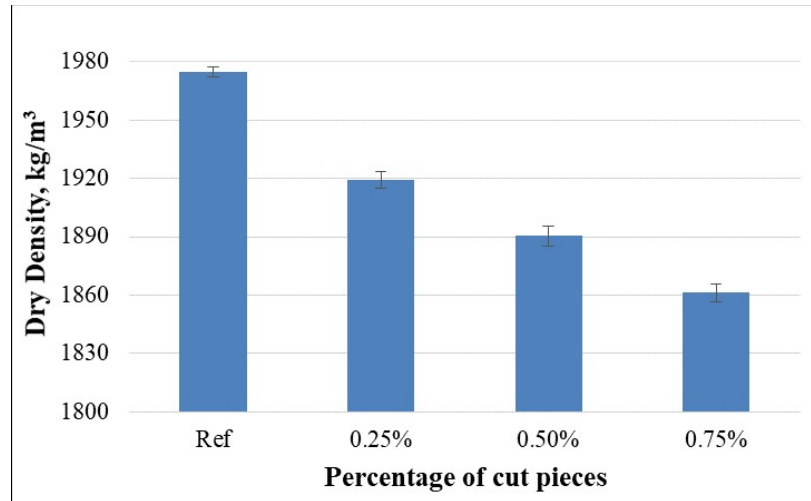
## **2.2. Effect of cut pieces on physical properties**

### **2.2.1. Dry density**

It can be underlined from *Figure 4- 22* that the dry density has decreased with the incorporation of plastic fabrics and such reduction was more significant for higher percentages of non-woven fabrics. The reason behind this can be the lower specific gravity and bulk density of non-woven sheets compared to cement and sand, and the porous nature of samples containing observed for the samples containing 0.25%, 0.50%, and 0.75% of cut pieces, respectively compared to the control ones.

This phenomenon was confirmed by former research study performed on PP/PE blended fibers introduced into mortar mixtures. The authors found that the fiber-reinforced mortar has lower apparent density than the control ones and this reduction was more significant for higher volume fractions of plastic fibers [97], due to the low density of incorporated fibers.



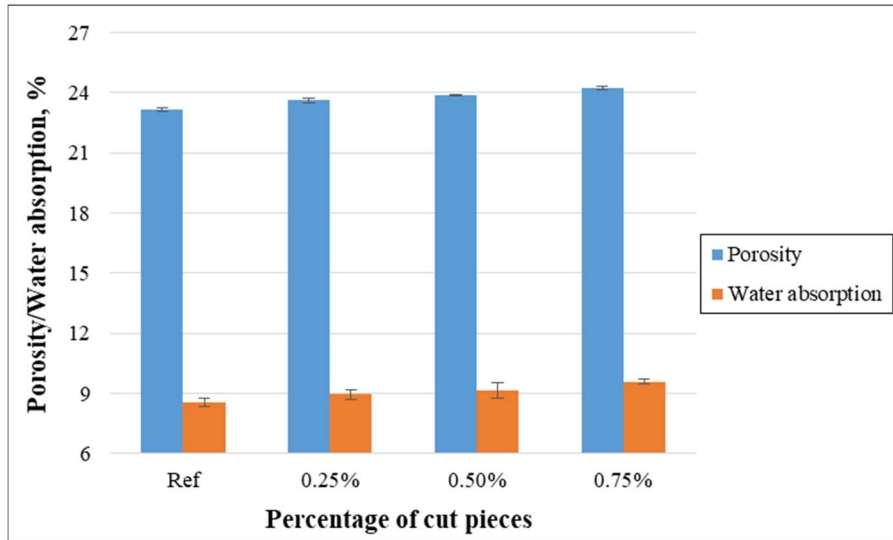


*Figure 4- 22: Dry density of mortar specimens with GHORI cement*

### **2.2.2. Porosity and water absorption**

A high porosity often results in less resistance and lower durability in cementitious materials. It can be observed from *Figure 4- 23* that the porosity has slightly increased with the incorporation of cut pieces in mortar samples compared to the reference ones. The higher percentage of cut pieces, the higher the porosity is. In particular, an increase of 1.96%, 3.03% and 4.67% was recorded for specimens containing 0.25%, 0.50% and 0.75% of cut pieces respectively compared to controls. This phenomenon could be due to the incorporation of non-woven plastic tissue resulting in the disruption of the continuity of material microstructure, poor transition zone, and presence of cavities in the interfacial transition zone between cement paste and pieces of non-woven fabric.

In addition, it was found that the water absorption has considerably increased with the increase of non-woven plastic cut pieces as shown in *Figure 4- 23*. This can be attributed to the high porosity and water absorption behaviors of non-woven pieces themselves.



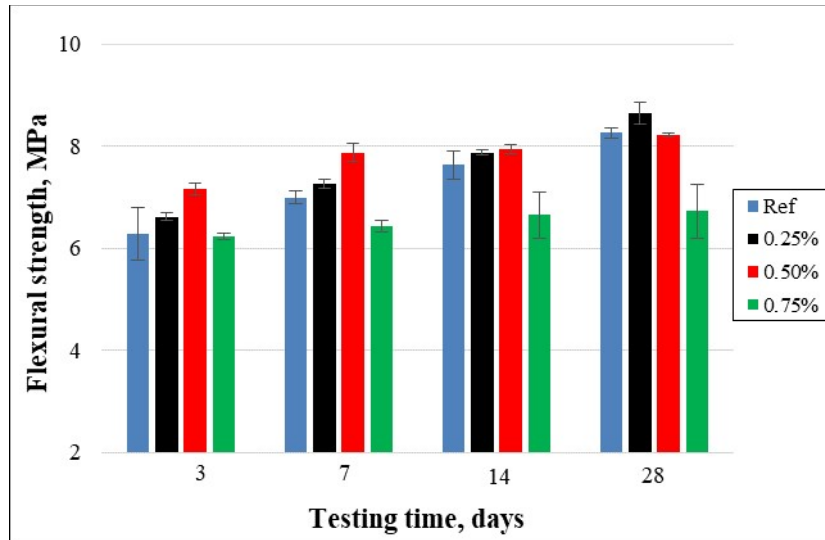
*Figure 4- 23: Porosity and water absorption of mortar specimens with GHORI cement*

The results of porosity and water absorption have been verified in research works performed on the physical and mechanical properties of fiber-reinforced mortar with 0%, 0.5%, 1.0%, and 1.5% of PET fibers. Researchers observed that the water absorption and porosity of fiber-reinforced mortar were higher than that obtained for control specimens because of their porous nature [27].

### **2.3. Effect of cut pieces on mechanical properties**

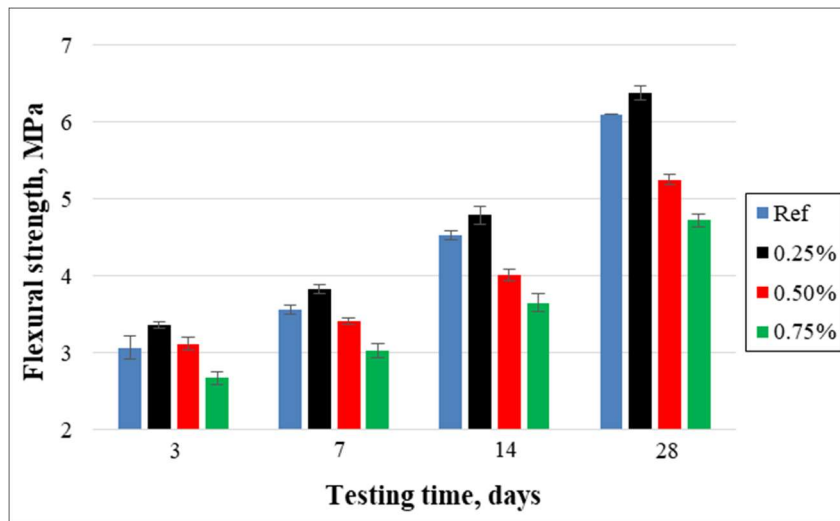
#### **2.3.1. Flexural Strength**

The prisms containing various percentages of cut pieces of non-woven sheets were tested in INSA after 3, 7, 14, and 28 days of curing and their results are shown in *Figure 4- 24*. The outcomes highlight that the flexural load capacity slightly increased, while 0.25% of cut pieces were incorporated into mortar mixtures. This is attributed to the fact that cut pieces of non-woven tissue lead to bridges and arrest the crack propagation and stop the propagation of micro cracks, which is resulting in more load to destroy the specimens. Thereafter, the flexural load capacity for prisms having 0.50% was almost similar to the reference ones and decreased remarkably for specimens containing 0.75% of such fabrics. This is due to the ununiformed inclusion and bundling properties of fibers in higher percentages that are resulting in lower bond behaviors between cut pieces and cement paste.



*Figure 4- 24: Flexural strength of mortar specimens with CEM I cement*

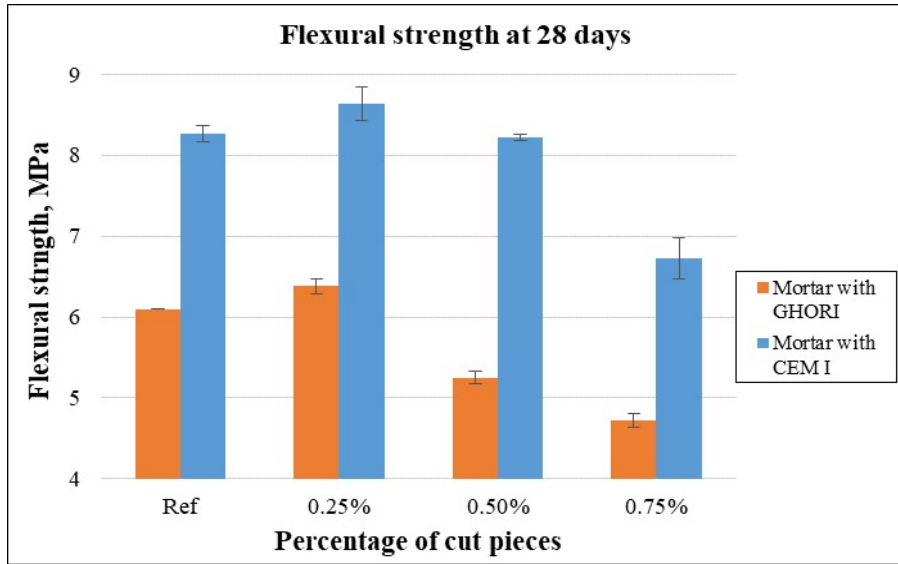
In addition, results with the same trends were recorded for the flexural strength using GHORI cement as was observed for CEM I. Which is a slight improvement for the samples containing 0.25% of cut pieces. Thereafter, the flexural strength decreased significantly for the specimens containing 0.50% and 0.75% of such fabrics as shown in *Figure 4- 25*.



*Figure 4- 25: Flexural strength of mortar specimens with GHORI cement*

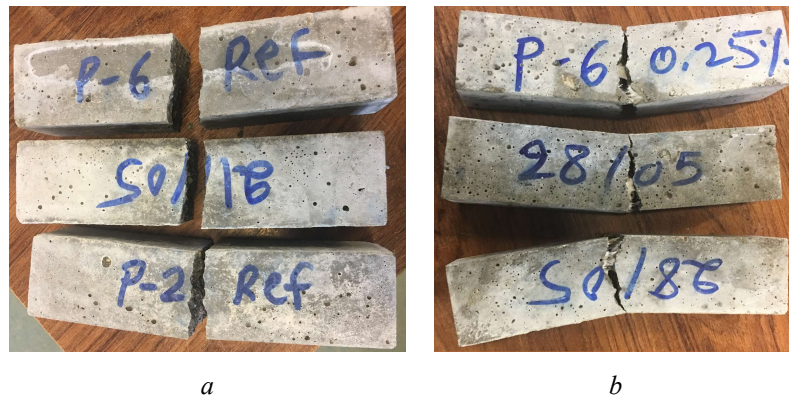
After 28 days of curing, the flexural strength observed with GHORI cement has increased by 4.4% only for 0.25% and then decreased significantly by 16.1% and 29.1% for 0.50% and 0.75% of cut pieces, respectively, compared to the control prisms as shown in *Figure 4- 26*. In addition, the prisms fabricated with CEM I followed almost the same trend which

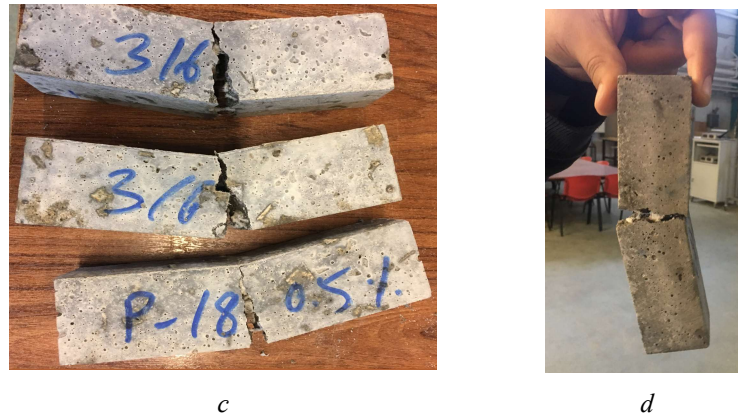
is a slight improvement in the flexural strength only for 0.25% and then the same value for 0.50% as reference and remarkable decrease for 0.75% of incorporated cut pieces.



**Figure 4- 26:** Flexural strength of mortar specimens after 28 days of curing with CEM I and GHORI

The cracking pattern of the samples containing 0%, 0.25%, 0.50%, and 0.75% of cut pieces of non-woven fabrics and tested in INSA are shown in **Figure 4- 27**. Generally, the prisms with cut pieces had better behaviors in terms of failure mechanisms than those for control ones. The control specimens failed in a brittle manner and separated into two separate portions after ultimate loading. While, similar to the prisms strengthened by non-woven sheets, the specimens containing cut pieces showed somewhat ductility and were not separated into two parts during damage, but were maintained by the small pieces of fabrics.





**Figure 4- 27:** Cracking pattern of mortar prisms with CEM I: a) Ref, b) 0.25%, c) 0.50%, and d) 0.75%

The specimens were examined closely and it was observed that cut pieces of non-woven sheets inside the prisms were not cut and play bridging roles between two parts and were able to maintain the two parts together as shown in **Figure 4- 28**.



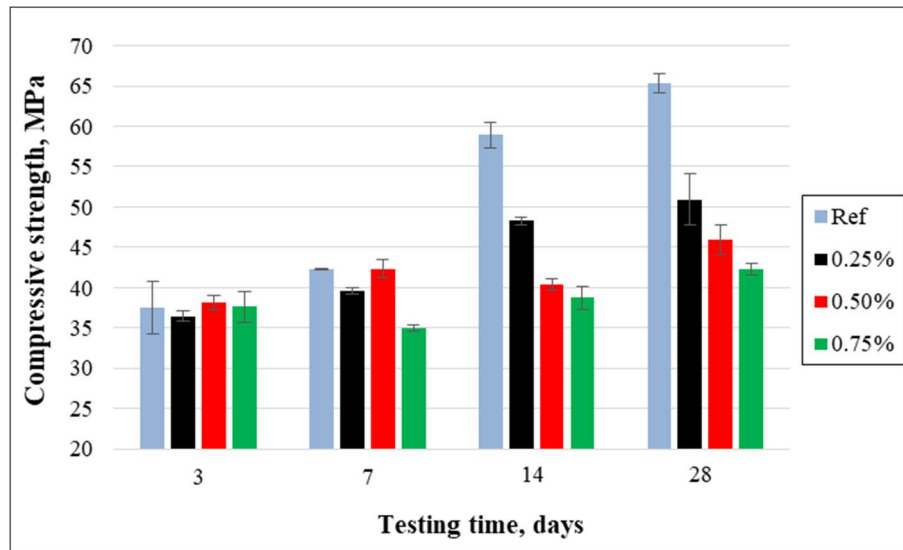
**Figure 4- 28:** Cut pieces inside the prism

Besides, similar crack patterns were observed for the prisms containing various percentages of cut pieces and tested in KPU laboratory.

### 2.3.2. Compressive strength

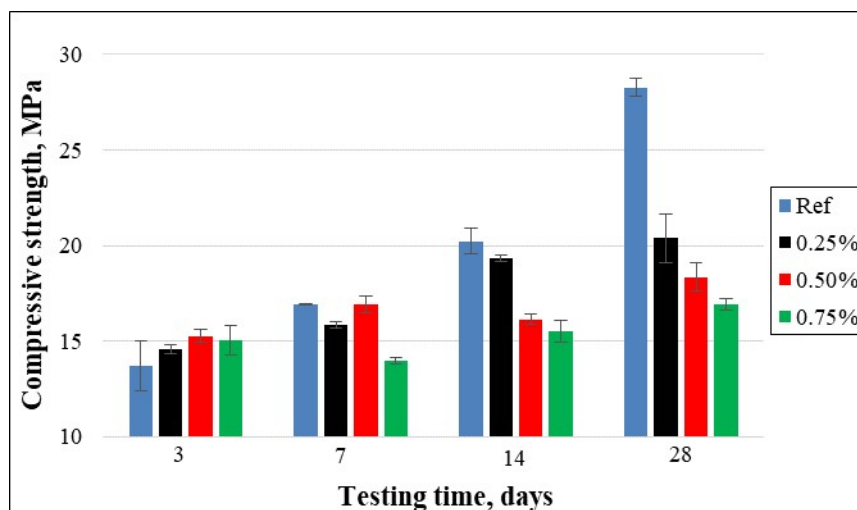
The compressive strengths of specimens containing various volume fractions of cut pieces of non-woven tissue for all curing regimes and tested in INSA are shown in **Figure 4- 29**. The results demonstrate that the compressive strength was affected by the incorporation of cut pieces of non-woven tissue into mortar mixtures since 0.25% of cut pieces. It means that the compressive strength has decreased significantly for the prisms containing such fabrics and this reduction was more significant for higher percentages of fabrics. This can

be attributed to the ununiformed distribution of pieces inducing lower adhesion between plastic fabrics and mortar.



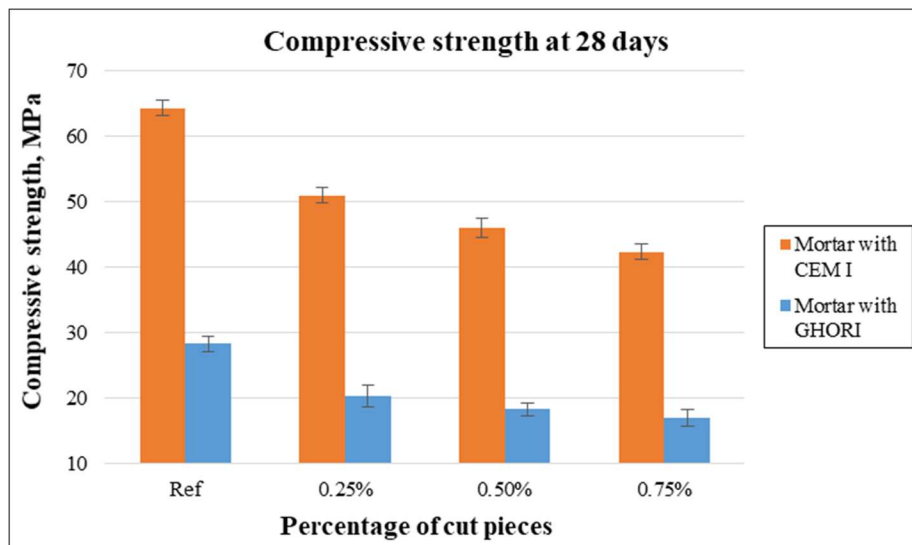
*Figure 4- 29: Compressive strength of mortar specimens with CEM I cement*

Moreover, the compressive strength using GHORI cement followed the same trends as for CEM I. It means that the compressive strength has decreased significantly for the samples having non-woven fabrics and this reduction was more significant for a higher volume fraction of fabrics as shown in *Figure 4- 30*.



*Figure 4- 30: Compressive strength of mortar specimens with GHORI cement*

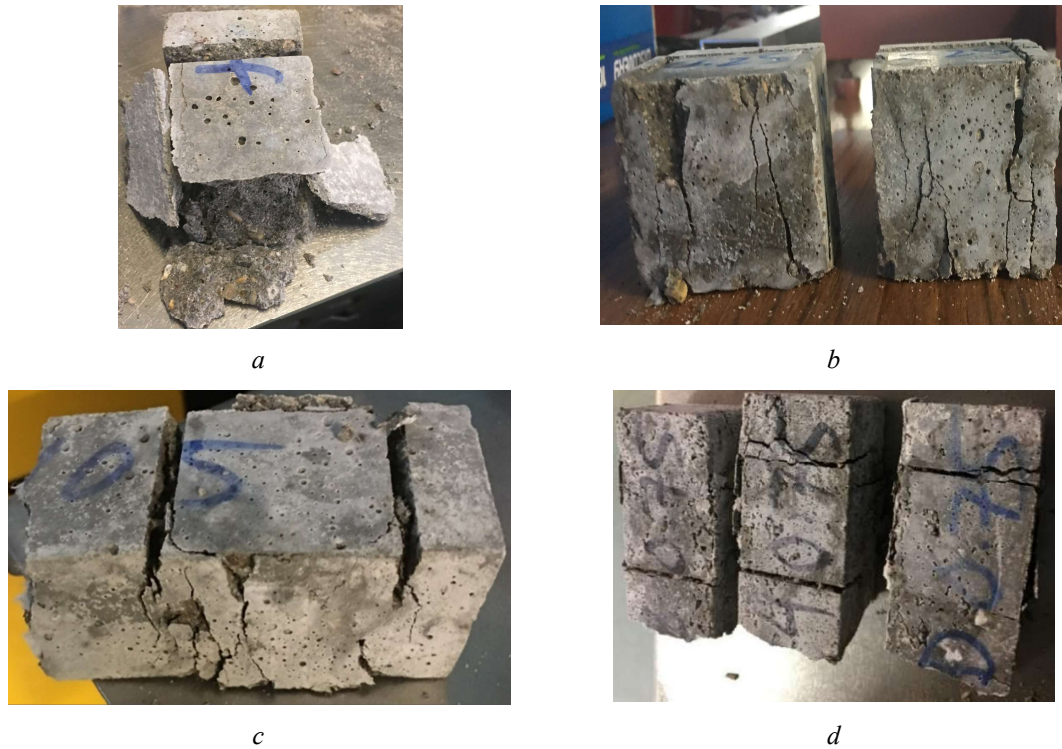
The compressive strength has decreased with the incorporation of cut pieces into mortar mixtures. This was due to the higher porosity of samples and bound between incorporated fabrics and cement matrix. After 28 days of curing, the compressive strength for specimens with CEM I has decreased by 26.0% and 39.9%, and 51.6% for 0.25%, 0.50%, and 0.75% of cut pieces, respectively, compared to the reference ones as shown in *Figure 4- 31*. In addition, the samples fabricated with GHORI cement followed the same trends which are reduction by 38.7%, 54.0%, and 66.9% for 0.25%, 0.50%, and 0.75% of incorporation of cut pieces.



*Figure 4- 31: Compressive strength of mortar specimens after 28 days of curing with CEM I and GHORI cements*

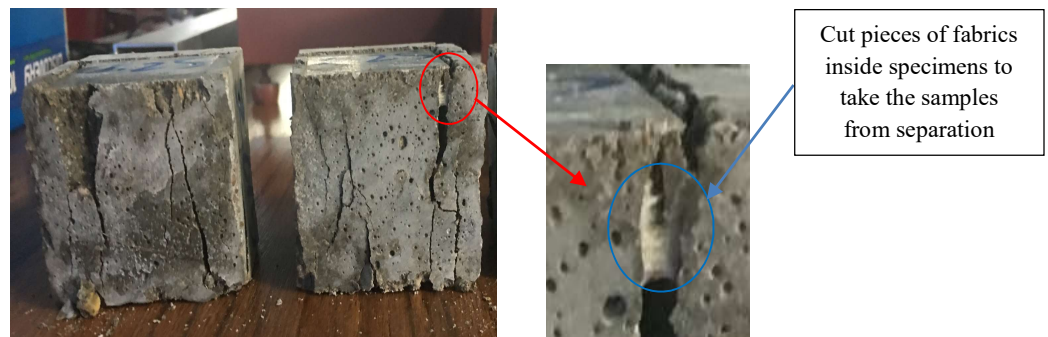
As it can be observed from *Figure 4- 32* while the reference samples exhibited a brittle type of failure and were broken into many pieces, samples with any percentage of cut fabrics showed ductility and were not separated into many parts but were maintained by the pieces of fabrics.





**Figure 4- 32:** Cracking pattern of mortar samples with CEM I: a) Ref, b) 0.25%, c) 0.50%, and d) 0.75%

Similar to the flexural failure, it was observed that cut pieces of non-woven sheets inside the samples were not cut and had bridging behaviors to maintain the specimens from the separation into many fragments like reference ones as shown in **Figure 4- 33**.



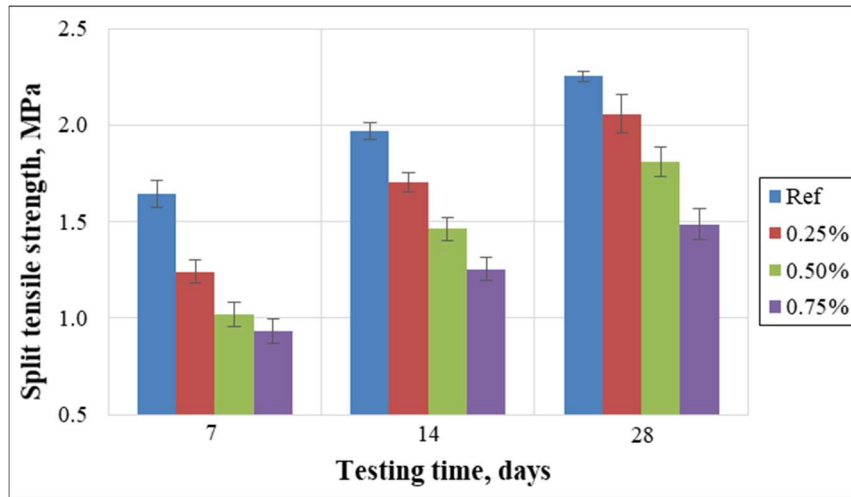
**Figure 4- 33:** Cut pieces inside the sample

Besides, similar crack patterns were observed for the specimens containing various percentages of cut pieces and tested in KPU laboratory.



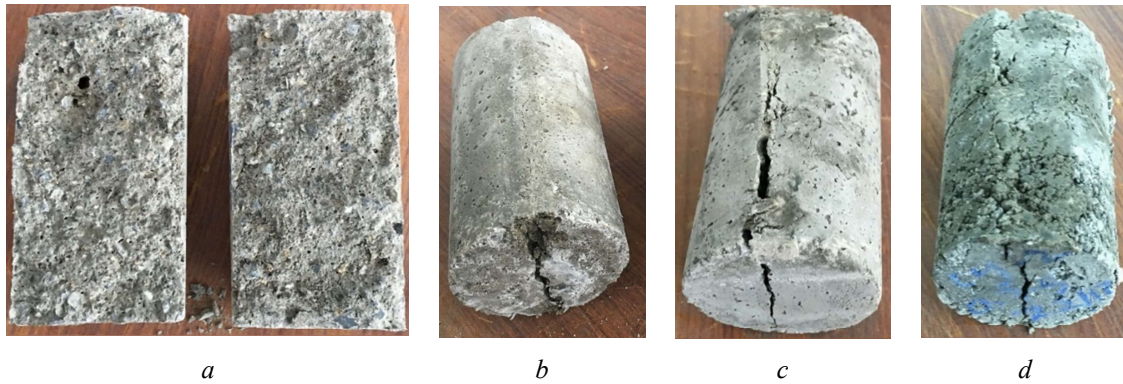
### 2.3.3. Split tensile strength

The splitting tensile test was carried out in KPU laboratory on (75×150) mm cylinders after 7, 14, and 28 days of curing. The outcomes demonstrate that such mechanical property has remarkably decreased with the incorporation of non-woven fabrics for all times of curing. For example, after 28 days of curing, the split tensile strength for control specimens was 2.25 MPa and such strength has decreased to 2.06 MPa, 1.81 MPa, and 1.49 MPa for specimens containing 0.25%, 0.50%, and 0.75% of cut pieces, respectively as shown in **Figure 4- 34**. This reduction is once again linked to the higher porosity and micro cracks and lower bond properties between cement paste and cut pieces, especially for higher percentages.



**Figure 4- 34:** Split tensile strength of mortar specimens with GHORI cement

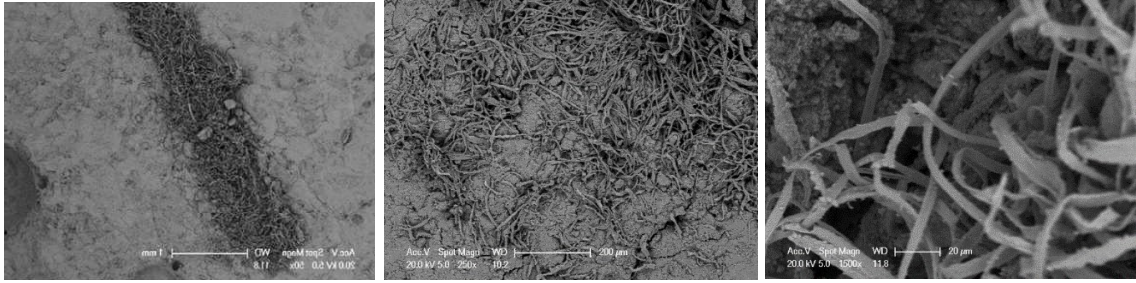
Even though the incorporation of cut pieces of non-woven tissue was not beneficial to improve the split tensile strength of the cylinders, the addition of small pieces of such sheets was advantageous to maintain the samples from separation. The control specimens failed with brittle fracture and were separated into two totally disjointed fragments, whereas cylinders containing small cut pieces of non-woven fabrics were not separated but taken by such fabrics especially in higher percentages as shown in **Figure 4- 35**.



**Figure 4- 35:** Cracking pattern of mortar cylinders with GHORI cement a) Ref, b) 0.25%, c) 0.50%, and d) 0.75%

Even though, the flexural strength of specimens containing cut pieces improved in a similar manner to that observed by the previous authors. However, opposite to the bibliographic research, the compressive and split tensile strengths have remarkably decreased with the introduction of cut pieces into mortar mixtures. This is due to the difference in the mechanical strengths of non-woven sheets and plastic fibers. It means that non-woven sheets have significantly lower mechanical strengths than the plastic fibers utilized in prior experiments. When it comes to the cracking mechanism, the findings of this study are consistent with those of prior research works. However, the incorporation of plastic fibers was realized with various dimensions compare to this study. The previous authors observed that the plain mortar specimens failed in a brittle manner with a little energy absorption; whereas the fiber reinforced specimens failed in a ductile flexural manner with very large energy absorption. In addition, reference samples were divided into two separate parts while fiber-reinforced samples were taken by PET plastic fibers [27,42,98].

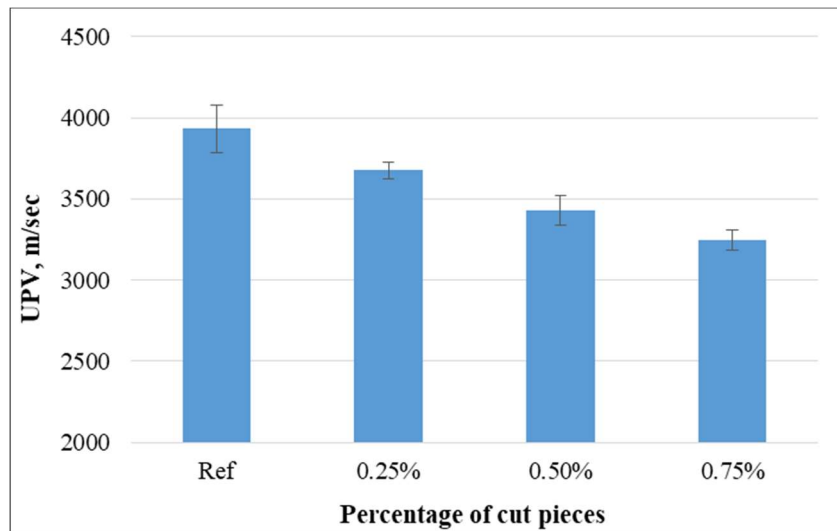
In order to better understand the reduction in the mechanical strengths of mortar containing non-woven tissue as cut pieces, Scanning Electron Microscopy (SEM) analysis was performed in INSA. The microscopic images of mortars indicate homogenous incorporation of non-woven tissue into the cement matrix. But the incorporation of cut pieces of such fabrics resulted in higher porosity due to a lower penetration of cement paste into fabrics as shown in **Figure 4- 36**.



**Figure 4- 36:** SEM images of mortar containing cut pieces of fabrics with CEM I

#### 2.4. Effect of cut pieces on ultrasonic pulse velocity (UPV)

The UPV values of mortar specimens having various percentages of non-woven sheets were measured after 28 days by a direct method. The outcomes clearly indicate that the UPV value decreased considerably with the incorporation of cut pieces of non-woven sheets compared to the control samples. This reduction was more significant for higher percentages as shown in **Figure 4- 37**. This is because of the porous nature of samples, lower UPV value for non-woven sheets, and sound absorbing behaviors of such fabrics.



**Figure 4- 37:** UPV values of mortar specimens with GHORI cement

These outcomes match with former research works those were conducted on the prismatic specimens containing 0% and 0.50% of PET fibers to investigate the ultrasonic pulse velocity (UPV) value. The results present that the incorporation of PET fibers resulted in 8–11% reduction of UPV values because of lower specific gravity and sound transfer properties of fibers compared to the concrete ingredients [44–46].

### ***Synthesis and discussion***

The introduction of non-woven tissue as cut pieces had a remarkable influence on certain properties of mortar. The slump value has decreased remarkably for the mixtures containing cut pieces compared to the control ones. This reduction was more significant for higher percentages of incorporation rate. It can be explained by the water absorbing behaviors of non-woven tissue and as well as cut pieces interrupt the viscosity of the matrix. Besides, similar outcomes were observed by some authors who incorporated plastic fibers into cementitious materials [97].

Furthermore, the fresh and dry densities have decreased with the incorporation of cut pieces and reduced further for higher volume fractions. This is due to the lower bulk density of non-woven sheets compared to mortar components. The reduction in fresh and dry densities of cementitious materials containing plastic fibers was observed by other researchers as well [97].

Moreover, the introduction of cut pieces resulted in the increase of porosity and water absorption and this was more significant at higher percentages. Some authors found also that the porosity and water absorption of cementitious materials were increased with the incorporation of plastic fibers [27].

Even though the mechanical strengths decreased with the amount of cut pieces incorporation, the cut pieces changed the cracking behavior from brittle to ductile and maintain samples from separation to many parts [27,42].

Additionally, the introduction of non-woven tissue as cut pieces resulted in a remarkable reduction of UPV value and this reduction had a direct relationship with the volume fraction of cut pieces. This is again linked to the lower UPV value and sound absorbing property of non-woven sheets. The reduction in UPV value of fiber-reinforced concrete was cited in some other papers as well [44–46].

The introduction of cut pieces resulted in a higher porosity evidenced by the SEM analysis showing voids between cement particles and PET fibers. The bond between cut pieces and cement matrix appear weakened notably in case of more important quantity of incorporation. Nevertheless, the cut pieces allowed to maintain the broken mortar parts together after flexural, compressive and splitting tension tests. This underlines the good

bound between some non-woven tissue cut pieces and cement when the cement paste has penetrated into fabrics.

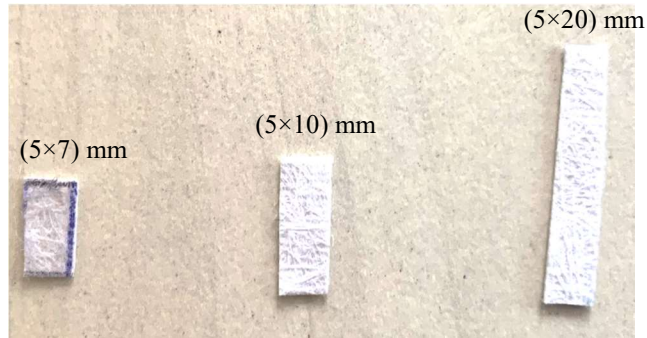
#### **4. Effect of aspect ratio ( $l/w$ ) of non-woven tissue on certain properties of mortar**

The dimensions and geometry of fibers are the key parameters that have remarkable effects on different properties of cementitious materials. For instance, research work was performed to study the effect of percentage and dimensions of PET fibers on various properties of concrete. The authors found that the reduction in slump and dry density and improvement in mechanical properties was more significant for thinner fibers compared to the wider ones [99]. In the previous sections, the sizes and dimensions of cut pieces were considered constant. The experimental work presented in this section was conducted in INSA and is focused on the effect of cut pieces of non-woven tissue with various dimensions on certain properties of mortar.

In order to know the effect of aspect ratio (length/width) of cut pieces, such sheets were cut into three various dimensions. Here, the width of pieces was considered constant but the length was varied to obtain pieces with different aspect ratios.

1. (5×7) mm
2. (5×10) mm
3. (5×20) mm, as shown in *Figure 4- 38*








**Figure 4- 38:** *Cu pieces of non-woven tissue with different aspect ratios*

Besides, cut pieces with each aspect ratio were incorporated into the mortar mixtures with three various percentages as presented in **Table 4- 3**. It should be mentioned that all percentages were taken by the weight of solid mortar components.

**Table 4- 3:** *Amount of cut pieces of non-woven fabrics*

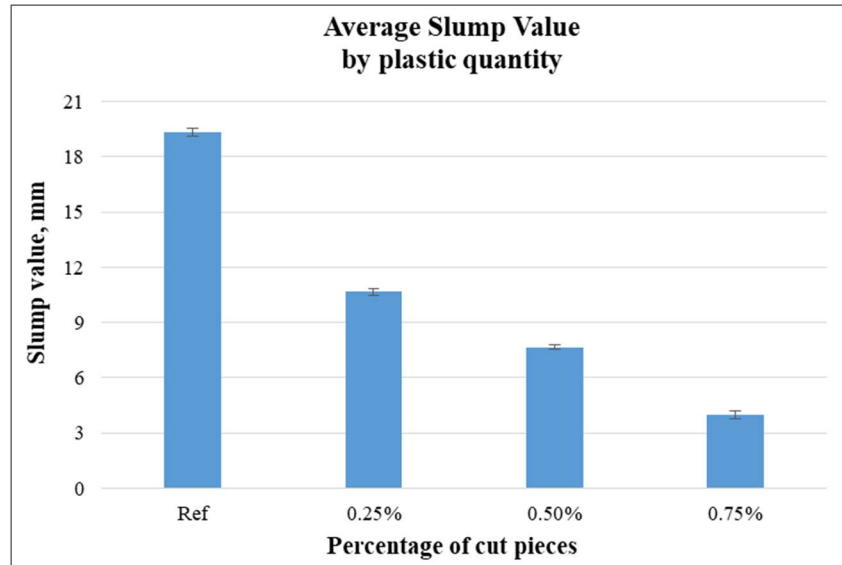
Percentages	0.25%	0.50%	0.75%
Amount of cut pieces (gr)	4.5	9.0	13.5
Image			

#### **4.1. Effect of aspect ratio on fresh properties of mortar**

##### **4.1.1. Workability**

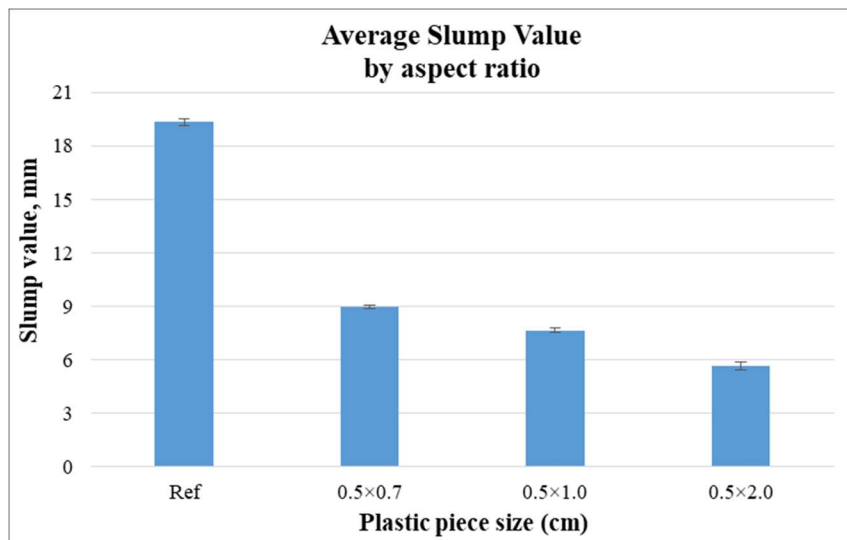
The slump test was carried out on mortar mixtures with various percentages and sizes of non-woven sheets. Firstly, the outcomes of slump values were presented as function of the amount of cut pieces as an average of all aspect ratios and presented in **Figure 4- 39**. The results show that the slump value has remarkably decreased with the incorporation of cut pieces of non-woven tissue. Specifically, 81.25%, 152.17%, and 383.33% reductions were obtained for mixtures containing 0.25%, 0.50%, and 0.75% of cut pieces, respectively compared to the standard mortar.





*Figure 4- 39: Average slump value versus percentage of plastic incorporation*

Furthermore, the average slump values were presented as function of the aspect ratio for all 3 percentages and shown in *Figure 4- 40*. The results present that the slump value decreased for longer pieces compared to shorter ones because of bad mixing and cumulating of pieces at the same area. Specifically, the slump value has decreased by 114.81%, 152.17%, and 241.18% for mortar mixtures containing (5×7) mm, (5×10) mm, and (5×20) mm of cut pieces as average of all percentages, compared to the standard mortar.



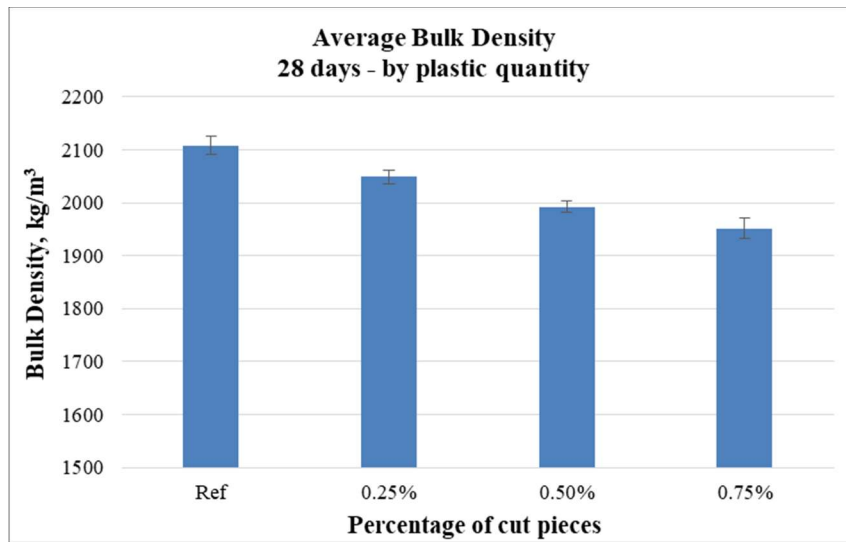
*Figure 4- 40: Average slump value versus aspect ratio*

This was confirmed by the previous study that considered various sizes and shapes of fibers obtained from PET bottles. The authors found that the mixtures with longer fibers had reduced workability compared to the shorter ones, and they summarized that fibers' dimensions play a significant role in achieving good workable concrete [46].

## 4.2. Effect of aspect ratio on physical properties

### 4.2.1. Bulk density

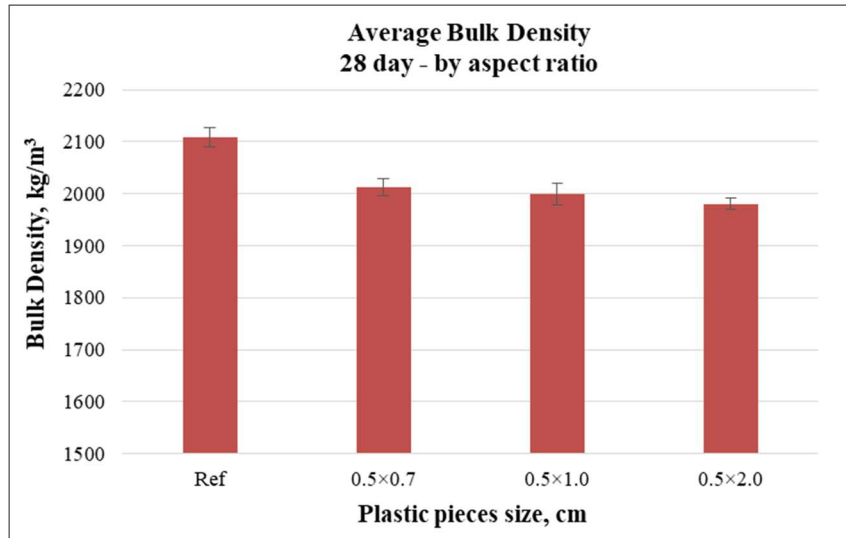
The bulk density was obtained for each percentage of incorporation as an average of all aspect ratios and their results are presented in *Figure 4- 41*. It can be obviously observed that the bulk density has decreased with the incorporation of plastic fabrics. Besides, the higher percentage of non-woven fabrics, the higher decrease in the bulk density. Specifically, 2.93%, 5.86%, and 8.05% reductions were obtained for samples containing 0.25%, 0.50%, and 0.75% of cut pieces, respectively compared to the standard mortar.



*Figure 4- 41: Average bulk density versus percentage of plastic incorporation*

Moreover, the average bulk densities arranged by aspect ratio are presented in *Figure 4- 42* and illustrate that the bulk density was slightly changed with the variation of fabrics aspect ratio. Specifically, the bulk density has decreased with the increase in the length of cut pieces. It means that 4.77%, 5.45%, and 6.50% reduction in bulk density was observed for (5×7) mm, (5×10) mm, and (5×20) mm plastic pieces, respectively, compared to the standard mortar. It is because of the effect of bundling for longer pieces during mixing that it is resulted in a more porous mixture.



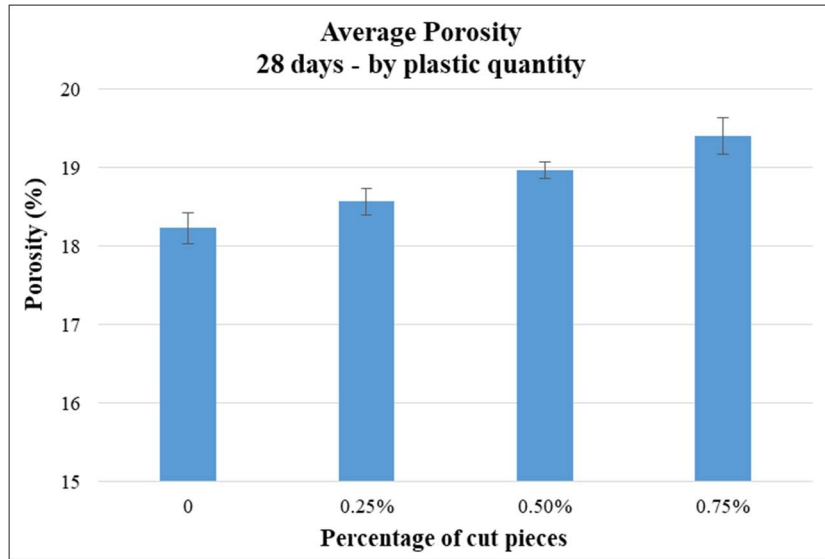


*Figure 4- 42: Average bulk density versus aspect ratio*

This phenomenon was observed by the authors who have already studied concrete containing PET fibers of various dimensions. The author found that the bulk density decreased with the incorporation of plastic fibers and decreased further for higher percentages. In addition, this reduction was more significant for longer fibers compared to the shorter ones [99].

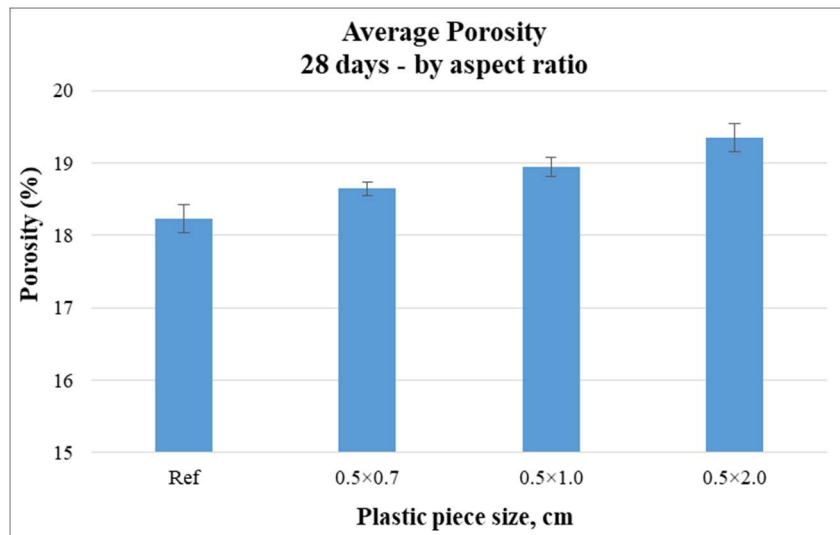
#### **4.2.2. Porosity**

The porosity is presented for the percentage of cut pieces as an average of all aspect ratios and shown in *Figure 4- 43*. It is clearly indicated that the porosity has increased with the enhancement of percentages of cut pieces. These average enhancements were 1.83%, 3.88% and 6.05% for the samples containing 0.25%, 0.50%, and 0.75% of cut pieces, respectively.



*Figure 4- 43: Average porosity versus percentage of plastic incorporation*

By sorting samples according to the aspect ratio of cut pieces, it was underlined that the porosity was slightly increased with the increase of cut pieces size as shown in *Figure 4-44*. These average increasing were 2.22%, 3.78% and 5.79% for the samples containing (5×7) mm, (5×10) mm, and (5×20) mm cut pieces, respectively.

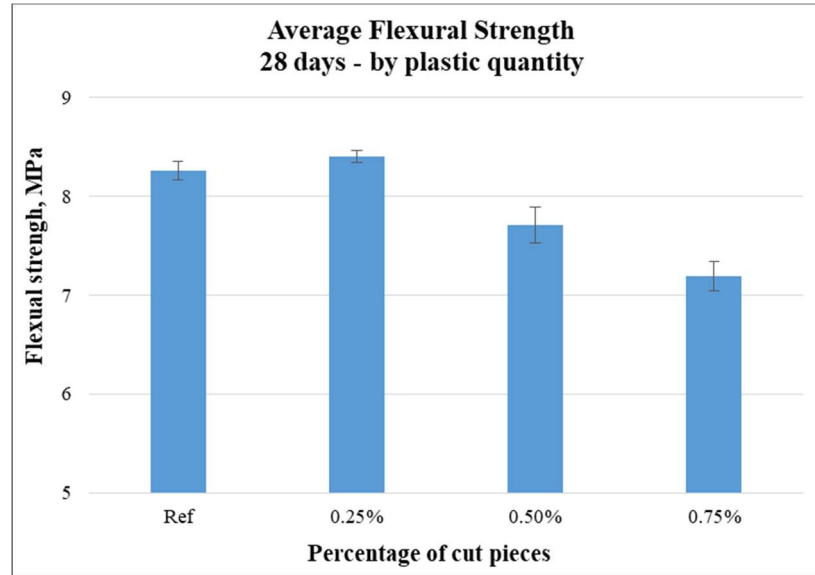


*Figure 4- 44: Average porosity versus aspect ratio*

### 4.3. Effect of aspect ratio on mechanical properties

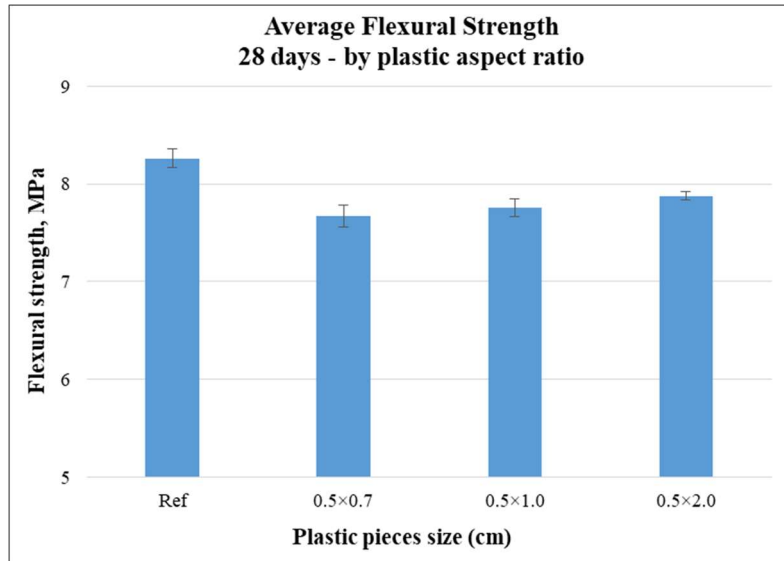
#### 4.3.1. Flexural strength

The outcomes of flexural strength was arranged by volume fraction of cut pieces as an average of all aspect ratios and shown in **Figure 4- 45** . The results clearly present that the flexural strength has slightly increased (1.67%) for 0.25% and decreased significantly by 6.55% and 13.87% for 0.50% and 075% of cut pieces' incorporation, respectively.



**Figure 4- 45:** Average flexural strength versus percentage of plastic incorporation

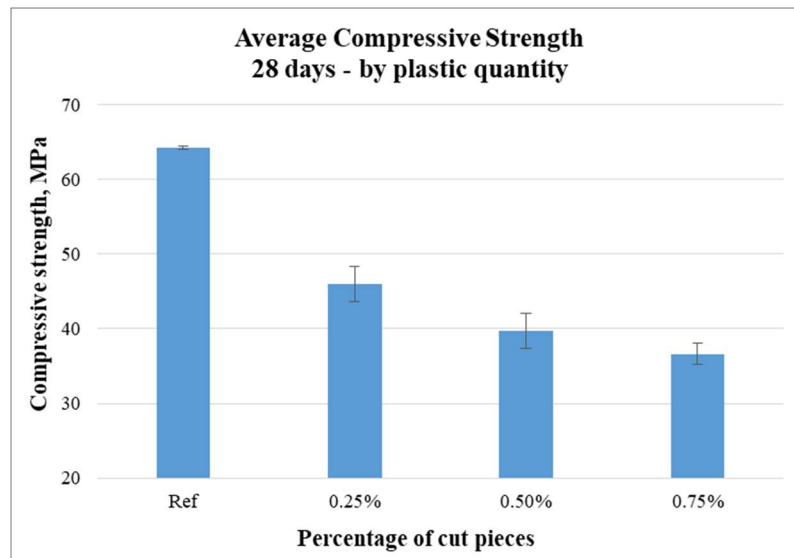
Finally, values of the flexural strength were arranged based on the sizes of plastic pieces as an average of all 3 percentages. The outputs clearly present that the reduction in flexural strength was slightly significant for longer pieces compared to the shorter ones. The reduction in flexural strength was 7.47%, 6.51%, and 4.87% for (5×7) mm, (5×10) mm, and (5×20) mm cut pieces of non-woven fabrics, respectively as shown in **Figure 4- 46**.



*Figure 4- 46: Average flexural strength versus plastic aspect ratio*

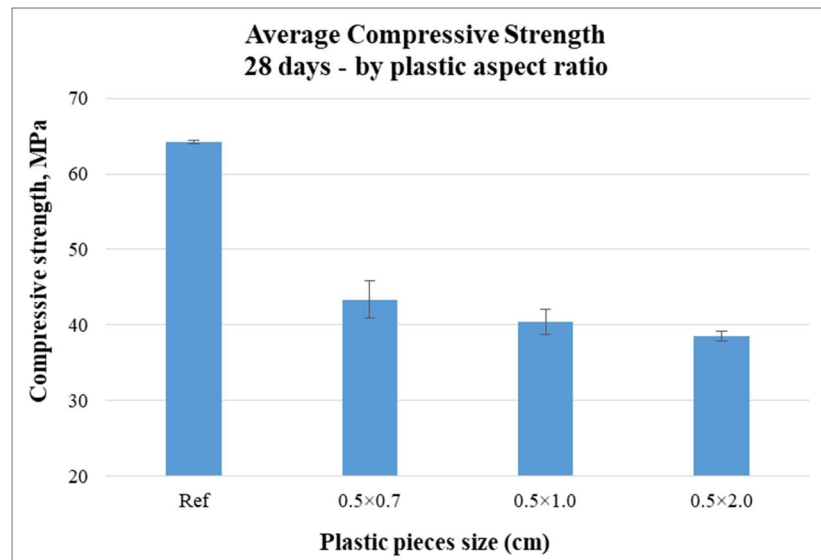
#### 4.3.2. Compressive strength

The compressive strength was greatly decreased with the incorporation of non-woven fabrics compared to the standard mortar and such reduction was more significant for higher percentages. The compressive strengths were arranged based on plastic quantity as an average for all sizes. The outcomes present that the compressive strength decreased by 39.73%, 61.64%, and 75.31% for the samples containing 0.25%, 0.50%, and 0.75% of cut pieces compared to the control ones as shown in *Figure 4- 47*.



*Figure 4- 47: Average compressive strength versus percentage of plastic incorporation*

Finally, values of the compressive strength were arranged based on the sizes of plastic pieces as an average of all 3 percentages. The outputs clearly present that the reduction in the compressive strength is more significant for the incorporation of longer plastic pieces (5×20) mm because it is difficult to obtain a homogenous matrix with longer fabrics. The reduction in the compressive strength was 47.98%, 59.01%, and 66.65% for cubes containing (5×7) mm, (5×10) mm, and (5×20) mm cut pieces of non-woven fabrics, respectively, compared to the control ones as shown in *Figure 4- 48*.



*Figure 4- 48: Average compressive strength versus plastic aspect ratio*

The outcomes were somewhat confirmed by research studies that considered plastic fibers with various percentages and dimensions. For instance, the compressive strength decreased with the increase of fiber content and this reduction was more significant for longer fibers than the shorter ones [100].

### ***Synthesis and Discussion***

The longer cut pieces resulted in less workable mixtures compared to the shorter ones because of bad mixing and cumulating of pieces at one point. This compiles with the previous study that considered various sizes and shapes of PET bottle fibers. The authors found that the mixtures with longer fibers reduced workability compared to the shorter ones, and they summarized that fiber dimensions play a significant role in achieving good workable concrete [46].

Moreover, the bulk density has decreased and porosity has increased with the increase in the length of cut pieces. It is because of the effect of bundling for longer pieces during mixing that it resulted in a more porous mixture. Besides, this phenomenon was verified by the authors who have already studied concrete containing PET fibers of various dimensions. The author found that the bulk density decreased with the incorporation of plastic fibers and decreased further for higher percentages. In addition, this reduction was more significant for longer fibers compared to the shorter ones [99].

The aspect ratios had a slight effect on mechanical strengths as well. The reduction in the flexural strength was less for longer cut pieces compared to the shorter ones because longer pieces will act as fibers and prevent the early cracking of samples. This complies with the previous research studies that considered plastic fibers with various percentages and dimensions. For instance, the compressive strength decreased with the increase of fiber content and this reduction was more significant for longer fibers than for shorter ones [100]. Finally, it appears that the percentage of incorporation has a greater influence than the cut pieces' size and that increasing the length of cut pieces induces a decrease of the mortar sample performances: less workability, more porosity and weaker mechanical resistances. It is only with 0.25% of the shorter cut pieces' introduction allows an improvement for mortar samples especially in flexural behavior.

## 5. Bond properties between non-woven sheets and mortar

This part that was performed in INSA describes the results and discussion of the experimental work related to the adhesion properties between mortar (with CEM I) and non-woven tissue. Two parameters having a significant influence on adhesion behaviors are discussed. This analysis mainly focuses on the effect of w/c ratio and amount of superplasticizer on the bond properties between mortar and the layer of non-woven plastic fabrics.

Therefore, this experimental work focuses two types of samples: 1) mixtures without superplasticizer but various w/c ratios of 0.45, 0.50, and 0.55. 2) Mixtures with superplasticizer and reduced w/c ratios of 0.40, and 0.45, as presented in **Table 4- 4**.

*Table 4- 4: Types of mixtures prepared for bond properties analysis in INSA*

Sample name	Cement (gr)	Water (gr)	SP (gr)	w/c ratio
-------------	-------------	------------	---------	-----------

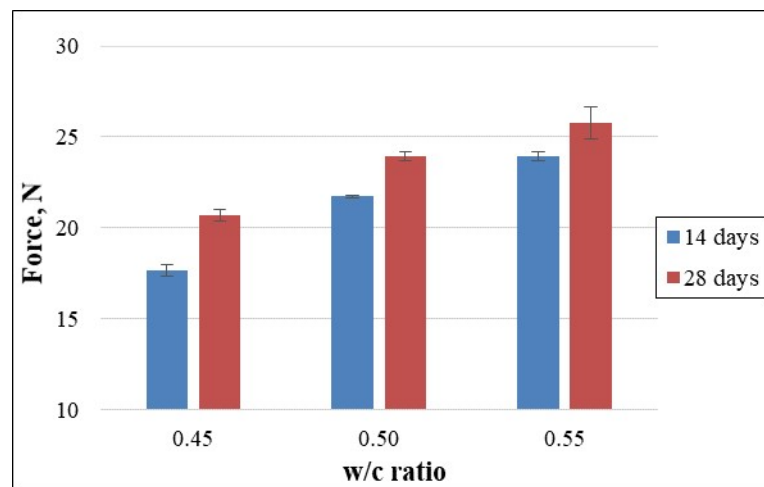
0.55-WSP	450	247.5	0	0.55
0.50-WSP	450	225.0	0	0.50
0.45-WSP	450	202.5	0	0.45
0.45-SP	450	202.5	5.0	0.45
0.40-SP	450	180.0	9.8	0.40

In the first column of **Table 4- 4**, the numerical value indicates w/c ratio and the alphabetical value means mixture with or without superplasticizer. For example, 0.55-WSP means prisms containing a w/c ratio of 0.55 and without superplasticizer. While 0.45-SP means specimens having w/c ratio of 0.45 and with superplasticizer.

An original setup described in Chapter #2 (**section 3.9**) allows evaluation of adhesion force between the different mortar samples and a non-woven sheet, then microscopic observations highlight the interfacial bound at different scales. Finally, flexural and compressive tests results are correlated with the other findings to evidence the influence of external application of non-woven sheet on mortars.

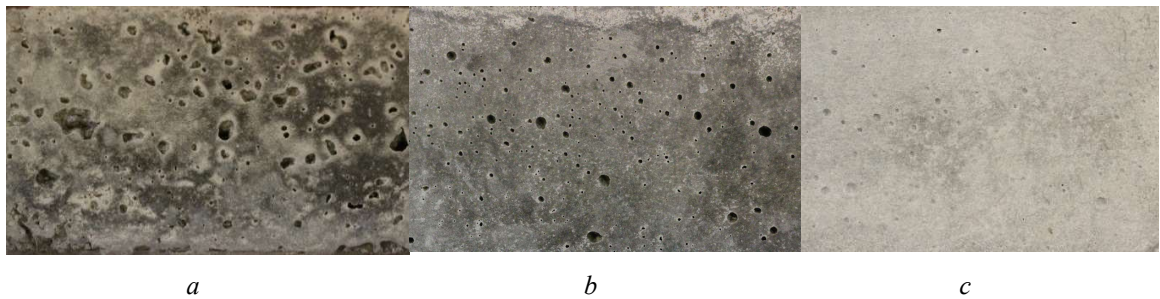
### 5.1. Effect of water content (w/c ratio) on adhesion force

The results presented in **Figure 4- 49** obviously illustrate that the maximum force to remove the non-woven plastic tissue from prisms has been improved with the increase of w/c ratio. Particularly, after 28 days of water curing the force was improved by 15.78% while w/c ratio has increased from 0.50 to 0.55. Contrary, the adhesion force was decreased by 24.50% with the reduction of w/c ratio from 0.50 to 0.45.



**Figure 4- 49:** Effect of w/c ratio on the adhesion force

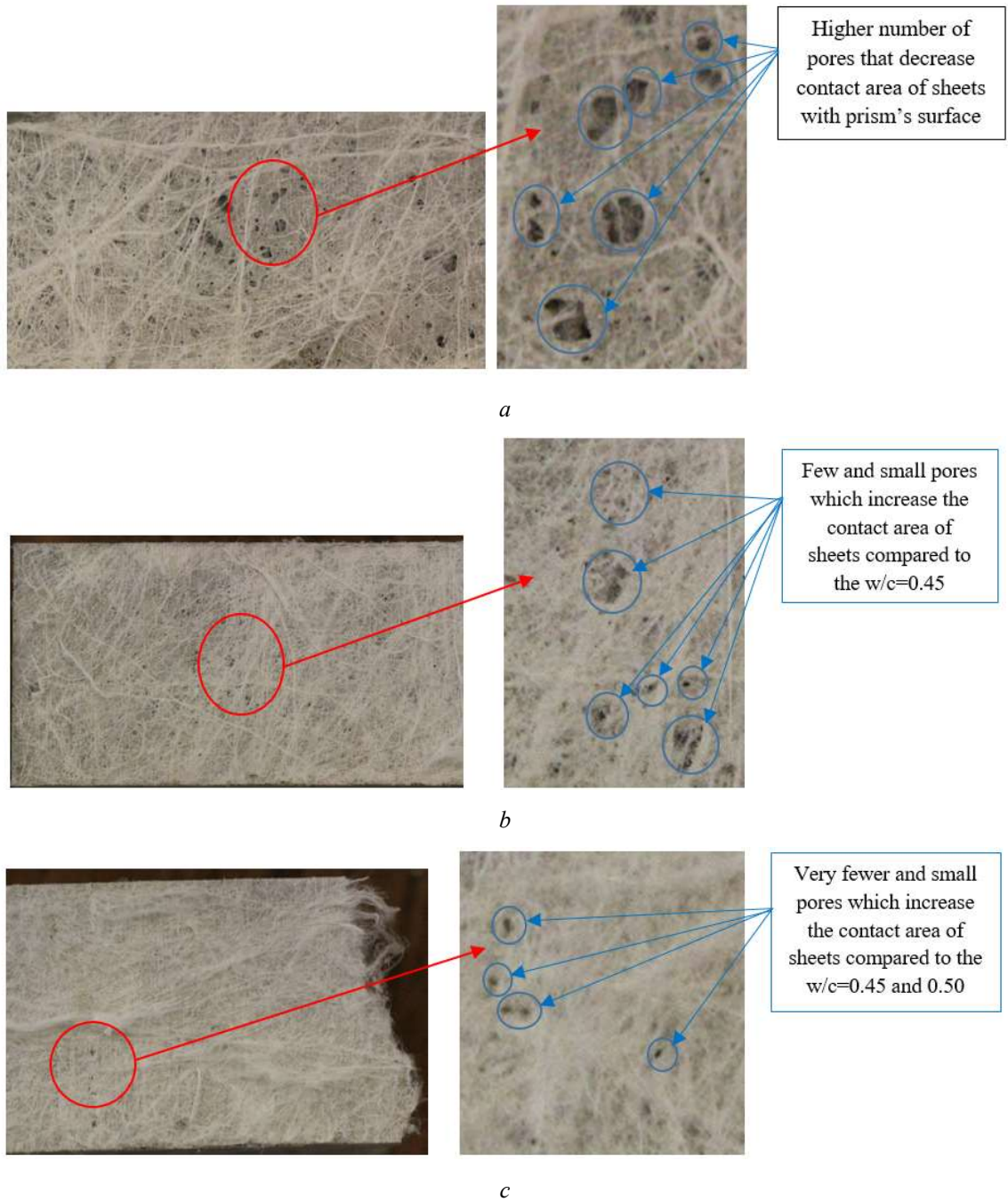
This can be attributed to the different surface textures of the specimens. It means that the prisms with a higher water content had a much denser microstructure, a smoother surface with fewer pores, and a greater contact area between cement paste and PET fibers of non-woven sheet, as shown in **Figure 4- 50**. The higher w/c ratio is, the greater contact area between cement paste and PET fibers of non-woven sheet are, which leads to higher bond force. Contrary, mortar specimens having w/c ratio of 0.45 have rougher surfaces with many pores and less ability for the cement paste to penetrate inside the voids of the non-woven sheet as shown in **Figure 4- 50a** resulting in a lower bond force.



**Figure 4- 50:** Surface textures of specimens with a) w/c=0.45, b) w/c=0.50, and c) w/c=0.55

Furthermore, the maximum value obtained for the detachment of non-woven sheets from mortar prisms with a water/cement ratio of 0.55 was 25.7 N that is largely lower than the 196 N needed to torn them. The failure occurred by the delamination of the fabrics confirmed by the amount of remaining fibers on the prisms' surface after the detachment of non-woven sheets from the specimens. It means that the specimens with a w/c ratio of 0.55 had remained fibers with high density on their surface as shown in **Figure 4- 51c**. However, the prisms containing a lower amount of water had lower amounts of remained fibers on the surface as shown in **Figure 4- 51a** and **Figure 4- 51b**.



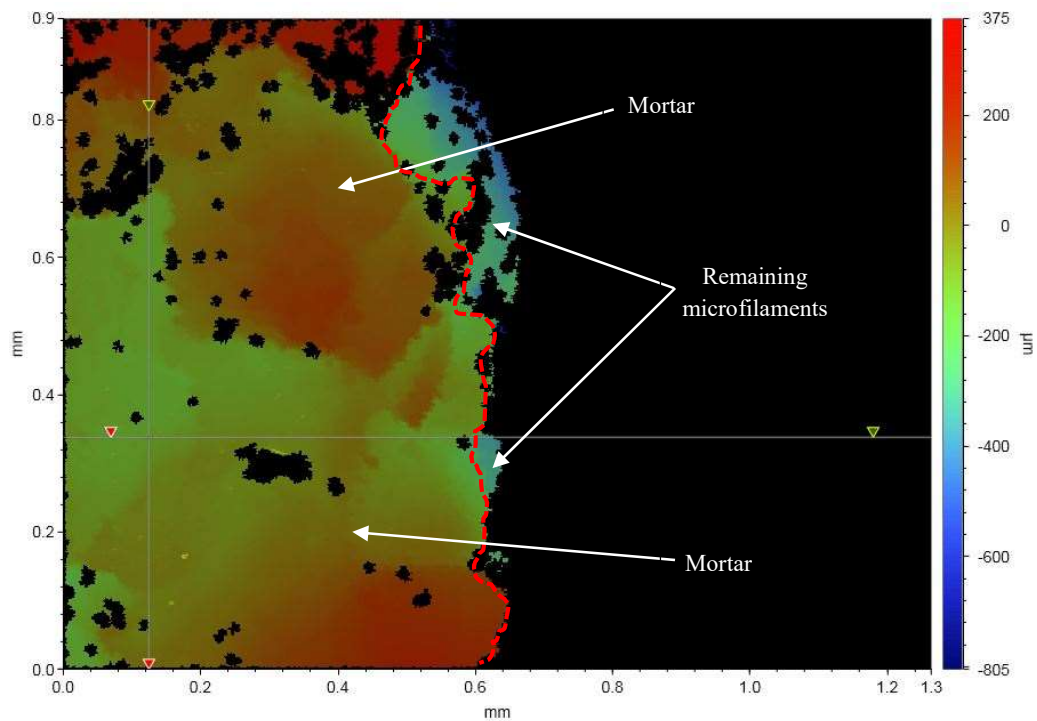


**Figure 4- 51:** Density of the remaining microfilaments on the surface of specimens with a)  $w/c=0.45$ , b)  $w/c=0.50$ , and c)  $w/c=0.55$

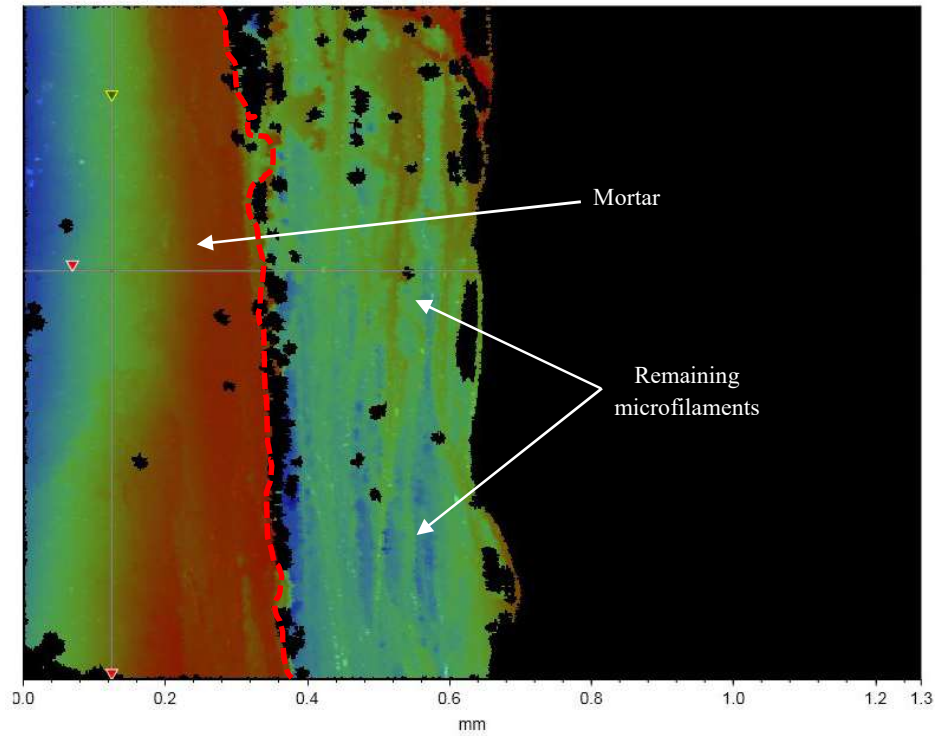
### 5.1.1. Interferometry analysis

Interferometers are devices that extract information from interference and are broadly used in science and industry for the measurement of small displacements, refractive index changes, and surface irregularities. Interferometry typically uses electromagnetic

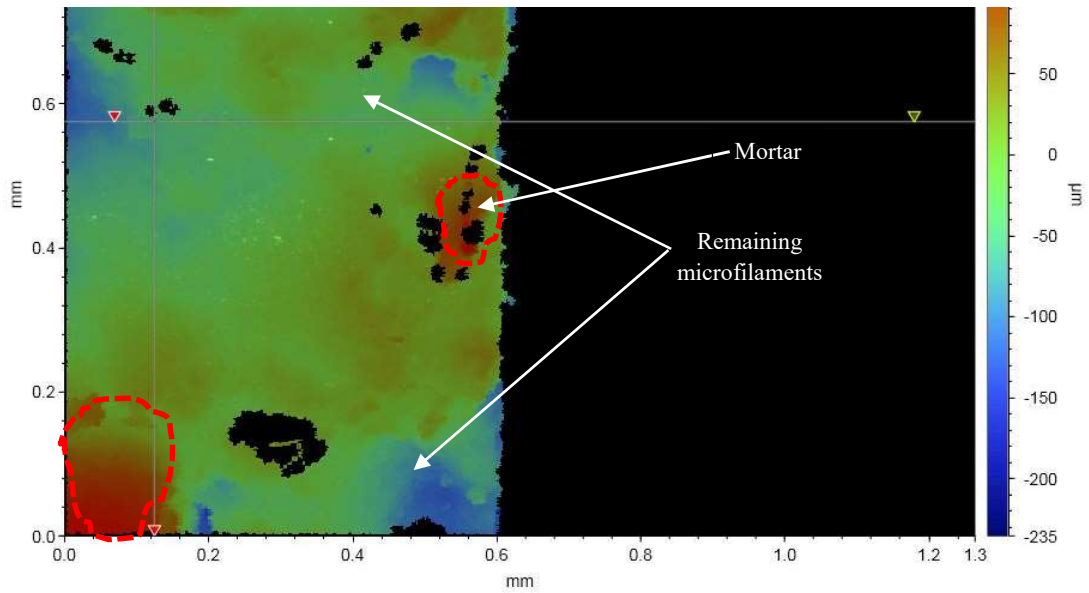
waves and the waves are superimposed to cause the phenomenon of interference, which is used to extract information. Here, the interferometry analysis was performed to find the surface texture and irregularities of samples and the concentration of fibers of non-woven sheets on the prisms' surface. The results clearly evidenced that samples with a w/c ratio of 0.45 had lots of irregularities which reduce the interaction of non-woven sheets with prisms and less amount of microfilaments of non-woven sheets on their surfaces as shown in *Figure 4- 52a*. The surface irregularities were decreased with the increase of water content. In addition, the amount of remaining fibers after detachment of non-woven sheets from the surface of specimens has increased remarkably for higher w/c ratios as presented in *Figure 4- 52b* and *Figure 4- 52c*.



*a*



*b*



*c*

**Figure 4- 52:** Surface irregularities and concentration of remaining fibers on prisms' surfaces; a)  $w/c=0.45$ , b)  $w/c=0.50$ , and c)  $w/c=0.55$

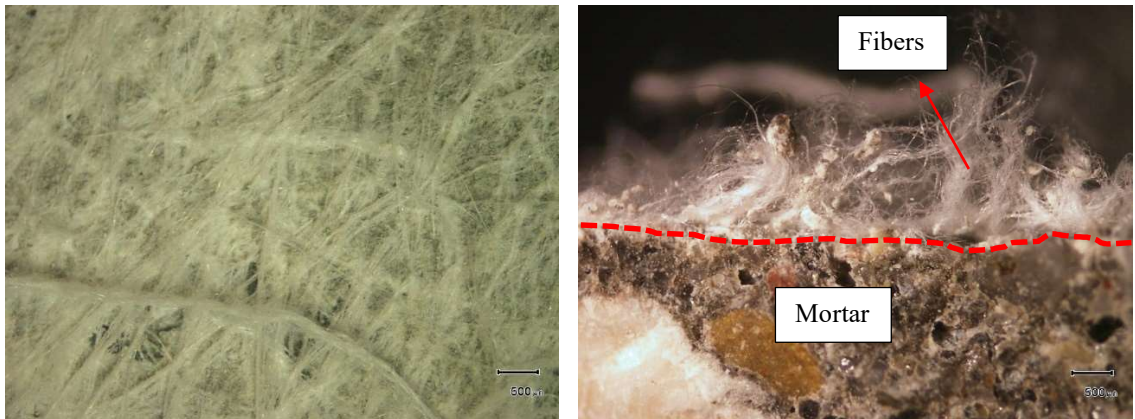
### 5.1.2. Microscopic analysis

After the detachment of non-woven sheets from prisms, the samples were investigated under microscopic analysis to better evaluate the surface textures, the concentration of

microfilaments, and the thickness of remaining fibers on the prisms' surface. The outputs highlight that the samples with a w/c ratio of 0.45 had many irregularities, and fewer and shorter microfilaments remained on their surfaces as shown in *Figure 4- 53a*. However, the specimens with higher w/c ratios had smoother surfaces with more, thicker and longer microfilaments remained on their surfaces as shown in *Figure 4- 53b* and *Figure 4- 53c*. The higher amount, thicker, and longer remaining fibers clearly demonstrate the best adhesion non-woven sheets and mortar. Moreover, the high density and amount of remained fibers have a direct relationship with the bond force. The bond force has improved considerably with the increase of water content due to the interaction and adhesion of more and longer fibers in mortar mixtures.

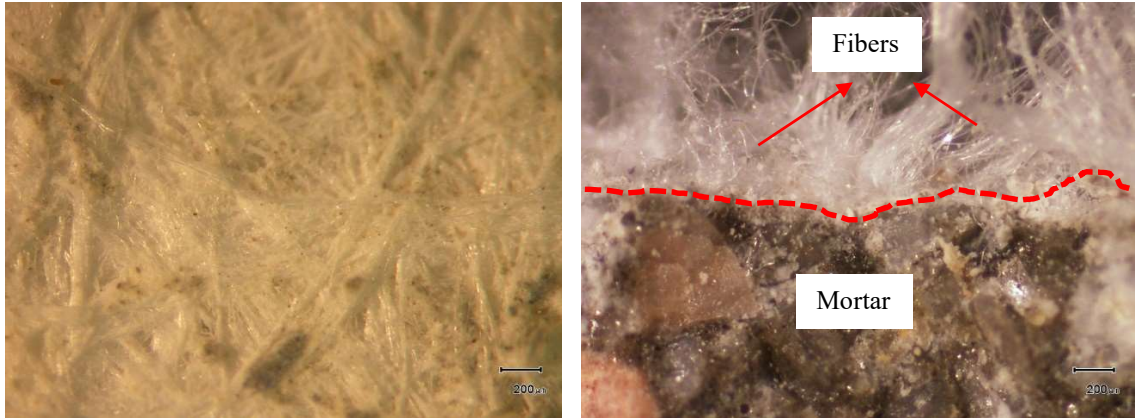


*a*



*b*

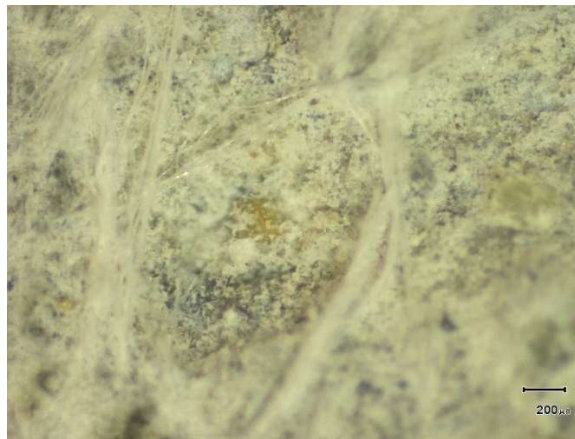




c

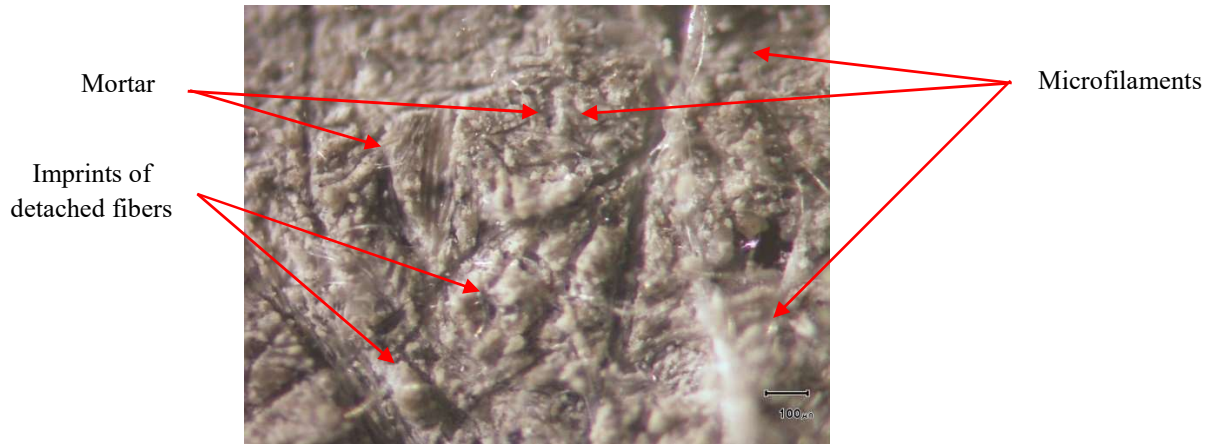
**Figure 4- 53:** Microscopic analysis of specimens with various  $w/c$  ratios; a)  $w/c=0.45$ , b)  $w/c=0.50$ , and  $w/c=0.55$

In addition, pictures of the samples' surfaces clearly indicate that the microfilaments of non-woven sheets intersect and adhere inside the mortar specimens which proves the good bond between mortar and non-woven sheets as shown in **Figure 4- 54**.



**Figure 4- 54:** Non-woven fabric on mortar specimen surface after bond test ( $w/c$  of 0.50)

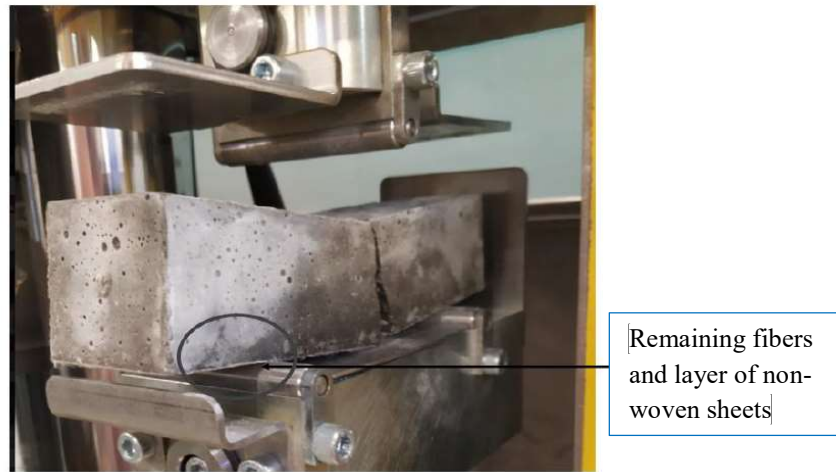
Finally, the samples were examined in more close views, with images depicting the remaining fibers, mortar, and the position of fibers that were detached during the bond test as shown in **Figure 4- 55**. It could be verified that such sheets and mortar mixtures adhere to each other, resulting in a strong bond.



*Figure 4- 55: The closer view of non-woven fabric on mortar specimen surface after bond test (w/c of 0.50)*

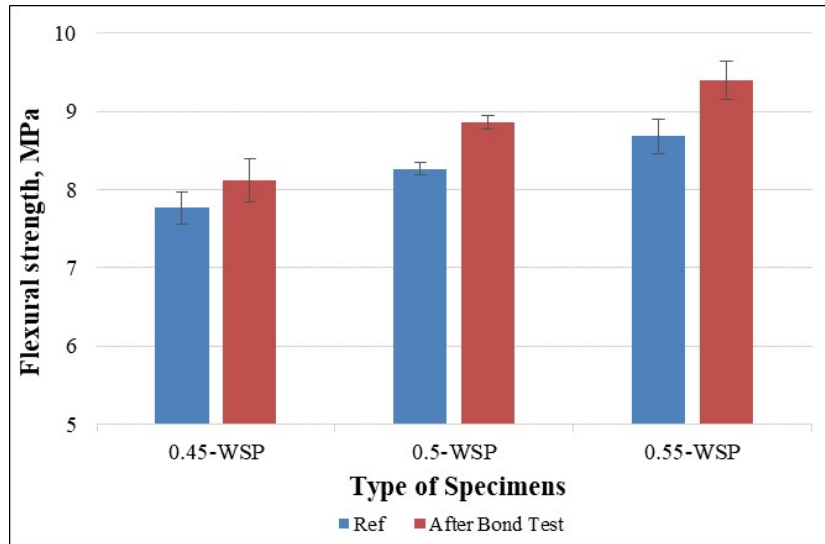
### **5.1.3. Mechanical strengths**

Finally, the improvement in mechanical strengths of mortar specimens were verified with the help of flexural and compression tests on the same prisms after the bond test as shown in *Figure 4- 56*.



*Figure 4- 56: Flexural strength test of samples after bond test*

The results indicate that the flexural strength has increased for the prisms, which were tested after the bond test compared to the references ones. This is due to the effect of remaining fibers on the surface of prisms that are able to restrain samples from early damage and increase load capacity. In addition, this improvement was more significant for higher w/c ratios compared to the lower ones because of the thicker layer of remaining fibers as presented in *Figure 4- 57*.



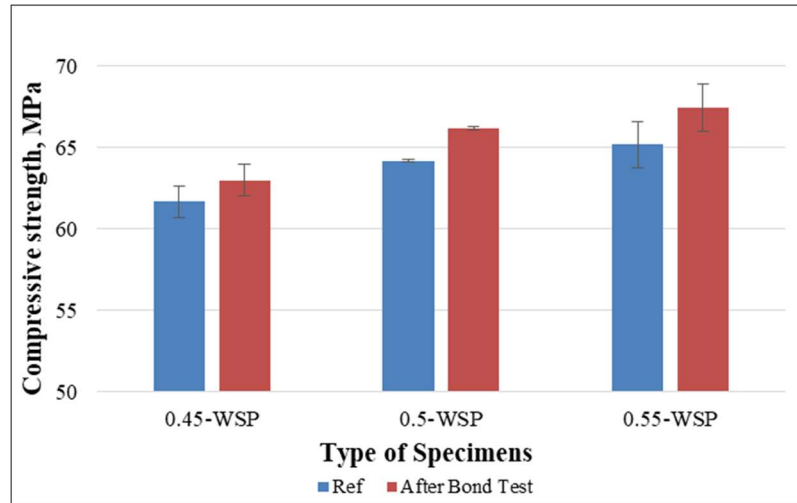
*Figure 4- 57: Flexural strength of reference samples and prisms after bond test*

In the same manner, the compression test was conducted on the same samples after the flexural test as shown in *Figure 4- 58*.



*Figure 4- 58: Compressive strength test of samples after bond test*

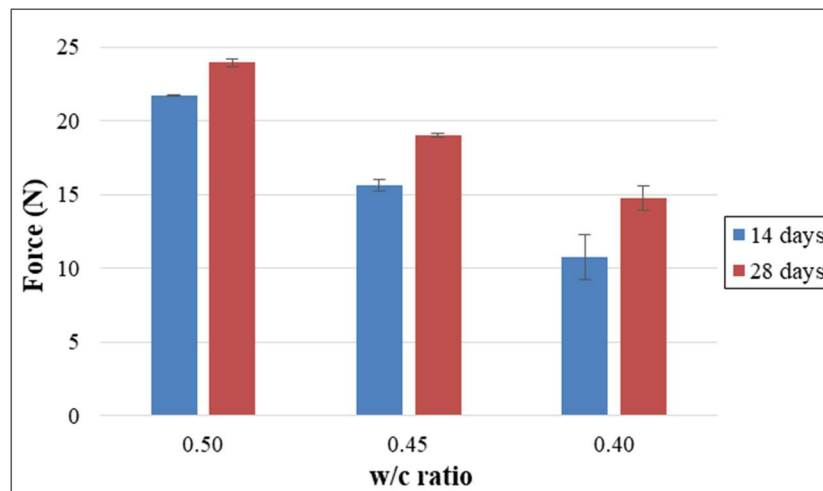
The compressive strength has slightly improved for the samples after bond test and containing fiber on their surfaces compared to the reference specimens as shown in *Figure 4- 59*.



*Figure 4- 59: Compressive strength of reference samples and prisms after bond test*

## 5.2. Effect of superplasticizer content on adhesion force

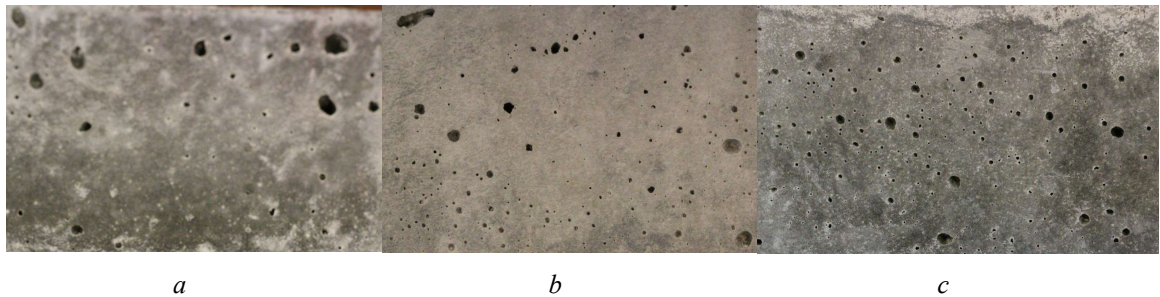
In this part of the experiment, the w/c ratio was decreased by reducing water content, but superplasticizer was added to maintain the consistency similar to the standard mortar. Two different w/c ratios of 0.40 and 0.45 were considered and their findings were compared with standard mortar of w/c = 0.50 to determine the effect of superplasticizer on adhesion properties between mortar and non-woven tissue. The results in *Figure 4- 60* clearly highlight that the detachment force has decreased significantly as the superplasticizer content has increased. After 28 days of curing, the bond force was reduced by 20.62% while the amount of superplasticizer increased from 0 gr to 5.0 gr, and the force was further decreased by 38.29% with the increase of superplasticizer from 5.0 to 9.8 gr.



*Figure 4- 60: Effect of superplasticizer content on bond force*

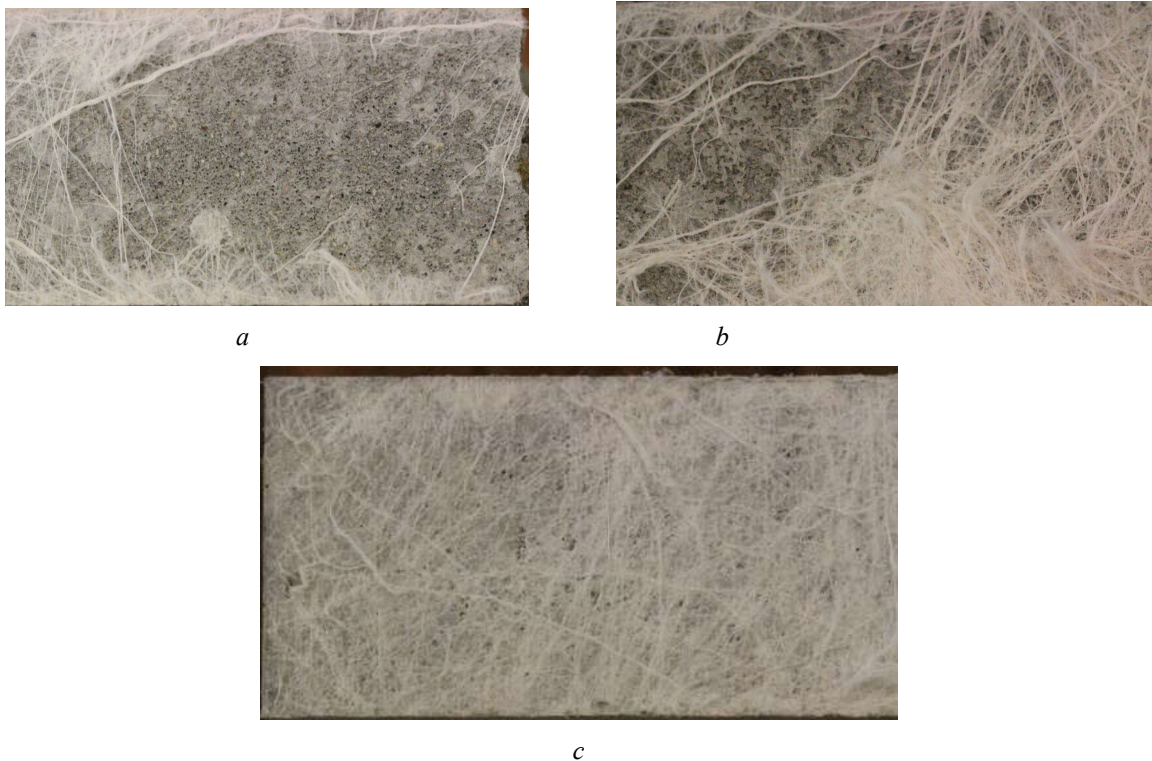


There was no significant difference in the surfaces textures of samples with different w/c ratios and constant workability due to the addition of superplasticizer. However, still, mortar specimens with lower water content and higher amount of superplasticizer showed larger pores compared to the small pores on the surface of specimens with a higher amount of water and a lower quantity of superplasticizer as presented in **Figure 4- 61**.



**Figure 4- 61:** Surface textures of mortar specimens containing various amount of SP and a) w/c=0.4, b) w/c=0.45, and c) w/c=0.50

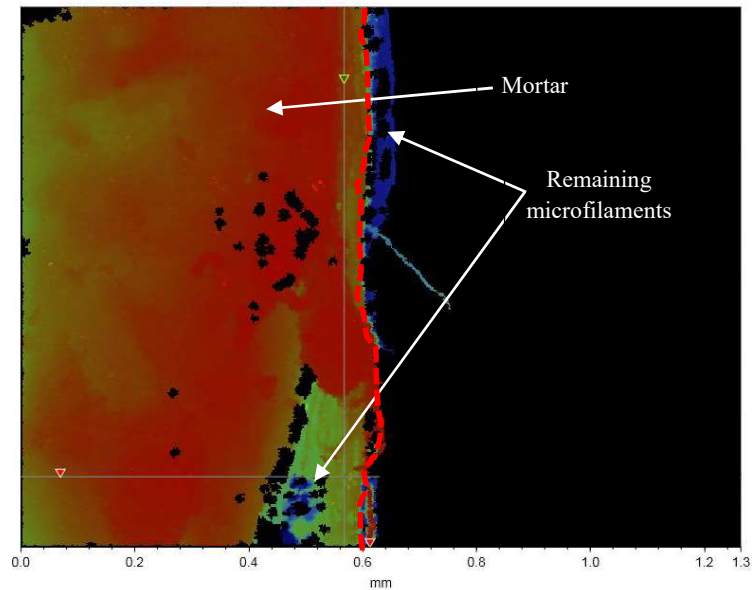
The specimens with a lower amount of water content and a higher amount of superplasticizer had fewer remaining microfilaments on their surfaces compared to the control mixtures as shown in **Figure 4- 62**.



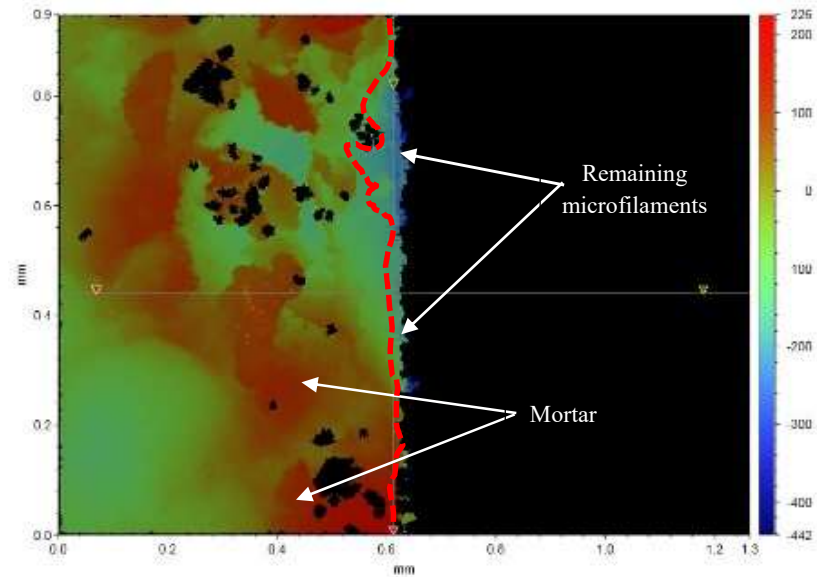
**Figure 4- 62:** Density of the microfilaments on the specimens' surfaces a)  $w/c=0.40+SP$ , b)  $w/c=0.45+SP$ , and c)  $w/c=0.50$

### 5.2.1. Interferometry analysis

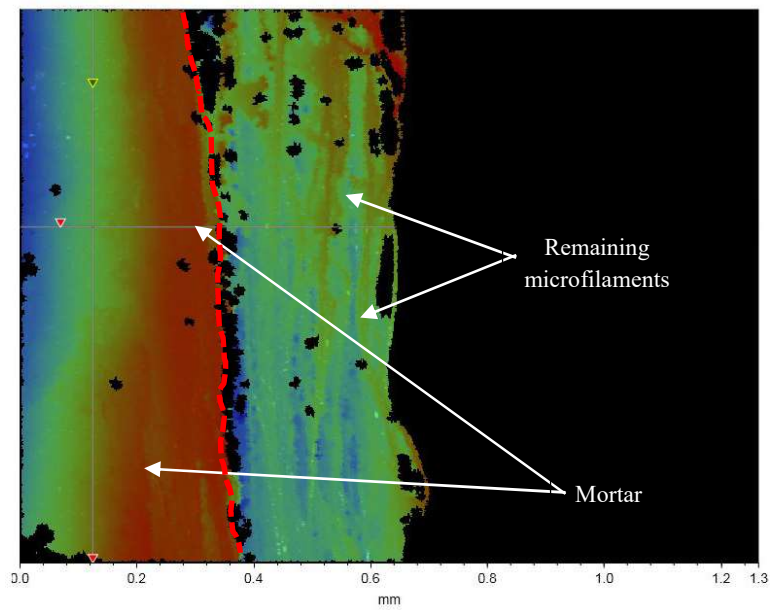
The results illustrate that no significant difference was observed in the surface texture of mortar samples with various  $w/c$  ratios and different amounts of superplasticizer, because of their similar workability. However, the photos clearly indicate that the specimens with a lower  $w/c$  ratio and higher amount of superplasticizer had a fewer amount of remaining microfilaments on their surfaces. The amount of remaining fibers was enhanced with the reduction of superplasticizer content and enhancement of  $w/c$  ratio as shown in **Figure 4- 63**. As previously mentioned, the amount of remaining fibers is directly related to the bond strength: a higher density of remaining fibers on prisms' surfaces witnesses a stronger bond between mortar and non-woven sheets is.



*a*



*b*



*c*

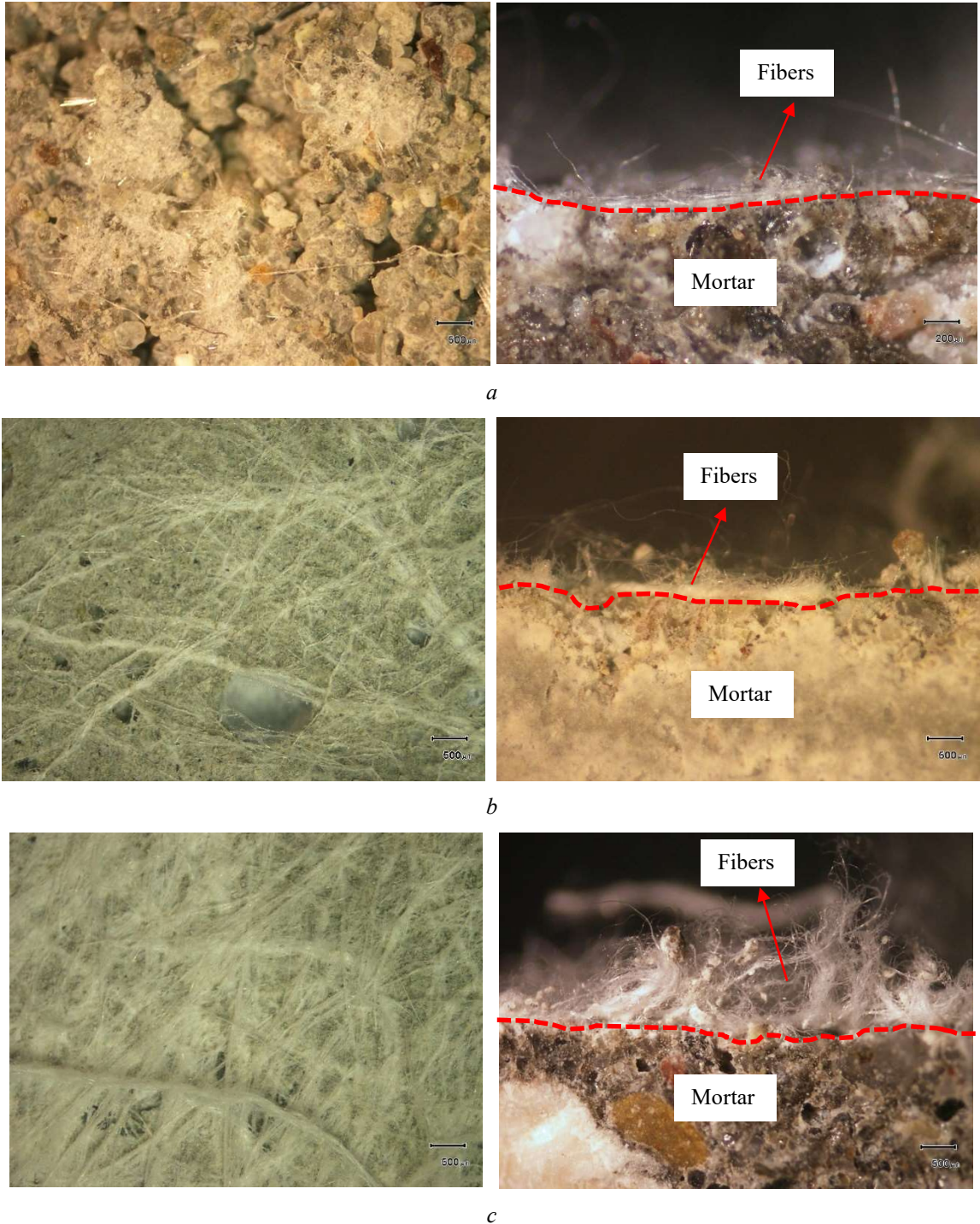
**Figure 4- 63:** Surface irregularities and density of remained fibers; a)  $w/c=0.40+SP$ , b)  $w/c=0.45+SP$ , and  $w/c=0.50$

### 5.2.2. Microscopic analysis

The results highlight that the samples with a  $w/c$  ratio of  $0.40+SP$  had slightly more irregularities on their surfaces than the ones with  $w/c$  ratios of  $0.45+SP$  and  $0.50$  as shown in **Figure 4- 64**. In addition, the amount and thickness of remaining microfilaments decreased with the increase of superplasticizer content and decrease of  $w/c$  ratio. The

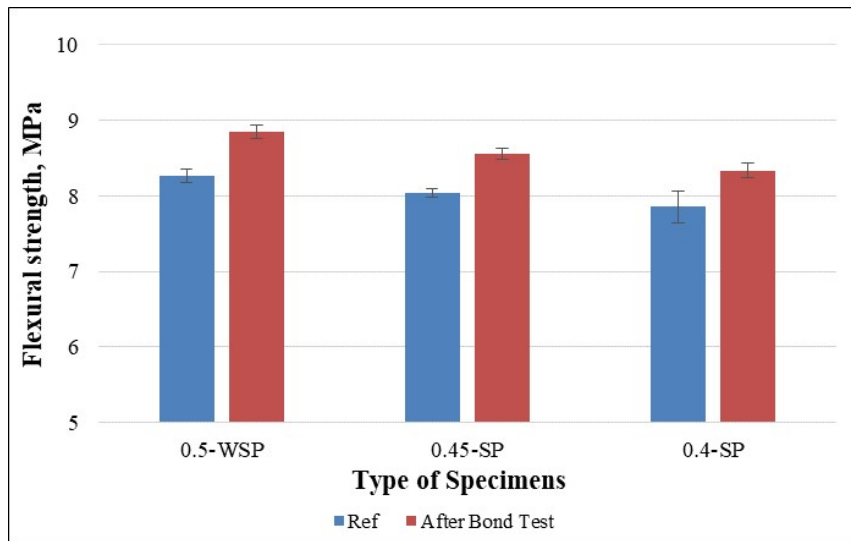


decreased amount of remaining fibers resulted in a significant reduction of bond strength. Therefore, in order to have a stronger bond between non-woven sheets and cementitious materials, it seems useful to decrease the amount of superplasticizer and increase w/c ratio.



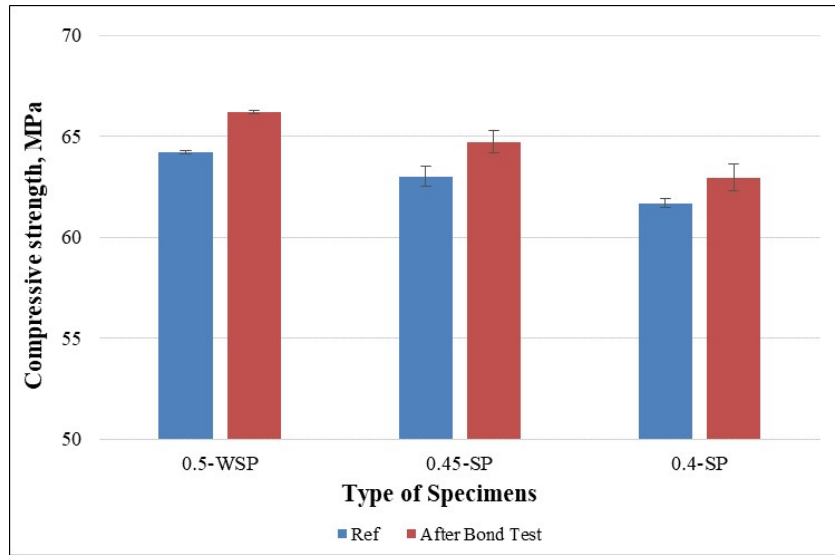
**Figure 4- 64:** Microscopic analysis of specimens with various w/c ratios; a)  $w/c=0.40+SP$ , b)  $w/c=0.45+SP$ , and  $w/c=0.50$

Finally, the effect of SP content on the adhesion force was studied based on the mechanical strengths of samples after the bond test. It was observed that the flexural strength has increased for the prisms tested after the bond essay compared to the references ones. However, this improvement was more significant for the prisms containing a higher amount of water and less amount of superplasticizer compared to the ones with higher content of superplasticizer. This is due to the thicker layer of remaining fibers for the specimens with a higher amount of water and less quantity of superplasticizer as presented in *Figure 4- 65*.



*Figure 4- 65: Flexural strength of reference samples and prisms after bond test*

In the same manner, the compression test was conducted on the same samples after the flexural test. The compressive strength has improved for the samples after the bond test that contains fiber on their surfaces compared to the reference specimens. This improvement was slightly more significant for the specimens containing a higher amount of water and less amount of superplasticizer compared to the specimens with higher content of superplasticizer. This is due to the thicker layer of remaining fibers for the specimens with a higher amount of water and less quantity of superplasticizer as presented in *Figure 4- 66*.



*Figure 4- 66: Compressive strength of reference samples and prisms after bond test*

### ***Synthesis and Discussion***

It was observed that non-woven tissue has a good bond with mortar specimens without using any adhesive materials. However, there are many factors that have significant effects on bond properties such as surface texture, workability, water content, superplasticizer amount.

The results indicated that the maximum force to remove non-woven sheets from the prisms was considerably enhanced with the increase of water content. This is due to smoother surface and enough amount of cement paste at the prisms' surfaces. Higher w/c ratio and smoother surface allow greater contact area between PET non-woven sheets and cement that can penetrate deeper inside them, which leads to higher bond force. The bond force increase with the amount of superplasticizer that appears less efficient than water for binding the PET non-woven sheets.

Moreover, the effect of w/c ratio and SP content was absolutely verified by interferometry analysis and microscopic analysis. It was observed that lowering the w/c ratio or addition of superplasticizer resulted in increased surface irregularities and pores and decreased amount and thickness of remained microfilaments.

## **6. Conclusions**

The main objective of the fourth chapter was to study the effect of the introduction of non-woven tissue as a layer or cut pieces into mortar mixtures. The fresh, physical, mechanical,

acoustic, microstructural, and bond properties of mortar samples were evaluated. Overall, the results indicate that non-woven sheets used as external layer without using any adhesive materials are able to improve certain properties of mortar samples.

The following concluding points are:

- The attachment of non-woven sheets as an external layer resulted in an improvement in mechanical strengths of mortar specimens compared to the reference ones. The enhancement was more significant for the samples strengthened at 2-Sides and 3-Sides compared to the reference and 1-Layer. Besides, the strengthened specimens showed ductile behaviors and were able to maintain their shapes from separation after ultimate load. Furthermore, the sound transfer property was reduced remarkably for the samples containing non-woven sheets as a layer compared to the reference ones.
- The incorporation of cut pieces of non-woven sheets resulted in a considerable decrease in slump value of mortar and this reduction was more significant for higher percentages. Besides, the introduction of cut pieces resulted in lightweight mortar because of the lower bulk density of non-woven sheets than mortar components.
- Moreover, the incorporation of cut pieces resulted in the increasing of porosity and water absorption of mortar, particularly at higher percentages.
- The effects of incorporation of non-woven tissue as cut pieces depend more of the size of the pieces than of the amount of introduced cut pieces. For small cut pieces a 0.25% (10×10) mm content induced a slight enhancement of mechanical performances particularly for the flexural strength. But for higher percentages of introduction or larger size of cut pieces, all the mechanical results were decreased.
- However, all small cut pieces in any configuration were able to change the cracking mechanism from brittle to ductile and maintain samples from separation to many fragments.
- The observations at different scales of the interfaces between non-woven sheets and cement allowed to correlate the mechanical behavior of the different mortar mixing with the adhesion between such types of waste and to compare them with the effect of fibers introduction in mortars.

### ***Scientific Valorization***

- 1) **Sifatullah Bahij**, Safiullah Omary, Vincent Steiner, Francoise Feugeas and Amanullah Faqiri. “Strengthening of Mortar Specimens with Non-Woven Plastic Sheets”, *Proceedings of Fib Symposium 2021*, Lisbon, June 14-16, 2021
- 2) **Sifatullah Bahij**, Safiullah Omary, Vincent Steiner, Francoise Feugeas, Amanullah Faqiri “Effect of PET Plastic Cut Pieces’ Aspect Ratio on Fresh and Mechanical Properties of Cement Mortar” **accepted** to *7<sup>th</sup> International Conference on Civil, Structural and Transportation Engineering (ICCSTE'22)*.



## CHAPTER # 5

### USE OF NON-WOVEN TISSUE IN CONCRETE

This chapter describes the experimental work conducted on ordinary concrete containing non-woven plastic sheets as a layer or cut pieces.

Firstly, non-woven tissue was applied as a layer with four various configurations (Ref, 1-Layer, 2-Sides, and 3-Sides) to strengthen concrete samples. Thereafter, the effect of such sheets on the mechanical (compressive, flexural, and split tensile strength), thermal, and sound properties of concrete was measured. It must be noted that the concrete mixtures were fabricated only with GHORI cement in KPU lab.

Secondly, the non-woven tissue was cut to (10×10) mm pieces and was incorporated into concrete mixtures with four various percentages of 0%, 0.25%, 0.50%, and 0.75% by mass of concrete solid ingredients. Then, the effect of cut pieces on the fresh, physical, mechanical, acoustic, and thermal properties of concrete was explored in detail.

Finally, the correlations between the different properties of concrete were established that are based on the experimental results of this study and those of the literature.

**Table 5- 1** presents the overall flow of this chapter, which presents the mix design, used cement type, incorporation of non-woven sheets, and the number of conducted tests.

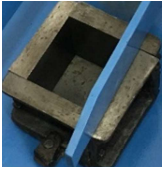






*Table 5- 1: Overall flow of chapter # 5*



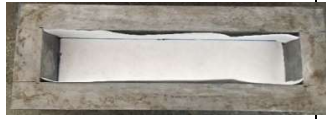



Mix design	Cement	Non-woven sheets	Configurations	Tests	Lab
Concrete	GHORI	As a layer	Detailed below	<ul style="list-style-type: none"> <li>• Flexural strength</li> <li>• Compressive Strength</li> <li>• Tensile splitting Strength</li> <li>• Ultrasonic Pulse Velocity</li> <li>• Thermal conductivity</li> </ul>	KPU
Concrete	GHORI	As cut pieces of 10×10 mm	Incorporation of 0%, 0.25%, 0.50% & 0.75% by mass of solid components	<ul style="list-style-type: none"> <li>• Workability</li> <li>• Density and Porosity</li> <li>• Compressive Strength</li> <li>• Tensile splitting Strength</li> <li>• Ultrasonic Pulse Velocity</li> <li>• Thermal conductivity</li> </ul>	KPU

## 1. Use of non-woven sheet as a layer in concrete

In order to explore the effect of non-woven fabrics as a layer on the fresh and hardened properties of concrete, samples with various strengthening configurations were prepared as presented in **Table 5- 2**. In addition, three samples were tested after 7, 14, and 28 days of curing for each strengthening configuration, and their averages were used as final results.

*Table 5- 2: Description of concrete samples strengthened with non-woven sheets*

Type of samples and their dimensions	Name	Description	Conducted tests	Image
Cube 100 mm	Ref	No sheet	Compressive strength and UPV	
	1-Layer	A layer of non-woven sheet at the bottom		
	2-Sides	Non-woven sheets at two vertical opposite sides		
	Full wrapped (4-Sides)	Non-woven sheets at all four vertical sides		
Cylinder (100×200) mm	Ref	No sheet	Compressive and split tensile strengths	
	Layer	Completely covered with non-woven sheets		
Beam (100×100×500) mm	Ref	No sheet	Flexural strength	

	1-Layer	A layer of non-woven sheet at the bottom		
	2-Sides	Non-woven sheets at two vertical opposite sides		
	3-Sides	Non-woven sheets at two vertical opposite sides and bottom		
Cylinder (100×70) mm	Ref	No sheet	Thermal conductivity	
	1-Layer	A layer of non-woven sheet at the bottom		
	2-Sides	Non-woven sheets at two sides		

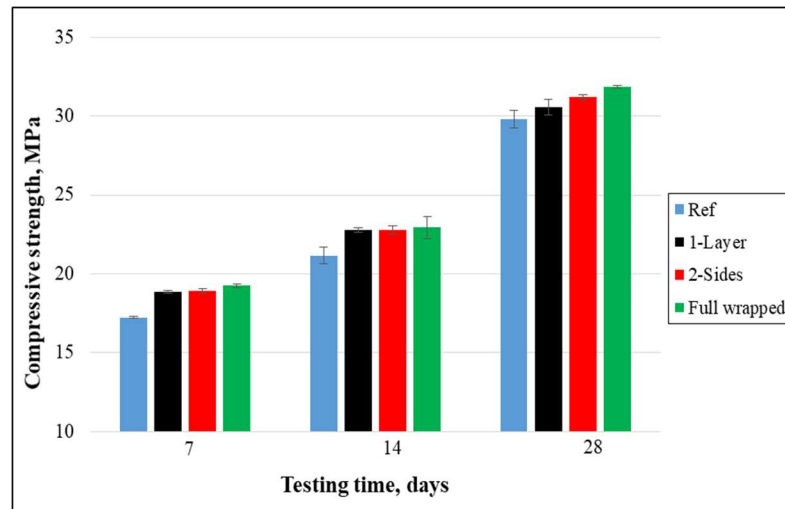
### 1.1. Effect of layer on fresh properties of concrete

Since non-woven fabrics were used as a layer with different configurations at the outer face of specimens, therefore, the same mix design was used for reference samples and the ones with non-woven sheets. Therefore, the layer of non-woven sheets had no effect on the workability and fresh density of concrete. However, to know the consistency of concrete mixtures prepared based on the above mentioned mix design, the slump test was conducted on three samples. The average slump value was  $162 \pm 10$  mm, which is in S4 class with the range of (160-210) mm [70]. Besides, the fresh density obtained from the average of three samples was  $2680.4 \pm 22.4$  kg/m<sup>3</sup>.

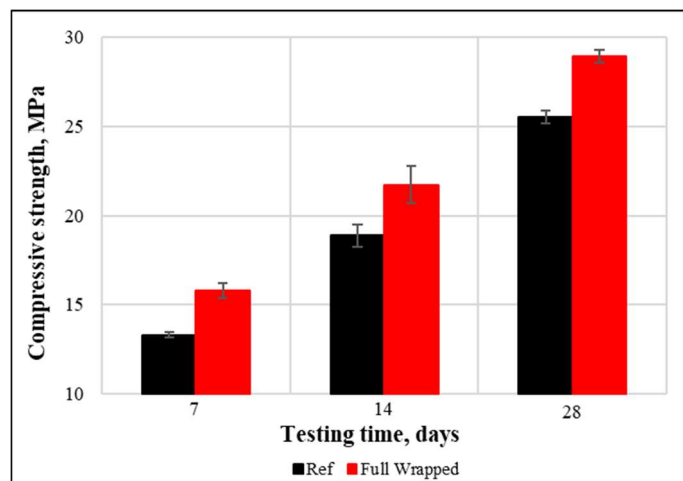
## 1.2. Effect of layer on mechanical properties of concrete

### 1.2.1. Compressive strength

The results of the cube compressive strength and their comparison after 7, 14, and 28 days of curing are shown in *Figure 5- 1*. The outcomes point out that applying non-woven tissue as a layer has a slight effect on the compressive strength of cubical specimens. It means that the cubical compressive strength has slightly increased when specimens were covered with non-woven fabrics of different configurations. However, the compressive strength of cylindrical samples strengthened by non-woven sheets has significantly enhanced compared to control ones as shown in *Figure 5- 2*.

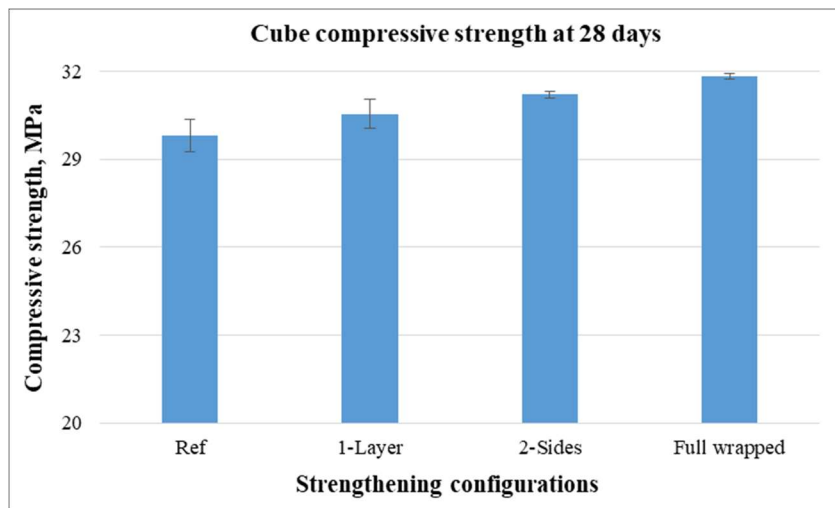


*Figure 5- 1: Cube compressive strength of concrete specimens*

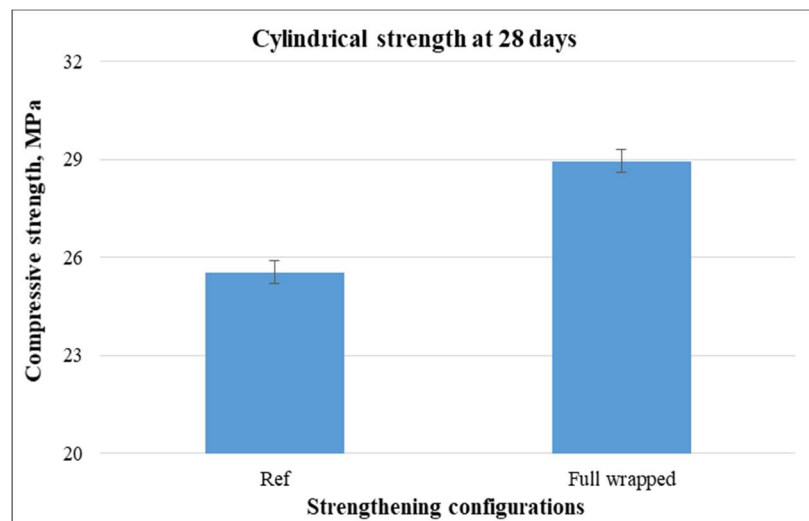


*Figure 5- 2: Cylindrical compressive strength of concrete specimens*

After 28 days of curing, it was observed that the compressive strength of cubical samples strengthened with 1-Layer, 2-Sides, and full wrapped configurations enhanced by 2.5%, 4.7%, and 6.8%, respectively, compared to the reference ones. While at the same curing time, the cylindrical compressive strength improved by 13.4% for covered specimens compared to the control ones as shown in **Figure 5- 3**. It is due to the fact that such tissue has the ability to confine the samples, restrain cracks extension, change the cracking path and delay the cracking growth rate.



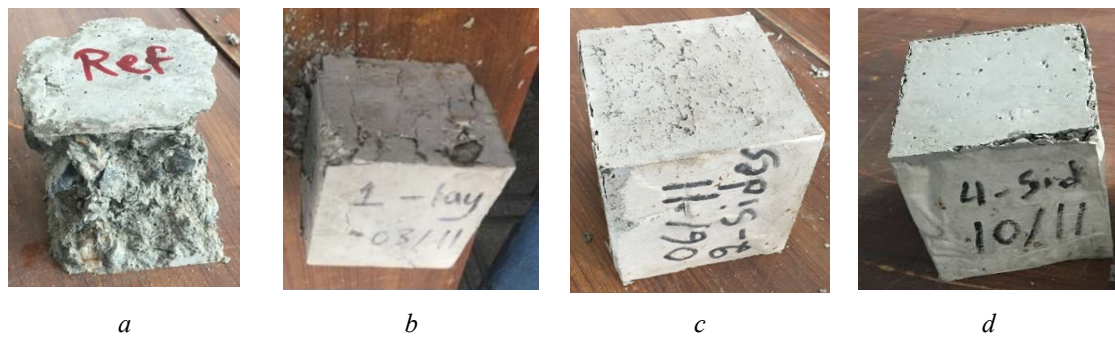
a



b

**Figure 5- 3:** Compressive strength of concrete specimens after 28 days a) cubic and b) cylindrical

It was clearly underlined from the crack pattern that the reference specimens have deteriorated into many parts after ultimate load, but specimens with 1-Layer, 2-Sides, and 4-Sides configurations were not parted into many segments. It means that samples were maintained by non-woven sheets especially, the sides, which were strengthened by the layer as shown in *Figure 5- 4*. Particularly, the cubes strengthened as full wrapped (4-Sides) were completely confined by non-woven sheets with only few detachments at the surface, where the load was applied as shown in *Figure 5- 4d*. Furthermore, in the case of cylindrical samples, the non-woven plastic sheets play a weightier role to retain the specimens from the separation as shown in *Figure 5- 5*. This performance of non-woven plastic fabrics could be then advantageous in the case of abrupt failure, particularly earthquake damages. It means that structural elements strengthened by such tissue will be safer than elements without non-woven sheets in case of earthquake.



*Figure 5- 4: Cracking patterns after compressive strength a) Ref, b) 1-Layer, c) 2-Sides, and d) full wrapped*

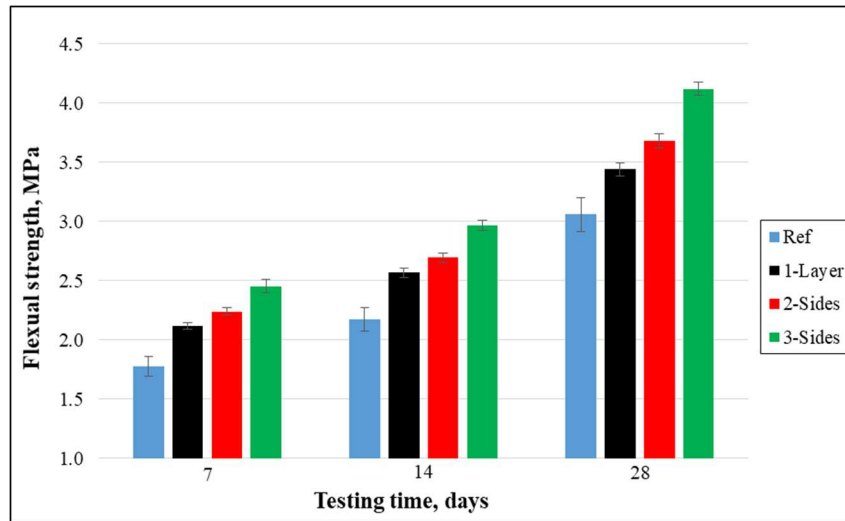


*Figure 5- 5: Cracking patterns after compressive strength a) Ref and b) full wrapped samples*

Even though, none of the research study considered plastic non-woven tissue for strengthening purposes, the improvement of the compressive strength has been verified by the previous experimental works, which strengthened concrete samples with fiber-reinforced polymer (FRP) sheets using various methods. However, there is a difference between the outcomes of the current study and the previous ones due to great difference between materials strengths, adhesive materials and etc. [94–96].

### 1.2.2. Flexural strength

The flexural strength was found under a four-point loading setup and their findings are presented in **Figure 5- 6**. The outcomes clearly demonstrate that the flexural strength has remarkably enhanced for the strengthened beams compared to the control ones.



**Figure 5- 6:** Flexural strength of concrete specimens

After 28 days of curing, the flexural strength improved by 12.4%, 20.3%, and 34.6% for the beams having non-woven fabrics at 1-Layer, 2-Sides, and 3-Sides, respectively, compared to the references ones as shown **Figure 5- 7**. This is due to the attachment and strengthening facts of the sheet on concrete beams that leads to postponing the crack propagation, and finally, more load is needed to damage the beams. The 3-Sides strengthened beams had the highest ultimate load capacity followed by 2-Sides and 1-Layer.

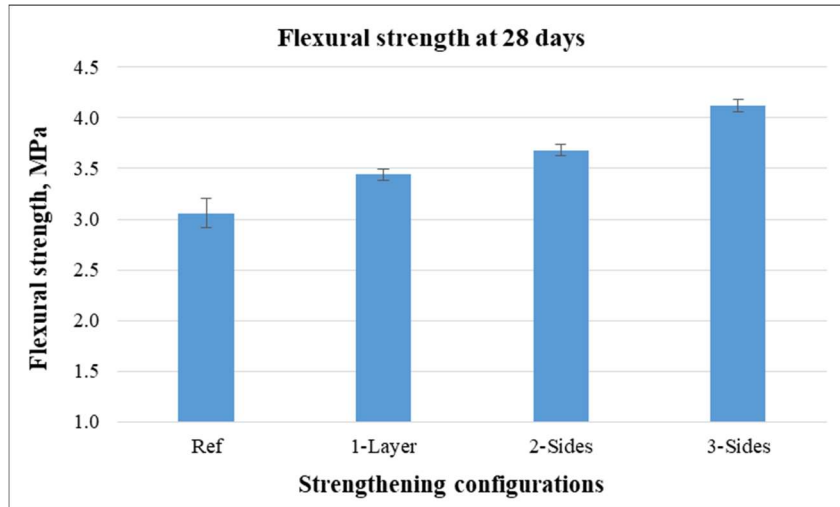


Figure 5- 7: Flexural strength of concrete specimens after 28 days of curing

➤ **Cracking mechanism**

For all strengthened beams, modes of failure were similar to the control ones, where flexural cracks were initiated at the middle parts between two loading points, propagated to the depth of beams, and followed by a single and widened crack up to the ultimate failure.

- **Reference beam:** The control beams were failed suddenly and completely divided into two parts after failure and had wider ultimate cracks during failure as shown in *Figure 5- 8*.

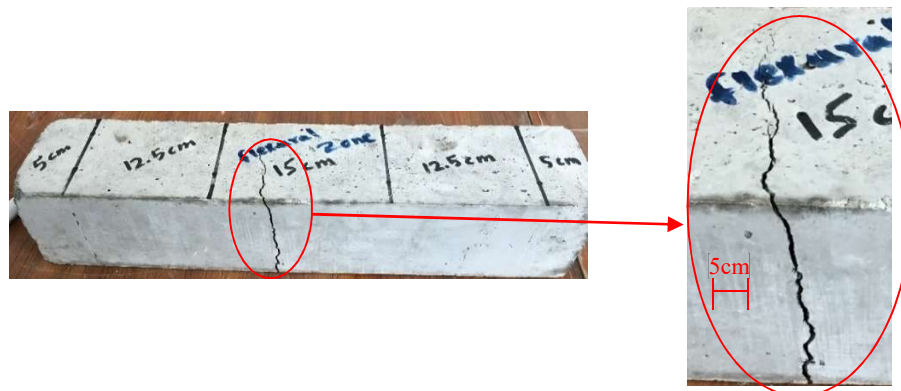
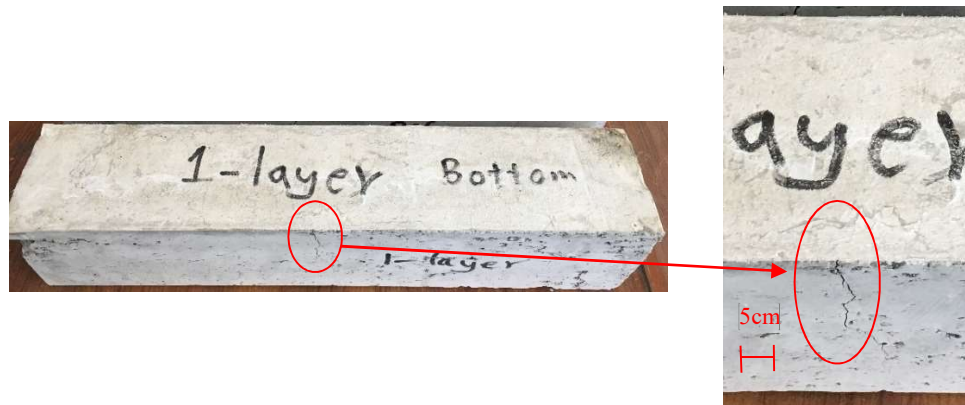


Figure 5- 8: Cracking pattern of beam (reference)

- **1-Layer:** After the ultimate loading, beams containing a single layer of non-woven tissue at the bottom were damaged but not divided into two portions and were maintained by the layers of non-woven sheets. Here, the width of crack was remarkably decreased as was observed for the reference beams. In addition, the



layer of non-woven sheets was locally detached at one or both sides of the crack but not broken as shown in *Figure 5- 9*.



*Figure 5- 9: Cracking patterns of beam (1-Layer)*

- **2-Sides:** The beams strengthened at two vertical opposite sides were broken at the bottom of the flexural zone. Here, the cracks were seen at the bottom and top of the beams but were covered completely by non-woven sheets at vertical faces. In addition, the tissue was slightly broken at the bottom of beams but was remaining unbroken close to the top of beams as shown in *Figure 5- 10*.



*Figure 5- 10: Cracking patterns of beam (2-Sides)*

- **3-Sides:** Here, the failure occurred at the bottom of the beam under non-woven sheets. In this case, the non-woven tissue was not broken but was detached around the entire cross-section and such detachment was more significant at the bottom of the beam. Moreover, the samples were entirely maintained by the tissue and was not separated into two parts as shown in *Figure 5- 11*.



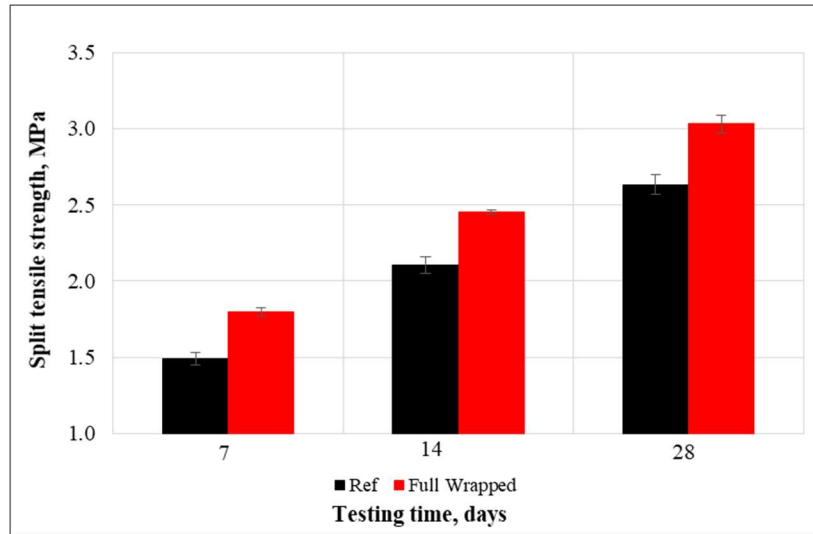
**Figure 5- 11:** Cracking patterns of beam (3-Sides)

Though, there is no bibliographic research that considered such fabrics to retrofit concrete samples. However, many researchers conducted similar works but they considered different materials such as FRP, cementitious materials, and etc. to strengthen concrete beams. Still the current outcomes match with the results of previous researchers. They also found a remarkable improvement with the application of strengthening materials. Besides, this improvement was more significant for U-wrapping, 2-Sides compared to the 1-Sides. The difference between the current results and previous ones is only linked to the properties of strengthening materials [101–104].

### **1.2.3. Split tensile strength**

The outcomes of cylinders tested under a tensile splitting setup are presented in **Figure 5-12**. The results clearly illustrate that the splitting tensile strength after 7, 14, and 28 days of curing have meaningfully enhanced for cylinders covered with non-woven sheets compared to non-covered samples.

After 28 days of curing, reference samples had a split tensile strength of 2.63 MPa, and this strength was increased by 15.1% to 3.03 MPa for covered specimens. This is attributed to the fact that non-woven sheets bridge the cracks and prevent samples from early damage.



*Figure 5- 12: Split tensile strength of concrete specimens*

Besides, the control specimens failed with brittle fracture and were separated into two entirely parted fragments. On the opposite, cylinders covered by non-woven fabrics were not separated but were maintained by such fabrics. This means that the attachment of plastic sheets makes samples sustain more splitting loads and the final fracture will be without separation as shown in *Figure 5- 13*. These findings highlight the ability to prevent catastrophic failure in case of excessive loads on structural elements.

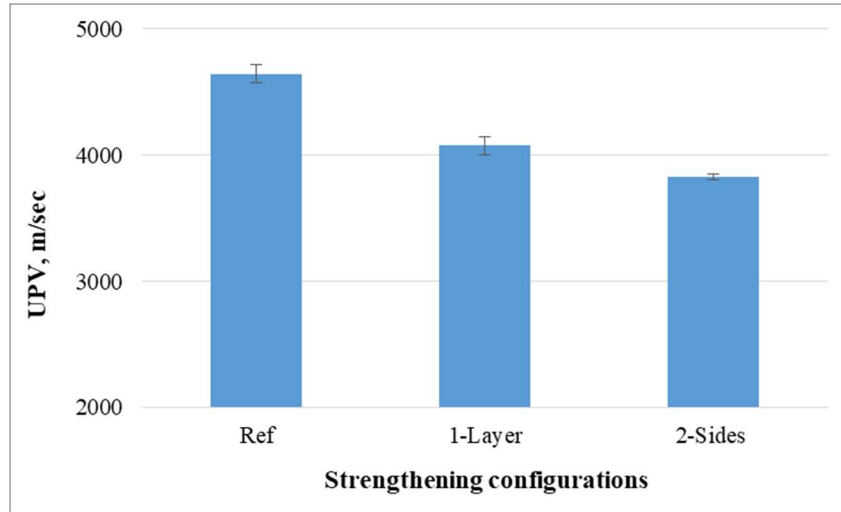


*Figure 5- 13: Cracking pattern after tensile splitting testing a) Ref and b) covered samples*

### **1.3. Effect of layer on ultrasonic pulse velocity (UPV) of concrete**

The findings of the UPV test are shown in *Figure 5- 14*. The results have documented that the attachment of non-woven sheets on concrete samples led to a decrease in the UPV value compared to the reference samples. After 28 days of curing the UPV value decreased by 12.3% and 17.6% for specimens containing non-woven sheets at one side and two sides,

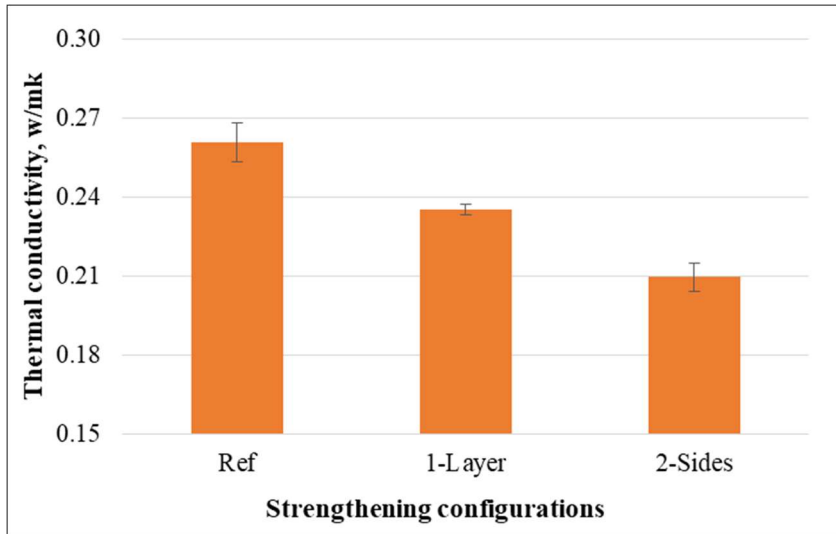
respectively, compared to the control ones. This can be attributed to the fact that the pulse velocity of plastic is less than concrete components. Moreover, it can be related to the high porosity of non-woven sheets.



*Figure 5- 14: Ultrasonic pulse velocity of concrete specimens*

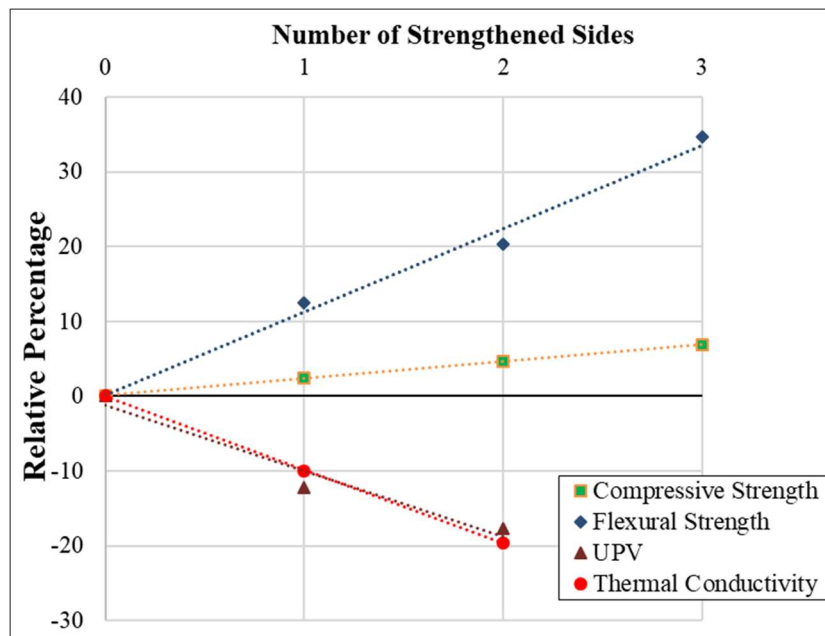
#### **1.4. Effect of layer on thermal properties of concrete**

It was observed that the attachment of non-woven PET fabrics on concrete specimens led to a decrease in the amount of heat transfer compared to control specimens. After 28 days of curing the thermal conductivity ( $\lambda$ ) decreased by 9.8% and 19.7% for specimens containing non-woven sheets at one side and two sides, respectively, compared to the control ones as presented in *Figure 5- 15*. This can be attributed to the fact that the amount of heat transfer in plastic is lower than in concrete mixtures. Therefore, the usage of non-woven fabrics as a layer can improve the thermal and acoustic properties of cementitious materials.



**Figure 5- 15:** Thermal conductivity of concrete specimens

On the other hand, the relationships between the strengthening configurations and various behaviors of concrete such as cubical compressive strength, flexural strength, thermal conductivity, and UPV have been plotted and shown in **Figure 5- 16**. R-squared correlation coefficient indicates a good correlation between the properties of concrete and the number of strengthened faces.



**Figure 5- 16:** Relations between percentages of non-woven cut pieces and various properties of concrete

### **Synthesis and Discussion**

Non-woven tissue has a good bond with concrete samples, therefore, the strengthened samples were completely confined and maintained from separation into many parts after the ultimate loading.

Besides, the introduction of the non-woven sheet as a layer has no effect on the fresh and physical properties of concrete. This is due to the usage of such tissue at the outer faces only as a cover.

Furthermore, the application of such sheets as a layer had a significant effect on the compressive, flexural, and split tensile strength of concrete samples. These strengths have improved remarkably for the strengthened samples compared to the non-strengthened ones. This phenomenon was confirmed by previous authors that used FRP for strengthening concrete samples [94–96,101–104].

Finally, it was found that the introduction of non-woven tissue could improve the acoustic and thermal properties of concrete specimens.

## 2. Use of non-woven sheets as cut pieces incorporated in concrete

In order to know the effect of cut pieces on the fresh, physical, mechanical, acoustic, and thermal properties of concrete, different types of samples with four various percentages of cut pieces (0%, 0.25%, 0.50%, and 0.75%) were cast as presented in **Table 5- 3**. In addition, three samples were tested after 7, 14, and 28 days of curing and their averages were used as final results.

**Table 5- 3:** Description of samples containing cut pieces of non-woven sheet

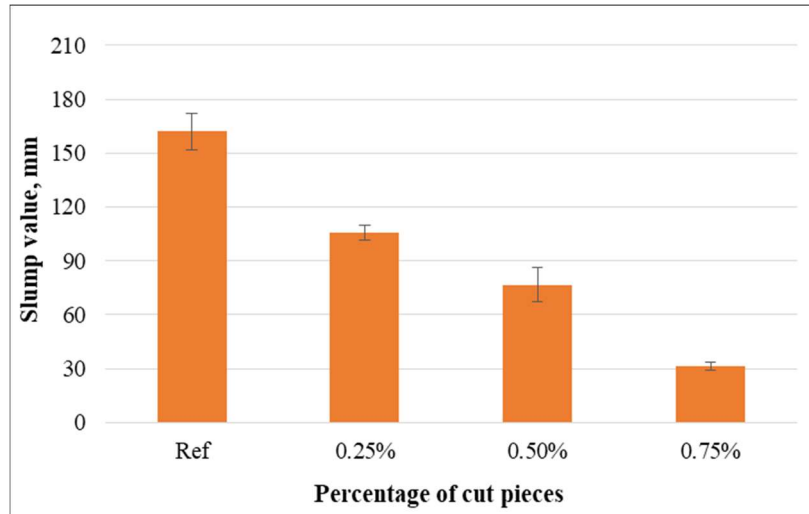
Type of samples and their dimensions	Name	Description	Conducted tests
Cube 100 mm	Ref	No cut pieces	Compressive strength
	0.25%	0.25% cut pieces of non-woven sheets	
	0.50%	0.50% cut pieces of non-woven sheets	
	0.75%	0.75% cut pieces of non-woven sheets	
(100×200) mm	Ref	No cut pieces	Split tensile strength
	0.25%	0.25% cut pieces of non-woven sheets	

	0.50%	0.50% cut pieces of non-woven sheets	
	0.75%	0.75% cut pieces of non-woven sheets	
Cylinder (100×70) mm	Ref	No cut pieces	Dry density, porosity, water absorption, UPV, and thermal conductivity
	0.25%	0.25% cut pieces of non-woven sheets	
	0.50%	0.50% cut pieces of non-woven sheets	
	0.75%	0.75% cut pieces of non-woven sheets	

## 2.1. Effect of cut pieces on fresh properties of concrete

### 2.1.1. Workability

The slump values of concrete mixtures containing various percentages of cut pieces are shown below in *Figure 5- 17*. The incorporation of cut pieces of non-woven fabrics remarkably alters the workability properties of concrete mixtures. This means that the workability was considerably reduced for mixtures containing such fabrics compared to the control ones and decreased more with the increase of volume fraction of non-woven fabrics. Specifically, concrete mixtures showed slump reduction by 34.8%, 52.7%, and 80.7%, while the percentage of cut pieces varied from 0.25% to 0.75%. This is attributed to the fact that the incorporation of cut pieces modifies the viscosity of the mix due to absorption of a large amount of water by them. Moreover, pieces of non-woven tissue occupy a large part of cement paste due to the large surface area and obstructs the flow as they form a mesh-like structure adhering to fine and coarse aggregates.



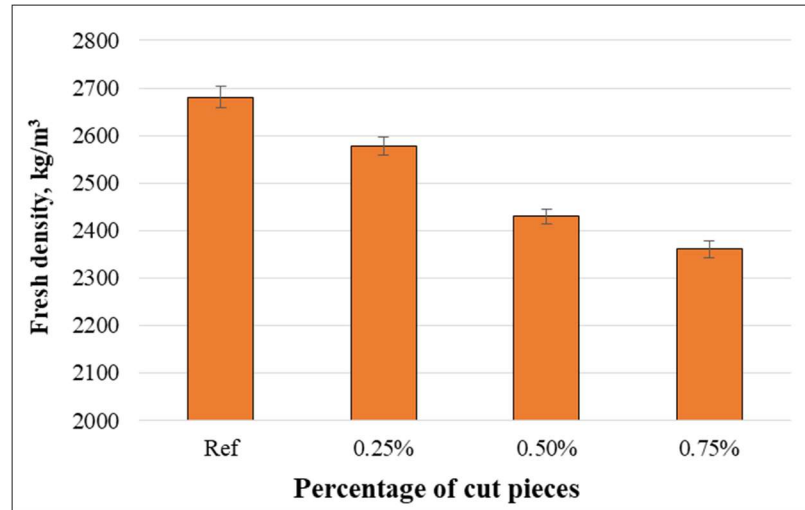
*Figure 5- 17: Slump values of concrete mixtures*

The reduction of slump value with the incorporation of cut pieces of non-woven tissue was confirmed by previous experimental works. The authors found that the workability has decreased with the incorporation of plastic fibers and this decrease was more significant for higher percentages [22,37]. This is due to the presence of fibers, which form a mesh-like structure adhering to fine and coarse aggregates of the mixtures.

### **2.1.2. Fresh density**

Wet densities varies from 2680.4 kg/m<sup>3</sup> to 2360.6 kg/m<sup>3</sup> as shown in *Figure 5- 18*. The wet density decreased as cut pieces of non-woven plastic fabrics were incorporated into concrete mixtures. It could be clearly observed that the concrete mixtures without fabrics had the highest wet density, but concrete containing 0.75% of such fabrics had the lowest density. This can be attributed to the fact that plastic fabrics had lower specific gravity than cement and aggregates, and plastic tissue needs more water to improve the density.





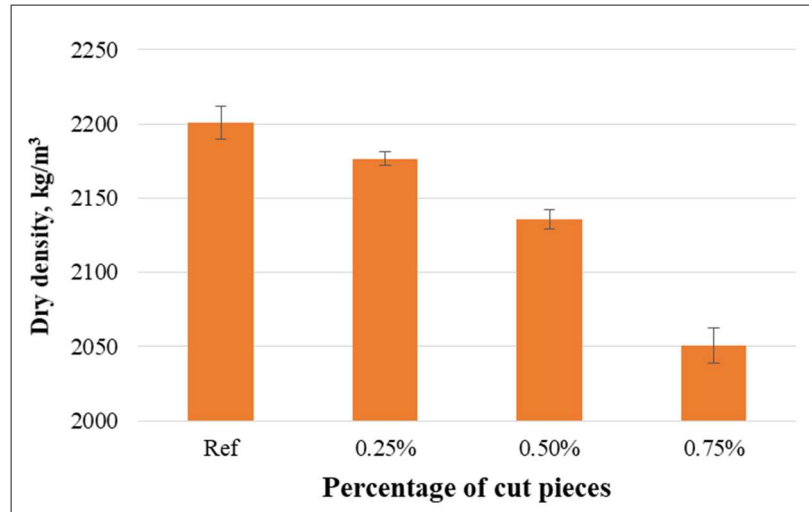
*Figure 5- 18: Fresh density of concrete mixtures*

Even though prior experimental studies incorporated other kind of materials with various properties into concrete mixtures, they found similar trends as was observed. But they found the same results with similar trends as was observed in the current study. The outputs indicate that that fresh density has decreased with the incorporation of plastic fibers and decreased further for higher volume fractions. The reason behind this can be the lower specific gravity of plastic fibers (1.12) compared to the concrete components [8].

## **2.2. Effect of cut pieces on physical properties of concrete**

### **2.2.1. Dry density**

The bulk densities of the studied concrete were within the range of 2201 kg/m<sup>3</sup> to 2084.9 kg/m<sup>3</sup>. The use of non-woven tissue resulted in a remarkable reduction of dry density because non-woven fabrics were lighter than cement and aggregates, and incorporation of such fabrics resulted in porous concrete compared to the control one. More important changes in the dry density were detected for a higher volume fraction of tissue, as presented in *Figure 5- 19*.

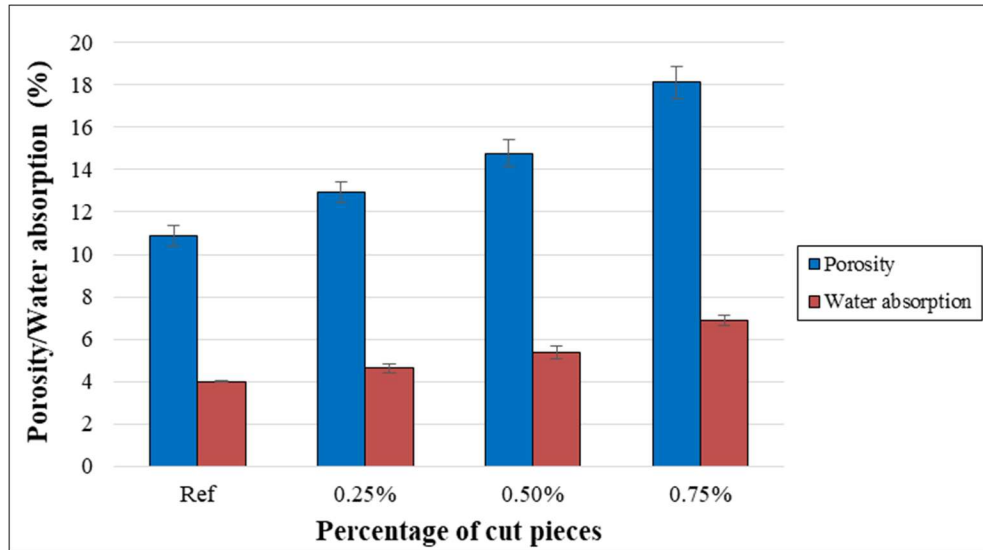


*Figure 5- 19: Dry density of concrete specimens*

### **2.2.2. Porosity and water absorption**

The porosity of concrete specimens containing various percentages of non-woven cut pieces is shown in *Figure 5- 20*. The outcomes illustrate that the porosity has significantly increased when plastic fabrics were added into concrete matrixes. In addition, such increase was more significant for concrete containing a higher amount of fabrics. This is due to the weak transition zone, macro cracks, and cavities presence in the interfacial transition zone between cement paste and plastic cut pieces.

In addition, the water absorption was calculated for concrete specimens containing non-woven plastic tissue from 0% up to 0.75%. The outcomes clearly demonstrate that concrete samples with plastic fabrics had higher water absorption than the control ones. This increase was more significant for higher volume fractions of plastic fabrics as shown in *Figure 5- 20*. This can be attributed to the fact that non-woven fabrics absorbed most of the water and incorporation of such fabrics resulted in porous concrete compared to control specimens.



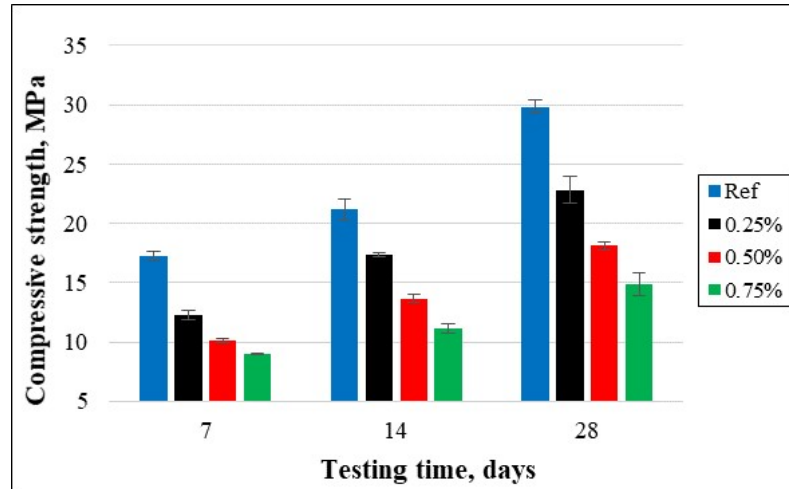
*Figure 5- 20: Porosity and water absorption of concrete specimens*

Although no research was available in the literature that considered cut pieces of non-woven sheets incorporated into concrete mixtures, the effect of non-woven tissue on the physical properties was confirmed by previous investigations. They found that the dry density has decreased, and porosity and water absorption have increased with the incorporation of plastic fibers and these variations were more remarkable for higher percentages [27,29].

## **2.3. Effect of cut pieces on mechanical properties of concrete**

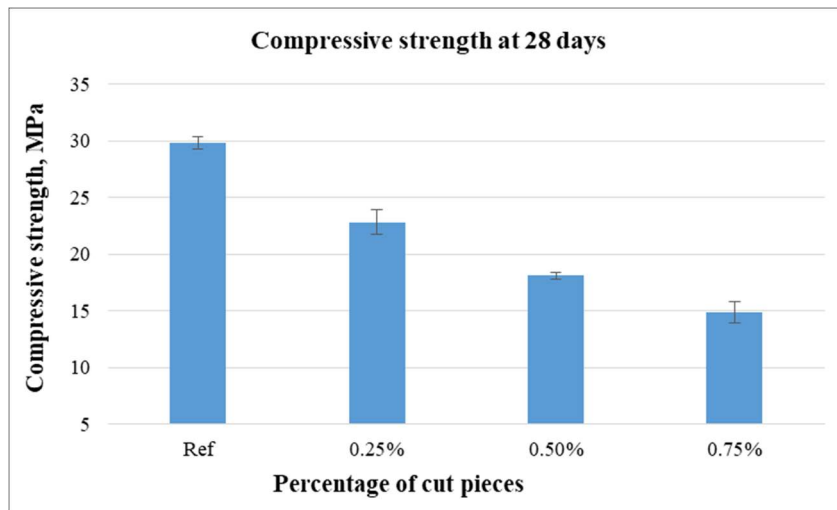
### **2.3.1. Compressive strength**

The compressive strength of concrete specimens containing various percentages of cut pieces is shown in *Figure 5- 21*. The outcomes clearly demonstrate that the compressive strength was greatly decreased with the increase of cut pieces in concrete mixtures.



*Figure 5- 21: Cube compressive strength of concrete specimens*

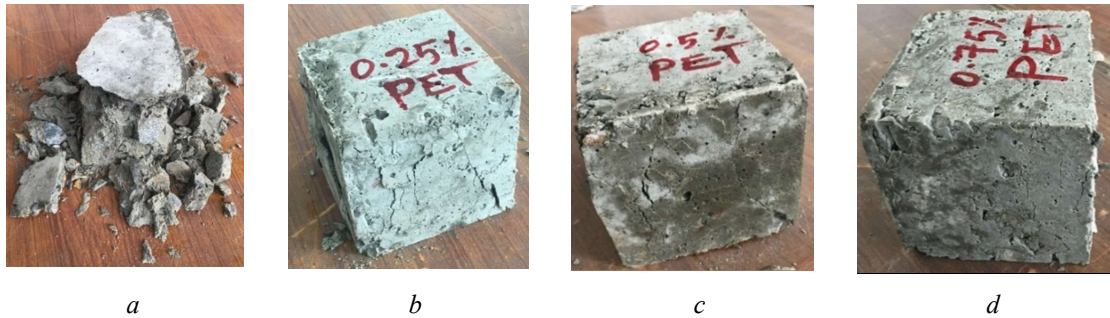
After 28 days of curing, the compressive strength of the reference samples was 29.8 MPa and such strength has decreased to 22.8 MPa, 18.1 MPa, and 14.8 MPa for samples having 0.25%, 0.50%, and 0.75% of non-woven fabrics, respectively as shown in *Figure 5- 22*. This is attributed to the weak interfacial transaction zone (ITZ) between cement paste and cut pieces of non-woven fabrics, as shown in SEM analyzes of mortars.



*Figure 5- 22: Cube compressive strength of concrete specimens after 28 days*

It was clearly observed from the cracking pattern that samples without cut pieces were damaged into many parts after the ultimate load. However, samples with 0.25%, 0.50%, and 0.75% were not separated into many parts and were maintained by such small pieces, especially, for the cubes containing 0.75% of cut pieces. This is attributed to the fact that

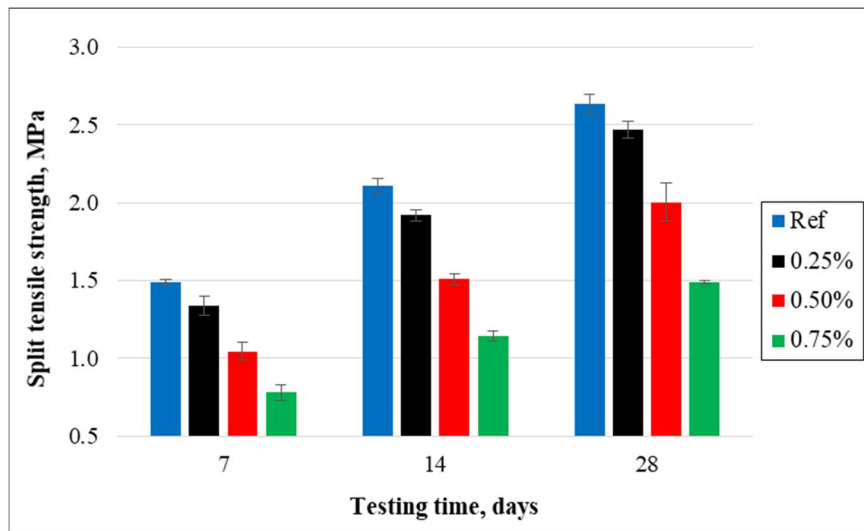
cut pieces will can act as fibers inside the concrete samples and prevent the pieces of concrete from separation as shown in *Figure 5- 23*.



*Figure 5- 23: Cracking pattern a) Ref, b) 0.25%, c) 0.50%, and d) 0.75%*

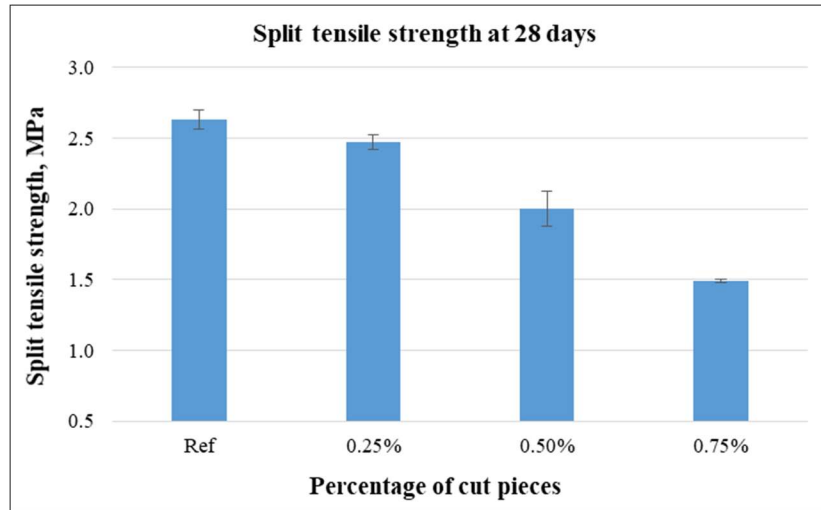
### 2.3.2. Split tensile strength

*Figure 5- 24* present the split tensile strength of concrete specimens containing various percentages of cut pieces and control samples. The findings reveal that the split tensile strength was reduced with the increase of cut pieces in concrete mixtures. This is attributed to the weak bond and adhesive properties between cement paste and cut pieces of non-woven fabrics.



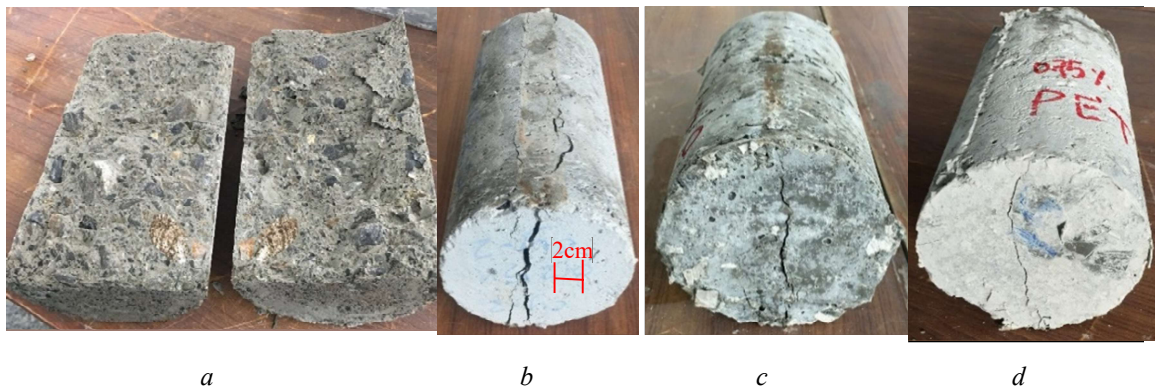
*Figure 5- 24: Split tensile strength of concrete specimens*

After 28 days of curing, the split tensile strength has decreased by 6.6%, 31.4%, and 76.9% for the concrete samples containing 0.25%, 0.50%, and 0.75% of cut pieces, respectively, compared to the control specimens as shown in *Figure 5- 25*. It can be highlighted that the use of non-woven sheet as cut pieces presents a negative effect on mechanical properties.



*Figure 5- 25: Split tensile strength of concrete specimens after 28 days*

Even though small pieces of non-woven tissue were not beneficial for split tensile strength, it was clearly observed from the cracking pattern that samples without cut pieces were divided into two separate parts, while samples with 0.25%, 0.50%, and 0.75% were not separated into two parts and were maintained by such small pieces from splitting. In addition, it could be clearly seen in the pictures that the width of splitting crack has decreased considerably with the increase of percentage of cut pieces as shown in *Figure 5- 26*.



*Figure 5- 26: Cracking patterns after splitting tensile testing a) Ref, b) 0.25%, c) 0.50%, and d) 0.75%*

In addition, the current results do not comply with the literature that present an improvement in the mechanical strengths after the introduction of plastic fibers. This is attributed to the mechanical properties of the materials themselves [22,26,31].

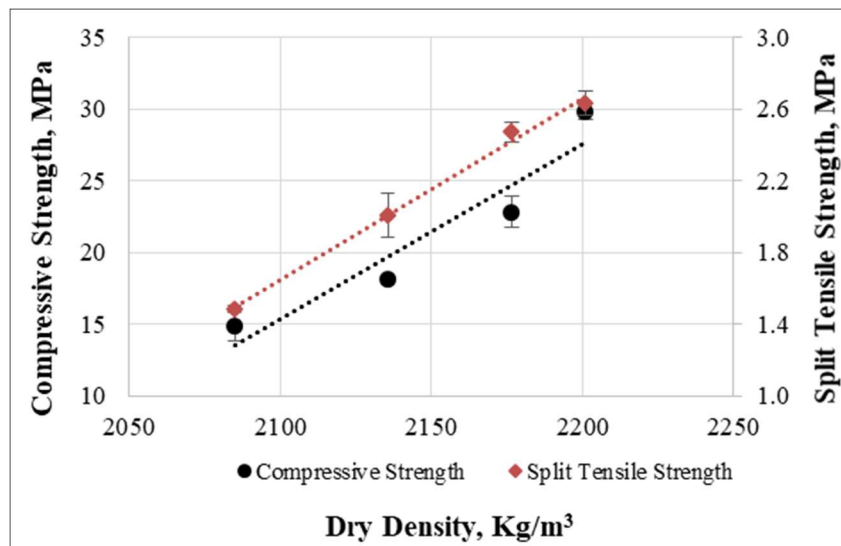
### Synthesis and Discussion

From the experimental work, the relationship between dry density and compressive and split tensile strengths has been plotted for concrete mixtures containing 0%, 0.25%, 0.50%, and 0.75% of cut pieces after 28 days of curing. **Figure 5- 27** shows the best fit line for the split tensile strength obtained from specimens having various dry densities. However, in the compressive strength, a slight variation was observed while density was changed, but still, the relationship between dry density and compressive strength is the best fit line (0.90) as shown in **Figure 5- 27**. Finally, these relations were written in the term of two equations to predict the compressive and split tensile strengths with dry density.

$$f_c = 0.1214\rho_d - 239.61$$

$$f_t = 0.0101\rho_d - 19.567$$

In the above equations,  $f_c$  is cube compressive strength,  $f_t$  is split tensile strength, and  $\rho_d$  is the dry density of concrete.



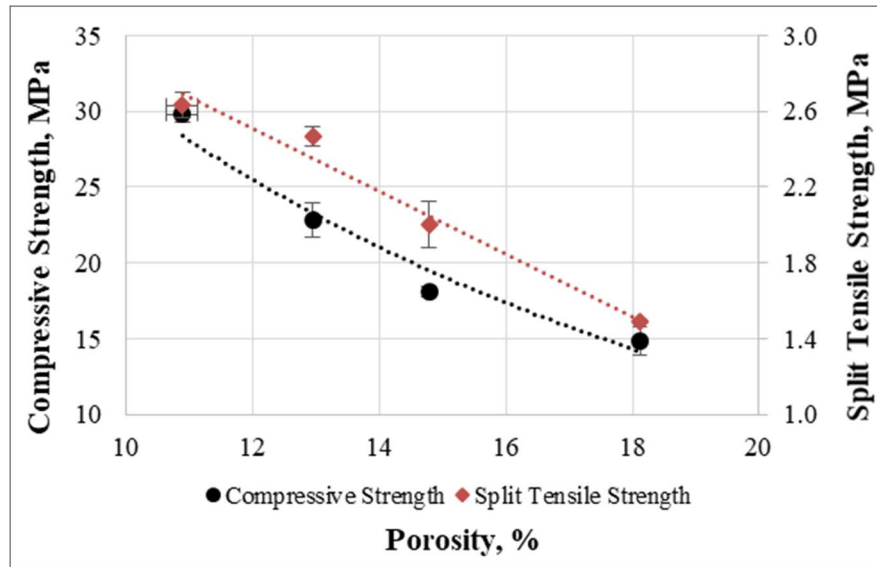
**Figure 5- 27:** Relations between dry density, compressive and split tensile strengths

In addition, the relations between the porosity and compressive and split tensile strengths are shown in **Figure 5- 28**. The trends clearly show that  $R^2$  is equal to 0.96 and 0.97 for the compressive strength and split tensile strengths, respectively. Finally, from the above correlations, the following equations were obtained to estimate the compressive and split tensile strengths with the porosity of concrete.

$$f_{cm} = 80.589e^{-0.096P} + 50.107$$

$$f_{ctm-sp} = -0.1655P + 4.4954$$

In the above equations,  $f_{cm}$  is cube compressive strength,  $f_{ctm-sp}$  is split tensile strength, and  $P$  is porosity of the concrete.



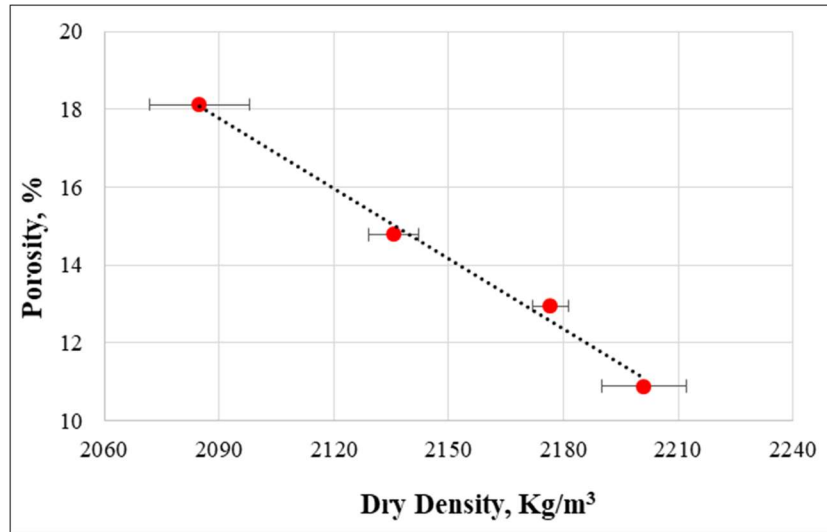
*Figure 5- 28: Relations between porosity, compressive and split tensile strengths*

Besides, the relationship between porosity and dry density has been plotted and it was observed that these properties have a linear relationship as shown in *Figure 5- 29*. Here, the porosity can be found from dry density with the help of the following formula.

$$P = -0.0602\rho_d + 143.51$$

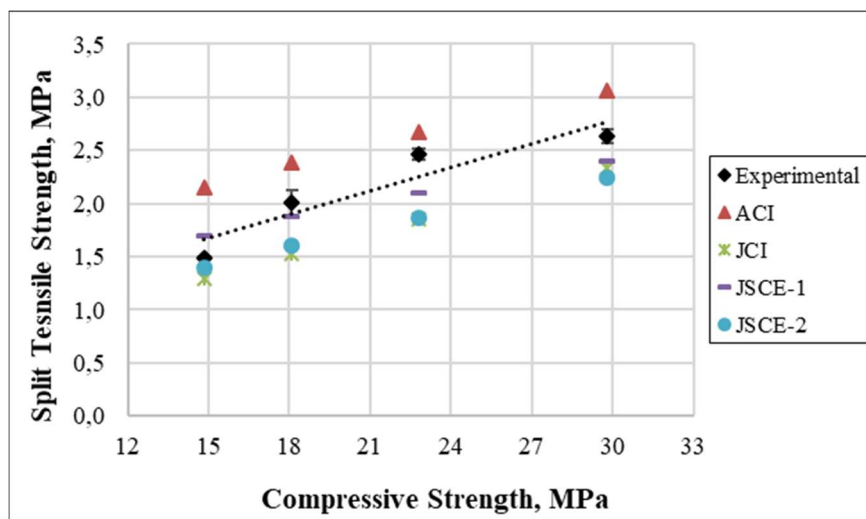
In the above equations,  $P$  is porosity,  $\rho_d$  is the dry density of the concrete.





*Figure 5- 29: Relations between porosity and dry density*

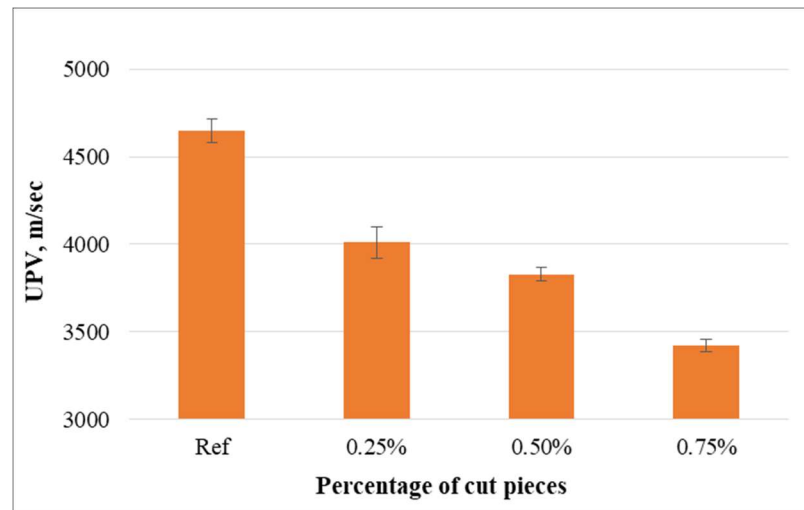
Furthermore, the splitting tensile strength has been plotted versus the compressive strength with results from the experiment and also to those found by previous investigators who worked on the incorporation of waste plastics in concrete mixtures. It was clearly observed from *Figure 5- 30* that there is a slight safety related to the relation obtained from the ACI 318-11 [105], while the JCI [106], JSCE-1 [107], and JSCE-2 [108] are quite conservative when applied to the current research data. However, overall the proposed model has a remarkable accuracy based on the present research data and previous models.



*Figure 5- 30: Relations between compressive and split tensile strengths*

#### 2.4. Effect of cut pieces on ultrasonic pulse velocity (UPV) of concrete

The UPV value was measured for concrete mixtures without fabrics and with 0.25%, 0.50%, and 0.75% of cut pieces. The results presented in *Figure 5- 31* highlight that UPV value has remarkably decreased while plastic fabrics were incorporated into concrete mixtures and such reduction was more significant for higher percentages. Furthermore, the reductions for the specimens containing non-woven tissue as 1-Layer and 2-Sides were 12.3% and 17.6%, while these reductions were 10.0%, 17.6%, and 26.3% for the specimens having 0.25%, 0.50%, and 0.75% of cut pieces, respectively, compared to the control ones. It means that applying non-woven sheets as a layer or incorporation of cut pieces is beneficial to improve the acoustic properties of concrete.

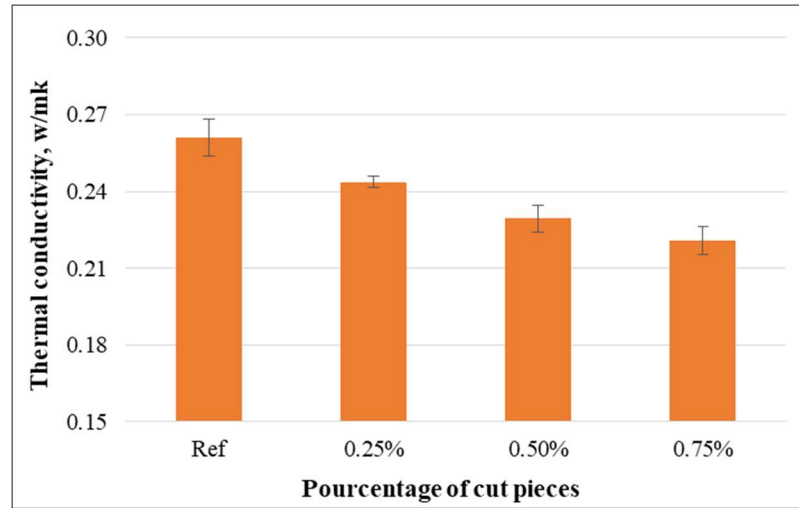


*Figure 5- 31: UPV of concrete specimens*

#### 2.5. Effect of cut pieces on thermal properties of concrete

The thermal conductivity has remarkably decreased for specimens containing cut pieces of non-woven tissue compared to control ones. Furthermore, the reduction was more significant for the specimens containing higher percentages of cut pieces as shown in *Figure 5- 32*. This can be attributed to the lower thermal conductivity of plastic fabrics, and the high porosity of those concretes containing non-woven fabrics. Moreover, thermal conductivity has decreased by 9.8% and 19.7% for the specimens containing non-woven tissue as 1-Layer and 2-Sides, while such property has decreased by 6.6%, 12.1%, and 15.5% for the specimens having 0.25%, 0.50%, and 0.75% of cut pieces, respectively,

compared to the references ones. Therefore, non-woven sheets as a layer or cut pieces could be preferably used to improve thermal insulation of concrete specimens.



*Figure 5- 32: Thermal conductivity of concrete specimens*

Even though no one studied the effect of cut pieces incorporated into concrete mixtures, the outcomes of the current study regarding the transfer properties are in good agreement with previous research works. It means that previous authors also found a decrease in transfer properties for fiber-reinforced concrete [45,46].

### ***Synthesis and Discussions***

The ultrasonic pulse velocity and thermal conductivity are greatly dependent on the dry density and porosity of concrete. Therefore, the relations of dry density with UPV and thermal conductivity have been plotted to predict such values while only the dry density of concrete is measured. **Figure 5- 33** present these relations and it can be clearly observed that UPV and thermal conductivity had a best-fitted line with dry density. The  $R^2$  values are 0.96 and 0.92 for UPV and thermal conductivity, respectively.

Here, the UPV value and thermal conductivity can be found from dry density with the help of the following formulas.

$$V = 17.451e^{0.0025\rho_d}$$

$$\lambda = 0.0118e^{0.0014\rho_d}$$

In the above equations,  $V$  is UPV value,  $\lambda$  is thermal conductivity, and  $\rho_d$  is the dry density of the concrete.

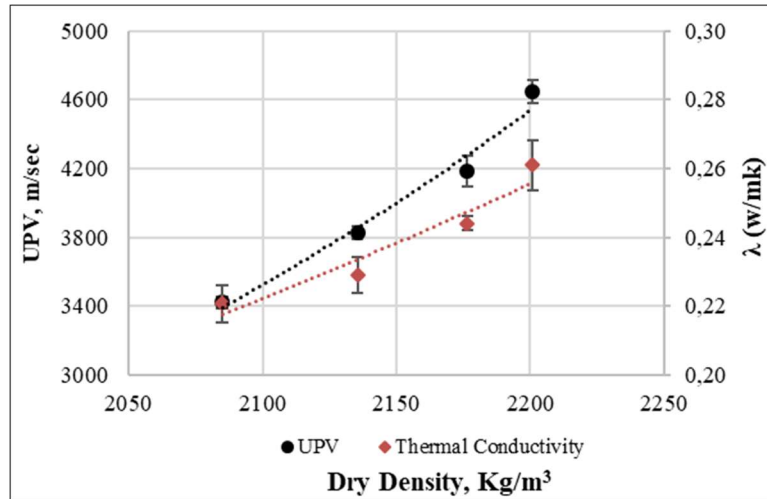


Figure 5- 33: Relations between UPV, thermal conductivity, and dry density

The relationships between the UPV, thermal conductivity, and porosity of concrete are shown in **Figure 5- 34**. R-squared correlation coefficient values are 0.97 and 0.92 for UPV and thermal conductivity, respectively, which indicate a good correlation between the UPV and porosity and thermal conductivity and porosity of the concrete.

Here, the UPV value and thermal conductivity can be found from the porosity with the help of the following formulas.

$$V = 7250.5e^{-0.042P}$$

$$\lambda = 0.3309e^{-0.023P}$$

In the above equations,  $V$  is UPV value,  $\lambda$  is thermal conductivity, and  $P$  is the porosity of the concrete.

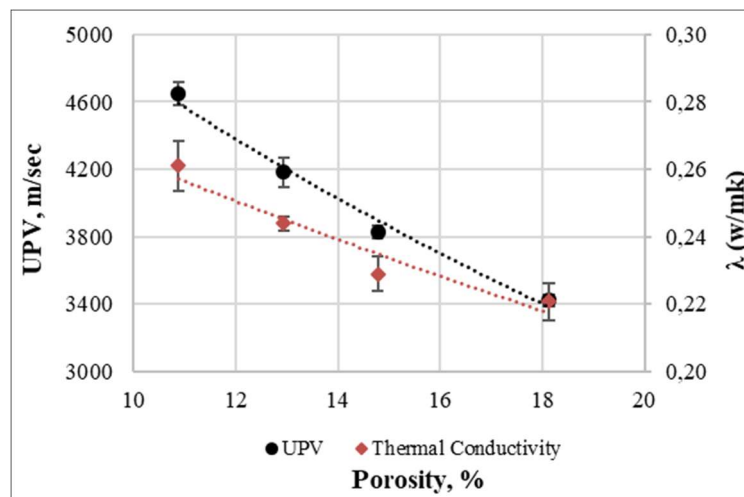


Figure 5- 34: Relations between UPV, thermal conductivity, and porosity

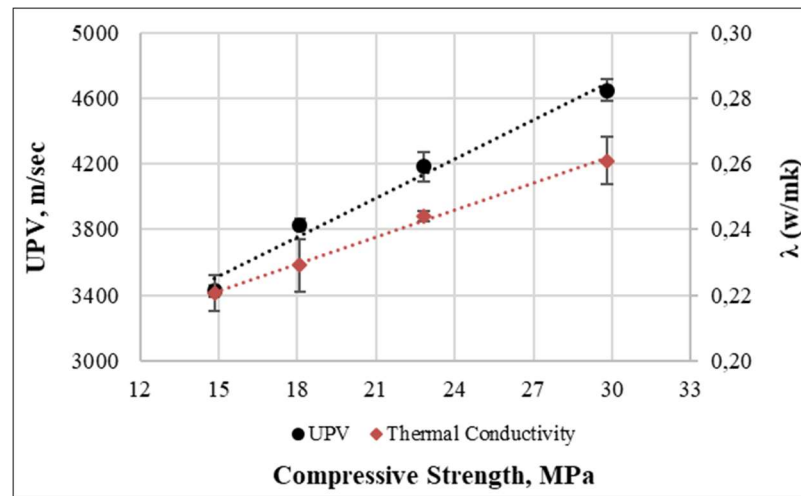
Furthermore, the relations between UPV, thermal conductivity, and the compressive strength of concrete have been plotted and shown in **Figure 5- 35**. The lines trend and their  $R^2$  coefficient clearly underlined that UPV and thermal conductivity can be correlated with the compressive strength in an accurate manner.

Here, the UPV value and thermal conductivity can be found from the compressive strength with the help of the following formulas.

$$V = 79.359f_{cm} + 2323.1$$

$$\lambda = 0.0027f_{cm} + 0.1803$$

In the above equations,  $V$  is UPV value,  $\lambda$  is thermal conductivity, and  $f_{cm}$  is the compressive strength of the concrete.



**Figure 5- 35:** Relations between UPV, thermal conductivity, and compressive strength

Besides, the correlation between UPV and the compressive strength is plotted and shown in **Figure 5- 36**. It can be clearly obtained from the  $R^2$  correlation coefficient (0.98) that for reference concrete mixtures and mixtures containing 0.25%, 0.50%, and 0.75% of PET cut pieces, the relation between UPV and compressive strength is very good. Thereafter, the present data were predicted by those models developed by previous investigators who worked on the incorporation of waste plastics in concrete mixtures. Even though the present model has a slight safety related to the relation obtained from the [28] and [109] it still has a good accuracy in the term of present data and is validated by previous experiments.

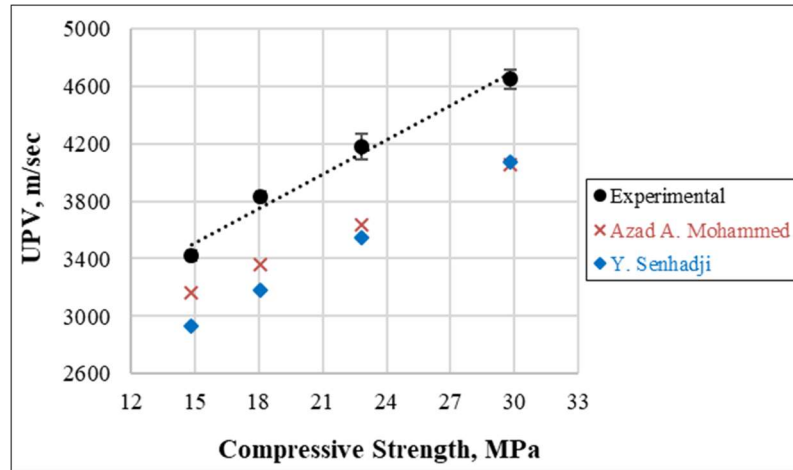


Figure 5- 36: Relations between UPV and compressive strength

Finally, the relationships between the percentages of non-woven cut pieces and various properties of concrete such as fresh, physical, mechanical, thermal, and acoustic have been plotted and shown in **Figure 5- 37**.  $R^2$  correlation coefficients clearly indicate that the percentages of incorporation of cut pieces have an excellent correlation with certain properties of concrete.

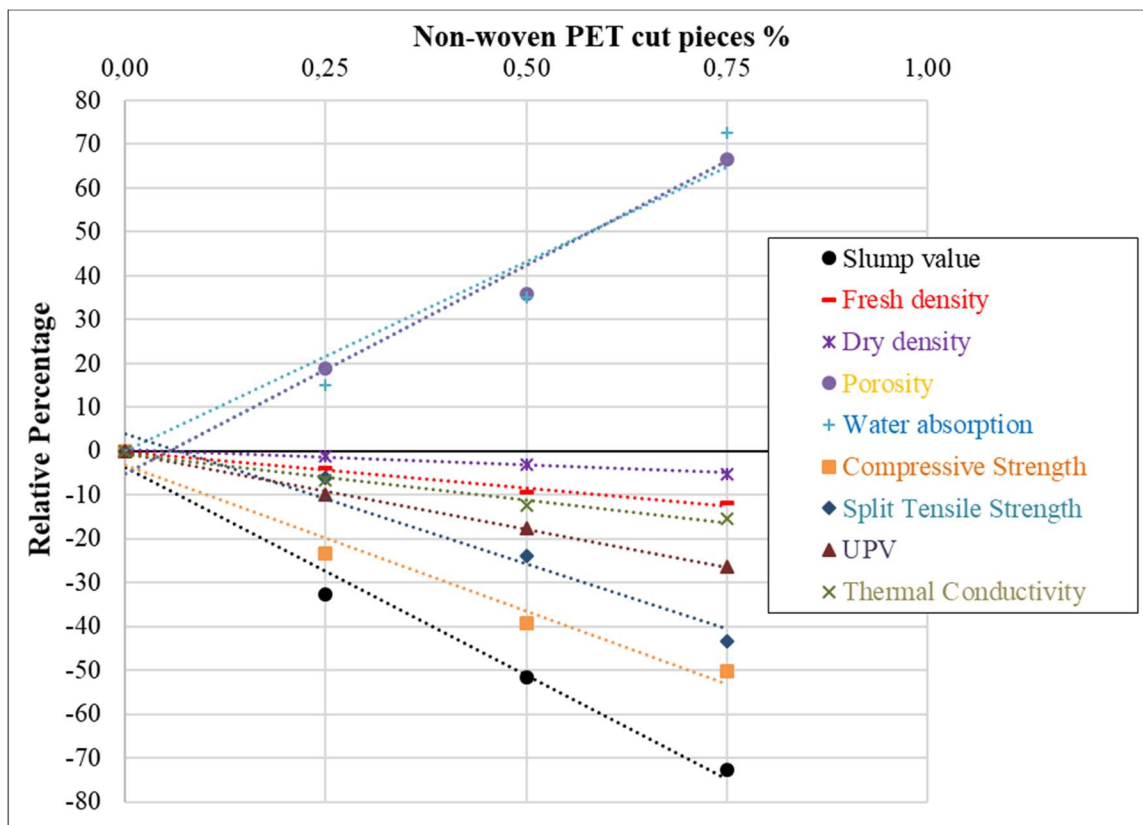


Figure 5- 37: Relations between percentages of non-woven cut pieces and various properties of concrete

### 3. Conclusions

The fifth chapter mainly focused on the introduction of non-woven tissue as a layer or cut pieces into ordinary concrete mixtures. Overall, the results indicate that the introduction of non-woven sheets could improve certain properties of concrete samples. The following concluding points are drawn:

- Since non-woven sheets were attached as a layer on the outer faces of specimens, such fabrics do than not have any effect on the workability and fresh density of concrete mixtures. While the introduction of cut pieces induce the decreasing of workability and fresh density have decreased significantly compared to the control mixtures.
- The incorporation of cut pieces has remarkable effects on the physical properties of concrete. It means that the dry density has decreased, and porosity and water absorption have increased with the incorporation of cut pieces. Besides, this reduction and increase were more significant for higher percentages of cut pieces.
- The mechanical strengths have increased significantly for the specimens strengthened with non-woven tissue. However, the introduction of cut pieces resulted in a remarkable decrease in mechanical strengths. On the other hand, non-woven tissue as a layer or cut pieces have altered the brittle properties of concrete samples to a more ductile one. In addition, the strengthened samples were confined completely by such sheets and not separated into many fragments as was observed for reference samples.
- The transfer properties (UPV value and thermal conductivity) have decreased remarkably for the samples containing layers or cut pieces of non-woven sheets compared to the control ones. The highest UPV and thermal conductivity values were achieved for the control specimens, while the lowest values were observed from the samples having non-woven sheets at two opposite sides or the highest percentage of cut pieces.
- Finally, the correlations between different properties of concrete have plotted between each other, the trend of lines and  $R^2$  coefficient clearly prove the excellent accuracies. It means that certain properties of such type of concrete can be predicted from other already known behaviors. In addition, the current research data were checked by previously developed models and shows great accuracy as well.

### ***Scientific Valorization***

- 1) **Sifatullah Bahij**, Safiullah Omary, Vincent Steiner, Francoise Feugeas, Amanullah Faqiri “Experimental study on concrete specimens strenghtened with non-woven sheets, *International Journal of Civil Infrastructure*, 4(2021): 128-137. DOI: [10.11159/ijci.2021.016](https://doi.org/10.11159/ijci.2021.016)
- 2) **Sifatullah Bahij**, Safiullah Omary, Francoise Feugeas and Amanullah Faqiri. “Use of Non-Woven Polyethylene Terephthalate (PET) Tissue to improve Certain Properties of the Concrete” *Proceedings of the 6<sup>th</sup> International Conference on Civil, Structural and Transportation Engineering (ICCSTE'21)* Niagara Falls, Canada – May 17-19, 2021. DOI: [10.11159/iccste21.157](https://doi.org/10.11159/iccste21.157) (**Best Paper Award**)



# GENERAL CONCLUSIONS AND PERSPECTIVES

## 1. Conclusions

This experimental study was carried out to determine the effects of the introduction of plastic non-woven tissue as a layer or cut pieces for the development of more environmentally friendly concrete. In order to carry out this research study, non-woven fabrics were associated with cementitious materials with two methods: a) as a layer with 5 various configurations of 1-Layer, 2-Layers, 2-Sides, 3-Sides, and full wrapping to strengthen specimens, and b) as cut pieces with four different incorporated percentages of 0%, 0.25%, 0.50%, and 0.75%. From the experimental results the following concluding points can be drawn:

- The incorporation of cut pieces of non-woven sheets resulted in a significant reduction of workability in mortar/concrete mixtures and was more significant for higher percentages of cut pieces' introduction. However, the slump value remained constant for the specimens containing non-woven sheets as a layer attached to the outer faces.
- The fresh and dry densities decreased with the incorporation of cut pieces into mortar/concrete mixtures and decreased further for higher volume fractions of such fabrics.
- The incorporation of cut pieces of non-woven tissue resulted in the increase of porosity and water absorption of mortar/concrete samples. These behaviors were higher when a higher amount of cut pieces were incorporated in mortar/concrete mixtures.
- The attachment of non-woven tissue has a minor effect on the cube compressive strength of mortar and concrete samples, whereas such strength improved significantly for cylindrical samples covered by non-woven fabrics. However, the compressive strength decreased significantly for the specimens containing cut pieces. Moreover, at the ultimate compressive load, samples with non-woven tissue had improved ductility and were not separated into many parts like reference ones.
- Flexural strength of both mortar prisms and concrete beams strengthened by 1-Layer, 2-Sides, and 3-Sides configurations of tissue is remarkably higher than the control ones. In addition, control specimens had a brittle failure and were separated

into two parts but samples having 1-Layer, 2-Sides, and 3-Sides of non-woven tissue showed somewhat ductile behavior and were not divided into two parts, and presented less widened cracks than control ones.

- The outcomes of the splitting tensile strength clearly indicate that this property significantly enhanced for the cylinders covered with non-woven sheets compared to the non-covered cylinders at all curing times. However, the split tensile strength has decreased significantly with the incorporation of cut pieces and such reduction was more significant for higher percentages. Besides, non-covered cylinders were divided into two separate parts, while covered samples were maintained by non-woven tissue after peak load.
- The acoustic and thermal conductivity of samples containing non-woven sheets as a layer or cut pieces decreased remarkably compared to the reference ones.
- Concerning the influence of the cut pieces' sizes on mortar mixings, the longer pieces resulted in a less workable and consistent mixture compared to the shorter ones because of bad mixing and cumulating of pieces at one point. Moreover, the average bulk density has decreased with the increase in the length of cut pieces. Besides, it was underlined that the porosity was slightly increased with the increase of plastic size. Moreover, the outputs clearly present that the reduction in flexural strength was almost similar for the specimens containing various sizes of cut pieces but this reduction was less for longer plastic pieces acting as fibers and preventing the early cracking of samples. In addition, the decrease in the compressive strength was more significant with the incorporation of longer plastic pieces.
- Overall, the non-woven sheets were bonded with mortar specimens using any w/c ratio or amount of superplasticizer. However, the adhesion force was considerably improved with the increase of w/c ratio. In addition, the adhesion force was considerably decreased with the reduction of water content and increase of superplasticizer content. This phenomenon was verified by interferometry analysis and microscopic analysis. It was observed that lowering the w/c ratio or addition of superplasticizer resulted in increased surface irregularities and pores and decreased amount and thickness of remaining microfilaments after bond tests.

- The correlations between different properties of concrete have been plotted between each other, the trend of lines and  $R^2$  coefficient clearly prove the excellent accuracies. It means that certain properties of such type of concrete can be predicted from other already known behaviors. In addition, the current research data was checked by previously developed models and shows great accuracy as well.
- Finally, non-woven sheet can be used for beams and slabs to increase their structural strength and prevent samples from damaging into multiple parts, particularly at the time of earthquake. In addition, such sheets as layer or cut pieces could be used in partition walls in buildings to reduce the sound and thermal transfer.

## **2. Perspectives**

This study confirms that non-woven tissue could be used with mortar/concrete samples due to their good bond and have the ability to improve certain properties of cementitious materials as well. Since non-woven fabrics were novel materials tested for strengthening specimens or incorporating them into mortar/concrete mixtures, only certain properties of mortar/concrete specimens containing such tissue were investigated in this research work. Thus, a window is open for further researches to explore the remaining parts and undertake a comprehensive study in this field.

- More investigations should be pursued to study durability, microstructural analysis, resistance in aggressive environments, etc. of mortar/concrete mixtures containing non-woven tissue as a layer or cut pieces.
- To know more about the bond between non-woven sheets and concrete needs further investigation. Especially, the effect of water content, the addition of superplasticizer, cement type, and surface textures on their bond properties.
- In this study, the non-woven sheets with a single thickness and constant mechanical properties and surface texture were considered, therefore, it would be useful to consider such fabrics with various thickness, mechanical properties, and surface textures.
- Due to time limitations imposed by COVID-19, it was not possible to undertake some numerical analysis for the samples strengthened with non-woven tissue.

Therefore, it is recommended for future researcher to perform simulation of specimens with such sheet.

- Finally, deeper investigations and life cycle analyses should be pursued to highlight the eco-friendly characteristic of concrete and mortar incorporating plastic waste that improve their properties.

## References

- [1] Ismail ZZ, Al-hashmi EA. Use of waste plastic in concrete mixture as aggregate replacement. *Waste Management* 2007;28:2041–2047.  
<https://doi.org/10.1016/j.wasman.2007.08.023>.
- [2] Al-Salem SM, Lettieri P, Baeyens J. Recycling and recovery routes of plastic solid waste (PSW): A review. *Waste Management* 2009;29:2625–43.  
<https://doi.org/10.1016/j.wasman.2009.06.004>.
- [3] Liguori B, Iucolano F, Capasso I, Lavorgna M, Verdolotti L. The effect of recycled plastic aggregate on chemico-physical and functional properties of composite mortars. *Materials and Design* 2014;57:578–84. <https://doi.org/10.1016/j.matdes.2014.01.006>.
- [4] Iucolano F, Liguori B, Caputo D, Colangelo F, Cioffi R. Recycled plastic aggregate in mortars composition: Effect on physical and mechanical properties. *Materials and Design* 2013;52:916–22. <https://doi.org/10.1016/j.matdes.2013.06.025>.
- [5] Guerrero LA, Maas G, Hogland W. Solid waste management challenges for cities in developing countries. *Waste Management* 2013;33:220–32.  
<https://doi.org/10.1016/j.wasman.2012.09.008>.
- [6] Wu G, Li J, Xu Z. Triboelectrostatic separation for granular plastic waste recycling: A review. *Waste Management* 2013;33:585–97.  
<https://doi.org/10.1016/j.wasman.2012.10.014>.
- [7] Ninoslav P, Stana Ž, Reyes G, Panos P. Mechanical properties of concrete reinforced with recycled HDPE plastic fibres. *Construction and Building Materials* 2016;115:362–70.  
<https://doi.org/10.1016/j.conbuildmat.2016.04.050>.
- [8] Al-hadithi AI, Hilal NN. The possibility of enhancing some properties of self-compacting concrete by adding waste plastic fibers. *Journal of Building Engineering* 2016;8:20–8.  
<https://doi.org/10.1016/j.jobbe.2016.06.011>.
- [9] Azhdarpour AM, Nikoudel MR, Taheri M. The effect of using polyethylene terephthalate particles on physical and strength-related properties of concrete; A laboratory evaluation. *Construction and Building Materials* 2016;109:55–62.  
<https://doi.org/10.1016/j.conbuildmat.2016.01.056>.
- [10] Pavlík Z, Záleská M, Pavlíková M, Pokorný J, Robert C. Structural , mechanical and hygrothermal properties of lightweight concrete based on the application of waste plastics. *Construction and Building Materials* 2018;180:1–11.  
<https://doi.org/10.1016/j.conbuildmat.2018.05.250>.
- [11] Almeshal I, Tayeh BA, Alyousef R, Alabduljabbar H, Mustafa Mohamed A, Alaskar A.

- Use of recycled plastic as fine aggregate in cementitious composites: A review. *Construction and Building Materials* 2020;253:119146.  
<https://doi.org/10.1016/j.conbuildmat.2020.119146>.
- [12] Siddiqui J, Pandey G. A Review of Plastic Waste Management Strategies. *Int Res J Environ Sci* 2013;2:84–8.
- [13] Chougule RS, College JJM. Use of Plastic Waste in Civil Construction. *International Journal of Engineering Technology, Management and Applied Sciences* 2017;5:186–90.
- [14] EPA U. Municipal Solid Waste Generation , Recycling , and Disposal in the United States Tables and Figures for 2012. U S Environmental Protection Agency Office of Resource Conservation and Recovery 2014:1–13.
- [15] Hassanvand MS, Nabizadeh R, Heidari M. Municipal Solid Waste Analysis in Iran. *Iranian Journal of Health and Environment* 2008;1:9–18.
- [16] Moghadam MRA, Mokhtarani N, Mokhtarani B. Municipal solid waste management in Rasht City , Iran. *Waste Management* 2009;29:485–9.  
<https://doi.org/10.1016/j.wasman.2008.02.029>.
- [17] Nikbin IM, Saman Rahimi R, Allahyari H, Fallah F. Feasibility study of waste Poly Ethylene Terephthalate (PET) particles as aggregate replacement for acid erosion of sustainable structural normal and lightweight concrete. *Journal of Cleaner Production* 2016;126:108–17. <https://doi.org/10.1016/j.jclepro.2016.02.143>.
- [18] Kamaruddin MA, Abdullah MMA, Zawawi MH, Zainol MRRA. Potential use of Plastic Waste as Construction Materials : Recent Progress and Future Prospect. *IOP Conf Series: Materials Science and Engineering* 2017;267. <https://doi.org/10.1088/1757-899X/267/1/012011>.
- [19] Frigione M. Recycling of PET bottles as fine aggregate in concrete. *Waste Management* 2010;30:1101–6. <https://doi.org/10.1016/j.wasman.2010.01.030>.
- [20] Ghernouti Y, Rabehi B, Bouziani T, Ghezraoui H, Makhloufi A. Fresh and hardened properties of self-compacting concrete containing plastic bag waste fibers (WFSCC). *Construction and Building Materials* 2015;82:89–100.  
<https://doi.org/10.1016/j.conbuildmat.2015.02.059>.
- [21] Jalaluddin M. Use of Plastic Waste in Civil Constructions and Innovative Decorative Material (Eco- Friendly). *MOJ Civil Engineering* 2017;3:359–68.  
<https://doi.org/10.15406/mojce.2017.03.00082>.
- [22] Shahidan S, Ranle NA, Zuki SSM, Khalid FS, Ridzuan M, Nazri FM, et al. Concrete Incorporated with Optimum Percentages of Recycled Polyethylene Terephthalate (PET)

- Bottle Fiber. *International Journal of Integrated Engineering* 2018;10:1–8.  
<https://doi.org/https://doi.org/10.30880/ijie.2018.10.01.001>.
- [23] Akçaözog K, Atis CD. Thermal conductivity , compressive strength and ultrasonic wave velocity of cementitious composite containing waste PET lightweight aggregate (WPLA). *Composites : Part B* 2013;45:721–6.  
<https://doi.org/https://doi.org/10.1016/j.compositesb.2012.09.012>.
- [24] Safi B, Saidi M, Aboutaleb D, Maallem M. The use of plastic waste as fine aggregate in the self-compacting mortars: Effect on physical and mechanical properties. *Construction and Building Materials* 2013;43:436–42.  
<https://doi.org/10.1016/j.conbuildmat.2013.02.049>.
- [25] Hannawi K, Prince W, Kamali-Bernard S. Effect of thermoplastic aggregates incorporation on physical, mechanical and transfer behavior of cementitious materials. *Waste and Biomass Valorization* 2010;1:251–9. <https://doi.org/h>.
- [26] Fernando P, Oscar Rubem KM, Philippe Jean, Paul Gleizeb Humberto RR. Mechanical Properties of Recycled PET Fibers in Concrete. *Materials Research* 2012;15:679–86.  
[https://doi.org/DOI: 10.1590/S1516-14392012005000088](https://doi.org/DOI:10.1590/S1516-14392012005000088).
- [27] Pereira De Oliveira LA, Castro-Gomes JP. Physical and mechanical behaviour of recycled PET fibre reinforced mortar. *Construction and Building Materials* 2011;25:1712–7.  
<https://doi.org/10.1016/j.conbuildmat.2010.11.044>.
- [28] Mohammed AA, Mohammed II, Mohammed SA. Some properties of concrete with plastic aggregate derived from shredded PVC sheets. *Construction and Building Materials* 2019;201:232–45. <https://doi.org/10.1016/j.conbuildmat.2018.12.145>.
- [29] Afroughsabet V, Ozbakkaloglu T. Mechanical and durability properties of high-strength concrete containing steel and polypropylene fibers. *Construction and Building Materials* 2015;94:73–82. <https://doi.org/10.1016/j.conbuildmat.2015.06.051>.
- [30] Vali M, Asadi SS. PET bottle waste as a supplement to concrete fine aggregate. *International Journal of Civil Engineering and Technology* 2017;8:558–68.
- [31] Fraternali F, Ciancia V, Chechile R, Rizzano G, Feo L, Incarnato L. Experimental study of the thermo-mechanical properties of recycled PET fiber-reinforced concrete. *Composite Structures* 2011;93:2368–74. <https://doi.org/10.1016/j.compstruct.2011.03.025>.
- [32] Kassa RB, Kanali C, Ambassah N. Environmental and Cost Advantages of Using Polyethylene Terephthalate Fibre Reinforced Concrete with Fly Ash as a Partial Cement Replacement. *Open Journal of Civil Engineering* 2019;09:281–90.  
<https://doi.org/10.4236/ojce.2019.94020>.

- [33] Evolon ® microfilament textile. Innovative microfilament textiles for a wide range of applications. Accessed on 15 March of 2021, on Web site: Freudenberg Innovating Together: <https://www.freudenberg-pm.com/Materials/evolon> n.d.
- [34] Bui NK, Satomi T, Takahashi H. Recycling woven plastic sack waste and PET bottle waste as fiber in recycled aggregate concrete: An experimental study. *Waste Management* 2018;78:79–93. <https://doi.org/10.1016/j.wasman.2018.05.035>.
- [35] Daniel W, Pawel Ł, Gabriel R. Application of fibres from recycled PET bottles for concrete reinforcement. *Journal of Building Chemistry* 2016;1:1–9. <https://doi.org/http://dx.doi.org/10.17461/j.buildchem.2016.101>.
- [36] Rinu-Isah RJ, Shruthi M V. Utilization of waste PET bottle fibers in reinforced concrete. *International Journal of Pure and Applied Mathematics* 2017;116:579–84.
- [37] Bhogayata AC, Arora NK. Fresh and strength properties of concrete reinforced with metalized plastic waste fibers. *Construction and Building Materials* 2017;146:455–63. <https://doi.org/10.1016/j.conbuildmat.2017.04.095>.
- [38] Bahij S, Omary S, Feugeas F, Faqiri A. Fresh and hardened properties of concrete containing different forms of plastic waste – A review. *Waste Management* 2020;113:157–75. <https://doi.org/10.1016/j.wasman.2020.05.048>.
- [39] Karahan O, Atiş CD. The durability properties of polypropylene fiber reinforced fly ash concrete. *Materials and Design* 2011;32:1044–9. <https://doi.org/10.1016/j.matdes.2010.07.011>.
- [40] Maqbool S, Sood H. Effect of PET fibers on the Performance of concrete. *International Journal of Scientific Research and Education* 2016;4:1–6.
- [41] Sanjaykumar B, Daule SN. Use of Plastic Fiber in the Concrete. *SSRG International Journal of Civil Engineering (SSRG – IJCE)* 2017;4:4–7.
- [42] Irwan JM, Asyraf RM, Othman N, Koh HB, Annas MMK, Faisal SK. The Mechanical Properties of PET Fiber Reinforced Concrete From Recycled Bottle Wastes. *Advanced Materials Research* 2013;795:347–51. <https://doi.org/10.4028/www.scientific.net/AMR.795.347>.
- [43] Poonyakan A, Rachakornkij M, Wecharatana M, Smittakorn W. Potential Use of Plastic Wastes for Low Thermal Conductivity Concrete. *Materials* 2018;11:1–17. <https://doi.org/10.3390/ma11101938>.
- [44] Marthong C, Sarma DK. Influence of PET fiber geometry on the mechanical properties of concrete: An experimental investigation. *European Journal of Environmental and Civil Engineering* 2016;20:771–84. <https://doi.org/10.1080/19648189.2015.1072112>.



- [45] Boiny HU, Alshkane YM, Rafiq SK. Mechanical Properties of Cement Mortar By Using Polyethylene 2016.
- [46] Marthong C. Effects of PET fiber arrangement and dimensions on mechanical properties of concrete. *IES Journal Part A: Civil and Structural Engineering* 2015;8:111–20.  
<https://doi.org/10.1080/19373260.2015.1014304>.
- [47] EN 197-1/A1. Cement - Part 1: composition, specifications and conformity criteria for common cements. European Standard 2012.
- [48] EQIOM GROUPE CRH. FICHE TECHNIQUE PRODUIT 2017.
- [49] ASTM C150. Standard Specification for Portland Cement. American Society for Testing and Materials 2009.
- [50] EN 934-2. Admixtures for concrete, mortar and grout. European Standard 2012.
- [51] SikaCem ® Fluidifiant. Superplastifiant haut reducteur d'eau. Accessed on 27 April 2021 on the website: [https://fra.sika.com/content/dam/dms/fr01/y/sikacem\\_fluidifiant.pdf](https://fra.sika.com/content/dam/dms/fr01/y/sikacem_fluidifiant.pdf). Sika 2017.
- [52] ADIUM 150. Technical Datasheet: New generation superplasticizer for pre-cast concrete elements. Isomat 2012.
- [53] Dasdemir M, Maze B, Pourdeyhimi NA& B. Influence of polymer type, composition, and interface on the structural and mechanical properties of core/sheath type bicomponent nonwoven fibers. *Journal of Material Science* 2012;47:5955–5969.  
<https://doi.org/https://doi.org/10.1007/s10853-012-6499-7>.
- [54] Hollowell KB, Anantharamaiah N, Pourdeyhimi B. Hybrid mixed media nonwovens composed of macrofibers and microfibers. Part I: three-layer segmented pie configuration. *Journal of the Textile Institute* 2013;104:972–9.  
<https://doi.org/10.1080/00405000.2013.767430>.
- [55] R G. Functional characteristics of modern microfilament nonwovens. In *Industral Textiles* 2001;4:37–40.
- [56] Pourdeyhimi B. Process of making mixed fibers and nonwoven fabrics, US Patent 7,981,336 B2 Jul. 19, 2011., 2011.
- [57] Hollowell KB. Hybrid Mixed Media Nonwovens: An Investigation of Structure-Property Relationships. North Carolina State University, 2012.
- [58] Shim E, Pourdeyhimi B, Latifi M. Three-dimensional analysis of segmented pie bicomponent nonwovens. *Journal of the Textile Institute* 2010;101:773–87.  
<https://doi.org/10.1080/00405000903357938>.
- [59] Pourdeyhimi B. Comments on the Paper Entitled “Splitting of Islands-in-the-Sea Fibers

- (PA6/COPET) during Hydroentangling of Nonwovens.” *Journal of Engineered Fibers and Fabrics* 2008;3:155892500800300. <https://doi.org/10.1177/155892500800300105>.
- [60] Mm K, Hm H, Hm M, A A-O. Antibacterial Activity of Cationised Cotton Dyed with Some Natural Dyes *Journal of Textile Science & Engineering* 2015;5:1–5. <https://doi.org/10.4172/2165-8064.1000>.
- [61] Andrew D. Colouration of Hydroentangled Nonwoven Fabrics, PhD Thesis, University of Leeds. University of Leeds, 2008.
- [62] ASTM C188-17. Standard Test Method for Density of Hydraulic Cement. American Society for Testing and Materials 2017.
- [63] NF EN 196-3. Cement test methods - Part 3: determination of setting time and stability. European Standard 2017.
- [64] EN 1097-6. Tests to determine the mechanical and physical characteristics of aggregates - Part 6: determination of the actual density and the water absorption coefficient. European Standard 2014.
- [65] EN 933-1. Tests for determining the geometrical characteristics of aggregates - Part 1: determination of granularity - Particle size analysis by sieving. European Standard 2012.
- [66] ASTM C131-20. Standard Test Method for Resistance to Degradation of Small-Size Coarse Aggregate by Abrasion and Impact in the Los Angeles Machine. American Society for Testing and Materials 2020.
- [67] NF EN 196-1. Methods of testing cement — Part 1: Determination of strength. European Standard 2016.
- [68] ACI 211.1-91. Standard Practice of Selecting Proportions for Normal, Heavyweight, and Mass Concrete. *ACI Manual of Concrete Practice, Part 1: Materials and General Properties of Concrete*, Detroit, Michigan 1994.
- [69] EN 1015-3. Test methods for masonry mortars - Part 3: determination of the consistency of fresh mortar. European Standard 1999.
- [70] EN 12350-2. Testing fresh concrete - Part 2 : slump test. European Standard 2019.
- [71] EN 12350-2. Tests for fresh concrete - Part 2: slump test. European Standard 2019.
- [72] EN 1015-6/A1. Test methods for masonry mortars - Part 6: determination of the apparent density of fresh mortar. European Standard 2007.
- [73] EN 12350-6. Tests for fresh concrete - Part 6: density. European Standard 2019.
- [74] NF P18-459. Concrete - Testing hardened concrete - Testing porosity and density. European Standard 2010.
- [75] EN 1015-11. Test methods for masonry mortars - Part 11: determination of the flexural

- and compressive strength of hardened mortar. European Standard 2019.
- [76] EN 12390-5. Tests for hardened concrete - Part 5: flexural strength of test pieces. European Standard 2019.
- [77] EN 12390-3. Tests for hardened concrete - Part 3: compressive strength of test pieces. European Standard 2019.
- [78] EN 12390-4. Tests for hardened concrete - Part 4: compressive strength - Characteristics of testing machines. European Standard 2019.
- [79] EN 12390-6. Tests for hardened concrete - Part 6: determination of the tensile strength by splitting of test pieces. European Standard 2012.
- [80] ASTM C597-16. Standard Test Method for Pulse Velocity Through Concrete. American Society for Testing and Materials 2016.
- [81] EN 12667. Thermal performance of building materials and products - Determination of thermal resistance by means of guarded hot plate and heat flow meter methods - Products of high and medium thermal resistance. European Standard 2001.
- [82] <https://www.eqiom.com/produits/ciments> n.d.
- [83] Snelson D, Wild S, Farrell MO. Setting times of portland cement-metakaolin-fly ash blends. *Journal of Civil Engineering and Management* 2011;17:55–62. <https://doi.org/10.3846/13923730.2011.554171>.
- [84] America's Cement Manufacturer. <https://www.cement.org/> n.d.
- [85] [http://www.aso-cement.jp/en/products/product\\_ordinary.html](http://www.aso-cement.jp/en/products/product_ordinary.html) n.d.
- [86] IS 8041:1990. Rapid Hardened Portland Cement Specification. Indian Standard 2005.
- [87] *Building Materials in Civil Engineering*. 4-Cement, 2014, p. 46–80.
- [88] ASTM C33/ C33M-18. Standard Specification for Concrete Aggregates. American Society for Testing and Materials 2018.
- [89] EN 12620+A1. Aggregates for concrete. European Standard 2002.
- [90] Zhu Z, Zhu E. Flexural behavior of large-size RC beams strengthened with side near surface mounted (SNSM) CFRP strips. *Composite Structures* 2018;201:178–92. <https://doi.org/10.1016/j.compstruct.2018.06.031>.
- [91] Reda RM, Sharaky IA, Ghanem M, Seleem MH, Sallam HEM. Flexural behavior of RC beams strengthened by NSM GFRP Bars having different end conditions. *Composite Structures* 2016;147:131–42. <https://doi.org/10.1016/j.compstruct.2016.03.018>.
- [92] Baggio D, Soudki K, Noël M. Strengthening of shear critical RC beams with various FRP systems. *Construction and Building Materials* 2014;66:634–44. <https://doi.org/10.1016/j.conbuildmat.2014.05.097>.

- [93] Zheng Y, Wang W, Brigham JC. Flexural behaviour of reinforced concrete beams strengthened with a composite reinforcement layer : BFRP grid and ECC. *Construction and Building Materials* 2016;115:424–37.  
<https://doi.org/10.1016/j.conbuildmat.2016.04.038>.
- [94] Seffo M, Hamcho M. Strength of concrete cylinder confined by composite materials (CFRP). *Energy Procedia* 2012;19:276–85. <https://doi.org/10.1016/j.egypro.2012.05.207>.
- [95] Baasankhuu B, Choi D, Ha S. Behavior of Small-Scale Concrete Cylinders in Compression Laterally Confined by Basalt Fiber and PEN Fiber Reinforced Polymer Composites. *International Journal of Concrete Structures and Materials* 2020;14.  
<https://doi.org/10.1186/s40069-019-0384-6>.
- [96] Murugan M, Natarajan C, and Muthukkumaran K. Compressive Behavior of Concrete Cylinders Confined With Glass and Carbon Fiber Reinforced Polymer. *Int J Struct & Civil Engg Res* 2013;2:69–76.
- [97] Silva ER, Coelho JFJ, Bordado JC. Strength improvement of mortar composites reinforced with newly hybrid-blended fibres: Influence of fibres geometry and morphology. *Construction and Building Materials* 2013;40:473–80.  
<https://doi.org/10.1016/j.conbuildmat.2012.11.017>.
- [98] Al-Tulaian BS, Al-Shannag MJ, Al-Hozaimy AR. Recycled plastic waste fibers for reinforcing Portland cement mortar. *Construction and Building Materials* 2016;127:102–10. <https://doi.org/10.1016/j.conbuildmat.2016.09.131>.
- [99] Nagarnaik PB, Parbat DK, Polytechnic G. Strength and fracture properties of post consumed waste plastic fiber reinforced concrete. *International Journal of Civil, Structural, Environmental and Infrastructure Engineering Research and Development (IJCSEIERD)* 2013;3:9–16.
- [100] Cui X, Liu G, Wang CL, Qi Y. Effects of PET Fibers on Pumpability, Shootability, and Mechanical Properties of Wet-Mix Shotcrete. *Advances in Civil Engineering* 2019;2019.  
<https://doi.org/10.1155/2019/2756489>.
- [101] Wang W, Zheng Y. Flexural Strengthening Rc Beams Using a Composite Reinforcement Layer: FRP Grid and ECC. *The 12th International Symposium on Fiber Reinforced Polymers for Reinforced Concrete Structures (FRPRCS-12) & The 5th Asia-Pacific Conference on Fiber Reinforced Polymers in Structures (APFIS-2015) Joint Conference, 14-16 December 2015, Nanjing, China* 2015:14–6.
- [102] Kankeri P, Prakash SS. Experimental evaluation of bonded overlay and NSM GFRP bar strengthening on flexural behavior of precast prestressed hollow core slabs. *Engineering*

- Structures 2016;120:49–57. <https://doi.org/10.1016/j.engstruct.2016.04.033>.
- [103] Bukhari IA, Vollum RL, Ahmad S, Sagaseta J. Shear strengthening of reinforced concrete beams with CFRP. Magazine of Concrete Research 2010;62:65–77. <https://doi.org/10.1680/mac.2008.62.1.65>.
- [104] Hollaway LC. Key issues in the use of fibre reinforced polymer (FRP) composites in the rehabilitation and retrofitting of concrete structures. Service Life Estimation and Extension of Civil Engineering Structures 2010;3–74. <https://doi.org/10.1016/B978-1-84569-398-5.50001-8>.
- [105] ACI Committee 318-11. “Building code requirements for structural concrete (ACI 318-11) and commentary.” American Concrete Institute, Farmington Hills, Mich 2011:pp111.
- [106] JCI 2008. “Guidelines for Control of Cracking of Mass Concrete 2008.” Japan Concrete Institute 2011.
- [107] JSCE 2002. “Standard specifications for concrete structures-2002”, Materials and Construction. Japan Society of Civil Engineers, JSCE, No6 2002.
- [108] JSCE 2007. “Standard specifications for concrete structures-2007”, Materials and Construction. Japan Society of Civil Engineers, JSCE, No7 2007.
- [109] Senhadji Y, Escadeillas G, Benosman AS, Mouli M, Khelafi H, Kaci SO, et al. Effect of incorporating PVC waste as aggregate on the physical , mechanical , and chloride ion penetration behavior of concrete. Journal of Adhesion Science and Technology 2015;4243:1–16. <https://doi.org/10.1080/01694243.2014.1000773>.

## Annexes

### Annex 1: Experimental methods for characterization of cement

#### 1. Specific gravity

This test was conducted according to the ASTM C188-17 standard considerations [59].

##### a) Apparatus

In order to find the specific gravity of cement, the following equipment and materials are necessary:

- Ethanol
- Le chatelier flask
- Ordinary Portland Cement
- Weighing balance with 0.1g accuracy

##### b) Test procedure

The specific gravity test was conducted as follow:

- Le chatelier flask was free from the liquid and completely dried. The empty flask was weighed ( $W_1$ ).
- 50 gr of cement was added into the flask and weighed with its stopper ( $W_2$ ).
- Then ethanol was added into the flask up to the top of the bottle, cement and ethanol were mixed well to remove any air bubbles in it. The weight of cement, ethanol, and flask was taken ( $W_3$ ).
- The flask was cleaned from cement, dried again, and filled only from ethanol to the top and weighed ( $W_4$ ), **Figure 1**.



*Figure 1: Test procedure for specific gravity of cement*

Finally, the specific gravity was calculated throughout the following formula:

$$\text{Specific gravity} = \frac{W_2 - W_1}{(W_2 - W_1) - (W_3 - W_4)} \times 0.8$$

## 2. Bulk density

The bulk density of cement was measured according to the ASTM C188-17 standard considerations [59].

### a) Apparatus

The following equipment and materials are required for measuring the bulk density of cement:

- Ethanol
- Le chatelier flask
- Ordinary Portland cement
- Weighing balance with 0.1g accuracy

### b) Test Procedure

The bulk density test was carried out with the followings steps:

- 64 gr of cement were weighted ( $M$ ).
- Le-Chatelier flask was cleaned and dried from any debris.
- Then the flask was filled with ethanol until 0 reading.
- Thereafter, cement was added into the flask in small increments to avoid splashing and see that the cement does not adhere inside of the flask above the liquid. After the addition of all cement into the flask, the stopper was placed on the flask and the flask was rolled in an inclined position.
- Finally, the volume of replaced liquid was recorded from the top of the flask ( $V$ ).

The bulk density was calculated throughout the following formula:

$$\text{Bulk density} = \frac{M}{V}$$

## 3. Normal consistency and setting times (initial and final setting time)

These behaviors of cement were measured in compliance with the EN NF 196-3 [60] standard considerations.

**a) Apparatus**

In order to measure the aforementioned behaviors of cement, the following equipment and materials are needed:

- Vicat Apparatus having a frame with scale.
- Free sliding  $10 \pm 0.05$  mm diameter plunger containing  $300 \pm 1$  g of weight (normal consistency).
- Needle, having  $1.13 \pm 0.05$  mm diameter and at least 45 mm of length (initial setting time).
- Needle, containing at least 5 mm diameter ring attachment (final setting time).
- Conical Vicat ring with the bottom plate.
- A mechanical mixer.
- A balance with an accuracy of 0.05 % of the weight of the sample.

**b) Test procedure**

These behaviors of cement were calculated with the following procedure:

- 500 g of cement and 125 gr of water were weighted.
- The water and cement were placed into the bowl, and the process was completed within 10 sec.
- The mixer has started immediately at low speed while starting the timing of the mixing stages. In addition, the time has been recorded to the nearest minute as 'zero time'. Zero time is the point from which the initial and final setting times are calculated.
- The mixer has stopped after 90 sec for 30 sec, during the stoppage of the mixer all the paste adhering to the wall and bottom of the bowl has been removed with the help of a scraper.
- The mixer has restarted and run at low speed for another 90 sec. The total mixing time was 3 min.

➤ **Initial setting time**

- The plunger has changed with the needle containing  $1.13 \pm 0.05$  mm diameter.



- Immediately, after mixing the cement paste of normal consistency (previously measured) was transferred to the oiled mold and the mold was filled to the excess. The air voids inside the paste have been removed with the help of mold tapping and finally, the excess paste was removed by a straight-edged ruler.
- The ring has been centered under the needle such that the 1.13 mm needle was in contact with the paste surface and then the screw of the needle was tightened.
- The needle has been released after setting the scale to zero reading. The reading for the penetration of needle (the space between the top of the base plate and the bottom of a needle) has been recorded after 30 sec of release.
- The test was repeated at 10 minutes intervals and different places based on EN 196-3 standard [60] (minimum 8 mm apart for the rim of mold, 5 mm from each other, and 10 mm from last penetration).
- Finally, the time between ‘zero time’ and time at which the space between the needle of initial setting time and base plate was 7 mm was recorded as initial setting time.

➤ ***Final setting time***

- The mold which was used for the initial setting time was inverted, and the needle containing at least 5 mm diameter ring attachment was used.
- Immediately, after mixing the cement paste with normal consistency (previously calculated) was transferred to the previously oiled mold and the mold was filled in excess. The air voids inside the paste have been removed with the help of mold tapping and finally, the excess of the paste was removed by a straight-edged ruler.
- The ring has been centered under the needle such that the needle was in contact with the paste surface and then the screw of the needle was tightened.
- The needle has been released after setting the scale to zero reading. The reading for the penetration of a needle (the space between the top of the base plate and the bottom of a needle) has been recorded after 30 sec of release.
- The test was repeated at 10 minutes intervals, and at different places based on EN 196-3 standard [60] (minimum 8 mm apart for the rim of mold, 5 mm from each other, and 10 mm from last penetration).

- Finally, the time between ‘zero time’ and the time at which the needle first penetrates 0.5 mm into the cement paste was recorded as a final setting time.

## **Annex 2: Experimental methods for characterization of aggregates**

### **1. Specific gravity and water absorption**

Specific gravity and water absorption were measured according to the NF EN 1097-6 [62] standard considerations.

#### ***b) Apparatus***

For conducting the above tests, the following equipment are required:

- Weighing balance
- Oven
- Pycnometer

#### ***c) Test procedure***

The specific gravity and water absorption of fine and coarse aggregates were obtained according to the following procedure:

- 1000 gr of aggregates were weighted.
- The weighted aggregates were added into the pycnometer, then water was added up to the top of pycnometer, and the weight of aggregate sample + water + pycnometer was taken ( $W_1$ ).
- Pycnometer was filled only from water and weight of pycnometer + water was recorded ( $W_2$ ).
- After that the sample was put in water for 24 hours.
- Thereafter, surfaces of aggregates were dried with the help of cloth and then the sample was weighed ( $W_3$ ).
  - ✓ Surfaces of coarse aggregates were dried with the help of cloth until the brightness of surfaces was removed.
  - ✓ For fine aggregate, the cone mold was used to know the surface dryness of aggregates. To conduct this process, the drying of fine aggregates was continued and mold tests were performed on a continuous basis. Each time mold was filled with the sand, rodded with the tamping rod, then the mold was removed, and monitored the shape of a cone. Finally, after the mold

was removed, fine aggregates were spread, indicating that the sand has surface dried.

- Finally, the sample was put in the oven for 24 hours and the oven-dried sample was weighed ( $W_4$ ).

## **2. Bulk density**

This test was performed in compliance with the NF EN 1097-6 [62] standard considerations.

### ***a) Apparatus***

In order to calculate the bulk density of aggregates, the following apparatuses were used:

- Weighing balance
- Tamping rod
- Measuring cylinder
- Shove or stool

### ***b) Test procedure***

A similar test procedure was applied for both fine and coarse aggregates only with a difference in the quantity of aggregates.

- Empty cylinder was weighed ( $W_1$ ).
- The mass of aggregates was selected based on EN 1097-6 [62], then volume of the selected cylinder was calculated ( $V$ ).
- Aggregates were added to the cylinder, and the weight of cylinder and aggregates was recorded ( $W_2$ ).
- For rodded bulk density, the cylinder was filled in three layers and each layer was rodded 25 times with the tamping rod evenly distributed over the surface, and then the weight was taken ( $W_3$ ).

## **3. Size distribution**

This property of aggregates was measured based on NF EN 933-1 [63] standard considerations as follows:

### ***a) Apparatus***

In order to test grading and fineness modulus of aggregates, the following equipment is needed:

- Weighing balance with 0.1 g accuracy.
- Sieves mounted on suitable frames, designed not to leak.
- Mechanical sieve shaker, if used, must provide a vertical or lateral and vertical motion to the sieve.
- Oven, capable of maintaining  $230 \pm 9$  °F ( $110 \pm 5$ °C).

**b) Test procedure**

To perform the above mentioned test, it is required to follow the below procedure:

- Samples were brought from the field and reduced to the test size in accordance.
- Samples were dried to a constant weight in an oven set at  $230 \pm 9$  °F ( $110 \pm 5$  °C).
- The original sample was reduced to a test sample size that falls within the minimum weight as presented in **Table 1**.

*Table 1: Minimum mass of test portion required for sieve analysis*

Nominal size of material mm	Minimum mass of test portion Kg.
63	50
50	35
40	15
28	5
20	2
14	1
10	0.5
6	0.2
5	0.2
3	0.2
less than 3	0.1

- Three sets of sieves were selected based on the type of aggregates and then agitating and shaking of the sample were started for a sufficient amount of time.
  - ✓ Fine aggregates (0.063, 0.125, 0.25, 0.5, 1.0, 2.0, 4.0, and 6.3) mm
  - ✓ Coarse aggregates (2.0, 4.0, 6.3, 8.0, 10, 12) mm
  - ✓ Coarse aggregates (6.3, 8.0, 10, 12, 14, 16, 20, 24) mm
- For coarse aggregates, after the materials have been sieved, each tray has been removed and weighted to the nearest 0.1 g. Before weighting, the aggregates trapped within the sieve openings were removed by flat metal until the aggregates is freed.

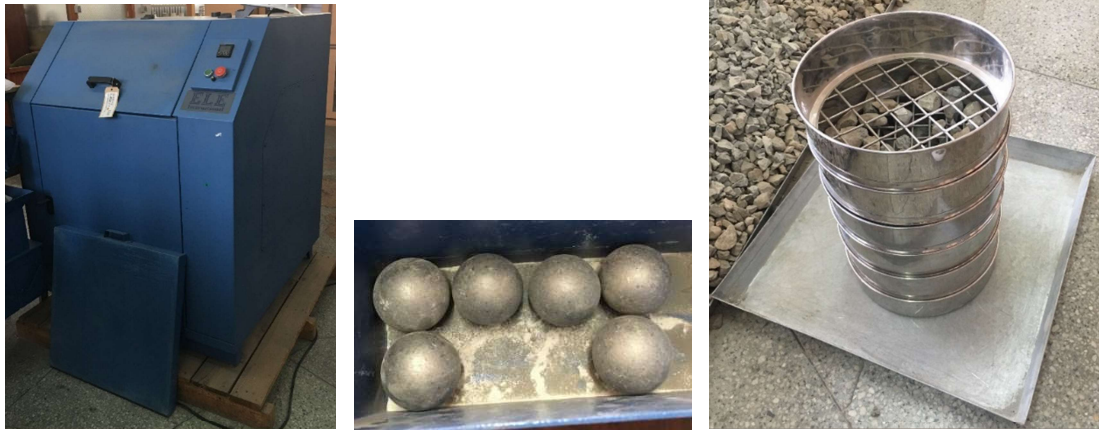
- For fine aggregates, after the materials have been sieved, each tray has been removed and weighted to the nearest 0.1 g. Before weighting, the aggregates trapped within the sieve openings were removed by brushes.
- After taking the weights of retained aggregates in each sieve, a curve of aggregate grading is plotted, where the x-axis represents the size of aggregates, and the y-axis indicates the percentage of passing.

#### 4. Los Angeles

This test was performed based on ASTM M C131 [64] standard considerations.

##### a) Apparatus

- Los Angeles machine (*Figure 2*).
- 12 abrasive steel balls, containing 48 mm diameter and 390 to 445 g weight.
- Sieves: 1.70, 2.36, 4.75, 6.3, 10, 12.5, 20, 25, 40, 50, 63, 80 mm IS sieves.
- Balance with a capacity of 10 kg.



*Figure 2: Apparatus for the test of Los Angeles*

##### b) Test procedure

- The sample should be prepared from clean and oven-dried aggregates based on *Table 2*. The total weight of samples for each type of grade is 5000 gr ( $W_1$ ).

*Table 2: Grading of test samples*

Sieve Sizes		Weight of Sample (gr) for different Grades			
Passed	Retained	A	B	C	D
37.5	25	1250±25			
25	19	1250±25			

19	12.5	1250±25		
12.5	9.5	1250±25	2500±25	
9.5	6.3		2500±25	2500±25
6.3	4.75			2500±25
4.75	2.36			5000±25

- Take 5 kg of sample for grades A, B, C, and D.
- Choose the number of abrasive steel balls according to **Table 3** depending on the grading of aggregates.

*Table 3: Number of required steel balls*

Grades	A	B	C	D
Number of Balls	12	11	8	6

- Place the aggregates and steel balls on the cylindrical part of the Los Angeles testing machine and fix the cover.
- Reset the machine for 0-500 rotations at a speed of 30 to 33 revolutions per minute. The number of revolutions is 500 for grades A, B, C, and D.
- The machine is stopped after completing the 500 revolutions and material is discharged to a tray.
- The discharged materials are sieved on a 1.70 mm sieve.
- The materials coarser than 1.7 mm size is weighed ( $W_2$ ).

### **Annex 3: Experimental methods for characterization of water**

#### **1. pH value**

pH value was measured with the help of PHM 210 standard pH meter as follows:

##### ***a) Apparatus***

The following apparatuses were used for conducting pH tests:

- 50 mL wide-mouth glass beaker with a watch glass for cover.
- PHM 210 standard pH meter.
- Standard buffer solutions of known pH value
- Distilled water (**Figure 3**).



*Figure 3: Apparatus for pH value of water*

### ***b) Test procedure***

The pH value of water was calculated as follow:

- Water sample was stirred vigorously using a clean glass stirring rod.
- $40 \pm 5$  mL sample was poured into the glass beaker using the watch glass for a cover.
- The sample was left to stand for a minimum of one hour to allow the temperature to stabilize, stirring it occasionally while waiting.
- The temperature was monitored and the pH meter was standardized using the standard solution.
- The electrodes of the pH meter were immersed into the water and the beaker was slightly turned to obtain good contact between the water and the electrodes.
- The electrodes require immersion of 30 sec or longer in the sample before reading to allow the meter to stabilize. If the meter has an auto-read system, it will automatically signal when stabilized.
- The pH value was read and recorded to the nearest tenth of a whole number.

## **Annex 4: Experimental methods for mortar/concrete**

### **1. Fresh properties**

#### ***1.1. Workability***

This test was performed for mortar mixtures according to the EN 1015-3 [67] standard considerations with the following procedure.

#### **a) Apparatus**

- Flow table
- A conical steel mold containing  $60 \pm 0.5$  mm height and internal diameter at the bottom  $100 \pm 0.5$  mm and at the top  $70 \pm 0.5$  mm.
- A tamper rod having 40 mm diameter and 200 mm long and  $0.25 \pm 0.015$  kg mass.
- Calipers or ruler
- Trowel

**b) Test procedure**

- Before starting the test, the mortar was mixed by hand using a trowel.
- The mold, flow table, and rod were cleaned and dried with the help of a cloth.
- The mold was placed centrally on the flow table and the mortar was poured into two layers.
- Each layer was compacted by at least 10 short strokes uniformly.
- The excess mortar was skimmed off.
- The mold was raised vertically and after 15 seconds the difference was recorded between the top of samples and top of the mold.

On the other hand, this test was performed on concrete mixtures according to the EN 12350-2 [68] standard considerations as follow:

**a) Apparatus**

- Mold made of metal, shall be smooth and free from projections and have the following internal dimensions:
  - ✓ Base diameter:  $(200 \pm 2)$  mm
  - ✓ Top diameter:  $(100 \pm 2)$  mm
  - ✓ Height:  $(300 \pm 2)$  mm
- Compacting rod of circular cross-section, straight, made of steel, having a diameter of  $(16 \pm 1)$  mm and a length of  $(600 \pm 5)$  mm, and with rounded ends.
- Funnel, made of non-absorbent material not readily attacked by cement paste and having a collar to enable the funnel to be located on the mold.
- Ruler, having the dimensions of 0 mm to 300 mm.
- Non-absorbent, rigid, flat, plate or other surfaces on which to place the mold.



- Shovel with a square mouth, to ensure proper mixing of material on the remixing container.
- Scoop, approximately 100 mm in width.

**b) Test procedure**

- Tighten the mold on the horizontal base plate.
- Fill the mold in three layers.
- Compact each layer with 25 strokes of the tamping rod uniformly.
- Remove the spilled and excess concrete from the base plate and mold.
- Lift the mold from the concrete by raising it carefully in a vertical direction in 2 to 5 seconds.
- After removal of the mold, record the slump value from the difference between mold height and the highest point of the concrete specimen.

**1.2. Fresh density**

This test was carried out based on EN 1015-6/A1 [69] standard considerations on mortar mixtures with the following apparatus and testing procedure.

**a) Apparatus**

- A watertight measuring vessel with the dimensions of 125 mm.
- Vibrating table that operated vertically with  $50 \pm 1$  Hz frequency.
- Scale to determine the mass of compacted mortar to an accuracy of 1.0 gr.
- Scoop
- Trowel

**b) Test procedure**

- The volume of the container was measured ( $V$ ).
- The weight of the container was calculated ( $m_1$ ).
- The mortar was compacted in a vessel until no further settling can be observed.
- The surface of the vessel was leveled.
- The weight of container + mortar was taken ( $m_2$ ).

While considering concrete mixtures, the fresh density was measured based on EN 12350-6 [70] standard consideration with slight changes compared to the mortar mixtures.

**a) Apparatus**

- A watertight container with the dimensions of at least four times the maximum nominal size of coarse aggregates in the concrete, but not less than 150 mm.
- Vibrating table or compacting rod having a diameter of 16 mm and length of 600 mm.
- Scale to determine the mass of the compacted concrete to an accuracy of 0.01 kg.
- Scoop of approximately 100 mm width.
- Shovel

**b) Test procedure**

- Measure the volume of the container ( $V$ ).
- Take the weight of the container ( $m_1$ ).
- Filling the container in two or more layers and then compact it.
- Level the surface of the container.
- Take the weight of container + concrete ( $m_2$ ).

**2. Physical properties**

The physical properties (density, porosity, and water absorption) of mortar/concrete specimens were conducted based on NF P18-459 [71] standard considerations.

**a) Apparatus**

- Oven
- Hydrostatic balance with an accuracy of 0.01% of the mass of the sample
- Vacuum equipment
- Thermometer
- Container with sufficient volume

**b) Test procedure**

- Firstly, 50 mm cubes were prepared.
- Thereafter, the samples were immersed in the water and the weight was taken, while the samples are completely inside the water ( $M_1$ ).
- After 24 hours of immersing in water, samples were surface dried and the weight of samples was taken by a hydrostatic balance in the air ( $M_2$ ).

- Samples were put in the oven for 24 hours at a temperature of  $105 \pm 5 \text{ }^\circ\text{C}$  and the oven-dried weight was taken ( $M_3$ ).

### 3. Mechanical properties

#### 3.1. Flexural strength

The flexural test was conducted according to EN 1015-11 [72] standard consideration on (40×40×160) mm mortar prisms.

##### a) Apparatus

- The 3R flexural and compressive automatic and ADR-Auto 250/25 cement machines were used in the INSA and KPU, respectively as shown in *Figure 4*.



a



b

*Figure 4: Flexural testing machine: a) INSA and b) KPU*

##### b) Test procedure

- Specimens were prepared and positioned in the following steps:
  - ✓ The machine was cleaned and any loose grit or materials were removed.
  - ✓ The specimen was located properly.
- The load was applied within the range of 10 N/s to 50 N/s and the maximum load in kN and stress in MPa was recorded.

Furthermore, the flexural strength of concrete specimens was measured according to EN 12390-5 [73] standard consideration on (100×100×500) mm beams.

##### a) Apparatus

- An ELE® 50 kN Mini-Flexural machine.

##### b) Test procedure

- The testing machine was cleaned and any loose grit or other extraneous materials were removed.
- The excess water was removed from the surfaces of specimens.
- The specimen was located in the machine correctly and according to the arrangement.
- The load was applied within a constant rate of 0.04 MPa/sec to 0.06 MPa/sec.
- Finally, the maximum load and strength were recorded.

### 3.2. *Compressive strength*

The compressive strength was conducted on 40 mm mortar cubes based on EN 1015-11 [72] standard considerations.

#### a) *Apparatus*

- The same machine but with the option of compressive strength and conforming EN-1015-11 [72] standard considerations was used that contains two steel plates of  $40 \pm 0.1$  mm long and  $40 \pm 0.1$  mm wide apart.

#### b) *Test procedure*

- The testing machine was cleaned and any loose grit or other extraneous materials were removed.
- The specimen was taken from the flexural machine, any excess materials were removed, then put between steel plates of the compressive strength machine.
- The load was applied within a constant rate of 0.5 to 1.0 MPa/sec.
- The maximum load and stress were recorded.

While considering concrete specimens, the compressive strength was conducted on 100 mm cube and (100×200) mm cylinders according to the EN 12390-3 [75] standard considerations.

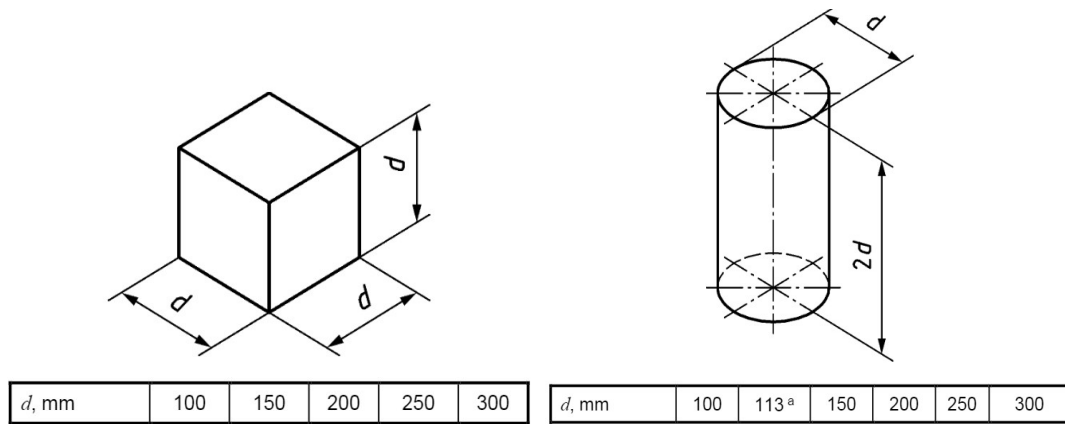
#### a) *Apparatus*

- ELE<sup>®</sup> ADR 1500 Compression machine as shown in *Figure 5*.



**Figure 5:** Compressive strength machine in KPU

- The test specimens could be a cube, cylinder, or core cylinder with various sizes as indicated in **Figure 6**.



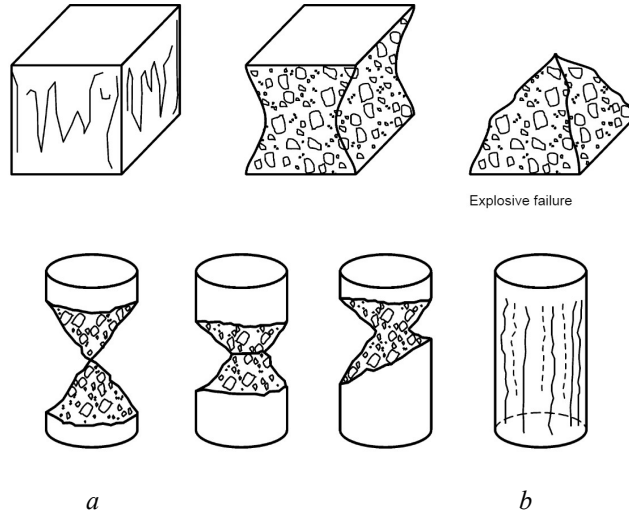
**Figure 6:** Nominal sizes for samples [75]

**b) Test procedure**

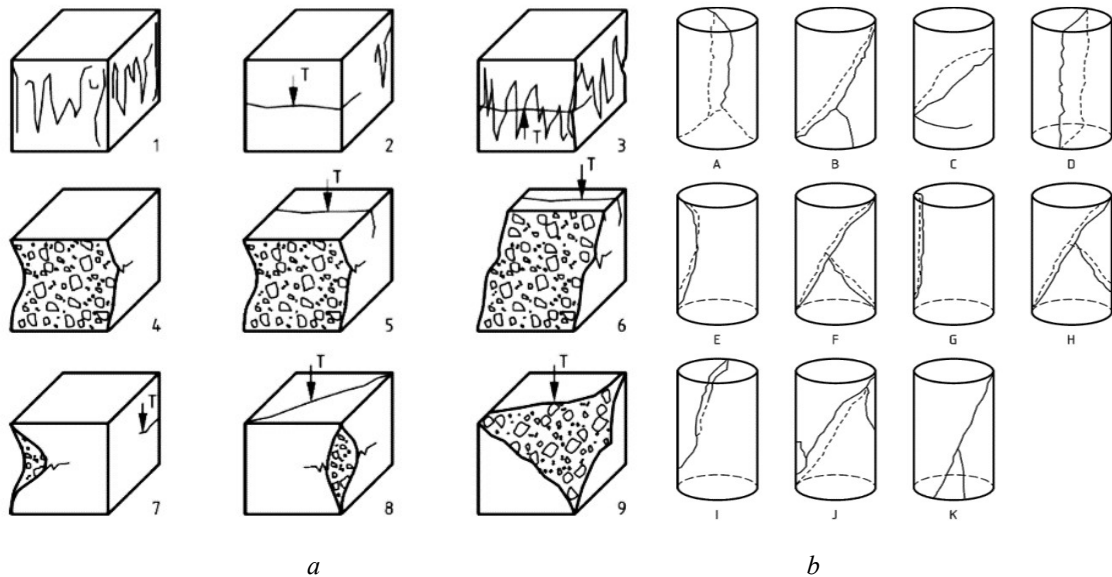
- Specimens were prepared and positioned in the following steps:
  - ✓ The machine was cleaned and any loose grit or materials were removed.
  - ✓ The specimen was located between platens that the load was applied perpendicularly to the direction of casting.
  - ✓ The surface of cylindrical samples was polished before the compression test in order to obtain a flat surface.

- A constant rate for loading was selected within the range of  $0.6 \pm 0.2$  MPa/sec and the maximum load in KN and stress in MPa was recorded.
- Finally, the type of failure was assessed.

After testing, the failure of a specimen can present that the tests have proceeded satisfactorily or not. The satisfactory failures are shown in **Figure 7** and the unsatisfactory failures are shown in **Figure 8**.



**Figure 7:** Satisfactory failures: a) cubes, and b) cylinders [75]



**Figure 8:** Unsatisfactory failures: a) cubes, and b) cylinders [75]

### 3.3. Split tensile strength

The tensile splitting test was conducted on (75×150) mm cylinder according to the EN 12390-6 [76] standard considerations for mortar.

**a) Apparatus**

- Similar testing machine that was used for the compressive strength but with split tensile mode was applied conforming to EN 12390-4 [74].
- Small steel loading pieces were used in place of conventional plane platens.

**b) Test procedure**

- The machine, steel strips, and specimens were cleaned and any excess materials were removed from their surfaces.
- The surface of the specimen was dried.
- The specimen was placed centrally in the testing machine and then the strips were located under and above the cylindrical specimen. Ensure that the upper platen is parallel with the lower platen, during loading.
- The sample was loaded with a constant rate of stress within the range of 0.04 MPa/sec to 0.06 MPa/sec. |

## Valorization of Plastic Non-Woven Sheets of Polyethylene Terephthalate (PET) for the Development of Environmental Friendly Concrete

### Résumé :

Cette étude vise à lever certains verrous scientifiques afin de rendre possible l'utilisation des déchets de polyéthylène téréphtalate (PET) intissé pour élaborer de nouveaux mortiers ou bétons et d'étudier leurs effets sur les propriétés à l'état frais, propriétés physiques, propriétés mécaniques, propriétés acoustiques, propriétés thermiques et microstructurales des matériaux cimentaires. Le PET intissé a été utilisé en faisant varier le type d'incorporation : a) comme une couche et b) sous forme de pièces découpées. Dans le cadre d'utilisation en tant qu'une couche, 5 différentes configurations ont été réalisées : 1 couche, 2 couches, 2 faces, 3 faces et enveloppement complet pour renforcer des échantillons. De plus, sous forme de morceau avec une dimension de (10×10) mm, trois différents taux d'incorporation de 0,25 %, 0,50 % et 0,75 % ont été incorporés dans le mortier/béton. Enfin, le phénomène d'adhésion entre intissé et matériaux cimentaire a été également analysé. Les résultats expérimentaux obtenus dans cadre de ce travail permettent la mise en évidence de l'incorporation des déchets de polyéthylène téréphtalate (PET) intissé dans les matériaux cimentaires. Utilisation d'intissé comme une couche présente une amélioration significative des propriétés mécaniques avec un comportement ductile sous une sollicitation mécanique. Par contre, ces propriétés diminuent en incorporant l'intissé sous une forme de morceau. Indépendamment de type d'usage d'intissé, les propriétés de transferts : acoustique et thermique des matériaux cimentaires améliorent. De plus, les résultats d'adhésion montrent qu'une bonne adhésion a été enregistrée entre l'intissé et le mortier. Par ailleurs, les analyses microscopiques (interférométrie, optique, électronique) montrent qu'une couche d'environ 0,6 mm d'intissé reste sur la surface de l'éprouvette après le test d'arrachage, ce qui démontre une très bonne adhésion. Les résultats soulignent que l'augmentation du rapport E/C et la diminution de superplastifiant permettent une amélioration de l'adhésion. Enfin, l'utilisation de ce genre des déchets (PET intissé) peut-être recommandé comme une couche pour l'amélioration des propriétés mécaniques et des transferts.

**Mots clés :** *Intissé, Mortier/béton, Propriétés physiques, Propriétés mécaniques, Propriétés transferts, adhésion*

### Abstract:

This study intends to investigate the effect of non-woven polyethylene terephthalate (PET) waste plastic tissue on the fresh, physical, mechanical, acoustic, thermal, and microstructural behaviors of mortar and concrete. Including reference specimens, non-woven fabrics were considered in two ways: a) as a layer with 5 various configurations of 1-Layer, 2-Layers, 2-Sides, 3-Sides, and full wrapping to strengthen specimens, and b) as cut pieces (10×10) mm with four different incorporated ratios of 0%, 0.25%, 0.50%, and 0.75%. Lastly, the bond properties between non-woven sheets and cementitious materials were investigated as well. The results indicate that the mechanical properties (compressive, split tensile, and flexural strengths) were remarkably improved while applying non-woven sheets as a layer. Even though SEM analysis observed excellent distribution of cut pieces and good bonding between cementitious materials and PET fabrics, but mechanical properties were decreased with the incorporation of non-woven tissue as cut pieces. Moreover, the control specimens showed brittle behaviors and were damaged to many fragments after mechanical testing. While samples strengthened or containing cut pieces of non-woven tissue had improved ductility, were maintained together, and not separated into many small parts. On the other hand, the incorporation of cut pieces of non-woven sheets resulted in the reduction of workability, fresh and dry densities and these reductions were more significant for higher percentages. Additionally, the porosity and water absorption were enhanced with the incorporation of cut pieces and increased further for higher volume fractions of cut pieces. Also, the attachment of non-woven tissue as a layer to strengthened concrete samples or incorporation of cut pieces in concrete mixtures resulted in remarkable improvements in acoustic and thermal properties. Furthermore, it was found that non-woven tissue has a very good bond with cementitious materials without using any adhesive materials. However, the bond behaviors enhanced with the increase of w/c ratio and reduction of superplasticizer content. This is because of the microstructure of non-woven sheet that is made of hairlines microfilaments that interacted inside the cement paste after mortar casting. This phenomenon was verified by interferometry and microscopic analysis as well. Finally, the correlations between different properties of concrete have plotted between each other, the trend of lines and R<sup>2</sup> coefficient clearly prove the excellent accuracies. It means that certain properties of such type of concrete could be predicted from other already known behaviors. In addition, the current research data was checked by previously developed models and shows great accuracy as well.

**Keywords:** *Non-woven sheets, Mortar/concrete, Physical properties, Mechanical properties, UPV, Thermal conductivity, Adhesion properties*