



HAL
open science

Adaptive approaches to energy management and energy harvesting for connected objects

Sara Kassan

► **To cite this version:**

Sara Kassan. Adaptive approaches to energy management and energy harvesting for connected objects. Eco-conception. Université de Haute Alsace - Mulhouse, 2019. English. NNT : 2019MULH3699 . tel-03711881

HAL Id: tel-03711881

<https://theses.hal.science/tel-03711881v1>

Submitted on 1 Jul 2022

HAL is a multi-disciplinary open access archive for the deposit and dissemination of scientific research documents, whether they are published or not. The documents may come from teaching and research institutions in France or abroad, or from public or private research centers.

L'archive ouverte pluridisciplinaire **HAL**, est destinée au dépôt et à la diffusion de documents scientifiques de niveau recherche, publiés ou non, émanant des établissements d'enseignement et de recherche français ou étrangers, des laboratoires publics ou privés.

THESE DE DOCTORAT DE L'ETABLISSEMENT UNIVERSITE DE HAUTE-ALSACE

Ecole doctorale **ED269**

École doctorale mathématiques, sciences de l'information et de l'ingénieur

Doctorat en ingénierie informatique

Par

KASSAN Sara

**Approches adaptatives pour la gestion d'énergie pour les
objets connectés**

Thèse présentée et soutenue à **Mulhouse**, le -- 2019

Composition du Jury :

Président		
Rapporteur	Ahmed SEHROUCHNI	Professeur des Universités, Télécom Paris Tech
Rapporteur	Tarek EL GHAZAWI	Professeur , George Washington University
Directeur de thèse	Pascal LORENZ	Professeur des universités, UHA
Co-directeur de thèse	Jaafar GABER	Maître de conférences HDR, UTBM
Invité	Maxime WACK	Professeur Émérite, UTBM

Preface

The research presented in this PhD. thesis, has been prepared at the Institute of research in Computer Science, Mathematics, Automatics and Signal IRIMAS laboratory , Mathematics, Information Sciences, and Engineer Doctoral School (ED269), University of Haute-Alsace - Alsace, UHA, from May 2017 to July 2019.

Acknowledgments

This thesis was carried out during the period 2017-2019. It was supervised by Professor Jaafar Gaber from the FEMTO-ST Institute (Franche-Comté Electronics Mechanics Thermics and Optics-Sciences and Technologies) and Professor Pascal Lorenz from the IRIMAS laboratory (Institute of research in Informatics, Automatics and Signals).

I would like to thank my supervisors Jaafar Gaber and Pascal Lorenz for giving me an opportunity to work under their advice and guidance throughout the thesis. Their valuable suggestions and ideas have given me a great flexibility to work in the best possible way to achieve the goals of this project. I would like to thank them for all of their encouragement, guidance, dedication, availability and precious support, throughout my PhD studies. I would like to express my thanks to all staff members in the department for their respectfulness and friendship, and I am grateful to my colleagues for the enjoyable time that we spent together in the department.

Finally, I am grateful to my family and my friends. Particularly, I must thank my parents for providing me continuous moral support during all stages of my studies.

Abbreviations

WSN	Wireless Sensor Network
RCSF	Réseau des Capteurs sans Fil
EH	Energy Harvesting
LEACH	Low Energy Adaptive Clustering Hierarchy protocol
MCU	Micro Controller Unit
TEG	Thermoelectric Generation
CH	Cluster Head
BS	Base Station
RF	Radio Frequency
PV	Photovoltaic
MPPT	Maximum Power Point Tracking
TC	Topology Control
DSM	Distributed Source Modeling
DTC	Distributed Transform Coding
DSC	Distributed Source Coding
CS	Compressing Sensing
LEC	Lossless Entropy Compression
TMT	Tchebichef Moment Transform
LTC	Lightweight Temporal Compression
DPCM	Differential Pulse Code Modulation
GT	Game Theory
NE	Nah Equilibrium
MSD	Mass Spring Damper
PID	Proportional Integral Derivative

Abstract

During recent years, wireless technologies have been increasingly used in different fields. Wireless sensor network consists of three main components: a large number of nodes or connected objects, gateways and softwares. Wireless Sensor Network (WSN) workload depends on the WSN lifetime. Wireless sensor nodes are deployed in large number to detect information from their environment, communicate autonomously by wireless links to let the information messages reach the Base Station. Nevertheless, sensors suffer generally from limited resources as limited memory, limited computations and especially in terms of energy. Therefore, there is a need to develop energy-efficient mechanisms solutions to extend the network lifetime.

In this thesis, we propose new strategies to increase the WSN lifetime. These strategies are based on energy management and energy harvesting in the wireless sensors' batteries.

After an introduction of the wireless sensor network architectures and applications, we analyse the advantage of using WSN in corresponding areas. Then, some main research results of energy saving and node deployment are provided. Afterwards, we propose two new approaches: The first one is a hierarchical clustering protocol based on election and location. The second approach is based on a game theory routing protocol. The second part of work concerns harvesting environmental energy control to recharge wireless sensors' batteries. Our results show that the wireless sensors lifetime can be extended using the proposed strategies. All obtained results are supported by numerical experiments and extensive simulations. Finally, we conclude this thesis by providing insights for research directions about energy conservation and harvesting in WSN.

Résumé

Les réseaux sans fil et les réseaux des objets connectés sont de plus en plus utilisés dans différents domaines. Un réseau de capteurs sans fil est constitué de trois composants principaux : un grand nombre de nœuds, des passerelles et des logiciels. La charge de travail d'un réseau dépend de la durée de vie de ses nœuds. Ces derniers sont déployés en grand nombre pour détecter les informations de leur environnement et communiquer de manière autonome via des liaisons sans fil pour permettre aux messages d'informations d'atteindre une station de base. Cependant, les capteurs souffrent généralement de ressources réduites telles qu'une mémoire limitée, des capacités de calculs simplifiées et en particulier une ressource finie en termes d'énergie. Par conséquent, il est nécessaire de développer des approches pour prolonger la durée de vie du réseau.

Dans cette thèse, nous proposons de nouvelles stratégies originales et performantes pour prolonger la durée de vie des réseaux des capteurs sans fil ou des réseaux des objets connectés. Ces stratégies reposent sur la gestion ou la récupération d'énergie depuis l'environnement ou la récupération d'énergie dans les batteries des capteurs sans fil.

Les contributions de la thèse sont les suivantes :

- 1) Une approche distribuée basée sur l'élection et la localisation des nœuds pour augmenter la durée de vie du réseau de stockage est proposée ;
- 2) Une approche adaptative basée sur la théorie des jeux de décision permettant aux capteurs de prendre part ou non aux communications en vue des décisions en vue de prolonger la durée de vie du RCSF est proposée ;
- 3) Une approche autonome de contrôle permettant de compenser l'énergie consommée à l'aide d'un système piezo autonome de récupération d'énergie est proposée.

Après une introduction aux architectures de réseaux des capteurs sans fil, nous présentons un état d'art sur les applications en analysant les avantages apportés par RCSFs dans ces domaines. Ensuite, des résultats de recherche principaux sur la conservation de l'énergie et le déploiement des nœuds sont fournis. Ensuite, nous

proposons deux nouvelles approches : la première est un protocole de classification hiérarchique basé sur l'élection et la localisation des capteurs sans fil. La seconde approche concerne un protocole de routage basé sur la théorie des jeux dans l'algorithme de classification hiérarchique proposé. Nos résultats montrent que la durée de vie des capteurs sans fil peut être prolongée à l'aide des stratégies proposées. Tous les résultats obtenus sont étayés par des expériences numériques et des simulations approfondies. Dans la deuxième partie de ce travail, nous nous sommes intéressés à la récupération de l'énergie environnementale pour recharger les piles rechargeables des capteurs sans fil. Nous proposons une approche permettant de récupérer l'énergie produite par vibration et contrôler les batteries rechargeables des capteurs sans fil. Les résultats montrent que l'énergie consommée durant les activités des capteurs peut être compensée et la durée de vie des capteurs sans fil est étendue. Enfin, nous concluons cette thèse en présentant les futures recherches sur la conservation et la récupération de l'énergie dans RCSF.

Keywords

Wireless Sensors Network's lifetime; energy saving mechanisms; energy harvesting; clustering protocols; game theory routing protocol; Nash equilibrium; autonomous piezoelectric energy harvesting management and control.

List of publications

This thesis arises four international publications that are listed below:

International journals

1. S. Kassan, J. Gaber and P. Lorenz, "Game Theory based distributed clustering approach to maximize Wireless Sensors Network lifetime," *Journal of Network and Computer Applications*, Elsevier, vol. 123, pp. 80-88, 2018. (IF 5,273)
2. S. Kassan, J. Gaber and P. Lorenz, "Autonomous Energy Management system achieving piezoelectric energy harvesting in Wireless Sensors," *Journal of Mobile Networks and Applications*, Springer, pp. 1-12, 2019. (IF 2,39)

International conferences

S. Kassan, P. Lorenz and J. Gaber, "Low Energy and Location Based Clustering Protocol for Wireless Sensor Network," *2018 IEEE International Conference on Communications (ICC)*, Kansas City, MO, pp. 1-6, 2018.

Workshops

S. Kassan, P. Lorenz and J. Gaber, "An adaptive clustering protocol for Wireless Sensor Network protocol based on energy and location," *7th N2Women And Wice: Professional Development Workshop*, Kansas City, MO, pp. 1-3, 2018.

Under Preparation

S. Kassan, J. Gaber and P. Lorenz, "Subsiding the consumption of energy harvesting in Wireless Sensors Network: A comprehensive review,"

Table of contents

Preface	1
Acknowledgments.....	2
Abbreviations.....	3
Abstract	4
Résumé	5
Keywords.....	6
List of Publications.....	7
List of Figures	12
List of Tables.....	14
1 General introduction	15
1.1 Research domain.....	16
1.2 Problem Statement	16
1.3 Contributions and thesis outline	17
1.4 Organization of the manuscript	18
2 Wireless sensors network	21
2.1 Introduction	22
2.2 WSN architectures.....	23
2.2.1 Flat architecture	24
2.2.2 Hierarchical architecture	25
2.3 WSN applications	26
2.3.1 Smart cities.....	26
2.3.2 Environmental monitoring	27
2.3.3 Healthcare applications	28
2.3.4 Military applications	29
2.3.5 Industrial control.....	30
2.4 Conclusion	31
3 Energy consumption, saving and harvesting in WSN	32
3.1 Introduction	34
3.2 Energy consumption in WSN	34

3.3	Energy harvesting sources	36
3.3.1	Light power	37
3.3.2	Kinetic power	37
3.3.2.1	Electromagnetic energy harvesting.....	38
3.3.2.2	Electrostatic energy harvesting	38
3.3.2.3	Magnetostrictive energy harvesting.....	38
3.3.2.4	Piezoelectric energy harvesting	39
3.3.3	Thermal power	40
3.3.4	Human-body based energy harvesting.....	41
3.4	Energy harvesting saving methods	41
3.4.1	Topology control	41
3.4.1.1	Clustering protocols	43
3.4.1.2	MAC protocols.....	43
3.4.1.3	Routing protocols.....	44
3.4.1.4	Control of radio model transmission	46
3.4.2	Data reduction.....	46
3.4.2.1	Data compression	46
3.4.2.2	Data aggregation	47
3.4.2.3	Network coding.....	48
3.4.2.4	Adaptive sampling data	48
3.5	Recharging sensors' battery in WSN	48
3.6	Conclusion	50
4	Low energy adaptive clustering protocols in WSN	51
4.1	Introduction	52
4.2	Related work	52
4.2.1	Centralized clustering protocols	52
4.2.2	Distributed clustering protocols.....	53
4.3	Low energy adaptive clustering protocols in WSN	54
4.4	Low energy and location based clustering protocol in WSN.....	57
4.5	Simulation results	61
4.6	Conclusion	67
5	Energy saving with a Game Theory based approach in WSN.....	68
5.1	Introduction	69
5.2	Related work	69
5.2.1	Cooperative game theory based approach.....	70

5.2.2	Non-cooperative game theory based approach	70
5.3	Game theory based distributed clustering approach to maximize WSN lifetime	71
5.4	Performance evaluation	84
5.5	Conclusion	88
6	Control approach to harvest energy	90
6.1	Introduction	91
6.2	Related work	91
6.3	The proposed adaptive energy management system	94
6.4	Piezoelectric energy harvesting model.....	99
6.5	Performance evaluation	108
6.6	Conclusion	113
7	Conclusion	114
7.1	Summary	115
7.2	Future Work	116
	Bibliography	117

List of figures

1.1. Overview of our contributions	19
2.1. Sensor node structure	22
2.2. Multihop flat architecture	24
2.3. Hierarchical multihop clustering architecture	25
2.4. Applications of WSNs	26
3.1. First-order wireless communication radio model.....	35
3.2. Different energy saving mechanisms in Wireless Sensor Networks	42
3.3. Classification of Data Compression approaches (DC)	47
3.4. Classification of recharging batteries techniques for WSNs.....	49
4.1. Thresholds for 200 rounds	55
4.2. Clustering phases	58
4.3. States of 100 nodes after 100 rounds	63
4.4. Energy consumption of LEACH protocol and our adaptive clustering protocol	64
4.5. Packets received by BS in LEACH protocol for 1000 rounds.....	65
4.6. Packets received by BS in our adaptive protocol for 1000 rounds.....	66
4.7. Packets received by BS in our adaptive protocol for 5000 rounds.....	66
5.1. Energy harvesting for WSN model.....	73
5.2. Set-up and steady phases	73
5.3. Flowchart for the set-up phase	75

5.4. The expected utility function varies with the number of nodes neighbors and the probability $P_i(j)$ and has a maximum that corresponds to the maximum battery capacity.....	79
5.5. Entering game probability varies with the number of nodes neighbors for a Nash Equilibrium mixed strategy	83
5.6. Energy consumption by the network.....	85
5.7. Dead nodes in the network	87
5.8. Number of Data Packets received by the BS. With P _{nash} GT, the network is still active as the packets continue to be received by BS beyond the other protocols.....	88
6.1. Architecture of the global system of wireless sensor composed of two main blocks one to manage energy consumed and residual energy in the battery and another one to harvest energy from the ambient source.....	95
6.2. Schematic of piezoelectric harvesting structure.....	99
6.3. Equivalent MSD model	100
6.4. Transfer function between the input vibration force and the output displacement for an open loop without the PID controller.....	102
6.5. Flowchart to find the transfer function for the PID controller based on Ziegler-Nichols heuristic tuning method	106
6.6. Transfer function between the input vibration force and the output displacement for a closed-loop with an adaptive PID controller based on Ziegler-Nichols tuning method	108
6.7. Self-power manager behavior without the adaptive PID controller	111
6.8. The self-power manager controller organizes its wake-up mode to do its activities and its off mode to harvest energy controlled by the adaptive PID controller depending on its residual energy	112

List of tables

3.1. Comparison of the different kinetic types of harvesting energy	39
4.1. Simulation parameters	61
5.1. Notations definition	72
5.2. Symetric entering market game matrix	82
5.3. Simulation parameters	84
6.1. List of variables used in the study	97
6.2. Electro-mechanical analogy of piezoelectric energy harvesting system	102
6.3. The effects of PID controller parameters on a closed-loop system	106
6.4. The PID controller parameters according to Ziegler-Nichols tuning method on a closed-loop system	106
6.5. Simulation parameters	109

Chapter 1

General Introduction

Contents | Chapter 1

1. Introduction-----	16
1.1. Research domain-----	16
1.2. Problem statement-----	16
1.3. Contributions and thesis outline-----	17
1.4. Organization of the manuscript -----	18

1. Introduction

This chapter constitutes a general introduction of the thesis report by presenting an overview of the problem statement, the contributions discussed and thesis outline in addition to organization of the manuscript.

1.1. Research domain

General context : Wireless Sensor Networks lifetime

Specific context : Adaptive energy harvesting approaches to extend the Wireless Sensor Network lifetime.

1.2. Problem statement

Recent progresses in wireless communications have allowed the development of wireless sensor networks (WSN) which are one of the most promising technologies. Wireless sensor network consists of a set of small, low-cost sensors powered with a battery devices whose sensing capabilities enable them to detect information from their environment. Sensor nodes can be deployed in a large number in a physical area to cooperate with each other and to form a wireless sensor network through wireless links. This attracts tremendous attention for various domain applications where remote monitoring abilities are required. Sensor nodes are expected to operate autonomously in a region of interest for long period of time. The WSN lifetime depends on limited power in sensors' batteries. However, replacing exhausted batteries may be very high costing in terms of time and budget and may be even impossible in a harsh or hostile environment. Severe energy, computation, storage constraints and the size of sensor nodes present new challenges in the development and applications of WSN. Especially, the design of power efficient in wireless sensor networks is, however, a very challenging issue. The communication

among sensor nodes in WSN is one of the most dominant factor that consumes the energy of the source nodes. Therefore, the development of energy-aware solutions for wireless sensors communications is necessary to increase the lifetime of wireless sensor networks.

1.3. Contributions and thesis outline

In this thesis, we propose new solutions to improve the wireless sensor network lifetime and performance. The main contributions of this thesis are as:

- 1) Distributed energy aware protocols to increase WSN lifetime;
- 2) Game theory adaptive decisions approaches applied in Wireless Sensors to making decisions to extend the WSN lifetime;
- 3) Rewarding energy consumed by an autonomous energy harvesting system with Proportional Integral Derivative control.

The first part of this thesis consists of a literature review of WSN architectures and a study of the different WSN applications. Then, we present the different energy sources and a comprehensive review of existing energy harvesting mechanisms designed for wireless sensor networks. After that, two contributions, which can be applied in the communication between wireless sensors to extend the network lifetime, are proposed. The first one exploits the fact that one of the solutions to save energy in WSN is to divide the networks into clusters depending on low energy and location of sensor nodes.

In this context, we propose a new energy-efficient hierarchical clustering scheme that update the election of cluster heads and the formation of clusters in setup phase to extend the network lifetime. Compared to the famous clustering protocol LEACH (Low Energy Adaptive Clustering Hierarchy), our proposed distributed clustering protocol

achieves better lifetime while guaranteeing more information messages reach the Base Station (BS). In our second contribution, we propose a new solution for sending messages between sensors in our proposed clustering scheme. Once deployed, after the formation of clusters in setup phase, the messages are compressed in the steady phase. Then, we propose a non-cooperative game theory based algorithm to control the energy consumed by the sensors in the network. This algorithm is called the Profitable Energy Market Game (PEMG) wherein each player has to decide if he wants to participate or to stay out of the market at each round. The market defines trading rules according to a strategy. In this work, the strategy has two actions: to enter the game or to stay out the game. Each player (i.e. sensor) calculates a payoff that can affect or be affected by the payoffs of other players (i.e. its neighbours). The payoff is a function of the sensor's residual energy. More precisely, the payoffs depend on the players' strategies that stay in the sleeping mode to charge their batteries or enter the game to transmit the sensing data messages. For each cluster, each sensor and its neighbours play this game theory to send messages. Our solution effectively reduces the number of dead sensors, prolong the network lifetime and achieves better performance in term of information arriving to the BS. The second part of this thesis is dedicated to recharge sensors' batteries by harvesting energy to increase the network lifetime. We introduce a controller to tune the energy harvesting and a controller to manage the energy in the sensor according to its activities needs. This new self-organization power system insures the prolongation of the WSN lifetime by rewarding the energy consumed and balancing the rest of energy in the sensors' batteries.

1.4. Organization of the manuscript

The rest of this thesis is organized as follows. In Chapter 2, we present the different architectures of WSN and we describe their applications. Then, in Chapter 3, we give details of energy consumption in WSN and we give a review of energy harvesting sources. In addition, we provide a comprehensive review on existing

energy saving mechanisms for wireless sensor networks. In Chapter 4, we present our hierarchical clustering approach based on low energy and location and we compare its performance against existing approach. Afterwards, in Chapter 5, we present our approach based on Game theory in our clustering hierarchy. In order to assess the efficiency of our proposed approach, we evaluate it by comparing our results with first proposed approach and other existing approach in terms of energy consumption, Network lifetime and packets information reached the sink. In Chapter 6, we propose a self-organized manager of energy to reward the energy consumed during the sensors' activities in the rechargeable batteries by harvesting energy from the sensors' environment. The results approve that the proposed self-organized manager of energy recompense the energy dissipated during the sensor's activities and give it more power to stay in life and achieve next activities. Finally, in Chapter 7, we conclude this thesis by providing a summary of our contributions, and discussing prospects for the future work.

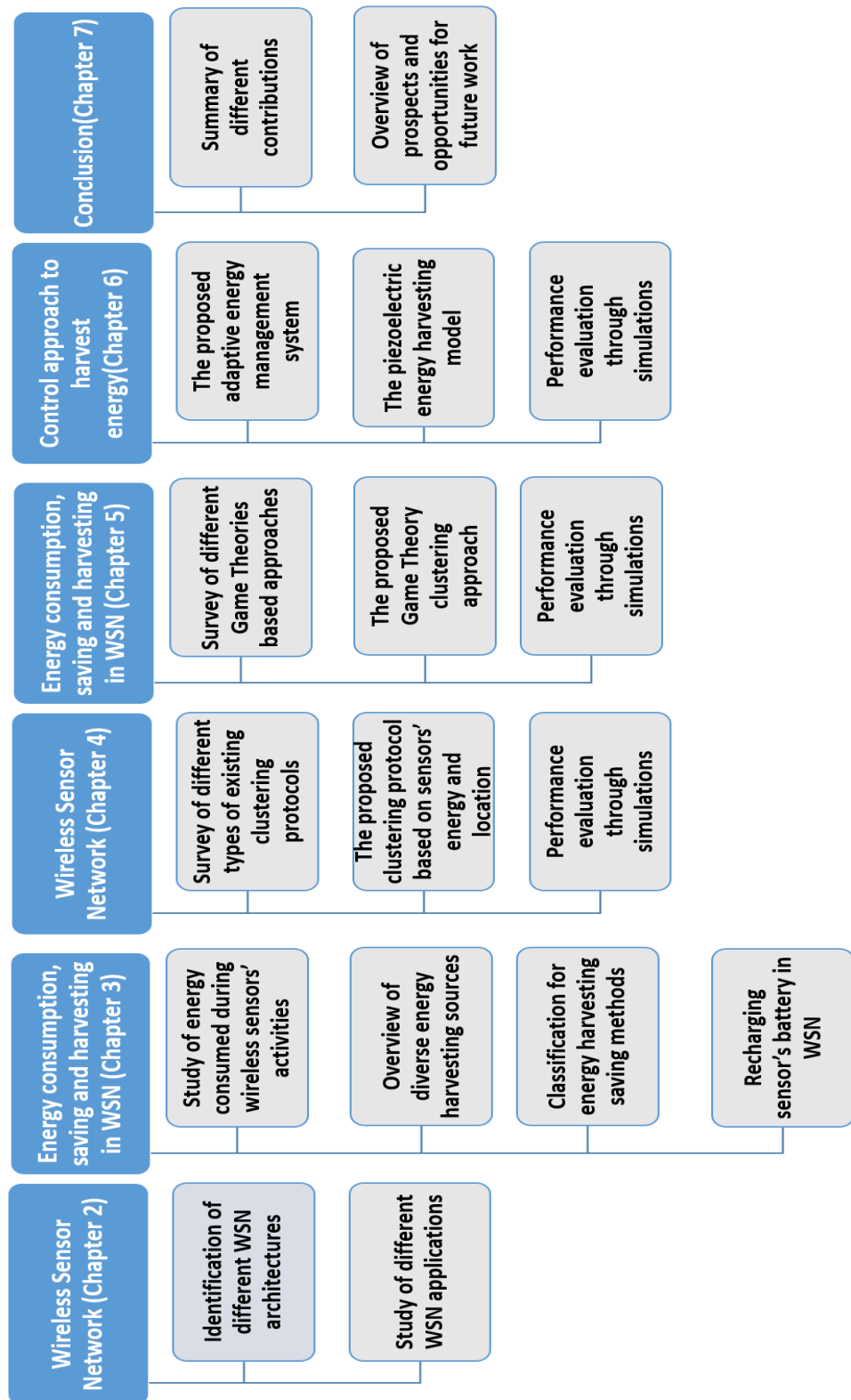

Figure 1.1: Overview of thesis organization

Chapter 2

Wireless sensors network

Contents | Chapter 2

2.1. Introduction	22
2.2. WSN architectures	23
2.2.1. Flat architecture	24
2.2.2. Hierarchical architecture	25
2.3. WSN applications	26
2.3.1. Smart cities	26
2.3.2. Environmental monitoring	27
2.3.3. Healthcare applications	28
2.3.4. Military applications	29
2.3.5. Industrial control	30
2.4. Conclusion	31

2.1. Introduction

A sensor node consists of four essential components : the sensing unit, the processing unit, the communication unit, and the power supply unit. The sensing unit includes one or several sensors equipped with analog-to-digital converters (ADCs) for data information collection. The ADCs convert the analog signals based on data information collection into digital units, which are then transmitted to the processing unit. The processing unit usually includes a microprocessor or a microcontroller (MCU) and a storage memory, which cooperate to process the sensed data from local environment. The communication unit consists of a radio model to perform data information transmission and reception over channels. The power supply unit includes one or more batteries to drive all components of the sensor node system with power. In addition, a sensor node can be equipped with other optional units depending on specific application requirements.

All the sensor node's units need to be fabricated in small modules with low energy consumption and low assembly cost. Figure 2.1 describes the structure of a typical wireless sensor node and interconnections between its components.

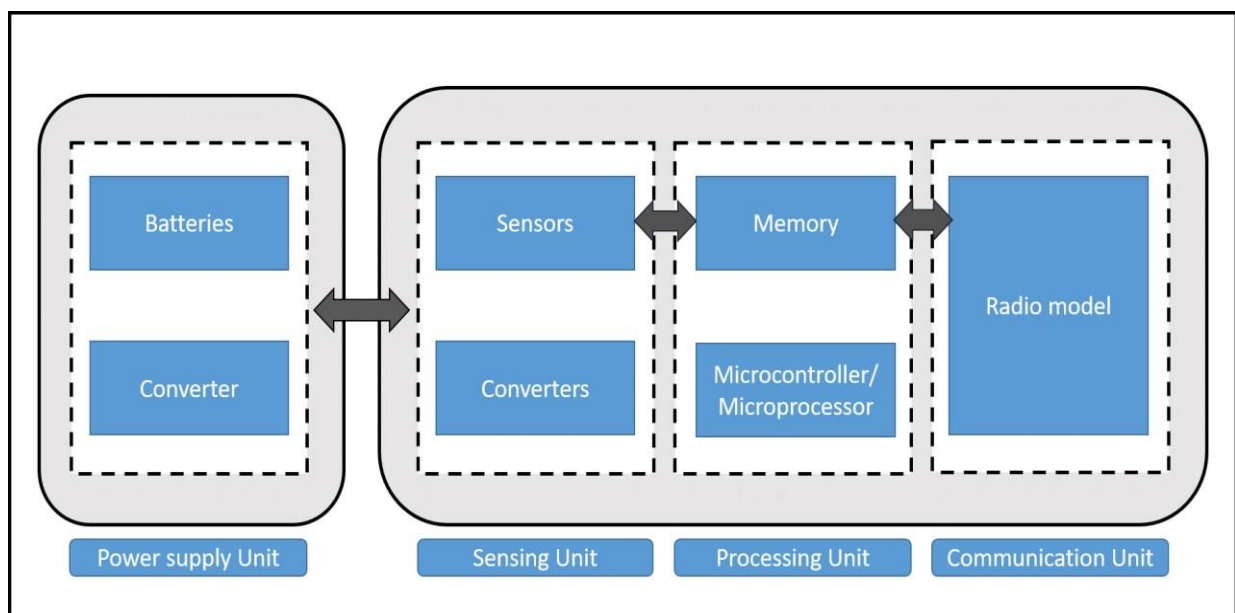

Figure 2.1: Sensor node structure

WSNs have interesting advantages that can not only reduce the cost and delay in development, but can also be applied to any environment, especially those that are not easily accessible by human. In this chapter, we introduce the different existing wireless sensor networks architectures and applications.

The rest of this chapter is organised as follows. In the next section, we provide the structure of typical sensor node and the fundamental concepts on wireless sensor networks architectures. Then, in Section 2.3, we present the main categories of applications we have identified and their respective requirements. Finally, Section 2.4 we summarize this chapter.

2.2. WSN architectures

Wireless sensor network widely consists of a large number of low cost sensor nodes deployed in an area of interest, and one or more sinks are located close to or inside the sensing area. WSNs can be classified into three types: homogenous, heterogeneous and hybrid sensors. For homogenous network, the sensor nodes have the same computational power and storage capacity. The heterogeneous network consists of sinks, normal sensor nodes and sophisticated sensor nodes with advanced abilities in terms of embedded processing, communicating capabilities as compared to normal sensor nodes.

To transmit data information to the base station or sink, each sensor node can use single hop long distance transmission. Nevertheless, long distance transmission is very costly in terms of energy consumption. Furthermore, the energy consumed to transmit data messages dominates the total available energy and grows exponentially with the increase of distance and reduces the network lifetime. In order to save energy and extend the operational network lifetime, the amount of transmission distance and traffic needs to be reduced. For this reason, researchers propose the multihop communication. In multihop communication, sensors transmit sensed data information toward the sink via one or more intermediate sensor nodes, which can reduce the energy consumed during communication activity. Meanwhile,

the sink can also work as a gateway to send relevant data information via internet to the users of this data information.

The architecture of a multihop short distance communication for wireless network can be organized into two categories : flat and hierarchical architectures.

2.2.1. Flat architecture

In a flat network, all the sensors are peers and have the same role in performing a sensing task. It is very difficult to assign a global identifier for each node due to the large number of sensor nodes in the network. Therefore, data gathering is usually accomplish using data-centric routing protocol. The sink plays the role of the coordinator that manage the transmission of data information. The sink transmits a message to all the sensors and only sensor nodes that have the data matching the message received will respond to the sink. The communication between each sensor node and the sink is based on multihop path and each sensor used its peer nodes as relays.

Figure 2.2.1 illustrates typically the flat network architecture.

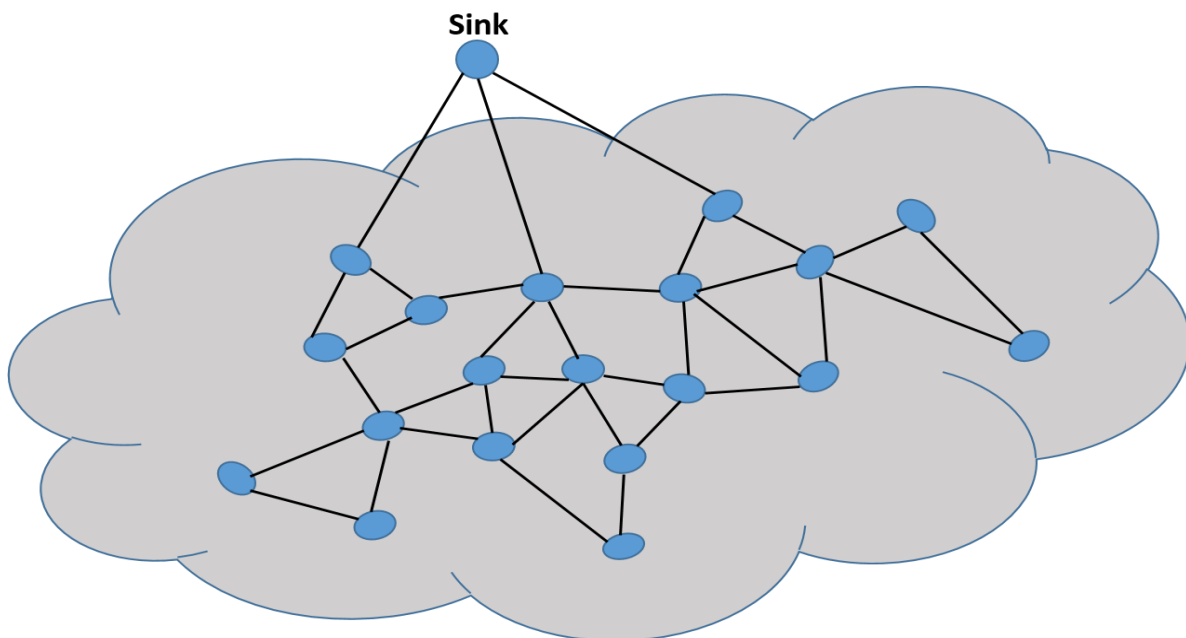

Figure 2.2: Multihop flat architecture

2.2.2. Hierarchical architecture

In a hierarchical network, the sensors are classified into clusters. The cluster heads organize the messages communication. Since the data aggregation in the hierarchical network involves data fusion at cluster heads, the number of redundant messages transmitted to the sink is reduced and the energy efficiency of the network is improved. The major problem with clustering is how to select cluster heads and to form clusters. In this purpose, there are many clustering strategies to select cluster heads and organize clusters. Figure 2.2.2 illustrates an example of hierarchical architecture.

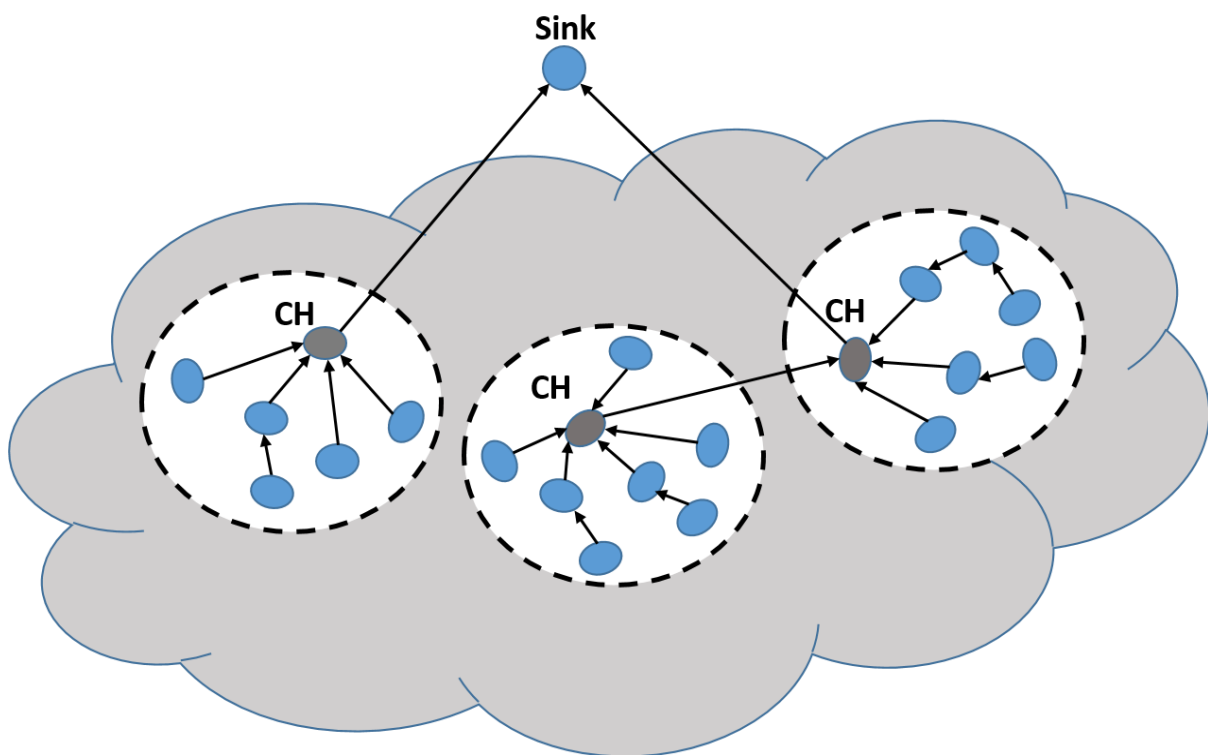

Figure 2.3: Hierarchical multihop clustering architecture

2.3. WSN applications

Wireless sensor networks have been one of the very important researched areas, which have attracted the researchers' attention. Wireless sensor networking

is an emerging technology that can be applied for potential applications in different domains. It can be used to monitor or detect different physical conditions and parameters such as humidity, temperature, rapidity, pressure, radiation, and so on.

Figure 2.3 shows a broad classification of WSNs applications in different disciplines.



Figure 2.4: Applications of WSNs

2.3.1. Smart cities

Big cities suffer from several problems including: high number of habitants, vehicles, and buildings and these issues need smart surveillance systems to provide high levels of security.

An approach to use cameras exploiting wireless sensor networks as surveillance systems to collect visual data from cameras is proposed. It is a controlled sink mobility algorithm that uses the RL of sensor nodes to calculate the position of a single sink in a WSN.

Due to the huge increasing of number of habitants in cities, security is one of the most significant need for smart cities from the citizens' point of view. The entire smart city has to be continuously monitored and observed to discover criminal acts, thefts and so on. Therefore, smart surveillance systems based on wireless sensor networks that have the ability not just to detect information but also have the ability of intelligent processing and alarm in case of any event of interest occurs.

With the rising of vehicular traffic around the world in urban areas, new traffic management solutions become a need to manage the traffic flows. It is visibly in our daily life through traffic snarl and increasing number of accidents. Therefore, Wireless sensor networks based intelligent transportation systems are deployed. This technology enables a new broad range of smart city applications around urban sensing including traffic safety, traffic jam control, road state monitoring, vehicular warning services, speed control and parking management.

2.3.2. Environmental monitoring

The development of environmental monitoring system has rapidly grown in agricultural monitoring, indoor monitoring, greenhouse monitoring, climate monitoring and forest monitoring. Environmental monitoring applications are the first ones that have been advanced for wireless sensor networks.

For security indoor environment, wireless sensors for safety in living monitoring have become one of the main preferences for people. Implemented wireless sensor network for security system using Bluetooth technology consists of relay control nodes and a control system that can be placed in an area in a building. The sensor and relay nodes can detect the events that happened and report collected information to the control nodes. Then, control nodes send detected information to alert the local security control system. In addition, wireless home security system is also designed to detect any intruder in houses and buildings. It uses motion sensor as the sensor node. When the motion sensor detects an intruder, it sends a report to the end node. The end node is linked with an interface between user and system. A new architecture

of WSN with UC Berkeley motes sensors nodes was proposed for real world habitat monitoring.

For greenhouse monitoring, wireless sensors network is used to measure and monitor environmental parameters including temperature, humidity, light. The system collects, sends and controls the parameters information automatically and it is proven that the performance of the system is efficient as the user can collect high precision data of the environment without any disturbance. The implementation of greenhouse environment monitoring based on ZigBee wireless sensor network in [30] use analysis and experimental test methods to ensure the system efficiency. It collects the humidity, temperature and carbon dioxide concentration, which are the parameters of greenhouse environmental parameters, and demonstrate the nodes and network coordinator communications perform network stabilization, and compliance between theoretical data and real situations.

In forest, Wildfire monitoring with WSN are used to predict future forest incidents, to tracking a fire in temporal evolution. WSN measure the amount of CO and H₂ in air, relative humidity, pressure, light intensity, and other environmental parameters. A combination of developed ZigBee-WSN-based multi-sensor system (smoke sensor, CO sensor, temperature sensor, relative humidity sensor) and an Artificial Neural Network have been developed to identify the different fire conditions in real time.

2.3.3. Healthcare applications

WSNs can be used to track patients' healthcare purposes. Indeed, in healthcare applications, sensors are used to monitor patients' body temperature, brain activity, muscle motions, to capture data information during daily life or extended stays in hospital or to track the health of patients at home by using embedded technology. In addition, WSN allows access to patient information everywhere and on real-time.

A hospital care base on wireless sensor networks have the access to detect the patient's data at any point in time without the need for doctors or nurses to be present physically in the patient's room to examine the readings.. The network nodes can be

interfaced to different vital sign sensors like electrocardiograms, blood pressure, and heart rate and so on. The sensor node can initiate a reading, collecting data and forwarded the data to the base station. They are connected to a graphical user interface to store and display data on the base station server. A technological platform PlalMoS that includes WSN to transmit data about blood oxygen, respiration rate, and galvanic resistance via a serial link was created to monitor cardiovascular and respiratory variables.

Home healthcare can replace the social and financial burdens especially for an aging population.

WSNs can be installed in a patient's home environment to achieve the home healthcare by acquiring physiological and behavioral data information from patients for diagnosis, monitoring, or chronic disease management in real time.

2.3.4. Military applications

WSN is introduced in defense applications and it can play a big role for different military purposes such as detection and tracking of enemy movements, force protection, and urban warfare.

WSNs can be useful for defense purposes. Those types of applications are very important in military perspectives. The deployment of sensors in low-flying airplanes or drones that can collect information from the surrounding area of war zone when the airplanes or drones land and approach from the earth. After detecting data information, wireless sensors send data to a powerful base station located inside the plane. Data are gathered and analysed by the BS and determine strategic information such as type and number of tanks in the battlefield, number of militaries, elevation of ground, and types of hiding spaces such as bunkers. These information messages are very important to be ready to defend against a threat or a danger.

In addition, Wireless sensors are not expensive. Therefore, the damage of some nodes by hostile actions in the battlefields may not affect a military operation. The structures of robustness, selforganizing and fault tolerance make sensor networks

suitable for military use. The butterfly surveillance system is developed to monitor the enemy arms as missiles and aircrafts in which the mobile WSNs are linked to the cloud computing. This mobile WSN performs the parameter estimation for effectively pointing out the enemy movements. In addition, Sensors can be also used to detect biological and chemical attacks. Trace detection sensors can collect information and alert soldiers about bombs, explosive materials and so on. For this reason, this technology is very important to prevent attacks and save the life of people and save buildings from damage in the urban warfare.

2.3.5. Industrial control

WSNs have a huge application in industrial fields. It can be deployed in industry to monitor and control manufacturing processes, and equipment.

Industrial automation systems have become more and more common in industries and factories and they play an essential role to provide the dynamic link between control systems and the physical world. Due to the employment of a huge variety of wireless industrial sensor networks with their geographical distribution over factory or industry, the capability to communicate and control data information have become more sophisticated and easy ranging from low-level to high-level control. For example to ensure the efficient operation for pipes and systems, heat tracing wireless sensor network is used to keep pipes within a particular temperature range. WSNs can also be deployed to monitor the execution of process periods in industrial deployments by providing the operator with means to adapt process parameters on demand.

In addition, WSNs can be applied in the Machine surveillance and maintenance field. Wireless sensors can be deployed for condition-based maintenance of machines exploiting the ability of local data processing and providing monitoring data in real time in order to enhance the utilization and lifetime of the monitored equipment.

2.4. Conclusion

In this chapter, we have introduced the Wireless Sensor Networks, where we have presented the different architectures. In addition, we have presented the applications of WSNs in various domains, which is why it is important at this time to implement WSNs. In next chapter, we introduce the energy consumed during communication between sensors in wireless networks and we present different methods to harvest energy to recompose the energy consumed in WSNs.

Chapter 3

Energy consumption, saving and harvesting in WSN

Contents | Chapter 3

3.1. Introduction-----	34
3.2. Energy consumption in Wireless Sensor Networks -----	34
3.3. Energy harvesting sources-----	36
3.3.1. Light power-----	37
3.3.2. Kinetic power -----	37
3.3.2.1. Electromagnetic energy harvesting-----	38
3.3.2.2. Electrostatic energy harvesting-----	38
3.3.2.3. Magnetostrictive energy harvesting-----	38
3.3.2.4. Piezoelectric energy harvesting-----	39
3.3.3. Thermal power-----	40
3.3.4. Human-body based energy harvesting-----	41
3.4. Energy harvesting saving methods-----	41
3.4.1. Topology control-----	42
3.4.1.1. Clustering protocols-----	43
3.4.1.2. Mac protocols-----	43
3.4.1.3. Routing protocols-----	44
3.4.1.4. Control of radio model transmission-----	46
3.4.2. Data reduction-----	46
3.4.2.1. Data compression -----	46

3.4.2.2. Data aggregation-----	47
3.4.2.3. Network coding-----	48
3.4.2.4. Adaptive sampling data -----	48
3.5. Recharging sensors' battery in WSN-----	48
3.6. Conclusion-----	50

3.1. Introduction

In recent years, Wireless Sensor Networks (WSNs) have been considered as one of the most attractive technologies due to development of sensor devices for different domain's applications. In addition, wireless sensors are not high cost and can be deployed in inaccessible environments. Therefore, this technology make monitoring and controlling easier especially in the hostile areas. However, WSN consists of a large number of sensor nodes with limited power capabilities, limited storage capacity, limited energy supplied, and multiple on-board sensors that can take readings, such as temperature, pressure, humidity and so on. Sensor nodes are typically equipped by batteries, which are limited in energy capacity. In addition, wireless sensors are mostly deployed in inaccessible or polluted environments where replacement batteries is very difficult or even impossible. For this purpose, there is a need for efficient power saving mechanisms to decrease the energy consumption for sensor nodes and to prolong the network lifetime.

The rest of this chapter is organized as follows. Section 3.2 is dedicated for energy consumption in Wireless Sensor Networks. Then, in Section 3.3, we give an overview of the different existing sources of energy harvesting. Section 3.4 provides a variety of power saving mechanisms conducted by researchers. Finally, Section 3.5 summarizes this chapter with a brief discussion of future works.

3.2. Energy consumption in Wireless Sensor Networks

WSNs have primary goal of transmitting data information from sensor nodes to the sink node effectively. The energy consumed in WSNs is due to different activities namely sensing data, data processing, data communication, and microcontroller (MCU) switching.

Sensing energy consumption

The sensing energy cost depends on the type of sensors. For example, the temperature sensors consumed less important energy than gas sensors. The sensor

node can contain diverse sensors, and each one has its individual energy consumption attributes. Generally, the sensing energy consumption for a S_i can be expressed as follows:

$$E_s = L(S_i) \times V_{dc} \times I_{sens} \times T_{sens} \quad (1)$$

where I_{sens} is the needed amount of current, and T_{sens} is the duration to detect and collect $L(S_i)$ bits data information.

Processing energy consumption

The sensor consumes energy to read the data message and to write it in its memory. The processing energy consumption could be calculated by:

$$E_p = \frac{L(S_i) \times V_{dc}}{8} \times (I_{Write} \times T_{Write} + I_{Read} \times T_{Read}) \quad (2)$$

where I_{Write} and I_{Read} are the necessary amount current to write and read one byte data. T_{Write} and T_{Read} are the necessary duration to treat the $L(S_i)$ data information.

Communicating energy consumption

The energy consumed to transmit and receive (S_i) is computed following the first-order wireless communication model for the radio hardware illustrated in figure 3.2.

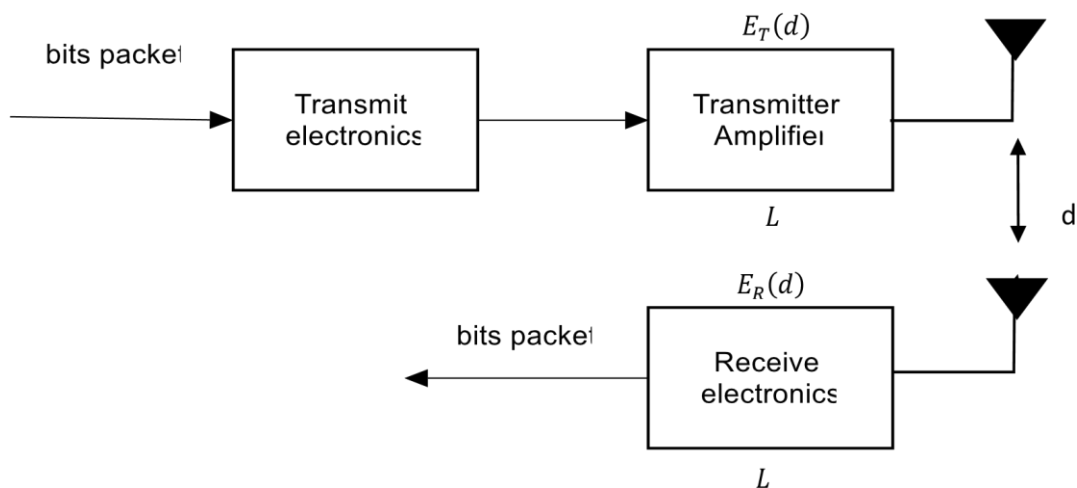

Figure 3.1: First-order wireless communication radio model

Transmitter expends energy to run the radio electronics and the power amplifier. The necessary energy required to transmit (S_i) bits data message is:

$$E_{T_i} = \begin{cases} L(S_i) \times E_{elec} + L(S_i) \times E_{fs} \times d^2 & \text{when } d < d_0 \\ L(S_i) \times E_{elec} + L(S_i) \times E_{mp} \times d^4 & \text{when } d > d_0 \end{cases} \quad (3)$$

where E_{elec} represents the energy consumed to transmit or receive 1 bit message, the constants E_{fs} and E_{mp} depend on the transmitter amplifier model. E_{fs} is for the free space model, E_{mp} is for multipath model, d is the transmitter receiver distance and d_0 is a threshold distance calculated as follows :

$$d_0 = \sqrt{E_{fs}/E_{mp}} \quad (4)$$

and the energy consumed by the radio to receive $L(S_i)$ bits data information is defined by:

$$E_{R_i} = L(S_i) \times E_{elec} \quad (5)$$

Switching the microcontroller (MCU) mode energy consumption

The sensor wastes energy by switching between the MCU modes. In this paper, we just take in consideration the active mode and the sleeping mode. The energy cost for the computational MCU mode can be expressed as :

$$E_{Switch-Radio} = \frac{V_{dc}}{2} \times (I_{st_j} - I_{st_i}) \times T_{st_{i,j}} \quad (6)$$

3.3. Energy harvesting sources

With the extensive improvements in the domain of wireless sensor networks, some applications necessitate a long lifetime for the sensor nodes. An alternative type of power source to rechargeable batteries can be considered. This process helps in providing unlimited energy for the lifespan of the electronic device. Therefore, the

process of extracting energy from the ambient environment and converting it into consumable electrical energy is identified as energy harvesting or power scavenging.

Due to the fact that the WSN lifetime varies proportionally with the residual energy in sensors' battery, researchers have hardly worked in the generation of electrical power by scavenging ambient energy from the environment. There are different types of energy harvesting and researchers have proposed generators of Energy Harvesting technologies. The electrical energy required to run different sensors' devices can be obtained by tapping the environmental light, kinetic, thermal, electromagnetic and human body energy harvesting. Small devices like wireless sensors can capture this energy and stock it in their rechargeable batteries to ensure the continuity of sensors' activities.

3.3.1. Light power

Radiant energy is harvested from the sun and from radio frequency waves, for both indoor and outdoor systems. In recent years, energy harvesting from radio frequency and sunlight has been sightseen widely in an attempt to utilize this source of energy to power wireless sensor networks for environmental monitoring applications. Light energy can be converted into electrical energy using photovoltaic cells (PV). The type of energy exploited is usually light energy obtained from sunlight or artificial lights. With respect to solar energy harvesters, Maximum Power Point Tracking (MPPT) is designed to maximize the amount of power harvested from solar cells.

3.3.2. Kinetic Power

Ambient mechanical power can be obtained from different sources such as wind, continual vibrations from industrial machines, and ocean waves. This energy can be converted into electrical energy and can be considered as sufficient solutions for low duty-cycled communications. Mechanical energy can be converted to electrical energy using various mechanisms: Electromagnetic energy harvesting,

electrostatic energy harvesting, magnetostrictive energy harvesting and piezoelectric transduction.

3.3.2.1. Electromagnetic energy harvesting

EMEH includes collecting radio frequency (RF) signals emitted from base stations, network routers, smartphones, and any other sources by using large aperture power receiving antennae, and converting the attained waves into utilizable dc power. Their performance strongly depends on the RF-to-dc conversion efficiency and the amount of power received by the antennae. Although this method is a reliable solution unaffected by the environmental variables, providing relatively low power densities, necessitating close deployment to the network transmitters, and requiring additive components, such as filters and voltage multipliers can be counted as its main shortcomings. Moreover, in case the nodes are sparsely deployed, available energy to be harvested may be too low, which might limit the use of EM EH. Due to the abundance of EM propagation in urban areas, RF EH is mostly preferred to operate IoT-assisted Smart City services.

3.3.2.2. Electrostatic energy harvesting

This type of harvesting is based on the changing capacitance of vibration-dependent varactors i.e. variable capacitor. Vibrations separate the plates of an originally charged varactor, and mechanical power is converted into electrical power. Electrostatic transducers are mechanical devices that can produce electricity by using manual power. There are three types of electrostatic generator which are : in-plane overlap, in-plane gap closing and out-of-plane gap closing.

3.3.2.3. Magnetostrictive energy harvesting

Magnetostrictive harvesters electrical energy from vibration sources in two steps:

First step: Mechanical energy is transferred to magnetic energy via the magneto-mechanical coupling of magnetostrictive materials;

Second step: Magnetic energy is converted to electrical energy via the electromagnetic coupling on electrical circuits.

Magnetic field (M-field) EH is based on coupling the field flow around the ac current carrying conductors that is clamped by current transformers. This technique is able to provide an adequate rate of continuous power so long as current flow in the line is sufficient. As the amount of current on power distribution level is considered, M-field EH stands as the best candidate for the energization of high power requiring IoT networks. However, gathering energy from a high current carrying asset in close proximity to the harvester in a safe way is still a challenging issue. To mitigate the safety concerns, M-field-based methods need to be equipped with advanced protection and control mechanisms. This issue compels their utilization in terms of circuit complexity and implementation flexibility.

3.3.2.4. Piezoelectric energy harvesting

Piezoelectric materials can convert mechanical energy from vibrations or force into electrical energy. These materials have the ability to generate electrical charge when a mechanical load is applied on them. The property of piezoelectric materials is used by the researchers to develop different piezoelectric harvesters in order to power wireless sensors to achieve their various applications.

Table 3.1: Comparison of the different kinetic types of harvesting energy

Technique type	Advantages	Disadvantages
<input type="checkbox"/> Electromagnetic	-Strong coupling -No smart materials	-Difficulty to be integrated by small Wireless Sensors -Low voltage generated
<input type="checkbox"/> Electrostatic	-Compatible with manufacturing	-Voltage source or load Required -Mechanical constraints required

	Wireless Sensors -Strong tensions generated	-Capacitive
<input type="checkbox"/> Magnetostrictive	- High coupling - No depolarization - Flexibility	- Difficult small Wireless Sensor integration - fragility - nonlinear Effects - Possible need for magnets polarization
<input type="checkbox"/> Piezoelectric	Compact -Compatible with integration small Wireless Sensors -Strong tensions generated -Strong coupling for single crystals	-Depolarization -Fragility of the piezo layers -High impedance

3.3.3. Thermal Power

The phenomena of creating electric potential with a temperature difference and vice-versa can be termed as thermoelectricity. Here, the thermal energy is scavenged to obtain electrical energy to power the electronic devices. Thermoelectric devices are primarily used in space and terrestrial applications. Thermoelectric generation (TEG), is based on converting temperature gradients into electrical power with respect to the seeback effect occurred in semiconductor junctions. TEG is an innate power provision technique for smart grid communications, in which temperature

swings between the power line and the environment is used to extract energy. In small scale, Peltier/thermoelectric coolers and thermocouples are widely used for building delay tolerant wireless indoor networks. Although harnessing power from temperature gradients sounds promising, there is a fundamental limit, namely Carnot cycle, to the maximum efficiency at which energy can be harvested from a temperature difference.

3.3.4. Human body-based energy harvesting

Human body based on WSN have received a lot of attention. In these networks, sensor nodes are deployed on or inside of the human body to monitor health evaluation and bodily parameters continuously. Due to their positioning in humans, the nodes need to be operational for long periods of times and preferably for the lifetime of the humans being monitored. Thus, energy can be harvested from humans in different ways, such as through locomotion or changes in finger position, and blood flow and temperature gradients between the warmer body core and colder areas beneath. Human body-based energy harvesting can be widely considered as activity based harvesters and natural physiological parameters based harvesters.

3.4. Energy harvesting saving methods

Energy efficiency is of primary important factor affecting the individual node and the entire network operational lifetime.

Energy harvesting is an emerging and reasonably mature technology to overcome the limited lifetime of battery-operated wearable devices and allows continuous recharging of the energy storage during use. The sources Energy harvesting has a big future to power autonomous sensors and insure the continuity of their activities. For this reason, researchers proposed different types of batteries to store energy harvesting as rechargeable batteries, fiber supercapacitors made of Nanowire-Fiber hybrid structures for wearable/flexible energy storage, Above-IC Microbattery, Hybrid

Nanogenerator. We review the major existing approaches proposed to tackle the energy consumption problem of battery-powered motes. Figure fig. 3.2 presents the classification of energy efficiency saving mechanisms in WSNs.

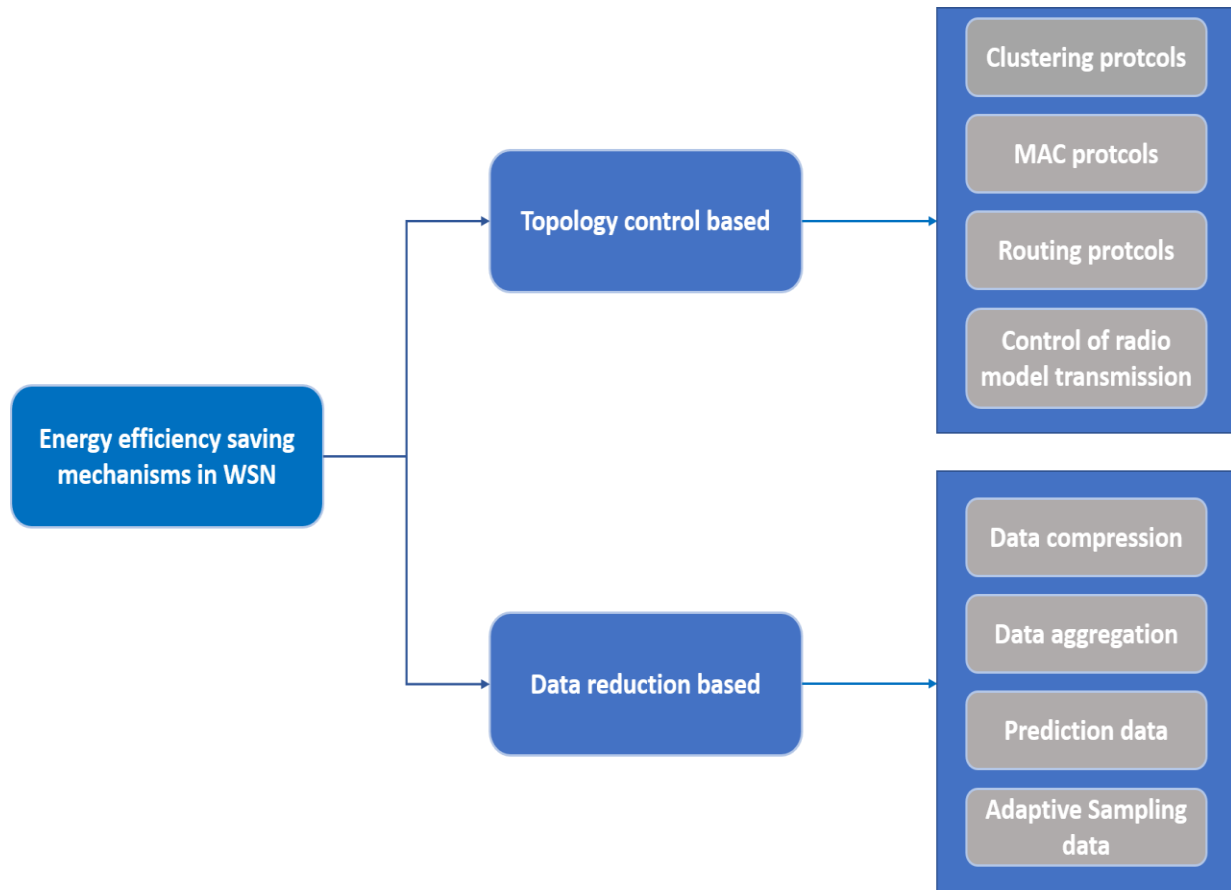

Figure 3.2: Different energy saving mechanisms in Wireless Sensor Networks

3.4.1. Topology control

One of the most important technique used in wireless sensor networks to manage the energy consumption of the WSN energy is Topology Control (TC). We can classify Topology Control (TC) methods in four categories: clustering protocols, MAC protocols, routing protocols and control of radio model transmission.

3.4.1.1. Clustering protocols

Cluster architectures aim to organize the network into clusters. Each cluster is coordinated by a selected node known as the Cluster Head (CH). The CH is responsible for managing the cluster members' activities and communicating with other CHs to transmit data information to the base station (BS).

Clustering protocols have been proposed to improve energy efficiency. They can limit energy consumption via different incomes:

- 1) they reduce the communication range inside the cluster which requires less transmission power;
- 2) they limit the number of message transmissions thanks to fusion performed by the CH;
- 3) they reduce energy-intensive operations such as coordination and aggregation to the cluster head;
- 4) they enable to power-off some nodes inside the cluster while the CH takes forwarding responsibilities;
- 5) they balance energy consumption among nodes via CH rotation.

In addition to energy-efficiency, cluster architectures also improve network scalability by maintaining a hierarchical network.

3.4.1.2. MAC protocols

Various MAC protocols aim at the enhancing energy efficiency of the wireless network. We can classify MAC protocols in three main categories.

- TDMA-based: for this category of protocols, time is divided into slots distributed among the sensor nodes. Each slot represented an interval of time to send or receive data information. This technique ensures a collision free medium access to sensor nodes. It is suitable for periodic traffic. TRAMA is the earliest proposed traffic-adaptive TDMA-based protocol. For each time

slot, one transmitter within two-hop neighbors is selected based on a distributed algorithm. Time is divided into a random access period to compete for slots and a scheduled access period. FLAMA [56] is derived from TRAMA and dedicated to data gathering applications. FLAMA avoids the periodic information exchange between two-hop neighbors by transmitting upon request only.

- Contention-based: S-MAC tries to force neighbor nodes to adopt the same active/sleep schedule. For that purpose, neighbor nodes exchange their schedules using SYNC messages sent in the first subperiod. The second subperiod is dedicated to data exchange. However, listen and sleep periods of the protocols cannot be varied after node deployment. For this end, T-MAC enhances SMAC by allowing nodes to sleep again if no message has been received for a specified duration. The motivation of D-MAC is to guarantee that all nodes on a multihop path to the sink are awake when the data delivery is in progress. D-MAC schedules the active/sleep period based on its depth on the forwarding tree. To reduce synchronization overhead, asynchronous sleep/wakeup schemes are based on periodic listening. In B-MAC, nodes wake up to check the channel for activity and remain active only for a short duration in the absence of traffic.
- Hybrid: This type of protocols switches between TDMA and CSMA protocols to accommodate to variable traffic patterns. One of the most known is Z-MAC protocol. It runs CSMA in low traffic and switches to TDMA in high traffic conditions.

3.4.1.3. Routing protocols

Many routing protocols have been proposed to balance energy consumption so as to extend the WSN lifetime. Energy efficiency routing protocols have been designed with the target of maximizing network lifetime by minimizing the energy consumed by the end-to-end transmission and avoiding nodes with low residual energy. Some protocols use geographical coordinates of nodes to build a route

toward the destination. Others build a hierarchy of nodes to simplify routing and reduce its overhead. Finally, data centric protocols send data only to interested nodes in order to spare useless transmissions.

- Hierarchical based: Hierarchical based routing techniques have advantages in scalability and efficient communication. In addition, the concept of hierarchical routing is also used to perform energy-efficient routing in WSNs. In a hierarchical architecture, higher energy sensor nodes can be used to transmit data information, while low energy sensor nodes can be used to perform the sensing in the proximity of the target to conserve energy in the network. The formation of clusters and assigning special responsibilities to cluster heads can significantly contribute to overall network scalability, energy efficiency and lifetime. CHs selection is based on sensor node location and its current residual energy. This approach is efficient in terms of energy dissipation, the number of packets received by the BS and the network lifetime. This approach is more efficient than the known protocol LEACH protocol in terms of energy, number of packets received by the BS and the network lifetime.

- Data centric or flat routing based: These protocols are query-based and depend on the naming of their data attributes, which help in removing many redundant transmissions. The sink transmits queries to certain areas and waits for data information from the sensor nodes located in the particular areas. Since data information is being requested through queries, attribute-based naming is necessary to specify the properties of data information. Nodes route any data packet by looking at its content. In the literature, two approaches were proposed. The first one is Sensor Protocol for Information via Negotiation (SPIN) where any node advertises the availability of data and waits for requests from interested nodes. The second is Directed Diffusion (DD) in which sinks broadcast an important message to sensor nodes and only concerned nodes response with a gradient message. Hence, both interest and gradients establish paths between sink and concerned sensor nodes.

- Geographical and energy based: Geographic and Energy Aware Routing (GEAR) protocols use energy-aware and geographically informed neighbor selection

heuristics to route a packet toward the destination area. The important idea is to limit the number of interests in directed diffusion by only considering a certain area rather than sending the interests to the whole network. GEAR can save more energy than directed diffusion. Each node in GEAR keeps an estimated cost and a learning cost of reaching the destination through its neighbors. The estimated cost is a combination of residual energy in sensor battery and distance to destination. The learned cost is a refinement of the estimated cost that accounts for routing around holes in the network. A hole occurs when a node does not have any closer neighbor to the target region than itself. If there are no holes, the estimated cost is equal to the learned cost. To conserve more energy, some location-based schemes enable nodes to go to sleeping mode if there is no activity. More energy savings can be obtained by having as many sleeping nodes in the network as possible.

3.4.1.4. Control of radio model transmission

Extending the WSN lifetime can be achieved by reducing the transmission power of sensors. The radio component is the focal module that causes the consumption of energy in the battery of sensor nodes. To decrease energy waste due to wireless communications, optimizations of radio parameters such as coding and modulation schemes, power transmission and antenna are proposed.

3.4.2. Data reduction based

This category aims to reduce the amount of data messages to be delivered to the BS. This category covers the limitation of unnecessary samples and the limitation of sensing tasks because both data transmission and acquisition consume energy. We can classify data reduction techniques in four types.

3.4.2.1. Data compression

This type of protocols encodes information in such a way that the number of bits needed to represent the initial message is reduced. It is energy-efficient because it

reduces transmission times as the packet size is smaller. However, existing compression algorithms are not applicable to sensor nodes because of their resource limitations. Therefore, specific techniques have been developed to adapt to the computational and power capabilities of wireless nodes. Data compression methods contain distributed and local data compression approaches. Figure 3.3 summarizes data compression approaches.

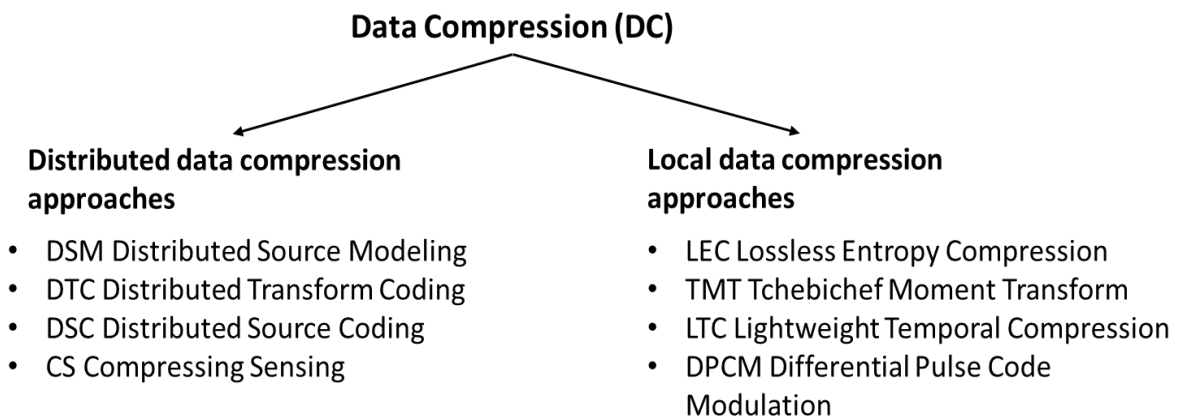

Figure 3.3: Classification of Data Compression approaches (DC)

3.4.2.2. Data aggregation

The attentiveness to data aggregation techniques has increased recently. Data aggregation method is one of the factors, which can influence the energy consumed in WSN. In data aggregation structures, nodes along a path towards the sink perform data fusion to reduce the amount of data forwarded towards it. A node can retransmit only the average or the minimum of the received data. Moreover, data aggregation may reduce the latency since it reduces traffic, thus improving delays. However, data aggregation techniques may reduce the accuracy of the collected data. Indeed, depending on the aggregation function, original data may not be recovered by the sink, thus information precision can be lost.

3.4.2.3. Network coding

These methods are used to decrease the traffic in broadcast scenarios by sending a linear combination of different packets instead of a copy of each packet. Data compression (DC): These techniques encode data information in such a way that the number of bits required to represent the initial message is reduced. This type of DC is energy-efficient because it can reduce transmission times as the packet size is smaller. Data Compression can be divided in two categories: Distributed data compression and local data compression approaches.

3.4.2.4. Adaptive sampling data

The sensing task can be energy-consuming and may generate unneeded samples which affects communication resources and processing costs. Adaptive sampling techniques adjust the sampling rate at each sensor node while ensuring that application requirements are met in terms of coverage or data information precision. In human activity recognition applications, adjust the acquisition frequency to the user activity is proposed that may not be necessary to sample at the same rate when the user is sitting or running.

3.5. Recharging sensors' battery in WSN

In the last few years, researchers have proposed different methods to increase the WSN lifetime via energy saving approaches as presented in section III. The main goal of these methods is saving energy, during the communication between sensors, without compensation for the energy dissipated via scavenging ambient energy. In this section, we provide recharging batteries based on energy transferred techniques. Figure fig. 3.4 shows the two approaches to recharge wireless human body sensors' batteries.

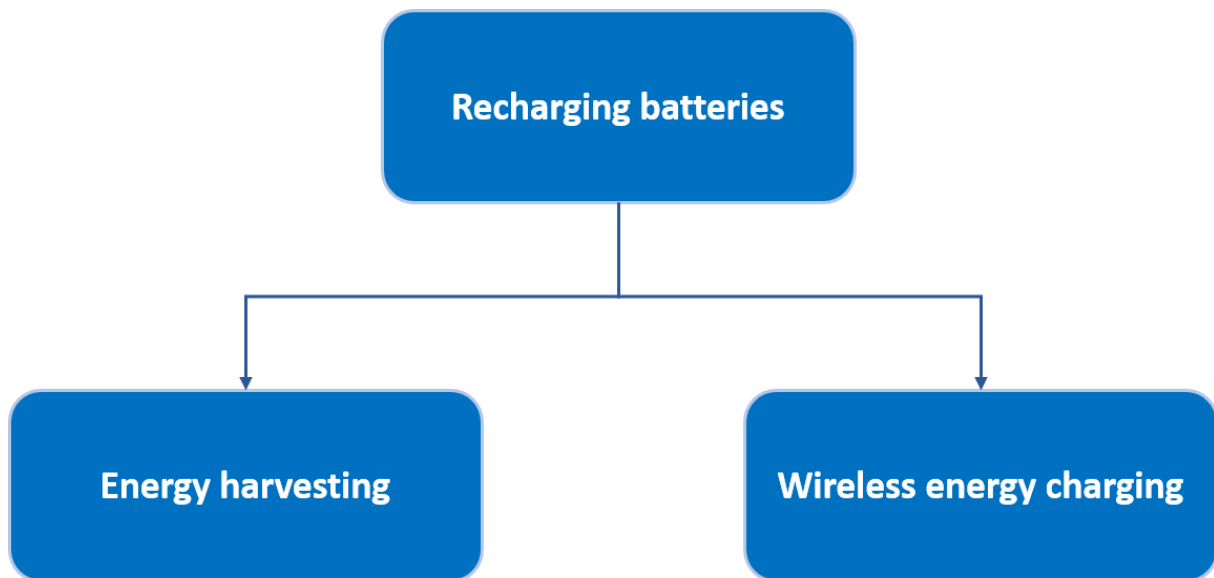

Figure 3.4: Classification of recharging batteries techniques for WSNs

Recharging batteries methods have extensively attracted the attention of researchers. These two approaches can recharge the battery of WSNs without any human intervention.

- **Energy Harvesting:** In human body networks, wireless sensor nodes are deployed on or inside of the human body to monitor health evaluation and bodily parameters continuously. Due to their positioning in humans, the nodes need to be operational for long periods of times and preferably for the lifetime of the humans being monitored. Thus, energy can be harvested from humans in different ways, such as through locomotion, blood flow as kinetic power by piezoelectric technique [21] and temperature gradients between the warmer body core and colder areas beneath by thermoelectric generation technique [22]. Human body-based energy harvesting can be widely considered as activity-based harvesters and natural physiological parameters based harvesters. It is essential to note that sensor nodes are considered as energy constrained even during energy harvesting process, so they still require adopting energy conserving approaches.

- **Wireless energy charging:** The widely development of wireless energy transfer is anticipated to increase the sustainability of WHBSNs. Therefore, wireless energy transfer can be perpetually operational, because these techniques can be utilized to transmit power between wearable devices and can power implantable sensor nodes without any information exchange between sensor nodes and the Base Station (BS). Wireless energy charging in WHBSNs can generally be obtained by electromagnetic (EM) radiation and magnetic resonant coupling methods. However, magnetic resonant coupling emerges to be the most promising technique to address energy requirement of WBSNs, because of its high efficiency at extended distance. One of the actual challenges raised by wireless energy charging technologies is energy cooperation, because it is very vital to transfer energy to neighboring nodes. In future, wireless sensor nodes are intended to have the capacity to harvest energy from the environment and to be efficient in multi-hop energy transferring to other sensor nodes that cannot harvest energy from their environment, to build an autonomous network.

3.6. Conclusion

The availability of different sensor devices allows a variety of applications to emerge. However, the problem of energy limits the activities of sensors. In this chapter, we have presented different energy harvesting sources. In addition, we have summarized different techniques that tackle the energy efficiency challenge in WSNs and classified them in two major main classes as shown in Figure 3.2. In next chapter, we present our works that proposed new protocol based on energy efficiency mechanisms.

Chapter 4

Low energy adaptive clustering protocols in WSN

Contents | Chapter 4

4.1. Introduction-----	52
4.2. Related work-----	52
4.2.1. Centralized clustering-----	52
4.2.2. Distributed clustering -----	53
4.3. Low energy adaptive clustering protocols in WSN-----	54
4.4. Low energy and location based clustering protocol in WSN-----	57
4.5. Simulation results-----	61
4.6. Conclusion-----	67

4.1. Introduction

WSN workload needs an unlimited lifetime energy without depending on a limited energy usage while sensor nodes are supplied by batteries or supercapacitors with limited energy. Particular algorithms must be employed so that energy consumption is reduced. In this paper, clustering protocols are investigated and a new approach based on clustering protocols is proposed to increase the lifetime of the wireless sensor network. Simulation results show that its performance is better in terms of prolonging the lifetime of the network and increasing the number of data packets received by the Base Station (BS).

4.2. Related Work

Clustering has proven to be an effective approach of broadcasting for organizing the network and prolonging its lifetime. Selection of cluster heads (CHs) play an important role in energy consumption management. We can classify clustering protocols into two categories: centralized and decentralized clustering algorithms.

4.2.1. Centralized clustering techniques

In centralized clustering techniques, the BS is the organizer to form clusters. At the start of each round, sensors nodes have to transmit their location information and energy status to the BS. The BS will collect all information from all the sensors nodes in the network, select Cluster Heads (CH), and form clusters. This type of clustering is not a very suitable way to do clustering for a large number of sensors or large network wide.

For example, BCDPC (Base-Station Controlled Dynamic Clustering Protocol) is a centralized clustering protocol with a unique BS that is capable of complex computation, the CHs are selected by the BS randomly and all the routes and paths for transmission and reception of data information are selected by the BS. Each node needs to transmit data messages regarding its location and residual energy to the BS

during the formation of clusters. Therefore, BCDCP increases the design complexity and the energy consumption of the nodes in the large-range networks. BCSP (Base station Centralized Simple Clustering Protocol) is a protocol where in the BS does not collect any information about location of the sensor nodes but utilizes information about remaining energy of each sensor node and the number of CHs depending on the circumstance of the sensor network. Each node should send its current energy information along with the sensing information, increasing the overhead. The drawback of this protocol is that due to its centralized implementation, it is not so appropriate for sensor networks with a large number of nodes. In addition, without any location information, BCSP cannot guarantee a uniform distribution of CHs nodes and their clusters.

4.2.2. Distributed clustering techniques

Distributed clustering techniques eliminate the need of a centralized station to create CHs and clusters. The low energy and hierarchical structure models are generally used to create clusters and select CHs in two levels. At the first level, there is a selection of CHs and at the second level, the data messages are transferred by sensor nodes to BS via CHs. BS just receives messages and does not control the creation of clusters. EEMDC (Energy Efficient Multi level and Distance aware Clustering) is that extends the WSN lifetime while providing more stability and reliability to the network. This routing protocol splits the network area into three logical layers. After the partition of the network area, the hotspot problem is fixed, the distance between the nodes and the CH and between the CH and the BS are taken into account when considering the hop-count value of the nodes. In addition, CHs are elected by acquiring the average leftover energy of the nodes, and the data messages are delivered to the BS using the shortest distance path to the BS. ICCBP (Inter Cluster Chain Based Protocol) is a new clustering algorithm that uses multi-hop and intra-cluster communication with updating CHs when the existing CHs dissipate their energy. A new structure to construct clusters and establish connections between sensors is proposed. In this protocol, the distance between CHs depends on a

threshold calculated by the signal message transmission to insure the connections between clusters. In addition, this protocol creates a virtual wireless sensor networks.

4.3. Low energy adaptive clustering protocol in WSN

LEACH (Low-Energy Adaptive Clustering Hierarchy) protocol is a decentralized clustering protocol based on the homogeneous WSNs. Its first phase consists in grouping sensors into clusters. LEACH is a dynamic clustering method that update clusters and head clusters (CH) each round. Each round starts with a setup phase and finishes with steady state. In the setup phase, it rotates the CHs role among all sensor nodes to expend energy uniformly. Each sensor will pick a random number between 0 and 1. If this number is less than a threshold $T(n)$ that will be defined the sensor node becomes a CH for the current round. The threshold is set as follows:

$$T(n) = \begin{cases} \frac{p}{1 - p \left(r \times \text{mod} \frac{1}{p} \right)}, & \text{for } n \in G \\ 0, & \text{Otherwise} \end{cases} \quad (7)$$

where p is the cluster head probability in the network, r is the current round of election and G is the set of nodes that were not cluster head in the last round. The behavior of (n) is illustrated in Fig. 4.1:

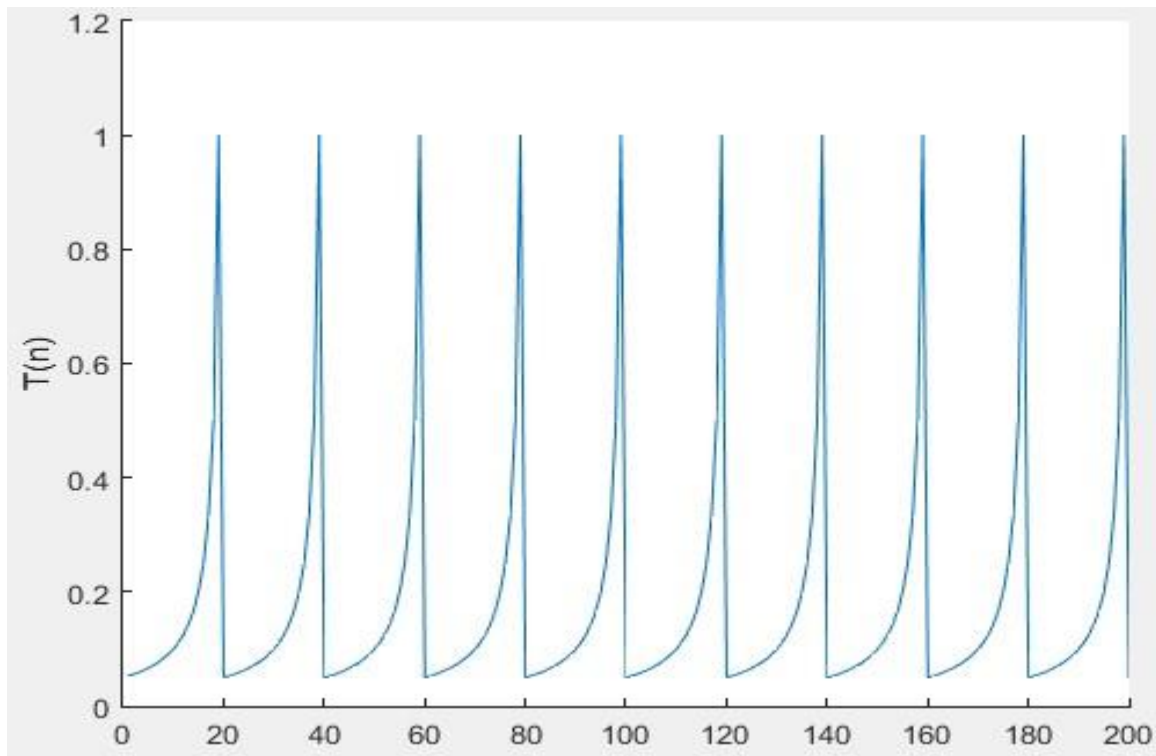

Figure 4.1: Thresholds for 200 rounds

when $r = 0$, each node has a possibility of p to become a CH. If it is selected as a CH node in the first r rounds, it cannot be re-elected before $\left(\frac{1}{p} - r\right)$ rounds which enhances the chance of other nodes to become CHs. After $\left(\frac{1}{p}\right)$ rounds, all nodes have a probability of p to be a CH once again, over and over again.

In this protocol, the selection of CHs is the main task. However, if a CH is out of energy, all the nodes in its cluster will not be able to communicate with the BS. Each node has a chance to be selected as a cluster head according to equation (1) but no optimization in terms of energy consumption is considered. The method to optimize the CH probability applied is as follows:

$$p_{opt} = \begin{cases} \frac{\frac{D_{Max}}{D_{toBS}} \times \sqrt{\frac{n}{2\pi}}}{n} & \text{for } D_{toBS} \leq d_0 \\ \frac{\frac{D_{Max}}{D_{toBS}} \times d_0 \times \sqrt{\frac{n}{2\pi}}}{n} & \text{for } D_{toBS} > d_0 \end{cases} \quad (8)$$

where p_{opt} is the expected optimal CH probability, n is the initial number of sensors nodes, D_{toBS} is the distance between each sensor node and the BS, D_{Max} is the maximal distance between all sensor nodes, and d_0 is a threshold distance defined by:

$$d_0 = \sqrt{\frac{E_{fs}}{E_{mp}}} \quad (9)$$

where E_{fs} and E_{mp} depend on the transmitter amplifier model; E_{fs} is for the free space model and E_{mp} is for multipath model. According to the formula mentioned in [16], the optimal probability for nodes to become cluster heads chosen in this article is 5%. It is worth to note that LEACH protocol do not provide an efficient energy optimization solution. It does not have a strategy to specify CHs positioning and distribution. The random selection of CHs may cause higher communication overhead for the nodes when they communicate with their corresponding CHs and between CHs and the BS. In the steady phase, clusters are formed and CHs are selected. CHs collect all data information from nodes in their cluster, compress it and transmit it to the BS. Other nodes cannot communicate directly with the BS, they transmit their data information to their CHs. In next rounds, the CHs will be re-elected and clusters will be formed again.

4.4. Low energy and location based clustering protocol in WSN

A new approach based on LEACH protocol with a new strategy based on location and residual energy of a sensor node to select the CHs is proposed. In our work, we consider that the sensors are heterogeneous, not mobile and randomly distributed in the network. In our designed WSN, we use the following uniform random distribution algorithm to deploy the nodes in the sensing area.

$$S(i, X) = \begin{cases} \frac{1}{Width}, & \text{for } 0 \leq X \leq Width \\ 0, & \text{for } 0 \geq X \text{ or } X \geq Width \end{cases} \quad (10)$$

$$S(i, Y) = \begin{cases} \frac{1}{Length}, & \text{for } 0 \leq Y \leq Length \\ 0, & \text{for } 0 \geq Y \text{ or } Y \geq Length \end{cases} \quad (11)$$

where $S(i, X)$ and $S(i, Y)$ are the probability density of the coordinates x and y for sensors nodes in the network area. The sink or the BS is unique, fixed at the center of the network and has a continual energy.

Each node has an initial energy:

$$E_0(i) = \alpha \times E_0 \quad (12)$$

where $E_0(i)$ is the initial energy of sensor $S(i)$, α is a random value between 0 and 1, and E_0 is an initial energy value (see table 4.1). The protocol is divided into two phases. The first one consists of selecting CHs and the second one concerns the formation of clusters and the transmission of data information to the sink (i.e., BS). Each cluster has a unique CH that can be changed after each round epochs.

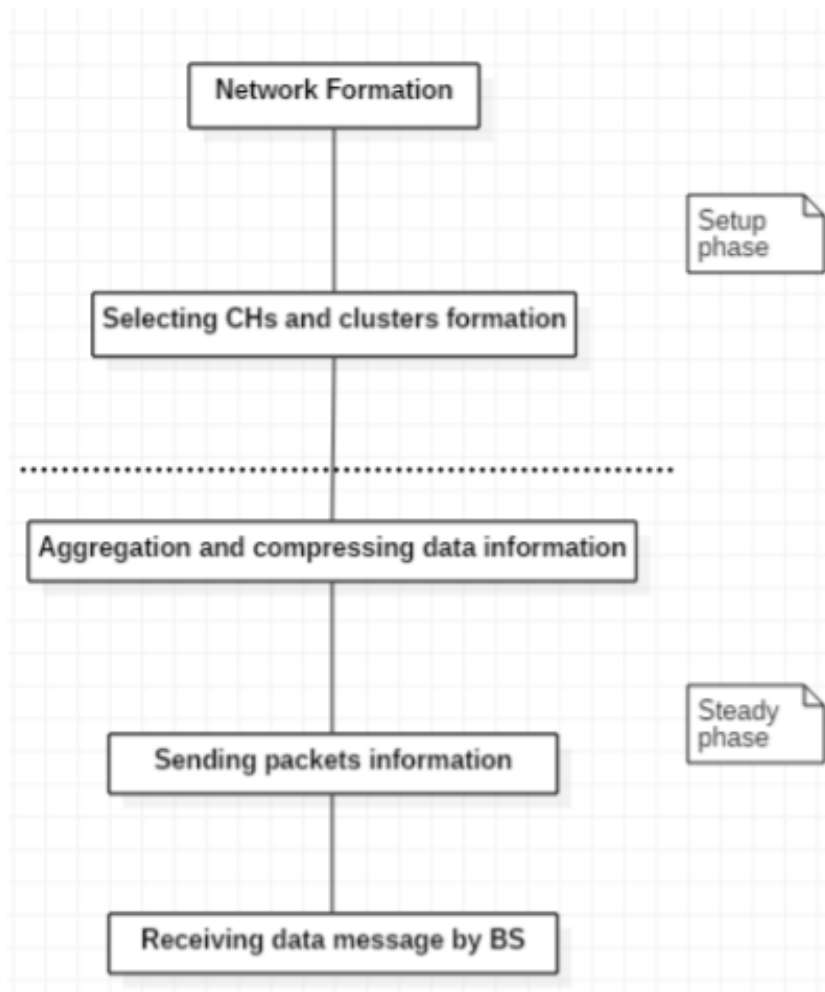

Figure 4.2: Clustering phases

It should be noted that in LEACH protocol, nodes initially have the same energy. Selection CHs is very important to maximize the lifetime of the network. CHs have an important role that they are the sensors that collect all data messages from all their dependent nodes to compress them and send them to the BS in the second step. Their role needs more energy than other sensors that they just send or receive messages from their sensors neighbors and will not communicate with the BS. If all CHs are dead, the network is dead even if sensors have energy to communicate and if just one CH is dead and it is not replaced by another sensor node, the BS cannot receive any information from all the nodes in its cluster. The selection of CHs affects the network lifetime and the packets messages received by the BS. For these

reasons, we propose an approach to the selection of CHs. It is different from LEACH that cannot ensure real load balancing in the case of heterogeneous sensor nodes with different amounts of initial energy. CHs are selected periodically in terms of probabilities without any energy considerations, sensor nodes that have a lower initial energy will be selected as CHs for the same number of rounds as other sensor nodes and will die prematurely. We select CHs without using randomized rotation of the cluster heads. For the setup phase, our approach has been performed based on a hybrid combination of two steps to select periodically CHs and form clusters. The first step depends on the node's residual energy, and the other one depends on the sensor node location.

First step to select CHs based on distance

The distance plays an important role in the CHs selection. A large number of CHs in a network exhausts the energy rapidly and reduces the network lifetime. For a round, if the current sensor is far from all current CHs, this sensor node cannot send any message to any CHs, it will not be in any cluster group and the BS cannot receive any information from CHs about this node. For this issue, we consider that if the distance between current sensor and all other CHs is higher than a distance D which is the minimum distance between the CHs, sensor node could become a CH.

Second step to select CHs based on energy consumption

The second step is about the current sensors' energy in a current round. For LEACH, the nodes with low remnant energy have the same priority to be a CH as the node with high remnant energy. For an iteration, if the residual energy of current sensor is less than the sufficient energy to transmit a data information to the BS, it stills can be selected as a CH despite the fact that it cannot play its role. In addition, replacing a dead sensor by the selection of another CH next round, conducts the network to a waste of energy and a short lifetime of the network. Therefore, we take into consideration the residual energy for each sensor node. If the residual energy for a

sensor node is higher than the sufficient energy to transmit a number of data to the BS, it could be selected as a CH.

$$E(i) > \beta \times E_{toSink} \quad (13)$$

Where (i) is the current energy of the sensor (i) , β is a coefficient that we will explain it and E_{toSink} is the sensor energy sufficient to transmit a data information to the BS. To determine β_{opt} , we suppose that the ideal network is when the initial energy for each sensor is sufficient to let the sensor in life and in work for a number maximum fixed of rounds. For a current round, if the current energy of the sensor is sufficient to send a number of data messages to the BS for the rest of the life of the network, the current sensor is selected to be a CH as follows:

$$\beta_{opt} = \frac{(r_{max} - r)}{\left(r_{max} \times \frac{E_{toSink}}{E_0(i)}\right)} \quad (14)$$

where r_{max} is the maximal number of rounds or the lifetime of the network and r is the current round. Our approach considers the both parameters distance and residual energy. In a current round, the distance between current sensor node and other CHs should be higher than D and its residual energy should be higher than its proportional initial energy. If the two conditions are satisfied, the sensor node can be a CH. In the second-step, sensors transmit and receive messages according to the first-order wireless communication model for the radio hardware energy dissipation. Transmitter dissipates energy to run the radio electronics and power amplifier. Energy required to transmit L bits data message is:

$$E_T(i) = \begin{cases} L \times E_{elec} + L \times E_{fs} \times d^2, & \text{if } d < d_0 \\ L \times E_{elec} + L \times E_{mp} \times d^4, & \text{if } d > d_0 \end{cases} \quad (15)$$

where $E_T(i)$ is the sensor energy consumption to transmit L bits message, E_{elec} represents the energy consumed to transmit or receive 1 bit message, d is the

distance between the transmitter and receiver, the threshold distance d_0 . The energy required by radio to receive L bits data information is defined as:

$$E_R(i) = L \times E_{elec} \quad (16)$$

where $E_R(i)$ is the sensor energy consumption to receive a L bits data message. The radio parameters used during simulation are mentioned in table 4.1. Our approach, CHs selection and clusters formation depend on the distance between sensor and other CHs selected in the previous round and by considering the current sensor energy. After the selection of CHs, these CHs inform all other nodes that they are elected as heads. Then each node non-CH will decide to be in the cluster of the CH that is less furthest from its location.

4.5. Simulation results

For performance evaluation, we have implemented LEACH and our improved protocol. We run the simulations to compare the performance of these protocols on the basis of energy consumption, packet received by the BS and the lifetime of the network.

In our experiments, we used 100 sensors nodes heterogeneous with different initial energy. There are two types of sensors nodes; nodes with high energy and nodes with less energy. These sensors nodes are randomly distributed in 100×100 network. The BS is located at the middle of the graph. Each data message was 4000 bits long. The basic parameters used in the simulation are listed in Table 4.1.

Table 4.1: Simulation parameters

Parameter	value
Network area (m2)	100×100
BS location	(50, 50)
Sensor nodes n	100

Initial energy (J) E_0	0.5
E_{elec} (nJ/bit)	50
Parameters of amplifier energy Consumption E_{mp} (pJ/bit/m4) and E_{fs} (pJ/bit/m2)	0.0013 and 10
Data aggregation energy (J)	5×10^{-12}
Size of data packet (bits) L	4000
Round epochs r_{max}	1000, 5000
Proper percentage of CH nodes (%) p	5
Distance (m) D	10
Threshold Percentage (%)	30

Figure 4.3 shows the state of the network after 1000 rounds with different states of the sensors nodes.

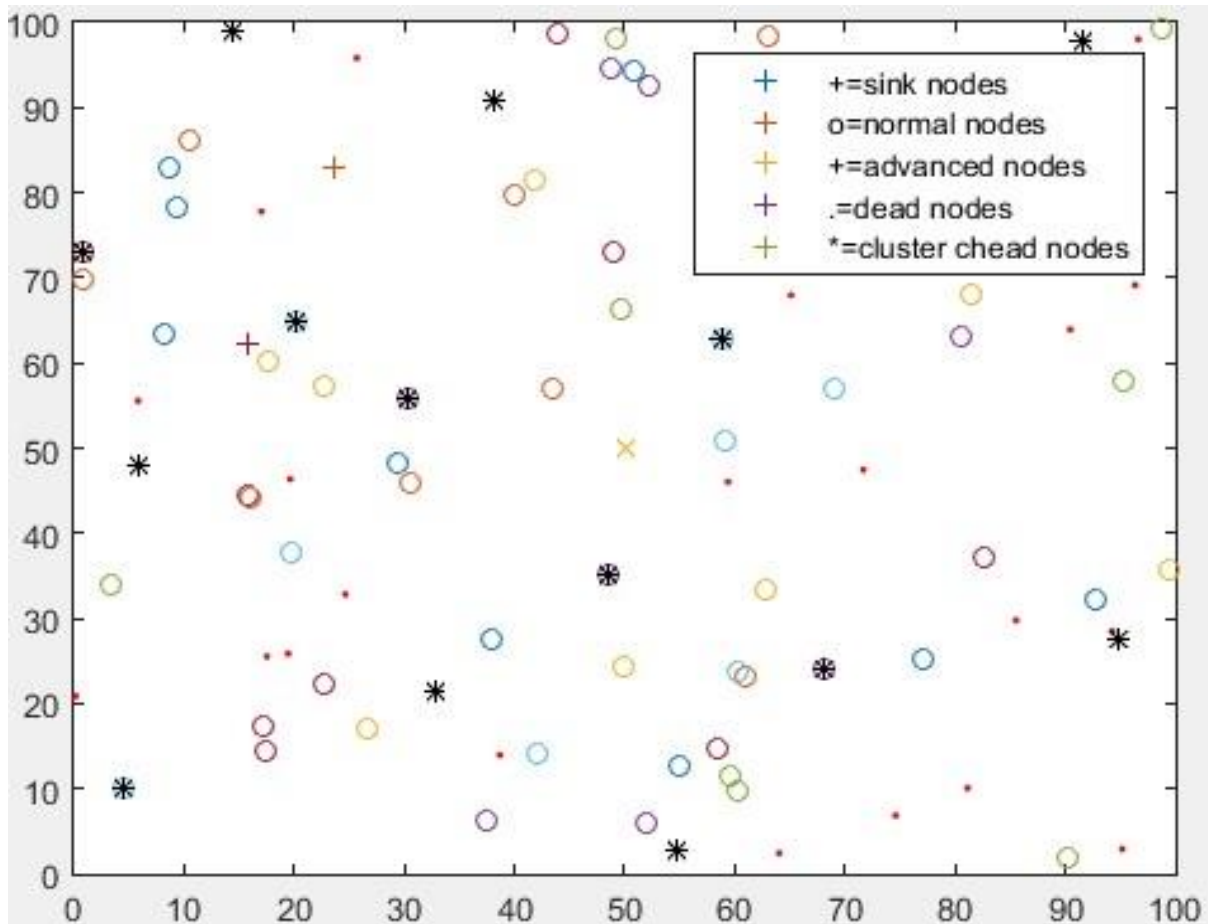

Figure 4.3: States of 100 nodes after 100 rounds

The energy consumption for all the network is calculated as follows:

$$E_c(r) = \sum_{i=1}^n E_0 E(i, r) \quad (17)$$

where $E_c(r)$ is the energy consumption of the network in round r and it is equal of the difference between the sum of initial energy of each sensor node and the sum of the residual energy of each sensor node in current round. Fig. 4.4 shows that LEACH protocol consumes more energy in comparison with our adaptive protocol. The difference of energy consumption between these protocols is caused by the selection strategy of cluster head.

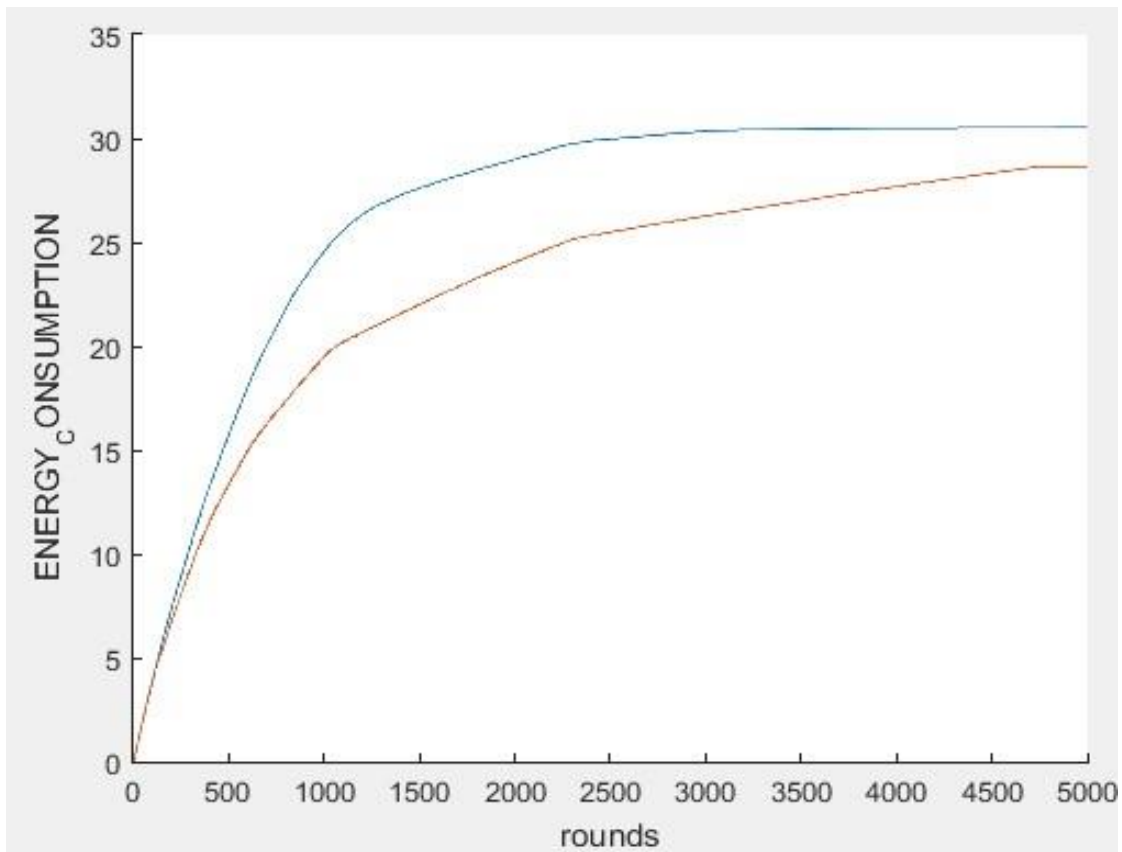

Figure. 4.4: Energy consumption for LEACH protocol and our adaptive protocol

Fig. 4.5 and 4.6 show that the number of packets received by the BS in LEACH and our protocol. Our protocol achieves higher data delivery compared to LEACH for 1000 rounds. In addition, the lifetime of the network for LEACH protocol is about 1000 rounds; the BS does not receive anymore packets as shown in fig. 4.4. Despite the fact that the network does not consume all its initial energy, the network is dead. For our protocol, the network lifetime of the network is extended beyond 5000 rounds as shown in fig. 4.6. The network lifetime is increased beyond four times better than LEACH protocol.

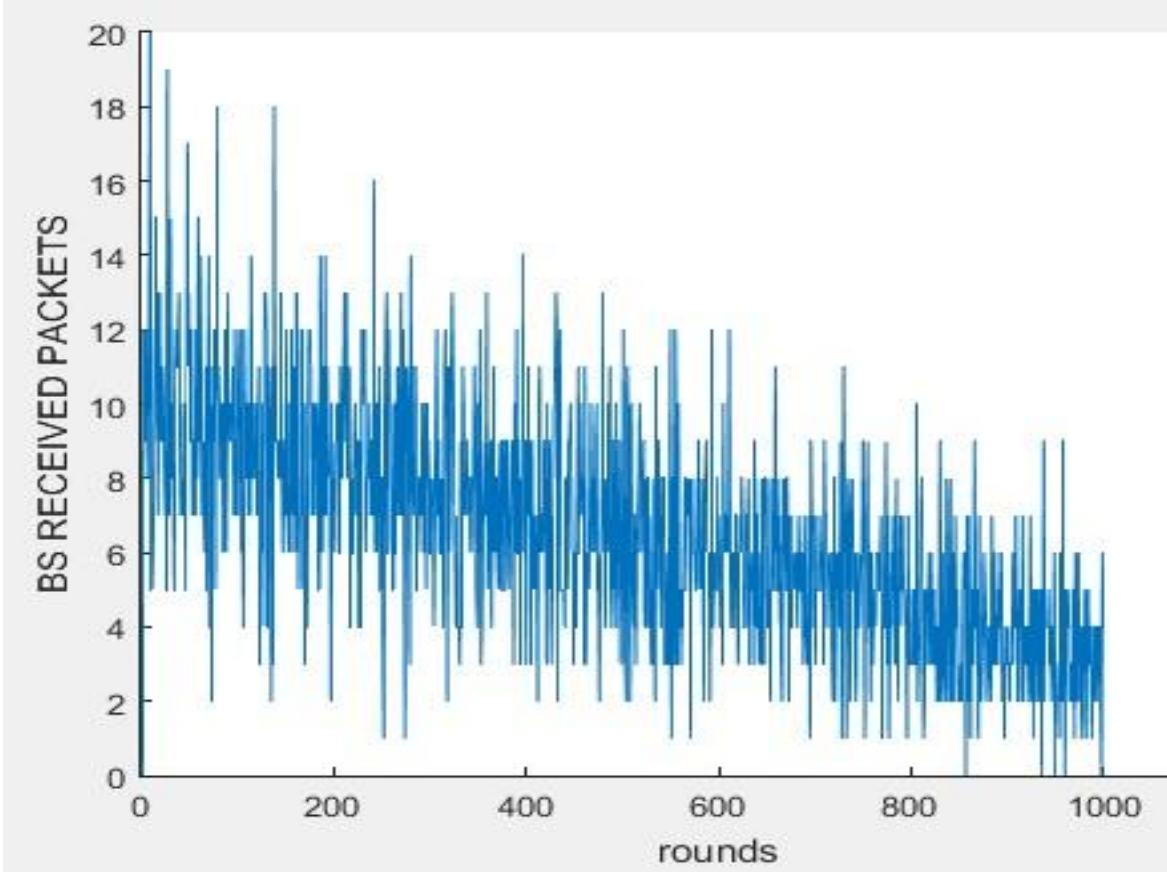

Figure. 4.5: Packets received by BS in LEACH Protocol for 1000 rounds

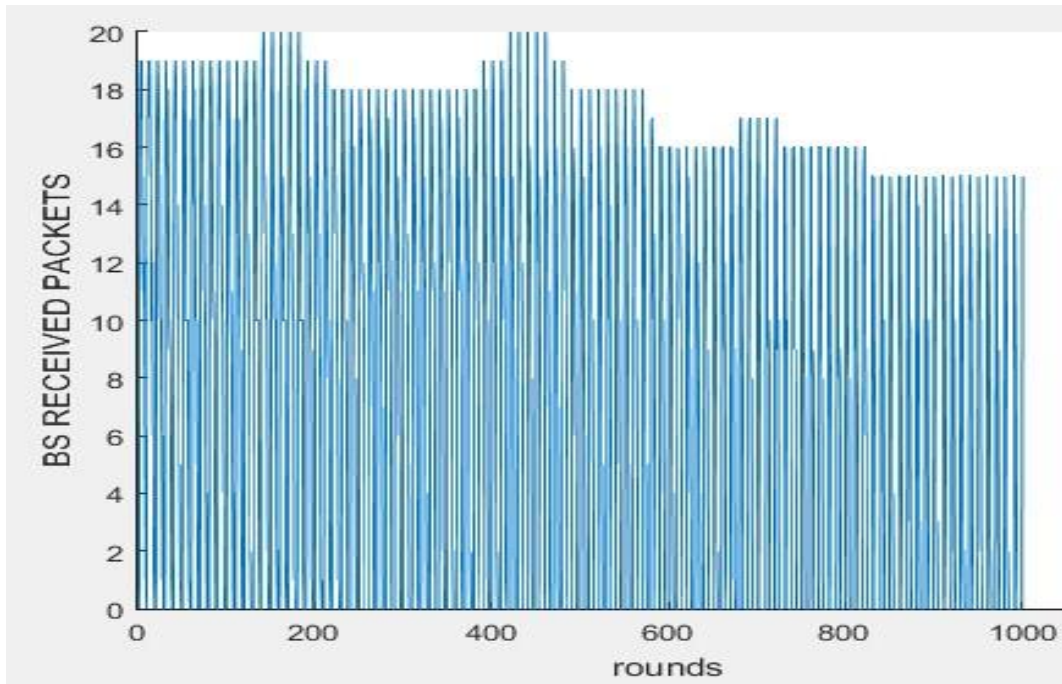

Figure. 4.6: Packets received by BS in our adaptive protocol for 1000 rounds

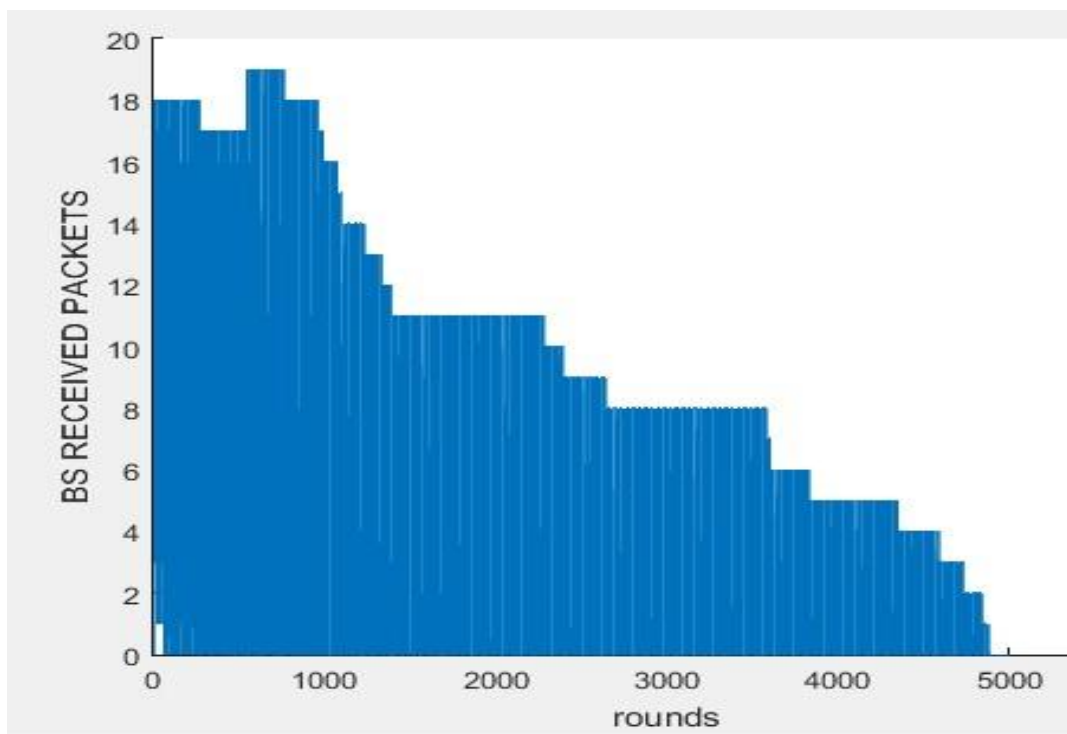

Figure. 4.7: Packets received by BS in our adaptive protocol for 5000 rounds

4.5. Conclusion

A new adaptive approach for clustering in WSN is proposed. CHs selection is based on sensor node location and its current residual energy. This approach is efficient in terms of energy dissipation, the number of packets received by the BS and the network lifetime. The simulation results show that our approach prolongs the network lifetime about four times better than LEACH protocol and the number of packets received by the BS is more important than in LEACH protocol. In next chapter, we propose an extension for this protocol to prolong the network lifetime, limit the dead nodes and to ameliorate the data packet transmission performance.

Chapter 5

Energy saving with a Game Theory based approach in WSN

Contents | Chapter 5

5.1. Introduction-----	69
5.2. Related work-----	69
5.2.1. Cooperative game theory based approach-----	70
5.2.2. Non-cooperative game theory approach -----	70
5.3. Game theory based distributed clustering approach to maximize WSN lifetime-----	71
5.4. Performance evaluation-----	84
5.5. Conclusion-----	88

5.1. Introduction

One of the most significant difficulty in Wireless Sensors Network (WSN) is the development of an effective topology control method that can support the quality of the network, respect the limited memory and at the same time increase the lifetime of the network. This chapter introduces a new approach by mixing a non-cooperative Game Theory technique with a decentralized clustering algorithm presented in chapter 4 to address the problem of maximizing the network lifetime. More precisely, this approach uses Game Theory techniques to control the activities of a sensor node and its neighbors to limit the number of the forwarding messages and to maximize the lifetime of the sensor's battery. In other words, the approach will decrease the energy consumed by the WSN by decreasing the number of forwarded packets and improve the network lifetime by harvesting energy from the environment. The simulations results show that the performances in terms of energy saving and increasing the number of data packets received by base station outperforms those with distributed based clustering algorithms without GT, such as low energy and location based clustering LELC and LEACH algorithms.

5.2. Related work

The Game Theory (GT) is extensively applied in economics to maximize the outcomes by using the mathematical models such as the strategic game theory for the differential information economy which players suggest net trades and prices [8]. In the recent years, GT is increasingly applied in WSN for different objectives, such as communication security, energy efficiency, control power transmission, data collection and pursuit evasion [9] [10] [11] [12]. In this section, we review the GT used to enhance the energy conservation and extend the network lifetime. The GT can be classified in two top main categories: cooperative and non-cooperative games.

5.2.1. Cooperative game theory based approach

To decrease the energy consumed in the network, some sensor nodes cooperate to form coalitions. The coalitional game is considered as one of the most significant type of cooperative game theory. A power control game theoretic model is proposed to optimize the trade-off between energy consumption, and data packets transmission performance. It takes in consideration the individual utility of each sensor player. A novel approach is proposed to identify the overlapping community form in social networks. This approach is based on the shapely values mechanism. It activates with a weight function to find the stable coalitions of underlying community form of the network. The shapely values and the weight function are updated by the community detection algorithm using the local information. Another type of cooperative game is the bargaining game theory. To achieve the two opposite objectives, which are prolonging the WSN lifetime and maintaining the quality of the sensors' activities in parallel, a Kalai-Smordinsky Bargaining Solution is used to find the best distribution among coalition members.

5.2.2. Non-cooperative game theory based approach

For the non-cooperative game theory, sensor nodes react selfishly to preserve their residual energy by refusing to receipt a data information and forward it in multi-hop network. The optimal responses for energy efficient non-cooperative game theoretic are obtained when each sensor player improves its strategy to maximize its utility, given the strategies of other sensors players. A non-cooperative game theory model is proposed to control the transmit power levels and the Nash Equilibrium solution exists and attained according to the channel condition and power level. In addition, a non-cooperative game theory is used in the election of the CHs for the clustering model in the literature. In this game model, the sensor node decides to declare itself as a CH or not by calculating the optimal probability in the mixed strategy that depends on the maximizing of its payoff.

In addition to the non-cooperative and cooperative game theories, the repeated game theory is involved with a class of active games, in which a game is played for several times and the players have the ability to spot the result of the preceding game before attending the upcoming repetition, a control scheme based on reinforcement learning and game theory is proposed as a routing game model to provide a packet-forwarding mechanism for underwater wireless sensors network and reduces the energy consumption.

5.3. Game Theory based distributed clustering approach to maximize WSN lifetime

The energy cost for a sensor depends on the energy consumed to achieve its activities. In this section, we present the different factors that play a main role in the consumption of energy. To determinate the residual energy of a node, it is required to find the total energy consumption of a node in the operating of one data packet information. The notations utilized for the factors causing energy consumption by a sensor node are described in Table 5.1.

Table 5.1: Notations definition

Notations	Definition
n	Number of sensor nodes in the network
S_i	Sensor node where $i = \{1, 2, \dots, n\}$
E_S	Sensing energy cost
E_P	Processing energy cost
E_T	Transmitting energy cost

E_R	Receiving energy cost
E_I	Idling energy cost
$E_{Switch-Radio}$	Switching state energy cost in the radio
$E_{Switch-MCU}$	Switching mode energy cost in the MicroController Unit (MCU)
V_{dc}	Voltage supply
C	Total energy consumption
$L(S_i)$	Number of bits information

A. Rechargeable battery model

The applications of the sensor node are limited by the availability of the power stored in its battery. If the sensor node expends all its energy, it is considered as dead. Moreover, it disturbs the dispatching of the information data to reach the sink. In view of the fact that the replacing of the sensor's battery by a new one and the redeployment of the sensors are very costly, it is not appropriate to change the sensor's battery. To overcome these problems, the sensors nodes can use energy harvesting supplies to recharge their batteries. However, the utilization of renewable energy depends on the network environmental conditions as solar, wind, hydrogen, and hybrid sources [22]. In this article, we considered that the sensor's battery can be recharged from the environment (see Fig.2).

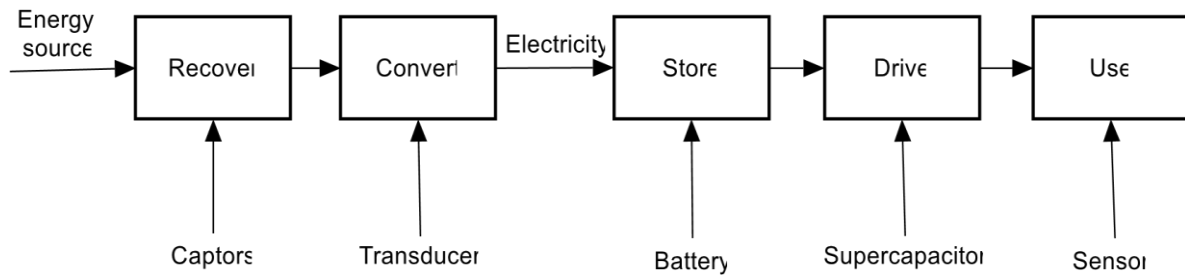

Figure. 5.1. Energy harvesting for WSN model

The distributed clustering algorithm uses round as unit, each round is made up of set-up phase and steady phase for the purpose of reducing unnecessary energy costs. Set-up phase is for the building of the clusters and the election of the CHs and steady phase is for the sensor's states (see Fig.5.2).

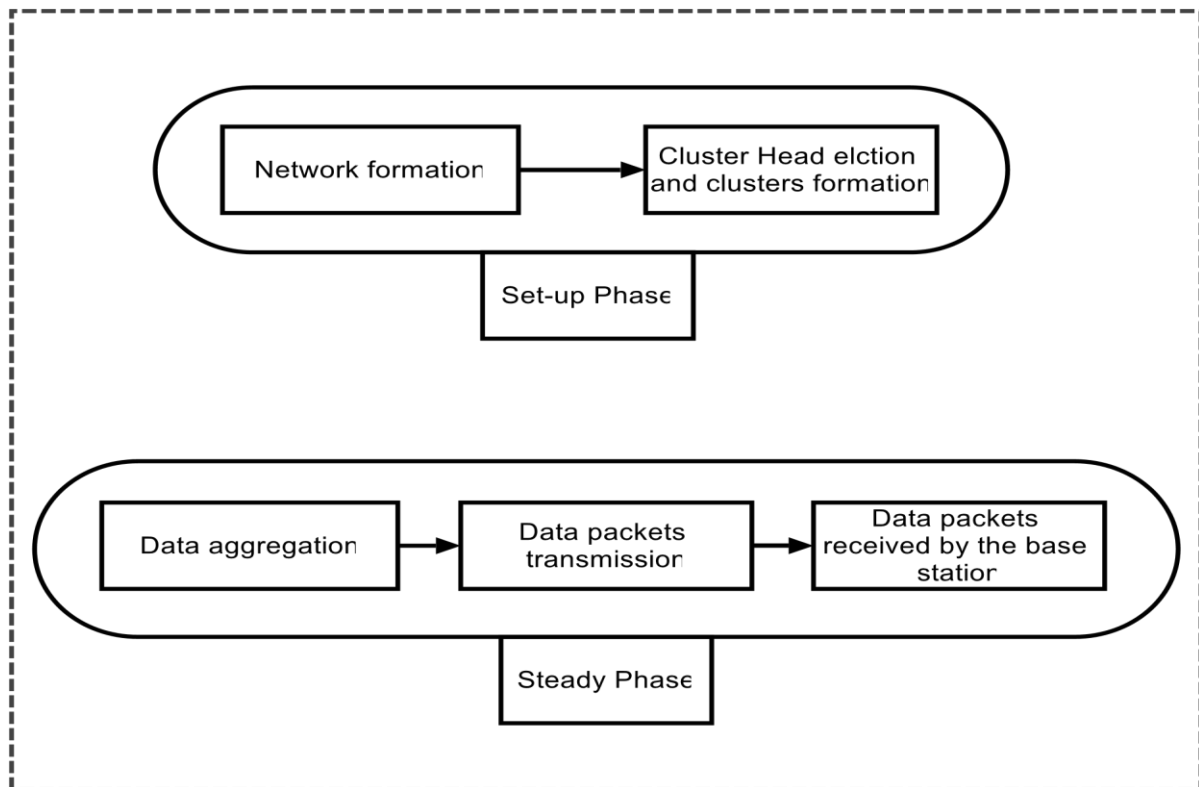

Figure. 5.2: Set-up and steady phases

A. Set-up phase

It concerns the formation of the clusters and their heads for each round using sensor location and individual energy consumption. Two CHs cannot be in the same cluster. For this reason, the distance between CHs should be bigger than a threshold distance. The remaining energy level in each sensor node plays an important role in increasing the lifetime of the network. CHs can ensure the link between sensors and the Base Station (BS). For a round, if a CHs is dead, the communications between the sensor nodes in its cluster and the BS are interrupted and no data information from this cluster can reach the BS. A sensor node that has a residual energy bigger than a threshold energy could become a CH for the actual round.

The proposed set-up phase is illustrated by a flowchart scheme in figure fig. 5.3.

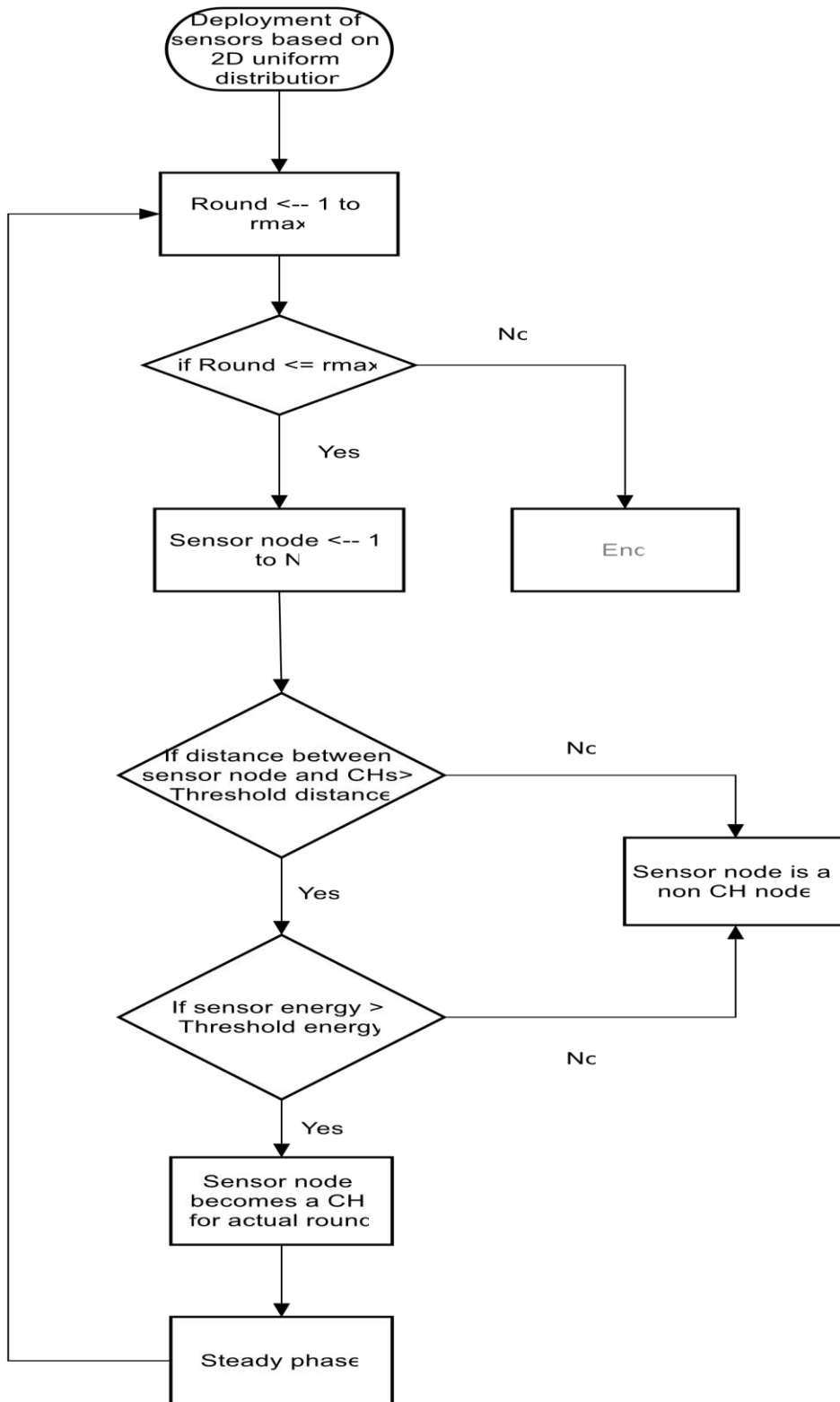

Figure. 5.3: Flowchart for the set-up phase

For each round, the selection of the CHs is based on the location and residual energy. After, each non-CH sensor decides to belong the cluster that corresponds to the minimum distance between its location and the CH location.

B. Steady phase

It corresponds to the data processing, transmitting and receiving between the sensors in the same cluster. This phase is divided in two stages: Data information aggregation and entry market game theory for the communication between neighbors' nodes in the same cluster.

- Data information aggregation

To save the maximum amount of energy consuming during sensors communications and to increase the limited available space in the memory, the data messages are compressed before their registration in the sensor's memory.

If we compress a message of $L(S_i)$ bits to a message of $L(S_i)/a$, the saving energy obtained by compressing the data information can be expressed as follows:

$$E_{savings_i} = [1 - 1/a]. [E_P + E_T + E_R] - E_{compress} \quad (18)$$

where $E_{compress}$ is the energy cost to compress $L(S_i)$ bits data packet message.

- The Game Theory based control

At this stage, we propose a non-cooperative game theory based algorithm to control the energy consumed by the sensors in the network. This algorithm is called the Profitable Energy Market Game (PEMG) wherein each player has to decide if he wants to participate or to stay out of the market at each round. The market defines trading rules according to a strategy. In this work, the strategy has two actions: to enter the game or to stay out the game. Each player (i.e. sensor) calculates a payoff that can affect or be affected by the payoffs of other players (i.e. its neighbors). The payoff is a function of the sensor's residual energy. More precisely, the payoffs

depend on the players' strategies that stay in the sleeping mode to charge their batteries or enter the game to transmit the sensing data messages.

In what follows, a PEMG is deployed within each cluster. The players in each cluster i are $S_i(j)$ where $j = \{1, 2 \dots N_i\}$ is the current number of sensors in the cluster for the round r , $m_i(k)$ denotes the number of messages sent by a given player $S_i(k)$, M_j is the number of $S_i(j)$ neighbors and $U_i(j)$ is the individual utility function that will be presented later.

The player $S_i(j)$ can take one of two decisions denoted by $x_i(j)$ set to 0 or 1: Entering the game with $x_i(j) = 1$ and participate by sending messages or staying out of the game and harvesting energy to charge its battery with $x_i(j) = 0$. The sensor's decisions can be expressed as follows:

$$x_i(j) = \begin{cases} 1, & S_i(j) \text{ enters the game} \\ 0, & S_i(j) \text{ stays out the game} \end{cases} \quad (19)$$

In this paper, our game model in each cluster is defined by:

$$G_i = \{N_i, M_j, X_i(j)_{j \in N_i}, U_i(j)_{j \in N_i}\} \quad (20)$$

The utility function for a sensor node depends on the cost of the strategy decision taken and it can be expressed by:

$$U_i(x_i(j)) = \begin{cases} g_i(j) - C_i(j), & \text{if } x_i(j) = 0 \text{ and } \exists x_i(k) = 1 \\ g_i(j) + f_i(j), & \text{if } x_i(j) = 0 \text{ for all } j \in M_j \\ 0, & \text{if } x_i(j) = 1 \end{cases} \quad (21)$$

where $k \neq j$, the cost function $C_i(j)$ is the total energy consumed by $S_i(j)$ to send a message, the gain function $g_i(j)$ is its residual energy and $f_i(j)$ is the energy harvested to recharge the sensor's battery.

When a sensor player j selects the action *to enter the game* to transmit messages and its neighbors sensors not then the utility is $g_i(j) - C_i(j)$. The utility is $g_i(j) + f_i(j)$, if the sensor player j decides *not to enter the game* to harvest and charge its battery and that, one of its neighbors enters the game.

In our proposed non-cooperative market entry game, the best response dynamics for the sensors players can be acquired in the context that each sensor node updates its strategy in order to maximize its utility, given the strategy of its neighbors (i.e., a mixed strategy).

To determine a mixed strategy equilibrium, we need to consider the expected utility of each player. If a randomly node j in the cluster i enters the market with a probability $P_i(j)$, the expected utility of the node j can be expressed as follows:

$$E[U_i(x_i(j))] = P_i(j) \times (g_i(j) - C_i(j)) + (1 - P_i(j)) \times (g_i(j) + f_i(j)) \times \left(1 - \prod_{k \neq j}^{M_j} (1 - P_i(k))\right) \quad (22)$$

It should be noted this expected utility of node j reaches its maximum when the battery of the sensor is full (i.e., the residual energy $g_i(j)$ is at its maximum) and the energy consumption $C_i(j)$ is 0.

The Figure fig.4 shows the variation of the expected utility function for a given sensor j , with the variation of the number of neighbors between 1 and 30 and the variation of the probability to enter the game, e.g., $P_i(j)$ is between 0.1 and 1. We consider that the neighbors have the same probability to enter the game $P_i(k) = 0.3, k \neq j$.

Assuming in the simulation that the maximum energy capacity available is $0.5 j$, the result shown in figure fig. 5.4 shows that the expected utility function has a maximum which is the maximum energy in the sensor's battery.

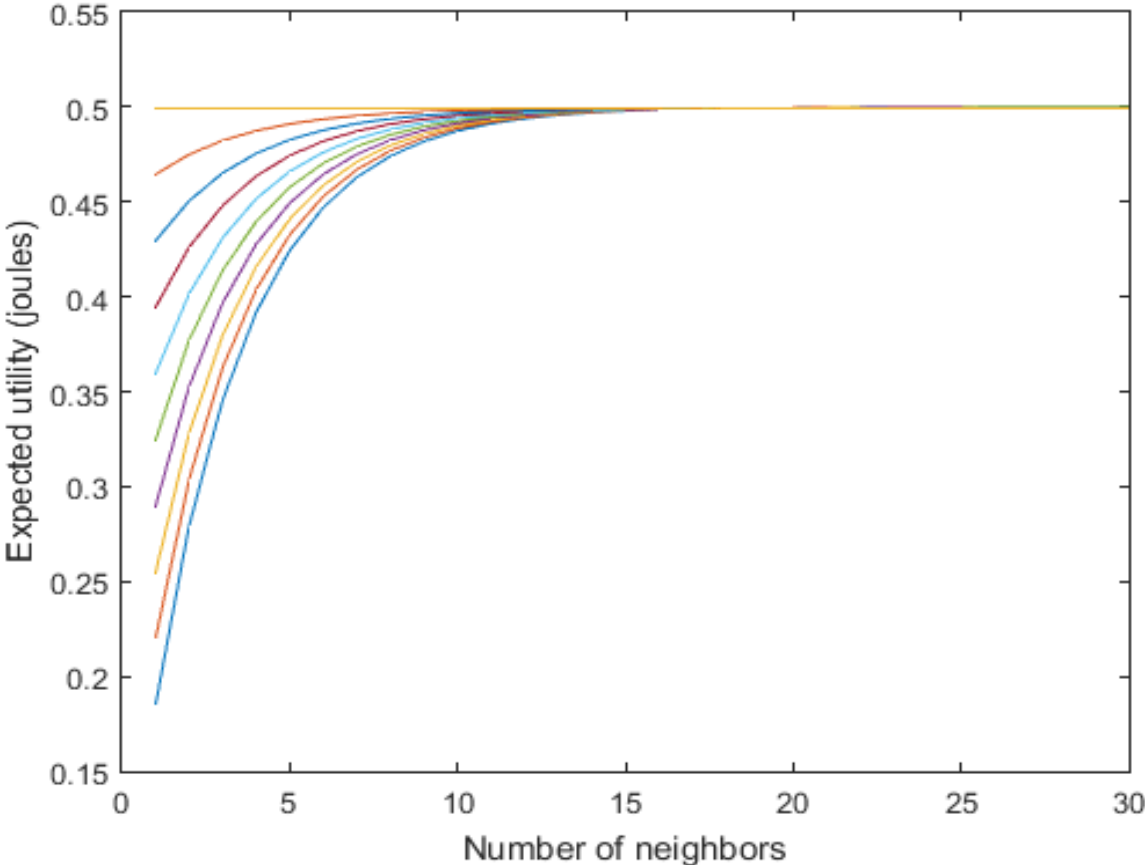

Figure. 5.4: The expected utility function varies with the number of nodes neighbors and the probability $P_i(j)$ and has a maximum that corresponds to the maximum battery capacity.

Since the best response for a sensor node is when its utility reaches its maximum, we derive the expected utility function and the derivation is obtained by:

$$\frac{\partial E[U_i(x_i(j))]}{\partial P_i(j)} = -(C_i(j) + f_i(j)) + (g_i(j) + f_i(j)) \times \prod_{k \neq j}^{M_j} (1 - P_i(k)) \quad (23)$$

Setting the derivation to zero, we get the maximum as follows:

$$\frac{(C_i(j) + f_i(j))}{(g_i(j) + f_i(j))} = \prod_{k \neq j}^{M_j} (1 - P_i(k)) \quad (24)$$

Letting $\alpha_i(j) = \frac{(C_i(j)+f_i(j))}{(g_i(j)+f_i(j))}$ and $q_i(k) = (1 - P_i(k))$, we obtain a system of M_j equations from eq. 24 that can be written as:

$$\left\{ \begin{array}{l} \alpha_i(1) = q_i(2) \times q_i(3) \times \dots \times q_i(M_j) \\ \alpha_i(2) = q_i(1) \times q_i(3) \times \dots \times q_i(M_j) \\ \vdots \\ \alpha_i(M_j - 1) = q_i(1) \times \dots \times q_i(M_j - 2) \times q_i(M_j) \\ \alpha_i(M_j) = q_i(1) \times \dots \times q_i(M_j - 2) \times q_i(M_j - 1) \end{array} \right. \quad (25)$$

which can be rewritten as:

$$\left(\prod_{j=1}^{M_j} (q_i(k)) \right)^{M_j-1} = \prod_{j=1}^{M_j} (\alpha_i(j)) \quad (26)$$

since $q_i(k) = (1 - P_i(k))$, the eq. 26 becomes :

$$\left(\prod_{j=1}^{M_j} (1 - p_i(k)) \right)^{M_j-1} = \prod_{j=1}^{M_j} (\alpha_i(j)) \quad (27)$$

The optimal probability for a given sensor node j in the cluster i to enter the market game can be then expressed as follows:

$$P_i(j) = 1 - \frac{\sqrt[M_{j-1}]{\prod_{k=1}^{M_j} (\alpha_i(k))}}{\alpha_i(j)} \quad (28)$$

The maximum utility for a sensor player depends on its strategy and also on the combination decisions of all other neighbors players.

The utility matrix for sensor player $S_i(j)$ is shown in Table 5.1.

For the calculation of the utility matrix for each cluster game, the resulting utility coming from the combination of the actions taken by the players (to enter the market game or not to enter the market game) are taken into consideration as indicated by eq.21. If a node player j in the cluster i enters the market, its utility will be $(g_i(j) - C_i(j))$ regardless of the action of its neighbors in this cluster. If none of the nodes in the same cluster enters the market, this means that all the nodes j and their neighbors' nodes are out of energy and cannot find any available energy sources to harvest and charge their batteries. For this reason, these sensors receive a payoff equal to 0. It is assumed that $(C_i(j) < g_i(j))$, so that at least a node would enter the market if no other sensor node does. However, if one node enters the market, then each of its neighbors would prefer to be selfish and would maximize its residual energy by charging its battery.

Table 5.2: Symetric entering market game matrix

	All $S_i(k)$ do not enter the market	At least one enters the market
$S_i(j)$ enters the market	$g_i(j) - C_i(j)$	$g_i(j) - C_i(j)$
$S_i(j)$ doesn't enter the market	0	$g_i(j) + f_i(j)$

Let $X = \{x_i(1), \dots, x_i(M_j)\}$ be the vector representation of the strategies played by the sensors.

The utility matrix for $S_i(j)$ can be written as follows:

$$U_i(j) = \begin{bmatrix} (g_i(j) - C_i(j)) & (g_i(j) - C_i(j)) \\ 0 & (g_i(j) + f_i(j)) \end{bmatrix} \quad (29)$$

In a symmetrical market game, the strategy that a sensor player and its neighbors decide to enter the game market, i.e., $X = \{1 \dots 1\}$, or the strategy that a sensor player and its neighbors decide to charge their battery in an idle mode, i.e., $X = \{0 \dots 0\}$, are not Nash equilibria. Indeed, it is impossible for each node to find out a best response to the strategy decisions. Namely, no pure-strategy Nash Equilibrium exists in our game. However, to permit the entry market game to have symmetrical Nash equilibria, the players can adopt mixed strategies. For any node, as $(g_i(j) - C_i(j)) > 0$, the sensors players do not have a dominant strategy. We assumed that each sensor player is allowed to choose its strategy decisions randomly following a probability distribution. In other words, there are M_j mixed strategies Nash equilibria in the game and the best responses are obtained when the utility of a node j to enter the market is equal to the utility of the node j to stay out of the market and thus we can compute the equilibrium probability from the table 5.1 by:

$$U_i(x_i(j) = 0) = U_i(x_i(j) = 1) \quad (30)$$

$$(g_i(j) - C_i(j)) \times p = (g_i(j) + f_i(j)) \times (1 - (1 - p)^{M_j-1}) \quad (31)$$

Therefore, from the above eq. 23, we can calculate the equilibrium probability P_E to enter the game for a M_j Nash equilibrium with a mixed strategies as follows:

$$P_{E_i}(j) = 1 - \left(1 - \frac{(g_i(j) - C_i(j))}{(g_i(j) + f_i(j))}\right)^{\frac{1}{M_j-1}} \quad (32)$$

since we have $0 < \frac{(g_i(j)-c_i(j))}{(g_i(j)+f_i(j))} < 1$. Subsequently, from the eq. 32, we can notice that the probability decreases when the number of neighbors players increases. For example, in the limiting cases, while $(M_j - 1)$ is varying from 1 to infinity, the probability of entering the market game will be changing from 1 to 0.

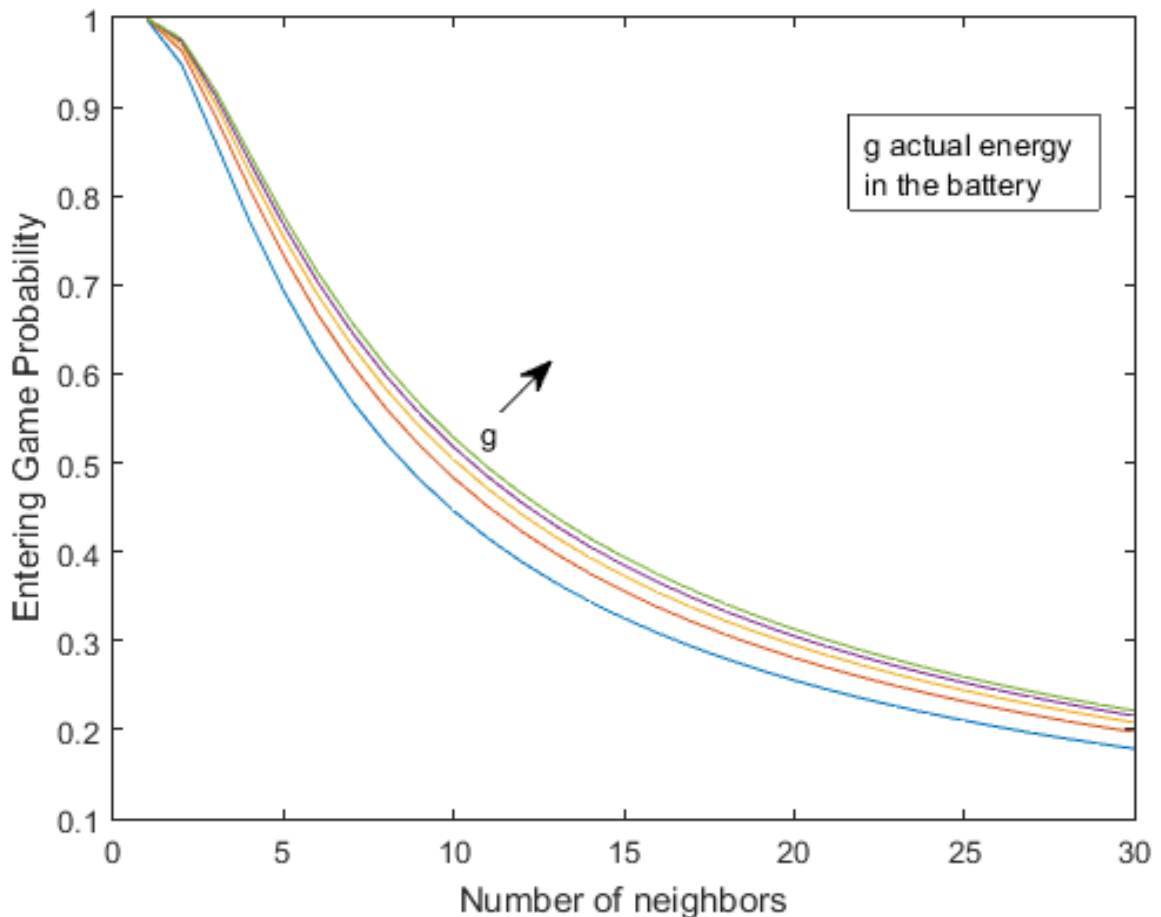

Figure. 5.5: Entering game probability varies with the number of nodes neighbors for a Nash Equilibrium mixed strategies.

Fig. 5.5 depicts the entering game probability that is given in Eq. 24 with increasing number of neighbors of the source, from 1 to 30, for different values of actual energy in the battery $g_i(j)$. When the number of neighbors decreases (from 30 to 1) when some neighbors nodes dead, the forwarding entering game increases.

5.4. Performance evaluation

For our experiments, we used 200 sensor nodes in our network, where nodes are randomly distributed in 1000x1000 m² area. The BS is deployed at the center of the area. For the simulations, a sensor node considers another sensor as a neighbor if the distance that separate them is lower than a threshold D . This threshold D is the maximum radius with which a sensor can receive a fixed number of bits for a fixed power transmission.

Table 5.3: Simulation parameters

Parameter	value
Network area (m ²)	100×100
BS location	(50, 50)
Number of sensor nodes n	200
Initial energy (J) E_0	0.5
E_{elec} (nJ/bit)	50
parameters of amplifier energy consumption E_{mp} (pJ/bit/m ⁴) and E_{fs} (pJ/bit/m ²)	0.0013 and 10
Data aggregation energy (J)	5×10^{-12}
Size of data packet (bits) F	4000
Number of bits transmitted by sensor (bits) L	2500
Compression percentage (%)	20
Round epochs r_{max}	5000, 10000
Proper percentage of CH nodes (%) p	5
Distance (m) D	10

In figure fig. 5.6, we compare the energy consumed by the network for 7000 rounds by comparing our proposed approach with other protocols from the literature: the Leach clustering protocol and a clustering based protocol. The results show that these Leach protocol consumes all its energy after 2000 rounds. An improved version of Leach via a low energy and location based clustering approach (LELC) presented in [6] stills have energy for 5000 rounds. Figure fig. 5.6 shows also the results of the two versions of the proposed PEMG with Game Theory (GT), Popt GT and Pnash GT, according respectively to Eq.28 (optimal probability) and Eq.32 (Nash equilibrium probability). The either PEMG versions extend the lifetime of the network beyond 7000 rounds. The results show also that Popt GT consumes less energy than the PEMG with Nash probability Pnash GT.

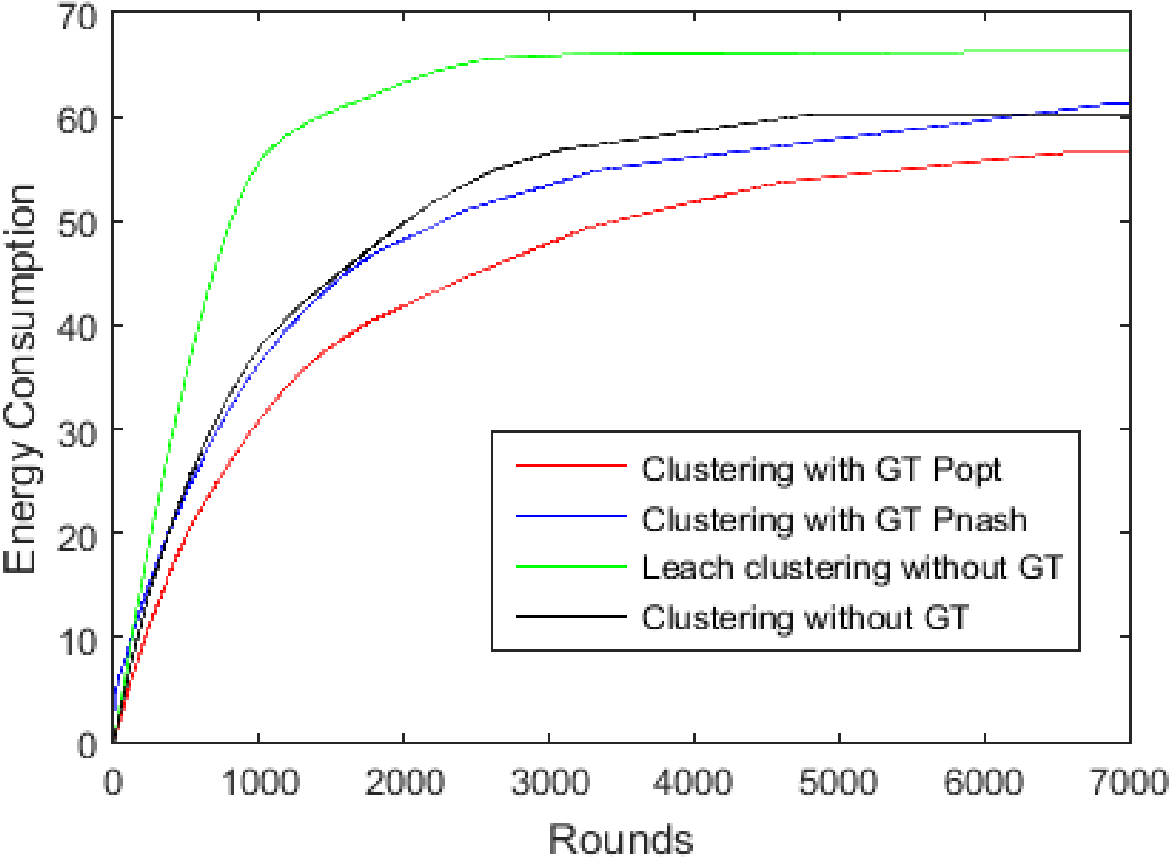

Figure. 5.6: Energy consumption by the network.

Figure fig. 5.7 shows the evolution of number of dead sensors. For Leach clustering protocol, the majority of sensor nodes are died before 2000 rounds of time. At the same time, with LELC clustering protocol, the number of dead sensors is less than the half of the number of dead sensor nodes in Leach protocol. Moreover, when the WSN is dead, after 5000 rounds, the number of dead nodes is 120. It stills less than the dead nodes in Leach protocol after 2000 rounds.

In the case of Pnash GT, the number of dead nodes is the half of the total number after 7000 rounds (i.e., 50%), while in the case of Popt GT and LELC without GT, 60% of the initial number of sensors are dead. This is mainly because of our GT based protocols provide the harvesting option to the sensors. Moreover, with Popt GT, the strategy taken by a sensor privilege the action to enter the market and thus sending messages, i.e., maximizing the strategy of communicating messages via Popt maximization. However, for Pnash GT, all the strategies taken by the sensor are equally probable.

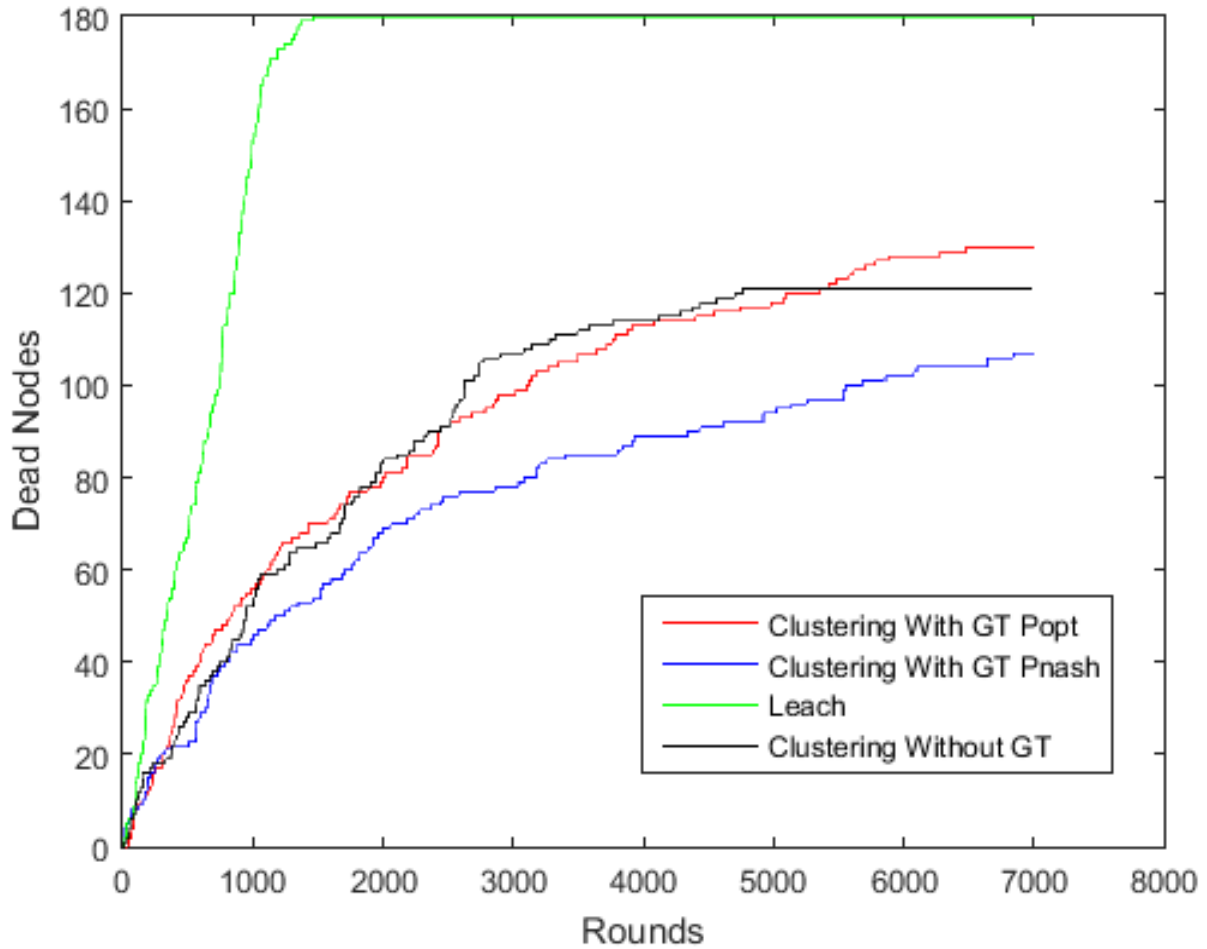

Figure. 5.7: Dead Nodes in the network.

The simulation results reported in figure fig. 5.8 show that the number of packets received by the BS for PEMGT with Pnash in our clustering protocol is more important than all the other approaches and that the network is still active after 7000 rounds. However, in the case of clustering without any GT, the network lifetime is limited to 5000 rounds. In addition, the small difference in energy consumed by the network between Pnash and Popt in PEMGT is justified by the number of packets information that reach the BS and the extension of the network lifetime.

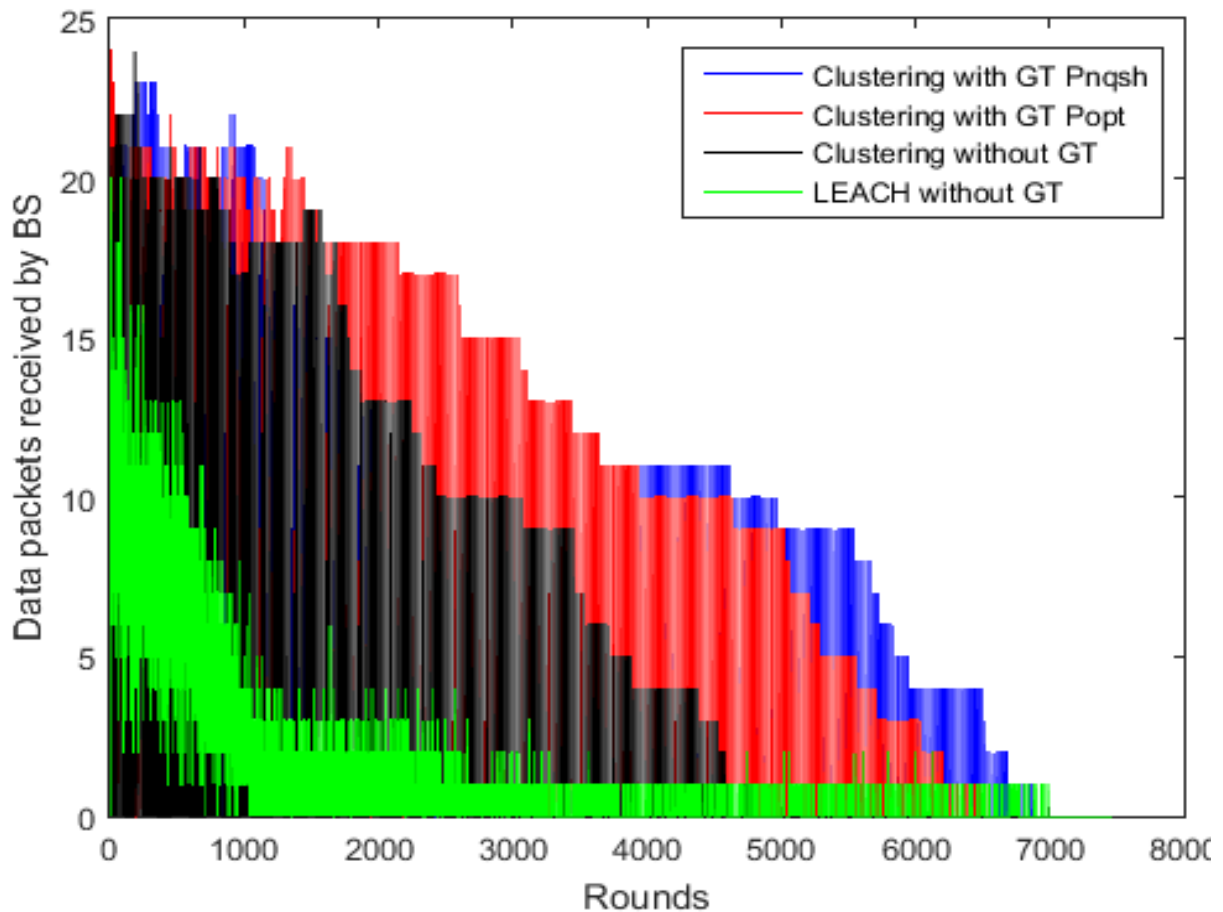

Figure. 5.8: Number of Data Packets received by the BS. With Pnash GT, the network is still active as the packets continue to be received by BS beyond the other protocols.

5.5. Conclusion

In chapter 5, a new clustering based protocol using a non-cooperative game theory (GT) approach is proposed with the aims to prolong WSN lifetime. The GT permits to a sensor to decide between two actions: to enter the game and transmit a message or to stay out the game and harvest to charge its battery. For the network organization, a clustering protocol based on sensors locations and energy consumptions is used and a GT based algorithm is deployed within each cluster. The objective is to find out the Nash Equilibrium (NE) solution for mixed strategies. The simulation results show that the proposed approaches outperform those without GT

in terms of energy consumption, nodes and network lifetimes. In other words, combining a GT based approach with a clustering protocol provides an efficient solution for energy harvesting to prolong WSNs lifetime. The future work will focus on the control of the energy harvesting process in the sensors.

Chapter 6

Control approach to harvest energy

Contents | Chapter 6

6.1. Introduction-----	91
6.2. Related work-----	91
6.3. The proposed adaptive energy management system-----	94
6.4. Piezoelectric energy harvesting model-----	99
6.5. Performance evaluation-----	108
6.6. Conclusion-----	113

6.1. Introduction

The possibility to avert replacing drained batteries is extremely important in Wireless Sensor Networks to avoid the high cost and time to replace batteries and redeploy them. Therefore, energy harvesting has attracted researchers and developers to recharge low power devices as Vivo-Nano-Robots, MEMS, Claytronics and WSN. Energy harvesting is the method of extracting energy from the environment through different sources of energy. It is considered an emerging and reasonably mature technology to overcome the limited lifetime of battery-operated wearable devices and allows continuous recharging of the energy stored during use. The environmental energy for scavenging is mostly provided by ambient light (artificial lighting and solar lighting), radio frequency, thermal sources, kinetic and vibration sources. To harvest energy from vibration, there are different techniques such as electrostatic, electromagnetic, magnetostrictive and piezoelectric.

6.2. Related work

Extending WSN lifetime is one of the most critical challenges in WSNs. In the last years, researchers have proposed different methods to increase the WSN lifetime via saving approaches. The main goal of these methods is saving energy during the communication between sensors without a compensation for the energy dissipated via scavenging ambient energy. Specifically, we can classify energy methods in different energy saving mechanisms to reduce the energy consumption in WSN and energy harvesting to recompense the energy consumed during sensors' activities.

Most of proposed approaches in literature are saving energy based mechanisms such as sensors deployment strategies, data oriented techniques, topology control methods, energy routing protocols.

For example in the literature, some researchers propose a statistical strategy for the deployment of nodes. The statistical node deployment strategy is based on Quasi-

random method of low-discrepancy sequences to increase the lifetime and the coverage of the network.

The attentiveness to data oriented techniques has increased recently. These approaches reduce the size of information via compression. Therefore, data oriented techniques are efficient to save energy during transmission and reception of these data information. In addition, the reduction of data is not only efficient in saving energy but also in saving more memory in the sensors.

An adaptive Energy efficient distributed compression technique based on DCS and QCS is proposed in the literature for sensor network data compressed gathering. This method is more performance in terms of conservation energy compared to conventional QCS architecture for data collection in WSN.

Other researchers proposed a Distributed Distortion-Rate Optimized Compressed Sensing (DQCS) method to compress data in WSN under complexity-constrained encoding which minimizes a weighted sum between the mean square error (MSE) signal reconstruction distortion and the average encoding rate.

A local lossless neighborhood indexing sequence (NIS) compression algorithm for data compression in WSN is proposed. NIS approach dynamically assigns shorter length code information to each character in the input sequence by exploiting the occurrence of neighboring bits and every data packet is decompressed independently from others. Therefore, NIS algorithm helps to decrease the network load, which results in low data packet loss.

Regarding topology control techniques in saving energy category in WSN, energy harvesting Media Access Control (MAC) protocols are one of the most notable mechanisms and recently used. Different energy harvesting MAC protocols are discussed to prolong the network lifetime.

A topology control protocol based on learning automaton is proposed. The mechanism chooses the proper smallest transmission range of the node using the reinforcement signal produced by the learning automaton of neighbor sensor nodes.

Consequently, the choice of transmission range affects the energy consumed by nodes and the overall network lifetime.

A hierarchical clustering protocol based on sensors location and energy consumptions using a non-cooperative game theory (GT) approach to extend the WSN lifetime is proposed. The GT permits to a sensor to decide between two actions: to enter the game and transmit a message or to stay out the game and harvest energy to charge its battery to reach the Nash Equilibrium (NE) solution for mixed strategies.

In order to increase the energy efficiency and enhance the network life cycle, a Genetic algorithmbased Energy-efficient Clustering and Routing Approach (GECRA) is presented. GECR algorithm aims to calculate the total energy consumed by all sensor nodes where the algorithm encodes the clustering scheme and routing scheme together in the same chromosome.

Researchers have worked to reduce the energy consumption in the stage of wireless sensors deployment and during sensors activities as communication and sensing data via energy saving mechanisms. Therefore, the WSN lifetime will be extended but for a limited time. Instead of applying the energy saving methods, the energy harvesting can be used to recharge sensor's battery to increase the power stored in the sensor's battery thereby extending the overall network lifetime depending on the availability of the ambient energy harvesting resources. This article presents a new self-management of energy based on Proportional Integral Derivative (PID) controller to tune the energy harvesting and Microprocessor Controller Unit (MCU) to control the sensor modes.

6.3. The proposed adaptive energy management system

Wireless Sensor Networks (WSNs) are extensively used in monitoring applications such as humidity and temperature sensing in smart buildings, industrial automation, and predicting crop health. Sensor nodes are deployed in remote places to sense the data information from the environment and to transmit the sensing data to the Base Station (BS). When a sensor is drained of energy, it can no longer achieve its role without a substituted source of energy. However, limited energy in a sensor's battery prevents the long-term process in such applications. In addition, replacing the sensors' batteries and redeploying the sensors is very expensive in terms of time and budget. To overcome the energy limitation without changing the size of sensors, researchers have proposed the use of energy harvesting to reload the rechargeable battery by power. Therefore, efficient power management is required to increase the benefits of having additional environmental energy. This paper presents a new self-management of energy based on Proportional Integral Derivative controller (PID) to tune the energy harvesting and Microprocessor Controller Unit (MCU) to control the sensor modes.

The target is an autonomous system to harvest energy spontaneously upon reaching a threshold of energy consumption. The system proposed is composed of two main blocks as designed in figure fig. 6.1: The Battery Management Subsystem block that manages a rechargeable battery or a super-capacitor of the sensor and monitors its states via two (Management Controller Unit) MCU modes. In on mode, the sensor is active and can sense information from its environment, write/read data from memory, and communicate messages with other wireless sensors. During achieving activities, the sensor consumes energy until a threshold and the MCU turns to off mode. In the off mode, the block piezoelectric energy harvesting structure is triggered. This block is controlled via a control loop feedback using a Proportional Integral Derivate controller PID that scavenges ambient energy to recharge the sensor's battery.

In this work, we assume that the vibration resource exists continuously. Moreover, the piezoelectric harvesting energy system is modeled by an equivalent Mass-Spring-Damper (MSD) model (discussed in the section below IV) with a PID controller that adapts the quantity of energy harvested by the sensor node to still alive and continue its processes. The harvesting energy will be tuned to reduce the error e between the setpoint or reference energy RE .

When the error e is bigger than a threshold T , the sensor node dissipates the majority of its residual energy and the microcontroller MCU switches to off mode and lets the sensors node harvest energy. Otherwise, the MCU is still in on mode and continues normally its activities. The energy consumption for one sensor depends on the energy consumed for its activities. The system block diagram is shown in Figure fig. 6.1.

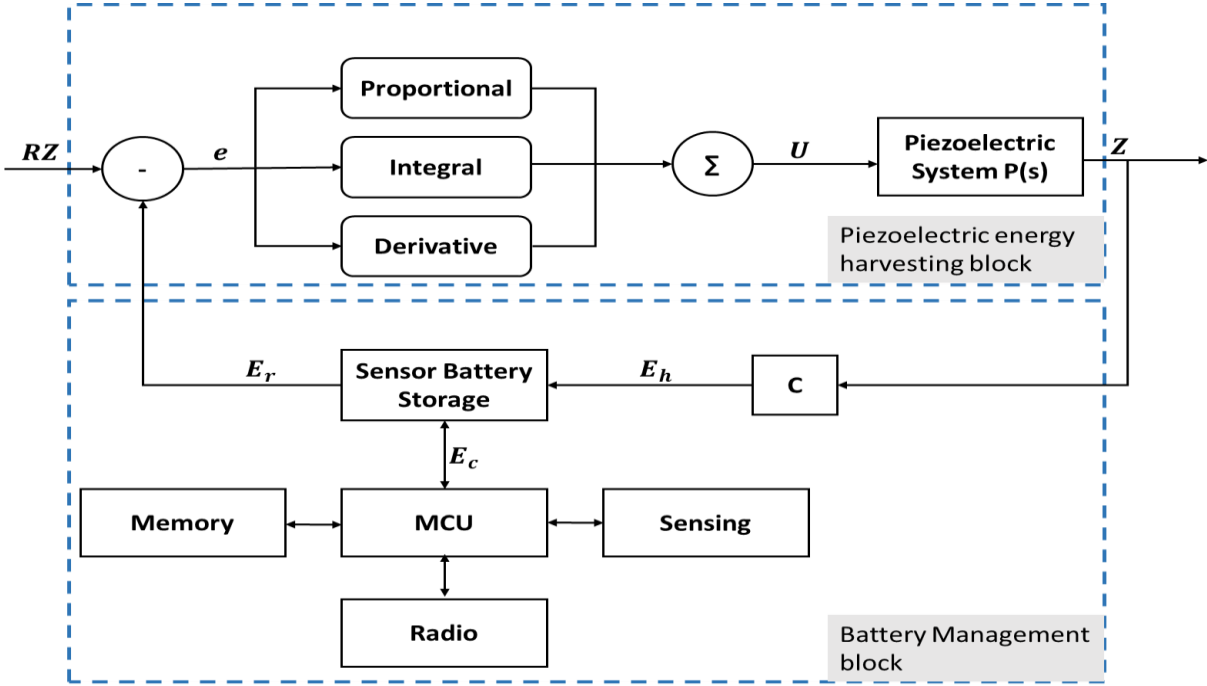

Figure. 6.1: Architecture of the global system of wireless sensor composed of two main blocks one to manage energy consumed and residual energy in the battery and another one to harvest energy from the ambient source

In what follows, the model is formulated mathematically in terms of energy consumption by sensor nodes. All the symbols used in this study are listed in Table 6.1.

TABLE 6.1: List of variables used in the study.

Variables	Definition
RE (J)	Reference Energy
$e(t)$	Energy error in time t
	Threshold energy
V_{ref}	Reference fixed voltage
$V_r(t)$	Current-voltage
C	Capacitance
$E_r(t)$	Residual energy at time t
$E_h(t)$	Harvesting energy at time t
$E_c(t)$	Energy consumed at time t
E_S	Sensing energy consumption
N	Number of bits transmitted by the sensor
α	Data compression percentage
T_{Sens} (ms)	Sensing time for one bit data
I_{Sens} (mA)	Sensing current
E_p	Processing energy consumption
I_{Write} (mA)	Writing current
T_{Write} (ms)	Writing time for one bit
I_{Read} (mA)	Reading current
T_{Read} (μ s)	Reading time for one bit
E_T	Data transmission energy consumption
E_{elec} (nJ/bit)	Energy dissipation: electronics
	Energy consumption in multipath model

Variables	Definition
E_{mp} (pJ/bit/m ⁴)	
E_{fs} (pJ/bit/m ²)	Energy consumption in the free space model
d_0	Threshold distance
d	Transmitter-receiver distance
E_R	Data reception energy consumption
$E_{Switch-MCU}$	Energy consumption for switching MicroController Unit (MCU) modes
I_{ON} (mA)	On mode for the MicroController Unit (MCU) current
T_{ON} (ms)	On mode for the MicroController Unit (MCU) time
I_{OFF} (μA)	Off mode for the MicroController Unit (MCU) current
T_{OFF} (ms)	Off mode for the MicroController Unit (MCU) time
M_{pzt} (g)	Mass
D_{pzt} (N. m ⁻¹ . s ⁻¹)	The damping ratio of the structure
K_{pzt} (N. m ⁻¹)	Spring stiffness constant
E_0 (J)	Initial energy
$z(t)$	Displacement
$f(t)$	External vibration force
$q(t)$	Quantity of electricity
$V(t)$	Electromotive force voltage
L	Inductance
R	Resistance
$P(s)$	Plant transfer function
$u(t)$	Control signal

Variables	Definition
$U(s)$	Plant control signal
K_p	Proportional controller parameter
K_i	Integral controller parameter
K_d	Derivative controller parameter
$E(s)$	Sensitivity function
$T(s)$	Complementary sensitivity function
$I(s)$	Input sensitivity function
K_u	Ultimate gain parameter
T_u	Time to attain ultimate gain parameter

The energy error e can be written as follows:

$$e(t) = RE - E_r(t) \quad (33)$$

where the reference energy RE is a fixed energy harvesting to charge the sensor's battery and E_r is the current residual energy in the sensor's battery.

$$e(t) = \frac{1}{2}C(V_{ref}^2 - V_r(t)^2) \quad (34)$$

where the reference voltage V_{ref} is the desired fixed voltage and $V_r(t)$ is the current voltage for the sensor's battery in time t .

$$E_r(t) = E_h(t) + E_r(t - 1) - E_c(t) \quad (35)$$

It is required to find the total energy consumption of a node in the treatment of one data packet information. The total energy consumed by a wireless sensor node includes sensing, processing, communicating data information, switching radio model states and switching MCU modes.

6.4. Piezoelectric energy harvesting model

For the piezoelectric energy harvesting model, the piezoelectric layers connected on a cantilever beam can be considered as a simple energy-harvesting device. The dimensions of piezoelectric, schematic and coordinate directions are shown in figure fig. 6.2. When the cantilever vibrates, at the first mode, the force which proceeds on the piezoelectric layers can be simplified to a 1-D model and regarded as a force f acting on the lateral surface.

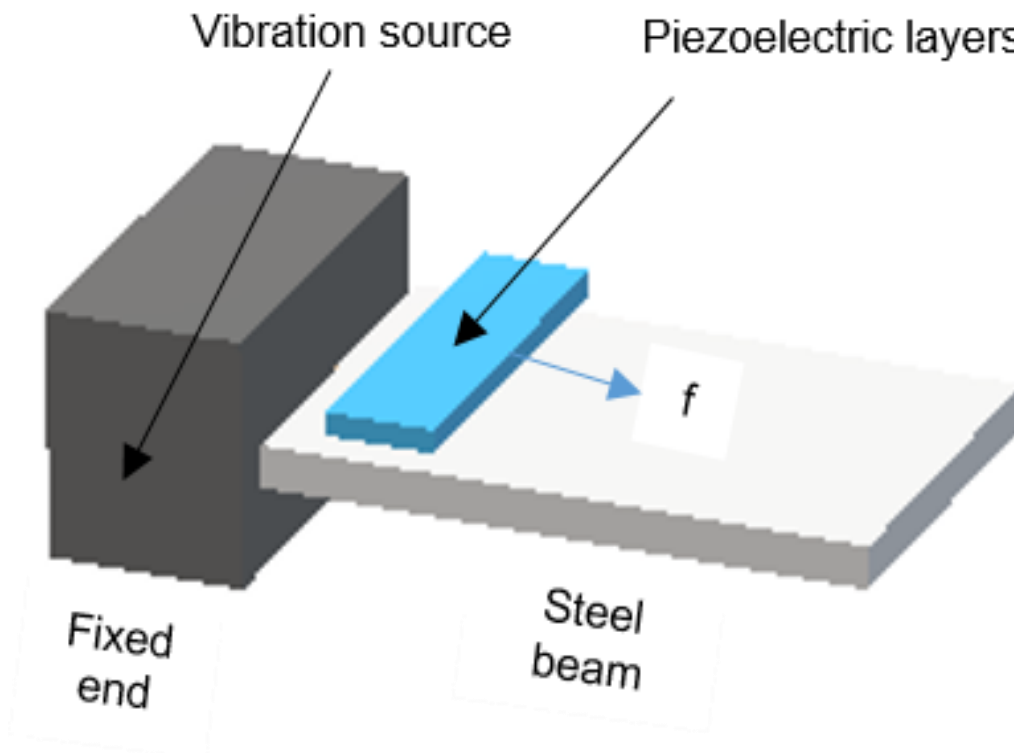

Figure. 6.2: Schematic of piezoelectric harvesting structure

The mechanical characteristics of a piezoelectric heap can be represented by an equivalent Mass-Spring-Damper (MSD) model with one degree. It consists of an equivalent mass M_{pzt} linked with a spring that has a constant coefficient K_{pzt} and a damper with a damping coefficient D_{pzt} and input displacement of the frame(t).

The MSD model of the piezoelectric heap is presented in figure fig. 6.3.

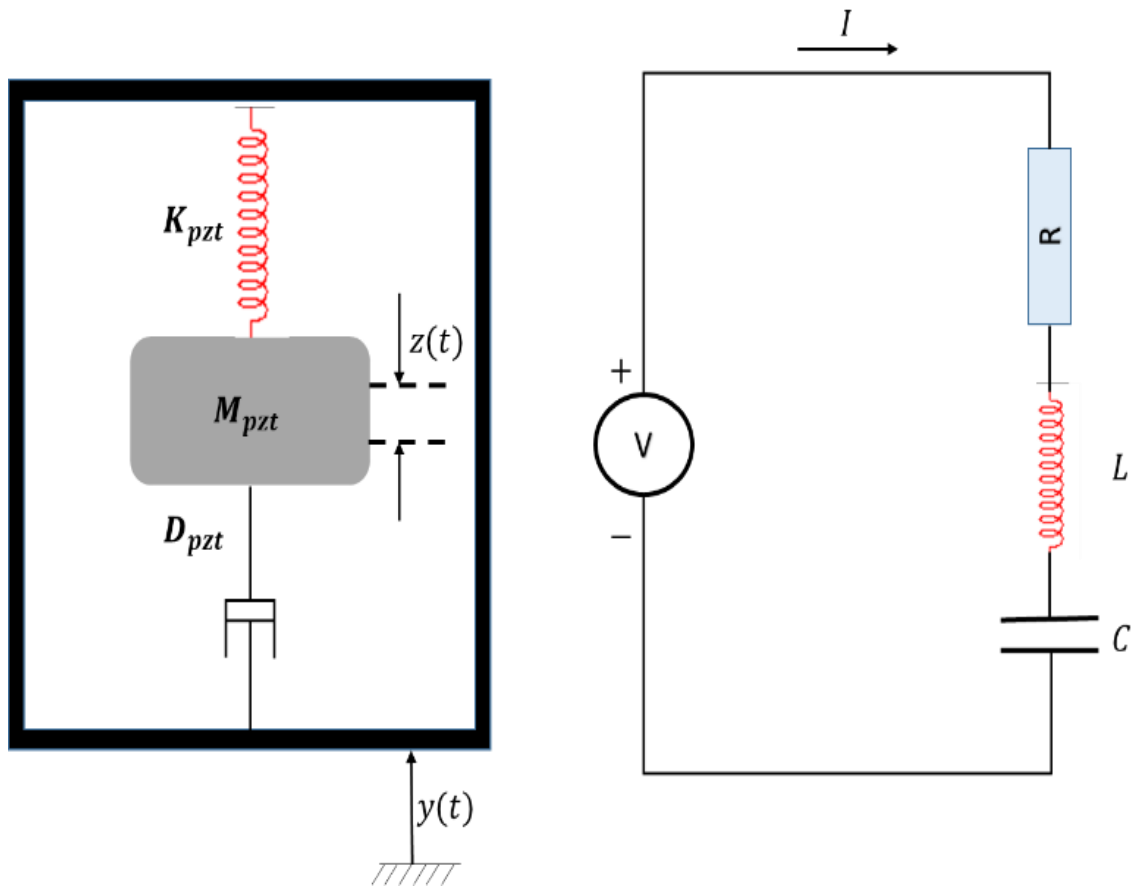

Figure. 6.3: Equivalent MSD model

The displacement $z(t)$ of the mass relative to the frame is characterized by the differential equation, with the mass M_{pzt} , the spring constant; the equivalent short circuit stiffness; K_{pzt} , the damping coefficient D_{pzt} and the input displacement of the frame $y(t)$. V is the voltage across the load resistance, C is the capacitance, R is the resistance and i is the electric current. The governing equation can be found by applying Newton's second law.

$$M_{pzt}\ddot{z}(t) + D_{pzt}\dot{z}(t) + K_{pzt}z(t) = f(t) \quad (36)$$

where

$$f(t) = -M_{pzt}\ddot{y} \quad (37)$$

We can present the equivalence mechanical equation of (36) by the electrical equation by applying Kirchhoff's law for an RLC circuit:

$$L\ddot{q}(t) + R\dot{q}(t) + \frac{1}{C}q(t) = V(t) \quad (38)$$

Where L is the inductance, R is the resistance, C is the battery's capacitance and $q(t)$ is the quantity of electricity generated by the electromotive force voltage $V(t)$.

The electro-mechanical analogy of our system is represented as follows in Table 6.2.

TABLE 6.2: Electro-mechanical analogy of piezoelectric energy harvesting system

Mechanical system	Electrical system
Position $z(t)$	Electrical charge $q(t)$
Mass M_{pzt}	Inductance L
Damping coefficient D_{pzt}	Resistance R
Spring constant K_{pzt}	Inverse of capacitance C
External force $f(t)$	Voltage $V(t)$

Applying the Laplace transform on equation (36) with zero initial conditions:

$$Z(s) = \mathcal{L}\{z(t)\} \text{ and } F(s) = \mathcal{L}\{f(t)\} \quad (39)$$

$$M_{pzt}s^2Z(s) + D_{pzt}sZ(s) + K_{pzt}Z(s) = F(s) \quad (40)$$

The open-loop plant transfer function between the input vibration force; $F(s)$ and the output displacement $Z(s)$ is given by:

$$P(s) = \frac{Z(s)}{F(s)} \quad (41)$$

$$P(s) = \frac{1}{(M_{pzt}s^2 + D_{pzt}s + K_{pzt})} \quad (42)$$

Figure Fig. 6 shows the displacement of the mass M_{pzt} produced by an external vibration effort F . The DC gain is $1/K_{pzt}$, so 0.8116 is the final value of the output for a unit step input. The rise time is about 0.4 s, the settling time is about 6.562 s and the overshoot is about 50.6432.

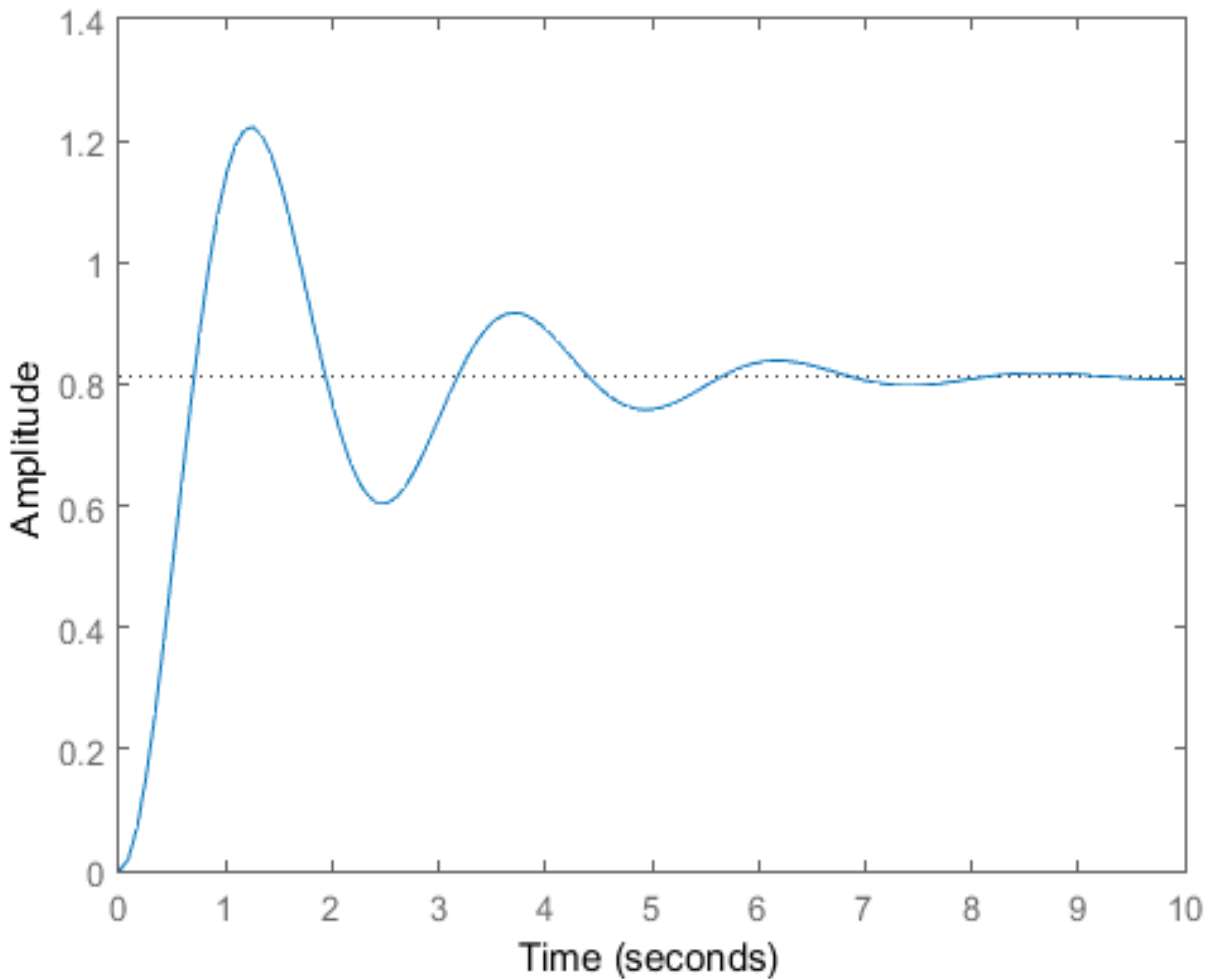

Figure 6.4: Transfer function between the input vibration force and the output displacement for an open loop without the PID controller

For the closed-loop, there are three transfer functions between the setpoint and the output under the PID controller and they are given by:

- The sensitivity function:

$$E(s) = \frac{1}{1 + P(s)U(s)} \quad (42)$$

- The complementary sensitivity function:

$$T(s) = \frac{P(s)U(s)}{1 + P(s)U(s)} \quad (43)$$

$$T(s) = \frac{(k_d s^2 + k_p s + k_i)}{(M_{pzt} s^3 + (D_{pzt} + k_d) s^2 + (K_{pzt} + k_p) s + k_i)} \quad (44)$$

- The input sensitivity function:

$$I(s) = \frac{U(s)}{1 + P(s)U(s)} \quad (45)$$

Proportional Integral Derivative (PID) controllers are extensively used to provide robustness and optimal performance for stable, unstable, and nonlinear processes [18]. It can be simply implementable in analog or digital form. Further, it supports tuning and online retuning based on the performance requirement of the process to be controlled. The output of a PID controller is calculated in the time domain from the response error and it can be expressed mathematically by the equation eq. 46 as follows:

$$u(t) = k_d \frac{de(t)}{dt} + k_p e(t) + k_i \int_0^T e(t) \quad (46)$$

where $u(t)$ and $e(t)$ are the control and the error signals respectively, k_d , k_p and k_i are the parameters to be tuned.

Taking the Laplace transform of equation 46, the transfer function for a PID controller can be expressed as follows:

$$U(s) = \frac{k_d s^2 + k_p s + k_i}{s} \quad (47)$$

In this section, tuning the energy harvested by the piezoelectric system is indispensable to control the quantity of energy harvested, the stability of the system. Therefore, a Proportional Integral Derivative controller (PID) is adapted to the model represented above. The PID controller uses a control loop feedback mechanism to control the piezoelectric energy harvesting system. The parameters of the PID controller are the proportional gain k_p , the integral parameter k_i and the derivative parameter k_d that affect the control of the system.

The overall effects of controller parameters k_p , k_i and k_d on a closed-loop system are summarized in Table 6.3.

Improving proportional gain k_p has the effect of equivalently increasing the control signal for the same level of error. The fact that the controller will drive harder for a given level of error lets the closed-loop system react more speedily, but also to overshoot more. In addition, increasing k_p helps to decrease the steady-state error.

The addition of the integral parameter k_i will continually increase over time to drive the steady-state error to attain zero. If there is a steady error, the integral response will slowly increase the control signal to the error down. However, the integral term can make the system more sluggish since when the error signal changes sign. It can take a while for the integral windup phenomenon when integral action saturates a controller without the controller driving the error signal toward zero.

The derivative controller parameter k_d appends the ability of the control signal to become large, if the error begins sloping upward, even while the amplitude of the error is still quite small. This anticipation helps to add damping to the system, thereby

decreasing overshoot. However, the addition of this parameter will not affect the steady-state error.

TABLE 6.3: The effects of PID controller parameters on a closed-loop system

PID parameter	Rise Time	Overshoot	Settling time	Steady-State error
k_p	Decrease	Increase	Small changes	Decrease
k_i	Decrease	Increase	Increase	Decrease
k_d	Small changes	Decrease	Decrease	No change

There are different methods to find the PID controller parameters that satisfy these goals. The fast rise time, the minimal overshoot, the minimal steady-state error and the minimal settling time. The gains of a PID controller can be found by trial and error method. In our work, we apply Ziegler-Nichols heuristic tuning method to find the PID controller parameters. It consists to find the ultimate gain K_u and the period T_u by setting the Integral and Derivative gains to zero. The Proportional gain G increases until it reaches the ultimate gain, at which the output displacement of the control loop has consistent oscillations. For a classic PID controller, we can find k_p , k_i and k_d by the relations as in Table 6.4:

TABLE 6.4: The PID controller parameters according to Ziegler-Nichols tuning method on a closed-loop system

k_p	k_i	k_d
$0.6K_u$	$1.2 \frac{K_u}{T_u}$	$0.075K_u T_u$

The Flow Chart as shown in figure fig. 6.5 explains how to find the PID controller parameters based on Ziegler-Nichols heuristic tuning method.

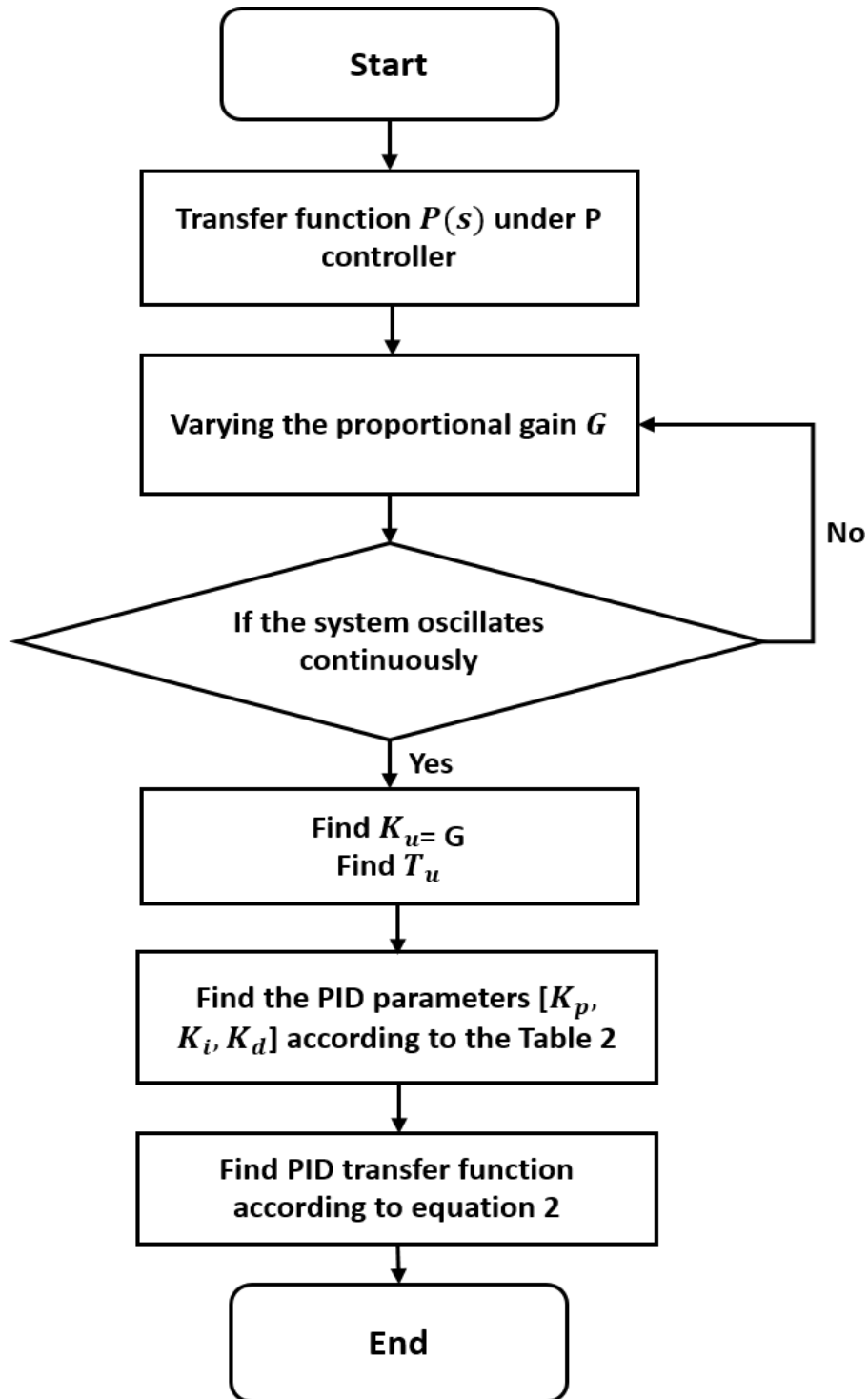

Figure. 6.5: Flowchart to find the transfer function for the PID controller based on Ziegler-Nichols heuristic tuning method

Applying the Ziegler-Nichols heuristic tuning method, we find $K_u = 33.727$ and $T_u = 3.90176$. The PID controller parameters are calculated according to Table 6.4. The transfer function for the PID controller can be found from eq. 2 and can be rewritten as follows:

$$u(s) = \frac{9.8699s^2 + 20.2366s + 10.3729}{s} \quad (48)$$

Applying Routh-Hurwitz criterion, we can verify if the system in a closed loop converges, stable or not.

The following structure of Routh-Hurwitz criterion matrix for the complementary sensitivity transfer function is shown as follows:

$$\begin{pmatrix} M_{pzt} & (K_{pzt} + k_p) \\ (D_{pzt} + k_d) & k_i \\ \frac{((D_{pzt} + k_d) \times (K_{pzt} + k_p)) - (k_i \times M_{pzt})}{(D_{pzt} + k_d)} & 0 \\ k_i & 0 \end{pmatrix} \quad (49)$$

All the values of column 1 of the table are positive. There is no sign changed. Therefore, the system controlled by our PID controller is stable for the closed loop.

Figure Fig. 8 shows the displacement of the mass M_{pzt} produced by an external vibration effort F controlled by our PID controller. This controller is designed based on Ziegler-Nichols tuning method. The new system has a fast rise time 0.0311 s, it reduces also the settling time 0.0509 s, and minimize the overshoot 1.1887 .

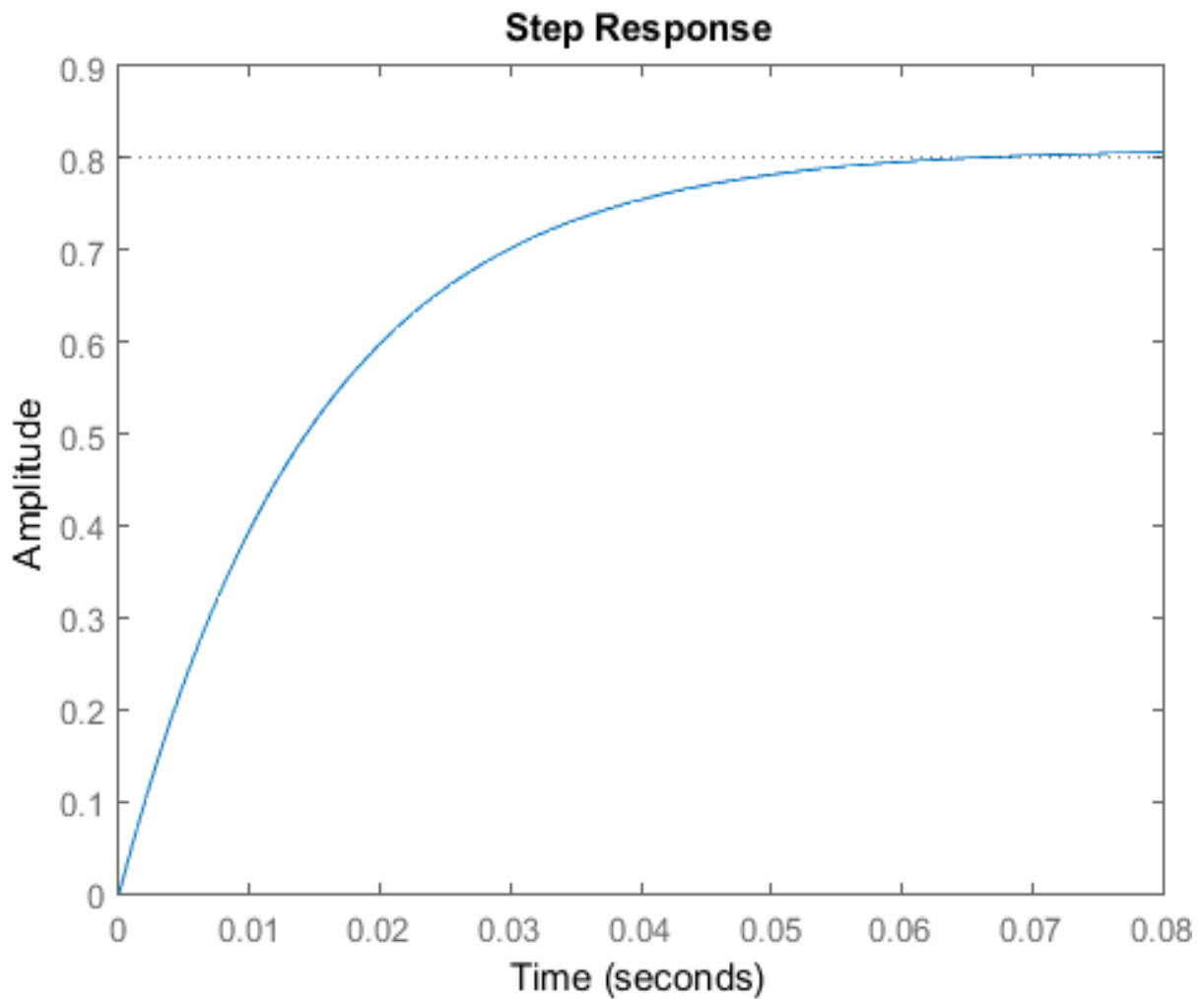

Figure. 6.6: Transfer function between the input vibration force and the output displacement for a closed-loop with an adaptive PID controller based on Ziegler-Nichols tuning method.

6.5. Performance Evaluation

The values of the hardware parameters used in our simulations are those of Mica2 Motes. All parameters used in our energy model are listed in Table 6.5. We also indicate the references where these values originated. Our results are based on existing device parameters. Moreover, that is why they can reflect a real energy model for a type of wireless sensors.

TABLE 6.5: Simulation parameters

Parameter	value
The supply voltage to the sensor V_{dc} (V)	2.7
Reference Energy RE (J)	0.2
Threshold energy	0.1
Sensing time for one bit of data T_{Sens} (ms)	0.5
Sensing current I_{Sens} (mA)	25
Writing current I_{Write} (mA)	18.4
Writing time for one bit T_{Write} (ms)	12.9
Reading current I_{Read} (mA)	6.2
Reading time for one bit T_{Read} (μ s)	565
On mode for the MicroController Unit (MCU) current I_{Active} (mA)	8
On mode for the MicroController Unit (MCU) time T_{Active} (ms)	1
Off mode for the MicroController Unit (MCU) current I_{Sleep} (μ A)	1
Off mode for the MicroController Unit (MCU) time T_{Sleep} (ms)	299
Initial energy (J) E_0	0.5α
Energy dissipation: electronics E_{elec} (nJ/bit)	50
parameters of amplifier energy consumption E_{mp} (pJ/bit/m4) and E_{fs} (pJ/bit/m2)	0.0013 and 10
Data aggregation energy (J)	5×10^{-12}
Size of the data packet (bits) N	4000
Compression percentage (%) α	20
Mass M_{pzt} (g)	182

Parameter	value
The supply voltage to the sensor V_{dc} (V)	2.7
The damping ratio of the structure D_{pzt} ($N \cdot m^{-1} \cdot s^{-1}$)	0.2
Spring stiffness constant K_{pzt} ($N \cdot m^{-1}$)	0.12320
Proportional controller parameter K_p	20.2366
Integral controller parameter K_i	10.3729
Derivative controller parameter K_d	9.8699

Figure fig. 6.7 shows the residual energy in the sensor's battery. When the battery is out of energy, the MCU switches to off mode. During the off mode, the battery is charged with a vibration harvesting energy without the adaptive PID controller. The battery is recharged to 0.1245 *Joules* and cannot reach more than this value. Therefore, there is a need to include an adaptive PID controller to the system that can enhance the stability and the performance of the system.

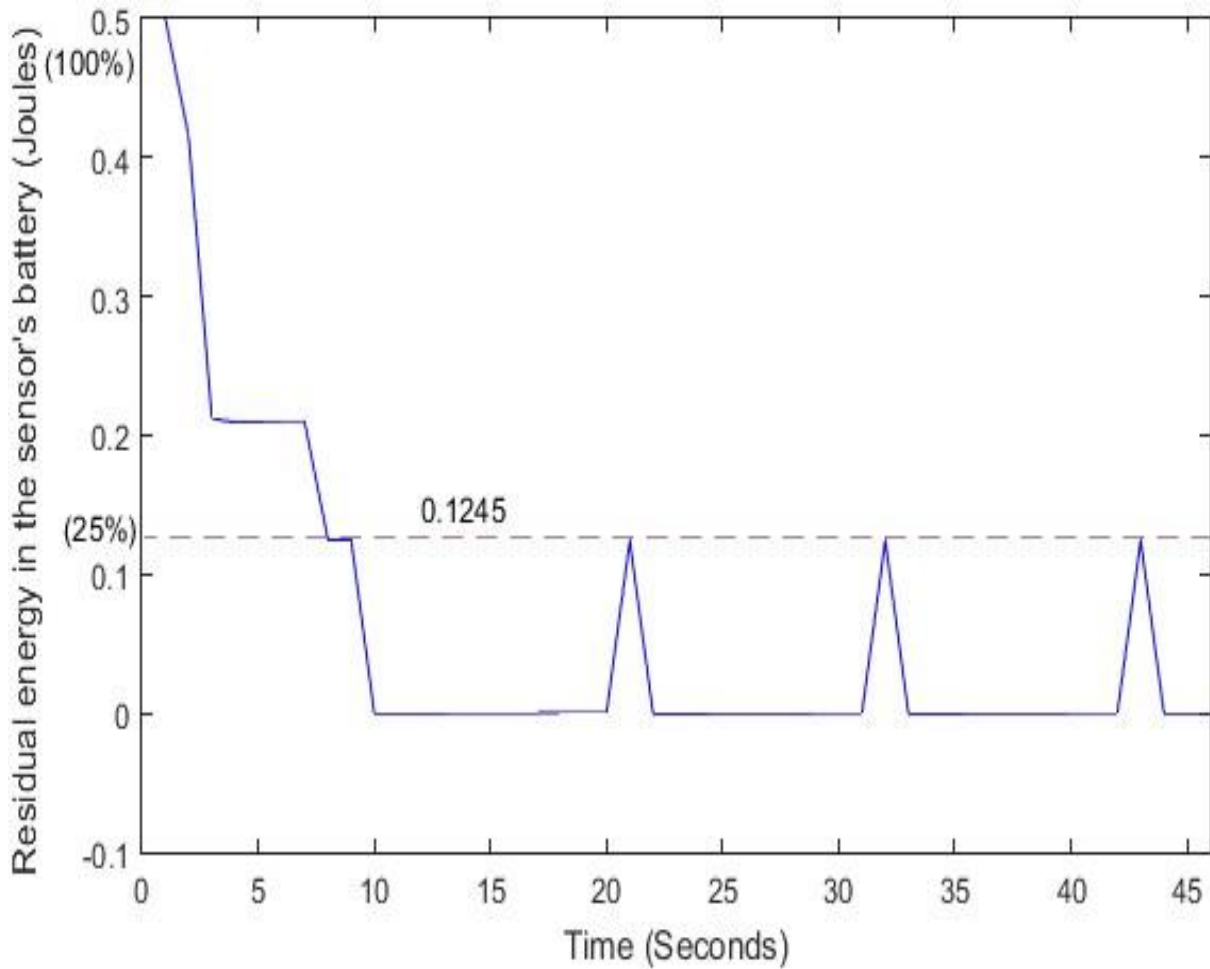

Figure 6.7: Self-power manager behavior without the adaptive PID controller.

Figure fig. 6.8 shows the residual energy in the sensor's battery. When the residual energy is less than a given threshold value (e.g.20%,) of the initial energy 0.5Jouleswith $\alpha = 1$, the MCU switches to off mode. During the off mode, the battery is charged with a vibration harvesting energy controlled by the adaptive PID controller. The battery is recharged to a fixed threshold 0.3249 Joules.

The results illustrate that the system is still cyclical stable even if the energy consumption depends on different sensor's activities and it is not the same for each time period.

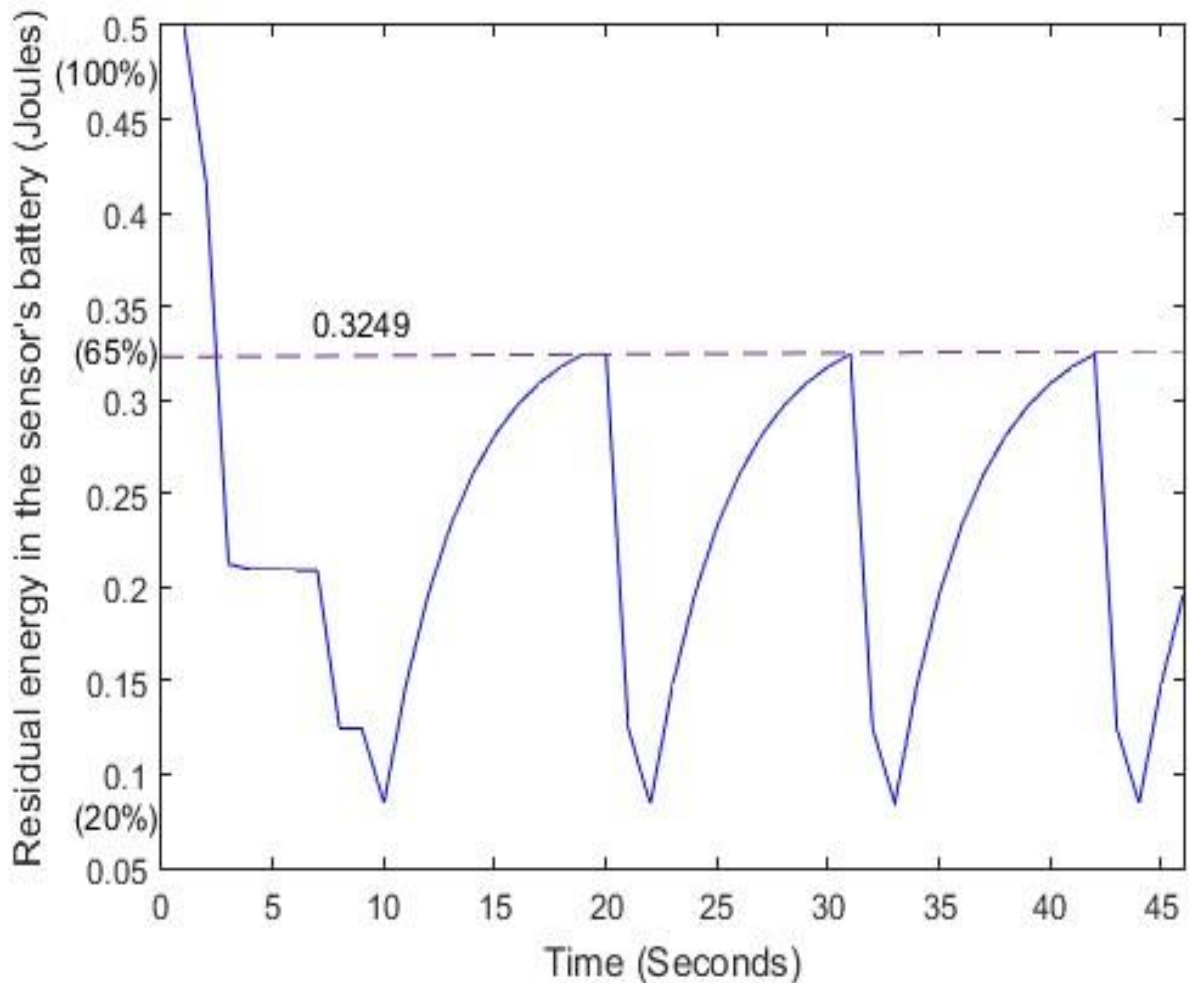

Figure. 6.8: The self-power manager controller organizes its wake-up mode to do its activities and its off mode to harvest energy controlled by the adaptive PID controller depending on its residual energy.

The self-power manager system including the PID controller can recharge 65% of the battery as shown in Figure Fig. 9 while the system without the adaptive PID controller cannot charge more than 25% at the same period of time as shown in Figure fig. 9. Therefore, the self-power manager system must be tuned by an adaptive PID controller, to recharge the battery spontaneously (according to a critical threshold value), and stabilize the system whatever are the sensor's activities.

6.6. Conclusion

An adaptive energy manager is essential to harvest energy in WSNs. Its core goal is to control the energy harvesting to maximize the lifetime of the sensor nodes and give the sensors the power to achieve their activities. In this paper, autonomous power management with a PID controller provides practical adaptation to the harvested and consumed energy for a sensor node. Moreover, an adaptive controller for the MCU modes, to extend a sensor lifetime depending on the existing vibration in the environment, is presented. Future work will cover a combination between simulation results and real experimental validation of the proposed autonomous energy management system. In addition, we will focus our work on the integration of some existing management energy efficient methods in our self-organized power manager system to save more energy during communications and to reduce the rapid consumption of residual energy in the sensor's battery and from the environmental energy resources. Applying energy efficient protocols for sensors' communications with the autonomous energy management system will increase the overall WSN lifetime.

Chapter 7

Conclusion

Contents | Chapter 7

7.1. Summary	115
7.2. Future work	116

7.1. Summary

The development of wireless communications and Micro-Electro-Mechanical systems have enabled the advancements in wireless sensor networks (WSN), which are used in different fields such as healthcare, supervision, environmental and industrial systems. However, due to the limitation of available energy in battery's sensors, these applications still face a major energy issue that prevent their extensive adoption. In this thesis, we present the topic of Wireless Sensor Network lifetime and we overcome this challenge through several contributions. We proposed distributed algorithms and we developed new architectures and models to improve the WSN lifetime performances and we evaluated our methods through extensive numerical experiments and simulations.

At first part of this thesis, we introduce general wireless sensor networks and their various application families. This top-down study surveys a comprehensive review of existing energy-efficient mechanisms designed for wireless sensor networks in the literature and various energy harvesting extraction methods. Afterwards, we proposed a low energy and location based clustering protocol to improve the energy efficiency in wireless sensor network. The network is divided into clusters and each cluster has a cluster head as responsible of data transmission between clusters to transmit data information to the base station. The clusters and their cluster heads are updated depending on residual energy in the battery powered sensors and the distance between sensors and BS. Then, we have proposed a game theory based clustering protocol which is an extension of the low energy and location based clustering protocol that aim at load balancing, minimizing the energy consumed by transmission of data packets and avoiding nodes with low residual energy.

The second part of this thesis contains an autonomous energy management system achieving piezoelectric energy harvesting to recompense energy consumed in wireless sensors. This system model proposed can tune the extraction of energy

from vibration sources in the environment and can satisfy the energy-demand of sensors by PID and MCU controllers.

7.2. Future work

In this thesis, we put emphasis on of energy efficiency challenge in wireless sensor networks.

Regarding the first part of this thesis, as a future work, we envisage to compare the proposed clustering protocol with other protocols other than LEACH protocol and we will consider the mobility of sensors for data collection in WSN.

For the second part of this thesis, we will focus our work on the integration of some existing energy management saving methods in our self-energy management system to save more energy during communications, to find out a schedule to minimize the charging latency and to reduce the rapid consumption of residual energy in the sensor's battery and from the environmental energy resources. Ideally, we will conduct in-field experiments in order to characterize the performance of our self-energy management system.

Bibliography

1. I. F. Akydi, W. Su, Y. Sankarasubramaniam and E. Cayirci, "Wireless sensor networks: a survey," sciencedirect, vol. 38, no. 4, pp. Pages 393-422, 2002.
2. network survey," Computer Networks: The International Journal of Computer and Telecommunications Networking, vol. 52, no. 12, pp. Pages 2292-2330, 2008.
3. L. Xuxun, "A Survey on Clustering Routing Protocols in Wireless Sensor Networks," Sensors, p. pages: 11113–11153, 2017.
4. S. K. Gupta, N. JAin and P. Sinha, "Clustering Protocols in Wireless Sensor Networks: A Survey," International Journal of Applied Information Systems (IJAIS), vol. 5, no. 2, p. Pages: 10, 2013.
5. S. Sirsikar and k. Wankhede, "Comparison of Clustering Algorithms to Design New Clustering Approach," Elsevier, vol. 49, pp. Pages 147-154, 2015.
6. S. Muruganathan , D. C. F. Ma and R. I. Bhasin, "A centralized energy-efficient routing protocol for wireless sensor networks," IEEE Communications Magazine, vol. 43, no. 3, pp. S8 - 13, 2005.
7. I. Bukhari, A. Harwood and S. Karunasekera, "Optimum Benefit Protocol: A fast converging, bandwidth-efficient decentralized similarity overlay," Journal of Parallel and Distibuted Computing, vol. 109, 2017.

8. S. Cai, Q. Jia and Z. Liu, "Cluster synchronization for directed heterogeneous dynamical networks via decentralized adaptive intermittent pinning control," *Nonlinear Dynamics*, vol. 82, pp. Pages: 689-702, 2015.
9. S. Mehta, S. Vhatkar and M. Atique, "Comparative Study of BCDCP protocols in Wireless sensor network," in *International Conference and Workshop on Emerging Trends in Technology*, Maharashtra, India, 2015.
10. G. Lee, M. Lee, W. Seok, J. Kong and O. Byeon, "A Base Station Centralized Simple Clustering Protocol for Sensor Network," in *International Conference on Embedded and Ubiquitous Computing*, Seoul, South Korea, 2006.
11. M. B. Yassein, Y. Khamayseh and W. Mardini, "Improvement on LEACH protocol of wireless sensor network (VLEACH)," *Int. J. Digit. Content Technol. Appl.*, pp. 132-136, 2009.
12. F. Xiangning and S. Yulin, "Improvement on LEACH Protocol of Wireless Sensor Network," in *IEEE*, Valencia, Spain, 2007.
13. M. J. Handy, M. Haase and D. Timmermann, "Low Energy Adaptive Clustering Hierarchy with Deterministic Cluster-Head Selection," in *Fourth IEEE Conference on Mobile and Wireless Communications Networks*, Stockholm, 2002.
14. O. M. Alia, "A Decentralized Fuzzy C-Means-Based Energy-Efficient Routing Protocol for Wireless Sensor Networks," *The Scientific World Journal*, vol. 2014, p. 9, 2014.
15. L. Ying and Y. Haibin, "Energy Adaptive Cluster-Head Selection For Wireless Sensor Networks," *Energy Adaptive International Conference on Parallel and Distributed Computing Applications and Technologies*, 2005.

16. C. Fu, Z. Jiang, W. Wei and A. Wei, "An Energy Balanced Algorithm of LEACH Protocol in WSN," *IJCSI International Journal of Computer Science*, vol. 10, p. 6, 2013.
17. G. Han, X. Jiang, A. Qian, J. Rodrigues and L. Cheng, "A Comparative Study of Routing Protocols of Heterogeneous Wireless Sensor Networks," *The Scientific World Journal*, p. 11, 2014.
18. W. R. Heinzelman, A. Chandrakasan and H. Balakrishnan, "Energy-Efficient Communication Protocol for Wireless Microsensor Networks," in *Hawaii International Conference on System Sciences*, Hawaii, 2000.
19. L. Shi, J. Zhang, Y. Shi, X. Ding and Z. Wei, "Optimal Base Station Placement for Wireless Sensor Networks with Successive Interference Cancellation," *Sensors*, vol. 15, no. 1, p. 1676-1690, 2015.
20. S. B. Mohammed and K. Lee, "WSN based IoT Healthcare Application," *Challenges and Solution: A Comprehensive Review*, *International Journal of Computer and Information Technology*, vol. 06, n°05, 2017.
21. M. A. Moridi, M. Sharifzadeh, Y. Kawamura and H.D. Jang, "Development of wireless sensor networks for underground communication and monitoring systems (the cases of underground mine environments)," *Tunnelling and Underground Space Technology*, vol. 37, pp. 127-138, 2018.
22. A. A. Aziz, Y. A. Sekercioglu, P. Fitzpatrick and M. Ivanovich, "A Survey on Distributed Topology Control Techniques for Extending the Lifetime of Battery Powered Wireless Sensor Network," *IEEE communications surveys & tutorials*, vol. 15, 2013.

23. M. B. Krishna and N. Vashishta, "Energy Efficient Data Aggregation Techniques in Wireless Sensor Networks," 5th International Conference on Computational Intelligence and Communication Networks, 2013.
24. I. Ullah, R. Ahmad and D. Kim, "A Prediction Mechanism of Energy Consumption in Residential Buildings Using Hidden Markov Model," *Energies*, vol. 11, pp. 1996-1073, 2018.
25. S. Kassan, P. Lorenz and J. Gaber, "Low energy and location based clustering protocol for Wireless Sensor Network," International Conference on communication, Kansas, 2018.
26. G. Fugarolas-Alvarez-Ude, C. Hérves-Beloso, E. Moreno-García and J. P. Torres-Martínez, "A market game approach to differential information economies," *Economic Theory*, vol. 38, no. 2, pp. 321- 330, February 2009.
27. E. D. SPYROU, S. YANG and D. K. MITRAKOS, "Game-Theoretic Optimal Power-Link Quality Topology Control in Wireless Sensor Networks," *Sensors & Transducers*, vol. 212, no. 5, pp. 1-14, May 2017.
28. A. S. Sani, D. Yuan, J. Jin, L. Gao, S. Yu and Z. Y. Dong, "Cyber security framework for Internet of Things-based Energy Internet," *Future Generation Computer Systems*, February 2018.
29. T. Alskaf, M. G. Zapata, and B. Bellalta, "Game Theory for Energy Efficiency in Wireless Sensor Networks: Latest Trends," *Journal of Network and Computer Applications*, vol. 54, pp. 33-61, 2015.

- 30.H. Y. Shi, W. L. Wang, N. M. Kwok and S. Y. Chen, "Game Theory for Wireless Sensor Networks: A Survey," *Sensors*, vol. 12, pp. 9055-9097, 2012.
- 31.D. Wu, Y. Cai, L. Zhou and J. Wang, "A Cooperative Communication Scheme Based on Coalition Formation Game in Clustered Wireless Sensor Networks,"*IEEE Transactions on Wireless Communications*, vol. 11, no. 3, pp. 1190-1200, March 2012.
- 32.A. Jonnalagadda, L. Kuppusamy, "A cooperative game framework for detecting overlapping communities in social networks,"*Physica A: Statistical Mechanics and its Applications*, vol. 491, pp. 498-515, 2018.
- 33.C. D. Truong, M. A. Khan, F. Sivrikaya and S. Albayrak, "Cooperative game theoretic approach to energy-efficient coverage in wireless sensor networks,"*Seventh International Conference on Networked Sensing Systems (INSS)*, Kassel, pp. 73- 76, 2010.
- 34.S. Sengupta, M. Chatterjee and K. Kwiat, "A Game Theoretic Framework for Power Control in Wireless Sensor Networks," *IEEE Transactions on Computers*, vol. 59, no. 2, pp. 231-242, February. 2010.
- 35.L. Yang, Y. Lu, L. Xiong, Y. Tao and Y. Zhong, "A Game Theoretic Approach for Balancing Energy Consumption in Clustered Wireless Sensor Networks," *Sensors*, vol. 17, pp. 2654, 2017.
- 36.D. T. Hoang, X. Lu, D. Niyato, P. Wang, D. I. Kim and Z. Han, "Applications of Repeated Games in Wireless Networks: A Survey," *IEEE Communications Surveys & Tutorials*, vol. 17, PP. 2102 - 2135, 2015.

37. B. Pati, J. L. Sarkar and C. R. Panigrahi, "An Energy Efficient Approach to Select Cluster-Head in Wireless Sensor Networks," *Arabian Journal for Science and Engineering*, vol. 42, pp. 669-676, 2017.
38. C. Knight, J. Davidson and S. Behrens, "Energy Options for Wireless Sensor Nodes," *Sensors*, vol. 8, pp. 8037-8066, 2008.
39. S. Dolev, S. Frenkel, M. Rosenblit, R. P. Narayanan and K. M. Venkateswarlu, "In-vivo energy harvesting nano robots," 2016 IEEE International Conference on the Science of Electrical Engineering (ICSEE), Eilat, pp. 1-5, 2016.
40. H. Nesser, H. Débeda, J. Yuan, A. Colin, P. Poulin, I. Dufour and C. Ayela, "All-organic microelectromechanical systems integrating electrostrictive nanocomposite for mechanical energy harvesting," *Nano Energy*, vol. 44, pp. 1-6, 2018.
41. H. H. R. Sherazi, L. A. Grieco and G. Boggia, "A comprehensive review on energy harvesting MAC protocols in WSNs: Challenges and tradeoffs," *Ad Hoc Networks*, vol. 71, pp. 117-134, 2018.
42. F. K. Shaikh and S. Zeadally, "Energy harvesting in wireless sensor networks: A comprehensive review," *Renewable and Sustainable Energy Reviews*, vol. 55, pp. 1041-1054, 2016.
43. K. S. Adu-Manu, A. N. Adam, A. C. Tapparello, A. H. Ayatollahi and A. W. Heinzelman, "Energy-Harvesting Wireless Sensor Networks (EH-WSNs): A Review," *ACM Trans. Sen. Netw.*, vol. 14, no. 02 pp. 1-50, 2018.
44. F. Narita and M. Fox, "A Review on Piezoelectric, Magnetostrictive, and Magnetoelectric Materials and Device Technologies for Energy Harvesting Applications," *Adv. Eng. Mater.*, vol. 20, no. 05, 2017.

45. K. S. Adu-Manu, N. Adam, C. Tapparello, H. Ayatollahi and W. Heinzelman, "Energy-Harvesting Wireless Sensor Networks (EH-WSNs): A Review," *ACM Transaction on Sensor Networks*, vol. 14, no. 10, pp. 01-50, 2018.
46. J. Siang, M. H. Lim, and M. S. Leong, "Review of vibration-based energy harvesting technology: Mechanism and architectural approach," *International Journal of Energy Research*, vol. 42, no. 05, pp. 1866-1893, 2018.
47. H. Yetgin, K. T. K. Cheung, M. El-Hajjar and L. H. Hanzo, "A Survey of Network Lifetime Maximization Techniques in Wireless Sensor Networks," in *IEEE Communications Surveys & Tutorials*, vol. 19, no. 2, pp. 828-854, 2017.
48. T. Rault, A. Bouabdallah, and Y. Challal, "Energy efficiency in wireless sensor networks: A top-down survey," *Computer Networks*, vol. 67, pp. 104-122, 2014.
49. F. Aznoli and N. J. Navimipou, "Deployment Strategies in the Wireless Sensor Networks: Systematic Literature Review, Classification, and Current Trends," *Wireless Personal Communication*, vol. 95, no. 02, pp. 819-846, 2017.
50. N. Kulkarni, N. R. Prasad and R. Prasad, "A Novel Sensor Node Deployment using Low Discrepancy Sequences for WSN," *Wireless Personal Communications*, vol. 100, no. 02, pp. 241-254, 2018.
51. T. Srisooksai, K. Keamarungsi, P. Lamsrichan, and K. Araki, "Practical data compression in wireless sensor networks: A survey," *Journal of Network and Computer Applications*, vol. 35, pp. 37-59, 2012.
52. W. Wang, D. Wang, and Y. Jiang, "Energy efficient distributed compressed data gathering for sensor networks," *Ad Hoc Networks*, vol. 58, pp. 112 -117, 2017.

53. M. Leinonen, M. Codreanu and M. Juntti, "Distributed Distortion-Rate Optimized Compressed Sensing in Wireless Sensor Networks," *IEEE Transaction on Communications*, vol. 66, no. 4, pp. 1609-1623, 2018.
54. J. Uthayakumar, T. Vengattaraman, and P. Dhavachelvan, "A new lossless neighborhood indexing sequence (NIS) algorithm for data compression in wireless sensor networks," *Ad Hoc Networks*, vol. 83, pp. 149-154, 2019.
55. H. H. R. Sherazi, L. A. Grieco, and G. Boggia, "A comprehensive review on energy harvesting MAC protocols in WSNs: Challenges and tradeoffs," *Ad Hoc Networks*, vol. 71, pp. 117-134, 2018.
56. T. AlSkaif, B. Bellalta, M. Guerrero Zapata, and J. M. B. Ordinas, "Energy efficiency of MAC protocols in low data rate wireless multimedia sensor networks: A comparative study," *Ad Hoc Networks*, vol. 56, pp. 141-157, 2017.
57. M. Javadi, H. Mostafaei, M. U. Chowdhury, and J. H. Abawajy, "Learning automaton based topology control protocol for extending wireless sensor networks lifetime," *Journal of Network and Computer Applications*, vol. 122, pp. 128-136, 2018.
58. S. Kassar, J. Gaber, and P. Lorenz, "Game theory based distributed clustering approach to maximize wireless sensors network lifetime," *Journal of Network and Computer Applications*, vol. 123, pp. 80-88, 2018.
59. T. Wang, G. Zhang, X. Yang, and A. Vajdi, "Genetic algorithm for energy-efficient clustering and routing in wireless sensor networks," *Journal of Systems and Software*, vol. 146, pp. 196-214, 2018.

60. C. Williams and R. Yates, "Analysis of a micro-electric generator for microsystems," in Proc. Transducers, Eurosensors IX, Stockholm, Sweden, vol. 1, pp. 369-372, 1995.
61. K. H. Ang, G. Chong and Y. Li, "PID Control System Analysis, Design, and Technology," IEEE Transaction On Control Systems Technology, vol. 13, no. 4, pp. 559-576, 2005.
62. J. G. Ziegler and N. B. Nichols, "Optimum settings for automatic controllers," Transaction for the ASME, vol. 64, pp. 759-768, 1942.
63. K. J. Åström, C. C. Hang, P. Persson, and W.K. Ho, "Towards intelligent PID control," Automatica, vol. 28, no. 01, pp. 1-9, 1992.
64. J.M. Peña, "Characterizations and stable tests for the Routh–Hurwitz conditions and for total positivity," Linear Algebra and its Applications, vol. 393, pp. 319-332, 2004.
65. S. Kassan, J. Gaber and P. Lorenz, "Autonomous Energy Management system achieving piezoelectric energy harvesting in Wireless Sensors," Journal of Mobile Networks and Applications, pp. 1-12, 2019.
66. I. Dietrich and F. Dressler, "On the lifetime of wireless sensor networks," Journal ACM Transactions on Sensor Networks (TOSN), vol. 5, no. 5, 2009.
67. Z. Manap, B. M. Ali, C. K. Ng. K. Noordin and A. Sali, "A Review on Hierarchical Routing Protocols for Wireless Sensor Networks," Wireless Personal Communications, vol. 72, pp. 1077-1104, 2013.

68. Y. Yu, D. Estrin, and R. Govindan, "Geographical and Energy-Aware Routing: A Recursive Data Dissemination Protocol for Wireless Sensor Networks," UCLA Comp. Sci. Dept. tech. rep., UCLA-CSD TR-010023, 2001.
69. N. Kimura and S. Latifi, "A survey on data compression in wireless sensor networks," International Conference on Information Technology: Coding and Computing (ITCC'05), vol. 2, Las Vegas, NV, pp. 8-13, 2005.
70. G. Lu, B. Krishnamachari, C.S. Raghavendra, "An adaptive energy efficient and low-latency Mac for data gathering in wireless sensor networks," in Proc. 18th International Parallel and Distributed Processing Symposium, New Mexico, USA, pp. 26-30, 2004.
71. E. Woodrow and W. Heinzelman, "SPIN-IT: A Data Centric Routing Protocol for Image Retrieval in Wireless Networks," ICIP (3), pp. 913-916, 2002.