



HAL
open science

Modifications d'acides gras pour une utilisation comme matériaux à changement de phase dans des applications de refroidissement électronique

Ibrahim Mjallal

► **To cite this version:**

Ibrahim Mjallal. Modifications d'acides gras pour une utilisation comme matériaux à changement de phase dans des applications de refroidissement électronique. Thermique [physics.class-ph]. Université d'Angers, 2021. Français. NNT : 2021ANGE0064 . tel-03712858

HAL Id: tel-03712858

<https://theses.hal.science/tel-03712858>

Submitted on 4 Jul 2022

HAL is a multi-disciplinary open access archive for the deposit and dissemination of scientific research documents, whether they are published or not. The documents may come from teaching and research institutions in France or abroad, or from public or private research centers.

L'archive ouverte pluridisciplinaire **HAL**, est destinée au dépôt et à la diffusion de documents scientifiques de niveau recherche, publiés ou non, émanant des établissements d'enseignement et de recherche français ou étrangers, des laboratoires publics ou privés.

THESE DE DOCTORAT DE

L'UNIVERSITE D'ANGERS
COMUE UNIVERSITE BRETAGNE LOIRE

ECOLE DOCTORALE N° 602
Sciences pour l'Ingénieur
Spécialité : Energétique-Thermique-Combustion

Par

M. Ibrahim Mjallal

Modifications d'acides gras pour une utilisation comme matériaux à changement de phase dans des applications de refroidissement électronique

Modification of fatty acids to render their uses for electronic cooling application

Thèse présentée et soutenue à Angers, le 1 Décembre 2021

Unité de recherche : **LARIS EA 7315**

Thèse N° :

JURY

Présidente :	Mme Laurence FOURNAISON	DR, INRAE Anthony
Rapporteurs :	M. Patrick GLOUANNEC	Pr., Université Bretagne Sud
	M. Laurent ROYON	Pr., Université Paris-Diderot
Directeur de thèse :	M. Thierry LEMENAND	MCF HDR, Polytech Angers
Co-directeur de thèse :	M. Mohammad HAMMOUD	MCF, LIU University (Liban)
Encadrant :	M. Charbel HABCHI	MCF, HDR, NDU University (Liban)
Invité :	M. Elias FEGHALI	MCF, NDU University (Liban)

Table des Matières

Introduction générale	1
Chapitre 1.	5
Revue bibliographique et état de l'art.....	5
1.1 Matériaux à changement de phase.....	7
1.1.1 Applications	7
1.1.2 Types de PCM.....	8
1.2 Refroidissement des appareils électroniques	11
1.2.1 PCM pour le refroidissement électronique.....	12
1.2.2 Améliorations de PCM	13
1.3 Les acides gras utilisés comme PCM	15
1.4 Dispositifs utilisés pour mesurer les propriétés thermophysiques	18
1.5 Etudes récentes sur le PCM	22
1.6 Conclusion	26
Références	28
Chapitre 2.	33
Modification des propriétés colligatives de l'acide décanoïque pour adapter son utilisation comme matériau à changement de phase	33
2.1 Introduction.....	37
2.2 Material and methods	41
2.2.1 Preparation of the mixtures	42
2.2.2 DSC test	43
2.2.3 Uncertainty analysis.....	44
2.3 Results and discussion.....	44
2.4 Conclusions.....	52
References	53
Chapitre 3.	57
Modification des propriétés colligatives de l'acide arachidique pour une utilisation potentielle comme PCM.....	57
3.1 Introduction.....	63
3.2 Material and methods	67
3.2.1 Preparation of acid mixtures.....	67

3.2.2 Melting behavior of the mixtures	68
3.2.3 Degree of crystallinity.....	68
3.2.4 Heat capacity (C_p) measurement	69
3.2.5 Uncertainty analysis.....	69
3.3 Results and Discussion	70
3.4 Conclusions and Perspectives	77
References	79
Chapitre 4.	81
Dispositif économique pour caractériser les matériaux à changement de phase.....	81
4.1 Introduction.....	86
4.2 Experimental protocol	88
4.2.1 Apparatus and instruments.....	88
4.2.2 Experimental procedure	90
4.2.3 Heat transfer type.....	91
4.3 Experiments and uncertainty analysis	92
4.3.1 Experiments results.....	92
4.3.2 Uncertainty analysis.....	94
4.3.3 Evaluation of the thermal conductivity.....	95
4.3.4 Evaluation of the specific heat	97
4.3.5 Evaluation of the melting point	98
4.4 Conclusion	99
References	100
Chapitre 5.	103
Effet d'un matériau à changement de phase sur les performances thermiques d'un dissipateur thermique de modem.....	103
5.1 Introduction.....	108
5.2 Experimental setup.....	112
5.2.1 Apparatus and instruments.....	112
5.2.2 Experiment procedure	113
5.2.3 Uncertainty analysis.....	114
5.3 PCM thermophysical properties.....	115
5.3.1 Differential scanning calorimetric	115
5.3.2 Thermal conductivity measurement.....	116
5.4 Results	117
5.5 Discussion.....	122

5.6 Conclusions.....	124
References	125
Conclusion générale	127

Introduction générale

La révolution technologique des appareils électroniques a conduit de nos jours à augmenter la dissipation thermique au sein de ces appareils puis à augmenter la température des composants internes. Cette avancée fait de la gestion thermique des puces électroniques un facteur important pour éviter la surchauffe, les dommages et pour prolonger la durée de vie des puces. Plusieurs techniques de refroidissement actif et passif sont utilisées pour améliorer les performances thermiques. Étant donné que les appareils électroniques sont de plus en plus minces avec des batteries plus capacitives pour permettre de longues périodes de travail, et également en raison du bruit, de la consommation d'énergie supplémentaire et des coûts de maintenance élevés, tous les éléments précédents rendent les techniques de refroidissement actif indésirables. De plus, les techniques classiques de refroidissement passif sont insuffisantes pour maintenir l'évolution rapide des applications électroniques. Les chercheurs se concentrent donc sur la recherche et le développement de nouvelles techniques de refroidissement passif. L'utilisation de matériaux à changement de phase (MCP – Phase Change Material, PCM¹) est une technique de refroidissement passif prometteuse qui bénéficie de la chaleur latente élevée des PCM pour absorber l'énergie thermique générée par la puce pendant la période de service en retardant sa température maximale pour maintenir une température convenable à la fin du service en dessous de la température critique de cette puce. Pendant la période de repos, le PCM libère la chaleur absorbée et se solidifie, préparant un nouveau cycle.

Afin de bénéficier de la chaleur latente élevée, le PCM doit se solidifier à nouveau, ce qui fait du

¹ Ce document étant rédigé en partie en français mais majoritairement en anglais, nous utiliserons systématiquement le sigle PCM

PCM un bon choix pour les applications non continues telles que les téléphones mobiles.

La majorité de cette étude se concentre sur la façon de trouver de nouvelles techniques de refroidissement à l'aide de PCM.

Dans ce travail, l'acide arachidique ($C_{20}H_{40}O_2$) et l'acide décanoïque ($C_{10}H_{20}O_2$) sont deux acides gras proposés pour être utilisés comme PCM. Ces acides se caractérisent par leur chaleur latente de fusion élevée et leurs températures de fusion élevées. Concernant la température de fusion, ces acides sont à modifier pour les adapter aux applications des dispositifs électroniques. D'autre part, la chaleur latente de fusion doit rester aussi élevée que possible.

La procédure numérique et expérimentale est la suivante : d'abord une étude numérique est effectuée sur un dissipateur thermique défini pour déterminer le profil de température du dissipateur lorsqu'il est soumis à une charge thermique spécifique avec et sans PCM. Ensuite, une étude numérique est réalisée sur les PCM modifiés incorporés dans différents types de dissipateurs thermiques. Ces dissipateurs correspondent à une application spécifique (modem). La même étude est réalisée à l'aide d'autres PCM bien connus pour montrer l'efficacité du processus de modification du PCM.

Avant de commencer l'étude expérimentale, certaines conditions préalables telles que les propriétés thermophysiques du PCM doivent être connues. Pour mesurer ces paramètres et éviter d'utiliser des appareils onéreux, un nouveau dispositif de mesure bon marché est conçu. La conductivité thermique ainsi que la chaleur spécifique sont mesurées à l'aide de ce nouveau dispositif, puis ces propriétés sont ensuite utilisées pour mieux comprendre les résultats expérimentaux.

Le manuscrit de thèse est divisé en cinq chapitres. Le **chapitre 1** décrit les matériaux à changement de phase, leurs types et comment ils peuvent être utilisés dans les dispositifs électroniques. De

plus, une démonstration du PCM qui va être utilisé et sa modification est décrite. Enfin, les dispositifs traditionnels utilisés pour mesurer les propriétés thermophysiques du PCM sont présentés. Au **chapitre 2**, l'acide décanoïque utilisé comme PCM est détaillé, en plus des modifications appliquées et de ses nouvelles propriétés thermophysiques. De plus, une discussion est menée sur les propriétés thermophysiques obtenues et sur la manière de tirer parti de ce PCM dans les appareils électroniques. Le **chapitre 3** décrit la modification de l'acide arachidique après avoir tiré parti des résultats obtenus par la modification de l'acide décanoïque. À la fin de ce chapitre, une application détaillée sera donnée pour les PCM modifiés. Le **chapitre 4** explique le fonctionnement du nouvel appareil proposé, conçu et fabriqué et l'avantage qu'il procure en remplacement d'appareils coûteux traditionnels, de même que les résultats et le calcul des propriétés d'un PCM bien connu sont présentés et comparés à ceux obtenus à partir de l'appareil pour validation. Ensuite, l'analyse d'incertitude est effectuée pour qualifier ce dispositif expérimental. Enfin, l'appareil est utilisé pour mesurer la conductivité thermique de l'acide décanoïque et arachidique. Le **chapitre 5** traite de la configuration expérimentale qui est principalement un dissipateur de chaleur avec un PCM modifié incorporé. La géométrie du dissipateur est décrite en détail dans ce chapitre et une comparaison du profil de température du dissipateur avec et sans PCM est effectuée. Enfin, **une conclusion générale et des perspectives** à ce travail sont présentées dans le dernier chapitre.

Chapitre 1.

Revue bibliographique et état de l'art

Les composants électroniques sont utilisés dans une large gamme de produits manufacturés, tels que les radios, la télévision, les ordinateurs, etc. La dépendance vis-à-vis des puces de micro-traitement hautes performances s'est intensifiée, contraignant ainsi les fabricants à augmenter les performances, la vitesse de calcul et la fonctionnalité des puces de circuits intégrés en plus de minimiser leur taille, ce qui entraîne une dissipation de puissance élevée dans des boîtiers plus petits. Cela fait de la gestion thermique des appareils électroniques un facteur important si l'on souhaite augmenter la fiabilité et éviter d'endommager les puces.

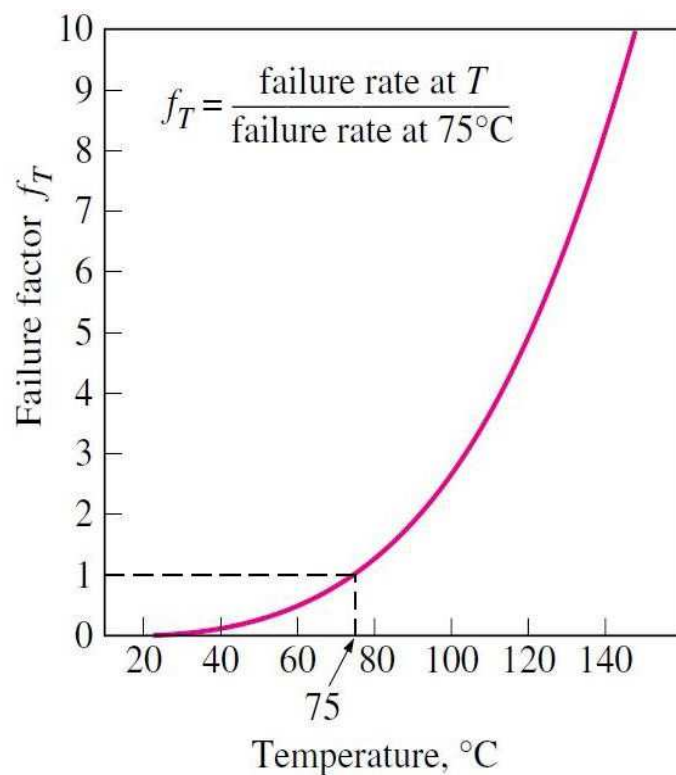

Figure 1. Variation de la défaillance des appareils électroniques par rapport à la température [1].

Comme le montre la figure 1, la relation entre la température et la défaillance des appareils électroniques est clairement démontrée. Gardant à l'esprit que les températures maximales admissibles pour la plupart des puces électroniques varient entre 70 et 85 °C [2].

Diverses méthodes de refroidissement, actives et passives, ont été appliquées pour refroidir les puces électroniques. Les méthodes actives ont besoin d'énergie pour fonctionner, telles que la ventilation forcée à l'aide de ventilateurs électriques, le refroidissement liquide par microcanaux [3] et les caloducs dans les systèmes sans ventilateur. Alors que dans les méthodes de refroidissement passif, aucune alimentation n'est nécessaire pour lancer le processus de refroidissement et aucune pièce mécanique mobile n'est utilisée, comme les dissipateurs thermiques et les PCM [4], qui sont une option attrayante pour les systèmes à faible puissance.

Ce chapitre se propose de décrire la voie pour atteindre les objectifs proposés de ce doctorat. La **section 1** est consacrée à illustrer la définition du PCM, ses applications et ses types. Alors que la **section 2** présente les études réalisées dans le refroidissement des appareils électroniques, principalement à l'aide de PCM et les améliorations apportées à ces appareils de refroidissement. La **section 3** démontre l'utilisation d'acides gras comme PCM dans les appareils électroniques. Afin d'utiliser ces acides gras en tant que matériau à changement de phase, les propriétés thermophysiques de ces acides doivent être déterminées. Cela dit, la **section 4** présente les dispositifs disponibles utilisés pour extraire ces propriétés thermophysiques. Enfin, une **conclusion** récapitulative est tirée pour éclairer la capacité à utiliser les acides arachidique et décanoïque comme matériaux à changement de phase pour extraire la chaleur des appareils électroniques principalement.

1.1 Matériaux à changement de phase

Les PCM sont des substances à chaleur latente de fusion élevée, qui absorbent une quantité relativement importante d'énergie pendant la fusion, puis libèrent cette énergie pendant la solidification. Ainsi, les PCM peuvent être classés comme des unités de stockage de chaleur latente (Latent Heat Storage LHS). Les PCM sont adaptés pour les applications avec de grands avantages par rapport aux petites variations de température et aux applications de plus petite taille, mais il peut être également possible d'utiliser un système PCM pour refroidir les systèmes à grande échelle.

1.1.1 Applications

En plus d'être une bonne alternative pour la gestion thermique électronique, les matériaux à changement de phase sont utilisés dans de nombreuses applications telles que le stockage d'énergie thermique, les applications de construction, le refroidissement de panneaux solaires (panneau photovoltaïque) et bien d'autres applications.

L'utilisation du PCM dans le stockage d'énergie thermique (Thermal Energy Storage TES) a été étudiée par Al-Kyiem et al [5]. Ils ont discuté de l'effet de l'intégration directe du PCM sur un panneau de chauffage solaire d'eau sur la température de l'eau, ils ont constaté que l'intégration du PCM augmente la température de l'eau du réservoir de 5 °C après 24 h de fonctionnement. Une autre revue a été réalisée par Pielichowska et Pielichowski [6], sur l'utilisation du PCM dans les applications de stockage d'énergie thermique. Ils ont classé les PCM en fonction de leurs propriétés thermophysiques, ils ont également montré quels PCM pourraient être utilisés pour l'application TES. Enfin, ils ont conclu que le manque de normes techniques internationales pour tester les PCM, est le principal obstacle empêchant le développement de l'application PCM.

Ma et al. [7] ont étudié les avantages économiques de l'utilisation du PCM pour refroidir les panneaux photovoltaïques. Ils ont constaté que les PCM ne sont pas économiquement réalisables lorsqu'ils sont utilisés uniquement pour améliorer l'efficacité de conversion photovoltaïque (PV). Ils ont montré que si la chaleur stockée par le PCM était utilisée pour l'un des services de chauffage du bâtiment, le système serait réalisable du point de vue économique. De plus, Browne et al. [8] ont montré que l'utilisation d'un PCM dans le refroidissement du panneau PV améliore toujours son efficacité, mais le principal problème auquel cette technique est confrontée est la resolidification du PCM pendant la nuit afin de bénéficier de la capacité de stockage maximale le jour suivant. Ainsi, une amélioration du système PV-PCM doit être réalisée pour permettre au PCM de libérer toute l'énergie stockée pendant la nuit.

Enfin, le PCM est largement utilisé dans les applications de construction comme le chauffage au sol, le refroidissement et également dans l'isolation. Zhang et al. [9] ont étudié les propriétés thermophysiques d'une nouvelle forme de PCM stabilisé qui peut être utilisé pour une application de chauffage par le sol.

1.1.2 Types de PCM

La capacité de stockage du matériau dépend principalement de l'énergie spécifique et de l'énergie latente. L'énergie latente peut être classée en fonction du processus de changement de phase (figure 2) solide-solide, solide-liquide et liquide-gaz.

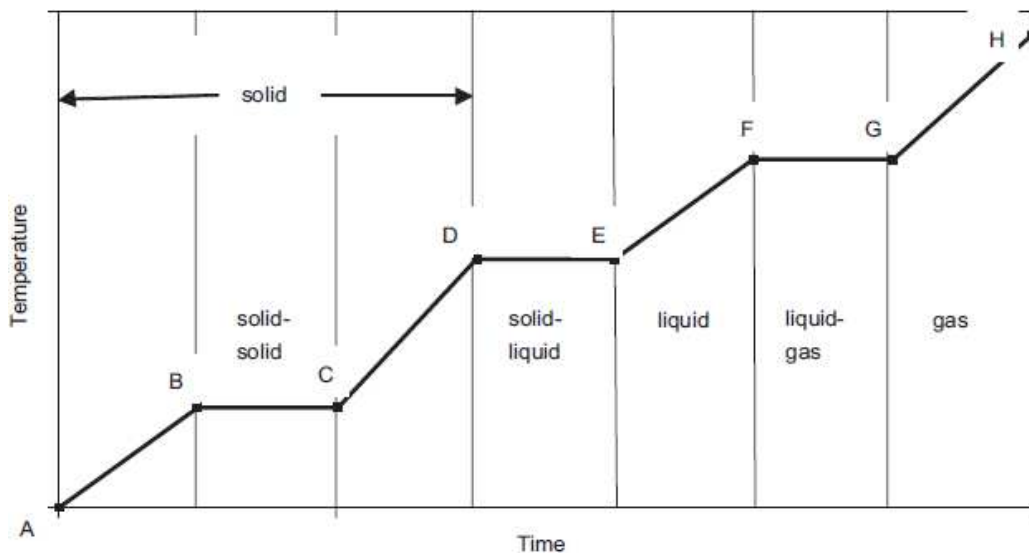

Figure 2. Diagramme de changement de phase.

Le problème majeur du PCM solide-solide est qu'il a une faible énergie latente, tandis que la contrainte de l'utilisation du PCM liquide-gaz est son confinement dans un domaine fermé, ce qui rend le PCM solide-liquide plus fiable en raison de sa forte énergie latente et du problème de faible confinement.

Le PCM solide-liquide est divisé en deux catégories principales, à savoir les matières organiques et inorganiques (figure 3). Les PCM inorganiques tels que les hydrates de sel, se composent de sels inorganiques et d'eau. Leur température de point de fusion varie entre 15 °C et 18 °C. Les avantages des hydrates de sel sont un faible coût du matériau, une capacité de stockage de chaleur latente élevée, un point de fusion précis, une conductivité thermique élevée et aucune inflammabilité. Certains des inconvénients comprennent la surfusion, le phénomène dans lequel une substance refroidit en dessous de son point de congélation sans se solidifier. Cela peut être avantageux dans certaines applications, mais pour la plupart des utilisations, des agents de nucléation doivent être ajoutés pour résoudre ce problème. De plus, ils présentent un changement

de volume d'environ 10% lors du changement de phase solide-liquide. Certains hydrates de sel sont toxiques, corrosifs pour les métaux et peuvent parfois ne pas se recristalliser.

Les PCM organiques ont attiré davantage l'attention des chercheurs que les autres types de PCM. Les PCM biosourcés sont un type de composés organiques dérivés de graisses animales et d'huiles végétales. Leurs températures de point de fusion varient entre -40 °C et 151 °C. Les PCM biosourcés les plus courants sont dérivés d'acides gras et ont une efficacité plus élevée que les hydrates de sel et les matériaux à changement de phase à base de pétrole. Ce sont des matériaux stables et non toxiques qui durent des décennies. D'autres types de PCM organique sont les substances paraffiniques, qui sont des dérivés du pétrole qui ont une consistance cireuse à température ambiante. Leur température de point de fusion varie entre -8 °C et 40 °C. Ils ne sont pas corrosifs et se solidifient sans surfusion. Ils présentent également l'avantage de la stabilité chimique sur de nombreux cycles de chauffage et de refroidissement. Cependant, leurs effets sur l'environnement et la santé peuvent être importants ; certains peuvent blesser la peau, les yeux et les muqueuses.

Cette étude se concentre sur les acides gras en tant que PCM potentiels en raison de leur capacité de stockage de chaleur latente élevée, de leur bon comportement thermique, de leur stabilité chimique, de l'absence de surfusion, du changement de volume négligeable lors du changement de phase et de l'approvisionnement continu à partir de sources naturelles.

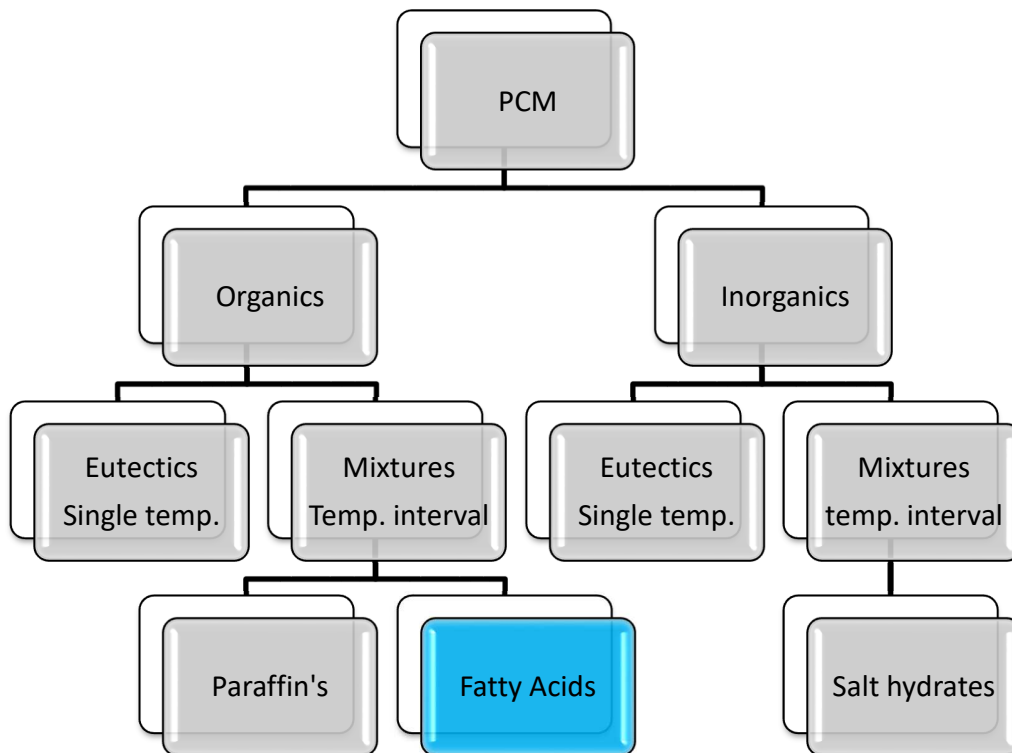

Figure 3. Classification des PCM.

1.2 Refroidissement des appareils électroniques

Le taux de défaillance des équipements électroniques augmente de façon exponentielle avec la température (Figure 1). Des températures plus élevées, augmentent la fuite de courant et dégradent la fiabilité de la puce. En général, les températures maximales admissibles globales de diverses puces varient entre 85 °C et 120 °C [10]. Pour éviter le problème de dépassement d'une température maximale, les boîtiers de circuits intégrés doivent être conçus pour évacuer toute chaleur excessive. La gestion efficace de la température du processeur est une question importante qui doit être étudiée. Afin d'éviter des niveaux de chaleur excessifs et pour réduire la température, des techniques de refroidissement actif et passif sont utilisées. Dans de nombreuses applications, les méthodes de refroidissement standard pourraient être insuffisantes pour la charge certaines

limitations telles que la conductivité thermique limitée de l'air pour la convection et du cuivre pour la conduction et les petits espaces diminuant les performances des capacités.

1.2.1 PCM pour le refroidissement électronique

Comme indiqué précédemment, les PCM sont intégrés dans les composants électroniques dans le cadre de la gestion thermique de ces dispositifs. Lorsque le PCM fond, il absorbe une grande quantité d'énergie sous forme de chaleur latente de fusion. Afin de bénéficier de l'énergie latente, les PCM doivent se solidifier à nouveau, ce qui fait des PCM un bon choix pour les applications non continues telles que les téléphones, les imprimantes et autres appareils mobiles.

L'utilisation des PCM dans les applications électroniques a commencé dans les années 1990 avec les travaux de Pal et Joshi [11] et maintenant les études se concentrent sur la manière d'améliorer les techniques existantes ainsi que de trouver de nouvelles techniques utilisant les PCM.

Kandasamy et al. [12] ont étudié l'effet de l'incorporation du PCM sur un dissipateur de chaleur pour différents niveaux de puissance et ils ont constaté que l'inclusion du PCM dans les cavités des dissipateurs de chaleur augmente les performances de refroidissement par rapport au cas sans PCM.

De plus, l'effet du dissipateur thermique à base de PCM pour différentes géométries et différents types de PCM, à savoir la cire de paraffine et le n-eicosane, a été étudié par Ali et al. [13] et Arshad et al. [14] qui ont montré la différence entre deux géométries : broche et aileron. Ils ont constaté que l'ailette de 3 mm de diamètre présente de meilleures performances que le dissipateur de chaleur à ailettes carrées de 2 mm. Ils concluent également que le n-eicosane et la paraffine améliorent les performances de refroidissement. De plus, ils ont estimé que la fraction volumique

de PCM (quantité de PCM utilisée) affectait directement les performances de refroidissement d'un dissipateur thermique. Une autre étude expérimentale a été réalisée par Gharbi et al. [15] pour étudier l'effet du PCM pour retarder la température de pointe en utilisant une configuration différente de dissipateur thermique. Ils ont montré que l'utilisation du PCM prolonge deux fois le temps nécessaire pour atteindre la température de pointe par un dissipateur de chaleur.

Un système d'emballage différent est suggéré par Kaplan et al. [16]. Leur étude s'est concentrée sur l'inclusion du PCM sur le radiateur directement et non entre les ailettes du dissipateur. Ce nouveau modèle a une meilleure précision que l'emballage précédent.

Enfin, une application directe sur les appareils mobiles a été réalisée par Tomizawa et al. [17]. L'influence de la masse, de la chaleur latente et de la conductivité thermique sur la température du téléphone intelligent a été étudiée par les auteurs. Une feuille PCM à partir de paraffine a été préparée en utilisant de la cire comme PCM et cette feuille a été directement placée sur la puce électronique. Ils ont constaté que la feuille PCM retardait le temps de saturation. Ils ont conclu que la relation entre la masse du PCM et le temps de saturation est linéaire et que le temps de saturation augmente avec l'augmentation de la masse de la feuille. Ils concluent également que la chaleur latente a un effet plus important sur la chaleur saturée que sur la chaleur sensible.

1.2.2 Améliorations de PCM

De nombreuses tentatives ont été menées pour améliorer les performances du PCM dans le refroidissement des dispositifs électroniques. Il a été constaté que l'augmentation de la conductivité thermique peut améliorer les performances du PCM. Une faible conductivité thermique conduit à une fusion incomplète du PCM provoquant une surchauffe dans la couche

liquide près de la source de chaleur qui provoque une augmentation de la température de la puce réduisant ainsi ses performances. Weinstein et al. [18] ont étudié l'effet de l'ajout de nanofibres de carbone (Carbon nanofibres, CNF) à la cire de paraffine. Ils ont constaté que l'ajout d'une quantité critique de pourcentage en poids améliorerait les performances thermiques puisque le CNF conduit à améliorer la dissipation thermique de la couche supérieure du PCM. Mais l'augmentation du pourcentage en poids des fibres au-dessus d'une valeur critique entraîne une fusion incomplète du PCM et isole la couche de fusion de la couche solide. Shaikh et Lafdi [19] ont étudié l'effet de l'ajout de nanotubes de carbone (Carbon nanotubes CNT) sur la conductivité thermique. Ils ont constaté que l'ajout de ces CNT augmente la conductivité thermique du PCM et diminue la température en régime permanent. Ils ont également conclu qu'en optimisant la chaleur dissipée et l'énergie stockée, la masse critique du PCM peut être trouvée. Pour comparer les performances du CNF et du CNT, Cui et al. [20] ont étudié l'effet de l'addition de nanofibres de carbone et de nanotubes de carbone sur la cire de soja et la cire de paraffine. Ils ont constaté qu'à 10% en poids, la conductivité thermique du soja-CNF augmente à 0,469 W/m K et celle du soja-CNT augmente à 0,403 W/m K contre 0,324 W/m K sans aucun additif. Notons que ces additifs n'affectent pas l'énergie latente du PCM. L'effet de la nano plaque de graphite exfolié sur la conductivité thermique du PCM a été étudié par Kim et Drzal [21]. Il a été constaté que l'augmentation du pourcentage en poids de la nano plaque augmente la conductivité thermique et que la relation entre le pourcentage en poids de la nano plaque et la conductivité thermique du PCM est linéaire.

Loin du graphite, Ho et Gao [22] ont étudié l'effet des nanoparticules en utilisant l'émulsification de l'aluminium dans la paraffine. Mesalhy et al. [23] ont étudié numériquement l'effet de l'ajout d'une matrice solide au PCM et la meilleure amélioration se produit en utilisant une matrice avec une porosité élevée et une conductivité thermique élevée. Différentes méthodes de valorisation des

matériaux ont été étudiées par Chintakrinda et al. [24] utilisant de la mousse de graphite, de la mousse d'aluminium et du CNF et les résultats ont été comparés à la paraffine pure. Il a été constaté que le CNF présente la meilleure efficacité pour retarder la température de pointe de l'appareil. L'intégration du graphite peut augmenter la conductivité thermique jusqu'à 130 fois comme l'ont prouvé Mills et al. [25].

Gong et Mujumdar [26] ont découvert de nouvelles techniques pour améliorer les performances thermiques en utilisant plusieurs PCM. Ils ont montré que la sélection des caractéristiques du PCM d'un système à plusieurs PCM a un effet important sur les performances du système.

Toutes ces études ont été effectuées pour augmenter la conductivité thermique du PCM, mais la plupart d'entre elles sont considérées comme non fonctionnelles en raison du mélange non homogène du PCM avec l'additif, ce qui conduit à la désintégration du mélange entre le PCM et l'additif après plusieurs cycles.

1.3 Les acides gras utilisés comme PCM

La capacité des acides gras à être produits à partir de sources naturelles fait de ces acides une solution alternative à utiliser comme PCM dans le refroidissement des appareils électroniques. Les acides gras se trouvent soit saturés soit insaturés, la différence résidant dans la présence d'une double liaison dans les acides gras insaturés. Pour le même nombre de chaînes carbonées, les acides gras saturés présentent une température de fusion plus élevée. D'autre part, il existe deux formes d'acides gras insaturés CIS ou TRANS, les acides gras CIS sont très probablement trouvés dans la nature alors que la plupart des acides gras TRANS sont fabriqués en laboratoire. En tant que propriété des acides gras, le nombre de carbones dans la chaîne carbonée est directement

proportionnel à la chaleur latente de fusion et à la température de fusion des acides. L'augmentation de la chaleur latente est hautement souhaitable. Cependant, l'augmentation de la température de fusion limite l'utilisation de l'acide gras comme PCM pour refroidir les dispositifs électroniques, au lieu de cela, il est préférable de la diminuer.

Pour diminuer la température de fusion de l'acide gras, soit la fonction carboxylique peut être modifiée, soit une double liaison Trans peut être produite pour transformer l'acide gras en sa forme insaturée. En utilisant des méthodes pratiques, des acides gras modifiés peuvent être obtenus.

Donc, à notre connaissance, il n'y a pas d'études critiques sur les acides gras comme solution alternative pour le refroidissement électronique. La plupart des études sur les acides gras comme PCM tentent de stabiliser la forme des acides gras ou de produire un acide gras eutectique afin de l'utiliser dans des applications de chauffage par le sol ou de refroidissement solaire.

L'avantage du stabilisateur de forme est que le PCM conserve une forme macro solide même lorsqu'il fond. Wang et Meng [27] ont étudié la stabilisation de la forme du PCM en utilisant du polyméthacrylate de méthyle (PMMA) sur des acides gras eutectiques (acide caprique-acide laurique, acide caprique-acide myristique, acide caprique-acide stéarique et acide laurique-acide myristique). Tout au long de ce travail, la chaleur latente et la chaleur spécifique ont été déterminées à l'aide de l'analyse calorimétrique différentielle (differential scanning calorimetric, DSC).

Alkan et Sari [28] ont étudié un stabilisateur de forme utilisant le PMMA sur quatre types d'acides gras à savoir l'acide stéarique, l'acide palmitique, l'acide myristique et l'acide laurique. Leurs propriétés thermophysiques ont été trouvées et comparées à l'encapsulation traditionnelle. Ils ont conclu que ce type de stabilisation de forme est bien meilleur car il élimine la résistance thermique causée par l'encapsulation traditionnelle et maintient les propriétés thermophysiques.

Une étude similaire a été réalisée par Sari et al. [29] utilisant du styrène anhydride maléique (SMA) au lieu du PMMA. Ils ont constaté que les meilleurs résultats des tests d'étanchéité étaient obtenus lorsque des proportions de 85% en poids d'acides gras et de 15% de SMA étaient mélangées. Ces types de stabilisation de forme peuvent être utilisés pour une application de chauffage par le sol en raison de leurs bonnes propriétés thermiques et de leur simplicité à préparer dans une dimension souhaitée.

Une autre méthode de stabilisation de la forme a été étudiée par Li et al. [30]. La diatomite a été utilisée pour stabiliser la forme de l'acide gras binaire. Le principal inconvénient de cette méthode est la réduction de la chaleur latente de fusion par rapport aux acides gras purs (où elle atteint 58%). Li et al. [31] ont étudié l'effet de la surface de la diatomite et comment elle affecte les propriétés thermophysiques PCM / diatomite. Ils ont constaté que plus la surface de la diatomite est grande, plus la masse des acides gras est absorbée.

Outre la stabilisation de la forme, la conductivité thermique est également une préoccupation des chercheurs. De nombreuses tentatives ont été faites par Sari et Karaipekli [32] comme la combinaison entre l'acide palmitique et le graphite expansé. Les résultats ont montré qu'à 20% en poids du graphite expansé, la conductivité thermique est augmentée 2,5 fois. Ils ont également montré que le composite est stable même après 3000 cycles thermiques.

Pour déterminer la compatibilité des acides avec différents matériaux, Kahwaji et al. [33] ont étudié cinq types d'acides gras à savoir : l'acide caprique, l'acide laurique, l'acide myristique, l'acide palmitique et l'acide stéarique. Toutes les propriétés thermophysiques ont été trouvées en utilisant le DSC et le système de mesure des propriétés physiques (Physical Properties Measurement System, PPMS). Ils ont constaté que les acides gras ne sont compatibles ni avec l'alliage de cuivre, ni avec le plastique, à l'exception du polycarbonate, ni avec le silicium. Ainsi, un dissipateur

thermique en alliage de cuivre ne peut pas être utilisé avec une application d'acides gras.

Comme remarqué dans les études mentionnées précédemment, la plupart de ces études n'utilisaient que cinq acides gras, à savoir : l'acide caprique, l'acide laurique, l'acide myristique, l'acide palmitique et l'acide stéarique. La majorité de ces études ont tenté de trouver les propriétés thermophysiques des acides avant et après modification sans utiliser ces acides dans le refroidissement électronique. Dans ce travail, les acides arachidique et décanoïque sont utilisés comme PCM et la température de fusion est modifiée et finalement ces acides sont utilisés pour le refroidissement électronique.

1.4 Dispositifs utilisés pour mesurer les propriétés thermophysiques

La plupart des études se concentrent désormais sur la modélisation numérique du matériau à changement de phase à l'aide d'un logiciel par éléments finis. La simulation numérique du PCM fait gagner du temps et de l'argent mais elle fait face à une contrainte majeure qui est le manque d'informations sur les propriétés thermophysiques du PCM et nécessite donc une étape préalable pour trouver toutes les propriétés nécessaires à la réalisation de la simulation. Des machines coûteuses et précises telles que la calorimétrie différentielle à balayage (DSC) et les systèmes de mesure des propriétés physiques (PPMS) sont utilisées pour déterminer les propriétés thermophysiques du PCM. Hasan et al. [34] ont utilisé la DSC pour déterminer la chaleur spécifique, la température de fusion et la chaleur latente de fusion pour le PCM avant de faire les simulations. Mills et al. [35] et Kim et Drzal [36] ont utilisé ces machines pour déterminer les propriétés du PCM.

Dans un test DSC, il existe deux matériaux, un matériau de référence bien connu et l'échantillon à

tester. La technique DSC trouve l'énergie nécessaire pour établir une différence de température nulle entre l'échantillon et le matériau de référence en fonction de la température. Le matériau de référence et l'échantillon sont chauffés par des éléments chauffants séparés (figure 4) de telle sorte que leur température reste égale tandis que ces températures sont augmentées ou diminuées linéairement. Les propriétés thermophysiques du matériau de référence doivent être bien connues.

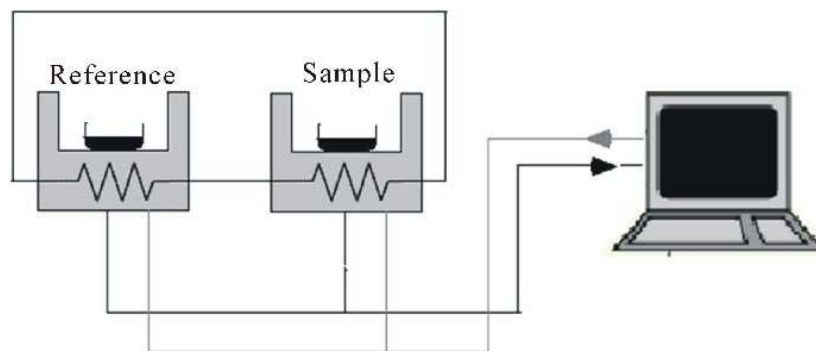

Figure 4. Schéma d'une machine DSC

Il convient de mentionner que les valeurs d'enthalpie du chauffage-refroidissement sont systématiquement affectées par le gradient de température à l'intérieur du PCM et dépendent de la vitesse de chauffage / refroidissement et de la masse de l'échantillon. Le mode de balayage le plus largement utilisé consiste en des segments de chauffage et de refroidissement à des taux constants (méthode dynamique) [37]. La principale limitation du DSC est que les échantillons doivent être : petits, purs et homogènes [38].

En analysant le graphique (figure 5) de la machine DSC, la température de fusion, la chaleur spécifique ainsi que la chaleur latente de fusion peuvent être déduites. Deux courbes sont tracées : la bleue représente le processus de refroidissement, tandis que la rouge représente le processus de fusion endothermique.

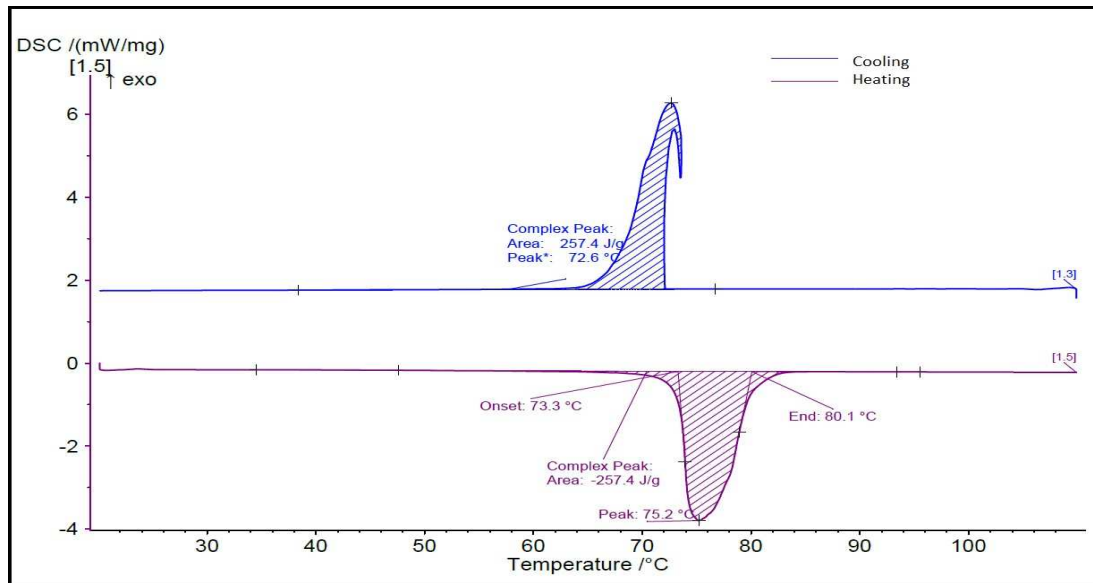

Figure 5. Résultats du thermogramme DSC.

Le système de mesure des propriétés physiques (PPMS) mesure la conductivité thermique d'un matériau en surveillant la chute de température à l'intérieur d'un matériau lorsqu'une quantité connue de chaleur traverse le matériau (voir Figure 6).

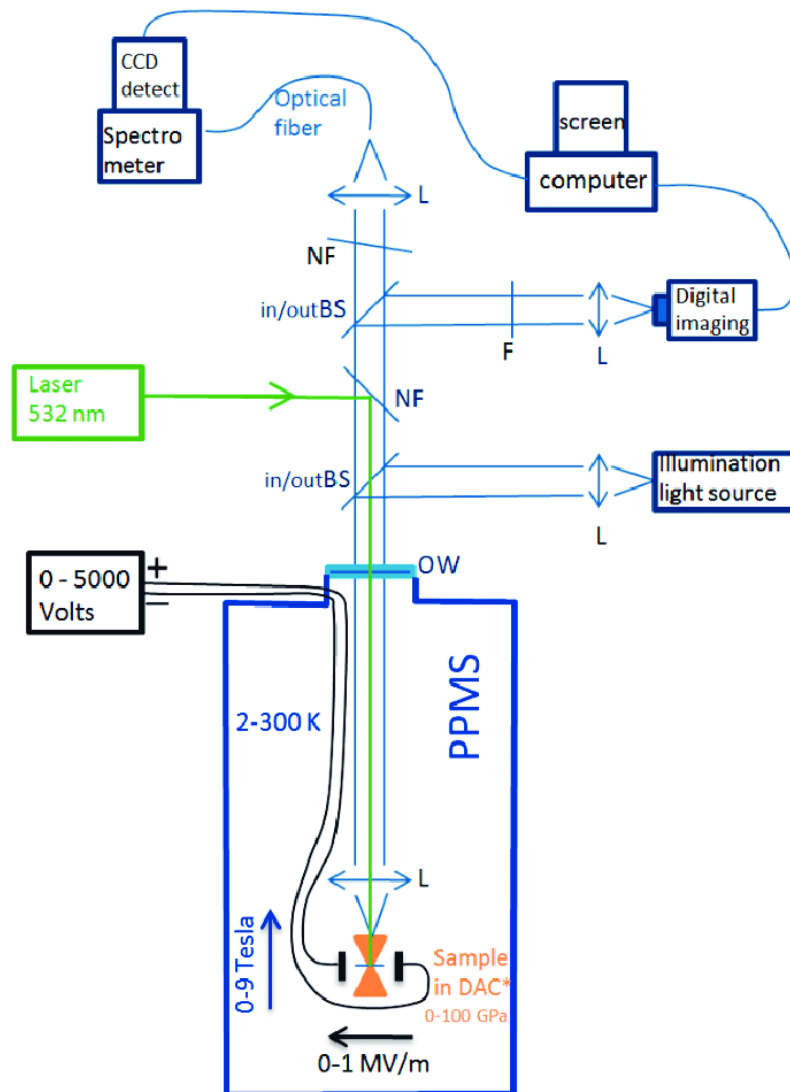

Figure 6. Schéma du PPMS.

Ces deux machines volumineuses sont principalement utilisées pour trouver les propriétés thermophysiques du PCM. Dans ce travail, une machine bon marché est conçue pour remplacer ces deux machines afin de mesurer les propriétés thermophysiques du PCM modifié.

D'autres dispositifs et procédés ont été inventés, tels que la méthode du bain double, un appareil conçu et construit à Çukurova (Turquie) pour mesurer les courbes enthalpie-température [39,40].

Comme son nom l'indique, il se compose de deux bains identiques bien agités chauffés par une résistance électrique. En supposant que toute l'énergie électrique fournie à la résistance chauffante est convertie en chaleur, la charge énergétique est contrôlée avec l'ajusté. La tension instantanée et les courants électriques sont mesurés et enregistrés par un enregistreur de données afin de déterminer les entrées de puissance pour chaque bain individuel. Pour refroidir les bains à température ambiante, on utilise des serpentins en cuivre à ailettes identiques avec de l'eau froide qui circule à l'intérieur. Pour des températures inférieures à la température ambiante, des systèmes de pompe à chaleur supplémentaires peuvent être utilisés.

1.5 Etudes récentes sur le PCM

Un récapitulatif d'études, publiés ces dernières années, réalisées sur les matériaux PCM et leurs performances, est présenté dans le tableau 1.

Tableau 1. Études sur les performances de PCM

Reference, year, Journal name	Title	Type of study	Topics and main results
Kumar <i>et al.</i> [41], 2021, Microelectronics Reliability	Thermal performance of heat sink using nano-enhanced phase change material (NePCM) for cooling of electronic components	Experimental	<ul style="list-style-type: none"> ➤ Conduct an experimental study for a heat sink based Nano-enhanced phase change material with different configuration of heat sink. ➤ Copper oxide was used as nanoparticle and paraffin wax as PCM. ➤ Four configurations of PCM were used, heat sink with no fins, heat sink with rectangular plate fins, heat sink with square plate fins and heat sink with circular plate fins. ➤ The maximum reduction in temperature is found to be equal to 15°C for heat sink with square plate fins.
Hayat <i>et al.</i> [42], 2020, Journal of Energy Storage	Phase change material/heat pipe and Copper foam-based heat sinks for thermal management of electronic systems	Experimental	<ul style="list-style-type: none"> ➤ Copper foam is used as thermal conductivity enhancer between the phase changer material and heater. ➤ The experiment is done with and without PCM and also with and without fan and the PCM used is RT-35 HC with melting temperature equal to 34°C. ➤ The maximum temperature reduction was obtained for the system with fan and with PCM and its equal to 54% for a heat flux of 3 KW/m².
Chad <i>et al.</i> [43], 2021, Journal of Energy Storage	Thermophysical characteristics and enhancement analysis of carbon-additives phase change mono and hybrid materials for thermal management of electronic devices	Experimental	<ul style="list-style-type: none"> ➤ Conduct an experiment on the Nano-enhanced phase change material using four additives, multi wall carbon Nano-tube (MWCNT), graphene oxide (GO), reduced graphene oxide (RGO) and graphene Nano-tube on RT- 35 HC PCM. ➤ The experiment was conducted with mono and hybrid (GO+MWCNT, RGO+MWCNT and GNP+MWCNT) nanoparticles. ➤ Results show that the effect of hybrid nanoparticles were more preferable than the mono nanoparticles. ➤ The thermal conductivity enhanced by 182.7%, 183.8% and 185.3% while the values of latent heat of fusion 237.42, 235.35 and 230.82 J/g were achieved for GO+MWCNT, RGO+MWCNT and GNP+MWCNT respectively
Nazari <i>et al.</i> [44], 2021, Journal of Energy Storage	Multicomponent bio-based fatty acids system as phase change material for low temperature energy storage	Experimental	<ul style="list-style-type: none"> ➤ An experimental study on coconut oil fatty acids (CoFA) and commercial grades of oleic (OA) and linoleic acid (LA) was done at different compositions of OA and LA. ➤ Thermal and chemical properties were studied using differential scanning calorimetric (DSC), T-history, transient hot wire and Fourier Transform Infrared spectroscopy (FTIR-ATR) ➤ The melting zone of the developed PCM's were in the range of the human comfort zone (18-25 °C). ➤ The specific heat, latent heat and thermal conductivity of the developed PCM's range between 1-5 J/g.K, 40-100 J/g and 0.2-0.35 W/m.K ➤ The developed PCM's can be used in building application materials.

Emam <i>et al.</i> [45], 2019, Renewable Energy	Thermal management of electronic devices and concentrator photovoltaic systems using phase change material heat sinks: Experimental investigations	Experimental	<ul style="list-style-type: none"> ➤ Experimental setup using Phase Change Material for passive cooling of electronic devices and concentrator photovoltaic (CPV). ➤ RT252HC, RT35HC and RT44HC are the used PCM for the experimental study. ➤ Results revealed that the using of the PCM decreased the temperature of the electronic devices and CPV. ➤ The air cavities insides the solid PCMs has a great effect of the cooling performance of the system.
Al Siyabi <i>et al.</i> [46], 2018,Energies	Multiple Phase Change Material (PCM) Configuration for PCM-Based Heat Sinks—An Experimental Study	Experimental	<ul style="list-style-type: none"> ➤ Cooling performance of heat sink with different sink configurations and different PCM combination are studied experimentally. ➤ RT50 and RT55 delay and reduce the peak temperature of the sink. ➤ The delay time increases by increasing the thickness of the PCM from 30 mm to 60 mm. ➤ The delay time decreases by increases the power generation by the chip.
Bayat <i>et al.</i> [47], 2018, ThermalScience and Engineering Progress	Investigation of finned heat sink performance with nano enhanced phase change material (NePCM)	Numerical	<ul style="list-style-type: none"> ➤ Numerical investigation of the cooling performance of a finned heat sink. ➤ The sink is studied with PCM and with NePCM ➤ Results showed that the normal PCM enhanced the thermal performance of the sink ➤ The NePCM improves the performance of the sink than the normal PCM. ➤ Increasing the weight fraction of nanoparticles decreases the sink performance.
Arshad <i>et al.</i> [48], 2018, Applied Thermal Engineering	An experimental study of enhanced heat sinks for thermal management using n-eicosane as phase change material	Experimental	<ul style="list-style-type: none"> ➤ Experimental investigation of the cooling performance of portable electronic device using n-eicosane as PCM. ➤ The heat sink studied has pin fin geometry. ➤ Four configurations were studied at different volume fraction of n-eicosane. ➤ The addition of n-eicosane keep the temperature of mobile devices in comfortable zone. ➤ 2 mm thick pin-fin heat sink had the best performance and best reliability.
Bondareva <i>et al.</i> [49], 2019,International Journal of Heat and Mass transfer	Heat transfer performance of the finned nano-enhanced phase change material system under the inclination influence	Numerical	<ul style="list-style-type: none"> ➤ A numerical study for the heat sink using paraffin with alumina nanoparticles as PCM was done. ➤ The heat sink is studied with different inclination angles and with different Rayleigh number (Ra) to investigate the effect of the inclination on the natural convection. ➤ when lowering the natural convection, the melting time of the PCM is reduced. ➤ The Nano-Paraffin melts faster at inclination angle higher than 90°

Hua <i>et al.</i> [50], 2021 Journal of Molecular Liquids	Research on passive cooling of electronic chips based on PCM: A review	Review	<ul style="list-style-type: none"> ➤ The performance of the chips is directly related to its temperature, thus the increase in power density shortens the life of the chips. ➤ The latent heat of the inorganic salt hydrate and organic acid is between 100 to 300 KJ/kg. ➤ The solid-gas and liquid-gas PCM are never used before in electronic cooling application. ➤ The Nano-enhanced PCM increase the thermal conductivity of the pure PCM and by that increase the melting time and reduce the solidification time of the heat sink. ➤ The mass fraction for the nano-PCM is between 0.2 and 1%.
Bondareva and Sheremet [51], 2020, Nanomaterials	Effect of Nano-sized heat transfer enhancers on PCM-based heat sink performance at various heat loads	Numerical	<ul style="list-style-type: none"> ➤ Due to thermal conductivity of the paraffins and fatty acids a thermal conductivity enhancing techniques is needed. ➤ The nanoparticle enhanced PCM inside a close copper radiator is numerically investigated. ➤ The effect of the nanoparticles on system is directly related to the Rayleigh number.
Kurhade <i>et al.</i> [52], 2021, Materials Today: Proceedings	Computational study of PCM cooling for electronic circuit of smart-phone	Numerical	<ul style="list-style-type: none"> ➤ The nowadays games and applications leads to increase the heat dissipation of the smartphone by about 2 to 6 W. ➤ A smartphone will be modeled and studied numerically to investigate the effect of the PCM on the cooling of the electronic arrangement of the smartphone. ➤ The PCM delays the peak temperature by absorbing the heat dissipated and convert its phase from solid to liquid.
Rostamian <i>et al.</i> [53], 2021, International Communication in Heat and Mass Transfer	Management of electronic board temperature using heat sink containing pure and microencapsulated phase change materials	Experimental	<ul style="list-style-type: none"> ➤ An electronic board heat sink is studied experimentally with and without PCM. ➤ The electronic board is studied under fixed and pulsed power with wide power range (5 to 18 W), for different heat sink configuration and with different volume fraction of PCM. ➤ The time taken by heat sink to reach steady state for stearic acid, lauric acid, paraffin as pure PCM and PX52 and Gr42 as commercial microencapsulated PCM were 33, 31, 36, 32 and 26 min ➤ The square 7fins heat sink has better performance than square 3fins and circular 12 fins.
Hasan <i>et al.</i> [54], 2016, Applied Sciences	Comparative effectiveness of different phase change materials to improve cooling performance of heat sinks for electronic devices	Experimental and numerical	<ul style="list-style-type: none"> ➤ Investigation of the effect of salt hydrate, paraffin wax and milk fat as phase change material on the performance of heat sink. ➤ The experiment is conducted at different heat loads (4 to 10 W) and under natural ventilation and forced ventilation. ➤ A numerical modeled is developed using Ansys fluent. ➤ The peak temperature of the forced ventilation is much lower than the natural ventilation. ➤ At same thermal conductivity and latent and specific heat, the PCM with higher density has better performance of the temperature behavior of the heat sink.

Ahmed <i>et al.</i> [55], 2019, Applied Sciences	Passive thermal management of tablet pcs using phase change materials: intermittent operation	Experimental	<ul style="list-style-type: none"> ➤ A tablet PC is experimentally studied to investigate the effect of the PCM on the thermal management of the PC under intermittent operation. ➤ The system is studied under 15 min of operation and 15 min of rest. ➤ A remarkable reduction in the rate of temperature increases during transient operation for both chip and tablet cover. ➤ A decrease by 20°C was noticed for the back-cover during the maximum power operation (8W). ➤ The inclination of the tablet doesn't affect the PCM performance during on period.
--	---	--------------	---

1.6 Conclusion

Le PCM se révèle être une technique prometteuse pour le refroidissement électronique passif. Il absorbe la chaleur générée par les puces sous forme de chaleur latente de fusion et libère cette énergie pendant la période d'arrêt des appareils électroniques. Afin de bénéficier de l'énergie latente, le PCM utilisé doit avoir une température de fusion raisonnable. En d'autres termes, la température de fusion du PCM doit être supérieure à la température ambiante maximale et inférieure à la température maximale admissible de la puce. Sinon, le PCM ne peut pas être efficace pour le refroidissement électronique. Un autre facteur doit être pris en considération, à savoir la chaleur spécifique et la conductivité thermique. Plus la chaleur spécifique est élevée, plus l'énergie sensible peut être absorbée par le PCM avant et après la fusion, tandis que la conductivité thermique affecte directement l'absorption et la libération de l'énergie.

Tous ces facteurs doivent être pris en compte pour sélectionner un PCM pour le refroidissement électronique. L'acide arachidique comme PCM montre des propriétés adéquates pour être utilisé en refroidissement électronique, mais il a une contrainte, sa température de fusion qui est considérablement élevée (proche de la limite de la température maximale admissible). Pour cela, cet acide sera modifié afin de diminuer sa température de fusion. Ainsi, un nouveau type d'acides gras est mis en évidence et utilisé comme PCM. Cela nous permettra de sortir des études

traditionnelles et du PCM utilisé pour le refroidissement électronique. L'acide modifié sera ensuite étudié expérimentalement pour étudier son effet sur différentes applications. Mais avant de commencer avec l'acide arachidique, l'acide décanoïque sera d'abord modifié pour étudier l'effet des additifs sur les propriétés thermophysiques de l'acide gras.

Références

- [1] Reliability Prediction of Electronic Equipment. U.S. Department of Defense, MIL-HDBK-2178B, NTIS, Springfield, VA, 1974.
- [2] Benloucif, S., Guico, M. J., Reid, K. J., Wolfe, L. F., L'Hermite-Balériaux, M., & Zee, P. C. (2005). Stability of melatonin and temperature as circadian phase markers and their relation to sleep times in humans. *Journal of biological rhythms*, 20(2), 178-188.
- [3] H. Xie, A. Ali. 2011. "The use of heat pipes in personal computers." *ITHERM* 331-340
- [4] Kandasamy, Ravi. 2007. "Transient cooling of electronics using phase change material (PCM)-based heat sinks." *Elsevier*, December 23: 11.
- [5] Al-Kayiem, H. H., & Lin, S. C. (2014). Performance evaluation of a solar water heater integrated with a PCM nanocomposite TES at various inclinations. *Solar Energy*, 109, 82-92.
- [6] Pielichowska, K., & Pielichowski, K. (2014). Phase change materials for thermal energy storage. *Progress in materials science*, 65, 67-123.
- [7] Ma, T., Yang, H., Zhang, Y., Lu, L., & Wang, X. (2015). Using phase change materials in photovoltaic systems for thermal regulation and electrical efficiency improvement: a review and outlook. *Renewable and Sustainable Energy Reviews*, 43, 1273-1284.
- [8] Browne, M. C., Norton, B., & McCormack, S. J. (2015). Phase change materials for photovoltaic thermal management. *Renewable and Sustainable Energy Reviews*, 47, 762-782.
- [9] Zhang, Y. P., Lin, K. P., Yang, R., Di, H. F., & Jiang, Y. (2006). Preparation, thermal performance and application of shape-stabilized PCM in energy efficient buildings. *Energy and Buildings*, 38(10), 1262-1269.
- [10] Hill, M. (n.d.). Cooling of Electronic Equipments "chapter 15". Higher education.
- [11] Pal, D., & Joshi, Y. (1996). Application of phase change materials for passive thermal control of plastic quad flat packages: a computational study. *Numerical Heat Transfer, Part A Applications*, 30(1), 19-34.
- [12] Kandasamy, R., Wang, X. Q., & Mujumdar, A. S. (2008). Transient cooling of electronics using phase change material (PCM)-based heat sinks. *Applied Thermal Engineering*, 28(8), 1047-1057.
- [13] Ali, H. M., Arshad, A., Jabbal, M., & Verdin, P. G. (2018). Thermal management of electronics devices with PCMs filled pin-fin heat sinks: A comparison. *International Journal of Heat and Mass Transfer*, 117, 1199-1204.
- [14] Arshad, A., Ali, H. M., Ali, M., & Manzoor, S. (2017). Thermal performance of phase change material (PCM) based pin-finned heat sinks for electronics devices: Effect of pin thickness and PCM volume fraction. *Applied Thermal Engineering*, 112, 143-155.
- [15] Gharbi, S., Harmand, S., & Jabrallah, S. B. (2015). Experimental comparison between different configurations of PCM based heat sinks for cooling electronic components. *Applied Thermal Engineering*, 87, 454-462.

- [16] Kaplan, F., De Vivero, C., Howes, S., Arora, M., Homayoun, H., Burlison, W., ... & Coskun, A. K. (2014, October). Modeling and analysis of phase change materials for efficient thermal management. In *Computer Design (ICCD), 2014 32nd IEEE International Conference on* (pp. 256-263). IEEE.
- [17] Tomizawa, Y., Sasaki, K., Kuroda, A., Takeda, R., & Kaito, Y. (2016). Experimental and numerical study on phase change material (PCM) for thermal management of mobile devices. *Applied Thermal Engineering*, 98, 320- 329.
- [18] Weinstein, R. D., Kopec, T. C., Fleischer, A. S., D'Addio, E., & Bessel, C. A. (2008). The experimental exploration of embedding phase change materials with graphite nanofibers for the thermal management of electronics. *Journal of Heat Transfer*, 130(4), 042405.
- [19] Shaikh, S., & Lafdi, K. (2012). A carbon nanotube-based composite for the thermal control of heat loads. *Carbon*, 50(2), 542-550.
- [20] Cui, Y., Liu, C., Hu, S., & Yu, X. (2011). The experimental exploration of carbon nanofiber and carbon nanotube additives on thermal behavior of phase change materials. *Solar Energy Materials and Solar Cells*, 95(4), 1208-1212.
- [21] Kim, S., & Drzal, L. T. (2009). High latent heat storage and high thermal conductive phase change materials using exfoliated graphite nanoplatelets. *Solar Energy Materials and Solar Cells*, 93(1), 136-142.
- [22] Ho, C. J., & Gao, J. Y. (2009). Preparation and thermophysical properties of nanoparticle-in-paraffin emulsion as phase change material. *International Communications in Heat and Mass Transfer*, 36(5), 467-470.
- [23] Mesalhy, O., Lafdi, K., Elgafy, A., & Bowman, K. (2005). Numerical study for enhancing the thermal conductivity of phase change material (PCM) storage using high thermal conductivity porous matrix. *Energy Conversion and Management*, 46(6), 847-867.
- [24] Chintakrinda, K., Weinstein, R. D., & Fleischer, A. S. (2011). A direct comparison of three different material enhancement methods on the transient thermal response of paraffin phase change material exposed to high heat fluxes. *International Journal of Thermal Sciences*, 50(9), 1639-1647.
- [25] Mills, A., Farid, M., Selman, J. R., & Al-Hallaj, S. (2006). Thermal conductivity enhancement of phase change materials using a graphite matrix. *Applied Thermal Engineering*, 26(14-15), 1652-1661.
- [26] Gong, Z. X., & Mujumdar, A. S. (1996). Enhancement of energy charge-discharge rates in composite slabs of different phase change materials. *International Journal of Heat and Mass Transfer*, 39(4), 725-733.
- [27] Wang, L., & Meng, D. (2010). Fatty acid eutectic/polymethyl methacrylate composite as form-stable phase change material for thermal energy storage. *Applied Energy*, 87(8), 2660-2665.
- [28] Alkan, C., & Sari, A. (2008). Fatty acid/poly (methyl methacrylate) (PMMA) blends as form-stable phase change materials for latent heat thermal energy storage. *Solar energy*, 82(2), 118-124.
- [29] Sari, A., Alkan, C., Karaipekli, A., & Önal, A. (2008). Preparation, characterization and thermal properties of styrene maleic anhydride copolymer (SMA)/fatty acid composites as form stable phase change materials. *Energy Conversion and Management*, 49(2), 373-380.

- [30] Li, M., Wu, Z., & Kao, H. (2011). Study on preparation and thermal properties of binary fatty acid/ diatomite shape-stabilized phase change materials. *Solar Energy Materials and Solar Cells*, 95(8), 2412-2416.
- [31] Li, M., Kao, H., Wu, Z., & Tan, J. (2011). Study on preparation and thermal property of binary fatty acid and the binary fatty acids/diatomite composite phase change materials. *Applied energy*, 88(5), 1606-1612.
- [32] Sari, A., & Karaipekli, A. (2009). Preparation, thermal properties and thermal reliability of palmitic acid/expanded graphite composite as form-stable PCM for thermal energy storage. *Solar Energy Materials and Solar Cells*, 93(5), 571-576.
- [33] Kahwaji, S., Johnson, M. B., Kheirabadi, A. C., Groulx, D., & White, M. A. (2017). Fatty acids and related phase change materials for reliable thermal energy storage at moderate temperatures. *Solar Energy Materials and Solar Cells*, 167, 109-120.
- [34] Hasan, A., Hejase, H., Abdelbaqi, S., Assi, A., & Hamdan, M. O. (2016). Comparative effectiveness of different phase change materials to improve cooling performance of heat sinks for electronic devices. *Applied Sciences*, 6(9), 226.
- [35] Mills, A., Farid, M., Selman, J. R., & Al-Hallaj, S. (2006). Thermal conductivity enhancement of phase change materials using a graphite matrix. *Applied Thermal Engineering*, 26(14-15), 1652-1661.
- [36] Kim, S., & Drzal, L. T. (2009). High latent heat storage and high thermal conductive phase change materials using exfoliated graphite nanoplatelets. *Solar Energy Materials and Solar Cells*, 93(1), 136-142.
- [37] Barreneche C, Solé A, Miró L, Martorell I, Fernández AI, Cabeza LF. Study on differential scanning calorimetry analysis with two operation modes and organic and inorganic phase change material (PCM). *Thermochimica Acta*, Volume 553, Feb 2013, Pages 23-26
- [38] Luisa F, Camila B. Unconventional experimental technologies available for phase change materials (PCM) characterization. Part 1. Thermophysical properties. *Renewable and Sustainable Energy Reviews*, Volume 43, March 2015, Pages 1399-1414
- [39] Demirel Y, Paksoy HO. Thermal analysis of heat storage materials. *Thermochim Acta* 1993; 213:211-21
- [40] Paksoy HO. Determining thermal properties of heat storage materials using twin bath method. *Energy Convers Manage* 1996 ;37(3) :261-8
- [41] Kumar, A., Kothari, R., Sahu, S. K., & Kundalwal, S. I. (2021). Thermal performance of heat sink using nano- enhanced phase change material (NePCM) for cooling of electronic components. *Microelectronics Reliability*, 121, 114144.
- [42] Hayat, M. A., Ali, H. M., Janjua, M. M., Pao, W., Li, C., & Alizadeh, M. (2020). Phase change material/heat pipe and Copper foam-based heat sinks for thermal management of electronic systems. *Journal of Energy Storage*, 32, 101971.
- [43] Arshad, A., Jabbal, M., Shi, L., & Yan, Y. (2021). Thermophysical characteristics and enhancement analysis of carbon-additives phase change mono and hybrid materials for thermal management of electronic devices. *Journal of Energy Storage*, 34, 102231.

- [44] Nazari, M., Jebrane, M., & Terziev, N. (2021). Multicomponent bio-based fatty acids system as phase change material for low temperature energy storage. *Journal of Energy Storage*, 39, 102645.
- [45] Emam, M., Ookawara, S., & Ahmed, M. (2019). Thermal management of electronic devices and concentrator photovoltaic systems using phase change material heat sinks: Experimental investigations. *Renewable energy*, 141, 322-339.
- [46] Al Siyabi, I., Khanna, S., Mallick, T., & Sundaram, S. (2018). Multiple phase change material (PCM) configuration for PCM-based heat sinks—an experimental study. *Energies*, 11(7), 1629.
- [47] Bayat, M., Faridzadeh, M. R., & Toghraie, D. (2018). Investigation of finned heat sink performance with nano enhanced phase change material (NePCM). *Thermal Science and Engineering Progress*, 5, 50-59.
- [48] Arshad, A., Ali, H. M., Yan, W. M., Hussein, A. K., & Ahmadlouydarab, M. (2018). An experimental study of enhanced heat sinks for thermal management using n-eicosane as phase change material. *Applied Thermal Engineering*, 132, 52-66.
- [49] Bondareva, N. S., Buonomo, B., Manca, O., & Sheremet, M. A. (2019). Heat transfer performance of the finned nano-enhanced phase change material system under the inclination influence. *International Journal of Heat and Mass Transfer*, 135, 1063-1072.
- [50] Hua, W., Zhang, L., & Zhang, X. (2021). Research on passive cooling of electronic chips based on PCM: A review. *Journal of Molecular Liquids*, 117183.
- [51] Bondareva, N. S., & Sheremet, M. A. (2020). Effect of nano-sized heat transfer enhancers on PCM-based heat sink performance at various heat loads. *Nanomaterials*, 10(1), 17. [52] Kurhade, A., Talele, V., Rao, T. V., Chandak, A., & Mathew, V. K. (2021). Computational study of PCM cooling for electronic circuit of smart-phone. *Materials Today: Proceedings*.
- [53] Rostamian, F., Etesami, N., & Haghgoo, M. (2021). Management of electronic board temperature using heat sink containing pure and microencapsulated phase change materials. *International Communications in Heat and Mass Transfer*, 126, 105407.

Chapitre 2.

Modification des propriétés colligatives de l'acide décanoïque pour adapter son utilisation comme matériau à changement de phase

La gestion thermique est principalement définie par le contrôle de la température grâce à une technologie basée sur le transfert de chaleur et la thermodynamique. Le fossé entre les exigences du système et les spécifications du système peut être résolu par la gestion thermique. En chauffant, en refroidissant, en répartissant uniformément la température, en effectuant des cycles de température et même en contrôlant le temps de la température maximale.

Le contrôle du temps nécessaire pour atteindre la température maximale peut être mis en œuvre en permettant à la chaleur de s'écouler vers une autre application ou un autre système afin d'augmenter ce temps. Le matériau à changement de phase s'avère être une technologie prometteuse dans la gestion thermique grâce à laquelle la chaleur peut s'écouler vers le PCM. D'autre part, l'acide gras est un type de matériau à changement de phase organique qui présente un point de fusion relativement élevé en fonction de l'application cible.

De rares études ont été réalisées sur des matériaux à changement de phase organique dans lesquelles la plupart des études sont effectuées sur les matériaux les plus populaires, la cire de paraffine. Sur la base de ce qui précède, cette étude est réalisée sur un type d'acide gras qui est l'acide décanoïque. L'étude vise à modifier les propriétés thermophysiques de l'acide décanoïque pour adapter son utilisation comme matériau à changement de phase. Ce chapitre est composé d'une **introduction** générale comprenant un résumé des travaux antérieurs. La **section 2** illustre le matériau utilisé et la méthode de préparation du mélange, y compris le protocole de test DSC et

l'analyse d'incertitude. La **section 3** présente les principaux résultats obtenus et enfin une conclusion récapitulative est tirée dans la **section 4**.

Le concept de l'étude est d'ajouter cinq additifs avec des pourcentages différents à l'acide décanoïque pour modifier ses propriétés thermophysiques. Chaque additif a été étudié dans trois proportions molaires différentes. L'acétate d'ammonium, l'oléate de sodium, l'oléate de potassium, l'hydroxyde de sodium et le décanoate de sodium ont été utilisés pour réaliser cette étude.

Les résultats ont été extraits en utilisant le test DSC. Les résultats montrent que 10% de NaOH fournit les meilleurs résultats dans lesquels la plage de fusion est passée de (29,4 ~ 34,9 °C) à (27,3 ~ 35 °C) et la température maximale a diminué de 33,1 °C à 28,6 °C tout en maintenant une chaleur latente élevée de 186,8 J/g contre 188,7 J/g pour l'acide décanoïque pur. La deuxième modification applicable est l'ajout de 10% d'acétate d'ammonium qui diminue la chaleur latente de 4,7% pour s'établir 179,8 J/g, et élargi la plage de fusion commençant à 25,1 °C et se terminant à 35,4 °C, avec un pic de fusion de 29,6 °C. En outre, sur la base de l'analyse d'incertitude, il a été calculé qu'une erreur relative de 5,22% devait être prise en compte.

Modification des propriétés Colligatives de l'acide décanoïque pour adapter son utilisation comme matériau à changement de phase

Cet article est soumis à « Journal of Thermal Analysis and Calorimetry »

Résumé - La gestion thermique est aujourd'hui considérée comme un défi crucial qui a un impact sur diverses applications telles que les appareils électroniques, le stockage thermique et les espaces de vie. À partir de nombreuses techniques de gestion thermique, l'utilisation d'un matériau à changement de phase (PCM) s'avère prometteuse en termes de propriétés thermiques. Néanmoins, les acides gras présentent des points de fusion relativement élevés par rapport à l'application cible. Cet article présente une méthode simple et économique pour modifier le point de fusion de l'acide décanoïque, un acide gras largement utilisé dans le domaine, par l'ajout de cinq composants chimiques à de faibles pourcentages molaires. Le mélange le plus approprié pour le refroidissement des appareils électroniques, en termes de diminution du point de fusion et de conservation de la chaleur latente, s'est avéré être 10% de NaOH, qui permet une diminution du point de fusion de 30,8 °C à 28,6 °C tout en maintenant une chaleur latente relativement constante.

Modifying the colligative properties of Decanoic acid to render its use as a phase change material

This article is submitted to “Journal of Thermal Analysis and Calorimetry”

Abstract Thermal management is considered nowadays a crucial challenge that impacts various applications such as electronic devices, thermal storage, and living spaces. From numerous thermal management techniques, the use of a Phase Change Material (PCM) proved to be promising in terms of thermal properties. Nonetheless, fatty acids exhibit relatively high melting points with reference to the target application. This paper presents a simple and cost-efficient method to modify the melting point of decanoic acid, a fatty acid widely used in the field, through the addition of five chemical components in low molar percentages. The most suitable mixture for electronic devices cooling, in terms of melting point depreciation and conservation of latent heat, was found to be 10% NaOH which permitted a decrease in the melting point from 30.8°C to 28.6°C while maintaining a relatively constant latent heat.

Keywords Decanoic acid • salt mixture melting point • latent heat • thermal management

2.1 Introduction

The capability of phase change materials (PCMs) to absorb a large amount of energy as latent heat of fusion provides them as interesting candidates for potential use in thermal energy management and storage. The selection of a PCM for a specific application is directly related to its thermo-physical properties and more precisely to its melting temperature.

Zhou *et al.* [1] reviewed the use of PCMs in building application and described a variety of applications for PCMs in enhancing the living conditions, such as thermal insulation and under floor heating. It was recommended that the melting point of PCMs used in building application should range between 18°C and 30°C. Lee *et al.* [2] investigated a new shape stabilization PCM to be used for building application. The new shape stabilized PCM contributes in reducing the building energy by 255.44 kWh.

In the case of thermal energy storage applications [3–5], PCMs are used as thermal batteries. The melting temperature of PCMs is much wider and is specifically linked to each application. Mazman *et al.* [6] used PCMs in solar water heating application in which the melting temperature ranges between 50°C and 65°C. Melted PCM during sunny days are used to heat water during cloudy days or at night, since PCMs act as thermal batteries they discharge the stored energy when the surrounding's temperature decreases below their melting temperature. Hasnain [7] showed that the melting temperature of PCMs in thermal energy storage application can reach 450°C. However, Kaygusuz and Sari [8] worked on a form stable PCM using paraffin wax and high-density polyethylene for thermal energy storage application. A 3 wt% of expanded and exfoliated graphite was added to the composite PCM to enhance its thermal conductivity. The results showed that the form-stable composite PCM has a great potential for thermal energy storage application.

The usage of PCMs in electronic devices leads to an improvement in the efficiency as well as the reliability of the electronic devices [9–13]. The maximum allowable temperatures for electronic devices are 70, 85 and 125°C for commercial, industrial, and military applications, respectively. This means that PCMs used in electronic applications must have melting points above the ambient temperature and just below the maximum allowable temperature of the electronic device.

Javani *et al.* [14] used PCM for cooling the battery pack of the electric vehicle. They used finite volume based numerical model for the numerical simulation, and they showed that the temperature distribution obtained is more uniform when the PCM is employed.

Many attempts were done by researchers to enhance the thermo-physical properties of the PCM [15, 16]. Zeng *et al.* [17] used silver nanowires in order to enhance the thermal conductivity of the organic PCM. The results showed that the Ag nanowires might be strong candidates for thermal conductivity enhancement of organic PCMs. Similarly, Wu *et al.* [18] worked on enhancing the thermal conductivity of the PCM but using copper nanoparticles. The authors found that the thermal conductivity was enhanced up to 18.1%.

A summary of the melting range of PCMs for different applications is presented in Table 1. This table shows that the melting range for an application can be either narrow like the case of under floor heating, either wide like the case of battery thermal management system.

PCMs are divided into two main categories, Organic and Inorganic.

Table 1 Melting temperature range of PCMs for different types of applications.

Application	Melting range (°C)	Reference
Water heating	50-70	[18]
Handled electronic device	<45	[11]
Photovoltaic cooling	25-60	[11]
Battery thermal management system	25-60	[11]
Building application	18-30	[1]
Under floor heating	25-28	[32]

So far, the use of fatty acids as PCMs was very limited in the literature since most of the studies focused on the well-known inorganic PCMs such as salt hydrate and paraffin wax.

A chemical modification of the fatty acids was described by Bockish [19]. The saturated fatty acids were chemically oxidized in order to generate an unsaturated form of the acid.

Yuan *et al.* [20] worked on a ternary eutectic mixture of fatty acids with activated carbon (AC) for high temperature cooling application. The authors showed that the melting temperature of the composites decreases gradually with increasing in AC content, whereas the freezing temperature increases.

Zhang *et al.* [21] investigated a method for the prediction of the melting temperatures and the latent heat of eutectic PCMs. They were able to predict and validate the results obtained for 15 eutectic mixtures of fatty acids. Additionally, it was proved that the mixtures can be used for water heating applications. Moreover, Sari *et al.* and Kaygusuz *et al.* [22, 23] worked on modifying the thermophysical properties of the fatty acids in order to use it in thermal energy storage applications.

On the other hand, [24–26] modified fatty acids by the mean of esterification. 5% of expanded graphite was added to the ester by Sari *et al.* [24] in order to enhance the thermal conductivity of the mixture. Due to the thermal reliability and thermal conductivity of the synthesized product, the authors suggested its employment in energy storage application. All the previous chemical modifications (i.e., double bond formation and esterification) are relatively difficult to conduct, time and energy consuming and therefore economically not viable.

Finally, Fu *et al.* [27] and Hasanabadi *et al.* [28] worked on a form-stable phase change material using stearic acid and paraffin wax, and they showed that the mixture has a good thermal stability.

The novelty of this work consists of adding impurities, salts in particular, instead of chemically

modifying the fatty acids themselves, or mixing fatty acids together as in common existing studies. These modifications aim to reach a desired melting temperature while maintaining the latent heat as high as possible.

The paper is organized as follows: the materials used and the preparation method of the mixtures are presented in section 2. In section 3, the differential scanning calorimetry DSC test results are shown and discussed. Finally, the paper is ended up with a conclusion and perspectives.

2.2 Material and methods

This paper shed lights on organic PCMs, more precisely on fatty acids which are characterized by their chemical stability. Moreover, these acids are environmentally friendly since they can be derived from natural resources (e.g., waste food and vegetable oil) and can be recycled. Therefore, the use of PCMs is considered as a favorable route in order to achieve sustainability in the field of thermal energy management.

Consequently, decanoic acid is selected as a potential PCM model. Five different salts are added to pure decanoic acid in order to decrease its melting temperature.

Decanoic acid, ammonium acetate, sodium oleate, potassium oleate, sodium hydroxide and sodium decanoate were purchased from Sigma-Aldrich and used without further modifications in the tests.

The CAS registry numbers and the purities of the materials used are shown in Table 2.

Table 2. CAS Registry Number, Mass Fraction purity of the chemicals

Component	CAS Reg.No.	mass fraction
Decanoic acid	334-48-5	0.99
Ammonium acetate	631-61-8	0.99
Sodium oleate	143-19-1	0.99
Potassium oleate	143-18-0	0.99
Sodium hydroxide	1310-73-2	0.99
Sodium decanoate	1002-62-6	0.99

2.2.1 Preparation of the mixtures

Samples of 250 mg of the decanoic acid and the five additives were weighed using an analytical balance and were put inside glass test tubes. The additives were added according to the following three molar proportions: 10%, 25% and 33%.

After a rigorous mechanical mixing using a spatula, the mixtures were melted inside a bain-marie. When the mixtures were completely melted, the samples were removed from the bain-marie and shaken in order to homogenize the liquid phase. All in all, fifteen mixtures were obtained with different combinations, five additives and three proportions. Table 3 recapitulates the components of the different mixtures and the denomination of these mixtures by a mixture number. After returning to room temperature, the obtained solids were milled and tested using a differential scanning calorimetry (DSC).

It can be noticed that in the case of sodium hydroxide addition, the main aim is to form sodium decanoate salt that will act as the principal impurity. The reaction of decanoic acid with NaOH is spontaneous and quantitative. Therefore, we consider that all the added NaOH served to deprotonate a similar quantity of decanoic acid and generate sodium decanoate salt and water. On the other hand, all the other four organic salts present no chemical reactivity towards decanoic

acid.

Table 3. Components of different mixtures.

Components	Mixture number
Decanoic acid + Ammonium acetate	Mix 1
Decanoic acid + Potassium oleate	Mix 2
Decanoic acid + Sodium decanoate	Mix 3
Decanoic acid + Sodium hydroxide	Mix 4
Decanoic acid + Sodium oleate	Mix 5

2.2.2 DSC test

The melting behavior is investigated by DSC using a Netzsch DSC Polyma 214 and according to ASTM D3418 standard. For each sample, a mass of 10 mg is heated under a nitrogen atmosphere over a temperature range between -20°C and 60°C using a DSC heating-cooling cycle. An endothermic melting peak occurs during the heating phase. The Scanning rate is set at 5°C/min for cooling and heating. The second heating thermogram is recorded in order to study the effect of the composition of the mixture on melting point and crystallization kinetics. The samples were analyzed in three replicates in order to insure a good reproducibility of the results. The degree of crystallinity X_c is estimated using the following equation [29]:

$$X_c = \frac{\Delta H_m}{\Delta H_m^0(1 - \varphi)}$$

where X_c is the crystallinity expressed in percentage, ΔH_m the melting enthalpy in J/g, ΔH_m^0 the theoretical melting enthalpy of perfectly crystalline decanoic acid, and φ the weight fraction of the fillers. The reference heat of melting of pure decanoic acid is 176.6 J/g as taken from the literature [30].

2.2.3 Uncertainty analysis

To assess the degree of confidence in the results, an uncertainty assessment is done. The uncertainty in the experiments can be due to the mass balance and the DSC test machine mainly.

The relative uncertainty on the DSC machine is $e_d = 5\%$ as given by the manufacturer. The absolute uncertainty of the mass balance is $\Delta_m = \pm 0.1$ mg as provided by the manufacturer. To convert the absolute uncertainty to a percent relative uncertainty we use the below expression [31]:

$$e = \frac{\text{absolute uncertainty}}{\text{value read by the equipment}}$$

In the worst-case scenario, this relative uncertainty is the highest when measuring the mixture with the lowest weight, which is for 10% NaOH equal to 6.4 mg. Hence using the above-mentioned equation, we get $e_b = 1.5\%$ as maximum relative uncertainty on the mass measurements.

The total uncertainty is the norm of all uncertainties as mentioned by [31]

$$e = \sqrt{e_d^2 + e_b^2} = 5.22\%.$$

Hence, when analyzing the experimental data, a relative error of 5.22% should be considered.

2.3 Results and discussion

As mentioned before, the first heating-cooling cycle was not recorded, instead, it was done to assure the mixing of the samples without any impurities and to delete the thermal history of the sample. In Figure 1 two curves are plotted; the blue one represents the exothermic (up) cooling process, whereas the red one represents the endothermic (down) melting process. In the remaining figures, only the melting process is plotted.

DSC tests were carried out under the ASTM D3418 standard. Figure 1 shows the thermogram

obtained for pure decanoic acid. The thermogram indicates that the endothermic melting process which starts at 29.4°C and ends at 34.9°C where the majority of PCM melts at a peak temperature of 30.8°C. The area under the curve represents the latent heat which was found to be 188.7 J/g.

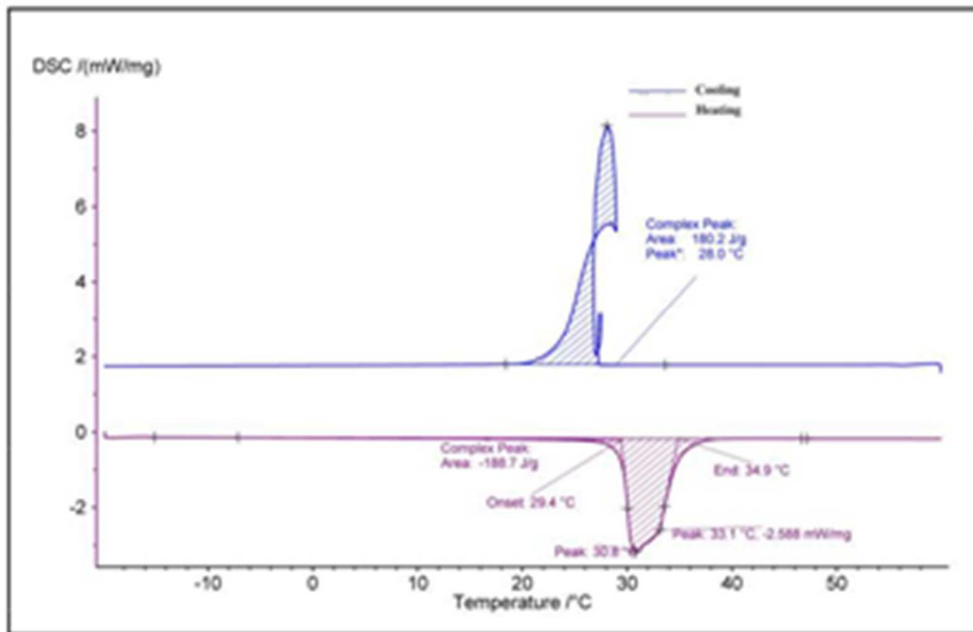

Fig. 1 DSC results for Decanoic acid. The blue curve represents the cooling cycle while the purple one is for the heating cycle.

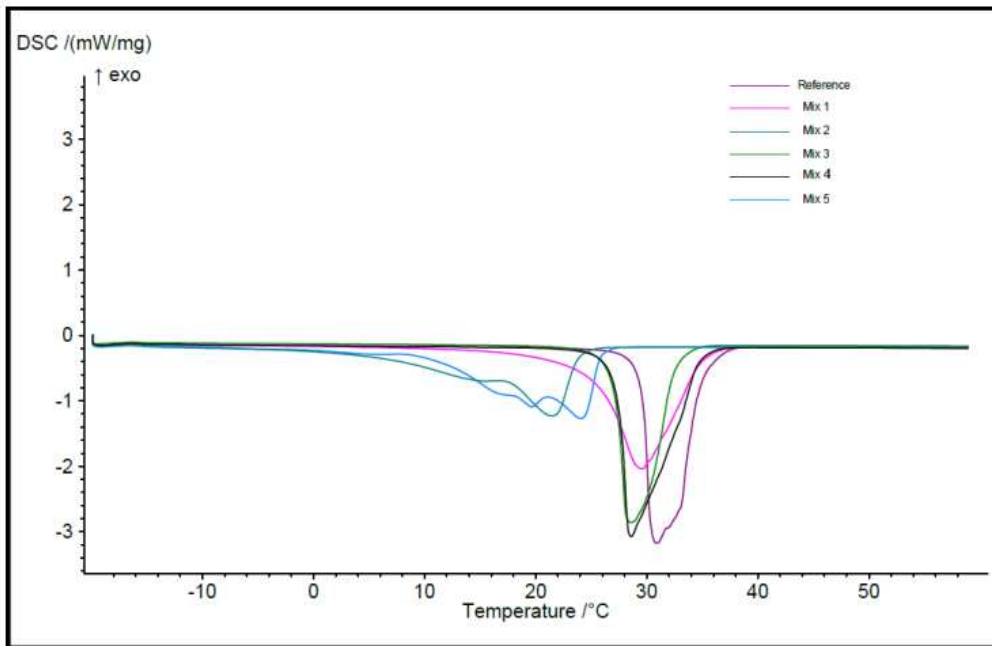

Fig. 2 DSC results for the 10% mixtures.

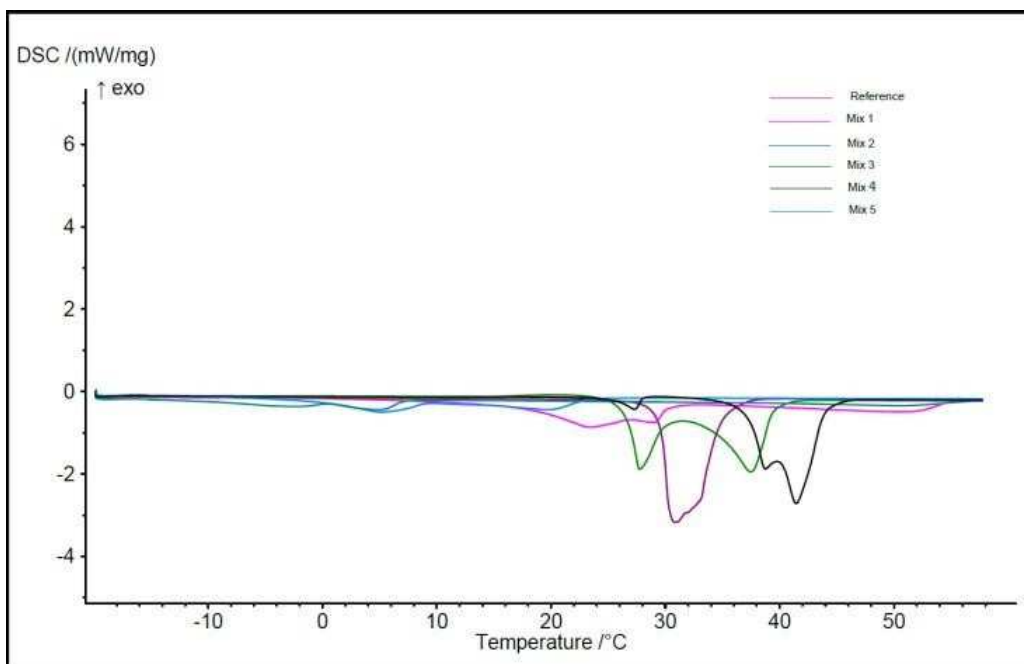

Fig. 3 DSC results for the 25% mixtures.

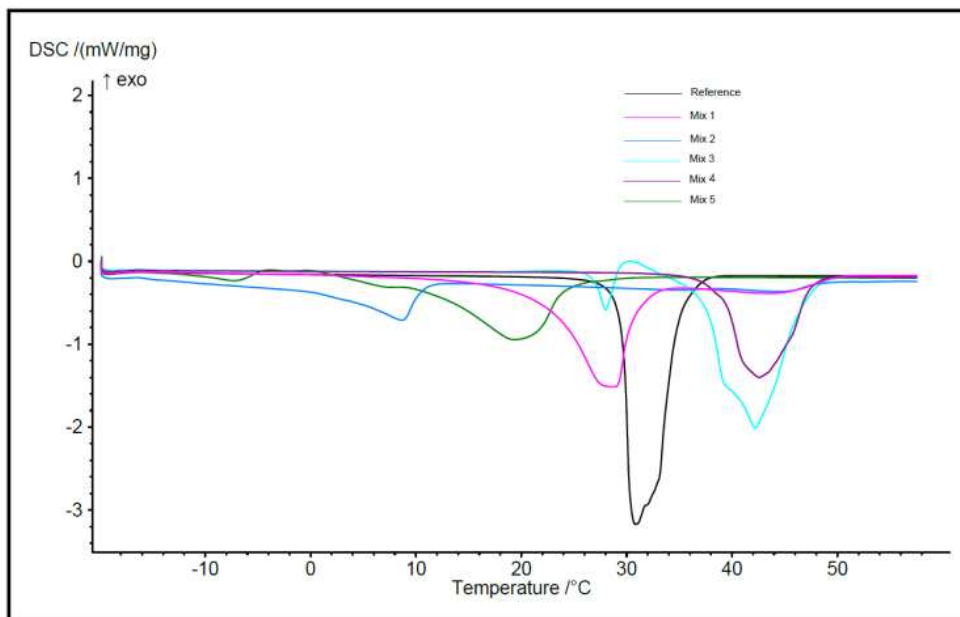

Fig. 4 DSC results for the 33% mixtures.

Figures 2, 3 and 4 show the DSC curves for the mixtures containing decanoic acid mixed with the five selected additives. Figure 2 shows the thermal behavior of the decanoic acid when mixed with 10% of ammonium acetate, sodium oleate, potassium oleate, sodium hydroxide and sodium decanoate. Figure 3 and 4 show the results of the same procedure but when adding 25 and 33% of each additive, respectively.

Table 4 summarizes the DSC results of the modified mixtures: onset temperature, melting peak, end melting temperature, latent heat, and the percentage of change in latent heat compared to the reference pure decanoic acid.

The DSC results for pure decanoic acid show that the melting heat is 188 J/g whereas in the literature it was considered 176.6 J/g. This difference could be due to the purity of the material used, experimental errors or variations in the operating conditions. The onset, melting peak, and end temperatures were found to be 29.4 °C, 30.8 °C and 34.9 °C, respectively.

When adding 10% mole of different types of salts, it is observed that, the latent heat of fusion remained constant for NaOH (Mix 4) and ammonium acetate (Mix 1). The highest decrease in the latent heat (about 30%) as well as the highest decrease in the melting peak (11.6 °C), compared to 30.8 °C for pure decanoic acid is obtained with potassium oleate (Mix 2). Concerning mix 3 the melting temperature decreased to 28.6 °C. The good results obtained when adding sodium hydroxide could be the result of the generation of sodium decanoate from the reaction of NaOH with decanoic acid. Indeed, sodium

decanoate has the same carbon chain length as decanoic acid but is different by the presence of a sodium ion instead of an acid function. This similarity in the chemical structure with a big difference in the physico-chemical properties of the salt and the acid could make sodium decanoate act as a soluble impurity in the melted decanoic acid and therefore induce a melting point range broadening and depreciation while keeping a similar latent heat.

In the case of 25% mole of salts, sodium decanoate (Mix 3) and NaOH (Mix 4), they exhibited the highest latent heat; 172.3 and 152.3 J/g, respectively. Nevertheless, the melting peak increased to 37.5 and 41.4 °C, respectively. Concerning the other additives, a huge drop in latent heat occurred. Therefore, these mixtures are considered unuseful PCMs in certain applications such as cooling electronic devices.

When adding 33% mole additives of sodium decanoate, a slightly lower latent heat of the mixture was obtained (172.32 J/g) compared to pure decanoic acid, but still the highest of the tested mixtures. The melting peak temperature increased to reach 42.2 °C. The addition of ammonium acetate leads to a latent heat of 170.5 J/g, but decreased the melting peak to 28.6 °C. Whereas, Mixture 2 which contains potassium oleate leads to a latent heat of 71.9 J/g and a melting temperature of 44 °C. Mixture 4, which contains NaOH showed a decrease in the latent heat (94.37

J/g) and an increase in the melting temperature (42.6 °C). Finally, mix 5 showed the worst results since latent heat decreased drastically and reached 17.78 J/g.

Although two PCMs may have the same latent heat, which is the area under the curve as mentioned before, they could be very different in terms of application. For example, after the addition of 33% mole of ammonium acetate to decanoic acid, latent heat remained around 180 J/g which is almost the same as pure decanoic acid, nonetheless the melting range (onset and end points) changed from 29.4 and 34.9 °C to 22.3 and 49.8 °C. Whereas the peak temperature decreased from 30.8 °C to 28.6 °C. Thus, the addition of the additives makes the usage of the PCM wider by changing the melting range.

Table 4. Summary of the results.

Mixtures		Onset (°C)	Melting Peak (°C)	End (°C)	Latent heat (J/g)	% of decrease in latent heat
Reference		29.4	30.8	34.9	188.7	-
Mix 1	10% Ammonium acetate	25.1	29.6	35.4	179.8	4.7
	25% Ammonium acetate	17.4	23.4	54.9	51.3	72.8
	33% Ammonium acetate	22.3	28.6	59.8	170.5	9.5
Mix 2	10% Potassium oleate	15.7	21.5	27.8	128.9	30.0
	25% Potassium oleate	9.1	50.6	57.5	64.7	65.7
	33% Potassium oleate	28.3	44.0	52.5	71.91	61.9
Mix 3	10% Sodium decanoate	27.0	28.6	32.7	160.5	14.9
	25% Sodium decanoate	30.9	37.5	43.6	172.3	8.7
	33% Sodium decanoate	37.6	42.2	47.0	172.3	8.7
Mix 4	10% Sodium hydroxide	27.3	28.6	35.0	186.6	1.1
	25% Sodium hydroxide	37.1	41.4	43.9	152.4	19.2
	33% Sodium hydroxide	38.9	42.6	47.5	91.4	49.9
Mix 5	10% Sodium oleate	7.5	24.1	25.9	150.1	20.5
	25% Sodium oleate	-0.6	19.6	31.1	76.3	59.5
	33% Sodium oleate	-13	19.3	36.9	17.8	37.5

Concerning mix 1, the highest latent heat (179.8 J/g) is achieved when only 10% of ammonium acetate is added to decanoic acid while adding 25% and 33% led to 51.3 and 170.5 J/g, respectively. Mix 2 shows the same trend as Mix 1 where adding 10% of potassium oleate produces the highest latent heat 128.9 J/g greater than 25% and 33% mixtures. Mix 3 shows that the addition of 25% and 33% gave 172.3 J/g higher than the addition of 10% that led to 160.5 J/g. The trend changes for Mix 5 in comparison with the other mixtures where the addition of 10% gave 150.1 J/g higher than 25% (76.25 J/g) which likewise is higher than 33% (17.78 J/g). Concerning Mix 4, the same trend as Mix 5 is observed. It was noticed that the effect of the addition of the additives does not follow a predictable path. For example, if adding 10% of an additive enhanced the characteristics, 25% may drastically affect the characteristics. In general, adding any of the additives mentioned always leads to the decrease in the latent heat of the reference PCM.

Table 5. PCM mixtures and their probable application (+ can be convenient for the application, — can't be convenient for the application).

Mixture	Water heating	Handled electronic devices	Photovoltaic cooling	Battery thermal management system	Building applications	Under floor heating
Mix 1	10% Ammonium acetate	+	+	+	+	
	33% Ammonium acetate	-	+	+	+	-
Mix 2	10% Potassium oleate	-	+	-	+	-
	10% Sodium decanoate		+	+	+	+
	25% Sodium decanoate	-	+	+	+	-
Mix 3	33% Sodium decanoate	-	+	+	-	-
	25% Sodium hydroxide	-	+	+	+	-
Mix 4	10% Sodium hydroxide	-	+	+	-	-
	10% Sodium oleate	-	+	-	-	+

Finally, Table 5 illustrates the applications in which the most promising mixtures can be used. Mixtures are considered effective if the latent heat obtained is higher than 100 J/g, because the main advantage of the PCM is that it has high latent heat of fusion per unit volume to store more

energy in a given volume. As we can see from this table, all the effective mixtures are not convenient for the water heating application because the melting range for this application is higher than those for the other mixtures. Also, we can notice that only the 10% sodium oleate and the 10% sodium decanoate can be convenient for the under-floor heating application while the reference PCM is not convenient for this application.

2.4 Conclusions

The use of colligative properties is an efficient and economic simple method for melting point depreciation. The mixing of five additives in different percentages with pure decanoic acid was studied using DSC. The best result is obtained when adding 10% of sodium hydroxide to decanoic acid. This addition changed the melting range from (29.4 ~ 34.9 °C) to (27.3 ~ 35 °C) and decreased the peak temperature from 30.8 °C to 28.6 °C while maintaining high latent heat of 186.8 J/g compared to 188.7 J/g for pure decanoic acid. This widening of the range may change the application of the PCM. The second applicable modification is the addition of 10% of ammonium acetate where it decreased the latent heat by 4.7% to become 179.8 J/g, and widened the melting range starting at 25.1 °C and ending at 35.4 °C, with a melting peak of 29.6 °C.

In fact, most of the results are appealing with different potentials. After the obvious changes in the characteristics of decanoic acid when adding different salts, this encourages the authors to test different types of PCMs with a direct application to the cooling of electronic devices, a recent hot topic in research.

References

1. Zhou D, Zhao CY, Tian Y. Review on thermal energy storage with phase change materials (PCMs) in building applications. *Applied energy*. 2012; 92:593–605.
2. Lee J, Wi S, Yun BY, Chang SJ, Kim S. Thermal and characteristic analysis of shape-stabilization phase change materials by advanced vacuum impregnation method using carbon-based materials. *Journal of Industrial and Engineering Chemistry*. 2019; 70:281–289.
3. Anghel EM, Georgiev A, Petrescu S, Popov R, Constantinescu M. Thermo-physical characterization of some paraffins used as phase change materials for thermal energy storage. *Journal of Thermal Analysis and Calorimetry*. 2014;117(2):557–566.
4. Zhao Y, Zhang X, Xu X, Zhang S. Development, characterization and modification study of eutectic fatty alcohol for cold energy storage application. *Journal of Thermal Analysis and Calorimetry*. 2020; p. 1–15.
5. Rao ZH, Wang SH, Zhang YL, Zhang GQ, Zhang JY. Thermal properties of paraffin/nano-AlN phase change energy storage materials. *Energy Sources, Part A: Recovery, Utilization, and Environmental Effects*. 2014;36(20):2281–2286.
6. Mazman M, Cabeza LF, Mehling H, Nogues M, Evliya H, Paksoy HÖ. Utilization of phase change materials in solar domestic hot water systems. *Renewable Energy*. 2009;34(6):1639–1643.
7. Hasnain SM. Review on sustainable thermal energy storage technologies, Part I: heat storage materials and techniques. *Energy conversion and management*. 1998;39(11):1127–1138.
8. Kaygusuz K, Sari A. High density polyethylene/paraffin composites as form-stable phase change material for thermal energy storage. *Energy Sources, Part A: Recovery, Utilization, and Environmental Effects*. 2007;29(3):261–270.
9. Mjallal I, Farhat H, Hammoud M, Ali S, Assi I. Improving the cooling efficiency of heat sinks through the use of different types of phase change materials. *Technologies*. 2018;6(1):5.
10. Kandasamy R, Wang XQ, Mujumdar AS. Application of phase change materials in thermal management of electronics. *Applied Thermal Engineering*. 2007;27(17-18):2822–2832.
11. Ling Z, Zhang Z, Shi G, Fang X, Wang L, Gao X, et al. Review on thermal management systems using phase change materials for electronic components, Li-ion batteries and photovoltaic modules. *Renewable and Sustainable Energy Reviews*. 2014; 31:427–438.
12. Assi I, Mjallal I, Farhat H, Hammoud M, Ali S, Shaer AA, et al. Using phase change material in heat sinks to cool electronics devices with intermittent usage. In: 2017 IEEE 7th International Conference on Power and Energy Systems (ICPES); 2017. p. 66–69.
13. Rao ZH, Wang SF, Zhang YL. Thermal management with phase change material for a power battery under cold temperatures. *Energy Sources, Part A: Recovery, Utilization, and Environmental Effects*. 2014;36(20):2287–2295.

14. Javani N, Dincer I, Naterer GF. Numerical modeling of submodule heat transfer with phase change material for thermal management of electric vehicle battery packs. *Journal of Thermal Science and Engineering Applications*. 2015;7(3).
15. Saydam V, Duan X. Dispersing different nanoparticles in paraffin wax as enhanced phase change materials. *Journal of Thermal Analysis and Calorimetry*. 2019;135(2):1135–1144.
16. Zhang P, Kang M, Hu Y. Influence of layered zinc hydroxide nitrate on thermal properties of paraffin/intumescent flame retardant as a phase change material. *Journal of Thermal Analysis and Calorimetry*. 2013;112(3):1199–1205.
17. Zeng JL, Cao Z, Yang DW, Sun LX, Zhang L. Thermal conductivity enhancement of Ag nanowires on an organic phase change material. *Journal of Thermal Analysis and Calorimetry*. 2010;101(1):385–389.
18. Wu SY, Wang H, Xiao S, Zhu DS. An investigation of melting/freezing characteristics of nanoparticle-enhanced phase change materials. *Journal of Thermal Analysis and Calorimetry*. 2012;110(3):1127–1131.
19. Bockisch M. Preface to the English Edition. In: and others, editor. *Fats and Oils Handbook*. AOCS press; 1998. p. vii.
20. Yuan Y, Li T, Zhang N, Cao X, Yang X. Investigation on thermal properties of capric-palmitic-stearic acid/activated carbon composite phase change materials for high-temperature cooling application. *Journal of Thermal Analysis and Calorimetry*. 2016;124(2):881–888.
21. Zhang Y, Su Y, Ge X. Prediction of the melting temperature and the fusion heat of (quasi-) eutectic PCM. *Journal of china university of science and technology*. 1995;25(4):474–478.
22. Sari A, Karaipekli A, Kaygusuz K. Fatty acid/expanded graphite composites as phase change material for latent heat thermal energy storage. *Energy Sources, Part A: Recovery, Utilization, and Environmental Effects*. 2008;30(5):464–474.
23. Kaygusuz K, Alkan C, Sari A, Uzun O. Encapsulated fatty acids in an acrylic resin as shape-stabilized phase change materials for latent heat thermal energy storage. *Energy Sources, Part A: Recovery, Utilization, and Environmental Effects*. 2008;30(11):1050–1059.
24. Sari A, Biçer A, Karaipekli A. Synthesis, characterization, thermal properties of a series of stearic acid esters as novel solid-liquid phase change materials. *Materials Letters*. 2009;63(13-14):1213–1216.
25. Feldman D, Banu D, Hawes D. Low chain esters of stearic acid as phase change materials for thermal energy storage in buildings. *Solar Energy Materials and Solar Cells*. 1995;36(3):311–322.
26. Parameshwaran R, Jayavel R, Kalaiselvam S. Study on thermal properties of organic ester phase-change material embedded with silver nanoparticles. *Journal of Thermal Analysis and Calorimetry*. 2013;114(2):845–858.
27. Fu X, Liu Z, Wu B, Wang J, Lei J. Preparation and thermal properties of stearic acid/diatomite composites as form-stable phase change materials for thermal energy storage via direct impregnation method. *Journal of Thermal Analysis and Calorimetry*. 2016;123(2):1173–1181.

28. Hasanabadi S, Sadrameli SM, Sami S. Preparation, characterization and thermal properties of surface-modified expanded perlite/paraffin as a form-stable phase change composite in concrete. *Journal of Thermal Analysis and Calorimetry*. 2020; p. 1–9.
29. Zhang D, He M, Qin S, Yu J. Effect of fiber length and dispersion on properties of long glass fiber reinforced thermoplastic composites based on poly (butylene terephthalate). *RSC advances*. 2017;7(25):15439–15454.
30. Kahwaji S, White MA. Data supporting the prediction of the properties of eutectic organic phase change materials. *Data in brief*. 2018; 17:724–730.
31. Mjallal I, Hammoud M, Habchi C, Lemenand T. Cost-effective device to characterize phase change materials. *Measurement Science and Technology*. 2019;31(2):025903.
32. Barzin R, Chen JJ, Young BR, Farid MM. Application of PCM underfloor heating in combination with PCM wallboards for space heating using price-based control system. *Applied Energy*. 2015; 148:39–48

Chapitre 3.

Modification des propriétés colligatives de l'acide arachidique pour une utilisation potentielle comme PCM

Toutes les applications qui génèrent ou reçoivent de la chaleur sont affectées par cette chaleur de manière positive et négative. Ces applications sont limitées à une température spécifique dans laquelle son dépassement entraîne un défaut dans le processus de fonctionnement de ces applications. La gestion thermique est une solution à mettre en place dans ces system pour maintenir des conditions optimisées permettant d'atteindre le meilleur fonctionnement du système.

Le matériau à changement de phase est une technologie prometteuse dans la gestion thermique démontrée par sa capacité à stocker la chaleur. Il est classé en deux catégories PCM organique et non organique tel que l'acide gras et la cire de paraffine respectivement. Dans ce chapitre, l'étude portera sur les acides gras et principalement sur l'acide arachidique (AA).

Cette étude reprend un déroulement similaire a l'étude du chapitre 2. L'acide arachidique est mélangé avec 5 additifs différents et étudié pour différents pourcentages molaires. Les résultats ciblent les propriétés thermophysiques du nouveau mélange, principalement la modification du point de fusion et de la chaleur latente de fusion.

La **section 1** de cette étude présente une introduction sur le travail, associée à des travaux antérieurs. La **section 2** illustre le matériau qui sera utilisé pour préparer le mélange, le comportement de fusion du mélange, le degré de cristallinité et l'analyse d'incertitude. Les résultats sont présentés dans la **section 3** principalement le pic de fusion, la température de fin de fusion, la

chaleur latente de fusion et le pourcentage de variation de la chaleur latente extraite en utilisant le test DSC. Enfin, une conclusion récapitulative est tirée dans la **section 4**.

De l'acide arachidique, de l'acétate d'ammonium, de l'oléate de sodium, de l'oléate de potassium, de l'hydroxyde de sodium ou du décanoate de sodium ont été ajoutés à l'acide arachidique. Chaque additif a été ajouté deux fois avec de l'acide arachidique avec un pourcentage molaire différent (10% et 15%) conduisant à 10 échantillons. Ces échantillons ou mélanges ont été testés en utilisant le test DSC pour extraire leurs propriétés thermophysiques.

Les résultats montrent que la chaleur latente la plus élevée (222 J/g) a été obtenue en ajoutant 10% en mole de décanoate de sodium à l'acide arachidique -AA10Sd- et une température de solidus de 48 °C. En outre, l'ajout de 15% en mole de l'un des cinq additifs testés à l'acide arachidique pur conduit à une propriété thermophysique améliorée par rapport à l'ajout de 10% en mole, sauf pour la chaleur latente jusqu'à 75 °C, où les résultats de 10 % moles des ajouts sont devenus meilleurs. La capacité thermique la plus élevée a été enregistrée pour le mélange AA10Sd avec $C_p = 2,36$ J/g.K. En outre, on constate que l'ajout de 10 % d'oléate de potassium à l'acide arachidique est un mélange prometteur qui peut être utilisé pour le refroidissement électronique car il maintient une chaleur latente élevée tandis que la température du solidus diminue de 23.3 °C, ce qui devient acceptable pour le dispositif électronique le plus conventionnel.

Modification des propriétés colligatives de l'acide arachidique pour une utilisation potentielle comme PCM

Cet article est publié dans « Solar Energy »

doi.org/10.1016/j.solener.2020.11.020

Résumé – L'utilisation de matériaux naturels, en particulier les acides gras comme matériaux à changement de phase (PCM) pour différentes applications, est considérée comme un défi actuel pour la communauté scientifique. Les principaux avantages des acides gras sont qu'ils couvrent une large gamme de températures de fusion et absorbent une importante quantité de chaleur latente en passant d'un état d'agrégation à un autre. Ce travail se concentre sur l'acide arachidique, un acide gras qui présente des propriétés thermiques remarquables qui permettent son utilisation comme PCM. L'acide arachidique est mélangé à différents sels chimiques peu coûteux, afin de modifier ses caractéristiques thermiques. Le principal objectif des modifications est de maintenir une chaleur latente élevée, avec une plage de température de fusion plus large et une température de pic de fusion plus faible pour s'adapter aux températures admissibles des dispositifs électroniques. Des propriétés spécifiques telles que la capacité thermique, la nouvelle chaleur latente (J/g) et la température de pic (°C) ont été déterminées afin d'analyser la fiabilité et la stabilité des acides gras comme PCM. Les résultats montrent que l'acide arachidique mélangé à 10 % de décanoate de sodium présente la diminution du point de fusion la plus élevée, de 75,2 °C à 71,9 °C, tout en maintenant une chaleur latente de fusion élevée (222 J/g).

Exploring the colligative properties of Arachidic acid for potential use as PCM

This article is published in « Solar Energy »

doi.org/10.1016/j.solener.2020.11.020

Abstract- The use of natural materials especially fatty acids as phase change materials (PCM) for different applications is considered as a current challenge for the scientific community. The main advantages of fatty acids are that they cover a wide range of melting temperatures and consume a good amount of latent heat while transiting from a state of aggregation to another. This work focuses on Arachidic acid, a fatty acid which presents some remarkable thermal properties that enable its use as PCM. Arachidic acid is mixed with different chemical salts in a cost-efficient manner, in order to alter its thermal characteristics. The main objective of the modifications is to maintain high latent heat, with a wider span of melting temperature and a smaller melting peak temperature to accommodate with the allowable electronic devices' temperatures. Specific properties such as the heat capacity, the new latent heat (J/g), and peak temperature (°C) were determined in order to analyze the reliability and stability of fatty acids as PCM. The results showed that Arachidic acid mixed with 10 mol% sodium decanoate exhibited the highest melting point depreciation, from 75.2 °C to 71.9 °C, while maintaining a high latent heat of fusion (222 J/g).

Keywords: *Phase change material, Fatty acids, Arachidic acid, Heat capacity, heat transfer management*

Nomenclature

PCM	Phase Change Material
C_p	Heat Capacity
X_c	Crystallinity
ΔH_m	Melting enthalpy
ΔH_m^0	Theoretical melting enthalpy of perfectly crystalline arachidic acid
φ	Weight fraction of filler
e	Uncertainty
e_b	Balance uncertainty
e_d	DSC uncertainty
H	Latent heat
β	PCM quality
AA	Arachidic acid
T	Temperature
DSC	Differential Scanning Calorimetry

3.1 Introduction

The use of PCM as a sustainable mean for thermal energy storage and control has been an attractive topic in research for the last two decades. PCMs, have great advantages over small temperature swing, and smaller sizes applications. Furthermore, large scale PCM could be employed to cool large-scale systems Tuckerman and Pease (1981). Owing to their wide range of latent heat capacity and melting temperatures, PCMs are employed in the thermal management for a variety of applications e.g. thermal reservoirs (Zhang et al. (2012)), water heating (Hasnain, 1998), batteries thermal management systems (Ping et al. (2018); Bonyadi et al. (2018)), electronic chips cooling (Hu et al. (2016); Faraji et al. (2019)), building applications (Sarı et al. (2008); Zhang and Wang (2019); Cheng et al. (2014)) such as air conditioning (Zalba et al. (2004)), and thermal management of photovoltaic panels (Kawtharani et al. (2017)). PCMs undergo a physical phase change when a sufficient amount of heat is supplied. During duty or heat application periods, the temperature increases until it reaches the melting temperature of the PCM, this energy will get trapped inside. At this point, the PCM starts melting and absorbs heat in the form of latent heat of fusion, until it's completely melted. Then, the temperature increases again to reach the steady state temperature that would have been reached without implementing the PCM (Mjallal et al. (2018, 2020); Kawtharani et al. (2017)).

During idle periods, the stored energy will be lost and the PCM will re-solidify. Since PCMs can stabilize the temperature at a value around their melting point, PCMs are employed in thermal regulation applications.

Konuklu (2014) worked on micro-encapsulation of the PCM using cylindrical-type ceramic containers. The capsule PCM showed a good thermal conductivity compared to other methods.

Also, an excellent corrosive resistance and cycling performance was obtained on the PCM capsule.

Hawlader et al. (2003) investigated the effect of the micro encapsulated of the Paraffin wax for later use in solar application. The results showed a small reduction in the latent heat.

Another packaging method was investigated by Cheng et al. (2015) where a shape stabilized PCM was used in under floor heating application. The shape stabilized PCM maintains a macro solid shape even when the PCM melts.

Alawadhi (2005) worked on a new thermal insulation technique for pipes using PCM. The only restraint for this technique is that the operating time for the pipes must be limited so that the PCM can release the absorbed energy and re-solidify.

Recently, Abdullah et al. (2020) investigated the implementation of paraffin wax mixed with CuO nanoparticles as a PCM on the performance of water trays distiller. They found that the efficiency of the trays improved by 108%.

In order to develop a more sustainable approach in the use of PCMs, several researchers recently employed fatty acids as PCMs (Yuan et al. (2014)). These acids can be derived from vegetables such as peas, and animals (Lee and Mattick (1961)). Lately, mixtures of fatty acids or modified fatty acids were employed as PCMs. The results showed an enlargement of the phase change temperature range while maintaining a high latent heat. This breakthrough result has boosted research in order to find novel engineering applications of fatty acids as PCM.

Hosseinzadeh et al. (2020) worked on enhancing the thermal conductivity of PCM using Hybrid Nano-Particles (HNP) and using fins. The HNP was applied with different concentration to the composite PCM. It was shown that a remarkable improvement of the solidification rate by using each technique individually, while the lowest solidification rate occurs for the combination

of both techniques.

To enhance energy production, Thalib et al. (2020) studied the difference between Conventional Tubular Solar Still (CTSS), Tubular Solar Still with Phase Change Material (TSSPCM) and Tubular Solar Still with Nano Phase Change Material (TSS-NPCM). The authors concluded that the addition of paraffin wax and graphene plus paraffin wax increased the daily energy efficiency of the stills from 31% to 59%. In addition, the cost of freshwater yield was decreased compared to the traditional tubular solar stills.

Fauzi et al. (2014) enhanced the thermal properties of a eutectic mixture of fatty acid by adding an acid-based surfactant. The authors proved that the 10 % SL significantly increased the latent heat and the thermal conductivity of the PCM. In another study, Alkan and Sari (2008) worked on a form stable PCM using poly (methyl methacrylate) (PMMA) blends. The results showed that there were no appreciable changes in the phase transition temperatures. Similarly, Karaipekli and Sari (2009) worked on a form stable of fatty acid but this time using vermiculite composite. The results showed that the PCM can be used for so many thermal energy storage applications.

Arachidic acid (AA), is a saturated fatty acid consisting of 20 carbons chain ($C_{20}H_{40}O_2$). Aydın and Okutan (2011a) prepared a range of long-chain fatty acid esters via the etherification of myristyl alcohol with Arachidic acids under vacuum without the use of a catalyst. The authors found that the melting temperature of the products ranged between 38°C and 53°C, and the latent heat values were above 200 J/g. Compared to other PCMs with the same enthalpy 200 J/g but having melting temperatures above 60°C, those long-chain fatty acid esters offer the advantage of use in lower temperature applications.

Additionally, Aydın and Okutan (2011b) have synthesized four long-chain fatty acid esters with myristyl alcohol and odd carbon atom fatty acids as PCMs. The fatty acid esters showed a

phase change temperature range of 40–50°C and a phase change enthalpy range of 203–218 J/g. Aydın and Aydın (2012) used C10–C20 fatty acids with even carbon numbers as PCMs. The authors prepared six long-chain esters using 1-hexadecanol to produce low temperature PCMs with a phase change temperature ranging from 29 to 60°C and a latent heat ranging from 186 to 226 J/g.

Lately, in previous research we have proved that the melting temperature and the capability of Decanoic acid to absorb latent heat of fusion can be altered through the addition of organic salts Mjallal et al. (2020). It was found that the most suitable mixture for cooling electronic devices cooling, in terms of melting point depreciation and conservation of latent heat, was a mixture of Decanoic acid with 10 mol% NaOH which permitted a decrease in the melting point from 33.1°C to 28.6 °C while maintaining a relatively constant latent heat.

The current study aims to apply this methodology on AA in order to determine specific thermal properties e.g., heat capacity (C_p) and latent heat (J/g)) for its corresponding mixtures. AA was used in combination with selected organic salts and without the use of expensive and complex chemical reactions to alter its structure. This approach offers a simple and non-expensive path for the valorization of AA and the evaluation of its potential use as a PCM in engineering applications. By this method the melting temperature for AA will be wider and will be more suitable for solar applications.

The remainder of this paper is organized as follows: Section 2 covers the materials used and the preparation of the mixtures. Then, the results are illustrated and discussed in section 3. Finally, section 4 consists of a conclusion and future recommendations.

3.2 Material and methods

Arachidic acid, Ammonium acetate, Sodium oleate, Potassium oleate, Sodium hydroxide and Sodium decanoate were acquired from Netherlands by Sigma-Aldrich and used as received.

The CAS registry number and the purity of the materials used are shown in Table 1.

3.2.1 Preparation of acid mixtures

Ten samples of AA mixtures were prepared by weighing 250 g using Kern analytical balance (ALS-A/ALJ-A) and adding 10 and 15 mol% of the five additives as shown in table 2.

Table 1. CAS Registry Number, purity of the chemicals

Component	CAS. Reg. No	Nomenclature	Purity (mass percentage)
Arachidic acid	506-30-9	eicosanoic acid	≥ 0.99
Ammonium acetate	631-61-8	azanium;acetate	≥ 0.99
Sodium oleate	143-19-1	sodium;(Z)-octadec-9-enoate	≥ 0.99
Potassium oleate	143-18-0	potassium;(Z)-octadec-9-enoate	≥ 0.99
Sodium hydroxide	1310-73-2	sodium;hydroxide	≥ 0.99
Sodium decanoate	1002-62-6	sodium;decanoate	≥ 0.99

After a vigorous mechanical mixing with a spatula, the mixtures were melted inside a Bain-marie (Grant InstrumentsTMJBN18) which is set at 80°C. Upon melting, each of the ten mixtures formed one liquid phase. Then, the samples were removed from the bath and well homogenized manually. Finally, the mixtures were allowed to return to room temperature, and the formed solids were grinded using a spatula and subsequently analyzed by Differential Scanning Calorimetry (DSC)

using a Netzsch DSC Polyma 214 (made in Germany) and according to ASTM D3418 standard.

Table 2. composition of the tested mixtures

Mixtures	Labels
Arachidic acid + 10 mol% Ammonium Acetate	Mix AA10Aa
Arachidic acid + 15 mol% Ammonium Acetate	Mix AA15Aa
Arachidic acid + 10 mol% Potassium Oleate	Mix AA10Po
Arachidic acid + 15 mol% Potassium Oleate	Mix AA15Po
Arachidic acid + 10 mol% Sodium Decanoate	Mix AA10Sd
Arachidic acid + 15 mol% Sodium Decanoate	Mix AA15Sd
Arachidic acid + 10 mol% Sodium Hydroxide	Mix AA10Sh
Arachidic acid + 15 mol% Sodium Hydroxide	Mix AA15Sh
Arachidic acid + 10 mol% Sodium Oleate	Mix AA10So
Arachidic acid + 15 mol% Sodium Oleate	Mix AA15So

3.2.2 Melting behavior of the mixtures

The melting behavior of the AA mixtures was investigated by DSC using a Netzsch DSC Polyma 214 and according to ASTM D3418 standard. A sample of 10 mg was taken from each mixture, and heated under nitrogen atmosphere over a temperature range between -20°C and 60°C using a DSC heating cycle. An endothermic melting peak occurs during the heating phase. The heating rate is set at 5°C /min. The second heating thermogram is recorded in order to study the effect of the composition of the mixture on melting point and crystallization kinetics.

3.2.3 Degree of crystallinity

The degree of crystallinity X_c is estimated by Equation (3.1) Zhang et al. (2017):

$$X_c = \frac{\Delta H_m}{\Delta H_m^0(1 - \varphi)} \quad (3.1)$$

where X_c is the crystallinity expressed in percent, ΔH_m the melting enthalpy in J/g, ΔH_m^0 the

theoretical melting enthalpy of perfectly crystalline arachidic acid and φ the weight fraction of the fillers. The reference heat of melting of pure AA is taken from the literature and corresponds to 257.4 J/g. After completing the heating-cooling cycle, the heat capacity of each mixture is calculated.

3.2.4 Heat capacity (C_p) measurement

DSC was used to determine the heat capacity of the mixtures. The heat flow determined is directly proportional to the specific heat capacity. Hence, C_p is calculated directly from the DSC signal (ϕ_{meas}). The DSC curve is corrected by subtracting a blank curve and the crucible masses are maintained very close to each other.

3.2.5 Uncertainty analysis

To assess the confidence in the results, an uncertainty assessment is done. The uncertainty in the experiments can be due to the mass balance and the DSC as summarized in Table 3.

Table 3. Experimental uncertainties

Equipment's	Experiment error
DSC	5%
Balance	0.1 mg

The absolute uncertainty in percentage is calculated using Equation (3.2):

$$e = \frac{\text{absolute uncertainty}}{\text{value read by the equipment}} \quad (3.2)$$

For the balance, the minimum weight is that for 10 mol% NaOH. Thus, the uncertainty of the Balance reading is equal to ($e_b = \frac{0.1}{3.6} = 2.7\%$). The uncertainty of the DSC is denoted by e_d and equals to 5%.

The total uncertainty is the norm of all uncertainties:

$$e = \sqrt{e_d^2 + e_b^2} = 5.68\%.$$

This value falls in the acceptable range.

3.3 Results and Discussion

The DSC test results obtained for pure AA, 10 mol%, and 15 mol% of added salts are illustrated in Figures 1, 2, and 3, respectively. Figure 1 displays the thermogram of pure AA which is considered the reference throughout this work. The thermogram shows the cooling process (upper blue), and the endothermic melting process (lower red) which is the interesting section of any PCM cycle. The melting process starts at 73.3°C, and ends at 80.1°C, where the peak of the melting process is found to be at 75.2°C. It's to be noted that the peak temperature corresponds to the temperature at which the higher percentage of the material is already melted. In addition, the latent heat of fusion, which is the area under the curve, is 257.4 J/g.

Upon adding 10 mol% of salts to AA, the results show a decrease in the peak temperature of the melting process (Figure 2). Moreover, mixture 4a exhibited the highest latent heat which is equal to 277.2 J/g, even greater than that of the reference 257.4 J/g. Mixtures 1a and 2a, recorded

the lowest latent heat which is equal to 140 J/g. Although the melting peaks of all the mixtures ranged around 70 and 80°C, the difference between the latent heats of fusion were dependent on the additive. The widest range of melting temperature is achieved by mixture AA10Sd for which the melting process started at 48°C and ended at 82.7°C. In contrary, mixture AA10So showed the least decrease in latent heat, only 7.1% less than the reference.

Figure 3 shows the results of adding 15 mol% of salts to the acid. Once again, mixture AA15Sh exhibited the highest latent heat of fusion 249.9 J/g, with a peak temperature at 73.9°C. The lowest melting peak temperature is obtained with mixture AA15Sd (70.1 J/g). Whereas, the lowest melting temperature and the widest range between onset and end melting points are obtained by mixture AA15Po, the melting process started at 46°C and ended at 88.5°C with a melting peak of 71°C. Nonetheless, the least decrease in the latent heat is reached for mixture AA15Sh (2.9%), although its onset melting temperature remained similar to the reference i.e. 73°C. The highest drop in the latent heat is 20% less than the reference, obtained by mixture AA15Sd.

All the DSC test results are summarized in Table 4 including onset temperature, peak melting temperature, end melting temperature, new latent heat, and the percentage of change in latent heat compared to the reference material.

On the other hand, heat capacity is one of the most important thermo-physical properties of the polymers and is often used to calculate other calorimetric properties such as enthalpy, entropy, and Gibbs free energy. This property is a macroscopic thermodynamic property that is based on the molecular motion and vibration of the molecules. The heat capacity of all 10 mol% mixture measured at 23°C, and 100°C is displayed in Figure 4. As shown, the heat capacity of the reference is 1.9 J/g K, and 2.19 J/g K at 23°C, and 100°C, respectively. First, the test was carried out at 23°C,

the highest heat capacity is found for mixture AA10Sd (2.33 J/g K), while the lowest is reached by mixture AA10Sh (1.75 J/g K), and the heat capacity of mix AA10Po and AA10So are 1.9 J/g K and 1.95 J/g K, respectively. The same test was repeated at 100°C, and the results were as follows: the highest heat capacity was found to be for mix AA10Po (2.3 J/g K) while the lowest value was for mix AA10Sh (2.13 J/g K) and the heat capacity of the mix AA10Po and AA10So are 2.31 J/g K and 2.3 J/g K, respectively.

Table 4. DSC test results

Materials	Onset °C	Melting peak °C	End Melting temperature °C	Latent heat of fusion J/g	% of variation of latent heat	
Reference material	73.3	75.2	80.1	257.4	-	
Mix 1	10% Ammonium acetate	66	74.2	80.5	214.0	-16.8%
	15% Ammonium acetate	66	75.0	80.3	241.2	-16.7%
Mix 2	10% Potassium oleate	50	71.9	83.3	214.0	-16.8%
	15% Potassium oleate	46	71.0	88.5	207.7	-19.3%
Mix 3	10% Sodium decanoate	48	71.9	82.7	222.1	-13.7%
	15% Sodium decanoate	52	70.1	87.0	206.3	-20.0%
Mix 4	10% Sodium hydroxide	67	74.1	82.8	277.2	+7.6%
	15% Sodium hydroxide	66	73.9	86.0	249.9	-2.9%
Mix 5	10% Sodium oleate	70.7	73.2	87.2	239.1	-7.1%
	15% Sodium oleate	68.8	72.5	86.0	217.7	-15.4%

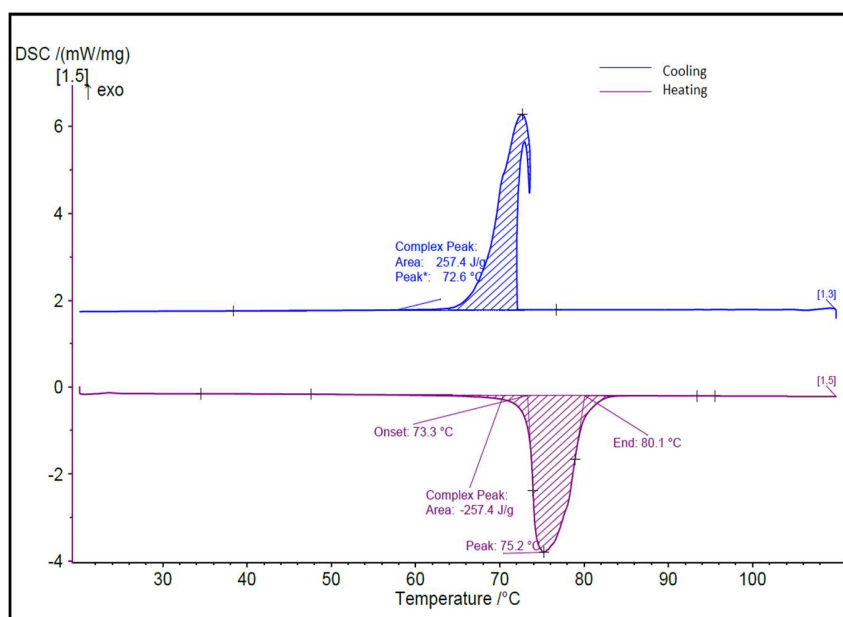

Figure 1. DSC results of pure Arachidic acid (A.A).

In order to make the comparison between the mixtures more sensible, two more parameters are added, the latent heat from the beginning of melting till 75°C, and beta coefficient. The latent heat until 75°C which is the beneficial portion of the latent heat of the mixtures, considered as heat absorbed starting from the beginning of the melting process until 75°C (the maximum allowable temperature specified by the author for the PCM used in solar thermal energy storage for residential application). The values of this variable are presented in Figure 5. Beta is a dimensionless parameter developed to compare PCM quality. It is also calculated at 23°C and 100°C, using the following formula:

$$\beta = \frac{H}{C_p T} \quad (3.3)$$

where H is the latent heat of fusion (J/g), C_p is the heat capacity (J/g K) and T is the temperature (K).

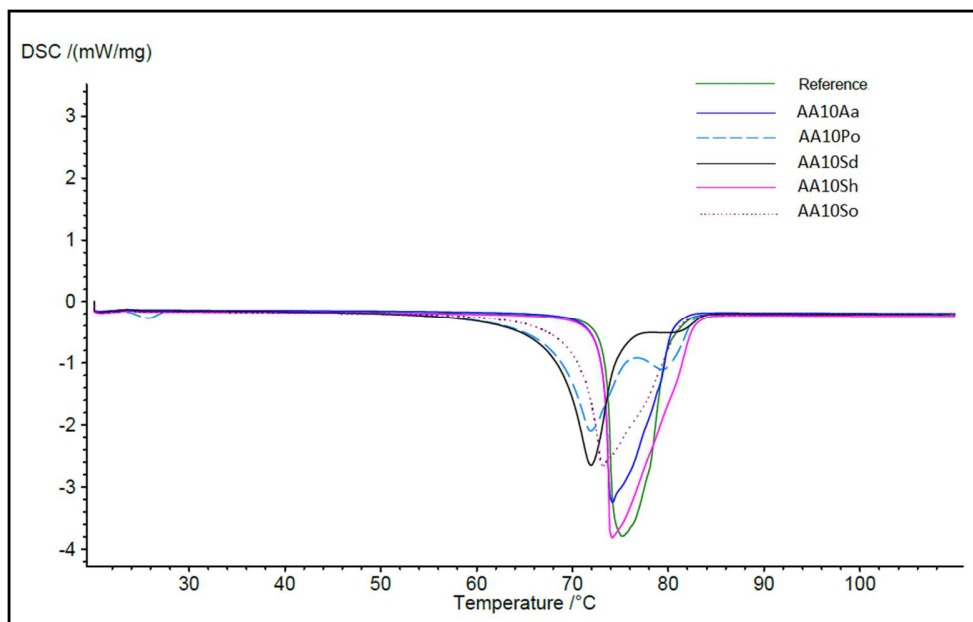

Figure 2. DSC results of all the 10 mol% mixtures.

The latent heat of the pure AA from the beginning of the melting process until 75°C, is 174.3 J/g. Concerning the 10 mol% addition, the highest latent heat is reached by the mixture AA10Po (192.6 J/g) and the lowest is by mixture AA10Aa (151 J/g) whereas the latent heat for mixture AA10Sd, AA10Sh, and AA10So are 171, 168.7, 165 J/g, respectively. For the 15 mol% addition, the highest value is recorded for mixture AA10Aa (172.3 J/g) and the lowest is for mixture AA10Sh (146.1J/g), in addition to 168, 146.7, and 125 J/g for mixtures AA10Po, AA10Sd, and AA10So, respectively.

Similar to the heat capacity, beta was calculated at 23 °C and at 100 °C. Figure 6 shows that the mixture AA10Sh exhibited the highest value (0.536) at 23°C, and the lowest value was reached by AA10Sd (0.322), whereas, the reference's beta was 0.46. On the other hand, beta of the reference at 100°C was 0.414. The highest value was exhibited by mixture AA10Sh (0.46) and the lowest is reached with mixture AA10Po (0.32).

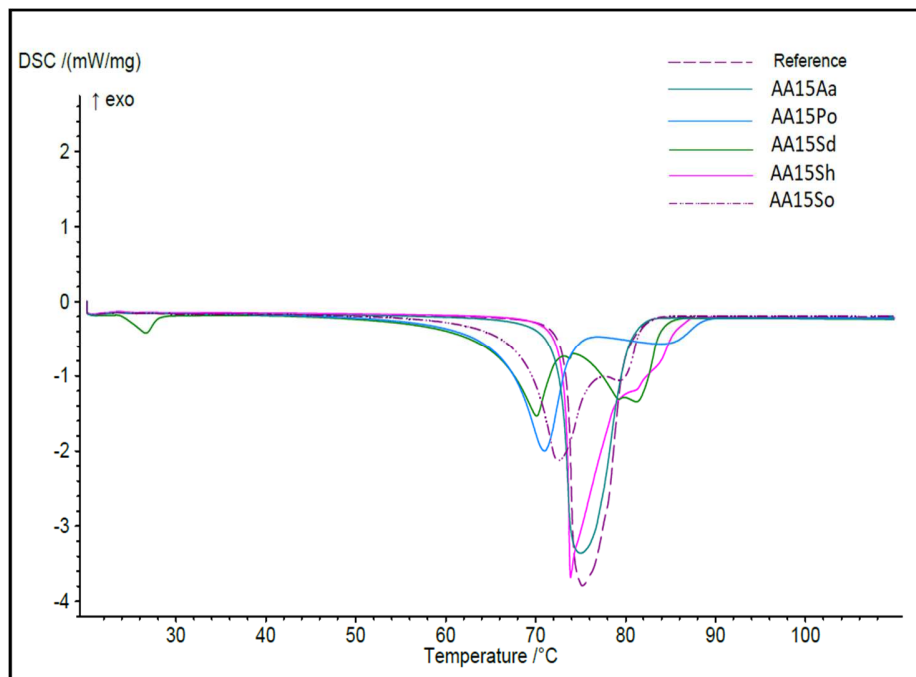

Figure 3. DSC results of the 15 mol% mixtures.

It could be observed that for mixture 1, adding 10 and 15 mol% gave the same results for the latent heat which is 214 J/g and did not decrease the melting peak considerably compared to the reference, the melting peak remained 75°C. Moreover, the latent heat decreased for both by 16%. For Mix AA15Po, adding 15 mol% decreased the latent heat and the melting peak slightly over that of the 10 mol%, and the range of melting temperatures for 15 mol% is wider than that of 10%. Concerning Mix AA15Sd, 15 mol% of sodium decanoate led to a smaller peak temperature and higher latent heat compared to 10 mol%, but 10 mol% started the melting process earlier, which led to higher latent heat until 75°C. Finally, mixtures 4 and 5 showed the same trend as mixture 3, that is 10 mol% gives higher latent heat until 75°C, whereas, 15 mol% gives lower peak temperature.

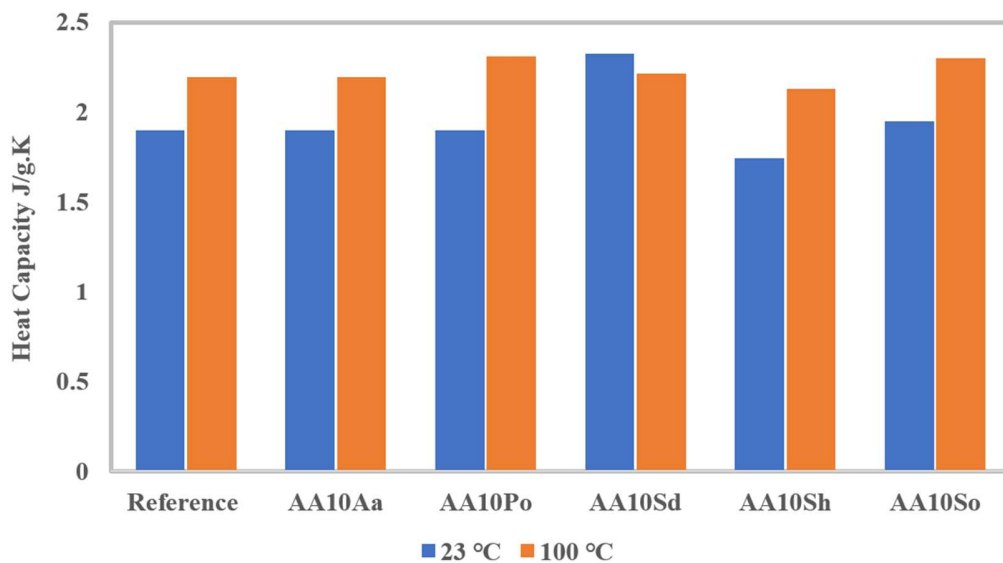

Figure 4. Heat capacity of all mixtures at 23°C and 100°C.

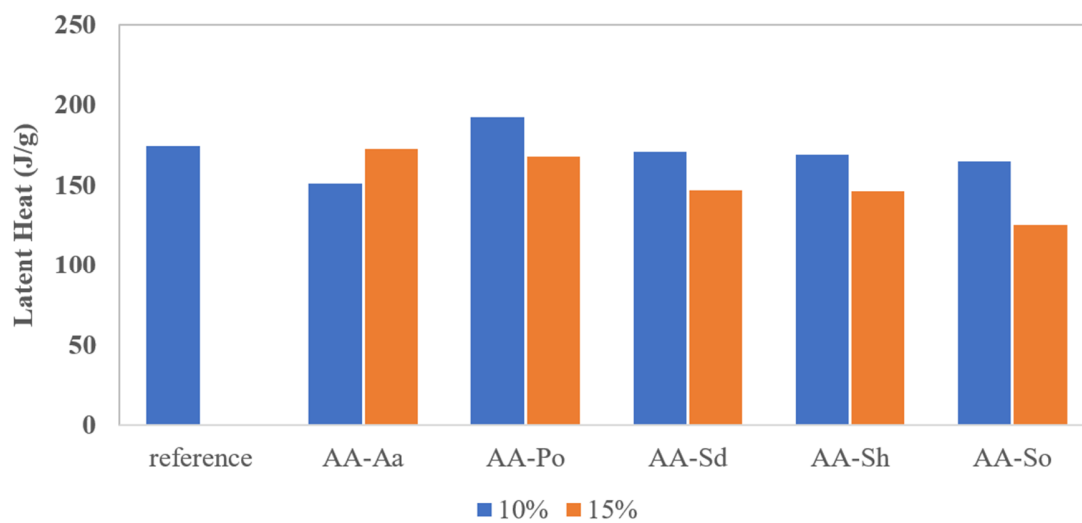

Figure 5. Latent heat of all mixtures till 75°C.

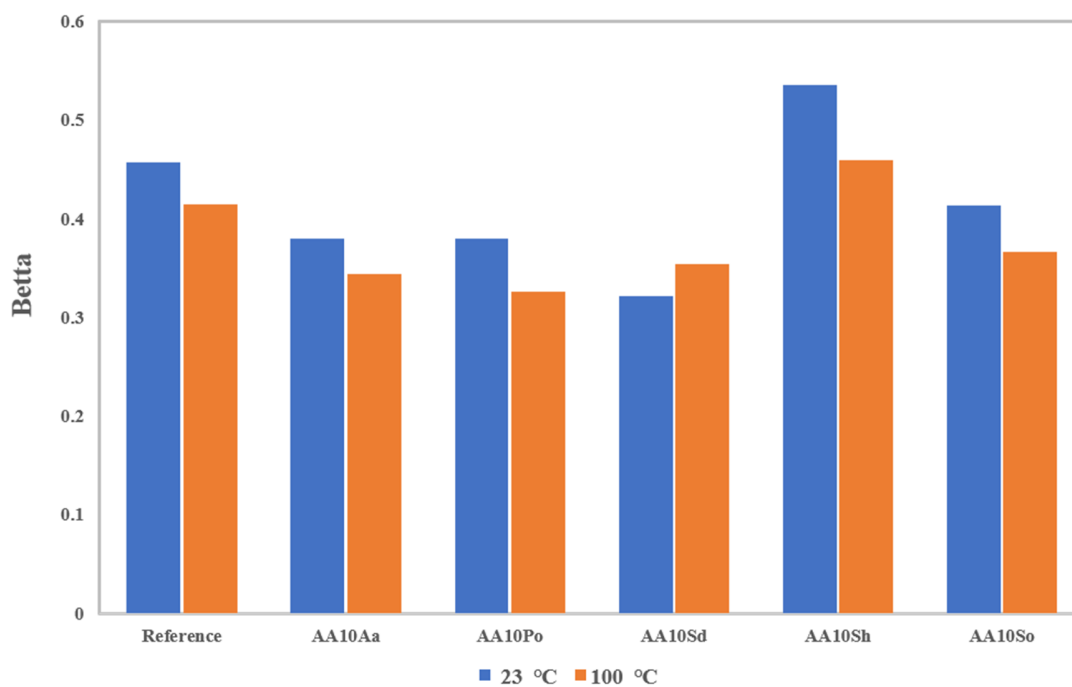

Figure 6. Beta coefficient of different mixtures at 23°C and 100°C.

3.4 Conclusions and Perspectives

The aim of this work is to add an impurity to a pure fatty acid in order to decrease its melting range to useful temperatures relative to solar and electronic applications. Furthermore, these physical modifications should maintain a high heat capacity C_p , the best PCM quality expressed by beta, a good latent heat of fusion till 75°C, and with the minimum drop in the overall latent heat.

The modified PCMs can be used for solar pool heating, solar water heating and other solar applications. When the water reaches the prescribed temperature of a solar pool heating or a solar water heating, the remaining solar energy is used to heat up and melt the PCM. The melted PCM will be used later on at night and during cloudy weather. The idea behind decreasing the onset temperature and making the melting range wider is to let the PCM melt easier by solar energy especially when the solar collector receives a low amount of solar energy.

The addition of 15 mol% of any of the five tested additives to the pure AA led to an improved thermal property compared to the 10 mol% addition, except for the latent heat until 75°C, where the results of 10 mol% additions are better. The best results are obtained when adding 10 mol% of sodium decanoate to Arachidic acid (AA10Sd), this mixture led to 222 J/g, and an onset temperature of 48°C, in addition to the highest heat capacity recorded $C_p = 2.36$ J/g.K.

Concerning the electronic cooling, the mixture AA10Po (AA+10 mol% Potassium oleate) is promising where the beneficial latent heat increased gradually to 192.6 J/g compared to 174.3 J/g for pure AA. This observation implies that AA10Po can absorb more heat before melting compared to the reference. Moreover, the other thermal properties i.e., heat capacity were comparable to pure AA.

More studies need to be done in order to explore the potential of AA based mixtures to decrease the power consumption when used on solar applications.

References

- [1] Abdullah, A.S., Essa, F.A., Bacha, H.B., Omara, Z.M., 2020. Improving the trays solar still performance using reflectors and phase change material with nanoparticles. *Journal of Energy Storage* 31, 101744.
- [2] Alawadhi, E.M., 2005. Thermal insulation for a pipe using phase change material. *Heat transfer engineering* 26, 32–40.
- [3] Alkan, C., Sari, A., 2008. Fatty acid/poly (methyl methacrylate) (PMMA) blends as form-stable phase change materials for latent heat thermal energy storage. *Solar energy* 82, 118–124.
- [4] Aydın, A.A., Aydın, A., 2012. High-chain fatty acid esters of 1-hexadecanol for low temperature thermal energy storage with phase change materials. *Solar Energy Materials and Solar Cells* 96, 93–100.
- [5] Aydın, A.A., Okutan, H., 2011a. High-chain fatty acid esters of myristyl alcohol with even carbon number: Novel organic phase change materials for thermal energy storage-1. *Solar Energy Materials and Solar Cells* 95, 2752–62.
- [6] Aydın, A.A., Okutan, H., 2011b. High-chain fatty acid esters of myristyl alcohol with odd carbon number : novel organic phase change materials for thermal energy storage. 2. *Solar Energy Materials and Solar Cells* 95, 2417–2440.
- [7] Bonyadi, N., Sömek, S.K., Özalevli, C.C., Baker, D., Tarı, I., 2018. Numerical analysis of phase change material characteristics used in a thermal energy storage device. *Heat Transfer Engineering* 39, 268–276.
- [8] Cheng, R., Wang, X., Zhang, Y., 2014. Energy-efficient building envelopes with phase-change materials: new understanding and related research. *Heat Transfer Engineering* 35, 970–984.
- [9] Cheng, W., Xie, B., Zhang, R., Xu, Z., Xia, Y., 2015. Effect of thermal conductivities of shape stabilized PCM on under-floor heating system. *Applied energy* 144, 10–18.
- [10] Faraji, H., Faraji, M., Alami, M.E., 2019. Numerical Study of the Transient Melting of Nano-Enhanced Phase Change Material. *Heat Transfer Engineering*, 1–20.
- [11] Fauzi, H., Metselaar, H.S., Mahlia, T.M.I., Silakhori, M., 2014. Sodium laurate enhancements the thermal properties and thermal conductivity of eutectic fatty acid as phase change material (PCM). *Solar energy* 102, 333–337.
- [12] Hasnain, S.M., 1998. Review on sustainable thermal energy storage technologies, Part I: heat storage materials and techniques. *Energy conversion and management* 39, 1127–1137.
- [13] Hawlader, M.N.A., Uddin, M.S., Khin, M.M., 2003. Microencapsulated PCM thermal-energy storage system. *Applied energy* 74, 195–202.
- [14] Hosseinzadeh, K., Moghaddam, M.E., Asadi, A., Mogharrebi, A.R., Ganji, D.D., 2020. Effect of internal fins along with Hybrid Nano-Particles on solid process in star shape triplex Latent Heat Thermal Energy Storage System by numerical simulation. *Renewable Energy*.
- [15] Hu, J., Hu, R., Zhu, Y., Luo, X., 2016. Experimental investigation on composite phase-change material (CPCM)-based substrate. *Heat Transfer Engineering* 37, 351–358.
- [16] Karaipekli, A., Sari, A., 2009. Capric-myristic acid/vermiculite composite as form-stable phase change material for thermal energy storage. *Solar Energy* 83, 323–332.
- [17] Kawtharani, F., Kawtharani, A., Hammoud, M., Hallal, A., Shaito, A., Assi, A., Assi, I., 2017. Cooling PV modules using phase change material, in: *29th International Conference on Microelectronics (ICM)*, December 10-13, 2017, Beirut, Lebanon, pp. 347–351.
- [18] Konuklu, Y., 2014. Microencapsulation of phase change material with poly (ethylacrylate) shell for thermal energy storage. *International Journal of Energy Research* 38, 2019–2029.

- [19]Lee, F.A., Mattick, L.R., 1961. Fatty Acids of the Lipids of Vegetables. I. Peas (*Pisum sativum*) a. *Journal of Food Science* 26, 273–275.
- [20]Mjallal, I., Farhat, H., Hammoud, M., Ali, S., Assi, I., 2018. Improving the cooling efficiency of heat sinks through the use of different types of phase change materials. *Technologies* 6, 5.
- [21]Mjallal, I., Hammoud, M., Feghali, E., Habchi, C., Lemenand, T., 2020. Modifying the thermophysical properties of Decanoic acid to render its use as a phase change material. *Journal of Thermal Analysis and Calorimetry* Under review.
- [22]Ping, P., Kong, D., Peng, R., 2018. Investigation on thermal management performance of PCM-fin structure for Li-ion battery module in high-temperature environment. *Energy Conversion and Management* 167, 131–146. doi: 10.1016/j.enconman.2018.09.025.
- [23]Sari, A., Karaipekli, A., Kaygusuz, K., 2008. Capric acid and stearic acid mixture impregnated with gypsum wallboard for low-temperature latent heat thermal energy storage. *International Journal of Energy Research* 32, 154–160.
- [24]Thalib, M.M., Manokar, A.M., Essa, F.A., Vasimalai, N., Sathyamurthy, R., Marquez, F.P.G., 2020. Comparative Study of Tubular Solar Stills with Phase Change Material and Nano-Enhanced Phase Change Material. *Energies* 13, 3989.
- [25]Tuckerman, D.B., Pease, R.F.W., 1981. High-performance heat sinking for VLSI. *IEEE Electron Device Letters* 2, 126–129.
- [26]Yuan, Y., Zhang, N., Tao, W., Cao, X., He, Y., 2014. Fatty acids as phase change materials: a review. *Renewable and Sustainable Energy Reviews* 29, 482–498.
- [27]Zalba, B., Marin, J.M., Cabeza, L.F., Mehlin, H., null Refrig, 2004. Free-cooling of building with phase change materials. *International Journal of Refrigeration* 27, 839–849.
- [28]Zhang, D., He, M., Qin, S., Yu, J., 2017. Effect of fiber length and dispersion on properties of long glass fiber reinforced thermoplastic composites based on poly (butylene terephthalate). *RSC advances* 7, 15439–15454.
- [29]Zhang, Y., Wang, Q., 2019. Impact of Phase Change Material's Thermal Properties on the Thermal Performance of Phase Change Material Hollow Block Wall. *Heat Transfer Engineering* 40, 1619–1632.
- [30]Zhang, Z., Zhang, N., Peng, J., Fang, X., Gao, X., Fang, Y., 2012. Preparation and thermal energy storage properties of paraffin/expanded graphite composite phase change material. *Applied Energy* 91, 426–431.

Chapitre 4.

Dispositif économique pour caractériser les matériaux à changement de phase

L'effet positif du matériau à changement de phase sur les performances thermiques de la puce électronique est actuellement bien connu du chercheur. Un PCM peut être utilisé seul ou comme assistant dans l'application de refroidissement électronique, comme l'utilisation du PCM directement sur la puce ou l'utilisation du PCM avec un système de refroidissement actif ou passif.

Bénéficiant de sa chaleur latente élevée, le PCM peut absorber l'énergie générée par les appareils électroniques jusqu'à ce qu'il soit complètement fondu et donc retarder au maximum la température de pic de ces appareils.

La température de fusion, la chaleur latente, la conductivité thermique et la chaleur spécifique sont les principales propriétés thermophysiques permettant de sélectionner l'application du PCM. Connaître et mesurer ces propriétés nécessite un laboratoire bien équipé. Sur cette base, nous envisageons la conception d'un nouvel appareil bon marché pour mesurer la conductivité thermique, la chaleur spécifique et la chaleur latente de fusion pour le PCM.

Ce chapitre est composé d'une **introduction** générale comprenant un résumé des travaux antérieurs. Le protocole expérimental est expliqué dans la **section 2**. Dans la **section 3**, les expériences réalisées pour calculer les propriétés thermophysiques du PCM sont présentées et analysées. De plus, une analyse d'incertitude est effectuée pour illustrer la précision du dispositif fabriqué. Le document se termine dans la **section 4** par une conclusion et des recommandations futures.

Dans ce travail, un nouvel appareil est fabriqué en utilisant une boîte carrée en fibre de verre avec des dimensions de paroi latérale interne de profondeur $d = 30$ mm et de hauteur $h = 10$ mm. Un radiateur à résistance Kapton avec les mêmes dimensions que la boîte est placée au fond de la boîte. En haut, la température est fixée à 18 °C à l'aide d'une plaque froide en cuivre. Deux thermocouples de type K avec une précision de $\pm 0,5$ °C sont séparés à une distance $\Delta Y = 2,3$ mm et connectés à un enregistreur de données. Une alimentation en courant continu (direct curent, DC) est utilisée pour réguler le réchauffeur avec une quantité d'énergie spécifique. Les parois de la boîte sont isolées par trois couches d'isolant.

À partir des mesures, les propriétés sont calculées et comparées à celles trouvées dans la littérature ouverte. La conductivité thermique, la chaleur spécifique et la température de fusion du sulfate de sodium décahydraté sont respectivement égales à $0,568$ ($\text{W}\cdot\text{m}^{-1}\cdot\text{K}^{-1}$), $1,896$ ($\text{kJ}/\text{kg}\cdot\text{K}$) et $31,7$ °C.

Dispositif économique pour caractériser les matériaux à changement de phase

Cet article est publié dans « Measurement Science and Technology »

doi.org/10.1088/1361-6501/ab3d19

Résumé – Les matériaux à changement de phase (PCM) sont un sujet de recherche émergent depuis quelques années. Cependant, le manque d'informations détaillées et précises sur leurs propriétés thermophysiques est une préoccupation majeure pour les chercheurs. Cet article présente une méthode simple pour déterminer la chaleur spécifique (C_p), la conductivité thermique (K) et la température de fusion (T_m) d'un PCM à l'aide d'un nouveau dispositif à faible coût. Par rapport aux méthodes conventionnelles existantes, telles que la calorimétrie différentielle à balayage (DSC), l'histogramme de la température, cette nouvelle méthode confère les caractéristiques suivantes : simplicité et facilité de fabrication et capacité à mesurer les propriétés thermophysiques d'échantillons PCM hétérogènes sans matériel de référence. En utilisant ce nouveau dispositif, les propriétés thermophysiques du sulfate de sodium décahydraté ont été mesurées et un bon accord est obtenu avec les valeurs recueillies dans la littérature ouverte en utilisant d'autres dispositifs.

Cost effective device to characterize phase change materials

This article is published in “Measurement Science and Technology”

doi.org/10.1088/1361-6501/ab3d19

Abstract

Phase Change Materials (PCM) have been an emerging research topic for the last few years. However, the lack of detailed and precise information regarding their thermophysical properties is a major concern for researchers. The current paper presents a simple method to determine the specific heat (C_p), thermal conductivity (K) and melting temperature (T_m) of a PCM using a novel low cost device. Compared to the conventional existing methods such as Differential Scanning Calorimetry (DSC), T-history, panel test and simple thermal analysis, this new method grants the following features: simplicity and ease of manufacturing and the ability to measure the thermophysical properties of heterogeneous PCMs samples without a reference material. Using this novel device, the thermophysical properties of the sodium sulfate decahydrate were measured and good agreement is obtained with values collected from the open literature using other devices.

Keywords: phase change material, thermal conductivity, specific heat, thermophysical properties, heat

4.1 Introduction

Phase Change Material (PCM) is a substance with high latent heat of fusion [1], which can absorb a large amount of energy during the process of melting and freezing. Therefore, PCM is a good choice for non-continuous applications [2,3], such as electronics cooling [4], thermal energy storage [5], building applications [6] and refrigeration applications [7].

The effect of PCM usage in cooling electronic devices was investigated in References [8, 9] where PCM based heat sink were studied for different sink geometries and different types of PCM namely paraffin wax and n-Eicosanoid. It was concluded that the n-Eicosanoid and paraffin enhanced the cooling performance. Moreover, the volume fraction of PCM (amount of PCM used) affects directly the cooling performance of a heat sink. Another experimental studies are done in references [10-12]. It is shown that the use of PCM extends twice the critical time of a heat sink or the time needed to reach the steady state [13].

Many other experimental studies are conducted in the literature highlighting the potentials of using PCM for various residential and thermal applications [14, 15].

Taking into account the high cost of PCM usage, most of the studies are now focusing on the numerical modeling of PCM before getting into the experimental setup since it is money and time saving. However, the lack of information of the thermophysical properties of PCM is a critical issue. This leads to a backward step to find first all the properties required in order to carry out the numerical simulations.

Cabeza *et al.* [16] presented a review on different methods used to measure the thermo-physical properties of PCM such as: Differential Scanning Calorimetry (DSC), T-history, Panel test, simple thermal analyser and themal test device.

The DSC machine [17-20] is widely used to determine the specific heat, the melting temperature and the latent heat of fusion for any type of materials especially for PCM. The disadvantage of this method is that the sample should be small, pure and homogeneous. Moreover, several crucial processes, such as subcooling, cannot be observed using this method.

The T-History method [21-23] makes use of two large tubes where the first one holds the PCM and the second one holds a reference material. This method is interesting for heterogeneous materials showing subcooling effects. By comparing the thermal performance of the tested material and the reference material, the thermophysical properties of the PCM can be obtained.

In the panel test and the thermal test methods [24], the PCM is sandwiched between two heat exchangers and two heat flux sensors. This method is used to measure the thermophysical properties of PCMs panel used in building applications. In this method, the simple test analysis [25] consists of a cylinder full of PCM and a heater at the middle of the cylinder. The system is fully insulated from the surrounding. The PCM is heated until melting and then it is cooled down. The enthalpy and the specific heat are thus calculated using this method.

In this paper, a new method is presented where a low cost device is manufactured to evaluate the thermal conductivity (K), the specific heat (C_p) and the melting temperature (T_m) of a specific PCM, the sodium sulfate decahydrate. The experimental setup is simple and can be built quickly since the materials used are highly available in the market.

To highlight the novelty of this method, a comparison with the existing methods is performed. In contrast to DSC, a large scale sample of PCM can be analyzed in the proposed method. Thus, the PCM studied can be heterogeneous and the subcooling effect can be recognized. Compared to the simple test analysis method, the cold plate used in the proposed method helps the PCM to reach the steady state, and then the thermal conductivity can be calculated which is not the case in the

above method. On the contrary of the T-history method used to calculate the thermophysical properties of PCMs, the proposed method does not have a reference material. Finally, in the panel test method, the geometry is not perfectly insulated, so 1-dimensional heat transfer by conduction cannot be reached; therefore the thermal conductivity cannot be calculated. In the proposed method, a perfect insulation is performed which allows the calculation of the thermal conductivity.

The paper is organized as follows: the experimental protocol is explained in section 2. In section 3, the experiments done to calculate the thermophysical properties of PCM are presented and analyzed. In addition, the uncertainty analysis is performed to illustrate the accuracy of the manufactured device. The paper is ended up in section 4 by a conclusion and future recommendations.

4.2 Experimental protocol

As stated in the objectives of the paper, an experiment will be designed in order to calculate the thermal conductivity (K), specific heat (C_p) and the melting point (T_m) of PCM.

4.2.1 Apparatus and instruments

As shown in figure 1, the PCM is filled inside a square-box made from glass fiber with internal side's wall dimension of $d = 30$ mm , and height $h = 10$ mm.

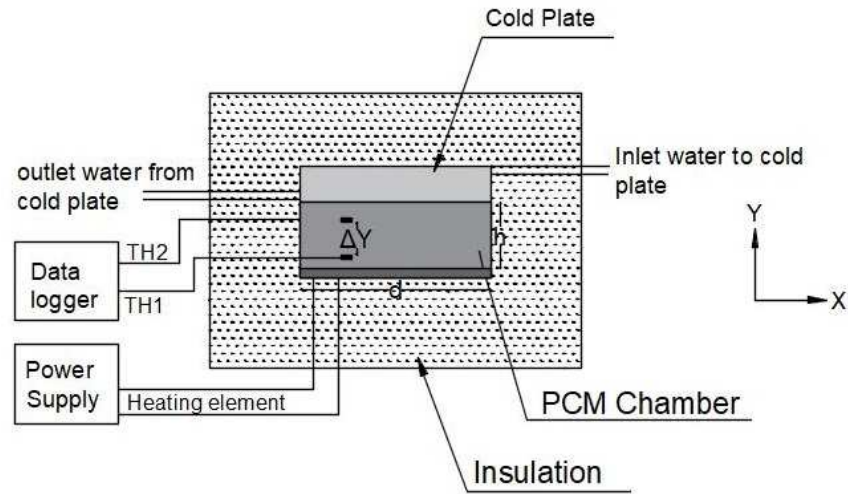

Figure 1. Schematic of the experimental setup

A Kapton resistance heater with the same dimensions of the box is placed at the bottom of the box. At the top, the temperature is fixed at 18 °C using a copper cold plate. Two K-type thermocouples with accuracy ± 0.5 °C and head diameter of 0.25 mm placed apart by a distance $\Delta Y = 0.23$ cm and connected to a data logger. The data logger is used to measure the temperature of PCM. A DC power supply is used to regulate the heater with a specific amount of power. Data acquisition is done through a computer connected to the data logger. The data saved consists of the thermocouples temperature.

The boundaries of the box are well insulated as shown in figure 2, by three layers of insulations (Rockwool, Clean Liner and Rockwool), to ensure that no heat loss happens. The thermal conductivities of the Rockwool and clean liner are 0.044 and 0.035 W/m.K, respectively. The thicknesses of the three layers are 5, 2 and 2.5 cm, respectively. The mass of PCM is measured using Camry (EHA601) Digital pocket balance with a high accuracy to 0.01 g. The PCM used is the sodium sulfate decahydrate ($H_2O Na_2 O_{14} S$).

The physical and thermal properties of the insulation layers are presented in table 1.

Table 1. Physical and thermal properties of the insulation used

	Layer		
	1	2	3
Thermal conductivity: K (W/m.K)	0.044	0.035	0.044
Thickness: t (cm)	5	2	2.5
Area: A (cm^2)	3	3	3
Thermal resistance: R (K/W)	3788	1904	1893

The total thermal resistance between the inlet and the outlet is 7585 (K/W). So the heat loss will be equal to the difference between inside and ambient temperatures divided by the thermal resistance, $q_{loss} = \frac{\Delta T}{R}$. In our case, $q_{loss} = 0.000882$ W in each face. Compared to the heat generated (0.5W), the heat loss represents around 0.7%. It can be neglected.

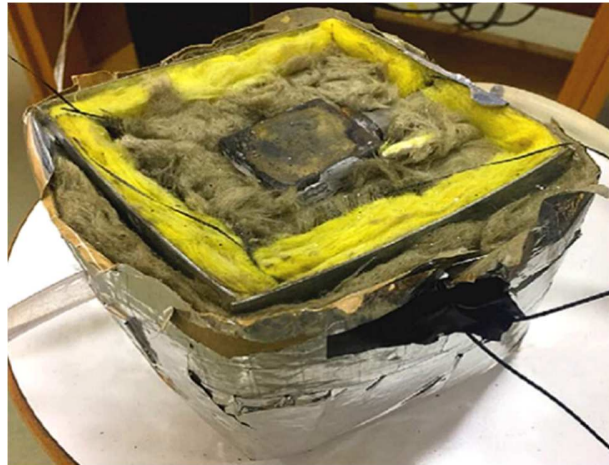

Figure 2. Insulation all around the square box where the cold plate appears in the top middle region

4.2.2 Experimental procedure

Firstly, the PCM is melted and filled inside the box. The PCM is left to re-solidify until its temperature becomes constant, approximately 18°C. The DC power supply is turned on where it

supplies the heater by a voltage equal to 2.5 V and a current equal to 0.2 A for approximately 10 min for K and C_p and a voltage equals to 9 V and current equal to 0.78 A for T_m . The temperatures of the thermocouples TH1 and TH2 are recorded every one second. The experiment is repeated 5 times in order to record accurate data for accuracy purpose. Each time, the heater dissipates heat for 10 minutes.

4.2.3 Heat transfer type

A 3-dimensional finite element model is developed in order to validate the distance between the two thermocouples. The studied domain has the same dimension of the box ($3 \times 3 \times 1 \text{ cm}^3$). Due to symmetry, one quarter of the domain is studied. The dimension of the simulated domain is reduced to ($1.5 \times 1.5 \times 1 \text{ cm}^3$). A heat flux is applied at the bottom of the PCM while as mentioned before the heat loss from the insulation is neglected. The top surface temperature of the PCM is fixed to 18°C.

The energy equation is solved in the PCM box. The second-order UPWIND with double precision is used to solve the continuity equation for mass and momentum, and COUPLED algorithm scheme is used for the pressure-velocity coupling. The domain is divided into 281250 hexahedral elements. The general energy equation used in the finite element software writes as:

$$\frac{\partial}{\partial t}(\rho C_p T) = \frac{\partial}{\partial x} \left(k \frac{\partial T}{\partial x} \right) + \frac{\partial}{\partial y} \left(k \frac{\partial T}{\partial y} \right) + \frac{\partial}{\partial z} \left(k \frac{\partial T}{\partial z} \right) \quad (4.1)$$

The temperature gradients at the line joining the two thermocouples are represented in figure 3. The temperature gradients along the x-axis and z-axis have the same trend and are approximately null. It is worth noted that the line joining the thermocouples is along y-axis.

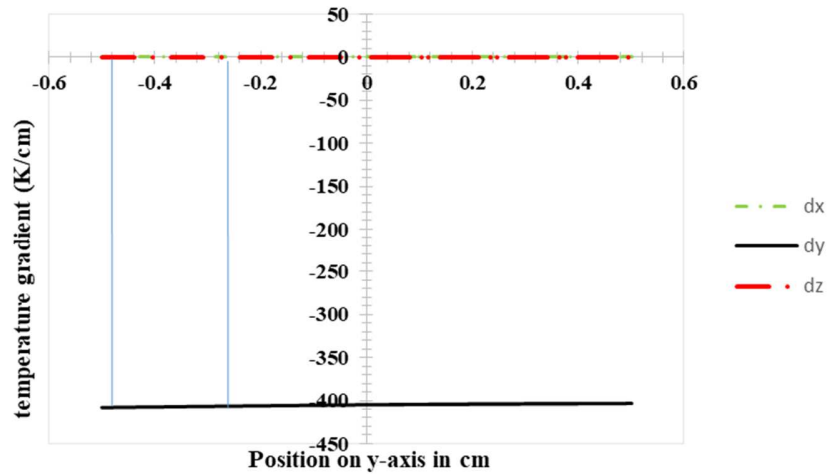

Figure 3. Temperature gradients of heat transfer in x, y and z direction.

Along the y-axis, the temperature gradient varies between 408 K/cm and 404.8 K/cm. Thus, to ensure a constant value of the temperature gradient, the distance between the thermocouples along y-axis should be as smaller as possible. From the numerical simulation, the smallest distance is around 0.23 cm. Thus, the heat transfer in the PCM at this distance is a 1-D conduction.

4.3 Experiments and uncertainty analysis

In this section, the experimental results along with the uncertainty analysis are presented.

4.3.1 Experiments results

The variation of the temperature of PCM in function of time at two positions 0.23 cm distant is measured by the mean of K-type thermocouples and a data logger. The experiment is repeated 5 times for accuracy purposes. Figure 3 shows the variation of TH1 temperature while figure 4 shows the variation of TH2 temperature.

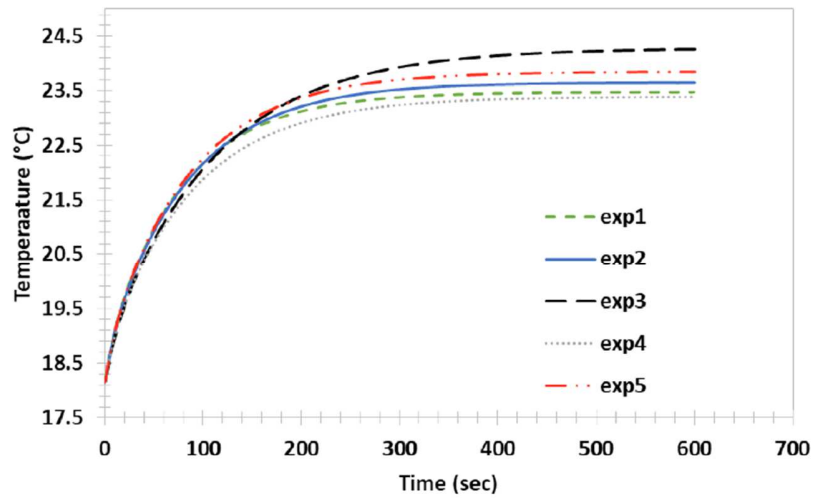

Figure 4. The variation of TH1 function of time

As shown in figure 4 and figure 5, the temperature increases significantly at the beginning. Then, its rate decreases with time until reaching the steady state, where it remains constant. The difference between the temperature at steady state for thermocouples 1 and 2 is due to the conductivity of the material, each material has its own thermal conductivity and the temperature difference is directly related to this parameter.

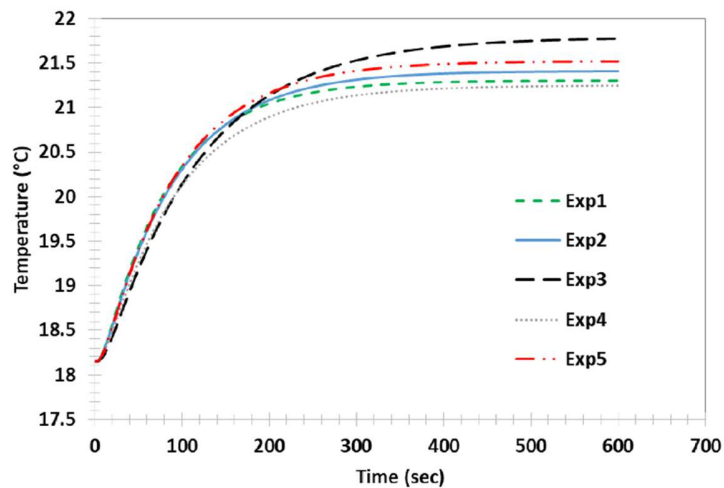

Figure 5. The variation of TH2 in function of time

Although, for the same thermocouples (TH1 or TH2), the path is slightly different for the five experiments. From Table 2, the difference in steady state temperature is very small (maximum value for TH1 is 24.26 °C and minimum value is 23.4 °C) and the standard deviation for TH1 is 0.327 °C while it is 0.187 °C for TH2.

Table 2. Steady state temperature for the five experiments

	TH 1(°C)	TH 2(°C)
Experiment 1	23.40	21.30
Experiment 2	23.65	21.40
Experiment 3	24.26	21.77
Experiment 4	23.37	21.24
Experiment 5	23.84	21.52
Standard deviation	0.327	0.187
Average	23.70	21.45

4.3.2 Uncertainty analysis

To assess the confidence in the results, an uncertainty assessment is done. The uncertainty in the experiments can be due to: the temperature reading, the DC power supply, the mass balance, the repetition, the length measurement between the two thermocouples and the heat flux as summarized in table 3.

Table 3. Experimental uncertainties

Equipment's	Experiment error
Thermocouple	±0.5°C
Balance	±0.01g
Power supply	±1%
Caliper	±0.01cm

The absolute uncertainty in percentage is calculated using the following formula:

$$e = \frac{\text{absolute uncertainty}}{\text{value read by the equipment}} \quad (4.2)$$

For the thermocouples, the minimum temperature that they can read is 18°C. Thus, the uncertainty of the temperature reading (e_t) is equal to:

$$e_t = \frac{0.5}{18} = 2.78\%.$$

Similarly, the uncertainty of the balance and caliper are equal to $e_b = 0.11\%$ and $e_c = 4.35\%$, respectively.

The uncertainty for the repeatability is calculated by:

$$e_R = \frac{\text{Standard deviation}}{\text{average Temperature}} \quad (4.3)$$

For TH1, the uncertainty is then equal 1.38% and 0.878% for TH2. By taking the maximum value, the uncertainty for the repeatability (e_R) is equal to 1.38%.

The uncertainty of the power supply is denoted by e_p and equals to 1.

The total uncertainty is the norm of all uncertainties:

$$e = \sqrt{e_t^2 + e_b^2 + e_c^2 + e_p^2 + e_R^2} \quad (4.4)$$

Substituting all calculated values, the total uncertainty is equal to: $e = 5.44\%$. This value falls in the acceptable range.

4.3.3 Evaluation of the thermal conductivity

As proved previously, the conduction in the PCM is one-dimensional direction. Thus, the heat is

calculated using the following equation:

$$q = K A \frac{\Delta T}{\Delta Y} \quad (4.5)$$

where q is the heat dissipated by the heater, ($q = 0.5 \text{ W}$), K is the thermal conductivity of the PCM, A is the cross sectional area equal to 9 cm^2 , and ΔT is the temperature difference between two points distant by ΔY ($\Delta Y = 0.23 \text{ cm}$ in this case).

Using equation (4), the average experimental value of the thermal conductivity K is equal to 0.568 (W/m.K) . Figure 6 shows a comparison between the experimental value of K and two values found in the literature [26, 27].

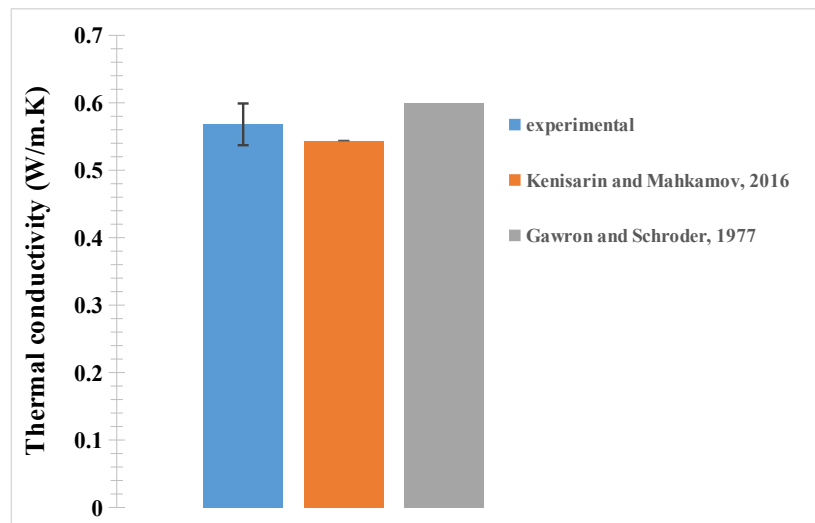

Figure 6. Thermal conductivity: experimental versus values found in the literature [27, 28]

A quick analysis shows that the experimental value of K is very close to those found in the literature ($0.544, 0.6 \text{ W/m.K}$). The maximum relative error doesn't exceed 6%.

4.3.4 Evaluation of the specific heat

The specific heat (C_p) for all the experiments is calculated at a temperature of 20 °C using the following equations:

$$C_p = \frac{\Delta Q}{m dT} \quad (4.6)$$

$$\Delta Q = \int_{t_{start}}^{t_{20}} q(t) dt \quad (4.7)$$

where ΔQ is the increase in the internal energy, m is the mass of the PCM, C_p is the specific heat and dT is the temperature variation.

The average specific heat is calculated in a temperature range. Substituting equation (4.6) into equation (4.7), the specific heat is then calculated by:

$$C_p = \frac{q}{m \frac{dT}{dt}} \quad (4.8)$$

where q is the power supplied by the heater, dT / dt is the variation of the temperature function of time.

The average experimental value of the specific heat is 1.896 kJ/kg.K. Figure 7 shows clearly that the experimental value is very close to the values found in the literature [26-28] with a relative error not exceeding 10%.

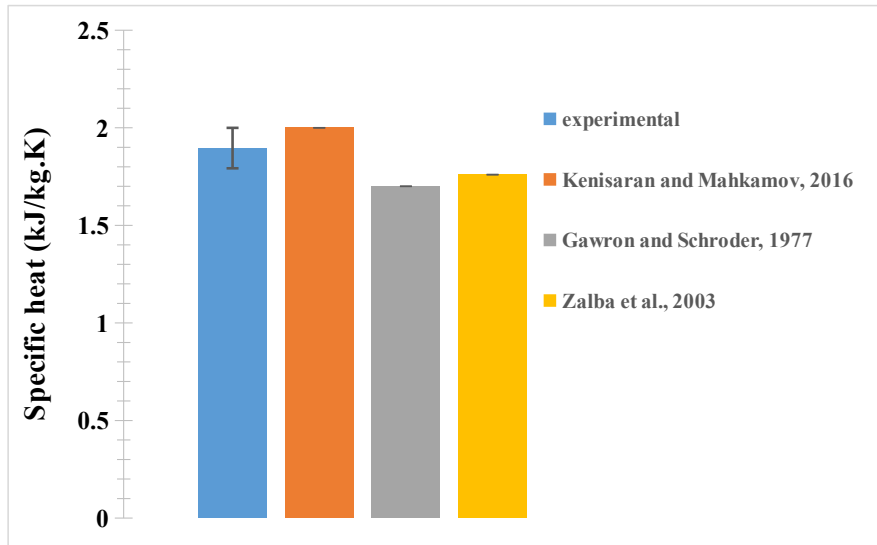

Figure. 7 Specific heat: experimental versus values found in the literature [6, 27, 28]

4.3.5 Evaluation of the melting point

The melting point of a PCM plays an important role in the selection of the type of PCM for the appropriate application.

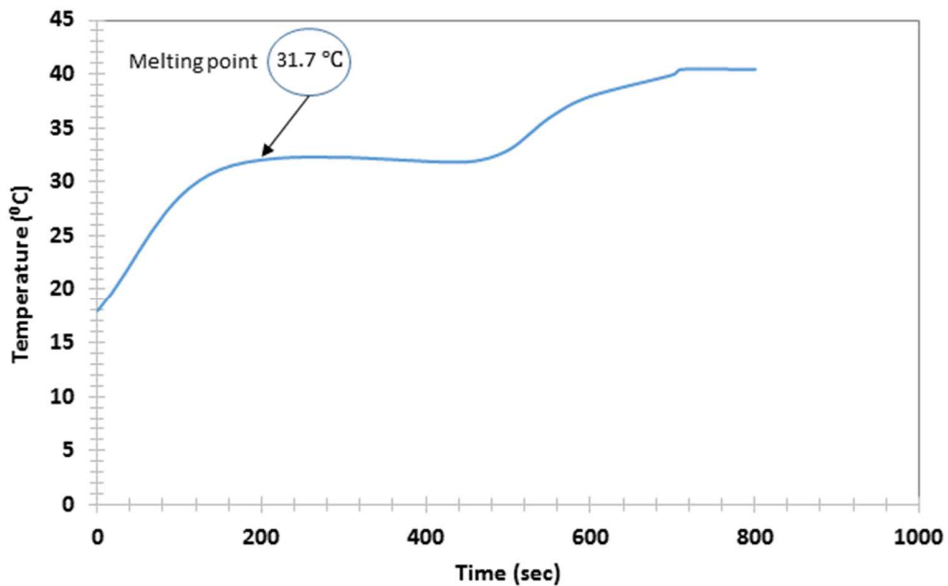

Figure 8. Phase change diagram of PCM sodium sulfate decahydrate ($H_{20}Na_2O_{14}S$)

An experiment was done to extract the melting point of the sulfate decahydrate ($H_{20}Na_2O_{14}S$) (PCM used in the experiments) from the evolution of its phase change diagram as shown in figure 8. From the graph, the melting temperature of the sulfate decahydrate is approximately 31.7 °C. Compared to the value found in the literature [27] of 32 °C, the relative error is evaluated to 1%.

4.4 Conclusion

In this paper, a novel low cost device was designed and manufactured to calculate the thermal conductivity, the specific heat and the melting temperature. The device is used to characterize sodium sulfate decahydrate ($H_{20}Na_2O_{14}S$). The uncertainty analysis showed that the maximum experimental error in this new device do not exceed 5.45%.

Moreover, the thermophysical properties of sodium sulfate decahydrate obtained from this new device were successfully validated by data from the open literature.

For instance, using the new device, it is found that the thermal conductivity, the specific heat and the melting temperature for sodium sulfate decahydrate are 0.568 (W/m.K), 1.896 (kJ/kg.K) and 31.7 °C, respectively.

As a future work, a control system can be embedded in the device in order to calculate directly the thermo-physical properties of PCMs.

References

- [1] Lee D Y and Vafai K 1999 Comparative analysis of jet impingement and microchannel cooling for high heat flux applications *Int. J. Heat. Mass. Tran.* **42** 1555-68
- [2] Liu C and Rao Z 2017 Chalnges in various thermal energy storage technologies *Sci. Bull.* **62** 231-3
- [3] Lasance C J and Simons R E 2005 Advances in high-performance cooling for electronics *Electronics Cooling* **11** 22-39
- [4] Tuckerman D B and Pease W 1981 High-performance heat sinking for VLSI *IEEE. Electr. Device. L.* **2** 126-9
- [5] Stritih U 2016 Increasing the efficiency of PV panel with the use of PCM *Renew. Energ.* **97** 671-79
- [6] Zalba B, Marin J M, Cabeza L F and Mehling H 2004 Free-cooling of buildings with phase change materials *Int. J. Refrig.* **27** 839-49
- [7] Fazeli H and Mirzaei M 2011 A comparative study of two methods for identifying the solidliquid interface in a cold storage system *P. I. Mech. Eng. C-J. Mec.* **225** 917-29
- [8] Ali H M, Arshad A, Jabbal M and Verdin P G 2018 Thermal management of electronics devices with PCMs filled pin-fin heat sinks: a comparison *Int. J. Heat. Mass. Tran.* **117** 1199-204
- [9] Arshad A, Ali H M, Ali M and Manzoor S 2017 Thermal performance of phase change material (PCM) based pin-finned heat sinks for electronics devices: effect of pin thickness and PCM volume fraction *Appl. Therm. Eng.* **112** 143-55
- [10] Ghrabi S, Harmand S and Jabrallah S B 2015 Experimental comparison between different configurations of PCM based heat sinks for cooling electronic components *Appl. Therm. Eng.* **87** 454-62
- [11] Mjallal I, Farhat H, Hammoud M, Ali S and Assi I 2018 Improving the Cooling Efficiency of Heat Sinks through the Use of Different Types of Phase Change Materials *Technologies* **6** 5
- [12] Assi I, Mjallal I, Farhat H, Hammoud M, Ali S, Al Shaer A and Assi A 2017 Using phase change material in heat sinks to cool electronics devices with intermittent *ICPES, IEEE 7th International Conference* 66-9
- [13] Xie J, Li Y, Wang W, Pan S, Cui N and Liu J 2013 Comments on thermal physical properties testing methods of phase change materials *Adv. Mech. Eng.* **5** 695762

- [14] Al Kayiem H H and Lin S C 2014 Performance evaluation of a solar water heater integrated with a PCM nanocomposite TES at various inclinations *Sol. Energy*. **109** 82-92
- [15] Zhang Y P, Lin K P, Yang R, Di H and Jiang Y 2006 Preparation, thermal performance and application of shape-stabilized PCM in energy efficient buildings *Energ. Buildings*. **38** 1262-9
- [16] Cabeza I, Barreneche C, Martorell I, Miro L, Sari-Bey S, Fois M, Paksoy H, Sahan N, Weber R, Constantinescu M, Anghel E, Malikova M, Krupa I, Delgado M, Dolado P, Furmanski P, Jaworski M, Haussmann T, Gschwander S, Fernandez A 2015 Unconventional experimental technologies available for phase change material (PCM) characterization. Part 1. Thermophysical properties *Renew. Sust. Energ. Rev.* **43** 1399-414
- [17] Hasan H, Abdelbaqi S, Assi A and Hamdan M O 2016 Comparative effectiveness of different phase change materials to improve cooling performance of heat sinks for electronic devices *Appl. Sci.* **6** 226
- [18] Mills A, Farid M, Selman J R and Al-Hallaj S 2006 Thermal conductivity enhancement of phase change materials using a graphite matrix *Appl. Therm. Eng.* **26** 1652-61
- [19] Kim s and Drzal L T 2009 High latent heat storage and high thermal conductive phase change materials using exfoliated graphite nanoplatelets *Sol. Energy. Mat. Sol. C.* **93** 136-42
- [20] Barreneche C, Sole A, Miro I Martorell I, Fernandez A and Cabeza L F 2012 New methodology developed for the differential scanning calorimetry analysis of polymeric matrixes incorporating phase change materials *Meas. Sci. Technol.* **23** 085606
- [21] Pasupathy A, Anthanasius L, Velraj R and Seeniraj R V 2008 Experimental investigation and numerical simulation analysis on the thermal performance of a building roof incorporating phase change material (PCM) for thermal management *Appl. Therm. Eng.* **28** 556-65
- [22] Yinping Z and Yi J 1999 A simple method, the-history method, of determining the heat of fusion, specific heat and thermal conductivity of phase-change materials *Meas. Sci. Technol.* **10** 201
- [23] Lazaro A, Gunther E, Mehling H, Hiebler S, Marin J M and Zalba B 2006 Verification of a T-history installation to measure enthalpy versus temperature curves of phase change materials *Meas. Sci. Technol.* **17** 2168
- [24] De Gracia A, Barreneche C, Farid MM, Cabeza LF 2011 New equipment for testing steady and transient thermal performance of multilayer building envelopes with PCM. *Energy Build* **43** 3704-9

- [25] Domanski R, and Jaworski M 1994 Measurements of thermal properties of PCM materials. 6th international conference on thermal energy storage. 487-94
- [26] Kravvaritis E D, Antonopoulos K A and Tzivanidis C 2010 Improvements to the measurement of the thermal properties of phase change materials *Meas. Sci. Technol.* **21** 045103
- [27] Kenisarin M and Mahkamov K 2016 Salt hydrates as latent heat storage materials: Thermophysical properties and costs *Sol. Energ. Mat. Sol. C.* **145** 255-86
- [28] Gawron K and Scroder J 1977 Properties of some salt hydrates for latent heat storage *Int. J. Energ. Res.* **1** 351-63

Chapitre 5.

Effet d'un matériau à changement de phase sur les performances thermiques d'un dissipateur thermique de modem

Les exigences actuelles des programmes, jeux et logiciels conduisent à augmenter la puissance des puces électroniques qui ont tendance à diminuer de taille, ainsi la dissipation de chaleur de ces puces augmente. Par conséquent, le refroidissement des appareils électroniques devient primordial pour réduire les dommages et prolonger la durée de vie des puces.

L'utilisation de matériau à changement de phase (PCM) dans le refroidissement électronique est maintenant une méthode conventionnelle explorée, mais trouver un PCM avec des propriétés thermophysiques optimales reste un défi pour le chercheur. Pour cela, de nombreuses études se concentrent désormais sur la modification des propriétés thermophysiques du PCM pour s'adapter au mieux aux applications nécessaires.

L'utilisation d'acides gras pour le refroidissement électronique est très limitée en raison de ses propriétés thermophysiques parce que l'acide gras ayant une chaleur latente élevée a un point de fusion élevé qui ne correspond pas au refroidissement de l'appareil le plus électronique. Ainsi, l'acide arachidique modifié au chapitre 3, sera maintenant utilisé dans une application de refroidissement électronique. L'acide gras modifié sera comparé au PCM pur pour déterminer l'effet de la modification du PCM sur le refroidissement électronique.

Un bref historique du sujet est présenté dans la **section 1**. L'appareil expérimental est présenté dans la **section 2**, l'incertitude de cet appareil est également présentée dans cette section. La **section 3**

affiche les propriétés thermophysiques des PCM utilisés. Les principaux résultats sont présentés dans la **section 4**. L'interprétation des résultats est discutée dans la **section 5**. Enfin, le travail se termine par une conclusion dans la **section 6**.

Le dissipateur thermique est étudié d'une part sans PCM pour avoir de référence et avec trois PCM à base d'acide arachidiques. Les PCM utilisés sont l'acide arachidique pur, et l'acide arachidique mélangé avec 10% d'oléate de potassium ou 10% d'oléate de sodium. Le dissipateur est étudié avec trois niveaux de puissance générées : 0,5, 1 et 2 W.

Les résultats ont montré que les deux mélanges présentent de meilleures performances que l'acide arachidique pur. Ils rendent le PCM plus adapté aux applications électroniques de dissipation thermique envisagés. De plus, pour le mélange d'acide arachidiques avec 10% d'oléate de potassium, la température maximale atteinte par le dissipateur thermique est réduite de 10 °C et le pic de température est retardé de 400 secondes par rapport à l'acide arachidique pur.

Effet d'un matériau à changement de phase sur les performances thermiques d'un dissipateur thermique de modem

Cet article est publié dans « Applied Sciences »

doi.org/10.3390/app11199201

Résumé – La température d'un appareil électronique est l'un des paramètres les plus importants à prendre en compte. Toute augmentation au-dessus des limites de température signifie une défaillance de l'appareil. Ainsi, pour un bon fonctionnement, un appareil électronique doit être refroidi. L'une des techniques prometteuses est l'utilisation de matériau à changement de phase (PCM) pour sa capacité bien connue à absorber la chaleur dissipée par le dispositif grâce à sa forte chaleur latente de fusion. L'acide arachidique est un acide gras, et nous avons montré que mélangé avec certains sels, il peut être utilisé comme un PCM prometteur en raison de sa large chaleur latente. Cet article vise à faire la lumière sur l'utilisation de mélanges d'acide arachidique dans le refroidissement d'un dissipateur thermique. Un dispositif expérimental est construit à cet effet. Les résultats montrent que les mélanges d'acide arachidique conviennent à une application de dissipation thermique intermédiaire.

The Effect of Arachidic Acid Mixtures on the Cooling Performance of Heat Sink

This article is published in “Applied Sciences”

doi.org/10.3390/app11199201

Abstract:

The temperature of an electronic device is one of the most important parameters to deal with. Any increase above the temperature limits means a failure in the device. Thus, for a good operation, an electronic device should be cooled. One of the promising techniques is the use of Phase Change Material (PCM) for its well-known ability to absorb the heat dissipated by the device thanks to its high latent heat of fusion. Arachidic acid is a fatty acid, when mixed with some salts can be used as a promising PCM due to its wide latent heat. This paper aims to shed light on the use of mixtures of arachidic acid in cooling a heat sink. An experimental setup is built for this purpose. The results showed that the arachidic acid mixtures are suitable for intermediate heat dissipation application.

Keywords: Phase change material; fatty acids; Arachidic acid; mixtures; thermophysical properties; melting range; heat sink.

5.1 Introduction

The economic development and environmental problems are two opposing aspects of technological advancement throughout human history, but the recent peak in technological development has shed more light on the environmental issues, therefore it has become important to improve energy utilization such as thermal energy storage techniques. This fact has made thermal management a critical feature of successful system designing, and finding new cooling techniques, passive ones in particular, has subsequently become much more valuable.

Electronic devices such as computers, mobiles and toys, have found their way to almost every aspect of human's life. What indicates the reliability of a system is the reliability of the electronics of a system. A rise in the heat's amount generated per unit volume can be harmful to electronic devices. Electronic devices' failure rate rises with the increase in the temperature. Therefore, the thermal control in the design of electronic devices should increase too. There are many ways in which excess heat may be extracted from electronic devices.

In electronics for instance, the increase in processing demands and data clock frequencies has forced manufacturers to increase the performance and functionality of integrated electronic chips, increasing the component power consumption and reducing design tolerances, in addition to minimizing their sizes for portability purposes, leading to high power dissipation through smaller packages, electronic components such as micro-processor, integrated circuit (IC) boards, transistors, resistors, batteries etc. generate heat. The high efficiency required and the fast calculation speed demands effective cooling to maintain best performance and to decrease failure risk.

The high temperature of the electronic devices reduces their effectiveness and life span as shown in Figure 1. As we can see in this figure, a small increase in the operating temperature causes a

sharp decrease in the life time. Various cooling mechanisms are utilized to prevent the malfunction of electronic devices, for example: microchannels [1], natural convection [2], forced-air cooling [3], immersion cooling [4], and heat pipes [5].

Because of the heat transfer ability restrictions concerning conventional coolants like oil, air, and water accompanied by dire heat transfer characteristics, especially thermal conductivity and convective heat transfer coefficient, majority of the cooling methods cannot attain the desired efficiency. In this project, PCMs are utilized in cooling electronic devices in order to reduce the temperature of the preferred applications. PCM is used to retain energy to prevent the enclosure from overheating.

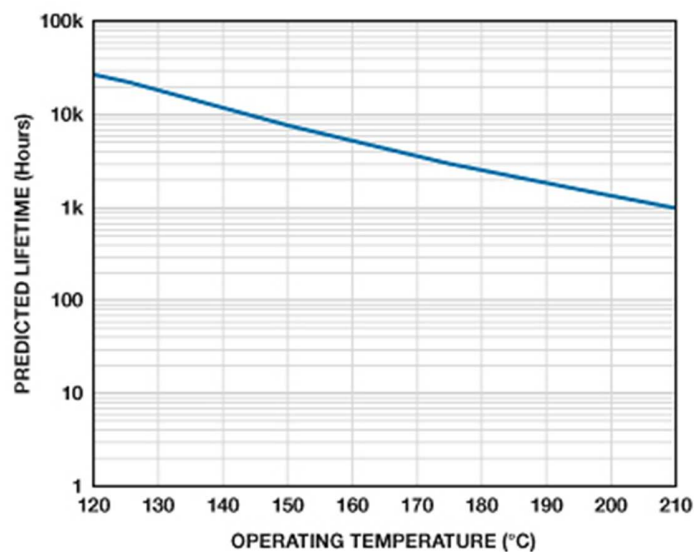

Figure 1. Lifetime degradation of electronic devices in function of the operating temperature [6].

The use of PCMs as thermal energy reservoirs [7] or temperature regulators appeared as a promising passive cooling technique benefiting from their thermophysical properties, mainly the latent heat of fusion and the melting temperature. The higher the latent heat of fusion the more energy can be absorbed by the material during melting.

PCMs possess high latent heat storage capacity which is used to absorb surrounding's thermal energy as latent energy and change from a phase to another [8]. Usually solid-liquid phase change materials are used, but other types such as solid-solid, solid-gas, and liquid-gas do exist. PCMs have been used in many applications such as thermal cooling of photovoltaic panels [9-10], thermal comfort of buildings [11], water heating [12], thermal management in batteries [13], and cooling of electrical equipment [14-15].

During the phase change, PCM's temperature remains constant as shown in Figure 2. Until all the material is completely molten, then the temperature increases again theoretically to what it would have reached without PCM, which will be shown later throughout the experimental results. When the heat source is turned off, the material re-solidifies and emits the absorbed heat out. That's why PCMs are advised to be used in application with non-continuous operation. For example, in cooling portable devices such as palm pilots, cellular phones and personal digital assistants, these devices are not used for more than a few hours continuously at peak load. In addition, their 'idle' time is typically long enough to solidify the molten PCM for reuse.

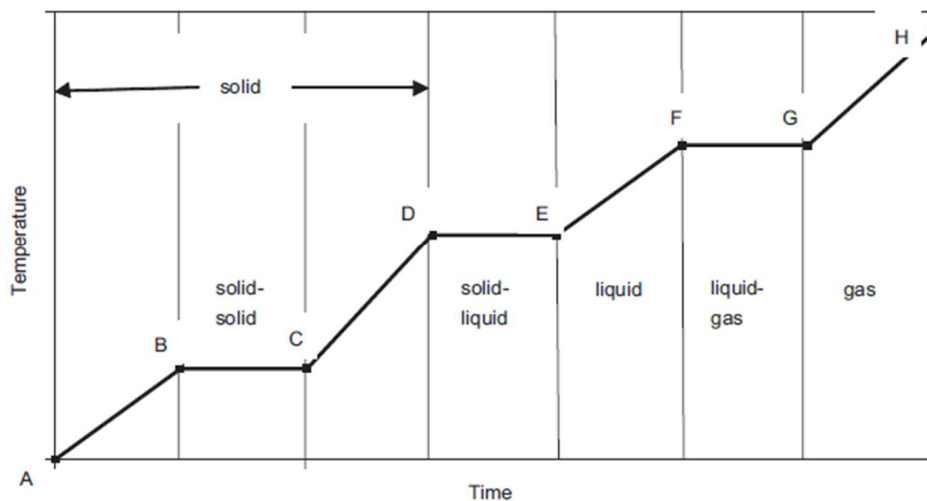

Figure 2. Phase change diagram of PCM during melting process [16]

Researches on PCM are focused on the thermal management of electronic devices at system level. Mjallal et al. [2] performed a numerical study of the distribution of temperature of a heat sink filled with two types of PCMs; salt-hydrate and wax. After performing multiple simulations, they concluded that a rise of heat flux leads to a reduction in the melting time of PCM. Moreover, they found that the salt-hydrate delays the peak temperature better than the wax. They also checked the significance of the density and thermal conductivity in delaying the steady state temperature. Fu et al. [17] performed experiments and numerical simulations of PCMs in cooling chips where they discovered that this method decreases the resistance of thermal heat transfer from the chip to the ambient. Muhammad Ali et al. [18] compared various configurations of heat sinks with two PCMs namely paraffin wax and n-eicosane. They found that circular pipes embedded with wax or n-eicosane are more effective than a heat sink that is 2 mm square pin-fin. Hasan and Tbena [19] introduced a numerical study of several configurations of a micro-channel heat sink with four PCMs (paraffin wax, n-eicosane, p116 and RT4). They concluded that PCM placed inside the base and channels of the heat sink grants a lower temperature. Kandasamy et al. [20] conducted numerical and experimental studies about PCM based heat sink in transient thermal management of plastic quad flat package electronic devices. Results showed that the presence of PCM in the cavities of the heat sinks increase the cooling performance more than the case without PCM. Tan and Tso [21] investigated the usage of four heaters placed on the top of a heat storage unit filled with PCM (n-eicosane) to cool a mobile electronic device. They concluded that utilizing larger amount of PCM can stabilize the mobile electronic device's temperature longer.

The heat used to be stored in the form of sensible heat such as heating water, oil, or rocks, but with the development that occurred in the energy domain, it was found that latent heat storage is one of the most efficient way to store thermal energy [22], in addition to the various possible

enhancements that could be applied to increase the efficiency. Keeping in mind that the latent heat storage techniques store higher heat compared to sensible heat storage ones but the former charging and discharging processes are slower. The hyper system uses the two properties of both sensible and latent heat storage systems. In this paper, different thermal management technique for chips using PCMs will be applied [23-24], keeping in mind that the usage of PCMs in electronic devices lead to an improvement in the efficiency as well as the reliability of the electronic devices.

In this work, the focus will be on the arachidic acid ($C_{20}H_{40}O_2$) to be used as PCM. Mjallal *et al.* [25] investigated the use of the arachidic acid mixed with some salts as a promising PCM in different applications. The thermophysical properties of the mixtures were measured using differential scanning calorimetric (DSC). As a continuity of this work, the promising mixtures of arachidic acid will be used to test experimentally the thermal performance of a heat sink. This describes the novel contribution of this paper where fatty acids are checked as potential PCMs candidate in cooling electronic devices.

5.2 Experimental setup

As stated in the objectives, an experiment is performed on a heat sink in order to study and compare the temperature profile of the heat sink with and without PCM.

5.2.1 Apparatus and instruments

As shown in Figures 3 and 4, the heat sink of a modem of dimensions $20 \times 20 \text{ mm}^2$ is used in the experimental setups. At the bottom of the heat sink, a Peltier thermo-electric heater of resistance

0.4 Ω is used. The heater is placed at the top of the electric board. A K-type thermocouple with accuracy ± 0.5 $^{\circ}\text{C}$ is used to measure the instantaneous temperature of the sink which is connected to an Arduino device to record these temperatures. A DC power supply is used to regulate the heater's temperature with the significant amount of power. For the case with PCM, the PCM will be added between the fins of the sink and occupied a volume approximately equal to 1450 mm^3 .

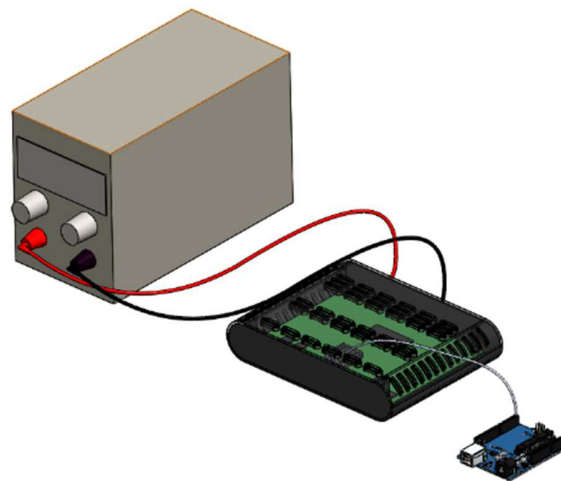

Figure 3. Three-Dimensional drawing of the experiment.

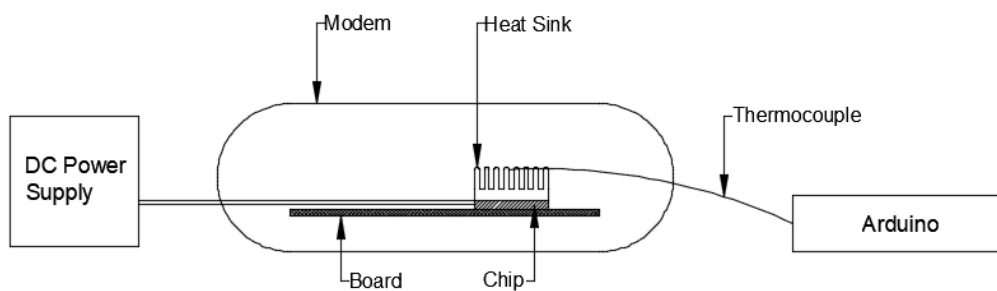

Figure 4. Schematic of the experiment.

5.2.2 Experiment procedure

The DC power supply is turned on and regulated to 1.12 A in order to dissipate heat equals to 0.5 W. At the same time, the Arduino device is turned on to record the temperature of the heat sink

and the surrounding. The power supply is kept turned on until the heat sink reaches the steady state temperature. The same procedure is repeated for 1.58 A and 2.23 A which are equivalent to 1 W and 2 W of heat dissipated, respectively.

In order to study the influence of PCM, it is embedded into the heat sink. First, it is melted externally and then filled between the fins. After the PCM re-solidifies and its temperature becomes equal to the ambient temperature, the same power input procedure is repeated as that of the case without PCM.

5.2.3 Uncertainty analysis

To evaluate the trust in the outcomes, an uncertainty analysis is done. The uncertainty in the experiments can be due to: the temperature measuring, the DC power supply, and heater temperature stability as summarized in Table 1.

Table 1. Experimental uncertainty

Equipments	Experiment error
Thermocouple	±0.5 °C
Power supply	±1%
Heater temperature stability	±0.1 °C

The absolute uncertainty in percentage is calculated using Equation (5.1):

$$e = \frac{\text{absolute uncertainty}}{\text{value read by the equipment}} \quad (5.1)$$

For the thermocouple, the minimum value that can be read is equal to 23 °C, thus the thermocouple uncertainty (e_t) is equal to:

$$e_t = \frac{0.5}{23} = 2.17\%$$

Similarly, for the heater temperature stability is equal to: $e_h = 0.43\%$. The uncertainty of the power supply (e_p) is equal to 1%.

The total uncertainty is the norm of all uncertainties and is calculated using Equation (5.2):

$$e = \sqrt{e_t^2 + e_h^2 + e_p^2} \quad (5.2)$$

Substituting all the above values in the equation of e, the total uncertainty was $e = 2.4\%$, which is in the acceptable range.

5.3 PCM thermophysical properties

Different studies were done on the arachidic acid and its mixtures to enhance their thermophysical properties. The mixtures of the arachidic acid are: Arachidic acid + 10% potassium oleate and Arachidic acid + 10% sodium decanoate. These mixtures were studied in Mjallal et al. [4].

5.3.1 Differential scanning calorimetric

A Differential Scanning Calorimetric (DSC) study was done by Mjallal *et al.* [25] to find the latent heat, specific heat and melting range for the used PCMs.

As shown in Table 2, the pure arachidic acid has the highest latent heat of 257.4 kJ/kg. While the mixture with 10% sodium decanoate has the highest specific heat for the solid phase and 10% potassium oleate has the highest specific heat for liquid phase of 2.33 kJ/kg.K and 2.36 kJ/kg.K, respectively. Finally, for the melting points, the solidus and liquidus temperatures for the Arachidic

acid are equal to 73.3 °C and 80.1 °C, while the melting range for the mixtures is much wider and equal to 50.0 °C and 83.3 °C for the 10% potassium oleate mixture and 48.0 °C and 82.7 °C for the 10% sodium decanoate mixture.

Table 2. Latent heat, specific heat and melting range of the Arachidic acid and its mixtures

Materials	Latent heat (J/kg)	Specific heat for Solid phase (kJ/kg. K)	Specific heat for Liquid phase (kJ/kg. K)	Solidus Temperature (°C)	Liquidus Temperature (°C)
Arachidic acid (AA)	257.4	1.90	2.19	73.3	80.1
AA + 10% potassium oleate	214.0	1.90	2.36	50.0	83.3
AA + 10% sodium decanoate	222.1	2.33	2.30	48.0	82.7

5.3.2 Thermal conductivity measurement

The thermal conductivity of the PCMs were measured using a device manufactured by Mjallal *et al.* [26]. The experiment is repeated three times and the average value for the three experiments will be taken as the thermal conductivity of the PCM. As shown in Figure 5 the average thermal conductivity for the pure Arachidic acid is 0.181 W/m K.

Figure 6 shows the thermal conductivity for the pure Arachidic acid, potassium mixture and sodium mixture. For the potassium mixture, the thermal conductivity increases by 66% to reach 0.300 W/m K while the thermal conductivity decreases for the sodium mixture by 20% to reach 0.145 W/m K.

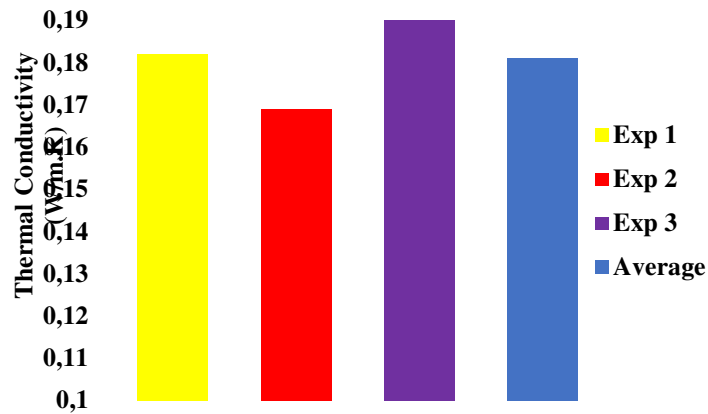

Figure 5. Thermal conductivity for arachidic acid

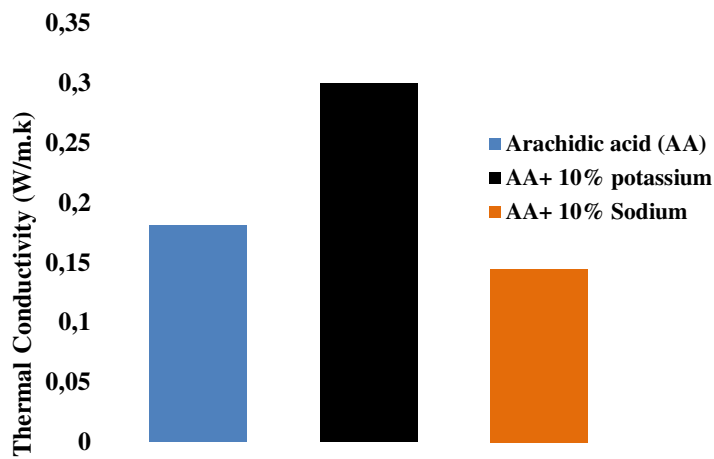

Figure 6. Thermal conductivity for Arachidic acid and its mixtures

5.4 Results

The first experiment was done for the case without PCM at a heat generated of 0.5 W. Figure 7 shows the temperature variation over time of the heat sink. As seen in Figure 7 the temperature starts to increase from ambient temperature 23 °C until reaching the steady state temperature at 50 °C. At the beginning, the temperature increases remarkably then its rate decreases over the time until the temperature becomes constant at steady state. The reason behind this variation is that the heat rejected by convection increases when the temperature of the sink increases and at steady

state the heat rejected from the sink becomes equal to the heat gained by the heater, 0.5 W in this case. The time taken by the sink to reach the steady state is about 900 s.

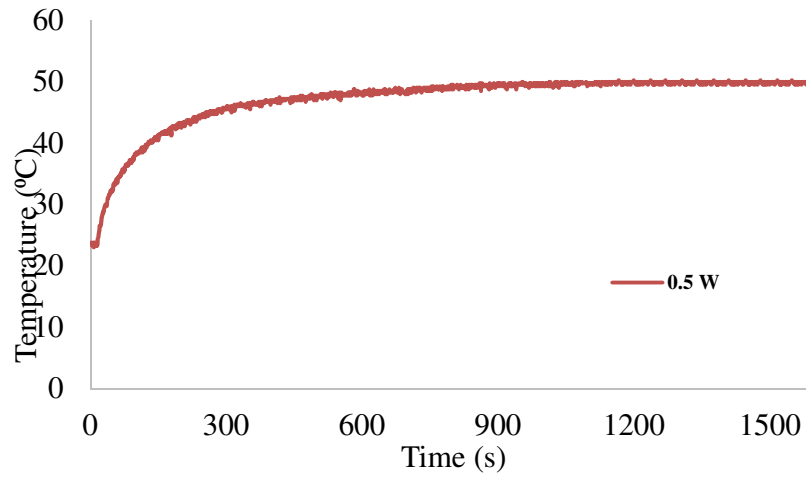

Figure 7. Temperature distribution for the heat sink at 0.5 W

As shown in Figure 8, when the heat generated by the chip increases, the steady state temperature increases. For this experiment the steady state temperature increases from 50 °C at 0.5 W to 72 °C and 109 °C for 1 W and 2 W, respectively.

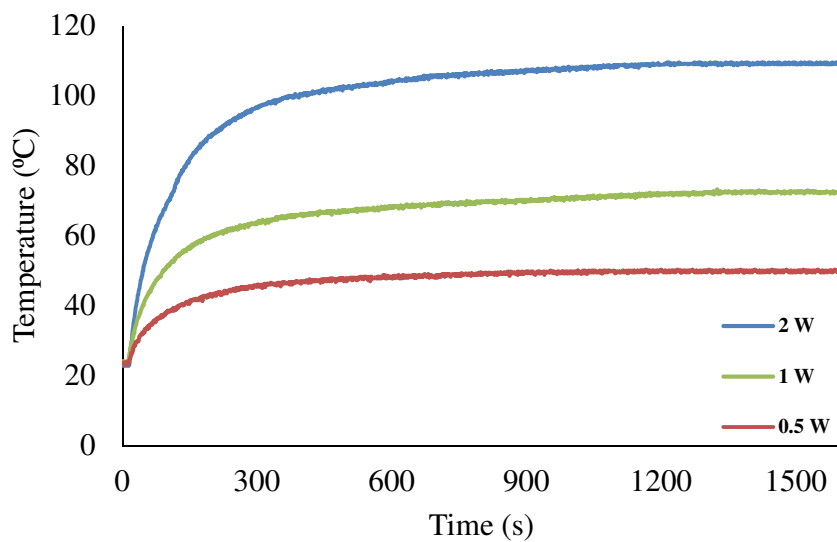

Figure 8. Temperature distribution for the heat sink for 0.5, 1, and 2 W.

To investigate the effect of arachidic acid and its mixtures on the cooling of the heat sink, a set of experiments will be done. By adding the arachidic acid (considered as PCM), the steady state temperatures for 0.5, 1 and 2 W are 41.75 °C, 65 °C and 104.5 °C, respectively. As one can see from Figure 9, the PCM doesn't melt for 0.5 and 1 W because the steady state temperature for those powers is less than the melting temperature of the arachidic acid. It took 500 s and 1000 s to reach the steady state temperature for the cases of 0.5 W and 1 W, respectively. While for the case of 2 W, the PCM melts completely after about 1180 s which delays the peak temperature of the sink by 300 s. As one may notice, the steady state temperatures of the three cases, even though without the melting of PCM, decreased compared to that without PCM.

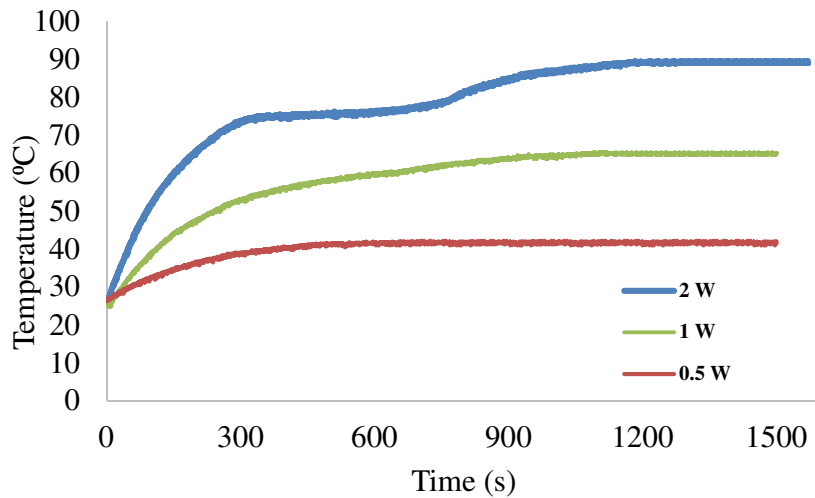

Figure 9. Temperature distribution for the heat sink with arachidic acid for 0.5, 1 and 2 W.

The temperature profiles for the heat sink without PCM, the heat sink with potassium mixture as PCM, the heat sink with sodium mixture as PCM and the heat sink with arachidic acid as PCM for 0.5, 1 and 2 W of heat dissipated are depicted in Figures 10, 11 and 12, respectively.

For 0.5 W, the arachidic acid and its mixtures do not melt but one can notice that the peak temperature reached by the heat sink without PCM (50 °C) is much higher than that for the heat sink with PCM (approximately 42 °C).

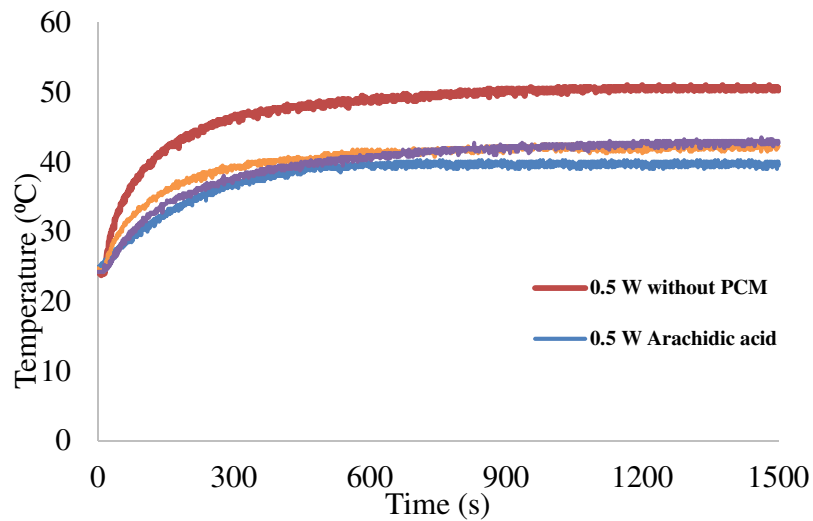

Figure 10. Temperature distribution for the heat sink without and with PCMs at 0.5 W.

As for the case 1 W, the temperature profile for the heat sink without PCM and the heat sink using arachidic acid and potassium mixture as PCMs continue to increase until reaching the steady state temperature while for the sodium mixture, the PCM melts and decreases the rate of the temperature during melting to delay the steady state time by 320 s. The steady state temperature for the sodium mixture and the sink without PCM is approximately the same. For the cases of arachidic acid and potassium mixture, they do not melt, but the steady state temperature (59°C) is lower than the case without PCM (72 °C).

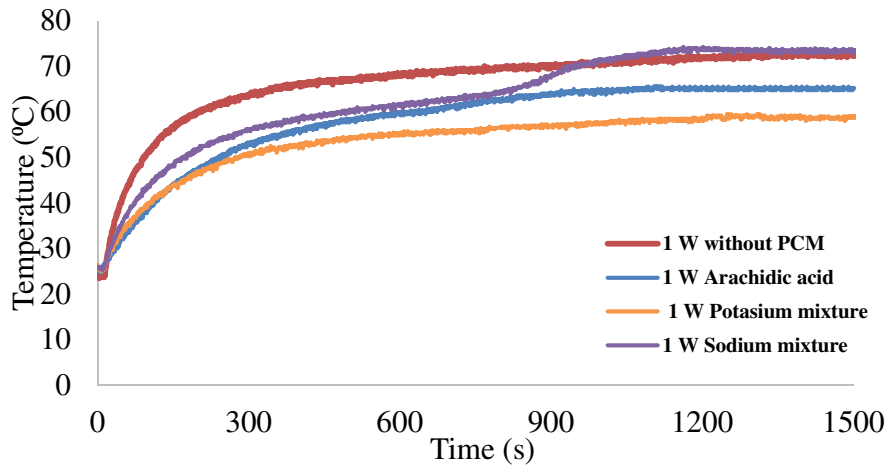

Figure 11. Temperature distribution for the heat sink without and with PCMs at 1 W.

Finally, for the case 2 W all PCMs melt with difference in the peak temperatures and delay time. For the arachidic acid, the peak temperature (104.5 °C) is lower than the case without PCM (109 °C), with a time delay equal to 300 s. For the sodium mixture, the peak temperature (111 °C) is higher than the case without PCM with a delay equal to 900 s. The best result is for the potassium mixture with the lowest peak temperature 95.25 °C and the highest time delay of 1050 s.

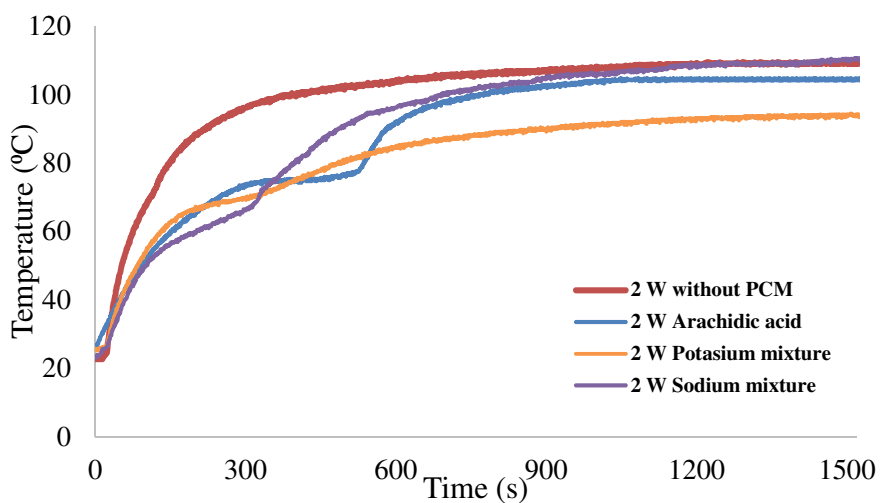

Figure 12. Temperature distribution for the heat sink without and with PCMs at 2W

Table 3 summarizes the peak temperature for all cases without and with PCMs and the time required to reach the steady state.

Table 3. Peak temperature and time to reach steady state

	Peak temperature (°C)	Time to steady state (s)
0.5 W	50	900
1 W	72	850
2 W	109	800
0.5 W (AA)	41.5	473
1 W (AA)	65	1120
2 W (AA)	89	1100
0.5 W (AA + Potassium)	42.5	500
1 W (AA + Potassium)	58.5	560
2 W (AA + Potassium)	95.25	1500
0.5 W (AA + Sodium)	42	908
1 W (AA + Sodium)	73	1160
2 W (AA + Sodium)	104	1607

5.5 Discussion

After performing several experiments, some conclusions can be outlined. First, when the heat generated increases, the peak temperature of the sink increases also. The effect of the PCM in delaying the peak temperature is clearly shown in Figure 9. When the PCM melts at 2 W it absorbs a high amount of energy during the phase transition which led to enhance the thermal performance of the heat sink. Another important thermophysical criteria that affects the thermal performance of the sink is the specific heat C_p . This is clearly shown in Figure 10 where the PCMs do not melt at 0.5 W but they have a smaller peak temperature due to the energy absorbed by the PCM as specific heat during temperature change from ambient to peak temperature. The effect of the thermal conductivity of the PCM is demonstrated in Figure 12, where all PCMs are totally melted and have

almost the same specific heat. The higher the thermal conductivity is, the lower the peak temperature is reached. As the thermal conductivity increases, the heat transfer rate between the bottom and the top surface of the PCM will increase, uniforming the temperature gradient. In addition, when the surface temperature of PCM increase, the natural convection at the surface will increase allowing to dissipate that heat faster.

Moreover, the influence of the mixtures is investigated in this work. Unlike the arachidic acid, the sodium mixture makes the PCM suitable for lower heat dissipated application as shown in Figure 11 when the sodium mixture is completely melted at 1 W and delayed the peak temperature of the sink by 320 s. Thus, this PCM can fit for the intermediate heat dissipation electronic devices.

Finally, for the potassium mixture, despite this PCM does not melt at 1 W but it can fit for the intermediate heat dissipation electronic device because the melting point for this mixture is 50 °C. The reason for not being melted significantly at 1 W is because the potassium mixture enhances the thermal performance of the heat sink by lowering its melting peak from 72 to 59 °C. So, the potassium mixture enhances the performance for the pure arachidic acid by making this PCM suitable for lower heat dissipation electronic devices and by enhancing the thermal performance for the electronic chip through increasing the specific heat and thermal conductivity. In addition, the potassium mixture has a much greater time delay than the pure arachidic acid. This is shown in Figure 12 where the potassium delays the peak temperature by 1050 s instead of 300 s as in the case of the pure arachidic acid, thus a 3.5 more-time delay compared to the pure arachidic acid with a better thermal performance for the higher heat dissipation electronic devices.

5.6 Conclusions

The goal of this paper is to investigate the effect of the arachidic acid and some mixtures on the thermal performance of heat sink. It shed lights on the effect of the thermophysical properties of the PCM on the thermal behavior of the heat sink.

The potassium mixture has the best effect on enhancing the cooling performance of the sink. While the deficiency of the thermal conductivity of the sodium mixture negatively affects its thermal cooling performance compared to the potassium mixture.

Both of these mixtures have better performance compared to the pure arachidic acid. They make the PCM more suitable for intermediate heat dissipation electronic applications unlike the pure arachidic which is only suitable for high heat dissipation electronic applications.

As a perspective, the thermal conductivity of the sodium mixture can be enhanced to improve its thermal performance. Also, a numerical modeling for the PCM can be implemented to decrease the cost of the experimental setup. This model can be validated through the experimental results. This will help to study different configurations and applications.

References

1. Mihai I. Heat transfer in minichannels and microchannels CPU cooling systems, chapter 4. In Heat Transfer – Theoretical Analysis, Experimental Investigations and Industrial Systems, Belmiloudi A (ed.). InTech: Rijeka, 2011.
2. Mjallal, I.; Farhat, H.; Hammoud, M.; Ali, S.; Assi, I. Improving the Cooling Efficiency of Heat Sinks through the Use of Different Types of Phase Change Materials. *Technologies* **2018**, *6*, 5.
3. Ellison GN. Thermal computations for electronics: conductive, radiative, and convective air cooling. New York: CRC Press; 2011.
4. Kuncoro, I. W.; Pambudi, N. A.; Biddinika, M. K.; Widiastuti, I.; Hijriawan, M.; Wibowo, K. M. Immersion cooling as the next technology for data center cooling: A review. *In Journal of Physics: Conference Series* **2019**, *1402*(4), 044057.
5. Tang, H.; Tang, Y.; Wan, Z. Review of applications and developments of ultra-thin micro heat pipes for electronic cooling. *Appl. Energy* **2018**, *223*, 383-400.
6. Watson, J.; Castro, G. High-temperature electronics pose design and reliability challenges. *Analog Dialogue* **2012**, *46*(2), 3-9.
7. Isa, M.H.M.; Zhao, X.; Yoshino, H. Preliminary study of passive cooling strategy using a combination of PCM and copper foam to increase thermal heat storage in building facade. *Sustainability* **2010**, *2*, 2365–2381
8. Thirugnanam, C.; Karthikeyan, S.; Kalaimurugan, K. Study of phase change materials and its application in solar cooker. *Materials Today: Proceedings* **2020**, *33*, 2890-2896.
9. Shaito, A.; Hammoud, M.; Kawtharani, F.; Kawtharani, A.; Reda, H. Power enhancement of a photovoltaic module using different types of phase change materials. *Energies*, **2021**, *14*(16), 5195.
10. Kawtharani, F.; Kawtharani, A.; Hammoud, M.; Hallal, A.; Shaito, A.; Assi, A.; Assi, I. Cooling PV modules using phase change material. In Proceedings of the 29th International Conference on Microelectronics, Beirut, Lebanon, 10–13 December 2017; pp. 347–351.
11. Barzin, R.; Chen, J. J.; Young, B. R.; Farid, M. M. Application of PCM underfloor heating in combination with PCM wallboards for space heating using price-based control system. *Appl. Energy* **2015**, *148*, 39–48.
12. Shukla, A.; Buddhi, D.; Sawhney, R. L. Solar water heaters with phase change material thermal energy storage medium: A review. *Renew. Sust. Energy Rev.* **2009**, *13* (8), 2119–2125.
13. Joshy, N.; Hajiyan, M.; Siddique, A.; Tasnim, S.; Simha, H. Experimental investigation of the effect of vibration on phase change material (PCM) based battery thermal management system. *J Power Sources* **2020**, *450*, 227717.
14. Assi, I.; Mjallal, I.; Farhat, H.; Hammoud, M.; Ali, S.; Shaer, A.A.L.; Assi, A. Using phase change material in heat sinks to cool electronics devices with intermittent usage. In Proceedings of the IEEE 7th International Conference on Power and Energy Systems ICPES, Toronto, ON, Canada, 1–3 November 2017pp. 66–69.

15. Mjallal, I.; Farhat, H.; Hammoud, M.; Ali, S.; Shaer, A.A.L.; Assi, A. Cooling Performance of Heat Sinks Used in Electronic Devices. *MATEC Web. Conf.* **2018**, *171*, 02003.
16. Yang, G.; Yim, Y. J.; Lee, J. W.; Heo, Y. J.; Park, S. J. Carbon-Filled Organic Phase-Change Materials for Thermal Energy Storage: A Review. *Molecules* **2019**, *24*(11), 2055.
17. Fu, J.; Pourbakhsh, S.A.; Chen, X.; Li, M.; Lin, Z.; Hou, L.; Haring, F.; Gong, N.; Wang, J. On-chip thermal management method based on phase change material. In 2017 IEEE 60th International Midwest Symposium on Circuits and Systems (MWSCAS), Medford, MA, United States, 6-9 August 2017pp. 985-988.
18. Ali, H. M.; Arshad, A.; Jabbal, M.; Verdin, P. G. Thermal management of electronics devices with PCMs filled pin-fin heat sinks: a comparison. *Int. J. Heat. Mass Transf.* **2018**, *117*, 1199-1204.
19. Hasan, M. I.; Tben, H. L. Using of phase change materials to enhance the thermal performance of micro channel heat sink. *Engineering Science and Technology, an International Journal* **2018**, *21*(3), 517-526.
20. Kandasamy, R.; Wang, X. Q.; Mujumdar, A. S. Transient cooling of electronics using phase change material (PCM)-based heat sinks. *Appl. Therm. Eng.* **2008**, *28*(8-9), 1047-1057.
21. Tan, F. L.; Tso, C. P. Cooling of mobile electronic devices using phase change materials. *Appl. Therm. Eng.* **2004**, *24*(2-3), 159-169.
22. Benli, H.; Durmuş, A. Performance analysis of a latent heat storage system with phase change material for new designed solar collectors in greenhouse heating. *Sol. Energy* **2009**, *83*(12), 2109-2119.
23. Coskun, A. K.; Atienza, D.; Rosing, T. S.; Brunschweiler, T.; Michel, B. Energy-efficient variable-flow liquid cooling in 3D stacked architectures. In 2010 Design, Automation & Test in Europe Conference & Exhibition (DATE 2010), Dresden, Germany, 8-12 March 2010pp. 111-116.
24. Xie, H.; Ali, A.; Bhatia, R. The use of heat pipes in personal computers. In Sixth Intersociety Conference on Thermal and Thermomechanical Phenomena in Electronic Systems (ITherm'98), Seattle, WA, USA 27-30 May 1998pp. 442-448.
25. Mjallal, I.; Feghali, E.; Hammoud, M.; Habchi C.; Lemenand T. Exploring the colligative properties of Arachidic acid for potential use as PCM. *Sol. Energy* **2021**, *214*, 19-25.
26. Mjallal, I.; Hammoud, M.; Habchi, C.; Lemenand, T. Cost Effective Device to Characterize Phase Change Materials. *Meas. Sci. Technol.* **2020**, *31*, 025903.

Conclusion générale

Pour suivre le développement technologique et l'investissement rapide dans les puces électroniques, différentes techniques de refroidissement actif et passif ont été mises en œuvre pour améliorer la gestion thermique du système et ainsi améliorer la fiabilité et éviter les défaillances. En tenant compte du fait que les appareils électroniques ont tendance à être minces, cela conduit à augmenter la densité de puissance de la puce et rend la dissipation thermique de cet appareil plus intensive. Ainsi, les techniques de refroidissement passif doivent être améliorées pour suivre le rythme de l'augmentation de la dissipation thermique.

Le matériau à changement de phase est un matériau à chaleur latente élevée, qui permet l'absorption d'une grande quantité d'énergie pendant la transition de phase. Cela fait du PCM une technique de refroidissement passif qui permet d'améliorer la gestion thermique d'une puce électronique en absorbant l'énergie dissipée de la puce sous forme de chaleur latente de fusion pendant la période de fonctionnement du dispositif électronique et de libérer cette énergie pendant la période d'arrêt.

De plus, le PCM peut être intégré en tant qu'assistant pour différentes méthodes de refroidissement actives et passives, comme l'ajout du PCM sur un dissipateur de chaleur pour améliorer les performances thermiques du dissipateur de chaleur.

Ce travail de doctorat a été consacré à l'étude de l'effet du PCM sur la gestion thermique du dissipateur de chaleur. Dans cette étude deux acides gras, spécialement décanoïque et arachidique, ont été étudiés et modifiés pour les adapter au mieux à l'application électronique, et enfin des résultats numériques et expérimentaux ont été obtenus en utilisant ce type de PCM modifié.

Le tableau suivant résume les résultats obtenus pendant cette thèse.

Titre de l'étude	Méthodologie de l'étude	Principaux résultats
<p>Modification des propriétés thermophysiques de l'acide décanoïque pour permettre son utilisation comme matériau à changement de phase</p>	<ul style="list-style-type: none"> ➤ Ajout de cinq additifs aux acides décanoïques : acétate d'ammonium, décanoate de sodium, oléate de sodium, oléate de potassium et hydroxyde de sodium. ➤ Chaque additif est ajouté dans trois proportions molaires : 10, 25 et 33%. ➤ Etude de l'effet des additifs sur les propriétés thermophysiques. ➤ Réalisation de l'analyse d'incertitude pour évaluer le degré de confiance. ➤ Extraction des propriétés thermophysiques du mélange par DSC. 	<ul style="list-style-type: none"> ✓ Le processus de fusion de l'acide décanoïque se produit entre 29,4 °C et 34,9 °C, avec un pic de fusion à 30,8 °C. ✓ Les résultats DSC pour l'acide décanoïque pur montrent que la chaleur de fusion est de 188 J/g. ✓ En ajoutant 10% de sels, la chaleur latente du mélange avec NaOH et de l'acétate d'ammonium reste sensiblement la même, tandis que le pic de fusion diminue à 28,6 et 29,6 °C respectivement. ✓ Les mélanges 25% à base de décanoate de sodium (Mix 3) et NaOH (Mix 4) présentent les chaleurs latentes les plus élevées, 172,3 et 152,3 J/g, respectivement. ✓ Le meilleur résultat est obtenu en ajoutant 10% d'hydroxyde de sodium à l'acide décanoïque. La plage de fusion est (27,3 ~ 35 °C), la température de pic est 28,6 °C et la chaleur latente élevée à 186,8 J/g.
<p>Modification des propriétés colligatives de l'acide arachidique pour une utilisation potentielle comme PCM</p>	<ul style="list-style-type: none"> ➤ Ajout de cinq additifs aux acides décanoïques : acétate d'ammonium, décanoate de sodium, oléate de sodium, oléate de potassium et hydroxyde de sodium. ➤ Chaque additif est ajouté dans deux proportions molaires : 10 et 15%. ➤ Etude de l'effet des additifs sur les propriétés thermophysiques. ➤ Réalisation de l'analyse d'incertitude pour évaluer le degré de confiance. ➤ Extraction des propriétés thermophysiques du mélange par DSC. 	<ul style="list-style-type: none"> ✓ La fusion de l'acide arachidique se produit entre 73,3 °C et 80,1 °C, le pic du processus se situe à 75,2 °C. ✓ Les résultats DSC pour l'acide Arachidique pur montrent que la chaleur de fusion est de 257,4 J/g. ✓ L'ajout de 10% de sels à AA entraîne une diminution du pic de température pour tous les mélanges. ✓ Le mélange d'hydroxyde de sodium présente la chaleur latente la plus élevée, égale à 277,2 J/g ✓ La capacité thermique la plus élevée à 23 °C est trouvée pour le mélange AA10Sd (2,33 J/g.K), tandis que la plus faible est atteinte par le mélange AA10Sh (1,75 J/g.K) ✓ Le mélange AA10Po (AA + 10 % d'oléate de potassium) est prometteur : la chaleur latente augmente à 192,6 J/g contre 174,3 J/g pour l'AA pur.

Dispositif économique pour caractériser les matériaux a changement de phase	<ul style="list-style-type: none"> ➤ Préparation de l'appareil de mesure expérimental. ➤ Réalisation de l'analyse d'incertitude pour évaluer le degré de confiance. ➤ Collecte des données de mesures. ➤ Calcul de la conductivité thermique, de la chaleur spécifique et de la température de fusion à l'aide des mesures. 	<ul style="list-style-type: none"> ✓ L'incertitude totale « e » de l'appareil est calculée à 5,44%. ✓ La valeur expérimentale moyenne de la conductivité thermique K est égale à 0,568 W.m⁻¹. K⁻¹. ✓ La valeur expérimentale moyenne de la chaleur spécifique est de 1,896 kJ kg⁻¹ K. ✓ La température de fusion du sulfate décahydraté est de 31,7 °C. ✓ Les propriétés thermophysiques du sulfate de sodium décahydraté obtenu à partir de ce nouveau dispositif ont été validées avec succès par les données de la littérature ouverte.
Effet du matériau à changement de phase modifié sur les performances thermiques d'un dissipateur thermique de modem	<ul style="list-style-type: none"> ➤ Préparation du montage expérimental ➤ Différentes expérimentations pour différentes chaleurs générées, en utilisant l'acide arachidique pur comme PCM, ou en utilisant des mélanges 	<ul style="list-style-type: none"> ✓ Pour le dissipateur thermique sans PCM, la température de pic à 0,5 W est égale à 50 °C, cette température augmente avec la chaleur générée pour atteindre 72 et 109 °C à 1 et 2 W respectivement. ✓ Pour le dissipateur thermique avec PCM: <ul style="list-style-type: none"> • L'acide arachidique pur et son mélange ne fondent pas à 0,5 W mais la température de pic est réduite de 50 à 42°C. • Seul le mélange de sodium fond à 1 W et retarde le pic de fusion de 320s. • Pour les mélanges purs d'arachide et de potassium, la température maximale à 1W est réduite à 65 et 59°C respectivement. • A 2 W, tout le PCM fond et retarde le pic de température. • Les meilleurs résultats se produisent pour le mélange de potassium où la température de pic est retardée de plus de 1000 s est réduite à 95,25 °C ✓ Le mélange d'acide arachidique et potassium est un matériau à changement de phase adapté pour le refroidissement des appareils électroniques

En ce qui concerne les travaux futurs, plus de configuration expérimentale pour l'utilisation de l'acide arachidique modifié pour refroidir le dispositif électronique sera effectuée, ainsi que la stabilité et la fiabilité de l'acide arachidique modifié seront étudiées. De plus, une polymérisation du mélange pourrait être réalisée pour assurer un contact direct entre le PCM et la puce. En outre, une étude peut être menée sur l'amélioration de la conductivité thermique, la conductivité thermique peut être augmenté par l'ajout de matériaux de remplissage. Enfin, l'effet de l'emplacement du dissipateur thermique intégré au PCM sera étudié.

Titre : Modifications d'acides gras pour une utilisation comme matériaux à changement de phase dans des applications de refroidissement électronique

Mots clés : PCM, Optimisation, Puce, Stockage de chaleur, Propriétés thermophysiques

Résumé : L'augmentation de la densité de puissance des puces électroniques affecte directement les performances des appareils électroniques. C'est pourquoi la gestion thermique de ces systèmes est un enjeu primordial pour éviter la dépréciation et prolonger la durée de vie de ces puces.

Le but de cette étude de doctorat consiste à modifier deux acides gras pour permettre leur utilisation en tant que matériau à changement de phase utilisés pour le refroidissement des appareils électroniques conventionnels. Dans un premier temps, l'acide décanoïque est modifié à l'aide de cinq additifs : oléate de potassium, décanoate de sodium, hydroxyde de sodium, oléate de sodium et acétate d'ammonium.

Chaque additif est utilisé dans trois proportions molaires : 10, 25 et 33%. Ensuite, bénéficiant de ces premiers résultats, l'acide arachidique est également modifié. Le but principal consistant à abaisser la température de solidus sans affecter la chaleur latente. En parallèle, un appareil expérimental de mesure de la conductivité thermique et la chaleur spécifique a été conçu, fabriqué et validé.

Enfin, nous avons conçu et testé un dispositif expérimental pour étudier l'effet de l'acide arachidique pur ou modifié sur les performances de refroidissement d'un appareil électronique.

Title: Modifications of fatty acids for use as phase change materials in electronic cooling applications

Keywords: PCM, Optimization, Sink, Heat storage, Thermophysical properties

Abstract: The increase of the power density of the electronic chips directly affects the performance of the electronic devices. This is why thermal management of these systems is essential to prevent depreciation and extent life of these chips. The purpose of the current PhD study is to modified two fatty acids to allow their uses as phase change material used for cooling conventional electronic devices. Firstly, decanoic acid is modified using five additives: potassium oleate, sodium decanoate, sodium hydroxide, sodium oleate and ammonium acetate; each additive is used in three molar proportions: 10, 25 and 33%.

Benefit from this result the arachidic acid is also modified. The main purpose is to lower its solidus temperature without affecting the latent heat. In parallel, an experimental device for measuring specific heat and thermal conductivity was designed, manufactured and validated.

Finally, we design and tested an experimental device to study the effect of pure and modified arachidic acid on the cooling performance of an electronic device.