



HAL
open science

Non Markovian stochastic linear-quadratic control : Volterra equations, rough volatility and equations with delay

Enzo Miller

► **To cite this version:**

Enzo Miller. Non Markovian stochastic linear-quadratic control : Volterra equations, rough volatility and equations with delay. Optimization and Control [math.OC]. Université Paris Cité, 2021. English. NNT : 2021UNIP7114 . tel-03714427

HAL Id: tel-03714427

<https://theses.hal.science/tel-03714427>

Submitted on 5 Jul 2022

HAL is a multi-disciplinary open access archive for the deposit and dissemination of scientific research documents, whether they are published or not. The documents may come from teaching and research institutions in France or abroad, or from public or private research centers.

L'archive ouverte pluridisciplinaire **HAL**, est destinée au dépôt et à la diffusion de documents scientifiques de niveau recherche, publiés ou non, émanant des établissements d'enseignement et de recherche français ou étrangers, des laboratoires publics ou privés.

UNIVERSITÉ DE PARIS



École Doctorale de Sciences Mathématiques de Paris Centre
Laboratoire de Probabilités, Statistique et Modélisation

THÈSE DE DOCTORAT *

en Mathématiques Appliquées

Présentée par

Enzo MILLER

**Contrôle Linéaire-Quadratique Stochastique Non Markovien
: Dynamique de Volterra, Volatilité Rugueuse et Équations
avec Retard**

**Non Markovian Stochastic Linear-Quadratic Control :
Volterra Equations, Rough Volatility and Equations with
Delay**

Sous la direction de **René AÏD** et **Huyên PHAM**

Soutenue le *25 mai 2021* devant le jury composé des Professeurs:

René AÏD	Université Paris-Dauphine	Directeur de thèse
Aurélien ALPHONSI	École Nationale des Ponts et Chaussées	Rapporteur
Christa CUCHIERO	University of Vienna	Rapporteur
Fausto GOZZI	Luiss University	Examineur
Huyên PHAM	Université Paris Diderot	Directeur de thèse
Mathieu ROSENBAUM	École Polytechnique	Présidents du jury
Agnès SULEM	Inria Paris	Examineur

*Ce document est mise à disposition selon les termes de la Licence Creative Commons.

Remerciements

Je remercie en premier lieu mes deux directeurs de thèse, René Aïd et Huyên Pham, qui ont su me mettre en confiance et m'aider durant ces trois années. Je suis particulièrement honoré que Aurélien Alphonsi et Christa Cuchiero aient accepté d'être rapporteurs de cette thèse, et je les remercie chaleureusement pour leur relecture attentive du manuscrit. Je remercie également Fausto Gozzi, Mathieu Rosenbaum et Agnès Sulem pour avoir accepté de participer à mon jury.

Je te remercie Eduardo pour cette magnifique expérience que fut de travailler avec toi. Mes mots ne sauraient ici exprimer ma gratitude à sa juste mesure. Du fond du coeur, merci.

Merci William d'avoir partagé avec moi mon dernier projet de thèse. J'y ai pris beaucoup de plaisir.

Je remercie aussi les doctorants ou post-docs avec lesquels j'ai partagé une fraction de cette thèse ou son intégralité : Assaf, Barbara, Benjamin, Bohdan, Clément, Clément, Côme, Cyril, Fabio, Guillaume, Hiroshi, Houzhi, Junchao, Laure, Lucas, Marc, Mi-Song, Sothea, Sylvain, Yann, Yiyang, Ziad. C'est grâce à vous que règne cette bonne ambiance qui nous caractérise. Côme, je te dédie une mention spéciale pour ce canevas de thèse que tu m'as donné, cette thèse est aussi la tienne.

Je remercie Valérie et Nathalie sans lesquelles mes voyages auraient été bien plus compliqués.

Mes derniers remerciements vont naturellement aux membres de ma famille qui m'ont toujours entouré de leur bienveillance.

Abstract

The present thesis deals with non Markovian linear-quadratic stochastic control problems. It is divided into three parts.

In the first part, we tackle stochastic Volterra control problems whose kernel can be expressed as Laplace transform. Such assumption is inspired from the rewriting of fractional Brownian motion as infinite sum of Markovian processes. The optimal control and value functions are expressed in terms of Banach valued Riccati equation whose existence and uniqueness are proved.

In the second part, we revisit the celebrated multivariate Markowitz portfolio selection problem combined with rough volatility. The optimal control and efficient frontier are derived in terms of explicit Hilbert valued Riccati operator. The completely explicit feature of our analysis enables us to implement an easy numerical scheme that we illustrate in the case of portfolio allocation with 2 assets, one rough $H \approx 0.1$ and one smooth $H \approx 0.45$. Surprisingly our simulations were able to reproduce the *buy rough sell smooth* strategy exhibited in [GH20a], thus providing an endogenous explanation over this allocation.

Finally, the last part deals with the delayed control of stochastic differential equations. We solve a simplified version by means of Riccati PDEs whose existence and uniqueness are derived, provided a condition combining the horizon, the delay, the drift and the volatility is satisfied. A deep learning method is used to solve the Riccati PDEs in the context of Markowitz portfolio selection with execution delay.

Keywords: Linear-quadratic stochastic control, stochastic Volterra equations, Riccati equations in Banach space, Infinite dimensional Lyapunov equation, integral operator Riccati equation, stochastic Volterra equations, mean-variance portfolio theory, rough volatility, correlation matrices, multidimensional Volterra process, non-Markovian Heston, Stein–Stein and Wishart models, delayed equation, Riccati PDEs, Markowitz portfolio allocation, deep learning, neural network.

List of papers being part of this thesis:

- Eduardo Abi Jaber, Enzo Miller, and Huy en Pham. “Linear–Quadratic control for a class of stochastic Volterra equations: solvability and approximation”. In: *Annals of Applied Probability* (2020).
- Eduardo Abi Jaber, Enzo Miller, and Huyen Pham. “Integral operator Riccati equations arising in stochastic Volterra control problems”. In: *SIAM Journal on Control and Optimization* (2021).
- Eduardo Abi Jaber, Enzo Miller, and Huy en Pham. “Markowitz portfolio selection for multivariate affine and quadratic Volterra models”. In: *SIAM Journal on Financial Mathematics* (2020).
- William Lefebvre and Enzo Miller. “Linear-quadratic stochastic delayed control and deep learning resolution”. In: *arXiv preprint arXiv:2102.09851* (2021).

Résumé

La présente thèse traite des problèmes de contrôle stochastique linéaire-quadratiques non markoviens. Elle est divisée en trois parties.

Dans la première partie, nous abordons des problèmes de contrôle de Volterra stochastique dont le noyau peut être exprimé sous forme de transformée de Laplace. Ces hypothèses sont inspirées de la réécriture du mouvement brownien fractionnaire comme somme infinie de processus markoviens. Les fonctions de commande de rétroaction et de valeur optimales sont exprimées en termes d'équations de Riccati à valeur dans un Banach dont l'existence et l'unicité sont prouvées.

Dans la deuxième partie, nous revisitons le célèbre problème de sélection de portefeuille multivarié de Markowitz où des actifs de différentes rugosités sont considérés. Le contrôle optimal et la frontière efficace sont dérivés en termes d'opérateur de Riccati à valeur dans un espace de Hilbert. Le caractère explicite de notre analyse nous permet de mettre en œuvre un schéma numérique simple que nous illustrons dans le cas de l'allocation de portefeuille avec 2 actifs, un rugueux $H \approx 0,1$ et un lisse $H \approx 0,45$. De manière surprenante, nos simulations ont pu reproduire la stratégie `textit buy rough sell smooth` exposée dans [cite glasserman2020](#), fournissant ainsi une explication endogène de cette allocation.

Enfin, la dernière partie traite du contrôle retardé des équations différentielles stochastiques. Nous résolvons une version simplifiée au moyen d'équations aux dérivées partielles de type Riccati dont l'existence et l'unicité sont prouvées, à condition qu'une condition combinant l'horizon, le retard, la dérive et la volatilité soit satisfaite. Une méthode de résolution par réseaux de neurones est utilisée pour résoudre les équations de Riccati dans le contexte de la sélection de portefeuille de Markowitz avec délai d'exécution.

Mots-clés: Contrôle stochastique linéaire-quadratique, équations de Volterra stochastiques, équations de Riccati dans un espace de Banach, équations de Lyapunov, opérateur intégral Équation de Riccati, équations stochastiques de Volterra, théorie du portefeuille de variance moyenne, volatilité rugueuse, matrices de corrélation, processus de Volterra multidimensionnel, Heston non-markovien, Modèles Stein–Stein et Wishart, équation retardée, équations aux dérivées partielles de type Riccati, allocation de portefeuille Markowitz, apprentissage en profondeur, réseau neuronal.

Liste des articles faisant partie de cette thèse:

- Eduardo Abi Jaber, Enzo Miller, and Huyên Pham. “Linear–Quadratic control for a class of stochastic Volterra equations: solvability and approximation”. In: *Annals of Applied Probability* (2020).
- Eduardo Abi Jaber, Enzo Miller, and Huyen Pham. “Integral operator Riccati equations arising in stochastic Volterra control problems”. In: *SIAM Journal on Control and Optimization* (2021).
- Eduardo Abi Jaber, Enzo Miller, and Huyên Pham. “Markowitz portfolio selection for multivariate affine and quadratic Volterra models”. In: *SIAM Journal on Financial Mathematics* (2020).
- William Lefebvre and Enzo Miller. “Linear-quadratic stochastic delayed control and deep learning resolution”. In: *arXiv preprint arXiv:2102.09851* (2021).

Contents

Abstract	v
Résumé	vii
I Introduction	1
1 Introduction (French version)	3
1.1 Contrôle sur les équations de Volterra	4
1.1.1 Motivations	4
1.1.2 Revue de littérature	5
1.1.3 Notre approche	6
1.1.4 Nos contributions	7
1.2 Markowitz rugueux	9
1.2.1 Quand Markowitz devient rugueux	9
1.2.2 Un exemple avec deux actifs	10
1.2.3 Des équations de Riccati à l'allocation de portefeuille	11
1.2.4 Résultats numériques	13
1.3 Contrôle avec retard	15
1.3.1 Résultats d'existence et de vérification	15
1.3.2 Résolution d'EDP par réseaux de neurones	17
1.3.3 Application à l'allocation de portefeuille de type Markowitz avec délai d'exécution	19
2 Introduction	23
2.1 Volterra control	24
2.1.1 Motivations	24
2.1.2 Literature review	25
2.1.3 Our approach	26
2.1.4 Our contributions	27
2.2 Rough Mean-Variance	29
2.2.1 When Markowitz gets rough	29
2.2.2 An example with two stocks	30
2.2.3 From Riccati equations to portfolio allocation	30
2.2.4 Numerical results	33
2.3 Control with delay	35
2.3.1 Verification and existence results	35

2.3.2	Deep learning scheme for PDEs	37
2.3.3	Application to Markowitz portfolio allocation with execution delay	38

II Volterra control 43

3 Linear–Quadratic control for a class of stochastic Volterra equations: solvability and approximation 45

3.1	Introduction	45
3.2	Formulation of the problem and preliminaries	48
3.2.1	Markovian representation	50
3.2.2	Formal derivation of the solution	52
3.3	Main results	54
3.3.1	Solvability: optimal control and value function	54
3.3.2	Stability and approximation by conventional LQ problems	59
3.4	An infinite dimensional SDE with Lipschitz coefficients	60
3.5	A martingale verification theorem	64
3.6	Proof of solvability result	69
3.7	Stability and approximation	70
3.7.1	A-priori L^2 -estimates for stochastic Volterra equations	71
3.7.2	Approximation of the value function	73
3.A	An elementary lemma	75

4 Integral operator Riccati equations arising in stochastic Volterra control problems 77

4.1	Introduction	77
4.2	Preliminaries and main result	80
4.3	Infinite dimensional Lyapunov equation	81
4.4	Solvability of the Riccati equation	86
4.4.1	Step 1: Construction of a sequence of Lyapunov solutions $(\Gamma_t^i)_{i \geq 0}$	86
4.4.2	Step 2: Convergence of $(\Gamma_t^i)_{i \geq 0}$ in $L^1(\mu \otimes \mu)$	88
4.4.3	Step 3: The limiting point of $(\Gamma_t^i)_{i \geq 0}$ solves the Riccati equation	93
4.4.4	Step 4: Continuity and uniqueness	94
4.A	Some elementary results	97

III Rough Mean-Variance 99

5 Markowitz portfolio selection for multivariate affine and quadratic Volterra models 101

5.1	Introduction	101
5.2	Formulation of the problem	104
5.3	A generic verification result	105
5.4	Multivariate affine Volterra models	107
5.5	Multivariate quadratic Volterra models	112
5.5.1	Integral operators	112
5.5.2	The model	113
5.5.3	The explicit solution	115
5.6	Numerical experiment: rough Stein-Stein for two assets	122
5.A	Proof of the verification result	126
5.B	Proofs of some technical lemmas	131
5.B.1	Reminder on resolvents of integral operators	131
5.B.2	Proof of Lemma 5.5.1	132

5.B.3	Proof of Lemma 5.5.3	133
5.B.4	Proof of Lemma 5.5.4	136
5.C	Additional proof for the martingale property	137

IV Stochastic delayed systems 139

6	Linear-quadratic stochastic delayed control and deep learning resolution	141
6.1	Introduction	141
6.2	Formulation of the problem and heuristic approach	143
6.3	Verification and existence results	146
6.4	Deep learning scheme	151
6.4.1	A quick reminder of PINNs and Deep Galerkin method for PDEs	151
6.4.2	A tailor-made algorithm for Riccati partial differential equations	151
6.5	Applications to mean-variance portfolio selection with execution delay	154
6.5.1	One asset with delay	154
6.5.2	One asset with delay and one without	157
6.A	Proof of Proposition 6.3.2	163
6.A.1	Slice $t \in [T - d, T]$, initialization	163
6.A.2	Slice $[T - 2d, T - d]$	163
6.A.3	From slice $[T - nd, T]$ to $[T - (n + 1)d, T]$	167

Bibliography 175

Part I

Introduction

Chapitre 1

Introduction (French version)

La thèse est divisée en trois parties qui peuvent être lues indépendamment. Dans la première partie, nous fournissons un traitement exhaustif des problèmes de contrôle linéaire-quadratique pour une classe d'équations de Volterra stochastiques de type convolution, dont les noyaux sont des transformées de Laplace de certaines mesures matricielles signées qui ne sont pas nécessairement finies. Ces équations ne sont en général ni markoviennes ni semi-martingales, et incluent le mouvement brownien fractionnaire avec un indice de Hurst inférieur à $1/2$ comme cas particulier. Nous établissons la correspondance du problème initial avec un problème markovien de dimension éventuellement infinie dans un espace de Banach, ce qui nous permet d'identifier les variables d'état contrôlées markoviennes. En utilisant un argument de vérification martingale combiné à une technique de complétion des carrés, nous prouvons que la fonction de valeur est de forme linéaire quadratique en ces variables d'état avec un contrôle optimal de réaction linéaire. Des équations de Riccati à valeurs dans un espace de Banach non standard sont exhibées. De plus, nous montrons que la fonction valeur du problème d'optimisation de Volterra stochastique peut être approchée par celle des problèmes linéaires-quadratiques markoviens de dimension finie. L'existence de l'équation de Riccati à valeurs dans un espace de Banach est rigoureusement étudiée. Dans la deuxième partie, nous étudions le problème de la variance moyenne de Markowitz en temps continu pour une classe multivariée de modèles de Volterra affine et quadratique. Dans ce cadre de marché incomplet non-markovien et non semi-martingale avec des coefficients aléatoires non bornés, la stratégie de portefeuille optimale est exprimée au moyen d'une équation différentielle stochastique rétrograde de type Riccati. Dans le cas des modèles affines de Volterra, nous dérivons des solutions explicites à ce BSDE en termes d'équations multidimensionnelles de type Riccati-Volterra. Ce cadre comprend des modèles Heston rugueux multivariés. Dans le cas quadratique, nous obtenons de nouvelles formules analytiques et nous établissons leurs liens avec les équations de Riccati de dimension infinie. Cela couvre les modèles de covariance de type Stein-Stein et Wishart. Les résultats numériques sur un modèle de Stein-Stein rugueux bidimensionnel illustrent l'impact des volatilités rugueuses et des corrélations stochastiques sur la stratégie de Markowitz optimale. En particulier pour les actifs positivement corrélés, nous constatons que la stratégie optimale dans notre modèle est une stratégie de type *textit buy rough sell smooth*. Dans la troisième partie de la thèse, nous considérons une classe de problèmes de contrôle stochastique avec un contrôle retardé, à la fois en dérive et en diffusion. Le contrôle optimal et la valeur du problème sont décrits en termes d'un ensemble d'équations aux dérivées partielles de type Riccati dont l'existence et l'unicité sont obtenues dans un cadre simplifié. Une condition d'existence suffisante, émergeant directement de la struc-

ture retardée, est fournie. Un schéma d'apprentissage par réseau de neurones est proposé et utilisé pour illustrer l'effet du retard sur le problème d'allocation de portefeuille de Markowitz avec retard d'exécution.

1.1 Contrôle sur les équations de Volterra

La première partie de la thèse est consacrée au contrôle des processus de Volterra stochastiques d -dimensionnelles de la forme

$$X_t^\alpha = X_0 + \int_0^t K(t-s)b(X_s^\alpha, \alpha_s)ds + \int_0^t K(t-s)\sigma(X_s^\alpha, \alpha_s)dW_s, \quad (1.1.1)$$

où W est un mouvement brownien réel, $b, \sigma : [0, T] \times \mathbb{R}^d \times \mathbb{R}^m \rightarrow \mathbb{R}^d$ des fonctions affines :

$$\begin{aligned} b(t, x, a) &= Bx + Ca, \\ \sigma(t, x, a) &= Dx + Fa, \end{aligned}$$

et K un noyau matriciel $d \times d'$. Nous dotons la dynamique d'un coût fonctionnel

$$J(\alpha) = \mathbb{E} \left[\int_0^T ((X_s^\alpha)^\top Q X_s^\alpha + (\alpha_s)^\top N \alpha_s) ds + (X_T^\alpha)^\top P X_T^\alpha \right]. \quad (1.1.2)$$

Ici, B, C, D, F, Q, N, P sont des matrices de dimensions appropriées.

Notez qu'en définissant $K \equiv 1$, l'équation (1.1.1) se réduit au cadre classique. Par conséquent, un tel modèle généralise le cadre stochastique linéaire-quadratique standard. Cependant, les méthodes habituelles pour les processus de Markov et le calcul stochastique pour les semimartingales ne peuvent plus être appliquées car un tel modèle ne tombe pas dans le cadre semimartingale, comme on peut le voir avec le célèbre noyau fractionnaire de Riemann-Liouville $K_H : t \mapsto t^{H-1/2}$ avec $H \in (0, 1/2)$. Par conséquent, nous développons dans la suite quelques techniques pour traiter de tels modèles. Notre approche consiste à réécrire le système (1.1.1) dans un espace dimensionnel infini où la dynamique est markovienne. Nous présentons d'abord quelques motivations.

1.1.1 Motivations

Du contrôle d'un mouvement brownien au contrôle d'un mouvement brownien rugueux

Considérons le problème de base du régulateur linéaire-quadratique perturbé par un mouvement brownien W , et décrit par un système dynamique linéaire contrôlé sur \mathbb{R} :

$$X_t^\alpha = \int_0^t \alpha_s ds + W_t, \quad t \geq 0,$$

et un coût quadratique fonctionnel sur un horizon fini pour minimiser le processus de contrôle à valeur réelle $\alpha = (\alpha_t)_t$

$$J(\alpha) = \mathbb{E} \left[\int_0^T (|X_t^\alpha|^2 + \alpha_t^2) dt \right].$$

Ce problème LQ peut être résolu explicitement par différentes méthodes, y compris la programmation dynamique standard, le principe du maximum reposant sur le calcul

stochastique Itô. Il est bien connu, voir par exemple [YZ99], que le contrôle optimal α^* est s'écrit comme une rétroaction linéaire en l'état contrôlé $X^* = X^{\alpha^*}$:

$$\alpha_t^* = -\Gamma(t)X_t^*, \quad 0 \leq t \leq T,$$

où Γ est solution positive déterministe d'une équation de Riccati. Ainsi le processus d'état optimal associé X^* est un processus de Markov de retour à la moyenne. Supposons maintenant que le bruit W soit remplacé par un processus gaussien avec mémoire, typiquement un mouvement brownien fractionnaire, ou plus généralement par un processus de Volterra stochastique.

$$X_t^\alpha = \int_0^t \alpha_s ds + \int_0^t K(t-s) dW_s, \quad t \geq 0, \quad K \in L^2(0, T).$$

Une question qui se pose naturellement est de savoir comment la structure de la solution est modifiée, et comment elle peut être dérivée, sachant que dans ce cas, nous ne pouvons pas appliquer directement le calcul stochastique pour les semi-martingales ainsi que les méthodes usuelles pour les processus de Markov.

Contrôle de la chaleur dans une barre

Prenons maintenant un exemple (un peu) moins jouet. Supposons que nous ayons une barre unidimensionnelle semi-infinie dont la température est décrite par le champ $t, x \in \mathbb{R}_+ \mapsto T(t, x)$ et supposez que vous contrôliez le taux d'énergie α que la barre échange avec l'extérieur à $x = 0$. Si la barre est isolée partout ailleurs, alors T est la solution du problème de contrôle

$$\begin{aligned} \partial_t T(t, x) &= \partial_{xx} T(t, x), & t, x \geq 0, \\ T(t, 0) &= \alpha_t + \dot{W}_t, \\ T(0, x) &= 0, \\ \lim_{x \rightarrow \infty} T(t, x) &= 0, \end{aligned}$$

où \dot{W} indique un bruit blanc. En utilisant la transformation de Laplace, le lecteur peut alors remarquer que T peut être réécrit comme

$$T(t, x) = \frac{1}{\sqrt{\pi}} \int_0^t (t-s)^{-1/2} e^{-x^2/(4(t-s))} (\alpha_s ds + dW_s).$$

Par conséquent, garder par exemple la température à la position x^* autour d'une cible T_t^* peut être converti en un problème de contrôle de type Volterra

$$\begin{aligned} T^\alpha(t, x^*) &= \int_0^t K_{x^*}(t-s) (\alpha_s ds + dW_s), \\ J(\alpha) &= \mathbb{E} \left[\int_0^T (T^\alpha(s, x^*) - T_s^*)^2 + \alpha_s^2 ds \right], \end{aligned}$$

où $K_{x^*}(t) = \left(\frac{1}{t\pi}\right)^{1/2} e^{-(x^*)^2/(4t)}$.

1.1.2 Revue de littérature

Le contrôle optimal des équations de Volterra stochastiques a été étudié dans [Yon06] via la méthode du principe du maximum. Cela conduit à une caractérisation de la solution en termes d'une équation de Volterra stochastique rétrogrades pour le processus adjoint. Dans [AØ15], les auteurs utilisent également le principe du maximum avec le calcul de

Malliavin pour obtenir une équation adjointe d'équations différentielles stochastiques rétrogrades. Bien que le noyau considéré dans ces articles susmentionnés ne se limite pas à être de type convolution, les conditions requises n'englobent pas le cas où K possède une singularité en zéro, excluant donc le cas d'un noyau fractionnaire avec le paramètre $H < 1/2$. Plus récemment, une équation de Bellman étendue a été dérivée dans [HW19] pour l'équation de Volterra contrôlée associée.

La solution au problème de contrôle LQ comme dans (3.1.1) avec dérive contrôlée et bruit additif a été obtenue dans [KBV03] lorsque le bruit est un mouvement brownien fractionnaire avec paramètre de Hurst $H > 1/2$, et dans [DPD13] lorsque le bruit est un processus gaussien général avec un contrôle optimal exprimé comme somme de la commande de rétroaction linéaire bien connue pour le problème de commande déterministe linéaire-quadratique et de la prédiction de la réponse du système au futur processus de bruit. Récemment, l'article [Wan18] a étudié le problème LQ des équations de Volterra stochastiques en fournissant des caractérisations du contrôle optimal en termes d'un système forward-backward, mais en laissant de côté leur solvabilité, et sous certaines hypothèses de coefficients qui excluent les noyaux singuliers tels que le noyau fractionnaire avec le paramètre $H < 1/2$.

1.1.3 Notre approche

Notre approche consiste principalement à faire l'hypothèse que le noyau de Volterra K est la transformée de Laplace

$$K(t) = \int_{\mathbb{R}_+} e^{-\theta t} \mu(d\theta), \quad t > 0, \quad (1.1.3)$$

d'une mesure matricielle $d \times d'$ signée μ satisfaisant

$$\int_{\mathbb{R}_+} (1 \wedge \theta^{-1/2}) |\mu|(d\theta) < \infty. \quad (1.1.4)$$

Lorsqu'une telle hypothèse est en vigueur, une chose naturelle à faire est d'approcher la mesure μ par une somme finie de Dirac

$$\mu \approx \mu^n = \sum_{i=1}^n c_i^n \delta_{\theta_i^n},$$

induisant ainsi une approximation pour le noyau K

$$K^n(t) = \int_{\mathbb{R}_+} e^{-\theta t} \mu^n(d\theta), \quad t > 0. \quad (1.1.5)$$

où $(x_i^n)_i$ et $(\eta_i^n)_i$ sont des suites appropriées de nombres réels positifs. Ensuite, l'observation clé peut être faite en observant qu'une telle approximation donne la réécriture de X^α comme une somme finie de facteurs

$$X_t^{n,\alpha} = \sum_{i=1}^n c_i^n Y_t^{n,i,\alpha},$$

où chaque facteur Y_i^n est un processus d'Ornstein–Uhlenbeck markovien

$$\begin{cases} dY_t^{n,i,\alpha} &= -\theta_i^n Y_t^{n,i,\alpha} + (B \sum_{i=1}^n c_i^n Y_t^{n,i,\alpha} + C \alpha_t) dt + (D \sum_{i=1}^n c_i^n Y_t^{n,i,\alpha} + F \alpha_t) dW_t \\ Y_0^{n,i,\alpha} &= 0. \end{cases}$$

Par conséquent, le problème d'optimisation non-markovienne (1.1.1) - (1.1.2) en dimension d semble approchable par une suite de problèmes d'optimisation markoviens en dimension nd

$$\begin{aligned} dY_t^{n,i,\alpha} &= -\theta_i^n Y_t^{n,i,\alpha} + (B\mu^n(Y_t^{n,\alpha}) + C\alpha_t)dt + (D\mu^n(Y_t^{n,\alpha}) + F\alpha_t)dW_t, \quad t \leq T, \\ Y_0^{n,i,\alpha} &= 0, \\ J^n(\alpha) &= \mathbb{E} \left[\int_0^T ((\mu^n(Y_s^{n,\alpha}))^\top Q(\mu^n(Y_s^{n,\alpha})) + \alpha_s^\top N\alpha_s) ds + (\mu^n(Y_T^{n,\alpha}))^\top P(\mu^n(Y_T^{n,\alpha})) \right]. \end{aligned} \quad (1.1.6)$$

Notez que, par conséquent, nous sommes maintenant ramené au cas classique du contrôle linéaire-quadratique stochastique où la rétroaction optimale et la fonction de valeur peuvent être facilement dérivées. De toutes ces considérations, plusieurs questions se posent

- Does the sequence of optimization problem (1.1.6) approximate the initial optimization problem (1.1.1)-(1.1.2) ?
- Pouvons-nous caractériser la fonction valeur et le contrôle optimal ?

1.1.4 Nos contributions

Pour répondre à ces interrogations, nous établissons la correspondance du problème initial (1.1.1) - (1.1.2) avec un problème de dimension infini markovien dans l'espace de Banach $L^1(\mu)$.

Result 1: Représentation markovienne de la dynamique contrôlée

Fixez $\alpha \in \mathcal{A}$. Supposons qu'il existe un processus progressivement mesurable tel que X^α résout (1.1.1), \mathbb{P} -p.s.. Alors, X^α admet la représentation

$$X_t^\alpha = X_0 + \int_{\mathbb{R}_+} \mu(d\theta) Y_t^\alpha(\theta),$$

où, pour chaque $\theta \in \mathbb{R}_+$,

$$Y_t^\alpha(\theta) = \int_0^t e^{-\theta(t-s)} b(s, X_s^\alpha, \alpha_s) ds + \int_0^t e^{-\theta(t-s)} \sigma(s, X_s^\alpha, \alpha_s) dW_s. \quad (1.1.7)$$

En partant du résultat 1, on obtient alors que la fonction valeur est de forme quadratique linéaire sur $L^1(\mu)$ avec un contrôle optimal linéaire également défini sur $L^1(\mu)$. Ces derniers sont exprimés en termes d'équations de Riccati non-standard sur $L^1(\mu)$. Pour voir cela, fixons quelques notations. On définit l'opérateur de retour à la moyenne A^{mr} agissant sur $\varphi \in L^1(\mu)$ par

$$(A^{mr}\varphi)(\theta) = -\theta\varphi(\theta), \quad \theta \in \mathbb{R}_+,$$

ainsi que le produit

$$\begin{aligned} \langle \varphi, \psi \rangle_\mu &= \int_{\mathbb{R}_+} \varphi(\theta)^\top \mu(d\theta) \psi(\theta), \quad (\varphi, \psi) \in L^1(\mu) \times L^\infty(\mu^\top) \\ &= \int_{\mathbb{R}_+} \psi(\theta)^\top \mu(d\theta) \varphi(\theta), \quad (\varphi, \psi) \in L^\infty(\mu) \times L^1(\mu^\top). \end{aligned}$$

Pour tout noyau à valeur matricielle G , on note \mathbf{G} l'opérateur intégral induit par G , défini par :

$$(\mathbf{G}\phi)(\theta) = \int_{\mathbb{R}_+} G(\theta, \theta') \mu(d\theta') \phi(\theta').$$

On note alors que (1.1.7) peut être réécrit

$$dY_t^\alpha = (A^{mr} Y_t^\alpha + \mathbf{B} Y_t^\alpha + C \alpha_t) dt + (\mathbf{D} Y_t^\alpha + F \alpha_t) dW_t, \quad Y_0^\alpha = 0.$$

Aussi, à partir du résultat 1 on voit que la fonctionnelle de coût (1.1.2) peut être reformulée dans $L^1(\mu)$

$$J(\alpha) = \mathbb{E} \left[\int_0^T (\langle Y_s^\alpha, \mathbf{Q} Y_s^\alpha \rangle_\mu + \alpha_s^\top N \alpha_s) ds \right],$$

où, par un léger abus de notations, C et F désignent les opérateurs constants induits par les matrices C et F :

$$(Ca)(\theta) = Ca, \quad (Fa)(\theta) = Fa, \quad \theta \in \mathbb{R}_+, \quad a \in \mathbb{R}^m.$$

Leurs opérateurs adjoints C^* , F^* prennent la forme

$$C^* g = C^\top \int_{\mathbb{R}_+} \mu(d\theta)^\top g(\theta), \quad F^* g = F^\top \int_{\mathbb{R}_+} \mu(d\theta)^\top g(\theta), \quad g \in L^1(\mu^\top).$$

Compte tenu de la structure linéaire-quadratique du problème, les résultats standard en théorie du contrôle stochastique de dimension finie, voir [yong1999stochastique], ainsi que dans les espaces de Hilbert, voir [Fla86 ; HT18], suggèrent le résultat de vérification suivant

Result 2: Théorème de vérification

Supposons qu'il existe une fonction à valeur opérateurs auto-adjoints $\mathbf{\Gamma}$ de $L^1(\mu)$ dans $L^\infty(\mu^\top)$ et. solution de l'équation de Riccati

$$\begin{cases} \mathbf{\Gamma}_T &= \mathbf{0} \\ \dot{\mathbf{\Gamma}}_t &= -\mathbf{\Gamma}_t A^{mr} - (\mathbf{\Gamma}_t A^{mr})^* - \mathbf{Q} - \mathbf{D}^* \mathbf{\Gamma}_t \mathbf{D} - \mathbf{B}^* \mathbf{\Gamma}_t - (\mathbf{B}^* \mathbf{\Gamma}_t)^* \\ &\quad + (C^* \mathbf{\Gamma}_t + F^* \mathbf{\Gamma}_t \mathbf{D})^* (N + F^* \mathbf{\Gamma}_t F)^{-1} (C^* \mathbf{\Gamma}_t + F^* \mathbf{\Gamma}_t \mathbf{D}), \quad t \in [0, T]. \end{cases}$$

Alors la fonction valeur de (1.1.1)-(1.1.2) se réécrit

$$V_t^{\alpha^*} = \langle Y_t^{\alpha^*}, \mathbf{\Gamma}_t Y_t^{\alpha^*} \rangle_\mu,$$

et le contrôle optimale prend la forme

$$\alpha_t^* = -(N + F^* \mathbf{\Gamma}_t F)^{-1} (C^* \mathbf{\Gamma}_t + F^* \mathbf{\Gamma}_t \mathbf{D}) Y_t^{\alpha^*}.$$

De plus, nous montrons que $\mathbf{\Gamma}$ est en fait un opérateur intégral dont le noyau symétrique associé satisfait l'équation de Riccati suivante :

$$\begin{cases} \Gamma_T(\theta, \tau) &= 0 \\ \dot{\Gamma}_t(\theta, \tau) &= (\theta + \tau) \Gamma_t(\theta, \tau) - Q - D^\top \int_{\mathbb{R}_+^2} \mu(d\theta')^\top \Gamma_t(\theta', \tau') \mu(d\tau') D \\ &\quad - B^\top \int_{\mathbb{R}_+} \mu(d\theta')^\top \Gamma_t(\theta', \tau) - \int_{\mathbb{R}_+} \Gamma_t(\theta, \tau') \mu(d\tau') B + S_t(\theta)^\top \hat{N}_t^{-1} S_t(\tau), \end{cases} \quad (1.1.8)$$

où

$$S_t(\tau) = C^\top \int_{\mathbb{R}_+} \mu(d\theta)^\top \Gamma_t(\theta, \tau) + F^\top \int_{\mathbb{R}_+^2} \mu(d\theta')^\top \Gamma_t(\theta', \tau') \mu(d\tau') D$$

$$\hat{N}_t = N + F^\top \int_{\mathbb{R}_+^2} \mu(d\theta)^\top \Gamma_t(\theta, \tau) \mu(d\tau) F.$$

Nous montrons un résultat d'existence pour l'équation de Riccati susmentionnée (1.1.8).

Result 3: Existence et unicité du noyau Riccati

Soit μ une mesure matricielle $d \times d'$ signée satisfaisant (1.1.4). Supposons que

$$Q \in \mathbb{S}_+^d, \quad N - \lambda I_m \in \mathbb{S}_+^m,$$

Pour au moins un λ tel que $\lambda > 0$. Alors il existe une unique solution $\Gamma \in C([0, T], L^1(\mu \otimes \mu))$ à l'équation de Riccati (1.1.8) tel que $\Gamma_t \in \mathbb{S}_+^d(\mu \otimes \mu)$, pour tout $t \leq T$.

Enfin, nous montrons que la fonction valeur de le problème d'optimisation de Volterra stochastique (1.1.1) - (1.1.2) peut être approché par une suite de problèmes conventionnels markoviens linéaire – quadratique de dimensions finies. Cela ouvre la porte à des simulations numériques faciles à mettre en oeuvre.

Result 4: Approximation en dimension finie

Supposons que μ satisfasse (1.1.4) et soit K comme en (1.1.3). Soit $(K^n)_{n \geq 1}$ une suite de noyaux de la forme (1.1.5) avec des mesures respectives μ^n satisfaisant (1.1.4), pour chaque $n \in \mathbb{N}$. Supposons (??) et que Q soit inversible. Notons V^* et V^{n*} les fonctions valeurs optimales respectives de (1.1.1) - (1.1.2) et (1.1.6). Si

$$\|K^n - K\|_{L^2(0, T)} \rightarrow 0, \quad \text{as } n \rightarrow \infty,$$

Alors,

$$V^{n*} \rightarrow V^*, \quad \text{as } n \rightarrow \infty.$$

1.2 Markowitz rugueux

1.2.1 Quand Markowitz devient rugueux

Dans cette partie, nous étudions le problème d'allocation de portefeuille de type Markowitz lorsque la volatilité devient rugueuse. Tout d'abord rappelons quel est le problème d'allocation de portefeuille de Markowitz. L'objectif est le suivant : supposons que vous disposiez d'un ensemble d'actions que vous pouvez acheter et vendre. Bien sûr leurs prix peuvent évoluer aléatoirement mais vous avez développé un modèle et avez une estimation de leurs dérives, de leurs volatilités, de leurs corrélations, etc. La question est alors : comment puis-je assurer un certain rendement moyen pour mon portefeuille tout en minimisant la volatilité de ce dernier ?

$$\min_{\mathbb{E}(X_T)=m} \text{Var}(X_T).$$

Un vaste volume de recherche a été consacré à ce problème et à son extension. La modélisation des processus financiers s’est grandement améliorée depuis les travaux fondateurs de Louis Bachelier ([Dav+11]) et les marches aléatoires. Il est maintenant bien établi depuis l’article fondateur de [GJR18a] que la volatilité des actifs est rugueuse et mieux modélisée par un mouvement brownien fractionnaire avec un petit paramètre de Hurst.

$$\sigma_t \approx \int_0^t (t-s)^{H-1/2} dW_s, \quad H \approx 0.1.$$

Évidemment, un investisseur avisé aurait tendance à préférer les actions à haut rendement, à faible volatilité et non corrélées (voire anti-corrélées) mais la question de savoir comment les investisseurs doivent prendre en compte la rugosité des actions reste ouverte. La recherche sur l’optimisation de portefeuille dans des environnements fractionnaires et rugueux est encore peu développée mais a gagné une attention croissante à travers les articles récents de [FH18; BD20; HW20b], qui considèrent les modèles fractionnaires de volatilité stochastique de type Ornstein-Uhlenbeck et Heston pour la fonction d’utilité, et les travaux de [HW20a] où les auteurs étudient le problème de Markowitz dans un modèle de Volterra Heston, qui couvre le modèle de Heston rugueux [EER18]. La question sur laquelle nous aimerions progresser est la suivante : **Étant donné un marché aux actifs multiples, comment la rugosité d’une action doit-elle être prise en compte dans l’allocation du portefeuille ?**

1.2.2 Un exemple avec deux actifs

Fix some horizon $T > 0$, and consider a financial market on $[0, T]$ with a non-risky asset S^0

$$S_t^0 = 1,$$

et deux actifs risqués $S_t = (S_t^1, S_t^2)$: $dS_t = \text{diag}(S_t)(\sigma_t \lambda_t dt + \sigma_t dB_t)$ où B est un mouvement brownien bidimensionnel. Ici σ denote un processus à valeur dans $\mathbb{R}^{2 \times 2}$ que l’on appelle volatilité stochastique, et λ un processus à valeur dans \mathbb{R}^2 appelé prime de risque ($\approx \frac{\text{€}}{\text{risk}}$). Pour travailler avec un modèle simple, supposons que les cours des actions suivent

$$\begin{cases} dS_t^i &= S_t^i \left(\theta(Y_t^i)^2 dt + Y_t^i d\tilde{B}_t^i \right), \\ Y_t^i &= Y_0 + \int_0^t (t-s)^{H_i-1/2} \eta_i dW_s^i, \quad i = 1, 2, \end{cases} \quad (1.2.1)$$

avec $0 < H_1 < H_2 \leq 1/2$ et une structure de corrélations

$$\tilde{B}^1 = B^1, \quad \tilde{B}^2 = \rho B^1 + \sqrt{1-\rho^2} B^2, \quad W^i = c_i \tilde{B}^i + \sqrt{1-c_i^2} \tilde{B}^{i,\perp},$$

où $(B^{1,\perp}, B^{2,\perp})$ est un mouvement brownien bidimensionnel indépendant de B et $\eta = (\eta_1, \eta_2)$ la volatilité de volatilité.

Remark 1.2.1. Dans cette introduction, nous motivons notre travail avec le modèle Stein-Stein à 2 actifs. On se réfère à la partie III pour un traitement général des modèles affine et quadratique.

Soient π_t^0, π_t^1 et π_t^2 les montants respectivement investis dans l’actif non risqué et l’actif risqué au moment t . If $N_t = (N_t^1, N_t^2)^\top$ est le nombre d’actions détenues dans

les actifs risqués, alors la dynamique de la richesse $X_t = N_t^\top S_t + \pi_t^0$ du portefeuille autofinancé est donné par

$$\begin{aligned} dX_t &= N_t^\top dS_t \\ &= N_t^\top \text{diag}(S_t) [(\sigma_t \lambda_t) dt + \sigma_t dB_t] \\ &= \alpha_t^\top (\lambda_t dt + dB_t), \quad X_0 = x_0 \in \mathbb{R}, \end{aligned}$$

où nous avons défini $\alpha = \sigma^\top \pi$.

Remark 1.2.2. *Le modèle (1.2.1) implique*

$$\sigma = \begin{pmatrix} Y_1 & 0 \\ Y_2 \rho & Y_2 \sqrt{1 - \rho^2} \end{pmatrix}, \quad \lambda = \begin{pmatrix} 1 & 0 \\ \rho & \sqrt{1 - \rho^2} \end{pmatrix}^{-1} \begin{pmatrix} \theta_1 Y_1 \\ \theta_2 Y_2 \end{pmatrix}.$$

Le problème de sélection de portefeuille de Markowitz en temps continu consiste alors à résoudre le problème contraint suivant

$$\begin{aligned} V(m) &= \inf_{\alpha \in \mathcal{A}} \{ \text{Var}(X_T) : \text{s.t. } \mathbb{E}[X_T] = m \} \\ dX_t &= \alpha_t^\top (\lambda_t dt + dB_t), \quad X_0 = x_0 \in \mathbb{R}. \end{aligned}$$

1.2.3 Des équations de Riccati à l'allocation de portefeuille

Notez que contrairement à la section 1.1, la dynamique de l'état contrôlé X est markovienne. Ainsi, il peut être résolu avec la méthode classique du contrôle linéaire quadratique. Nous avons les résultats suivants.

Result 5: Théorème de vérification

Supposons qu'il existe un triplet solution (Γ, Z^1, Z^2) de l'équation de Riccati

$$\begin{cases} d\Gamma_t &= \Gamma_t \left[|\lambda_t + Z_t^1 + CZ_t^2|^2 dt + (Z_t^1)^\top dB_t + (Z_t^2)^\top dW_t \right], \\ \Gamma_T &= 1, \end{cases} \quad (1.2.2)$$

tel que

(H1) $0 < \Gamma_0 < e^{2 \int_0^T r(s) ds}$, et $\Gamma_t > 0$, pour tout $t \leq T$,

(H2) Il existe un entier $p > 2$ tel que

$$\mathbb{E} \left[\exp \left(a(p) \int_0^T (|\lambda_s|^2 + |Z_s^1|^2 + |Z_s^2|^2) ds \right) \right] < \infty,$$

où $a(p)$ est une constante explicite.

Alors, le contrôle optimal est donné par

$$\alpha_t^* = (\lambda_t + Z_t^1 + CZ_t^2)(\xi^* - X_t^*), \quad \xi^* = \frac{m - \Gamma_0 x_0}{1 - \Gamma_0},$$

et la valeur du processus de richesse optimal est

$$V(m) = \mathbb{V}(X_T^*) = \Gamma_0 \frac{|x_0 - m|^2}{1 - \Gamma_0}.$$

Bien que la structure du résultat ci-dessus soit assez classique, notez la présence de la condition (H2) qui nous permet d'unifier de nombreux résultats dans la littérature, voir le tableau 5.1. En regardant de près ξ^* , il est facile de voir que $\xi^* \geq m$ (rappelons que $x_0 < m$). Ainsi, la dynamique de la richesse optimale contrôlée X^* est régit par

$$dX_t^* = (\lambda_t + Z_t^1 + CZ_t^2)(\xi^* - X_t^*)(\lambda_t dt + dB_t).$$

De $x_0 < m < \xi^*$ et de la continuité de X^* , nous avons $X^* \leq \xi^*$ sur $[0, T]$. Par conséquent, pour saisir l'effet de la rugosité des actions sur la stratégie d'investissement, il faut comprendre son effet sur Z^1 et Z^2 .

$$\alpha_t^* = \underbrace{(\lambda_t + Z_t^1 + CZ_t^2)}_{\text{vecteur aléatoire à étudier}} \underbrace{(\xi^* - X_t^*)}_{\in \mathbb{R}_+}.$$

Pour ce faire, l'idée clé est d'observer que, si une telle solution existe, alors, elle admet la représentation suivante d'une transformée de Laplace de la norme au carré d'une variable gaussienne :

$$\Gamma_t = \mathbb{E} \left[\exp \left(- \underbrace{\int_t^T (|\lambda_s + Z_s^1 + CZ_s^2|^2) ds}_{\approx \text{Gaussienne au carré}} \right) \middle| \mathcal{F}_t \right], \quad 0 \leq t \leq T.$$

Or, si $G \sim N(\mu, \Sigma)$ est une variable gaussienne n -dimensionnelle, alors

$$\mathbb{E}(\exp(-u|G|^2)) = \frac{\exp(-u(\mu^\top(I_n + 2\Sigma u)^{-1}\mu))}{\det(I_n + 2\Sigma u)^{1/2}}, \quad u \geq 0.$$

D'après l'expression ci-dessus, on voit qu'une chose intuitive à faire est d'approximer

$$\int_t^T |\lambda_s + Z_s^1 + CZ_s^2|^2 ds \approx n^{-1} \sum_{i=1}^n G_{iT/n}^2 \sim |N(\mu_n, \Sigma_n)|^2,$$

où $G_{i/n} = |\lambda_{iT/n} + Z_{iT/n}^1 + CZ_{iT/n}^2|^2$ et

$$\mu_n = \mathbb{E}[(G_{T/n}, \dots, G_T) | \mathcal{F}_t], \quad \Sigma_n = \mathbb{E}[(G_{T/n}, \dots, G_T)^T (G_{T/n}, \dots, G_T) | \mathcal{F}_t].$$

Ainsi, on s'attend à

$$\begin{aligned} \Gamma_t &= \mathbb{E} \left[\exp \left(- \int_t^T (|\lambda_s + Z_s^1 + CZ_s^2|^2) ds \right) \middle| \mathcal{F}_t \right] \\ &\approx \lim_{n \rightarrow \infty} \frac{\exp(-(\mu_n^\top(I_n + 2\Sigma_n)^{-1}\mu_n))}{\det(I_n + 2\Sigma_n)^{1/2}}. \end{aligned}$$

Les questions naturelles sont donc

1. Vers quelles limites ces objets convergent-ils lorsque $n \rightarrow \infty$?
 - Quand n tend vers l'infini, les grandes matrices convergent vers les opérateurs. Ainsi, un espace de dimension infini apparaît : $L^2([0, T])$.
2. Qui devrait jouer le rôle de μ_n ?
 - Le *forward process* $g_t(s) = \mathbb{E}[Y_s | \mathcal{F}_t]$, $s \geq t$.

3. Qui devrait jouer le rôle de Σ_n ?

- grosso modo, le *processus de covariance conditionnelle* du *forward process*.

Pour répondre à ces questions, nous introduisons le cadre infini dimensionnel pertinent. Soit $\langle \cdot, \cdot \rangle_{L^2}$ un produit scalaire sur $L^2([0, T], \mathbb{R}^N)$ tel que

$$\langle f, g \rangle_{L^2} = \int_0^T f(s)^\top g(s) ds.$$

Pour tout $K \in L^2([0, T]^2, \mathbb{R}^{N \times N})$, nous notons \mathbf{K} l'opérateur intégral induit :

$$(\mathbf{K}g)(s) = \int_0^T K(s, u)g(u)du.$$

On a alors le résultat suivant.

Result 6: Backward stochastique de type Riccati - Operateur de type Riccati - Forward process

Soit $t \mapsto \Psi_t$ la solution de l'équation de Riccati à valeur opérateur

$$\begin{aligned} \dot{\Psi}_t &= 2\Psi_t \dot{\Sigma}_t \Psi_t, \quad t \in [0, T], \\ \Psi_T &= -(\text{Id} - \hat{\mathbf{K}})^{-*} \Theta^\top \Theta (\text{Id} - \hat{\mathbf{K}})^{-1}, \end{aligned} \quad (1.2.3)$$

où

- $\hat{\mathbf{K}}$ est l'opérateur intégral induit par le noyau $\hat{K} = -2K(\eta C^\top \Theta)$,
- $\tilde{\Sigma}_t = (\text{Id} - \hat{\mathbf{K}})^{-1} \Sigma_t (\text{Id} - \hat{\mathbf{K}})^{-*}$,
- Σ_t est défini comme l'opérateur intégral associé au noyau.

$$\Sigma_t(s, u) = \int_t^{s \wedge u} K(s, z) \eta (U - 2C^\top C) \eta^\top K(u, z)^\top dz, \quad t \leq T,$$

où $U = (1_{i=j} + 1_{i \neq j} c_i c_j)_{1 \leq i, j \leq 2}$ and $C = (c_1, c_2)^\top$.

Alors, le processus (Γ, Z^1, Z^2) défini par

$$\begin{cases} \Gamma_t &= \exp(\phi_t + \langle g_t, \Psi_t g_t \rangle_{L^2}), \quad t \leq T, \\ Z_t^1 &= 0, \\ Z_t^2 &= 2((\Psi_t \mathbf{K} \eta)^* g_t)(t), \end{cases}$$

où $\Phi_t = \ln(\det(\Psi_t \Lambda_t))$, est solution de la Riccati (1.2.2).

1.2.4 Résultats numériques

Par conséquent, le contrôle optimal est de la forme

$$\alpha_t^* = \underbrace{\left((\Theta + 2C [\Psi_t \mathbf{K} \eta]^*) g_t \right)(t)}_{\substack{\text{Facilement calculable} \\ \text{avec de l'algèbre linéaire!}}} (\xi^* - X_t^{\alpha^*}).$$

Enfin, nous affirmons que $t \mapsto 2C[\Psi_t \mathbf{K} \eta]^* g_t(t)$ est facile à approcher avec de l'algèbre linéaire de base. Les raisons sont les suivantes :

1. La fonction à valeur opérateur $t \mapsto \Psi_t$ est explicite ;
2. les opérateurs et les fonctions peuvent être stockés sous forme de matrices.

La première affirmation vient du résultat suivant.

Result 7: Explicite Ψ

La solution Ψ de (1.2.3) est de la forme

$$\Psi_t = -\left(\text{Id} - \hat{\mathbf{K}}\right)^{-*} \Theta^\top \left(\text{Id} + 2\Theta \tilde{\Sigma}_t \Theta^\top\right)^{-1} \Theta \left(\text{Id} - \hat{\mathbf{K}}\right)^{-1}, \quad 0 \leq t \leq T.$$

Enfin, expliquons la deuxième allégation. L'idée vient de l'argument limite présenté dans la section 1.2.3 et est la suivante : supposons que \mathbf{H} est un opérateur intégral induit par un noyau $H \in L^2([0, T]^2)$ et f une fonction dans $L^2([0, T])$. On procède par discrétisation :

$$(\mathbf{H}f)(s) = \int_0^T H(s, r) f(r) dr \approx \frac{1}{n} \sum_1^n H\left(s, \frac{iT}{n}\right) f\left(\frac{iT}{n}\right), \quad s \in \left\{\frac{T}{n}, \dots, T\right\}.$$

Ainsi les objets à stocker pour représenter l'opérateur \mathbf{H} et l'élément f sont respectivement une matrice $(H(iT/n, jT/n))_{1 \leq i, j \leq n}$ et un vecteur $(f(\frac{iT}{n}))_{1 \leq i \leq n}$. Chaque fois que nous devons composer un opérateur intégral avec un autre, nous multiplions les matrices impliquées et appliquons la mise à l'échelle $\frac{T}{n}$. Attention, lorsque l'opérateur n'est pas de type intégral, par exemple :

$$(\Theta f)(s) = \theta f(s),$$

Alors la mise à l'échelle en T/N n'est plus nécessaire. Dans un tel cas, l'opérateur est simplement stocké sous forme de matrice $\text{Id}_n \otimes \theta$ où \otimes désigne le produit de kronecker.

Remark 1.2.3. *Comme on l'a peut-être remarqué, il y a un petit problème lorsque plusieurs opérateurs, qui sont la somme d'un opérateur intégral et d'un opérateur non intégral, sont composés (ce qui est le cas de Ψ). Par exemple, supposons que*

$$(\mathbf{H}f)(s) = \theta f(s) + \int_0^T H(s, r) f(r) dr,$$

alors $\mathbf{H} - \theta$ est un opérateur intégral mais pas θ .

Simulations numériques : Nous partageons nos différentes simulations sur le modèle (1.2.1) dans un notebook IPython *. Nous avons pu reproduire une stratégie de type *buy rough sell smooth* dans le cas où $\rho > 0$, c'est-à-dire lorsque les actions sont similaires dans le sens où leurs prix montent et descendent ensemble en moyenne. Voir la figure ?? . A ce stade, il n'y a pas d'explication intuitive et claire quant à la raison pour laquelle une telle allocation devrait donner des résultats supérieurs, même si nous faisons une hypothèse dans [JMP20b]. Néanmoins, notre analyse tend vers une explication endogène des phénomènes observés, complémentaire de celles données dans [GH20b] où des influences exogènes telles que la *compensation du risque d'événement idiosyncratique à court terme* sont données. Enfin notre analyse tend à montrer, selon [GH20b], que la longueur de l'horizon T compte. Tester des données avec différents T pourrait être intéressant. Une analyse plus approfondie est effectuée dans la partie III.

*https://colab.research.google.com/drive/1P_SYE3WgFgwUKpOo8uCBDdIC04XyxE2a?usp=sharing

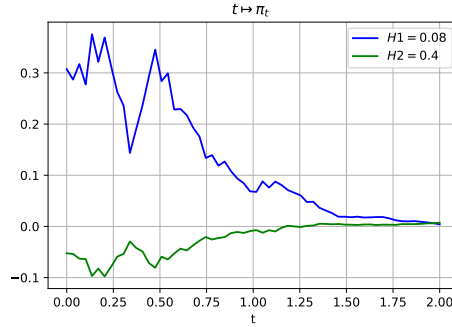

FIGURE 1.1 – $\rho = 0.7$, $H_1 = 0.08$, $H_2 = 0.4$, $T = 2.1$, $\eta_1 = \eta_2 = 1$, $c_i = -0.7$. La stratégie de type *buy rough sell smooth* décrite dans [GH20b] est retrouvée.

1.3 Contrôle avec retard

La partie IV est consacré au contrôle des systèmes avec des retards. Le temps nécessaire pour acquérir des informations, calculer la décision et exécuter les ordres rend les retards dans les systèmes de contrôle omniprésents. Différents effets des retards sur la modélisation des flux de trafic, les processus chimiques, la dynamique des populations, la chaîne d’approvisionnement, la publicité ont été étudiés dans la littérature.

Dans un système contrôlé retardé, l’état X et la commande α sont les deux composants principaux qui peuvent présenter un retard. Lorsque le retard n’est présent que dans la variable d’état, le problème est maintenant bien compris. Une méthode de résolution consiste à réécrire la variable d’état dans un espace de dimension infini ($X_t : s \in [-d, 0] \mapsto X_{t+s}$), voir [DM72], [FGG10] pour n’en nommer que quelques-uns. Une situation beaucoup moins comprise est celle où le retard entre dans la variable de contrôle. Dans cette situation, deux approches principales ont émergé : la *méthode de l’état structural* et la *méthode de l’état étendu*, nous nous référons à [Ben+07, Partie II, Chapitre 3] pour l’étude de ces méthodes dans le cas déterministe et [FF14] pour l’approche de l’état structural dans le cas stochastique. Pour une liste complète des références, voir aussi [FF14].

Dans nos travaux, nous cherchons à éclairer le cas non déterministe où un retard entre dans le contrôle, à la fois dans le terme de dérive et celui de volatilité. Dans notre travail, nous considérons la classe suivante de problème de contrôle linéaire-quadratique retardé stochastique

$$\begin{cases} dX_t^\alpha = \alpha_{t-d}(bdt + \sigma dW_t), & 0 \leq t \leq T, \\ X_0 = x, \quad \alpha_s = \gamma(s), & s \in [-d, 0], \quad x \in \mathbb{R} \\ J(\alpha) = \mathbb{E}[(X_T^\alpha)^2]. \end{cases} \quad (1.3.1)$$

A l’exception de [FF14], cette situation n’est pas traitée théoriquement ni numériquement dans les références ci-dessus. La principale difficulté vient du fait que les problèmes d’optimisation avec un contrôle retardé appartiennent naturellement à la classe des *problèmes de contrôle aux bord*.

1.3.1 Résultats d’existence et de vérification

Notre approche est inspirée par l’approche de *état étendu* initiée par Ichikawa, voir [Ich82], où l’idée clé est de passer de l’espace d’état initial, à savoir \mathbb{R} , à l’espace de

Hilbert de dimension infinie $H = \mathbb{R} \times L^2([-d, 0], R)$, doté du produit scalaire

$$\langle x, y \rangle_H = x_0 y_0 + \int_{-d}^0 x_1(s) y_1(s) ds \quad x, y \in H.$$

Pour chaque élément $(x, u) \in H$, le premier élément x doit être interprété comme la position du système contrôlé, et le second $s \in [-d, 0] \mapsto u(s)$ comme l'historique du contrôle. Notre prochain résultat étend les résultats déterministes de [Ale+71] et [Ich82] au cas stochastique. La fonction valeur et le contrôle optimal de (1.3.1) sont exprimés en fonction d'une fonctionnelle auto-adjointe $P \in C([0, T], \mathcal{L}(H, H))$ de la forme

$$P_t : (x, \gamma(\cdot)) \mapsto \begin{pmatrix} P_{11}(t)x + \int_{-d}^0 P_{12}(t, s)\gamma(s)ds \\ P_{12}(t, \cdot)x + P_{22}(t, \cdot)\gamma(\cdot) + \int_{-d}^0 P_{22}(t, \cdot, s)\gamma(s)ds \end{pmatrix}.$$

qui satisfait un ensemble d'équations aux dérivées partielles de type Riccati

$$\begin{aligned} \dot{P}_{11}(t) &= \frac{P_{12}(t, 0)^2}{P_{22}(t, 0)}, & (\partial_t - \partial_s)(P_{12})(t, s) &= \frac{P_{12}(t, 0)P_{22}(t, s, 0)}{P_{22}(t, 0)}, & (1.3.2) \\ (\partial_t - \partial_s)(P_{22})(t, s) &= 0, & (\partial_t - \partial_s - \partial_r)(P_{22})(t, s, r) &= \frac{P_{22}(t, s, 0)P_{22}(t, 0, r)}{P_{22}(t, 0)}, \end{aligned}$$

avec les conditions aux bords

$$\begin{aligned} P_{12}(t, -d) &= bP_{11}(t), & P_{22}(t, -d) &= \sigma^2 P_{11}(t), & (1.3.3) \\ P_{22}(t, s, -d) &= bP_{12}(t, s), & P_{22}(t, -d, r) &= bP_{12}(t, r), \end{aligned}$$

et les conditions terminales

$$P_{11}(T) = 1, \quad P_{12}(T, s) = P_{22}(T, s) = P_{22}(T, s, r) = 0, \quad (1.3.4)$$

pour presque tout $s, r \in [-d, 0]$.

Result 8: Théorème de vérification

Supposons qu'il existe une solution P à (1.3.2) - (1.3.3) - (1.3.4). Alors, le contrôle optimal du problème d'optimisation (1.3.1) prend la forme

$$\alpha_t^* = \frac{-1_{t \leq T-d}}{P_{22}(t, 0)} \left\{ X_t^{\alpha^*} P_{11}(t, 0) + \int_{t-d}^t P_{22}(t, 0, s-t) \alpha_s^* ds \right\},$$

et la valeur optimale est donnée par

$$V(z) = \langle P_0 z, z \rangle_H,$$

où $z = (x, \gamma) \in H$ désigne l'état initial du système contrôlé.

L'étape suivante consiste à donner un résultat d'existence sur $P = (P_{11}, P_{12}, P_{22}, P_{22})$. Dans le cas sans délai, $d = 0$, bien que l'on ne pénalise pas le contrôle, le problème d'optimisation (1.3.1) admet un optimiseur pourvu que $\sigma \neq 0$. En effet, plus α est agressif pour amener X à 0, plus le deuxième moment de X augmente en raison du terme de diffusion. Il est facile d'observer cela dans le classique problème d'optimisation stochastique LQ avec une volatilité contrôlée telle que

$$\begin{aligned} dX_t^\alpha &= \alpha_t (bdt + \sigma dW_t), & t &\leq T, \\ X_0 &= x, \\ J(\alpha) &= \mathbb{E}[(X_T^\alpha)^2], \end{aligned}$$

où le contrôle optimal prend la forme $\alpha_t^* = -\frac{b}{\sigma^2} X_t^{\alpha^*}$ et la fonction valeur $V_t = e^{(t-T)\frac{b^2}{\sigma^2}}$. Une découverte surprenante de nos travaux est la nécessité d'une contrainte plus restrictive sur le coefficient de diffusion lorsque la contrainte de retard n'est pas nulle, $d > 0$.

Soit $a = (a_n)_{n \geq 1}$ la suite

$$\begin{cases} a_0 &= 1, \\ a_{n+1} &= a_n - \frac{d}{a_n} \left(\frac{b}{\sigma}\right)^2, \quad n \geq 0, \end{cases}$$

et $\mathcal{N} : (d, b, \sigma) \mapsto \inf\{n \geq 1 : a_n > 0 \text{ and } a_{n+1} \leq 0\}$. Nous exprimons le résultat d'existence sur P en fonction de la suite a .

Result 9: Existence de $t \in [0, T] \mapsto P_t$

Supposons que $T < \mathcal{N}(d, b, \sigma)d$. Alors (1.3.2)-(1.3.3)-(1.3.4) admet une unique solution P sur $[0, T]$ avec $0 < P_{11}(0) < 1$.

1.3.2 Résolution d'EDP par réseaux de neurones

Nous proposons maintenant un algorithme pour approximer $t \mapsto P_t$. Comme P est caractérisée par un ensemble d'équations différentielles, nous décidons d'utiliser des réseaux de neurones dans l'esprit de la littérature récente sur le sujet [SS18] et [RPK19] pour ne citer que quelques-uns.

Rappelons quelques-unes des idées principales. Supposons que nous voulions simuler une équation différentielle partielle non linéaire de la forme

$$\begin{aligned} \partial_t u + \mathcal{N}(u) &= 0, & \text{on } \Omega, \\ u &= g, & \text{on } \partial\Omega, \end{aligned} \tag{1.3.5}$$

où \mathcal{N} est un opérateur non linéaire, Ω un ensemble borné ouvert et g une fonction défini sur la frontière du domaine. L'idée clé est d'utiliser un réseau de neurones comme substitut à la solution u à (1.3.5). Ainsi, appelons $t \mapsto u(t, \Theta)$ tel réseau, où Θ désigne ses coefficients et t un élément générique de $\Omega \cup \partial\Omega$. La stratégie repose sur la minimisation de la fonctionnelle

$$\mathcal{L}(\Theta, \mathcal{T}) = \mathcal{L}_u(\Theta, \mathcal{T}) + \mathcal{L}_f(\Theta, \mathcal{T}), \tag{1.3.6}$$

où \mathcal{L}_u et \mathcal{L}_f sont définis comme

$$\mathcal{L}_r(\Theta, \mathcal{T}) = \frac{1}{|\mathcal{T}_r|} \sum_{t \in \mathcal{T}_r} |(\partial_t + \mathcal{N})u(t, \Theta)|^2, \quad \mathcal{L}_f(\Theta, \mathcal{T}) = \frac{1}{|\mathcal{T}_f|} \sum_{t \in \mathcal{T}_f} |u(t, \Theta) - g(t)|^2.$$

Les sous-ensembles $\mathcal{T}_r = \mathcal{T} \cap \Omega$ et $\mathcal{T}_f = \mathcal{T} \cap \partial\Omega$ sont respectivement des sous-ensembles de Ω et de $\partial\Omega$. Nous résumons la procédure numérique dans l'algorithme 1.1.

La structure précise de (1.3.2)-(1.3.3)-(1.3.4) nous a conduit vers une structure de réseau particulière, voir figure 1.2.

Commentaire sur la méthode : La méthode Deep Galerkin offre une procédure facile à mettre en oeuvre pour approximer les solutions de toute équation différentielle définie sur un domaine $\Omega \cup \partial\Omega$. Dans la partie IV, nous adaptons la méthode Deep Galerkin pour résoudre le système d'EDPs (1.3.2) - (1.3.3) - (1.3.4) dans le contexte de l'allocation de portefeuille de Markowitz avec délai d'exécution. Notez que dans ce cas, la dimension de sortie est 4.

Algorithm 1.1 Schéma de résolution d'EDP par réseau de neurones

Initialisez : le learning rate η et le réseau de neurones $u(\cdot, \Theta)$;

Pour chaque batch :

Echantillonnez $\mathcal{T} \subset \partial\Omega \cup \Omega$;

Calculer le gradient de la fonction de perte (1.3.6) : $\nabla_{\Theta} \mathcal{L}(\Theta, \mathcal{T}) = \nabla_{\Theta} (\mathcal{L}_r + \mathcal{L}_f)(\Theta, \mathcal{T})$;

Mettez à jour $\Theta \leftarrow \Theta - \eta \nabla_{\Theta} \mathcal{L}(\Theta, \mathcal{T})$;

Retournez : L'ensemble des paramètres optimisés Θ^* .

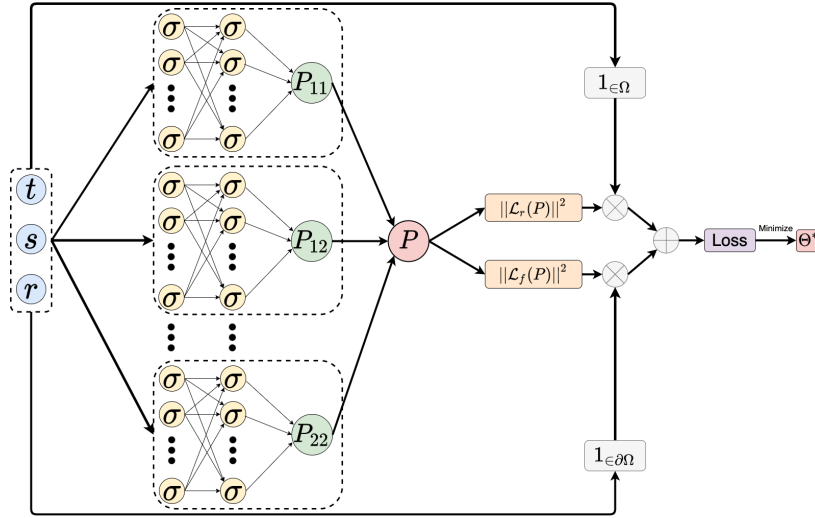

FIGURE 1.2 – Structure du réseau de neurones afin de résoudre (1.3.2)-(1.3.3)-(1.3.4).

Néanmoins, la méthode Deep Galerkin ne s'étend pas bien au cas où l'espace d'entrée est de grande dimension, disons 100 par exemple. Un tel cas est important car il est courant en finance, en recherche opérationnelle, en physique, etc. Dans [HJW18], l'auteur propose une autre approche basée sur la représentation de Feynman-Kac de certaines PDE émergeant de systèmes de particules. Ce type de méthode est bien adapté aux problèmes où l'espace d'état est de grande dimension et l'interprétation physique est basée sur des systèmes de particules. Toutefois il présente plusieurs inconvénients :

- la nécessité d'une formule de Feynman-Kac restreignant ainsi le type d'équations différentielles solubles,
- la dimension de sortie ne peut pas facilement être supérieure à 1,
- la solution n'est calculée que dans une petite zone du domaine.

Ainsi, nous considérons ces méthodes comme complémentaires et résumons certaines de leurs caractéristiques dans le tableau 1.1.

	dim. entrée $\gg 1$	dim. sortie $\gg 1$	toute eq. diff.
Deep backward ([HJW18])	✓	✗	✗
Deep Galerkin ([SS18])	✗	✓	✓

TABLE 1.1 – Comparaison des schémas de résolution d'EDPs par réseaux de neurones.

1.3.3 Application à l'allocation de portefeuille de type Markowitz avec délai d'exécution

Nous appliquons maintenant notre schéma numérique à la sélection de portefeuille, voir [Mar52b], avec délai d'exécution dans l'esprit du problème de couverture des options européennes présenté dans [FF14]. Le problème de sélection de portefeuille en temps continu consiste à résoudre le problème contraint suivant

$$\begin{cases} \min_{\alpha \in \mathcal{A}} \text{Var}(X_T^\alpha) \\ \text{s.t. } \mathbb{E}[X_T^\alpha] = c. \end{cases} \quad (1.3.7)$$

où X^α désigne la richesse de l'investisseur contrôlée par une stratégie d'investissement α . Dans notre travail, nous étudions d'abord le cas d'un actif seul avec retard

$$\begin{cases} dX_t^\alpha = \alpha_{t-d}((\sigma\lambda) dt + \sigma dW_t), & t \in [0, T], \\ X_0 = x_0, \quad \alpha_s = \gamma_s, & \forall s \in [-d, 0], \end{cases} \quad (1.3.8)$$

où α désigne le montant investi dans l'actif risqué, et λ et σ sont des constantes représentant respectivement la prime de risque et la volatilité de l'actif risqué. Notez que seul le cas avec un actif retardé permet une application directe du résultats 19 et 20 :

Result 10: Le cas d'un actif retardé

Supposons $T < dN(d, (\sigma\lambda), \sigma)$, fixons $\xi^* = c - \eta^*$ et

$$\eta^* = \frac{K(\gamma) + P_{11}(0)(x_0 - c)}{1 - P_{11}(0)},$$

$$K(\gamma) = \int_{-d}^0 \gamma_s P_{12}(0, s) ds.$$

Définissons $\alpha^*(\xi)$ comme la stratégie d'investissement

$$\alpha_t^*(\xi^*) = \frac{-1_{t \leq T-d}}{P_{22}(t, 0)} \left\{ (X_t^{\alpha^*} - \xi^*) P_{12}(t, 0) + \int_{t-d}^t \alpha_s^*(\xi) P_{22}(t, 0, s-t) ds \right\},$$

où P désigne la solution de (1.3.2)-(1.3.3)-(1.3.4). alors, le problème d'optimisation (1.3.7)-(1.3.8) admet $\alpha^*(\xi)$ comme contrôle optimal admissible et la fonction valeur est

$$\begin{aligned} \text{Var}(X_T^{\alpha^*}) &= \frac{P_{11}(0)}{1 - P_{11}(0)} (x_0 - c + K(\gamma))^2 \\ &+ \int_{-d}^0 \gamma_s^2 P_{22}(0, s) ds + \int_{[-d, 0]^2} \gamma_s \gamma_u P_{22}(0, s, r) ds dr. \end{aligned}$$

Résultats numériques : Du résultat mentionné ci-dessus émerge une application directe pour le schéma numérique présenté dans la section précédente. Voir les figures 1.3 et 1.4 pour quelques exemples.

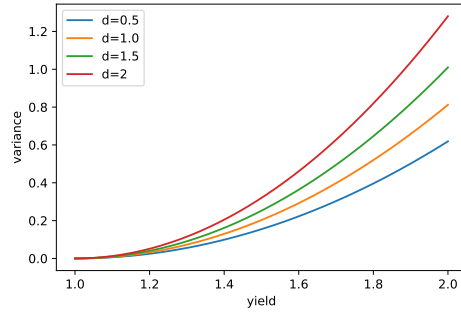
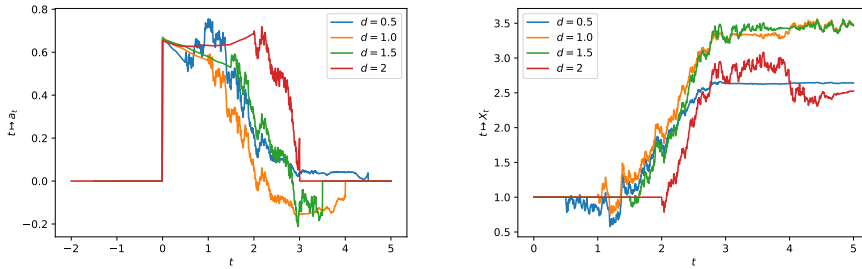
 FIGURE 1.3 – Frontière efficiente avec $\sigma = 1$, $\lambda = 0.5$, $T = 5$ et $\gamma \equiv 0$.

(a)

FIGURE 1.4 – Stratégies optimales et portefeuilles optimaux avec $c = 1.6$, $\sigma = 1$, $\lambda = 0.5$, et $T = 5$. Gauche : $t \mapsto \alpha^*$, droite : $t \mapsto X_t^*$. Notez l'effet de déstabilisation et le supplément de volatilité induit par la fonction de retard. Notez également la tendance à investir plus agressivement qu'à l'investisseur retardé, du fait du temps moindre pour assurer le rendement promis. $\xi^*(d = 0.5) = 2.57$, $\xi^*(d = 1) = 2.68$, $\xi^*(d = 1.5) = 2.80$, $\xi^*(d = 2) = 2.97$.

Pour explorer davantage l'effet du retard sur le problème de contrôle, nous étudions également, dans le chapitre IV, l'un des actifs avec retard et l'autre sans cas :

$$\begin{cases} dX_t^{(\alpha, \beta)} = \alpha_t \{(\sigma_1 \lambda_1) dt + \sigma_1 dW_t^1\} + \beta_{t-d} \{(\sigma_2 \lambda_2) dt + \sigma_2 dW_t^2\}, & t \in [0, T], \\ X_0 = x_0, \quad \beta_s = \gamma_s, \quad s \in [-d, 0], \\ \langle W^1, W^2 \rangle_t = \rho t, \end{cases} \quad (1.3.9)$$

où α désigne le montant investi dans l'actif risqué non retardé, β le montant investi dans l'actif retardé risqué, λ_i et σ_i sont des constantes représentant respectivement les primes de risque et les volatilités de les actifs risqués.

En suivant l'approche heuristique de la section 6.2, nous définissons l'ensemble sui-

vant d'EDPs de type Riccati sur $[0, T] \times [-d, 0]^2$

$$\dot{P}_{11}(t) = \lambda_1^2 P_{11}(t) + \frac{P_{12}(t, 0)^2}{P_{22}(t, 0)}, \quad (1.3.10)$$

$$(\partial_t - \partial_s)(P_{12})(t, s) = \lambda_1^2 P_{12}(t, s) + \frac{P_{12}(t, 0)P_{22}(t, s, 0)}{P_{22}(t, 0)},$$

$$(\partial_t - \partial_s)(P_{22})(t, s) = 0,$$

$$(\partial_t - \partial_s - \partial_r)(P_{22})(t, s, r) = \lambda_1^2 \frac{P_{12}(t, s)P_{12}(t, r)}{P_{11}(t)} + \frac{P_{22}(t, s, 0)P_{22}(t, 0, r)}{P_{22}(t, 0)},$$

accompagnée des conditions aux limites, pour presque tout $t, s \in [0, T] \times [-d, 0]$

$$P_{12}(t, -d) = \lambda_2 \sigma_2 \left(1 - \rho \frac{\lambda_1}{\lambda_2}\right) P_{11}(t), \quad P_{22}(t, -d) = \sigma_2^2 (1 - \rho^2) P_{11}(t), \quad (1.3.11)$$

$$P_{22}(t, s, -d) = \lambda_2 \sigma_2 \left(1 - \rho \frac{\lambda_1}{\lambda_2}\right) P_{12}(t, s), \quad P_{22}(t, -d, s) = \lambda_2 \sigma_2 \left(1 - \rho \frac{\lambda_1}{\lambda_2}\right) P_{12}(t, s),$$

et les contraintes terminales

$$P_{11}(T) = 1, \quad P_{12}(T, s) = P_{22}(T, s) = P_{22}(T, s, r) = 0, \quad (1.3.12)$$

for almost every $s, r \in [-d, 0]$.

Nous sommes maintenant équipés pour présenter la stratégie optimale ainsi que la fonction valeur du problème (1.3.1) dans le cas de 2 actifs.

Result 11: Un actif retardé et un actif non retardé

Supposons qu'il existe une solution P à (1.3.10)-(1.3.11)-(1.3.12). Soit $\xi^* = c - \eta^*$ et

$$\eta^* = \frac{K(\gamma) + P_{11}(0)(x_0 - c)}{1 - P_{11}(0)},$$

$$K(\gamma) = \int_{-d}^0 \gamma_s P_{12}(0, s) ds.$$

Définissons $(\alpha^*(\xi^*), \beta^*(\xi^*))$ comme

$$\alpha_t^*(\xi) = - \left\{ \frac{\lambda_1}{\sigma_1} (X_t^* - \xi) + \rho \frac{\sigma_2}{\sigma_1} \beta_{t-d}^* + \frac{\lambda_1}{\sigma_1 P_{11}(t)} \int_{t-d}^t \beta_s^*(\xi) P_{12}(t, s - t) ds \right\}.$$

$$\beta_t^*(\xi) = \frac{-1_{t \leq T-d}}{P_{22}(t, 0)} \left\{ P_{12}(t, 0) (X_t^* - \xi) + \int_{t-d}^t \beta_s^*(\xi) P_{22}(t, 0, r - t) dr \right\},$$

Alors, le problème d'optimisation (1.3.7)-(1.3.9) admet $(\alpha^*(\xi^*), \beta^*(\xi^*))$ comme stratégie optimale admissible et la fonction valeur est

$$\text{Var}(X_T^{\alpha^*}) = \frac{P_{11}(0)}{1 - P_{11}(0)} (x_0 - c + K(\gamma))^2$$

$$+ \int_{-d}^0 \gamma_s^2 P_{22}(0, s) ds + \int_{[-d, 0]^2} \gamma_s \gamma_u P_{22}(0, s, r) ds dr.$$

Simulations numériques : La flexibilité du schéma d'apprentissage présenté dans la section 2.3.2 permet une adaptation facile au nouvel ensemble d'EDPs de type Riccati

(1.3.10) - (??) - (1.3.12). Voir la figure 1.5 pour voir l'interaction entre la fonction de retard et la corrélation ρ , et le chapitre IV pour une analyse plus approfondie.

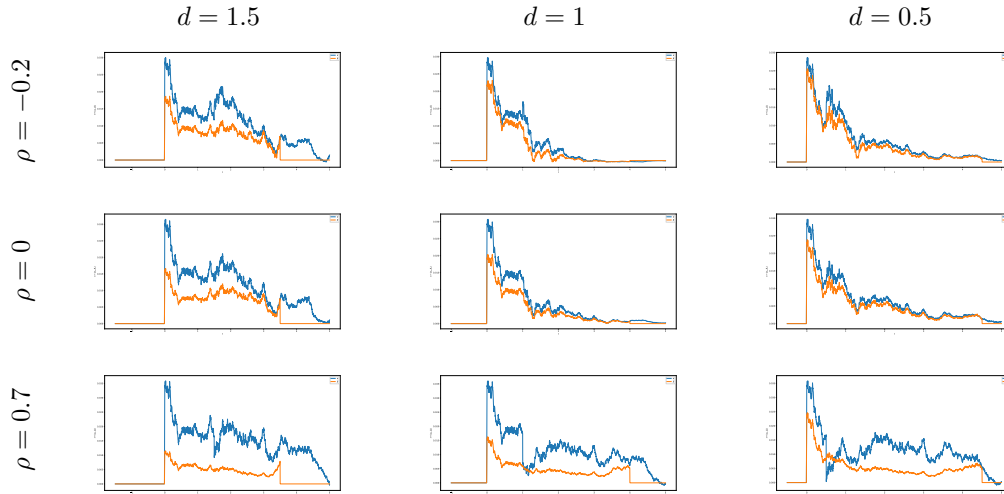

FIGURE 1.5 - $t \mapsto (\alpha_t^*, \beta_t^*)$, avec $\sigma_1 = \sigma_2 = 1$, $\lambda_1 = \lambda_2 = 0.5$ et $T = 5$. Bleu : α^* , orange : β^* . Les mêmes réalisations de W et B ont été utilisés pour toutes les expériences. Notez que plus les actifs sont corrélés positivement, plus l'actif non retardé est favorisé.

Introduction

The thesis is divided into three parts that can be read independently. In the first part, we provide an exhaustive treatment of Linear-Quadratic control problems for a class of stochastic Volterra equations of convolution type, whose kernels are Laplace transforms of certain signed matrix measures which are not necessarily finite. These equations are in general neither Markovian nor semimartingales, and include the fractional Brownian motion with Hurst index smaller than $1/2$ as a special case. We establish the correspondence of the initial problem with a possibly infinite dimensional Markovian one in a Banach space, which allows us to identify the Markovian controlled state variables. Using a refined martingale verification argument combined with a squares completion technique, we prove that the value function is of linear quadratic form in these state variables with a linear optimal feedback control, depending on non-standard Banach space valued Riccati equations. Furthermore, we show that the value function of the stochastic Volterra optimization problem can be approximated by that of conventional finite dimensional Markovian Linear-Quadratic problems. The existence of the Banach-valued Riccati equation is rigorously studied. In the second part, we study the continuous-time Markowitz mean-variance problem for a multivariate class of affine and quadratic Volterra models. In this incomplete non-Markovian and non-semimartingale market framework with unbounded random coefficients, the optimal portfolio strategy is expressed by means of a Riccati backward stochastic differential equation. In the case of affine Volterra models, we derive explicit solutions to this BSDE in terms of multi-dimensional Riccati-Volterra equations. This framework includes multivariate rough Heston models. In the quadratic case, we obtain new analytic formulae for the Riccati BSDE and we establish their link with infinite dimensional Riccati equations. This covers rough Stein-Stein and Wishart type covariance models. Numerical results on a two dimensional rough Stein-Stein model illustrate the impact of rough volatilities and stochastic correlations on the optimal Markowitz strategy. In particular for positively correlated assets, we find that the optimal strategy in our model is a *buy rough sell smooth* one. In the third part of the thesis, we consider a class of stochastic control problems with a delayed control, both in drift and diffusion. The optimal control and value of the problem are described in term of a set of Riccati partial differential equations whose existence and uniqueness are obtained in a simplified setting. A sufficient condition of existence, directly emerging from the delayed structure, is provided. A deep learning scheme is proposed and used to illustrate the effect of the delay on the Markowitz portfolio allocation problem with execution delay.

2.1 Volterra control

The first part of the thesis is dedicated to the control of d -dimensional stochastic Volterra processes of the form

$$X_t^\alpha = X_0 + \int_0^t K(t-s)b(X_s^\alpha, \alpha_s)ds + \int_0^t K(t-s)\sigma(X_s^\alpha, \alpha_s)dW_s, \quad (2.1.1)$$

with W a real valued Brownian motion, $b, \sigma : [0, T] \times \mathbb{R}^d \times \mathbb{R}^m \rightarrow \mathbb{R}^d$ of affine form:

$$\begin{aligned} b(t, x, a) &= Bx + Ca, \\ \sigma(t, x, a) &= Dx + Fa, \end{aligned}$$

and K a $d \times d'$ -matrix valued kernel. We endow the dynamic a cost functional

$$J(\alpha) = \mathbb{E} \left[\int_0^T ((X_s^\alpha)^\top Q X_s^\alpha + (\alpha_s)^\top N \alpha_s) ds + (X_T^\alpha)^\top P X_T^\alpha \right]. \quad (2.1.2)$$

Here, B, C, D, F, Q, N, P are matrices of suitable dimensions.

Note that by setting $K \equiv 1$, equation (2.1.1) reduces to the classical setting. Therefore, such model generalizes the standard Linear-Quadratic stochastic framework. However, usual methods for Markov processes and stochastic calculus for semimartingales can no longer be applied as such model do not fall in the semimartingale framework, as it can be seen with the celebrated Riemann-Liouville fractionnal kernel $K_H : t \mapsto t^{H-1/2}$ with $H \in (0, 1/2)$. Consequently, we develop in the following some techniques to treat such models. Our approach consists in lifting the system (2.1.1) in a infinite dimensional space where the dynamic is Markovian. But let us first present some motivations.

2.1.1 Motivations

From controlling a Brownian motion to controlling a rough Brownian motion

Consider the basic linear-quadratic regulator problem with Brownian motion noise W , described by a controlled linear dynamical system on \mathbb{R} :

$$X_t^\alpha = \int_0^t \alpha_s ds + W_t, \quad t \geq 0, \quad (2.1.3)$$

and a quadratic cost functional on finite horizon to minimize over real-valued control process $\alpha = (\alpha_t)_t$

$$J(\alpha) = \mathbb{E} \left[\int_0^T (|X_t^\alpha|^2 + \alpha_t^2) dt \right].$$

This LQ problem can be explicitly solved by different methods including standard dynamic programming, maximum principle or spike variation methods relying on Itô stochastic calculus, and it is well-known, see e.g. [YZ99], that the optimal control α^* is in linear feedback form w.r.t. the optimal state process $X^* = X^{\alpha^*}$:

$$\alpha_t^* = -\Gamma(t)X_t^*, \quad 0 \leq t \leq T,$$

where Γ is a deterministic positive function solution to a Riccati equation, and thus the associated optimal state process X^* is a mean-reverting Markov process. Suppose now

that the noise W is replaced by a Gaussian process with memory, typically a fractional Brownian motion, or more generally by stochastic Volterra processes.

$$X_t^\alpha = \int_0^t \alpha_s ds + \int_0^t K(t-s) dW_s, \quad t \geq 0, \quad K \in L^2(0, T).$$

A question that is naturally arising is how the structure of the solution is modified, and how it can be derived, knowing that in this case, we cannot directly apply stochastic calculus for semimartingales and usual methods for Markov processes.

Heat control in a bar

Let us now provide a (little bit) less toyish example. Suppose you have a semi-infinite one-dimensional bar whose temperature is described by the field $t, x \in \mathbb{R}_+ \mapsto T(t, x)$ and assume you control the rate of energy α the bar is exchanging with the exterior at $x = 0$. If the bar is insulated everywhere else, then T is solution to the boundary control problem

$$\begin{aligned} \partial_t T(t, x) &= \partial_{xx} T(t, x), & t, x \geq 0, \\ T(t, 0) &= \alpha_t + \dot{W}_t, \\ T(0, x) &= 0, \\ \lim_{x \rightarrow \infty} T(t, x) &= 0, \end{aligned}$$

where \dot{W} denotes a white noise. Using the Laplace transform, the reader may then notice that T can be rewritten as

$$T(t, x) = \frac{1}{\sqrt{\pi}} \int_0^t (t-s)^{-1/2} e^{-x^2/(4(t-s))} (\alpha_s ds + dW_s).$$

As a result, keeping for instance the temperature at position x^* around a target T_t^* can be cast as a Volterra control problem

$$\begin{aligned} T^\alpha(t, x^*) &= \int_0^t K_{x^*}(t-s) (\alpha_s ds + dW_s), \\ J(\alpha) &= \mathbb{E} \left[\int_0^T (T^\alpha(s, x^*) - T_s^*)^2 + \alpha_s^2 ds \right], \end{aligned}$$

where $K_{x^*}(t) = \left(\frac{1}{t\pi}\right)^{1/2} e^{-(x^*)^2/(4t)}$.

2.1.2 Literature review

The optimal control of stochastic Volterra equations has been considered in [Yon06] by maximum principle method leading to a characterization of the solution in terms of a backward stochastic Volterra equation for the adjoint process. In [AO15], the authors also use the maximum principle together with Malliavin calculus to obtain a corresponding adjoint equation as a standard backward SDE. Although the kernel considered in these aforementioned papers is not restricted to be of convolution type, the required conditions do not allow singularity of K at zero, hence excluding the case of a fractional kernel with parameter $H < 1/2$. More recently, an extended Bellman equation has been derived in [HW19] for the associated controlled Volterra equation.

The solution to the LQ control problem as in (3.1.1) with controlled drift and additive noise has been obtained in [KBV03] when the noise is a fractional Brownian motion with Hurst parameter $H > 1/2$, and in [DPD13] when the noise is a general Gaussian process with an optimal control expressed as the sum of the well-known linear feedback control

for the associated deterministic linear-quadratic control problem and the prediction of the response of the system to the future noise process. Recently, the paper [Wan18] investigated LQ problem of stochastic Volterra equations by providing characterizations of optimal control in terms of some forward-backward system, but leaving aside their solvability, and under some coefficients assumptions that preclude singular kernels such as the fractional kernel with parameter $H < 1/2$.

2.1.3 Our approach

Our approach mainly consists in making the hypothesis that the Volterra kernel K is the Laplace transform

$$K(t) = \int_{\mathbb{R}_+} e^{-\theta t} \mu(d\theta), \quad t > 0, \quad (2.1.4)$$

of a signed $d \times d'$ -measure μ satisfying

$$\int_{\mathbb{R}_+} (1 \wedge \theta^{-1/2}) |\mu|(d\theta) < \infty. \quad (2.1.5)$$

When such assumption is in force, a natural things to do is to approximate the measure μ with a finite sum of Dirac

$$\mu \approx \mu^n = \sum_{i=1}^n c_i^n \delta_{\theta_i^n},$$

thus inducing an approximation for the kernel K

$$K^n(t) = \int_{\mathbb{R}_+} e^{-\theta t} \mu^n(d\theta), \quad t > 0. \quad (2.1.6)$$

where $(x_i^n)_i$ and $(\eta_i^n)_i$ are appropriate sequences of non-negative real numbers. Then the key observation can be made by observing that such approximation yields the rewriting of X^α as a finite sum of factors

$$X_t^{n,\alpha} = \sum_{i=1}^n c_i^n Y_t^{n,i,\alpha},$$

where each factor Y_i^n is a Markovian OU-process

$$\begin{cases} dY_t^{n,i,\alpha} &= -\theta_i^n Y_t^{n,i,\alpha} + (B \sum_{i=1}^n c_i^n Y_t^{n,i,\alpha} + C\alpha_t)dt + (D \sum_{i=1}^n c_i^n Y_t^{n,i,\alpha} + F\alpha_t)dW_t \\ Y_0^{n,i,\alpha} &= 0. \end{cases}$$

Consequently, the non-Markovian optimization problem (2.1.1)-(2.1.2) in dimension d seems to be approachable through sequence of Markovian optimization problems in dimension nd

$$\begin{aligned} dY_t^{n,i,\alpha} &= -\theta_i^n Y_t^{n,i,\alpha} + (B\mu^n(Y_t^{n,\alpha}) + C\alpha_t)dt + (D\mu^n(Y_t^{n,\alpha}) + F\alpha_t)dW_t, \quad t \leq T, \\ Y_0^{n,i,\alpha} &= 0, \\ J^n(\alpha) &= \mathbb{E} \left[\int_0^T ((\mu^n(Y_s^{n,\alpha}))^\top Q(\mu^n(Y_s^{n,\alpha})) + \alpha_s^\top N \alpha_s) ds + (\mu^n(Y_T^{n,\alpha}))^\top P(\mu^n(Y_T^{n,\alpha})) \right]. \end{aligned} \quad (2.1.7)$$

Note that, as a result, we are now back to the classical realm of stochastic linear-quadratic control where the optimal feedback and the value function can be derived easily. From all these considerations, several question arise

- Does the sequence of optimization problem (2.1.7) approximate the initial optimization problem (2.1.1)-(2.1.2) ?
- Can we characterize the value function and the optimal feedback control ?

2.1.4 Our contributions

To answer these interrogations, we first draw the correspondence of the initial problem (2.1.1)-(2.1.2) with an infinite dimensional Markovian one in the Banach space $L^1(\mu)$.

Result 12: Markovian representation of the controlled dynamic

Fix $\alpha \in \mathcal{A}$. Assume that there exists a progressively measurable process such that X^α solves (2.1.1), \mathbb{P} -a.s., . Then, X^α admits the representation

$$X_t^\alpha = X_0 + \int_{\mathbb{R}_+} \mu(d\theta) Y_t^\alpha(\theta), \quad (2.1.8)$$

where, for each $\theta \in \mathbb{R}_+$,

$$Y_t^\alpha(\theta) = \int_0^t e^{-\theta(t-s)} b(s, X_s^\alpha, \alpha_s) ds + \int_0^t e^{-\theta(t-s)} \sigma(s, X_s^\alpha, \alpha_s) dW_s. \quad (2.1.9)$$

Starting from Result 12, we then obtain that the value function is of linear quadratic form on $L^1(\mu)$ with a linear optimal feedback control also on $L^1(\mu)$. These latter are expressed in terms of non-standard $L^1(\mu)$ -valued Riccati equations. To see this, let us fix some notations to work with. We define the mean-reverting operator A^{mr} acting on $\varphi \in L^1(\mu)$ by

$$(A^{mr}\varphi)(\theta) = -\theta\varphi(\theta), \quad \theta \in \mathbb{R}_+, \quad (2.1.10)$$

and set the dual pairing

$$\begin{aligned} \langle \varphi, \psi \rangle_\mu &= \int_{\mathbb{R}_+} \varphi(\theta)^\top \mu(d\theta)^\top \psi(\theta), \quad (\varphi, \psi) \in L^1(\mu) \times L^\infty(\mu^\top) \\ &= \int_{\mathbb{R}_+} \psi(\theta)^\top \mu(d\theta) \varphi(\theta), \quad (\varphi, \psi) \in L^\infty(\mu) \times L^1(\mu^\top). \end{aligned}$$

For any matrix-valued kernel G , we denote by \mathbf{G} the integral operator induced by G , defined by:

$$(\mathbf{G}\phi)(\theta) = \int_{\mathbb{R}_+} G(\theta, \theta') \mu(d\theta') \phi(\theta').$$

Then note that (3.2.10) can be rewritten

$$dY_t^\alpha = (A^{mr}Y_t^\alpha + \mathbf{B}Y_t^\alpha + C\alpha_t) dt + (\mathbf{D}Y_t^\alpha + F\alpha_t) dW_t, \quad Y_0^\alpha = 0.$$

Also, from Result (12) we see that the cost functional (2.1.2) can be reformulated in $L^1(\mu)$

$$J(\alpha) = \mathbb{E} \left[\int_0^T (\langle Y_s^\alpha, \mathbf{Q}Y_s^\alpha \rangle_\mu + \alpha_s^\top N \alpha_s) ds \right], \quad (2.1.11)$$

where, by a slight abuse of notations, C and F denote the respective constant operators induced by the matrices C and F :

$$(Ca)(\theta) = Ca, \quad (Fa)(\theta) = Fa, \quad \theta \in \mathbb{R}_+, \quad a \in \mathbb{R}^m.$$

Their adjoint operators C^*, F^* take the form

$$C^*g = C^\top \int_{\mathbb{R}_+} \mu(d\theta)^\top g(\theta), \quad F^*g = F^\top \int_{\mathbb{R}_+} \mu(d\theta)^\top g(\theta), \quad g \in L^1(\mu^\top).$$

Given the linear-quadratic structure of the problem, standard results in finite-dimensional stochastic control theory, see [YZ99, chapter 7], as well as in Hilbert spaces, see [Fla86; HT18], suggest the following verification result

Result 13: Verification theorem

Assume there exists auto-adjoint operator valued function $\mathbf{\Gamma}$ from $L^1(\mu)$ into $L^\infty(\mu^\top)$ solution to the Riccati equation

$$\begin{cases} \mathbf{\Gamma}_T = \mathbf{0} \\ \dot{\mathbf{\Gamma}}_t = -\mathbf{\Gamma}_t A^{mr} - (\mathbf{\Gamma}_t A^{mr})^* - \mathbf{Q} - \mathbf{D}^* \mathbf{\Gamma}_t \mathbf{D} - \mathbf{B}^* \mathbf{\Gamma}_t - (\mathbf{B}^* \mathbf{\Gamma}_t)^* \\ \quad + (\mathbf{C}^* \mathbf{\Gamma}_t + \mathbf{F}^* \mathbf{\Gamma}_t \mathbf{D})^* (N + \mathbf{F}^* \mathbf{\Gamma}_t \mathbf{F})^{-1} (\mathbf{C}^* \mathbf{\Gamma}_t + \mathbf{F}^* \mathbf{\Gamma}_t \mathbf{D}), \quad t \in [0, T]. \end{cases}$$

Then the value function of (2.1.1)-(2.1.2) reads

$$V_t^{\alpha^*} = \langle Y_t^{\alpha^*}, \mathbf{\Gamma}_t Y_t^{\alpha^*} \rangle_\mu,$$

and the optimal feedback control takes the form

$$\alpha_t^* = -(N + \mathbf{F}^* \mathbf{\Gamma}_t \mathbf{F})^{-1} (\mathbf{C}^* \mathbf{\Gamma}_t + \mathbf{F}^* \mathbf{\Gamma}_t \mathbf{D}) Y_t^{\alpha^*}.$$

Furthermore, we show that $\mathbf{\Gamma}$ is actually an integral operator whose associated symmetric kernel satisfies the following Riccati equation :

$$\begin{cases} \Gamma_T(\theta, \tau) = 0 \\ \dot{\Gamma}_t(\theta, \tau) = (\theta + \tau) \Gamma_t(\theta, \tau) - Q - D^\top \int_{\mathbb{R}_+^2} \mu(d\theta')^\top \Gamma_t(\theta', \tau') \mu(d\tau') D \\ \quad - B^\top \int_{\mathbb{R}_+} \mu(d\theta')^\top \Gamma_t(\theta', \tau) - \int_{\mathbb{R}_+} \Gamma_t(\theta, \tau') \mu(d\tau') B + S_t(\theta)^\top \hat{N}_t^{-1} S_t(\tau), \end{cases} \quad (2.1.12)$$

where

$$S_t(\tau) = C^\top \int_{\mathbb{R}_+} \mu(d\theta)^\top \Gamma_t(\theta, \tau) + F^\top \int_{\mathbb{R}_+^2} \mu(d\theta')^\top \Gamma_t(\theta', \tau') \mu(d\tau') D$$

$$\hat{N}_t = N + F^\top \int_{\mathbb{R}_+^2} \mu(d\theta)^\top \Gamma_t(\theta, \tau) \mu(d\tau) F.$$

We show an existence result for the aforementioned Riccati equation (4.1.1).

Result 14: Existence and uniqueness of Riccati kernel

Let μ be a $d \times d'$ -signed matrix measure satisfying (3.2.3). Assume that

$$Q \in \mathbb{S}_+^d, \quad N - \lambda I_m \in \mathbb{S}_+^m, \quad (2.1.13)$$

for some $\lambda > 0$. Then, there exists a unique solution $\Gamma \in C([0, T], L^1(\mu \otimes \mu))$ to the kernel Riccati equation (4.1.1) such that $\Gamma_t \in \mathbb{S}_+^d(\mu \otimes \mu)$, for all $t \leq T$.

Finally, we show that the value function of the stochastic Volterra optimization problem (2.1.1)-(2.1.2) can be approximated by that of conventional finite dimensional Markovian Linear-Quadratic problems, which opens the door for easy to implement numerical simulations.

Result 15: Finite dimensional approximation

Assume that μ satisfies (3.2.3) and let K be as in (3.2.2). Let $(K^n)_{n \geq 1}$ be a sequence of kernels of the form (3.3.19) with respective measures μ^n satisfying (3.2.3), for each $n \in \mathbb{N}$. Assume (4.2.6) and that Q is invertible. Denote by V^* and V^{n*} the respective optimal value functions of (2.1.1)-(2.1.2) and (2.1.7). If

$$\|K^n - K\|_{L^2(0,T)} \rightarrow 0, \quad \text{as } n \rightarrow \infty, \quad (2.1.14)$$

then,

$$V^{n*} \rightarrow V^*, \quad \text{as } n \rightarrow \infty. \quad (2.1.15)$$

2.2 Rough Mean-Variance

2.2.1 When Markowitz gets rough

In this part, we study the mean-variance portfolio selection problem combined when volatility gets rough. Let's recall what is the Markowitz portfolio allocation problem. The goal is the following: assume you have a set of stocks that you can buy and sell. Of course their prices can move randomly but you have developed a model and have a guess about their drift, their volatility, their correlations, etc. The question is then : How can I ensure a certain average yield for my portfolio while minimizing the volatility of my wealth ?

$$\min_{\mathbb{E}(X_T)=m} \text{Var}(X_T).$$

A vast volume of research has been devoted to this problem and its extension. In parallel, financial process modeling have greatly improved since the seminal work of Louis Bachelier ([Dav+11]) and random walks. It is now well-established since the seminal paper by [GJR18a] that volatility is rough, modeled by fractional Brownian motion with small Hurst parameter.

$$\sigma_t \approx \int_0^t (t-s)^{H-1/2} dW_s, \quad H \approx 0.1.$$

Obviously, a clever investor would tend to prefer stocks with high yield, low volatility and uncorrelated (or even anti-correlated) but the question of how investors should take into account the roughness of stocks remains open. The research on portfolio optimization in fractional and rough environments is still little developed but has gained an increasing attention with the recent papers of [FH18; BD20; HW20b], which consider fractional Ornstein-Uhlenbeck and Heston stochastic volatility models for power utility function criterion, and the work by [HW20a] where the authors study the Markowitz problem in a Volterra Heston model, which covers the rough Heston model of [EER18]. The question we would like to shed some lights on is the following: **Given a market with multiple assets, how is the roughness of a stock should be taken into account in portfolio allocation ?**

2.2.2 An example with two stocks

Fix some horizon $T > 0$, and consider a financial market on $[0, T]$ with a non-risky asset S^0

$$S_t^0 = 1,$$

and two risky stocks $S_t = (S_t^1, S_t^2) : dS_t = \text{diag}(S_t)(\sigma_t \lambda_t dt + \sigma_t dB_t)$ where B is a two dimensional Brownian motion. Here σ denotes a $\mathbb{R}^{2 \times 2}$ valued process called stochastic volatility, and λ a \mathbb{R}^2 valued stochastic called market price of risk ($\approx \frac{\sigma}{risk}$). In order to work with a simple model, assume that stock prices follow

$$\begin{cases} dS_t^i &= S_t^i \left(\theta(Y_t^i)^2 dt + Y_t^i d\tilde{B}_t^i \right), \\ Y_t^i &= Y_0 + \int_0^t (t-s)^{H_i-1/2} \eta_i dW_s^i, \quad i = 1, 2, \end{cases} \quad (2.2.1)$$

with $0 < H_1 < H_2 \leq 1/2$ and some correlation structure

$$\tilde{B}^1 = B^1, \quad \tilde{B}^2 = \rho B^1 + \sqrt{1-\rho^2} B^2, \quad W^i = c_i \tilde{B}^i + \sqrt{1-c_i^2} \tilde{B}^{i,\perp},$$

where $(B^{1,\perp}, B^{2,\perp})$ is a two dimensional Brownian motion independent of B and $\eta = (\eta_1, \eta_2)$ the *volatility of volatility*.

Remark 2.2.1. *In this introduction we motivate our work with the 2-assets Stein-Stein model. We refer to Part III for a general treatment of the affine and quadratic models.*

Let π_t^0, π_t^1 and π_t^2 be the amounts respectively invested in the non-risky asset and the risky assets 1 and 2 at time t . If $N_t = (N_t^1, N_t^2)^\top$ is the number of shares owned in the risky assets, then the dynamics of the wealth $X_t = N_t^\top S_t + \pi_t^0$ of the self-financing portfolio is given by

$$\begin{aligned} dX_t &= N_t^\top dS_t \\ &= N_t^\top \text{diag}(S_t) [(\sigma_t \lambda_t) dt + \sigma_t dB_t] \\ &= \alpha_t^\top (\lambda_t dt + dB_t), \quad X_0 = x_0 \in \mathbb{R}, \end{aligned}$$

where we have set $\alpha = \sigma^\top \pi$.

Remark 2.2.2. *Model (2.2.1) implies*

$$\sigma = \begin{pmatrix} Y_1 & 0 \\ Y_2 \rho & Y_2 \sqrt{1-\rho^2} \end{pmatrix}, \quad \lambda = \begin{pmatrix} 1 & 0 \\ \rho & \sqrt{1-\rho^2} \end{pmatrix}^{-1} \begin{pmatrix} \theta_1 Y_1 \\ \theta_2 Y_2 \end{pmatrix}.$$

The Markowitz portfolio selection problem in continuous-time then consists in solving the following constrained problem

$$\begin{aligned} V(m) &= \inf_{\alpha \in \mathcal{A}} \{ \text{Var}(X_T) : \text{s.t. } \mathbb{E}[X_T] = m \} \\ dX_t &= \alpha_t^\top (\lambda_t dt + dB_t), \quad X_0 = x_0 \in \mathbb{R}. \end{aligned} \quad (2.2.2)$$

2.2.3 From Riccati equations to portfolio allocation

Note that unlike in Section 2.1, the dynamics of the controlled state X is Markovian. Thus, it can be solved with classical method from linear quadratic control. We have the following result.

Result 16: Verification theorem

Assume that there exists a solution triplet (Γ, Z^1, Z^2) to the Riccati BSDE

$$\begin{cases} d\Gamma_t &= \Gamma_t \left[|\lambda_t + Z_t^1 + CZ_t^2|^2 dt + (Z_t^1)^\top dB_t + (Z_t^2)^\top dW_t \right], \\ \Gamma_T &= 1, \end{cases} \quad (2.2.3)$$

such that

(H1) $0 < \Gamma_0 < e^{2 \int_0^T r(s) ds}$, and $\Gamma_t > 0$, for all $t \leq T$,

(H2) There exists a $p > 2$ such that

$$\mathbb{E} \left[\exp \left(a(p) \int_0^T (|\lambda_s|^2 + |Z_s^1|^2 + |Z_s^2|^2) ds \right) \right] < \infty, \quad (2.2.4)$$

with $a(p)$ being an explicit constant.

Then, the optimal investment strategy is given by

$$\alpha_t^* = (\lambda_t + Z_t^1 + CZ_t^2)(\xi^* - X_t^*), \quad \xi^* = \frac{m - \Gamma_0 x_0}{1 - \Gamma_0}, \quad (2.2.5)$$

and the value of the optimal wealth process is

$$V(m) = \mathbb{V}(X_T^*) = \Gamma_0 \frac{|x_0 - m|^2}{1 - \Gamma_0}. \quad (2.2.6)$$

Although the structure of the above result is quite classical, note the presence of condition (H2) which enables us to unify numerous results in the literature, see Table 5.1. Looking closely at ξ^* it is easy to see that $\xi^* \geq m$ (recall that $x_0 < m$). Thus, the dynamics of the controlled optimal wealth X^* reads

$$dX_t^* = (\lambda_t + Z_t^1 + CZ_t^2)(\xi^* - X_t^*)(\lambda_t dt + dB_t).$$

From $x_0 < m < \xi^*$ and the continuity of X^* , we have $X^* \leq \xi^*$ on $[0, T]$. Consequently, to grasp the effect of the roughness's of stocks upon the investment strategy, one needs to understand its effect on Z^1 and Z^2 .

$$\alpha_t^* = \underbrace{(\lambda_t + Z_t^1 + CZ_t^2)}_{\text{random vector to study}} \underbrace{(\xi^* - X_t^*)}_{\in \mathbb{R}_+}.$$

To do so, the key idea is to observe that, if such solution exists, then, it admits the following representation of a Laplace transform of a squared norm of a Gaussian variable:

$$\Gamma_t = \mathbb{E} \left[\exp \left(- \underbrace{\int_t^T (|\lambda_s + Z_s^1 + CZ_s^2|^2) ds}_{\approx \text{squared Gaussian}} \right) \middle| \mathcal{F}_t \right], \quad 0 \leq t \leq T.$$

Or, if $G \sim N(\mu, \Sigma)$ is a n -dimensional Gaussian variable, then

$$\mathbb{E} (\exp(-u|G|^2)) = \frac{\exp(-u(\mu^\top(I_n + 2\Sigma u)^{-1}\mu))}{\det(I_n + 2\Sigma u)^{1/2}}, \quad u \geq 0.$$

From the expression above, one sees that an intuitive thing to do is to make the approximation

$$\int_t^T |\lambda_s + Z_s^1 + CZ_s^2|^2 ds \approx n^{-1} \sum_{i=1}^n G_{iT/n}^2 \sim |N(\mu_n, \Sigma_n)|^2,$$

where $G_{i/n} = \left| \lambda_{iT/n} + Z_{iT/n}^1 + CZ_{iT/n}^2 \right|^2$ and

$$\mu_n = \mathbb{E}[(G_{T/n}, \dots, G_T) | \mathcal{F}_t], \quad \Sigma_n = \mathbb{E}[(G_{T/n}, \dots, G_T)^T (G_{T/n}, \dots, G_T) | \mathcal{F}_t].$$

As a result, we expect

$$\begin{aligned} \Gamma_t &= \mathbb{E} \left[\exp \left(- \int_t^T (|\lambda_s + Z_s^1 + CZ_s^2|^2) ds \right) \mid \mathcal{F}_t \right] \\ &\approx \lim_{n \rightarrow \infty} \frac{\exp(-(\mu_n^\top (I_n + 2\Sigma_n)^{-1} \mu_n))}{\det(I_n + 2\Sigma_n)^{1/2}}. \end{aligned}$$

The natural questions are then

1. To what limit do these object of size n converge as $n \rightarrow \infty$?
 - As n tends to infinity, big matrices converge to operators. Thus, a natural infinite dimensional space appears : $L^2([0, T])$.
2. Who should play the role of μ_n ?
 - the *forward process* $g_t(s) = \mathbb{E}[Y_s | \mathcal{F}_t]$, $s \geq t$.
3. Who should play the role of Σ_n ?
 - roughly speaking, the *conditional covariance process* of the *forward process*

To answer these questions we introduce the relevant infinite dimensional setting. Let $\langle \cdot, \cdot \rangle_{L^2}$ be inner product on $L^2([0, T], \mathbb{R}^N)$ that is

$$\langle f, g \rangle_{L^2} = \int_0^T f(s)^\top g(s) ds.$$

For every $K \in L^2([0, T]^2, \mathbb{R}^{N \times N})$, we denote by \mathbf{K} the integral operator induced :

$$(\mathbf{K}g)(s) = \int_0^T K(s, u)g(u)du.$$

We then have the following result.

Result 17: Riccati BSDE - Riccati operator - Forward process

Let $t \mapsto \Psi_t$ be the solution of the operator Riccati equation

$$\begin{aligned} \dot{\Psi}_t &= 2\Psi_t \dot{\Sigma}_t \Psi_t, \quad t \in [0, T], \\ \Psi_T &= -\left(\text{Id} - \hat{K}\right)^{-*} \Theta^\top \Theta \left(\text{Id} - \hat{K}\right)^{-1}, \end{aligned} \quad (2.2.7)$$

where

- \hat{K} is the integral operator induced by the kernel $\hat{K} = -2K(\eta C^\top \Theta)$,
- $\tilde{\Sigma}_t = (\text{Id} - \hat{K})^{-1} \Sigma_t (\text{Id} - \hat{K})^{-*}$,
- Σ_t is defined as the integral operator associated to the kernel.

$$\Sigma_t(s, u) = \int_t^{s \wedge u} K(s, z) \eta (U - 2C^\top C) \eta^\top K(u, z)^\top dz, \quad t \leq T,$$

where $U = (1_{i=j} + 1_{i \neq j} c_i c_j)_{1 \leq i, j \leq 2}$ and $C = (c_1, c_2)^\top$.

Then, the process (Γ, Z^1, Z^2) defined by

$$\begin{cases} \Gamma_t &= \exp(\phi_t + \langle g_t, \Psi_t g_t \rangle_{L^2}), \quad t \leq T, \\ Z_t^1 &= 0, \\ Z_t^2 &= 2((\Psi_t K \eta)^* g_t)(t), \end{cases}$$

where $\Phi_t = \ln(\det(\Psi_t \Lambda_t))$, is solution to the Riccati BSDE (2.2.3).

2.2.4 Numerical results

Consequently, the optimal control is of the form

$$\alpha_t^* = \underbrace{\left((\Theta + 2C [\Psi_t K \eta]^*) g_t \right)}_{\text{Numerically tractable with simple linear algebra!}}(t) \left(\xi^* - X_t^{\alpha^*} \right).$$

Finally, we make the claim that $t \mapsto 2C [\Psi_t K \eta]^* g_t(t)$ is easy to approximate with basic linear algebra. The reasons are the following :

1. The operator valued function $t \mapsto \Psi_t$ is explicit;
2. Operators and functions can be stored as matrices.

The first claim comes from the next result

Result 18: Explicit Ψ

The solution operator Ψ of (2.2.7) is of the form

$$\Psi_t = -\left(\text{Id} - \hat{K}\right)^{-*} \Theta^\top \left(\text{Id} + 2\Theta \tilde{\Sigma}_t \Theta^\top\right)^{-1} \Theta \left(\text{Id} - \hat{K}\right)^{-1}, \quad 0 \leq t \leq T.$$

Finally, let us explain the second claim. The idea comes from the limit argument presented in Section 2.2.3 and is the following : assume \mathbf{H} is an integral operator induced

by a kernel $H \in L^2([0, T]^2)$ and f a function in $L^2([0, T])$. We proceed by discretization :

$$(\mathbf{H}f)(s) = \int_0^T H(s, r)f(r)dr \approx \frac{1}{n} \sum_1^n H(s, \frac{iT}{n})f(\frac{iT}{n}), \quad s \in \{\frac{T}{n}, \dots, T\}.$$

Thus the objects needed to be stored in order to represent the operator \mathbf{H} and the element f are respectively a matrix $(H(iT/n, jT/n))_{1 \leq i, j \leq n}$ and a vector $(f(\frac{iT}{n}))_{1 \leq i, j \leq n}$. Each time we need to compose an integral operator with another one, we multiply the matrices involved and apply the $\frac{T}{n}$ scaling. Beware when the operator is not of the integral type, for instance :

$$(\Theta f)(s) = \theta f(s),$$

as the T/N scaling is not needed anymore. In such a case, the operator is simply stored as a matrix $Id_n \otimes \theta$ where \otimes denotes the kronecker product. Note that when non-integral operators are composed, the $\frac{T}{n}$ scaling is not needed.

Remark 2.2.3. *As one may have noticed, there is a little issue when several operators that are the sum of an integral operator and a non-integral operator are composed (which is the case of Ψ in our case). For instance assume that*

$$(\mathbf{H}f)(s) = \theta f(s) + \int_0^T H(s, r)f(r)dr,$$

then $\mathbf{H} - \theta$ is an integral operator but not θ .

Numerical simulations: We share our various simulations on the model (2.2.1) in an IPython notebook*. We were able to reproduce a *buy rough sell smooth* strategy in the case where $\rho > 0$, i.e. when stocks are similar in the sense that their prices move up and down together on average. See Figure ???. At this stage, there is no clear explanation as of why such allocation should yield superior results, even if we make some hypothesis in [JMP20b]. Nonetheless, our analysis tends toward an endogenous explanation to this phenomena, complementary to the ones given in [GH20b] where exogenous influences such as *compensation for near-term idiosyncratic event risk* are given. Finally our analysis tends to show, in accordance to [GH20b], that the length of the horizon T matters. Testing data with different T could be an interesting line of work. To see more in depth analysis, see III.

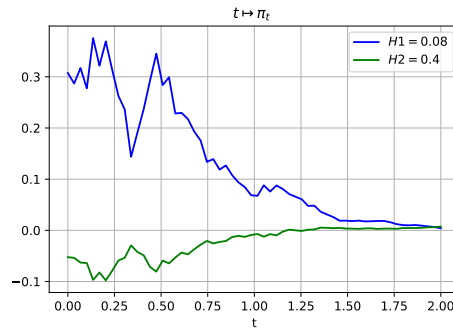

Figure 2.1 – $\rho = 0.7$, $H_1 = 0.08$, $H_2 = 0.4$, $T = 2.1$, $\eta_1 = \eta_2 = 1$, $c_i = -0.7$. The *buy rough sell smooth* strategy as described in [GH20b] is recovered.

*https://colab.research.google.com/drive/1P_SYE3WgFgwUKpOo8uCBDdIC04XyxE2a?usp=sharing

2.3 Control with delay

Part IV is devoted to the control of systems with delays. The time needed to acquire information, compute decision and execute make delays in control systems ubiquitous. Various effects of delays on traffic flow modelling, chemical processes, population dynamics, supply chain, advertising have been studied in the literature.

In a delayed controlled system, the state X and the control α are the two main components which can present a delay feature. When the delay is only present in the state variable, the problem is now well understood as it suffices to lift the state variable to the infinite dimensional space $(X_t, s \in [-d, 0] \mapsto X_{t+s})$, see [DM72], [FGG10] to name just a few. A much less understood situation is when the delay enters the control variable. In this situation, two main approaches have emerged: the *structural state method* and the *extended state method*, we refer to [Ben+07, Part II, Chapter 3] for the study of these latter in the deterministic case and [FF14] for the structural state approach in the stochastic case. For a complete list of references see also [FF14].

In our work, we aim at shedding some lights on the non deterministic case where a delay enters the control, both in drift and volatility. In our work, we consider the following class of stochastic delayed linear-quadratic control problem

$$\begin{cases} dX_t^\alpha = \alpha_{t-d}(bd + \sigma dW_t), & 0 \leq t \leq T, \\ X_0 = x, \quad \alpha_s = \gamma(s), & s \in [-d, 0], \quad x \in \mathbb{R} \\ J(\alpha) = \mathbb{E}[(X_T^\alpha)^2]. \end{cases} \quad (2.3.1)$$

Except in [FF14], this situation is not treated theoretically nor numerically in the references above. The main difficulty comes from the fact that optimization problems with a delayed control naturally belong to the class of *boundary control problems*.

2.3.1 Verification and existence results

Our approach is inspired from the *extended state* approach initiated by Ichikawa, see [Ich82], where the key idea is to lift the initial state space, namely \mathbb{R} , to the infinite dimensional Hilbert space $H = \mathbb{R} \times L^2([-d, 0], \mathbb{R})$, endowed with the inner product

$$\langle x, y \rangle_H = x_0 y_0 + \int_{-d}^0 x_1(s) y_1(s) ds \quad x, y \in H.$$

For each element $(x, u) \in H$, the first element x is to be interpreted as the *position* of the controlled system, and the second one $s \in [-d, 0] \mapsto u(s)$ as the history of the control. Our next result extends to the stochastic case deterministic results in [Ale+71] and [Ich82]. The value function and optimal control of (2.3.1) are expressed in terms of a self-adjoint bounded positive operator valued function $P \in C([0, T], \mathcal{L}(H, H))$ of the form

$$P_t : (x, \gamma(\cdot)) \mapsto \begin{pmatrix} P_{11}(t)x + \int_{-d}^0 P_{12}(t, s)\gamma(s)ds \\ P_{12}(t, \cdot)x + P_{22}(t, \cdot)\gamma(\cdot) + \int_{-d}^0 P_{22}(t, \cdot, s)\gamma(s)ds \end{pmatrix}.$$

which satisfies a set of Riccati partial differential equations

$$\begin{aligned} \dot{P}_{11}(t) &= \frac{P_{12}(t, 0)^2}{P_{22}(t, 0)}, & (\partial_t - \partial_s)(P_{12})(t, s) &= \frac{P_{12}(t, 0)P_{22}(t, s, 0)}{P_{22}(t, 0)}, & (2.3.2) \\ (\partial_t - \partial_s)(P_{22})(t, s) &= 0, & (\partial_t - \partial_s - \partial_r)(P_{22})(t, s, r) &= \frac{P_{22}(t, s, 0)P_{22}(t, 0, r)}{P_{22}(t, 0)}, \end{aligned}$$

together with boundary conditions

$$\begin{aligned} P_{12}(t, -d) &= bP_{11}(t), & P_{22}(t, -d) &= \sigma^2 P_{11}(t), \\ P_{22}(t, s, -d) &= bP_{12}(t, s), & P_{22}(t, -d, r) &= bP_{12}(t, r), \end{aligned} \quad (2.3.3)$$

and final conditions

$$P_{11}(T) = 1, \quad P_{12}(T, s) = P_{22}(T, s) = P_{22}(T, s, r) = 0, \quad (2.3.4)$$

for almost every $s, r \in [-d, 0]$.

Result 19: Verification theorem

Assume that there exists a solution P to (2.3.2)-(2.3.3)-(2.3.4). Then, the optimal control of optimization problem (2.3.1) is

$$\alpha_t^* = \frac{-1_{t \leq T-d}}{P_{22}(t, 0)} \left\{ X_t^{\alpha^*} P_{11}(t, 0) + \int_{t-d}^t P_{22}(t, 0, s-t) \alpha_s^* ds \right\},$$

and the optimal value is given by

$$V(z) = \langle P_0 z, z \rangle_H, \quad (2.3.5)$$

where $z = (x, \gamma) \in H$ denotes the initial state of the controlled system.

The next step is to give an existence result on $P = (P_{11}, P_{12}, P_{22}, P_{22})$. In the case without delay, $d = 0$, although we do not penalize the control, the optimization problem (2.3.1) admits an optimizer provided $\sigma \neq 0$. Indeed, the more α is aggressive in bringing X to 0, the more the second moment of X increases due to the diffusion term. It is easily observable in the classical LQ stochastic optimization problem with controlled volatility such as

$$\begin{aligned} dX_t^\alpha &= \alpha_t (bdt + \sigma dW_t), & t &\leq T, \\ X_0 &= x, \\ J(\alpha) &= \mathbb{E}[(X_T^\alpha)^2], \end{aligned}$$

where the optimal control reads $\alpha_t^* = -\frac{b}{\sigma^2} X_t^{\alpha^*}$ and the value function $V_t = e^{(t-T)\frac{b^2}{\sigma^2}}$. A surprising finding in our work is the necessity for a more restricting constraint on the diffusion coefficient when the delay feature is not null, $d > 0$.

Let $a = (a_n)_{n \geq 1}$ denotes the following sequence

$$\begin{cases} a_0 &= 1, \\ a_{n+1} &= a_n - \frac{d}{a_n} \left(\frac{b}{\sigma}\right)^2, \quad n \geq 0, \end{cases} \quad (2.3.6)$$

and define $\mathcal{N} : (d, b, \sigma) \mapsto \inf\{n \geq 1 : a_n > 0 \text{ and } a_{n+1} \leq 0\}$. We express the existence result on P in term of the sequence a .

Result 20: Existence of $t \in [0, T] \mapsto P_t$

Assume $T < \mathcal{N}(d, b, \sigma)d$. Then (2.3.2)-(2.3.3)-(2.3.4) has a unique solution P on $[0, T]$ with $0 < P_{11}(0) < 1$.

2.3.2 Deep learning scheme for PDEs

We now propose an algorithm to approximate $t \mapsto P_t$. As P is characterised by a set of differential equations, we decide to make use of neural networks in the spirit of the emerging Physics Informed Neural Networks (PINNs) and Deep Galerkin literatures, see [SS18] and [RPK19] to name just a few.

Let us recall some of the main ideas. Assume we want to simulate a nonlinear partial differential equation of the form

$$\begin{aligned} \partial_t u + \mathcal{N}(u) &= 0, & \text{on } \Omega, \\ u &= g, & \text{on } \partial\Omega, \end{aligned} \quad (2.3.7)$$

where \mathcal{N} is a nonlinear operator, Ω a bounded open subset and g a function on the boundary of the domain. The key idea is to use a neural network as a surrogate to the solution u to (2.3.7). Thus, let us call $t \mapsto u(t, \Theta)$ such network, where Θ denotes its coefficients and t a generic element of $\Omega \cup \partial\Omega$. The strategy rely on minimizing the following loss functional over mini batches:

$$\mathcal{L}(\Theta, \mathcal{T}) = \mathcal{L}_u(\Theta, \mathcal{T}) + \mathcal{L}_f(\Theta, \mathcal{T}), \quad (2.3.8)$$

where \mathcal{L}_u and \mathcal{L}_f are defined as

$$\mathcal{L}_r(\Theta, \mathcal{T}) = \frac{1}{|\mathcal{T}_r|} \sum_{t \in \mathcal{T}_r} |(\partial_t + \mathcal{N})u(t, \Theta)|^2, \quad \mathcal{L}_f(\Theta, \mathcal{T}) = \frac{1}{|\mathcal{T}_f|} \sum_{t \in \mathcal{T}_f} |u(t, \Theta) - g(t)|^2.$$

The subsets $\mathcal{T}_r = \mathcal{T} \cap \Omega$ and $\mathcal{T}_f = \mathcal{T} \cap \partial\Omega$ are respectively random subsets of Ω and $\partial\Omega$. We summarize the numerical procedure in Algorithm 2.1.

Algorithm 2.1 Deep learning scheme to solve PDEs

Initialize: the learning rate η and the neural network $u(\cdot, \Theta)$;

For each batch:

Randomly sample $\mathcal{T} \subset \partial\Omega \cup \Omega$;

Compute the gradient's loss (2.3.8): $\nabla_{\Theta} \mathcal{L}(\Theta, \mathcal{T}) = \nabla_{\Theta} (\mathcal{L}_r + \mathcal{L}_f)(\Theta, \mathcal{T})$;

Update $\Theta \leftarrow \Theta - \eta \nabla_{\Theta} \mathcal{L}(\Theta, \mathcal{T})$;

Return: The set of optimized parameters Θ^* .

The precise structure of (2.3.2)-(2.3.3)-(2.3.4) led us toward a tailored-made algorithm.

Comments on the method: The Deep Galerkin method offers an easy to implement procedure to approximate solutions of any differential equations on the whole domain $\Omega \cup \partial\Omega$. In theory they allow a high dimensional output space, although more investigations are expected on this topic. In Part IV, we adapt the Deep Galerkin method to solve the system of PDEs (2.3.2)-(2.3.3)-(2.3.4) in the context of Markowitz portfolio allocation with execution delay. Note that in this case the output dimension is 4.

Nonetheless, the Deep Galerkin method does not extend well to the case where the input space is high dimensional, say 100 for instance. Such case is important as it is common in finance, operational research, physics, etc. In [HJW18], the author suggests an another approach based on the Feynman-Kac representation of certain PDEs emerging from particle systems. This kind of method is well suited for high dimensional problem whose physicist's interpretation is based on particle systems but suffer from several drawbacks:

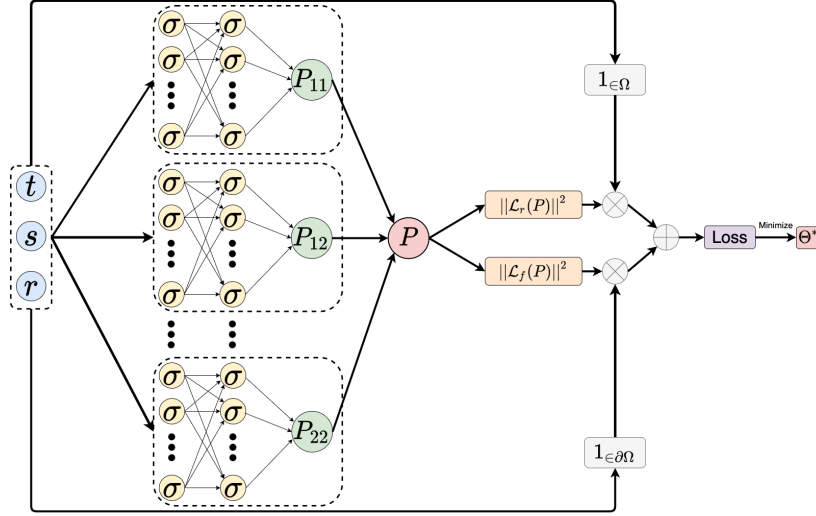

Figure 2.2 – Structure of the model used to solve (6.2.9)-(6.2.10)-(6.2.11).

- the need for a Feynman-Kac formula thus restricting the kind of differential equations solvable,
- the output dimension cannot easily be greater than 1,
- the solution is only computed in a small area of the domain.

Thus, we view these methods as being complementary and sum up some of their characteristic in Table 2.1

	dim. input $\gg 1$	dim. output $\gg 1$	Any diff. eq.
Deep backward ([HJW18])	✓	✗	✗
Deep Galerkin ([SS18])	✗	✓	✓

Table 2.1 – Comparison of neural networks schemes to solve PDEs.

2.3.3 Application to Markowitz portfolio allocation with execution delay

We now apply our numerical scheme to the mean-variance portfolio selection, see [Mar52b], with execution delay in the spirit of the problem of hedging of European options with execution delay presented in [FF14]. The Mean-Variance portfolio selection problem in continuous-time consists in solving the following constrained problem

$$\begin{cases} \min_{\alpha \in \mathcal{A}} \text{Var}(X_T^\alpha) \\ \text{s.t. } \mathbb{E}[X_T^\alpha] = c. \end{cases} \quad (2.3.9)$$

where X^α denotes the wealth of the investor controlled by an investment strategy α . In our work, we first study the one asset with delay case

$$\begin{cases} dX_t^\alpha = \alpha_{t-d} ((\sigma\lambda) dt + \sigma dW_t), & t \in [0, T], \\ X_0 = x_0, \quad \alpha_s = \gamma_s, & \forall s \in [-d, 0], \end{cases} \quad (2.3.10)$$

where α denotes the amount invested in the risky asset, and λ and σ are constants representing respectively the risk premium and the volatility of the risky asset. Note that the one delayed asset case allows for a direct application of Results 19 and 20:

Result 21: One delayed asset case

Assume $T < d\mathcal{N}(d, (\sigma\lambda), \sigma)$, set $\xi^* = c - \eta^*$ and

$$\eta^* = \frac{K(\gamma) + P_{11}(0)(x_0 - c)}{1 - P_{11}(0)},$$

$$K(\gamma) = \int_{-d}^0 \gamma_s P_{12}(0, s) ds.$$

Define $\alpha^*(\xi)$ as the investment strategy

$$\alpha_t^*(\xi^*) = \frac{-1_{t \leq T-d}}{P_{22}(t, 0)} \left\{ (X_t^{\alpha^*} - \xi^*) P_{12}(t, 0) + \int_{t-d}^t \alpha_s^*(\xi) P_{22}(t, 0, s-t) ds \right\},$$

where P denotes the solution to (2.3.2)-(2.3.3)-(2.3.4). Then, the optimization problem (2.3.9)-(2.3.10) admits $\alpha^*(\xi)$ as an admissible optimal feedback strategy and the optimal value is

$$\text{Var}(X_T^{\alpha^*}) = \frac{P_{11}(0)}{1 - P_{11}(0)} (x_0 - c + K(\gamma))^2 + \int_{-d}^0 \gamma_s^2 P_{22}(0, s) ds + \int_{[-d, 0]^2} \gamma_s \gamma_u P_{22}(0, s, r) ds dr.$$

Numerical results: From the aforementioned result emerges a direct application for the numerical scheme presented in the previous section. See Figures 2.3 and 2.4 for some examples of interests.

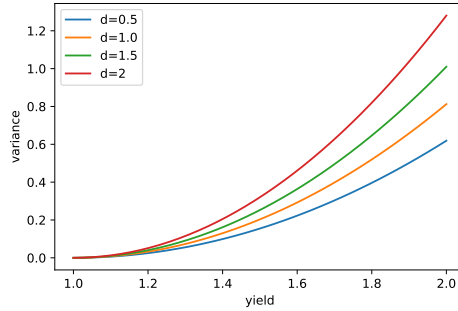

Figure 2.3 – Efficient frontier with $\sigma = 1$, $\lambda = 0.5$, $T = 5$ and $\gamma \equiv 0$.

To further explore the effect of the delay on the control problem we also study, in Chapter IV, the one asset with delay and one without case:

$$\begin{cases} dX_t^{(\alpha, \beta)} = \alpha_t \{(\sigma_1 \lambda_1) dt + \sigma_1 dW_t^1\} + \beta_{t-d} \{(\sigma_2 \lambda_2) dt + \sigma_2 dW_t^2\}, & t \in [0, T], \\ X_0 = x_0, & \beta_s = \gamma_s, & s \in [-d, 0], \\ \langle W^1, W^2 \rangle_t = \rho t, \end{cases} \quad (2.3.11)$$

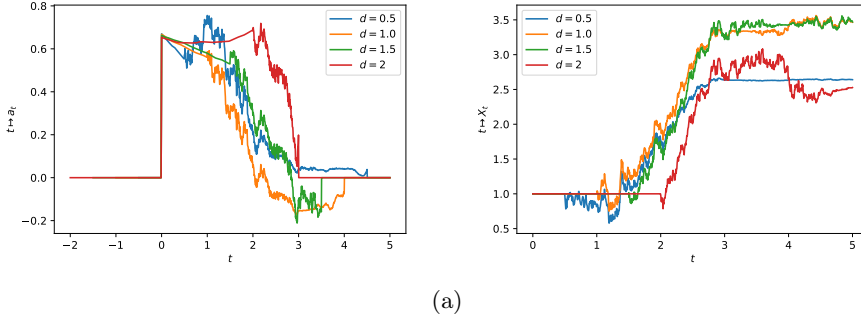

Figure 2.4 – Optimal strategies and optimal portfolios with $c = 1.6$, $\sigma = 1$, $\lambda = 0.5$, and $T = 5$. Left: $t \mapsto \alpha^*$, right: $t \mapsto X_t^*$. Note the destabilization effect and the supplement of volatility induced by the delay feature. Note also the tendency to invest more aggressively the delayed investor has, as she has less time to ensure the promised yield. $\xi^*(d = 0.5) = 2.57$, $\xi^*(d = 1) = 2.68$, $\xi^*(d = 1.5) = 2.80$, $\xi^*(d = 2) = 2.97$.

where α denotes the amount invested in the risky undelayed asset, β the amount invested in the risky delayed asset, and λ_i and σ_i are constants representing respectively the risk premiums and the volatilities of the risky assets.

Following the heuristic approach of Section 6.2, we define the following set of Riccati-PDEs on $[0, T] \times [-d, 0]^2$

$$\begin{aligned} \dot{P}_{11}(t) &= \lambda_1^2 P_{11}(t) + \frac{P_{12}(t, 0)^2}{P_{22}(t, 0)}, & (2.3.12) \\ (\partial_t - \partial_s)(P_{12})(t, s) &= \lambda_1^2 P_{12}(t, s) + \frac{P_{12}(t, 0)P_{22}(t, s, 0)}{P_{22}(t, 0)}, \\ (\partial_t - \partial_s)(P_{22})(t, s) &= 0, \\ (\partial_t - \partial_s - \partial_r)(P_{22})(t, s, r) &= \lambda_1^2 \frac{P_{12}(t, s)P_{12}(t, r)}{P_{11}(t)} + \frac{P_{22}(t, s, 0)P_{22}(t, 0, r)}{P_{22}(t, 0)}, \end{aligned}$$

accompanied by the boundary conditions, for almost any $t, s \in [0, T] \times [-d, 0]$

$$\begin{aligned} P_{12}(t, -d) &= \lambda_2 \sigma_2 \left(1 - \rho \frac{\lambda_1}{\lambda_2}\right) P_{11}(t), & P_{22}(t, -d) &= \sigma_2^2 (1 - \rho^2) P_{11}(t), & (2.3.13) \\ P_{22}(t, s, -d) &= \lambda_2 \sigma_2 \left(1 - \rho \frac{\lambda_1}{\lambda_2}\right) P_{12}(t, s), & P_{22}(t, -d, s) &= \lambda_2 \sigma_2 \left(1 - \rho \frac{\lambda_1}{\lambda_2}\right) P_{12}(t, s), \end{aligned}$$

and the terminal constraints

$$P_{11}(T) = 1, \quad P_{12}(T, s) = P_{22}(T, s) = P_{22}(T, s, r) = 0, \quad (2.3.14)$$

for almost every $s, r \in [-d, 0]$.

We are now equipped to present the optimal strategy and value of problem (2.3.1) in the 2-assets case

Result 22: One delayed asset and one undelayed asset case

Assume there exists a solution P to (2.3.12)-(2.3.13)-(2.3.14). Set $\xi^* = c - \eta^*$ and

$$\eta^* = \frac{K(\gamma) + P_{11}(0)(x_0 - c)}{1 - P_{11}(0)},$$

$$K(\gamma) = \int_{-d}^0 \gamma_s P_{12}(0, s) ds.$$

Define $(\alpha^*(\xi^*), \beta^*(\xi^*))$ as the investment strategy

$$\alpha_t^*(\xi) = - \left\{ \frac{\lambda_1}{\sigma_1} (X_t^* - \xi) + \rho \frac{\sigma_2}{\sigma_1} \beta_{t-d}^* + \frac{\lambda_1}{\sigma_1 P_{11}(t)} \int_{t-d}^t \beta_s^*(\xi) P_{12}(t, s - t) ds \right\}.$$

$$\beta_t^*(\xi) = \frac{-1_{t \leq T-d}}{P_{22}(t, 0)} \left\{ P_{12}(t, 0) (X_t^* - \xi) + \int_{t-d}^t \beta_s^*(\xi) P_{22}(t, 0, r - t) dr \right\},$$

Then, the optimization problem (2.3.9)-(2.3.11) admits $(\alpha^*(\xi^*), \beta^*(\xi^*))$ as an admissible optimal feedback strategy and the optimal value is

$$\text{Var}(X_T^{\alpha^*}) = \frac{P_{11}(0)}{1 - P_{11}(0)} (x_0 - c + K(\gamma))^2$$

$$+ \int_{-d}^0 \gamma_s^2 P_{22}(0, s) ds + \int_{[-d, 0]^2} \gamma_s \gamma_u P_{22}(0, s, r) ds dr.$$

Numerical simulations: The flexibility of the deep learning scheme presented in Section 2.3.2 allows for an easy adaptations to the new set of Riccati PDEs (2.3.12)-(2.3.13)-(2.3.14). See Figure 2.5 to see the interaction between the delay feature and the correlation ρ , and Chapter IV for a more in depth analysis.

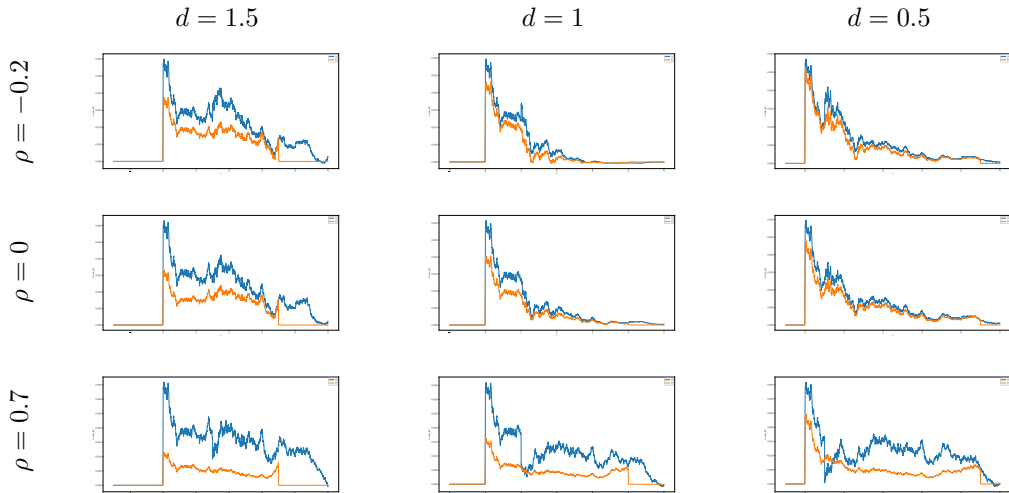

Figure 2.5 - $t \mapsto (\alpha_t^*, \beta_t^*)$, with $\sigma_1 = \sigma_2 = 1$, $\lambda_1 = \lambda_2 = 0.5$ and $T = 5$. Blue : α^* , orange : β^* . The same realizations of W and B were used for all experiments. Note that the more positively correlated the assets are, the more favored the undelayed asset is.

Part II

Volterra control

Linear–Quadratic control for a class of stochastic Volterra equations: solvability and approximation

Abstract We provide an exhaustive treatment of Linear–Quadratic control problems for a class of stochastic Volterra equations of convolution type, whose kernels are Laplace transforms of certain signed matrix measures which are not necessarily finite. These equations are in general neither Markovian nor semimartingales, and include the fractional Brownian motion with Hurst index smaller than $1/2$ as a special case. We establish the correspondence of the initial problem with a possibly infinite dimensional Markovian one in a Banach space, which allows us to identify the Markovian controlled state variables. Using a refined martingale verification argument combined with a squares completion technique, we prove that the value function is of linear quadratic form in these state variables with a linear optimal feedback control, depending on non-standard Banach space valued Riccati equations. Furthermore, we show that the value function of the stochastic Volterra optimization problem can be approximated by that of conventional finite dimensional Markovian Linear–Quadratic problems, which is of crucial importance for numerical implementation.

Keywords: Stochastic Volterra equations, linear-quadratic control, Riccati equations in Banach space.

3.1 Introduction

Let us consider the basic problem of controlling the drift α of a real-valued Brownian motion W

$$X_t^\alpha = \int_0^t \alpha_s ds + W_t, \quad t \geq 0, \quad (3.1.1)$$

in order to steer the system to zero with minimal effort by minimizing over a finite horizon the cost functional

$$J(\alpha) = \mathbb{E} \left[\int_0^T (|X_t^\alpha|^2 + \alpha_t^2) dt \right].$$

This problem fits into the class of linear-quadratic (LQ) regulator problem, and can be explicitly solved by different methods including standard dynamic programming, maximum principle or spike variation methods relying on Itô stochastic calculus. It is well-known, see e.g. [YZ99, Chapter 6], that the optimal control α^* is in linear feedback form with respect to the optimal state process $X^* = X^{\alpha^*}$:

$$\alpha_t^* = -\Gamma(t)X_t^*, \quad 0 \leq t \leq T,$$

where Γ is a deterministic nonnegative function solution to a Riccati equation, actually explicitly given by $\Gamma(t) = \tanh(T-t)$, and thus the associated optimal state process X^* is a mean-reverting Markov process.

Suppose now that the noise W is replaced by a Gaussian process with memory, typically a fractional Brownian motion, or more generally by stochastic Volterra processes. It is then natural to ask how the structure of the solution is modified, and how it can be derived, knowing that, in this case, usual methods for Markov processes and stochastic calculus for semimartingales can no longer be applied.

Stochastic Volterra processes appear in different applications for population dynamics, tumour growth, or energy finance, and provide suitable models for dynamics with memory and delay, see [BNBV11; GLS90; Sch06]. These processes have known a growing interest in finance with the recent empirical findings on rough volatility in [GJR18b]. Stochastic Volterra equations have been studied by numerous authors, see [AJLP19; MS15; PP90] and the references therein.

In this paper, we address the optimal control of d -dimensional stochastic Volterra equations of the form:

$$X_t^\alpha = g_0(t) + \int_0^t K(t-s) \left(b(s, X_s^\alpha, \alpha_s) ds + \sigma(s, X_s^\alpha, \alpha_s) dW_s \right), \quad (3.1.2)$$

where g_0 is a deterministic function and K is a (convolution) matrix-valued kernel of the form

$$K(t) = \int_{\mathbb{R}_+} e^{-\theta t} \mu(d\theta), \quad t > 0,$$

for some signed matrix measure μ . Our framework covers the case of the fractional kernel $K(t) = t^{H-1/2}/\Gamma(H+1/2)$ with $H \leq 1/2$, arising from the Mandelbrot-Van Ness representation of the fractional Brownian motion with Hurst index H . We shall mainly focus on the case where the coefficients b and σ are in linear form with respect to the state and control arguments, and the cost to be minimized is of linear-quadratic form.

Since the (controlled) stochastic Volterra process (3.1.2) is neither Markovian nor a semimartingale, it is natural to consider Markovian lifts for which suitable stochastic tools and control methods apply. Inspired by the Markovian representation of fractional Brownian motion introduced in [CC98], and more recently generalized to several un-controlled stochastic Volterra equations in [AJEE19a; CT18; HS19], we establish the correspondence of the initial problem with a lifted Markovian controlled system $(Y_t^\alpha)_{t \in [0, T]}$ taking its values in the possibly infinite-dimensional Banach space $L^1(\mu)$. Next, in the LQ case, i.e., when b, σ are of linear form, and the cost function is linear-quadratic, we prove by means of a refined martingale verification argument combined with a squares completion technique, that the value function is of quadratic form while the optimal control is in linear feedback form with respect to these lifted state variables. The coefficients of the quadratic and linear form of the value function and optimal control are expressed in terms of a non-standard system of integral operator Riccati equations whose solvability (existence and uniqueness) is proved in [AJMP19a]. A related infinite-dimensional Riccati equation appeared in [AS13] for the minimization problem of an

energy functional defined in terms of a non-singular (i.e. $K(0) < \infty$) completely monotone kernel. We stress that, although there exists several results for LQ control problems in infinite-dimension, and even for Volterra processes (see [BCM12]), they cannot be applied in our Banach-space context as they only concern Hilbert spaces. As detailed above, the first contribution of our paper lies in the rigorous derivation of the optimal solution for the stochastic Volterra control problem. A second important feature of our approach is to provide a natural approximation of such solution by a suitable discretization of the measure μ , leading to conventional finite-dimensional LQ control problems, which involve standard matrix Riccati equations that can be numerically implemented.

The paper is organized as follows. In Section 3.2, we formulate the control problem, justify the correspondence with the lifted Markovian system in the Banach space $L^1(\mu)$, and formally derive the Riccati equation. Section 4.2 presents the main results:

1. the analytic expression and solvability of the value function and optimal control in terms of a Banach-space valued Riccati equation. We illustrate our general result on the LQ regulator example mentioned in the beginning of the introduction with a fractional noise with Hurst parameter $H \leq 1/2$;
2. a general stability result for the solution of the stochastic Volterra control problem with respect to the kernel and its application for the approximation of the solution.

In Section 3.4, we prove a general existence result for SDEs with Lipschitz coefficients in Banach spaces, which is used in particular to get the existence of an optimal control for the LQ Volterra control problem. In Section 3.5, we provide a refined martingale verification theorem for LQ control problem in our context, which mainly relies on Itô's formula for quadratic functions in Banach spaces. The proof of the solvability result 1 is completed in Section 3.6, and that of the stability result 2 is detailed in Section 3.7.

Related literature. The optimal control of stochastic Volterra equations has been considered in [Yon06] by maximum principle method leading to a characterization of the solution in terms of a backward stochastic Volterra equation for the adjoint process. In [AØ15], the authors also use the maximum principle together with Malliavin calculus to obtain a corresponding adjoint equation as a standard backward SDE. Although the kernel considered in these aforementioned papers is not restricted to be of convolution type, the required conditions do not allow singularity of K at zero, hence excluding the case of a fractional kernel with parameter $H < 1/2$. More recently, an extended Bellman equation has been derived in [HW19] for the associated controlled Volterra equation.

The solution to the LQ control problem as in (3.1.1) with controlled drift and additive noise has been obtained in [KBV03] when the noise is a fractional Brownian motion with Hurst parameter $H > 1/2$, and in [DPD13] when the noise is a general Gaussian process with an optimal control expressed as the sum of the well-known linear feedback control for the associated deterministic linear-quadratic control problem and the prediction of the response of the system to the future noise process. Recently, the paper [Wan18] investigated LQ problem of stochastic Volterra equations by providing characterizations of optimal control in terms of some forward-backward system, but leaving aside their solvability, and under some coefficients assumptions that preclude singular kernels such as the fractional kernel with parameter $H < 1/2$.

Notations. For a Banach space \mathcal{B} , $L^2([0, T], \mathcal{B})$ denotes the space of measurable and square integrable functions from $[0, T]$ to \mathcal{B} .

For any $d \times d_1$ -matrix valued measure μ_1 on \mathbb{R}_+ , we denote by $|\mu_1|$ its total variation, which is a scalar nonnegative measure, refer to [GLS90, Section 3.5] for more details. The space $L^1(\mu_1)$ consists of μ_1 -a.e. equivalence classes of $|\mu_1|$ -integrable functions $\varphi : \mathbb{R}_+ \rightarrow \mathbb{R}^{d_1}$ endowed with the norm $\|\varphi\|_{L^1(\mu_1)} = \int_{\mathbb{R}_+} |\mu_1|(d\theta)|\varphi(\theta)|$, where we identify

the function φ with its class of equivalence. For any such φ the integral

$$\int_{\mathbb{R}_+} \mu_1(d\theta)\varphi(\theta)$$

is well defined by virtue of the inequality

$$\left| \int_{\mathbb{R}_+} \mu_1(d\theta)\varphi(\theta) \right| \leq \int_{\mathbb{R}_+} |\mu_1|(d\theta)|\varphi(\theta)|,$$

see [GLS90, Theorem 5.6]. If μ_2 is a $d \times d_2$ -matrix valued measure, the space $L^1(\mu_1 \otimes \mu_2)$ consists of $\mu_1 \otimes \mu_2$ -a.e. equivalence classes of $|\mu_1| \otimes |\mu_2|$ -integrable functions $\Phi : \mathbb{R}_+^2 \rightarrow \mathbb{R}^{d \times d}$ endowed with the norm $\|\Phi\|_{L^1(\mu_1 \otimes \mu_2)} = \int_{\mathbb{R}_+^2} |\mu_1|(d\theta)|\Phi(\theta, \tau)||\mu_2|(d\tau) < \infty$. For any such Φ , the integral

$$\int_{\mathbb{R}_+^2} \mu_1(d\theta)^\top \Phi(\theta, \tau) \mu_2(d\tau)$$

is again well defined by virtue of [GLS90, Theorem 5.6]. Both $(L^1(\mu_1), \|\cdot\|_{L^1(\mu_1)})$ and $(L^1(\mu_1 \otimes \mu_2), \|\cdot\|_{L^1(\mu_1 \otimes \mu_2)})$ are Banach spaces, see [Rud06, Theorem 3.11]. We also denote by $L^\infty(\mu_1)$ the set of measurable functions $\psi : \mathbb{R}_+ \rightarrow \mathbb{R}^{d_1}$, which are bounded μ_1 -a.e., and by $L^\infty(\mu_1 \otimes \mu_2)$ the set of measurable functions $\Phi : \mathbb{R}_+^2 \rightarrow \mathbb{R}^{d \times d}$, which are bounded $\mu_1 \otimes \mu_2$ -a.e, that we endow with their usual norms $\|\psi\|_{L^\infty(\mu_1)}$ and $\|\Phi\|_{L^\infty(\mu_1 \otimes \mu_2)}$.

3.2 Formulation of the problem and preliminaries

Let $(\Omega, \mathcal{F}, \mathbb{F} = (\mathcal{F}_t)_{t \geq 0}, \mathbb{P})$ be a filtered probability space supporting a one dimensional Brownian motion W . Fix $T > 0$ and $d, d', m \in \mathbb{N}$. We consider a controlled d -dimensional stochastic Volterra equation

$$X_t^\alpha = g_0(t) + \int_0^t K(t-s)b(s, X_s^\alpha, \alpha_s)ds + \int_0^t K(t-s)\sigma(s, X_s^\alpha, \alpha_s)dW_s, \quad (3.2.1)$$

where α is an element of the admissible set

$$\mathcal{A} = \left\{ \alpha : \Omega \times [0, T] \rightarrow \mathbb{R}^m \text{ progressively measurable such that } \sup_{0 \leq t \leq T} \mathbb{E}[|\alpha_t|^4] < \infty \right\},$$

$g_0 : [0, T] \rightarrow \mathbb{R}^d$ is a measurable function, $K : [0, T] \rightarrow \mathbb{R}^{d \times d'}$ is a measurable kernel, and $b, \sigma : [0, T] \times \mathbb{R}^d \times \mathbb{R}^m \rightarrow \mathbb{R}^{d'}$ are of affine form:

$$\begin{aligned} b(t, x, a) &= \beta(t) + Bx + Ca, \\ \sigma(t, x, a) &= \gamma(t) + Dx + Fa, \end{aligned}$$

where $B, D \in \mathbb{R}^{d' \times d}$, $C, F \in \mathbb{R}^{d' \times m}$, and $\beta, \gamma : [0, T] \rightarrow \mathbb{R}^{d'}$ are measurable functions. We are chiefly interested in the case where K is the Laplace transform

$$K(t) = \int_{\mathbb{R}_+} e^{-\theta t} \mu(d\theta), \quad t > 0, \quad (3.2.2)$$

of a signed $d \times d'$ -measure μ satisfying

$$\int_{\mathbb{R}_+} (1 \wedge \theta^{-1/2}) |\mu|(d\theta) < \infty, \quad (3.2.3)$$

where $|\mu|$ denotes the total variation of μ . While condition (3.2.3) does not exclude $\mu_{ij}(\mathbb{R}_+) = \pm\infty$ for some $i \leq d, j \leq d'$, or equivalently a singularity of the kernel K at 0, it does ensure that $K \in L^2([0, T], \mathbb{R}^{d \times d'})$ and that $|\mu|$ is σ -finite, see Lemma 3.A.1. The former implies that the stochastic convolution

$$t \mapsto \int_0^t K(t-s)\xi_s dW_s$$

is well defined as an Itô integral, for every $t \leq T$, for any progressively measurable process ξ such that

$$\sup_{t \leq T} \mathbb{E} [|\xi_t|^2] < \infty.$$

Indeed,

$$\mathbb{E} \left[\int_0^t |K(t-s)|^2 |\xi_s|^2 ds \right] \leq \|K\|_{L^2(0, T)}^2 \sup_{s \leq T} \mathbb{E} [|\xi_s|^2] < \infty,$$

for every $t \leq T$. The convolution

$$t \mapsto \int_0^t K(t-s)\xi_s ds,$$

is also well defined for every $t \leq T$, by virtue of the Cauchy–Schwarz inequality.

We can now make precise the concept of solution to the controlled equation (3.2.1). By a solution to (3.2.1), we mean an \mathbb{F} -adapted process X^α with continuous sample paths such that (3.2.1) holds for all $t \leq T$, \mathbb{P} -almost surely. Under (3.2.2)–(3.2.3), assuming that β, γ are measurable and bounded, Theorem 3.4.2 shows that the controlled stochastic Volterra equation (3.2.1) admits a unique continuous solution X^α , for any continuous input curve g_0 , and any admissible control $\alpha \in \mathcal{A}$. Furthermore, it holds that

$$\sup_{0 \leq t \leq T} \mathbb{E} [|X_t^\alpha|^4] < \infty. \quad (3.2.4)$$

Remark 3.2.1. Notice that due to the possible singularity of the kernel K , and in contrast with standard stochastic differential equations, the solution X^α to the controlled stochastic Volterra equation does not satisfy in general the usual square integrability condition of the form: $\mathbb{E}[\sup_{0 \leq t \leq T} |X_t^\alpha|^2] < \infty$. For this reason, we impose the stronger condition $\sup_{t \leq T} \mathbb{E}[|\alpha_t|^4] < \infty$ for the set of admissible controls \mathcal{A} , which will turn out to be crucial for the martingale verification result, see Section 3.5. \square

We consider a cost functional given by

$$J(\alpha) = \mathbb{E} \left[\int_0^T f(X_s^\alpha, \alpha_s) ds \right], \quad (3.2.5)$$

where the running cost f has the following quadratic form

$$f(x, \alpha) = x^\top Q x + \alpha^\top N \alpha + 2x^\top L, \quad (3.2.6)$$

for some $Q \in \mathbb{S}_+^d, N \in \mathbb{S}_+^m$ and $L \in \mathbb{R}^d$. Here \mathbb{S}_+^d denotes the set of d -dimensional nonnegative symmetric matrices. Note that by virtue of (3.2.4), $J(\alpha)$ is well defined for any $\alpha \in \mathcal{A}$. The aim is to solve

$$V_0 = \inf_{\alpha \in \mathcal{A}} J(\alpha). \quad (3.2.7)$$

Before going further, let us mention several kernels of interest that satisfy (3.2.2)–(3.2.3).

Example 3.2.1. 1. *Smooth kernels:* if $|\mu_{ij}(\mathbb{R}_+)| < \infty$, for every $i = 1, \dots, d, j = 1, \dots, d'$, then (3.2.3) is satisfied and K is infinitely differentiable on $[0, T]$. This is the case, for instance, when $\mu(d\theta) = \sum_{i=1}^n c_i^n \delta_{\theta_i^n}(d\theta)$, for some $c_i^n \in \mathbb{R}^{d \times d'}$ and $\theta_i^n \in \mathbb{R}_+$, $i = 1, \dots, n$, which corresponds to

$$K(t) = \sum_{i=1}^n c_i^n e^{-\theta_i^n t}.$$

2. *The fractional kernel* ($d = d' = 1$)

$$K_H(t) = \frac{t^{H-1/2}}{\Gamma(H+1/2)}, \quad (3.2.8)$$

for some $H \in (0, 1/2)$, which is the Laplace transform of

$$\mu_H(d\theta) = \frac{\theta^{-H-1/2}}{\Gamma(H+1/2)\Gamma(1/2-H)} d\theta, \quad (3.2.9)$$

and more generally the Gamma kernel $K(t) = K_H(t)e^{-\zeta t}$ for $H \in (0, 1/2)$ and $\zeta \in \mathbb{R}$ for which

$$\mu(d\theta) = \frac{(\theta - \zeta)^{-H-1/2} \mathbf{1}_{(\zeta, \infty)}(\theta)}{\Gamma(H+1/2)\Gamma(1/2-H)} d\theta.$$

3. If K_1 and K_2 satisfy (3.2.2), then so does $K_1 + K_2$ and $K_1 K_2$ with the respective measures $\mu_1 + \mu_2$ and $\mu_1 * \mu_2$. When μ_1, μ_2 satisfy (3.2.3), it is clear that $\mu_1 + \mu_2$ also satisfies (3.2.3). This condition is satisfied for the convolution $\mu_1 * \mu_2$ provided $\int_{[1, \infty)^2} (\theta + \tau)^{-1/2} \mu_1(d\theta) \mu_2(d\tau) < \infty$, which is the case for instance if either $\mu_1(\mathbb{R}_+)$ or $\mu_2(\mathbb{R}_+)$ are finite.
4. If K is a completely monotone kernel, i.e. K is infinitely differentiable on $(0, \infty)$ such that $(-1)^n K^{(n)}(t)$ is nonnegative for each $t > 0$, then, by Bernstein's theorem, there exists a nonnegative measure μ such that (3.2.2) holds, see [GLS90, Theorem 5.2.5].

□

3.2.1 Markovian representation

The solution X^α of (3.2.1) is in general neither Markovian nor a semimartingale as illustrated by the Riemann–Liouville fractional Brownian motion

$$t \mapsto \frac{1}{\Gamma(H+1/2)} \int_0^t (t-s)^{H-1/2} dW_s, \quad H \in (0, 1/2],$$

which is Markovian and a martingale only for $H = 1/2$. Inspired by the Markovian representation of fractional Brownian motion introduced in [CC98], and more recently generalized to several un–controlled stochastic Volterra equations for kernels of the form (3.2.2), see [AJEE19a, Section 4]; [CT18, Section 5.1]; [HS19]; we establish in the following theorem, by means of stochastic Fubini's theorem, the correspondence of (3.2.1) with a possibly infinite dimensional Markovian controlled system of the form

$$\begin{cases} dY_t^\alpha(\theta) &= \left(-\theta Y_t^\alpha(\theta) + \tilde{b} \left(t, \int_{\mathbb{R}_+} \mu(d\tau) Y_t^\alpha(\tau), \alpha_t \right) \right) dt \\ &\quad + \tilde{\sigma} \left(t, \int_{\mathbb{R}_+} \mu(d\tau) Y_t^\alpha(\tau), \alpha_t \right) dW_t \\ Y_0^\alpha(\theta) &= 0, \end{cases} \quad (3.2.10)$$

where the coefficients $\tilde{b} : [0, T] \times \mathbb{R}^d \times \mathbb{R}^m \rightarrow \mathbb{R}^{d'}$, $\tilde{\sigma} : [0, T] \times \mathbb{R}^d \times \mathbb{R}^m \rightarrow \mathbb{R}^{d'}$ are defined by

$$\begin{aligned}\tilde{b}(t, x, a) &= \tilde{\beta}(t) + Bx + Ca, \\ \tilde{\sigma}(t, x, a) &= \tilde{\gamma}(t) + Dx + Fa,\end{aligned}$$

with

$$\tilde{\beta} = \beta + Bg_0 \quad \text{and} \quad \tilde{\gamma} = \gamma + Dg_0.$$

Theorem 3.2.1. *Let g_0, β, γ be bounded functions on $[0, T]$ and K be given as in (3.2.2) such that (3.2.3) holds. Fix $\alpha \in \mathcal{A}$. Assume that there exists a progressively measurable process X^α that solves (3.2.1), \mathbb{P} -a.s., for each $t \leq T$, and that (3.2.4) holds. Then, for each $t \leq T$, X_t^α admits the representation*

$$X_t^\alpha = g_0(t) + \int_{\mathbb{R}_+} \mu(d\theta) Y_t^\alpha(\theta), \quad (3.2.11)$$

where, for each $\theta \in \mathbb{R}_+$,

$$Y_t^\alpha(\theta) = \int_0^t e^{-\theta(t-s)} b(s, X_s^\alpha, \alpha_s) ds + \int_0^t e^{-\theta(t-s)} \sigma(s, X_s^\alpha, \alpha_s) dW_s. \quad (3.2.12)$$

In particular, Y^α can be chosen to have continuous sample paths in $L^1(\mu)$, satisfies

$$\sup_{t \leq T} \mathbb{E} \left[\|Y_t^\alpha\|_{L^1(\mu)}^4 \right] < \infty, \quad (3.2.13)$$

$$\sup_{t \leq T} \sup_{\theta \in \mathbb{R}_+} |Y_t^\alpha(\theta)| < \infty, \quad (3.2.14)$$

and for each $\theta \in \mathbb{R}_+$, $t \mapsto Y_t^\alpha(\theta)$ solves (3.2.10). Conversely, assume that there exists a process Y^α continuous in $L^1(\mu)$ solution to (3.2.10), i.e., such that

$$\begin{aligned}Y_t^\alpha(\theta) &= \int_0^t e^{-\theta(t-s)} \tilde{b} \left(s, \int_{\mathbb{R}_+} \mu(d\tau) Y_s^\alpha(\tau), \alpha_s \right) ds \\ &\quad + \int_0^t e^{-\theta(t-s)} \tilde{\sigma} \left(s, \int_{\mathbb{R}_+} \mu(d\tau) Y_s^\alpha(\tau), \alpha_s \right) dW_s, \quad \mathbb{P} \otimes \mu - a.e. \quad (3.2.15)\end{aligned}$$

for each $t \leq T$, and that (3.2.13) holds. Then, the process X^α given by (3.2.11) is a continuous solution to (3.2.1) such that (3.2.4) holds.

Proof. Fix $t \leq T$ and set $Z_t^\alpha = \int_0^t b(s, X_s^\alpha, \alpha_s) ds + \int_0^t \sigma(s, X_s^\alpha, \alpha_s) dW_s$. We first plug (3.2.2) in (3.2.1) to get

$$X_t^\alpha - g_0(t) = \int_0^t K(t-s) dZ_s^\alpha = \int_0^t \left(\int_{\mathbb{R}_+} \mu(d\theta) e^{-\theta(t-s)} \right) dZ_s^\alpha.$$

An application of stochastic Fubini's, see [Ver12, Theorem 2.2], yields

$$\int_0^t \left(\int_{\mathbb{R}_+} \mu(d\theta) e^{-\theta(t-s)} \right) dZ_s^\alpha = \int_{\mathbb{R}_+} \mu(d\theta) \left(\int_0^t e^{-\theta(t-s)} dZ_s^\alpha \right),$$

where the interchange is possible since by Jensen's inequality on the normalized measure $(1 \wedge \theta^{-1/2})\mu(d\theta) / \int_{\mathbb{R}_+} (1 \wedge \tau^{-1/2})\mu(d\tau)$ the term

$$\int_{\mathbb{R}_+} \left(\int_0^t e^{-2\theta(t-s)} \mathbb{E} [d\langle Z^\alpha \rangle_s] \right)^{1/2} |\mu|(d\theta)$$

is bounded from above, for some $c > 0$ by,

$$c \sqrt{\sup_{r \leq T} (|\gamma(r)|^2 + \mathbb{E}[|\alpha_r|^2] + \mathbb{E}[|X_r^\alpha|^2])} \left(\int_{\mathbb{R}_+} \frac{1 - e^{-2\theta t}}{2\theta} (1 \wedge \theta^{1/2}) |\mu|(d\theta) \right)^{1/2}$$

which is finite due to the inequality

$$\frac{(1 - e^{-2\theta t})}{2\theta} \leq \frac{1}{2} (1 \vee 2t) (1 \wedge \theta^{-1}), \quad (3.2.16)$$

condition (3.2.3), the boundedness of γ , the admissible set \mathcal{A} and the estimate (3.2.4). The interchange is justified similarly for the drift part. It follows that

$$X_t^\alpha = g_0(t) + \int_{\mathbb{R}_+} \mu(d\theta) \left(\int_0^t e^{-\theta(t-s)} dZ_s^\alpha \right) = g_0(t) + \int_{\mathbb{R}_+} \mu(d\theta) Y_t^\alpha(\theta)$$

where $Y_t^\alpha(\theta)$ is given by (3.2.12) and corresponds to the variation of constants formula of (3.2.10). The claimed continuity statement together with (3.2.13)–(3.2.14) are proved in Lemma 3.4.1. The converse is proved along the exact same lines by working them backward. \square

Remark 3.2.2. *An alternative lift approach, in the spirit of [AJEE19a; EER18; HW19; JO19; VZ18], consists in introducing the double-indexed (controlled) processes*

$$G_t^\alpha(u) = \mathbb{E} \left[X_u^\alpha - \int_t^u K(u-s)b(s, X_s^\alpha, \alpha_s) ds \mid \mathcal{F}_t \right], \quad 0 \leq t \leq u \leq T.$$

The control problem can then be reformulated in terms of the infinite dimensional controlled Markov process $\{G_t^\alpha(\cdot), t \in [0, T]\}$ with Itô dynamics

$$dG_t^\alpha(u) = K(u-t) (b(t, X_t^\alpha, \alpha_t) dt + \sigma(t, X_t^\alpha, \alpha_t) dW_t), \quad 0 \leq t < u \leq T.$$

\square

3.2.2 Formal derivation of the solution

Thanks to Theorem 3.2.1, the possibly non-Markovian initial problem can be formally recast as a degenerate infinite dimensional Markovian problem in $L^1(\mu)$ on the state variables Y^α given by (3.2.10). To see this, we define the mean-reverting operator A^{mr} acting on measurable functions $\varphi \in L^1(\mu)$ by

$$(A^{mr}\varphi)(\theta) = -\theta\varphi(\theta), \quad \theta \in \mathbb{R}_+, \quad (3.2.17)$$

and consider the dual pairing

$$\langle \varphi, \psi \rangle_\mu = \int_{\mathbb{R}_+} \varphi(\theta)^\top \mu(d\theta)^\top \psi(\theta), \quad (\varphi, \psi) \in L^1(\mu) \times L^\infty(\mu^\top).$$

For any matrix-valued kernel G , we denote by \mathbf{G} the integral operator induced by G , defined by:

$$(\mathbf{G}\phi)(\theta) = \int_{\mathbb{R}_+} G(\theta, \theta') \mu(d\theta') \phi(\theta').$$

Notice that when $G \in L^\infty(\mu \otimes \mu)$, the operator \mathbf{G} is well-defined on $L^1(\mu)$, and we have $\mathbf{G}\phi \in L^\infty(\mu^\top)$ for $\phi \in L^1(\mu)$. In this case, $\langle \phi, \mathbf{G}\psi \rangle_\mu$ is well defined for all $\varphi, \psi \in L^1(\mu)$.

When $G \in L^1(\mu \otimes \mu)$, the operator \mathbf{G} is well-defined on $L^\infty(\mu)$, and we have $\mathbf{G}\phi \in L^1(\mu^\top)$, for $\phi \in L^\infty(\mu)$. In this case $\langle \mathbf{G}\phi, \psi \rangle_{\mu^\top}$ is well defined for all $\varphi, \psi \in L^\infty(\mu)$.

To fix ideas we set $g_0 = \beta = \gamma \equiv 0$ and $L = 0$. Noting that relation (3.2.15) is the mild form of the linear controlled dynamics in $L^1(\mu)$,

$$dY_t^\alpha = (A^{mr}Y_t^\alpha + \mathbf{B}Y_t^\alpha + C\alpha_t) dt + (\mathbf{D}Y_t^\alpha + F\alpha_t) dW_t, \quad Y_0^\alpha = 0,$$

we see that the optimization problem (3.2.7) can be reformulated as a Markovian problem in $L^1(\mu)$ with cost functional,

$$J(\alpha) = \mathbb{E} \left[\int_0^T (\langle Y_s^\alpha, \mathbf{Q}Y_s^\alpha \rangle_\mu + \alpha_s^\top N \alpha_s) ds \right], \quad (3.2.18)$$

where, by a slight abuse of notations, C and F denote the respective constant operators from \mathbb{R}^m into $L^\infty(\mu)$ induced by the matrices C and F :

$$(Ca)(\theta) = Ca, \quad (Fa)(\theta) = Fa, \quad \theta \in \mathbb{R}_+, \quad a \in \mathbb{R}^m.$$

Their adjoint operators C^*, F^* from $L^1(\mu^\top)$ into \mathbb{R}^m take the form

$$C^*g = C^\top \int_{\mathbb{R}_+} \mu(d\theta)^\top g(\theta), \quad F^*g = F^\top \int_{\mathbb{R}_+} \mu(d\theta)^\top g(\theta), \quad g \in L^1(\mu^\top).$$

Given the linear–quadratic structure of the problem, standard results in finite-dimensional stochastic control theory, see [YZ99, Chapter 6], as well as in Hilbert spaces, see [Fla86; HT18], suggest that the optimal value process V^α associated to the functional (3.2.18) should be of linear–quadratic form

$$V_t^{\alpha^*} = \langle Y_t^{\alpha^*}, \mathbf{\Gamma}_t Y_t^{\alpha^*} \rangle_\mu,$$

with an optimal feedback control α^* satisfying

$$\alpha_t^* = -(N + F^* \mathbf{\Gamma}_t F)^{-1} (C^* \mathbf{\Gamma}_t + F^* \mathbf{\Gamma}_t \mathbf{D}) Y_t^{\alpha^*}, \quad 0 \leq t \leq T,$$

where $\mathbf{\Gamma}_t$ is a symmetric operator from $L^1(\mu)$ into $L^\infty(\mu^\top)$, and solves the operator Riccati equation:

$$\begin{cases} \mathbf{\Gamma}_T &= \mathbf{0} \\ \dot{\mathbf{\Gamma}}_t &= -\mathbf{\Gamma}_t A^{mr} - (\mathbf{\Gamma}_t A^{mr})^* - \mathbf{Q} - \mathbf{D}^* \mathbf{\Gamma}_t \mathbf{D} - \mathbf{B}^* \mathbf{\Gamma}_t - (\mathbf{B}^* \mathbf{\Gamma}_t)^* \\ &\quad + (C^* \mathbf{\Gamma}_t + F^* \mathbf{\Gamma}_t \mathbf{D})^* (N + F^* \mathbf{\Gamma}_t F)^{-1} (C^* \mathbf{\Gamma}_t + F^* \mathbf{\Gamma}_t \mathbf{D}), \quad t \in [0, T]. \end{cases}$$

In particular, when $\mathbf{\Gamma}$ is an integral operator, this formally induces the following Riccati equation for the associated (symmetric) kernel Γ valued in $L^1(\mu \otimes \mu)$:

$$\begin{cases} \Gamma_T(\theta, \tau) &= 0 \\ \dot{\Gamma}_t(\theta, \tau) &= (\theta + \tau) \Gamma_t(\theta, \tau) - Q - D^\top \int_{\mathbb{R}_+^2} \mu(d\theta')^\top \Gamma_t(\theta', \tau') \mu(d\tau') D \\ &\quad - B^\top \int_{\mathbb{R}_+} \mu(d\theta')^\top \Gamma_t(\theta', \tau) - \int_{\mathbb{R}_+} \Gamma_t(\theta, \tau') \mu(d\tau') B + S_t(\theta)^\top \hat{N}_t^{-1} S_t(\tau), \end{cases} \quad (3.2.19)$$

where

$$\begin{aligned} S_t(\tau) &= C^\top \int_0^\infty \mu(d\theta)^\top \Gamma_t(\theta, \tau) + F^\top \int_{\mathbb{R}_+^2} \mu(d\theta')^\top \Gamma_t(\theta', \tau') \mu(d\tau') D \\ \hat{N}_t &= N + F^\top \int_{\mathbb{R}_+^2} \mu(d\theta)^\top \Gamma_t(\theta, \tau) \mu(d\tau) F, \end{aligned}$$

and provides an optimal control in the form

$$\alpha_t^* = -\hat{N}_t^{-1} \int_{\mathbb{R}_+} S_t(\theta) \mu(d\theta) Y_t^{\alpha^*}(\theta), \quad 0 \leq t \leq T.$$

Although the aforementioned infinite dimensional results provide formal expressions for the solution of the problem, they cannot be directly applied, since they concern Hilbert spaces. Here the infinite dimensional controlled process Y^α takes its values in the non reflexive Banach space $(L^1(\mu), \|\cdot\|_{L^1(\mu)})$. The rigorous derivation of the solution is the first main objective of the present paper. Our second goal is to show how to obtain an analytic finite-dimensional approximation of the original control problem after a suitable discretization of the operator Riccati equation.

3.3 Main results

We collect in this section our main results.

3.3.1 Solvability: optimal control and value function

Let $\alpha \in \mathcal{A}$. Given the linear-quadratic structure of the problem and the formal analysis of Section 3.2.2, it is natural to consider a candidate optimal value process $(V_t^\alpha)_{t \leq T}$ of linear-quadratic form in the state variable Y^α given by (3.2.15), that is

$$V_t^\alpha = \int_{\mathbb{R}_+^2} Y_t^\alpha(\theta)^\top \mu(d\theta)^\top \Gamma_t(\theta, \tau) \mu(d\tau) Y_t^\alpha(\tau) + 2 \int_{\mathbb{R}_+} \Lambda_t(\theta)^\top \mu(d\theta) Y_t^\alpha(\theta) + \chi_t \quad (3.3.1)$$

where the functions $t \mapsto \Gamma_t, \Lambda_t, \chi_t$ are solutions, in a suitable sense, of the following system of Riccati equations:

$$\begin{cases} \dot{\Gamma}_t(\theta, \tau) &= (\theta + \tau) \Gamma_t(\theta, \tau) - \mathcal{R}_1(\Gamma_t)(\theta, \tau), & \Gamma_T(\theta, \tau) &= 0 \\ \dot{\Lambda}_t(\theta) &= \theta \Lambda_t(\theta) - \mathcal{R}_2(t, \Gamma_t, \Lambda_t)(\theta), & \Lambda_T(\theta) &= 0 \\ \dot{\chi}_t &= -\mathcal{R}_3(t, \Gamma_t, \Lambda_t), & \chi_T &= 0, \end{cases} \quad (3.3.2)$$

where we defined

$$\begin{aligned} \mathcal{R}_1(\Gamma)(\theta, \tau) &= Q + D^\top \int_{\mathbb{R}_+^2} \mu(d\theta')^\top \Gamma(\theta', \tau') \mu(d\tau') D + B^\top \int_{\mathbb{R}_+} \mu(d\theta')^\top \Gamma(\theta', \tau) \\ &\quad + \int_0^\infty \Gamma(\theta, \tau') \mu(d\tau') B - S(\Gamma)(\theta)^\top \hat{N}^{-1}(\Gamma) S(\Gamma)(\tau) \end{aligned} \quad (3.3.3)$$

$$\begin{aligned} \mathcal{R}_2(t, \Gamma, \Lambda)(\theta) &= L + Q g_0(t) + B^\top \int_0^\infty \mu(d\theta')^\top \Lambda(\theta') + \int_0^\infty \Gamma(\theta, \tau') \mu(d\tau') \tilde{\beta}(t) \\ &\quad + D^\top \int_{\mathbb{R}_+^2} \mu(d\theta')^\top \Gamma(\theta', \tau') \mu(d\tau') \tilde{\gamma}(t) - S(\Gamma)(\theta)^\top \hat{N}(\Gamma)^{-1} h(t, \Gamma, \Lambda) \end{aligned} \quad (3.3.4)$$

$$\begin{aligned} \mathcal{R}_3(t, \Gamma, \Lambda) &= g_0(t)^\top Q g_0(t) + \tilde{\gamma}(t)^\top \int_{\mathbb{R}_+^2} \mu(d\theta')^\top \Gamma(\theta', \tau') \mu(d\tau') \tilde{\gamma}(t) \\ &\quad + \tilde{\beta}(t)^\top \int_0^\infty \mu(d\theta')^\top \Lambda(\theta') - h(t, \Gamma, \Lambda) \hat{N}(\Gamma)^{-1} h(t, \Gamma, \Lambda), \end{aligned} \quad (3.3.5)$$

with

$$\begin{aligned}
 S(\Gamma)(\tau) &= C^\top \int_0^\infty \mu(d\theta)^\top \Gamma(\theta, \tau) + F^\top \int_{\mathbb{R}_+^2} \mu(d\theta')^\top \Gamma(\theta', \tau') \mu(d\tau') D \\
 \hat{N}(\Gamma) &= N + F^\top \int_{\mathbb{R}_+^2} \mu(d\theta)^\top \Gamma(\theta, \tau) \mu(d\tau) F \\
 h(t, \Gamma, \Lambda) &= C^\top \int_0^\infty \mu(d\theta)^\top \Lambda(\theta) + F^\top \int_{\mathbb{R}_+^2} \mu(d\theta)^\top \Gamma(\theta, \tau) \mu(d\tau) \tilde{\gamma}(t).
 \end{aligned} \tag{3.3.6}$$

The two following definitions specify the concept of solution to the system (4.2.2).

Definition 3.3.1. Let $\Gamma : \mathbb{R}_+^2 \rightarrow \mathbb{R}^{d \times d}$ such that $\Gamma \in L^\infty(\mu \otimes \mu)$. We say that Γ is symmetric if

$$\Gamma(\theta, \tau) = \Gamma(\tau, \theta)^\top, \quad \mu \otimes \mu - a.e.$$

and nonnegative if

$$\int_{\mathbb{R}_+^2} \varphi(\theta)^\top \mu(d\theta)^\top \Gamma(\theta, \tau) \mu(d\tau) \varphi(\tau) \geq 0, \quad \text{for all } \varphi \in L^1(\mu).$$

We denote by $\mathbb{S}_+^d(\mu \otimes \mu)$ the set of all symmetric and nonnegative $\Gamma \in L^\infty(\mu \otimes \mu)$.

Remark 3.3.1. The integral operator $\mathbf{\Gamma}$ associated to a symmetric kernel $L^\infty(\mu \otimes \mu)$ is symmetric, in the sense that

$$\langle \varphi, \mathbf{\Gamma} \psi \rangle_\mu = \langle \psi, \mathbf{\Gamma} \varphi \rangle_\mu, \quad \varphi, \psi \in L^1(\mu).$$

Moreover, the nonnegativity of Γ translates into

$$\langle \varphi, \mathbf{\Gamma} \varphi \rangle_\mu \geq 0, \quad \varphi \in L^1(\mu).$$

□

Definition 3.3.2. By a solution to the system (4.2.2), we mean a triplet $(\Gamma, \Lambda, \chi) \in C([0, T], L^1(\mu \otimes \mu)) \times C([0, T], L^1(\mu^\top)) \times C([0, T], \mathbb{R})$ such that

$$\Gamma_t(\theta, \tau) = \int_t^T e^{-(\theta+\tau)(s-t)} \mathcal{R}_1(\Gamma_s)(\theta, \tau) ds, \quad 0 \leq t \leq T, \quad \mu \otimes \mu - a.e. \tag{3.3.7}$$

$$\Lambda_t(\theta) = \int_t^T e^{-\theta(s-t)} \mathcal{R}_2(s, \Gamma_s, \Lambda_s)(\theta) ds, \quad 0 \leq t \leq T, \quad \mu - a.e. \tag{3.3.8}$$

$$\chi_t = \int_t^T \mathcal{R}_3(s, \Gamma_s, \Lambda_s) ds, \quad 0 \leq t \leq T, \tag{3.3.9}$$

where \mathcal{R}_1 , \mathcal{R}_2 and \mathcal{R}_3 are defined respectively by (4.2.3), (3.3.4) and (3.3.5). In particular $\hat{N}(\Gamma_t)$ given by (4.2.4) is invertible for all $t \leq T$.

The existence and uniqueness of a solution to the Riccati system follows from [AJMP19a], and is stated in the next theorem. Its proof is given in Section 3.6.

Theorem 3.3.1. Let g_0, β, γ be bounded functions on $[0, T]$. Assume that μ satisfies (3.2.3) and that

$$Q \in \mathbb{S}_+^d, \quad N - \lambda I_m \in \mathbb{S}_+^m, \tag{3.3.10}$$

for some $\lambda > 0$. Then, there exists a unique triplet $(\Gamma, \Lambda, \chi) \in C([0, T], L^1(\mu \otimes \mu)) \times C([0, T], L^1(\mu^\top)) \times C([0, T], \mathbb{R})$ to the system of Riccati equation (4.2.2) such that (4.2.5), (3.3.8), (3.3.9) hold and $\Gamma_t \in \mathbb{S}_+^d(\mu \otimes \mu)$, for all $t \leq T$. Furthermore, there exists some positive constant $M > 0$ such that

$$\int_{\mathbb{R}_+} |\mu|(d\tau) |\Gamma_t(\theta, \tau)| \leq M, \quad \mu - a.e., \quad 0 \leq t \leq T. \quad (3.3.11)$$

Remark 3.3.2. Since $\Gamma_t \in \mathbb{S}_+^d(\mu \otimes \mu)$, we have $\Gamma_t \in L^1(\mu \otimes \mu) \cap L^\infty(\mu \otimes \mu)$, for all $t \leq T$. Similarly, $\Lambda_t \in L^1(\mu^\top) \cap L^\infty(\mu^\top)$. To see this, it suffices to observe that since $\Lambda \in C([0, T], L^1(\mu^\top))$, it is bounded in $L^1(\mu^\top)$. Combined with the boundedness of Γ in $L^1(\mu \otimes \mu)$, the estimate (4.2.7) and the boundedness of the coefficients, we obtain

$$|\mathcal{R}_1(\Gamma_t)(\theta, \tau)| + |\mathcal{R}_2(t, \Gamma_t, \Lambda_t)(\theta)| \leq c, \quad \mu \otimes \mu - a.e., \quad t \leq T,$$

for some constant c . Finally, from (3.3.8), we get that $\Lambda_t \in L^\infty(\mu^\top)$, for all $t \leq T$. \square

Remark 3.3.3. The process V^α given by (3.3.1) is well-defined and continuous, due to the continuity of (Γ, Λ, χ) , that of Y^α from Theorem 3.2.1 together with the bounds (3.2.14) and Remark 4.3.1. \square

Our first main result addresses the solvability of the problem (3.2.7). Theorem 3.3.2 establishes the existence of an optimal feedback control of linear form and provides an explicit expression for the value function in terms of the solution to the Riccati equation. The proof is collected in Section 3.6 and builds upon the results developed in Sections 3.4 and 3.5.

Theorem 3.3.2. Let β, γ be bounded functions on $[0, T]$ and g_0 continuous. Fix K, μ as in (3.2.2)–(3.2.3). Under (4.2.6), let (Γ, Λ, χ) be the solution to the system of Riccati equation (4.2.2) produced by Theorem 4.2.1. Then, there exists an admissible control $\alpha^* \in \mathcal{A}$ with corresponding controlled trajectory Y^{α^*} as in (3.2.15) such that

$$\alpha_t^* = -\hat{N}(\Gamma_t)^{-1} \left(h(t, \Gamma_t, \Lambda_t) + \int_{\mathbb{R}_+} S(\Gamma_t)(\theta) \mu(d\theta) Y_t^{\alpha^*}(\theta) \right) \quad (3.3.12)$$

for all $t \leq T$. Furthermore, α^* is an admissible optimal control, in the sense that

$$\inf_{\alpha \in \mathcal{A}} J(\alpha) = J(\alpha^*),$$

Y^{α^*} is the optimally controlled trajectory of the state variable and $V_t^{\alpha^*}$ given by (3.3.1) is the optimal value process of the problem, that is

$$V_t^{\alpha^*} = \inf_{\alpha \in \mathcal{A}_t(\alpha^*)} \mathbb{E} \left[\int_t^T f(X_s^\alpha, \alpha_s) ds \mid \mathcal{F}_t \right], \quad 0 \leq t \leq T, \quad (3.3.13)$$

where $\mathcal{A}_t(\alpha) = \{\alpha' \in \mathcal{A} : \alpha'_s = \alpha_s, s \leq t\}$.

Remark 3.3.4. From (3.3.13), it follows that at initial time $t = 0$, the optimal value V_0 is equal to $V_0 = V_0^{\alpha^*} = \chi_0$, hence

$$V_0 = \int_0^T \mathcal{R}_3(t, \Gamma_t, \Lambda_t) dt.$$

In particular, for a constant initial condition $g_0(t) \equiv X_0$ for some $X_0 \in \mathbb{R}^d$, we have

$$V_0 = X_0^\top \Psi(T) X_0 + \Phi(T) X_0 + \xi(T),$$

for suitable functions Ψ, Φ, ξ , which corresponds to the usual linear–quadratic form in X_0 . However, because of the possible non-Markovianity of the problem, for $t > 0$, the optimal value $V_t^{\alpha^*}$ is not necessarily linear–quadratic in $X_t^{\alpha^*}$ as in the standard case.

□

The following example treats the LQ regulator problem (3.1.1) with a general Volterra noise.

Example 3.3.1. *Let us consider a controlled equation with Volterra noise*

$$X_t^\alpha = \int_0^t \alpha_s ds + \int_0^t \tilde{K}(t-s) dW_s,$$

$$J(\alpha) = \mathbb{E} \left[\int_0^T (QX_s^2 + N\alpha_s^2) ds \right],$$

where $\tilde{K}(t) = \int_0^\infty e^{-\theta t} \tilde{\mu}(d\theta)$. Notice that X can be recast as

$$X_t^\alpha = \int_0^t K(t-s) (C\alpha_s ds + \gamma dW_s),$$

where K is the row vector $(1, \tilde{K})$, $C = (1, 0)^\top$ and $\gamma = (0, 1)^\top$. The kernel K is the Laplace transform of the 1×2 -matrix measure $\mu = (\delta_0(d\theta), \tilde{\mu}(d\theta))$. An application of Theorem 3.3.2 gives an optimal control of feedback form in Y :

$$\alpha_t^* = -\frac{1}{N} \left[\Gamma_t(0, 0) Y_t^1(0) + \int_{\mathbb{R}_+} \Gamma_t(\theta, 0) Y_t^2(\theta) \tilde{\mu}(d\theta) \right], \quad (3.3.14)$$

where Γ is solution to the real-valued infinite dimensional Riccati equation

$$\Gamma_t(\theta, \tau) = \int_t^T e^{-(\theta+\tau)(s-t)} (Q - \Gamma_s(\theta, 0) N^{-1} \Gamma_s(0, \tau)) ds, \quad \tilde{\mu} \otimes \tilde{\mu} - a.e., \quad t \in [0, T],$$

and $Y_t(\theta) = (Y_t^1(\theta), Y_t^2(\theta))^\top = \int_0^t e^{-\theta(s-t)} (C\alpha_s^* ds + \gamma dW_s)$. In particular,

$$Y_t^2(\theta) = \int_0^t e^{-\theta(t-s)} dW_s$$

$$Y_t^1(0) = \int_0^t \alpha_s^* ds = X_t^* - \int_0^t \tilde{K}(t-s) dW_s = X_t^* - \int_{\mathbb{R}_+} Y_t^2(\theta) \tilde{\mu}(d\theta),$$

where $X^* = X^{\alpha^*}$, and the last equality holds by stochastic Fubini's theorem. Plugging the expressions of Y^1 and Y^2 into (3.3.14) yields

$$\alpha_t^* = -\frac{1}{N} \left(\Gamma_t(0, 0) X_t^* + \int_0^\infty (\Gamma_t(\theta, 0) - \Gamma_t(0, 0)) Y_t^2(\theta) \tilde{\mu}(d\theta) \right),$$

which is the sum of a feedback form in X^* , and a second term capturing the non Markovianity of X , as for example in the case of a fractional noise with Hurst parameter $H \leq 1/2$. Note that $\Gamma(0, 0)$ satisfies the standard Riccati equation in LQ control problem. One can also note that when $\tilde{K} \equiv 1$ then $\tilde{\mu}(d\theta) = \delta_0(d\theta)$, which implies that the optimal control takes the standard feedback form $\alpha_t^* = -\frac{1}{N} \Gamma_t(0, 0) X_t^*$. □

Remark 3.3.5. *Conventional linear–quadratic models, see for instance [YZ99, Chapter 7], are naturally nested in our framework. Indeed, they are recovered by setting $d = d'$*

and $\mu = \delta_0 I_d$, which corresponds to $K(t) \equiv I_d$. In this case, the Riccati equations for $\Gamma(0, 0), \Lambda(0), \chi$ reduce to the conventional matrix Riccati equations and $Y^\alpha = X^\alpha$ so that we recover the usual expression for the optimal control (3.3.12) and the value function

$$\begin{aligned}\alpha_t^* &= -\hat{N}(\Gamma_t(0))^{-1} \left(h(t, \Gamma_t(0, 0), \Lambda_t(0)) + S(\Gamma_t)(0) X_t^{\alpha^*} \right), \\ V_t &= X_t^\top \Gamma_t(0, 0) X_t + 2X_t^\top \Lambda_t(0) + \chi_t.\end{aligned}$$

□

Conventional linear–quadratic models can also be recovered by considering a kernel which is a weighted sum of exponentials as detailed in the following example. This will turn out to be of crucial importance in the next section.

Example 3.3.2. We set $d = d' = m = 1$ and

$$K^n(t) = \sum_{i=1}^n c_i^n e^{-\theta_i^n t}, \quad (3.3.15)$$

for some $n \in \mathbb{N}$, $c_i^n \in \mathbb{R}$, $\theta_i^n \geq 0$, $i = 1, \dots, n$. This corresponds to (3.2.2) with $\mu(d\theta) = \sum_{i=1}^n c_i^n \delta_{\theta_i^n}(d\theta)$ and Theorem 3.2.1 gives the representation

$$X_t^{n, \alpha} = g_0^n(t) + \sum_{i=1}^n c_i^n Y_t^{n, i, \alpha}, \quad (3.3.16)$$

where $Y^{n, i, \alpha} := Y^\alpha(\theta_i^n)$ are such that

$$\begin{aligned}dY_t^{n, i, \alpha} &= \left[-\theta_i^n Y_t^{n, i, \alpha} + \tilde{b}\left(t, \sum_{j=1}^n c_j^n Y_t^{n, j, \alpha}, \alpha_t\right) \right] dt + \tilde{\sigma}\left(t, \sum_{j=1}^n c_j^n Y_t^{n, j, \alpha}, \alpha_t\right) dW_t \\ Y_0^{n, i, \alpha} &= 0, \quad i = 1, \dots, n.\end{aligned} \quad (3.3.17)$$

Whence, the problem reduces to a conventional linear–quadratic control for the finite-dimensional controlled system $(Y^{n, i, \alpha})_{1 \leq i \leq n}$. In particular, the system of Riccati (4.2.2) reduces to a standard one in finite-dimension. For instance the equation for Γ reduces to the standard $n \times n$ -matrix Riccati equation

$$\begin{cases} \dot{\Gamma}_t^n &= -Q^n - (B^n)^\top \Gamma_t^n - \Gamma_t^n B^n - (D^n)^\top \Gamma_t^n D^n \\ &\quad + ((F^n)^\top \Gamma_t^n D^n + (C^n)^\top \Gamma_t^n)^\top (N^n + (F^n)^\top \Gamma_t^n F^n)^{-1} ((F^n)^\top \Gamma_t^n D^n + (C^n)^\top \Gamma_t^n) \\ \Gamma_T^n &= 0, \end{cases} \quad (3.3.18)$$

where the coefficients $(B^n, C^n, D^n, F^n, N^n, Q^n) \in \mathbb{R}^{n \times n} \times \mathbb{R}^n \times \mathbb{R}^{n \times n} \times \mathbb{R}^n \times \mathbb{R}_+ \times \mathbb{S}_+^n$ are defined by

$$\begin{aligned}B_{i,j}^n &= Bc_i^n - \theta_i^n \delta_{ij}, & D_{i,j}^n &= Dc_i^n, \\ C_i^n &= Cc_i^n, & F_i^n &= Fc_i^n, \\ Q_{i,j}^n &= Q, & N^n &= N,\end{aligned}$$

for all $1 \leq i, j \leq n$. □

Remark 3.3.6. The proofs of Theorems 4.2.1 and 3.3.2 can be easily adapted to account for a multi-dimensional Brownian motion and time-dependent bounded coefficients. □

3.3.2 Stability and approximation by conventional LQ problems

The second main result of the paper concerns the approximation of the possibly non-Markovian control problem by sequences of finite dimensional Markovian ones, which is of crucial importance for numerical implementations. The main idea comes from the approximation of the measure μ , appearing in (3.2.2), by simpler measures μ^n , or equivalently approximating K by simpler kernels K^n given by

$$K^n(t) = \int_{\mathbb{R}_+} e^{-\theta t} \mu^n(d\theta), \quad t > 0. \quad (3.3.19)$$

We also authorize the approximation of the input curve g_0 . By substituting (K, g_0) with (K^n, g_0^n) , the approximating problem reads

$$V_0^n = \inf_{\alpha \in \mathcal{A}} J^n(\alpha) \quad (3.3.20)$$

where

$$J^n(\alpha) = \inf_{\alpha \in \mathcal{A}} \mathbb{E} \left[\int_0^T ((X_s^{n,\alpha})^\top Q X_s^{n,\alpha} + 2L_s^\top X_s^{n,\alpha} + \alpha_s^\top N \alpha_s) ds \right], \quad (3.3.21)$$

$$X_t^{n,\alpha} = g_0^n(t) + \int_0^t K^n(t-s)b(s, X_s^{n,\alpha}, \alpha_s) ds + \int_0^t K^n(t-s)\sigma(s, X_s^{n,\alpha}, \alpha_s) dW_s.$$

The following theorem establishes the stability of stochastic Volterra linear–quadratic control problems. Its proof is given in Section 3.7.2.

Theorem 3.3.3. *Let β, γ be bounded and measurable functions on $[0, T]$ and g_0 be continuous. Assume that μ satisfies (3.2.3) and let K be as in (3.2.2). Let $(g_0^n)_{n \geq 1}$ be a sequence of continuous functions and $(K^n)_{n \geq 1}$ be a sequence of kernels of the form (3.3.19) with respective measures μ^n satisfying (3.2.3), for each $n \in \mathbb{N}$. Assume (4.2.6) and that Q is invertible. Denote by V^* and V^{n*} the respective optimal value processes given by Theorem 3.3.2 for the respective inputs (g_0, K) and (g_0^n, K^n) , for $n \geq 1$. If*

$$\|K^n - K\|_{L^2(0,T)} \rightarrow 0 \quad \text{and} \quad \|g_0^n - g_0\|_{L^2(0,T)} \rightarrow 0, \quad \text{as } n \rightarrow \infty, \quad (3.3.22)$$

then,

$$V_0^{n*} \rightarrow V_0^*, \quad \text{as } n \rightarrow \infty, \quad (3.3.23)$$

with a rate of convergence given by

$$|V_0^* - V_0^{n*}| \leq c \left(\|g_0^n - g_0\|_{L^2(0,T)} + \|K^n - K\|_{L^2(0,T)} \right), \quad (3.3.24)$$

for some positive constant c independent of n .

Combined with Example 3.3.2, Theorem 3.3.3 provides an approximation of linear–quadratic stochastic Volterra optimal control problems by conventional Markovian linear–quadratic models in finite dimension. To ease notations we restrict to the case $d = d' = m = 1$, for higher dimension matrices need to be replaced by tensors in what follows. The idea is to approximate μ by a discrete measure μ^n as follows. Fix $n \geq 1$ and $(\eta_i^n)_{0 \leq i \leq n}$ a partition of \mathbb{R}_+ . Let $\mu^n(d\theta) = \sum_{i=1}^n c_i^n \delta_{\theta_i^n}(d\theta)$ with

$$c_i^n = \int_{\eta_{i-1}^n}^{\eta_i^n} \mu(dx) \quad \text{and} \quad \theta_i^n = \frac{1}{c_i^n} \int_{\eta_{i-1}^n}^{\eta_i^n} \theta \mu(d\theta), \quad i = 1, \dots, n. \quad (3.3.25)$$

Then, for a suitable choice of the partition $(\eta_i^n)_{0 \leq i \leq n}$, we obtain the convergence

$$\|K^n - K\|_{L^2(0,T)} \rightarrow 0, \quad \text{as } n \rightarrow \infty,$$

where K^n is given by (3.3.15), see for instance [AJEE19b, Proposition 3.3 and Remark 3.4]. In particular, for the fractional kernel K_H given by (3.2.8), an even n , and the geometric partition $\eta_i^n = r_n^{i-n/2}$ for $i = 0, \dots, n$, for some $r_n > 1$, the coefficients (3.3.25) with μ_H as in (3.2.9) are explicitly given by

$$c_i^n = \frac{(r_n^{1-\alpha} - 1)r_n^{(\alpha-1)(1+n/2)}}{\Gamma(\alpha)\Gamma(2-\alpha)} r_n^{(1-\alpha)i} \quad \text{and} \quad x_i^n = \frac{1-\alpha}{2-\alpha} \frac{r_n^{2-\alpha} - 1}{r_n^{1-\alpha} - 1} r_n^{i-1-n/2}, \quad i = 1, \dots, n,$$

where $\alpha := H + 1/2$. If the sequence $(r_n)_{n \geq 1}$ satisfies

$$r_n \downarrow 1 \quad \text{and} \quad n \ln r_n \rightarrow \infty, \quad \text{as } n \rightarrow \infty,$$

then,

$$\|K^n - K_H\|_{L^2(0,T)} \rightarrow 0, \quad \text{as } n \rightarrow \infty,$$

see [AJ19a, Lemma A.3]. In practice, the free parameter r_n can be chosen by minimizing the L^2 norm between K^n and K_H , for instance if $n = 20$, setting $r_{20} = 2.5$ yields very good approximations for the un-controlled stochastic Volterra equation, see [AJ19a] for a more detailed practical study. For each n , the approximate control problem is a conventional linear quadratic one in finite dimension for the state variables (3.3.17) with the standard $n \times n$ matrix Riccati equation (3.3.18). This allows to numerically solve the Riccati equations and simulate the process $X^{n,\alpha}$ given by (3.3.16), leading to computation of the value function V_0^{n*} and the optimal control α^n as in (3.3.12) with μ replaced by μ^n .

3.4 An infinite dimensional SDE with Lipschitz coefficients

We aim to establish the existence of a solution to the stochastic Volterra equation and that of an admissible optimal control. For this, we shall study more generally the existence and uniqueness of a solution to an infinite dimensional stochastic differential equation (SDE) in $L^1(\mu)$. Throughout this section, we fix $t \in [0, T]$, $d, d', n \in \mathbb{N}$, $p \geq 2$, μ a $d \times d'$ -measure satisfying (3.2.3), and W denotes an n -dimensional standard Brownian motion.

Let us consider the infinite dimensional SDE in $L^1(\mu)$:

$$d\tilde{Y}_s = (A^{mr}\tilde{Y}_s + \delta(s, \tilde{Y}_s))ds + \Sigma(s, \tilde{Y}_s)dW_s, \quad \tilde{Y}_t = \xi, \quad (3.4.1)$$

on $[t, T]$, where A^{mr} is the mean-reverting operator as defined in (3.2.17), the inputs $\xi \in L^1(\mu)$, and $\delta : [0, T] \times \Omega \times L^1(\mu) \rightarrow L^\infty(\mu)$, $\Sigma : [0, T] \times \Omega \times L^1(\mu) \rightarrow L^\infty(\mu)^n$.

We look for $L^1(\mu)$ -valued solutions to (3.4.1) in the strong probabilistic sense and in the mild analytical sense. More precisely, given a filtered probability space $(\Omega, \mathcal{F}, (\mathcal{F}_s)_{s \geq 0}, \mathbb{P})$ supporting a n dimensional Brownian motion W , we say that a progressively measurable process \tilde{Y} is a (mild) solution to (3.4.1) on $[t, T]$ if for each $s \in [t, T]$,

$$\begin{aligned} \tilde{Y}_s(\theta) = & e^{-\theta(s-t)}\xi(\theta) + \int_t^s e^{-\theta(s-u)}\delta(u, \tilde{Y}_u)(\theta)du \\ & + \int_t^s e^{-\theta(s-u)}\Sigma(u, \tilde{Y}_u)(\theta)dW_u, \quad \mu - a.e., \end{aligned} \quad (3.4.2)$$

such that

$$\sup_{t \leq s \leq T} \mathbb{E} \left[\|\tilde{Y}_s\|_{L^1(\mu)}^p \right] < \infty. \quad (3.4.3)$$

The following theorem establishes the strong existence and uniqueness of a solution to (3.4.2) under Lipschitz conditions.

Theorem 3.4.1. *Fix $p \geq 2$ and $t \leq T$. Assume that δ and Σ are progressively measurable and that there exists positive constants c_{LG} , c_{Lip} , and a progressively measurable process ϕ with*

$$\sup_{t \leq s \leq T} \mathbb{E}[\|\phi_s\|^p] < \infty,$$

such that for all $y, y' \in L^1(\mu)$, and $t \leq s \leq T$,

$$\begin{aligned} |\delta(s, y)(\theta)| + |\Sigma(s, y)(\theta)| &\leq c_{\text{LG}} (1 + |\phi_s| + \|y\|_{L^1(\mu)}) \quad (3.4.4) \\ |\delta(s, y)(\theta) - \delta(s, y')(\theta)| + |\Sigma(s, y)(\theta) - \Sigma(s, y')(\theta)| &\leq c_{\text{Lip}} \|y - y'\|_{L^1(\mu)}, \quad (3.4.5) \end{aligned}$$

$\mathbb{P} \otimes \mu - a.e.$ Then, for any \mathcal{F}_t -measurable random variable $\mathbb{E}[\|\xi\|_{L^1(\mu)}^p] < \infty$, there exists a unique strong solution Y to (3.4.2) on $[t, T]$ such that (3.4.3) holds.

Proof. The proof is an application of the contraction mapping principle. We denote by $\mathcal{S}_{t,T}^p$ the space of progressively measurable processes $\tilde{Y} : \Omega \times [t, T] \rightarrow L^1(\mu)$ such that

$$\|\tilde{Y}\|_{\mathcal{S}_{t,T}^p} := \sup_{t \leq s \leq T} \mathbb{E} \left[\|\tilde{Y}_s\|_{L^1(\mu)}^p \right]^{1/p} < \infty.$$

$(\mathcal{S}_{t,T}^p, \|\cdot\|_{\mathcal{S}_{t,T}^p})$ is a Banach space. We consider the following family of norms on $\mathcal{S}_{t,T}^p$:

$$\|\tilde{Y}\|_\lambda := \sup_{t \leq s \leq T} e^{-\lambda(s-t)} \mathbb{E} \left[\|\tilde{Y}_s\|_{L^1(\mu)}^p \right]^{1/p}, \quad \lambda > 0.$$

For every $\tilde{Y} \in \mathcal{S}_{t,T}^p$, define a new process $\mathcal{T}\tilde{Y}$ by

$$\begin{aligned} (\mathcal{T}\tilde{Y})_s(\theta) &= e^{-\theta(s-t)} \xi(\theta) + \int_t^s e^{-\theta(s-u)} \delta(u, \tilde{Y}_u)(\theta) du \\ &\quad + \int_t^s e^{-\theta(s-u)} \Sigma(u, \tilde{Y}_u)(\theta) dW_u \\ &= \mathbf{I}_s(\theta) + \mathbf{II}_s(\theta) + \mathbf{III}_s(\theta), \quad \mu - a.e., \quad t \leq s \leq T. \end{aligned}$$

Since the norms $\|\cdot\|_{\mathcal{S}_{t,T}^p}$ and $\|\cdot\|_\lambda$ are equivalent, it is enough to find $\lambda > 0$ such that \mathcal{T} defines a contraction on $(\mathcal{S}_{t,T}^p, \|\cdot\|_\lambda)$. That is, we look for $\lambda > 0$ and $M < 1$ such that

$$\|\mathcal{T}\tilde{Y} - \mathcal{T}\tilde{Z}\|_\lambda \leq M \|\tilde{Y} - \tilde{Z}\|_\lambda, \quad \tilde{Y}, \tilde{Z} \in \mathcal{S}_{t,T}^p. \quad (3.4.6)$$

Step 1: We first prove that $\mathcal{T}(\mathcal{S}_{t,T}^p) \subset \mathcal{S}_{t,T}^p$. Fix $\tilde{Y} \in \mathcal{S}_{t,T}^p$ and $t \leq s \leq T$. $\mathcal{T}\tilde{Y}$ is again progressively measurable. Jensen's inequality applied to the convex function $\|\cdot\|_{L^1(\mu)}^p$ leads to

$$\|(\mathcal{T}\tilde{Y})_s\|_{L^1(\mu)}^p \leq 3^{p-1} \left(\|\mathbf{I}_s\|_{L^1(\mu)}^p + \|\mathbf{II}_s\|_{L^1(\mu)}^p + \|\mathbf{III}_s\|_{L^1(\mu)}^p \right).$$

Since $\mathbb{E}[\|\xi\|_{L^1(\mu)}^p] < \infty$, we have

$$\mathbb{E}[\|\mathbf{I}_s\|_{L^1(\mu)}^p] = \mathbb{E} \left[\|e^{-\cdot(s-t)} \xi\|_{L^1(\mu)}^p \right] \leq \mathbb{E} \left[\|\xi\|_{L^1(\mu)}^p \right] < \infty,$$

where we used the bound $e^{-\theta(s-t)} \leq 1$, since μ is supported on \mathbb{R}_+ . Three successive application of Jensen's inequality on the normalized measures

$$\frac{(1 \wedge \theta^{-1/2})\mu(d\theta)}{\int_{\mathbb{R}_+} (1 \wedge \tau^{-1/2})\mu(d\tau)}, \quad \frac{du}{(s-t)}, \quad \frac{e^{-2\theta(s-u)} du}{\int_s^t e^{-2\theta(s-v)} dv},$$

yield for a constant c that may vary from line to line

$$\begin{aligned} \|\mathbf{II}_s\|_{L^1(\mu)}^p &= \left(\int_{\mathbb{R}_+} |\mu|(d\theta) \left| \int_t^s e^{-\theta(s-u)} \delta(u, \tilde{Y}_u)(\theta) du \right| \right)^p \\ &\leq c \int_{\mathbb{R}_+} |\mu|(d\theta) \left(1 \wedge \theta^{(p-1)/2} \right) \left| \int_t^s e^{-\theta(s-u)} \delta(u, \tilde{Y}_u)(\theta) du \right|^p \\ &\leq c \int_{\mathbb{R}_+} |\mu|(d\theta) \left(1 \wedge \theta^{(p-1)/2} \right) \left| \int_t^s e^{-2\theta(s-u)} |\delta(u, \tilde{Y}_u)(\theta)|^2 du \right|^{p/2} \\ &\leq c \int_{\mathbb{R}_+} |\mu|(d\theta) \left(1 \wedge \theta^{(p-1)/2} \right) \\ &\quad \times \int_t^s e^{-2\theta(s-u)} |\delta(u, \tilde{Y}_u)(\theta)|^p du \left(\int_t^s e^{-2\theta(s-v)} dv \right)^{(p-2)/2}. \end{aligned}$$

Taking expectation combined with the growth condition (3.4.4) and the fact that $\tilde{Y} \in \mathcal{S}_{t,T}^p$ leads to

$$\begin{aligned} \mathbb{E} \left[\|\mathbf{II}_s\|_{L^1(\mu)}^p \right] &\leq c \left(1 + \sup_{t \leq u \leq T} \mathbb{E} [|\phi_u|^p] + \|\tilde{Y}\|_{\mathcal{S}_{t,T}^p}^p \right) \\ &\quad \times \int_{\mathbb{R}_+} |\mu|(d\theta) \left(1 \wedge \theta^{(p-1)/2} \right) \left(\int_t^s e^{-2\theta(s-u)} du \right)^{p/2} \\ &= c \int_{\mathbb{R}_+} |\mu|(d\theta) \left(1 \wedge \theta^{(p-1)/2} \right) \left(\frac{1 - e^{-2\theta(s-t)}}{2\theta} \right)^{p/2}. \end{aligned}$$

Similarly, combining the same Jensen's inequalities with the Burkholder-Davis-Gundy inequality, we get

$$\begin{aligned} \mathbb{E} \left[\|\mathbf{III}_s\|_{L^1(\mu)}^p \right] &= \mathbb{E} \left[\left(\int_{\mathbb{R}_+} |\mu|(d\theta) \left| \int_t^s e^{-\theta(s-u)} \Sigma(u, \tilde{Y}_u)(\theta) dW_u du \right| \right)^p \right] \\ &\leq c \int_{\mathbb{R}_+} |\mu|(d\theta) (1 \wedge \theta^{(p-1)/2}) \\ &\quad \times \int_t^s e^{-2\theta(s-u)} \mathbb{E} \left[|\Sigma(u, \tilde{Y}_u)(\theta)|^p \right] du \left(\int_s^t e^{-2\theta(s-v)} dv \right)^{(p-2)/2} \\ &\leq c \int_{\mathbb{R}_+} |\mu|(d\theta) \left(1 \wedge \theta^{(p-1)/2} \right) \left(\frac{1 - e^{-2\theta(s-t)}}{2\theta} \right)^{p/2} \end{aligned}$$

where the last inequality follows from the growth condition (3.4.4) and the fact that $\tilde{Y} \in \mathcal{S}_{t,T}^p$. Recalling inequality (3.2.16), we get that

$$\int_{\mathbb{R}_+} |\mu|(d\theta) \left(1 \wedge \theta^{(p-1)/2} \right) \left(\frac{1 - e^{-2\theta(s-t)}}{2\theta} \right)^{p/2} \leq c \int_{\mathbb{R}_+} |\mu|(d\theta) \left(1 \wedge \theta^{-1/2} \right) \quad (3.4.7)$$

which is finite due to condition (3.2.3). This shows that

$$\mathbb{E} \left[\|\mathbf{II}_s\|_{L^1(\mu)}^p \right] + \mathbb{E} \left[\|\mathbf{III}_s\|_{L^1(\mu)}^p \right] \leq c < \infty.$$

Combining the above proves that $\|\mathcal{T}\tilde{Y}\|_{\mathcal{S}_{t,T}^p} < \infty$ and hence $\mathcal{T} : \mathcal{S}_{t,T}^p \rightarrow \mathcal{S}_{t,T}^p$.

Step 2: We prove that there exists $\lambda > 0$ such that (3.4.6) holds. Let $\tilde{Y}, \tilde{Z} \in \mathcal{S}_{t,T}^p$ such that $\|\tilde{Y}\|_\lambda$ and $\|\tilde{Z}\|_\lambda$ are finite. Similarly to Step 1, Jensen and Burkholder–Davis–Gundy inequalities combined with the Lipschitz condition (3.4.5) lead to

$$\|\mathcal{T}\tilde{Y} - \mathcal{T}\tilde{Z}\|_\lambda^p \leq M(\lambda)\|\tilde{Y} - \tilde{Z}\|_\lambda^p,$$

where

$$M(\lambda) = c \int_{\mathbb{R}_+} |\mu|(d\theta) \left(1 \wedge \theta^{(p-1)/2} \right) \int_t^s e^{-2\theta(s-u)} e^{-\lambda p(s-u)} du \left(\int_t^s e^{-2\theta(s-v)} dv \right)^{(p-2)/2}.$$

By the dominated convergence theorem, recall (3.4.7), $M(\lambda)$ tends to 0 as λ goes to $+\infty$. We can therefore choose $\lambda_0 > 0$ so that (3.4.6) holds with $M(\lambda_0) < 1$. An application of the contraction mapping theorem yields the claimed existence and uniqueness statement in $(\mathcal{S}_{t,T}^p, \|\cdot\|_{\mathcal{S}_{t,T}^p})$ together with (3.4.3). \square

Example 3.4.1. Fix $\alpha \in \mathcal{A}$, the conditions (3.4.4)-(3.4.5) are satisfied for the following specification of δ and Σ :

$$\begin{aligned} \delta(s, \omega, y)(\theta) &= b_0(s, \omega, \theta) + \int_{\mathbb{R}_+} B_0(s, \omega, \theta, \tau) \mu(d\tau) y(\tau) + C_0(s, \omega, \theta) \alpha_s(\omega) \\ \Sigma(s, \omega, y)(\theta) &= \gamma_0(s, \omega, \theta) + \int_{\mathbb{R}_+} D_0(s, \omega, \theta, \tau) \mu(d\tau) y(\tau) + F_0(s, \omega, \theta) \alpha_s(\omega), \end{aligned}$$

where

$$\begin{aligned} |b_0(s, \theta)| + |\gamma_0(s, \theta)| + |C_0(s, \theta)| + |F_0(s, \theta)| &\leq c, \quad \mathbb{P} \otimes \mu - a.e., \quad t \leq s \leq T, \\ |B_0(s, \theta, \tau)| + |D_0(s, \theta, \tau)| &\leq c, \quad \mathbb{P} \otimes \mu \otimes \mu - a.e., \quad t \leq s \leq T \end{aligned} \quad (3.4.8)$$

for some constant c . \square

The existence and uniqueness of a strong solution to the stochastic Volterra equation (3.2.1) readily follows from Theorem 3.4.1 when combined with Theorem 3.2.1. To prove continuity of the solution we need the following lemma.

Lemma 3.4.1. Let $Z_t = \int_0^t b_s ds + \int_0^t \sigma_s dW_s$, $0 \leq t \leq T$, such that b and σ are progressively measurable and

$$\sup_{t \leq T} \mathbb{E} [|b_t|^4] + \sup_{t \leq T} \mathbb{E} [|\sigma_t|^4] < \infty.$$

Then, the process

$$\tilde{Y}_t(\theta) = \int_0^t e^{-\theta(t-s)} dZ_s, \quad \theta \in \mathbb{R}_+,$$

solution in the mild sense to

$$d\tilde{Y}_s = A^{mr} \tilde{Y}_s ds + dZ_s, \quad \tilde{Y}_0 = 0,$$

admits a continuous modification in $L^1(\mu)$ and satisfies (3.2.13)-(3.2.14).

Proof. The bound (3.2.13) follows along the lines of the estimates in step 1 of the proof of Theorem 3.4.1 with $p = 4$, for getting (3.4.3), by successive applications of Jensen inequalities. Let us now show (3.2.14) and the continuity statement. Fix $\theta \in \mathbb{R}_+$ and $t \leq T$. An integration by parts leads to

$$\tilde{Y}_t(\theta) = e^{-\theta t} Z_t + \theta \int_0^t e^{-\theta(t-s)} (Z_t - Z_s) ds.$$

The Kolmogorov–Chentsov continuity criterion, yields that for each $\zeta \in (0, 1/4)$, the process Z admits a version with ζ -Hölder sample paths on $[0, T]$. We identify Z with this version so that

$$|Z_t(\omega) - Z_s(\omega)| \leq c_{T,\zeta}(\omega) |t - s|^\zeta, \quad s, t \leq T,$$

for some $c_{T,\zeta}(\omega) \geq 0$. Using this inequality and another integration by parts yields

$$\begin{aligned} |\tilde{Y}_t(\theta, \omega)| &\leq c_{T,\zeta}(\omega) e^{-\theta t} t^\zeta + c_{T,\zeta}(\omega) \theta \int_0^t e^{-\theta u} u^\zeta du \\ &= c_{T,\zeta}(\omega) \zeta \int_0^t e^{-\theta u} u^{\zeta-1} du. \end{aligned}$$

This proves (3.2.14). Furthermore,

$$\sup_{t \leq T} |\tilde{Y}_t(\theta, \omega)| \leq c_{T,\zeta}(\omega) \zeta \int_0^T e^{-\theta u} u^{\zeta-1} du,$$

where the right hand side is in $L^1(|\mu|)$ by virtue of the Cauchy–Schwarz inequality and Lemma 3.A.1. Since $t \mapsto \tilde{Y}_t(\theta, \omega)$ is continuous for each $\theta \in \mathbb{R}_+$, the dominated convergence theorem yields that the process \tilde{Y} is continuous in $L^1(\mu)$. \square

Theorem 3.4.2. *Let g_0 be continuous, β, γ be bounded measurable functions on $[0, T]$ and K be a kernel as in (3.2.2) such that (3.2.3) holds. Fix an admissible control $\alpha \in \mathcal{A}$. The stochastic Volterra equation (3.2.1) admits a unique continuous and adapted strong solution X^α such that (3.2.4) holds.*

Proof. Existence, uniqueness and (3.2.4) are straightforward from Theorem 3.4.1 combined with Theorem 3.2.1 and Example 3.4.1 for the coefficients

$$\begin{aligned} b_0(s, \theta) &= \beta(s) + Bg_0(s), & B_0(s, \theta, \tau) &= B, & C_0(s, \theta, \tau) &= C, \\ \gamma_0(s, \theta) &= \gamma(s) + Dg_0(s), & D_0(s, \theta, \tau) &= D, & F_0(s, \theta, \tau) &= F. \end{aligned}$$

The statement concerning the continuity of X^α is a direct consequence of the continuity of Y^α established in Lemma 3.4.1 and the converse direction in Theorem 3.2.1. \square

3.5 A martingale verification theorem

We first derive an Itô formula for quadratic functions in $L^1(\mu)$.

Lemma 3.5.1. *Fix a $d \times d$ -matrix measure μ on \mathbb{R}_+ such that $|\mu|$ is σ -finite, and $t \in [0, T]$. Let \tilde{Y} be a $L^1(\mu)$ -valued progressively measurable processes solution in the mild sense to*

$$d\tilde{Y}_s = A^{mr} \tilde{Y}_s + b_s ds + \sigma_s dW_s, \quad t \leq s \leq T, \quad \tilde{Y}_t = \xi, \quad (3.5.1)$$

for $\xi \in L^1(\mu)$ and some progressively measurable b, σ valued in $L^\infty(\mu)$ and satisfying

$$\int_t^T \|b_s\|_{L^\infty(\mu)} ds + \int_t^T \|\sigma_s\|_{L^\infty(\mu)}^2 ds < \infty, \quad \mathbb{P} - a.s. \quad (3.5.2)$$

Assume that \tilde{Y} is bounded in $s \in [t, T]$, $\mathbb{P} \otimes \mu$ -a.e. and has continuous sample paths in $L^1(\mu)$. Let $\tilde{\Gamma}, \tilde{\Lambda} \in C([t, T], L^1(\mu \otimes \mu)) \times C([t, T], L^1(\mu^\top))$ be solutions to

$$\begin{aligned} \dot{\tilde{\Gamma}}_s(\theta, \tau) &= (\theta + \tau)\tilde{\Gamma}_s(\theta, \tau) - R_s^1(\theta, \tau), & t \leq s \leq T, \quad \mu \otimes \mu - a.e. \\ \dot{\tilde{\Lambda}}_s(\theta) &= \theta\tilde{\Lambda}_s(\theta) - R_s^2(\theta), & t \leq s \leq T, \quad \mu - a.e. \end{aligned} \quad (3.5.3)$$

with $\tilde{\Gamma}_T \in L^\infty(\mu \otimes \mu)$, $\tilde{\Lambda}_T \in L^\infty(\mu^\top)$, and for some measurable functions $s \mapsto R_s^1$ and R_s^2 valued respectively in $L^\infty(\mu \otimes \mu)$ and $L^\infty(\mu^\top)$, such that

$$\int_t^T \|R_s^1\|_{L^\infty(\mu \otimes \mu)} ds + \int_t^T \|R_s^2\|_{L^\infty(\mu^\top)} ds < \infty. \quad (3.5.4)$$

Then, for all $t \leq s \leq T$, $\tilde{\Gamma}_s \in L^\infty(\mu \otimes \mu)$, $\tilde{\Lambda}_s \in L^\infty(\mu^\top)$, so that the processes

$$U_s^1 = \langle \tilde{Y}_s, \tilde{\Gamma}_s \tilde{Y}_s \rangle_\mu = \langle \tilde{\Gamma}_s \tilde{Y}_s, \tilde{Y}_s \rangle_{\mu^\top} \quad U_s^2 = \langle \tilde{Y}_s, \tilde{\Lambda}_s \rangle_\mu = \langle \tilde{\Lambda}_s, \tilde{Y}_s \rangle_{\mu^\top}, \quad t \leq s \leq T,$$

are well defined, where $\tilde{\Gamma}$ is the integral operator associated to the kernel $\tilde{\Gamma}$. Furthermore, we have for $i = 1, 2$,

$$dU_s^i = \Delta_s^i ds + \Sigma_s^i dW_s, \quad t \leq s \leq T, \quad (3.5.5)$$

where

$$\begin{aligned} \Delta_s^1 &= -\langle \tilde{Y}_s, \mathbf{R}_s^1 \tilde{Y}_s \rangle_\mu + \langle \tilde{\Gamma}_s \sigma_s, \sigma_s \rangle_{\mu^\top} + \langle \tilde{\Gamma}_s \tilde{Y}_s, b_s \rangle_{\mu^\top} + \langle \tilde{\Gamma}_s b_s, \tilde{Y}_s \rangle_{\mu^\top}, \\ \Sigma_s^1 &= \langle \tilde{\Gamma}_s \tilde{Y}_s, \sigma_s \rangle_{\mu^\top} + \langle \tilde{\Gamma}_s \sigma_s, \tilde{Y}_s \rangle_{\mu^\top}, \\ \Delta_s^2 &= -\langle \tilde{Y}_s, R_s^2 \rangle_\mu + \langle \tilde{\Lambda}_s, b_s \rangle_{\mu^\top}, \quad \Sigma_s^2 = \langle \tilde{\Lambda}_s, \sigma_s \rangle_{\mu^\top}, \end{aligned}$$

where \mathbf{R}^1 is the integral operator associated to the kernel R^1 .

Proof. We illustrate the proof only for U^2 , that of U^1 follows along the same lines. The idea is to apply Itô's formula θ by θ . By virtue of the inequality $|\mu(B)| \leq |\mu|(B)$, for any Borel set B , and the σ -finiteness of $|\mu|$, an application of the Radon–Nikodym theorem yields the existence of a measurable function $h : \mathbb{R}_+ \rightarrow \mathbb{R}^{d \times d}$ such that

$$\mu(d\theta) = h(\theta)|\mu|(d\theta) \quad (3.5.6)$$

with $|h(\theta)| = 1$, for all $\theta \in \mathbb{R}^d$, and $|h| \in L^1(|\mu|)$, see for instance [GLS90, Lemma 3.5.9]. Recall that by definition of a mild solution to (3.5.1), we mean that

$$\begin{aligned} \tilde{Y}_s(\theta) &= e^{-\theta(s-t)} \xi(\theta) + \int_t^s e^{-\theta(s-u)} b_u(\theta) du \\ &\quad + \int_t^s e^{-\theta(s-u)} \sigma_u(\theta) dW_u, \quad t \leq s \leq T, \quad \mathbb{P} \otimes \mu - a.e. \end{aligned} \quad (3.5.7)$$

Fix $t \leq T$, and observe that the solution $\tilde{\Lambda}$ to (3.5.3) is given by

$$\tilde{\Lambda}_s(\theta) = e^{-\theta(T-s)} \tilde{\Lambda}_T(\theta) + \int_s^T e^{-\theta(u-t)} R_u^2(\theta) du, \quad t \leq s \leq T, \quad \mu - a.e.,$$

which implies, with (3.5.4), that $\tilde{\Lambda}_s \in L^\infty(\mu^\top)$, $t \leq s \leq T$, together with the boundedness of $s \mapsto \tilde{\Lambda}_s$:

$$\sup_{t \leq s \leq T} |\tilde{\Lambda}_s(\theta)| \leq \|\tilde{\Lambda}_T\|_{L^\infty(\mu^\top)} + \int_t^T \|R_u^2\|_{L^\infty(\mu^\top)} du < \infty, \quad \mu - a.e. \quad (3.5.8)$$

Moreover, since \tilde{Y} is bounded in s , we have

$$\sup_{t \leq s \leq T} |\tilde{Y}_s(\theta)| < \infty, \quad \mathbb{P} \otimes \mu - a.e. \quad (3.5.9)$$

Define the $\mathbb{P} \otimes \mu$ -nullset

$$\mathcal{N} = \{(\omega, \theta) : \text{such that either (3.5.7) or (3.5.3) or (3.5.8) or (3.5.9) does not hold}\}.$$

Let $(\omega, \theta) \in \Omega \times \mathbb{R}_+ \setminus \mathcal{N}$ and observe that $s \mapsto \tilde{Y}_s(\theta, \omega)$ and $s \mapsto \tilde{\Lambda}_s(\theta)$ solve:

$$\begin{aligned} d\tilde{Y}_s(\theta, \omega) &= \left(-\theta \tilde{Y}_s(\theta, \omega) + b_s(\theta, \omega)\right) ds + \sigma_s(\theta, \omega) dW_s, \\ d\tilde{\Lambda}_s(\theta) &= \left(\theta \tilde{\Lambda}_s(\theta) - R_s^2(\theta)\right) ds. \end{aligned}$$

An application of Itô's formula to the process $u^2(\theta, \omega) : s \mapsto \tilde{\Lambda}_s(\theta)^\top h(\theta) \tilde{Y}_s(\theta)$ gives

$$u_s^2(\theta, \omega) = u_t^2(\theta, \omega) + \int_t^s \delta_u^2(\theta, \omega) du + \int_t^s \tilde{\Lambda}_u(\theta)^\top h(\theta) \sigma_u(\theta, \omega) dW_u, \quad t \leq s \quad (3.5.10)$$

with

$$\delta_u^2(\theta, \omega) = -R_u^2(\theta)^\top h(\theta) \tilde{Y}_u(\theta, \omega) + \tilde{\Lambda}_u(\theta)^\top h(\theta) b_u(\theta, \omega).$$

All the quantities appearing on the right hand side of (3.5.10) are well-defined thanks to the integrability assumptions (3.5.2)-(3.5.4) on the coefficients (b, σ, R^2) and the boundedness in s of $(\tilde{\Lambda}_s, \tilde{Y}_s)$ from (3.5.8)-(3.5.9). Whence, (3.5.10) holds $\mathbb{P} \otimes \mu$ almost everywhere. Next, by the boundedness (resulting from the continuity) of $s \mapsto \tilde{Y}_s$ in $L^1(\mu)$, $s \mapsto \tilde{\Lambda}_s$ in $L^1(\mu^\top)$, and again by the integrability conditions (3.5.2)-(3.5.4) on (b, σ, R^2) , all the terms appearing in (3.5.10) are in $L^1(|\mu|)$ so that an integration with respect to the θ variable against $|\mu|$ combined with the identity (3.5.6) and the stochastic Fubini's theorem, see [Ver12, Theorem 2.2], lead to (3.5.5). \square

The next theorem establishes a martingale verification result for the possibly non-Markovian optimization problem (3.2.1)-(3.2.7).

Theorem 3.5.1. *Let β, γ be bounded functions on $[0, T]$, g_0 continuous and $N \in \mathbb{S}_+^m$. Fix K, μ as in (3.2.2)-(3.2.3). Assume that:*

1. *there exists a solution $(\Gamma, \Lambda, \chi) \in C([0, T], L^1(\mu \otimes \mu)) \times C([0, T], L^1(\mu^\top)) \times C([0, T], \mathbb{R})$ such that (4.2.5), (3.3.8), (3.3.9) hold, and $\Gamma_t \in \mathbb{S}_+^d(\mu \otimes \mu)$, for all $t \leq T$, together with the estimate (4.2.7),*
2. *there exists an admissible control process $\alpha^* \in \mathcal{A}$ such that (3.3.12) holds for all $t \leq T$.*

Then, α^ is an optimal control, Y^{α^*} given by (3.2.10) is the optimally controlled trajectory of the state variable and V^{α^*} given by (3.3.1) is the optimal value process of the problem, in the sense that (3.3.13) holds, for all $t \leq T$.*

Proof. Step 1. For any $\alpha \in \mathcal{A}$, we know from Theorem 3.4.2 that there exists a continuous solution X^α to (3.2.1) such that (3.2.4) holds. Let us then define the continuous process

$$M_t^\alpha = \int_0^t f(X_s^\alpha, \alpha_s) ds + V_t^\alpha - \int_0^t (\alpha_s - \alpha_s^*)^\top \hat{N}_s (\alpha_s - \alpha_s^*) ds,$$

where f is the quadratic function in (3.2.6), V^α is the process given by (3.3.1) from the solution (Γ, Λ, χ) to the Riccati equation (4.2.2), α^* is given by (3.3.12), and \hat{N} by (4.2.4), recall Remark 3.3.3. The main point is to check that M^α is martingale for any $\alpha \in \mathcal{A}$. Indeed, if this the case, then, for each $t \leq T$, the equality $\mathbb{E}[M_T^\alpha | \mathcal{F}_t] = M_t^\alpha$ leads to

$$J_t(\alpha) - V_t^\alpha = \mathbb{E} \left[\int_t^T (\alpha_s - \alpha_s^*)^\top \hat{N}_s (\alpha_s - \alpha_s^*) ds \mid \mathcal{F}_t \right], \quad (3.5.11)$$

where we have set $J_t(\alpha) = \mathbb{E} \left[\int_t^T f(X_s^\alpha, \alpha_s) ds \mid \mathcal{F}_t \right]$, and used $V_T^\alpha = 0$, due to the vanishing terminal conditions of $(\Gamma, \Lambda, \Theta)$ and the continuity of V^α . Since $N \in \mathbb{S}_+^m$ and Γ is $\mathbb{S}_+^d(\mu \otimes \mu)$ valued, then $\hat{N} \in \mathbb{S}_+^m$ so that the right hand side of (3.5.11) is always nonnegative and vanishes for $\alpha = \alpha^*$. Fix now $t \leq T$, and observe that $V_t^{\alpha^*} = V_t^{\alpha'}$ for all $\alpha' \in \mathcal{A}_t(\alpha^*)$. We then deduce from (3.5.11) that

$$V_t^{\alpha^*} = J_t(\alpha^*) = \inf_{\alpha' \in \mathcal{A}_t(\alpha^*)} J_t(\alpha'),$$

which is the relation (3.3.13), and shows that α^* is an optimal control.

Step 2. We now prove that M^α is indeed a martingale by means of Itô's formula. To ease notations, we drop the superscript α from X^α and Y^α . The process V^α is written as

$$V_t^\alpha = U_t^1 + 2U_t^2 + \chi_t, \quad 0 \leq t \leq T,$$

where

$$U_t^1 = \langle Y_t, \Gamma_t Y_t \rangle_\mu, \quad U_t^2 = \langle \Lambda_t, Y_t \rangle_{\mu^\top},$$

and we recall that Y is bounded in (t, θ) from (3.2.14), and has continuous sample path in $L^1(\mu)$ by Theorem 3.2.1. From (3.2.14), and the admissibility condition on $\alpha \in \mathcal{A}$ combined with Cauchy-Schwarz inequality, it is clear that the drift $b_t := \tilde{\beta}(t) + \mathbf{B}Y_t + C\alpha_t$, and the diffusion coefficient $\sigma_t := \tilde{\gamma}(t) + \mathbf{D}Y_t + F\alpha_t$ of Y take values in $L^\infty(\mu)$, and satisfy the integrability condition (3.5.2). Moreover, from (4.2.7), and since $t \in [0, T] \mapsto \Gamma_t, \Lambda_t$ are bounded (by continuity) in $L^1(\mu \otimes \mu)$ and $L^1(\mu^\top)$, we see that $t \mapsto R_t^1 := \mathcal{R}_1(\Gamma_t)$ is valued in $L^\infty(\mu \otimes \mu)$, $t \mapsto R_t^2 := \mathcal{R}_2(t, \Gamma_t, \Lambda_t)$ is valued in $L^\infty(\mu^\top)$, and satisfy (see Remark 4.3.1):

$$\sup_{t \leq T} [\|R_t^1\|_{L^\infty(\mu \otimes \mu)} + \|R_t^2\|_{L^\infty(\mu^\top)}] < \infty,$$

which clearly implies the integrability condition (3.5.4). We can then apply Lemma 3.5.1 on U^1, U^2 . Recalling that Γ is symmetric, this yields, after re-arranging the quadratic and linear terms in Y and α , using the equation for Γ in (4.2.2) and applying Fubini's

theorem:

$$\begin{aligned}
 dU_t^1 &= \int_{\mathbb{R}_+^2} Y_t(\theta)^\top \mu(d\theta)^\top \left(S(\Gamma_t)(\theta) \hat{N}(\Gamma_t)^{-1} S(\Gamma_t)(\tau) - Q \right) \mu(d\tau) Y_t(\tau) dt \\
 &\quad + \int_{\mathbb{R}_+} 2Y_t(\theta)^\top \mu(d\theta)^\top \left(\int_{\mathbb{R}_+} \Gamma_t(\theta, \tau') \mu(d\tau') \tilde{\beta}(t) + D^\top \int_{\mathbb{R}_+^2} \mu(d\theta')^\top \Gamma_t(\theta', \tau') \mu(d\tau') \tilde{\gamma}(t) \right) dt \\
 &\quad + \alpha_t^\top F^\top \int_{\mathbb{R}_+^2} \mu(d\theta)^\top \Gamma_t(\theta, \tau) \mu(d\tau) F \alpha_t dt \\
 &\quad + 2\alpha_t^\top \left(\int_{\mathbb{R}_+} S(\Gamma_t)(\tau) \mu(d\tau) Y_t(\tau) + F^\top \int_{\mathbb{R}_+^2} \mu(d\tau)^\top \Gamma_t(\theta, \tau) \mu(d\tau) \tilde{\gamma}(t) \right) dt \\
 &\quad + \left(\tilde{\gamma}(t)^\top \int_{\mathbb{R}_+^2} \mu(d\theta')^\top \Gamma_t(\theta', \tau') \mu(d\tau') \tilde{\gamma}(t) \right) dt + H_t^1 dW_t,
 \end{aligned}$$

with

$$H_t^1 = 2\sigma(t, X_t, \alpha_t)^\top \int_{\mathbb{R}_+^2} \mu(d\theta)^\top \Gamma_t(\theta, \tau) \mu(d\tau) Y_t(\tau).$$

Similarly, using the equation for Λ in (4.2.2) we get

$$\begin{aligned}
 dU_t^2 &= \int_{\mathbb{R}_+} Y_t(\theta)^\top \mu(d\theta)^\top \left(S(\Gamma_t)(\theta)^\top \hat{N}(\Gamma_t)^{-1} h(t, \Gamma_t, \Lambda_t) - L \right) dt \\
 &\quad + \alpha_t^\top \left(C^\top \int_{\mathbb{R}_+} \mu(d\theta')^\top \Lambda_t(\theta') \right) dt + \tilde{\beta}(t)^\top \int_{\mathbb{R}_+} \mu(d\theta')^\top \Lambda_t(\theta') dt + H_t^2 dW_t,
 \end{aligned}$$

where

$$H_t^2 = \sigma(t, X_t, \alpha_t)^\top \int_{\mathbb{R}_+} \mu(d\theta)^\top \Lambda_t(\theta).$$

Now we write that

$$dM_t^\alpha = \left(X_t^\top Q X_t + \alpha_t^\top N \alpha_t - (\alpha_t - \alpha_t^*)^\top \hat{N}_t(\alpha_t - \alpha_t^*) + L^\top X_t + \dot{\chi}_t \right) dt + dU_t^1 + 2dU_t^2.$$

Completing the squares for the terms in α , observing that

$$\begin{aligned}
 X_t^\top Q X_t &= \int_{\mathbb{R}_+^2} Y_t(\theta)^\top \mu(d\theta)^\top Q \mu(d\tau) Y_t(\tau) + 2g_0(t)^\top \int_{\mathbb{R}_+} \mu(d\theta) Y_t(\theta) + g_0(t)^\top Q g_0(t), \\
 L^\top X_t &= L^\top \int_{\mathbb{R}_+} \mu(d\theta) Y_t(\theta) + L^\top g_0(t),
 \end{aligned}$$

using the equation for χ in (4.2.2), and adding all the above makes the drift in M^α vanish so that

$$dM_t^\alpha = (H_t^1 + 2H_t^2) dW_t.$$

This shows that M^α is a local martingale. To argue true martingality, successive applications of Jensen and Cauchy–Schwarz inequalities combined with the bound (4.2.7) yield, for a constant c ,

$$\begin{aligned}
 \int_0^T \mathbb{E} [|H_s^1|^2] ds &\leq cM^2 \int_0^T \mathbb{E} \left[(1 + |X_s|^2 + |\alpha_s|^2) \|Y_s\|_{L^1(\mu)}^2 \right] ds \\
 &\leq cM^2 \int_0^T \mathbb{E} \left[(1 + |X_s|^4 + |\alpha_s|^4) \right]^{1/2} \mathbb{E} \left[\|Y_s\|_{L^1(\mu)}^4 \right]^{1/2} ds
 \end{aligned}$$

which is finite due to (3.2.4), (3.2.13) and the admissibility of α . Since $\Lambda \in C([0, T], L^1(\mu^\top))$, we get similarly that

$$\int_0^T \mathbb{E} [|H_s^2|^2] ds < \infty.$$

Whence, by the Burkholder-Davis-Gundy inequality, M^α is a true martingale, and the proof is complete. \square

Remark 3.5.1. *Theorem 3.5.1 is still valid if one adds a linear quadratic terminal cost to the cost functional (3.2.5), that is*

$$J(\alpha) = \mathbb{E} \left[\int_0^T f(X_s^\alpha, \alpha_s) ds + (X_T^\alpha)^\top P X_T^\alpha + 2U^\top X_T^\alpha \right],$$

provided the terminal conditions of the system of Riccati equations (4.2.2) are updated to

$$\Gamma_T(\theta, \tau) = P, \quad \Lambda_T(\theta) = U + P g_0(T), \quad \chi_T = g_0(T)^\top P g_0(T) + 2U^\top g_0(T).$$

The main technical difficulty resides in Assumption 1. If K has no singularities at 0, then one can still construct continuous solutions to (4.2.2). However, in the presence of a singularity, the solution $t \rightarrow \Gamma_t$ inherits the singularity of the kernel and is no longer continuous but only lies in $L^1([0, T], L^1(\mu \otimes \mu))$. \square

3.6 Proof of solvability result

Proof of Theorem 4.2.1. First, the existence and uniqueness of a solution $\Gamma \in C([0, T], L^1(\mu \otimes \mu))$ to the Riccati equation (4.2.5) satisfying the estimate (4.2.7) and such that $\Gamma_t \in \mathbb{S}_+^d(\mu \otimes \mu)$, for all $t \leq T$, follow from [AJMP19a, Theorem 2.3].

Second, we note that equation (3.3.8) for Λ is a Lyapunov equation of the form

$$\Psi_t(\theta, \tau) = \int_t^T e^{-(\theta+\tau)(s-t)} F(s, \Psi_s)(\theta, \tau) ds, \quad t \leq T, \quad \mu \otimes \mu - a.e. \quad (3.6.1)$$

where

$$\begin{aligned} F(s, \Psi)(\theta, \tau) &= \tilde{Q}_s(\theta, \tau) + \tilde{D}_s^1(\theta)^\top \int_{\mathbb{R}_+^2} \mu_1(d\theta')^\top \Psi(\theta', \tau') \mu_2(d\tau') \tilde{D}_s^2(\tau) \\ &\quad + \tilde{B}_s^1(\theta)^\top \int_{\mathbb{R}_+} \mu_1(d\theta')^\top \Psi(\theta', \tau) + \int_{\mathbb{R}_+} \Psi(\theta, \tau') \mu_2(d\tau') \tilde{B}_s^2(\tau), \end{aligned} \quad (3.6.2)$$

where μ_i , $i = 1, 2$, $d_{i1} \times d_{i2}$ -matrix valued measures on \mathbb{R}_+ , with

$$d_{11} = d, \quad d_{12} = d', \quad d_{21} = d_{22} = 1, \quad \mu_1 = \mu, \quad \mu_2 = 0,$$

and with coefficients

$$\begin{aligned} \tilde{Q}_t(\theta, \tau) &= L + Q g_0(t) + \int_{\mathbb{R}_+} \Gamma_t(\theta, \tau') \mu(d\tau') \tilde{\beta}_t \\ &\quad - S(\Gamma_t)(\theta)^\top \hat{N}(\Gamma_t)^{-1} F^\top \int_{\mathbb{R}_+^2} \mu(d\theta')^\top \Gamma_t(\theta', \tau') \mu(d\tau') \tilde{\gamma}_t, \\ \tilde{B}_t^1(\theta) &= B - C \hat{N}(\Gamma_t)^{-1} S(\Gamma_t)(\theta), \quad \tilde{B}_t^2(\theta) = \tilde{D}_t^1(\theta) = \tilde{D}_t^2(\theta) = 0. \end{aligned}$$

From [AJMP19a, Theorem 3.1], we then get the existence and uniqueness of a solution $\Lambda \in C([0, T], L^1(\mu^\top))$ to the equation (3.3.8). Finally, we notice that the right hand side of equation (3.3.9) for χ , does not involve χ . Therefore, the existence and the continuity of χ follow upon simple integration, which is justified by the boundedness of g_0, β, γ , that of Λ in $L^1(\mu^\top)$ and that of Γ in $L^1(\mu \otimes \mu)$ together with the bound (4.2.7). \square

Proof of Theorem 3.3.2. The result is a direct consequence of Theorem 3.5.1 once we prove that conditions 1-2 are satisfied. Condition 1 follows from Theorem 4.2.1. It remains to prove condition 2, i. e. that there exists a progressively measurable process $\alpha^* \in \mathcal{A}$ associated to a controlled SDE $Y^{\alpha^*} \in L^1(\mu)$ such that (3.3.12) holds, and $\sup_{t \leq T} \mathbb{E}[|\alpha_t^*|^4] < \infty$. To this end, we consider the coefficients δ, Σ as in Example (3.4.1) with

$$\begin{aligned} b_0(t, \theta) &= \tilde{\beta}(t) - C\hat{N}(\Gamma_t)^{-1}h(t, \Gamma_t, \Lambda_t) \\ \gamma_0(t, \theta) &= \tilde{\gamma}(t) - F\hat{N}(\Gamma_t)^{-1}h(t, \Gamma_t, \Lambda_t) \\ B_0(t, \theta, \theta') &= B - C\hat{N}(\Gamma_t)^{-1}S(\Gamma_t)(\theta') \\ D_0(t, \theta, \theta') &= D - F\hat{N}(\Gamma_t)^{-1}S(\Gamma_t)(\theta') \\ C_0(t, \theta) &= F_0(t, \theta) = 0. \end{aligned}$$

By the boundedness of β, γ, g_0 , on $[0, T]$, the continuity hence the boundedness on $[0, T]$ of Γ in $L^1(\mu \otimes \mu)$ and Λ in $L^1(\mu^\top)$ together with the bound in Theorem 4.2.1, the previous coefficients satisfy (3.4.8)-(3.4.9). Whence, for any $p \geq 2$, Example 3.4.1, combined with Theorem 3.4.1, yields the existence of a process Y^* with initial condition $Y_0^* \equiv 0$, for the coefficients δ, Σ as defined above and such that (3.4.3) holds. One can therefore define a process α^* by

$$\alpha_t^* = -\hat{N}(\Gamma_t)^{-1} \left(h(t, \Gamma_t, \Lambda_t) + \int_{\mathbb{R}_+} S(\Gamma_t)(\theta) \mu(d\theta) Y_t^*(\theta) \right),$$

and see, again from the boundedness on $[0, T]$ of (Γ, Λ) in $L^1(\mu \otimes \mu) \times L^1(\mu^\top)$ together with the bound (4.2.7), that

$$\mathbb{E}[|\alpha_t^*|^p] \leq c(1 + M^4) \sup_{0 \leq t \leq T} \mathbb{E}[\|Y_t^*\|_{L^1(\mu)}^p], \quad 0 \leq t \leq T,$$

which is finite due to (3.4.3). In particular, for $p = 4$, we get that α^* lies in \mathcal{A} . Finally, by construction, the coefficients of Y^* can be re-written in terms of α^* as

$$\begin{aligned} \delta(t, \omega, Y_t^*) &= \tilde{\beta}(t) + B \int_{\mathbb{R}_+} \mu(d\theta) Y_t^*(\theta) + C\alpha_t^*, \\ \Sigma(t, \omega, Y_t^*) &= \tilde{\gamma}(t) + D \int_{\mathbb{R}_+} \mu(d\theta) Y_t^*(\theta) + F\alpha_t^*, \end{aligned}$$

which means that $Y^* = Y^{\alpha^*}$, and ends the proof. \square

3.7 Stability and approximation

In this section, we prove Theorem 3.3.3 starting with *a priori* L^2 -estimates for the controlled stochastic Volterra equation before approximating the value function.

3.7.1 A-priori L^2 -estimates for stochastic Volterra equations

Let X^α be the solution produced by Theorem 3.4.2. We provide an explicit bound for $\mathbb{E} \left[\|X^\alpha\|_{L^2(0,T)}^2 \right]$, which is finite due to (3.2.4). For this, let us introduce the resolvent of the second kind R of a scalar kernel k , defined as the unique $L^1([0, T], \mathbb{R})$ solution to the linear convolution equation

$$R(t) = k(t) + \int_0^t k(t-s)R(s)ds = k(t) + \int_0^t R(t-s)k(s)ds, \quad t \leq T.$$

Recall that the resolvent R exists, for any kernel $k \in L^1([0, T], \mathbb{R})$, see [GLS90, Theorems 2.3.1 and 2.3.5].

Lemma 3.7.1. *Fix $K \in L^2([0, T], \mathbb{R}^{d \times d'})$, $\alpha \in \mathcal{A}$, $g_0 \in L^2([0, T], \mathbb{R}^d)$ and $\beta, \gamma \in L^2([0, T], \mathbb{R}^{d'})$. If X^α is a progressively measurable process satisfying (3.2.1) with*

$$\mathbb{E} \left[\|X^\alpha\|_{L^2(0,T)}^2 \right] < \infty, \quad (3.7.1)$$

then, it holds that

$$\mathbb{E} \left[\|X^\alpha\|_{L^2(0,T)}^2 \right] \leq cm_T(g_0, K, \alpha) (1 + \|R\|_{L^1(0,T)}),$$

where c is a constant only depending on (T, B, C, D, F) ,

$$m_T(g_0, K, \alpha) = \|g_0\|_{L^2(0,T)}^2 + \|K\|_{L^2(0,T)}^2 \left(\|\beta\|_{L^2(0,T)}^2 + \|\gamma\|_{L^2(0,T)}^2 + \mathbb{E}[\|\alpha\|_{L^2(0,T)}^2] \right)$$

and R is the resolvent of $c|K|^2$.

Proof. Throughout the proof, we make use of the notations $(f * g)(t) = \int_0^t f(t-s)g(s)ds$ and $(f * dZ)_t = \int_0^t f(t-s)dZ_s$, and c will denote a constant depending exclusively on (T, B, C, D, F) that may vary from line to line. We first observe that by Jensen's inequality

$$\begin{aligned} \|X_t^\alpha\|_{L^2(0,T)}^2 &\leq 5\|g_0\|_{L^2(0,T)}^2 + 5\|K * (\beta + C\alpha)\|_{L^2(0,T)}^2 + 5\|K * BX^\alpha\|_{L^2(0,T)}^2 \\ &\quad + 5\|K * DX^\alpha dW\|_{L^2(0,T)}^2 + 5\|K * (\gamma + F\alpha) dW\|_{L^2(0,T)}^2 \\ &= 5(\mathbf{I} + \mathbf{II} + \mathbf{III} + \mathbf{IV} + \mathbf{V}). \end{aligned}$$

An application of Young and Cauchy-Schwarz inequalities yields

$$\mathbf{II} \leq c\|K\|_{L^2(0,T)}^2 \left(\|\beta\|_{L^2(0,T)}^2 + \|\alpha\|_{L^2(0,T)}^2 \right).$$

Successive applications of Cauchy-Schwarz, Tonelli's theorem and changes of variables lead to

$$\begin{aligned} \mathbf{III} &\leq c \int_0^T \int_0^t |K(t-s)|^2 |X_s^\alpha|^2 ds dt \\ &= c \int_0^T \int_0^t |K(s)|^2 |X_{t-s}^\alpha|^2 ds dt \\ &= c \int_0^T |K(s)|^2 \int_s^T |X_{t-s}^\alpha|^2 dt ds \\ &= c \int_0^T |K(T-s)|^2 \int_0^s |X_u^\alpha|^2 du ds \\ &= c \int_0^T |K(T-s)|^2 \|X^\alpha\|_{L^2(0,s)}^2 ds. \end{aligned}$$

Taking the expectation, we get

$$\begin{aligned} \mathbb{E}[\mathbf{II} + \mathbf{III}] &\leq c\|K\|_{L^2(0,T)}^2 \left(\|\beta\|_{L^2(0,T)}^2 + \mathbb{E} \left[\|\alpha\|_{L^2(0,T)}^2 \right] \right) \\ &\quad + c \int_0^T |K(T-s)|^2 \mathbb{E} \left[\|X^\alpha\|_{L^2(0,s)}^2 \right] ds. \end{aligned}$$

Similarly, Itô's isometry combined with Tonelli's theorem and multiple changes of variables give

$$\begin{aligned} \mathbb{E}[\mathbf{IV}] &= |D|^2 \mathbb{E} \left[\int_0^T \int_0^t |K(t-s)|^2 |X_s^\alpha|^2 ds dt \right] \\ &= |D|^2 \int_0^T |K(T-s)|^2 \mathbb{E} \left[\|X^\alpha\|_{L^2(0,s)}^2 \right] ds. \end{aligned}$$

Another application of Itô's isometry and Young's inequality shows that

$$\begin{aligned} \mathbb{E}[\mathbf{V}] &\leq c\|K\|^2 * (|\gamma|^2 + |F|^2|\alpha|^2) \|_{L^1(0,T)}^2 \\ &\leq c\|K\|_{L^2(0,T)}^2 \left(\|\gamma\|_{L^2(0,T)}^2 + \mathbb{E} \left[\|\alpha\|_{L^2(0,T)}^2 \right] \right). \end{aligned}$$

Combining the above yields

$$\begin{aligned} \mathbb{E} \left[\|X^\alpha\|_{L^2(0,T)}^2 \right] &\leq c\|g_0\|_{L^2(0,T)}^2 + c\|K\|_{L^2(0,T)}^2 \left(\|\beta\|_{L^2(0,T)}^2 + \|\gamma\|_{L^2(0,T)}^2 + \mathbb{E} \left[\|\alpha\|_{L^2(0,T)}^2 \right] \right) \\ &\quad + c \int_0^T |K(T-s)|^2 \mathbb{E} \left[\|X^\alpha\|_{L^2(0,s)}^2 \right] ds, \\ &\leq cm_T(g_0, K, \alpha) (1 + \|R\|_{L^1(0,T)}) \end{aligned}$$

where the last line follows from the generalized Gronwall inequality for convolution equations with R the resolvent of $c|K|^2$, see [GLS90, Theorem 9.8.2]. \square

Lemma 3.7.2. *Fix $n \in \mathbb{N}$. Let $K, K^n \in L^2([0, T], \mathbb{R}^{d \times d})$, $\alpha \in \mathcal{A}$, $g_0, g_0^n \in L^2([0, T], \mathbb{R}^d)$ and $\beta, \gamma \in L^2([0, T], \mathbb{R}^d)$. Assume that there exist two progressively measurable processes X and X^n satisfying (3.2.1) and (3.7.1) for the respective inputs (g_0, K, α) and (g_0^n, K^n, α) . Then,*

$$\mathbb{E} \left[\|X^n - X\|_{L^2(0,T)}^2 \right] \leq cm_n (1 + \|R^n\|_{L^1(0,T)}), \quad (3.7.2)$$

where

$$m_n = \|g_0^n - g_0\|_{L^2(0,T)}^2 + \|K^n - K\|_{L^2(0,T)}^2 \left(\mathbb{E} \left[\|X\|_{L^2(0,T)}^2 \right] + \mathbb{E} \left[\|\alpha\|_{L^2(0,T)}^2 \right] \right)$$

and R^n is the resolvent of $c|K^n|^2$. If in addition

$$\|g_0^n - g_0\|_{L^2(0,T)} \rightarrow 0, \quad \|K^n - K\|_{L^2(0,T)} \rightarrow 0, \quad (3.7.3)$$

as $n \rightarrow \infty$, then,

$$\mathbb{E} \left[\|X^n - X\|_{L^2(0,T)}^2 \right] \rightarrow 0, \quad \text{as } n \rightarrow \infty. \quad (3.7.4)$$

Proof. Fix $t \leq T$. We start by writing

$$\begin{aligned} X_t - X_t^n &= (g_0(t) - g_0^n(t)) + \int_0^t (K(t-s) - K^n(t-s))(BX_s + C\alpha_s) ds \\ &\quad - \int_0^t K^n(t-s)B(X_s^n - X_s) ds \\ &\quad + \int_0^t (K(t-s) - K^n(t-s))(DX_s + F\alpha_s) dW_s \\ &\quad - \int_0^t K^n(t-s)D(X_s^n - X_s) dW_s \\ &= \mathbf{I}_t + \mathbf{II}_t + \mathbf{III}_t + \mathbf{IV}_t + \mathbf{V}_t. \end{aligned}$$

In the sequel, c denotes a constant independent of n that may vary from line to line. Repeating the same argument as in the proof of Lemma 3.7.1, we get

$$\mathbb{E} \left[\|\mathbf{II}\|_{L^2(0,T)}^2 + \|\mathbf{IV}\|_{L^2(0,T)}^2 \right] \leq c \|K^n - K\|_{L^2(0,T)}^2 \left(\mathbb{E} \left[\|X\|_{L^2(0,T)}^2 \right] + \mathbb{E} \left[\|\alpha\|_{L^2(0,T)}^2 \right] \right),$$

which is finite due to Lemma 3.7.1. Similarly,

$$\mathbb{E} \left[\|\mathbf{III}\|_{L^2(0,T)}^2 + \|\mathbf{V}\|_{L^2(0,T)}^2 \right] \leq c \int_0^T |K^n(T-s)|^2 \mathbb{E} \left[\|X^n - X\|_{L^2(0,s)}^2 \right] ds.$$

Combining the above and invoking [GLS90, Theorem 9.8.2] for the generalized Gronwall inequality for convolution equations yields the estimate (3.7.2). We now prove that its right hand side goes to 0, as n goes to infinity. We first note that $R^n \rightarrow R$ in L^1 , by virtue of the continuous dependence of the resolvent on the kernel combined with the L^2 -convergence of $(K^n)_{n \geq 1}$ in (3.7.3), see [GLS90, Lemma 9.3.11]. Consequently, the sequences $(\|R^n\|_{L^1(0,T)})_{n \geq 1}$ and $(\|K^n\|_{L^2(0,T)})_{n \geq 1}$ are uniformly bounded in n , that is

$$\sup_{n \geq 1} \|R^n\|_{L^1(0,T)} + \sup_{n \geq 1} \|K^n\|_{L^2(0,T)} < \infty. \quad (3.7.5)$$

Thus, it follows from (3.7.2) that it is enough to prove that $m_n \rightarrow 0$ to get the claimed convergence (3.7.4). This is straightforward from (3.7.3) and the proof is complete. \square

3.7.2 Approximation of the value function

The proof of Theorem 3.3.3 now follows from the two following lemmas. In the sequel, we work under the assumptions of Theorem 3.3.3 and we recall the expressions of $J^n, X^{n,\alpha}$ in (3.3.21). To ease notations, we drop the α superscripts.

Lemma 3.7.3. *Let $\alpha \in \mathcal{A}$. Under (3.3.22) we have*

$$|J(\alpha) - J^n(\alpha)|^2 \leq c \left(2 + \left(\mathbb{E} \left[\|\alpha\|_{L^2(0,T)}^2 \right] \right)^2 \right) \left(\|g_0^n - g_0\|_{L^2(0,T)}^2 + \|K^n - K\|_{L^2(0,T)}^2 \right),$$

where c is a constant independent of n .

Proof. Fix $\alpha \in \mathcal{A}$, we start by writing

$$\begin{aligned} J(\alpha) - J^n(\alpha) &= \mathbb{E} \left[\int_0^T (X_s^\top Q X_s - (X_s^n)^\top Q X_s^n) ds \right] + \mathbb{E} \left[\int_0^T (X_s - X_s^n)^\top L ds \right] \\ &= \mathbb{E} \left[\int_0^T (X_s - X_s^n)^\top Q (X_s + X_s^n) ds \right] + \mathbb{E} \left[\int_0^T (X_s - X_s^n)^\top L ds \right] \\ &= \mathbf{I} + \mathbf{II} \end{aligned}$$

so that

$$|J(\alpha) - J^n(\alpha)|^2 \leq 2(\mathbf{I}^2 + \mathbf{II}^2).$$

We let c denote a constant independent of n that may vary from line to line. Successive applications of Cauchy–Schwarz inequality and Lemma 3.7.2 yield

$$\begin{aligned} \mathbf{II}^2 &\leq c\mathbb{E} \left[\|X - X^n\|_{L^2(0,T)}^2 \right] \\ &\leq c(1 + \|R^n\|_{L^1(0,T)}) \left(1 + \mathbb{E} \left[\|\alpha\|_{L^2(0,T)}^2 \right] \right) \left(\|g_0^n - g_0\|_{L^2(0,T)}^2 + \|K^n - K\|_{L^2(0,T)}^2 \right) \end{aligned}$$

where R^n is the resolvent of $c|K^n|^2$. By virtue of the L^2 convergence of the kernels $(K^n)_{n \geq 1}$ in (3.3.22), $\|R^n\|_{L^1(0,T)}$ is uniformly bounded in n , see (3.7.5). Whence,

$$\mathbf{II}^2 \leq c \left(1 + \mathbb{E} \left[\|\alpha\|_{L^2(0,T)}^2 \right] \right) \left(\|g_0^n - g_0\|_{L^2(0,T)}^2 + \|K^n - K\|_{L^2(0,T)}^2 \right).$$

Similarly, we get from Lemmas 3.7.1 and 3.7.2

$$\begin{aligned} \mathbf{I}^2 &\leq c \left(\mathbb{E} \left[\|X\|_{L^2(0,T)}^2 \right] + \mathbb{E} \left[\|X^n\|_{L^2(0,T)}^2 \right] \right) \mathbb{E} \left[\|X - X^n\|_{L^2(0,T)}^2 \right] \\ &\leq c \left(1 + \left(\mathbb{E} \left[\|\alpha\|_{L^2(0,T)}^2 \right] \right)^2 \right) \left(\|g_0^n - g_0\|_{L^2(0,T)}^2 + \|K^n - K\|_{L^2(0,T)}^2 \right), \end{aligned}$$

where the last inequality follows from the fact that $\sup_{n \geq 1} \mathbb{E} \left[\|X^n\|_{L^2(0,T)}^2 \right] < \infty$, since $\mathbb{E} \left[\|X^n - X\|_{L^2(0,T)}^2 \right] \rightarrow 0$ from Lemma 3.7.2. Combining the above yields the desired estimate. \square

Lemma 3.7.4. *Assume (4.2.6), (3.3.22) and that Q is invertible. Let α^* and α^{n*} be the optimal controls produced by Theorem 3.3.2 respectively for the problem (3.2.5) and its approximation (3.3.20). There exists a constant $\kappa > 0$ such that*

$$\mathbb{E} \left[\|\alpha^*\|_{L^2(0,T)}^2 \right] + \sup_{n \geq 1} \mathbb{E} \left[\|\alpha^{n*}\|_{L^2(0,T)}^2 \right] \leq \kappa. \quad (3.7.6)$$

Proof. Under (4.2.6), there exists $c > 0$ such that

$$|a|^2 \leq ca^\top Na, \quad a \in \mathbb{R}^m.$$

Denoting by $X^n = X^{n,\alpha^{n*}}$, it follows that

$$\begin{aligned} \mathbb{E} \left[\|\alpha^{n*}\|_{L^2(0,T)}^2 \right] &\leq (1 \vee c) \mathbb{E} \left[\int_0^T \left((\alpha_s^{n*})^\top N \alpha_s^{n*} + (X_s^n + Q^{-1}L)^\top Q (X_s^n + Q^{-1}L) \right) ds \right] \\ &= (1 \vee c) \left(J^n(\alpha^{n*}) + L^\top Q^{-1}L \right) \\ &\leq (1 \vee c) \left(J^n(\mathbf{0}) + L^\top Q^{-1}L \right), \end{aligned}$$

for all $n \in \mathbb{N}$, where the last inequality follows from the optimality of α^{n*} and $\mathbf{0}$ corresponds to the admissible control $\alpha_s = 0$, for all $s \leq T$. Applying Lemma 3.7.3, with $\alpha = \alpha^n = \mathbf{0}$, we obtain the convergence of the un-controlled functional cost: $\lim_{n \rightarrow \infty} J^n(\mathbf{0}) = J(\mathbf{0})$, which ensures that $J^n(\mathbf{0})$ is uniformly bounded in n . We then deduce the existence of a constant κ such that (3.7.6) holds. \square

The proof of Theorem 3.3.3 is now straightforward.

Proof of Theorem 3.3.3. Fix an arbitrary $\varepsilon > 0$, and let $c_\varepsilon > 0$ to be determined later. First note that Lemma 3.7.4 ensures the existence a constant $\kappa > 0$ such that for all $n \in \mathbb{N}$:

$$\begin{aligned} V_0^n &= \inf_{\alpha \in \mathcal{A}} J^n(\alpha) = \inf_{\alpha \in \mathcal{A}_\kappa} J^n(\alpha), \\ V_0 &= \inf_{\alpha \in \mathcal{A}} J(\alpha) = \inf_{\alpha \in \mathcal{A}_\kappa} J(\alpha), \end{aligned} \tag{3.7.7}$$

where $\mathcal{A}_\kappa = \{\alpha \in \mathcal{A} : \mathbb{E}[\|\alpha\|_{L^2(0,T)}^2] \leq \kappa\}$. Under condition (3.3.22), there exists $n_\varepsilon \in \mathbb{N}$ such that for every $n \geq n_\varepsilon$ we have $\|g_0^n - g_0\|_{L^2(0,T)}^2 + \|K^n - K\|_{L^2(0,T)}^2 \leq c_\varepsilon$. By Lemma 3.7.3, it follows that for any $\alpha \in \mathcal{A}_\kappa$, and $n \geq n_\varepsilon$,

$$|J(\alpha) - J^n(\alpha)|^2 \leq c(2 + \kappa^2)c_\varepsilon = \varepsilon,$$

by choosing $c_\varepsilon = \frac{\varepsilon}{c(2+\kappa^2)}$. Combined with (3.7.7), this gives (3.3.23) and also (3.3.24). \square

3.A An elementary lemma

Lemma 3.A.1. *Let K be given as in (3.2.2), and \bar{K} defined by*

$$\bar{K}(t) = \int_{\mathbb{R}_+} e^{-\theta t} |\mu|(d\theta), \quad t > 0.$$

Assume that (3.2.3) holds, then

$$\int_0^T |K(s)|^2 ds \leq \int_0^T \bar{K}(s)^2 ds < \infty.$$

Furthermore, $|\mu|$ is σ -finite.

Proof. Since, $|K(t)| \leq \bar{K}(t)$, for all $t > 0$, it is clear that $\int_0^T |K(s)|^2 ds \leq \int_0^T \bar{K}(s)^2 ds$. Furthermore,

$$\begin{aligned} \|\bar{K}\|_{L^2(0,T)} &= \left\| \int_{\mathbb{R}_+} e^{-\theta(\cdot)} |\mu|(d\theta) \right\|_{L^2(0,T)} \\ &\leq \int_{\mathbb{R}_+} \left\| e^{-\theta(\cdot)} \right\|_{L^2(0,T)} |\mu|(d\theta) = \int_{\mathbb{R}_+} \sqrt{\frac{1 - e^{-2\theta T}}{2\theta}} |\mu|(d\theta) \end{aligned}$$

which is finite due to inequality (3.2.16) and condition (3.2.3). To prove that $|\mu|$ is σ -finite, we observe that $\mathbb{R}_+ = \cup_{n \in \mathbb{N}} [0, n]$ such that for each $n \geq 1$,

$$\begin{aligned} |\mu|([0, n]) &= \int_0^1 |\mu|(d\theta) + \int_1^n |\mu|(d\theta) \leq \int_0^1 |\mu|(d\theta) + \sqrt{n} \int_1^n \theta^{-1/2} |\mu|(d\theta) \\ &\leq \sqrt{n} \int_{\mathbb{R}_+} (1 \wedge \theta^{-1/2}) |\mu|(d\theta) < \infty. \end{aligned}$$

\square

Chapter 4

Integral operator Riccati equations arising in stochastic Volterra control problems

Abstract We establish existence and uniqueness for infinite dimensional Riccati equations taking values in the Banach space $L^1(\mu \otimes \mu)$ for certain signed matrix measures μ which are not necessarily finite. Such equations can be seen as the infinite dimensional analogue of matrix Riccati equations and they appear in the Linear-Quadratic control theory of stochastic Volterra equations.

Keywords: Infinite dimensional Lyapunov equation, integral operator Riccati equation, linear-quadratic control, stochastic Volterra equations.

4.1 Introduction

Fix $d, d', m \in \mathbb{N}$ and μ a $d \times d'$ -matrix signed measure μ . This paper deals with the infinite dimensional Riccati equation

$$\begin{cases} \Gamma_T(\theta, \tau) &= 0 \\ \dot{\Gamma}_t(\theta, \tau) &= (\theta + \tau)\Gamma_t(\theta, \tau) - Q - D^\top \int_{\mathbb{R}_+^2} \mu(d\theta')^\top \Gamma_t(\theta', \tau') \mu(d\tau') D \\ &\quad - B^\top \int_{\mathbb{R}_+} \mu(d\theta')^\top \Gamma_t(\theta', \tau) - \int_{\mathbb{R}_+} \Gamma_t(\theta, \tau') \mu(d\tau') B + S_t(\theta)^\top \hat{N}_t^{-1} S_t(\tau), \end{cases} \quad (4.1.1)$$

where

$$\begin{aligned} S_t(\tau) &= C^\top \int_{\mathbb{R}_+} \mu(d\theta)^\top \Gamma_t(\theta, \tau) + F^\top \int_{\mathbb{R}_+^2} \mu(d\theta')^\top \Gamma_t(\theta', \tau') \mu(d\tau') D, \\ \hat{N}_t &= N + F^\top \int_{\mathbb{R}_+^2} \mu(d\theta)^\top \Gamma_t(\theta, \tau) \mu(d\tau) F, \end{aligned}$$

and $B, D \in \mathbb{R}^{d' \times d}$, $C, F \in \mathbb{R}^{d' \times m}$, $Q \in \mathbb{R}^{d \times d}$ and $N \in \mathbb{R}^{m \times m}$, and $^\top$ is the transpose operation. Here μ is not necessarily finite and satisfies

$$\int_{\mathbb{R}_+} (1 \wedge \theta^{-1/2}) |\mu|(d\theta) < \infty, \quad (4.1.2)$$

where $|\mu|$ denotes the total variation of μ . We look for solutions $\Gamma : [0, T] \times \mathbb{R}_+^2 \rightarrow \mathbb{R}^{d \times d}$ with values in $L^1(\mu \otimes \mu)$ (see the precise definition in Section 4.2) to ensure that equation (4.1.1) is well-posed.

In particular, if $d = d' = 1$ and $\mu(d\theta) = \sum_{i=1}^n \delta_{\theta_i^n}(d\theta)$, (4.1.1) reduces to a $n \times n$ -matrix Riccati equation for $\Gamma^n = (\Gamma(\theta_i^n, \theta_j^n))_{1 \leq i, j \leq n}$, only written componentwise. Such matrix Riccati equation appears in finite dimensional Linear-Quadratic (LQ) control theory, see e.g. [YZ99, chapter 7]. (One could also recover $d \times d$ -matrix Riccati equation by setting $d = d'$ and $\mu = I_d \delta_0$.)

For more general measures μ , e.g. with infinite support, (4.1.1) can be seen as the infinite-dimensional extension of matrix Riccati equations and one could expect a connection with LQ control in infinite dimension. This is indeed the case, and our motivation for studying the Riccati equation (4.1.1) comes from infinite dimensional lifts of LQ control theory of non-Markovian stochastic Volterra equations. Setting

$$K(t) = \int_{\mathbb{R}_+} e^{-\theta t} \mu(d\theta), \quad t > 0,$$

one can consider the controlled d -dimensional stochastic linear Volterra equation

$$X_t = \int_0^t K(t-s)(BX_s + C\alpha_s)ds + \int_0^t K(t-s)(DX_s + F\alpha_s)dW_s,$$

where W is a one dimensional Brownian motion and α is a suitable control taking its values in \mathbb{R}^m . Observe that the integrability condition on the measure μ allows singularity of the kernel K at 0, and includes the case of a fractional kernel $K_H(t) = t^{H-1/2}$ with Hurst parameter $H \in (0, 1/2)$ with a corresponding measure $\mu(d\theta) = c_H \theta^{-H-1/2} d\theta$, for some normalizing constant c_H . The linear-quadratic control problem consisting in the minimization over α of the cost functional

$$J(\alpha) = \mathbb{E} \left[\int_0^T (X_t^\top Q X_t + \alpha_t^\top N \alpha_t) dt \right],$$

can be explicitly solved using the Riccati equation (4.1.1), see [AJMP19b].

When $D = F = 0$, the Riccati equation (4.1.1) also enters in the computation of the Laplace transform of $\text{tr} \left(\int_0^T Z_s^\top Q Z_s ds \right)$, where Z is the $d \times n$ -matrix valued Gaussian process

$$Z_t = Z_0 + \int_0^t K(t-s)BZ_s ds + \int_0^t K(t-s)C d\widetilde{W}_s, \quad t \geq 0,$$

and \widetilde{W} is a $m \times n$ matrix Brownian motion, see [AJ].

The Riccati equation (4.1.1) can be also connected to an operator Riccati equation as follows. We denote by

- $L^1(\mu)$ the Banach space of μ -a.e. equivalence classes of $|\mu|$ -integrable functions $\varphi : \mathbb{R}_+ \rightarrow \mathbb{R}^{d'}$ endowed with the norm $\|\varphi\|_{L^1(\mu)} = \int_{\mathbb{R}_+} |\mu|(d\theta) |\varphi(\theta)|$,
- $L^\infty(\mu)$ the space of measurable functions from $\mathbb{R}_+ \rightarrow \mathbb{R}^{d'}$, which are bounded μ -a.e.,

and introduce the dual pairing:

$$\langle \varphi, \psi \rangle_\mu := \int_{\mathbb{R}_+} \varphi(\theta)^\top \mu(d\theta) \psi(\theta), \quad (\varphi, \psi) \in L^1(\mu) \times L^\infty(\mu^\top). \quad (4.1.3)$$

Given any bounded kernel solution Γ to (4.1.1), let us consider the corresponding linear integral operator $\mathbf{\Gamma} : [0, T] \times L^1(\mu) \rightarrow L^\infty(\mu^\top)$ defined by

$$(\mathbf{\Gamma}_t \varphi)(\theta) = \int_{\mathbb{R}_+} \Gamma_t(\theta, \tau) \mu(d\tau) \varphi(\tau), \quad t \in [0, T], \quad \varphi \in L^1(\mu).$$

It is then straightforward to see that $\mathbf{\Gamma}$ solves the operator Riccati equation on $L^1(\mu)$:

$$\begin{cases} \mathbf{\Gamma}_T &= \mathbf{0} \\ \dot{\mathbf{\Gamma}}_t &= -\mathbf{\Gamma}_t A^{mr} - (\mathbf{\Gamma}_t A^{mr})^* - \mathbf{Q} - \mathbf{D}^* \mathbf{\Gamma}_t \mathbf{D} - \mathbf{B}^* \mathbf{\Gamma}_t - (\mathbf{B}^* \mathbf{\Gamma}_t)^* \\ &\quad + (C^* \mathbf{\Gamma}_t + F^* \mathbf{\Gamma}_t \mathbf{D})^* (N + F^* \mathbf{\Gamma}_t F)^{-1} (C^* \mathbf{\Gamma}_t + F^* \mathbf{\Gamma}_t \mathbf{D}), \quad t \in [0, T], \end{cases} \quad (4.1.4)$$

where A^{mr} is the mean-reverting operator acting on measurable functions $\varphi \in L^1(\mu)$ by

$$(A^{mr} \varphi)(\theta) = -\theta \varphi(\theta), \quad \theta \in \mathbb{R}_+,$$

\mathbf{B} , \mathbf{D} are the integral operators on $L^1(\mu)$ (defined similarly to $\mathbf{\Gamma}$) induced by the constant matrices B , D , and by misuse of notation, C , F denote the respective constant operators on \mathbb{R}^m induced by the matrices C , F :

$$(Ca)(\theta) = Ca, \quad (Fa)(\theta) = Fa, \quad \theta \in \mathbb{R}_+, \quad a \in \mathbb{R}^m.$$

Here the symbol $*$ denotes the adjoint operation with respect to the dual pairing. The last equation (4.1.4) is more in line with the formulation of operator Riccati equations appearing in LQ control theory in Hilbert or Banach spaces, see [CP74; DP84; Fla86; GT05; Las05; Kos16; HT18; Art19].

Let us also mention that a related infinite-dimensional Riccati equation appeared in [AS13] for the minimization problem of an energy functional defined in terms of a non-singular (i.e. $K(0) < \infty$) completely monotone kernel.

The main contribution of the paper is to establish the existence and uniqueness of a solution to the kernel Riccati equation (4.1.1). The aforementioned results on the solvability of Riccati equations in infinite dimensional spaces cannot be directly applied in our setting for two reasons. First, they are valid for Hilbert and reflexive Banach spaces, while $L^1(\mu)$ is in general not reflexive, unless μ has finite support, and mostly apply to the cases without multiplicative noise, i.e., $\mathbf{D} = 0$, and without control on the diffusion coefficient, i.e. $\mathbf{F} = 0$, with the noticeable exception in [HT18]. Second, they concern the operator Riccati equation (4.1.4), which is not enough for our purposes, as we still need to argue that $\mathbf{\Gamma}$ is an integral operator induced by some bounded symmetric kernel function Γ satisfying (4.1.1). We will therefore work directly on the level of the kernel Riccati equation (4.1.1) (which will also be referred to as integral operator Riccati equation) by adapting the technique used in classical finite-dimensional linear-quadratic control theory

cite[Theorem 6.7.2]yong1999stochastic with the following steps: (i) we first construct a sequence of Lyapunov solutions $(\Gamma^i)_{i \geq 0}$ by successive iterations, (ii) we then show the convergence of $(\Gamma^i)_{i \geq 0}$ in $L^1(\mu \otimes \mu)$, (iii) we next prove that the limiting point is a solution to the Riccati equation (4.1.1), (iv) we finally prove the continuity and uniqueness for the Riccati solution. We stress that such method has already been applied to prove the existence of operator Riccati equations of the form (4.1.4) in Hilbert spaces (see [HT18]) and in reflexive Banach spaces (see [Art19]). However, for the kernel Riccati equation (4.1.1), the proof is more intricate. The reason is that we need to establish the convergence of the kernels $(\Gamma^i)_{i \geq 0}$ which is a stronger requirement than the usual convergence of the operators $(\mathbf{\Gamma}^i)_{i \geq 0}$. As a consequence, we obtain that the sequence of integral operators $(\mathbf{\Gamma}^i)_{i \geq 0}$ converges to some limit which is also an integral operator.

The paper is organized as follows. We formulate precisely our main result in Section 4.2. Section 4.3 establishes the existence of a solution to an infinite dimensional Lyapunov equation. Section 4.4 is devoted to the solvability of the Riccati equation. Finally, we collect in the Appendix some useful results.

4.2 Preliminaries and main result

Let us first introduce some notations that will be used in the sequel of the paper. For any $d_{11} \times d_{12}$ -matrix valued measure μ_1 , and $d_{21} \times d_{22}$ -matrix valued measure μ_2 on \mathbb{R}_+ , the Banach space $L^1(\mu_1 \otimes \mu_2)$ consists of $\mu_1 \otimes \mu_2$ -a.e. equivalence classes of $|\mu_1| \otimes |\mu_2|$ -integrable functions $\Phi : \mathbb{R}_+^2 \rightarrow \mathbb{R}^{d_{11} \times d_{21}}$ endowed with the norm $\|\Phi\|_{L^1(\mu_1 \otimes \mu_2)} = \int_{\mathbb{R}_+^2} |\mu_1|(d\theta) |\Phi(\theta, \tau)| |\mu_2|(d\tau) < \infty$. For any such Φ , the integral

$$\int_{\mathbb{R}_+^2} \mu_1(d\theta)^\top \Phi(\theta, \tau) \mu_2(d\tau)$$

is well defined by virtue of [GLS90, Theorem 5.6]. We also denote by $L^\infty(\mu_1 \otimes \mu_2)$ the set of measurable functions $\Phi : \mathbb{R}_+^2 \rightarrow \mathbb{R}^{d_{11} \times d_{21}}$, which are bounded $\mu_1 \otimes \mu_2$ -a.e.

We shall prove the existence of a nonnegative symmetric kernel solution to the Riccati equation (4.1.1) in the following sense.

Definition 4.2.1. Let $\Gamma : \mathbb{R}_+^2 \rightarrow \mathbb{R}^{d \times d}$ such that $\Gamma \in L^\infty(\mu \otimes \mu)$. We say that Γ is symmetric if

$$\Gamma(\theta, \tau) = \Gamma(\tau, \theta)^\top, \quad \mu \otimes \mu - a.e.$$

and nonnegative if

$$\int_{\mathbb{R}_+^2} \varphi(\theta)^\top \mu(d\theta)^\top \Gamma(\theta, \tau) \mu(d\tau) \varphi(\tau) \geq 0, \quad \text{for all } \varphi \in L^1(\mu).$$

We denote by $\mathbb{S}_+^d(\mu \otimes \mu)$ the set of all symmetric and nonnegative $\Gamma \in L^\infty(\mu \otimes \mu)$, and we define on $\mathbb{S}_+^d(\mu \otimes \mu)$ the partial order relation $\Gamma^1 \succeq_\mu \Gamma^2$ whenever $(\Gamma^1 - \Gamma^2) \in \mathbb{S}_+^d(\mu \otimes \mu)$.

Remark 4.2.1. $\mathbb{S}_+^d(\delta_0 \otimes \delta_0)$ reduces to \mathbb{S}_+^d , the cone of symmetric semidefinite $d \times d$ -matrices. \square

Given a kernel Γ , we define the integral operator $\mathbf{\Gamma}$ by

$$(\mathbf{\Gamma}\varphi)(\theta) = \int_{\mathbb{R}_+} \Gamma(\theta, \tau) \mu(d\tau) \varphi(\tau). \quad (4.2.1)$$

Notice that when $\Gamma \in L^1(\mu \otimes \mu)$, the operator $\mathbf{\Gamma}$ is well-defined on $L^\infty(\mu)$, and we have $\mathbf{\Gamma}\varphi \in L^1(\mu^\top)$, for $\varphi \in L^\infty(\mu)$. In this case $\langle \mathbf{\Gamma}\varphi, \psi \rangle_{\mu^\top}$ (recall (4.1.3)) is well defined for all $\varphi, \psi \in L^\infty(\mu)$. Moreover, when $\Gamma \in L^\infty(\mu \otimes \mu)$, the operator $\mathbf{\Gamma}$ is well-defined on $L^1(\mu)$, and we have $\mathbf{\Gamma}\varphi \in L^\infty(\mu^\top)$ for $\varphi \in L^1(\mu)$. In this case, $\langle \varphi, \mathbf{\Gamma}\psi \rangle_\mu$ is well defined for all $\varphi, \psi \in L^1(\mu)$.

Whenever $\Gamma \in L^\infty(\mu \otimes \mu)$ is a symmetric kernel, we have

$$\langle \varphi, \mathbf{\Gamma}\psi \rangle_\mu = \langle \psi, \mathbf{\Gamma}\varphi \rangle_\mu, \quad \varphi, \psi \in L^1(\mu),$$

and $\mathbf{\Gamma}$ is said to be symmetric. For $\Gamma \in \mathbb{S}_+^d(\mu \otimes \mu)$, the nonnegativity reads

$$\langle \varphi, \mathbf{\Gamma}\varphi \rangle_\mu \geq 0, \quad \forall \varphi \in L^1(\mu).$$

The kernel Riccati equation (4.1.1) can be compactly written in the form

$$\dot{\Gamma}_t(\theta, \tau) = (\theta + \tau)\Gamma_t(\theta, \tau) - \mathcal{R}(\Gamma_t)(\theta, \tau), \quad \Gamma_T(\theta, \tau) = 0 \quad (4.2.2)$$

where we define

$$\begin{aligned} \mathcal{R}(\Gamma)(\theta, \tau) = & Q + D^\top \int_{\mathbb{R}_+^2} \mu(d\theta')^\top \Gamma(\theta', \tau') \mu(d\tau') D + B^\top \int_{\mathbb{R}_+} \mu(d\theta')^\top \Gamma(\theta', \tau) \\ & + \int_{\mathbb{R}_+} \Gamma(\theta, \tau') \mu(d\tau') B - S(\Gamma)(\theta)^\top \hat{N}^{-1}(\Gamma) S(\Gamma)(\tau) \end{aligned} \quad (4.2.3)$$

with

$$\begin{cases} S(\Gamma)(\tau) = C^\top \int_{\mathbb{R}_+} \mu(d\theta)^\top \Gamma(\theta, \tau) + F^\top \int_{\mathbb{R}_+^2} \mu(d\theta')^\top \Gamma(\theta', \tau') \mu(d\tau') D \\ \hat{N}(\Gamma) = N + F^\top \int_{\mathbb{R}_+^2} \mu(d\theta)^\top \Gamma(\theta, \tau) \mu(d\tau) F. \end{cases} \quad (4.2.4)$$

The following definition specifies the concept of solution to the kernel Riccati equation (4.2.2).

Definition 4.2.2. *By a solution to the kernel Riccati equation (4.2.2), we mean a function $\Gamma \in C([0, T], L^1(\mu \otimes \mu))$ such that*

$$\Gamma_t(\theta, \tau) = \int_t^T e^{-(\theta+\tau)(s-t)} \mathcal{R}(\Gamma_s)(\theta, \tau) ds, \quad 0 \leq t \leq T, \quad \mu \otimes \mu - a.e. \quad (4.2.5)$$

where \mathcal{R} is defined by (4.2.3). In particular $\hat{N}(\Gamma_t)$ given by (4.2.4) is invertible for all $t \leq T$.

Our main result is stated as follows.

Theorem 4.2.1. *Let μ be a $d \times d$ -signed matrix measure satisfying (4.1.2). Assume that*

$$Q \in \mathbb{S}_+^d, \quad N - \lambda I_m \in \mathbb{S}_+^m, \quad (4.2.6)$$

for some $\lambda > 0$. Then, there exists a unique solution $\Gamma \in C([0, T], L^1(\mu \otimes \mu))$ to the kernel Riccati equation (4.2.2) such that $\Gamma_t \in \mathbb{S}_+^d(\mu \otimes \mu)$, for all $t \leq T$. Furthermore, there exists some positive constant M such that

$$\int_{\mathbb{R}_+} |\mu|(d\tau) |\Gamma_t(\theta, \tau)| \leq M, \quad \mu - a.e., \quad 0 \leq t \leq T. \quad (4.2.7)$$

The rest of the paper is dedicated to the proof of Theorem 4.2.1. Lemmas 4.4.6 and 4.4.7 provide the existence of a solution in $C([0, T], L^1(\mu \otimes \mu))$ such that $\Gamma_t \in \mathbb{S}_+^d(\mu \otimes \mu)$, for all $t \leq T$. The uniqueness statement is established in Lemma 4.4.8.

4.3 Infinite dimensional Lyapunov equation

Fix $d_{11}, d_{12}, d_{21}, d_{22} \in \mathbb{N}$. For each $i = 1, 2$, we let μ_i be a $d_{i1} \times d_{i2}$ -matrix valued measure on \mathbb{R}_+ , and we define the scalar kernel

$$\bar{K}_i(t) = \int_{\mathbb{R}_+} e^{-\theta t} |\mu_i|(d\theta), \quad t > 0, \quad (4.3.1)$$

which is in $L^2([0, T], \mathbb{R})$ provided that μ_i satisfies $\int_{\mathbb{R}_+} (1 \wedge \theta^{-1/2}) |\mu_i|(d\theta) < \infty$ (which we shall assume in this section), see [AJMP19b, Lemma A.1].

We first establish the existence and uniqueness for the following infinite dimensional Lyapunov equation:

$$\Psi_t(\theta, \tau) = \int_t^T e^{-(\theta+\tau)(s-t)} F(s, \Psi_s)(\theta, \tau) ds, \quad t \leq T, \quad \mu_1 \otimes \mu_2 - a.e. \quad (4.3.2)$$

where

$$\begin{aligned} F(s, \Psi)(\theta, \tau) = & \tilde{Q}_s(\theta, \tau) + \tilde{D}_s^1(\theta)^\top \int_{\mathbb{R}_+^2} \mu_1(d\theta')^\top \Psi(\theta', \tau') \mu_2(d\tau') \tilde{D}_s^2(\tau) \\ & + \tilde{B}_s^1(\theta)^\top \int_{\mathbb{R}_+} \mu_1(d\theta')^\top \Psi(\theta', \tau) + \int_{\mathbb{R}_+} \Psi(\theta, \tau') \mu_2(d\tau') \tilde{B}_s^2(\tau), \end{aligned} \quad (4.3.3)$$

for some coefficients $\tilde{Q}, \tilde{B}^1, \tilde{B}^2, \tilde{D}^1, \tilde{D}^2$ satisfying suitable assumptions made precise in the following theorem.

Theorem 4.3.1. *Let $\tilde{Q} : [0, T] \times \mathbb{R}_+^2 \rightarrow \mathbb{R}^{d_{11} \times d_{21}}$ be a measurable function and for each $i = 1, 2$, $\tilde{B}^i, \tilde{D}^i : [0, T] \times \mathbb{R}_+ \rightarrow \mathbb{R}^{d_{i2} \times d_{i1}}$ be two measurable functions. Assume that there exists $\kappa > 0$ such that*

$$|\tilde{Q}_s(\theta, \tau)| + \sum_{i=1}^2 |\tilde{B}_s^i(\theta)| + |\tilde{D}_s^i(\theta)|^{1/2} \leq \kappa, \quad dt \otimes \mu_1 \otimes \mu_2 - a.e. \quad (4.3.4)$$

Then, there exists a unique solution $\Psi \in C([0, T], L^1(\mu_1 \otimes \mu_2))$ to (4.3.2)-(4.3.3). In particular,

$$\sup_{t \leq T} \|\Psi_t\|_{L^1(\mu_1 \otimes \mu_2)} < \infty. \quad (4.3.5)$$

Furthermore, there exists a constant $\kappa' > 0$ such that

$$\int_{\mathbb{R}_+} |\mu_1|(d\theta) |\Psi_t(\theta, \tau)| \leq \kappa', \quad \mu_2 - a.e., \quad t \leq T, \quad (4.3.6)$$

$$\int_{\mathbb{R}_+} |\mu_2|(d\tau) |\Psi_t(\theta, \tau)| \leq \kappa', \quad \mu_1 - a.e., \quad t \leq T. \quad (4.3.7)$$

Remark 4.3.1. *Since the solution Ψ satisfies (4.3.5), (4.3.6) and (4.3.7), it follows that*

$$|F(\Psi)(\theta, \tau)| \leq c, \quad dt \otimes \mu \otimes \mu - a.e.$$

for some constant c . Combined with (4.3.2), one gets that $\Psi_t \in L^\infty(\mu_1 \otimes \mu_2)$, for all $t \leq T$. \square

The proof of Theorem 4.3.1 follows from the three following lemmas.

Lemma 4.3.1. *Under the assumptions of Theorem 4.3.1, there exists a unique $L^1(\mu_1 \otimes \mu_2)$ -valued function $t \in [0, T] \rightarrow \Psi_t$ satisfying (4.3.5), and such that (4.3.2)-(4.3.3) hold.*

Proof. The proof is an application of the contraction mapping principle. We denote by \mathcal{B}_T the space of measurable and bounded functions $\Psi : [0, T] \rightarrow L^1(\mu_1 \otimes \mu_2)$ endowed with the norm

$$\|\Psi\|_{\mathcal{B}_T} := \sup_{t \leq T} \|\Psi_t\|_{L^1(\mu_1 \otimes \mu_2)} < \infty.$$

The space $(\mathcal{B}_T, \|\cdot\|_{\mathcal{B}_T})$ is a Banach space. We consider the following family of norms on \mathcal{B}_T :

$$\|\Psi\|_\lambda := \sup_{t \leq T} e^{-\lambda(T-t)} \|\Psi_t\|_{L^1(\mu_1 \otimes \mu_2)}, \quad \lambda > 0.$$

For every $\Psi \in \mathcal{B}_T$, define a new function $t \mapsto (\mathcal{T}\Psi)_t$ by

$$(\mathcal{T}\Psi)_t(\theta, \tau) = \int_t^T e^{-(\theta+\tau)(s-t)} F(s, \Psi_s)(\theta, \tau) ds, \quad \mu_1 \otimes \mu_2 - a.e.,$$

where F is given by (4.3.3). Since the norms $\|\cdot\|_{\mathcal{B}_T}$ and $\|\cdot\|_\lambda$ are equivalent, it is enough to find $\lambda > 0$ such that \mathcal{T} defines a contraction on $(\mathcal{B}_T, \|\cdot\|_\lambda)$. We thus look for $\lambda > 0$ and $M < 1$ such that

$$\|\mathcal{T}\Psi - \mathcal{T}\Phi\|_\lambda \leq M \|\Psi - \Phi\|_\lambda, \quad \Psi, \Phi \in \mathcal{B}_T. \quad (4.3.8)$$

Step 1: We first prove that $\mathcal{T}(\mathcal{B}_T) \subset \mathcal{B}_T$. Fix $\Psi \in \mathcal{B}_T$ and $t \leq T$. An application of the triangle inequality combined with the assumption (4.3.4) leads to

$$\begin{aligned} \|(\mathcal{T}\Psi)_t\|_{L^1(\mu_1 \otimes \mu_2)} &\leq \kappa \int_{\mathbb{R}_+^2} |\mu_1|(d\theta) |\mu_2|(d\tau) \int_t^T e^{-(\theta+\tau)(s-t)} ds \\ &\quad + \kappa \int_{\mathbb{R}_+^2} |\mu_1|(d\theta) |\mu_2|(d\tau) \int_t^T e^{-(\theta+\tau)(s-t)} \|\Psi_s\|_{L^1(\mu_1 \otimes \mu_2)} ds \\ &\quad + \kappa \int_{\mathbb{R}_+^2} |\mu_1|(d\theta) |\mu_2|(d\tau) \int_t^T e^{-(\theta+\tau)(s-t)} \int_{\mathbb{R}_+} |\mu_1|(d\theta') |\Psi_s(\theta', \tau)| \\ &\quad + \kappa \int_{\mathbb{R}_+^2} |\mu_1|(d\theta) |\mu_2|(d\tau) \int_t^T e^{-(\theta+\tau)(s-t)} \int_{\mathbb{R}_+} |\Psi_s(\theta, \tau')| |\mu_2|(d\tau'), \\ &= \kappa(\mathbf{I}_t + \mathbf{II}_t + \mathbf{III}_t + \mathbf{IV}_t). \end{aligned}$$

Recalling the definition (4.3.1), an application of Tonelli's theorem and Cauchy-Schwarz inequality yields

$$\sup_{t \leq T} \mathbf{I}_t = \sup_{t \leq T} \int_t^T \bar{K}_1(s-t) \bar{K}_2(s-t) ds \leq \|\bar{K}_1\|_{L^2(0,T)} \|\bar{K}_2\|_{L^2(0,T)},$$

which is finite due to [AJMP19b, Lemma A.1]. Similarly,

$$\sup_{t \leq T} \mathbf{II}_t \leq \|\Psi\|_{\mathcal{B}_T} \|\bar{K}_1\|_{L^2(0,T)} \|\bar{K}_2\|_{L^2(0,T)} < \infty.$$

Now, as $e^{-\tau(s-t)} \leq 1$, and $e^{-\theta(s-t)} \leq 1$, for $s \geq t$, and $\theta, \tau \in \mathbb{R}_+$, another application of Tonelli's theorem leads to

$$\sup_{t \leq T} \mathbf{III}_t \leq \|\Psi\|_{\mathcal{B}_T} \|\bar{K}_1\|_{L^1(0,T)} < \infty, \quad \text{and} \quad \sup_{t \leq T} \mathbf{IV}_t \leq \|\Psi\|_{\mathcal{B}_T} \|\bar{K}_2\|_{L^1(0,T)} < \infty.$$

Combining the above inequalities proves that $\|\mathcal{T}\Psi\|_{\mathcal{B}_T} < \infty$ and hence $\mathcal{T} : \mathcal{B}_T \rightarrow \mathcal{B}_T$.

Step 2: We prove that there exists $\lambda > 0$ such that (4.3.8) holds. Fix $\lambda > 0$ and $\Psi, \Phi \in \mathcal{S}_T$ such that $\|\Psi\|_\lambda$ and $\|\Phi\|_\lambda$ are finite. Similarly to *Step 1*, the triangle inequality and Tonelli's theorem lead to

$$\sup_{t \leq T} e^{-\lambda(T-t)} \|(\mathcal{T}\Psi)_t - (\mathcal{T}\Phi)_t\|_{L^1(\mu_1 \otimes \mu_2)} \leq M(\lambda) \sup_{t \leq T} e^{-\lambda(T-t)} \|\Psi_t - \Phi_t\|_{L^1(\mu_1 \otimes \mu_2)},$$

where

$$M(\lambda) = \kappa \int_0^T e^{-\lambda s} (\bar{K}_1(s) + \bar{K}_2(s) + \bar{K}_1(s)\bar{K}_2(s)) ds.$$

By the dominated convergence theorem, $M(\lambda)$ tends to 0 as λ goes to $+\infty$. We can therefore choose $\lambda_0 > 0$ so that (4.3.8) holds with $M(\lambda_0) < 1$. An application of the contraction mapping theorem yields the existence and uniqueness statement in $(\mathcal{B}_T, \|\cdot\|_{\mathcal{B}_T})$ such that (4.3.2) holds, $\mu_1 \otimes \mu_2$ -a.e., for all $t \leq T$. The interchange of the quantifiers is possible due to the continuity of $t \mapsto \Psi_t(\theta, \tau)$ $\mu_1 \otimes \mu_2$ -a.e., which ends the proof. \square

Lemma 4.3.2. *The function Ψ constructed in Lemma 4.3.1 satisfies the estimates (4.3.6)-(4.3.7).*

Proof. We only prove (4.3.7), as (4.3.6) follows by the same argument. Integrating (4.3.2) over the τ variable leads to

$$\int_{\mathbb{R}_+} \Psi_t(\theta, \tau) \mu_2(d\tau) = \int_{\mathbb{R}_+} \int_t^T e^{-(\theta+\tau)(s-t)} F(s, \Psi_s)(\theta, \tau) ds \mu_2(d\tau), \quad t \leq T, \quad \mu_1 - \text{a.e.} \quad (4.3.9)$$

Let us define the μ_1 -null set

$$\mathcal{N} = \{\theta \in \mathbb{R}_+ : (4.3.9) \text{ does not hold}\},$$

and fix $\theta \in \mathbb{R}_+ \setminus \mathcal{N}$ and $t \leq T$. The triangle inequality on (4.3.9) and assumption (4.3.4) yields

$$\begin{aligned} \int_{\mathbb{R}_+} |\mu_2|(d\tau) |\Psi_t(\theta, \tau)| &\leq \kappa \int_{\mathbb{R}_+} |\mu_2|(d\tau) \int_t^T e^{-(\theta+\tau)(s-t)} ds \\ &\quad + \kappa \int_{\mathbb{R}_+} |\mu_2|(d\tau) \int_t^T e^{-(\theta+\tau)(s-t)} \|\Psi_s\|_{L^1(\mu_1 \otimes \mu_2)} ds \\ &\quad + \kappa \int_{\mathbb{R}_+} |\mu_2|(d\tau) \int_t^T e^{-(\theta+\tau)(s-t)} \int_{\mathbb{R}_+} |\mu_1|(d\theta') |\Psi_s(\theta', \tau)| ds \\ &\quad + \kappa \int_{\mathbb{R}_+} |\mu_2|(d\tau) \int_t^T e^{-(\theta+\tau)(s-t)} \int_{\mathbb{R}_+} |\mu_2|(d\tau') |\Psi_s(\theta, \tau')| ds. \end{aligned}$$

Using the bound $e^{-\theta(s-t)} \leq 1$, an application of Tonelli's theorem gives

$$\begin{aligned} \int_{\mathbb{R}_+} |\mu_2|(d\tau) |\Psi_t(\theta, \tau)| &\leq \kappa \left(1 + \sup_{s \leq T} \|\Psi_s\|_{L^1(\mu_1 \otimes \mu_2)} \right) \int_0^T (1 + \bar{K}_2(s)) ds \\ &\quad + \kappa \int_t^T \bar{K}_2(s-t) \int_{\mathbb{R}_+} |\mu_2|(d\tau') |\Psi_s(\theta, \tau')| ds. \end{aligned} \quad (4.3.10)$$

After a change of variable, we get that the function f^θ defined by

$$f^\theta(t) = \int_{\mathbb{R}_+} |\mu_2|(d\tau) |\Psi_{T-t}(\theta, \tau)|, \quad t \leq T,$$

satisfies the convolution inequality

$$f^\theta(t) \leq c_T + \kappa \int_0^t \bar{K}_2(t-s) f^\theta(s) ds,$$

with $c_T = \kappa (1 + \sup_{s \leq T} \|\Psi_s\|_{L^1(\mu_1 \otimes \mu_2)}) \int_0^T (1 + \bar{K}_2(s)) ds < \infty$. It follows from (4.3.5) that $f^\theta(t)$ is finite $\mu_1 \otimes dt$ -a.e., so that an application of the generalized Gronwall inequality for convolution equations, see [GLS90, Theorem 9.8.2], yields the estimate (4.3.7). \square

Lemma 4.3.3. *Under the assumptions of Theorem 4.3.1, let $t \in [0, T] \rightarrow \Psi_t$ be such that (4.3.2) holds, with (4.3.5), (4.3.6) and (4.3.7). Then, $\Psi \in \mathcal{C}([0, T], L^1(\mu_1 \otimes \mu_2))$.*

Proof. We first observe that by virtue of the boundedness of the coefficients (4.3.4) and the estimates (4.3.5), (4.3.6) and (4.3.7), we have

$$|F(s, \Psi_s)(\theta, \tau)| \leq c, \quad dt \otimes \mu_1 \otimes \mu_2 - a.e. \quad (4.3.11)$$

for some constant c , where F is given by (4.3.3). Fix $s \leq t \leq T$. Using (4.3.2), we write

$$\begin{aligned} \Psi_s(\theta, \tau) - \Psi_t(\theta, \tau) &= \int_s^t e^{-(\theta+\tau)(u-s)} F(u, \Psi_u)(\theta, \tau) ds \\ &\quad + \int_t^T \left(e^{-(\theta+\tau)(u-s)} - e^{-(\theta+\tau)(u-t)} \right) F(u, \Psi_u)(\theta, \tau) ds \\ &= \mathbf{I}_{s,t}(\theta, \tau) + \mathbf{II}_{s,t}(\theta, \tau) \end{aligned}$$

$\mu_1 \otimes \mu_2$ -a.e. Integrating over the θ and τ variables and successive applications of Tonelli's theorem and Cauchy-Schwarz inequality together with the bound (4.3.11) lead to

$$\begin{aligned} \|\mathbf{I}_{s,t}\|_{L^1(\mu_1 \otimes \mu_2)} &\leq c \int_s^t \bar{K}_1(u-s) \bar{K}_2(u-s) du \\ &\leq c \|\bar{K}_1\|_{L^2(0,t-s)} \|\bar{K}_2\|_{L^2(0,t-s)}. \end{aligned}$$

By virtue of the square integrability of \bar{K}_1 and \bar{K}_2 , the right hand side goes to 0 as $s \uparrow t$. Similarly, using also that $e^{-(\theta+\tau)(u-s)} \leq e^{-(\theta+\tau)(u-t)}$, we get

$$\begin{aligned} \|\mathbf{II}_{s,t}\|_{L^1(\mu_1 \otimes \mu_2)} &\leq c \int_t^T (\bar{K}_1(u-t) \bar{K}_2(u-t) - \bar{K}_1(u-s) \bar{K}_2(u-s)) du \\ &= c \int_0^{T-t} (\bar{K}_1(u) \bar{K}_2(u) - \bar{K}_1(t-s+u) \bar{K}_2(t-s+u)) du \\ &= c \int_0^{T-t} (\bar{K}_1(u) - \bar{K}_1(t-s+u)) \bar{K}_2(u) du \\ &\quad + c \int_0^{T-t} \bar{K}_1(t-s+u) (\bar{K}_2(u) - \bar{K}_2(t-s+u)) du \\ &= c(\mathbf{1}_{s,t} + \mathbf{2}_{s,t}). \end{aligned}$$

The right hand side goes also to 0 as $s \uparrow t$. To see this, an application of Cauchy-Schwarz inequality gives

$$\mathbf{1}_{s,t} \leq \left(\int_0^T (\bar{K}_1(u) - \bar{K}_1(t-s+u))^2 du \right)^{1/2} \|\bar{K}_2\|_{L^2(0,T)}.$$

Since \bar{K}_1 is an element of L^2 , it follows from [Bre10, Lemma 4.3] that

$$\lim_{h \rightarrow 0} \int_0^T |\bar{K}_1(u+h) - \bar{K}_1(u)|^2 du = 0, \quad (4.3.12)$$

showing that $\mathbf{1}_{s,t}$ converges to 0 as s goes to t . Interchanging the roles of \bar{K}_1 and \bar{K}_2 , we also get the convergence $\mathbf{2}_{s,t} \rightarrow 0$ as $s \uparrow t$. Combining the above leads to

$$\|\Psi_s - \Psi_t\|_{L^1(\mu_1 \otimes \mu_2)} \rightarrow 0, \quad \text{as } s \uparrow t.$$

Similarly, we get the same conclusion when $s \downarrow t$, and the proof is complete. \square

4.4 Solvability of the Riccati equation

The main goal of this section is to prove Theorem 4.2.1, i.e., the existence and uniqueness of a function $\Gamma \in C([0, T], L^1(\mu \otimes \mu))$ satisfying the kernel Riccati equation (4.2.5) (recall Definition 5.5.1), and the estimate (4.2.7). This is obtained by adapting the technique used in classical linear-quadratic control theory [Theorem 6.7.2]yong1999stochastic to our setting with the following steps:

1. Construct a sequence of Lyapunov solutions $(\Gamma^i)_{i \geq 0}$ by successive iterations,
2. Establish the convergence of $(\Gamma^i)_{i \geq 0}$ in $L^1(\mu \otimes \mu)$,
3. Prove that the limiting point is a solution to the Riccati equation (4.2.5),
4. Derive the estimate (4.2.7), the continuity and the uniqueness for the Riccati solution.

4.4.1 Step 1: Construction of a sequence of Lyapunov solutions

$$(\Gamma_t^i)_{i \geq 0}$$

Lemma 4.4.1. *Let $\Psi \in C([0, T], L^1(\mu \otimes \mu))$ denote the solution to the Lyapunov equation (4.3.2) produced by Theorem 4.3.1 for the configuration*

$$\begin{cases} d_{11} = d_{21} = d, & d_{12} = d_{22} = d', & \mu_1 = \mu_2 = \mu, \\ \tilde{B}^1 = \tilde{B}^2 = \tilde{B}, & & \tilde{D}^1 = \tilde{D}^2 = \tilde{D}. \end{cases} \quad (4.4.1)$$

and under the condition

$$\begin{cases} |\tilde{Q}_s(\theta, \tau)| \leq \kappa, & dt \otimes \mu \otimes \mu - a.e. \\ |\tilde{B}_s(\theta)| + |\tilde{D}_s(\theta)| \leq \kappa, & dt \otimes \mu - a.e. \end{cases} \quad (4.4.2)$$

If $\tilde{Q}_t \in \mathbb{S}_+^d(\mu \otimes \mu)$ for all $t \leq T$, then

1. $t \mapsto \Psi_t$ is a non-increasing $\mathbb{S}_+^d(\mu \otimes \mu)$ -valued function w.r.t the order relation \succeq_μ .
2. $t \mapsto \int_{\mathbb{R}_+^2} \mu(d\theta)^\top \Psi_t(\theta, \tau) \mu(d\tau)$ is a non-increasing \mathbb{S}_+^d -valued function on $[0, T]$.

Proof. Note that under (4.4.1), the Lyapunov equation (4.3.2) is invariant by transposition and exchange of θ and τ . By uniqueness of the solution, we deduce that $\Psi_t(\theta, \tau) = \Psi_t(\tau, \theta)^\top$, $\mu \otimes \mu$ -a.e., for all $t \leq T$. Fix $\varphi \in L^1(\mu)$ and $t \leq T$, and consider the following equation

$$\begin{cases} d\tilde{Y}_s(\theta) &= \left(-\theta \tilde{Y}_s(\theta) + \int_{\mathbb{R}_+} \tilde{B}_s(\tau) \mu(d\tau) \tilde{Y}_s(\tau) \right) ds + \left(\int_{\mathbb{R}_+} \tilde{D}_s(\tau) \mu(d\tau) \tilde{Y}_s(\tau) \right) dW_s \\ \tilde{Y}_t(\theta) &= \varphi(\theta), \end{cases}$$

which admits a unique $L^1(\mu)$ -valued solution such that

$$\sup_{t \leq s \leq T} \mathbb{E} \left[\|\tilde{Y}_s\|_{L^1(\mu)}^4 \right] < \infty, \quad (4.4.3)$$

see [AJMP19b, Theorem 4.1]. Recall the bold notation \mathbf{G} in (4.2.1) for the integral operator generated by a kernel G . Note that, by virtue of Remark 4.3.1, $\Psi_s \in L^\infty(\mu \otimes \mu)$, so that $\Psi_s : L^1(\mu) \rightarrow L^\infty(\mu^\top)$, for all $s \leq T$. This shows that $s \mapsto \langle \tilde{Y}_s, \Psi_s \tilde{Y}_s \rangle_\mu$ is well-defined \mathbb{P} -a.s. An application of Itô's formula (see [AJMP19b, Lemma 5.1]) to the process $s \rightarrow \langle \tilde{Y}_s, \Psi_s \tilde{Y}_s \rangle_\mu$ yields, due to the vanishing terminal condition for Ψ , and after successive applications of Fubini's theorem:

$$\begin{aligned} 0 &= \langle \varphi, \Psi_t \varphi \rangle_\mu - \int_t^T \langle \tilde{Y}_s, \tilde{\mathbf{Q}}_s \tilde{Y}_s \rangle_\mu ds \\ &+ \int_t^T \int_{\mathbb{R}_+} \tilde{Y}_s(\theta)^\top \mu(d\theta)^\top \tilde{D}_s(\theta)^\top \int_{\mathbb{R}_+^2} \mu(d\theta')^\top \Psi_s(\theta', \tau') \mu(d\tau') \tilde{Y}_s(\tau') dW_s \\ &+ \int_t^T \int_{\mathbb{R}_+^2} \tilde{Y}_s(\theta')^\top \mu(d\theta')^\top \Psi_s(\theta', \tau') \mu(d\tau') \int_{\mathbb{R}_+} \tilde{D}_s(\tau) \mu(d\tau) \tilde{Y}_s(\tau) dW_s. \end{aligned} \quad (4.4.4)$$

It is straightforward to check that the local martingales terms are in fact true martingales due to the boundedness conditions (4.4.2), (4.3.6) and the moment bound (4.4.3). Thus, taking the expectation on both sides of (4.4.4) yields that

$$\langle \varphi, \Psi_t \varphi \rangle_\mu = \mathbb{E} \left[\int_t^T \langle \tilde{Y}_s, \tilde{\mathbf{Q}}_s \tilde{Y}_s \rangle_\mu ds \right],$$

which ensures the positiveness and the non increasingness of $t \mapsto \langle \varphi, \Psi_t \varphi \rangle_\mu$ for any $\varphi \in L^1(\mu)$, since $s \rightarrow \tilde{\mathbf{Q}}_s$ is $\mathbb{S}_+^d(\mu \otimes \mu)$ -valued. This proves Assertion 1. Next, by considering the sequence of $L^1(\mu)$ -valued functions $(\varphi^n(\theta) = z 1_{[1/n, \infty)}(\theta))_{n \geq 1}$ for arbitrary $z \in \mathbb{R}^{d'} \setminus \{0\}$, using that $\Psi_t \in L^1(\mu \otimes \mu)$, and taking the limit, we obtain that $t \mapsto \int_{\mathbb{R}_+^2} \mu(d\theta)^\top \Psi_t(\theta, \tau) \mu(d\tau)$ is a non increasing \mathbb{S}_+^d -valued function. This proves Assertion 2 and concludes the proof. \square

From now on, we work under assumption (4.2.6). We construct a sequence of Lyapunov solutions $(\Gamma^i)_{i \geq 0}$ by induction as follows.

• *Initialization:* Let $\Gamma^0 \in C([0, T], L^1(\mu \otimes \mu))$ be the unique solution given by Theorem 4.3.1 to the following Lyapunov equation

$$\begin{cases} \Gamma_t^0(\theta, \tau) &= \int_t^T e^{-(\theta+\tau)(s-t)} F_0(\Gamma_s^0)(\theta, \tau) ds, \\ F_0(\Gamma)(\theta, \tau) &= Q + D^\top \int_{\mathbb{R}_+^2} \mu(d\theta')^\top \Gamma(\theta', \tau') \mu(d\tau') D \\ &+ B^\top \int_{\mathbb{R}_+} \mu(d\theta')^\top \Gamma(\theta', \tau) + \int_{\mathbb{R}_+} \Gamma(\theta, \tau') \mu(d\tau') B. \end{cases}$$

Since $Q \in \mathbb{S}_+^d$, an application of Lemma 4.4.1-2 yields that $F^\top \int_{\mathbb{R}_+^2} \mu(d\theta')^\top \Gamma_t^0(\theta', \tau') \mu(d\tau') F \in \mathbb{S}_+^m$, for all $t \leq T$. Combined with the assumption $N - \lambda I_m \in \mathbb{S}_+^m$, we obtain

$$N + F^\top \int_{\mathbb{R}_+^2} \mu(d\theta')^\top \Gamma_t^0(\theta', \tau') \mu(d\tau') F - \lambda I_m \in \mathbb{S}_+^m, \quad t \leq T.$$

• *Induction:* for $i \in \mathbb{N}$, having constructed $\Gamma^i \in C([0, T], L^1(\mu \otimes \mu))$ such that

$$N + F^\top \int_{\mathbb{R}_+^2} \mu(d\theta')^\top \Gamma_t^i(\theta', \tau') \mu(d\tau') F - \lambda I_m \in \mathbb{S}_+^m, \quad t \leq T. \quad (4.4.5)$$

and

$$\int_{\mathbb{R}_+} |\mu|(d\tau) |\Gamma_t^i(\theta, \tau)| \leq \kappa'_i, \quad \mu - a.e., \quad t \leq T, \quad (4.4.6)$$

for some $\kappa'_i > 0$, we define

$$\begin{aligned} \Theta_t^i(\tau) = & - \left(N + F^\top \int_{\mathbb{R}_+^2} \mu(d\theta')^\top \Gamma_t^i(\theta', \tau') \mu(d\tau') F \right)^{-1} \\ & \times \left(F^\top \int_{\mathbb{R}_+^2} \mu(d\theta')^\top \Gamma_t^i(\theta', \tau') \mu(d\tau') D + C^\top \int_{\mathbb{R}_+} \mu(d\theta') \Gamma_t^i(\theta', \tau) \right), \end{aligned} \quad (4.4.7)$$

together with the coefficients

$$\tilde{Q}_t^i(\theta, \tau) = Q + \Theta_t^i(\theta)^\top N \Theta_t^i(\tau), \quad \tilde{B}_t^i(\tau) = B + C \Theta_t^i(\tau), \quad \tilde{D}_t^i(\tau) = D + F \Theta_t^i(\tau). \quad (4.4.8)$$

Since $\Gamma^i \in C([0, T], L^1(\mu \otimes \mu))$, we have

$$\sup_{t \leq T} \|\Gamma_t^i\|_{L^1(\mu \otimes \mu)} < \infty.$$

Combined with the estimate (4.4.6), this yields the existence of $c_i > 0$ such that

$$\Theta_t^i(\theta) \leq c_i, \quad \mu - a.e., \quad t \leq T.$$

This implies that the coefficients $\tilde{Q}^i, \tilde{B}^i, \tilde{D}^i$ satisfy (4.4.2). Therefore, Theorem 4.3.1 can be applied to get the existence of a unique solution $\Gamma^{i+1} \in C([0, T], L^1(\mu \otimes \mu))$ to the following Lyapunov equation

$$\begin{cases} \Gamma_t^{i+1}(\theta, \tau) &= \int_t^T e^{-(\theta+\tau)(s-t)} F_i(s, \Gamma_s^{i+1})(\theta, \tau) ds, \\ F_i(s, \Gamma)(\theta, \tau) &= \tilde{Q}_s^i(\theta, \tau) + \tilde{D}_s^i(\theta)^\top \int_{\mathbb{R}_+^2} \mu(d\theta')^\top \Gamma(\theta', \tau') \mu(d\tau') \tilde{D}_s^i(\tau) \\ &\quad + \tilde{B}_s^i(\theta)^\top \int_{\mathbb{R}_+} \mu(d\theta')^\top \Gamma(\theta', \tau) + \int_{\mathbb{R}_+} \Gamma(\theta, \tau') \mu(d\tau') \tilde{B}_s^i(\tau), \end{cases} \quad (4.4.9)$$

such that the estimate (4.4.6) holds also for Γ^{i+1} . Furthermore, since \tilde{Q}_t^i clearly lies in $\mathbb{S}_+^d(\mu \otimes \mu)$, for all $t \leq T$, Lemma 4.4.1-2 yields that (4.4.5) is satisfied with Γ_t^i replaced by Γ_t^{i+1} , for all $t \leq T$. This ensures that the induction is well-defined.

4.4.2 Step 2: Convergence of $(\Gamma_t^i)_{i \geq 0}$ in $L^1(\mu \otimes \mu)$

Lemma 4.4.2. For $i \in \mathbb{N}$ and for a scalar function $\xi \in L^\infty(|\mu|)$ define the matrix-valued functions

$$\mathcal{U}^i = \int_{\mathbb{R}_+^2} \mu(d\theta)^\top \Gamma^i(\theta, \tau) \mu(d\tau), \quad \mathcal{V}^i(\xi) = \int_{\mathbb{R}_+^2} \mu(d\theta)^\top \Gamma^i(\theta, \tau) \mu(d\tau) \xi(\tau).$$

Then,

1. $(\mathcal{U}^i)_{i \geq 0}$ is a non-increasing sequence (meaning $\mathcal{U}_t^{i+1} \leq \mathcal{U}_t^i$, $i \in \mathbb{N}$ and $t \leq T$) of monotone non-increasing functions on the space $C([0, T], \mathbb{S}_+^d)$, converging pointwise to a limit denoted by \mathcal{U} ;
2. $(\mathcal{V}^i(\xi))_{i \geq 0}$ is a uniformly bounded sequence of functions on the space $C([0, T], \mathbb{R}^{d' \times d'})$, converging pointwise to a limit denoted by $\mathcal{V}(\xi)$, for any scalar function $\xi \in L^\infty(|\mu|)$.

Proof. Throughout the proof we consider the intermediate scalar sequences

$$U_t^i(\varphi) = \langle \Gamma_t^i \varphi, \varphi \rangle_{\mu^\top} \quad \text{and} \quad V_t^i(\varphi, \psi) = \langle \Gamma_t^i \varphi, \psi \rangle_{\mu^\top}, \quad t \leq T, \quad i \in \mathbb{N}, \quad \varphi, \psi \in L^\infty(\mu),$$

which are well-defined since $\Gamma_t^i \in L^1(\mu \otimes \mu)$ for all $t \leq T$. We also set $\Theta^{-1} = 0$, and for $i \geq 0$, and define

$$\Delta^i = \Gamma^i - \Gamma^{i+1}, \quad \rho^i = \Theta^{i-1} - \Theta^i,$$

where we recall that Θ^i is given by (4.4.7). Straightforward computations, detailed in Lemma 4.A.2 and Remark 4.A.1, yield that Δ^i solves the Lyapunov equation:

$$\begin{cases} \Delta_t^i(\theta, \tau) &= \int_t^T e^{-(\theta+\tau)(s-t)} F_t^\delta(s, \Delta_s^i)(\theta, \tau) ds, \\ F_t^\delta(t, \Delta)(\theta, \tau) &= \tilde{Q}_t^{i,\delta}(\theta, \tau) + \tilde{D}_t^i(\theta)^\top \int_{\mathbb{R}_+^2} \mu(d\theta')^\top \Delta(\theta', \tau') \mu(d\tau') \tilde{D}_t^i(\tau) \\ &\quad + \tilde{B}_t^i(\theta)^\top \int_{\mathbb{R}_+} \mu(d\theta')^\top \Delta(\theta', \tau) + \int_{\mathbb{R}_+} \Delta(\theta, \tau') \mu(d\tau') \tilde{B}_t^i(\tau), \end{cases} \quad (4.4.10)$$

where

$$\tilde{Q}_t^{i,\delta}(\theta, \tau) = \rho_t^i(\theta)^\top \left(N + F^\top \int_{\mathbb{R}_+^2} \mu(d\theta')^\top \Gamma_t^i(\theta', \tau') \mu(d\tau') F \right) \rho_t^i(\tau).$$

• Fix $i \in \mathbb{N}$. Since $\tilde{Q}_t^{i,\delta} \in \mathbb{S}_+^d(\mu \otimes \mu)$, an application of Lemma 4.4.1-1 on (4.4.10) shows that $t \mapsto \Delta_t^i$ is a non-increasing $\mathbb{S}_+^d(\mu \otimes \mu)$ -valued function. Thus, for any $\varphi \in L^1(\mu)$,

$$\langle \varphi, \mathbf{\Gamma}_0^0 \varphi \rangle_\mu \geq \langle \varphi, \mathbf{\Gamma}_t^0 \varphi \rangle_\mu \geq \langle \varphi, \mathbf{\Gamma}_t^i \varphi \rangle_\mu \geq \langle \varphi, \mathbf{\Gamma}_t^{i+1} \varphi \rangle_\mu \geq 0, \quad t \leq T, \quad i \in \mathbb{N},$$

Since for all $t \leq T$, Γ_t^i is also an element of $L^1(\mu \otimes \mu)$, the density of simple functions in $L^\infty(\mu)$ with respect to the uniform norm, implies that

$$0 \leq U_t^{i+1}(\varphi) \leq U_t^i(\varphi) \leq U_t^0(\varphi) \leq U_0^0(\varphi).$$

for all $\varphi \in L^\infty(\mu)$. This implies that the sequence of functions $(U^i(\varphi))_{i \geq 0}$ is non-increasing, nonnegative and converging pointwise to a limit that we denote by $U_t(\varphi)$ for any $t \in [0, T]$. Furthermore, $t \mapsto U_t^i(\varphi)$ is continuous, for all $i \in \mathbb{N}$ and $\varphi \in L^\infty(\mu)$, thanks to the continuity of $t \rightarrow \Gamma_t$ in $L^1(\mu \otimes \mu)$, see Lemma 4.3.3. The claimed statement 1 for \mathcal{U} now follows by evaluating with $\varphi(\theta) \equiv z$, where z ranges through \mathbb{R}^d .

• Since $\Gamma_t^i - \Gamma_t^j \in \mathbb{S}_+^d(\mu \otimes \mu)$ for any $i \leq j$, an application of the Cauchy-Schwarz inequality (see Lemma 4.A.1) yields

$$\langle \varphi, (\mathbf{\Gamma}_t^i - \mathbf{\Gamma}_t^j) \psi \rangle_\mu^2 \leq \langle \varphi, (\mathbf{\Gamma}_t^i - \mathbf{\Gamma}_t^j) \varphi \rangle_\mu \langle \psi, (\mathbf{\Gamma}_t^i - \mathbf{\Gamma}_t^j) \psi \rangle_\mu, \quad \varphi, \psi \in L^1(\mu) \quad (4.4.11)$$

Invoking once again the density of simple functions in $L^\infty(\mu)$ with respect to the uniform norm and the fact that for all $t \leq T$, $\Gamma_t \in L^1(\mu \otimes \mu)$, (4.4.11) gives

$$\left(V_t^i(\varphi, \psi) - V_t^j(\varphi, \psi) \right)^2 \leq \left(U_t^i(\varphi) - U_t^j(\varphi) \right) \left(U_t^i(\psi) - U_t^j(\psi) \right), \quad \varphi, \psi \in L^\infty(\mu).$$

Whence, the sequence of real valued functions $(t \mapsto V_t^i(\varphi, \psi))_{i \geq 0}$ is uniformly bounded. Furthermore, this also shows that the sequence $(t \mapsto V_t^i(\varphi, \psi))_{i \geq 0}$ is a real-valued Cauchy sequence that converges pointwise to a limit that we denote by $V_t(\varphi, \psi)$, for any $\varphi, \psi \in L^\infty(\mu)$. To obtain the continuity of $V^i(\varphi, \psi)$, note that $\Gamma_t^i - \Gamma_s^i \in \mathbb{S}_+^d(\mu \otimes \mu)$ for any $t \leq s$ and $\Gamma_s^i - \Gamma_t^i \in \mathbb{S}_+^d$ for any $s \leq t$, which allows us once again to apply the Cauchy Schwarz inequality (see Lemma 4.A.1) coupled with the density argument to obtain for any $s, t \in [0, T]$:

$$\left(V_t^i(\varphi, \psi) - V_s^i(\varphi, \psi) \right)^2 \leq \left(U_t^i(\varphi) - U_s^i(\varphi) \right) \left(U_t^i(\psi) - U_s^i(\psi) \right).$$

Consequently, the continuity of $U^i(\varphi)$ for any $\varphi \in L^\infty(\mu)$ implies that of $V^i(\varphi, \psi)$ for any $\varphi, \psi \in L^\infty(\mu)$. Fix $\xi \in L^\infty(|\mu|)$, the claimed statement 2 for $\mathcal{V}(\xi)$ now follows by evaluating with $\varphi(\theta) \equiv z$ and $\psi(\theta) = \xi(\theta)z'$, where z, z' range through \mathbb{R}^d . \square

Lemma 4.4.3. *There exists a constant $\kappa > 0$ such that for every $i \in \mathbb{N}$ and $t \in [0, T]$*

$$\left| \int_{\mathbb{R}_+} \Gamma_t^i(\theta, \tau) \mu(d\tau) \right| \leq \kappa \quad \mu - a.e. \quad (4.4.12)$$

Proof. Lemma 4.4.2 ensures that there exists a constant $M > 0$ such that for every $i \in \mathbb{N}$

$$\sup_{t \leq T} \left| \int_{\mathbb{R}_+^2} \mu(d\theta)^\top \Gamma_t^i(\theta, \tau) \mu(d\tau) \right| \vee \sup_{t \leq T} \left| \int_{\mathbb{R}_+^2} e^{-\theta t} \mu(d\theta)^\top \Gamma_t^i(\theta, \tau) \mu(d\tau) \right| \leq M. \quad (4.4.13)$$

Fix $i \in \mathbb{N}$. We proceed as in the proof of Lemma 4.3.2 to bound the quantity $g_t^i(\theta) = \left| \int_{\mathbb{R}_+} \Gamma_t^{i+1}(\theta, \tau) \mu(d\tau) \right|$. By construction Γ^{i+1} solves (4.4.9), so that an integration over the τ -variable combined with (4.4.13) and the triangle inequality yield

$$g_t^{i+1}(\theta) \leq 4rT + 4r \int_t^T (1 + |K(t-s)|) (g_s^i(\theta) + g_s^{i+1}(\theta)) ds, \quad (4.4.14)$$

where r is a constant only depending on B, D, Q, N and M . Let us now show the desired inequality (4.4.12). For $n \geq 0$, let us define

$$G_t^n(\theta) = \sup_{i=0, \dots, n} \left| \int_{\mathbb{R}_+} \Gamma_t^i(\theta, \tau) \mu(d\tau) \right|.$$

The inequality (4.4.14) yields for every $i \geq 0$

$$G_t^{i+1}(\theta) \leq 4rT + 4r \int_t^T (1 + 2|K(t-s)|) G_s^{i+1}(\theta) ds.$$

Consequently, the generalized Gronwall inequality implies that there exists a constant c only depending on B, C, D, F, N, T, K and M such that for every $n \in \mathbb{N}$, $t \in [0, T]$ we have $|G_t^n(\theta)| \leq c$ for μ -almost every θ and $t \in [0, T]$. \square

Lemma 4.4.4. *The sequence of functions $(\mathcal{U}^i)_{i \geq 0}$ converges uniformly on $C([0, T], \mathbb{S}_+^d)$ to its simple limit \mathcal{U} introduced in Lemma 4.4.2.*

Proof. From Lemma 4.4.2, we have that $(\mathcal{U}^i)_{i \geq 0}$ is a non increasing sequence of continuous functions converging pointwise to \mathcal{U} . To obtain the uniform convergence it suffices to show that \mathcal{U} is continuous and apply Dini's theorem. To do so our strategy is to show that $t \mapsto \mathcal{U}_t$ solves an equation whose solutions are continuous.

Step 1. Equation satisfied by \mathcal{U} . By definition Γ^{i+1} is solution to (4.4.9), thus by integrating over τ, θ and applying Fubini's theorem we get

$$\begin{cases} \mathcal{U}_t^{i+1} &= \int_t^T \tilde{F}_i(t, r) (\mathcal{U}^{i+1}) dr, \\ \tilde{F}_i(t, r) (\mathcal{U}^{i+1}) &= \mathbf{I}^i(t, r) + \mathbf{II}^i(t, r) + \mathbf{III}^i(t, r) + \mathbf{III}^i(t, r)^\top, \end{cases} \quad (4.4.15)$$

where

$$\begin{aligned} \mathbf{I}^i(t, r) &= \int_{\mathbb{R}_+^2} e^{-\theta(r-t)} \mu(d\theta)^\top \tilde{Q}_r^i(\theta, \tau) \mu(d\tau) e^{-\tau(r-t)}, \\ \mathbf{II}^i(t, r) &= \left(\int_{\mathbb{R}_+} e^{-\theta(r-t)} \mu(d\theta)^\top \tilde{D}_r^i(\theta)^\top \right) \mathcal{U}_r^{i+1} \left(\int_{\mathbb{R}_+} \tilde{D}_r^i(\tau) \mu(d\tau) e^{-\tau(r-t)} \right), \\ \mathbf{III}^i(t, r) &= \left(\int_{\mathbb{R}_+} e^{-\theta(r-t)} \mu(d\theta)^\top \tilde{B}_r^i(\theta)^\top \right) \mathcal{V}_r^i(e^{(t-r)}), \end{aligned}$$

with \tilde{B}^i , \tilde{D}^i and \tilde{Q}^i defined as in (4.4.8). The pointwise convergences and the uniform bounds stated in Lemma 4.4.2 allow us to apply the dominated convergence theorem to (4.4.15) to get

$$\begin{cases} \mathcal{U}_t &= \int_t^T \tilde{F}(t, r) (\mathcal{U}) dr, \\ \tilde{F}(t, r) (\mathcal{U}) &= \mathbf{I}(t, r) + \mathbf{II}(t, r) + \mathbf{III}(t, r) + \mathbf{III}(t, r)^\top, \end{cases} \quad (4.4.16)$$

where

$$\begin{aligned} \mathbf{I}(t, r) &= K(r-t)^\top Q K(r-t) + \tilde{\Theta}(t, r)^\top N \tilde{\Theta}(t, r), \\ \mathbf{II}(t, r) &= \left(DK(r-t) + F^\top \tilde{\Theta}(t, r) \right)^\top \mathcal{U}_r \left(DK(r-t) + F^\top \tilde{\Theta}(t, r) \right), \\ \mathbf{III}(t, r) &= \mathcal{V}_r(e^{-(t-r)}) \left(BK(t-r) + C^\top \tilde{\Theta}(t, r) \right), \\ \tilde{\Theta}(t, r) &= - \left(N + F^\top \mathcal{U}_r F \right)^{-1} \left(F^\top \mathcal{U}_r DK(r-t) + C^\top \mathcal{V}_r(e^{-(t-r)}) \right). \end{aligned}$$

Step 2. Continuity of $t \mapsto \mathcal{U}_t$. We first observe that by virtue of Lemma 4.4.2 $t \mapsto \mathcal{U}_t$ and $t \mapsto \mathcal{V}_t$ are bounded on $[0, T]$ so that there exists $c > 0$ such that

$$\left| \tilde{F}(t, r)(\mathcal{U}) \right| \leq c(1 + |K(r-t)|^2), \quad t \leq r \leq T. \quad (4.4.17)$$

Fixing $t \leq s \leq T$, it follows from (4.4.16) that

$$\begin{aligned} \mathcal{U}_t - \mathcal{U}_s &= \int_t^s \tilde{F}(t, r) (\mathcal{U}) dr + \int_s^T \left(\tilde{F}(t, r) (\mathcal{U}) - \tilde{F}(s, r) (\mathcal{U}) \right) dr \\ &= \mathbf{1}_{t,s} + \mathbf{2}_{t,s}. \end{aligned}$$

By (4.4.17),

$$|\mathbf{1}_{t,s}| \leq c \left(s - t + \|K\|_{L^2(0, s-t)}^2 \right).$$

By virtue of the square integrability of K , the right hand side goes to 0 as $t \uparrow s$. Similarly, using $u^\top Qu - v^\top Qv = (u+v)^\top Q(u-v)$, we get

$$\begin{aligned} |\mathbf{2}_{t,s}| &\leq c \int_s^T |K(r-t) - K(r-s)| |K(r-t) + K(r-s)| dr \\ &\quad + c \int_s^T |\mathcal{V}_r(e^{-(t-r)}) - \mathcal{V}_r(e^{-(s-r)})| dr \\ &\leq \mathbf{A}_{t,s} + \mathbf{B}_{t,s}, \end{aligned}$$

where c is a constant. The first term can be easily handled with Cauchy-Schwarz inequality

$$\mathbf{A}_{t,s} \leq 2c \|K\|_{L^2(0, T)}^2 \int_0^T |K(r+s-t) - K(r)|^2 dr,$$

which shows that $\mathbf{A}_{t,s}$ converges to zero as t goes to s , recall (4.3.12). For the second term note that for all $i \in \mathbb{N}$, $t \leq s \leq r \leq T$,

$$\begin{aligned} &\left| \int_{\mathbb{R}_+^2} \mu(d\theta)^\top \Gamma_r^i(\theta, \tau) \mu(d\tau) e^{-\tau(r-t)} - \int_{\mathbb{R}_+^2} \mu(d\theta)^\top \Gamma_r^i(\theta, \tau) \mu(d\tau) e^{-\tau(r-s)} \right| \\ &\leq \text{ess sup}_{\tau' \in \mathbb{R}_+} \left| \int_{\mathbb{R}_+} \mu(d\theta)^\top \Gamma_r^i(\theta, \tau') \right| \int_{\mathbb{R}_+} e^{-\tau(r-t)} - e^{-\tau(r-s)} |\mu|(d\tau) \\ &\leq \kappa \left| \bar{K}(r-s) - \bar{K}(r-t) \right|, \end{aligned} \quad (4.4.18)$$

where κ is the uniform bound from Lemma 4.4.3 and

$$\bar{K}(t) = \int_{\mathbb{R}_+} e^{-\theta t} |\mu|(d\theta), \quad t > 0. \quad (4.4.19)$$

Taking the limit $i \rightarrow \infty$ in (4.4.18) and invoking Lemma 4.4.2, we obtain

$$\left| \mathcal{V}_r(e^{-(t-r)}) - \mathcal{V}_r(e^{-(s-r)}) \right| \leq \kappa \left| \bar{K}(r-s) - \bar{K}(r-t) \right|.$$

Thus, similarly as for $\mathbf{A}_{t,s}$ we get that $\mathbf{B}_{t,s}$ converges to 0 as t goes to s . As a result \mathcal{U} is continuous. \square

Lemma 4.4.5. *For any $t \leq T$, $(\Gamma_t^i)_{i \geq 0}$ is a Cauchy sequence in $L^1(\mu \otimes \mu)$.*

Proof. Let $t \leq T$ and $i \leq j$. Let $\Theta^j, \tilde{B}^j, \tilde{D}^j$ be defined as in (4.4.8) for any $j \in \mathbb{N}$. Then cumbersome but straightforward computations, detailed in Lemma 4.A.2, yield that $\Delta_t^{i,j} = \Gamma_t^i - \Gamma_t^j$ solves the Lyapunov equation

$$\begin{cases} \Delta_t^{ij}(\theta, \tau) &= \int_t^T e^{-(\theta+\tau)(s-t)} F_{ij}^\delta(s, \Delta_s^{ij})(\theta, \tau) ds, \\ F_{ij}^\delta(t, \Delta)(\theta, \tau) &= \tilde{Q}_t^{ij, \delta}(\theta, \tau) + \tilde{D}_t^{j-1}(\theta)^\top \int_{\mathbb{R}_+^2} \mu(d\theta')^\top \Delta(\theta', \tau') \mu(d\tau') \tilde{D}_t^{j-1}(\tau) \\ &\quad + \tilde{B}_t^{j-1}(\theta)^\top \int_{\mathbb{R}_+} \mu(d\theta')^\top \Delta(\theta', \tau) + \int_{\mathbb{R}_+} \Delta(\theta, \tau') \mu(d\tau') \tilde{B}_t^{j-1}(\tau) \\ &\quad + S_t^{ij}(\theta)^\top \rho_t^{ij}(\tau) + \rho_t^{ij}(\theta)^\top S_t^{ij}(\tau), \end{cases} \quad (4.4.20)$$

where

$$\begin{aligned} \rho^{ij} &= \Theta^{i-1} - \Theta^{j-1}, \\ \tilde{Q}_t^{ij, \delta}(\theta, \tau) &= \rho_t^{ij}(\theta)^\top (N + F^\top \mathcal{U}_t^i F) \rho_t^{ij}(\tau), \\ S_t^{ij}(\tau) &= C^\top \int_{\mathbb{R}_+} \mu(d\theta')^\top \Gamma_t^i(\theta', \tau) + F^\top \mathcal{U}_t^i D + (N + F^\top \mathcal{U}_t^i F) \Theta_s^{j-1}(\tau), \end{aligned}$$

and \mathcal{U} is defined as in Lemma 4.4.2. We will show that $\|\Delta_t^{ij}\|_{L^1(\mu \otimes \mu)} \rightarrow 0$ as $i, j \rightarrow \infty$ by successive applications of Gronwall inequality and by showing that ρ^{ij} is small enough. For this, we fix $\epsilon > 0$ and we denote by $c > 0$ a scalar independent of i, j, t, τ and θ that may vary from line to line throughout the proof.

Step 1. We bound the terms $|\rho_t^{ij}(\tau)|$ and $\left| \int_{\mathbb{R}_+} \Delta_t^{ij}(\theta, \tau) \mu(d\tau) \right|$. We first write

$$\begin{aligned} \rho_t^{ij}(\tau) &= \left((N + F^\top \mathcal{U}_t^j F)^{-1} - (N + F^\top \mathcal{U}_t^i F)^{-1} \right) \left(F^\top \mathcal{U}_t^j D + C^\top \int_{\mathbb{R}_+} \mu(d\theta')^\top \Gamma_t^j(\theta', \tau) \right) \\ &\quad - (N + F^\top \mathcal{U}_t^i F)^{-1} \left(F^\top (\mathcal{U}_t^i - \mathcal{U}_t^j) D + C^\top \int_{\mathbb{R}_+} \mu(d\theta')^\top \Delta_t^{ij}(\theta', \tau) \right). \end{aligned} \quad (4.4.21)$$

By the uniform convergence of the sequence of functions $(\mathcal{U}^i)_{i \geq 0}$, obtained in Lemma 4.4.4, one can find $n' \in \mathbb{N}$ such that

$$\left| \mathcal{U}_t^i - \mathcal{U}_t^j \right| + \left| (N + F^\top \mathcal{U}_t^j F)^{-1} - (N + F^\top \mathcal{U}_t^i F)^{-1} \right| \leq \epsilon, \quad t \leq T, \quad i, j \geq n' \quad (4.4.22)$$

where the bound for the second term comes from the matrix identity $A^{-1} - B^{-1} = B^{-1}(B - A)A^{-1}$. Furthermore, it follows from Lemmas 4.4.2 and 4.4.3 that

$$\left| \mathcal{U}_t^i \right| \vee \left| \int_{\mathbb{R}_+} \Gamma_t^i(\theta, \tau) \mu(d\tau) \right| \leq c, \quad \mu - a.e., \quad t \leq T, \quad i \geq 0. \quad (4.4.23)$$

Combining the previous identity with (4.4.22) and (4.4.21) yields

$$|\rho_t^{ij}(\tau)| \leq c \left(\epsilon + \left| \int_{\mathbb{R}_+} \Delta_s^{ij}(\theta, \tau) \mu(d\tau) \right| \right), \quad \mu - a.e., \quad t \leq T, \quad i, j \geq n'.$$

In addition, (4.4.23) yields that

$$|\Theta_t^i(\theta)| \leq c, \quad \mu - a.e., \quad t \leq T, \quad i \geq 0, \quad (4.4.24)$$

which in turn implies

$$\int_{\mathbb{R}_+} e^{-\theta(s-t)} |\Theta_t^i(\theta)| |\mu|(d\theta) \leq \kappa' \bar{K}(s-t), \quad s \leq t \leq T, \quad i \geq 0,$$

where \bar{K} is given by (4.4.19). Fix $i, j \geq n'$ and $t \leq T$. Combining all the above and integrating equation (4.4.20) over the τ variable leads to

$$\left| \int_{\mathbb{R}_+} \Delta_t^{ij}(\theta, \tau) \mu(d\tau) \right| \leq c \int_t^T (1 + \bar{K}^2(s-t)) \left(\epsilon + \left| \int_{\mathbb{R}_+} \Delta_s^{ij}(\theta, \tau) \mu(d\tau) \right| \right) ds, \quad \mu - a.e.$$

An application of the generalized Gronwall inequality for convolution equation with R the resolvent of $c(1 + \bar{K}^2)$, see [GLS90, Theorem 9.8.2], yields

$$\left| \int_{\mathbb{R}_+} \Delta_t^{ij}(\theta, \tau) \mu(d\tau) \right| \leq \epsilon c \left(T + \|\bar{K}\|_{L^2(0,T)}^2 \right) (1 + \|R\|_{L^1(0,T)}), \quad \mu - a.e. \quad (4.4.25)$$

Step 2. Plugging (4.4.22), (4.4.23), (4.4.24), and (4.4.25) into (4.4.21), we obtain

$$\int_{\mathbb{R}_+} e^{-\theta(s-t)} |\rho_s^{ij}(\tau)| |\mu|(d\tau) \leq r \left(\epsilon (1 + \bar{K}(s-t)) + \|\Delta_s^{ij}\|_{L^1(\mu \otimes \mu)} \right). \quad (4.4.26)$$

Finally by plugging (4.4.23), (4.4.24), (4.4.25) and (4.4.26) into (4.4.20) and integrating over the θ and τ variables we obtain

$$\|\Delta_t^{ij}\|_{L^1(\mu \otimes \mu)} \leq c \int_t^T (1 + \bar{K}^2(t-s)) (\epsilon + \|\Delta_s^{ij}\|_{L^1(\mu \otimes \mu)}) ds.$$

Another application of the generalized Gronwall inequality for convolution equations yields that

$$\|\Delta_t^{ij}\|_{L^1(\mu \otimes \mu)} \leq \epsilon c \left(T + \|\bar{K}^2\|_{L^2(0,T)}^2 \right) (1 + \|R\|_{L^1(0,T)}).$$

This proves that $(\Gamma_t^i)_{i \geq 0}$ is a Cauchy sequence in $L^1(\mu \otimes \mu)$ for every $t \in [0, T]$. \square

4.4.3 Step 3: The limiting point of $(\Gamma_t^i)_{i \geq 0}$ solves the Riccati equation

Lemma 4.4.6. *Assume that (4.2.6) holds. For each $t \leq T$, denote by Γ_t the limiting point in $L^1(\mu \otimes \mu)$ of the sequence $(\Gamma_t^i)_{i \geq 0}$ obtained from Lemma 4.4.5. Then, $t \rightarrow \Gamma_t$ solves the Riccati equation (4.2.5) with*

$$\sup_{t \leq T} \|\Gamma_t\|_{L^1(\mu \otimes \mu)} < +\infty. \quad (4.4.27)$$

Proof. Fix $t \leq T$. By virtue of the $L^1(\mu \otimes \mu)$ convergence,

$$\Gamma_t^i(\theta, \tau) \rightarrow \Gamma_t(\theta, \tau) \quad \mu \otimes \mu - a.e.$$

Furthermore the boundedness of $(i, t) \mapsto \left| \int_{\mathbb{R}_+^2} \mu(d\theta)^\top \Gamma_t^i(\theta, \tau) \mu(d\tau) \right|$, $(i, t, \theta) \mapsto \left| \int_{\mathbb{R}_+} \Gamma_t^i(\theta, \tau) \mu(d\tau) \right|$ and $(i, t, \tau) \mapsto \left| \int_{\mathbb{R}_+} \mu(d\theta)^\top \Gamma_t^i(\theta, \tau) \right|$, see Lemmas 4.4.2 and 4.4.3, combined with equation (4.4.9) ensures that there exists a constant $c > 0$ such that $|\Gamma_t^i(\theta, \tau)| \leq c \int_t^T e^{-(\theta+\tau)(s-t)} ds \leq (1 \vee T) (1 \wedge (\theta + \tau)^{-1})$ since $1 - e^{-\theta t} \leq (1 \vee t) (1 \wedge \theta^{-1})$. Hence the dominated convergence theorem yields

$$\begin{aligned} \int_{\mathbb{R}_+^2} \mu(d\theta)^\top \Gamma_t^i(\theta, \tau) \mu(d\tau) &\rightarrow \int_{\mathbb{R}_+^2} \mu(d\theta)^\top \Gamma_t(\theta, \tau) \mu(d\tau), \\ \int_{\mathbb{R}_+^2} \mu(d\theta)^\top \Gamma_t^i(\theta, \tau) &\rightarrow \int_{\mathbb{R}_+^2} \mu(d\theta)^\top \Gamma_t(\theta, \tau) \quad \text{and} \quad \int_{\mathbb{R}_+^2} \Gamma_t^i(\theta, \tau) \mu(d\tau) \rightarrow \int_{\mathbb{R}_+^2} \Gamma_t(\theta, \tau) \mu(d\tau), \quad \mu - a.e. \end{aligned}$$

Thus, as $i \rightarrow \infty$ we have

$$\begin{aligned} \Theta_t^i(\theta) &\rightarrow \Theta_t(\theta) = \left(N + F^\top \int_{\mathbb{R}_+^2} \mu(d\theta)^\top \Gamma_t(\theta, \tau) \mu(d\tau) F \right)^{-1} \\ &\quad \times \left(F^\top \int_{\mathbb{R}_+^2} \mu(d\theta)^\top \Gamma_t(\theta, \tau) \mu(d\tau) D + C^\top \int_{\mathbb{R}_+} \Gamma_t(\theta, \tau) \mu(d\tau) \right), \\ B_t^i(\theta) &\rightarrow B + C^\top \Theta_t(\theta) \\ D_t^i(\theta) &\rightarrow D + F^\top \Theta_t(\theta) \end{aligned} \quad (4.28)$$

By plugging these convergences into (4.4.9) we obtain that the limit Γ solves

$$\Gamma_t(\theta, \tau) = \int_t^T e^{-(\theta+\tau)(s-t)} \tilde{\mathcal{R}}_s(\theta, \tau) ds, \quad \mu \otimes \mu - a.e. \quad (4.4.29)$$

with

$$\begin{aligned} \tilde{\mathcal{R}}_t(\theta, \tau) &= Q + \Theta_t(\theta) N \Theta_t(\tau) + \int_{\mathbb{R}_+} \Gamma_t(\theta, \tau) \mu(d\tau) (B + C^\top \Theta_t(\tau)) \\ &\quad + (B + C^\top \Theta_t(\theta))^\top \int_{\mathbb{R}_+} \mu(d\theta)^\top \Gamma_s(\theta, \tau) \\ &\quad + (D + F^\top \Theta_t(\theta))^\top \int_{\mathbb{R}_+^2} \mu(d\theta)^\top \Gamma_t(\theta, \tau) \mu(d\tau) (D + F^\top \Theta_t(\tau)). \end{aligned}$$

By using the expression of Θ exhibited in (4.4.28), we get that $\tilde{\mathcal{R}}_t(\theta, \tau) = \mathcal{R}(\Gamma_t)(\theta, \tau)$, where \mathcal{R} is given by (4.2.3), so that (4.4.29) is the desired Riccati equation. Finally, the uniform bounds obtained in Lemmas 4.4.3 and 4.4.4 and plugged into (4.4.29) imply (4.4.27). \square

4.4.4 Step 4: Continuity and uniqueness

We now establish the estimate (4.2.7) for the solutions of the Riccati equation, which in turn implies continuity.

Lemma 4.4.7. *Assume that there exists a $L^1(\mu \otimes \mu)$ -valued function $t \mapsto \Gamma_t$ such that (4.2.5) holds with (4.4.27). Then, the estimate (4.2.7) holds and $\Gamma \in C([0, T], L^1(\mu \otimes \mu))$. If in addition $Q \in \mathbb{S}_+^d$, then $\Gamma_t \in \mathbb{S}_+^d(\mu \otimes \mu)$, for all $t \leq T$.*

Proof. The proof of the estimate follows the same lines as that of Lemma 4.3.2, with constant coefficients. The only difference is the nonlinear term

$$\mathbf{V}_t(\theta, \tau) = \int_t^T e^{-(\theta+\tau)(s-t)} S(\Gamma_s)(\theta)^\top \hat{N}^{-1}(\Gamma_s) S(\Gamma_s)(\tau) ds,$$

which we can bound as follows. Let $\hat{S}(\Gamma)(s)(\theta) = |F| |D| \|\Gamma_s\|_{L^1(\mu \otimes \mu)} + |C| \int_{\mathbb{R}_+} |\mu|(d\tau') |\Gamma(\theta, \tau')|$. Integration over the τ -variable, using the bound $e^{-\theta(s-t)} \leq 1$ and Tonelli's theorem give for a constant c that may vary from line to line

$$\begin{aligned} \int_{\mathbb{R}_+} |\mu|(d\tau) |\mathbf{V}_t(\theta, \tau)| &\leq \int_{\mathbb{R}_+} |\mu|(d\tau) \int_t^T e^{-(\theta+\tau)(s-t)} \hat{S}(\Gamma)(s)(\theta) |N^{-1}| \hat{S}(\Gamma)(s)(\tau) ds \\ &\leq c \sup_{s \leq T} \|\Gamma_s\|_{L^1(\mu \otimes \mu)} \int_0^T (1 + \bar{K}(s)) ds \\ &\quad + c \sup_{s \leq T} \|\Gamma_s\|_{L^1(\mu \otimes \mu)} \int_t^T (1 + \bar{K}(s-t)) \int_{\mathbb{R}_+} |\mu|(d\tau') |\Gamma_s(\theta, \tau')| ds, \end{aligned}$$

where \bar{K} is defined as in (4.4.19). The first four terms appearing in $\int_{\mathbb{R}_+} |\mu|(d\tau) |\Gamma_t(\theta, \tau)|$ lead to inequality (4.3.10), with $(\Gamma, \bar{K}, \mu, c)$ instead of $(\Psi, \bar{K}_2, \mu_2, \kappa)$. Adding the previous bound for the fifth nonlinear term yields

$$\begin{aligned} \int_{\mathbb{R}_+} |\mu|(d\tau) |\Gamma_t(\theta, \tau)| &\leq c \left(1 + \sup_{s \in [0, T]} \|\Gamma_s\|_{L^1(\mu_1 \otimes \mu)} \right) \int_0^T (1 + \bar{K}(s)) ds \\ &\quad + c \int_t^T (1 + \bar{K}(s-t)) \int_{\mathbb{R}_+} |\mu|(d\tau') |\Gamma_s(\theta, \tau')| ds. \end{aligned}$$

The claimed estimate now follows from the generalized Gronwall inequality for convolution equations, see [GLS90, Theorem 9.8.2].

To argue continuity, we recall that the Riccati equation (4.2.5) can be recast as a Lyapunov equation as in (4.4.29). The claimed continuity is therefore a consequence of Lemma 4.3.3 provided that the coefficients of (4.4.29) are bounded, which amounts to showing that the functions $t \mapsto \int_{\mathbb{R}_+^2} \mu(d\theta)^\top \Gamma_t(\theta, \tau) \mu(d\tau)$ and $(t, \theta) \mapsto \int_{\mathbb{R}_+} \Gamma_t(\theta, \tau) \mu(d\tau)$ are bounded. The boundedness of the former is ensured by (4.4.27) and that of the latter follows from the estimate (4.2.7). If in addition $Q \in \mathbb{S}_+^d$, then Lemma 4.4.1 applied for (4.4.29) yields that $\Gamma_t \in \mathbb{S}_+^d(\mu \otimes \mu)$ for any $t \leq T$. \square

Finally, exploiting once more the correspondence with the Lyapunov equation, uniqueness for the Riccati equation is obtained as a consequence of Theorem 4.3.1 and Lemma 4.4.1.

Lemma 4.4.8. *There exists at most one solution to (4.2.5) such that (4.2.7) and (4.4.27) hold.*

Proof. Let Γ^a and Γ^b be two solutions of (4.2.5) such that (4.2.7) and (4.4.27) hold. For $i \in \{a, b\}$, observe that Γ^i can be recast as a solution to a Lyapunov equation with bounded coefficients in the form (4.4.9). As a result, $\Delta = \Gamma^a - \Gamma^b$ can be written as a solution to the following Lyapunov equation with bounded coefficients (see Lemma

4.A.2 for details):

$$\begin{cases} \Delta_t(\theta, \tau) &= \int_t^T e^{-(\theta+\tau)(s-t)} F_{ab}(s, \Delta_s)(\theta, \tau) ds, \\ F_{ab}(t, \Delta)(\theta, \tau) &= Q_t^{ab}(\theta, \tau) + D_t^b(\theta)^\top \int_{\mathbb{R}_+^2} \mu(d\theta')^\top \Delta(\theta', \tau') \mu(d\tau') D_t^b(\tau) \\ &\quad + B_t^b(\theta)^\top \int_{\mathbb{R}_+} \mu(d\theta')^\top \Delta(\theta', \tau) + \int_{\mathbb{R}_+} \Delta(\theta, \tau') \mu(d\tau') B_t^b(\tau) \\ &\quad + S_t^{ab}(\theta)^\top \rho_t^{ab}(\tau) + \rho_t^{ab}(\theta)^\top S_t^{ab}(\tau), \end{cases} \quad (4.4.30)$$

where

$$\begin{aligned} \rho^{ab} &= \Theta^a - \Theta^b, \\ Q_t^{ab}(\theta, \tau) &= \rho_t^{ab}(\theta)^\top \left(N + F^\top \int_{\mathbb{R}_+^2} \mu(d\theta')^\top \Gamma_t^a(\theta', \tau') \mu(d\tau') F \right) \rho_t^{ab}(\tau), \\ S_t^{ab}(\tau) &= C^\top \int_{\mathbb{R}_+} \mu(d\theta')^\top \Gamma^a(\theta', \tau) + F^\top \int_{\mathbb{R}_+^2} \mu(d\theta') \Gamma_s^a(\theta', \tau') \mu(d\tau') D + \\ &\quad + \left(N + F^\top \int_{\mathbb{R}_+^2} \mu(d\theta') \Gamma_s^a(\theta', \tau') \mu(d\tau') F \right) \Theta_s^a(\tau). \end{aligned}$$

The fact that the coefficients are bounded comes from (4.2.7) and (4.4.27) on Γ^a and Γ^b . Now, one can note similarly as in (4.4.21) that ρ^{ab} can be re-written as

$$\begin{aligned} \rho_s^{ab}(\tau) &= - \left(N + F^\top \int_{\mathbb{R}_+^2} \mu(d\theta')^\top \Gamma_t^a(\theta', \tau') \mu(d\tau') F \right)^{-1} \\ &\quad \times \left(F^\top \int_{\mathbb{R}_+^2} \mu(d\theta')^\top \Delta_t(\theta', \tau') \mu(d\tau') D + C^\top \int_{\mathbb{R}_+} \mu(d\theta')^\top \Delta_t(\theta', \tau) \right) \\ &\quad + \left(\left(N + F^\top \int_{\mathbb{R}_+^2} \mu(d\theta')^\top \Gamma_t^b(\theta', \tau') \mu(d\tau') F \right)^{-1} - \left(N + F^\top \int_{\mathbb{R}_+^2} \mu(d\theta')^\top \Gamma_t^a(\theta', \tau') \mu(d\tau') F \right)^{-1} \right) \\ &\quad \times \left(F^\top \int_{\mathbb{R}_+^2} \mu(d\theta')^\top \Gamma_t^b(\theta', \tau') \mu(d\tau') D + C^\top \int_{\mathbb{R}_+} \mu(d\theta')^\top \Gamma_t^b(\theta', \tau) \right) \\ &= \mathbf{A}(\tau) + \mathbf{B}(\tau), \end{aligned}$$

which is linear in Δ since $\mathbf{B}(\tau)$ can be rewritten as

$$\begin{aligned} &\left| \left(N + F^\top \int_{\mathbb{R}_+^2} \mu(d\theta')^\top \Gamma_t^b(\theta', \tau') \mu(d\tau') F \right)^{-1} - \left(N + F^\top \int_{\mathbb{R}_+^2} \mu(d\theta')^\top \Gamma_t^a(\theta', \tau') \mu(d\tau') F \right)^{-1} \right| \\ &= \left| \left(N + F^\top \int_{\mathbb{R}_+^2} \mu(d\theta')^\top \Gamma_t^b(\theta', \tau') \mu(d\tau') F \right)^{-1} \left(F^\top \int_{\mathbb{R}_+^2} \mu(d\theta')^\top (\Delta_t(\theta', \tau')) \mu(d\tau') F \right) \right. \\ &\quad \left. \times \left(N + F^\top \int_{\mathbb{R}_+^2} \mu(d\theta')^\top \Gamma_t^a(\theta', \tau') \mu(d\tau') F \right)^{-1} \right|. \end{aligned}$$

Consequently, $\Delta = \Gamma^a - \Gamma^b$ is solution to a homogeneous linear Lyapunov equation with bounded coefficients, and no affine term. Thus, the generalized Gronwall inequality for convolution equations, see [GLS90, Theorem 9.8.2] ensures that $\|\Delta_t\|_{L^1(\mu \otimes \mu)} = 0$ for every $t \in [0, T]$, which proves uniqueness. \square

4.A Some elementary results

Lemma 4.A.1. *Let $\Psi \in \mathbb{S}_+^d(\mu \otimes \mu)$, and Ψ its corresponding linear integral operator. Then for any $\varphi, \psi \in L^1(\mu)$*

$$\langle \varphi, \Psi \psi \rangle_\mu^2 \leq \langle \varphi, \Psi \varphi \rangle_\mu \cdot \langle \psi, \Psi \psi \rangle_\mu$$

Proof. Since $\Psi \in \mathbb{S}_+^d(\mu \otimes \mu)$, then for any $\varphi, \psi \in L^1(\mu)$ and $\lambda \in \mathbb{R}$ we have

$$\int_{\mathbb{R}_+^2} (\varphi(\theta) + \lambda\psi(\theta))^\top \mu(d\theta)^\top \Psi(\theta, \tau) \mu(d\tau) (\varphi(\tau) + \lambda\psi(\tau)) \geq 0.$$

By expanding the square we obtain a non negative second order polynomial in λ whose discriminant must be non positive. This combined with $\Psi(\theta, \tau) = \Psi(\tau, \theta)^\top$ yields the claimed inequality. \square

Lemma 4.A.2. *Let $(\Gamma^i)_{i \geq 0}$ be the sequence defined in (4.4.9). Then for any $1 \leq i < j$, $\Delta^{ij} = \Gamma^i - \Gamma^j$ is solution to*

$$\begin{cases} \Delta_t^{ij}(\theta, \tau) &= \int_t^T e^{-(\theta+\tau)(s-t)} F_{ij}^\delta(s, \Delta_s^{ij})(\theta, \tau) ds, \\ F_{ij}^\delta(t, \Delta)(\theta, \tau) &= Q_t^{ij, \delta}(\theta, \tau) + D_t^{j-1}(\theta)^\top \int_{\mathbb{R}_+^2} \mu(d\theta')^\top \Delta(\theta', \tau') \mu(d\tau') D_t^{j-1}(\tau) \\ &\quad + B_t^{j-1}(\theta)^\top \int_{\mathbb{R}_+} \mu(d\theta')^\top \Delta(\theta', \tau) + \int_{\mathbb{R}_+} \Delta(\theta, \tau') \mu(d\tau') B_t^{j-1}(\tau) \\ &\quad + S_t^{ij}(\theta)^\top \rho_t^{ij}(\tau) + \rho_t^{ij}(\theta)^\top S_t^{ij}(\tau), \end{cases} \quad (4.A.1)$$

where

$$\begin{aligned} \rho^{ij} &= \Theta^{i-1} - \Theta^{j-1}, \\ Q_t^{ij, \delta}(\theta, \tau) &= \rho_t^{ij}(\theta)^\top \left(N + F^\top \int_{\mathbb{R}_+^2} \mu(d\theta')^\top \Gamma_t^i(\theta', \tau') \mu(d\tau') F \right) \rho_t^{ij}(\tau), \\ S_t^{ij}(\tau) &= C^\top \int_{\mathbb{R}_+} \mu(d\theta')^\top \Gamma^i(\theta', \tau) + F^\top \int_{\mathbb{R}_+^2} \mu(d\theta')^\top \Gamma_s^i(\theta', \tau') \mu(d\tau') D + \\ &\quad + \left(N + F^\top \int_{\mathbb{R}_+^2} \mu(d\theta')^\top \Gamma_s^i(\theta', \tau') \mu(d\tau') F \right) \Theta_s^{j-1}(\tau). \end{aligned}$$

Remark 4.A.1. *Note that when $j = i + 1$, then $S^{i(i+1)} = 0$. Indeed, in such case we have*

$$\begin{aligned} S_s^{i(i+1)}(\theta) &= C^\top \int_{\mathbb{R}_+} \mu(d\theta')^\top \Gamma_s^i(\theta', \tau) + F^\top \int_{\mathbb{R}_+^2} \mu(d\theta')^\top \Gamma_s^i(\theta', \tau') D_s^{j-1}(\tau) + N \Theta_s^i(\tau) \\ &= C^\top \int_{\mathbb{R}_+} \mu(d\theta')^\top \Gamma_s^i(\theta', \tau) + F^\top \int_{\mathbb{R}_+^2} \mu(d\theta')^\top \Gamma_s^i(\theta', \tau') D \\ &\quad + \left(N + F^\top \int_{\mathbb{R}_+^2} \mu(d\theta')^\top \Gamma_s^i(\theta', \tau') \mu(d\tau') F \right) \Theta_s^i(\tau) = 0. \end{aligned}$$

As a consequence, in the particular case where $j = i + 1$, $\Delta^i = \Delta^{i(i+1)}$ is solution to (4.4.10). \square

Proof. Let $t \in [0, T]$, for almost every θ, τ we have

$$\begin{aligned} \Delta_t^{ij}(\theta, \tau) &= \Gamma_t^i(\theta, \tau) - \Gamma_t^j(\theta, \tau) \\ &= \int_t^T e^{-(\theta+\tau)(s-t)} \left(\mathbf{I}_s^{ij, \delta}(\theta, \tau) + \left(\mathbf{I}_s^{ij, \delta}(\tau, \theta) \right)^\top + \mathbf{II}_s^{ij, \delta}(\theta, \tau) + \mathbf{III}_s^{ij, \delta}(\theta, \tau) \right) ds, \end{aligned} \quad (4.A.2)$$

where $\mathbf{I}^{ij,\delta}$, $\mathbf{II}^{ij,\delta}$ and $\mathbf{III}^{ij,\delta}$ are defined as follows

$$\begin{aligned}
\mathbf{I}_s^{ij,\delta}(\theta, \tau) &= \int_{\mathbb{R}_+} \Gamma_s^i(\theta, \tau') \mu(d\tau') B_s^{i-1}(\tau) - \int_{\mathbb{R}_+} \Gamma_s^j(\theta, \tau') \mu(d\tau') B_s^{j-1}(\tau) \\
&= \int_{\mathbb{R}_+} \Delta_s^{ij}(\theta, \tau') \mu(d\tau') B_s^{j-1}(\tau) + \int_{\mathbb{R}_+} \Gamma_s^i(\theta, \tau') \mu(d\tau') (B_s^{i-1}(\tau) - B_s^{j-1}(\tau)) \\
&= \int_{\mathbb{R}_+} \Delta_s^{ij}(\theta, \tau') \mu(d\tau') B_s^{j-1}(\tau) + \int_{\mathbb{R}_+} \Gamma_s^i(\theta, \tau') \mu(d\tau') C \rho_s^{ij}(\tau) \\
\mathbf{II}_s^{ij,\delta}(\theta, \tau) &= D_s^{i-1}(\theta)^\top \int_{\mathbb{R}_+^2} \mu(d\theta')^\top \Gamma_s^i(\theta, \tau) \mu(d\tau') D_s^{i-1}(\tau) - D_s^{j-1}(\theta)^\top \int_{\mathbb{R}_+^2} \mu(d\theta')^\top \Gamma_s^j(\theta, \tau) \mu(d\tau') D_s^{j-1}(\tau) \\
&= D_s^{j-1}(\theta)^\top \int_{\mathbb{R}_+^2} \mu(d\theta')^\top \Delta_s^{ij}(\theta, \tau) \mu(d\tau') D_s^{j-1}(\tau) \\
&\quad + \rho_s^{ij}(\theta)^\top F^\top \int_{\mathbb{R}_+^2} \mu(d\theta')^\top \Gamma_s^i(\theta', \tau') \mu(d\tau') F \rho_s^{ij}(\tau) \\
&\quad + \rho_s^{ij}(\theta)^\top F^\top \int_{\mathbb{R}_+^2} \mu(d\theta')^\top \Gamma_s^i(\theta', \tau') D_s^{j-1}(\tau) \\
&\quad + D_s^{j-1}(\theta)^\top \int_{\mathbb{R}_+^2} \mu(d\theta')^\top \Gamma_s^i(\theta', \tau') \mu(d\tau') F \rho_s^{ij}(\tau) \\
\mathbf{III}_s^{ij,\delta}(\theta, \tau) &= Q_s^{i-1}(\theta, \tau) - Q_s^{j-1}(\theta, \tau) \\
&= \rho_s^{ij}(\theta)^\top N \rho_s^{ij}(\tau) + \rho_s^{ij}(\theta)^\top N \Theta_s^{j-1}(\tau) + \Theta_s^{j-1}(\theta) N \rho_s^{ij}(\tau)
\end{aligned}$$

By plugging the expressions of $\mathbf{I}^{ij,\delta}$, $\mathbf{II}^{ij,\delta}$, $\mathbf{III}^{ij,\delta}$ into (4.A.2) we obtain (4.A.1). \square

Part III

Rough Mean-Variance

Markowitz portfolio selection for multivariate affine and quadratic Volterra models

Abstract This paper concerns portfolio selection with multiple assets under rough covariance matrix. We investigate the continuous-time Markowitz mean-variance problem for a multivariate class of affine and quadratic Volterra models. In this incomplete non-Markovian and non-semimartingale market framework with unbounded random coefficients, the optimal portfolio strategy is expressed by means of a Riccati backward stochastic differential equation (BSDE). In the case of affine Volterra models, we derive explicit solutions to this BSDE in terms of multi-dimensional Riccati-Volterra equations. This framework includes multivariate rough Heston models and extends the results of [HW20a]. In the quadratic case, we obtain new analytic formulae for the the Riccati BSDE and we establish their link with infinite dimensional Riccati equations. This covers rough Stein-Stein and Wishart type covariance models. Numerical results on a two dimensional rough Stein-Stein model illustrate the impact of rough volatilities and stochastic correlations on the optimal Markowitz strategy. In particular for positively correlated assets, we find that the optimal strategy in our model is a ‘buy rough sell smooth’ one.

Keywords: Mean-variance portfolio theory; rough volatility; correlation matrices; multidimensional Volterra process; Riccati equations; non-Markovian Heston, Stein-Stein and Wishart models.

5.1 Introduction

The [Mar52a] mean-variance portfolio selection problem is the cornerstone of modern portfolio allocation theory. Investment decisions rules are made according to a trade-off between return and risk, and the use of Markowitz efficient portfolio strategies in the financial industry has become quite popular mainly due to its natural and intuitive formulation. A vast volume of research has been devoted over the last decades to extend Markowitz problem from static to continuous-time setting, first in Black-Scholes and complete markets ([ZL00]), and then to consider more general frameworks with random

coefficients and multiple assets, see e.g. [Lim04], [CW14], or more recently [IP19] for taking into account model uncertainty on the assets correlation.

In the direction of more realistic modeling of asset prices, it is now well-established that volatility is rough [GJR18a], modeled by fractional Brownian motion with small Hurst parameter, which captures empirical facts of times series of realized volatility and key features of implied volatility surface, see [ALV07; Fuk11]. Subsequently, an important literature has focused on option pricing and asymptotics in rough volatility models. In comparison, the research on portfolio optimization in fractional and rough models is still little developed but has gained an increasing attention with the recent papers of [FH18; BD20; HW20b], which consider fractional Ornstein-Uhlenbeck and Heston stochastic volatility models for power utility function criterion, and the work by [HW20a] where the authors study the Markowitz problem in a Volterra Heston model, which covers the rough Heston model of [EER18].

Most of the developments in rough volatility literature for asset modeling, option pricing or portfolio selection have been carried out in the mono-asset case. However, investment in multi-assets by taking into account the correlation risk is an importance feature in portfolio choice in financial markets, see [BPT10]. Inspired by the recent papers [AJ19b; AJLP19; CT19; RT19] that consider multivariate versions of rough Volterra volatility models, the basic goal of this paper is to enrich the literature on portfolio selection:

- (i) by introducing a class of multivariate Volterra models, which captures stylized facts of financial assets, namely various rough volatility patterns across assets, (possibly random) correlation between stocks, and leverage effects, i.e., correlation between a stock and its volatility.
- (ii) by keeping the model tractable for explicit computations of the optimal Markowitz portfolio strategy, which can be a quite challenging task in multivariate non-Markovian settings.

Main contributions. In this paper, we study the continuous-time Markowitz problem in a multivariate setting with a focus on two classes: (i) affine Volterra models as in [AJLP19] that include multivariate rough Heston models, (ii) quadratic Volterra models, which are new class of Volterra models, and embrace multivariate rough Stein-Stein models, and rough Wishart type covariance matrix models, in the spirit of [AJ19b; CT19]. We provide:

- **A generic verification result** for the corresponding mean-variance problem, which is formulated in an incomplete non-Markovian and non-semimartingale framework with unbounded random coefficients of the volatility and market price of risk, and under general filtration. This result expresses the solution to the Markowitz problem in terms of a Riccati backward stochastic differential equation (BSDE) by checking in particular the admissibility condition of the optimal control. We stress that related existing verification results in the literature (see [Lim04], [JSM12], [CW14], [She15]) cannot be applied directly to our setting, and we shall discuss more in detail this point in Section 5.3.
- **Explicit solutions** to the Riccati BSDE in two concrete specifications of multivariate Volterra models exploiting the representation of the solution in terms of a Laplace transform:
 1. **the affine case:** the optimal Markowitz strategy is expressed in terms of multivariate Riccati-Volterra equations which naturally extends the one obtained in [HW20a]. We point out that the martingale distortion arguments

used in [HW20a] for the univariate Volterra Heston model, do not apply in higher dimensions, unless the correlation structure is highly degenerate.

2. **the quadratic case:** our major result is to derive analytic expressions for the optimal investment strategy by explicitly solving operator Riccati equations. This gives new explicit formulae for rough Stein-Stein and Wishart type covariance models. These analytic expressions can be efficiently implemented: the integral operators can be approximated by closed form expressions involving finite dimensional matrices and the underlying processes can be simulated by the celebrated Cholesky decomposition algorithm.
- **Numerical simulations** of the optimal Markowitz strategy in a two-asset rough Stein-Stein model to illustrate our results.* We depict the impact of some parameters onto the optimal investment when one asset is rough, and the other smooth (in the sense of the Hurst index of their volatility), and show in particular that for positively correlated assets, the optimal strategy is to “buy rough, sell smooth”, which is consistent with the empirical backtesting in [GH20b].

Outline of the paper. The rest of the paper is organized as follows: Section 5.2 formulates the financial market model and the mean-variance problem in a multivariate setting with random covariance matrix and market price of risk, and defines the general correlation structure. We state in Section 5.3 our generic verification result, which can be seen as unifying framework for previous results obtained in related literature. Section 5.4 is devoted to affine Volterra models where we derive an explicit expression for the optimal Markowitz strategy. In Section 5.5, we consider the class of quadratic Volterra models, and we show how to solve the infinite-dimensional Riccati equations that appear in the closed-form expressions of the optimal portfolio. Numerical illustrations on the behavior of the optimal investment in a two-asset rough Stein-Stein model are given in Section 5.6. Finally, the proof of the verification result and other technical lemmas are postponed to the Appendices.

Notations. Given a probability space $(\Omega, \mathcal{F}, \mathbb{P})$ and a filtration $\mathbb{F} = (\mathcal{F}_t)_{t \geq 0}$ satisfying the usual conditions, we denote by

$$\begin{aligned} L_{\mathbb{F}}^{\infty}([0, T], \mathbb{R}^d) &= \left\{ Y : \Omega \times [0, T] \mapsto \mathbb{R}^d, \mathbb{F} - \text{prog. measurable and bounded a.s.} \right\} \\ L_{\mathbb{F}}^p([0, T], \mathbb{R}^d) &= \left\{ Y : \Omega \times [0, T] \mapsto \mathbb{R}^d, \mathbb{F} - \text{prog. measurable s.t. } \mathbb{E} \left[\int_0^T |Y_s|^p ds \right] < \infty \right\} \\ \mathbb{S}_{\mathbb{F}}^{\infty}([0, T], \mathbb{R}^d) &= \left\{ Y : \Omega \times [0, T] \mapsto \mathbb{R}^d, \mathbb{F} - \text{prog. measurable s.t. } \sup_{t \leq T} |Y_t(w)| < \infty \text{ a.s.} \right\}. \end{aligned}$$

Here $|\cdot|$ denotes the Euclidian norm on \mathbb{R}^d . Classically, for $p \in \llbracket 1, \infty \rrbracket$, we define $L_{\mathbb{F}}^{p,loc}([0, T], \mathbb{R}^d)$ as the set of progressive processes Y for which there exists a sequence of increasing stopping times $\tau_n \uparrow \infty$ such that the stopped processes Y^{τ_n} are in $L_{\mathbb{F}}^p([0, T], \mathbb{R}^d)$ for every $n \geq 1$, and we recall that it consists of all progressive processes Y s.t. $\int_0^T |Y_t|^p dt < \infty$, a.s. To unclutter notation, we write $L_{\mathbb{F}}^{p,loc}([0, T])$ instead of $L_{\mathbb{F}}^{p,loc}([0, T], \mathbb{R}^d)$ when the context is clear.

*The code of our implementation can be found at the following [link](#).

5.2 Formulation of the problem

Fix $T > 0$, $d, N \in \mathbb{N}$. We consider a financial market on $[0, T]$ on some filtered probability space $(\Omega, \mathcal{F}, \mathbb{F} := (\mathcal{F}_t)_{t \geq 0}, \mathbb{P})$ with a non-risky asset S^0

$$dS_t^0 = S_t^0 r(t) dt,$$

with a deterministic short rate $r : \mathbb{R}_+ \rightarrow \mathbb{R}$, and d risky assets with dynamics

$$dS_t = \text{diag}(S_t) [(r(t)\mathbf{1}_d + \sigma_t \lambda_t) dt + \sigma_t dB_t], \quad (5.2.1)$$

driven by a d -dimensional Brownian motion B , with a $d \times d$ -matrix valued stochastic volatility process σ and a \mathbb{R}^d -valued continuous stochastic process λ , called *market price of risk*. Here $\mathbf{1}_d$ denotes the vector in \mathbb{R}^d with all components equal to 1. The market is typically incomplete, in the sense that the dynamics of the continuous volatility process σ is driven by an N -dimensional process $W = (W^1, \dots, W^N)^\top$ defined by:

$$W_t^k = C_k^\top B_t + \sqrt{1 - C_k^\top C_k} B_t^{\perp, k}, \quad k = 1, \dots, N, \quad (5.2.2)$$

where $C_k \in \mathbb{R}^d$ s.t. $C_k^\top C_k \leq 1$, and $B^\perp = (B^{\perp, 1}, \dots, B^{\perp, N})^\top$ is an N -dimensional Brownian motion independent of B . Note that $d\langle W^k \rangle_t = dt$ but W^k and W^j can be correlated, hence W is not necessarily a Brownian motion. Observe that processes λ and σ are \mathbb{F} -adapted, possibly unbounded, but not necessarily adapted to the filtration generated by W . We point out that \mathbb{F} may be strictly larger than the augmented filtration generated by B and B^\perp as we shall deal with weak solutions to stochastic Volterra equations.

Remark 5.2.1. *In our applications, we will be chiefly interested in the case where λ_t is linear in σ_t , and where the dynamics of the matrix-valued process σ is governed by a Volterra equation of the form*

$$\sigma_t = g_0(t) + \int_0^t \mu(t, s, \omega) ds + \int_0^t \chi(t, s, \omega) dW_s. \quad (5.2.3)$$

The class of models that we shall develop in Sections 5.4 and 5.5 includes in particular the case of Volterra Heston model when $d = 1$ with $\lambda_t = \theta \sigma_t$, for some constant θ , as studied in [HW20a], and the case of Wishart process for the covariance matrix process $V_t = \sigma_t \sigma_t^\top$, as studied in [CW14]. The class of models that we will develop in Sections 5.4 and 5.5 includes in particular the case of

1. multivariate Volterra Heston models based on Volterra square-root processes, see [AJLP19, Section 6], we refer to [RT19] for a microstructural foundation. When $d = 1$, we recover the results of [HW20a], which cover the case of the rough Heston model of [EER19].
2. multivariate Volterra Stein-Stein and Wishart type in the sense of [AJ19b], where the instantaneous covariance is given by squares of Gaussians. Under the Markovian setting, we recover a similar structure as in the results of [CW14].

Mean-variance optimization problem. Let π_t denote the vector of the amounts invested in the risky assets S at time t in a self-financing strategy and set $\alpha = \sigma^\top \pi$. Then, the dynamics of the wealth X^α of the portfolio we seek to optimize is given by

$$dX_t^\alpha = (r(t)X_t^\alpha + \alpha_t^\top \lambda_t) dt + \alpha_t^\top dB_t, \quad t \geq 0, \quad X_0^\alpha = x_0 \in \mathbb{R}. \quad (5.2.4)$$

By a solution to (5.2.4), we mean an \mathbb{F} -adapted continuous process X^α satisfying (5.2.4) on $[0, T]$ \mathbb{P} -a.s. and such that

$$\mathbb{E}\left[\sup_{t \leq T} |X_t^\alpha|^2\right] < \infty. \quad (5.2.5)$$

The set of admissible investment strategies is naturally defined by

$$\mathcal{A} = \{\alpha \in L_{\mathbb{F}}^{2,loc}([0, T], \mathbb{R}^d) \text{ such that (5.2.4) has a solution satisfying (5.2.5)}\}.$$

The Markowitz portfolio selection problem in continuous-time consists in solving the following constrained problem

$$V(m) := \inf_{\alpha \in \mathcal{A}} \{\text{Var}(X_T) : \text{s.t. } \mathbb{E}[X_T] = m\}. \quad (5.2.6)$$

given some expected return value $m \in \mathbb{R}$, where $\text{Var}(X_T) = \mathbb{E}[(X_T - \mathbb{E}[X_T])^2]$ stands for the variance.

5.3 A generic verification result

In this section, we establish a generic verification result for the optimization problem (5.2.6) given the solution of a certain Riccati BSDE. We stress that our mean-variance problem deals with incomplete markets with unbounded random coefficients σ and λ , so that existing results cannot be applied directly to our setting: [Lim04] presents a general methodology to solve the MV problem for the wealth process (5.2.4) in an incomplete market without assuming any particular dynamics on σ nor that the excess return is proportional to σ . However, a nondegeneracy assumption is made on $\sigma\sigma^\top$, see [Lim04, Assumption (A.1)]. The main verification result in [Lim04, Proposition 3.3], based on a completion of squares argument, states that if a solution to a certain (nonlinear) Riccati BSDE exists, then the MV is solvable. The difficulty resides in proving the existence of solutions to such nonlinear BSDEs (see also [LZ02] for similar results in complete markets).

Here, we assume that the excess return is proportional to σ (instead of the nondegeneracy condition) and state a verification result in terms of solutions of Riccati BSDEs (completion of squares, ie LQ problem with random coefficients). A verification result depending on the solution of a Riccati BSDE is also stated in [CW14], but the admissibility of the optimal candidate control is not proved. We also mention the paper of [JSM12] where the authors adopt a BSDE approach for general semimartingales, but focusing on situations in which the existence of an optimal strategy is assumed. In our case, the existence of an admissible optimal control is obtained under a suitable exponential integrability assumption involving the market price of risk and the Z components of the BSDE, which extends the condition in [She15].

Our main result of this section, Theorem 6.3.1 below, can be seen as unifying framework for the aforementioned results, refer to Table 5.1. For the sake of presentation, we postpone its proof to Appendix 5.A.

We define $C \in \mathbb{R}^{N \times d}$ by

$$C = (C_1, \dots, C_N)^\top, \quad (5.3.1)$$

where we recall that the vectors $C_i \in \mathbb{R}^d$ come from the correlation structure (5.2.2). We will use the matrix norm $|A| = \text{tr}(A^\top A)$ in the subsequent theorem.

	Random coef.	Unbounded coef.	degenerate σ	Incomplete market
[LZ02]	✓	✗	✗	✗
[Lim04]	✓	✗	✗	✓
[She15]	✓	✓	✗	✗
Theorem 6.3.1	✓	✓	✓	✓

Table 5.1 – Comparison to existing verification results for mean-variance problems.

Theorem 5.3.1. *Assume that there exists a solution triplet $(\Gamma, Z^1, Z^2) \in \mathbb{S}_{\mathbb{F}}^{\infty}([0, T], \mathbb{R}) \times L_{\mathbb{F}}^{2,loc}([0, T], \mathbb{R}^d) \times L_{\mathbb{F}}^{2,loc}([0, T], \mathbb{R}^N)$ to the Riccati BSDE*

$$\begin{cases} d\Gamma_t &= \Gamma_t \left[(-2r(t) + |\lambda_t + Z_t^1 + CZ_t^2|^2) dt + (Z_t^1)^{\top} dB_t + (Z_t^2)^{\top} dW_t \right], \\ \Gamma_T &= 1, \end{cases} \quad (5.3.2)$$

such that

(H1) $0 < \Gamma_0 < e^{2 \int_0^T r(s) ds}$, and $\Gamma_t > 0$, for all $t \leq T$,

(H2)

$$\mathbb{E} \left[\exp \left(a(p) \int_0^T (|\lambda_s|^2 + |Z_s^1|^2 + |Z_s^2|^2) ds \right) \right] < \infty, \quad (5.3.3)$$

for some $p > 2$ and a constant $a(p)$ given by

$$a(p) = \max \left[p(3 + |C|), 3(8p^2 - 2p)(1 + |C|^2) \right]. \quad (5.3.4)$$

Then, the optimal investment strategy for the Markowitz problem (5.2.6) is given by the admissible control

$$\alpha_t^* = -(\lambda_t + Z_t^1 + CZ_t^2)(X_t^{\alpha^*} - \xi^* e^{-\int_t^T r(s) ds}), \quad (5.3.5)$$

where

$$\xi^* = \frac{m - \Gamma_0 e^{-\int_0^T r(t) dt} x_0}{1 - \Gamma_0 e^{-2 \int_0^T r(t) dt}}. \quad (5.3.6)$$

Furthermore, the value of (5.2.6) for the optimal wealth process $X^* = X^{\alpha^*}$ is

$$V(m) = \text{Var}(X_T^*) = \Gamma_0 \frac{|x_0 - m e^{-\int_0^T r(t) dt}|^2}{1 - \Gamma_0 e^{-2 \int_0^T r(t) dt}}. \quad (5.3.7)$$

Proof. We refer to Appendix 5.A. □

Remark 5.3.1. *By setting $\tilde{Z}_t^i = \Gamma_t Z_t^i$, $i = 1, 2$, the BSDE (5.3.2) agrees with the one in [CW14, Theorem 3.1]:*

$$d\Gamma_t = \Gamma_t \left[\left(-2r(t) + \left| \lambda_t + \frac{\tilde{Z}_t^1 + C\tilde{Z}_t^2}{\Gamma_t} \right|^2 \right) dt + (\tilde{Z}_t^1)^{\top} dB_t + (\tilde{Z}_t^2)^{\top} dW_t, \right]$$

and justifies the terminology Riccati BSDE.

In the sequel, we will provide concrete specifications of multivariate stochastic Volterra models for which the solution to the non-linear Riccati BSDE (5.3.2) can be computed in closed and semi-closed forms, while satisfying conditions (H1) and (H2). The key idea is to observe that, first, if such solution exists, then, it admits the following representation as a Laplace transform:

$$\Gamma_t = \mathbb{E} \left[\exp \left(\int_t^T (2r(s) - |\lambda_s + Z_s^1 + CZ_s^2|^2) ds \right) \middle| \mathcal{F}_t \right], \quad 0 \leq t \leq T.$$

In the special case where λ is deterministic, then the solution to (5.3.2) trivially exists with $Z^1 = Z^2 = 0$, and condition (H1) and (H2) are obviously satisfied when λ is nonzero and bounded. In the general case where λ is an (unbounded) stochastic process, the admissibility of the optimal control is obtained under finiteness of a certain exponential moment of the solution triplet (Γ, Z^1, Z^2) and the risk premium λ as precised in (H2). Such estimate is crucial to deal with the unbounded random coefficients in (5.2.4), see for instance [HW20a; SZS14; She15] where similar conditions appear. If the coefficients are bounded, such condition is not needed, see [Lim04, Lemma 3.1].

Our main interest is to find specific dynamics for the volatility σ and for the market price of risk λ such that the Laplace transform can be computed in (semi)-explicit form. We shall consider models as mentioned in Remark 5.2.1, where all the randomness in λ comes from the process W driving σ , and for which we naturally expect that $Z^1 = 0$. We solve more specifically this problem for two classes of models:

1. Multivariate affine Volterra models of Heston type in Section 5.4. This extends the results of [HW20a] to the multi dimensional case and provides semi-closed formulas.
2. Multivariate quadratic Volterra models of Stein-Stein and Wishart type in Section 5.5 for which we derive new closed-form solutions.

5.4 Multivariate affine Volterra models

We let $K = \text{diag}(K_1, \dots, K_d)$ be diagonal with scalar kernels $K_i \in L^2([0, T], \mathbb{R})$ on the diagonal, $\nu = \text{diag}(\nu_1, \dots, \nu_d)$ and $D \in \mathbb{R}^{d \times d}$ such that

$$D_{ij} \geq 0, \quad i \neq j.$$

We assume that σ in (5.2.3) is given by $\sigma = \sqrt{\text{diag}(V)}$, where $V = (V^1, \dots, V^d)^\top$ is the following \mathbb{R}_+^d -valued Volterra square-root process

$$V_t = g_0(t) + \int_0^t K(t-s)DV_s ds + \int_0^t K(t-s)\nu\sqrt{\text{diag}(V_s)}dW_s. \quad (5.4.1)$$

Here $g_0 : \mathbb{R}_+ \rightarrow \mathbb{R}_+^d$, W is a d -dimensional Brownian motion and the correlation structure with B is given by

$$W^i = \rho_i B^i + \sqrt{1 - \rho_i^2} B^{\perp, i}, \quad i = 1, \dots, d, \quad (5.4.2)$$

for some $(\rho_1, \dots, \rho_d) \in [-1, 1]^d$. This corresponds to a particular case of the correlation structure in (5.2.2) with $N = d$, and $C_i = (0, \dots, \rho_i, \dots, 0)^\top$. Furthermore, the risk premium is assumed to be in the form $\lambda = (\theta_1 \sqrt{V^1}, \dots, \theta_d \sqrt{V^d})^\top$, for some $\theta_i \geq 0$, so that the dynamics for the stock prices (5.2.1) reads

$$dS_t^i = S_t^i (r(t) + \theta_i V_t^i) dt + S_t^i \sqrt{V_t^i} dB_t^i, \quad i = 1, \dots, d. \quad (5.4.3)$$

We assume that there exists a continuous \mathbb{R}_+^{2d} -valued weak solution (V, S) to (5.4.1)-(5.4.3) on some filtered probability space $(\Omega, \mathcal{F}, (\mathcal{F})_{t \geq 0}, \mathbb{P})$ such that

$$\sup_{t \leq T} \mathbb{E} [|V_t|^p] < \infty, \quad p \geq 1. \quad (5.4.4)$$

For instance, weak existence of V such that (5.4.4) holds is established under suitable assumptions on the kernel K and specifications g_0 as shown in the following remark. The existence of S readily follows from that of V .

Remark 5.4.1. *Assume that, for each $i = 1, \dots, d$, K_i is completely monotone on $(0, \infty)^\dagger$, and that there exists $\gamma_i \in (0, 2]$ and $k_i > 0$ such that*

$$\int_0^h K_i^2(t) dt + \int_0^T (K_i(t+h) - K_i(t))^2 dt \leq k_i h^{\gamma_i}, \quad h > 0. \quad (5.4.5)$$

This covers, for instance, constant non-negative kernels, fractional kernels of the form $t^{H-1/2}/\Gamma(H+1/2)$ with $H \in (0, \frac{1}{2}]$, and exponentially decaying kernels $e^{-\beta t}$ with $\beta > 0$. Moreover, sums and products of completely monotone functions are completely monotone, refer to [AJLP19] for more details.

- *If $g_0(t) = V_0 + \int_0^t K(t-s)b^0 ds$, for some $V_0, b^0 \in \mathbb{R}_+^d$, then [AJLP19, Theorem 6.1] ensures the existence of V such that (5.4.4) holds,*
- *In [AJEE19a], the existence is obtained for more general input curves g_0 for the case $d = 1$, the extension to the multi-dimensional setting is straightforward.*

Exploiting the affine structure of (5.4.1)-(5.4.3), see [AJLP19], we provide an explicit solution to the Riccati BSDE (5.3.2) in terms of the Riccati-Volterra equation

$$\psi^i(t) = \int_0^t K_i(t-s)F_i(\psi(s))ds, \quad (5.4.6)$$

$$F_i(\psi) = -\theta_i^2 - 2\theta_i\rho_i\nu_i\psi^i + (D^\top \psi)_i + \frac{\nu_i^2}{2}(1 - 2\rho_i^2)(\psi^i)^2, \quad i = 1, \dots, d, \quad (5.4.7)$$

and the \mathbb{R}^d -valued process

$$g_t(s) = g_0(s) + \int_0^t K(s-u)DV_u du + \int_0^t K(s-u)\nu\sqrt{\text{diag}(V_u)}dW_u, \quad s \geq t \quad (5.4.8)$$

One notes that for each, $s \leq T$, $(g_t(s))_{t \leq s}$ is the adjusted forward process

$$g_t(s) = \mathbb{E} \left[V_s - \int_t^s K(s-u)DV_u du \mid \mathcal{F}_t \right].$$

Lemma 5.4.1. *Assume that there exists a solution $\psi \in C([0, T], \mathbb{R}^d)$ to the Riccati-Volterra equation (5.4.6)-(5.4.7). Let (Γ, Z^1, Z^2) be defined as*

$$\begin{cases} \Gamma_t &= \exp \left(2 \int_t^T r(s)ds + \sum_{i=1}^d \int_t^T F_i(\psi(T-s))g_t^i(s)ds \right), \\ Z_t^1 &= 0, \\ Z_t^{2,i} &= \psi^i(T-t)\nu_i\sqrt{V_t^i}, \quad i = 1, \dots, d, \quad 0 \leq t \leq T, \end{cases} \quad (5.4.9)$$

where $g = (g^1, \dots, g^d)^\top$ is given by (5.4.8). Then, (Γ, Z^1, Z^2) is a $\mathbb{S}_{\mathbb{F}}^\infty([0, T], \mathbb{R}) \times L_{\mathbb{F}}^2([0, T], \mathbb{R}^d) \times L_{\mathbb{F}}^2([0, T], \mathbb{R}^d)$ -valued solution to (5.3.2).

[†]A function f is completely monotone on $(0, \infty)$ if it is infinitely differentiable on $(0, \infty)$ such that $(-1)^n f^{(n)}(t) \geq 0$, for all $n \geq 1$ and $t > 0$.

Proof. We first observe that the correlation structure (5.4.2) implies that C in (5.3.1) is given by $C = \text{diag}(\rho_1, \dots, \rho_d)$. Set

$$G_t = 2 \int_t^T r(s) ds + \sum_{i=1}^d \int_t^T F_i(\psi(T-s)) g_t^i(s) ds, \quad t \leq T.$$

Then, $\Gamma = \exp(G)$ and

$$d\Gamma_t = \Gamma_t \left(dG_t + \frac{1}{2} d\langle G \rangle_t \right). \quad (5.4.10)$$

Using (5.4.8), and by stochastic Fubini's theorem, see [Ver12, Theorem 2.2], the dynamics of G reads as

$$\begin{aligned} dG_t &= \left(-2r(t) - \sum_{i=1}^d F_i(\psi(T-t)) V_t^i + \sum_{j=1}^d \int_t^T F_j(\psi(T-s)) K_j(s-t) ds \sum_{i=1}^d D_{ji} V_t^i \right) dt \\ &\quad + \sum_{i=1}^d \int_t^T F_i(\psi(T-s)) K_i(s-t) ds \nu_i \sqrt{V_t^i} dW_t^i \\ &= \left(-2r(t) - \sum_{i=1}^d F_i(\psi(T-t)) V_t^i + \sum_{j=1}^d \psi^j(T-t) \sum_{i=1}^d D_{ji} V_t^i \right) dt \\ &\quad + \sum_{i=1}^d \psi^i(T-t) \nu_i \sqrt{V_t^i} dW_t^i, \end{aligned}$$

where we changed variables and used the Riccati–Volterra equation (5.4.6) for ψ for the last equality. This yields that the dynamics of Γ in (5.4.10) is given by

$$\begin{aligned} d\Gamma_t &= \Gamma_t \left(-2r(t) + \sum_{i=1}^d V_t^i (-F_i(\psi(T-t)) + \sum_{j=1}^d D_{ji} \psi^j(T-t) + \frac{\nu_i^2}{2} (\psi^i(T-t))^2) \right) dt \\ &\quad + \Gamma_t \sum_{i=1}^d \psi^i(T-t) \nu_i \sqrt{V_t^i} dW_t^i \\ &= \Gamma_t \left[(-2r(t) + \sum_{i=1}^d V_t^i (\theta_i + \rho_i \nu_i \psi^i(T-t))) dt + (Z_t^2)^\top dW_t \right], \end{aligned} \quad (5.4.11)$$

where we used (5.4.7) for the last identity. Finally, observing that

$$|\lambda_t + Z_t^1 + CZ_t^2|^2 = \sum_{i=1}^d (\theta_i + \rho_i \nu_i \psi^i(T-t))^2 V_t^i,$$

together with $\Gamma_T = 1$, we get that (Γ, Z^1, Z^2) as defined in (5.4.9) solves the BSDE (5.3.2).

It remains to show that $(\Gamma, Z^1, Z^2) \in \mathbb{S}_{\mathbb{F}}^\infty([0, T], \mathbb{R}) \times L_{\mathbb{F}}^2([0, T], \mathbb{R}^d) \times L_{\mathbb{F}}^2([0, T], \mathbb{R}^d)$. For this, define the process

$$M_t = \Gamma_t \exp \left(\int_t^T (-2r(s) + \sum_{i=1}^d V_s^i (\theta_i + \rho_i \nu_i \psi^i(T-s))^2) ds \right), \quad t \leq T.$$

An application of Itô's formula combined with the dynamics (5.4.11) shows that $dM_t = M_t(Z_t^2)^\top dW_t$, and so M is a local martingale of the form

$$M_t = \mathcal{E} \left(\int_t^T \sum_{i=1}^d \psi^i(T-s) \nu_i \sqrt{V_s^i} dW_s^i \right).$$

Since ψ is continuous, it is bounded so that a straightforward adaptation of [AJLP19, Lemma 7.3] to the multi-dimensional setting, recall (5.4.4), yields that M is a true martingale. Since $M_T = 1$, writing $\mathbb{E}[M_T | \mathcal{F}_t] = M_t$, we obtain

$$\Gamma_t = \mathbb{E} \left[\exp \left(\int_t^T (2r(s) - \sum_{i=1}^d V_s^i (\theta_i + \rho_i \nu_i \psi^i(T-s))^2) ds \right) \mid \mathcal{F}_t \right], \quad t \leq T \quad (5.4.12)$$

which ensures that $0 < \Gamma_t \leq e^{2 \int_t^T r(s) ds}$, $\mathbb{P} - a.s.$, since $V \in \mathbb{R}_+^d$. As for Z^2 , it is clear that it belongs to $L_{\mathbb{F}}^2([0, T], \mathbb{R}^d)$ since Γ and ψ are bounded and $\mathbb{E} \left[\int_0^T \sum_{i=1}^d V_s^i ds \right] < \infty$ by (5.4.4). \square

The following remark makes precise the existence of a continuous solution to the Riccati-Volterra equation (5.4.6)-(5.4.7).

Remark 5.4.2. *Assume that K satisfies the assumptions of Remark 5.4.1.*

- *If $1 - 2\rho_i^2 \geq 0$, then [AJLP19, Lemma 6.3] provides the existence of a unique solution $\psi \in L^2([0, T], \mathbb{R}^d)$. Continuity of such solution can then be easily established, since as opposed to [AJLP19, Lemma 6.3], (5.4.6) starts from 0.*
- *If $d = 1$ and $1 - 2\rho_1^2 < 0$, [HW20a, Lemma A.4] establishes the existence of a continuous solution ψ .*

Using Theorem 6.3.1, we can now explicitly solve the Markowitz problem (5.2.6) in the multivariate Volterra Heston model (5.4.1)-(5.4.2)-(5.4.3). The next theorem extends [HW20a, Theorem 4.2] to the multivariate case. Notice that the martingale distortion argument in this cited paper is specific to the dimension $d = 1$, and here, instead, we rely on the generic verification result in Theorem 6.3.1.

Theorem 5.4.1. *Assume that there exists a solution $\psi \in C([0, T], \mathbb{R}^d)$ to the Riccati-Volterra equation (5.4.6)-(5.4.7) such that*

$$\max_{1 \leq i \leq d} \max_{t \in [0, T]} (\theta_i^2 + \nu_i^2 \psi^i(t)^2) \leq \frac{a}{a(p)}, \quad \text{for some } p > 2, \quad (5.4.13)$$

where $a(p)$ is given by (5.3.4) and the constant $a > 0$ is such that $\mathbb{E} \left[\exp \left(a \int_0^T \sum_{i=1}^d V_s^i ds \right) \right] < \infty$. Assume that $g_0^i(0) > 0$ for some $i \leq d$. Then, the optimal investment strategy for the maximization problem (5.2.6) in the multivariate Volterra Heston model (5.4.1)-(5.4.2)-(5.4.3) is given by the admissible control

$$\alpha_t^{*i} = -(\theta_i + \rho_i \nu_i \psi^i(T-t)) \sqrt{V_t^i} \left(X_t^{\alpha^*} - \xi^* e^{-\int_t^T r(s) ds} \right), \quad 1 \leq i \leq d, \quad (5.4.14)$$

where ξ^* is defined as in (6.5.6), the wealth process $X^* = X^{\alpha^*}$ by (5.2.4) with $\lambda = (\theta_1 \sqrt{V^1}, \dots, \theta_d \sqrt{V^d})^\top$, and the optimal value is given by (6.5.7) with Γ_0 as in (5.4.12).

Proof. First note that under the specification (5.4.9), the candidate for the optimal feedback control defined in (5.3.5) takes the form

$$\begin{aligned}\alpha_t^* &= -(\lambda_t + Z_t^1 + CZ_t^2)(X_t^* - \xi^* e^{-\int_t^T r(s)ds}) \\ &= \left(-(\theta_i + \rho_i \nu_i \psi^i(T-t)) \sqrt{V_t^i} (X_t^* - \xi^* e^{-\int_t^T r(s)ds}) \right)_{1 \leq i \leq d}.\end{aligned}$$

It then suffices to check that the assumptions of Theorem 6.3.1 are verified to ensure that such α^* is optimal and to get that (6.5.7) is the optimal value. The existence of a solution triplet $(\Gamma, Z^1, Z^2) \in \mathbb{S}_{\mathbb{F}}^\infty([0, T], \mathbb{R}) \times L_{\mathbb{F}}^2([0, T], \mathbb{R}^d) \times L_{\mathbb{F}}^2([0, T], \mathbb{R}^N)$ to the stochastic backward Riccati equation (5.3.2) is ensured by Lemma 5.4.1. In addition, (5.4.12) implies that $\Gamma_0 < e^{2\int_0^T r(s)ds}$ since $g_0^i(0) > 0$ for some $i \leq d$ by assumption and V^i is continuous. Thus condition (H1) of Theorem 6.3.1 is verified. As for condition (H2) of Theorem 6.3.1, note that

$$a(p) \left(|\lambda_s|^2 + |Z_s^1|^2 + |Z_s^2|^2 \right) = a(p) \sum_{i=1}^d V_s^i (\theta_i^2 + \nu_i^2 \psi^i(t)^2) \leq a \sum_{i=1}^d V_s^i,$$

which implies that $\mathbb{E} \left[\exp \left(a(p) \int_0^T \left(|\lambda_s|^2 + |Z_s^1|^2 + |Z_s^2|^2 \right) ds \right) \right] < \infty$ and ends the proof. \square

Remark 5.4.3. Condition (5.4.13) concerns the risk premium constants $(\theta_1, \dots, \theta_d)$. For $a > 0$, a sufficient condition ensuring $\mathbb{E} \left[\exp \left(a \int_0^T \sum_{i=1}^d V_s^i ds \right) \right] < \infty$ is the existence of a continuous solution $\tilde{\psi}$ to the Riccati–Volterra

$$\tilde{\psi}^i(t) = \int_0^t K_i(t-s) \left(a + (D\tilde{\psi}(s))_i + \frac{\nu_i^2}{2} \tilde{\psi}^i(s) \right) ds,$$

see [AJLP19, Theorem 4.3]. In the one dimensional case $d = 1$, such existence is established in [HW20a, Lemma A.2] for the case where $g_0(t) = V_0 + \kappa \int_0^t K(t-s)\phi ds$, $\phi \geq 0$, $D = -\kappa$ and $a < \frac{\kappa^2}{2\nu^2}$.

Remark 5.4.4. Note that in the one dimensional case the condition (5.4.13) can be made more explicit by bounding ψ with respect to θ . Indeed since $-\theta^2 < 0$ we get from [AJEE19c, Theorem C.1] that ψ is non-positive. Furthermore, the fact that ψ is solution to the following linear Volterra equation

$$\chi(t) = \int_0^t K(t-s) \left(-\theta^2 + ((D - 2\theta\rho\nu) + \frac{\nu^2}{2}(1 - 2\rho^2)\psi(s))\chi(s) \right) ds,$$

leads to, see [AJEE19c, Corollary C.4],

$$\sup_{t \in [0, T]} |\psi_t| \leq |\theta|^2 \int_0^T R_D(s) ds,$$

where R_D is the resolvent of KD . Consequently, a sufficient condition on θ to ensure (5.4.13) would be

$$\theta^2 \left(1 + (\theta\nu)^2 \int_0^T R_D(s) ds \right) \leq \frac{a}{a(p)}.$$

Remark 5.4.5. *In order to numerically implement the optimal strategy (5.4.14), one needs to simulate the possibly non-Markovian process V and to discretize the Riccati-Volterra equation for ψ . [AJ19a; AJEE19c] develop a tailor-made approximating procedure for the stochastic Volterra equation (5.4.1) (resp. the Riccati-Volterra equation (5.4.6)), using finite-dimensional Markovian semimartingales (resp. finite-dimensional Riccati ODE's). An illustration of such procedure on the mean-variance problem in the univariate Volterra Heston model for the fractional kernel is given in [HW20a, Section 5].*

5.5 Multivariate quadratic Volterra models

Before we introduce the class of multivariate quadratic Volterra models, we need to define and introduce some notations on integral operators.

5.5.1 Integral operators

Fix $T > 0$. We denote by $\langle \cdot, \cdot \rangle_{L^2}$ the inner product on $L^2([0, T], \mathbb{R}^N)$ that is

$$\langle f, g \rangle_{L^2} = \int_0^T f(s)^\top g(s) ds, \quad f, g \in L^2([0, T], \mathbb{R}^N).$$

We define $L^2([0, T]^2, \mathbb{R}^{N \times N})$ to be the space of measurable kernels $K : [0, T]^2 \rightarrow \mathbb{R}^{N \times N}$ such that

$$\int_0^T \int_0^T |K(t, s)|^2 dt ds < \infty.$$

For any $K, L \in L^2([0, T]^2, \mathbb{R}^{N \times N})$ we define the \star -product by

$$(K \star L)(s, u) = \int_0^T K(s, z) L(z, u) dz, \quad (s, u) \in [0, T]^2,$$

which is well-defined in $L^2([0, T]^2, \mathbb{R}^{N \times N})$ due to the Cauchy-Schwarz inequality. For any kernel $K \in L^2([0, T]^2, \mathbb{R}^{N \times N})$, we denote by \mathbf{K} the integral operator induced by the kernel K that is

$$(\mathbf{K}g)(s) = \int_0^T K(s, u) g(u) du, \quad g \in L^2([0, T], \mathbb{R}^N).$$

\mathbf{K} is a linear bounded operator from $L^2([0, T], \mathbb{R}^N)$ into itself. If \mathbf{K} and \mathbf{L} are two integral operators induced by the kernels K and L in $L^2([0, T]^2, \mathbb{R}^{N \times N})$, then $\mathbf{K}\mathbf{L}$ is the integral operator induced by the kernel $K \star L$.

We denote by K^* the adjoint kernel of K for $\langle \cdot, \cdot \rangle_{L^2}$, that is

$$K^*(s, u) = K(u, s)^\top, \quad (s, u) \in [0, T]^2,$$

and by \mathbf{K}^* the corresponding adjoint integral operator.

Definition 5.5.1. A kernel $K \in L^2\left([0, T]^2, \mathbb{R}^{N \times N}\right)$ is symmetric nonnegative if $K = K^*$ and

$$\int_0^T \int_0^T f(s)^\top K(s, u) f(u) du ds \geq 0, \quad \forall f \in L^2\left([0, T], \mathbb{R}^N\right).$$

In this case, the integral operator \mathbf{K} is said to be symmetric nonnegative and $\mathbf{K} = \mathbf{K}^*$ and $\langle f, \mathbf{K}f \rangle_{L^2} \geq 0$. \mathbf{K} is said to be symmetric nonpositive, if $(-\mathbf{K})$ is symmetric nonnegative.

We recall the definition of Volterra kernels of continuous and bounded type in the terminology of [GLS90, Definitions 9.2.1, 9.5.1 and 9.5.2].

Definition 5.5.2. A kernel $K : \mathbb{R}_+^2 \rightarrow \mathbb{R}^{N \times N}$ is a Volterra kernel of continuous and bounded type in L^2 if $K(t, s) = 0$ whenever $s > t$ and

$$\sup_{t \in [0, T]} \int_0^T |K(t, s)|^2 ds < \infty, \quad \text{and} \quad \lim_{h \rightarrow 0} \int_0^T |K(u+h, s) - K(u, s)|^2 ds = 0, \quad u \leq T. \quad (5.5.1)$$

Any convolution kernel of the form $K(t, s) = k(t-s)\mathbf{1}_{s \leq t}$ with $k \in L^2\left([0, T], \mathbb{R}^{N \times N}\right)$ satisfies (5.5.1), we refer to [AJ19b, Example 3.1] for additional examples. Note that $(s, t) \mapsto K(s, t)$ is not necessarily continuous nor bounded.

For completeness, we collect in Appendix 5.B.1 below standard results for integral operators and their resolvents.

5.5.2 The model

In this section, we assume that the components of the stochastic volatility matrix σ in (5.2.1) are given by $\sigma^{ij} = \gamma_{ij}^\top Y$, where $\gamma_{ij} \in \mathbb{R}^N$ and $Y = (Y^1, \dots, Y^N)^\top$ is the following N -dimensional Volterra Ornstein–Uhlenbeck process

$$Y_t = g_0(t) + \int_0^t K(t, s) D Y_s ds + \int_0^t K(t, s) \eta dW_s, \quad (5.5.2)$$

where $D, \eta \in \mathbb{R}^{N \times N}$, $g_0 : \mathbb{R}_+ \rightarrow \mathbb{R}^N$ is locally bounded, W is a N -dimensional process as in (5.2.2), i.e.,

$$W_t^k = C_k^\top B_t + \sqrt{1 - C_k^\top C_k} B_t^{\perp, k}, \quad (5.5.3)$$

where $C_k \in \mathbb{R}^d$, such that $C_k^\top C_k \leq 1$, $k = 1, \dots, N$, and $K : [0, T]^2 \rightarrow \mathbb{R}^{N \times N}$ is a Volterra kernel of continuous and bounded type in L^2 as in Definition 5.5.2. We stress that the process W is not necessarily a N -dimensional Brownian motion due to the possible correlations.

Furthermore, the risk premium is assumed to be in the form

$$\lambda_t = \Theta Y_t, \quad t \leq T,$$

for some $\Theta \in \mathbb{R}^{d \times N}$, so that the dynamics for the stock prices (5.2.1) reads as

$$dS_t^i = S_t^i \left(r(t) + \sum_{k=1}^N \sum_{j=1}^d \gamma_{ij}^\ell \Theta^{jk} Y_t^\ell Y_t^k \right) dt + S_t^i \sum_{j=1}^d \gamma_{ij}^\top Y_t dB_t^j, \quad i = 1, \dots, d. \quad (5.5.4)$$

The appellation quadratic reflects the quadratic dependence of the drift and the covariance matrix of $\log S$ in Y . Such models nest as special cases the Volterra extensions of the celebrated [SS91] or [SZ99] model and certain Wishart models of [Bru91] as shown in the following example.

Example 5.5.1. (i) *The multivariate Volterra Stein-Stein model:*

For $N = d$, $K = \text{diag}(K^1, \dots, K^d)$ and $\gamma_{ij} = \beta_{ij}e_i$ with $\beta_{ij} \in \mathbb{R}$ such that $\sum_{j=1}^d \beta_{ij}^2 = 1$ and (e_1, \dots, e_d) the canonical basis of \mathbb{R}^d , we recover the multivariate Volterra Stein-Stein model defined by

$$\begin{cases} dS_t^i &= S_t^i \left(r(t) + \sum_{j,k=1}^d \beta_{ij} \Theta^{jk} Y_t^i Y_t^k \right) dt + S_t^i Y_t^i \sum_{j=1}^d \beta_{ij} dB_t^j, \\ Y_t^i &= g_0^i(t) + \int_0^t K^i(t, s) \sum_{j=1}^d D^{ij} Y_s^j ds + \int_0^t K^i(t, s) \eta^i dW_s^i, \quad i = 1, \dots, d, \end{cases}$$

and $C_i = \rho_i(\beta_{i1}, \dots, \beta_{id})^\top$ to take into account the leverage effect. Recall that W is possibly correlated and is not necessarily a Brownian motion.

(ii) *The Volterra Wishart covariance model:*

Using the vectorization operator, which stacks the columns of a matrix one underneath another in a vector, see [AJ19b, Section 3.1], one can recover the Volterra Wishart covariance model for $N = d^2$:

$$\begin{cases} dS_t &= \text{diag}(S_t) [r(t) \mathbf{1}_d dt + \tilde{Y}_t dB_t], \quad S_0 \in \mathbb{R}_+^d, \\ \tilde{Y}_t &= \tilde{g}_0(t) + \int_0^t \tilde{K}(t, s) DY_s ds + \int_0^t \tilde{K}(t, s) \eta dW_s, \end{cases}$$

with $\tilde{g}_0 : [0, T] \rightarrow \mathbb{R}^{d \times d}$, a suitable measurable kernel $\tilde{K} : [0, T]^2 \rightarrow \mathbb{R}^{d \times d}$, a $d \times d$ Brownian motion W and

$$W^{ij} = \rho_{ij}^\top B + \sqrt{1 - \rho_{ij}^\top \rho_{ij}} B^{\perp, ij}, \quad i, j = 1, \dots, d,$$

for some $\rho_{ij} \in \mathbb{R}^{d \times d}$ such that $\rho_{ij}^\top \rho_{ij} \leq 1$, for $i, j = 1, \dots, d$, where B^\perp is a $d \times d$ -dimensional Brownian motion independent of B . Here the process \tilde{Y} is $d \times d$ -matrix valued.

Remark 5.5.1. Note that with (5.5.3), there are no restrictions on the correlations between Y^i and the stocks S^i in (5.5.2) and (5.5.4), in contrast with the correlation structure (5.4.1) of the multivariate Volterra Heston model. Moreover, the models in Example 5.5.1 allow us to deal with correlated stocks in contrast with the multivariate Heston model in (5.4.3) where no correlation between the driving Brownian motion of the assets S^i and S^j is allowed in order to keep the affine structure.

Since K is a Volterra kernel of continuous and bounded type in L^2 , there exists a progressively measurable $\mathbb{R}^N \times \mathbb{R}_+^d$ -valued strong solution (Y, S) to (5.5.2) and (5.5.4) such that

$$\sup_{t \leq T} \mathbb{E} [|Y_t|^p] < \infty, \quad p \geq 1.$$

Indeed, the solution for (5.5.2) is given in the following closed form

$$Y_t = g_0(t) + \int_0^t R_D(t, s) g_0(s) ds + \int_0^t (K(t, s) + R_D(t, s)) \eta dW_s, \quad (5.5.5)$$

where R_D is the resolvent of KD , whose existence is ensured by Lemma 5.B.2-1 below, we refer to Appendix 5.B.1 for more details on the resolvents. The existence of S readily follows from that of Y and is given as a stochastic exponential. In the sequel, we will assume that the solution Y is continuous. Additional conditions on K , in the spirit of (5.4.5), are needed to ensure the existence of continuous modification, by an application of the Kolmogorov-Chentsov continuity criterion, for instance, as shown in the following remark.

Remark 5.5.2. For $s \leq t$ and $p \geq 2$, an application of Jensen and Burkholder-Davis-Gundy's inequalities yield

$$\mathbb{E}[|(Y_t - g_0(t)) - (Y_s - g_0(s))|^p] \leq c \left(1 + \sup_{r \leq T} \mathbb{E}[|Y_s|^p]\right) \times \left(\int_s^t |K(t, r)|^2 dr + \int_0^T |K(t, r) - K(s, r)|^2 dr \right)^{p/2}.$$

This shows that $(Y - g_0)$ admits a continuous modification, by the Kolmogorov-Chentsov continuity criterion, provided that

$$\int_s^t |K(t, r)|^2 dr + \int_0^T |K(t, r) - K(s, r)|^2 dr \leq c|t - s|^\gamma,$$

for some $\gamma > 0$.

5.5.3 The explicit solution

In this section, we provide an explicit solution for the Markowitz problem for quadratic Volterra models, and our main result is stated in Theorem 5.5.1 below.

Exploiting the quadratic structure of (5.5.2)-(5.5.4), see [AJ19b], we provide an explicit solution to the Riccati BSDE in Lemma 5.5.2 below, in terms of the following family of linear operators $(\Psi_t)_{0 \leq t \leq T}$ acting on $L^2([0, T], \mathbb{R}^N)$:

$$\Psi_t = -(\text{Id} - \hat{\mathbf{K}})^{-*} \Theta^\top (\text{Id} + 2\Theta \tilde{\Sigma}_t \Theta^\top)^{-1} \Theta (\text{Id} - \hat{\mathbf{K}})^{-1}, \quad 0 \leq t \leq T, \quad (5.5.6)$$

where $\mathbf{F}^{-*} := (\mathbf{F}^{-1})^*$, and $\hat{\mathbf{K}}$ is the integral operator induced by the kernel $\hat{K} = K(D - 2\eta C^\top \Theta)$ and $\tilde{\Sigma}_t$ the integral operator defined by

$$\tilde{\Sigma}_t = (\text{Id} - \hat{\mathbf{K}})^{-1} \Sigma_t (\text{Id} - \hat{\mathbf{K}})^{-*}, \quad t \in [0, T], \quad (5.5.7)$$

with Σ_t defined as the integral operator associated to the kernel

$$\Sigma_t(s, u) = \int_t^{s \wedge u} K(s, z) \eta (U - 2C^\top C) \eta^\top K(u, z)^\top dz, \quad t \in [0, T], \quad (5.5.8)$$

where $U = \frac{d(W)_t}{dt} = (1_{i=j} + 1_{i \neq j} (C_i)^\top C_j)_{1 \leq i, j \leq N}$.

We start by deriving some first properties of $t \mapsto \Psi_t$, namely that it is well-defined, strongly differentiable and satisfies an operator Riccati equation under the following additional assumption on the kernel:

$$\sup_{t \leq T} \int_0^T |K(s, t)|^2 ds < \infty. \quad (5.5.9)$$

We recall that $t \mapsto \Psi_t$ is said to be strongly differentiable at time $t \geq 0$, if there exists a bounded linear operator $\dot{\Psi}_t$ from $L^2([0, T], \mathbb{R}^N)$ into itself such that

$$\lim_{h \rightarrow 0} \frac{1}{h} \|\Psi_{t+h} - \Psi_t - h \dot{\Psi}_t\|_{\text{op}} = 0, \quad \text{where } \|\mathbf{G}\|_{\text{op}} = \sup_{f \in L^2([0, T], \mathbb{R}^N)} \frac{\|\mathbf{G}f\|_{L^2}}{\|f\|_{L^2}}.$$

Lemma 5.5.1. *Fix a kernel K as in Definition 5.5.2 satisfying (5.5.9). Assume that $(U - 2C^\top C) \in \mathbb{S}_+^N$. Then, for each $t \leq T$, Ψ_t given by (5.5.6) is well-defined and is a bounded linear operator from $L^2([0, T], \mathbb{R}^N)$ into itself. Furthermore,*

1. $(\Theta^\top \Theta \text{Id} + \Psi_t)$ is an integral operator induced by a kernel $\psi_t(s, u)$ such that

$$\sup_{t \leq T} \int_{[0, T]^2} |\psi_t(s, u)|^2 ds du < \infty. \quad (5.5.10)$$

2. For any $f \in L^2([0, T], \mathbb{R}^N)$,

$$(\Psi_t f \mathbf{1}_t)(t) = (-\Theta^\top \Theta \text{Id} + \hat{K}^* \Psi_t)(f \mathbf{1}_t)(t),$$

where $\mathbf{1}_t : s \mapsto \mathbf{1}_{t \leq s}$.

3. $t \mapsto \Psi_t$ is strongly differentiable and satisfies the operator Riccati equation

$$\begin{aligned} \dot{\Psi}_t &= 2\Psi_t \dot{\Sigma}_t \Psi_t, & t \in [0, T] \\ \Psi_T &= -(\text{Id} - \hat{K})^{-*} \Theta^\top \Theta (\text{Id} - \hat{K})^{-1} \end{aligned} \quad (5.5.11)$$

where $\dot{\Sigma}_t$ is the strong derivative of $t \mapsto \Sigma_t$ induced by the kernel

$$\dot{\Sigma}_t(s, u) = -K(s, t) \eta (U - 2C^\top C) \eta^\top K(u, t)^\top, \quad a.e. \quad (5.5.12)$$

Proof. The proof is given in Appendix 5.B.2. □

We are now ready to provide a solution for the Riccati-BSDE (5.3.2). For this, denote by g the process

$$g_t(s) = \mathbf{1}_{t \leq s} \left(g_0(s) + \int_0^t K(s, u) D Y_u du + \int_0^t K(s, u) \eta dW_u \right). \quad (5.5.13)$$

One notes that for each, $s \leq T$, $(g_t(s))_{t \leq s}$ is the adjusted forward process

$$g_t(s) = \mathbb{E} \left[Y_s - \int_t^s K(s, u) D Y_u du \mid \mathcal{F}_t \right], \quad s \geq t.$$

We also denote the trace of an integral operator \mathbf{F} by $\text{Tr}(\mathbf{F}) = \int_0^T \text{tr}(F(s, s)) ds$, where tr is the usual trace of a matrix, and we define the function ϕ by

$$\begin{cases} \dot{\phi}_t &= \text{Tr}(\Psi_t \dot{\Lambda}_t) - 2r(t) \\ &= \int_{(t, T]} \text{tr}(\Theta^\top \Theta K(s, t) \eta U \eta^\top K(s, t)^\top) ds \\ &\quad - \int_{(t, T]^2} \text{tr}(\psi_t(s, u) K(u, t) \eta U \eta^\top K(s, t)^\top) ds du - 2r(t), \\ \phi_T &= 0, \end{cases} \quad (5.5.14)$$

where $\dot{\Lambda}_t$ is the integral operator induced by the kernel given by

$$\dot{\Lambda}_t(s, u) = -K(s, t) \eta U \eta^\top K(u, t)^\top, \quad u, s \leq T.$$

Lemma 5.5.2. Fix a kernel K as in Definition 5.5.2 satisfying (5.5.9). Assume that $(U - 2C^\top C) \in \mathbb{S}_+^N$. Let Ψ be the operator defined in (5.5.6). Then, the process (Γ, Z^1, Z^2) defined by

$$\begin{cases} \Gamma_t &= \exp(\phi_t + \langle g_t, \Psi_t g_t \rangle_{L^2}), \\ Z_t^1 &= 0, \\ Z_t^2 &= 2((\Psi_t K \eta)^* g_t)(t), \end{cases} \quad (5.5.15)$$

where g and ϕ are respectively given by (5.5.13) and (5.5.14), is a $\mathbb{S}_{\mathbb{F}}^\infty([0, T], \mathbb{R}) \times L_{\mathbb{F}}^2([0, T], \mathbb{R}^d) \times L_{\mathbb{F}}^2([0, T], \mathbb{R}^N)$ -valued solution to the Riccati-BSDE (5.3.2).

Proof. Set $G_t = \phi_t + \langle g_t, \Psi_t g_t \rangle_{L^2}$, so that $\Gamma_t = \exp(G_t)$ and

$$d\Gamma_t = \Gamma_t(dG_t + \frac{1}{2}d\langle G \rangle_t). \quad (5.5.16)$$

To obtain the dynamics of G it suffices to determine the dynamics of the process $t \mapsto \langle g_t, \Psi_t g_t \rangle_{L^2}$.

Step 1. In this step we prove that the dynamics of $t \mapsto \langle g_t, \Psi_t g_t \rangle_{L^2}$ is given by

$$d\langle g_t, \Psi_t g_t \rangle_{L^2} = \left(\langle g_t, \dot{\Psi}_t g_t \rangle_{L^2} + \lambda_t^\top \lambda_t + 2\lambda_t^\top C Z_t^2 + \text{Tr}(\Psi_t \dot{\Lambda}_t) \right) dt + (Z_t^2)^\top d\mathbb{W}_t. \quad (5.5.17)$$

We first note that

$$\langle g_t, \Psi_t g_t \rangle_{L^2} = \int_0^T g_t(s)^\top (\Psi_t g_t)(s) ds,$$

and compute the dynamics of $t \mapsto g_t(s)^\top (\Psi_t g_t)(s)$. For fixed $s \leq T$, it follows from (5.5.13) and the fact that $Y_t = g_t(t)$, that

$$dg_t(s) = -\delta_{t=s} g_t(t) dt + K(s, t) Dg_t(t) dt + K(s, t) \eta dW_t.$$

Together with Lemma 5.5.1-3, we deduce that $t \mapsto (\Psi_t g_t)(s)$ is a semimartingale with the following dynamics

$$\begin{aligned} d(\Psi_t g_t)(s) &= (\dot{\Psi}_t g_t)(s) dt + (\Psi_t dg_t)(s) \\ &= (\dot{\Psi}_t g_t)(s) dt - \psi_t(s, t) g_t(t) dt + (\Psi_t K(\cdot, t) Dg_t(t))(s) dt + (\Psi_t K(\cdot, t) \eta dW_t)(s). \end{aligned}$$

Here, we used the fact that $\text{Id} \delta_t = 0$: indeed, for every $f \in L^2([0, T], \mathbb{R}^d)$ we have $(\text{Id} \delta_t)(f) = (f(\cdot) \mathbf{1}_{t=\cdot}) = 0_{L^2}$. Moreover,

$$\begin{aligned} d\langle g(\cdot, s), (\Psi \cdot g)(s) \rangle_t &= -\text{tr}(\Theta^\top \Theta K(s, t) \eta U \eta^\top K(s, t)^\top) dt \\ &\quad + \int_t^T \text{tr}(\psi_t(s, u) K(u, t) \eta U \eta^\top K(s, t)^\top) du dt \\ &= \text{tr}(\Theta^\top \Theta \dot{\Lambda}_t(s, s)) dt - \int_t^T \text{tr}(\psi_t(s, u) \dot{\Lambda}_t(u, s)) du dt \\ &= -\text{tr}\left(\left(\Psi_t \dot{\Lambda}_t(\cdot, s)\right)(s)\right). \end{aligned}$$

Whence, combining the previous three identities, we get

$$\begin{aligned} d(g_t(s)^\top (\Psi_t g_t)(s)) &= dg_t(s)^\top (\Psi_t g_t)(s) + g_t(s)^\top d(\Psi_t g_t)(s) + d\langle g(\cdot, s), (\Psi \cdot g)(s) \rangle_t \\ &= -\delta_{t=s} g_t(t)^\top (\Psi_t g_t)(s) dt + g_t(t)^\top D^\top K(s, t)^\top (\Psi_t g_t)(s) dt \\ &\quad + g_t(s)^\top (\dot{\Psi}_t g_t)(s) dt - g_t(s)^\top \psi_t(s, t) g_t(t) dt + g_t(s)^\top (\Psi_t K(\cdot, t) Dg_t(t))(s) dt \\ &\quad - \text{tr}\left(\left(\Psi_t \dot{\Lambda}_t(\cdot, s)\right)(s)\right) \\ &\quad + dW_t^\top \eta^\top K(s, t)^\top (\Psi_t g_t)(s) + g_t(s)^\top (\Psi_t K(\cdot, t) \eta dW_t)(s) \\ &= \left[\mathbf{I}(s) + \mathbf{II}(s) + \mathbf{III}(s) + \mathbf{IV}(s) + \mathbf{V}(s) + \mathbf{VI}(s) \right] dt + \mathbf{VII}(s) + \mathbf{VIII}(s). \end{aligned}$$

We now integrate in s . First, using Lemma 5.5.1-1 we get that

$$\begin{aligned} \int_0^T [\mathbf{I}(s) + \mathbf{IV}(s)] ds &= -g_t(t)^\top (\Psi_t g_t)(t) - g_t(t)^\top \int_t^T \psi_t(t, u) g_t(u) du \\ &= \lambda_t^\top \lambda_t - 2g_t(t)^\top \int_t^T \psi_t(t, u) g_t(u) du \\ &= \lambda_t^\top \lambda_t - 2g_t(t)^\top ((\Psi_t + \Theta^\top \Theta \text{Id}) g_t)(t). \end{aligned}$$

On the other hand, since, $\Psi^* = \Psi$, we have

$$\int_0^T [\mathbf{II}(s) + \mathbf{V}(s)] ds = 2g_t(t)^\top \left(((\mathbf{KD})^* \Psi_t) g_t \right)(t).$$

Therefore, summing the above, using Lemma 5.5.1-2, and the definition of $\hat{\mathbf{K}}$, we get

$$\begin{aligned} \int_0^T [\mathbf{I}(s) + \mathbf{IV}(s) + \mathbf{II}(s) + \mathbf{V}(s)] ds &= \lambda_t^\top \lambda_t - 2g_t(t)^\top \left((\Psi_t + \Theta^\top \Theta \text{Id} - ((\mathbf{KD})^* \Psi_t) g_t) \right)(t) \\ &= \lambda_t^\top \lambda_t + 4g_t(t)^\top ((\mathbf{K} \eta C^\top \Theta)^* \Psi_t) g_t(t) \\ &= \lambda_t^\top \lambda_t + 2\lambda_t^\top C Z_t^2. \end{aligned}$$

Finally, observing that

$$\begin{aligned} \int_0^T \mathbf{III}(s) ds &= \langle g_t, \dot{\Psi}_t g_t \rangle_{L^2}, \quad \int_0^T \mathbf{VI}(s) ds = \text{Tr}(\Psi_t \dot{\Lambda}_t), \\ \int_0^T [\mathbf{VII}(s) + \mathbf{VIII}(s)] ds &= (Z_t^2)^\top dW_t, \end{aligned}$$

we obtain the claimed dynamics (5.5.17).

Step 2. Plugging the dynamics (5.5.17) in (5.5.16) yields

$$\begin{aligned} \frac{d\Gamma_t}{\Gamma_t} &= \underbrace{\left[\dot{\phi}_{t,T} - \text{Tr}(\Psi_t \dot{\Lambda}_t) \right]}_1 + \underbrace{\langle g_t, \dot{\Psi}_t g_t \rangle_{L^2} + \frac{(Z_t^2)^\top U Z_t^2}{2}}_2 + \underbrace{\lambda_t^\top \lambda_t + 2\lambda_t^\top C Z_t^2}_3 \\ &\quad + (Z_t^2)^\top dW_t. \end{aligned}$$

By (5.5.14), we have: $\mathbf{1} = -2r(t)$. From the definition of Z^2 , we have

$$\begin{aligned} \frac{(Z_t^2)^\top U Z_t^2}{2} &= 2 \left[\left((\Psi_t \mathbf{K} \eta)^* g_t \right)(t) \right]^\top U \left((\Psi_t \mathbf{K} \eta)^* g_t \right)(t) \\ &= -2 \langle g_t, (\Psi_t \dot{\Lambda}_t \Psi_t) g_t \rangle_{L^2}. \end{aligned}$$

Thus, using the Riccati relation (5.5.11), we get

$$\begin{aligned} \mathbf{2} &= \langle g_t, (\dot{\Psi}_t - \Psi_t \dot{\Lambda}_t \Psi_t) g_t \rangle_{L^2} = 4 \left[\left((\Psi_t \mathbf{K} \eta)^* g_t \right)(t) \right]^\top C^\top C \left((\Psi_t \mathbf{K} \eta)^* g_t \right)(t) \\ &= (Z_t^2)^\top C C^\top Z_t^2. \end{aligned}$$

Combining **1**, **2** and **3** yields

$$\frac{d\Gamma_t}{\Gamma_t} = \left(-2r(t) + |\lambda_t + Z_t^1 + C Z_t^2|^2 \right) dt + (Z_t^2)^\top dW_t.$$

This shows that (Γ, Z^1, Z^2) solves (5.3.2).

Step 3. It remains to check that $(\Gamma, Z^1, Z^2) \in \mathbb{S}_{\mathbb{F}}^{\infty}([0, T], \mathbb{R}) \times L_{\mathbb{F}}^2([0, T], \mathbb{R}^d) \times L_{\mathbb{F}}^2([0, T], \mathbb{R}^N)$. For this, observe that since Ψ is a nonpositive operator over $[0, T]$, we have the bound $0 < \Gamma_t \leq e^{\int_t^T 2r(s)ds}$. Finally, to show that $Z^2 \in L_{\mathbb{F}}^2([0, T], \mathbb{R}^d)$, it is enough to show that

$$\mathbb{E} \left[\int_0^T \left| \int_t^T K(s, t)^{\top} g_t(s) ds \right|^2 dt \right] < \infty,$$

and

$$\mathbb{E} \left[\int_0^T \left| \int_{(t, T]^2} K(v, t)^{\top} \psi_t(v, s) g_t(s) dv ds \right|^2 dt \right] < \infty.$$

This follows from the fact that K and ψ satisfy (5.5.1)-(5.5.10) respectively, and

$$\sup_{0 \leq t \leq s \leq T} \mathbb{E} [|g_t(s)|^2] \leq \sup_{s \leq T} |g_0(s)|^2 \left(1 + \sup_{s \leq T} \int_0^T |R_D(s, u)|^2 du \right) < \infty,$$

where R_D is the resolvent of KD . \square

From Theorem 6.3.1, we can now explicitly solve the Markowitz problem (5.2.6) in the quadratic Volterra model (5.5.2), (5.5.3) and (5.5.4), see Theorem 5.5.1 below. In order to verify condition (H2) of Theorem 6.3.1, we will first need the following lemma whose proof is postponed to Appendix 5.B.3.

Lemma 5.5.3. *Let the assumptions of Lemma 5.5.2 be in force. Assume $|D - 2\eta C^{\top} \Theta| \times \|K\|_{L^2([0, T]^2)}^2 < 1$, then*

$$|\lambda_s|^2 + |Z_s^1|^2 + |Z_s^2|^2 \leq \kappa(\Theta) \left(|g_s(s)|^2 + \int_0^T |g_s(u)|^2 du \right), \quad s \leq T, \quad \Theta \in \mathbb{R}^{d \times N} \quad (5.5.18)$$

where $\kappa(\Theta) = c|\Theta|^2(1 + |\Theta|^4 \hat{\kappa}(\Theta))$ with $c > 0$ independent of Θ and

$$\hat{\kappa}(\Theta) = \left(\frac{|f(\Theta)| \times \|K\|_{L^2([0, T]^2)}^2}{1 - |f(\Theta)| \times \|K\|_{L^2([0, T]^2)}^2} \right)^4.$$

Proof. See Appendix 5.B.3. \square

We now arrive to the main result of this section.

Theorem 5.5.1. *Fix a kernel K as in Definition 5.5.2 satisfying (5.5.9) and assume that $(U - 2C^{\top}C) \in \mathbb{S}_+^N$. Let $a(p)$ be as in (5.3.4) and κ the function defined in Lemma 5.5.3. Assume that there exists $\Theta \in \mathbb{R}^{d \times N}$ such that*

$$\mathbb{E} \left[\exp \left(a(p) \kappa(\Theta) \int_0^T (|g_s(s)|^2 + \int_0^T |g_s(u)|^2 du) ds \right) \right] < \infty, \quad (5.5.19)$$

for some $p > 2$. Assume that $g_0^i(0) > 0$ for some $i \leq d$. Then, the optimal investment strategy for the Markowitz problem (5.2.6) is given by the admissible control

$$\alpha_t^* = - \left((\Theta + 2C [\Psi_t K \eta]^*) g_t \right) (t) \left(X_t^{\alpha^*} - \xi^* e^{-\int_t^T r(s)ds} \right), \quad (5.5.20)$$

where ξ^* is defined in (6.5.6), and the optimal value is given by (6.5.7) with Γ_0 as in (5.5.15).

Proof. First note that under the specification (5.5.15), and $\lambda_t = \Theta Y_t = \Theta g_t(t)$, the candidate for the optimal feedback control defined in (5.3.5) takes the form

$$\begin{aligned}\alpha_t^* &= -(\lambda_t + Z_t^1 + CZ_t^2)(X_t^{\alpha^*} - \xi e^{-\int_t^T r(s)ds}) \\ &= \left((\Theta + 2C[\Psi_t \mathbf{K} \eta]^*) g_t \right)(t) (X_t^{\alpha^*} - \xi e^{-\int_t^T r(s)ds}).\end{aligned}$$

It thus suffices to check that the assumptions of Theorem 6.3.1 are verified to ensure that $\alpha^*(\xi^*)$ is optimal and to get that (6.5.7) is the optimal value. The existence of a solution triplet $(\Gamma, Z^1, Z^2) \in \mathbb{S}_{\mathbb{F}}^\infty([0, T], \mathbb{R}) \times L_{\mathbb{F}}^2([0, T], \mathbb{R}^d) \times L_{\mathbb{F}}^2([0, T], \mathbb{R}^N)$ to the stochastic backward Riccati equation (5.3.2) is ensured by Lemma 5.5.2. In addition, we have

$$\Gamma_0 = \mathbb{E} \left[e^{\int_0^T (2r(s) - |\lambda_s + Z_s^1 + CZ_s^2|^2) ds} \right] = \mathbb{E} \left[e^{\int_0^T [2r(s) - |((\Theta + 2C[\Psi_s \mathbf{K} \eta]^*) g_s)(s)|^2] ds} \right],$$

which implies that $\Gamma_0 < e^{2\int_0^T r(s)ds}$ since $g_0^i(0) > 0$ for some $i \leq d$ by assumption. Thus condition (H1) of Theorem 6.3.1 is verified. Condition (H2) follows directly from Lemma 5.5.3 and (5.5.19). The proof is complete. \square

The following lemma provides a general sufficient condition for the existence of Θ satisfying (5.5.19). Without loss of generality, we assume that $D = 0$ in (5.5.2).[‡] Define $Z(s, u) = (\frac{1}{T}g_s(s), g_s(u))^\top$ for any $s, u \in [0, T]$, which we view as a random variable in $L^2([0, T]^2, \mathbb{R}^{2N})$. Its mean is given by $\mu(s, u) = \mathbb{E}[Z(s, u)] = (\frac{1}{T}g_0(s), g_0(u))^\top$ and its covariance kernel by

$$\bar{\Sigma}((s, u), (t, r)) = \mathbb{E} \left[\left(Z(s, u) - \mathbb{E}(Z(s, u)) \right) \left(Z(t, r) - \mathbb{E}(Z(t, r)) \right)^\top \right], \quad s, u, t, r \in [0, T],$$

which is symmetric and nonnegative. It follows from assumption (5.5.1) that $\bar{\Sigma}$ is continuous on $[0, T]^4$ so that an application of Mercer's theorem, see [SW09, Theorem 1 p.208], yields the existence of a countable orthonormal basis $(e^n)_{n \geq 1}$ in $L^2([0, T]^2, \mathbb{R}^{2N})$ and a non increasing sequence of nonnegative numbers $(\lambda^n)_{n \geq 1}$, with $\lambda^n \rightarrow 0$, as $n \rightarrow \infty$, such that

$$\bar{\Sigma}((s, u), (t, r)) = \sum_{n \geq 1} \lambda^n e^n(s, u) e^n(t, r)^\top. \quad (5.5.21)$$

In addition, we observe by virtue of (5.5.1) that

$$\begin{aligned}\sum_{n \geq 1} \lambda^n &= \text{tr}(\bar{\Sigma}) = \frac{1}{T} \int_0^T \left(\int_0^s \text{tr} (K(s, z) \eta U \eta^\top K(s, z)^\top) dz \right) ds \\ &\quad + \int_0^T \left(\int_0^T \left(\int_0^u \text{tr} (K(s, z) \eta U \eta^\top K(s, z)^\top) dz \right) ds \right) du < \infty.\end{aligned} \quad (5.5.22)$$

Lemma 5.5.4. *Set $D = 0$. Let $a > 0$ be such that $2a < \frac{1}{\lambda^1}$. Then,*

$$\mathbb{E} \left[\exp \left(a \int_0^T (|g_s(s)|^2 + \int_0^T |g_s(u)|^2 du) ds \right) \right] < \infty.$$

In particular, (5.5.19) holds if $2a(p)\kappa(\Theta) < \frac{1}{\lambda^1}$ for some $p > 2$.

[‡]If $D \neq 0$, then making use of the resolvent kernel R_D of KD , we reduce to the case $D = 0$ as illustrated in (5.5.5) by working on the kernel $(K + R_D)$ instead of K .

Proof. We refer to Appendix 5.B.4. \square

Remark 5.5.3. In practice, as $\lambda_1 \leq \text{tr}(\bar{\Sigma})$, it follows from Lemma 5.5.4 and (5.5.22), that a sufficient condition for the existence of Θ satisfying (5.5.19) would be

$$2a(p)\kappa(\Theta) < \frac{1}{\text{tr}(\bar{\Sigma})}.$$

For instance, for the fractional convolution kernel $K(t, s) = \mathbf{1}_{s \leq t}(t - s)^{H-1/2}$, we have $\int_0^T \int_0^T |K(t, s)|^2 ds dt = T^{2H+1}$. Consequently $\text{tr}(\bar{\Sigma}) \geq \eta^2(T^{2H} + T^{2(H+1)})$ and the condition on Θ reads

$$\kappa(\Theta) \leq (2a(p)\eta^2(T^{2H} + T^{2(H+1)}))^{-1}.$$

The following corollary treats the standard Markovian and semimartingale case for $K = I_N$ and shows how to recover the well-known formulae in the spirit of [CW14].

Corollary 5.5.1. Set $K(t, s) = I_N \mathbf{1}_{s \leq t}$ and $g_0(t) \equiv Y_0$ for some $Y_0 \in \mathbb{R}^N$. Then, the solution to the Riccati BSDE can be re-written in the form

$$\Gamma_t = \exp(\phi_t + Y_t^\top P_t Y_t), \quad \text{and} \quad Z_t^2 = 2\eta^\top P_t Y_t, \quad (5.5.23)$$

where $P : [0, T] \mapsto \mathbb{R}^{N \times N}$ and ϕ solve the conventional system of $N \times N$ -matrix Riccati equations

$$\begin{cases} \dot{P}_t &= \Theta^\top \Theta + P_t(2\eta C^\top \Theta - D) + (2\eta C^\top \Theta - D)^\top P_t + 2P_t(\eta(U - 2C^\top C)\eta^\top)P_t, \\ P_T &= 0, \\ \dot{\phi}_t &= -2r(t) - \text{tr}(P_t \eta U \eta^\top), \quad t \in [0, T], \\ \phi_T &= 0. \end{cases}$$

Furthermore, the optimal control reads

$$\alpha_t^* = -\left(\Theta + 2C(D\eta)^\top P_t Y_t\right) \left(X_t^{\alpha^*} - \xi^* e^{-\int_t^T r(s) ds}\right). \quad (5.5.24)$$

Proof. For $K(t, s) = I_N \mathbf{1}_{s \leq t}$,

$$Y_s = Y_t + \int_t^s DY_u du + \int_t^s \eta dW_u, \quad s \geq t,$$

so that the adjusted forward process reads

$$g_t(s) = \mathbb{E}\left[Y_s - \int_t^s DY_u du \mid \mathcal{F}_t\right] = \mathbf{1}_{t \leq s} Y_t,$$

and the solution to the Riccati BSDE can be re-written in the form

$$\Gamma_t = \exp(\phi_t + \langle g_t, \Psi_t g_t \rangle_{L^2}) = \exp(\phi_t + Y_t^\top P_t Y_t),$$

where $P_t = \int_t^T (\Psi_t \mathbf{1}_t)(s) ds$ with the \mathbb{R}^N -valued indicator function $\mathbf{1}_t : (s) \mapsto (\mathbf{1}_{t \leq s}, \dots, \mathbf{1}_{t \leq s})^\top$. We now derive the equations satisfied by P and ϕ . First we have $K_T = 0$ and

$$\begin{aligned} \dot{P}_t &= -(\Psi_t \mathbf{1}_t)(t) + \int_t^T \frac{d(\Psi_t \mathbf{1}_t)(s)}{dt} ds \\ &= -(\Psi_t \mathbf{1}_t)(t) + \int_t^T (\dot{\Psi}_t \mathbf{1}_t)(s) ds - \int_t^T \psi_t(s, t) ds \\ &= \mathbf{1} + \mathbf{2} + \mathbf{3}. \end{aligned}$$

Using Lemma 5.5.1–2 and the expression $\hat{K}(s, u) = 1_{u \leq s}(D - 2\eta C^\top \Theta)$ we get

$$\mathbf{1} = (-\Theta^\top \Theta \text{Id} + \hat{\mathbf{K}}^* \Psi_t)(1)(t) = -\Theta^\top \Theta + (D - 2\eta C^\top \Theta)^\top P_t.$$

Furthermore, Lemma 5.5.1–3 and $\dot{\Sigma}_t(s, u) = 1_{t \leq s \wedge u} \eta(U - 2C^\top C) \eta^\top$ yield

$$\begin{aligned} \mathbf{2} &= \int_t^T (\dot{\Psi}_t 1_t)(s) ds = \int_t^T (\Psi_t \dot{\Sigma}_t \Psi_t 1_t)(s) ds \\ &= \left(\int_t^T (\Psi_t 1_t)(s) ds \right) \eta(U - 2C^\top C) \eta^\top \left(\int_t^T (\Psi_t 1_t)(s) ds \right) \\ &= P_t (\eta(U - 2C^\top C) \eta^\top) P_t. \end{aligned}$$

Moreover, by using Lemma 5.5.1–1–2, we obtain

$$\mathbf{3} = - \int_t^T \psi_t(s, t) ds = -(\Psi_t + \Theta^\top \Theta \text{id})^*(1_t) = -(\hat{\mathbf{K}}^* \Psi_t)^*(1)(t) = -P_t (D - 2\eta C^\top \Theta).$$

This proves the equation for P , and that of ϕ is immediate. Finally to prove the formula of Z^2 in (5.5.23) and α^* in (5.5.24) it suffices to observe the following identity

$$((\Psi_t \mathbf{K} \eta)^* g_t)(t) = \eta^\top P_t Y_t.$$

□

5.6 Numerical experiment: rough Stein-Stein for two assets

We illustrate the results of Section 5.5 on a special case of the two dimensional rough Stein-Stein model as described in Example 5.5.1. We consider a four dimensional Brownian motion $(B^1, B^2, B^{1,\perp}, B^{2,\perp})$, and define

$$\tilde{B}^1 = B^1, \quad \tilde{B}^2 = \rho B^1 + \sqrt{1 - \rho^2} B^2, \quad W^i = c_i \tilde{B}^i + \sqrt{1 - c_i^2} \tilde{B}^{\perp, i},$$

for some $\rho \in [-1, 1]$, and $c_i \in [-1, 1]$, $i = 1, 2$.

For simplicity we set $r \equiv 0$, and consider two stocks of price process S^1 and S^2 with the following dynamics[§]

$$\begin{cases} dS_t^i &= S_t^i \theta_i (Y_t^i)^2 dt + S_t^i Y_t^i d\tilde{B}_t^i, \\ Y_t^i &= Y_0^i + \frac{1}{\Gamma(H_i + 1/2)} \int_0^t (t-s)^{H_i - 1/2} \eta_i dW_s^i, \quad i = 1, 2, \end{cases}$$

with $H^i > 0$, $\eta_i, \theta_i \geq 0$ and $Y_0^i \in \mathbb{R}$.

Although the framework of Section 5.5 allows for a more general correlation structure for the Brownian motion, the model is already rich enough to capture the following stylized facts:

- the two stocks S^i , $i = 1, 2$, are correlated through ρ ,
- each stock S^i has a stochastic rough volatility $|Y^i|$ with possibly different Hurst indices H_i ,

[§]This corresponds to Example 5.5.1-(i) with $(\beta_{11}, \beta_{12}, \beta_{21}, \beta_{22}) = (1, 0, \rho, \sqrt{1 - \rho^2})$ and $\Theta = \beta^{-1} \text{diag}(\theta_1, \theta_2)$.

- each stock S^i is correlated with its own volatility process through c_i to take into account the leverage effect.

Our main motivation for considering the multivariate rough Stein-Stein model is to study the ‘buy rough sell smooth’ strategy of [GH20b] that was backtested empirically: this strategy consisting in buying the roughest assets while shorting on the smoothest ones was shown to be profitable. We point out that the numerical simulations for the one dimensional rough Heston model carried in [HW20a] by varying the Hurst index H could not provide much insight on such strategy, apart from suggesting that the vol-of-vol has a possible impact on the ‘buy rough sell smooth strategy’. Our quadratic multivariate framework allows for more flexible simulations, with a richer correlation structure compared to multivariate extensions of the rough Heston model, recall Remark 5.5.1. Our results below provide new insights on the strategy by showing that the correlation between stocks plays a key role.

Our present goal is to illustrate the influence of some parameters, namely the horizon T , the vol-of-vol η and the correlation ρ between the stocks, onto the optimal investment strategy when two assets, one rough and one smooth with $H_1 < H_2$, are at stakes. To ease comparison, we set $c_1 = c_2 = -0.7$ for the leverage effects, $Y_0^1 = Y_0^2$ and we normalize the vol-of-vols by setting $\eta_1 = \eta_2$. We consider the evolution of optimal vector of amount invested into each stock, i.e., $t \mapsto \pi_t^*$ (recall that $\alpha_t^* = \sigma_t^\top \pi_t^*$ with $\sigma = \text{diag}(Y^1, Y^2)\beta$ and α^* is given by (5.5.20)). π being a stochastic process, we also consider the deterministic function $t \mapsto ((\Theta + 2C[\Psi_t \mathbf{K} \eta]^*)Y_0)(t)(\xi^*)$, where ξ^* is defined in (6.5.6), to help us in our analysis.

For our implementation of α^* given by (5.5.20), we discretize in time the operators acting on L^2 , so that the kernel of the operator Ψ in (5.5.6) is approximated by a finite dimensional matrix (see for instance [AJ19b, Section 2.3] for a similar procedure) and the Gaussian process $(g_t(s))_{t \leq s \leq T}$ defined in (5.5.13) is simulated by Cholesky’s decomposition algorithm. We refer to the following [url](#) for the full code and additional simulations.

Our observations from the simulations are the following.

1. Horizon T : With the goal of understanding the effect of the horizon T on the investment strategy, we fix all parameters but T with $\rho = 0$. The results are illustrated on Figures 6.5a-6.5b-5.1c and 5.2a-5.2b-5.2c. We can distinguish 3 regimes:

- $T \ll 1$: When the investment horizon is close to the end, the rough asset is overweighted over the smooth one.
- $T \approx 1$: A transition appears, as the smooth asset is first overweighted and then the rough asset becomes overweighted as we approach the final horizon.
- $T \gg 1$: The smooth asset is overweighted all along the experiment, letting its first position only when the maturity is close, suggesting that the transition point becomes closer to T as T grows.

One possible interpretation of this transition is the following. Rough processes are more volatile than smooth processes in the short term but less volatile in the long term, since their variances evolve approximately as t^{2H} . Thus, when there is not much time left, it seems natural to look for rough processes to obtain some performance. Conversely, the more time we have, the more we favor the smooth asset.

2. Vol-of-vol η : The volatility of volatility seems to have the opposite effect of the horizon T over the investment strategy as shown on Figures 5.3a-5.3b.

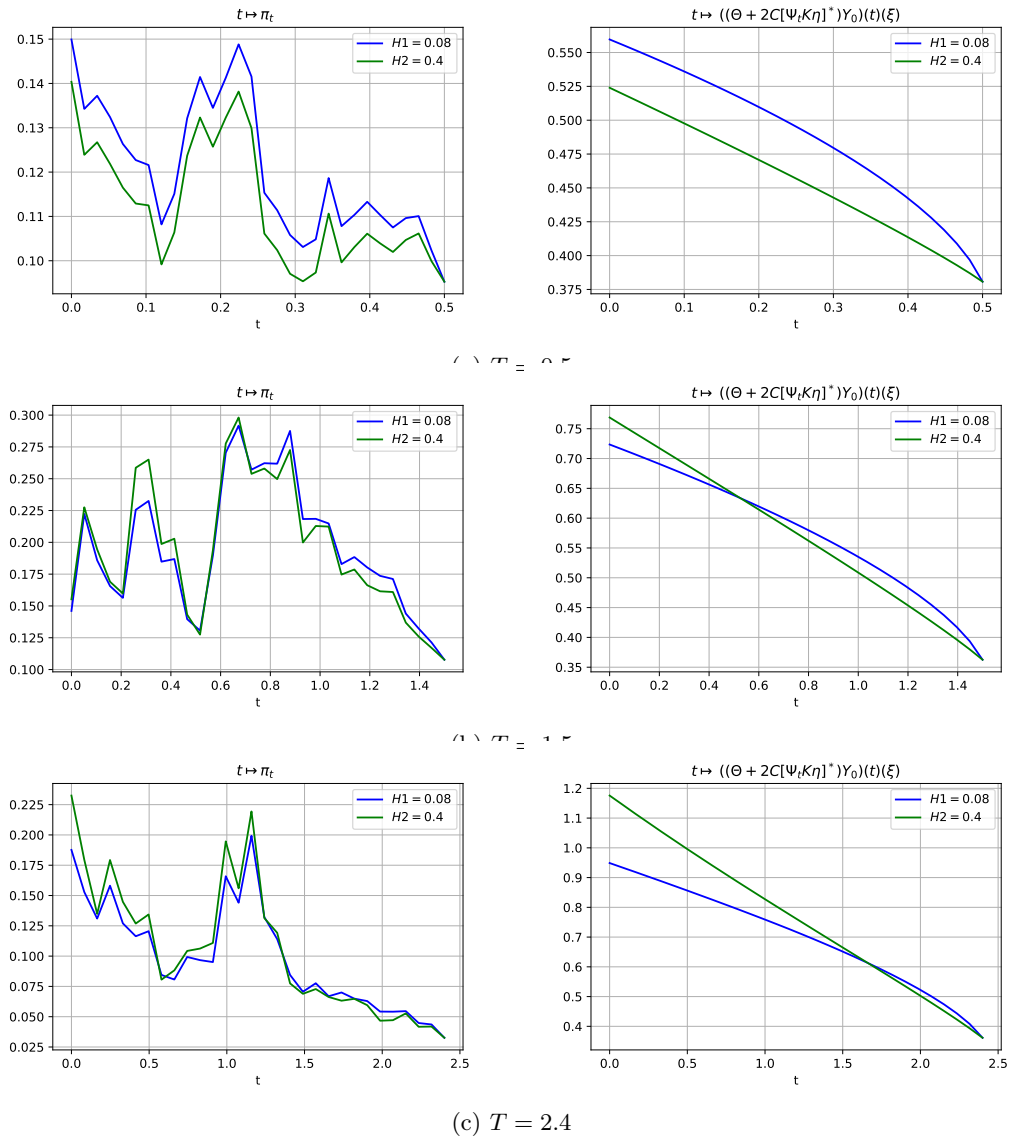

Figure 5.1 – Effect of the horizon T on the optimal allocation strategy. When the horizon T approaches, the rough stock in blue is preferred. When T is big enough and the horizon far enough the smooth stock in green is preferred. (The parameters are: $H_1 = 0.08$, $H_2 = 0.4$, $\rho = 0$, $\eta_1 = \eta_2 = 1$, $c_i = -0.7$.)

- $\eta \ll 1$: The smooth asset and then the rough asset are successively overweighted.
- $\eta \gg 1$: The rough asset is overweighted.

It is quite natural to expect the vol-of-vol to have an inverse effect when compared to the horizon T , since increasing the vol-of-vol is similar to accelerating the time scale at a certain rate depending on H (think of the self-similarity property of fractional Brownian motion).

3. Correlation ρ :

5.6. Numerical experiment: rough Stein-Stein for two assets

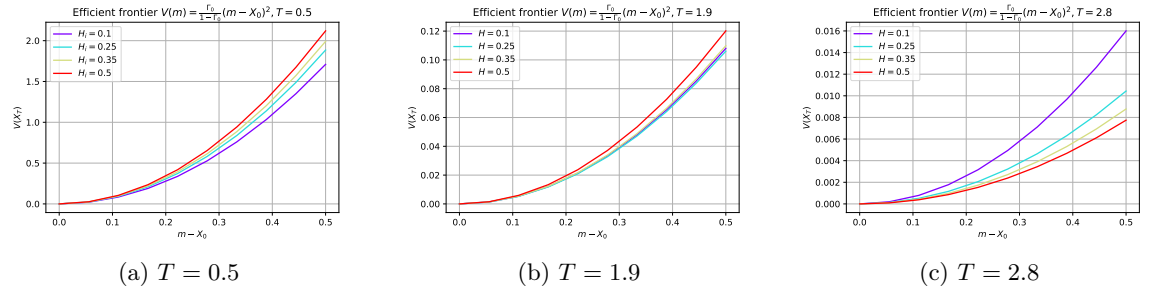

Figure 5.2 – The efficient frontier in the case where both assets have the same roughness $H_1 = H_2 = H$. When the horizon T is small, the rough stocks allows for lower variance. When T increases we observe a transition and an inversion of the relation order. Indeed, when T increases, it is the smoothest stocks that allow for a lower variance.

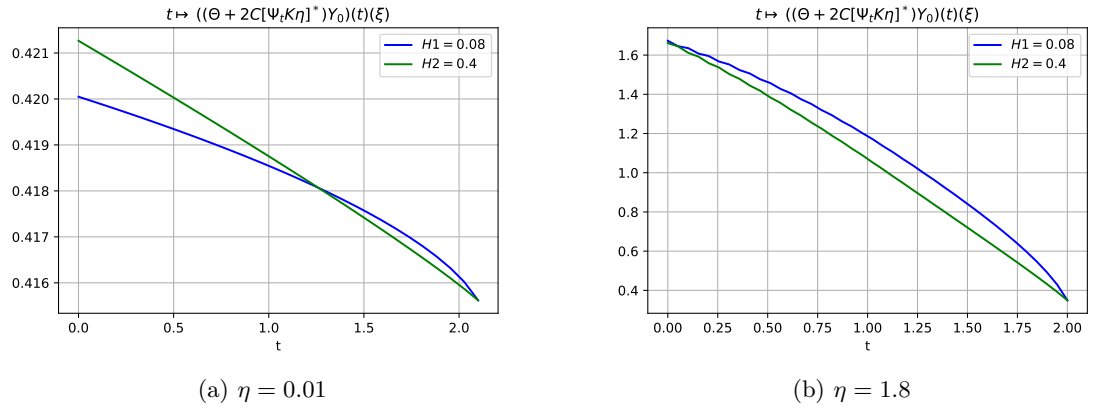

Figure 5.3 – As the vol-of-vol η increases, it is as if the horizon T was decreasing and the rough stock in blue begins to be preferred. $H_1 = 0.08$, $H_2 = 0.4$, $T = 2.1$, $\rho = 0$, $c_i = -0.7$.

- $\rho < 0$: In the case of negatively correlated assets it is natural to expect the following strategy : pick both assets in order to be protected from volatility and benefit from the drift. So we expect the case $\rho < 0$ to be similar from $\rho = 0$ except that the transition from $T \ll 1$ to $T \gg 1$ should appear at a greater T . This is what we observe on Figures 5.5a-5.5b-5.5c. We interpret this evolution towards the equally weighted portfolio as the possibility to be protected from volatility by holding both assets.
- $\rho > 0$: when the two stocks are positively correlated with $\rho > 0$, there is no minimization of variance through diversification by going long in both assets. Thus in the case a positively correlated assets, it is natural to expect the emergence of a starker choice between the assets. In the $\rho > 0$ case, see Figures ??-??, we observe a *buy rough sell smooth* strategy as the one empirically found in [GH20b].

As a further line of research, we see two interesting paths :

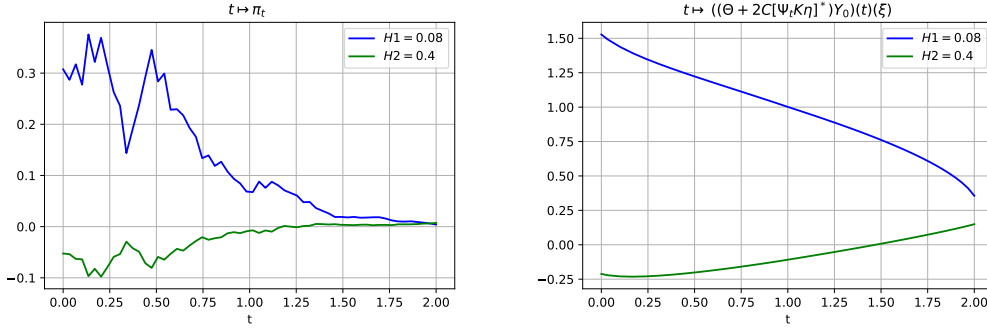

Figure 5.4 – $\rho = 0.7$, when the two assets are positively correlated we recover *the buy rough sell smooth* strategy as it is described in [GH20b]. (the parameters are: $H_1 = 0.08$, $H_2 = 0.4$, $T = 2.1$, $\eta_1 = \eta_2 = 1$, $c_i = -0.7$.)

- A theoretical study of influence of the parameters onto the investments strategies.
- An empirical study testing the different conjectures made about the influence of some parameters such as T, η, ρ, H , etc.

Our numerical results extend to larger horizon T . For instance, in Figure 5.6, we took a maturity of $T = 20$ years, although we noted that a smaller $\eta = 0.1$ had to be chosen to avoid any blow-up, in accordance with Remark 5.5.3.

5.A Proof of the verification result

In this section, we provide a detailed proof of Theorem 6.3.1. It is well-known that Markowitz problem (5.2.6) is equivalent to the following max-min problem, see e.g. [Pha09, Proposition 6.6.5]:

$$V(m) = \max_{\eta \in \mathbb{R}} \min_{\alpha \in \mathcal{A}} \left\{ \mathbb{E} \left[|X_T^\alpha - (m - \eta)|^2 \right] - \eta^2 \right\}. \quad (5.A.1)$$

Thus, solving problem (5.2.6) involves two steps. First, the internal minimization problem in term of the Lagrange multiplier η has to be solved. Second, the optimal value of η for the external maximization problem has to be determined. Let us then introduce the inner optimization problem:

$$\tilde{V}(\xi) := \min_{\alpha \in \mathcal{A}} \mathbb{E} \left[|X_T^\alpha - \xi|^2 \right], \quad \xi \in \mathbb{R}. \quad (5.A.2)$$

First, we provide a verification result for the inner optimization problem (5.A.2) via the standard completion of squares technique, see for instance [LZ02, Proposition 3.1], [Lim04, Proposition 3.3] and [CW14, Theorem 3.1].

Lemma 5.A.1. *Assume there exists a solution triplet $(\Gamma, Z^1, Z^2) \in \mathbb{S}_{\mathbb{F}}^\infty([0, T], \mathbb{R}) \times L_{\mathbb{F}}^{2,loc}([0, T], \mathbb{R}^d) \times L_{\mathbb{F}}^{2,loc}([0, T], \mathbb{R}^N)$ to the Riccati BSDE (5.3.2) such that $\Gamma_t > 0$, for all $t \leq T$. Fix $\xi \in \mathbb{R}$, and assume that there exists an admissible control $\alpha^*(\xi)$ satisfying*

$$\alpha_t^*(\xi) = - \left(\lambda_t + Z_t^1 + CZ_t^2 \right) \left(X_t^{\alpha^*(\xi)} - \xi e^{-\int_t^T r(s)ds} \right), \quad 0 \leq t \leq T. \quad (5.A.3)$$

Then, the inner minimization problem (5.A.2) admits $\alpha^(\xi)$ as an optimal feedback control and the optimal value is*

$$\tilde{V}(\xi) = \Gamma_0 \left| x_0 - \xi e^{-\int_0^T r(s)ds} \right|^2. \quad (5.A.4)$$

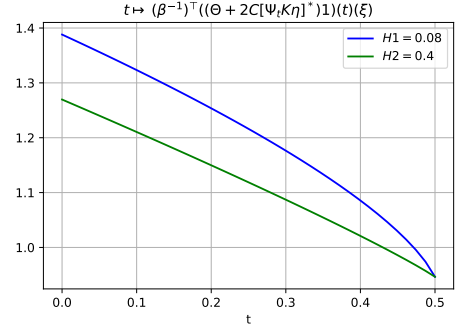
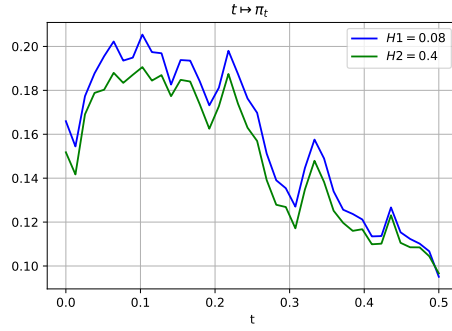

(a) $T = 0.5$

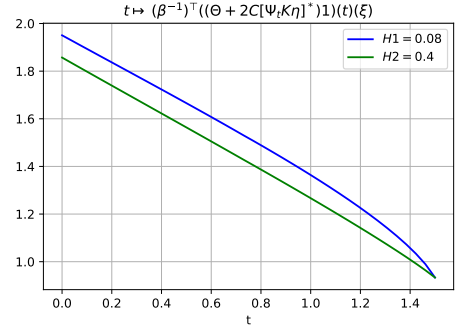
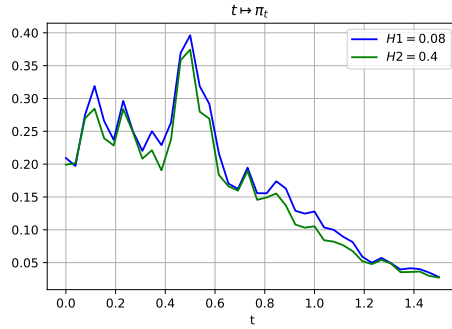

(b) $T = 1.5$

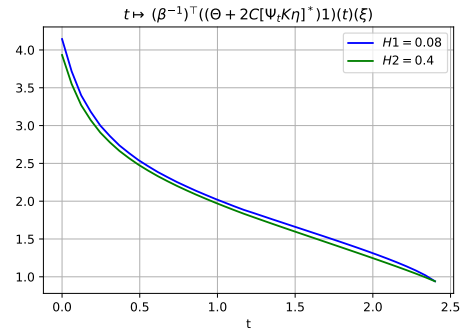
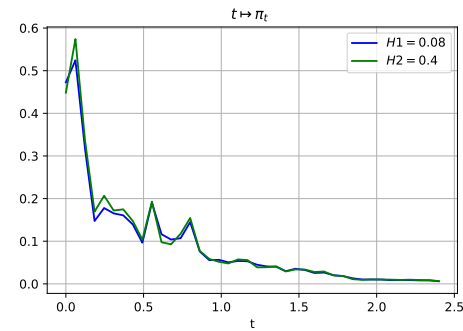

(c) $T = 2.4$

Figure 5.5 – Effect of the horizon T on the optimal allocation strategy when the two assets are negatively correlated ($\rho = -0.4$), $H_1 = 0.08$, $H_2 = 0.4$. As T increases the smooth stock in green is more and more weighted in comparison to the rough one in blue. But the transition takes more time compared to the case $\rho = 0$, see Figures 6.5a-5.1c. $\eta_1 = \eta_2 = 1, c_i = -0.7$. Note the beginning of the blow-up when T reaches $T = 2.4$, as it could be foreseen by the condition of Lemma 5.5.4.

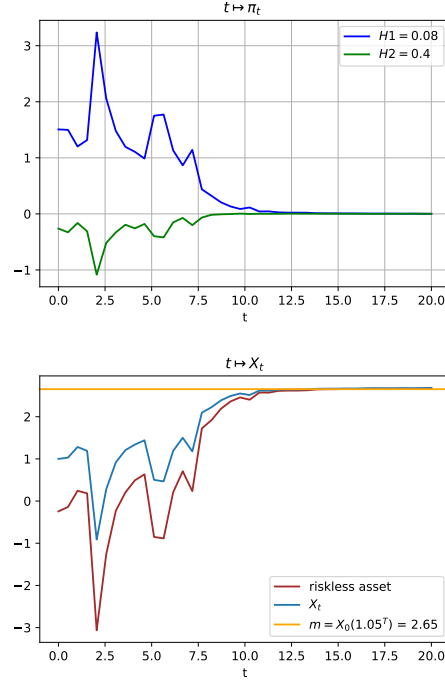

Figure 5.6 – Simulation for a larger horizon $T = 20$ years. Note that a smaller η had to be chosen in accordance with Remark 5.5.3. (The parameters are: $H_1 = 0.08$, $H_2 = 0.4$, $\rho = 0$, $\eta_1 = \eta_2 = 0.1$, $c_i = -0.7$.)

Proof. Let us first define $\tilde{X}_t^\alpha = X_t^\alpha - \xi e^{-\int_t^T r(s)ds}$, for any $\alpha \in \mathcal{A}$. Then, by Itô's lemma we have

$$d\tilde{X}_t^\alpha = (r(t)\tilde{X}_t^\alpha + \alpha_t^\top \lambda_t)dt + \alpha_t^\top dB_t, \quad 0 \leq t \leq T, \quad \tilde{X}_0^\alpha = x_0 - \xi e^{-\int_0^T r(s)ds}.$$

As a result, \tilde{X}^α and X^α have the same dynamics and $\tilde{X}_T^\alpha = X_T^\alpha - \xi$ so that problem (5.A.2) can be alternatively written as

$$\min_{\alpha \in \mathcal{A}} \mathbb{E} \left[|\tilde{X}_T^\alpha|^2 \right].$$

To ease notations, we set $h_t = \lambda_t + Z_t^1 + CZ_t^2$. For any $\alpha \in \mathcal{A}$, Itô's lemma combined with (5.3.2) and a completion of squares in α yield

$$\begin{aligned} d\left(\Gamma_t |\tilde{X}_t^\alpha|^2\right) &= |\tilde{X}_t^\alpha|^2 \Gamma_t (-2r(t) + h_t^\top h_t)dt + \Gamma_t |\tilde{X}_t^\alpha|^2 \left((Z_t^1)^\top dB_t + (Z_t^2)^\top dW_t \right) \\ &\quad + \Gamma_t \left(2\tilde{X}_t^\alpha (r(t)\tilde{X}_t^\alpha + \alpha_t^\top \lambda_t) + \alpha_t^\top \alpha_t \right) dt + 2\Gamma_t \tilde{X}_t^\alpha \alpha_t^\top dB_t \\ &\quad + 2\alpha_t^\top (Z_t^1 + CZ_t^2) \tilde{X}_t^\alpha dt \\ &= (\alpha_t + h_t \tilde{X}_t^\alpha)^\top \Gamma_t (\alpha_t + h_t \tilde{X}_t^\alpha) dt \\ &\quad + 2\Gamma_t \tilde{X}_t^\alpha \alpha_t^\top dB_t + \Gamma_t |\tilde{X}_t^\alpha|^2 \left((Z_t^1)^\top dB_t + (Z_t^2)^\top dW_t \right). \end{aligned}$$

As a consequence, using $\Gamma_T = 1$, we get

$$\begin{aligned} |\tilde{X}_T^\alpha|^2 &= \Gamma_0 |\tilde{X}_0^\alpha|^2 + \int_0^T (\alpha_s + h_s \tilde{X}_s^\alpha)^\top \Gamma_s (\alpha_s + h_s \tilde{X}_s^\alpha) ds \\ &\quad + \int_0^T 2\Gamma_s \tilde{X}_s^\alpha \alpha_s^\top dB_s + \int_0^T 2\Gamma_s |\tilde{X}_s^\alpha|^2 \left((Z_s^1)^\top dB_s + (Z_s^2)^\top dW_s \right). \end{aligned}$$

Note that the stochastic integrals

$$\int_0^\cdot 2\Gamma_s \tilde{X}_s^\alpha \alpha_s^\top dB_s, \quad \int_0^\cdot \Gamma_s |\tilde{X}_s^\alpha|^2 (Z_s^1)^\top dB_s, \quad \int_0^\cdot \Gamma_s (\tilde{X}_s^\alpha)^2 (Z_s^2)^\top dW_s,$$

are well-defined since X^α is continuous, (α, Z^1, Z^2) are in $L_{\mathbb{F}}^{2,loc}([0, T])$ and Γ in $\mathbb{S}_{\mathbb{F}}^\infty([0, T], \mathbb{R})$. Furthermore, they are local martingales. Let $\{\tau_k\}_{k \geq 1}$ be a common localizing increasing sequence of stopping times converging to T . Then,

$$\mathbb{E} \left[|\tilde{X}_{T \wedge \tau_k}^\alpha|^2 \right] = \Gamma_0 |\tilde{X}_0^\alpha|^2 + \mathbb{E} \left[\int_0^{T \wedge \tau_k} (\alpha_s + h_s \tilde{X}_s^\alpha)^\top \Gamma_s (\alpha_s + h_s \tilde{X}_s^\alpha) ds \right].$$

Since $\alpha \in \mathcal{A}$, X^α satisfies (5.2.5), and so $\mathbb{E} \left[\sup_{t \leq T} |\tilde{X}_t^\alpha|^2 \right] < \infty$. An application of the dominated convergence theorem on the left term combined with the monotone convergence theorem on the right term, recall that Γ is \mathbb{S}_+^d -valued, yields, as $k \rightarrow \infty$,

$$\mathbb{E} \left[|\tilde{X}_T^\alpha|^2 \right] = \Gamma_0 |\tilde{X}_0^\alpha|^2 + \mathbb{E} \left[\int_0^T (\alpha_s + h_s \tilde{X}_s^\alpha)^\top \Gamma_s (\alpha_s + h_s \tilde{X}_s^\alpha) ds \right].$$

Since Γ_s is positive definite for any $s \leq T$, we obtain that the optimal strategy $\alpha^*(\xi)$ is given by (6.5.4) and the optimal value of (5.A.2) is equal to

$$\tilde{V}(\xi) = \Gamma_0 |\tilde{X}_0^{\alpha^*(\xi)}|^2 = \Gamma_0 |X_0 - \xi e^{-\int_0^T r(s) ds}|^2,$$

which gives (5.A.4). \square

We next address the admissibility of the candidate for the optimal control.

Lemma 5.A.2. *Assume that there exists a solution triplet $(\Gamma, Z^1, Z^2) \in \mathbb{S}_{\mathbb{F}}^\infty([0, T], \mathbb{R}) \times L_{\mathbb{F}}^{2,loc}([0, T], \mathbb{R}^d) \times L_{\mathbb{F}}^{2,loc}([0, T], \mathbb{R}^N)$ to the Riccati BSDE (5.3.2) such that (5.3.3) holds for some $p > 2$ and a constant $a(p)$ given by (5.3.4). Then, for any $\xi \in \mathbb{R}$, there exists an admissible control process $\alpha^*(\xi)$ satisfying (6.5.4).*

Proof. Fix $\xi \in \mathbb{R}$. We first prove that there exists a control $\alpha^*(\xi)$ satisfying (6.5.4). For this, we prove that the corresponding wealth equation (5.2.4) admits a solution. As in the proof of Lemma 5.A.1, it is enough to consider the modified equation

$$d\tilde{X}_t^* = (r(t)\tilde{X}_t^* + \lambda_t^\top A_t \tilde{X}_t^*) dt + (A_t \tilde{X}_t^*)^\top dB_t, \quad \tilde{X}_0^* = x_0 - \xi e^{-\int_0^T r(s) ds},$$

where $A_t = -(\lambda_t + Z_t^1 + CZ_t^2)$, and then set $X_t^* = \tilde{X}_t^* + \xi e^{-\int_t^T r(s) ds}$. By virtue of Itô's lemma the unique continuous solution is given by

$$\tilde{X}_t^* = \tilde{X}_0^* \exp \left(\int_0^t (r(s) + \lambda_s^\top A_s - \frac{A_s^\top A_s}{2}) ds + \int_0^t A_s^\top dB_s \right).$$

Setting $\alpha_t^*(\xi) := A_t \tilde{X}_t^*$, we obtain that $\alpha^*(\xi)$ satisfies (6.5.4) with the controlled wealth $X^{\alpha^*(\xi)*} = X^*$. The crucial step is now to obtain the admissibility condition (5.2.5).

For that purpose, observe by virtue of (5.3.3), that the Doléans-Dade exponential $\mathcal{E}(\int_0^\cdot A_s^\top dB_s)$ satisfies Novikov's condition, and is therefore a true martingale. Whence, successive applications of the inequality $ab \leq (a^2 + b^2)/2$ and Doob's maximal inequality yield, for some constant $K > 0$ which may vary from line to line,

$$\begin{aligned} \mathbb{E} \left[\sup_{t \in [0, T]} |\tilde{X}_t^*|^p \right] &\leq K \mathbb{E} \left[\sup_{t \in [0, T]} \left| e^{\int_0^t (r(s) + \lambda_s^\top A_s) ds} \right|^{2p} \right] + K \mathbb{E} \left[\sup_{t \in [0, T]} \left| e^{-\int_0^t \frac{A_s^\top A_s}{2} ds + \int_0^t A_s^\top dB_s} \right|^{2p} \right] \\ &\leq K \mathbb{E} \left[e^{\int_0^T 2p |\lambda_s^\top A_s| ds} \right] + K \mathbb{E} \left[e^{-p \int_0^T A_s^\top A_s ds + 2p \int_0^T A_s^\top dB_s} \right] \\ &= K (\mathbf{1} + \mathbf{2}), \end{aligned}$$

which is finite since

$$\mathbf{1} \leq \mathbb{E} \left[\exp \left(a(p) \int_0^T (|\lambda_s|^2 + |Z_s^1|^2 + |Z_s^2|^2) ds \right) \right] < \infty,$$

and, by virtue of the Cauchy-Schwarz inequality,

$$\begin{aligned} \mathbf{2} &\leq \left(\mathbb{E} \left[e^{(8p^2 - 2p) \int_0^T A_s^\top A_s ds} \right] \right)^{1/2} \left(\mathbb{E} \left[e^{-8p^2 \int_0^T A_s^\top A_s ds + 4p \int_0^T A_s^\top dB_s} \right] \right)^{1/2} \\ &\leq \left(\mathbb{E} \left[e^{a(p) \int_0^T (|\lambda_s|^2 + |Z_s^1|^2 + |Z_s^2|^2) ds} \right] \right)^{1/2} \times 1 < \infty, \end{aligned}$$

where we used Jensen's inequality to bound

$$A_s^\top A_s = |\lambda_s + Z_s^1 + CZ_s^2|^2 \leq 3(|\lambda_s|^2 + |Z_s^1|^2 + |CZ_s^2|^2) \leq 3(1 + |C|^2)(|\lambda_s|^2 + |Z_s^1|^2 + |Z_s^2|^2),$$

together with assumption (H2) and Novikov's condition to the Doléans-Dade exponential $\mathcal{E}(4p \int_0^\cdot A_s^\top dB_s)$. Finally, to get that $\alpha^*(\xi)$ is admissible, we are left to prove that $\alpha^*(\xi) \in L_{\mathbb{F}}^2([0, T], \mathbb{R}^d)$. Let $2/p + 1/\hat{q} = 1$, by Hölder's inequality we obtain

$$\begin{aligned} \mathbb{E} \left[\int_0^T |\alpha_s^*(\xi)|^2 ds \right] &= \mathbb{E} \left[\int_0^T |A_s \tilde{X}_s^*|^2 ds \right] \\ &\leq \mathbb{E} \left[\sup_{t \in [0, T]} |\tilde{X}_t^*|^2 \int_0^T |A_s|^2 ds \right] \\ &\leq \left(\mathbb{E} \left[\sup_{t \in [0, T]} |\tilde{X}_t^*|^p \right] \right)^{2/p} \left(\mathbb{E} \left[\left(\int_0^T |A_s|^2 ds \right)^{\hat{q}} \right] \right)^{1/\hat{q}} \\ &\leq C \left(\mathbb{E} \left[\sup_{t \in [0, T]} |\tilde{X}_t^*|^p \right] \right)^{2/p} \left(\mathbb{E} \left[\left(\int_0^T (|\lambda_s|^2 + |Z_s^1|^2 + |Z_s^2|^2) ds \right)^{\hat{q}} \right] \right)^{1/\hat{q}} \\ &< \infty, \end{aligned}$$

where the last term is finite due to condition (5.3.3) and the inequality $|z|^q \leq c_q e^{|z|}$. The proof is complete. \square

Finally, combining the above, we deduce the solution for the outer optimization problem (5.2.6) under a non-degeneracy condition on the solution Γ to the Riccati BSDE, yielding Theorem 6.3.1.

Proof of Theorem 6.3.1. From Lemmas 5.A.1 and 5.A.2, we have that the max-min problem (6.5.2) (which is equivalent to the Markowitz problem (5.2.6)) is equivalent to

$$\max_{\eta \in \mathbb{R}} J(\eta), \quad \text{with } J(\eta) = \Gamma_0 |X_0 - (m - \eta)e^{-\int_0^T r(s)ds}|^2 - \eta^2.$$

Furthermore, condition (H1): $\Gamma_0 < e^{2\int_0^T r(s)ds}$, ensures that the quadratic function J is strictly concave. This yields that the maximum is achieved from the first-order condition $J'(\eta^*) = 0$, which gives

$$\eta^* = \frac{\Gamma_0 e^{-\int_0^T r(s)ds} \left(x_0 - m e^{-\int_0^T r(s)ds} \right)}{1 - \Gamma_0 e^{-2\int_0^T r(s)ds}},$$

and thus $\xi^* = m - \eta^*$ is given by (6.5.6). We conclude that the optimal control is equal to $\alpha^* = \alpha^*(\xi^*)$ as in (5.3.5), and by (6.5.2), the optimal value of (5.2.6) is equal to $V(m) = \tilde{V}(\xi^*) - (\eta^*)^2$, given by (6.5.7). \square

5.B Proofs of some technical lemmas

5.B.1 Reminder on resolvents of integral operators

Lemma 5.B.1. *Let K satisfy (5.5.1) and $L \in L^2([0, T]^2, \mathbb{R}^{N \times N})$. Then, $K \star L$ satisfies (5.5.1). Furthermore, if L satisfies (5.5.1), then, $(s, u) \mapsto (K \star L^*)(s, u)$ is continuous.*

Proof. An application of the Cauchy-Schwarz inequality yields the first part. The second part follows along the same lines as in the proof of [AJ19b, Lemma 3.2]. \square

For a kernel $K \in L^2([0, T]^2, \mathbb{R}^{N \times N})$, we define its resolvent $R_T \in L^2([0, T]^2, \mathbb{R}^{N \times N})$ by the unique solution to

$$R_T = K + K \star R_T, \quad K \star R_T = R_T \star K. \quad (5.B.1)$$

In terms of integral operators, this translates into

$$\mathbf{R}_T = \mathbf{K} + \mathbf{K} \mathbf{R}_T, \quad \mathbf{K} \mathbf{R}_T = \mathbf{R}_T \mathbf{K}.$$

In particular, if K admits a resolvent, $(\text{Id} - \mathbf{K})$ is invertible and

$$(\text{Id} - \mathbf{K})^{-1} = \text{Id} + \mathbf{R}_T, \quad (5.B.2)$$

where Id denotes the identity operator, i.e. $(\text{Id}f) = f$ for all $f \in L^2([0, T], \mathbb{R}^N)$.

The following lemma establishes the existence of resolvents for the two classes of kernels introduced above.

Lemma 5.B.2. *Let $K \in L^2([0, T]^2, \mathbb{R}^{N \times N})$. K admits a resolvent if either one of the following conditions hold:*

1. *K is a Volterra kernel of continuous and bounded type in L^2 in the sense of Definition 5.5.2. In this case, the resolvent is again a Volterra kernel of continuous and bounded type.*
2. *K is symmetric nonpositive in the sense of Definition 5.5.1 and $(s, u) \mapsto K(s, u)$ is continuous.*

Proof. 1 follows from [GLS90, Lemma 9.3.3, Theorem 9.5.5(i)]. 2 follows from an application of Mercer's theorem, see [AJ19b, Section 2.1]. \square

5.B.2 Proof of Lemma 5.5.1

Fix $t \leq T$. We start by proving that Ψ_t is well defined and is a bounded linear operator from $L^2([0, T], \mathbb{R}^N)$ to $L^2([0, T], \mathbb{R}^N)$. First, since K is a Volterra kernel of continuous and bounded type in L^2 , so is \hat{K} , and Lemma 5.B.2-1 yields the existence of its resolvent \hat{R} such that

$$\sup_{s \leq T} \int_0^T |\hat{R}(s, u)| ds < \infty, \quad \sup_{u \leq T} \int_0^T |\hat{R}(s, u)| du < \infty. \quad (5.B.3)$$

In particular, denoting by \hat{R} the integral operator induced by \hat{R} , we obtain that $(\text{Id} - \hat{K})$ is invertible with an inverse given by $(\text{Id} - \hat{K})^{-1} = \text{Id} + \hat{R}$, recall (5.B.2). Next, we prove that $(\text{Id} + 2\Theta \tilde{\Sigma}_t \Theta^\top)$ is invertible. It follows from (5.5.7) that

$$\tilde{\Sigma}_t = (\text{Id} + \hat{R}) \Sigma_t (\text{Id} + \hat{R})^* = \Sigma_t + \Sigma_t \hat{R}^* + \hat{R} \Sigma_t + \hat{R} \Sigma_t \hat{R}^*.$$

Whence, $\tilde{\Sigma}_t$ is an integral operator generated by the kernel

$$\tilde{\Sigma}_t = \Sigma_t + \Sigma_t \star \hat{R}^* + \hat{R} \star \Sigma_t + \hat{R} \star \Sigma_t \star \hat{R}^*. \quad (5.B.4)$$

Since K satisfies (5.5.1) and $(U - 2C^\top C) \in \mathbb{S}_+^N$, Σ_t defined in (5.5.8) is clearly a symmetric nonnegative kernel. Combined with (5.B.4), we get that $\tilde{\Sigma}_t$ is symmetric nonnegative. Successive applications of Lemma 5.B.1 yield that $(s, u) \mapsto \tilde{\Sigma}_t(s, u)$ is continuous. Therefore, $(-2\Theta \tilde{\Sigma}_t \Theta^\top)$ is symmetric nonpositive and continuous so that an application of Lemma 5.B.2-2 yields the existence of its resolvent R_t^\ominus . In particular, $(\text{Id} + 2\Theta \tilde{\Sigma}_t \Theta^\top)$ is invertible with an inverse given by $(\text{Id} + R_t^\ominus)$, recall (5.B.2). Combining the above, we get that Ψ_t is well-defined, and satisfies

$$\begin{aligned} \Psi_t &= -(\text{Id} + \hat{R})^* \Theta^\top (\text{Id} + R_t^\ominus) \Theta (\text{Id} + \hat{R}) \\ &= -\Theta^\top \Theta \text{Id} - \hat{R}^* \Theta^\top \Theta - \Theta^\top \Theta \hat{R} - \hat{R}^* \Theta^\top R_t^\ominus \Theta - \Theta^\top R_t^\ominus \Theta \hat{R} \\ &\quad - \hat{R}^* \Theta^\top R_t^\ominus \Theta \hat{R} - \hat{R}^* \Theta^\top \Theta \hat{R} - \Theta^\top R_t^\ominus \Theta, \end{aligned} \quad (5.B.5)$$

showing that Ψ_t is a bounded operator.

1: From (5.B.5), we see that $(\Theta^\top \Theta \text{Id} + \Psi_t)$ is an integral operator whose kernel is of the form

$$\begin{aligned} \psi_t &= -\hat{R}^* \Theta^\top \Theta - \Theta^\top \Theta \hat{R} - \hat{R}^* \Theta^\top \star R_t^\ominus \Theta - \Theta^\top R_t^\ominus \star \Theta \hat{R} \\ &\quad - \hat{R}^* \Theta^\top \star R_t^\ominus \star \Theta \hat{R} - \hat{R}^* \Theta^\top \star \Theta \hat{R} - \Theta^\top R_t^\ominus \Theta. \end{aligned}$$

Then, from [AJ19b, Lemma C.1] we get that

$$\sup_{t \leq T} \int_{[0, T]^2} |R_t^\ominus(s, u)|^2 ds du < \infty,$$

which, combined with (5.B.3) ensures (5.5.10).

2: Fix $f \in L^2([0, T], \mathbb{R}^N)$ and $t \leq T$. We first argue that

$$R_t^\ominus(t, \cdot) = 0 \text{ and } \hat{R}(s, u) = 0, \quad \text{for any } s < u. \quad (5.B.6)$$

Indeed, since \hat{K} is a Volterra kernel, its resolvent \hat{R} is also a Volterra kernel so that $R(s, u) = 0$ whenever $s < u$. This, combined with the fact that $\Sigma_t(t, \cdot) = 0$ and (5.B.4),

yields that $\tilde{\Sigma}_t(t, \cdot) = 0$, so that $R_t^\Theta(t, \cdot) = 0$ by virtue of the resolvent equation (5.B.1). Using the relations (5.B.6), we compute

$$\begin{aligned} (\Theta^\top \Theta \hat{R})(f1_t)(t) &= \Theta^\top \Theta \int_0^T \hat{R}(t, s) f(s) 1_t(s) ds = 0, \\ (\Theta^\top R_t^\Theta \Theta)(f1_t)(t) &= \Theta^\top \int_0^T R_t^\Theta(t, s) \Theta f(s) 1_t(s) ds = 0, \\ (\Theta^\top R_t^\Theta \Theta \hat{R})(f1_t)(t) &= \Theta^\top \int_0^T \int_0^T R_t^\Theta(t, u) \Theta \hat{R}(u, s) f(s) 1_t(s) dud s = 0. \end{aligned} \quad (5.B.7)$$

Thus, (5.B.7) combined with (5.B.5) and the resolvent's relations $\hat{R} = \hat{K} + \hat{K} \hat{R}$ and $\hat{R}^* = \hat{K}^* + \hat{K}^* \hat{R}^*$ yield

$$\begin{aligned} -(\Theta^\top \Theta \text{Id} + \Psi_t)(f1_t)(t) &= (\hat{R}^* \Theta^\top \Theta + \hat{R}^* \Theta^\top R^\Theta \Theta + \hat{R}^* \Theta^\top R_t^\Theta \Theta \hat{R} + \hat{R}^* \Theta^\top \Theta \hat{R})(f1_t)(t) \\ &= -(\hat{K}^* \Psi_t)(f1_t)(t) \end{aligned}$$

which proves the second claim 2.

3: Under (5.5.9), [AJ19b, Lemma 3.2] yields that $t \mapsto \Sigma_t$ is strongly differentiable on $[0, T]$ with a derivative given by $t \mapsto \dot{\Sigma}_t$ induced by the kernel (5.5.12). Whence, it follows from (5.5.7), that $t \mapsto \tilde{\Sigma}_t$ is also differentiable such that $\dot{\tilde{\Sigma}}_t = (\text{Id} - \hat{K})^{-1} \dot{\Sigma}_t (\text{Id} - \hat{K})^{-*}$. Thus, (5.5.6) yields that $t \mapsto \Psi_t$ is strongly differentiable with a derivative given by

$$\begin{aligned} \dot{\Psi}_t &= 2(\text{Id} - \hat{K})^{-*} \Theta^\top (\text{Id} + 2\Theta \tilde{\Sigma}_t \Theta^\top)^{-1} \Theta \dot{\tilde{\Sigma}}_t \Theta^\top (\text{Id} + 2\Theta \tilde{\Sigma}_t \Theta^\top)^{-1} \Theta (\text{Id} - \hat{K})^{-1} \\ &= 2\Psi_t \dot{\Sigma}_t \Psi_t. \end{aligned}$$

Finally, evaluating (5.5.8) at $t = T$, yields that $\Sigma_T(s, u) = 0$ for all $s, u \leq T$, leading to $\Sigma_T = \mathbf{0}$ so that $\Psi_T = -(\text{Id} - \hat{K})^{-*} \Theta^\top \Theta (\text{Id} - \hat{K})^{-1}$. This proves (5.5.11).

5.B.3 Proof of Lemma 5.5.3

We start with a lemma to bound the kernel $\tilde{\Sigma}$.

Lemma 5.B.3. *Let $f(\Theta) = D - 2\eta C^\top \Theta$ and assume that $|f(\Theta)| \times \|K\|_{L^2([0, T]^2)}^2 < 1$. Then there exists a constant $c > 0$ such that*

$$\sup_{t \leq T} \|\tilde{\Sigma}_t\|_{L^2([0, T]^2)}^2 \leq c(1 + \hat{\kappa}(\Theta)), \quad (5.B.8)$$

where $\hat{\kappa}$ is defined as

$$\hat{\kappa}(\Theta) = \left(\frac{|f(\Theta)| \times \|K\|_{L^2([0, T]^2)}^2}{1 - |f(\Theta)| \times \|K\|_{L^2([0, T]^2)}^2} \right)^4. \quad (5.B.9)$$

Proof. Let \hat{R} denote the resolvent kernel of $\hat{K} = Kf(\Theta)$ as in the proof of Lemma 5.5.1. First note that the relation $(\text{Id} - \hat{K})^{-1} = \text{Id} + \hat{R}$ yields

$$\begin{aligned} \|\tilde{\Sigma}_t\|_{L^2([0, T]^2)}^2 &= \|(\text{Id} - \hat{K})^{-1} \star \Sigma_t \star (\text{Id} - \hat{K})^{-*}\|_{L^2([0, T]^2)}^2 \\ &= \|\Sigma_t + \hat{R} \star \Sigma_t + \Sigma_t \star \hat{R} + \hat{R} \star \Sigma_t \star \hat{R}\|_{L^2([0, T]^2)}^2 \\ &\leq 2^3 \left(\|\Sigma_t\|_{L^2([0, T]^2)}^2 + \|\hat{R} \star \Sigma_t\|_{L^2([0, T]^2)}^2 \right. \\ &\quad \left. + \|\Sigma_t \star \hat{R}\|_{L^2([0, T]^2)}^2 + \|\hat{R} \star \Sigma_t \star \hat{R}\|_{L^2([0, T]^2)}^2 \right). \end{aligned}$$

An application of the Cauchy-Schwarz inequality combined with Tonelli's theorem implies that

$$\|K \star H\|_{L^2([0, T]^2)} \leq \|K\|_{L^2([0, T]^2)} \|H\|_{L^2([0, T]^2)}, \quad K, H \in L^2([0, T]^2, \mathbb{R}^{N \times N}), \quad (5.B.10)$$

so that

$$\begin{aligned} \|\tilde{\Sigma}_t\|_{L^2([0, T]^2)}^2 &\leq 2^3 \left(\|\Sigma_t\|_{L^2([0, T]^2)}^2 + \|\hat{R} \star \Sigma_t\|_{L^2([0, T]^2)}^2 + \|\Sigma_t \star \hat{R}\|_{L^2([0, T]^2)}^2 + \|\hat{R} \star \Sigma_t \star \hat{R}\|_{L^2([0, T]^2)}^2 \right) \\ &\leq 2^3 \|\Sigma_t\|_{L^2([0, T]^2)}^2 \left(1 + \|\hat{R}\|_{L^2([0, T]^2)}^2 + \|\hat{R}\|_{L^2([0, T]^2)}^4 \right) \\ &\leq c \|\Sigma_t\|_{L^2([0, T]^2)}^2 \left(1 + \|\hat{R}\|_{L^2([0, T]^2)}^4 \right), \end{aligned}$$

where $c > 0$ is a constant independent of Σ and \hat{R} . Thus, to obtain (5.B.8) it is enough to show that $\|\hat{R}\|_{L^2([0, T]^2)}^2 \leq \left(\frac{|f(\Theta)| \times \|K\|_{L^2([0, T]^2)}^2}{1 - |f(\Theta)| \times \|K\|_{L^2([0, T]^2)}^2} \right)^2$. For this, note that applying successive Picard's iteration to $\hat{R} = \hat{K} + \hat{K} \star R$ yields

$$\hat{R}(s, u) = \sum_{n=1}^{\infty} \hat{K}^{\star n}(s, u) = \sum_{n=1}^{\infty} (Kf(\Theta))^{\star n}(s, u), \quad (5.B.11)$$

where $\hat{K}^{\star n}$ is the (n) -fold \star -product of \hat{K} by itself. Combining (5.B.10) and (5.B.11) together with the submultiplicativity of the Frobenius norm yields

$$\begin{aligned} \|\hat{R}\|_{L^2([0, T]^2)}^2 &\leq \sum_{1 \leq n, m \leq \infty} \int_0^T \int_0^T |(K(s, u)f(\Theta))^{\star n}| |(K(s, u)f(\Theta))^{\star m}| ds du \\ &\leq \sum_{1 \leq n, m \leq \infty} |f(\Theta)|^{n+m} \|K^{\star n}\|_{L^2([0, T]^2)}^2 \|K^{\star m}\|_{L^2([0, T]^2)}^2 \\ &= \left(\sum_{n=1}^{\infty} |f(\Theta)|^n \|K^{\star n}\|_{L^2([0, T]^2)}^2 \right)^2 \\ &\leq \left(\sum_{n=1}^{\infty} |f(\Theta)|^n \|K\|_{L^2([0, T]^2)}^{2n} \right)^2 \\ &\leq \left(\frac{|f(\Theta)| \times \|K\|_{L^2([0, T]^2)}^2}{1 - |f(\Theta)| \times \|K\|_{L^2([0, T]^2)}^2} \right)^2. \end{aligned}$$

This proves the desired inequality on \hat{R} and the claimed inequality (5.B.8) follows. \square

We can now complete the proof of Lemma 5.5.3.

Proof of Lemma 5.5.3. Fix $s \leq T$ and $\Theta \in \mathbb{R}^{d \times N}$. We first note that

$$|\lambda_s|^2 + |Z_s^1|^2 + |Z_s^2|^2 = |\Theta g_s(s)|^2 + 4 |((\Psi_s \mathbf{K} \eta)^* g_s)(s)|^2.$$

Using 5.5.1-1, and denoting by ψ_s^{op} the operator induced by the kernel ψ_s there, we write

$$\begin{aligned} |((\Psi_s \mathbf{K} \eta)^* g_s)(s)|^2 &= | -((\Theta^\top \Theta \mathbf{K} \eta)^* g_s)(s) + ((\psi_s^{\text{op}} \mathbf{K} \eta)^* g_s)(s) |^2 \\ &= |\mathbf{1} + \mathbf{2}|^2 \\ &\leq 2(|\mathbf{1}|^2 + |\mathbf{2}|^2). \end{aligned}$$

An application of the Cauchy-Schwarz inequality combined with (5.5.9) leads to

$$|\mathbf{1}|^2 = \left| - \int_0^T \eta^T K(z, s)^\top \Theta^\top \Theta g_s(z) dz \right|^2 \leq |\eta|^2 |\Theta \Theta^\top|^2 \sup_{u' \leq T} \int_0^T |K(z, u')|^2 du' \int_0^T |g_s(u)|^2 du. \quad (5.B.12)$$

Similarly,

$$\begin{aligned} |\mathbf{2}|^2 &= \left(\int_0^T \eta^\top \left(\int_0^T K(r, s)^\top \psi_s(r, z) dr \right) g_s(z) dz \right)^2 \\ &\leq |\eta|^2 \left(\int_0^T \int_0^T |K(r, s)|^2 |\psi_s(r, z)|^2 dr dz \right) \left(\int_0^T |g_s(z)|^2 dz \right) \\ &\leq |\eta|^2 \sup_{u' \leq T} \int_0^T |K(r, u')|^2 dr \left(\int_0^T \int_0^T |\psi_s(r, z)|^2 dr dz \right) \left(\int_0^T |g_s(z)|^2 dz \right), \end{aligned}$$

where we stress that ψ_s is the only term on the right hand side depending on Θ . Let us now show that there exists a constant $c > 0$ independent of Θ such that

$$\sup_{s \in [0, T]} \int_0^T \int_0^T |\psi_s(r, z)|^2 dr dz \leq c |\Theta|^2 (1 + |\Theta|^4 \hat{\kappa}(\Theta)), \quad (5.B.13)$$

where $\hat{\kappa}$ is defined as in (5.B.9). Recall from (5.B.5) that we have

$$\begin{aligned} \psi_t &= -\hat{R}^* \Theta^\top \Theta - \Theta^\top \Theta \hat{R} - \hat{R}^* \Theta^\top \star R_t^\Theta \Theta - \Theta^\top R_t^\Theta \star \Theta \hat{R} \\ &\quad - \hat{R}^* \Theta^\top \star R_t^\Theta \star \Theta \hat{R} - \hat{R}^* \Theta^\top \star \Theta \hat{R} - \Theta^\top R_t^\Theta \Theta. \end{aligned}$$

Thus, recalling (5.B.3), there exists a constant $c > 0$ independent of Θ such that

$$\sup_{s \in [0, T]} \int_0^T \int_0^T |\psi_s(r, z)|^2 dr dz \leq c |\Theta|^2 \left(1 + \sup_{t \in [0, T]} \int_0^T \int_0^T |R_t^\Theta(s, u)|^2 ds du \right) \quad (5.B.14)$$

To obtain (5.B.13), it is enough to show that

$$\sup_{t \in [0, T]} \int_0^T \int_0^T |R_t^\Theta(s, u)|^2 ds du \leq c |\Theta|^4 (1 + \hat{\kappa}(\Theta)), \quad (5.B.15)$$

for some constant $c > 0$ not depending on Θ and $\hat{\kappa}$ defined in (5.B.9). For this recall that R_t^Θ is the resolvent of $-2\Theta \tilde{\Sigma}_t \Theta^\top$ which implies that $R_t^\Theta = (\text{Id} + 2\Theta \tilde{\Sigma}_t \Theta^\top)^{-1} - \text{Id}$. Since, for each $t \leq T$, $\Theta \tilde{\Sigma}_t \Theta^\top$ is a positive symmetric operator on $L^2([0, T], \mathbb{R}^d)$ induced by a continuous kernel, an application of Mercer's theorem, see [SW09, Theorem 1, p.208], yields the existence of a countable orthonormal basis $(e_{t, \Theta}^n)_{n \geq 1}$ of $L^2([0, T], \mathbb{R}^d)$ such that

$$2\Theta \tilde{\Sigma}_t(s, u) \Theta = \sum_{n \geq 1} \lambda_{t, \Theta}^n e_{t, \Theta}^n(s) e_{t, \Theta}^n(u)^\top,$$

where $\lambda_{t, \Theta}^n \geq 0$, for all $n \geq 1$. Consequently

$$R_t^\Theta(s, u) = \sum_{n \geq 1} \frac{-\lambda_{t, \Theta}^n}{1 + \lambda_{t, \Theta}^n} e_{t, \Theta}^n(s) e_{t, \Theta}^n(u)^\top,$$

which yields

$$\begin{aligned}
 \int_0^T \int_0^T |R_t^\Theta(s, u)|^2 ds du &= \sum_{n \geq 1} \frac{(\lambda_{t, \Theta}^n)^2}{(1 + \lambda_{t, \Theta}^n)^2} \\
 &\leq \sum_{n \geq 1} (\lambda_{t, \Theta}^n)^2 = \int_0^T \int_0^T |2\Theta \tilde{\Sigma}_t(s, u) \Theta^\top|^2 ds du \\
 &\leq 4|\Theta|^4 \sup_{t \leq T} \int_0^T \int_0^T |\tilde{\Sigma}_t(s, u)|^2 ds du \\
 &\leq c|\Theta|^4(1 + \hat{\kappa}(\Theta)),
 \end{aligned}$$

where the last inequality comes from Lemma 5.B.3. Consequently, inequality (5.B.15) combined with (5.B.14) yield inequality (5.B.13). Finally, the claimed bound (5.5.18) follows by recollecting inequalities (5.B.13) and (5.B.12).

5.B.4 Proof of Lemma 5.5.4

Proof. Recalling the decomposition (5.5.21), the process Z admits the following Karhunen-Loeve representation

$$Z(s, u) = \sum_{n \geq 1} \xi_n e^n(s, u), \quad s, u \in [0, T]^2, \quad (5.B.16)$$

where $(\xi_n)_{n \geq 1}$ is a sequence of independent Gaussian random variables with mean $\mu_n = \langle \mu, e^n \rangle_{L^2([0, T]^2, \mathbb{R}^{2N})}$ and variance λ^n , for each $n \in \mathbb{N}$. Now observe that the representation (5.B.16) combined with the orthogonality of $(e_n)_{n \geq 1}$ in $L^2([0, T]^2, \mathbb{R}^{2N})$ yields

$$a \int_0^T \left(|g_s(s)|^2 + \int_0^T |g_s(u)|^2 du \right) ds = a \|Z\|_{L^2([0, T]^2, \mathbb{R}^{2N})}^2 = \sum_{n \geq 1} a \xi_n^2,$$

so that the independence of $(\xi_n)_{n \geq 1}$ leads to

$$\begin{aligned}
 \mathbb{E} \left[\exp \left(a \int_0^T \left(|g_s(s)|^2 + \int_0^T |g_s(u)|^2 du \right) ds \right) \right] &= \mathbb{E} \left[\exp \left(\sum_{n \geq 1} a \xi_n^2 \right) \right] \quad (5.B.17) \\
 &= \prod_{n \geq 1} \mathbb{E} [\exp (a \xi_n^2)] \\
 &= \prod_{n \geq 1} \frac{e^{\frac{a \mu_n^2}{1 - 2a \lambda^n}}}{\sqrt{1 - 2a \lambda^n}}
 \end{aligned}$$

where the last equality follows from the fact that ξ_n^2 is chi-squared distributed and $0 < 1 - 2a \lambda^n < 1 - 2a \lambda^1$ by hypothesis. We now argue that the right hand side of (5.B.17) is finite. For the denominator, due to the inequality $\sum_{n \geq 1} \lambda^n < \infty$, we obtain that $\prod_{n \geq 1} (1 - 2a \lambda^n) > 0$. For the numerator, since $\lambda^n \rightarrow 0$, as $n \rightarrow \infty$, $\left(\frac{1}{1 - 2a \lambda^n} \right)_{n \geq 1}$ is uniformly bounded by a constant $c > 0$ so that an application of Parseval's identity

yields

$$\begin{aligned} \prod_{n \geq 1} \exp\left(\frac{a\mu_n^2}{1-2a\lambda^n}\right) &\leq \exp\left(ca\|\mu\|_{L^2([0,T]^2, \mathbb{R}^{2N})}^2\right) \\ &= \exp\left(ca\left(\int_0^T \int_0^T \left(\frac{1}{T^2}|g_0(s)|^2 + |g_0(u)|^2\right) dsdu\right)\right) \\ &= \exp\left(ca\left(T + \frac{1}{T}\right)\|g_0\|_{L^2([0,T], \mathbb{R}^N)}^2\right) < \infty. \end{aligned}$$

The proof is complete. \square

5.C Additional proof for the martingale property

For completeness, we adapt [AJLP19, Lemma 7.3] to the multi-dimensional setting to prove that the local martingale

$$M_t = M_0 \mathcal{E}\left(-\int_0^t \sum_{i=1}^d \psi^i(T-s) \nu_i \sqrt{V_s^i} dW_s^i\right).$$

is a true martingale. For this we set $U = \int_0^\cdot V_s ds$ and we observe that, thanks to stochastic Fubini's theorem, integrating (5.4.1) yields

$$U_t^i = \int_0^t g_0^i(s) ds + \int_0^t K_i(t-s) Z_s^i ds$$

with

$$Z_t^i = \int_0^t (DV_s)_i ds + \int_0^t \nu_i \sqrt{V_s^i} dW_s^i.$$

Proof. Since M is a nonnegative local martingale, it is a supermartingale by Fatou's lemma. Whence to obtain the true martingality it suffices to show that $\mathbb{E}[M_T] = 1$ for any $T \in \mathbb{R}_+$. To this end, fix $T > 0$ and define the stopping times $\tau_n = \inf\{t \geq 0: \int_0^t V_s^i ds > n \text{ for some } i \leq d\} \wedge T$. Novikov's condition, recall that ψ is bounded on $[0, T]$ being continuous, yields that $M^{\tau_n} = M_{\tau_n \wedge \cdot}$ is a uniformly integrable martingale for each n . Whence,

$$1 = M_0^{\tau_n} = \mathbb{E}_{\mathbb{P}}[M_T^{\tau_n}] = \mathbb{E}_{\mathbb{P}}[M_T \mathbf{1}_{\tau_n \geq T}] + \mathbb{E}_{\mathbb{P}}[M_{\tau_n} \mathbf{1}_{\tau_n < T}],$$

where we made the dependence of the expectation on \mathbb{P} explicit. Since $\mathbb{E}_{\mathbb{P}}[M_T \mathbf{1}_{\tau_n \geq T}] \rightarrow \mathbb{E}_{\mathbb{P}}[M_T]$ as $n \rightarrow \infty$, by dominated convergence, in order to get that $\mathbb{E}_{\mathbb{P}}[M_T] = 1$, it suffices to prove that

$$\mathbb{E}_{\mathbb{P}}[M_{\tau_n} \mathbf{1}_{\tau_n < T}] \rightarrow 0, \quad \text{as } n \rightarrow \infty. \quad (5.C.1)$$

To this end, since M^{τ_n} is a martingale, we may define probability measures \mathbb{Q}^n by

$$\frac{d\mathbb{Q}^n}{d\mathbb{P}} = M_{\tau_n}^{\tau_n}.$$

By Girsanov's theorem, the process $W^n = (W^{n,1}, \dots, W^{n,d})$ defined by

$$W^{n,i} = W^i + \int_0^\cdot \mathbf{1}_{s \leq \tau_n} \psi^i(T-s) \nu_i \sqrt{V_s^i} ds, \quad i = 1, \dots, d,$$

is a Brownian motion under \mathbb{Q}^n . Furthermore, under \mathbb{Q}^n , we have

$$\begin{aligned} U_t^i &= \int_0^t g_0^i(s) ds + \int_0^t K_i(t-s) Z_s^{n,i} ds \\ Z_t^{n,i} &= \int_0^t ((DV_s)_i - \mathbf{1}_{s \leq \tau_n} \psi^i(T-s) \nu_i^2 V_s^i) ds + \int_0^t \nu_i \sqrt{V_s^i} dW_s^{n,i}. \end{aligned}$$

and we observe that, due to the boundedness of ψ , the drift of Z^n under \mathbb{Q}^n satisfy a linear growth condition in U for some constant κ_L independent of n . An application of the generalized Grönwall inequality for convolution equations would yield the moment bound

$$\mathbb{E}_{\mathbb{Q}^n} [|U_T|^2] \leq \eta(\kappa_L, T, K, g_0),$$

where $\eta(\kappa_L, T, K, g_0)$ does not depend on n , see for instance [AJ19c, Lemma 3.1]. We then get by an application of Chebyshev's inequality

$$\begin{aligned} \mathbb{E}_{\mathbb{P}} [M_{\tau_n} \mathbf{1}_{\tau_n \leq T}] &= \mathbb{Q}^n(\tau_n < T) \\ &\leq \sum_{i=1}^d \mathbb{Q}^n(U_T^i > n) \\ &\leq \sum_{i=1}^d \frac{1}{n^2} \mathbb{E}_{\mathbb{Q}^n} [|U_T^i|^2] \\ &= \frac{1}{n^2} \mathbb{E}_{\mathbb{Q}^n} [|U_T|^2] \\ &\leq \frac{1}{n^2} \eta(\kappa_L, T, K, g_0). \end{aligned}$$

Sending $n \rightarrow \infty$, we obtain (5.C.1), proving that M is martingale. \square

Part IV

Stochastic delayed systems

Chapter 6

Linear-quadratic stochastic delayed control and deep learning resolution

Abstract We consider a class of stochastic control problems with a delayed control, both in drift and diffusion, of the type $dX_t = \alpha_{t-d}(bdt + \sigma dW_t)$. We provide a new characterization of the solution in terms of a set of Riccati partial differential equations. Existence and uniqueness are obtained under a sufficient condition expressed directly as a relation between the horizon T and the quantity $d(b/\sigma)^2$. Furthermore, a deep learning scheme* is designed and used to illustrate the effect of delay on the Markowitz portfolio allocation problem with execution delay.

Keywords: Linear-quadratic stochastic control; delay; Riccati PDEs; Markowitz portfolio allocation.

6.1 Introduction

The control of systems whose dynamic contains delays on the state and/or control has attracted the attention of the optimization and engineering communities in the last decades due to its wide variety of applications, allowing to tackle problems where the past of a system influences its present or where an agent controls a system with a latency. As a non-exhaustive list of applications we may cite the following papers, classified by their applications domain: Engineering ([TG99], [Huz+02]); Advertising ([Set74], [Pau77], [GRM05], [GMS09]); Learning by doing with memory effect ([dAVV12]); Growth model with lags between investment decision and project completion ([AZ99], [Hal+77], [JD07], [Bam08], [BFG12]); Investment ([Tso11], [KP82]). More recently, the introduction of delayed control together with mean-field effects was studied ([Car+18], [FZ19]) and new machine learning methods have been designed to numerically solve stochastic control problems with delay ([HH21]). We also refer to the monograph [Sip+11] to find literature on the various effects of delays on traffic flow modelling, chemical processes, population dynamics, supply chain, etc.

In the optimal control community, two main approaches have emerged: the *structural state method* and the *extended state method*, and we refer to [Ben+07, Part II, Chapter 3] for the study of the latter in the deterministic case and [FF14] for the structural state

*The code is available in a [IPython notebook](#).

approach in the stochastic case. Let us also mention the paper by [FF14] for an overview and exhaustive list of references.

In this paper, we aim at studying the challenging case where there is a delayed control both in the drift and volatility. Except in [FF14], this situation is not treated theoretically nor numerically in the references above. The main difficulty comes from the fact that the natural formulation of a control problem with delayed control involves a *boundary control problem*. Indeed, assume for instance that X denotes a state variable following the simple dynamic $\dot{X}_t = \alpha_{t-d}$, where α denotes the control. For any time t and index $s \in [-d, 0]$, set $u_t(s) = \alpha_{t+s}$, the *memory* of the control α . Then, note that $\partial_t u_t(s) = \partial_s u_t(s)$ and $u_t(0) = \alpha_t$. Thus, the natural infinite dimensional formulation of the controlled system is

$$\begin{aligned} \text{State eq. on } (X, u) & \left\{ \begin{array}{l} \dot{X}_t = \mathcal{M}u_t \\ (\partial_t - \partial_s)u_t(s) = 0, \end{array} \right. \\ \text{Boundary constraint} & \left\{ \mathcal{B}u_t = \alpha_t, \right. \\ \text{Initial conditions} & \left\{ u_0(s) = \gamma_s, \quad X_0 = x, \right. \end{aligned}$$

where $t, s \in [0, T] \times [-d, 0]$, $\mathcal{M}u := u(-d)$, $\mathcal{B}u := u(0)$ and γ is the initial value of the control over $[-d, 0]$. Consequently, any delayed controlled problem where the delay appears in the control variable can be recast as a boundary control problem whose geometry is parametrized by the delay d , see Figure 6.1.

Main contributions. Our goal is to shed some lights on the difficulty related to delayed control on the volatility and to provide a practical and simple tool for designing a numerical scheme practitioners can play with. In this paper, we study the most simple linear-quadratic control problem with delayed control both in drift and volatility. The optimal feedback control and the value function are given in terms of Riccati partial differential equations and the extended state $(x, u) \in H = \mathbb{R} \times L^2([0, T], \mathbb{R})$, where x denotes the position and $s \in [-d, 0] \mapsto u(s)$ the memory of the control. The existence and uniqueness of these latter are proven under a condition, emerging from the delay feature, involving the drift b , the volatility σ , the delay d and the horizon T . Finally, we adopt a deep learning approach in the spirit of the papers by [RPK19] (Physics Informed Neural Network) and [SS18] (Deep Galerkin) to propose a numerical scheme. Our results are illustrated on the celebrated Markowitz portfolio allocation problem where we take into account execution delay. We believe the semi-explicit resolution of infinite dimensional control problem by means of deep learning method will open the door to several interesting applications such as quick simulations of richer models, precise benchmarking of *reinforcement learning* algorithms, etc.

Outline of the paper. The rest of the paper is organized as follows: In Section 6.2 we formulate the stochastic delayed control problem and derive an heuristic approach through a lifting in an infinite dimensional space, namely the *extended state space* in the spirit of [Ich82], but without the use of semi-group theory. We state in Section 6.3 a verification theorem and prove existence and uniqueness results for the Riccati PDEs. A deep learning based numerical scheme with two applications on Markowitz portfolio allocation is given in Section 6.4, with a detailed analysis of the effect of the delay feature on the allocation strategy.

Notations.

Given a probability space (Ω, \mathcal{F}, P) , a filtration $F = (\mathcal{F}_t)_{t \geq 0}$ satisfying the usual condi-

tions and $a < b$ two real numbers, we denote by

$$L^2([a, b], \mathbb{R}) = \left\{ Y : [a, b] \mapsto \mathbb{R}, \text{ s.t. } \int_a^b |Y_t|^2 dt < \infty \right\},$$

$$L^2_{\mathbb{F}}([a, b], \mathbb{R}) = \left\{ Y : \Omega \times [a, b] \mapsto \mathbb{R}, F\text{-prog. measurable s.t. } \mathbb{E} \left[\int_a^b |Y_t|^2 dt \right] < \infty \right\}.$$

Here $|\cdot|$ denotes the Euclidian norm on \mathbb{R} or \mathbb{R}^d , and $H = \mathbb{R} \times L^2([0, T], \mathbb{R})$ denotes the *extended state space* endowed with the scalar product $\langle x, y \rangle_H = x_0 y_0 + \int_{-d}^0 x_1(s) y_1(s) ds$. For any $z = (x, u) \in H$, we use the notation $z_0 = x$ and $z_1 = u$.

6.2 Formulation of the problem and heuristic approach

Let $(\Omega, \mathcal{F}, \mathbb{F} := (\mathcal{F}_t)_{t \leq 0}, \mathbb{P})$ be a complete filtered probability space on which a real-valued Brownian motion $(W_t)_{t \leq 0}$ is defined and consider the simple system defined on $[0, T]$ by the following dynamics

$$\begin{cases} dX_t^\alpha = \alpha_{t-d}(bdt + \sigma dW_t), & 0 \leq t \leq T, \\ X_0 = x, \quad \alpha_s = \gamma(s), & s \in [-d, 0], \end{cases} \quad (6.2.1)$$

endowed with the cost functional

$$J(\alpha) = \mathbb{E} [(X_T^\alpha)^2], \quad (6.2.2)$$

where $\gamma \in L^2([-d, 0], \mathbb{R})$ and α models the control chosen in the set of admissible strategies \mathcal{A} :

$$\mathcal{A} = \left\{ \alpha \in L^2_{\mathbb{F}}([0, T], \mathbb{R}) \text{ such that (6.2.1) has a solution satisfying } \mathbb{E} \left[\sup_{t \leq T} |X_t^\alpha|^2 \right] < \infty \right\}.$$

For any $0 \leq a < b \leq T$, we also define the set $\mathcal{A}_{a,b}$ as the restriction of \mathcal{A} to $L^2_{\mathbb{F}}([a, b], \mathbb{R})$.

Remark 6.2.1. *At this point, we may expect a priori that the optimization problem (6.2.1)-(6.2.2) admits an optimizer provided $\sigma \neq 0$, even if the control is not directly penalized. The intuition behind this a priori belief is that, the more α is aggressive in bringing X to 0, the more the variance of X increases due to the diffusion term. It is the case in the classical LQ stochastic optimization problem with controlled volatility such as*

$$\begin{aligned} dX_t^\alpha &= \alpha_t(bdt + \sigma dW_t), & t \leq T, \\ X_0 &= x, \\ J(\alpha) &= \mathbb{E}[(X_T^\alpha)^2], \end{aligned}$$

where the optimal control reads $\alpha_t^* = -\frac{b}{\sigma^2} X_t^{\alpha^*}$ and the value function $V_t = e^{(t-T)\frac{b^2}{\sigma^2}}$. A surprising finding in our paper is the necessity for a more restricting condition on the diffusion coefficient due to the delay feature, see Proposition 6.3.2.

Remark 6.2.2. *In the rest of the paper we focus on the one dimensional case with delayed control both in drift and volatility which features the main difficulties related*

to the presence of the delay. Although Proposition 6.3.2 concerning the existence and uniqueness of a Riccati-PDE system does not directly extend to the multidimensional case, the verification Theorem can easily be adapted to the multidimensional case with delayed state and control.

The first step consists in lifting the dynamics in the infinite dimensional Hilbert space $H = \mathbb{R} \times L^2([0, T], \mathbb{R})$, where the system is naturally Markovian. To do so, denote $u_t(s) = \alpha_{t+s}$ for any $t \leq T$ and $s \in [-d, 0]$, a transport of the control. The dynamics (6.2.1) then reads

$$\begin{cases} dZ_t^\alpha = AZ_t^\alpha dt + BZ_t^\alpha dW_t + Cd\alpha_t, & 0 \leq t \leq T, \\ Z_0 = (x, \gamma), \end{cases} \quad (6.2.3)$$

where Z^α is defined as the $H = \mathbb{R} \times L^2([0, T], \mathbb{R})$ -valued random process $Z_t^\alpha = (X_t^\alpha, u_t(\cdot))$ and

$$A = \begin{pmatrix} 0 & b\delta_{-d} \\ 0 & \partial_s \end{pmatrix}, \quad B = \begin{pmatrix} 0 & \sigma\delta_{-d} \\ 0 & 0 \end{pmatrix}, \quad C = \begin{pmatrix} 0 \\ 1_0(\cdot) \end{pmatrix}.$$

Let V be the value function

$$V(t, z) = V(t, (x, u)) = \inf_{\alpha \in \mathcal{A}_{t, T}} \mathbb{E}[(Z_T^\alpha)_0^2] = \inf_{\alpha \in \mathcal{A}_{t, T}} \mathbb{E}[(X_T^\alpha)^2], \quad z \in H,$$

where Z^α denotes the solution to (6.2.3) starting from $z = (x, u)$ at time t . Then, assuming $V \in C^{1,2}([0, T] \times L^2([-d, 0], \mathbb{R}))$, the dynamic programming principle reads

$$\begin{aligned} V(t, z) &= \inf_{\alpha \in \mathcal{A}_{t, t+h}} \mathbb{E}[V(t+h, Z_{t+h}^\alpha)] \\ &= \inf_{\alpha \in \mathcal{A}_{t, t+h}} \mathbb{E} \left[V(t, z) + \int_t^{t+h} \partial_t V(s, Z_s^\alpha) ds + \int_t^{t+h} \partial_z V(s, Z_s^\alpha) dZ_s^\alpha \right. \\ &\quad \left. + \frac{1}{2} \int_t^{t+h} \partial_z^2 V(s, Z_s^\alpha) d\langle Z^\alpha \rangle_s \right]. \\ &= \inf_{\alpha \in \mathcal{A}_{t, t+h}} \mathbb{E} \left[V(t, z) + \int_t^{t+h} \partial_t V(s, Z_s^\alpha) ds + \int_t^{t+h} \partial_z V(s, Z_s^\alpha) (AZ_s^\alpha ds + Cd\alpha_s) \right. \\ &\quad \left. + \frac{1}{2} \int_t^{t+h} \partial_z^2 V(s, Z_s^\alpha) d\langle Z^\alpha \rangle_s \right], \end{aligned}$$

Note that $1_0(\cdot) = 0_{L^2}$. As a result, simplifying by $V(t, z)$, dividing by h and letting $h \rightarrow 0$ yields (informally) the Hamilton-Jacobi equation

$$\begin{aligned} \partial_t V + \inf_{\alpha \in \mathbb{R}} \{ \partial_z V A z + \partial_z^2 V (Bz \otimes Bz) \} &= 0, \quad t \leq T, \quad z \in L^2([-d, 0], \mathbb{R}), \\ V(T, z) &= z_0^2. \end{aligned} \quad (6.2.4)$$

Recall that in equation (6.2.4), we have $z_1(0) = u(0) = \alpha$. Let us now assume that the value function V is of the following form

$$V(t, z) = \langle P_t z, z \rangle_H,$$

where $P \in C([0, T], \mathcal{L}(H, H))$ is a self-adjoint bounded positive operator valued function of the form

$$P_t : (x, \gamma(\cdot)) \mapsto \begin{pmatrix} P_{11}(t)x + \int_{-d}^0 P_{12}(t, s)\gamma(s)ds \\ P_{12}(t, \cdot)x + P_{22}(t, \cdot)\gamma(\cdot) + \int_{-d}^0 P_{22}(t, \cdot, s)\gamma(s)ds \end{pmatrix}.$$

Thus, for any $z = (x, u) \in H$ such that $u(0) = \alpha$ and $t \leq T$, equation (6.2.4) reduces to

$$\langle \dot{P}_t z, z \rangle_H + \inf_{\alpha \in \mathbb{R}} \{ \langle P_t A z, z \rangle_H + \langle P_t z, A z \rangle_H + \langle P_t B z, B z \rangle_H \} = 0. \quad (6.2.5)$$

Furthermore, using the boundary condition $u(0) = \alpha$ together with integration by part, we have

$$\begin{aligned} \langle P_t z, A z \rangle_H &= (P_t z)_0 (A z)_0 + \int_{-d}^0 (P_t z)_1(s) (A z)_1(s) ds \\ &= bu(-d) \left(P_{11}(t)x + \int_{-d}^0 P_{12}(t, s)u(s)ds \right) + \alpha x P_{12}(t, 0) - u(-d)x P_{12}(t, -d) \\ &\quad - x \int_{-d}^0 \partial_s P_{12}(t, s)u(s)ds + \alpha \int_{-d}^0 P_{22}(t, 0, s)u(s)ds \\ &\quad - u(-d) \int_{-d}^0 P_{22}(t, -d, s)u(s)ds - \int_{-d}^0 \int_{-d}^0 \partial_s P_{22}(t, s, r)u(s)u(r)dsdr \\ &\quad + \alpha^2 P_{22}(t, 0) - u(-d)^2 P_{22}(t, -d) - \int_{-d}^0 \partial_s P_{22}(t, s)ds, \end{aligned} \quad (6.2.6)$$

and

$$\langle P_t B z, B z \rangle_H = \sigma^2 P_{11}(t)u(-d)^2. \quad (6.2.7)$$

Remark 6.2.3. In (6.2.6), along with the integration by part, formulas such as $u \partial_s u = \partial_s u^2$ were (formally) used. However, as it appears in the verification Theorem 6.3.1, the feedback optimal control obtained is as regular as the controlled process X^α and thus as regular as the Brownian motion W . This is why our approach is only heuristic and justifies the need for the verification Theorem 6.3.1.

As a consequence, the minimizer of the Hamiltonian in (6.2.5) reads

$$\alpha^*(t, z) = -\frac{1}{P_{22}(t, 0)} \left(x P_{12}(t, 0) + \int_{-d}^0 P_{22}(t, 0, s)u(s)ds \right). \quad (6.2.8)$$

Remark 6.2.4. Note that when $d \rightarrow 0$, then $\alpha^*(t, z) \rightarrow -\frac{b}{\sigma^2}x$ which agrees with the optimal strategy in the undelayed case.

Combining (6.2.5), (6.2.6) and (6.2.7) yields the set of Riccati partial differential equations

$$\begin{aligned} \dot{P}_{11}(t) &= \frac{P_{12}(t, 0)^2}{P_{22}(t, 0)}, & (\partial_t - \partial_s)(P_{12})(t, s) &= \frac{P_{12}(t, 0)P_{22}(t, s, 0)}{P_{22}(t, 0)}, \\ (\partial_t - \partial_s)(P_{22})(t, s) &= 0, & (\partial_t - \partial_s - \partial_r)(P_{22})(t, s, r) &= \frac{P_{22}(t, s, 0)P_{22}(t, 0, r)}{P_{22}(t, 0)}, \end{aligned} \quad (6.2.9)$$

accompanied by the boundary conditions

$$\begin{aligned} P_{12}(t, -d) &= bP_{11}(t), & P_{22}(t, -d) &= \sigma^2 P_{11}(t), \\ P_{22}(t, s, -d) &= bP_{12}(t, s), & P_{22}(t, -d, r) &= bP_{12}(t, r), \end{aligned} \quad (6.2.10)$$

and the final conditions

$$P_{11}(T) = 1, \quad P_{12}(T, s) = P_{22}(T, s) = P_{22}(T, s, r) = 0, \quad (6.2.11)$$

for almost every $s, r \in [-d, 0]$.

Remark 6.2.5. Looking at the expression (6.2.8), we can already guess some effects of the existence of a delay on the optimal strategy. Indeed, from (6.2.10) one notes that $P_{12} \approx b$, $P_{\hat{2}2} \approx \sigma^2$, $P_{22} \approx b^2$, and we may write

$$\alpha \approx \frac{-1}{\sigma^2}(bx + db^2\alpha) \approx \frac{-bx}{\sigma^2(1 + d(b/\sigma)^2)}.$$

In Section 6.4, we illustrate numerically the various effects of the delayed control through two examples of Markowitz portfolio allocation with execution delay.

Note that due to the existence of the delay, the value function is independent of the control chosen after $T - d$, so that $P_{12}(t, s) = P_{\hat{2}2}(t, s) = P_{22}(t, s, r) = 0$ whenever $t + s \geq T - d$ or $t + r \geq T - d$. Similarly, the optimal control defined in (6.2.8) is ill defined on $[T - d, T]$ so we decide to set to zero the control after time $T - d$ and rewrite

$$\alpha^*(t, z) = -\frac{1_{t \leq T-d}}{P_{\hat{2}2}(t, 0)} \left(xP_{12}(t, 0) + \int_{-d}^0 P_{22}(t, 0, s)u(s)ds \right). \quad (6.2.12)$$

Thus, to make sense of the set of Ricatti partial differential equations (6.2.9)-(6.2.10)-(6.2.11) and the optimal control (6.2.12), we adopt the convention $0^2/0 = 0$ and define the concept of solution as follows

Definition 6.2.1. A 4-uplets $P = (P_{11}, P_{12}, P_{\hat{2}2}, P_{22})$ is said to be a solution to (6.2.9)-(6.2.10)-(6.2.11) if $P_{11} : [0, T] \mapsto \mathbb{R}$, $P_{22}, P_{\hat{2}2} : [0, T] \times [-d, 0] \mapsto \mathbb{R}$ and $P_{22} : [0, T] \times [-d, 0]^2 \mapsto \mathbb{R}$ are piecewise absolutely continuous functions satisfying (6.2.9)-(6.2.10)-(6.2.11) with $P_{\hat{2}2}(t) > 0$ for any $t < T - d$.

The reason we chose *piecewise* absolutely continuous functions as our set of functions is because we expect the kernel P to be discontinuous. To illustrate this consideration, cut the domain \mathcal{D} into three pieces $\mathcal{D} = [0, T] \times [-d, 0]^2 = \mathcal{D}_a \cup \mathcal{D}_b \cup \mathcal{D}_c$ as represented in Figure 6.1, with

$$\begin{aligned} \mathcal{D}_a &= [0, T - d] \times [-d, 0]^2, \\ \mathcal{D}_b &= \{(t, s, r) \in \mathcal{D} \text{ s.t. } t > T - d, \quad t + s \vee r < T - d\}, \\ \mathcal{D}_c &= \{(t, s, r) \in \mathcal{D} \text{ s.t. } t > T - d, \quad t + s \vee r \geq T - d\} \end{aligned}$$

and note that, necessarily, $P_{12}, P_{\hat{2}2}$ and P_{22} are null on \mathcal{D}_c but not on the remaining domain, see also the numerical simulations in Figure 6.5.

In the next section, we provide a proof of the existence and uniqueness of system (6.2.9)-(6.2.10)-(6.2.11), and a verification theorem yielding rigorously the optimal control and value of (6.2.1)-(6.2.2).

6.3 Verification and existence results

In this section, we establish a verification result for the optimization problem (6.2.1)-(6.2.2).

Theorem 6.3.1 (Verification Theorem). *Assume that*

1. *There exists a solution P to (6.2.9)-(6.2.10)-(6.2.11) in the sense of Definition 6.2.1,*
2. *The control strategy defined as*

$$\alpha_t^* = \frac{-1_{t \leq T-d}}{P_{\hat{2}2}(t, 0)} \left\{ X_t^{\alpha^*} P_{11}(t, 0) + \int_{t-d}^t P_{22}(t, 0, s-t)\alpha_s^* ds \right\}. \quad (6.3.1)$$

where X^{α^*} denotes the controlled state is an admissible control.

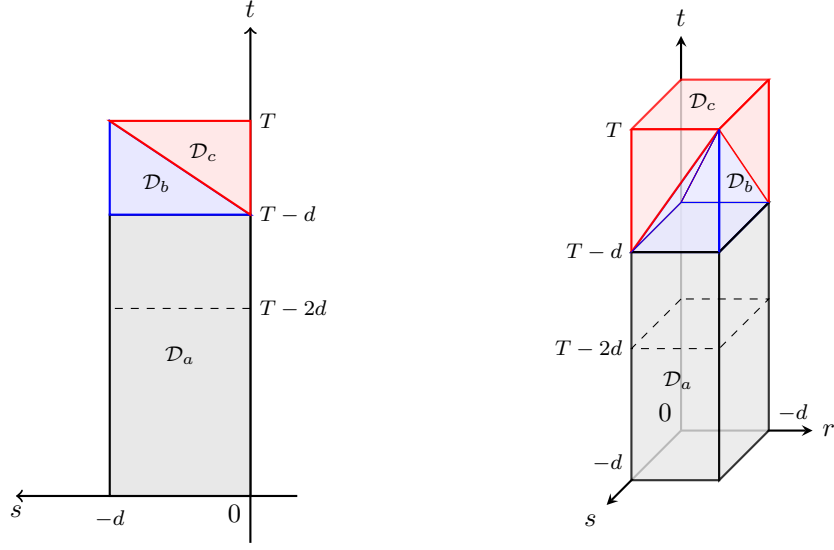

Figure 6.1 – Left: Cross section of \mathcal{D} along $r = 0$. Right: full domain $\mathcal{D} = \mathcal{D}_a \cup \mathcal{D}_b \cup \mathcal{D}_c$.

Then the optimization problem (6.2.1)-(6.2.2) admits (6.3.1) as an optimal feedback control. Furthermore, for $z = (x, \gamma) \in H$, the value is given by

$$\begin{aligned} V(z) &= P_{11}(0)x^2 + 2x \int_{-d}^0 P_{12}(0, s)\gamma_s ds + \int_{-d}^0 P_{22}(0, s)\gamma_s^2 ds \\ &\quad + \int_{[-d, 0]^2} \gamma_s \gamma_u P_{22}(0, s, r) ds dr \\ &= \langle P_0 z, z \rangle_H. \end{aligned} \quad (6.3.2)$$

Proof. The proof is a basic application of the martingale optimality principle, see [EK81]. Let $\alpha \in \mathcal{A}$ and define

$$\begin{aligned} V_t^\alpha &= P_{11}(t)(X_t^\alpha)^2 + 2x \int_{t-d}^t P_{12}(t, s-t)\alpha_s ds + \int_{t-d}^t P_{22}(t, s-t)\alpha_s^2 ds \\ &\quad + \int_{[t-d, t]^2} P_{22}(t, s-t, r-t)\alpha_s \alpha_r ds dr \\ &= \langle P_t Z_t^\alpha, Z_t^\alpha \rangle_H. \end{aligned} \quad (6.3.3)$$

An application of Itô's formula to (6.3.3) combined with differentiation under the integral symbol, authorized by the assumed boundness of P and its derivatives, yield

$$\begin{aligned} dV_t^\alpha &= \left\{ \mathbf{1}_t (X_t^\alpha)^2 + 2 \left(\mathbf{2}_t X_t^\alpha \alpha_t + \mathbf{3}_t X_t^\alpha \alpha_{t-d} + X_t^\alpha \int_{t-d}^t \mathbf{4}_t(s) \alpha_s ds \right) \right. \\ &\quad + \mathbf{5}_t \alpha_{t-d}^2 + \alpha_{t-d} \mathbf{6}_t(s) \int_{t-d}^t \alpha_s ds + \alpha_t \int_{t-d}^t \mathbf{7}_t(s) \alpha_s ds \\ &\quad \left. + \int_{t-d}^t \mathbf{8}_t(s) \alpha_s^2 ds + \int_{[t-d, t]^2} \mathbf{9}_t(s, u) \alpha_s \alpha_u ds du \right\} dt + Z_t^\alpha dW_t, \end{aligned}$$

where we have set

$$\begin{aligned}
 \mathbf{1}_t &= \dot{P}_{11}(t) & \mathbf{2}_t &= P_{12}(t, 0) \\
 \mathbf{3}_t &= 2bP_{11}(t) - P_{12}(t, -d) & \mathbf{4}_t(s) &= (\partial_t - \partial_s)(E_2)(t, s - t) \\
 \mathbf{5}_t &= \sigma^2 P_{11}(t) - P_{\hat{2}2}(t, -d) & \mathbf{6}_t(s) &= (bP_{12}(t, \cdot) - P_{22}(t, \cdot, -d))(s - t) \\
 \mathbf{7}_t(s) &= P_{22}(t, 0, s - t) & \mathbf{8}_t(s) &= (\partial_t - \partial_s)(P_{\hat{2}2})(t, s - t) \\
 \mathbf{9}_t(s, r) &= (\partial_t - \partial_s - \partial_r)(P_{22})(t, s - t, r - t),
 \end{aligned}$$

and

$$Z_t^\alpha = 2\sigma\alpha_{t-d} \left(X_t^\alpha P_{11}(t) + \int_{t-d}^t \alpha_s P_{12}(t, s - t) ds \right).$$

Then, using the set of constraints (6.2.9)-(6.2.10)-(6.2.11) together with (6.3.1) and a completion of the square in α yield

$$dV_t^\alpha = \left(P_{\hat{2}2}(t, 0) (\alpha_t - \mathcal{T}(\alpha)_t)^2 \right) dt + Z_t^\alpha dW_t,$$

where $\mathcal{T}(\alpha)$ is defined as

$$\mathcal{T}(\alpha)_t = -\frac{1_{t \leq T-d}}{P_{\hat{2}2}(t, 0)} \left\{ X_t^\alpha P_{12}(t, 0) + \int_{t-d}^t \alpha_s P_{22}(t, 0, s - t) ds \right\}, \quad t \leq T.$$

Note that since the kernels P_i 's are bounded and the control α^* is assumed to be admissible, $\alpha^* \in L_{\mathbb{F}}^2([0, T], \mathbb{R})$, X^α is continuous and the stochastic integral $\int_0^\cdot Z_s^\alpha dW_s$ is well posed. Furthermore it is a local martingale. Thus, there exists a localizing increasing sequence of stopping times $\{\tau_k\}_{k \geq 1}$ converging to T such that $\int_0^{\cdot \wedge \tau_k} Z_s^\alpha dW_s$ is a martingale for every $k \geq 1$. Then, for any $k \geq 1$

$$\mathbb{E} [V_{T \wedge \tau_k}^\alpha] = V_0^\alpha + \mathbb{E} \left[\int_0^{T \wedge \tau_k} P_{\hat{2}2}(s, 0) (\alpha_s - \mathcal{T}(\alpha)_s)^2 ds \right].$$

Note that $t \mapsto V_t^\alpha$ is continuous since P is bounded and $\alpha \in L_{\mathbb{F}}^2([-d, T], \mathbb{R})$. Thus, an application of the dominated convergence theorem on the left term (recall that $\mathbb{E} [\sup_{t \leq T} |X_t^\alpha|^2] < \infty$, $\alpha \in L_{\mathbb{F}}^2([-d, T], \mathbb{R})$ as $\alpha \in \mathcal{A}$) combined with the monotone convergence theorem on the right term yields, as $k \rightarrow \infty$

$$\mathbb{E} [V_T^\alpha] = \mathbb{E} [(X_T^\alpha)^2] = V_0^\alpha + \mathbb{E} \left[\int_0^T P_{\hat{2}2}(s, 0) (\alpha_s - \mathcal{T}(\alpha)_s)^2 ds \right].$$

Note that here we used the assumption $P_{\hat{2}2}(t, 0) \geq 0$ on $[0, T]$. Since $P_{\hat{2}2}$ is non-negative, we obtain that the optimal strategy is given by α^* and that the optimal value equals (6.3.2). \square

Proposition 6.3.1. *Assume that there exists a bounded 4-uplets P solution to (6.2.9)-(6.2.10)-(6.2.11) in the sense of Definition 6.2.1. Then (6.3.1) defines an admissible control.*

Proof. Let $\gamma \in L^2([-d, 0], \mathbb{R})$. To prove the claim, note that it suffices to show that the equation

$$\begin{cases} \alpha_t &= \frac{-1_{t \leq T-d}}{P_{22}(t,0)} \left\{ P_{12}(t,0) \left(x + \int_0^t \alpha_{s-d} (bds + \sigma dW_s) \right) + \int_{t-d}^t \alpha_s P_{22}(t,0, s-t) ds \right\}, \\ \alpha_s &= \gamma_s, \quad s \in [-d, 0], \end{cases} \quad (6.3.4)$$

admits a solution in $L^2_{\mathbb{F}}([0, T], \mathbb{R})$ and that the process X , then defined as

$$X_t = x + \int_0^t \alpha_{s-d} (bds + \sigma dW_s), \quad t \leq T, \quad (6.3.5)$$

satisfies $\mathbb{E} [\sup_{t \leq T} |X_t|^2] < \infty$. To prove the first point, consider the linear operator ϕ on $L^2_{\mathbb{F}}([0, T], \mathbb{R})$ defined as, for any $a \in L^2_{\mathbb{F}}([0, T], \mathbb{R})$

$$\phi(a)_t = \frac{-1}{P_{22}(t,0)} \left\{ P_{12}(t,0) \left(x + \int_0^t \hat{a}_{s-d} (bds + \sigma dW_s) \right) + \int_{t-d}^t \hat{a}_s P_{22}(t,0, s-t) ds \right\},$$

where $\hat{a}_t = 1_{t \leq 0} \gamma_t + 1_{t > 0} a_t$. For $\lambda \leq 0$, we endow $L^2_{\mathbb{F}}([0, T], \mathbb{R})$ with the norm $\|a\|_{2,\lambda} = \sqrt{\int_0^T e^{-\lambda s} |a_s|^2 ds}$. Then, for any $a, a' \in L^2_{\mathbb{F}}([0, T], \mathbb{R})$, we have

$$\begin{aligned} \|\phi(a) - \phi(a')\|_{2,\lambda}^2 &= \mathbb{E} \left[\int_0^T e^{-\lambda s} |\phi(a)_s - \phi(a')_s|^2 ds \right] \\ &\leq 2(\mathbf{I} + \mathbf{II}). \end{aligned} \quad (6.3.6)$$

An application of Jensen's inequality on the normalised measure $\frac{dr}{s}$ on $[0, s]$, combined with $\frac{1-e^{-\lambda(T-r)}}{\lambda} \leq (1 \vee T)(1 \wedge \lambda^{-1})$, and the Burkholder-Davis-Gundy inequality lead to

$$\begin{aligned} \mathbf{I} &\leq \mathbb{E} \left[\int_0^T e^{-\lambda s} \left| \frac{P_{12}(s,0)}{P_{22}(s,0)} \int_0^s (\hat{a}_{r-d} - \hat{a}'_{r-d}) (bdr + \sigma dW_r) \right|^2 ds \right] \\ &\leq \sup_{s \leq T} \left| \frac{P_{12}(s,0)}{P_{22}(s,0)} \right|^2 \left\{ \mathbb{E} \left[\int_0^T e^{-\lambda s} \left(\int_0^s (\hat{a}_{r-d} - \hat{a}'_{r-d}) bdr \right)^2 ds \right] \right. \\ &\quad \left. + \mathbb{E} \left[\int_0^T e^{-\lambda s} \left(\int_0^s (\hat{a}_{r-d} - \hat{a}'_{r-d}) \sigma dW_r \right)^2 ds \right] \right\} \\ &\leq c(1 \wedge \lambda^{-1}) \mathbb{E} \left[\int_0^T e^{-\lambda r} (\hat{a}_{r-d} - \hat{a}'_{r-d})^2 dr \right], \end{aligned}$$

where $c > 0$ depends only on b, σ, T and $\sup_{s \leq T} \left| \frac{P_{12}(s,0)}{P_{22}(s,0)} \right|$. Furthermore, we have

$$\begin{aligned} \mathbf{II} &\leq \mathbb{E} \left[\int_0^T e^{-\lambda s} \left| \frac{1}{P_{22}(s,0)} \int_{s-d}^s (\hat{a}_r - \hat{a}'_r) P_{22}(r,0, s-r) dr \right|^2 ds \right] \\ &\leq \sup_{\substack{s \leq T \\ r \in [-d, 0]}} \left| \frac{P_{22}(s,0,r)}{P_{22}(s,0)} \right|^2 \mathbb{E} \left[\int_0^T e^{-\lambda s} \left| \int_0^s (\hat{a}_r - \hat{a}'_r) dr \right|^2 ds \right] \\ &\leq \hat{c}(1 \wedge \lambda^{-1}) \mathbb{E} \left[\int_0^T e^{-\lambda r} (a_r - \hat{a}'_r)^2 dr \right], \end{aligned}$$

where $\hat{c} > 0$ depends only on T and $\sup_{\substack{s \leq T \\ r \in [-d, 0]}} \left| \frac{P_{22}(s,0,r)}{P_{22}(s,0)} \right|$. Consequently, (6.3.6) reduces to

$$\|\phi(a) - \phi(a')\|_{2,\lambda}^2 \leq (c + \hat{c})(1 \wedge \lambda^{-1}) \|a - a'\|_{2,\lambda}^2.$$

As a result, for λ large enough, ϕ is a contraction on the Banach space $(L^2_{\mathbb{F}}([0, T], \mathbb{R}), \|\cdot\|_{2, \lambda})$, thus proving the existence of $\alpha \in L^2_{\mathbb{F}}([0, T], \mathbb{R})$ solution to (6.3.4). Finally, an application of Burkholder-Davis-Gundy's inequality to (6.3.5) yields $\mathbb{E}[\sup_{t \leq T} |X_t|^2]$. The proof is thus complete. \square

Next, we give a sufficient condition for the existence of $P = (P_{11}, P_{12}, P_{22}, P_{22})$ in terms of b, σ, d and T . Let $a = (a_n)_{n \geq 1}$ be the sequence defined as

$$\begin{cases} a_0 &= 1, \\ a_{n+1} &= a_n - \frac{d}{a_n} \left(\frac{b}{\sigma}\right)^2, \quad n \geq 0. \end{cases} \quad (6.3.7)$$

Let us denote $\mathcal{N} : (d, b, \sigma) \mapsto \inf\{n \geq 1 : a_n > 0 \text{ and } a_{n+1} \leq 0\}$. Clearly, \mathcal{N} is a well defined finite valued function on \mathbb{R}^3 whose image is not restricted to $\{0\}$.

Proposition 6.3.2. *Assume $\mathcal{N}(d, b, \sigma) \geq 2$ and $T < \mathcal{N}(d, b, \sigma)d$. Then (6.2.9)-(6.2.10)-(6.2.11) has a unique solution in the sense of definition 6.2.1 on $[0, T]$ with $0 < a_{\mathcal{N}(d, b, \sigma)} \leq P_{11}(0) < 1$.*

Proof. See appendix 6.A. \square

Remark 6.3.1. *Note that when $d = 0$, the sufficient condition above reduces to $\sigma \neq 0$.*

Let us give some intuition as of why the delay feature induces the condition on the coefficients described above to ensure existence. We focus on the first slice $[T - 2d, T - d] \times [-d, 0]$ of the domain, where the solution P is not trivial.

First, note that since P_{22} is a transport of P_{11} which takes the form $P_{22}(t, s) = \sigma^2 P_{11}(t + s + d) 1_{t+s+d \leq T} = \sigma^2 1_{t+s+d \leq T}$. On this slice, the kernel P_{11} can be expressed in the following integral form

$$P_{11}(t) = 1 - \left(\frac{b}{\sigma}\right)^2 \int_t^{T-d} \left(\frac{P_{12}(s, 0)}{b}\right)^2 ds, \quad (6.3.8)$$

for $t \in [T - 2d, T - d]$. Looking at $P_{12}(\cdot, 0)$, we have

$$P_{12}(t, 0) = b - \sigma^{-2} \int_t^{T-d} P_{12}(x, 0) \times \underbrace{P_{22}(x, t-x, 0)}_{\lesssim b^2} dx,$$

see also (6.A.4). On the right, we represent the value of the normalized kernel P_{12}/b in the different areas of the domain $[T - 2d, T] \times [-d, 0]$. If we visualize the evolution of the normalized kernel P_{12}/b in a backward way on the slice $[T - 2d, T - d]$, we see that this term is equal to a transport of its value on the boundary $\frac{P_{12}(T-d, s)}{b} = 1$, represented by the blue arrows, minus the integral of a positive source term which is independent of $t \in [T - 2d, T - d] \mapsto P_{11}(t)$.

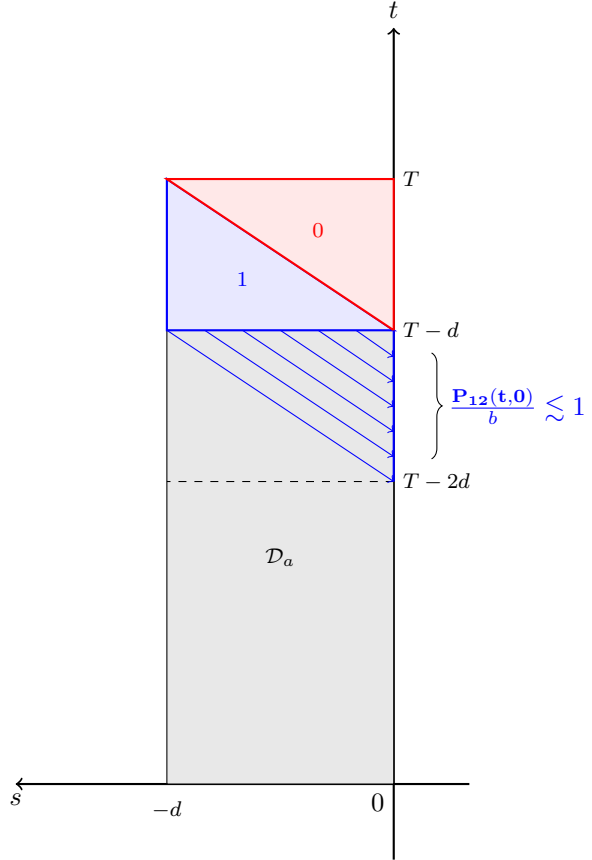

Consequently, the delay $d > 0$ makes the integral term in (6.3.8) independent of $t \in [T - 2d, T - d] \mapsto P_{11}(t)$ and of the order of $d \left(\frac{b}{\sigma}\right)^2$. If this quantity is too large, the kernel P_{11} can then reach negative values, thus making P_{22} negative on the next slice $[T - 3d, T - 2d]$ and therefore preventing the system (6.2.9)-(6.2.10)-(6.2.11) from having a solution. Repeating this argument from slice to slice of size d in a backward manner induces the aforementioned sufficient condition. Note that these arguments break down when $d = 0$. These arguments are precisely developed in Appendix 6.A.

6.4 Deep learning scheme

6.4.1 A quick reminder of PINNs and Deep Galerkin method for PDEs

In order to solve (6.2.9)-(6.2.10)-(6.2.11), we will make use of neural networks in the spirit of the emerging Physics Informed Neural Networks (PINNs) and Deep Galerkin literatures, see [SS18] and [RPK19] to name just a few. We first recall some of the main ideas. Assume we have a nonlinear partial differential equation of the form

$$\begin{aligned} \partial_t u + \mathcal{N}(u) &= 0, & \text{on } \Omega, \\ u &= g, & \text{on } \partial\Omega, \end{aligned} \tag{6.4.1}$$

where \mathcal{N} is a nonlinear operator, Ω a bounded open subset and g a function on the boundary of the domain. The main idea is to approximate the solution u to (6.4.1) by a deep neural network. Let us call $t \mapsto u(t, \Theta)$ this network, where Θ and t denote respectively its parameters and a generic element of $\Omega \cup \partial\Omega$. The goal is to find a Θ so that $t \mapsto u(t, \Theta)$ satisfies (6.4.1). To do so, the idea is to proceed by minimizing the mean square error loss

$$\begin{aligned} \mathcal{L}(\Theta, \mathcal{T}) &= \mathcal{L}_u(\Theta, \mathcal{T}) + \mathcal{L}_f(\Theta, \mathcal{T}), \\ \mathcal{L}_u(\Theta, \mathcal{T}) &= \frac{1}{|\mathcal{T}|} \sum_{t \in \mathcal{T}} |(\partial_t + \mathcal{N})u(t, \Theta)|^2 1_{t \in \Omega}, \\ \mathcal{L}_f(\Theta, \mathcal{T}) &= \frac{1}{|\mathcal{T}|} \sum_{t \in \mathcal{T}} |u(t, \Theta) - g(t)|^2 1_{t \in \partial\Omega}, \end{aligned}$$

where \mathcal{L}_f is the loss associated with the initial and boundary constraints on $\partial\Omega$, \mathcal{L}_u the loss associated to the PDE constraint $\partial_t u + \mathcal{N}(u) = 0$ on Ω and \mathcal{T} a random subset of $\partial\Omega \cup \Omega$.

6.4.2 A tailor-made algorithm for Riccati partial differential equations

Although (6.2.9)-(6.2.10)-(6.2.11) naturally fits the framework of PINNs, we make use of the structure exhibited on the operator P to build a tailor-made algorithm to approximate the system of Riccati transport PDEs (6.2.9)-(6.2.10)-(6.2.11).

Step 1: We define one neural network for each kernel $P_{11}, P_{12}, P_{22}, P_{22}$, as described in Figure 6.2. Note that usually a unique neural network is used as a surrogate to the function that is to be approximated.

Step 2: We build specific loss functionals for each of our neural networks. To illustrate this, consider for instance the constraint imposed on the derivative of $t \mapsto P_{11}(t)$:

$$\dot{P}_{11}(t) = \frac{P_{12}(t, 0)^2}{P_{22}(t, 0)}, \quad t \in [0, T]. \tag{6.4.2}$$

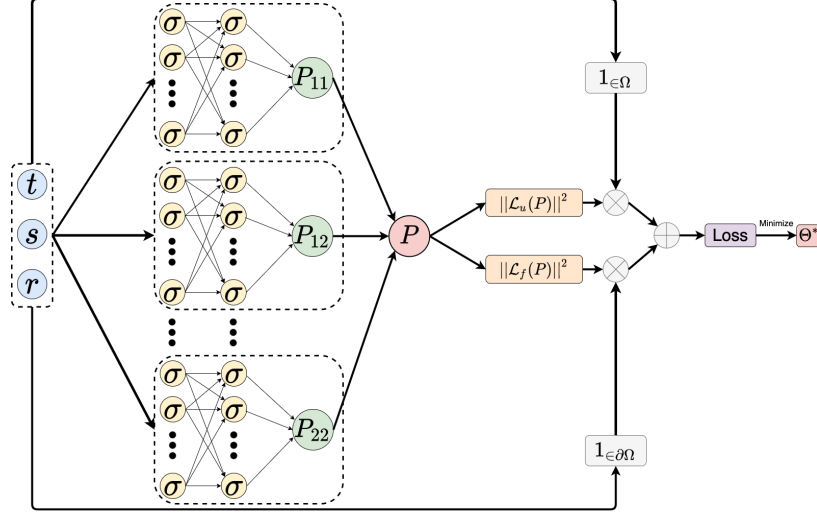

Figure 6.2 – Structure of the model used to solve (6.2.9)-(6.2.10)-(6.2.11).

Note here that, as in the previous sections, we use the convention $0^2/0 = 0$. As a result (6.4.2) can be rewritten as

$$\begin{aligned} \dot{P}_{11}(t) &= \frac{P_{12}(t, 0)^2}{P_{22}(t, 0)}, & t \leq T - d, \\ \dot{P}_{11}(t) &= 0, & t > T - d. \end{aligned}$$

Thus, a natural contribution to the total loss function to enforce (6.4.2) would be

$$\mathcal{L}_{11}(\Theta_{11}, \Theta_{12}, \Theta_{22}, \mathcal{T}) = \frac{1}{|\mathcal{T}|} \sum_{t \in \mathcal{T}} \left(\partial_t P_{11}(\Theta_{11}, t) - \frac{P_{12}(\Theta_{12}, t, 0)^2}{P_{22}(\Theta_{22}, t, 0)} \right)^2, \quad \mathcal{T} \subset [0, T],$$

and the natural gradient descent step associated to the constraint (6.4.2) would be

$$\Theta_i \leftarrow \Theta_i - \eta \nabla_{\Theta_i} \mathcal{L}_{11}(\Theta_{11}, \Theta_{12}, \Theta_{22}, \mathcal{T}), \quad i \in \{11, 12, \hat{2}2\},$$

Consequently, the constraint (6.4.2) a priori entails the updating of P_{11} , P_{12} and P_{22} . In particular, it requires to compute the gradient of $(\Theta_{12}, \Theta_{22}) \mapsto \sum_{t \in \mathcal{T}} \frac{P_{12}(\Theta_{12}, t, 0)^2}{P_{22}(\Theta_{22}, t, 0)}$ which is expected to be highly unstable as $t, s \mapsto P_{22}(t, s)$ vanishes for $t + s \geq T - d$. To mitigate this issue, the term $t \mapsto \frac{P_{12}(\Theta_{12}, t, 0)^2}{P_{22}(\Theta_{22}, t, 0)}$ is considered as an exogenous source term for P_{11} which is fixed when we train P_{11} .

$$\dot{P}_{11}(t) = \underbrace{\frac{P_{12}(t, 0)^2}{P_{22}(t, 0)}}_{\text{Seen as a fixed exogenous source term when } P_{11} \text{ is trained}}, \quad t \in [0, T].$$

Seen as a fixed exogenous source term when P_{11} is trained

To implement this idea, a second set of neural networks $(\tilde{P}_k(\tilde{\Theta}_k))_{k \in \{11, 12, \hat{2}2, 22\}}$ is initialized with $\tilde{\Theta}_k = \Theta_k$ for $k \in \{11, 12, \hat{2}2, 22\}$ at initialization. These additional networks are then used as surrogates to the right-hand side source terms and will not be used for the computation of the gradients of the losses. They will only be updated at the end of

each batch training. Consequently, the gradient descent scheme implemented for each batch \mathcal{T} is the following:

$$\begin{aligned} \text{Step 1} & \begin{cases} \Theta_{11} \leftarrow \Theta_{11} - \eta \nabla_{\Theta_{11}} \left(\mathcal{L}_{11}^r(\Theta_{11}, \tilde{\Theta}_{12}, \tilde{\Theta}_{22}, \mathcal{T}) + \mathcal{L}_1^f(\Theta_{11}, \mathcal{T}) \right) \\ \Theta_{12} \leftarrow \Theta_{12} - \eta \nabla_{\Theta_{12}} \left(\mathcal{L}_{12}^r(\Theta_{12}, \tilde{\Theta}_{22}, \tilde{\Theta}_{22}, \mathcal{T}) + \mathcal{L}_{12}^b(\tilde{\Theta}_{11}, \Theta_{12}, \mathcal{T}) + \mathcal{L}_{12}^f(\Theta_{12}, \mathcal{T}) \right) \\ \Theta_{22} \leftarrow \Theta_{22} - \eta \nabla_{\Theta_{22}} \left(\mathcal{L}_{22}^r(\Theta_{22}, \mathcal{T}) + \mathcal{L}_{22}^b(\tilde{\Theta}_{11}, \Theta_{22}, \mathcal{T}) + \mathcal{L}_{22}^f(\Theta_{22}, \mathcal{T}) \right) \\ \Theta_{22} \leftarrow \Theta_{22} - \eta \nabla_{\Theta_{22}} \left(\mathcal{L}_4^r(\Theta_{22}, \Theta_{22}, \tilde{\Theta}_{22}, \mathcal{T}) + \mathcal{L}_{22}^b(\Theta_{12}, \Theta_{22}, \tilde{\Theta}_{22}, \mathcal{T}) + \mathcal{L}_{22}^f(\Theta_{22}, \mathcal{T}) \right), \end{cases} \\ \text{Step 2} & \left\{ \tilde{\Theta}_k \leftarrow \Theta_k, \quad k \in \{11, 12, \hat{2}2, 22\}, \right. \end{aligned} \quad (6.4.3)$$

where the \mathcal{L}_i^r 's stand for the *residual loss*, the \mathcal{L}_i^b 's stand for the *boundary loss* and the \mathcal{L}_i^f 's stand for the *final loss*. The precise definitions of the losses are given below.

For each neural network $P_k(\Theta_k)$, $k \in \{11, 12, \hat{2}2, 22\}$, a *follower network* is initialized $\tilde{P}_k(\tilde{\Theta}_k)$, $k \in \{11, 12, \hat{2}2, 22\}$. These follower networks serve as surrogate for the source terms in (6.2.9)-(6.2.10)-(6.2.11). They condition the loss functionals that are used to train the P_k 's and are updated at the end of each batch as described in Algorithm 6.1.

Losses of P_{11} :

$$\begin{aligned} \mathcal{L}_{11}^r(\Theta_{11}, \tilde{\Theta}_{12}, \tilde{\Theta}_{22}) &= \frac{1}{|\mathcal{T}|} \sum_{t \in \mathcal{T}} \left(\partial_t P_{11}(t, \Theta_{11}) - \frac{\tilde{P}_{12}(t, 0, \tilde{\Theta}_{12})^2}{\tilde{P}_{22}(t, 0, \tilde{\Theta}_{22})} \right)^2, \\ \mathcal{L}_{11}^f(\Theta_{11}, \mathcal{T}) &= \frac{1}{|\mathcal{T}|} \sum_{t \in \mathcal{T}} \left((P_{11}(t, \Theta_{11}) - 1)^2 \mathbf{1}_{t=T} \right). \end{aligned}$$

Losses of P_{12} :

$$\begin{aligned} \mathcal{L}_{12}^r(\Theta_{12}, \tilde{\Theta}_{22}, \tilde{\Theta}_{22}, \mathcal{T}) &= \frac{1}{|\mathcal{T}|} \sum_{t, s \in \mathcal{T}} \left((\partial_t - \partial_s) P_{12}(t, s, \Theta_{12}) - \frac{\tilde{P}_{12}(t, 0, \tilde{\Theta}_{12}) \tilde{P}_{22}(t, s, 0, \tilde{\Theta}_{22})}{\tilde{P}_{22}(t, 0, \tilde{\Theta}_{22})} \right)^2, \\ \mathcal{L}_{12}^b(\tilde{\Theta}_{11}, \Theta_{12}, \mathcal{T}) &= \frac{1}{|\mathcal{T}|} \sum_{t, s \in \mathcal{T}} \left(P_{12}(t, s, \Theta_{12}) - b \tilde{P}_{11}(t, \tilde{\Theta}_{11}) \right)^2 \mathbf{1}_{s=0, t \neq 0}, \\ \mathcal{L}_{12}^f(\Theta_{12}, \mathcal{T}) &= \frac{1}{|\mathcal{T}|} \sum_{t, s \in \mathcal{T}} (P_{12}(t, s, \Theta_{12})^2 \mathbf{1}_{t=T}). \end{aligned}$$

Losses of $P_{\hat{2}2}$:

$$\begin{aligned} \mathcal{L}_{\hat{2}2}^r(\Theta_{\hat{2}2}, \mathcal{T}) &= \frac{1}{|\mathcal{T}|} \sum_{t, s \in \mathcal{T}} ((\partial_t - \partial_s) P_{\hat{2}2}(t, s, \Theta_{\hat{2}2}))^2, \\ \mathcal{L}_{\hat{2}2}^b(\tilde{\Theta}_{11}, \Theta_{\hat{2}2}, \mathcal{T}) &= \frac{1}{|\mathcal{T}|} \sum_{t, s \in \mathcal{T}} \left(P_{\hat{2}2}(t, s, \Theta_{\hat{2}2}) - \sigma^2 \tilde{P}_{11}(t, \tilde{\Theta}_{11}) \right)^2 \mathbf{1}_{s=0, t \neq T}, \\ \mathcal{L}_{\hat{2}2}^f(\Theta_{\hat{2}2}, \mathcal{T}) &= \frac{1}{|\mathcal{T}|} \sum_{t, s \in \mathcal{T}} (P_{\hat{2}2}(t, s, \Theta_{\hat{2}2})^2 \mathbf{1}_{t=T}). \end{aligned}$$

Losses of P_{22} :

$$\begin{aligned}\mathcal{L}_{22}^r(\Theta_{22}, \tilde{\Theta}_{22}, \mathcal{T}) &= \frac{1}{|\mathcal{T}|} \sum_{t,s,r \in \mathcal{T}} \left((\partial_t - \partial_s - \partial_r) P_4(t, s, r, \Theta_{22}) - \frac{\tilde{P}_{22}(t, 0, r, \tilde{\Theta}_{22}) \tilde{P}_{22}(t, s, 0, \tilde{\Theta}_{22})}{\tilde{P}_{22}(t, 0, \tilde{\Theta}_{22})} \right)^2, \\ \mathcal{L}_{22}^b(\tilde{\Theta}_{12}, \Theta_{22}, \mathcal{T}) &= \frac{1}{|\mathcal{T}|} \sum_{t,s,r \in \mathcal{T}} \left(P_{22}(t, s, r, \Theta_{22}) - b\tilde{P}_{22}(t, s, \tilde{\Theta}_{12}) \right)^2 \mathbf{1}_{r=0, t \neq T} \\ &\quad + \frac{1}{|\mathcal{T}|} \sum_{t,s,r \in \mathcal{T}} \left(P_{22}(t, s, r, \Theta_{22}) - b\tilde{P}_{22}(t, r, \tilde{\Theta}_{12}) \right)^2 \mathbf{1}_{s=0, t \neq T}, \\ \mathcal{L}_{22}^f(\Theta_{22}, \mathcal{T}) &= \frac{1}{|\mathcal{T}|} \sum_{t,s,r \in \mathcal{T}} (P_{22}(t, s, r, \Theta_{22})^2 \mathbf{1}_{t=T}).\end{aligned}$$

Algorithm 6.1 Deep learning scheme to solve (6.2.9)-(6.2.10)-(6.2.11)

Initialize: the learning rate η , the neural networks $P(\Theta) = (P_k(\Theta_k))_k$ and $\tilde{P}(\tilde{\Theta}) = (\tilde{P}_k(\tilde{\Theta}_k))_k$.
Copy the weights $\tilde{\Theta}_k \leftarrow \Theta_k, k \in \{11, 12, \hat{2}2, 22\}$

For each batch:

- Randomly sample $\mathcal{T} \subset \partial\Omega \cup \Omega$;
- Compute the gradient $\nabla_{\Theta} \mathcal{L}(\Theta, \tilde{\Theta}, \mathcal{T})$ as in (6.4.3);
- Update $\Theta \leftarrow \Theta - \eta \nabla_{\Theta} \mathcal{L}(\Theta, \tilde{\Theta}, \mathcal{T})$;
- Update $\tilde{\Theta} \leftarrow \Theta$;

Return: The set of optimized parameters Θ^* .

6.5 Applications to mean-variance portfolio selection with execution delay

6.5.1 One asset with delay

We now aim at solving the celebrated example of mean-variance portfolio selection, see [Mar52b], with execution delay in the spirit of the problem of hedging of European options with execution delay presented in [FF14]. We present here the settings. Let us consider a standard Black-Scholes financial market, composed of a risk-less asset with zero interest rate

$$S_t^0 = 1, \quad t \in [0, T],$$

and a risky asset with dynamics

$$dS_t = S_t \{(\sigma\lambda) dt + \sigma dW_t\}, \quad t \in [0, T],$$

where λ and σ are constants representing respectively the risk premium and the volatility of the risky asset. At every time $t \in [0, T]$ the investor chooses, based on the information \mathcal{F}_t , to allocate the amount of money $\alpha_t \in \mathbb{R}$ into the risky asset. However, due to execution delays this order will be executed at time $t + d$. Set N_t^α (respectively N_t^0) the number of risky (respectively risk-less) shares held at time t . Then, given an investment

strategy $\alpha \in \mathcal{A}$, the value $(X_t^\alpha)_{t \in [0, T]}$ of the portfolio, that we suppose self-financing, follows the dynamics

$$\begin{aligned} dX_t^\alpha &= N_t^\alpha dS_t + \underbrace{(dN_t^\alpha)S_t + (dN_t^0)S_t^0}_{=0, \text{ self-financing}} \\ &= \underbrace{N_t S_t}_{\alpha_{t-d}} \{(\sigma\lambda)dt + \sigma dW_t\}. \end{aligned}$$

Consequently, the controlled state equation of the portfolio's value is of the form

$$\begin{cases} dX_t^\alpha = \alpha_{t-d} ((\sigma\lambda) dt + \sigma dW_t), & t \in [0, T], \\ X_0 = x_0, \quad \alpha_s = \gamma_s, & \forall s \in [-d, 0], \end{cases}$$

with $x_0 > 0$ and $\gamma \in L^2([-d, 0], \mathbb{R})$. The Mean-Variance portfolio selection problem in continuous-time consists in solving the following constrained problem

$$\begin{cases} \min_{\alpha \in \mathcal{A}} \text{Var}(X_T^\alpha) \\ \text{s.t. } \mathbb{E}[X_T^\alpha] = c. \end{cases} \quad (6.5.1)$$

It is well-known that problem (6.5.1) is equivalent to the following **max-min problem**, see [Pha09, Section 6.6.2]

$$\max_{\eta \in \mathbb{R}} \min_{\alpha \in \mathcal{A}} \mathbb{E} \left[(X_T^\alpha - (c - \eta))^2 \right] - \eta^2. \quad (6.5.2)$$

Thus, solving problem (6.5.1) involves two steps. First, the internal minimization problem in terms of the Lagrange multiplier η has to be solved. Second, the optimal value of η for the external maximization problem has to be determined. Thus, with $\xi = c - \eta$, we first define the **Inner optimization problem**:

$$\min_{\alpha \in \mathcal{A}} \mathbb{E} \left[(X_T^\alpha - \xi)^2 \right]. \quad (6.5.3)$$

Note that, by setting $\tilde{X}^\alpha = X^\alpha - \xi$, the inner problem (6.5.3) fits into the delayed LQ control problem analysed in Section 6.3. We first solve the inner optimization problem (6.5.3) in the following lemma.

Lemma 6.5.1. *Fix $\eta \in \mathbb{R}$ and $\xi = c - \eta$. Assume $T < d\mathcal{N}(d, (\sigma\lambda), \sigma)$ and define $\alpha^*(\xi)$ as the investment strategy*

$$\alpha_t^*(\xi) = \frac{-1_{t \leq T-d}}{P_{22}(t, 0)} \left\{ (X_t^{\alpha^*} - \xi) P_{12}(t, 0) + \int_{t-d}^t \alpha_s^*(\xi) P_{22}(t, 0, s-t) ds \right\}, \quad (6.5.4)$$

where P denotes the solution to (6.2.9)-(6.2.10)-(6.2.11) in the sense of Definition 6.2.1. Then, the inner minimization problem (6.5.3) admits $\alpha^*(\xi)$ as an admissible optimal feedback strategy and the optimal value is

$$V_0(\xi) = P_{11}(0)(x_0 - \xi)^2 + R(x_0 - \xi, \gamma), \quad (6.5.5)$$

where $R(\gamma)$ denotes the cost associated to the initial investment strategy γ on $[-d, 0]$

$$R(x, \gamma) = 2x \int_{-d}^0 \gamma_s P_{12}(0, s) ds + \int_{-d}^0 \gamma_s^2 P_{22}(0, s) ds + \int_{[-d, 0]^2} \gamma_s \gamma_u P_{22}(0, s, r) ds dr.$$

Proof. First, note that Proposition 6.3.2 yields the existence and uniqueness of a solution P to (6.2.9)-(6.2.10)-(6.2.11). Furthermore the admissibility of $\alpha^*(\xi)$ results from Proposition 6.3.1. For any $\alpha \in \mathcal{A}$, define $\tilde{X}_t^\alpha = X_t^\alpha - \xi$. Then, by Itô's formula we have

$$\begin{cases} d\tilde{X}_t^\alpha = \alpha_{t-d}((\sigma\lambda)dt + \sigma dW_t), & t \in [0, T], \\ \tilde{X}_0 = x_0 - \xi, \quad \alpha_s = \gamma_s, & \forall s \in [-d, 0]. \end{cases}$$

As a result, \tilde{X}^α and X^α have the same dynamics and $\tilde{X}_T^\alpha = X_T^\alpha - \xi$ so that problem (6.5.3) can be alternatively written as

$$\min_{\alpha \in \mathcal{A}} \mathbb{E} \left[\left(\tilde{X}_T^\alpha \right)^2 \right].$$

Thus, the optimality of $\alpha^*(\xi)$ and the value (6.5.5) are immediately given by the verification theorem 6.3.1. \square

Theorem 6.5.1. *Assume $T < d\mathcal{N}(d, (\sigma\lambda), \sigma)$. Then, the optimal investment strategy for the maximization problem (6.5.1) is given by $\alpha^*(\xi^*)$ defined in (6.5.4) with $\xi^* = c - \eta^*$ and*

$$\begin{aligned} \eta^* &= \frac{K(\gamma) + P_{11}(0)(x_0 - c)}{1 - P_{11}(0)}, \\ K(\gamma) &= \int_{-d}^0 \gamma_s P_{12}(0, s) ds. \end{aligned} \tag{6.5.6}$$

Furthermore, the value of (6.5.1) is

$$\begin{aligned} \text{Var}(X_T^{\alpha^*}) &= \frac{P_{11}(0)}{1 - P_{11}(0)} (x_0 - c + K(\gamma))^2 \\ &+ \int_{-d}^0 \gamma_s^2 P_{22}(0, s) ds + \int_{[-d, 0]^2} \gamma_s \gamma_u P_{22}(0, s, r) ds dr. \end{aligned} \tag{6.5.7}$$

Proof. As $T < d\mathcal{N}(d, (\sigma\lambda), \sigma)$, Proposition 6.3.2 ensures the existence and uniqueness of a solution P to (6.2.9)-(6.2.10)-(6.2.11). From Lemma 6.5.1 and (6.5.2), we have that the max-min problem (6.5.2), which is equivalent to (6.5.1), reduces to

$$\begin{aligned} &\max_{\eta \in \mathbb{R}} \left\{ V_0(c - \eta) - \eta^2 \right\} \\ &= \max_{\eta \in \mathbb{R}} \left\{ P_{11}(0) (x_0 - (c - \eta))^2 + R(x_0 - (c - \eta), \gamma) - \eta^2 \right\}. \end{aligned}$$

Furthermore, since $T < d\mathcal{N}(d, (\sigma\lambda), \sigma)$, Proposition 6.3.2 ensures $0 < P_{11}(0) < 1$ so that the maximization problem is strictly concave. Consequently, η^* given by (6.5.6) is the optimal parameter. Setting $\xi^* = c - \eta^*$ in (6.5.4) and (6.5.5) results in the optimality of $\alpha^*(\xi^*)$, and the optimal value (6.5.7) for the mean-variance problem (6.5.1). \square

Remark 6.5.1. *In the absence of pre-investment strategy, $\gamma = 0$, we recover the usual form of the efficient frontier formula*

$$\text{Var}(X_T^{\alpha^*}) = \frac{P_{11}(0)}{1 - P_{11}(0)} (x_0 - c)^2.$$

Our observations from the simulations are the following.

Efficient frontier: In Figure 6.3, we plot the efficient frontier for different delays d . Note that the greater the delay, the greater is the variance. This could have been foreseen by observing that, when the initial control is set to 0, i.e. $\gamma = 0_{L^2}$, the value function takes the form $V(x, 0_{L^2}) = P_{11}(0)x^2$, see (6.3.2). As the value function is clearly an increasing function of the delay, the terminal variance of the portfolio $\text{Var}(X_T^{\alpha^*}) = \frac{P_{11}(0)}{1-P_{11}(0)}(x_0 - c)^2$ is also an increasing function of the delay.

Destabilization effect : In Figure 6.4, we plot different scenarios of portfolio allocation. We observe a destabilization effect and a supplement of volatility induced by the delay feature. We also note the tendency to invest more aggressively for greater values of the delay, as the investor has less time to ensure that the promised yield is achieved. We propose the following interpretation: In the classical setting, where $d = 0$, if Y^* denotes the optimal portfolio value process, the optimal investment strategy is of the form $\alpha_t^* = -\frac{b}{\sigma^2}(Y^{\alpha^*} - \mu^*)$ for a certain constant $\mu^* > c$. It can then easily be shown that $Y^* \leq \mu^*$. Thus, the optimal strategy consists in aiming from below at a fixed target μ^* . When $d > 0$, the optimal control is composed of an additional *inertial term*

$$\alpha_t^*(\xi^*) = \frac{-1_{t \leq T-d}}{P_{22}(t, 0)} \left\{ \underbrace{(X_t^{\alpha^*} - \xi^*)P_{12}(t, 0)}_{\text{Usual mean-reverting term}} + \underbrace{\int_{t-d}^t \alpha_s^*(\xi)P_{22}(t, 0, s-t)ds}_{\text{New inertial term}} \right\},$$

so that, contrary to the case where $d = 0$, the optimal control does not cancel when the target ξ^* is attained. Also, note that at every time t , the agent doesn't have any control on the near future from t to $t + d$.

Kernel P : In Figure 6.5, we plot the kernels P_{11}, P_{12}, P_{22} , and P_{22} . Note the discontinuity between \mathcal{D}_b and \mathcal{D}_c also described in Figure 6.1.

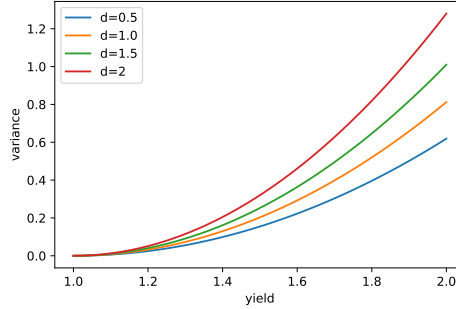

Figure 6.3 – Efficient frontier with $\sigma = 1, \lambda = 0.5, T = 5$ and $\gamma \equiv 0$.

6.5.2 One asset with delay and one without

To further explore the effect of the delay on the control, we now study a toy example where the investor has two investment opportunities, one with a delayed execution and one without. More precisely, consider the following portfolio dynamic

$$\begin{cases} dX_t^{(\alpha, \beta)} = \alpha_t \{(\sigma_1 \lambda_1)dt + \sigma_1 dW_t^1\} + \beta_{t-d} \{(\sigma_2 \lambda_2)dt + \sigma_2 dW_t^2\}, & t \in [0, T], \\ X_0 = x_0, \quad \beta_s = \gamma_s, \quad s \in [-d, 0], \\ \langle W^1, W^2 \rangle_t = \rho t, \end{cases}$$

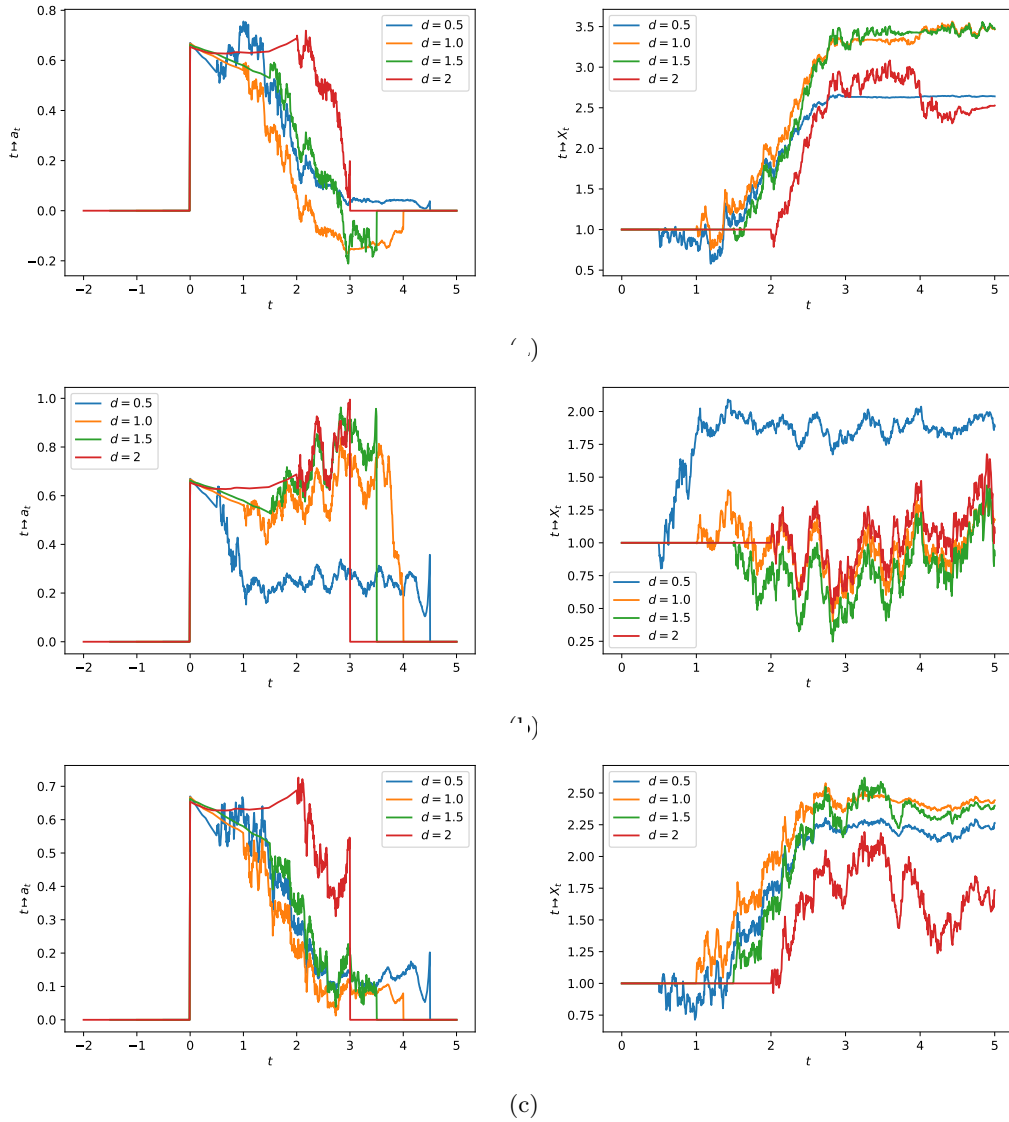
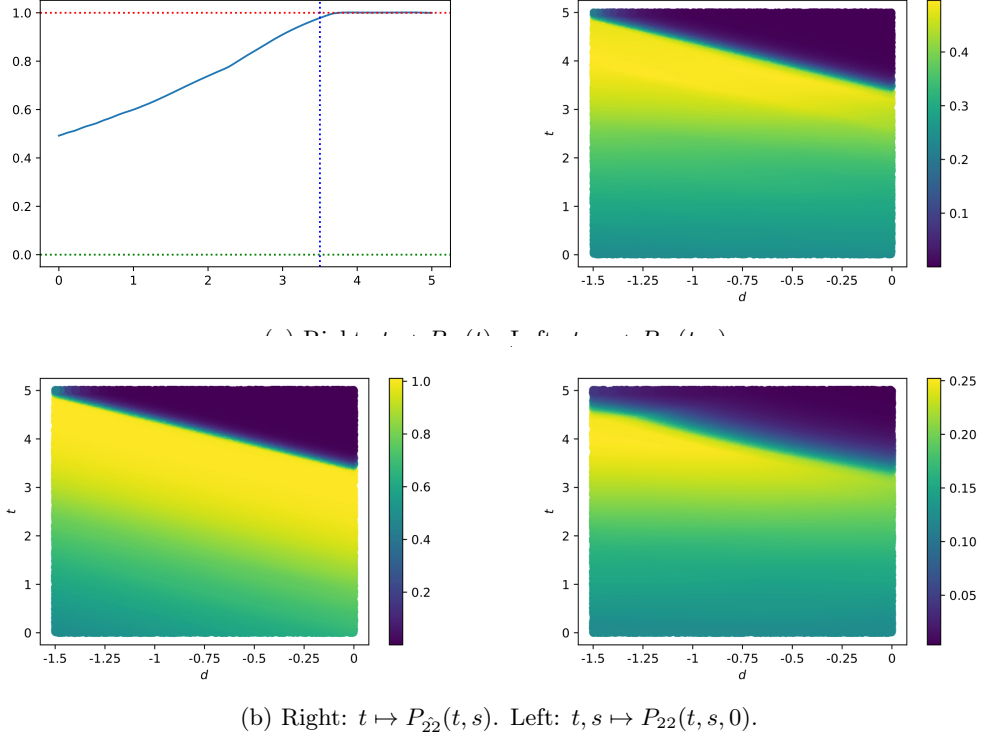

Figure 6.4 – Different scenarios of the optimal portfolio with $c = 1.6$, $\sigma = 1$, $\lambda = 0.5$, and $T = 5$. Left: $t \mapsto \alpha_t^*$, right: $t \mapsto X_t^*$. Note the destabilization effect and the supplement of volatility induced by the delay feature. Note also the tendency to invest more aggressively the delayed investor has, as she has less time to ensure the promised yield. $\xi^*(d = 0.5) = 2.57$, $\xi^*(d = 1) = 2.68$, $\xi^*(d = 1.5) = 2.80$, $\xi^*(d = 2) = 2.97$.

where $x_0 > 0$ and $\gamma \in L^2([-d, 0], \mathbb{R})$, together with the same optimization objective (6.5.1) as before. Here, α_t and β_t correspond respectively to the amounts of money the investor decides to invest at time t in the undelayed and the delayed risky assets. The constants λ_i and σ_i represent respectively the risk premium and the volatility of the risky asset i . Following the heuristic approach of Section 6.2, we define the following set

 Figure 6.5 – Numerical results of Algorithm 6.1 with $\sigma = 1$, $\lambda = 0.5$, $d = 1.5$, and $T = 5$.

of Riccati-PDEs on $[0, T] \times [-d, 0]^2$

$$\begin{aligned} \dot{P}_{11}(t) &= \lambda_1^2 P_{11}(t) + \frac{P_{12}(t, 0)^2}{P_{22}(t, 0)}, \\ (\partial_t - \partial_s)(P_{12})(t, s) &= \lambda_1^2 P_{12}(t, s) + \frac{P_{12}(t, 0)P_{22}(t, s, 0)}{P_{22}(t, 0)}, \\ (\partial_t - \partial_s)(P_{22})(t, s) &= 0, \\ (\partial_t - \partial_s - \partial_r)(P_{22})(t, s, r) &= \lambda_1^2 \frac{P_{12}(t, s)P_{12}(t, r)}{P_{11}(t)} + \frac{P_{22}(t, s, 0)P_{22}(t, 0, r)}{P_{22}(t, 0)}, \end{aligned} \quad (6.5.8)$$

accompanied by the boundary conditions, for almost any $t, s \in [0, T] \times [-d, 0]$

$$\begin{aligned} P_{12}(t, -d) &= \lambda_2 \sigma_2 \left(1 - \rho \frac{\lambda_1}{\lambda_2}\right) P_{11}(t), & P_{22}(t, -d) &= \sigma_2^2 (1 - \rho^2) P_{11}(t), \\ P_{22}(t, s, -d) &= \lambda_2 \sigma_2 \left(1 - \rho \frac{\lambda_1}{\lambda_2}\right) P_{12}(t, s), & P_{22}(t, -d, s) &= \lambda_2 \sigma_2 \left(1 - \rho \frac{\lambda_1}{\lambda_2}\right) P_{12}(t, s), \end{aligned} \quad (6.5.9)$$

and the terminal constraints

$$P_{11}(T) = 1, \quad P_{12}(T, s) = P_{22}(T, s) = P_{22}(T, s, r) = 0, \quad (6.5.10)$$

for almost every $s, r \in [-d, 0]$.

As in the previous section, we first solve the inner optimization problem 6.5.3.

Lemma 6.5.2. Fix $\eta \in \mathbb{R}$ and $\xi = c - \eta$. Assume (6.5.8)-(6.5.9)-(6.5.10) admits a piecewise absolutely continuous solution with $P_{22}(t) > 0$ for any $t \leq T - d$, and define

the couple $(\alpha^*, \beta^*)(\xi)$ as the investment strategies

$$\begin{aligned}\alpha_t^*(\xi) &= - \left\{ \frac{\lambda_1}{\sigma_1} (X_t^* - \xi) + \rho \frac{\sigma_2}{\sigma_1} \beta_{t-d}^* + \frac{\lambda_1}{\sigma_1 P_{11}(t)} \int_{t-d}^t \beta_s^*(\xi) P_{12}(t, s-t) ds \right\}. \\ \beta_t^*(\xi) &= \frac{-1_{t \leq T-d}}{P_{22}(t, 0)} \left\{ P_{12}(t, 0) (X_t^* - \xi) + \int_{t-d}^t \beta_s^*(\xi) P_{22}(t, 0, r-t) dr \right\},\end{aligned}$$

where X^* denotes the state process $X^{(\alpha^*, \beta^*)}$. Then, the inner minimization problem (6.5.3) admits $(\alpha^*(\xi), \beta^*(\xi))$ as an optimal feedback strategy and the optimal value is

$$V_0(\xi) = P_{11}(0)(x_0 - \xi)^2 + R(x_0 - \xi, \gamma),$$

where $R(\gamma)$ denotes the cost associated to the initial investment strategy γ on $[-d, 0]$

$$R(x, \gamma) = 2x \int_{-d}^0 \gamma_s P_{12}(0, s) ds + \int_{-d}^0 \gamma_s^2 P_{22}(0, s) ds + \int_{[-d, 0]^2} \gamma_s \gamma_u P_{22}(0, s, r) ds dr.$$

Proof. The proof is similar to the one of Lemma 6.5.1. \square

Finally, the parameter η^* and efficient frontier $\text{Var}(X_T^*) = f(c)$ are given by the same formulas (6.5.6) and (6.5.7) as in the mono-asset case, γ being the pre-investment strategy of the delayed asset.

Remark 6.5.2. One surprise that emerges is that the "buy the good stock sell the bad one" criterion is unchanged for the delayed asset. Indeed, the sign of the control for this asset is still given by the sign of $1 - \rho \frac{\lambda_1}{\lambda_2}$, that fixes the sign of the P_{12} and P_{22} , as it would be in the case without delay[†], see the boundary conditions (6.5.9). But this threshold disappears in the undelayed asset's control as now only the term $\frac{\lambda_1}{\sigma_1}$ remains in the mean-reverting term.

Numerical simulations: To exhibit the effect of the correlation ρ , we generate two independent Brownian motions $(W_t^1)_{t \in [0, T]}$ and $(B_t)_{t \in [0, T]}$ and define the Brownian motion $(W_t^2)_{t \in [0, T]}$ as

$$W_t^2 = \rho W_t^1 + \sqrt{1 - \rho^2} B_t, \quad t \in [0, T].$$

We then compare different scenarios with different values of correlation ρ and delay d while fixing W^1 and B . The numerical simulations can be found in Figures 6.6, 6.7 and 6.8. As it could have been expected, we see from (6.5.9) and Figure 6.6, that the greater ρ is, the more favored the undelayed asset is.

[†]When $d = 0$, recall that $\alpha_t^* = \frac{\lambda_1 P_t}{\sigma_1(1-\rho^2)}(1 - \rho \frac{\lambda_2}{\lambda_1})(\xi^* - X_t^*)$ and $\beta^* = \frac{\lambda_2 P_t}{\sigma_2(1-\rho^2)}(1 - \rho \frac{\lambda_1}{\lambda_2})(\xi^* - X_t^*)$ with P being a positive function and $\xi^* \geq X^*$. Thus, in the classical setting, the buy or sell thresholds are $(1 - \rho \frac{\lambda_2}{\lambda_1})$ and $(1 - \rho \frac{\lambda_1}{\lambda_2})$.

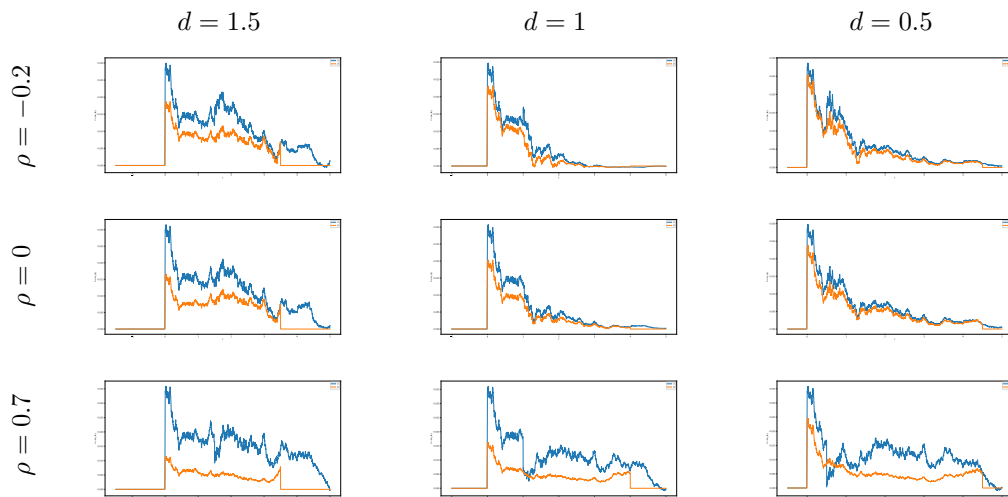

Figure 6.6 – $t \mapsto (\alpha_t^*, \beta_t^*)$, with $\sigma_1 = \sigma_2 = 1$, $\lambda_1 = \lambda_2 = 0.5$ and $T = 5$. Blue : α^* , orange : β^* . The same realizations of W and B were used for all experiments. Note that the more positively correlated the assets are, the more favored the undelayed asset is.

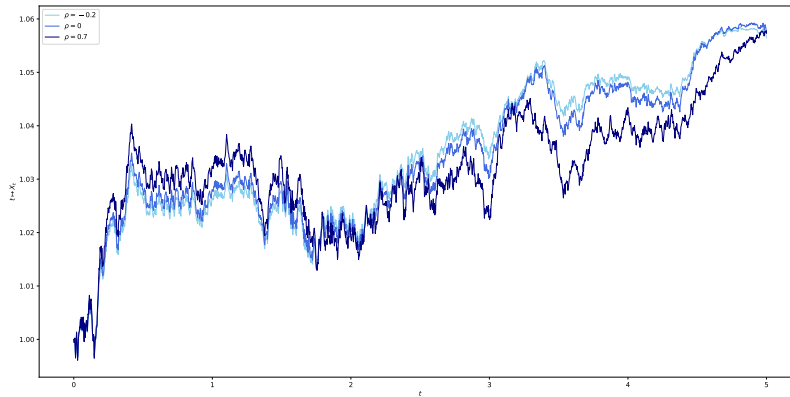

Figure 6.7 $-t \mapsto X_t^*$, with $\sigma_1 = \sigma_2 = 1$, $\lambda_1 = \lambda_2 = 0.5$, $T = 5$ and $d = 1.5$ for $\rho = -0.7$, 0 and 0.7. The same realizations of the Brownian motions W^1 and B was used for all experiments.

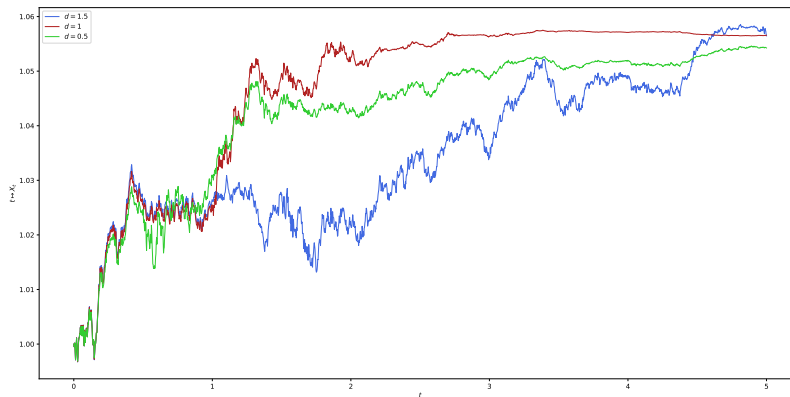

Figure 6.8 $-t \mapsto X_t^*$, with $\sigma_1 = \sigma_2 = 1$, $\lambda_1 = \lambda_2 = 0.5$, $T = 5$ and $\rho = -0.7$ for $d = 1.5$, 1 and 0.5. The same realizations of the Brownian motions W^1 and B was used for all experiments.

6.A Proof of Proposition 6.3.2

Our proof extends [Ale+71, Theorem 5] to the case where the volatility is controlled. It consists in slicing the domain \mathcal{D} in slices of size d and proceeding by a backward recursion. More precisely, we show existence, uniqueness, and positiveness of the first coordinates, over a sequence of slices $([T - (n + 1)d, T - nd] \times [-d, 0]^2)_n$. We then concatenate the sequence of absolutely continuous solutions obtained, which yields a piece-wise absolutely continuous solution. In each slice, the proof consists of the following steps

1. Show that there exists a unique solution on a small interval;
2. Prove that the local solution is Lipschitz;
3. As a result extend the solution to the whole slice.

We finally concatenate the sequence of solutions obtained above.

6.A.1 Slice $t \in [T - d, T]$, initialization

On $\mathcal{D}_b \cup \mathcal{D}_c$, the constraints (6.2.9)-(6.2.10)-(6.2.11) on $P_{12}, P_{\hat{2}2}$ and P_{22} reduce to linear homogeneous transport equations admitting closed form solutions given, for every $(t, s, r) \in \mathcal{D}_b \cup \mathcal{D}_c$, by

$$\begin{aligned} P_{12}(t, s) &= bP_{11}(t + s + d)\mathbf{1}_{t+s+d \leq T}, & P_{\hat{2}2}(t, s) &= \sigma^2 P_{11}(t + s + d)\mathbf{1}_{t+s+d \leq T}, \\ P_{22}(t, s, r) &= b^2 P_{11}(t + s \vee r + d)\mathbf{1}_{t+s \vee r + d \leq T}. \end{aligned}$$

Or, as $P_{11}(t) = 1$ for any $t \geq T - d$, we then have for every $(t, s, r) \in \mathcal{D}_b \cup \mathcal{D}_c$

$$\begin{aligned} P_{11}(t) &= 1, & P_{12}(t, s) &= b\mathbf{1}_{t+s+d \leq T}, \\ P_{\hat{2}2}(t, s) &= \sigma^2 \mathbf{1}_{t+s+d \leq T}, & P_{22}(t, s, r) &= b^2 \mathbf{1}_{t+s \vee r + d \leq T}. \end{aligned}$$

The existence and uniqueness in the sense of Definition 6.2.1 are thus trivially proved on $[T - d, T]$.

6.A.2 Slice $[T - 2d, T - d]$

On $[T - 2d, T - d] \times [-d, 0]^2$, we have $P_{\hat{2}2}(t, s) = \sigma^2 P_{11}(t + s + d)$ so that $P_{\hat{2}2}(t, 0) = \sigma^2 P_{11}(t + d) = \sigma^2$. Consequently, the system (6.2.9)-(6.2.10)-(6.2.11) reduces to

$$\begin{aligned} \dot{P}_{11}(t) &= \frac{P_{12}(t, 0)^2}{\sigma^2}, & (6.A.1) \\ (\partial_t - \partial_s)(P_{12})(t, s) &= \frac{P_{12}(t, 0)P_{22}(t, s, 0)}{\sigma^2}, \\ (\partial_t - \partial_s - \partial_r)(P_{22})(t, s, r) &= \frac{P_{22}(t, s, 0)P_{22}(t, 0, r)}{\sigma^2}, \end{aligned}$$

with terminal conditions

$$P_{11}(T - d) = 1, \quad P_{12}(T - d, s) = b, \quad P_{22}(T - d, s, r) = b^2, \quad (6.A.2)$$

and boundary constraints

$$P_{12}(t, -d) = bP_{11}(t), \quad P_{22}(t, s, -d) = bP_{12}(t, s). \quad (6.A.3)$$

Thus, for every $(t, s, r) \in [T - 2d, T - d] \times [-d, 0]^2$, the set of equations (6.A.1) and constraints (6.A.2)-(6.A.3) can be rewritten in the following integral form

$$\begin{aligned}
 P_{11}(t) &= 1 - \sigma^{-2} \int_t^{T-d} P_{12}(x, 0)^2 dx, \\
 P_{12}(t, s) &= bP_{11}((T-d) \wedge (t+s+d)) \\
 &\quad - \sigma^{-2} \int_t^{(T-d) \wedge (t+s+d)} P_{12}(x, 0) P_{22}(x, t+s-x, 0) dx, \\
 P_{22}(t, s, r) &= bP_{12}((T-d) \wedge (t+s \wedge r+d), (s-r) \vee (r-s) - d) \\
 &\quad - \sigma^{-2} \int_t^{(T-d) \wedge (t+s \wedge r+d)} P_{22}(x, t+s-x, 0) P_{22}(x, 0, t+r-x) dx.
 \end{aligned} \tag{6.A.4}$$

We then make use of the following lemma to prove local existence of a solution.

Lemma 6.A.1. *There exists $\tau \in (0, d]$ such that system (6.A.4) has a unique absolutely continuous solution on $[T - \tau - d, T - d] \times [-d, 0]^2$.*

Proof. Let $\tau \in (0, d]$ and \mathcal{S}_τ denote the Banach space of absolutely continuous functions $\xi = (\xi_1(\cdot), \xi_2(\cdot, \cdot), \xi_3(\cdot, \cdot, \cdot))$ defined on

$$\mathcal{D}_\tau = \{(t, s, r) \mid T - d - \tau \leq t \leq T - d, -d \leq s, r \leq 0\},$$

endowed with the sup-norm

$$\|\xi\|_\infty = \|\xi_1\|_\infty + \|\xi_2\|_\infty + \|\xi_3\|_\infty,$$

where $\|\xi_1\|_\infty$, $\|\xi_2\|_\infty$ and $\|\xi_3\|_\infty$ denote, with a slight abuse of notation, the respective sup-norm on $[T - d - \tau, T - d]$, $[T - d - \tau, T - d] \times [-d, 0]$ and $[T - d - \tau, T - d] \times [-d, 0]^2$. Let \mathcal{B}_τ denote the ball in \mathcal{S}_τ

$$\mathcal{B}_\tau = \{(\xi_1, \xi_2, \xi_3) \in \mathcal{S}_\tau : \|\xi_1 - 1\| \leq 1/2, \|\xi_2 - b\| \leq |b|/2, \|\xi_3 - b^2\| \leq b^2/2\},$$

On \mathcal{B}_τ , we denote by $\phi = (\phi_1, \phi_2, \phi_3)$ the operator defined as follows

$$\begin{aligned}
 (\phi_1 \xi)(t) &= 1 - \sigma^{-2} \int_t^{T-d} \xi_2(x, 0)^2 dx \\
 (\phi_2 \xi)(t, s) &= b\phi_1(\xi)((T-d) \wedge (t+s+d)) \\
 &\quad - \sigma^{-2} \int_t^{(T-d) \wedge (t+s+d)} \xi_2(r, 0) \xi_3(r, t+s-x, 0) dx \\
 (\phi_3 \xi)(t, s, r) &= b\phi_2(\xi)((T-d) \wedge (t+s \wedge r+d), (s-r) \vee (r-s) - d) \\
 &\quad - \sigma^{-2} \int_t^{(T-d) \wedge (t+s \wedge r+d)} \xi_3(x, t+s-x, 0) \xi_3(x, 0, t+r-x) dx.
 \end{aligned}$$

Clearly, there exists $\tilde{\tau} > 0$ such that for any $\tau \leq \tilde{\tau}$, $\phi(\mathcal{B}_\tau) \rightarrow \mathcal{B}_\tau$. We show a contraction property on ϕ . For any $\xi, \xi' \in \mathcal{B}_\tau$, we have the following inequalities

$$\begin{aligned}
 \|\phi_1(\xi) - \phi_1(\xi')\|_\infty &\leq 4\tau\sigma^{-2}|b|\|\xi_2 - \xi'_2\|_\infty, \\
 \|\phi_2(\xi) - \phi_2(\xi')\|_\infty &\leq 4\tau\sigma^{-2}(|b|\|\xi_2 - \xi'_2\|_\infty + |b|^2\|\xi_3 - \xi'_3\|_\infty) \\
 &\quad + |b|\|\phi_1(\xi) - \phi_1(\xi')\|_\infty, \\
 \|\phi_3(\xi) - \phi_3(\xi')\|_\infty &\leq |b|\|\phi_2(\xi) - \phi_2(\xi')\|_\infty + 4\tau\sigma^{-2}|b|^2\|\xi_3 - \xi'_3\|_\infty.
 \end{aligned}$$

Consequently, the operator ϕ satisfies

$$\|\phi(\xi) - \phi(\xi')\|_\infty \leq \tau m \|\xi - \xi'\|_\infty,$$

where $m > 0$ depends on b and σ . Therefore, for $\tau < \tilde{\tau} \wedge m^{-1}$, the operator ϕ is a contraction of \mathcal{B}_τ into itself. Thus, ϕ admits a unique fixed point in \mathcal{B}_τ , which is solution to (6.A.4) on \mathcal{D}_τ . \square

Lemma 6.A.2. *Let $\xi = (\xi_1, \xi_2, \xi_3)$ denote the absolutely continuous solution of (6.A.4) on \mathcal{D}_τ from Lemma 6.A.1. Then ξ is Lipschitz in each variable on \mathcal{D}_τ .*

Proof. As ξ_1, ξ_2 and ξ_3 are continuous on \mathcal{D}_τ , there exists a constant $m > 0$ such that $|\xi_1| \wedge |\xi_2| \wedge |\xi_3| \leq m$ on \mathcal{D}_τ . Thus, ξ_1 is Lipschitz with constant $\kappa = m^2 \sigma^{-2}$. Let us now show that ξ_2 and ξ_3 are Lipschitz in the s -variable. Fix $t \in [T - d - \tau, T - d]$ and $\eta > 0$. Then, for any $s \in [-d, 0]$ such that $s + \eta \in [-d, 0]$, we have

$$\begin{aligned} |\xi_2(t, s) - \xi_2(t, s + \eta)| &\leq \kappa \eta + \sigma^{-2} \left| \int_t^{(T-d) \wedge (t+s+\eta+d)} \xi_2(x, 0) \xi_3(x, t + s + \eta - x, 0) dx \right. \\ &\quad \left. - \int_t^{(T-d) \wedge (t+s+d)} \xi_2(x, 0) \xi_3(x, t + s - x, 0) dx \right| \\ &\leq \kappa \eta + \mathbf{I}(t, s) + \mathbf{II}(t, s), \end{aligned}$$

Since $|\xi_2| \leq m$, it yields

$$\begin{aligned} \mathbf{I}(t, s) &\leq \int_t^{(T-d) \wedge (t+s+d)} |\xi_2(x, 0)| |\xi_3(x, t + s + \eta - x, 0) - \xi_3(x, t + s - x, 0)| dx \\ &\leq m \int_t^{(T-d) \wedge (t+s+d)} \epsilon(x) dx, \end{aligned}$$

where ϵ is defined as

$$\epsilon(x) = \sup_{\substack{s, r \\ \in [-d, 0]^2}} |\xi_3(x, s, r) - \xi_3(x, s + \eta, r)| + \sup_{s \in [-d, 0]} |\xi_2(x, s) - \xi_2(x, s + \eta)|.$$

Futhermore, as $|\xi_2| \wedge |\xi_3| \leq m$ on \mathcal{D}_τ , we have

$$\begin{aligned} \mathbf{II}(t, s) &\leq \int_{(T-d) \wedge (t+s+d)}^{(T-d) \wedge (t+s+\eta+d)} |\xi_2(x, 0) \xi_3(x, t + s + \eta - x, 0)| dx \\ &\leq m^2 \eta. \end{aligned}$$

Consequently, for any $t \in [T - d - \tau, T - d]$, we obtain

$$\sup_s |\xi_2(t, s) - \xi_2(t, s + \eta)| \leq m^2 \eta + m \int_t^{T-d} \epsilon(r) dr. \quad (6.A.5)$$

Looking at the equation of ξ_3 in system (6.A.4), we obtain in a similar manner

$$|\xi_3(t, s, r) - \xi_3(t, s + \eta, r)| \leq |b| \mathbf{I}(t, s, r) + \sigma^{-2} \mathbf{II}(t, s, r). \quad (6.A.6)$$

An application to the triangle inequality combined with (6.A.5) and the lipshitzianity of ξ_1 leads to

$$\begin{aligned}
 \mathbf{I}(t, s, r) &\leq |\xi_2((T-d) \wedge (t + (s + \eta) \wedge r + d), (s + \eta - r) \vee (r - (s + \eta)) - d) \\
 &\quad - \xi_2((T-d) \wedge (t + s \wedge r + d), (s - r) \vee (r - s) - d)| \\
 &\leq (\kappa + m^2(1 + \sigma^{-2}))\eta + m \int_{(T-d) \wedge (t+s \wedge r+d)}^{T-d} \epsilon(x) dx \\
 &\leq (1 + 2\kappa)\eta + m \int_t^{T-d} \epsilon(x) dx.
 \end{aligned} \tag{6.A.7}$$

Furthermore

$$\begin{aligned}
 \mathbf{II}(t, s, r) &\leq \left| \int_t^{(T-d) \wedge (t+(s+\eta) \wedge r+d)} \xi_3(x, t + s + \eta - x, 0) \xi_3(x, 0, t + r - x) dx \right. \\
 &\quad \left. - \int_t^{(T-d) \wedge (t+s \wedge r+d)} \xi_3(x, t + s - x, 0) \xi_3(x, 0, t + u - x) dx \right| \\
 &\leq \int_t^{(T-d) \wedge (t+s \wedge r+d)} |\xi_3(x, 0, t + r - x)| |\xi_3(x, t + s - x, 0) \\
 &\quad - \xi_3(x, t + (s + \eta) - x, 0)| dx \\
 &\quad + \int_{(T-d) \wedge (t+s \wedge r+d)}^{(T-d) \wedge (t+(s+\eta) \wedge r+d)} |\xi_3(x, t + (s + \eta) - x, 0) \xi_3(r, 0, t + r - x)| dx \\
 &\leq m^2 \eta + \int_t^{T-d} \epsilon(r) dr
 \end{aligned} \tag{6.A.8}$$

Thus, inequality (6.A.7) together with (6.A.8) and (6.A.6) yield the existence of a positive constant $c > 0$, independent of η , such that

$$\sup_{\substack{s, r \\ \in [-d, 0]^2}} |\xi_3(t, s, r) - \xi_3(t, s + \eta, r)| \leq c \left(\eta + \int_t^{T-d} \epsilon(r) dr \right),$$

which, combined with (6.A.5) leads, for any $t \in [T - d - \tau, T - d]$, to

$$\epsilon(t) \leq c \left(\eta + \int_t^{T-d} \epsilon(r) dr \right).$$

Consequently, an application to Gronwall's lemma yields $\epsilon(t) \leq m' \eta$ on $[T - d - \tau, T - d]$, with $m' > 0$. Thus, ξ_2 and ξ_3 are Lipschitz in the s -variable. The arguments for showing that ξ_2 and ξ_3 are Lipschitz in the t -variable and ξ_3 Lipschitz in the r -variable follow the same line. \square

Lemma 6.A.3. *There exists a unique absolutely continuous solution $\xi = (\xi_1, \xi_2, \xi_3)$ of (6.A.4) on $[T - 2d, T - d] \times [-d, 0]^2$ such that $\xi_1 \geq 1 - d \left(\frac{b}{\sigma}\right)^2 > 0$.*

Proof. Let $\theta \in [T - 2d, T - d)$ denote the lower limit of all τ 's such that there exists an absolutely continuous solution (ξ_1, ξ_2, ξ_3) to (6.A.4) on $[\theta, T - d]$. Assume $\theta > T - 2d$. From Lemma 6.A.2, ξ_1, ξ_2 and ξ_3 are Lipschitz in each variable and thus admit a limit, when $t \rightarrow \theta$, which is Lipschitz. Therefore, the argument of Lemma (6.A.1) can be repeated to extend the existence and uniqueness of the solution of system (6.A.4) on

$[\xi, T-d]$ for $T-2d \leq \xi < \theta$. As a result, we necessarily have $\theta = T-2d$. It remains to prove that $0 < \xi_1$. For this, note that since ξ_1 is solution to (6.A.4), we have

$$\|\xi_1 - 1\|_\infty \leq \frac{d}{\sigma^2} \sup_{\substack{t \in \\ [T-2d, T-d]}} |\xi_2(t, 0)|^2. \quad (6.A.9)$$

By injecting the boundary condition (6.A.2) into the system (6.A.4), one notes that $t \in [T-2d, T-d] \mapsto \xi_2(t, 0)$ is solution to

$$\xi_2(t, 0) = b - \sigma^{-2} \int_t^{T-d} \xi_2(x, 0) \xi_3(x, t-x, 0) dx, \quad T-2d \leq t \leq T-d.$$

Or, for every $t \in [T-2d, T-d]$, $f_t : x \in [t, T-d] \mapsto f_t(x) := \xi_3(x, t-x, 0)$ takes only positive values as f_t is solution to the system

$$\begin{aligned} f_t(x) &= b^2 - \sigma^{-2} \int_x^{T-d} f_t(u) \xi_3(u, 0, x-u) du, & x \in [t, T-d], \\ f_t(T-d) &= b^2, \end{aligned}$$

which can be proven to admit, through a contraction proof in the Banach space $C([t, T-d], \mathbb{R})$, a unique positive solution since ξ and its derivatives are bounded. Similarly, we also have $\xi_2(t, 0) \geq 0$ for any $t \in [T-2d, T-d]$. As a result, we have $\text{sign}(\xi_2) = \text{sign}(b)$ and

$$\sup_{\substack{t \in \\ [T-2d, T-d]}} |\xi_2(t, 0)| \leq |b|. \quad (6.A.10)$$

Consequently, (6.A.9) and (6.A.10) yield that for any $T-2d \leq t \leq T-d$, we have $\xi_1 \geq 1 - d \left(\frac{b}{\sigma}\right)^2 = a_2 > 0$ as $\mathcal{N}(d, b, \sigma)$ is assumed to be greater than 2. \square

Finally, by setting $P_{11}(t) = \xi_1(t)$, $P_{12}(t, s) = \xi_2(t, s)$, $P_{22}(t, s, r) = \xi_3(t, s, r)$ and $P_{22}(t, s) = \xi_1(t+s+d)$ for any $(t, s, r) \in [T-2d, T-d] \times [-d, 0]^2$, Lemma 6.A.3 yields the existence and uniqueness of a solution P to (6.2.9)-(6.2.10)-(6.2.11) in the sense of definition 6.2.1 on $[T-2d, T-d]$. The concatenation of the unique solution on (6.2.9)-(6.2.10)-(6.2.11) on $[T-d, T]$ and $[T-2d, T-d]$ leads to a unique solution on $[T-2d, T]$.

6.A.3 From slice $[T-nd, T]$ to $[T-(n+1)d, T]$

Let n be an integer such that $2 \leq n < \mathcal{N}(d, b, \sigma)$. Assume that there exists a solution P to (6.2.9)-(6.2.10)-(6.2.11) in the sense of Definition 6.2.1 on $[T-nd, T]$ such that $0 < a_n \leq P_{11}(t) \leq 1$, for any $t \geq T-nd$. Recall the Definition (6.3.7) of $(a_n)_{n \geq 0}$. Consider the following system on $[T-(n+1)d, T-nd] \times [-d, 0]^2$

$$\begin{aligned} P_{11}(t) &= P_{11}(T-nd) - \int_t^{T-nd} \frac{P_{12}(x, 0)^2}{\sigma^2 P_{11}(x+d)} dx, \\ P_{12}(t, s) &= b P_{11}((T-nd) \wedge (t+s+d)) - \int_t^{(T-nd) \wedge (t+s+d)} \frac{P_{12}(x, 0) P_{22}(x, t+s-x, 0)}{\sigma^2 P_{11}(x+d)} dx, \\ P_{22}(t, s, r) &= b P_{12}((T-nd) \wedge (t+s \wedge r+d), (s-r) \vee (r-s) - d) \\ &\quad - \int_t^{(T-nd) \wedge (t+s \wedge r+d)} \frac{P_{22}(x, t+s-x, 0) P_{22}(x, 0, t+r-x)}{\sigma^2 P_{11}(x+d)} dx. \end{aligned} \quad (6.A.11)$$

Note that this system is the same as (6.A.4), the only difference being the term $x \in [T - (n + 1)d, T - nd] \mapsto P_{11}(x + d)$ which comes from the previous slice $[T - nd, T - (n - 1)d]$. Therefore, it can be considered as a positive continuous coefficient by induction hypothesis. As result, existence and uniqueness on $[T - (n + 1)d, T - nd]$ can be proven in the same fashion as in Lemmas 6.A.1-6.A.2-6.A.3. It remains to prove that $P_{11}(t) \geq a_{n+1}$ for any $t \in [T - (n + 1)d, T - nd]$. As in Lemma 6.A.3, and by using the induction hypothesis, we have

$$|P_{12}(t, -d)| \leq |bP_{11}(T - nd)| \leq |b|, \quad t \in [T - (n + 1)d, T - nd]. \quad (6.A.12)$$

Furthermore, P_{11} satisfies (6.A.11) on $[T - (n + 1)d, T - nd]$, which, combined with $P_{11} \geq a_n$ on $[T - nd, T - (n - 1)d]$ and (6.A.12) yields

$$\begin{aligned} P_{11}(t) &\geq P_{11}(T - nd) - \frac{d}{a_n} \left(\frac{b}{\sigma} \right)^2 \\ &\geq a_n - \frac{d}{a_n} \left(\frac{b}{\sigma} \right)^2 = a_{n+1} > 0, \end{aligned}$$

for any $t \in [T - (n + 1)d, T - nd]$, which ends the proof.

Bibliography

- [AJ] Eduardo Abi Jaber. “The Laplace transform of the integrated Volterra Wishart process”. In preparation.
- [AJ19a] Eduardo Abi Jaber. “Lifting the Heston model”. In: *Quantitative Finance* 19.12 (2019), pp. 1995–2013.
- [AJ19b] Eduardo Abi Jaber. “The Laplace transform of the integrated Volterra Wishart process”. In: *arXiv preprint arXiv:1911.07719* (2019).
- [AJ19c] Eduardo Abi Jaber. “Weak existence and uniqueness for affine stochastic Volterra equations with L1-kernels”. In: *arXiv preprint arXiv:1912.07445, Bernoulli Journal, to appear* (2019).
- [AJEE19a] Eduardo Abi Jaber and Omar El Euch. “Markovian structure of the Volterra Heston model”. In: *Statistics & Probability Letters* (2019).
- [AJEE19b] Eduardo Abi Jaber and Omar El Euch. “Multifactor Approximation of Rough Volatility Models”. In: *SIAM Journal on Financial Mathematics* 10.2 (2019), pp. 309–349.
- [AJEE19c] Eduardo Abi Jaber and Omar El Euch. “Multifactor approximation of rough volatility models”. In: *SIAM Journal on Financial Mathematics* 10.2 (2019), pp. 309–349.
- [AJLP19] Eduardo Abi Jaber, Martin Larsson, and Sergio Pulido. “Affine Volterra processes”. In: *The Annals of Applied Probability* 29.5 (2019), pp. 3155–3200.
- [AJMP19a] Eduardo Abi Jaber, Enzo Miller, and Huyên Pham. “Integral operator Riccati equations arising in stochastic Volterra control problems”. In: *arXiv:1911.01903* (2019).
- [AJMP19b] Eduardo Abi Jaber, Enzo Miller, and Huyên Pham. “Linear–Quadratic control for a class of stochastic Volterra equations: solvability and approximation”. In: *arXiv:1911.01900* (2019).
- [Ale+71] Yogish Alekal, Pavol Brunovsky, DH Chyung, and E Lee. “The quadratic problem for systems with time delays”. In: *IEEE Transactions on Automatic Control* 16.6 (1971), pp. 673–687.
- [ALV07] Elisa Alòs, Jorge A León, and Josep Vives. “On the short-time behavior of the implied volatility for jump-diffusion models with stochastic volatility”. In: *Finance and Stochastics* 11.4 (2007), pp. 571–589.
- [AØ15] Nacira Agram and Bernt Øksendal. “Malliavin calculus and optimal control of stochastic Volterra equations”. In: *Journal of Optimization Theory and Applications* 167.3 (2015), pp. 1070–1094.

- [Art19] NV Artamonov. “Solvability of an Operator Riccati Integral Equation in a Reflexive Banach Space”. In: *Differential Equations* 55.5 (2019), pp. 718–728.
- [AS13] Aurélien Alfonsi and Alexander Schied. “Capacitary measures for completely monotone kernels via singular control”. In: *SIAM Journal on Control and Optimization* 51.2 (2013), pp. 1758–1780.
- [AZ99] Patrick K Asea and Paul J Zak. “Time-to-build and cycles”. In: *Journal of economic dynamics and control* 23.8 (1999), pp. 1155–1175.
- [Bam08] Mauro Bambi. “Endogenous growth and time-to-build: The AK case”. In: *Journal of Economic Dynamics and Control* 32.4 (2008), pp. 1015–1040.
- [BCM12] Stefano Bonaccorsi, Fulvia Confortola, and Elisa Mastrogiacomo. “Optimal control for stochastic Volterra equations with completely monotone kernels”. In: *SIAM Journal on Control and Optimization* 50.2 (2012), pp. 748–789.
- [BD20] Nicole Bäuerle and Sascha Desmettre. “Portfolio optimization in fractional and rough Heston models”. In: *SIAM Journal on Financial Mathematics* 11.1 (2020), pp. 240–273.
- [Ben+07] Alain Bensoussan, Giuseppe Da Prato, Michel C Delfour, and Sanjoy K Mitter. *Representation and control of infinite dimensional systems*. Springer Science & Business Media, 2007.
- [BFG12] Mauro Bambi, Giorgio Fabbri, and Fausto Gozzi. “Optimal policy and consumption smoothing effects in the time-to-build AK model”. In: *Economic Theory* 50.3 (2012), pp. 635–669.
- [BNBV11] Ole Barndorff-Nielsen, Fred Benth, and Almut Veraart. “Ambit processes and stochastic partial differential equations”. In: *Advances mathematical methods for finance*, eds G. Di Nunno and B. Oksendal. 2011, pp. 35–74.
- [BPT10] Andrea Buraschi, Paolo Porchia, and Fabio Trojani. “Correlation risk and optimal portfolio choice”. In: *Journal of Finance* 65.393-420 (2010).
- [Bre10] Haim Brezis. *Functional analysis, Sobolev spaces and partial differential equations*. Springer Science & Business Media, 2010.
- [Bru91] Marie-France Bru. “Wishart processes”. In: *Journal of Theoretical Probability* 4.4 (1991), pp. 725–751.
- [Car+18] René Carmona, Jean-Pierre Fouque, Seyyed Mostafa Mousavi, and Li-Hsien Sun. “Systemic risk and stochastic games with delay”. In: *Journal of Optimization Theory and Applications* 179.2 (2018), pp. 366–399.
- [CC98] Philippe Carmona and Laure Coutin. “Fractional Brownian motion and the Markov property”. In: *Electronic Communications in Probability* 3 (1998), pp. 95–107.
- [CP74] Ruth Curtain and A.J. Pritchard. “The infinite-dimensional Riccati equation”. In: *Journal of Mathematical Analysis and Applications* 47 (1974), pp. 43–57.
- [CT18] Christa Cuchiero and Josef Teichmann. “Generalized Feller processes and Markovian lifts of stochastic Volterra processes: the affine case”. In: *arXiv preprint arXiv:1804.10450* (2018).
- [CT19] Christa Cuchiero and Josef Teichmann. “Markovian lifts of positive semidefinite affine Volterra-type processes”. In: *Decisions in Economics and Finance* 42.2 (2019), pp. 407–448.

- [CW14] Mei Choi Chiu and Hoi Ying Wong. “Mean–variance portfolio selection with correlation risk”. In: *Journal of Computational and Applied Mathematics* 263 (2014), pp. 432–444.
- [Dav+11] Mark Davis, Louis Bachelier, Alison Etheridge, and Paul A Samuelson. “Louis Bachelier’s Theory of Speculation: The Origins of Modern Finance”. In: (2011).
- [dAVV12] Hippolyte d’Albis, Emmanuelle Augeraud-Véron, and Alain Venditti. “Business cycle fluctuations and learning-by-doing externalities in a one-sector model”. In: *Journal of Mathematical Economics* 48.5 (2012), pp. 295–308.
- [DM72] Michel C Delfour and Sanjoy K Mitter. “Hereditary differential systems with constant delays. I. General case”. In: *Journal of Differential Equations* 12.2 (1972), pp. 213–235.
- [DP84] Giuseppe Da Prato. “Direct Solution of a Riccati Equation Arising in Stochastic Control Theory”. In: *Applied Mathematics and Optimization* 11 (1984), pp. 191–208.
- [DPD13] Tyrone E Duncan and Bozenna Pasik-Duncan. “Linear-quadratic fractional Gaussian control”. In: *SIAM Journal on Control and Optimization* 51.6 (2013), pp. 4504–4519.
- [EER18] Omar El Euch and Mathieu Rosenbaum. “Perfect hedging in rough Heston models”. In: *The Annals of Applied Probability* 28.6 (2018), pp. 3813–3856. DOI: [10.1214/18-AAP1408](https://doi.org/10.1214/18-AAP1408). URL: <https://doi.org/10.1214/18-AAP1408>.
- [EER19] Omar El Euch and Mathieu Rosenbaum. “The characteristic function of rough Heston models”. In: *Mathematical Finance* (2019). DOI: [10.1111/mafi.12173](https://doi.org/10.1111/mafi.12173). URL: <https://doi.org/10.1111/mafi.12173>.
- [EK81] Nicole El Karoui. “Les aspects probabilistes du contrôle stochastique”. In: *École d’été de Probabilités de Saint-Flour IX-1979*. Springer, 1981, pp. 73–238.
- [FF14] Giorgio Fabbri and Salvatore Federico. “On the infinite-dimensional representation of stochastic controlled systems with delayed control in the diffusion term”. In: *Mathematical Economics Letters* 2.3-4 (2014), pp. 33–43.
- [FGG10] Salvatore Federico, Ben Goldys, and Fausto Gozzi. “HJB equations for the optimal control of differential equations with delays and state constraints, I: regularity of viscosity solutions”. In: *SIAM Journal on Control and Optimization* 48.8 (2010), pp. 4910–4937.
- [FH18] Jean-Pierre Fouque and Ruiming Hu. “Optimal portfolio under fast mean-reverting fractional stochastic environment”. In: *SIAM Journal on Financial Mathematics* 6.2 (2018), pp. 564–601.
- [Fla86] Franco Flandoli. “Direct solution of a Riccati equation arising in a stochastic control problem with control and observation on the boundary”. In: *Applied Mathematics and Optimization* 14.1 (1986), pp. 107–129.
- [Fuk11] Masaaki Fukasawa. “Asymptotic analysis for stochastic volatility: martingale expansion”. In: *Finance and Stochastics* 15.4 (2011), pp. 635–654.
- [FZ19] Jean-Pierre Fouque and Zhaoyu Zhang. “Deep Learning Methods for Mean Field Control Problems with Delay”. In: *arXiv preprint arXiv:1905.00358* (2019).
- [GH20a] Paul Glasserman and Pu He. “Buy rough, sell smooth”. In: *Quantitative Finance* 20.3 (2020), pp. 363–378.

- [GH20b] Paul Glasserman and Pu He. “Buy rough, sell smooth”. In: *Quantitative Finance* 20.3 (2020), pp. 363–378.
- [GJR18a] Jim Gatheral, Thibault Jaisson, and Mathieu Rosenbaum. “Volatility is rough”. In: *Quantitative Finance* 18.6 (2018), pp. 933–949.
- [GJR18b] Jim Gatheral, Thibault Jaisson, and Mathieu Rosenbaum. “Volatility is rough”. In: *Quantitative Finance* 18.6 (2018), pp. 933–949. DOI: [10.1080/14697688.2017.1393551](https://doi.org/10.1080/14697688.2017.1393551). URL: <https://doi.org/10.1080/14697688.2017.1393551>.
- [GLS90] Gustaf Gripenberg, Stig-Olof Londen, and Olof Staffans. *Volterra integral and functional equations*. Vol. 34. Encyclopedia of Mathematics and its Applications. Cambridge University Press, Cambridge, 1990, pp. xxii+701. ISBN: 0-521-37289-5. DOI: [10.1017/CBO9780511662805](https://doi.org/10.1017/CBO9780511662805). URL: <http://dx.doi.org/10.1017/CBO9780511662805>.
- [GMS09] Fausto Gozzi, Carlo Marinelli, and Sergei Savin. “On controlled linear diffusions with delay in a model of optimal advertising under uncertainty with memory effects”. In: *Journal of optimization theory and applications* 142.2 (2009), pp. 291–321.
- [GRM05] Fausto Gozzi, Sociali di Roma, and Carlo Marinelli. “Stochastic Optimal Control of Delay Equations Arising in Advertising Models”. In: *Stochastic Partial Differential Equations and Applications-VII* (2005), p. 133.
- [GT05] Giuseppina Guatteri and Gianmario Tessitore. “On the backward stochastic Riccati equation in infinite dimension”. In: *SIAM Journal on Control and Optimization* 44.1 (2005), pp. 159–194.
- [Hal+77] Robert E Hall, Christopher A Sims, Franco Modigliani, and William Brainard. “Investment, interest rates, and the effects of stabilization policies”. In: *Brookings papers on economic activity* 1977.1 (1977), pp. 61–121.
- [HH21] Jiequn Han and Ruimeng Hu. “Recurrent Neural Networks for Stochastic Control Problems with Delay”. In: *arXiv preprint arXiv:2101.01385* (2021).
- [HJW18] Jiequn Han, Arnulf Jentzen, and E Weinan. “Solving high-dimensional partial differential equations using deep learning”. In: *Proceedings of the National Academy of Sciences* 115.34 (2018), pp. 8505–8510.
- [HS19] Philipp Harms and David Stefanovits. “Affine representations of fractional processes with applications in mathematical finance”. In: *Stochastic Processes and their Applications* 129.4 (2019), pp. 1185–1228.
- [HT18] Ying Hu and Shanjian Tang. “Stochastic LQ and Associated Riccati equation of PDEs Driven by State-and Control-Dependent White Noise”. In: *arXiv preprint arXiv:1809.05308* (2018).
- [Huz+02] Mihai Huzmezan, William A Gough, Guy A Dumont, and Sava Kovac. “Time delay integrating systems: a challenge for process control industries. A practical solution”. In: *Control Engineering Practice* 10.10 (2002), pp. 1153–1161.
- [HW19] Bingyan Han and Hoi Ying Wong. “Time-consistent feedback strategies with Volterra processes”. In: *arXiv preprint arXiv:1907.11378* (2019).
- [HW20a] Bingyan Han and Hoi Ying Wong. “Mean-Variance Portfolio Selection Under Volterra Heston Model”. In: *Applied Mathematics & Optimization* (2020), pp. 1–28.

-
- [HW20b] Bingyan Han and Hoi Ying Wong. “Merton’s portfolio problem under Volterra Heston model”. In: *Finance Research Letters* (2020), p. 101580.
- [Ich82] Akira Ichikawa. “Quadratic control of evolution equations with delays in control”. In: *SIAM Journal on control and optimization* 20.5 (1982), pp. 645–668.
- [IP19] Amine Ismail and Huy en Pham. “Robust Markowitz mean-variance portfolio selection under ambiguous covariance matrix”. In: *Mathematical Finance* 29.1 (2019), pp. 174–207.
- [JD07] Elias Jarlebring and Tobias Damm. “The Lambert W function and the spectrum of some multidimensional time-delay systems”. In: *Automatica* 43.12 (2007), pp. 2124–2128.
- [JMP20a] Eduardo Abi Jaber, Enzo Miller, and Huy en Pham. “Linear–Quadratic control for a class of stochastic Volterra equations: solvability and approximation”. In: *Annals of Applied Probability* (2020).
- [JMP20b] Eduardo Abi Jaber, Enzo Miller, and Huy en Pham. “Markowitz portfolio selection for multivariate affine and quadratic Volterra models”. In: *SIAM Journal on Financial Mathematics* (2020).
- [JMP21] Eduardo Abi Jaber, Enzo Miller, and Huyen Pham. “Integral operator Riccati equations arising in stochastic Volterra control problems”. In: *SIAM Journal on Control and Optimization* (2021).
- [JO19] Antoine Jacquier and Mugad Oumgari. “Deep PPDEs for rough local stochastic volatility”. In: *arXiv:1906.02551* (2019).
- [JSM12] Monique Jeanblanc, Martin Schweizer, and Michael Mania. “Mean-variance hedging via stochastic control and BSDEs for general semimartingales”. In: *Annals of applied probability* 22.6 (2012), pp. 2388–2428.
- [KBV03] Marina Kleptsyna, Alain Le Breton, and Michel Viot. “About the linear quadratic regulator problem under a fractional Brownian perturbation,” in: *ESAIM Probab. Stat* 9 (2003), pp. 161–170.
- [Kos16] Sergei Koshkin. “Positive semigroup and algebraic Riccati equations in Banach spaces”. In: *Positivity* 20 (2016), pp. 541–563.
- [KP82] Finn E Kydland and Edward C Prescott. “Time to build and aggregate fluctuations”. In: *Econometrica: Journal of the Econometric Society* (1982), pp. 1345–1370.
- [Las05] Irena Lasiecka. “Optimal control problems and Riccati equations for systems with unbounded controls and partially analytic generators”. In: *Functional Analytic Methods for Evolution Equations* (2005), pp. 313–371.
- [Lim04] Andrew EB Lim. “Quadratic hedging and mean-variance portfolio selection with random parameters in an incomplete market”. In: *Mathematics of Operations Research* 29.1 (2004), pp. 132–161.
- [LM21] William Lefebvre and Enzo Miller. “Linear-quadratic stochastic delayed control and deep learning resolution”. In: *arXiv preprint arXiv:2102.09851* (2021).
- [LZ02] Andrew EB Lim and Xun Yu Zhou. “Mean-variance portfolio selection with random parameters in a complete market”. In: *Mathematics of Operations Research* 27.1 (2002), pp. 101–120.
- [Mar52a] Harry Markowitz. “Portfolio selection”. In: *Journal of Finance* (1952), pp. 77–91.

- [Mar52b] Harry Markowitz. “Portfolio Selection”. In: *The Journal of Finance* 7.1 (1952), pp. 77–91. DOI: [10.1111/j.1540-6261.1952.tb01525.x](https://doi.org/10.1111/j.1540-6261.1952.tb01525.x). eprint: <https://onlinelibrary.wiley.com/doi/pdf/10.1111/j.1540-6261.1952.tb01525.x>. URL: <https://onlinelibrary.wiley.com/doi/abs/10.1111/j.1540-6261.1952.tb01525.x>.
- [MS15] Leonid Mytnik and Thomas S. Salisbury. “Uniqueness for Volterra-type stochastic integral equations”. In: *arXiv preprint arXiv:1502.05513* (2015).
- [Pau77] Wilfried Pauwels. “Optimal dynamic advertising policies in the presence of continuously distributed time lags”. In: *Journal of Optimization Theory and Applications* 22.1 (1977), pp. 79–89.
- [Pha09] Huy en Pham. *Continuous-time stochastic control and optimization with financial applications*. Vol. 61. Springer Science & Business Media, 2009.
- [PP90]  tienne Pardoux and Philip Protter. “Stochastic Volterra equations with anticipating coefficients”. In: *Ann. Probab.* 18.4 (1990), pp. 1635–1655. ISSN: 0091-1798. URL: [http://links.jstor.org/sici?sici=0091-1798\(199010\)18:4<1635:SVEWAC>2.0.CO;2-9&origin=MSN](http://links.jstor.org/sici?sici=0091-1798(199010)18:4<1635:SVEWAC>2.0.CO;2-9&origin=MSN).
- [RPK19] Maziar Raissi, Paris Perdikaris, and George E Karniadakis. “Physics-informed neural networks: A deep learning framework for solving forward and inverse problems involving nonlinear partial differential equations”. In: *Journal of Computational Physics* 378 (2019), pp. 686–707.
- [RT19] Mathieu Rosenbaum and Mehdi Thomas. “From microscopic price dynamics to multidimensional rough volatility models”. In: *arXiv:1910.13338* (2019).
- [Rud06] Walter Rudin. *Real and complex analysis*. Tata McGraw-hill education, 2006.
- [Sch06] Juergen Schmiegel. “Self-scaling tumor growth”. In: *Physica A: Statistical Mechanics and its Applications*, 367(C) (2006), pp. 509–524.
- [Set74] Suresh P Sethi. “Sufficient conditions for the optimal control of a class of systems with continuous lags”. In: *Journal of Optimization Theory and Applications* 13.5 (1974), pp. 545–552.
- [She15] Yang Shen. “Mean–variance portfolio selection in a complete market with unbounded random coefficients”. In: *Automatica* 55 (2015), pp. 165–175.
- [Sip+11] Rifat Sipahi, Silviu-Iulian Niculescu, Chaouki T Abdallah, Wim Michiels, and Keqin Gu. “Stability and stabilization of systems with time delay”. In: *IEEE Control Systems Magazine* 31.1 (2011), pp. 38–65.
- [SS18] Justin Sirignano and Konstantinos Spiliopoulos. “DGM: A deep learning algorithm for solving partial differential equations”. In: *Journal of Computational Physics* 375 (2018), pp. 1339–1364.
- [SS91] Elias M Stein and Jeremy C Stein. “Stock price distributions with stochastic volatility: an analytic approach”. In: *The review of financial studies* 4.4 (1991), pp. 727–752.
- [SW09] Galen R Shorack and Jon A Wellner. *Empirical processes with applications to statistics*. SIAM, 2009.
- [SZ99] Rainer Sch obel and Jianwei Zhu. “Stochastic volatility with an Ornstein–Uhlenbeck process: an extension”. In: *Review of Finance* 3.1 (1999), pp. 23–46.

- [SZS14] Yang Shen, Xin Zhang, and Tak Kuen Siu. “Mean–variance portfolio selection under a constant elasticity of variance model”. In: *Operations Research Letters* 42.5 (2014), pp. 337–342.
- [TG99] Yu-Chu Tian and Furong Gao. “Control of integrator processes with dominant time delay”. In: *Industrial & engineering chemistry research* 38.8 (1999), pp. 2979–2983.
- [Tso11] John D Tsoukalas. “Time to build capital: Revisiting investment-cash-flow sensitivities”. In: *Journal of Economic Dynamics and Control* 35.7 (2011), pp. 1000–1016.
- [Ver12] Mark Veraar. “The stochastic Fubini theorem revisited”. In: *Stochastics* 84.4 (2012), pp. 543–551. ISSN: 1744-2508. DOI: [10.1080/17442508.2011.618883](https://doi.org/10.1080/17442508.2011.618883). URL: <http://dx.doi.org/10.1080/17442508.2011.618883>.
- [VZ18] Frederi Viens and Jianfeng Zhang. “A martingale approach for fractional Brownian motions and related path dependent PDEs”. In: *Annals of Applied Probability, to appear* (2018).
- [Wan18] Tianxiao Wang. “Linear quadratic control problems of stochastic Volterra integral equations”. In: *ESAIM: Control, Optimisation and Calculus of Variations* 24 (2018), pp. 1849–1879.
- [Yon06] Jiongmin Yong. “Backward stochastic Volterra integral equations and some related problems”. In: *Stochastic Processes and their Applications* 116.5 (2006), pp. 779–795.
- [YZ99] Jiongmin Yong and Xun Yu Zhou. *Stochastic controls: Hamiltonian systems and HJB equations*. Vol. 43. Springer Science & Business Media, 1999.
- [ZL00] Xun Yu Zhou and Duan Li. “Continuous-time mean-variance portfolio selection: a stochastic LQ framework”. In: *Applied Mathematics and Optimization* 42 (2000), pp. 19–33.

CONTRIBUTIONS TO NON MARKOVIAN STOCHASTIC LINEAR-QUADRATIC CONTROL

The present thesis deals with non Markovian linear-quadratic stochastic control problems. It is divided into three parts.

In the first part, we tackle stochastic Volterra control problems whose kernel can be expressed as Laplace transform. Such assumptions is inspired from the rewriting of fractional Brownian motion as infinite sum of Markovian processes. The optimal control and value functions are expressed in terms of Banach valued Riccati equation whose existence and uniqueness are proved.

In the second part, we revisit the celebrated multivariate Markowitz portfolio selection problem combined with rough volatility. The optimal control and efficient frontier are derived in terms of explicit Hilbert valued Riccati operator. The completely explicit feature of our analysis enables us to implement an easy numerical scheme that we illustrate in the the case of portfolio allocation with 2 assets, one rough $H \approx 0.1$ and one smooth $H \approx 0.45$. Surprisingly our simulations were able to reproduce the *buy rough sell smooth* strategy exhibited in [GH20a], thus providing an endogenous explanation over this allocation.

Finally, the last part deals with the delayed control of stochastic differential equations. We solve a simplified version by means of Riccati PDEs whose existence and uniqueness are derived, provided a condition combining the horizon, the delay, the drift and the volatility is satisfied. A deep learning method is used to solve the Riccati PDEs in the context of Markowitz portfolio selection with execution delay.

Keywords: Linear-quadratic stochastic control, stochastic Volterra equations, Riccati equations in Banach space, Infinite dimensional Lyapunov equation, integral operator Riccati equation, stochastic Volterra equations, mean-variance portfolio theory, rough volatility, correlation matrices, multidimensional Volterra process, non-Markovian Heston, Stein–Stein and Wishart models, , delayed equation, Riccati PDEs, Markowitz portfolio allocation.

List of papers being part of this thesis:

- Eduardo Abi Jaber, Enzo Miller, and Huy en Pham. “Linear–Quadratic control for a class of stochastic Volterra equations: solvability and approximation”. In: *Annals of Applied Probability* (2020).
- Eduardo Abi Jaber, Enzo Miller, and Huyen Pham. “Integral operator Riccati equations arising in stochastic Volterra control problems”. In: *SIAM Journal on Control and Optimization* (2021).
- Eduardo Abi Jaber, Enzo Miller, and Huy en Pham. “Markowitz portfolio selection for multivariate affine and quadratic Volterra models”. In: *SIAM Journal on Financial Mathematics* (2020).
- **controlretard.**