



HAL
open science

Local approximation by linear systems and Almost-Riemannian Structures on Lie groups and Continuation method in rolling problem with obstacles

Ronald Manríquez Peñafiel Manríquez

► **To cite this version:**

Ronald Manríquez Peñafiel Manríquez. Local approximation by linear systems and Almost-Riemannian Structures on Lie groups and Continuation method in rolling problem with obstacles. Differential Geometry [math.DG]. Université Paris-Saclay, 2022. English. NNT : 2022UPAST104 . tel-03716186

HAL Id: tel-03716186

<https://theses.hal.science/tel-03716186v1>

Submitted on 7 Jul 2022

HAL is a multi-disciplinary open access archive for the deposit and dissemination of scientific research documents, whether they are published or not. The documents may come from teaching and research institutions in France or abroad, or from public or private research centers.

L'archive ouverte pluridisciplinaire **HAL**, est destinée au dépôt et à la diffusion de documents scientifiques de niveau recherche, publiés ou non, émanant des établissements d'enseignement et de recherche français ou étrangers, des laboratoires publics ou privés.

Local approximation by linear systems
and Almost-Riemannian Structures on Lie
groups and Continuation method in
rolling problem with obstacles

*Approximation locale par des systèmes linéaires et
structures presque-Riemanniennes et Méthode de
continuation dans un problème de roulement avec
obstacles*

Thèse de doctorat de l'université Paris-Saclay

École doctorale n°580, sciences et technologies de l'information et de la
communication (STIC)

Spécialité de doctorat: Automatique

Graduate School: Sciences de l'ingénierie et des systèmes, Référent:
Faculté des sciences d'Orsay

Thèse préparée dans l'unité de recherche **Laboratoire des Signaux et Systèmes**
(Université Paris-Saclay, CNRS, CentraleSupélec) et le **Laboratoire de
Mathématiques Raphaël Salem** (Université de Rouen Normandie), sous la
direction de **Yacine CHITOUR**, Professeur, Université Paris-Saclay et sous la
co-direction de **Philippe JOUAN**, Maître de Conférences (H.D.R), Université de
Rouen.

Thèse soutenue à Paris-Saclay, le 1er Juillet 2022, par

Ronald MANRÍQUEZ PEÑAFIEL

Composition du jury

Catherine BONNET Directrice de recherche, Inria Saclay	Présidente
Emmanuel TRÉLAT Professeur, Sorbonne Université	Rapporteur & Examineur
Mario SIGALOTTI Directeur de recherche, Inria Paris	Rapporteur & Examineur
Rachida EL ASSOUDI Maître de Conférences, INSA Rouen Normandie	Examinatrice
Frédéric JEAN Professeur, ENSTA Paris	Examineur
Ulysse SERRES Maître de conférences, Université Claude Bernard Lyon 1	Examineur
Yacine CHITOUR Professeur, Université Paris Saclay	Directeur de thèse

Titre: Approximation locale par des systèmes linéaires et structures presque-Riemanniennes et Méthode de continuation dans un problème de roulement avec obstacles.

Mots clés: Géométrie presque riemannienne, approximation nilpotente, approximation résoluble, problème des corps roulants, obstacles, planification nonholonomique du mouvement.

Résumé: L'objectif de cette thèse est d'étudier deux sujets en géométrie sub-riemannienne. D'une part, l'approximation locale d'une structure presque riemannienne aux points singuliers, et d'autre part, le système cinématique d'une variété à 2 dimensions roulant (sans tourner ni glissement) sur le plan euclidien avec des régions interdites.

Une structure presque Riemannienne de dimension n peut être définie localement par n champs vectoriels satisfaisant la condition de rang de l'algèbre de Lie, jouant le rôle d'un cadre orthonormé. L'ensemble des points où ces champs vectoriels sont colinéaires est appelé l'ensemble singulier (\mathcal{Z}). Aux points de tangence, c'est-à-dire aux points où l'espace linéaire engendré par champs vectoriels est égale à l'espace tangent de \mathcal{Z} , l'approximation nilpotente peut être remplacée par l'approximation résoluble. Dans cette thèse, sous des conditions génériques, nous établissons l'ordre d'approximation de la distance originale par \tilde{d} (la distance induite par l'approximation solvable) et nous prouvons que \tilde{d} est plus proche que la distance induite par l'approximation nilpotente de la

distance originale. En ce qui concerne les structures des systèmes d'approximation, l'algèbre de Lie générée par cette nouvelle famille de champs vectoriels est de dimension finie et solvable (dans le cas générique). De plus, l'approximation solvable est équivalente à un ARS linéaire sur un espace homogène ou un groupe de Lie.

D'autre part, les systèmes nonholonomes ont attiré l'attention de nombreux auteurs de différentes disciplines pour leurs applications variées, principalement en robotique. Le problème du corps roulant (sans glissement ni rotation) d'une variété riemannienne bidimensionnelle sur une autre variété peut être écrit comme un système nonholonomique. De nombreuses méthodes, algorithmes et techniques ont été développés pour le résoudre. Une implémentation numérique de la méthode de continuation pour résoudre le problème dans lequel une surface convexe roule sur le plan euclidien avec des régions interdites (ou obstacles) sans glisser ou tourner est effectuée. Plusieurs exemples sont illustrés.

Title: Local approximation by linear systems and Almost-Riemannian Structures on Lie groups and Continuation method in rolling problem with obstacles.

Keywords: Almost-Riemannian geometry, nilpotent approximation, solvable approximation, rolling body problem, obstacles, nonholonomic motion planning.

Abstract: The aim of this thesis is to study two topics in sub-Riemannian geometry. On the one hand, the local approximation of an almost-Riemannian structure at singular points, and on the other hand, the kinematic system of a 2-dimensional manifold rolling (without twisting or slipping) on the Euclidean plane with forbidden regions.

A n -dimensional almost-Riemannian structure can be defined locally by n vector fields satisfying the Lie algebra rank condition, playing the role of an orthonormal frame. The set of points where these vector fields are colinear is called the singular set (\mathcal{Z}). At tangency points, i.e., points where the linear span of the vector fields is equal to the tangent space of \mathcal{Z} , the nilpotent approximation can be replaced by the solvable one. In this thesis, under generic conditions, we state the order of approximation of the original distance by \tilde{d} (the distance induced by the solvable approximation), and we prove that \tilde{d} is closer than the distance induced

by the nilpotent approximation to the original distance. Regarding the structure of the approximating system, the Lie algebra generated by this new family of vector fields is finite-dimensional and solvable (in the generic case). Moreover, the solvable approximation is equivalent to a linear ARS on a homogeneous space or a Lie group.

On the other hand, nonholonomic systems have attracted the attention of many authors from different disciplines for their varied applications, mainly in robotics. The rolling-body problem (without slipping or spinning) of a 2-dimensional Riemannian manifold on another one can be written as a nonholonomic system. Many methods, algorithms, and techniques have been developed to solve it. A numerical implementation of the Continuation Method to solve the problem in which a convex surface rolls on the Euclidean plane with forbidden regions (or obstacles) without slipping or spinning is performed. Several examples are illustrated.

Contents

1	Acknowledgments	7
2	General Introduction	9
I	Local approximation	13
1	Introduction	16
2	Mathematical prerequisites	20
1.2	Almost Riemannian structures	20
2.2	ARS on Lie groups and homogeneous spaces	22
1.2.2	Linear vector fields	22
2.2.2	Linear ARS's on Lie groups	22
3.2.2	Linear ARS's on homogeneous spaces	22
3.2	Nilpotent approximation	23
1.3.2	Nonholonomic orders	23
2.3.2	Privileged coordinates	24
3.3.2	Nilpotent approximation	25
3	Results in dimension 3	26
1.3	Solvable approximation	26
1.1.3	Structure of the approximating system	27
2.1.3	Distance	28
2.3	The 3-dimensional generic case	28
1.2.3	Distance in the 3D generic case	30
2.2.3	Geodesics	31
4	Nilpotent and Solvable approximations	35
1.4	Nilpotent and Solvable approximations	35
1.1.4	The generated Lie algebra	37
2.1.4	The Nilpotent case	37
3.1.4	The non-nilpotent case	38

4.1.4	Examples	39
2.4	Genericity	41
1.2.4	Generic distribution	42
2.2.4	Normal Form	43
3.2.4	Nilpotent and solvable approximation of generic distribution	44
3.4	Distance induced	45
1.3.4	Solvable approximation	45
2.3.4	Comparison of distances	46
3.3.4	Translation	48
4.3.4	Solvable distance better than the nilpotent one	51

II Continuation Method in the rolling problem 53

1	Introduction	55
2	Mathematical prerequisites	58
1.2	Differential geometry	58
1.1.2	Geodesic coordinates	58
2.1.2	Orthonormal moving frame (OMF)	58
3.1.2	Christoffel symbols and connection form	59
4.1.2	Parallel vector field	59
5.1.2	Gaussian curvature and geodesics	59
2.2	Rolling body problem	60
3.2	Continuation Method	61
3	Numerical implementation	64
1.3	Rolling surface and obstacles	64
1.1.3	Obstacles and dynamics of the control system	65
2.1.3	Conjeture	66
2.3	Key points for numerical implementation	68
1.2.3	Discretizing \mathcal{H}	68
2.2.3	Computing $DE_p(u)$	69
3.2.3	Lifting the plane curve $\tilde{\gamma}_1$ on A_2	70
3.3	Examples	70
1.3.3	Sphere	72
2.3.3	Egg	73
3.3.3	Flattened ball	74
4.3	Conclusions and comments	75

Bibliography	77
A Synthèse en français	82
1.A Approximation locale	85
2.A Méthode de continuation	89
B Paper 1	103
C Paper 2	132
D Paper 3	158

Acknowledgments

I want to begin by thanking two fundamental people in this process, to my thesis director Professor Dr. Yacine Chitour, who accepted me as a doctoral student right away. I deeply admire his work, and I thank him for the opportunity he gave me, undoubtedly a privilege to work with him. To my co-director Professor Dr. Philippe Jouan, who welcomed me in France as if he had known me all my life. Without his academic and personal help, everything would have been more complex. I feel deep gratitude for all these years.

To laboratoire des Signaux et Systèmes (L2S) and laboratoire de Mathématiques Raphaël Salem, of CentraleSupélec and the Université de Rouen, respectively, made my study time more comfortable and pleasant for many months and hours of the day.

Thanks also to Agencia Nacional de Investigación y Desarrollo de Chile (ANID) who financed my Ph.D. for these 4 years.

I do not forget my office colleagues. In particular, Thomas GKELINIS and Samuel TRETON, great people who made my coffee moments very pleasant.

A hug full of love and gratitude for my friends Audrey and Panos (and little Timothée). Without you, our stay in France would not have been the same. What Rouen and the music have united, let the distance not separate. We will be waiting for you in Chile.

I will never forget my Valparaíso and its people. My friends Víctor, Priscila, Aldo, Daniela, and Guillermo have always been present and will continue to be. I am particularly grateful to Víctor. The distance was never an obstacle to strengthen our friendship. I deeply value always counting on you.

To my friends "del tablón", Negro, Carlitos, and Jofré, thanks for the "awante": in good times and in bad times even more.

Camilo, thank you for accompanying me to discover other fields of knowledge. Your words of encouragement were always welcome and timely.

I want to end these thanks with the most important people in my life. To Lukas, who perhaps without knowing it, is the engine of my existence and the driver of my actions. You are and you will always be my "regalón". Thank you for your unconditional love. Natalia, there

are no equations or geometries that describe or explain what I feel for you. I can only thank you for always being by my side. You are the support of my fragile soul. Finally, to Salvador my wonderful baby. You came to teach me so much more than I could ever be able to teach you. I hope I can live up to what you deserve. Lukas, Natalia, and Salvador I love you more than any fundamental force in the universe.

Ronald Alejandro Manríquez Peñafiel

Paris-Rouen, Juin 2022.

General Introduction

The sub-Riemannian geometry is a generalization of the Riemannian geometry (geometry which was born with the work of Bernhard Riemann to generalize some of Gauss's results concerning the curvature). Its origin is in the paper [Strichartz, 1986]. However, some elements, examples, or applications of the sub-Riemannian geometry can be situated before, for instance, in works related to optimal control problems [Brockett, 1982], thermodynamic [Carathéodory, 1909], or even in papers related to the Riemannian geometry [Hermann, 1973] and the study of the geometry of the Heisenberg group, which is a famous example of the sub-Riemannian geometry [Gaveau, 1977]. This geometry exists thanks to the idea of non-integrable constraints; this is to say a constraint on the admissible direction of movements, and thus, it has received increasing attention in many disciplines such as control theory, robotics, classical mechanics, analysis of hypoelliptic operator, diffusion manifold, and even in other branches of geometry as Cauchy-Riemann geometry.

A particular sub-Riemannian structure is the so-called *almost-Riemannian structure*. Formally, a n -dimensional Almost-Riemannian Structure (ARS in short) is a rank-varying sub-Riemannian structure that can be locally defined by a set of n smooth vector fields on a n -dimensional manifold, satisfying the Lie algebra rank condition. The set of points where the dimension of the linear span of the vector fields is not full is called the singular locus (or the singular set) and is denoted by \mathcal{Z} . Attractive models of ARS's can be described on Lie groups using invariant and linear vector fields. They are referred to as linear (or simple) ARSs on Lie groups (see [Ayala and Jouan, 2016]).

The aim of this thesis is to study two topics in sub-Riemannian geometry. On the one hand, the local approximation of an almost-Riemannian structure at singular points, where the nilpotent approximation lost the original structure, and on the other hand, the kinematic system of a manifold rolling on another manifold without twisting or slipping, particularly a numerical implementation of the Continuation Method when a 2-dimensional manifold rolling on the Euclidean plane with forbidden regions.

Local approximation by linear systems and almost-Riemannian structures on Lie group

The purpose of this first part is to locally approximate almost-Riemannian structures at singular points by ARSs on Lie groups (or homogeneous spaces) and to show that this approximation is generally better than the nilpotent one.

Let M be an n -dimensional differential manifold and consider $\{X_1, X_2, \dots, X_n\}$ a set

of smooth vector fields on M . Locally, an ARS on M can be defined by $\{X_1, X_2, \dots, X_n\}$ satisfying the Lie algebra rank condition (Larc in short). This set of vector fields is considered as an orthonormal frame. We denote by Δ_p the linear span of the vector fields $\{X_1, X_2, \dots, X_n\}$ at the point p . Recall that $\mathcal{Z} = \{p \in M : \text{rank}(\Delta_p) < n\}$. If \mathcal{Z} is empty, then the almost-Riemannian structure is a Riemannian one (more details in [Agrachev et al., 2019]). In the 3-dimensional generic case, the singular set is formed by two types of points (see Figure 2.1): type-1 points where Δ_p has dimension 2 and is transversal to \mathcal{Z} , and type-2 points where Δ_p has dimension 2 and is tangent to \mathcal{Z} . Moreover, type-2 points are isolated (more details see [Boscain et al., 2015]). In the 2-dimensional generic case also there are points where Δ_p is tangent to \mathcal{Z} and isolated. Such points are called *tangency points* in [Agrachev et al., 2008].

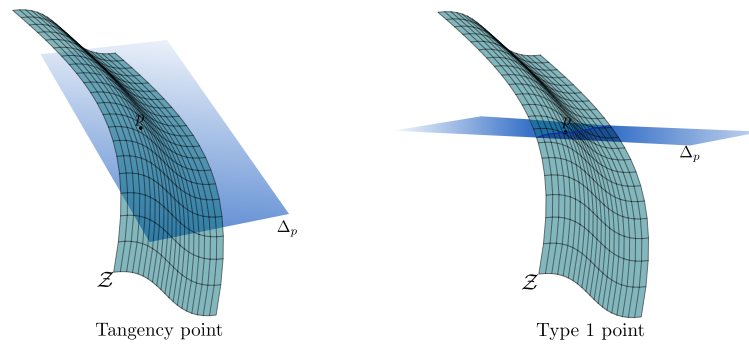

Figure 2.1: Two different points from \mathcal{Z} in the 3-D generic case.

On the other hand, nilpotent approximations are used to locally study the behavior of almost-Riemannian structures due to their significant similarity to the original dynamics. However, there are cases where the nilpotent approximation of an ARS turns out to be a constant rank sub-Riemannian structure. That is, some vector fields may vanish. The above is precisely what happens in the generic 3-dimensional case, dealt in [Boscain et al., 2015], where at type-2 points (or tangency points), the nilpotent approximation is the Heisenberg sub-Riemannian structure and hence is not a 3-ARS.

The solvable approximation was introduced in [Jouan and Manríquez, 2022] to recover the almost-Riemannian structure lost in the nilpotent approximation. In that paper was considered the case where only one of the vector fields vanishes in the nilpotent approximation and the other ones are independents. Then, the solvable approximation is a local approximation of an ARS at singular points where the nilpotent approximation is no longer an ARS but a constant rank sub-Riemannian structure. A generalization of this approximation is given in [?], where a complete description of the nilpotent and solvable approximations is addressed, including the generic ones.

We can identify, mainly, two axes of work in the research, related basically to the structures of the approximation systems and estimation of the different distances defined by the original structure, the nilpotent approximation and the solvable one. Concerning structures, the Lie algebra generated by this new family of vector fields is finite-dimensional and solvable (in the generic case). Thanks to the equivalence theorem of [Jouan, 2010] we know that the space \mathbb{R}^n is diffeomorphic to some homogeneous space or Lie groups. Through this diffeomorphism, the

solvable approximation and the nilpotent one are equivalent to a linear ARS on a homogeneous space or a Lie group. Moreover, when we work with n -ARS, we can find different and complex structures. For this reason, we dealt with generic ARSs by determining the generic distributions on a n -dimensional connected manifold and used them to exhibit the generic nilpotent and solvable approximations. Regarding the axis of the distance estimation, the original system, the nilpotent and solvable approximations give rise to three different distances: d , \hat{d} and \tilde{d} respectively. We stated that generically, the distance \tilde{d} is closer than \hat{d} to d . To prove this result, it is important to determine two facts. First, to state the order of approximations of d by \tilde{d} , and second, to find translation directions such that the distance \tilde{d} of a pair of translated points is decreasing.

Continuation Method in rolling problem with obstacles.

In the second part of this thesis, we address the motion planning problem of a strictly convex body A_2 rolling (without slipping nor spinning) on the Euclidean plane \mathbb{R}^2 with obstacles, with a numerical implementation of the Continuation Method.

A nonholonomic system on a n -dimensional manifold M is a control system which is of the form

$$\dot{x} = \sum_{i=1}^m u_i X_i(x), \quad x \in M,$$

where $m > 1$ is an integer and X_1, X_2, \dots, X_m are C^∞ vector field on M (cf. [Jean, 2014]). These systems have attracted the attention of many authors from different disciplines for their varied applications, mainly in robotics (see [Murray et al., 2017] and references therein). The rolling body problem (without slipping or spinning) of a 2-dimensional Riemannian manifold on another one (which is an excellent example of the fusion between the sub-Riemannian geometry and the (geometric) control theory), can be written as a nonholonomic system. More accurately, the rolling-body problem (without slipping nor spinning) is a control system Σ , which models the rolling of an embedded connected surface A_2 in \mathbb{R}^3 on another A_1 one. As a consequence of the rolling constraints, and given an absolutely continuous (a.c.) curve γ_1 on A_1 , there exists a unique a.c. curve Γ in the state space, which describes the rolling of the surface A_2 onto the surface A_1 along the curve γ_1 . Thus, the admissible controls of Σ correspond to the a.c. curves γ_1 of A_1 by their derivatives $\dot{\gamma}_1$. Then, the system of control can be written, in local coordinates, as a nonholonomic system

$$\Sigma : \dot{x} = u_1 X_1 + u_2 X_2,$$

where $(u_1, u_2) \in \mathbb{R}^2$ is the control, and X_1 and X_2 are vector fields.

The Continuation Method, was introduced in [Sussmann, 1992] and [Sussmann, 1993] and widely developed in [Chitour and Sussmann, 1998], [Chitour, 2002], and [Chitour, 2006]. It is used to solve nonlinear equations of the form $\mathcal{L}(x) = y$, where x is the unknown, and $\mathcal{L} : X \rightarrow Y$ is surjective. In the context of motion planning, \mathcal{L} is the endpoint map (associated with some fixed point p) from the space of admissible inputs to the state space, that is $E_p : \mathcal{H} \rightarrow M$.

The convex body A_2 , which can be embedded as a convex surface in \mathbb{R}^3 , is assumed to have a stable periodic geodesic and it is defined by the function $a(x, y, z)$ such that $A_2 = a^{-1}(0)$. We denote the state space simply by M . An obstacle \mathcal{W} in \mathbb{R}^2 is a nonempty compact subset of \mathbb{R}^2 . \mathcal{W} maps in M a region C . Thus, an obstacle in M is a nonempty closed subset of M such that $\widehat{M} = M \setminus C$ is also nonempty. Let us consider the control system on M defined by

$$\dot{y} = v_1 \overline{X}_1(y) + v_2 \overline{X}_2(y)$$

where $\overline{X}_i = \zeta X_i$, $i = 1, 2$ and $\zeta : M \rightarrow \mathbb{R}$ such that $\zeta > 0$ on \widehat{M} , $\zeta = 0$ on C . Then \widehat{M} is invariant under the above control system. Thus, the motion planning problem with obstacles is reduced to a motion planning problem for each connected component of \widehat{M} .

Therefore, we provide a complete numerical implementation of the Continuation Method presented above to solve the motion planning problem with forbidden regions on the plane. We give details about the fundamental points for the numerical implementation, which are the discretization of the control space \mathcal{H} , the computation of $DE_p(u)$, and the lift of the curve $\tilde{\gamma}_1$ on the convex body A_2 . This part provides three examples of the bodies rolling on the Euclidean plane (with obstacles): the sphere, the flattened ball, and an egg, this is to say, with a stable periodic geodesic (see Figure A.2). However, when we relax this geometric property, the method implemented still works.

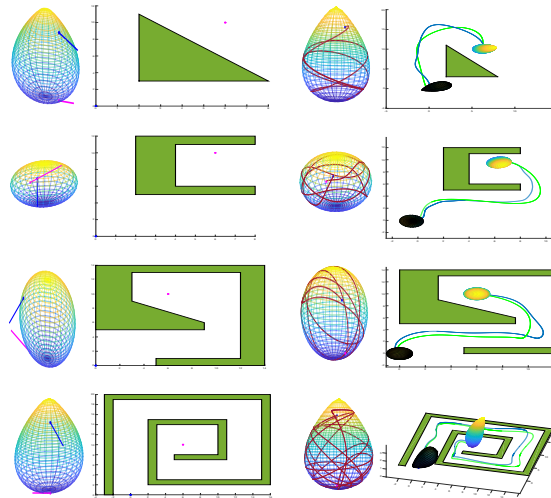

Figure 2.2: Different examples of bodies rolling on the plane with obstacles.

Part I

Local approximation by linear systems and Almost-Riemannian Structures on Lie groups

Contents

1	Introduction	16
2	Mathematical prerequisites	20
1.2	Almost Riemannian structures	20
2.2	ARS on Lie groups and homogeneous spaces	22
1.2.2	Linear vector fields	22
2.2.2	Linear ARS's on Lie groups	22
3.2.2	Linear ARS's on homogeneous spaces	22
3.2	Nilpotent approximation	23
1.3.2	Nonholonomic orders	23
2.3.2	Privileged coordinates	24
3.3.2	Nilpotent approximation	25
3	Results in dimension 3	26
1.3	Solvable approximation	26
1.1.3	Structure of the approximating system	27
2.1.3	Distance	28
2.3	The 3-dimensional generic case	28
1.2.3	Distance in the 3D generic case	30
2.2.3	Geodesics	31
4	Nilpotent and Solvable approximations	35
1.4	Nilpotent and Solvable approximations	35
1.1.4	The generated Lie algebra	37
2.1.4	The Nilpotent case	37
3.1.4	The non-nilpotent case	38
4.1.4	Examples	39
2.4	Genericity	41
1.2.4	Generic distribution	42
2.2.4	Normal Form	43
3.2.4	Nilpotent and solvable approximation of generic distribution	44
3.4	Distance induced	45
1.3.4	Solvable approximation	45

2.3.4	Comparison of distances	46
3.3.4	Translation	48
4.3.4	Solvable distance better than the nilpotent one	51

Introduction

An Almost-Riemannian Structure (ARS in short) on an n -dimensional differential manifold is a rank-varying sub-Riemannian structure that can be defined, at least locally, by a set of n vector fields satisfying the Lie algebra rank condition (Larc in short). We denote by Δ_p the linear span of the vector fields at the point p . The set of points where $\dim(\Delta_p) < n$ is called the singular locus or the singular set and denoted by \mathcal{Z} . Many papers dedicated to the study of ARSs can be found in the literature, for instance [Agrachev et al., 2010], [Bonnard et al., 2009], [Bonnard et al., 2011], [Boscain et al., 2013a] [Boscain et al., 2013b].

In the generic 3-dimensional case, in which we are particularly interested, the singular set is a codimension one embedded submanifold and the points where $\Delta_p = T_p\mathcal{Z}$ are isolated. Such points are called *tangency points* in [Agrachev et al., 2008] and *type-2 points* in [Boscain et al., 2015].

We are likewise interested in the so-called **linear ARSs** on Lie groups (or homogeneous space)(see [Ayala and Jouan, 2016]) because they will be used as approximating structures for general ARSs. Under some conditions, the singular set of such structures is a subgroup or an analytic, embedded, codimension one submanifold (for more details about these structures, see [Ayala and Jouan, 2016], and [Jouan et al., 2018]).

On the other hand, nilpotent approximations are used to locally study the behavior of almost-Riemannian structures due to their significant similarity to the original dynamics. However, in some cases the nilpotent approximation of an ARS degenerates, because it is no longer an ARS but a constant rank sub-Riemannian structure. In other words, it may happen that some of the vector fields of the nilpotent approximation vanish, changing the almost-Riemannian structure into a constant rank sub-Riemannian one. For instance, if

$$X_1 = \begin{pmatrix} 1 \\ 0 \\ 0 \end{pmatrix}, \quad X_2 = \begin{pmatrix} 0 \\ 1 \\ x \end{pmatrix} \quad \text{and} \quad X_3 = \begin{pmatrix} 0 \\ 0 \\ x^2 \end{pmatrix},$$

then its nilpotent approximation is

$$\hat{X}_1 = \begin{pmatrix} 1 \\ 0 \\ 0 \end{pmatrix}, \quad \hat{X}_2 = \begin{pmatrix} 0 \\ 1 \\ x \end{pmatrix} \quad \text{and} \quad \hat{X}_3 = 0.$$

that is, the Heisenberg sub-Riemannian structure. The above is exactly what happens in the generic 3-dimensional case, dealt in [Boscain et al., 2015].

We assume that only m elements of the $\widehat{X}_1, \widehat{X}_2, \dots, \widehat{X}_n$ are linearly independent. Let us assume without loss of generality that these vector fields are $\widehat{X}_1, \widehat{X}_2, \dots, \widehat{X}_m$ and that $\widehat{X}_{m+1}, \widehat{X}_{m+2}, \dots, \widehat{X}_n$ vanish. Our aim consists in recovering the almost-Riemannian structure lost in the nilpotent approximation thanks to the vector fields, denoted by \widetilde{X}_i for $i = m+1, m+2, \dots, n$, which are the homogeneous component of degree 0 of the Taylor expansion in privileged coordinates of the vector fields that vanish. The new family of vector fields composed by $\widehat{X}_1, \widehat{X}_2, \dots, \widehat{X}_m$ and $\widetilde{X}_{m+1}, \widetilde{X}_{m+2}, \dots, \widetilde{X}_n$ is called the solvable approximation. The Lie algebra generated by this new family of vector fields is finite-dimensional. Moreover, when only one of the vector fields vanishes and the other ones are independent, this Lie algebra is solvable (hence the name of this approximation). We are also interested in some nilpotent Lie group on which $\widetilde{X}_{m+1}, \widetilde{X}_{m+2}, \dots, \widetilde{X}_n$ act as linear vector fields (see Definition 2.2.1).

This first part is organized as follows.

Chapter 2 contains generalities about ARSs, nonholonomic order, privileged coordinates, the nilpotent approximation, linear vector fields, and linear ARS on Lie groups or homogeneous spaces.

In the first section of Chapter 3, we introduce the definition of a solvable approximation considering $s = 1$; this is to say only one of the vector fields vanishes, and the other ones are independent in the nilpotent approximation; we analyze its algebraic structures and the distance defined by the solvable approximation (\widetilde{d}), concluding that the Lie algebra generated by this new family of vector fields is finite-dimensional and solvable (Proposition 1.3.1), the solvable approximation is equivalent to a simple ARS on a homogeneous space or a Lie group (Theorem 1.3.1), and the distance \widetilde{d} always satisfies $\widetilde{d} \leq \widehat{d}$ (Proposition 1.3.3), where \widehat{d} is the distance induced by the nilpotent approximation.

In the second section, we addressed the 3-dimensional generic case. Here, we show that the solvable approximation is a simple ARS on \mathbb{R}^3 diffeomorphic to a quotient of the 5-dimensional group Heisenberg \mathbb{H}^2 . Regarding the distance issue, we have obtained in some cases that the order of the approximation of d (the original distance) by \widetilde{d} is better than the order of the approximation of d by \widehat{d} (Theorem 2.3.1). Assuming that for some pairs (q, q') of points translated from the singular locus the distance is decreasing (Theorem 2.3.2) and considering the order of approximation by \widetilde{d} , we prove that the difference $|d(q, q') - \widetilde{d}(q, q')|$ is strictly smaller than $|d(q, q') - \widehat{d}(q, q')|$. Finally, we provide the Hamiltonian associated to the flow defined by the solvable approximation in the 3D generic case and we compute the geodesics with initial condition $x(0) = y(0) = z(0) = 0$.

Chapter 4 is devoted to general nilpotent and solvable approximations of almost-Riemannian structures. Firstly, we show that it is always possible to define the ARS locally, around the point $p = 0$ in local privileged coordinates, by a set of n orthonormal vector fields X_1, \dots, X_n such that the solvable approximation

$$\widehat{X}_1, \dots, \widehat{X}_k, \widehat{X}_{k+1}, \dots, \widehat{X}_m, \widetilde{X}_{m+1}, \dots, \widetilde{X}_n,$$

satisfies

- $\widehat{X}_i(0) \neq 0$ for $i = 1, \dots, k$;
- $\widehat{X}_i \neq 0$ but $\widehat{X}_i(0) = 0$ for $i = k + 1, \dots, m$;
- $\widehat{X}_i = 0$ for $i = m + 1, \dots, n$.

Secondly, we prove that the nilpotent or solvable approximation of an ARS at a singular point is a linear almost-Riemannian structure on a Lie group or a homogeneous space (Theorem 1.4.2 and 1.4.4 respectively), except in some very degenerated cases where neither the nilpotent approximation nor the solvable one defines an ARS.

When we work with n -ARS, we can find different and complex structures. For this reason, thirdly we determine the generic structures. It is shown in particular that generically: (1) the singular set \mathcal{Z} is a union of submanifolds \mathcal{Z}_r of codimension r^2 where the rank is $n - r$; (2) the rank of $\Delta + [\Delta, \Delta]$ is everywhere full (Δ stands for the distribution) (Theorem 2.4.1). The structure of the points of \mathcal{Z}_r where $\dim(T_p \mathcal{Z}_r) + \dim(\Delta_p)$ is not maximal is described in Theorem 2.4.2. For example in \mathcal{Z}_1 these points are the so-called *tangency points* (see [Boscaín et al., 2015]), i.e. the points where $T_p \mathcal{Z}_1 = \Delta_p$. They are generically isolated in \mathcal{Z}_1 .

Thanks to these genericity results and with the help of local normal forms (see Section 2.2.4) it is finally shown that generically, there are only two possibilities for the nilpotent/solvable approximation at a point $p \in \mathcal{Z}$ (Theorem 2.4.3):

1. At a tangency point p in \mathcal{Z}_1 one vector field of the nilpotent approximation vanishes, but the solvable approximation is not degenerated and defines a linear ARS.
2. At all other points, that is to say, at non-tangency points of \mathcal{Z}_1 and at all points in \mathcal{Z}_r with $r \geq 2$, the nilpotent approximation is not degenerated.

In conclusion, the only *generic* points where the solvable approximation is useful are tangency points in \mathcal{Z}_1 .

In the last section, we deal with the distance induced by the solvable approximation, at tangency points, of an n -dimensional ARS considering generic assumptions and the normal form when the point belonging to the singular set is a tangency point.

Let d , \widetilde{d} , and \widehat{d} be the distances induced by the original structure, the solvable approximation, and the nilpotent one, respectively. The main result is Theorem 3.4.4 which states that generically, the distance \widetilde{d} is closer to d than \widehat{d} for pairs of points translated in an appropriate direction (Section 4.3.4). This translation condition is significant because the distance \widetilde{d} is not closer to d than the distance induced by the nilpotent approximation for any pair of points. Then to prove the main result, it is essential to determine two facts. First, to state the order of approximation of d by \widetilde{d} (Theorem 3.4.1), and second, to find translation directions such that the distance \widetilde{d} of a pair of translated points is decreasing.

To state the order of approximation of d by \widetilde{d} , we analyze the divergence of curves admissible for d and \widetilde{d} , defined by the same control functions and starting at the same point (see Proposition 3.4.1). By using this fact, we obtain that the distance induced by the solvable approximation improves the order of approximation of d given by \widehat{d} (see Theorem 3.4.1).

To find translation directions, we consider a vector field $Y \in \mathfrak{g}^1$ and then $Y \in \mathfrak{g}^2$, where $\mathfrak{g} = \mathfrak{g}^1 \oplus \mathfrak{g}^2$ is the ideal generated in \mathcal{L} by $\widehat{X}_1, \dots, \widehat{X}_{n-1}$, with \mathfrak{g}^s the set of homogeneous vector fields of order $-s$, and \mathcal{L} the Lie algebra generated by the solvable approximation.

Mathematical prerequisites

This chapter aims to present some fundamental notions briefly for the comprehension of this thesis. They are the almost-Riemannian structure, linear almost-Riemannian structure, non-holonomic order, privileged coordinates, and nilpotent approximation.

For everything related to general sub-Riemannian geometry, including almost-Riemannian one, the reader is referred to [Agrachev et al., 2019], except for the linear almost-Riemannian structure; in this case, the reader is referred to [Ayala and Jouan, 2016]. Regarding the rest of the topics, the reader is referred to [Jean, 2014] or [Bellaïche, 1996].

1.2 . Almost Riemannian structures

Let M be a n -dimensional, connected, C^∞ manifold. The C^∞ -module of C^∞ vector fields on M is denoted by $\Gamma(M)$. Let Δ be a sub-module of $\Gamma(M)$. The flag of submodules

$$\Delta = \Delta^1 \subseteq \Delta^2 \subseteq \dots \subseteq \Delta^{k-1} \subseteq \Delta^k \subseteq \dots \quad (2.1)$$

is defined by induction: $\Delta^2 = \Delta + [\Delta, \Delta]$ is the sub-module of $\Gamma(M)$ generated by Δ and the Lie algebra of its elements, and $\Delta^{k+1} = \Delta^k + [\Delta, \Delta^k]$. The Lie algebra generated by Δ is $\mathcal{L}(\Delta) = \bigcup_{k \geq 1} \Delta^k$. The sub-module Δ satisfies the rank condition if the evaluation of $\mathcal{L}(\Delta)$ at each point p is equal to $T_p M$.

Definition 1.2.1 *An almost-Riemannian structure (resp. distribution) on a smooth n -dimensional manifold M is a triple $(E, f, \langle \cdot, \cdot \rangle)$ (resp. a pair (E, f)) where E is a rank n vector bundle over M , $f : E \rightarrow TM$ is a morphism of vector bundles, and $(E, \langle \cdot, \cdot \rangle)$ is an Euclidean bundle, that is $\langle \cdot, \cdot \rangle_p$ is an inner product on the fiber E_p of E , smoothly varying w.r.t. p , assumed to satisfy the following properties:*

1. *The set of points $p \in M$ such that the restriction of f to E_p is onto is a proper open and dense subset of M ;*

2. the module Δ of vector fields on M defined as the image by f of the module of smooth sections of E satisfies the rank condition.

The set of points of M where the rank of $f(E_p) = \Delta_p$ is less than n is called the singular locus (or singular set) of the almost-Riemannian structure and denoted by \mathcal{Z} .

The inner product on E induces a bilinear symmetric and positive definite mapping, also denoted by $\langle \cdot, \cdot \rangle$, from $\Delta \times \Delta$ to $C^\infty(M)$. Indeed, and element $X \in \Delta$ (resp. $Y \in \Delta$) is the image by f of a unique section σ (resp. η) of E and we can set $\langle X, Y \rangle_p = \langle \sigma, \eta \rangle_p$. Consequently and almost-Riemannian structure (ARS in short) can be alternately defined as follows.

Definition 1.2.2 An almost-Riemannian structure on a smooth n -dimensional manifold M is a pair $(\Delta, \langle \cdot, \cdot \rangle)$ where Δ is a sub-module of $\Gamma(M)$ that can be locally defined by n vector fields and satisfies the rank condition, and $\langle \cdot, \cdot \rangle$ is a bilinear symmetric and positive definite mapping from $\Delta \times \Delta$ to $C^\infty(M)$, such that the set \mathcal{Z} of points p where the dimension of Δ_p is less than n is nonempty but with empty interior.

Around any point $p \in M$ the sub-module Δ can be locally defined by an orthonormal frame (X_1, X_2, \dots, X_n) . It is enough to select a set of n sections (e_1, e_2, \dots, e_n) of E orthonormal in a neighborhood of p and define $X_i = f_*e_i$, where $f_*e_i = f \circ e_i$.

The almost-Riemannian norm on Δ_p is defined by

$$\|v\| = \min \{ \|u\|^2 : u \in E_p, f(u) = v \}.$$

An absolutely continuous curve $\gamma : [0, T] \rightarrow M$ is admissible for E if there exists a measurable essentially bounded function $t \mapsto u(t)$ from $[0, T]$ into $E_{\gamma(t)}$ called control function such that $\dot{\gamma}(t) = f(u(t))$ for almost every $t \in [0, T]$. Locally this means that $\dot{\gamma}(t) = u_1(t)X_1(\gamma(t)) + u_2(t)X_2(\gamma(t)) + \dots + u_n(t)X_n(\gamma(t))$ for almost every $t \in [0, T]$, where $X_1, X_2, \dots, X_n \in \Delta$.

Given an admissible curve $\gamma : [0, T] \rightarrow M$, the length of γ is defined by

$$l(\gamma) = \int_0^T \|\dot{\gamma}(t)\| dt.$$

The almost-Riemannian distance (or Carnot-Carathéodory distance) on M associated with the n -ARS is defined as

$$d(p_0, p_1) = \inf \{ l(\gamma) : \gamma(0) = p_0, \gamma(T) = p_1, \gamma \text{ admissible} \}.$$

It induces the usual topology on M .

Remark 1.2.1 The structure is Riemannian out of \mathcal{Z} .

2.2 . ARS on Lie groups and homogeneous spaces

1.2.2 . Linear vector fields

Let G be a connected Lie group and \mathfrak{g} its Lie algebra (the set of left-invariant vector fields, identified with the tangent space at the identity). The set of analytic vector fields on G is denoted by $V^\omega(G)$, and the normalizer of \mathfrak{g} in $V^\omega(G)$ is by definition

$$\mathcal{N} = \text{norm}_{V^\omega(G)}\mathfrak{g} = \{X \in V^\omega(G) : \forall Y \in \mathfrak{g} \quad [X, Y] \in \mathfrak{g}\}.$$

Definition 2.2.1 *A vector field \mathcal{X} on G is said to be linear or to be infinitesimal automorphism (see [Bourbaki, 2007]), if \mathcal{X} belongs to \mathcal{N} and $\mathcal{X}(e) = 0$, where e is the identity of G .*

We can see in [Jouan, 2010] that a vector field \mathcal{X} on G if and only its flow $(\phi_t)_{t \in \mathbb{R}}$ is a one-parameter group of automorphisms of G and a linear vector field is consequently analytic and complete.

2.2.2 . Linear ARS's on Lie groups

Linear and invariant vector fields make it possible to define almost-Riemannian structures on Lie groups.

Definition 2.2.2 *A linear ARS on G is an almost-Riemannian structure defined by a set of*

- $n - s$ left-invariant vector fields Y_1, Y_2, \dots, Y_{n-s} .
- $s > 0$ linear vector fields $\mathcal{X}_{n-s+1}, \dots, \mathcal{X}_n$,

assumed to satisfy the rank condition and to have full rank on a proper open and dense subset of G .

A linear ARS is said to be simple if $s = 1$.

For instance, the famous Grushin plane on the Abelian Lie group \mathbb{R}^2 is a simple ARS. This structure was introduced in [Ayala and Jouan, 2016] and its isometries have been studied in [Jouan et al., 2018].

3.2.2 . Linear ARS's on homogeneous spaces

Consider a homogeneous space G/H of a connected and simply connected Lie group G by a closed subgroup H (the elements of G/H are right cosets of H because we deal with left-invariant vector fields). Since we are interested in simply connected quotients, we assume H to be connected. The projection of a left-invariant vector field Y onto G/H is well-defined, is referred to as a left-invariant vector field, and we can assume that it vanishes identically only if Y is the zero-field (see details in [Jouan, 2010]). On the other hand, the projection of a linear field \mathcal{X} of G does exist on G/H if and only if H is invariant under its flow, or equivalently,

because H is connected if the Lie algebra of H is $\text{ad}(\mathcal{X})$ -invariant. This allows to define linear vector fields and linear ARS on G/H in the same way as on Lie groups.

In the sequel, we will need a version of the equivalence Theorem (see [Jouan, 2010] and [Ayala and Jouan, 2016]).

Theorem 2.2.1 (Equivalence Theorem) *Let f_1, \dots, f_n be a set of n complete vector fields on a manifold M and let us assume:*

1. f_1, \dots, f_n define an almost-Riemannian structure on M ;
2. The Lie algebra \mathcal{L} generated by f_1, \dots, f_n is finite dimensional;
3. The ideal \mathfrak{g} generated in \mathcal{L} by f_1, \dots, f_{n-s} is nilpotent;

Then M is diffeomorphic to a homogeneous space G/H of the nilpotent simply connected group G generated by \mathfrak{g} and f_1, \dots, f_n defines a linear ARS on G/H . More accurately the vector fields f_1, \dots, f_{n-s} are left-invariant and f_{n-s+1}, \dots, f_n are linear on this homogeneous space.

3.2 . Nilpotent approximation

1.3.2 . Nonholonomic orders

Definition 3.2.1 *Let $f : M \rightarrow \mathbb{R}$ be a continuous function. The nonholonomic order of f at p , denoted $\text{ord}_p(f)$, is the real number defined by*

$$\text{ord}_p(f) = \sup \{s \in \mathbb{R} : f(q) = O(d(p, q)^s)\}.$$

This order is always nonnegative.

Let $C^\infty(p)$ denote the set of germs of smooth functions at p . For $f \in C^\infty(p)$, we call nonholonomic derivative of order 1 of f the Lie derivatives $X_1 f, \dots, X_n f$. We call further $X_i X_j f, X_i X_j X_k f, \dots$, the nonholonomic derivatives of f of order 2, 3, ... of f . The nonholonomic derivative of order 0 of f at p is $f(p)$.

As a consequence, the nonholonomic order of a smooth (germ of) function is given by the formula

$$\text{ord}_p(f) = \min \{s \in \mathbb{N} : \exists i_1, \dots, i_s \in \{1, \dots, n\} \text{ s.t. } (X_{i_1} \dots X_{i_s} f)(p) \neq 0\},$$

where as usual we adopt the convention that $\min \emptyset = +\infty$.

Let $VF(p)$ denote the set of germs of smooth vector fields at p .

Definition 3.2.2 *Let $X \in VF(p)$. The nonholonomic order of X at p , denoted by $\text{ord}_p(X)$, is the real number defined by:*

$$\text{ord}_p(X) = \sup \{\sigma \in \mathbb{R} : \text{ord}_p(Xf) \geq \sigma + \text{ord}_p(f), \forall f \in C^\infty(p)\}.$$

2.3.2 . Privileged coordinates

Let p be a point of M and let Δ_p^k , $k \geq 1$ be the evaluation of the submodule Δ^k at p . Thanks to the rank condition these submodules at p forms a flag of subspaces of T_pM ,

$$\Delta_p^1 \subset \Delta_p^2 \subset \dots \subset \Delta_p^{r-1} \subsetneq \Delta_p^r = T_pM, \quad (2.2)$$

where $r = r(p)$ is called the degree of nonholonomy at p . Let $n_i(p) = \dim \Delta_p^i$. The r -tuple of integers $(n_1(p), \dots, n_r(p))$ is called the growth vector at p . The first integer in the growth vector is the rank $n_1(p) \leq n$ of the family $X_1(p), \dots, X_n(p)$, and the last one $n_r(p) = n$ is the dimension of M . The structure of the flag (2.2) may also be described by another sequence of integers. We define the weights at p , $w_i = w_i(p)$, $i = 1, \dots, n$, by setting $w_j = s$ if $n_{s-1}(p) < j \leq n_s(p)$, where $n_0 = 0$. In other words, we have

$$w_1 = \dots = w_{n_1} = 1, w_{n_1+1} = \dots = w_{n_2} = 2, \dots, w_{n_{r-1}+1} = \dots = w_{n_r} = r.$$

Definition 3.2.3 *A system of privileged coordinates at p is a system of local coordinates (x_1, \dots, x_n) such that $\text{ord}_p(x_j) = w_j$, for $j = 1, \dots, n$.*

Constructions of privileged coordinates can be found in [Bellaïche, 1996] and [Jean, 2014].

On the other hand, systems of privileged coordinates always exist (under the rank condition) and in such a system, given a sequence of integers $\alpha = (\alpha_1, \dots, \alpha_n)$, we define the weight of the monomial $x^\alpha = x_1^{\alpha_1} \dots x_n^{\alpha_n}$ to be $w(\alpha) = w_1\alpha_1 + \dots + w_n\alpha_n$ and the weighted degree of the monomial vector field $x^\alpha \frac{\partial}{\partial x_j}$ to be $w(\alpha) - w_j$.

More generally, the nonholonomic order at p of a function f (resp. a vector field X) is the minimum of the homogeneous nonholonomic orders of the monomials of its Taylor series. It will be denoted by $\text{ord}_p(f)$ (resp. $\text{ord}_p(X)$) (see [Jean, 2014], Proposition 2.2).

Proposition 3.2.1 ([Bellaïche, 1996], Proposition 5.16) *Let X and Y be vector fields on M . If X and Y are homogeneous of degree k and l respectively (in the chosen system of privileged coordinates), then $[X, Y]$ is homogeneous of degree $k + l$ or vanishes.*

Definition 3.2.4 *The function defined in privileged coordinates, by $x \mapsto \|x\|_p = \sum_{i=1}^n |x_i|^{\frac{1}{w_i}}$ is the so-called pseudo-norm at p .*

Remark 3.2.1 *Let $x = (x_1, \dots, x_n)$ be a system of privileged coordinates defined on an open neighborhood U of the point p . When composed with the coordinate functions, the pseudo-norm at p is (non smooth) homogeneous of order 1, that is, $\|x(q)\|_p = O(d(p, q))$, where $x(q)$ are the coordinates of $q \in U$.*

3.3.2 . Nilpotent approximation

Fix a system of privileged coordinates (x_1, \dots, x_n) at p . Every vector field X_i is of order ≥ -1 , hence it has, in x coordinates, a Taylor expansion

$$X_i(x) \sim \sum_{\alpha, j} a_{\alpha, j} x^\alpha \frac{\partial}{\partial x_j},$$

where $w(\alpha) \geq w_j - 1$ if $a_{\alpha, j} \neq 0$. Grouping together the monomial vector fields of same weighted degree we express X_i as a series of homogeneous vector fields of the form

$$X_i = X_i^{(-1)} + X_i^{(0)} + X_i^{(1)} + X_i^{(2)} + \dots, \quad (2.3)$$

where $X_i^{(s)}$ has degree s . We set

$$\widehat{X}_i = \widehat{X}_i^{(-1)}, \quad i = 1, \dots, n.$$

Definition 3.2.5 *The family of vector fields $(\widehat{X}_1, \dots, \widehat{X}_n)$ is called the nilpotent approximation of the system (X_1, \dots, X_n) at p .*

Proposition 3.2.2 ([Bellaïche, 1996], Proposition 5.17) *The vector fields $\widehat{X}_i, i = 1, \dots, n$, generate a nilpotent Lie algebra $\text{Lie}(\widehat{X}_1, \dots, \widehat{X}_n)$ of step $r = w_n$. They satisfy Larc at every point $y \in \mathbb{R}^n$, and the distance \widehat{d} is finite for every $x, y \in \mathbb{R}^n$.*

To finish, we recall the very important Theorem 7.32 of [Bellaïche, 1996] stated here with a slight modification.

Theorem 3.2.1 (Theorem 7.32 in [Bellaïche, 1996]) *There exist constants $\varepsilon > 0$ and $C > 0$ such that for any $q, q' \in B(p, \varepsilon)$, we have*

$$-C\tau d(q, q')^{\frac{1}{r}} \leq d(q, q') - \widehat{d}(q, q') \leq C\widehat{\tau} \widehat{d}(q, q')^{\frac{1}{r}},$$

where $\tau = \max(\|q\|_p, d(q, q'))$ and $\widehat{\tau} = \max(\|q\|_p, \widehat{d}(q, q'))$.

Remark 3.2.2 *The original result stated in [Bellaïche, 1996] is as it follows*

$$-C\widehat{d}(p, q)d(p, q')^{\frac{1}{r}} \leq d(q, q') - \widehat{d}(q, q') \leq C\widehat{d}(p, q)\widehat{d}(q, q')^{\frac{1}{r}}.$$

Notice that if we consider $q = p$, we obtain that $d(p, q') = \widehat{d}(p, q')$. Of course, this is not always true.

Solvable approximation and the 3-dimensional generic case

The content of this chapter is the result of an article in collaboration with Philippe Jouan, which was published in the journal *Mathematical Control & Related Fields*, volume 12 (2022), Issue 2 (June), pp.303-326. ([Jouan and Manríquez, 2022]).

1.3 . Solvable approximation

In this section, we introduce the solvable approximation of an ARS, we analyze its algebraic structure and the distance induced by it.

Let $\{X_1, \dots, X_n\}$ be a set of vector fields defining an almost-Riemannian structure on an open neighborhood of $0 \in \mathbb{R}^n$. The point $p = 0$ is assumed to belong to the singular locus, the natural coordinates of \mathbb{R}^n to be privileged and we consider the nilpotent approximation $\{\hat{X}_1, \dots, \hat{X}_n\}$ of $\{X_1, \dots, X_n\}$ at $p = 0$.

It may happen that some of the vector fields \hat{X}_i vanish, possibly changing the almost-Riemannian structure defined by X_1, \dots, X_n into a constant rank sub-Riemannian one. It is what happens in some cases of generic 3-dimensional ARSs (see [Boscain et al., 2015]) that are described in detail in Section 2.3. In what follows, we are interested in the case where only one of the \hat{X}_i 's vanishes, say $\hat{X}_n = 0$. The other ones are independent and define a left-invariant sub-Riemannian structure on a Lie group, or a homogeneous space, the underlying manifold of which is \mathbb{R}^n .

Recall that each X_i can be expanded in a series of homogeneous vector fields in the system of privileged coordinates at $p = 0$, this is

$$X_i = X_i^{(-1)} + X_i^{(0)} + X_i^{(1)} + \dots, \quad \forall i \in \{1, \dots, n\},$$

where $X_i^{(k)}$ is the homogeneous component of degree k (see [Bellaïche, 1996]). Denoting $\tilde{X}_n = X_n^{(0)} \neq 0$, we introduce the following definition:

Definition 1.3.1 (Solvable approximation) *The family $\{\hat{X}_1, \dots, \hat{X}_{n-1}, \tilde{X}_n\}$ is the solvable approximation of $\{X_1, \dots, X_n\}$.*

The Lie algebra generated by this new family of vector fields is finite dimensional and solvable. Formally,

Proposition 1.3.1 $\mathcal{L} = \text{Lie}(\hat{X}_1, \dots, \hat{X}_{n-1}, \tilde{X}_n)$ is a finite dimensional solvable Lie algebra. Its step of solvability is less than or equal to $\log_2(r) + 1$, where r is the degree of nonholonomy at $p = 0$.

1.1.3 . Structure of the approximating system

Despite the previous result, we are not interested in the solvable Lie group associated to the Lie algebra $\text{Lie}\{\hat{X}_1, \dots, \hat{X}_{n-1}, \tilde{X}_n\}$ but in some nilpotent Lie group on which \tilde{X}_n acts as a linear vector field. For this reason, we denote by \mathfrak{h} the Lie algebra generated by $\hat{X}_1, \dots, \hat{X}_{n-1}$ and by \mathfrak{g} the ideal generated by \mathfrak{h} in $\mathcal{L} = \text{Lie}\{\hat{X}_1, \dots, \hat{X}_{n-1}, \tilde{X}_n\}$.

Proposition 1.3.2 *The ideal \mathfrak{g} is the space of vector fields of \mathcal{L} whose nonholonomic order is negative. It is a nilpotent Lie algebra and*

$$\mathcal{L} = \mathfrak{g} \oplus \mathbb{R}\tilde{X}_n.$$

Moreover $D = -\text{ad}(\tilde{X}_n)$ is a derivation of \mathfrak{g} .

Let G be the simply connected Lie group whose Lie algebra is isomorphic to \mathfrak{g} . According to [Jouan, 2010] there exists a linear vector field on G associated to the derivation $D = -\text{ad}(\tilde{X}_n)$. With a clear abuse of notation we will denote it by \tilde{X}_n .

Thanks to the Theorem 2.2.1 (equivalence theorem) of [Jouan, 2010], we know that the space \mathbb{R}^n is diffeomorphic to a homogeneous space. The solvable approximation is equivalent to a simple ARS on a homogeneous space or a Lie group through this diffeomorphism.

Theorem 1.3.1 *The space \mathbb{R}^n is diffeomorphic to a homogeneous space G/G_0 of G . Through this diffeomorphism $\{\hat{X}_1, \dots, \hat{X}_{n-1}, \tilde{X}_n\}$ is equivalent to a simple ARS on G/G_0 , and the Lie algebra \mathfrak{g}_0 of G_0 is isomorphic to the set of vector fields of \mathfrak{g} that vanish at 0.*

We are also interested in conditions for which $G = \mathbb{R}^n$.

Theorem 1.3.2 *With the previous notations, the following assertions are equivalent:*

- (i) $\text{ad}(\tilde{X}_n) \cdot \hat{X}_i$ belongs to $\text{Span}\{\hat{X}_1, \dots, \hat{X}_{n-1}\}$ for $i = 1, \dots, n-1$;
- (ii) \mathfrak{h} is $\text{ad}(\tilde{X}_n)$ -invariant;
- (iii) $\mathfrak{h} = \mathfrak{g}$.

Under these conditions \tilde{X}_n is a linear vector field on $\exp(\mathfrak{h})$.

2.1.3 . Distance

On the other hand, the solvable approximation gives rise to a distance denoted by \tilde{d} . This distance has the advantage to be really almost-Riemannian unlike the distance \hat{d} associated to the nilpotent approximation in the degenerated cases. Moreover, the distance \tilde{d} always satisfies $\tilde{d} \leq \hat{d}$. This is to say,

Proposition 1.3.3 *For all $x, y \in \mathbb{R}^n$, $\tilde{d}(x, y) \leq \hat{d}(x, y)$.*

Remark 1.3.1 *It is not possible to define the solvable approximation in a 2-dimensional ARS because if a vector field vanishes in the nilpotent approximation, then it does not satisfy LARC, which is a contradiction according to Proposition 3.2.2.*

2.3 . The 3-dimensional generic case

In this section, we describe the solvable approximation in the 3-dimensional generic case, this is to say, the algebraic structure, the distance issue, and we compute the geodesic with initial condition $x(0) = y(0) = z(0) = 0$ and covector $\lambda = (p, q, r) \in T^*\mathbb{R}^3$.

Regarding the results about the algebraic structure, we show that the solvable approximation is a simple ARS on \mathbb{R}^3 diffeomorphic to a quotient of the 5-dimensional Heisenberg group \mathbb{H}^2 . Concerning the distance issue, we have obtained that the solvable approximation improves the order of approximation of d given by the nilpotent approximation (Theorem 2.3.1). Moreover, we set directions of translation for a pair of points in which \tilde{d} is decreasing (Theorem 2.3.2 and 2.3.3). The latter is fundamental because it allows us to show that the solvable distance is closer than the nilpotent one to the original distance for a pair of points translated in such directions.

Recall that $\Delta_p = \text{span}\{X_1(p), \dots, X_n(p)\}$ and the singular locus \mathcal{Z} is the set of points of \mathbb{R}^n where the rank of the linear span of the vector fields is less than n . From [Boscain et al., 2015] we take the following.

Proposition 2.3.1 *Consider a 3-ARS. The following conditions are generic for 3-ARSs*

- (G1) $\dim(\Delta_p) \geq 2$ and $\Delta_p + [\Delta, \Delta]_p = T_p M$ for every $p \in M$;
- (G2) \mathcal{Z} is an embedded (possibly empty) two-dimensional submanifold of M ;
- (G3) the points where $\Delta_p = T_p \mathcal{Z}$ are isolated.

Proposition 2.3.2 *Under the previous conditions there are three types of points:*

1. Riemannian points where $\Delta_p = T_p M$.
2. type-1 points where Δ_p has dimension 2 and is transversal to \mathcal{Z} .
3. type-2 points where Δ_p has dimension 2 and is tangent to \mathcal{Z} .

Moreover, type-2 points are isolated, type-1 points form a 2-dimensional manifold, and all other points are Riemannian.

The local representation of the 3-dimensional ARS at type-2 points (see more details in [Boscain et al., 2015]) is given by the vector fields:

$$X_1 = \begin{pmatrix} 1 \\ 0 \\ 0 \end{pmatrix}, \quad X_2 = \begin{pmatrix} 0 \\ 1 + \delta(x, y, z) \\ x(1 + \theta(x, y, z)) \end{pmatrix}, \quad X_3 = \begin{pmatrix} 0 \\ 0 \\ az + bx^2 + cy^2 + o(x^2 + y^2 + |z|) \end{pmatrix},$$

where δ and θ are smooth functions of order greater than or equal to 1 and a, b, c are not all zero. Furthermore, its nilpotent approximation in privileged coordinates is:

$$\widehat{X}_1 = X_1 = \begin{pmatrix} 1 \\ 0 \\ 0 \end{pmatrix}, \quad \widehat{X}_2 = \begin{pmatrix} 0 \\ 1 \\ x \end{pmatrix}, \quad \widehat{X}_3 = 0.$$

and

$$\widetilde{X}_3 = \begin{pmatrix} 0 \\ 0 \\ az + bx^2 + cy^2 \end{pmatrix}.$$

Then $(\widehat{X}_1, \widehat{X}_2, \widetilde{X}_3)$ is the solvable approximation at $p = 0$ in case when 0 is a tangential (type-2) point.

Notice that the Lie algebra generated by \widehat{X}_1 and \widehat{X}_2 is:

$$\mathfrak{h} = \text{Span} \left\{ \widehat{X}_1, \widehat{X}_2, Z = [\widehat{X}_1, \widehat{X}_2] \right\} \quad \text{where} \quad Z = \begin{pmatrix} 0 \\ 0 \\ 1 \end{pmatrix} = \frac{\partial}{\partial z},$$

that is the Heisenberg algebra. On the other hand the algebra generated by \widehat{X}_1 , \widehat{X}_2 and \widetilde{X}_3 is $\text{Span} \left\{ \widehat{X}_1, \widehat{X}_2, Z, [\widehat{X}_1, \widetilde{X}_3], [\widehat{X}_2, \widetilde{X}_3], \widetilde{X}_3 \right\}$, where:

$$[\widehat{X}_1, \widetilde{X}_3] = \begin{pmatrix} 0 \\ 0 \\ 2bx \end{pmatrix} = 2bx \frac{\partial}{\partial z} \quad \text{and} \quad [\widehat{X}_2, \widetilde{X}_3] = \begin{pmatrix} 0 \\ 0 \\ 2cy + ax \end{pmatrix} = (2cy + ax) \frac{\partial}{\partial z},$$

and the ideal generated by \widehat{X}_1 and \widehat{X}_2 is:

$$\mathfrak{g} = \text{Span} \left\{ \frac{\partial}{\partial x}, \frac{\partial}{\partial y} + x \frac{\partial}{\partial z}, 2bx \frac{\partial}{\partial z}, 2cy \frac{\partial}{\partial z} + ax \frac{\partial}{\partial z}, \frac{\partial}{\partial z} \right\}.$$

A straightforward computation shows that \widetilde{X}_3 acts as a derivation on \mathfrak{g} . If we assume $b \neq 0$ and $c \neq 0$ then we have also:

$$\mathfrak{g} = \text{Span} \left\{ \frac{\partial}{\partial x}, x \frac{\partial}{\partial z}, \frac{\partial}{\partial y}, y \frac{\partial}{\partial z}, \frac{\partial}{\partial z} \right\}.$$

This is the 5-dimensional Heisenberg Lie algebra \mathfrak{h}^2 , and in this basis, the derivation $D = -\text{ad}(\tilde{X}_3)$ is given by the following matrix:

$$D = \begin{pmatrix} 0 & 0 & & & \\ 2b & a & & & \\ & & 0 & 0 & \\ & & 2c & a & \\ & & & & a \end{pmatrix}.$$

Finally, the solvable approximation $(\hat{X}_1, \hat{X}_2, \tilde{X}_3)$ is a simple ARS on \mathbb{R}^3 diffeomorphic to a quotient of the 5-dimensional group Heisenberg \mathbb{H}^2 .

1.2.3 . Distance in the 3D generic case

We denote by d the distance associated with the 3-dimensional almost-Riemannian structure defined by the vector fields X_1, X_2 and X_3 at type-2 points. The following Theorem state the order of approximation of d by \tilde{d} .

Theorem 2.3.1 *If $\text{ord}_p(\delta) \geq 2$ and $\text{ord}_p(\theta) \geq 2$, then there exist constants C and $\epsilon > 0$, such that, for all $q, q' \in B(p, \epsilon)$, we have*

$$-C\tau^{\frac{3}{2}}d(q, q')^{\frac{1}{2}} \leq d(q, q') - \tilde{d}(q, q') \leq C \cdot \tilde{\tau}^{\frac{3}{2}}\tilde{d}(q, q')^{\frac{1}{2}}, \quad (3.1)$$

where

$$\begin{aligned} \tau &= \max(\|q\|_p, d(q, q')) \\ \tilde{\tau} &= \max(\|q\|_p, \tilde{d}(q, q')). \end{aligned}$$

Thanks to formula (3.1) of Theorem 2.3.1, we know that, at least in some 3D generic cases, the order of the approximation of d by \tilde{d} is better than the one of the approximation of d by \hat{d} (see Theorem 3.2.1). Indeed, this order is d^2 in the first case and $d^{\frac{3}{2}}$ in the second one. However, this does not prove that the solvable approximation is really better than the nilpotent one, and anyway, it is certainly not valid for any pair of points.

Since the nilpotent distance \hat{d} is left-invariant while d and \tilde{d} are not (may be decreasing), we are interested in conditions under which $\tilde{d}(g, g \cdot q) \leq \tilde{d}(0, q)$, where the product is the Heisenberg one, q is a point in a neighborhood of 0, and $g \in \mathbb{R}^3$.

Let $\gamma(t) = (x(t), y(t), z(t))$ be a geodesic of \tilde{d} such that $\gamma(0) = 0$ with control functions u_1, u_2 and u_3 . We consider $g = (g_1, g_2, g_3) \in \mathbb{R}^3$. Let $\gamma_g(t) = L_g(\gamma(t))$. The goal is to find conditions for g such that γ_g has a length less than γ .

Since $\text{Lie}\{\hat{X}_1, \hat{X}_2\}$ is the Heisenberg algebra, then

$$L_g(\gamma(t)) = (x(t) + g_1, y(t) + g_2, z(t) + g_1y(t) + g_3).$$

We set $h(x, y, z) = az + bx^2 + cy^2$. Then $h(\gamma_g) = h(\gamma) + h(g) + f(g, \gamma)$, where $f(g, \gamma) = (2bx + ay)g_1 + 2cyg_2$.

We assume that $h(\gamma_g)$ does not vanish, this is to say γ_g is not on \mathcal{Z} . In particular for $t = 0$, $h(\gamma_g) = h(g)$ then $h(g) \neq 0$ this is equivalent to $g \notin \mathcal{Z}$.

We have the following results.

Theorem 2.3.2 *Let $\gamma : [0, T] \rightarrow \mathbb{R}^n$ be a length minimizer of \tilde{d} with control functions $u_1(t)$, $u_2(t)$, $u_3(t)$ with $u_3(t) \neq 0$ a.e, and $h(\gamma_g) \neq 0$. If $|h(\gamma)| \leq |h(\gamma_g)|$ then $\tilde{d}(\gamma_g(0), \gamma_g(T)) \leq \tilde{d}(\gamma(0), \gamma(T))$.*

Theorem 2.3.3 *With the same conditions of the above. If $\frac{\partial}{\partial g_i} (h(g) + f(g, \gamma)) / h(\gamma_g) > 0$ then $\tilde{d}(\gamma_g(0), \gamma_g(T)) < \tilde{d}(\gamma(0), \gamma(T))$.*

Finally, assuming that for some pairs (q, q') of points translated from the singular locus the distance \tilde{d} is decreasing and by considering the order of approximation by \tilde{d} , we prove that the difference $|d(q, q') - \tilde{d}(q, q')|$ is strictly smaller than $|d(q, q') - \hat{d}(q, q')|$. We can find this proof in Chapter 4, Section 3.4, where this issue is adressed in the n -dimensional generic case.

2.2.3 . Geodesics

In this section the Hamiltonian for the normal flow defined by the solvable approximation in the 3D generic case is given. We compute the geodesic with initial condition $x(0) = y(0) = z(0) = 0$ and covector $\lambda = (p, q, r) \in T^*\mathbb{R}^3$ with $p(0) = \cos(\theta)$, $q(0) = \sin(\theta)$, $r(0) = r$.

From the above sections, the solvable approximation is defined by

$$\hat{X}_1 = X_1, \quad \hat{X}_2 = \frac{\partial}{\partial y} + x \frac{\partial}{\partial z}, \quad \tilde{X}_3 = (az + bx^2 + cy^2) \frac{\partial}{\partial z}. \quad (3.2)$$

From (3.2), the Hamiltonian for the normal flow is given by

$$H(\lambda) = \frac{1}{2} \left(\left\langle \lambda, \hat{X}_1(x, y, z) \right\rangle^2 + \left\langle \lambda, \hat{X}_2(x, y, z) \right\rangle^2 + \left\langle \lambda, \tilde{X}_3(x, y, z) \right\rangle^2 \right)$$

$$H(\lambda) = \frac{1}{2} \left(p^2 + (q + rx)^2 + r^2 (az + bx^2 + cy^2)^2 \right),$$

where $\lambda = (p, q, r) \in T^*\mathbb{R}^3$. Hence

$$\begin{aligned} \dot{x}(t) &= p & \dot{p}(t) &= -(q + rx)r - 2bxr^2(az + bx^2 + cy^2) \\ \dot{y}(t) &= q + rx & \dot{q}(t) &= -2cyr^2(az + bx^2 + cy^2) \\ \dot{z}(t) &= (q + rx)x + r(az + bx^2 + cy^2)^2 & \dot{r}(t) &= -ar^2(az + bx^2 + cy^2) \end{aligned}$$

are the associated Hamiltonian equations to the solvable approximation.

The geodesic with initial condition $x(0) = y(0) = z(0) = 0$ and $p(0) = \cos(\theta)$, $q(0) = \sin(\theta)$ and $r(0) = r = 0$ is given by

$$\begin{aligned} x(t) &= t \cos(\theta) \\ y(t) &= t \sin(\theta) \\ z(t) &= \frac{1}{4}t^2 \sin(2\theta), \end{aligned} \tag{3.3}$$

because $p(t) = \cos(\theta)$ and $q(t) = \sin(\theta)$, this is to say p and q are constants.

Notice that the above geodesic for \hat{d} is the same as the geodesic for \widehat{d} . The above implies that this geodesic is optimal for any time and has no conjugate time (see Theorem 5.1 and 5.2 in [Boscain et al., 2015]). We can see some geodesics in Figure 3.1 when $r = 0$.

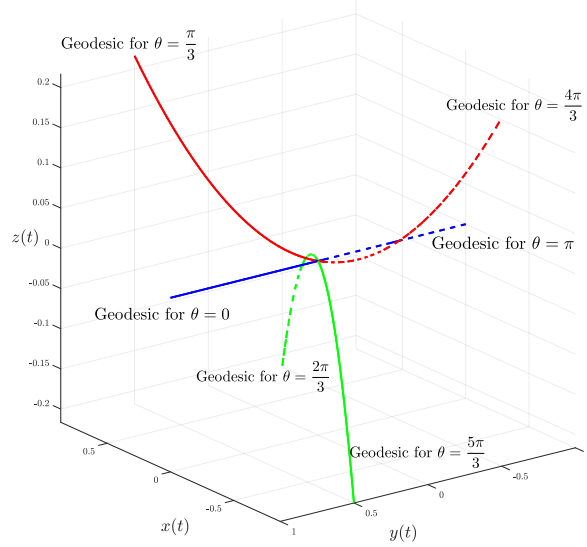

Figure 3.1: Geodesics for $\theta \in \{0, \frac{\pi}{3}, \frac{2\pi}{3}, \pi, \frac{4\pi}{3}, \frac{5\pi}{3}\}$ when $r = 0$.

Due to the complexity of the Hamiltonian system of equations, we compute the geodesics considering $a = c = 0$ and $b = 1$. Thus the Hamiltonian is

$$H(\lambda) = \frac{1}{2} (p^2 + (q + rx)^2 + r^2 x^4),$$

hence

$$\begin{aligned} \dot{x}(t) &= p & \dot{p}(t) &= -(q + rx)r - 2r^2 x^3 \\ \dot{y}(t) &= q + rx & \dot{q}(t) &= 0 \\ \dot{z}(t) &= xq + rx^2 + rx^4 & \dot{r}(t) &= 0 \end{aligned} \tag{3.4}$$

Considering the initial condition $x(0) = 0$ then $p(0) = \cos(\theta)$, $q(0) = \sin(\theta)$ and $r(0) = r$. If $r = 0$ then the solution to the differential systems (3.4) is given by (3.3).

If $r(0) = r \neq 0$, since $\dot{x}(t) = p$, we get

$$\ddot{x} + r^2 x + 2r^2 x^3 = -rq.$$

Since $q(0) = \sin(\theta)$ and $\dot{q} = 0$, then $q = \sin(\theta)$. Hence $\ddot{x} + r^2x + 2r^2x^3 = -r \sin(\theta)$. The above equation is equivalent to

$$\ddot{x} + r^2x + 2r^2x^3 = -r \sin(\theta) \operatorname{cn}(0, k^2), \quad (3.5)$$

where $\operatorname{cn}(0 \cdot t, k^2)$ is the Jacobian elliptic function that has a period in $0 \cdot t$ equal to $4K(k^2)$ and $K(k^2)$ is the complete elliptic integral of the first kind for the modulus k (see more in [Byrd and Friedman, 1954]). This equivalence is due to the fact that $\operatorname{cn}(0, k^2) = 1$.

In [Zúñiga, 2006] a general solution to equation (3.5) is given, and hence by using the initials conditions $x(0) = y(0) = z(0) = 0$, and straightforward computation (see details in [Jouan and Manríquez, 2022]), we obtain

$$\begin{aligned} x(t) &= a_1 \left(\operatorname{cn}(w_1 t + \phi, k_1^2) - \operatorname{cn}(\phi, k_1^2) \right) \\ y(t) &= \left(\sin(\theta) - r a_1 \operatorname{cn}(\phi, k_1^2) \right) t + \frac{r a_1}{k_1^2 w_1} \cdot y_1 \\ z(t) &= - \left(r a_1^4 \operatorname{cn}(\phi, k_1^2)^4 + r a_1^2 \operatorname{cn}(\phi, k_1^2)^2 + \sin(\theta) \right) a_1 \operatorname{cn}(\phi, k_1^2) t + \frac{r a_1^4}{3 k_1^8 w_1} z_1(t) \\ &\quad + \frac{4 r a_1^4 \operatorname{cn}(\phi, k_1^2)}{2 k_1^6 w_1} z_2(t) + \frac{6 r a_1^4 \operatorname{cn}(\phi, k_1^2)^2 + r a_1^2}{k_1^4 w_1} z_3(t) \\ &\quad + \frac{4 r a_1^4 \operatorname{cn}(\phi, k_1^2)^3 + 2 r a_1^2 \operatorname{cn}(\phi, k_1^2) + \sin(\theta)}{k_1^2 w_1} z_4(t), \end{aligned}$$

where $k_1'^2 + k_1^2 = 1$, $E(\cdot)$ is the incomplete elliptic integral of the second kind and

$$\begin{aligned} y_1 &= \left(\arccos(\operatorname{dn}(w_1 t + \phi, k_1^2)) - \arccos(\operatorname{dn}(\phi, k_1^2)) \right) \\ z_1(t) &= (2 - 3 k_1^4) k_1'^4 w_1 t + 2(2 k_1^4 - 1) (E(w_1 t + \phi) - E(\phi)) \\ &\quad + k_1^4 (\operatorname{sn}(w_1 t + \phi, k_1^2) \operatorname{cn}(w_1 t + \phi, k_1^2) \operatorname{dn}(w_1 t + \phi, k_1^2) \\ &\quad - \operatorname{sn}(\phi, k_1^2) \operatorname{cn}(\phi, k_1^2) \operatorname{dn}(\phi, k_1^2)) \\ z_2(t) &= (2 k_1^4 - 1) \left(\arcsin(k_1^2 \operatorname{sn}(w_1 t + \phi, k_1^2)) - \arcsin(k_1^2 \operatorname{sn}(\phi, k_1^2)) \right) \\ &\quad + k_1^2 \left(\operatorname{sn}(w_1 t + \phi, k_1^2) \operatorname{dn}(w_1 t + \phi, k_1^2) - \operatorname{sn}(\phi, k_1^2) \operatorname{dn}(w_1 t + \phi, k_1^2) \right) \\ z_3(t) &= E(w_1 t + \phi) - E(\phi) - k_1'^4 w_1 t \\ z_4(t) &= \arccos(\operatorname{dn}(w_1 t + \phi, k_1^2)) - \arccos(\operatorname{dn}(\phi, k_1^2)). \end{aligned}$$

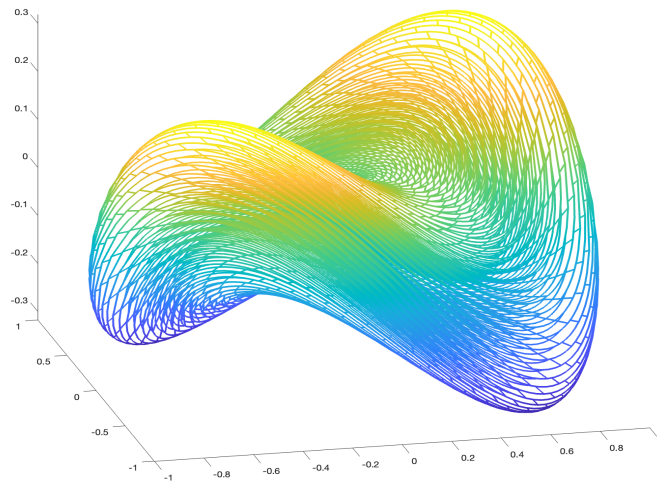

Figure 3.2: Ball in 3-D generic case.

General Nilpotent and Solvable Approximations of Almost-Riemannian Structures

The content of this chapter is the result of two articles in collaboration with Philippe Jouan, and Yacine Chitour, one of which was submitted to the journal *Discrete and Continuous Dynamical Systems* ([Manríquez et al., 2022]) and the other is in progress. ([Manríquez, 2022]).

1.4 . Nilpotent and Solvable approximations are linear

This section shows that the nilpotent or the solvable approximation of an almost-Riemannian structure at a singular point is always a linear almost-Riemannian structure on a Lie group or a homogeneous space.

The following definition is an extension of the model shown in Chapter 3.

Consider a set X_1, X_2, \dots, X_n of vector fields that generates Δ around p . In privileged coordinates each X_j can be decomposed into

$$X_j = X_j^{(-1)} + X_j^{(0)} + X_j^{(1)} + \dots + X_j^{(s)} + \dots$$

where $X_j^{(s)}$ is the component of X_j of homogeneous order s .

It may happen that some of the vector fields \widehat{X}_j globally vanish. In that case they can be replaced by $\widetilde{X}_j = X_j^{(0)}$. Let us assume that only m elements of $\widehat{X}_1, \widehat{X}_2, \dots, \widehat{X}_n$ are linearly independent (as vector fields). As explained below, we can assume without loss of generality that these vector fields are $\widehat{X}_1, \widehat{X}_2, \dots, \widehat{X}_m$ and that $\widehat{X}_{m+1}, \dots, \widehat{X}_n$ vanish. The set of vector fields

$$\widehat{X}_1, \dots, \widehat{X}_k, \dots, \widehat{X}_m, \widetilde{X}_{m+1}, \dots, \widetilde{X}_n,$$

is called the **solvable approximation** of X_1, X_2, \dots, X_n .

Though this section deals with local questions, around a point p belonging to the singular locus, it will be more convenient to assume the ARS defined by a bundle E and a morphism f from E to TM as in Definition 1.2.1.

Firstly it is necessary to show that it is always possible to define the ARS locally, around the point $p = 0$ in local privileged coordinates, by a set of n orthonormal vector fields X_1, \dots, X_n such that the solvable approximation

$$\widehat{X}_1, \dots, \widehat{X}_k, \widehat{X}_{k+1}, \dots, \widehat{X}_m, \widetilde{X}_{m+1}, \dots, \widetilde{X}_n,$$

satisfies

- $\widehat{X}_i(0) \neq 0$ for $i = 1, \dots, k$;
- $\widehat{X}_i \neq 0$ but $\widehat{X}_i(0) = 0$ for $i = k + 1, \dots, m$;
- $\widehat{X}_i = 0$ for $i = m + 1, \dots, n$.

Let K_p be the kernel of the restriction of f to E_p , and let V_p be an orthogonal complement to K_p in E_p , that is $K_p \perp V_p$ and $K_p \oplus V_p = E_p$.

Let e_1, \dots, e_n be a set of n sections of E , orthonormal in a neighborhood of p , such that $e_j(p) \in V_p$ for $j = 1, \dots, k$ and $e_j(p) \in K_p$ for $j = k + 1, \dots, n$.

The vector fields $X_j = f_*(e_j)$, $j = 1, \dots, n$ define the ARS around p . Let (x_1, \dots, x_n) be a set of privileged coordinates and $\widehat{X}_1, \dots, \widehat{X}_n$ be the related nilpotent approximation. Let \mathcal{L} be the submodule of $\Gamma(E)$ generated by e_j for $j = k + 1, \dots, n$. Consider now the mapping $e \in \mathcal{L} \mapsto \widehat{f}_*e$.

Its rank is $m - k$ with $k \leq m \leq n$ and we can assume without loss of generality that e_{m+1}, \dots, e_n belong to the kernel of that linear map, and that e_{k+1}, \dots, e_m are orthogonal to that kernel.

The vector fields X_1, \dots, X_n satisfy the above conditions.

It may happen that the vector fields $\widetilde{X}_{m+1}, \dots, \widetilde{X}_n$ fail to be linearly independent. In that case, neither the nilpotent approximation nor the solvable one defines an almost-Riemannian structure.

For that reason, we will always assume in what follows that the vector fields

$$\widehat{X}_1, \dots, \widehat{X}_k, \widehat{X}_{k+1}, \dots, \widehat{X}_m, \widetilde{X}_{m+1}, \dots, \widetilde{X}_n,$$

are linearly independent. Denote by \mathcal{Z}_a (a for approximation) the set of points where their rank is not full. It is not empty because at least one vector field vanishes at $p = 0$. On the other hand, the approximating vector fields are polynomial, and the interior of \mathcal{Z}_a is empty. Consequently, \mathcal{Z}_a is a proper subset of \mathbb{R}^n with empty interior, and the set of approximating vector fields defines an ARS.

Remark 1.4.1 *In the case where some of the \widetilde{X}_j vanish or are linearly dependent, it seems difficult, if not impossible, to go one step further by considering homogeneous approximations of nonholonomic order $s > 0$ because, as explained in the sequel, two important properties*

could be lost. First, a homogeneous vector field of degree $s > 0$ need not be complete. Second, the Lie algebra generated by the approximating vector fields would not generally be finite-dimensional. These two drawbacks are related, see [Palais, 1957] or [Jean, 2010].

1.1.4 . The generated Lie algebra

In view of the next sections, it is important to notice that all involved vector fields are complete because of their triangular form. This fact is well-known for the \widehat{X}_i (see [Bellaïche, 1996] or [Jean, 2014]).

Proposition 1.4.1 *The vector fields \widehat{X}_j and \widetilde{X}_j defined above are complete.*

This important property does not hold for homogeneous vector fields of positive degree, for example the first coordinate such a vector field could be $x_1^2 \frac{\partial}{\partial x_1}$, but $\dot{x}_1 = x_1^2$ is not complete.

The second feature we will use in the following subsections is the finiteness of the generated Lie algebra;

Proposition 1.4.2 *The Lie algebra \mathcal{L} generated by*

$$\widehat{X}_1, \dots, \widehat{X}_k, \widehat{X}_{k+1}, \dots, \widehat{X}_m, \widetilde{X}_{m+1}, \dots, \widetilde{X}_n,$$

is finite dimensional.

2.1.4 . The Nilpotent case

It is the case where the vector fields $\widehat{X}_1, \dots, \widehat{X}_n$ are linearly independent and the vectors $\widehat{X}_1(0), \dots, \widehat{X}_k(0)$ are independent in \mathbb{R}^n . In particular no vector field \widehat{X}_i vanishes, and $m = n$.

For $j = k + 1, \dots, n$ let D_j stand for $\text{ad}(\widehat{X}_j)$ and for any multi-index $J = (j_1, \dots, j_s)$ let $D_J = D_{j_s} \circ \dots \circ D_{j_1}$ (here $k + 1 \leq j_u \leq n$ and $s \geq 0$). Let

$$\mathcal{D} = \text{Span}\{D_J(\widehat{X}_i) / i = 1, \dots, k; J \text{ as above}\}.$$

Lemma 1.4.1 *The Lie algebra \mathfrak{g} generated by \mathcal{D} is D_j -invariant for $j = k + 1, \dots, n$.*

Let \mathcal{L} stand for the Lie algebra generated by $\widehat{X}_1, \dots, \widehat{X}_n$. It is a well-known fact that this Lie algebra is nilpotent and finite-dimensional (see [Bellaïche, 1996] or [Jean, 2014]).

Theorem 1.4.1 *1. The ideal generated in \mathcal{L} by $\widehat{X}_1, \dots, \widehat{X}_k$ is \mathfrak{g} . It is a nilpotent Lie algebra.*

2. The vector fields $\widehat{X}_{k+1}, \dots, \widehat{X}_n$ do not belong to \mathfrak{g} and act on \mathfrak{g} as derivations.

3. The rank at $p = 0$ of the elements of \mathfrak{g} is full.

After this analysis at the algebra level, we can turn our attention to the Lie group level.

Let G be the simply connected Lie group whose Lie algebra is \mathfrak{g} . Since \mathfrak{g} is nilpotent the underlying manifold of G is \mathbb{R}^N , $N = \dim(\mathfrak{g})$. The first task is to show that \mathbb{R}^n is a homogeneous space of G . This is mainly because homogeneous vector fields generate \mathfrak{g} .

Lemma 1.4.2 *The set \mathbb{R}^n is a homogeneous space of G . More accurately, if H stands for the connected subgroup of G whose Lie algebra is the set of elements of \mathfrak{g} that vanish at 0, then \mathbb{R}^n is diffeomorphic to the quotient G/H .*

To complete the construction we associate to the derivation $D_j = \text{ad}(\widehat{X}_j)$ of \mathfrak{g} a linear vector field \mathcal{X}_j on G for $j > k$ (\mathcal{X}_j does exist because G is simply connected). It is clear that the projection of \mathcal{X}_j on \mathbb{R}^n is \widetilde{X}_j (see [Jouan, 2010] for details). Finally the vector fields $\widehat{X}_1, \dots, \widehat{X}_k$ are invariant, and $\widehat{X}_{k+1}, \dots, \widehat{X}_n$ are linear vector fields on the homogeneous space $\mathbb{R}^n = G/H$.

We can state:

Theorem 1.4.2 *The space \mathbb{R}^n is a homogeneous space of the nilpotent Lie group G whose Lie algebra is \mathfrak{g} .*

The vector fields $\widehat{X}_1, \dots, \widehat{X}_k$ are projections of invariant vector fields of G and $\widehat{X}_{k+1}, \dots, \widehat{X}_n$ are projections of linear vector fields of G .

Consequently the set $\widehat{X}_1, \dots, \widehat{X}_n$ defines a linear ARS on the homogeneous space \mathbb{R}^n .

3.1.4 . The non-nilpotent case

We set $D_j = \text{ad}(\widehat{X}_j)$ for $j = k + 1, \dots, m$ and $D_j = \text{ad}(\widetilde{X}_j)$ for $j = m + 1, \dots, n$. As well as in the nilpotent case we set $D_J = D_{j_s} \circ \dots \circ D_{j_1}$ for any multi-index $J = (j_1, \dots, j_s)$ where $s \geq 0$ and $k + 1 \leq j_u \leq n$, and

$$\mathcal{D} = \text{Span}\{D_J(X_i) / i = 1, \dots, k; J \text{ as above}\}.$$

The Lie algebra \mathfrak{g} generated by \mathcal{D} is again D_j -invariant for $j = k + 1, \dots, n$, which shows that \mathfrak{g} is the ideal generated in \mathcal{L} by $\widehat{X}_1, \dots, \widehat{X}_k$.

Theorem 1.4.3 *1. The ideal generated in \mathcal{L} by $\widehat{X}_1, \dots, \widehat{X}_k$ is \mathfrak{g} . It is a nilpotent Lie algebra.*

- 2. The vector fields $\widetilde{X}_{m+1}, \dots, \widetilde{X}_n$ do not belong to \mathfrak{g} and act on \mathfrak{g} as derivations.*
- 3. The vector fields \widehat{X}_j , with $k+1 \leq j \leq m$ that do not belong to \mathfrak{g} act on \mathfrak{g} as derivations.*
- 4. The rank at $p = 0$ of the elements of \mathfrak{g} is full.*

Opposite to the nilpotent case we cannot assert that the vector fields $\widehat{X}_{k+1}, \dots, \widehat{X}_m$ do not belong to \mathfrak{g} . Because of this phenomenon, illustrated by Example 3 in Section 4.1.4, we are lead to introduce one more index. Up to a reordering we can assume that $\widehat{X}_{k+1}, \dots, \widehat{X}_l$ belong to \mathfrak{g} and that $\widehat{X}_{l+1}, \dots, \widehat{X}_m$ do not belong to \mathfrak{g} , where $k + 1 \leq l \leq m$.

Theorem 1.4.4 *The space \mathbb{R}^n is a homogeneous space of the nilpotent Lie group G whose Lie algebra is \mathfrak{g} .*

The vector fields $\widehat{X}_1, \dots, \widehat{X}_l$ are projections of invariant vector fields of G . The vector fields $\widehat{X}_{l+1}, \dots, \widehat{X}_m$ are projections of linear or affine vector fields of G and $\widetilde{X}_{m+1}, \dots, \widetilde{X}_n$ are projections of linear ones.

Consequently the set of vector fields $\widehat{X}_1, \dots, \widehat{X}_m, \widetilde{X}_{m+1}, \dots, \widetilde{X}_n$ defines a linear ARS on the homogeneous space \mathbb{R}^n .

Remark 1.4.2 *As shown by Example 4 in Section 4.1.4, the Lie algebra \mathcal{L} generated by the vector fields $\widehat{X}_1, \dots, \widehat{X}_m, \widetilde{X}_{m+1}, \dots, \widetilde{X}_n$ need not be solvable when $m \leq n - 2$. However, it is solvable if $m = n - 1$ (see Proposition 1.3.1), and it will be proven in the next section that generically $m = n - 1$ or $m = n$.*

It is why we call solvable the approximations of the previous kind.

4.1.4 . Examples

The first one is a standard example of a solvable approximation on the group Heisenberg. Example 2 shows that the elements of the Lie algebra \mathcal{L} of nonholonomic order smaller than -1 are not necessarily in \mathfrak{g} . We exhibit a vector field of the distribution that vanishes at p but belongs to the ideal \mathfrak{g} in Example 3 (which implies that the rank of the nilpotent approximation is not full).

To finish, the Lie algebra \mathcal{L} of Example 4 is not solvable, it contains a semi-simple subalgebra. Recall that this is not generic.

In these four examples, the vector fields are equal to their nilpotent or solvable approximations at 0. It is of course possible to add terms of higher nonholonomic order without modifying the conclusions.

Example 1

Consider in \mathbb{R}^3 the almost-Riemannian structure defined by the vector fields:

$$X_1 = \partial_x, \quad X_2 = \partial_y + x\partial_z, \quad X_3 = x\partial_y + \frac{1}{2}x^2\partial_z.$$

At $p = (0, 0, 0)$ the coordinates (x, y, z) are privileged with weights $(1, 1, 2)$, the vector fields X_1 and X_2 are homogeneous of order -1 and X_3 is homogeneous of order 0, so that $\widehat{X}_1 = X_1$, $\widehat{X}_2 = X_2$, $\widehat{X}_3 = 0$ and $\widetilde{X}_3 = X_3$. The nilpotent approximation at p is not an almost-Riemannian structure, it is the constant rank 2 sub-Riemannian structure defined by X_1 and X_2 .

The Lie algebra generated by $\widehat{X}_1, \widehat{X}_2, \widetilde{X}_3$ is $\mathcal{L} = \text{Span}\{\widehat{X}_1, \widehat{X}_2, \widetilde{X}_3, \partial_z\}$, the ideal $\mathfrak{g} = \text{Span}\{\widehat{X}_1, \widehat{X}_2, \partial_z\}$ is here the Heisenberg Lie algebra, and \widetilde{X}_3 is a linear vector field on \mathfrak{g} . Finally $\widehat{X}_1, \widehat{X}_2, \widetilde{X}_3$ is a linear ARS on the Heisenberg group.

Example 2

The almost-Riemannian structure is here defined in \mathbb{R}^3 by:

$$X_1 = \partial_x, \quad X_2 = x\partial_y, \quad X_3 = y^2\partial_z.$$

The Lie algebra \mathcal{L} contains X_1, X_2, X_3 and

$$\begin{aligned} X_4 &= [X_1, X_2] = \partial_y, & X_5 &= \frac{1}{2}[X_4, X_3] = y\partial_z, \\ X_6 &= [X_2, X_5] = x\partial_z, & X_7 &= [X_1, X_6] = [X_4, X_5] = \partial_z \\ X_8 &= \frac{1}{2}[X_2, X_3] = xy\partial_z, & X_9 &= [X_2, X_8] = x^2\partial_z. \end{aligned}$$

Therefore:

$$\begin{aligned} \Delta^1 &= \Delta = \{X_1, X_2, X_3\}, & \Delta^2 &= \Delta^1 + \{X_4, X_8\} \\ \Delta^3 &= \Delta^2 + \{X_5, X_9\}, & \Delta^4 &= \Delta^3 + \{X_6\}, & \Delta^5 &= \Delta^4 + \{X_7\}. \end{aligned}$$

The canonical coordinates are privileged with weights $(1, 2, 5)$ and the vector fields X_1, X_2 , and X_3 are homogeneous of order -1 hence equal to their nilpotent approximations.

The algebra \mathfrak{g} is here the ideal of \mathcal{L} generated by X_1 that is

$$\mathfrak{g} = \text{Span}\{X_1, X_4, X_5, X_6, X_7\}.$$

The vector fields X_2 and X_3 are linear, as well as $X_8 = \frac{1}{2}[X_2, X_3]$ and $X_9 = [X_2, X_8]$.

The orders of X_8 and X_9 are respectively -2 and -3 , which shows that the vector fields of order smaller than -1 are not necessarily in \mathfrak{g} .

Notice that the singular locus is here $\mathcal{Z} = \{xy = 0\}$. ■

Example 3

Consider in \mathbb{R}^4 the almost-Riemannian structure defined by the vector fields:

$$X_1 = \partial_x, \quad X_2 = \partial_y + x\partial_z, \quad X_3 = y\partial_w, \quad X_4 = \frac{1}{2}x^2\partial_z + \frac{1}{2}y^2\partial_w.$$

Since $[X_1, X_2] = \partial_z$ and $[X_2, X_3] = \partial_w$, the coordinates (x, y, z, w) are privileged with weights $(1, 1, 2, 2)$ at $p = (0, 0, 0, 0)$. The vector fields X_1, X_2 are homogeneous of order -1 and independent at 0 , and the vector field X_3 is homogeneous of order -1 but vanishes at 0 . The last field X_4 is homogeneous of order 0 . Consequently the first three are equal to their nilpotent approximation and $X_4 = \tilde{X}_4$. According to the notations of Section 1.4 we have $k = 2$ and $m = 3$.

The Lie algebra \mathcal{L} is spanned by X_1, X_2, X_3, X_4 and

$$X_5 = [X_1, X_2] = \partial_z, \quad X_6 = [X_2, X_3] = \partial_w, \quad X_7 = [X_1, X_4] = x\partial_z.$$

Despite the fact that $\hat{X}_3(0) = X_3(0) = 0$ we cannot assert as in the nilpotent case that X_3 does not belong to \mathfrak{g} (see subsection 3.1.4 after Theorem 1.4.3). Indeed the ideal generated in \mathcal{L} by X_1 and X_2 is here

$$\mathfrak{g} = \text{Span}\{X_1, X_2, X_3, X_5, X_6, X_7\}$$

because $X_3 = [X_2, X_4]$.

As explained in subsection 3.1.4 this may happen when $k < m < n$.

Notice that the determinant of X_1, X_2, X_3, X_4 is $-\frac{1}{2}x^2y$. Therefore the singular locus is $\mathcal{Z} = \{xy = 0\}$ which shows that the structure is not generic.

■

In the general case, the Lie algebra \mathcal{L} need not be solvable. Indeed it is a subalgebra of the semi-direct product of \mathfrak{g} by its algebra of derivations. But the algebra of derivations of a nilpotent Lie algebra is not solvable in general. For instance, the derivations of the Heisenberg algebra is the set of endomorphisms, the matrix of which writes in the canonical basis:

$$D = \begin{pmatrix} a & b & 0 \\ c & d & 0 \\ e & f & a+d \end{pmatrix}$$

The subalgebra of such derivations that moreover satisfy $e = f = a + d = 0$ is equal to \mathfrak{sl}_2 hence semisimple.

Example 4 illustrates that possibility.

Example 4

Consider in \mathbb{R}^5 , with coordinates (x, y, z, w, t) :

$$\begin{aligned} X_1 &= \partial_x, & X_2 &= \partial_y + x\partial_w + z\partial_t, & X_3 &= \partial_z + x\partial_t, \\ X_4 &= x\partial_y + \frac{1}{2}x^2\partial_w, & X_5 &= y\partial_x + \frac{1}{2}y^2\partial_w \end{aligned}$$

The Lie algebra \mathcal{L} contains also

$$\begin{aligned} X_6 &= [X_1, X_2] = \partial_w, & X_7 &= [X_1, X_3] = [X_3, X_2] = \partial_t, \\ X_8 &= [X_3, X_5] = -y\partial_t, & X_9 &= [X_8, X_4] = x\partial_t, \\ X_{10} &= [X_4, X_5] = x\partial_x - y\partial_y. \end{aligned}$$

The coordinates (x, y, z, w, t) are privileged with weights $(1, 1, 1, 2, 2)$ at the origin. At this point the vector fields X_1, X_2, X_3 (resp. X_4, X_5) are homogeneous of order -1 (resp. 0), hence equal to their nilpotent approximations (resp. $\tilde{X}_4 = X_4$ and $\tilde{X}_5 = X_5$).

Since $X_{10} = [X_4, X_5]$, $[X_{10}, X_4] = 2X_4$ and $[X_{10}, X_5] = -2X_5$ the vector fields X_4, X_5 and X_{10} , that do not belong to \mathfrak{g} , generate a semi-simple Lie algebra isomorphic to \mathfrak{sl}_2 . Consequently the algebra \mathcal{L} is not solvable.

The singular locus is here $\mathcal{Z} = \{xyz = 0\}$, and again the structure is not generic.

■

2.4 . Genericity

In this section, we investigate the generic properties of almost-Riemannian structures in all dimensions, and we identify the generic nilpotent and solvable approximations.

The examples of Section 4.1.4 show that many different, complicated structures may arise, and the aim of this section is to determine the generic ones.

In what follows, we will say that a property of almost-Riemannian distributions (resp. structures) on a manifold M is **generic** if for any rank n vector bundle E (resp. Euclidean vector bundle $(E, \langle \cdot, \cdot \rangle)$) over M the set of smooth morphisms of vector bundles from E to TM for

which this property is satisfied is open and dense in the \mathcal{C}^2 Whitney topology.

Let U be an open subset of M on which E and TM are trivialisable, and let Π be the projection from E onto M . Then the restriction to $\Pi^{-1}(U)$ of a vector bundle morphism f is equivalent to a smooth mapping X from U to the set $\mathcal{M}_n(\mathbb{R})$ of $n \times n$ square matrices.

Alternately X can be viewed as a mapping (X_1, X_2, \dots, X_n) from U to the set $\Gamma(U)^n$ of n vector fields on U .

It is not helpful to assume that f satisfies the properties of almost-Riemannian distributions because these conditions will turn out to be generic.

The first two theorems deal with distributions only and do not require neither metric, nor normal forms.

In what follows, we denote by $\mathcal{M}_{n \times m}(\mathbb{R})$ the set of real $n \times m$ matrices (simply $\mathcal{M}_n(\mathbb{R})$) if $m = n$) and by L^r the set of elements of $\mathcal{M}_{n \times m}(\mathbb{R})$ of corank r . It is a submanifold of $\mathcal{M}_{n \times m}(\mathbb{R})$ of codimension $(n - q + r)(m - q + r)$ where $q = \min\{n, m\}$ (see [Golubitsky and Guillemin, 1986]).

Recall from Chapter 2, Section 1.2 that f being given, Δ stands for the submodule of $\Gamma(M)$ it defines.

1.2.4 . Generic distribution

Theorem 2.4.1 *The following properties are generic:*

1. Let R be the largest integer such that $R^2 \leq n$. For $1 \leq r \leq R$ let \mathcal{Z}_r be the set of points where the rank of f_p , or locally the rank of $\{X_1, X_2, \dots, X_n\}$, is $n - r$. Each \mathcal{Z}_r is a codimension r^2 submanifold and the singular locus \mathcal{Z} is the union of these disjoint submanifolds.
2. The submanifold \mathcal{Z}_{r+1} is included in the closure $\overline{\mathcal{Z}_r}$ of \mathcal{Z}_r for $r = 1, \dots, R - 1$.
3. For any local representation X of the distribution the mapping $x \mapsto \det(X(x))$ is a submersion at all points $x \in \mathcal{Z}_1$.
4. For $n \geq 3$ the rank of $\Delta + [\Delta, \Delta]$ is full at all points.

Two subspaces of $T_p M$ are attached to a point p belonging to the strate \mathcal{Z}_r of the singular locus, namely Δ_p , the distribution at p , and $T_p \mathcal{Z}_r$, the tangent subspace to \mathcal{Z}_r at p . Their dimensions being respectively $n - r$ and $n - r^2$, the dimension of $T_p \mathcal{Z}_r + \Delta_p$ is at most equal to $\min(n, 2n - r^2 - r)$. We are interested in the cases where the actual dimension of $T_p \mathcal{Z}_r + \Delta_p$ is less than $\min(n, 2n - r^2 - r)$. For example in \mathcal{Z}_1 this means that $\Delta_p = T_p \mathcal{Z}_r$ (tangency points).

In what follows, we note $s = \min(n, 2n - r^2 - r) - \dim(T_p \mathcal{Z}_r + \Delta_p)$, and $[\alpha]$ stands for the integer part of the real number α .

Theorem 2.4.2 *The following properties are generic:*

- $r = 1$. The points $p \in \mathcal{Z}_1$ where $T_p\mathcal{Z}_1 = \Delta_p$ are isolated in \mathcal{Z}_1 .
- $r \geq 2$. Let $m(n, r)$ be the largest dimension that $T_p\mathcal{Z}_r + \Delta_p$ may reach, that is $m(n, r) = \min(n, 2n - r^2 - r)$, and let $s = m(n, r) - \dim(T_p\mathcal{Z}_r + \Delta_p)$. Then
 1. The set of points $p \in \mathcal{Z}_r$ where $s = 1$ is a submanifold of \mathcal{Z}_r for $n \geq r^2 + r - \lfloor \frac{r-1}{2} \rfloor$. It is empty if $n < r^2 + r - \lfloor \frac{r-1}{2} \rfloor$.
 2. The set of points $p \in \mathcal{Z}_r$ where $s \geq 2$ and $s^2 \leq r$ is a submanifold of \mathcal{Z}_r for $r^2 + r - \lfloor \frac{r-s^2}{s-1} \rfloor \leq n \leq r^2 + r + \lfloor \frac{r-s^2}{s-1} \rfloor$. It is empty if n is not in this interval.
 3. The set of points $p \in \mathcal{Z}_r$ where $s \geq 2$ and $s^2 > r$ is empty.

2.2.4 . Normal Form

We consider an almost-Riemannian structure defined by a Euclidean vector bundle $(E, \langle \cdot, \cdot \rangle)$ and a vector bundle morphism f . We are interested in local normal forms of orthonormal vector fields defining the structure in a neighborhood of a point p that we can assume to be $p = 0$ in local coordinates.

These normal forms turn out to be the key to the next section.

First we follow the lines of [Agrachev et al., 2008] (also used in [Boscain et al., 2013a] and [Boscain et al., 2015]).

Let W be a codimension 1 submanifold transversal to the distribution. We can define a coordinate system $y = (x_2, \dots, x_n)$ in W , and choose an orientation transversal to W . Let γ_y be the family of normal geodesics parametrized by arclength, transversal to W at y , and positively oriented. The mapping $(x_1, y) \mapsto \gamma_y(x_1)$ is a local diffeomorphism and the geodesics $x_1 \mapsto \gamma_y(x_1)$ realize the minimal distance between $W = \{x_1 = 0\}$ and the surfaces $\{x_1 = c\}$ for c small enough. The transversality conditions of the PMP are consequently satisfied along all these surfaces: if $\lambda(x_1)$ is a covector associated to one of these geodesics then the tangent space to $\{x_1 = c\}$ at $\gamma_y(x_1)$ is $\ker(\lambda(x_1))$.

Now let $X_1 = \partial_{x_1}$ be the vector field defined by $X_1(q) = \frac{d}{dx_1} \gamma_y(x_1)$ at the point $q = \gamma_y(x_1)$. It is a unitary vector field belonging to Δ . Let X_2, \dots, X_n be $n - 1$ vector fields such that $\{X_1, X_2, \dots, X_n\}$ be an orthonormal frame of Δ . For geodesics the control functions (u_1, u_2, \dots, u_n) from the PMP satisfy $u_j = \langle \lambda, X_j \rangle$. But here $(u_1, u_2, \dots, u_n) = (1, 0, \dots, 0)$ so that $\langle \lambda, X_j \rangle = 0$ for $j = 2, \dots, n$ and the vector fields X_2, \dots, X_n are tangent to the surfaces $\{x_1 = c\}$. Consequently the vector fields have the following form:

$$X_1 = \begin{pmatrix} 1 \\ 0 \\ \cdot \\ \cdot \\ 0 \end{pmatrix}, \quad X_j = \begin{pmatrix} 0 \\ a_{2,j} \\ \cdot \\ \cdot \\ a_{n,j} \end{pmatrix} \quad \text{for } 1 < j < n$$

for any choice of the coordinates in W and any choice of X_2, \dots, X_n , under the condition that they provide an orthonormal frame related to the sub-Riemannian metric.

Notice that thanks to the transversality conditions, the vectors fields X_2, \dots, X_n are not only orthogonal to X_1 for the sub-Riemannian metric but also for the canonical inner product of \mathbb{R}^n for the chosen coordinates.

Let us assume now that $p = 0$ belongs to \mathcal{Z}_r with $r \geq 1$ and $r^2 \leq n$. We want to show that the coordinates and X_2, \dots, X_n can be chosen in such a way that they write:

$$X_1 = \begin{pmatrix} 1 \\ 0 \\ \cdot \\ \cdot \\ \cdot \\ \cdot \\ 0 \end{pmatrix} \quad X_2 = \begin{pmatrix} 0 \\ 1 + b_2(x) \\ a_{3,2}(x) \\ \cdot \\ \cdot \\ \cdot \\ a_{n,2}(x) \end{pmatrix} \quad \dots \quad X_{n-r} = \begin{pmatrix} 0 \\ \cdot \\ \cdot \\ 1 + b_{n-r}(x) \\ a_{n-r+1,n-r} \\ \cdot \\ a_{n,n-r}(x) \end{pmatrix} \quad \text{and}$$

$$(X_{n-r+1} \quad \dots \quad X_n) = \begin{pmatrix} 0 \\ \cdot \\ \cdot \\ 0 \\ \text{-----} \\ D(x) \end{pmatrix} \quad \text{where } D(x) \in \mathcal{M}_r(\mathbb{R}),$$

$b_j(0) = a_{i,j}(0) = 0$, and $D(0) = 0$.

Firstly we can assume that $X_j(0) = \partial_{x_j}$ for $j = 2, \dots, n - r$ and $X_j(0) = 0$ for $j = n - r + 1, \dots, n$. Indeed X_2, \dots, X_n are tangent to W where we can choose freely the coordinates (x_2, \dots, x_n) .

If $r = n - 1$, which is generically possible only if $n = 2$ and $r = 1$, it is finished. Otherwise we can first replace X_2 by the normalization of $\sum_{j=2}^n a_{2j} X_j$. Then we replace X_j by $X_j - \frac{a_{2j}}{a_{22}} X_2$ for $j > 2$. These vector fields belong to Δ , their first two coordinates vanish, and they are orthonormal to (the new) X_2 . It remains to orthonormalize these $n - 2$ vector fields. This cannot be done directly because some of them vanish in the singular locus. However, they are images by the vector bundle morphism f of locally nonvanishing smooth sections of E that can be orthonormalized.

The desired form of the vector fields is obtained by induction.

3.2.4 . Nilpotent and solvable approximation of generic distribution

Thanks to the genericity results of the previous sections and with the help of local normal forms, it is finally shown that generically there are only two possibilities for the nilpotent/solvable approximation at a point $p \in \mathcal{Z}$:

Theorem 2.4.3 *For a generic distribution holds:*

- (i) *Let p be a tangency point in \mathcal{Z}_1 , that is a point where $T_p \mathcal{Z}_1 = \Delta_p$. Then $\widehat{X}_n = 0$ but $\widetilde{X}_n \neq 0$, in normal form.*

(ii) At all other points, including all points in \mathcal{Z}_r with $r \geq 2$, the nilpotent approximation $\widehat{X}_1, \widehat{X}_2, \dots, \widehat{X}_n$ is a set of n linearly independant vector fields.

In conclusion, the only generic points where the solvable approximation is useful are tangency points in \mathcal{Z}_1 .

3.4 . Distance Induced by the Solvable Approximation of n -dimensional Almost-Riemannian Structures

The original system, the nilpotent and solvable approximations give rise to three different distances: d , \widehat{d} and \widetilde{d} respectively. This section deals with the almost-Riemannian distance defined by the solvable approximation at tangency points, of an n -dimensional ARS considering generic assumptions. The main result is Theorem 3.4.4 which states that generically, the distance \widetilde{d} is closer to d than \widehat{d} for pairs of points translated in an appropriate direction (Section 4.3.4). This translation condition is significant because the distance \widehat{d} is not closer to d than the distance induced by the nilpotent approximation for any pair of points. Then to prove the main result, it is essential to determine two facts. First, to state the order of approximation of d by \widetilde{d} (Theorem 3.4.1), and second, to find translation directions such that the distance \widetilde{d} of a pair of translated points is decreasing (see Section 3.3.4).

1.3.4 . Solvable approximation

By Theorem 2.4.1, generically there are points where the rank is $n - r$, as long as $r^2 < n$. In this section, we consider only points belonging to \mathcal{Z}_1 because the only generic points where the solvable approximation is useful are tangency points in \mathcal{Z}_1 (see Theorem 2.4.3). Hence the distribution at $p = 0$ has always dimension $n - 1$, then assume that $X_j(0) = \frac{\partial}{\partial x_j}$ for $j = 2, \dots, n - 1$. In Section 2.2.4, it is shown that the coordinates and X_1, \dots, X_n can be chosen in such a way that:

$$X_1 = \begin{pmatrix} 1 \\ 0 \\ \vdots \\ \vdots \\ 0 \end{pmatrix}, X_2 = \begin{pmatrix} 0 \\ 1 + \beta_2(x) \\ \alpha_{3,2}(x) \\ \vdots \\ \vdots \\ \alpha_{n,2}(x) \end{pmatrix}, \dots, X_{n-1} = \begin{pmatrix} 0 \\ \vdots \\ \vdots \\ 0 \\ 1 + \beta_{n-1}(x) \\ \alpha_{n,j}(x) \end{pmatrix}, X_n = \begin{pmatrix} 0 \\ \vdots \\ \vdots \\ \vdots \\ 0 \\ \alpha_n(x) \end{pmatrix}$$

where $\beta_j(0) = \alpha_{i,j}(0) = 0$ $i, j = 2, \dots, n$.

By the normal form of the vector fields, the singular locus is locally $\mathcal{Z} = \mathcal{Z}_1 = \{\alpha_n(x) = 0\}$.

Let $\alpha_n(x) = \widehat{\alpha}_n(x) + \widetilde{\alpha}_n(x) + \overline{\alpha}_n(x)$, that is α_n decomposed into its components of nonholonomic order 1, 2 and greater than or equal to 3 respectively. Let p be a tangency point in \mathcal{Z}_1 , then by Theorem 2.4.3, $\widehat{X}_n = 0$ and $\widetilde{X}_n \neq 0$, hence $\alpha_n(x) = \widetilde{\alpha}_n(x) + \overline{\alpha}_n(x)$.

Moreover, since $\text{ord}_p(\tilde{\alpha}_n) = 2$ we get $\alpha_n(x) = ax_n + Q(x_1, x_2, \dots, x_{n-1}) + \bar{\alpha}_n(x)$, where $Q(x_1, x_2, \dots, x_{n-1})$ is quadratic. Notice that, since the determinant is a submersion at p (Theorem 2.4.1 item 3) $a \neq 0$.

We can find the nilpotent and solvable approximation in the coordinate system constructed in the normal form. Since $p = 0$ is a tangency point and the weights of the coordinates are $w_1 = \dots = w_{n-1} = 1$, and $w_n = 2$, the nilpotent approximation is defined by

$$\begin{aligned}\widehat{X}_1 &= X_1 = \frac{\partial}{\partial x_1}, \\ \widehat{X}_j &= \frac{\partial}{\partial x_j} + \widehat{\alpha}_{n,j}(x) \frac{\partial}{\partial x_n} \quad \text{for } j = 2, \dots, n-1, \text{ and} \\ \widehat{X}_n &= 0,\end{aligned}$$

where $\widehat{\alpha}_{n,j}$ is the component of $\alpha_{n,j}$ of nonholonomic order 1, hence it is linear in x_1, x_2, \dots, x_{n-1} .

Therefore, the solvable approximation in the tangency case is defined by $\{\widehat{X}_1, \dots, \widehat{X}_{n-1}, \widetilde{X}_n\}$ where

$$\widetilde{X}_n = (ax_n + Q(x_1, x_2, \dots, x_{n-1})) \frac{\partial}{\partial x_n} = \tilde{\alpha}_n(x) \frac{\partial}{\partial x_n},$$

2.3.4 . Comparison of distances

In this subsection, we state the order of approximation of the original distance by \tilde{d} . An important conclusion is that \tilde{d} improves the order of approximation of d given by the nilpotent approximation.

Let q and q' belong to the ball centered at p and radius ϵ , denoted by $B(p, \epsilon)$. We start by analyzing the divergence of curves respectively admissible for d and \tilde{d} , defined by the same control functions and starting at the same point q . Let us consider the vector fields X_1, \dots, X_n in normal form as in the above subsection. Hence we can express each vector field X_j for $j = 2, \dots, n-1$, as

$$X_j = \begin{pmatrix} 0 \\ \vdots \\ 1 + \beta_j(x) \\ \alpha_{j+1,j}(x) \\ \vdots \\ \alpha_{n,j}(x) \end{pmatrix}.$$

Notice that $\alpha_{n,j}(x)$ can be split into components of order 1 and the remainder i.e $\alpha_{n,j}(x) = \widehat{\alpha}_{n,j}(x) + \alpha_{n,j}^+(x)$. We denote by $\rho_{n,j}^+$ the order of $\alpha_{n,j}^+$ for $j = 2, \dots, n-1$.

Proposition 3.4.1 *Let γ be the geodesic for d such that $\gamma(0) = q$, $\gamma(T) = q'$ and associated with the control function $u(\cdot)$ satisfying $\|u\| = 1$. Let $\tilde{\gamma}$ be the admissible curve for \tilde{d} defined by the same control functions as γ and $\tilde{\gamma}(0) = q$. If $\rho_{n,j}^+ \geq 3$ for $j = 2, \dots, n-1$, then*

$$\|\gamma(t) - \tilde{\gamma}(t)\|_p \leq \text{Cst} \cdot \tau^{\frac{3}{2}} \cdot t^{\frac{1}{2}}, \quad (4.1)$$

where $\tau = \max(\|q\|_p, t)$.

In order to state the result related to the comparison of distances, we need upper bounds for the distances d and \tilde{d} . So, from Theorems 7.31 and 7.26 of [Bellaïche, 1996] we get

$$d(q, q') \leq \text{Cst} \sum_{k,j|w_k \leq w_j} \|q\|_p^{1-\frac{w_k}{w_j}} |q_k - q'_k|^{\frac{1}{w_j}}, \text{ and}$$

$$\widehat{d}(q, q') \leq \text{Cst} \sum_{k,j|w_k \leq w_j} \|q\|_p^{1-\frac{w_k}{w_j}} |q_k - q'_k|^{\frac{1}{w_j}}.$$

Since $\tilde{d}(q, q') \leq \widehat{d}(q, q')$, we get

$$\tilde{d}(q, q') \leq \text{Cst} \sum_{k,j|w_k \leq w_j} \|q\|_p^{1-\frac{w_k}{w_j}} |q_k - q'_k|^{\frac{1}{w_j}}.$$

Since the weights of the coordinates are $w_1 = \dots = w_{n-1} = 1$, and $w_n = 2$, we obtain

$$d(q, q') \leq \text{Cst} \left(\|q - q'\|_p + \|q\|_p^{\frac{1}{2}} \left(\sum_{k=1}^{n-1} |q_k - q'_k|^{\frac{1}{2}} \right) \right), \quad (4.2)$$

$$\tilde{d}(q, q') \leq \text{Cst} \left(\|q - q'\|_p + \|q\|_p^{\frac{1}{2}} \left(\sum_{k=1}^{n-1} |q_k - q'_k|^{\frac{1}{2}} \right) \right). \quad (4.3)$$

The following notation and proposition are required for the comparison of distances result.

We denote by $\rho_{i,j}$ the order of $\alpha_{i,j}$ for $j = 2, \dots, n-1$ and $i = j, \dots, n-1$ with the convention that $\alpha_{i,j} = \beta_j$ if $i = j$.

Proposition 3.4.2 *Let γ be the geodesic for d such that $\gamma(0) = q$, $\gamma(T) = q'$ and associated with the control function $u(\cdot)$ satisfying $\|u\| = 1$. Let $\tilde{\gamma}$ be the admissible curve for \tilde{d} defined by the same control functions as γ and $\tilde{\gamma}(0) = q$. If $\rho_{i,j} \geq 2$ and $\rho_{n,j}^+ \geq 3$ for $j = 2, \dots, n-1$ and $i = j, \dots, n-1$, then*

1. $\tilde{d}(\gamma(t), \tilde{\gamma}(t)) \leq \text{Cst} \cdot t^{\frac{1}{2}} \cdot \tau^{\frac{3}{2}}$.
2. $d(\gamma(t), \tilde{\gamma}(t)) \leq \text{Cst} \cdot t^{\frac{1}{2}} \cdot \tau^{\frac{3}{2}}$,

where $\tau = \max(\|q\|_p, t)$.

Theorem 3.4.1 (Comparison of distances) *If $\rho_{i,j} \geq 2$ and $\rho_{n,j}^+ \geq 3$ for $j = 2, \dots, n-1$ and $i = j, \dots, n-1$, then there exist constants C and $\epsilon > 0$, such that, for all $q, q' \in B(p, \epsilon)$, we have*

$$-C\tau^{\frac{3}{2}}d(q, q')^{\frac{1}{2}} \leq d(q, q') - \tilde{d}(q, q') \leq C \cdot \tilde{\tau}^{\frac{3}{2}}\tilde{d}(q, q')^{\frac{1}{2}}, \quad (4.4)$$

where $\tau = \max(\|q\|_p, d(q, q'))$, $\tilde{\tau} = \max(\|q\|_p, \tilde{d}(q, q'))$.

Notice that, if $d(q, q') \geq d(p, q)$ we get $|d(q, q') - \tilde{d}(q, q')| \leq Cd(q, q')^2$. The similar inequality for \widehat{d} is $|d(q, q') - \widehat{d}(q, q')| \leq Cd(q, q')^{\frac{3}{2}}$. This show that the order of bound of $|d(q, q') - \tilde{d}(q, q')|$ is strictly better than the one of $|d(q, q') - \widehat{d}(q, q')|$.

3.3.4 . Translation

In this subsection, we address the second fact needed to prove the main result of this paper, that is, to find directions where the distance of a pair of translated points is decreasing. These directions are the appropriate ones where \tilde{d} is closer to d than \hat{d} .

It is well known that the distance defined by the nilpotent approximation is left-invariant (cf. [Jean, 2014]) while \tilde{d} is not. Let p_2 be a point in a neighborhood of $p = 0$ and $g \in \mathbb{R}^n$. We are interested in conditions under which $\tilde{d}(g, g \cdot p_2) \leq \tilde{d}(0, p_2)$ (this means decreasing), where the product is the Lie group one. For this, some elements are required.

Let $\mathcal{L} = \text{Lie}(\hat{X}_1, \dots, \hat{X}_{n-1}, \tilde{X}_n)$, \mathfrak{g} the ideal generated in \mathcal{L} by $\hat{X}_1, \dots, \hat{X}_{n-1}$ and G the simply connected Lie group whose Lie algebra is \mathfrak{g} that is, the set of left-invariant vector fields on G . We know that \mathfrak{g} is a nilpotent Lie algebra. This Lie algebra \mathfrak{g} can be split into homogeneous components

$$\mathfrak{g} = \mathfrak{g}^1 \oplus \mathfrak{g}^2,$$

where \mathfrak{g}^s is the set of homogeneous vector fields of order $-s$.

The translation will be dealt with by considering a vector field $Y \in \mathfrak{g}^1$ and then $Y \in \mathfrak{g}^2$. We start by considering $Y \in \mathfrak{g}^1$. For the above, Definition 3.4.1 and Theorem 3.4.2 are necessary and they come from [Lee, 2006] and [Do Carmo, 1992].

Definition 3.4.1 *Let $\gamma : [0, T] \rightarrow \mathbb{R}^n$ be a smooth curve, and $\epsilon > 0$. A variation of γ is a smooth map $F : [0, T] \times (-\epsilon, \epsilon) \rightarrow \mathbb{R}^n$ such that*

$$F(t, 0) = \gamma(t)$$

for all $t \in [0, T]$.

For each $s \in (-\epsilon, \epsilon)$, the curve $\gamma_s : [0, T] \rightarrow \mathbb{R}^n$ given by $\gamma_s(t) = F(s, t)$, is called a curve of the variation F .

A variation F of γ determines a differentiable vector field $V(t)$ along γ by $V(t) = \frac{\partial F}{\partial s}(t, 0)$.

We denote by $l(\gamma_s)$ the length of the curve γ_s .

Theorem 3.4.2 (First variation of length, [Lee, 2006]) *Let $\gamma : [0, T] \rightarrow \mathbb{R}^n$ be any unit speed admissible curve and $F(t, s)$ a smooth variation of γ . Then*

$$\frac{d}{ds} l(\gamma_s)(0) = - \int_0^T \langle V(t), \nabla_{\dot{\gamma}} \dot{\gamma} \rangle dt + \langle V(T), \dot{\gamma}(T) \rangle - \langle V(0), \dot{\gamma}(0) \rangle,$$

where ∇ is the Levi-Civita connection.

From [Manríquez et al., 2022], we have that \mathbb{R}^n is diffeomorphic to the quotient G/H where H stands for the connected subgroup of G whose Lie algebra is the set of elements of \mathfrak{g} that vanish at 0. Moreover, the homogeneous space G/H is the manifold of the right cosets

of H . We denote by Π the canonical projection of G onto G/H .

Let $\gamma : [0, T] \rightarrow \mathbb{R}^n$ be a geodesic of \tilde{d} such that $\gamma(t) \notin \mathcal{Z}$ for $t \in]0, T]$. Let $Y \in \mathfrak{g}^1$, and $F : [0, T] \times (-\epsilon, \epsilon) \rightarrow \mathbb{R}^n$ a variation of γ such that

$$F(t, s) = \gamma_s(t) = \gamma(t)\Pi(\exp(sY)) = L_{\gamma(t)}(\Pi(\exp(sY))),$$

where $L_{\gamma(t)}$ is the left translation by $\gamma(t)$.

For each $Y \in \mathfrak{g}^1$, the projection of Y onto G/H is denoted by Π_*Y , the latter is an invariant vector field on G/H (cf. [Jouan, 2010])

Denoting by $V(t)$ the variation field of F , we get

$$V(t) = \frac{\partial F}{\partial s}(t, 0) = \frac{\partial}{\partial s} \Big|_{s=0} \gamma_s(t) = TL_{\gamma(t)} \cdot \Pi_*Y = (\Pi_*Y)(\gamma(t)).$$

Then by Theorem 3.4.2,

$$\frac{d}{ds}l(\gamma_s)(0) = \langle V(T), \dot{\gamma}(T) \rangle - \langle V(0), \dot{\gamma}(0) \rangle = \langle (\Pi_*Y)(\gamma(T)), \dot{\gamma}(T) \rangle - \langle (\Pi_*Y)(0), \dot{\gamma}(0) \rangle.$$

Notice that the integral vanishes because γ is a geodesic for \tilde{d} and hence $\nabla_{\dot{\gamma}}\dot{\gamma} = 0$.

Since we want to study the translation of the curve γ then $Y(0)$ must not be zero. Indeed, if $Y(0) = 0$ then $\gamma(t)\Pi(\exp(0)) = \gamma(t)$. So, we must look for a vector field $Y \in \mathfrak{g}^1$ such that $Y(0) \neq 0$.

So, we have the following proposition.

Proposition 3.4.3 *Let $\gamma : [0, T] \rightarrow \mathbb{R}^n$ be a length minimizer of \tilde{d} with control functions*

$$u_1, \dots, u_n, \text{ and } Y \in \mathfrak{g}^1 \text{ such that } Y(\gamma(t)) = \sum_{i=1}^{n-1} \alpha_i \hat{X}_i(\gamma(t)).$$

$$\text{If } \sum_{i=1}^{n-1} \alpha_i (u_i(T) - u_i(0)) < 0 \text{ then } \frac{d}{ds}l(\gamma_s)(0) < 0.$$

To deal with the case where the translation is in direction of a vector field $Y \in \mathfrak{g}^2$, i.e., a vector field Y such that its evaluation does not belong to the tangent space at 0, we must change the above strategy since it depends on $\langle Y(0), \dot{\gamma}(0) \rangle$, so if $Y(0)$ does not belong to the tangent space at 0, $\langle Y(0), \dot{\gamma}(0) \rangle$ does not make sense.

The below (Proposition 3.4.4) is necessary and comes from [Bonfiglioli, 2007].

Let G be a connected, simply connected Lie group of dimension n such that G is a Carnot (or stratified) group of step r (see more details in [Bonfiglioli, 2007]) and \mathfrak{g} its Lie algebra. After the choice of a basis X_1, \dots, X_n for \mathfrak{g} , the group G is identified with \mathbb{R}^n via the exponential mapping; this means that a point $x = (x_1, \dots, x_n) \in \mathbb{R}^n$ is identified with the point $\exp(x_1X_1 + \dots + x_nX_n)$ of the group. Hence we have the following result obtained from [Bonfiglioli, 2007] and [Serra Cassano, 2016].

Proposition 3.4.4 *The group product has the form*

$$x \cdot y = x + y + Q(x, y) \quad \forall x, y \in \mathbb{R}^n, \quad (4.5)$$

where $Q = (Q_1, \dots, Q_n) : \mathbb{R}^n \times \mathbb{R}^n \rightarrow \mathbb{R}^n$ and Q_j is a homogeneous polynomial of degree w_j . Moreover, for all $x, y \in \mathbb{R}^n$ $Q_1(x, y) = \dots = Q_{n_1}(x, y) = 0$, where n_1 is such that $w_1 = \dots = w_{n_1} = 1$, and

$$Q_i(x, y) = \sum_{h,k} \mathcal{R}_{k,h}^i(x, y)(x_k y_h - x_h y_k),$$

where the functions $\mathcal{R}_{k,h}^i$ are polynomials, homogenous of degree $w_i - w_h - w_k$ with respect to group dilations, and the sum is extended to all h, k such that $w_k + w_h \leq w_i$.

Remark 3.4.1 *In the context of the generic case, which is the case that interests us in this section, $n_1 = n - 1$, and since $\text{rank}(\Delta_p + [\Delta, \Delta]_p) = n$ at all points then $\mathcal{R}_{k,h}^n$ is a constant, and $w_k = w_h = 1$.*

Let $Y \in \mathfrak{g}^2$. In local coordinates $Y(x) = \sum_{i=1}^n f_i(x) \frac{\partial}{\partial x_i}$. Since $w_1 = \dots = w_{n-1} = 1$ and $w_n = 2$ then $f_i(x) \equiv 0$ for $i = 1, \dots, n - 1$, and $f_n(x)$ is a constant different from 0, hence $Y(x) = \nu \frac{\partial}{\partial x_n}$, with $\nu \neq 0$ (see Figure 4.1).

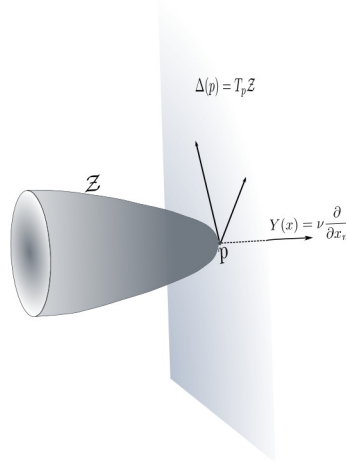

Figure 4.1: Singular set and its tangent space at p with the translation vector $Y(x)$.

Let μ_Y be the integral curve of Y passing through the identity of G when $t = 0$, then

$$\dot{\mu}_Y(t) = Y(\mu_Y(t)) = \nu \frac{\partial}{\partial x_n},$$

hence

$$\mu_Y(t) = \begin{pmatrix} 0 \\ \vdots \\ 0 \\ t\nu \end{pmatrix}.$$

Since $\exp(Y) = \mu_Y(1)$ (see more details in [Bonfiglioli, 2007]), then $\exp(Y) = \begin{pmatrix} 0 \\ \vdots \\ 0 \\ \nu \end{pmatrix}$.

Let $\gamma : [0, T] \rightarrow \mathbb{R}^n$ be a geodesic of \tilde{d} such that $\gamma(t) = (\gamma_1(t), \dots, \gamma_n(t))$, $\gamma(t) \notin \mathcal{Z}$ for $t \in]0, T[$, and $\gamma(0) = 0$, with control functions u_1, \dots, u_n . We consider $Y \in \mathfrak{g}^2$ such that, $Y(x) = \nu \frac{\partial}{\partial x_n}$. Let $\gamma_{LY}(t) = L_{\exp(Y)}(\gamma(t)) = (\gamma_{1Y}(t), \dots, \gamma_{nY}(t))$ and $\bar{u}_1, \dots, \bar{u}_n$ its control functions.

Recall that $\tilde{a}_n(x) = ax_n + Q(x_1, x_2, \dots, x_{n-1})$, where $Q(x_1, x_2, \dots, x_{n-1})$ is quadratic. We set $\tilde{a}_n(\gamma) = \tilde{a}_n(\gamma(t))$.

The following result provides conditions on Y such that γ_{LY} has a length less than γ .

Theorem 3.4.3 *Let $\gamma : [0, T] \rightarrow \mathbb{R}^n$ be a length minimizer of \tilde{d} with control functions $u_1(t), \dots, u_n(t)$ with $u_n(t) \neq 0$ almost everywhere, and $\tilde{a}_n(\gamma) + a\nu \neq 0$. If $|\tilde{a}_n(\gamma)| < |\tilde{a}_n(\gamma) + a\nu|$ then $\tilde{d}(\gamma_{LY}(0), \gamma_{LY}(T)) < \tilde{d}(\gamma(0), \gamma(T))$.*

4.3.4 . Solvable distance better than the nilpotent one

It is known that the almost-Riemannian distance d of the original system, close to $p = 0$, behaves at the first-order as the distance defined by the nilpotent approximation at $p = 0$. However, thanks to Theorem 3.4.1 we know that the solvable approximation improves the order of approximation of d given by the nilpotent approximation. Despite the above, we can not state that the solvable distance is closer than the nilpotent one to the original distance for all pairs of points.

In this section, we prove that the approximation by \tilde{d} is better than the one by \hat{d} for a pair of points translated in a direction where the distance \tilde{d} is decreasing.

Before that, notice that we know by Proposition 1.3.3 that $\tilde{d}(q, q') \leq \hat{d}(q, q')$ then we can conclude that for \tilde{d} to be better than \hat{d} it must be satisfied that $\frac{\tilde{d}(q, q') + \hat{d}(q, q')}{2} > d(q, q')$.

Let $\gamma(t) = (\gamma_1(t), \dots, \gamma_n(t))$ be a (normal) geodesic of \tilde{d} such that $\gamma(0) = 0$ with control functions u_1, u_2, \dots, u_n parametrized by arc length on $[0, T]$, and the length of the curve γ is denoted by $l(\gamma)$. We consider $g \in \mathbb{R}^n$ such that $g = \exp(Y)$ with $Y \in \mathfrak{g}$ and Y satisfying Theorem 3.4.3. Let $\gamma_g(t) = L_g(\gamma(t))$ and $\bar{u}_1, \bar{u}_2, \dots, \bar{u}_n$ its control functions. Note that γ_g is admissible for \tilde{d} as long as it does not meet \mathcal{Z} . Indeed, all absolutely continuous curves are admissible out of the singular locus since the metric is Riemannian.

Let $\epsilon > 0$ such that $C_2 \cdot \tilde{d}(0, \gamma(T)) = C_2 \cdot T \leq \epsilon$, where C_2 is the constant of inequality 4.4 of Theorem 3.4.1.

On the other hand, by Proposition 3.4.4 we have that $u_i(t) = \bar{u}_i$ for $i = 1, \dots, n - 1$ and since $l(\gamma_g) < l(\gamma)$, we can assume that there exists $C : [0, T] \rightarrow [0, 1[$ such that

$$|u_n(t)|C(t) = |\bar{u}_n(t)|. \quad (4.6)$$

Moreover, from Pontryagin's maximum principle (more details see [Agrachev et al., 2019]) we know that

$$u_n(t) = \langle \lambda(t), \tilde{X}_i \rangle = \lambda_n(t) \cdot (ax_n + Q(x_1, x_2, \dots, x_{n-1})) \quad (4.7)$$

where $\lambda(t) \in T_{\gamma(t)}^* \mathbb{R}^n$.

$$\text{Let } b = \max(C(t), t \in [0, T]) \text{ and } S = \frac{(1 - b^2)\lambda_n(0)^2(n - 2)^2 a^2}{40(n - 1)^2} T^4.$$

The following Theorem is the main result in this section.

Theorem 3.4.4 *With the previous notations. If $\frac{2\epsilon}{1 + 2\epsilon} < S$ then*

$$\left| \widehat{d}(\gamma_g(0), \gamma_g(T)) - d(\gamma_g(0), \gamma_g(T)) \right| > \left| d(\gamma_g(0), \gamma_g(T)) - \widetilde{d}(\gamma_g(0), \gamma_g(T)) \right|,$$

and in consequence \widetilde{d} is closer than \widehat{d} to d .

Part II

Continuation Method in the rolling problem with obstacles

Contents

1	Introduction	55
2	Mathematical prerequisites	58
1.2	Differential geometry	58
1.1.2	Geodesic coordinates	58
2.1.2	Orthonormal moving frame (OMF)	58
3.1.2	Christoffel symbols and connection form	59
4.1.2	Parallel vector field	59
5.1.2	Gaussian curvature and geodesics	59
2.2	Rolling body problem	60
3.2	Continuation Method	61
3	Numerical implementation	64
1.3	Rolling surface and obstacles	64
1.1.3	Obstacles and dynamics of the control system	65
2.1.3	Conjeture	66
2.3	Key points for numerical implementation	68
1.2.3	Discretizing \mathcal{H}	68
2.2.3	Computing $DE_p(u)$	69
3.2.3	Lifting the plane curve $\tilde{\gamma}_1$ on A_2	70
3.3	Examples	70
1.3.3	Sphere	72
2.3.3	Egg	73
3.3.3	Flattened ball	74
4.3	Conclusions and comments	75

Introduction

A nonholonomic system on a n -dimensional manifold M is a control system which is of the form

$$\dot{x} = \sum_{i=1}^m u_i X_i(x), \quad x \in M, \quad (1.1)$$

where $m > 1$ is an integer and X_1, X_2, \dots, X_m are C^∞ vector field on M (cf. [Jean, 2014]). From the control viewpoint, nonholonomic systems are nonlinear systems, and whose tangent linearization does not preserve controllability. These systems provide an important class of mechanical control systems such as rolling contact or sliding contact (cf. [Bloch, 2003]). With the great development of robotics, these systems have become very important; in particular, nonholonomy of rolling is relevant to robotic manipulation (see for instance [Chung, 2004], [Kolmanovsky and McClamroch, 1995], [Marigo and Bicchi, 2000], [Murray et al., 2017]).

The rolling-body problem (without slipping nor spinning) is a control system Σ , which models the rolling of an embedded connected surface A_2 in \mathbb{R}^3 on another A_1 one. A state of the system is an orientation-preserving isometry. The state space of the system Σ , denoted by $\mathcal{Q}(A_1, A_2)$, is a 5-dimensional connected manifold (details in [Agrachev and Sachkov, 2004]). As a consequence of the rolling constraints (no slipping and no spinning), and given an absolutely continuous (a.c.) curve γ_1 on A_1 , there exists a unique a.c. curve Γ in \mathcal{Q} , which describes the rolling of the surface A_2 onto the surface A_1 along the curve γ_1 . Thus, the admissible controls of Σ correspond to the a.c. curves γ_1 of A_1 by their derivatives $\dot{\gamma}_1$. Then, the system of control can be written, in local coordinates, as a nonholonomic system

$$\Sigma : \dot{x} = u_1 X_1 + u_2 X_2,$$

where $(u_1, u_2) \in \mathbb{R}^2$ is the control, and X_1 and X_2 are vector fields defined in the domain of the chart.

We can identify three aspects that arise in the rolling bodies problem: modeling of rolling surfaces, motion planning for rolling systems, and controllability. Regarding the modeling of rolling surfaces, several papers can be found where first and second-order kinematic contact equations are derived, see for instance the papers [Cai and Roth, 1987], [Montana, 1988], [Sarkar et al., 1997] and [Woodruff and Lynch, 2019]. A historical account of the problem of rolling two Riemannian manifolds one on the other, ranging from classical to modern results, can be found in [Chitour et al., 2014]. Concerning the motion planning problem, the simplest

model is a sphere rolling on the plane. The first time that this problem was considered as worthy of study was in the papers of Chaplygin ([Chaplygin, 2002] and [Chaplygin, 2012]) afterwards, it has been dealt in many papers, for instance [Li and Canny, 1990], [Oriolo and Vendittelli, 2005], and [Jurdjevic, 1993]. Considering a more general convex body in the motion planning problem, Marigo and Bicchi proposed an approximate motion-planning algorithm for general convex body A_2 [Marigo and Bicchi, 2000]. Alouges et al. in [Alouges et al., 2010] provide an algorithm, which is based on the Continuation Method for a convex surface rolling on a plane (more detail about the Continuation Method, see Section 3.2). In [Woodruff et al., 2020], the authors presented a method to generate motion plans and stabilize feedback controllers for general, smooth, 3-dimensional objects in rolling contact. Chelouah and Chitour give an approach resting on the Liouvillian character of Σ . More precisely, if just one of the manifolds has a symmetry of revolution (i.e., A_1 or A_2), then Σ is shown to be a Liouvillian system. If, in addition, that manifold is convex and the other one is a plane, then a maximal linearizing output is explicitly computed [Chelouah and Chitour, 2003]. In the framework of the motion planning problem with obstacles, Bicchi and Marigo used a lattice structure on the state space and translated Li-Canny's (see [Li and Canny, 1990]) global and exact computation into a series of local and approximate ones with good topological properties so that it could be incorporated into a more-general motion-planning algorithm dealing with obstacles in the plane [Bicchi and Marigo, 2002]. Grushkovskaya and Zuyev present a theoretical analysis of the obstacle avoidance problem and prove asymptotic stability. The time-varying control strategy is defined explicitly in terms of the gradient of a potential function [Grushkovskaya and Zuyev, 2018]. Divelbiss and Wen consider the path planning problem without obstacles by transforming it into a nonlinear least-squares problem in an augmented space which is then iteratively solved. Obstacle avoidance is included as inequality constraints, and exterior penalty functions are used to convert the inequality constraints into equality restrictions [Divelbiss and Wen, 1997]. Concerning the controllability issues, Agrachev and Sachkov [Agrachev and Sachkov, 2004] show that the control system Σ is locally controllable at a point $q \in \mathcal{Q}$ if the local Gaussian curvatures of A_1 and A_2 are not equal. Furthermore, they proved that Σ is completely controllable if and only if A_1 and A_2 are not isometric. In [Marigo and Bicchi, 2000], necessary conditions for the reachability of rolling contacts are defined.

In this part of the thesis, we address the motion planning problem of a strictly convex body A_2 rolling (without slipping nor spinning) on the Euclidean plane \mathbb{R}^2 with obstacles, with a numerical implementation of the Continuation Method.

The Continuation Method, also called homotopy method or continuous Newton's algorithm [Allgower and Georg, 1993], was introduced in [Sussmann, 1992] and [Sussmann, 1993] and widely developed in [Chitour and Sussmann, 1998], [Chitour, 2002], and [Chitour, 2006]. It is used to solve nonlinear equations of the form $\mathcal{L}(x) = y$, where x is the unknown, and $\mathcal{L} : X \rightarrow Y$ is surjective. In the context of the motion planning, \mathcal{L} is the endpoint map (associated with some fixed point p) from the space of admissible inputs to the state space, that is $E_p : \mathcal{H} \rightarrow M$, and it proceeds by starting from a value $u_0 \in \mathcal{H}$ and $y_0 = E_p(u_0)$, then by joining y_0 to the given y by a continuous path π and by trying to lift π to the path

Π so that $E_p \circ \Pi = \pi$. To construct such a path Π , we may differentiate $E_p(\Pi(s)) = \pi(s)$ to get $DE_p(\Pi(s))\dot{\Pi}(s) = \dot{\pi}(s)$. The latter is satisfied if we can solve $\dot{\Pi}(s) = F(\Pi(s))\dot{\pi}(s)$ where $F(x)$ is a right inverse of $DE_p(u)$. Therefore, solving $E_p(u) = y$ is equivalent to firstly show that $F(\Pi(s))$ exists (for instance if $DE_p(\Pi(s))$ is surjective) and secondly, proving that the ODE in \mathcal{H} , $\dot{\Pi}(s) = F(\Pi(s))\dot{\pi}(s)$, which is also called the path-lifting equation (PLE) or Wazewski equation [Wazewski, 1947], admits a global solution. The singularities of the E_p are exactly the abnormal extremals of the sub-Riemannian metric induced by the dynamics of the system, which are usually a significant obstacle to efficiently apply the Continuation Method to the motion planning problem. In the case of Σ , nontrivial abnormal extremals and their trajectories were determined in [Chelouah and Chitour, 2003], and they are precisely the horizontal geodesics of Σ . However, by assuming that the surface A_2 is strictly convex and possesses a stable periodic geodesic, and A_1 is a plane, it was shown in [Chelouah and Chitour, 2003] that the PLE $\dot{\Pi}(s) = F(\Pi(s))\dot{\pi}(s)$ has a global solution, that is, the Continuation Method offers a total solution to the motion planning problem.

The convex body A_2 , which can be embedded as a convex surface in \mathbb{R}^3 , is assumed to have a stable periodic geodesic. We denote the state space $\mathcal{Q}(\mathbb{R}^2, A_2)$ simply by M . An obstacle \mathcal{W} in \mathbb{R}^2 is a nonempty compact subset of \mathbb{R}^2 . \mathcal{W} maps in M a region C . Thus, an obstacle in M is a nonempty closed subset of M such that $\widehat{M} = M \setminus C$ is also nonempty. Let us consider the control system on M defined by

$$\dot{y} = v_1 \overline{X}_1(y) + v_2 \overline{X}_2(y)$$

where $\overline{X}_i = \zeta X_i$, $i = 1, 2$ and $\zeta : M \rightarrow \mathbb{R}$ such that $\zeta > 0$ on \widehat{M} , $\zeta = 0$ on C . Then \widehat{M} is invariant under the above control system. Thus, the motion planning problem with obstacles is reduced to a motion planning problem for each connected component of \widehat{M} .

Therefore, we provide a complete numerical implementation of the Continuation Method presented above to solve the motion planning problem with forbidden regions on the plane.

The second part of this thesis is organized as follows.

Chapter 2 contains generalities about differential geometry (geodesic coordinates, orthonormal moving frame, Christoffel symbols, connection form, Gaussian curvature, and geodesics), rolling body problem, and Continuation Method.

In Chapter 3, we fix the definition of an obstacle, and we provide the dynamics of the control system on the state space $\mathcal{Q}(A_1, A_2)$ such that $A_1 = \mathbb{R}^2$ and A_2 is an oriented surface of \mathbb{R}^3 with a geometric condition. Moreover, Section 2.3 provides a detailed description of the fundamental points for the numerical implementation: discretizing the control space, computing the differential of endpoint map, and the lift of the curve on the convex body A_2 . Section 3.3 provides three examples of the bodies rolling on the Euclidean plane: the sphere, the flattened ball, and an egg. Finally, Section 4.3 contains conclusions and some comments.

Mathematical prerequisites

This section is dedicated to present some definitions and results used in this part of the thesis related to differential geometry, rolling body problem, and the Continuation Method.

1.2 . Differential geometry

The following definitions and results come from [Agrachev et al., 2019], [Klingenberg, 1982], and [Berger and Gostiaux, 2012].

Let $(A, \langle \cdot, \cdot \rangle)$ be a 2-dimensional, connected, oriented, smooth, complete Riemannian manifold for the Riemannian metric $\langle \cdot, \cdot \rangle$. We use TS to denote the tangent bundle over A and UA the unit tangent bundle, i.e., the subset of TA of points (x, v) such that $x \in A$ and $v \in T_x A$, $\langle v, v \rangle = 1$.

Let $\{U_\alpha, \alpha\}_{\alpha \in \mathcal{A}}$ be an atlas on A . For $\alpha_1, \alpha_2 \in \mathcal{A}$ such that $U_{\alpha_1} \cap U_{\alpha_2}$ is not empty, we denote by $J_{\alpha_2 \alpha_1}$ the Jacobian matrix of $\varphi^{\alpha_2} \circ (\varphi^{\alpha_1})^{-1}$ the coordinate transformation on $\varphi^{\alpha_1}(U_{\alpha_1} \cap U_{\alpha_2})$. For $\alpha_1 \in \mathcal{A}$, the Riemannian metric is represented by the symmetric positive-definite matrix \mathcal{I}^{α_1} and set $M^{\alpha_1} = \sqrt{\mathcal{I}^{\alpha_1}}$.

1.1.2 . Geodesic coordinates

The geodesic coordinates on A are charts (v, w) defined such that G^{α_1} is diagonal with $g_{11} = 1$ and $g_{22} = \vartheta^2(v, w)$. The function ϑ is defined in an open neighborhood of $(0, 0)$ (the domain of the chart) and satisfies $\vartheta(0, w) = 1$, $\vartheta_v(0, w) = 0$, and $\vartheta_{vv} + K\vartheta = 0$, where K denotes the Gaussian curvature of A at (v, w) ; and $\vartheta_v(\vartheta_{vv})$ is the (double) partial derivative of ϑ with respect to v .

2.1.2 . Orthonormal moving frame (OMF)

Definition 1.2.1 For $x \in A$, a frame Φ at x is an ordered basis for $T_x A$ and, for $\alpha_1, \alpha_2 \in \mathcal{A}$, we have $\Phi^{\alpha_2} = J_{\alpha_2 \alpha_1} \Phi^{\alpha_1}$. The frame Φ is orthonormal if, in addition, $M^{\alpha_1} \Phi^{\alpha_1}$ is an orthogonal

matrix.

An orthonormal moving frame (OMF), defined on an open subset U of A , is a smooth map assigning to each $x \in U$ a positively oriented orthonormal frame $\Phi(x)$ of T_xA .

3.1.2 . Christoffel symbols and connection form

Let ∇ be the Riemannian connection on A .

For a given OMF Φ defined on $U \subset A$, the Christoffel symbols associated with $\Phi = (\Phi_1, \Phi_2)$ are defined by $\nabla_{\Phi_i}\Phi_j = \sum_k \Gamma_{ij}^k \Phi_k$ where $1 \leq i, j, k \leq 2$.

The connection form ω is the mapping defined on U such that, for every $x \in U$, ω_x is the linear application from T_xA to the set of 2×2 skew-symmetric matrices given as follows. For $i, j, k = 1$ and 2 , the (i, j) th coefficient of $\omega_x(\Phi_k)$ is equal to Γ_{ij}^k .

4.1.2 . Parallel vector field

Let $\gamma : I \rightarrow A$ be an a.c curve in A with I compact interval of \mathbb{R} . Set $X(t) := \dot{\gamma}(t)$ in I , which defines a vector field along γ . Let $Y : I \rightarrow TA$ be an a.c. assignment such that, for every $t \in I$, $Y(t) \in T_{\gamma(t)}A$.

Definition 1.2.2 We say that Y is parallel along γ if $\nabla_X Y = 0$ for almost all $t \in I$. Moreover, in the domain of an OMF Φ , that equation can be written as follows: $\dot{Y}^k = - \sum_{1 \leq i, j, k \leq 2} \Gamma_{ij}^k X^i Y^j$

or equivalently $\dot{Y} = -\omega(X)Y$.

5.1.2 . Gaussian curvature and geodesics

Let A be an oriented surface of \mathbb{R}^3 with metrics induced by the Euclidean metric of \mathbb{R}^3 . We assume that A is defined as one bounded connected component of the zero-level set of a smooth real-valued function $a : \mathbb{R}^3 \rightarrow \mathbb{R}$, and let K be the Gaussian curvature of A .

Proposition 1.2.1 ([Berger and Gostiaux, 2012]) With the previous notation, we have

$$K = - \frac{\det \begin{pmatrix} \nabla^2 a & \nabla a \\ (\nabla a)^T & 0 \end{pmatrix}}{\|\nabla a\|^4}, \tag{2.1}$$

where $\nabla^2 a$ is the Hessian matrix of a , and $(\nabla a)^T$ denotes the transpose matrix of ∇a .

Definition 1.2.3 A smooth curve $\gamma : [0, 1] \rightarrow A$ parametrized with constant speed is called geodesic if it satisfies

$$\ddot{\gamma}(t) \perp T_{\gamma(t)}A$$

for almost t in $[0, 1]$.

Since A is defined as (a bounded connected component of) the zero-level set of a real-valued function a , we have the following Proposition

Proposition 1.2.2 (see [Agrachev et al., 2019]) *A smooth curve $\gamma : [0, 1] \rightarrow A$ is a geodesic if and only if it satisfies*

$$\ddot{\gamma} = -\frac{\dot{\gamma}^T \nabla^2 a(\gamma) \dot{\gamma}}{\|\nabla a(x)\|^2} \nabla a(\gamma). \quad (2.2)$$

2.2 . Rolling body problem

Let us consider the rolling body problem with no slipping or spinning of A_2 on top of A_1 . We adopt the viewpoint presented in [Agrachev and Sachkov, 2004].

Let A_1 and A_2 be two-dimensional connected, oriented Riemannian manifold (surfaces of the rolling bodies). At the contact points of the bodies $x_1 \in A_1$ and $x_2 \in A_2$, their tangent spaces are identified by an orientation-preserving isometry $q : T_{x_2}A_2 \rightarrow T_{x_1}A_1$ (see Figure 2.1). Such an isometry q is a state of the system, and the state space is given by

$$\mathcal{Q}(A_1, A_2) = \{q : T_{x_2}A_2 \rightarrow T_{x_1}A_1 \mid x_1 \in A_1, x_2 \in A_2, q \text{ an isometry}\}.$$

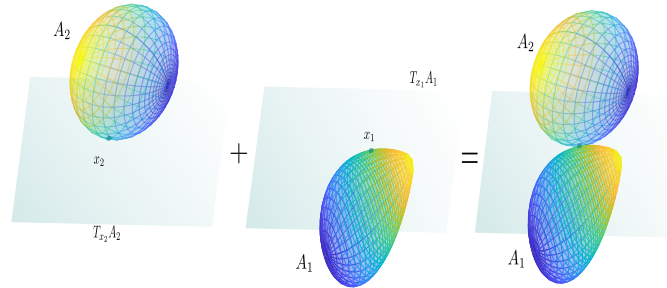

Figure 2.1: Identification of tangent spaces at a contact point.

As the set of all orientation-preserving isometries in \mathbb{R}^2 is $SO(2)$, which can be identified with the unit circle S^1 in \mathbb{R}^2 , $\mathcal{Q}(A_1, A_2)$ is a 5-dimensional connected manifold. A point $q \in \mathcal{Q}(A_1, A_2)$ is locally parametrized by (x_1, x_2, R) with $x_1 \in A_1$, $x_2 \in A_2$, and $R \in SO(2)$.

Let Φ_1 and Φ_2 be two OMFs defined on the chart domains of α_1, α_2 . For $i = 1, 2$, consider a curve $\gamma_i^{\alpha_i}$ defined inside the chart domain α_i on the body A_i . Let $b_i(t) = \Phi_i(\gamma_i(t)) R_i(t)$ parallel along $\gamma_i^{\alpha_i}$, $i = 1, 2$, and $R := R_2(t)R_1(t)^{-1} \in SO(2)$, which measures, by definition, the relative position of Φ_2 with respect to Φ_1 along $(\gamma_1^{\alpha_1}, \gamma_2^{\alpha_2})$. The variation of R_i along $\gamma_i^{\alpha_i}$, for $i = 1, 2$, is given by $\dot{R}_i = -\omega_i(\dot{\gamma}_i^{\alpha_i}) R_i$.

Given an a.c. curve $\gamma_1 : [0, T] \rightarrow A_1$, the rolling of A_2 on A_1 without slipping or spinning along γ_1 is characterized by a curve $\Gamma = (\gamma_1, \gamma_2, R) : [0, T] \rightarrow \mathcal{Q}(A_1, A_2)$, which is defined by

the following two equations:

$$M^{\alpha_2} \dot{\gamma}_2^{\alpha_2}(t) = RM^{\alpha_1} \dot{\gamma}_1^{\alpha_1}(t) \quad (\text{no-slipping condition}) \quad (2.3)$$

$$\dot{R}R^{-1} = \omega_1(\dot{\gamma}_1^{\alpha_1}) - \omega_2(\dot{\gamma}_2^{\alpha_2}) \quad (\text{no-spinning condition}) \quad (2.4)$$

Definition 2.2.1 *The surface A_2 rolls on A_1 without slipping nor spinning if, for every $x = (x_1, x_2, R_0) \in \mathcal{Q}(A_1, A_2)$ and a.c curve $\gamma_1 : [0, T] \rightarrow A_1$ starting at x_1 , there exists an a.c curve $\Gamma : [0, T] \rightarrow \mathcal{Q}(A_1, A_2)$, with $\Gamma(t) = (\gamma_1(t), \gamma_2(t), R(t))$, $\Gamma(0) = x$ and for every $t \in [0, T]$, such that, on appropriate charts, equations (2.3) and (2.4) are satisfied. We call the curve $\Gamma(t)$ an admissible trajectory.*

Equations (2.3) and (2.4) can be rewritten in local coordinates by considering f_1 and f_2 two OMFs and if the state $x = (\gamma_1, \gamma_2, R)$ then for almost all t such that $x(t)$ remains in the domain of an appropriate chart, there exists a measurable function $u : [b, d] \rightarrow \mathbb{R}^2$ (which is called control) such that

$$\begin{aligned} \dot{\gamma}_1(t) &= u_1(t)\Phi_1^1(\gamma_1(t)) + u_2(t)\Phi_2^1(\gamma_1(t)) \\ \dot{\gamma}_2(t) &= u_1(t)(\Phi^2(\gamma_2(t))R(t))_1 + u_2(t)(\Phi^2(\gamma_2(t))R(t))_2 \\ \dot{R}(t)R^{-1}(t) &= \sum_{i=1}^2 u_i(t) \left(\omega_1(\Phi_i^1(\gamma_1(t))) - \omega_2(\Phi^2(\gamma_2(t))R(t))_i \right). \end{aligned}$$

Then, we can rewrite the above system of equations as follows:

$$\dot{x} = u_1 X_1(x) + u_2 X_2(x), \quad (2.5)$$

where $X_i = \left(\Phi_i^1, (\Phi^2 R)_i, \left(\omega_1(\Phi_i^1) - \omega_2(\Phi^2 R(t))_i \right) \right)^T$, $i = 1, 2$.

The following proposition describes a fundamental property of the rolling-body problem (see [Chelouah and Chitour, 2003] for more details).

Proposition 2.2.1 *Let $u \in \mathcal{H}$ be an admissible control that gives rise to the admissible trajectory $\Gamma = (\gamma_1, \gamma_2, R) : [0, 1] \rightarrow \mathcal{Q}(A_1, A_2)$. Then, the following statements are equivalent:*

1. *The curve $\gamma_1 : [0, 1] \rightarrow A_1$ is a geodesic;*
2. *The curve $\gamma_2 : [0, 1] \rightarrow A_2$ is a geodesic;*
3. *The curve $\Gamma : [0, 1] \rightarrow \mathcal{Q}(A_1, A_2)$ is a horizontal geodesic.*

3.2 . Continuation Method

This section provides a complete and general description of the Continuation Method and comes from [Chitour, 2006].

We fix some notations. The admissible inputs u are elements of $\mathcal{H} = L^2([0, 1], \mathbb{R}^2)$. To denote $(u_1(t)^2 + u_2(t)^2)^{\frac{1}{2}}$ and $\left(\int_0^1 \|u(t)\|^2 dt\right)^{\frac{1}{2}}$ we use $\|u(t)\|$ and $\|u\|_{\mathcal{H}}$ respectively. If $u, v \in \mathcal{H}$, then $(u, v)_{\mathcal{H}} = \int_0^1 u(t)^T v(t) dt$.

As mentioned in the Introduction Section, the Continuation Method is used to solve non-linear equations of the form $\mathcal{L}(x) = y$, where x is the unknown, and $\mathcal{L} : X \rightarrow Y$ is surjective.

In the context of the motion planning problem, the map \mathcal{L} is the end-point $E_p : \mathcal{H} \rightarrow M$ associated with some fixed $p \in M$. For $u \in \mathcal{H}$ and $p \in M$, let $\gamma_{p,u}$ be the trajectory of Σ starting at p for $t = 0$ and corresponding to u . Then for $v \in \mathcal{H}$, $E_p(v)$ is given by $E_p(v) := \gamma_{p,v}(1)$.

Recall that $E_p(v)$ is defined for every $v \in \mathcal{H}$. The motion planning problem can be reformulated as follows:

For every $p, q \in M$, exhibit a control $u_{p,q} \in \mathcal{H}$ such that $E_p(u_{p,q}) = q$. Meaning, we must find the right inverse of the endpoint map E_p . This right inverse exists in a neighborhood of any point $u \in \mathcal{H}$ such that DE_p is surjective (by the contrability assumption). More accurately, we begin with an arbitrary control u_0 . Set $q_0 := E_p(u_0)$, and choose a path $\pi : [0, 1] \rightarrow M$ such that $\pi(0) := q_0$ and $\pi(1) := q$. We now look for a path $\Pi : [0, 1] \rightarrow \mathcal{H}$ such that, for every $s \in [0, 1]$

$$E_p(\Pi(s)) = \pi(s) \quad (2.6)$$

Differentiating equation (2.6) yields

$$DE_p(\Pi(s)) \cdot \frac{d\Pi}{ds}(s) = \frac{d\pi}{dt}(s). \quad (2.7)$$

If $DE_p(\Pi(s))$ has full rank, then equation (2.7) can be solved for $\Pi(s)$ by taking Π such that

$$\frac{d\Pi}{ds}(s) = F(\Pi(s)) \cdot \frac{d\pi}{dt}(s). \quad (2.8)$$

where $F(\cdot)$ is a right inverse of $DE_p(\cdot)$. For instance, we can choose $F(\cdot)$ to be the Moore-Penrose pseudoinverse of $DE_p(\cdot)$. Equation (2.8) is called the *Path Lifting Equation* (PLE) which is an Ordinary Differential Equation (ODE) on \mathcal{H} (cf. [Ważewski, 1947]).

Notice that, by construction, the control defined by $u^{final} := \Pi(1)$ steers the system from p to q . In order to get the value of $\Pi(1)$, it suffices, to solve the initial value problem defined in the control space \mathcal{H}

$$\begin{aligned} \frac{d\Pi}{ds}(s) &= F(\Pi(s)) \cdot \frac{d\pi}{dt}(s) \\ \Pi(0) &= u_0. \end{aligned} \quad (2.9)$$

To successfully apply the Continuation Method to the motion planning problem, we must guarantee the existence of $F(\Pi(s))$ for every $s \in [0, 1]$ in such a way equation (2.8) is always well defined, this is to say $DE_p(\Pi(s))$ must always have rank equal to 5. Moreover, since we

need to evaluate $\Pi(1)$ to get a control steering the system from p to q , the PLE defined in (2.8) must have a global solution on $[0, 1]$.

In conclusion, the application of the Continuation Method to the motion planning problem is decomposed into two steps: to characterize (when possible) $S_p = \{u \in \mathcal{H} : \text{rank}(DE_p(u)) < 5\}$ and its image under E_p , and lifting the paths $\pi : [0, 1] \rightarrow M$ avoiding $E_p(S_p)$ to paths $\Pi : [0, 1] \rightarrow \mathcal{H}$ globally defined on $[0, 1]$ by (2.8).

In section 1.3, we address the above two issues.

Numerical implementation

1.3 . Rolling surface and obstacles

In this section, we set the definition of an obstacle, and we provide the dynamics of the control system on $\mathcal{Q}(A_1, A_2)$ such that $A_1 = \mathbb{R}^2$ and A_2 is an oriented surface of \mathbb{R}^3 .

Since A_2 is a two-dimensional connected oriented Riemannian manifold, then A_2 can be embedded as a convex surface in \mathbb{R}^3 (see [Berger and Gostiaux, 2012]). Hence, hereafter, we assume that A_2 is an oriented surface of \mathbb{R}^3 with metrics induced by the Euclidean metric of \mathbb{R}^3 . Moreover, we assume that A_2 is defined as one bounded connected component of the zero-level set of a smooth real-valued function $a : \mathbb{R}^3 \rightarrow \mathbb{R}$. The normal vector field to A_2 is given by $\frac{\nabla a}{\|\nabla a\|}$, where $\nabla a = (a_x, a_y, a_z)$ denotes the gradient vector of a . The Gaussian curvature of A_2 is denoted by K .

Recall that the rolling-body problem assumes that the tangent spaces at the contact points are identified. In \mathbb{R}^3 , this is equivalent to identify the normal vectors. Then at contact points, we assign $\frac{\nabla a}{\|\nabla a\|}$ to $-N_{\mathbb{R}^2}$, where $N_{\mathbb{R}^2}$ is the normal vector to the plane \mathbb{R}^2 .

Using the fact that $\mathcal{Q}(\mathbb{R}^2, A_2)$ is a circle bundle when A_2 is a 2-dimensional manifold, and taking geodesic coordinates ϑ for A_2 at contact point x_2 , and consider coordinates $x = (v_1, w_1, v_2, w_2, \psi)$ in some neighborhood of $(0, \psi_0)$ in $\mathbb{R}^4 \times S^1$, the control system (2.5) can be locally written as

$$\dot{x} = u_1 X_1(x) + u_2 X_2(x), \quad (3.1)$$

with

$$X_1(x) = \left(1, 0, \cos(\psi), -\frac{\sin(\psi)}{\vartheta}, -\frac{\vartheta_{v_2}}{\vartheta} \sin(\psi) \right)^T \quad (3.2)$$

$$X_2(x) = \left(0, 1, -\sin(\psi), -\frac{\cos(\psi)}{\vartheta}, -\frac{\vartheta_{v_2}}{\vartheta} \cos(\psi) \right)^T. \quad (3.3)$$

For a detailed development of how obtaining the system (3.1) with the vector fields X_1 and X_2 defined by (3.2) and (3.3) respectively, see [Chelouah and Chitour, 2003].

1.1.3 . Obstacles and dynamics of the control system

Hereafter, the estate space $\mathcal{Q}(\mathbb{R}^2, A_2)$ is simply denoted by M .

To deal with the problem of motion planning with obstacles, we follow a strategy suggested by E. Sontag in [Sontag, 1995].

Definition 1.3.1 *We say that \mathcal{W} is an obstacle of \mathbb{R}^2 if \mathcal{W} is a nonempty compact subset of \mathbb{R}^2 .*

From the above definition, we can assume that there exists a function $\xi : \mathbb{R}^2 \rightarrow \mathbb{R}$ such that $\mathcal{W} = \{w \in \mathbb{R}^2 \mid \xi(w) \leq 0\}$.

An obstacle \mathcal{W} maps in M a region (see Figure 3.1), denoted by C , defined by

$$C = \{x = (\gamma_1, \gamma_2, R) \in M \mid \gamma_1 \in \mathcal{W}\} = \{x \in M \mid \xi(\gamma_1) \leq 0\}.$$

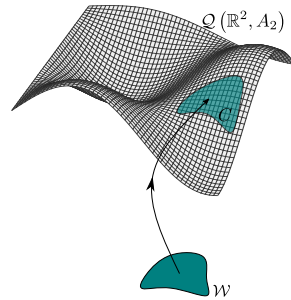

Figure 3.1: Obstacle maps in M .

Hence, C is an obstacle in the estate space M . This is to say, an obstacle in M is a nonempty closed subset of M such that $\widehat{M} = M \setminus C$ is also nonempty.

Consider an increasing sequence $(W_i)_{i \geq 0}$ of the compact subsets of M such that $C = \cup_{i \geq 0} W_i$. For every $i \geq 0$, we can construct a smooth function $\zeta_i : M \rightarrow \mathbb{R}$ such that $\zeta_i \equiv 0$ on W_i and $0 < \zeta_i(x) \leq \inf(1, d(\gamma_1, W_i))$ for $x \in M \setminus W_i$. Let

$$M_i := \sup_{x \in M} (\|D\zeta_i(x)\| + \|D^2\zeta_i(x)\|).$$

Thus, we define

$$\zeta(x) = \sum_{i \geq 0} \frac{1}{2^i M_i} \zeta_i(x). \quad (3.4)$$

Then, there exists a smooth bounded function $\zeta : M \rightarrow \mathbb{R}$ such that $\zeta > 0$ on \widehat{M} , $\zeta = 0$ on C and $(\widehat{M}, \langle \langle \cdot, \cdot \rangle \rangle_x)$ is a complete Riemannian manifold, where

$$\langle \langle \cdot, \cdot \rangle \rangle_x = \frac{\langle \cdot, \cdot \rangle}{\zeta^2}. \quad (3.5)$$

Let us consider the control system on M defined by

$$\dot{y} = v_1 \overline{X}_1(y) + v_2 \overline{X}_2(y) \quad (3.6)$$

where $\overline{X}_i = \zeta X_i$, $i = 1, 2$. Then \widehat{M} is invariant under the control system (3.6), more accurately,

Lemma 1.3.1 $\forall v \in \mathcal{H}, \forall p \in \widehat{M}$, if $\overline{\gamma}_v$ is the solution of (3.6) with $\overline{\gamma}(0) = p$ then $\overline{\gamma}([0, 1]) \subset \widehat{M}$.

In other words, for every $t \in [0, 1]$, $\overline{\gamma}(t)$ belongs to the connected component of \widehat{M} containing p . Thus, the motion planning problem with obstacles is reduced to a motion planning problem for each connected component of \widehat{M} . (For more details about ζ and the proof of Lemma 1.3.1 see [Chitour, 2006]).

We now describe how to apply the Continuation Method to solve the motion planning problem for the control system (3.6). First of all, it must be taken into account that $\mathcal{Q}(\mathbb{R}^2, A_2) = M$ is simply equal to $\mathbb{R}^2 \times T_1 A_2$, where $T_1 A_2$ is the unit tangent bundle of A_2 (more details see [Chelouah and Chitour, 2003] and [Bryant and Hsu, 1993]). Then, we can write for $z = (x, y) \in \mathbb{R}^2 \times T_1 A_2$, the vector fields X_1 and X_2 defined in (3.2) and (3.3) respectively, as

$$\begin{aligned} X_1(z) &= (1, 0, f(y))^T \\ X_2(z) &= (0, 1, h(y))^T \end{aligned}$$

where f is the infinitesimal generator of the geodesic flow on $T_1 A_2$ and h is a vector field on $T_1 A_2$ whose integral curves are also geodesics (cf. [Chelouah and Chitour, 2003]). Hence, the control system (3.6) can now be written as:

$$\begin{aligned} \dot{v}_1 &= \zeta(x) u_1 \\ \dot{w}_1 &= \zeta(x) u_2 \\ \dot{y} &= \zeta(x) (u_1 f(y) + u_2 h(y)) \end{aligned} \quad (3.7)$$

with $x = (v_1, w_1) \in \mathbb{R}^2 \setminus \bigcup_i \mathcal{W}_i$ and $y \in T_1 A_2$.

2.1.3 . Conjeture

Since we want to implement the Continuation Method applied to the motion planning problem with obstacles, we must ensure that its application is successful, that is, $DE_p(u)$ must always have an equal rank to 5, and the PLE defined in (2.8) must have a global solution on $[0, 1]$.

A sufficient condition resolving the above is as follows (cf. [Chitour and Sussmann, 1998]). Let $S_p = \{u \in \mathcal{H} : \text{rank}(DE_p(u)) < 5\}$.

Condition 1.3.1 We say that a closed subset \mathcal{K} of \widehat{M} verifies this condition if

1. \mathcal{K} is disjoint from $\overline{E_p(S_p)}$, where $\overline{E_p(S_p)}$ is the closure of $E_p(S_p)$;
2. there exists $c_{\mathcal{K}} > 0$ such that, for every $u \in \mathcal{H}$ with $E_p(u) \in \mathcal{K}$, we have

$$\|F(u)\| \leq c_{\mathcal{K}} \|u\|$$

$$\text{where } \|F(u)\| = \left(\inf_{\|z\|=1} z^T D E_p(u) D E_p(u)^T z \right)^{-\frac{1}{2}}, \text{ with } z \in T_{E_p(u)}^* \widehat{M}.$$

In the case of a convex surface A_2 rolling on a plane without forbidden regions, it is shown in [Chelouah and Chitour, 2003] that if A_2 verifies Condition 1.3.2 (below), then there exists a compact subset \mathcal{K} in the state space M verifying the Condition 1.3.1, which is large enough to completely resolve the motion planning problem.

Let d_2 be the distance function associated to the Riemannian metric of A_2 . The curve $\gamma : \mathbb{R}^+ \rightarrow T_1 A_2$ is a periodic geodesic of $T_1 A_2$ if there exists $L \geq \frac{2\pi}{\sqrt{K_{\max}}}$ such that $\gamma(t+L) = \gamma(t)$ for all $t \geq 0$. We use G to denote the closed subset of $T_1 A_2$, $\gamma([0, L])$. For $r > 0$, let $N_r(G)$ be the open set of points $y \in T_1 A_2$ such that $d_2(y, G) < r$. Let $\phi(y, t)$ be the geodesic flow of $T_1 A_2$.

Condition 1.3.2 ([Chelouah and Chitour, 2003]) We say that a surface A_2 verifies Condition 1.3.2 if there exists a geodesic curve $\gamma : \mathbb{R}^+ \rightarrow T_1 A_2$, $L > 0$ and $\rho_0 > 0$ such that

1. $\gamma(t+L) = \gamma(t)$ for all $t \geq 0$;
2. For all $r < \rho_0$, $\exists \mu > 0$, $\forall y_0 \in N_r(G)$, $\forall t \geq 0$ we have

$$\phi(y_0, t) \in N_{\mu}(G).$$

Remark 1.3.1 The geometric property of having a stable periodic geodesic (and then satisfying Condition 1.3.2) is true for any convex compact surface having symmetry of revolution. It is generic within the convex compact surfaces verifying $\frac{K_{\min}}{K_{\max}} > \frac{1}{4}$, where K_{\min} and K_{\max} denote the minimum and the maximum of the Gaussian curvature over the surface, respectively (cf. [Klingenberg, 1982]).

Let \overline{M}_i be a connected component of \widehat{M} and let S_i be an open line segment contained in the connected component of \mathbb{R}^2 which defines \overline{M}_i for $i = 1, \dots, N$.

For $r \in (0, r_0)$, we define \mathcal{K}_r as the complement in \overline{M}_i of $S_i \times N_r(G)$. Since γ is periodic $N_r(G)$ is diffeomorphic to the product of a small two-dimensional ball and a closed path in $T_1 A_2$ (cf. [Chelouah and Chitour, 2003]). Therefore \mathcal{K}_r is closed and arcwise-connected.

We conjecture the following.

Conjecture 1 With the previous notations, there exists $\bar{r} \in (0, r_0)$ such that for every $r \in (0, \bar{r})$, \mathcal{K}_r satisfies Condition 1.3.1.

If Conjecture 1 is true then an application of Gronwall lemma to the PLE (2.8) yields that, for every path $\pi : [0, 1] \rightarrow \mathcal{K}_r$ of class C^1 and every control $\bar{u} \in \mathcal{H}$ such that $E_p(\bar{u}) = \pi(0)$, the solution of the PLE defined in equation (2.8) with initial condition \bar{u} exists globally on $[0, 1]$.

In other words, the veracity of Conjecture 1 implies that the Continuation Method can be successfully applied to solving the rolling problem with obstacles.

An important fact for our purpose is that the singular controls in the case of convex surfaces rolling on the plane are exactly straight lines on the plane (see Proposition 5 in [Chelouah and Chitour, 2003]). We guess that, according to the Conjecture, the singular controls in each connected component of \widehat{M} must also be straight lines (or segments of them).

In conclusion, from now on, A_2 is a strictly convex surface with symmetry of revolution, and the initial input u_0 is not a line on the plane. Finally, to delimit our proposal, we will consider a finite number of obstacles in the plane.

2.3 . Key points for numerical implementation

In [Chitour, 2006] is proved that, for every compact subinterval $J = [0, a]$ of the interval of existence of the maximal solution of the equation (2.8), denoted by I , the numerical approximation of equation (2.8) defined by $E_{p,j}$ and associated to π has a global solution on J for a large enough j . In particular, if $J = I = [0, 1]$ (i.e. the PLE has a global solution) the above result can be seen as a theoretical justification of the use of Galerkin's procedure in numerical implementations of the Continuation Method.

In this Section, we want to show how the Continuation Method, presented in Section 3.2 can be numerically implemented to solve the motion planning problem with obstacles when a convex surface of \mathbb{R}^3 rolls on the plane with forbidden regions (or obstacles).

In the following three subsections, we give details about the fundamental points for the numerical implementation, which are the discretization of the control space \mathcal{H} , the computation of $DE_p(u)$, and the lift of the curve $\tilde{\gamma}_1$ on the convex body A_2 . The ideas come from [Alouges et al., 2010].

1.2.3 . Discretizing \mathcal{H}

Recall that the control space \mathcal{H} is, in general, an infinite-dimensional vector space, then we start by discretizing \mathcal{H} because we need to solve the initial-value problem defined in (2.9). In this case, the controls are plane curves $\gamma_1 : [0, 1] \rightarrow \mathbb{R}^2$ such that

$$\dot{\gamma}_1(t) = \zeta(x(t))(u_1, u_2), \quad x(t) = (\gamma_1(t), \gamma_2(t), R(t)).$$

We divide the interval $[0, 1]$ into $n - 1$ parts and approximate the control space \mathcal{H} by the $2n$ -dimensional subspace $\tilde{\mathcal{H}}$ of piecewise-linear functions (more details see [Gautschi, 2012]). Then, γ_1 can be approximated by $\tilde{\gamma}_1$, i.e., the linear interpolation of $(\gamma_1^1, \dots, \gamma_1^n)$, where $\gamma_1^{i+1} = \gamma_1 \left(\frac{i}{n-1} \right) = (x_{i+1}, y_{i+1})^T$ for $i = 0, \dots, n-1$.

On each segment $[t_{i+1}, t_{i+2}] = \left[\frac{i}{n-1}, \frac{i+1}{n-1} \right]$ the approximate control $(\tilde{u}_1^{i+1}, \tilde{u}_2^{i+1})^T$ is proportional to the vector $\frac{1}{\zeta(x(t))} (x_{i+2} - x_{i+1}, y_{i+2} - y_{i+1})^T$ for $i = 0, \dots, n-2$.

Notice that, when elements in $\tilde{\mathcal{H}}$ are piecewise-linear functions with more than one piece, they are not singular controls. Then, the corresponding trajectories on A_2 are also easy to obtain by integrating some geodesic equations by using Proposition 2.2.1. Finally, Euler's method is used to integrate (2.9).

2.2.3 . Computing $DE_p(u)$

To evaluate $DE_p(u)$, for $u \in \mathcal{H}$, the following is necessary (see [Chelouah and Chitour, 2003]).

For $z \in T_{E_p(u)}^*M$, let $\lambda_{z,u} : [0, 1] \rightarrow T^*M$ be the field of covectors along $\gamma_{p,u}$ such that it satisfies, in coordinates, the adjoint equation along $\gamma_{p,u}$ with terminal condition z , that is, $\lambda_{z,u}(1) = z$ and for a.e $t \in [0, 1]$ we have

$$\dot{\lambda}_{z,u}(t) = -\lambda_{z,u}(t) \cdot \left(u_1(t)DX_1(\lambda_{z,u}(t)) + u_2(t)DX_2(\lambda_{z,u}(t)) \right).$$

If V is a C^∞ vector field on M , the switching function $\varphi_{V,z,u}(t)$ associated to V is the evaluation of $\lambda \cdot V(x)$, the Hamiltonian function of V along $(\gamma_{p,u}, \lambda_{p,u})$, i.e., for $t \in [0, 1]$

$$\varphi_{V,z,u}(t) := \lambda_{z,u} \cdot V(\gamma_{p,u}(t)).$$

Then $DE_p(u)$ can be computed thanks to the following formula: for $z \in T_{E_p(u)}^*M$ and $u, v \in \mathcal{H}$

$$z \cdot DE_p(u)(v) = (v, \varphi_{z,u})_{\mathcal{H}}, \quad (3.8)$$

where the switching-function vector $\varphi_{z,u}$ is the solution of the Cauchy problem, which is defined, in coordinates, by

$$\begin{aligned} \dot{\varphi}_1 &= -u_2 K \varphi_3 \\ \dot{\varphi}_2 &= u_1 K \varphi_3 \\ \dot{\varphi}_3 &= -u_2 \varphi_4 + u_1 \varphi_5 \\ \dot{\varphi}_4 &= -u_2 K \varphi_3 \\ \dot{\varphi}_5 &= u_1 K \varphi_3 \end{aligned} \quad (3.9)$$

with terminal condition $\varphi_{z,u}(1) = z$.

In practice, since the discrete $DE_p(u)$ is a 5×5 matrix and its image is given by (3.8), it suffices to take the five vectors of the canonical basis of \mathbb{R}^5 , as final conditions z , and integrate (3.9) in reverse time. In the simulations, a fourth-order Runge-Kutta numerical scheme is used for integration, the scalar product $(\cdot, \cdot)_{\mathcal{H}}$ in control space \mathcal{H} is evaluated by Gaussian quadrature, and the Gaussian curvature K is computed by using the Proposition 1.2.1.

3.2.3 . Lifting the plane curve $\tilde{\gamma}_1$ on A_2

Note that the curvature K appearing in (3.9) is taken at the final contact point on the surface A_2 after it has rolled along the piecewise-constant curve $\tilde{\gamma}_1$. Thus, to locate the final point, we need to *lift* the plane curve $\tilde{\gamma}_1$ on A_2 , and the lifting dynamics are given by (3.7). However, since the geodesic coordinates involved in (3.7) are not given explicitly in practice, the numerical lifting method is based on Proposition 2.2.1.

On each interval $[t_{i+1}, t_{i+2}]$, the approximate control curve $\tilde{\gamma}_1$ is a straight line (i.e., a geodesic in \mathbb{R}^2), and then, by Proposition 2.2.1, the lifting curve $\tilde{\gamma}_1$ on A_2 is also a geodesic on each interval $[t_{i+1}, t_{i+2}]$ for all $i = 0, \dots, n - 2$. Then, from the initial contact point x_0 on A_2 , we can integrate successively (with fourth-order Runge–Kutta scheme) the geodesic equation, given by Proposition 1.2.2 (equation 2.2), on each $[t_{i+1}, t_{i+2}]$ with initial conditions equal to $\tilde{\gamma}_1(t_{i+1})$ and $(\tilde{u}_1^{i+1}, \tilde{u}_2^{i+1})$, for $i = 0, \dots, n - 2$.

A very important difficulty is that the numerical integration is performed on the manifold A_2 , $t > 0$. Assuming that we are at point $x \in A_2$ at time t , then, at time $t + \delta t$, we move to $x_{new} = x + (\delta t)e$, with $e \in T_x A_2$, but x_{new} does not belong to A_2 if e is nonzero. Therefore, at each integration step, we have to *project* x_{new} on A_2 . In details, let us assume that the point $(0, 0, 0)$ is inside the convex body A_2 . Since A_2 is defined as (a bounded connected component of) the zero-level set of a smooth function a , we assume that $|a(x_{new})| \leq \varepsilon$ for some $\varepsilon \ll 1$, i.e., x_{new} is close to A_2 . Then, by the convexity of A_2 , there exists a unique real number μ close to 1 such that $a(\mu x_{new}) = 0$. The *projection* issue to be addressed is a local one, and therefore, Newton's method is efficient to find μ . The derivative with respect to μ is also needed, which is evaluated by a finite-difference scheme.

3.3 . Examples

This section provides three examples of the rolling bodies on the Euclidean plane: the sphere, the flattened ball, and an egg. The simulations were developed in Matlab software, and the code was run on a Macbook Pro Apple M1 8Go of RAM for 100 iterations with $n - 1 = 100$ for the discretization of control space.

To illustrate how the convex body rolls along the curve obtained by the application of the Continuation Method, see Figure 3.2.

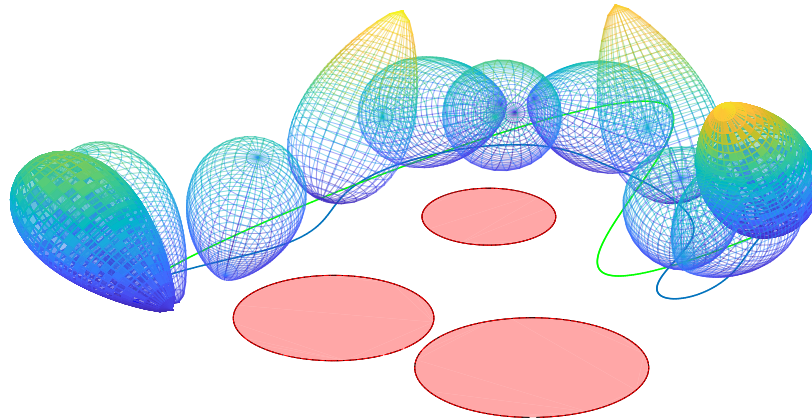

Figure 3.2: Convex body rolling along the curve obtained by the application of the Continuation Method (blue curve).

Each convex body A_2 (the sphere, the flattened ball, and an egg) is defined by a function $a(x, y, z)$ such that $A_2 = a^{-1}(0)$. The initial points of contact are blue and the end contact points are magenta. The initial and end orientations have the same color as the initial and end points. Obstacles are circular regions in the plane, and they are colored red (see Figures 3.3, 3.5 and 3.7).

The initial chosen curve to apply the Continuation Method is the green curve, and the curve obtained by this process is colored blue. In each example, three different curves are chosen to evaluate the method. Finally, the red curve on the convex body is obtained by the lifting of the curve computed by the Continuation Method (blue curve) (see Figures 3.4, 3.6 and 3.8).

1.3.3 . Sphere

The sphere is defined by the zero-level set of the function a , with $a(x, y, z) = x^2 + y^2 + z^2 - 1$.

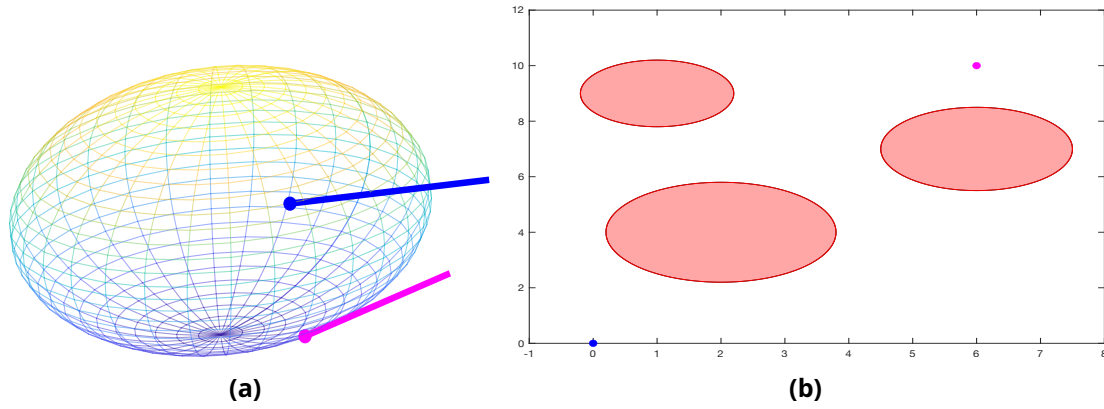

Figure 3.3: Left side: sphere with initial and end contact points and its orientations. Right side: obstacles (in red) and initial and end contact points on the plane.

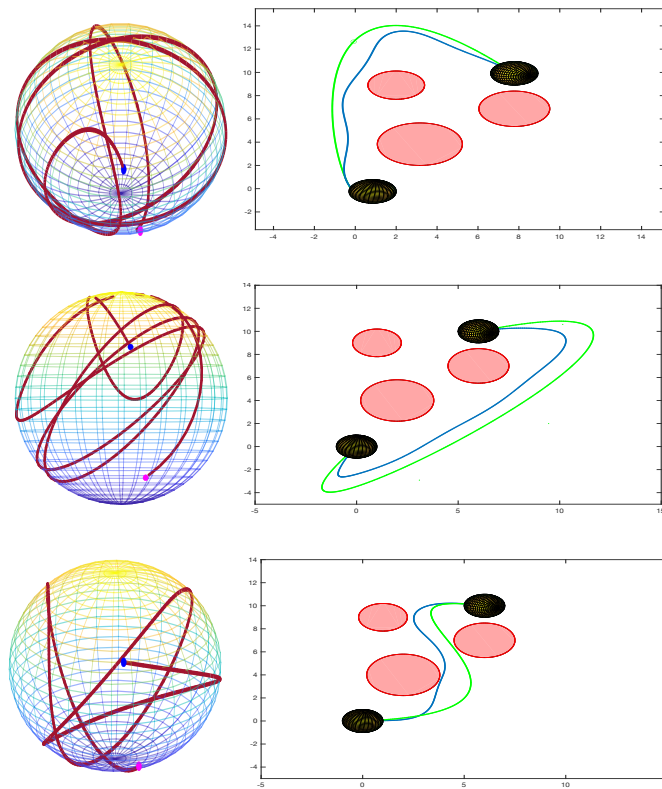

Figure 3.4: Left side: curve γ_2 on the sphere. Right side: Curve obtained by applying the Continuation Method (blue) to initial chosen curve (green).

2.3.3 . Egg

This egg is defined by the zero-level set of the function a , defined by $a(x, y, z) = \frac{x^2+y^2}{1-0.4z} + \frac{1}{4}z^2 - 1$

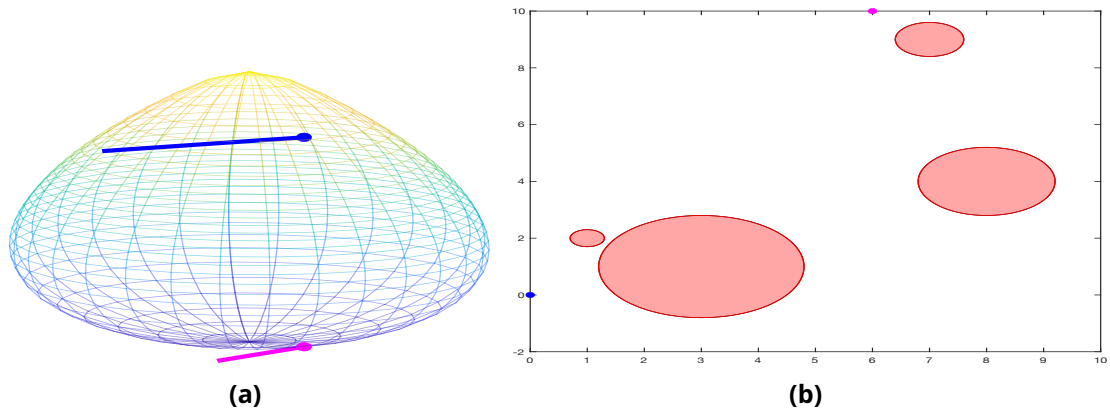

Figure 3.5: Left side: egg with initial and end contact points and its orientations. Right side: obstacles (in red) and initial and end contact points on the plane.

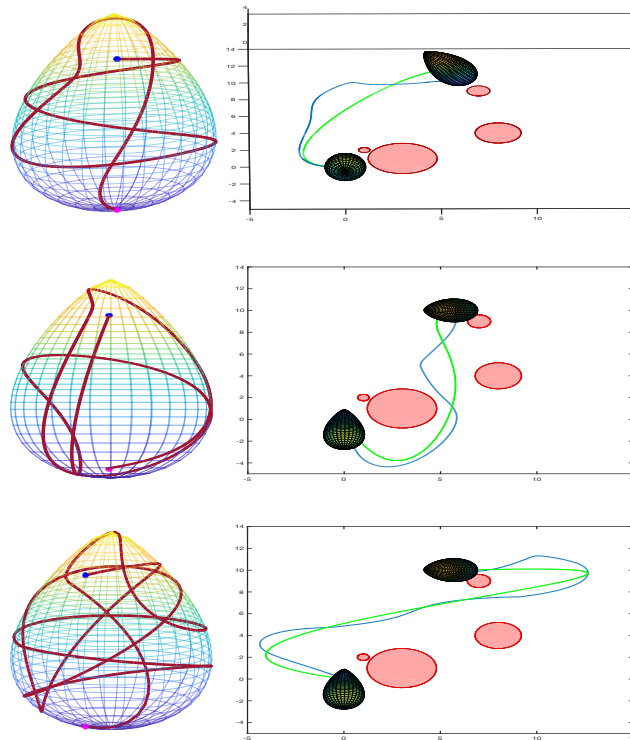

Figure 3.6: Left side: curve γ_2 on the egg. Right side: Curve obtained by applying the Continuation Method (blue) to initial chosen curve (green).

3.3.3 . Flattened ball

The flattened ball A_2 is defined by the function a such that $A_2 = a^{-1}(0)$, with $a(x, y, z) = x^2 + y^2 + 5z^2 - 1$.

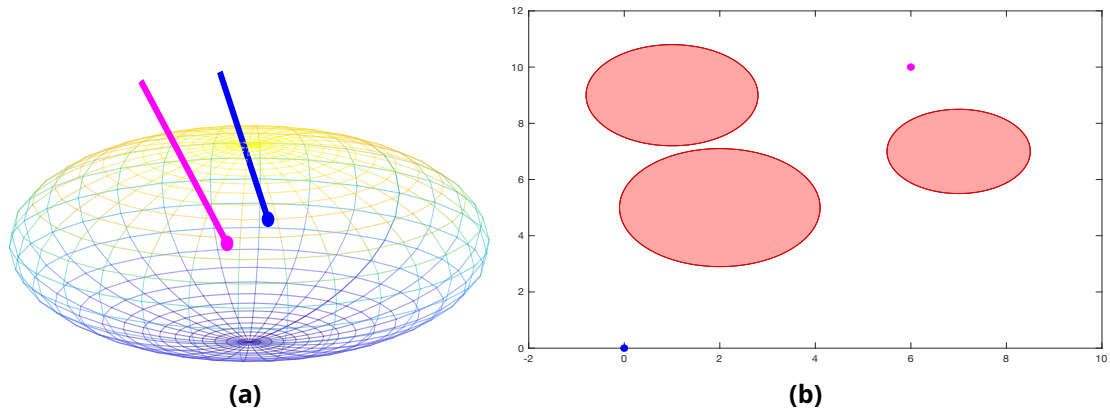

Figure 3.7: Left side: flattened ball with initial and end contact points and its orientations. Right side: obstacles (in red) and initial and end contact points on the plane.

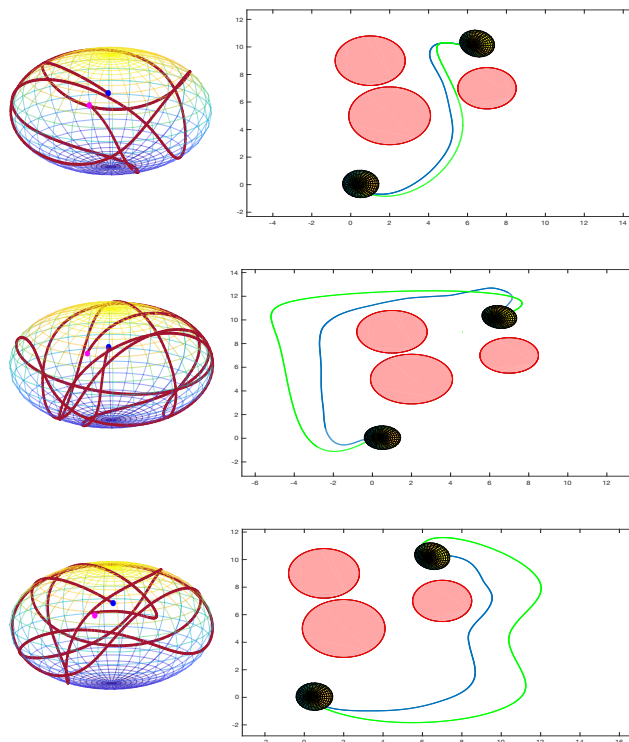

Figure 3.8: Left side: curve γ_2 on the flattened ball. Right side: curve obtained by applying the Continuation Method (blue) to initial chosen curve (green).

Finally, to show how well the implemented method works, we have considered obstacles with more complexity and the same convex bodies. The initial chosen curve is colored green, and the one obtained by the Continuation Method is colored blue. The obstacles are colored green. See Figure 3.9.

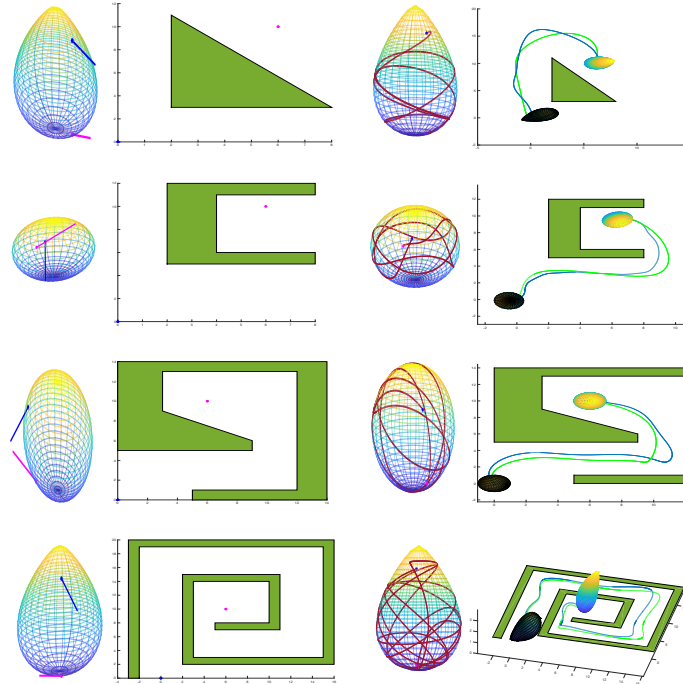

Figure 3.9: Left side: convex body with initial and end contact points with orientations and obstacles on the plane (in green). Right side: curve γ_2 on the convex body and curve obtained by applying the Continuation Method (blue) to the initial chosen curve (green).

4.3 . Conclusions and comments

This part of the thesis presents a numerical implementation of the Continuation Method to solve the motion planning problem when a convex body rolls on the Euclidean plane with obstacles, detailing the discretization of the control space \mathcal{H} , the evaluation of $DE_p(u)$, and the lift of the curve $\tilde{\gamma}_1$ on the convex body A_2 . The convex body is considered as an oriented surface of \mathbb{R}^3 and hence it is defined by a function $a : \mathbb{R}^3 \rightarrow \mathbb{R}$ such that $A_2 = \widetilde{a^{-1}(0)}$. In addition, we conjecture the existence of a closed subset \mathcal{K}_r in the state space \widetilde{M} that guarantees the successful application of the Continuation Method if we consider that A_2 has a stable periodic geodesic. This property is true for any convex compact surface having symmetry of revolution (cf. [Klingenberg, 1982]). For this reason, the sphere, the flattened ball, and an egg have been considered for simulations. However, when we relax this geometric property, the method implemented still works. The above can be seen as the robustness of the method. Therefore, there are two challenges: 1) To prove that Conjecture 1 is true and 2) to research

a theoretical convergence result that ensures the successful application of the Continuation Method when the convex body does not satisfy the geometrical condition of symmetry of revolution. We believe that the above is related to the fact that $\nabla a(x, y, z) \neq 0$ on the zero-level set of a , because, according to Propositions 1.2.1 and 1.2.2, the Gaussian curvature of the surface A_2 and the lift of the plane curve on A_2 respectively, depend on $\nabla a(x, y, z)$, indeed, if $\nabla a(x, y, z) \neq 0$ the equations (2.1) and (2.2) that define the Gaussian curvature and the lift respectively, are always well defined. For instance, let us consider A_2 an oriented surface without symmetric axis, defined by $a(x, y, z) = \frac{x^2}{1 - 0.7y} + \frac{3y^2}{1 - 0.1z} + \frac{0.3z^2}{1 - 0.3x - 0.1y} - 1$

and hence $\nabla a(x, y, z) = \begin{pmatrix} \frac{9z^2}{(3x+y-10)^2} - \frac{20x}{7y-10} \\ \frac{3z^2}{(3x+y-10)^2} - \frac{60y}{z-10} + \frac{70x^2}{(7y-10)^2} \\ \frac{3y^2}{(z-0.1)^2} - \frac{3z}{0.75x+0.5y-5} \end{pmatrix} \neq 0$ on the zero-level set of a .

Figure 3.10, we can see how well the method works.

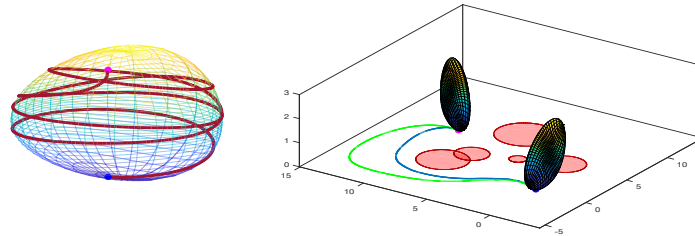

Figure 3.10: Left side: Non-symmetric convex body with initial and end contact points and curve γ_2 . Right side: Curve obtained by applying the Continuation Method (blue) to the initial chosen curve (green).

Furthermore, if we consider a more complex obstacle, its performance is still good. Figure 3.11 illustrates its performance. Finally, we are interested in adapting this proposal in the motion planning problem in other situations of the rolling body problem, which are to consider a convex body A_2 rolling on a plane with forbidden regions in A_2 , and a strictly convex body rolling on the other without or with forbidden regions.

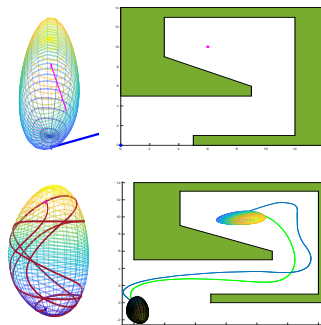

Figure 3.11: Top: Non-symmetric convex body with initial and end contact points with orientations and obstacle on the plane (in green). Bottom: curve γ_2 on the convex body and curve obtained by applying the Continuation Method (blue) to the initial chosen curve (green).

Bibliography

- [Agrachev et al., 2019] Agrachev, A., Barilari, D., and Boscain, U. (2019). *A Comprehensive Introduction to Sub-Riemannian Geometry*. Cambridge Studies in Advanced Mathematics. Cambridge University Press, Cambridge.
- [Agrachev et al., 2010] Agrachev, A., Boscain, U., Charlot, G., Ghezzi, R., and Sigalotti, M. (2010). Two-dimensional almost-Riemannian structures with tangency points. *Annales de l'Institut Henri Poincaré / Analyse non lineaire*, 27(3):793–807.
- [Agrachev et al., 2008] Agrachev, A., Boscain, U., and Sigalotti, M. (2008). A Gauss-bonnet-like formula on two-dimensional almost-riemannian manifolds. *Discrete and Continuous Dynamical Systems*, 20(4):801–822.
- [Agrachev and Sachkov, 2004] Agrachev, A. and Sachkov, Y. (2004). *Control Theory from the Geometric Viewpoint*. Encyclopaedia of Mathematical Sciences, Control Theory and Optimization. Springer-Verlag, Berlin Heidelberg.
- [Allgower and Georg, 1993] Allgower, E. and Georg, K. (1993). Continuation and path following. *Acta numerica*, 2:1–64.
- [Alouges et al., 2010] Alouges, F., Chitour, Y., and Long, R. (2010). A motion-planning algorithm for the rolling-body problem. *IEEE Transactions on Robotics*, 26(5):827–836.
- [Ayala and Jouan, 2016] Ayala, V. and Jouan, P. (2016). Almost-Riemannian Geometry on Lie Groups. *SIAM Journal on Control and Optimization*, 54(5):2919–2947.
- [Bellaïche, 1996] Bellaïche, A. (1996). The Tangent space in sub-Riemannian geometry. In Jean-Jacques, B. A.-R., editor, *Sub-Riemannian Geometry*, Progress in Mathematics, pages 1–78. Birkhäuser Basel.
- [Berger and Gostiaux, 2012] Berger, M. and Gostiaux, B. (2012). *Differential Geometry: Manifolds, Curves, and Surfaces: Manifolds, Curves, and Surfaces*, volume 115. Springer Science & Business Media.
- [Bicchi and Marigo, 2002] Bicchi, A. and Marigo, A. (2002). Dexterous Grippers: Putting Nonholonomy to Work for Fine Manipulation. *The International journal of robotics research*, 21(5-6):427–442.
- [Bloch, 2003] Bloch, A. (2003). *Nonholonomic Mechanics and Control*. Interdisciplinary Applied Mathematics. Springer, New York, 1st. edition.

- [Bonfiglioli, 2007] Bonfiglioli, A. (2007). *Stratified Lie Groups and Potential Theory for Their Sub-Laplacians*. Springer Monographs in Mathematics. Springer Berlin Heidelberg, New York.
- [Bonnard et al., 2009] Bonnard, B., Caillau, J.-B., Sinclair, R., and Tanaka, M. (2009). Conjugate and cut loci of a two-sphere of revolution with application to optimal control. *Annales de l'Institut Henri Poincaré (C) Analyse Non Linéaire*, 26(4):1081–1098.
- [Bonnard et al., 2011] Bonnard, B., Charlot, G., Ghezzi, R., and Janin, G. (2011). The sphere and the cut locus at a tangency point in two-dimensional almost-Riemannian geometry. *Journal of Dynamical and Control Systems*, 17(1):141–161.
- [Boscain et al., 2015] Boscain, U., Charlot, G., Gaye, M., and Mason, P. (2015). Local properties of almost-Riemannian structures in dimension 3. *Discrete and Continuous Dynamical Systems- Series A*, 35(9):4115–4147.
- [Boscain et al., 2013a] Boscain, U., Charlot, G., and Ghezzi, R. (2013a). Normal forms and invariants for 2-dimensional almost-Riemannian structures. *Differential Geometry and its Applications*, 31(1):41–62.
- [Boscain et al., 2013b] Boscain, U., Charlot, G., Ghezzi, R., and Sigalotti, M. (2013b). Lipschitz Classification of Almost-Riemannian Distances on Compact Oriented Surfaces. *Journal of Geometric Analysis*, 23(1):438–455.
- [Bourbaki, 2007] Bourbaki, N. (2007). *Eléments De Mathématique. Groupes et Algèbres de Lie: Chapitres 2 et 3*. Germany: Springer Verlag, second edition.
- [Brockett, 1982] Brockett, R. (1982). Control theory and singular Riemannian geometry. In *New Directions in Applied Mathematics*, pages 11–27. Springer.
- [Bryant and Hsu, 1993] Bryant, R. and Hsu, L. (1993). Rigidity of integral curves of rank 2 distributions. *Inventiones mathematicae*, 114(1):435–461.
- [Byrd and Friedman, 1954] Byrd, P. F. and Friedman, M. D. (1954). *Handbook of Elliptic Integrals for Engineers and Physicists*. Springer-Verlag Berlin Heidelberg, Berlin.
- [Cai and Roth, 1987] Cai, C. and Roth, B. (1987). On the spatial motion of a rigid body with point contact. In *Proceedings. 1987 IEEE International Conference on Robotics and Automation*, volume 4, pages 686–695. IEEE.
- [Carathéodory, 1909] Carathéodory, C. (1909). Untersuchungen über die Grundlagen der Thermodynamik. *Mathematische Annalen*, 67(3):355–386.
- [Chaplygin, 2002] Chaplygin, S. (2002). On a ball's rolling on a horizontal plane. *Regular and Chaotic Dynamics*, 7(2):131–148.
- [Chaplygin, 2012] Chaplygin, S. (2012). On some generalization of the area theorem with applications to the problem of rolling balls. *Regular and Chaotic Dynamics*, 17(2):199–217.

- [Chelouah and Chitour, 2003] Chelouah, A. and Chitour, Y. (2003). On the motion planning of rolling surfaces. *Forum Math.*, 15(5):727–758.
- [Chitour, 2002] Chitour, Y. (2002). Path planning on compact Lie groups using a homotopy method. *Systems & control letters*, 47(5):383–391.
- [Chitour, 2006] Chitour, Y. (2006). A continuation method for motion-planning problems. *ESAIM: Control, Optimisation and Calculus of Variations*, 12(1):139–168.
- [Chitour et al., 2014] Chitour, Y., Godoy, M., and Kokkonen, P. (2014). The rolling problem: Overview and challenges. *Geometric Control Theory and Sub-Riemannian Geometry*, pages 103–122.
- [Chitour and Sussmann, 1998] Chitour, Y. and Sussmann, H. (1998). Line-integral estimates and motion planning using the continuation method. In *Essays on Mathematical Robotics*, volume 104 of *IMA Math. Appl.*, pages 91–125. Springer-Verlag, New York.
- [Chung, 2004] Chung, W. (2004). *Nonholonomic Manipulators*. Springer Tracts in Advanced Robotics. Springer Berlin Heidelberg, 1st. edition.
- [Divelbiss and Wen, 1997] Divelbiss, A. and Wen, J. (1997). A path space approach to non-holonomic motion planning in the presence of obstacles. *IEEE Transactions on Robotics and Automation*, 13(3):443–451.
- [Do Carmo, 1992] Do Carmo, M. (1992). *Riemannian Geometry*. Translated by Francis Flaherty. Mathematics Theory and Applications. Birkhäuser, Boston Basel Berlin.
- [Gautschi, 2012] Gautschi, W. (2012). *Numerical Analysis*. Birkhäuser Boston, Boston, second edition.
- [Gaveau, 1977] Gaveau, B. (1977). Principe de moindre action, propagation de la chaleur et estimées sous elliptiques sur certains groupes nilpotents. *Acta mathematica*, 139:95–153.
- [Golubitsky and Guillemin, 1986] Golubitsky, M. and Guillemin, V. (1986). *Stable Mappings and Their Singularities*, volume 14. Springer-Verlag Berlin Heidelberg.
- [Grushkovskaya and Zuyev, 2018] Grushkovskaya, V. and Zuyev, A. (2018). Obstacle avoidance problem for second degree nonholonomic systems. In *IEEE Conference on Decision and Control*, pages 1500–1505. IEEE.
- [Hermann, 1973] Hermann, R. (1973). Geodesics of singular Riemannian metrics. *Bulletin of the American Mathematical Society*, 79(4):780–782.
- [Jean, 2014] Jean, F. (2014). *Control of Nonholonomic Systems: From Sub-Riemannian Geometry to Motion Planning*. SpringerBriefs in Mathematics. Springer International Publishing.
- [Jouan, 2010] Jouan, P. (2010). Equivalence of control systems with linear systems on Lie groups and homogeneous spaces. *ESAIM: Control, Optimisation and Calculus of Variations*, 16(4):956–973.

- [Jouan and Manríquez, 2022] Jouan, P. and Manríquez, R. (2022). Solvable approximations of 3-dimensional almost-Riemannian structures. *Mathematical Control & Related Fields*, 12(2):303–326.
- [Jouan et al., 2018] Jouan, P., Zsigmond, G., and Ayala, V. (2018). Isometries of almost-Riemannian structures on Lie groups. *Differential Geometry and its Applications*, 61:59–81.
- [Jurdjevic, 1993] Jurdjevic, V. (1993). The geometry of the plate-ball problem. *Archive for Rational Mechanics and Analysis*, 124(4):305–328.
- [Klingenberg, 1982] Klingenberg, W. (1982). *Riemannian Geometry*. Studies in Mathematics 1. De Gruyter, Berlin New York.
- [Kolmanovsky and McClamroch, 1995] Kolmanovsky, I. and McClamroch, N. (1995). Developments in nonholonomic control problems. *IEEE Control Systems Magazine*, 15(6):20–36.
- [Lee, 2006] Lee, J. M. (2006). *Riemannian Manifolds: An Introduction to Curvature*, volume 176. New York, NY: Springer New York, New York, NY.
- [Li and Canny, 1990] Li, Z. and Canny, J. (1990). Motion of two rigid bodies with rolling constraint. *IEEE Transactions on Robotics and Automation*, 6(1):62–72.
- [Manríquez, 2022] Manríquez, R. (2022). Distance induced by the Solvable approximation of n-dimensional Almost-Riemannian Structures.
- [Manríquez et al., 2022] Manríquez, R., Jouan, P., and Chitour, Y. (2022). General nilpotent and solvable approximations of almost-Riemannian structures. <https://hal.archives-ouvertes.fr/hal-03636478>.
- [Marigo and Bicchi, 2000] Marigo, A. and Bicchi, A. (2000). Rolling bodies with regular surface: Controllability theory and applications. *IEEE Transactions on Automatic Control*, 45(9):1586–1599.
- [Montana, 1988] Montana, D. (1988). The kinematics of contact and grasp. *The International Journal of Robotics Research*, 7(3):17–32.
- [Murray et al., 2017] Murray, R., Li, Z., and Sastry, S. (2017). *A Mathematical Introduction to Robotic Manipulation*. CRC press.
- [Oriolo and Vendittelli, 2005] Oriolo, G. and Vendittelli, M. (2005). A framework for the stabilization of general nonholonomic systems with an application to the plate-ball mechanism. *IEEE Transactions on Robotics*, 21(2):162–175.
- [Palais, 1957] Palais, R. (1957). *A Global Formulation of the Lie Theory of Transportation Groups*. Number 22 in Mem. American Mathematical Society.
- [Sarkar et al., 1997] Sarkar, N., Yun, X., and Kumar, V. (1997). Control of contact interactions with acatastatic nonholonomic constraints. *The International Journal of Robotics Research*, 16(3):357–374.

- [Serra Cassano, 2016] Serra Cassano, F. (2016). Some topics of geometric measure theory in Carnot groups. In Barilari, D., Boscain, U., and Sigalotti, M., editors, *Geometry, Analysis and Dynamics on Sub-Riemannian Manifolds*, volume I, pages 1–121. Series of lectures in Mathematics.
- [Sontag, 1995] Sontag, E. (1995). Control of systems without drift via generic loops. *IEEE Transactions on Automatic Control*, 40(7):1210–1219.
- [Strichartz, 1986] Strichartz, R. (1986). Sub-riemannian geometry. *Journal of Differential Geometry*, 24(2):221–263.
- [Sussmann, 1992] Sussmann, H. (1992). New differential geometric methods in nonholonomic path finding. In *Systems, Models and Feedback: Theory and Applications*, pages 365–384. Springer.
- [Sussmann, 1993] Sussmann, H. (1993). A continuation method for nonholonomic path-finding problems. In *Proceedings of 32nd IEEE Conference on Decision and Control*, pages 2718–2723. IEEE.
- [Ważewski, 1947] Ważewski, T. (1947). Sur l'évaluation du domaine d'existence des fonctions implicites réelles ou complexes. *Ann. Soc. Pol. Math.*, 20:81–120.
- [Woodruff and Lynch, 2019] Woodruff, J. and Lynch, K. (2019). Second-order contact kinematics between three-dimensional rigid bodies. *Journal of Applied Mechanics*, 86(8).
- [Woodruff et al., 2020] Woodruff, J., Ren, S., and Lynch, K. (2020). Motion Planning and Feedback Control of Rolling Bodies. *IEEE Access*, 8:31780–31791.
- [Zúñiga, 2006] Zúñiga, E. (2006). A General Solution of the Duffing Equation. *Nonlinear Dynamics*, 45(3):227–235.

Synthèse en français

Introduction générale

La géométrie sub-riemannienne est une généralisation de la géométrie riemannienne (géométrie qui est née avec les travaux de Bernhard Riemann dans le but de généraliser certains résultats de Gauss concernant la courbure). Son origine se trouve dans l'article [Strichartz, 1986]. Cependant, certains éléments, exemples ou applications de la géométrie sub-riemannienne peuvent être situés avant, par exemple, dans des travaux relatifs aux problèmes de contrôle optimal [Brockett, 1982], de thermodynamique [Carathéodory, 1909], ou encore dans des articles relatifs à la géométrie riemannienne [Hermann, 1973] et à l'étude de la géométrie du groupe d'Heisenberg, qui est un exemple célèbre de géométrie sub-riemannienne [Gaveau, 1977]. Cette géométrie existe grâce à l'idée de contraintes non-intégrables ; c'est à dire une contrainte sur la direction admissible des mouvements, et ainsi, elle a reçu une attention croissante dans de nombreuses disciplines telles que la théorie du contrôle, la robotique, la mécanique classique, l'analyse de l'opérateur hypoelliptique, le collecteur de diffusion, et même dans d'autres branches de la géométrie comme la géométrie de Cauchy-Riemann.

Une structure sous-riemannienne particulière est ce que l'on appelle les *structures presque riemanniennes*. Formellement, une structure presque riemannienne à n -dimensions (ARS en abrégé) est une structure sub-riemannienne à rang variable qui peut être définie localement par un ensemble de n champs vectoriels lisses sur une variété à n dimensions, satisfaisant la condition de rang de l'algèbre de Lie. L'ensemble des points où la dimension de l'étendue linéaire des champs de vecteurs n'est pas complète est appelé le lieu singulier (ou l'ensemble singulier) et est noté \mathcal{Z} . Les modèles attractifs de ARS peuvent être décrits sur des groupes de Lie en utilisant des champs vectoriels invariants et linéaires. Ils sont appelés ARS linéaires (ou simples) sur les groupes de Lie (voir [Ayala and Jouan, 2016]).

L'objectif de cette thèse est d'étudier deux sujets en géométrie sub-riemannienne. D'une part, l'approximation locale d'une structure presque riemannienne aux points singuliers, où l'approximation nilpotente a perdu la structure originale, et d'autre part, le système cinéma-

tique d'un variété roulant sur un autre variété sans tourner ni glissement, en particulier une implémentation numérique de la Méthode de Continuation lorsqu'un variété à 2-dimensions roule sur le plan euclidien avec des régions interdites.

Approximation locale par systèmes linéaires et structures quasi-riemanniennes sur les groupes de Lie

Dans cette première partie, nous nous sommes consacrés à l'approximation locale des structures quasi-riemanniennes aux points singuliers par des ARS sur les groupes de Lie et à montrer que cette approximation est généralement meilleure que celle du nilpotent.

Soit M une variété différentiel de dimension n et considérons $\{X_1, X_2, \dots, X_n\}$ un ensemble de champs vectoriels lisses sur M . Localement, un ARS sur M peut être défini par $\{X_1, X_2, \dots, X_n\}$ satisfaisant la condition de rang de l'algèbre de Lie (Larc en abrégé). Cet ensemble de champs vectoriels est considéré comme un cadre orthonormé. Nous désignons par Δ_p l'étendue linéaire des champs de vecteurs $\{X_1, X_2, \dots, X_n\}$ au point p . Rappelons que $\mathcal{Z} = \{p \in M : \text{rank}(\Delta_p) < n\}$. Si \mathcal{Z} est vide, alors la structure presque riemannienne est une structure riemannienne (plus de détails dans [Agrachev et al., 2019]). Dans le cas générique à 3 de dimension, l'ensemble singulier est formé par deux types de points (voir Figure A.1): les points de type-1 où Δ_p a une dimension 2 et est transversal à \mathcal{Z} , et les points de type-2 où Δ_p a une dimension 2 et est tangent à \mathcal{Z} . De plus, les points de type 2 sont isolés (pour plus de détails, voir [Boscain et al., 2015]). Dans le cas générique de dimension 2, il existe également des points où Δ_p est transversal à \mathcal{Z} et isolé. De tels points sont appelés *points de tangence* dans [Agrachev et al., 2008].

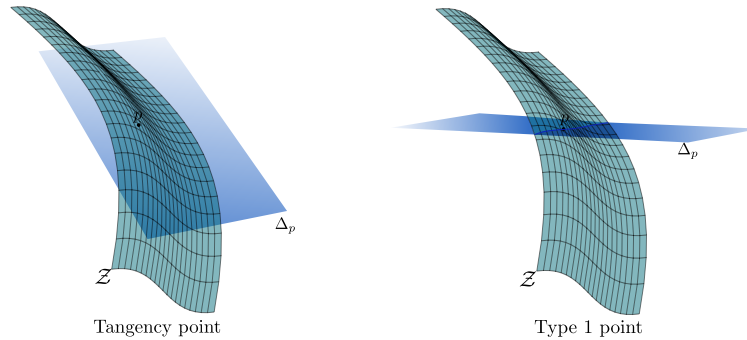

Figure A.1: Deux points différents forment \mathcal{Z} dans le cas générique 3D.

D'autre part, les approximations nilpotentes sont utilisées pour étudier localement le comportement des structures quasi riemanniennes en raison de leur grande similitude avec la dynamique originale. Cependant, il existe des cas où l'approximation nilpotente d'une ARS s'avère être une structure sous-riemannienne de rang constant. En d'autres termes, certains champs vectoriels peuvent disparaître. C'est précisément ce qui se passe dans le cas générique à 3 de dimension, traité dans [Boscain et al., 2015], où aux points de type 2 (ou points de tangence), l'approximation nilpotente est la structure sous-riemannienne de Heisenberg et n'est donc pas une 3-ARS.

L'approximation résoluble a été introduite dans [Jouan and Manríquez, 2022] pour récupérer la structure presque riemannienne perdue dans l'approximation nilpotente. Dans cet article, on a considéré le cas où un seul des champs vectoriels disparaît et les autres sont indépendants. L'approximation soluble est alors une approximation locale d'un ARS aux points singuliers où l'approximation nilpotente n'est plus un ARS mais une structure sous-riemannienne de rang constant. Une généralisation de cette approximation est donnée dans [Manríquez et al., 2022], où une description complète des approximations nilpotentes et solubles est abordée, y compris les approximations génériques.

Nous pouvons identifier, principalement, deux axes de travail dans la recherche, liés essentiellement aux structures des systèmes d'approximation et à l'estimation des différentes distances définies par la structure originale, l'approximation nilpotente et celle résoluble. En ce qui concerne les structures, l'algèbre de Lie générée par cette nouvelle famille de champs vectoriels est de dimension finie et résoluble (dans le cas générique). Grâce au théorème d'équivalence de [Jouan, 2010] nous savons que l'espace \mathbb{R}^n est difféomorphe à un certain espace homogène ou groupes de Lie. Grâce à ce difféomorphisme, l'approximation résoluble et l'approximation nilpotente sont équivalentes à une ARS linéaire sur un espace homogène ou un groupe de Lie. De plus, nous pouvons trouver des structures dures ou complexes et de nombreuses structures différentes. Pour cette raison, nous avons traité les ARS génériques en déterminant les distributions génériques sur une variété connectée de dimension n et les avons utilisées pour exposer les approximations nilpotentes et résoluble génériques. En ce qui concerne l'axe d'estimation de la distance, nous avons établi l'ordre des approximations de la distance originale par celle définie par l'approximation résoluble, en obtenant que l'approximation résoluble améliore l'ordre d'approximation de la distance originale par l'approximation nilpotente. Soit d, \tilde{d}, \hat{d} les distances induites par la structure originale, l'approximation résoluble, et l'approximation nilpotente. Nous montrons que l'approximation par \tilde{d} est strictement meilleure que celle par \hat{d} pour une paire de points translatés dans une direction où la distance \tilde{d} est décroissante.

Méthode de continuation dans un problème de roulement avec obstacles.

Dans la deuxième partie de cette thèse, nous abordons le problème de la planification du mouvement d'un corps strictement convexe A_2 roulant (sans glisser ni tourner) sur le plan euclidien \mathbb{R}^2 avec obstacles, avec une implémentation numérique de la Méthode des Continuités.

Un système nonholonomique sur une variété n -dimensionnel M est un système de contrôle qui est de la forme

$$\dot{x} = \sum_{i=1}^m u_i X_i(x), \quad x \in M,$$

où $m > 1$ est un entier et X_1, X_2, \dots, X_m sont des champs de vecteurs C^∞ sur M (cf. [Jean, 2014]). Ces systèmes ont attiré l'attention de nombreux auteurs de différentes disciplines pour leurs applications variées, principalement en robotique (cf. [Murray et al., 2017] et ses références). Le problème du corps roulant (sans glissement ni rotation) d'une variété riemannienne bidimensionnel sur un autre (qui est un excellent exemple de la fusion entre la géométrie sub-riemannienne et la théorie du contrôle (géométrique)), peut être écrit comme un système

nonholonomique. Plus précisément, le problème du corps roulant (sans glissement ni rotation) est un système de contrôle Σ , qui modélise le roulement d'une surface connectée encastrée A_2 dans \mathbb{R}^3 sur une autre surface A_1 . En conséquence des contraintes de roulement, et étant donné une courbe absolument continue (a.c.) γ_1 sur A_1 , il existe une unique courbe a.c. Γ dans l'espace d'état, qui décrit le roulement de la surface A_2 sur la surface A_1 le long de la courbe γ_1 . Ainsi, les commandes admissibles de Σ correspondent aux courbes a.c. γ_1 de A_1 par leurs dérivées $\dot{\gamma}_1$. Alors, le système de contrôle peut être écrit, en coordonnées locales, comme un système nonholonomique

$$\Sigma : \dot{x} = u_1 X_1 + u_2 X_2,$$

où $(u_1, u_2) \in \mathbb{R}^2$ est la commande, et X_1 et X_2 sont des champs vectoriels.

La Méthode de Continuation, a été introduite dans [Sussmann, 1992] et [Sussmann, 1993] et largement développée dans [Chitour and Sussmann, 1998], [Chitour, 2002], et [Chitour, 2006]. Il est utilisé pour résoudre des équations non linéaires de la forme $\mathcal{L}(x) = y$, où x est l'inconnue, et $\mathcal{L} : X \rightarrow Y$ est surjectif. Dans le contexte de la planification du mouvement, \mathcal{L} est la carte du point final (associée à un certain point fixe p) de l'espace des entrées admissibles à l'espace d'état, c'est-à-dire $E_p : \mathcal{H} \rightarrow M$.

On considère le corps convexe A_2 , qui peut être intégré comme une surface convexe dans \mathbb{R}^3 , avec une géodésique périodique stable et il est défini par la fonction $a(x, y, z)$ telle que $A_2 = a^{-1}(0)$. Nous désignons l'espace des domaines simplement par M . Un obstacle \mathcal{W} dans \mathbb{R}^2 est un sous-ensemble compact non vide de \mathbb{R}^2 . Un obstacle \mathcal{W} fait correspondre dans M une région C . Ainsi, un obstacle dans M est un sous-ensemble fermé non vide de M tel que $\widehat{M} = M \setminus C$ est également non vide. Considérons le système de contrôle sur M défini par

$$\dot{y} = v_1 \overline{X}_1(y) + v_2 \overline{X}_2(y)$$

où $\overline{X}_i = \zeta X_i$, $i = 1, 2$ et $\zeta : M \rightarrow \mathbb{R}$ tel que $\zeta > 0$ sur \widehat{M} , $\zeta = 0$ sur C . Alors \widehat{M} est invariant sous le système de contrôle ci-dessus. Ainsi, le problème de planification du mouvement avec obstacles est réduit à un problème de planification du mouvement pour chaque composant connecté de \widehat{M} .

Par conséquent, nous fournissons une implémentation numérique complète de la méthode de continuation présentée ci-dessus pour résoudre le problème de planification de mouvement avec des régions interdites sur le plan. Nous détaillons les points fondamentaux de l'implémentation numérique, qui sont la discrétisation de l'espace de contrôle \mathcal{H} , le calcul de $DE_p(u)$, et la levée de la courbe $\tilde{\gamma}_1$ sur le corps convexe A_2 . Cette partie fournit trois exemples de corps roulant sur le plan euclidien (avec obstacles) : la sphère, la boule aplatie, et un œuf, c'est-à-dire avec une géodésique périodique stable (voir Figure A.2). Cependant, lorsque nous relâchons cette propriété géométrique, la méthode mise en œuvre fonctionne toujours.

1.A . Approximation locale par des systèmes linéaires et structures presque-Riemanniennes

Comme nous l'avons dit dans l'introduction précédente, une structure presque-Riemannienne (ARS en abrégé) sur une variété différentiel de dimension n est une structure sous-Riemannienne

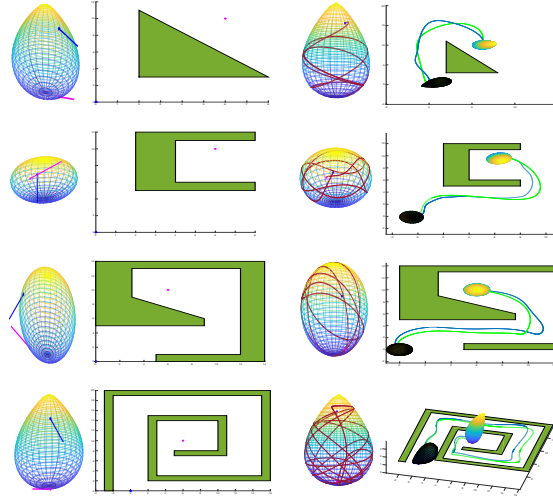

Figure A.2: Différents exemples de corps roulant sur le plan avec des obstacles.

à rang variable qui peut être définie, au moins localement, par un ensemble de champs vectoriels n satisfaisant la condition de rang de l'algèbre de Lie (Larc en abrégé). Nous désignons par Δ_p l'étendue linéaire des champs vectoriels au point p . L'ensemble des points où $\dim(\Delta_p) < n$ est appelé locus singulier ou ensemble singulier et noté \mathcal{Z} . De nombreux articles dédiés à l'étude des ARSs peuvent être trouvés dans la littérature, par exemple: [Agrachev et al., 2010], [Bonnard et al., 2009], [Bonnard et al., 2011], [Boscain et al., 2013a] [Boscain et al., 2013b].

Dans le cas générique tridimensionnel, qui nous intéresse particulièrement, l'ensemble singulier est un sous-variété intégrée de codimension un et les points où $\Delta_p = T_p\mathcal{Z}$ sont isolés. De tels points sont appelés *points de tangence* dans [Agrachev et al., 2008] et *points de type 2* dans [Boscain et al., 2015].

Nous nous intéressons également aux ARS linéaires sur les groupes de Lie (ou les espaces homogènes) (voir [Ayala and Jouan, 2016]) car elles seront utilisées comme structures d'approximation pour les ARS générales.

D'autre part, les approximations nilpotentes sont utilisées pour étudier localement le comportement des structures presque riemanniennes en raison de leur grande similitude avec la dynamique originale. Cependant, dans certains cas, l'approximation nilpotente d'une ARS dégénère, car il ne s'agit plus d'une ARS mais d'une structure sous-riemannienne de rang constant. En d'autres termes, il peut arriver que certains des champs vectoriels de l'approximation nilpotente disparaissent, transformant la structure presque riemannienne en une structure sous-riemannienne de rang constant. Par exemple, si

$$X_1 = \begin{pmatrix} 1 \\ 0 \\ 0 \end{pmatrix}, \quad X_2 = \begin{pmatrix} 0 \\ 1 \\ x \end{pmatrix} \quad \text{and} \quad X_3 = \begin{pmatrix} 0 \\ 0 \\ x^2 \end{pmatrix},$$

alors son approximation nilpotente est

$$\widehat{X}_1 = \begin{pmatrix} 1 \\ 0 \\ 0 \end{pmatrix}, \quad \widehat{X}_2 = \begin{pmatrix} 0 \\ 1 \\ x \end{pmatrix} \quad \text{and} \quad \widehat{X}_3 = 0.$$

c'est-à-dire la structure sub-riemannienne de Heisenberg. C'est exactement ce qui se passe dans le cas générique à 3 dimensions, traité dans [Boscaïn et al., 2015].

Nous supposons, sans perte de généralité, que les derniers champs de vecteurs $m \geq 1$ disparaissent dans l'approximation nilpotente. Notre objectif consiste à récupérer la structure quasi riemannienne perdue dans l'approximation nilpotente grâce aux champs de vecteurs, notés \widetilde{X}_i pour $i = n - m, \dots, n$, qui sont la composante homogène de degré 0 du développement de Taylor en coordonnées privilégiées des champs de vecteurs qui disparaissent. La nouvelle famille de champs de vecteurs composée par l'approximation nilpotente et $\widetilde{X}_{n-m}, \widetilde{X}_{n-m+1}, \dots, \widetilde{X}_n$ est appelée approximation résoluble. L'algèbre de Lie générée par cette nouvelle famille de champs vectoriels est de dimension finie. De plus, lorsqu'un seul des champs vectoriels disparaît et que les autres sont indépendants, cette algèbre de Lie est solvable (d'où son nom). Nous nous intéressons également à un groupe de Lie nilpotent sur lequel $\widetilde{X}_{n-m}, \widetilde{X}_{n-m+1}, \dots, \widetilde{X}_n$ agissent comme des champs de vecteurs linéaires.

Cette première partie est organisée comme suit.

Le chapitre 2 contient des généralités sur les ARS, l'ordre nonholonomique, les coordonnées privilégiées, l'approximation nilpotente, les champs vectoriels linéaires et les ARS linéaires sur les groupes de Lie ou les espaces homogènes.

Dans le Chapitre 3, dans la première section, nous introduisons la définition d'une approximation résoluble en considérant $m = 1$; c'est-à-dire qu'un seul des champs vectoriels disparaît et les autres sont indépendants; nous analysons ses structures algébriques et la distance définie par l'approximation résoluble (\widetilde{d}), en concluant que l'algèbre de Lie générée par cette nouvelle famille de champs vectoriels est de dimension finie et résoluble (Proposition 1.3.1), l'approximation résoluble est équivalente à une ARS simple sur un espace homogène ou un groupe de Lie (Théorème 1.3.1), et la distance \widetilde{d} satisfait toujours $\widetilde{d} \leq \widehat{d}$ (Proposition 1.3.3), où \widehat{d} est la distance induite par l'approximation nilpotente.

Dans la deuxième section, nous avons abordé le cas générique tridimensionnel. Ici, nous montrons que l'approximation résoluble est un ARS simple sur \mathbb{R}^3 difféomorphe à un quotient du groupe de Heisenberg à 5 dimension \mathbb{H}^2 . Concernant la question de la distance, nous avons obtenu dans certains cas que l'ordre de l'approximation de d (la distance originale) par \widetilde{d} est meilleur que l'ordre de l'approximation de d par \widehat{d} (Théorème 3.4.1). En utilisant le fait que pour certaines paires (q, q') de points translétés du lieu singulier la distance est décroissante (Théorème 2.3.2) et l'ordre d'approximation par \widetilde{d} , nous prouvons que la différence $|d(q, q') - \widetilde{d}(q, q')|$ est strictement plus petite que $|d(q, q') - \widehat{d}(q, q')|$. Enfin, nous donnons l'hamiltonien associé au flux défini par l'approximation résoluble dans le cas générique 3D et nous calculons les géodésiques avec la condition initiale $x(0) = y(0) = z(0) = 0$ and $p(0) = \cos(\theta)$, $q(0) = \sin(\theta)$, $r(0) = r$ dans un cas particulier.

Le chapitre 4 est consacré aux approximations générales nilpotentes et solvables des structures presque-Riemanniennes. Tout d'abord, nous montrons qu'il est toujours possible de définir l'ARS localement, autour du point $p = 0$ en coordonnées locales privilégiées, par un ensemble de n champs de vecteurs orthonormés X_1, \dots, X_n tel que l'approximation résoluble

$$\widehat{X}_1, \dots, \widehat{X}_k, \widetilde{X}_{k+1}, \dots, \widehat{X}_m, \widetilde{X}_{m+1}, \dots, \widetilde{X}_n,$$

satisfait à

- $\widehat{X}_i(0) \neq 0$ pour $i = 1, \dots, k$;
- $\widehat{X}_i \neq 0$ mais $\widehat{X}_i(0) = 0$ pour $i = k + 1, \dots, m$;
- $\widehat{X}_i = 0$ pour $i = m + 1, \dots, n$.

Le premier objectif est ici de prouver que l'approximation nilpotente ou résoluble d'un ARS en un point singulier est une structure linéaire presque Riemannienne sur un groupe de Lie ou un espace homogène (Théorème 1.4.2 et 1.4.4 respectivement), sauf dans certains cas très dégénérés où ni l'approximation nilpotente ni l'approximation résoluble ne définissent un ARS.

Lorsque nous travaillons avec n -ARS, nous pouvons trouver des structures difficiles ou complexes et de nombreuses structures différentes. Pour cette raison, le deuxième objectif est de déterminer les structures génériques. On montre en particulier que génériquement: (1) l'ensemble singulier \mathcal{Z} est une union de sous-variété \mathcal{Z}_r de codimension r^2 où le rang est $n - r$; (2) le rang de $\Delta + [\Delta, \Delta]$ est partout plein (Δ représente la distribution) (Théorème 2.4.1). La structure des points de \mathcal{Z}_r où $\dim(T_p \mathcal{Z}_r) + \dim(\Delta_p)$ n'est pas maximale est décrite dans le Théorème 2.4.2. Par exemple, dans \mathcal{Z}_1 , ces points sont les soi-disant *points de tangence* (voir [Boscaïn et al., 2015]), c'est-à-dire les points où $T_p \mathcal{Z}_1 = \Delta_p$. Ils sont génériquement isolés dans \mathcal{Z}_1 .

Grâce à ces résultats de généricité et à l'aide des formes normales locales (voir la section 2.2.4), on montre finalement que génériquement il n'y a que deux possibilités pour l'approximation nilpotente/résoluble en un point $p \in \mathcal{Z}$ (Théorème 2.4.3):

1. En un point de tangence p dans \mathcal{Z}_1 , un champ de vecteurs de l'approximation nilpotente disparaît, mais l'approximation résoluble n'est pas dégénérée et définit une ARS linéaire.
2. En tous les autres points, c'est-à-dire les points non tangents de \mathcal{Z}_1 et tous les points dans \mathcal{Z}_r avec $r \geq 2$, l'approximation nilpotente n'est pas dégénérée.

En conclusion, les seuls points *generic* où l'approximation résoluble est utile sont les points de tangence dans \mathcal{Z}_1 .

Dans la dernière section, nous traitons de la distance induite par l'approximation résoluble, aux points de tangence, d'un ARS n -dimensionnel en considérant des hypothèses génériques et la forme normale lorsque le point appartenant à l'ensemble singulier est un point tangent.

2.A . Méthode de continuation dans un problème de roulement avec obstacles.

Dans cette partie de la thèse, nous abordons le problème de la planification du mouvement d'un corps A_2 strictement convexe roulant (sans glisser ni tourner) sur le plan euclidien \mathbb{R}^2 avec obstacles, avec une implémentation numérique de la Méthode de Continuation.

Nous commençons par décrire le problème du corps roulant, puis la méthode de continuation.

Le problème du corps roulant

Considérons le problème du corps roulant sans glissement ni rotation de A_2 sur le dessus de A_1 . Nous adoptons le point de vue présenté dans [Agrachev and Sachkov, 2004].

Soit A_1 et A_2 des variétés riemanniennes bidimensionnelles connectées et orientées (surfaces des corps roulants). Aux points de contact des corps $x_1 \in A_1$ et $x_2 \in A_2$, leurs espaces tangents sont identifiés par une isométrie préservant l'orientation $q : T_{x_2}A_2 \rightarrow T_{x_1}A_1$ (voir figure A.3). Une telle isométrie q est un état du système, et l'espace d'état est donné par

$$\mathcal{Q}(A_1, A_2) = \{q : T_{x_2}A_2 \rightarrow T_{x_1}A_1 \mid x_1 \in A_1, x_2 \in A_2, q \text{ un isométrie}\}.$$

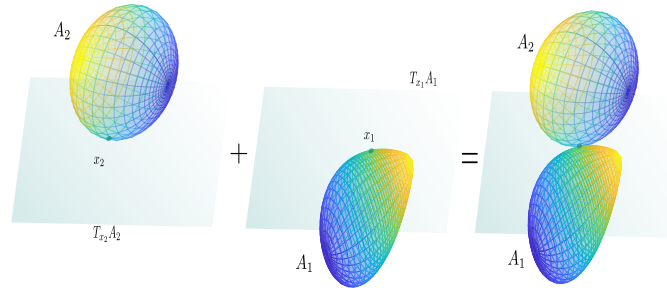

Figure A.3: Idétification des espaces tangents au point de contact.

Comme l'ensemble de toutes les isométries préservant l'orientation dans \mathbb{R}^2 est $SO(2)$, qui peut être identifié avec le cercle unitaire S^1 dans \mathbb{R}^2 , $\mathcal{Q}(A_1, A_2)$ est une variété. Un point $q \in \mathcal{Q}(A_1, A_2)$ est localement paramétré par (x_1, x_2, R) avec $x_1 \in A_1$, $x_2 \in A_2$, et $R \in SO(2)$.

Soit Φ_1 et Φ_2 deux OMFs définis sur les domaines de diagramme de α_1, α_2 . Pour $i = 1, 2$, on considère une courbe $\gamma_i^{\alpha_i}$ définie à l'intérieur du domaine graphique α_i sur le corps A_i . Soit $b_i(t) = \Phi_i(\gamma_i(t)) R_i(t)$ parallèle le long de $\gamma_i^{\alpha_i}$, $i = 1, 2$, et $R := R_2(t)R_1(t)^{-1} \in SO(2)$, qui, par définition, mesure la position relative de Φ_2 par rapport à Φ_1 le long de $(\gamma_1^{\alpha_1}, \gamma_2^{\alpha_2})$. La variation de R_i le long de $\gamma_i^{\alpha_i}$, pour $i = 1, 2$, est donnée par $\dot{R}_i = -\omega_i(\dot{\gamma}_i^{\alpha_i}) R_i$.

Étant donné une courbe a.c. $\gamma_1 : [0, T] \rightarrow A_1$, le roulement de A_2 sur A_1 sans glisser ou tourner le long de γ_1 est caractérisé par une courbe $\Gamma = (\gamma_1, \gamma_2, R) : [0, T] \rightarrow \mathcal{Q}(A_1, A_2)$, qui

est définie par les deux équations suivantes :

$$M^{\alpha_2} \dot{\gamma}_2^{\alpha_2}(t) = RM^{\alpha_1} \dot{\gamma}_1^{\alpha_1}(t) \quad (\text{condition de non-glissement}) \quad (\text{A.1})$$

$$N\beta_1 \dot{R}R^{-1} = \omega_1(\dot{\gamma}_1^{\alpha_1}) - \omega_2(\dot{\gamma}_2^{\alpha_2}) \quad (\text{condition sans rotation}) \quad (\text{A.2})$$

Definition 2.A.1 *La surface A_2 roule sur A_1 sans glisser ni tourner si, pour chaque $x = (x_1, x_2, R_0) \in \mathcal{Q}(A_1, A_2)$ et courbe a.c. $\gamma_1 : [0, T] \rightarrow A_1$ commençant à x_1 , il existe une courbe a.c. $\Gamma : [0, T] \rightarrow \mathcal{Q}(A_1, A_2)$, avec $\Gamma(t) = (\gamma_1(t), \gamma_2(t), R(t))$, $\Gamma(0) = x$ et pour chaque $t \in [0, T]$, telle que, sur des graphiques appropriés, les équations (A.1) et (A.2) sont satisfaites. Nous appelons la courbe $\Gamma(t)$ une trajectoire admissible.*

Les équations (A.1) et (A.2) peuvent être réécrites en coordonnées locales en considérant f_1 et f_2 deux OMFs et si l'état $x = (\gamma_1, \gamma_2, R)$ alors pour presque tous les t tels que $x(t)$ reste dans le domaine d'un graphique approprié, il existe une fonction mesurable $u : [b, d] \rightarrow \mathbb{R}^2$ (que l'on appelle contrôle) telle que

$$\begin{aligned} \dot{\gamma}_1(t) &= u_1(t) \Phi_1^1(\gamma_1(t)) + u_2(t) \Phi_2^1(\gamma_1(t)) \\ \dot{\gamma}_2(t) &= u_1(t) (\Phi^2(\gamma_2(t)) R(t))_1 + u_2(t) (\Phi^2(\gamma_2(t)) R(t))_2 \\ \dot{R}(t)R^{-1}(t) &= \sum_{i=1}^2 u_i(t) (\omega_1(\Phi_i^1(\gamma_1(t))) - \omega_2(\Phi^2(\gamma_2(t)) R(t))_i) \end{aligned}$$

Ensuite, nous pouvons réécrire le système d'équations ci-dessus comme suit :

$$\dot{x} = u_1 X_1(x) + u_2 X_2(x), \quad (\text{A.3})$$

où $X_i = \left(\Phi_i^1, (\Phi^2 R)_i, (\omega_1(\Phi_i^1) - \omega_2(\Phi^2 R(t))_i) \right)^T$, $i = 1, 2$.

La proposition suivante décrit une propriété fondamentale du problème du corps roulant (voir [Chelouah and Chitour, 2003] pour plus de détails).

Proposition 2.A.1 *Soit $u \in \mathcal{H}$ une commande admissible qui donne lieu à la trajectoire admissible $\Gamma = (\gamma_1, \gamma_2, R) : [0, 1] \rightarrow \mathcal{Q}(A_1, A_2)$. Alors, les affirmations suivantes sont équivalentes :*

1. *La courbe $\gamma_1 : [0, 1] \rightarrow A_1$ est une géodésique ;*
2. *La courbe $\gamma_2 : [0, 1] \rightarrow A_2$ est une géodésique ;*
3. *La courbe $\Gamma : [0, 1] \rightarrow \mathcal{Q}(A_1, A_2)$ est une géodésique horizontale.*

Méthode de Continuation

Nous fixons quelques notations.

Les entrées admissibles u sont des éléments de $\mathcal{H} = L^2([0, 1], \mathbb{R}^2)$. Pour désigner $(u_1(t)^2 + u_2(t)^2)^{\frac{1}{2}}$ et $\left(\int_0^1 \|u(t)\|^2 dt\right)^{\frac{1}{2}}$ nous utilisons respectivement $\|u(t)\|$ et $\|u\|_{\mathcal{H}}$. Si $u, v \in \mathcal{H}$, alors $(u, v)_{\mathcal{H}} = \int_0^1 u(t)^T v(t) dt$.

Comme mentionné dans la section Introduction, la méthode de continuité est utilisée pour résoudre des équations non linéaires de la forme $\mathcal{L}(x) = y$, où x est l'inconnue, et $\mathcal{L} : X \rightarrow Y$ est surjectif.

Dans le contexte du problème de planification du mouvement, la fonction \mathcal{L} est le point final $E_p : \mathcal{H} \rightarrow M$ associé à un certain $p \in M$ fixe. Pour $u \in \mathcal{H}$ et $p \in M$, soit $\gamma_{p,u}$ la trajectoire de Σ commençant à p pour $t = 0$ et correspondant à u . Alors pour $v \in \mathcal{H}$, $E_p(v)$ est donné par $E_p(v) := \gamma_{p,v}(1)$.

Rappelons que $E_p(v)$ est défini pour chaque $v \in \mathcal{H}$. Le problème de planification du mouvement peut être reformulé comme suit :

Pour chaque $p, q \in M$, trouver une commande $u_{p,q} \in \mathcal{H}$ telle que $E_p(u_{p,q}) = q$. En d'autres termes, nous devons trouver l'inverse droit de la carte du point final E_p . Cet inverse droit existe dans un voisinage de tout point $u \in \mathcal{H}$ tel que DE_p est surjectif (par l'hypothèse de contrabilité). Plus précisément, on commence avec un contrôle arbitraire u_0 . On définit $q_0 := E_p(u_0)$, et on choisit un chemin $\pi : [0, 1] \rightarrow M$ tel que $\pi(0) := q_0$ et $\pi(1) := q$. Nous cherchons maintenant un chemin $\Pi : [0, 1] \rightarrow \mathcal{H}$ tel que, pour tout $s \in [0, 1]$, il y a

$$E_p(\Pi(s)) = \pi(s) \quad (\text{A.4})$$

En différentiant l'équation (A.4), on obtient

$$DE_p(\Pi(s)) \cdot \frac{d\Pi}{ds}(s) = \frac{d\pi}{dt}(s). \quad (\text{A.5})$$

Si $DE_p(\Pi(s))$ a un rang complet, alors l'équation (A.5) peut être résolue pour $\Pi(s)$ en prenant Π tel que

$$\frac{d\Pi}{ds}(s) = F(\Pi(s)) \cdot \frac{d\pi}{dt}(s). \quad (\text{A.6})$$

où $F(\cdot)$ est un inverse droit de $DE_p(\cdot)$. Par exemple, nous pouvons choisir $F(\cdot)$ comme étant le pseudo-inverse de Moore-Penrose de $DE_p(\cdot)$. L'équation (A.6) est appelée l'équation de levage de chemin d'accès (PLE), qui est une équation différentielle ordinaire (ODE) sur \mathcal{H} (cf. [Wazewski, 1947]).

Remarque que, par construction, la commande définie par $u^{final} := \Pi(1)$ dirige le système de p à q . Afin d'obtenir la valeur de $\Pi(1)$, il suffit de résoudre le problème de la valeur initiale défini dans l'espace de contrôle \mathcal{H} .

$$\begin{aligned} \frac{d\Pi}{ds}(s) &= F(\Pi(s)) \cdot \frac{d\pi}{dt}(s) \\ \Pi(0) &= u_0. \end{aligned} \quad (\text{A.7})$$

Pour appliquer avec succès la méthode de continuation au problème de planification du mouvement, nous devons garantir l'existence de $F(\Pi(s))$ pour chaque $s \in [0, 1]$ de telle sorte que l'équation (A.6) soit toujours bien définie, c'est-à-dire que $DE_p(\Pi(s))$ doit toujours avoir un rang égal à 5. De plus, puisque nous avons besoin d'évaluer $\Pi(1)$ pour obtenir une commande dirigeant le système de p à q , la PLE définie dans (A.6) doit avoir une solution globale sur $[0, 1]$.

En conclusion, l'application de la méthode de continuation au problème de planification du mouvement se décompose en deux étapes: caractériser (lorsque cela est possible) $S_p = \{u \in \mathcal{H} : \text{rank}(DE_p(u)) < 5\}$ et son image sous E_p , et lever les chemins $\pi : [0, 1] \rightarrow M$ évitant $E_p(S_p)$ vers les chemins $\Pi : [0, 1] \rightarrow \mathcal{H}$ globalement définis sur $[0, 1]$ par (A.6).

Surface convexe roulant sur le plan avec obstacles

Puisque A_2 est une variété riemannienne orientée, connectée et bidimensionnelle, alors A_2 peut être intégrée comme une surface convexe dans \mathbb{R}^3 (voir [Berger and Gostiaux, 2012]). Par conséquent, dans la suite, nous supposons que A_2 est une surface orientée de \mathbb{R}^3 avec une métrique induite par la métrique euclidienne de \mathbb{R}^3 . De plus, nous supposons que A_2 est définie comme une composante connexe bornée de l'ensemble de niveau zéro d'une fonction lisse à valeur réelle $a : \mathbb{R}^3 \rightarrow \mathbb{R}$. Le champ de vecteurs normaux à A_2 est donné par $\frac{\nabla a}{\|\nabla a\|}$, où $\nabla a = (a_x, a_y, a_z)$ désigne le vecteur gradient de a . La courbure gaussienne de A_2 est désignée par K .

Rappelons que le problème du corps roulant suppose que les espaces tangents aux points de contact sont identifiés. Dans \mathbb{R}^3 , ceci est équivalent à l'identification des vecteurs normaux. Soit n_2 le vecteur normal de A_2 , Puis, aux points de contact, nous attribuons $\frac{\nabla a}{\|\nabla a\|}$ à $-N_{\mathbb{R}^2}$, où $N_{\mathbb{R}^2}$ est le vecteur normal au plan \mathbb{R}^2 .

En utilisant le fait que $\mathcal{Q}(\mathbb{R}^2, A_2)$ est un bundle de cercle quand A_2 est une variété à 2 dimensions, et en prenant les coordonnées géodésiques ϑ pour A_2 au point de contact x_2 , et en considérant les coordonnées $x = (v_1, w_1, v_2, w_2, \psi)$ dans un certain voisinage de $(0, \psi_0)$ dans $\mathbb{R}^4 \times S^1$, le système de contrôle (A.3) peut s'écrire localement comme suit

$$\dot{x} = u_1 X_1(x) + u_2 X_2(x), \quad (\text{A.8})$$

avec

$$X_1(x) = \left(1, 0, \cos(\psi), -\frac{\sin(\psi)}{\vartheta}, -\frac{\vartheta_{v_2}}{\vartheta} \sin(\psi) \right)^T \quad (\text{A.9})$$

$$X_2(x) = \left(0, 1, -\sin(\psi), -\frac{\cos(\psi)}{\vartheta}, -\frac{\vartheta_{v_2}}{\vartheta} \cos(\psi) \right)^T. \quad (\text{A.10})$$

Pour un développement détaillé de la manière d'obtenir le système (A.8) avec les champs de vecteurs X_1 et X_2 définis respectivement par (A.9) et (A.10), voir [Chelouah and Chitour, 2003].

Obstacles et dynamique du système de contrôle

Par la suite, l'espace des domaines $\mathcal{Q}(\mathbb{R}^2, A_2)$ est simplement désigné par M .

Pour traiter le problème de planification de mouvement avec obstacles, nous suivons une stratégie suggérée par E. Sontag dans [Sontag, 1995].

Definition 2.A.2 *Nous disons que \mathcal{W} est un obstacle de \mathbb{R}^2 si \mathcal{W} est un sous-ensemble compact non vide de \mathbb{R}^2 .*

D'après la définition ci-dessus, on peut supposer qu'il existe une fonction $\xi : \mathbb{R}^2 \rightarrow \mathbb{R}$ telle que $\mathcal{W} = \{w \in \mathbb{R}^2; \xi(w) \leq 0\}$.

Un obstacle \mathcal{W} fait correspondre dans M une région (voir Figure A.4), notée C , définie par

$$C = \{x = (\gamma_1, \gamma_2, R) \in M; \gamma_1 \in \mathcal{W}\} = \{x \in M; \xi(\gamma_1) \leq 0\}.$$

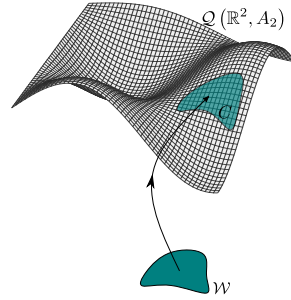

Figure A.4: Application d'obstacles dans M .

Par conséquent, C est un obstacle dans l'espace des domaines M . Autrement dit, un obstacle dans M est un sous-ensemble fermé non vide de M tel que $\widehat{M} = M \setminus C$ est également non vide.

Considérons une suite croissante $(W_i)_{i \geq 0}$ des sous-ensembles compacts de M telle que $C = \cup_{i \geq 0} W_i$. Pour chaque $i \geq 0$, on peut construire une fonction lisse $\zeta_i : M \rightarrow \mathbb{R}$ telle que $\zeta_i \equiv 0$ sur W_i et $0 < \zeta_i(x) \leq \inf(1, d(\gamma_1, W_i))$ pour $x \in M \setminus W_i$. Soit

$$M_i := \sup_{x \in M} (\|D\zeta_i(x)\| + \|D^2\zeta_i(x)\|).$$

On définit alors

$$\zeta(x) = \sum_{i \geq 0} \frac{1}{2^i M_i} \zeta_i(x). \quad (\text{A.11})$$

Alors, il existe une fonction lisse bornée $\zeta : M \rightarrow \mathbb{R}$ telle que $\zeta > 0$ sur \widehat{M} , $\zeta = 0$ sur C et $(\widehat{M}, \langle \cdot, \cdot \rangle_x)$ est une variété riemannienne complète, où

$$\langle \cdot, \cdot \rangle_x = \frac{\langle \cdot, \cdot \rangle}{\zeta^2}. \quad (\text{A.12})$$

Considérons le système de contrôle sur M défini par

$$\dot{y} = v_1 \bar{X}_1(y) + v_2 \bar{X}_2(y) \quad (\text{A.13})$$

où $\bar{X}_i = \zeta X_i$, $i = 1, 2$. Nous pouvons vérifier que le système (A.13), restreint à \widehat{M} , satisfait la condition LARC (voir [Chitour and Sussmann, 1998]).

Alors \widehat{M} est invariant sous le système de contrôle (A.13), plus précisément,

Lemma 2.A.1 *pour tout $v \in \mathcal{H}$, pour tout $p \in \widehat{M}$, si $\bar{\gamma}_v$ est la solution de (A.13) avec $\bar{\gamma}(0) = p$ alors $\bar{\gamma}([0, 1]) \subset \widehat{M}$.*

En d'autres termes, pour chaque $t \in [0, 1]$, $\bar{\gamma}(t)$ appartient à la composante connectée de \widehat{M} contenant p . Ainsi, le problème de planification du mouvement avec obstacles se réduit à un problème de planification du mouvement pour chaque composante connectée de \widehat{M} . (Pour plus de détails sur ζ et la preuve du lemme 2.A.1, voir [Chitour, 2006]).

Points clés pour la mise en œuvre numérique

Dans [Chitour, 2006] est prouvé que, pour tout sous-intervalle compact $J = [0, a]$ de l'intervalle d'existence de la solution maximale de l'équation (2.8), noté I , l'approximation numérique de l'équation (2.8) définie par $E_{p,j}$ et associée à π a une solution globale sur J pour j suffisamment grand. En particulier, si $J = I = [0, 1]$ (c'est-à-dire que la PLE a une solution globale), le résultat ci-dessus peut être considéré comme une justification théorique de l'utilisation de la procédure de Galerkin dans les implémentations numériques de la méthode de continuité.

Dans cette Section, nous voulons montrer comment la Méthode de Continuation, présentée dans la Section 3.2 peut être implémentée numériquement pour résoudre le problème de planification de mouvement avec obstacles lorsqu'une surface convexe de \mathbb{R}^3 roule sur le plan avec des régions interdites (ou obstacles).

Dans les trois sous-sections suivantes, nous détaillons les points fondamentaux de l'implémentation numérique, qui sont la discrétisation de l'espace de contrôle \mathcal{H} , le calcul de $DE_p(u)$, et le soulèvement de la courbe $\tilde{\gamma}_1$ sur le corps convexe A_2 . Les idées proviennent de [Alouges et al., 2010].

Discrétisation de \mathcal{H}

Rappelons que l'espace de contrôle \mathcal{H} est, en général, un espace vectoriel de dimension infinie, alors nous commençons par discrétiser \mathcal{H} car nous devons résoudre le problème de valeur initiale défini dans (2.9). Dans ce cas, les commandes sont des courbes planes $\gamma_1 : [0, 1] \rightarrow \mathbb{R}^2$ telles que

$$\dot{\gamma}_1(t) = \zeta(x(t))(u_1, u_2), \quad x(t) = (\gamma_1(t), \gamma_2(t), R(t)).$$

Nous divisons l'intervalle $[0, 1]$ en $n - 1$ parties et approximations l'espace de contrôle \mathcal{H} par le sous-espace $\tilde{\mathcal{H}}$ à $2n$ dimensions des fonctions linéaires par morceaux (pour plus de détails, voir [Gautschi, 2012]). Alors, γ_1 peut être approximé par $\tilde{\gamma}_1$, c'est-à-dire, l'interpolation linéaire de

$(\gamma_1^1, \dots, \gamma_1^n)$, où $\gamma_1^{i+1} = \gamma_1 \left(\frac{i}{n-1} \right) = (x_{i+1}, y_{i+1})^T$ pour $i = 0, \dots, n-1$.

Sur chaque segment $[t_{i+1}, t_{i+2}] = \left[\frac{i}{n-1}, \frac{i+1}{n-1} \right]$ la commande approximative $(\tilde{u}_1^{i+1}, \tilde{u}_2^{i+1})^T$ est proportionnelle au vecteur $\frac{1}{\zeta(x(t))} (x_{i+2} - x_{i+1}, y_{i+2} - y_{i+1})^T$ pour $i = 0, \dots, n-2$.

Remarquez que lorsque les éléments dans $\tilde{\mathcal{H}}$ sont des fonctions linéaires par morceaux avec plus d'un morceau, alors ce ne sont pas des contrôles singuliers. Ensuite, les trajectoires correspondantes sur A_2 sont également faciles à obtenir en intégrant certaines équations géodésiques en utilisant la Proposition 2.2.1. Enfin, on utilise la méthode d'Euler pour intégrer (2.9).

Calculer $DE_p(u)$.

Pour évaluer $DE_p(u)$, pour $u \in \mathcal{H}$, ce qui suit est nécessaire.

Plus de détails voir [Chelouah and Chitour, 2003].

Pour $z \in T_{E_p(u)}^* M$, soit $\lambda_{z,u} : [0, 1] \rightarrow T^* M$ le champ de covecteurs le long de $\gamma_{p,u}$ tel qu'il satisfasse, en coordonnées, l'équation adjointe le long de $\gamma_{p,u}$ avec la condition terminale z , c'est-à-dire $\lambda_{z,u}(1) = z$ et pour a . e $t \in [0, 1]$ on a

$$\dot{\lambda}_{z,u}(t) = -\lambda_{z,u}(t) \cdot \left(u_1(t) DX_1(\lambda_{z,u}(t)) + u_2(t) DX_2(\lambda_{z,u}(t)) \right).$$

Si V est un champ de vecteurs C^∞ sur M , la fonction de commutation $\varphi_{V,z,u}(t)$ associée à V est l'évaluation de $\lambda \cdot V(x)$, la fonction hamiltonienne de V le long de $(\gamma_{p,u}, \lambda_{p,u})$, c'est-à-dire que pour $t \in [0, 1]$, on obtient

$$\varphi_{V,z,u}(t) := \lambda_{z,u} \cdot V(\gamma_{p,u}(t)).$$

Ensuite, $DE_p(u)$ peut être calculé grâce à la formule suivante: pour $z \in T_{E_p(u)}^* M$ et $u, v \in \mathcal{H}$

$$z \cdot DE_p(u)(v) = (v, \varphi_{z,u})_{\mathcal{H}}, \quad (\text{A.14})$$

où le vecteur de la fonction de commutation $\varphi_{z,u}$ est la solution du problème de Cauchy, qui est défini, en coordonnées, par

$$\begin{aligned} \dot{\varphi}_1 &= -u_2 K \varphi_3 \\ \dot{\varphi}_2 &= u_1 K \varphi_3 \\ \dot{\varphi}_3 &= -u_2 \varphi_4 + u_1 \varphi_5 \\ \dot{\varphi}_4 &= -u_2 K \varphi_3 \\ \dot{\varphi}_5 &= u_1 K \varphi_3 \end{aligned} \quad (\text{A.15})$$

avec la condition terminale $\varphi_{z,u}(1) = z$.

En pratique, puisque la matrice discrète $DE_p(u)$ est une matrice 5×5 et que son image est donnée par (A.14), il suffit de prendre les cinq vecteurs de la base canonique de \mathbb{R}^5 , comme conditions finales z , et d'intégrer (A.15) en temps inverse. Dans les simulations, un schéma numérique Runge-Kutta d'ordre 4 est utilisé pour l'intégration, le produit scalaire $(\cdot, \cdot)_{\mathcal{H}}$ dans l'espace de contrôle \mathcal{H} est évalué par quadrature gaussienne, et la courbure gaussienne K est calculée en utilisant la proposition 1.2.1.

Lifting de la courbe plane $\tilde{\gamma}_1$ sur A_2 .

Notez que la courbure K apparaissant dans (3.9) est prise au point de contact final sur la surface A_2 après qu'elle ait roulé le long de la courbe à constante par morceaux $\tilde{\gamma}_1$. Ainsi, pour localiser le point final, nous devons *soulève* la courbe plane $\tilde{\gamma}_1$ sur A_2 , et la dynamique de soulèvement est donnée par (3.7). Cependant, puisque les coordonnées géodésiques impliquées dans (3.7) ne sont pas données explicitement en pratique, la méthode numérique de soulèvement est basée sur la proposition 2.2.1.

Sur chaque intervalle $[t_{i+1}, t_{i+2}]$, la courbe de contrôle approximative $\tilde{\gamma}_1$ est une ligne droite (c'est-à-dire une géodésique dans \mathbb{R}^2), et alors, par la Proposition 2.2.1, la courbe de soulèvement $\tilde{\gamma}_1$ sur A_2 est également une géodésique sur chaque intervalle $[t_{i+1}, t_{i+2}]$ pour tous les $i = 0, \dots, n-2$. Alors, à partir du point de contact initial x_0 sur A_2 , on peut intégrer successivement (avec un schéma Runge-Kutta d'ordre 4) l'équation géodésique, donnée par la Proposition 1.2.2 (équation 2.2), sur chaque $[t_{i+1}, t_{i+2}]$ avec des conditions initiales égales à $\tilde{\gamma}_1(t_{i+1})$ et $(\tilde{u}_1^{i+1}, \tilde{u}_2^{i+1})$, pour $i = 0, \dots, n-2$.

Une difficulté très importante est que l'intégration numérique s'effectue sur le collecteur A_2 , $t > 0$. En supposant que nous soyons au point $x \in A_2$ au temps t , alors, au temps $t + \delta t$, nous nous déplaçons à $x_{new} = x + (\delta t)e$, avec $e \in T_x A_2$, mais x_{new} n'appartient pas à A_2 si e est non nul. Il faut donc, à chaque pas d'intégration, *projeter* x_{new} sur A_2 . En détail, supposons que le point $(0, 0, 0)$ est à l'intérieur du corps convexe A_2 . Puisque A_2 est défini comme (une composante connexe bornée de) l'ensemble de niveau zéro d'une fonction lisse a , nous supposons que $|a(x_{new})| \leq \varepsilon$ pour un certain $\varepsilon \ll 1$, c'est-à-dire que x_{new} est proche de A_2 . Alors, par la convexité de A_2 , il existe un unique nombre réel μ proche de 1 tel que $a(\mu x_{new}) = 0$. Le problème de la *projection* à traiter est local, et par conséquent, la méthode de Newton est efficace pour trouver μ . La dérivée par rapport à μ est également nécessaire, et est évaluée par un schéma à différences finies.

Exemples

Cette section présente trois exemples de corps roulant sur le plan euclidien : la sphère, la boule aplatie et un œuf. Les simulations ont été développées dans le logiciel Matlab, et le code a été exécuté sur un Macbook Pro Apple M1 8Go de RAM pour 100 itérations avec $n - 1 = 100$ pour la discrétisation de l'espace de contrôle.

Chaque corps convexe A_2 est défini par la fonction $a(x, y, z)$ telle que $A_2 = a^{-1}(0)$. Les points de contact initiaux sont **bleu** et les points de contact finaux sont **magenta**. Les orientations initiales et finales ont la même couleur que les points initiaux et finaux. Les obstacles sont des régions circulaires dans le plan, et ils sont colorés en rouge (voir les figures A.5, A.7 et A.9).

La courbe initiale choisie pour appliquer la méthode de continuation est la courbe verte, et la courbe obtenue par ce processus est colorée en bleu. Dans chaque exemple, trois courbes différentes sont choisies pour évaluer la méthode. Enfin, la courbe rouge sur le corps convexe est obtenue à partir du soulèvement de la courbe calculée par la méthode de continuation (courbe bleue) (voir figures A.6, A.8 et A.10).

Sphère

Cette sphère est définie par l'ensemble des niveaux zéro de la fonction a , définie par

$$a(x, y, z) = x^2 + y^2 + z^2 - 1.$$

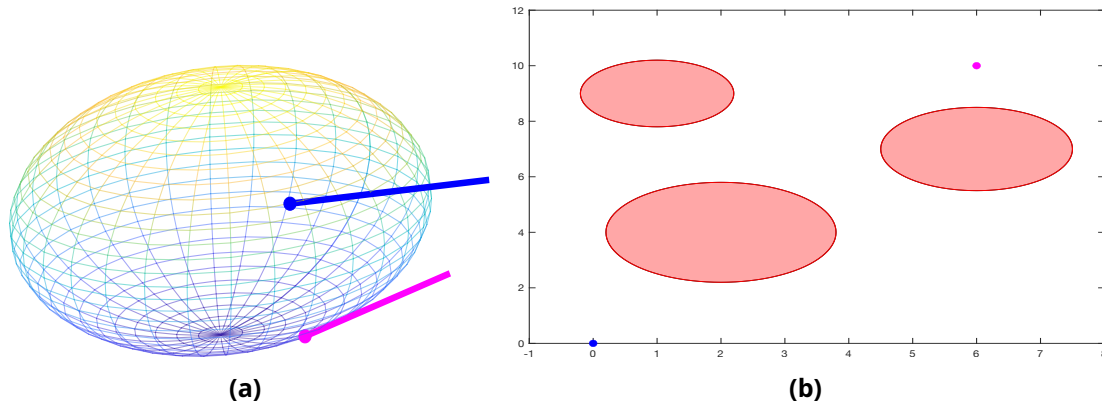

Figure A.5: Côté gauche: sphère avec points de contact initiaux et finaux et ses orientations. Côté droit : obstacles (en rouge) et points de contact initiaux et finaux sur le plan.

Oeuf

Cet oeuf est défini par l'ensemble de niveau zéro de la fonction a , définie par

$$a(x, y, z) = \frac{x^2 + y^2}{1 - 0.4z} + \frac{1}{4}z^2 - 1.$$

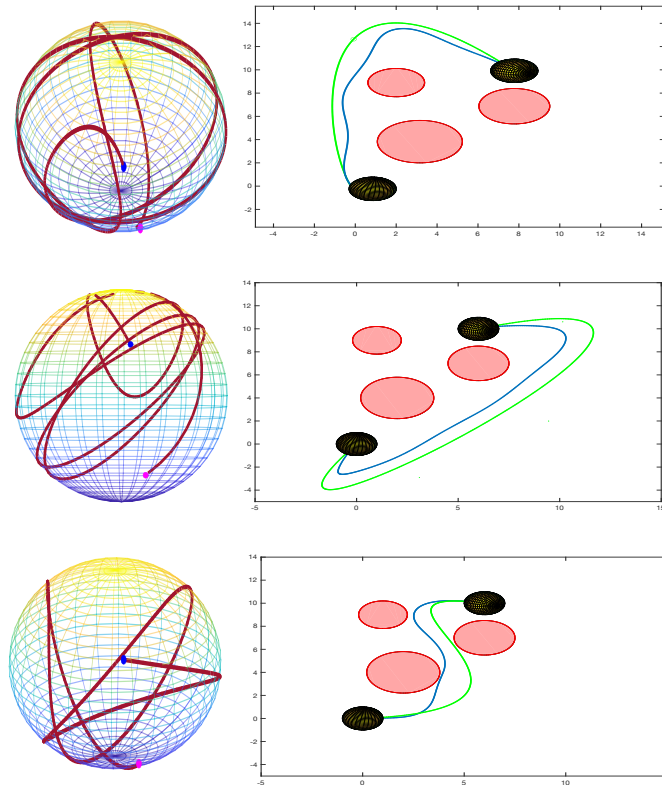

Figure A.6: À gauche: courbe γ_2 sur la sphère. Côté droit : Courbe obtenue en appliquant la méthode de continuation (bleu) à la courbe initiale choisie (vert).

Boule aplatie

Cette boule aplatie est définie par l'ensemble de niveau zéro de la fonction a , définie par

$$a(x, y, z) = x^2 + y^2 + 5z^2 - 1.$$

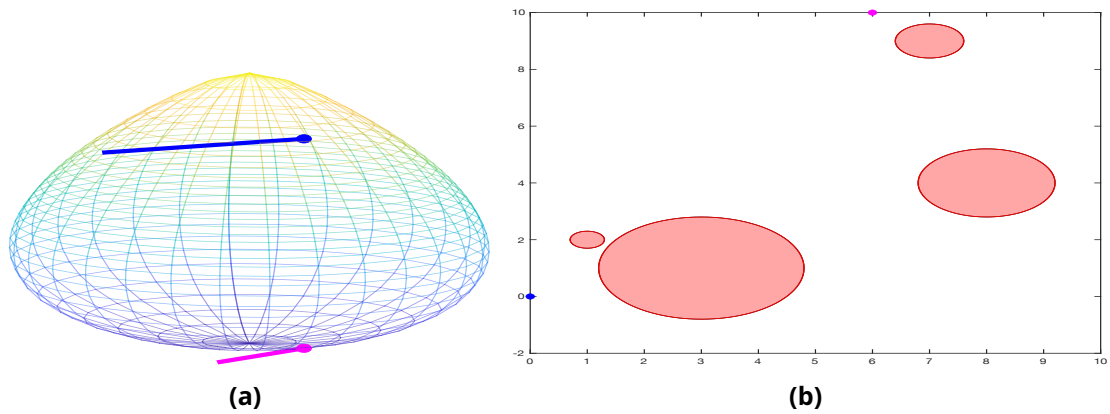

Figure A.7: Côté gauche: oeuf avec points de contact initiaux et finaux et ses orientations. Côté droit: obstacles (en rouge) et points de contact initiaux et finaux sur le plan.

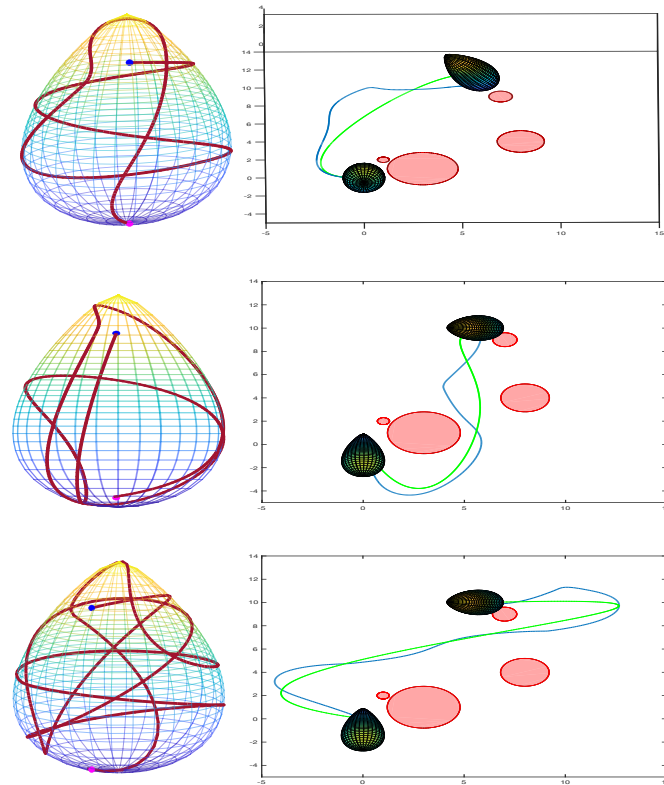

Figure A.8: À gauche: courbe γ_2 sur le oeuf. Côté droit : Courbe obtenue en appliquant la méthode de continuation (bleu) à la courbe initiale choisie (vert).

Enfin, pour montrer le bon fonctionnement de la méthode mise en œuvre, nous avons considéré des obstacles plus complexes avec les mêmes corps convexes. La courbe initiale choisie est colorée en vert, et celle obtenue par la méthode de continuation est colorée en bleu.

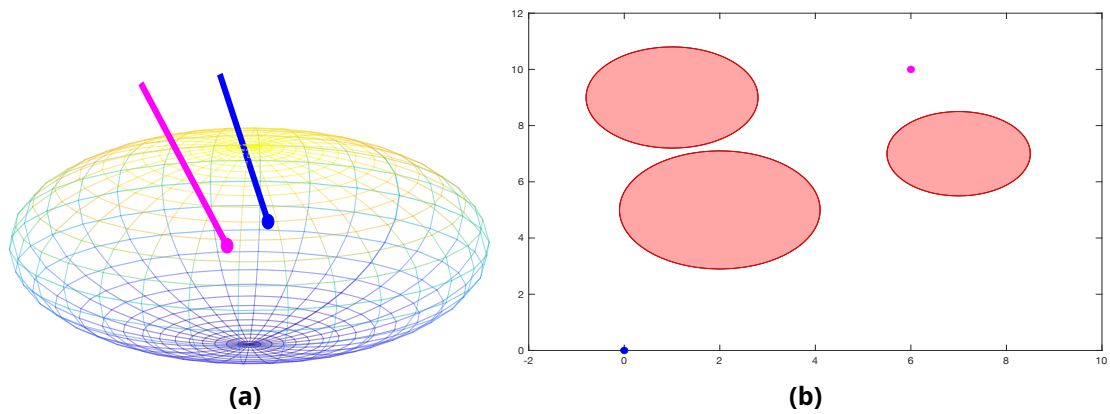

Figure A.9: Côté gauche: boule aplatie avec points de contact initiaux et finaux et ses orientations. Côté droit: obstacles (en rouge) et points de contact initiaux et finaux sur le plan.

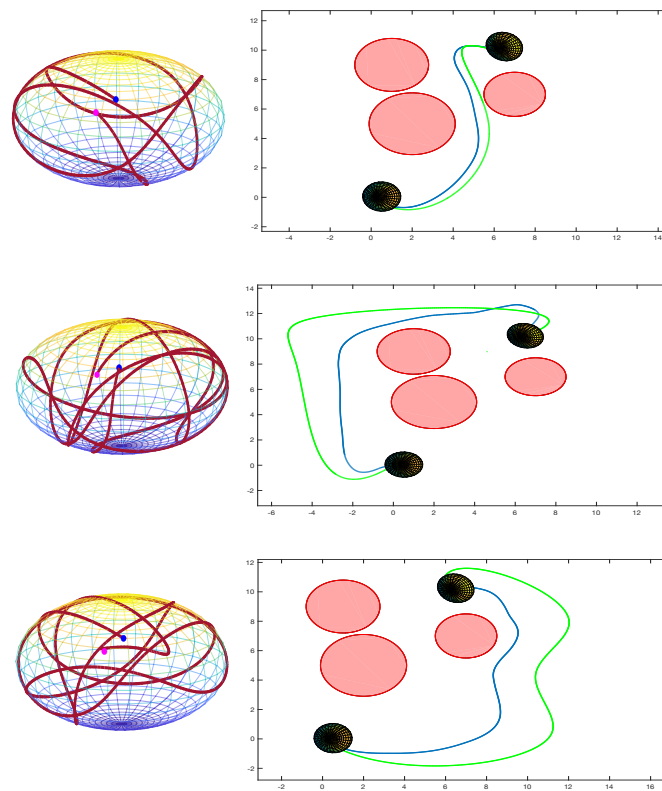

Figure A.10: À gauche: courbe γ_2 sur la boule aplatie. Côté droit : Courbe obtenue en appliquant la méthode de continuation (bleu) à la courbe initiale choisie (vert).

Les obstacles sont colorés en vert. Voir la figure A.11.

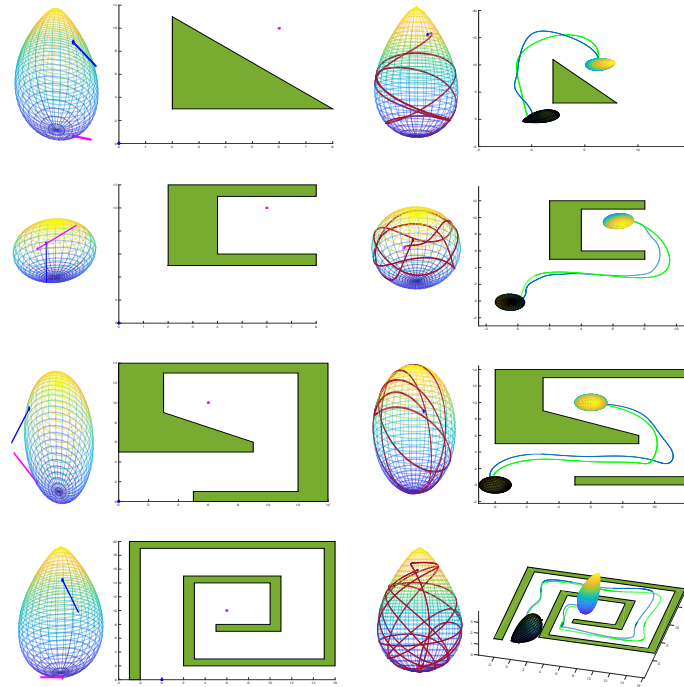

Figure A.11: Côté gauche: corps convexe avec points de contact initial et final avec orientations et obstacle sur le plan (en vert). Côté droit: courbe γ_2 sur le corps convexe et courbe obtenue en appliquant la méthode de continuation (en bleu) à la courbe initiale choisie (en vert).

Conclusions et commentaires

Cette partie de la thèse présente une implémentation numérique pour résoudre le problème de planification de mouvement lorsqu'un corps convexe roule sur le plan euclidien avec des obstacles, en détaillant la discrétisation de l'espace de contrôle \mathcal{H} , l'évaluation de $DE_p(u)$, et la levée de la courbe $\tilde{\gamma}_1$ sur le corps convexe A_2 . Le corps convexe est considéré comme une surface orientée de \mathbb{R}^3 et donc il est défini par une fonction $a : \mathbb{R}^3 \rightarrow \mathbb{R}$ telle que $A_2 = a^{-1}(0)$. De plus, pour appliquer avec succès la méthode de continuation, A_2 doit avoir une géodésique périodique stable. Cette propriété est vraie pour toute surface compacte convexe ayant une symétrie de révolution (cf. [Chelouah and Chitour, 2003]). Pour cette raison, la sphère, la balle aplatie et un œuf ont été considérés pour les simulations. Cependant, lorsque nous relaxons cette propriété géométrique, la méthode mise en œuvre fonctionne toujours. Ce qui précède peut être considéré comme la robustesse de la méthode. Il y a un défi à relever ici: rechercher un résultat théorique de convergence qui assure l'application réussie de la méthode de continuation lorsque le corps convexe ne satisfait pas la condition géométrique de symétrie de révolution. Nous pensons que ce résultat est lié au fait que $\nabla a(x, y, z) \neq 0$ sur l'ensemble de niveau zéro de a , car, selon les propositions 1.2.1 et 1.2.2, la courbure gaussienne de la surface A_2 et la levée de la courbe plane sur A_2 respectivement, dépendent de $\nabla a(x, y, z)$, en effet, si $\nabla a(x, y, z) \neq 0$ les équations (2.1) et (2.2) qui définissent respectivement la courbure gaussienne et le lift, sont toujours bien définies. Par exemple, considérons A_2 une surface

orientée sans axe de symétrie, définie par $a(x, y, z) = \frac{x^2}{1 - 0.7y} + \frac{3y^2}{1 - 0.1z} + \frac{0.3z^2}{1 - 0.3x - 0.1y} - 1$

et donc $\nabla a(x, y, z) = \left(\begin{array}{c} \frac{9z^2}{(3x+y-10)^2} - \frac{20x}{7y-10} \\ \frac{3z^2}{(3x+y-10)^2} - \frac{60y}{z-10} + \frac{70x^2}{(7y-10)^2} \\ \frac{3y^2}{(z-0.1)^2} - \frac{3z}{0.75x+0.5y-5} \end{array} \right) \neq 0$ sur l'ensemble de niveau zéro de

a. Dans la Figure A.12, nous pouvons voir comment la méthode fonctionne.

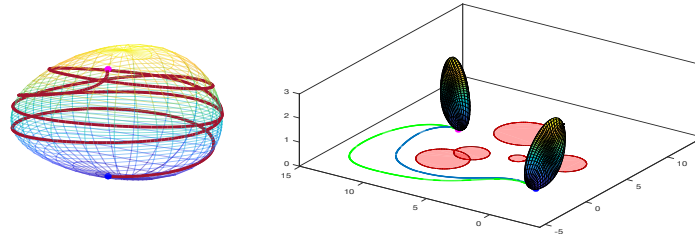

Figure A.12: Côté gauche: Corps convexe non symétrique avec points de contact initial et final et courbe γ_2 . Côté droit: Courbe obtenue en appliquant la méthode de continuation (bleu) à la courbe initiale choisie (vert).

Paper 1

Solvable approximation of 3-dimensional almost-Riemannian structures, article in collaboration with Philippe Jouan. It was published in the journal *Mathematical Control & Related Fields*, volume 12 (2022), Issue 2 (June), pp.303-326. (see online [link](#)).

Solvable Approximations of 3-dimensional Almost-Riemannian structures

Philippe Jouan* and Ronald Manríquez†

July 8, 2021

Abstract

In some cases, the nilpotent approximation of an almost-Riemannian structure can degenerate into a constant rank sub-Riemannian one. In those cases, the nilpotent approximation can be replaced by a solvable one that turns out to be a linear ARS on a nilpotent Lie group or a homogeneous space.

The distance defined by the solvable approximation is analyzed in the 3D-generic cases. It is shown that it is a better approximation of the original distance than the nilpotent one.

Key words: Almost-Riemannian geometry, Nilpotent approximation.

AMS subject classifications: 53C15, 53C17, 22E25, 53B99.

1 Introduction

The aim of this paper is to locally approximate almost-Riemannian structures (ARS in short) at singular points, by ARSs on Lie groups and to show that this approximation is generally better than the nilpotent one.

An ARS on an n -dimensional differential manifold is a rank-varying sub-Riemannian structure that can be defined, at least locally, by a set of n vector fields satisfying the Lie algebra rank condition (Larc in short). We denote by Δ_p the linear span of the vector fields at the point p . The set of points where $\dim(\Delta_p) < n$ is called the singular locus or the singular set and denoted by \mathcal{Z} . Many papers dedicated to the study of ARSs can be found in the literature, for instance [2], [8], [9], [11] [12].

In the generic 3-dimensional case, in which we are particularly interested, the singular set is a codimension one embedded submanifold and the points where $\Delta_p = T_p\mathcal{Z}$ are isolated (see [3] and [10]).

We are likewise interested in the so-called **simple ARSs** on Lie groups (or homogeneous space) because they will be used as approximating structures for general

*Lab. R. Salem, CNRS UMR 6085, Université de Rouen, avenue de l'université BP 12, 76801 Saint Étienne-du-Rouvray, France, philippe.jouan@univ-rouen.fr

†Université Paris-Saclay, CNRS, CentraleSupélec, Laboratoire des signaux et systèmes, 91190, Gif-sur-Yvette, France and Lab. R. Salem, CNRS UMR 6085, Université de Rouen, ronald.manriquez-penafiel@universite-paris-saclay.fr

ARSs: a simple ARS on an n -dimensional Lie group is an almost-Riemannian structure defined by $n - 1$ left-invariant vector fields and one vector field whose flow is a one-parameter group of automorphisms, called linear in the sequel. Under some conditions, the singular set of such structures is a subgroup or an analytic, embedded, codimension one submanifold (see [5] and [17]).

In some cases the nilpotent approximation of an ARS degenerates, because it is no longer an ARS but a constant rank sub-Riemannian structure. In other words, it may happen that some of the vector fields of the nilpotent approximation vanish, changing the almost-Riemannian structure into a constant rank sub-Riemannian one. For instance, if

$$X_1 = \begin{pmatrix} 1 \\ 0 \\ 0 \end{pmatrix}, \quad X_2 = \begin{pmatrix} 0 \\ 1 \\ x \end{pmatrix} \quad \text{and} \quad X_3 = \begin{pmatrix} 0 \\ 0 \\ x^2 \end{pmatrix},$$

then its nilpotent approximation is

$$\widehat{X}_1 = \begin{pmatrix} 1 \\ 0 \\ 0 \end{pmatrix}, \quad \widehat{X}_2 = \begin{pmatrix} 0 \\ 1 \\ x \end{pmatrix} \quad \text{and} \quad \widehat{X}_3 = 0.$$

It is what happens in some generic 3-dimensional cases (see for instance [10]). In this paper we are interested in the case where only one of the vector fields vanishes and the other ones are independent: then they define a left-invariant sub-Riemannian structure on a Lie group (or a homogeneous space).

Our aim consists in recovering the almost-Riemannian structure lost in the nilpotent approximation, thanks to a vector field, denoted \widetilde{X}_n which is the homogeneous component of degree 0 of the Taylor expansion in privileged coordinates of the vector field that vanishes. The new family of vector fields composed by the nilpotent approximation and \widetilde{X}_n is called the solvable approximation.

The Lie algebra generated by this new family of vector fields is finite dimensional and solvable. However, we are interested in some nilpotent Lie group on which \widetilde{X}_n acts as a linear vector field (these vector fields were generalized in [6]). Thanks to the equivalence theorem of [16] we know that the space \mathbb{R}^n is diffeomorphic to a homogeneous space. Through this diffeomorphism, the solvable approximation is equivalent to a simple ARS on a homogeneous space or a Lie group. It is important to notice that in the 3D-generic case the non-degenerated nilpotent approximation, and the solvable one in the degenerated case, are simple ARSs on Lie groups or homogeneous space (see Section 3.3).

On the other hand, the solvable approximation gives rise to a distance denoted by \widetilde{d} . This distance has the advantage to be really almost-Riemannian unlike the distance \widehat{d} associated to the nilpotent approximation in the degenerated cases. The distance \widetilde{d} is not homogeneous but always satisfies $\widetilde{d} \leq \widehat{d}$.

Denoting by d the distance associated to the original structure we show that in some 3D-generic cases the order of $|d - \widetilde{d}|$ is strictly better than the one of $|d - \widehat{d}|$. More accurately, the order of $|d - \widetilde{d}|$ is $d^{\frac{3}{2}}$ and the one of $|d - \widehat{d}|$ is d^2 in the cases we consider.

Moreover, the nilpotent distance \widehat{d} is left-invariant while d and \widetilde{d} are not. Using this fact we prove that for some pairs (q, q') of points translated from the singular locus the difference $|d(q, q') - \widetilde{d}(q, q')|$ is strictly smaller than $|\widehat{d}(q, q') - \widetilde{d}(q, q')|$.

The paper is organized as follows. Section 2 contains generalities about ARSs, nonholonomic order, privileged coordinates, the nilpotent approximation, linear vector fields and simple ARS on Lie groups or homogeneous spaces.

In Section 3 we introduce the definition of a solvable approximation, we analyze its algebraic structure and an example is detailed.

Section 4 is divided in two parts. In the first one, we state two propositions about the almost-Riemannian distance \widetilde{d} defined by the solvable approximation. The second part is devoted to analyze \widetilde{d} in the 3-dimensional generic case.

Finally, in Section 5 we provide the Hamiltonian associated to the flow defined by the solvable approximation in the 3D generic case and we compute the geodesics with initial condition $x(0) = y(0) = z(0) = 0$ and $p(0) = \cos(\theta)$, $q(0) = \sin(\theta)$, $r(0) = r$ in a particular case.

2 Preliminaries

In this section some definitions and results are reviewed and come from [4], [7] and [15].

2.1 Almost-Riemannian structures

An almost-Riemannian structure can always be locally defined by a set of n vector fields, where n is the dimension of the state space. Since we are interested in local questions, the following definition will be enough in this paper, and the reader is referred to [4], [5] and [15] for the global definition on manifolds.

We denote by $Lie(X_1, \dots, X_n)$ the Lie algebra generated by the vector fields X_1, \dots, X_n on \mathbb{R}^n .

Definition 1. *We say that the vector fields X_1, \dots, X_n satisfy the Lie algebra rank condition (Larc in short) on an open set Ω of \mathbb{R}^n if*

$$Lie(X_1, \dots, X_n)(p) = T_p\mathbb{R}^n,$$

for all $p \in \Omega$.

Definition 2. *The set $\{X_1, \dots, X_n\}$ defines an almost-Riemannian structure (ARS in short) on the open and connected subset Ω of \mathbb{R}^n if:*

- (i) *It satisfies Larc.*
- (ii) *The singular locus, that is $\mathcal{Z} = \{p \in \Omega / \text{rank}(X_1(p), X_2(p), \dots, X_n(p)) < n\}$ is non-empty, but with empty interior.*

The metric is defined by declaring the frame to be orthonormal.

Remark 1.

1. The structure is Riemannian out of \mathcal{Z} .

2. Let $v \in T_p\Omega$. If p is a Riemannian point then $v = \sum_{i=1}^n u_i X_i(p)$ in a unique way

and its length is $\|v\| = \left(\sum_{i=1}^n u_i^2 \right)^{\frac{1}{2}}$. If $p \in \mathcal{Z}$ then the decomposition of v , if

it exists, is not unique and $\|v\| = \inf \left\{ \left(\sum_{i=1}^n u_i^2 \right)^{\frac{1}{2}} : v = \sum_{i=1}^n u_i X_i(p) \right\}$.

An absolutely continuous curve $\gamma : [0, T] \rightarrow \mathbb{R}^n$ is admissible if there exists a measurable essentially bounded function $t \mapsto u(t)$ from $[0, T]$ into \mathbb{R}^n called control function such that $\dot{\gamma}(t) = u_1(t)X_1(\gamma(t)) + u_2(t)X_2(\gamma(t)) + \dots + u_n(t)X_n(\gamma(t))$ for almost every $t \in [0, T]$. Given an admissible curve $\gamma : [0, T] \rightarrow \mathbb{R}^n$, the length of γ is

$$l(\gamma) = \int_0^T \|\dot{\gamma}(t)\| dt.$$

The almost-Riemannian distance (or Carnot-Caratheodory distance) on Ω associated with the n -ARS is defined by

$$d(p_0, p_1) = \inf \{l(\gamma) : \gamma(0) = p_0, \gamma(T) = p_1, \gamma \text{ admissible}\}.$$

It induces the usual topology on Ω .

2.2 Nonholonomic orders

In what follows $\{X_1, X_2, \dots, X_n\}$ defines an ARS on $\Omega \subset \mathbb{R}^n$.

Definition 3. Let $f : M \rightarrow \mathbb{R}$ be a continuous function. The nonholonomic order of f at p , denoted $\text{ord}_p(f)$, is the real number defined by

$$\text{ord}_p(f) = \sup \{s \in \mathbb{R} : f(q) = O(d(p, q)^s)\}.$$

This order is always nonnegative.

Let $C^\infty(p)$ denote the set of germs of smooth functions at p . For $f \in C^\infty(p)$, we call nonholonomic derivative of order 1 of f the Lie derivatives $X_1 f, \dots, X_n f$. We call further $X_i X_j f, X_i X_j X_k f, \dots$, the nonholonomic derivatives of f of order 2, 3, ... of f . The nonholonomic derivative of order 0 of f at p is $f(p)$.

As a consequence, the nonholonomic order of a smooth (germ of) function is given by the formula

$$\text{ord}_p(f) = \min \{s \in \mathbb{N} : \exists i_1, \dots, i_s \in \{1, \dots, n\} \text{ s.t. } (X_{i_1} \dots X_{i_s} f)(p) \neq 0\},$$

where as usual we adopt the convention that $\min \emptyset = +\infty$.

Let $VF(p)$ denote the set of germs of smooth vector fields at p .

Definition 4. Let $X \in VF(p)$. The nonholonomic order of X at p , denoted by $\text{ord}_p(X)$, is the real number defined by:

$$\text{ord}_p(X) = \sup \{\sigma \in \mathbb{R} : \text{ord}_p(Xf) \geq \sigma + \text{ord}_p(f), \forall f \in C^\infty(p)\}.$$

2.3 Privileged coordinates

We adopt the notation of [15] to define privileged coordinates. Let $VF(\Omega)$ denote the set of smooth vector fields on Ω . We define $\Delta^1 = \text{span}\{X_1, \dots, X_n\}$. For $s \geq 1$, define $\Delta^{s+1} = \Delta^s + [\Delta^1, \Delta^s]$, where

$$[\Delta^1, \Delta^s] = \text{span}\{[X, Y] : X \in \Delta^1, Y \in \Delta^s\}.$$

For $p \in \Omega$, we set for $s \geq 1$, $\Delta^s(p) = \{X(p) : X \in \Delta^s\}$. By definition these sets are linear subspaces of $T_p\Omega$.

The evaluation of these sets at p forms a flag of subspaces of $T_p\Omega$, and since X_1, \dots, X_n satisfy Larc, we get,

$$\Delta^1(p) \subset \Delta^2(p) \subset \dots \subset \Delta^{r-1}(p) \subsetneq \Delta^r(p) = T_p\Omega, \quad (1)$$

where $r = r(p)$ is called the degree of nonholonomy at p . Let $n_i(p) = \dim \Delta^i(p)$. The r -tuple of integers $(n_1(p), \dots, n_r(p))$ is called the growth vector at p . The first integer in the growth vector is the rank $n_1(p) \leq n$ of the family $X_1(p), \dots, X_n(p)$, and the last one $n_r(p) = n$ is the dimension of \mathbb{R}^n .

Definition 5. *The point p is regular if the growth vector is constant in some neighborhood of p . Otherwise we say that p is a singular point.*

The structure of the flag (1) may also be described by another sequence of integers. We define the weights at p , $w_i = w_i(p)$, $i = 1, \dots, n$, by setting $w_j = s$ if $n_{s-1}(p) < j \leq n_s(p)$, where $n_0 = 0$. In other words, we have

$$w_1 = \dots = w_{n_1} = 1, w_{n_1+1} = \dots = w_{n_2} = 2, \dots, w_{n_{r-1}+1} = \dots = w_{n_r} = r.$$

Definition 6. *A system of privileged coordinates at p is a system of local coordinates (x_1, \dots, x_n) such that $\text{ord}_p(x_j) = w_j$, for $j = 1, \dots, n$.*

On the other hand, given a sequence of integers $\alpha = (\alpha_1, \dots, \alpha_n)$ we define the weight of the monomial $x^\alpha = x_1^{\alpha_1} \dots x_n^{\alpha_n}$ to be $w(\alpha) = w_1\alpha_1 + \dots + w_n\alpha_n$ and the weighted degree of the monomial vector field $x^\alpha \frac{\partial}{\partial x_j}$ to be $w(\alpha) - w_j$. The weighted degrees allow to compute the orders of functions and vector fields in a purely algebraic way.

Constructions of privileged coordinates can be found in [7] and [15].

Proposition 1 ([15], Proposition 2.2). *For a smooth function f with a Taylor expansion in privileged coordinates*

$$f(x) \sim \sum_{\alpha} c_{\alpha} x^{\alpha},$$

the order of f is the least weighted degree of monomials having a nonzero coefficient in the Taylor series.

For a vector field X with a Taylor expansion in privileged coordinates

$$X(x) \sim \sum_{\alpha, j} a_{\alpha, j} x^{\alpha} \frac{\partial}{\partial x_j},$$

the order of X is the least weighted degree of a monomial vector field having a nonzero coefficient in the Taylor series.

Remark 2. A vector field of degree $< -r$ vanishes.

The one-parameter family of dilations $\delta_\lambda : \mathbb{R}^n \rightarrow \mathbb{R}^n$ is defined by $\delta_\lambda(x) = (\lambda^{w_1}x_1, \lambda^{w_2}x_2, \dots, \lambda^{w_n}x_n)$, $\lambda \geq 0$. A dilation δ_λ acts also on functions and vector fields by pull-back: $\delta_\lambda^*f = f \circ \delta_\lambda$ and δ_λ^*X is the vector field such that $(\delta_\lambda^*X)(\delta_\lambda^*f) = \delta_\lambda^*(Xf)$. So we have the following definition.

Definition 7. A function f is homogeneous of degree s if $\delta_\lambda^*f = \lambda^s f$. A vector field X is homogeneous of degree s if $\delta_\lambda^*X = \lambda^s X$.

Proposition 2 ([7], Proposition 5.16). Let X and Y be vector fields on M . If X and Y are homogeneous of degree k and l respectively (in the chosen system of privileged coordinates) then $[X, Y]$ is homogeneous of degree $k + l$ or vanishes.

Definition 8. The function defined by $x \mapsto \|x\|_p = \sum_{i=1}^n |x_i|^{\frac{1}{w_i}}$ is the so-called pseudo-norm at p .

Remark 3. Let $x = (x_1, \dots, x_n)$ be a system of privileged coordinates defined on an open neighborhood U of the point p . When composed with the coordinate functions, the pseudo-norm at p is (non smooth) homogeneous of order 1, that is, $\|x(q)\|_p = O(d(p, q))$, where $x(q)$ are the coordinates of $q \in U$.

2.4 Nilpotent approximation

Fix a system of privileged coordinates (x_1, \dots, x_n) at p . Every vector field X_i is of order ≥ -1 , hence it has, in x coordinates, a Taylor expansion

$$X_i(x) \sim \sum_{\alpha, j} a_{\alpha, j} x^\alpha \frac{\partial}{\partial x_j},$$

where $w(\alpha) \geq w_j - 1$ if $a_{\alpha, j} \neq 0$. Grouping together the monomial vector fields of same weighted degree we express X_i as a series of homogeneous vector fields of the form

$$X_i = X_i^{(-1)} + X_i^{(0)} + X_i^{(1)} + X_i^{(2)} + \dots, \quad (2)$$

where $X_i^{(s)}$ has degree s . We set

$$\widehat{X}_i = X_i^{(-1)}, \quad i = 1, \dots, n.$$

Definition 9. The family of vector fields $(\widehat{X}_1, \dots, \widehat{X}_n)$ is called the nilpotent approximation of the system (X_1, \dots, X_n) at p .

Proposition 3 ([7], Proposition 5.17). The vector fields \widehat{X}_i , $i = 1, \dots, n$, generate a nilpotent Lie algebra $\text{Lie}(\widehat{X}_1, \dots, \widehat{X}_n)$ of step $r = w_n$. They satisfy Larc at every point $y \in \mathbb{R}^n$, and the distance \widehat{d} is finite for every $x, y \in \mathbb{R}^n$.

The following results are found in [7] and [15] and will be useful in this work.

Proposition 4 ([7] Proposition 7.25 and [15], Lemma 2.1). *There exist positive constants C, C' such that for all $q \in \mathbb{R}^n$ we have*

$$C\|q\|_p \leq \widehat{d}_p(p, q) \leq C'\|q\|_p.$$

Lemma 1 ([15], Lemma 2.2). *There exists constant C and $\varepsilon > 0$, such that, for any $z^0 \in \mathbb{R}^n$ and any $t \in \mathbb{R}^+$ satisfying $\tau = \max(\|z^0\|_p, t) < \varepsilon$, we have*

$$\|z(t) - \widehat{z}(t)\|_p \leq C\tau t^{\frac{1}{r}},$$

where $z(\cdot)$ and $\widehat{z}(\cdot)$ are trajectories of the nonholonomic systems defined respectively by X_1, \dots, X_n and $\widehat{X}_1, \dots, \widehat{X}_n$ starting at the same point z^0 , associated with the same control function $u(\cdot)$, and satisfying $\|u(t)\| = 1$ a.e.

To finish, we recall the very important Theorem 7.32 of [7] stated here with a slight modification.

Theorem 1 (Theorem 7.32 in [7]). *There exist constants $\varepsilon > 0$ and $C > 0$ such that for any $q, q' \in B(p, \varepsilon)$, we have*

$$-C\tau d(q, q')^{\frac{1}{r}} \leq d(q, q') - \widehat{d}(q, q') \leq C\widehat{\tau}\widehat{d}(q, q')^{\frac{1}{r}},$$

where τ is as in Lemma 1 and $\widehat{\tau}$ is similarly defined, this is $\tau = \max(\|q\|_p, d(q, q'))$ and $\widehat{\tau} = \max(\|q\|_p, \widehat{d}(q, q'))$.

2.5 Linear vector fields

The definition of linear vector fields comes from [6] and [16].

Let G be a connected Lie group and \mathfrak{g} its Lie algebra (the set of left-invariant vector fields, identified with the tangent space at the identity). The set of analytic vector fields on G is denoted by $V^\omega(G)$, and the normalizer of \mathfrak{g} in $V^\omega(G)$ is by definition

$$\mathcal{N} = \text{norm}_{V^\omega(G)}\mathfrak{g} = \{X \in V^\omega(G) : \forall Y \in \mathfrak{g} \quad [X, Y] \in \mathfrak{g}\}.$$

Definition 10. *A vector field \mathcal{X} on G is said to be linear or to be infinitesimal automorphism (see [13]), if \mathcal{X} belongs to \mathcal{N} and $\mathcal{X}(e) = 0$, where e is the identity of G .*

We can see in [16] that a vector field \mathcal{X} on G if and only its flow $(\phi_t)_{t \in \mathbb{R}}$ is a one-parameter group of automorphisms of G and a linear vector field is consequently analytic and complete.

2.5.1 Simple ARS's on Lie groups

Linear and invariant vector fields make it possible to define almost-Riemannian structures on Lie groups. The following definition is given in [5].

Definition 11. *A simple ARS is an ARS defined on a connected Lie group G by a set of n vector fields $\{\mathcal{X}, Y_1, \dots, Y_{n-1}\}$ where \mathcal{X} is linear, Y_1, \dots, Y_{n-1} are left-invariant, $\dim G = n$ and the rank of $\mathcal{X}, Y_1, \dots, Y_{n-1}$ is full on a non empty subset of G and the set $\{\mathcal{X}, Y_1, \dots, Y_{n-1}\}$ satisfies Larc.*

For instance, the famous Grushin plane on the Abelian Lie group \mathbb{R}^2 is a simple ARS. This structure was introduced in [5] and its isometries have been study in [17].

In Section 3.3 a 3-dimensional example will be provided.

2.5.2 Simple ARS's on homogeneous spaces

Consider a homogeneous space G/H of a connected and simply connected Lie group G by a closed subgroup H (the elements of G/H are right cosets of H because we deal with left-invariant vector fields). Since we are interested in simply connected quotients we assume H to be connected. Let \mathfrak{g} be the Lie algebra of G , identified with the space of left-invariant vector fields. The projection of such a vector field Y on G/H is well-defined, is referred to as a left-invariant vector field, and we can assume that it vanishes identically only if Y is the zero field (see details in [16]). On the other hand the projection of a linear field \mathcal{X} of G does exist on G/H if and only if H is invariant under its flow, or equivalently, because H is connected, if the Lie algebra of H is $\text{ad}(\mathcal{X})$ -invariant. This allows to define linear vector fields and simple ARS on G/H :

Let $Y_1, \dots, Y_{n-1}, \mathcal{X}$ be a set of $n = \dim(G/H)$ vectors fields on G/H , where Y_1, \dots, Y_{n-1} are invariant and \mathcal{X} is linear. It defines a simple ARS if

1. *They satisfy Larc.*
2. *The singular set \mathcal{Z} where their rank is less than n is proper with empty interior.*

In the sequel, we will need (a simplified version of) the equivalence Theorem (see [16] and [5]).

Theorem 2 (Equivalence Theorem). *Let f_1, \dots, f_n be a set of n complete vector fields on \mathbb{R}^n and let us assume:*

1. *f_1, \dots, f_n define an Almost-Riemannian Structure on \mathbb{R}^n ;*
2. *The Lie algebra \mathcal{L} generated by f_1, \dots, f_n is finite dimensional;*
3. *The ideal \mathfrak{g} generated in \mathcal{L} by f_1, \dots, f_{n-1} is nilpotent and of codimension 1 in \mathcal{L} .*

Then \mathbb{R}^n is diffeomorphic to a homogeneous space G/H of the nilpotent simply connected group G generated by \mathfrak{g} and f_1, \dots, f_n defines a simple ARS on G/H . More accurately the vector fields f_1, \dots, f_{n-1} are left-invariant and f_n is linear on this homogeneous space.

3 Solvable Approximation

In this section we introduce the solvable approximation of an ARS and we analyze its algebraic structure.

3.1 Definition

Let $\{X_1, \dots, X_n\}$ be a set of vector fields defining an almost-Riemannian structure on an open neighborhood of $0 \in \mathbb{R}^n$. The point $p = 0$ is assumed to belong to the singular locus, the natural coordinates of \mathbb{R}^n to be privileged and we consider the nilpotent approximation $\{\widehat{X}_1, \dots, \widehat{X}_n\}$ of $\{X_1, \dots, X_n\}$ at $p = 0$.

It may happen that some of the vector fields \widehat{X}_i vanish, possibly changing the almost-Riemannian structure defined by X_1, \dots, X_n into a constant rank sub-Riemannian one. It is what happens in some cases of generic 3-dimensional ARSs that are described in detail in Section 3.3. In what follows we are interested in the case where only one of the \widehat{X}_i 's vanishes, say $\widehat{X}_n = 0$, and the other ones are independent and define a left-invariant sub-Riemannian structure on a Lie group, or a homogeneous space, the underlying manifold of which is \mathbb{R}^n . Recall that each X_i can be expanded in a series of homogeneous vector fields in the system of privileged coordinates at $p = 0$, this is

$$X_i = X_i^{(-1)} + X_i^{(0)} + X_i^{(1)} + \dots, \quad \forall i \in \{1, \dots, n\},$$

where $X_i^{(k)}$ is the homogeneous component of degree k . Denoting $\widetilde{X}_n = X_n^{(0)}$, we introduce the following definition:

Definition 12 (Solvable approximation). *The family $\{\widehat{X}_1, \dots, \widehat{X}_{n-1}, \widetilde{X}_n\}$ is the solvable approximation of $\{X_1, \dots, X_n\}$.*

Proposition 5. $\mathcal{L} = \text{Lie}(\widehat{X}_1, \dots, \widehat{X}_{n-1}, \widetilde{X}_n)$ is a finite dimensional solvable Lie algebra. Its step of solvability is less than or equal to $\log_2(r) + 1$, where r is the degree of nonholonomy at $p = 0$.

Proof. Let $\mathcal{D}^k \mathcal{L}$ stand for the k^{th} derived algebra of \mathcal{L} , with $\mathcal{L} = \mathcal{D}^0 \mathcal{L}$. According to Proposition 2 and Remark 2 the algebra \mathcal{L} is generated by homogeneous vector fields of degree $0, -1, \dots, -r$ because the \widehat{X}_i 's are homogeneous of degree -1 , for $i = 1, \dots, n-1$, and \widetilde{X}_n is homogeneous of degree 0 . According to Proposition 2 again $\mathcal{D}^1 \mathcal{L}$ is generated by homogeneous vector fields of degree $-1, \dots, -r$. More generality $\mathcal{D}^s \mathcal{L}$ is generated by homogeneous vector fields of degree $-2^{s-1}, -2^s, \dots, -r$, so that $\mathcal{D}^s \mathcal{L} = 0$ if $2^s > r$. Therefore \mathcal{L} is solvable and the step of solvability σ of \mathcal{L} satisfies $\sigma \leq \log_2(r) + 1$. On the other hand, the Lie algebra \mathcal{L} splits into homogeneous components

$$\mathcal{L} = \mathcal{L}^0 \oplus \mathcal{L}^{-1} \oplus \mathcal{L}^{-2} \oplus \dots \oplus \mathcal{L}^{-r},$$

where \mathcal{L}^{-s} is the set of homogeneous vector fields of degree $-s$ under the action of δ_λ . A homogeneous vector field X of degree $w \in \{0, -1, -2, \dots, -r\}$ writes in coordinates $X(x) = \sum_{i=1}^n f_i(x) \frac{\partial}{\partial x_i}$, where $f_i(x)$ is a homogeneous polynomial function of degree $w + \text{ord}(x_i)$. Since the space of polynomials of degree $w + \text{ord}(x_i)$ is finite dimensional, \mathcal{L}^{-w} is finite dimensional. Therefore \mathcal{L} is finite dimensional. \square

Remark 4. *It is clear that the families of vector fields $\{\widehat{X}_1, \dots, \widehat{X}_{n-1}, \widetilde{X}_n\}$ and $\{X_1, \dots, X_n\}$ have the same nilpotent approximation. Consequently the family of vector fields $\{\widehat{X}_1, \dots, \widehat{X}_{n-1}, \widetilde{X}_n\}$ satisfies Larc on \mathbb{R}^n and the growth vector at 0 of $\{\widehat{X}_1, \dots, \widehat{X}_{n-1}, \widetilde{X}_n\}$ is equal to the one of $\{X_1, \dots, X_n\}$.*

3.2 Structure of the approximating system

Fundamental remark. *Despite the previous result we are not interested in the solvable Lie group associated to the Lie algebra $\text{Lie}\{\widehat{X}_1, \dots, \widehat{X}_{n-1}, \widetilde{X}_n\}$ but in some nilpotent Lie group on which \widetilde{X}_n acts as a linear vector field.*

For this reason we denote by \mathfrak{h} the Lie algebra generated by $\widehat{X}_1, \dots, \widehat{X}_{n-1}$ and by \mathfrak{g} the ideal generated by \mathfrak{h} in $\mathcal{L} = \text{Lie}\{\widehat{X}_1, \dots, \widehat{X}_{n-1}, \widetilde{X}_n\}$.

Proposition 6. *The ideal \mathfrak{g} is the space of vector fields of \mathcal{L} whose nonholonomic order is negative. It is a nilpotent Lie algebra and*

$$\mathcal{L} = \mathfrak{g} \oplus \mathbb{R}\widetilde{X}_n.$$

Moreover $D = -\text{ad}(\widetilde{X}_n)$ is a derivation of \mathfrak{g} .

Proof. Since \mathfrak{g} is the ideal generated by \mathfrak{h} in \mathcal{L} , we have $\mathcal{L} = \mathbb{R}\widetilde{X}_n \oplus \mathfrak{g}$ and $\text{ad}(\widetilde{X}_n)$ is a derivation of \mathfrak{g} . \square

Let G be the simply connected Lie group whose Lie algebra is isomorphic to \mathfrak{g} . According to [16] there exists a linear vector field on G associated to the derivation $D = -\text{ad}(\widetilde{X}_n)$. With a clear abuse of notation we will denote it by \widetilde{X}_n . Thanks to the equivalence theorem we have the following:

Theorem 3. *The space \mathbb{R}^n is diffeomorphic to a homogeneous space G/G_0 of G . Through this diffeomorphism $\{\widehat{X}_1, \dots, \widehat{X}_{n-1}, \widetilde{X}_n\}$ is equivalent to a simple ARS on G/G_0 , and the Lie algebra \mathfrak{g}_0 of G_0 is isomorphic to the set of vector fields of \mathfrak{g} that vanish at 0.*

Proof. First of all, notice that the vector fields $\{\widehat{X}_1, \dots, \widehat{X}_{n-1}, \widetilde{X}_n\}$ are complete from their triangular form, namely, in the equation $\dot{x} = \sum_{i=1}^n u_i \widehat{X}_i(x) + u_n \widetilde{X}_n(x)$, \dot{x}_j is linear with respect to the coordinates of weight w_j and polynomial with respect to coordinates of weight $< w_j$ (see [7] or [15] for details). They define an ARS, hence in particular satisfy Larc and generate a finite dimensional Lie algebra (Proposition 5). According to Theorem 2 \mathbb{R}^n is diffeomorphic to a homogeneous space G/G_0 of G , where G_0 is the connected subgroup of G whose Lie algebra is, after identification of $L(G)$ with \mathfrak{g} , the set of elements of \mathfrak{g} that vanish at 0. Thanks to the diffeomorphism between \mathbb{R}^n and G/G_0 the system $\{\widehat{X}_1, \dots, \widehat{X}_{n-1}, \widetilde{X}_n\}$ can be identified to a simple ARS on G/G_0 . \square

We are also interested in conditions for which $G = \mathbb{R}^n$.

Theorem 4. *With the previous notations the following assertions are equivalent:*

- (i) $ad(\tilde{X}_n) \cdot \hat{X}_i$ belongs to $Span\{\hat{X}_1, \dots, \hat{X}_{n-1}\}$ for $i = 1, \dots, n-1$;
- (ii) \mathfrak{h} is $ad(\tilde{X}_n)$ -invariant;
- (iii) $\mathfrak{h} = \mathfrak{g}$.

Under these conditions \tilde{X}_n is a linear vector field on $\exp(\mathfrak{h})$.

Proof.

(i) \Rightarrow (ii) It is an immediate consequence of the Jacobi identity.

(ii) \Rightarrow (iii) Condition (ii) implies $\mathcal{L} = \mathfrak{h} \oplus \mathbb{R}\tilde{X}_n$, hence $\mathfrak{h} = \mathfrak{g}$.

(iii) \Rightarrow (i) Condition (iii) implies that \mathfrak{h} is $ad(\tilde{X}_n)$ -invariant. According to Proposition 2 the set of elements of \mathfrak{h} of order -1 is $Span\{\hat{X}_1, \dots, \hat{X}_{n-1}\}$. For $i = 1, \dots, n-1$ the bracket $[\hat{X}_i, \tilde{X}_n]$ belongs to \mathfrak{h} , since $\mathfrak{h} = \mathfrak{g}$, and is of order -1 or is equal to 0. Therefore it belongs to $Span\{\hat{X}_1, \dots, \hat{X}_{n-1}\}$.

□

3.3 Example. The 3D-generic case

The local representation of a generic ARS in dimension 3 is detailed in Section 4.2. Its nilpotent approximation at a point of the singular locus is the following:

$$\hat{X}_1 = \begin{pmatrix} 1 \\ 0 \\ 0 \end{pmatrix}, \quad \hat{X}_2 = \begin{pmatrix} 0 \\ 1 \\ x \cos \sigma \end{pmatrix}, \quad \hat{X}_3 = \begin{pmatrix} 0 \\ 0 \\ x \sin \sigma \end{pmatrix}, \quad \text{where } \sigma \in \left[0, \frac{\pi}{2}\right].$$

There are two particular cases, according to the value of the parameter σ . The first one for $\sigma = \frac{\pi}{2}$, because the bracket of \hat{X}_1 and \hat{X}_2 vanishes, and the second one for $\sigma = 0$, because \hat{X}_3 vanishes, it is the tangent case.

More accurately the Lie brackets are:

$$[\hat{X}_1, \hat{X}_2] = \begin{pmatrix} 0 \\ 0 \\ \cos \sigma \end{pmatrix}, \quad [\hat{X}_1, \hat{X}_3] = \begin{pmatrix} 0 \\ 0 \\ \sin \sigma \end{pmatrix}, \quad [\hat{X}_2, \hat{X}_3] = 0.$$

The analysis of the different cases is as follows:

1. **General case** $\sigma \in]0, \frac{\pi}{2}[$.

We can set $Z = \begin{pmatrix} 0 \\ 0 \\ \cos \sigma \end{pmatrix}$ so that $[\widehat{X}_1, \widehat{X}_2] = Z$ and $(\widehat{X}_1, \widehat{X}_2, Z)$ is the Heisenberg Lie algebra. Since \widehat{X}_3 vanishes at $(0, 0, 0)$ and since its Lie brackets with $\widehat{X}_1, \widehat{X}_2$ and Z are

$$[\widehat{X}_1, \widehat{X}_3] = \tan(\sigma)Z \quad \text{and} \quad [\widehat{X}_2, \widehat{X}_3] = [Z, \widehat{X}_3] = 0,$$

it is a linear vector field on the Heisenberg group, the associated derivation of which is

$$D = \begin{pmatrix} 0 & 0 & 0 \\ 0 & 0 & 0 \\ \tan \sigma & 0 & 0 \end{pmatrix}.$$

The conclusion is that $(\widehat{X}_1, \widehat{X}_2, \widehat{X}_3)$ defines a simple ARS on the 3D Heisenberg group.

2. **Particular case** $\sigma = \frac{\pi}{2}$. Then

$$\widehat{X}_1 = \begin{pmatrix} 1 \\ 0 \\ 0 \end{pmatrix}, \quad \widehat{X}_2 = \begin{pmatrix} 0 \\ 1 \\ 0 \end{pmatrix}, \quad \widehat{X}_3 = \begin{pmatrix} 0 \\ 0 \\ x \end{pmatrix}.$$

It is a simple ARS on the Abelian Lie group \mathbb{R}^3 . Indeed \widehat{X}_1 and \widehat{X}_2 are (left and right) invariant and \widehat{X}_3 is linear.

3. **Tangent case** $\sigma = 0$. Here the nilpotent approximation degenerates into the following sub-Riemannian structure on the Heisenberg group

$$\widehat{X}_1 = \begin{pmatrix} 1 \\ 0 \\ 0 \end{pmatrix}, \quad \widehat{X}_2 = \begin{pmatrix} 0 \\ 1 \\ x \end{pmatrix}, \quad \widehat{X}_3 = \begin{pmatrix} 0 \\ 0 \\ 0 \end{pmatrix}.$$

However we will see after the next remark that in case where the component \widetilde{X}_3 of order 0 of the vector field X_3 does not vanish then $(\widehat{X}_1, \widehat{X}_2, \widetilde{X}_3)$ defines a simple ARS on a homogeneous space.

Remark 5. *In the cases $\sigma = \frac{\pi}{2}$ and $\sigma \in]0, \frac{\pi}{2}[$ the Lie algebra generated by $\widehat{X}_1, \widehat{X}_2, \widehat{X}_3$ is 4-dimensional and two points of view are possible. The usual one consists in considering \mathbb{R}^3 as a homogeneous space of a nilpotent 4-dimensional Lie group. Our point of view is to consider \widehat{X}_3 as a linear vector field on the 3-dimensional Lie group \mathbb{R}^3 endowed with the Abelian structure if $\sigma = \frac{\pi}{2}$ and the Heisenberg one if $\sigma \in]0, \frac{\pi}{2}[$.*

Following this way we will consider the solvable approximation whenever $\sigma = 0$, and finally all approximations of generic 3D-ARS will appear as being simple ARS.

The solvable approximation of the tangent case $\sigma = 0$.

The homogeneous component of nonholonomic order 0 of X_3 is

$$\tilde{X}_3 = \begin{pmatrix} 0 \\ 0 \\ az + bx^2 + cy^2 \end{pmatrix} = (az + bx^2 + cy^2) \frac{\partial}{\partial z} \quad (\text{See Section 4.2 again}).$$

As well as in the general case the Lie algebra generated by \hat{X}_1 and \hat{X}_2 is:

$$\mathfrak{h} = \text{Span} \left\{ \hat{X}_1, \hat{X}_2, Z = [\hat{X}_1, \hat{X}_2] \right\} \quad \text{where} \quad Z = \begin{pmatrix} 0 \\ 0 \\ 1 \end{pmatrix} = \frac{\partial}{\partial z},$$

that is the Heisenberg algebra. On the other hand the algebra generated by \hat{X}_1 , \hat{X}_2 and \tilde{X}_3 is $\text{Span} \left\{ \hat{X}_1, \hat{X}_2, Z, [\hat{X}_1, \tilde{X}_3], [\hat{X}_2, \tilde{X}_3], \tilde{X}_3 \right\}$, where:

$$[\hat{X}_1, \tilde{X}_3] = \begin{pmatrix} 0 \\ 0 \\ 2bx \end{pmatrix} = 2bx \frac{\partial}{\partial z} \quad \text{and} \quad [\hat{X}_2, \tilde{X}_3] = \begin{pmatrix} 0 \\ 0 \\ 2cy + ax \end{pmatrix} = (2cy + ax) \frac{\partial}{\partial z},$$

and the ideal generated by \hat{X}_1 and \hat{X}_2 is:

$$\mathfrak{g} = \text{Span} \left\{ \frac{\partial}{\partial x}, \frac{\partial}{\partial y} + x \frac{\partial}{\partial z}, 2bx \frac{\partial}{\partial z}, 2cy \frac{\partial}{\partial z} + ax \frac{\partial}{\partial z}, \frac{\partial}{\partial z} \right\}.$$

A straightforward computation shows that \tilde{X}_3 acts as a derivation on \mathfrak{g} . If we assume $b \neq 0$ and $c \neq 0$ then we have also:

$$\mathfrak{g} = \text{Span} \left\{ \frac{\partial}{\partial x}, x \frac{\partial}{\partial z}, \frac{\partial}{\partial y}, y \frac{\partial}{\partial z}, \frac{\partial}{\partial z} \right\}.$$

This is the 5-dimensional Heisenberg Lie algebra \mathfrak{h}^2 and in this basis the derivation $D = -\text{ad}(\tilde{X}_3)$ is given by the following matrix:

$$D = \begin{pmatrix} 0 & 0 & & & \\ 2b & a & & & \\ & & 0 & 0 & \\ & & 2c & a & \\ & & & & a \end{pmatrix}.$$

Finally the solvable approximation $(\hat{X}_1, \hat{X}_2, \tilde{X}_3)$ is a simple ARS on \mathbb{R}^3 diffeomorphic to a quotient of the 5-dimensional group Heisenberg \mathbb{H}^2 .

4 Distances

We can distinguish three different families of vector fields from the above section: $\{X_1, X_2, \dots, X_n\}$, $\{\hat{X}_1, \dots, \hat{X}_{n-1}\}$ and $\{\hat{X}_1, \dots, \hat{X}_{n-1}, \tilde{X}_n\}$ which satisfy Larc. Assuming orthonormality, they define three different distances: d , \hat{d} and \tilde{d} respectively,

where \tilde{d} and \hat{d} are defined on \mathbb{R}^n . This section is divided in two parts. In the first one, we give two propositions about the almost-Riemannian distance \tilde{d} defined by the solvable approximation. The second part is devoted to analyze \tilde{d} in the 3-dimensional generic case.

4.1 The almost-Riemannian distance \tilde{d}

The following proposition establishes a relation between \tilde{d} and \hat{d} . It is important because it allows us to find an upper bound for \tilde{d} (see Section 4.2.2) and to compare the distances of the solvable and nilpotent approximation.

Proposition 7. *For all $x, y \in \mathbb{R}^n$, $\tilde{d}(x, y) \leq \hat{d}(x, y)$.*

Proof. Let $x, y \in \mathbb{R}^n$ and let γ be a minimizing geodesic for $\dot{x} = \sum_{i=1}^{n-1} u_i \hat{X}_i$, such that $\gamma(0) = x$, $\gamma(T) = y$. Setting $u_n = 0$ the curve γ is admissible for $\dot{x} = \sum_{i=1}^{n-1} u_i \hat{X}_i + u_n \tilde{X}_n$. Since $u_n = 0$ the length of γ is the same for both metrics, hence $\tilde{d}(x, y) \leq l(\gamma) = \hat{d}(x, y)$. \square

Let δ_λ be the dilation related to the privileged coordinates and the weights at $p = 0$. We know that the distance \hat{d} is homogeneous of degree 1 with respect to δ_λ (see [15]). However \tilde{d} does not possess this property. This is due to the fact that \tilde{X}_n and the \hat{X}_i 's do not have the same degree of homogeneity.

Proposition 8. *The almost-Riemannian distance \tilde{d} is not homogeneous.*

Proof. Let γ be an admissible curve for \tilde{d} , that is

$$\dot{\gamma}(t) = \sum_{i=1}^{n-1} u_i \hat{X}_i(\gamma(t)) + u_n \tilde{X}_n(\gamma(t)). \quad (3)$$

Since \hat{X}_i and \tilde{X}_n are homogeneous of degree -1 and 0 respectively and the pullback by δ_λ of a vector field X (see [1]) is defined by

$$d\delta_\lambda(q) (\delta_\lambda^* X(q)) = X(\delta_\lambda(q)), \quad (4)$$

we get

$$\begin{aligned} d\delta_\lambda(q) \cdot \hat{X}_i(q) &= d\delta_\lambda(q) \cdot \lambda \cdot \delta_\lambda^* \hat{X}_i(q) = \lambda \hat{X}_i(\delta_\lambda(q)) \quad \text{and} \\ d\delta_\lambda(q) \cdot \tilde{X}_n(q) &= d\delta_\lambda(q) \cdot \delta_\lambda^* \tilde{X}_n(q) = \tilde{X}_n(\delta_\lambda(q)). \end{aligned} \quad (5)$$

Therefore

$$\begin{aligned} \frac{d}{dt} (\delta_\lambda \circ \gamma)(t) &= d\delta_\lambda(\gamma(t)) \cdot \dot{\gamma}(t) \\ &= \sum_{i=1}^{n-1} u_i d\delta_\lambda(\gamma(t)) \cdot \hat{X}_i(\gamma(t)) + u_n d\delta_\lambda(\gamma(t)) \cdot \tilde{X}_n(\gamma(t)) \\ &= \sum_{i=1}^{n-1} \lambda u_i \hat{X}_i(\delta_\lambda(\gamma(t))) + u_n \tilde{X}_n(\delta_\lambda(\gamma(t))). \end{aligned}$$

This implies that $l(\delta_\lambda \gamma) \neq \lambda l(\gamma)$, except if $u_n(t)$ vanishes a.e. This proves the non homogeneity of \tilde{d} . \square

4.2 The 3D-tangential case

In Section 3, we have established a model to locally approximate an n -ARS whose nilpotent approximation is a constant rank sub-Riemannian structure, by a solvable approximation. In this context we want to determine conditions for $|d - \tilde{d}|$ to be smaller than $|d - \hat{d}|$.

Recall that $\Delta(p) = \text{span}\{X_1(p), \dots, X_n(p)\}$ and the singular locus \mathcal{Z} is the set of points of \mathbb{R}^n where the rank of the linear span of the vector fields is less than n . From [10] we take the following.

Proposition 9. *Consider a 3-ARS. The following conditions are generic for 3-ARSs*

(G1) $\dim(\Delta(p)) \geq 2$ and $\Delta(p) + [\Delta(p), \Delta(p)] = T_p M$ for every $p \in M$;

(G2) \mathcal{Z} is an embedded (possibly empty) two-dimensional submanifold of M ;

(G3) the points where $\Delta(p) = T_p \mathcal{Z}$ are isolated.

Proposition 10. *Under the previous conditions there are three types of points:*

1. *Riemannian points where $\Delta(p) = T_p M$.*
2. *type-1 points where $\Delta(p)$ has dimension 2 and is transversal to \mathcal{Z} .*
3. *type-2 points where $\Delta(p)$ has dimension 2 and is tangent to \mathcal{Z} .*

Moreover type-2 points are isolated, type-1 points form a 2 dimensional manifold and all other points are Riemannian.

The local representation of the 3-dimensional ARS at type-2 points is given by the vector fields

$$X_1 = \begin{pmatrix} 1 \\ 0 \\ 0 \end{pmatrix}, \quad X_2 = \begin{pmatrix} 0 \\ 1 + \delta(x, y, z) \\ x(1 + \theta(x, y, z)) \end{pmatrix}, \quad X_3 = \begin{pmatrix} 0 \\ 0 \\ az + bx^2 + cy^2 + o(x^2 + y^2 + |z|) \end{pmatrix},$$

where δ and θ are smooth functions of order greater than or equal to 1 and a, b, c are not all zero. Furthermore, from Subsection 3.3, the nilpotent approximation in privileged coordinates is

$$\hat{X}_1 = X_1 = \begin{pmatrix} 1 \\ 0 \\ 0 \end{pmatrix}, \quad \hat{X}_2 = \begin{pmatrix} 0 \\ 1 \\ x \end{pmatrix}, \quad \hat{X}_3 = 0.$$

and

$$\tilde{X}_3 = \begin{pmatrix} 0 \\ 0 \\ az + bx^2 + cy^2 \end{pmatrix}.$$

$(\hat{X}_1, \hat{X}_2, \tilde{X}_3)$ is the solvable approximation at $p = 0$ in case when 0 is a tangential (type-2) point.

4.2.1 Divergence of curves

Let $p = 0$ be a type-2 point such that the coordinates centered at p are privileged and q, q' belonging to the ball centered at p and radius ϵ , denoted by $B(p, \epsilon)$.

In this subsection we analyze the divergence of curves respectively admissible for d and \tilde{d} , defined by the same control functions and starting at the same point q . More accurately: let γ be the geodesic for d such that $\gamma(0) = q$, $\gamma(T) = q'$ with $u_1^2 + u_2^2 + u_3^2 = 1$ and let $\tilde{\gamma}$ be the admissible curve for \tilde{d} defined by the same control functions as γ with $\tilde{\gamma}(0) = q$. We have the following:

$$\begin{aligned} \dot{\gamma}(t) - \dot{\tilde{\gamma}}(t) &= u_1 \left(X_1(\gamma) - \hat{X}_1(\tilde{\gamma}) \right) + u_2 \left(X_2(\gamma) - \hat{X}_2(\tilde{\gamma}) \right) + u_3 \left(X_3(\gamma) - \hat{X}_3(\tilde{\gamma}) \right) \\ \begin{pmatrix} \dot{x}(t) - \dot{\tilde{x}}(t) \\ \dot{y}(t) - \dot{\tilde{y}}(t) \\ \dot{z}(t) - \dot{\tilde{z}}(t) \end{pmatrix} &= \begin{pmatrix} 0 \\ u_2 \delta(x, y, z) \\ u_2 x \theta(x, y, z) + u_3 (a(z - \tilde{z}) + b(x^2 - \tilde{x}^2) + c(y^2 - \tilde{y}^2) + o(x^2 + y^2 + |z|)) \end{pmatrix} \end{aligned}$$

We have successively:

- $\dot{x}(t) = \dot{\tilde{x}}(t)$, hence $x(t) = \tilde{x}(t)$.
- $\dot{y}(t) - \dot{\tilde{y}}(t) = u_2 \delta(x, y, z)$, hence $y(t) - \tilde{y}(t) = \int_0^t u_2(s) \delta(x, y, z) ds$.

We denote by $\rho \geq 1$ the order of δ . Then $|\delta(x, y, z)| \leq \text{Cst} \cdot \|\gamma(s)\|_p^\rho \leq \text{Cst} \cdot \tau^\rho$ because $\|\gamma(s)\|_p \leq \text{Cst} \cdot \tau$, where $\tau = \max(\|q\|_p, t)$ (the proof of the above inequality is given in the proof of Lemma 1 of [15]), hence

$$|y(t) - \tilde{y}(t)| \leq \int_0^t \text{Cst} \cdot \|\gamma(s)\|_p^\rho ds \leq \int_0^t \text{Cst} \cdot \tau^\rho ds = \text{Cst} \cdot \tau^\rho \cdot t. \quad (6)$$

- $\dot{z}(t) - \dot{\tilde{z}}(t) = u_2 x \theta(x, y, z) + u_3 (a(z - \tilde{z}) + c(y^2 - \tilde{y}^2) + o(x^2 + y^2 + |z|))$, hence $z(t) - \tilde{z}(t) = \int_0^t u_2(s) x \theta(x, y, z) ds + \int_0^t u_3(s) a(z - \tilde{z}) ds + \int_0^t u_3(s) c (y^2 - \tilde{y}^2) ds + \int_0^t u_3(s) o(x^2 + y^2 + |z|) ds$.

Since (x, y, z) are privileged coordinates at 0, then $x^2 + y^2 + |z| \leq C \cdot d(0, (x, y, z))^2$. Moreover, if $f((x, y, z)) = o(x^2 + y^2 + |z|)$, then $f((x, y, z)) = o(d(0, (x, y, z))^2)$. This implies that $\text{ord}_p(f) > 2$, hence $f(\gamma(t)) = O(d(0, \gamma(t))^3)$. Therefore $|f(\gamma(t))| \leq \text{Cst} \cdot \tau^3$. On the other hand, let us denote by $m \geq 1$ the order of θ . Then $|x \cdot \theta(x, y, z)| \leq \text{Cst} \cdot \tau \cdot \|\gamma(s)\|_p^m \leq \text{Cst} \cdot \tau^{m+1}$ because $\dot{x} = u_1$, hence $|x| \leq \text{Cst} \cdot t + \|q\|_p \leq \text{Cst} \cdot \tau$. Also notice

$$|y^2 - \tilde{y}^2| = |y + \tilde{y}| |y - \tilde{y}| \leq \text{Cst} \cdot \tau^\rho \cdot t \cdot \tau = \text{Cst} \cdot t \cdot \tau^{\rho+1},$$

because $\dot{y} = u_2(1 + \delta(x, y, z))$, hence $|y| \leq \text{Cst} \cdot t + \|q\|_p \leq \text{Cst} \cdot \tau$. Similarly for \tilde{y} .

Then

$$\begin{aligned} |z(t) - \tilde{z}(t)| &\leq \text{Cst} \cdot t \cdot \tau^{m+1} + \text{Cst} \cdot t^2 \cdot \tau^{\rho+1} + \text{Cst} \cdot t \cdot \tau^3 + \int_0^t |a||z - \tilde{z}| ds \\ |z(t) - \tilde{z}(t)| &\leq \text{Cst} \cdot (t \cdot \tau^{m+1} + t^2 \cdot \tau^{\rho+1} + t \cdot \tau^3) e^{|a|t} \\ |z(t) - \tilde{z}(t)| &\leq \text{Cst} \cdot t \cdot \tau^{\min(m+1, \rho+1, 3)}. \end{aligned} \quad (7)$$

Finally,

$$\begin{aligned}
\|\gamma(t) - \tilde{\gamma}(t)\|_p &= |x(t) - \tilde{x}(t)| + |y(t) - \tilde{y}(t)| + |z(t) - \tilde{z}(t)|^{\frac{1}{2}} \\
&\leq \text{Cst} \left(t \cdot \tau^\rho + t^{\frac{1}{2}} \cdot \tau^{\frac{\min(m+1, \rho+1, 3)}{2}} \right) \\
&\leq \text{Cst} \cdot t^{\frac{1}{2}} \cdot \tau^{\frac{\min(m+1, \rho+1, 3)}{2}}.
\end{aligned} \tag{8}$$

Remark 6. *The order of $\delta(x, y, z)$ does not change the inequality*

$$\|\gamma(t) - \hat{\gamma}(t)\|_p \leq \text{Cst} \cdot \tau \cdot t^{\frac{1}{2}},$$

that comes from Lemma 1. Indeed,

$$\|\gamma(t) - \hat{\gamma}(t)\|_p \leq \text{Cst} \left(t \cdot \tau^\rho + t^{\frac{1}{2}} \cdot \tau \right) \leq \text{Cst} \cdot t^{\frac{1}{2}} \cdot \tau.$$

4.2.2 Upper bounds

In order to state our main result in the next section, we need upper bounds for the distances d and \tilde{d} .

We know that the distance \hat{d} is left-invariant, this is to say, $\hat{d}(q, q') = \hat{d}(a \cdot q, a \cdot q')$, for all $a \in \mathbb{R}^3$. Here \cdot stands for the Heisenberg product defined by

$$(x, y, z) \cdot (x', y', z') = (x + x', y + y', z + z' + xy'). \tag{9}$$

Recall also that $\tilde{d}(q, q') \leq \hat{d}(q, q')$. Considering the above, we have

$$\tilde{d}(q, q') \leq \hat{d}(q, q') = \hat{d}(0, q^{-1}q') \leq C\|q^{-1}q'\|_p. \tag{10}$$

Considering $q = (x, y, z)$ and $q' = (x', y', z')$ and from (10) and (9) we have

$$\begin{aligned}
\tilde{d}(q, q') &\leq C\|q^{-1} \cdot q'\|_p = C \left(|x' - x| + |y' - y| + |z' - z + x(y - y')|^{\frac{1}{2}} \right) \\
&\leq C \left(|x - x'| + |y - y'| + |z - z'|^{\frac{1}{2}} + |x(y - y')|^{\frac{1}{2}} \right) \\
&\leq C \left(\|q - q'\|_p + \|q\|_p^{\frac{1}{2}} |y - y'|^{\frac{1}{2}} \right).
\end{aligned} \tag{11}$$

4.2.3 Upper bound for d

From Theorems 7.31 and 7.26 of [7] we get

$$d(q, q') \leq \text{Cst} \sum_{k, j | w_k \leq w_j} \|q\|_p^{1 - \frac{w_k}{w_j}} |q_k - q'_k|^{\frac{1}{w_j}}, \tag{12}$$

Since $w_1 = w_2 = 1$ and $w_3 = 2$ we obtain that

$$d(q, q') \leq \text{Cst} \left(\|q - q'\|_p + \|q\|_p^{\frac{1}{2}} \left(|y - y_2|^{\frac{1}{2}} + |x - x_2|^{\frac{1}{2}} \right) \right). \tag{13}$$

4.2.4 Main result

We have seen that the order of δ does not change the estimation of $\|\gamma(t) - \widehat{\gamma}(t)\|_p$ according to Lemma 1, moreover, it does not change the estimates of \widehat{d} as well, this is to say, $\widehat{d}(\gamma(t), \widehat{\gamma}(t)) \leq \text{Cst} \cdot t^{\frac{1}{2}} \cdot \tau$. Indeed, from inequality (10) and Remark 6, we get

$$\widehat{d}(\gamma(t), \widehat{\gamma}(t)) \leq \text{Cst} \left(t^{\frac{1}{2}} \cdot \tau + t \cdot \tau^{\frac{1}{2} + \rho} \right),$$

then $\widehat{d}(\gamma(t), \widehat{\gamma}(t)) \leq \text{Cst} \cdot t^{\frac{1}{2}} \cdot \tau$. However, the above is not true when we want to estimate \widetilde{d} , because the estimates depend of ρ and m . Indeed, from inequalities (8) and (11) we get

$$\widetilde{d}(\gamma(t), \widetilde{\gamma}(t)) \leq \text{Cst} \cdot \left(t^{\frac{1}{2}} \cdot \tau^{\frac{\min(m+1, \rho+1, 3)}{2}} + t^{\frac{1}{2}} \cdot t^{\frac{1}{2}} \cdot \tau^{\frac{\rho}{2}} \right) \leq \text{Cst} \cdot t^{\frac{1}{2}} \cdot \tau^{\frac{\min(m+1, \rho+1, 3)}{2}}.$$

Therefore, we can conclude that if $\rho \geq 2$ and $m \geq 2$ then

$$\widetilde{d}(\gamma(t), \widetilde{\gamma}(t)) \leq \text{Cst} \cdot t^{\frac{1}{2}} \cdot \tau^{\frac{3}{2}}.$$

Finally, we obtain:

Proposition 11. *If $\text{ord}_p(\delta) \geq 2$ and $\text{ord}_p(\theta) \geq 2$, then*

1. $\widetilde{d}(\gamma(t), \widetilde{\gamma}(t)) \leq \text{Cst} \cdot t^{\frac{1}{2}} \cdot \tau^{\frac{3}{2}}$.
2. $d(\gamma(t), \widetilde{\gamma}(t)) \leq \text{Cst} \cdot t^{\frac{1}{2}} \cdot \tau^{\frac{3}{2}}$.

Proof. The proof of item 2 follows from inequalities (8) and (13). \square

Theorem 5. *If $m \geq 2$ and $\rho \geq 2$, then there exists constants C and $\epsilon > 0$, such that, for all $q, q' \in B(p, \epsilon)$, we have*

$$-C\tau^{\frac{3}{2}}d(q, q')^{\frac{1}{2}} \leq d(q, q') - \widetilde{d}(q, q') \leq C \cdot \widetilde{\tau}^{\frac{3}{2}}\widetilde{d}(q, q')^{\frac{1}{2}}, \quad (14)$$

where

$$\begin{aligned} \tau &= \max(\|q\|_p, d(q, q')) \\ \widetilde{\tau} &= \max(\|q\|_p, \widetilde{d}(q, q')). \end{aligned}$$

Proof. Let q belonging to $B(p, \epsilon)$. Let us consider the geodesics $\gamma : [0, T] \rightarrow M$ for the distance d such that $\gamma(0) = q$, $\gamma(T) = q'$ and associated with the control function $u(\cdot)$ satisfying $\|u(t)\| = 1$ and $\widetilde{\gamma}$ the admissible curve for \widetilde{d} defined by the same control functions that γ with $\widetilde{\gamma}(0) = q$. By Proposition 11 item 1

$$\widetilde{d}(\gamma(T), \widetilde{\gamma}(T)) \leq \text{Cst} \cdot T^{\frac{1}{2}} \cdot \tau^{\frac{3}{2}}. \quad (15)$$

On the other hand, note that

$$d(q, q') = l(\gamma) = l(\widetilde{\gamma}) \geq \widetilde{d}(q, \widetilde{\gamma}(T)).$$

Moreover, by triangle inequality, we have

$$\tilde{d}(q, \tilde{\gamma}(T)) \geq \tilde{d}(q, q') - \tilde{d}(q', \tilde{\gamma}(T)),$$

Then, from (15), transitivity and since $\gamma(T) = q'$, we get

$$\begin{aligned} d(q, q') &\geq \tilde{d}(q, q') - \text{Cst} \cdot T^{\frac{1}{2}} \cdot \tau^{\frac{3}{2}} \\ d(q, q') - \tilde{d}(q, q') &\geq -\text{Cst} \cdot T^{\frac{1}{2}} \cdot \tau^{\frac{3}{2}} \end{aligned} \quad (16)$$

Now, we change the roles of d and \tilde{d} and by Proposition 11 item 2, we obtain

$$d(q, q') - \tilde{d}(q, q') \leq \text{Cst} \cdot \tilde{T}^{\frac{1}{2}} \cdot \tilde{\tau}^{\frac{3}{2}}, \quad (17)$$

where $\tilde{T} = \tilde{d}(q, q')$.

Therefore from (16) and (17)

$$-C\tau^{\frac{3}{2}}d(q, q')^{\frac{1}{2}} \leq d(q, q') - \tilde{d}(q, q') \leq C \cdot \tilde{\tau}^{\frac{3}{2}}\tilde{d}(q, q')^{\frac{1}{2}}.$$

The proof is complete. \square

4.2.5 Translations

We mentioned in Section 4.2.2 that the distance \hat{d} is left-invariant. It is not the case of \tilde{d} . Let q be a point in a neighborhood of 0 and $g \in \mathbb{R}^3$. We are interested in conditions under which $\tilde{d}(g, g \cdot q) \leq \tilde{d}(0, q)$ (the product is the Heisenberg one).

Let $\gamma(t) = (x(t), y(t), z(t))$ be a geodesic of \tilde{d} such that $\gamma(0) = 0$ with control functions u_1, u_2 and u_3 . We consider $g = (g_1, g_2, g_3) \in \mathbb{R}^3$. Let $\gamma_g(t) = L_g(\gamma(t)) = (x_g(t), y_g(t), z_g(t))$ and $\bar{u}_1, \bar{u}_2, \bar{u}_3$ its control functions. Note that γ_g is admissible for \tilde{d} as long as it does not meet \mathcal{Z} . Indeed, all absolutely continuous curves are admissible out of the singular locus since the metric is Riemannian. The goal is to find conditions for g such that γ_g has a length less than γ . Since $\text{Lie}\{\hat{X}_1, \hat{X}_2\}$ is the Heisenberg algebra, then

$$L_g(\gamma(t)) = (x(t) + g_1, y(t) + g_2, z(t) + g_1y(t) + g_3).$$

We set $h(x, y, z) = az + bx^2 + cy^2$. Then

$$\begin{aligned} h(\gamma_g) &= a(z + g_1y + g_3) + b(x + g_1)^2 + c(y + g_2)^2 \\ &= h(\gamma) + h(g) + (2bx + ay)g_1 + 2cyg_2 = h(\gamma) + h(g) + f(g, \gamma), \end{aligned}$$

where $f(g, \gamma) = (2bx + ay)g_1 + 2cyg_2$.

We assume that $h(\gamma_g)$ does not vanish, this is to say γ_g is not on \mathcal{Z} . In particular for $t = 0$, $h(\gamma_g) = h(g)$ then $h(g) \neq 0$ this is equivalent to $g \notin \mathcal{Z}$.

We have the following result.

Theorem 6. *Let $\gamma : [0, T] \rightarrow \mathbb{R}^n$ be a length minimizer of \tilde{d} with control functions $u_1(t), u_2(t), u_3(t)$ with $u_3(t) \neq 0$ a.e, and $h(\gamma_g) \neq 0$. If $|h(\gamma)| \leq |h(\gamma_g)|$ then $\tilde{d}(\gamma_g(0), \gamma_g(T)) \leq \tilde{d}(\gamma(0), \gamma(T))$.*

Proof. Since $x_g(t) = x(t) + g_1$ then $\dot{x}_g(t) = \dot{x}(t) = u_1(t)$. This implies that $u_1(t) = \bar{u}_1(t)$. In the same way, we obtain $u_2(t) = \bar{u}_2(t)$ because $y_g(t) = y(t) + g_2$. Furthermore, $z_g(t) = z(t) + g_1 y(t) + g_3$ then

$$\dot{z}_g(t) = \dot{z}(t) + g_1 \dot{y}(t) = u_2(t)x_g(t) + u_3(t)h(\gamma(t)). \quad (18)$$

Besides the above equation, $z_g(t)$ satisfies the equation

$$\dot{z}_g(t) = \bar{u}_2(t)x_g(t) + \bar{u}_3(t)h(\gamma_g(t)), \quad (19)$$

because γ_g is an admissible curve for \tilde{d} . Finally, from the equations (19) and (18) and as $u_2(t) = \bar{u}_2(t)$ we get

$$\bar{u}_3(t) = \frac{u_3(t)h(\gamma(t))}{h(\gamma_g(t))}.$$

The condition $|h(\gamma)| \leq |h(\gamma_g)|$ implies that $|\bar{u}_3(t)| \leq |u_3(t)|$, hence $\bar{u}_3(t)^2 \leq u_3(t)^2$. Therefore the length of γ_g decreases and consequently $\tilde{d}(\gamma_g(0), \gamma_g(T)) \leq \tilde{d}(\gamma(0), \gamma(T))$. \square

In the same sense of the above theorem, the following result gives us a sufficient condition to determine when the distance of the points translated by g is less than the distance from the origin to $\gamma(T)$.

Theorem 7. *With the same conditions of the above. If $\frac{\partial}{\partial g_i}(h(g) + f(g, \gamma)) > 0$ then $\tilde{d}(\gamma_g(0), \gamma_g(T)) < \tilde{d}(\gamma(0), \gamma(T))$.*

Proof. From Theorem 6, the control functions of γ_g are $u_1(t)$, $u_2(t)$ and $\bar{u}_3(t)$, hence

$$\begin{aligned} l(\gamma_g) &= \int_0^T (u_1(t)^2 + u_2(t)^2 + \bar{u}_3(t)^2)^{\frac{1}{2}} dt \\ &= \int_0^T \left(u_1(t)^2 + u_2(t)^2 + \frac{u_3(t)^2 h(\gamma(t))^2}{h(\gamma_g(t))^2} \right)^{\frac{1}{2}} dt \\ \frac{\partial}{\partial g_i} l(\gamma_g) &= \int_0^T \frac{1}{2} \left(\frac{(u_1(t)^2 + u_2(t)^2) h(\gamma_g(t))^2 + u_3(t)^2 h(\gamma(t))^2}{h(\gamma_g(t))^2} \right)^{-\frac{1}{2}} \cdot \frac{\partial}{\partial g_i} \left(\frac{u_3(t)^2 h(\gamma(t))^2}{h(\gamma_g(t))^2} \right) dt \\ &= \int_0^T \frac{-|h(\gamma_g(t))| u_3(t)^2 h(\gamma(t))^2}{((u_1(t)^2 + u_2(t)^2) h(\gamma_g(t))^2 + u_3(t)^2 h(\gamma(t))^2)^{\frac{1}{2}} h(\gamma_g(t))^3} \cdot \frac{\partial}{\partial g_i} (h(g) + f(g, \gamma)) dt \\ &= - \int_0^T \frac{u_3(t)^2 h(\gamma(t))^2 \frac{\partial}{\partial g_i} (h(g) + f(g, \gamma))}{((u_1(t)^2 + u_2(t)^2) h(\gamma_g(t))^2 + u_3(t)^2 h(\gamma(t))^2)^{\frac{1}{2}} |h(\gamma_g(t))| h(\gamma_g(t))} dt. \end{aligned}$$

Note that the function S defined by

$$S(t) = \frac{u_3(t)^2 h(\gamma(t))^2 \frac{\partial}{\partial g_i} (h(g) + f(g, \gamma))}{(u_1(t)^2 + u_2(t)^2 h(\gamma_g(t))^2 + u_3(t)^2 h(\gamma(t))^2)^{\frac{1}{2}} |h(\gamma_g(t))| h(\gamma_g(t))}$$

is positive if and only if

$$\frac{\frac{\partial}{\partial g_i} (h(g) + f(g, \gamma))}{h(\gamma_g(t))} > 0.$$

In this case $\frac{\partial l(\gamma_g)}{\partial g_i} < 0$ and $\tilde{d}(\gamma_g(0), \gamma_g(T)) < \tilde{d}(\gamma(0), \gamma(T))$.

In particular at $g = (0, 0, 0)$,

$$\left. \frac{\partial}{\partial g_i} l(\gamma_g) \right|_{(g_1, g_2, g_3) = (0, 0, 0)} = - \int_0^T \frac{u_3(t)^2 \frac{\partial}{\partial g_i} (h(g) + f(g, \gamma))}{h(\gamma(t))} dt.$$

□

4.2.6 Conclusion

In Section 3, we have shown that in case where the nilpotent approximation of an ARS degenerates, that is when it is no longer an ARS but a sub-Riemannian structure, we can replace it by a simple ARS on a Lie group or a homogeneous space. Thanks to formula (14) of Theorem 5 we know that, at least in some 3D generic cases, the order of the approximation of d by \tilde{d} is better than the one of the approximation of d by \hat{d} . Indeed, this order is d^2 in the first case and $d^{\frac{3}{2}}$ in the second one. However, this does not prove that the solvable approximation is really better than the nilpotent one, and anyway it is certainly not true for any pair of points.

Since under left translations the nilpotent distance \hat{d} is invariant while the solvable distance \tilde{d} may be decreasing, we can expect to prove that the approximation by \tilde{d} is strictly better than the one by \hat{d} for pairs of points translated in a suitable direction.

For this purpose, we consider here the 3D-generic case of Section 4.2 with the particular values $a = 1$, $b = c = 0$, that is $\tilde{X}_3 = z \frac{\partial}{\partial z}$. The singular locus of the solvable approximation is then the plane $\{z = 0\}$.

In what follows we consider a (normal) geodesic γ for \tilde{d} , originated at $(0, 0, 0)$ and parametrized by arc length on $[0, T]$. Denoting $\gamma(t) = (x(t), y(t), z(t))$ it is moreover assumed that $z(t) > 0$ on $]0, T]$.

This geodesic is translated by $\mathbf{g} = (0, 0, g)$, with $g \geq 0$, into $\gamma_g = L_{\mathbf{g}}\gamma$. Since \mathbf{g} belongs to the center of the Heisenberg group the curve γ_g is simply $\gamma_g(t) = (x(t), y(t), z(t) + g)$.

The different distances between g and $\gamma_g(T)$ are analyzed in several steps.

1. Since the controls associated to γ_g are u_1 , u_2 , and $\frac{z(t)}{z(t) + g} u_3$ the length of γ_g related to \tilde{d} is

$$\tilde{l}(\gamma_g) = \int_0^T \left(u_1^2 + u_2^2 + \left(\frac{z(t)}{z(t) + g} \right)^2 u_3^2 \right)^{\frac{1}{2}} dt.$$

Since $z \mapsto \frac{z}{z+g}$ is increasing we have $\tilde{l}(\gamma_g) \leq I_g$, where I_g stands for

$$I_g = \int_0^T \left(u_1^2 + u_2^2 + \left(\frac{z_m}{z_m + g} \right)^2 u_3^2 \right)^{\frac{1}{2}} dt,$$

with $z_m = \max\{z(t); t \in [0, T]\}$.

2. We apply now formula (14), which writes here:

$$d(\mathbf{g}, \gamma_g(T)) \leq \tilde{d}(\mathbf{g}, \gamma_g(T)) + C \cdot \tilde{\tau}^{\frac{3}{2}} \tilde{d}(\mathbf{g}, \gamma_g(T))^{\frac{1}{2}},$$

where $\tilde{\tau} = \max\{\|\mathbf{g}\|_p, \tilde{d}(\mathbf{g}, \gamma_g(T))\}$. It will always be assumed that $\|\mathbf{g}\|_p \leq \tilde{d}(\mathbf{g}, \gamma_g(T))$, that is $g^{\frac{1}{2}} \leq \tilde{d}(\mathbf{g}, \gamma_g(T))$. Taking into account $\tilde{d}(\mathbf{g}, \gamma_g(T)) \leq \hat{d}(\mathbf{g}, \gamma_g(T)) = \hat{d}(0, \gamma(T))$, we get

$$\begin{aligned} d(\mathbf{g}, \gamma_g(T)) &\leq \tilde{d}(\mathbf{g}, \gamma_g(T)) + C \cdot \tilde{d}(\mathbf{g}, \gamma_g(T))^2 \\ &\leq \frac{I_g}{T} \tilde{d}(0, \gamma(T)) + C \cdot \left(\frac{I_g}{T} \right)^2 \tilde{d}(0, \gamma(T))^2 \\ &\leq \frac{I_g}{T} \hat{d}(0, \gamma(T)) \left(1 + \frac{I_g}{T} C \cdot \tilde{d}(0, \gamma(T)) \right). \end{aligned}$$

3. In order to approximate $z(t)$ and $u_3(t)$, we consider the Hamiltonian equations (see details in the next section), for the values $a = 1, b = c = 0$. They are:

$$\begin{cases} \dot{x} = p \\ \dot{y} = q + rx \\ \dot{z} = (q + rx)x + rz^2 \end{cases} \quad \begin{cases} \dot{p} = -(q + rx)r \\ \dot{q} = 0 \\ \dot{r} = -r^2z \end{cases}$$

It is important to notice that r_0 can be chosen arbitrarily large because $H(t = 0) = \frac{1}{2}(p_0^2 + q_0^2)$. We make the choice $p_0 = q_0$ and the following approximations hold:

$$x(t) \approx p_0 t, \quad \dot{z} \approx q_0 p_0 t = \frac{1}{2} t, \quad z(t) \approx \frac{1}{4} t^2, \quad u_3(t) = r(t)z(t) \approx \frac{1}{4} r_0 t^2.$$

In order to compute $\tilde{l}(\gamma_g)$, we need to apply the condition $g^{\frac{1}{2}} \leq \tilde{d}(\mathbf{g}, \gamma_g(T))$ of point 2. We do not know $\tilde{d}(\mathbf{g}, \gamma_g(T))$ but we can set $\tilde{d}(\mathbf{g}, \gamma_g(T)) = \beta T$ with $0 < \beta < 1$ (this estimation ‘‘a priori’’ will be justified later), and set $g = \beta^2 T^2$. Then we get

$$\frac{z}{z+g} \leq \frac{z_m}{z_m+g} \approx \frac{\frac{1}{4}T^2}{\frac{1}{4}T^2 + \beta^2 T^2} = \frac{1}{1 + 4\beta^2}.$$

Therefore

$$\begin{aligned}
\tilde{l}(\gamma_g) &\leq I_g = \int_0^T \left(u_1^2 + u_2^2 + \left(\frac{1}{1+4\beta^2} \right)^2 u_3^2 \right)^{\frac{1}{2}} dt \\
&= \int_0^T \left(1 - u_3^2 + \left(\frac{1}{1+4\beta^2} \right)^2 u_3^2 \right)^{\frac{1}{2}} dt = \int_0^T \left(1 - \frac{16\beta^4 + 8\beta^2}{(1+4\beta^2)^2} u_3^2 \right)^{\frac{1}{2}} dt \\
&\approx \int_0^T \left(1 - \frac{16\beta^4 + 8\beta^2}{(1+4\beta^2)^2} \frac{1}{16} r_0^2 t^4 \right)^{\frac{1}{2}} dt = \int_0^T \left(1 - \frac{2\beta^4 + \beta^2}{2(1+4\beta^2)^2} r_0^2 t^4 \right)^{\frac{1}{2}} dt.
\end{aligned}$$

We write $\delta = \frac{2\beta^4 + \beta^2}{2(1+4\beta^2)^2}$ and we set $\delta r_0^2 T^4 = \frac{1}{2}$. Notice that this is possible, even if T is small, by increasing r_0 . Thanks to $(1-c)^{\frac{1}{2}} \leq 1 - 0.5c$ whenever $0 \leq c \leq 1$ we get:

$$\tilde{l}(\gamma_g) \leq I_g \leq \int_0^T (1 - 0.5\delta r_0^2 t^4) dt = T - 0.5\delta r_0^2 \frac{T^5}{5} = T(1 - 0.1\delta r_0^2 T^4) \approx 0.95T.$$

4. Assuming $C \cdot \tilde{d}(0, \gamma(T)) = C \cdot T \leq 0.01$ we get on one hand:

$$\begin{aligned}
d(\mathbf{g}, \gamma_g(T)) &\leq \tilde{d}(\mathbf{g}, \gamma_g(T)) + C \cdot \tilde{d}(\mathbf{g}, \gamma_g(T))^2 \\
&= \tilde{d}(\mathbf{g}, \gamma_g(T))(1 + C \cdot \tilde{d}(\mathbf{g}, \gamma_g(T))) \\
&\leq 1.01\tilde{d}(\mathbf{g}, \gamma_g(T)).
\end{aligned}$$

On the other hand:

$$\begin{aligned}
\hat{d}(\mathbf{g}, \gamma_g(T)) - d(\mathbf{g}, \gamma_g(T)) &\geq \hat{d}(\mathbf{g}, \gamma_g(T)) \left(1 - 1.01 \frac{I_g}{T} \right) \\
&= \tilde{d}(\mathbf{g}, \gamma_g(T)) \frac{\hat{d}(\mathbf{g}, \gamma_g(T))}{\tilde{d}(\mathbf{g}, \gamma_g(T))} \left(1 - 1.01 \frac{I_g}{T} \right) \\
&\geq \tilde{d}(\mathbf{g}, \gamma_g(T)) \frac{T}{I_g} \left(1 - 1.01 \frac{I_g}{T} \right) \\
&= \tilde{d}(\mathbf{g}, \gamma_g(T)) \left(\frac{T}{I_g} - 1.01 \right).
\end{aligned}$$

Therefore $\hat{d}(\mathbf{g}, \gamma_g(T)) - d(\mathbf{g}, \gamma_g(T)) > d(\mathbf{g}, \gamma_g(T)) - \tilde{d}(\mathbf{g}, \gamma_g(T))$ as soon as $\frac{T}{I_g} - 1.01 > 0.01$ hence as soon as $\frac{I_g}{T} < 0.98$.

According to Point 3, we can obtain $I_g \leq 0.95T$ and in that case the solvable distance between \mathbf{g} and $\gamma_g(T)$ is strictly closer to the original distance between these points than the nilpotent one.

5 Geodesics

In this section the Hamiltonian for the normal flow defined by the solvable approximation in the 3D generic case is given. We compute the geodesic with initial condition $x(0) = y(0) = z(0) = 0$ and covector $\lambda = (p, q, r) \in T^*\mathbb{R}^3$ with $p(0) = \cos(\theta)$,

$$q(0) = \sin(\theta), r(0) = r.$$

From the above sections, the solvable approximation is defined by

$$\widehat{X}_1 = X_1, \quad \widehat{X}_2 = \frac{\partial}{\partial y} + x \frac{\partial}{\partial z}, \quad \widetilde{X}_3 = (az + bx^2 + cy^2) \frac{\partial}{\partial z}. \quad (20)$$

From (20), the Hamiltonian for the normal flow is given by

$$H(\lambda) = \frac{1}{2} \left(\left\langle \lambda, \widehat{X}_1(x, y, z) \right\rangle^2 + \left\langle \lambda, \widehat{X}_2(x, y, z) \right\rangle^2 + \left\langle \lambda, \widetilde{X}_3(x, y, z) \right\rangle^2 \right)$$

$$H(\lambda) = \frac{1}{2} \left(p^2 + (q + rx)^2 + r^2 (az + bx^2 + cy^2)^2 \right),$$

where $\lambda = (p, q, r) \in T^*\mathbb{R}^3$. Hence

$$\begin{aligned} \dot{x}(t) &= p & \dot{p}(t) &= -(q + rx)r - 2bxr^2(az + bx^2 + cy^2) \\ \dot{y}(t) &= q + rx & \dot{q}(t) &= -2cyr^2(az + bx^2 + cy^2) \\ \dot{z}(t) &= (q + rx)x + r(az + bx^2 + cy^2)^2 & \dot{r}(t) &= -ar^2(az + bx^2 + cy^2) \end{aligned}$$

are the associated Hamiltonian equations to the solvable approximation.

The geodesic with initial condition $x(0) = y(0) = z(0) = 0$ and $p(0) = \cos(\theta)$, $q(0) = \sin(\theta)$ and $r(0) = r = 0$ is given by

$$\begin{aligned} x(t) &= t \cos(\theta) \\ y(t) &= t \sin(\theta) \\ z(t) &= \frac{1}{4} t^2 \sin(2\theta), \end{aligned} \quad (21)$$

because $p(t) = \cos(\theta)$ and $q(t) = \sin(\theta)$, this is to say p and q are constants.

Notice that the above geodesic for \widetilde{d} is the same as the geodesic for \widehat{d} . The above implies that this geodesic is optimal for any time and has no conjugate time (see Theorem 5.1 and 5.2 in [10]). We can see some geodesics in Figure 1 when $r = 0$.

Due to the complexity of the Hamiltonian system of equations, we compute the geodesics considering $a = c = 0$ and $b = 1$. Thus the Hamiltonian is

$$H(\lambda) = \frac{1}{2} (p^2 + (q + rx)^2 + r^2 x^4),$$

hence

$$\begin{aligned} \dot{x}(t) &= p & \dot{p}(t) &= -(q + rx)r - 2r^2 x^3 \\ \dot{y}(t) &= q + rx & \dot{q}(t) &= 0 \\ \dot{z}(t) &= xq + rx^2 + rx^4 & \dot{r}(t) &= 0 \end{aligned} \quad (22)$$

Considering the initial condition $x(0) = 0$ then $p(0) = \cos(\theta)$, $q(0) = \sin(\theta)$ and $r(0) = r$. If $r = 0$ then the solution to the differential systems (22) is given by (21). If $r(0) = r \neq 0$, since $\dot{x}(t) = p$, we get

$$\begin{aligned} \ddot{x} &= -r(q + rx) - 2r^2 x^3 \\ \ddot{x} + r^2 x + 2r^2 x^3 &= -rq. \end{aligned}$$

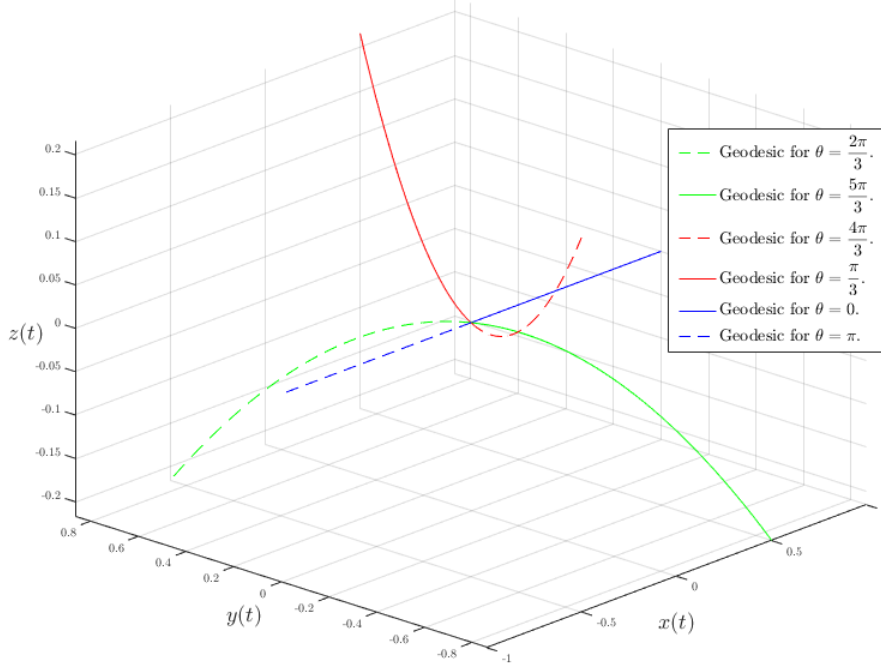

Figure 1: Geodesics for $\theta \in \{0, \frac{\pi}{3}, \frac{2\pi}{3}, \pi, \frac{4\pi}{6}, \frac{5\pi}{6}\}$ when $r = 0$.

Since $q(0) = \sin(\theta)$ and $\dot{q} = 0$, then $q = \sin(\theta)$. Hence

$$\ddot{x} + r^2x + 2r^2x^3 = -r \sin(\theta). \quad (23)$$

The equation (23) is equivalent to

$$\ddot{x} + r^2x + 2r^2x^3 = -r \sin(\theta) \text{cn}(0, k^2), \quad (24)$$

where $\text{cn}(0 \cdot t, k^2)$ is the Jacobian elliptic function that has a period in $0 \cdot t$ equal to $4K(k^2)$ and $K(k^2)$ is the complete elliptic integral of the first kind for the modulus k (see more in [14]). This equivalence is due to the fact that $\text{cn}(0, k^2) = 1$.

In [18] a general solution to

$$\ddot{x} + c_n \dot{x} + w_n x + \epsilon x^3 = F \text{cn}(wt, k^2),$$

is given by

$$x(t) = a_1(t) \text{cn}(w_1 t + \phi, k_1^2) + A_1(t) \text{cn}(wt, k^2) + B_1(t) \cdot \text{sn}(wt, k^2).$$

Therefore, the solution for the equation (24) is given by

$$x(t) = a_1(t) \text{cn}(w_1 t + \phi, k_1^2) + A_1(t),$$

where $a_1(t)$, $A_1(t)$, w_1 , ϕ and k_1 need to be determined. Notice that $B_1(t) \cdot \text{sn}(wt, k^2)$ vanishes because $\text{sn}(0, k^2) = 0$.

From [18] is possible to obtain that $a_1(t)$ and $A_1(t)$ are constants. Then

$$x(t) = a_1 \operatorname{cn}(w_1 t + \phi, k_1^2) + A_1. \quad (25)$$

Moreover, since $x(0) = 0$

$$-A_1 = a_1 \cdot \operatorname{cn}(\phi, k_1^2). \quad (26)$$

Furthermore, differentiating in (25) and since $\dot{x}(0) = p(0) = \cos(\theta)$, we have

$$a_1 = \frac{\cos(\theta) \operatorname{ns}(\phi, k_1^2) \operatorname{nd}(\phi, k_1^2)}{w_1}.$$

Finally, since $y(0) = z(0) = 0$,

$$\begin{aligned} x(t) &= a_1 (\operatorname{cn}(w_1 t + \phi, k_1^2) - \operatorname{cn}(\phi, k_1^2)) \\ y(t) &= (\sin(\theta) - r a_1 \operatorname{cn}(\phi, k_1^2)) t + \frac{r a_1}{k_1^2 w_1} \left(\arccos(\operatorname{dn}(w_1 t + \phi, k_1^2)) - \arccos(\operatorname{dn}(\phi, k_1^2)) \right) \\ z(t) &= - \left(r a_1^4 \operatorname{cn}(\phi, k_1^2)^4 + r a_1^2 \operatorname{cn}(\phi, k_1^2)^2 + \sin(\theta) \right) a_1 \operatorname{cn}(\phi, k_1^2) t + \frac{r a_1^4}{3 k_1^8 w_1} z_1(t) \\ &\quad + \frac{4 r a_1^4 \operatorname{cn}(\phi, k_1^2)}{2 k_1^6 w_1} z_2(t) + \frac{6 r a_1^4 \operatorname{cn}(\phi, k_1^2)^2 + r a_1^2}{k_1^4 w_1} z_3(t) \\ &\quad + \frac{4 r a_1^4 \operatorname{cn}(\phi, k_1^2)^3 + 2 r a_1^2 \operatorname{cn}(\phi, k_1^2) + \sin(\theta)}{k_1^2 w_1} z_4(t), \end{aligned}$$

where $k_1'^2 + k_1^2 = 1$, $E(\cdot)$ is the incomplete elliptic integral of the second kind and

$$\begin{aligned} z_1(t) &= (2 - 3 k_1^4) k_1'^4 w_1 t + 2(2 k_1^4 - 1) (E(w_1 t + \phi) - E(\phi)) \\ &\quad + k_1^4 (\operatorname{sn}(w_1 t + \phi, k_1^2) \operatorname{cn}(w_1 t + \phi, k_1^2) \operatorname{dn}(w_1 t + \phi, k_1^2) - \operatorname{sn}(\phi, k_1^2) \operatorname{cn}(\phi, k_1^2) \operatorname{dn}(\phi, k_1^2)) \\ z_2(t) &= (2 k_1^4 - 1) \left(\arcsin(k_1^2 \operatorname{sn}(w_1 t + \phi, k_1^2)) - \arcsin(k_1^2 \operatorname{sn}(\phi, k_1^2)) \right) \\ &\quad + k_1^2 \left(\operatorname{sn}(w_1 t + \phi, k_1^2) \operatorname{dn}(w_1 t + \phi, k_1^2) - \operatorname{sn}(\phi, k_1^2) \operatorname{dn}(w_1 t + \phi, k_1^2) \right) \\ z_3(t) &= E(w_1 t + \phi) - E(\phi) - k_1'^4 w_1 t \\ z_4(t) &= \arccos(\operatorname{dn}(w_1 t + \phi, k_1^2)) - \arccos(\operatorname{dn}(\phi, k_1^2)). \end{aligned}$$

References

- [1] R. Abraham, J. Marsden, and T. Ratiu, *Manifolds, tensor analysis, and applications*, 2nd ed., Applied mathematical sciences, no. v. 75, Springer-Verlag, New York, 1988.
- [2] A. Agrachev, U. Boscain, G. Charlot, R. Ghezzi, and M. Sigalotti, *Two-dimensional almost-Riemannian structures with tangency points*, Annales de l'Institut Henri Poincaré / Analyse non lineaire **27** (2010), no. 3, 793–807.

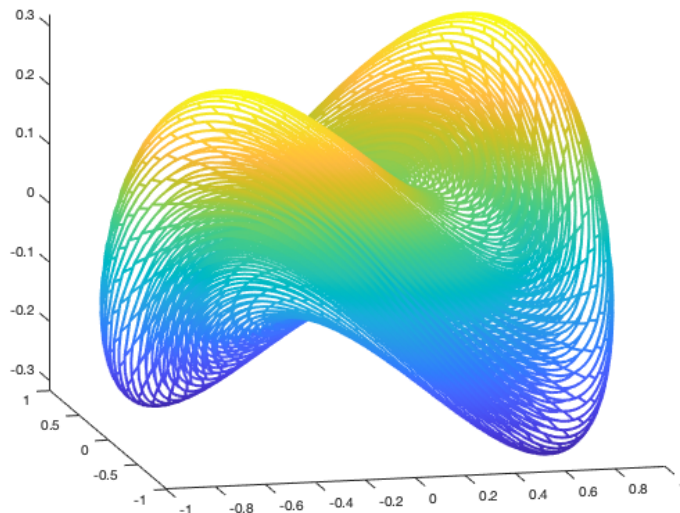

Figure 2: Ball in 3-D generic case.

- [3] A. Agrachev, U. Boscain, and M. Sigalotti, *A gauss-bonnet-like formula on two-dimensional almost-riemannian manifolds*, *Discrete and Continuous Dynamical Systems* **20** (2008), no. 4, 801–822.
- [4] Andrei Agrachev, Davide Barilari, and Ugo Boscain, *A comprehensive introduction to sub-riemannian geometry*, *Cambridge Studies in Advanced Mathematics*, Cambridge University Press, 2019.
- [5] V. Ayala and P. Jouan, *Almost-Riemannian Geometry on Lie Groups*, *SIAM Journal on Control and Optimization* **54** (2016), no. 5, 2919–2947.
- [6] V. Ayala and J. Tirao, *Linear control systems on Lie groups and controllability*, in *Proceedings of Symposia in Pure Mathematics* **64** (1999), 47–64.
- [7] A. Bellaïche, *The Tangent space in sub-Riemannian geometry*, *Sub-Riemannian geometry* (Bellaïche André-Risler Jean-Jacques, ed.), *Progress in Mathematics*, Birkhäuser Basel, 1996, pp. 1–78.
- [8] B. Bonnard, J.-B. Caillau, R. Sinclair, and M. Tanaka, *Conjugate and cut loci of a two-sphere of revolution with application to optimal control*, *Annales de l’Institut Henri Poincaré (C) Analyse Non Linéaire* **26** (2009), no. 4, 1081–1098.
- [9] B. Bonnard, G. Charlot, R. Ghezzi, and G. Janin, *The sphere and the cut locus at a tangency point in two-dimensional almost-Riemannian geometry*, *Journal of Dynamical and Control Systems* **17** (2011), no. 1, 141–161.
- [10] U. Boscain, G. Charlot, M. Gaye, and P. Mason, *Local properties of almost-Riemannian structures in dimension 3*, *Discrete and Continuous Dynamical Systems- Series A* **35** (2015), no. 9, 4115–4147.

- [11] U. Boscain, G. Charlot, and R. Ghezzi, *Normal forms and invariants for 2-dimensional almost-Riemannian structures*, *Differential Geometry and its Applications* **31** (2013), no. 1, 41–62.
- [12] U. Boscain, G. Charlot, R. Ghezzi, and M. Sigalotti, *Lipschitz Classification of Almost-Riemannian Distances on Compact Oriented Surfaces*, *Journal of Geometric Analysis* **23** (2013), no. 1, 438–455.
- [13] N. Bourbaki, *Eléments De Mathématique. Groupes et Algèbres de Lie: Chapitres 2 et 3*, 2 ed., Germany: Springer Verlag, 2007.
- [14] P. F. Byrd and M. D Friedman, *Handbook of elliptic integrals for engineers and physicists*, Springer-Verlag Berlin Heidelberg, 1954.
- [15] F. Jean, *Control of Nonholonomic Systems: from Sub-Riemannian Geometry to Motion Planning*, SpringerBriefs in Mathematics, Springer International Publishing, 2014.
- [16] P. Jouan, *Equivalence of control systems with linear systems on Lie groups and homogeneous spaces*, *ESAIM: Control, Optimisation and Calculus of Variations* **16** (2010), no. 4, 956–973.
- [17] P. Jouan, G. Zsigmond, and V. Ayala, *Isometries of almost-Riemannian structures on Lie groups*, *Differential Geometry and its Applications* **61** (2018), 59–81.
- [18] E. Zúñiga, *A General Solution of the Duffing Equation*, *Nonlinear Dynamics* **45** (2006), no. 3, 227–235.

Paper 2

General Nilpotent and Solvable Approximations of Almost-Riemannian Structures, article in collaboration with Yacine Chitour and Philippe Jouan. Submitted to the journal *Discrete and Continuous Dynamical Systems (DCDS)* (see online [link](#)).

General Nilpotent and Solvable Approximations of Almost-Riemannian Structures

Yacine Chitour, Philippe Jouan and Ronald Manríquez

April 14, 2022

Abstract

It is first shown that the nilpotent or the solvable approximation of an almost-Riemannian structure at a singular point is always a linear almost-Riemannian structure on a Lie group or a homogeneous space.

The generic properties of almost-Riemannian structures are then investigated in all dimensions and the generic nilpotent and solvable approximations are identified.

Keywords: Almost-Riemannian geometry; Nilpotent approximation; Solvable approximation; Genericity.

1 Introduction

The aim of this paper is twofold. On the first hand it is shown that the nilpotent or the solvable approximation of an almost-Riemannian structure at a singular point is always a linear almost-Riemannian structure on a Lie group or a homogeneous space. On the other hand the generic almost-Riemannian structures are described and used to exhibit the generic nilpotent and solvable approximations.

More precisely an almost-Riemannian structure, ARS in short, on an n -dimensional differential manifold is a rank-varying sub-Riemannian structure that can be locally defined by a set of n vector fields satisfying the Lie algebra rank condition and such that the singular locus \mathcal{Z} , that is the set of points where their rank is not full, is a proper but with empty interior subset (see [2], [3], [4], [6], [7], [12]).

In particular almost-Riemannian structures on Lie groups or homogeneous spaces that are defined by invariant and linear vector fields only are referred to as linear ARSs (a vector field on a Lie group is linear if its flow is a one-parameter group of automorphisms)(see [4]).

Following [5] and [10] the nilpotent approximation of such a structure at a point p of the singular locus has been used in [7] and [6] to investigate the behaviour around p in dimension respectively 2 and 3.

However it may happen that some vector fields of the nilpotent approximation vanish, changing the almost-Riemannian structure into a sub-Riemannian one. In that case the nilpotent approximation can be replaced by a solvable one, the definition of which was stated in [13] and is recalled in Section 2.2. In [13] the solvable approximation is used to study the distance around some singular points in the generic $3D$ -case.

The first aim is herein to prove that the nilpotent or solvable approximation of an ARS at a singular point is a linear almost-Riemannian structure on a Lie group or a homogeneous space, excepted in some very degenerated cases where neither the nilpotent approximation nor the solvable one defines an ARS. It is the purpose of Section 3, and the statements are illustrated by examples postponed to Section 5.

The generic properties of almost-Riemannian structures are then examined in Section 4. It is in particular shown that generically: (1) the singular set \mathcal{Z} is a union of submanifolds \mathcal{Z}_r of codimension r^2 where the rank is $n - r$; (2) the rank of $\Delta + [\Delta, \Delta]$ is everywhere full (Δ stands for the distribution). The structure of the points of \mathcal{Z}_r where $\dim(T_p\mathcal{Z}_r) + \dim(\Delta_p)$ is not maximal is described in Theorem 6. For example in \mathcal{Z}_1 these points are the so-called *tangency points* (see [6]), i.e. the points where $T_p\mathcal{Z}_1 = \Delta_p$. They are generically isolated in \mathcal{Z}_1 .

Thanks to these genericity results and with the help of local normal forms (see Section 4.2) it is finally shown that generically there are only two possibilities for the nilpotent/solvable approximation at a point $p \in \mathcal{Z}$:

1. At a tangency point p in \mathcal{Z}_1 one vector field of the nilpotent approximation vanishes, but the solvable approximation is not degenerated and defines a linear ARS.
2. At all other points, that is nontangency points of \mathcal{Z}_1 and all points in \mathcal{Z}_r with $r \geq 2$, the nilpotent approximation is not degenerated.

In conclusion the only *generic* points where the solvable approximation is useful are tangency points in \mathcal{Z}_1 .

As shown by the examples the picture is very different for nongeneric ARSs.

2 Basic definitions

2.1 Almost-Riemannian structures

For all that concern general sub-Riemannian geometry, including almost-Riemannian one, the reader is referred to [1].

Let M be a n -dimensional, connected, C^∞ manifold. The C^∞ -module of C^∞ vector fields on M is denoted by $\Gamma(M)$. Let Δ be a submodule of $\Gamma(M)$. The flag of submodules

$$\Delta = \Delta^1 \subseteq \Delta^2 \subseteq \Delta^3 \subseteq \dots \subseteq \Delta^k \subseteq \dots$$

is defined by induction: $\Delta^2 = \Delta + [\Delta, \Delta]$ is the submodule of $\Gamma(M)$ generated by Δ and the Lie brackets of its elements, and $\Delta^{k+1} = \Delta^k + [\Delta, \Delta^k]$. The Lie algebra generated by Δ is $\mathcal{L}(\Delta) = \bigcup_{k \geq 1} \Delta^k$. The submodule Δ satisfies the rank condition if the evaluation of $\mathcal{L}(\Delta)$ at each point q is equal to $T_q M$.

Definition 1 *An almost-Riemannian structure (resp. distribution) on a smooth n -dimensional manifold M is a triple $(E, f, \langle \cdot, \cdot \rangle)$ (resp. a pair (E, f)) where E is a rank n vector bundle over M , $f : E \rightarrow TM$ is a morphism of vector bundles, and $(E, \langle \cdot, \cdot \rangle)$ is an Euclidean bundle, that is $\langle \cdot, \cdot \rangle_q$ is an inner product on the fiber E_q of E , smoothly varying w.r.t. q , assumed to satisfy the following properties:*

- (i) *The set of points $q \in M$ such that the restriction of f to E_q is onto is a proper open and dense subset of M ;*
- (ii) *The module Δ of vector fields of M , defined as the image by f of the module of smooth sections of E , satisfies the rank condition.*

The set of points of M where the rank of $f(E_q) = \Delta_q$ is less than n is called the singular locus of the ARS and denoted by \mathcal{Z} .

The inner product on E induces a bilinear symmetric and positive definite mapping, also denoted by $\langle \cdot, \cdot \rangle$, from $\Delta \times \Delta$ to $C^\infty(M)$ ¹. Indeed an element $X \in \Delta$ (resp. $Y \in \Delta$) is the image by f of an unique section σ (resp. η) of E and we can set $\langle X, Y \rangle_q = \langle \sigma, \eta \rangle_q$.

Consequently an ARS can be alternately defined as follows.

¹i.e. $(X, Y) \mapsto \langle X, Y \rangle$ is $C^\infty(M)$ -bilinear; $\langle X, X \rangle_q \geq 0$ for all $q \in M$ and $\langle X, X \rangle_q = 0 \implies X_q = 0$

Definition 2 An almost-Riemannian structure on a smooth n -dimensional manifold M is a pair $(\Delta, \langle \cdot, \cdot \rangle)$ where Δ is a submodule of $\Gamma(M)$ that can be locally defined by n vector fields and satisfies the rank condition, and $\langle \cdot, \cdot \rangle$ is a bilinear symmetric and positive definite mapping from $\Delta \times \Delta$ to $C^\infty(M)$, such that the set \mathcal{Z} of points q where the dimension of Δ_q is less than n is nonempty but with empty interior.

Around any point $p \in M$ the submodule Δ can be locally defined by an orthonormal frame (X_1, X_2, \dots, X_n) . It is enough to select a set of n sections (e_1, e_2, \dots, e_n) of E orthonormal in a neighborhood of p and define $X_i = f_*e_i$ where by definition $f_*e_i = f \circ e_i$.

Norm

The almost-Riemannian norm on Δ_q is defined by

$$\|v\| = \min\{\|u\|; u \in E_q \text{ and } f(u) = v\}.$$

2.2 Privileged coordinates and approximations

All the material of this section comes from [5] and [10], excepted the solvable approximations that are defined in [13].

Let p be a point of M and let $\Delta^k(p)$, $k \geq 1$ be the evaluation of the submodule Δ^k at p . Thanks to the rank condition these submodules verify $\Delta^1(p) \subset \Delta^2(p) \subset \dots \subset \Delta^r(p) = T_pM$ for some integer r referred to as the degree of nonholonomy at p . Let n_j stand for the dimension of $\Delta^j(p)$. The nonholonomic weights w_1, w_2, \dots, w_n at p are defined by $w_i = j \iff n_{j-1} < i \leq n_j$.

Let (x_1, x_2, \dots, x_n) be a system of coordinates centered at p . These coordinates are privileged if for each i there exist w_i vector fields in Δ such that the Lie derivative $X_{j_1}X_{j_2} \dots X_{j_{w_i}}x_i$ does not vanish at $p = 0$ but that any such Lie derivative of length smaller than w_i vanishes at 0 (see [5] or [10]).

Systems of privileged coordinates always exist (under the rank condition) and in such a system the weighted degree (homogeneous nonholonomic order) of the monomial $x_1^{\alpha_1}x_2^{\alpha_2} \dots x_n^{\alpha_n}$ is $\alpha_1w_1 + \alpha_2w_2 + \dots + \alpha_nw_n$, the weighted degree of the vector field $\frac{\partial}{\partial x_j}$ is $-w_j$, and the weighted degree of the vector field $x_1^{\alpha_1}x_2^{\alpha_2} \dots x_n^{\alpha_n} \frac{\partial}{\partial x_j}$ is $\alpha_1w_1 + \alpha_2w_2 + \dots + \alpha_nw_n - w_j$.

More generally the nonholonomic order at p of a function f (resp. a vector field X) is the minimum of the homogeneous nonholonomic orders of the monomials of its Taylor series.

It is important to notice that the nonholonomic degree $\text{ord}_p X$ of a vector field X at p cannot be less than $-r$, and that $\text{ord}_p[X, Y] = \text{ord}_p X + \text{ord}_p Y$ if X and Y are homogeneous and $[X, Y] \neq 0$ (see [5] or [10]).

The nonholonomic order of a vector field X belonging to Δ is at least equal to -1 . Consider a set X_1, X_2, \dots, X_n of vector fields that generates Δ around p . In privileged coordinates each X_j can be decomposed into

$$X_j = X_j^{(-1)} + X_j^{(0)} + X_j^{(1)} + \dots + X_j^{(s)} + \dots$$

where $X_j^{(s)}$ is the component of X_j of homogeneous order s .

The **nilpotent approximation** of $X_j \in \Delta$ is $\widehat{X}_j = X_j^{(-1)}$.

The Lie algebra generated by $\widehat{X}_1, \widehat{X}_2, \dots, \widehat{X}_n$ is nilpotent and finite dimensional. The rank condition is preserved: it is satisfied by $\widehat{X}_1, \widehat{X}_2, \dots, \widehat{X}_n$ as soon it is satisfied by X_1, X_2, \dots, X_n .

It may happen that some of the vector fields \widehat{X}_j globally vanish. In that case they can be replaced by $\widetilde{X}_j = X_j^{(0)}$. Let us assume that only m elements of $\widehat{X}_1, \widehat{X}_2, \dots, \widehat{X}_n$ are linearly independant (as vector fields). As explained in the next section we can assume without lost of generality that these vector fields are $\widehat{X}_1, \widehat{X}_2, \dots, \widehat{X}_m$ and that $\widehat{X}_{m+1}, \dots, \widehat{X}_n$ vanish. The set of vector fields

$$\widehat{X}_1, \dots, \widehat{X}_k, \dots, \widehat{X}_m, \widetilde{X}_{m+1}, \dots, \widetilde{X}_n,$$

is called the **solvable approximation** of X_1, X_2, \dots, X_n .

2.3 ARSs on Lie groups and homogeneous spaces

The purpose of this section is to recall the definition of linear ARSs on Lie groups and homogeneous spaces (see [4]).

Let G be a connected Lie group and \mathfrak{g} its Lie algebra (the set of left-invariant vector fields, identified with the tangent space at the identity). A vector field \mathcal{X} on G is **linear** if its flow is a one-parameter group of automorphisms or equivalently if $\mathcal{X}(e) = 0$ and for any left-invariant field Y the Lie bracket $[\mathcal{X}, Y]$ is also left-invariant.

A linear ARS on G is an almost-Riemannian structure defined by a set of:

- $n - s$ left-invariant vector fields Y_1, \dots, Y_{n-s} .
- $s > 0$ linear vector fields $\mathcal{X}_{n-s+1}, \dots, \mathcal{X}_n$.

assumed to satisfy the rank condition and to have full rank on a proper open and dense subset of G . The almost-Riemannian metric is defined by the orthonormality of this set of vector fields.

The singular set \mathcal{Z} where their rank is less than n cannot be empty because at least \mathcal{X}_n vanishes at the identity. On the other hand its interior is empty by analyticity as soon as the rank is full at one point.

A linear ARS is said to be simple if $s = 1$. For instance, the famous Grushin plane on the Abelian Lie group \mathbb{R}^2 is a simple ARS.

Consider a homogeneous space G/H of G by a closed and connected subgroup H (the elements of G/H are the right cosets of H). The projection of a left-invariant vector field Y onto G/H is well-defined and will be referred to as a left-invariant vector field (see details in [11]). On the other hand the projection of a linear field \mathcal{X} of G does exist on G/H if and only if H is invariant under its flow, or equivalently, because H is connected, if the Lie algebra of H is $\text{ad}(\mathcal{X})$ -invariant. This allows to define linear vector fields and linear ARSs on homogeneous spaces in exactly the same way than on Lie groups.

3 Nilpotent and solvable approximations are linear

Though this section deals with local questions, around a point p belonging to the singular locus, it will be more convenient to assume the ARS defined by a bundle E and a morphism f from E to TM as in Definition 1.

Firstly it is necessary to show that it is always possible to define the ARS locally, around the point $p = 0$ in local privileged coordinates, by a set of n orthonormal vector fields X_1, \dots, X_n such that the solvable approximation

$$\widehat{X}_1, \dots, \widehat{X}_k, \widehat{X}_{k+1}, \dots, \widehat{X}_m, \widetilde{X}_{m+1}, \dots, \widetilde{X}_n,$$

satisfies

- $\widehat{X}_i(0) \neq 0$ for $i = 1, \dots, k$;
- $\widehat{X}_i \neq 0$ but $\widehat{X}_i(0) = 0$ for $i = k + 1, \dots, m$;
- $\widehat{X}_i = 0$ for $i = m + 1, \dots, n$.

Let K_p be the kernel of the restriction of f to E_p , and let V_p be an orthogonal complement to K_p in E_p , that is $K_p \perp V_p$ and $K_p \oplus V_p = E_p$.

Let e_1, \dots, e_n be a set of n sections of E , orthonormal in a neighborhood of p , such that $e_j(p) \in V_p$ for $j = 1, \dots, k$ and $e_j(p) \in K_p$ for $j = k + 1, \dots, n$.

The vector fields $X_j = f_*(e_j)$, $j = 1, \dots, n$ define the ARS around p . Let (x_1, \dots, x_n) be a set of privileged coordinates and $\widehat{X}_1, \dots, \widehat{X}_n$ be the related nilpotent approximation. Let \mathcal{L} be the submodule of $\Gamma(E)$ generated by e_j for $j = k + 1, \dots, n$. Consider now the mapping $e \in \mathcal{L} \mapsto \widehat{f_*e}$.

Its rank is $m - k$ with $k \leq m \leq n$ and we can assume without loss of generality that e_{m+1}, \dots, e_n belong to the kernel of that linear map, and that e_{k+1}, \dots, e_m are orthogonal to that kernel.

The vector fields X_1, \dots, X_n satisfy the above conditions.

It may happen that the vector fields $\widetilde{X}_{m+1}, \dots, \widetilde{X}_n$ fail to be linearly independant. In that case neither the nilpotent approximation nor the solvable one define an almost-Riemannian structure.

For that reason we will always assume in what follows that the vector fields

$$\widehat{X}_1, \dots, \widehat{X}_k, \widehat{X}_{k+1}, \dots, \widehat{X}_m, \widetilde{X}_{m+1}, \dots, \widetilde{X}_n,$$

are linearly independant. Denote by \mathcal{Z}_a (a for approximation) the set of points where their rank is not full. It is not empty because at least one vector field vanishes at $p = 0$. On the other hand the approximating vector fields are polynomial and the interior of \mathcal{Z}_a is empty. Consequently \mathcal{Z}_a is a proper with empty interior subset of \mathbb{R}^n and the set of approximating vector fields defines an ARS.

Remarks.

1. It will be shown in the second part of the paper that generically $m = n$ or $m = n - 1$ and that in the second case $\widetilde{X}_n \neq 0$.
2. In the case where some of the \widetilde{X}_j vanish or are linearly dependant it seems difficult, if not impossible, to go one step further by considering homogeneous approximations of nonholonomic order $s > 0$ because, as explained in the sequel, two important properties could be lost. First a homogeneous vector field of degree $s > 0$ need not be complete. Second the Lie algebra generated by the approximating vector fields would not be finite dimensional in general. These two drawbacks are related, see [14] or [11].

3.1 The generated Lie algebra

In view of the next sections it is very important to notice that all involved vector fields are complete, because of their triangular form.

This fact is well-known for the \widehat{X}_i (see [5] or [10]).

It is as well true for the order zero homogeneous fields \tilde{X}_i . Indeed such a field writes:

$$\tilde{X}_i = \sum_{j=1}^n P_{ij}(x) \frac{\partial}{\partial x_j}$$

where P_{ij} is polynomial of nonholonomic degree w_j . In particular P_{ij} depends linearly on the coordinates $(x_{j_1}, \dots, x_{j_s})$ of weight w_j , is polynomial in the coordinates of weight smaller than w_j , and does not depend on the coordinates of weight greater than w_j . The associated differential equation is consequently triangular: the coordinates of weight 1 satisfy a linear homogeneous equation, the coordinates of weight 2 satisfy a linear equation with a second member that depends on the the coordinates of weight 1 only, and so on. All solutions are therefore defined on \mathbb{R} and \tilde{X}_i is complete. We can state:

Proposition 1 *The vector fields \hat{X}_j and \tilde{X}_j defined above are complete.*

This important property does not hold for homogeneous vector fields of positive degree, for example the first coordinate such a vector field could be $x_1^2 \frac{\partial}{\partial x_1}$, but $\hat{x}_1 = x_1^2$ is not complete.

The second feature we will use in the next subsections is the finiteness of the generated Lie algebra;

Proposition 2 *The Lie algebra \mathcal{L} generated by*

$$\hat{X}_1, \dots, \hat{X}_k, \hat{X}_{k+1}, \dots, \hat{X}_m, \tilde{X}_{m+1}, \dots, \tilde{X}_n,$$

is finite dimensional.

Proof. The nonholonomic order of these vector fields is 0 or -1 , and the nonholonomic order of their brackets is in the range $-r, \dots, 0$ where r is the nonholonomic degree of the set of vector fields. Consequently, their components are polynomials of degrees less than or equal to r . The Lie algebra \mathcal{L} is thus a subspace of a finite-dimensional vector space of polynomials. ■

3.2 The nilpotent case

It is the case where the vector fields $\hat{X}_1, \dots, \hat{X}_n$ are linearly independent and the vectors $\hat{X}_1(0), \dots, \hat{X}_k(0)$ are independent in \mathbb{R}^n . In particular no vector field \hat{X}_i vanishes, and $m = n$.

For $j = k + 1, \dots, n$ let D_j stand for $\text{ad}(\widehat{X}_j)$ and for any multi-index $J = (j_1, \dots, j_s)$ let $D_J = D_{j_s} \circ \dots \circ D_{j_1}$ (here $k + 1 \leq j_u \leq n$ and $s \geq 0$). Let

$$\mathcal{D} = \text{Span}\{D_J(\widehat{X}_i) / i = 1, \dots, k; J \text{ as above}\}.$$

Lemma 1 *The Lie algebra \mathfrak{g} generated by \mathcal{D} is D_j -invariant for $j = k + 1, \dots, n$.*

Proof. Let $D_{J_1}(\widehat{X}_{i_1})$ and $D_{J_2}(\widehat{X}_{i_2})$ in \mathcal{D} . Then

$$D_j[D_{J_1}(\widehat{X}_{i_1}), D_{J_2}(\widehat{X}_{i_2})] = [D_j \circ D_{J_1}(\widehat{X}_{i_1}), D_{J_2}(\widehat{X}_{i_2})] + [D_{J_1}(\widehat{X}_{i_1}), D_j \circ D_{J_2}(\widehat{X}_{i_2})]$$

belongs to \mathfrak{g} . ■

Let \mathcal{L} stand for the Lie algebra generated by $\widehat{X}_1, \dots, \widehat{X}_n$. It is a well-known fact that this Lie algebra is nilpotent and finite dimensional (see [5] or [10]).

Theorem 1 1. *The ideal generated in \mathcal{L} by $\widehat{X}_1, \dots, \widehat{X}_k$ is \mathfrak{g} . It is a nilpotent Lie algebra.*

2. *The vector fields $\widehat{X}_{k+1}, \dots, \widehat{X}_n$ do not belong to \mathfrak{g} and act on \mathfrak{g} as derivations.*

3. *The rank at $p = 0$ of the elements of \mathfrak{g} is full.*

Proof.

1. Since \mathfrak{g} is D_j -invariant for $j > k$ it is clear that it is an ideal of \mathcal{L} that contains $\widehat{X}_1, \dots, \widehat{X}_k$. The ideal generated by these vector fields contains all the $D_J(\widehat{X}_i)$ hence is equal to \mathfrak{g} .

2. Let us assume that \widehat{X}_j belongs to \mathfrak{g} for some $j > k$. Because of the rule about the nonholonomic order of brackets of homogeneous vector fields, all the elements of \mathfrak{g} of order -1 are linear combinations of $\widehat{X}_1, \dots, \widehat{X}_k$. The vector field \widehat{X}_j is homogeneous of order -1 and can consequently be written as:

$$\widehat{X}_j = \sum_{i=1}^k \lambda_i \widehat{X}_i.$$

But \widehat{X}_j vanishes at 0 and the vectors $\widehat{X}_i(0)$ are independent by assumption, so that the λ_i 's are all equal to 0, a contradiction.

3. Let $Y \in \mathcal{L} \setminus \mathfrak{g}$. It can be obtained only as brackets of $\widehat{X}_{k+1}, \dots, \widehat{X}_n$, hence $Y(0) = 0$ because all these fields vanish at 0.

If \mathfrak{g} did not satisfy the rank condition then the Lie algebra \mathcal{L} neither would satisfy it. This proves item 3. ■

After this analysis at the algebra level we can turn our attention to the Lie group level.

Let G be the simply connected Lie group whose Lie algebra is \mathfrak{g} . Since \mathfrak{g} is nilpotent the underlying manifold of G is \mathbb{R}^N , $N = \dim(\mathfrak{g})$. The first task is to show that \mathbb{R}^n is a homogeneous space of G . This is mainly due to the fact that \mathfrak{g} is generated by homogeneous vector fields.

Lemma 2 *The set \mathbb{R}^n is a homogeneous space of G . More accurately if H stands for the connected subgroup of G whose Lie algebra is the set of elements of \mathfrak{g} that vanish at 0, then \mathbb{R}^n is diffeomorphic to the quotient G/H .*

Proof.

Since the elements of \mathfrak{g} are complete vector fields of \mathbb{R}^n the group G acts naturally on \mathbb{R}^n as a group of diffeomorphisms, and it is enough to show that this action is transitive. More accurately G is the set of $\exp(t_s Y_s) \dots \exp(t_1 Y_1)$ where $Y_i \in \mathfrak{g}$ is a vector field on \mathbb{R}^n and $t_i \in \mathbb{R}$, i.e. a group of diffeomorphisms of \mathbb{R}^n .

Let us begin by a simple remark. Let $Y = \sum_{j=1}^n y_j(x) \frac{\partial}{\partial x_j}$ be an element of \mathfrak{g} , and assume that Y is homogeneous and that $Y(0) \neq 0$. There exists an index i such that $y_i(0) \neq 0$, and by homogeneity y_i is constant: $\forall x \in \mathbb{R}^n$, $y_i(x) = a_i \neq 0$. By homogeneity again the polynomials y_j are homogeneous of order $w_j - w_i$. Consequently

$$Y = \sum_{w_j=w_i} a_j \frac{\partial}{\partial x_j} + \sum_{w_j>w_i} y_j(x) \frac{\partial}{\partial x_j} \quad \text{where } a_i \neq 0.$$

Since \mathfrak{g} is generated by homogeneous elements and its rank is full at 0, we can choose in \mathfrak{g} a set n homogeneous elements Y_1, Y_2, \dots, Y_n linearly independant at 0. We can also assume that the nonholonomic order at p of Y_1, \dots, Y_{n_1} is -1 , the one of $Y_{n_1+1}, \dots, Y_{n_2}$ is -2 and so on. Up to linear combinations we can assume that Y_1, \dots, Y_{n_1} have the following form:

$$Y_i = \frac{\partial}{\partial x_i} + \sum_{w_j>1} y_j(x) \frac{\partial}{\partial x_j}.$$

More generally we can assume that if the order of Y_i is w_i then

$$Y_i = \frac{\partial}{\partial x_i} + \sum_{w_j > w_i} y_j(x) \frac{\partial}{\partial x_j}.$$

This way it is clear that the rank of the set of vector fields Y_1, Y_2, \dots, Y_n is full everywhere in \mathbb{R}^n . This implies that the action of G on \mathbb{R}^n is transitive. \blacksquare

To complete the construction we associate to the derivation $D_j = \text{ad}(\widehat{X}_j)$ of \mathfrak{g} a linear vector field \mathcal{X}_j on G for $j > k$ (\mathcal{X}_j does exist because G is simply connected). It is clear that the projection of \mathcal{X}_j on \mathbb{R}^n is \widehat{X}_j (see [11] for details). Finally the vector fields $\widehat{X}_1, \dots, \widehat{X}_k$ are invariant, and $\widehat{X}_{k+1}, \dots, \widehat{X}_n$ are linear vector fields on the homogeneous space $\mathbb{R}^n = G/H$.

We can state:

Theorem 2 *The space \mathbb{R}^n is a homogeneous space of the nilpotent Lie group G whose Lie algebra is \mathfrak{g} .*

The vector fields $\widehat{X}_1, \dots, \widehat{X}_k$ are projections of invariant vector fields of G and $\widehat{X}_{k+1}, \dots, \widehat{X}_n$ are projections of linear vector fields of G .

Consequently the set $\widehat{X}_1, \dots, \widehat{X}_n$ defines a linear ARS on the homogeneous space \mathbb{R}^n .

3.3 The non-nilpotent case

We set $D_j = \text{ad}(\widehat{X}_j)$ for $j = k+1, \dots, m$ and $D_j = \text{ad}(\widetilde{X}_j)$ for $j = m+1, \dots, n$. As well as in the nilpotent case we set $D_J = D_{j_s} \circ \dots \circ D_{j_1}$ for any multi-index $J = (j_1, \dots, j_s)$ where $s \geq 0$ and $k+1 \leq j_u \leq n$, and

$$\mathcal{D} = \text{Span}\{D_J(X_i) / i = 1, \dots, k; J \text{ as above}\}.$$

The Lie algebra \mathfrak{g} generated by \mathcal{D} is again D_j -invariant for $j = k+1, \dots, n$, which shows that \mathfrak{g} is the ideal generated in \mathcal{L} by $\widehat{X}_1, \dots, \widehat{X}_k$.

Theorem 3 *1. The ideal generated in \mathcal{L} by $\widehat{X}_1, \dots, \widehat{X}_k$ is \mathfrak{g} . It is a nilpotent Lie algebra.*

2. The vector fields $\widetilde{X}_{m+1}, \dots, \widetilde{X}_n$ do not belong to \mathfrak{g} and act on \mathfrak{g} as derivations.

3. The vector fields \widehat{X}_j , with $k+1 \leq j \leq m$ that do not belong to \mathfrak{g} act on \mathfrak{g} as derivations.

4. The rank at $p = 0$ of the elements of \mathfrak{g} is full.

Proof. The proofs that \mathfrak{g} is the ideal generated in \mathcal{L} by $\widehat{X}_1, \dots, \widehat{X}_k$ and that its rank at $p = 0$ is full are identical to the nilpotent case.

The Lie algebra \mathfrak{g} is generated by homogeneous vector fields of order at most -1 . Since the order of a Lie bracket is the sum of the orders of the factors and a vector field of order less than $-r$ vanishes, all brackets of length larger than r vanish, which shows that \mathfrak{g} is nilpotent.

The points 2. and 3. are clear. ■

Opposite to the nilpotent case we cannot assert that the vector fields $\widehat{X}_{k+1}, \dots, \widehat{X}_m$ do not belong to \mathfrak{g} . Because of this phenomenon, illustrated by Example 3 in Section 5, we are lead to introduce one more index. Up to a re-ordering we can assume that $\widehat{X}_{k+1}, \dots, \widehat{X}_l$ belong to \mathfrak{g} and that $\widehat{X}_{l+1}, \dots, \widehat{X}_m$ do not belong to \mathfrak{g} , where $k + 1 \leq l \leq m$.

Theorem 4 *The space \mathbb{R}^n is a homogeneous space of the nilpotent Lie group G whose Lie algebra is \mathfrak{g} .*

The vector fields $\widehat{X}_1, \dots, \widehat{X}_l$ are projections of invariant vector fields of G . The vector fields $\widehat{X}_{l+1}, \dots, \widehat{X}_m$ are projections of linear or affine vector fields of G and $\widetilde{X}_{m+1}, \dots, \widetilde{X}_n$ are projections of linear ones.

Consequently the set of vector fields $\widehat{X}_1, \dots, \widehat{X}_m, \widetilde{X}_{m+1}, \dots, \widetilde{X}_n$ defines a linear ARS on the homogeneous space \mathbb{R}^n .

Proof. Similar to the one of Theorem 2. ■

Remark.

As shown by Example 4 in Section 5 the Lie algebra \mathcal{L} generated by $\widehat{X}_1, \dots, \widehat{X}_m, \widetilde{X}_{m+1}, \dots, \widetilde{X}_n$ need not be solvable when $m \leq n - 2$.

However it is solvable if $m = n - 1$ and it will be proven in the next section that generically $m = n - 1$ or $m = n$.

It is why we call *solvable* the approximations of the previous kind.

4 Genericity

The examples of Section 5 show that many different, complicated structures may arise and the aim of this section is to determine the generic ones.

In what follows we will say that a property of almost-Riemannian distributions (resp. structures) on a manifold M is **generic** if for any rank n

vector bundle E (resp. Euclidean vector bundle $(E, \langle \cdot, \cdot \rangle)$) over M the set of smooth morphisms of vector bundles from E to TM for which this property is satisfied is open and dense in the \mathcal{C}^2 Whitney topology.

Let U be an open subset of M on which E and TM are trivializable, and let Π be the projection from E onto M . Then the restriction to $\Pi^{-1}(U)$ of a vector bundle morphism f is equivalent to a smooth mapping X from U to the set $\mathcal{M}_n(\mathbb{R})$ of $n \times n$ square matrices.

Alternately X can be viewed as a mapping (X_1, X_2, \dots, X_n) from U to the set $\Gamma(U)^n$ of n vector fields on U .

It is not useful to assume that f satisfies the properties of almost-Riemannian distributions because these conditions will turn out to be generic.

The first two theorems deal with distributions only, and do not require neither metric, nor normal forms.

In what follows we denote by $\mathcal{M}_{n \times m}(\mathbb{R})$ the set of real $n \times m$ matrices (simply $\mathcal{M}_n(\mathbb{R})$) if $m = n$) and by L^r the set of elements of $\mathcal{M}_{n \times m}(\mathbb{R})$ of corank r . It is a submanifold of $\mathcal{M}_{n \times m}(\mathbb{R})$ of codimension $(n-q+r)(m-q+r)$ where $q = \min\{n, m\}$ (see [8]).

Recall from Section 2 that f being given, Δ stands for the submodule of $\Gamma(M)$ it defines.

4.1 Generic distributions

Theorem 5 *The following properties are generic:*

1. Let R be the largest integer such that $R^2 \leq n$. For $1 \leq r \leq R$ let \mathcal{Z}_r be the set of points where the rank of f_p , or locally the rank of $\{X_1, X_2, \dots, X_n\}$, is $n - r$. Each \mathcal{Z}_r is a codimension r^2 submanifold and the singular locus \mathcal{Z} is the union of these disjoint submanifolds.
2. The submanifold \mathcal{Z}_{r+1} is included in the closure $\overline{\mathcal{Z}_r}$ of \mathcal{Z}_r for $r = 1, \dots, R - 1$.
3. For any local representation X of the distribution the mapping $x \mapsto \det(X(x))$ is a submersion at all points $x \in \mathcal{Z}_1$.
4. For $n \geq 3$ the rank of $\Delta + [\Delta, \Delta]$ is full at all points.

Proof.

1. Let E be a rank n vector bundle over M and let $\mathcal{H}om$ be the vector bundle over M whose fiber at $p \in M$ is the vector space $\mathcal{H}om_p = \mathcal{H}om(E_p, T_pM)$ of homomorphisms from E_p to T_pM .

A smooth vector bundle morphism f from E to TM can be viewed as a smooth section of $\mathcal{H}om$.

In each fiber $\mathcal{H}om_p$ the set of morphisms of corank $r > 0$ is a submanifold of $\mathcal{H}om_p$ of codimension r^2 . Their union over M defines a codimension r^2 submanifold S^r of $\mathcal{H}om$. Since the union of the S^r for $r = 1, \dots, n$ is closed, the set of smooth sections of $\mathcal{H}om$ that are transversal to all the S^r is open and dense in the set of smooth sections of $\mathcal{H}om$ endowed with the \mathcal{C}^2 Whitney topology.

The codimension of S^r is r^2 and transversality means nonintersection if $r^2 > n$. If $f^{-1}(S^r)$ is not empty transversality implies that it is a submanifold of M of codimension r^2 . This proves 1.

2. *In what follows we will always assume that the distributions under consideration are transversal to the manifolds S^r for $r = 1, \dots, n$.*

Let such a distribution be locally defined by X around a point p assumed to belong to \mathcal{Z}_r with $r \geq 2$. The rank of $\Lambda = X(p)$ is $n-r$ and there exists an invertible matrix P such that $P\Lambda P^{-1} = \begin{pmatrix} A_\Lambda & B_\Lambda \\ C_\Lambda & D_\Lambda \end{pmatrix}$ where $A_\Lambda \in \mathcal{M}_{n-r}(\mathbb{R})$ is invertible. As in the proof of the product of coranks Theorem we consider $T = \begin{pmatrix} I & 0 \\ -C_\Lambda A_\Lambda^{-1} & I \end{pmatrix}$ so that $TP\Lambda P^{-1} = \begin{pmatrix} A_\Lambda & B_\Lambda \\ 0 & D_\Lambda - C_\Lambda A_\Lambda^{-1} B_\Lambda \end{pmatrix}$.

Let the matrix P be fixed. The set Ω of matrices Q such that, with obvious notations, A_Q is invertible, hence $\Phi(Q) = D_Q - C_Q A_Q^{-1} B_Q$ is well defined, is open and the mapping Φ is a submersion from this open subset of $\mathcal{M}_n(\mathbb{R})$ onto $\mathcal{M}_r(\mathbb{R})$. Clearly $\text{rank}(Q) = n - r + \text{rank}(\Phi(Q))$ and for $0 \leq s \leq r$ we have $L_{\mathcal{M}_n(\mathbb{R})}^s = \Phi^{-1}(L_{\mathcal{M}_r(\mathbb{R})}^s)$ (with obvious notations again).

Since the distribution is generic we have $X \bar{\cap}_p L^r$ which implies that $\Phi \circ X$ is a submersion at p (see [8], Lemma 4.3). Let V be an open neighborhood of p and $W = V \cap X^{-1}(\Omega)$. Then $\Phi \circ X(W)$ is a neighborhood of 0 in $\mathcal{M}_r(\mathbb{R})$ that encounters $L_{\mathcal{M}_r(\mathbb{R})}^s$ for $0 \leq s \leq r$. Consequently

$$\forall s, \quad 0 < s < r, \quad V \cap \mathcal{Z}_s \neq \emptyset.$$

3. Consider now the determinant mapping, denoted by \det , from $\mathcal{M}_n(\mathbb{R})$ to \mathbb{R} . The differential of \det at Λ applied to H is $d\det(\Lambda).H = \text{Trace}(\tilde{\Lambda}H)$ where $\tilde{\Lambda}$ stands for the transpose of the matrix of cofactors of Λ . Consequently $d\det(\Lambda) \neq 0$ if and only if $\text{rank}(\Lambda) \geq n-1$. This shows that \det is a submersion on $\mathcal{M}_n(\mathbb{R}) \setminus \left(\bigcup_{r \geq 2} L^r \right)$. In particular \det is a submersion in a neighborhood W of L^1 small enough for $L^1 = \{\det = 0\} \cap W$.

Let us consider a distribution locally defined by X around a point p assumed to belong to \mathcal{Z}_1 . Since $X \overline{\cap}_p L^1$ and according to [8] (Lemma 4.3) $\det \circ X$ is a submersion at p . In other words $q \mapsto \det(X(q))$ is a submersion at p .

4. It remains to show that the rank of $\Delta + [\Delta, \Delta]$ is generically full everywhere. Let $X = (X_1, \dots, X_n)$ be a set of n vector fields on an open subset U of M that define locally the distribution. Up to a system of coordinates X is a mapping from U to $(\mathbb{R}^n)^n \equiv \mathcal{M}_n(\mathbb{R})$. Let J^1 be a typical fiber of the space of 1-jets of sections of $T^n U$, identified with $(\mathbb{R}^n)^n \times (\mathcal{M}_n(\mathbb{R}))^n$. The set F_i of elements $\overline{X} = (X, dX)$ of J^1 such that $X_i = 0$ and $\text{rank}(dX_i) < n$ is closed with empty interior: it is a finite union of submanifolds of codimension $n + \rho^2$, where ρ is the corank of dX_i . Consequently the set $\mathcal{O} = J^1 \setminus (\bigcup_{i=1}^n F_i)$ is the open and dense subset of J^1 of elements that verify $X_i = 0 \implies dX_i$ invertible.

Let Ψ be the mapping from J^1 to $\mathcal{M}_{n \times \frac{n(n+1)}{2}}(\mathbb{R})$ defined by

$$\Psi(\overline{X}) = \left(X, ([X_i, X_j] = dX_j \cdot X_i - dX_i \cdot X_j)_{1 \leq i < j \leq n} \right).$$

The mapping Ψ is a submersion on \mathcal{O} .

On the other hand the set L^r of elements of $\mathcal{M}_{n \times \frac{n(n+1)}{2}}(\mathbb{R})$ of corank r is a submanifold of codimension $r \left(\frac{n(n-1)}{2} + r \right)$ and $\Psi^{-1}(L^r) \cap \mathcal{O}$ is a submanifold of \mathcal{O} of the same codimension.

But $n < r \left(\frac{n(n-1)}{2} + r \right)$ excepted in the particular case $n = 2$ and $r = 1$ where there is equality (this case has been studied in [3]).

To finish the set of X that are transversal to the F_i , the union of which is closed, is open and dense. Such distributions take their values in \mathcal{O} , and the set of X that are moreover transversal to all the $\Psi^{-1}(L^r) \cap \mathcal{O}$ is open and dense.

Excepted in the case $n = 2$ and $r = 1$ transversality means nonintersection and implies that the rank of $\Delta + [\Delta, \Delta]$ is full at all points. ■

Two subspaces of $T_p M$ are attached to a point p belonging to the strata \mathcal{Z}_r of the singular locus, namely Δ_p , the distribution at p , and $T_p \mathcal{Z}_r$, the tangent subspace to \mathcal{Z}_r at p . Their dimensions being respectively $n - r$ and $n - r^2$, the dimension of $T_p \mathcal{Z}_r + \Delta_p$ is at most equal to $\min(n, 2n - r^2 - r)$. We are interested in the cases where the actual dimension of $T_p \mathcal{Z}_r + \Delta_p$ is less than $\min(n, 2n - r^2 - r)$. For example in \mathcal{Z}_1 this means that $\Delta_p = T_p \mathcal{Z}_r$ (tangency points).

In what follows we note $s = \min(n, 2n - r^2 - r) - \dim(T_p \mathcal{Z}_r + \Delta_p)$, and $\lfloor \alpha \rfloor$ stands for the integer part of the real number α .

Theorem 6 *The following properties are generic:*

- $r = 1$. The points $p \in \mathcal{Z}_1$ where $T_p \mathcal{Z}_1 = \Delta_p$ are isolated in \mathcal{Z}_1 .
- $r \geq 2$. Let $m(n, r)$ be the largest dimension that $T_p \mathcal{Z}_r + \Delta_p$ may reach, that is $m(n, r) = \min(n, 2n - r^2 - r)$, and let $s = m(n, r) - \dim(T_p \mathcal{Z}_r + \Delta_p)$. Then
 1. The set of points $p \in \mathcal{Z}_r$ where $s = 1$ is a submanifold of \mathcal{Z}_r for $n \geq r^2 + r - \lfloor \frac{r-1}{2} \rfloor$. It is empty if $n < r^2 + r - \lfloor \frac{r-1}{2} \rfloor$.
 2. The set of points $p \in \mathcal{Z}_r$ where $s \geq 2$ and $s^2 \leq r$ is a submanifold of \mathcal{Z}_r for $r^2 + r - \lfloor \frac{r-s^2}{s-1} \rfloor \leq n \leq r^2 + r + \lfloor \frac{r-s^2}{s-1} \rfloor$. It is empty if n is not in this interval.
 3. The set of points $p \in \mathcal{Z}_r$ where $s \geq 2$ and $s^2 > r$ is empty.

Proof. In this proof all distributions are assumed to satisfy the transversality conditions of Theorem 5.

1. Let us consider such a distribution and a point p in \mathcal{Z}_r for some $r > 0$, locally defined by X on an open set U containing p .

Moreover the set L^r is a codimension r^2 submanifold of $\mathcal{M}_n(\mathbb{R})$ and it can be locally defined, in a neighborhood V of the point $X(p) \in L^r$, by a submersion Φ from V to \mathbb{R}^{r^2} , so that $L^r \cap V = \Phi^{-1}(0)$.

2. Let us denote by $d(p)$ the dimension of the quotient $(T_p \mathcal{Z}_r + \Delta_p) / T_p \mathcal{Z}_r$. Since the dimension of \mathcal{Z}_r is $n - r^2$ and the one of Δ_p is $n - r$ we have $n - r \leq \dim(T_p \mathcal{Z}_r + \Delta_p) \leq \min(n, 2n - r^2 - r)$, and:

$$r^2 - r \leq d(p) \leq \min(n - r, r^2).$$

The distribution being assumed to be transversal to L^r at p the restriction of dX at any supplementary subspace to $T_p \mathcal{Z}_r$ in $T_p U$ is an isomorphism onto its image. On the other hand $dX(p)(T_p \mathcal{Z}_r) \subset \ker(d\Phi(X_p))$ because $\mathcal{Z}_r = X^{-1}(L^r)$, and since Φ is a submersion at p we obtain $d(p) = \text{rank } d(\Phi \circ X)(p).X(p)$.

Moreover there are exactly $n - r$ indices such that the vector fields $X_{i_1}, X_{i_2}, \dots, X_{i_{n-r}}$ are independant at p so that

$$d(p) = \text{rank } (d(\Phi \circ X)(p).X_{i_1}(p), \dots, d(\Phi \circ X)(p).X_{i_{n-r}}(p)).$$

3. In a neighborhood of p where the vector fields $X_{i_1}, X_{i_2}, \dots, X_{i_{n-r}}$ are independent at all points we define:

$$x \mapsto \Theta(x) = (X(x); d(\Phi \circ X)(x).X_{i_1}(x), \dots, d(\Phi \circ X)(x).X_{i_{n-r}}(x))$$

The mapping Θ takes its values in $\mathcal{M}_n(\mathbb{R}) \times \mathcal{M}_{r^2 \times (n-r)}(\mathbb{R})$ and $\Theta(x)$ belongs to $L^r \times L^s$ if and only if $x \in \mathcal{Z}_r$ and $d(x) = \min(r^2, n-r) - s$.

This shows that s measures the gap between $d(p)$ and the maximal value it can take. Consequently we are interested in the values of s that verify:

$$0 \leq s \leq \min(r, n - r^2).$$

4. The sets $L^r \times L^s$ are submanifolds in the typical fibers of the space of 1-jets of smooth sections of $\mathcal{H}om$. Since their union is closed the set of smooth sections of $\mathcal{H}om$ that are transversal to all these submanifolds is open and dense in the set of smooth sections of $\mathcal{H}om$ endowed with the Whitney \mathcal{C}^2 topology.

5. Let us first assume that $n - r \geq r^2$. The codimension of $L^r \times L^s$ in $\mathcal{M}_n(\mathbb{R}) \times \mathcal{M}_{r^2 \times (n-r)}(\mathbb{R})$ is $r^2 + s(n - r^2 - r + s)$.

For $s = 1$ it is $n - r + 1$. Since $n \geq n - r + 1$ the set of points of \mathcal{Z}_r where $s = 1$ is generically a submanifold of codimension $n - r + 1$. In particular for $r = 1$ the codimension of this submanifold is n and it consists in isolated points.

For $s \geq 2$ transversality means nonintersection if $n < r^2 + s(n - r^2 - r + s)$. But the two conditions $n \geq r^2 + s(n - r^2 - r + s)$ and $n - r \geq r^2$ are equivalent to $0 \leq n - r^2 - r \leq \frac{r - s^2}{s - 1}$, hence to:

$$r^2 + r \leq n \leq r^2 + r + \lfloor \frac{r - s^2}{s - 1} \rfloor. \quad (1)$$

Notice that $s^2 \leq r$ is a necessary condition for this inequality to hold.

6. Let us now assume that $n - r \leq r^2$. The codimension of $L^r \times L^s$ is $r^2 + s(r^2 + r + s - n)$. Again transversality means nonintersection if $n < r^2 + s(r^2 + r + s - n)$. The two conditions $n - r \leq r^2$ and $n \geq r^2 + s(r^2 + r + s - n)$ are equivalent to:

$$r^2 + r - \lfloor \frac{r - s^2}{s - 1} \rfloor \leq n \leq r^2 + r \quad (2)$$

Again $s^2 \leq r$ is necessary for this inequality to hold.

7. The results of items 4 and 5 provide all the statements of the theorem.

4.2 Normal forms of almost-Riemannian structures

We consider an almost-Riemannian structure defined by a Euclidean vector bundle $(E, \langle \cdot, \cdot \rangle)$ and a vector bundle morphism f , and we are interested in local normal forms of orthonormal vector fields defining the structure in a neighborhood of a point p that we can assume to be $p = 0$ in local coordinates.

These normal forms turn out to be the key of the next section.

First we follow the lines of [2] (also used in [7] and [6]).

Let W be a codimension 1 submanifold transversal to the distribution. We can define a coordinate system $y = (x_2, \dots, x_n)$ in W , and choose an orientation transversal to W . Let γ_y be the family of normal geodesics parametrized by arclength, transversal to W at y , and positively oriented. The mapping $(x_1, y) \mapsto \gamma_y(x_1)$ is a local diffeomorphism and the geodesics $x_1 \mapsto \gamma_y(x_1)$ realize the minimal distance between $W = \{x_1 = 0\}$ and the surfaces $\{x_1 = c\}$ for c small enough. The transversality conditions of the PMP are consequently satisfied along all these surfaces: if $\lambda(x_1)$ is a covector associated to one of these geodesics then the tangent space to $\{x_1 = c\}$ at $\gamma_y(x_1)$ is $\ker(\lambda(x_1))$.

Now let $X_1 = \partial_{x_1}$ be the vector field defined by $X_1(q) = \frac{d}{dx_1} \gamma_y(x_1)$ at the point $q = \gamma_y(x_1)$. It is a unitary vector field belonging to Δ . Let X_2, \dots, X_n be $n-1$ vector fields such that $\{X_1, X_2, \dots, X_n\}$ be an orthonormal frame of Δ . For geodesics the control functions (u_1, u_2, \dots, u_n) from the PMP satisfy $u_j = \langle \lambda, X_j \rangle$. But here $(u_1, u_2, \dots, u_n) = (1, 0, \dots, 0)$ so that $\langle \lambda, X_j \rangle = 0$ for $j = 2, \dots, n$ and the vector fields X_2, \dots, X_n are tangent to the surfaces $\{x_1 = c\}$. Consequently the vector fields have the following form:

$$X_1 = \begin{pmatrix} 1 \\ 0 \\ \cdot \\ \cdot \\ 0 \end{pmatrix}, \quad X_j = \begin{pmatrix} 0 \\ a_{2,j} \\ \cdot \\ \cdot \\ a_{n,j} \end{pmatrix} \quad \text{for } 1 < j < n$$

for any choice of the coordinates in W and any choice of X_2, \dots, X_n , under the condition that they provide an orthonormal frame related to the sub-Riemannian metric.

Notice that thanks to the transversality conditions the vectors fields X_2, \dots, X_n are not only orthogonal to X_1 for the sub-Riemannian metric but also for the canonical inner product of \mathbb{R}^n for the chosen coordinates.

Let us assume now that $p = 0$ belongs to \mathcal{Z}_r with $r \geq 1$ and $r^2 \leq n$. We want to show that the coordinates and X_2, \dots, X_n can be chosen in such a way that they write:

$$X_1 = \begin{pmatrix} 1 \\ 0 \\ \cdot \\ \cdot \\ \cdot \\ \cdot \\ 0 \end{pmatrix} \quad X_2 = \begin{pmatrix} 0 \\ 1 + b_2(x) \\ a_{3,2}(x) \\ \cdot \\ \cdot \\ \cdot \\ a_{n,2}(x) \end{pmatrix} \quad \dots \quad X_{n-r} = \begin{pmatrix} 0 \\ \cdot \\ \cdot \\ 1 + b_{n-r}(x) \\ a_{n-r+1,n-r} \\ \cdot \\ a_{n,n-r}(x) \end{pmatrix} \quad \text{and}$$

$$(X_{n-r+1} \quad \dots \quad X_n) = \begin{pmatrix} 0 \\ \cdot \\ \cdot \\ 0 \\ \text{-----} \\ D(x) \end{pmatrix} \quad \text{where } D(x) \in \mathcal{M}_r(\mathbb{R}),$$

$b_j(0) = a_{i,j}(0) = 0$, and $D(0) = 0$.

Firstly we can assume that $X_j(0) = \partial_{x_j}$ for $j = 2, \dots, n-r$ and $X_j(0) = 0$ for $j = n-r+1, \dots, n$. Indeed X_2, \dots, X_n are tangent to W where we can choose freely the coordinates (x_2, \dots, x_n) .

If $r = n-1$, which is generically possible only if $n = 2$ and $r = 1$, it is finished. Otherwise we can first replace X_2 by the normalization of $\sum_{j=2}^n a_{2j} X_j$. Then we replace X_j by $X_j - \frac{a_{2j}}{a_{22}} X_2$ for $j > 2$. These vector fields belong to Δ , their first two coordinates vanish and they are orthonormal to (the new) X_2 . It remains to orthonormalize these $n-2$ vector fields. This cannot be done directly because some of them vanish in the singular locus. However they are images by the vector bundle morphism f of locally nonvanishing smooth sections of E that can be orthonormalized.

The desired form of the vector fields is obtained by induction.

4.3 Nilpotent and solvable approximations of generic distributions

Theorem 7 *For a generic distribution holds:*

- (i) *Let p be a tangency point in \mathcal{Z}_1 , that is a point where $T_p \mathcal{Z}_1 = \Delta_p$. Then $\widehat{X}_n = 0$ but $\widetilde{X}_n \neq 0$, in normal form.*

(ii) At all other points, including all points in \mathcal{Z}_r with $r \geq 2$, the nilpotent approximation $\widehat{X}_1, \widehat{X}_2, \dots, \widehat{X}_n$ is a set of n linearly independent vector fields.

Proof.

Consider a generic distribution, a point p in \mathcal{Z}_1 and privileged coordinates centered at p such that

$$X_1 = \begin{pmatrix} 1 \\ 0 \\ \cdot \\ \cdot \\ 0 \end{pmatrix} X_2 = \begin{pmatrix} 0 \\ 1 + b_2(x) \\ a_{3,2}(x) \\ \cdot \\ a_{n,2}(x) \end{pmatrix} \dots X_{n-1} = \begin{pmatrix} 0 \\ \cdot \\ \cdot \\ 0 \\ 1 + b_{n-1}(x) \\ a_{n,n-1}(x) \end{pmatrix} X_n = \begin{pmatrix} 0 \\ \cdot \\ \cdot \\ \cdot \\ 0 \\ a_n(x) \end{pmatrix}$$

where $b_j(0) = a_{i,j}(0) = 0$. The determinant of X is $a_n(x) \prod_{j=2}^{n-1} (1 + b_j(x))$ and the singular locus is locally $\mathcal{Z} = \mathcal{Z}_1 = \{a_n = 0\}$.

Let $a_n(x) = \sum_{i=1}^n \alpha_i x_i + o(\|x\|)$. Since the determinant is a submersion at p there exists i such that $\alpha_i \neq 0$.

1. If there exists $i_0 \leq n - 1$ such that $\alpha_{i_0} \neq 0$ then $\widehat{X}_n \neq 0$. Moreover $da_n(0) \cdot X_{i_0} = \alpha_{i_0} \neq 0$. Hence $X_{i_0}(0) \notin T_0 \mathcal{Z}_1$ and $T_0 \mathcal{Z}_1 + \Delta_0 = \mathbb{R}^n$.

2. If $\alpha_i = 0$ for $i = 1, \dots, n - 1$, then $\widehat{X}_n = 0$, but $\alpha_n \neq 0$ and $\widetilde{X}_n = (\alpha_n x_n + q(x_1, \dots, x_{n-1})) \frac{\partial}{\partial x_n}$, where $q(x_1, \dots, x_{n-1})$ is quadratic.

Moreover $T_0 \mathcal{Z}_1 = \ker da_n(0) = \{x_n = 0\}$, hence $X_j(0) \in T_0 \mathcal{Z}_1$ for $j = 1, \dots, n - 1$ and $\Delta_0 = T_0 \mathcal{Z}_1$.

Let now $p \in \mathcal{Z}_r$ with $r \geq 2$. We can choose privileged coordinates centered at p such that:

$$X_1 = \begin{pmatrix} 1 \\ 0 \\ \cdot \\ \cdot \\ \cdot \\ \cdot \\ 0 \end{pmatrix} X_2 = \begin{pmatrix} 0 \\ 1 + b_2(x) \\ a_{3,2}(x) \\ \cdot \\ \cdot \\ a_{n,2}(x) \end{pmatrix} \dots X_{n-r} = \begin{pmatrix} 0 \\ \cdot \\ \cdot \\ 1 + b_{n-r}(x) \\ a_{n-r+1,n-r} \\ \cdot \\ a_{n,n-r}(x) \end{pmatrix} \quad \text{and}$$

$$(X_{n-r+1} \quad \dots \quad X_n) = \begin{pmatrix} 0 \\ \vdots \\ 0 \\ \hline D(x) \end{pmatrix}$$

where $b_j(0) = a_{i,j}(0) = 0$ and $D(x) \in \mathcal{M}_r(\mathbb{R})$.

Let $x = (y, z)$ where $y = (x_1, \dots, x_{n-r})$ and $z = (x_{n-r+1}, \dots, x_n)$. The assumption $p = 0 \in \mathcal{Z}_r$ implies $D(0) = 0$ and we can write:

$$D(x) = l(y) + k(z) + \mathcal{Q}(y, z)$$

where l and k are linear and \mathcal{Q} contains all the terms of degree greater than one. Here $l(y) = (l_{ij}(y))_{n-r+1 \leq i, j \leq n}$ belongs to $\mathcal{M}_r(\mathbb{R})$ and each entry l_{ij} is linear w.r.t. $y = (x_1, \dots, x_{n-r})$.

As in the proof of Theorem 6 we denote by $d(p)$ the dimension of the quotient $(T_p \mathcal{Z}_r + \Delta_p) / T_p \mathcal{Z}_r$. It is clear that here $d(0) = \dim(dD(0).\Delta_0)$, at $p = 0$. But $\Delta_0 = \text{Span}\{X_1(0), \dots, X_{n-r}(0)\}$ and for $j = 1, \dots, n-r$:

$$dD(0).X_j(0) = \frac{\partial D}{\partial x_j}(0) = \frac{\partial l}{\partial x_j}(0).$$

Consequently $d(0) = \text{rank}(l)$ (as a mapping from \mathbb{R}^{n-r} to $\mathcal{M}_r(\mathbb{R})$).

For $j = n-r+1, \dots, n$ the nilpotent approximation \widehat{X}_j of X_j is

$$\widehat{X}_j = \sum_{i=n-r+1}^n l_{ij}(y) \frac{\partial}{\partial x_i}.$$

This is due to the fact that the weights of the coordinates are 1 for $i = 1, \dots, n-r$ and 2 for $i = n-r+1, \dots, n$.

Let us assume that the vector fields $\widehat{X}_{n-r+1}, \dots, \widehat{X}_n$ are not linearly independent. Then the mapping l takes its values in a subspace of $\mathcal{M}_r(\mathbb{R})$ of dimension $r^2 - r$ and $d(p)$ is smaller than or equal to $r^2 - r$. But $r^2 - r \leq d(p) \leq \min(n-r, r^2)$ according to the proof of Theorem 6 and the equality can hold for $r = 1$ only. Indeed let $s = \min(n-r, r^2) - d(p)$ as in the proof of Theorem 6. Then:

1. If $n-r \geq r^2$ then $s = r^2 - (r^2 - r) = r$. But $r \geq 2$ implies $s \geq 2$ and $s^2 > r$ which is impossible according to Theorem 6.
2. If $n-r < r^2$ then $s = n-r - (r^2 - r) = n - r^2$. But n, r and s must satisfy $n \geq r^2 + s(r^2 + r + s - n)$ according to the proof of Theorem 6. For $s = n - r^2$ this is $s \geq sr$ which is impossible for $r \geq 2$.

■

5 Examples

The following four examples use the notations of Section 3.

The first one is a standard example of a solvable approximation on the group Heisenberg. Example 2 shows that the elements of the Lie algebra \mathcal{L} of nonholonomic order smaller than -1 are not necessarily in \mathfrak{g} . We exhibit a vector field of the distribution that vanishes at p but belongs to the ideal \mathfrak{g} in Example 3 (which implies that the rank of the nilpotent approximation is not full).

To finish the Lie algebra \mathcal{L} of Example 4 is not solvable, it contains a semi-simple subalgebra. Recall that this is not generic.

In these four examples, the vector fields are equal to their nilpotent or solvable approximations at 0. It is of course possible to add terms of higher nonholonomic order without modifying the conclusions.

Example 1

Consider in \mathbb{R}^3 the almost-Riemannian structure defined by the vector fields:

$$X_1 = \partial_x, \quad X_2 = \partial_y + x\partial_z, \quad X_3 = x\partial_y + \frac{1}{2}x^2\partial_z.$$

At $p = (0, 0, 0)$ the coordinates (x, y, z) are privileged with weights $(1, 1, 2)$, the vector fields X_1 and X_2 are homogeneous of order -1 and X_3 is homogeneous of order 0, so that $\hat{X}_1 = X_1$, $\hat{X}_2 = X_2$, $\hat{X}_3 = 0$ and $\tilde{X}_3 = X_3$. The nilpotent approximation at p is not an almost-Riemannian structure, it is the constant rank 2 sub-Riemannian structure defined by X_1 and X_2 .

The Lie algebra generated by $\hat{X}_1, \hat{X}_2, \tilde{X}_3$ is $\mathcal{L} = \text{Span}\{\hat{X}_1, \hat{X}_2, \tilde{X}_3, \partial_z\}$, the ideal $\mathfrak{g} = \text{Span}\{\hat{X}_1, \hat{X}_2, \partial_z\}$ is here the Heisenberg Lie algebra, and \tilde{X}_3 is a linear vector field on \mathfrak{g} . Finally $\hat{X}_1, \hat{X}_2, \tilde{X}_3$ is a linear ARS on the Heisenberg group.

Example 2

The almost-Riemannian structure is here defined in \mathbb{R}^3 by:

$$X_1 = \partial_x, \quad X_2 = x\partial_y, \quad X_3 = y^2\partial_z.$$

The Lie algebra \mathcal{L} contains X_1, X_2, X_3 and

$$\begin{aligned} X_4 &= [X_1, X_2] = \partial_y, & X_5 &= \frac{1}{2}[X_4, X_3] = y\partial_z, \\ X_6 &= [X_2, X_5] = x\partial_z, & X_7 &= [X_1, X_6] = [X_4, X_5] = \partial_z \\ X_8 &= \frac{1}{2}[X_2, X_3] = xy\partial_z, & X_9 &= [X_2, X_8] = x^2\partial_z. \end{aligned}$$

Therefore:

$$\begin{aligned} \Delta^1 &= \Delta = \{X_1, X_2, X_3\}, & \Delta^2 &= \Delta^1 + \{X_4, X_8\} \\ \Delta^3 &= \Delta^2 + \{X_5, X_9\}, & \Delta^4 &= \Delta^3 + \{X_6\}, & \Delta^5 &= \Delta^4 + \{X_7\}. \end{aligned}$$

The canonical coordinates are privileged with weights $(1, 2, 5)$ and the vector fields X_1 , X_2 , and X_3 are homogeneous of order -1 hence equal to their nilpotent approximations.

The algebra \mathfrak{g} is here the ideal of \mathcal{L} generated by X_1 that is

$$\mathfrak{g} = \text{Span}\{X_1, X_4, X_5, X_6, X_7\}.$$

The vector fields X_2 and X_3 are linear, as well as $X_8 = \frac{1}{2}[X_2, X_3]$ and $X_9 = [X_2, X_8]$.

The orders of X_8 and X_9 are respectively -2 and -3 which shows that the vector fields of order smaller than -1 are not necessarily in \mathfrak{g} .

Notice that the singular locus is here $\mathcal{Z} = \{xy = 0\}$. ■

Example 3

Consider in \mathbb{R}^4 the almost-Riemannian structure defined by the vector fields:

$$X_1 = \partial_x, \quad X_2 = \partial_y + x\partial_z, \quad X_3 = y\partial_w, \quad X_4 = \frac{1}{2}x^2\partial_z + \frac{1}{2}y^2\partial_w.$$

Since $[X_1, X_2] = \partial_z$ and $[X_2, X_3] = \partial_w$, the coordinates (x, y, z, w) are privileged with weights $(1, 1, 2, 2)$ at $p = (0, 0, 0, 0)$. The vector fields X_1 , X_2 are homogeneous of order -1 and independent at 0 , and the vector field X_3 is homogeneous of order -1 but vanishes at 0 . The last field X_4 is homogeneous of order 0 . Consequently the first three are equal to their nilpotent approximation and $X_4 = \tilde{X}_4$. According to the notations of Section 3 we have $k = 2$ and $m = 3$.

The Lie algebra \mathcal{L} is spanned by X_1, X_2, X_3, X_4 and

$$X_5 = [X_1, X_2] = \partial_z, \quad X_6 = [X_2, X_3] = \partial_w, \quad X_7 = [X_1, X_4] = x\partial_z.$$

Despite the fact that $\hat{X}_3(0) = X_3(0) = 0$ we cannot assert as in the nilpotent case that X_3 does not belong to \mathfrak{g} (see Section 3.3 after Theorem 3). Indeed the ideal generated in \mathcal{L} by X_1 and X_2 is here

$$\mathfrak{g} = \text{Span}\{X_1, X_2, X_3, X_5, X_6, X_7\}$$

because $X_3 = [X_2, X_4]$.

As explained in Section 3.3 this may happen when $k < m < n$.

Notice that the determinant of X_1, X_2, X_3, X_4 is $-\frac{1}{2}x^2y$. Therefore the singular locus is $\mathcal{Z} = \{xy = 0\}$ which shows that the structure is not generic.

■

In the general case the Lie algebra \mathcal{L} need not be solvable. Indeed it is a subalgebra of the semi-direct product of \mathfrak{g} by its algebra of derivations. But the algebra of derivations of a nilpotent Lie algebra is not solvable in general. For instance the derivations of the Heisenberg algebra is the set of endomorphisms the matrix of which writes in the canonical basis:

$$D = \begin{pmatrix} a & b & 0 \\ c & d & 0 \\ e & f & a+d \end{pmatrix}$$

The subalgebra of such derivations that moreover satisfy $e = f = a + d = 0$ is equal to \mathfrak{sl}_2 hence semisimple.

Example 4 illustrates that possibility.

Example 4

Consider in \mathbb{R}^5 , with coordinates (x, y, z, w, t) :

$$\begin{aligned} X_1 &= \partial_x, & X_2 &= \partial_y + x\partial_w + z\partial_t, & X_3 &= \partial_z + x\partial_t, \\ X_4 &= x\partial_y + \frac{1}{2}x^2\partial_w, & X_5 &= y\partial_x + \frac{1}{2}y^2\partial_w \end{aligned}$$

The Lie algebra \mathcal{L} contains also

$$\begin{aligned} X_6 &= [X_1, X_2] = \partial_w, & X_7 &= [X_1, X_3] = [X_3, X_2] = \partial_t, \\ X_8 &= [X_3, X_5] = -y\partial_t, & X_9 &= [X_8, X_4] = x\partial_t, \\ X_{10} &= [X_4, X_5] = x\partial_x - y\partial_y. \end{aligned}$$

The coordinates (x, y, z, w, t) are privileged with weights $(1, 1, 1, 2, 2)$ at the origin. At this point the vector fields X_1, X_2, X_3 (resp. X_4, X_5) are homogeneous of order -1 (resp. 0), hence equal to their nilpotent approximations (resp. $\tilde{X}_4 = X_4$ and $\tilde{X}_5 = X_5$).

Since $X_{10} = [X_4, X_5]$, $[X_{10}, X_4] = 2X_4$ and $[X_{10}, X_5] = -2X_5$ the vector fields X_4, X_5 and X_{10} , that do not belong to \mathfrak{g} , generate a semi-simple Lie algebra isomorphic to \mathfrak{sl}_2 . Consequently the algebra \mathcal{L} is not solvable.

The singular locus is here $\mathcal{Z} = \{xyz = 0\}$, and again the structure is not generic.

■

References

[1] A. Agrachev, D. Barilari and U. Boscain, *A Comprehensive Introduction to Sub-Riemannian Geometry*, Cambridge Studies in Advanced Mathematics, 181. Cambridge University Press, Cambridge, 2020.

- [2] A. Agrachev, U. Boscain, M. Sigalotti, *A Gauss-Bonnet like formula on two-dimensional almost-Riemannian manifolds*, Discrete Contin. Dyn. Syst. 20 (4) (2008) 801-822.
- [3] A. Agrachev, U. Boscain, G. Charlot, R. Ghezzi, and M. Sigalotti, *Two dimensional almost-Riemannian structures with tangency points*. Ann. Inst. H. Poincaré. Anal. Non Linéaire 27 (2010), 793-807.
- [4] V. Ayala and P. Jouan, *Almost-Riemannian geometry on Lie groups*, SIAM Journal on Control and Optimization, 54 (2016), 2919–2947.
- [5] A. Bellaïche *The tangent space in sub-Riemannian geometry* in Sub-Riemannian Geometry (A. Bellaïche and J.-J. Risler, Eds.), Birkhäuser, 1996, pp. 1-78.
- [6] U. Boscain, G. Charlot, M. Gaye, P. Mason *Local properties of almost-Riemannian structures in dimension 3*, Discrete and Continuous Dynamical Systems-A, Volume 35, Issue 9 (2015), pp. 4115-4147.
- [7] U. Boscain, G. Charlot, R. Ghezzi *Normal forms and invariants for 2-dimensional almost-Riemannian structures*, Differential Geometry and its Applications 31 (2013) 41-62.
- [8] M. Golubitsky and V. Guillemin *Stable mappings and their singularities*, third edition, Springer 1986.
- [9] M. Hirsch *Differential topology*, Graduate texts in mathematics 33, Springer, 1976.
- [10] F. Jean *Control of Nonholonomic Systems: from Sub-Riemannian Geometry to Motion Planning*, Springer 2014.
- [11] Ph. Jouan *Equivalence of Control Systems with Linear Systems on Lie Groups and Homogeneous Spaces*, ESAIM: Control Optimization and Calculus of Variations, 16 (2010) 956-973.
- [12] P. Jouan, G. Zsigmond and V. Ayala, *Isometries of almost-Riemannian structures on Lie groups*, Differential Geometry and its Applications, 61 (2018), 59–81
- [13] P. Jouan, R. Manríquez, *Solvable approximations of 3-dimensional almost-Riemannian structures*, MCRF, June 2022, 12(2): 303-326.
- [14] R.S. Palais *A global formulation of the Lie theory of transformation groups*, Mem. Amer. Math. Soc. No 22 1957.

Paper 3

Distance Induced by the Solvable approximation of n -dimensional Almost-Riemannian Structures, article in progress.

Distance Induced by the Solvable Approximation of n -dimensional Almost-Riemannian Structures

Ronald Manríquez*

Abstract

The nilpotent and solvable approximations of a n -dimensional almost-Riemannian structure (ARS) induce two different distances denoted by \hat{d} and \tilde{d} respectively. In this paper, under generic conditions, we prove that \tilde{d} is closer to the original distance associated with the ARS than \hat{d} .

Key words: Almost-Riemannian geometry, Nilpotent approximation, Solvable approximation.

AMS subject classifications: 53C15, 53C17, 22E25, 53B99.

1 Introduction

This paper aims to prove that generically, the distance induced by the solvable approximation is closer than the one induced by the nilpotent approximation to the original distance of a n -dimensional almost-Riemannian structure.

An almost-Riemannian structure (ARS) on a n -dimensional differential manifold M , locally can be defined by a set of n smooth vector fields on M , $\{X_1, X_2, \dots, X_n\}$, satisfying the Lie algebra rank condition (Larc in short). This set of n vector fields is considered an orthonormal frame. The set of points where the linear span of the vector fields is not full-rank is called the singular locus or the singular set and denoted by \mathcal{Z} . If \mathcal{Z} is empty, then the almost-Riemannian structure is a Riemannian one (more details in [1]).

In the generic 2 and 3-dimensional cases, \mathcal{Z} is a codimension one embedded submanifold. Furthermore, if $\Delta_p = \text{span}\{X_1(p), X_2(p), \dots, X_n(p)\}$, the points where $\Delta_p = T_p\mathcal{Z}$ are isolated (see Figure 1). Such points are called *tangency points* in [2] and *type-2 points* in [5]. In [6], the authors show that for generic n -dimensional ARSs, the singular locus \mathcal{Z} is a union of submanifolds \mathcal{Z}_r of codimension r^2 where the rank of Δ is $n - r$ and the tangency points in \mathcal{Z}_1 are isolated.

*Université Paris-Saclay, CNRS, CentraleSupélec, Laboratoire des signaux et systèmes, 91190 Gif-sur-Yvette, France. ronald.manriquez-penafiel@universite-paris-saclay.fr

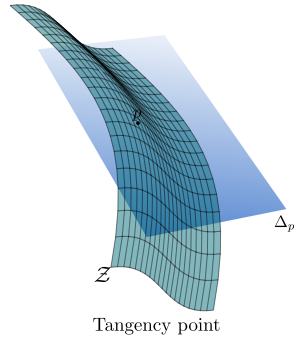

Figure 1: Representation of a tangency point.

On the other hand, nilpotent approximations are used to locally study the behavior of almost-Riemannian structures due to their significant similarity to the original dynamics. However, there are cases where the nilpotent approximation of an ARS turns out to be a constant rank sub-Riemannian structure. That is, some vector fields may vanish. The above is exactly what happens in the generic 3-dimensional case, dealt in [5], where in privileged coordinates, the local representation of a 3-dimensional ARS at tangency points has the following nilpotent approximation (see section 2.2)

$$\hat{X}_1 = \begin{pmatrix} 1 \\ 0 \\ 0 \end{pmatrix}, \quad \hat{X}_2 = \begin{pmatrix} 0 \\ 1 \\ x \end{pmatrix}, \quad \hat{X}_3 = 0,$$

which is the Heisenberg sub-Riemannian structure, and hence is not an ARS.

To recover the almost-Riemannian structure lost in the nilpotent approximation, the solvable approximation is introduced in [10]. In that paper, it was considered the case where only one of the vector fields of the nilpotent approximation vanishes and the other ones are independents. A generalization of this approximation is given in [6], where a complete description of the nilpotent and solvable approximations is addressed, and the generic almost-Riemannian structures are described.

This paper deals with the distance induced by the solvable approximation at tangency points, of an n -dimensional ARS considering generic assumptions, which are: the rank of $\Delta_p + [\Delta, \Delta]_p$ is n for all $p \in M$, the singular set is a union of submanifolds \mathcal{Z}_r of codimension r^2 where the rank of Δ is $n - r$, the points $p \in \mathcal{Z}_1$ where $T_p \mathcal{Z}_1 = \Delta_p$ are isolated in \mathcal{Z}_1 , and the solvable approximation can be defined only at a tangency point in \mathcal{Z}_1 . Under the above conditions, we get a normal form of a generic n -dimensional ARS at a tangency point belonging to the singular set, and thus we obtain the nilpotent and solvable approximations with this local representation.

The original system, the nilpotent and solvable approximations give rise to three different distances: d , \tilde{d} and $\tilde{\tilde{d}}$ respectively. Section 4 deals with the

almost-Riemannian distance defined by the solvable approximation. The main result is Theorem 5 which states that generically, the distance \tilde{d} is closer to \hat{d} than d for pairs of points translated in an appropriate direction (Section 4.3). To prove this result, it is important to determine two facts. First, to state the order of approximation of d by \tilde{d} (Theorem 2), and second, to find translation directions such that the distance \tilde{d} of a pair of translated points is decreasing (see Section 4.2).

To state the order of approximation of d by \tilde{d} , we analyze the divergence of curves admissible for d and \tilde{d} , defined by the same control functions and starting at the same point (see Proposition 2). By using this fact, we obtain that the distance induced by the solvable approximation improves the order of approximation of d given by \hat{d} (see Theorem 2).

To find translation directions, we consider a vector field $Y \in \mathfrak{g}^1$ and then $Y \in \mathfrak{g}^2$, where $\mathfrak{g} = \mathfrak{g}^1 \oplus \mathfrak{g}^2$ is the ideal generated in \mathcal{L} by $\hat{X}_1, \dots, \hat{X}_{n-1}$, where \mathfrak{g}^s is the set of homogeneous vector fields of order $-s$, and \mathcal{L} is the Lie algebra generated by the solvable approximation.

The paper is organized as follows. Section 2 contains generalities about ARSs, nonholonomic order, privileged coordinates, the nilpotent approximation, and solvable one.

Section 3 is devoted to provide the normal form of a generic n -dimensional ARS at tangency points. Moreover, subsection 3.2 provides the solvable approximation, and the Hamiltonian associated with the flow defined by the solvable approximation in the normal form.

In Section 4, we analyze the divergence of curves admissible for d and \tilde{d} , we state the result related to the comparison of distances, and we address the translation, more accurately, we state conditions under which the distance defined by the solvable approximation is decreasing. Finally, subsection 4.3 is devoted to prove that the distance induced by the solvable approximation is strictly closer than \hat{d} to the original distance d .

2 Preliminaries

This section is dedicated to present some definitions and results used in this paper related to the almost-Riemannian structures, nonholonomic order, privileged coordinates, the nilpotent approximation, and solvable one.

2.1 Almost-Riemannian structures

For all that concern general sub-Riemannian geometry, including almost-Riemannian one, the reader is referred to [1].

Let M be a n -dimensional, connected, C^∞ manifold. The C^∞ -module of C^∞ vector fields on M is denoted by $\Gamma(M)$. Let Δ be a sub-module of $\Gamma(M)$.

The flag of submodules

$$\Delta = \Delta^1 \subseteq \Delta^2 \subseteq \dots \subseteq \Delta^{k-1} \subseteq \Delta^k \subseteq \dots \quad (1)$$

is defined by induction: $\Delta^2 = \Delta + [\Delta, \Delta]$ is the sub-module of $\Gamma(M)$ generated by Δ and the Lie algebra of its elements, and $\Delta^{k+1} = \Delta^k + [\Delta, \Delta^k]$. The Lie algebra generated by Δ is $\mathcal{L}(\Delta) = \bigcup_{k \geq 1} \Delta^k$. The sub-module Δ satisfies the rank condition if the evaluation of $\mathcal{L}(\Delta)$ at each point p is equal to $T_p M$.

Definition 1. *An almost-Riemannian structure (resp. distribution) on a smooth n -dimensional manifold M is a triple $(E, f, \langle \cdot, \cdot \rangle)$ (resp. a pair (E, f)) where E is a rank n vector bundle over M , $f : E \rightarrow TM$ is a morphism of vector bundles, and $(E, \langle \cdot, \cdot \rangle)$ is an Euclidean bundle, that is $\langle \cdot, \cdot \rangle_p$ is an inner product on the fiber E_p of E , smoothly varying w.r.t. p , assumed to satisfy the following properties:*

1. *The set of points $p \in M$ such that the restriction of f to E_p is onto is a proper open and dense subset of M ;*
2. *the module Δ of vector fields on M defined as the image by f of the module of smooth sections of E satisfies the rank condition.*

The set of points of M where the rank of $f(E_p) = \Delta_p$ is less than n is called the singular locus (or singular set) of the almost-Riemannian structure and denoted by \mathcal{Z} .

The inner product on E induces a bilinear symmetric and positive definite mapping, also denoted by $\langle \cdot, \cdot \rangle$, from $\Delta \times \Delta$ to $C^\infty(M)$. Indeed, an element $X \in \Delta$ (resp. $Y \in \Delta$) is the image by f of a unique section σ (resp. η) of E and we can set $\langle X, Y \rangle_p = \langle \sigma, \eta \rangle_p$. Consequently an almost-Riemannian structure (ARS in short) can be alternately defined as follows.

Definition 2. *An almost-Riemannian structure on a smooth n -dimensional manifold M is a pair $(\Delta, \langle \cdot, \cdot \rangle)$ where Δ is a sub-module of $\Gamma(M)$ that can be locally defined by n vector fields and satisfies the rank condition, and $\langle \cdot, \cdot \rangle$ is a bilinear symmetric and positive definite mapping from $\Delta \times \Delta$ to $C^\infty(M)$, such that the set \mathcal{Z} of points p where the dimension of Δ_p is less than n is nonempty but with empty interior.*

Around any point $p \in M$ the sub-module Δ can be locally defined by an orthonormal frame (X_1, X_2, \dots, X_n) . It is enough to select a set of n sections (e_1, e_2, \dots, e_n) of E orthonormal in a neighborhood of p and define $X_i = f_* e_i$, where $f_* e_i = f \circ e_i$.

Remark 1. *The structure is Riemannian out of \mathcal{Z} .*

The almost-Riemannian norm on Δ_p is defined by

$$\|v\| = \min \{ \|u\|^2 : u \in E_p, f(u) = v \}.$$

An absolutely continuous curve $\gamma : [0, T] \rightarrow M$ is admissible for E if there exists a measurable essentially bounded function $t \mapsto u(t)$ from $[0, T]$ into $E_{\gamma(t)}$ called control function such that $\dot{\gamma}(t) = f(u(t))$ for almost every $t \in [0, T]$. Locally this means that $\dot{\gamma}(t) = u_1(t)X_1(\gamma(t)) + u_2(t)X_2(\gamma(t)) + \dots + u_n(t)X_n(\gamma(t))$ for almost every $t \in [0, T]$, where $X_1, X_2, \dots, X_n \in \Delta$.

Given an admissible curve $\gamma : [0, T] \rightarrow M$, the length of γ is defined by

$$l(\gamma) = \int_0^T \|\dot{\gamma}(t)\| dt.$$

The almost-Riemannian distance (or Carnot-Caratheodory distance) on M associated with the n -ARS is defined as

$$d(p_0, p_1) = \inf \{ l(\gamma) : \gamma(0) = p_0, \gamma(T) = p_1, \gamma \text{ admissible} \}.$$

It induces the usual topology on M .

2.2 Privileged coordinates and approximations

Everything related to privileged coordinates and nilpotent approximation comes from [8] and [3]. The definition of solvable approximation was introduced in [10].

Let p be a point of M and let Δ_p^k , $k \geq 1$ be the evaluation of the submodule Δ^k at p . Thanks to the rank condition these submodules verify $\Delta_p^1 \subset \Delta_p^2 \subset \dots \subset \Delta_p^{r-1} \subsetneq \Delta_p^r = T_p M$, for some r referred to as the degree of nonholonomy at p . Let $n_j(p) = \dim \Delta_p^j$. The nonholonomic weights w_1, w_2, \dots, w_n at p are defined by $w_i = j \Leftrightarrow n_{j-1}(p) < i \leq n_j(p)$. Let (x_1, x_2, \dots, x_n) be a system of coordinates centered at p . These coordinates are privileged if for each i there exist w_i vector fields in Δ such that the Lie derivative $X_{j_1} X_{j_2} \dots X_{j_{w_i}} x_i$ does not vanish at $p = 0$ but that any such Lie derivative of length smaller than w_i vanishes at 0.

Systems of privileged coordinates always exist (under the rank condition) and in such a system the weighted degree (homogeneous nonholonomic order) of the monomial $x_1^{\alpha_1} x_2^{\alpha_2} \dots x_n^{\alpha_n}$ is $w_1 \alpha_1 + \dots + w_n \alpha_n$, the the weighted degree of the vector field $\frac{\partial}{\partial x_j}$ is $-w_j$, and the weighted degree of the vector field $x_1^{\alpha_1} x_2^{\alpha_2} \dots x_n^{\alpha_n} \frac{\partial}{\partial x_j}$ is $w_1 \alpha_1 + \dots + w_n \alpha_n - w_j$.

More generally, the nonholonomic order at p of a function f (resp. a vector field X) is the minimum of the homogeneous nonholonomic orders of the monomials of its Taylor series.

Definition 3. The function defined by $x \mapsto \|x\|_p = \sum_{i=1}^n |x_i|^{\frac{1}{w_i}}$ is the so-called pseudo-norm at p .

Remark 2. Let $x = (x_1, \dots, x_n)$ be a system of privileged coordinates defined on an open neighborhood U of the point p . When composed with the coordinate functions, the pseudo-norm at p is (non smooth) homogeneous of order 1, that is, $\|x(q)\|_p = O(d(p, q))$, where $x(q)$ are the coordinates of $q \in U$.

It is important to notice that the nonholonomic degree $\text{ord}_p X$ of a vector field X at p cannot be less than $-r$, and that $\text{ord}_p[X, Y] = \text{ord}_p X + \text{ord}_p Y$ if X and Y are homogeneous and $[X, Y] \neq 0$ (more details see [3] and [8]).

The nonholonomic order of a vector field X belonging to Δ is at least equal to -1 . Consider a set of vector fields $\{X_1, X_2, \dots, X_n\}$ that generates Δ around p . In privileged coordinates each X_i can be decomposed into

$$X_i = X_i^{(-1)} + X_i^{(0)} + X_i^{(1)} + X_i^{(2)} + \dots,$$

where $X_i^{(s)}$ is the component of X_i of homogeneous order s .

The nilpotent approximation of $X_i \in \Delta$ is $\widehat{X}_i = X_i^{(-1)}$.

The Lie algebra generated by $\widehat{X}_1, \widehat{X}_2, \dots, \widehat{X}_n$ is nilpotent and finite dimensional. The rank condition is satisfied by $\widehat{X}_1, \widehat{X}_2, \dots, \widehat{X}_n$ as soon it is satisfied by X_1, X_2, \dots, X_n .

We consider the nilpotent approximation $\{\widehat{X}_1, \dots, \widehat{X}_n\}$ of $\{X_1, \dots, X_n\}$ at $p = 0$ such that $\widehat{X}_n = 0$. Denoting $\widetilde{X}_n = X_n^{(0)} \neq 0$, we have the following definition:

Definition 4 (Solvable approximation). *The family $\{\widehat{X}_1, \dots, \widehat{X}_{n-1}, \widetilde{X}_n\}$ is the solvable approximation of $\{X_1, \dots, X_n\}$.*

More details see [10].

3 Generic n -dimensional almost-Riemannian structures

This section provides a normal form of a n -dimensional ARS around the point $p \in \mathcal{Z}$ such that $T_p \mathcal{Z} = \Delta_p$, under generic conditions. Moreover, we compute its solvable approximation. This normal form is essential in the following sections.

When we work with n -ARS, we can find different and complex structures. For this reason, in the following, we deal only with generic ARSs. We will say that a property of almost-Riemannian distributions (resp. structures) on a manifold M is generic if for any rank n vector bundle E (resp. Euclidean vector bundle $(E, \langle \cdot, \cdot \rangle)$) over M the set of smooth morphisms of vector bundles from E to TM for which this property is satisfied is open and dense in the \mathcal{C}^2 Whitney topology.

We take from [6] the following results.

Theorem 1 ([6]). *The following properties are generic:*

1. *Let R be the largest integer such that $R^2 \leq n$. For $1 \leq r \leq R$ let \mathcal{Z}_r be the set of points where the rank of $\{X_1, \dots, X_n\}$ is $n - r$. Each \mathcal{Z}_r is a codimension r^2 submanifold and the singular locus \mathcal{Z} is the union of these disjoint submanifolds.*
2. *The points $p \in \mathcal{Z}_1$ where $T_p \mathcal{Z}_1 = \Delta_p$ are isolated in \mathcal{Z}_1 .*
3. *The mapping $x \mapsto \det(X(x))$ is a submersion at all points $x \in \mathcal{Z}_1$, where X is the $n \times n$ matrix whose j th column is X_j .*
4. *Let p be a tangency point in \mathcal{Z}_1 , that is a point where $T_p \mathcal{Z}_1 = \Delta_p$. Then $\hat{X}_n = 0$ but $\tilde{X}_n \neq 0$, in normal form.*
5. *At all other points, including the points in \mathcal{Z}_r , $r \geq 2$, the nilpotent approximation $\hat{X}_1, \dots, \hat{X}_n$ is a set of n linearly independent vector fields.*
6. *The rank of $\Delta_p + [\Delta, \Delta]_p$ is full at all points.*

In conclusion, generically: (1) the points $p \in \mathcal{Z}_1$ where $T_p \mathcal{Z}_1 = \Delta_p$ are isolated in \mathcal{Z}_1 ; (2) the solvable approximation can be defined only at a tangency point in \mathcal{Z}_1 ; (3) the degree of nonholonomy is 2.

3.1 Normal forms: n -dimensional case

We consider an ARS defined by a Euclidean vector bundle $(E, \langle \cdot, \cdot \rangle)$ and a vector bundle morphism f . We are interested in local normal forms of orthonormal vector fields defining the structure in a neighborhood of a point p that we can assume $p = 0 \in \mathcal{Z}$ in local coordinates.

By Theorem 1, generically there are points where the rank is $n - r$, as long as $r^2 < n$. In this paper, we consider only points belonging to \mathcal{Z}_1 because the only generic points where the solvable approximation is useful are tangency points in \mathcal{Z}_1 (see Theorem 1 item 4 and 5). Hence the distribution at $p = 0$ has always dimension $n - 1$, then assume that $X_j(0) = \frac{\partial}{\partial x_j}$ for $j = 2, \dots, n - 1$. It is shown in [6] that the coordinates and X_1, \dots, X_n can be chosen in such a way that:

$$X_1 = \begin{pmatrix} 1 \\ 0 \\ \vdots \\ \vdots \\ \vdots \\ 0 \end{pmatrix}, X_2 = \begin{pmatrix} 0 \\ 1 + \beta_2(x) \\ \alpha_{3,2}(x) \\ \vdots \\ \vdots \\ \alpha_{n,2}(x) \end{pmatrix}, \dots, X_{n-1} = \begin{pmatrix} 0 \\ \vdots \\ \vdots \\ 0 \\ 1 + \beta_{n-1}(x) \\ \alpha_{n,j}(x) \end{pmatrix}, X_n = \begin{pmatrix} 0 \\ \vdots \\ \vdots \\ \vdots \\ 0 \\ \alpha_n(x) \end{pmatrix}$$

where $\beta_j(0) = \alpha_{i,j}(0) = 0$, $j = 2, \dots, n$.

By the normal form of the vector fields, the singular locus is locally $\mathcal{Z} = \mathcal{Z}_1 = \{\alpha_n(x) = 0\}$.

Let $\alpha_n(x) = \hat{\alpha}_n(x) + \tilde{\alpha}_n(x) + \bar{\alpha}_n(x)$, that is α_n decomposed into its components of nonholonomic order 1, 2 and greater than or equal to 3 respectively. Let p be a tangency point in \mathcal{Z}_1 , then by Theorem 1, $\hat{X}_n = 0$ and $\tilde{X}_n \neq 0$, hence $\alpha_n(x) = \tilde{\alpha}_n(x) + \bar{\alpha}_n(x)$. Moreover, since $\text{ord}_p(\tilde{\alpha}_n) = 2$ we get $\alpha_n(x) = ax_n + Q(x_1, x_2, \dots, x_{n-1}) + \bar{\alpha}_n(x)$, where $Q(x_1, x_2, \dots, x_{n-1})$ is quadratic. Notice that, since the determinant is a submersion at p (Theorem 1 item 3) $a \neq 0$.

3.2 Solvable approximation

We can find the nilpotent and solvable approximation in the coordinate system constructed in the normal form. Since $p = 0$ is a tangency point and the weights of the coordinates are $w_1 = \dots = w_{n-1} = 1$, and $w_n = 2$, the nilpotent approximation is defined by

$$\begin{aligned}\hat{X}_1 &= X_1 = \frac{\partial}{\partial x_1}, \\ \hat{X}_j &= \frac{\partial}{\partial x_j} + \hat{\alpha}_{n,j}(x) \frac{\partial}{\partial x_n} \quad \text{for } j = 2, \dots, n-1, \text{ and} \\ \hat{X}_n &= 0,\end{aligned}$$

where $\hat{\alpha}_{n,j}$ is the component of $\alpha_{n,j}$ of nonholonomic order 1, hence it is linear in x_1, x_2, \dots, x_{n-1} .

Therefore, the solvable approximation in the tangent case is defined by $\{\hat{X}_1, \dots, \hat{X}_{n-1}, \tilde{X}_n\}$ where

$$\tilde{X}_n = (ax_n + Q(x_1, x_2, \dots, x_{n-1})) \frac{\partial}{\partial x_n} = \tilde{a}_n(x) \frac{\partial}{\partial x_n},$$

3.2.1 Hamiltonian equations to the solvable approximation

The following is helpful to prove one of the main results of this paper (see Section 4.3).

With the normal forms of the vector fields, the Hamiltonian for the normal flow is given by

$$\begin{aligned}H(\lambda(t)) &= \frac{1}{2} \left(\sum_{i=1}^{n-1} \langle \lambda(t), \hat{X}_i(x) \rangle^2 + \langle \lambda(t), \tilde{X}_n(x) \rangle^2 \right), \\ &= \frac{1}{2} \left(\lambda_1^2 + \sum_{i=2}^{n-1} (\lambda_i + \lambda_n \hat{\alpha}_{n,i}(x))^2 + \lambda_n^2 \tilde{a}_n(x)^2 \right),\end{aligned}$$

where $\lambda(t) = (\lambda_1, \dots, \lambda_n) \in T_{\gamma(t)}^* \mathbb{R}^n$. Hence

$$\begin{aligned} \dot{x}_1(t) &= \lambda_1 \\ \dot{x}_j(t) &= \lambda_j + \lambda_n \hat{\alpha}_{n,j}(x) \quad (\text{for } j = 2, \dots, n-1) \\ \dot{x}_n(t) &= \sum_{i=2}^{n-1} \hat{\alpha}_{n,i}(x) (\lambda_i + \lambda_n \hat{\alpha}_{n,i}(x)) + \lambda_n \tilde{a}_n(x)^2 \\ \dot{\lambda}_j(t) &= - \sum_{i=2}^{n-1} \lambda_n \frac{\partial}{\partial x_j} \hat{\alpha}_{n,i}(x) (\lambda_i + \lambda_n \hat{\alpha}_{n,i}(x)) - \frac{\partial}{\partial x_j} Q(x_1, \dots, x_{n-1}) \lambda_n^2 \tilde{a}_n(x), \text{ for } j = 1, \dots, n-1 \\ \dot{\lambda}_n(t) &= -a \lambda_n^2 \tilde{a}_n(x) \end{aligned}$$

are the associated Hamiltonian equations to the solvable approximation in the normal form.

Remark 3. Notice that $H(\lambda(0)) = \frac{1}{2} \sum_{i=1}^{n-1} \lambda_i(0)^2$, and then it does not depend of $\lambda_n(0)$. In consequence, $\lambda_n(0)$ can be chosen arbitrarily.

4 Distance induced by the solvable approximation

The original system, the nilpotent and solvable approximations give rise to three different distances: d , \hat{d} and \tilde{d} respectively. This section deals with the almost-Riemannian distance defined by the solvable approximation. The main result is Theorem 5 which states that generically, the distance \tilde{d} is closer to d than \hat{d} for pairs of points translated in an appropriate direction (Section 4.3). This translation condition is significant because the distance \tilde{d} is not closer to d than the distance induced by the nilpotent approximation for any pair of points. Then to prove the main result, it is essential to determine two facts. First, to state the order of approximation of d by \tilde{d} (Theorem 2), and second, to find translation directions such that the distance \tilde{d} of a pair of translated points is decreasing (see Section 4.2).

A first proposition provides a relation between the solvable distance and the nilpotent one. This result is important because is useful to prove the main result of subsection 4.3.

Proposition 1. For all $x, y \in \mathbb{R}^n$, $\tilde{d}(x, y) \leq \hat{d}(x, y)$.

Proof. See [10]. □

4.1 Comparison of distances

In this subsection, we state the order of approximation of the original distance by \tilde{d} . An important conclusion is that \tilde{d} improves the order of approximation

of d given by the nilpotent approximation.

Let q and q' belong to the ball centered at p and radius ϵ , denoted by $B(p, \epsilon)$. We start by analyzing the divergence of curves respectively admissible for d and \tilde{d} , defined by the same control functions and starting at the same point q . Let us consider the vector fields X_1, \dots, X_n in normal form as in the above section. Hence we can express each vector field X_j for $j = 2, \dots, n-1$, as

$$X_j = \begin{pmatrix} 0 \\ \vdots \\ 1 + \beta_j(x) \\ \alpha_{j+1,j}(x) \\ \vdots \\ \alpha_{n,j}(x) \end{pmatrix}.$$

Notice that $\alpha_{n,j}(x)$ can be split into components of order 1 and the remainder i.e $\alpha_{n,j}(x) = \tilde{\alpha}_{n,j}(x) + \alpha_{n,j}^+(x)$. We denote by $\rho_{n,j}^+$ the order of $\alpha_{n,j}^+$ for $j = 2, \dots, n-1$.

Proposition 2. *Let γ be the geodesic for d such that $\gamma(0) = q$, $\gamma(T) = q'$ and associated with the control function $u(\cdot)$ satisfying $\|u\| = 1$. Let $\tilde{\gamma}$ be the admissible curve for \tilde{d} defined by the same control functions as γ and $\tilde{\gamma}(0) = q$. If $\rho_{n,j}^+ \geq 3$ for $j = 2, \dots, n-1$, then*

$$\|\gamma(t) - \tilde{\gamma}(t)\|_p \leq Cst \cdot \tau^{\frac{3}{2}} \cdot t^{\frac{1}{2}}, \quad (2)$$

where $\tau = \max(\|q\|_p, t)$.

Proof. We have the following:

$$\dot{\gamma}(t) - \dot{\tilde{\gamma}}(t) = \sum_{j=1}^{n-1} u_j(t) \left(X_j(\gamma(t)) - \hat{X}_j(\tilde{\gamma}(t)) \right) + u_n(t) \left(X_n(\gamma(t)) - \tilde{X}_n(\tilde{\gamma}(t)) \right).$$

In details,

1. $\dot{\gamma}_1(t) - \dot{\tilde{\gamma}}_1(t) = 0$,
2. $\dot{\gamma}_i(t) - \dot{\tilde{\gamma}}_i(t) = \sum_{j=2}^{i-1} u_j(t) \alpha_{i,j}(\gamma(t)) + u_i(t) \beta_i(\gamma(t))$, for $i = 2, \dots, n-1$,

3.

$$\begin{aligned} \dot{\gamma}_n(t) - \dot{\tilde{\gamma}}_n(t) &= \sum_{j=2}^{n-1} u_j(t) \alpha_{n,j}^+(\gamma(t)) + \sum_{j=2}^{n-1} u_j(t) \left(\hat{\alpha}_{n,j}(\gamma(t)) - \hat{\alpha}_{n,j}(\tilde{\gamma}(t)) \right) + \\ &\quad u_n \left(a(\gamma_n(t) - \tilde{\gamma}_n(t)) + Q(\gamma_1(t), \dots, \gamma_{n-1}(t)) - \right. \\ &\quad \left. Q(\tilde{\gamma}_1(t), \dots, \tilde{\gamma}_{n-1}(t)) + \bar{\alpha}_n(\gamma(t)) \right). \end{aligned}$$

We have successively,

1. $\gamma_1(t) = \tilde{\gamma}_1(t)$.

2. $\dot{\gamma}_i(t) - \dot{\tilde{\gamma}}_i(t) = \sum_{j=2}^i u_j(t) \alpha_{i,j}(\gamma(t)) + u_i(t) \beta_i(\gamma(t))$, hence $|\dot{\gamma}_i(t) - \dot{\tilde{\gamma}}_i(t)| \leq \sum_{j=2}^i |\alpha_{i,j}(\gamma(t))|$, for $i = 2, \dots, n-1$.

Since $\text{ord}_p(\alpha_{i,j}) \geq 1$, for $j = 2, \dots, n-1$, then $|\alpha_{i,j}(\gamma(t))| \leq \text{Cst} \cdot \|\gamma(t)\| \leq \text{Cst} \cdot \tau$ because $\|\gamma(t)\|_p \leq \text{Cst} \cdot \tau$, where $\tau = \max(\|q\|_p, t)$ (the proof of the above inequality is given in [8] in the proof of Lemma 2.2). Similarly for β_i , hence

$$|\gamma_i(t) - \tilde{\gamma}_i(t)| \leq \text{Cst} \cdot \tau \cdot t \quad \text{for } i = 2, \dots, n-1. \quad (3)$$

3.

$$\begin{aligned} \dot{\gamma}_n(t) - \dot{\tilde{\gamma}}_n(t) &= \sum_{j=2}^{n-1} u_j(t) \alpha_{n,j}^+(\gamma(t)) + \sum_{j=2}^{n-1} u_j(t) \left(\hat{\alpha}_{n,j}(\gamma(t)) - \hat{\alpha}_{n,j}(\tilde{\gamma}(t)) \right) + \\ &\quad + u_n \left(a(\gamma_n(t) - \tilde{\gamma}_n(t)) + \sum_{k=2}^{n-1} (\gamma_k(t) - \tilde{\gamma}_k(t)) P_{n,k}(\gamma, \tilde{\gamma}) + \right. \\ &\quad \left. \bar{\alpha}_n(\gamma(t)) \right), \end{aligned}$$

where $P_{n,k}(\gamma, \tilde{\gamma})$ is a homogeneous polynomial of weighted degree 1, hence

$$\begin{aligned} |\gamma_n(t) - \tilde{\gamma}_n(t)| &\leq \int_0^t |\alpha_{n,j}^+(s)| ds + \int_0^t \sum_{k=2}^{n-1} |\hat{\alpha}_{n,j}(\gamma(s)) - \hat{\alpha}_{n,j}(\tilde{\gamma}(s))| ds + \\ &\quad \int_0^t |a| |\gamma_n(s) - \tilde{\gamma}_n(s)| ds + \int_0^t |\bar{\alpha}_n(\gamma(s))| ds + \\ &\quad \int_0^t \sum_{k=2}^{n-1} |\gamma_k(s) - \tilde{\gamma}_k(s)| |P_{n,k}(\gamma, \tilde{\gamma})| ds. \end{aligned}$$

Since $\text{ord}_p(\bar{\alpha}_n) \geq 3$ then $|\bar{\alpha}_n(\gamma(s))| \leq \text{Cst} \cdot \tau^3$. Moreover, since $\rho_{n,j}^+ \geq 3$ is the order of $\alpha_{n,j}^+$, for $j = 2, \dots, n-1$, then $|\alpha_{n,j}^+(\gamma(s))| \leq \text{Cst} \cdot \tau^3$. Furthermore, by inequality (3) $|\gamma_k(s) - \tilde{\gamma}_k(s)| \leq \text{Cst} \cdot \tau^2 \cdot t$, then

$$|\gamma_k(t) - \tilde{\gamma}_k(t)| |P_{n,k}(\gamma, \tilde{\gamma})| \leq \text{Cst} \cdot \tau^2 \cdot t \cdot \tau = \text{Cst} \cdot \tau^3 \cdot t.$$

Also, we know that $\hat{\alpha}_{n,j}$ is linear on x_1, \dots, x_{n-1} , hence by inequality (3) $|\hat{\alpha}_{n,j}(\gamma(s)) - \hat{\alpha}_{n,j}(\tilde{\gamma}(s))| \leq \text{Cst} \cdot \tau \cdot t$. Then

$$|\gamma_n(t) - \tilde{\gamma}_n(t)| \leq \int_0^t |a| |\gamma_n(s) - \tilde{\gamma}_n(s)| ds + \text{Cst} \cdot \tau^3 \cdot t.$$

By Gronwall lemma we get

$$\begin{aligned} |\gamma_n(t) - \tilde{\gamma}_n(t)| &\leq \text{Cst} \cdot \tau^3 \cdot t \cdot e^{|a|t} \\ |\gamma_n(t) - \tilde{\gamma}_n(t)| &\leq \text{Cst} \cdot \tau^3 \cdot t. \end{aligned}$$

Finally, we have

$$\|\gamma(t) - \tilde{\gamma}(t)\|_p = \sum_{i=1}^n |\gamma_i(t) - \tilde{\gamma}_i(t)|^{\frac{1}{w_i}} \leq \text{Cst} \cdot \tau^{\frac{3}{2}} \cdot t^{\frac{1}{2}}. \quad (4)$$

□

In order to state the result related to the comparison of distances, we need upper bounds for the distances d and \tilde{d} . So, from Theorems 7.31 and 7.26 of [3] we get

$$d(q, q') \leq \text{Cst} \sum_{k,j | w_k \leq w_j} \|q\|_p^{1-\frac{w_k}{w_j}} |q_k - q'_k|^{\frac{1}{w_j}}, \text{ and}$$

$$\hat{d}(q, q') \leq \text{Cst} \sum_{k,j | w_k \leq w_j} \|q\|_p^{1-\frac{w_k}{w_j}} |q_k - q'_k|^{\frac{1}{w_j}}.$$

Since $\tilde{d}(q, q') \leq \hat{d}(q, q')$, we get

$$\tilde{d}(q, q') \leq \text{Cst} \sum_{k,j | w_k \leq w_j} \|q\|_p^{1-\frac{w_k}{w_j}} |q_k - q'_k|^{\frac{1}{w_j}}.$$

Since the weights of the coordinates are $w_1 = \dots = w_{n-1} = 1$, and $w_n = 2$, we obtain

$$d(q, q') \leq \text{Cst} \left(\|q - q'\|_p + \|q\|_p^{\frac{1}{2}} \left(\sum_{k=1}^{n-1} |q_k - q'_k|^{\frac{1}{2}} \right) \right), \quad (5)$$

$$\tilde{d}(q, q') \leq \text{Cst} \left(\|q - q'\|_p + \|q\|_p^{\frac{1}{2}} \left(\sum_{k=1}^{n-1} |q_k - q'_k|^{\frac{1}{2}} \right) \right). \quad (6)$$

The following notation and proposition are required for the comparison of distances result.

We denote by $\rho_{i,j}$ the order of $\alpha_{i,j}$ for $j = 2, \dots, n-1$ and $i = j, \dots, n-1$ with the convention that $\alpha_{i,j} = \beta_j$ if $i = j$.

Proposition 3. *Let γ be the geodesic for d such that $\gamma(0) = q$, $\gamma(T) = q'$ and associated with the control function $u(\cdot)$ satisfying $\|u\| = 1$. Let $\tilde{\gamma}$ be the admissible curve for \tilde{d} defined by the same control functions as γ and $\tilde{\gamma}(0) = q$. If $\rho_{i,j} \geq 2$ and $\rho_{n,j}^+ \geq 3$ for $j = 2, \dots, n-1$ and $i = j, \dots, n-1$, then*

1. $\tilde{d}(\gamma(t), \tilde{\gamma}(t)) \leq Cst \cdot t^{\frac{1}{2}} \cdot \tau^{\frac{3}{2}}$.
2. $d(\gamma(t), \tilde{\gamma}(t)) \leq Cst \cdot t^{\frac{1}{2}} \cdot \tau^{\frac{3}{2}}$,

where $\tau = \max(\|q\|_p, t)$.

Proof. 1. If $\rho_{i,j} \geq 2$ is the order of $\alpha_{i,j}$ for $j = 2, \dots, n-1$ and $i = j, \dots, n-1$ then

$$\left| \gamma_k(t) - \tilde{\gamma}_k(t) \right| \leq Cst \cdot \tau^2 \cdot t \quad \text{for } k = 2, \dots, n-1. \quad (7)$$

Finally, by inequalities (7) and (6), and Proposition 2

$$\tilde{d}(q, q') \leq Cst \left(t^{\frac{1}{2}} \cdot \tau^{\frac{3}{2}} + \tau^{\frac{1}{2}} (\tau^2 \cdot t)^{\frac{1}{2}} \right) \leq Cst \cdot t^{\frac{1}{2}} \cdot \tau^{\frac{3}{2}}.$$

2. The proof of this item is similar to the previous one, only exchanging the roles of d and \tilde{d} , and considering inequality (5). □

Theorem 2 (Comparison of distances). *If $\rho_{i,j} \geq 2$ and $\rho_{n,j}^+ \geq 3$ for $j = 2, \dots, n-1$ and $i = j, \dots, n-1$, then there exist constants C and $\epsilon > 0$, such that, for all $q, q' \in B(p, \epsilon)$, we have*

$$-C\tau^{\frac{3}{2}}d(q, q')^{\frac{1}{2}} \leq d(q, q') - \tilde{d}(q, q') \leq C \cdot \tilde{\tau}^{\frac{3}{2}}\tilde{d}(q, q')^{\frac{1}{2}}, \quad (8)$$

where $\tau = \max(\|q\|_p, d(q, q'))$, $\tilde{\tau} = \max(\|q\|_p, \tilde{d}(q, q'))$.

Proof. Let q belonging to $B(p, \epsilon)$. Let us consider the geodesic $\gamma : [0, T] \rightarrow M$ for the distance d such that $\gamma(0) = q$, $\gamma(T) = q'$ and associated with the control function $u(\cdot)$ satisfying $\|u(t)\| = 1$ and $\tilde{\gamma}$ the admissible curve for \tilde{d} defined by the same control functions that γ with $\tilde{\gamma}(0) = q$. By Proposition 3 item 1

$$\tilde{d}(\gamma(T), \tilde{\gamma}(T)) \leq Cst \cdot T^{\frac{1}{2}} \cdot \tau^{\frac{3}{2}}. \quad (9)$$

On the other hand, note that

$$d(q, q') = l(\gamma) = l(\tilde{\gamma}) \geq \tilde{d}(q, \tilde{\gamma}(T)).$$

Moreover, by triangle inequality, we have

$$\tilde{d}(q, \tilde{\gamma}(T)) \geq \tilde{d}(q, q') - \tilde{d}(q', \tilde{\gamma}(T)),$$

Then, from (9), transitivity and since $\gamma(T) = q'$, we get

$$\begin{aligned} d(q, q') &\geq \tilde{d}(q, q') - \text{Cst} \cdot T^{\frac{1}{2}} \cdot \tau^{\frac{3}{2}} \\ d(q, q') - \tilde{d}(q, q') &\geq -\text{Cst} \cdot T^{\frac{1}{2}} \cdot \tau^{\frac{3}{2}} \end{aligned} \quad (10)$$

Now, we change the roles of d and \tilde{d} and by Proposition 3 item 2, we obtain

$$d(q, q') - \tilde{d}(q, q') \leq \text{Cst} \cdot \tilde{T}^{\frac{1}{2}} \cdot \tilde{\tau}^{\frac{3}{2}}, \quad (11)$$

where $\tilde{T} = \tilde{d}(q, q')$.

Therefore from (10) and (11)

$$-C\tau^{\frac{3}{2}}d(q, q')^{\frac{1}{2}} \leq d(q, q') - \tilde{d}(q, q') \leq C \cdot \tilde{\tau}^{\frac{3}{2}}\tilde{d}(q, q')^{\frac{1}{2}}.$$

The proof is complete. \square

Notice that, if $d(q, q') \geq d(p, q)$ we get $|d(q, q') - \tilde{d}(q, q')| \leq Cd(q, q')^2$. The similar inequality for \hat{d} is $|d(q, q') - \hat{d}(q, q')| \leq Cd(q, q')^{\frac{3}{2}}$. This show that the order of bound of $|d(q, q') - \tilde{d}(q, q')|$ is strictly better than the one of $|d(q, q') - \hat{d}(q, q')|$.

4.2 Translation

In this subsection, we address the second fact needed to prove the main result of this paper, that is, to find directions where the distance of a pair of translated points is decreasing. These directions are the appropriate ones where \tilde{d} is closer to d than \hat{d} .

It is well known that the distance defined by the nilpotent approximation is left-invariant (cf. [8]) while \tilde{d} is not. Let p_2 be a point in a neighborhood of $p = 0$ and $g \in \mathbb{R}^n$. We are interested in conditions under which $\tilde{d}(g, g \cdot p_2) \leq \tilde{d}(0, p_2)$ (this means decreasing), where the product is the Lie group one. For this, some elements are required.

Let $\mathcal{L} = \text{Lie}(\hat{X}_1, \dots, \hat{X}_{n-1}, \hat{X}_n)$, \mathfrak{g} the ideal generated in \mathcal{L} by $\hat{X}_1, \dots, \hat{X}_{n-1}$ and G the simply connected Lie group whose Lie algebra is \mathfrak{g} that is, the set of left-invariant vector fields on G . We know that \mathfrak{g} is a nilpotent Lie algebra. This Lie algebra \mathfrak{g} can be split into homogeneous components

$$\mathfrak{g} = \mathfrak{g}^1 \oplus \mathfrak{g}^2,$$

where \mathfrak{g}^s is the set of homogeneous vector fields of order $-s$.

The translation will be dealt with by considering a vector field $Y \in \mathfrak{g}^1$ and then $Y \in \mathfrak{g}^2$. We start by considering $Y \in \mathfrak{g}^1$. For the above, Definition 5 and Theorem 3 are necessary and they come from [11] and [7].

Definition 5. Let $\gamma : [0, T] \longrightarrow \mathbb{R}^n$ be a smooth curve, and $\epsilon > 0$. A variation of γ is a smooth map $F : [0, T] \times (-\epsilon, \epsilon) \longrightarrow \mathbb{R}^n$ such that

$$F(t, 0) = \gamma(t)$$

for all $t \in [0, T]$.

For each $s \in (-\epsilon, \epsilon)$, the curve $\gamma_s : [0, T] \rightarrow \mathbb{R}^n$ given by $\gamma_s(t) = F(s, t)$, is called a curve of the variation F .

A variation F of γ determines a differentiable vector field $V(t)$ along γ by $V(t) = \frac{\partial F}{\partial s}(t, 0)$.

We denote by $l(\gamma_s)$ the length of the curve γ_s .

Theorem 3 (First variation of length, [11]). Let $\gamma : [0, T] \longrightarrow \mathbb{R}^n$ be any unit speed admissible curve and $F(t, s)$ a smooth variation of γ . Then

$$\frac{d}{ds}l(\gamma_s)(0) = - \int_0^T \langle V(t), \nabla_{\dot{\gamma}} \dot{\gamma} \rangle dt + \langle V(T), \dot{\gamma}(T) \rangle - \langle V(0), \dot{\gamma}(0) \rangle,$$

where ∇ is the Levi-Civita connection.

From [6], we have that \mathbb{R}^n is diffeomorphic to the quotient G/H where H stands for the connected subgroup of G whose Lie algebra is the set of elements of \mathfrak{g} that vanish at 0. Moreover, the homogeneous space G/H is the manifold of the right cosets of H . We denote by Π the canonical projection of G onto G/H .

Let $\gamma : [0, T] \longrightarrow \mathbb{R}^n$ be a geodesic of \tilde{d} such that $\gamma(t) \notin \mathcal{Z}$ for $t \in]0, T[$. Let $Y \in \mathfrak{g}^1$, and $F : [0, T] \times (-\epsilon, \epsilon) \longrightarrow \mathbb{R}^n$ a variation of γ such that

$$F(t, s) = \gamma_s(t) = \gamma(t)\Pi(\exp(sY)) = L_{\gamma(t)}(\Pi(\exp(sY))),$$

where $L_{\gamma(t)}$ is the left translation by $\gamma(t)$.

For each $Y \in \mathfrak{g}^1$, the projection of Y onto G/H is denoted by Π_*Y , the latter is an invariant vector field on G/H (cf. [9])

Denoting by $V(t)$ the variation field of F , we get

$$V(t) = \frac{\partial F}{\partial s}(t, 0) = \frac{\partial}{\partial s} \Big|_{s=0} \gamma_s(t) = TL_{\gamma(t)} \cdot \Pi_*Y = (\Pi_*Y)(\gamma(t)).$$

Then by Theorem 3,

$$\frac{d}{ds}l(\gamma_s)(0) = \langle V(T), \dot{\gamma}(T) \rangle - \langle V(0), \dot{\gamma}(0) \rangle = \langle (\Pi_*Y)(\gamma(T)), \dot{\gamma}(T) \rangle - \langle (\Pi_*Y)(\gamma(0)), \dot{\gamma}(0) \rangle.$$

Notice that the integral vanishes because γ is a geodesic for \tilde{d} and hence $\nabla_{\dot{\gamma}} \dot{\gamma} = 0$.

Since we want to study the translation of the curve γ then $Y(0)$ must not be zero. Indeed, if $Y(0) = 0$ then $\gamma(t)\Pi(\exp(0)) = \gamma(t)$. So, we must look for a vector field $Y \in \mathfrak{g}^1$ such that $Y(0) \neq 0$.

To obtain conditions on Y such that the distance \tilde{d} be decreasing in the direction of Y , we will analyze $\langle V(t), \dot{\gamma}(t) \rangle$ considering $Y \in \text{span} \left\{ \widehat{X}_1, \dots, \widehat{X}_{n-1} \right\}$.

We assume that $Y \in \text{span} \left\{ \widehat{X}_1, \dots, \widehat{X}_{n-1} \right\}$. Hence there exist constants $\alpha_1, \alpha_2, \dots, \alpha_{n-1}$ such that $Y(\gamma(t)) = \sum_{i=1}^{n-1} \alpha_i \widehat{X}_i(\gamma(t))$. Since γ is an admissible curve for \tilde{d} , this is to say,

$$\dot{\gamma}(t) = \sum_{i=1}^{n-1} u_i \widehat{X}_i(\gamma(t)) + u_n \widetilde{X}_n(\gamma(t)),$$

and $\left\{ \widehat{X}_1, \dots, \widehat{X}_{n-1}, \widetilde{X}_n \right\}$ is an orthonormal frame for the metric, we have

$$\langle Y(\gamma(t)), \dot{\gamma}(t) \rangle = \sum_{i=1}^{n-1} \alpha_i u_i(t).$$

Then

$$\langle Y(\gamma(T)), \dot{\gamma}(T) \rangle - \langle Y(0), \dot{\gamma}(0) \rangle = \sum_{i=1}^{n-1} \alpha_i (u_i(T) - u_i(0)).$$

So, we have obtained the following proposition.

Proposition 4. *Let $\gamma : [0, T] \longrightarrow \mathbb{R}^n$ be a length minimizer of \tilde{d} with control functions u_1, \dots, u_n , and $Y \in \mathfrak{g}^1$ such that $Y(\gamma(t)) = \sum_{i=1}^{n-1} \alpha_i \widehat{X}_i(\gamma(t))$.*

If $\sum_{i=1}^{n-1} \alpha_i (u_i(T) - u_i(0)) < 0$ then $\frac{d}{ds} l(\gamma_s)(0) < 0$.

To deal with the case where the translation is in direction of a vector field $Y \in \mathfrak{g}^2$, i.e., a vector field Y such that its evaluation does not belong to the tangent space at 0, we must change the above strategy since Lemma ?? depends on $\langle Y(0), \dot{\gamma}(0) \rangle$, so if $Y(0)$ does not belong to the tangent space at 0, $\langle Y(0), \dot{\gamma}(0) \rangle$ does not make sense. The below (Proposition 5) is necessary and comes from [4].

Let G be a connected, simply connected Lie group of dimension n such that G is a Carnot (or stratified) group of step r (see more details in [4]) and \mathfrak{g} its Lie algebra. After the choice of a basis X_1, \dots, X_n for \mathfrak{g} , the group G is identified with \mathbb{R}^n via the exponential mapping; this means that a point $x = (x_1, \dots, x_n) \in \mathbb{R}^n$ is identified with the point $\exp(x_1 X_1 + \dots + x_n X_n)$ of the group. Hence we have the following result obtained from [4] and [12].

Proposition 5. *The group product has the form*

$$x \cdot y = x + y + Q(x, y) \quad \forall x, y \in \mathbb{R}^n, \quad (12)$$

where $Q = (Q_1, \dots, Q_n) : \mathbb{R}^n \times \mathbb{R}^n \rightarrow \mathbb{R}^n$ and Q_j is a homogeneous polynomial of degree w_j . Moreover, for all $x, y \in \mathbb{R}^n$ $Q_1(x, y) = \dots = Q_{n_1}(x, y) = 0$, where n_1 is such that $w_1 = \dots = w_{n_1} = 1$, and

$$Q_i(x, y) = \sum_{h,k} \mathcal{R}_{k,h}^i(x, y)(x_k y_h - x_h y_k),$$

where the functions $\mathcal{R}_{k,h}^i$ are polynomials, homogenous of degree $w_i - w_h - w_k$ with respect to group dilations, and the sum is extended to all h, k such that $w_k + w_h \leq w_i$.

Remark 4. In the context of the generic case, which is the case that interests us in this paper, $n_1 = n - 1$, and since $\text{rank}(\Delta_p + [\Delta, \Delta]_p) = n$ at all points then $\mathcal{R}_{k,h}^n$ is a constant, and $w_k = w_h = 1$.

Let $Y \in \mathfrak{g}^2$. In local coordinates $Y(x) = \sum_{i=1}^n f_i(x) \frac{\partial}{\partial x_i}$. Since $w_1 = \dots = w_{n-1} = 1$ and $w_n = 2$ then $f_i(x) \equiv 0$ for $i = 1, \dots, n - 1$, and $f_n(x)$ is a constant different from 0, hence $Y(x) = \nu \frac{\partial}{\partial x_n}$, with $\nu \neq 0$ (see Figure 2).

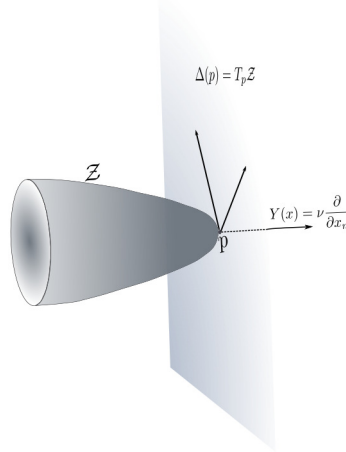

Figure 2: Singular set and its tangent space at p with the translation vector $Y(x)$.

Let μ_Y be the integral curve of Y passing through the identity of G when $t = 0$, then

$$\dot{\mu}_Y(t) = Y(\mu_Y(t)) = \nu \frac{\partial}{\partial x_n},$$

hence

$$\mu_Y(t) = \begin{pmatrix} 0 \\ \vdots \\ 0 \\ t\nu \end{pmatrix}.$$

Since $\exp(Y) = \mu_Y(1)$ (see more details in [4]), then $\exp(Y) = \begin{pmatrix} 0 \\ \vdots \\ 0 \\ \nu \end{pmatrix}$.

Let $\gamma : [0, T] \rightarrow \mathbb{R}^n$ be a geodesic of \tilde{d} such that $\gamma(t) = (\gamma_1(t), \dots, \gamma_n(t))$, $\gamma(t) \notin \mathcal{Z}$ for $t \in]0, T[$, and $\gamma(0) = 0$, with control functions u_1, \dots, u_n . We consider $Y \in \mathfrak{g}^2$ such that, $Y(x) = \nu \frac{\partial}{\partial x_n}$. Let $\gamma_{LY}(t) = L_{\exp(Y)}(\gamma(t)) = (\gamma_{1Y}(t), \dots, \gamma_{nY}(t))$ and $\bar{u}_1, \dots, \bar{u}_n$ its control functions.

Recall that $\tilde{a}_n(x) = ax_n + Q(x_1, x_2, \dots, x_{n-1})$, where $Q(x_1, x_2, \dots, x_{n-1})$ is quadratic. We set $\tilde{a}_n(\gamma) = \tilde{a}_n(\gamma(t))$.

The following result provides conditions on Y such that γ_{LY} has a length less than γ .

Theorem 4. *Let $\gamma : [0, T] \rightarrow \mathbb{R}^n$ be a length minimizer of \tilde{d} with control functions $u_1(t), \dots, u_n(t)$ with $u_n(t) \neq 0$ almost everywhere, and $\tilde{a}_n(\gamma) + a\nu \neq 0$. If $|\tilde{a}_n(\gamma)| < |\tilde{a}_n(\gamma) + a\nu|$ then $\tilde{d}(\gamma_{LY}(0), \gamma_{LY}(T)) < \tilde{d}(\gamma(0), \gamma(T))$.*

Proof. By Proposition 5, the curve $\gamma_{LY}(t)$ is simply $\gamma_{LY}(t) = (\gamma_1(t), \dots, \gamma_n(t) + \nu)$. Then $\dot{\gamma}_{LY}(t) = \dot{\gamma}(t)$ i.e. $\dot{\gamma}_{iY}(t) = \dot{\gamma}_i(t)$ for $i = 1, \dots, n$. The latter has two implications: (1) Since $\dot{\gamma}_{iY}(t) = \dot{\gamma}_i(t) = u_i(t)$ then $\bar{u}_i(t) = u_i(t)$ for $i = 1, \dots, n-1$. (2) Since $\dot{\gamma}_{nY}(t) = \dot{\gamma}_n(t)$ then

$$\begin{aligned} \bar{u}_n(t) (\tilde{a}_n(\gamma) + a\nu) &= u_n(t) \tilde{a}_n(\gamma) \\ \bar{u}_n(t) &= u_n(t) \frac{\tilde{a}_n(\gamma)}{\tilde{a}_n(\gamma) + a\nu}. \end{aligned}$$

The condition $|\tilde{a}_n(\gamma)| < |\tilde{a}_n(\gamma) + a\nu|$ implies that $|\bar{u}_n(t)| < |u_n(t)|$, hence $\bar{u}_n(t)^2 < u_n(t)^2$. In consequence the length of γ_{LY} is less than the length of γ . Therefore $\tilde{d}(\gamma_{LY}(0), \gamma_{LY}(T)) < \tilde{d}(\gamma(0), \gamma(T))$. \square

4.3 Solvable distance is better than the nilpotent one

It is known that the almost-Riemannian distance d of the original system, close to $p = 0$, behaves at the first-order as the distance defined by the nilpotent approximation at $p = 0$. However, thanks to Theorem 2 we know that the solvable approximation improves the order of approximation of d given by the nilpotent approximation. Despite the above, we can not state that the solvable distance is closer than the nilpotent one to the original distance for all pairs of points.

In this section, we prove that the approximation by \tilde{d} is better than the one by \hat{d} for a pair of points translated in a direction where the distance \tilde{d} is decreasing.

Before that, notice that by Proposition 1 we know that $\tilde{d}(q, q') \leq \hat{d}(q, q')$ then we can conclude that for \tilde{d} to be better than \hat{d} it must be satisfied that $\frac{\tilde{d}(q, q') + \hat{d}(q, q')}{2} > d(q, q')$.

Let $\gamma(t) = (\gamma_1(t), \dots, \gamma_n(t))$ be a (normal) geodesic of \tilde{d} such that $\gamma(0) = 0$ with control functions u_1, u_2, \dots, u_n parametrized by arc length on $[0, T]$, and the length of the curve γ is denoted by $l(\gamma)$. We consider $g \in \mathbb{R}^n$ such that $g = \exp(Y)$ with $Y \in \mathfrak{g}$ and Y satisfying Theorem 4. Let $\gamma_g(t) = L_g(\gamma(t))$ and $\bar{u}_1, \bar{u}_2, \dots, \bar{u}_n$ its control functions. Note that γ_g is admissible for \tilde{d} as long as it does not meet \mathcal{Z} . Indeed, all absolutely continuous curves are admissible out of the singular locus since the metric is Riemannian.

Let $\epsilon > 0$ such that $C_2 \cdot \tilde{d}(0, \gamma(T)) = C_2 \cdot T \leq \epsilon$, where C_2 is the constant of inequality 8 of Theorem 2.

On the other hand, by Proposition 5 we have that $u_i(t) = \bar{u}_i$ for $i = 1, \dots, n-1$ and since $l(\gamma_g) < l(\gamma)$, we can assume that there exists $C : [0, T] \rightarrow [0, 1[$ such that

$$|u_n(t)|C(t) = |\bar{u}_n(t)|. \quad (13)$$

Moreover, from Pontryagin's maximum principle (more details see [1]) we know that

$$u_n(t) = \left\langle \lambda(t), \tilde{X}_i \right\rangle = \lambda_n(t) \cdot (ax_n + Q(x_1, x_2, \dots, x_{n-1})) \quad (14)$$

where $\lambda(t) \in T_{\gamma(t)}^* \mathbb{R}^n$.

$$\text{Let } b = \max(C(t), t \in [0, T]) \text{ and } S = \frac{(1 - b^2)\lambda_n(0)^2(n-2)^2a^2}{40(n-1)^2} T^4.$$

The following Theorem is the main result in this section.

Theorem 5. *With the previous notations. If $\frac{2\epsilon}{1+2\epsilon} < S$ then*

$$\left| \hat{d}(\gamma_g(0), \gamma_g(T)) - d(\gamma_g(0), \gamma_g(T)) \right| > \left| d(\gamma_g(0), \gamma_g(T)) - \tilde{d}(\gamma_g(0), \gamma_g(T)) \right|,$$

and in consequence \tilde{d} is closer than \hat{d} to d .

Proof. The different distances between $\gamma_g(0)$ and $\gamma_g(T)$ are analyzed in several steps.

1. Since the controls associated to γ_g are $u_1, \dots, u_{n-1}, \bar{u}_n$, then by equation (13) the length of γ_g related to \tilde{d} is

$$\tilde{l}(\gamma_g) = \int_0^T \left(\sum_{i=1}^{n-1} u_i^2 + u_n^2 C(t)^2 \right)^{\frac{1}{2}} dt.$$

Let

$$I_b = \int_0^T \left(\sum_{i=1}^{n-1} u_i^2 + u_n^2 b^2 \right)^{\frac{1}{2}} dt, \quad (15)$$

then $\tilde{l}(\gamma_g) \leq I_b$. Since $\sum_{i=1}^n u_i^2 = 1$ then $\sum_{i=1}^{n-1} u_i^2 = 1 - u_n^2$. Replacing in equation (15)

$$\begin{aligned} I_b &= \int_0^T (1 - u_n^2 + u_n^2 b^2)^{\frac{1}{2}} dt \\ &= \int_0^T (1 + (b^2 - 1)u_n^2)^{\frac{1}{2}} dt \end{aligned}$$

Since $b \in [0, 1[$ then $b^2 - 1 < 0$. We set $-\beta = b^2 - 1$. Hence

$$I_b = \int_0^T (1 - \beta u_n^2)^{\frac{1}{2}} dt. \quad (16)$$

2. Approximation of u_n .

From the Hamiltonian equations (section 3.2.1), we make the choice $\lambda_1(0) = \lambda_2(0) = \dots = \lambda_{n-1}(0) = \lambda_0$ and the following approximations hold:

$$\begin{aligned} x_i &\approx \lambda_0 \cdot t, \quad \text{for } i = 1, \dots, n-1, \\ x_n &\approx \frac{t^2(n-2)}{2(n-1)}. \end{aligned} \quad (17)$$

Replacing approximations (17) in equation (14) we obtain

$$u_n \approx \frac{\lambda_n(0)(n-2)}{2(n-1)} at^2. \quad (18)$$

3. Considering the above approximation of u_n , and replacing in equation (16) we get:

$$\begin{aligned} I_b &= \int_0^T (1 - \beta u_n^2)^{\frac{1}{2}} dt \leq \int_0^T \left(1 - \beta \cdot \frac{\lambda_n(0)^2(n-2)^2}{4(n-1)^2} a^2 t^4 \right)^{\frac{1}{2}} dt \\ &\leq \int_0^T \left(1 - \beta \cdot \frac{\lambda_n(0)^2(n-2)^2}{8(n-1)^2} a^2 t^4 \right) dt, \end{aligned}$$

the latter inequality is thanks to $(1-c)^{\frac{1}{2}} \leq 1 - 0.5c$ whenever $0 \leq c \leq 1$. Finally,

$$\tilde{l}(\gamma_g) \leq I_b \leq \int_0^T \left(1 - \beta \cdot \frac{\lambda_n(0)^2(n-2)^2}{8(n-1)^2} a^2 t^4 \right) dt = T - \frac{\beta \lambda_n(0)^2(n-2)^2 a^2}{40(n-1)^2} T^5 = T - ST.$$

We assume $S < 1$. This is possible, even if T is small, because by Remark 3 $H(\lambda(0))$ does not depend of $\lambda_n(0)$. In consequence, $\lambda_n(0)$ can be chosen arbitrarily large. Hence

$$\tilde{l}(\gamma_g) \leq I_b \leq (1 - S)T. \quad (19)$$

4. We assume $\|g\|_p \leq \tilde{d}(\gamma_g(0), \gamma_g(T))$. We apply now inequality 8 of Theorem 2 and since $C_2 \cdot \tilde{d}(0, \gamma(T)) = C_2 \cdot T \leq \epsilon$ we get

$$\begin{aligned} d(\gamma_g(0), \gamma_g(T)) - \tilde{d}(\gamma_g(0), \gamma_g(T)) &\leq C_2 \cdot \tilde{d}(\gamma_g(0), \gamma_g(T))^2 \\ d(\gamma_g(0), \gamma_g(T)) - \tilde{d}(\gamma_g(0), \gamma_g(T)) &\leq C_2 \cdot \tilde{d}(\gamma_g(0), \gamma_g(T))\tilde{d}(\gamma_g(0), \gamma_g(T)) \end{aligned}$$

since $\tilde{d}(\gamma_g(0), \gamma_g(T)) \leq \tilde{d}(\gamma(0), \gamma(T))$ then

$$\begin{aligned} d(\gamma_g(0), \gamma_g(T)) - \tilde{d}(\gamma_g(0), \gamma_g(T)) &\leq C_2 \cdot \tilde{d}(\gamma_g(0), \gamma_g(T))\tilde{d}(\gamma(0), \gamma(T)) \\ d(\gamma_g(0), \gamma_g(T)) - \tilde{d}(\gamma_g(0), \gamma_g(T)) &\leq \epsilon \cdot \tilde{d}(\gamma_g(0), \gamma_g(T)) \end{aligned} \quad (20)$$

$$d(\gamma_g(0), \gamma_g(T)) \leq \tilde{d}(\gamma_g(0), \gamma_g(T))(1 + \epsilon). \quad (21)$$

From inequality (21)

$$d(\gamma_g(0), \gamma_g(T)) \leq (1 + \epsilon) \cdot T \cdot \frac{I_b}{T} \leq (1 + \epsilon) \cdot \hat{d}(\gamma(0), \gamma(T)) \frac{I_b}{T},$$

then

$$\begin{aligned} \hat{d}(\gamma_g(0), \gamma_g(T)) - d(\gamma_g(0), \gamma_g(T)) &\geq -(1 + \epsilon) \cdot \hat{d}(\gamma(0), \gamma(T)) \frac{I_b}{T} + \hat{d}(\gamma_g(0), \gamma_g(T)) \\ &\geq \tilde{d}(\gamma_g(0), \gamma_g(T)) \cdot \frac{\hat{d}(\gamma_g(0), \gamma_g(T))}{\tilde{d}(\gamma_g(0), \gamma_g(T))} \left(1 - (1 + \epsilon) \frac{I_b}{T}\right) \\ &\geq \tilde{d}(\gamma_g(0), \gamma_g(T)) \cdot \frac{T}{I_b} \left(1 - (1 + \epsilon) \frac{I_b}{T}\right) \\ \hat{d}(\gamma_g(0), \gamma_g(T)) - d(\gamma_g(0), \gamma_g(T)) &\geq \tilde{d}(\gamma_g(0), \gamma_g(T)) \cdot \left(\frac{T}{I_b} - (1 + \epsilon)\right). \end{aligned} \quad (22)$$

Therefore from inequalities (20) and (22)

$$\hat{d}(\gamma_g(0), \gamma_g(T)) - d(\gamma_g(0), \gamma_g(T)) > d(\gamma_g(0), \gamma_g(T)) - \tilde{d}(\gamma_g(0), \gamma_g(T))$$

as soon as

$$\begin{aligned} \frac{T}{I_b} - (1 + \epsilon) &> \epsilon, \\ \frac{T}{I_b} &> 1 + 2\epsilon \\ I_b &< \frac{1}{1 + 2\epsilon} T. \end{aligned}$$

According to inequality (19): $I_b \leq (1 - S)T$, and since $\frac{2\epsilon}{1 + 2\epsilon} < S$, then $1 - S < \frac{1}{1 + 2\epsilon}$ and in consequence \tilde{d} is closer to d than \hat{d} .

□

Acknowledgments. The author is deeply grateful to Philippe Jouan for his guidance, discussions, and invaluable comments on this work.

References

- [1] A. Agrachev, Davide Barilari, and U. Boscain. *A Comprehensive Introduction to Sub-Riemannian Geometry*. Cambridge Studies in Advanced Mathematics. Cambridge University Press, Cambridge, 2019.
- [2] A. Agrachev, U. Boscain, and M. Sigalotti. A gauss-bonnet-like formula on two-dimensional almost-riemannian manifolds. *Discrete and Continuous Dynamical Systems*, 20(4):801–822, 2008.
- [3] A. Bellaïche. The Tangent space in sub-Riemannian geometry. In Bellaïche André-Risler Jean-Jacques, editor, *Sub-Riemannian Geometry*, Progress in Mathematics, pages 1–78. Birkhäuser Basel, 1996.
- [4] A. Bonfiglioli. *Stratified Lie Groups and Potential Theory for Their Sub-Laplacians*. Springer Monographs in Mathematics. Springer Berlin Heidelberg, New York, 2007.
- [5] U. Boscain, G. Charlot, M. Gaye, and P. Mason. Local properties of almost-Riemannian structures in dimension 3. *Discrete and Continuous Dynamical Systems- Series A*, 35(9):4115–4147, 2015.
- [6] Y. Chitour, P. Jouan, and Ronald Manríquez. General nilpotent and solvable approximations of almost-Riemannian structures. <https://hal.archives-ouvertes.fr/hal-03636478>, 2022.
- [7] M.P. Do Carmo. *Riemannian Geometry*. Translated by Francis Flaherty. Mathematics Theory and Applications. Birkhäuser, Boston Basel Berlin, 1992.
- [8] F. Jean. *Control of Nonholonomic Systems: From Sub-Riemannian Geometry to Motion Planning*. SpringerBriefs in Mathematics. Springer International Publishing, 2014.
- [9] P. Jouan. Equivalence of control systems with linear systems on Lie groups and homogeneous spaces. *ESAIM: Control, Optimisation and Calculus of Variations*, 16(4):956–973, October 2010.

- [10] P. Jouan and R. Manríquez. Solvable approximations of 3-dimensional almost-Riemannian structures. *Mathematical Control & Related Fields*, 12(2):303–326, 2022.
- [11] John M Lee. *Riemannian Manifolds: An Introduction to Curvature*, volume 176. New York, NY: Springer New York, New York, NY, 2006.
- [12] F. Serra Cassano. Some topics of geometric measure theory in Carnot groups. In D. Barilari, U. Boscain, and M. Sigalotti, editors, *Geometry, Analysis and Dynamics on Sub-Riemannian Manifolds*, volume I, pages 1–121. Series of lectures in Mathematics, 2016.