



HAL
open science

The genetic toolbox of arbuscular mycorrhizal fungi for carbon trading with their host plants

Loïc Cusant

► **To cite this version:**

Loïc Cusant. The genetic toolbox of arbuscular mycorrhizal fungi for carbon trading with their host plants. *Vegetal Biology*. Université Paul Sabatier - Toulouse III, 2019. English. NNT : 2019TOU30341 . tel-03716208

HAL Id: tel-03716208

<https://theses.hal.science/tel-03716208>

Submitted on 7 Jul 2022

HAL is a multi-disciplinary open access archive for the deposit and dissemination of scientific research documents, whether they are published or not. The documents may come from teaching and research institutions in France or abroad, or from public or private research centers.

L'archive ouverte pluridisciplinaire **HAL**, est destinée au dépôt et à la diffusion de documents scientifiques de niveau recherche, publiés ou non, émanant des établissements d'enseignement et de recherche français ou étrangers, des laboratoires publics ou privés.



THÈSE

En vue de l'obtention du DOCTORAT DE L'UNIVERSITÉ DE TOULOUSE

Délivré par l'Université Toulouse 3 - Paul Sabatier

Présentée et soutenue par

Loïc CUSANT

Le 17 décembre 2019

**La boîte à outils génétique des champignons mycorhiziens pour
les échanges de carbone avec leurs plantes hôtes**

Ecole doctorale : **SEVAB - Sciences Ecologiques, Vétérinaires, Agronomiques et
Bioingenieries**

Spécialité : **Interactions plantes-microorganismes**

Unité de recherche :

LRSV - Laboratoire de Recherche en Sciences Végétales

Thèse dirigée par
Christophe ROUX

Jury

Mme Marie-Noëlle ROSSO, Rapporteur
M. Daniel WIPF, Rapporteur
Mme Annegret KOHLER, Examinatrice
M. Christophe DUNAND, Examineur
M. Didier REINHARDT, Examineur
M. Pierre-Emmanuel COURTY, Examineur
M. Christophe ROUX, Directeur de thèse

Remerciements

Je tiens à remercier tout particulièrement Christophe, qui m'a tant appris, autant au niveau scientifique que professionnel. Tu as été un excellent mentor pour moi. J'ai beaucoup aimé travailler avec toi ainsi que nos discussions autour d'une cigarette ou en fin de journée. Je remercie également les membres de mon jury ainsi que les examinateurs de mon manuscrit. Surtout, merci à toi, Charlotte qui a su m'apporter du soutien dans les moments difficiles et qui a toujours cru en moi pendant toutes ces années.

Mes remerciements vont aussi à l'équipe myco, aux membres des services communs, aux stagiaires avec qui j'ai travaillé, ainsi qu'à mes étudiants et surtout aux non permanents. Merci aussi à ma famille et aux amis Grenoblois, Montpelliérains et Toulousains pour leur soutien. Merci à tous ceux que j'ai pu rencontrer pendant ces années et tous ceux qui m'ont aidé à faire cette thèse d'une manière ou d'une autre.

Je dédie cette thèse à Imran.

Résumé

La symbiose mycorhizienne à arbuscules (MA) est une interaction mutualiste entre la plupart des plantes terrestres et des champignons appartenant à l'embranchement des Gloméromycètes. Dans cette interaction, le champignon agit en extension du système racinaire et permet à la plante d'accéder à des minéraux inaccessibles par le seul système racinaire. Les minéraux récupérés dans le sol, particulièrement le phosphore, sont ensuite échangés dans les racines des plantes hôtes contre des molécules carbonées nécessaires à la croissance de ces champignons. Les champignons MA sont en effet dépendants d'hexoses et de l'acide palmitique fournis par la plante hôte. Cette double dépendance inhabituelle soulève plusieurs questions biologiques. Autant les transporteurs fongiques de sucres ont été caractérisés, autant l'acquisition des acides gras (AG) demeure mal décrite. La régulation de cette double dépendance est inconnue : les transports de sucres et d'AG sont-ils co-régulés ? Il a été décrit que de fortes concentrations en phosphate dans la rhizosphère bloque le transport symbiotique de sucres. Cette répression agit-elle dans le transport des AG ? Comment un champignon MA associé à plusieurs plantes régule-t-il l'acquisition des différents nutriments de ces multiples hôtes ? Les échanges sont-ils équivalents ? Peut-il obtenir plus de sucres de la part d'une plante et plus d'AG de la part de l'autre ? Pour y répondre, des designs expérimentaux originaux ont été mis au point, parallèlement à des outils de transcriptomique et des stratégies de validation fonctionnelle.

Le premier chapitre présente un nouvel outil d'analyse de l'expression de gènes pour le champignon modèle *Rhizophagus irregularis* DAOM 197198 : RhiirExpress. Cet atlas de gènes, est un site web regroupant des multiples données de séquençage des ARN. Les données publiques ainsi que des données du laboratoire ont été traitées par un même pipeline informatique. Une première application de RhiirExpress a porté sur l'analyse du transportome de *Rhizophagus irregularis* dans 54 conditions biologiques différentes. Cette première analyse a permis de caractériser les différents patrons d'expression des gènes du transportome selon les phases de croissance asymbiotiques, présymbiotiques et symbiotiques. Cette analyse a démontré des mécanismes d'absorption et d'utilisation des nutriments très contrastés selon les stades physiologiques du champignon.

Le second chapitre s'intéresse au fonctionnement du champignon lorsque celui-ci est simultanément connecté à un plant de sorgho et un plant de peuplier, ainsi qu'aux perturbations engendrées selon la disponibilité en phosphate. Ce design expérimental a permis de démontrer que le champignon ne se comporte pas équitablement selon les plantes. Dans notre cas le peuplier est une plante ligneuse pérenne avec un métabolisme C3 alors que le sorgho est une herbacée annuelle avec un métabolisme C4. Nos résultats montrent que *R. irregularis* est capable d'allouer différemment ses ressources aux différentes plantes hôtes, et suggèrent que les transports de sucres et d'AG pourraient être modulés de façon disjointes.

Dans le dernier chapitre, les gènes de *R. irregularis* impliqués dans le métabolisme des AG sont analysés. Les principaux acteurs du métabolisme des AG sont analysés durant toutes les étapes du cycle de vie des champignons MA avec une attention particulière apportée aux lipases sécrétées qui pourraient jouer un rôle dans l'acquisition des AG de l'hôte. L'intensité lumineuse ainsi que la concentration en phosphate ont été utilisés afin de moduler les transports symbiotiques, révélant des gènes candidats. Enfin, nous proposons que l'acquisition des AG impliquent un transport actif dans les arbuscules matures, et un mécanisme passif lors de la dégradation des arbuscules.

Ce travail a permis de dresser un portrait du métabolisme des AG en relation avec transportome de ces champignons MA à forte incidence écologique.

Abstract

Arbuscular mycorrhizal (AM) symbiosis is a widespread mutualistic interaction between most land plants and fungi in the phylum of Glomeromycota. During this interaction, the fungus acts as an extension of the root system to recruit soil minerals and water, otherwise out of reach for plants. These minerals foraged by the fungus, particularly phosphorus, are bartered in host roots for carbon molecules necessary for development as AM fungi are unable to grow saprotrophically. It was recently demonstrated that AM fungi are dependent on hexoses and fatty acid (FA) delivered by the host plant. Such double dependency is intriguing and opens several biological questions. Firstly, although sugar transporters involved in AM symbiosis were identified, transport of lipids remains elusive. Secondly, regulation of this double C transport is unknown: are sugar/FA transports intertwined or independent? It was described that a high concentration of phosphate in the rhizosphere blocks symbiotic sugar transport. Is such regulation involved for FA exchanges? Thirdly, an AM fungus can be associated at the same time to different plants, even different plant species. How does the fungus regulate its nutrient exchanges? Are they stoichiometrically regulated whatever host plants, or does the fungus obtain more palmitic acid from one plant whereas more sugar from another? To deal with these questions, original experimental designs were developed, as transcriptomic specific tools and strategies of functional validation.

The first chapter presents a new tool to investigate gene regulation from the model fungus *Rhizophagus irregularis* DAOM 197198: RhiirExpress. This gene atlas, based on the Rhiir2.1 version gene repertoire, consists of a website gathering public and in house mRNAseq data analyzed with the same bioinformatic pipeline. The first application of Rhiirexpress was dedicated to analyzing the regulation of genes involved in the transportome of *Rhizophagus irregularis* in 54 biological conditions. This analysis allowed characterizing transporter gene patterns differently expressed in asymbiotic, presymbiotic and symbiotic stages, pointing out very contrasted absorptive strategies according to developmental stages.

In the second chapter we address the issue of the functioning of the fungus when connecting poplar and sorghum, and the disturbance of phosphate availability in the CMN on its functioning. Using transcriptomic and metabolic measures, this original experimental set-up showed that the fungus is acting very differently between plants having different demands. Poplar is a perennial woody plant with a C3 metabolism while sorghum is an annual grass with a C4 metabolism. The results showed that *R. irregularis* is able to differently allocate its resources according to host plants, and suggested that sugar and FA transports could be differentially modulated.

In the last chapter, the genes involved in FA metabolism of *Rhizophagus irregularis* were analyzed. Key players of the FA metabolism were characterized along AM fungal life cycle, with a specific focus on putative secreted lipases that could be involved in plant FA acquisition. Light intensity and excess of phosphate were used as modulators of symbiotic activity and FA transport. Functional approaches were carried out to investigate the role of candidate genes. Finally, we propose that FA acquisition occurred by active transport in mature arbuscules, and a passive mechanism when arbuscules collapse. We propose that the limitation of FA acquisition to arbuscule collapsing is an adaptive mechanism to a long biotrophic interaction.

This work aims at drawing up an overall picture of the FA metabolism in relation to the transportome of these ecologically important fungi.

Abbreviations

ABC transporter	ATP Binding Cassette transporters
AM	Arbuscular Mycorrhiza
AMF	Arbuscular Mycorrhizal Fungi
AMS	Arbuscular Mycorrhizal Symbiosis
AMT	AMmonium Transporter
ARB	RNAseq library containing microdissected arbuscules
C16	Palmitic Acid (16 Carbon containing fatty acid)
CMN	Common Mycelial Network
DAG	Di Acyl Glycerol
ERM	Extra Radical Mycelium
FA	Fatty Acid
FatM	Acyl-ACP Thioesterase-like Mycorrhiza specific
Fe	Iron
GPAT	Glycerol-3-Phosphate Acyl Transferase
HP	High Phosphate
ICH	Inter Cellular Hyphae
IRM	Intra Radical Mycelium
IRV	Intra Radical Vesicule
K	Potassium
KAS1 or DIS	Keto-Acyl ACP Synthase
LD	Lipid Droplets
LP	Low Phosphate
MAG	Mono Acyl Glycerol
MFS	Major Facilitator Superfamily
Mg	Magnesium
Mn	Manganese
N	Nitrogen
ORF	Open Reading Frame
P	Phosphate
PAM	Peri-Arbuscular Membrane
PAS	Peri-Arbuscular Space
Pi	inorganic Phosphate
PKS	Poly Ketide Synthase
PPA	Pre Penetration Apparatus
PT	Phosphate Transporter
PUFA	PolyUnsaturated FA
RAM2	Reduced Arbuscular Mycorrhiza
SP	Secreted Peptides
STR/STR2	STunted aRbuscule
SUT	SUcrose Transporter
TAG	Tri Acyl Glycerol
TG	TriGlycerides

Table of content

Introduction.....	1
I. Plants host microbial consortia.....	1
A. What is a plant?	1
B. The rhizosphere: a soil-root interface.....	3
II. Arbuscular Mycorrhizal (AM) Fungi	5
A. Description of AM fungi	5
B. Biology of AM fungi: from spore germination to symbiotic interaction	7
III. Genomics of AM fungi	17
A. Rhiir2-1, an elite gene repertoire of <i>R. irregularis</i> DAOM197198.....	19
B. Intraspecific diversity and pangenome of <i>R. irregularis</i>	19
IV. AM fungi are oleogenic organisms that do not synthesize their fatty acids.....	29
A. Dependency to plant fatty acids	29
B. Fungal FAS.....	31
C. Fatty acids: “Make it or Take it”.....	33
D. Host plant FA acquisition by AM fungi: how to take it?.....	37
E. From FA acquisition to hyphal transport: lipid droplets, little known actors of AM fungal lipid metabolism	39
V. Thesis objectives and strategies	43
Chapter 1 - RhiirExpress, a gene atlas of the model symbiotic fungus <i>Rhizophagus irregularis</i> DAOM197198	45
I. Abstract	47
II. Introduction	49
III. Results and Discussion.....	51
A. RNA-Seq data source and processing	51
B. Data mining tools	53
C. Visualization and clustering analysis.....	55
D. Revisiting the biology of <i>R. irregularis</i> thanks to RhiirExpress.....	55
IV. Conclusion.....	69
V. Material and methods.....	77
VI. Bibliography.....	77
Chapter 2 - Imbalanced regulation of fungal nutrient transports according to phosphate availability in a symbiocosm formed by poplar, sorghum, and <i>Rhizophagus irregularis</i>	89
I. Highlight.....	93
II. Abstract	93
III. Keywords	95
IV. Abbreviations	95

V.	Introduction	97
VI.	Material and Methods	105
A.	Experimental set-up.....	105
B.	Harvest	107
C.	Colonization measurements and P extraction.....	109
D.	RNA extraction	109
E.	Reverse transcription and qRT-PCR.....	109
F.	RNA sequencing and data analysis	111
G.	Metabolite profiling and data analysis.....	113
VII.	Results	113
A.	Colonization, and N and P measurements	113
B.	Patterns of ERM and IRM expressomes in the symbiocosm.....	115
C.	Regulation of phosphate transporter expression	121
D.	Regulation of transporters involved in nitrogen exchange.....	123
E.	Gene expression related to carbon exchange	127
F.	Primary metabolism of poplar and sorghum roots, and the ERM of <i>R. irregularis</i>	129
VIII.	Discussion	131
A.	Differential resource allocation in the CMN.....	131
B.	Symbiotic phosphorus exchange	133
C.	P-dependent regulation of PT expression.....	135
IX.	Conclusion.....	145
X.	Acknowledgment.....	147
XI.	References	147
	Chapter 3 - The “fat” expressome of <i>Rhizophagus irregularis</i>	159
I.	Working hypotheses and objectives	159
II.	Results and discussion	161
A.	Key players of fatty acid metabolism in <i>R. irregularis</i>	161
B.	Lipid metabolism during AM fungal development	169
C.	Regulation of C exchanges: are FA and hexose transfers similarly regulated? ...	173
III.	Conclusion.....	187
	Discussion and perspectives.....	189
I.	AM fungi: strange or usual Eukaryotes?	191
II.	RhiiExpress.....	191
III.	Symbiocosms as a mean to study carbon stock exchange.....	193
IV.	Comment on HIGS strategy.....	195
V.	Fatty acid recovery mechanism	197
VI.	Le gras, c’est la vie.....	203

VII. The promises of analytical cytology	205
VIII. What's next?	207
Methods.....	209
I. Biological material	209
II. Transformation protocol.....	209
III. cDNA synthesis and RT-qPCR expression analysis.....	213
IV. Chimeric plants transformation	215
V. Light and Phosphate treatments	215
A. Plant material and AM Inoculation:	215
B. Phosphate kinetic analysis	217
C. Light treatment	217
D. Harvest and plant storage	217
E. Measurement of mycorrhizal colonization level	219
F. Analysis of gene regulation.....	219
References	220
Annexes.....	235
Annexes of Chapter 1.....	235
Annexes of Chapter 2.....	239
Annexes of Chapter 3.....	255

Introduction

I. Plants host microbial consortia

A. What is a plant?

Asking this question to plant biologist at the previous century, the answer would have been “Plants are sessile organisms at the bottom of the food chain (primary producers), able to reduce atmospheric CO_2 in glucose through photosynthesis, getting water and minerals (N, P, K, Fe, Mg, Mn...) from the soil by their roots”. Asking this question to plant microbiologist, the current answer is “Plants are primary organisms that host several consortia of microbes: on leaf surface (phyllosphere), in the vicinity and surface of roots (Rhizosphere), and also in their tissues (endophytes)”. This shift of definition is not only a difference of perception of their working subject by scientists, but an evolution of knowledge. Works on coral reefs pioneered this integrated view on the organization of micro-organisms and macro-organisms in an organized community, the holobiont (Knowlton and Rohwer, 2003). This definition was rapidly adapted to plants (Vandenkoornhuysen et al., 2015; Zilber-Rosenberg and Rosenberg, 2008). Plants indeed formed different biocenoses - roots, aerial parts - colonized by different communities of organisms (Figure 1).

The development of next-generation sequencing technologies open the ability to deeply investigate these microbiomes, thus investigating the relations between environment and plant genetics (particularly their immunity) that support microbial communities and therefore the fitness of plant to their environment (Bulgarelli et al., 2013). Functional studies on these microbiomes are now in great development and will provide strong development on the biology of plants: growth, resistance to heat, drought, and health. Particularly, root microbiota provides a fascinating field of investigation, as it is strongly involved in plant nutrition, at the interface of soil and roots.

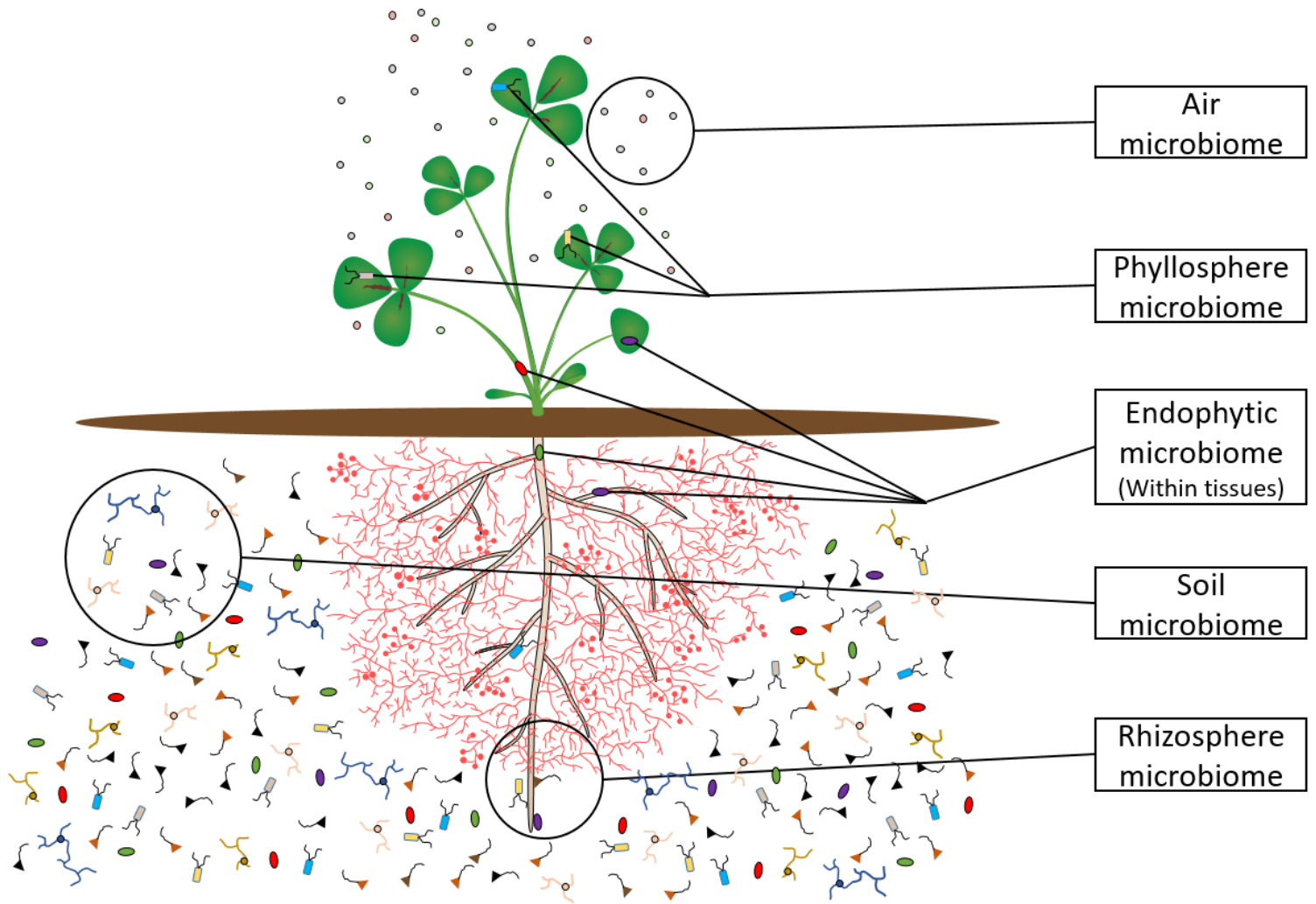

Figure 1: The plant as a holobiont forming different microbiomes.

B. The rhizosphere: a soil-root interface

1. Soil: a microbial fermenter rich in nutrient resources

Soil is composed of humus and clay mixed in micro aggregates sticking to each other to form macroaggregates. The humus is the result of the degradation of organic matter by many organisms. Clay, on the other hand, adsorbs ionic minerals thanks to their charges. Therefore, even a tiny spoon of soil contains enough carbon, water, nitrogen, phosphorous and other minerals to support tremendous number of life forms. It is estimated that 1 gram of topsoil contains on average of 4-20 10^9 bacteria, 200 m of fungal hyphae among which half of arbuscular mycorrhizal fungi, 150-1000 protists, hundreds of nematodes (Bardgett and van der Putten, 2014). Therefore, soil is one of the richest ecosystems found on earth. Actually, it is estimated that 75% of all biomass on earth is present under our feet (Willgoose, 2018).

The soil is rich in minerals but reaching and extracting them can be extremely difficult. For instance, many soils in the world contain total P stocks that largely exceed plant requirements. However, P is mainly unavailable to the plant. P is present in organic and inorganic forms in soil, but plants take up only free inorganic orthophosphate (P_i) ions in soil solution. Moreover, P_i forms insoluble complexes with cations, particularly aluminum and iron under acid conditions and calcium under alkaline conditions (Hinsinger et al., 2011). The high immobility of P_i in soil, the low soil solution circulation associated with a rapid root absorption results in the development of a depletion zone around the roots. Consequently, P is frequently a limiting factor for plant growth and development, and the extent of rhizosphere coverage largely determines the P pool available for plants.

2. The rhizosphere

To overcome the limitation of mineral nutrients such as P, plant roots associate in the natural environment with a microbiota that plays a major role in the recruitment of soil mineral nutrients. In the case of phosphorus, for example, many bacteria act as phosphate solubilizers, providing free phosphate to plants (Rodriguez and Fraga, 1999; Wei et al., 2018). Such bacteria are abundant in the vicinity of roots, mainly due to sugars and organic compounds exuded by roots - the rhizodeposits (Jones et al., 2004) - providing carbon sources for bacteria and inducing chemical changes

facilitating phosphate availability (Hinsinger, 2001). In addition to bacteria, the role of arbuscular mycorrhizal (AM) fungi in plant host P nutrition is well established. They are estimated to provide up to 90% of the P required by plants.

II. Arbuscular Mycorrhizal (AM) Fungi

A. Description of AM fungi

AM fungi are soil microorganisms interacting with plant roots to form a mutualistic interaction, the arbuscular mycorrhizal symbiosis.

1. Phylogeny and diversity of AM fungi

AM fungi belong to the monophyletic clade of Glomeromycotina. All AM fungal species form symbioses with plants, at the exception of the species *Geosiphon pyriformis*, which is associated with cyanobacteria. More recent phylogenetic works based on comparative genomics group Glomeromycotina, Mortierellomycotina and Mucoromycotina in the basal fungal phylum of Mucoromycota (Morin et al., 2019; Spatafora et al., 2016). The diversity of AM fungi is still uncertain as species delimitation remains doubtful (Bruns et al., 2018). One reason is that their genome organization was controversial for a long time in the scientific community (see chapter on genomics). Another limitation is that these fungi, although abundantly present all over the world, are discrete soil organisms with few morphological features that can be used for their differentiation: spore morphology (cell walls, suspensors, and internal invagination), color and size. According to the most used classification based on molecular phylogeny (Redecker et al., 2013a; Schüßler and Walker, 2010), 318 binomial taxons are currently defined (see <http://amf-phylogeny.com/>).

2. Co-evolution of AM fungi with plants

The mutualism of AM fungi with plants probably evolved as soon as plants started colonizing lands and fossil records dating back to 400MY suggest the symbiosis was already present (Redecker, 2000; Taylor et al., 1995). It was proposed that this ancient co-evolution helped plants colonize lands by promoting root development (Brundrett, 2002; Field et al., 2015; Humphreys et al., 2010), or cuticle development

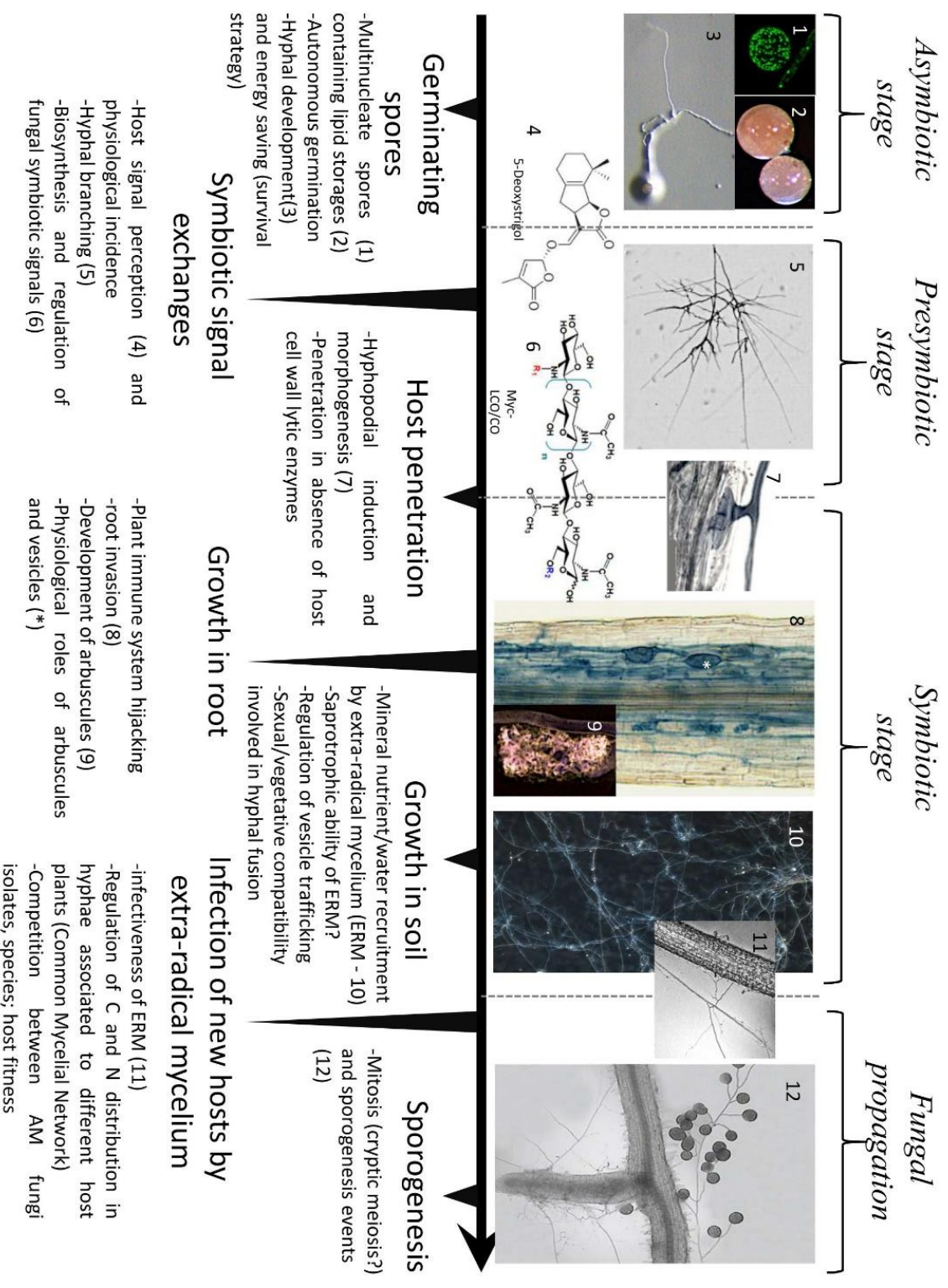

Figure 2: Developmental stages of AM fungi. In addition to host infection by hyphae from germinating spores, AM fungi can efficiently colonize new plant hosts from extra-radical mycelium (ERM) densely present in soil from a previously symbiotic stage. One fungal individual can then be connected to different plants, forming a common mycelial network (CMN).

(Delaux et al., 2012) thanks to pre-existing functions already present in algae (Delaux et al., 2015). As a consequence of this ancient association, a vast majority of land plants - estimated to 71% of all species (Brundrett and Tedersoo, 2018; Wang and Qiu, 2006a) - can associate with AM fungi to form an AM symbiosis. Such plants are sometimes called mycotrophic or mycophilic. Interestingly, all AM fungi are obligate biotrophs, *i.e.* they cannot grow in absence of a host plant. That assumes, as a most parsimonious hypothesis, that symbiotic mechanisms involved in fungal obligate biotrophy appeared early during evolution with plants, and were shared to the whole group.

3. Ecology of AM fungi

Although discrete, AM fungi are abundant in soil (several tens of meters of hyphae per g of topsoil) and are present on all continents, except Antarctica (Brundrett and Tedersoo, 2018; Öpik et al., 2010). Their abundance in the soils depends on soil type, minerals, and on plant communities on the ground cover (Johnson et al., 2004; Smith and Read, 2010). An extraordinary feature is that these fungi present an unusual broad host spectrum. Host capability can, however, vary according to fungal species. *Rhizophagus irregularis* seems to have no limitation and can associate with all mycotrophic plants, but not *Gigaspora rosea* that cannot associate with liverworts (Tang et al., 2016). As they are able to colonize around 200.000 plant species in any given ecosystem, each mycophylic plant will be colonized by numerous different AM fungi. Moreover, each of these fungi is able to colonize at the same time different plants, even belonging to different clades. The plants are thus connected to each other through mycelium that creates an underground fungal network sometimes called the Common Mycelial Network (CMN - (Selosse et al., 2006).

B. Biology of AM fungi: from spore germination to symbiotic interaction

As obligate biotrophs, the life cycle of AM fungi is dependent on the plant's one. The figure 2 illustrates the fungal development from spore germination to sporogenesis, usually divided into three stages: a-symbiotic, pre-symbiotic and symbiotic stages.

1. A-symbiotic stage

During their life cycle, AM fungi do not form any mono-nucleate cell, at least as an independent structure, but large spores (50 to over 500 μm) that contain hundreds to thousands of nuclei. These spores contain large amounts of lipids as energetic storage, forming lipid droplets (figure 2). Spores of AM fungi present in the soil can germinate autonomously when environmental conditions are favorable. High temperature (optimum 30°C) and CO_2 concentration (optimum 2%) induce spontaneous germination of AM spores. At this point, the fungus solely relies on its triglycerides reserves to produce new hyphae. If the fungus fails to meet a root, the cytoplasm can either retract back to the spore, allowing later germination (several tens of times according to fungal species) or it can produce new smaller spores, depending on AM fungal species or the molecules present in their environment (Kameoka et al., 2019a; Sugiura et al., 2019a). In each scenario, the fungus saves as much carbon storage as possible and this a-symbiotic phase is described as an energy-saving growth.

2. Pre-symbiotic stage

When germinating hyphae are in the vicinity of plant roots, they can perceive root-exuded molecules that modify fungal physiology and morphology (highly branched hyphae), supposedly by shifting to a more energetic-consuming growth (Besserer et al., 2006). Among different molecules that participate in this host signaling effect (Bucher et al., 2009; Siqueira et al., 1991), strigolactones were proven to be released by roots in response to mineral starvation such as phosphorus (López-Ráez et al., 2008). Strigolactones are perceived by AM fungal hyphae (Akiyama et al., 2005). Once an AM fungus perceives a strigolactone molecule, hyphal growth is triggered, forming branched hyphae. Similarly to yeast invasive growth (Cullen and Sprague, 2000; Kumamoto, 2005), this branching increases soil exploration and raises the probability of hyphae to encounter roots. The development of germinating hyphae is accompanied by the production and release of signal molecules targeting the plant roots (Genre et al., 2013; Maillet et al., 2011). Their perception by the roots is followed by a signaling cascade inducing a new genetic program for symbiosis (common symbiotic pathway - (Oldroyd, 2013; Zipfel and Oldroyd, 2017)), leading to

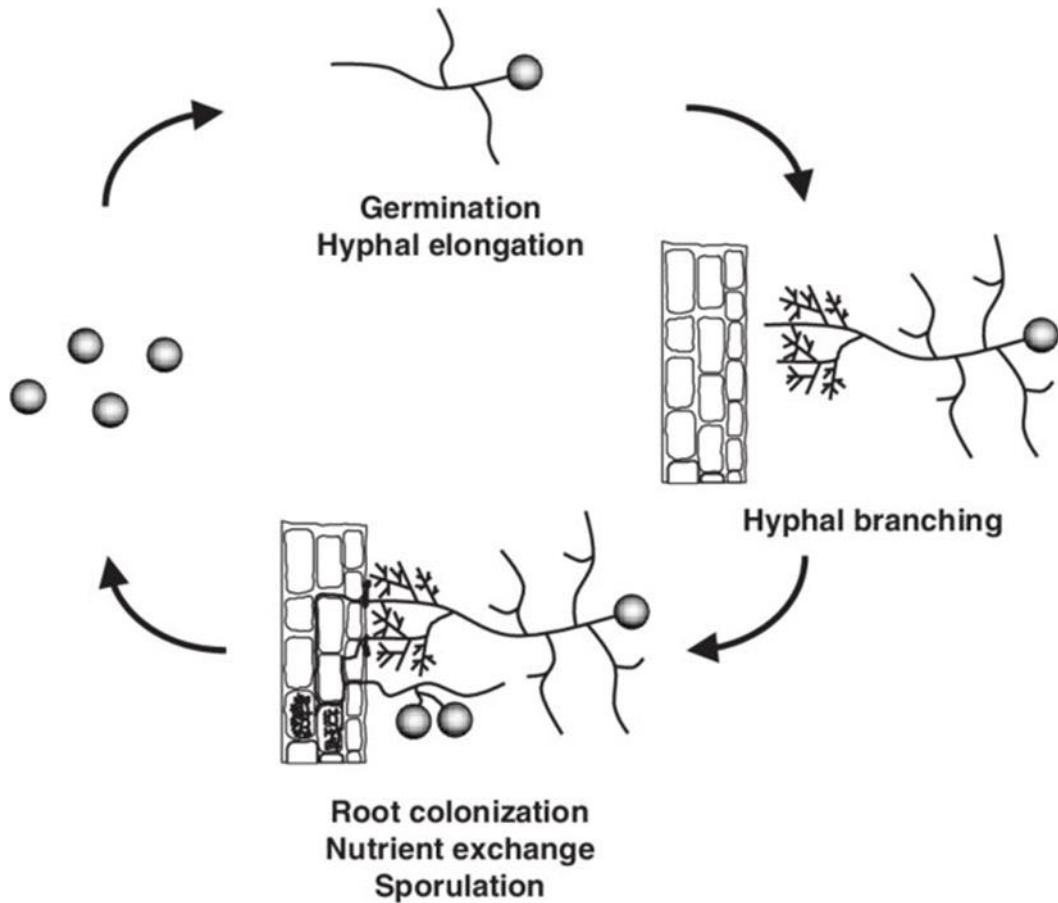

Figure 3: Schematic representation of the symbiotic stage of AM symbiosis from penetration by hyphopodium to arbuscule formation (From (Akiyama, 2007))

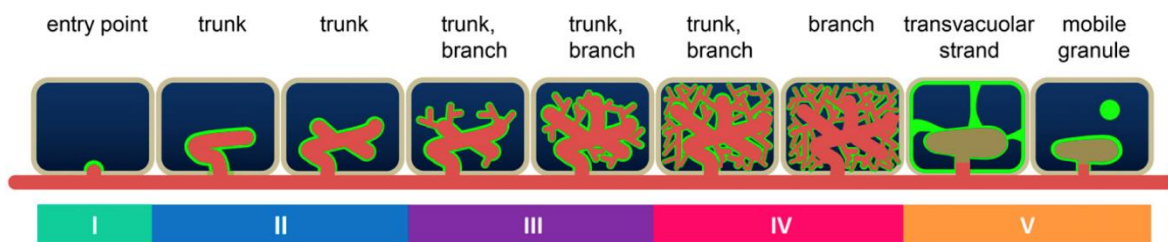

Figure 4: schematic representation of arbuscule lifespan (From (Kobae et al., 2016))

the development of lateral roots and allowing the accommodation of the fungus inside the root.

3. Symbiotic stage

Root invasion

At the contact of the root surface, AM fungi develop a structure called hyphopodia allowing plant penetration (Bonfante and Genre, 2015). As for fungal pathogens, these structures anchor the mycelium on plant root epidermis to allow penetration. Their development is partly controlled by similar transcription factors (Tollot et al., 2009), but they differ as they do not present an internal high pressure for breaking plant cell wall, and host penetration does not involve cell wall hydrolyzing enzymes as AM fungal genomes have lost most of glycosyl hydrolases (Tisserant et al., 2013). Instead, the epidermis plant cell under the hyphopodia will rearrange its cytoskeleton so as to accommodate the fungal penetration (Genre et al., 2005, 2008). The pre-penetration apparatus (PPA) is the name given to this reorganization in the plant epidermal cell where the nucleus migrates under the hyphopodium, then the cytoskeleton is reorganized so that microtubules, actin fibers and the endoplasmic reticulum form a column where plant plasma membrane will invaginate in order to roll out the red carpet for the fungus (Harrison, 2012). The fact that this PPA is created few hours before the fungal entry indicates that this process is mainly under control of the plant. The PPAs allow the fungus to go from the epiderm of the root to the cortex either inter-cellularly or through PPA-like structures without going through any plant plasma membrane.

Arbuscule formation and lifespan

The cortex of the root is the main region where the symbiosis takes place. Here, some cells will also reorganize their cytoplasm before the fungus goes through the plant cell wall and starts branching in contact with the invaginating plasma membrane to accommodate the fungus. This structure is called an arbuscule because of the similarity with a tiny tree developed inside the plant cell. Between the plant plasma membrane (or peri arbuscular membrane, or PAM) and the fungal cell wall, lies an interfacial matrix called the periarbuscular space (PAS). This space is 80-100 nm in width (Bonfante and Perotto, 1995; Cox and Sanders, 1974) and is composed

of polysaccharides with similar composition as the plant's primary cell wall. This observation plus the inability to detect chitin molecules led to thinking that this space is of plant origin (Bonfante-Fasolo et al., 1990; Ivanov et al., 2019).

As illustrated in Figure 4, arbuscules are transient structures with a lifespan estimated between 5 to 10 days (Kobae and Hata, 2010). Inside a mycorrhized plant root system, the fungus can enter simultaneously in different roots and every point of infection leads to multiple inter-cellular hyphae, each one being able to produce many arbuscules. As a result, the whole root system of a plant is constantly being colonized by fungal hyphae, each one leading to new arbuscules being constantly replaced. At any time point, some arbuscules are being formed, some others are functional and some are collapsing, while new inter-cellular hyphae are spreading through the cortex to produce arbuscules in new zones of the root system. The dynamic renewal of arbuscules is a key element of AM symbiosis functioning (Kobae, 2019).

Arbuscules are the main structure of exchanges between AM fungi and plants. Many trans-membrane transporters are located in these membranes both on the plant side and the fungal side and they are involved in nutrient transfer in both directions (Garcia et al., 2016; Wang et al., 2017). Hexoses stemming from photosynthesis are transferred to the AM fungus (Pfeffer et al., 1999; Shachar-Hill et al., 1995) thanks to hexose transporters located in the PAM (Ait Lahmidi et al., 2016; Garcia et al., 2016; Helber et al., 2011). More recently, it was demonstrated that plant fatty acids (FA) was delivered to AM fungi (Bravo et al., 2017; Keymer et al., 2017; Luginbuehl et al., 2017). These works have changed our view on fungus-host plant exchanges, and raised multiple debates and thinking about the double dependency of AM fungi to plant carbon sources and incidence of P on symbiotic physiology (Rich et al., 2017; Roth and Paszkowski, 2017; Wipf et al., 2019).

In addition to arbuscules, many AM fungi (mainly Glomales) form inter-cellular structures called vesicles. Vesicles are bulging hyphae rich in phospholipids (Jabaji-Hare et al., 1984) and containing numerous nuclei. The role and functioning of these structures were not investigated in detail, they are thought to be storage structures. As an illustration, they also appear rapidly during host colonization, their

number increases after high phosphate addition to rice symbiotic roots (Kobae et al., 2016) and at the end of annual plant life cycle (Kobae, 2019).

Extra-radical mycelium (ERM)

In the literature, there is some confusion in reducing the symbiotic phase of AM symbiosis to *in planta* interactions. During the symbiotic phase, an AM fungus has a bipolar organization: intra-radicular mycelium (IRM) and extra-radical mycelium (ERM). IRM and ERM present specific gene regulation, but these two fungal organizations developed during symbiotic phase present interconnected metabolisms. Depending on species and host colonization strategy, AM fungi could invest more energy and carbon in developing mycelium outside than inside of the roots. As an illustration, Glomeraceae species are described to colonize host roots rapidly and invest more biomass inside the host root while the Gigasporaceae species have a relatively slower colonization rate and higher ratio of ERM to IRM (Maherali and Klironomos, 2007; Parniske, 2008).

The ERM is exploring the soil to find and assimilate mineral nutrients. Recent reviews (Ferrol et al., 2019; Kameoka et al., 2019b) describe the mechanisms of phosphorus acquisition by ERM as it is the main mineral taken up by the fungus and also has a regulatory role for the maintenance of symbiotic exchanges. In addition to phosphorus, nitrogen, potassium, iron, sulfur, boron, aluminum, manganese, zinc, copper are also efficiently recruited by the ERM (Pepe et al., 2017).

ERM are also involved in the colonization of new host plants. In laboratory, mycorrhizal plants cultivated in pots, called nurse plants, produce a dense mycelial network in the substrate (Montesinos-Navarro et al., 2012). These nurse plants are often used for rapid mycorrhization of plantlets, or to force mycorrhizal association, in non-myc mutants of mycophilic plants (Javot et al., 2011; Luginbuehl et al., 2017; Rich et al., 2017) or even in non-host plants like *Arabidopsis thaliana* (Veiga et al., 2013). As an interesting point, the secretome of ERM has more similarities with IRM than with hyphae of germinating spores (Kamel et al., 2017). As underlined by independent studies (Kamel et al., 2017; Zeng et al., 2018), many small-secreted proteins are expressed in ERM, as RiSP7 that was described to interfere with the pathogenesis-related transcription factor ERF19, suppressing plant immune response and facilitating root colonization (Kloppholz et al., 2011).

Lastly, ERM have a crucial role in AM fungal life cycle as they support sporogenesis. Detailed cytological analyses indicated that the numerous nuclei present in spores originated both from mycelium migration and mitotic mechanisms (Marleau et al., 2011). Recent transcriptomic works also observed a burst of activity of mitotic genes during sporogenesis (Kameoka et al., 2019b).

III. Genomics of AM fungi

As previously mentioned, AM fungi are obligate biotrophs and do not present a mononucleate phase during their life cycle. For these reasons, there is no available genetic strategy based on transformation and selection of transformants. Genomics approaches are the main tools to advance knowledge on AM fungi. The adventure to obtain the first AM fungal genome was previously published in detail (Malbreil et al., 2014) and here we just highlight some points of interest for the thesis. The AM fungus chosen as model organism was *Rhizophagus irregularis* (formerly *Glomus intraradices*), particularly the in vitro culture DAOM197198 (Chabot et al., 1992) issuing from the whole-plant propagated isolate DAOM181602 (Plenchette et al., 1983). Pointing out the continuous effort of the scientific community to decipher the biology of these fungi, four genome assemblies were produced on this isolate: Gloin1 (Tisserant et al., 2013), RIR (Lin et al., 2014), Rhiir2.1 (Chen et al., 2018; Morin et al., 2019) and RIR17 (Maeda et al., 2018). Genomic resources on AM fungi increased, and genome assemblies are currently available for 7 species: *R. irregularis* (Chen et al., 2018), *R. clarus* (Kobayashi et al., 2018), *R. diaphanus*, *R. cerebriforme*, *Gigaspora rosea* (Morin et al., 2019), *G. margarita* (Venice et al., 2019) and *Diversispora epigaea* (Sun et al., 2019). Although these genomic resources are limited to the two orders Glomales and Diversisporales among the four orders of AM fungi (Redecker et al., 2013b), they now allow performing, fruitful genome comparisons to provide core genetic features of these symbiotic fungi (Morin et al., 2019). Considering the species *R. irregularis*, in addition to the 4 genomic assemblies of DAOM197198, genome assemblies of 5 additional strains were also obtained (Chen et al., 2018).

A. Rhiir2-1, an elite gene repertoire of *R. irregularis* DAOM197198

Among the four genome assemblies published on this strain, three were performed from Illumina sequencing (Gloin1, shotgun; RIR, whole genome amplification and shotgun; Rhiir2-1, 3kb/8kb + shotgun) and one from PacBio sequencing (RIR17 - Maeda et al., 2019). This last one is the most accomplished genome assembly, with 97% of the genome assembled in 210 contigs (147Mb among 154 Mb estimated - (Sędziewska et al., 2011)). However, according to the authors, even if 1676 more additional ORF were predicted in RIR17 gene repertoire compared to Rhiir2-1 (27 859 vs 26183), “*gene completeness was slightly [higher in Rhiir2-1], indicating the advantage of using the JGI annotation pipeline*] to analyze gene expression. JGI annotation pipeline indeed integrates different *ab initio* gene predictions, confronted with partial transcriptome assemblies for defining open reading frames. The Rhiir2-1 gene repertoire is available on the JGI web site (https://mycocosm.jgi.doe.gov/Rhiir2_1/Rhiir2_1.home.html). The resulting annotation is, however, perfectible and manual curation is sometimes necessary to correct gene prediction, as several inexact decisions are proposed when *ab initio* predictions and transcriptome assemblies are conflictual.

B. Intraspecific diversity and pangenome of *R. irregularis*

This paragraph corresponds to a review published in New Phytologist (Mathieu et al., 2018) after the comparison of the genomes of 6 strains of *R. irregularis* was published (Chen et al., 2018).

This article underlines that:

- 1) Only one genome is found per strain, the divergence of analyses on genome organization in AM fungi is debated (see below);
- 2) High intraspecific genome plasticity and diversity was observed, leading to an unusual large pangenome. A general hypothesis about the adaptive incidence of genomic plasticity on symbiotic efficiency was proposed.

*Tansley insight*

Arbuscular mycorrhizal fungi: intraspecific diversity and pangenomes

Author for correspondence:
Nicolas Corradi
Tel: +1 613 562 5800 ext. 6563
Email: ncorradi@uottawa.ca

Received: 23 April 2018
Accepted: 21 May 2018

Stephanie Mathieu^{1*}, Loïc Cusant^{2*}, Christophe Roux² and Nicolas Corradi¹

¹Department of Biology, University of Ottawa, Ottawa, ON K1N 6N5, Canada; ²Laboratoire de Recherche en Sciences Végétales, Université de Toulouse, UPS, CNRS 24 Chemin de Borde Rouge-Auzeville, Castanet-Tolosan, France

Contents

Summary	1129	V. Pangenomes and the future of AMF ecological genomics	1131
I. Introduction	1129	Acknowledgements	1133
II. Intraspecific phenotypic variation and the plant host	1130	References	1133
III. High inter-isolate genetic diversity in model AMF	1130		
IV. Genome diversity within the model AM fungus <i>Rhizophagus irregularis</i>	1131		

New Phytologist (2018) **220**: 1129–1134
doi: 10.1111/nph.15275

Key words: arbuscular mycorrhizal fungi (AMF), intraspecific diversity, pangenomes, *Rhizophagus irregularis*, transposable elements.

Summary

Arbuscular mycorrhizal fungi (AMF) are ubiquitous plant symbionts with an intriguing population biology. Conspecific AMF strains can vary substantially at the genetic and phenotypic levels, leading to direct and quantifiable variation in plant growth. Recent studies have shown that high intraspecific diversity is very common in AMF, and not only found in model species. Studies have also revealed how the phenotype of conspecific isolates varies depending on the plant host, highlighting the functional relevance of intraspecific phenotypic plasticity for the AMF ecology and mycorrhizal symbiosis. Recent work has also demonstrated that conspecific isolates of the model AMF *Rhizophagus irregularis* harbor large and highly variable pangenomes, highlighting the potential role of intraspecific genome diversity for the ecological adaptation of these symbionts.

I. Introduction

Arbuscular mycorrhizal fungi (AMF) are obligate plant symbionts that associate with over 80% of vascular plants; an association believed to date back nearly 400 Myr to the colonization of land by plants (Martin *et al.*, 2017; Strullu-Derrien *et al.*, 2018). These fungi participate in underground nutrient exchanges by associating with plant roots, providing them with increased access to soil nutrients, such as nitrates and phosphates, in exchange for carbon-based photosynthetic byproducts (Jakobsen & Rosendahl, 1990; Parniske, 2008), particularly sugars (Trépanier *et al.*, 2005; Helber

et al., 2011) and lipids (Bravo *et al.*, 2017; Jiang *et al.*, 2017; Keymer *et al.*, 2017; Luginbuehl *et al.*, 2017). In addition to trophic advantages, these fungi enhance plant protection against parasites and increase drought tolerance in their host, resulting in higher plant fitness (van der Heijden *et al.*, 1998; Corradi & Bonfante, 2012; Chitarra *et al.*, 2016).

To date, *c.* 300 species of Glomeromycotina have been described based on spore morphology, but environmental ribosomal DNA sequences suggest that up to 1600 operational taxonomic units (OTUs) may exist (Öpik & Davison, 2016). Furthermore, AMF have been shown to interact with *c.* 200 000 plant species, which led for some time to the confounding question of how few taxa with restricted morphological diversity can interact with such a broad

*These authors contributed equally to this work.

host range (Brundrett, 2009; Öpik *et al.*, 2013; Rodríguez-Echeverría *et al.*, 2017). Technological advances in genomics are finally providing answers to this question and are revealing new aspects of AMF molecular diversity that could lead to a better understanding of their evolution and ecology.

II. Intraspecific phenotypic variation and the plant host

Seminal work by Koch and colleagues has shown that hyphal length, as well as spore counts and density, can vary significantly among conspecific AMF isolates (Box 1) harvested from the same field, and that this variation is correlated with differences in plant growth (Koch *et al.*, 2006). It is now generally accepted that AMF intraspecific diversity (Box 1) has wide-ranging effects on terrestrial ecosystems, a finding with many potential applications in

agricultural and environmental procedures. In particular, recent data has shown that the plasticity observed among isolates correlates with downstream functional effects on the level of host interactions, whereby some isolates provide greater benefits to the plant while others can be detrimental (Hart & Reader, 2002; Munkvold *et al.*, 2004; Koch *et al.*, 2006).

In a recent study based on a large taxonomical sampling of AMF species, Koch and colleagues (Koch *et al.*, 2017) have further confirmed that within-species variation is an important determinant of plant growth, regardless of the AM species investigated. The latter point is particularly relevant as it shows that intraspecific functional variation is not restricted to model species. In this study, authors found that most variation in plant fitness occurs as a result of using different isolates of the same species, rather than different species. In the future, it will be interesting to see if the isolates of all AMF families show similar functional benefits to the plant, and whether some lineages or species produce isolates with a particularly high functional diversity.

Koch *et al.* (2017) also found evidence that the AMF phenotype varies depending on the plant host. Specifically, conspecific isolates were found to grow at various rates and to produce different structures depending on the identity of their host. For example, some isolates produced either more or larger spores when forming symbioses with the plant *Achillea millefolium* but would otherwise extend larger extraradical hyphal networks when in symbiosis with *Medicago trunculata*. Future studies should now aim to identify the molecular mechanisms underlying this intraspecific phenotypic plasticity.

III. High inter-isolate genetic diversity in model AMF

Cultures produced from single spores (i.e. isolates) of the same AMF species can also differ substantially at the genetic level. The existence of high genetic variability among conspecific AMF strains has been known to exist for over a decade through studies of the model species *Rhizophagus irregularis* (Koch *et al.*, 2004). Originally, this intraspecific diversity was proposed to result from a combination of heterokaryosis (Box 1), and additional polymorphism due to copy number variation (CNV) (Box 1), as based on data obtained using amplified fragment length polymorphism (AFLP) and single gene comparisons between strains (Koch *et al.*, 2004, 2006; Corradi & Sanders, 2006; Corradi *et al.*, 2007; Croll *et al.*, 2009).

More recent attempts to explore intraspecific diversity in these plant symbionts have focused on genome-wide diversity scans of *R. irregularis* isolates harvested from different geographical locations using a 'restriction site associated DNA sequencing' approach (RAD-Seq) (Wyss *et al.*, 2016) (Box 1). The RAD-seq method allows sequencing of short DNA genome fragments generated through digestion of genomic DNA with the *MseI* and *EcoRI* restriction enzymes using the Illumina technology. By mapping reads onto a reference genome (e.g. *R. irregularis* DAOM 197198), Wyss and colleagues uncovered large levels of inter-isolate diversity, as indicated by a 20-fold variation in the number of single nucleotide substitutions (SNP; Box 1). These findings revealed that some of the isolates analysed diverge

Box 1 Glossary of specialist terms used in the paper

Isolate: fungal culture produced from a single spore

Intraspecific diversity: In arbuscular mycorrhizal fungi (AMF) research, this term is synonymous to *within-species* variation, and highlights the existence of genetic or phenotypic differences between members (individuals) of the same species. This term is highly dependent on the tools used for taxonomical nomenclature. In the case of AMF, taxonomical nomenclature has been heavily reliant on phylogenetic analyses based on ribosomal sequences

AMF phenotypic variation: Variance in the culture's hyphal and spore mass and densities, as well as in its rate of mycorrhization, and its effect on plant fitness and root dry mass

Heterokaryosis: The existence of more than one nuclear genotype – or nucleotype – within one cytoplasm

Copy number variation (CNV): Variation in the number of genomic regions, including genes encoding proteins, transposable elements and noncoding DNA

RAD-Seq: Genome sequencing is becoming cheaper, but genome-wide analyses of entire populations can still be costly. The RAD-seq method offsets such costs by targeting Illumina sequencing to polymorphic genomic regions. Such regions are defined by restriction enzymes, typically *EcoRI* and *MseI*. This method allows for the simultaneous identification of thousands of isolate-specific genetic markers

Single nucleotide polymorphism (SNP): A single base pair substitution in a DNA sequence. Such substitutions can be used to genetically distinguish, for example, different isolates of the same species, or different species

Pangenome: This term was originally coined to describe genome diversity in prokaryotes. In bacteria, this intraspecific genome variation is generally seen as resulting from horizontal gene-transfer between coexisting taxa. Researchers are now realizing that populations of eukaryotic microbes can sometimes harbour genomes that are very variable in term of content. This variation can affect not only the total number of genes, but also the genome structure. The term 'Pangenome' was recently applied to Fungi to describe the large intraspecific genome diversity frequently found in this Kingdom. High genome diversity has been linked with fungal virulence – for instance with high-speed evolutionary regions that can present effectors – and is generally seen as providing evolutionary and ecological advantages within a species

substantially from the reference, and this wide-ranging inter-isolate variability was proposed to result from varying genomic conditions such as heterokaryosis, CNV, aneuploidy or a combination of these.

IV. Genome diversity within the model AM fungus *Rhizophagus irregularis*

For some time, studies have shown that within-species diversity in AMF is high and important for their interaction with their surrounding environment. What has been unclear, however, is how this elevated diversity originates within their genomes and which genomic regions are most affected by such variation. This lack of knowledge stemmed from the methods previously used to detect AMF genome variability, such as AFLP, microsatellite analysis, single-gene sequencing or RAD-seq. In particular, these techniques are unable to extract meaningful functional information from genome data, as they provide a mainly quantitative overview of genetic diversity present between individuals.

An improved view of intraspecific diversity in AMF was recently obtained through genome analyses of six model isolates. Specifically, Chen and colleagues (Chen *et al.*, 2018) have discovered that conspecific *R. irregularis* isolates share as little as 50% of their gene repertoire. This genome diversity is remarkable, as similar analyses performed on conspecific strains of distant fungi show variation in gene count reaching at most 3% (Lysøe *et al.*, 2014; Walkowiak *et al.*, 2015; Plissonneau *et al.*, 2016). In *R. irregularis*, most molecular functions are affected by CNV, with inter-isolate variability occurring in crucial pathways such as those predicted to be involved in the dialogue between the host and appears to affect almost all Pfam domains. These findings indicate substantial variation in the molecular function of each isolate, with many implications for our understanding of AMF population and genome dynamics.

Comparing *R. irregularis* genomes also revealed the potential role of transposable elements (TE) in creating genome diversity. TE abundance influences the extent of genome reorganization in many taxa by increasing adaptability to environmental change – for example, a host switch – particularly in organisms where sex is seemingly absent (Seidl & Thomma, 2014; Faino *et al.*, 2016). Most recent analyses indicate that TE compose at least 23% of the *R. irregularis* genome (Chen *et al.*, 2018). These TE are also extremely variable among conspecific isolates, with certain TE families being abundant in some *R. irregularis* isolates and absent in others. To our knowledge, the degree of TE variability discovered in *R. irregularis* is unprecedented, and it is possible that AMF genome evolution follows a ‘two-speed genome’ model, which posits that genomic regions containing a high density of TE evolve more rapidly (Raffaele & Kamoun, 2012; Dong *et al.*, 2015). These mobile elements are also widely expressed in *R. irregularis*, as measured by RNA-seq read mapping (Chen *et al.*, 2018). Evidence for their expression indicates that they are active and may play a driving role in reshaping genome diversity within AMF species (Faino *et al.*, 2016). Since the evolution of effector genes is tightly linked to

the activity of transposable elements (Plissonneau *et al.*, 2017), future analyses should aim to understand whether the observed variation in TE abundance and activity correlates with effector diversity and abundance within AM species.

V. Pangenomes and the future of AMF ecological genomics

The most recent genome studies have also introduced the notion of ‘pangenome’ in AMF research (Box1). The term generally indicates that the total number of genes available to one microbial species can far exceed those encoded by one single individual (Plissonneau *et al.*, 2018). In *R. irregularis*, the pangenome already exceeds 150 000 genes (Chen *et al.*, 2018), which means that model AMF (and probably all lineages in the group) carry vast arrays of ‘accessory genes’. Accessory genes are thought to represent genomic regions providing evolutionary and ecological advantages to some isolates under changing environments – for example, the ability to colonize certain plant hosts, or some environments more efficiently (Fig. 1). Within this context, the molecular diversity that exists in just six laboratory-grown *R. irregularis* isolates offers only a small view of the genome diversity present in the natural populations of these symbionts.

In order to facilitate future work linking AMF genome diversity with the ecosystem – that is, ecological genomics – studies should now aim to acquire optimal assemblies from as many AMF lineages as possible. Indeed, all genome data currently available from this group come from only one model species, and the genome content and diversity of most AM families is virtually unknown. It will also be essential to improve both current and future AMF genome assemblies because, with the exception of DAOM 197198, all available genome data are fragmented into tens of thousands of contigs. This fragmentation hampers the detection of synteny blocks and structural variants, and thus the identification of mechanisms that create variability within and among species. The identification of single-copy regions in these highly paralogous genomes also requires clean assemblies, which is particularly relevant to distinguish between intra- and inter-isolate polymorphism in genetic studies based on fingerprinting methods such as RAD-seq or low-coverage sequencing (Sanders & Rodriguez, 2016). Improving assemblies can be done by combining long-read sequencing technologies (Rhoads & Au, 2015; Jain *et al.*, 2018), with Illumina sequencing data obtained from paired end and mate paired libraries. In return, optimal assemblies will allow us to obtain a precise view of the changes that occur among homologous regions of closely related individuals, for example, by revealing which TE or genes are more prone to move among or change within isolates and along the genome.

Because long-read technologies are based on single DNA molecule sequencing, their use will also expose the extent and location of variations that can exist among nuclei coexisting within the AMF mycelium or within single spores. When applied to DNA from conspecific isolates, this method could help us to determine how frequently isolates can exchange genetic material in the field (Chen *et al.*, 2018), and whether such events result from mating processes – that is, recombination events occurring between closely

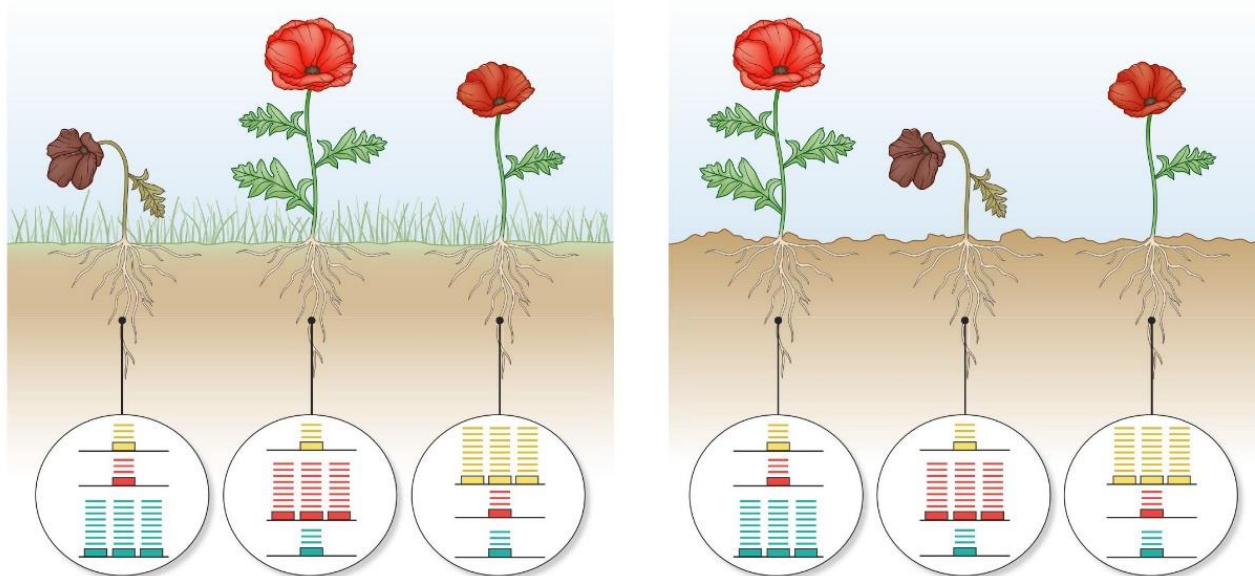

Fig. 1 Hypothesis on the effect of copy number variation (CNV) on plants located in natural (left) and disturbed (right) environments. Conspecific arbuscular mycorrhizal fungal (AMF) spores are represented by circles and different gene families are shown as small rectangles with different colours (green, red and yellow). Variation in the number of rectangles indicates intraspecific CNV. In this example, high copy number of red genes is proposed to be beneficial in the first environment (left) but detrimental in the second (right). The opposite is true for green genes, whereas the yellow gene family confers equal growth in both environments. Horizontal lines represent transcripts produced by these genes, which should theoretically affect the AMF and plant phenotype.

related isolates (Riley & Corradi, 2013) – or from horizontal gene transfers (Fitzpatrick, 2012; Gluck-Thaler & Slot, 2015).

These analyses will also benefit greatly from recent breakthroughs in the area of single-cell (and single nucleus) genomics and transcriptomics (de Bekker *et al.*, 2011; Shapiro *et al.*, 2013; Kolisko *et al.*, 2014; Macaulay & Voet, 2014). Questions to be addressed using these techniques include: are certain mutations/genes/genomic locations particularly abundant under certain environmental conditions, and are these specific genomic conditions always linked with a unique culture phenotype, or with the AMF association with a specific plant species?

Ultimately, understanding intraspecific fungal phenotypic variation and its effect on plants and ecosystems will also require a better understanding of AMF gene expression regulatory networks, through transcriptomics and epigenetics studies. Single cell transcriptomics (SCT) procedures are now available (de Bekker *et al.*, 2011; Kolisko *et al.*, 2014), and could be used to understand where or when conspecific AMF single spores are transcriptionally active in the field, or whether changes in transcriptional patterns are linked to variability in host-specificity or soil parameters (e.g. pH, salinity), stratification and plant abundance. Recently, SCT procedures were successfully applied to obtain transcript datasets from several AMF taxa, including genetically obscure genera such as *Paraglomus*, *Ambispora* and *Diversispora* (Beaudet *et al.*, 2018) isolated from pot-cultures. As discussed earlier, optimal reference genomes from most AMF families and genera will be crucial to investigate intraspecific variation in transcriptional patterns across

the Glomeromycotina phylogeny. These data will also be key to identifying intraspecific variability in the epigenome using ChIP-seq (chromatin immunoprecipitation sequencing), or whole-genome bisulfite sequencing approaches (Chung *et al.*, 2014; Jeon *et al.*, 2015; So *et al.*, 2018). Such techniques respectively allow the detection of binding sites for transcription factors and methylation patterns that have direct effects on the fungal phenotype (Chujo & Scott, 2014; Jeon *et al.*, 2015; Kronholm *et al.*, 2016). In AMF, such epimutations could modulate intraspecific phenotypic diversity, for example, in response to symbiosis with different plant species or environmental disturbance.

Better taxonomical definitions would also benefit our understanding of AMF ecological genomics. Critical issues surrounding AMF taxonomy have been raised recently by others (Bruns *et al.*, 2018), as species delineation is at the core of how we define populations. Conspecific isolates are expected to undergo anastomosis and exchange nuclei (Croll *et al.*, 2009; Sbrana *et al.*, 2018), thus, in addition to morphology and phylogenetics, species designation could also be supported by anastomosis experiments (Giovannetti *et al.*, 2003). Genome-driven approaches to AM taxonomy may also resolve recent challenges in taxonomy, for example, by exploring TE exchange across isolates with sequenced genomes. Indeed, the presence of TE is linked with sexual reproduction, and compatible isolates of the same species are expected to share more TE. The recent genome study by Chen and colleagues (Chen *et al.*, 2018) has revealed that not all *R. irregularis* isolates with sequenced genomes share

the same amount of TE. Lastly, isolates of the same species should also be able to exchange nuclei, undergo karyogamy, and eventually recombine through meiosis or parasexuality. Past genome explorations have proven useful in detecting the presence of such events in AMF (Croll & Sanders, 2009; Riley *et al.*, 2014; Ropars *et al.*, 2016).

Acknowledgements

We thank Francis Martin, Allyson MacLean and Linda Bonen for their comments on an earlier version of this manuscript. N.C.'s work is supported by the Discovery program from the Natural Sciences and Engineering Research Council of Canada (NSERC-Discovery) and Early Researcher Award from the Ontario Ministry of Research and Innovation (ER13-09-190). C.R. is a member of the Plant Science Research Laboratory (LRSV), part of the 'Laboratoire d'Excellence' (LABEX) entitled TULIP (ANR-10-LABX-41). L.C. is granted by the French Ministry of Higher Education, Research and Innovation (MESRI).

ORCID

Nicolas Corradi  <http://orcid.org/0000-0002-7932-7932>

References

- Beaudet D, Chen ECH, Mathieu S, Yildirim G, Ndikumana S, Dalpé Y, Séguin S, Farinelli L, Stajich JE, Corradi N. 2018. Ultra-low input transcriptomics reveal the spore functional content and phylogenetic affiliations of poorly studied arbuscular mycorrhizal fungi. *DNA Research* 25: 217–227.
- de Bekker C, Bruning O, Jonker MJ, Breit TM, Wösten HAB. 2011. Single cell transcriptomics of neighboring hyphae of *Aspergillus niger*. *Genome Biology* 12: R71.
- Bravo A, Brands M, Wewer V, Dörmann P, Harrison MJ. 2017. Arbuscular mycorrhiza-specific enzymes FatM and RAM2 fine-tune lipid biosynthesis to promote development of arbuscular mycorrhiza. *New Phytologist* 214: 1631–1645.
- Brundrett MC. 2009. Mycorrhizal associations and other means of nutrition of vascular plants: understanding the global diversity of host plants by resolving conflicting information and developing reliable means of diagnosis. *Plant and Soil* 320: 37–77.
- Bruns TD, Corradi N, Redecker D, Taylor JW, Öpik M. 2018. Glomeromycotina: what is a species and why should we care? *New Phytologist* 220: 963–967.
- Chen ECH, Morin E, Beaudet D, Noel J, Yildirim G, Ndikumana S, Charon P, St-Onge C, Giorgi J, Krüger M *et al.* 2018. High intraspecific genome diversity in the model arbuscular mycorrhizal symbiont *Rhizophagus irregularis*. *New Phytologist* 220: 1161–1171.
- Chitarra W, Pagliarani C, Maserti B, Lumini E, Siciliano I, Cascone P, Schubert A, Gambino G, Balestrini R, Guerrieri E. 2016. Insights on the impact of arbuscular mycorrhizal symbiosis on tomato tolerance to water stress. *Plant Physiology* 171: 1009–1023.
- Chujo T, Scott B. 2014. Histone H3K9 and H3K27 methylation regulates fungal alkaloid biosynthesis in a fungal endophyte-plant symbiosis. *Molecular Microbiology* 92: 413–434.
- Chung D, Barker BM, Carey CC, Merriman B, Werner ER, Lechner BE, Dhingra S, Cheng C, Xu W, Blosser SJ *et al.* 2014. ChIP-seq and *in vivo* transcriptome analyses of the *Aspergillus fumigatus* SREBP SrbA reveals a new regulator of the fungal hypoxia response and virulence. *PLoS Pathogens* 10: e1004487.
- Corradi N, Bonfante P. 2012. The arbuscular mycorrhizal symbiosis: origin and evolution of a beneficial plant infection. *PLoS Pathogens* 8: e1002600.
- Corradi N, Croll D, Colard A, Kuhn G, Ehinger M, Sanders IR. 2007. Gene copy number polymorphisms in an arbuscular mycorrhizal fungal population. *Applied and Environmental Microbiology* 73: 366–369.
- Corradi N, Sanders IR. 2006. Evolution of the P-type II ATPase gene family in the fungi and presence of structural genomic changes among isolates of *Glomus intraradices*. *BMC Evolutionary Biology* 6: 21.
- Croll D, Giovannetti M, Koch AM, Sbrana C, Ehinger M, Lammers PJ, Sanders IR. 2009. Nonsell vegetative fusion and genetic exchange in the arbuscular mycorrhizal fungus *Glomus intraradices*. *New Phytologist* 181: 924–937.
- Croll D, Sanders IR. 2009. Recombination in *Glomus intraradices*, a supposed ancient asexual arbuscular mycorrhizal fungus. *BMC Evolutionary Biology* 9: 13.
- Dong S, Raffaele S, Kamoun S. 2015. The two-speed genomes of filamentous pathogens: waltz with plants. *Current Opinion in Genetics and Development* 35: 57–65.
- Faino L, Seidl MF, Shi-Kunne X, Pauper M, Van Den Berg GCM, Wittenberg AHJ, Thomma BPHJ. 2016. Transposons passively and actively contribute to evolution of the two-speed genome of a fungal pathogen. *Genome Research* 26: 1091–1100.
- Fitzpatrick DA. 2012. Horizontal gene transfer in fungi. *FEMS Microbiology Letters* 329: 1–8.
- Giovannetti M, Sbrana C, Strani P, Agnolucci M, Rinaudo V, Avio L. 2003. Genetic diversity of isolates of *Glomus mosseae* from different geographic areas detected by vegetative compatibility testing and biochemical and molecular analysis. *Applied and Environmental Microbiology* 69: 616–624.
- Gluck-Thaler E, Slot JC. 2015. Dimensions of horizontal gene transfer in eukaryotic microbial pathogens. *PLoS Pathogens* 11: e1005156.
- Hart MM, Reader RJ. 2002. Host plant benefit from association with arbuscular mycorrhizal fungi: variation due to differences in size of mycelium. *Biology and Fertility of Soils* 36: 357–366.
- van der Heijden MGA, Klironomos JN, Ursic M, Moutoglou S, Streitwolf-Engel R, Boller T, Wiemken A, Sanders IR. 1998. Mycorrhizal fungal diversity determines plant biodiversity, ecosystem variability and productivity. *Nature* 396: 69–72.
- Helber N, Wipfel K, Sauer N, Schaarschmidt S, Hause B, Requena N. 2011. A versatile monosaccharide transporter that operates in the arbuscular mycorrhizal fungus *Glomus* sp is crucial for the symbiotic relationship with plants. *Plant Cell* 23: 3812–3823.
- Jain M, Koren S, Miga KH, Quick J, Rand AC, Sasani TA, Tyson JR, Beggs AD, Dilthey AT, Fiddes IT *et al.* 2018. Nanopore sequencing and assembly of a human genome with ultra-long reads. *Nature Biotechnology* 36: 338–345.
- Jakobsen I, Rosendahl L. 1990. Carbon flow into soil and external hyphae from roots of mycorrhizal cucumber plants. *New Phytologist* 115: 77–83.
- Jeon J, Choi J, Lee G-W, Park S-Y, Huh A, Dean RA, Lee Y-H. 2015. Genome-wide profiling of DNA methylation provides insights into epigenetic regulation of fungal development in a plant pathogenic fungus, *Magnaporthe oryzae*. *Scientific Reports* 5: 8567.
- Jiang Y, Wang W, Xie Q, Liu N, Liu L, Wang D, Zhang X, Yang C, Chen X, Tang D *et al.* 2017. Plants transfer lipids to sustain colonization by mutualistic mycorrhizal and parasitic fungi. *Science* 356: 1172–1173.
- Keymer A, Pimprikar P, Wewer V, Huber C, Brands M, Bucerius SL, Delaux P-M, Klingl V, von Ropenack-Lahaye E, Wang TL *et al.* 2017. Lipid transfer from plants to arbuscular mycorrhiza fungi. *eLife* 6: e2910.
- Koch AM, Antunes PM, Maherali H, Hart MM, Klironomos JN. 2017. Evolutionary asymmetry in the arbuscular mycorrhizal symbiosis: conservatism in fungal morphology does not predict host plant growth. *New Phytologist* 214: 1330–1337.
- Koch AM, Croll D, Sanders IR. 2006. Genetic variability in a population of arbuscular mycorrhizal fungi causes variation in plant growth. *Ecology Letters* 9: 103–110.
- Koch AM, Kuhn G, Fontanillas P, Fumagalli L, Goudet J, Sanders IR. 2004. High genetic variability and low local diversity in a population of arbuscular mycorrhizal fungi. *Proceedings of the National Academy of Sciences, USA* 101: 2369–2374.
- Kolisko M, Boscaro V, Burki F, Lynn DH, Keeling PJ. 2014. Single-cell transcriptomics for microbial eukaryotes. *Current Biology* 24: R1081–R1082.

- Kronholm I, Johannesson H, Ketola T. 2016. Epigenetic control of phenotypic plasticity in the filamentous fungus *Neurospora crassa*. *G3* 6: 4009–4022.
- Luginbuehl LH, Menard GN, Kurup S, Van Erp H, Radhakrishnan GV, Breakspear A, Oldroyd GED, Eastmond PJ. 2017. Fatty acids in arbuscular mycorrhizal fungi are synthesized by the host plant. *Science* 356: 1175–1178.
- Lysøe E, Harris LJ, Walkowiak S, Subramaniam R, Divon HH, Riiser ES, Llorens C, Gabaldón T, Kistler HC, Jonkers W *et al.* 2014. The genome of the generalist plant pathogen *Fusarium avenaceum* is enriched with genes involved in redox, signaling and secondary metabolism. *PLoS ONE* 9: e112703.
- Macaulay IC, Voet T. 2014. Single cell genomics: advances and future perspectives. *PLoS Genetics* 10: e1004126.
- Martin FM, Uroz S, Barker DG. 2017. Ancestral alliances: plant mutualistic symbioses with fungi and bacteria. *Science* 356: eaad4501.
- Munkvold L, Kjoller L, Vestberg M, Rosendahl S, Jakobsen I. 2004. High functional diversity within species of arbuscular mycorrhizal fungi. *New Phytologist* 164: 357–364.
- Öpik M, Davison J. 2016. Uniting species- and community-oriented approaches to understand arbuscular mycorrhizal fungal diversity. *Fungal Ecology* 24: 106–113.
- Öpik M, Zobel M, Cantero JJ, Davison J, Facelli JM, Hiiesalu I, Jairus T, Kalwij JM, Koorem K, Leal ME *et al.* 2013. Global sampling of plant roots expands the described molecular diversity of arbuscular mycorrhizal fungi. *Mycorrhiza* 23: 411–430.
- Parniske M. 2008. Arbuscular mycorrhiza: the mother of plant root endosymbioses. *Nature Reviews Microbiology* 6: 763–775.
- Plissonneau C, Benevenuto J, Mohd-Assaad N, Fouché S, Hartmann FE, Croll D. 2017. Using population and comparative genomics to understand the genetic basis of effector-driven fungal pathogen evolution. *Frontiers in Plant Science* 8: 1–15.
- Plissonneau C, Hartmann FE, Croll D. 2018. Pangenome analyses of the wheat pathogen *Zymoseptoria tritici* reveal the structural basis of a highly plastic eukaryotic genome. *BMC Biology* 16: 5.
- Plissonneau C, Stürchler A, Croll D. 2016. The evolution of orphan regions in genomes of a fungal pathogen of wheat. *mBio* 7: e01231-16.
- Raffaële S, Kamoun S. 2012. Genome evolution in filamentous plant pathogens: why bigger can be better. *Nature Reviews Microbiology* 10: 417–430.
- Rhoads A, Au KF. 2015. PacBio sequencing and its applications. *Genomics, Proteomics and Bioinformatics* 13: 278–289.
- Riley R, Charron P, Idnurm A, Farinelli L, Dalpé Y, Martin F, Corradi N. 2014. Extreme diversification of the mating type–high-mobility group (MATA-HMG) gene family in a plant-associated arbuscular mycorrhizal fungus. *New Phytologist* 201: 254–268.
- Riley R, Corradi N. 2013. Searching for clues of sexual reproduction in the genomes of arbuscular mycorrhizal fungi. *Fungal Ecology* 6: 44–49.
- Rodríguez-Echeverría S, Teixeira H, Correia M, Timóteo S, Heleno R, Öpik M, Moora M. 2017. Arbuscular mycorrhizal fungi communities from tropical Africa reveal strong ecological structure. *New Phytologist* 213: 380–390.
- Ropars J, Toro KS, Noel J, Pelin A, Charron P, Farinelli L, Marton T, Krüger M, Fuchs J, Brachmann A *et al.* 2016. Evidence for the sexual origin of heterokaryosis in arbuscular mycorrhizal fungi. *Nature Microbiology* 1: 16033.
- Sanders IR, Rodríguez A. 2016. Aligning molecular studies of mycorrhizal fungal diversity with ecologically important levels of diversity in ecosystems. *ISME Journal* 10: 2780–2786.
- Sbrana C, Strani P, Pepe A, de Novais CB, Giovannetti M. 2018. Divergence of *Funneliformis mosseae* populations over 20 years of laboratory cultivation, as revealed by vegetative incompatibility and molecular analysis. *Mycorrhiza* 28: 329–341.
- Seidl MF, Thomma BPHJ. 2014. Sex or no sex: evolutionary adaptation occurs regardless. *BioEssays* 36: 335–345.
- Shapiro E, Biezuner T, Linnarsson S. 2013. Single-cell sequencing-based technologies will revolutionize whole-organism science. *Nature Reviews Genetics* 14: 618–630.
- So K-K, Ko Y-H, Chun J, Bal J, Jeon J, Kim J-M, Choi J, Lee Y-H, Huh JH, Kim D-H. 2018. Global DNA methylation in the chestnut blight fungus *Cryphonectria parasitica* and genome-wide changes in DNA methylation accompanied with sectorization. *Frontiers in Plant Science* 9: 103.
- Strullu-Derrien C, Selsos M-A, Kenrick P, Martin FM. 2018. The origin and evolution of mycorrhizal symbioses: from palaeomycology to phylogenomics. *New Phytologist* 220: 1012–1030.
- Trépanier M, Bécard G, Moutoglou P, Willemot C, Gagné S, Avis TJ, Rioux JA. 2005. Dependence of arbuscular-mycorrhizal fungi on their plant host for palmitic acid synthesis. *Applied and Environmental Microbiology* 71: 5341–5347.
- Walkowiak S, Bonner CT, Wang L, Blackwell B, Rowland O, Subramaniam R. 2015. Intraspecific interaction of *Fusarium graminearum* contributes to reduced toxin production and virulence. *Molecular Plant–Microbe Interactions* 28: 1256–1267.
- Wyss T, Masclaux FG, Rosikiewicz P, Pagni M, Sanders IR. 2016. Population genomics reveals that within-fungus polymorphism is common and maintained in populations of the mycorrhizal fungus *Rhizophagus irregularis*. *ISME Journal* 10: 2514–2526.



About New Phytologist

- *New Phytologist* is an electronic (online-only) journal owned by the New Phytologist Trust, a **not-for-profit organization** dedicated to the promotion of plant science, facilitating projects from symposia to free access for our Tansley reviews and Tansley insights.
- Regular papers, Letters, Research reviews, Rapid reports and both Modelling/Theory and Methods papers are encouraged. We are committed to rapid processing, from online submission through to publication 'as ready' via *Early View* – our average time to decision is <26 days. There are **no page or colour charges** and a PDF version will be provided for each article.
- The journal is available online at Wiley Online Library. Visit **www.newphytologist.com** to search the articles and register for table of contents email alerts.
- If you have any questions, do get in touch with Central Office (np-centraloffice@lancaster.ac.uk) or, if it is more convenient, our USA Office (np-usaoffice@lancaster.ac.uk)
- For submission instructions, subscription and all the latest information visit **www.newphytologist.com**

Additional comment to this review

Are arbuscular mycorrhizal fungi heterokaryotic or homokaryotic?

Spores of AM fungi are usually described as asexual structures filled with hundreds to thousands of nuclei, without a mononucleate cell stage. These unusual features contributed to the hypothesis that AM fungi could have an atypical nuclear organization, each spore containing different nucleotypes. For the authors supporting this hypothesis, such a unique organization could explain the broad host range of these fungi (Wang and Qiu, 2006b). The hypothesis that different nucleotypes allow a better fitness with different hosts first originated from a study on *Scutellospora castanea* in which sequences from various AM fungal species were observed (Hijri et al., 1999), leading to the hypothesis that these fungi contain a syncytium of different nuclei (Sanders, 1999). Although the initial data on *S. castanea* were invalidated later (Redecker et al., 1999), additional arguments were proposed to support this hypothesis: (i) several genes, usually present as single copies in fungi, were found in multiple copies in AM isolates (Hijri and Sanders, 2005; Kuhn et al., 2001); (ii) the ITS ribosomal regions of AM fungi reach the highest variation rates for fungi (Schoch et al., 2012); (iii) and allelic frequencies of polymorphic regions in AM isolates are variable in sister spores after colonizing different host plants, suggesting the interesting possibility of nucleotype selection based on host characteristics (Angelard and Sanders, 2011; Angelard et al., 2010, 2014).

The efforts in genomics on *R. irregularis* DAOM197198 provided additional arguments that shed new light on previous data and interpretations. Shotgun sequencing did not reveal contradictory or competitive genome assemblies, as the presence of different nucleotypes should have led (Tisserant *et al.*, 2013). The greatest difficulties of assembly resulted from the high level of transposable elements (36% of the genome) and gene family expansion. The rate of single nucleotide polymorphisms (SNPs) in *R. irregularis* was similar to other fungal genomes (0.43 SNP per kb, compared to 0.06 in *Tuber melanosporum* and 0.78 in *Laccaria bicolor*). In comparison, true heterokaryotic fungi reach or exceed 10 SNPs per kb (Hane et al., 2014). The analysis of genomic sequences from different strains of *R. irregularis* recently confirmed the low rate of SNPs (Ropars et al., 2016a). By sequencing individual nuclei, Lin *et al.* (2014) showed that ribosomal regions are highly variable within each nucleus. BiP genes, used by Kühn *et al.* (2001) as an argument for heterokaryotism, were present in three copies in each sequenced nucleus. PacBio sequencing allowing long reads assembly showed that the high variability of ITS found for each individual of AM fungi could not result from the presence of different nuclei, but from an atypical organization of ribosomal regions: in *R. irregularis* DAOM197198, 10 loci of 45S organized in non-tandem repeats were found (Maeda et al., 2019).

The controversy is now shifting from a supposed high heterokaryosis (Boon et al., 2015) to a more moderate one (Wyss et al., 2016) and a question of technics of analysis (Ropars and Corradi, 2015). Finally, this moderate heterokaryotism could be a case of pseudo-dikaryotism (Masclaux et al., 2018; Ropars et al., 2016b). Although transient, heteroplasmic and heterokaryotic stages were already reported among fungi (Kokkoris and Hart, 2019). Dikaryotic organization raises the question of sexuality among AM fungi. Arguments accumulate on the presence of putative meiotic machinery in these fungi but no mating events were reported. It was recently reported that the presence of rare genomic recombination events could support the possibility of cryptic meiotic mechanisms (Chen et al., 2018), but interpretation of data was found questionable (Auxier and Bazzicalupo, 2019). However, although the theory of a high heterokaryosis is contradicted genome after genome, it is still popular in the scientific community (Scott et al., 2019).

IV. AM fungi are oleogenic organisms that do not synthesize their fatty acids

A. Dependency to plant fatty acids

AM fungi are oleaginous fungi; simple microscopic observation reveals numerous lipid vesicles moving in the hyphae. Lipids represent up to 20% of the total dry mass of these fungi (Olsson and Johansen, 2000). For a long time, it was thought that the hexoses provided by the plant were turned into fatty acids (FA), and then turned into triacylglycerols in order to be stored for later use. Experiments in split root system experiment (ERM isolated from symbiotic compartment) using different radiolabelled carbon sources showed that FA were only produced inside host plant roots but not in ERM. Only FA with carbon chain longer than 18 atoms were labeled after addition of [¹⁴C]acetate and [¹⁴C]sucrose on ERM, not C16 palmitic acid (Trepanier et al., 2005). This result suggests that C16 FA might be produced in *in planta* symbiotic structures, but elongation and desaturation were occurring normally in all the fungus.

In 2014, Wewer and colleagues found that the Fatty Acid Synthase complex was absent from the gene repertoire of *Rhizophagus irregularis* (Wewer et al., 2014). The absence of evidence is not evidence of absence. Nevertheless, none of the million reads obtained through RNA or DNA sequencing was accounting for FAS. The absence of FAS was similarly found on genomic data of *Gigaspora rosea*, *R. diaphanus*, *R. cerebriforme* and *R. clarus* (Kobayashi et al., 2018; Morin et al., 2019; Tang et al., 2016). It appears that the loss of FAS is common throughout the Glomeromycotina group. In 2017, several works were published to argue the hypothesis that plants provide FA to AM fungi. Direct and indirect transfer of plant FA to AM fungi was demonstrated using genetic and metabolomics approaches (Bravo et al., 2017; Jiang et al., 2017; Keymer et al., 2017; Luginbuehl et al., 2017). From these works and previous ones, the current proposed mechanism for plant FA delivery to AM fungi starts with KAS1, a keto-acyl ACP synthase part of plant's FAS, that elongates precursors into a C16:0 FA. FatM, an acyl-ACP thioesterase-like protein, removes the ACP from the previously produced FA, thus inducing its export from the plastid and ending its chain elongation. Once in the endoplasmic reticulum, these

C16:0 are esterified on sn-2 position of glycerol to produce a C16:0 mono-acyl glycerol β -MAG by the glycerol-3-phosphate acyl transferase (GPAT) called RAM2. Then, an ABC transporter called STR/STR2 possibly translocates the β -MAG to the peri-arbuscular space. All of these plant genes are up-regulated during symbiosis and mutant plants of these 4 genes (DIS, FatM, RAM2 and STR) present similar symbiotic phenotypes: a reduced branching during arbuscule development; a lower root colonization; a reduction in the quantity of C16 FA produced during symbiosis (Brands et al., 2018; Bravo et al., 2016, 2017; Gobbato et al., 2012; Gutjahr et al., 2012; Wang et al., 2012; Zhang et al., 2010). According to this global schema (see for reviews (Keymer and Gutjahr, 2018; MacLean et al., 2017; Rich et al., 2017)), the molecule proposed to be transferred is a sn-2 monoacyl-palmitate (or β -MAG), although this is not supported by direct evidence.

B. Fungal FAS

FAS is an enzymatic complex present both in prokaryotes and eucaryotes although coded differently (Bukhari et al., 2014). Fungal FAS (type I) are dodecamers $\alpha 6\beta 6$ proteins encoded by two exons. In *Mucor* and *Mortierella* species, oleogenic zygomycetes belonging to sister clades of Glomeromycotina among Mucoromycota, the two exons are fused in a >12kb gene coding for a single polypeptide (Wang et al., 2011). FAS is a major enzyme as it produces the founding stone of FA metabolism: palmitic acid, a 16 carbon saturated FA. FA exist in many lengths and number of unsaturations so as to fulfill many different roles ranging from structural components in biological membranes to signaling. From Palmitic acid, elongases can elongate the carbon chain by adding two other carbon molecules so the C16 FA becomes a C18 (stearic acid). If the process is repeated, the carbon chain can reach 40 atoms long (tetracontanoic acid). FA can also be desaturated by inserting a double bond. One or many unsaturations can be inserted in different places in the carbon chain. This desaturation is performed by enzymes called desaturases. Once synthesized, the FA can be released as a free FA or it can be esterified to a glycerol molecule to form an acyl-glycerol. Depending on the number of FA linked on one glycerol, mono acylglycerols (MAG), diacylglycerols (DAG) or triacylglycerols (TAG) can exist. Flippases are also important in FA metabolism as they lay inside the lipid bilayer and take acylglycerol on one side to put it on the other side of the bilayer. While AMF do

possess elongases, desaturases, and flippases, the first step of the whole FA metabolism is missing.

The biological significance of the loss of a gene so important for cell biology remains elusive. According to gene loss in other obligate biotrophs (Raffaele and Kamoun, 2012; Raffaele et al., 2010) it probably results from a genome erosion after the function was not needed anymore (Visser et al., 2010). Absence of FAS in all considered AM fungal genomes argues for an ancient loss of the FAS gene and not a recent erosion of the coding sequence. In accordance, no trace of this gene was found in the genome of *R. irregularis* or *G. rosea*: using the FAS gene of *Mortierella elongata*, a saprotrophic species belonging to a sister clade of Glomeromycotina among Mucoromycota, no similarity was found on the Rhiir2-1 or RIR17 genome assemblies (pers. analysis). More, no synteny was observed between the scaffold of *M. elongata* with the FAS gene and *R. irregularis* genome, indicating that this genomic region was totally reshuffled after FAS gene loss. Is the loss of such an important gene rare? How can AMF be auxotroph to FA if their whole metabolism relies on fatty acids?

C. Fatty acids: "Make it or Take it".

Such expression is issuing from an article from (Mazumdar and Striepen, 2007) reviewing the diversity of mechanisms developed by Apicomplexan to obtain their FA. In this review, it is described that Apicomplexan, as obligate parasites, present a high plasticity of FA metabolism or acquisition from host. According to species, palmitate could be synthesized by eukaryotic FAS, a bacterial-like FAS, polyketide synthases, elongases, or from the host. Starting my Ph.D., plant genetic works demonstrating that host plant FA are transferred to AM fungi were not published. To make sure these fungi were indeed palmitate auxotrophs, we first envisaged alternative hypotheses of fungal FA biosynthesis. As synthesis of palmitate was supposed to only occur *in planta*, not in ERM (Trepanier et al., 2005), candidate genes from alternative pathways specifically expressed in plant were investigated.

FAS is a multifunctional enzymatic complex that synthesizes palmitic acid. FAS activity is present from bacteria to eukaryotic cells, although the organization of this enzymatic complex largely differs according to evolutionary clades. Depending on

their origin, FAS proteins form dimers (fungal FAS) or hexamers. Each function is performed by peptidic modules that are rearranged in different subunits. Eukaryotic cells possess two FAS: cytosolic and mitochondrial FAS. Could mitochondrial FAS compensate the loss of nuclear FAS in AM fungi? First, mitochondrial FAS was described to synthesize C8 FA, which serves as a precursor for lipoic acid, an essential cofactor involved in oxidative decarboxylation reactions (Tehlivets et al., 2007; Wada et al., 1997). Analysis of previously published transcriptomic data (Tisserant et al., 2012) did not reveal any change in mitochondrial FAS expression between the IRM and the ERM. Other supposed alternative pathways for the biosynthesis of palmitate would be elongases and Poly Ketide Synthase (PKS). As for mitochondrial FAS, elongases present in *R. irregularis* genome are not specifically expressed *in planta*. PKS is a modular multifunctional enzyme able to produce many secondary compounds including polyunsaturated FA, or PUFA (Metz et al., 2001). Although the genome of *R. irregularis* (Tisserant et al., 2013) presents some exons involved in PKS, there is no ORF presenting all exons involved in PUFA biosynthesis (pers. observation). Some AMF species were shown to possess endobacteria (Bianciotto, 2003; Bianciotto et al., 2000). One possibility would be that endobacteria provide C16 to their host. Although possible, not all AM fungi possess endobacteria, as it is the case for *Rhizophagus irregularis*. C16 FA delivery from endobacteria, if it is effective, would then be a secondary source of FA for AM fungi.

FAS being a mandatory enzymatic activity for cellular systems, open questions are the occurrence of such gene loss and its adaptive advantage. Many fungi are biotrophic parasites, either obligate as *Golovinomyces cichoracerum*, or facultative as *Ustilago maydis*. These fungi still possess in their genome a FAS gene and are not auxotrophic for host FA. However, they are known to induce host fatty acid production upon host infection (Spanu et al., 2010; Teichmann et al., 2007). Congruent results indicate *G. cichoracerum* can take up plant FA that improves its pathogenicity (Jiang et al., 2017). The unique (so far known) example of fungi presenting an auxotrophy to host FA due to FAS gene loss is *Malassezia* sp.. These yeasts are found on the skin and scalp of many mammals, including humans (Triana et al., 2017; Xu et al., 2007). They meet their palmitate demand by consuming the sebum produced by the animal they live on. The lipid-rich medium they live in allows them to fulfill all their FA needs without producing them. The only way to culture

these species is by adding palmitate to their growth medium. They produce and secrete high amounts of triglyceride (TG) lipases, an enzyme that hydrolyzes the bond between glycerol and FA (DeAngelis et al., 2007). The released free FA are proposed to trigger skin inflammation and it is thought that the presence of these yeasts could be the cause of most dandruff crisis in humans.

D. Host plant FA acquisition by AM fungi: how to take it?

After evidence that host plants transfer FA to AM fungi, following questions are “how do AM fungi incorporate host FA?”, “How is this acquisition regulated?”, “What is the selective advantage for AM fungi to have a double host carbon dependency?”.

The previous mechanism of acquisition of FA from animal skin by *Malassezia* sp by the secretion of TG lipases relies on a saprotrophic acquisition of nutrients. Another example of FAS-free organism is *Plasmodiophora brassicae* (Schwelm et al., 2015). *P brassicae* belongs to Rhizaria, a Eukaryotic clade distinct from fungi, and causes clubroot disease of Brassicaceae. It is an obligate biotrophic plant pathogen that depends on the lipids produced by their host. Interestingly, although *Malassezia* sp. and *P brassicae* belong to independent eukaryotic clades and are respectively dependent on animal skin surface FA or plant root cell FA, they present the same adaptive mechanisms to host FA acquisition: they secrete TG lipases to recruit host FA. Could AM fungi possess same adaptive strategy for FA acquisition? Thanks to the high number of putative secreted lipase-coding genes in the gene repertoire of *R. irregularis*, we explored this hypothesis in chapter 3 of this manuscript. Alternative active (membrane transporters) or passive (membrane diffusion) mechanisms are also envisaged.

Phosphate is the main mineral source provided by AM fungi to their host plants and was extensively described as a regulator of carbon exchanges, particularly hexoses. In chapter 2 of this manuscript, we investigated a global view of C/P exchanges in AM symbiosis, including FA metabolism. The question of the regulation of fatty acid exchanges is then particularly addressed in chapter 3 of the manuscript.

E. From FA acquisition to hyphal transport: lipid droplets, little known actors of AM fungal lipid metabolism

Lipid Droplets (LD) exist in every cell type from archaea to prokaryotes to eukaryotes. In multi-cellular organisms, they can be restricted to certain cell types. They exist in many shapes, number, and composition according to their functions. These are roundish spherical bodies with a diameter ranging from 1 to 5 μm . They are the only organelles with a monolayer of phospholipid delimiting a hydrophobic compartment where sterols, free FA, or acyl-glycerols are stored. While they have been regarded as simple fat storage, technical advances are shedding new light on these highly dynamic and important organelles. Numerous LD functions have been described in plants. In the statocytes (gravity sensing cells) of cress seedlings, LD may be a component of the positive orthogravitropic growth of roots (Hensel, 1986). In meristematic apical cells, LD are involved in the dormancy-release mechanism (Rinne et al., 2001). LD may also be involved in dormancy processes in root nodules (Gurusamy et al., 2000). Finally, flower's colors are often determined by pigment contained in LD located in the plastid (and called plastoglobules, (Brehelin et al., 2007; Murphy, 2012)). They originate from the ER where lipid biosynthesis occurs and they bud out from the ER's membrane before going to the cytosol where they can grow in size, fuse to another LD or be degraded under the action of lipases. Their fate is regulated by LD surrounding proteins and proteomic analysis of LD are being investigated. In plants, a class of LD associated protein is called oleosins. They are retrieved in multicellular plants but in algae, another LD-associated protein class of protein is called caleosins. Interestingly, orthologs of algal and land plant caleosin gene have been found in many fungal genomes whereas no such genes are present in any metazoan lineages. This implies that caleosin genes may have been transferred between basal algal and fungal species at some point in the remote past (Murphy, 2012; Partridge and Murphy, 2009). Intensive use of LD has been observed during parasite infections. It is the case upon malarial infection by *Plasmodium falciparum* or during African trypanosomiasis by *Trypanosoma brucei* where the parasite stimulates the accumulation of TAG-rich LDs (coming from the host in both cases) (Cronan, 2006; Flaspholer et al., 2010; Palacpac, 2004).

Fungal accumulation of LD can be observed in certain developmental stages. They are frequently encountered during the vegetative growth of saprotrophs and during formation of reproductive structures (Murphy, 2012, 2005). In fungal pathogens, LD are essential to produce a high pressure in appressoria (Wang and St. Leger, 2007). In *Fusarium graminearum* or *Aspergillus nidulans*, LDs have been reported to play a role in sexual development (Guenther et al., 2009; Tsitsigiannis et al., 2004). *Plasmodiophora brassicae* (previously introduced as a FAS lacking plant pathogen fungus), transiently synthesizes LD in its cytosol after having hijacked metabolites from its host plant (Prasad and Ghannoum, 1996).

In arbuscular mycorrhizal interactions, numerous LD are present in the mycelium where they can reach 16% of the hyphal volume. Hundreds of LD are trafficking along the hyphae in both directions following defined patterns, suggesting an active transport of these LD along with cytoskeletal structures (Bago et al., 2002; Murphy, 2001). It was estimated that in the biggest hyphae, 1.3 μ g of TAG are transported per hour. While they are supposed to transport lipids from the arbuscule to the tips of growing hyphae or to the spores, their biology is poorly investigated and other functions are possible but remain hypothetical. They are probably used to transport other molecules such as hormones or plant stress signals. During arbuscule collapsing, the emergence of lipid droplets has been documented (Kobae et al., 2014).

Two recent publications describe other “vesicular structures” occurring during the arbuscule life cycle, from its development to its collapse. (Ivanov et al., 2019; Roth et al., 2019) describe vesicular-tubular extensions observed in the Peri-Arbuscular Space (PAS) and categorizes them in 2 subtypes called IMC-I and IMC-II. (Roth et al., 2019) focused its observations on membrane tubules (called memtubes) that were located between the fungal plasma membrane and the fungal cell wall. These two publications used high-pressure freezing followed by freeze-substitution to preserve these membranes. These delicate structures have already been observed before but the previous lack of good preservation techniques made their observation uncertain (Cox and Sanders, 1974; Dexheimer et al., 1979, 1985).

V. Thesis objectives and strategies

In this thesis, I investigated different hypotheses of fatty acid acquisition by AM fungi. Fatty acids can be regarded as energy stocks during the non-symbiotic stages of the fungal life cycle and as exchange currency during the symbiotic life stages. Given the number of gene duplications in *Rhizophagus irregularis* genome, deciphering gene function can be very difficult. In addition, the transformation of these fungi is impossible; as a result, comparative transcriptomic approaches were the core strategy of my works, associated with original experimental designs in order to modulate symbiotic transfers either by phosphate or photosynthetic activity (light effect). Physiological approaches have been used alongside gene expression analysis to unravel basal metabolism from symbiotic metabolism. The balance of carbon transfers in relation to resource allocation during symbiotic transfers have been assessed. Gene silencing through plant transformation will be initiated. Hypotheses regarding FA acquisition and bartering mechanism are proposed.

The first chapter, in collaboration with Dr. M. Zouine and collaborators, presents the definition of a gene atlas of Rhiir2-1 in various biological conditions; the second chapter, in collaboration with P-E Courty and colleagues, investigates the balance of nutrient exchanges in a symbiocosm; the third chapter presents a set of experiments performed to investigate the regulation of fatty acid acquisition in *R. irregularis* DAOM197198.

Chapter 1 - RhiirExpress, a gene atlas of the model symbiotic fungus *Rhizophagus irregularis* DAOM197198

Since *Rhizophagus irregularis* DAOM197198 has been erected as a genomic AM fungal model for the scientific community, an increasing number of RNAseq data was deposited in databases. Such data are useful for all the community. One difficulty is the heterogeneity of analyses. Since the time that the team is working on DAOM197198 transcriptomics, normalized approaches were developed for candidate gene expression analysis, based on the selection of elite libraries (in house and from databases) and a stable pipeline of analysis (gene repertoire, mapping conditions, statistics). A limitation was the output form, consisting of Excel tables for visualization. In order to propose a handy and friendly tool shared with the community we developed a collaboration with Dr. M. Zouine and his colleagues who previously developed TomExpress (<http://tomexpress.toulouse.inra.fr/>), an interface to visualize and analyze RNAseq data.

We here present a β -version of RhiirExpress, a gene atlas of *R. irregularis* DAOM197198. My work consisted of analyzing and curating data with Arnaud de Ruffray, a student that I co-supervised with Pr C. Roux during his master internship (01/2019-06/2019).

Although the web interface is still in development, we used calculation for a first global analysis. This chapter will be deposited in Bioarchives in the following months.

RhiirExpress, a gene atlas of the model symbiotic fungus Rhizophagus irregularis DAOM197198

Loïc Cusant^{1*}, Anis Djari^{2,3*}, Arnaud De-Ruffray¹, Elie Maza^{2,3}, Marina Diaz Uzquiano^{2,3}, Abdelaziz Smouni⁴, Pierre Frasse^{2,3}, Mohammed Zouine^{2,3§}, Christophe Roux^{1§}

¹ Laboratoire de Recherche en Sciences Végétales, Université de Toulouse, UPS, CNRS, 24 Chemin de Borde Rouge-Auzeville, Castanet-Tolosan, France

²University of Toulouse, INPT, Laboratory of Genomics and Biotechnology of Fruit, Avenue de l'Agrobiopôle BP 32607, Castanet-Tolosan F-31326, France

³INRA, UMR990 Génomique et Biotechnologie des Fruits, Chemin de Borde Rouge, Castanet-Tolosan F-31326, France

⁴Laboratoire de Biotechnologie et Physiologie Végétales, Centre de recherche BioBio, Faculté des Sciences – Université Mohammed V de Rabat 4, Av. Ibn Batouta – BP. 1014 R.P., 10000, Rabat, Morocco

*: *co-first authors*

§: *co-last authors*

Corresponding author: Christophe Roux roux@lrsv.ups-tlse.fr

I. Abstract

Rhizophagus irregularis DAOM 197198 is a widely used model among arbuscular mycorrhizal fungi: a long read genome sequencing PacBio quality genome and a robust gene repertoire are available, as numerous RNAseq libraries in databases. Transcriptome comparison is a useful strategy for the identification and characterization of genes underlying fungal growth and symbiotic physiology. We propose a gene atlas web platform of *R. irregularis* DAOM 197198 providing a standard of fungal gene expression and comparison to the mycorrhizal research community. The RhiirExpress platform consists of a browser with integrated tools for public and in-house RNA-seq data visualization and analyses. The architecture is based on TomExpress platform, adapted and developed for *R. irregularis*. The most robust and homogenous libraries were selected from statistical comparisons. The normalization process, aiming at making comparable the whole set of genes among conditions from different projects, is, up to a scaling parameter the same as in TomExpress. As illustrated by original results obtained from expression patterns of

genes involved in secretome and transportome, RhiirExpress consists of a powerful platform allowing identification of genes and metabolic pathways involved in fungal development during asymbiotic, pre-symbiotic or symbiotic stages.

II. Introduction

Arbuscular Mycorrhizal fungi (AMF) are obligate biotrophic organisms belonging to the glomeromycota group. They interact with the roots of most land plants to form arbuscular mycorrhizal symbiosis (Smith & Read 2010). During this interaction, the fungus provides the plant with mineral nutrients from the soil in exchange for plant carbon derivatives (Garcia et al., 2016; Rich et al., 2017). While having high ecological importance, the biology of these fungi remained scarce for a long time. Due to their obligate status, their multinucleate coenocytic organization and the absence of mononucleate cell stage, no genetic tool is available for functional analysis. Genomics is the main strategy to investigate their biology. *Rhizophagus irregularis* DAOM197198 has been the first AMF which genome has been sequenced (Tisserant et al., 2013, Lin et al. 2014). This effort of the community is still ongoing, and a PacBio genome assembly RIR17 was recently published (Maeda et al., 2019) as a robust gene repertoire Rhiir2.1 (Chen et al., 2018). Based on these genomic resources, numerous RNA sequencing approaches were published these last years allowing identification of genes and metabolic pathways of importance in symbiosis. As an illustration, *R. irregularis*, as all other AMF investigated, was found to be fatty acids and vitamin B1 auxotroph due to gene loss involved in these metabolic pathways (Morin et al., 2019; Tang et al., 2016a; Wewer et al., 2014). However, the great diversity of biological conditions and treatments published for transcriptome analyses remains scattered even though they could be a huge source of discoveries. In order to go deeper into the biology of AMF through the analysis of fungal gene expression, we offer to the mycorrhizal research community a gene atlas under a standardized *R. irregularis* DAOM197198 RNA-seq platform. We took advantage of the previous TomExpress architecture platform (Zouine et al., 2017) to develop an advanced version for *R. irregularis*: RhiirExpress. Public and in house RNAseq raw sequence data were integrated in RhiirExpress, representing different fungal developmental stages: hyphae issuing from spores (HS - asymbiotic stage) at different time-points, responding or not to root exudates or exuded molecules (pre-symbiotic

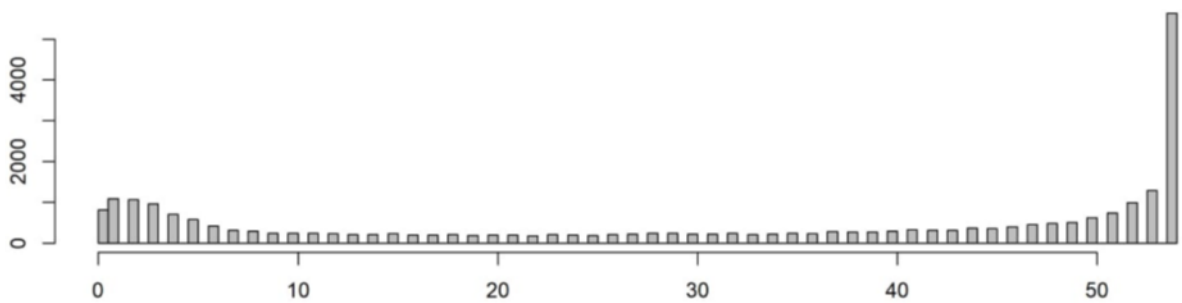
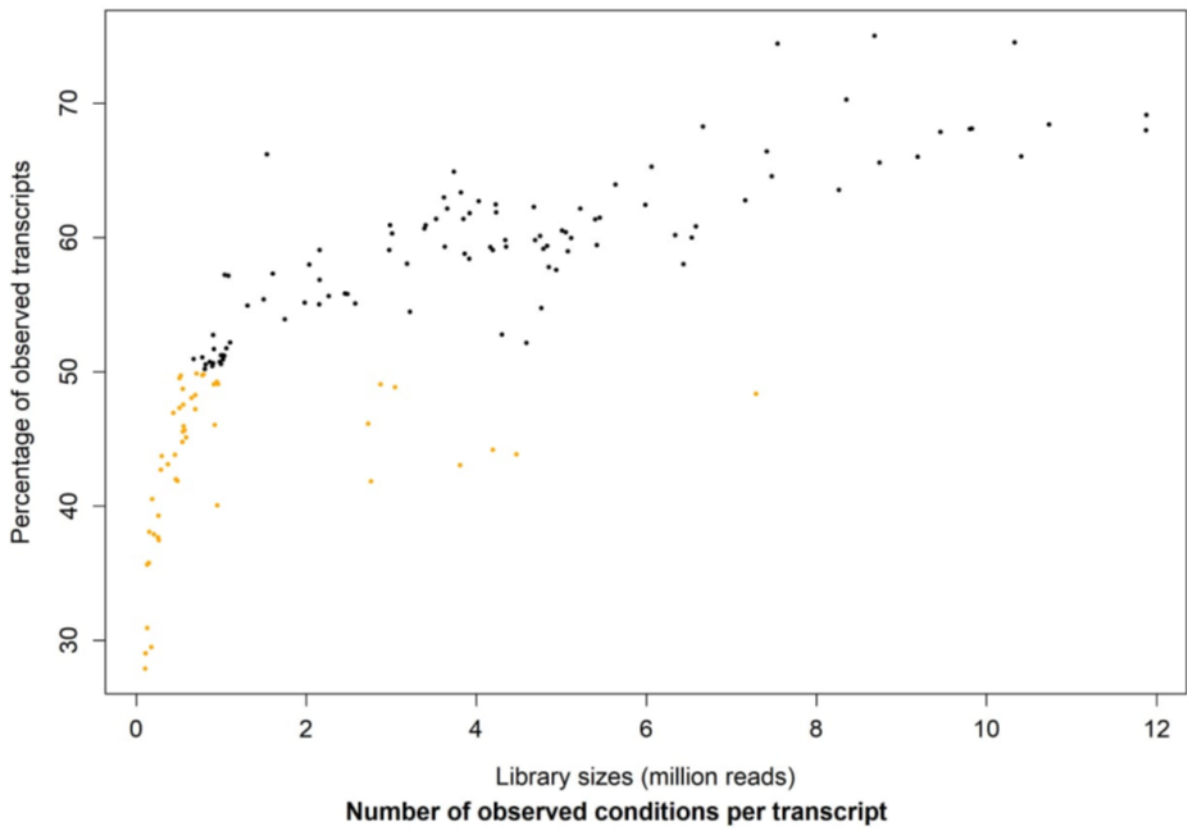
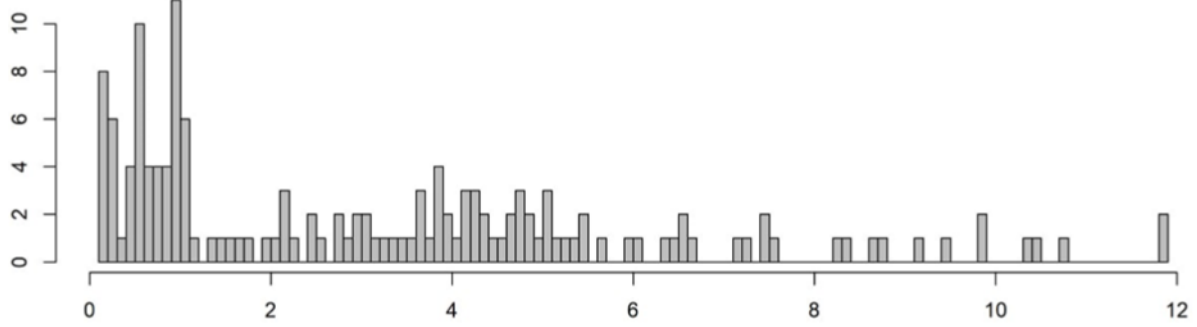

Figure 1: Global analysis of samples used for RhiirExpress. (A) Repartition of the 148 libraries size (in million reads). (B) Ratio of genes mapped by reads in relation to library size. Yellow dots correspond to libraries mapping less than 50% of the gene repertoire. (C) Repartition of mapped reads on the 26183 genes in the 54 conditions

stage), extra-radical mycelium (ERM) and intra-radical hyphae (IRM) from different host plants (symbiotic stage). Among IRM, data issuing from laser micro-dissection allow differentiating different fungal structures inside roots (arbuscules - ARB - or inter-cellular hyphae - ICH). We here present the statistical method used for expression raw data normalization, the different tools of the platform, and an overview of nutrient transports from these data.

III. Results and Discussion

A. RNA-Seq data source and processing

Public databases (SRA, GEO, DDBJ) were queried for *R. irregularis* DAOM197198 RNAseq libraries to complete our in-house data. A set of 158 RNA samples corresponding to 54 biological conditions were collected (Table S1). Raw data were mapped against Rhiir2.1 gene repertoire using the same software and parameters to unify the whole set of data. Principal component analysis based on covariance analysis of the reads mapped (Figure S1) showed that samples clustered according to fungal biological conditions and data project, suggesting a great incidence of experimental design and sequencing platform. Large variations in sequencing depths (Figure 1A) were observed according to the sequencing technology and the fungal compartment considered. The enrichment in fungal reads was indeed greater in libraries performed on the fungus in pure culture (HS, ERM) compared to libraries where the fungus is present in root tissues, due to RNA dilution. Depending on the richness in fungal reads in samples and fungal biological stages, the percentage of the gene repertoire covered by at least one read ranged from less than 30% up to 75% (Figure 1B). As expected, the bigger the library the better the coverage. Interestingly, around 5000 genes are expressed in each library (Figure 1C), representing the core set of genes necessary to fulfill the basic cellular processes (including housekeeping genes) (Table S2). On the opposite side, around 1000 genes do not have any reads in any conditions (Table S3). These genes could either be cryptic genes, poorly defined ORFs, genes with very low expression, or genes specifically expressed in biological conditions not included in our samples.

The normalization process carried out on RhiirExpress samples is slightly the same as the one performed in TomExpress, in order to make gene expression values

comparable between genes and conditions (Zouine et al., 2017). For this purpose, the normalization takes into account the biases induced by the relative size of studied transcriptomes, the library sizes and the gene lengths (Maza, 2016; Maza et al., 2013). In TomExpress, at the end of the normalization process, each mean normalized count was divided by the length of the corresponding gene (the number of bases) to make gene expressions comparable. We then obtained “mean normalized counts per base” that were very low and not very understandable. In another way, in RhiirExpress, each mean normalized count is multiplied by 100 that is, roughly speaking, the length of mapped fragments, before dividing it by the length of the corresponding gene. Then values are rounded to upper integers. Thus, the normalized values correspond now to a kind of estimation of the number of transcripts of each gene in each condition.

To take into consideration the different biological conditions from the public data, each of them was described by a list of features to facilitate data mining. Among them are Host Plant Species and Genotype, Fungal Species and Strains, Fungal Status and Compartment, Fungal Stage, Treatment Type, and Duration.... Depending on the experimental design, these features contain different values for a given condition (Table S1). The exhaustive list of these values is available within the platform (Figure S4).

B. Data mining tools

In order to explore the processed data, users need to target specific genes. A comprehensive form page allows browsing genes by using either the Transcript ID, the Gene Ontology ID, or functional description. For the latter, an autocomplete widget suggests keywords as the end-user types in (Figure S2.A).

The conditions of interest can be filtered in the “advanced search” checkbox form. Filters can be applied to the host plant, fungal organ, symbiotic status, and treatments. (Figure S2.B).

Once the query is submitted, users are taken to a new page containing a Data visualization table. From this point forward the user has access to two interactive “Stat-tools”: The first one being an expression chart and the second one a clustered

heatmap (double dendrogram). Both tools use external javascript libraries: “highcharts” (<http://www.highcharts.com>) for the expression profile and InCHlib (Škuta et al., 2014) for the clustered heatmap.

To enable these “Stat-tools”, the user must select a subset of genes from the data table (Figure S3.A). Depending on the number of genes selected, the user has access to one or both tools. By selecting one gene, just the expression profile “Stat-Tool” is enabled, and it will output a bar plot. With two or more genes selected, both the expression profile and the heatmap are enabled. In this case, a line chart will be outputted from the expression profiling tool.

C. Visualization and clustering analysis.

When analyzing the expression pattern of a gene (transcript ID from Rhiir2.1), the expression chart displays (Figure S3.B) different biological situations: Asymbiotic fungus (germinating spores), Pre-symbiotic fungus (spores treated with root exudates or strigolactone), and Symbiotic fungus. The latter includes Extra-Radical Mycelium (ERM) and Intra Radical Mycelium (IRM) in different host plants. These different conditions allowed us to pinpoint different expression patterns. Some genes present a constitutive expression (housekeeping genes); some others are highly expressed during Asymbiotic and Presymbiotic stages; some genes are only expressed during the symbiotic phase in the ERM and others are only expressed *in planta*.

It is also possible to display heatmaps calculated either with a Pearson or Euclidean distance between the genes and/or conditions (FigureS3.C); the first distance will cluster together genes with similar profiles, the second one will cluster genes with similar expression levels.

D. Revisiting the biology of *R.irregularis* thanks to RhiirExpress

1. Fungal secretome

In order to colonize their host plant, AMF, as many plant-interacting microorganisms, secrete proteins that interfere with plant immunity (Kloppholz et al., 2011). A previous analysis of expression of genes putatively encoding for secreted proteins

Gene expression

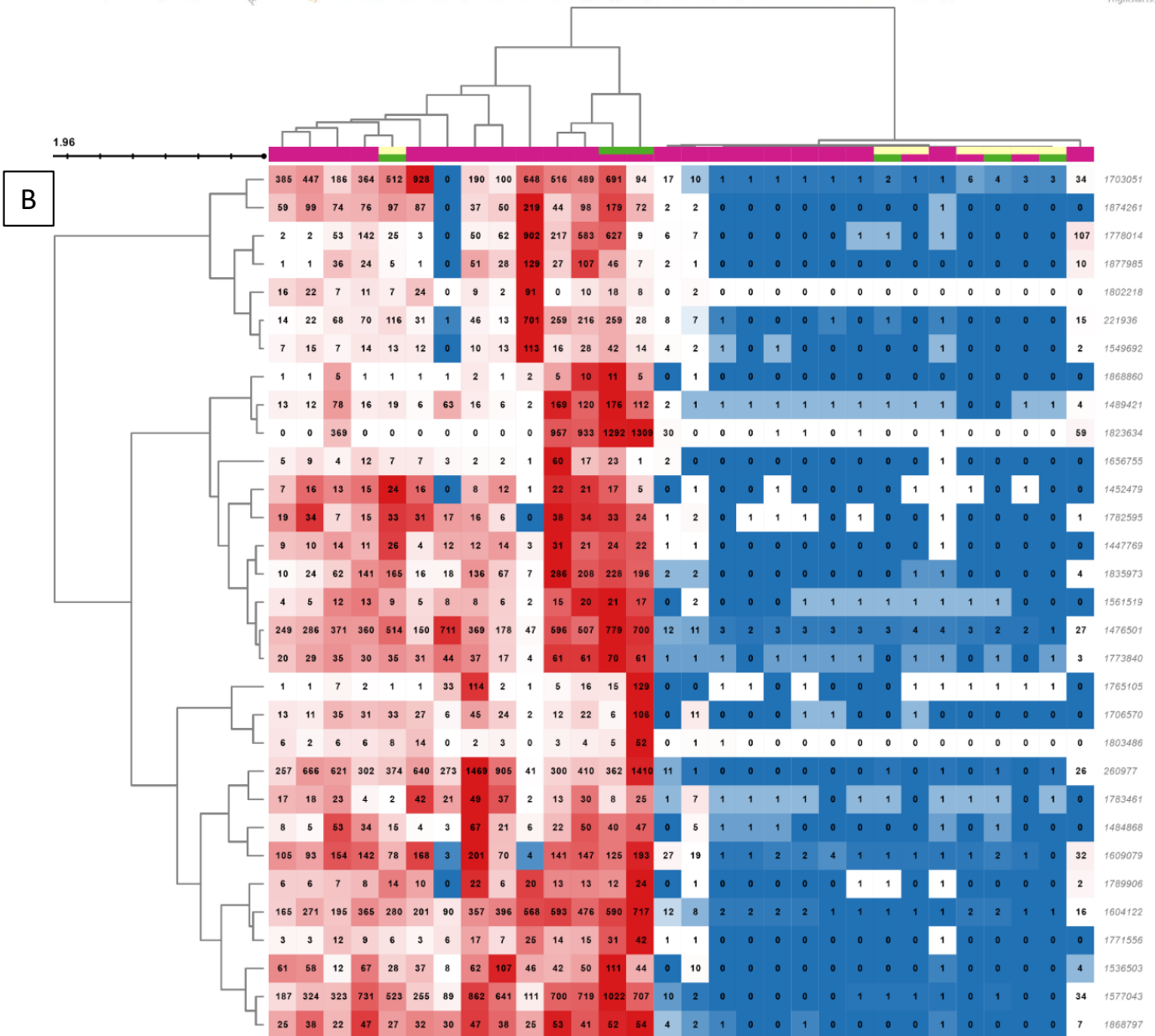
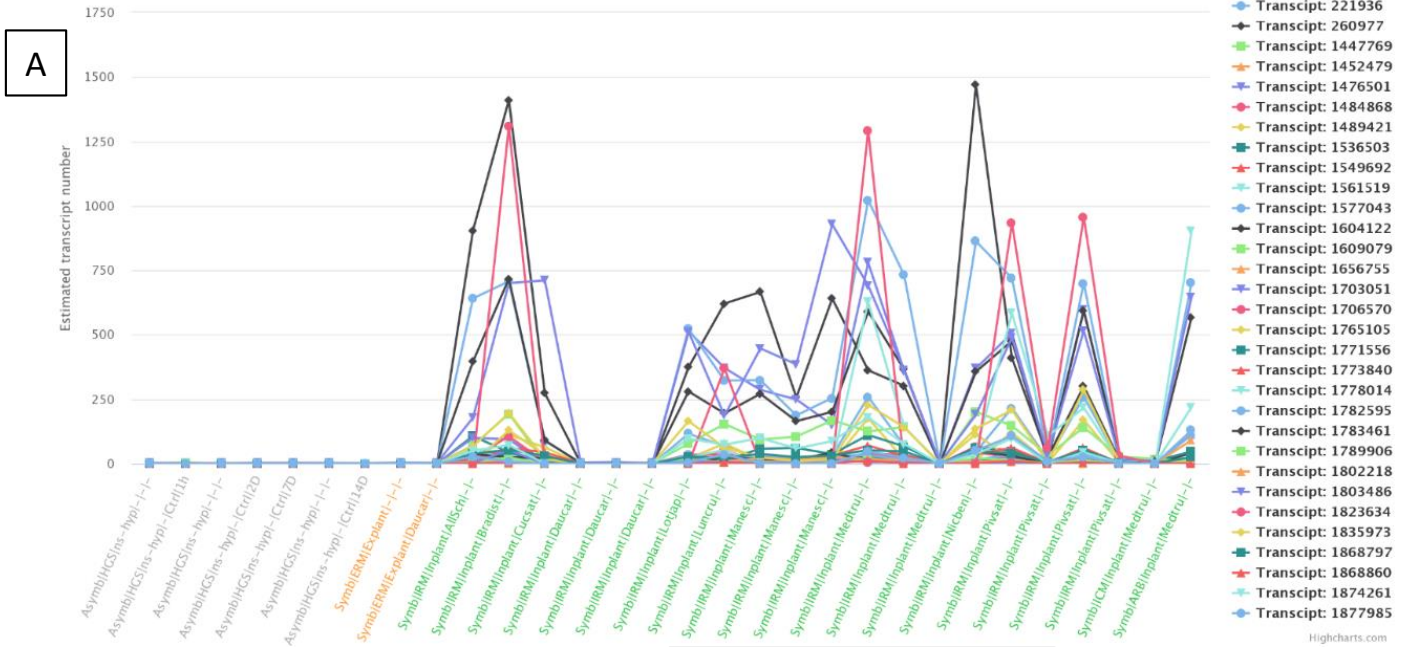

Figure 2: (A) Expression patterns of 31 genes coding for putative secreted protein. Note that no reads were only found in planta (green captions). (B) Heat Map showing this dual pattern of expression.

(SP) allowed identification of 34 SP overexpressed in three plants (*Medicago truncatula*, *Brachypodium distachyon* and *Lunularia cruciata*), but not expressed in ERM (Kamel et al., 2016). Using this set of candidate genes of interest in RhiirExpress showed that, as previously observed, no expression was found in asymbiotic and presymbiotic stages, whereas many transcripts were found in planta (Figure 2). Interestingly, some genes were not found expressed in all plants, indicating that these SPs are not as universal as previously supposed. More, most of these genes were found overexpressed in arbuscules but not in intercellular mycelium. This points out original results not yet investigated.

2. Fungal transportome

Many plant transporters have been identified to be symbiosis specific (Garcia et al., 2016). To investigate these exchanges on the fungal side, we used the annotation provided by Gene Ontology; Interpro; EC classification; KOG and SignalP, as found on the JGI (https://mycocosm.jgi.doe.gov/Rhiir2_1/Rhiir2_1.home.html). The following keywords were used to obtain the genes of interest: GO0055085: transmembrane transport, GO0022857: transmembrane transporter activity, GO0005215: transporter activity, PF00005: ABC transporter, sugars, PF07690: Major Facilitator Superfamily, IPR003439: ABC transporter-like. The investigated metabolisms are: Nitrogen metabolism (Fellbaum et al., 2012, 2012; Kikuchi et al., 2014; López-Pedrosa et al., 2006; Pérez-Tienda et al., 2011) ; Phosphate metabolism (Walder et al., 2016); Potassium transport (Garcia and Zimmermann, 2014); Sugar metabolism and transport (Ait Lahmidi et al., 2016; Helber et al., 2011a) ; Aquaporins (Kikuchi et al., 2016; Li et al., 2013); general transporters (Gómez-Gallego et al., 2019; Tamayo et al., 2014) and uncharacterized transporters (Garcia and Zimmermann., 2014). Among these genes, many were already published as transporters. For these genes, their names were kept but the other genes were named according to the metabolism they were involved in (gene IDs provided in the JGI are too long, thus not convenient). The list of the 438 genes investigated and their corresponding aliases can be found in Table1.

A

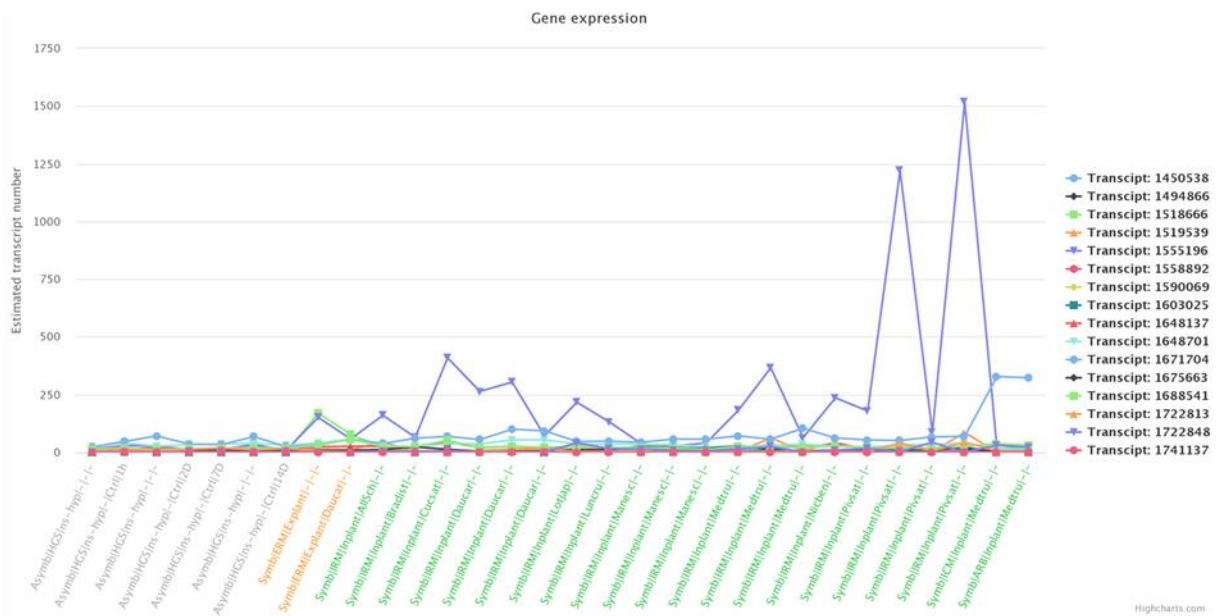

B

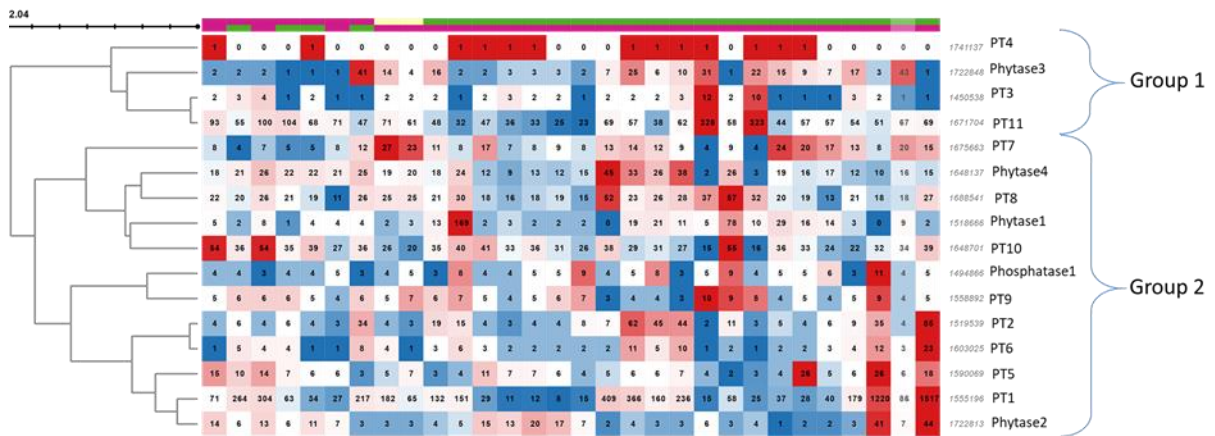
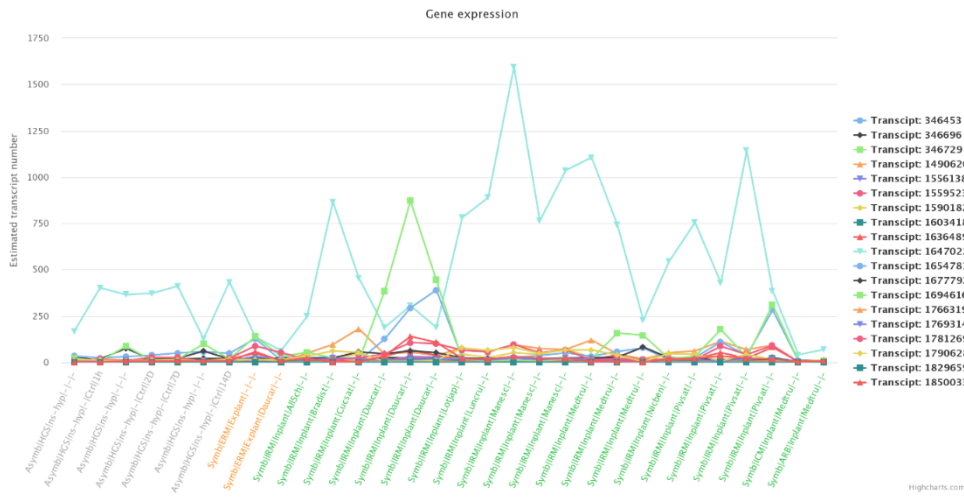

Figure 3: (A) Plot of the genes involved in phosphate metabolism. (B) Heat Map of these genes with clusterization.

Phosphate metabolism

Phosphorus is the key element of mycorrhizal interactions, especially in AMS. Seven fungal phosphate transporters (PT) have been described to date (Walder et al., 2016). An investigation of the gene repertoire led us to find eleven PTs among which the seven published ones were retrieved. The names given to the four new PTs follow the same nomenclature as the previously described ones. Therefore, the published phosphate transporters were named RiPT1 to RiPT7 and the new PTs found are named RiPT8 to RiPT11. In addition to these PTs, AMF are able to recruit different chemical forms of phosphate in the soil. Once the phosphate is internalized, it will be polymerized to polyphosphate so as to be transported toward the IRM. In the arbuscule, polyphosphate is depolymerized and exchanged with the plant. Therefore, we also included a phosphatase and four phytases to our list of interest. The expression pattern of these 16 genes segregates them into two groups (Figure 3). The first one is mainly expressed in planta and shows a clear overexpression in the ICH and arbuscule. This group is composed of three transporters (PT3, PT4, and PT11) and one phytase (Phytase3) with PT11 whose expression is, by far, the highest in the ICH and arbuscules. In the second group, genes are expressed homogeneously between the different conditions, without a clear overexpression in the micro-dissected samples. The Phytase1 is overexpressed in the ERM, suggesting a specific role for this gene. The same level of expression is found for PT1 in this condition but it is very highly expressed in planta. This suggests that PT1 is only active during the symbiotic phase of the fungal life, however, the expression retrieved in the ICH or the arbuscule is quite low.

A



B

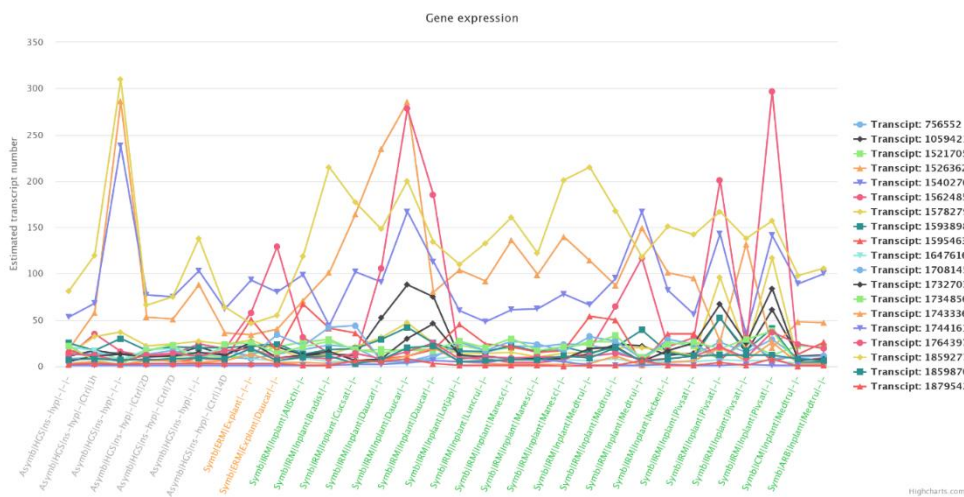

C

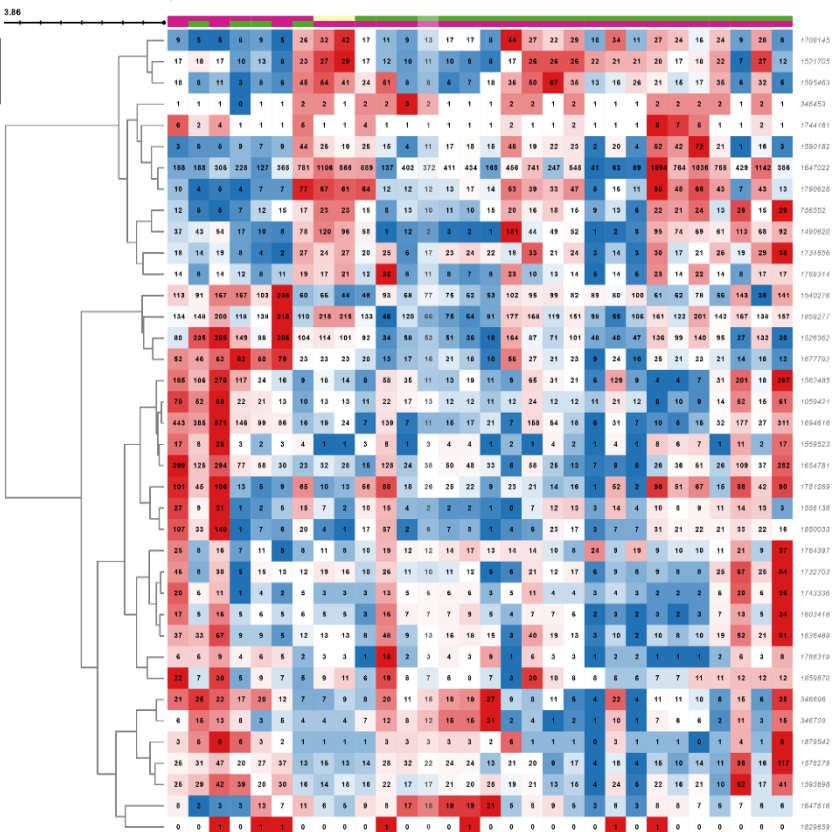

Figure 4: (A and B) Plots of the genes involved in nitrogen metabolism. (C) Heat Map of these genes with clusterization.

Nitrogen metabolism

Nitrogen metabolism has been investigated in detail by (Kikuchi et al., 2014). Surprisingly, none of the genes investigated shows a clear overexpression in the ICH or in the arbuscules (Figure 4.A and B). GS2 is highly expressed in all fungal life stages and particularly in planta while RiPTR2 is specifically expressed in planta. Both genes cluster together (Figure 4 C). The most highly expressed nitrogen related genes are CPS1, NRT1, ASS, ARG, OTA and VTC1 (Figure 4). GintAMT1 is the most highly expressed Ammonium Transporter (AMT) and it is preferentially expressed during the symbiotic phase, both in the IRM and the ERM. GintAMT2 and GintAMT3 are also overexpressed in the symbiotic stage but to a lower extent. Nitrogen metabolism is of primary importance, hence a constitutive expression, however the symbiotic phases are more active in order to meet the higher demand. Transporters, however, do not show a clear function in our dataset as we expected them to be highly expressed at the arbuscular interface.

Potassium transporters

Potassium is the third more abundant mineral nutrient found in plants and can account for up to 10% of the plant's dry mass (Zhang et al., 2017) as it is mandatory for many biological processes. Both ectomycorrhizal (Guerrero-Galán et al., 2018) and AM symbioses are known to transfer potassium to their host plant and four putative potassium transporters were identified in *Rhizophagus irregularis* (Garcia and Zimmermann, 2014): RiHAK, RiSKC1, RiSKC2 et RiSKC3. We identified a fifth potassium transporter whose sequence is very close to the published HAK, thus it was named RiHAK2. RiHAK is highly expressed in the pre-symbiotic stages. The rest of the transporters is poorly expressed and no clear patterns of expression can be drawn out from the available data (Figure 5 A). One of the treated conditions corresponds to an experiment with high or low potassium, but even this treatment did not affect the potassium transportome, suggesting that the identification of potassium transport mechanisms in AMF is still incomplete.

A

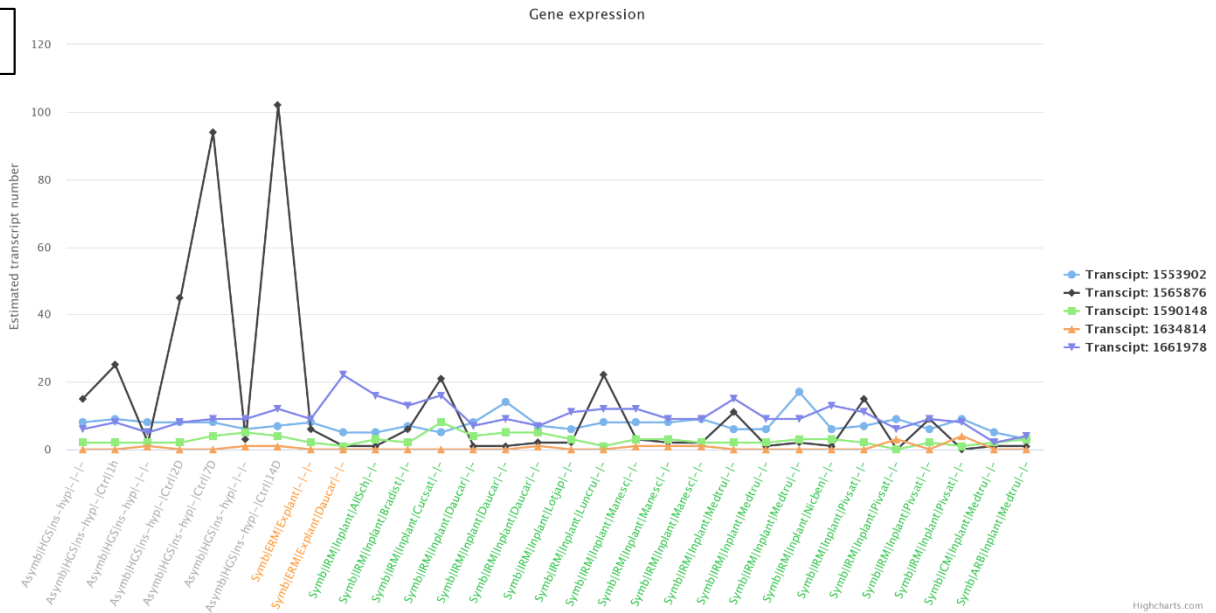

B

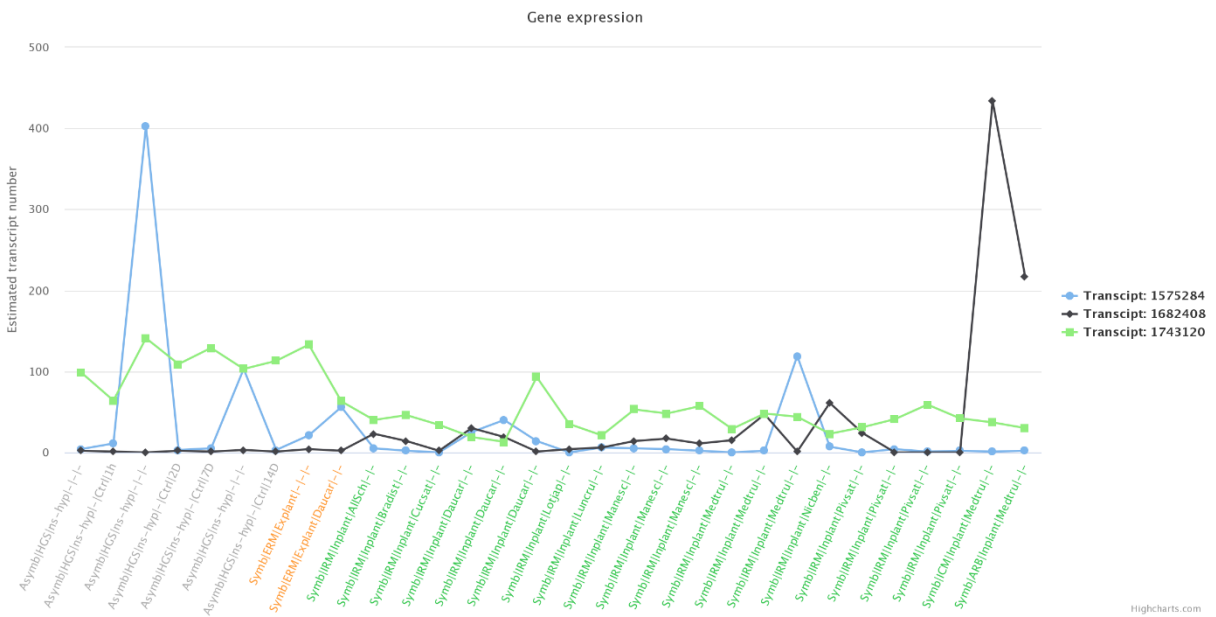

Figure 5: (A) Histogram of the expression of potassium transporters. (B) Plots of the expression of aquaporin genes.

Water transport

Aquaporins are known to be active in the arbuscular interface and it has been proposed that the flow of water going from the roots to the leaves might be continuous with the water flow inside fungal hyphae (Kikuchi et al., 2016). The putatively generated cytoplasmic flux would go from the soil exploring hyphae down to the arbuscules and this could create a driving force helping to carry the mineral nutrients along the hyphae without a need for an energy-consuming process. Two aquaporins have been published and named AQPF1 and AQPF2 (Li et al., 2013). An investigation of the gene repertoire using annotation entries allowed me to find a third one that was plainly named AQPF3. The expression plot shows that AQPF1 and AQPF2 seem to play major roles during the non-symbiotic stages and it looks like AQPF3 takes over during the symbiotic stages and particularly in the ICH and the arbuscule (Figure 5 B). Our data suggest that the aquaporin that would ensure the continuum of water flow between the two symbionts would be AQPF3.

Sugar metabolism and transport

In addition to the published sugar transporters, key-word research allowed us to find 57 extra genes. MST2 has been proposed to be the major actor in monosaccharide import into the arbuscule. Its silencing leads to degenerative arbuscules and impaired symbiosis (Helber et al., 2011b). RhiirExpress data confirms the specific expression of MST2 in planta, as it is almost non-detected in the ERM or in the non-symbiotic data (Figure 6.A). However surprisingly, its expression drops in the ICH or the arbuscules. In the ICH and arbuscules, MST6 has the same level of expression as MST2 but it is almost exclusively expressed in the ICH and arbuscules. If we consider the full list of sugar transporters (both published and unpublished - Figure 6C), MST2 is clustered with SugTrans52 as they show the same pattern of expression.

Gene expression

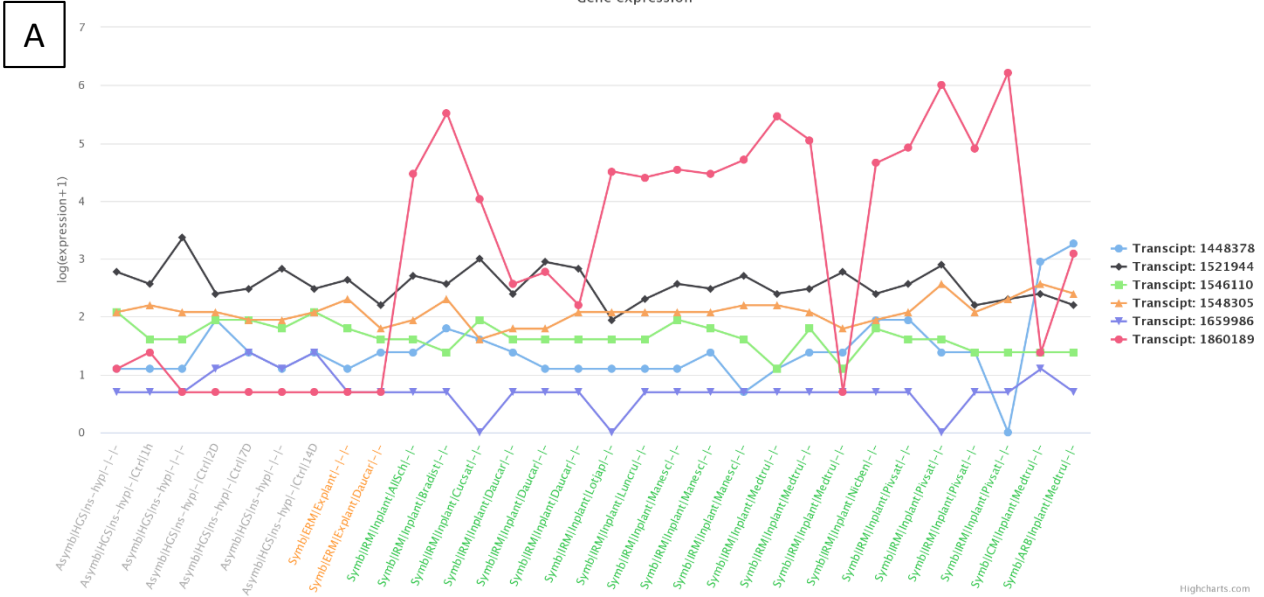

Highcharts.com

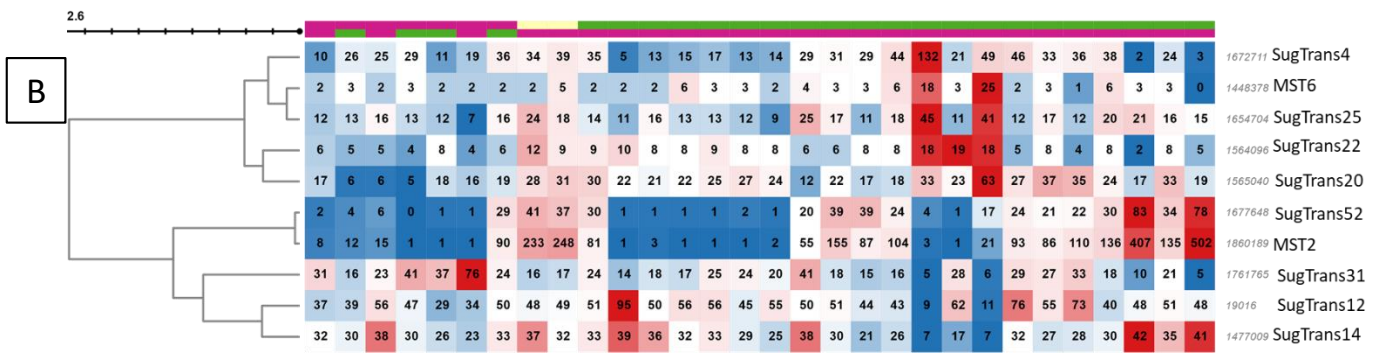
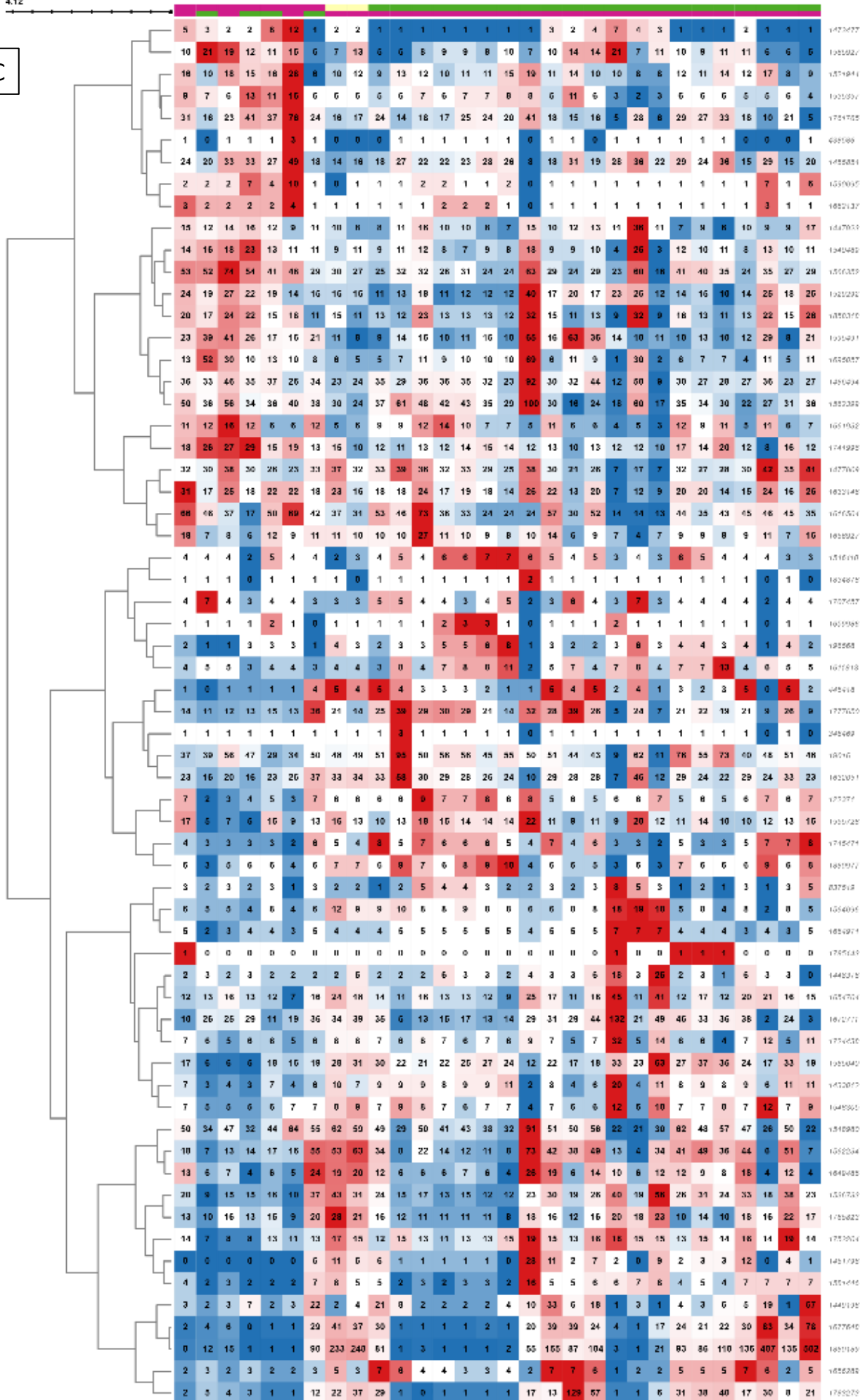

Figure 6: (A) Plot of published sugar transporters. The data are represented as log of the expression. (B) Heat Map of the sugars with an interesting pattern of expression. (C) Heat map of all putative sugar transporters.

C



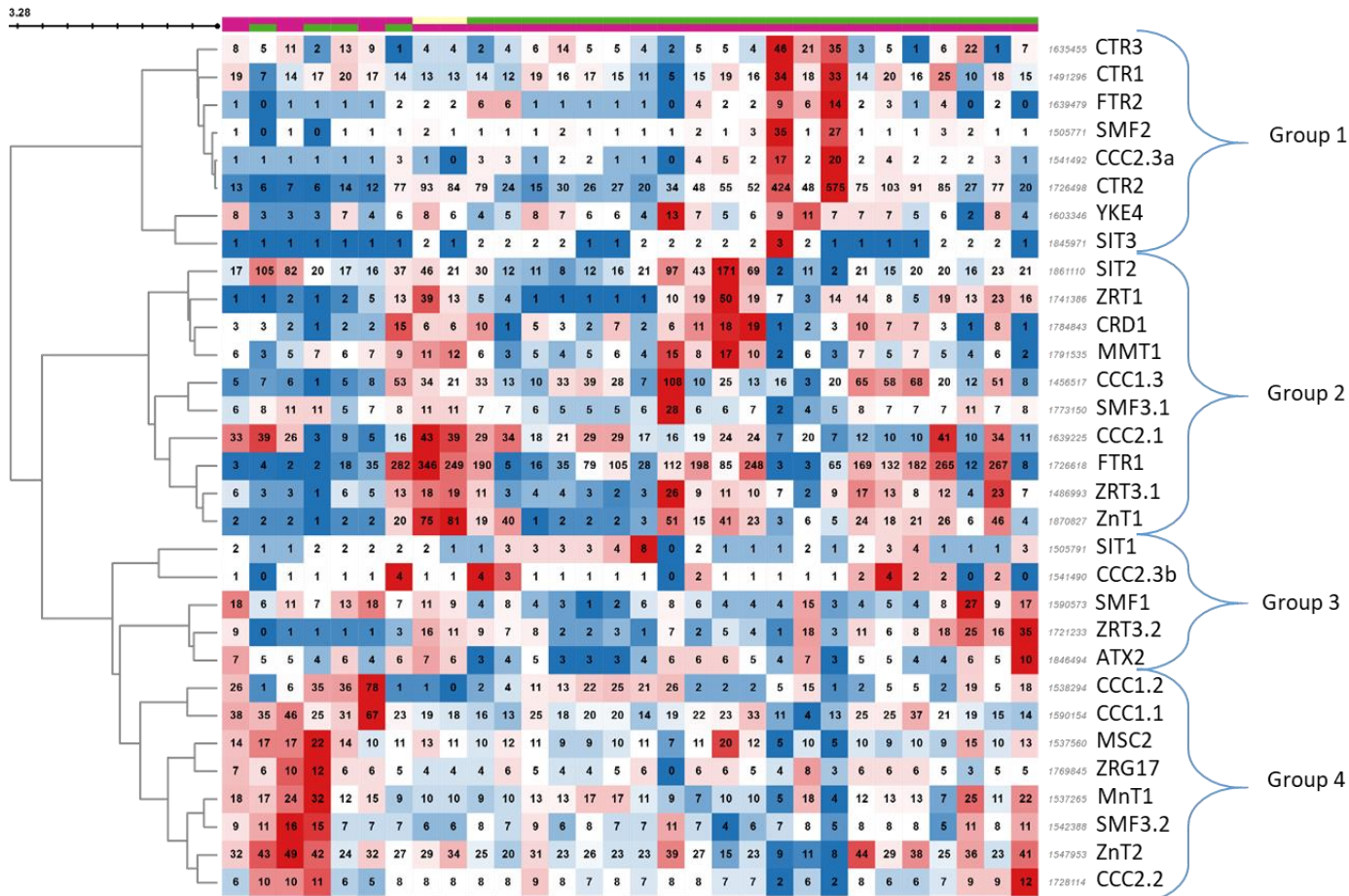

Figure 7: Heat Map of the expression of Metallic transporters with a clustering into 4 groups according to expression profiles

MST6 is clusterized with SugTrans25 which has a slightly higher expression in every condition. SugTrans4 and SugTrans54 are also clustered with MST6 but SugTrans4 is the most highly expressed putative sugar transporter expressed in the microdissected samples. These data indicate that the sugar transporters that should be involved in sugar transport at the arbuscule interface are MST6, SugTrans25, SugTrans54, and SugTrans4 (Figure 6B).

Metal transporters

Metallic micronutrients are of tremendous importance in plant growth even though they are not the most heavily transported substrates. Tamayo published a genome-wide analysis of copper, iron, zinc and manganese transporters in 2014. The list of 31 metal transporters was used to decipher gene regulation of this highly important gene family. This set of genes clustered into four groups (Figure 7). The first group gathers transporters which expression is important in the arbuscules or the ICH libraries. The four metals are encompassed in this group with CTR2 being the most highly expressed. The second group is composed of genes that are highly expressed *in planta* compared to non-symbiotic conditions. The iron transporter FTR1 is included in this cluster alongside zinc, and manganese transporters. The third group is expressed in every condition with a slight overexpression in *planta*. Finally, the last group gathers transporters whose expression is the highest in the non-symbiotic life stages of the fungus. The CCC1.1 and CCC1.2 are the most expressed genes in this cluster.

Uncharacterized transporters

The use of keywords to retrieve transporters yielded a list of 281 genes involved in transport activities. In this list, we obtained many different transport systems such as Major Facilitator Superfamily (MFS), ATP Binding Cassette transporters (ABC transporters), ion pores or channels, antiporters or symporters systems, etc. Although annotation can give clues on the gene function, the transported substrate is not always known (Lefevre et al., 2015). Consequently, we do not know towards which biological membrane the transporter is addressed, neither do we know the direction of the transport. Among the 281 genes, 54 showed distinctive patterns of expression. A heat map of these transporters gave five groups of genes according to the expression patterns (Figure 8). The first group includes genes highly expressed

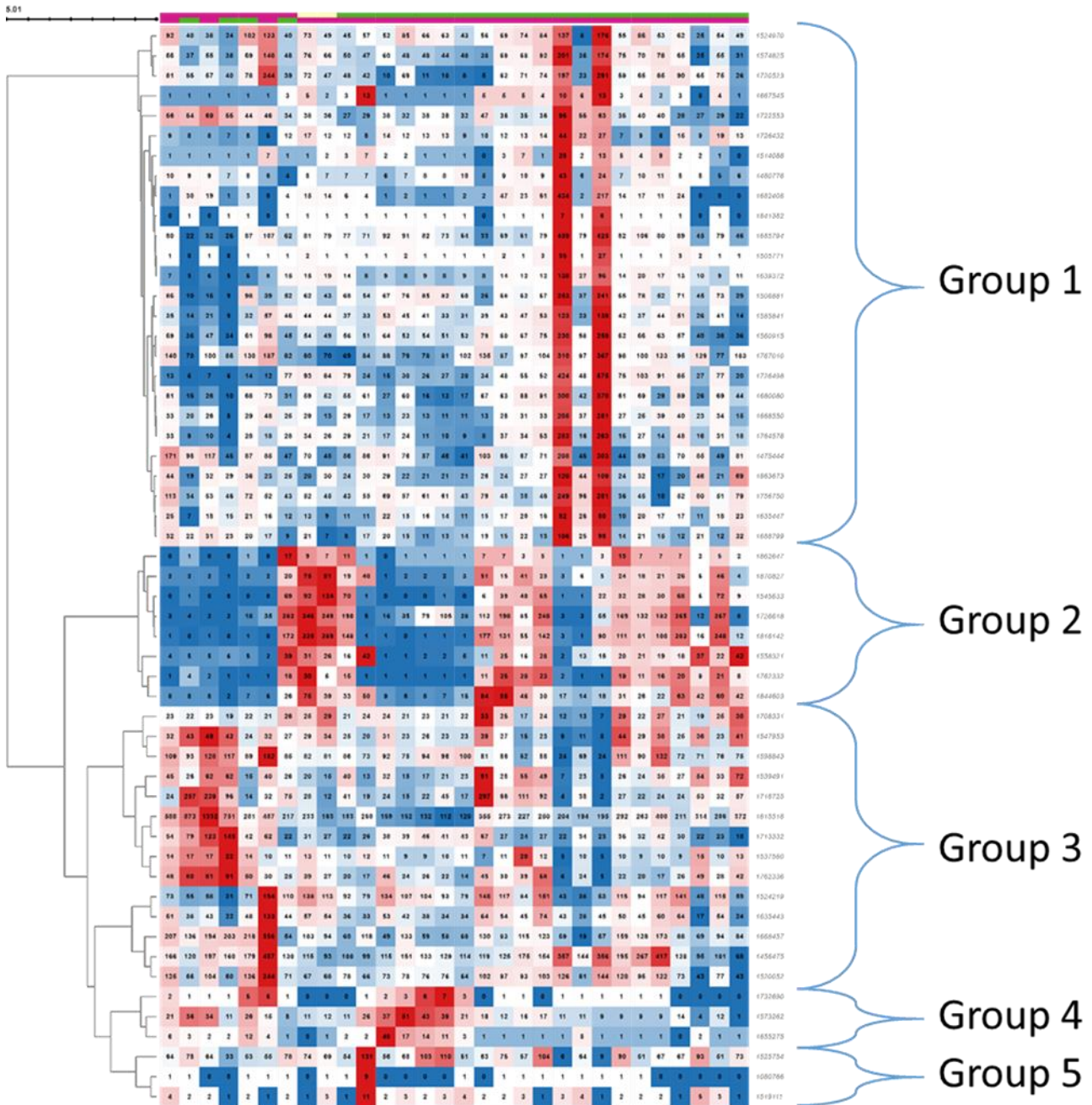

Figure 8: Heat Map of the expression of uncharacterized transporters with a clustering according to expression profiles.

in the ICH and/or arbuscule. In this cluster, we could find cation and ion transporters and some subunits of Clathrin adaptors. Unexpectedly, many genes in this group are annotated as subunits of ATPase or subunits of cytochrome c oxidase. The second group of transporters shows an overexpression in planta. In this cluster, we can find an ABC transporter (Transp176), MFS (Transp9, Transp148), a calcium transporter (Transp185), a urea transporter (Transp5), and a phosphate transporter (Transp307). The third group encompasses constitutively and highly expressed genes. Here again, some proton pumps and cytochrome c oxidase subunits are retrieved. In addition, putative transporters of magnesium, potassium, molybdenum, zinc, and ions follow this expression pattern. Genes expressed preferentially in the non-symbiotic stages are in the fourth group. This group only includes three ion channels. The last and fifth group contains three genes whose expression pattern includes an overexpression in the ERM. The three genes of this group are transporters of sulfur, ions, and potassium. The clusterization allows discriminating groups based on the stage at which they are expressed. While some genes are only expressed in non-symbiotic stages, others will be specifically expressed in planta. Based on the pattern of expression during the different life stages, a specific function can be supposed.

IV. Conclusion

The impossibility to genetically manipulate Glomeromycota fungi entangles the understanding of the biology of this ecologically important group of organisms. The development, this last decade of high-quality genomic resources on *R. irregularis* DAOM197198 gave the opportunity to use this strain as the “white mouse” of AMF. Many transcriptomic data are now available to help in deciphering its symbiotic biology. However comparing transcriptomic patterns from many different biological conditions can be difficult to manage. RhiirExpress renders available the identification of genes of interest before engaging in functional validation. The analysis of fungal transportome presented here shows that some genes of interest can be pointed out only with the use of multiple conditions, as pair comparisons would not always yield the same results. The analysis presented here points to transport of some nutrients that are of major importance in symbiotic exchanges.

As seen in this analysis, MST2 is indeed the most highly expressed sugar transporter in the IRM. The use of micro-dissected arbuscules and intercellular hyphae (ICH)

added a cloud on the horizon: the genes highly expressed in the IRM do not show the same expression in the arbuscules and the ICH. When harvesting mycorrhizal plant roots to analyze gene expression in the Intra Radical Mycelium, the selected sample is expected to contain arbuscules, intercellular hyphae, vesicles, haustoria and possibly some bits of the extra radical mycelium. The main compartments composing the *in planta* sample are (in terms of biomass) the ICH, then the arbuscule and vesicles. Unfortunately, the vesicles are not included in the GlomExpress set so far. We can only assume that genes expressed in the IRM but not in the ICH or arbuscules must be strongly expressed in the IRS to explain the observed pattern. It will be necessary to enrich the database with other microdissections to get a clear picture. Having only one type of sample for these highly important structures induces a lot of uncertainty. The same logic applies to ERM because so far, only two samples are available. Another concern with the data input is that when finding and downloading RNAseq data from different publications, most samples are biological replicates (typically triplicates and sometimes quadruplicates) but including duplicates or even simplicates strongly decreases the relevance of the global analysis. In like manner, the sequencing technology used to generate the data and the depth of sequencing might alter the output data. The more consistent the protocol, the more reliable the data.

For a long time, it has been supposed that the photosynthetates exchanged between the plant and the fungus during AMS were sugars. The sugar transporters involved in these exchanges remained hard to find using transcriptomic approaches as many sugar transporters exist in the fungal genome, and many of them are expressed in the host roots. MST2 was proposed to be the major actor of such exchanges as its silencing leads to lower the fungal root colonization and reduced the arbuscule development. Our data suggest that MST2 might indeed be one of the many fungal sugar transporter involved in sugar uptake. Among the 57 putative sugar transporters investigated, most of them happen to be expressed in the IRM. It is noteworthy that sugar flux might not be restricted to the arbuscule as the intercellular hyphae actually develop within the plant sugar-rich apoplast. Passive diffusion through the fungal cell wall and plasma membrane might occur alongside an active transport. The present analysis gives us a glimpse of fungal phosphate metabolism. First, it seems that phosphate metabolism is slow during the non-symbiotic stages where a

small expression is found. Then, phosphate is recruited in the soil with the use of Phytase1 (which is supposed to be secreted according to TMHMM) and metabolized in the ERM thanks to PT1. Once inside the host plant, the transporter PT1 still seems to be very active. The delivery of phosphate to the plant partner seems to be done by PT11. It has been proposed that nitrogen transfer might occur alongside phosphate transfer. The Ammonium Transporters (AMT) investigated here show a smaller slight expression during non-symbiotic stages compared to symbiotic ones. There is a preferential involvement of AMT1 in the ERM compartment and the three other AMTs are active in planta. Strangely though, none of the investigated transporters are expressed in the ICH or the arbuscules.

The bulk of genes retrieved thanks to keywords is annotated as transporters of multiple or unknown substrates. The biggest cluster of genes is overexpressed in the micro-dissected samples, indicating a highly active transportome in these samples. When looking closely at the annotations, many genes of this cluster actually are proton pumps. Many ATPase subunits belong to this cluster alongside subunits of cytochrome c oxidase. These enzymes are involved in proton transport and electron transport respectively, hence their selection in our keyword-based search. The fact that we find them overexpressed in the arbuscules and ICH can be explained by three hypotheses. The first and most straightforward is the fact that these genes are nuclear-encoded genes whose protein is addressed to the mitochondrion. Given the high-energy demand in the arbuscule, it can be speculated that this overexpression is just a consequence of the high mitochondrial activity. Other hypotheses would be that these proteins are not addressed to the mitochondria but to the plasma membrane instead. It is known that the PAS has to be protonated in order to power the transport activities occurring in this interface (Dreyer et al., 2019). The overexpression of a plant's proton pump led us to think that it fell upon the plant to acidify this compartment (Krajinski et al., 2014). This might not be true if these fungal ATPase were to be located at the PAM. In this case, the fungus would be contributing to this energy-intensive phenomenon. Given that proton pumps and ATPases are the same molecules working in reverse, it is tempting to consider that the AMF could use the proton gradient (instead of helping create it) to produce ATP at the expenses of the plant. While the two later hypotheses are quite bold to speculate, the rise in mitochondrial activity looks more cautious. Apart from these

unexpected enzymes, the first cluster also gathers actual transporters such as copper, manganese, iron and zinc transporters. These transporters were studied in detail by (Gómez-Gallego et al., 2019; Tamayo et al., 2014). Here, we strengthen the hypothetical involvement of these transporters in symbiotic nutrient transfer. In addition, a water transporter (AKA aquaporin) was found in this list. Curiously, *Rhizophagus irregularis* possess two described aquaporins (Li et al., 2013) but this third one has never been described even though it looks like being very important for continuous water flow between the plant and the fungus. The second cluster represents genes overexpressed in planta (but not in the ICH and arbuscules) and include other zinc and iron transporters described by (Tamayo et al., 2014) but also a calcium transporter, urea transporter and some MFS and ABC transporters with unknown substrate specificity. The third cluster also came with few surprises. In this group, genes are constitutively and strongly expressed. Transporters of magnesium, potassium and molybdenum were recovered alongside ion transporters and ABC/MFS. Finally, even though it is a small group, the last one is very interesting as it is expressed in the ERM. Sulfur and potassium transporters are expressed in this compartment, suggesting a role for these proteins in the recruitment in the soil of these minerals. This list of general transporters happens to contain genes related to Clathrin-mediated processes, suggesting a use of endocytosis during symbiotic transfers. The intense exchanges occurring at the symbiotic interface are revealed by our data, as distinct transcriptomic patterns are clearly identifiable. As this study is focusing on the fungal transportome, particular attention is brought to inter-symbiont exchanges, thus the treatment conditions were not used as we wanted to evaluate the metabolism in basal conditions. The set of genes expressed in the arbuscules and ICH are candidate genes potentially involved in direct symbiotic exchanges. However, our data also allows the study of mechanisms in the ERM, asymbiotic and pre-symbiotic conditions. The tool presented here provided useful information on different metabolisms in different conditions. Some genes are never expressed in any of the conditions available so far. These genes might be of major interest to assess future assemblage quality and robustness. Such tool might also be very useful in order to identify new reference genes for qPCR applications. Finally, the laser microdissection coupled to low input RNA sequencing looks promising, as it is the only way to distinguish functionally different fungal structures embedded in

the same tissue. However, the database has to be updated as better gene repertoire become available and continuous enrichment of the database has to be done as new publications include RNAseq data using *Rhizophagus irregularis* DAOM197198.

V. Material and methods

RNAseq data processing

A set of 158 RNAseq libraries obtained on *R. irregularis* DAOM197198 was collected. These libraries correspond to 54 biological conditions mainly in triplicates (14 biological conditions obtained in our team and 40 downloaded from SRA Genbank and DDBJ - supplementary data). RNA-seq analyses were performed using CLC Genomics Workbench 11.0 (<https://www.qiagenbioinformatics.com/>). RNAseq data were imported in CLC and associated with their corresponding metadata when available. Reads were trimmed to remove the adapter and mapped on Rhiir 2.1 (gene repertoire containing 26183 genes) with stringent settings (similarity and length read mapping criteria at 98% and 95%, respectively).

VI. Bibliography

Ai, P., Sun, S., Zhao, J., Fan, X., Xin, W., Guo, Q., Yu, L., Shen, Q., Wu, P., and Miller, A.J. (2009). Two rice phosphate transporters, OsPht1; 2 and OsPht1; 6, have different functions and kinetic properties in uptake and translocation. *The Plant Journal* 57, 798-809.

Ait Lahmidi, N., Courty, P.-E., Brulé, D., Chatagnier, O., Arnould, C., Doidy, J., Berta, G., Lingua, G., Wipf, D., and Bonneau, L. (2016). Sugar exchanges in arbuscular mycorrhiza: RiMST5 and RiMST6, two novel *Rhizophagus irregularis* monosaccharide transporters, are involved in both sugar uptake from the soil and from the plant partner. *Plant Physiology and Biochemistry* 107, 354-363.

An, J., Zeng, T., Ji, C., de Graaf, S., Zheng, Z., Xiao, T.T., Deng, X., Xiao, S., Bisseling, T., Limpens, E., et al. (2019). A *Medicago truncatula* SWEET transporter implicated in arbuscule maintenance during arbuscular mycorrhizal symbiosis. *New Phytologist*.

Aung, K., Lin, S.-I., Wu, C.-C., Huang, Y.-T., Su, C., and Chiou, T.-J. (2006). pho2, a phosphate overaccumulator, is caused by a nonsense mutation in a microRNA399 target gene. *Plant Physiology* 141, 1000-1011.

Baggerly, K.A., Deng, L., Morris, J.S., and Aldaz, C.M. (2003). Differential expression in SAGE: accounting for normal between-library variation. *Bioinformatics* 19, 1477-1483.

- Bago, B., Vierheilig, H., Piché, Y., and Azcón-Aguilar, C. (1996). Nitrate depletion and pH changes induced by the extraradical mycelium of the arbuscular mycorrhizal fungus *Glomus intraradices* grown in monoxenic culture. *New Phytologist* 133, 273-280.
- Beard, G., Doner, L.W., Rolin, D.B., Douds, D.D., and Pfeffer, P.E. (1991). Identification and quantification of trehalose in vesicular-arbuscular mycorrhizal fungi by in vivo ¹³C NMR and HPLC analyses*. *New Phytologist* 118, 547-552.
- Benedetto, A., Magurno, F., Bonfante, P., and Lanfranco, L. (2005). Expression profiles of a phosphate transporter gene (*GmosPT*) from the endomycorrhizal fungus *Glomus mosseae*. *Mycorrhiza* 15, 620-627.
- Benjamini, Y., and Hochberg, Y. (1995). Controlling the False Discovery Rate: A Practical and Powerful Approach to Multiple Testing. *Journal of the Royal Statistical Society: Series B (Methodological)* 57, 289-300.
- Boldt, K., Pörs, Y., Haupt, B., Bitterlich, M., Kühn, C., Grimm, B., and Franken, P. (2011). Photochemical processes, carbon assimilation and RNA accumulation of sucrose transporter genes in tomato arbuscular mycorrhiza. *Journal of Plant Physiology* 168, 1256-1263.
- Brandizzi, F., and Barlowe, C. (2013). Organization of the ER-Golgi interface for membrane traffic control. *Nature Reviews Molecular Cell Biology* 14, 382-392.
- Branscheid, A., Sieh, D., Pant, B.D., May, P., Devers, E.A., Elkrog, A., Schauer, L., Scheible, W.-R., and Krajinski, F. (2010). Expression pattern suggests a role of MiR399 in the regulation of the cellular response to local Pi increase during arbuscular mycorrhizal symbiosis. *Molecular Plant-Microbe Interactions* 23, 915-926.
- Bravo, A., Brands, M., Wewer, V., Dörmann, P., and Harrison, M.J. (2017). Arbuscular mycorrhiza-specific enzymes FatM and RAM2 fine-tune lipid biosynthesis to promote development of arbuscular mycorrhiza. *New Phytologist* 214, 1631-1645.
- Breullin-Sessoms, F., Floss, D.S., Gomez, S.K., Pumplin, N., Ding, Y., Levesque-Tremblay, V., Noar, R.D., Daniels, D.A., Bravo, A., Eaglesham, J.B., et al. (2015). Suppression of Arbuscule Degeneration in *Medicago truncatula phosphate transporter4* Mutants Is Dependent on the Ammonium Transporter 2 Family Protein AMT2;3. *The Plant Cell* 27, 1352-1366.
- Brundrett, M.C., Piché, Y., and Peterson, R.L. (1984). A new method for observing the morphology of vesicular-arbuscular mycorrhizae. *Canadian Journal of Botany* 62, 2128-2134.
- Bücking, H., Mensah, J.A., and Fellbaum, C.R. (2016). Common mycorrhizal networks and their effect on the bargaining power of the fungal partner in the arbuscular mycorrhizal symbiosis. *Communicative & Integrative Biology* 9, e1107684.
- Calabrese, S., Pérez-Tienda, J., Ellerbeck, M., Arnould, C., Chatagnier, O., Boller, T., Schübler, A., Brachmann, A., Wipf, D., and Ferrol, N. (2016). GintAMT3-a low-

affinity ammonium transporter of the arbuscular mycorrhizal *Rhizophagus irregularis*. *Frontiers in Plant Science* 7, 679.

Chen, E.C.H., Morin, E., Beaudet, D., Noel, J., Yildirim, G., Ndikumana, S., Charron, P., St-Onge, C., Giorgi, J., Krüger, M., et al. (2018). High intraspecific genome diversity in the model arbuscular mycorrhizal symbiont *Rhizophagus irregularis*. *New Phytologist* 220, 1161-1171.

Chen, L.-Q., Hou, B.-H., Lalonde, S., Takanaga, H., Hartung, M.L., Qu, X.-Q., Guo, W.-J., Kim, J.-G., Underwood, W., Chaudhuri, B., et al. (2010). Sugar transporters for intercellular exchange and nutrition of pathogens. *Nature* 468, 527-532.

Chiou, T.-J., Aung, K., Lin, S.-I., Wu, C.-C., Chiang, S.-F., and Su, C. (2006). Regulation of phosphate homeostasis by microRNA in *Arabidopsis*. *The Plant Cell* 18, 412-421.

Courty, P.-E., Franc, A., Pierrat, J.-C., and Garbaye, J. (2008). Temporal Changes in the Ectomycorrhizal Community in Two Soil Horizons of a Temperate Oak Forest. *Applied and Environmental Microbiology* 74, 5792-5801.

Courty, P.E., Smith, P., Koegel, S., Redecker, D., and Wipf, D. (2015). Inorganic nitrogen uptake and transport in beneficial plant root-microbe interactions. *Critical Reviews in Plant Sciences* 34, 4-16.

Couturier, J., Montanini, B., Martin, F., Brun, A., Blaudez, D., and Chalot, M. (2007). The expanded family of ammonium transporters in the perennial poplar plant. *New Phytologist* 174, 137-150.

Dethloff, F., Erban, A., Orf, I., Alpers, J., Fehrle, I., Beine-Golovchuk, O., Schmidt, S., Schwachtje, J., and Kopka, J. (2014). Profiling Methods to Identify Cold-Regulated Primary Metabolites Using Gas Chromatography Coupled to Mass Spectrometry. In *Plant Cold Acclimation*, D.K. Hinch, and E. Zuther, eds. (New York, NY: Springer New York), pp. 171-197.

Dietrich, D., Hammes, U., Thor, K., Suter-Grotemeyer, M., Flückiger, R., Slusarenko, A.J., Ward, J.M., and Rentsch, D. (2004). AtPTR1, a plasma membrane peptide transporter expressed during seed germination and in vascular tissue of *Arabidopsis*: Peptide transporter of *Arabidopsis*. *The Plant Journal* 40, 488-499.

Doidy, J., Grace, E., Kühn, C., Simon-Plas, F., Casieri, L., and Wipf, D. (2012a). Sugar transporters in plants and in their interactions with fungi. *Trends in Plant Science* 17, 413-422.

Doidy, J., van Tuinen, D., Lamotte, O., Corneillat, M., Alcaraz, G., and Wipf, D. (2012b). The *Medicago truncatula* Sucrose Transporter Family: Characterization and Implication of Key Members in Carbon Partitioning towards Arbuscular Mycorrhizal Fungi. *Molecular Plant* 5, 1346-1358.

Dreyer, I., Spitz, O., Kanonenberg, K., Montag, K., Handrich, M.R., Ahmad, S., Schott-Verdugo, S., Navarro-Retamal, C., Rubio-Meléndez, M.E., Gomez-Porras, J.L.,

- et al. (2019). Nutrient exchange in arbuscular mycorrhizal symbiosis from a thermodynamic point of view. *New Phytologist* 222, 1043-1053.
- Dumbrell, A.J., Ashton, P.D., Aziz, N., Feng, G., Nelson, M., Dytham, C., Fitter, A.H., and Helgason, T. (2011). Distinct seasonal assemblages of arbuscular mycorrhizal fungi revealed by massively parallel pyrosequencing. *New Phytologist* 190, 794-804.
- Ellerbeck, M., Schüßler, A., Brucker, D., Dafinger, C., Loos, F., and Brachmann, A. (2013). Characterization of three ammonium transporters of the glomeromycotan fungus *Geosiphon pyriformis*. *Eukaryotic Cell* 12, 1554-1562.
- Ezawa, T., Smith, S.E., and Smith, F.A. (2002). P metabolism and transport in AM fungi. *Plant and Soil* 244, 221-230.
- Fellbaum, C.R., Gachomo, E.W., Beesetty, Y., Choudhari, S., Strahan, G.D., Pfeffer, P.E., Kiers, E.T., and Bucking, H. (2012). Carbon availability triggers fungal nitrogen uptake and transport in arbuscular mycorrhizal symbiosis. *Proceedings of the National Academy of Sciences* 109, 2666-2671.
- Fellbaum, C.R., Mensah, J.A., Cloos, A.J., Strahan, G.E., Pfeffer, P.E., Kiers, E.T., and Bücking, H. (2014). Fungal nutrient allocation in common mycorrhizal networks is regulated by the carbon source strength of individual host plants. *New Phytologist* 203, 646-656.
- Feraru, E., Feraru, M.I., Asaoka, R., Paciorek, T., De Rycke, R., Tanaka, H., Nakano, A., and Friml, J. (2012). BEX5/RabA1b Regulates *trans* -Golgi Network-to-Plasma Membrane Protein Trafficking in *Arabidopsis*. *The Plant Cell* 24, 3074-3086.
- Fiorilli, V., Lanfranco, L., and Bonfante, P. (2013). The expression of GintPT, the phosphate transporter of *Rhizophagus irregularis*, depends on the symbiotic status and phosphate availability. *Planta* 237, 1267-1277.
- Flügge, U.-I. (2001). Plant Chloroplasts and Other Plastids. In *Encyclopedia of Life Sciences*, John Wiley & Sons, Ltd, ed. (Chichester, UK: John Wiley & Sons, Ltd), p.
- Frey, B., and Schüepp, H. (1993). Acquisition of nitrogen by external hyphae of arbuscular mycorrhizal fungi associated with *Zea mays* L. *New Phytologist* 124, 221-230.
- Gamas, P. (1996). Use of a Subtractive Hybridization Approach to Identify New *Medicago truncatula* Genes Induced During Root Nodule Development. *Molecular Plant-Microbe Interactions* 9, 233.
- Garcia, K., and Zimmermann, S.D. (2014). The role of mycorrhizal associations in plant potassium nutrition. *Frontiers in Plant Science* 5.
- Garcia, K., Doidy, J., Zimmermann, S.D., Wipf, D., and Courty, P.-E. (2016). Take a Trip Through the Plant and Fungal Transportome of Mycorrhiza. *Trends in Plant Science* 21, 937-950.

Ge, L., Sun, S., Chen, A., Kapulnik, Y., and Xu, G. (2008). Tomato sugar transporter genes associated with mycorrhiza and phosphate. *Plant Growth Regulation* 55, 115-123.

Glassop, D., Smith, S.E., and Smith, F.W. (2005). Cereal phosphate transporters associated with the mycorrhizal pathway of phosphate uptake into roots. *Planta* 222, 688-698.

Gomez, S.K., Javot, H., Deewatthanawong, P., Torres-Jerez, I., Tang, Y., Blancaflor, E.B., Udvardi, M.K., and Harrison, M.J. (2009). *Medicago truncatula* and *Glomus intraradices* gene expression in cortical cells harboring arbuscules in the arbuscular mycorrhizal symbiosis. *BMC Plant Biology* 9, 10.

Gómez-Gallego, T., Benabdellah, K., Merlos, M.A., Jiménez-Jiménez, A.M., Alcon, C., Berthomieu, P., and Ferrol, N. (2019). The *Rhizophagus irregularis* Genome Encodes Two CTR Copper Transporters That Mediate Cu Import Into the Cytosol and a CTR-Like Protein Likely Involved in Copper Tolerance. *Frontiers in Plant Science* 10.

Govindarajulu, M., Pfeffer, P.E., Jin, H., Abubaker, J., Douds, D.D., Allen, J.W., Bücking, H., Lammers, P.J., and Shachar-Hill, Y. (2005). Nitrogen transfer in the arbuscular mycorrhizal symbiosis. *Nature* 435, 819.

Guerrero-Galán, C., Delteil, A., Garcia, K., Houdinet, G., Conéjéro, G., Gaillard, I., Sentenac, H., and Zimmermann, S.D. (2018). Plant potassium nutrition in ectomycorrhizal symbiosis: properties and roles of the three fungal TOK potassium channels in *Hebeloma cylindrosporum*: TOK potassium channels of an ectomycorrhizal fungus. *Environmental Microbiology* 20, 1873-1887.

Guether, M., Neuhäuser, B., Balestrini, R., Dynowski, M., Ludewig, U., and Bonfante, P. (2009). A mycorrhizal-specific ammonium transporter from *Lotus japonicus* acquires nitrogen released by arbuscular mycorrhizal fungi. *Plant Physiology* 150, 73-83.

Harrison, M.J., and van Buuren, M.L. (1995). A phosphate transporter from the mycorrhizal fungus *Glomus versiforme*. *Nature* 378, 626.

Harrison, M.J., Dewbre, G.R., and Liu, J. (2002). A Phosphate Transporter from *Medicago truncatula* Involved in the Acquisition of Phosphate Released by Arbuscular Mycorrhizal Fungi. *The Plant Cell* 14, 2413-2429.

Hawkins, H.-J., Johansen, A., and George, E. (2000). Uptake and transport of organic and inorganic nitrogen by arbuscular mycorrhizal fungi. *Plant and Soil* 226, 275-285.

Helber, N., Wippel, K., Sauer, N., Schaarschmidt, S., Hause, B., and Requena, N. (2011a). A Versatile Monosaccharide Transporter That Operates in the Arbuscular Mycorrhizal Fungus *Glomus* sp Is Crucial for the Symbiotic Relationship with Plants. *The Plant Cell* 23, 3812-3823.

Helber, N., Wippel, K., Sauer, N., Schaarschmidt, S., Hause, B., and Requena, N. (2011b). A Versatile Monosaccharide Transporter That Operates in the Arbuscular

Mycorrhizal Fungus *Glomus* sp Is Crucial for the Symbiotic Relationship with Plants. *The Plant Cell* 23, 3812-3823.

Hodge, A., and Storer, K. (2015). Arbuscular mycorrhiza and nitrogen: implications for individual plants through to ecosystems. *Plant and Soil* 386, 1-19.

Hodge, A., Helgason, T., and Fitter, A.H. (2010). Nutritional ecology of arbuscular mycorrhizal fungi. *Fungal Ecology* 3, 267-273.

Javot, H., Penmetsa, R.V., Terzaghi, N., Cook, D.R., and Harrison, M.J. (2007a). A *Medicago truncatula* phosphate transporter indispensable for the arbuscular mycorrhizal symbiosis. *Proceedings of the National Academy of Sciences* 104, 1720-1725.

Javot, H., Pumplin, N., and Harrison, M.J. (2007b). Phosphate in the arbuscular mycorrhizal symbiosis: transport properties and regulatory roles. *Plant, Cell & Environment* 30, 310-322.

Jiang, Y., Wang, W., Xie, Q., Liu, N., Liu, L., Wang, D., Zhang, X., Yang, C., Chen, X., Tang, D., et al. (2017). Plants transfer lipids to sustain colonization by mutualistic mycorrhizal and parasitic fungi. *Science* eaam9970.

Jin, H., Pfeffer, P.E., Douds, D.D., Piotrowski, E., Lammers, P.J., and Shachar-Hill, Y. (2005). The uptake, metabolism, transport and transfer of nitrogen in an arbuscular mycorrhizal symbiosis. *New Phytologist* 168, 687-696.

Kammerer, B., Fischer, K., Hilpert, B., Schubert, S., Gutensohn, M., Weber, A., and Flügge, U.-I. (1998). Molecular Characterization of a Carbon Transporter in Plastids from Heterotrophic Tissues: The Glucose 6-Phosphate/Phosphate Antiporter. *The Plant Cell* 10, 105-117.

Karim, S., Lundh, D., Holmström, K.-O., Mandal, A., and Pirhonen, M. (2005). Structural and functional characterization of AtPTR3, a stress-induced peptide transporter of *Arabidopsis*. *Journal of Molecular Modeling* 11, 226-236.

Karim, S., Holmström, K.-O., Mandal, A., Dahl, P., Hohmann, S., Brader, G., Palva, E.T., and Pirhonen, M. (2007). AtPTR3, a wound-induced peptide transporter needed for defence against virulent bacterial pathogens in *Arabidopsis*. *Planta* 225, 1431-1445.

Keymer, A., Pimprikar, P., Wewer, V., Huber, C., Brands, M., Bucerius, S., Delaux, P.-M., Klingl, V., von Roepenack-Lahaye, E., Wang, T.L., et al. (2017). Lipid transfer from plants to arbuscular mycorrhiza fungi. *BioRxiv* 143883.

Kiers, E.T., West, S.A., Wyatt, G.A.K., Gardner, A., Bücking, H., and Werner, G.D.A. (2016). Misconceptions on the application of biological market theory to the mycorrhizal symbiosis. *Nature Plants* 2.

Kikuchi, Y., Hijikata, N., Yokoyama, K., Ohtomo, R., Handa, Y., Kawaguchi, M., Saito, K., and Ezawa, T. (2014). Polyphosphate accumulation is driven by transcriptome alterations that lead to near-synchronous and near-equivalent uptake

of inorganic cations in an arbuscular mycorrhizal fungus. *New Phytologist* 204, 638-649.

Kikuchi, Y., Hijikata, N., Ohtomo, R., Handa, Y., Kawaguchi, M., Saito, K., Masuta, C., and Ezawa, T. (2016). Aquaporin-mediated long-distance polyphosphate translocation directed towards the host in arbuscular mycorrhizal symbiosis: application of virus-induced gene silencing. *New Phytologist*.

Kobae, Y., Tamura, Y., Takai, S., Banba, M., and Hata, S. (2010). Localized Expression of Arbuscular Mycorrhiza-Inducible Ammonium Transporters in Soybean. *Plant and Cell Physiology* 51, 1411-1415.

Koegel, S., Lahmidi, N.A., Arnould, C., Chatagnier, O., Walder, F., Ineichen, K., Boller, T., Wipf, D., Wiemken, A., and Courty, P.-E. (2013). The family of ammonium transporters (AMT) in *Sorghum bicolor*: two AMT members are induced locally, but not systemically in roots colonized by arbuscular mycorrhizal fungi. *New Phytologist* 198, 853-865.

Krajinski, F., Courty, P.-E., Sieh, D., Franken, P., Zhang, H., Bucher, M., Gerlach, N., Kryvoruchko, I., Zoeller, D., Udvardi, M., et al. (2014). The H⁺-ATPase HA1 of *Medicago truncatula* Is Essential for Phosphate Transport and Plant Growth during Arbuscular Mycorrhizal Symbiosis. *The Plant Cell* 26, 1808-1817.

Lefevre, F., Baijot, A., and Boutry, M. (2015). Plant ABC transporters: time for biochemistry? *Biochemical Society Transactions* 43, 931-936.

Leigh, J., Hodge, A., and Fitter, A.H. (2009). Arbuscular mycorrhizal fungi can transfer substantial amounts of nitrogen to their host plant from organic material. *New Phytologist* 181, 199-207.

Li, T., Hu, Y.-J., Hao, Z.-P., Li, H., Wang, Y.-S., and Chen, B.-D. (2013). First cloning and characterization of two functional aquaporin genes from an arbuscular mycorrhizal fungus *Glomus intraradices*. *New Phytologist* 197, 617-630.

López-Pedrosa, A., González-Guerrero, M., Valderas, A., Azcón-Aguilar, C., and Ferrol, N. (2006). GintAMT1 encodes a functional high-affinity ammonium transporter that is expressed in the extraradical mycelium of *Glomus intraradices*. *Fungal Genetics and Biology* 43, 102-110.

Loth-Pereda, V., Orsini, E., Courty, P.-E., Lota, F., Kohler, A., Diss, L., Blaudez, D., Chalot, M., Nehls, U., and Bucher, M. (2011). Structure and expression profile of the phosphate Pht1 transporter gene family in mycorrhizal *Populus trichocarpa*. *Plant Physiology* 156, 2141-2154.

Luginbuehl, L.H., Menard, G.N., Kurup, S., Van Erp, H., Radhakrishnan, G.V., Breakspear, A., Oldroyd, G.E., and Eastmond, P.J. (2017). Fatty acids in arbuscular mycorrhizal fungi are synthesized by the host plant. *Science* eaan0081.

MacLean, A.M., Bravo, A., and Harrison, M.J. (2017). Plant signaling and metabolic pathways enabling arbuscular mycorrhizal symbiosis. *The Plant Cell* tpc.00555.2017.

Mäder, P., Vierheilig, H., Streitwolf-Engel, R., Boller, T., Frey, B., Christie, P., and Wiemken, A. (2000). Transport of ^{15}N from a soil compartment separated by a polytetrafluoroethylene membrane to plant roots via the hyphae of arbuscular mycorrhizal fungi. *The New Phytologist* 146, 155-161.

Maldonado-Mendoza, I.E., Dewbre, G.R., and Harrison, M.J. (2001). A Phosphate Transporter Gene from the Extra-Radical Mycelium of an Arbuscular Mycorrhizal Fungus *Glomus intraradices* Is Regulated in Response to Phosphate in the Environment. *Molecular Plant-Microbe Interactions* 14, 1140-1148.

Marschner, H., and Dell, B. (1994). Nutrient uptake in mycorrhizal symbiosis. *Plant and Soil* 159, 89-102.

Maza, E. (2016). In Papyro Comparison of TMM (edgeR), RLE (DESeq2), and MRN Normalization Methods for a Simple Two-Conditions-Without-Replicates RNA-Seq Experimental Design. *Frontiers in Genetics* 7.

Maza, E., Frasse, P., Senin, P., Bouzayen, M., and Zouine, M. (2013). Comparison of normalization methods for differential gene expression analysis in RNA-Seq experiments: a matter of relative size of studied transcriptomes. *Communicative & Integrative Biology* 6, e25849.

McCormick, R.F., Truong, S.K., Sreedasyam, A., Jenkins, J., Shu, S., Sims, D., Kennedy, M., Amirebrahimi, M., Weers, B.D., McKinley, B., et al. (2018). The *Sorghum bicolor* reference genome: improved assembly, gene annotations, a transcriptome atlas, and signatures of genome organization. *The Plant Journal* 93, 338-354.

McFarlane, H.E., Watanabe, Y., Yang, W., Huang, Y., Ohlrogge, J., and Samuels, A.L. (2014). Golgi- and Trans-Golgi Network-Mediated Vesicle Trafficking Is Required for Wax Secretion from Epidermal Cells. *Plant Physiology* 164, 1250-1260.

Morin, E., Miyauchi, S., San Clemente, H., Chen, E.C.H., Pelin, A., Providencia, I., Ndikumana, S., Beaudet, D., Hainaut, M., Drula, E., et al. (2019). Comparative genomics of *Rhizophagus irregularis*, *R. cerebriforme*, *R. diaphanus* and *Gigaspora rosea* highlights specific genetic features in Glomeromycotina. *New Phytologist* 222, 1584-1598.

Murphy, J., and Riley, J.P. (1962). A modified single solution method for the determination of phosphate in natural waters. *Analytica Chimica Acta* 27, 31-36.

Nagy, R., Karandashov, V., Chague, V., Kalinkevich, K., Tamasloukht, M., Xu, G., Jakobsen, I., Levy, A.A., Amrhein, N., and Bucher, M. (2005). The characterization of novel mycorrhiza-specific phosphate transporters from *Lycopersicon esculentum* and *Solanum tuberosum* uncovers functional redundancy in symbiotic phosphate transport in solanaceous species. *The Plant Journal* 42, 236-250.

Norambuena, L., Marchant, L., Berninsone, P., Hirschberg, C.B., Silva, H., and Orellana, A. (2002). Transport of UDP-galactose in Plants: identification and functional characterization of AtUTr1, an *Arabidopsis thaliana* udp-galactose/udp-glucose transporter. *Journal of Biological Chemistry* 277, 32923-32929.

- Olsson, P.A., Rahm, J., and Aliasghar Zad, N. (2010). Carbon dynamics in mycorrhizal symbioses is linked to carbon costs and phosphorus benefits. *FEMS Microbiology Ecology* 72, 125-131.
- Pao, S.S., Paulsen, I.T., and Saier, M.H. (1998). Major facilitator superfamily. *Microbiol. Mol. Biol. Rev.* 62, 1-34.
- Paszkowski, U. (2006). A journey through signaling in arbuscular mycorrhizal symbioses 2006. *New Phytologist* 172, 35-46.
- Pérez-Tienda, J., Testillano, P.S., Balestrini, R., Fiorilli, V., Azcón-Aguilar, C., and Ferrol, N. (2011). GintAMT2, a new member of the ammonium transporter family in the arbuscular mycorrhizal fungus *Glomus intraradices*. *Fungal Genetics and Biology* 48, 1044-1055.
- Poirier, Y., and Bucher, M. (2002). Phosphate transport and homeostasis in *Arabidopsis*. *The Arabidopsis Book/American Society of Plant Biologists* 1.
- Pumplin, N., and Harrison, M.J. (2009). Live-Cell Imaging Reveals Periarbuscular Membrane Domains and Organelle Location in *Medicago truncatula* Roots during Arbuscular Mycorrhizal Symbiosis. *Plant physiology* 151, 809-819.
- Pumplin, N., Zhang, X., Noar, R.D., and Harrison, M.J. (2012). Polar localization of a symbiosis-specific phosphate transporter is mediated by a transient reorientation of secretion. *Proceedings of the National Academy of Sciences* 109, E665-E672.
- Rausch, C., and Bucher, M. (2002). Molecular mechanisms of phosphate transport in plants. *Planta* 216, 23-37.
- Rausch, C., Daram, P., Brunner, S., Jansa, J., Laloi, M., Leggewie, G., Amrhein, N., and Bucher, M. (2001). A phosphate transporter expressed in arbuscule-containing cells in potato. *Nature* 414, 462.
- Rautengarten, C., Ebert, B., Moreno, I., Temple, H., Herter, T., Link, B., Donas-Cofre, D., Moreno, A., Saez-Aguayo, S., Blanco, F., et al. (2014). The Golgi localized bifunctional UDP-rhamnose/UDP-galactose transporter family of *Arabidopsis*. *Proceedings of the National Academy of Sciences* 111, 11563-11568.
- Rich, M.K., Nouri, E., Courty, P.-E., and Reinhardt, D. (2017). Diet of Arbuscular Mycorrhizal Fungi: Bread and Butter? *Trends in Plant Science* 22, 652-660.
- Schachtman, D.P., Reid, R.J., and Ayling, S.M. (1998). Phosphorus Uptake by Plants: From Soil to Cell. *Plant Physiology* 116, 447-453.
- Schüßler, A., Martin, H., Cohen, D., Fitz, M., and Wipf, D. (2006). Characterization of a carbohydrate transporter from symbiotic glomeromycotan fungi. *Nature* 444, 933-936.
- Selle, A., Willmann, M., Grunze, N., Geßler, A., Weiß, M., and Nehls, U. (2005). The high-affinity poplar ammonium importer PttAMT1. 2 and its role in ectomycorrhizal symbiosis. *New Phytologist* 168, 697-706.

Škuta, C., Bartlouněk, P., and Svozil, D. (2014). InChIlib-interactive cluster heatmap for web applications. *Journal of Cheminformatics* 6, 44.

Smith, S.E., and Read, D.J. (2010). *Mycorrhizal Symbiosis* (Academic Press).

Smith, S.E., and Smith, F.A. (2011). Roles of Arbuscular Mycorrhizas in Plant Nutrition and Growth: New Paradigms from Cellular to Ecosystem Scales. *Annual Review of Plant Biology* 62, 227-250.

Strehmel, N., Hummel, J., Erban, A., Strassburg, K., and Kopka, J. (2008). Retention index thresholds for compound matching in GC-MS metabolite profiling. *Journal of Chromatography B* 871, 182-190.

Takabatake, R., Hata, S., Taniguchi, M., Kouchi, H., Sugiyama, T., and Izui, K. (1999). Isolation and characterization of cDNAs encoding mitochondrial phosphate transporters in soybean, maize, rice, and Arabidopsis. *Plant Molecular Biology* 40, 479-486.

Tamayo, E., Gázquez-Gallego, T., Azcón-Aguilar, C., and Ferrol, N. (2014). Genome-wide analysis of copper, iron and zinc transporters in the arbuscular mycorrhizal fungus *Rhizophagus irregularis*. *Frontiers in Plant Science* 5.

Tang, N., San Clemente, H., Roy, S., Bécard, G., Zhao, B., and Roux, C. (2016a). A survey of the gene repertoire of *Gigaspora rosea* unravels conserved features among Glomeromycota for obligate biotrophy. *Frontiers in Microbiology* 7, 233.

Tang, N., San Clemente, H., Roy, S., Bécard, G., Zhao, B., and Roux, C. (2016b). A Survey of the Gene Repertoire of *Gigaspora rosea* Unravels Conserved Features among Glomeromycota for Obligate Biotrophy. *Frontiers in Microbiology* 7.

Tatry, M.-V., El Kassis, E., Lambilliotte, R., Corratgé, C., Van Aarle, I., Amenc, L.K., Alary, R., Zimmermann, S., Sentenac, H., and Plassard, C. (2009). Two differentially regulated phosphate transporters from the symbiotic fungus *Hebeloma cylindrosporum* and phosphorus acquisition by ectomycorrhizal *Pinus pinaster*. *The Plant Journal* 57, 1092-1102.

Toussaint, J.-P., St-Arnaud, M., and Charest, C. (2004). Nitrogen transfer and assimilation between the arbuscular mycorrhizal fungus *Glomus intraradices* Schenck & Smith and Ri T-DNA roots of *Daucus carota* L. in an in vitro compartmented system. *Canadian Journal of Microbiology* 50, 251-260.

Tuskan, G.A., DiFazio, S., Jansson, S., Bohlmann, J., Grigoriev, I., Hellsten, U., Putnam, N., Ralph, S., Rombauts, S., Salamov, A., et al. (2006). The Genome of Black Cottonwood, *Populus trichocarpa* (Torr. & Gray). *Science* 313, 1596-1604.

Villegas, J., Williams, R.D., Nantais, L., Archambault, J., and Fortin, J.A. (1996). Effects of N source on pH and nutrient exchange of extramatrical mycelium in a mycorrhizal Ri T-DNA transformed root system. *Mycorrhiza* 6, 247-251.

Walder, F., and van der Heijden, M.G.A. (2015). Regulation of resource exchange in the arbuscular mycorrhizal symbiosis. *Nature Plants* 1.

Walder, F., Niemann, H., Natarajan, M., Lehmann, M.F., Boller, T., and Wiemken, A. (2012). Mycorrhizal Networks: Common Goods of Plants Shared under Unequal Terms of Trade. *PLANT PHYSIOLOGY* 159, 789-797.

Walder, F., Boller, T., Wiemken, A., and Courty, P.-E. (2016). Regulation of plants' phosphate uptake in common mycorrhizal networks: Role of intraradical fungal phosphate transporters. *Plant Signaling & Behavior* 11, e1131372.

Wewer, V., Brands, M., and Dörmann, P. (2014). Fatty acid synthesis and lipid metabolism in the obligate biotrophic fungus *Rhizophagus irregularis* during mycorrhization of *Lotus japonicus*. *Plant J* 79, 398-412.

Whiteside, M.D., Werner, G.D.A., Caldas, V.E.A., van't Padje, A., Dupin, S.E., Elbers, B., Bakker, M., Wyatt, G.A.K., Klein, M., Hink, M.A., et al. (2019). Mycorrhizal Fungi Respond to Resource Inequality by Moving Phosphorus from Rich to Poor Patches across Networks. *Current Biology* 29, 2043-2050.e8.

Wipf, D., Krajinski, F., van Tuinen, D., Recorbet, G., and Courty, P.-E. (2019). Trading on the arbuscular mycorrhiza market: from arbuscules to common mycorrhizal networks. *New Phytologist*.

Zhang, H., Wei, S., Hu, W., Xiao, L., and Tang, M. (2017). Arbuscular Mycorrhizal Fungus *Rhizophagus irregularis* Increased Potassium Content and Expression of Genes Encoding Potassium Channels in *Lycium barbarum*. *Frontiers in Plant Science* 8.

Zheng, C., Ji, B., Zhang, J., Zhang, F., and Bever, J.D. (2015). Shading decreases plant carbon preferential allocation towards the most beneficial mycorrhizal mutualist. *New Phytologist* 205, 361-368.

Zouine, M., Maza, E., Djari, A., Lauvernier, M., Frasse, P., Smouni, A., Pirrello, J., and Bouzayen, M. (2017). TomExpress, a unified tomato RNA-Seq platform for visualization of expression data, clustering and correlation networks. *The Plant Journal* 92, 727-735.

Chapter 2 - Imbalanced regulation of fungal nutrient transports according to phosphate availability in a symbiocosm formed by poplar, sorghum, and *Rhizophagus irregularis*.

This chapter corresponds to a manuscript accepted in *Frontiers in Plant Sciences* (minor revision). The work consists of a combination of three original approaches.

The first one is the experimental design developed by Dr. P-E Courty, consisting of a symbiocosm where poplar, a tree with C3 photosynthesis, is associated with sorghum, an annual plant with C4 physiology, by a common mycelial network formed by hyphae of *Rhizophagus irregularis*.

The second one is the biological question addressed using this experimental design, dealing with the regulation of symbiotic nutrient exchanges by comparing their activity after the addition of 2 concentrations of phosphate (28 μM or 560 μM , i.e. low-P or high-P) to the fungal compartment of the CMN. This approach represents a departure from the question usually addressed on the perturbing role of phosphate on the establishment on AM symbiosis by adding high concentration of phosphate to mycorrhizal roots. Biochemical and transcriptomic comparisons of these two symbiotic functioning situations allowed us identifying new fungal and plant transporters or actors involved in symbiotic nutrient exchanges.

The third original approach consists of the multiple co*-comparative transcriptomic analysis based on 14 biological conditions (sorghum+fungus/CMN/poplar+fungus,

*co-comparative= analysis of transcriptomic patterns of *R. irregularis* mirroring those of sorghum and poplar in symbiotic tissues.

sorghum+/-fungus, poplar+/-fungus, 2 concentration of P) leading to a combination of 150 possible comparisons. My work was focused on these analyses, which participated to the interpretation that the fungus unequally regulates its nutrient exchanges between the two plants according to phosphate concentration.

As an additional conclusion, these works point out that in the field, where one fungus is associated to multiple plants, the dynamic of carbon exchanges are balanced by master criteria: *i*) host photosynthetic physiology, and then development stage, illumination, temperature; *ii*) nutrient availability in soil (showing micro-environmental changes) correlated to soil pH, microbial environment. A third parameter will have to be included: additional AM fungal species with antagonist or synergetic (cooperative) effects to *R. irregularis*. Although simple, symbiocosm experimental design allows investigating the incidence of such parameters, mimicking symbiotic functioning in natural environment. This experimental system will enrich our knowledge to better define the theoretical considerations on the biological market that represents AM symbiosis (Bücking et al., 2016; Kiers et al., 2016; Walder and van der Heijden, 2015; Wipf et al., 2019).

Imbalanced regulation of fungal nutrient transports according to phosphate availability in a symbiocosm formed by poplar, sorghum, and Rhizophagus irregularis.

Silvia Calabrese^{1*}, Cusant Loïc^{2*}, Alexis Sarazin^{3*}, Annette Niehl¹, Alexander Erban⁴, Daphnée Brulé^{1,5}, Ghislaine Recorbet⁵, Daniel Wipf⁵, Christophe Roux², Joachim Kopka⁴, Thomas Boller¹, Pierre-Emmanuel Courty^{†1,5}

¹ Department of Environmental Sciences, Botany, Zurich-Basel Plant Science Center, University of Basel, Hebelstrasse 1, Basel, 4056, Switzerland

² Laboratoire de Recherche en Sciences Végétales, Université de Toulouse, UPS, CNRS, 24 Chemin de Borde Rouge-Auzeville, Castanet-Tolosan, France

³ Department of Biology at the Swiss Federal Institute of Technology Zurich, Universitätstrasse 2, 8092, Zurich, Switzerland

⁴ Max Planck Institute of Molecular Plant Physiology, Am Mühlberg 1, Potsdam-Golm, 14476, Germany

⁵ Agroécologie, AgroSupDijon, CNRS, INRA, Université de Bourgogne Franche-Comté, 21000 Dijon, France

*: these authors contributed equally to the work.

† **Corresponding Author:** Dr. PE Courty, Agroécologie, AgroSupDijon, CNRS, INRA, Université de Bourgogne Franche-Comté, 21000 Dijon, France, Tel: +33 3 80 69 33 55, pierre-emmanuel.courty@inra.fr

I. Highlight

Gene expression analysis in arbuscular mycorrhizal symbiosis upon phosphate variations reveals imbalanced fungal gene regulation between perennial/C3 and annual/C4 host, highlights new mycorrhiza-inducible transporters and suggests active fungal carbohydrate uptake.

II. Abstract

In arbuscular mycorrhizal (AM) symbiosis, key components of nutrient uptake and exchange are specialized transporters that facilitate nutrient transport across membranes. As phosphate is a nutrient and a regulator of nutrient exchanges, we

investigated the effect of P availability to extra-radical mycelium (ERM) on both plant and fungus transcriptomes and metabolomes in a symbiocosm system. By perturbing nutrient exchanges under the control of P, our objectives were to identify new fungal genes involved in nutrient transports, and to characterize in which extent the fungus differentially modulates its metabolism when interacting with two different plant species. We performed transportome analysis on the extraradical (ERM) and intraradical mycelium (IRM) of the AM fungus *Rhizophagus irregularis* associated with *Populus trichocarpa* and *Sorghum bicolor* under high and low P availability in ERM, using quantitative RT-PCR and Illumina mRNA-sequencing. We observed that mycorrhizal symbiosis induces expression of specific phosphate and ammonium transporters in both plants. Furthermore, we identified new AM-inducible transporters and showed that a subset of phosphate transporters is regulated independently of symbiotic nutrient exchange. mRNA-Sequencing revealed that the fungal transportome was not similarly regulated in the two host plant species according to P availability. Mirroring this effect, many plant carbohydrate transporters were down-regulated in *P. trichocarpa* mycorrhizal root tissue. Metabolome analysis revealed further that AM root colonization led to a modification of root primary metabolism under low and high P availability and to a decrease of primary metabolite pools in general. Moreover, the downregulation of the sucrose transporters (SUT) suggests that the plant limits carbohydrate long-distance transport (*ie* from shoot to the mycorrhizal roots). By simultaneous uptake/reuptake of nutrients from the apoplast at the biotrophic interface, plant and fungus are both able to control reciprocal nutrient fluxes.

III. Keywords

Arbuscular mycorrhizal fungi, Symbiocosm, Extraradical mycelium, Intraradical mycelium, Phosphorus, Ammonium, Carbohydrates transporters, Lipid metabolism

IV. Abbreviations

AM, Arbuscular mycorrhiza; AMF, Arbuscular mycorrhizal fungi; AMT, Ammonium transporter; ERM, Extraradical mycelium; IRM, Intraradical mycelium; N, Nitrogen;

P, Phosphorus; Pi, inorganic phosphate; PT, Phosphate transporter; GS/GOGAT, glutamine synthetase/glutamine oxoglutarate aminotransferase

V. Introduction

Phosphorus (P), and nitrogen (N), are among the most essential nutrients for plants. As P is present in many biological compounds and is involved in many key metabolic processes, it can make up to 0.2% of the dry weight of a plant (Schachtman et al., 1998). In living plants, the cellular inorganic phosphate (Pi) concentration ranges between 1-10mM whereas the soil water Pi concentration is about 10,000-times less (Ai et al., 2009; Branscheid et al., 2010; Rausch and Bucher, 2002). Due to its negative charge and its low mobility, Pi is rapidly sequestered by cations and organic substances in the soil (*e.g.* clay) and therefore only barely accessible to plants (Aung et al., 2006; Chiou et al., 2006; Javot et al., 2007a; Poirier and Bucher, 2002; Tatry et al., 2009). To prevent mineral nutrient deficiency and P deficiency in particular, a majority of land plants form symbioses with the so-called arbuscular mycorrhizal (AM) fungi. In the AM symbiosis the AM fungus provides macro and micronutrients to the plants and in return receives carbohydrates from the host plant (Smith and Read, 2010). AM fungi have a broad host range: each fungal species (each genet) can colonize several plant individuals (also from different species) connected to each other and forming a so-called common mycorrhizal network (Fellbaum et al., 2014; Walder et al., 2012). The extraradical mycelium (ERM) of the AM fungi engaged in such a network is able to acquire nutrients that are out of reach or not accessible to the plant partners. For a given plant, this makes the mycorrhizal uptake pathway often more effective than the direct uptake pathway (Wipf et al., 2019). The nutrients taken up by the ERM are transported to the hyphal network inside the host root via the intraradical mycelium (IRM), which forms highly branched tree-like structures (arbuscules) inside the root cortical cells. The arbuscules are still surrounded by the plant cell-derived periarbuscular membrane and the inter-membrane interstice, the periarbuscular space. Within this structure, the mineral nutrients acquired by the AM fungus are exported to the periarbuscular space, and taken up by plant nutrient transporters of the periarbuscular membrane (Smith and Smith, 2011).

With respect to Pi, the extent to which plants cover their Pi-demand through the AM fungus ranges from only a small percentage to 100 % (Javot et al., 2007a; Paszkowski, 2006). The Pi taken up by the ERM is incorporated into poly-P, transported to the arbuscules, hydrolyzed and translocated to the periarbuscular space (Ezawa et al., 2002; Javot et al., 2007a; Kikuchi et al., 2016). Essential key players in this process are transporters and permeases that facilitate uptake and transport of nutrients across membranes. The expression of transporters is regulated by nutrient availability. In this way, a steady and efficient translocation of nutrients, adapted to given environmental conditions, can be guaranteed (Courty et al., 2015; Garcia et al., 2016; Smith and Smith, 2011; Wipf et al., 2019).

In AM fungi, only few phosphate transporters (PT) were characterized so far: one in *Funneliformis mosseae* (GmosPT, Benedetto et al., 2005) and *Glomus versiforme* (GvPT, Harrison and Buuren 1995), and seven in *Rhizophagus irregularis* (formerly *Glomus intraradices*, RiPT1-RiPT7; Maldonado-Mendoza et al., 2001; Walder et al., 2016). Expression of the three high-affinity transporters, *RiPT1*, *GvPT*, and *GmosPT*, is dependent on external Pi concentrations in the ERM (Benedetto et al., 2005; Harrison and van Buuren, 1995; Maldonado-Mendoza et al., 2001). Reduced expression of *GmosPT* in the intraradical mycelium (IRM) compared to the extraradical mycelium (ERM) suggested a concentration-dependent regulation of PTs in the symbiotic root tissue.

In plants, the family of PTs can be divided into three subfamilies. Subfamily I transporters (Pht1) are membrane-bound H⁺/P symporters driven by an H⁺ gradient. They are a subgroup of the major facilitator superfamily to which most of the PTs known to date belong (Pao et al., 1998). Subfamily II members are located in the plastids and function as antiporters (Javot et al., 2007b; Poirier and Bucher, 2002; Rausch and Bucher, 2002); members of the subfamily III are located in the mitochondrial inner membrane and are predicted to function as H⁺/P symporters or as P/OH⁻ antiporters (Javot et al., 2007b; Takabatake et al., 1999). In mycorrhizal plants, some Pht1 phosphate transporters are specifically induced during symbiotic interaction. The first mycorrhiza-inducible PT was identified in *Solanum tuberosum* (StPT3) and was localized in arbusculated root sections (Rausch et al., 2001). Then, more mycorrhiza-inducible transporters were identified in several other plants

(Glassop et al., 2005; Harrison et al., 2002; Loth-Pereda et al., 2011; Nagy et al., 2005). StPT3 and MtPT4 from *Medicago truncatula* were present in the periarbuscular membrane only. Furthermore, it was demonstrated that MtPT4-deficient plants accumulated Pi as poly-P in the arbuscules, which resulted in a premature collapse of the arbuscules and in inefficient symbiosis (Breuillin-Sessoms et al., 2015; Javot et al., 2007a).

For N, it was long assumed that AM symbiosis plays only a minor role in plant nutrition. In the soil, inorganic N is mostly present as nitrate or ammonium, both of which are readily mobile in the soil. Therefore, it was assumed that AM fungi take up N with the same efficiency as plants (Hodge et al., 2010; Marschner and Dell, 1994; Smith and Smith, 2011). But, it was shown that AM fungi can contribute up to 42% of the plant N demand (Frey and Schüepp, 1993; Govindarajulu et al., 2005; Mäder et al., 2000). In addition to the uptake of ammonium and nitrate, it was shown that AM fungi can take up N in the form of organic molecules (*i.e.* small peptides and amino acids) (Bago et al., 1996; Govindarajulu et al., 2005; Hawkins et al., 2000; Jin et al., 2005; Mäder et al., 2000) and possibly also in the form of more complex organic compounds (Hodge et al., 2010; Leigh et al., 2009). However, in plants as well as in AM fungi, it was shown that ammonium is the preferred N source, as it can be directly incorporated into glutamine by the glutamine synthetase/glutamine oxoglutarate aminotransferase (GS/GOGAT) pathway whereas nitrate needs to be reduced to ammonium before N assimilation in the GS/GOGAT pathway (Hawkins et al., 2000; Toussaint et al., 2004; Villegas et al., 1996). In the ERM of AM fungi, the glutamine is further metabolized into amino acids such as arginine, alanine, and asparagine for transport. Studies using ¹⁵N showed that arginine was the most common labeled amino acid in the ERM of AM fungi (Govindarajulu et al., 2005). Arginine is then transported from the ERM to the IRM where it is cleaved by arginases in the arbuscules. The released ammonium is transported to the periarbuscular space where it can be taken up by the plant ammonium transporters (AMT). So far, only six transporters have been identified and functionally characterized in Glomeromycotina, three in *R. irregularis* GintAMT1, GintAMT2 and GintAMT3 (Calabrese et al., 2016; López-Pedrosa et al., 2006; Pérez-Tienda et al., 2011), and three in *Geosiphon pyriformis* (GpAmt1, GpAmt2, GpAmt3; (Ellerbeck et al., 2013)).

In plants, the family of AMT can be divided into two subfamilies: subfamily I and subfamily II (reviewed in Courty et al., 2015). While members of the subfamily I were found to be mostly expressed in roots, members of the subfamily II were preferentially expressed in shoots (Couturier et al., 2007). Several mycorrhiza-inducible AMTs have been identified through gene expression analysis in several plant species (Gomez et al., 2009; Guether et al., 2009; Kobae et al., 2010), including *PtAMT1;2* in poplar (Couturier et al., 2007; Selle et al., 2005) and *SbAMT3;1* and *SbAMT4* in sorghum (Koegel et al., 2013).

In return for the mineral nutrient, the AM fungi receive photosynthetates from the plants. In absence of gene encoding fatty acid synthase in their genome (Tang et al., 2016b; Wewer et al., 2014), AM fungi are dependent on host fatty acids. Although the mechanism of transfer remains unknown, it was demonstrated that palmitic acid is transferred from plant roots to symbiotic mycelium, putatively esterified as monoacyl-glycerol (Bravo et al., 2017; Jiang et al., 2017; Keymer et al., 2017; Luginbuehl et al., 2017). Research on sugar transporter (SUT) expression in plants is not as consistent. Mycorrhization caused either increased or decreased expression of SUTs in root and shoots of the host plants (Boldt et al., 2011; Doidy et al., 2012a; Ge et al., 2008). A new class of SUT, the SWEETs, was identified. These transporters are located in the plasma membrane and have been shown to function as bidirectional sugar uniporters (Chen et al., 2010). Due to their involvement in rhizobial symbiosis it is assumed that they may also play a role in other biotrophic plant symbioses such as the AM symbiosis (Doidy et al., 2012b; Gamas, 1996).

In the AM fungus *R. irregularis*, four carbohydrate transporters have been identified (Helber et al., 2011a). The gene encoding the monosaccharide transporter *RiMST2* was the most highly expressed transporter in symbiotic tissue, and it could be localized in the arbuscules and in the IRM. Within this line, An et al. recently showed that the expression of the gene encoding *M. truncatula* *SWEET1b* transporter is strongly enhanced in arbuscule-containing cells compared to roots and localizes to the peri-arbuscule membrane (An et al., 2019).

A comprehensive view of symbiosis under environmental and nutritional stress is important in times of climate change and resource shortening, as AM symbiosis is a key component of nutrient uptake and exchange through their transport systems.

However, despite accumulating knowledge about transporter expression and metabolic activity in AM symbiosis, we still lack a precise understanding of their regulation and their importance for metabolism. Here, our objectives were to define the effects of P availability on two plants connected through a mycorrhizal network. Therefore, we analyzed the effects of mycorrhization and contrasting P nutrition on the transporter expression and metabolite accumulation in *Populus trichocarpa* (poplar) and *Sorghum bicolor* (sorghum) when colonized by the AM fungus *R. irregularis*. Our main focus was on the regulatory role of the mycorrhization and P nutrition on the expression of the Pht1 PTs in the plants and in the AM fungus. Further, we assessed the effect of the applied conditions on AMTs and carbohydrate transporters. In the AM fungus *R. irregularis*, we determined expression of PTs, AMTs, monosaccharide transporters (MST) and fatty acid metabolism in the ERM and in the IRM of colonized poplar and sorghum roots. We identified new specific mycorrhiza-inducible PTs and AMTs in poplar and sorghum. Moreover, our data allowed us to gain further insight into symbiotic carbon exchange.

VI. Material and Methods

A. Experimental set-up

Experiments were performed with *P. trichocarpa* cuttings (clone 10174, Orléans, France) and *S. bicolor* (L.) Moench, cv Pant-5. Sorghum seeds were kindly provided by I.G.F.R.I. (CSS Agriculture University of Hissar, Haryana, India) and G.B. Pant University of Agriculture and Technology (Pantanagar, Uttaranchal, India). Seeds were surface-sterilized in 2.5% KClO for 10 min, rinsed several times with sterile deionized water and soaked overnight in sterile deionized water. Seeds were germinated in the dark at 25°C for three days. Plants were inoculated with 1 ml liquid inoculum of *R. irregularis*, isolate BEG75 (Inoculum Plus, Dijon, France), in 0.01 M citrate buffer (pH 6) with about 110 spores/ml. The microcosms were set up in tripartite compartments (mycorrhizal treatment) or single compartments (non-mycorrhizal treatments). Compartments were filled with an autoclaved (120°C, 20 min) quartz sand (Alsace, Kaltenhouse, Trafor AG, Basel): zeolite (Symbion, Czech

Republic) substrate (1:1, w:w). In the tripartite compartment system, poplar cuttings were planted in the left compartment and sorghum seedlings in the right compartment. Both plants were inoculated with *R. irregularis* to create a common mycorrhizal network and to increase poplar root colonization (**Figure S1**). Compartments were separated by two 21 μm meshes and one 3 mm mesh, to allow the AM fungus to grow from one compartment to the other but to avoid plant roots protruding the neighboring compartment. As control, non-inoculated poplar and sorghum plantlets grew in single compartments receiving the Pi containing fertilizer treatments directly to their roots. Plants were fertilized once a week with 10 ml Hoagland solution without P until all plants showed signs of P depletion, indicated by anthocyanin accumulation. From the 22nd week high-P (560 μM) or low-P (28 μM) containing Hoagland solution was applied to the first compartment for 9 weeks, to obtain ERM and to ensure that P was delivered via the mycorrhizal uptake pathway. Control plants received fertilizer treatment directly to their root systems.

B. Harvest

The ERM was harvested by dispersing the substrate with tap water and fishing it from the surface using a 32 μM mesh. These steps were repeated several times. Afterward, the cleaned ERM samples were snap-frozen in liquid nitrogen and stored at -80°C .

For RNA extractions, two leaves from the top of Poplar plants and two young leaves of Sorghum plants were snap-frozen in liquid nitrogen and stored at -80°C . The rest of the shoots was harvested and dried in an oven at 55°C for 4 days for total P measurement.

Roots were removed from the substrate under tap water and cut into ~1 cm small pieces. Two subsamples of about 100 mg were immediately frozen in liquid nitrogen and stored at -80°C . One subsample of about 100 mg was taken for root colonization measurements. The remaining roots were placed in a paper bag and dried at 55°C for 3.5 days for determination of total P and N content.

C. Colonization measurements and P extraction

Roots were immersed in 10% KOH and stored at 4°C overnight. The next day, the roots were rinsed with tap water and immersed in 2% HCl for 1 hour at room temperature. Then, the roots were rinsed with tap water, immersed in 0.005% trypan blue (w:v in lactic-acid: glycerol: water, 1:1:1, v:v:v) and stored at 4°C o/n. The next day, the roots were rinsed and immersed in lactic-acid glycerol water (1:1:1, v:v:v) for destaining. Total colonization count was performed using the gridline intersection method as described (Brundrett et al., 1984). Differences between means of variables were assessed by t-test ($p < 0.05$), using Microsoft Excel 2010.

For determination of P concentration in the plants, dried root and shoot samples of six biological replicates were ground using a ball mill. Up to 500mg were used for the modified P extraction method by (Murphy and Riley, 1962).

D. RNA extraction

Total RNA was extracted from six biological replicates per plant species and mycelium, respectively. Total RNA was extracted from lyophilized extraradical mycelia, root and leaf samples using the RNeasy Plant Mini Kit (Qiagen, Courtaboeuf, France). RNA extracts were DNase treated with the DNA-free™ Kit, DNase Treatment and Removal Reagents (AMBION® by life technologies). Total RNA was quantified with the Qbit RNA BR Assay kit and purity was estimated using the Nanodrop (ND-1000, Witec, Switzerland).

E. Reverse transcription and qRT-PCR

cDNAs from three biological replicates were obtained using the iScript™cDNA Synthesis Kit (BIO RAD Laboratories, Paolo Alto, CA, United States), using 200ng of total RNA per reaction, using same RNA extracts as for mRNA sequencing. For quantification, a two-step quantitative RT-PCR approach was used. Gene-specific primers were designed in Primer 3 (http://frodo.wi.mit.edu/cgi-bin/primer3/primer3_www.cgi) and tested as well in amplify 3.1 (<http://engels.genetics.wisc.edu/amplify>). Target gene expressions were normalized to the expression of the reference gene ubiquitin in Poplar (Potri.015G013600) and Sorghum (Sb10g026870) and translation elongation factor in

R. irregularis, respectively. All primers used are listed in **Table S1**. qRT-PCRs were run in a 7500 real-time PCR system (Roche) using the following settings: 95°C for 3 min and then 40 cycles of 95°C for 30 s, 60°C for 1 min and 72°C for 30 s. There were three biological and three technical replicates per treatment. Differences in gene expression between applied conditions were tested by a one-way ANOVA using SPSS Statistics, version 22 (IBM, Chicago, USA).

F. RNA sequencing and data analysis

Total RNA sequencing was done for three biological replicates per condition. Eighteen libraries were prepared and paired-end Illumina HiSeq mRNA sequencing (2x100bp RNA-Seq) was performed by Beckman Coulter Genomics France (Grenoble, France), which produced around 2x80 million reads per library on average. After quality check using FastQC, adaptor sequences were removed using FASTX-Toolkit. Only inserts of at least 30-nt were conserved for further analysis. Reads were mapped with CLC Genomics Workbench 11 (CLC Bio workbench, Qiagen, Aarhus, Denmark) using manufacturer's recommendations on Poplar genome and gene annotation *P. trichocarpa*_210_v3.0 (Tuskan et al., 2006), on Sorghum genome and gene annotation *Sbicolor*_313_v3.1 (McCormick et al., 2018), and on *R. irregularis* gene annotation Rhiir2-1 (Morin et al., 2019). The mapped reads for each transcript were calculated and normalized as RPKM for calculating gene expression (reads per kilobase of transcripts per million reads mapped—Mortazavi et al., 2008). Intact and broken pairs were both counted as one. The RPKMs of each transcript in different conditions were compared using proportion-based test statistics (Baggerly et al., 2003) implemented in CLC genomic Workbench suite. This beta-binomial test compares the proportions of counts in a group of samples against those of another group of samples. Different weights are given to the samples, depending on their sizes (total counts). The weights are obtained by assuming a Beta distribution on the proportions in a group and estimating these, along with the proportion of a binomial distribution, by the method of moments. The result is a weighted *t*-type test statistic. We then calculated False Discovery Rate (FDR) correction for multiple-hypothesis test (Benjamini and Hochberg, 1995). Only genes showing a difference of 10 reads between compared conditions were considered as significantly expressed. Genes were considered as differentially expressed when meeting the requirements

of fold change $\geq |2|$ and FDR ≤ 0.05 . The expression was then normalized using RPKM. Raw RNAseq data and global mapping data analyses were deposited at GEO (GSE138316).

G. Metabolite profiling and data analysis

For extraction of soluble metabolites about 90 mg of deep-frozen poplar root and ERM samples (three biological replicates per condition) were pulverized in liquid nitrogen. Metabolite profiling was performed as described in (Dethloff et al., 2014) by gas chromatography coupled to electron impact ionization/time-of-flight mass spectrometry (GC-EI/TOF-MS) using an Agilent 6890N24 gas chromatograph (Agilent Technologies, Böblingen, Germany; <http://www.agilent.com>). Guidelines for manually supervised metabolite identification were the presence of at least 3 specific mass fragments per compound and a retention index deviation $< 1.0\%$ (Strehmel et al., 2008). For quantification purposes all mass features were evaluated for best specific, selective and quantitative representation of observed analytes. Laboratory and reagent contaminations were evaluated and removed according to non-sample control experiments. Metabolites were routinely assessed by log₂-transformed relative changes expressed as response ratios. Statistical testing, namely 2-way analysis of variance (ANOVA) and Wilcoxon-Mann-Whitney testing of significance were performed using relative abundances or log₂-transformed ratios. Statistical assessments and data visualizations were performed using the multi-experiment viewer software, MeV (Version 4.9; <http://www.tm4.org/mev.html>; Saeed et al., 2006) and the Microsoft-Excel 2010 program.

VII. Results

A. Colonization, and N and P measurements

AM colonization of roots was between 79% and 87% (poplar) and about 93% (sorghum) (Table S2). Non-AM plants were not colonized. The hyphal colonization and the percentage of vesicles were not significantly different between low-P and high-P treatments in sorghum and poplar plants. However, significantly, sorghum roots contained three times more arbuscules in the low-P treatment, indicating that P starvation supported mycorrhization.

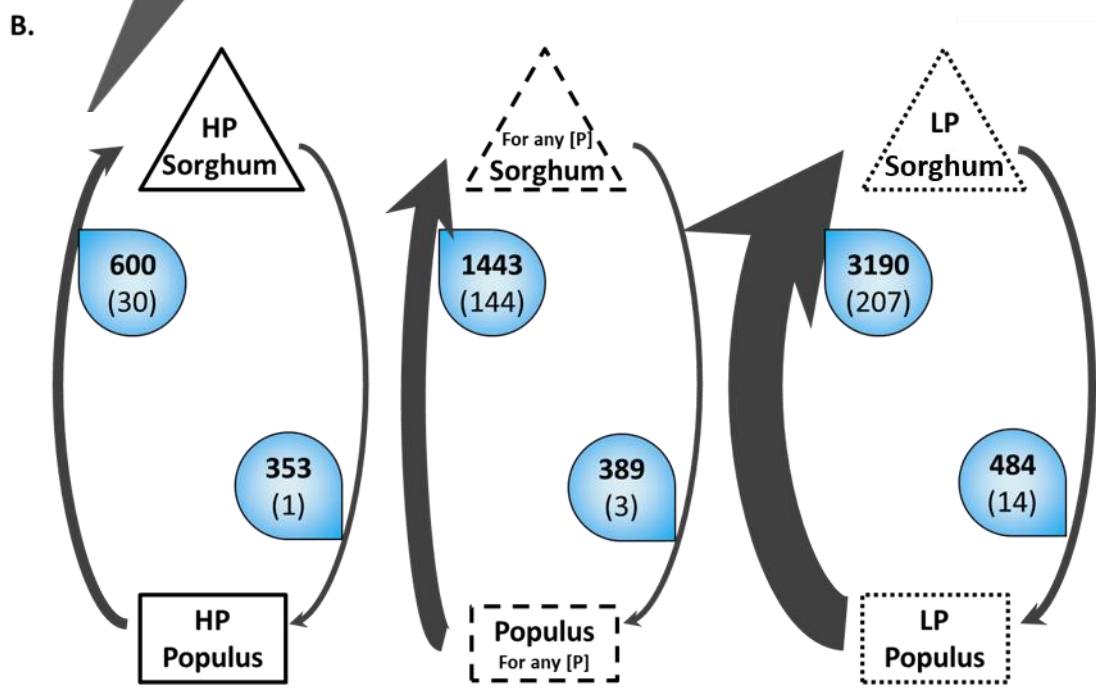
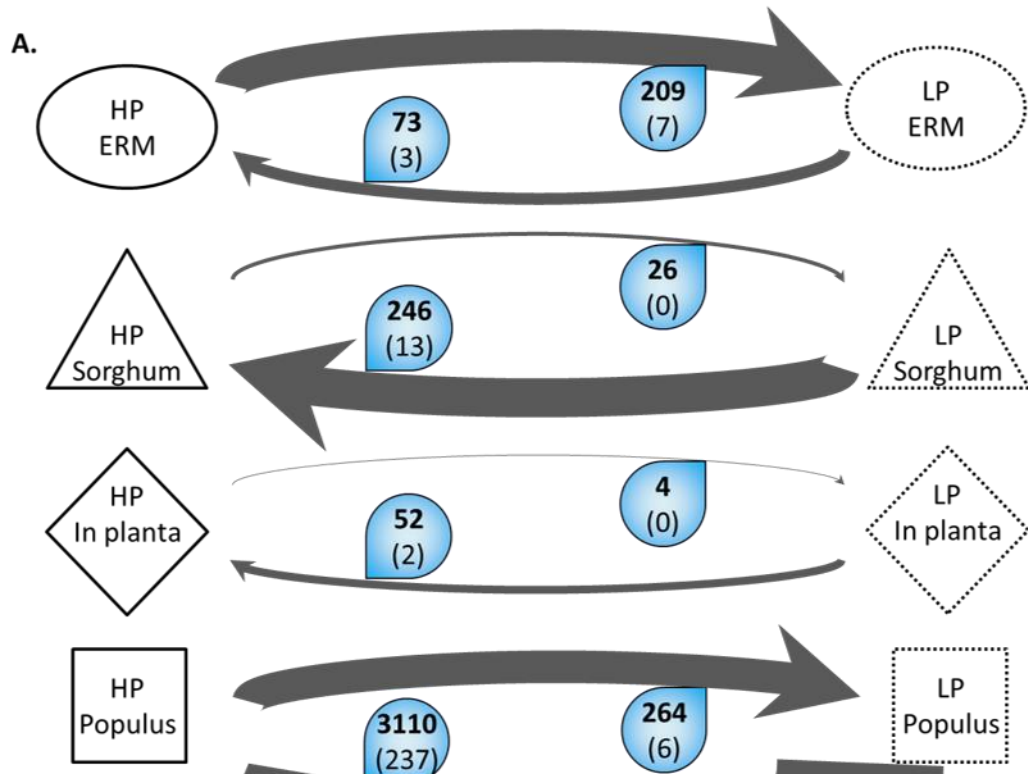

Figure 1. Overall variations of the number of Differentially Expressed Genes (DEG) of *R. irregularis*

A. Variations according to P. The arrows represent the number of differentially expressed genes in *R. irregularis*. Black bold numbers represent the number of genes with a fold change ≥ 2 and a FDR $\leq 0,05$. White numbers in brackets represent the number of genes involved in the transportome. The width of the arrow is proportional to the number of up-regulated genes.

For example, the top arrow means that in the ERM grown in Low Phosphate, 209 genes are significantly up regulated at least 2 times compared to the ERM grown in High Phosphate. Among these 209 genes, 7 are involved in the transportome.

B. Variations according to host plant. The arrows represent number of differentially expressed genes in *R. irregularis* between the two compared conditions. Black bold numbers represent the number of genes with a fold change ≥ 2 and a FDR $\leq 0,05$. White numbers in brackets represent the number of genes involved in the transportome. The width of the arrow is proportional to the number of up-regulated genes.

ERM : Extra Radical Mycelium ; HP: High Phosphate ; LP : Low Phosphate ; *in planta* : Intra Radical Mycelium of both Sorghum and Poplar.

P treatment had significant effects on P content in the shoots and roots of poplar and sorghum (Figure S2). High-P treatment on ERM increased P content in roots and shoots, except for the roots from non-AM sorghum plants. Under the same P supply conditions, non-AM poplar accumulated more P than AM poplar whereas, in AM sorghum, P accumulation was comparable to non-AM plants.

B. Patterns of ERM and IRM expressomes in the symbiocosm

1. Incidence of phosphate availability

The symbiotic part of the mycelium in roots (Intra Radical Mycelium, IRM) showed different gene expression patterns according to phosphate concentration and plant host. The total number of differentially expressed genes (DEG) differs around 10 fold between the two plants with 298 genes differentially regulated in *S. bicolor* plants against 3162 in *P. trichocarpa* in response to phosphate treatment (Figure 1A). High phosphate concentration has a fewer incidence on the IRM transcriptome in *S. bicolor* than in *P. trichocarpa* whereas the fungus is connected to both plants, indicating that the allocation of mineral nutrients is more tightly regulated in *P. trichocarpa*

than in *S. bicolor*. In both plants, the number of up-regulated fungal genes is 10 times the number of down-regulated fungal genes in high-P condition compared to low-P.

This indicates that the fungus is metabolically more active in high-P condition, consistent with the fact that adding a high-P solution in the CMN compartment enhances the fungal-dependent Pi acquisition pathway. Only two fungal genes were significantly up-regulated in both plants in response to high-P treatment and are involved in vesicular cargo. In Sorghum, the few up-regulated genes were involved in vesicular trafficking, lipid binding, nitrate reduction, and general transport. In *P. trichocarpa*, the genes up-regulated by high-P belonged to vesicle metabolism, fatty acid metabolism and transport of nitrogen, Pi, sugars, and water. Interestingly, only one gene (a short-chain dehydrogenase) was significantly up-regulated in both plants and in the ERM in response to high-P treatment.

It is noteworthy that on the one hand, while cultivated in high-P, 3408 genes were overexpressed in IRM (either in *S. bicolor* or in *P. trichocarpa* or in both host plants) against 73 in the ERM compartment. On the other hand, while grown in low-P, the number of up-regulated genes *in planta* dropped to 294 against 209 in the ERM. These overall expressome patterns suggest that when Pi is abundant in soil, the fungus invests little energy in recruiting the Pi but is highly active in exchanging this nutrient with the plants. On the opposite, when Pi is scarce in the medium, the extra radicle mycelium has to put a lot of energy in recovering the mineral in the soil but has fewer nutrients to exchange with the plants.

2. Incidence of host plant

We correlated the difference of DEG in the IRM in the two host plants connected by the same fungus at a given time point to the amount of nutrient resources that the fungus allocates to the two plants. Even though AM fungus has a very broad host range, their expressome differs according to host independently to P concentration (Figure 1B). In poplar, only 389 DEG were found among which only 3 are involved in the transportome (1 vesicle transport and 2 transporters). In *S. bicolor*, a set of 1443 fungal genes were found up-regulated, indicating active exchanges. A tenth of them (144) is involved in the transportome, representing all metabolisms (fatty acids,

nitrogen, phosphate, sugars, potassium, general transporters, water, and vesicle transport). This difference indicates that AM symbiosis is more active and more tightly regulated in sorghum than in poplar (Figure 1B). The total P concentrations measured in the two mycorrhizal plants are consistent with this observation as more P was accumulated in mycorrhizal sorghum than in mycorrhizal poplar under low P fertilization (Figure S2).

In the mesocosm grown in low-P, the fungus does not allocate nutrients equally between the different host plants. The number of genes up-regulated in *S. bicolor* is 6.5 times the number of genes overexpressed in *P. trichocarpa* (3190 and 484 respectively). Not all these genes are supposed to be involved in trophic exchanges but the genes involved in transportome between the two plants showed a similar pattern. In *S. bicolor*, 207 fungal genes were up-regulated, corresponding to all the different metabolisms and transporters we investigated (fatty acids, nitrogen, phosphate, sugars, transporters, water and vesicle transport, with the exception of potassium). In *P. trichocarpa* however, only 14 genes belonged to our transportome list and were involved in sugar transport, vesicle trafficking, and general transporters. In low-P condition, the AMF seems to favor the exchanges with the Sorghum at the expense of the Poplar. This observation correlates with the total phosphate measured in the two plants (Figure S2).

Under high-P, the difference in gene expression is lower than in low-P. We observe only a 2-fold difference between the number of overexpressed genes in *S. bicolor* and *P. trichocarpa* (600 and 353 respectively). Moreover, the number of genes involved in transportome is much lower. Only one gene involved in vesicular trafficking is specifically expressed in *P. trichocarpa*. In *S. bicolor*, 30 genes involved in fatty acid metabolism, sugar transport, vesicle transport, and general transport were recovered. The high-P makes it easily recoverable by the AM fungus and improves symbiotic exchanges with both plants, thus minimizing the preference for *S. bicolor* over *P. trichocarpa*. This balanced fungal transcriptome is supported by plant P concentration as the measurements in the two plants are very close, with a slight abundance in poplar.

C. Regulation of phosphate transporter expression

1. Gene expression of plant Pht1 transporters

Using qRT-PCR, we measured the expression of the twelve Pht1 phosphate transporters in roots and shoots of AM and non-AM poplar plants grown in high-P and low-P conditions. *PtPT8* and *PtPT10* were induced in AM-roots only, which implies an important role of these two transporters in symbiotic Pi uptake at the periarbuscular space (Figure S3).

Low-P treatment and mycorrhization induced expression of *PtPT1.1*, *PtPT1.2*, *PtPT1.4*, *PtPhT1.7* and *PtPT1.11* in roots (Figure S3B). *PtPT1.2*, *PtPT1.4*, and *PtPT1.11* were strongly induced in shoots, suggesting that these transporters are involved in intercellular Pi transfer and Pi transport over long distances, respectively (Figure S3A). *PtPT1.3* and *PtPT1.6* were neither expressed in roots nor in shoots. mRNA-Seq analysis independently confirmed our results for Pht1 expression (Figure S4).

In sorghum, *SbPT1.8* and *SbPT1.10* were induced in AM roots like *PtPT1.8* and *PtPT1.10* (Figure S5). *SbPT1.1*, *SbPT1.2*, *SbPT1.4*, *SbPT1.6*, and *SbPT1.7* were significantly induced in the non-AM low-P treatment. It seems that mycorrhization complemented sufficiently the P deficiency by increased Pi transfer to its host plant (Figure S2). In comparison to poplar Pht1, sorghum Pht1 was more susceptible to mycorrhization than to Pi concentration.

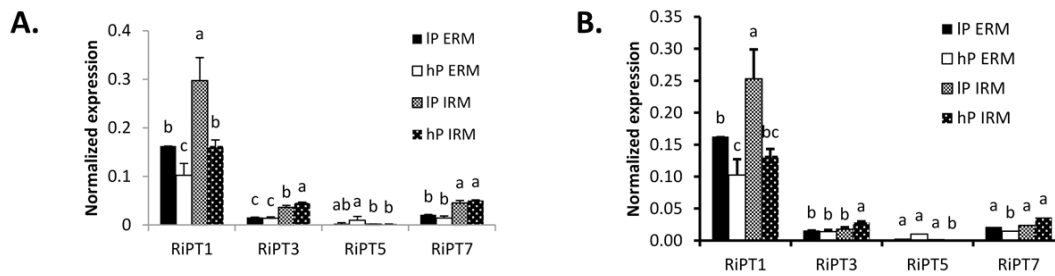

Figure 2

Figure 2. Quantification by qRT-PCR of the transcript abundances of phosphate transporters in *R. irregularis* when associated with *P. trichocarpa* (a) and *S. bicolor* (b). Quantification of transcript levels of transporters in the ERM and in the IRM of the host plant under high (hP) and low (lP) availability of P. Values are means of three biological and three technical replicates. Error bars represent the SE. Translational elongation factor was used as a reference transcript. Statistical analysis was performed by analysis of variance for each gene, followed by Tuckey honest significant difference

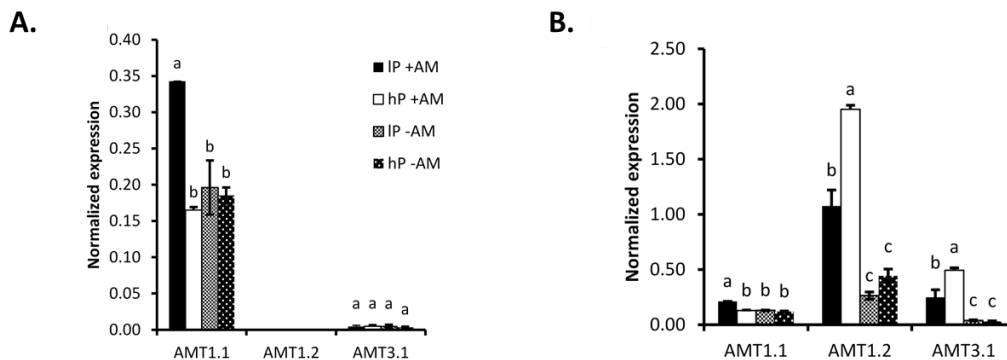

Figure 3

Figure 3. Quantification by qRT-PCR of the transcript abundances of the three ammonium transporters of poplar *PtAMT1.1*, *PtAMT1.2* and *PtAMT3.1* in the shoot (A) and root (B) of mycorrhized (+AM) and non-mycorrhized (-AM) *P. trichocarpa* under low P (lP) and high P (hP) condition. Values are the means of three biological replicates and three technical replicates, each. Error bars represent the SE. Ubiquitin was used as reference transcript. Statistical analysis was performed by analysis of variance (ANOVA) per gene, followed by Tuckey honest significant difference test (Tuckey HSD; $p < 0.05$).

2. Gene expression of mycorrhizal phosphate transporters (PT)

In mycorrhizal poplar plants, qRT-PCR analysis of PT in the AM fungus *R. irregularis* in the ERM and IRM revealed expression of *RiPT1*, *RiPT3*, *RiPT5*, and *RiPT7*, with highest expression values for *RiPT1* (Figure 2A). *RiPT1* was significantly more expressed in the IRM compared to the ERM in low-P treatment. *RiPT1* expression was significantly higher under low-P treatment in the ERM and the IRM compared to high-P treatment. *RiPT7* tended to be highly expressed in the IRM compared to the ERM and *RiPT3* was lowly expressed in the ERM and induced in high-P treatment in the IRM. In Sorghum, we observed similar expression patterns except for *RiPT3* and *RiPT7*, significantly induced in the IRM than in the ERM (Figure 2B).

D. Regulation of transporters involved in nitrogen exchange

1. Gene expression of plant AMTs

As nitrogen is a major component of AM symbiosis, transcript abundances of AMTs in poplar were analyzed (Figure S6). The expression of three of them (*PtAMT1.1*, *PtAMT1.2*, and *PtAMT3.1*) was dependent on either mycorrhizal symbiosis or P-treatment or both. We then measured their expression in poplar by qRT-PCR. While *PtAMT1.1* and *PtAMT1.2* were described as induced in poplar upon mycorrhization with the ectomycorrhizal fungi *Paxillus involutus* (Couturier et al., 2007) and *Amanita muscaria* (Selle et al., 2005), no previous expression data were available for *PtAMT3.1*. Interestingly, *PtAMT3.1* clustered next to the three AM-inducible transporters *GmAMT3.1* (Kobae et al., 2010), *SbAMT3.1* (Koegel et al., 2013) and *OsAMT3.1* (Pérez-Tienda et al., 2014) (Figure S6). Here, *PtAMT1.1* was induced in the AM low-P treatment and the *PtAMT1.2* and *PtAMT3.1* were induced in the AM treatments (Figure 3). In addition, *PtAMT1.2* and *PtAMT3.1* were even higher expressed in the high-P condition, suggesting that both AMTs play a major role in symbiotic nitrogen transfer. Higher expression of these transporters under AM high-P condition might point to an increased nitrogen transfer when the AM fungus has

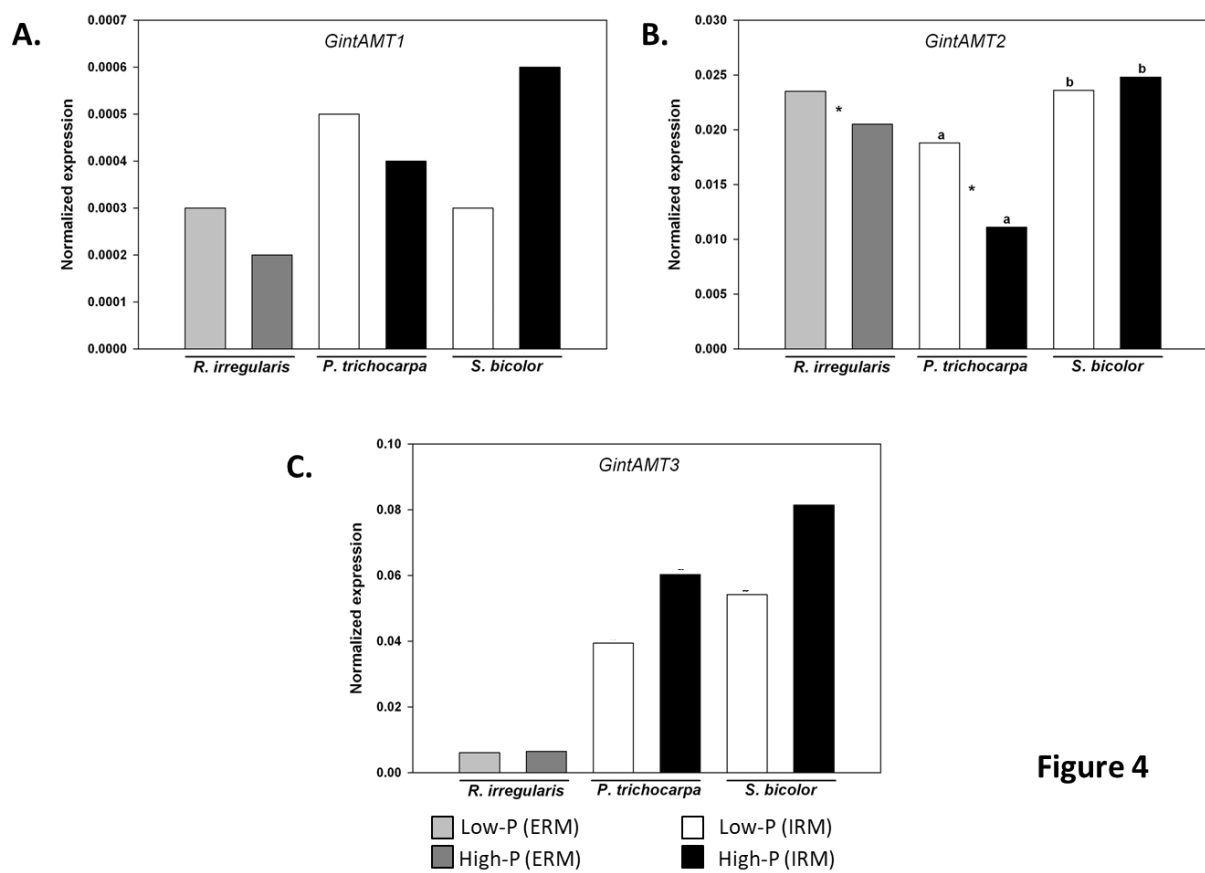

Figure 4

Figure 4. Quantification by qRT-PCR of the transcript abundances of ammonium transporters in *R. irregularis*. Transcript abundances were measured under low-P and high-P availability. Transcript abundances of the three transporters *GintAMT1*, *GintAMT2*, *GintAM3* were measured in the extra-radical mycelium (ERM) and in the intraradical mycelium (IRM) when associated to the host plants poplar and sorghum. Values are means of three biological and three technical replicates. Translational elongation factor was used as a reference transcript. Statistical analysis was performed by analysis of variance for each gene, followed by Tuckey honest significant difference test (Tuckey HSD; $p < 0.05$).

access to more Pi. In shoots, *PtAMT1.1* has a similar expression pattern as in roots. *PtAMT3.1* was only marginally expressed and *PtAMT1.2* was not expressed in leaves (Figure 3). mRNA-Seq confirmed our observations for AMT expression levels in the roots of Poplar (Figure S6). In a previous transcriptome study (Calabrese et al., 2017), in which AM poplar plants were exposed to nitrogen deficiency, *PtAMT4.1*, *PtAMT4.2* and *PtAMT4.3* were AM-induced. Consistent with this previous study, we observed a specific induction of *PtAMT2.2*, *PtAMT4.1*, *PtAMT4.2* and *PtAMT4.3* upon mycorrhization even though these transporters were expressed at lower levels compared to *PtAMT1.2* and *PtAMT3.1*.

In Sorghum, *SbAMT3.1* was specifically induced in AM-roots, and *SbAMT1.1* and *SbAMT1.2* were induced in the non-AM low-P treatment (Figure S7). However, *SbAMT1.1* and *SbAMT1.2* were nearly twice more expressed in shoots compared to roots.

2. Gene expression AMTs in R. irregularis

Quantitative expression analysis of the three AMTs in the AM fungus revealed that their expression is not significantly different in the ERM between the low-P and high-P treatments. The expression of *GintAMT3* was significantly higher in the IRM compared to the ERM (Calabrese et al., 2017). *GintAMT2* and *GintAMT1* were equally expressed in the ERM and IRM in poplar and sorghum (Figure 4). *GintAMT2* was significantly highly expressed in the IRM of sorghum compared to poplar. Specific induction of *GintAMT3* in the IRM might indicate a possible localization of the transporter at the arbuscular side for the transfer of ammonium to the periarbuscular side to enable ammonium uptake for the plant.

3. Gene expression of amino acid and H⁺/oligopeptide transporters

In our study, we identified several amino acid transporters and H⁺/oligopeptide symporters that were either specifically induced or repressed upon mycorrhization (Table S3). Here, root colonization highly induced expression of two H⁺/oligopeptide transporters. Potri.005G233500, a homologous gene of *AtPTR1* shown to transport di-/tripeptides with low selectivity in *Arabidopsis thaliana*, was highly induced. *AtPTR1* is situated in the plasma membrane of vascular tissue which indicates a role in long-

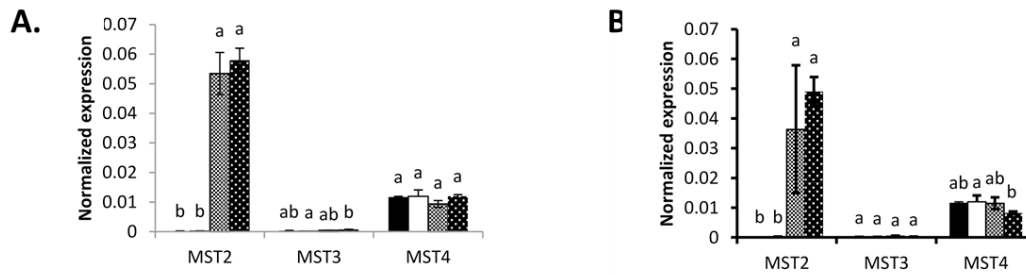

Figure 5

Figure 5. Quantification by qRT-PCR of the transcript abundances of monosaccharide transporters (MST) in *R. irregularis* when associated with *P. trichocarpa* (a) and *S. bicolor* (b). Quantification of transcript levels of transporters in the ERM and in the IRM of the host plant under high (hP) and low (lP) availability of P. Values are means of three biological and three technical replicates. Error bars represent the SE. Translational elongation factor was used as a reference transcript. Statistical analysis was performed by analysis of variance for each gene, followed by Tuckey honest significant difference

distance transport (Dietrich et al., 2004). *AtPTR3*, a homolog of Potri.002G258900, was induced upon salt stress and was shown to be regulated by methyl jasmonate, salicylic acid, and abscisic acid. Further *AtPTR3* was induced upon inoculation of the plant with pathogens. Reduced activation of *AtPTR3* in *hrpA* mutant indicated that it is a defense-related gene protecting the plant against abiotic and biotic stress (Karim et al., 2005, 2007). The differential expression of these transporters upon mycorrhization may suggest a role of the transporters in N uptake but also a role in AM root colonization.

E. Gene expression related to carbon exchange

1. Gene expression of sugar transporters

Quantitative expression analysis using qRT-PCR of five sugar transporters (*SUT1* and *SUT3* to *SUT6*) in poplar revealed that all were expressed (Figure S8-S9). *SUT1* was only marginally expressed while *SUT4* was strongly expressed in roots and shoots. While *SUT1* and *SUT4* were not differentially expressed upon mycorrhization, surprisingly, *SUT3* was down-regulated upon mycorrhization in roots and shoots of poplar. Interestingly, *SUT6* was down-regulated in shoots by mycorrhization. In sorghum, *SUT1* was also down-regulated (Figure S10). In Poplar, we screened our transcriptome data set for other carbohydrate transporters. We found three carbohydrate transporters induced and four repressed upon mycorrhization (Table S3). Among them, only the transporter/ spinster transmembrane protein Potri.001G286600 presents characteristics for plasma membrane localization. The UDP-galactose transporter related proteins are localized at the lumen of the Golgi cisternae (Norambuena et al., 2002). On the fungal side, the monosaccharide transporter *GintMST2* was specifically induced in the IRM of mycorrhizal poplar and sorghum and its expression was not affected by P concentration (Figure 5). The induction of gene expression the two predicted carbohydrate transporters suggested a role in symbiotic carbohydrate transfer but functional properties still need to be determined. The down-regulation of the expression of the six carbohydrate transporters whereas the fungal *GintMST2* is still expressed in the IRM indicates that the AM fungus obtains the sugar from the intercellular space without the cooperation of the plant itself, turning the AM root into a sink for sugars.

2. Expression of fatty acid genes

Expression of different genes involved in fatty acid synthesis and transfer were screened. The expression of these genes is mandatory in order to accommodate the AM fungus and allow the formation of the arbuscules. *Ram2*, *FatM*, *STR1* were specifically expressed in mycorrhizal Sorghum and *STR2*, *CCaMK*, *RAD1*, *Cyclops* and *Castor/pollux* were upregulated when the plant was in symbiosis (Table S4). These genes followed the same pattern of expression in poplar either in low-P or in high-P condition.

On the fungal side, no fatty acid transporter has been identified yet, suggesting another form of acquisition. However, many genes involved in fatty acid metabolism were overexpressed in the different plants. Multiple lipases and lipid recognition proteins are overexpressed *in planta* compared to the ERM (Table S5). These might play a role both in managing the TAG stock or acquiring fatty acids from the host plant. 3 desaturases and 1 elongase show a slight increase in expression *in planta* compared to *ex planta*. Pi addition had little effect on the ERM but increased the expression of several lipases *in planta*.

F. Primary metabolism of poplar and sorghum roots, and the ERM of *R. irregularis*

To gain further insights into the changes of root primary metabolism caused by the interaction between poplar, sorghum and *R. irregularis* we conducted exemplary GC-MS metabolite profiling experiments. Under our experimental conditions, the ERM metabolite profile of *R. irregularis* was not significantly affected by P conditions (Table 1, S6). In the ERM, we observed slight but mostly non-significant increases of organic acids, glucose, trehalose, glycine and of amino acids with branched aliphatic side chains, with leucine as the only significant increase in our experiment (Table 1, S6).

In contrast, non-AM low-P treatment on poplar roots increased general organic acid and amino acid pools and coincidentally decreased pools of glucose-6-phosphate or fructose-6-phosphate (Table 2, S7). Analysis of variance indicated significant general accumulation of only few metabolites, *i.e.*, 4-amino-butanoic acid (GABA),

isoleucine, phenylalanine, serine, threonic acid, ribonic acid, and arabinonic acid-1,4-lactone independently of the mycorrhizal status (Table 2, S7). AM colonization enhanced nutrient acquisition in the low-P treatment (Table 2, S7). In addition, mycorrhization modified the root primary metabolism under low-P and high-P and caused a general decrease of the metabolite pools. Thirty-eight out of 79 monitored primary metabolite pools were decreased with only one exception besides few still non-identified metabolites, namely trehalose (Table 2, S7). Trehalose is a major storage carbohydrate of AM fungi (Becard et al., 1991). Mycorrhization not only decreased the main organic acids of the TCA cycle, e.g., malic acid, aconitic acid, 2-oxo-glutaric acid, succinic acid, and fumaric acid, but also many amino acids including aspartic and glutamic acid, as well as phenylalanine, glycine, serine, leucine, isoleucine, and valine. In addition, mycorrhization decreased the glucose-6-phosphate, fructose-6-phosphate, *myo*-inositol and galactinol pools and additional carbohydrates including maltose. For sorghum, the effect of P treatment on AM colonized plants was studied only. Compared to poplar, AM sorghum plants are slightly affected by the low-P treatment; we observed only a slight significant decrease of fructose-6-phosphate, glucose-6-phosphate and phosphoric acid under low-P treatment (Table 3).

VIII. Discussion

In this study, we described the effects of P supply and AM colonization on PTs, AMTs, carbohydrate transporters and lipid genes in poplar and sorghum, and in the ERM and IRM of the AM fungus *R. irregularis*.

A. Differential resource allocation in the CMN

In the symbiosome, we observed disequilibrium in fungal DEG patterns according to sorghum and poplar symbiotic tissues in response to high-P concentration supplied to ERM. Sorghum is an annual grass with a C4 metabolism and poplar a perennial tree with a C3 metabolism. The fungal transportome in the fast-growing Poaceae is always more important than in poplar in any given P concentration. It has been shown that the fungus is able to adapt its resource allocation to the best symbiont available

Figure 6

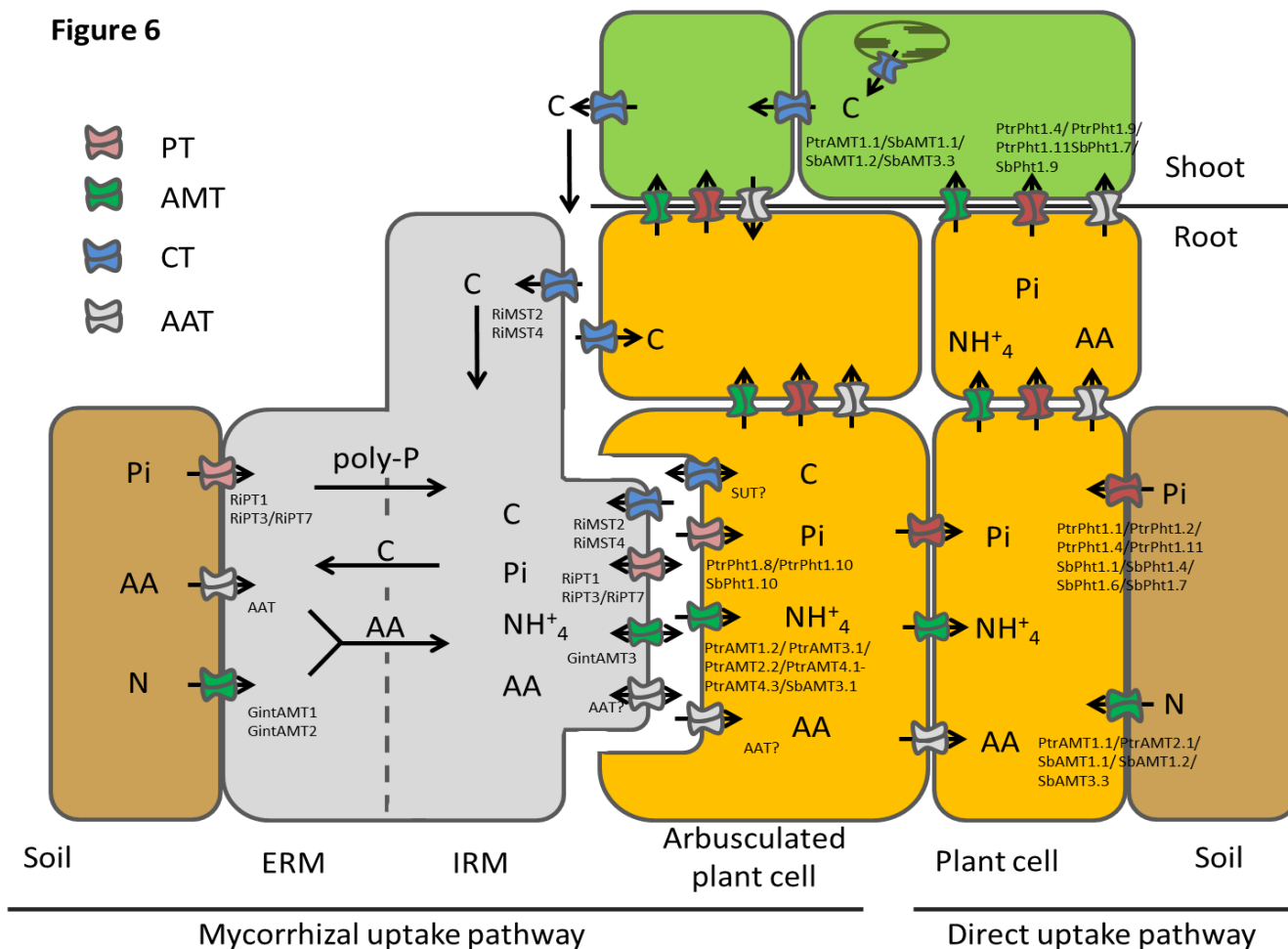

Figure 6. Schematic representation of the mycorrhizal nutrient uptake pathway and the direct nutrient uptake pathway in our model systems poplar and sorghum when colonized by *R. irregularis*. In the direct uptake pathway (right hand side) nutrients, *i.e.* inorganic phosphate (Pi) and nitrogen (N) are taken up from the rhizosphere by phosphate transporters (PT) and ammonium transporters (AMT) and are transported to the shoot. In symbiotic interaction, the AMF partially takes over nutrition of the plant. Nutrients are taken up by specialized transporters in the extraradical mycelium (ERM) and are further transported to the intraradical mycelium (IRM) where they are transferred to the periarbuscular space, to be taken up by plant transporters. N has been suggested to be additionally taken up from the soil in form of amino acids (AA) by predicted amino acid transporters (AAT). In exchange for the transfer of the mineral nutrients the mycorrhizal fungus is rewarded with essential carbohydrates from the plant. As some transporters were specifically induced by mycorrhization a possible localization at the periarbuscular membrane was assumed for the plant transporters. High induction of mycorrhizal transporters in the IRM compared to the extraradical mycelium ERM suggest that these transporters are mainly involved in nutrient exchange at the symbiotic interface. The reality is probably much more complex, with reuptake of nutrients (double-headed arrow) at the biotrophic interface, allowing both partners to, at least partially, control the exchanges.

(Fellbaum et al., 2014; Whiteside et al., 2019). Our data provide same conclusion at the transcriptomic level. However, we have no information about CMN formation and extent of the ERM developed by each of the two host plants and reaching the fungal compartment can be obtained, so differences observed between the two hosts may depend also on a differential ability of the symbiont to form functional ERM. Anyway, we could hypothesize that the perennial poplar plant is less mycorrhiza-dependent than the annual sorghum.

B. Symbiotic phosphorus exchange

In our study, we confirmed the expression of *PtPT1.10* in Poplar AM roots only (Figure S3) as already reported (Loth-Pereda et al., 2011). In addition, *PtPT1.8* was also expressed in AM roots only. In sorghum roots, AM colonization induced the specific expression of *SbPT1.8*, *SbPT1.10* and partially of *SbPT1.11* (Figure S5). The specific induction of *PtPT1.8* and *PtPT1.10* in poplar and of *SbPT1.8*, *SbPT1.10* in sorghum upon mycorrhization strongly suggested that there is a symbiosis-dependent Pi uptake system. In *M. truncatula*, it has been shown that *MtPT4* is specifically expressed in the periarbuscular membrane (Harrison et al., 2002). The specific induction of *PtPT1.8* and *PtPT1.10* in poplar and of *SbPT1.8*, *SbPT1.10* in sorghum suggested that these transporters are localized at the periarbuscular membrane (Figure 6).

On the fungal side, the PTs of *R. irregularis* were expressed in the ERM and in the IRM of poplar and sorghum roots. The high-affinity transporter *RiPT1* was previously found to be regulated in the ERM by external Pi concentration (Maldonado-Mendoza et al., 2001) and expressed at the arbuscular side (Fiorilli et al., 2013). Here, *RiPT1* was up-regulated by external low-P concentrations in the ERM but also in the IRM. High expression of *RiPT1* suggests that *RiPT1* is the main transporter for Pi uptake and symbiotic Pi transfer in our conditions. Maldonado-Mendoza et al. (2001) predicted the existence of other PTs operating at high external P concentrations. Indeed, *RiPT3* and *RiPT7* were expressed but not affected by the nutrient conditions in the ERM. It might be that higher Pi concentrations are needed to increase expression of these possible high-affinity transporters. Clearly, *RiPT3* and *RiPT7* were induced in the IRM with sorghum, with a similar tendency in poplar, suggesting that they participate also in symbiotic Pi transfer, acting as export carriers.

C. P-dependent regulation of PT expression

Low-P conditions induced expression of *PtPT1.1*, *PtPT1.2*, *PtPT1.4* and *PtPT1.11* in poplar roots, showing that expression and regulation of PTs is dependent on Pi availability (Figure S3). In the mycorrhizal microcosm, the only Pi source was the AM fungal symbiont, and the absence of a direct Pi source further increased the expression of these four transporters. As we still observed a Pi-dependent regulation of transporter expression, our data suggest that these PTs are regulated by external and internal Pi-concentrations and are regulated independently by the mycorrhizal pathway. Increased expression of PTs in low-P condition further suggests that the AM fungus supplies the host plant with more Pi if the fungus itself has increased access to Pi. By regulating these PTs independently poplar ensures a P nutrition uncoupled from the AM symbiont. Symbiosis-independent P-nutrition is necessary for perennial plants as mycorrhizal abundance varies in nature with the seasons (Courty et al., 2008; Dumbrell et al., 2011).

The fact that *PtPT1.2*, *PtPT1.4*, and *PtPT1.11* expression was also induced upon P-limiting conditions in the shoots suggests that they function in Pi uptake at the root-soil interface as well as in intercellular distribution and translocation of Pi from root to shoot. *PtPT1.9* was mainly expressed in the shoot, which suggests that it is mainly responsible for Pi allocation in the shoots.

Sorghum, on the other hand, turned out to be more mycorrhiza-dependent than poplar. Under mycorrhization PTs were equally low expressed as under a non-mycorrhizal high-P condition, indicating that the AM fungus was able to cover the Pi needs of sorghum. Induction of PT in the shoots in the non-mycorrhizal low-P condition further showed that the plant suffered from P deficiency and therefore probably reallocated Pi from old leaves (source) to young leaves (sink). The stronger dependency of sorghum to the AM fungus was also indicated by Pi-accumulation in mycorrhizal and non-mycorrhizal sorghum (Figure S2).

1. Symbiotic nitrogen exchange

As symbiotic N transfer is also an important aspect of AM symbiosis we analyzed the effects of mycorrhization and Pi availability on plant and AM fungal AMT expression (Figure 6). In poplar mycorrhization induced expression of three AMTs. Our results are supported by previous studies which showed that *PtAMT1.1* and *PtAMT1.2* were mycorrhiza-inducible when poplar was mycorrhizal with the ectomycorrhizal fungi *P. involutus* (Couturier et al., 2007) and *Amanita muscaria* (Selle et al., 2005) (Figure S6). In addition, we found that *AMT3.1* is as well a mycorrhiza-inducible transporter in the roots, which is in contrast to the data of Couturier et al. (2007) who detected *PtAMT3;1* solely in senescing leaves. Further, increased expression of *PtAMT1;2* and *PtAMT3;1* suggests an increased ammonium transfer when the fungal needs of Pi are accomplished. Analysis of the transcriptome dataset revealed that *PtAMT4;1*, *PtAMT4;2* and *PtAMT4;3* were also induced upon mycorrhization independently from the P supply of the fungus as it was the case in our previous study where mycorrhizal poplar was set under N stress (Calabrese et al., 2016).

As there is an ongoing debate on whether amino acids as an organic N source can be taken up by AM fungi and transferred from the fungus to the plant (reviewed in (Hodge and Storer, 2015)) we screened the transcriptome data of poplar and identified several amino acid transporters and H⁺/oligopeptide symporters that were either induced or repressed upon mycorrhization (Table S3). Specific induction of amino acid transporters and one of the H⁺/oligopeptide transporters indicate that amino acids are transferred from the AM fungus to the plant as an alternative N source. However, our metabolome analysis on mycorrhizal and non-mycorrhizal poplar roots showed that mycorrhization reduced the abundance of most metabolites including amino acids in the colonized roots tissue (Table 2, Table S7), suggesting high rates of metabolic turnover by the fungus or the host roots or, alternatively, transport to the shoots. Interestingly, an accumulation of relevant metabolites might be detectable in the shoots as it was demonstrated by Whiteside et al. (2012) for the amino acids phenylalanine, lysine, asparagine, arginine, histidine, cysteine, methionine, and tryptophan with quantum dot analysis.

In the well-established mycorrhizal symbiosis described here, *GintAMT3* was significantly induced in the IRM in both hosts, poplar and sorghum (Figure 4),

indicating a major participation of this transporter in the transfer of ammonium from the arbuscule to the periarbuscular space where it is accessible to the plant (Calabrese et al., 2017). High *GinAMT2* expression levels independent of Pi-supply and localization in the ERM and IRM indicate that it is a low-affinity transporter for ammonium. Moreover, *GinAMT2* displays high sequence similarity to *GintAMT3* which is a low-affinity transporter (Calabrese et al., 2017). *GintAMT1* on the other hand, a high-affinity transporter, was expressed at low levels in the ERM and IRM independent of the P availability. Together, these findings indicate that *GintAMT1* and *GintAMT2* are mainly involved in the uptake of ammonium in the ERM and in the IRM and that *GintAMT3* is mainly involved in the transfer of ammonium to the periarbuscular space to make it available for the host plant.

In sorghum, only *SbAMT3.1* was induced in mycorrhizal roots (Figure S7). In contrast to Koegel et al. (2013), *SbAMT4* was not expressed in our experimental conditions. Induced expression of *SbAMT1;1* and *SbAMT1;2* in the low-P condition suggests that upon sensing of nutrient stress the plant activates a general nutrient uptake program to avoid running short on one or more essential nutrients. In addition our data show that regulation of sorghum AMTs is less mycorrhiza-dependent than nutrient-dependent. Under mycorrhization the plant is supplied with sufficient P and N to keep the P and N level constant within the plant. This scenario may explain the unchanged expression of the *SbAMTs*. Interestingly, mycorrhization induced expression of *SbAMT1.1* and *SbAMT1.2* in the shoots in low-P and of *SbAMT3.3* in high-P conditions. An increased translocation rate of ammonium from root to shoot upon mycorrhization may be a possible explanation. Moreover, *SbAMT1;1* and *SbAMT1;2* expression levels have a tendency to be also concentration-dependent. Strong induction of *SbAMT3.3* in the shoots indicated an increased ammonium flux during high-P and mycorrhizal condition.

2. Symbiotic carbon exchange

In order to shed some light on symbiotic carbon exchange, we used qRT-PCR and mRNA-Seq analysis to identify possible transporters that enable carbohydrate transport from the plant to the fungus. Interestingly, quantitative RT-PCR expression analysis and mRNA-Seq analysis revealed downregulation of carbohydrate transporters in poplar (Figure S8, Figure 6) and sorghum (Figure S9), which might

indicate that carbohydrates are actively sequestered by the fungus. But we also identified two carbohydrate transporters induced upon mycorrhization (Table S3). The UDP-galactose transporters are intracellular transporters situated in the cisternae of the Golgi lumen where UDP-galactose is used for synthesis of non-cellulosic polysaccharides and glycoproteins (Norambuena et al., 2002). Only recently, it was shown that they also transport rhamnose (Rautengarten et al., 2014). In the Golgi-network and the early endosome the newly synthesized proteins are sorted either for the secretion to the plasma membrane, the extracellular matrix or for degradation (Brandizzi and Barlowe, 2013; Feraru et al., 2012; McFarlane et al., 2014). Induced expression of UDP-galactose, therefore, indicates an increased transport activity of proteins to colonized cells which goes along with increased plasma membrane synthesis. In *M. truncatula*, it has been shown that arbuscule development goes along with the synthesis of the periarbuscular membrane which is distinct from the plasma membrane (Pumplin and Harrison, 2009). Further it has been shown that AM-induced transporters are specifically directed to the periarbuscular membrane and involvement of the trans-Golgi for PT has been implicated (Pumplin et al., 2012). The other transporter induced upon mycorrhization is a sugar transporter/spinster transmembrane protein, a member of the major facilitator proteins, which makes it a candidate for being localized at the cell membrane eventually stimulating carbohydrate transport to the AM symbiont.

Interesting is also that a Glucose-6-phosphate/phosphate and phosphoenolpyruvate/phosphate antiporter was induced. Glucose-6 phosphate/phosphate antiporters are normally expressed in non-green plastids and serve as carbohydrate importer. In amyloplasts glucose-6 phosphate/phosphate antiporters are located at the site of starch and fatty acids synthesis (Flügge, 2001; Kammerer et al., 1998). Phosphoenolpyruvate/ phosphate antiporter mediates the transport of Phosphoenolpyruvate into the organelles as in amyloplasts, for the synthesis of aromatic amino acids and several secondary compounds. Increased activity of this transporter suggests a decrease of freely available sugars, of storing starch and of aromatic amino-acids synthesis. These results shed light the link between carbon, phosphorus, but also nitrogen.

In the AM fungi *Geosiphon pyriformis* and *R. irregularis* several carbohydrate transporters were identified. For GpMST1 and RiMST2, it was shown that they specifically transport monosaccharides. *RiMST2* was found to be expressed at the arbuscular site and in the intraradical hyphae (Helber et al., 2011a; Schüßler et al., 2006). Helber et al. (2011) proposed a model in which the absorbed sugars might derive from cell wall degradation but this is contradictory to previous observations in which carbohydrate transfer varied with the source strength of the host plant (Fellbaum et al., 2014; Olsson et al., 2010; Zheng et al., 2015). We demonstrated that RiMST2 was induced in the IRM of its host plants poplar (Figure 3) and sorghum (Figure 3) and that its expression level remained unchanged by Pi availability. The metabolome analysis revealed further that mycorrhization significantly decreased the abundance of monosaccharides (*i.e.* glucose, rhamnose, and ribose) in AM poplar roots. In AM fungi it has been shown that hexoses received from the host plants are transformed into glycogen, trehalose. Our observations are consistent with these findings that monosaccharides are taken up mainly by RiMST2 from the apoplast, converted into disaccharides (*i.e.* trehalose) for transport and hydrolyzed in the ERM into monosaccharides, ready for direct usage or for storage. The mycorrhizal-dependent downregulation of carbohydrate transporters and monosaccharide abundance in poplar roots, along with reduced RiMST2 expression at the arbuscular site and in the IRM suggests that the fungus actively sequesters the sugars on its own demand. As sugars are also transported via the apoplastic pathway the plant has only limited possibilities to restrict carbohydrate flux towards the fungal symbiont.

Taken together our data suggest that the plant strictly regulates carbohydrate allocation on mycorrhizal roots. With the Sugar transporter/spinster transmembrane protein a possible candidate for symbiotic carbon transfer from the plant to the periarbuscular space is found. The fungus may take up sugars from there by RiMST2.

AMF are fatty acid (FA) auxotrophs as their fatty acids are provided by their host plant (MacLean et al., 2017). To date, the mechanisms of FA transport are unknown. We observed that fungal lipid metabolism is highly expressed in the IRM. While many lipases, elongases, and desaturases are expressed both in the ERM and IRM, they might play a role in the storage and use of triglycerides in lipid droplets. However,

their over-expression *in planta* could be a clue of the recovering process of FA from the plant.

IX. Conclusion

Here, we demonstrated that mycorrhization leads to the specific induction of a variety of transporters. As P and N are key elements of mycorrhizal symbiosis, we tested the expression of PT and AMT and show that mycorrhization specifically induces expression of a selection of PT and AMTs in poplar and in sorghum. Further, we identified one carbohydrate transporter specifically induced in mycorrhizal root tissue that might be a possible candidate for symbiotic carbon exchange. By contrast, other carbohydrate transporters were down-regulated upon mycorrhization indicating that the plant may not volunteer provision of carbohydrates in exchange for mineral nutrients. We further showed that some nutrient transporters are more strongly expressed in the IRM compared to the ERM, which indicates that they are directly involved in nutrient transfer at the arbuscular membrane or, as in the case of MST, in nutrient uptake into the intraradical hyphae (Figure 6). Nevertheless, despite its importance, the release of major nutrients taken up by the ERM into the root apoplasm occurs through widely unknown mechanisms, which must include the differentiation and polarisation of the fungal membrane transport functions. Transport processes across the polarised membrane interfaces are of major importance in the functioning of the established mycorrhizal association as the symbiotic relationship is based on an apparent 'fair-trade' between fungus and host plant. In fact, the reality is probably much more complex, with reuptake of nutrients at the biotrophic interface allowing both partners to, at least partially, control the exchanges (Figure 6).

In agriculture, vast amounts of mineral fertilizers are applied to the field to increase crop yield. Indeed, the amount of applied fertilizer might actually exceed the plant's needs for mineral nutrients. Collecting data such as ours will help to further deepen our understanding of the plant-AM symbiosis and may lead to development of more sustainable agriculture with a reduced fertilizer input and improved adaptation to changing environmental conditions.

X. Acknowledgment

This project was supported by the Swiss National Science Foundation (grants no. PZ00P3_136651 to P-E.C. and no. 127563 to T.B.). The authors thank the following Institutions for financial support: the Burgundy Franche Comté Regional Council, the division of Plant Health and Environment of the French National Institute for Agricultural Research (INRA). We would like to thank De-Roman Yvan for his help in establishing the fungal transportome list. LRSV is part of the TULIP ‘Laboratoire d’Excellence’ (ANR-10-LABX-41). The authors are grateful to the anonymous reporters for constructive comments on the manuscript.

XI. References

Ai, P., Sun, S., Zhao, J., Fan, X., Xin, W., Guo, Q., Yu, L., Shen, Q., Wu, P., and Miller, A.J. (2009). Two rice phosphate transporters, OsPht1; 2 and OsPht1; 6, have different functions and kinetic properties in uptake and translocation. *The Plant Journal* 57, 798-809.

Ait Lahmidi, N., Courty, P.-E., Brulé, D., Chatagnier, O., Arnould, C., Doidy, J., Berta, G., Lingua, G., Wipf, D., and Bonneau, L. (2016). Sugar exchanges in arbuscular mycorrhiza: RiMST5 and RiMST6, two novel Rhizophagus irregularis monosaccharide transporters, are involved in both sugar uptake from the soil and from the plant partner. *Plant Physiology and Biochemistry* 107, 354-363.

An, J., Zeng, T., Ji, C., de Graaf, S., Zheng, Z., Xiao, T.T., Deng, X., Xiao, S., Bisseling, T., Limpens, E., et al. (2019). A *Medicago truncatula* SWEET transporter implicated in arbuscule maintenance during arbuscular mycorrhizal symbiosis. *New Phytologist*.

Aung, K., Lin, S.-I., Wu, C.-C., Huang, Y.-T., Su, C., and Chiou, T.-J. (2006). *pho2*, a phosphate overaccumulator, is caused by a nonsense mutation in a microRNA399 target gene. *Plant Physiology* 141, 1000-1011.

Baggerly, K.A., Deng, L., Morris, J.S., and Aldaz, C.M. (2003). Differential expression in SAGE: accounting for normal between-library variation. *Bioinformatics* 19, 1477-1483.

Bago, B., Vierheilig, H., Piché, Y., and Azcón-Aguilar, C. (1996). Nitrate depletion and pH changes induced by the extraradical mycelium of the arbuscular mycorrhizal fungus *Glomus intraradices* grown in monoxenic culture. *New Phytologist* 133, 273-280.

Becard, G., Doner, L.W., Rolin, D.B., Douds, D.D., and Pfeffer, P.E. (1991). Identification and quantification of trehalose in vesicular-arbuscular mycorrhizal fungi by in vivo ¹³C NMR and HPLC analyses*. *New Phytologist* 118, 547-552.

- Benedetto, A., Magurno, F., Bonfante, P., and Lanfranco, L. (2005). Expression profiles of a phosphate transporter gene (GmosPT) from the endomycorrhizal fungus *Glomus mosseae*. *Mycorrhiza* 15, 620-627.
- Benjamini, Y., and Hochberg, Y. (1995). Controlling the False Discovery Rate: A Practical and Powerful Approach to Multiple Testing. *Journal of the Royal Statistical Society: Series B (Methodological)* 57, 289-300.
- Boldt, K., Pörs, Y., Haupt, B., Bitterlich, M., Kühn, C., Grimm, B., and Franken, P. (2011). Photochemical processes, carbon assimilation and RNA accumulation of sucrose transporter genes in tomato arbuscular mycorrhiza. *Journal of Plant Physiology* 168, 1256-1263.
- Brandizzi, F., and Barlowe, C. (2013). Organization of the ER-Golgi interface for membrane traffic control. *Nature Reviews Molecular Cell Biology* 14, 382-392.
- Branscheid, A., Sieh, D., Pant, B.D., May, P., Devers, E.A., Elkrog, A., Schauser, L., Scheible, W.-R., and Krajinski, F. (2010). Expression pattern suggests a role of MiR399 in the regulation of the cellular response to local Pi increase during arbuscular mycorrhizal symbiosis. *Molecular Plant-Microbe Interactions* 23, 915-926.
- Bravo, A., Brands, M., Wewer, V., Dörmann, P., and Harrison, M.J. (2017). Arbuscular mycorrhiza-specific enzymes FatM and RAM2 fine-tune lipid biosynthesis to promote development of arbuscular mycorrhiza. *New Phytologist* 214, 1631-1645.
- Breullin-Sessoms, F., Floss, D.S., Gomez, S.K., Pumplin, N., Ding, Y., Levesque-Tremblay, V., Noar, R.D., Daniels, D.A., Bravo, A., Eaglesham, J.B., et al. (2015). Suppression of Arbuscule Degeneration in *Medicago truncatula phosphate transporter4* Mutants Is Dependent on the Ammonium Transporter 2 Family Protein AMT2;3. *The Plant Cell* 27, 1352-1366.
- Brundrett, M.C., Piché, Y., and Peterson, R.L. (1984). A new method for observing the morphology of vesicular-arbuscular mycorrhizae. *Canadian Journal of Botany* 62, 2128-2134.
- Bücking, H., Mensah, J.A., and Fellbaum, C.R. (2016). Common mycorrhizal networks and their effect on the bargaining power of the fungal partner in the arbuscular mycorrhizal symbiosis. *Communicative & Integrative Biology* 9, e1107684.
- Calabrese, S., Pérez-Tienda, J., Ellerbeck, M., Arnould, C., Chatagnier, O., Boller, T., Schübler, A., Brachmann, A., Wipf, D., and Ferrol, N. (2016). GintAMT3-a low-affinity ammonium transporter of the arbuscular mycorrhizal *Rhizophagus irregularis*. *Frontiers in Plant Science* 7, 679.
- Chen, E.C.H., Morin, E., Beaudet, D., Noel, J., Yildirim, G., Ndikumana, S., Charron, P., St-Onge, C., Giorgi, J., Krüger, M., et al. (2018). High intraspecific genome diversity in the model arbuscular mycorrhizal symbiont *Rhizophagus irregularis*. *New Phytologist* 220, 1161-1171.

- Chen, L.-Q., Hou, B.-H., Lalonde, S., Takanaga, H., Hartung, M.L., Qu, X.-Q., Guo, W.-J., Kim, J.-G., Underwood, W., Chaudhuri, B., et al. (2010). Sugar transporters for intercellular exchange and nutrition of pathogens. *Nature* 468, 527-532.
- Chiou, T.-J., Aung, K., Lin, S.-I., Wu, C.-C., Chiang, S.-F., and Su, C. (2006). Regulation of phosphate homeostasis by microRNA in Arabidopsis. *The Plant Cell* 18, 412-421.
- Courty, P.-E., Franc, A., Pierrat, J.-C., and Garbaye, J. (2008). Temporal Changes in the Ectomycorrhizal Community in Two Soil Horizons of a Temperate Oak Forest. *Applied and Environmental Microbiology* 74, 5792-5801.
- Courty, P.E., Smith, P., Koegel, S., Redecker, D., and Wipf, D. (2015). Inorganic nitrogen uptake and transport in beneficial plant root-microbe interactions. *Critical Reviews in Plant Sciences* 34, 4-16.
- Couturier, J., Montanini, B., Martin, F., Brun, A., Blaudez, D., and Chalot, M. (2007). The expanded family of ammonium transporters in the perennial poplar plant. *New Phytologist* 174, 137-150.
- Dethloff, F., Erban, A., Orf, I., Alpers, J., Fehrle, I., Beine-Golovchuk, O., Schmidt, S., Schwachtje, J., and Kopka, J. (2014). Profiling Methods to Identify Cold-Regulated Primary Metabolites Using Gas Chromatography Coupled to Mass Spectrometry. In *Plant Cold Acclimation*, D.K. Hinch, and E. Zuther, eds. (New York, NY: Springer New York), pp. 171-197.
- Dietrich, D., Hammes, U., Thor, K., Suter-Grotemeyer, M., Flückiger, R., Slusarenko, A.J., Ward, J.M., and Rentsch, D. (2004). AtPTR1, a plasma membrane peptide transporter expressed during seed germination and in vascular tissue of Arabidopsis: Peptide transporter of Arabidopsis. *The Plant Journal* 40, 488-499.
- Doidy, J., Grace, E., Kühn, C., Simon-Plas, F., Casieri, L., and Wipf, D. (2012a). Sugar transporters in plants and in their interactions with fungi. *Trends in Plant Science* 17, 413-422.
- Doidy, J., van Tuinen, D., Lamotte, O., Corneillat, M., Alcaraz, G., and Wipf, D. (2012b). The *Medicago truncatula* Sucrose Transporter Family: Characterization and Implication of Key Members in Carbon Partitioning towards Arbuscular Mycorrhizal Fungi. *Molecular Plant* 5, 1346-1358.
- Dreyer, I., Spitz, O., Kanonenberg, K., Montag, K., Handrich, M.R., Ahmad, S., Schott-Verdugo, S., Navarro-Retamal, C., Rubio-Meléndez, M.E., Gomez-Porras, J.L., et al. (2019). Nutrient exchange in arbuscular mycorrhizal symbiosis from a thermodynamic point of view. *New Phytologist* 222, 1043-1053.
- Dumbrell, A.J., Ashton, P.D., Aziz, N., Feng, G., Nelson, M., Dytham, C., Fitter, A.H., and Helgason, T. (2011). Distinct seasonal assemblages of arbuscular mycorrhizal fungi revealed by massively parallel pyrosequencing. *New Phytologist* 190, 794-804.

- Ellerbeck, M., Schüßler, A., Brucker, D., Dafinger, C., Loos, F., and Brachmann, A. (2013). Characterization of three ammonium transporters of the glomeromycotan fungus *Geosiphon pyriformis*. *Eukaryotic Cell* 12, 1554-1562.
- Ezawa, T., Smith, S.E., and Smith, F.A. (2002). P metabolism and transport in AM fungi. *Plant and Soil* 244, 221-230.
- Fellbaum, C.R., Gachomo, E.W., Beesetty, Y., Choudhari, S., Strahan, G.D., Pfeffer, P.E., Kiers, E.T., and Bücking, H. (2012). Carbon availability triggers fungal nitrogen uptake and transport in arbuscular mycorrhizal symbiosis. *Proceedings of the National Academy of Sciences* 109, 2666-2671.
- Fellbaum, C.R., Mensah, J.A., Cloos, A.J., Strahan, G.E., Pfeffer, P.E., Kiers, E.T., and Bücking, H. (2014). Fungal nutrient allocation in common mycorrhizal networks is regulated by the carbon source strength of individual host plants. *New Phytologist* 203, 646-656.
- Feraru, E., Feraru, M.I., Asaoka, R., Paciorek, T., De Rycke, R., Tanaka, H., Nakano, A., and Friml, J. (2012). BEX5/RabA1b Regulates *trans* -Golgi Network-to-Plasma Membrane Protein Trafficking in *Arabidopsis*. *The Plant Cell* 24, 3074-3086.
- Fiorilli, V., Lanfranco, L., and Bonfante, P. (2013). The expression of GintPT, the phosphate transporter of *Rhizophagus irregularis*, depends on the symbiotic status and phosphate availability. *Planta* 237, 1267-1277.
- Flügge, U.-I. (2001). Plant Chloroplasts and Other Plastids. In *Encyclopedia of Life Sciences*, John Wiley & Sons, Ltd, ed. (Chichester, UK: John Wiley & Sons, Ltd), p.
- Frey, B., and Schüepp, H. (1993). Acquisition of nitrogen by external hyphae of arbuscular mycorrhizal fungi associated with *Zea mays* L. *New Phytologist* 124, 221-230.
- Gamas, P. (1996). Use of a Subtractive Hybridization Approach to Identify New *Medicago truncatula* Genes Induced During Root Nodule Development. *Molecular Plant-Microbe Interactions* 9, 233.
- Garcia, K., and Zimmermann, S.D. (2014). The role of mycorrhizal associations in plant potassium nutrition. *Frontiers in Plant Science* 5.
- Garcia, K., Doidy, J., Zimmermann, S.D., Wipf, D., and Courty, P.-E. (2016). Take a Trip Through the Plant and Fungal Transportome of Mycorrhiza. *Trends in Plant Science* 21, 937-950.
- Ge, L., Sun, S., Chen, A., Kapulnik, Y., and Xu, G. (2008). Tomato sugar transporter genes associated with mycorrhiza and phosphate. *Plant Growth Regulation* 55, 115-123.
- Glassop, D., Smith, S.E., and Smith, F.W. (2005). Cereal phosphate transporters associated with the mycorrhizal pathway of phosphate uptake into roots. *Planta* 222, 688-698.

Gomez, S.K., Javot, H., Deewatthanawong, P., Torres-Jerez, I., Tang, Y., Blancaflor, E.B., Udvardi, M.K., and Harrison, M.J. (2009). *Medicago truncatula* and *Glomus intraradices* gene expression in cortical cells harboring arbuscules in the arbuscular mycorrhizal symbiosis. *BMC Plant Biology* 9, 10.

Gómez-Gallego, T., Benabdellah, K., Merlos, M.A., Jiménez-Jiménez, A.M., Alcon, C., Berthomieu, P., and Ferrol, N. (2019). The *Rhizophagus irregularis* Genome Encodes Two CTR Copper Transporters That Mediate Cu Import Into the Cytosol and a CTR-Like Protein Likely Involved in Copper Tolerance. *Frontiers in Plant Science* 10.

Govindarajulu, M., Pfeffer, P.E., Jin, H., Abubaker, J., Douds, D.D., Allen, J.W., Bücking, H., Lammers, P.J., and Shachar-Hill, Y. (2005). Nitrogen transfer in the arbuscular mycorrhizal symbiosis. *Nature* 435, 819.

Guerrero-Galán, C., Delteil, A., Garcia, K., Houdinet, G., Conéjéro, G., Gaillard, I., Sentenac, H., and Zimmermann, S.D. (2018). Plant potassium nutrition in ectomycorrhizal symbiosis: properties and roles of the three fungal TOK potassium channels in *Hebeloma cylindrosporum*: TOK potassium channels of an ectomycorrhizal fungus. *Environmental Microbiology* 20, 1873-1887.

Guether, M., Neuhäuser, B., Balestrini, R., Dynowski, M., Ludewig, U., and Bonfante, P. (2009). A mycorrhizal-specific ammonium transporter from *Lotus japonicus* acquires nitrogen released by arbuscular mycorrhizal fungi. *Plant Physiology* 150, 73-83.

Harrison, M.J., and van Buuren, M.L. (1995). A phosphate transporter from the mycorrhizal fungus *Glomus versiforme*. *Nature* 378, 626.

Harrison, M.J., Dewbre, G.R., and Liu, J. (2002). A Phosphate Transporter from *Medicago truncatula* Involved in the Acquisition of Phosphate Released by Arbuscular Mycorrhizal Fungi. *The Plant Cell* 14, 2413-2429.

Hawkins, H.-J., Johansen, A., and George, E. (2000). Uptake and transport of organic and inorganic nitrogen by arbuscular mycorrhizal fungi. *Plant and Soil* 226, 275-285.

Helber, N., Wippel, K., Sauer, N., Schaarschmidt, S., Hause, B., and Requena, N. (2011a). A Versatile Monosaccharide Transporter That Operates in the Arbuscular Mycorrhizal Fungus *Glomus* sp Is Crucial for the Symbiotic Relationship with Plants. *The Plant Cell* 23, 3812-3823.

Helber, N., Wippel, K., Sauer, N., Schaarschmidt, S., Hause, B., and Requena, N. (2011b). A Versatile Monosaccharide Transporter That Operates in the Arbuscular Mycorrhizal Fungus *Glomus* sp Is Crucial for the Symbiotic Relationship with Plants. *The Plant Cell* 23, 3812-3823.

Hodge, A., and Storer, K. (2015). Arbuscular mycorrhiza and nitrogen: implications for individual plants through to ecosystems. *Plant and Soil* 386, 1-19.

Hodge, A., Helgason, T., and Fitter, A.H. (2010). Nutritional ecology of arbuscular mycorrhizal fungi. *Fungal Ecology* 3, 267-273.

- Javot, H., Penmetsa, R.V., Terzaghi, N., Cook, D.R., and Harrison, M.J. (2007a). A *Medicago truncatula* phosphate transporter indispensable for the arbuscular mycorrhizal symbiosis. *Proceedings of the National Academy of Sciences* *104*, 1720-1725.
- Javot, H., Pumplin, N., and Harrison, M.J. (2007b). Phosphate in the arbuscular mycorrhizal symbiosis: transport properties and regulatory roles. *Plant, Cell & Environment* *30*, 310-322.
- Jiang, Y., Wang, W., Xie, Q., Liu, N., Liu, L., Wang, D., Zhang, X., Yang, C., Chen, X., Tang, D., et al. (2017). Plants transfer lipids to sustain colonization by mutualistic mycorrhizal and parasitic fungi. *Science* eaam9970.
- Jin, H., Pfeffer, P.E., Douds, D.D., Piotrowski, E., Lammers, P.J., and Shachar-Hill, Y. (2005). The uptake, metabolism, transport and transfer of nitrogen in an arbuscular mycorrhizal symbiosis. *New Phytologist* *168*, 687-696.
- Kammerer, B., Fischer, K., Hilpert, B., Schubert, S., Gutensohn, M., Weber, A., and Flügge, U.-I. (1998). Molecular Characterization of a Carbon Transporter in Plastids from Heterotrophic Tissues: The Glucose 6-Phosphate/Phosphate Antiporter. *The Plant Cell* *10*, 105-117.
- Karim, S., Lundh, D., Holmström, K.-O., Mandal, A., and Pirhonen, M. (2005). Structural and functional characterization of AtPTR3, a stress-induced peptide transporter of *Arabidopsis*. *Journal of Molecular Modeling* *11*, 226-236.
- Karim, S., Holmström, K.-O., Mandal, A., Dahl, P., Hohmann, S., Brader, G., Palva, E.T., and Pirhonen, M. (2007). AtPTR3, a wound-induced peptide transporter needed for defence against virulent bacterial pathogens in *Arabidopsis*. *Planta* *225*, 1431-1445.
- Keymer, A., Pimprikar, P., Wewer, V., Huber, C., Brands, M., Bucerius, S., Delaux, P.-M., Klingl, V., von Roepenack-Lahaye, E., Wang, T.L., et al. (2017). Lipid transfer from plants to arbuscular mycorrhiza fungi. *BioRxiv* 143883.
- Kiers, E.T., West, S.A., Wyatt, G.A.K., Gardner, A., Bücking, H., and Werner, G.D.A. (2016). Misconceptions on the application of biological market theory to the mycorrhizal symbiosis. *Nature Plants* *2*.
- Kikuchi, Y., Hijikata, N., Yokoyama, K., Ohtomo, R., Handa, Y., Kawaguchi, M., Saito, K., and Ezawa, T. (2014). Polyphosphate accumulation is driven by transcriptome alterations that lead to near-synchronous and near-equivalent uptake of inorganic cations in an arbuscular mycorrhizal fungus. *New Phytologist* *204*, 638-649.
- Kikuchi, Y., Hijikata, N., Ohtomo, R., Handa, Y., Kawaguchi, M., Saito, K., Masuta, C., and Ezawa, T. (2016). Aquaporin-mediated long-distance polyphosphate translocation directed towards the host in arbuscular mycorrhizal symbiosis: application of virus-induced gene silencing. *New Phytologist*.

- Kobae, Y., Tamura, Y., Takai, S., Banba, M., and Hata, S. (2010). Localized Expression of Arbuscular Mycorrhiza-Inducible Ammonium Transporters in Soybean. *Plant and Cell Physiology* 51, 1411-1415.
- Koegel, S., Lahmidi, N.A., Arnould, C., Chatagnier, O., Walder, F., Ineichen, K., Boller, T., Wipf, D., Wiemken, A., and Courty, P.-E. (2013). The family of ammonium transporters (AMT) in *Sorghum bicolor*: two AMT members are induced locally, but not systemically in roots colonized by arbuscular mycorrhizal fungi. *New Phytologist* 198, 853-865.
- Krajinski, F., Courty, P.-E., Sieh, D., Franken, P., Zhang, H., Bucher, M., Gerlach, N., Kryvoruchko, I., Zoeller, D., Udvardi, M., et al. (2014). The H⁺-ATPase HA1 of *Medicago truncatula* Is Essential for Phosphate Transport and Plant Growth during Arbuscular Mycorrhizal Symbiosis. *The Plant Cell* 26, 1808-1817.
- Lefevre, F., Baijot, A., and Boutry, M. (2015). Plant ABC transporters: time for biochemistry? *Biochemical Society Transactions* 43, 931-936.
- Leigh, J., Hodge, A., and Fitter, A.H. (2009). Arbuscular mycorrhizal fungi can transfer substantial amounts of nitrogen to their host plant from organic material. *New Phytologist* 181, 199-207.
- Li, T., Hu, Y.-J., Hao, Z.-P., Li, H., Wang, Y.-S., and Chen, B.-D. (2013). First cloning and characterization of two functional aquaporin genes from an arbuscular mycorrhizal fungus *Glomus intraradices*. *New Phytologist* 197, 617-630.
- López-Pedrosa, A., González-Guerrero, M., Valderas, A., Azcón-Aguilar, C., and Ferrol, N. (2006). GintAMT1 encodes a functional high-affinity ammonium transporter that is expressed in the extraradical mycelium of *Glomus intraradices*. *Fungal Genetics and Biology* 43, 102-110.
- Loth-Pereda, V., Orsini, E., Courty, P.-E., Lota, F., Kohler, A., Diss, L., Blaudez, D., Chalot, M., Nehls, U., and Bucher, M. (2011). Structure and expression profile of the phosphate Pht1 transporter gene family in mycorrhizal *Populus trichocarpa*. *Plant Physiology* 156, 2141-2154.
- Luginbuehl, L.H., Menard, G.N., Kurup, S., Van Erp, H., Radhakrishnan, G.V., Breakspear, A., Oldroyd, G.E., and Eastmond, P.J. (2017). Fatty acids in arbuscular mycorrhizal fungi are synthesized by the host plant. *Science* eaan0081.
- MacLean, A.M., Bravo, A., and Harrison, M.J. (2017). Plant signaling and metabolic pathways enabling arbuscular mycorrhizal symbiosis. *The Plant Cell* tpc.00555.2017.
- Mäder, P., Vierheilig, H., Streitwolf-Engel, R., Boller, T., Frey, B., Christie, P., and Wiemken, A. (2000). Transport of ¹⁵N from a soil compartment separated by a polytetrafluoroethylene membrane to plant roots via the hyphae of arbuscular mycorrhizal fungi. *The New Phytologist* 146, 155-161.
- Maldonado-Mendoza, I.E., Dewbre, G.R., and Harrison, M.J. (2001). A Phosphate Transporter Gene from the Extra-Radical Mycelium of an Arbuscular Mycorrhizal

Fungus *Glomus intraradices* Is Regulated in Response to Phosphate in the Environment. *Molecular Plant-Microbe Interactions* 14, 1140-1148.

Marschner, H., and Dell, B. (1994). Nutrient uptake in mycorrhizal symbiosis. *Plant and Soil* 159, 89-102.

Maza, E. (2016). In Papyro Comparison of TMM (edgeR), RLE (DESeq2), and MRN Normalization Methods for a Simple Two-Conditions-Without-Replicates RNA-Seq Experimental Design. *Frontiers in Genetics* 7.

Maza, E., Frasse, P., Senin, P., Bouzayen, M., and Zouine, M. (2013). Comparison of normalization methods for differential gene expression analysis in RNA-Seq experiments: a matter of relative size of studied transcriptomes. *Communicative & Integrative Biology* 6, e25849.

McCormick, R.F., Truong, S.K., Sreedasyam, A., Jenkins, J., Shu, S., Sims, D., Kennedy, M., Amirebrahimi, M., Weers, B.D., McKinley, B., et al. (2018). The *Sorghum bicolor* reference genome: improved assembly, gene annotations, a transcriptome atlas, and signatures of genome organization. *The Plant Journal* 93, 338-354.

McFarlane, H.E., Watanabe, Y., Yang, W., Huang, Y., Ohlrogge, J., and Samuels, A.L. (2014). Golgi- and Trans-Golgi Network-Mediated Vesicle Trafficking Is Required for Wax Secretion from Epidermal Cells. *Plant Physiology* 164, 1250-1260.

Morin, E., Miyauchi, S., San Clemente, H., Chen, E.C.H., Pelin, A., Providencia, I., Ndikumana, S., Beaudet, D., Hainaut, M., Drula, E., et al. (2019). Comparative genomics of *Rhizophagus irregularis*, *R. cerebriforme*, *R. diaphanus* and *Gigaspora rosea* highlights specific genetic features in Glomeromycotina. *New Phytologist* 222, 1584-1598.

Murphy, J., and Riley, J.P. (1962). A modified single solution method for the determination of phosphate in natural waters. *Analytica Chimica Acta* 27, 31-36.

Nagy, R., Karandashov, V., Chague, V., Kalinkevich, K., Tamasloukht, M., Xu, G., Jakobsen, I., Levy, A.A., Amrhein, N., and Bucher, M. (2005). The characterization of novel mycorrhiza-specific phosphate transporters from *Lycopersicon esculentum* and *Solanum tuberosum* uncovers functional redundancy in symbiotic phosphate transport in solanaceous species. *The Plant Journal* 42, 236-250.

Norambuena, L., Marchant, L., Berninsone, P., Hirschberg, C.B., Silva, H., and Orellana, A. (2002). Transport of UDP-galactose in Plants: IDENTIFICATION AND FUNCTIONAL CHARACTERIZATION OF AtUTr1, AN *ARABIDOPSIS THALIANA* UDP-GALACTOSE/UDP-GLUCOSE TRANSPORTER. *Journal of Biological Chemistry* 277, 32923-32929.

Olsson, P.A., Rahm, J., and Aliasghar Zad, N. (2010). Carbon dynamics in mycorrhizal symbioses is linked to carbon costs and phosphorus benefits. *FEMS Microbiology Ecology* 72, 125-131.

- Pao, S.S., Paulsen, I.T., and Saier, M.H. (1998). Major facilitator superfamily. *Microbiol. Mol. Biol. Rev.* 62, 1-34.
- Paszkowski, U. (2006). A journey through signaling in arbuscular mycorrhizal symbioses 2006. *New Phytologist* 172, 35-46.
- Pérez-Tienda, J., Testillano, P.S., Balestrini, R., Fiorilli, V., Azcón-Aguilar, C., and Ferrol, N. (2011). GintAMT2, a new member of the ammonium transporter family in the arbuscular mycorrhizal fungus *Glomus intraradices*. *Fungal Genetics and Biology* 48, 1044-1055.
- Poirier, Y., and Bucher, M. (2002). Phosphate transport and homeostasis in *Arabidopsis*. *The Arabidopsis Book/American Society of Plant Biologists* 1.
- Pumplin, N., and Harrison, M.J. (2009). Live-Cell Imaging Reveals Periarbuscular Membrane Domains and Organelle Location in *Medicago truncatula* Roots during Arbuscular Mycorrhizal Symbiosis. *PLANT PHYSIOLOGY* 151, 809-819.
- Pumplin, N., Zhang, X., Noar, R.D., and Harrison, M.J. (2012). Polar localization of a symbiosis-specific phosphate transporter is mediated by a transient reorientation of secretion. *Proceedings of the National Academy of Sciences* 109, E665-E672.
- Rausch, C., and Bucher, M. (2002). Molecular mechanisms of phosphate transport in plants. *Planta* 216, 23-37.
- Rausch, C., Daram, P., Brunner, S., Jansa, J., Laloi, M., Leggewie, G., Amrhein, N., and Bucher, M. (2001). A phosphate transporter expressed in arbuscule-containing cells in potato. *Nature* 414, 462.
- Rautengarten, C., Ebert, B., Moreno, I., Temple, H., Herter, T., Link, B., Donas-Cofre, D., Moreno, A., Saez-Aguayo, S., Blanco, F., et al. (2014). The Golgi localized bifunctional UDP-rhamnose/UDP-galactose transporter family of *Arabidopsis*. *Proceedings of the National Academy of Sciences* 111, 11563-11568.
- Rich, M.K., Nouri, E., Courty, P.-E., and Reinhardt, D. (2017). Diet of Arbuscular Mycorrhizal Fungi: Bread and Butter? *Trends in Plant Science* 22, 652-660.
- Schachtman, D.P., Reid, R.J., and Ayling, S.M. (1998). Phosphorus Uptake by Plants: From Soil to Cell. *Plant Physiology* 116, 447-453.
- Schüßler, A., Martin, H., Cohen, D., Fitz, M., and Wipf, D. (2006). Characterization of a carbohydrate transporter from symbiotic glomeromycotan fungi. *Nature* 444, 933-936.
- Selle, A., Willmann, M., Grunze, N., Geßler, A., Weiß, M., and Nehls, U. (2005). The high-affinity poplar ammonium importer PttAMT1. 2 and its role in ectomycorrhizal symbiosis. *New Phytologist* 168, 697-706.
- Škuta, C., Bartůněk, P., and Svozil, D. (2014). InChIlib-interactive cluster heatmap for web applications. *Journal of Cheminformatics* 6, 44.
- Smith, S.E., and Read, D.J. (2010). *Mycorrhizal Symbiosis* (Academic Press).

- Smith, S.E., and Smith, F.A. (2011). Roles of Arbuscular Mycorrhizas in Plant Nutrition and Growth: New Paradigms from Cellular to Ecosystem Scales. *Annual Review of Plant Biology* 62, 227-250.
- Strehmel, N., Hummel, J., Erban, A., Strassburg, K., and Kopka, J. (2008). Retention index thresholds for compound matching in GC-MS metabolite profiling. *Journal of Chromatography B* 871, 182-190.
- Takabatake, R., Hata, S., Taniguchi, M., Kouchi, H., Sugiyama, T., and Izui, K. (1999). Isolation and characterization of cDNAs encoding mitochondrial phosphate transporters in soybean, maize, rice, and Arabidopsis. *Plant Molecular Biology* 40, 479-486.
- Tamayo, E., Gázquez-Gallego, T., Azcón-Aguilar, C., and Ferrol, N. (2014). Genome-wide analysis of copper, iron and zinc transporters in the arbuscular mycorrhizal fungus *Rhizophagus irregularis*. *Frontiers in Plant Science* 5.
- Tang, N., San Clemente, H., Roy, S., Bécard, G., Zhao, B., and Roux, C. (2016a). A survey of the gene repertoire of *Gigaspora rosea* unravels conserved features among Glomeromycota for obligate biotrophy. *Frontiers in Microbiology* 7, 233.
- Tang, N., San Clemente, H., Roy, S., Bécard, G., Zhao, B., and Roux, C. (2016b). A Survey of the Gene Repertoire of *Gigaspora rosea* Unravels Conserved Features among Glomeromycota for Obligate Biotrophy. *Frontiers in Microbiology* 7.
- Tatry, M.-V., El Kassis, E., Lambilliotte, R., Corratgé, C., Van Aarle, I., Amenc, L.K., Alary, R., Zimmermann, S., Sentenac, H., and Plassard, C. (2009). Two differentially regulated phosphate transporters from the symbiotic fungus *Hebeloma cylindrosporum* and phosphorus acquisition by ectomycorrhizal *Pinus pinaster*. *The Plant Journal* 57, 1092-1102.
- Toussaint, J.-P., St-Arnaud, M., and Charest, C. (2004). Nitrogen transfer and assimilation between the arbuscular mycorrhizal fungus *Glomus intraradices* Schenck & Smith and Ri T-DNA roots of *Daucus carota* L. in an in vitro compartmented system. *Canadian Journal of Microbiology* 50, 251-260.
- Tuskan, G.A., DiFazio, S., Jansson, S., Bohlmann, J., Grigoriev, I., Hellsten, U., Putnam, N., Ralph, S., Rombauts, S., Salamov, A., et al. (2006). The Genome of Black Cottonwood, *Populus trichocarpa* (Torr. & Gray). *Science* 313, 1596-1604.
- Villegas, J., Williams, R.D., Nantais, L., Archambault, J., and Fortin, J.A. (1996). Effects of N source on pH and nutrient exchange of extramatrical mycelium in a mycorrhizal Ri T-DNA transformed root system. *Mycorrhiza* 6, 247-251.
- Walder, F., and van der Heijden, M.G.A. (2015). Regulation of resource exchange in the arbuscular mycorrhizal symbiosis. *Nature Plants* 1.
- Walder, F., Niemann, H., Natarajan, M., Lehmann, M.F., Boller, T., and Wiemken, A. (2012). Mycorrhizal Networks: Common Goods of Plants Shared under Unequal Terms of Trade. *PLANT PHYSIOLOGY* 159, 789-797.

- Walder, F., Boller, T., Wiemken, A., and Courty, P.-E. (2016). Regulation of plants' phosphate uptake in common mycorrhizal networks: Role of intraradical fungal phosphate transporters. *Plant Signaling & Behavior* 11, e1131372.
- Wewer, V., Brands, M., and Dörmann, P. (2014). Fatty acid synthesis and lipid metabolism in the obligate biotrophic fungus *Rhizophagus irregularis* during mycorrhization of *Lotus japonicus*. *Plant J* 79, 398-412.
- Whiteside, M.D., Werner, G.D.A., Caldas, V.E.A., van't Padjé, A., Dupin, S.E., Elbers, B., Bakker, M., Wyatt, G.A.K., Klein, M., Hink, M.A., et al. (2019). Mycorrhizal Fungi Respond to Resource Inequality by Moving Phosphorus from Rich to Poor Patches across Networks. *Current Biology* 29, 2043-2050.e8.
- Wipf, D., Krajinski, F., van Tuinen, D., Recorbet, G., and Courty, P.-E. (2019). Trading on the arbuscular mycorrhiza market: from arbuscules to common mycorrhizal networks. *New Phytologist*.
- Zhang, H., Wei, S., Hu, W., Xiao, L., and Tang, M. (2017). Arbuscular Mycorrhizal Fungus *Rhizophagus irregularis* Increased Potassium Content and Expression of Genes Encoding Potassium Channels in *Lycium barbarum*. *Frontiers in Plant Science* 8.
- Zheng, C., Ji, B., Zhang, J., Zhang, F., and Bever, J.D. (2015). Shading decreases plant carbon preferential allocation towards the most beneficial mycorrhizal mutualist. *New Phytologist* 205, 361-368.
- Zouine, M., Maza, E., Djari, A., Lauvernier, M., Frasse, P., Smouni, A., Pirrello, J., and Bouzayen, M. (2017). TomExpress, a unified tomato RNA-Seq platform for visualization of expression data, clustering and correlation networks. *The Plant Journal* 92, 727-735.

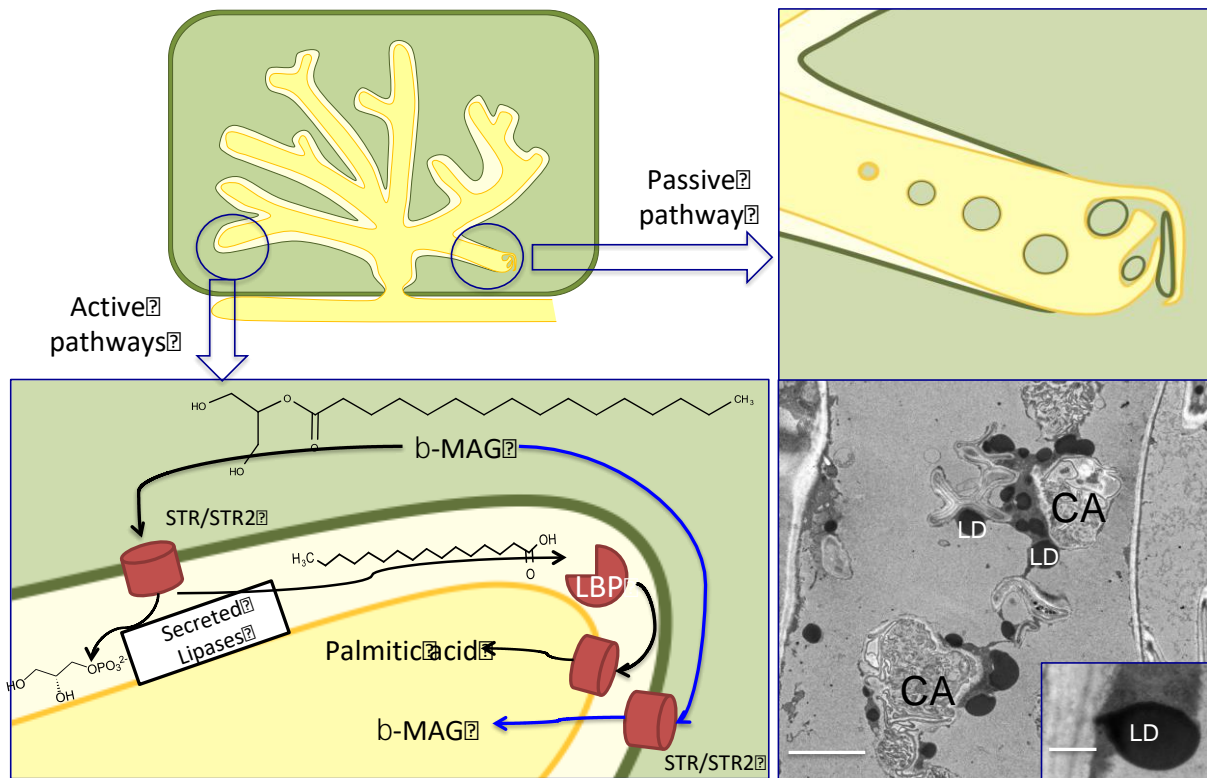

Figure 3.0: drawings representing hypothetic mechanisms of host FA acquisition by AM fungi (see text for details). β -MAB: sn-2 mono-palmitoyl-glycerol, STR/STR2: plant ABC transporters involved in β -MAB export to the peri-arbuscular space (pale yellow in the drawings), LBP : putative lipid binding proteins. The image bottom right corresponds to TEM observation of collapsed arbuscules (CA) with many lipid droplets (LD) (bar: 2 μ m, in insert 0.5 μ m). Personal observation.

Chapter 3 - The “fat” expressome of

Rhizophagus irregularis

I. Working hypotheses and objectives

As biotrophic organisms, AM fungi mainly rely on plant host carbon to accomplish their life cycle. For 40 years, sugars were supposed to be the unique carbon compounds delivered by plants (Ho and Trappe, 1973). The recent discovery that AM fungi are auxotrophic for fatty acids (FA) and depend on host FA (cf introduction) opens new questions, new field of investigations. We took advantage of available genomic resources on *R. irregularis* to investigate in this chapter the fungal FA metabolism and its transcriptional regulation during the life cycle.

The supposed FA form provided by plants would be a β -mono-acylglycerol (β -MAG; C16:0 sn-2 mono-palmitoyl-glycerol - Bravo et al. 2017). However, the exact pathway of FA acquisition and metabolization by the fungus is not described and different hypotheses can be proposed (Figure 3.0).

One hypothesis involved active pathways of FA acquisition by mature arbuscules, where plant cells deliver β -MAG in PAS via STR/STR2 ABC transporters. β -MAG could either diffuse in fungal cells (blue arrows) or be desesterified by plant/fungal secreted lipases into glycerol and palmitic acid (black arrows). Palmitic acid can be carried by lipid-domain proteins to the fungal membrane or to fungal transporters for fungal internalization. Another hypothesis is that β -MAG or triglycerides could accumulate in peri-arbuscular membranes or space during arbuscule maturation, and then be acquired by AM fungi during arbuscule collapsing. Many lipid droplets indeed accumulate during arbuscule collapsing, correlated with lipid droplets accumulation in arbuscular trunk and hyphae (Kobae et al., 2015). Each of these mechanisms would involve different gene patterns.

Using the RhiirExpress tool described in Chapter 1, the fatty acid metabolism of *R. irregularis* was investigated. Fungal lipases, elongases, desaturases and other genes that might be necessary to transform and synthesize all the different FAs from the

A

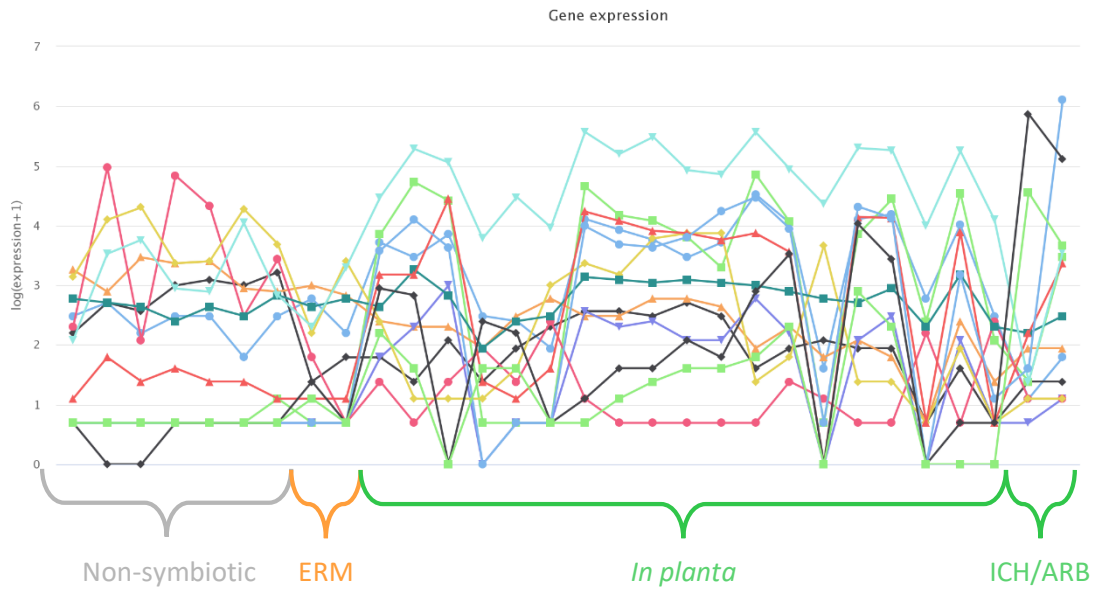

Highcharts.com

B

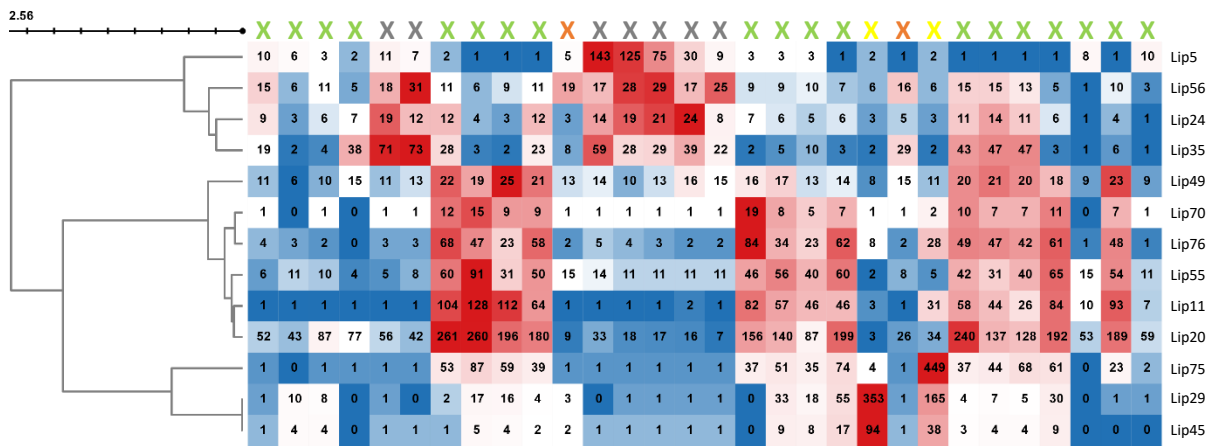

Figure 3.1: (A) Histogramm of the fungal lipases displaying a pattern of expression of interest. Non-symbiotic bracket represents asymbiotic and pre-symbiotic conditions. ERM: Extra-Radical Mycelium; *in planta* represents symbiotic conditions. The two last columns represent microdissected samples: Inter Cellular Hyphae (ICH) and Arbuscules (ARB). (B) Heatmap of same fungal lipases clustered with a Pearson correlation. The colors of X headers of columns are the same that those for the different biological conditions in (A) except for the yellow columns representing the micro dissected samples (ICH is on the left and ARB on the right).

stored TAGs or from the plant-derived palmitate moieties were manually curated from the Rhiir2-1 gene repertoire (https://mycocosm.jgi.doe.gov/Rhiir2_1/Rhiir2_1.home.html). This set of elite genes is mainly required in basal FA metabolism to ensure housekeeping functions. However, some of them might play a role during symbiotic exchanges. To identify those involved in fatty acid metabolism directly dedicated to symbiotic physiology, we explored their regulation - without excluding non-selected genes in the elite list - in contrasting situations (light modulation of photosynthetic activity, phosphate inhibitory effect).

II. Results and discussion

A. Key players of fatty acid metabolism in *R. irregularis*

The list of manually curated genes analyzed in this chapter - Fatty Acid Metabolism List (FAML) - is reported in Table 1.

1. Lipases

Putative lipases were obtained from the annotated Rhiir2-1 gene repertoire. No additional lipase was identified by Blast. Domains were confirmed by using SMART (<http://smart.embl-heidelberg.de/>) or NCBI domain search (<https://www.ncbi.nlm.nih.gov/Structure/cdd/wrpsb.cgi>). Annotation was curated on the expert databases ESTHER (<http://bioweb.supagro.inra.fr/ESTHER/>) and Lipase Engineering Database (<http://www.led.uni-stuttgart.de/>) to better characterize lipase family. Putative signal peptide predicted on JGI website was checked with SignalP v4.1. From the 76 lipases identified, 20 presented a putative peptide signal necessary for protein secretion among which 13 were confirmed by different versions of SignalP. Their expression profiles were analyzed in different biological situations (Figure 3.1A). Lip5 is specifically expressed in non-symbiotic hyphae (Figure 3.1B). Lip35, Lip56, Lip24 are expressed in symbiotic and non-symbiotic conditions. On the other hand, Lip11, Lip20, Lip55, Lip49, Lip70, and Lip76 are expressed mainly *in planta* but not specifically in arbuscules. Lip29, Lip45, and Lip75 are exclusively expressed in *in planta* conditions and present a high expression

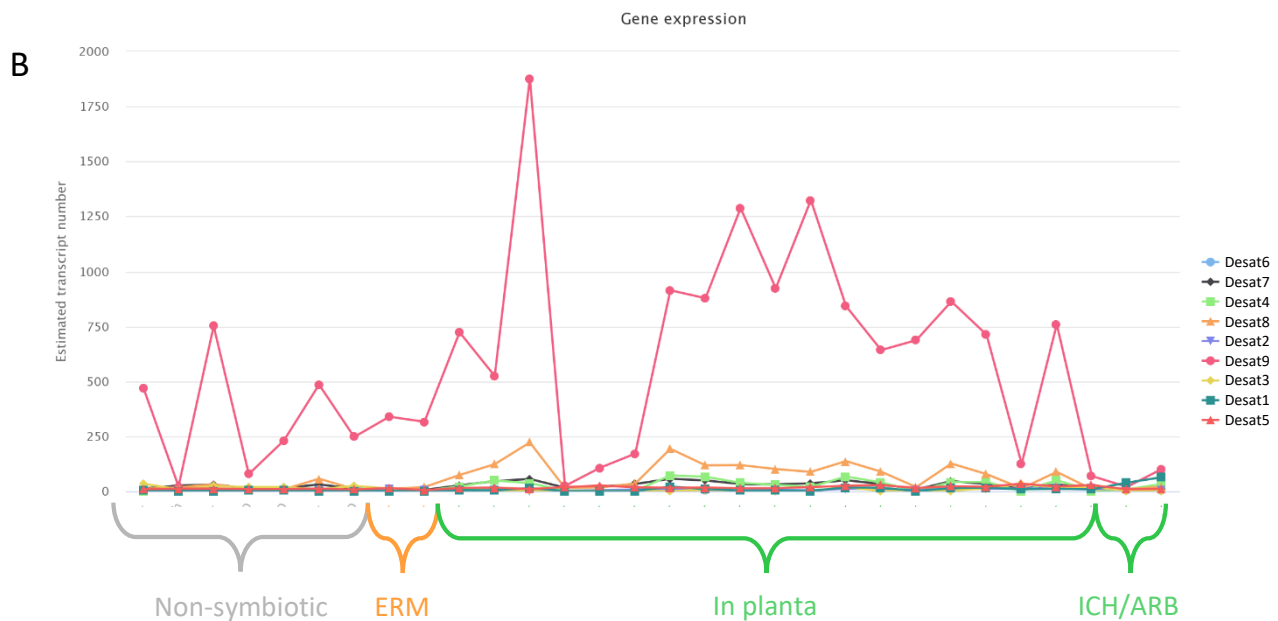
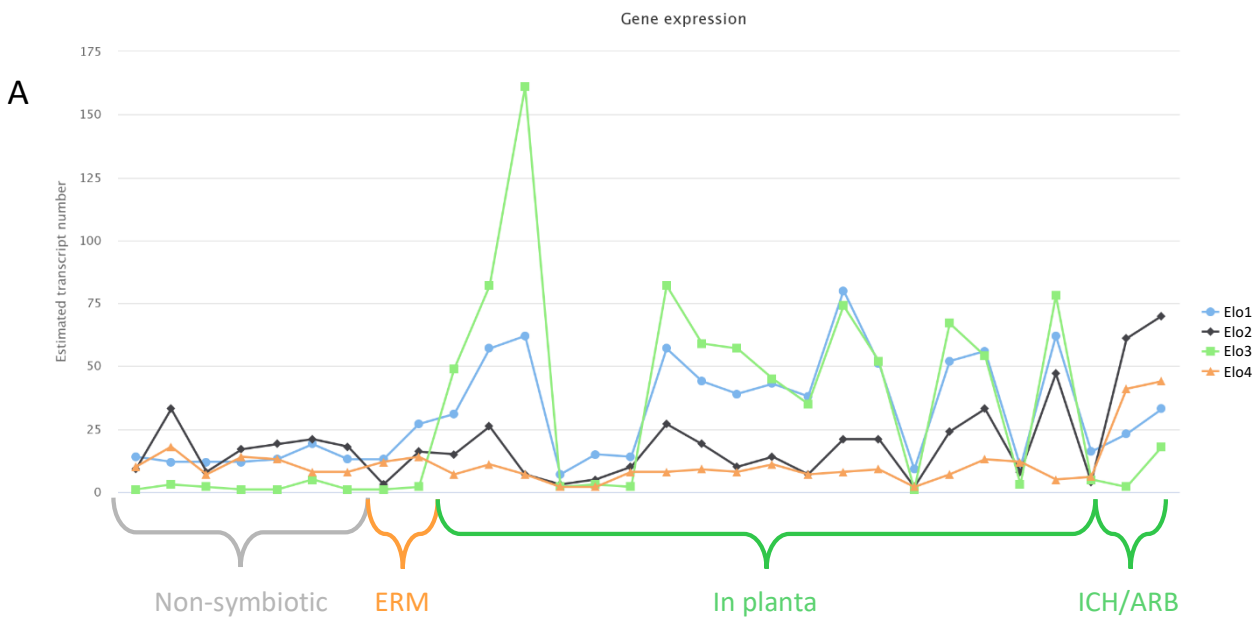

Figure 3.2: (A) Histogramm of the fungal elongases. (B) Histogramm of the fungal desaturases. Non-symbiotic bracket represents asymbiotic and pre-symbiotic conditions. ERM: Extra-Radical Mycelium; *in planta* represents symbiotic conditions. The two last columns represent microdissected samples: Inter Cellular Hyphae (ICH) and Arbuscules (ARB).

in arbuscules. These lipases are candidate genes for active symbiotic fatty acid retrieval from PAS.

2. Elongases and Desaturases

Although AM fungi are auxotrophs for palmitic acid, they possess many genes to elongate and modify FA. Four elongases were identified in the Rhiir2-1 gene repertoire. Elo1 is mostly expressed in planta, with relatively low expression in arbuscules (Figure 3.2A). The same pattern is found for Elo3 but with higher expression in the non-symbiotic stages. Elo2 has a constitutive expression in every condition tested but it shows a clear over-expression in the ICH and arbuscule. Elo4 is expressed in the same way but it seems to be almost specific to ICH and arbuscule.

Desaturases add unsaturations in the carbon chain of the FA. Nine of them were found in Rhiir2_1. Desat9 is by far the most expressed desaturase in all life stages of the fungus except for the ICH and the arbuscule compartments (Figure 3.2B). Desat4, Desat7, and Desat8 are mainly expressed in planta but fewly in the ICH and arbuscule. Desat2, Desat3, Desat5, and Desat6 all have low and constitutive expression, however Desat3 is slightly more expressed during the non-symbiotic stages of the development while the others show the opposite pattern. None of the above-mentioned desaturases is expressed in the microdissected samples. One possibility is that these enzymes could mainly be expressed in vesicles. Desat1 presents a drastic overexpression in the ICH and arbuscule, while it is almost unexpressed in non-symbiotic conditions.

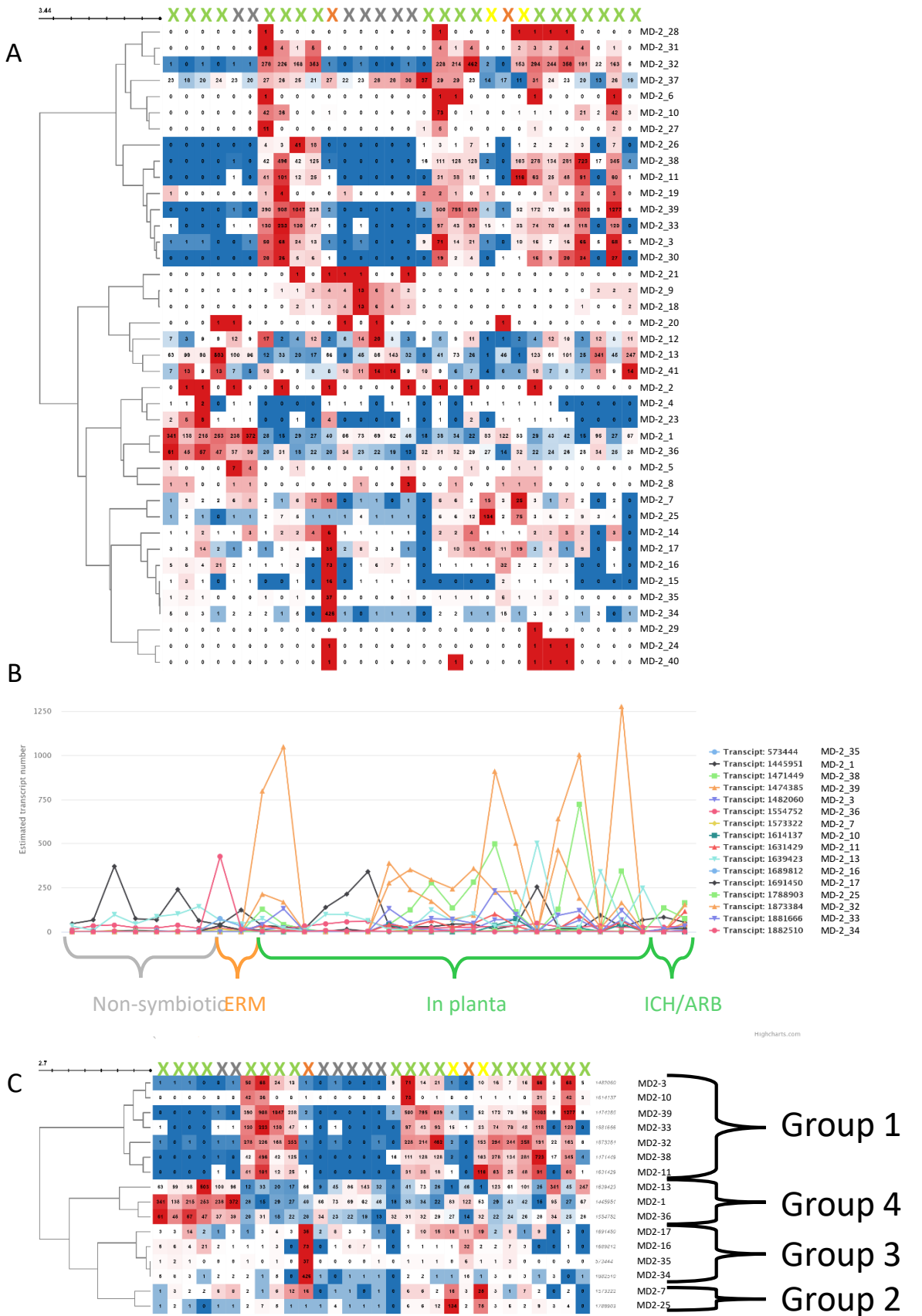

Figure 3.3: (A) Heatmap of all genes containing a MD-2 domain (only 40 out of the 41 are represented since MD2-22 has a null variance). (B) Histogramm of the MD2 domain containing genes displaying an expression pattern of interest. Non-symbiotic bracket represents asymbiotic and pre-symbiotic conditions. ERM: Extra-Radical Mycelium; *in planta* represents symbiotic conditions. The two last brackets represent microdissected samples: Inter Cellular Hyphae (ICH) and Arbuscules (ARB). (C) Heatmap of the same genes as (B) clustered with a Pearson correlation. The colors of X headers of columns are the same that those for the different biological conditions in (B) except for the yellow columns representing the micro dissected samples (ICH is on the left and ARB on the right).

3. Lipid binding proteins

Many transcripts retrieved in the IRM contained a domain named “MD-2-related lipid-recognition domain”. We suggest that these proteins could act as chaperones protein that would transport β -MAG or free fatty acids provided by the plant towards the fungal membrane before being translocated to the cytoplasm via a transmembrane transporter or direct absorption. Genes coding for 41 proteins containing the MD-2 domain were added to our FAML (Table 1). Among them, 15 were never or almost never expressed in the available conditions (Figure 3.3A). MD-2 domain-coding genes present 4 distinct clusters of genes according to their expression pattern (Figure 3.3B and C). Group1 is composed of genes that are specifically expressed in planta with an expression in the arbuscules, but not in intercellular hyphae. In this group, MD-2_39 and MD-2_38 and MD-2_32 display the strongest expression levels. Group 2 contains only two genes (MD-2_7 and MD-2_25) that are expressed in the microdissected samples. Group 3 is specifically expressed in the ERM compartment, MD-2_34 showing a typical expression. MD-2_17 has a slight expression in the ICH and arbuscule. The fourth group includes genes with a constitutive expression in every condition with MD-2_1 and MD-2_13 being the most expressed. Given the strong expression found in arbuscules by genes MD-2_32, MD-2_38, MD-2_39, that all present robust secreted peptide prediction, they might be suited candidates to bind FAs provided by the host plant, either in PAS or in the fungus.

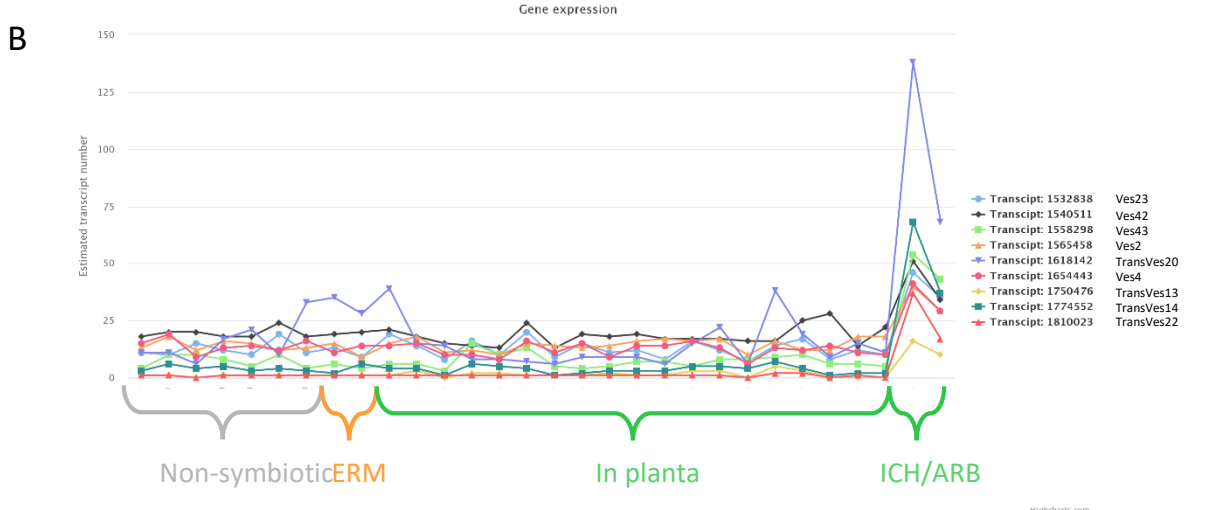
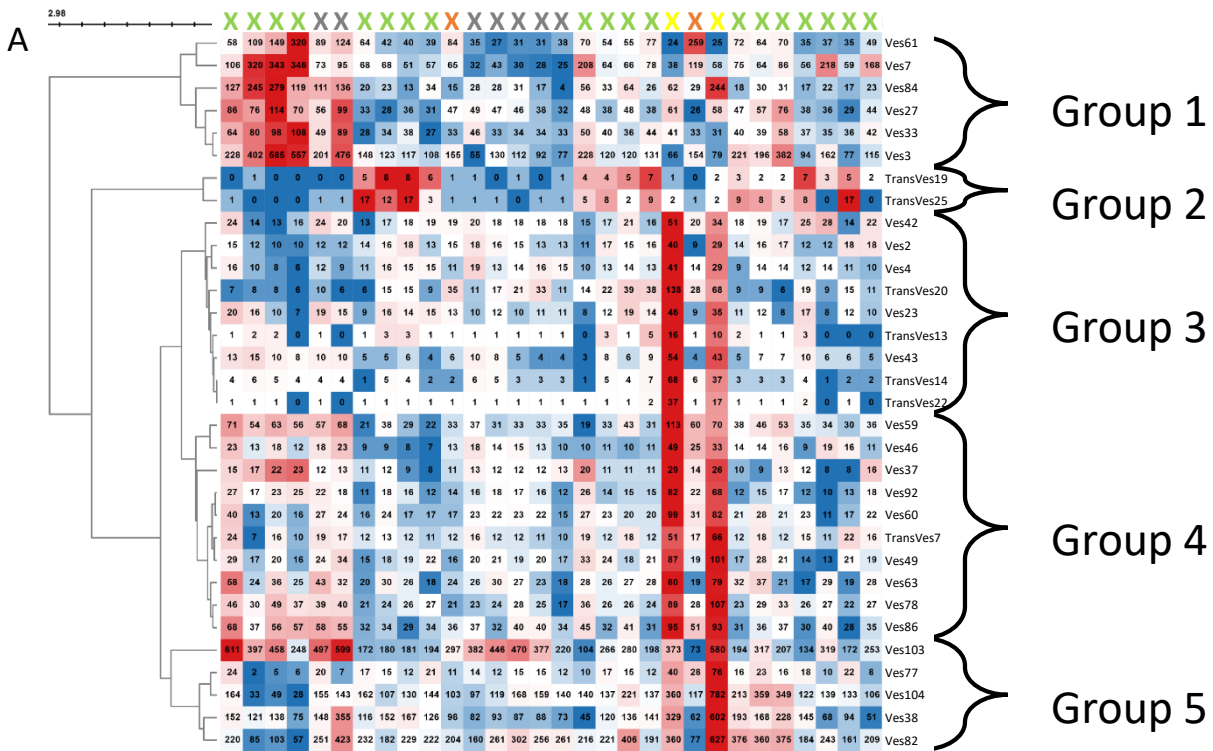

Figure 3.4: (A) Heatmap of all vesicle related genes clustered with a Pearson correlation. The colors of X headers of columns are the same that those for the different biological conditions in (B) except for the yellow columns representing the micro dissected samples (ICH is on the left and ARB on the right). (B) Histogramm of the third group of vesicle related genes. It is noteworthy that the expression is higher in the Inter Cellular Hyphae than in the arbuscules. Non-symbiotic bracket represents asymbiotic and pre-symbiotic conditions. ERM: Extra-Radical Mycelium; *in planta* represents symbiotic conditions. The two last columns represent microdissected samples: Inter Cellular Hyphae (ICH) and Arbuscules (ARB).

4. Vesicles formation and transport

Abundant lipid vesicles are visible in AM fungal hyphae, involved in the transport of fatty acids/triglycerides. Numerous vesicles are also visible in the trunk of arbuscules and intercellular hyphae during arbuscular collapsing (Ivanov et al., 2019; Kobae et al., 2014; Roth et al., 2019). Vesicle metabolism and transport might be involved in fungal fatty acid acquisition during symbiosis. We identified 144 genes that could be related to vesicle metabolism or transport. Among them, 32 show expression patterns of interest (Figure 3.4A). Five groups of expression profiles were differentiated. Group1 includes genes with a constitutive expression in every stage of the life cycle, with Ves3 being the most highly expressed gene in this group. These genes probably have a role in the general vesicular metabolism in order to carry substances from their storage to the hyphal tips where growth is occurring. Group2 correspond to genes highly expressed in planta, but not in ICH or the arbuscules. Group3 contains genes that are almost exclusively expressed in microdissected samples, particularly in intercellular hyphae (Figure 3.4B; see TransVes14 and TransVes20 for a typical expression pattern). It must be mentioned that ICH were obtained by laser microdissection in the vicinity of arbuscules, not in area free for arbuscules. This suggests a role in nutrient transport correlated to arbuscule activity. Group4 corresponds to genes showing an over-expression in the ICH compared to the arbuscules but not specifically. Genes from group 5 are constitutively expressed but expression values found in arbuscules are higher than in ICH. The high vesicular metabolism observed at the transcriptomic level is consistent with the massive translocating activity happening at the symbiotic interface. Genes from groups 1 and 2 might play a role in the general vesicular metabolism of AMF while groups 3, 4 and 5 include the best candidates to play roles in nutrient delivery via vesicle trafficking in AM fungi.

AMF are equipped with a huge set of genes able to transport and modify FAs. This genetic toolbox displays specificities in expression according to the life stage and fungal tissue. Consequently, we can trace the use of the different enzymes relative to the different stages of development from the spore to the established symbiosis.

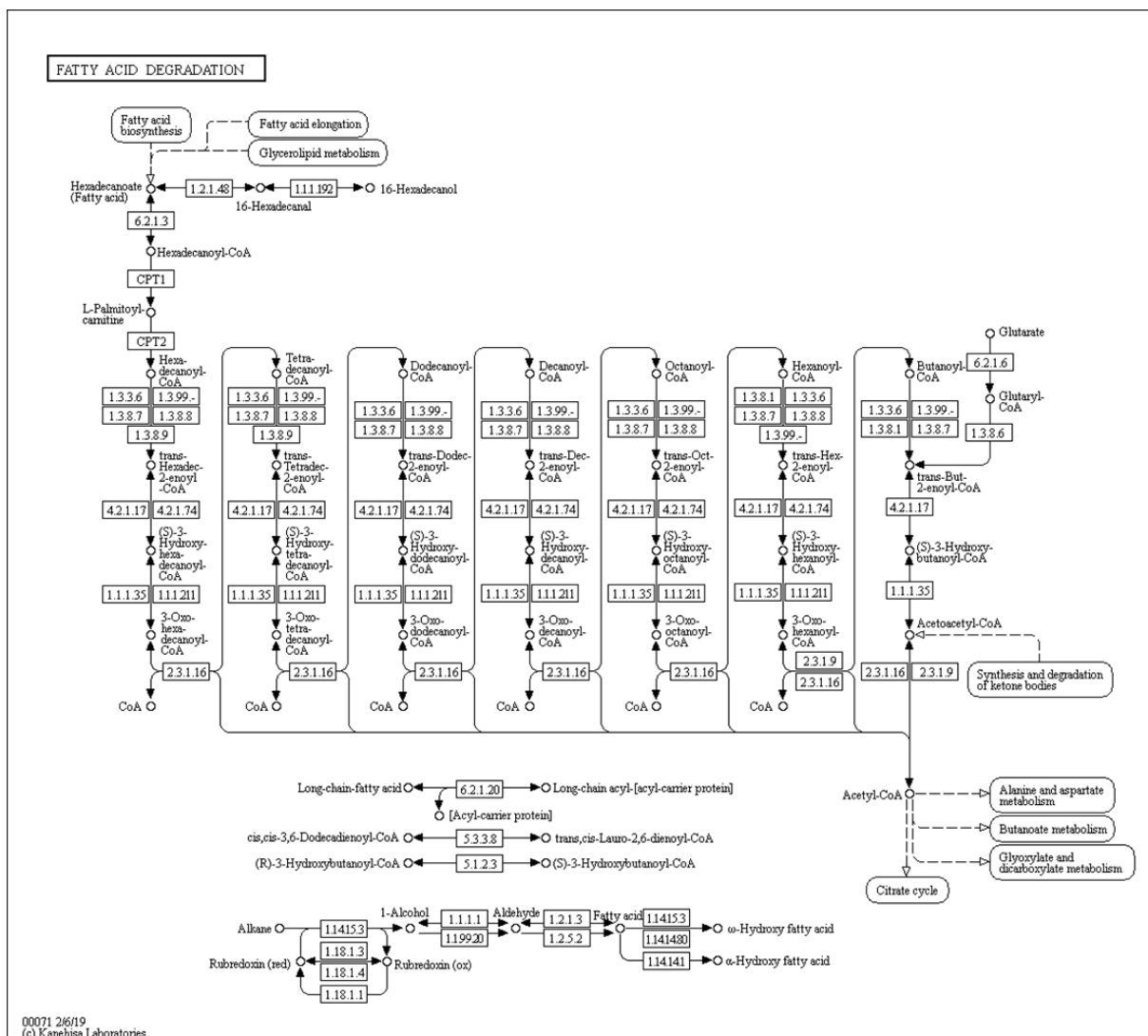

Figure 3.5: KEGG Map of the Fatty acid degradation (Reference pathway)

B. Lipid metabolism during AM fungal development

1. Spore germination, from asymbiotic to pre-symbiotic stages

During their formation, large amounts of lipid reserves are stored in spores under the form of acylglycerols, mainly TAG (Sancholle et al., 2001). The use of these reserves during germination has to be finely tuned to avoid wasting the scarce stock of FA. In response to plant exuded signals, their metabolism is activated (Tamasloukht et al., 2003). ATP production is driven by oxidative catabolism of TAGs (Besserer et al., 2009). Lipases are necessary for this step. Lip5 is a TG lipase specifically expressed during this stage (Fig 3.1A).

This enzyme could be involved in TAG hydrolysis to release glycerol and free FA. The released FA can be processed through β -oxidation (Figure 3.5). This pathway is activated when spores are treated with GR24 treatment. Lip24, Lip35, and Lip56 are expressed at this stage but not specifically. Gluconeogenesis is also activated at this stage suggesting that lipid reserves fuel glucose anabolism (Figure 3.6). In addition to using TAGs to get energy, free FA can be used to produce phospholipids necessary to synthesize new membranes during hyphal development. The production of these molecules is performed by elongases and desaturases and both Desat3 and Elo3 are highly expressed during these stages (Figure 3.2 A and B). These enzymes are preferentially expressed during non-symbiotic stages but their functional specificity is unclear. Some of the lipid-binding proteins containing the MD-2 motif are also expressed during these stages, mainly MD2_1 and MD2_13, and they might be useful to translocate newly formed hydrophobic molecules up to the hyphal tip where phospholipids are necessary for membrane budding (spitzenkörper).

Vesicular trafficking can be responsible for the transport of newly synthesized phospholipids. Among the 144 genes related to vesicular transport, 5 clusters of expression patterns are recovered (represented in Figure 3.4). The first cluster of genes involved in vesicular transport and metabolism gathers genes whose highest expression is recovered in the non-symbiotic conditions. Given that vesicles are ubiquitous in AM fungi, it is not surprising to find a group of genes whose expression

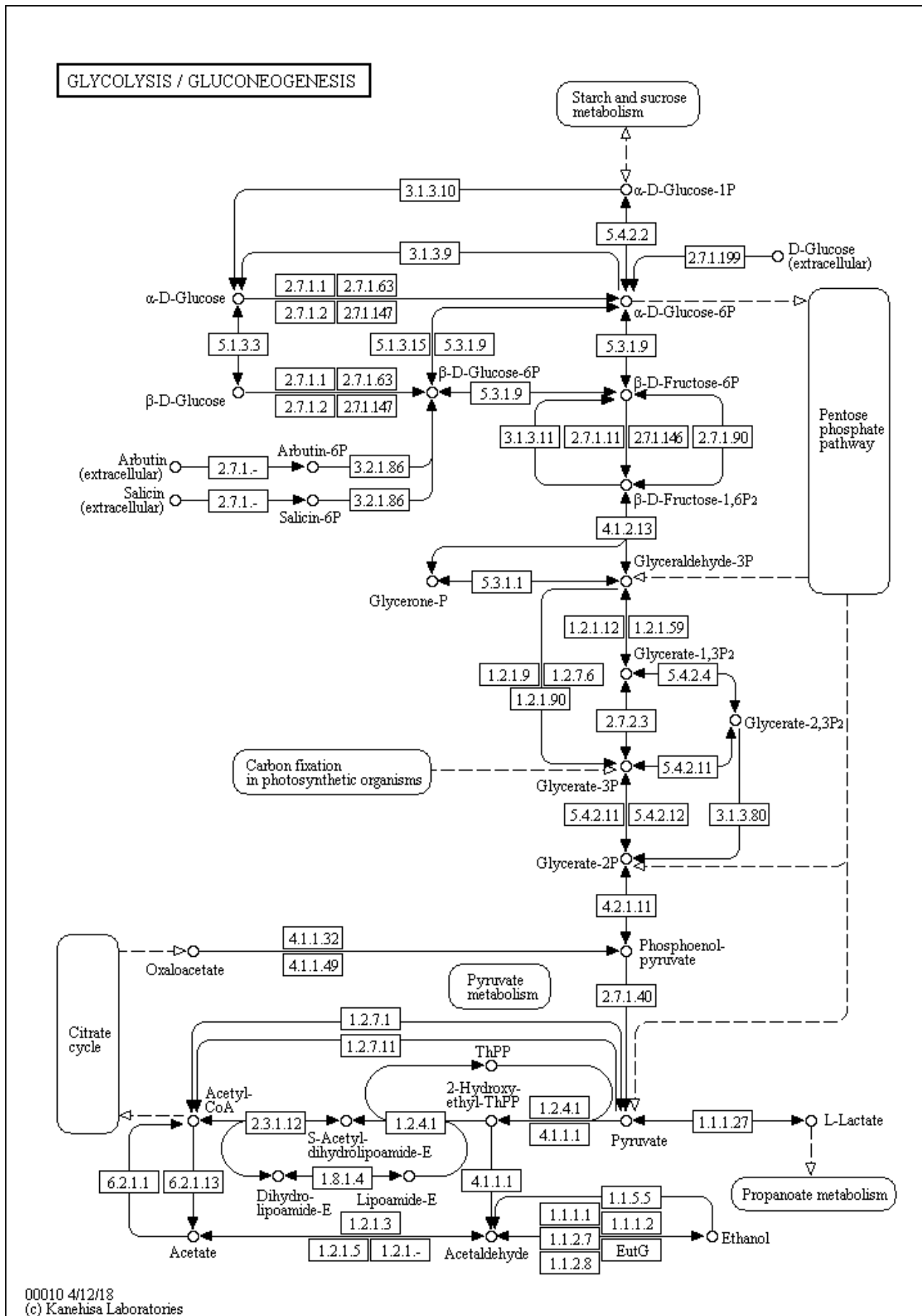

Figure 3.6: KEGG Map of Glycolysis and Neoglucogenesis (Reference pathway)

is constitutive in any condition. The large number of genes present in this cluster mostly indicates that housekeeping functions are being put in place.

The setting up of basal metabolism is mandatory for full spore function and further development of secondary metabolisms. Once the metabolism has been triggered, stored lipid energetic reserves are running out without the possibility of refilling as long as symbiotic interaction occurs. Therefore, it is important for the fungus to be able to maintain tight control of its development if a host plant is not in the vicinity. In such case, the fungus is able to stop its development and forming septates in hyphae, retracting its cytoplasm in spore, and go back to dormant physiology. An experiment using temperature to trigger spore germination has been conducted to see how many germination/withdrawal cycles can be performed before emptying the spores of a Gigasporaceae (Lumini et al., 2007). The result is still unknown because the spores' endurance outlasted the experimenter's patience. Indeed, after more than 35 repetitions, the spores were still able to germinate (P Jargeat, pers. communication).

2. Symbiotic stages: in planta

As previously underlined, Lip29, Lip45, and Lip75 are highly expressed in arbuscules and might play a role in FA acquisition, for instance by degrading the numerous vesicles observed in PAS. Similarly, the secreted lipid-binding proteins with MD-2 domain MD-2_7 and MD-2_25 presents are specifically present in arbuscules. The combo of lipases and lipid-binding proteins look like good candidate genes to capture and store the FA provided by the plant. Turning these saturated short-chain FAs into longer and/or desaturated FA is achieved by elongases and desaturases respectively. Elo2 and Elo4 are fungal elongases overexpressed in the arbuscules. The same pattern of expression is found in Desat1. In addition to arbuscules, *R. irregularis* forms intercellular vesicles in colonized roots; they are different from the vesicles (lipid droplets) above-mentioned, which refer to subcellular organelles. Intraradical vesicles (IRV) are poorly studied and their exact function remains elusive. Given the amount of TAG stored in these structures, they are believed to be transient tanks of FA provided by the plant. IRV are also units of fungal propagation: they have the ability to germinate and colonize plant roots, much like the spores produced out of the roots (Jabaji-Hare et al., 1984). In RhiirExpress, there is some inconsistency

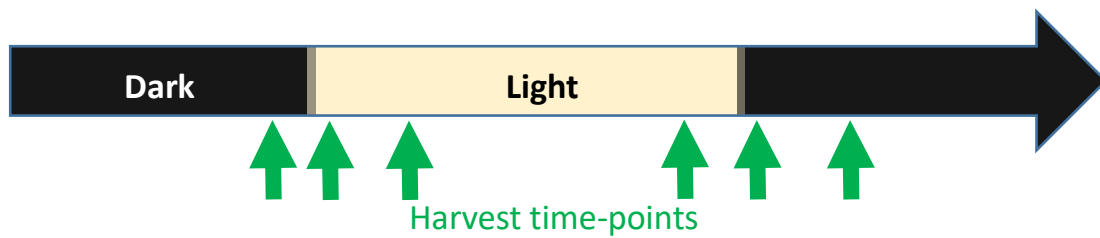

Figure 3.7: Harvest time-points during the photoperiod (16h light / 8h dark)

found from results issuing from whole plant tissues, arbuscules (ARB) and intercellular hyphae (ICH). Some genes are found expressed in whole plant tissues, but neither in ARB or in ICH. It can not be excluded analytical errors, but another reason is that ICH, as already mentioned, correspond to libraries obtained by laser microdissection of tissues with intercellular hyphae around arbuscules, without IRV. Including expression data from IRV in RhiirExpress will help to decipher the exact role of these structures. ICH develops in the apoplastic compartment of the plant root system. As mentioned in Chapter 1, the aquaporin AQPF3 is very highly expressed in this compartment. Although apoplast, where the fungus is growing, is rich in available sugars, no sugar transporters were found clearly expressed in ICH. The most expressed sugar-related gene the most expressed in this compartment is SugTrans4, a glucosamine-6-phosphate isomerase. Considering fatty acid metabolism, transcriptomic pattern of ICH does not present a specific identity.

C. Regulation of C exchanges: are FA and hexose transfers similarly regulated?

Fatty acid metabolism was not of particular interest until the FAS complex was found lost from AM genomes. Up to then, it was assumed that only hexoses were bartered to feed the fungus. Hexoses/phosphate exchanges were intensively studied, but incidence on phosphate on FA exchanges is poorly documented. In order to shed light on the regulation of plant Hexose+FA delivery to *R. irregularis*, I will present different approaches to symbiotic disruption.

1. Light as a regulator of symbiotic exchanges

Photosynthesis is the source of all carbon molecules in plants. If the plant is mycorrhized, then most of the fungal carbon also originates from photosynthesis. AM fungi are considered as carbon sinks as they can take up to 20% of the total assimilates fixed by a plant (Bago et al., 2000). Therefore, the photosynthetates pool is tightly regulated by synthesizing transient stocks under the form of starch for example (Kölling et al., 2015). These stocks are varying throughout the diurnal cycle in order to maintain continuous growth. Given the dependency of AM fungi on this photosynthetate pool, how is the symbiosis responding to variations in light availability? The effect of intensity or deprivation (Ait Lahmidi et al., 2016;

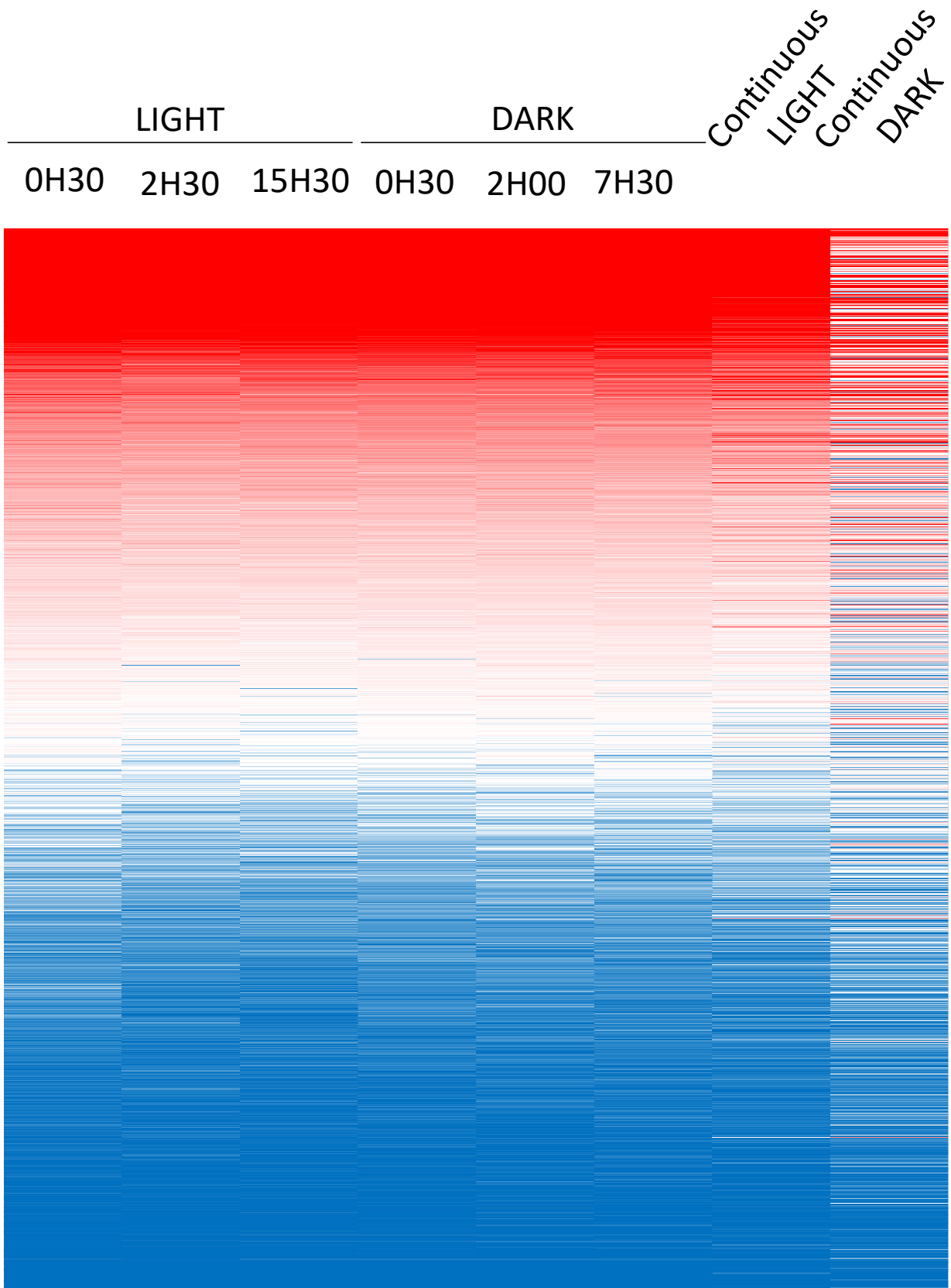

Figure 3.8: Heatmap of fungal gene expression on a typical day/night cycle and in continuous dark for 6 days. The data represent fold changes compared to libraries of non mycorrhizal *Medicago truncatula*. Only the 1686 most Differentially Expressed Genes (DEG) are represented. The blue colors represent a decrease in gene expression while the red ones show an increase compared to the control situation. Note that the gene expression shows major differences in continuous night compared to the rest of the time points of the night/day cycle.

Konvalinková and Jansa, 2016) has already been investigated on the expression of specific genes. We here performed a global transcriptome analysis during photoperiod in order to provide a complete landscape of gene regulations corresponding to the functioning in natural life.

To answer this question, we conducted an experiment to assess the influence of diurnal fluctuations on the symbiotic carbon transfer. Mycorrhizal *Medicago truncatula* plants were harvested at different times of the light/dark photoperiod (Figure 3.7). In addition, plants were collected after 6 days in continuous light (CL) and continuous dark (CD) conditions. RNAseq data were mapped on Rhiir2-1 gene repertoire and variation of expression was analyzed as Fold Changes using ERM condition as a reference. Typically, strong homeostasis of gene expression was observed throughout the photoperiod, and very few genes present a fold change over ± 2 (2126 DEG - Figure 3.8). Checking on the plant transcriptome, same steady expression was observed (1630 DEG Figure 3.9). Symbiotic exchanges are not modulated during photoperiod at transcriptional level, although post-transcriptional regulation of some pathways can be suggested. This also underlines that host lipids (vesicles/membranes) and hexoses (starch) stored in roots and polyphosphate stored in AM fungal hyphae are sufficient to maintain a continuous functioning of AM symbiotic exchanges during photoperiod.

CL condition did not differ largely from the 24H samples. In contrast, CD conditions strongly disrupted the symbiotic physiology and particularly the steady exchanges. In CD condition, the level of colonization was still high (80%) even though the plant remained in the dark during the last 6 days before harvest. At 6-days of CD, all fungal genes involved in fatty acid metabolism (elongases, desaturases), carbohydrate biosynthetic pathways and transport, ammonium metabolisms were down-regulated, whereas plant symbiotic FA metabolism was inactive (Table 2). Given the scarcity of carbon molecules to barter with the fungus, the reciprocal exchange became unbalanced, leading the fungus to stop providing minerals. It is very likely that the arbuscules, made useless by the arrest of transfers, would have started collapsing soon after the harvest, we did not notice changes in arbuscules morphology (they were still entirely filling the plant cell). It is known that both the plant and the fungus are able to modulate the rate of nutrient delivery to different partners in

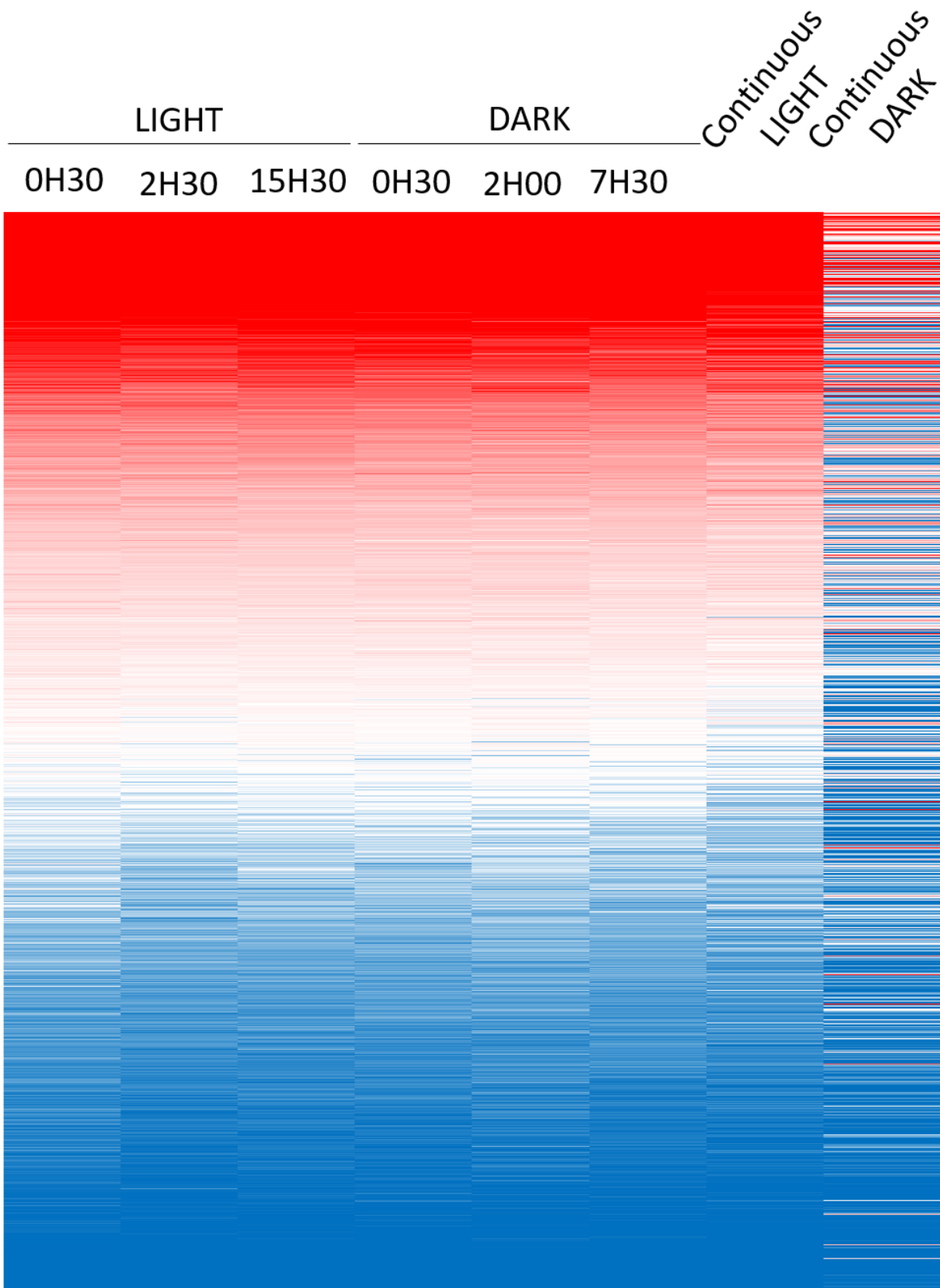

Figure 3.9: Heatmap of plant gene expression on a typical day/night cycle and in continuous dark for 6 days. The data represent fold changes compared to libraries of non mycorrhizal *Medicago truncatula*. Only the 1686 most Differentially Expressed Genes (DEG) are represented. The blue colors represent a decrease in gene expression while the red ones show an increase compared to the control situation. Note that the gene expression shows major differences in continuous night compared to the rest of the time points of the night/day cycle.

order to reward the most beneficial one (Werner and Kiers, 2015). This type of regulation is believed to be mandatory for a stable mutualism (Kiers et al., 2011). However, it is interesting to point out that this a-physiological situation could mimic the end of the host plant cycle, inducing the recovery of storage compounds by AM fungi in intra-radical vesicles (IRV) and spores (Kobae, 2019). Genes from FAML found induced in arbuscules were repressed (particularly Lip29, Lip45, and Lip75 MD-2 and MD-2_25), except MD-2_7 that is overexpressed, compensated by new lipases (LIP25, LIP46, LIP56, LIP14, LIP27) and many genes coding for proteins involved in vesicle trafficking. Such activation of a new genetic program could indeed be correlated to IRV biology

2. Phosphate as a regulator of symbiotic exchanges

As discussed in chapter 2, the arbuscular mycorrhizal symbiosis can be regarded as a market theory (Kiers et al., 2011; Walder and van der Heijden, 2015) where the fungus can have access to carbon molecules in exchange to phosphate. Phosphorus is not only a nutrient that modulates the intensity of symbiotic exchanges according to the amount of phosphate delivered to their host plants as observed in chapter 2, it is also a well-described regulator of the symbiotic association as plants can either use their autonomous mechanism of phosphate acquisition or the symbiotic one according to the amount of phosphate in root environment. The addition of a high concentration of phosphate (HP) to *Petunia hybrida* colonized with *Rhizophagus irregularis* (MUCL 43204) significantly decreased the colonization rate after two weeks of treatment (Breuillin et al., 2010). The lag of two weeks after the phosphate addition suggests that HP treatment did not induce a collapse of existing arbuscules but rather stopped the fungus from producing new ones (Kobae et al., 2016). Then arbuscule turnover led to a decrease in the overall colonization rate. Using HP treatment as a symbiotic disruptor also offers an advantage as it allows a gradual stopping of the transfers while still having the fungus present inside the roots.

To investigate the regulation of symbiotic exchanges by an excess of phosphate, we performed RNAseq time-course experiments where mycorrhized *Medicago truncatula* plants were exposed to a high concentration (1 mM) of phosphate, also physiological. Mycorrhizal *M. truncatula* plants were grown for 5 weeks in low P (LP -7,5 μ M) condition before addition of 1 mM phosphate solution (HP). Root systems were

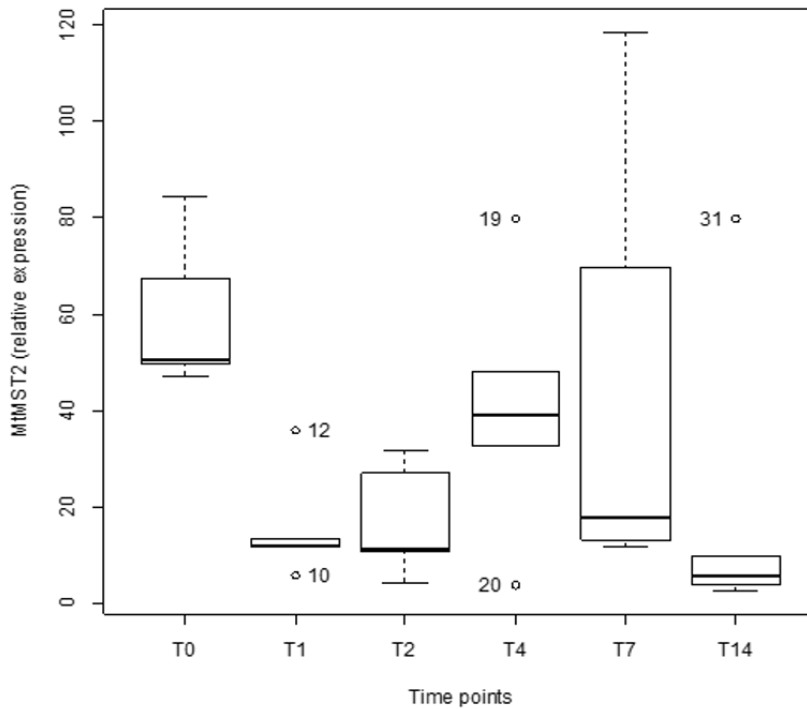
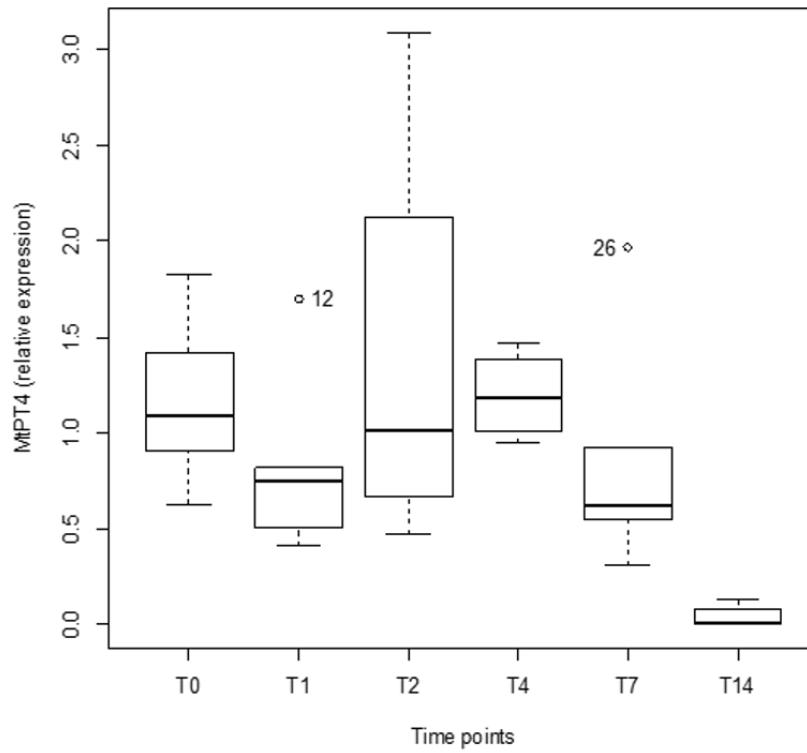

Figure 3.10: Gene expression of plant symbiotic phosphate transporter MtPT4 (compared to Ubiquitin) and fungal sucrose transporter RiMST2 (compared to TEF1) obtained through RT-qPCR. The time points are expressed in days: T0 = before phosphate treatment, T1= 1 day after treatment, T2= 2 days, T4= 4 days, T7= 7 days, T14= 14 days. Note that the watering was done with water before T2 and T4 to avoid high phosphate induced toxicity, hence the increase in gene expression at these times. This issue was addressed during the second kintic analysis.

harvested at different time points before RNA extraction and gene expression analysis. Previous experiments were carried out to define optimal phosphate concentration, watering period and time-points after HP addition on gene expression on both partners. The targeted temporal window spanned from one to 14 days. qPCR analysis of MtPT4 expression showed a decrease, confirming the repression of the symbiotic pathway. RiMST2, however, did not show any variation of expression during the experiment (Figure 3.10). This can either suggest that sugar transfer is still active even after 14 days, or that RiMST2 is less essential for these stages for sugar exchanges as previously described (Helber et al., 2011). Based on RT qPCR results, we selected 3 time points for mRNA sequencing : T0 (control: plants grown for 5 weeks in LP), 1dpa (1 day post addition: plants grown for 5 weeks in LP, then watered one day with HP) and 14dpa (14 days post addition: plants grew for 5 weeks in LP, then watered two weeks with HP). At 1dpa, consistent variation of fungal gene expression was observed (2188 DEGs with a threshold of fold change FC +/-2 and 155 DEGs at FC +/-5). Fewer plant genes were differentially regulated (663 DEGs at FC +/-2 and 26 at FC +/-10).

It underlines that rapid metabolic shift occurred between mycorrhizal to direct pathway of plant phosphate acquisition. After 14 days of treatment however, the number of DEG grew up to 6112 with a threshold of FC +/-2 and 1165 at +/-10) and the symbiotic pathway in *M. truncatula* is stopped (Table 3). The genes necessary for FA production and transfer are down-regulated, as the expressions of HA1 or PT4 (Fold changes <-12). Interestingly, the sugar transporters published on the plant side did not show a clear down-regulation, except for SWEET1b, which is the only one down-regulated (FC<-6). The same trend is observed on the fungal side with 3372 DEGs at FC +/-2 and 687 DEGs at FC +/-10. Both the symbiotic phosphate transfer and the aquaporins, and the putative lipases and Lipid Recognition Proteins involved in FA recovery are down-regulated. On the other hand, the expression of RiMSTs is almost unchanged, with only a slight downregulation of MST6 (FC= -3.6). While phosphate and FA metabolisms are very tightly correlated, the sugar transfer appears to be impacted to a lesser extent by the disruption of the symbiotic transfers.

In order to get a clearer picture of the down-regulation happening at early stages of the disruption of symbiotic exchanges, we repeated the experiment with a higher

A

Time Point	H0	H1	H3	H9	H24	H48	H96
Mycorrhization Level (%)	65,33%	51,50%	60,33%	64,33%	57,50%	56,17%	62,17%

B

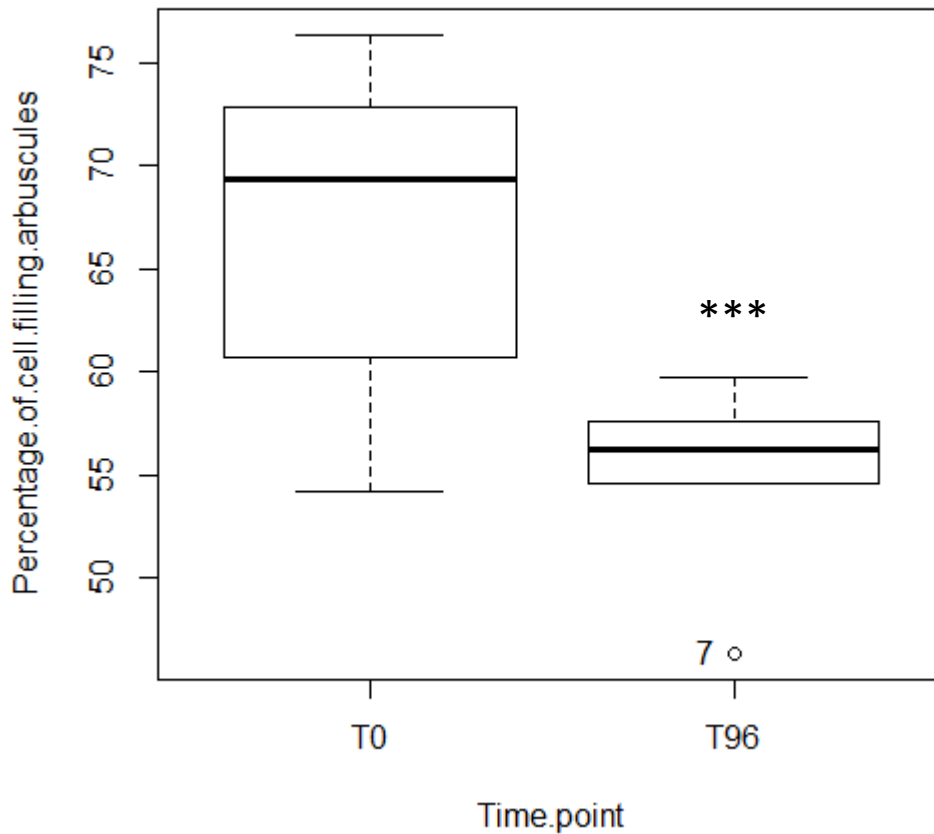

Figure 3.11: Phenotyping of mycorrhizal structures from the second kinetic analysis in response to phosphate 5mM. (A) Fungus colonisation measured on 6 replicates at each time-point with the gridline intersection method. No significant difference observed (one-way ANOVA). (B) cell-fulfilling arbuscule counted on H0 and H96 replicates for each time point (one-way anova)

concentration of phosphate (5 mM) and with earlier time-points in order to narrow down the temporal window of symbiotic switch-off. It was expected that the higher concentration of phosphate would accelerate the rate of disruption consequently, some time points surrounded the 24h milestone. The time points spanned from 1 hour to 4 days and the selected ones were T0 (control), 9hpa (9 Hours Post Addition of HP) and 96hpa (96 hours post addition of HP). It should be noted that after four days of very high phosphate treatment, the mycorrhizal levels were unchanged but the percentage of arbuscules fulfilling the plant cell decreased significantly (Figure 3.11). This corresponds to a situation where the fungus is still metabolically active even though the process of symbiotic disruption is engaged. In *Medicago truncatula*, the expression of the FA producing and transferring genes does not show a strong down-regulation at H9 compared to T0 (Table 4). Nevertheless, at 96hpa these genes presented a reduction in their expression. Regarding sugar transfers, the published sugar transporters neither showed statistically significant differences in their expression after nine hours of HP treatment nor did they after 96 hours. MtPT4 was down-regulated at 4 days but not at 9 hours. Surprisingly, the expression of HA1 was not significantly repressed neither after 9 hours nor 4 days. On the fungal side, none of the lipases or the MD-2 containing genes were statistically different at 9hpa compared to H0 (Table 4), however, they did show a decrease in expression after 96 hours (FC <-2). The sugar transport metabolism did not show significant differences in both 9dpa and 96dpa when compared to H0. The fungal phosphate metabolism is unchanged at 9dpa for most of the genes except for RiPT1, RiPT7, and the phytase2, which are up-regulated at least 2 times. At 96 hpa, such overexpression is still active whereas other phosphate fungal genes are repressed: phytase 3 (FC<-2,5) and RiPT2 (FC<-11).

The results of these two kinetic analyses showed that symbiotic phosphate transfer starts to be down-regulated after 4 days of HP treatment (5mM) both in the fungus and in the plant. The reduction of gene expression gets stronger when the treatment is carried on until 14 days. The fatty acid metabolism follows the same pattern with a slight decrease in gene expression after 4 days of HP treatment and stronger repression after two weeks. While the FA and phosphate metabolisms are tightly regulated at the transcriptomic level, the sugar metabolism is not regulated in the same way and barely shows any regulation throughout the two-week assay. The

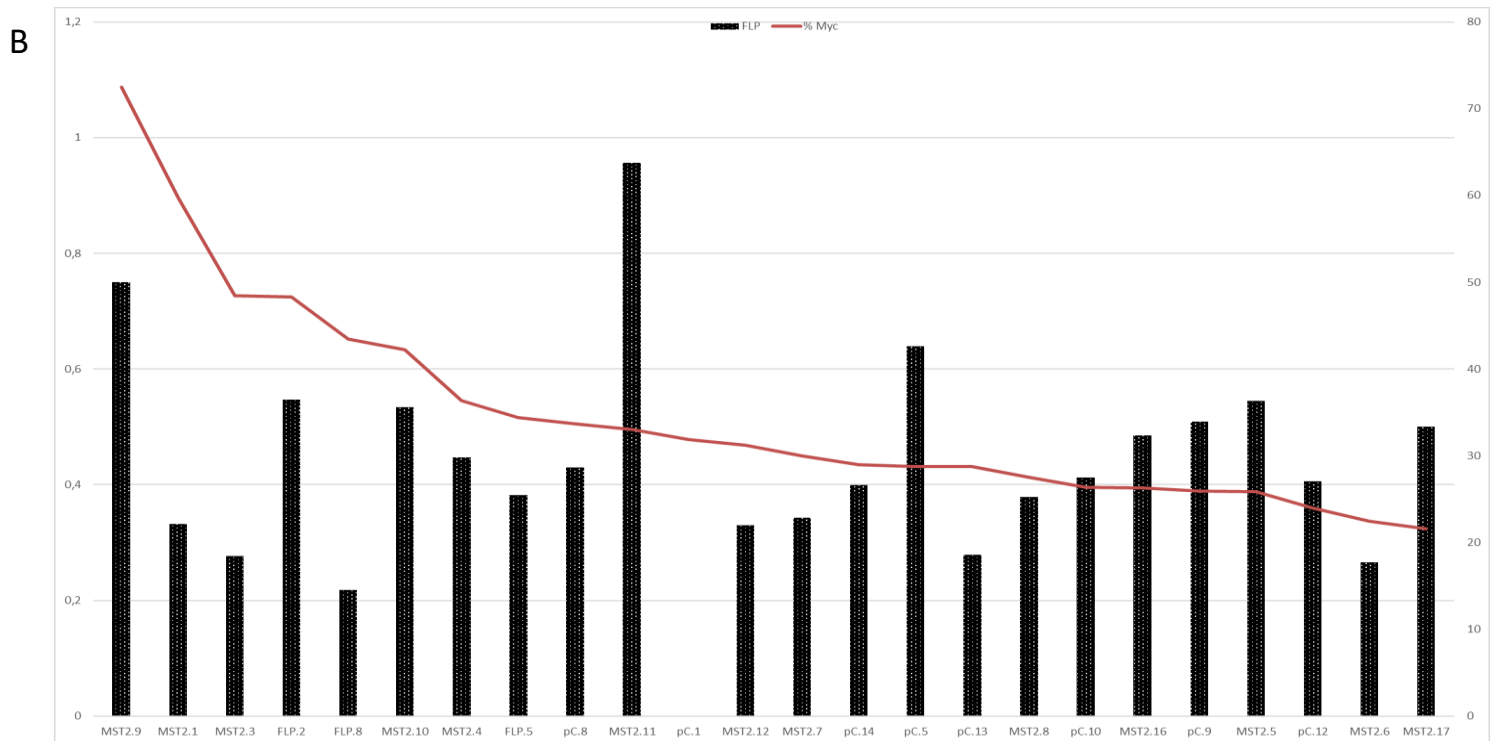
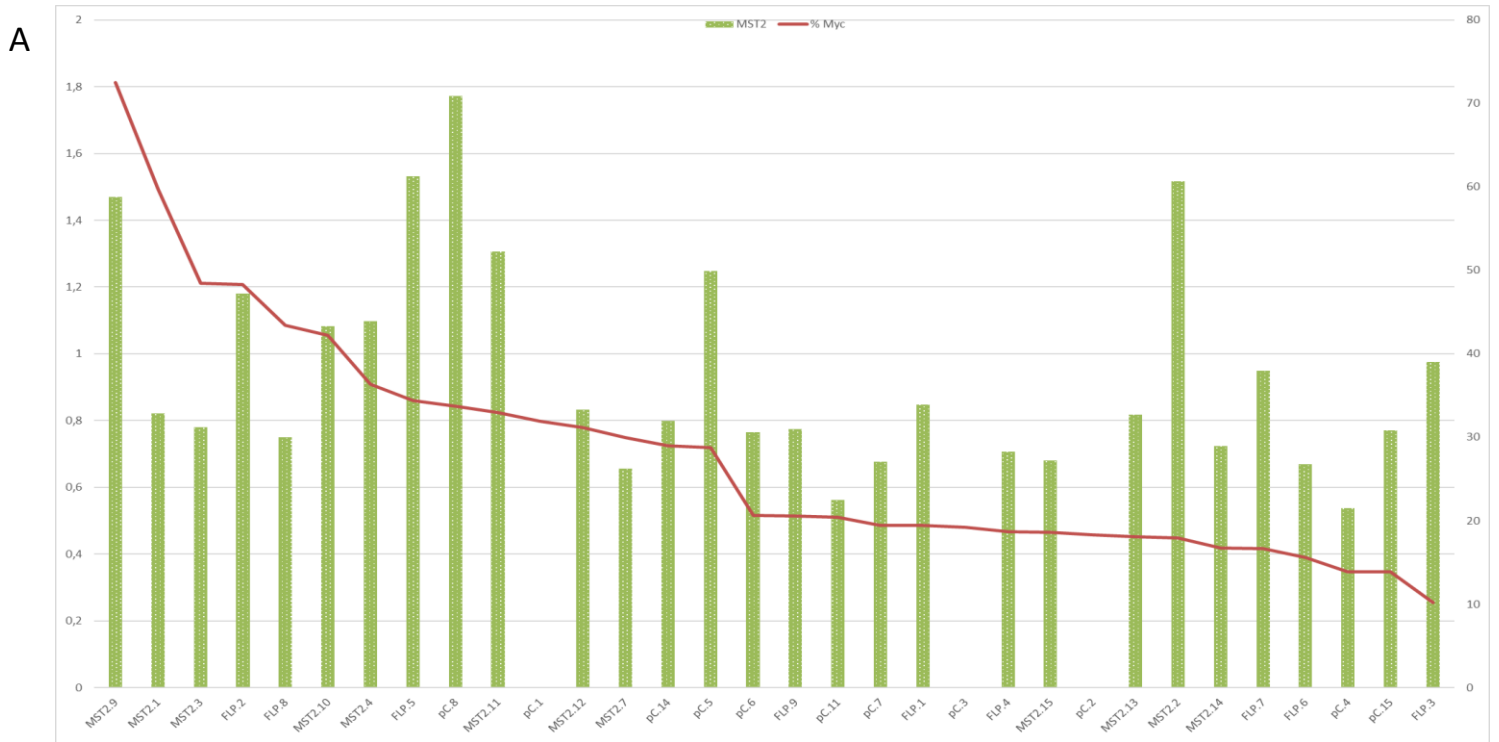

Figure 3.12: Histograms of gene expression of fungal genes after (an attempt of) gene silencing. (A) Histogram of RiMST2 expression in plants transformed with an empty vector (PC) or plants transformed with a construct targeting RiMST2 or plants transformed with a construct targeting 3 candidate lipases (FLP). (B) Histogram of the combined expression of 3 candidate lipases (FLP) in the same plants. The red line represents the percentage of colonisation.

similarity between the patterns of expression between FAs and phosphate suggests a reciprocal exchange for these two substrates between the symbionts, whereas the correlated mechanisms have to be discovered.

3. Functional validation assays for candidate genes

Among the fungal genes up-regulated in planta compared to the ERM condition, my works have pointed out enrichment in annotations corresponding to lipases (Fig310). To check whether some candidates could be involved in AM symbiosis functioning, we planned to silence their expression by Host Induced Gene Silencing (HIGS). According to previous works showing the role of *MST2* in sugar transfers in AM symbiosis (Helber et al., 2011), this gene was targeted as experimental control. Based on expression data previously presented, 6 candidate lipases of *R. irregularis* were selected. As two of them presented close sequences, they are targeted by same RNAi construction. As a result, 5 gene constructions were carried out: 4 specifically targeting one candidate lipase each and the last one targeting 2 lipases. Based on RNAi constructions from Helber and colleague's material and methods, RNAi constructs targets the 300bp region on the 5' end of the ORF. This portion of the CDS was expressed in a hairpin loop under the control of the 35S promoter. After validation of constructs, plantlets of *M. truncatula* were transformed with agrobacteria. Hybrid transformants with roots expressing RNAi construction were used for mycorrhizal association. When analyzing target gene expression by RT-qPCR, we observed a high range of responses according to independent transformation events. Gene expression ranged from low (silencing) to overexpression and include expression equivalent to empty vector, (Figure 3.12). Such erratic results with HIGS were also reported from previous experiments in our team or other labs. For all genes analyzed, even RNAi targeting *Ri MST2*, variation of gene expression was not strictly correlated with plant colonization level.

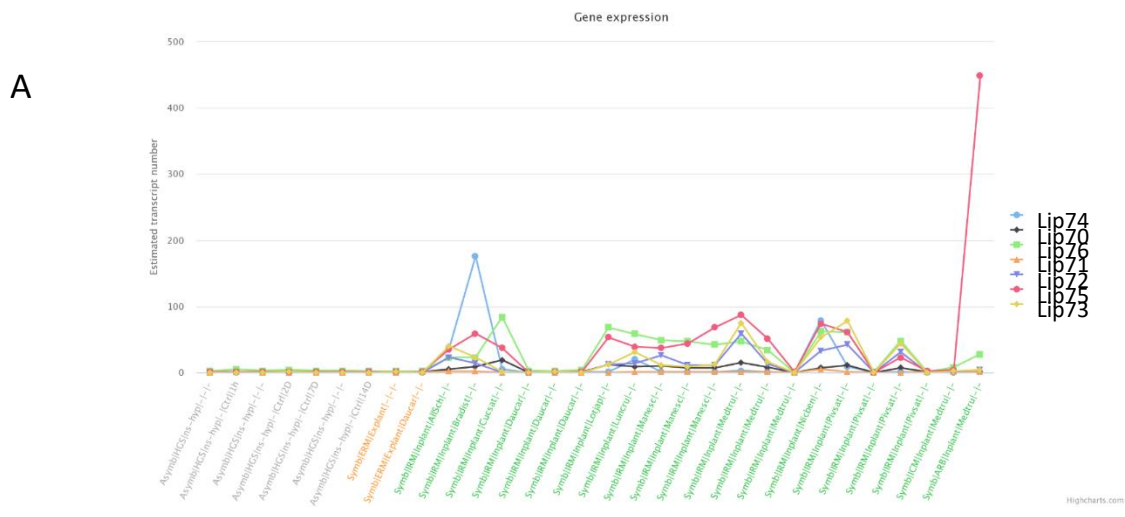

Figure 3.13: Expression of candidate lipases. Lip75 and Lip76 are the most expressed in ARB.

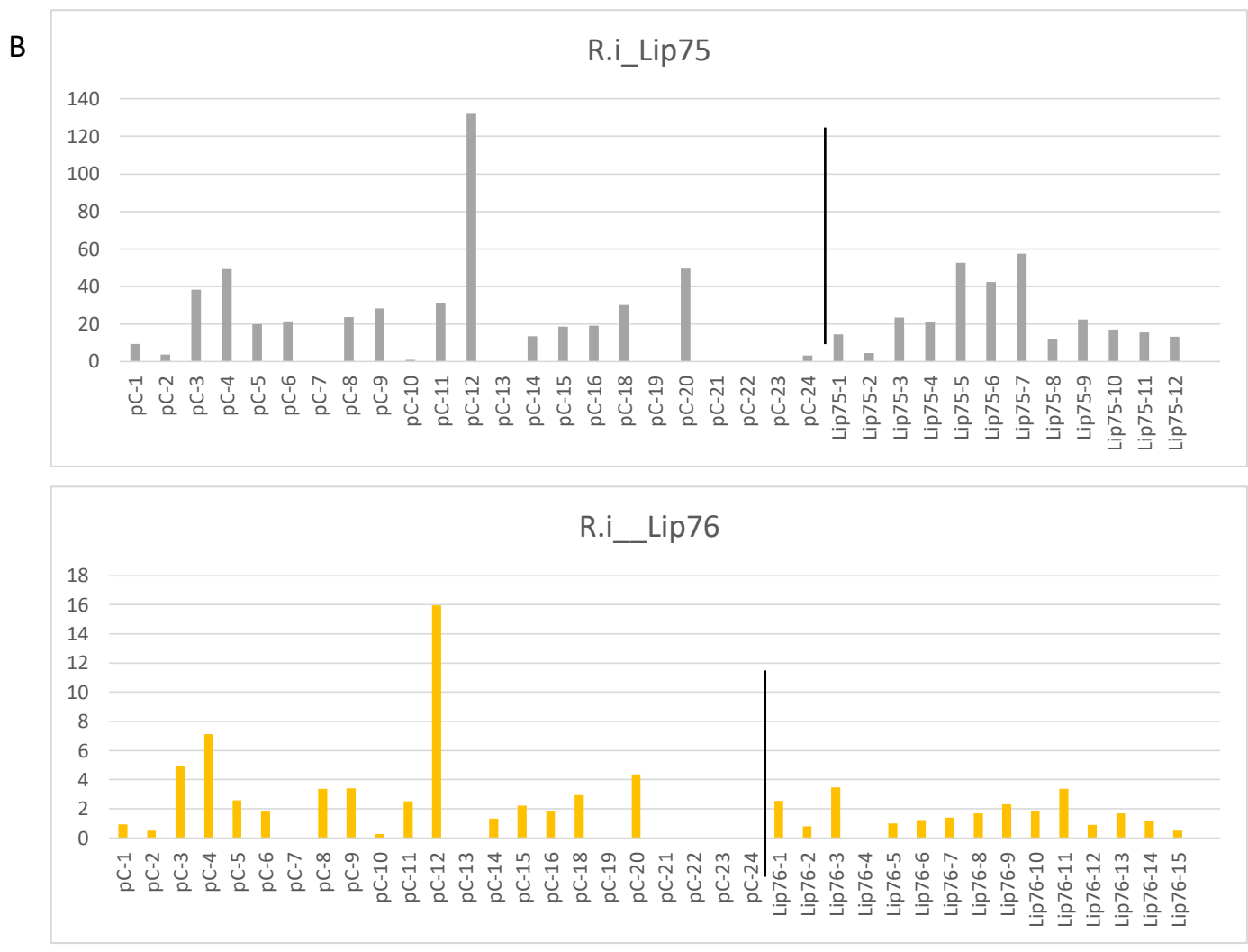

Figure 3.14: Histograms of gene expression of fungal genes after gene silencing. (A) Histogram of Lip75 expression in plants transformed with an empty vector (pC) or plants transformed with a construct targeting Lip75. (B) Histogram of Lip76 expression in plants transformed with an empty vector (pC) or plants transformed with a construct targeting Lip76. The expression of Lip75 is not statistically different from the control situation (p-value = 0,8693) neither is Lip76 (p-value = 0,152).

One suggestion was that 35S promoter appears to be very lowly expressed in arbuscocytes (P.M Delaux personal communication). In all constructions, the 35S promoter was replaced by MtPT4 promoter, which is specifically and strongly expressed in arbuscocytes. This new set of construction was restricted to 2 candidate genes particularly expressed arbuscules (Figure 3.13). But here again, expression levels of targeted genes were not statistically different from the control plants (Fig 3.14).

While thoroughly analyzing the RT-qPCR data, we noticed that the expression of RiMST2 was uncoupled with symbiotic activity, suggesting that it would not be a good marker gene for fungal symbiotic activity. In contrast, candidate lipases were highly correlated with the expression of plant genes MtPT4 and MtRAM2, which are plant genes considered good markers of the symbiotic activity (Figure 3.15). Interestingly, the abundance of transcripts of candidate fungal lipases was correlated with the abundance of these plant marker genes. In order to reinforce that, an R^2 was calculated for each combination of genes. It turns out that the Lipase320 is highly correlated with RAM2 expression with an R^2 higher than MtPT4 and RAM2. This strong correlation suggests that these plant and fungal genes are acting in concert. Indeed, this is a good hint that these fungal lipases are mirroring the FA production in plant arbuscocytes (approximated by RAM2 expression). This also suggests that fungal lipase expression is correlated with phosphate delivery in the symbiotic interface, reinforcing the market theory hypothesis.

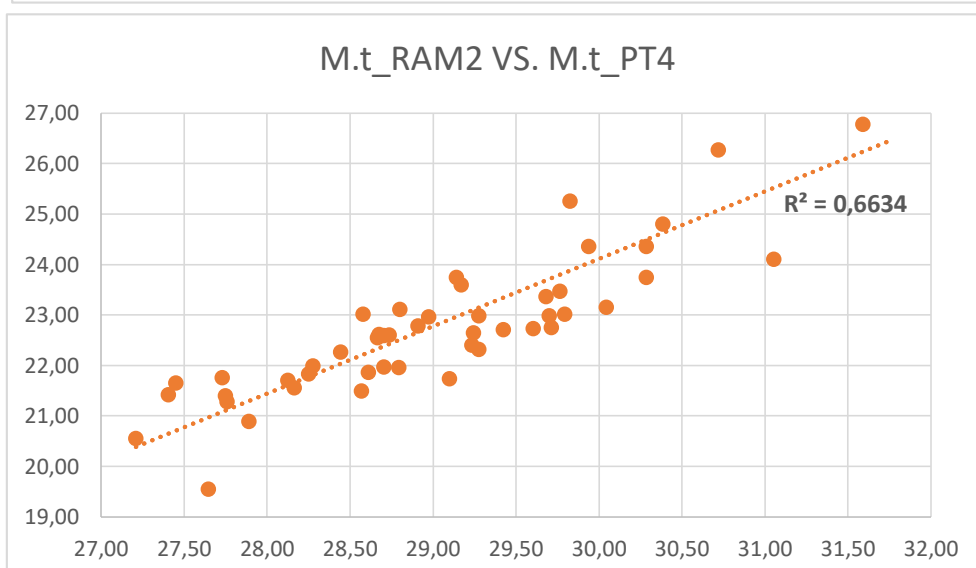
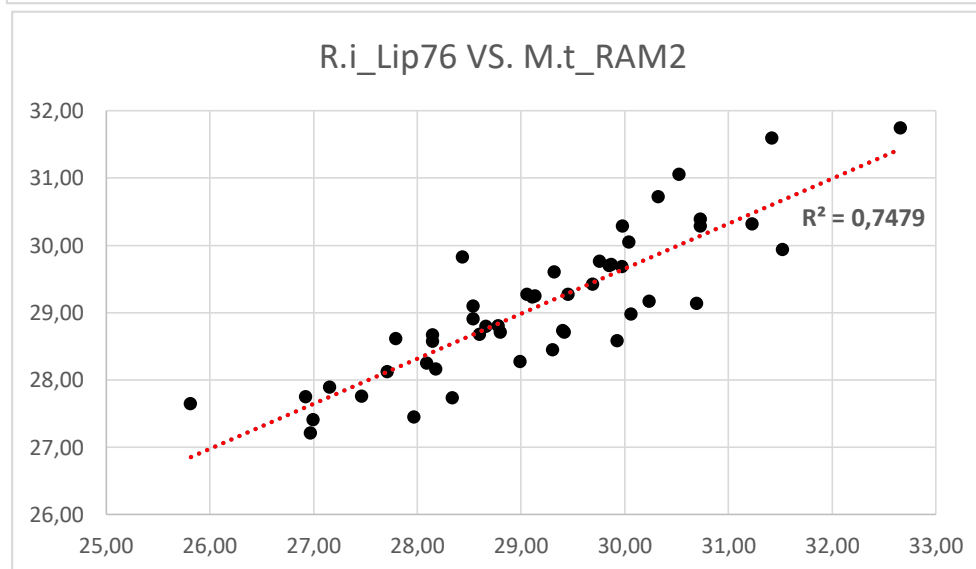
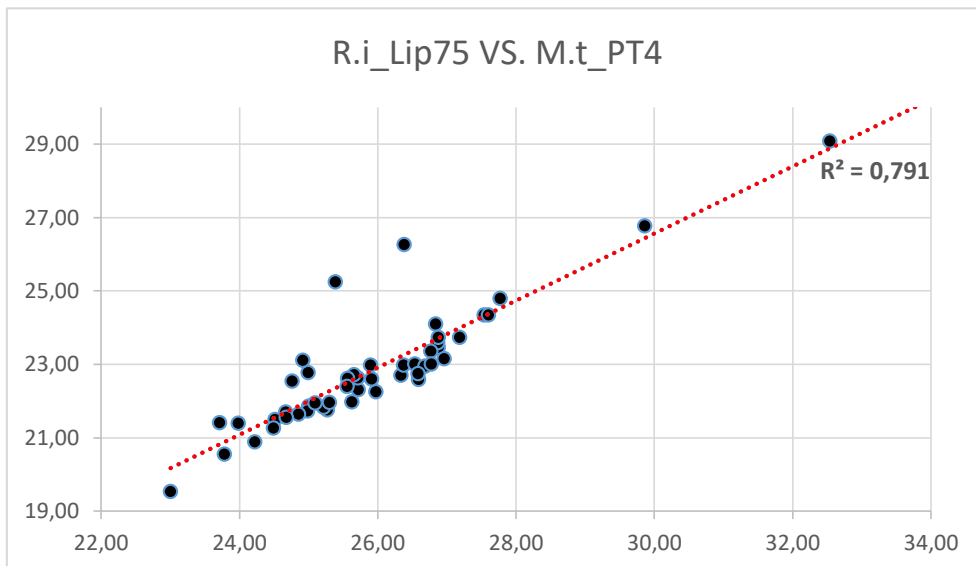

Figure 3.15: Measure of correlation coefficient between my two best candidate lipases and two plant symbiotic marker genes (MtPT4 and MtRAM2). We can see that the correlation between the two plant marker genes are not as good as with the fungal ones.

III. Conclusion

This chapter provides an overview of fungal mechanisms involved in fatty acid metabolism and possible ways of host FA acquisition.

We first performed an expert curation of fungal genes correlated to FA metabolism: lipases, elongases, desaturases, lipid-binding proteins, genes coding in vesicle formation. Not all these genes were identified in Rhiir2-1 JGI web site for these functions.

By analyzing expression patterns with RhiirExpress we then identified candidate fungal secreted lipases and MD2 related proteins putatively involved in host FA acquisition by an active mechanism based on β -MAG deesterification. We also proposed that MD-2_32, MD-2_38, MD-2_39, strongly expressed in arbuscules, could be involved in host FA acquisition. Among elongases and desaturases that are expressed in *R. irregularis*, Desat1 is quite dedicated to arbuscules and related intercellular hyphae. This desaturase might be involved in a rapid modification of plant FA in 16:1 ω 5, an abundant specific AM fungal FA. Finally, several protein coding genes associated with vesicle trafficking particularly in hyphae closed to arbuscules.

By perturbing symbiotic exchanges by high phosphate or photosynthetic activity, we were able to show that 1-plant FA metabolism and fungal FA metabolism are correlated; 2-addition of a high phosphate concentration on symbiotic roots differentially affects symbiotic sugar and FA exchanges; FA transfer being narrowly coupled to phosphate transfer.

HP first leads to a downregulation of FA symbiotic gene expression. This process takes around 4 days to be significant both in the plant and the fungus. We could infer that the plant decreases MtPT4 gene expression; hence, stopping phosphate flow through the arbuscular interface. Downregulation of mycorrhizal pathway shuts off the fatty acid tap; thus reducing fungal gene expression. After two weeks of treatment, the FA transfer is almost completely stopped at the transcriptomic level. The sugar transfer, however, does not seem to display any type of regulation even after two weeks of treatment. Our data suggest that while the FA

transfer is tightly regulated to phosphate transfer, differently to the carbohydrate one, although definitive proofs of gene function are still missing.

In addition to these reported data, we also investigated metabolisms associated with glycerophospholipids. Our attention has focused on a 1-acyl-sn-glycerol-3-phosphate acyltransferase (RiGPAT), expressed in all fungal development stage, but with high expression in ICH and arbuscules. Such GPAT converts 1-acyl-sn-glycerol-3-phosphate (lysophosphatidic acid) into 1,2-diacyl-sn-glycerol-3-phosphate. Other fungal genes involved in the metabolism of phospholipids were identified as highly expressed in arbuscules and proximal intercellular hyphae metabolism as phosphatidylinositol synthase and a N-acetylglucosaminyl-transferase complex, required for phosphatidylinositol biosynthesis. As phosphatidyl inositol synthase was shown to interplay with acylglycerol in membranes (Bankaitis and Grabon, 2011), these genes could participate to a mechanism where FA acquisition is coupled with phosphate transfer (although performed by active transporters).

Discussion and perspectives

Fungi are fascinating organisms that are present *per se* on earth since *c.a.* 1,000 Mya according to molecular clock studies (Berbee et al., 2017). When first plants conquered lands around 500 Mya later, they were confronted with a dense microbial diversity. It is proposed that the green conquest would probably never have happened without the help of fungi (Kenrick and Strullu-Derrien, 2014). Some early diverging fungi took advantage of the arrival of these pioneering green organisms struggling to survive on land (Spatafora et al., 2016). They evolved through mutualism and became the current most widespread group of symbionts on earth: the arbuscular mycorrhizal fungi. Although ancient, ubiquitous and abundant in soil, they all belong to the homogenous and small fungal phylogenetic clade of Glomeromycota. Not only this fungal group has biological, ecological, evolutionary interests, but it also presents important agronomical applications. From the dawn of agriculture, around 10 thousand years,

until the agricultural “green revolution”, we heavily relied on these fungi to grow food, even though we were not aware of it. Recently, the last agricultural revolution hindered their evolution as human agriculture suddenly stopped relying on them. The use of phosphate-based fertilizers made them redundant. However, phosphate deposits are finite resources and it is expected that in less than a hundred years phosphate extraction will end out of resource scarcity. The benefit of these fungi on agronomic plant growth was observed at first time in 1953 (Mosse, 1953) but we are only starting to understand what has literally, always been under our feet. The urgency of this situation persuaded me to do my Ph.D. on AM fungi. Making our knowledge go forward on this specific subject is essential if we want to be able to make use of these organisms in enlightened choices.

I. AM fungi: strange or usual Eukaryotes?

As “discrete but abundant soil pseudo-asexual aseptate multinucleate-sporal, obligate with broad-host spectrum” organisms, AM fungi cumulate a number of particularities and it is tempting to depict them as non-usual Eukaryotes. In an evolutive point of view, it is most parsimonious to propose that these fungi already possess enough biological specificities not to propose additional biological strangeness. This was the case with the recent history of genomics of AM fungi (see introduction). Although we are far from understanding all the mechanisms underlying the biological adaptive features of these fungi, it is currently most parsimonious to consider that classical genome concepts - including genome plasticity, mosaicism, genetic and epigenetic regulations - provide enough degree of freedom to explain them. The robust genome assembly and gene repertoire of the model AM fungus *R. irregularis* DAOM197198, the white mouse of AM fungi, are now providing clues to decipher its biology, step by step.

II. RhiirExpress

Given the scarcity of tools in our possession to study AM fungi, the conception of the gene atlas RhiirExpress will reinforce the possibility for researchers from AMS community - and others - to investigate the biology of AM fungi. Although genetic protocols are lacking on AM fungi, genes of interest will be available for heterologous functional analysis. At this stage of the tool development, one difficulty is to better

homogenize RNAseq data to include them in the platform. One limitation is that biological conditions are highly variable. As described in chapters 2 and 3, phosphate availability, illumination and all conditions that can interfere with symbiotic physiology will interfere with results homogeneity. As a result, the different symbiotic roots used for RNAseq do not seem to correspond to comparable biological situations. As an illustration, one condition (*in vitro* carrot roots) used in the current version systematically displays low expression for elite symbiotic genes, although raw data reach the required quality for analysis. It can be supposed that these *in vitro* carrot roots used for RNAseq, also used for production of ERM, were old biological tissues, where AM symbiosis is thought to move from an active to conservative biology. Taking in mind these difficulties, it will be necessary to update the web site when new data will become available, and even when gene repertoire version will be upgraded. As mentioned in the first chapter, some tissues and biological situations are not represented yet on the platform, namely immature and mature spores, different types of extra radical mycelium (running hyphae, branched absorbing structures), IRV (large vesicles). Libraries corresponding to the fungus *in planta* are already diverse; however, this collection could be enriched with plants of agricultural interest (*e.g.* wheat, corn and rice and also tomato, whose reads could be embedded both in the RhiirExpress and TomExpress) or basal plants such as hornworts, liverworts (*Marchantia paleacea*), ferns and mosses. The name of this tool refers to *Rhizophagus irregularis* and it might be interesting to develop the same architecture for other AMF whose genomes are sequenced (to date, 7 AMF species are sequenced or about to be). These tools could be grouped under a GlomExpress website.

III. Symbiocosms as a mean to study carbon stock exchange

A conclusion from chapter 2 is that AM fungi are able to differentiate plants and allocate resources accordingly. What could happen in natural grassland? The use of a microcosm allows studying this symbiosis in a situation that is closer to the real situation. There is a tremendous diversity of possible combinations to explore using, for example different plants in different phenological states, with competing

symbionts, such as different AM fungi, various rhizospheric microbiota (phosphate solubilizing bacteria, PGPR, nitrogen-fixing bacteria) and even different types of mycorrhiza or dark septate endophytes. These symbioses can enable us to study not only the exchanges of phosphate but also N, K, Fe, B, S, Mo, Mn, Cu, Al, Zn, or H₂O on the carbon stock market.

Associated with the mesocosm system, an efficient strategy to understand symbiotic biology is to perturb the equilibrium of exchanges. In chapter two, a high concentration of phosphate was added to the mycelium compartment, therefore high quantities of phosphate were available through the mycorrhizal pathway, thus enhancing symbiotic exchanges. During the kinetic analysis in chapter 3, the phosphate was added directly to the plant root system, making the fungus useless, thus lowering symbiotic transfers. Unfortunately, we failed to use plant mutants (RAM2, STR) in the frame of this thesis. This will provide original information, as mutants can be impaired in different stages of AM symbiosis. Such dissecting approach would allow identifying genes specifically expressed in diverse fungal development stages. Similarly, modulation of symbiotic transfers can be used with myco-heterotrophic plants. Parasitic plants were described to meet their carbon requirements by parasitizing mycorrhizal fungi. Such plant connected to the mycelium of an established symbiosis will act as a strong carbon sink in the fungal hyphae. We could expect the carbon sink to be stronger in the arbuscules of the mycorrhized plant (Bidartondo et al., 2002; Leake, 2004; Merckx et al., 2009).

IV. Comment on HIGS strategy

Definitive validation of a gene's function has to be done through molecular studies. Unfortunately, the stable transformation of these organisms is (to date) impossible to achieve. As a result, indirect silencing techniques, taking advantage of the obligate biotrophy of these fungi are used. The Host Induced Gene Silencing (HIGS) is yet the only strategy available to disrupt gene expression. So far, only few studies managed to perform HIGS by actually reducing the expression of a targeted gene. However, the results obtained by me and other Ph.D. students in our lab are highly inconsistent. In some cases, the expression of the targeted gene can be enhanced instead of being silenced. It can be difficult to know exactly how successful the technique is given that unsuccessful experiments are rarely published. Consequently,

the published scientific literature is biased, as a bibliographic state of the art falsely suggests that the technique works efficiently. Therefore, it should be remembered that in scientific research, there is no such thing as negative results, all results are results. As a consequence, the results obtained through my Ph.D. led to the conclusion that HIGS did not allow me to significantly silence the expression of the candidate lipases.

V. Fatty acid recovery mechanism

When starting my Ph.D. in 2016, the transfer of fatty acid from host to AM fungi was not yet demonstrated. The first stages of my Ph.D. consisted of definitively prove AM fungal FA auxotrophy. Based on genetic evidence, I showed that *R. irregularis* does not possess alternative mechanism for FA biosynthesis: they do not possess the necessary sub-units of Poly Ketid Synthase; none of the elongases present in *R. irregularis* has a sequence resembling the elongase present in Apicomplexans (which allows them to elongate C4 molecules up to C16) or a specific *in planta* expression profile; the expression of the mitochondrial FAS does not show any strong variation in the different conditions and their biochemical biosynthetic capabilities is not compatible with palmitate production. Consequently, the massive FA metabolism observed in AM fungi has to be supported by a strong source of FA.

At this point, we cannot exclude a hypothetical recovery of soil-borne FA at the ERM level. A former publication of (Hildebrandt et al., 2006) managed to produce spores able to complete the life cycle of *R. irregularis* strain while co-cultivating it with a bacterial culture of *Paenibacillus validus*. Two recent publications (Kameoka et al., 2019a; Sugiura et al., 2019a) are shedding new light on the possibility of axenic growth of AMF. In the first one, Kameoka et al., managed an axenic culture by adding a methyl branched fatty acid ((*S*)-12-methyltetradecanoic acid) into the culture medium. Sugiura and co-authors came to the same result by adding myristate into the medium and they also showed that the compound was indeed used as a carbon source by the fungus. All these pieces of information taken together suggest that we are at the dawn of a revolution for symbiologist researchers as they might soon be able to produce their own inocula for later experimental use. Although these work support new field of investigation on the saprotrophic ability of ERM, FA acquisition

by ERM can hardly be sufficient or steady enough to support the whole FA metabolism. If an ERM based FA recovery was to exist, it would not be able to solely support the whole FA metabolism on its own. Instead, it would be a complementary mechanism to the steady and reliable main system of acquisition.

In 2017, several publications provided congruent arguments and proof demonstrating that plant FA are transferred to AM fungi, and that this biosynthesis occurs in arbuscules (Jiang et al., 2017; Luginbuehl et al., 2017; Keymer et al., 2017; Bravo et al., 2017). It is highly probable that acylglycerols (α -MAG, DAG, TAG) are directly transferred in peri-arbuscular space through STR/STR2 (Gutjahr et al., 2012; Zhang et al., 2010) although there is no definitive proof. On fungal side, the mechanisms of FA acquisition remained elusive.

Regarding fungal FA acquisition, three mechanisms can be considered. First, we could imagine the involvement of a specialized transporter, mirroring the process happening at the plant PAM with the ABC transporter STR/STR2. However, such a mechanism would induce a burst in expression of a fungal transporter and RNAseq based transportome analysis (Chapter 1 and 3) would have pointed it out. This first hypothesis, although straightforward, is not supported by our data. The second and third hypotheses do not require a specialized transporter but a facilitation of the transfer. A transfer of FA by direct adsorption of plant provided FA on fungal plasma membrane can be conceivable if the constantly growing plasma membrane was compensated by an endocytosis mechanism (Clathrin sub units recovered in chapter 3). Otherwise, a facilitated diffusion across fungal cell wall and membrane can be envisaged, putatively acyl-phospho-glycerol metabolism, activated in arbuscules. This last mechanism requires a reduction in cell wall thickness as observed by (Ivanov et al., 2019; Roth et al., 2019). It is noteworthy that both adsorption and facilitated diffusion mechanisms require the involvement of lipid-binding proteins and vesicular cargo that were shown to be highly induced in arbuscules.

My work also addressed the temporality of FA transfer. The observed correlation in the expression of some candidate lipases with MtPT4 and MtRAM2 is in favor of a mechanism of co-occurrence of P and FA transfers in mature and maturing arbuscules. The descriptions provided by the works of Ivanov and co-authors (2019)

and Roth and co-authors (2019) argue for a co-transfer in mature, non-collapsing arbuscules.

In addition to this transfer in mature active arbuscule, FA acquisition could happen when arbuscules collapse. This hypothesis is supported by the observation that phosphate addition on plant roots (chapter 3) did not induce collapsing of existing arbuscules but only impaired the development of new ones. In addition, plant phosphate transporter MtPT4 and plant FA transporter STR/STR2 are located at the tip of the growing fine branches (Harrison et al., 2002; Zhang et al., 2010). This constant growth of the branches induces a constant production of plasma membranes from both symbionts. Consequently, most of the membranes contained in the arbuscocyte are not supporting any symbiotic transfer. During arbuscule collapse, the useless membranes are turned into lipid droplets and will be recycled by one or both symbionts. The reason for this constant production/degradation of membranes can account for this passive hypothesis. In addition, the passive hypothesis offers an explanation for the short arbuscule lifespan and their perpetual renewal.

Both hypotheses of FA acquisition in mature and collapse arbuscules are not exclusive and could happen alongside. In order to provide information regarding the relative importance of one hypothesis against the other (or their dual involvement), it would be necessary to analyze gene expression at different stages of arbuscule development. The use mutants impaired in arbuscule turn over, or laser microdissection coupled with low input mRNA sequencing could allow us to assess gene expression in developing, mature and collapsing arbuscules.

Although my Ph.D. was focusing on fungal genes, host transcriptomes were also investigated. As I was focusing on lipase gene expression, I checked plant's lipases expression and found that one of them is very highly expressed in symbiotic conditions and it is predicted to be secreted (Medtr8g074560.1). Two other plant lipases are also mycorrhiza specific but they are not believed to be secreted: Medtr8g074570.1 and Medtr8g074580.1. Targeting these plant genes before engaging in functional validation of fungal genes would have been a smart decision. Unfortunately, this discovery came out too late in my Ph.D. While looking into RNAseq data on the plant side, another detail caught my attention: the transporter responsible for fatty acid translocation from the plant cytoplasm to the PAS is an

ABC transporter. This transporter is located at the plant PAM and it is supposed to be a dimer. The two subunits of this dimer are named STR and STR2. However, when looking at expression data, we can see that the two subunits do not have the same level of expression. The expression of STR is always higher than the expression of STR2 (on average, it is 1.5 times more expressed). Given that ABC transporters are always dimers (either homo or hetero) only a combination of the two forms could explain the observed expression (e.g: with 4 STR and 6 STR2 we can produce two heterodimers, one homodimer STR/STR and two homodimers STR2/STR2).

VI. Le gras, c'est la vie

FAS is a ubiquitous enzyme that is fundamental in metabolism as it is at the base of the production of one of the four essential types of biomolecules. The selection pressure at the origin of such loss is difficult to grasp. The organism lacking the gene was not disadvantaged compared to an individual still possessing it. This type of selection is at the origin of many gene loss: if the function of the gene is obsolete, the useless gene can disappear without negatively affecting the host's fitness (Albalat and Cañestro, 2016). Therefore, what are the selective advantages of losing such important gene? It can be suggested a synergy between an energetic hypothesis and an evolutive fitness hypothesis. Firstly, the synthesis of FA by FAS has a high energetic cost: 7 ATP and 14 NADPH from acetyl-CoA, the synthesis of the FAS itself, as a large protein. Secondly, the suggested ability of AM fungi to obtain their FA from collapsing arbuscules gave them access to a large quantity of FA. It was energetically costless to use these plants FA than to synthesize them.

As carbon auxotrophs, AMF managed to find carbon molecules in their biotic environment. Exchanging phosphate to get sugars in return is not as interesting as getting FA because from a thermodynamic point of view, fatty acids are more energy-dense than carbohydrates as they contain around 9 Kcal per gram against 4 Kcal respectively (Stryer, 1995). Consequently, AMF rely on β -oxidation to meet their carbohydrate requirements and they delegated their FA biosynthesis to the plant's FAS. This shift makes sense because, from a metabolic point of view, the complete oxidation of a C18 fatty acid yields 120 ATP per 18 carbons versus 90 ATP for the same number of glucose carbons (Goetzman, 2011). In addition, if the transferred molecule is indeed a MAG, then the glycerol might also be internalized by the fungus

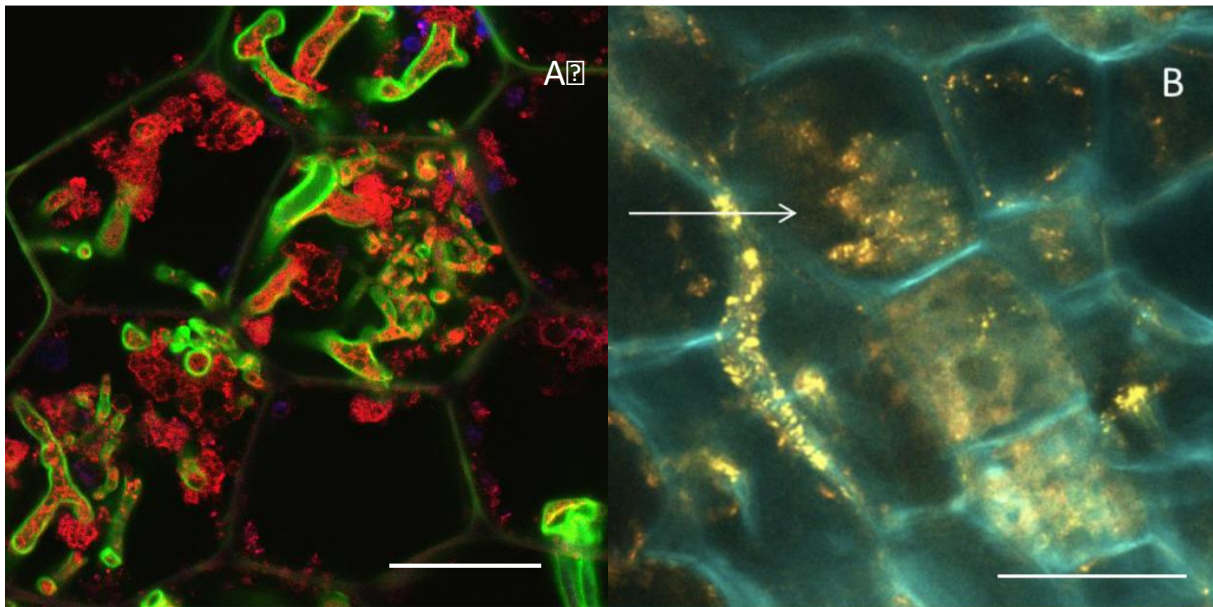

Figure 1: Confocal observation after Nile red staining showing distribution of lipid droplets (depending on wavelength, visible in red on left and yellow on right). Calcofluor allows visualising plant cell walls (stained in green at right, in blue at left). A. lipid droplets inside and outside arbuscules of *R. irregularis* in colonized thallus of *Marchantia paleacea*. (bars: 10 μ m). B. lipid droplets in hyphae and arbuscules of *R. irregularis* in *M. truncatula* roots at 96dpa of HP (chapter 3). Arrow shows a glittering staining near arbuscules roots (bars: 50 μ m). A Jauneau and A Leru, Imagery facility of Toulouse.

and this would yield an additional 22 molecules of ATP per glycerol molecule (Feher, 2012). Therefore, one mole of MAG containing a C16 will yield around 128 moles of ATP while one mole of glucose would yield only 22 moles of ATP. If the fungus also metabolizes the glycerol, then it would mean that AMF hijack three sources of carbon from their host plant: sugars, fatty acids and glycerols.

AM fungi are dependent upon FA to complete their life cycle and this dependence probably explains their obligate biotrophy. For the fungus, obtaining FA is costly in terms of minerals. If an AMF hypha was to encounter a source of FA while foraging in the soil, it looks unlikely that the fungus will not take advantage of this available pool of FA. Therefore, is it possible to grow these fungi anexically if we provide them with FA in the culture medium? This idea led me to try adding FAs in growth medium and try to see if a fungal growth shift can be observed (increased mycelium growth or sporogenesis). Many sources of FAs had to be tested. Based on culture medium used to grow *Malassezia sp.* (which also lost its FAS) where Tween 40 is added, I tested the incidence of solubilized olive oil and palm oil, which are mixtures of different short chains containing FAs, MAG, DAG and TAG. However, the very high number of lipidic molecules to test combined with the difficulty to follow hyphal growth on large distances during long periods and the crystallization of the different substrates discouraged me to pursue this time-consuming experiment on my own. A master intern continued this work. The publication of two papers (Kameoka et al., 2019a; Sugiura et al., 2019b) shut down this axis of research in our team.

VII. The promises of analytical cytology

Investigating symbiotic exchanges by analytical cytological technics is challenging but promising. As performed by Kobae et al. (2016), investigating the dynamics of lipid droplets using confocal technics allows investigating the regulation of exchanges, for instance in response to HP (Figure 1).

Other techniques are emerging to couple observation and molecular signature. Coherent Anti Stokes Raman Spectrometry (CARS). Similar to infrared spectroscopy, CARS allows observing emission light from chemical functions after laser excitation (Figure 2). This technique is particularly efficient for lipids, for instance to analyze the lipidic layer on axon of neurons. In collaboration with Hassan Boukhaddaoui

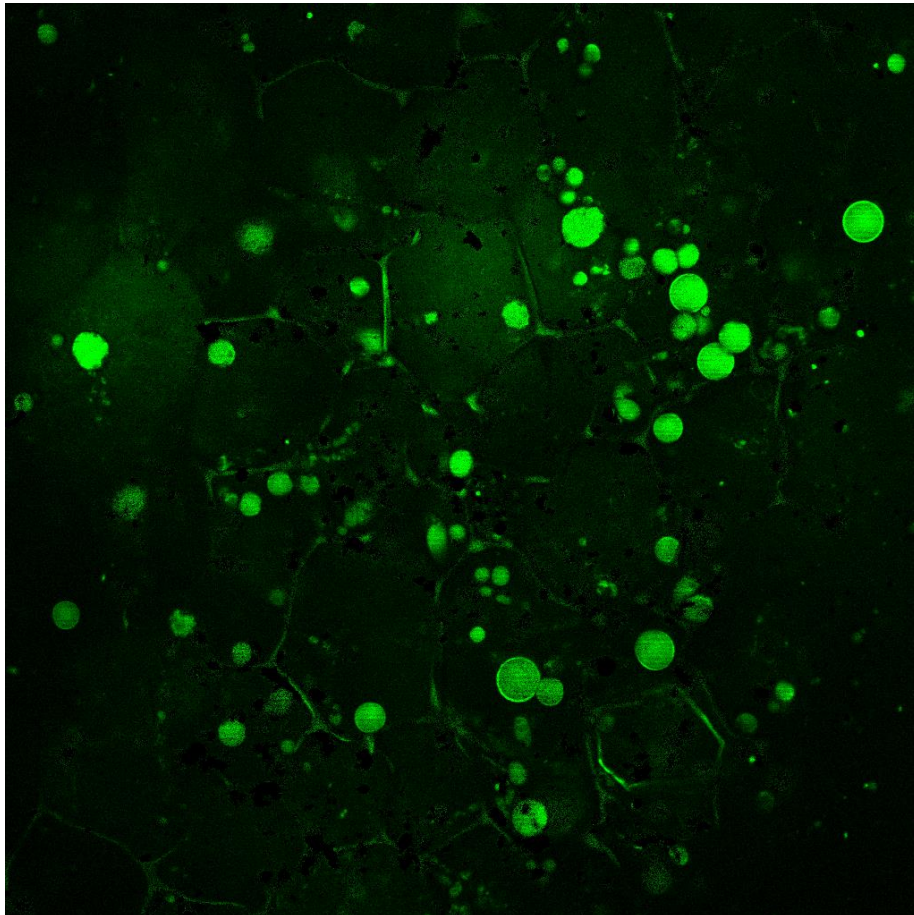

Figure 2: CARS observation of *Marchantia paleacea* thallus. Green signal corresponds to palmitic acid.

(NeuroSciences Institute of Montpellier) we tested the relevance of such technic on hand-cuttings of thallus of *Marchantia palceacea*. We were able to identify lipid droplets of palmitic TG in tissues in the vicinity of arbuscules. No staining is necessary and visible signals correspond to targeted molecular functions. This approach will need further development to ensure that lipid droplets do not emerge from the cutting itself. Lastly, techniques coupling microscopy and mass spectrometry may be of interest. We tried the Secondary Ion Mass Spectrometry (SIMS, in collaboration with David Touboul-CNRS Gif). This tool is able to analyze chemical composition of surfaces thanks to a focused ion beam. Because this technology uses Time Of Flight (TOF), sample preparation is even more tricky as the sample has to be lyophilized and the section's surface has to remain perfectly flat, otherwise it would lead to false identification of the secondary ions. Unfortunately, here again the spatial resolution was too large to work at the arbuscule level. The NanoSIMS works at the nanoscale and could allow us to work at the sub-arbuscule level.

More direct technology is currently under development. The development of Nuclear Magnetic Resonance (NMR) antennas is very promising. NMR's sensibility is dependent on the size of the antenna and its vicinity with the sample to study. Some work has been performed on tomato (Sidi-Boulenouar et al., 2018) to assess water flows occurring inside the stem.

This very promising approach enables the identification of water-soluble compounds and the measurement of the amount of dissolved compounds and the rate of flow. If a circular antenna could be installed around a hyphopodium forming hypha, we could measure in real-time the bidirectional flow of nutrients. Now if we imagine this antenna put in place around a hypha entering a plant cell at the moment of penetration, we could measure the amount of sugar, fatty acid, phosphorus, nitrogen, iron, etc during the whole life cycle of one arbuscule. Such technological advancement could even allow us to determine the exchange rate existing within

AMS

VIII. What's next?

As always in science research, untangling one question leads to many more. What is the exchange rate occurring between plants and fungi? Is one mole of phosphate

equivalent to one mole of nitrogen, or FA? Among the carbon molecules taken up by the fungus, what is the ratio between hexoses and fatty acids? What happens if we add another “economic actor” in our system, such as nitrogen-fixing bacteria? Would the fungal carbon allocation be diminished? Would the fungal nitrogen supply be stopped? What would be the consequences on the rate of transfer of the other minerals? Is a mineral translocation possible through multiple fungi and hosts? Can a plant growth be supported only through mycorrhizal nutrient transfer? What is the maximum distance the mycelium can reach from its host plant? What does influence the lifespan of arbuscules? What is the role of apocarotenoids? Do they even have a role? Or are they just by-products? Can we use their synthesis in a practical way? Are Paris and Arum types of mycorrhiza as efficient? What is the determinant of these mycorrhizal types? The fungus species? The plant species? A combination of both?

Plant microbiota promises to be a powerful tool for whoever knows how to use it. Although these questions are fascinating, time will be necessary to answer them all. With 7 billion and a half mouth to feed relying on plant production, it is urgent to react responsibly.

Methods

I. Biological material

Sterile spores of *Rhizophagus irregularis* DAOM 197198 were provided by Agronutrition (Labège, France). *Medicago truncatula* (Jemalong A17) seeds were provided by Dr. Jean-Marie Prospero (Cirad, Montpellier, France). Seeds were scarified with sulfuric acid for 8 minutes and then rinsed with osmosed water. Seeds were then sterilized with bleach (2.4%) during one minute, and then rinsed at least 5 times with sterile water. Then sterilized seeds were scattered on a Petri dish containing 10 g/L of Agar (Sigma #A9799) in water. The Petri dishes were put in the dark at 4°C for 5 days.

II. Transformation protocol

E.coli DH5α cells were cultured over-night in LB medium at 37°C under agitation. A sub-culture was taken from 1 mL of the initial culture and grown in 500 mL of LB

medium until OD at 600 nm reached 0.3. At this point, bacterial growth is stopped by putting the flask in ice for 15 minutes. The culture was then centrifuged (4000 rpm) for 10 minutes at 4°C. The pellet was re-suspended in cold with CaCl₂ 0.1 M and maintained for 30 minutes at 4°C. The solution is centrifuged again and the pellet is re-suspended in 0.1M CaCl₂ containing glycerol (15%). The tubes were frozen in liquid nitrogen and stored at -80°C.

Agrobacterium rhizogenes A4 were pre-grown overnight at 28°C under agitation in LB medium (with 20µg/mL of Rifampicine). The cell suspension was diluted at 1% in fresh LB medium at 28°C under agitation and let to grow until OD at 600 nm reached a value between 0.5 and 1. The growth was stopped by putting the flask in ice and the bacterial suspension was centrifuged for 5 minutes at 3000 rpm. The pellet was then suspended in a solution of CaCl₂ 20mM with 10% glycerol and frozen in liquid nitrogen and stored at -80°C.

Cloning candidate genes through Golden Gate. cDNA from mycorrhizal roots were used as a matrix for gene cloning. Amplification PCRs were performed with GoTaq polymerase (Promega) following the manufacturer's recommendations. The thermal cycler was set up as follows: 95°C, 1 min; [95°C, 30s ; 56°C, 30s; 72°C, 30s to 2min depending on fragment's length] x 32 cycles; 72°C, 7 min. The number of cycles is dependent on the abundance of the transcript. 100 ng of the PCR product was inserted in pGEM-T easy® vector (Promega) following manufacturer's recommendations. The combination of the gene inserted in the vector (written pGEM-T::gene) was used to transform thermocompetent *E.coli*. bacteria and DNA were mixed and maintained in ice for 30 minutes before the heat shock. The heat shock consists of putting the tubes containing the solution on water heated at 42°C for 45 seconds and directly put back in ice for 1 minute. 900 µL of LB was added and the tubes were put at 37°C for 1 hour. After 1 hour, the bacteria were plated on Petri dishes containing LB + 50 µg/mL of X-Gal + 50 µg/mL of Ampicilline and put to grow at 37 °C. White colonies were selected to check the integration of the gene fragment by performing PCR with SP6 and T7 primers. The program of the thermal cycler was this one: 95°C, 5 min ; [95°C, 30 s; 56°C, 30 s; 72°C, 2 min] x 26 cycles; 72°C, 7 min. The validated plasmids were extracted (Wizard Plus SV Miniprep DNA purification system, Promega) and sequenced. Once the inserted fragment's

sequence is validated, the different plasmids (pGEM-T::containing the candidate gene in the + direction ; pGEM-T::containing the candidate gene in the - direction; pGEM-T::p35S (or pGEM-T::pMtPT4); pGEM-T::spacer) are mixed together with the empty pCAMBIA2200 Gold in order to digest and ligate the different parts. The intronic spacer sequence had been cloned into pGEM-T in our lab (Vancanneyt et al., 1990). 100 ng of each plasmid was selected and mixed with 1 μ L of 10X ligase buffer (Promega), 0.75 μ L of T4 DNA ligase and 0.25 μ L of Bsal enzyme (NEB) and water to reach 10 μ L of final reaction volume. The parameters of the thermal cycler were: [3 min at 37°C; 4 min at 16°C] x25 cycles; then 20 min at 16°C; 5 min at 37°C; 5 min at 50 ° C; 5 min at 80°C. The obtained construction in pCambia is p35S::candidate gene(-):spacer:candidate gene(+) or pMtPT4::candidate gene(-):spacer:candidate gene(+). These constructions were used to transform thermocompetent *E.coli* DH5 α . The insertion was checked by PCR using Pro35S and Ter35S primers. The validated plasmids are extracted and used to transform *A.rhizogenes* bacteria as follows: 50 μ L of thermocompetent bacteria are mixed with the DNA and incubated for 10 minutes in ice, then put in liquid nitrogen until it stops boiling, then the bacteria are grown at 37 ° C for 5 min. Finally, bacteria are diluted in 1 mL of LB for 3 hours at 28°C before being plated in LB containing 25 μ g/mL of Kanamycin for two days.

III. cDNA synthesis and RT-qPCR expression analysis

Total mRNA of mycorrhizal plants was extracted with RNeasy Mini kit (Qiagen) following manufacturer's instructions. The mRNA was then quantified by spectrophotometry (Nanodrop DN-1000 - Labtech). 1 μ g of RNA was treated with RQ1 DNase and used to synthesize cDNA thanks to the M-MLV reverse transcriptase (Promega #M6101) following manufacturer's instructions.

RT-qPCR primers were designed with the software primer3 with the following parameters: Tm of 60°C and amplicon length between 75 and 125 bp. Transcript abundance is estimated with LightCycler® 480 SYBR green master mix (Roche Applied Science) and the cycles were performed in the LightCycler® 480 detection system (Roche Applied Science). The RT-qPCR was done in a 384 well-plate and each well

contained 10 μ L of mix composed of 5 μ L of SYBR green master mix, 0.5 μ L of each primer (0.5 nM of final concentration for each primer) and 50 ng of cDNA matrix. The

cycles were as follows: 50°C during 2 min, 95°C during 10 min, [95°C, 30s ; 56°C, 30s; 72°C, 30s] during 40 cycles. Data were analyzed with the software LightCycler 480 (Roche). Fungal gene expression was normalized relative to PhosphoFructKinase (PFK) or Translation Elongation Factor 1 (TEF1) of *Rhizoglyphus irregularis* and plant gene expression in *Medicago truncatula* was compared to Ubiquitin (UBI) or the SEC61 transporter protein (Kamel et al., 2017).

IV. Chimeric plants transformation

M. truncatula roots were transformed according to the protocol described in (Boisson-Dernier et al., 2001). Sterile germinated seeds had their root tip cut and were put in contact with transformed *A. rhizogenes*. The seedlings were then put in square Petri dishes containing Fahraeus medium. The dishes were then put vertically in light at 22°C long enough for the transformed roots to develop (around 4 weeks). The transformed roots were then observed on wide-field fluorescence binocular (Axiozoom V16, Zeiss) to check for DsRed expression. The transformed plants were transplanted into a basin containing a mix of sterilized quartz sand and zeolithe (1:1; v/v) with 500 spores per plant during the next 3 to 4 weeks in order to acclimate. When plants resumed their growth, the fluorescence was assessed once again and non-transformed roots were cut. The plants were then transplanted into individual pots and left to grow for 3 to 4 more weeks. Control plants transformed with an empty vector were randomly harvested to check for fungal colonization. When control plants reached 70% of colonization, the harvest was done.

V. Light and Phosphate treatments

A. Plant material and AM Inoculation:

Seeds of *M. truncatula* A17 strain were treated with sulfuric acid 98% for 8 minutes and thoroughly rinsed with water. They were put in 400mL pots with a sterilized mixture of river sand and zeolite (Symbiom, Czech Republic) (1:1, v:v) mixed with 1000 spores of *R. irregularis* DAOM 197198 per pot. Plants were watered daily several during 5 or 6 weeks for AM symbiosis establishment with 30 mL of modified Long Ashton solution (Hewitt, 1966) containing 15µM of phosphate. They grew in a growth

chamber with a photoperiod of 16h of light at 22 °C, 8h of dark at 20 °C with 70% of humidity to establish a strong symbiosis before treatment and/or harvesting.

B. Phosphate kinetic analysis

A first kinetics of regulation of symbiotic exchanges by phosphate was realized on 5 week-old mycorrhizal plants daily watered during 2 weeks alternatively with a modified Long Ashton solution containing 1mM of phosphate ($\text{Na}_2\text{HPO}_4/\text{KH}_2\text{PO}_4$) or with water. Six plants were collected just before the first watering (T0) and at days 1, 2, 4, 7 and 14 (1dpa, 2dpa, 4dpa, 7dpa, 14dpa respectively).

The second kinetics was performed on 6 week-old mycorrhizal plants by watering daily with Long Ashton containing 5mM of phosphate ($\text{K}_2\text{HPO}_4/\text{KH}_2\text{PO}_4$) during 1 week. Here, Na_2HPO_4 was replaced by K_2HPO_4 to avoid any toxic effect of sodic ion at 5 mM. Ten plants were collected just before the first watering (T0) and at 1 hour (1hpa), 3 hours (3hpa), 9 hours (9hpa), 1 day (24hpa), 2 days (48hpa), and 4 days (96hpa) after the first addition.

C. Light treatment

A17 *M. truncatula* were grown in a mix of Zeolite (2.5 to 5 mm, symbiom Czech Republic) and sand (1:1 v:v). Spores were mixed with the substrate (4500 spores/L) before adding the seeds. Mycorrhizal plants grew during 4 weeks in a growth chamber with a photoperiod of 16/8 at 22 °C with 50% relative atmospheric humidity. Plants were harvested at different time points: 30 minutes before lights switched on (7h30 dark); 30 minutes after lights switched on (30' light); 2 hours and 30 minutes after lights switched on (2h30 light); 30 minutes before lights switched off (15h30 light); 30 minutes after lights switched off (30' dark); 2 hours after lights switched off (2h night). 4-week-mycorrhizal plants were also harvested after 6 days of continuous light (CL) or continuous dark (CD) treatment.

D. Harvest and plant storage

At each time point, root fragments were randomly sampled, then frozen in liquid nitrogen and stored at -80 °C to perform RNA extraction. The remaining root system was conserved in ethanol 50% to measure the colonization level. Frozen root samples were lyophilized during 48h then crushed for 2 minutes at 30 Hz (Mixer Mill MM400,

RETSCH). The mRNA extraction was performed with the Omega BIO-TEK E.Z.N.A.® Plant RNA following the manufacturer's instructions.

E. Measurement of mycorrhizal colonization level

As plants collected for the first kinetics presented many vesicles, the Trouvelot method (Trouvelot et al 1986) was used to determine the level of root colonization while the gridline intersection method was used for the second kinetics (Giovannetti and Mosse, 1980). In this second experiment, the ratio of cell-fulfilling arbuscules was measured on 24 randomly sampled root fragments of each sample. Arbuscocytes completely or partially filled with arbuscules were counted (over 11000 arbuscules controlled in both T0 and 96hpa conditions). Cell-fulfilling arbuscules are considered mature, whereas arbuscules incompletely invading arbuscocytes can be either immature or collapsed arbuscules (Kobae et al., 2016).

F. Analysis of gene regulation

cDNA library construction and sequencing were performed either at the genomic platform in Toulouse (GeT-PlaGe) or by GeneWiz (Leipzig Germany) according to standard Illumina protocols. Bioinformatics procedures for transcript profiling were used as follows: trimmed paired-end reads were mapped onto predicted genes from *R. irregularis* (genome assembly Rhiir2.1) using CLC Genomics Workbench (Qiagen) with stringent settings (similarity and length read mapping criteria at 98% and 95%, respectively). Total mapped paired-end reads for each gene were calculated and total read counts were normalized as fragments per kilobase of gene model per million fragments mapped (FPKM). Gene expression in the Intra Radical Mycelium was either compared to asymbiotic hyphae or ERM as reference (see text). Fold-change values were calculated both by proportion-based statistical test (Morris et al., 2003) and edgeR (Robinson et al., 2010) with a False Discovery Rate (FDR) correction for multiple testing (Benjamini and Hochberg, 1995).

References

- Ait Lahmidi, N., Courty, P.-E., Brulé, D., Chatagnier, O., Arnould, C., Doidy, J., Berta, G., Lingua, G., Wipf, D., and Bonneau, L. (2016). Sugar exchanges in arbuscular mycorrhiza: RiMST5 and RiMST6, two novel Rhizophagus irregularis monosaccharide transporters, are involved in both sugar uptake from the soil and from the plant partner. *Plant Physiology and Biochemistry* 107, 354-363.
- Akiyama, K., Matsuzaki, K., and Hayashi, H. (2005). Plant sesquiterpenes induce hyphal branching in arbuscular mycorrhizal fungi. *Nature* 435, 824.
- Albalat, R., and Cañestro, C. (2016). Evolution by gene loss. *Nature Reviews Genetics* 17, 379-391.
- Angelard, C., and Sanders, I.R. (2011). Effect of segregation and genetic exchange on arbuscular mycorrhizal fungi in colonization of roots. *New Phytol* 189, 652-657.
- Angelard, C., Colard, A., Niculita-Hirzel, H., Croll, D., and Sanders, I.R. (2010). Segregation in a Mycorrhizal Fungus Alters Rice Growth and Symbiosis-Specific Gene Transcription. *Current Biology* 20, 1216-1221.
- Angelard, C., Tanner, C.J., Fontanillas, P., Niculita-Hirzel, H., Masclaux, F., and Sanders, I.R. (2014). Rapid genotypic change and plasticity in arbuscular mycorrhizal fungi is caused by a host shift and enhanced by segregation. *The ISME Journal* 8, 284-294.
- Auxier, B., and Bazzicalupo, A. (2019). Comment on “Single nucleus sequencing reveals evidence of inter-nucleus recombination in arbuscular mycorrhizal fungi.” *ELife* 8.
- Bago, B., Pfeffer, P.E., and Shachar-Hill, Y. (2000). Carbon Metabolism and Transport in Arbuscular Mycorrhizas. *Plant Physiol.* 124, 949-958.
- Bago, B., Zipfel, W., Williams, R.M., Jun, J., Arreola, R., Lammers, P.J., Pfeffer, P.E., and Shachar-Hill, Y. (2002). Translocation and Utilization of Fungal Storage Lipid in the Arbuscular Mycorrhizal Symbiosis. *PLANT PHYSIOLOGY* 128, 108-124.
- Bankaitis, V.A., and Grabon, A. (2011). Phosphatidylinositol synthase and diacylglycerol platforms bust a move. *Developmental Cell* 21, 810-812.
- Bardgett, R.D., and van der Putten, W.H. (2014). Belowground biodiversity and ecosystem functioning. *Nature* 515, 505-511.
- Benjamini, Y., and Hochberg, Y. (1995). Controlling the False Discovery Rate: A Practical and Powerful Approach to Multiple Testing. *Journal of the Royal Statistical Society: Series B (Methodological)* 57, 289-300.
- Berbee, M.L., James, T.Y., and Strullu-Derrien, C. (2017). Early diverging fungi: diversity and impact at the dawn of terrestrial life. *Annual Review of Microbiology* 71.

- Besserer, A., Puech-Pagès, V., Kiefer, P., Gomez-Roldan, V., Jauneau, A., Roy, S., Portais, J.-C., Roux, C., Bécard, G., and Séjalon-Delmas, N. (2006). Strigolactones Stimulate Arbuscular Mycorrhizal Fungi by Activating Mitochondria. *PLoS Biology* 4, e226.
- Besserer, A., Becard, G., Roux, C., and Séjalon-Delmas, N. (2009). Role of mitochondria in the response of arbuscular mycorrhizal fungi to strigolactones. *Plant Signaling & Behavior* 4, 75-77.
- Bianciotto, V. (2003). "Candidatus Glomeribacter gigasporarum" gen. nov., sp. nov., an endosymbiont of arbuscular mycorrhizal fungi. *INTERNATIONAL JOURNAL OF SYSTEMATIC AND EVOLUTIONARY MICROBIOLOGY* 53, 121-124.
- Bianciotto, V., Lumini, E., Lanfranco, L., Minerdi, D., Bonfante, P., and Perotto, S. (2000). Detection and Identification of Bacterial Endosymbionts in Arbuscular Mycorrhizal Fungi Belonging to the Family Gigasporaceae. *Applied and Environmental Microbiology* 66, 4503-4509.
- Bidartondo, M.I., Redecker, D., Hijri, I., Wiemken, A., Bruns, T.D., Domínguez, L., Sérsic, A., Leake, J.R., and Read, D.J. (2002). Epiparasitic plants specialized on arbuscular mycorrhizal fungi. *Nature* 419, 389.
- Boisson-Dernier, A., Chabaud, M., Garcia, F., Bécard, G., Rosenberg, C., and Barker, D.G. (2001). Agrobacterium rhizogenes-transformed roots of Medicago truncatula for the study of nitrogen-fixing and endomycorrhizal symbiotic associations. *Molecular Plant-Microbe Interactions* 14, 695-700.
- Bonfante, P., and Genre, A. (2015). Arbuscular mycorrhizal dialogues: do you speak 'plantish' or 'fungish'? *Trends in Plant Science* 20, 150-154.
- Bonfante, P., and Perotto, S. (1995). Tansley Review No. 82. Strategies of arbuscular mycorrhizal fungi when infecting host plants. *New Phytologist* 130, 3-21.
- Bonfante-Fasolo, P., Vian, B., Perotto, S., Faccio, A., and Knox, J.P. (1990). Cellulose and pectin localization in roots of mycorrhizal *Allium porrum*: labelling continuity between host cell wall and interfacial material. *Planta* 180, 537-547.
- Boon, E., Halary, S., Baptiste, E., and Hijri, M. (2015). Studying Genome Heterogeneity within the Arbuscular Mycorrhizal Fungal Cytoplasm. *Genome Biology and Evolution* 7, 505-521.
- Brands, M., Wewer, V., Keymer, A., Gutjahr, C., and Dörmann, P. (2018). The *Lotus japonicus* acyl-acyl carrier protein thioesterase FatM is required for mycorrhiza formation and lipid accumulation of *Rhizophagus irregularis*. *The Plant Journal*.
- Bravo, A., York, T., Pumplin, N., Mueller, L.A., and Harrison, M.J. (2016). Genes conserved for arbuscular mycorrhizal symbiosis identified through phylogenomics. *Nature Plants* 2.

- Bravo, A., Brands, M., Wewer, V., Dörmann, P., and Harrison, M.J. (2017). Arbuscular mycorrhiza-specific enzymes FatM and RAM2 fine-tune lipid biosynthesis to promote development of arbuscular mycorrhiza. *New Phytologist* 214, 1631-1645.
- Brehelin, C., Kessler, F., and Vanwijk, K. (2007). Plastoglobules: versatile lipoprotein particles in plastids. *Trends in Plant Science* 12, 260-266.
- Breuillin, F., Schramm, J., Hajirezaei, M., Ahkami, A., Favre, P., Druège, U., Hause, B., Bucher, M., Kretzschmar, T., Bossolini, E., et al. (2010). Phosphate systemically inhibits development of arbuscular mycorrhiza in *Petunia hybrida* and represses genes involved in mycorrhizal functioning: Phosphate and *Petunia* mycorrhiza development and functioning. *The Plant Journal* 64, 1002-1017.
- Brundrett, M.C. (2002). Coevolution of roots and mycorrhizas of land plants. *New Phytologist* 154, 275-304.
- Brundrett, M.C., and Tedersoo, L. (2018). Evolutionary history of mycorrhizal symbioses and global host plant diversity. *New Phytologist* 220, 1108-1115.
- Bruns, T.D., Corradi, N., Redecker, D., Taylor, J.W., and Öpik, M. (2018). Glomeromycotina: what is a species and why should we care? *New Phytologist* 220, 963-967.
- Bucher, M., Wegmueller, S., and Drissner, D. (2009). Chasing the structures of small molecules in arbuscular mycorrhizal signaling. *Current Opinion in Plant Biology* 12, 500-507.
- Bücking, H., Mensah, J.A., and Fellbaum, C.R. (2016). Common mycorrhizal networks and their effect on the bargaining power of the fungal partner in the arbuscular mycorrhizal symbiosis. *Communicative & Integrative Biology* 9, e1107684.
- Bukhari, H.S.T., Jakob, R.P., and Maier, T. (2014). Evolutionary Origins of the Multienzyme Architecture of Giant Fungal Fatty Acid Synthase. *Structure* 22, 1775-1785.
- Bulgarelli, D., Schlaeppli, K., Spaepen, S., Van Themaat, E.V.L., and Schulze-Lefert, P. (2013). Structure and functions of the bacterial microbiota of plants. *Annual Review of Plant Biology* 64, 807-838.
- Chabot, S., Becard, G., and Piche, Y. (1992). Life Cycle of *Glomus intraradix* in Root Organ Culture. *Mycologia* 84, 315.
- Chen, E.C.H., Morin, E., Beaudet, D., Noel, J., Yildirim, G., Ndikumana, S., Charron, P., St-Onge, C., Giorgi, J., Krüger, M., et al. (2018). High intraspecific genome diversity in the model arbuscular mycorrhizal symbiont *Rhizophagus irregularis*. *New Phytologist* 220, 1161-1171.
- Cox, G., and Sanders, F. (1974). ULTRASTRUCTURE OF THE HOST-FUNGUS INTERFACE IN A VESICULAR-ARBUSCULAR MYCORRHIZA. *New Phytologist* 73, 901-912.
- Cronan, J.E. (2006). Avant Garde Fatty Acid Synthesis by Trypanosomes. *Cell* 126, 641-643.

Cullen, P.J., and Sprague, G.F. (2000). Glucose depletion causes haploid invasive growth in yeast. *Proceedings of the National Academy of Sciences* 97, 13619-13624.

DeAngelis, Y.M., Saunders, C.W., Johnstone, K.R., Reeder, N.L., Coleman, C.G., Kaczvinsky, J.R., Gale, C., Walter, R., Mekel, M., and Lacey, M.P. (2007). Isolation and expression of a *Malassezia globosa* lipase gene, LIP1. *Journal of Investigative Dermatology* 127, 2138-2146.

Delaux, P.-M., Nanda, A.K., Mathé, C., Sejalón-Delmas, N., and Dunand, C. (2012). Molecular and biochemical aspects of plant terrestrialization. *Perspectives in Plant Ecology, Evolution and Systematics* 14, 49-59.

Delaux, P.-M., Radhakrishnan, G.V., Jayaraman, D., Cheema, J., Malbreil, M., Volkening, J.D., Sekimoto, H., Nishiyama, T., Melkonian, M., Pokorny, L., et al. (2015). Algal ancestor of land plants was preadapted for symbiosis. *Proceedings of the National Academy of Sciences* 112, 13390-13395.

Dexheimer, J., Gianinazzi, S., and Gianinazzi-Pearson, V. (1979). Ultrastructural Cytochemistry of the Host-Fungus Interfaces in the Endornycorrhizal Association *Glomus mosseae* / *Allium cepa*. *Zeitschrift Für Pflanzenphysiologie* 92, 191-206.

Dexheimer, J., Marx, C., Gianinazzi-Pearson, V., and Gianinazzi, S. (1985). Ultracytological studies of plasmalemma formations produced by host and fungus in vesicular-arbuscular mycorrhizae. *CYTOLOGIA* 50, 461-471.

Feher, J. (2012). ATP Production III. In *Quantitative Human Physiology*, (Elsevier), pp. 191-201.

Ferrol, N., Azcón-Aguilar, C., and Pérez-Tienda, J. (2019). Review: Arbuscular mycorrhizas as key players in sustainable plant phosphorus acquisition: An overview on the mechanisms involved. *Plant Science* 280, 441-447.

Field, K.J., Pressel, S., Duckett, J.G., Rimmington, W.R., and Bidartondo, M.I. (2015). Symbiotic options for the conquest of land. *Trends in Ecology & Evolution* 30, 477-486.

Flaspohler, J.A., Jensen, B.C., Saveria, T., Kifer, C.T., and Parsons, M. (2010). A Novel Protein Kinase Localized to Lipid Droplets Is Required for Droplet Biogenesis in Trypanosomes. *Eukaryotic Cell* 9, 1702-1710.

Garcia, K., Doidy, J., Zimmermann, S.D., Wipf, D., and Courty, P.-E. (2016). Take a Trip Through the Plant and Fungal Transportome of Mycorrhiza. *Trends in Plant Science* 21, 937-950.

Genre, A., Chabaud, M., Timmers, T., Bonfante, P., and Barker, D.G. (2005). Arbuscular Mycorrhizal Fungi Elicit a Novel Intracellular Apparatus in *Medicago truncatula* Root Epidermal Cells before Infection. *The Plant Cell* 17, 3489-3499.

Genre, A., Chabaud, M., Faccio, A., Barker, D.G., and Bonfante, P. (2008). Prepenetration Apparatus Assembly Precedes and Predicts the Colonization Patterns

of Arbuscular Mycorrhizal Fungi within the Root Cortex of Both *Medicago truncatula* and *Daucus carota*. *The Plant Cell* 20, 1407-1420.

Genre, A., Chabaud, M., Balzergue, C., Puech-Pagès, V., Novero, M., Rey, T., Fournier, J., Rochange, S., Bécard, G., Bonfante, P., et al. (2013). Short-chain chitin oligomers from arbuscular mycorrhizal fungi trigger nuclear Ca²⁺ spiking in *Medicago truncatula* roots and their production is enhanced by strigolactone. *New Phytologist* 198, 190-202.

Gobbato, E., Marsh, J.F., Vernié, T., Wang, E., Maillet, F., Kim, J., Miller, J.B., Sun, J., Bano, S.A., Ratet, P., et al. (2012). A GRAS-Type Transcription Factor with a Specific Function in Mycorrhizal Signaling. *Current Biology* 22, 2236-2241.

Goetzman, E.S. (2011). Modeling Disorders of Fatty Acid Metabolism in the Mouse. In *Progress in Molecular Biology and Translational Science*, (Elsevier), pp. 389-417.

Guenther, J.C., Hallen-Adams, H.E., Bücking, H., Shachar-Hill, Y., and Trail, F. (2009). Triacylglyceride Metabolism by *Fusarium graminearum* During Colonization and Sexual Development on Wheat. *Molecular Plant-Microbe Interactions* 22, 1492-1503.

Gurusamy, C., Davis, P.J., and Bal, A.K. (2000). Seasonal Changes in Perennial Nodules of Beach Pea (*Lathyrus maritimus* [L.] Bigel.) with Special Reference to Oleosomes. *International Journal of Plant Sciences* 161, 631-638.

Gutjahr, C., Radovanovic, D., Geoffroy, J., Zhang, Q., Siegler, H., Chiapello, M., Casieri, L., An, K., An, G., Guiderdoni, E., et al. (2012). The half-size ABC transporters STR1 and STR2 are indispensable for mycorrhizal arbuscule formation in rice: Role of rice STR1 and STR2 in arbuscule formation. *The Plant Journal* 69, 906-920.

Hane, J.K., Anderson, J.P., Williams, A.H., Sperschneider, J., and Singh, K.B. (2014). Genome Sequencing and Comparative Genomics of the Broad Host-Range Pathogen *Rhizoctonia solani* AG8. *PLoS Genetics* 10.

Harrison, M.J. (2012). Cellular programs for arbuscular mycorrhizal symbiosis. *Current Opinion in Plant Biology* 15, 691-698.

Harrison, M.J., Dewbre, G.R., and Liu, J. (2002). A Phosphate Transporter from *Medicago truncatula* Involved in the Acquisition of Phosphate Released by Arbuscular Mycorrhizal Fungi. *The Plant Cell* 14, 2413-2429.

Helber, N., Wippel, K., Sauer, N., Schaarschmidt, S., Hause, B., and Requena, N. (2011). A Versatile Monosaccharide Transporter That Operates in the Arbuscular Mycorrhizal Fungus *Glomus* sp Is Crucial for the Symbiotic Relationship with Plants. *The Plant Cell* 23, 3812-3823.

Hensel, W. (1986). Cytodifferentiation of polar plant cells Use of anti-microtubular agents during the differentiation of statocytes from cress roots (*Lepidium sativum* L.). *Planta* 169, 293-303.

- Hijri, M., and Sanders, I.R. (2005). Low gene copy number shows that arbuscular mycorrhizal fungi inherit genetically different nuclei. *Nature* 433, 160-163.
- Hijri, M., Hosny, M., van Tuinen, D., and Dulieu, H. (1999). Intraspecific ITS polymorphism in *Scutellospora castanea* (Glomales, Zygomycota) is structured within multinucleate spores. *Fungal Genetics and Biology* : FG & B 26, 141-151.
- Hildebrandt, U., Ouziad, F., Marnier, F.-J., and Bothe, H. (2006). The bacterium *Paenibacillus validus* stimulates growth of the arbuscular mycorrhizal fungus *Glomus intraradices* up to the formation of fertile spores. *FEMS Microbiology Letters* 254, 258-267.
- Hinsinger, P. (2001). Bioavailability of soil inorganic P in the rhizosphere as affected by root-induced chemical changes: a review. *Plant and Soil* 237, 173-195.
- Hinsinger, P., Betencourt, E., Bernard, L., Brauman, A., Plassard, C., Shen, J., Tang, X., and Zhang, F. (2011). P for Two, Sharing a Scarce Resource: Soil Phosphorus Acquisition in the Rhizosphere of Intercropped Species. *Plant Physiology* 156, 1078-1086.
- Ho, I., and Trappe, J.M. (1973). Translocation of 14 C from *Festuca* plants to their endomycorrhizal fungi. *Nature New Biology* 244, 30.
- Humphreys, C.P., Franks, P.J., Rees, M., Bidartondo, M.I., Leake, J.R., and Beerling, D.J. (2010). Mutualistic mycorrhiza-like symbiosis in the most ancient group of land plants. *Nature Communications* 1.
- Ivanov, S., Austin, J., Berg, R.H., and Harrison, M.J. (2019). Extensive membrane systems at the host-arbuscular mycorrhizal fungus interface. *Nature Plants* 5, 194-203.
- Jabaji-Hare, S., Sridhara, S.I., and Kendrick, B. (1984). A technique for the isolation of intramatrical vesicles from vesicular-arbuscular mycorrhizae. *Canadian Journal of Botany* 62, 1466-1468.
- Javot, H., Penmetsa, R.V., Breuillin, F., Bhattarai, K.K., Noar, R.D., Gomez, S.K., Zhang, Q., Cook, D.R., and Harrison, M.J. (2011). *Medicago truncatula* mtpt4 mutants reveal a role for nitrogen in the regulation of arbuscule degeneration in arbuscular mycorrhizal symbiosis: N status and arbuscule degeneration in mtpt4 mutants. *The Plant Journal* 68, 954-965.
- Jiang, Y., Wang, W., Xie, Q., Liu, N., Liu, L., Wang, D., Zhang, X., Yang, C., Chen, X., Tang, D., et al. (2017). Plants transfer lipids to sustain colonization by mutualistic mycorrhizal and parasitic fungi. *Science* eaam9970.
- Johnson, D., Vandenkoornhuyse, P.J., Leake, J.R., Gilbert, L., Booth, R.E., Grime, J.P., Young, J.P.W., and Read, D.J. (2004). Plant communities affect arbuscular mycorrhizal fungal diversity and community composition in grassland microcosms. *New Phytologist* 161, 503-515.

- Jones, D.L., Hodge, A., and Kuzyakov, Y. (2004). Plant and mycorrhizal regulation of rhizodeposition. *New Phytologist* 163, 459-480.
- Kamel, L., Tang, N., Malbreil, M., San Clemente, H., Le Marquer, M., Roux, C., and Frei dit Frey, N. (2017). The Comparison of Expressed Candidate Secreted Proteins from Two Arbuscular Mycorrhizal Fungi Unravels Common and Specific Molecular Tools to Invade Different Host Plants. *Frontiers in Plant Science* 8.
- Kameoka, H., Tsutsui, I., Saito, K., Kikuchi, Y., Handa, Y., Ezawa, T., Hayashi, H., Kawaguchi, M., and Akiyama, K. (2019a). Stimulation of asymbiotic sporulation in arbuscular mycorrhizal fungi by fatty acids. *Nature Microbiology*.
- Kameoka, H., Maeda, T., Okuma, N., and Kawaguchi, M. (2019b). Structure-Specific Regulation of Nutrient Transport and Metabolism in Arbuscular Mycorrhizal Fungi. *Plant and Cell Physiology* pcz122.
- Kenrick, P., and Strullu-Derrien, C. (2014). The origin and early evolution of roots. *Plant Physiology* 166, 570-580.
- Keymer, A., and Gutjahr, C. (2018). Cross-kingdom lipid transfer in arbuscular mycorrhiza symbiosis and beyond. *Current Opinion in Plant Biology* 44, 137-144.
- Keymer, A., Pimprikar, P., Wewer, V., Huber, C., Brands, M., Bucerius, S., Delaux, P.-M., Klingl, V., von Roepenack-Lahaye, E., Wang, T.L., et al. (2017). Lipid transfer from plants to arbuscular mycorrhiza fungi. *BioRxiv* 143883.
- Kiers, E.T., Duhamel, M., Beesetty, Y., Mensah, J.A., Franken, O., Verbruggen, E., Fellbaum, C.R., Kowalchuk, G.A., Hart, M.M., Bago, A., et al. (2011). Reciprocal Rewards Stabilize Cooperation in the Mycorrhizal Symbiosis. *Science* 333, 880-882.
- Kiers, E.T., West, S.A., Wyatt, G.A.K., Gardner, A., Bücking, H., and Werner, G.D.A. (2016). Misconceptions on the application of biological market theory to the mycorrhizal symbiosis. *Nature Plants* 2.
- Kloppholz, S., Kuhn, H., and Requena, N. (2011). A secreted fungal effector of *Glomus intraradices* promotes symbiotic biotrophy. *Current Biology* 21, 1204-1209.
- Knowlton, N., and Rohwer, F. (2003). Multispecies microbial mutualisms on coral reefs: the host as a habitat. *The American Naturalist* 162, S51-S62.
- Kobae, Y. (2019). Dynamic Phosphate Uptake in Arbuscular Mycorrhizal Roots Under Field Conditions. *Front. Environ. Sci.* 6.
- Kobae, Y., and Hata, S. (2010). Dynamics of Periarbuscular Membranes Visualized with a Fluorescent Phosphate Transporter in Arbuscular Mycorrhizal Roots of Rice. *Plant and Cell Physiology* 51, 341-353.
- Kobae, Y., Gutjahr, C., Paszkowski, U., Kojima, T., Fujiwara, T., and Hata, S. (2014). Lipid Droplets of Arbuscular Mycorrhizal Fungi Emerge in Concert with Arbuscule Collapse. *Plant and Cell Physiology* 55, 1945-1953.

- Kobae, Y., Ohmori, Y., Saito, C., Yano, K., Ohtomo, R., and Fujiwara, T. (2016). Phosphate Treatment Strongly Inhibits New Arbuscule Development But Not the Maintenance of Arbuscule in Mycorrhizal Rice Roots. *Plant Physiology* 171, 566-579.
- Kobayashi, Y., Maeda, T., Yamaguchi, K., Kameoka, H., Tanaka, S., Ezawa, T., Shigenobu, S., and Kawaguchi, M. (2018). The genome of *Rhizophagus clarus* HR1 reveals a common genetic basis for auxotrophy among arbuscular mycorrhizal fungi. *BMC Genomics* 19.
- Kokkoris, V., and Hart, M. (2019). In vitro Propagation of Arbuscular Mycorrhizal Fungi May Drive Fungal Evolution. *Frontiers in Microbiology* 10.
- Kölling, K., Thalmann, M., Müller, A., Jenny, C., and Zeeman, S.C. (2015). Carbon partitioning in *A. thaliana* is a dynamic process controlled by the plants metabolic status and its circadian clock: Dynamic carbon partitioning in *Arabidopsis*. *Plant, Cell & Environment* 38, 1965-1979.
- Konvalinková, T., and Jansa, J. (2016). Lights off for arbuscular mycorrhiza: on its symbiotic functioning under light deprivation. *Frontiers in Plant Science* 7, 782.
- Kuhn, G., Hijri, M., and Sanders, I.R. (2001). Evidence for the evolution of multiple genomes in arbuscular mycorrhizal fungi. *Nature* 414, 745-748.
- Kumamoto, C.A. (2005). A contact-activated kinase signals *Candida albicans* invasive growth and biofilm development. *Proceedings of the National Academy of Sciences* 102, 5576-5581.
- Leake, J.R. (2004). Myco-heterotroph/epiparasitic plant interactions with ectomycorrhizal and arbuscular mycorrhizal fungi. *Current Opinion in Plant Biology* 7, 422-428.
- Lin, K., Limpens, E., Zhang, Z., Ivanov, S., Saunders, D.G.O., Mu, D., Pang, E., Cao, H., Cha, H., Lin, T., et al. (2014). Single Nucleus Genome Sequencing Reveals High Similarity among Nuclei of an Endomycorrhizal Fungus. *PLoS Genetics* 10, e1004078.
- López-Ráez, J.A., Charnikhova, T., Gómez-Roldán, V., Matusova, R., Kohlen, W., De Vos, R., Verstappen, F., Puech-Pages, V., Bécard, G., and Mulder, P. (2008). Tomato strigolactones are derived from carotenoids and their biosynthesis is promoted by phosphate starvation. *New Phytologist* 178, 863-874.
- Luginbuehl, L.H., Menard, G.N., Kurup, S., Van Erp, H., Radhakrishnan, G.V., Breakspear, A., Oldroyd, G.E., and Eastmond, P.J. (2017). Fatty acids in arbuscular mycorrhizal fungi are synthesized by the host plant. *Science* eaan0081.
- Lumini, E., Bianciotto, V., Jargeat, P., Novero, M., Salvioli, A., Faccio, A., Bécard, G., and Bonfante, P. (2007). Presymbiotic growth and sporal morphology are affected in the arbuscular mycorrhizal fungus *Gigaspora margarita* cured of its endobacteria. *Cellular Microbiology* 9, 1716-1729.
- MacLean, A.M., Bravo, A., and Harrison, M.J. (2017). Plant signaling and metabolic pathways enabling arbuscular mycorrhizal symbiosis. *The Plant Cell* tpc.00555.2017.

- Maeda, T., Kobayashi, Y., Kameoka, H., Okuma, N., Takeda, N., Yamaguchi, K., Bino, T., Shigenobu, S., and Kawaguchi, M. (2018). Evidence of non-tandemly repeated rDNAs and their intragenomic heterogeneity in *Rhizophagus irregularis*. *Communications Biology* 1.
- Maherali, H., and Klironomos, J.N. (2007). Influence of Phylogeny on Fungal Community Assembly and Ecosystem Functioning. *Science* 316, 1746-1748.
- Maillet, F., Poinso, V., André, O., Puech-Pagès, V., Haouy, A., Gueunier, M., Cromer, L., Giraudet, D., Formey, D., Niebel, A., et al. (2011). Fungal lipochitooligosaccharide symbiotic signals in arbuscular mycorrhiza. *Nature* 469, 58-63.
- Malbreil, M., Tisserant, E., Martin, F., and Roux, C. (2014). Genomics of Arbuscular Mycorrhizal Fungi. In *Advances in Botanical Research*, (Elsevier), pp. 259-290.
- Marleau, J., Dalpé, Y., St-Arnaud, M., and Hijri, M. (2011). Spore development and nuclear inheritance in arbuscular mycorrhizal fungi. *BMC Evolutionary Biology* 11.
- Masclaux, F.G., Wyss, T., Mateus-Gonzalez, I.D., Aletti, C., and Sanders, I.R. (2018). Variation in allele frequencies at the bg112 locus reveals unequal inheritance of nuclei in a dikaryotic isolate of the fungus *Rhizophagus irregularis*. *Mycorrhiza* 28, 369-377.
- Mathieu, S., Cusant, L., Roux, C., and Corradi, N. (2018). Arbuscular mycorrhizal fungi: intraspecific diversity and pangenomes. *New Phytologist* 220, 1129-1134.
- Mazumdar, J., and Striepen, B. (2007). Make It or Take It: Fatty Acid Metabolism of Apicomplexan Parasites. *Eukaryotic Cell* 6, 1727-1735.
- Merckx, V., Bidartondo, M.I., and Hynson, N.A. (2009). Myco-heterotrophy: when fungi host plants. *Annals of Botany* 104, 1255-1261.
- Metz, J.G., Roessler, P., Facciotti, D., Levering, C., Dittrich, F., Lassner, M., Valentine, R., Lardizabal, K., Domergue, F., Yamada, A., et al. (2001). Production of polyunsaturated fatty acids by polyketide synthases in both prokaryotes and eukaryotes. *Science* 293, 290-293.
- Montesinos-Navarro, A., Segarra-Moragues, J.G., Valiente-Banuet, A., and Verdú, M. (2012). The network structure of plant-arbuscular mycorrhizal fungi. *New Phytologist* 194, 536-547.
- Morin, E., Miyauchi, S., San Clemente, H., Chen, E.C.H., Pelin, A., Providencia, I., Ndikumana, S., Beaudet, D., Hainaut, M., Drula, E., et al. (2019). Comparative genomics of *Rhizophagus irregularis*, *R. cerebriforme*, *R. diaphanus* and *Gigaspora rosea* highlights specific genetic features in Glomeromycotina. *New Phytologist* 222, 1584-1598.
- Mosse, B. (1953). Fructifications associated with mycorrhizal strawberry roots. *Nature* 171, 974.

- Murphy, D. (2001). The biogenesis and functions of lipid bodies in animals, plants and microorganisms. *Progress in Lipid Research* 40, 325-438.
- Murphy, D.J. (2012). The dynamic roles of intracellular lipid droplets: from archaea to mammals. *Protoplasma* 249, 541-585.
- Oldroyd, G.E.D. (2013). Speak, friend, and enter: signalling systems that promote beneficial symbiotic associations in plants. *Nature Reviews Microbiology* 11, 252-263.
- Olsson, P. al A., and Johansen, A. (2000). Lipid and fatty acid composition of hyphae and spores of arbuscular mycorrhizal fungi at different growth stages. *Mycological Research* 104, 429-434.
- Öpik, M., Vanatoa, A., Vanatoa, E., Moora, M., Davison, J., Kalwij, J.M., Reier, Ü., and Zobel, M. (2010). The online database MaarjAM reveals global and ecosystemic distribution patterns in arbuscular mycorrhizal fungi (Glomeromycota). *New Phytologist* 188, 223-241.
- Palacpac, N.M.Q. (2004). Developmental-stage-specific triacylglycerol biosynthesis, degradation and trafficking as lipid bodies in *Plasmodium falciparum*-infected erythrocytes. *Journal of Cell Science* 117, 1469-1480.
- Parniske, M. (2008). Arbuscular mycorrhiza: the mother of plant root endosymbioses. *Nature Reviews Microbiology* 6, 763-775.
- Partridge, M., and Murphy, D.J. (2009). Roles of a membrane-bound caleosin and putative peroxygenase in biotic and abiotic stress responses in *Arabidopsis*. *Plant Physiology and Biochemistry* 47, 796-806.
- Pepe, A., Sbrana, C., Ferrol, N., and Giovannetti, M. (2017). An in vivo whole-plant experimental system for the analysis of gene expression in extraradical mycorrhizal mycelium. *Mycorrhiza* 27, 659-668.
- Pfeffer, P.E., Douds, D.D., Bécard, G., and Shachar-Hill, Y. (1999). Carbon uptake and the metabolism and transport of lipids in an arbuscular mycorrhiza. *Plant Physiology* 120, 587-598.
- Plenchette, C., Furlan, V., and Fortin, J.A. (1983). Responses of endomycorrhizal plants grown in a calcined montmorillonite clay to different levels of soluble phosphorus. I. Effect on growth and mycorrhizal development. *Canadian Journal of Botany* 61, 1377-1383.
- Prasad, R., and Ghannoum, A.M. (1996). *Lipids of Pathogenic Fungi* CRC press.
- Raffaele, S., and Kamoun, S. (2012). Genome evolution in filamentous plant pathogens: why bigger can be better. *Nature Reviews Microbiology* 10, 417.
- Raffaele, S., Farrer, R.A., Cano, L.M., Studholme, D.J., MacLean, D., Thines, M., Jiang, R.H.Y., Zody, M.C., Kunjeti, S.G., Donofrio, N.M., et al. (2010). Genome Evolution Following Host Jumps in the Irish Potato Famine Pathogen Lineage. *Science* 330, 1540-1543.

- Redecker, D. (2000). Glomalean Fungi from the Ordovician. *Science* 289, 1920-1921.
- Redecker, D., Hijri, M., Dulieu, H., and Sanders, I.R. (1999). Phylogenetic analysis of a dataset of fungal 5.8S rDNA sequences shows that highly divergent copies of internal transcribed spacers reported from *Scutellospora castanea* are of ascomycete origin. *Fungal Genetics and Biology* 28, 238-244.
- Redecker, D., Schüßler, A., Stockinger, H., Stürmer, S.L., Morton, J.B., and Walker, C. (2013a). An evidence-based consensus for the classification of arbuscular mycorrhizal fungi (Glomeromycota). *Mycorrhiza* 23, 515-531.
- Redecker, D., Schüßler, A., Stockinger, H., Stürmer, S.L., Morton, J.B., and Walker, C. (2013b). An evidence-based consensus for the classification of arbuscular mycorrhizal fungi (Glomeromycota). *Mycorrhiza* 23, 515-531.
- Rich, M.K., Nouri, E., Courty, P.-E., and Reinhardt, D. (2017). Diet of Arbuscular Mycorrhizal Fungi: Bread and Butter? *Trends in Plant Science* 22, 652-660.
- Rinne, P.L.H., Kaikuranta, P.M., and Van Der Schoot, C. (2001). The shoot apical meristem restores its symplasmic organization during chilling-induced release from dormancy: Chilled AM restores its symplasmic network. *The Plant Journal* 26, 249-264.
- Robinson, M.D., McCarthy, D.J., and Smyth, G.K. (2010). edgeR: a Bioconductor package for differential expression analysis of digital gene expression data. *Bioinformatics* 26, 139-140.
- Rodriguez, H., and Fraga, R. (1999). Phosphate solubilizing bacteria and their role in plant growth promotion. *Biotechnology Advances* 17, 319-339.
- Ropars, J., and Corradi, N. (2015). Homokaryotic vs heterokaryotic mycelium in arbuscular mycorrhizal fungi: different techniques, different results? *New Phytologist* 208, 638-641.
- Ropars, J., Toro, K.S., Noel, J., Pelin, A., Charron, P., Farinelli, L., Marton, T., Krüger, M., Fuchs, J., Brachmann, A., et al. (2016a). Evidence for the sexual origin of heterokaryosis in arbuscular mycorrhizal fungi. *Nature Microbiology* 16033.
- Ropars, J., Toro, K.S., Noel, J., Pelin, A., Charron, P., Farinelli, L., Marton, T., Krüger, M., Fuchs, J., Brachmann, A., et al. (2016b). Evidence for the sexual origin of heterokaryosis in arbuscular mycorrhizal fungi. *Nature Microbiology* 1.
- Roth, R., and Paszkowski, U. (2017). Plant carbon nourishment of arbuscular mycorrhizal fungi. *Current Opinion in Plant Biology* 39, 50-56.
- Roth, R., Hillmer, S., Funaya, C., Chiapello, M., Schumacher, K., Lo Presti, L., Kahmann, R., and Paszkowski, U. (2019). Arbuscular cell invasion coincides with extracellular vesicles and membrane tubules. *Nature Plants* 5, 204-211.
- Sancholle, M., Dalpé, Y., and Grandmougin-Ferjani, A. (2001). Lipids of Mycorrhizae. In *Fungal Associations*, B. Hock, ed. (Berlin, Heidelberg: Springer Berlin Heidelberg), pp. 63-93.

Sanders, I.R. (1999). Evolutionary genetics. No sex please, we're fungi. *Nature* 399, 737-739.

Schoch, C.L., Seifert, K. a., Huhndorf, S., Robert, V., Spouge, J.L., Levesque, C. a., Chen, W., Consortium, F.B., Bolchacova, E., Voigt, K., et al. (2012). Nuclear ribosomal internal transcribed spacer (ITS) region as a universal DNA barcode marker for Fungi. *Proceedings of the National Academy of Sciences of the United States of America* 109, 1-6.

Schüßler, A., and Walker, C. (2010). *The Glomeromycota: a species list with new families and new genera*. The Royal Botanic Garden Kew, Botanische Staatssammlung Munich, and Oregon State University 19.

Schwelm, A., Fogelqvist, J., Knaust, A., Jülke, S., Lilja, T., Bonilla-Rosso, G., Karlsson, M., Shevchenko, A., Dhandapani, V., Choi, S.R., et al. (2015). The *Plasmodiophora brassicae* genome reveals insights in its life cycle and ancestry of chitin synthases. *Scientific Reports* 5, 11153.

Scott, T.W., Kiers, E.T., Cooper, G.A., dos Santos, M., and West, S.A. (2019). Evolutionary maintenance of genomic diversity within arbuscular mycorrhizal fungi. *Ecology and Evolution* 9, 2425-2435.

Sędziewska, K.A., Fuchs, J., Temsch, E.M., Baronian, K., Watzke, R., and Kunze, G. (2011). Estimation of the *Glomus intraradices* nuclear DNA content: Letter. *New Phytologist* 192, 794-797.

Selosse, M.-A., Richard, F., He, X., and Simard, S.W. (2006). Mycorrhizal networks: des liaisons dangereuses? *Trends in Ecology & Evolution* 21, 621-628.

Shachar-Hill, Y., Pfeffer, P.E., Douds, D., Osman, S.F., Doner, L.W., and Ratcliffe, R.G. (1995). Partitioning of Intermediary Carbon Metabolism in Vesicular-Arbuscular Mycorrhizal Leek. *Plant Physiology* 108, 7-15.

Sidi-Boulenouar, R., Reis, A., Nativel, E., Buy, S., de Pellegars, P., Liu, P., Zanca, M., Goze-Bac, C., Barbat, J., Alibert, E., et al. (2018). Homogenous static magnetic field coils dedicated to portable nuclear magnetic resonance for agronomic studies. *Journal of Sensors and Sensor Systems* 7, 227-234.

Siqueira, J.O., Safir, G.R., and Nair, M.G. (1991). Stimulation of vesicular-arbuscular mycorrhiza formation and growth of white clover by flavonoid compounds. *New Phytologist* 118, 87-93.

Smith, S.E., and Read, D.J. (2010). *Mycorrhizal Symbiosis* (Academic Press).

Spanu, P.D., Abbott, J.C., Amselem, J., Burgis, T.A., Soanes, D.M., Stüber, K., Themaat, E.V.L. van, Brown, J.K.M., Butcher, S.A., Gurr, S.J., et al. (2010). Genome Expansion and Gene Loss in Powdery Mildew Fungi Reveal Tradeoffs in Extreme Parasitism. *Science* 330, 1543-1546.

Spatafora, J.W., Chang, Y., Benny, G.L., Lazarus, K., Smith, M.E., Berbee, M.L., Bonito, G., Corradi, N., Grigoriev, I., and Gryganskyi, A. (2016). A phylum-level

phylogenetic classification of zygomycete fungi based on genome-scale data. *Mycologia* 108, 1028-1046.

Stryer, L. (1995). *Biochemistry*, 4th edition (WH Freeman and).

Sugiura, Y., Akiyama, R., Tanaka, S., Yano, K., Kameoka, H., Kawaguchi, M., Akiyama, K., and Saito, K. (2019a). Myristate as a carbon and energy source for the asymbiotic growth of the arbuscular mycorrhizal fungus. *BioRxiv*.

Sugiura, Y., Akiyama, R., Tanaka, S., Yano, K., Kameoka, H., Kawaguchi, M., Akiyama, K., and Saito, K. (2019b). Myristate as a carbon and energy source for the asymbiotic growth of the arbuscular mycorrhizal fungus *Rhizophagus irregularis*. *BioRxiv* 731489.

Sun, X., Chen, W., Ivanov, S., MacLean, A.M., Wight, H., Ramaraj, T., Mudge, J., Harrison, M.J., and Fei, Z. (2019). Genome and evolution of the arbuscular mycorrhizal fungus *Diversispora epigaea* (formerly *Glomus versiforme*) and its bacterial endosymbionts. *New Phytologist* 221, 1556-1573.

Tamasloukht, M., Séjalon-Delmas, N., Kluever, A., Jauneau, A., Roux, C., Bécard, G., and Franken, P. (2003). Root Factors Induce Mitochondrial-Related Gene Expression and Fungal Respiration during the Developmental Switch from Asymbiosis to Presymbiosis in the Arbuscular Mycorrhizal Fungus *Gigaspora rosea*. *Plant Physiology* 131, 1468-1478.

Tang, N., San Clemente, H., Roy, S., Bécard, G., Zhao, B., and Roux, C. (2016). A Survey of the Gene Repertoire of *Gigaspora rosea* Unravels Conserved Features among Glomeromycota for Obligate Biotrophy. *Frontiers in Microbiology* 7.

Taylor, T.N., Remy, W., Hass, H., and Kerp, H. (1995). Fossil arbuscular mycorrhizae from the Early Devonian. *Mycologia* 87, 560-573.

Tehlivets, O., Scheuringer, K., and Kohlwein, S.D. (2007). Fatty acid synthesis and elongation in yeast. *Biochimica et Biophysica Acta (BBA) - Molecular and Cell Biology of Lipids* 1771, 255-270.

Teichmann, B., Linne, U., Hewald, S., Marahiel, M.A., and Bölker, M. (2007). A biosynthetic gene cluster for a secreted cellobiose lipid with antifungal activity from *Ustilago maydis*. *Molecular Microbiology* 66, 525-533.

Tisserant, E., Kohler, A., Dozolme-Seddas, P., Balestrini, R., Benabdellah, K., Colard, A., Croll, D., Da Silva, C., Gomez, S.K., Koul, R., et al. (2012). The transcriptome of the arbuscular mycorrhizal fungus *Glomus intraradices* (DAOM 197198) reveals functional tradeoffs in an obligate symbiont. *New Phytologist* 193, 755-769.

Tisserant, E., Malbreil, M., Kuo, A., Kohler, A., Symeonidi, A., Balestrini, R., Charron, P., Duensing, N., Frei dit Frey, N., Gianinazzi-Pearson, V., et al. (2013). Genome of an arbuscular mycorrhizal fungus provides insight into the oldest plant symbiosis. *Proceedings of the National Academy of Sciences* 110, 20117-20122.

Tollot, M., Hoi, J.W.S., Tuinen, D.V., Arnould, C., Chatagnier, O., Dumas, B., Gianinazzi-Pearson, V., and Seddas, P.M.A. (2009). An STE12 gene identified in the mycorrhizal fungus *Glomus intraradices* restores infectivity of a hemibiotrophic plant pathogen. *New Phytologist* 181, 693-707.

Trepanier, M., Becard, G., Moutoglis, P., Willemot, C., Gagne, S., Avis, T.J., and Rioux, J.-A. (2005). Dependence of Arbuscular-Mycorrhizal Fungi on Their Plant Host for Palmitic Acid Synthesis. *Applied and Environmental Microbiology* 71, 5341-5347.

Triana, S., de Cock, H., Ohm, R.A., Danies, G., Wösten, H.A.B., Restrepo, S., González Barrios, A.F., and Celis, A. (2017). Lipid Metabolic Versatility in *Malassezia* spp. Yeasts Studied through Metabolic Modeling. *Frontiers in Microbiology* 8.

Tsitsigiannis, D.I., Zarnowski, R., and Keller, N.P. (2004). The Lipid Body Protein, PpoA, Coordinates Sexual and Asexual Sporulation in *Aspergillus nidulans*. *Journal of Biological Chemistry* 279, 11344-11353.

Vandenkoornhuise, P., Quaiser, A., Duhamel, M., Le Van, A., and Dufresne, A. (2015). The importance of the microbiome of the plant holobiont. *New Phytologist* 206, 1196-1206.

Veiga, R.S.L., Faccio, A., Genre, A., Pieterse, C.M.J., Bonfante, P., and Heijden, M.G.A. van der (2013). Arbuscular mycorrhizal fungi reduce growth and infect roots of the non-host plant *Arabidopsis thaliana*. *Plant, Cell & Environment* 36, 1926-1937.

Venice, F., Ghignone, S., Salvioli di Fossalunga, A., Amselem, J., Novero, M., Xie, X., Sędziewska Toro, K., Morin, E., Lipzen, A., Grigoriev, I.V., et al. (2019). At the nexus of three kingdoms: the genome of the mycorrhizal fungus *Gigaspora margarita* provides insights into plant, endobacterial and fungal interactions. *Environmental Microbiology*.

Visser, B., Le Lann, C., den Blanken, F.J., Harvey, J.A., van Alphen, J.J.M., and Ellers, J. (2010). Loss of lipid synthesis as an evolutionary consequence of a parasitic lifestyle. *Proceedings of the National Academy of Sciences* 107, 8677-8682.

Wada, H., Shintani, D., and Ohlrogge, J. (1997). Why do mitochondria synthesize fatty acids? Evidence for involvement in lipoic acid production. *Proceedings of the National Academy of Sciences* 94, 1591-1596.

Walder, F., and van der Heijden, M.G.A. (2015). Regulation of resource exchange in the arbuscular mycorrhizal symbiosis. *Nature Plants* 1.

Wang, B., and Qiu, Y.-L. (2006a). Phylogenetic distribution and evolution of mycorrhizas in land plants. *Mycorrhiza* 16, 299-363.

Wang, B., and Qiu, Y.L. (2006b). Phylogenetic distribution and evolution of mycorrhizas in land plants. *Mycorrhiza* 16, 299-363.

Wang, C., and St. Leger, R.J. (2007). The *Metarhizium anisopliae* Perilipin Homolog MPL1 Regulates Lipid Metabolism, Appressorial Turgor Pressure, and Virulence. *Journal of Biological Chemistry* 282, 21110-21115.

- Wang, E., Schornack, S., Marsh, J.F., Gobbato, E., Schwessinger, B., Eastmond, P., Schultze, M., Kamoun, S., and Oldroyd, G.E.D. (2012). A Common Signaling Process that Promotes Mycorrhizal and Oomycete Colonization of Plants. *Current Biology* 22, 2242-2246.
- Wang, L., Chen, W., Feng, Y., Ren, Y., Gu, Z., Chen, H., Wang, H., Thomas, M.J., Zhang, B., Berquin, I.M., et al. (2011). Genome Characterization of the Oleaginous Fungus *Mortierella alpina*. *PLoS ONE* 6, e28319.
- Wang, W., Shi, J., Xie, Q., Jiang, Y., Yu, N., and Wang, E. (2017). Nutrient Exchange and Regulation in Arbuscular Mycorrhizal Symbiosis. *Molecular Plant* 10, 1147-1158.
- Wei, Y., Zhao, Y., Shi, M., Cao, Z., Lu, Q., Yang, T., Fan, Y., and Wei, Z. (2018). Effect of organic acids production and bacterial community on the possible mechanism of phosphorus solubilization during composting with enriched phosphate-solubilizing bacteria inoculation. *Bioresource Technology* 247, 190-199.
- Werner, G.D.A., and Kiers, E.T. (2015). Partner selection in the mycorrhizal mutualism. *New Phytologist* 205, 1437-1442.
- Wewer, V., Brands, M., and Dörmann, P. (2014). Fatty acid synthesis and lipid metabolism in the obligate biotrophic fungus *Rhizophagus irregularis* during mycorrhization of *Lotus japonicus*. *Plant J* 79, 398-412.
- Willgoose, G. (2018). *Principles of soilscape and landscape evolution* (Cambridge University Press).
- Wipf, D., Krajinski, F., van Tuinen, D., Recorbet, G., and Courty, P.-E. (2019). Trading on the arbuscular mycorrhiza market: from arbuscules to common mycorrhizal networks. *New Phytologist*.
- Wyss, T., Masclaux, F.G., Rosikiewicz, P., Pagni, M., and Sanders, I.R. (2016). Population genomics reveals that within-fungus polymorphism is common and maintained in populations of the mycorrhizal fungus *Rhizophagus irregularis*. *The ISME Journal* 10, 2514-2526.
- Xu, J., Saunders, C.W., Hu, P., Grant, R.A., Boekhout, T., Kuramae, E.E., Kronstad, J.W., DeAngelis, Y.M., Reeder, N.L., Johnstone, K.R., et al. (2007). Dandruff-associated *Malassezia* genomes reveal convergent and divergent virulence traits shared with plant and human fungal pathogens. *Proceedings of the National Academy of Sciences* 104, 18730-18735.
- Zeng, T., Holmer, R., Hontelez, J., te Lintel-Hekkert, B., Marufu, L., de Zeeuw, T., Wu, F., Schijlen, E., Bisseling, T., and Limpens, E. (2018). Host- and stage-dependent secretome of the arbuscular mycorrhizal fungus *Rhizophagus irregularis*. *The Plant Journal* 94, 411-425.
- Zhang, Q., Blaylock, L.A., and Harrison, M.J. (2010). Two *Medicago truncatula* Half-ABC Transporters Are Essential for Arbuscule Development in Arbuscular Mycorrhizal Symbiosis. *THE PLANT CELL ONLINE* 22, 1483-1497.

Zilber-Rosenberg, I., and Rosenberg, E. (2008). Role of microorganisms in the evolution of animals and plants: the hologenome theory of evolution. *FEMS Microbiology Reviews* 32, 723-735.

Zipfel, C., and Oldroyd, G.E.D. (2017). Plant signalling in symbiosis and immunity. *Nature* 543, 328-336.

(2005). *Plant lipids: biology, utilisation, and manipulation* (Oxford : Boca Raton, FL: Blackwell Pub. : CRC Press).

Annexes

Annexes of Chapter 1

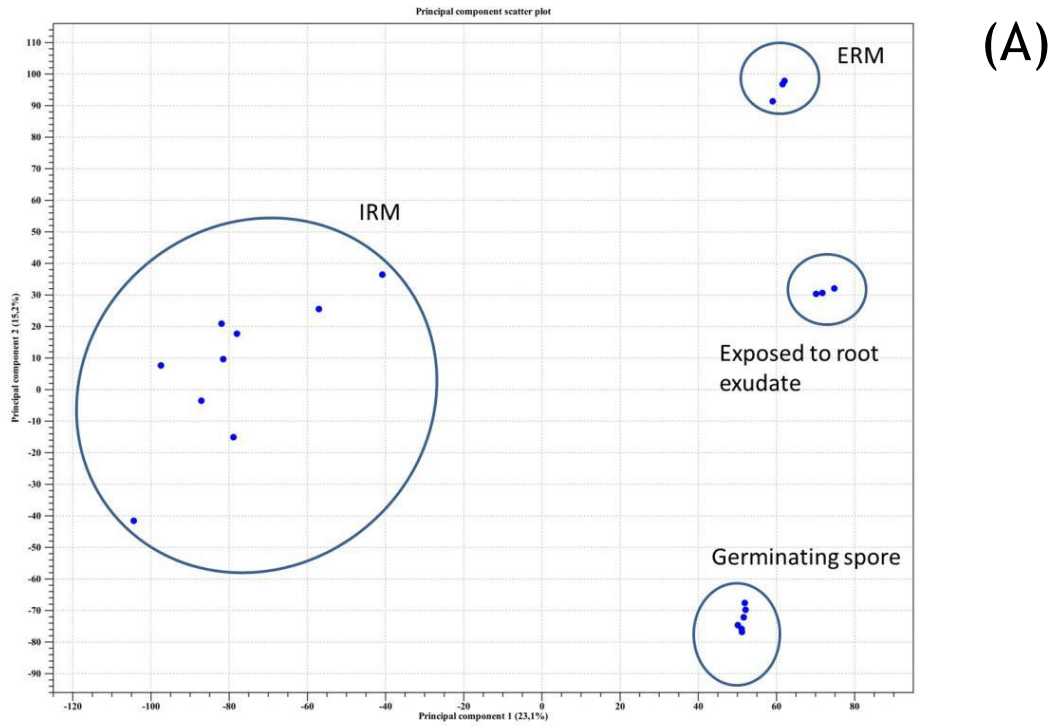

(A)

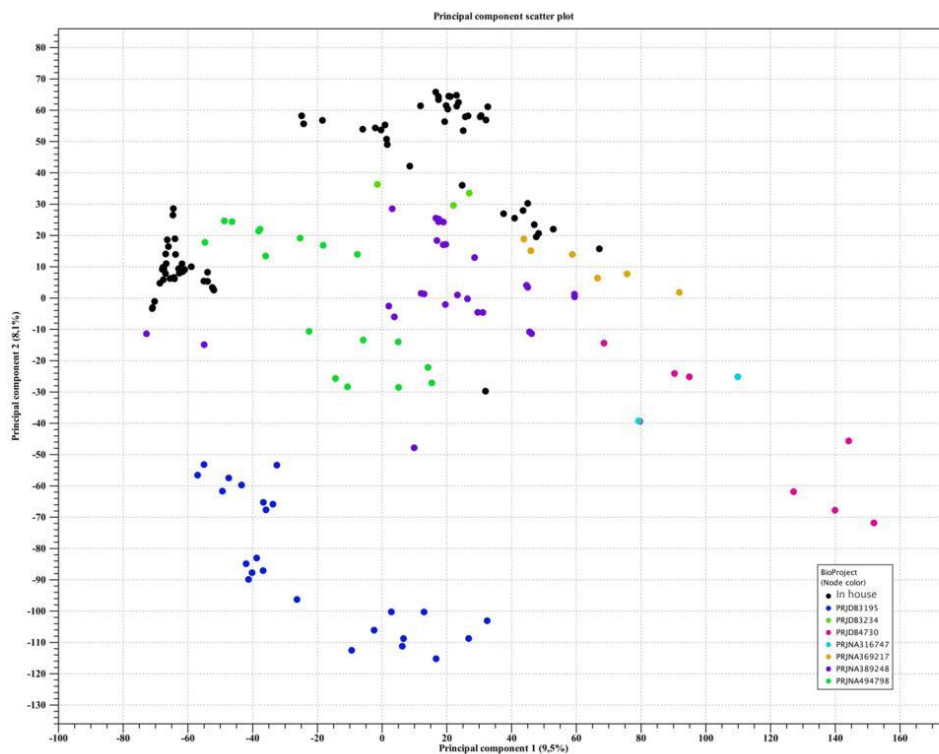

(B)

Figure S1: Principal component analysis based on covariance analysis of the reads mapped. A: distribution of in house samples. The different biological conditions are clustered together, indicating homogeneity of samples according to biological conditions. B: Distribution of public samples. The distribution is scattered and mainly grouped by data project.

(A)

Search genes by:

Transcript ID
 Gene Ontology
 Description

ex: 1011281,100198 [Load example](#)

[Advanced Search >](#)

(B)

Search genes by:

Transcript ID
 Gene Ontology
 Description

ex: 1011281,100198 [Load example](#)

[Advanced Search >](#)

<input type="checkbox"/> Host Plant	<input type="checkbox"/> Fungal Organ	<input type="checkbox"/> Non symbiotic	<input type="checkbox"/> Symbiotic	<input type="checkbox"/> Treatment
<input type="checkbox"/> No Host Plant	<input type="checkbox"/> Intra Radical Mycelium	<input type="checkbox"/> Asymbiotic	<input type="checkbox"/> Ex planta	<input type="checkbox"/> Yes
<input type="checkbox"/> Allium schoenoprasum	<input type="checkbox"/> Hyphae from Germinating Spores	<input type="checkbox"/> Presymbiotic	<input type="checkbox"/> In Planta	<input type="checkbox"/> No
<input type="checkbox"/> Brachypodium distachyon	<input type="checkbox"/> Extra Radical Mycelium			
<input type="checkbox"/> Cucumis sativus	<input type="checkbox"/> Intercellular Mycelium			
<input type="checkbox"/> Daucus carota	<input type="checkbox"/> Arbuscule			
<input type="checkbox"/> Lotus japonicus				
<input type="checkbox"/> Lunularia cruciata				
<input type="checkbox"/> Manihot esculenta				
<input type="checkbox"/> Medicago truncatula				
<input type="checkbox"/> Nicotiana benthamiana				
<input type="checkbox"/> Pisum sativum				

Figure S2: Screenshots of the RhiirExpress platform form page. (A) search gene by 3 criteria. (B) Advanced search for condition filtering.

(A)

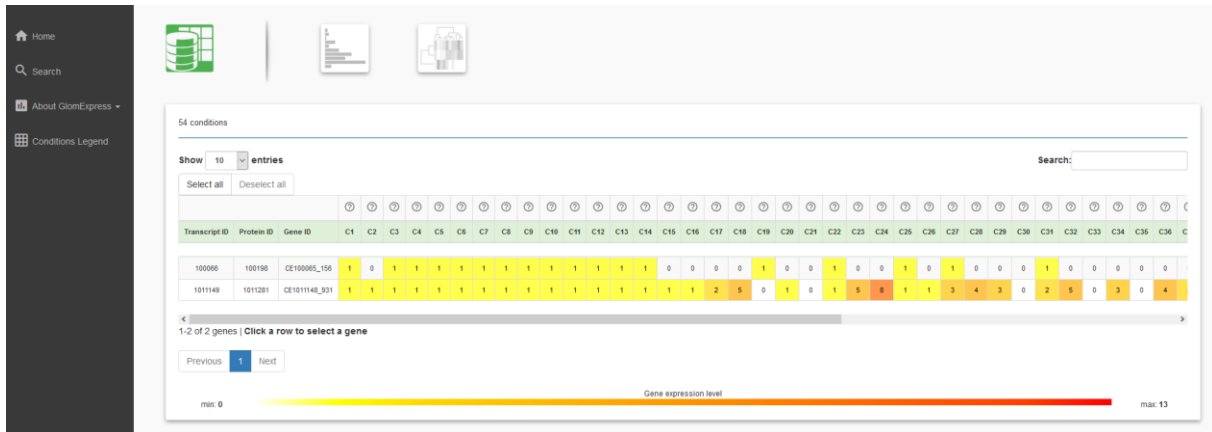

(B)

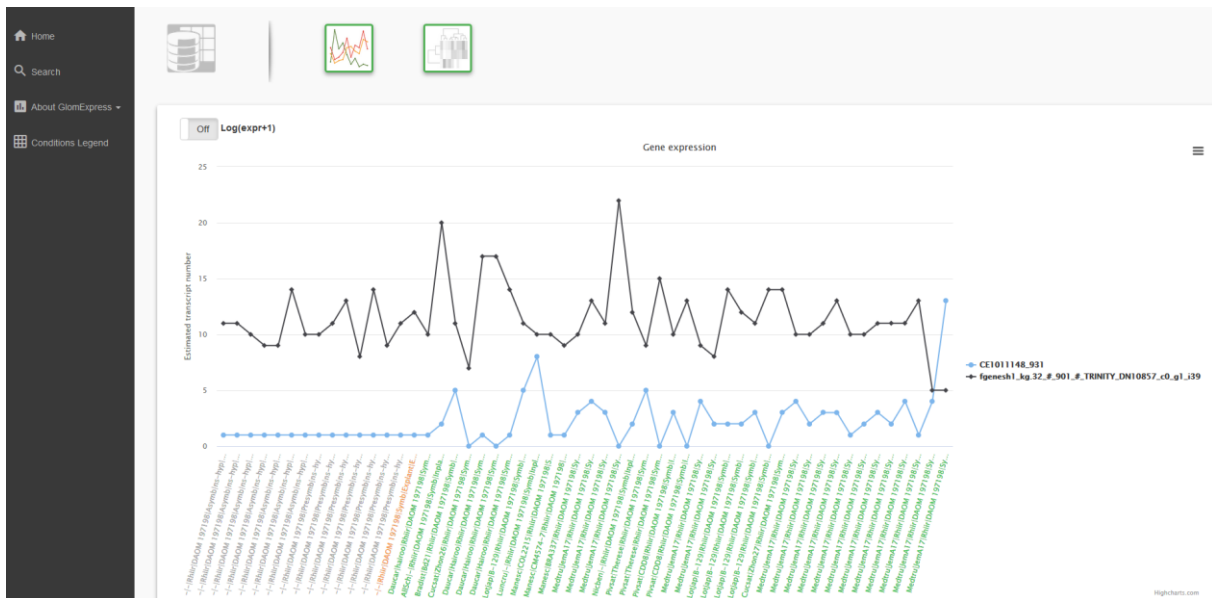

(C)

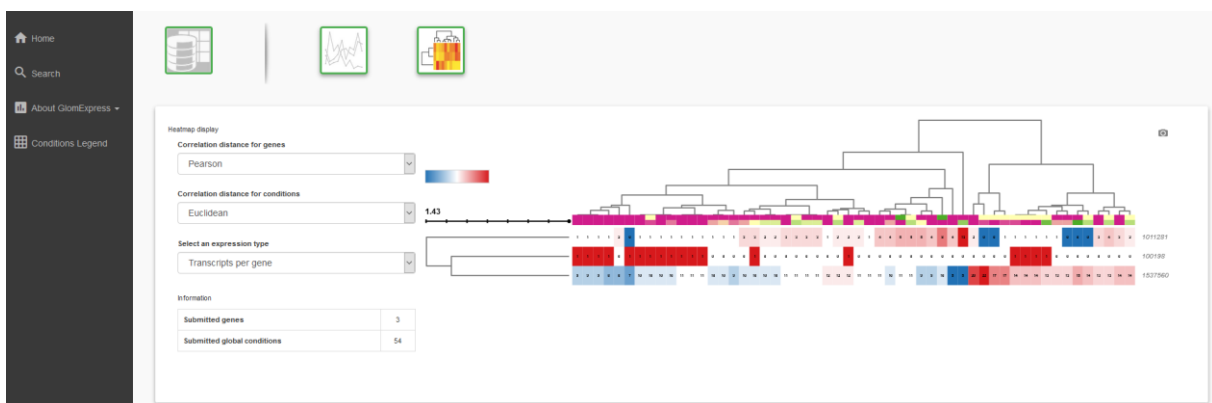

Figure S3: Screenshots of the RhiirExpress platform (A) Gene selection and overview of the expression data. (B) Plot of the transcriptomic expression. Grey legends represent non-symbiotic conditions, orange legend represents symbiotic ex planta condition (ERM) and green represents symbiotic in planta (IRM) condition. (C) Heatmap of hierarchical clustering of normalized expression data.

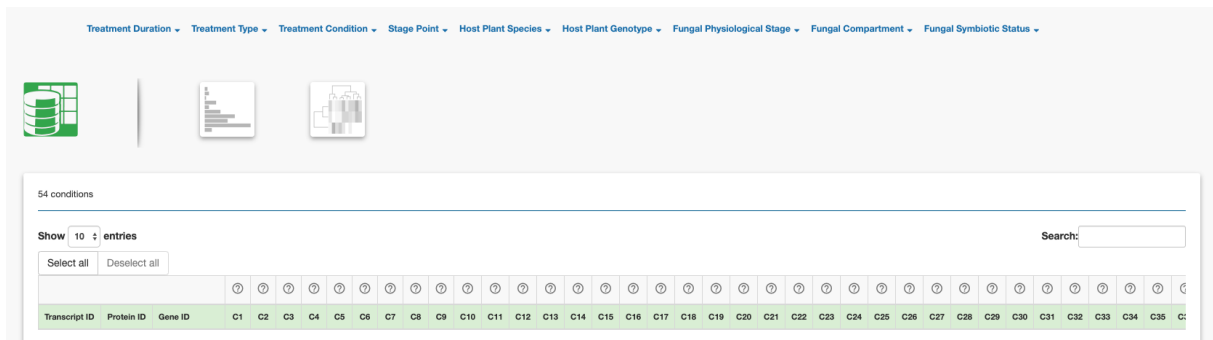

Figure S4: interactive Condition Legend.

Annexes of Chapter 2

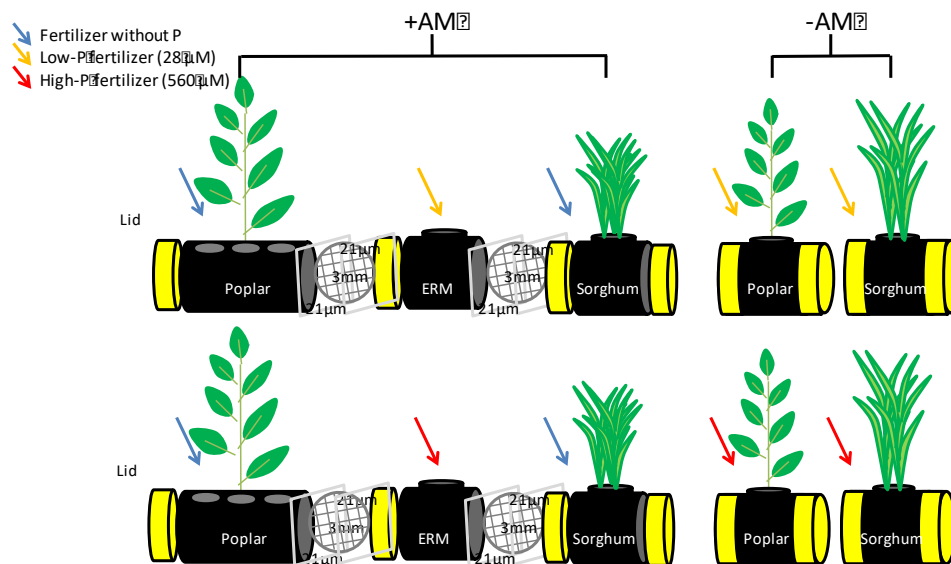

Figure S1 Symbiocosms. For a deeper understanding of symbiotic P transport microcosms with tripartite compartments (mycorrhizal treatment; +AM) or single compartments (non-mycorrhizal treatments; -AM) were set-up. All compartments contained a mixture of sand: zeolithe (1:1; w:w). In the mycorrhizal treatments a *P. trichocarpa* (poplar) cutting was planted in the middle compartment and *S. bicolor* (sorghum) seedlings were planted in the right compartment to create a common mycorrhizal network and to increase poplar root colonization. Both poplar and sorghum were inoculated with the AM fungus *R. irregularis* and were fertilized once a week with Hoagland solution without phosphorus (P). To obtain extraradical mycelium (ERM), P containing Hoagland solution (low-P, 28 μM; high-P, 560 μM) was applied in a third compartment where only the mycorrhizal fungus had access to it. In the non-mycorrhizal treatment poplar cuttings and sorghum seedling grew separately from each other in a single compartment. The control plants received the P containing fertilizer directly into their root compartment.

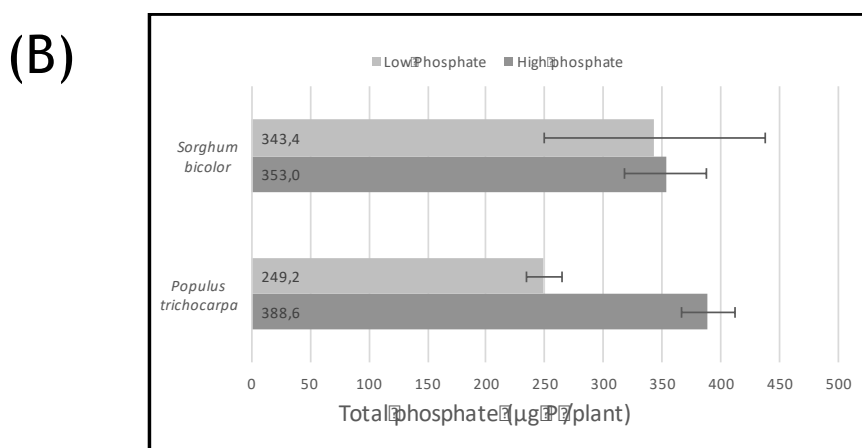
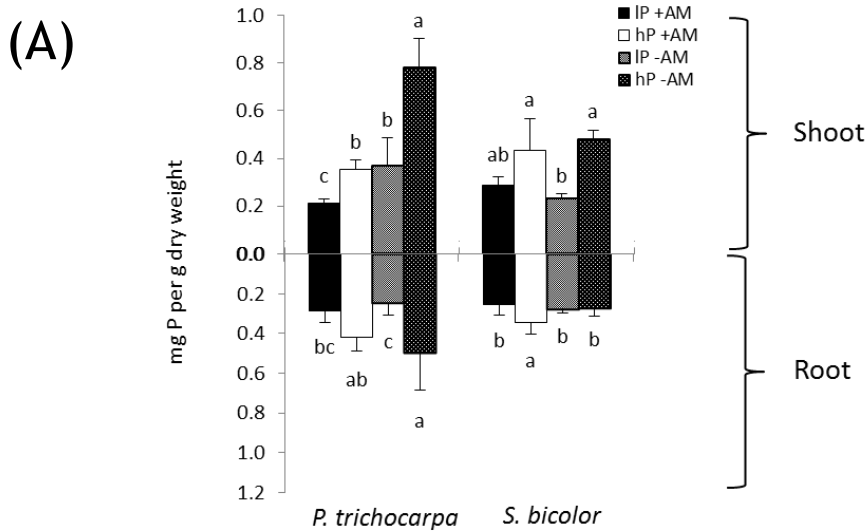

Figure S2. P content in *P. trichocarpa* and *S. bicolor* plants

A. Shoots and roots P content of mycorrhizal (+AM) and non-mycorrhizal (-AM) *P. trichocarpa* and *S. bicolor* plants. P content was measured in low-P (IP) and high-P (hP) treatments. Values are means of six biological replicates. Differences between treatments were estimated by analysis of variance (ANOVA) per plant species and organ, followed by Tuckey honestly significant test (Tuckey HSD; $p < 0.05$). Statistical differences are indicated by lower case letters.

B. Total P content of the mycorrhized plants. Data represent the mean value of both root and shoot content of the different mycorrhized plants. Error bars represent the standard deviation (7 plants per condition)

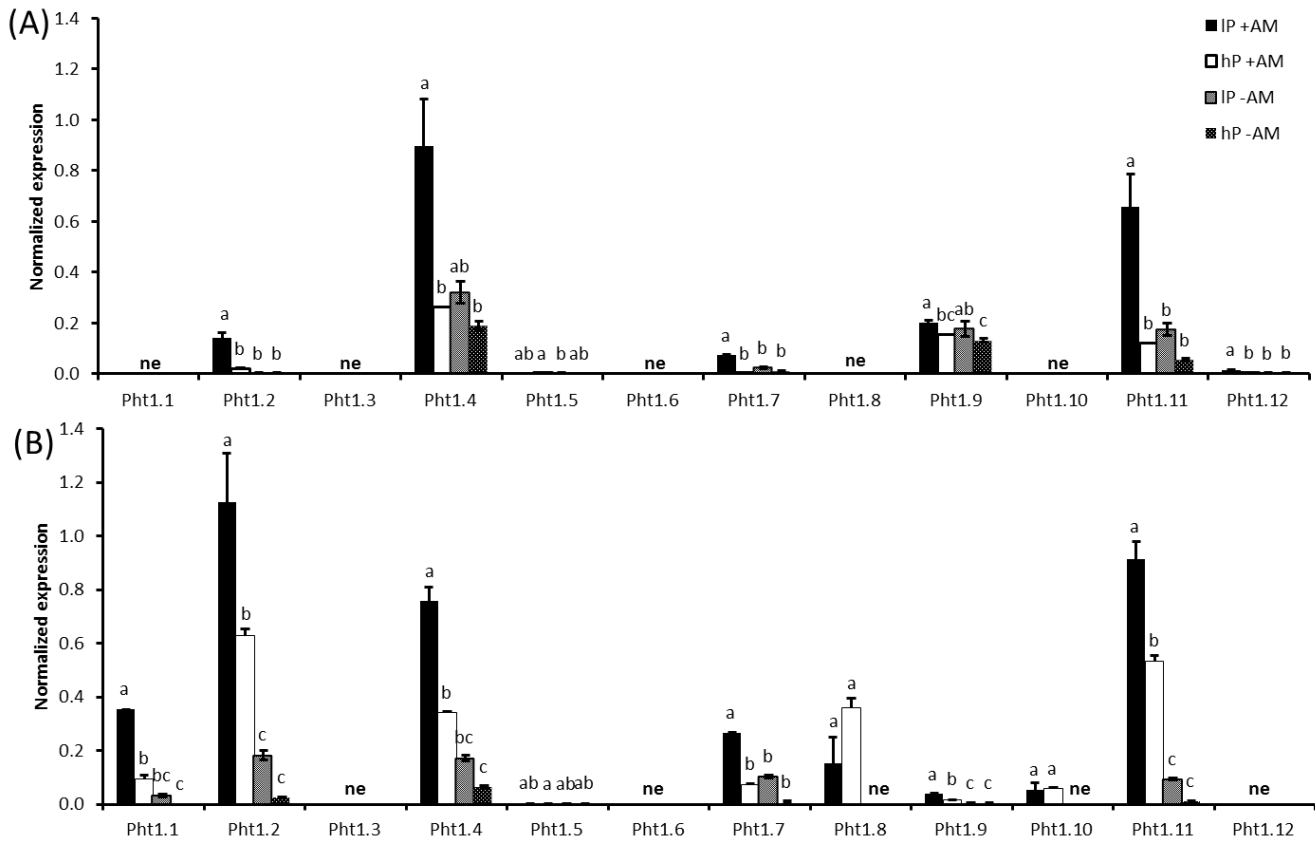

Figure S3. Quantification by qRT-PCR of the transcript abundances of Pht1 genes in *P. trichocarpa*. Quantification of transcript levels of the 12 Pht1 transporter genes in the shoots (A) and roots (B) in *P. trichocarpa* when mycorrhized (+AM) or not mycorrhized (-AM) with *R. irregularis* under low-P (lP) and high-P (hP) conditions. Transporter Pht1.3, Pht1.6 and Pht1.12 were not expressed; Pht1.8 and Pht1.10 only when the plant was mycorrhized and Pht1.1 was root specific. Values are the means of three biological and three technical replicates. Error bars represent the SE. Ubiquitin was used as reference transcript. Statistical analysis was performed by analysis of variance (ANOVA) for each gene, followed by Tukey honest significant difference test (Tukey HSD; $p < 0.05$).

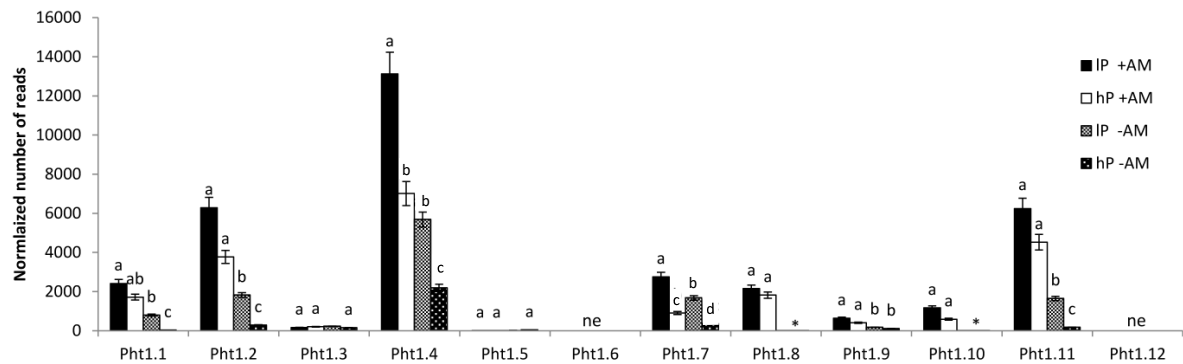

Figure S4 Quantification by mRNA - Sequencing (RNAseq) of the transcript abundances of Pht1 phosphate transporters in the roots of *P. trichocarpa*. Transcript abundances of the 12 Pht genes in *P. trichocarpa* were quantified in mycorrhized (+AM) and non-mycorrhized (-AM) roots in high-P (hP) and low-P (IP) treatment. PtrPht1.6 and PtrPht1.12 were not expressed (ne). Bar labeled with an asterisk had less than 10 reads and were considered as not expressed. Significant differences were estimated per gene using the Wald test. Lower case letters indicate significant differences in transcript abundances (p -value < 0.05).

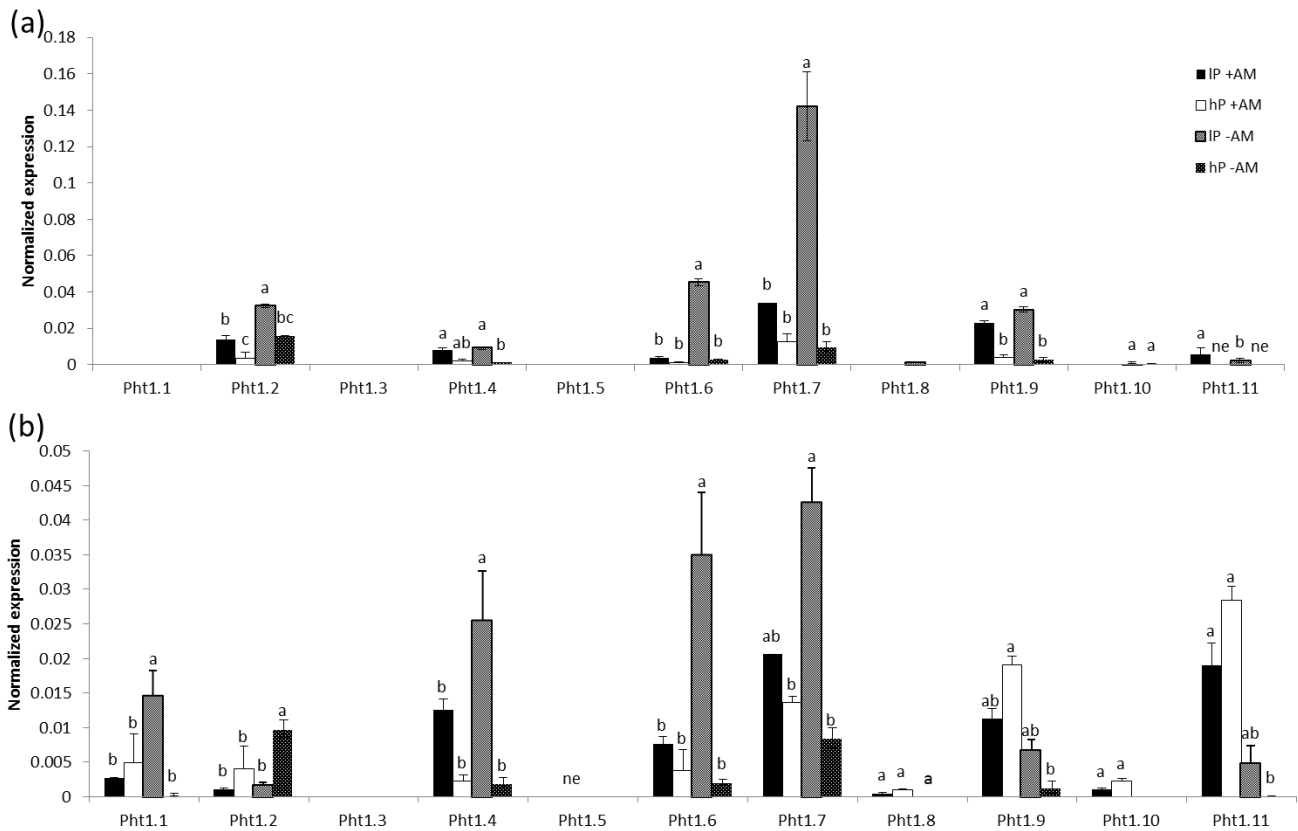

Figure S5 Quantification by qRT-PCR of the transcript abundances of Pht1 phosphate transporter genes in *S. bicolor*. Quantification of transcript levels of the 11 Pht1 transporter genes in the shoots (a) and roots (b) *S. bicolor* when mycorrhized (+AM) or not (-AM) by the AM fungus *R.irregularis* in low-P (IP) and high P (hP) conditions. Transporter Pht1.3 and Pht1.5 were not expressed; Pht1.10 only in roots when mycorrhized and only in shoots when plant was not mycorrhized and Pht1.1 was root specific. Values are the means of three biological and three technical replicates. Error bars represent the SE. Ubiquitin was used as reference transcript. Statistical analysis was performed by analysis of variance (ANOVA) for each gene, followed by Tuckey honest significant difference test (Tuckey HSD; $p < 0.05$).

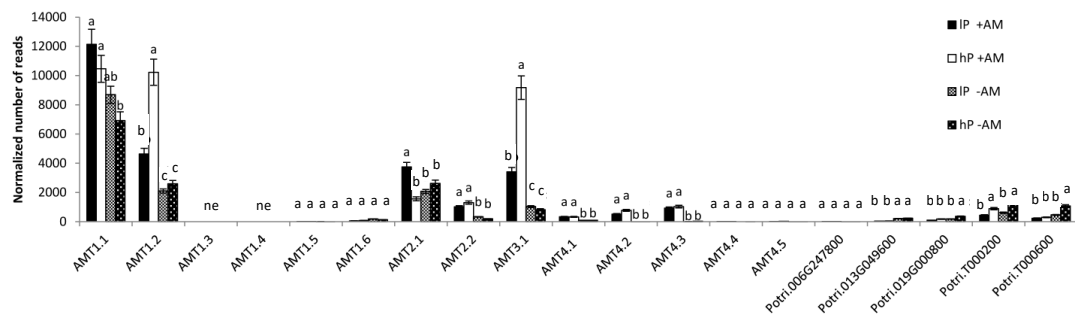

Figure S6. Quantification by mRNA - Sequencing (RNAseq) of the transcript abundances of ammonia transporters in the roots of *P. trichocarpa*. Transcript abundances of 19 AMT genes in *P. trichocarpa* when mycorrhized (+AM) or not (-AM) by the AM fungus *R.irregularis* in low-P (IP) and high-P (hP) conditions. Bars labeled with an asterisk had less than ten reads and were considered as not expressed. Significant differences were estimated per gene using the Wald test. Lower case letters indicate significant differences in transcript abundances (p-value < 0.05). Number of reads in the three biological replicates per condition were normalized per gene using DESeq2.

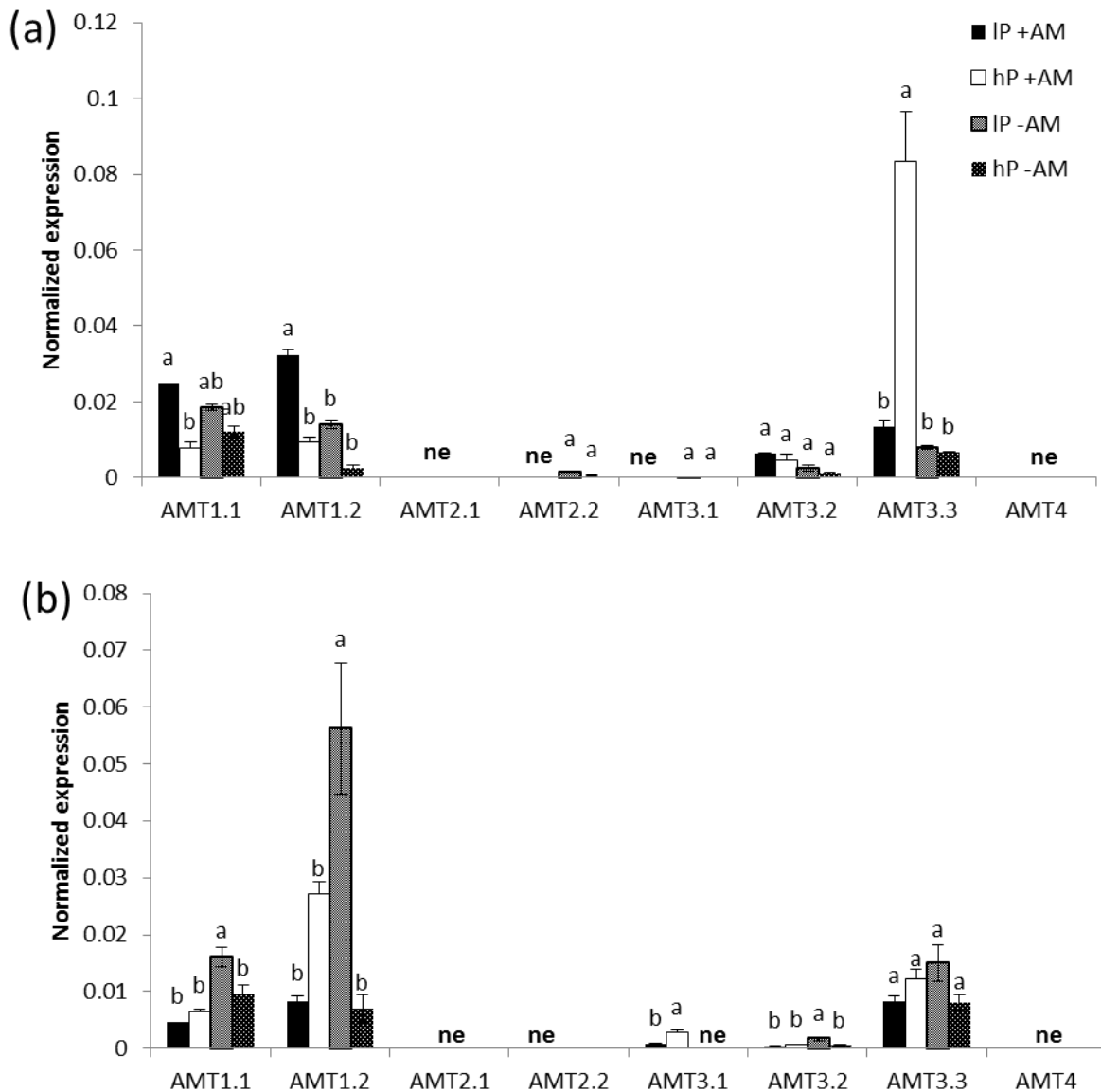

Figure S7 Quantification by qRT-PCR of the transcript abundances of the three ammonium transporters in the shoot (a) and root (b) of mycorrhized (+AM) and non-mycorrhized (-AM) *S. bicolor* under low P (IP) and high P (hP) condition. Values are the means of three biological replicates and three technical replicates, each. Error bars represent the SE. Ubiquitin was used as reference transcript. Statistical analysis was performed by analysis of variance (ANOVA) per gene, followed by Tukey honest significant difference test (Tukey HSD; $p < 0.05$).

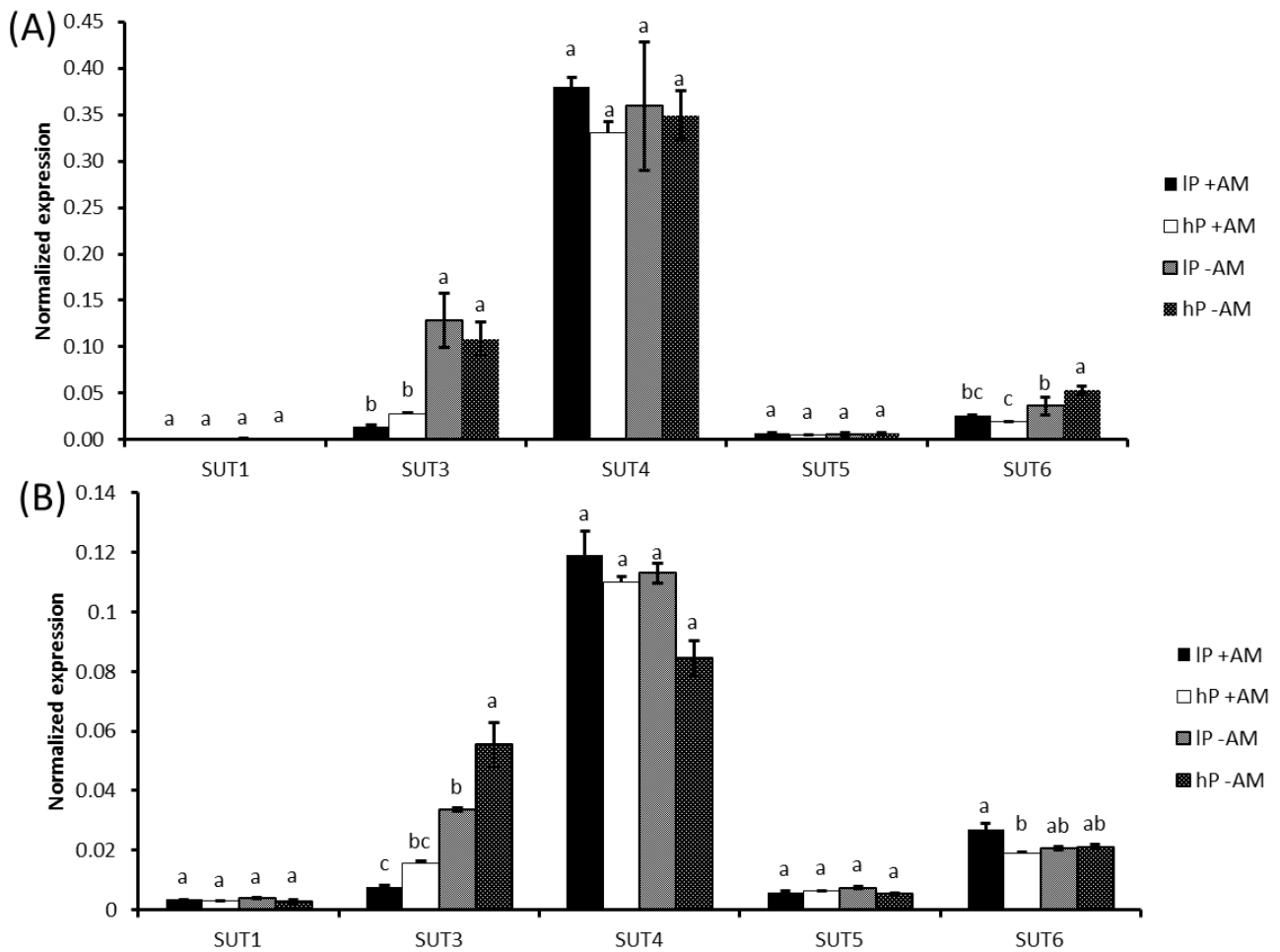

Figure S8. Quantification by qRT-PCR of the transcript abundances of five sugar transporters (SUT) in the shoots (A) and roots (B) of mycorrhized (+AM) and non-mycorrhized (-AM) *P. trichocarpa* under low P (IP) and high P (hP) condition. Values are the means of three biological replicates and three technical replicates, each. Error bars represent the SE. Ubiquitin was used as reference transcript. Statistical analysis was performed by analysis of variance (ANOVA) per gene, followed by Tukey honest significant difference test (Tukey HSD; $p < 0.05$).

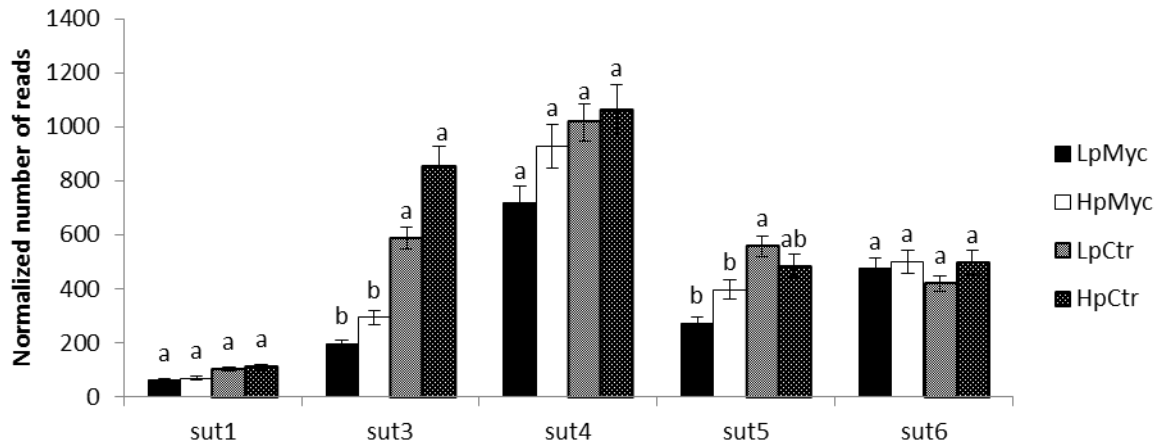

Figure S9: Quantification by mRNA - Sequencing (RNAseq) of the transcript abundances of sugar transporters (SUT) in the roots of *P. trichocarpa*. Transcript abundances of six SUT genes in *P. trichocarpa* were quantified in mycorrhized (+AM) and non-mycorrhized (-AM) roots under high P (hP) and low P (lP) availability. Significant differences were estimated per gene using the Wald test. Lower case letters indicate significant differences in transcript abundances (p-value < 0.05). Number of reads in the three biological replicates per condition were normalized per gene using DESeq2.

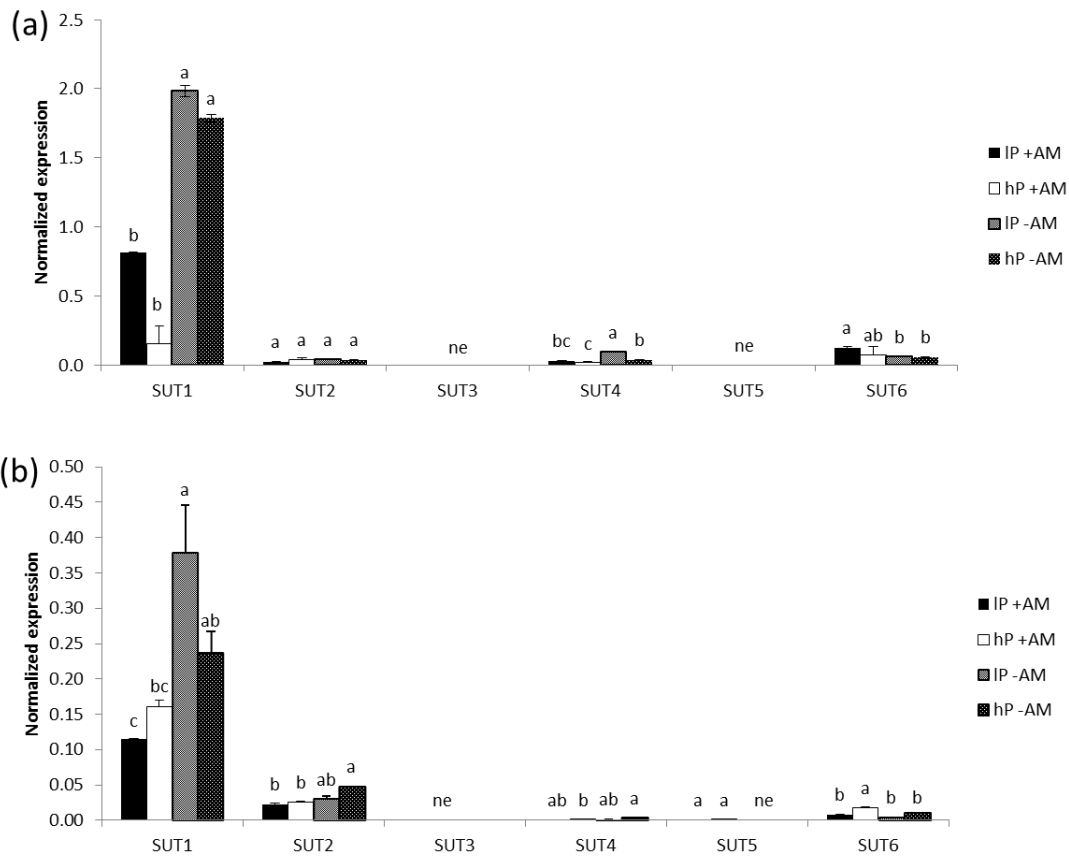

Figure S10 Quantification by qRT-PCR of the transcript abundances of 6 sugar transporters (SUT) in the shoots(a) and roots (b) of mycorrhized (+AM) and non-mycorrhized (-AM) *S. bicolor* under low P (IP) and high P (hP) condition. Values are the means of three biological replicates and three technical replicates, each. Error bars represent the SE. Ubiquitin was used as reference transcript. Statistical analysis was performed by analysis of variance (ANOVA) per gene, followed by Tuckey honest significant difference test (Tuckey HSD; $p < 0.05$).

Class	Name	log2 ratio IP vs hP	p-value
Acids	Aconitic acid, cis-	-0.53	0.275
Acids	Benzoic acid	0.02	0.827
Acids	Benzoic acid, 4-hydroxy-	0.04	0.827
Acids	Citric acid	0.25	0.827
Acids	Fumaric acid	0.36	0.513
Acids	Isocitric acid	0.32	0.513
Acids	Lactic acid	-0.34	0.275
Acids	Malic acid	0.60	0.275
Acids	Pyruvic acid	0.11	0.275
Acids	Quinic acid	-1.88	0.513
Acids	Succinic acid	0.26	0.827
Alcohols	Benzylalcohol	-0.18	0.513
Amino Acids	Aspartic acid	-0.24	0.513
Amino Acids	Glutamic acid	-0.44	0.513
Amino Acids	Glycine	0.80	0.275
Amino Acids	Isoleucine	0.63	0.513
Amino Acids	Leucine	0.19	0.050
Amino Acids	Lysine	0.11	0.564
Amino Acids	Ornithine	-1.28	0.127
Amino Acids	Phenylalanine	-0.12	0.827
Amino Acids	Pyroglutamic acid	-0.06	0.513
Amino Acids	Serine	0.19	0.827
Amino Acids	Valine	0.62	0.513
N- Compounds	Ethanolamine	0.15	0.275
N- Compounds	Putrescine	0.14	0.513
N- Compounds	Pyridine, 2-hydroxy-	0.02	0.827
Phenylpropanoids	Caffeic acid, trans-	-0.03	1.000
Phosphates	Phosphoric acid	0.25	0.513
Phosphates	Phosphoric acid monomethyl ester	-0.06	0.827
Polyols	Arabitol	-0.07	0.827
Polyols	Glycerol	-0.24	0.513
Polyols	Inositol, myo-	0.05	0.827
Polyols	Mannitol	-0.92	0.513
Sugar Conjugates	Galactinol	-2.29	0.248
Sugar Conjugates	Salicin	-4.25	1.000
Sugars	Glucose	0.41	0.127
Sugars	Glucose, 1,6-anhydro-, beta-	0.11	0.513
Sugars	Rhamnose	0.16	0.513
Sugars	Ribose	-0.32	0.564
Sugars	Sucrose	-0.06	0.827
Sugars	Trehalose, alpha-alpha'	0.28	0.127

Table 1: Relative abundances of metabolites detected in the ERM of *R. irregularis* in response to low (IP) and high P (hP) concentrations. Data was log transformed and tested by Wilcoxon rank sum test ($p < 0.05$, $n = 3$) in MeV v4.9 (<http://www.tm4.org/mev.html>). Significant p-values are highlighted in bold.

Class	Name	log2 ratios	2-way ANOVA
-------	------	-------------	-------------

		+AM vs -AM	IP+AM vs hP+AM	IP-AM vs hP - AM	IP-AM vs hP - AM	hP +AM vs hP-AM	Effect of mycorrhiz ation	Effect of p- availab ility	Effect of interactio n
Acids	Aconitic acid, cis-	-1.62	-0.01	-0.17	-1.54	-1.69	0.006	0.863	0.934
Acids	Benzoic acid	-0.63	-0.18	0.72	-1.03	-0.13	0.013	0.182	0.034
Acids	Benzoic acid, 3,4-dihydroxy-	-0.16	-0.09	0.13	-0.27	-0.05	0.750	0.839	0.602
Acids	Benzoic acid, 4-hydroxy-	0.09	-0.10	0.83	-0.32	0.62	0.767	0.426	0.162
Acids	Citric acid	0.46	0.06	0.65	0.20	0.78	0.054	0.125	0.172
Acids	Fumaric acid	-0.87	0.25	0.34	-0.92	-0.82	0.038	0.325	0.814
Acids	Glutaric acid, 2-hydroxy-	-1.59	-0.28	0.58	-2.00	-1.14	0.003	0.546	0.420
Acids	Glutaric acid, 2-oxo-	-1.70	0.18	1.64	-2.21	-0.75	0.009	0.111	0.180
Acids	Glutaric acid, 3-hydroxy-3-methyl-	-0.87	-0.37	0.80	-1.41	-0.24	0.065	0.549	0.199
Acids	Isocitric acid	0.57	0.18	0.86	0.29	0.97	0.054	0.084	0.190
Acids	Lactic acid	-0.74	-0.68	1.36	-1.65	0.39	0.083	0.389	0.013
Acids	Malic acid	0.07	-0.21	0.72	-0.35	0.57	0.958	0.412	0.135
Acids	Malic acid, 2-isopropyl-	ND	ND	1.04	ND	ND	ND	ND	ND
Acids	Malic acid, 2-methyl-	ND	ND	0.85	ND	ND	ND	ND	ND
Acids	Pyruvic acid	0.31	0.05	0.29	0.20	0.44	0.147	0.400	0.454
Acids	Quinic acid	-0.15	-0.79	0.92	-0.98	0.72	0.895	0.723	0.092
Acids	Shikimic acid	-2.32	-0.73	0.82	-3.08	-1.53	0.000	0.658	0.008
Acids	Succinic acid	-0.85	0.04	0.72	-1.14	-0.46	0.032	0.212	0.552
Acids	Vanillic acid	-0.29	0.18	0.51	-0.44	-0.10	0.353	0.258	0.631
Alcohols	Benzylalcohol	-0.37	-0.09	0.95	-0.81	0.23	0.479	0.180	0.104
Amino Acids	Aspartic acid	-4.52	0.82	0.59	-4.43	-4.66	0.000	0.134	0.845
Amino Acids	Butanoic acid, 4-amino-	-3.03	0.68	0.51	-2.96	-3.13	0.000	0.032	0.572
Amino Acids	Glutamic acid	-2.87	1.27	-0.85	-1.88	-4.01	0.001	0.574	0.090
Amino Acids	Glycine	-0.92	0.44	0.63	-0.99	-0.80	0.023	0.112	0.736
Amino Acids	Isoleucine	-1.75	0.51	0.66	-1.81	-1.67	0.000	0.041	0.873
Amino Acids	Leucine	-1.25	-0.06	0.34	-1.44	-1.04	0.001	0.483	0.306
Amino Acids	Phenylalanine	-3.55	0.76	0.65	-3.51	-3.61	0.000	0.048	0.964
Amino Acids	Pyroglutamic acid	-1.45	0.24	-0.05	-1.31	-1.60	0.001	0.532	0.762
Amino Acids	Serine	-1.09	0.45	0.58	-1.14	-1.02	0.000	0.014	0.765
Amino Acids	Valine	-2.32	-0.09	0.78	-2.71	-1.83	0.000	0.224	0.118
Aromatic	Catechol	-1.33	1.43	1.85	-1.43	-1.00	0.245	0.276	0.598
N- Compounds	Ethanolamine	-0.05	-0.16	-0.02	-0.13	0.02	0.927	0.722	0.594
N- Compounds	Phenol, 2-amino-	-1.28	0.26	0.87	-1.53	-0.91	0.019	0.242	0.306
N- Compounds	Putrescine	0.19	0.02	0.19	0.11	0.27	0.362	0.499	0.616
N- Compounds	Pyridine, 2-hydroxy-	-0.08	-0.33	0.34	-0.41	0.25	0.803	0.872	0.161
Phenylpropanoids	Caffeic acid, cis-	0.15	0.03	0.91	-0.21	0.66	0.298	0.070	0.075
Phenylpropanoids	Caffeic acid, trans-	-0.05	0.06	1.14	-0.48	0.60	0.666	0.056	0.070
Phenylpropanoids	Cinnamic acid, 4-hydroxy-, trans-	ND	ND	0.60	ND	-0.47	ND	ND	ND
Phenylpropanoids	Epicatechin	-0.14	-0.16	0.60	-0.50	0.26	0.668	0.323	0.138
Phenylpropanoids	Ferulic acid, trans-	-0.12	0.10	0.94	-0.47	0.37	0.703	0.066	0.121
Phenylpropanoids	Quinic acid, 3-caffeoyl-, cis-	1.01	0.16	0.07	1.05	0.96	0.102	0.745	0.572
Phenylpropanoids	Quinic acid, 3-caffeoyl-, trans-	0.80	0.13	0.42	0.68	0.96	0.155	0.487	0.347
Phosphates	Fructose-6-phosphate	-1.85	-0.51	-0.22	-2.01	-1.73	0.003	0.420	0.806
Phosphates	Glucose-6-phosphate	-2.22	-1.10	-0.43	-2.64	-1.97	0.000	0.065	0.453
Phosphates	myo-Inositol-phosphate	ND	ND	-1.11	-1.17	ND	ND	ND	ND
Phosphates	Phosphoric acid	-3.48	0.45	-2.86	-1.22	-4.54	0.042	0.634	0.468
Phosphates	Phosphoric acid monomethyl ester	-2.35	-0.39	-0.05	-2.53	-2.20	0.001	0.648	0.676
Polyhydroxy Acids	Arabinonic acid-1,4-lactone	-0.18	0.51	1.57	-0.52	0.53	0.914	0.001	0.041
Polyhydroxy Acids	Galactaric acid	-1.18	-0.25	0.81	-1.66	-0.60	0.011	0.455	0.209
Polyhydroxy Acids	Galactonic acid	-1.45	-0.63	0.64	-2.08	-0.81	0.002	0.963	0.100
Polyhydroxy Acids	Gluconic acid	-1.14	-0.22	1.22	-1.73	-0.29	0.018	0.217	0.139
Polyhydroxy Acids	Glyceric acid	-1.62	-0.28	0.20	-1.87	-1.38	0.000	0.900	0.238
Polyhydroxy Acids	Gulonic acid	-0.36	0.04	0.62	-0.61	-0.03	0.425	0.257	0.311
Polyhydroxy Acids	Lyxonic acid-1,4-lactone	-0.11	0.30	0.91	-0.35	0.26	0.772	0.080	0.292
Polyhydroxy Acids	Ribonic acid	-1.15	0.42	0.51	-1.19	-1.10	0.001	0.048	0.686

Polyhydroxy Acids	Saccharic acid	-1.77	0.01	1.37	-2.30	-0.94	0.001	0.065	0.039
Polyhydroxy Acids	Threonic acid	-2.04	0.50	1.05	-2.24	-1.69	0.000	0.019	0.292
Polyols	Arabitol	-1.19	-0.20	0.26	-1.42	-0.97	0.004	0.722	0.471
Polyols	Galactitol	-0.16	0.54	-0.46	0.33	-0.67	0.507	0.853	0.143
Polyols	Glycerol	0.17	-0.86	-0.12	-0.27	0.48	0.927	0.307	0.475
Polyols	Inositol, myo-	-2.84	0.98	0.26	-2.56	-3.28	0.000	0.123	0.422
Polyols	Mannitol	-0.23	0.26	-0.86	0.39	-0.74	0.896	0.895	0.468
Sugar Conjugates	Galactinol	-2.34	0.70	-0.99	-1.45	-3.14	0.010	0.829	0.391
Sugar Conjugates	Salicin	-0.94	0.72	1.58	-1.21	-0.35	0.193	0.137	0.275
Sugar Conjugates	Salicylic acid-glucopyranoside	-2.48	-0.06	-1.13	-1.84	-2.90	0.038	0.913	0.998
Sugars	Arabinose	-1.21	-0.18	0.38	-1.48	-0.92	0.008	0.776	0.575
Sugars	Fructose	0.65	0.30	>0.01	0.79	0.49	0.300	0.769	0.986
Sugars	Galactose	0.22	-0.38	0.64	-0.26	0.75	0.984	0.813	0.615
Sugars	Glucose	0.18	0.23	-0.23	0.41	-0.05	0.728	0.791	0.941
Sugars	Glucose, 1,6-anhydro-, beta-	-0.75	-0.13	0.70	-1.13	-0.29	0.001	0.076	0.018
Sugars	Maltose	-1.35	0.36	0.85	-1.55	-1.05	0.006	0.139	0.622
Sugars	Mannose	0.05	-0.68	-0.03	-0.32	0.33	0.800	0.791	0.866
Sugars	Raffinose	-1.59	1.23	-4.14	2.12	-3.25	0.602	0.766	0.173
Sugars	Rhamnose	-1.00	-0.04	0.48	-1.24	-0.72	0.009	0.674	0.351
Sugars	Ribose	-1.96	0.13	0.89	-2.28	-1.52	0.001	0.258	0.258
Sugars	Sucrose	0.10	-0.02	0.11	0.04	0.17	0.534	0.669	0.658
Sugars	Trehalose, alpha, alpha'-	1.20	-0.49	-0.18	1.03	1.33	0.046	0.883	0.841
Sugars	Xylose	-0.50	-0.12	0.94	-0.95	0.10	0.639	0.526	0.363
Sugars	Xylulose	ND	ND	1.14	-2.36	ND	ND	ND	ND

Table 2 Relative abundances of metabolites detected in poplar roots. Abundances were measured in the mycorrhized (+AM) and non-mycorrhized (-AM) poplar roots under high (hP) and low (lP) P availability. Data was log transformed and tested by γ 2-way analysis of variance (ANOVA) ($p < 0.05$, $n = 3$) in MeV v4.9 (<http://www.tm4.org/mev.html>). Significant p-values are highlighted in bold.

Class	Name	log2 ratios	2-way ANOVA
		IP+AM vs hP+AM	Effect of p-availability
Acids	Aconitic acid, cis-	0,31	0,04
Acids	Benzoic acid	0,97	0,51
Acids	Benzoic acid, 3,4-dihydroxy-	0,63	0,22
Acids	Benzoic acid, 4-hydroxy-	0,98	0,51
Acids	Citric acid	1,30	0,51
Acids	Fumaric acid	1,34	0,51
Acids	Glutaric acid, 2-hydroxy-	1,44	0,04
Acids	Glutaric acid, 2-oxo-	0,97	0,51
Acids	Glutaric acid, 3-hydroxy-3-methyl-	ND	ND
Acids	Isocitric acid	1,29	0,51
Acids	Lactic acid	2,08	0,13
Acids	Malic acid	1,19	0,83
Acids	Malic acid, 2-isopropyl-	ND	ND
Acids	Malic acid, 2-methyl-	ND	ND
Acids	Pyruvic acid	1,10	0,51
Acids	Quinic acid	1,22	0,83
Acids	Shikimic acid	1,71	0,28
Acids	Succinic acid	2,21	0,51
Acids	Vanillic acid	1,10	0,83
Alcohols	Benzylalcohol	1,18	0,51
Amino Acids	Aspartic acid	1,97	0,51
Amino Acids	Butanoic acid, 4-amino-	2,32	0,28
Amino Acids	Glutamic acid	1,30	0,51
Amino Acids	Glycine	1,03	0,83
Amino Acids	Isoleucine	1,05	0,83
Amino Acids	Leucine	1,13	0,22
Amino Acids	Phenylalanine	1,13	0,83
Amino Acids	Pyroglutamic acid	0,91	0,28
Amino Acids	Serine	1,01	0,51
Amino Acids	Valine	1,14	0,83
Aromatic	Catechol	ND	ND
N- Compounds	Ethanolamine	1,11	0,83
N- Compounds	Phenol, 2-amino-	ND	ND
N- Compounds	Putrescine	1,08	0,83
N- Compounds	Pyridine, 2-hydroxy-	1,15	0,83
Phenylpropanoids	Caffeic acid, cis-	ND	ND
Phenylpropanoids	Caffeic acid, trans-	1,22	0,28
Phenylpropanoids	Cinnamic acid, 4-hydroxy-, trans-	1,19	0,83
Phenylpropanoids	Epicatechin	2,13	0,51
Phenylpropanoids	Ferulic acid, trans-	ND	ND
Phenylpropanoids	Quinic acid, 3-caffeoyl-, cis-	1,48	0,83
Phenylpropanoids	Quinic acid, 3-caffeoyl-, trans-	7,08	0,22
Phosphates	Fructose-6-phosphate	0,63	0,04

Phosphates	Glucose-6-phosphate	0,61	0,04
Phosphates	myo-Inositol-phosphate	ND	ND
Phosphates	Phosphoric acid	0,69	0,04
Phosphates	Phosphoric acid monomethyl ester	0,75	0,28
Polyhydroxy Acids	Arabinonic acid-1,4-lactone	ND	ND
Polyhydroxy Acids	Galactaric acid	0,73	0,28
Polyhydroxy Acids	Galactonic acid	1,06	0,83
Polyhydroxy Acids	Gluconic acid	0,70	0,51
Polyhydroxy Acids	Glyceric acid	1,34	0,22
Polyhydroxy Acids	Gulonic acid	ND	ND
Polyhydroxy Acids	Lyxonic acid-1,4-lactone	1,50	0,83
Polyhydroxy Acids	Ribonic acid	1,12	0,51
Polyhydroxy Acids	Saccharic acid	1,34	0,51
Polyhydroxy Acids	Threonic acid	0,94	0,83
Polyols	Arabitol	0,53	0,28
Polyols	Galactitol	2,07	0,51
Polyols	Glycerol	1,08	0,83
Polyols	Inositol, myo-	1,26	0,83
Polyols	Mannitol	0,71	0,51
Sugar Conjugates	Galactinol	1,67	0,28
Sugar Conjugates	Salicin	1,05	0,51
Sugar Conjugates	Salicylic acid-glucopyranoside	ND	ND
Sugars	Arabinose	1,06	0,51
Sugars	Fructose	0,86	0,83
Sugars	Galactose	1,71	0,51
Sugars	Glucose	1,47	0,83
Sugars	Glucose, 1,6-anhydro-, beta-	1,09	0,51
Sugars	Maltose	2,33	0,22
Sugars	Mannose	ND	ND
Sugars	Raffinose	1,21	0,83
Sugars	Rhamnose	0,54	0,05
Sugars	Ribose	1,48	0,51
Sugars	Sucrose	1,18	0,51
Sugars	Trehalose, alpha,alpha'-	0,93	0,83
Sugars	Xylose	2,44	0,51
Sugars	Xylulose	2,17	1,00

Table 3 Relative abundances of metabolites detected in sorghum roots. Abundances were measured in the mycorrhized (+AM) sorghum roots under high (hP) and low (lP) P availability. Data was log transformed and tested by Wilcoxon rank sum test ($p < 0.05$, $n=3$) in MeV v4.9 (<http://www.tm4.org/mev.html>). Significant p-values are highlighted in bold.

Annexes of Chapter 3

Table 1: Fatty Acid Metabolism List (FAML)

Alias	Transcript ID	Gene ID
Elo1	1460815	e_gw1.174.50.1
Elo2	1509945	fgenesh1_kg.12_#_1417_#_remain_c904
Elo3	1578847	fgenesh1_kg.74_#_620_#_TRINITY_DN16378_c0_g1_i1
Elo4	1664819	fgenesh1_kg.210_#_263_#_TRINITY_DN9348_c1_g1_i1
Desat1	1719792	fgenesh1_kg.431_#_107_#_ACTTGA_L001_R1_(paired)_contig_9578
Desat2	1612416	fgenesh1_kg.115_#_127_#_ACTTGA_L001_R1_(paired)_contig_348
Desat3	1639097	fgenesh1_kg.156_#_11_#_remain_c1679
Desat4	1524953	fgenesh1_kg.23_#_824_#_ACTTGA_L001_R1_(paired)_contig_14017
Desat5	1773571	gm1.12325_g
Desat6	1454775	e_gw1.82.129.1
Desat7	1486628	fgenesh1_pg.355_#_14
Desat8	1538150	fgenesh1_kg.33_#_109_#_ACTTGA_L001_R1_(paired)_contig_6835
Desat9	1627990	fgenesh1_kg.137_#_231_#_MblContig2380
Lip1	1431521	gw1.15.42.1
Lip10	1859549	estExt_Genewise1.C_1440078
Lip11	1515031	fgenesh1_kg.16_#_1428_#_TRINITY_DN8237_c0_g2_i1
Lip12	1600736	fgenesh1_kg.101_#_125_#_TRINITY_DN10873_c1_g1_i1
Lip13	1762058	gm1.812_g
Lip14	1836649	estExt_fgenesh1_pg.C_270068
Lip15	1846050	estExt_fgenesh1_pg.C_2670026
Lip16	1526962	fgenesh1_kg.25_#_154_#_remain_c7345
Lip17	1541585	fgenesh1_kg.35_#_559_#_TRINITY_DN8900_c0_g2_i1
Lip18	1555127	fgenesh1_kg.49_#_22_#_MblContig10869

Lip19	1594705	fgenes1_kg.94_#_312_#_TRINITY_DN9344_c0_g2_i3
Lip2	1433454	gw1.353.2.1
Lip20	1621852	fgenes1_kg.127_#_592_#_TRINITY_DN9776_c0_g2_i4
Lip21	1646192	fgenes1_kg.169_#_80_#_TRINITY_DN4529_c0_g1_i4
Lip22	1773667	gm1.12421_g
Lip23	1430444	gw1.94.29.1
Lip24	1480505	fgenes1_pg.144_#_7
Lip25	1875141	estExt_Genemark1.C_920075
Lip26	1881639	estExt_Genemark1.C_2450045
Lip27	1557495	fgenes1_kg.51_#_647_#_TRINITY_DN6087_c0_g1_i2
Lip28	1787144	gm1.25898_g
Lip29	1847639	estExt_fgenes1_pg.C_3820008
Lip3	1461056	e_gw1.179.65.1
Lip30	1615273	fgenes1_kg.120_#_138_#_TRINITY_DN11958_c0_g2_i1
Lip31	1772942	gm1.11696_g
Lip32	1427913	gw1.291.1.1
Lip33	1480950	fgenes1_pg.153_#_6
Lip34	1543838	fgenes1_kg.37_#_236_#_MblContig5759
Lip35	1597953	fgenes1_kg.98_#_136_#_TRINITY_DN8879_c0_g1_i3
Lip36	1619763	fgenes1_kg.125_#_294_#_TRINITY_DN7308_c1_g1_i1
Lip37	1646446	fgenes1_kg.169_#_334_#_MblContig5759
Lip38	1648732	fgenes1_kg.172_#_540_#_TRINITY_DN11661_c1_g2_i1
Lip39	1672718	fgenes1_kg.233_#_79_#_MblContig2937
Lip4	1467994	e_gw1.491.17.1
Lip40	1711049	fgenes1_kg.375_#_93_#_MblContig1232
Lip41	1725751	fgenes1_kg.480_#_34_#_ACTTGA_L001_R1_(paired)_contig_13657
Lip42	1610492	fgenes1_kg.113_#_117_#_ACTTGA_L001_R1_(paired)_contig_13802
Lip43	1656899	fgenes1_kg.190_#_351_#_TRINITY_DN13659_c0_g1_i1
Lip44	1755455	estExt_Genewise1Plus.C_1840061

Lip45	1879792	estExt_Genemark1.C_1850048
Lip46	1515079	fgenesh1_kg.16_#_1476_#_TRINITY_DN1583_c0_g2_i1
Lip47	1604117	fgenesh1_kg.106_#_285_#_MblContig3202
Lip48	1664541	fgenesh1_kg.209_#_655_#_ACTTGA_L001_R1_(paired)_contig_4384
Lip49	1598888	fgenesh1_kg.99_#_650_#_TRINITY_DN10037_c0_g1_i3
Lip5	1575030	fgenesh1_kg.70_#_876_#_TRINITY_DN12090_c0_g3_i1
Lip50	1613004	fgenesh1_kg.115_#_715_#_TRINITY_DN19221_c0_g1_i1
Lip51	1758357	estExt_Genewise1Plus.C_3150027
Lip52	1769490	gm1.8244_g
Lip53	625560	CE625427_231
Lip54	1447946	e_gw1.10.22.1
Lip55	1473250	fgenesh1_pg.32_#_91
Lip56	1534809	fgenesh1_kg.30_#_508_#_ACTTGA_L001_R1_(paired)_contig_4468
Lip57	1573097	fgenesh1_kg.68_#_518_#_TRINITY_DN8487_c0_g1_i4
Lip58	1662204	fgenesh1_kg.203_#_262_#_ACTTGA_L001_R1_(paired)_contig_11461
Lip59	1684811	fgenesh1_kg.262_#_160_#_ACTTGA_L001_R1_(paired)_contig_4372
Lip6	1784257	gm1.23011_g
Lip60	1694328	fgenesh1_kg.292_#_371_#_ACTTGA_L001_R1_(paired)_contig_1730
Lip61	1811242	MIX18671_28_29
Lip62	1868980	estExt_Genemark1.C_160127
Lip63	1458584	e_gw1.132.62.1
Lip64	1590621	fgenesh1_kg.88_#_602_#_V1MblContig6096
Lip65	1677830	fgenesh1_kg.246_#_103_#_TRINITY_DN8720_c0_g2_i1
Lip66	1773539	gm1.12293_g
Lip67	1786016	gm1.24770_g
Lip68	1532283	fgenesh1_kg.28_#_1207_#_TRINITY_DN8919_c0_g1_i2
Lip69	1523356	fgenesh1_kg.22_#_273_#_TRINITY_DN12029_c0_g1_i2
Lip7	1785113	gm1.23867_g
Lip70	1537822	fgenesh1_kg.32_#_1163_#_TRINITY_DN11133_c0_g1_i4

Lip71	1766518	gm1.5272_g
Lip72	1822551	MIX29980_19_68
Lip73	1877996	estExt_Genemark1.C_1420051
Lip74	1479135	fgenes1_pg.117_#_11
Lip75	1835113	estExt_fgenes1_pg.C_100088
Lip76	1600691	fgenes1_kg.101_#_80_#_MblContig3102
Lip8	1787049	gm1.25803_g
Lip9	1848446	estExt_fgenes1_pg.C_4660007
MD-2_1	1445951	gw1.4.215.1
MD-2_10	1614137	fgenes1_kg.117_#_406_#_remain_c4548
MD-2_11	1631429	fgenes1_kg.143_#_454_#_remain_c9925
MD-2_12	1632856	fgenes1_kg.147_#_17_#_TRINITY_DN11283_c5_g1_i1
MD-2_13	1639423	fgenes1_kg.156_#_337_#_V1MblContig4681
MD-2_14	1667510	fgenes1_kg.216_#_324_#_TRINITY_DN5238_c0_g1_i2
MD-2_15	1689810	fgenes1_kg.278_#_53_#_CGATGT_L007_contig_38471
MD-2_16	1689812	fgenes1_kg.278_#_55_#_MblContig8060
MD-2_17	1691450	fgenes1_kg.284_#_5_#_MblContig6603
MD-2_18	1716025	fgenes1_kg.405_#_203_#_remain_c4739
MD-2_19	1722335	fgenes1_kg.453_#_39_#_remain_c4548
MD-2_2	1478753	fgenes1_pg.110_#_40
MD-2_20	1730137	fgenes1_kg.525_#_24_#_MblContig8373
MD-2_21	1730141	fgenes1_kg.525_#_28_#_MblContig8373
MD-2_22	1768468	gm1.7222_g
MD-2_23	1771632	gm1.10386_g
MD-2_24	1778013	gm1.16767_g
MD-2_25	1788903	gm1.27657_g
MD-2_26	1794929	MIX2358_65_72
MD-2_27	1818918	MIX26347_4_22
MD-2_28	1822014	MIX29443_6_39

MD-2_29	1839602	estExt_fgenesh1_pg.C_740044
MD-2_3	1482060	fgenesh1_pg.180_#_26
MD-2_30	1846678	estExt_fgenesh1_pg.C_3050007
MD-2_31	1868882	estExt_Genemark1.C_150100
MD-2_32	1873384	estExt_Genemark1.C_660086
MD-2_33	1881666	estExt_Genemark1.C_2460026
MD-2_34	1882510	estExt_Genemark1.C_2780010
MD-2_35	573444	CE573311_6772
MD-2_36	1554752	fgenesh1_kg.48_#_641_#_TRINITY_DN3398_c1_g2_i1
MD-2_37	1558918	fgenesh1_kg.53_#_505_#_ACTTGA_L001_R1_(paired)_contig_2992
MD-2_38	1471449	fgenesh1_pg.15_#_82
MD-2_39	1474385	fgenesh1_pg.45_#_61
MD-2_4	1487499	fgenesh1_pg.415_#_8
MD-2_40	1800388	MIX7817_182_28
MD-2_41	1872702	estExt_Genemark1.C_570006
MD-2_5	1491738	fgenesh1_kg.2_#_84_#_step3_rep_c1429
MD-2_6	1554015	fgenesh1_kg.47_#_432_#_remain_c4548
MD-2_7	1573322	fgenesh1_kg.69_#_8_#_MblContig7701
MD-2_8	1573333	fgenesh1_kg.69_#_19_#_remain_c3357
MD-2_9	1613657	fgenesh1_kg.116_#_575_#_remain_c4739
Ves1	1459418	e_gw1.148.75.1
Ves10	1578078	fgenesh1_kg.73_#_817_#_ACTTGA_L001_R1_(paired)_contig_7803
Ves100	1699393	fgenesh1_kg.315_#_272_#_TRINITY_DN9927_c0_g2_i1
Ves101	1711999	fgenesh1_kg.381_#_70_#_TRINITY_DN1641_c1_g1_i1
Ves102	1726969	fgenesh1_kg.489_#_34_#_V1MblContig9038
Ves103	1726959	fgenesh1_kg.489_#_24_#_MblContig15520
Ves104	1726949	fgenesh1_kg.489_#_14_#_step3_c2291
Ves105	1741061	fgenesh1_pm.5_#_10
Ves106	1752971	estExt_Genewise1Plus.C_1270025

Ves107	1774643	gm1.13397_g
Ves108	1420504	gw1.58.2.1
Ves109	1432586	gw1.7.71.1
Ves11	1597146	fgenesh1_kg.96_#_1272_#_ACTTGA_L001_R1_(paired)_contig_5887
Ves110	1449756	e_gw1.25.93.1
Ves111	1465737	e_gw1.339.14.1
Ves112	1596717	fgenesh1_kg.96_#_843_#_ACTTGA_L001_R1_(paired)_contig_8108
Ves113	1610982	fgenesh1_kg.113_#_607_#_remain_c4885
Ves114	1634017	fgenesh1_kg.149_#_107_#_V1MblContig1892
Ves115	1635445	fgenesh1_kg.150_#_616_#_TRINITY_DN6599_c1_g1_i1
Ves116	1742348	fgenesh1_pm.120_#_6
Ves117	1764413	gm1.3167_g
Ves118	1505227	fgenesh1_kg.9_#_1123_#_ACTTGA_L001_R1_(paired)_contig_9898
Ves119	1659799	fgenesh1_kg.198_#_410_#_TRINITY_DN11733_c0_g2_i1
Ves12	1664555	fgenesh1_kg.209_#_669_#_ACTTGA_L001_R1_(paired)_contig_17581
Ves120	1673558	fgenesh1_kg.236_#_8_#_TRINITY_DN16466_c0_g1_i1
Ves13	1742053	fgenesh1_pm.85_#_2
Ves14	1783242	gm1.21996_g
Ves15	1447864	e_gw1.9.129.1
Ves16	1585500	fgenesh1_kg.82_#_303_#_remain_c12256
Ves17	1638721	fgenesh1_kg.155_#_418_#_ACTTGA_L001_R1_(paired)_contig_10872
Ves18	1724691	fgenesh1_kg.470_#_30_#_TRINITY_DN2339_c0_g2_i1
Ves19	61665	CE61532_727
Ves2	1565458	fgenesh1_kg.60_#_605_#_remain_c5078
Ves20	1470812	fgenesh1_pg.10_#_65
Ves21	1508737	fgenesh1_kg.12_#_209_#_ACTTGA_L001_R1_(paired)_contig_8354
Ves22	1526056	fgenesh1_kg.24_#_299_#_TRINITY_DN8800_c0_g1_i2
Ves23	1532838	fgenesh1_kg.29_#_352_#_remain_c6136
Ves24	1664716	fgenesh1_kg.210_#_160_#_TRINITY_DN28841_c0_g1_i1

Ves25	1679813	fgenes1_kg.250_#_251_#_ACTTGA_L001_R1_(paired)_contig_3865
Ves26	1715323	fgenes1_kg.401_#_47_#_CGATGT_L007_contig_987
Ves27	1783874	gm1.22628_g
Ves28	1463896	e_gw1.261.12.1
Ves29	1617709	fgenes1_kg.123_#_15_#_TRINITY_DN478_c0_g1_i2
Ves3	1534162	fgenes1_kg.29_#_1676_#_GATCAG_L001_R1_without_duplicates_conti g_40837
Ves30	1767930	gm1.6684_g
Ves31	1461395	e_gw1.186.24.1
Ves32	1490882	fgenes1_kg.1_#_1190_#_TRINITY_DN13530_c0_g1_i1
Ves33	1493059	fgenes1_kg.3_#_43_#_TRINITY_DN16526_c0_g1_i1
Ves34	1465726	e_gw1.339.5.1
Ves35	1445993	gw1.123.126.1
Ves36	1554635	fgenes1_kg.48_#_524_#_TRINITY_DN9651_c0_g1_i9
Ves37	1554827	fgenes1_kg.48_#_716_#_TRINITY_DN11559_c1_g1_i1
Ves38	1578836	fgenes1_kg.74_#_609_#_TRINITY_DN1086_c0_g2_i1
Ves39	1656131	fgenes1_kg.188_#_162_#_CGATGT_L007_contig_1341
Ves4	1654443	fgenes1_kg.184_#_208_#_step3_c3189
Ves40	1669897	fgenes1_kg.223_#_205_#_TRINITY_DN6379_c0_g3_i1
Ves41	1465385	e_gw1.323.10.1
Ves42	1540511	fgenes1_kg.34_#_1069_#_TRINITY_DN8224_c0_g2_i2
Ves43	1558298	fgenes1_kg.52_#_647_#_MblContig8312
Ves44	1577920	fgenes1_kg.73_#_659_#_MblContig3467
Ves45	1633169	fgenes1_kg.148_#_87_#_ACTTGA_L001_R1_(paired)_contig_5735
Ves46	1684021	fgenes1_kg.259_#_521_#_step3_c1265
Ves47	1705825	fgenes1_kg.351_#_396_#_TRINITY_DN9812_c0_g2_i2
Ves48	1721327	fgenes1_kg.442_#_140_#_ACTTGA_L001_R1_(paired)_contig_6606
Ves49	1741792	fgenes1_pm.60_#_18
Ves5	1689748	fgenes1_kg.277_#_562_#_ACTTGA_L001_R1_(paired)_contig_2424
Ves50	1772546	gm1.11300_g

Ves51	1773843	gm1.12597_g
Ves52	1546488	fgenesh1_kg.40_#_122_#_ACTTGA_L001_R1_(paired)_contig_5349
Ves53	1596512	fgenesh1_kg.96_#_638_#_V1MblContig56
Ves54	1607939	fgenesh1_kg.110_#_260_#_TRINITY_DN9609_c1_g1_i4
Ves55	1570749	fgenesh1_kg.65_#_1059_#_ACTTGA_L001_R1_(paired)_contig_10690
Ves56	1572985	fgenesh1_kg.68_#_406_#_MblContig731
Ves57	1463546	e_gw1.250.65.1
Ves58	1468080	e_gw1.500.10.1
Ves59	1514648	fgenesh1_kg.16_#_1045_#_ACTTGA_L001_R1_(paired)_contig_555
Ves6	1723873	fgenesh1_kg.463_#_134_#_ACTTGA_L001_R1_(paired)_contig_6402
Ves60	1596934	fgenesh1_kg.96_#_1060_#_TRINITY_DN9389_c0_g1_i5
Ves61	1618566	fgenesh1_kg.123_#_872_#_V1MblContig1425
Ves62	1721329	fgenesh1_kg.442_#_142_#_MblContig16603
Ves63	1789452	gm1.28206_g
Ves64	1539553	fgenesh1_kg.34_#_111_#_TRINITY_DN8972_c0_g1_i3
Ves65	1609563	fgenesh1_kg.111_#_492_#_ACTTGA_L001_R1_(paired)_contig_7619
Ves66	1612648	fgenesh1_kg.115_#_359_#_TRINITY_DN10210_c2_g1_i6
Ves67	1619749	fgenesh1_kg.125_#_280_#_ACTTGA_L001_R1_(paired)_contig_107
Ves68	1629322	fgenesh1_kg.139_#_274_#_TRINITY_DN9640_c0_g1_i2
Ves69	1673604	fgenesh1_kg.236_#_54_#_ACTTGA_L001_R1_(paired)_contig_5034
Ves7	1736641	fgenesh1_kg.612_#_61_#_TRINITY_DN7351_c0_g2_i1
Ves70	1680159	fgenesh1_kg.250_#_597_#_TRINITY_DN11718_c4_g1_i9
Ves71	47119	CE46986_6742
Ves72	1451523	e_gw1.41.18.1
Ves73	1452955	e_gw1.60.58.1
Ves74	1459649	e_gw1.150.11.1
Ves75	1473407	fgenesh1_pg.34_#_35
Ves76	1504294	fgenesh1_kg.9_#_190_#_step3_c1551
Ves77	1518143	fgenesh1_kg.18_#_1056_#_TRINITY_DN10803_c3_g1_i1

Ves78	1529476	fgenes1_kg.26_#_1066_#_TRINITY_DN19646_c0_g1_i1
Ves79	1572660	fgenes1_kg.68_#_81_#_TRINITY_DN6564_c0_g1_i1
Ves8	1789606	gm1.28360_g
Ves80	1602557	fgenes1_kg.104_#_256_#_ACTTGA_L001_R1_(paired)_contig_1818
Ves81	1639045	fgenes1_kg.155_#_742_#_TRINITY_DN16702_c0_g1_i1
Ves82	1726954	fgenes1_kg.489_#_19_#_ACTTGA_L001_R1_(paired)_contig_1143
Ves83	1776489	gm1.15243_g
Ves84	1789922	gm1.28676_g
Ves85	1814605	MIX22034_126970_82
Ves86	1849825	estExt_Genewise1.C_30010
Ves87	775932	CE775799_24936
Ves88	1647959	fgenes1_kg.171_#_779_#_ACTTGA_L001_R1_(paired)_contig_2949
Ves89	1659814	fgenes1_kg.198_#_425_#_ACTTGA_L001_R1_(paired)_contig_1111
Ves9	1490300	fgenes1_kg.1_#_608_#_MblContig7689
Ves90	1452034	e_gw1.48.98.1
Ves91	1456646	e_gw1.106.85.1
Ves92	1518004	fgenes1_kg.18_#_917_#_ACTTGA_L001_R1_(paired)_contig_4059
Ves93	1521229	fgenes1_kg.20_#_501_#_TRINITY_DN6861_c0_g1_i2
Ves94	1538737	fgenes1_kg.33_#_696_#_TRINITY_DN27006_c0_g1_i1
Ves95	1541314	fgenes1_kg.35_#_288_#_ACTTGA_L001_R1_(paired)_contig_2823
Ves96	1553922	fgenes1_kg.47_#_339_#_ACTTGA_L001_R1_(paired)_contig_4655
Ves97	1606096	fgenes1_kg.108_#_715_#_ACTTGA_L001_R1_(paired)_contig_3083
Ves98	1633618	fgenes1_kg.148_#_536_#_MblContig15040
Ves99	1694125	fgenes1_kg.292_#_168_#_TRINITY_DN10177_c1_g1_i8
TransVes1	138130	CE137997_696
TransVes10	1833417	estExt_fgenes1_pm.C_2310001
TransVes11	1727022	fgenes1_kg.489_#_87_#_TRINITY_DN7061_c1_g2_i3
TransVes12	1544044	fgenes1_kg.37_#_442_#_TRINITY_DN12914_c0_g2_i1
TransVes13	1750476	estExt_Genewise1Plus.C_850013

TransVes14	1774552	gm1.13306_g
TransVes15	1869227	estExt_Genemark1.C_190006
TransVes16	1448006	e_gw1.10.5.1
TransVes17	1460277	e_gw1.164.23.1
TransVes18	1460283	e_gw1.164.27.1
TransVes19	1481408	fgenesh1_pg.164_#_8
TransVes20	1618142	fgenesh1_kg.123_#_448_#_TRINITY_DN9305_c0_g2_i10
TransVes21	1644115	fgenesh1_kg.164_#_404_#_ACTTGA_L001_R1_(paired)_contig_10371
TransVes22	1810023	MIX17452_222_98
TransVes23	1825696	MIX33125_77_98
TransVes24	1876004	estExt_Genemark1.C_1060085
TransVes25	1876872	estExt_Genemark1.C_1210051
TransVes3	1604415	fgenesh1_kg.106_#_583_#_V1MblContig935
TransVes4	1565464	fgenesh1_kg.60_#_611_#_ACTTGA_L001_R1_(paired)_contig_9043
TransVes5	1476999	fgenesh1_pg.82_#_48
TransVes6	1538102	fgenesh1_kg.33_#_61_#_ACTTGA_L001_R1_(paired)_contig_5403
TransVes7	1694430	fgenesh1_kg.293_#_45_#_TRINITY_DN5399_c0_g2_i1
TransVes8	1595534	fgenesh1_kg.95_#_361_#_TRINITY_DN8014_c0_g1_i6
TransVes9	1697347	fgenesh1_kg.305_#_99_#_TRINITY_DN7823_c0_g1_i2

Feature ID	Aliases	Fold Change	FDR p-value
Medtr1g096910.1	SUT1-1	2,16	3E-15
Medtr3g089125.1	SWEET1b	-2,06	6E-09
Medtr8g442410.1	GRAS6 (paralogue RAD1)	-2,89	6E-14
Medtr1g040500.1	RAM2	-7,33	2E-187
Medtr1g109110.1	FatM	-7,41	5E-29
Medtr4g104020.1	RAD1	-7,50	1E-165
Medtr8g006790.1	HA1	-8,00	1E-127
Medtr1g028600.1	PT4	-9,16	3E-146
Medtr8g107450.1	STR1	-10,41	5E-160
Medtr8g074580.1	Lipase3	-21,78	4E-68
Medtr8g074560.1	Lipase1	-28,72	3E-109
Medtr7g027190.1	RAM1	-35,16	7E-138
Medtr8g074570.1	Lipase2	-53,20	2E-143
Feature ID	Aliases	Fold Change	FDR p-value
estExt_Genemark1.C_920075	Lip25	11,41	1E-07
gw1.7.71.1	Ves109	9,00	1E-06
fgenes1_pg.10_#_65	Ves20	5,36	1E-12
CE137997_696	TransVes1	5,05	0E+00
fgenes1_kg.82_#_303_#_remain_c12256	Ves16	4,34	4E-04
fgenes1_kg.69_#_8_#_MblContig7701	MD-2_7	3,77	0E+00
fgenes1_kg.16_#_1476_#_TRINITY_DN1583_c0_g2_i1	Lip46	3,49	1E-02
gm1.11300_g	Ves50	2,59	0E+00
fgenes1_kg.188_#_162_#_CGATGT_L007_contig_1341	Ves39	2,55	0E+00
gw1.4.215.1	MD-2_1	2,49	2E-11
fgenes1_kg.156_#_337_#_V1MblContig4681	MD-2_13	2,46	0E+00
fgenes1_kg.30_#_508_#_ACTTGA_L001_R1_(paired)_contig_4468	Lip56	2,36	9E-13
fgenes1_kg.24_#_299_#_TRINITY_DN8800_c0_g1_i2	Ves22	2,33	8E-05
fgenes1_kg.148_#_536_#_MblContig15040	Ves98	2,27	0E+00
fgenes1_kg.51_#_647_#_TRINITY_DN6087_c0_g1_i2	Lip27	2,10	1E-06
estExt_fgenes1_pg.C_270068	Lip14	2,10	1E-04
fgenes1_kg.1_#_1190_#_TRINITY_DN13530_c0_g1_i1	Ves32	2,07	0E+00
gm1.13306_g	TransVes14	-2,06	3E-04
fgenes1_kg.236_#_8_#_TRINITY_DN16466_c0_g1_i1	Ves120	-2,07	2E-15
fgenes1_pg.355_#_14	Desat7	-2,38	7E-27
fgenes1_kg.12_#_1417_#_remain_c904	Elo2	-2,59	2E-20
gm1.12325_g	Desat5	-2,59	7E-42
e_gw1.174.50.1	Elo1	-2,73	2E-66
fgenes1_kg.33_#_109_#_ACTTGA_L001_R1_(paired)_contig_6835	Desat8	-2,77	1E-46
fgenes1_kg.375_#_93_#_MblContig1232	Lip40	-2,84	2E-34
e_gw1.82.129.1	Desat6	-2,85	7E-16
fgenes1_kg.284_#_5_#_MblContig6603	MD-2_17	-3,48	2E-06
estExt_Genewise1Plus.C_850013	TransVes13	-3,88	1E-11

gm1.25898_g	Lip28	-3,88	3E-04
fgenes1_pg.32_#_91	Lip55	-4,03	2E-119
fgenes1_kg.16_#_1428_#_TRINITY_DN8237_c0_g2_i1	Lip11	-5,57	8E-75
fgenes1_kg.137_#_231_#_MblContig2380	Desat9	-5,87	4E-95
estExt_fgenes1_pg.C_3820008	Lip29	-6,50	3E-134
estExt_Genemark1.C_1850048	Lip45	-6,86	4E-49
fgenes1_kg.127_#_592_#_TRINITY_DN9776_c0_g2_i4	Lip20	-7,28	2E-91
fgenes1_pg.164_#_8	TransVes19	-8,42	4E-23
fgenes1_kg.442_#_142_#_MblContig16603	Ves62	-9,28	2E-26
fgenes1_kg.431_#_107_#_ACTTGA_L001_R1_(paired)_contig_9578	Desat1	-9,62	4E-56
fgenes1_kg.101_#_125_#_TRINITY_DN10873_c1_g1_i1	Lip12	-10,15	1E-52
fgenes1_kg.74_#_620_#_TRINITY_DN16378_c0_g1_i1	Elo3	-10,98	1E-86
estExt_fgenes1_pg.C_100088	Lip75	-11,76	9E-58
fgenes1_kg.101_#_80_#_MblContig3102	Lip76	-12,06	9E-94
estExt_Genemark1.C_1210051	TransVes25	-12,14	7E-37
gm1.27657_g	MD-2_25	-12,70	9E-26
fgenes1_kg.32_#_1163_#_TRINITY_DN11133_c0_g1_i4	Lip70	-13,94	3E-64
fgenes1_kg.23_#_824_#_ACTTGA_L001_R1_(paired)_contig_14017	Desat4	-17,67	4E-123
gw1.291.1.1	Lip32	-21,56	6E-16
fgenes1_pg.15_#_82	MD-2_38	-24,84	2E-91
fgenes1_kg.143_#_454_#_remain_c9925	MD-2_11	-26,01	2E-70
estExt_Genemark1.C_1420051	Lip73	-28,07	2E-69
fgenes1_pg.180_#_26	MD-2_3	-35,16	1E-158
estExt_Genemark1.C_2460026	MD-2_33	-38,06	5E-101
fgenes1_pg.45_#_61	MD-2_39	-42,45	8E-108
estExt_Genemark1.C_660086	MD-2_32	-47,90	1E-145
fgenes1_pg.117_#_11	Lip74	-68,60	2E-26
MIX29980_19_68	Lip72	-85,32	2E-64

Table 2

Aliases	Feature ID	T1 vs T0		T14 vs T0	
		Fold Change	FDR	Fold Change	FDR
FatM	Medtr1g109110.1	1,072	1,000	-12,325	0,000
GRAS6 (paralogue RAD1)	Medtr8g442410.1	-1,266	0,000	-4,534	0,000
HA1	Medtr8g006790.1	-1,318	1,000	-8,239	0,000
KASI	Medtr8g099700.1	1,000	1,000	1,000	1,000
KASI	Medtr8g099715.1	1,000	1,000	1,000	1,000
KASI (myc)	Medtr8g099695.1	1,000	1,000	10000,000	0,733
Lipase1	Medtr8g074560.1	-1,397	1,000	-31,273	0,000
Lipase2	Medtr8g074570.1	-1,933	0,000	-92,833	0,000
Lipase3	Medtr8g074580.1	-1,120	1,000	-87,990	0,000
MtHext1	Medtr1g104780.1	-1,153	0,859	1,348	0,569
Mtst1	Medtr4g091370.1	1,381	0,000	-1,647	0,298
PT4	Medtr1g028600.1	-1,287	1,000	-18,269	0,000
RAD1	Medtr4g104020.1	-1,555	0,379	-35,622	0,000
RAM1	Medtr7g027190.1	-1,121	1,000	-49,628	0,000
RAM2	Medtr1g040500.1	-1,172	1,000	-16,450	0,000
ST1	Medtr1g038630.1	1,875	1,000	-10000,000	0,733
ST10	Medtr4g090600.1	-1,742	0,071	-4,825	0,000
ST12	Medtr4g116770.1	-1,007	1,000	-1,802	0,000
ST13	Medtr5g006070.1	-1,628	1,000	22,986	0,000
ST14	Medtr5g041550.1	10000,000	0,063	10000,000	0,172
ST15	Medtr5g082540.1	-2,041	1,000	-1,137	1,000
ST16	Medtr5g094760.1	-2,216	1,000	1,998	0,160
ST17	Medtr6g087040.1	10000,000	1,000	10000,000	0,733
ST18	Medtr8g102860.1	1,039	1,000	-1,153	1,000
ST19	Medtr8g073100.1	-10000,000	1,000	3,366	1,000
ST2	Medtr1g104750.1	-1,462	1,000	2,002	0,138
ST20	Medtr5g044910.1	10000,000	1,000	10000,000	0,733
ST21	Medtr5g024740.1	-2,072	0,000	2,819	0,000
ST22	Medtr3g116060.1	1,000	1,000	1,000	1,000
ST23	Medtr3g118530.1	1,526	0,822	1,442	0,325
ST24	Medtr2g013310.1	-1,339	1,000	-1,112	1,000
ST25	Medtr3g116240.1	1,916	0,560	15,375	0,225
ST26	Medtr4g072030.1	-1,256	1,000	-1,396	0,688
ST27	Medtr5g019870.1	-10000,000	1,000	3,608	0,838
ST28	Medtr5g075300.1	1,000	1,000	1,000	1,000
ST29	Medtr6g007340.1	1,000	1,000	1,000	1,000
ST3	Medtr1g104770.1	-1,536	1,000	-1,239	1,000
ST30	Medtr6g088450.1	-1,356	1,000	1,497	0,733
ST31	Medtr8g077890.1	1,072	1,000	-2,197	0,021

ST32	Medtr8g103500.1	1,469	0,163	1,696	0,013
ST34	Medtr4g064820.1	-1,163	1,000	-1,249	0,314
ST35	Medtr3g080240.1	-1,346	0,030	-1,640	0,013
ST36	Medtr6g087910.1	-1,081	1,000	3,116	0,007
ST37	Medtr7g082270.1	-1,066	1,000	-1,365	0,180
ST38	Medtr2g020710.1	1,000	1,000	1,000	1,000
ST39	Medtr4g118610.1	-2,285	0,011	2,237	0,500
ST4	Medtr3g007910.1	-10000,000	1,000	2,804	0,751
ST40	Medtr5g020270.1	1,000	1,000	1,000	1,000
ST41	Medtr7g113960.1	1,669	0,000	-1,824	0,000
ST42	Medtr7g113970.1	1,164	1,000	1,363	0,014
ST43	Medtr8g077300.1	-10000,000	1,000	3,865	0,532
ST44	Medtr8g077310.1	1,000	1,000	1,000	1,000
ST46	Medtr1g116650.1	1,568	0,000	5,416	0,000
ST47	Medtr1g116660.1	-1,119	1,000	3,657	0,036
ST48	Medtr2g026140.1	-1,401	1,000	2,540	0,000
ST49	Medtr2g026160.1	-1,473	0,112	16,103	0,000
ST5	Medtr3g008160.1	-2,010	1,000	48,767	0,056
ST50	Medtr2g048720.1	-1,423	0,833	12,796	0,000
ST51	Medtr2g049020.1	-4,633	0,000	87,068	0,006
ST52	Medtr3g084110.1	-2,632	0,003	4,589	0,000
ST53	Medtr5g077580.1	-1,340	1,000	-1,262	1,000
ST54	Medtr7g005910.1	-1,693	0,014	2,309	0,000
ST6	Medtr3g008170.1	-2,273	0,476	5,137	0,000
ST7	Medtr3g023480.1	1,000	1,000	10000,000	0,733
ST8	Medtr3g093010.1	-1,989	1,000	1,732	1,000
ST9	Medtr3g093060.1	3,252	0,536	1,360	1,000
STR1	Medtr8g107450.1	-1,369	1,000	-24,388	0,000
STR2	Medtr5g030910.1	-1,502	0,519	-5,420	0,000
SUT1-1	Medtr1g096910.1	1,827	0,009	2,766	0,010
SUT1-2	Medtr6g043880.1	10000,000	1,000	10000,000	0,018
SUT1-3	Medtr4g131920.1	-1,731	1,000	6,113	0,251
SUT2	Medtr8g468330.1	-1,073	1,000	1,171	0,014
SUT4-1	Medtr5g067470.1	1,129	0,584	-1,418	0,063
SUT4-2	Medtr3g110880.1	-1,032	1,000	-1,201	0,367
SUTp1	Medtr4g102110.1	1,000	1,000	10000,000	0,733
SUTp2	Medtr4g102190.1	1,000	1,000	1,000	1,000
SWEET1b	Medtr3g089125.1	-1,807	0,011	-6,787	0,000

Table 3

Aliases	Feature ID	H9 vs H0		H96 vs H0	
		Fold Change	FDR	Fold Change	FDR
FatM	Medtr1g109110.1	1,147	1,000	-1,285	0,840
GRAS6 (parologue RAD1)	Medtr8g442410.1	-1,758	0,000	-2,435	0,000
HA1	Medtr8g006790.1	-1,416	0,489	-1,635	0,297
KASI	Medtr8g099700.1	1,000	1,000	10000,000	0,786
KASI	Medtr8g099715.1	1,000	1,000	1,000	1,000
KASI (myc)	Medtr8g099695.1	10000,000	0,747	10000,000	0,786
Lipase1	Medtr8g074560.1	-1,564	0,687	-6,857	0,028
Lipase2	Medtr8g074570.1	-1,774	0,199	-8,684	0,000
Lipase3	Medtr8g074580.1	-1,669	0,368	-17,605	0,000
MtHex1	Medtr1g104780.1	1,034	1,000	1,219	0,942
Mtst1	Medtr4g091370.1	1,395	0,000	2,018	0,435
PT4	Medtr1g028600.1	-1,483	0,590	-3,461	0,018
RAD1	Medtr4g104020.1	-1,437	0,697	-12,222	0,001
RAM1	Medtr7g027190.1	-1,285	0,803	-4,594	0,014
RAM2	Medtr1g040500.1	-1,413	0,747	-2,893	0,073
ST1	Medtr1g038630.1	1,000	1,000	1,000	1,000
ST10	Medtr4g090600.1	-1,492	0,498	-4,468	0,003
ST12	Medtr4g116770.1	1,039	1,000	-1,055	1,000
ST13	Medtr5g006070.1	-2,930	0,000	1,086	1,000
ST14	Medtr5g041550.1	-1,612	1,000	-10000,000	0,376
ST15	Medtr5g082540.1	1,000	1,000	1,000	1,000
ST16	Medtr5g094760.1	-2,055	0,709	-2,190	0,737
ST17	Medtr6g087040.1	1,000	1,000	10000,000	0,786
ST18	Medtr8g102860.1	1,018	1,000	1,434	0,817
ST19	Medtr8g073100.1	1,000	1,000	1,000	1,000
ST2	Medtr1g104750.1	1,591	1,000	5,076	0,786
ST20	Medtr5g044910.1	1,226	1,000	-10000,000	0,786
ST21	Medtr5g024740.1	-2,485	0,000	1,064	1,000
ST22	Medtr3g116060.1	1,076	0,747	-1,085	1,000
ST23	Medtr3g118530.1	-1,056	0,747	-1,208	0,773
ST24	Medtr2g013310.1	-1,486	0,459	-1,519	0,663
ST25	Medtr3g116240.1	9,923	0,307	13,346	0,037
ST26	Medtr4g072030.1	-1,036	1,000	1,099	1,000
ST27	Medtr5g019870.1	10000,000	0,567	1,000	1,000
ST28	Medtr5g075300.1	1,000	1,000	1,000	1,000
ST29	Medtr6g007340.1	1,062	1,000	1,317	0,076
ST3	Medtr1g104770.1	10000,000	0,747	10000,000	0,786
ST30	Medtr6g088450.1	-2,592	0,089	1,564	0,786
ST31	Medtr8g077890.1	-1,106	1,000	-4,842	0,174

ST32	Medtr8g103500.1	1,470	0,103	1,088	1,000
ST34	Medtr4g064820.1	-1,162	0,627	-1,137	0,786
ST35	Medtr3g080240.1	-1,076	0,905	1,057	1,000
ST36	Medtr6g087910.1	-1,176	0,488	-1,561	0,111
ST37	Medtr7g082270.1	-1,218	0,034	1,037	1,000
ST38	Medtr2g020710.1	-2,230	0,000	3,760	0,406
ST39	Medtr4g118610.1	-2,464	0,006	5,762	0,596
ST4	Medtr3g007910.1	1,000	1,000	1,000	1,000
ST40	Medtr5g020270.1	-1,146	0,746	1,490	0,492
ST41	Medtr7g113960.1	2,328	0,000	1,387	0,002
ST42	Medtr7g113970.1	1,254	0,002	1,030	1,000
ST43	Medtr8g077300.1	-10000,000	0,747	-10000,000	0,786
ST44	Medtr8g077310.1	-1,058	0,847	2,416	0,027
ST46	Medtr1g116650.1	1,152	0,747	5,670	0,220
ST47	Medtr1g116660.1	-1,114	1,000	4,560	0,490
ST48	Medtr2g026140.1	-1,131	1,000	-3,053	0,268
ST49	Medtr2g026160.1	-1,803	0,164	11,888	0,010
ST5	Medtr3g008160.1	2,457	0,464	1,001	1,000
ST50	Medtr2g048720.1	-1,225	0,489	1,024	1,000
ST51	Medtr2g049020.1	1,113	1,000	1,506	0,866
ST52	Medtr3g084110.1	-2,328	0,000	1,528	0,036
ST53	Medtr5g077580.1	-1,384	0,598	1,098	1,000
ST54	Medtr7g005910.1	-1,912	0,000	1,018	1,000
ST6	Medtr3g008170.1	-2,206	0,068	-1,065	1,000
ST7	Medtr3g023480.1	1,000	1,000	1,000	1,000
ST8	Medtr3g093010.1	1,000	1,000	10000,000	0,786
ST9	Medtr3g093060.1	10000,000	0,747	10000,000	0,269
STR1	Medtr8g107450.1	-1,526	0,379	-4,660	0,001
STR2	Medtr5g030910.1	-1,366	0,747	-1,794	0,483
SUT1-1	Medtr1g096910.1	1,545	0,000	1,545	0,115
SUT1-2	Medtr6g043880.1	1,000	1,000	1,000	1,000
SUT1-3	Medtr4g131920.1	-4,344	0,053	1,288	1,000
SUT2	Medtr8g468330.1	1,041	0,928	1,175	0,712
SUT4-1	Medtr5g067470.1	-1,066	0,755	1,140	0,540
SUT4-2	Medtr3g110880.1	1,195	0,939	1,251	0,847
SUTp1	Medtr4g102110.1	1,000	1,000	10000,000	0,786
SUTp2	Medtr4g102190.1	1,000	1,000	1,000	1,000
SWEET1b	Medtr3g089125.1	-2,560	0,169	1,206	1,000

Table 4

