



HAL
open science

Experimental assessment of the motion behaviour of benthic foraminifera in intertidal sediment : implications for sediment mixing

Noémie Deldicq

► **To cite this version:**

Noémie Deldicq. Experimental assessment of the motion behaviour of benthic foraminifera in intertidal sediment : implications for sediment mixing. Ecosystems. Université de Lille, 2021. English. NNT : 2021LILUR019 . tel-03725195

HAL Id: tel-03725195

<https://theses.hal.science/tel-03725195>

Submitted on 16 Jul 2022

HAL is a multi-disciplinary open access archive for the deposit and dissemination of scientific research documents, whether they are published or not. The documents may come from teaching and research institutions in France or abroad, or from public or private research centers.

L'archive ouverte pluridisciplinaire **HAL**, est destinée au dépôt et à la diffusion de documents scientifiques de niveau recherche, publiés ou non, émanant des établissements d'enseignement et de recherche français ou étrangers, des laboratoires publics ou privés.

THESE DE DOCTORAT

Pour obtenir le grade de docteur de l'Université de Lille

*Ecole doctorale Science de la Matière du Rayonnement et de l'Environnement
Spécialité : Géosciences, Ecologie, Paléontologie, Océanographie*

Par Noémie DELDICQ

**Evaluation expérimentale du comportement de déplacement
des foraminifères benthiques : implications dans les
processus de remaniement sédimentaire des écosystèmes
intertidaux**



**Experimental assessment of the motion behaviour of benthic
foraminifera in intertidal sediment: implications for
sediment mixing**

Soutenue publiquement le 27 mai 2021 devant un jury composé de

Emmanuelle GESLIN, Professeure, Université d'Angers (France)	Rapporteuse – Présidente du jury
Francisco NASCIMENTO, Professeur assistant, Université de Stockholm (Suède)	Rapporteur
Elisabeth ALVE, Professeure, Université d'Oslo (Norvège)	Examinatrice
Olivier MAIRE, Maître de conférences, Université de Bordeaux (France)	Examineur
Filip MEYSMAN, Professeur, Université d'Anvers (Belgique)	Examineur
Nicolas SPILMONT, Maître de conférences-HDR, Université de Lille (France)	Examineur
Grégory BEAUGRAND, Directeur de Recherche, CNRS (France)	Directeur de thèse
Vincent BOUCHET, Maître de conférences, Université de Lille (France)	Co-encadrant
Laurent SEURONT, Directeur de Recherche, CNRS (France)	Membre invité

THESE DE DOCTORAT

Pour obtenir le grade de docteur de l'Université de Lille

*Ecole doctorale Science de la Matière du Rayonnement et de l'Environnement
Spécialité : Géosciences, Ecologie, Paléontologie, Océanographie*

Par Noémie DELDICQ

**Evaluation expérimentale du comportement de déplacement
des foraminifères benthiques : implications dans les
processus de remaniement sédimentaire des écosystèmes
intertidaux**



**Experimental assessment of the motion behaviour of benthic
foraminifera in intertidal sediment: implications for
sediment mixing**

Soutenue publiquement le 27 mai 2021 devant un jury composé de

Emmanuelle GESLIN, Professeure, Université d'Angers (France)	Rapporteuse – Présidente du jury
Francisco NASCIMENTO, Professeur assistant, Université de Stockholm (Suède)	Rapporteur
Elisabeth ALVE, Professeure, Université d'Oslo (Norvège)	Examinatrice
Olivier MAIRE, Maître de conférences, Université de Bordeaux (France)	Examineur
Filip MEYSMAN, Professeur, Université d'Anvers (Belgique)	Examineur
Nicolas SPILMONT, Maître de conférences-HDR, Université de Lille (France)	Examineur
Grégory BEAUGRAND, Directeur de Recherche, CNRS (France)	Directeur de thèse
Vincent BOUCHET, Maître de conférences, Université de Lille (France)	Co-encadrant
Laurent SEURONT, Directeur de Recherche, CNRS (France)	Membre invité

FUNDING

The PhD fellowship was funded by the Ministère de l'Enseignement Supérieur et de la Recherche.

This work is a part of the COFFEE research project (COntribution of benthic Foraminifera to the Functioning of benthic EcosystEm) led by Dr. V.M.P Bouchet in the Laboratory of Oceanology and Geosciences (Wimereux, France).

This work received the financial support of the CPER research project CLIMIBIO funded by the Région Hauts-de-France, the Ministère de l'Enseignement Supérieur et de la Recherche and the European Fund for Regional Economic Development.

Thanks to the Cushman Foundation for Foraminiferal Research (Joseph A. Cushman Award for Student Travel) for their financial support.



MINISTÈRE
DE L'ÉDUCATION NATIONALE,
DE L'ENSEIGNEMENT SUPÉRIEUR
ET DE LA RECHERCHE



Cushman
Foundation for
Foraminiferal
Research Inc



ACKNOWLEDGMENTS

Mes premiers remerciements s'adressent sans aucun doute à Vincent. Merci pour ta confiance sans faille et toutes ces opportunités que tu m'as offertes. Merci pour ta pédagogie, ton soutien et ton encadrement. Même dans mes moments de doutes, tu étais là pour m'épauler et me guider. Tu as fait preuve d'une bienveillance à toute épreuve face à une version de moi parfois (souvent) éprouvée. Je réalise la chance que j'ai eue d'avoir pour encadrant une personne telle que toi et je souhaite à chaque étudiant d'avoir la même veine que moi. Merci.

Je remercie mon directeur de thèse Grégory Beaugrand pour l'aide qu'il m'a apportée dans la rédaction de ce manuscrit de thèse.

Je remercie l'ensemble des personnes avec lesquelles j'ai eu la chance de travailler durant ces 3 années. Merci à Laurent Seuront et Dewi Langlet pour leurs conseils avisés et l'aide au combien précieuse qu'ils m'ont apportés. Je remercie vivement les membres de mon comité de thèse : le Dr. Edouard Metzger, le Dr. Florian Mermillod-Blondin et le Dr. Eric Arminot du Châtelet pour leur investissement, leur bienveillance et leurs suggestions dans la construction de ce travail. Que l'ensemble du personnel de la station marine soit également remercié pour leur aide tant administrative que technique et en particulier Dominique Menu, Gwendoline Duong, Lucdivine Bonnamy, Thierry Caron, Michel Priem et Philippe Notez. Je remercie les directeurs du LOG : le Pr. François Schmitt et le Dr. Hubert Loisel ainsi que le directeur de la station marine de Wimereux, le Pr. Lionel Denis pour m'avoir accueilli au sein du laboratoire durant cette thèse. J'adresse également mes remerciements aux membres du jury qui ont acceptés d'évaluer mon travail.

L'aboutissement de ce travail n'aurait jamais vu le jour sans les personnes extraordinaires qui partagent mon quotidien. J'ai une pensée tout particulière pour ma Mimi. Bientôt 6 ans qu'on ne se quitte plus et j'ai toujours pu compter sur ton soutien. Merci pour ces discussions sans fin sur nos vies et les projets qui les animent. Malgré

les doutes, les pleurs et les crises de nerf il y a surtout eu la joie, le rire et la chance d'avoir pu évoluer ensemble sur le chemin difficile que constitue une thèse. Merci à ma kette d'avoir veillé sur moi de loin et d'avoir quitté de nombreuses fois tes Ardennes natales pour m'écouter parler autour d'une bouteille de vin. Merci à doudou, mon binôme légendaire pour avoir partagé avec moi ton petit bout de paradis fidjien. Je ne manquerai pas d'aller trinquer avec vous en Corse très rapidement. Merci à Cappuccino pour m'avoir accueillie à bras ouvert à mon arrivée en master et pour être toujours restée depuis. Merci mille fois à tous les autres, si nombreux, pour m'avoir épaulé, écouté, consolé, soutenu et surtout d'avoir égayé mon quotidien. Merci à mes ami(e)s et collègues, aux sardines run, à la belle-famille, au musos, ma réglisse et aux ami(e)s d'ailleurs pour tous ces innombrables moments de rire, de partage et d'évasion.

A Federica, Clelia et Vincent : inconditionnellement merci pour votre soutien et votre confiance.

Pour finir, je ne remercierai jamais assez ma famille : mes sœurs, ma grand-mère et surtout mes parents pour m'avoir donné le goût de l'écologie depuis toute petite. Ces heures passées à observer la vie des plages bretonnes y sont certainement pour quelque chose. Merci de m'avoir accompagné partout sans jamais rechigner. Votre indéfectible soutien est sans aucun doute à l'origine des pages qui vont suivre. Merci de m'avoir accompagné jusqu'à la ligne d'arrivée. J'espère que vous êtes fier de moi autant que je suis fière de vous. Tout cela c'est grâce à vous.

Enfin, à toi Emil, qui est arrivé en dernier dans ma vie mais qui l'a toute chamboulée. Merci d'y avoir remis des couleurs, du bruit, du goût. Merci pour tout.

« Chaque thèse est une leçon de ténacité. Il en faut pour ne pas perdre de vue l'idée initiale, telle qu'elle a germé, pour en conserver la fraîcheur en dépit des milliers d'heures passées à en épuiser tous les aspects »

Inspiré de Bernard Minier, auteur de polar

SCIENTIFIC CONTRIBUTION DURING MY PHD THESIS

PEER-REVIEWED PUBLICATIONS

FROM THIS PHD THESIS

1. **Deldicq N.**, Seuront L., Langlet D., Bouchet V.M.P. “Assessing behavioural traits of benthic foraminifera: implications for sediment mixing” published in *Marine Ecology Progress Series* **643**: 21-31 (2020).
2. **Deldicq N.**, Langlet D., Delaeter C., Beaugrand G., Seuront L., Bouchet V.M.P. “Effects of temperature on the behaviour and metabolism of an intertidal foraminifera and consequences for benthic ecosystem functioning” published in *Scientific Reports* **11**: 4013 (2021).
3. **Deldicq N.**, Seuront L., Bouchet V.M.P. “Inter-specific and inter-individual trait variability matter in surface sediment reworking rates of intertidal foraminifera” revised in *Marine Biology*.

OTHER

4. **Deldicq N.**, Alve E., Schweizer M., Polovodova-Asteman I., Hess S., Darling K., Bouchet V.M.P. “History of the introduction of a species resembling the benthic foraminifera *Nonionella stella* in the Oslofjord (Norway): morphological, molecular and paleo-ecological evidences” published in *Aquatic Invasions* **14**(2): 182-205 (2019).
5. Bouchet V.M.P., **Deldicq N.**, Baux N., Dauvin J-C., Pezy J-P., Seuront L., Méar Y. “Benthic foraminifera to assess ecological quality statuses: the case of salmon fish farming” published in *Ecological Indicators* **117**: 106607 (2020).

ORAL COMMUNICATIONS

FROM THIS PHD THESIS

1. **Deldicq N.**, Seuront L., Langlet D., Bouchet V.M.P. “Linking life-traits and contribution to sediment reworking in intertidal benthic foraminifera” *The Micropalaeontological Society’s Joint Foraminifera and Nanofossil Meeting*. July 1-4 (2019), Fribourg, Switzerland.
2. **Deldicq N.**, Seuront L., Langlet D., Bouchet V.M.P. “Unity makes strength: high contribution of intertidal benthic foraminifera to sediment reworking” *The 17th International Meiofauna Conference*. July 7-12 (2019), Evora, Portugal.

OTHER

3. **Deldicq N.**, Alve E., Schweizer M., Polovodova-Asteman I., Hess S., Darling K., Bouchet V.M.P. “Is the foraminifera species resembling *Nonionnella stella* a non-indigenous species (NIS) in the Oslofjord (Norway)?” *FORAMS 2018, International symposium on foraminifera – Foraminifera in a changing world*. June 17-22 (2018), Edinburgh, UK.
4. **Deldicq N.**, Bouchet V.M.P., Méar Y., Baux N., Dauvin J-C. “Benthic foraminifera to assess ecological quality status in the salmon farm of the “Rade de Cherbourg” (France)” *FORAMS 2018, International symposium on foraminifera – Foraminifera in a changing world*. June 17-22 (2018), Edinburgh, UK.
5. Bouchet V.M.P., **Deldicq N.**, Seuront L. “Functional role of benthic foraminifera: experimental quantification of bioturbation processes” *FORAMS 2018, International symposium on foraminifera – Foraminifera in a changing world*. June 17-22 (2018), Edinburgh, UK.

TEACHING

During my first two years of PhD, I have taught biostatistics classes to Bachelor and Master Students from the University of Lille.

2017 – 2018

- 36h of tutorial classes: second year of bachelor
- 28h of practical work: third year of bachelor

2018 – 2019

- 36h of tutorial classes: second year of bachelor
- 20h of practical work: first year of master

In addition, I have supervised 8h of practical work for subtidal sampling with third-year bachelor students (2018 – 2019).

NOTE

In the present work, the terms *Quinqueloculina seminula* and *Quinqueloculina seminulum* refer to the same species. According to World Register of Marine Species database (WoRMS), *Q. seminulum* is the accepted species name. Please note that the name *Q. seminula* was only used in Deldicq et al. (2020) that is published in Marine Ecology Progress Series 643: 21-31.

TABLE OF CONTENTS

GENERAL INTRODUCTION

1. Benthic foraminifera	3
1.1. <i>Basic ecology of benthic foraminifera</i>	3
1.2. <i>Benthic foraminifera in intertidal areas</i>	6
1.3. <i>Benthic foraminiferal contribution to ecosystem functioning</i>	7
2. What is bioturbation?	9
3. What do we know about meiobenthos bioturbation?	15
3.1. <i>Meiofauna-mediated effects on physical and chemical properties of the sediment</i>	16
3.2. <i>Meiofauna-induced inter-specific facilitation</i>	18
4. What about bioturbation by benthic foraminifera?	19
4.1. <i>Motion behaviour of benthic foraminifera</i>	19
4.2. <i>Foraminiferal interaction with the sediment</i>	21
4.2.1. <i>Formation of cysts</i>	21
4.2.2. <i>Foraminiferal crawling and burrowing behaviour lead to the displacement of sediment</i>	23
4.3. <i>Sediment reworking by benthic foraminifera</i>	25
5. How biotic and abiotic factors may mediate bioturbation?	26
5.1. <i>Size matters in bioturbation</i>	27
5.2. <i>Bioturbation under thermal variation</i>	27
5.3. <i>Food availability can affect bioturbation</i>	29
6. Objectives of the PhD thesis	31

CHAPTER I

Summary	39
----------------------	----

ASSESSING BEHAVIOURAL TRAITS OF BENTHIC FORAMINIFERA: IMPLICATIONS FOR SEDIMENT MIXING

1. Introduction	43
------------------------------	----

2. Materials and methods	45
2.1. <i>Sediment sampling and experimental set-up</i>	45
2.2. <i>Quantification of behavioural traits</i>	47
2.3. <i>Statistical analyses</i>	49
3. Results	49
3.1. <i>Activity index (A_i)</i>	49
3.2. <i>Distance (D_i) and velocity</i>	51
3.3. <i>Tortuosity</i>	51
3.4. <i>Vertical position</i>	51
4. Discussion	53
4.1. <i>Foraminifera as biodiffusors</i>	53
4.1.1. <i>Epifaunal-biodiffusors</i>	53
4.1.2. <i>Surficial-biodiffusors</i>	54
4.1.3. <i>Gallery-biodiffusors</i>	55
4.2. <i>Features explaining intra-functional group variability</i>	56
5. Conclusion	57

INTER-SPECIFIC AND INTER-INDIVIDUAL TRAIT VARIABILITY MATTER IN SURFACE SEDIMENT REWORKING RATES OF INTERTIDAL FORAMINIFERA

1. Introduction	63
2. Materials and methods	65
2.1. <i>Studied species</i>	65
2.2. <i>Sediment sampling and experimental set-up</i>	66
2.3. <i>Quantification of behavioural traits</i>	67
2.4. <i>Quantification of surface sediment reworking rates</i>	68
2.5. <i>Data analysis</i>	71
3. Results	71
3.1. <i>Species-specific size</i>	71
3.2. <i>Travelled distance</i>	71
3.3. <i>Surface sediment reworking rate</i>	72
4. Discussion	74
4.1. <i>A methodological note on individual surface sediment reworking calculation</i>	74
4.2. <i>SSRR_i is not size-dependent but trait-dependent through interspecific differences in motion behaviour</i>	74
4.3. <i>Inter-individual variability matters in the contribution of benthic foraminifera to SSRR_i</i>	76
5. Conclusion	77

CHAPTER II

Summary.....	83
--------------	----

SIZE MATTERS IN THE MOTION-BEHAVIOUR AND THE SURFACE SEDIMENT REWORKING RATE OF THE BENTHIC FORAMINIFERA *HAYNESINA GERMANICA*

1. Introduction	85
2. Materials and Methods	86
2.1. <i>Size categories and experimental conditions</i>	86
2.2. <i>Collection and experimental set-up</i>	87
2.3. <i>Qualitative observation of the cyst building behaviour at the sediment surface</i>	87
2.4. <i>Quantification of behavioural traits</i>	87
2.5. <i>Individual surface sediment reworking rate calculation</i>	88
2.6. <i>Data analysis</i>	89
3. Results	89
3.1. <i>Cyst building behaviour</i>	89
3.2. <i>Behavioural parameters</i>	90
3.3. <i>Width of the path</i>	92
3.4. <i>Individual surface sediment reworking rate</i>	93
4. Discussion	94
4.1. <i>The motion behaviour of <i>H. germanica</i> is dependent of the experimental conditions</i>	94
4.2. <i>A methodological note on individual surface sediment reworking calculation</i>	94
4.3. <i>Test size matters in <i>H. germanica</i> motion behaviour and its contribution to surface sediment reworking</i>	95
5. Conclusion	96

BEHAVIOURAL RESPONSE OF THE INTERTIDAL FORAMINIFERA *HAYNESINA GERMANICA* TO DIFFERENT ORGANIC CARBON CONCENTRATIONS IN SEDIMENT: IMPLICATION FOR SURFACE SEDIMENT MIXING

1. Introduction	99
2. Materials and Methods	101
2.1. <i>Sediment sampling</i>	101
2.2. <i>Haynesina germanica collection</i>	101
2.3. <i>Experimental set-up</i>	102
2.4. <i>Sediment analysis</i>	103
2.5. <i>Quantification of behavioural traits</i>	103

2.6. <i>Individual surface sediment reworking rate</i>	104
2.7. <i>Statistical analyses</i>	104
3. Results	104
3.1. <i>Total organic carbon content</i>	104
3.2. <i>Activity and travelled distance</i>	105
3.3. <i>Tortuosity of the path</i>	107
3.4. <i>Individual surface sediment reworking rate</i>	108
4. Discussion	109
4.1. <i>H. germanica behavioural response to total organic carbon concentration</i>	109
4.2. <i>Implications for H. germanica contribution to sediment reworking</i>	111
5. Conclusion	112

EFFECTS OF TEMPERATURE ON THE BEHAVIOUR AND METABOLISM OF AN
INTERTIDAL FORAMINIFERA AND CONSEQUENCES FOR BENTHIC ECOSYSTEM
FUNCTIONING

1. Introduction	117
2. Materials and methods	119
2.1. <i>Collection</i>	119
2.2. <i>Motion behaviour and recovery experiments</i>	120
2.3. <i>Motion traits</i>	121
2.4. <i>Surface sediment reworking rate</i>	123
2.5. <i>Oxygen consumption and production</i>	124
2.6. <i>Respiration and photosynthesis calculations</i>	125
2.7. <i>Data analysis</i>	126
3. Results	127
3.1. <i>Motion traits</i>	127
3.2. <i>Recovery experiment</i>	130
3.3. <i>Respiration and photosynthesis</i>	131
3.4. <i>Surface sediment reworking rate and oxygen budget</i>	131
4. Discussion	133
4.1. <i>The resilience of H. germanica motion behaviour to temperature fluctuations reveals plasticity to seasonal thermal variations</i>	133
4.2. <i>Thermal control of the position of H. germanica in the sediment</i>	134
4.3. <i>Effect of temperature of H. germanica metabolism: an adaptation to variable thermal forcing</i>	135
4.4. <i>Fast behavioural and metabolic responses of H. germanica to extreme temperatures: a key for survival in an era of climate change?</i>	136

4.5. <i>Consequences of marine heatwaves on H. germanica contribution to benthic ecosystem functioning and services</i>	137
5. Conclusion	139

CHAPTER III

Summary	147
----------------------	-----

TUBE-BUILDING AND VERTICAL MOTION BEHAVIOUR OF THE BENTHIC FORAMINIFERA *HAYNESINA GERMANICA* IN INTERTIDAL MUDDY SEDIMENTS

1. Introduction	149
2. Materials and Methods	151
2.1. <i>In situ assessment of the vertical distribution of H. germanica in the sediment</i>	151
2.2. <i>Experimental assessment of the vertical motion behaviour of H. germanica</i>	151
2.2.1. <i>Experimental set-up</i>	151
2.2.2. <i>Sampling of living individuals of Haynesina germanica</i>	152
2.2.3. <i>Quantification of behavioural traits</i>	152
2.2.4. <i>Quantification of biogenic structures built by Haynesina germanica</i>	153
2.3. <i>Statistical analysis</i>	154
3. Results	154
3.1. <i>In situ vertical distribution of H. germanica in the Authie Bay</i>	154
3.2. <i>Motion behaviour of H. germanica in the sediment</i>	155
3.3. <i>Surface occupied by H. germanica galleries network</i>	157
4. Discussion	159
4.1. <i>Haynesina germanica is an infaunal species</i>	159
4.2. <i>Haynesina germanica is a tube-building species</i>	160
4.3. <i>Haynesina germanica can perform trail following</i>	161
4.4. <i>Haynesina germanica's velocity is physically constrained</i>	162
5. Conclusion	162

SEDIMENT MIXING BY THE INTERTIDAL FORAMINIFERA *HAYNESINA GERMANICA*: IMPORTANCE OF DENSITY

1. Introduction	165
2. Materials and Methods	166
2.1. <i>Sediment sampling</i>	166

2.2. <i>Haynesina germanica</i> collection and maintenance.....	167
2.3. <i>Experimental set-up</i>	167
2.4. <i>Luminophores counting</i>	168
2.5. <i>Sediment reworking coefficients</i>	169
2.6. <i>Statistical analysis</i>	171
3. Results	171
3.1. <i>Size selectivity</i>	171
3.2. <i>Effect of density</i>	172
4. Discussion	174
4.1. <i>Particle size selectivity</i>	174
4.2. <i>Vertical sediment reworking by <i>H. germanica</i></i>	175
4.3. <i>Density may control the burrowing behaviour of <i>H. germanica</i></i>	176
4.4. <i>Density matters in the contribution of <i>H. germanica</i> to particle transport</i>	176
5. Conclusion	177

GENERAL DISCUSSION

1. New insights into the ecology of intertidal foraminifera: what we learnt from the motion behaviour of dominant key species?	186
1.1. <i>Foraminiferal motion behaviour is species-specific</i>	186
1.1.1. <i>Species-specific motion behaviour is related to morphology</i>	186
1.1.2. <i>Food matters in the species-specific motion behaviour</i>	188
1.2. <i>Behavioural plasticity leads to intra-specific variability in the motion behaviour</i>	190
2. Benthic foraminifera play a (key?) role in sediment reworking in intertidal ecosystem?	191
2.1. <i>Foraminiferal bioturbation at the sediment water-interface</i>	191
2.1.1. <i>A complex interplay between functional classification and species-specific motion traits</i>	191
2.1.2. <i>Methodological note on the SSRR_i calculation</i>	193
2.1.3. <i>Foraminiferal bioturbation as a function of biotic and abiotic parameter</i>	194
2.1.4. <i>Does foraminiferal bioturbation matter in surface sediment reworking?</i>	196
2.2. <i>Foraminiferal bioturbation in the sediment column</i>	197
2.2.1. <i>New insights in the vertical distribution of benthic foraminifera in the sediment</i>	197
2.2.2. <i><i>H. germanica</i> is a gallery-biodiffusor species</i>	198
2.2.3. <i><i>H. germanica</i> induces vertical sediment reworking</i>	199

GENERAL CONCLUSION

.....205

PERSPECTIVES

-How foraminifera may affect the erodibility of muddy sediment?.....212

-How much space is occupied by benthic foraminiferal biogenic structures?.....214

-May foraminifera be involved in bioirrigation in muddy sediment?.....216

-May interspecific facilitation by benthic foraminifera favour microbial communities?

.....218

-End note.....219

REFERENCES

.....222

SUPPLEMENTARY PUBLICATIONS

.....271

Résumé.....286

Abstract.....286

LIST OF FIGURES

GENERAL INTRODUCTION

- Figure 1.** (A) Wall types of the four major groups of foraminifera (B) Basic patterns of chamber arrangements in foraminifera. After Culver (1993), modified from Scott et al. (2001).....3
- Figure 2.** (A) Scanning electron micrograph of two *Cibicides wuellerstorfi* colonizing the posterior extremity of the pantopod *Achelia echinata* (scaled bar = 400 μ m) (B) Ventral side of the pantopod *Achelia echinata*. The extremities are densely colonized by *Cibicides wuellerstorfi* that are covered by resuspended materials (scaled bar = 3 mm). From Linke & Lutze (1993).....5
- Figure 3.** Schema showing the main foraminiferal drivers in four natural intertidal areas of the Eastern English Channel. From Francescangeli (2017).....6
- Figure 4.** Food-web structure in deep-sea environments (Sagami Bay; Japan) suggested by carbon and nitrogen isotopic compositions. From Nomaki et al. (2008)...8
- Figure 5.** The four major types of particle reworking conducted by benthic fauna in aquatic environments illustrating with representative species (A) at left: *Hediste diversicolor* (polychaete) and right: spatangoid urchin, (B) fiddler crab (C) *Cirriformia grandis* (polychaete) and (D) *Arenicola marina* (lugworm). Orange arrows correspond to the random redistribution of sediment particles in both direction and around the organism microhabitat. Yellow and blue arrows denote the downward and upward transport of particles within the sediment respectively. Direct and indirect sediment reworking induced by fauna activity are indicated with complete and dotted arrow respectively.....11
- Figure 6.** The three major modes of bioirrigation pattern. (A) Open-ended burrow, (B) blind-ended burrow in cohesive sediment and (C) blind-ended burrow in non-cohesive sediment. Orange arrows correspond to advective transport of water from ventilation activity while dotted black arrows correspond to consecutive diffusion between wall of the burrow and water. From Kristensen et al. (2012).....13
- Figure 7.** Visual evidence of meiofaunal microbioturbation under (A) low density and (B) high density conditions. Scaled bar = 500 μ m. From Bonaglia et al. (2014).....16
- Figure 8.** Meiofaunal-mediated effect of sediment properties and microbial community. Plus and minus symbols respectively refer to the destabilising and stabilising effects of meiofaunal locomotion and grazing activities on the sediment properties and microbial community. Green line within the burrow correspond to the production of mucus by organism to bound sediment particles together17

Figure 9. (A) *Pseudorotalia gaimardii* moving toward left through sediment. Pseudopodia extend from both primary aperture and supplementary apertures toward direction of movement. Conical cavity formed in front of test. (B) Pseudopodial network on glass surface of petri dish of *Quinqueloculina lamarckiana* d'Orbigny. From Kitazato (1988). (C) Rotating movement of *Ammonia* species digging into the uppermost sediment surface layer of tidal flats. From Langer et al. (1989).....20

Figure 10. Illustration of the variability in the travelled distance (A) and instantaneous velocity (B-D) of three individuals of *Ammonia tepida*. Experiment were conducted in circular experimental arenas 7.5 cm in diameter under homogenous light and temperature conditions. From Seuront & Bouchet (2015).21

Figure 11. (A) Unilocular agglutinated species on the glass wall and (B) isolated. (C) Unidentified species, building a cyst-like structure with reticulopodia on the glass of the aquarium. (D) Cyst of *Cibicidoides* sp. On the glass surface of the aquarium. (E) Cyst of *Melonis barleeaanum* on the glass of the aquarium. (F) Cyst (left) and free species (right) of *Ammonia beccarii* in a Petri dish. From Heinz et al. (2005).....22

Figure 12. (A) *Elphidium incertum* gathering mineral and detritic materials by pseudopodial activity to build an agglutinated cyst. From Linke & Lutze (1993). (B) Locomotion of *Quinqueloculina lamarckiana* at the sediment surface. From Gross (2002). (C) *Pyrgo rotalaria* lying on the sediment surface. From Linke & Lutze (1993). (D) Effects on sediments from movement in the laboratory by *Laticarinina pauperata*. From Weinberg (1991). (E) Surface trails formed by *Quinqueloculina impressa* on a silty-clay surface. Fom Severin et al. (1982). (F) Living burrows formed by *Q. impressa* in the top centimetre of sediment. From Severin et al. (1982). (G) *Rupertina stabilis* at its wall (white arrows), extending their pseudopodia into the respiratory current of the megafauna inhabitant. From Linke & Lutze (1993). (H) *Fontbotia wuellerstorfi* living in a chamber-building cyst. From Gross (2002). (I) Bioturbation of *Bathysiphon* sp. in the sediment leaving a distinct type of burrow behind the individual. From Gross (2002)23

Figure 13. Schematic influence of foraminiferal migration on the sediment regime. Bioirrigation (porewater flow) and bioturbation (particle transport) are enhanced by passive and active reworking of foraminiferal pseudopodia and by the traces. Vertical section. From Gross (2002)24

Figure 14. Minimum and maximum population-level surface sediment reworking rate $SSRR_p$ ($\text{cm}^2 \text{m}^{-2} \text{d}^{-1}$) of the two studied foraminiferal species, *Quinqueloculina seminula* and *Ammonia tepida*. From Bouchet & Seuront (2020)25

Figure 15. Effect of the burrowing of *Capitella* sp. on oxygen gradient across three temperature treatments: (A) $15.4 \pm 0.3^\circ\text{C}$, (B) $21 \pm 0.3^\circ\text{C}$ and (C) $31.5^\circ\text{C} \pm 0.1^\circ\text{C}$. Note that worms died in the hottest treatment and no burrows were formed. Top panels

represent raw pictures taken in visible light while bottom panels represent O₂ planar optode pseudocolor images (O₂ scale key at lower right: % saturation at experiment temperature). From Przeswalski et al. (2009).....28

Figure 16. Increasing burrowing activity of the polychaete *Nephtys incisa* exposed to (N) natural, (A) intermediate and (R) high food concentrations. From Michaud et al. (2010).....30

Figure 17. SEM images of the dorsal side of the five intertidal species studied in this PhD work (a) *Miliammina fusca*, (b) *Quinqueloculina seminulum*, (c) *Ammonia tepida*, (d) *Criboelphidium williamsoni* and (e) *Haynesina germanica*. Scaled bar = 100 µm33

Figure 18. Conceptual schema illustrating the step-by-step methods used from the description of foraminiferal behavioural traits to the evaluation of their contribution to sediment reworking35

CHAPTER I

Figure 19. Experimental set-up for time-lapse assessment of foraminiferal motion-traits (left-hand side) and examples of the movement paths of 2 foraminifera over a 24 h period (right-hand side)46

Figure 20. (A–C) Schematic representations and (D–F) images of the 3 vertical positions assumed by a foraminifer: surface (A,D), sediment–water interface (B,E); burrowed (C,F). Examples from *Haynesina germanica* (D,E) and *Quinqueloculina seminula* (F). Scale bars = 0.2 mm48

Figure 21. Calculated parameters for the investigated foraminifera species: (A) activity index, (B) distance travelled (over 24 h), (C) velocity, (D) tortuosity. Letters above plots (‘a’, ‘b’, ‘c’) indicate significant differences among measurements (Mann-Whitney test, $p < 0.05$). The box represents the first, second and third quartiles and the whiskers extend to 1.5 times the interquartile range; values outside this range are represented by open circles.....50

Figure 22. Temporal evolution of the vertical position of each studied foraminifera species52

Figure 23. Conceptual schema summarizing the difference between studied species and their classification into functional groups, with *Q. seminula* and *M. fusca* in the gallery-biodiffusor group, *A. tepida* and *H. germanica* in the surficial-biodiffusor group and *C. williamsoni* in the epifaunal-biodiffusor group.....55

Figure 24. SEM images of the dorsal side of the five studied foraminifera (a) *Miliammina fusca*, (b) *Quinqueloculina seminulum*, (c) *Ammonia tepida*, (d) *Criboelphidium williamsoni* and (e) *Haynesina germanica*. Scale bar = 100 μm65

Figure 25. Experimental set-up for time-lapse assessment of foraminiferal motion-traits (left-hand side) and examples of the movement paths of 2 foraminifera over a 24-h period (right-hand side)67

Figure 26. Illustration of the cross section of (A) polychaete and (B) benthic foraminifera that may be used for sediment reworking calculation69

Figure 27. Discrimination between the vertical positions taken by benthic foraminifera in the sediment to estimate $SSRR_{it}$. Images were taken from experiments containing living individuals of *H. germanica*70

Figure 28. Value of the travelled distance (mm) for each experiment performed on the five tested species. The box represents the first, second and third quartiles and the whiskers extend to 1.5 times the interquartile range; Individual values are represented by black dots. n denotes the number of individuals used in the experiments. Letters on top ('a', 'b' and 'c') identify significantly different groups (Dunn test, $p < 0.05$) between species72

Figure 29. Value of the $SSRR_i$ for each experiment performed on the five tested species. The box represents the first, second and third quartiles and the whiskers extend to 1.5 times the interquartile range; Individual values are represented by black dots. n denotes the number of individuals used in the experiments. Letters on top ('a', 'b' and 'c') identify significantly different groups (Dunn test, $p < 0.05$) between species73

CHAPTER II

Figure 30. Images of the cyst building behaviour over 0, 10, 20 and 45 min observation of 5 individuals under binocular microscope. Scaled bar = 0.5 mm. The difference between the individual test length and the width of its path is shown with the white arrows at t_0 and t_{45} min respectively89

Figure 31. The influence of body size on the activity of *H. germanica* for experiments performed both with water sediment (C_1 condition) and thawed sediment (C_2 condition). The box represents the first, second and third quartiles and the whiskers extend to 1.5 times the interquartile range. Significant different groups (Dunn test, $p < 0.05$) are indicated above the boxes90

Figure 32. The influence of body size on the travelled distance over 24h of *H. germanica* for experiments performed both with water (C_1 condition) and thawed sediment (C_2 condition).. The box represents the first, second and third quartiles and

the whiskers extend to 1.5 times the interquartile range. Significant different groups (Dunn test, $p < 0.05$) are indicated above the boxes.....91

Figure 33. The influence of body size on the tortuosity of *H. germanica* for experiments performed both with water (C_1 condition) and thawed sediment (C_2 condition). The box represents the first, second and third quartiles and the whiskers extend to 1.5 times the interquartile range. Significant different groups (Dunn test, $p < 0.05$) are indicated above the boxes.....92

Figure 34. (A)The width of the path as a function of size category for experiments performed with thawed sediment (C_2 condition). The box represents the first, second and third quartiles and the whiskers extend to 1.5 times the interquartile range. Significant different groups (Dunn test, $p < 0.05$) are indicated above the boxes. (B) Illustration of individual path in the two size ranges. Scale bar = 0.5 mm93

Figure 35. The influence of body size on the $SSRR_i$ ($\text{mm}^3 \text{ indiv}^{-1} \text{ day}^{-1}$) of *H. germanica* for experiments performed with thawed sediment (C_2 condition). The box represents the first, second and third quartiles and the whiskers extend to 1.5 times the interquartile range. Significant different groups (Dunn test, $p < 0.05$) are indicated above the boxes93

Figure 36. Two-dimensional representation of extensive (black line) and intensive (grey line) foraging trajectory. The extensive and intensive trajectories are respectively a Lévy flight and a Brownian random walk. Inspired from (Seuront & Cribb 2017)100

Figure 37. Experimental set-up for time-lapse assessment of foraminiferal motion-traits under different organic matter concentrations103

Figure 38. The relationship between the percentage of dried sediment and the Total Organic Carbon (TOC) content (%). The box represents the first, second and third quartiles and the whiskers extend to 1.5 times the interquartile range. Individual's values are represented by black dots. Letters on top ('a', 'b' 'c' and 'd') identify significant different groups (Dunn test, $p < 0.05$) between experimental conditions.....105

Figure 39. The relationship between the percentage of dried sediment and the activity index. The box represents the first, second and third quartiles and the whiskers extend to 1.5 times the interquartile range. Individual's values are represented by black dots. Letters on top ('a', 'b' 'c') identify significant different groups (Dunn test, $p < 0.05$) between experimental conditions.106

Figure 40. The relationship between the percentage of dried sediment and the travelled distance. The box represents the first, second and third quartiles and the whiskers extend to 1.5 times the interquartile range. Individual's values are represented by black

dots. Letters on top ('a', 'b' 'c') identify significant different groups (Tukey test, $p < 0.05$) between experimental conditions106

Figure 41. Illustration of the typical trajectories of individuals of *H. germanica* exposed to increasing TOC contents (from 0 to 100% dried sediment (DS) content)107

Figure 42. Tortuosity of *H. germanica* under different proportion of dried sediment. The box represents the first, second and third quartiles and the whiskers extend to 1.5 times the interquartile range; values outside this range are represented by open circles. Individual's values are represented by black dots. Letters on top ('a', 'b' 'c') identify significant different groups (Tukey test, $p < 0.05$) between experimental conditions108

Figure 43. Individual surface sediment reworking ($SSRR_i$, $\text{mm}^3 \text{ indiv}^{-1} \text{ d}^{-1}$) of *H. germanica* under different proportion of dried sediment. The box represents the first, second and third quartiles and the whiskers extend to 1.5 times the interquartile range; values outside this range are represented by open circles. Individual's values are represented by black dots. Letters on top ('a', 'b' 'c') identify significant different groups (Tukey test, $p < 0.05$) between experimental conditions109

Figure 44. Schematic side-view representation of the vertical position (A, B and C) and top-view images of the sediment surface showing actual trajectories of foraminifera (D, E and F) related to the three vertical position categories, which can be taken by a foraminifera, i.e. surface (A and D) sediment-water interface, (B and E), and burrowed (C and F). Scale bars = 0.2 mm. From Deldicq et al. (2020).....123

Figure 45. The influence of temperature on (A) the activity (B) the distance travelled (over 24h), (C) the velocity and (D) the fractal dimension of *H. germanica*. The box represents the first, second and third quartiles and the whiskers extend to 1.5 times the interquartile range; values outside this range are represented by open circles. Number of replicates are 30, 23, 30, 25, 15, 69, 28 and 26 for 6, 12, 18, 24, 30, 32, 34 and 36°C respectively. Due to the absence of motion it was impossible to estimate fractal dimension at 32, 34 and 36°C. Letters above the boxes ('a', 'b', 'c' and 'd') identify significant different groups (Dunn test, $p < 0.05$)127

Figure 46. Temporal changes in the vertical position of *H. germanica* for each tested temperature. Number of individuals are shown in Supplementary Table 2129

Figure 47. Temporal changes in the mean velocity of 9 *H. germanica* individuals previously exposed at (A) 6°C then 18°C and (B) 36°C then 18°C. The grey line is the instantaneous velocity and the red line is the 3-order simple moving average of the velocity. Yellow triangles correspond to water-temperature changes through time130

Figure 48. Mean values of (A) respiration and (B) gross photosynthesis ($\text{pmol.O}_2 \text{ indiv}^{-1} \text{ h}^{-1}$) of *H. germanica* under different thermal regime in 3 replicate measurements. The error bars are the standard errors of the mean. Letters ‘a’ and ‘b’ identify significant different groups (Tukey test, $p < 0.05$)131

Figure 49. Individual surface sediment reworking ($\text{mm}^3 \text{ indiv}^{-1} \text{ d}^{-1}$) of *H. germanica* under different thermal regime. Letters above plots (‘a’, ‘b’, ‘c’) indicate significant differences among measurements (Dunn test, $p < 0.05$). The box represents the first, second and third quartiles and the whiskers extend to 1.5 times the interquartile range; values outside this range are represented by open circles132

Figure 50. Daily oxygen budget of *H. germanica* ($\text{pmolO}_2 \text{ indiv}^{-1} \text{ d}^{-1}$) under 12h (black dots) and 6h (grey squares) light exposure and thermal regimes. The error bars are the standard errors calculated on the 3 replicates at each temperature.....133

CHAPTER III

Figure 51. Experimental set-up for time-lapse assessment of foraminiferal motion-traits over a 72 h period152

Figure 52. Methodology used to estimate both burrow occupation level and maximum depth (black arrow) in the experimental set-up using the (A) raw picture and (B-C) ImageJ Analysis tool. Scaled bar = 2 mm154

Figure 53. Mean densities (with standard deviation) of *H. germanica* for 50 cm^3 for each layers155

Figure 54. Illustration of the typical trajectories of 4 specimens of *H. germanica*. Dot at one-end of each trajectory correspond to the starting point of each individual. Scaled bar = 1mm.....156

Figure 55. Temporal change in the instantaneous velocity of an individual of *H. germanica*. The black line corresponds to a situation when the individual is burrowed in the sediment without trail following behaviour while the grey line corresponds to a situation when the individual is at the sediment surface with a trail following behaviour. The red-line is the 3-order simple moving average of the velocity157

Figure 56. Archetypical structuration of the gallery network consecutive of the displacement of *H. germanica* in the sediment after 24, 48 and 72h of the experiment R2. Scaled bar = 1cm.....158

Figure 57. Temporal changes in the surface occupied by the gallery network (S_G in %) for the three experiments: R₁ (grey square). R₂ (grey triangle), R₃ (black diamonds)158

Figure 58. Experimental set-up to assess the vertical distribution of particle-tracers as a function of *H. germanica* displacements within the sediment column.....167

Figure 59. Typical examples of (A) raw and (B) binary pictures used for the count of luminophores particles.....169

Figure 60. Depth profiles (means \pm SD) of luminophores (black diamonds) in the four treatments and calculated profiles obtained with the advection–diffusion–nonlocal model (grey circles). Treatments: Control, LD (30 indiv cm⁻²), MD (60 indiv cm⁻²), HD (90 indiv cm⁻²).....172

Figure 61. Biodiffusion (A) and nonlocal transport (B) per individual as a function of *H. germanica* density. Values for each replicate are presented with dark circles and mean value for the three replicates with grey diamonds174

GENERAL DISCUSSION

Figure 62. Conceptual schema summarising the main findings of my PhD thesis and links between the three chapters dealing with the role of intertidal benthic foraminifera in sediment reworking processes. Plus and minus symbols refer to either positive or negative effect of abiotic/abiotic parameters on the sediment reworking rate of intertidal foraminifera..... 185

Figure 63. (A) Archetypical illustration of the vertically-orientation mechanism of *H. germanica* before its displacement in the sediment. (B) Visual observation of the positioning mode adopted by *H. germanica* for moving in the sediment. Scaled bar = 200 μ m.....187

Figure 64. Visual observation of the width of the path that is greatly larger than the individual during the displacement of *Q. seminulum*. The position of the individual in both images is indicated by blue circles. Scaled bar = 0.5 mm.....193

Figure 65. Principle of the microtopography mapping method. Successive microtopography mapping can be assessed (A) using a laser telemeter mounted on 2 crossed-step motor tables allowing for 2-dimensional displacements above the sediment surface or (B) through the projection of a laser line onto the sediment surface. A glass plate places at the air-water interface ensures well-defined and constant refraction. An image of the projected laser line is recorded by a digital camera. The position of the laser line in the image is then determined allowing for estimations of sediment surface elevations. From Maire et al. (2008)194

Figure 66. Illustration of the typical seasonal trend of the three parameters studied in this work that could mediate the *SSRR_i* of intertidal benthic foraminifera (A) variability in the Total Organic Carbon (TOC) content between the four seasons in the harbour of Boulogne-sur-Mer (Francescangeli 2017), (B) Thermal variation usually encountered

in the field over a year in the Western coast of France (Harrison & Phizacklea 1987; Guarini et al. 1997), (C) Community size-structure of *H. germanica* along the English coastlines (Murray 1983).....195

Figure 67. Surface sediment reworking at the population-level $SSRR_p$ ($\text{cm}^3 \text{m}^{-2} \text{d}^{-1}$) of two macrofaunal species (in black) and the five studied foraminiferal species (in grey) in respect with their functional classification. *Echinocardium* spp. from Lohrer et al. (2005), *A. virens* from Ouellette et al. (2004).....197

GENERAL CONCLUSION

Figure 68. (A) Depth profiles (means \pm SD) of luminophores in the three temperature treatments. Note that the control profile is superimpose on those obtained for 6°C (Lagos, Serra, Hache, *com. pers.*) (B) Temporal evolution of the vertical position of *H. germanica* in the sediment. From Deldicq et al. (2021)201

PERSPECTIVES

Figure 69. Potential consequences of the activity of foraminifera on particle displacement and consecutive fluxes of solutes. Orange text correspond to the experimental insights that may be applied on foraminifera to understand their bioturbation effect on benthic ecosystem functioning.....211

Figure 70. Surface sediment structure (A) before and (B) after 24h of *H. germanica* displacement. Scaled bar = 50 mm212

Figure 71. Schematic representation of the benthic flume that may be used with foraminifera. Inspired from Orvain et al. (2003).....213

Figure 72. 3D images of the biogenic structures obtained by axial tomography (left) and corresponding vertical distribution of macrofaunal species (right). From Bouchet et al. (2009).....214

Figure 73. *Abra ovata*. Presentation of the three main types of luminophores vertical profiles: upper panes are original images; lower panels are the corresponding vertical profiles. From Maire et al. (2006)215

Figure 74. Experimental set-up to assess the effect of foraminifera on porewater exchange using continuous record of tracer concentration in the water column.....217

Figure 75. (A) Oxygen penetration depths (OPDs) and (B) depth of sulfide horizons measured with microsensors in the four treatments. Different letters on top of each bar indicate significant differences among density treatments. Bars represent average values \pm SD (n=9 replicates). From Bonaglia et al. (2020)..... 218

Figure 76. Cumulative amount of mineralized ^{14}C in the three treatments. HM= High Meiofauna; LM = Low Meiofauna; Mac = treatment with *Macoma balthica* (bivalve) and high meiofauna; N = unmanipulated treatment. Values are means \pm SE (n=7). From Nascimento et al. (2012).....219

LIST OF TABLES

Table 1. Number (N) of individuals of each species used for experiments and the subsequent number (n) of individuals for which (x,y) coordinates were extracted, with mean and SD for each parameter	49
Table 2. Number (n) of individuals and surface area (mm ²) measured for each species with minimal, mean \pm SD and maximal values	71
Table 3. Summary of the experiments performed on <i>H. germanica</i> on four size categories in different experimental conditions. N= number of individuals studied in each experiment, n= number of analysed individuals	88
Table 4. Number of experiments (N _{exp}) performed for each condition with the number of individuals (N) of <i>H. germanica</i> and the subsequent number (n) of individuals for which (x,y) coordinates were extracted	102
Table 5. Minimal, maximal and mean values \pm SD of behavioural parameters	156
Table 6. Analyses of the effect of surface position and trail following on individual instantaneous velocity.....	157
Table 7. Mixing rates of sediment estimated in the four treatments. Advective, diffusive and nonlocal transport coefficients are presented as means (SD) (N=3 for each treatment). Z _{min} and Z _{max} are the respective upper and lower limits of the sediment layer influenced by nonlocal transport	173
Table 8. Effect of each density treatment on coefficient of sediment reworking (comparison with the control treatment) and maximum penetration depth (Z _{max}). Bonferroni-Dunn test with N=3 for each treatments. 0: no significant difference; +: significant increase	173

LIST OF SUPPLEMENTARY MATERIALS

FIGURES

- Suppl. Fig. 1.** Linear regression between tortuosity and TOC content. Equations, coefficient and p-values are indicated on top. Black points correspond to individual value for each experiment. Shaded error bands showed 95% confidence interval ...113
- Suppl. Fig. 2.** Temperatures in the incubator for each temperature tested in this study (6, 12, 18, 24, 30, 32, 34 and 36°) recorded with a temperature logger every 10 min (black curves; DSL1922L iButtons, resolution 0.1°C). Red dots corresponds to the temperature displayed by the incubator' screen every hour. Yellow line corresponds to the change of light regime from light to dark condition141
- Suppl. Fig. 3.** Experimental set-up for time-lapse assessment of foraminiferal life trait141
- Suppl. Fig. 4.** Depth profiles (means \pm SD) of green (green circles) and pink (pink triangles) luminophores size fractions in the four treatments. Treatments: Control (n=0), LA (n=30), MA (n=60), HA (n=90)179

TABLES

- Suppl. Table 1.** Values of Total Inorganic and Organic Carbon in relation with percentage of dried sediment used for each condition. Values are presented with Mean \pm SD113
- Suppl. Table 2.** Date of experiment and number of individuals of *Haynesina germanica* used for different thermal regimes. N=used individuals, n=analysed individuals142
- Suppl. Table 3.** Respiration, rate, net and gross photosynthesis values of *Haynesina germanica* under different thermal regimes. N= used individuals. n= number of replicates. \bar{X} denotes the mean and SE the standard error.....142

GENERAL INTRODUCTION

Coastal zones are highly complex socio-ecological systems at the interface between terrestrial and marine environments (Turner & Schaafsma 2015). They are naturally enriched in organic matter (Pusceddu et al. 2003), characterised by strong environmental gradients and high variability in physico-chemical parameters (e.g. salinity, temperature, grain-size, oxygen) and are under the influence of marine and freshwater inputs (Elliott & Quintino 2007, Elliott & Whitfield 2011). Coastal zones exhibit a mosaic of environments e.g. beaches, estuaries, lagoon, salt marshes that provide important ecological and economical services (Meire et al. 2005, Garten 2016). They provide a protection to storm and flooding, contribute to shoreline stabilisation, and offer habitats for various taxonomic groups e.g. plant, crustacean, fish, bird and mammal (Parry et al. 2007, Rönnbäck et al. 2007, Henseler et al. 2019). Coastal environments are among the most productive systems in the world as they support many ecosystem services such as biogeochemical cycle (i.e. carbon and nitrogen cycling), movement of nutrients, primary and biological production (Daily et al. 1997, Beaumont et al. 2007, Banerjee et al. 2013, Russi et al. 2013, Cohen-Shacham et al. 2014, Hattam et al. 2014, Boerema & Meire 2017). Noticeably, intertidal areas provide habitat and food resources for migratory birds (Degré et al. 2006) and nursery habitats for larval and juvenile fish of high commercial value (e.g. eel, flatfish; Beck et al. 2001, Couturier et al. 2007). Furthermore, they represent an important location for human settlements as they provide significant food resources for human population (Costanza et al. 1993, 1997, Parry et al. 2007).

Nearly 40% of humans live within 100 kilometres of the coast with 71% of this population within 50 kilometres of estuaries (Millennium Ecosystem Assessment 2005). As a consequence, coastal areas and in particular wetlands and mangroves, have been drastically modified by humans that exploit them for aquaculture i.e. fish/shrimp farming, recreational, agricultural and industrial activities (Jackson et al. 2001, Harley et al. 2006). This irremediably leads to an increase in nutrient and pollutant concentrations in the marine environment, which alters ecosystem balance and has dramatic impacts on biological productivity and species diversity and abundance (Dolbeth et al. 2014, Peng et al. 2016, Wernberg et al. 2016, Johansen et al. 2018).

Moreover, in an era of rapid climate change and growing human footprint, coastal zones such as intertidal areas and their services are threatened by sea-level rise, increasing erosion, extreme weather/climatic events, as for instance marine heatwaves or precipitation events (Hov et al. 2013), and overfishing (Coll et al. 2008, Boerema & Meire 2017). All these anthropogenic pressures are thereby superimposed onto the high natural variability that already exerts a strong pressure on intertidal and transitional ecosystems and their functioning (Underwood & Kromkamp 1999, Liqueste et al. 2013, Maes et al. 2016).

In order to protect and sometimes restore these environments, a comprehensive assessment of the mechanisms (e.g. organic matter mineralisation and nutrient cycle) that drive ecosystem functions is essential (Levin et al. 2001, Covich et al. 2004, Solan et al. 2004). These mechanisms are mainly driven by biotic compartments i.e. macrofauna, meiofaunal and microbial communities (Karlson et al. 2005, 2007, Snelgrove et al. 2014, 2018). However, among studies that have explicitly assess the role of species on ecosystem processes, relatively few have dealt with those that are hardly visible to the naked eyes, i.e. meiofauna (Schratzberger & Ingels 2018). This group of small-sized protozoans and metazoans species (i.e. between 63 μm and 1 mm in size) are however abundantly distributed in numerous marine and freshwater environments. Moreover, recent studies suggested that the meiobenthos may play a key role in the functioning of benthic ecosystems through their biological activity i.e. bioturbation and grazing (Giere 2009, Nascimento et al. 2012, Piot et al. 2013, Bonaglia et al. 2014, 2020, Schratzberger & Ingels 2018 and references therein, Bouchet & Seuront 2020). While there is an increasing knowledge on two dominant groups, copepods and nematodes, the functional role of other meiofaunal compartments, such as benthic foraminifera, is still largely overlooked. The aim of this PhD is to improve our understanding on the role of benthic foraminifera in the functioning of intertidal areas; specifically, their contribution to fluxes at the sediment-water interface.

1. Benthic foraminifera

1.1. Basic ecology of benthic foraminifera

Foraminifera are marine protozoans (unicellular eukaryotes), belonging to the super-group of SAR (Stramenopiles, Alveolata and Rhizaria), phylum Retaria (Cavalier-Smith & Chao 2003), sub-phylum Foraminifera (d'Orbigny 1826). Their size typically ranges within the micrometre scale but some species can be larger than 10 cm in length (Tendal & Gooday 1981, Hottinger 1982, Hallock 1985, Gooday et al. 2018). They are classified as amoeboid organisms as they have the ability to deform their cell by extending or retracting granular and reticulose pseudopodia (Jepps 1942). This pseudopodial network allows foraminifera to feed, move, build and structure their shell (Jepps 1942, Kitazato 1988, Linke & Lutze 1993). Furthermore, foraminifera are characterized by an external shell (generally called “test”) that is thought to reduce biological, physical and chemical stress they may experience in their environment (Armstrong & Brasier 2005).

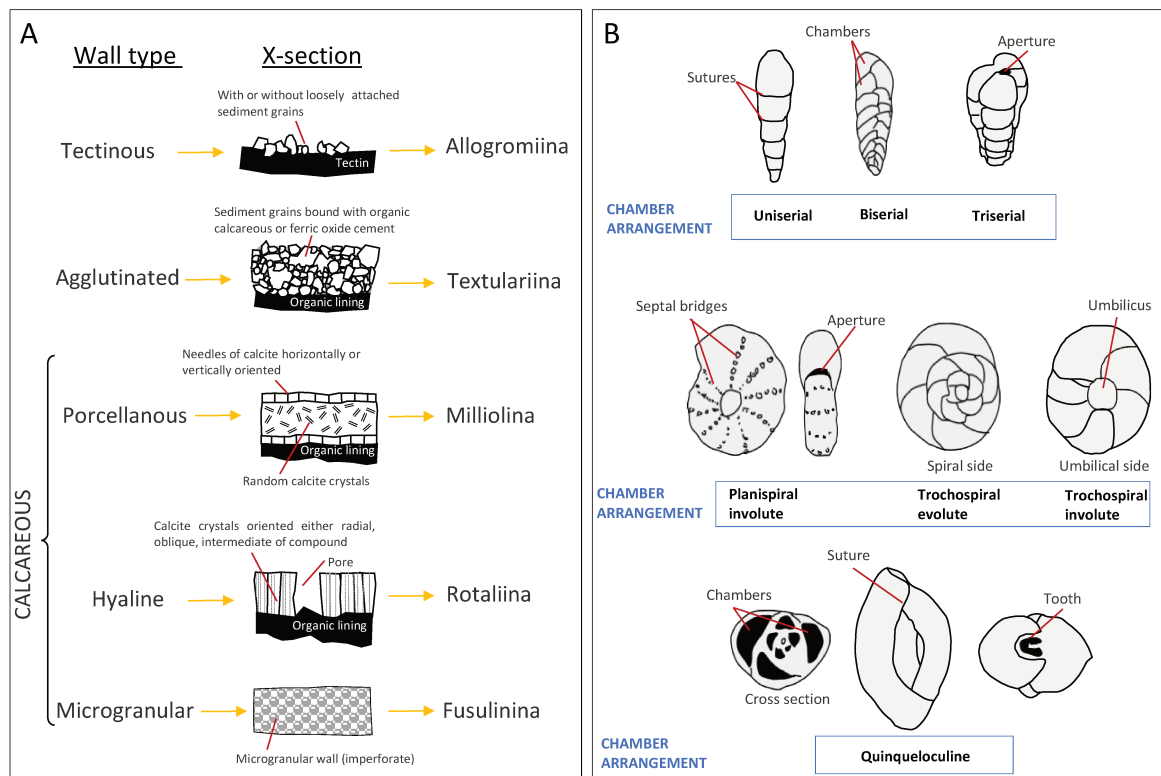

Figure 1. (A) Wall types of the four major groups of foraminifera (B) Basic patterns of chamber arrangements in foraminifera. After Culver (1993), modified from Scott et al. (2001).

There is a large number of test morphologies which vary in the type of wall structure and composition, growth, chamber arrangement and shape, aperture and ornamentation (Fig. 1; Culver 1993, Scott et al. 2001). As a consequence, morphological-taxonomy criteria depend on the structure of their test within three main groups: soft-shell organic, hard shell-calcareous (sub-divided in hyaline and porcelaneous) and agglutinated species (Fig. 1).

More than 10,000 recent living hard-shelled species have been described but the real number is expected to be closer than 15,000 (Adl et al. 2007). Foraminiferal tests are the second most abundant component (after coccoliths) of the calcareous marine sediment which may represent half of the ocean floor (Kennett 1982). In addition, tests are well preserved in sediments making foraminifera among the most widely studied organisms in ocean paleo-sciences (Sen Gupta 1999). Therefore, they are essential in bio-stratigraphic and paleo-environmental research (Gustafsson & Nordberg 2002, Filipsson 2008, Mendes et al. 2012, Francescangeli et al. 2016) and have been longer studied through their fossil form rather than their living form. Nevertheless, considerable efforts have been made in the last decades to fill the lack of knowledge on their ecology.

Foraminifera are found in a large range of marine environments in high abundance and diversity (Murray 2006). Their biomass ranges from 55% (Arctic ecosystems) to 90% (deep-sea ecosystems), making them one of the most diverse, ubiquitous and abundant meiobenthic group of organisms in marine environments (Culver 1993, Sen Gupta 1999, Murray 2006). Furthermore, benthic foraminifera colonise various microhabitats depending on their ecological requirements. Noticeably, some species prefer elevated position above the sediment surface i.e. epifaunal, attached to stones, shells, sponges, macrofaunal tubes, plants and even motile macrofauna (Fig. 2; Linke & Lutze 1993 and references therein). Other species are found both lying on the sediment surface while some are infaunal and stay at a particular sediment depth or within macrofaunal burrows (Linke & Lutze 1993). Their vertical position is intrinsically linked to the availability of food and to the oxygenation dynamic of the

sediment (Linke & Lutze 1993, Jorissen et al. 1995, Fontanier et al. 2002, Geslin et al. 2004).

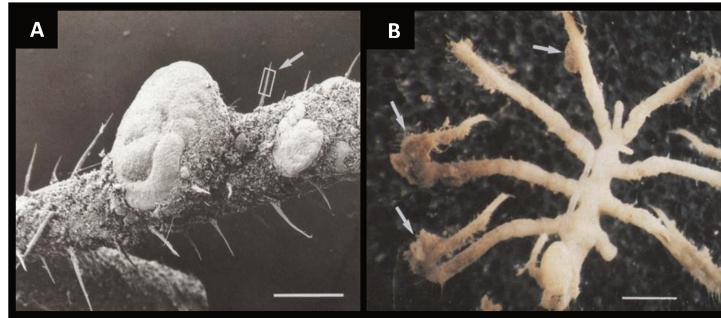

Figure 2. (A) Scanning electron micrograph of two *Cibicides wuellerstorfi* colonizing the posterior extremity of the pantopod *Achelia echinata* (scaled bar = 400 μ m) (B) Ventral side of the pantopod *Achelia echinata*. The extremities are densely colonized by *Cibicides wuellerstorfi* that are covered by resuspended materials (scaled bar = 3 mm). From Linke & Lutze (1993).

In terms of diet, numerous species may display an opportunistic behaviour switching from herbivorous to carnivorous (Pascal et al. 2008, Dupuy et al. 2010). Hence, most species are considered to be omnivorous, feeding on bacteria, organic detritus, microalgae but also on nematode or invertebrate larvae (Langer & Gehring 1993, Ward et al. 2003, Armstrong & Brasier 2005, Jauffrais et al. 2016b, Wukovits et al. 2018, Chronopoulou et al. 2019).

Such plasticity in their feeding behaviour superimposes onto the large morphological, physiological and behavioural adaptations that foraminifera may display. Under oxygen-depleted conditions, they can store nitrates and used them to perform anaerobic respiration (Risgaard-Petersen et al. 2006, Piña-Ochoa et al. 2010, Choquel et al. 2021). They also exhibit morphological adaptations such as larger pore diameter to increase the gas exchanges between the shell and the surrounding environment (Glock et al. 2013, Petersen et al. 2016, Richirt et al. 2019). In food-depleted environments, benthic foraminifera can also sequester chloroplasts from diatoms (Lopez 1979, Pillet et al. 2011, Jauffrais et al. 2016a) and used them to feed or benefit from their photosynthetic activity as chloroplasts remain functional inside the foraminiferal protoplasm, a phenomenon called kleptoplasty (Lopez 1979, Bernhard & Bowser 1999, Austin et al. 2005, Pillet et al. 2011, Jauffrais et al. 2016a, Le Kieffre et al. 2018, Bird et al. 2020). Some species are also observed to host symbionts such as

bacteria or algae (Hallock 1985, Hohenegger 2006, Bernhard et al. 2010, 2018). Finally, under extreme condition, foraminifera can (i) enter into dormancy (diapause or quiescence), stopping their active life or (ii) reduce their metabolic activities, with the ability to recover after disturbances (Alve & Goldstein 2003, 2010, Guidetti et al. 2011, Lennon & Jones 2011, see Ross & Hallock 2016 for a review).

As a consequence, benthic foraminifera are largely distributed in high diversity and abundance in marine ecosystems including extreme environments such as intertidal areas, oxygen minimum zone or severely contaminated sediments (Alve 1995, Debenay et al. 2006, Langlet et al. 2013, Armynot du Châtelet et al. 2018).

1.2. Benthic foraminifera in intertidal areas

Intertidal ecosystems are characterized by high spatial and temporal variability due to the tidal regime. The coast of the Eastern English Channel is a tide-dominated system where tidal range can exceed 10 m during highest astronomical tides (McLusky & Elliott 2004). As a consequence, there is a spatial segregation of intertidal areas with successive belts from the tidal channel to the terrestrial environment (Fig. 3). Typical zone that is daily flooded by water is an unvegetated wetland area (generally called “tidal flat”) covered by fine sand and/or silt sediment (Ashley 1990, Tessier et al. 2010). In contrast, salt marshes i.e. the upper part of the shore that are only flooded during highest tide events, are colonised by successive communities of halophytic plants (Fig. 3).

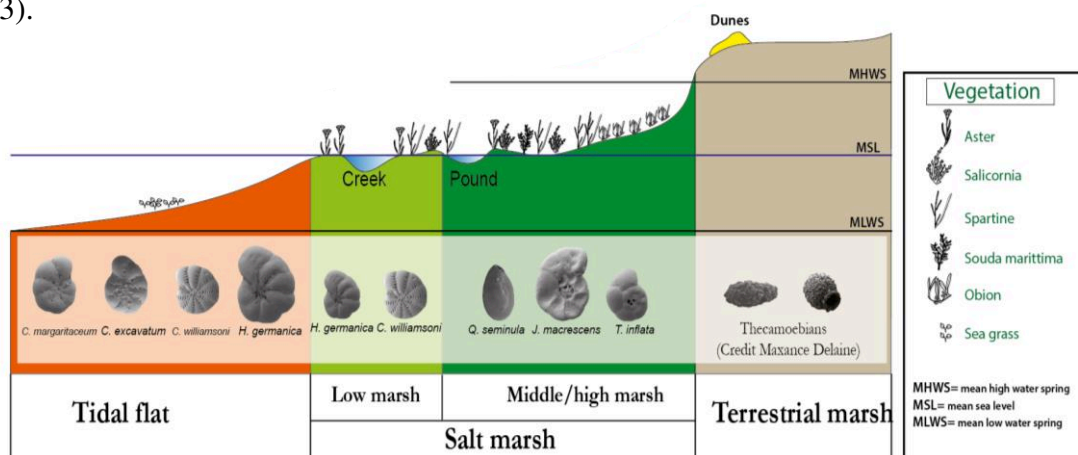

Figure 3. Schema showing the main foraminiferal drivers in four natural intertidal areas of the Eastern English Channel. From Francescangeli (2017).

Distribution patterns of benthic foraminifera are clearly constrained by the stressful natural conditions occurring in intertidal areas (Horton 1999, Horton & Murray 2007, Frontalini & Coccioni 2011, Armynot du Châtelet et al. 2016). In temperate intertidal areas, the upper vegetated belt (i.e. salt marshes) is dominated by agglutinated species such as *Miliammina fusca*, *Entzia macrescens* and *Trochammina inflata* (Alve & Murray 1999, Debenay et al. 2000, Cearreta et al. 2002, Fatela et al. 2009); while calcareous species such as *Ammonia tepida*, *Criboelphidium excavatum*, *Haynesina germanica* and *C. gunteri* are found in the lower part i.e. tidal flat (Debenay & Guillou 2002, Francescangeli 2017).

In addition to the tidal regime that mediates foraminiferal distribution in intertidal mudflat, the abundance and diversity of communities vary seasonally in response to the variation in biotic (e.g. competition, food) and abiotic factors (e.g. temperature, salinity, dissolved oxygen concentration; De Rijk & Troelstra 1999, Murray & Alve 2000, Alve & Murray 2001, Cearreta et al. 2002, Debenay & Guillou 2002, Morvan et al. 2006, Francescangeli 2017, Armynot du Châtelet et al. 2018). In the Vie estuary (France) for instance, *C. excavatum* reproduces in winter and autumn in response to the increase in food concentration (Debenay et al. 2006).

The distribution of benthic foraminifera in intertidal areas is therefore a complex interplay between tidal condition and biotic/abiotic factors variations.

1.3. Benthic foraminiferal contribution to ecosystem functioning

Although some aspects of their role in ecosystem functioning remain poorly known, benthic foraminifera can contribute to ecosystem processes e.g. nutrient cycling and denitrification (Glock et al. 2013, Choquel et al. 2021). As carbonate-producing organisms (e.g. Hallock 1981, Hallock et al. 1986, Langer et al. 1997, Langer 2008), they contribute to the cementation and stability of reefs as they annually generate ~43 million tons of calcium carbonate (Langer et al. 1997, Langer 2008). Noticeably, they can contribute to more than 21% of the annual global ocean carbonate production making them a high contributor to the CaCO₃ budget of the world's oceans (Langer 2008).

Furthermore, they play a key role in both carbon and nitrogen cycles. Their contribution to the total nitrate loss by means of nitrate storage and anaerobic respiration (Risgaard-Petersen et al. 2006, Piña-Ochoa et al. 2010, Langlet et al. 2020b) range from 4% (Sagami Bay, Japan; Glud et al. 2009) to more than 70 % (Bay of Biscay; France and Skagerrak; Piña-Ochoa et al. 2010). Noticeably, in some Oxygen Minimum Zones (OMZs), foraminifera strongly dominate meiofaunal communities and their denitrification account for the total benthic denitrification (Piña-Ochoa et al. 2010, Glock et al. 2013). They also influence organic matter mineralization and nutrient cycles at the sediment-water interface although they displayed a limited contribution to global aerobic respiration in coastal areas (Geslin et al. 2011, Cesbron et al. 2016). Numerous studies highlighted their crucial role in the trophic food web as an intermediate link between primary producers and secondary producers (Lipps & Valentine 1970, Buzas 1978, Altenbach 1992, Gooday et al. 1992, Linke et al. 1995, Nomaki et al. 2008, Wukovits et al. 2018, Chronopoulou et al. 2019).

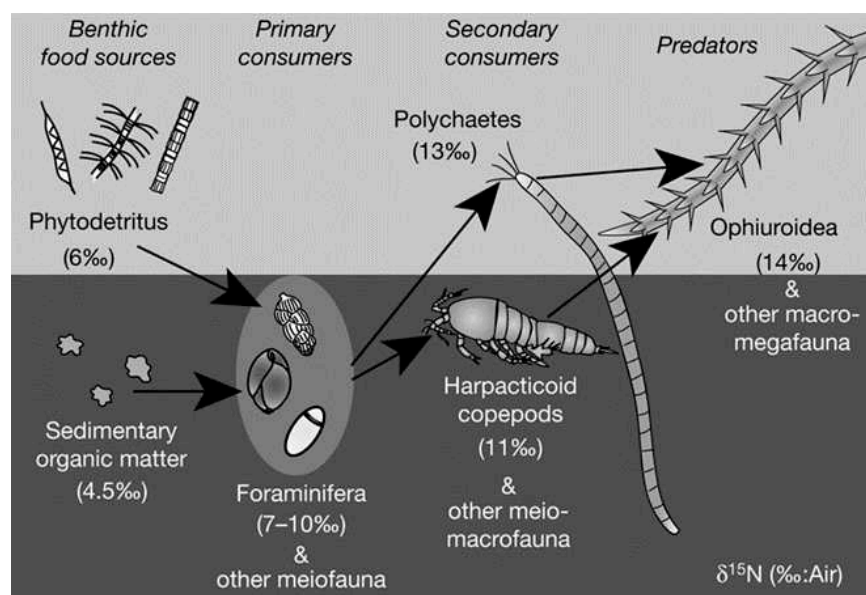

Figure 4. Food-web structure in deep-sea environments (Sagami Bay; Japan) suggested by carbon and nitrogen isotopic compositions. From Nomaki et al. (2008).

Indeed, foraminifera are important consumers of low trophic level, feeding on fresh phytodetritus, bacteria and living microphytobenthic preys (Moodley et al. 2002, Austin et al. 2005, Jauffrais et al. 2016b). Furthermore, they are expected to be an

important food source for metazoan species i.e. polychaetes, gastropods, isopods (Lipps & Ronan 1974, Herbert 1991, Gudmundsson et al. 2000). In deep-sea environments for instance, isotopic compositions show an increase in the C/N ratios from particulate organic matter ingested by foraminifera to metazoan meiobenthos (Fig. 4; Nomaki et al. 2008).

To summarize, benthic foraminifera constitute an important bridge in the energy flow within the trophic food web (Gooday et al. 1992, Schratzberger & Ingels 2018). In addition, conversely to epifaunal species that display a suspension feeding mode, species inhabiting surface and deeper sediments were observed actively moving in the search for food (Kitazato 1981, 1988, Linke & Lutze 1993, Kitazato 1994, Hemleben & Kitazato 1995, Gross 2000, 2002). Such displacements generate the movement of adjacent sediment particles in both vertical and horizontal directions (Kitazato 1981, 1988, Severin et al. 1982, Severin 1987, Wetmore 1988, Langer et al. 1989, Langer & Gehring 1993). Therefore, sediment mixing induced by foraminiferal species may potentially affect bioturbation process.

2. What is bioturbation?

In marine ecosystems, bioturbation covers all fluxes at the sediment-water interface induced by biological activities and associated physical and chemical modifications (François et al. 1997, Gérino et al. 2003, Kristensen et al. 2012). Specifically, it includes two mechanisms: (i) the displacement of particles (i.e. sediment reworking) and (ii) water fluxes (i.e. bioirrigation) at the interface and in the sediment column (Kristensen et al. 2012).

Particle reworking is induced by organism locomotion (i.e. crawling, burrowing) and nutrition (i.e. ingestion, defecation) and by the construction and maintenance of biogenic structures (i.e. cavities, tubes, galleries) in the sediment (Rhoads 1974, Aller 1982, François et al. 2001). It leads to horizontal, upward and downward displacements of sediment particles that therefore structure the sedimentary matrix by locally modifying the physical and chemical properties of the sediment (Aller 1994, Gilbert et al. 1996, Volkenborn et al. 2012, 2016). For instance, the bioturbation activity of

Hydrobia ulvae (gastropod) and *Macoma balthica* (bivalve) in cohesive sediment increases resuspension rate of both sediment particles and microphytobenthic organisms in the water column (Blanchard et al. 1997, Willows et al. 1998, Andersen et al. 2002, Orvain et al. 2003). Other species such as *Alitta virens* (polychaete) and *Upogebia pusilla* (mud shrimp) enhance sediment compaction and therefore the exchange of water and dissolved fluxes along their burrow walls (Dorgan 2015, Pascal et al. 2019).

Furthermore, depending on their mode of sediment reworking, organisms can be classified in functional groups of species sharing similar particles reworking mode (François et al. 1997, Gérino et al. 2003, Kristensen et al. 2012; Fig. 5). Four functional groups have been described and used for the classification of macrofaunal species: biodiffusor, regenerator, downward conveyor and upward conveyor (Boudreau 1986a b, François et al. 1997, 2002, Gérino et al. 2003, Solan & Wigham 2005, Kristensen et al. 2012).

- Biodiffusors typically induce “*the constant and random local sediment biomixing over short distances resulting in transport of particles analogous to molecular or eddy diffusion*” (Kristensen et al. 2012, p 289). Depending in their vertical position in the sediment, biodiffusor may be sub-classified as epifaunal, surficial and gallery biodiffusors (Kristensen et al. 2012). Typical examples of epifaunal biodiffusors are sand bubbler crabs which can displace a consequent number of particles through their foraging activity along the upper millimetres of surface sediment (Penha-Lopes et al. 2009, Kristensen et al. 2012). Surficial biodiffusors mainly live at the sediment surface and may further bury into the sediment as observed for spatangoid urchins and brittle stars, which can move down to 5 cm depth in the sediment (Lohrer et al. 2005, Gilbert et al. 2007; Fig.5A). In contrast, gallery-biodiffusor species such as the polychaete *Hediste diversicolor* preferentially live in deeper sediment layers i.e. down to 30 cm depth hence contributing to the downward transport of sediment through their burrows

that are connected to the surface (François et al. 2002, Duport et al. 2006, Quintana et al. 2007; Fig.5A).

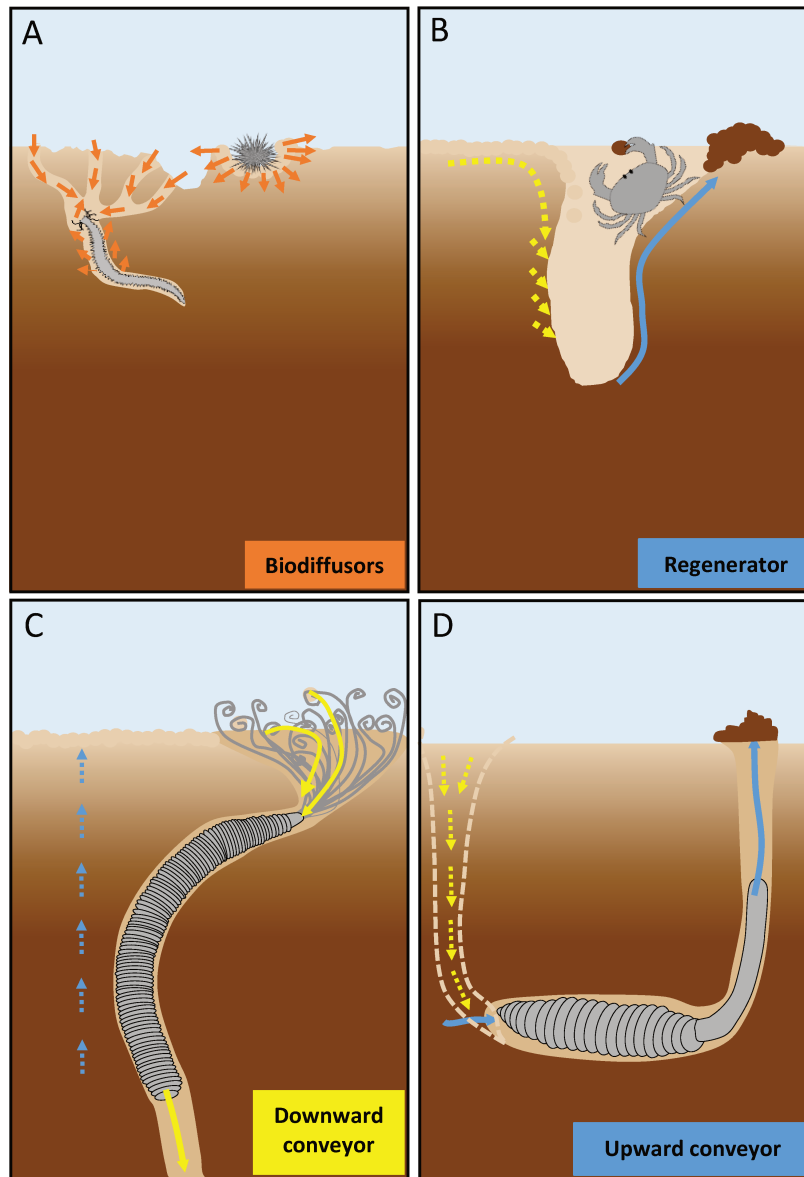

Figure 5. The four major types of particle reworking conducted by benthic fauna in aquatic environments illustrating with representative species (A) at left: *Hediste diversicolor* (polychaete) and right: spatangoid urchin, (B) fiddler crab (C) *Cirriformia grandis* (polychaete) and (D) *Arenicola marina* (lugworm). Orange arrows correspond to the random redistribution of sediment particles in both direction and around the organism microhabitat. Yellow and blue arrows denote the downward and upward transport of particles within the sediment respectively. Direct and indirect sediment reworking induced by fauna activity are indicated with complete and dotted arrow respectively.

- Regenerator like mud shrimps and fiddler crabs (Penha-Lopes et al. 2009, Maire et al. 2016; Fig.5B) are “excavators that dig and continuously maintain burrows in the sediment” (Kristensen et al. 2012, p 292). The

excavation of sediment has two effects: (1) the direct upward transport of deep particles during digging and the (2) indirect downward transport of surface particles to the bottom of the burrow after it has been deserted and filled with water (Gérino et al. 2003; Fig. 5B).

- Downward conveyors are “*head-upward, vertically oriented species that cause an active transport of sediment through their gut from the sediment water-interface to their egestion depth*” (Gérino et al. 2003; p 227). For instance, *Cirriformia grandis* (cirratulid, polychaete) feeds on surface deposits using its tentacles and defecates at several centimetres in depth at the bottom of its burrow (Shull & Yasuda 2001; Fig. 5C).
- Upward conveyors are “*vertically oriented species that typically feed head-down at depth in the sediment*” (Gérino et al. 2003, p 227; Fig. 5D). One of the most known head-down species is the lugworm *Arenicola marina* (Cadée 1976) which is widely distributed in intertidal sandy area along the North-Western European coasts (Beukema & De Vlas 1979, Riisgård & Banta 1998, Valdemarsen et al. 2011). It typically lives in a J-shaped burrows where it ingests deep sediments that are ejected at surface through defecation. As a consequence, the feeding activity of *A. marina* generates a funnel-shaped depression at the sediment surface which induces the downward transport of sediment particles (Kristensen et al. 2012; Fig. 5D).

Benthic macro-invertebrates may also be further classified according to the way they affect sediment bioirrigation i.e. water fluxes, both through passive biodiffusion and active ventilation (Michaud et al. 2006, Kristensen et al. 2012). Specifically, to renew oxygen and nutrients within their burrows and microhabitats, organisms display different behavioural and morphological adaptations. Burrowed bivalves such as *Abra ovata* and *Macoma nasuta*, for instance, extend their siphons up to the sediment water-interface to feed in the water column (e.g. Specht & Lee 1989, Grémare et al. 2004, Maire et al. 2006) while crustaceans and polychaetes, respectively, use peristaltic movements of their body and beatings of appendages to generate a water current within their burrows (Barrow & Wells 1982, Forster & Graf 1995, Stamhuis & Videler 1998,

Morad et al. 2010). Such a ventilation strongly affects the vertical concentration gradients of dissolved elements in the sediment. The presence of bioturbator organisms, therefore, enhances the transport of solutes i.e. O_2 , HCO_3^- , NH_4^+ , SO_4^{2-} in the sediment (Woodin et al. 2010, Volkenborn et al. 2012, Aller 2014).

Three modes of bioirrigation have been described depending on (1) the morphology of the burrow i.e. number of openings and (2) the sediment properties i.e. cohesive and non-cohesive (Fig. 6) :

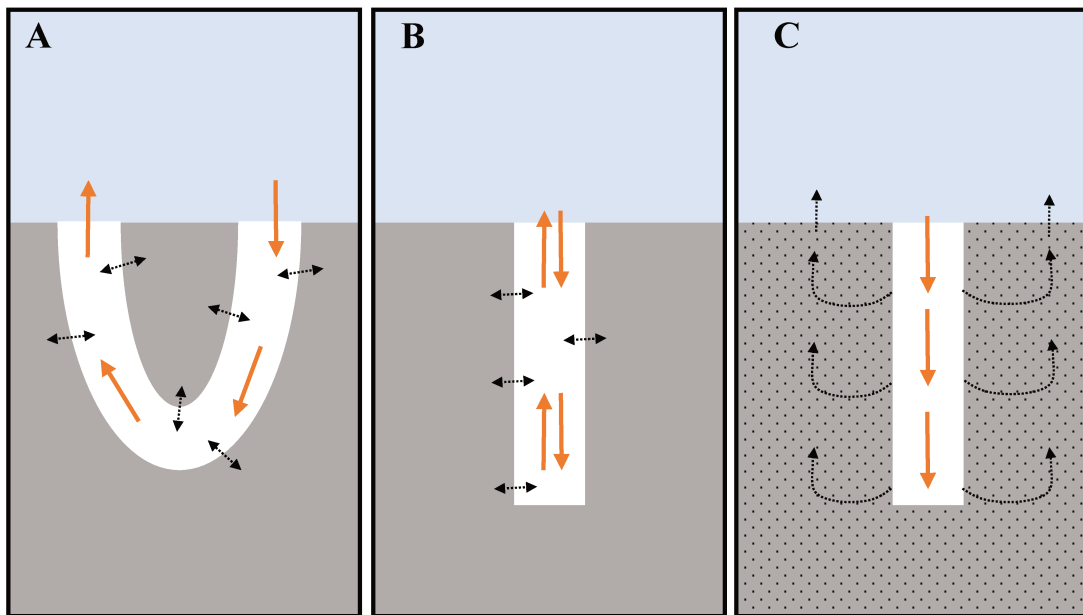

Figure 6. The three major modes of bioirrigation pattern. (A) Open-ended burrow, (B) blind-ended burrow in cohesive sediment and (C) blind-ended burrow in non-cohesive sediment. Orange arrows correspond to advective transport of water from ventilation activity while dotted black arrows correspond to consecutive diffusion between wall of the burrow and water. From Kristensen et al. (2012).

- In open ended burrow in cohesive sediment (i.e. two openings at the surface), bioirrigation occurs by radial diffusion between the wall of the burrow and the unidirectional water flux induced by the ventilating activity of the organism (Fig. 6A).
- In blind-ended burrow in cohesive sediment, water is bidirectionally ventilated and bioirrigation occurs by radial diffusion across the wall-water interface (Fig. 6B).
- In blind-ended burrow in non-cohesive sediment, water is ventilated unidirectionally and bioirrigation takes place when the water left the burrow

by advective percolation of pore water towards the sediment-water interface (Fig. 6C).

For example, *Hediste diversicolor* (gallery biodiffusor species) and *Arenicola marina* (upward conveyor species) display open ended and one ended burrows, respectively (Fig. 5A,D; Fig. 6A,B).

Bioturbation by macro-invertebrate species increases the transport of most energetically favourable electron acceptor (i.e. oxygen) in deep anoxic sediment layers, therefore enhancing the decomposition of the organic matter by microbial community (Volkenborn et al. 2016). Thereby, bioturbation enhances the sediment capacity for organic matter mineralisation; favoring carbon and nutrient cycling (Aller 1994, Lohrer et al. 2004, Mermillod-Blondin & Rosenberg 2006).

Furthermore, understanding bioturbation processes in benthic species, i.e. sediment reworking and bioirrigation modes, is not necessarily straightforward. For instance, one species may display distinct or successive sediment reworking modes depending on its activity in the sediment e.g. feeding, hosting (Kristensen et al. 2012). Fiddler crabs may for instance, either behave as a biodiffusor when feeding or as a regenerator when being sheltered in its cavity. Deciphering the specific contribution to bioturbation processes therefore requires robust knowledge on the motion behaviour of species relative to their locomotion, feeding or hosting activities (Grémare et al. 2004, De Backer et al. 2011, Pascal et al. 2019). A significant number of studies allowed to classify benthic macro-invertebrates into functional groups of bioturbator including in freshwater ecosystem (Gérino et al. 2003, Mermillod-Blondin et al. 2003, Mermillod-Blondin 2011, see review in Kristensen et al. 2012 for marine organisms). Moreover, it is now well recognized that diversity in bioturbation modes mediates the functioning of soft-ecosystem processes e.g. nutrient cycling, organic matter mineralisation, bacterial community and primary productivity (Biles et al. 2002, Kogure & Wada 2005, Zorn et al. 2006, Solan et al. 2008, Laverock et al. 2011, Gagic et al. 2015). **Nevertheless, among the studies that assessed the impact of bioturbation on benthic ecosystem functioning, relatively few considered meiofaunal species as potential key**

bioturbators although they are a crucial component of the benthic compartment (Sheppard 2006, Schratzberger 2012).

3. What do we know about meiobenthos bioturbation?

Meiobenthos represent an important component of benthic ecosystems as they often occur in high density and diversity in a large range of both marine and freshwater environments (Heip et al. 1985, Glud et al. 1994, Coull 1999, Danovaro et al. 2010, Balsamo et al. 2012). Moreover, they represent a fundamental link between smaller (e.g. bacteria, primary producers) and larger organisms (e.g. macrofauna) in the trophic food web (Giere 1993, 2009, Piot et al. 2013).

Like macrofauna, meiofauna may contribute to bioturbation processes (Cullen 1973, Aller & Aller 1992, Schratzberger & Ingels 2018). In the Baltic Sea for instance, macrofauna and meiofauna have an equally important contribution to the transport of particles within the sediment (Bradshaw et al. 2006). However, among the studies dealing with meiofauna and bioturbation, only a few attempted to understand their contribution to sediment reworking and bioirrigation processes. In most cases, studies assessed the meiofaunal vertical distribution, abundance and diversity as a response to macrofaunal bioturbation activity (Bouchet et al. 2009, Urban-Malinga et al. 2013, Ingels et al. 2014, Alvarez et al. 2015, Abdullah & Lee 2016, Citadin et al. 2016, Maire et al. 2016). Although it is recognized that meiofaunal distribution may be tightly linked to the activity of larger organisms (Reise 1983, Bouchet et al. 2009, Maire et al. 2016), numerous species i.e. copepods, nematodes, foraminifera can actively migrate using self-locomotion in and on the sediment (Severin & Erskian 1981, Severin et al. 1982, Severin 1987, Linke & Lutze 1993, Nascimento et al. 2012, Bouchet & Seuront 2020). This further suggests that meiofauna may also contribute to the displacement of sediment particles and to the transport of dissolved fluxes. Below, I propose an overview of what we know on the role of meiofauna in bioturbation processes by describing their effects of both physical and biochemical sediment properties and therefore the consequences on the functioning of benthic ecosystems. Note that the

majority of meiofaunal studies deals with nematodes and harpacticoid copepods (see review in Schratzberger & Ingels 2018).

Meiofauna display a large range of biological activities i.e. locomotion on or in the sediment, burrowing, construction and maintenance of burrows, ingestion/defecation of particles and excretion of metabolic wastes (Fig. 7; Cullen 1973, Pike et al. 2001, Schratzberger & Ingels 2018). Noticeably, species such as nematodes can continuously construct microscale burrows in the sediment column (Chandler & Fleeger 1984, Nehring et al. 1990, Reichelt 1991, Nehring 1993, Pike et al. 2001). Furthermore, meiofaunal species are intensive grazers of microphytobenthos and extracellular polymeric substance (i.e. EPS) produced by bacteria; eating their body weight equivalent in microorganisms each day (Montagna 1984, Heip et al. 1985).

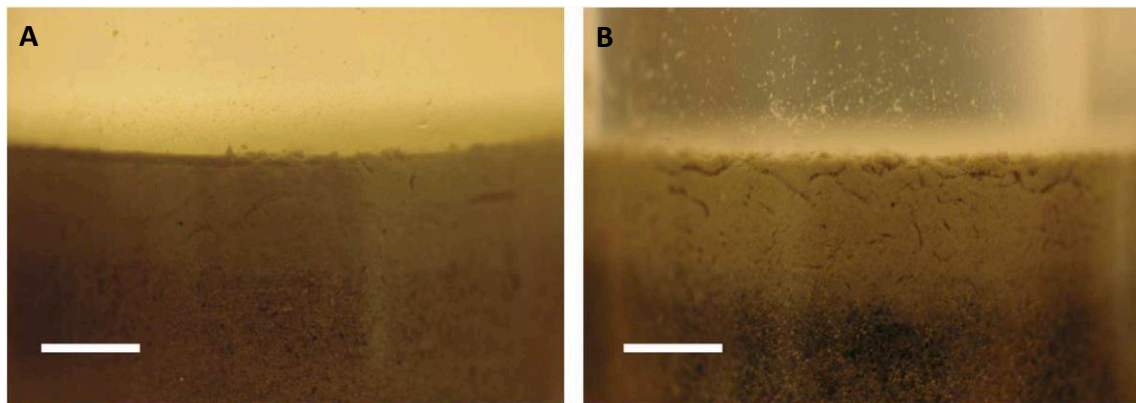

Figure 7. Visual evidence of meiofaunal microbioturbation under (A) low density and (B) high density conditions. Scaled bar = 500 μm . From Bonaglia et al. (2014).

3.1. Meiofauna-mediated effects on physical and chemical properties of the sediment

Meiofauna may increase the cohesion of the sediment, hence its stability within their burrows via the secretion of EPS during the construction of mucus-lined burrows (Fig. 8) while displacements, burrowing and grazing activities would decrease the sediment stability by increasing porosity and erodibility (Fig. 8; Riemann & Schrage 1978, Aller & Aller 1992, De Deckere et al. 2001, Pemberton et al. 2008, Hubas et al. 2010). As a consequence, meiobenthic organisms affect solutes transport and nutrients exchanges

occurring at the sediment-water interface (Fig. 8; Bonaglia et al. 2020). They can for instance, increase solutes fluxes by a factor of 1.5 to 3.2 compared to molecular diffusion (Aller & Aller 1992, Rysgaard et al. 2000), which stimulate aerobic decomposition and associated processes e.g. nitrification (Fig. 8; Aller & Aller 1992). Bioturbation by nematodes can for instance, increase the oxygen concentration in the sediment, hence stimulating microbial activity as it provides more energetically favourable electron acceptors i.e. O_2 for microbial decomposition rate (Alkemade et al. 1992, Middelburg & Meysman 2007).

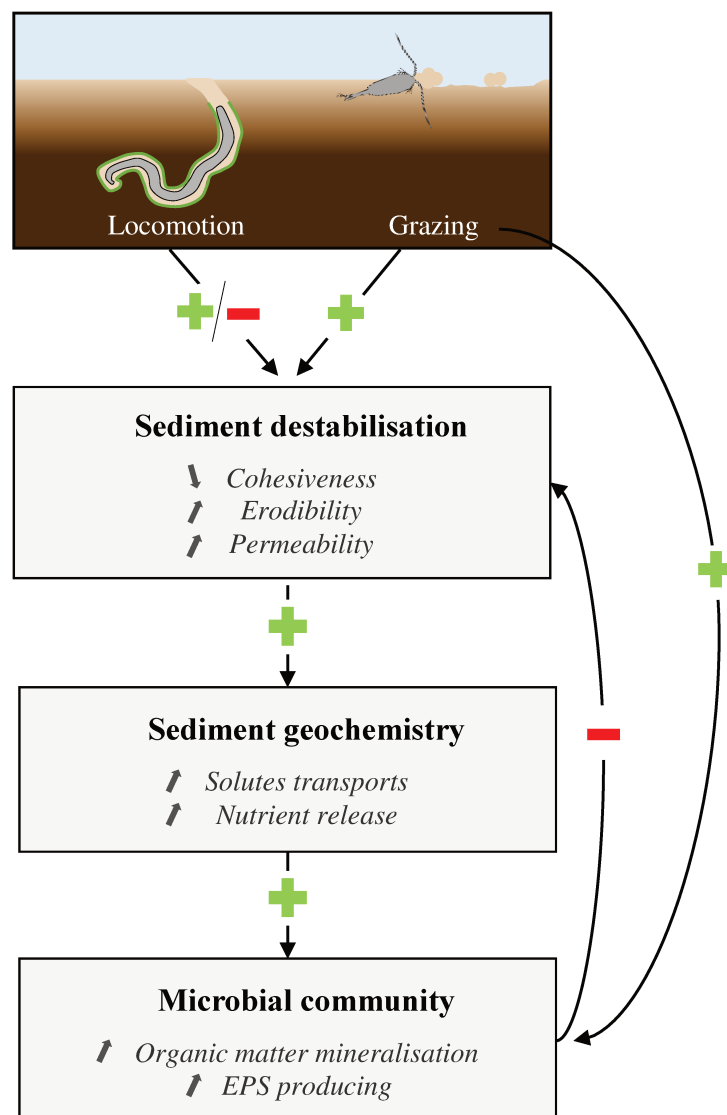

Figure 8. Meiofaunal-mediated effect of sediment properties and microbial community. Plus and minus symbols respectively refer to the destabilising and stabilising effects of meiofaunal locomotion and grazing activities on the sediment properties and microbial community. Green line within the burrow correspond to the production of mucus by organism to bound sediment particles together.

More recently, meiofaunal bioturbation activity was observed to strongly increase the oxygen penetration depth up to 85% (Bonaglia et al. 2020). Such an oxygenation process thereby decreases the sulphide fluxes from 8.8 to 0.4 mmol m⁻² d⁻¹ and leads to a more oxidized and sulphide-free environment (Bonaglia et al. 2020). This mechanism may enhance iron (Fe) and manganese (Mn) cycling that leads to removal of free H₂S in the sediment as previously evidenced for macrofauna (Seitaj et al. 2015, Bonaglia et al. 2019).

3.2. Meiofauna-induced inter-specific facilitation

Besides the locomotion effect on sediment physical properties and solutes fluxes, grazing activity would indirectly matter in meiofauna-mediated bioturbation. Indeed, as they exert a predatory pressure through their grazing activity, meiofaunal species may stimulate bacterial and diatom populations' growth thereby enhancing the bacterial and microphytobenthic production of EPS (Hubas et al. 2010, Moens et al. 2013, D'Hondt et al. 2018). This, in turn, increases the stability of the sediment matrix (Fig. 8; Decho 1990, Underwood et al. 1995). In addition, previous studies have shown an increase in the organic matter decomposition rate in the presence of meiofaunal species (Aller & Aller 1992, Braeckman et al. 2013). As, meiofauna directly affects the growth, activity and community structure of prokaryote, they indirectly mediate the process of mineralisation in marine sediment (Fig. 8; De Mesel et al. 2004, Hubas et al. 2010, Nascimento et al. 2012).

Furthermore, experiments showed that meiofauna can drastically affect nutrient cycling through its effects on nitrifying and denitrifying bacteria (Prast et al. 2007, Bonaglia et al. 2014, Stock et al. 2014). Indeed, organisms release a large quantity of nitrogen during their grazing activity. This in turn affects the carbon to nitrogen ratio, leading to an increase in both the availability of ammonium for nitrifying bacteria and the availability of nitrate and labile organic matter which simulated heterotrophic denitrification (Bonaglia et al. 2014).

Overall, by reworking sediment during locomotion or burrow construction and displacing organic matter and microorganisms during feeding, meiofauna directly and

indirectly, positively and negatively affect various ecosystem services such as sediment stabilisation, nutrient and dissolved fluxes or food web dynamic. All the studies conducted on meiofaunal bioturbation have shown that such small-organism display a wide diversity in their locomotion and feeding behaviour. This leads to specific effects on both sediment reworking mode and intensity and therefore dissolved fluxes. Conversely to macrofauna, no functional classification in bioturbator group has been established yet for meiofaunal species, however. This further stresses the interest to unify the knowledge on macrofaunal and meiofaunal bioturbation as these two components display similar bioturbation modes although their contributions may occur at different spatial scales.

4. What about bioturbation by benthic foraminifera?

As a component of benthic meiofauna, the interest of foraminifera in studies dealing with bioturbation was mostly to show the vertical transport of benthic foraminifera by benthic macro-invertebrates (Thomsen & Altenbach 1993, Bouchet et al. 2009, Maire et al. 2016, Pérez-Asensio et al. 2017). Although it was rarely quantified, foraminiferal bioturbation can however contribute to the benthic ecosystem functioning (Aller & Aller 1992, Gross 2002, Giere 2009). Nevertheless, benthic foraminifera have been ignored in most studies dealing with meiofaunal bioturbation and little is known on how they affect the sediment matrices and the consecutive dissolved fluxes. Earlier studies have however well described some aspects of their motion behaviour both at the sediment surface and in the sediment column (Jepps 1942, Murray 1963, Severin & Erskian 1981, Severin et al. 1982, Severin 1987, Kitazato 1988, 1994, Wetmore 1988, Langer et al. 1989, Altenbach et al. 1993, Linke & Lutze 1993, Hemleben & Kitazato 1995, Moodley et al. 1998, Gross 2000, 2002).

4.1. Motion behaviour of benthic foraminifera

By deploying their pseudopodial network, foraminifera anchored themselves by attaching the distal portion of their pseudopods to sediment particles, and then move

by dragging their test toward the tips of the pseudopodia (Fig. 9A,B; Jepps 1942, Kitazato 1988).

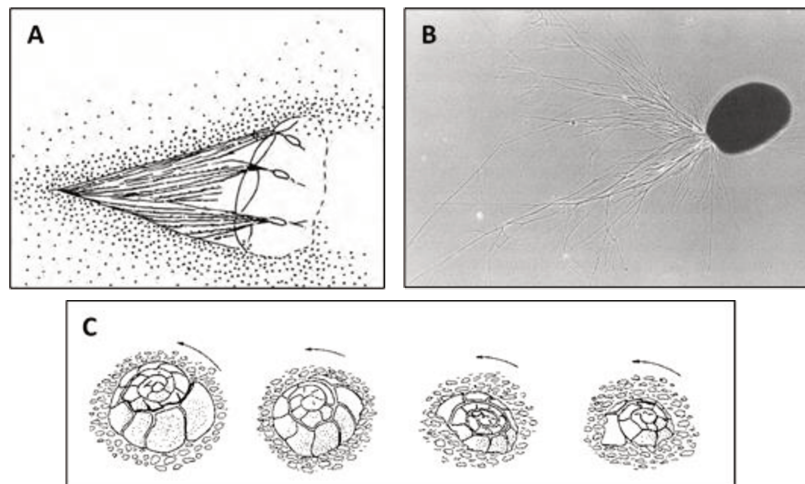

Figure 9. (A) *Pseudorotalia gaimardii* moving toward left through sediment. Pseudopodia extend from both primary aperture and supplementary apertures toward direction of movement. Conical cavity formed in front of test. (B) Pseudopodial network on glass surface of petri dish of *Quinqueloculina lamarckiana* d'Orbigny. From Kitazato (1988). (C) Rotating movement of *Ammonia* species digging into the uppermost sediment surface layer of tidal flats. From Langer et al. (1989).

Foraminiferal species display distinct motion rates, i.e. velocities, that are expected to be correlated with the number of pseudopods, morphology and structure of the test and respective mode of life i.e. infaunal, epifaunal (Kitazato 1988, Bornmalm et al. 1997). Although they inhabit the same environment, agglutinated, ovoid-shaped and infaunal species were observed moving with a lower velocity than calcareous, discoid-shaped and epifaunal ones (Kitazato 1988, Bornmalm et al. 1997, Gross 2000). This highlights the importance of species-specific traits i.e. morphology, size and vertical distribution in the velocity of intertidal foraminifera. Recently, experiments performed on three intertidal foraminiferal species (i.e. *Ammonia tepida*, *Haynesina germanica* and *Criboelphidium excavatum*) have shown that the motion-behaviour of foraminifera is characterised by a strong inter-specific, inter- and intra-individual variability in their travelled distance and velocity (Fig. 10, Seuront & Bouchet 2015).

Such variabilities were reported thanks to continuous observation of several motion traits, including some that were never been described before in benthic foraminifera (i.e. direction of movement and complexity of the path). They exhibited species-specific behavioural properties, which were specifically related to differences in their

activity, direction of movement, velocity and trajectory complexity (Seuront & Bouchet 2015).

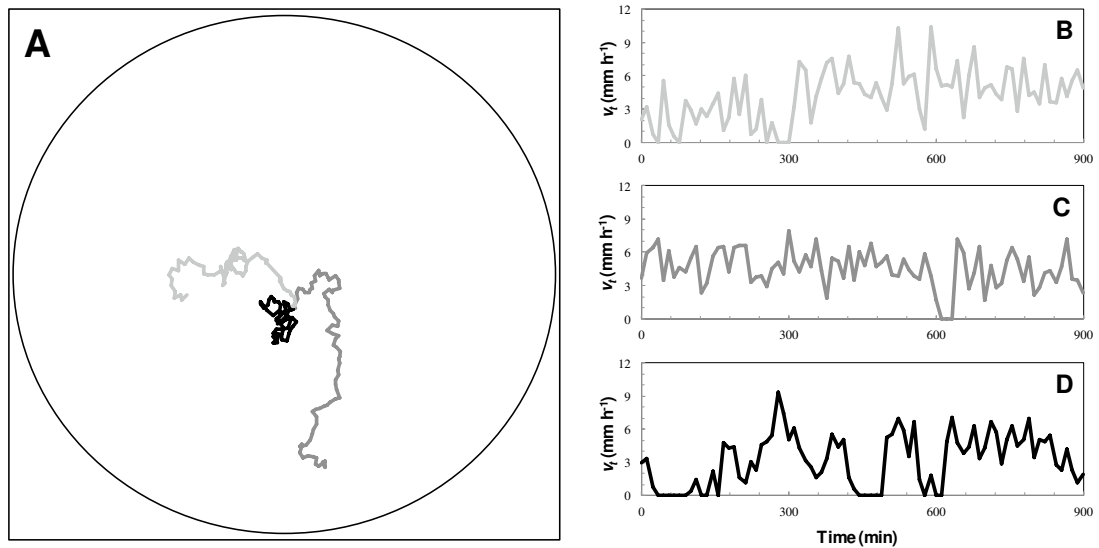

Figure 10. Illustration of the variability in the travelled distance (A) and instantaneous velocity (B-D) of three individuals of *Ammonia tepida*. Experiment were conducted in circular experimental arenas 7.5 cm in diameter under homogenous light and temperature conditions. From Seuront & Bouchet (2015).

For instance, the authors have shown for the first time the foraminiferal ability to orient their displacement following gravity; further suggesting that they are able to respond to a stimuli or a cue. This feature is expected to be a useful parameter to assess the optimal positioning of species in the sediment column i.e. infaunal vs epifaunal form (Seuront & Bouchet 2015). This highly support the need to expand the diversity of behavioural parameters that can be used to further understand the motion behaviour of benthic foraminifera. Moreover, each species may have a behavioural plasticity i.e. variability within conspecific individuals that could be involved in species ability to face environmental changes. For instance, *Ammonia tepida* can exhibit differences in the locomotion speed under different food sources (Jaufrais et al. 2016b).

4.2. Foraminiferal interaction with the sediment

4.2.1. Formation of cysts

During their movements, some species gather sediment particles and build a rigid detritic cyst that surrounds the test (Fig. 11; Jepps 1942, Linke & Lutze 1993, Cedhagen

1996, Heinz et al. 2005 and references therein). Cyst building behaviour might be an adaptation against mechanical and chemical disturbances that may also provide food sources for foraminifera and face predatory pressure (Fig. 11; Myers 1936, Richter 1965, Angell 1990, Langer & Gehring 1993, Heinz et al. 2005).

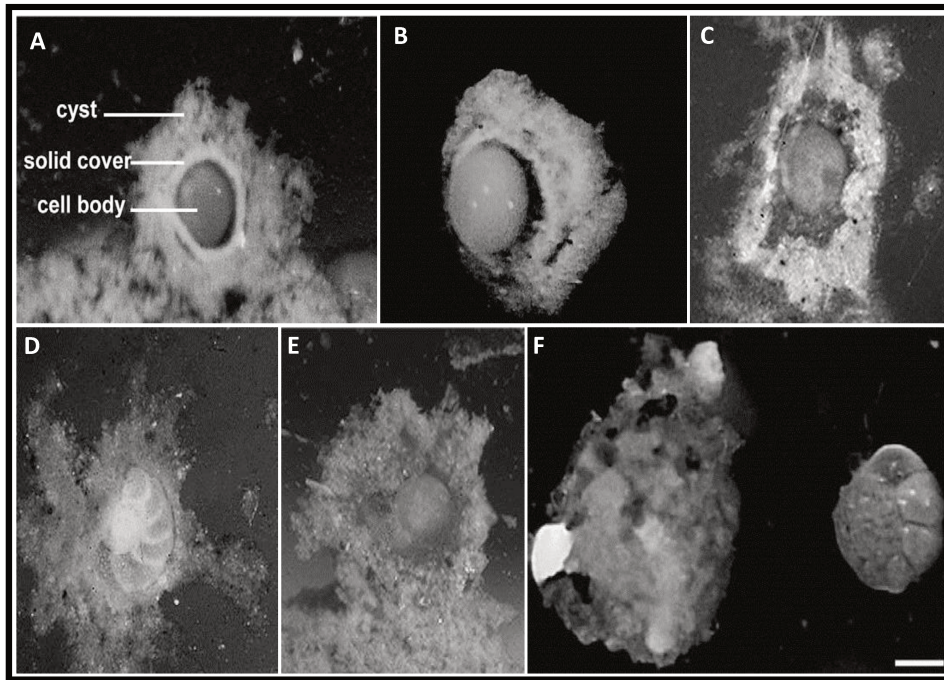

Figure 11. (A) Unilocular agglutinated species on the glass wall and (B) isolated. (C) Unidentified species, building a cyst-like structure with reticulopodia on the glass of the aquarium. (D) Cyst of *Cibicidoides* sp. On the glass surface of the aquarium. (E) Cyst of *Melonis barleeanum* on the glass of the aquarium. (F) Cyst (left) and free species (right) of *Ammonia beccarii* in a Petri dish. From Heinz et al. (2005).

Foraminifera typically keep their cysts for hours to weeks and generally immediately started to build a new one after leaving the former (Heinz et al. 2005). The composition and the frequency of cyst building may vary among species and depend on their functions. For instance, in species such as *Trochammina quadriloba*, reproduction starts with the construction of an agglutinated cyst combined with excretion of undigested food from the protoplasm (Salami 1976, Angell 1990). This behaviour is therefore a dynamic mechanism that involves the frequent dislodgement of sediment particles from the sediment matrix to the foraminiferal shell. In addition, as evidenced in Fig. 11F, encysted individuals fill more space in the sediment than free ones.

4.2.2. Foraminiferal crawling and burrowing behaviour lead to the displacement of sediment

Foraminifera can move to colonise various habitats both in surface and in the sediment column depending on their ecological requirements (Corliss 1985, 1991, Linke & Lutze 1993, Alve & Bernhard 1995, Geslin et al. 2004, Dessandier et al. 2015, Cesbron et al. 2016). For instance, Elphidiidae crawl at the sediment surface while *Melonis barleeaanum* presumably move up to a particular sediment depth when conditions are favourable (Richter 1964, Linke & Lutze 1993). Noticeably, Elphidiidae and *Ammonia* dig themselves into the sediment with a cork-skrew movement in less than 15 min (Fig. 9C; Langer et al. 1989). In contrast, foraminifera such as quinqueloculine-shaped species vertically-orient their test with the aperture side-down before movement (Frail-Gauthier et al. 2019).

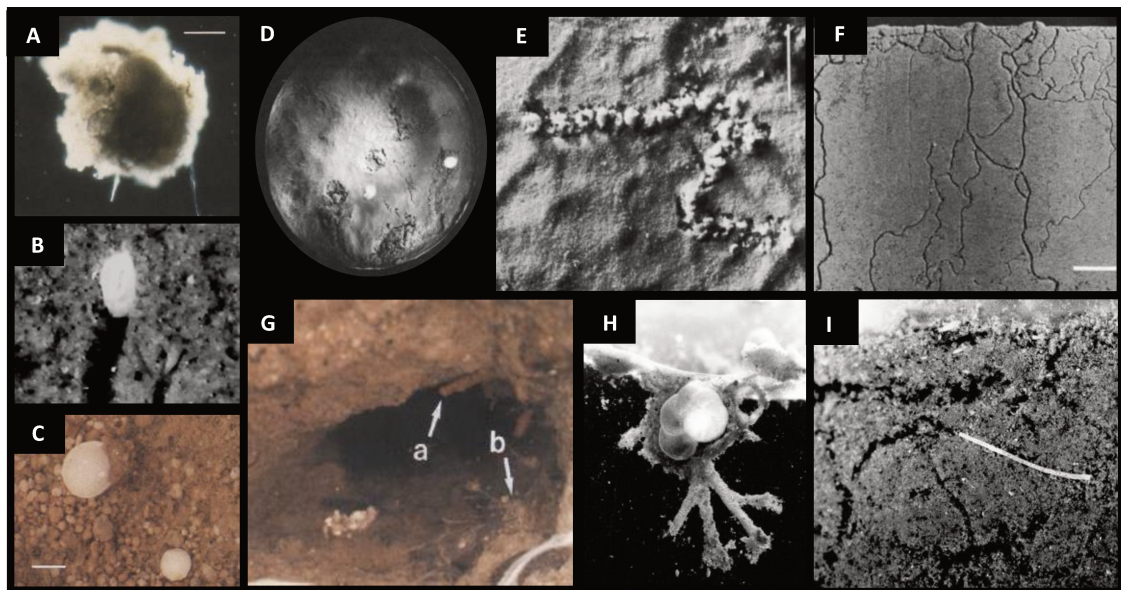

Figure 12. (A) *Elphidium incertum* gathering mineral and detritic materials by pseudopodial activity to build an agglutinated cyst. From Linke & Lutze (1993). (B) Locomotion of *Quinqueloculina lamarckiana* at the sediment surface. From Gross (2002). (C) *Pyrgo rotalaria* lying on the sediment surface. From Linke & Lutze (1993). (D) Effects on sediments from movement in the laboratory by *Laticarinina pauperata*. From Weinberg (1991). (E) Surface trails formed by *Quinqueloculina impressa* on a silty-clay surface. From Severin et al. (1982). (F) Living burrows formed by *Q. impressa* in the top centimetre of sediment. From Severin et al. (1982). (G) *Rupertina stabilis* at its wall (white arrows), extending their pseudopodia into the respiratory current of the megafauna inhabitant. From Linke & Lutze (1993). (H) *Fontbotia wuellerstorfi* living in a chamber-building cyst. From Gross (2002). (I) Bioturbation of *Bathysiphon* sp. in the sediment leaving a distinct type of burrow behind the individual. From Gross (2002).

Infaunal species are often very motile and are able to burrow in the sediment and migrate back to the surface after burial (Fig. 12F,I; Myers 1943, Richter 1964, Severin & Erskian 1981, Severin et al. 1982). For instance, *Quinqueloculina impressa* which preferred surface sediment, can generate straight escape burrows within the sediment column after being involuntarily buried (Fig. 12F; Severin & Erskian 1981, Severin et al. 1982) while *Ammotium cassis* preferably lives at 3-4 cm depth (Linke & Lutze 1993). These vertical displacements lead to the construction of biogenic structures such as networks of galleries (Fig. 12F), tubes (Fig. 12I) and cavities (Fig. 12H) in the sediment (Wetmore 1988, Linke & Lutze 1993, Gross 2002). As a consequence, foraminifera induced the displacement of adjacent sediment particles both at surface and in the sediment column (Fig. 12B,C,D,E, F,I; Fig. 13; Hemleben & Kitazato 1995, Gross 2002). This may affect the erodibility of sediment and the transport of surface particles within their biogenic structures (e.g. Gross 2002); strongly suggesting the foraminiferal contribution to bioturbation processes (Fig. 13)

However, the wide diversity in the motion behaviour, cyst building, microhabitat selection or burrowing mode stresses that species may not identically contribute to bioturbation processes in term of intensity and mode of sediment reworking. Hence, similarly to macro-invertebrates, it can be hypothesised that different bioturbating modes may exist in benthic foraminifera.

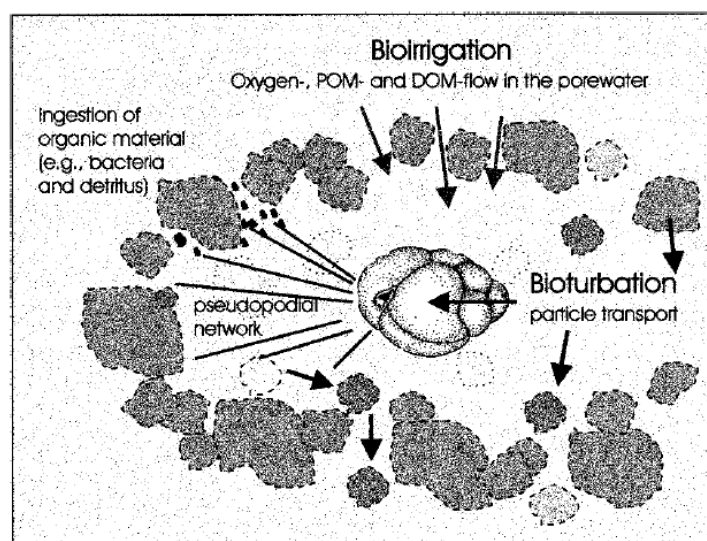

Figure 13. Schematic influence of foraminiferal migration on the sediment regime. Bioirrigation (porewater flow) and bioturbation (particle transport) are enhanced by passive and active reworking of foraminiferal pseudopodia and by the traces. Vertical section. From Gross (2002).

Noticeably, it is needed to understand how species-specific test shape and structure, and motion behaviour mediate the mode of sediment reworking and the intensity; both at the sediment-water interface and in the sediment column.

4.3. Sediment reworking by benthic foraminifera

Although many studies have well described the locomotion of benthic foraminifera in the sediment (section 4.1), only two have specifically quantified their contribution to sediment reworking (Gross 2002, Bouchet & Seuront 2020). Noticeably, bioturbation rate of a population of deep-sea foraminifera can reach $0.2 \text{ cm}^2 \text{ year}^{-1}$ (Gross 2002), which is comparable to the rate reported for a population of macrofaunal species in a coastal lagoon i.e. $0.5 \text{ cm}^2 \text{ year}^{-1}$ (Thau lagoon; France, Duport et al. 2007). This study was however performed on a foraminiferal community that therefore does not provide information on the species-specific contribution to bioturbation. A recent study dealing with foraminiferal bioturbation described the contribution to surface sediment reworking of two key foraminiferal species on temperate intertidal mudflats i.e. *Ammonia tepida* and *Quinqueloculina seminulum* (Bouchet & Seuront 2020). They showed that the individual surface sediment reworking rate ($SSRR_i$) of both species can reach $\sim 0.3 \text{ cm}^2 \text{ indv}^{-1} \text{ day}^{-1}$ (Fig. 14).

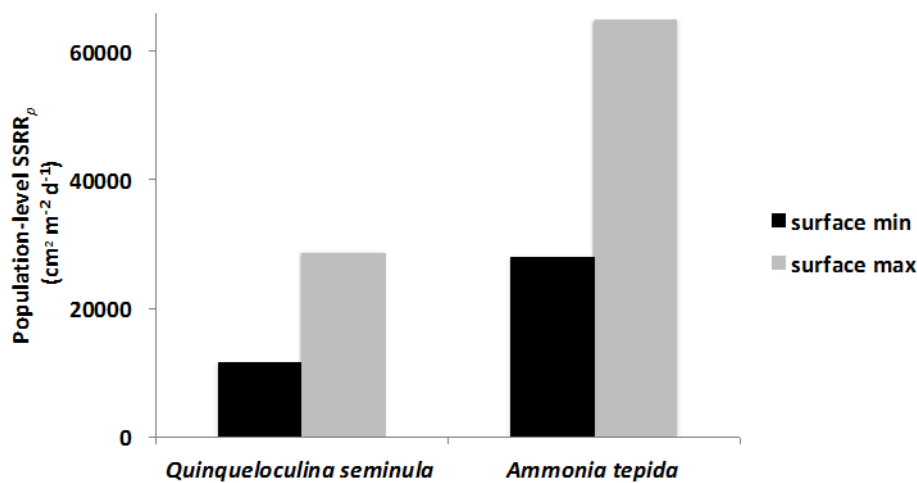

Figure 14. Minimum and maximum population-level surface sediment reworking rate $SSRR_p$ ($\text{cm}^2 \text{ m}^{-2} \text{ d}^{-1}$) of the two studied foraminiferal species, *Quinqueloculina seminulum* and *Ammonia tepida*. From Bouchet & Seuront (2020).

Given the natural abundance of *Q. seminulum* and *A. tepida* in intertidal mudflat, the $SSRR_p$ at the population-level were subsequently estimated as ranging between 11,484 and 28,710 $\text{cm}^2 \text{m}^{-2} \text{day}^{-1}$ and between 27,876 and 65,044 $\text{cm}^2 \text{m}^{-2} \text{day}^{-1}$ respectively (Fig. 14; Bouchet & Seuront 2020). These rates were noticeably similar to those reported in the literature for other macrofaunal species such as *Melinna palmata* (polychaete; Massé et al. 2019) and *Abra ovata* (bivalve; (Maire et al. 2007b).

In addition, the authors also observed that both species were consistently hidden in the sediment which suggest that their movements (1) are not restricted to the sediment surface and (2) may likely affect the sediment column hence the sediment properties i.e. porosity, permeability and consecutive dissolved fluxes (Chandler 1989, Bouchet & Seuront 2020). This is consistent with previous studies that showed a significant increase in the solutes transport across the sediment water interface in sediment inhabited by meiofaunal species including foraminifera (Aller & Aller 1992, Green & Chandler 1994, Pike et al. 2001, Giere 2009).

Taken together, these evidences strongly suggests that despite their minute size, benthic foraminifera may play a significant role in bioturbation process. **Therefore, it is high time to further assess sediment reworking rates in benthic foraminifera.**

5. How biotic and abiotic factors may mediate bioturbation?

Benthic communities are typically subjected to the variation of biotic and abiotic factors occurring in the environment (Moens & Vincx 2000, Horton & Murray 2007, Przeslawski et al. 2009, Venturini et al. 2011, Wohlgemuth et al. 2017). The effect of biotic factors includes both interactions e.g. predation, competition and species-specific features e.g. size, physiological rates, growth. Specifically, size is a fundamental trait that determines basic-life processes of organism including physiological rates mobility, depth of burial and energy demand (Thrush et al. 2006, Norkko et al. 2013, Woodin et al. 2016). Furthermore, numerous studies have examined the effect of environmental factors such as temperature, organic matter input and salinity on the contribution of organism to bioturbation (Levinton & Stewart 1988, Hymel & Plante 2000, Lardies et al. 2001, Ouellette et al. 2004, Kristensen & Kostka 2005, Bernard et al. 2016, Wu et

al. 2017, Koo et al. 2019). They showed that their effects on bioturbation were likely linked to changes in the individual behaviour and metabolism. Below are summarised the typical strategies that individuals may adopt in response to changing temperature and food proxies (i.e. concentration, availability) as these two factors were widely acknowledged for their regulation effect on bioturbation (Ouellette et al. 2004, Maire et al. 2006, Bernard et al. 2016, Wu et al. 2017, Vianna et al. 2020).

5.1. Size matters in bioturbation

Both species and individual size would consistently affect the intensity of bioturbation processes. Indeed, larger species such as urchin display higher sediment reworking rate than polychaetes that are smaller (Gilbert et al. 2007). Moreover, within a single species, change in the size structure can either decrease or increase the bioturbation intensity of the community thereby affecting the nutrient fluxes and primary productivity (Adkins et al. 2014, Thomas et al. 2021). Specifically, in foraminifera, small individuals of *Ammonia tepida* have a more important contribution to phytodetritus processing and therefore nutrient cycling than larger individuals (Langezaal et al. 2005, Nomaki et al. 2011, Wukovits et al. 2018). **As foraminiferal community displays an evolving size pattern throughout a year (e.g. Murray 1983, Cearreta 1988, Murray & Alve 2000), it sounds interesting to investigate whether sediment reworking in benthic foraminifera might increase or decrease as a function of individual test size.**

5.2. Bioturbation under thermal variation

Each macro-invertebrates species has a tolerance for temperatures usually encountered in the field (Pörtner 2001). Both species and individual may otherwise display distinct behavioural responses within its thermal tolerance range as observed in experimental studies simulating seasonal changes (Gee 1985, Aller & Aller 1992, Berkenbush & Rowden 1999, Bernard et al. 2016, Pascal et al. 2019). Typically, a decrease in individual activity and metabolism were observed under low temperatures

i.e. winter and autumn periods. In contrast, under warmer temperatures representative of spring and summer periods, individuals were more active both for feeding or hosting (Ouellette et al. 2004, Bernard et al. 2016, Pascal et al. 2019). In the mud shrimp *Upogebia pusilla*, the proportion of time allocated to an active behaviour i.e. burrowing, walking and ventilating increase by a factor 2.5 between winter and summer (Pascal et al. 2019). Similarly, the network of siphonal galleries and the frequency of feeding in the bivalve *Abra alba* tend to be higher at summer than at autumn temperatures (Bernard et al. 2016). Noticeably, to be more active under warmer period leads to an increase the bivalve's contribution to bioturbation as it specifically enhances sediment reworking intensity and bioirrigation in the sediment (Grémare et al. 2004, Maire et al. 2007a,b).

Macro-invertebrates also adapt their vertical position in the sediment column as a response to temperature (Tsubokura et al. 1997, Lardies et al. 2001, Vianna et al. 2020). Such behaviour therefore changes the spatial-scale at which particles are reworked. The polychaetes species *Neanthes virens* and *Capitella* sp. (Fig. 15) reduce the maintenance activity of their burrows and their burrowing depth under low temperatures (Ouellette et al. 2004, Przeslawski et al. 2009).

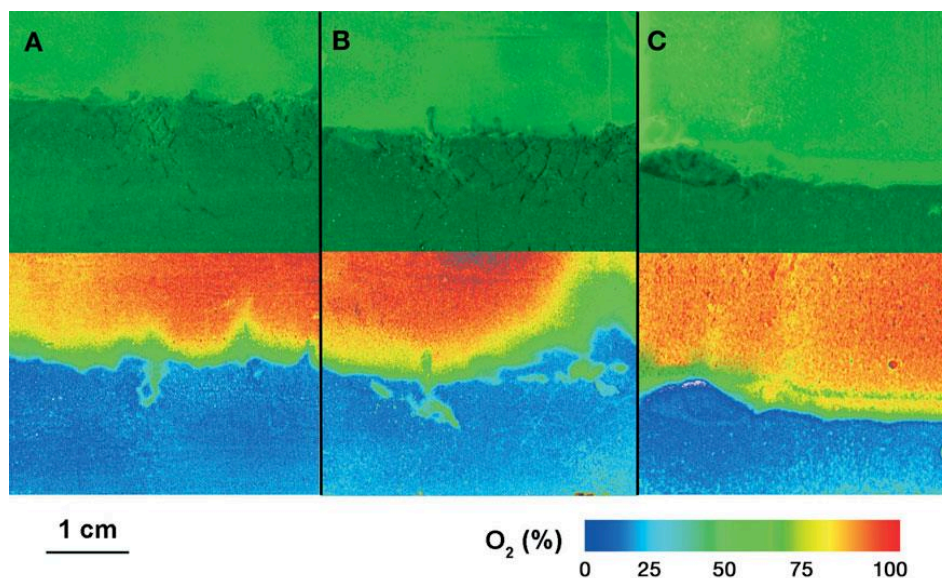

Figure 15. Effect of the burrowing of *Capitella* sp. on oxygen gradient across three temperature treatments: (A) $15.4 \pm 0.3^\circ\text{C}$, (B) $21 \pm 0.3^\circ\text{C}$ and (C) $31.5^\circ\text{C} \pm 0.1^\circ\text{C}$. Note that worms died in the hottest treatment and no burrows were formed. Top panels represent raw pictures taken in visible light while bottom panels represent O_2 planar optode pseudocolor images (O_2 scale key at lower right: % saturation at experiment temperature). From Przeslawski et al. (2009)

This further decreases the number of particles transported downward by advective transports and the oxygen penetration depth within the sediment (see Fig. 15; Ouellette et al. 2004, Przeslawski et al. 2009).

Many studies have shown that temperature can affect the survival, diversity, growth, morphology and feeding of intertidal foraminifera (Bradshaw 1961, Pascal et al. 2008, Schmidt et al. 2011, Wukovits et al. 2017, Stuhr et al. 2018, Li et al. 2019). For instance, the grazing rate and metabolic activity of *Ammonia tepida* decreased for temperature above 30°C (Bradshaw 1961, Pascal et al. 2008). As recently evidenced (e.g. Dong et al. 2019, Li et al. 2019), high temperatures might decrease species survival hence the mortality of foraminiferal community. Temperature therefore appears to be an important factor that induces behavioural and physiological changes in benthic foraminifera. **It would therefore be interesting to monitor the effect of temperature on benthic foraminiferal motion-behaviour, and to further consider the potential effect on sediment reworking.** This is particularly relevant in an era of global warming which exposed intertidal organisms to more frequent and longer extreme climatic events such as heatwaves and cold spell (Frölicher et al. 2018, Hobday et al. 2018, Oliver et al. 2018, Holbrook et al. 2019).

5.3. Food availability can affect bioturbation

Food availability indirectly affects species contribution to bioturbation through its direct effect on the foraging activity and strategy of species i.e. feeding-intensity and locomotion. Indeed, organisms may adopt different strategies, i.e. extensive or intensive exploration of their habitat, as a response to change in food concentrations which potentially affect the displacement of sediment particles (Pyke 1984, Gaillard et al. 2010, Reynolds 2018). Species either increase or decrease their activities i.e. feeding, burrowing, and crawling with increasing food concentration (Fig. 16; Stead & Thompson 2006, Michaud et al. 2010, Venturini et al. 2011). The choice between these two strategies depends on the species feeding requirements that are in turn related to individual growth and metabolic activities (Bhaud 1988, Levri & Lively 1996).

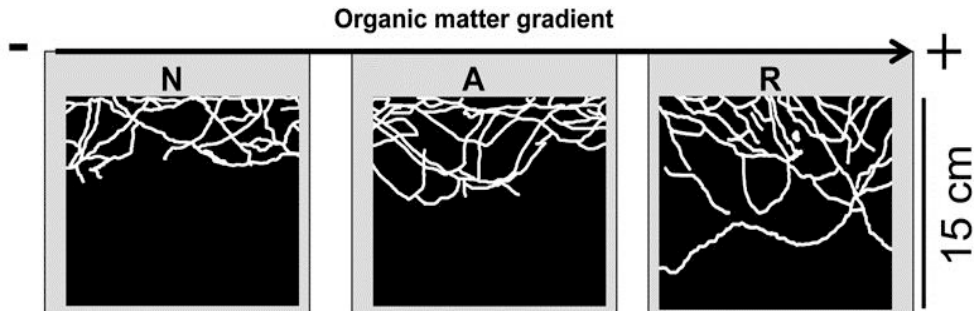

Figure 16. Increasing burrowing activity of the polychaete *Nephtys incisa* exposed to (N) natural, (A) intermediate and (R) high food concentrations. From Michaud et al. (2010)

In benthic fauna, the effect of food availability on bioturbation have been well studied in infaunal bivalves (Grémare et al. 2004, Maire et al. 2006, Bernard et al. 2016). They extend the inhalant siphon up to surface of the sediment to feed on microphytobenthos. Such a strategy leads to the displacement of sediment particles around the tip of the inhalant siphon (Hughes 1975, Grémare et al. 2004). In the bivalves *Abra ovata* and *Abra nitida*, higher food concentration leads to an increase in their feeding activity (Grémare et al. 2004). However, the species show different functional responses to increasing food concentration as they display their highest feeding-activity levels at intermediate and high food concentrations for *A. ovata* and *A. nitida*, respectively (Grémare et al. 2004). Such variability in the feeding strategy influences the downward transport of surface sediments (Maire et al. 2006, Bernard et al. 2016). Furthermore, *A. alba* has the ability to switch from deposit to suspension feeding mode depending on the abundance of food at the sediment surface (Levinton 1990, Rosenberg 1993). Noticeably, when the species exhibits a suspension feeding behaviour, it induces a drastic decrease in particles reworking as its inhalant siphon remains immobile (Grémare et al. 2004).

Meiofaunal species also displayed changes in their feeding strategies in response to the diel and availability of food sources (Buffan-Dubau & Carman 2000, Riera & Hubas 2003, Lebreton et al. 2012). Copepods and ostracods can for instance increase their grazing activity with rising food concentration (Buffan-Dubau & Carman 2000). Similarly, individuals of the benthic foraminifera *Ammonia tepida* exposed to organic matter had faster locomotion speed than individuals exposed to live prey (Jauffrais et

al. 2016b). Variability in the food supply, i.e. constant or single pulse, causes strong variation in the assimilation rate of individuals of *A. tepida*; suggesting that foraminifera can display short term adaptation to the variation of food availability (Wukovits et al. 2018). Moreover, even in the absence of any food cue, foraminiferal species displayed distinct foraging strategies that support the presence of an innate determinant to foraging strategy (Seuront & Bouchet 2015). Little is known however on how it may affect species bioturbation as these studies were focused on the role of foraminifera in the trophic structure of the studied ecosystems. We may however suggest that variations in food availability would affect the bioturbation of foraminiferal species as observed for macrofauna. Indeed, the locomotion of foraminifera in the sediment is intrinsically linked to food availability and diversity in the sediment (Linke & Lutze 1993, Heinz 1999, Gross 2002, Jauffrais et al. 2016b). **Therefore, food concentrations in sediment may induce different motion-behaviour responses in benthic foraminifera; and may further lead to increase or decrease in sediment reworking.**

6. Objectives of the PhD thesis

This thesis is the first work that thoroughly considers the ability of intertidal foraminifera to contribute to bioturbation. Specifically, as there is a substantial lack of information on the contribution of benthic foraminifera to bioturbation, and in particular for intertidal species, we considered that among the bioturbation processes, sediment reworking mechanism should be the first aspect to investigate. Noticeably, motion-behaviour appears to be a key factor controlling the mode and the intensity of particles mixing.

Therefore, the objectives of this PhD thesis were to fill the knowledge gap in the motion behaviour and in the role of intertidal foraminifera in sediment reworking processes. Specifically, it aimed at:

- (i) Characterising the motion behaviour of key benthic foraminifera species of different test shape and structure (Fig. 17) from intertidal mudflats

from the Eastern English Channel at the sediment water interface and used it as a stepping stones to objectively classify this species into functional groups of bioturbation (Chapter I-Part 1),

- (ii) Estimating surface sediment reworking rates of the above-mentioned key species (Chapter I-Part 2),
- (iii) Understanding how biotic, i.e. individual size (Chapter II-Part 1), and abiotic, i.e. total organic carbon (TOC) concentration (Chapter II-Part 2) and temperature (Chapter II-Part 3), parameters affect the mode and the intensity of surface sediment reworking of the dominant benthic foraminiferal species *Haynesina germanica* in the intertidal mudflats of the Eastern English Channel.
- (iv) Describing in *Haynesina germanica* (a) its vertical burrowing dynamics, (b) the biogenic structures built (Chapter III-Part 1) and (c) and finally quantifying its vertical sediment reworking rate as a function of density (Chapter III-Part 2).

To do so, we structured this study in three chapters in which we investigated several aspects of the motion behaviour of foraminifera and their consecutive effect on sediment reworking process (Fig. 18).

In chapter I, the objectives were to assess the dynamics of the motion behaviour of five intertidal foraminiferal species at the sediment-water interface. Several parameters such as activity level, travelled distance, tortuosity of the path, vertical position were measured on *Ammonia tepida*, *Haynesina germanica*, *Criboelphidium williamsoni*, *Quinqueloculina seminulum* and *Miliammina fusca* using tracking-method (Fig. 18). The behavioural properties of each species were described and expected as informative features to classify them into functional bioturbator groups that were so far only used

for macro-invertebrates. In addition, their displacements in the sediment were used to estimate the species-specific surface sediment reworking rate.

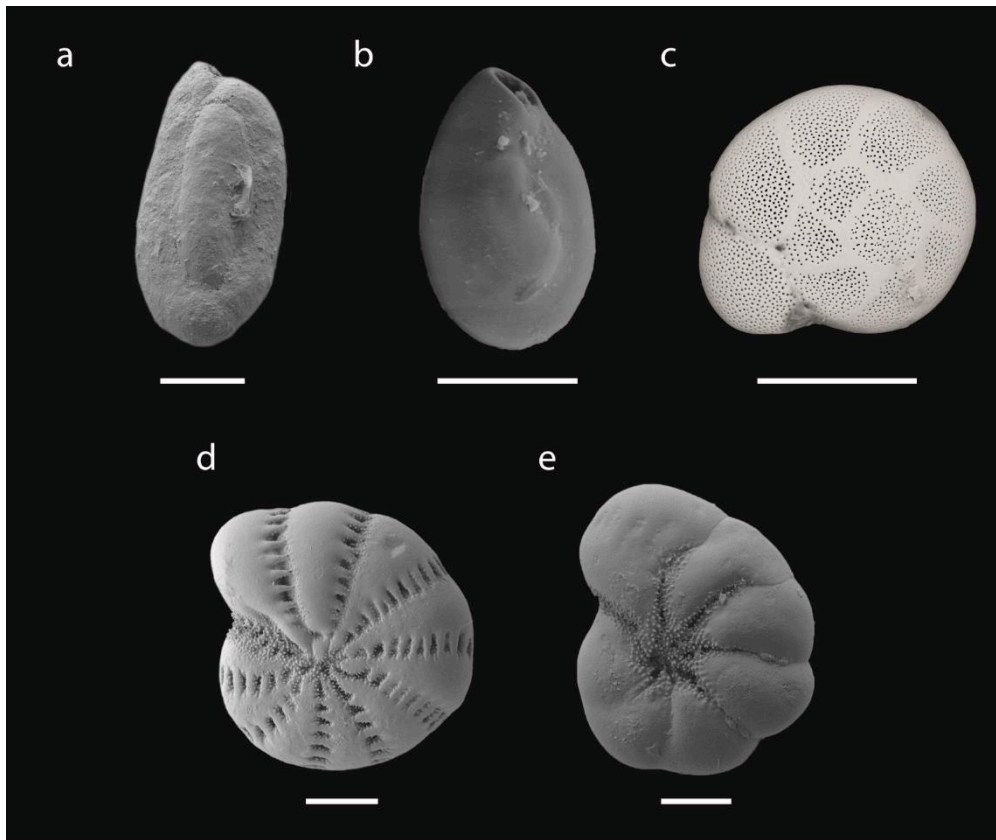

Figure 17. SEM images of the dorsal side of the five intertidal species studied in this PhD work (a) *Miliammina fusca*, (b) *Quinqueloculina seminulum*, (c) *Ammonia tepida*, (d) *Cribroelphidium williamsoni* and (e) *Haynesina germanica*. Scaled bar = 100 μm .

In chapter II, we specifically focused on *H. germanica*, one of the most dominant foraminiferal species in the intertidal mudflats of the Eastern English Channel, to assess the effect of biotic and abiotic factors on its motion behaviour and the consecutive effects on the surface sediment reworking rate. To do so, the motion behaviour of individuals of *H. germanica* was described for different category of size to assess the effect of intra-specific size variability on the specific surface sediment reworking rate. In addition, individuals of *H. germanica* were exposed to different regimes of TOC concentrations and temperatures in order to understand how the species may deal with short-term environmental changes by adapting its motion behaviour.

Surface sediment reworking rates were then estimated to assess the effects of both abiotic factor on species contribution to benthic ecosystem function. Furthermore, in

the case of temperature, metabolic rates (respiration and photosynthesis) were also considered.

In chapter III, we focused on the vertical motion behaviour of *H. germanica* in muddy sediment. To do so, the vertical distribution of the species was evaluated with a sediment core marked with CellTracker Green[®]. The *in situ* vertical distribution was coupled with experimental assessment of the dynamics in the vertical motion behaviour of *H. germanica* to characterise its motion behaviour and biogenic structures. Finally, fluorescent tracers, i.e. luminophores that mimic the behaviour of natural sediment particles, were used under different condition of density to estimate the vertical sediment mixing induced by the species (Fig. 18).

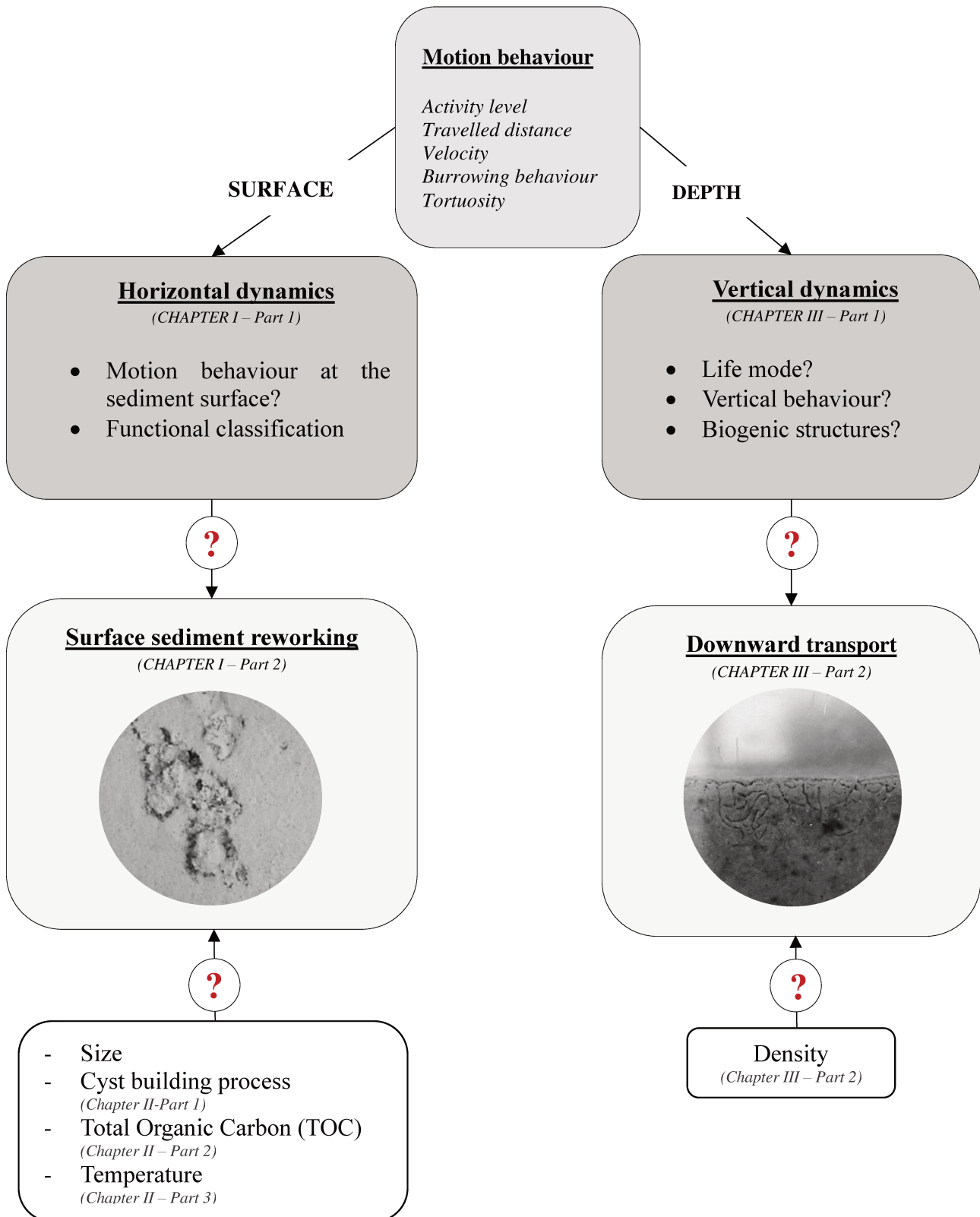

Figure 18. Conceptual schema illustrating the step-by-step methods used from the description of foraminiferal behavioural traits to the evaluation of their contribution to sediment reworking.

CHAPTER I

MODES AND INTENSITY OF SURFACE SEDIMENT REWORKING IN INTERTIDAL BENTHIC FORAMINIFERA

SUMMARY

The first aim of my PhD is to determine if different modes of sediment reworking may exist in intertidal benthic foraminifera. To do so, it is important to investigate their motion behaviour through the characterisation of their displacement and vertical position at the sediment interface. Chapter I is thus devoted to describe the motion behaviour of five dominant foraminiferal species in intertidal areas from the Eastern English Channel: *Haynesina germanica*, *Ammonia tepida*, *Criboelphidium williamsoni*, *Miliammina fusca* and *Quinqueloculina seminulum*. Their movements at the sediment-water interface allow to classify each species into bioturbating groups that have been so far only describe for macrofauna. Finally, the surface sediment reworking rate of each species is calculated and further linked to their functional classification.

ASSESSING BEHAVIOURAL TRAITS OF BENTHIC FORAMINIFERA: IMPLICATIONS FOR SEDIMENT MIXING

Noémie Deldicq^{1,*}, Laurent Seuront^{1,2,3,4}, Dewi Langlet¹, Vincent M.P. Bouchet¹

¹Univ. Lille, CNRS, Univ. Littoral Côte d'Opale, UMR 8187, LOG, Laboratoire d'Océanologie et de Géosciences, 62930, Wimereux, France

²CNRS, Univ. Lille, Univ. Littoral Côte d'Opale, UMR 8187, LOG, Laboratoire d'Océanologie et de Géosciences, 62930, Wimereux, France

³Department of Marine Resources and Energy, Tokyo University of Marine Science and Technology, 4-5-7 Konan, Minato-ku, Tokyo 108-8477, Japan

⁴Department of Zoology and Entomology, Rhodes University, Grahamstown, 6140, South Africa

Published in *Marine Ecology Progress Series* **643**: 21-31 (2020)

Submitted: November 29, 2019

Accepted: April 16, 2020

ABSTRACT

The assessment of behavioural traits of marine organisms is increasingly recognized as a key issue to understanding their role in ecosystem processes such as bioturbation and nutrient cycling. The movement ability of intertidal foraminifera suggest that they may have a role, yet to be quantified, in benthic–pelagic coupling through their movement on the sediment surface, at the sediment–water interface and within the sediment. In this context, we investigated the behavioural traits of 5 benthic foraminiferal species typical of European temperate mudflats under standardized trophic light and temperature conditions. Behavioural traits related to motion of *Ammonia tepida*, *Haynesina germanica*, *Criboelphidium williamsoni*, *Miliammina fusca* and *Quinqueloculina seminula* were assessed through their travelled distance, velocity, tortuosity of the path, position in the sediment and activity index. By analogy with macrofauna bioturbation functional groups, we describe the studied foraminifera as biodiffusor species with 3 sub-groups defined according to their vertical position in the sediment. *C. williamsoni* belongs to the epifaunal-biodiffusors, *A. tepida* and *H. germanica* belong to the surficial-biodiffusors, and *Q. seminula* and *M. fusca* are considered gallery-biodiffusors. Our results further suggest that features such as velocity, activity and tortuosity may mediate sediment-mixing intensity. Therefore, *Q. seminula*, *H. germanica* and *C. williamsoni*, which are the most active species, would have a larger effect on particle reworking rates than the less active *A. tepida* and *M. fusca*. Our results suggest that benthic foraminifera may play an underestimated role in bioturbation processes.

Key words

Benthic foraminifera · Intertidal · Motion behaviour · Functional trait · Bioturbator groups

1. Introduction

Trait-based studies have largely been implemented to describe ecosystem functioning, especially over the last decade (Braeckman et al. 2010, Cardinale et al. 2011, Gothland et al. 2014). Specifically, traits - defined as ‘the morphological, physiological or phenological features measurable at the individual level, from the cell to the whole-organism level’ (Violle et al. 2007, p. 884) - can either be demographical (e.g. birth, mortality), biological (e.g. size, growth), ecophysiological (e.g. nutrient assimilation, resource uptake) or behavioural (e.g. locomotion, species interactions). These features determine the role of a species in the ecosystem and hence allow definition of functional traits (Violle et al. 2007, Gagic et al. 2015).

A comprehensive assessment of species-specific behavioural traits associated with locomotion is one way to understand the role of species in the structure and functioning of coastal ecosystems. Specifically in soft-sediment environments, the behavioural traits related to faunal motion are intrinsically considered as functional traits involved in bioturbation processes through the displacement of sediment particles and the related enhancement of fluxes of both dissolved and particulate materials (Mermillod-Blondin et al. 2004, Mermillod-Blondin & Rosenberg 2006, Kristensen et al. 2012, 2014). For instance, surface sediment displacement intensity is directly linked to the type of activity (feeding, tube building) in the terebellid polychaete *Eupolyornia nebulosa* (Maire et al. 2007c). Recent methodological improvements such as high-frequency image analysis and automated acquisition help to quantify behavioural traits associated with bioturbation (see Maire et al. 2008 for a review). Continuous observation of *Abra ovata* showed that this bivalve’s behavioural activity is linked to sediment-mixing intensity (Maire et al. 2007a). Depending on their behavioural traits, bioturbating species can induce various changes in the benthic compartment such as the microbial community structure (Banta et al. 1999, Marinelli et al. 2002, Papaspyrou et al. 2006) and in the biogeochemical reactions occurring in the sedimentary column (Gutiérrez & Jones 2006). Trait-based approaches therefore allow the description of different functional groups of macrofauna species, such as gallery-diffusers, biodiffusers, regenerators and upward- and downward-conveyors (François et al. 1997). However,

knowledge is still limited on the role of the meiobenthic compartment in bioturbation processes (see review by Schratzberger & Ingels 2018).

The activity of meiofaunal taxa (nematodes and copepods) increases bacterial growth, oxygen fluxes, denitrification and organic matter mineralisation (Aller & Aller 1992, Bradshaw et al. 2006, Middelburg & Meysman 2007, Nascimento et al. 2012, Piot et al. 2013, Bonaglia et al. 2014). Benthic foraminifera, despite their high abundance and ecological importance in the marine meiobenthos (Murray 2006, Schönfeld et al. 2012), have essentially been ignored in most studies dealing with meiofaunal bioturbation. Furthermore, little is known on foraminiferal traits (e.g. habitats, metabolism, feeding modes, displacements), and only a few studies have quantified the motion behaviour of foraminifera (e.g. Kitazato 1981, 1988, Seuront & Bouchet 2015, Jauffrais et al. 2016b). Thus, all benthic foraminiferal functions may not yet be identified, particularly those involved in bioturbation processes. Benthic foraminifera can move over relatively long distances (Seuront & Bouchet 2015), and their movement types (rotating, spinning, crawling) are driven by both their number of pseudopods (Kitazato 1994) and the morphology of their tests (i.e. spiral or quinqueloculine, Wetmore 1988). Foraminiferal motion varies in intensity (Severin 1987, Gross 2002) and induces sediment displacements (Kitazato 1988, Hemleben & Kitazato 1995) that have thus far only been quantified for deep-sea communities (Gross 2002). These displacements create trails at the sediment surface (e.g. *Quinqueloculina impressa*, *Criboelphidium excavatum*) and galleries (e.g. *Ammotium cassis*, *C. excavatum* subsp. *clavatum*) in the sediment (Richter 1964, Severin et al. 1982, Linke & Lutze 1993, Hemleben & Kitazato 1995, Bornmalm et al. 1997, Gross 2002). Recently, Seuront & Bouchet (2015) demonstrated negative geotaxis in *Ammonia tepida* and positive geotaxis in both *C. excavatum* and *Haynesina germanica*, suggesting that these species move on and in the sedimentary column to colonize different microhabitats depending on their ecological requirements (Wetmore 1988, Linke & Lutze 1993, Murray 2006). Hence, benthic foraminiferal functional traits associated with motion behaviour may exist and be involved in sediment mixing. This further suggests that the assessment of behavioural traits is an absolute prerequisite to

a comprehensive description of the foraminiferal role in particulate fluxes at the sediment–water interface. Yet, behavioural traits such as activity, motion intensity and vertical position are poorly described in benthic foraminifera.

In this context, the objectives of this study were to (1) assess the horizontal and vertical dynamics of 5 intertidal foraminiferal species at the sediment–water interface, (2) quantify the motion behaviour of these species and (3) use the emergent vertical position and behavioural traits as a stepping stone to objectively classify these species into functional groups. In intertidal mudflats in temperate environments, oxygen penetration depth rarely reaches 1 cm, and foraminifera are mainly distributed in the 0–1 cm layer (Geslin et al. 2011, Cesbron et al. 2016). We therefore specifically focussed on foraminifera living in the top 1 cm of sediment.

2. Materials and methods

2.1. Sediment sampling and experimental set-up

Surface sediment (0–1 cm) was collected from February to June 2018 at low tide in Authie Bay (50° 22' 20'' N, 1° 35' 45'' E), an intertidal mudflat located on the French coast of the English Channel, and sampled for living benthic foraminifera. Samples were stored in plastic containers (100 ml) and transported to the laboratory, then washed through a 125 µm mesh sieve. Living benthic foraminifera were subsequently individually sorted with a brush and identified, and their pseudopodial activities were checked with an inverted phase-contrast microscope. Five intertidal species were selected for this study due to their high density at the study site: the planispiral species *Haynesina germanica* and *Criboelphidium williamsoni*, the trochospiral species *Ammonia tepida*, the agglutinated species *Miliammina fusca* and the porcelaneous species *Quinqueloculina seminula*. Recent molecular investigations showed that the phylotypes *H. germanica* S16, *C. williamsoni* S1 and *A. tepida* T6 occur in Authie Bay (M. Schweizer unpubl. data). Individual sizes ranged from 300 to 800 µm in diameter. Depending on their abundance at the time of sampling, a total of 8 to 33 individuals per species were analysed throughout all the experiments (see Table 1).

Before behavioural observations, individuals were kept overnight (12 h) for acclimation to the experimental condition in a controlled-temperature room at 18°C. Behavioural observations were performed in 300 ml aquaria filled with 25–30 ml of thawed Authie Bay sediment (previously sampled in January 2017, N. Deldicq unpubl. data) and 250 ml unfiltered eastern English Channel seawater (30 PSU).

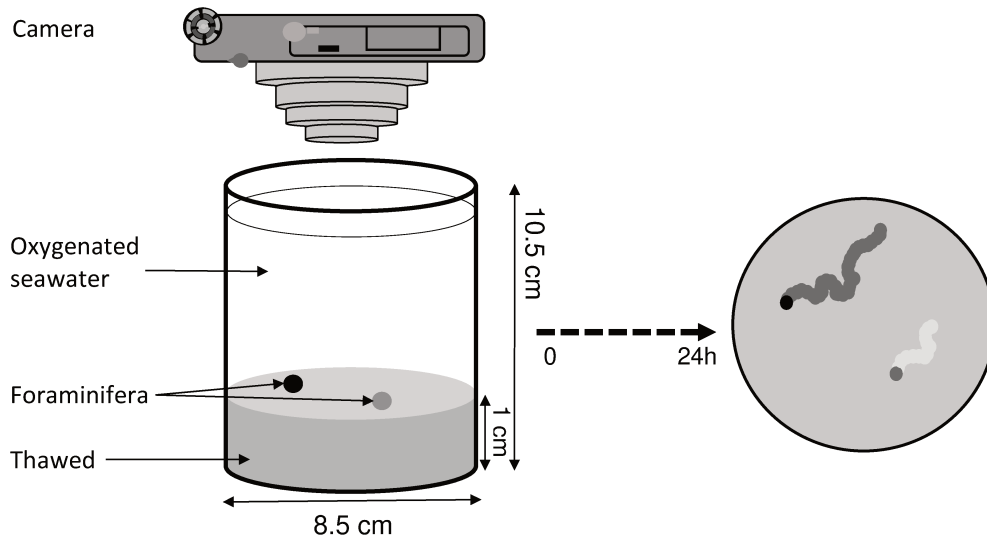

Figure 19. Experimental set-up for time-lapse assessment of foraminiferal motion-traits (left-hand side) and examples of the movement paths of 2 foraminifera over a 24 h period (right-hand side)

We used previously frozen sediment to ensure that the sediment was free of moving macro- and meio-organisms (since nematodes, copepods and macrofaunal organisms are killed during sediment freezing) so that the only tracks observed on the sediment surface would be those from foraminifera. After the 12 h acclimation period, foraminifera were placed randomly on the sediment surface (Fig. 19). Note that the overlaying water was fully saturated with oxygen by 10 min of vigorous air bubbling immediately before spreading foraminifera on the sediment surface. At the end of each 24 h experiment, dissolved oxygen saturation was about 56% in the overlaying seawater directly above the sediment-water interface (HI9829 Multi-parameter Meter, Hannah Instruments).

2.2. Quantification of behavioural traits

Individual displacements in and on the sediment were recorded by time-lapse photography (1 image every 10 min for 24 h) using a digital camera (Nikon V1 with a Nikkor 10–30 mm lens; Fig. 19). For each foraminifer, 144 images were combined in the image-analysis software Fiji to extract (x,y) coordinates using the manual tracking plugin (Schindelin et al. 2012). The behavioural traits of the above-mentioned species were investigated, adapting the method described by Seuront & Bouchet (2015). Five parameters were used to characterise the traits of each study species.

First, the level of activity, i.e. time allocated to motion by each individual, was estimated with the activity index A_i (%). This index is based on the ratio between the total time taken by an individual (i) to move from its initial to its final position (t_{move}) and the time that the individual spent moving between these positions (t_{active}):

$$A_i = 100 \times (t_{\text{active}} / t_{\text{move}}) \quad (1)$$

The distance travelled by each individual between 2 images (i.e. 10 min) (D_t , mm) was calculated as:

$$D_t = \sqrt{[(x_t - x_{t+10})^2 + (y_t - y_{t+10})^2]} \quad (2)$$

where (x_t, y_t) and (x_{t+10}, y_{t+10}) are the coordinates between 2 successive images taken at times t and $t+10$ min, and the velocity (mm h^{-1}) of each individual was subsequently calculated considering the total distance travelled in 24 h.

The complexity (or tortuosity) of movement paths was assessed using fractal analysis. The fractal dimension measures the degree to which the trajectory fills the available space and is bounded between $D = 1$ for a line (i.e. the simplest instance of a trajectory) and $D = 2$ for a movement so complex that it actually fills the whole available space. The fractal dimensions of foraminifera trajectories were estimated using the box dimension method (see Seuront 2010a, 2015b for reviews), which relies on the ‘ l cover’ of the object, i.e. the number of boxes of length l required to cover the object. A more practical alternative is to superimpose a regular grid of boxes of length l on the object and count the number of boxes occupied by a subset of the object. This

procedure is repeated using different values of l . The surface occupied by the trajectory of a foraminifer is then estimated using a series of counting boxes spanning a range of surfaces down to some small fraction of the entire surface. The number of occupied boxes increases with decreasing box size, leading to the following power-law relationship:

$$N(l) \propto l^{-D_b} \quad (3)$$

where l is the box size, $N(l)$ is the number of boxes occupied by the trajectory, and D_b is the box fractal dimension. The fractal dimension D_b is estimated from the slope of the linear trend of the log–log plot of $N(l)$ versus l .

Finally, to assess the preferential position of the 5 studied species, the vertical position in the sediment of each individual was determined for every picture based on a classification with 3 depth categories.

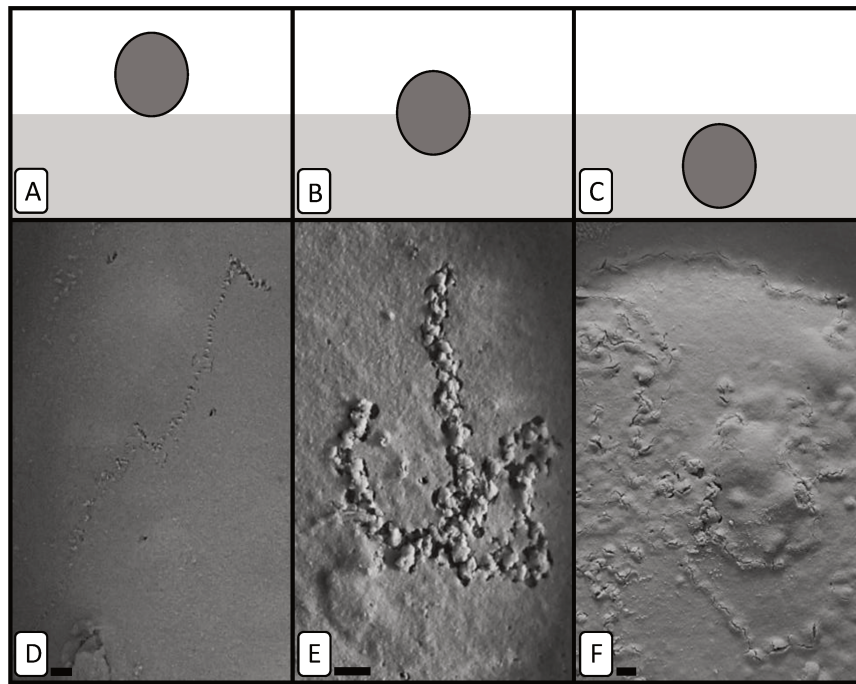

Figure 20. (A–C) Schematic representations and (D–F) images of the 3 vertical positions assumed by a foraminifer: surface (A,D), sediment–water interface (B,E); burrowed (C,F). Examples from *Haynesina germanica* (D,E) and *Quinqueloculina seminula* (F). Scale bars = 0.2 mm

When the test remained visible at the surface and the width of the path was indistinguishable, the individual was considered to be crawling on the sediment surface (Fig. 20A,D). In turn, when the individual was burrowing into the sediment, its position

was divided in 2 categories: it was considered as moving at the sediment–water interface when half of the test was visible (Fig. 20B,E) and as having fully burrowed into the sediment when a swelling at the sediment surface was the only indication of the presence of the test in the sediment (Fig. 20C,F).

2.3. Statistical analyses

Because A_i , D_t and velocity were non-normally distributed (Kolmogorov-Smirnov test, $p < 0.05$), multiple comparisons between species were conducted using the Kruskal-Wallis test, and a subsequent multiple comparison procedure based on the Mann-Whitney test was used to identify distinct groups of measurements. The presence of significant differences in fractal dimensions between species was assessed using ANCOVA (Zar 2009). All statistical analyses were performed using © R.3.5.2. software (R Core Team 2019).

3. Results

Among the 230 individuals selected for the experiment, 103 individuals were analysed, as we kept only those that we were able to track from the start to the end of the experiment (Table 1).

Table 1. Number (N) of individuals of each species used for experiments and the subsequent number (n) of individuals for which (x,y) coordinates were extracted, with mean and SD for each parameter

Species	No. of expts.	Total Analysed		Distance moved 24 h (mm)		Velocity (mm h ⁻¹)		Activity index (%)		Tortuosity	
		ind. N	ind. n	Mean	SD	Mean	SD	Mean	SD	Mean	SD
<i>Quinqueloculina seminula</i>	2	30	16	88.25	32.95	3.67	1.37	76.33	17.41	1.16	0.05
<i>Haynesina germanica</i>	6	90	30	51.51	19.63	2.15	0.82	83.31	12.21	1.15	0.03
<i>Criboelphidium williamsoni</i>	2	30	16	44.18	13.50	1.84	0.56	89.80	7.08	1.10	0.05
<i>Ammonia tepida</i>	4	60	33	17.29	5.94	0.72	0.25	78.49	13.17	1.14	0.03
<i>Miliammina fusca</i>	1	20	8	14.06	4.67	0.59	0.19	50.77	15.52	1.12	0.03

3.1. Activity index (A_i)

Criboelphidium williamsoni was the most active species, with a mean A_i of 89%, corresponding to 21/24h of displacement in the sediment (Fig. 21A, Table 1). The A_i

of this species was significantly higher ($p < 0.05$) than those of *Ammonia tepida*, *Haynesina germanica* and *Quinqueloculina seminula*, which were not significantly different from each other ($p < 0.05$). These 4 species had a significantly higher A_i than *Miliammina fusca* ($p < 0.05$), which was the least active species with a mean A_i of 50% (Fig. 21A).

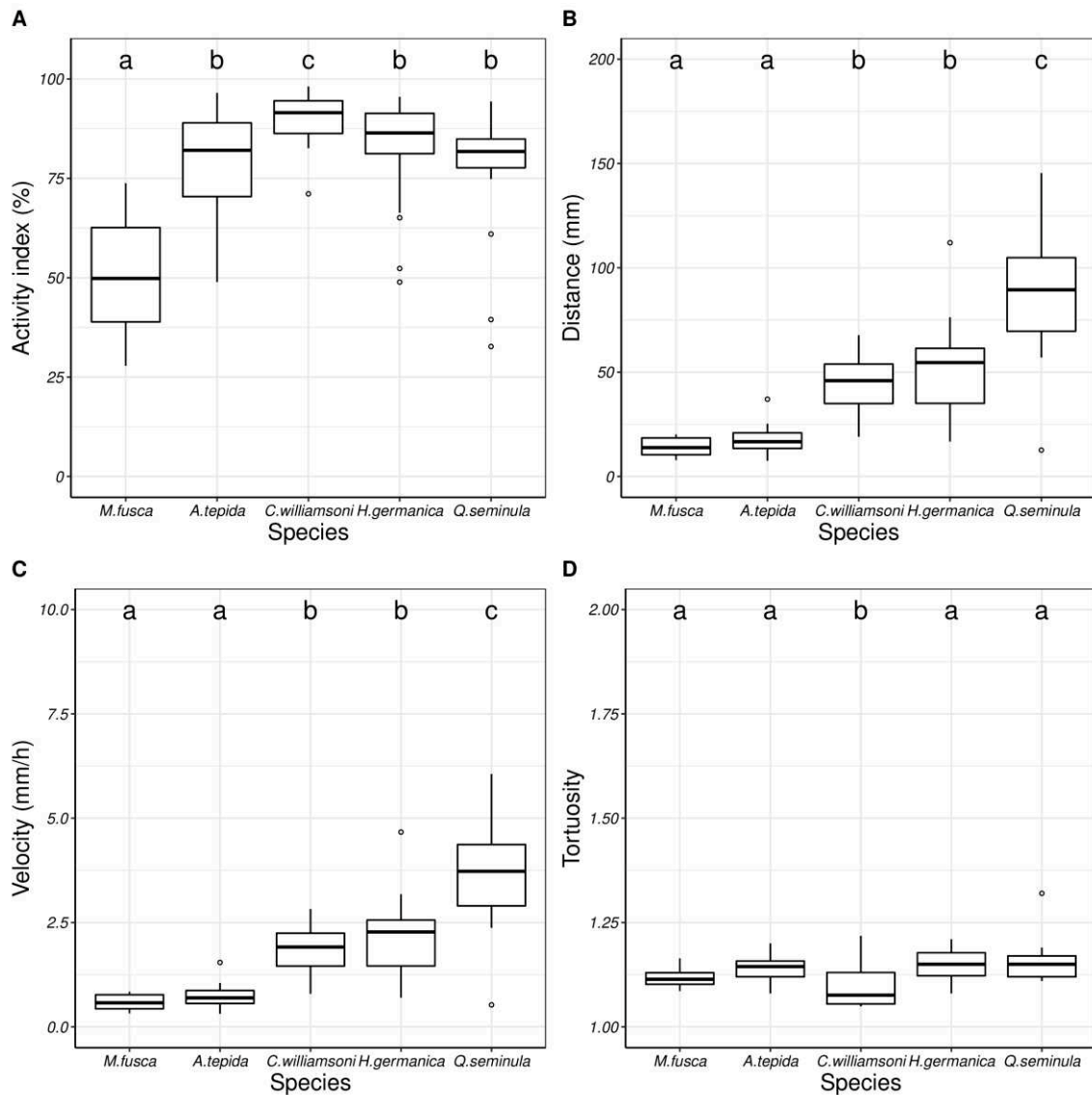

Figure 21. Calculated parameters for the investigated foraminifera species: (A) activity index, (B) distance travelled (over 24 h), (C) velocity, (D) tortuosity. Letters above plots ('a', 'b', 'c') indicate significant differences among measurements (Mann-Whitney test, $p < 0.05$). The box represents the first, second and third quartiles and the whiskers extend to 1.5 times the interquartile range; values outside this range are represented by open circles

3.2. Distance (D_t) and velocity

Q. seminula moved significantly faster ($p < 0.05$, Fig. 21C) and over longer distances (Fig. 21B) than the other species. The 4 other species were discriminated into 2 homogeneous groups, with species moving slowly over short distances (*M. fusca* and *A. tepida*; Fig. 21B,C, Table 1) and species moving at intermediate speed over intermediate distances (*C. williamsoni* and *H. germanica*; Fig. 21B,C, Table 1).

3.3. Tortuosity

Fractal dimensions D were in the range 1–1.3, indicating relatively linear trajectories. ANCOVA identified a group of 4 species (*M. fusca*, *A. tepida*, *H. germanica* and *Q. seminula*) moving significantly more tortuously than *C. williamsoni* (Fig. 21D).

3.4. Vertical position

M. fusca and *Q. seminula* individuals were essentially observed (i.e. 100% and 70–90%, respectively) burrowed in the sediment throughout the experiment (Fig. 22A,B). Conversely, the vast majority (90–100%) of *C. williamsoni* individuals remained on the sediment surface during the first 3 h, before progressively moving to the sediment–water interface (10–100%) and were rarely observed burrowing down into the sediment (Fig. 22C).

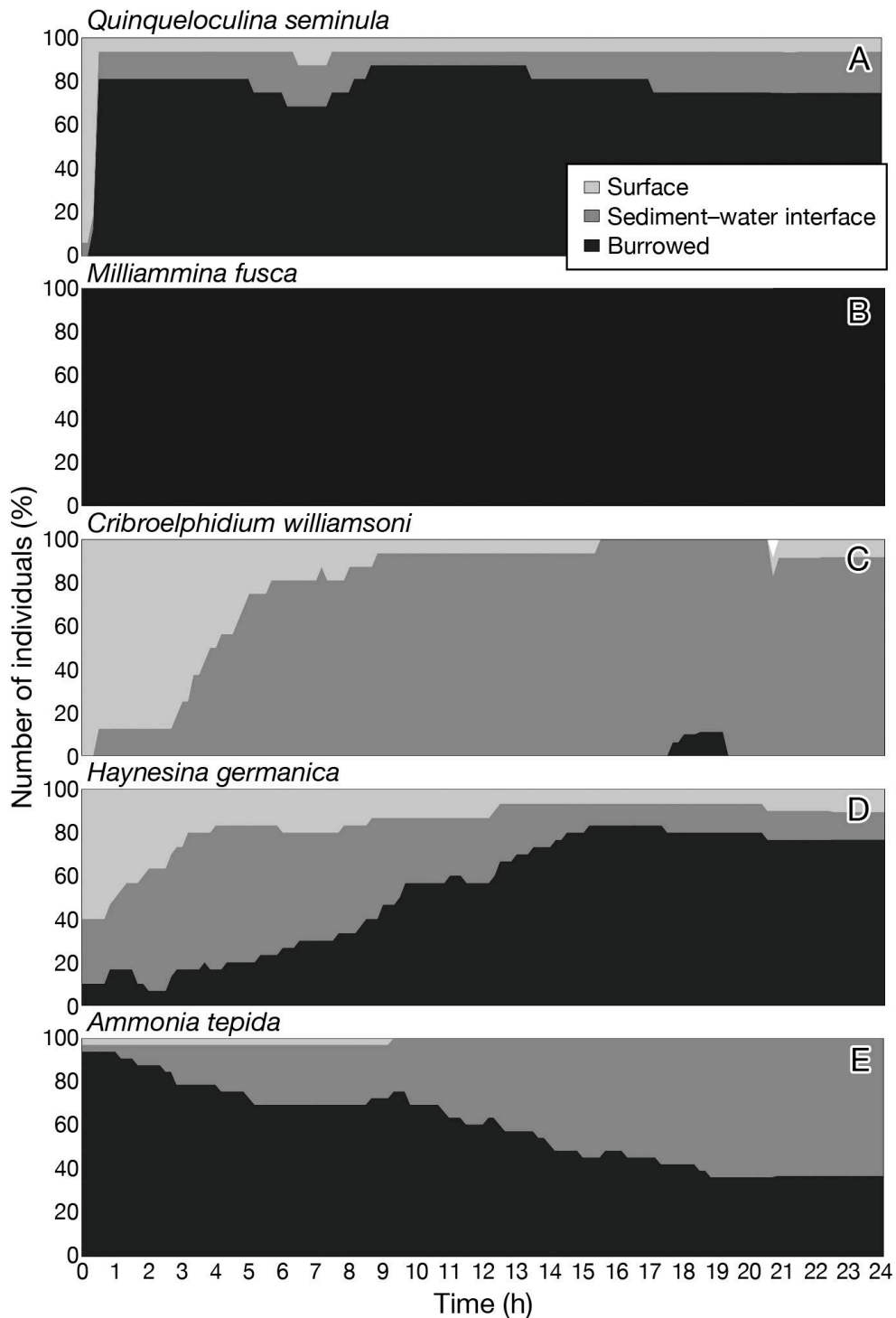

Figure 22. Temporal evolution of the vertical position of each studied foraminifera species

H. germanica gradually burrowed from the sediment surface down into the sediment with time to be essentially (75–80%) located in the sediment after 15 h of observation (Fig. 22D). Finally, *A. tepida* exhibited a slightly different temporal pattern. First, a vast majority of individuals (95%) dug from the sediment surface down into the

sediment in less than 1 h, before progressively spreading out back up towards to sediment–water interface (Fig. 22E).

4. Discussion

This study is based on 24 h long observations assessing the behavioural traits of 5 species of benthic foraminifera to further understand their roles in sediment mixing. Behavioural traits of macrofaunal species affect the way they displace sediment particles (François et al. 1997, Maire et al. 2006, 2007a). These traits allow for their classification in functional groups, i.e. biodiffusors, regenerators or conveyors (François et al. 1997, Kristensen et al. 2012). The intensity of species activity is, further, directly linked to its life-mode, i.e. vertical position, movements and feeding habits in the sediment, which drives sediment mixing and bio-irrigation (Gérino et al. 2003, Gilbert et al. 2007, Maire et al. 2008, 2016, Kristensen et al. 2012). Considering that foraminifera fundamentally displace sediment over short distances due to their small size (Gross 2002, this study), we hereafter consider foraminifera as biodiffusors since they are ‘*organisms with activities that usually result in a constant and random local sediment bio-mixing over short distance*’ (Kristensen et al. 2012, p. 289).

More specifically, biodiffusors are typically divided into 3 subgroups (epifaunal-, gallery- and surficial-biodiffusors) depending on their life-mode in the sediment (Kristensen et al. 2012). In this context, our high-frequency image analysis of foraminiferal behaviour showed species-specific preferential depths of activity, which we use hereafter to classify the studied intertidal foraminiferal species in different functional biodiffusor subgroups (Fig. 23). Furthermore, motion-behaviour features (A_i , D_i , velocity and tortuosity) drive intra-functional group variability.

4.1. Foraminifera as biodiffusors

4.1.1. Epifaunal-biodiffusors

In our experiments, *Criboelphidium williamsoni* only moved on the sediment surface and at the sediment–water interface. This observation is consistent with

previous studies describing this species as epifaunal (Allison et al. 2010) and reporting the highest density of the species in the uppermost oxygenated sediment layers (Alve & Murray 2001, Bouchet et al. 2009). This kleptoplastic species can host 10 times more active chloroplasts in its cytoplasm than other temperate-water species (Lopez 1979). Kleptoplasty suggests a preference for well-lighted surface sediment, so this species most likely has a surface-limited effect on sediment mixing and bio-irrigation. Consequently, *C. williamsoni* may be considered as an epifaunal-biodiffusor (Fig. 23), a group which includes ‘organisms that occur predominantly above the sediment–water interface. Their activities are limited to near-surface sediments and generally redistribute fine particles randomly over very short distances along the surface’ (Kristensen et al. 2012, p. 290).

4.1.2. Surficial-biodiffusors

Haynesina germanica and *Ammonia tepida* tended to avoid the surface sediment, and both preferred the sediment–water interface and burrowed position. Specifically, at the end of the experiment, *A. tepida* individuals were evenly distributed between these 2 positions, while *H. germanica* preferred to be completely burrowed. These results are consistent with *in situ* observations where *A. tepida* is found on and in the sediment (Goldstein et al. 1995, Bouchet et al. 2009), while *H. germanica* mainly occurs at the sediment surface (Alve & Murray 2001, Bouchet et al. 2009). The latter can sequester photosynthetically active chloroplasts, which might be used as food sources under low-light conditions (Jauffrais et al. 2016a). Our results suggest that both species could alternate between epifaunal and infaunal micro-habitats (Fig. 23). As a consequence, we classify these species in the surficial-biodiffusors group, which comprises ‘organisms with activities mostly restricted to the uppermost few centimetres of the sediment, and these species rarely venture above the sediment–water interface’ (Kristensen et al. 2012, p. 290). To be consistent with this definition, further assessments are needed to understand how deep *H. germanica* and *A. tepida* can mix the sediment.

4.1.3. Gallery-biodiffusors

Quinqueloculine species (i.e. *Quinqueloculina seminula* and *Miliammina fusca*) moved immediately from the surface down into the sediment layer and stayed buried during the remainder of the experiment. These 2 species are hence clearly not restricted to the sediment–water interface. *Q. seminula* has previously been described as an epifaunal species (Di Bella et al. 2015, Martins et al. 2015) preferring the oxic zone (Moodley et al. 1998), but is also known to be tolerant to periods of low oxygen levels (Bernhard et al. 1997, Martins et al. 2011, 2013, Langlet et al. 2014). Since in our 24 h long observations specimens never returned to the surface, these species may rather be considered as infaunal, with the ability to create galleries in the sediment (Severin & Erskian 1981, Severin et al. 1982). As a consequence, *Q. seminula* and *M. fusca* should be considered as gallery-biodiffusors (Fig. 23) which are organisms ‘*inducing diffusive local bio-mixing of particles and vertical transport of particles from the upper regions of the sediment to the lower limit of burrow penetration*’ (Kristensen et al. 2012, p. 291).

Species	Activity	Distance	Position
<i>Quinqueloculina seminula</i>	Intensive	High	Burrowed
<i>Criboelphidium williamsoni</i>		Medium	Surface
<i>Haynesina germanica</i>		Low	Surface → Burrowed
<i>Ammonia tepida</i>	Low	Low	Burrowed
<i>Miliammina fusca</i>			

Gallery-biodiffusor	Surficial-biodiffusor	Epifaunal-biodiffusor
		

Figure 23. Conceptual schema summarizing the difference between studied species and their classification into functional groups, with *Q. seminula* and *M. fusca* in the gallery-biodiffusor group, *A. tepida* and *H. germanica* in the surficial-biodiffusor group and *C. williamsoni* in the epifaunal-biodiffusor group

4.2. Features explaining intra-functional group variability

Traits such as individual size and foraging strategy affect species-specific functional roles in bioturbation processes (François et al. 1997, Gérino et al. 2003, Solan et al. 2004, Mermillod-Blondin 2011). For instance, macrofauna species displace a quantity of sediment which is in direct proportion to their volumetric size (Dorgan et al. 2005). In our study, quinqueloculine species (i.e. *Q. seminula* and *M. fusca*) have larger test volumes compared to the other species investigated, suggesting that they would displace more sediment. However, effects of benthic fauna on fluxes at the sediment–water interface depend on sediment reworking and bio-irrigation modes rather than on the biogenic structure volume produced (Bouchet et al. 2009). Intensity of bioturbation is hence a complex interplay between numerous traits.

More specifically, the rate at which particles are physically moved also depends on feeding strategies (Gérino et al. 2007). Tortuosity provides key information on this life history trait (Pyke 1984, Bell 1991). In our study, the 5 species exhibited relatively low tortuosity values, suggesting that they explored their environment extensively with close-to-linear trajectory. Such an extensive search strategy (or transecting, e.g. Bell 1991) in the case of the 5 studied species is optimal under patchily distributed food sources (Pyke 1984, Seuront & Stanley 2014, Seuront & Bouchet 2015). This foraging strategy is consistent with what is known of the trophic ecology of the 5 species used in this study which feed on microphytobenthos, bacteria and metazoans (Nomaki et al. 2008, Dupuy et al. 2010, Jauffrais et al. 2016b, Chronopoulou et al. 2019). For instance, *H. germanica* and *A. tepida* are both herbivorous, feeding on benthic diatoms (Ward et al. 2003, Pascal et al. 2008).

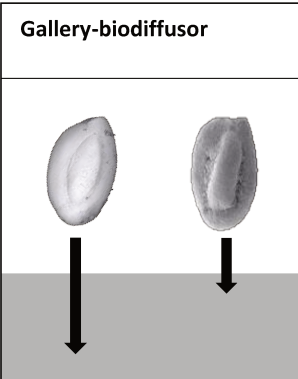
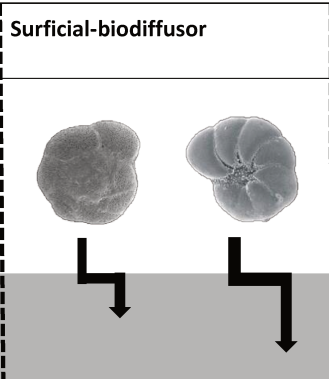
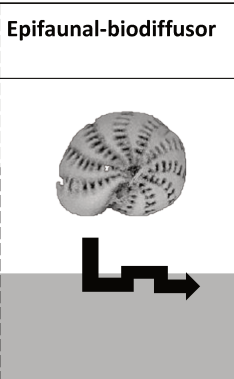
Recently, an *in situ* study showed that the feeding behaviour of intertidal benthic foraminifera is more complex than what has been observed experimentally (Chronopoulou et al. 2019). Intertidal foraminifera exhibited clear varied and species-specific trophic behaviours and were actually able to feed on different food sources (Jauffrais et al. 2016b and reference therein). Specifically, *A. tepida* may prefer to consume algae, but is also able to feed on bacteria (Pascal et al. 2008). Since microscale (i.e. millimetre-scale) distributions of microphytobenthos, bacteria and metazoans are

extremely patchy (Pinckney & Sandulli 1990, Danovaro et al. 2001, Spilmont et al. 2011), all of the studied species would benefit from an extensive search strategy to optimize their likelihood of locating food patches. Such extensive displacement tends to maximize sediment mixing (Seuront 2010b, Viswanathan et al. 2011). However, species' feeding strategies were not investigated in our experiment, since we used homogenized, prefrozen surface sediment containing labile organic matter, living bacteria and dead macro- and meio-faunal organisms, and non-filtered overlying water which may have contained microalgae. To further assess whether foraging strategy would affect sediment-mixing rate, the motion-behaviour of foraminiferal species under patchy vs. homogeneous controlled food conditions needs to be assessed.

The 5 studied species showed significant differences in their respective A_i , D_i and velocity. Within the functional groups described in Section 4.1, species may not have the same sediment-mixing intensity, and this intensity may most likely depend on the detailed properties of species-specific motion behaviour. Within the gallery-biodiffusors, *Q. seminula* was the second-most active species and travelled the longest distances, while *M. fusca* was the least active species and travelled the shortest distances. Similarly, the surficial-biodiffusor *H. germanica* was more active and moved further than *A. tepida*. As a consequence, *Q. seminula* and *H. germanica* may rework a larger volume of sediment. Furthermore, irrespective of their functional group, the most active species (i.e. *C. williamsoni*, *Q. seminula* and *H. germanica*) may contribute more to sediment mixing than the less active species such as *A. tepida* and *M. fusca* (Fig. 23).

5. Conclusion

Based on the monitoring of species-specific behavioural traits, this study assigned, for the first time, intertidal benthic foraminiferal species into the biodiffusors-functional group. Hence, the preferential depth of activity is fundamentally the prime feature allowing differentiating between species. Secondary features like size, feeding mode, activity index, travelled distance, velocity and tortuosity would most likely mediate the intensity of bioturbation and explain the intra-functional group differences.

To definitively validate our classification, further work is needed on the quantification of sediment reworking rate of the 5 studied species. Furthermore, our observations showed that foraminifera create physical disturbances at the sediment surface, previously described as sediment pellets (Chandler 1989). Such a pelletised surface layer created by the activity of benthic organisms can ease the resuspension of sediments by tidal currents (Davis 1993, Willows et al. 1998, Orvain et al. 2003, 2004) and affect sediment bio-irrigation. These physical and chemical changes will affect microbial communities (Bertics & Ziebis 2009, Piot et al. 2013), organic matter mineralisation and nutrient cycles (Gilbertson et al. 2012, Aller 2014). The activity of meiofaunal species such as copepods, nematodes and foraminifera will consequently increase organic matter and NO_x fluxes, which strongly affect benthic-pelagic coupling and therefore ecosystem functions (Danovaro et al. 2008, de Goeij et al. 2013). Our results suggest that foraminifera might play an underestimated role in sediment cohesiveness and benthic fluxes of dissolved elements (Schratzberger & Ingels 2018). This study supports that, in the context of biodiversity change, assessing life traits of benthic foraminifera is critically needed to understand their role in ecosystem functioning.

Acknowledgements

We thank the Région Hauts-de-France, the Ministère de l'Enseignement Supérieur et de la Recherche and the European Fund for Regional Economic Development for their financial support through the CPER research project CLIMIBIO. The PhD fellowship of N.D. was funded by the Ministère de l'Enseignement Supérieur et de la Recherche. The post-doctoral fellowship of D.L. was supported by the STARS research project COFFEE of the Région Hauts-de-France and the CPER research project CLIMIBIO. Molecular investigations of spiral-shaped foraminifera phylotypes were done within the research project AMTEP, funded by the CNRS-INSU program EC2CO.

INTER-SPECIFIC AND INTER-INDIVIDUAL TRAIT VARIABILITY MATTER
IN SURFACE SEDIMENT REWORKING RATES OF INTERTIDAL
FORAMINIFERA

Noémie Deldicq^{1*}, Laurent Seuront^{1,2,3}, Vincent M.P. Bouchet¹

¹Univ. Lille, CNRS, Univ. Littoral Côte d'Opale, UMR 8187, LOG, Laboratoire d'Océanologie et de Géosciences, Station Marine de Wimereux, F 59000, Lille, France.

²Department of Marine Resources and Energy, Tokyo University of Marine Science and Technology, 4-5-7 Konan, Minato-ku, Tokyo 108-8477, Japan.

³Department of Zoology and Entomology, Rhodes University, Grahamstown, 6140, South Africa

Revised in *Marine Biology*

Submitted: December 13, 2020

Current status: revised manuscript under review

ABSTRACT

Although benthic foraminifera are an important component of meiofauna and contribute to carbonate production and carbon/nitrogen cycles, their role in bioturbation processes remains poorly known. Five dominant intertidal benthic foraminifera were recently classified into functional bioturbator groups according to their sediment reworking mode and intensity. Our study aimed at identifying potential drivers (i.e. size and/or travelled distance) of species-specific surface sediment reworking rate. The travelled distance and surface sediment reworking rate of *Haynesina germanica*, *Criboelphidium williamsoni*, *Ammonia tepida*, *Quinqueloculina seminulum* and *Miliammina fusca* were assessed through image analysis. Our results show that the surface sediment reworking performed by these species is not size-dependent, but dependent on their motility traits through interspecific differences in the travelled distance. Smaller species (i.e. *Quinqueloculina seminulum* and *Haynesina germanica*) contribute more to surface sediment reworking than larger ones (i.e. *Ammonia tepida*, *Criboelphidium williamsoni* and *Miliammina fusca*). These observations stress the critical role of motion behaviour in surface sediment reworking processes by intertidal foraminifera. Finally, we stress that the high inter-individual variability observed in conspecific motion behaviour may be important to decipher the role of foraminifera in sediment bioturbation. Noticeably, the species characterized by a strong inter-individual variability are also the species that have the highest surface sediment reworking rates. This last observation may inform on the species-specific phenotypic plasticity and therefore the potential for the functional role of these species to be maintained in their natural environment. This is particularly relevant in an era of global change where ecosystem balance is increasingly threatened by various stressors such as heat-waves, ocean acidification and plastic pollution.

Keywords

Benthic foraminifera – surface sediment reworking rate – intertidal mudflats – motion behaviour – interspecific variability – inter-individual variability

1. Introduction

Bioturbation activities of benthic fauna contribute to the structure and functioning of most marine soft-sediment ecosystems; see Kristensen et al. (2012) for a review. Sediment particle reworking typically drives (i) substrate physical properties such as granulometry and erodibility and (ii) bacterial communities (Orvain et al. 2003, 2004). This process affects chemical gradients and increases dissolved fluxes at the sediment-water interface (Orvain et al. 2004, Kristensen et al. 2012, Schratzberger & Ingels 2018, Bonaglia et al. 2020). Overall, bioturbation contributes to the mineralisation of organic matter; thereby enhancing carbon and nutrient cycling (Aller 1994, Mermillod-Blondin & Rosenberg 2006, Meysman et al. 2006, Kristensen et al. 2012).

Meiobenthos refers to organisms with a size ranging from 63 μm to 1 mm that occur in a large range of both marine and freshwater environments (Mare 1942, Hulings & Gray 1971, Higgins & Thiel 1988). Their role in bioturbation processes has received an increasing amount of attention over the last decade. Beyond the fact that they may be more abundant, diverse and resilient than macro-invertebrates (Gerlach 1978, Bouchet et al. 2018, 2020), their contribution to sediment reworking and bio-irrigation is non-negligible compared to the one of macro-invertebrates (Rysgaard et al. 2000, Gross 2002, Näslund et al. 2010, Bonaglia et al. 2014, Bouchet & Seuront 2020). Through their movement and feeding activity, meiofaunal organisms further structure and constrain microbial communities that are crucial for organic matter mineralization (De Mesel et al. 2004, Moens et al. 2005, Nascimento et al. 2012). They also affect the oxygen penetration depth, increasing solute transport (e.g. sulphides) into the sediment (Aller & Aller 1992, Rysgaard et al. 2000, Bonaglia et al. 2020). For instance, in an intertidal mudflat, nematode displacements have been shown to stimulate microphytobenthos accumulation in the surface biofilm leading to a shift in diatom community (D'Hondt et al. 2018). Taken together, these observations strongly suggest that the role of meiofauna in bioturbation processes needs to be urgently considered in studies dealing with benthic ecosystem functioning as they play an important role in soft sediment ecosystems (Näslund et al. 2010, Nascimento et al. 2012, Bonaglia et al. 2014, 2020).

Traditionally, foraminifera have been overlooked in studies assessing total meiofaunal bioturbation probably, mostly because these works only considered metazoan meiofauna (Schratzberger & Ingels 2018). These abundant and diverse organisms in intertidal mudflats are able to significantly alter sediment structure through the creation of burrows and cyst building both at the interface and deeper into the sediment (Severin & Erskian 1981, Kitazato 1988, 1994, Chandler 1989, Green & Chandler 1994, Gross 2000, 2002, Bouchet & Seuront 2020, Deldicq et al. 2020), leading to sediment mixing (Gross 2002). Surface sediment reworking rates of the intertidal foraminiferal species *Ammonia tepida* and *Quinqueloculina seminulum* were recently shown as comparable to those of macrofaunal species (Bouchet & Seuront 2020). These observations highlighted the non-negligible importance of benthic foraminifera to contribute to sediment reworking processes. Furthermore, meiofauna (including foraminifera) can increase rate of solute transport and stimulate aerobic decomposition and nitrification processes in the oxic zone (Aller & Aller 1992, Aller 1994, Bonaglia et al. 2020). Recently, five dominant intertidal foraminifera have been classified in distinct functional groups (e.g. surficial-, epifaunal- and gallery-biodiffusors; see Deldicq et al. 2020) that underpinned their differences in the type and intensity of sediment reworking. Distinct species-specific behavioural patterns related to their displacement both within the sediment and at the sediment-water interface were therefore hypothesized to differently affect sediment reworking rate (Deldicq et al. 2020).

These preliminary results on the potential of benthic foraminifera to contribute to bioturbation processes emphasize the need to further estimate surface sediment reworking rates of foraminiferal species to better understand their role in benthic ecosystem functioning. In this context, the specific objectives of the study were (i) to estimate individual surface sediment reworking rate (hereafter referred as $SSRR_i$) of five dominant intertidal foraminifera species in temperate intertidal mudflats, (ii) to understand how morphological traits or those related to their displacements would influence $SSRR_i$ and (iii) to further link these traits and $SSRR_i$ intensity to the functional groups recently introduced for benthic foraminifera (Deldicq et al. 2020).

2. Materials and methods

2.1. Studied species

Five intertidal species were selected considering their high abundance in the foraminiferal assemblage at the study site: (i) the prolate ellipsoid-shaped *Quinqueloculina seminulum* and *Miliammina fusca* (Fig. 24a,b), (ii) the trochospiral *Ammonia tepida* (Fig. 24c) and (iii) the planispiral *Haynesina germanica* and *Criboelphidium williamsoni* (Fig. 24 d,e). In contrast to the other species that have a calcareous shell, *Miliammina fusca* is an agglutinated species.

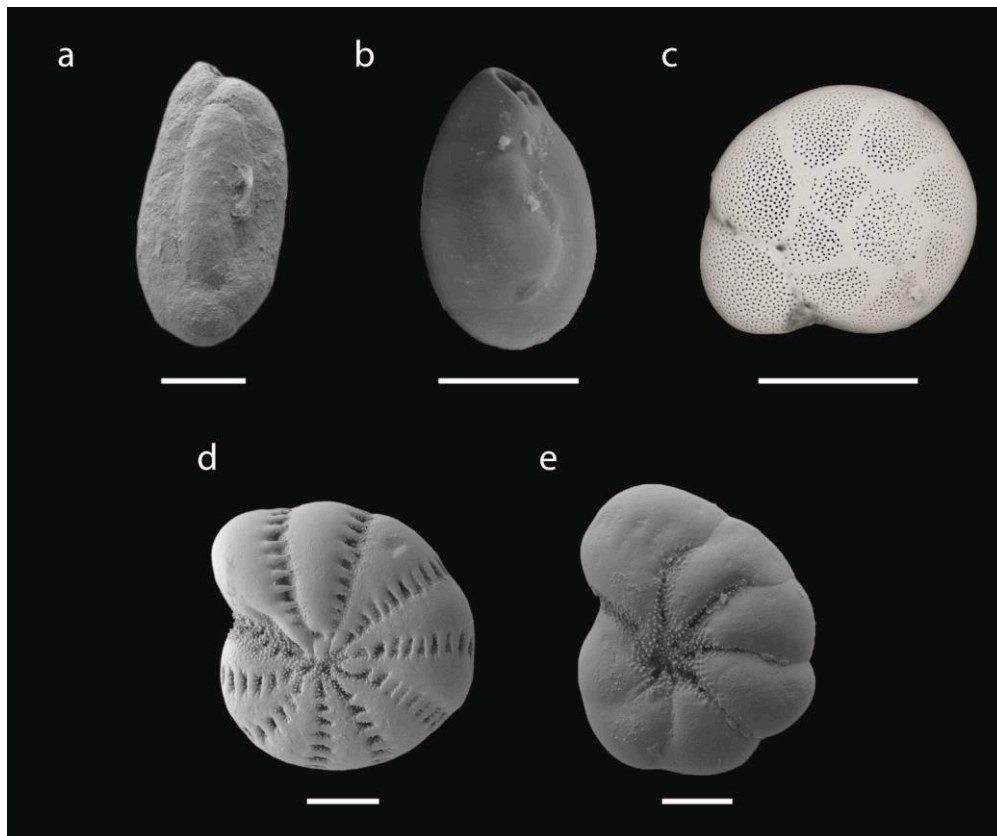

Figure 24. SEM images of the dorsal side of the five studied foraminifera (a) *Miliammina fusca*, (b) *Quinqueloculina seminulum*, (c) *Ammonia tepida*, (d) *Criboelphidium williamsoni* and (e) *Haynesina germanica*. Scaled bar = 100 μm .

Note that *C. williamsoni*, *H. germanica* and *A. tepida* may co-occur with species that are morphologically identical though they are genetically distinct (Pawlowski et al. 1995, Hayward et al. 2004, Saad & Wade 2016). Despite they are morphologically

similar, those species may have different ecological requirements (Richirt et al. 2020), hence different behavioural traits. Molecular identification is therefore needed to discriminate morphospecies before the assessment of their behavioural traits. In our sampling site, we find *H. germanica* S16, *C. williamsoni* S1 and *A. tepida* T6 (Schweizer M., personal communication). Depending at the abundance at the time of sampling, between 8 and 33 individuals per species with similar sizes were used for the experiment (Table 2).

2.2. Sediment sampling and experimental set-up

Sampling was performed in the Authie Bay (50°22'20"N, 1°35'45"E) which is an intertidal mudflat located on the French coast of the English Channel. This estuary is a well-preserved area (e.g. Henry et al. 2004) characterized by a semidiurnal macrotidal regime where tidal range can exceed 10 m during highest astronomical tides (McLusky & Elliott 2004). Among the intertidal zones located along the northern part of the French coast, the Authie Bay is the one displaying the highest diversity in foraminiferal species (Francescangeli et al. 2020).

Surface-sediment (0-1 cm) was collected from February to June 2018 at low tide and stored in plastic containers (100-ml). Samples were then transported to the laboratory, where it was washed through a 125- μ m mesh-size sieve. During the sampling period, temperature has increased from $\sim 7^{\circ}\text{C}$ (February) to $\sim 18^{\circ}\text{C}$ (June), which may have induced a seasonal effect on the organism' activity as evidenced for macrofaunal species (Pascal et al. 2019). A recent study on *Haynesina germanica* showed however, that foraminiferal *SSRR*_i has a low thermal dependence in the range 6-24°C (Deldicq et al. 2021). In this study, we assume that the potential seasonal effect could be negligible through the use of an acclimation period carried out before running the experiment. Hence, living benthic foraminifera were subsequently individually sorted with a brush, identified and their pseudopodial activities checked under an inverted phase-contrast microscope (Olympus IX71, Japan). Only active individuals were subsequently imaged to measure the shell size parameter i.e. maximum length and width of each individual (Olympus SZX16, Japan, TC capture software).

Prior to behavioural observations, individuals were kept for 24-h at the experimental temperature (18°C) in a temperature-controlled room (MIR-154, Panasonic, Japan; temperature fluctuation $\pm 0.3^\circ\text{C}$, light intensity $170 \mu\text{mol m}^{-2} \text{s}^{-1}$). Behavioural observations were performed in 300-ml aquaria filled with 25–30-ml of thawed Authie Bay sediment (i.e. $\sim 1\text{cm}$ thick) (Fig. 25). We used previously frozen sediment to ensure that the sediment was free of moving macro- and meio-organisms so that the only tracks observed on the sediment surface would be those from foraminifera.

2.3. Quantification of behavioural traits

After the acclimation period, foraminifera were randomly placed on the sediment surface (Fig. 25), under 250-ml of natural unfiltered and air saturated seawater (salinity = 33) following 10 min of vigorous air bubbling immediately before spreading foraminifera on the sediment surface. In total 15 experiments were performed.

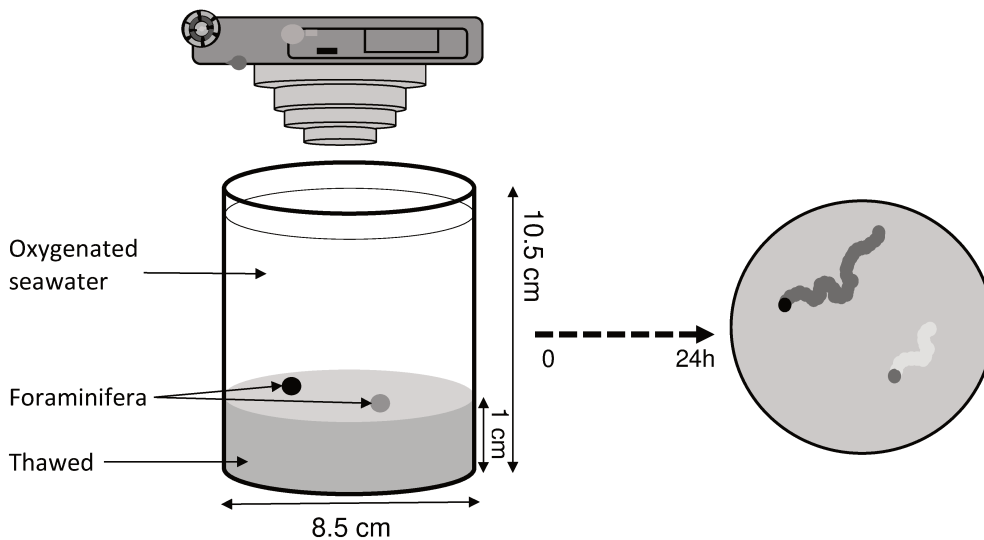

Figure 25. Experimental set-up for time-lapse assessment of foraminiferal motion-traits (left-hand side) and examples of the movement paths of 2 foraminifera over a 24-h period (right-hand side)

Individual displacements in and on the sediment were recorded by time-lapse photography (Fig. 25; 1 image every 10 min for 24-hours) using a digital camera (Nikon V1 with a Nikkor 10-30mm lens). For each foraminifera, 144 images were combined in the image-analysis software Fiji to extract (x,y) coordinates using the

Manual tracking plugin (Schindelin et al. 2012). A total of 230 active (i.e. moving) individuals was initially selected for the experiment. During the experiment, it was not possible to track all individuals (i) because some burrowed into the sediment up to a depth where their paths were not visible and/or (ii) because some paths crossed and consequently individual trajectories were lost. We therefore only kept individuals that exhibited visible tracks throughout the whole 24-h experiment so that the information related to their behavioural traits had the same statistical weight. In total we followed the trajectories of 103 individuals. Note that at the end of each 24-h experiment, dissolved oxygen saturation was consistently ca. 56% in the overlying seawater directly above the sediment-water interface (HI9829 MULTIPARAMETER METER, HANNAH INSTRUMENTS).

The distance travelled by each individual between two images (i.e. 10 min) was calculated as:

$$D_t = \sqrt{(x_t - x_{t+10})^2 + (y_t - y_{t+10})^2}$$

where (x_t, y_t) and (x_{t+10}, y_{t+10}) are the coordinates between two successive images taken at times t and $t + 10$ min respectively. The total distance travelled within 24 hours, D_{24} , was subsequently calculated by summing individual D_t .

2.4. Quantification of surface sediment reworking rates

To estimate the surface sediment reworking rate of intertidal foraminifera we used the calculation method previously used for macrofaunal species such as sea urchin (Hollertz & Duchêne 2001, Lohrer et al. 2005, Maire et al. 2008):

$$SR = \frac{(DT \times CS)}{\Delta t}$$

where DT is the distance travelled during a time interval Δt and CS the cross section, i.e. surface reworked along the motion plane (Maire et al. 2008, see Fig. 26A for an example). This calculation method was recently applied on two intertidal foraminiferal species i.e. *Ammonia tepida* and *Quinqueloculina seminulum* (Bouchet & Seuront

2020). Nevertheless, in their calculations, the authors used the maximum test length rather than the cross section as the morphological component. However, test length may not be optimal as some foraminifera such as *Q. seminulum* and *M. fusca*, have asymmetrical shapes with test length greater than test width (Fig. 24a,b). Noticeably, the length/width ratio is close to 1 for *A. tepida*, 1.2 for *H. germanica* and *C. williamsoni* and to 2 for *Q. seminulum* and *M. fusca*. The use of the surface area therefore appears to be more accurate for the calculation. However, measurement of the cross section involves the characterisation of the organism's height (Fig. 26). Due to their small size, foraminifera are manipulated under binocular microscope that makes very difficult to measure their cross section as it involves a vertically-positioning of the individual (Fig. 26B).

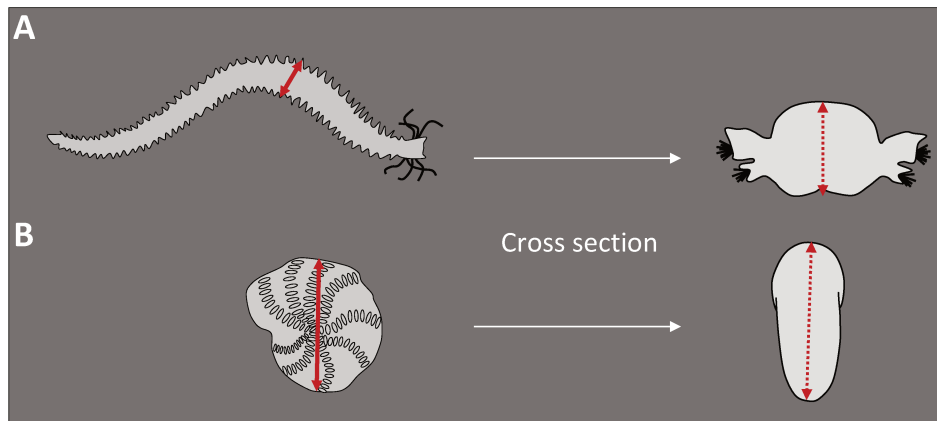

Figure 26. Illustration of the cross section of (A) polychaete and (B) benthic foraminifera that may be used for sediment reworking calculation.

We therefore assume that the surface area corresponding to the larger part of the test i.e. dorsal or umbilical sides may be used for the estimation of the surface sediment reworking performed by foraminifera. Hence, using the measurements of maximum length and width (see section 2.2), the surface area (mm^2) of each individual (S_i) was estimated under the assumption of an ellipse-shaped shell:

$$S_i = \pi \times \frac{\text{Length}}{2} \times \frac{\text{Width}}{2}$$

Since we used conspecifics of similar size, the mean surface area S for each species was then calculated and subsequently used for the calculation of the individual surface sediment reworking rate ($SSRR_{it}$, $\text{mm}^3 \text{ ind}^{-1} 10\text{min}^{-1}$) as follow:

$$SSRR_{it} = S \times D_t$$

where D_t is the distance travelled ($\text{mm ind}^{-1} \text{d}^{-1}$) by each individual between two images (i.e. 10min).

In our experiments, individuals of both species can moved on the surface (Fig. 27A), at the interface (Fig. 27B) or in the sediment (Fig. 27C).

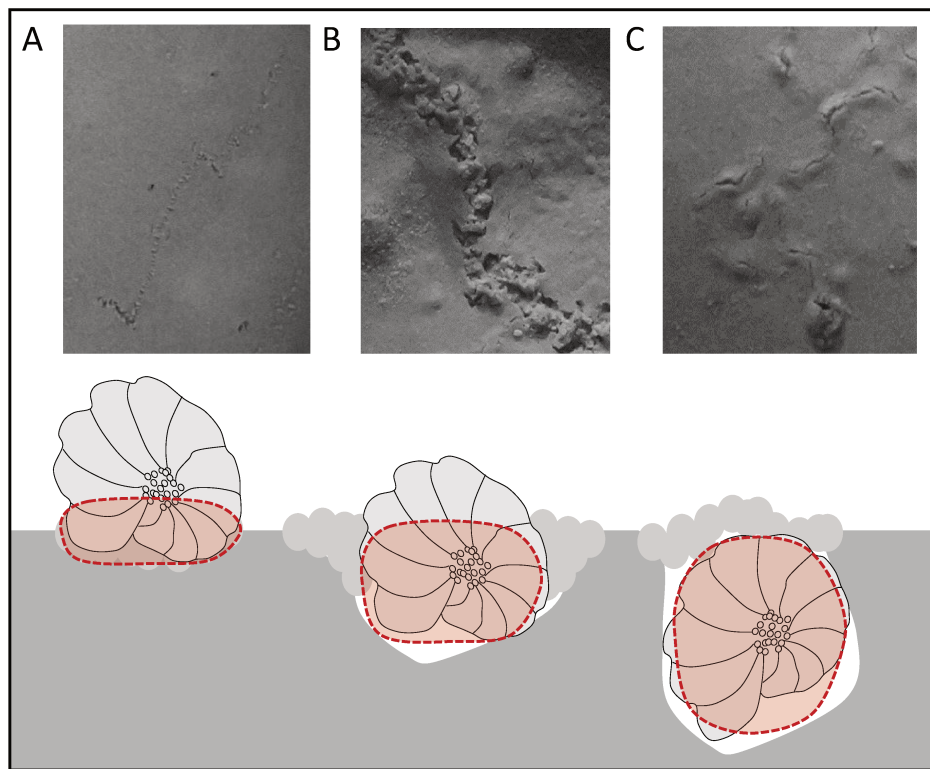

Figure 27. Discrimination between the vertical positions taken by benthic foraminifera in the sediment to estimate $SSRR_{it}$. Images were taken from experiments containing living individuals of *H. germanica*.

When the individual was observed crawling at the sediment surface or at the interface only $\frac{1}{3}$ and $\frac{1}{2}$ of the mean surface area S was considered in the $SSRR_i$ calculation respectively (Fig. 27A,B). Conversely, when the individual was observed burrowed in the sediment, the total of the mean surface area S was used (Fig. 27C).

Finally, the individual surface sediment reworking rate ($SSRR_i$, $\text{mm}^3 \text{ ind}^{-1} \text{ day}^{-1}$) were estimated as follow:

$$SSRR_i = \sum SSRR_{i(t)}$$

where $SSRR_{i(t)}$ is the individual surface sediment reworking rate between two images (i.e. within 10min).

2.5. Data analysis

Because the surface area of individual foraminifera, their travelled distances and $SSRR_i$ were non-normally distributed (Shapiro-Wilk test, $p < 0.05$), a Kruskal-Wallis test was applied to infer the presence of significant differences between species, and eventually followed by a Dunn test to identify distinct groups of measurements. All statistical analyses were performed using R.3.5.2. software (R Core Team 2019).

3. Results

3.1. Species-specific size

In our experiment, the mean surface area of *A. tepida* is almost twice as large as those of *H. germanica* and *Q. seminulum* (Table 2). Indeed, there were significant differences in the surface area S_i between species (KW test, $p < 0.05$), and three distinct groups were identified as $S_{H. germanica} = S_{Q. seminulum} < S_{M. fusca} < S_{C. williamsoni} = S_{A. tepida}$ (Dunn test, $p < 0.01$; Table 2).

Table 2. Number (n) of individuals and surface area (mm^2) measured for each species with minimal, mean \pm SD and maximal values.

Species	n	Surface (mm^2)		
		Min	Mean \pm SD	Max
<i>Haynesina germanica</i>	30	0.06	0.12 ± 0.02	0.17
<i>Quinqueloculina seminulum</i>	16	0.08	0.13 ± 0.04	0.22
<i>Miliammina fusca</i>	8	0.11	0.14 ± 0.03	0.20
<i>Criboelphidium williamsoni</i>	16	0.13	0.18 ± 0.03	0.24
<i>Ammonia tepida</i>	33	0.13	0.21 ± 0.03	0.3

3.2. Travelled distance

Among the five studied species, *Q. seminulum* display the highest mean travelled distance, i.e. 130 mm d⁻¹. In contrast, *M. fusca* and *A. tepida* are the species that travelled the lowest distances i.e. between 12 and 32 mm d⁻¹ and 17 and 37 mm d⁻¹ respectively (Fig. 28). With intermediate value, the mean travelled distance of *H. germanica* and *C. williamsoni* ranged between 16 and 112 mm d⁻¹ and 19 and 67 mm d⁻¹ (Fig. 28). Hence, three groups of homogeneous travelled distance were identified: $D_{M. fusca} = D_{A. tepida} < D_{C. williamsoni} = D_{H. germanica} < D_{Q. seminulum}$ (Fig. 28; Dunn test, $p < 0.01$).

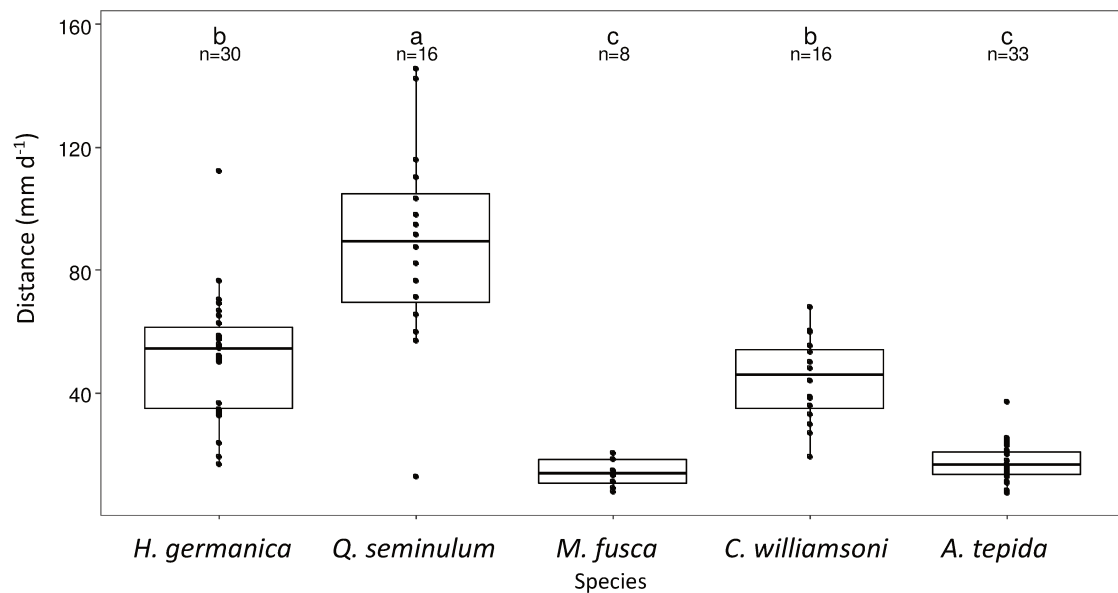

Figure 28. Value of the travelled distance (mm) for each experiment performed on the five tested species. The box represents the first, second and third quartiles and the whiskers extend to 1.5 times the interquartile range; Individual values are represented by black dots. n denotes the number of individuals used in the experiments. Letters on top ('a', 'b' and 'c') identify significantly different groups (Dunn test, $p < 0.05$) between species.

Our results showed a strong intra specific variability in the distance travelled by individuals of *H. germanica*, *C. williamsoni* and *Q. seminulum*. For instance, the travelled distance between individuals of *Q. seminulum* may range from 12 to 142 mm d⁻¹ (Fig. 28).

3.3. Surface sediment reworking rate

Individual surface sediment reworking rates ranged from 1.15 mm³ day⁻¹ for *M. fusca* up to 21.6 mm³ day⁻¹ for *Q. seminulum*, and significantly differed between species (KW test, $p < 0.05$; Fig. 29). *Quinqueloculina seminulum* showed higher $SSRR_i$ than the other species (Dunn test, $p < 0.01$).

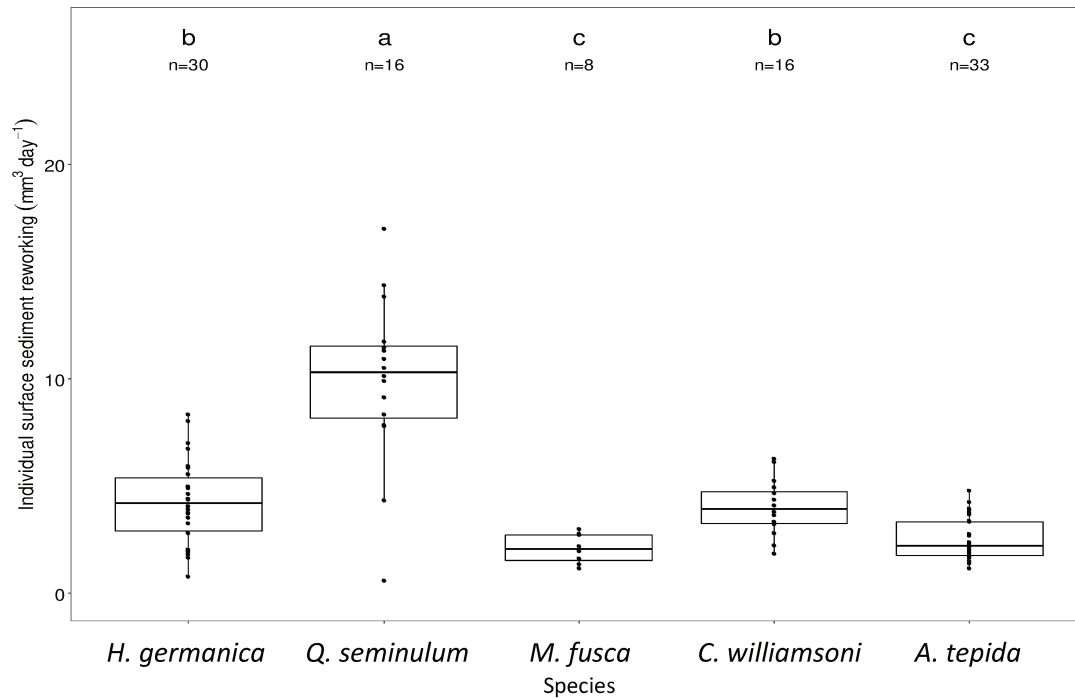

Figure 29. Value of the $SSRR_i$ for each experiment performed on the five tested species. The box represents the first, second and third quartiles and the whiskers extend to 1.5 times the interquartile range; Individual values are represented by black dots. n denotes the number of individuals used in the experiments. Letters on top ('a', 'b' and 'c') identify significantly different groups (Dunn test, $p < 0.05$) between species.

Three groups of $SSRR_i$ were subsequently identified as $SSRR_{i-A. tepida} = SSRR_{i-M. fusca} < SSRR_{i-C. williamsoni} = SSRR_{i-H. germanica} < SSRR_{i-Q. seminulum}$ (Fig. 29; Dunn test, $p < 0.01$). As a consequence, the most and the least efficient surface sediment reworkers are *Q. seminulum* and *M. fusca* respectively. As previously evidenced for the travelled distance, $SSRR_i$ values showed a strong intraspecific variability in *H. germanica*, *Q. seminulum* and *C. williamsoni* species. Noticeably, the difference in the $SSRR_i$ between individual of the aforementioned species may be one order of magnitude while it is restricted between 1 and 3 mm³ day⁻¹ for *M. fusca* (Fig. 29).

4. Discussion

4.1. A methodological note on individual surface sediment reworking calculation

In the present work, $SSRR_i$ was estimated using the surface area of the test, whereas Bouchet & Seuront (2020) considered the test length in their calculation. Hence, these authors showed $SSRR_i$ values expressed as a surface unit i.e. in $\text{cm}^2 \text{ind}^{-1} \text{d}^{-1}$. However, the studied foraminifera (*A. tepida* and *Q. seminulum*) moved in and on the sediment, hence were *ipso facto* displacing a volume of particles rather than a surface. The use of the surface area of the test instead of the maximum test length therefore appears as more ecologically relevant allowing to express $SSRR_i$ as volume of sediment particle displaced. Furthermore, the prolate ellipsoid-shaped test of *Q. seminulum* and *M. fusca* is asymmetrical with the length being much larger than the width. Similarly, within rotaliid species i.e. *A. tepida*, *H. germanica* and *C. williamsoni* test length typically is about 1.2 times larger than test width. As a consequence, the approach followed by Bouchet & Seuront (2020) most likely leads to a biased estimation of the $SSRR_i$ values by considering only the length as representative of the test size. In addition, in the present study we consider the temporal evolution in the vertical position of each individual in our $SSRR_i$ calculation. This method allows a more rigorous estimation of the surface sediment reworking intensity of each species as it consider the real portion of the surface area of the test that is actually involve in the reworking of surface particles during individual displacement (Fig. 27).

Taken together, these suggest that considering both the surface area of the test as a proxy of foraminiferal test size and the position of each individual in the sediment may allow a reliable assessment of species-specific surface sediment reworking rate.

4.2. $SSRR_i$ is not size-dependent but trait-dependent through interspecific differences in motion behaviour

Our results showed that the largest foraminiferal species (*A. tepida*) did not rework the sediment more than the smallest species such as *H. germanica* and *Q. seminulum*.

In contrast, *Q. seminulum* can even rework up to 3 times more sediment than *A. tepida* (Fig. 29) despite a test surface area nearly twice smaller (Table 2). This result indicates that the species-specific $SSRR_i$ could be inversely size-dependent as evidenced in the five species. Specifically, the higher the surface area of the test, the lower the species-specific $SSRR_i$. Here, the travelled distance is likely the parameter that drives the intensity in the surface sediment reworking performed by the five foraminiferal species. These results are consistent with previous works on macro-invertebrate species, where large bivalves may have lowest sediment reworking rates than small polychaetes since the latter have more intensive displacements, i.e. different motion-behaviour traits (Mermillod-Blondin et al. 2004, Michaud et al. 2005, Gilbert et al. 2007).

Furthermore, differences in $SSRR_i$ between foraminiferal species have been previously hypothesised following the assumption that species with distinct bioturbating modes would exhibit different $SSRR_i$; see Deldicq et al. (2020) for further details. Noticeably, the five species considered in the present study were recently classified in the following bioturbating groups: *Q. seminulum* and *M. fusca* as gallery-biodiffusors, *H. germanica* and *A. tepida* as surficial-biodiffusors and *C. williamsoni* as an epifaunal-biodiffusor (Deldicq et al. 2020). This classification implies that they would contribute differently to benthic-ecosystem functioning (Deldicq et al. 2020). For instance, *C. williamsoni* that prefers surface sediment was classified as epifaunal-biodiffusor meaning that the species would rework particles along at surface. In contrast, *H. germanica* and *A. tepida* move in and on the sediment hence they may rework particles more deeply than *C. williamsoni* (Deldicq et al. 2020). Finally, *Q. seminulum* and *M. fusca* prefer to be burrowed in the sediment that may likely induce the reworking of sediment particles below the interface. As these species do not occupy the same microhabitat, they may consequently exhibit difference in their $SSRR_i$. Therefore, to consider the functional classification of the five studied species in the estimation of their $SSRR_i$, we include the position of their test in the sediment.

Based on this study findings, it occurs that, although *C. williamsoni* is larger than *H. germanica* and that both species displayed similar travelled distance, the latest rework the surface-sediment more efficiently. This is consistent with previous studies

which showed that gallery-biodiffusor (i.e. burrow-dwelling organism) macro-invertebrates are more efficient bioturbators than epifaunal-biodiffusors as they displaced a larger amount of sediment particles through their burrowing activity (Mermillod-Blondin et al. 2004, Michaud et al. 2005). However, in the present study, the most and the least efficient species in reworking surface sediment (i.e. *Q. seminulum* and *M. fusca*) both belong to the gallery-biodiffusor group. As a consequence, the potential link between the intensity of surface sediment reworking and the functional group of a species is not straightforward. We may suggest that the motion behaviour of foraminifera i.e. travelled distance and vertical position (e.g. Deldicq et al. 2020) both matter in their ability to rework surface-sediment. Noticeably, the $SSRR_i$ intensity and sediment particles spatial displacement may be a function of these two behavioural traits.

4.3. Inter-individual variability matters in the contribution of benthic foraminifera to $SSRR_i$

Beyond the interspecific variability discussed above (Section 4.2), $SSRR_i$ of the five studied species were consistently characterised by a high inter-individual variability (i.e. up to one order of magnitude for *Q. seminulum*; see Fig. 28,29). Note that the differences identified here cannot be related to environmental factors or size, since our experiments were performed on similar-sized individuals under controlled conditions in the absence of any cues. The above mentioned inter-individual variability is then more likely to be an intrinsic property of the species considered here.

Behavioural plasticity has previously been reported in foraminifera (Hallock & Hansen 1979, Seuront & Bouchet 2015, Prazeres et al. 2017), but also in pelagic copepods (e.g Seuront et al. 2004) and intertidal gastropods (e.g. Chapperon & Seuront 2011a) with individuals from the same species showing both a large repertoire of behavioural traits (e.g. feeding activity, trajectory complexity, intensity of displacement) and a large variability in the values of each trait. Noticeably, in our experiments, conspecific individuals of *Q. seminulum*, *C. williamsoni* and *H. germanica* displayed a high variability in their travelled distance but also in their

motion behaviour, e.g. tortuosity, vertical position (Deldicq et al. 2020). Having a wide diversity in the behavioural repertoire between conspecific individuals may be a selective advantage for species to face long-term environmental fluctuations as previously suggested for intertidal gastropods (Chappon & Seuront 2011a). Such evolutionary adaptation to increase survival in a changing environment can, in turn, also affect individual contribution to ecosystem processes (Maltagliati et al. 2006, Bolnick et al. 2011). Noticeably, the species characterized by the highest inter-individual variability (i.e. *Q. seminulum*, *C. williamsoni* and *H. germanica*) are also the species that contribute most to $SSRR_i$ (see Fig. 29). This last observation is particularly relevant as it may inform on the species-specific phenotypic plasticity and therefore the sustainability of the functional role of these species that live in a highly variable environment such as intertidal sedimentary ecosystems.

Taken together our observations may suggest that individual trait variations matter in the $SSRR_i$ of the five studied foraminiferal species. This is consistent with previous studies showing that inter-individual variations can have large ecological consequences on ecosystem processes such as primary production, nutrient cycling than interspecific variability (Crutsinger 2006, Lecerf & Chauvet 2008, Bolnick et al. 2011).

5. Conclusion

Our study revealed that bioturbation by benthic foraminifera is the result of the complex interplay between species-specific features such as motion-behaviour, phenotypic plasticity and functional classification i.e. bioturbation mode. Despite their relatively small size, these five benthic foraminiferal species showed a non-negligible sediment mixing rates at the sediment water-interface through their active displacements. Additional studies are nevertheless needed to further estimate the role of intertidal foraminifera to bioturbation processes because the species-specific traits which control their activity in and on the sediment may depend on both allogenic (e.g. temperature, food availability) and autogenic (e.g. size, age) factors. Noticeably, our experimental set-up do not provide all the food sources such as live prey that some species such as *A. tepida* may feed (e.g. Dupuy et al. 2010, Jauffrais et al. 2016b) as

we used thawed sediment to eliminate macro- and meiobenthic bioturbation effects. Foraging activity is however intrinsically linked to organism displacement (e.g. Pyke 1984, Bell 1991, Seuront 2010a, 2015b). It therefore stresses the need to further investigate the effect of food concentration and diversity on the $SSRR_i$ of intertidal foraminifera. In addition, the effect of progressive oxygen depletion on foraminiferal activity hence sediment reworking intensity should be further investigated although we did not observed temporal changes in the activity of our five species during our experiments.

Acknowledgment

The PhD fellowship of N.D. was funded by the Ministère de l'Enseignement Supérieur et de la Recherche. We thank the Région Hauts-de-France, the Ministère de l'Enseignement Supérieur et de la Recherche and the European Fund for Regional Economic Development for their financial support through the CPER research project CLIMIBIO. The authors are grateful to Magali Schweizer for providing information on the phylotypes occurring at the sampling site (research project AMTEP, funded by the CNRS-INSU programme EC2CO) and Fabio Francescangeli for the SEM-images of foraminiferal species. The authors are grateful to Grégory Beaugrand for his comments on an earlier version of the manuscript. The editor and the four reviewers' comments greatly contributed to improve this paper.

Authors' contribution

N.D. and V.M.P.B. conceived the idea of this study and V.M.P.B. obtained financial support. N.D. and V.M.P.B. provided significant input on experimental design. N.D. performed the behavioural experiments and analysed the images. N.D. analysed the data and performed the statistical analyses. N.D., L.S. and V.M.P.B. contributed to the interpretation of the data and the discussion of the results presented in the manuscript. N.D. wrote the draft manuscript. N.D., L.S. and V.M.P.B. revised the article critically for intellectual content and gave final approval of the submitted version.

CHAPTER II

BIOTIC AND ABIOTIC PARAMETERS CONSTRAIN SURFACE
SEDIMENT REWORKING BY *HAYNESINA GERMANICA*

SUMMARY

The next step in the understanding of foraminiferal bioturbation is the characterisation of the biotic and abiotic parameters that may constrain their displacement, focusing on the most abundant species, *Haynesina germanica*. Chapter II is devoted to the understanding of how variation in foraminiferal test size, temperature and food concentration can mediate the motion behaviour of *H. germanica*. To do so, the variability in the motion behaviour of the species is described for individuals belonging to different size categories. The behavioural response of *H. germanica* is also assessed under different thermal and food regimes. Such experiments are particularly relevant for intertidal organisms that live in a highly variable environment. Finally, these experiments further allow a better understanding of the effect of abiotic and biotic parameters on the surface sediment reworking rate of *H. germanica*.

SIZE MATTERS IN THE MOTION-BEHAVIOUR AND THE SURFACE
SEDIMENT REWORKING RATE OF THE BENTHIC FORAMINIFERA
HAYNESINA GERMANICA

1. Introduction

Among individual traits, body size is a fundamental feature that may be used as a proxy of the individual performance i.e. physiological rates, resource uptake, behaviour (Dame 2012, Norkko et al. 2013, Woodin et al. 2016, Koo et al. 2019). This master parameter strongly influences ecosystem functioning and services (Reiss et al. 2009, 2011, Reiss & Schmid-Araya 2010). Given that population size-structure changes with individual ontogeny, understanding the importance of size is a prerequisite to better evaluate species-specific contribution to ecosystem functions (Bolnick et al. 2011, Norkko et al. 2013).

This is particularly true for ecosystem engineers, which modify their environment through bioturbation (Kristensen et al. 2012). For instance, small individuals of fiddler crab which are more active than larger ones, greatly enhance oxygen penetration in the sediment and therefore organic matter mineralisation and nutrient cycle than adults do (Koo et al. 2019). Bioturbation by meiobenthic organisms e.g. foraminifera, nematodes, copepods play a major role in biogeochemical or ecosystem processes (Pyke 1984, Nascimento et al. 2012, Bonaglia et al. 2014, 2020, Bouchet & Seuront 2020), yet, little is known about the influence of individual body size on their bioturbation efficiency. Previous studies reported that intertidal and deep-sea foraminifera had highly variable food uptake between different individual size (Nomaki et al. 2011, Wukovits et al. 2018). This further suggests that size may have an effect on individual contribution to ecosystem functions as feeding activity is involved in the phytodetritus processes and therefore nutrient cycling (Nomaki et al. 2011, Wukovits et al. 2018). In addition, foraminifera display a large spectrum of size in natural environment (Murray & Alve 2000, Alve & Murray 2001, Murray 2006, Geslin et al. 2011, Cesbron et al. 2016). For instance, individuals can range from micrometres to millimetres in size length within a species (Murray 1983, 2006, Caralp 1989, Alve

& Goldstein 2003, 2010, Ross & Hallock 2016). In chapter I (Deldicq et al. *revised*; see Chapter I, Part 2 for further details), it is shown that the contribution of five intertidal foraminiferal species to surface sediment reworking is more controlled by species-specific motion traits rather than by size. Furthermore, foraminifera can collect sediment particles around their test and used them to build a protective envelop or for food sources i.e. a cyst (Gooday & Alve 2001, Murray 2006). Such behaviour may potentially further increase their volume in the sediment. These findings highlight that the effect of intraspecific variability in size needs to be examined in the context of the understanding of the contribution of foraminifera to surface sediment reworking.

Taken together, these results motivated the central question of this study: does test size matter in the contribution to sediment reworking of benthic foraminifera? We chose *Haynesina germanica*, a dominant species in temperate intertidal mudflat (e.g. Alve & Murray 1994, 2001, Debenay et al. 2006, Morvan et al. 2006, Cesbron et al. 2016) to (i) experimentally assess the motion behaviour i.e. activity and travelled distance of individuals of different test sizes, and (ii) further quantify its contribution to surface sediment reworking.

2. Materials and Methods

2.1. Size categories and experimental conditions

Four categories of size were investigated in this study: 63-125, 125-200, 200-280 and 300-500 μm . For the largest size range, we reused previous data (Deldicq et al. 2020, see Chapter I, Part 1 for further details) that were obtained from the same experimental set-up described below. The experiments for the three other size categories i.e. 63-125, 125-200 and 200-280 μm were performed on May 2020. The motion behaviour of *H. germanica* was evaluated under two conditions: (C_1) natural filtered sea-water and (C_2) natural filtered sea-water with surface sediment. Please note that the data reused from Deldicq et al. (2020) were obtained in C_2 condition (Table 3). In addition, due to the lack of active individuals in the size category 63-125 μm at the time of sampling, only experiments in C_1 condition were performed (Table 3).

2.2. Collection and experimental set-up

Surface sediment (0-1 cm) was collected in May 2020 at low tide in the harbour of Boulogne-sur-Mer (50°43'6"N, 1°34'25"E), an intertidal mudflat located along the French coasts of the English Channel. Sampled sediment were stored in plastic containers (100 ml) and transported to the laboratory, where they were washed through two 125- μm and 63- μm mesh-size sieves. Living benthic foraminifera were subsequently individually sorted with a brush and only active individuals (i.e. producing a displacement track on a thin layer of sediment; Geslin et al. 2011, Cesbron et al. 2017, Langlet et al. 2020a) were chosen and subsequently imaged to assess the shell size parameter measurements (Olympus SZX16, Japan, TC capture software with a calibrated tool for the estimation of the maximum length and width of each individual) prior to each experiment. Before behavioural observations, individuals were kept 24 h for acclimation to the experimental condition in a controlled-temperature room at 18°C.

2.3. Qualitative observation of the cyst building behaviour at the sediment surface

The motion behaviour of 5 living individuals were recorded under a stereomicroscope with a real-time video camera (Olympus SZX16, Japan, TC capture software). Such observations allowed us to monitor cyst-building dynamics which occurs before the individuals started to move into the sediment.

2.4. Quantification of behavioural traits

Ten experiments (Table 3) each containing 20 living individuals were performed in 300 ml aquaria with 250 ml filtered and oxygenated seawater (30 PSU) for C₁ condition (Table 3). For C₂ condition, behavioural observations were made in 300 ml aquaria filled with 25–30 ml of thawed Authie Bay sediment and 250 ml filtered and oxygenated seawater (30 PSU; Table 3).

Table 3. Summary of the experiments performed on *H. germanica* on four size categories in different experimental conditions. N= number of individuals studied in each experiment, n= number of analysed individuals.

Size category (μm)	Experimental condition	Date of experiment (2020)	N	n
63-125	Sea water (C ₁)	May 25, 26	40	5
125-200	Sea water (C ₁)	May 25, 26 June 3	60	31
	Sea water + thawed sediment (C ₂)	June 3	20	14
200-280	Sea water (C ₁)	May 25, 26 June 3	60	32
	Sea water + thawed sediment (C ₂)	June 3	20	13
300-500	Sea water + thawed sediment (C ₂)	February 27 April 20, 24	90	30

We used previously frozen sediment to ensure that the sediment was free of other macro- and meio-organisms (nematodes, copepods and macrofaunal organisms are killed during sediment freezing) so that the only tracks observed on the sediment surface were those from foraminifera. After the 24 h acclimation period, foraminifera were placed randomly on the bottom of the aquaria or in the sediment surface for experiments performed with thawed sediment.

Using the extracted coordinates, the level of activity A_i (i.e. time allocated to locomotion), the travelled distance within 24h and the fractal dimension were estimated for each individual with the method described in Deldicq et al. (2020; see Chapter I, Part 1 for further details).

In addition, to assess the width of the path for experiment performed with thawed sediment, measurements of the path of the different trajectories were calculated for each individual. Only three size categories were analysed i.e. 125-200, 200-280 and 300-500 μm as we only performed experiment with thawed sediment on these 3 categories of size.

2.5. Individual surface sediment reworking rate calculation

The individual surface sediment reworking rate ($SSRR_i$) for experiment performed with thawed sediment (C₂ condition) was estimated with the same calculation as described in Deldicq et al. (*revised*; see Chapter I, Part 2 for further details).

2.6. Data analysis

Because behavioural parameters, width of the path and $SSRR_i$ values were not normally distributed (Shapiro-Wilk test, $p < 0.05$), a Kruskal-Wallis test and a subsequent multiple comparison procedure based on a Dunn test was carried out to examine the significance of both size and experimental condition effects (Zar 2009). All statistical analyses were performed using R.3.5.2. Software (R Core Team 2019).

3. Results

3.1. Cyst building behaviour

The observation of living individuals under stereomicroscope showed that all the individuals accumulated sediment particles with pseudopods, thus progressively forming a sedimentary envelope (Fig. 30). Then, all the individuals started to move in the sediment while keeping the cyst around their test (Fig. 30).

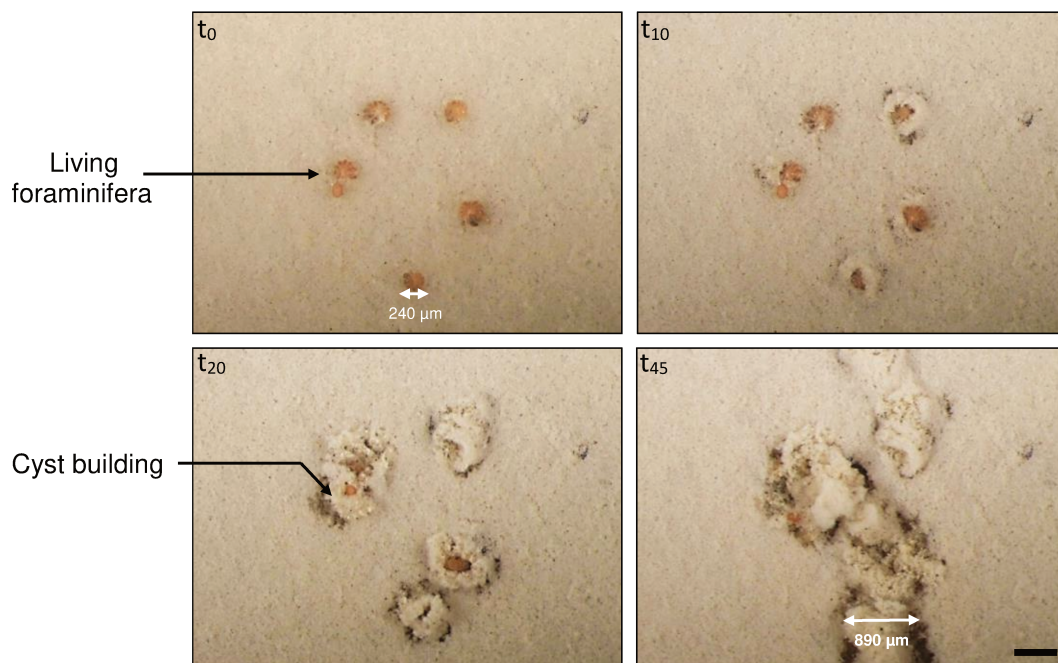

Figure 30. Images of the cyst building behaviour over 0, 10, 20 and 45 min observation of 5 individuals under binocular microscope. Scaled bar = 0.5 mm. The difference between the individual test length and the width of its path is shown with the white arrows at t_0 and t_{45} min respectively.

3.2. Behavioural parameters

Among the 200 individuals we selected for the experiment, 95 were analysed as we only kept those for which we had a track over a period of at least ~8h (Table 3). The results also included the 30 individuals (300-500 μ m size range), which were analysed in a previous study (Deldicq et al. 2020).

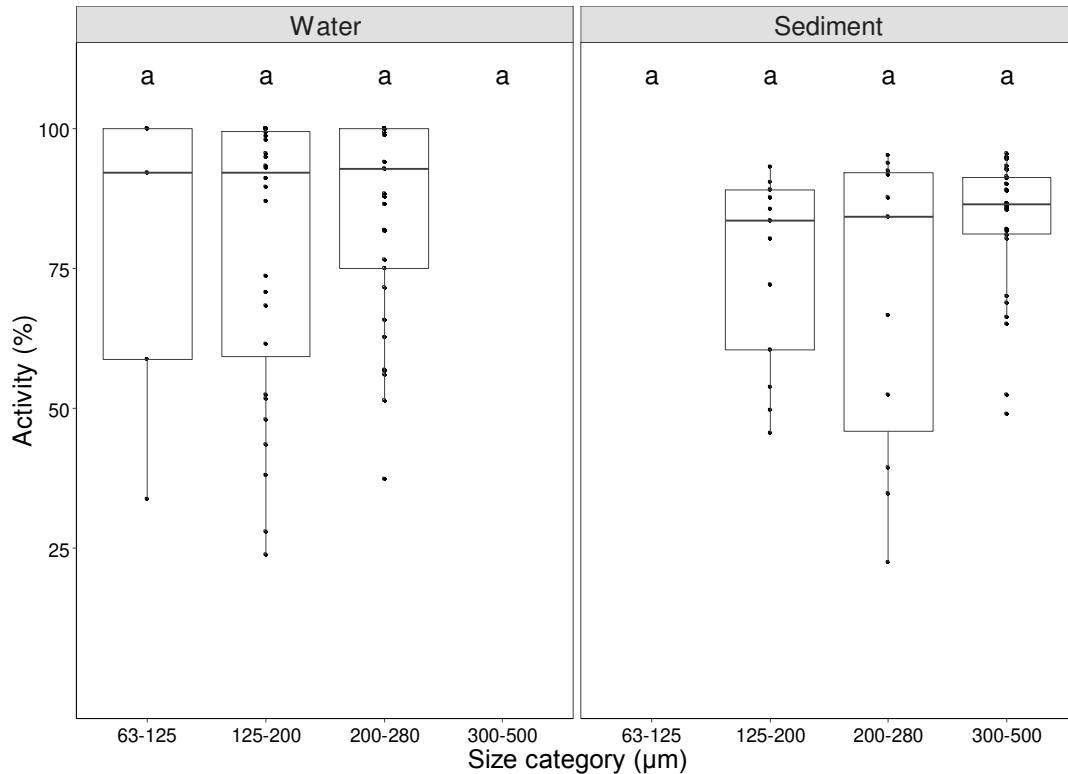

Figure 31. The influence of body size on the activity of *H. germanica* for experiments performed both with water sediment (C_1 condition) and thawed sediment (C_2 condition). The box represents the first, second and third quartiles and the whiskers extend to 1.5 times the interquartile range. Significant different groups (Dunn test, $p < 0.05$) are indicated above the boxes.

All tested individuals were active either on glass surface or in the sediment during the experiment (Fig. 31). Individual activity level ranged from 15 to 100 % with a large majority of individuals showing activity level above 75% (Fig. 31). There were no significant differences in the activity index between both size categories and experimental conditions after applying a Dunn test ($p < 0.05$).

In contrast, statistical analyses revealed significant differences in the travelled distance over 24h between treatments (Dunn test, $p < 0.05$). Individuals on the thawed sediment travelled almost twice less than individuals on the glass surface (Fig. 32). In

the experiments performed with water (C_1 condition), smaller individuals (63-125 μm) moved over longer distances than larger ones (i.e. 125-200, 200-280 μm). Conversely, in the experiments performed with thawed sediment (C_2 condition), larger individuals (i.e. 300-500 μm) travelled a longer distance than smaller ones.

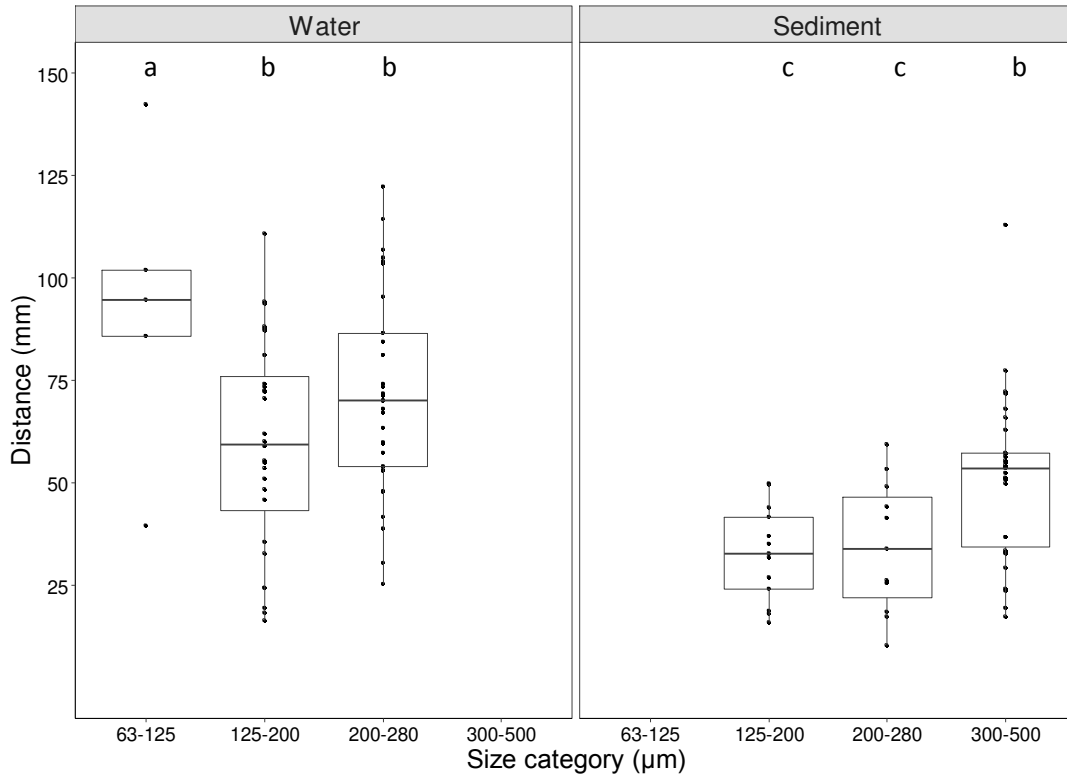

Figure 32. The influence of body size on the travelled distance over 24h of *H. germanica* for experiments performed both with water (C_1 condition) and thawed sediment (C_2 condition).. The box represents the first, second and third quartiles and the whiskers extend to 1.5 times the interquartile range. Significant different groups (Dunn test, $p < 0.05$) are indicated above the boxes.

Statistical analyses showed significant differences among size categories and three groups could be further identified as $D_{63-125\mu\text{m-Water}} > D_{125-200\mu\text{m-Water}} = D_{200-280\mu\text{m-Water}} = D_{300-500\mu\text{m-Sed}} > D_{125-200\mu\text{m-Sed}} = D_{200-280\mu\text{m-Sed}}$ (Dunn test, $p < 0.05$).

In contrast, there were no significant differences in the tortuosity of the trajectory between categories of size within each condition. However, significant differences were found in the tortuosity between the two conditions (Fig. 33; KW test, $p < 0.05$).

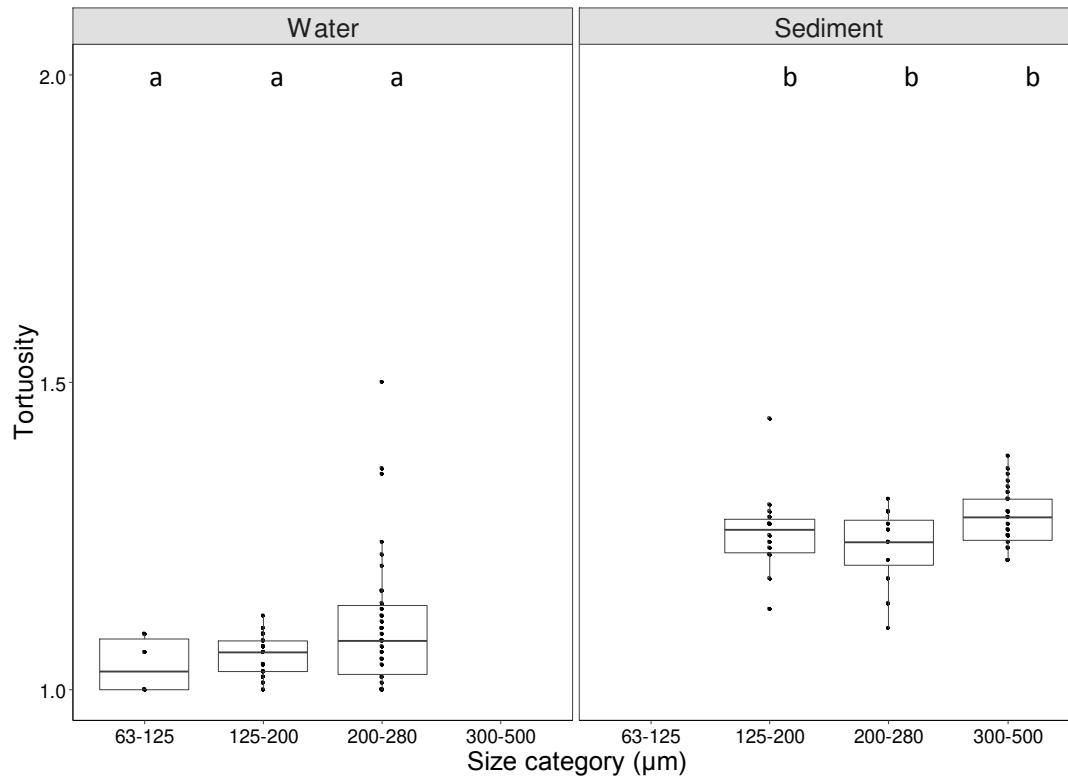

Figure 33. The influence of body size on the tortuosity of *H. germanica* for experiments performed both with water (C_1 condition) and thawed sediment (C_2 condition). The box represents the first, second and third quartiles and the whiskers extend to 1.5 times the interquartile range. Significant different groups (Dunn test, $p < 0.05$) are indicated above the boxes.

Specifically, the tortuosity of individuals from the experiments performed in thawed sediment (C_2 condition) were significantly lower than those of individuals from the experiments performed with water (C_1 condition).

3.3. Width of the path

The width of the path was almost 4 and 5 times larger than the individual size for 125-200 μm and 200-280 μm range, respectively (Fig. 34). Expectedly, individuals ranging from 200 to 280 μm showed significant largest trajectories than individuals ranging from 125 to 200 μm (Dunn test, $p < 0.05$).

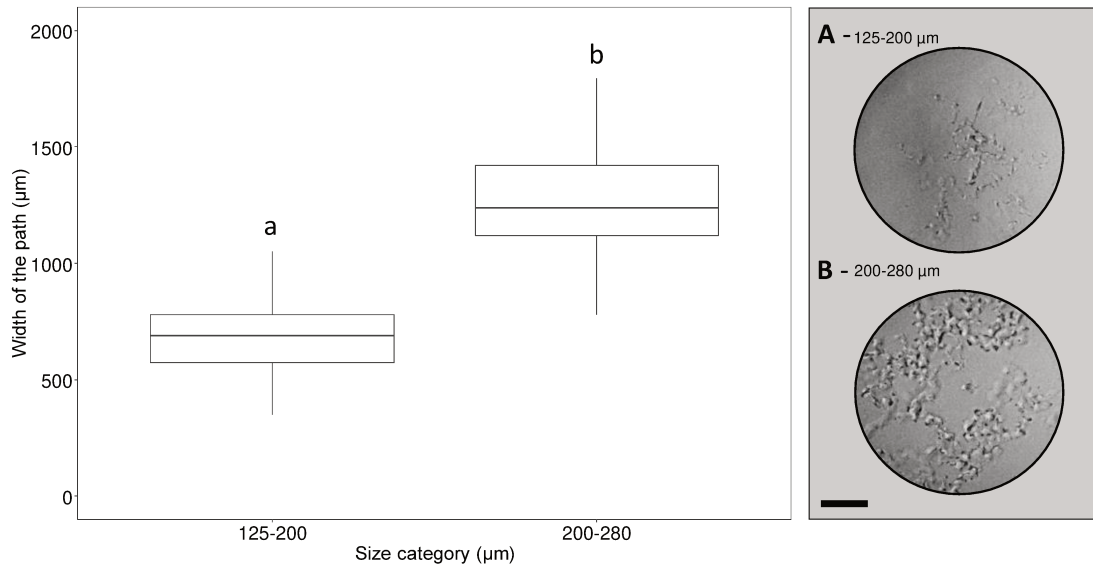

Figure 34. (A) The width of the path as a function of size category for experiments performed with thawed sediment (C_2 condition). The box represents the first, second and third quartiles and the whiskers extend to 1.5 times the interquartile range. Significant different groups (Dunn test, $p < 0.05$) are indicated above the boxes. (B) Illustration of individual path in the two size ranges. Scaled bar = 0.5 mm.

3.4. Individual surface sediment reworking rate

Results showed a significant increase in the $SSRR_i$ with increasing size category (Fig. 35). More specifically, larger individuals (i.e. 300-500 μm) had a higher $SSRR_i$ than smaller ones (i.e. 125-200, 200-280 μm) (Dunn test, $p < 0.05$).

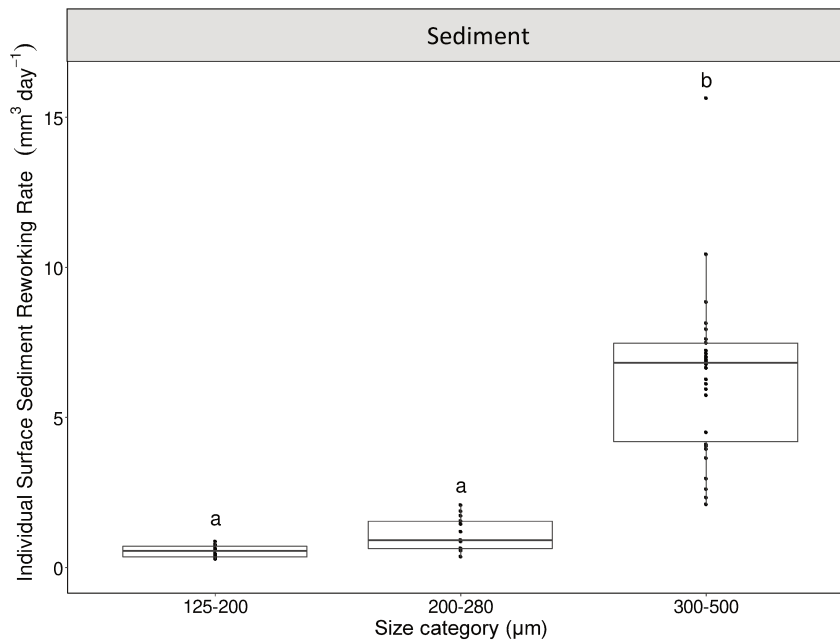

Figure 35. The influence of body size on the $SSRR_i$ ($\text{mm}^3 \text{indiv}^{-1} \text{day}^{-1}$) of *H. germanica* for experiments performed with thawed sediment (C_2 condition). The box represents the first, second and third quartiles and the whiskers extend to 1.5 times the interquartile range. Significant different groups (Dunn test, $p < 0.05$) are indicated above the boxes.

4. Discussion

4.1. *The motion behaviour of H. germanica is dependent of the experimental conditions*

In our experiments, travelled distance significantly differed between the two experimental conditions. Unsurprisingly, individuals moving on glass surface travelled twice more than individuals on thawed sediment. Values corresponding to the size category 125-200 μm were consistent with measurements of locomotion speed on glass petri dish previously observed by Seuront & Bouchet (2015). Similarly, earlier study observed that the foraminiferal species *Quinqueloculina lamarckiana* moved 5 times faster on glass than in the sediment, as glass offers less resistance to movement (Kitazato 1988). In addition, individuals showed higher NGDRs values in experiment performed with water (C_1 condition) which suggest that they explored their environment with straighter trajectories (Bell 1991, Seuront & Bouchet 2015). Such behavioural strategy was observed when the organism does not get any information such as food cue from the environment, like in our experiments (Bell 1991). It hence adopt a strategy with randomly orientated straight long displacements which thereby does not reflect the real behaviour of the individual in natural environment (Bell 1991). These observations support the need to assess the motion behaviour of foraminifera using experimental conditions representative of the *in-situ* conditions; hence with sediment. As a consequence, in the following sections of the discussion, only results obtained with experiments performed with thawed sediment (C_2 condition) are discussed.

4.2. *A methodological note on individual surface sediment reworking calculation*

In our experiments, width of the path are 4 and 5 times larger than the individual width for the 125-200 and 200-280 μm size categories, respectively. This might be the result of the “cyst building behaviour” where individual aggregates sediment particles around the test as evidenced by binocular observation (Linke & Lutze 1993). Such a behaviour likely increases the occupied space, which may in turn affects the volume of

sediment displaced by an individual. In benthic fauna, similar examples are spatangoid urchins which move at the sediment-water interface, displacing particles with their bodies and specialized spines (Lohrer et al. 2005, Kristensen et al. 2012). These appendages substantially increase the amount of surrounding sediment displaced by urchin activity (Lohrer et al. 2005).

Here, we suggest that only considering body size in the $SSRR_i$ calculation might lead to an underestimation of the surface sediment mixing induced by foraminifera. However, little is known on the sustainability of the cyst during activity especially when foraminifera are burrowed in the sediment. Additional studies are needed to better understand the cyst building behaviour (Heinz et al. 1999) and its implication in foraminiferal sediment reworking.

*4.3. Test size matters in *H. germanica* motion behaviour and its contribution to surface sediment reworking*

In our experiments, all individuals showed similar activity index, being very active in the sediment. However, there was a significant increase in the travelled distance with increasing size categories from 125-280 μm to 300-500 μm . Such a difference in the motion behaviour was previously reported in other benthic organisms (Longo et al. 2015). It may likely results from changes in individual morphology; explaining its ability to move over longer distances (Longo et al. 2015). In gastropod and crustacean species for instance, individual growth increases the size of the locomotor appendages, providing more strength for movements (Lissman 1945, Millers 1974, Longo et al. 2015). Foraminifera used their pseudopodial network to move through the sediment (Kitazato 1988). It further allows to catch food in the sediment and to bring it to the test aperture (Pascal et al. 2008, Dupuy et al. 2010, Chronopoulou et al. 2019). The number of pseudopods is however intrinsically linked to individual size (Kitazato 1988). Overall, our results suggest that test size plays a role in the motion behaviour of *H. germanica*. Furthermore, in our experiment, larger individuals displaced more surface sediment than smaller ones as evidenced by $SSRR_i$; highlighting that test size may contrain *H. germanica*'s contribution to surface sediment reworking. Such

observations were previously reported on macrofauna with a direct relationship between sediment mixing and biovolume of the organisms (Gilbert et al. 2007) as each organism consistently filled the space in proportion to its volumetric size (Dorgan et al. 2005).

Nevertheless, the inter-specific differences observed between $SSRR_i$ of five intertidal foraminiferal species was shown to be control by specific motion traits rather than species-specific size (Deldicq et al. *revised*; see Chapter I, Part 2 for further details). Our results suggests that body size may drive the contribution to sediment reworking at the intra-specific level; and not at the inter-specific one. Therefore, foraminiferal contribution to bioturbation might result from the complex interplay between species specific traits (i.e. specific motion behaviour and feeding requirements, Deldicq et al. *revised*; see Chapter I, Part 2 for further details) and individual traits variations (here body size). These findings stress the need to consider traits variation at both inter and intra specific levels to better estimate species contribution to bioturbation.

5. Conclusion

Our results showed that body size matters in *H. germanica* motion behaviour and therefore affects its contribution to surface sediment reworking, larger individual contributing more to surface sediment reworking than smaller ones. However, in temperate intertidal mudflat, *H. germanica* displays an evolving size pattern through the year (Murray 1983, Cearreta 1988, Grimmelpont & Pavard, *unpubl. data*). Further studies dealing with population sized-structure are therefore needed to better evaluate *H. germanica* contribution to sediment reworking. In addition, our findings stress the need to consider the cyst building process which increase the individual track in the sediment hence clearly influence *H. germanica* contribution to sediment reworking.

**BEHAVIOURAL RESPONSE OF THE INTERTIDAL FORAMINIFERA
HAYNESINA GERMANICA TO DIFFERENT ORGANIC CARBON
CONCENTRATIONS IN SEDIMENT: IMPLICATION FOR SURFACE
SEDIMENT MIXING**

1. Introduction

Motion-behaviour of benthic foraminifera was recently described by assessing different traits such as the travelled distance, the activity level, the vertical position and the tortuosity of the path (Deldicq et al. 2020, Deldicq et al. *revised*; see Chapter I, Part 2 for further details). Noticeably, the tortuosity of the path is a powerful tool to understand the ecology of benthic species as it may inform on the response of the individuals to food distribution patterns in the sediment (Pyke 1984, 2015, Humphries et al. 2010, Kölzsch et al. 2015). Specifically, species with different feeding requirements (e.g. herbivorous, carnivorous) are expected to differ in the geometrical complexity of their movements (Pyke 1984, Humphries et al. 2010). For instance, the benthic foraminifera *Criboelphidium excavatum* exhibits highly convoluted trajectory as the species experiences a homogenous distribution of its food in its environment (e.g. metazoans and benthic diatoms; Murray 2006) in the sediment (Seuront & Bouchet 2015). In contrast, species feeding on heterogeneously distributed microphytobenthos such as *Haynesina germanica* exhibits straighter trajectories (Seuront & Bouchet 2015). The aforementioned trajectory pattern has been recently reformulated under the Lévy flight foraging hypothesis (Fig. 36), which has been used to explain the strategies of organisms searching for food sparsely and randomly distributed (Viswanathan et al. 1999). Organisms would adopt linear and longest trajectories (i.e. Lévy flight; Fig. 36) under low food concentration and more tortuous and shortest trajectories (i.e. Brownian random walk; Fig. 36) under higher food concentration (Reynolds 2018). Previous study showed for instance, that an enrichment in organic matter leads to an increase in the travelled distance and the complexity of trajectory in polychaetes (Michaud et al. 2010), starfish (Barahona & Navarrete 2010) and in gastropods species (Seuront L, *unpubl. data*).

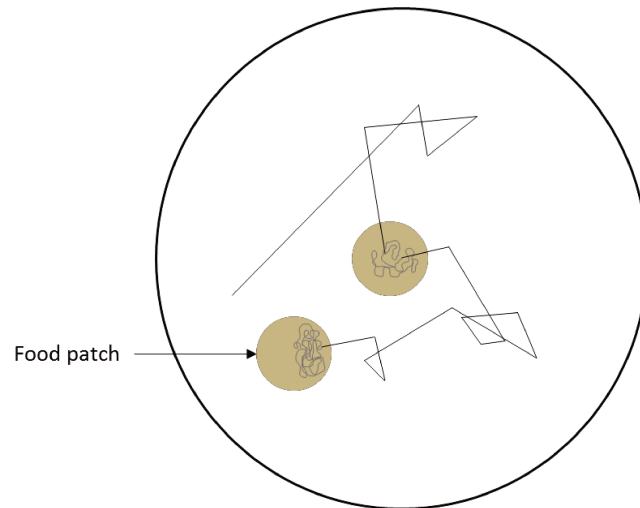

Figure 36. Two-dimensional representation of extensive (black line) and intensive (grey line) foraging trajectory. The extensive and intensive trajectories are respectively a Lévy flight and a Brownian random walk. Inspired from (Seuront & Cribb 2017).

Furthermore, within a species, each individual can adapt its motion behaviour by alternating between extensive, intensive and a combination of both strategies in response to abiotic and biotic cues present in its surrounding environment (Reynolds 2015, 2018, Sims 2015, Pyke 2019). Such plasticity therefore allows the individual to evolve and adopt movements that optimise its survival (McFarland 1977, Pyke 1984, Dale et al. 2005, Gaillard et al. 2010).

Foraging strategy would in turn affect the way an organism can contribute to bioturbation processes. For instance, conspecific individuals of fiddlers crabs exhibiting distinct trajectory complexities do not equally contribute to sediment reworking (Koo et al. 2019). Similarly, changes in the burrowing behaviour of polychaete species in response to an organic matter enrichment strongly alter biogeochemical reactions and decrease dissolved fluxes at the water-sediment interface (Michaud et al. 2010). In foraminifera, little is known on how organic matter concentration, diversity and availability may affect species specific motion-behaviour. The only study dealing with organic matter and motion behaviour in intertidal foraminifera was those carried out by (Jaufrais et al. 2016b). They showed that organic matter affects the locomotion speed of the species *Ammonia tepida*. Nevertheless, there is a lack of knowledge on the effects of the organic matter on the motion-behaviour *stricto sensu* of foraminifera and therefore, how it may affect the contribution of

benthic foraminifera to surface sediment reworking (Bouchet & Seuront 2020, Deldicq et al. *revised*; see Chapter I, Part 2 for further details).

In this context, this study aimed at understanding if the benthic foraminifera *Haynesina germanica* is able to respond to an abiotic cue, consisting in different sediment total organic carbon contents. Specifically, the objectives of this study were (i) to characterise the motion-behaviour of *H. germanica* under different total organic carbon concentrations, and (ii) to further understand how food concentration may constrain the contribution of this species to surface sediment reworking.

2. Materials and Methods

2.1. Sediment sampling

Surface sediment (0-1cm) was collected in August 2020 at low tide in the Boulogne-sur-Mer harbour (50°43'6"N, 1°34'25"E), an intertidal mudflat located on the French coasts of the English Channel. Sampled sediment was stored in plastic containers (2 litres) and transported to the laboratory, where it was frozen to ensure that the sediment was free of moving macro- and meio-organisms (since nematodes, copepods and macrofaunal organisms are killed during sediment freezing). After 72h, sediment were 3 times washed with freshwater and dried 48-h long at 40°C to remove water content. The half of dried sediment was burned at 550°C to remove the organic matter for 5 hours.

2.2. *Haynesina germanica* collection

The day before running the experiment, surface sediment was collected in the same location i.e. Boulogne-sur-Mer harbour. Samples were stored in plastic containers (100 ml) and transported to the laboratory, then washed through a 125 µm mesh sieve. Living similar-sized individuals of *H. germanica* were extracted subsequently sorted with a brush and only active individuals (i.e. producing a displacement track on a thin layer of sediment, e.g. Langlet et al. 2020a). Active individuals were kept overnight

(12 h) for acclimation to the experimental condition in a controlled-temperature room at 18°C in oxygenated artificial sea water.

2.3. Experimental set-up

Dried and burned sediment were mixed to obtain the different proportion of organic matter content (Table 4). In total five conditions (Table 4) were chosen: (1) 100% burned sediment (0%_{DS} / 100%_{BS}), (2) 25% dried and 75% burned sediments (25%_{DS} / 75%_{BS}), (3) 50% dried and 50% burned sediments (50%_{DS} / 50%_{BS}), (4) 75% dried and 25% burned sediments (75%_{DS} / 25%_{BS}) and (5) 100 % dried sediment to mimic natural sediment (100%_{DS} / 0%_{BS}).

Table 4. Number of experiments (N_{exp}) performed for each condition with the number of individuals (N) of *H. germanica* and the subsequent number (n) of individuals for which (x,y) coordinates were extracted.

Treatments	Percentage of dried sediment	Weight (g)	N_{exp}	N	n
<i>Burned (BS)</i>	0	5	5	90	14
<i>Dried/Burned (DS/BS)</i>	25	1.25 / 3.75	3	55	21
	50	2.5 / 2.5	2	40	13
	75	3.75 / 1.25	4	69	31
<i>Dried (DS)</i>	100	5	4	76	9

All mixtures (5g in total; Table 4) were gently humidified in 600 ml breaker filled with 500 ml of artificial (35g of Red Sea salt per liter of MilliQ ultrapure water, and referred to as ASW hereafter). Breakers were kept in larger aquarium (20 litres) filled with oxygenated ASW for few days to allow for the compaction of the sediment and to give enough equilibration time to establish redox fronts seawater (Fig. 37).

The day after the collection of living individuals of *H. germanica* (section 2.2), between 15 and 20 similar-sized individuals were placed randomly on the sediment surface of each experiment (Table 4). Their displacements in and on the sediment were recorded by time-lapse photography (1 image every 10 min for 24 h) using a digital camera (Nikon V1 with a Nikkor 10–30 mm lens).

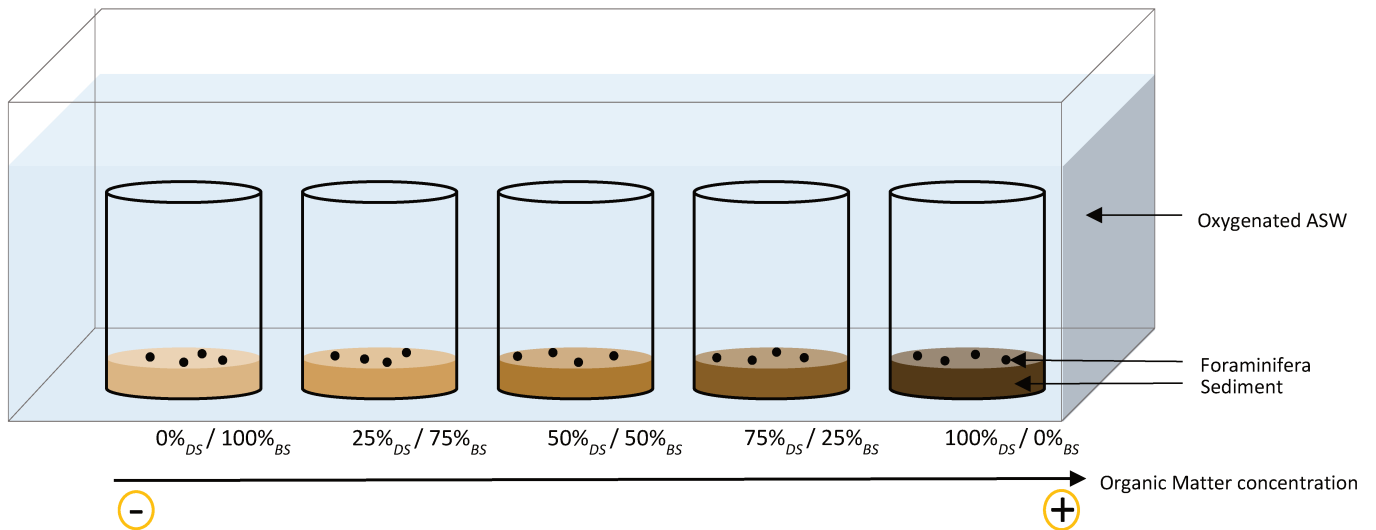

Figure 37. Experimental set-up for time-lapse assessment of foraminiferal motion-traits under different organic matter concentrations.

2.4. Sediment analysis

A CHN analyser (ThermoFisher Flash 2000) was used to measure the total organic carbon content (referred to TOC hereafter) of the sediment from each experiment. The analysis was performed on three subsamples previously dried (48h, 40°C) to estimate the total amount of carbon. Then, subsamples were burned at 550° for 5 hours to estimate the amount of inorganic carbon. The TOC was then determined by subtracting the amount of inorganic carbon to the total amount of carbon.

2.5. Quantification of behavioural traits

Using the extracted coordinates, the level of activity A_i (i.e. time allocated to locomotion), the travelled distance within 24h (D_{24}) and the fractal dimension (i.e. tortuosity of the path) were estimated for each individual following the method described in Deldicq et al. (2020; see Chapter I, Part 1 for further details).

2.6. Individual surface sediment reworking rate

The individual surface sediment reworking rate ($SSRR_i$) for each treatment was estimated with the same calculation as described in Deldicq et al. (*revised*; see Chapter I, Part 2 for further details).

2.7. Statistical analyses

Activity and TOC parameters were non-normally distributed (Shapiro-Wilk test, $p < 0.05$). The non-parametric Kruskal-Wallis test was used to assess the effect of TOC on individual activity. In case of significant differences a Dunn post-hoc test was applied for two-sample comparisons (Zar 2009). In turn, travelled distance, tortuosity and $SSRR_i$ parameters rate were normally distributed (Shapiro-Wilk test, $p > 0.05$). A one-way analysis of variance (ANOVA) was conducted and followed by a two-sample comparison (HSD Tukey test) to identify distinct groups of measurement (Zar 2009). Correlations (Kendall's r values) between the tortuosity and TOC were performed and the normality, independency and homogeneity of residuals obtained from linear regression were checked using the Shapiro-Wilk test, the Durbin-Watson test and the Breush-Pagan test respectively (Zar 2009). All statistical analyses were performed using R.3.6.3. software (R Core Team 2019).

3. Results

3.1. Total organic carbon content

Total organic carbon content ranged from 0.1 to 0.8 % for burned (0% $_{DS}$ / 100% $_{BS}$) and dried sediment (100% $_{DS}$ / 0% $_{BS}$) respectively. Statistical analyses showed a significant increase in the TOC with the increase in percentage of dried sediment (100% $_{DS}$ / 0% $_{BS}$) used for each condition (Kruskal-Wallis test, $p < 0.05$; Fig. 38). There was no significant difference between the conditions containing 50% (50% $_{DS}$ / 50% $_{BS}$) and 75% (75% $_{DS}$ / 25% $_{BS}$) dried sediment (Dunn test, $p < 0.05$; Fig. 38).

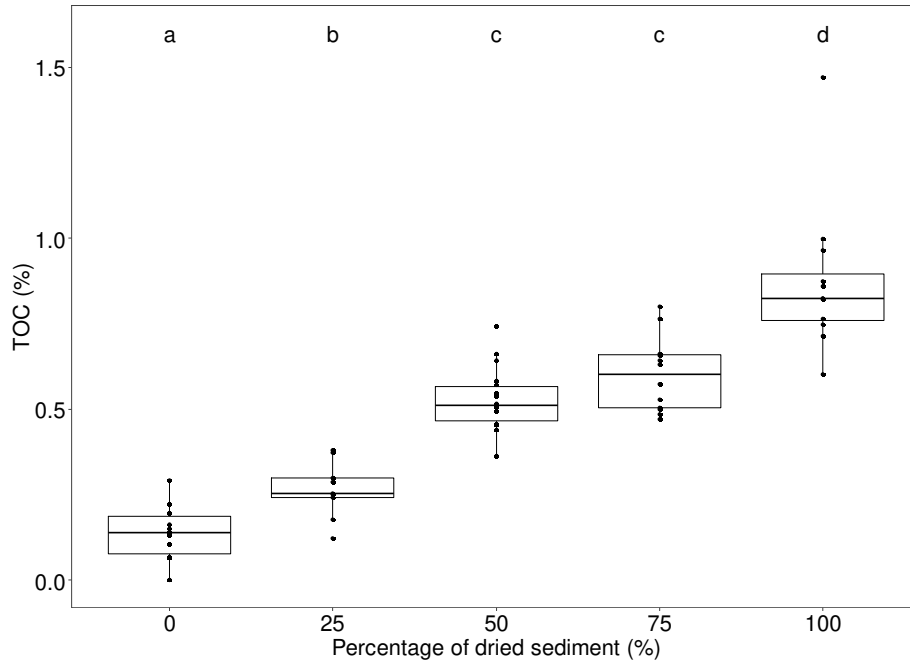

Figure 38. The relationship between the percentage of dried sediment and the Total Organic Carbon (TOC) content (%). The box represents the first, second and third quartiles and the whiskers extend to 1.5 times the interquartile range. Individual's values are represented by black dots. Letters on top ('a', 'b' 'c' and 'd') identify significant different groups (Dunn test, $p < 0.05$) between experimental conditions.

Specifically, five groups can be identified as: $\text{TOC}_{0\%DS/100\%BS} < \text{TOC}_{25\%DS/75\%BS} < \text{TOC}_{50\%DS/50\%BS} = \text{TOC}_{75\%DS/25\%BS} < \text{TOC}_{100\%DS/0\%BS}$ (Dunn test, $p < 0.05$; Fig. 38).

3.2. Activity and travelled distance

Activity index showed a significant increase with increasing TOC (Kruskal-Wallis test, $p < 0.05$). Noticeably, from 50% of dried sediment and above (50%_{DS} / 50%_{BS}), individuals were active more than 22/24h (Fig. 39). Individual exposed to burned sediment (i.e. 0%_{DS} / 100%_{BS}) significantly decrease their activity up to 42% i.e. 10/24h of activity in the sediment (Dunn test, $p < 0.05$)

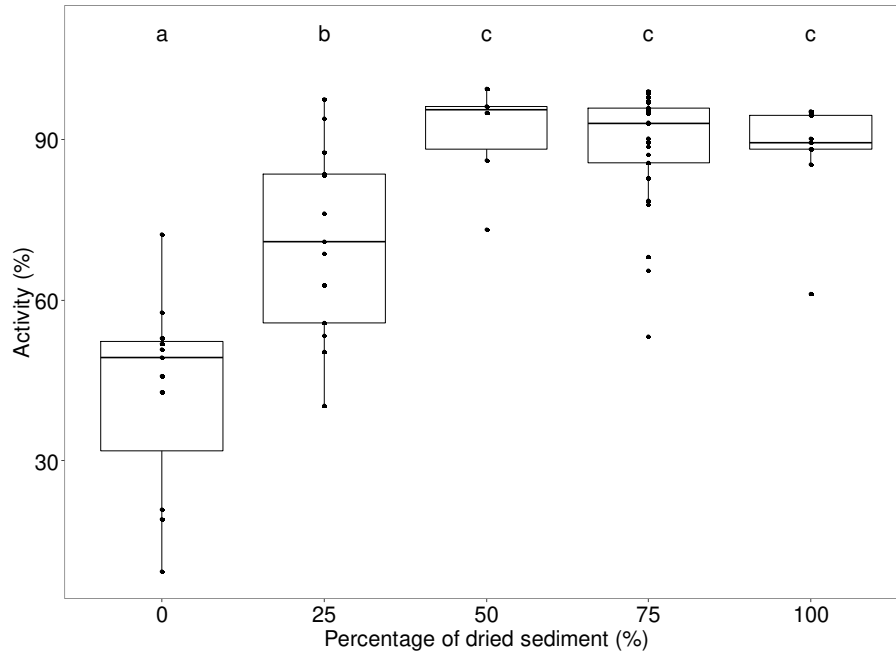

Figure 39. The relationship between the percentage of dried sediment and the activity index. The box represents the first, second and third quartiles and the whiskers extend to 1.5 times the interquartile range. Individual's values are represented by black dots. Letters on top ('a', 'b' 'c') identify significant different groups (Dunn test, $p < 0.05$) between experimental conditions.

The mean travelled distance ranged from 19 to 50 mm for conditions containing 0 (0%*DS* / 100%*BS*) and 50% (50%*DS* / 50%*BS*) dried sediment respectively (Fig. 40).

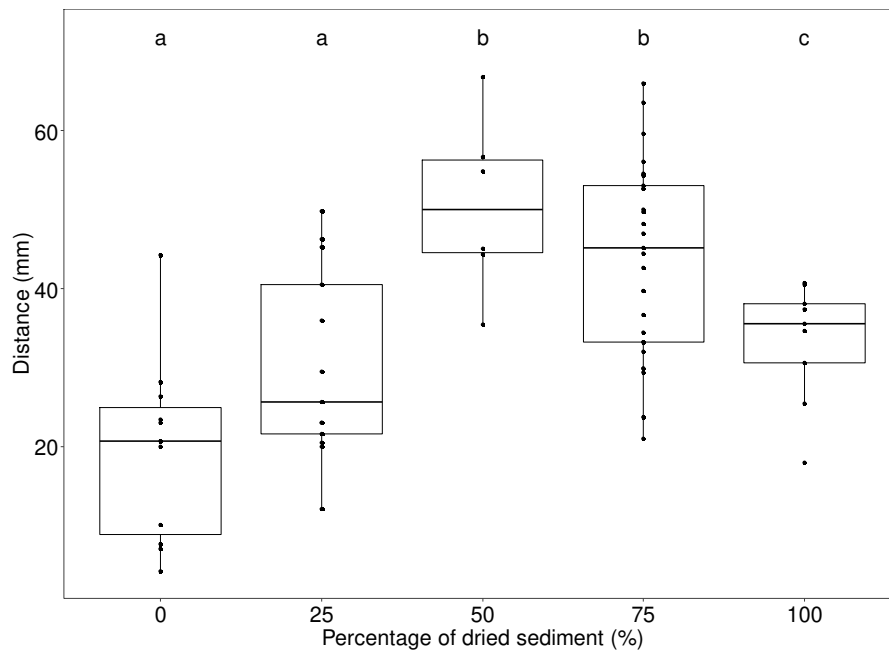

Figure 40. The relationship between the percentage of dried sediment and the travelled distance. The box represents the first, second and third quartiles and the whiskers extend to 1.5 times the interquartile range. Individual's values are represented by black dots. Letters on top ('a', 'b' 'c') identify significant different groups (Tukey test, $p < 0.05$) between experimental conditions.

Hence, there was a significant increase in the travelled distance with the increase in dried sediment proportion up to the condition containing 50% (50%_{DS} / 50%_{BS}) dried sediment (One-way ANOVA, $p < 0.05$; Fig. 40). Above condition with 75% (75%_{DS} / 25%_{BS}) dried sediment, the travelled distance significantly decrease (One-way ANOVA, $p < 0.05$; Fig. 40). More specifically, the travelled distance of *H. germanica* trajectories were discriminated into several groups, i.e. $D_{t(0\%_{DS}/100\%_{BS})} = D_{t(25\%_{DS}/75\%_{BS})} < D_{t(100\%_{DS}/0\%_{BS})} < D_{t(50\%_{DS}/50\%_{BS})} = D_{t(75\%_{DS}/25\%_{BS})}$ (Tukey test, $p < 0.05$).

3.3. Tortuosity of the path

Individuals of *H. germanica* exposed to different TOC content exhibited trajectories with distinct levels of complexity (Fig. 41).

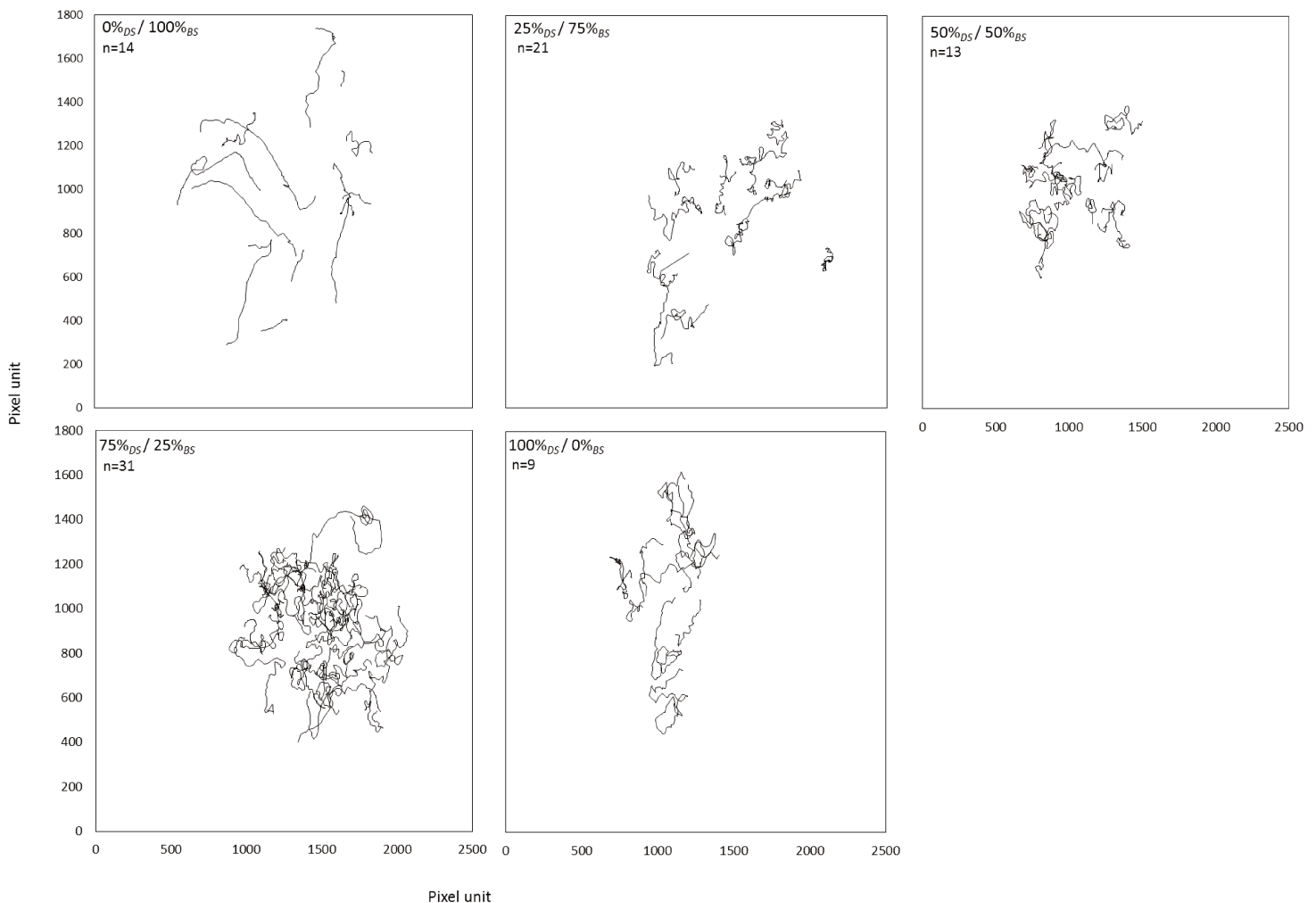

Figure 41. Illustration of the typical trajectories of individuals of *H. germanica* exposed to increasing TOC contents (from 0 to 100% dried sediment (DS) content).

Fractal dimensions of *H. germanica* trajectory ranged from 1.1 to 1.2 indicating a more complex trajectory with increasing TOC contents (Fig. 42; Suppl. Fig. 1). Specifically, individuals exposed to burned sediment (i.e. 0%_{DS}/ 100%_{BS}) showed more linear trajectories than individuals in the other conditions (Fig. 41, 42). There was a significant increase in the fractal dimension i.e. tortuosity with the increase in dried sediment proportion (One-way ANOVA, $p < 0.05$) and three groups can be further identified as: $Tortuosity_{(0\%DS/100\%BS)} < Tortuosity_{(25\%DS/75\%BS)} = Tortuosity_{(50\%DS/50\%BS)} = Tortuosity_{(75\%DS/25\%BS)} < Tortuosity_{(100\%DS/0\%BS)}$ (Tukey test, $p < 0.05$; Fig. 42).

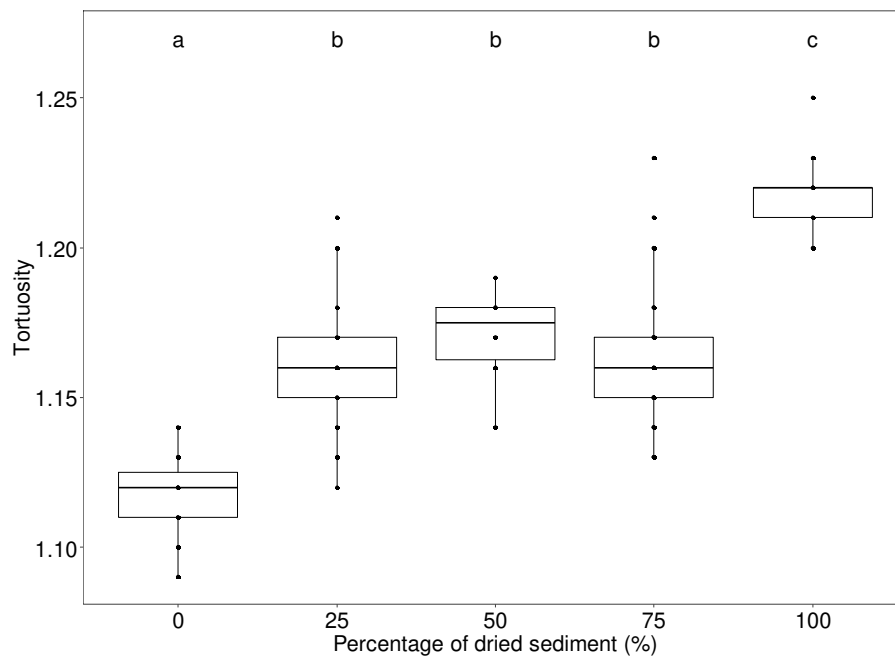

Figure 42. Tortuosity of *H. germanica* under different proportion of dried sediment. The box represents the first, second and third quartiles and the whiskers extend to 1.5 times the interquartile range; values outside this range are represented by open circles. Individual's values are represented by black dots. Letters on top ('a', 'b' 'c') identify significant different groups (Tukey test, $p < 0.05$) between experimental conditions.

3.4. Individual surface sediment reworking rate

Individual surface sediment reworking rate ($SSRR_i$) ranged from 0.5 to 1.3 $\text{mm}^3 \text{indiv}^{-1} \text{day}^{-1}$ for experiments performed with 0 (0%_{DS}/ 100%_{BS}) and 50% (50%_{DS}/ 50%_{BS}) dried sediment respectively (Fig. 43). As previously observed for travelled distance, there was a significant increase in the $SSRR_i$ up to the experiment performed with 50% (50%_{DS}/ 100%_{BS}) dried sediment (One-way ANOVA, $p < 0.05$). Nevertheless, there was

a significant decrease in the $SSRR_i$ above experiment performed with 75% ($75\%_{DS} / 25\%_{BS}$) dried sediment (One-way ANOVA, $p < 0.05$; Fig. 43). Specifically, the $SSRR_i$ of *H. germanica* were discriminated into several groups, i.e. $SSRR_{i(0\%_{DS}/100\%_{BS})} < SSRR_{i(25\%_{DS}/75\%_{BS})} = SSRR_{i(100\%_{DS}/0\%_{BS})} < SSRR_{i(50\%_{DS}/50\%_{BS})} = SSRR_{i(75\%_{DS}/25\%_{BS})}$ (Tukey test, $p < 0.05$).

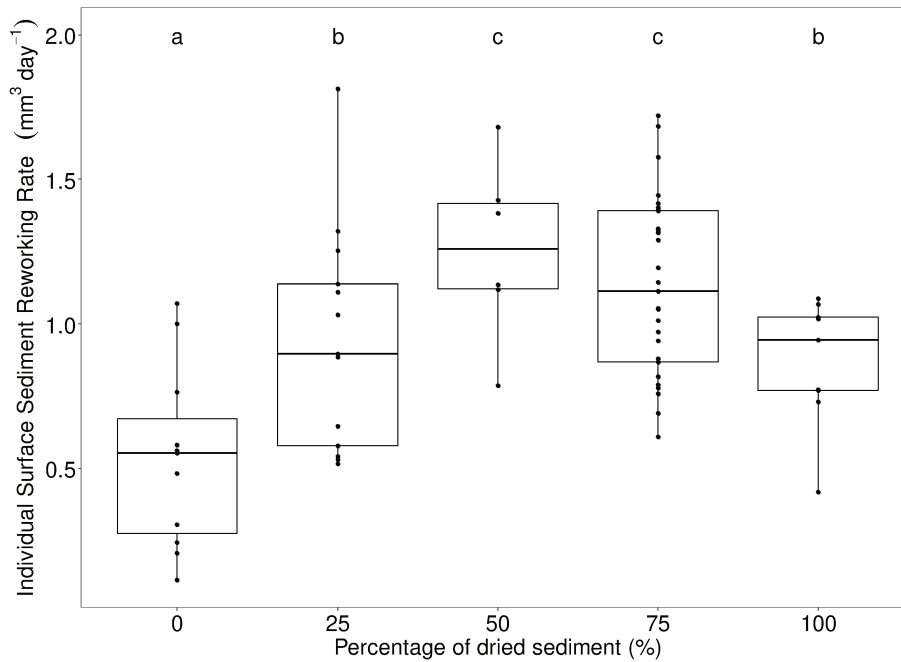

Figure 43. Individual surface sediment reworking ($SSRR_i$, $\text{mm}^3 \text{indiv}^{-1} \text{d}^{-1}$) of *H. germanica* under different proportion of dried sediment. The box represents the first, second and third quartiles and the whiskers extend to 1.5 times the interquartile range; values outside this range are represented by open circles. Individual's values are represented by black dots. Letters on top ('a', 'b' 'c') identify significant different groups (Tukey test, $p < 0.05$) between experimental conditions.

4. Discussion

4.1. *H. germanica* behavioural response to total organic carbon concentration

Individuals exposed to experimental conditions with low TOC concentrations (i.e. $0\%_{DS}/100\%_{BS}$ and $25\%_{DS}/75\%_{BS}$) were less active than individuals exposed to higher TOC concentrations (i.e. $50\%_{DS}/50\%_{BS}$, $75\%_{DS}/25\%_{BS}$ and $100\%_{DS}/0\%_{BS}$). Indeed, under low TOC concentrations (i.e. $0\%_{DS}/100\%_{BS}$ and $25\%_{DS}/75\%_{BS}$), individuals were observed to cease their foraging activity respectively after 10h and 17h of activity, then to remain inactive until the end of the experiment. This result suggests that (1) *H.*

germanica has the ability to collect information from its habitat and (2) in the absence of any cue (here organic matter available) around its surrounding environment individuals may reduce their activity and displacement until more favourable condition. Decreasing activity was previously described for other species that were experimentally exposed to extremely low food concentration (Nogaro et al. 2008, Yawata et al. 2020). In addition, individuals exhibited low tortuosity values indicative of an extensive foraging strategy typically adopted by stressed organism (see Seuront 2011a, 2015b for further details).

In contrast, in environment where TOC concentrations were higher (i.e. 25%_{DS}/75%_{BS}, 50%_{DS}/50%_{BS}, 75%_{DS}/25%_{BS} and 100%_{DS}/0%_{BS}), *H. germanica* travelled distance and geometrical complexity i.e. tortuosity increased. This result suggests that individuals were able to detect the presence of food, and thereby to adapt their motion-behaviour to explore a larger area of sediment. Such an intensive foraging strategy, i.e. increase travelled distance and tortuosity, allows individuals to increase the probability to find food in the environment (Viswanathan et al. 1999, Barahona & Navarrete 2010, Kölzsch et al. 2015, Pyke 2019). Note that, the longest trajectories were recorded when the TOC reached intermediate concentrations (i.e. 50%_{DS}/50%_{BS} and 75%_{DS}/25%_{BS}). Indeed, for such conditions, the TOC remains less abundant than in natural sediment (i.e. 100%_{DS}/0%_{BS}) individuals therefore needed to increase their travelled distance more than individuals exposed to higher concentration.

As shown for other intertidal species (e.g. Bell 1991, Chapman 2000a b, Chapperon & Seuront 2011a), individuals can adopt a combination of both strategies during their foraging activity. Hence, in heterogeneous environments such as intertidal mudflat (e.g. Seuront & Spilmont 2002, Seuront & Leterme 2006, Spilmont et al. 2011), one organism typically adopts a foraging strategy in (1) moving with straight displacements up to reach a food patch from where it (2) increase its prospecting area with highly convoluted displacement (Reynolds 2018).

The present study showed that *H. germanica* can modify its behaviour in response to an abiotic cue. Specifically, this species adapted its motion-behaviour to TOC concentrations in the sediment in terms of activity, travelled distance and tortuosity of

the path. Regarding these findings, it would be interesting to quantify the behavioural response of *H. germanica* to a TOC concentration gradient to assess the individual ability to instantaneously adjust its foraging strategy.

4.2. Implications for *H. germanica* contribution to sediment reworking

Total organic carbon concentration may affect *Haynesina germanica* contribution to surface sediment reworking. Individuals exposed to intermediate TOC concentrations (i.e. 50%_{DS}/50%_{BS}, 75%_{DS}/25%_{BS}) showed higher $SSRR_i$ values than individuals exposed to natural sediment (i.e. 100%_{DS}/0%_{BS}). In fact, as individuals increased their foraging activity in response to the depletion of food in the sediment, they consequently increased the amount of surface sediment they reworked through their displacement. Conversely, in the experiment with low TOC concentrations (i.e. 0%_{DS}/100%_{BS}, 25%_{DS}/100%_{BS}) individual showed lower $SSRR_i$ than individuals exposed to natural sediment (i.e. 100%_{DS}/0%_{BS}). Such findings highlight the importance to consider species' foraging strategy in experimental studies dealing with the understanding of bioturbation processes performed by benthic foraminifera.

Indeed, as evidenced for macro-invertebrates species, organic matter availability and diversity can radically change the intensity and the mode of bioturbation exhibited by benthic organisms (Dauwe et al. 1998, Grémare et al. 2004, Nogaro et al. 2008, Bernard et al. 2016). Hence, changes in the burrowing behaviour, the feeding mode and the displacement intensity in response to organic matter variations would either decrease or increase the specie specific contribution to sediment mixing (Needham et al. 2010, Venturini et al. 2011, Bernard et al. 2016). For instance, the bioturbation of the polychaete *Hediste diversicolor* was three times higher during food supply event (Deschênes et al. 2005, Nogaro et al. 2008). Similarly, the bivalve *Yoldia hyperborea*, showed higher bioturbation rates of surface sediment with increasing food quality (Stead & Thompson 2006). Our findings highlight the fast and variable behavioural response of *H. germanica* to different food concentration. Here, *H. germanica* showed a maximum contribution to $SSRR_i$ for intermediate TOC concentrations while there is decrease in $SSRR_i$ for natural TOC content. Hence, when exposed to natural sediment,

the species decrease its foraging strategy and therefore its contribution to $SSRR_i$. It would be interesting to study the spatio-temporal dynamics of the organic matter in our sampling area to thoroughly evaluate the contribution of *H. germanica* to surface sediment reworking

5. Conclusion

Haynesina germanica seems to be able to collect cue information in its surrounding environment, and to further adapt its motion behaviour, i.e. activity, travelled distance and tortuosity. Specifically, in the present study, *H. germanica* displayed an instantaneous response to TOC concentrations by adapting its foraging strategy. Such a plasticity in the foraging strategy may improve the survival of each individual but in turn, can affect the species contribution to ecosystem functions such as surface sediment reworking as evidenced by our $SSRR_i$ values. Here we assessed the effect of food concentration by diminish the TOC concentration the species experienced in the field at the time of sampling. It would be interesting to study the effect of food enrichment on the species contribution to $SSRR_i$ as previous studies showed that high food supply strongly increases the activity or macrofaunal species (Michaud et al. 2010).

Acknowledgements

Dr Laurent Seuront is warmly thank for providing fractal dimension values.

Supplementary materials

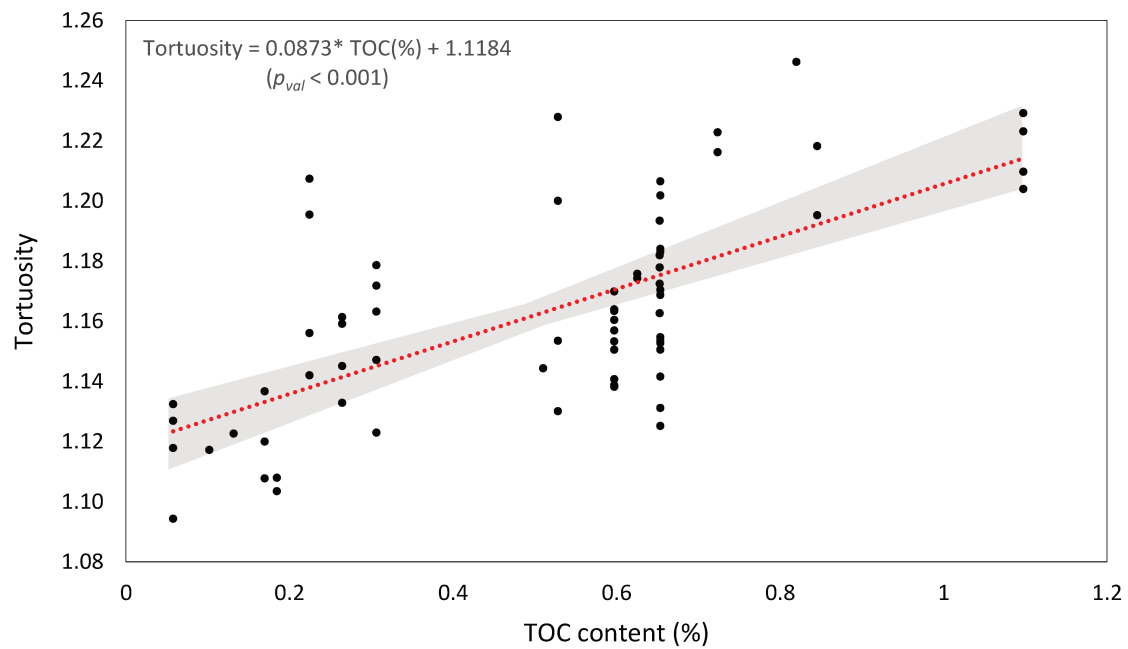

Suppl. Fig. 1. Linear regression between tortuosity and TOC content. Equations, coefficient and p-values are indicated on top. Black points correspond to individual value for each experiment. Shaded error bands showed 95% confidence interval.

Suppl. Table 1. Values of Total Inorganic and Organic Carbon in relation with percentage of dried sediment used for each condition. Values are presented with Mean \pm SD.

Condition (% Dried Sediment / % Burned sediment)	Inorganic Carbon	Organic Carbon
0% _{DS} /100% _{BS}	0.8 \pm 0.11	0.1 \pm 0.08
25% _{DS} /75% _{BS}	1 \pm 0.03	0.3 \pm 0.08
50% _{DS} /50% _{BS}	1.1 \pm 0.07	0.5 \pm 0.09
75% _{DS} /25% _{BS}	1.2 \pm 0.09	0.6 \pm 0.1
100% _{DS} /0% _{BS}	1.3 \pm 0.11	0.9 \pm 0.21

EFFECTS OF TEMPERATURE ON THE BEHAVIOUR AND METABOLISM OF
AN INTERTIDAL FORAMINIFERA AND CONSEQUENCES FOR BENTHIC
ECOSYSTEM FUNCTIONING

Noémie Deldicq^{1*}, Dewi Langlet¹, Camille Delaeter¹, Grégory Beaugrand^{1,2}, Laurent Seuront^{1,3,4}, Vincent M.P. Bouchet¹

¹Univ. Lille, CNRS, Univ. Littoral Côte d'Opale, UMR 8187, LOG, Laboratoire d'Océanologie et de Géosciences, F-59000, Lille, France.

²Marine Biological Association, The CPR survey, The Laboratory, Citadel Hill, Plymouth, United Kingdom.

³Department of Marine Resources and Energy, Tokyo University of Marine Science and Technology, 4-5-7 Konan, Minato-ku, Tokyo 108-8477, Japan.

⁴Department of Zoology and Entomology, Rhodes University, Grahamstown, 6140, South Africa.

Published in *Scientific Reports* **11**: 4013 (2021)

Submitted: August 11, 2020

Accepted: February 2, 2021

ABSTRACT

Heatwaves have increased in intensity, duration and frequency over the last decades due to climate change. Intertidal species, living in a highly variable environment, are likely to be exposed to such heatwaves since they can be emerged for more than six hours during a tidal cycle. Little is known, however, on how temperature affects species traits (e.g. locomotion and behaviour) of slow-moving invertebrates such as benthic foraminifera (single-celled protists), which abound in marine sediments. Here, we examine how temperature influences motion-behaviour and metabolic traits of the dominant temperate foraminifera *Haynesina germanica* by exposing individuals to usual (6, 12, 18, 24, 30°C) and extreme (high; i.e. 32, 34, 36°C) temperature regimes. Our results show that individuals reduced their activity by up to 80% under high temperature regimes whereas they remained active under the temperatures they usually experience in the field. When exposed to a hyper-thermic stress (i.e. 36°C), all individuals remained burrowed and the photosynthetic activity of their sequestered chloroplasts significantly decreased. Recovery experiments subsequently revealed that individuals initially exposed to a high thermal regime partially recovered when the hyper-thermic stress ceased. *H. germanica* contribution to sediment reworking substantially diminished from 10 mm³ indiv⁻¹ d⁻¹ (usual temperature) to 0 mm³ indiv⁻¹ d⁻¹ when individuals were exposed to high temperature regimes (i.e. above 32°C). Given their role in sediment reworking and organic matter remineralisation, our results suggest that heatwaves may have profound long-lasting effects on the functioning of intertidal muddy ecosystems and some key biogeochemical cycles.

1. Introduction

Over the last decades, anthropogenic pressures such as industrial activity, intensive agriculture, pollution, deforestation and overfishing have altered the terrestrial and marine biosphere (Wernberg et al. 2016, Oliver et al. 2018, 2019). Greenhouse gas emissions have risen substantially, affecting the global climate and the frequency and magnitude of extreme weather or climatic events such as storms, floods, droughts and heatwaves (Della-Marta et al. 2007, Oswald & Rood 2014, Bond et al. 2015, Smale et al. 2017, Oliver et al. 2018). Over the period 1982-2010, extremely hot days have been more frequent along 38% of the world's coastlines (Lima & Wethey 2012) and a recent study suggests that 50% of the ocean surface may suffer from a permanent marine heatwave state by the late 21st century (Oliver et al. 2019). Marine heatwaves which result from the warming of both air and seawater temperature (Hobday et al. 2016, 2018), have caused unprecedented mass mortalities of a wide range of intertidal species such as mussels and limpets (Harley et al. 2006, Garrabou et al. 2009, Caputi et al. 2016, 2019, Seuront et al. 2019). In the intertidal environment, sessile and slow-moving invertebrates are more likely to be exposed to extreme temperature events. Noticeably, in temperate ecosystems, surface soft-sediment temperature (i.e. within the first centimetre) can frequently reach up to 30°C (Murphy & Reidenbach 2016) and sometimes even 40°C during summer at low tide (Gouletquer et al. 1998, Li et al. 2019) during spring and summer. Typically, in European Atlantic mudflats, organisms can experience daily rise in sediment temperature up to 20°C in 2 hours at emersion (Gouletquer et al. 1998). Consequently, intertidal species are more eurytherm than their subtidal counterparts (Pörtner 2001, 2012, Straub et al. 2019). However, these organisms often live close to the upper limit of their thermal tolerance window, which make them also sensitive to thermal stress (Stillman & Somero 1996, Pörtner 2001, 2012, Straub et al. 2019). Outside their thermal range, temperature may have adverse effects on behaviour (e.g. locomotion), metabolism and reproductive strategy, which ultimately affect species survival (Pörtner 2001, Wernberg et al. 2016, Joint & Smale 2017). To alleviate a thermal stress, organisms typically decrease their metabolic rate by reducing their activity such as locomotion and feeding, which decrease the space

they explore and hamper their foraging strategy (Pörtner 2001, Pörtner & Farrell 2008, Wu et al. 2017, Vianna et al. 2020). Thermal stress may have substantial implications for soft-bottom ecosystem functioning and services. Indeed, the movements of benthic species affect biogeochemical or ecosystem processes since they contribute to sediment reworking and dissolved material fluxes (François et al. 1997, Kristensen et al. 2012, Piot et al. 2013, Bonaglia et al. 2014, 2020). In this context, assessing how temperature might affect movements, activity and metabolic rate of intertidal organisms is a critical prerequisite to better understand how their contribution to ecosystem functioning may be affected by the increasing occurrence of marine heatwaves in the context of global warming.

In soft sediment, macrofaunal taxa such as molluscs, shrimps or crabs have been well studied since they play a key role in habitat structuration (Mermillod-Blondin & Rosenberg 2006, Kristensen 2008, Pascal et al. 2019, Vianna et al. 2020). Meiobenthic organisms such as benthic foraminifera also play a major role in biogeochemical or ecosystem processes (Pike et al. 2001, Risgaard-Petersen et al. 2006, Woulds et al. 2007, Høglund et al. 2008, Bernhard et al. 2009) yet, little is known about their behavioural and metabolic response to changing temperatures. Many studies have shown that temperature can affect intertidal foraminifera survival, diversity, growth, morphology and feeding (Bradshaw 1961, Pascal et al. 2008, Schmidt et al. 2011, Wukovits et al. 2017, Stuhr et al. 2018, Li et al. 2019) and that some foraminiferal species also increase their locomotion speed and oxygen consumption up to a point where temperature negatively impede movement, behaviour and metabolism (Bradshaw 1961, Gross 2000). Under moderate temperature, *Haynesina germanica* is the most active species (i.e. with an important time allocated to motion) amongst dominant European mudflat foraminifera and may be a key contributor to sediment reworking (Seuront & Bouchet 2015, Deldicq et al. 2020). Furthermore, *H. germanica* can sequester chloroplasts from diatoms and use them for photosynthesis, which implies that this species contributes to both oxygen consumption and production in the sediment (Austin et al. 2005, Cesbron et al. 2017). In contrast to tropical species (Schmidt et al. 2011, van Dam et al. 2012, Sinutok et al. 2014, Stuhr et al. 2018), the

metabolic response of *H. germanica* to changing temperatures remains unknown. Given its high abundance in temperate intertidal mudflats (Alve & Murray 2001, Debenay et al. 2006, Morvan et al. 2006, Francescangeli et al. 2020), high level of activity and subsequent putative contribution to sediment reworking, *H. germanica* is a good candidate to experimentally assess the effects of temperature on soft-bottom ecosystem functioning, especially in the context of global warming.

The objectives of this study are (i) to experimentally describe the responses of *H. germanica* to temperature in terms of motion behaviour and metabolic rate using a thermal gradient usually encountered in temperate intertidal environments (i.e. 6 – 30°C), (ii) to characterize the effects of experimentally-induced heatwaves ranging from 32 to 36°C and (iii) to experimentally assess the ability of the species to recover after being exposed to extreme temperatures i.e. 6 and 36°C. We also discuss possible consequences of an acute hyperthermic stress on *H. germanica* and its putative consequences on benthic ecosystem functioning and services.

2. Materials and methods

2.1. Collection

Surface sediment (0-1 cm) were gently scrapped off with a spoon in April, May and June 2019 in two intertidal mudflats located on the French coasts of the eastern English Channel, i.e. Authie Bay (50°22'20"N, 1°35'45"E) and Boulogne-sur-Mer harbour (50°43'6"N, 1°34'25"E). Both sampling sites showed similar grain size (20% sand, 80 silt), TOC contents (between 1 and 2%; Francescangeli et al. 2020), temperature and salinity values (18°C, 33.8 PSU; Amara et al. 2007). Samples were stored in plastic containers (100 ml) and transported to the laboratory, then washed through a 125 µm mesh sieve. Living *H. germanica* of similar size were sorted individually with a brush and subsequently kept for 24 hours in temperature-controlled incubators (MIR-154, Panasonic, Japan; temperature fluctuation $\pm 0.3^\circ\text{C}$, light intensity $170 \mu\text{mol m}^{-2} \text{s}^{-1}$). Temperatures at which individuals were acclimated corresponded to those used for the experiments (i.e. 6, 12, 18, 24, 30, 32, 34 and 36°C, see section below). Additionally,

the temperature was monitored inside each incubator with a temperature logger (DSL1922L iButtons, resolution 0.1°C, Supplementary Fig. 2). Only active individuals (i.e. producing a displacement track on a thin layer of sediment; Geslin et al. 2011, Cesbron et al. 2017, Langlet et al. 2020a) were chosen and subsequently imaged to assess the shell size parameter measurements (Olympus SZX16, Japan, TC capture software with a calibrated tool for the estimation of the maximum length and width of each individual) prior to each experiment.

2.2. Motion behaviour and recovery experiments

Active individuals were transferred into a 400 ml aquarium containing 25-30 ml of de-frozen sediment (i.e. ~1 cm thick) corresponding to their sampling site, free of moving animals with oxygenated overlaying natural seawater (33PSU; Supplementary Fig. 3). Eight temperatures (6, 12, 18, 24, 30, 32, 34, and 36°C; see Supplementary Fig. 2 for temperature records) were tested. The ranges 6-30°C and 32-36°C were respectively considered as usual (i.e. temperature regularly experienced in the field) and extreme (i.e. temperature rarely or never reached so far in the field) temperatures in the intertidal mudflats located along the French side of the eastern English Channel. Fifteen experiments containing between 20 and 30 individuals were performed in temperature-controlled incubators (MIR-154, Panasonic, Japan, temperature fluctuation $\pm 0.3^\circ\text{C}$, light intensity $170 \mu\text{mol m}^{-2} \text{s}^{-1}$) in April, May and June 2019 (Supplementary Table. 2). Living foraminifera were randomly placed on the sediment surface and the displacement of each individual in and on the sediment was recorded using time-lapse photography (i.e. one image every 10min during 24h; Nikon V1 with a Nikkor 10-30mm lens). Then, the images were analysed by using the software Fiji (Schindelin et al. 2012). Such a method allowed us to visually follow each individual and extract the coordinates from each of the ~144 images combined by the computer program. The coordinates thereby gave the individual's trajectory during the time of the experiment.

Additional recovery experiments were performed on one of each experiment carried out at 6 and 36°C to assess specifically the resilience of *H. germanica* at extreme

temperatures i.e. near the limit of their thermal range. To do so, one of each 24-h experiments carried out at 6°C and 36°C were pursued for extra 24-h by increasing or decreasing the temperature until 18°C, respectively. Displacements were subsequently recorded every 10 min for 24 hours. The mean distance travelled within 10 min was calculated with a 3-order simple moving average to reduce the influence of short-term fluctuations.

2.3. Motion traits

A total of 713 active individuals was initially selected for the experiment; note that they all moved. During the experiment, it was not possible to track some individuals because (i) they burrowed into the sediment up to a depth where their paths were not visible and/or (ii) in the case of intersecting trajectories belonging to different individuals, it was not anymore possible to assign a track to each individual. As a consequence, for motion-traits assessment, we only kept individuals that exhibited visible tracks throughout the whole 24h experiment. In total we were able to follow the trajectories of 246 individuals.

Four motion traits were investigated following Seuront & Bouchet (2015) and Deldicq et al. (2020).

First, the level of activity (i.e. time allocated to locomotion by each individual) was estimated with the activity index A_i that is based on the ratio t_{move} and t_{active} as follows:

$$A_i = 100 \times (t_{\text{active}} / t_{\text{move}})$$

where t_{move} includes the total time taken by an individual to move from its initial position to its final position, which thereby includes the time periods when individual remains inactive. In contrast, t_{active} only considers the time periods when an individual actually moves between its initial and final position.

The distance travelled by each individual between two images (i.e. 10 min) was assessed as follows:

$$D_t = \sqrt{((x_t - x_{t+1})^2 + (y_t - y_{t+1})^2)}$$

where (x_t, y_t) and (x_{t+1}, y_{t+1}) are the coordinates between two successive images taken at times t and $t+10$ min and the total distance travelled within 24 hours was then calculated (D_{24}) and normalized by the experiment duration to obtain velocity.

The complexity of the trajectory of each individual was assessed using fractal dimension analysis. Because the principles behind fractal theory, fractal analysis techniques and their applications to behavioural data, including foraminifera behaviour (Deldicq et al. 2020), have all been described in detail elsewhere (Seuront 2010a, 2015b, Seuront & Cribb 2017), we only briefly describe hereafter the basic principles of the box-counting method, which is likely among the most widely applied and intuitive methods available to date to characterize the geometric complexity of movement paths. This method superimposes a regular grid of squares of length l on a path and counts the number of occupied squares, $N(l)$. This procedure is repeated using different values of l . The surface occupied by a trajectory is then estimated using a series of boxes spanning a range of surfaces down to some small fraction of the entire space, typically the size of the organism considered. The number of occupied squares fundamentally increases with decreasing square size, and the presence of a fractal structure manifests itself by a power-law relationship of the form $N(l) = k \times l^{-D}$, where k is an empirical constant and D the fractal dimension. The fractal dimension D , estimated from the slope of the linear trend of the log-log plot of $N(l)$ versus l , fundamentally measures the degree to which the trajectory fills the available space and is bounded between $D = 1$ for a line (i.e. the simplest instance of a trajectory) and $D = 2$ for a movement so complex that it actually fills the whole available space.

Following the method newly described in Deldicq et al. (2020), the vertical position of *Haynesina germanica* in the sediment for every individual and picture was determined based on a classification with 3 depth categories. When part of the test remained visible at the surface and the width of the path was indistinguishable an individual was considered to be crawling on the sediment surface (Fig. 44A,D). When an individual was burrowing into the sediment, its position was divided into two categories: (i) it was considered as moving at the sediment–water interface when half of the test was visible (Fig. 44B,E) and (ii) as having fully burrowed into the sediment

when a swelling at the sediment surface was the only indication of the presence of a test in the sediment (Fig. 44C,F). The number of individuals was estimated for each position and each 10-min period during the time of the experiment.

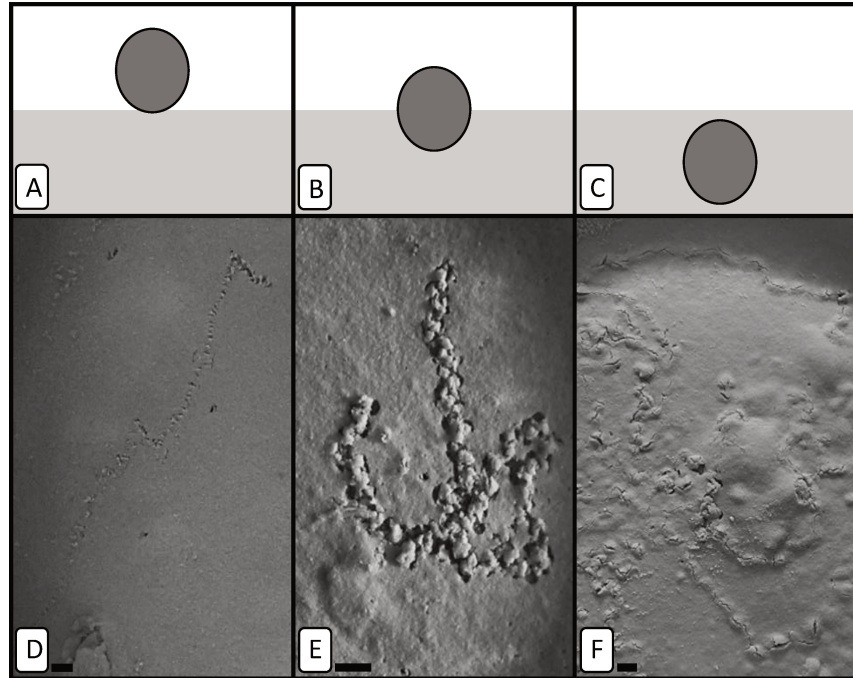

Figure 44. Schematic side-view representation of the vertical position (A, B and C) and top-view images of the sediment surface showing actual trajectories of foraminifera (D, E and F) related to the three vertical position categories, which can be taken by a foraminifera, i.e. surface (A and D) sediment-water interface, (B and E), and burrowed (C and F). Scaled bars = 0.2 mm. From Deldicq et al. (2020).

2.4. Surface sediment reworking rate

To assess *H. germanica* contribution to sediment reworking, the test surface TS_i (mm^2) of each individual was estimated by measuring individual maximum length and width and assuming that the species has an ellipse-shape shell:

$$TS_i = \pi \times \frac{\text{Length}}{2} \times \frac{\text{Width}}{2}$$

Since there was no significant difference in term of individual size between each set of experiment (Kruskal-Wallis test, $p < 0.05$), the mean test surface TS was calculated for each set of experiment and used for the calculation of the Individual Surface Sediment Reworking Rate, $SSRR_i$ ($\text{mm}^3 \text{indiv}^{-1} \text{d}^{-1}$):

$$SSRR_i = TS \times D_{24}$$

where D_{24} is the total distance travelled (in mm) by each individual.

2.5. Oxygen consumption and production

Active individuals used for respiration measurements were acclimated overnight with artificial seawater (35g of Red Sea salt per liter of MilliQ ultrapure water, and referred to as ASW hereafter) at the temperature corresponding to the experimental condition (i.e. 6, 12, 18, 24, 30 and 36°C). Three sets of five active individuals (with homogenised shell length ranging from 340 to 420 μm , Kruskal-Wallis test, $p < 0.05$) were transferred to a 1-mm wide and 1-cm high glass microtube containing ASW (35 g of Red Sea salt per liter of MilliQ ultrapure water) for each chosen temperature (6, 12, 18, 24, 30 and 36°C, Supplementary Table 3). Measurements within the microtube were carried out in a temperature-controlled water bath (Huber CC-K12, Germany) to estimate oxygen fluxes at 6, 12, 18, 24 and 30°C. To this end, a 50- μm Clark-type oxygen microelectrode (Unisense, Denmark) was 2-point calibrated (Revsbech 1989) using oxygen-saturated seawater (considering O_2 saturation at 35 PSU and at the chosen temperatures) and an anoxic solution (20 g of sodium ascorbate per liter of 0.1 mol L^{-1} NaOH solution). The electrode was then placed in the measurement microtube about 300 μm above the 5 individuals. Oxygen profiles were realized with a 50- μm vertical resolution to determine the oxygen consumption gradient (dC/dz , in $\text{pmol}\cdot\text{cm}^{-4}$) in the first millimetre above the foraminifera (Høgslund et al. 2008, Geslin et al. 2011).

Oxygen consumption gradients were first measured in the dark to estimate foraminiferal respiration and then oxygen production gradients were estimated under homogeneous light conditions to determine net photosynthesis (photosynthetically active radiation 170 $\mu\text{mol photon m}^{-2} \text{ s}^{-1}$; SA-190 quantum sensor, LI-COR, USA, provided by two arrays of LEDs (YN-160 III, Yongnuo, China). Given that previous studies show that ASW alone does not produce nor consume oxygen (Geslin et al. 2011, Glock et al. 2013, Choquel et al. 2021), no further blank controls were performed for

this experiment and the measured oxygen production or consumption was assumed to originate from the foraminifera themselves.

2.6. Respiration and photosynthesis calculations

Oxygen fluxes J ($\text{pmolO}_2 \text{ cm}^{-1} \text{ s}^{-1}$) were calculated using Fick's first law of free diffusion, as follows:

$$J = D \times dC/dz$$

where D is the free diffusion coefficient for oxygen in seawater at a given temperature and dC/dz the oxygen gradient 1 mm above the foraminifera in the microtube. Oxygen solubility and free diffusion coefficients (D) were selected from tables compiled by Ramsing & Gundersen (1994; Unisense, Denmark). All respiration measurements were performed in the dark in a temperature-controlled water bath (Huber CC-K12, Germany).

Individual respiration rate R ($\text{pmolO}_2 \text{ indiv}^{-1} \text{ h}^{-1}$) and net photosynthesis rate NP ($\text{pmolO}_2 \text{ indiv}^{-1} \text{ h}^{-1}$) were subsequently calculated as:

$$R = J_{\text{dark}} \times S/n$$

$$NP = J_{\text{light}} \times S/n$$

where S is the microtube inner section ($S = 7.9 \cdot 10^{-3} \text{ cm}^2$), n the number of individuals (i.e. $n = 5$) and J the fluxes estimated under dark and light conditions, respectively.

Gross photosynthesis (GP) was estimated from respiration (R) and net photosynthesis (NP) rates as follow:

$$GP = NP + R$$

In addition, to estimate the influence of temperature on *H. germanica* physiological rate, Q_{10} was calculated within the ranges 6-24°C and 24-36°C. The Q_{10} values quantify changes in the metabolic rate for a 10°C increase:

$$Q_{10} = \left(\frac{R(T_2)}{R(T_1)} \right)^{\frac{10}{T_2 - T_1}}$$

where $R(T_1)$ and $R(T_2)$ ($\text{nmolO}_2 \text{ indiv}^{-1} \text{ h}^{-1}$) are the metabolic rate (i.e. respiration or gross photosynthesis) respectively measured at extreme tested temperatures (i.e. 6 and 36°C) and 24°C.

To estimate the daily oxygen budget, i.e. the balance between oxygen consumption (respiration) and production (photosynthesis) within a day, we calculated the amount of oxygen produced in a day for a 12-h light exposure duration (to account for diurnal cycles) and 6-h light exposure duration (to account for both diurnal and tidal cycles, assuming that coastal seawater turbidity is so high that no light is reaching the sediment during immersion). Such calculations were done by pondering net photosynthesis with respiration rates with a 0.5 and 0.75 ratio for 12-h and 6-h light exposure, respectively.

2.7. Data analysis

Because behavioural parameters were non-normally distributed (Shapiro-Wilk test, $p < 0.05$). Kruskal-Wallis tests were conducted for activity and sediment reworking rate in order to discriminate temperatures. In case of significant differences a Dunn post-hoc test was applied for two-sample comparisons (Zar 2009). In turn, metabolic parameters rate were normally distributed (Shapiro-Wilk test, $p > 0.05$) and an analysis of variance (ANOVA) was conducted on respiration rates and photosynthesis followed by a two-sample comparison (Tukey test) to identify distinct groups of measurement (Zar 2009). The presence of significant differences between fractal dimensions was assessed using an analysis of covariance. All statistical analyses were performed using R.3.5.2. software (R Core Team 2019).

3. Results

3.1. Motion traits

Individuals were most active between 6 and 30°C, spending more than 90% of their time moving into the sediment (Fig. 45A). Individuals exposed to extremely high temperatures (*i.e.* 32-36°C) significantly decreased their activity from *circa* 90% to *ca.* 15% (Dunn test, $p < 0.01$; Fig. 45A).

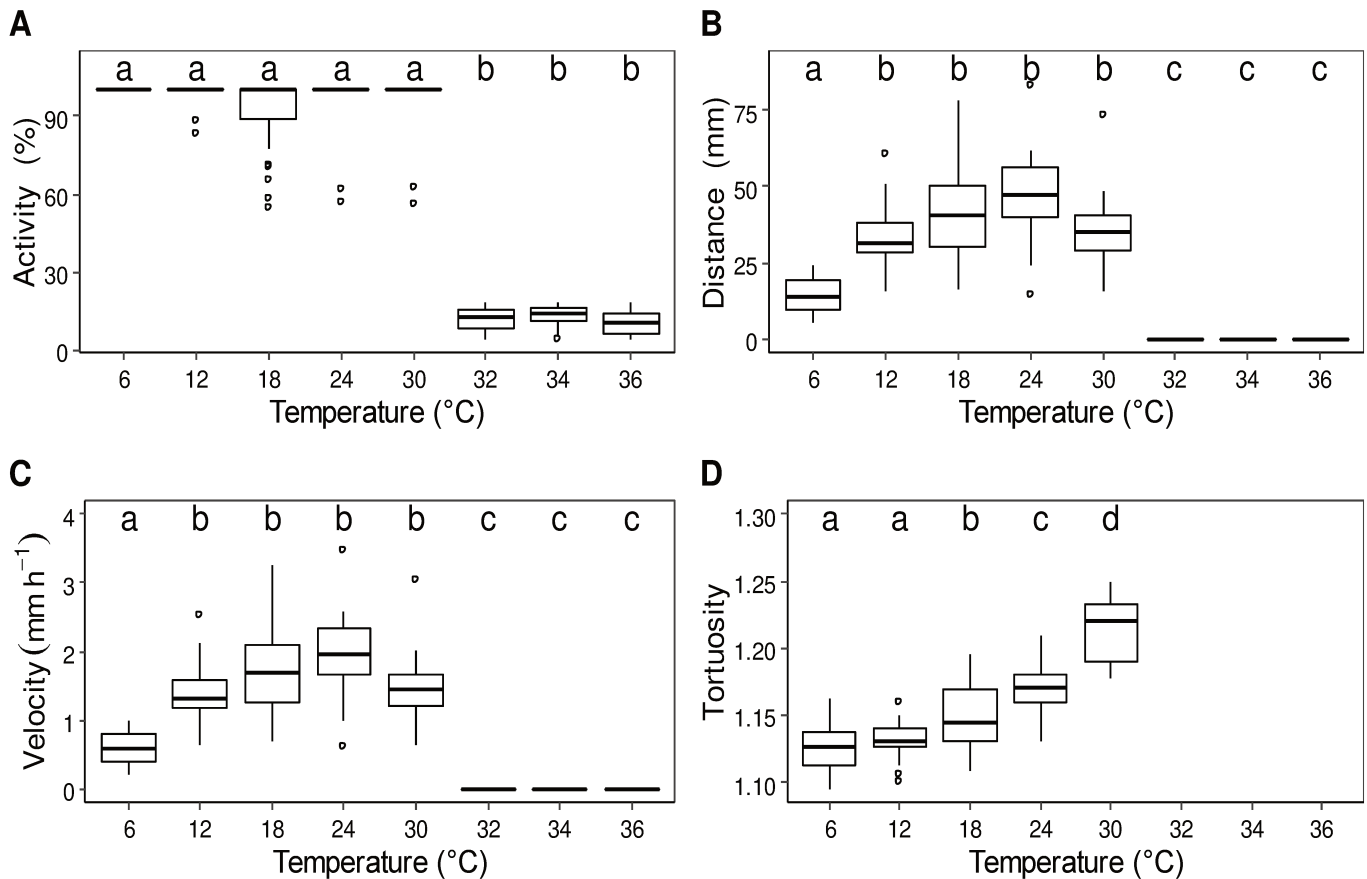

Figure 45. The influence of temperature on (A) the activity (B) the distance travelled (over 24h), (C) the velocity and (D) the fractal dimension of *H. germanica*. The box represents the first, second and third quartiles and the whiskers extend to 1.5 times the interquartile range; values outside this range are represented by open circles. Number of replicates are 30, 23, 30, 25, 69, 28 and 26 for 6, 12, 18, 24, 30, 32, 34 and 36°C respectively. Due to the absence of motion it was impossible to estimate fractal dimension at 32, 34 and 36°C. Letters above the boxes ('a', 'b', 'c' and 'd') identify significant different groups (Dunn test, $p < 0.05$).

The highest velocities and the longest distances travelled during the 24-h experiment were observed in the range 12°-30°C (Fig. 45B,C). The longest trajectories were measured at 24°C with a mean travelled distance of 46.9 mm (Fig. 45B,C). Beyond

32°C, individuals started burrowing into the sediment at the beginning of the experiment but there was no subsequent displacement throughout the rest of the experiment (Fig. 45B,C). More specifically, the travelled distance of *H. germanica* trajectories were discriminated into several groups, i.e. $D_{t(36^\circ\text{C})} = D_{t(34^\circ\text{C})} = D_{t(32^\circ\text{C})} < D_{t(6^\circ\text{C})} < D_{t(12^\circ\text{C})} = D_{t(18^\circ\text{C})} = D_{t(24^\circ\text{C})} = D_{t(30^\circ\text{C})}$ (Dunn test, $p < 0.01$).

Since there were no displacements between 32°C and 36°C, the complexity of movement (i.e. fractal analysis) was not assessed for these temperatures. However, all trajectories considered at cooler temperature (i.e. 6, 12, 18, 24, 30°C) were characterized by a fractal property, i.e. a highly significantly linear behaviour of $N(l)$ vs. l in log-log plots ($r^2 > 0.99$, $p < 0.01$). The fractal dimension D ranged from 1.09 to 1.22 and significantly differed between treatments (Fig. 45D; Kruskal-Wallis test, $p < 0.01$). The trajectories of *H. germanica* was subsequently discriminated into several homogeneous groups, i.e. $D_{6^\circ\text{C}} = D_{12^\circ\text{C}} < D_{18^\circ\text{C}} < D_{24^\circ\text{C}} < D_{30^\circ\text{C}}$, which overall indicated an increase in movement complexity with rising temperature.

For intermediate temperatures (18, 24, 30°C), individuals were alternatively observed at the sediment-water interface or burrowed in the sediment during the experiment (Fig. 46). At the hottest temperatures e.g. 32- 36°C, individuals moved rapidly from the surface down to the sub-surface and stayed buried during the remaining time of the experiment. In contrast, they were observed at the sediment-water interface between 6°C and 12°C (Fig. 46).

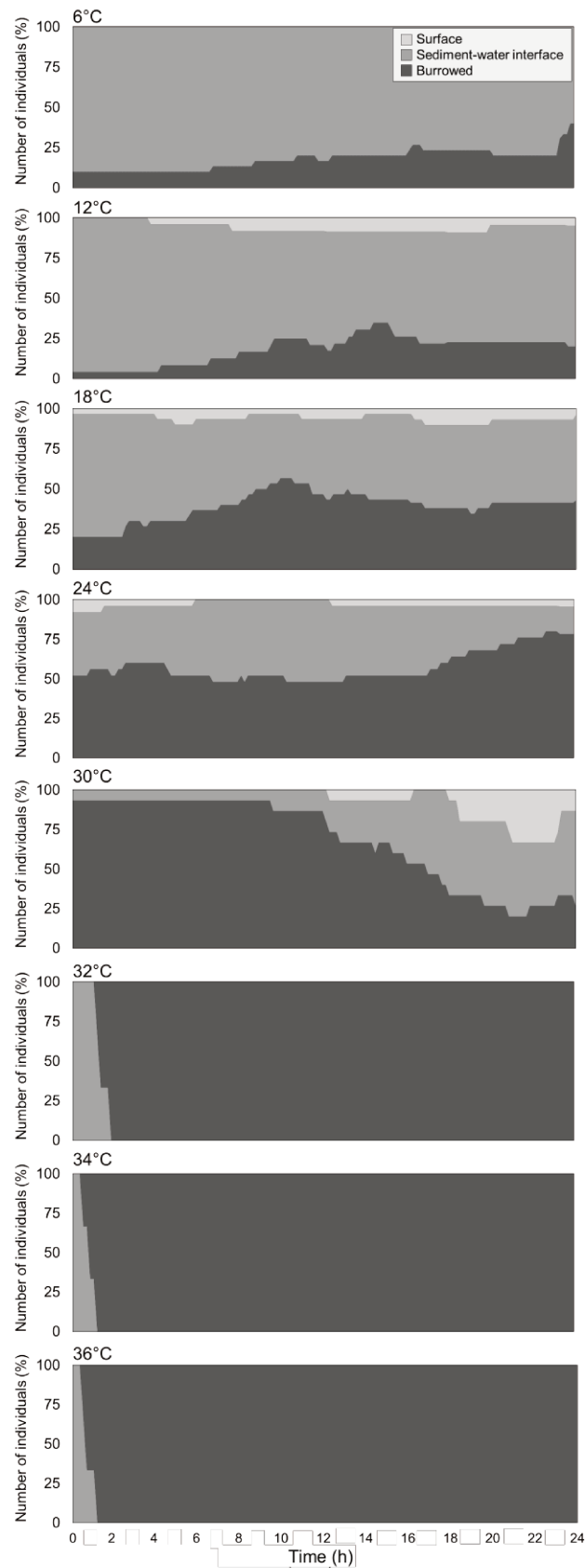

Figure 46. Temporal changes in the vertical position of *H. germanica* for each tested temperature. Number of individuals are shown in Supplementary Table 2.

3.2. Recovery experiment

After a 24-h exposure to a temperature of 6°C, individuals exposed to 18°C increased their velocity from an average of 0.8 mm h⁻¹ in the first 24 hours of the experiment up to approximately 1.6 mm h⁻¹ in average over the 30-55h time interval (Fig. 47A). This increase started as soon as the temperature rose in the experiment container (Fig. 47A). Noticeably, the recovered velocity at 18°C (1.6 mm h⁻¹) was close to the value observed for individuals solely exposed to 18°C (1.74 mm h⁻¹, Fig. 45C).

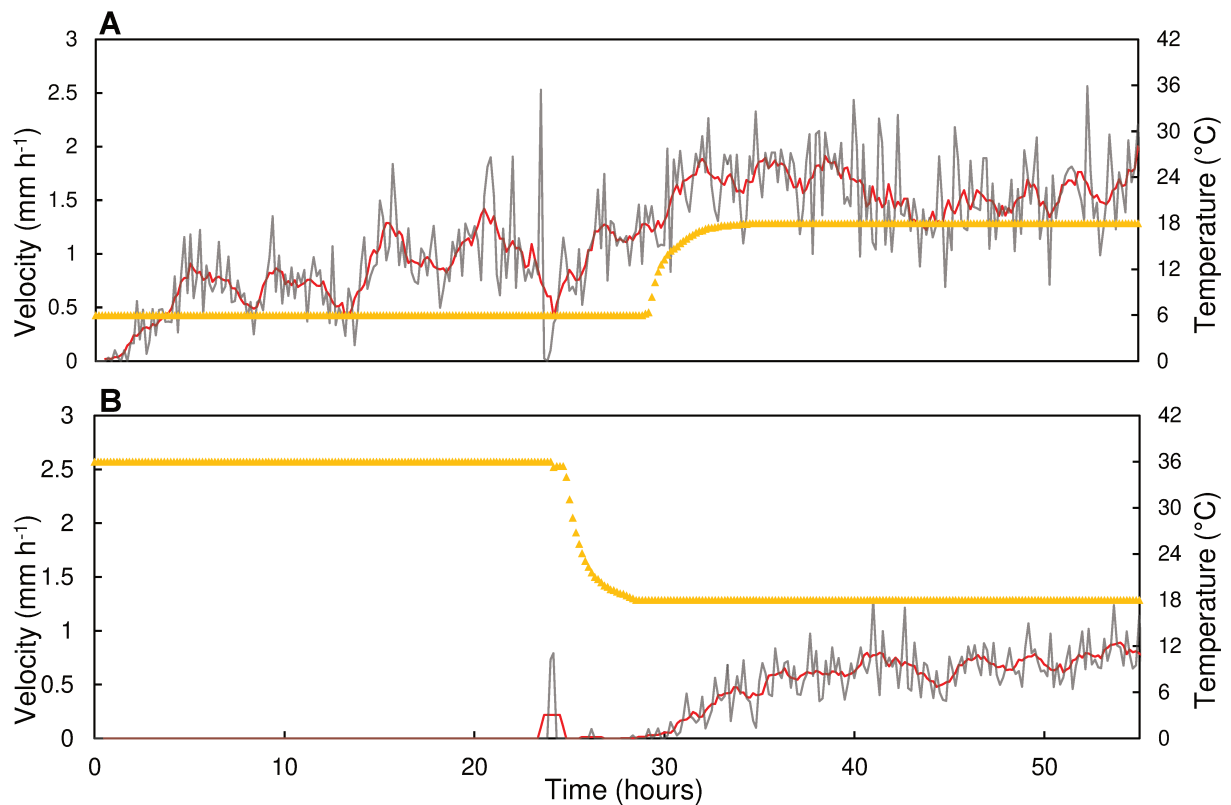

Figure 47. Temporal changes in the mean velocity of 9 *H. germanica* individuals previously exposed at (A) 6°C then 18°C and (B) 36°C then 18°C. The grey line is the instantaneous velocity and the red line is the 3-order simple moving average of the velocity. Yellow triangles correspond to water-temperature changes through time.

At 36°C, the distance travelled was nearly nil during the first day of the experiment. Individuals exposed to 36°C for a 24-h period started to move only 4 h after the decrease in temperature from 36 to 18°C (Fig. 47B). The recovered mean velocity at 18°C (0.57 mm h⁻¹) never reached the mean velocity where individuals were solely exposed to a thermal regime of 18°C (1.7 mm h⁻¹; Fig. 45C).

3.3. Respiration and photosynthesis

Oxygen respiration rates did not significantly differ between 6 and 12°C (Tukey test, $p < 0.01$). However, respiration rates were significantly higher for warmer temperatures (Tukey test, $p < 0.01$). Hence, oxygen consumption increased from 24.5 pmolO₂ indiv⁻¹ h⁻¹ (12°C) to 55.7 pmolO₂ indiv⁻¹ h⁻¹ (24°C), then decreased down to 48.5 pmolO₂ indiv⁻¹ h⁻¹ at 36°C (Fig. 48A). Gross photosynthesis also increased up to 77 pmolO₂ indiv⁻¹ h⁻¹ when temperature warmed from 6 to 24°C. A significant diminution was subsequently observed from 24°C to 30°C (Tukey test, $p < 0.01$; Fig. 48B).

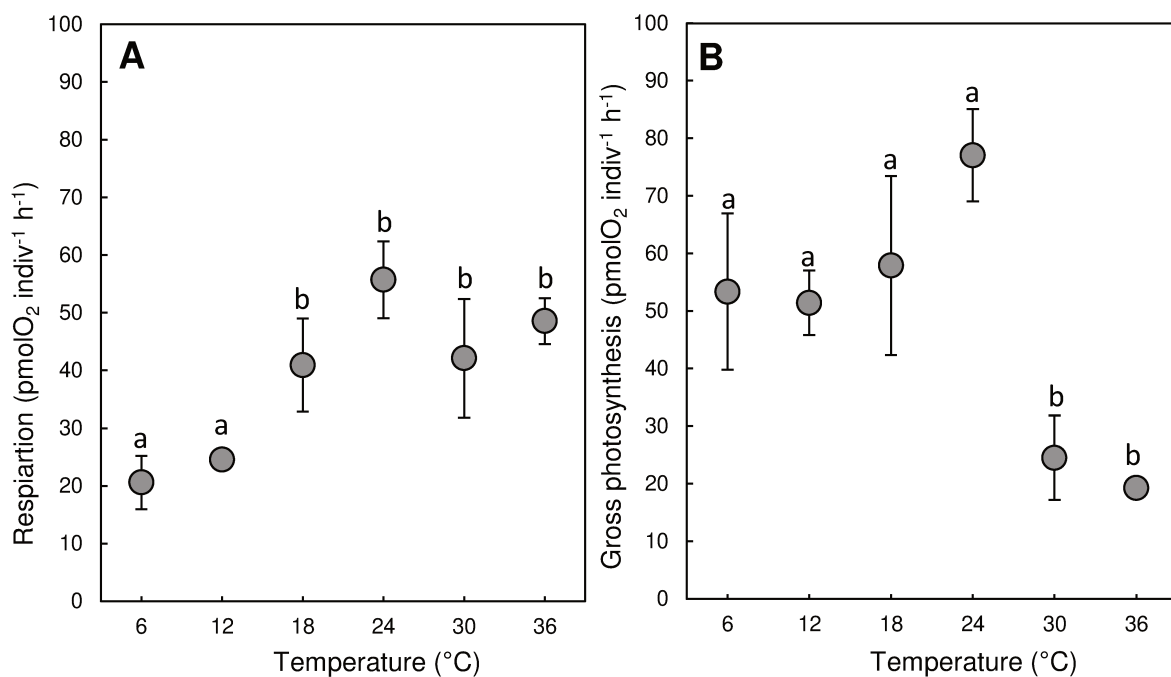

Figure 48. Mean values of (A) respiration and (B) gross photosynthesis (pmol.O₂ indiv⁻¹ h⁻¹) of *H. germanica* under different thermal regime in 3 replicate measurements. The error bars are the standard errors of the mean. Letters ‘a’ and ‘b’ identify significant different groups (Tukey test, $p < 0.05$).

The increase in respiration and gross photosynthesis between 6 and 24°C can be described with $Q_{10} = 1.75$ and $Q_{10} = 1.22$, respectively. However, the influence of the warmest temperatures on respiration decrease ($Q_{10} = 0.89$) was lower than for gross photosynthesis decrease ($Q_{10} = 0.32$) over the 24-36°C range.

3.4. Surface sediment reworking rate and oxygen budget

Due to low travelled distances, there was no surface sediment reworking beyond 32°C. In contrast, for lower temperatures, individuals could rework between 3.7 and 10.1 mm³ indiv⁻¹ d⁻¹ (respectively 6 and 24°C; Fig. 49). Statistical analyses showed significant differences in the $SSRR_i$ between temperatures (Kruskal-Wallis test, $p < 0.05$) and four groups were further identified as $SSRR_{i(32^\circ\text{C})} = SSRR_{i(34^\circ\text{C})} = SSRR_{i(36^\circ\text{C})} < SSRR_{i(6^\circ\text{C})} < SSRR_{i(12^\circ\text{C})} = SSRR_{i(18^\circ\text{C})} = SSRR_{i(30^\circ\text{C})} < SSRR_{i(24^\circ\text{C})}$. Q₁₀ of surface sediment reworking in the thermal range 6-24°C was 1.75.

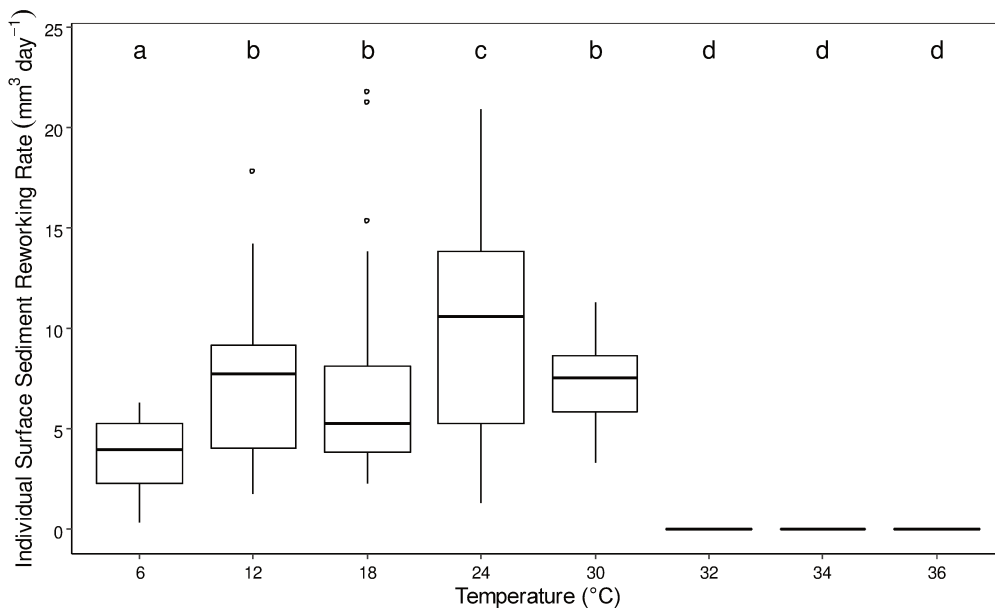

Figure 49. Individual surface sediment reworking (mm³ indiv⁻¹ d⁻¹) of *H. germanica* under different thermal regime. Letters above plots ('a', 'b', 'c') indicate significant differences among measurements (Dunn test, $p < 0.05$). The box represents the first, second and third quartiles and the whiskers extend to 1.5 times the interquartile range; values outside this range are represented by open circles.

For a 6-h light exposure, daily oxygen budget was negative at all temperatures and significantly decreased above 12°C (Fig. 50, Tukey test $p < 0.05$). When considering a 12h light exposure cycle, average daily oxygen productive was positive at 6 and 12°C and gradually decreased to reach negative values within the thermal range 18-36°C.

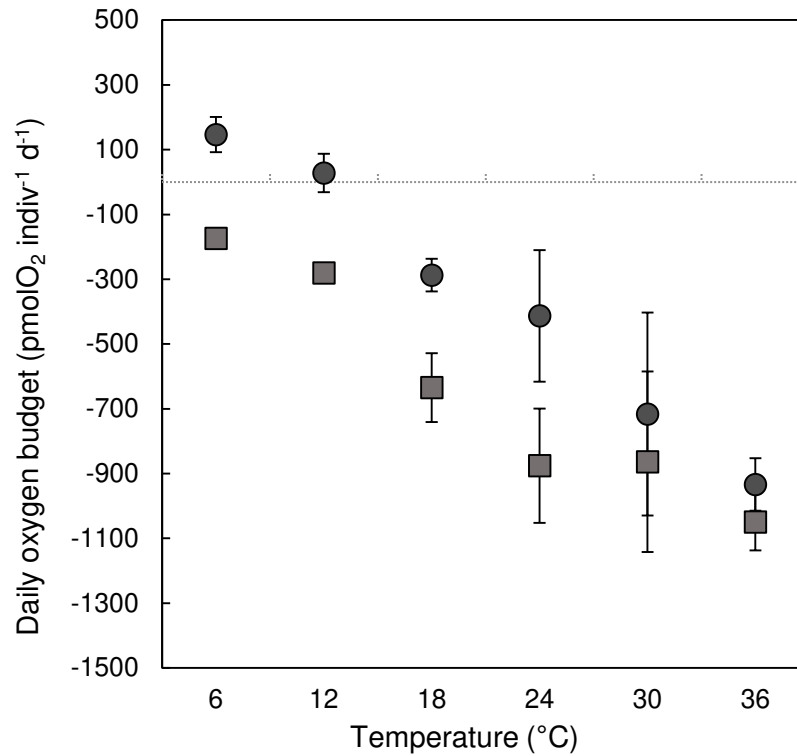

Figure 50. Daily oxygen budget of *H. germanica* (pmolO₂ indiv⁻¹ d⁻¹) under 12h (black dots) and 6h (grey squares) light exposure and thermal regimes. The error bars are the standard errors calculated on the 3 replicates at each temperature.

4. Discussion

4.1. The resilience of *H. germanica* motion behaviour to temperature fluctuations reveals plasticity to seasonal thermal variations

Haynesina germanica was more active in the range 6-30°C, with the highest velocities and distances travelled being in the range 12-24°C. Specifically, individuals were 1.4 times faster at 24°C than at 12°C (Fig. 45C). This is consistent with previous measurements of locomotion speed on glass petri dish, velocity being nearly twice lower at 12°C (~2 mm h⁻¹; Langlet et al. 2020a) than at 22°C (~4 mm h⁻¹; Seuront & Bouchet 2015). This observation confirms that cold temperatures may reduce the activity of temperate foraminifera (Bradshaw 1961). In our experiments, *H. germanica* explored actively its environment from 6 to 30°C by consistently moving vertically and horizontally into the sediment between 22 and 24 hours. However, specimens remained only active between 3 and 4 hours in the sediment at temperatures above 30°C with

velocities and travelled distances being nil above 32°C. Increasing fractal dimensions in the range 12-30°C were also indicative of more intensive foraging behaviour consistent with the more complex trajectories and more intensive foraging behaviour exhibited by unstressed organisms (Seuront 2011a b, 2015a, Seuront & Bouchet 2015). Note that these results may also indicate that foraging behaviour may differ at the sediment-water interface and within the sediment. The observed adaptive responses to a range of temperatures typically encountered in temperate intertidal mudflats (i.e. 6-30°C; Harrison & Phizacklea 1987, Gouilletquer et al. 1998, Bouchet et al. 2007) as well as more extreme and rare temperature (36°C) may suggest that *H. germanica* behavioural flexibility would have specifically evolved to optimize the timing of their response to thermal stress at temporal scales typical of the tidal alternance of immersion and emersion. In fact, many studies have shown that intertidal invertebrates often live close to the upper limit of their thermal tolerance windows (Stillman & Somero 1996, Somero 2002, Pörtner et al. 2007). Our findings therefore suggest that irrespective of species physiological and behavioural plasticity, unusual temperatures such as those caused by heatwaves may affect species performance and perhaps survival. After being exposed to extremely hot temperatures, *H. germanica* was nevertheless able to quickly recover. After bringing them back to 18°C, all individual exposed to cold and hot temperatures (6°C and 36°C), started exploring all potential habitats i.e. both surface and deeper sediment, suggesting that the protist can exhibit a thermotactic behaviour.

4.2. Thermal control of the position of *H. germanica* in the sediment

At temperatures corresponding to autumn and winter (i.e. 6-12°C), *H. germanica* preferably remained at the sediment-water interface. At intermediate temperatures (18 and 24°C) corresponding to spring and summer conditions, individuals alternatively moved in and on the sediment during the whole experiment with a proportion of burrowed individuals increasing with temperatures. For instance, at 30°C more than 90% of the individuals were observed below the sediment-water interface. Habitat selection as a function of environmental conditions has also been reported in a wide range of organisms such as crabs, worms and gastropods (Przeslawski et al. 2009,

Chapperon & Seuront 2011b, Vianna et al. 2020). Organisms inhabiting intertidal mudflats move toward a more favourable habitat following the vertical thermal gradient they experience in soft sediments (Tsubokura et al. 1997, Lardies et al. 2001). Under low temperatures (here 6, 12°C), basking behaviour, i.e. a common thermoregulatory behaviour observed in many ectotherms, might allow species to live in the limited-oxygenated zone to draw benefit from solar heating (Diaz & Cabezas-Diaz 2004, Lencioni 2004, Dubois et al. 2009, Chapperon & Seuront 2012, Koo et al. 2019). In contrast, burrowing deep into the sediment may provide cooler environment and leads to a decrease in cell temperature (Gosling 2004, Przeslawski et al. 2009, Verdelhos et al. 2015). Considering that the thin sediment layer used in our experiments is unlikely to generate a thermal gradient, our results strongly suggest that benthic foraminifera, in particular *H. germanica*, may have an intrinsically basking- and burrowing behaviour to regulate their inner body temperature.

*4.3. Effect of temperature of *H. germanica* metabolism: an adaptation to variable thermal forcing*

In our experiments, highest respiration and photosynthesis rates were recorded between 18 and 24°C. Outside this range, *H. germanica* respiration rates strongly decreased at cooler temperatures (6, 12°C) while there was a decrease in gross photosynthesis at 30°C. Metabolic change is a common response to temperature in ectothermic species (Angilletta 2009), including benthic and planktonic foraminifera (Bradshaw 1961, Lombard et al. 2009). Instability in metabolism affects macro-invertebrate species performance such as feeding, mating and locomotion (Fraser et al. 2002, Gilbert et al. 2010, Sunday et al. 2012, Lou et al. 2019), which is consistent with our observations on *H. germanica* motion-behaviour, where travelled distances, and hence velocities, consistently decreased at cooler and warmer temperatures. Our results open a new perspective on our understanding of the physiology of *H. germanica*. In our experiments, the Q_{10} values reported in the range 6-24°C for respiration ($Q_{10} = 1.75$) and photosynthesis ($Q_{10} = 1.22$) suggest (i) a maximum performance level and a relatively low thermal dependence of respiration and (ii) that photosynthesis is not

affected by temperature inside this thermal range. Low Q_{10} values have been interpreted as characteristic of the optimal temperature range of a species in its natural habitat (Wieser 1973). Noticeably, our Q_{10} calculated on respiration is substantially lower than previous direct Q_{10} estimates for planktonic foraminifera ($Q_{10} = 3.18$; Lombard et al. 2009) and for the intertidal foraminifera *Ammonia beccarii tepida* ($Q_{10} = 3.2$ in the north-eastern regions of the Pacific; Bradshaw 1961) but in the same order of magnitude as Arcachon Basin mudflats for *Ammonia tepida* and *Haynesina germanica* ($Q_{10} = 1.4$ and $Q_{10} = 1.8$ respectively; Cesbron et al. 2017). Compared to other meiobenthic species from the English Channel mudflats, *H. germanica* respiration Q_{10} in the 6-24°C range is lower than those reported in the 0-20°C range in the sabellid polychaete *Manayunkia aestuarina* ($Q_{10} = 2.19$) and in the copepod *Tachidius discipes* ($Q_{10} = 2.17$; Price & Warwick 1980). Our findings suggest that the protist is particularly well adapted to the frequently-occurring thermal range 6-24°C in intertidal soft-sediments in temperate environments. Similarly, a vast majority of intertidal macro-invertebrates can easily tolerate thermal variation with no adverse effects on their physiological rates (Stillman & Somero 2000, Somero 2002), like on metabolic rates of fiddler crabs (Vernberg & Vernberg 1972).

4.4. Fast behavioural and metabolic responses of H. germanica to extreme temperatures: a key for survival in an era of climate change?

At high temperatures (32, 34 and 36°C), *H. germanica* individuals immediately burrowed in the sediment and then remained inactive throughout the rest of the experiment. These two successive behaviours (i.e. burrowing then inactivity) are typically observed in macro-invertebrate intertidal species exposed to temperatures outside their tolerance thermal range (Przeslawski et al. 2009, Mestre et al. 2013, Verdelhos et al. 2015). Note that this strategy may also be detrimental given the low oxygen penetration depth and the intense hydrogen sulphide production in coastal marine sediments (Meysman et al. 2010, Mouret et al. 2010), which are known to hamper benthic foraminifera (Bernhard 1993, Maire et al. 2016, Richirt et al. 2020). Noticeably, the lethal limit of *H. germanica* was never reached since after being

inactive for 24-h at 36°C, all individuals started to move (though they never recovered their baseline behaviour and activity during the time of the experiment) when temperature decreased at 18°C. The distance travelled at 18°C by individuals previously exposed at 36°C was twice lower than the distance travelled by individuals previously exposed to 6°C, suggesting that although not lethal, the 24 hours spent by *H. germanica* individuals at 36°C had long-lasting harmful consequences. In the literature, temperature LT_{50} (i.e. the temperature for which 50% of individuals die) for intertidal foraminifera typically ranged from 37.5 to 45°C (Bradshaw 1961). Exposure to high temperatures have important adverse effects such as production of reactive oxygen species and DNA degradation (Somero 2002, Pörtner & Farrell 2008). This is confirmed by the metabolic Q_{10} value, which dropped below 1 in the range 24-36°C (respectively $Q_{10} = 0.89$ and $Q_{10} = 0.32$ for respiration and gross photosynthesis), suggesting that biological functions are altered in *H. germanica* above 24°C. Our respiration Q_{10} is similar to the one of the intertidal nematode *Pellioiditis marina* from the south-western regions of the Netherlands ($Q_{10} = 0.76$ in the range 25-35°C; Moens & Vincx 2000), although thermal dependence is much higher in *Ammonia beccarii tepida* from the eastern Pacific ($Q_{10}=0.17$ in the 34-45°C range; Bradshaw 1961) suggesting that *H. germanica* respiration might also be inhibited beyond 36°C. Photosynthetic activity of *H. germanica* is more affected than respiration, a result that has been found in other symbiont-bearing benthic foraminifera (van Dam et al. 2012, Sinutok et al. 2014, Pinko et al. 2020). Our results therefore suggest that *H. germanica* may not benefit from autotrophic nutrition since sequestered chloroplast photosynthetic activity was strongly inhibited beyond 24°C. Further analyses are needed to identify whether the plastids could recover after being exposed to high temperatures and whether *individuals* maintain them in their cell or use them as a source of food.

4.5. Consequences of marine heatwaves on *H. germanica* contribution to benthic ecosystem functioning and services

The shifts in metabolism and motion behaviour observed in this study provide evidence that heatwaves may alter the contribution of *H. germanica* to benthic

ecosystem functioning. Specifically, sediment reworking directly depends on motion-behaviour (e.g. crawling, burrowing), which leads to sediment particle displacements (Maire et al. 2007a,b,c, Pascal et al. 2019). The Q_{10} value reported in the range 6-24°C for surface sediment reworking rate ($Q_{10} = 1.75$) indicated a thermal dependence in the range 6-24°C. Hence, *H. germanica* can rework a larger amount of sediment within the range 18-30°C. In addition, individuals intensively explored the environment by moving vertically and horizontally into the sediment. This diversity of movements would most likely lead to more intense sediment mixing since particles are carried out in both directions. In contrast, at lower temperatures, *H. germanica* remained in the upper millimetres of sediment inducing a space-scale limited contribution to surface sediment reworking. The intertidal polychaete species *Neanthes virens* also showed a lower bioturbation rate at 6°C, which limits sediment transport and dissolved fluxes (Ouellette et al. 2004). At temperatures > 32°C, *H. germanica* sediment reworking activity fully ceased. Such temperatures can be reached during summer in temperate intertidal mudflats (Gouletquer et al. 1998, Guarini et al. 2000, Murphy & Reidenbach 2016). Heatwaves may therefore limit *H. germanica* contribution to surface sediment reworking. Although heatwaves have limited duration, they actually continue to increase in frequency and intensity (Oliver et al. 2019). The repetition of such extreme events over successive periods has dramatic consequences on species' survival and associated ecosystem functions (Garrabou et al. 2009, Wernberg et al. 2016, Benthuyzen et al. 2018, Seuront et al. 2019). As previously evidenced for other macro-invertebrates inhabiting the Eastern English Channel coastlines (Seuront et al. 2019), we suggest that the thermal tolerance of *H. germanica* and therefore its contribution to ecosystem functions could be altered by the successive exposition to extreme temperatures. It would be interesting to perform successive thermal exposure to high temperature (i.e. chronic stress) to further investigate the ability of *H. germanica* to acclimate extreme temperatures.

Benthic foraminifera may also affect benthic fluxes directly by consuming or producing oxygen. Our results suggest that foraminiferal oxygen uptake increases in the 6-24°C range and that high temperatures may most likely limit the contribution of

H. germanica to oxygen fluxes. Noticeably, oxygen production by photosynthesis, and to a lesser extent oxygen consumption, decreased at 30°C and above. It further co-occurred with individuals reduced-surface sediment reworking activity during heatwaves. Our daily oxygen budget calculations under realistic light exposure revealed that *H. germanica* oxygen production was closed to 0 or negative at all measured temperatures. Specimens from Atlantic mudflats showed similar negative oxygen production under 12h light exposure (i.e. -283 at 13°C and -327 pmolO₂ indiv⁻¹ d⁻¹ at 18°C; recalculated respectively from Jauffrais et al. (2016a) and Cesbron et al. (2017). Within European waters kleptoplastic intertidal species, only *Criboelphidium williamsoni* showed positive oxygen production budget under a 12h dark-light cycle (5165 pmolO₂ indiv⁻¹ d⁻¹; recalculated from (Jauffrais et al. 2019). This result confirms that *H. germanica* has a minimal impact on benthic oxygen production (up to 0.2%).

5. Conclusion

Global climate change has now unambiguous effects on many marine biological and ecological systems of the world. Among observed consequences of global climate change, marine heatwaves have become more frequent and prominent. In this context, we have examined some biological responses of the temperate foraminifera *H. germanica* to thermal changes in soft-sediment habitats over a short period. Although some thermal plasticity is observed for temperatures commonly observed in the field, we show that a hyper-thermic stresses typical of a marine heatwave strongly affects the behaviour and the metabolism of the protist, triggering responses that were not entirely reversed during the time of the experiments. Our results also suggest that these biological alterations have consequences on the species contribution to sediment reworking.

Acknowledgements

The authors thank the Région Hauts-de-France, the Ministère de l'Enseignement Supérieur et de la Recherche and the European fund for regional economic development for their financial support through the attribution of the CPER research project CLIMIBIO. Noémie Deldicq PhD fellowship is funded by the Ministère de l'Enseignement Supérieur et de la Recherche. Dewi Langlet Post-doctoral fellowship is supported by the STARS research project COFFEE of the Région Hauts-de-France and the CPER research project CLIMIBIO. The authors are grateful to E. Metzger, F. Mermillod-Blondin and E. Armynot du Châtelet members of N. Deldicq's PhD thesis survey committee for suggesting to test the effect of temperature on benthic foraminifera.

Authors' contribution

N.D. and V.M.P.B. conceived the idea of this study and V.M.P.B. obtained financial support. N.D., D.L. and V.M.P.B. provided significant input on experimental design. N.D. and C.D. performed the behavioural experiments and analysed the images. D.L. and C.D. performed the respiration experiments. N.D., D.L. and L.S. analysed the data and performed the statistical analyses. N.D., D.L., L.S. and V.M.P.B. contributed to the interpretation of the data and the discussion of the results presented in the manuscript. N.D. wrote the draft manuscript. N.D., D.L., C.D., G.B., L.S. and V.M.P.B. revised the article critically for intellectual content and gave final approval of the submitted version.

Supplementary material

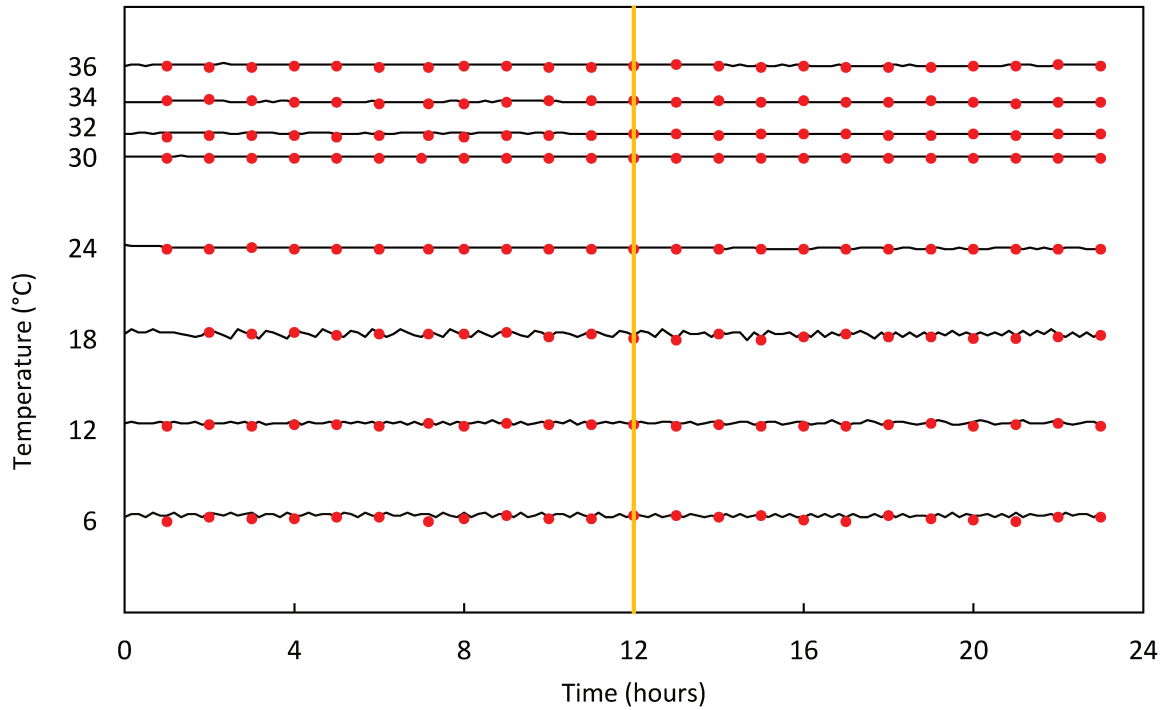

Suppl. Fig. 2. Temperatures in the incubator for each temperature tested in this study (6, 12, 18, 24, 30, 32, 34 and 36°) recorded with a temperature logger every 10 min (black curves; DSL1922L iButtons, resolution 0.1°C). Red dots corresponds to the temperature displayed by the incubator' screen every hour. Yellow line corresponds to the change of light regime from light to dark condition.

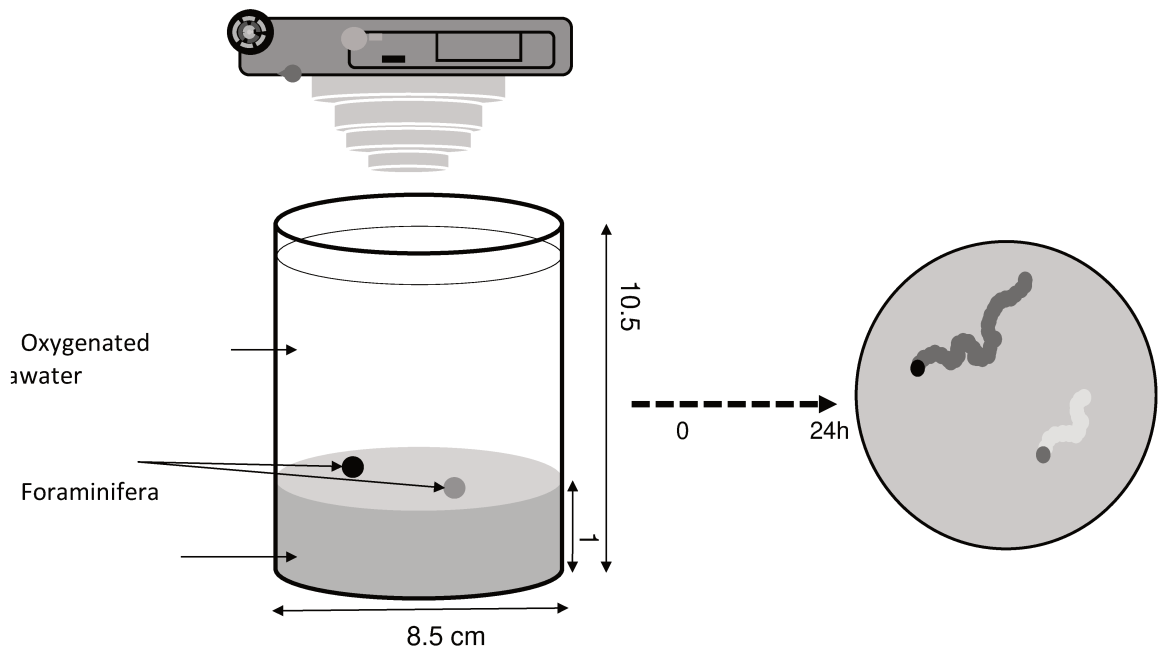

Suppl. Fig. 3. Experimental set-up for time-lapse assessment of foraminiferal life trait.

Suppl. Table 2. Date of experiment and number of individuals of *Haynesina germanica* used for different thermal regimes. N=used individuals, n=analysed individuals.

Temperature (°C)	Date of experiment (2019)	N	n
6	April 3,16,17	75	30
12	April 3,11,12,16,17	110	24
18	April 9,12,17	97	30
	June 6,26		
24	April 19,24	78	25
	June 6,7		
30	April 19,24	80	15
	June 6		
32	April 26	122	69
	May 3,15		
	June 12,20		
34	May 15	75	28
	June 12,20		
36	April 19	76	26
	May 3		
	June 6		

Suppl. Table 3. Respiration, rate, net and gross photosynthesis values of *Haynesina germanica* under different thermal regimes. N= used individuals. n= number of replicates. \bar{X} denotes the mean and SE the standard error.

Temperature (°C)	Date of experiments (2019)	N	n	Respiration rate (pmolO ₂ indiv ⁻¹ h ⁻¹)		Net photosynthesis (pmolO ₂ indiv ⁻¹ h ⁻¹)		Gross photosynthesis (pmolO ₂ indiv ⁻¹ h ⁻¹)	
				\bar{X}	SE	\bar{X}	SE	\bar{X}	SE
6	June 11	15	3	20.6	9.2	32.8	17.9	53.4	27.1
12	June 13	15	3	24.5	0.7	26.8	10.5	51.4	11.2
18	June 13, 14	15	3	40.9	16.1	17.0	16.1	57.9	31.1
24	June 12	15	3	55.7	13.3	21.3	22.8	77.1	16.1
30	June 11, 12	15	3	42.1	20.6	-17.6	32.4	24.5	14.7
36	June 14	15	3	48.5	7.9	-29.2	5.8	19.3	3.5

CHAPTER III

HAYNESINA GERMANICA: BURROWING BEHAVIOUR AND VERTICAL SEDIMENT MIXING

SUMMARY

The last step of this PhD aims at describing the vertical displacement of *Haynesina germanica* in the sediment matrix. Chapter III is thus devoted to characterise the vertical dynamics and the biogenic structure built by this species in the sediment. Thin aquaria and particle-tracer method are used to monitor the behaviour of the species and its putative effects on both sediment matrix (i.e. biogenic structure) and sediment reworking (i.e. downward transport of particles). Such an experiment further gives insights in the microhabitat choice of intertidal foraminifera within the sediment, which ultimately provides a better characterisation of the spatial distribution and the intensity at which sediment particles are displaced.

TUBE-BUILDING AND VERTICAL MOTION BEHAVIOUR OF THE BENTHIC FORAMINIFERA *HAYNESINA GERMANICA* IN INTERTIDAL MUDDY SEDIMENTS

1. Introduction

Benthic foraminifera are mainly known to live at the sediment surface but numerous studies reported the presence of living individuals within the sediment matrix (e.g. Buzas 1965, Boltovskoy 1966, Matera & Lee 1972, Alve & Murray 2001). Noticeably, specimens (Rose Bengal-stained) were observed alive up to 60 cm depth and studies showed that some species have a clear preference for deeper sediments (Goldstein et al. 1995, Saffert & Thomas 1998, Hippensteel et al. 2000). With a more selective method (i.e. CellTracker™ Green; Bernhard et al. 2006), living individuals were already observed below the sediment water interface up to 7 cm depth (Cesbron et al. 2016). The occurrence of foraminifera deeper in the sediment was previously explained as a consequences of macrofaunal bioturbation activities (Lipps 1983, Moodley et al. 1998, Geslin et al. 2004, Berkeley et al. 2007, Nardelli et al. 2014, Maire et al. 2016).

Intertidal foraminifera are, however, able to actively burrow in the sediment and may further remained below the sediment-water interface (Kitazato 1988, Linke & Lutze 1993, Bouchet & Seuront 2020, Deldicq et al. 2020). Furthermore, earlier studies reported the ability of benthic foraminifera to actively migrate within the sediment by creating escape burrows after being experimentally buried at several cm depth in the sediment (Severin & Erskian 1981, Severin et al. 1982). Similarly, deep-sea species were observed to actively move in the sediment to reach their preferential microhabitat (Geslin et al. 2004). Through their displacement in the sediment, macro-invertebrates may create biogenic structures such as gallery, cavity or tube (François et al. 1997, Dorgan et al. 2005, Kristensen et al. 2012). Similarly, meiofaunal organisms such as copepods and nematodes were observed generated tube-like structure down to 1 cm depth in the sediment (Chandler & Fleeger 1984, Nehring et al. 1990, Nehring 1993). Such vertical movements are expected to have major impacts on the stability and erodibility of the surficial sediment layer (Nehring 1993, Coull 1999). Indeed, by

generating bioconstruction, meiofaunal may produce a substantial down-transport of particles and associated dissolved fluxes in deeper sediment (Aller & Aller 1992, Nehring 1993, Schratzberger & Ingels 2018). Literature also suggest that foraminifera may generate biogenic structures such as cavity and gallery hence also contributing to the alteration of the sediment matrix (Langer & Gehring 1993, Kitazato 1994, Gross 2002, Deldicq et al. 2020). However, the nature of the biogenic structures built by benthic foraminifera and their vertical motion-behaviour in the sediment matrix are still rather untapped areas of research.

In this context, describing the vertical motion-behaviour of benthic foraminifera appears to be an absolute prerequisite to further understand how and where they can alter the sediment matrix. The benthic foraminifera *Haynesina germanica*, a dominant species in temperate European intertidal mudflats, was selected to experimentally assess its vertical motion-behaviour in the sediment column (Alve & Murray 2001, Debenay et al. 2006, Morvan et al. 2006, Bouchet et al. 2009, Cesbron et al. 2016). Indeed, despite the need to understand its specific role in the ecosystem, there are still inconsistencies on its vertical distribution in the sediment and numerous study described *H. germanica* as infaunal (Saffert & Thomas 1998, Tobin et al. 2005) or epifaunal (Bouchet et al. 2009, Seuront & Bouchet 2015). A recent study (e.g. Deldicq et al. 2020) showed however, that the species can alternate between infaunal and epifaunal mode. Furthermore, although this species may dig into the sediment, there is no information on its potential to build biogenic structures. Hence, the objectives of this study were (i) to characterize the *in situ* vertical distribution of *H. germanica* in the sediment to further validate the presence of living individual below the sediment surface. (ii) to experimentally assess its vertical motion-behaviour, (iii) to describe and quantify, if any, the biogenic structures built by this species.

2. Materials and Methods

2.1. *In situ* assessment of the vertical distribution of *H. germanica* in the sediment

Three replicate cores (\varnothing 9 cm) were sampled for the analysis of vertical distribution of *H. germanica* in April 2019 at the Authie Bay ($50^{\circ}22'18.6''\text{N}$, $1^{\circ}36'06''\text{E}$), an intertidal mudflat located along the Eastern coast of the Northern English Channel. The cores were collected at low tide using Plexiglas tubes then sliced into 0.5 cm intervals until 5 cm depth. To distinguish living foraminifera, a method based on enzymatic reactions was used on each samples (Bernhard et al. 2006). One milligram of Cell-TrackerTM Green (CTG 5 CMFDA: 5-chloromethylfluorescein diacetate) was dissolved in 1 mL of dimethylsulfoxide (DMSO). Samples were incubated 24h long in controlled-temperature room (18°C) in the dark in a solution of in situ filtered seawater with a CTG final concentration of $1\ \mu\text{mol L}^{-1}$ (Bernhard et al. 2006). After incubation, samples were preserved in 70% ethanol and stored at ambient temperature. Samples were sieved over 125 and 63 μm sieves and counts were performed in the both 63-125 and $> 125\mu\text{m}$ fractions using an epifluorescence stereomicroscope (Olympus SZX16 with a fluorescent light source Olympus URFL-T). The samples were not split and only specimens with a clear fluorescence were counted. The density of *H. germanica* in each sample is expressed per $50\ \text{cm}^3$ volume. Average and standard deviation for each sediment layer are shown in this paper.

2.2. *Experimental assessment of the vertical motion behaviour of H. germanica*

2.2.1. *Experimental set-up*

Experiment were conducted in thin aquaria ($10\ \text{x}\ 1\ \text{x}\ 10\ \text{cm}$, $n = 3$) filled with thawed sediment from Authie Bay (depth of 7-8cm) and overlain with oxygenated natural sea water (Fig. 51). All aquaria were maintained at temperature of 18°C for 2 weeks prior to the introduction of foraminifera to allow for the compaction of the sediment and to give enough equilibration time to establish redox fronts (Fig. 51).

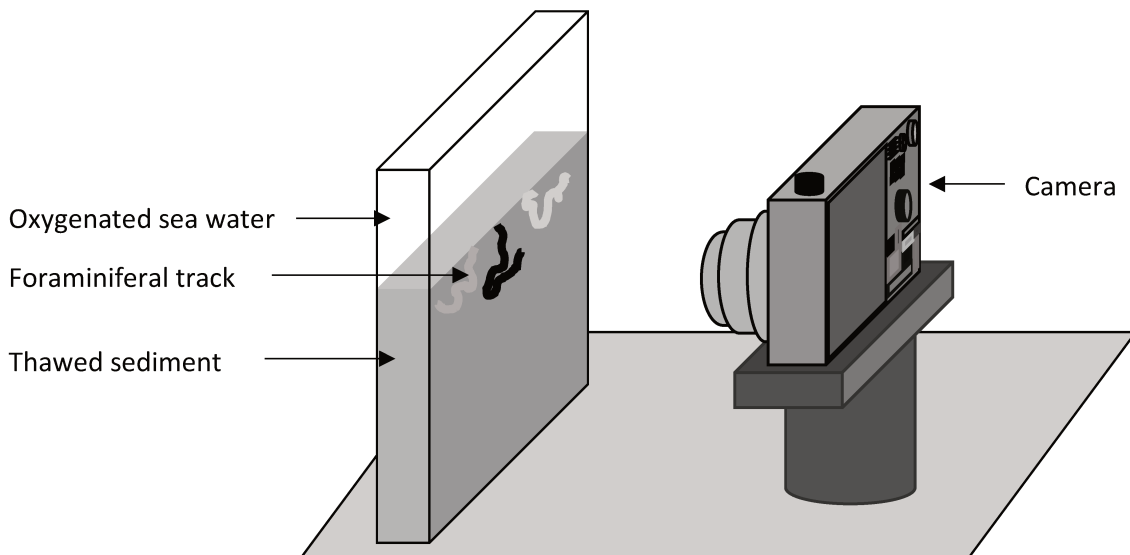

Figure 51. Experimental set-up for time-lapse assessment of foraminiferal motion-traits over a 72 h period.

2.2.2. Sampling of living individuals of *Haynesina germanica*

Surface sediment (i.e. 0-1cm) was collected in February 20 and March 04 (2019) at low tide in Authie Bay (50°22'20''N, 1°35'45''E). Samples were stored in plastic containers (100ml) and transported to the laboratory, then washed through a 125 μm sieve. Individuals of *H. germanica* were sorted with a brush and only active individuals (i.e. producing a displacement track on a thin layer of sediment; Langlet et al. 2020a) were kept overnight (12 h) for acclimation to the experimental condition in a controlled-temperature room at 18°C. Next day, about 150 individuals were randomly placed at the sediment surface corresponding to an abundance of 15 indiv cm^2 . In total, 3 experiments were performed: one in February (R_1) and two in March (R_2 , R_3). Please note that the experiments were ran over 48 and 72h in February and March respectively.

2.2.3. Quantification of behavioural traits

Using the extracted coordinates, the level of activity A_i (i.e. time allocated to locomotion) and the travelled distance within 24h were estimated for each individual with the method described in Deldicq et al. (2020; see Chapter I, Part 1). The instantaneous velocity (i.e. distance travelled between 2 images) represented in Figure

55 was calculated by means of a 3-order simple moving average to reduce the influence of short-term fluctuations.

To assess the preferential position of *H. germanica*, the vertical position of each individual in the sediment was recorded for every picture based on a 2-depth classification depending on the test position, i.e. “Surface” when the test remained visible at the surface and “Burrowed” when the test is below the sediment water. The number of individuals was estimated for each position and each 10-min period during the time of the experiment. The maximum depth reached by *H. germanica* for each experiment was also recorded by measuring the length of the deepest gallery from the interface.

Preliminary observations indicated a behaviour similar to trail following with individual moving in existing burrow. Thereby, the intensity and the occurrence of such behaviour was monitored for each individual.

2.2.4. Quantification of biogenic structures built by *Haynesina germanica*

To quantify how much *Haynesina germanica* can alter the sediment matrix, the length and width of each visible burrow were measured every 2 hours for each experiment. Image analyses were done with the Fiji software (Fig. 52).

The surface occupied by each burrow (S_i) was estimated as follow:

$$S_i = \text{Length} \times \text{Width}$$

Then the surface occupied by all the burrows (hereafter S_B) within the first centimetre of the sediment (Fig. 52) was estimated every 2 hours by summing together all the surface burrow S_i previously calculated. The percentage of S_B every 2 hours are shown in this paper.

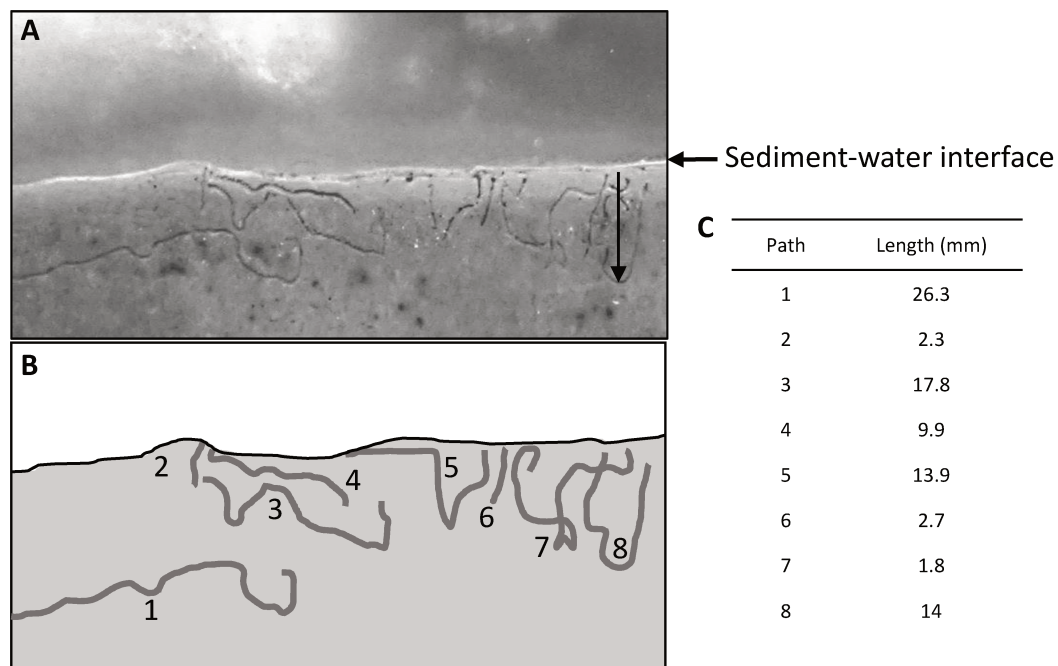

Figure 52. Methodology used to estimate both burrow occupation level and maximum depth (black arrow) in the experimental set-up using the (A) raw picture and (B-C) ImageJ Analysis tool. Scaled bar = 2 mm.

2.3. Statistical analysis

The effect of vertical position and trail following behaviour on individual instantaneous velocity were analysed using linear mixed model with vertical position (i.e. surface, burrowed) and trail following (i.e. yes, no) as fixed factors. Values for each individual was included as repeated measurements within individual. All statistical analyses were performed using the “lme4” package (Bates et al. 2007) of the R.3.5.2. software (R Core Team 2019).

3. Results

3.1. In situ vertical distribution of *H. germanica* in the Authie Bay

In both replicates, *H. germanica* were mainly distributed in the superficial sediment layer (i.e. 0-0.5 cm) with a number of ~180 individuals (Fig. 53). However, between 2 and 10 living individuals were observed below the surface and up to 5 cm depth (Fig. 53).

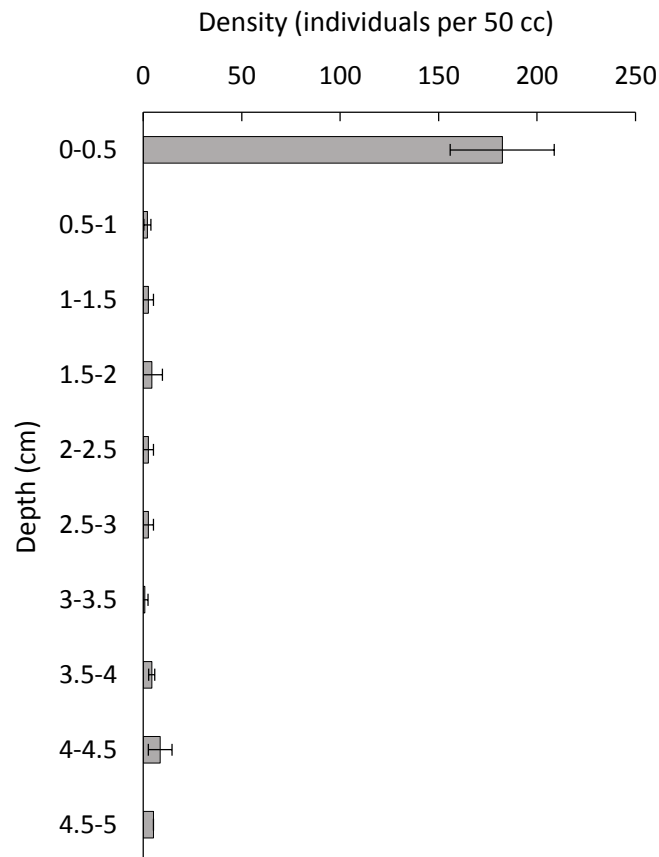

Figure 53. Mean densities (with standard deviation) of *H. germanica* for 50 cm³ for each layers.

3.2. Motion behaviour of *H. germanica* in the sediment

In the three experiments, all the individuals that started to move exhibited a similar behaviour i.e. surface displacement for several minutes consistently followed by active burial. However, individuals showed different types of strategy (i) staying a long period burrowed in the sediment or (ii) rapidly get back to the upper millimetres though they rarely return to the sediment surface (Fig. 54).

Trajectories of 35 individuals were extracted from the 3 experiments we performed. All individuals actively moved in the sediment being active almost 72% of their time in the sediment (Table 5). Some individuals showed a permanent activity throughout the experiment i.e. 72h-long. The distance travelled by individuals ranged from 7 to 52 mm with a mean distance at 26 mm (Table 5). During the experiment, 19 individuals were observed having a trail following behaviour i.e. moved through existing gallery

previously built either by another congener or by itself. Individual typically spend ~15% of their time used existing track (Table 5).

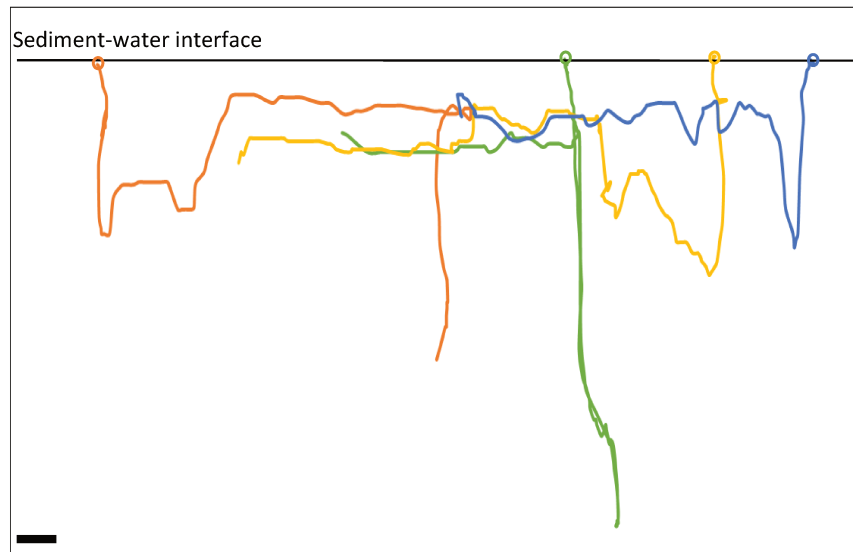

Figure 54. Illustration of the typical trajectories of 4 specimens of *H. germanica*. Dot at one-end of each trajectory correspond to the starting point of each individual. Scaled bar = 1mm.

The majority of individuals spent more than 70% of their time burrowed in the sediment (Table 5). Whether some individuals reached the sediment surface, they preferentially returned just below the upper millimetres of sediment after several minutes crawling at the surface. Visible galleries can reached a maximum depth of 1 cm and the majority of individual went below ~0.5 cm depth.

Table 5. Minimal, maximal and mean values \pm SD of behavioural parameters

Parameters	Min	Mean \pm SD	Max
Activity (%)	32	73 \pm 17	100
Distance (mm)	7	25 \pm 0.97	52
Velocity (mm h ⁻¹)	0.28	1.1. \pm 0.4	2.2
Trail following (%)	0	15 \pm 19	65
Depth occupation (%)	0	72 \pm 26	97

The linear mixed model showed that velocity is controlled both by individual position in the sediment and trail following behaviour (Table 6). Individuals having a trail following behaviour or moving at the sediment surface showed a 0.47 and 0.15 times higher velocity respectively (Table 6; Fig. 55).

Table 6. Analyses of the effect of surface position and trail following on individual instantaneous velocity

Predictor	Estimate	Std. Error	df	<i>t</i> value	<i>p</i> value
<i>Surface</i>	0.15	0.07	17	2.1	0.04*
<i>Trail following</i>	0.47	0.06	7.9	7.3	8 x 10 ⁻⁵ ***

Consequently, individuals moving in an existing track at the sediment surface exhibited the highest instantaneous velocity (Fig. 55).

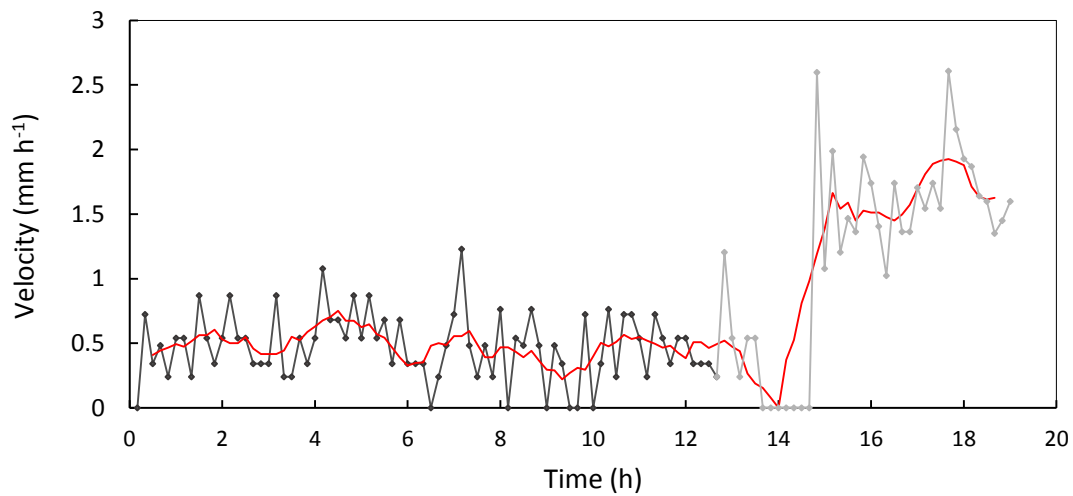

Figure 55. Temporal change in the instantaneous velocity of an individual of *H. germanica*. The black line corresponds to a situation when the individual is burrowed in the sediment without trail following behaviour while the grey line corresponds to a situation when the individual is at the sediment surface with a trail following behaviour. The red-line is the 3-order simple moving average of the velocity.

3.3. Surface occupied by *H. germanica* galleries network

During the experiment, individuals generated an intense network of burrows in the first centimetre of sediment which persisted throughout the experiment (Fig. 56).

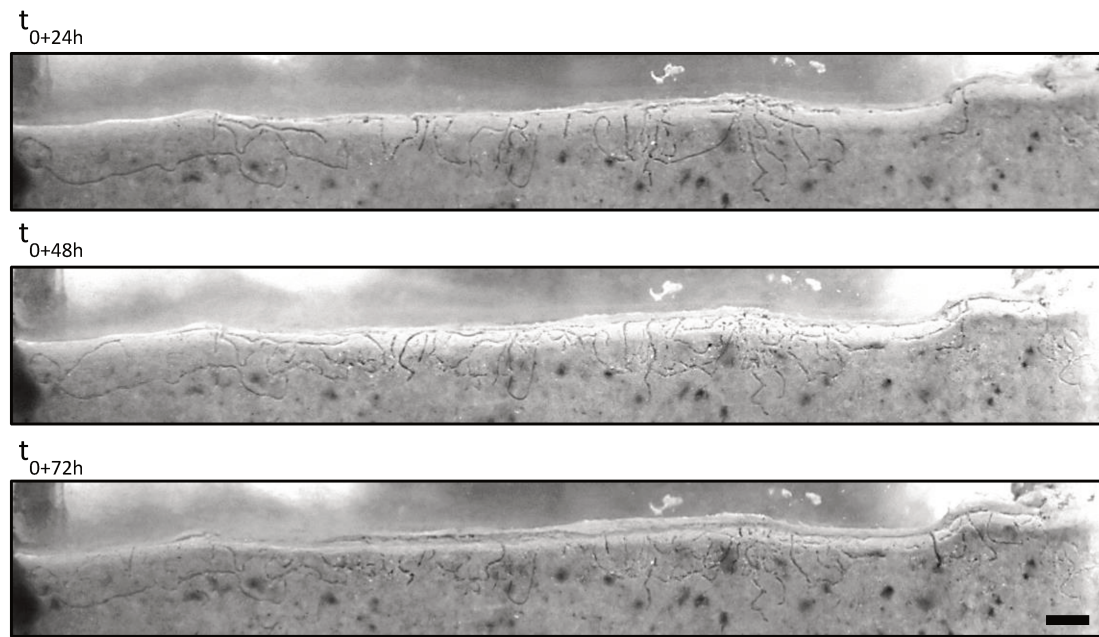

Figure 56. Archetypical structuration of the gallery network consecutive of the displacement of *H. germanica* in the sediment after 24, 48 and 72h of the experiment R2. Scaled bar = 1cm.

The surface of burrows (S_B) rapidly increased at the start of the experiment from 0 to $\sim 5\%$ (i.e. $0.5/10\text{cm}^2$) within 24h (Fig. 57). There is a continuous increase in the S_B throughout the experiment up to $\sim 10\%$ at the end of the experiments (Fig. 57).

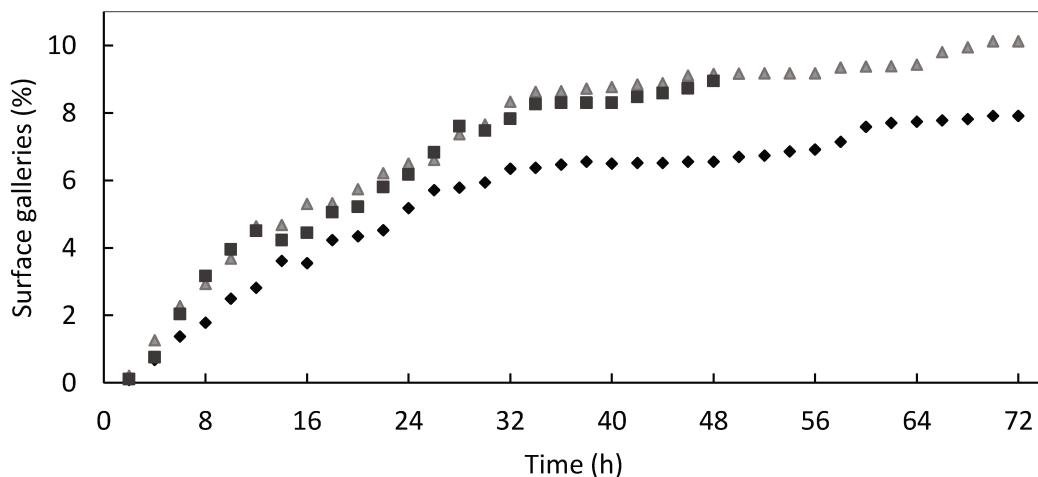

Figure 57. Temporal changes in the surface occupied by the gallery network (S_G in %) for the three experiments: R₁ (grey square), R₂ (grey triangle), R₃ (black diamonds).

4. Discussion

4.1. *Haynesina germanica* is an infaunal species

In the intertidal mudflat of the Authie Bay, living *H. germanica* were distributed down to 5 cm depth in the sediment; most individuals were nevertheless observed in the upper five millimetres. Such vertical distribution is in line with previous studies; suggesting that *H. germanica* may prefer sediment surface (Murray & Alve 2000, Alve & Murray 2001, Papaspyrou et al. 2006, Bouchet et al. 2009, Cesbron et al. 2016). The present *in situ* distribution is however only a snap shot of the vertical distribution of the species at the time of sampling. Our experiments showed that although *H. germanica* occasionally moved at the surface, the species preferred to burrow in the first centimetre of sediment. This migratory behaviour to colonize the topmost sediment layers confirms experimentally assessed positive geotaxis of this species (Seuront & Bouchet 2015) and suggest a species preference for an infaunal mode. In our experiments, *H. germanica* appears to be restricted to the first centimetre of sediment while *in situ* vertical distribution revealed living individuals up to 5 cm depth. Additional experiments should be performed in the presence of other organisms including larger bioturbator species to better understand the presence of living specimens below 1 cm depth.

Other foraminiferal species were often reported to live within the first 5 cm of the sediment column with a clear preference for environment below the sediment water interface (Barmawidjaja et al. 1992, Jorissen et al. 1992, Ernst et al. 2002, Duijnsteet et al. 2003, Geslin et al. 2004, Langlet et al. 2014). For instance, the agglutinated species *Eggerelloides scaber* can live down to 7 cm depth (Cesbron et al. 2016) and has been observed to tolerate anoxia and low-organic matter quality (Ernst et al. 2002, Diz & Francés 2008, Duchemin et al. 2008, Goineau et al. 2011, Langlet et al. 2013, Cesbron et al. 2016). Although highly speculative, this suggest that, as *E. scaber*, *H. germanica* may tolerate short period of anoxia and therefore moves below the oxygenated layer. Infaunal behaviour may provide an advantage to *H. germanica* to limit inter-specific competition. Indeed, the presence of numerous meiofaunal organisms e.g. nematodes,

copepods and macro-invertebrates at the sediment surface leads to higher competition for food and space (Michaud et al. 2010). Noticeably, meiofaunal species showed similar feeding mode and preferentially feed on benthic diatoms (Lee et al. 1966, Tietjen & Lee 1973, van Oevelen et al. 2006, Chronopoulou et al. 2019). Nevertheless, *H. germanica* may also ingest bacteria suggesting that they can switch their feeding modes from herbivorous to bacterivorous (Mojtahid et al. 2011). Thereby, alternating between infaunal and epifaunal modes may be a behavioural response to both space and food competition as the species can actively adapt its vertical position depending on its ecological requirements. Such behavioural pattern was already observed on polychaete species with displacements closely related to feeding activity, predator avoidance and density dependant interactions e.g. competition for space (Dorgan et al. 2006, Duport et al. 2006).

4.2. *Haynesina germanica* is a tube-building species

For the first time, this study described the biogenic structures built by the intertidal foraminifera *H. germanica*. The experiment showed that each individual rapidly created a sustainable one-end tube within the first centimetre of sediment. Within the first 24h, the surface occupied by the biogenic structures (i.e. S_B) increased from 5 to 10% in 24h. Building such structures led to the alteration of the sediment matrix as shown by the number of tubes. In benthic foraminifera, biogenic structures have only been reported and described for *Quinqueloculina impressa* (Severin & Erskian 1981, Severin et al. 1982) and Rotaliidae (Langer & Gehring 1993). Similarly to benthic foraminifera, other meiobenthic species e.g. nematode, copepod, ostracod and macro-invertebrates are able to disturb the sediment through their biological activities (Cullen 1973, Kristensen et al. 2012). They generated biogenic structures which alter sediment properties and bio irrigation (Aller & Aller 1992, Coull 1999, Giere 2009). However, biogenic structures built by meiofauna are rather limited to the uppermost millimetres of sediment (e.g. Bonaglia et al. 2014). In our experiment, *H. germanica* can alter the sediment up to 1cm depth suggesting that the species might also contribute to the downward-transport of sediment particles (Nascimento et al. 2012, Bonaglia et al.

2014, 2020). Note that the surface occupied by *H. germanica* tubes was most likely underestimated, since it was possible to analyse only the visible part of the aquaria. In fact, the tube network may be potentially extended through the whole aquarium, further stressing the need for more thorough assessments of such structures.

To further assess the volume of biogenic structures, axial tomodesitometry could be used to visualize the three-dimensional structure created by foraminifera (Mermillod-Blondin et al. 2003, Bouchet et al. 2009). Furthermore, the use of fluorescent inert tracers (i.e. luminophores) would allow the quantification of vertical sediment mixing induced by benthic fauna. Both methods have been already successfully applied on marine invertebrate's species including foraminifera (Gross 2002, Gérino et al. 2003, Maire et al. 2007a,b).

4.3. *Haynesina germanica* can perform trail following

In the experiments, many individuals moved in existing tracks built either by other individuals or by themselves. To reuse an existing track is a strategy well-known in marine gastropod species as an adaptation to reduce the cost of locomotion (Tankersley 1989, Davies & Blackwell 2007). Furthermore, trail following allows gastropod species to reduce their mucus production which is a considerable energetic burden (Davis & Blackwell 2007). Benthic foraminifera are also able to produce mucus (e.g. Langer & Gehring 1993); similar to the one of gastropods (Ng et al. 2013). Besides allowing individuals to adhere to the substrate and move faster, mucus may also stabilize the sediment as particles are bound together by extracellular polymeric substance secreted by organisms (Riemann & Schrage 1978, Chandler & Fleeger 1984, Nehring et al. 1990, Reichelt 1991, Nehring 1993). Moreover, mucus layers may enhance bacterial and fungi development (Moens et al. 2005) which are potential food sources of benthic foraminifera (Langer & Gehring 1993, Mojtahid et al. 2011). The sustainability of the tubes built by *H. germanica* may be enhanced by individual mucus production which would contribute to the stabilisation of the sediment matrix.

4.4. *Haynesina germanica*'s velocity is physically constrained

In the present study's experiments, *Haynesina germanica* travelled distances and velocities were lower than the ones observed in previous study (Deldicq et al. 2020). Indeed, burrowing is more energetically expensive than other forms of locomotion such as swimming, flying and running (Trevor 1978, Hunter & Elder 1989). To move in muddy sediment requires morphological adaptations (e.g. body deformation, appendages) and it implies displacing particles within a cohesive sediment matrix (Dorgan et al. 2005, 2006). Our results are consistent with the above-mentioned assumption as individuals moving at sediment surface showed higher instantaneous velocities than individuals burrowed in the sediment. Decrease in velocity, hence travelled distance, was previously reported in macroinvertebrates species with organisms moving slowly in the sediment (Gordon 1991, Dorgan et al. 2008, Dorgan 2015, Grill & Dorgan 2015). In muddy sediments for instance, the polychaete *Nereis virens* must first push away the particles using body deformation before moving in its burrow (Dorgan et al. 2005, 2007, 2008). Similarly, foraminifera were observed to attach their pseudopodia to sediment particles and then to drag their own test towards the direction of their pseudopodia (Kitazato 1988). In the present study, individuals with a trail following behaviour showed an increase in their instantaneous velocity when they were moving in an existing tube. Interestingly, in our experiment, trail following consistently occurred when individuals are burrowed in the sediment. This suggest that trail-following in *H. germanica* may be an adaptive response to the physical constrain triggered by cohesive sediment.

5. Conclusion

The present study results open new perspective on the understanding of the benthic foraminifera *H. germanica* specific behavioural traits. The species can move both at the sediment surface and deeper in the sediment suggesting that this species may have the ability to tolerate low-oxygen condition. The trail following behaviour, which is reported here or the first time in benthic foraminifera, might be a behavioural

adaptation to move in cohesive muddy sediment to decrease the cost of locomotion. Overall, our findings suggest that foraminifera potentially contribute to vertical sediment mixing as their displacements are closely similar to other meiobenthic species. Quantifying the vertical transport of particles induced by foraminiferal displacement would be the subsequent step in the evaluation on the role of benthic foraminifera in bioturbation.

SEDIMENT MIXING BY THE INTERTIDAL FORAMINIFERA *HAYNESINA GERMANICA*: IMPORTANCE OF DENSITY

1. Introduction

The benthic foraminifera *Haynesina germanica* can alternate between epifaunal and infaunal mode, with a clear preference for sub-surface sediment micro-habitat (see Chapter III, Part 1 for further details), leading to the construction of a complex of one-end tubes within the first centimetre of sediment. This species displacements are similar to those of other meiofaunal species e.g. nematodes, copepods (Nehring et al. 1990, Nehring 1993) and macro-invertebrates species e.g. polychaetes (Chandler & Fleeger 1984, Braeckman et al. 2010). In benthic macrofauna, the construction of biogenic structures and the associated sediment bio-irrigation enhance the down- and upward displacement of particles and water in the sediment (Kristensen 1983, Reichardt 1988, Mermillod-Blondin et al. 2004, Michaud et al. 2005, Kristensen et al. 2012). Although the vertical transport of sediment particles is well-studied in macro-invertebrate species, this research area remains largely untapped for meiofaunal species, noticeably for benthic foraminifera. Findings from this PhD on the motion behaviour of the benthic foraminifera *H. germanica* suggest that this species may actively contribute to sediment mixing.

In order to evaluate the species-specific transport of particles in the sediment column, methods using particle-tracer were developed (Aller et al. 1980, Mahaut & Graf 1987, Gérino et al. 1998). These methods are based on the evaluation of the vertical distribution of inert fluorescent particles within the sediment column that were initially deposited at the sediment surface; then displaced by benthic fauna (Gilbert et al. 2007). Specifically, luminophores are natural sediment particles that are surrounded by a thin layer of UV fluorescent paint with properties similar to natural sediments e.g. diameter, density (Mahaut & Graf 1987, Gérino 1990). Therefore, luminophores are used to mimic the behaviour of sediment particles (Maire et al. 2008). Tracer experiments can be coupled with mathematical models fitted to vertical tracers' profile to estimate sediment reworking coefficients (Boudreau 1986b, Wheatcroft et al. 1990,

François et al. 1997, 2002, Meysman et al. 2007). Sediments coefficients further allow an evaluation of the intensity of species-specific sediment mixing to classify them into different functional groups (see review in Gérino et al. 2003). To our knowledge only one study quantified sediment mixing rates of benthic foraminifera in deep-sea sediment (Gross 2000). The quantified sediment particles transport showed a very high mixing rate (i.e. $D_b = 0.19 \text{ cm}^2 \text{ day}^{-1}$) in the upper 5 mm of sediment (Gross 2002). Results from this PhD (Chapter III, Part 1) suggest that *H. germanica* can move down to about 1-2cm into the sediment; hence potentially displaced particles deeper in the sediment column than shown by Gross (2002) in the deep-sea.

In this context, the objective of the present study was to evaluate vertical sediment mixing in the intertidal foraminifera *H. germanica*. We used experimental microcosms with several treatments of increasing densities. Luminophore profiles were then analysed with a diffusion-advection-nonlocal model to estimate the vertical sediment reworking mode of *H. germanica* (Mugnai et al. 2003).

2. Materials and Methods

2.1. Sediment sampling

Sediment cores (1 x 1 x 5 cm, N = 15) were collected in August 2020 in Boulogne-sur-Mer harbour (50°43'6"N, 1°34'25"E), an intertidal mudflat located on the French coasts of the English Channel. After collection, cores were stored 48h-long in a freezer to ensure that the sediment was free of moving macro- and meio-organisms so that the only displacements which may induce particles tracer movements were those from foraminifera. Frozen sediment cores were disposed in a 15 litres aquarium (35 x 20 x 25 cm) filled with natural filtered and oxygenated sea water (Fig. 58).

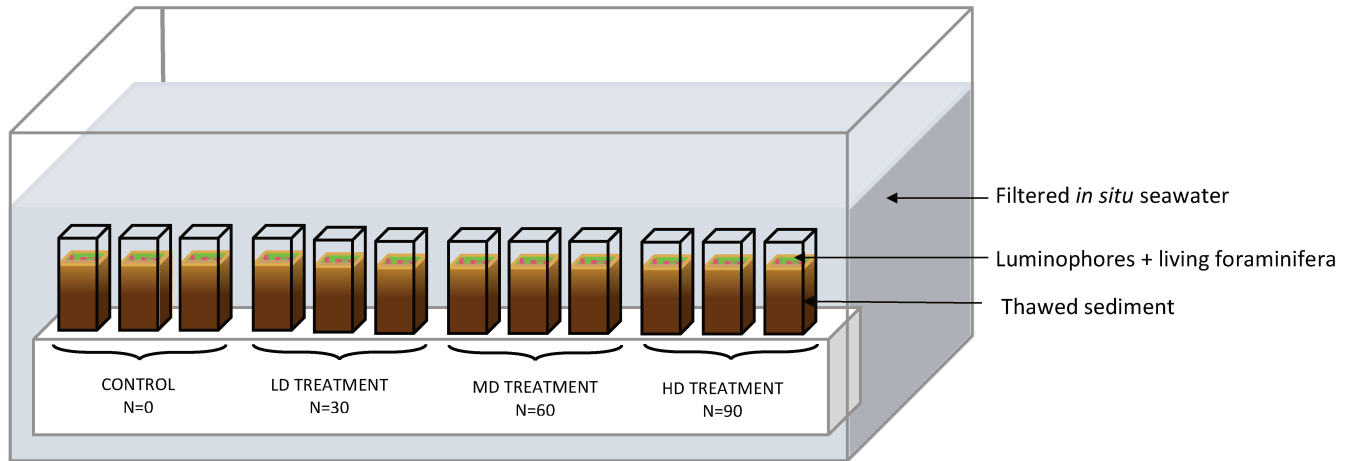

Figure 58. Experimental set-up to assess the vertical distribution of particle-tracers as a function of *H. germanica* displacements within the sediment column

The aquarium was kept in temperature-controlled incubators (MIR-154, Panasonic, Japan) at 20°C with a 12h:12h light/dark cycle for few days.

2.2. *Haynesina germanica* collection and maintenance

Surface sediment was collected in August 2020 in the same above-mentioned location i.e. Boulogne-sur-Mer harbour. Samples were stored in plastic containers (100 ml) and transported to the laboratory, where it was washed through a 125 µm mesh-size sieve. Individuals of *H. germanica* were subsequently sorted with a brush then acclimated for 24 hours in temperature-controlled incubators at 20°C with filtered natural seawater.

2.3. Experimental set-up

Luminophores i.e. natural sediment particles coloured with fluorescent paint (Mahaut & Graf, 1987) allowed us to evaluate sediment reworking rates. To represent the *in situ* granulometry (70% silt, 30% sand; Francescangeli et al. 2020) two size fractions of luminophores were used: <63 µm pink silt ($D_{50} \approx 10-20$ µm, Environmental Tracing LLC, UK) and >125 µm green sand ($D_{50} \approx 175-200$ µm, Environmental Tracing LLC, UK).

In total four treatments were chosen: (1) without foraminifera (Control, N= 3), (2) low foraminiferal density (LD = 30 indiv cm⁻², N = 3), (3) medium density (MD = 60 indiv cm⁻², N = 3), (4) high foraminiferal density (HD = 90 indiv cm⁻², N = 3) (Fig. 58). Experimental densities were determined following local in-situ densities of *H. germanica* through a year (Bouchet, *unpubl. data*) and assuming that the highest and the lowest densities used in this study correspond to summer and winter periods, respectively.

Before running the experiments, active individuals (i.e. producing a displacement track on a thin layer of sediment; Langlet et al. 2020a) were extracted from previously acclimated individuals (section 2.2.) then gently deposited on the sediment surface in sediment cores corresponding to LD, MD and HD treatments. Considering that living foraminifera usually start to move within a few minutes (Seuront & Bouchet 2015, Bouchet & Seuront, 2020, Deldicq et al. 2020), a mixture of 20 mg of pink silt and 20 mg of green sand luminophores were homogeneously and gently spread on the sediment surface of each core with a Pasteur pipette (Fig. 58) one hour later.

The experiment lasted for 14 days. Then, the water was removed and sediment cores were frozen. The next day the top 2 cm of sediment was sliced in 0.2 cm-thick layers (i.e. 0-0.2 cm, 0.2-0.4 cm, etc.).

2.4. Luminophores counting

Each layer was homogenized and dried at 50°C and subsequently photographed under UV lights using a digital camera (Nikon V1 with a Nikkor 10–30 mm lens; Fig. 59). Settings were adjusted for adequate fluorescent detection and the photographic field (10 × 8 cm) allowing to visualize luminophores particles. Images were then analysed with the image-analysis software Fiji (Schindelin et al. 2012).

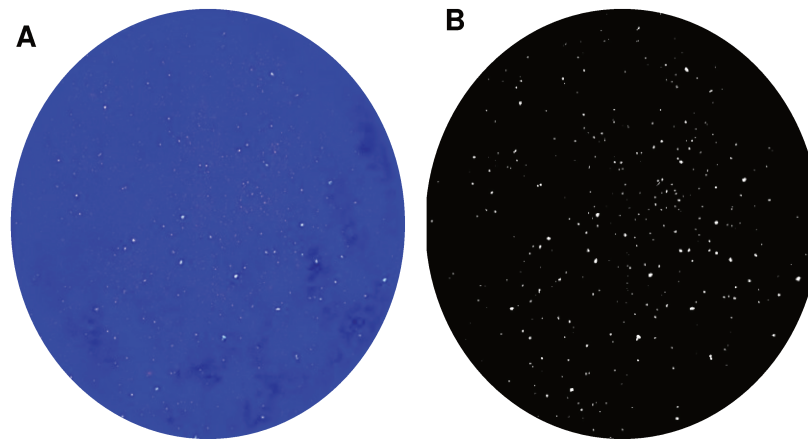

Figure 59. Typical examples of (A) raw and (B) binary pictures used for the count of luminophores particles

Luminophores were selected using an appropriate set of RGB threshold levels that differentiated fluorescent particles from the sediment (Fig.59A). Pixels above the threshold were added to a binary matrix where luminophore pixels were assigned a value of 1 and sediment pixels a value of 0 (Fig. 59B) and were counted using the Analyze Particle tools. The number of luminophores was then converted into percentage of tracer in each sediment layer.

2.5. Sediment reworking coefficients

The effect of *H. germanica* on particle transport was estimated using the diffusion-advection-nonlocal model in non-steady state conditions (Mugnai et al. 2003). This model links a nonlocal component to a diffusion–advection model (Officer & Lynch 1982, Gérino et al. 1994). Biological diffusive transport (diffusion (D), square centimetres per year) was defined as omnidirectional transport in the sediment column and is analogous to molecular diffusion in water. Biodiffusion spreads tracers in the sediment column (Guinasso & Schink 1975) by the exchange of small amounts of material with adjacent parcels of sediment. Biologically mediated vertical transports account for advective transport and nonlocal transport. Bioadvection (V , centimetres per year) is created by head-down deposit-feeders like worms that feed in the deeper sediment and egest faecal pellets at the surface (conveyor belt organisms). This feeding mode causes an accelerated rate of sediment and pore water burial within the feeding

zone. Nonlocal transport results from largely open burrows into which surface particles may fall, and this type of vertical transport is much more rapid than bioadvection. This nonlocal mixing is modelled as a removal function that simulates the deposition of surface material (expressed in grams of transported tracer per day) in a deposition zone.

The basic equation is

$$\frac{\partial C_{(z,t)}}{\partial t} = D \frac{\partial^2 C_{(z,t)}}{\partial z^2} - V \frac{\partial C_{(z,t)}}{\partial z} + K_{(z,t)} - R_{(z,t)}$$

where C is the normalized tracer concentration, t is time (years), z is depth (centimetres), D is the diffusive mixing rate (square centimetres per year), V is the advective transport rate (centimetres per year), R is the removal function that determines the mass of tracer (grams per day) removed from the surface and K is the injection function of the nonlocal transport that simulates tracer inputs (grams per day) into the injection zone of the sediment column; K_e is a constant parameter (per day) estimated from the model, and depths Z_{min} and Z_{max} represent the upper and lower limits of the injection zone, respectively. The nonlocal transport is thus quantified by a flux of sediment removed from the surface. In this case, $R_{(z,t)} = 0$ for $z > 0$ and $R_{(z,t)} = K_{(z,t)}(Z_{max} - Z_{min})$ for $z = 0$ and $K_{(z,t)} = K_e$ for $z \in [Z_{min}, Z_{max}]$ and $K_{(z,t)} = 0$ for $z \in [Z_{min}, Z_{max}]$.

Luminophores were added as pulse input at the surface of the sediment at the beginning of each experiment so that the model was applied under non-steady-state conditions. Thus, model eq. 1 was used with the upper boundary condition of an instantaneous source of unit strength (maximal C of tracer) at $z = 0$ at $t = 0$, a lower boundary $C \rightarrow 0$ at $z \rightarrow \infty$, and initial condition $C = 0$ at $z > 0$. The general solution was given by Officer and Lynch (1982) as:

$$C_{(z,t)} = \frac{1}{\sqrt{\pi D t}} \exp \left[-\frac{(z - V t)^2}{4 D t} \right] - \frac{V}{2 D} \exp \left(\frac{V z}{2 D} \right) \operatorname{erfc} \left(\frac{z + V t}{4 D t} \right) - R_e t + K_e t$$

with

$$R_e = K_e (Z_{max} - Z_{min})$$

and

$$\text{erfc}(x) = 1 - \frac{2}{\sqrt{\pi}} \int_0^x e^{-t^2} dt$$

where c is a normalized concentration relative to unit input. The model allows the calculation of the theoretical tracer concentration given suitable values of the parameters D , V , Z_{min} , Z_{max} , and K_e . These parameters were obtained from profiles that produced the best fit with the experimental data using the least squares method.

Sediment reworking coefficients (i.e. biodiffusion, advection and nonlocal transport) were calculated both for each replicates and for each individual by dividing sediment reworking coefficients by the abundance within each replicates (Duport et al. 2006).

2.6. Statistical analysis

Results of luminophores profiles are presented with the mean \pm SD of the three replicate measurements. Differences in sediment coefficients (i.e. biodiffusion, nonlocal transport and advection) and maximum penetration depth (Z_{max}) between treatments and between luminophores size fractions were assessed using a one-way analysis of variance (ANOVA) after the values were $\ln(x+1)$ transformed to homogenize variances. Bonferroni-Dunn post hoc test were subsequently performed if significant differences were detected to distinguish between different groups of measurement (Zar 2009). All statistical analyses were performed using R.3.5.2. software (R Core Team 2019).

3. Results

3.1. Size selectivity

The two size fractions of luminophores used in the present study (i.e. green sand and pink silt), showed similar vertical depth profiles (Suppl. Mat. Fig. 4). Furthermore, no significant differences in sediment coefficients and maximum penetration depth were found between the two size fractions (Bonferroni-Dunn test, $p < 0.05$). From now on,

the two size fractions are pooled together and presented as the total luminophores (in percentage) for each layer.

3.2. Effect of density

Total luminophore profiles at the end of the experiments showed that the average percentage of tracer measured at the sediment surface (0–0.2 cm layer) was the highest in the control columns (92%) and only 77, 50% and 54% in LD, MD and HD treatments (Fig. 60).

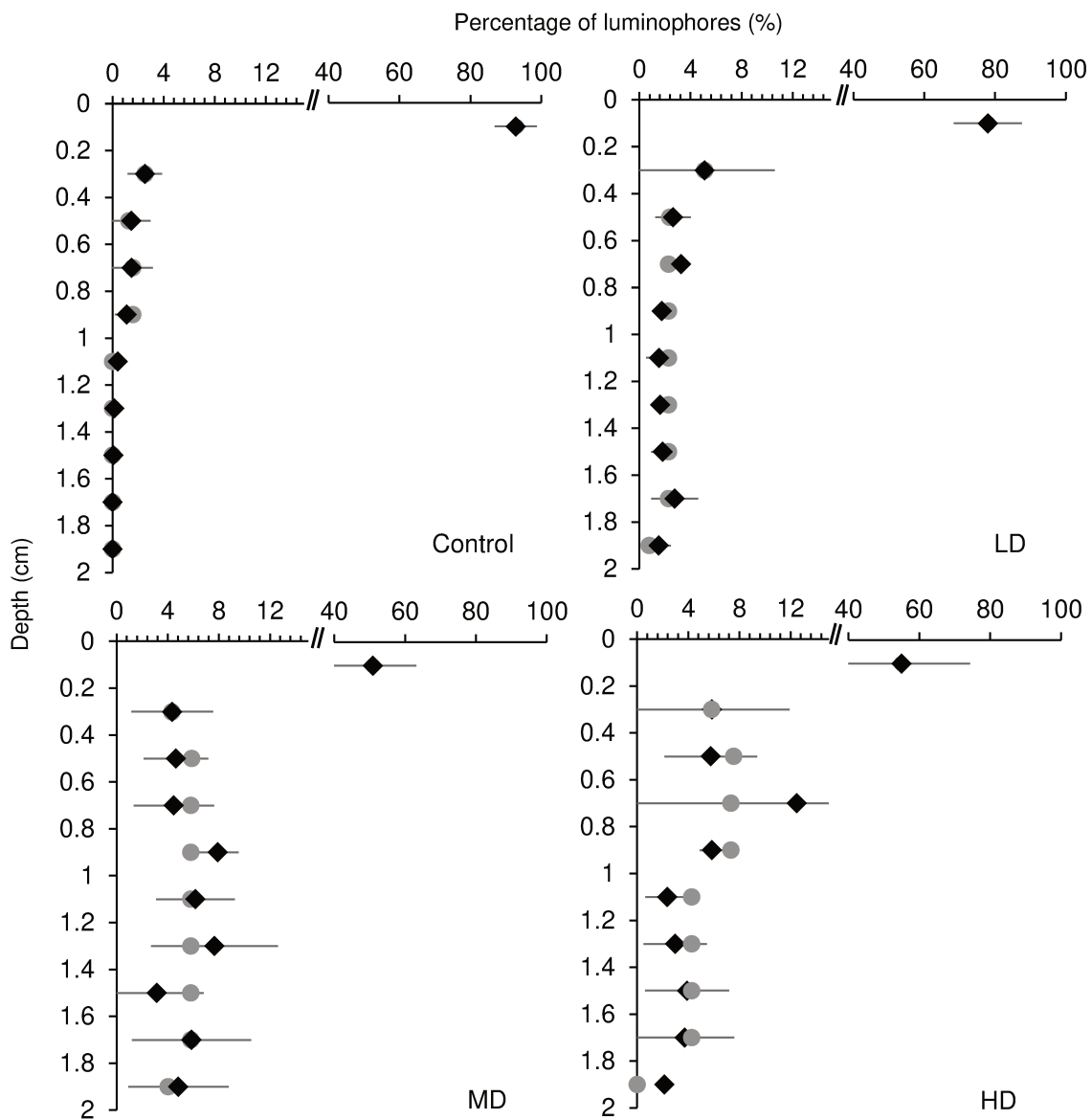

Figure 60. Depth profiles (means \pm SD) of luminophores (black diamonds) in the four treatments and calculated profiles obtained with the advection–diffusion–nonlocal model (grey circles). Treatments: Control, LD (30 indiv cm²), MD (60 indiv cm²), HD (90 indiv cm²).

In treatments containing foraminifera, luminophores profiles were characterized by a decrease of luminophores with depth, indicating a biodiffusive reworking of sediment. Furthermore, between 1.5 and 5 % of total luminophores were found down to 1.8-2 cm in the sediment (Fig. 60). The maximum penetration depth (Z_{\max}) varied between 1 cm in the control treatment, and 1.87 cm, 1.93 cm and 1.53 cm in the LD, MD and HD treatments, respectively (Table 7). Noticeably, in the MD treatment, the maximum penetration depth is significantly higher than in the other treatments (Bonferroni-Dunn test, $p < 0.05$)

Table 7. Mixing rates of sediment estimated in the four treatments. Advective, diffusive and nonlocal transport coefficients are presented as means (SD) (N=3 for each treatment). Z_{\min} and Z_{\max} are the respective upper and lower limits of the sediment layer influenced by nonlocal transport.

Treatment	Advection (cm y ⁻¹)	Biodiffusion (cm ² y ⁻¹)	Nonlocal transport (g d ⁻¹)	Z_{\min} (cm)	Z_{\max} (cm)
Control	0 (0)	0.14 (0.03)	0.02 (0.02)	0.47	1.00
LD (30 indiv cm ⁻²)	0 (0)	0.19 (0.09)	0.07 (0.03)	0.27	1.87
MD (60 indiv cm ⁻²)	0 (0)	0.21 (0.08)	0.29 (0.15)	0.40	1.93
HD (90 indiv cm ⁻²)	0 (0)	0.23 (0.1)	0.29 (0.27)	0.40	1.53

Model data fitted experimental data well (Fig. 60). Sediment reworking coefficients obtained from model simulations are shown in Table 7. No bioadvection was observed in the experiments. Biodiffusion and nonlocal transports coefficients varied significantly between treatments (One-way ANOVA, $p < 0.05$; Tables 7, 8). Noticeably, biodiffusion was highest in the HD treatment with 0.23 ± 0.1 cm² y⁻¹ (Bonferroni-Dunn test, $p < 0.05$; Table 8). Highest nonlocal transport rates were observed in the MD and HD treatments with 0.29 ± 0.15 g d⁻¹ and 0.29 ± 0.27 g d⁻¹, respectively (Bonferroni-Dunn test, $p < 0.05$; Table 8).

Table 8. Effect of each density treatment on coefficient of sediment reworking (comparison with the control treatment) and maximum penetration depth (Z_{\max}). Bonferroni-Dunn test with N=3 for each treatments. 0: no significant difference; +: significant increase.

Variable	Density treatment		
	LD (30 indiv cm ⁻²)	MD (60 indiv cm ⁻²)	HD (90 indiv cm ⁻²)
Biodiffusion	0	0	+
Nonlocal transport	0	+	+
Maximum penetration depth	0	+	0

The individual contribution to biodiffusion showed a significant decrease above the LD treatment (Bonferroni-Dunn test, $p < 0.05$, Fig. 61). Similarly the individual contribution to nonlocal transport significantly decreased between the MD and the HD treatments (Bonferroni-Dunn test, $p < 0.05$, Fig. 61).

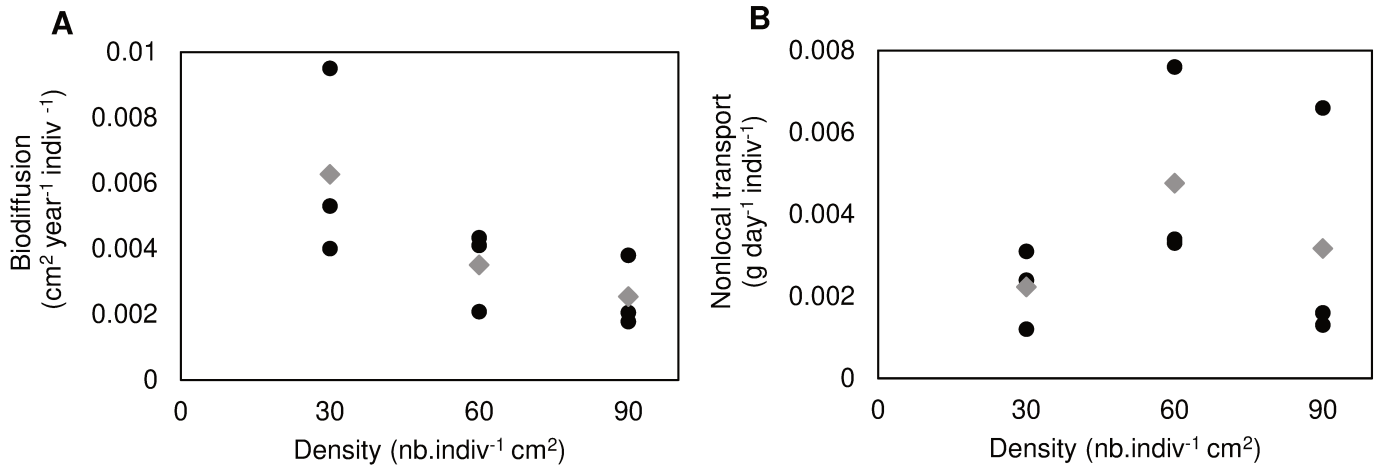

Figure 61. Biodiffusion (A) and nonlocal transport (B) per individual as a function of *H. germanica* density. Values for each replicate are presented with dark circles and mean value for the three replicates with grey diamonds.

4. Discussion

4.1. Particle size selectivity

Haynesina germanica individuals deposited at the sediment surface induced similar downward transport to 2 cm depth of the two size fractions of luminophores. This result suggests that *H. germanica* reworked the sediment particles irrespectively of the size of the particle. Other benthic species e.g. *Corophium volutator* displaced both mud and fine sediment fractions at equal rate and in a similar way (De Backer et al. 2010, 2011). In contrast, deposit feeding species such as *Cirratulid* polychaete exhibited a size-dependent particle mixing as the species preferred ingesting particles within the size range of 16-32 μm (Shull & Yasuda 2001). Such a selective feeding leads to an increase in the downward transport of fine particles while larger size fractions remain at the sediment surface (Ruddiman et al. 1980, Wheatcroft & Jumars 1987, Wheatcroft 1992, Shull & Yasuda 2001). Selective downward particle transport has several implications for quantifying geochemical fluxes as it may lead to a wrong estimation of sediment

reworking coefficient (Shull & Yasuda 2001). In our experiment, *H. germanica* displacement did not preferentially induce the transport of a specific size fraction. We suggest that the diffusion-advection-nonlocal model used in this study is adapted to *H. germanica* and allows a proper estimation of the sediment reworking coefficient.

4.2. Vertical sediment reworking by *H. germanica*

In our experiments, we showed that the displacement of *H. germanica* induced the biodiffusive and the nonlocal transport of particles. Similarly to *C. volutator*, *H. germanica* is able to build tube through its displacement in the sediment column (see Chapter III, Part 1 for further details). This tube dwelling behaviour may favour the nonlocal transport of particles as surface sediment may fall in species-created open burrow. Nevertheless, *C. volutator* was observed only induced biodiffusive mixing with no tracer peak at depth indicative of a nonlocal transport process (Mermillod-Blondin et al. 2004, De Backer et al. 2011). To maintain its burrow, *C. volutator* removes the accumulation of sediment particles at the bottom of the burrow whilst flushing it during submersion. Such behaviours would therefore make impossible the detection of nonlocal transport processes in a study only dealing with tracer profiles (De Backer et al. 2009, 2010a). Conversely, *H. germanica* does not permanently stay in its tube (see Chapter III, Part 1 for further details) hence does not remove particles in its burrow as *C. volutator* can do. The displacement of *H. germanica* would therefore allow the quantification of the nonlocal transport with the particle tracer method.

Overall, the sediment reworking of *H. germanica* includes two processes: the biodiffusion of sediment particles likely occurring in the surface layer and the nonlocal transport of particles within the one-end tube structures (François et al. 2002). This mode of sediment reworking is characteristic of gallery-biodiffusor species (Mermillod-Blondin et al. 2004, Michaud et al. 2005, Duport et al. 2006, Gilbert et al. 2007). These findings helped to precise the bioturbating mode of *H. germanica*, wrongly classified as a surficial-biodiffusor since individuals were observed to both crawl at surface and to burrow in the sediment (see Deldicq et al. 2020; Chapter I, Part 1 for further details). In fact, surficial biodiffusors do not display a burrow-dwelling

behaviour and hence do not generate biogenic structures such as gallery and tube in the sediment (Mermillod-Blondin et al. 2003, Kristensen et al. 2012).

*4.3. Density may control the burrowing behaviour of *H. germanica**

In our experiments, luminophores were found down in the 1.8-2 cm layer for the LD, MD and HD treatments. This result suggests that living individuals of *H. germanica* moved down to 2 cm depth during the experiment, which corresponds to the bottom of the cores. The percentage of buried luminophores in the 1.8-2 cm layers significantly differed between treatments suggesting that increasing density may force *H. germanica* to increase its burrowing depth. Variability in the migratory behaviour of macro-invertebrate species was previously considered to be density-dependant (Peterson & Andre 1980, Rosenberg et al. 1997, Duport et al. 2006). For instance, the brittle star *Amphiura filiformis* showed higher migration rate toward deeper sediment layers when the species density increases (Rosenberg et al. 1997). Similarly, the polychaete *H. diversicolor* was observed to increase its prospecting area when worm density increased (Duport et al. 2006). Our results are consistent with previous studies and we suggest that *H. germanica* would change its migratory behaviour (i.e. burrowing deeper) as a function of density. To further validate this hypothesis, the use of luminophores coupled to the labelling of individuals with the CellTracker Green method (e.g. Bernhard et al. 2006) may be relevant as it would provide information on the vertical distribution of living foraminifera and particles tracers within the sediment.

*4.4. Density matters in the contribution of *H. germanica* to particle transport*

There was a positive effect of *Haynesina germanica* abundances on biodiffusion and nonlocal transport processes. Indeed, there is a significant increase in biodiffusion transport between the MD (60 indiv cm⁻²) and the HD (90 indiv cm⁻²) treatments. Furthermore, the nonlocal transport was four time higher in the MD treatment than in the LD one (30 indiv cm⁻²). Previous studies dealing with other macro-invertebrates biodiffusers species also reported higher sediment mixing with increasing densities

(Sun et al. 1999, Ingalls et al. 2000, Sandnes et al. 2000, Ouellette et al. 2004, Duport et al. 2006). However, there is a threshold from which density negatively impacts sediment mixing. It has been suggested that even if the overall community sediment mixing activity is stimulated by increasing densities, in turn, this increase constrains the individual contribution (Sun et al. 1999, Ingalls et al. 2000, Sandnes et al. 2000, Duport et al. 2006). Our results were consistent with previous studies as we observed a significant reduction in the individual contribution to biodiffusion and nonlocal transport at the abundance of 90 indiv cm⁻² (Fig. 61). Higher density may enhance competition for trophic resource and space which may in turn, hamper the individual feeding rate and crawling behaviour (Levinton 1979, 1985, Miron et al. 1991, 1992, Sun et al. 1999, Ingalls et al. 2000, Sandnes et al. 2000).

The present findings confirm that *H. germanica* density controls its contribution to the vertical transport of sediment particles both positively and negatively. Therefore, population density appears to be an important factor, which may further constrain the contribution of benthic foraminifera to bioturbation processes.

5. Conclusion

The present study allowed us to further precise the bioturbating mode of *H. germanica* as a gallery-biodiffusors species with a non-negligible contribution to biodiffusion and nonlocal transport processes. In previous experiments (Chapter III, Part 1), *H. germanica* remained active in its tube, suggesting that the species did not behave like bigger gallery-biodiffusor species do. Indeed, typical gallery-biodiffusors species remain in their burrow and flushed it by movement of their body to renew dissolved oxygen and nutrients content (Kristensen 1983, Kristensen & Kostka 2005, Kristensen et al. 2012). Such a ventilation greatly enhances the exchange of dissolved element between sediment and water and therefore affect geochemical processes and micro- and meiobenthic communities (Aller 1994, Mermillod-Blondin & Rosenberg 2006, Michaud et al. 2009). As the motion behaviour of organisms is intrinsically linked to their foraging activity (Pyke 1984), further studies are needed to understand the benefit of tube-building behaviour for *H. germanica* and its effects on dissolved

fluxes. Our results also highlight a density-effect of both community and individual sediment reworking intensity. It would be interesting to study the density-sediment reworking relationships with communities where different functional groups can occur as other foraminiferal species has been classified into separate functional groups i.e. epifaunal-, surficial- and gallery biodiffusors (Deldicq et al. 2020).

Acknowledgements

Dr Florian Mermillod-Blondin is warmly thank for calculating sediment reworking coefficients.

Supplementary material

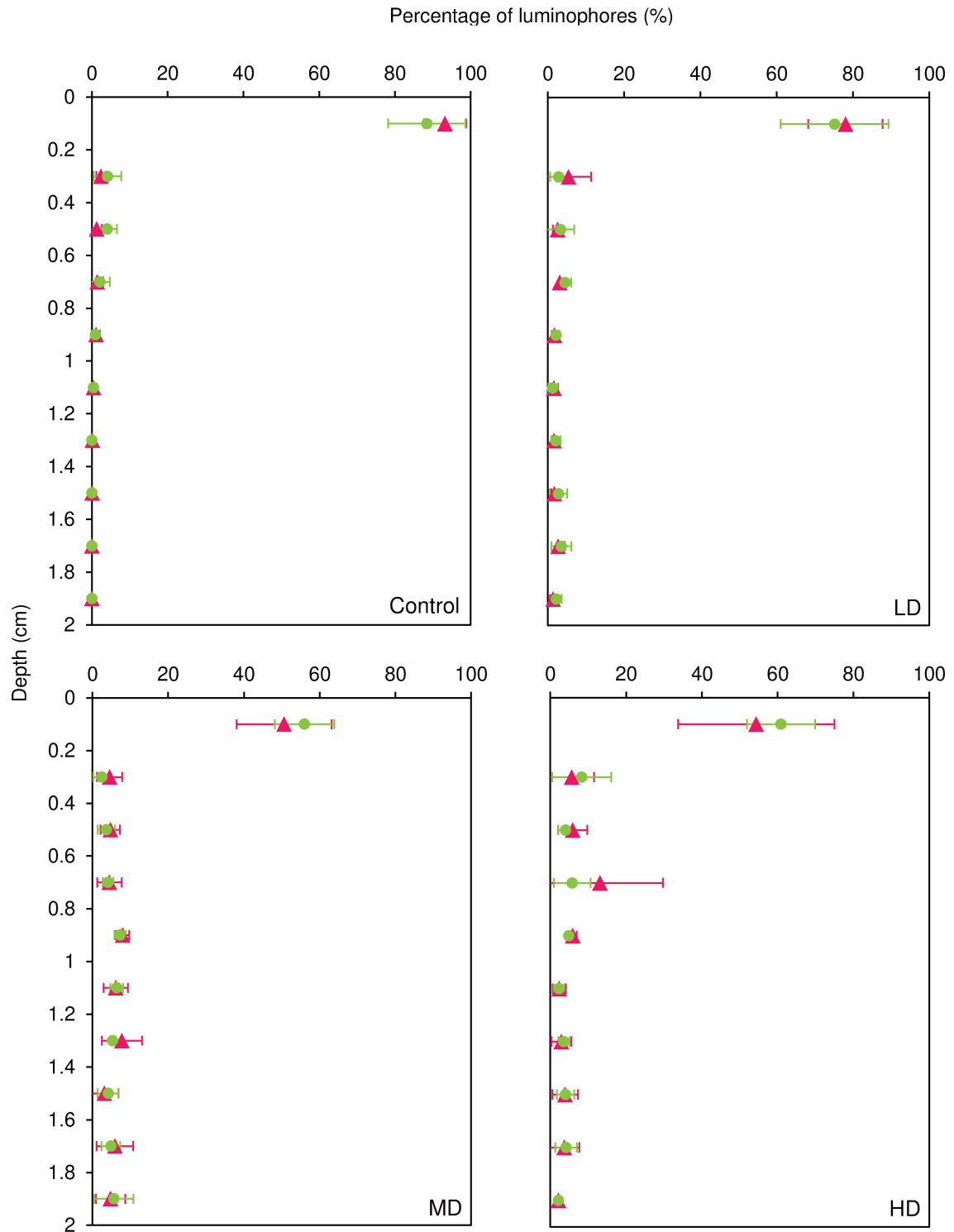

Suppl. Fig. 4. Depth profiles (means \pm SD) of green (green circles) and pink (pink triangles) luminophores size fractions in the four treatments. Treatments: Control (n=0), LD (n=30), MD (n=60), HD (n=90).

GENERAL DISCUSSION

The structure of marine ecosystems is controlled by both abiotic and biotic factors. Identifying these factors and quantifying their relative importance is fundamental because any alteration in ecosystem structure influences trophodynamics and regulating services. Bioturbation by benthic fauna is a key biological function affecting the texture of the substrate and bio-geomorphological processes e.g. organic matter mineralisation, nutrient exchange (François et al. 1997, Gérino et al. 2003, Solan et al. 2004, Kristensen et al. 2012). Each size fraction of the biocenosis (i.e. micro-, meio-, macro- and mega-fauna) not only contributes in a specific way but also interacts with each other to rework the sediment. To investigate bioturbation, a typical approach is the characterisation of species-traits such as morphology and behaviour (Nordhaus et al. 2009, Massé et al. 2019, Pascal et al. 2019). In macrofauna, behaviours e.g. walking, feeding, ventilating or burrowing activities can be easily identified and characterised because these organisms are macroscopic. As a consequence, the importance of macrofaunal species in the bioturbation processes has been largely studied in contrast to meiofaunal species such as foraminifera. Indeed, these small organisms are often more difficult to observe and the characterisation of their behavioural properties involves the use of specific instruments, experimental design and observation procedures. Earlier studies have used the motion rate as a quantitative parameter to describe foraminiferal displacement in the sediment column (Kitazato 1981, 1988, Severin & Erskian 1981, Severin et al. 1982, Severin 1987, Hemleben & Kitazato 1995, Gross 2000, 2002). Recently, the diversity and complexity in the motion behaviour of three dominant foraminiferal species have been highlighted (Seuront & Bouchet 2015). Although no study has described the diversity and the functionality of the motion traits of benthic foraminifera in and on the sediment, such an exploration is needed to understand their role in the functioning of benthic ecosystems (Mermillod-Blondin et al. 2003, 2004, Michaud et al. 2005, 2010, Mermillod-Blondin & Rosenberg 2006).

In this PhD, I investigated the role of benthic foraminifera in bioturbation processes occurring in intertidal sediments by means of motion behaviour assessment. Specifically, I measured the following behavioural parameters: (i) the activity level, (ii) the travelled distance, (iii) the velocity, (iv) the vertical position and (v) the

complexity of their path. Such parameters helped to highlight the complexity of the motion behaviour of intertidal foraminifera both at the intra- and inter-specific levels, and to identify further implications in sediment reworking. The main results are discussed in the following sections and summarized in Figure 62.

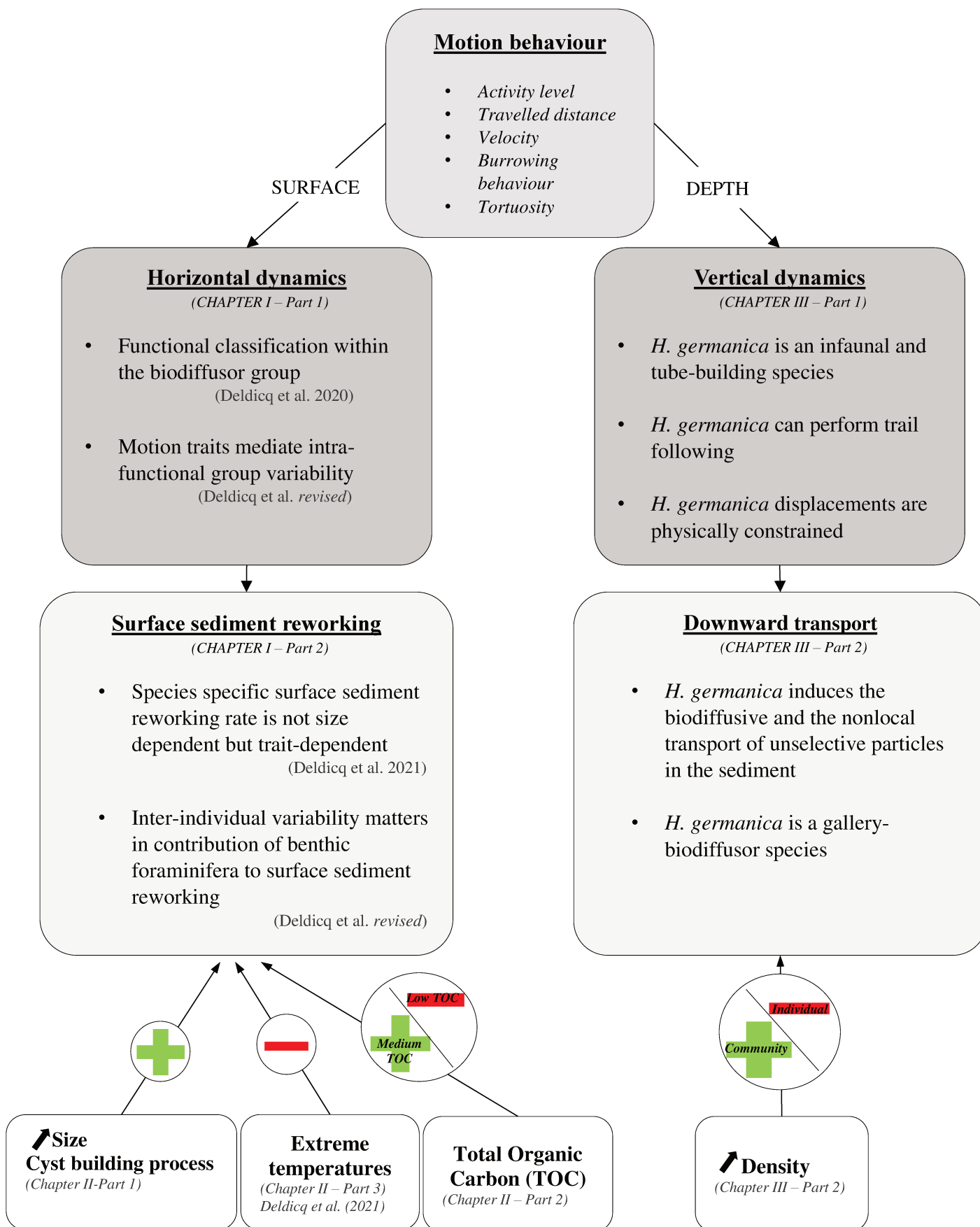

Figure 62. Conceptual schema summarising the main findings of my PhD thesis and links between the three chapters dealing with the role of intertidal benthic foraminifera in sediment reworking processes. Plus and minus symbols refer to either positive or negative effect of abiotic/abiotic parameters on the sediment reworking rate of intertidal foraminifera.

1. New insights into the ecology of intertidal foraminifera: what we learnt from the motion behaviour of dominant key species?

1.1. Foraminiferal motion behaviour is species-specific

The behavioural properties assessed by continuous measurements of *Q. seminulum*, *H. germanica*, *C. williamsoni*, *A. tepida* and *M. fusca* movements are clearly species-specific and differ significantly among species although they were exposed to similar controlled experimental conditions (Chapter I, Part 1: 43-57). This result suggests that processes driving the observed motility patterns involve the presence of an innate determinant to motion behaviour as previously suggested for gastropods and copepods (Bell 1991, Chapperon & Seuront 2011a, Seuront & Stanley 2014). The motion behaviour of foraminifera may therefore be linked to their specific traits i.e. morphological features and ecological requirements, which lead to inter-specific differences.

1.1.1. Species-specific motion behaviour is related to morphology

The morphology of the test (i.e. rotalid, ovoid forms) is an important feature involved in the displacement of species (Chapter I, Part 2: 61-75). As previously described (Langer et al. 1989), rotalid species, i.e. *Ammonia tepida*, dig into the sediment with rotating movements of the test. In contrast, *Quinqueloculina seminulum* and *Miliammina fusca* orient themselves vertically with the aperture-side-down to anchor in the sediment and put their pseudopodial network in the direction of locomotion (Kitazato 1988, Langer et al. 1989). Similar burying mode was also observed for the rotalid species *H. germanica* and *C. williamsoni* (Fig. 63), though they were subsequently observed shifting their umbilical and dorsal sides in the direction of their displacement. Indeed, reticulose pseudopodia may be extended outside the shell through primary and supplementary apertures (Jepps 1942). As a consequence, some species may orient the larger surface area of their test toward the direction of movement (Kitazato 1988, Hottinger 2006). This simple, but crucial information, is important to understand how morphological features mediates the motion behaviour of foraminifera.

Moreover, previous studies reported that species moving with rotating movements display higher velocity than those extending their pseudopods through single apertures such as quinqueloculine species (Kitazato 1988). In the present work however, *Quinqueloculina seminulum* moved faster and travelled a longer distance than *Ammonia tepida* (Chapter I, Part 1: 43-57). Ovoid-shaped species e.g. *Q. lamarckiana*, *Q. seminulum* were previously reported as rapidly moving in and on the sediment (e.g. Severin & Erskian 1981, Severin et al. 1982). They can therefore cover a similar distance than rotalid species (Bouchet & Seuront 2020).

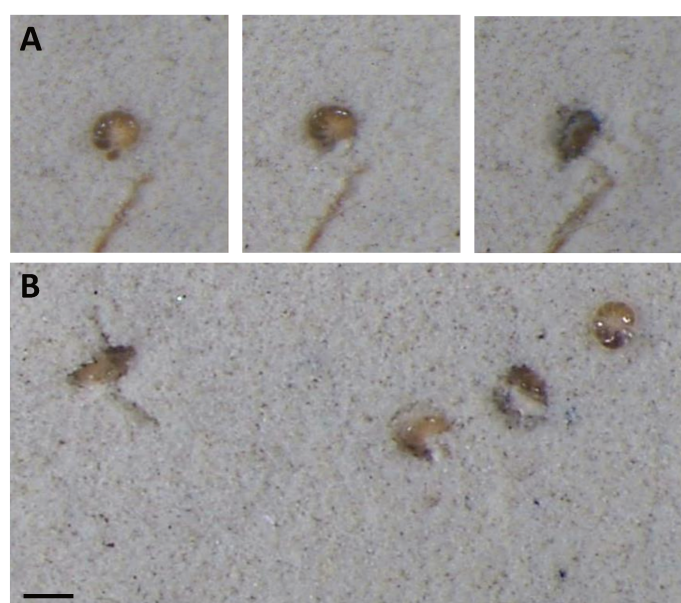

Figure 63. (A) Archetypical illustration of the vertically-orientation mechanism of *H. germanica* before its displacement in the sediment. (B) Visual observation of the positioning mode adopted by *H. germanica* for moving in the sediment. Scaled bar = 200 μm .

Morphology of the test may not be a sufficient criterion to understand the motion behaviour of benthic foraminifera that may be motivated by other biotic parameters such as feeding mode or preferential habitat (Gross 2000). Noticeably, innate information can be genetically determined and/or transferred through heredity or derived from exogenous sources (Bell 1991). Hence, the inter-specific behavioural differences observed in this study can be thought as a reminiscence of the trophic conditions encountered in the field (Chapperont & Seuront 2011a).

1.1.2. Food matters in the species-specific motion behaviour

Tortuosity of the path provides key information on life history trait (Pyke 1984, 2015, Bell 1991) as organism displacement is under the influence of the distribution of resources and their space-time availabilities (Chapperon & Seuront 2011a). In the present work, the five species exhibited relatively low tortuosity values, suggesting that they explore their environment extensively with close-to-linear trajectory (Chapter I, Part 1: Fig. 21). Such an extensive search strategy (or transecting, e.g. Bell 1991) is optimal under patchily distributed food sources (Pyke 1984, Seuront & Stanley 2014, Seuront & Bouchet 2015). This is consistent with what is known of the trophic ecology of these species that typically feed on microphytobenthos, bacteria and metazoans (Pascal et al. 2008, Nomaki et al. 2008, Dupuy et al. 2010, Jauffrais et al. 2016b, Wukovits et al. 2018). However, an *in situ* study recently revealed that the feeding behaviour of intertidal benthic foraminifera is more complex than what is experimentally observed (Chronopoulou et al. 2019). Intertidal foraminifera exhibit clear diverse and species-specific trophic behaviours and are actually able to feed on different food sources (Jauffrais et al. 2016b and reference therein). This is consistent with my results which suggest that the studied species exhibit different foraging strategies. Noticeably, species displayed differences in their activity level and travelled distance as for instance *A. tepida* that moved five time less than *Q. seminulum*, although both adopt an extensive search strategy (Chapter I, Part 1: Fig. 21). For instance, *A. tepida* and *M. fusca*, prey opportunistically on metazoan, microalgae and bacteria (Dupuy et al. 2010, Chronopoulou et al. 2019) and on suspended detritus (Frail-Gauthier et al. 2019), respectively. As a consequence, these species may not need to travel over long distances to find their food in the sediment. In contrast, *Q. seminulum*, *H. germanica* and *C. williamsoni* that preferentially feed on patchy-distributed benthic diatoms are more likely to exhibit longer displacement than *A. tepida* and *M. fusca* (Bell 1991, Ward et al. 2003, Pascal et al. 2008, Dupuy et al. 2010, Chronopoulou et al. 2019).

Methodological comment on the calculation of the tortuosity of the path

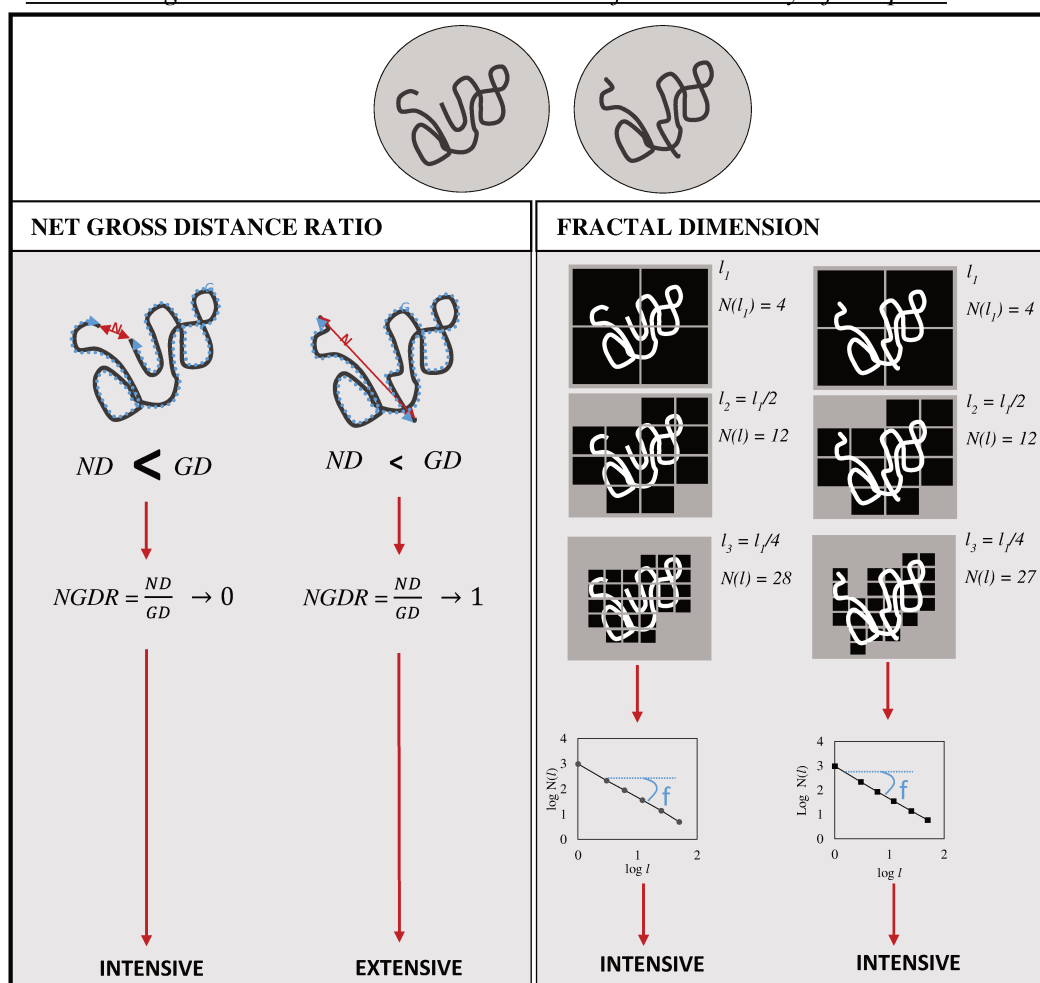

The tortuosity of the path may be estimated by means of the NGDR or the fractal dimension. The NGDR parameter is the ratio between the net and the gross distance travelled (Box 1). It depends on the resolution and the length of the path while fractal dimension (used in this work) is supposedly not due to its scale invariant property (Seuront et al. 2004, Seuront 2010a, 2015b). As evidenced in Box 1, using the NGDR, closely similar trajectories with identical tortuosity may be characterised as intensive or extensive, leading to different ecological conclusions. In contrast, the fractal dimension provides consistent results for both study cases (Box 1). It highlights the importance of using an adapted tool to assess the species-specific variability in the motion behaviour of foraminifera; the fractal dimension being more relevant than the NGDR to assess the tortuosity of the path.

Box 1. Comparison between the two methods that can be used to assess the complexity of the path of benthic foraminifera applied on two trajectories.

These observations converge towards the fact that motion behaviour of foraminifera is essentially driven by their feeding modes and preferences, through related optimal foraging strategies. Consequently, each species has its own behavioural repertoire, being constituted by the travelled distance, activity level and tortuosity of the path. This fact probably originates from natural selection through the selection of the searching strategy that is best adapted to the ecological requirements of each species (Pyke 1984, Bell 1991). This supports previous findings on *Criboelphidium excavatum*, *Haynesina germanica* and *Ammonia tepida* through the characterisation of their Net Gross Distance Ratio (NGDR, Seuront & Bouchet 2015).

1.2. Behavioural plasticity leads to intra-specific variability in the motion behaviour

Under different TOC concentration regime (Chapter II, Part 2: 95-108), *H. germanica* is able to adapt its foraging strategy by altering its motion behaviour. Indeed, each individual used different behavioural repertoire such as low travelled distance, linear trajectory and low level of activity under low TOC concentration. Conversely, they increased their travelled distance, activity and tortuosity with increasing TOC concentrations. This suggests a strong flexibility in the motion behaviour within *H. germanica* that may be seen as an adaptation to short-term environmental changes. This behavioural flexibility is essential to the survival of foraminifera inhabiting extreme habitats such as intertidal mudflat since they have to respond to rapid and large environmental fluctuations that are either predictable (i.e. tide) or unpredictable (i.e. weather conditions, food variability) in both space and time (Underwood & Chapman 2000).

This is consistent, with what is observed when *H. germanica* is exposed to different thermal regimes (Chapter II, Part 3: 113-135). Increasing fractal dimensions were indicative of changes in the foraging strategy i.e. more complex trajectories and more intensive displacement as a response to a short-term temperature exposure. Moreover, foraminifera may also show variability in their microhabitat in response to thermal variation. Specifically, *H. germanica* may have an intrinsically basking (i.e. staying at surface sediment to benefit from solar heating) and burrowing (i.e. go deeper in the

sediment to reach cooler sediment layers) behaviour to regulate their inner body temperature (Chapter III, Part 3: Fig. 46). These observations highlight the behavioural response to short-term temperature variations that *H. germanica* frequently experiences in its natural environment. This phenomenon is largely known for other intertidal organisms (Chapman 2000a, Chapperon & Seuront 2011a,b, 2012).

In the present work, the behavioural plasticity in the foraging strategy and vertical position was only reported for *H. germanica*. However, the other foraminiferal species studied in this work may also display a behavioural plasticity as I observed inter-individual variability in the motion traits within the four other studied species (Chapter I, Part 2: 61-75). Considering the inter-individual variability may inform on the species ability to rapidly response to short-term environmental variations. To further validate this assumption, it would be interesting to perform the same experiments with the other species that displayed lower inter-individual variability, for instance *A. tepida*.

2. Benthic foraminifera play a (key?) role in sediment reworking in intertidal ecosystem?

2.1. Foraminiferal bioturbation at the sediment water-interface

2.1.1. A complex interplay between functional classification and species-specific motion traits.

The inter-specific diversity in the motion behaviour was characterized with newly parameters that allowed for the first time to different modes of bioturbation in benthic foraminifera (Fig. 62). Considering that foraminifera fundamentally displace sediment over short distances due to their small size (Gross 2002, this study), the five studied species were defined as biodiffusors. Such a group gathers species “*with activities that usually result in a constant and random local sediment bio-mixing over short distance*” (Kristensen et al. 2012, p. 289). Specifically, the preferential depth of activity was used to sub-classify the species into 3 subgroups (epifaunal-, gallery- and surficial-biodiffusors; Kristensen et al. 2012). It means that species would not have the same

effect on the spatial displacement of sediment particles. Noticeably, the surficial-biodiffusor *C. williamsoni* would mix sediment particles along the surface. The gallery-biodiffusor species i.e. *Q. seminulum* and *M. fusca* most likely induce the downward transport of sediment from the surface to deep sediment layers. To further validate the functional classification of species, experimental assessment of the dynamics of their vertical displacement is further needed. For instance, *H. germanica*, that was initially classified as surficial-biodiffusor species, is in fact a gallery-biodiffusor (Chapter III, Part 2: 159-171).

Furthermore, although *M. fusca* and *Q. seminulum* are both classified as gallery-biodiffusors, they do not rework surface sediment with the same intensity. Indeed, the latest is twice more active and travelled a distance 5 time longer than *M. fusca* (Chapter I, Part 1: Fig. 21). As a result, the estimation of the individual surface sediment reworking rate ($SSRR_i$) showed that *Q. seminulum* and *M. fusca* are the most and the last efficient bioturbating species, respectively. This result suggests that motion traits control the intensity of species-specific bioturbation that in turn leads to intra-functional group differences (Fig. 62). Furthermore, the $SSRR_i$ performed by the five studied species appeared to be motion trait-dependent rather than test size-dependant. In the present work, smaller species contribute more to surface sediment reworking than larger ones (Fig. 62).

This work shows that different species may exhibit different mode of bioturbation. For the time being, we still remain at the very early stage of understanding these differences in benthic foraminifera. As a consequence, we need supplementary works to further understand the bioturbation of benthic foraminifera and I suggest to consider all the motion traits that may be involved in the intensity and the mode of sediment reworking.

2.1.2. Methodological note on the $SSRR_i$ calculation

The surface area of the test was used as the morphological component in surface sediment reworking rate ($SSRR_i$) calculation. Indeed, I observed that rotalid species with pores (e.g. *A. tepida*, *C. williamsoni*, *H. germanica*) orient the larger surface area of their test, i.e. dorsal and umbilical side, toward the direction of the movement. This behaviour allows the extension of the pseudopodial network through supplementary apertures. Quinqueloculine species such as *M. fusca* and *Q. seminulum* extended their pseudopodia through a single aperture i.e. their mouth to move (Severin & Erskian 1981, Severin et al. 1982, Frail-Gauthier et al. 2019). Hence as suggested in chapter I, this may lead to an overestimation of their $SSRR_i$. However, as shown in figures 62, 30 and 34 (Chapter II, Part 1), foraminifera leave a track that are much larger than their individual size. This therefore suggests an underestimation of the $SSRR_i$ of both species.

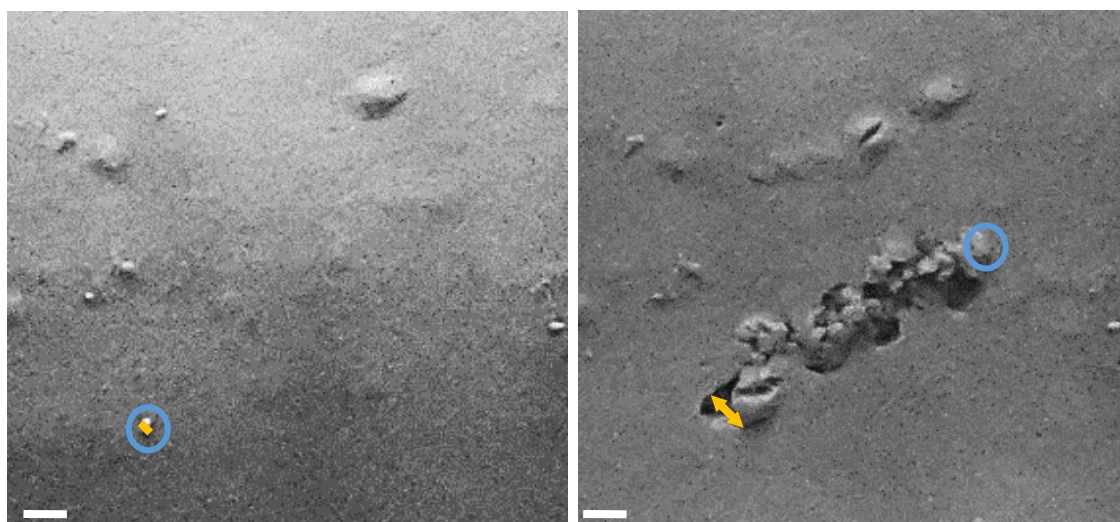

Figure 64. Visual observation of the width of the path that is greatly larger than the individual during the displacement of *Q. seminulum*. The position of the individual in both images is indicated by blue circles. Scaled bar = 0.5 mm.

To confirm the calculation of the $SSRR_i$ used in the present work, microtopography mapping may be implemented (Roy et al. 2002, 2005, Maire et al. 2007b). Such a method allows to monitor the temporal changes of the sediment surface. The original sediment-water interface is used as a reference and the sediment accumulated above this level is assumed to result from sediment reworking by benthic fauna (Fig. 65;

Maire et al. 2008). For instance, it would be well appropriated for *C. williamsoni*. It would be useful to perform microtopography mapping on intertidal foraminifera to rightly estimate the real surface area that is involved in the displacement of surface sediment particles.

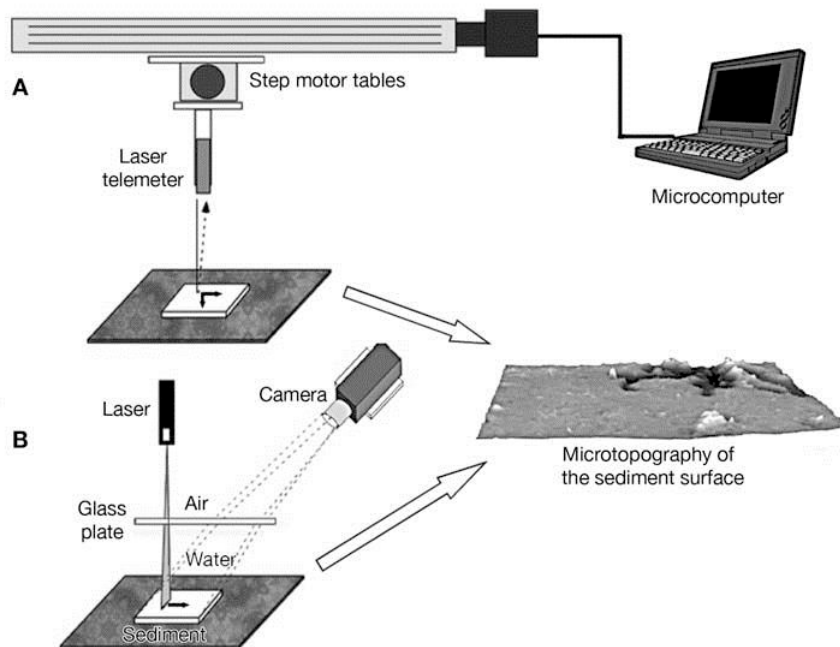

Figure 65. Principle of the microtopography mapping method. Successive microtopography mapping can be assessed (A) using a laser telemeter mounted on 2 crossed-step motor tables allowing for 2-dimensional displacements above the sediment surface or (B) through the projection of a laser line onto the sediment surface. A glass plate places at the air-water interface ensures well-defined and constant refraction. An image of the projected laser line is recorded by a digital camera. The position of the laser line in the image is then determined allowing for estimations of sediment surface elevations. From Maire et al. (2008).

2.1.3. Foraminiferal bioturbation as a function of biotic and abiotic parameters

Inter-individual variability in size mediates the intensity of the $SSRR_i$ (Chapter II, Part 1: 83-94). Larger individuals of *H. germanica* are more efficient reworkers than smaller ones (Fig. 62). I may therefore suggest that the sediment reworking performed by a population of *H. germanica* could vary with the seasonal variation of the species size structure. Throughout a year, *H. germanica* may have several reproduction periods that lead to an increase in the number of small individuals. For instance, the number of juveniles is higher at warmer periods while adults mainly dominated the community in

winter (Fig. 66C; Murray 1983, Cearreta 1988, Murray & Alve 2000, Grimmelpont & Pavard, *unpubl. data*). In addition, individuals grow rapidly and reach large size ($> 125 \mu\text{m}$) in less than 3 months (Cearreta 1988). This leads to high turnover and a strong variability in the size-structure of the community.

Additionally, environmental parameters may also constrain the $SSRR_i$ of *H. germanica* (Fig. 62). Indeed, under different thermal and organic matter regimes, individuals of *H. germanica* displayed distinct behavioural patterns. At lower temperature for instance, there is a decrease in the species activity as well as a decrease in the area explored by an individual. Furthermore, stressing conditions like experimentally-simulated heatwaves and food-depleted sediments strongly affect activity level, tortuosity, travelled distance and vertical position of *H. germanica* in the sediment. This in turn modifies the mode of sediment reworking and limits its intensity. This is superimposed to intra- and inter- specific behavioural properties.

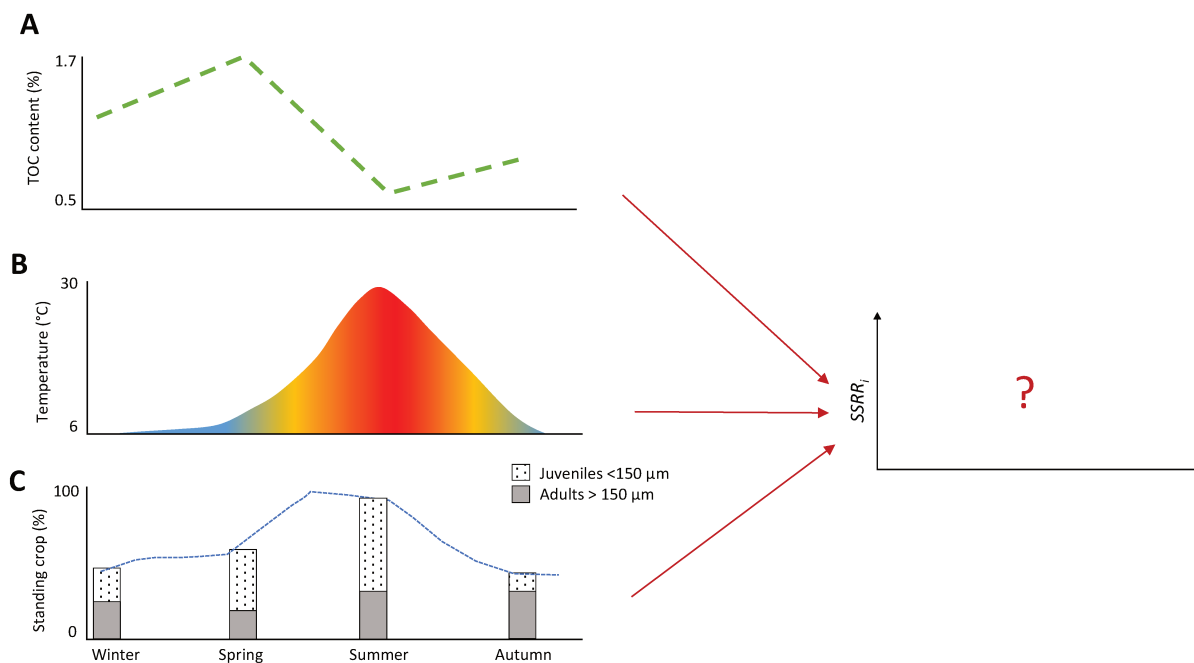

Figure 66. Illustration of the typical seasonal trend of the three parameters studied in this work that could mediate the $SSRR_i$ of intertidal benthic foraminifera (A) variability in the Total Organic Carbon (TOC) content between the four seasons in the harbour of Boulogne-sur-Mer (Francescangeli 2017), (B) Thermal variation usually encountered in the field over a year in the Western coast of France (Harrison & Phizacklea 1987, Guarini et al. 1997), (C) Community size-structure of *H. germanica* along the English coastlines (Murray 1983).

Overall, given that community size-structure and environmental factors change throughout a year (Fig. 66), it would be of interest to predict the temporal evolution of the $SSRR_i$ performed by intertidal foraminifera seasonally. This may allow one to identify which factors drive the $SSRR_i$ at both species and individual levels over large temporal scales (Fig. 66). To do so, supplementary experiments are needed to increase our understanding on the parameters that may affect the $SSRR_i$ of intertidal foraminifera. Such assessment is crucial to better understand the role of this biotic compartment in bioturbation process and therefore benthic ecosystem functioning and associated regulating services. This is particularly relevant in the era of global change as anthropogenic pressure and climate warming irremediably affect species and their function within the ecosystem.

2.1.4. Does foraminiferal bioturbation matter in surface sediment reworking?

In-situ abundance of the five species may be used to scale the individual $SSRR_i$ up to a surface unit of 1 m^2 as a population-level surface sediment reworking rate $SSRR_p$ ($\text{cm}^3 \text{ m}^{-2} \text{ d}^{-1}$, Rhoads 1963, Wheatcroft et al. 1990, Lohrer et al. 2005, Bouchet & Seuront 2020) as follows:

$$SSRR_p = \sum SSRR_{sp} \times A$$

where A and $SSRR_{sp}$ correspond to the *in-situ* abundance and the mean $SSRR_i$ of each considered species in the calculation (Bouchet & Seuront 2020).

Here, to be consistent with their mode of sediment reworking, the $SSRR_p$ of foraminifera are compared with the $SSRR_p$ of macrofaunal species that are classified as biodiffusors. For instance, the displacement of *C. williamsoni*, *H. germanica* and *A. tepida* are close to the crawling activity of species moving on surface sediment such as sea urchin and gastropod (Orvain et al. 2003, 2004, Lohrer et al. 2005). The volume of surface sediment displaced by a population (40 ind. m^{-2}) of the spatangoid *Echinocardium* spp. can reach up to $20,000 \text{ cm}^3 \text{ m}^{-2} \text{ d}^{-1}$ (Lohrer et al. 2005). By comparison, a population of *H. germanica* ($33 \pm 7 \text{ ind. cm}^{-2}$ at sampling site; mean \pm

SD), *C. williamsoni* (7 ± 2 ind. cm^{-2} at sampling site) and *A. tepida* (46 ± 12 ind. cm^{-2} at sampling site) can rework up to $5,300 \text{ cm}^3 \text{ m}^{-2} \text{ d}^{-1}$ (Fig. 67).

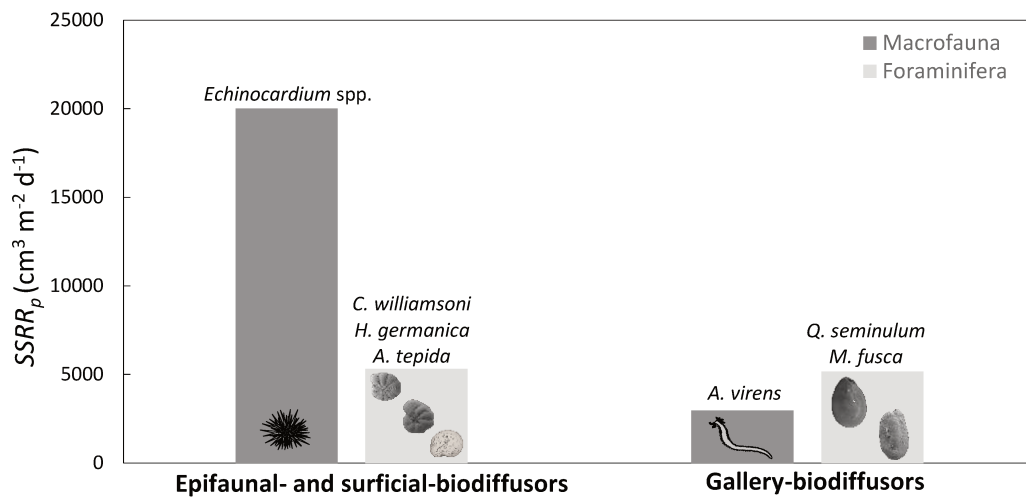

Figure 67. Surface sediment reworking at the population-level $SSRR_p$ ($\text{cm}^3 \text{ m}^{-2} \text{ d}^{-1}$) of two macrofaunal species (in black) and the five studied foraminiferal species (in grey) in respect with their functional classification. *Echinocardium* spp. from Lohrer et al. (2005). *A. virens* from Ouellette et al. (2004).

Similarly, the volume of sediment displaced by a population (500 ind. m^{-2}) of the gallery-biodiffusor *Alitta virens* (polychaete) can reach $2,956 \text{ cm}^3 \text{ m}^{-2} \text{ d}^{-1}$ (Ouellette et al. 2004). A population of the two gallery-biodiffusor species *Q. seminulum* (43 ± 8 ind. cm^{-2}) and *M. fusca* (1 ± 0.5 ind. cm^{-2}) can rework up to $5,166 \text{ cm}^3 \text{ m}^{-2} \text{ d}^{-1}$ which is therefore more important than *Alitta virens* (Fig. 67).

This comparison highlights the non-negligible role of foraminifera in sediment reworking in intertidal environments. This should be however considered with caution as the sediment reworking performed by macrofaunal and foraminiferal species may differ in the vertical spatial distribution of particles within the sediment column.

2.2. Foraminiferal bioturbation in the sediment column

2.2.1. New insights in the vertical distribution of benthic foraminifera in the sediment

The vertical position of foraminifera is a dynamic process that reflects the species microhabitat preference at the time of observation (Chapter I, Part 1: Fig. 22 and

Chapter II, Part 2: Fig. 46). Typical examples are *H. germanica* and *A. tepida* that alternate between surface and burrowed position during the experiments. Specifically, one individual can be observed crawling at the surface at the start of the experiment then be burrowed in the sediment 3 hours later. *In situ*, sediment cores are typically used to assess the vertical distribution of foraminifera in the sediment (Bernhard et al. 1997, Gustafsson & Nordberg 2001, Geslin et al. 2011, Cesbron et al. 2016). It provides a static view of the vertical position of a species at the time of sampling. As a consequence, it may not reflect the preferential mode of the species. For instance, our *in situ* vertical distribution assessment (sediment core labelled with CellTracker Green, Chapter III, Part 2: Fig. 53) showed that living individuals of *H. germanica* can be distributed up to 5 cm depth while our laboratory experiments suggest that the species mainly explore the first centimetre of the sediment. *In situ* and experimental laboratory assessment appear to be complementary to understand the vertical distribution of benthic foraminifera in intertidal sediments.

Nevertheless, in the present work, differences in the vertical position of the five studied species confirm known species-specific preferences. For instance, *C. williamsoni* prefers surface sediment while *Q. seminulum* and *M. fusca* are clearly not restricted to the sediment–water interface as they were burrowed throughout the experiment. Foraminifera moved in the sediment layer depending on (i) the spatial distribution of food (e.g. Linke & Lutze 1993, Gross 2000), (ii) geochemical properties of the sediment such as oxygen and sulphide (e.g. Alve & Bernhard 1995, Jorissen et al. 1995, Moodley et al. 1998, Duijnsteet et al. 2003, Geslin et al. 2004) and (iii) biotic interaction e.g. competition, predation, bioturbation by larger organism (Maire et al. 2016). Hence, supplementary experiments are needed to describe the parameters that drive the preferential depth of activity of intertidal foraminifera.

2.2.2. *H. germanica* is a gallery-biodiffusor species

The use of thin aquarium (Chapter III, Part 1: 143-156) revealed the ability of *H. germanica* to build biogenic structures. This species can create one-end tubes within the first centimetre of the sediment (Chapter III, Part 1: Fig. 54). In addition, *H.*

germanica was also observed having a trail following behaviour that may be seen as an adaptive response to move in a physically constraining environment. Such observations were reported for the first time in foraminifera and stress the need to investigate the dynamics of the vertical position of foraminifera to describe the species-specific differences in the displacement and opportunistic behaviour such as trail following.

2.2.3. *H. germanica* induces vertical sediment reworking

For this aspect, I focused on the intertidal foraminifera *H. germanica* to investigate the contribution of benthic foraminifera to vertical sediment reworking process. The active displacement of *H. germanica* induced the creation of one-end tubes that are interconnected. This, therefore, led to the biodiffusive and the advective downward transports of surface sediment. This highlight for the first time, the ability of *H. germanica* to contribute to vertical sediment mixing and suggest that *Q. seminulum*, *M. fusca* and *A. tepida* would also contribute to such process as they displayed infaunal lifestyle. This needs to be further assessed.

Our biodiffusion coefficient are similar to those of the gallery biodiffusors *Scalibregma inflatum* in the Gullmar fjord (Gilbert et al. 2003) but less important than those of *Hediste diversicolor* (Duport et al. 2006). Given their small size, the vertical sediment reworking induced by *H. germanica* is generally lower than those of larger species such as macrofauna (Mermillod-Blondin et al. 2003, 2004, Duport et al. 2006, De Backer et al. 2011). However, it induces a non-selective transport of particle from the surface to the bottom of the one-end tube. In addition, *H. germanica* displayed high activity level, allowing most of the time to move within the sediment. This is consistent with the continuous increase in the surface of gallery that is observed in the experiment. In contrast, other burrowing species e.g. shrimp, bivalve can displayed inactivity period both for feeding or maintain their burrows (Meysman et al. 2005, Kristensen 2008, Pascal et al. 2019). Hence, the intensive displacement of *H. germanica* matters in the downward transport of unselective size of sediment particles as evidenced by luminophores profiles (Chapter III, Part 2: Fig. 60). This may have therefore several

implications on the intensity in the burying of organic materials that are mineralised by microbial communities. Moreover, as evidenced for macrofaunal species, burrowing foraminiferal species may increase the exchange of solutes and nutrient between surface and deeper sediments (Mermillod-Blondin et al. 2004). In the sampling areas (i.e. Authie Bay, Boulogne sur Mer harbour) foraminifera mainly co-occur with two larger species: (i) *P. ulvea* that inhabit surface sediment and (ii) *H. diversicolor* which prefer deeper sediment layers i.e. 8 to 20 cm depth. It would be interesting to quantify the vertical sediment mixing induced by these three species to validate the importance of foraminifera in the bioturbation of intertidal environment.

In addition, density may control the contribution of both individual and community to vertical sediment mixing. This is consistent with our findings that have shown the importance of biotic and abiotic factors in the surface sediment reworking rate of *H. germanica*. Noticeably, as for the surface sediment reworking rate, temperature could have mediating effects on the vertical sediment mixing induced by *H. germanica*. Preliminary experiments (L. Lagos, J. Serra, A. Hache) that have dealt with luminophore profiles under different thermal regimes observed a decrease in the number of buried luminophores with decreasing temperature (Fig. 68A).

This is consistent with our observation on the vertical position of *H. germanica* under different temperatures (Fig. 68B). The subsequent next step would be the estimation of the sediment reworking coefficient to assess whether temperature affects both biodiffusive and nonlocal transport of particles induced by *H. germanica*.

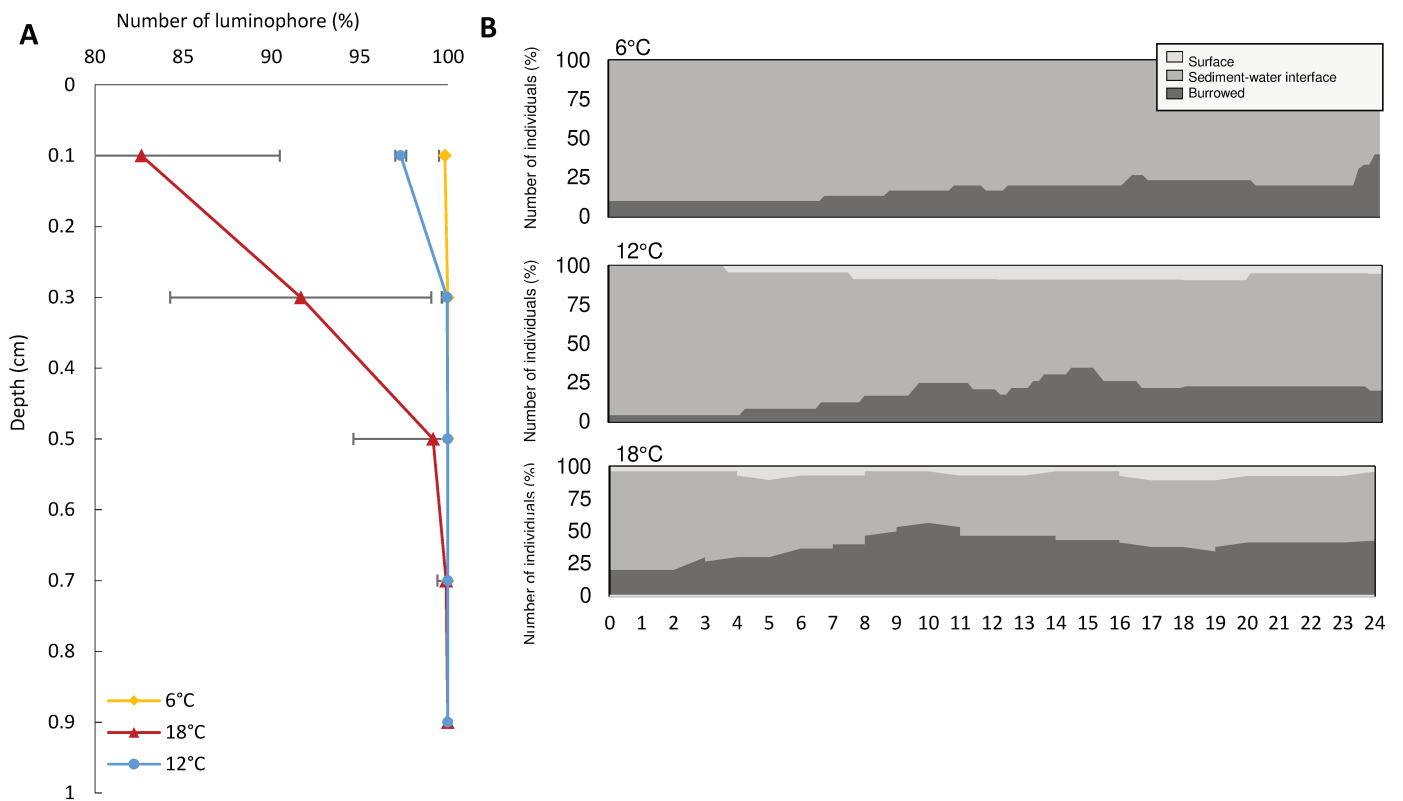

Figure 68. (A) Depth profiles (means \pm SD) of luminophores in the three temperature treatments. Note that the control profile is superimpose on those obtained for 6°C (Lagos, Serra, Hache, *com. pers.*). (B) Temporal evolution of the vertical position of *H. germanica* in the sediment. From Deldicq et al. (2021)

GENERAL CONCLUSION

This PhD work illustrates the high diversity and complexity in the motion behaviour of intertidal foraminifera that is a complex interplay between:

- ➔ Species traits i.e. morphology and ecological requirements (feeding- and life-mode preferences) that leads to inter-specific differences in the motion behaviour.
- ➔ Behavioural plasticity of conspecific individuals in response to environmental variations (i.e. temperature, food concentration) that leads to intra-specific differences in the motion behaviour.

Such a result highlight the importance to work at both the intra- and inter-specific levels to further understand processes that affect their motion behaviour and therefore their ecology. Studies aiming at understanding the interaction between foraminifera and their environment generally work at the cellular or community level (e.g. Jauffrais et al. 2017, Bouchet et al. 2018, Le Kieffre et al. 2018, Ciacci et al. 2019, Li et al. 2019). This work suggests to investigate what is happening for foraminifera at the individual level. In addition, it open new perspectives on the understanding of their ecology and support the need to consider motion trait such as the vertical position and the tortuosity of the path as highly informative tools that should be used in studies dealing with the bioturbation of these small-sized organisms. It also illustrates the vertical distribution of benthic foraminifera in intertidal sediments, which appears to be a dynamic process to respond to environmental constrains.

Such assessment allows to understand the involvement of benthic intertidal foraminifera in bioturbation. Through their activity in and on the sediment and their ability to rapidly respond to short term environmental changes, foraminifera should be seen as non-negligible contributors to sediment reworking processes in intertidal ecosystems. They are therefore likely to play a role both in sediment reworking at the sediment-water interface and in enhancing sediment mixing from to the surface to the sediment matrix. For the first time, a classification of benthic foraminifera in different functional groups according to their mode of bioturbation is proposed. Some species

may noticeably compete with macro-invertebrates in terms of volume of surface sediment reworked. This therefore open research perspective on the role of benthic foraminifera in sedimentary and dissolved fluxes, interspecific facilitation and benthic ecosystem processes i.e. organic matter mineralisation, nutrient cycle (Fig. 69).

PERSPECTIVES

The present work allowed to state that benthic foraminifera contribute to sediment reworking. Quite a number of questions arises to further explore the role of foraminifera in the benthic ecosystem functioning (Fig. 69).

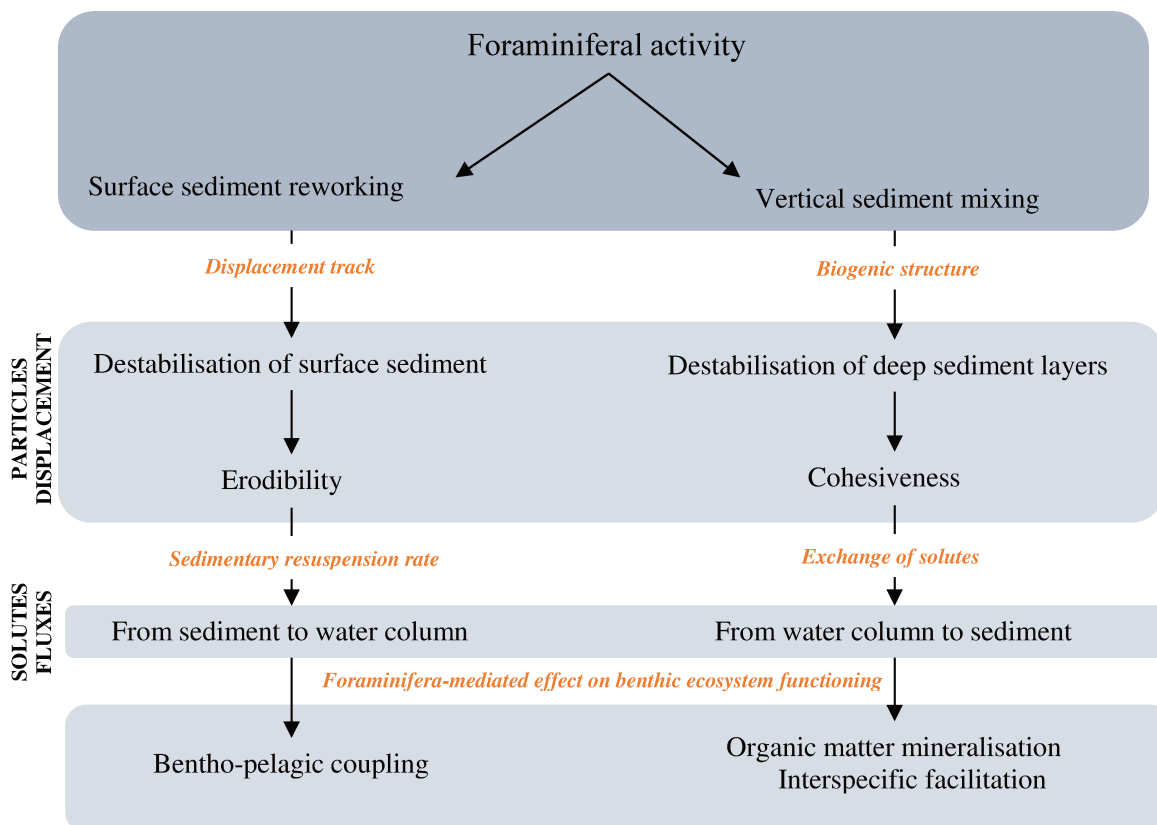

Figure 69. Potential consequences of the activity of foraminifera on particle displacement and consecutive fluxes of solutes. Orange text correspond to the experimental insights that may be applied on foraminifera to understand their bioturbation effect on benthic ecosystem functioning.

Specifically, displacements of benthic foraminifera at the sediment surface may alter the physical structure of the sediment matrix, yet, **how benthic foraminifera may affect the erodibility of muddy sediment?** Furthermore, biogenic structures built in the sedimentary column needs to be further assessed. Noticeably, **how much space is occupied by benthic foraminiferal biogenic structures?** These structures connect the surface with the sediment matrix, allowing to particulate and dissolved fluxes at the interface.

The present work highlighted the particulate fluxes induced by *H. germanica* vertical displacements; the associated dissolved fluxes are yet to be monitored. Note that downward sediment particles fluxes still needs to be assessed in some of the most

dominant species in intertidal sediments. Hence, **may benthic foraminifera be involved in bio-irrigation in muddy sediments?** Finally, microhabitats provided by benthic foraminiferal biogenic structures are potential niches for other groups, noticeably, **may interspecific facilitation by benthic foraminifera favour microbial communities?**

How foraminifera may affect the erodibility of muddy sediment?

Benthic foraminifera may strongly modify the top layer of surface sediment through their displacement (Fig. 70).

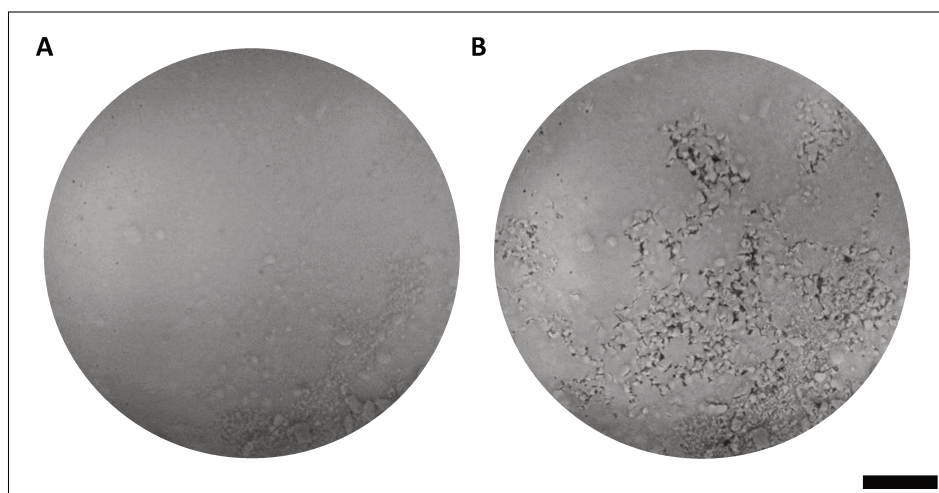

Figure 70. Surface sediment structure (A) before and (B) after 24h of *H. germanica* displacement. Scaled bar = 50 mm.

Specifically, their crawling behaviour are similar to those of the gastropod *Peringia ulvae* that is known to enhance the production of a pelletised surface layer generally called “biogenic fluffy layer” (Willows et al. 1998, Widdows et al. 2000, Orvain et al. 2003, 2004).

Such layer that is an assemblage of floes, microorganisms, mucous tracks, pellets and sediment (Blanchard et al. 1997, Andersen et al. 2002) is more easily resuspended than the bulk sediment matrix and is therefore involved in the benthic-pelagic coupling (Rhoads & Young 1970, Jumars & Nowell 1984, Willows et al. 1998, Widdows et al. 2000). Noticeably, displacements and grazing activity of *Peringia ulvae* strongly affect the dynamics of the microphytobenthos in the fluffy layer and the resuspension of

chlorophyll *a* and suspended particulate matter in the water column (Orvain & Sauriau 2002, Orvain et al. 2003, 2004, Le Hir et al. 2007, van Prooijjen et al. 2011, Cozzoli et al. 2019). Infaunal species may also have an effect on sediment erosion through their burrowing activity that destabilise subsurface sediment (Orvain et al. 2006, Le Hir et al. 2007). Benthic foraminifera may similarly affect the fluff layer as *P. ulvae* do and enhance the benthic-pelagic coupling.

To further investigate this hypothesis, laboratory flume experiments may be used to measure the effects of fauna on the erodibility of the sediment. Here I present the experimental set up established by Orvain et al. (2003) for *P. ulvae* that could be implemented on foraminifera. Flume is a long vertically recirculating flow system where water flow is generated by turbines. The curved shape of the walls and the flume set-up allow to generate a stable and unidirectional flow, assuring reproducibility of flow conditions (Fig. 71).

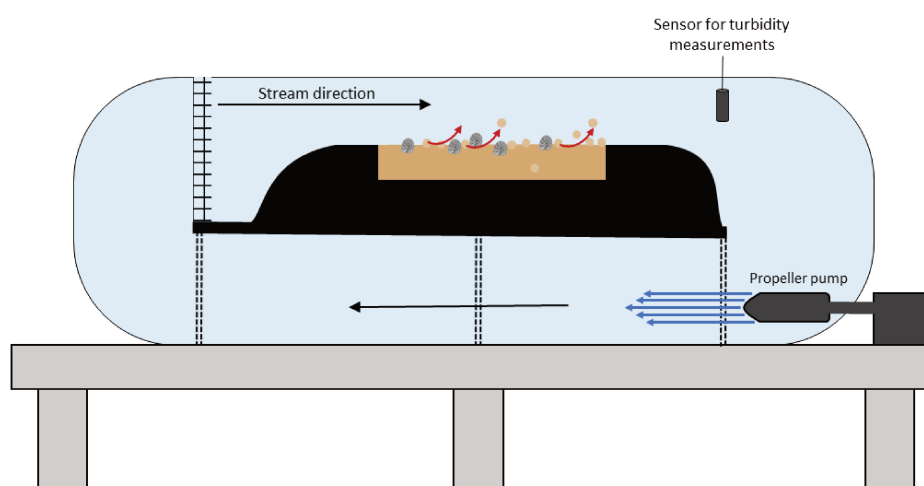

Figure 71. Schematic representation of the benthic flume that may be used with foraminifera. Inspired from Orvain et al. (2003).

The generated flow may be representative of the tidal current conditions typically encountered in intertidal mudflat i.e. from 5.5. to 97.5 cm s⁻¹ (Seuront 2005). Living foraminifera can be added in a compartment filled with muddy sediment (Fig. 71). After some hours, the effect of foraminiferal activity on sediment properties, i.e. resuspension rate, can be quantified in response to stepwise increase in current velocity. To do so, sediment resuspension is assimilated as ambient turbidity and is estimated

through the concentration of suspended particulate matter in the water compartment (Orvain et al. 2003). Such experiment may therefore allow me to evaluate the effect of foraminiferal bioturbation on the sediment erodibility and resuspension rate that are involved in the benthic-pelagic coupling (Orvain et al. 2012).

How much space is occupied by benthic foraminiferal biogenic structures?

To further assess and understand the role of benthic foraminifera in particulate and dissolved fluxes at the sediment-water interface, it will be relevant to further investigate the features of their biogenic structures. In the present work, *H. germanica* built interconnected and sustainable one-end tubes down to 1 cm depth in the sediment. It was possible to characterize the two-dimensional features of this species' biogenic structures. To go farther in the assessment of these biogenic structures, non-destructive techniques such as computing tomography may be used. It is now well recognized to be an efficient tool for the three-dimensional exploration of biogenic structures (Fig. 72; Perez et al. 1999, Mermillod-Blondin et al. 2003, Rosenberg et al. 2007, 2008, Bouchet et al. 2009).

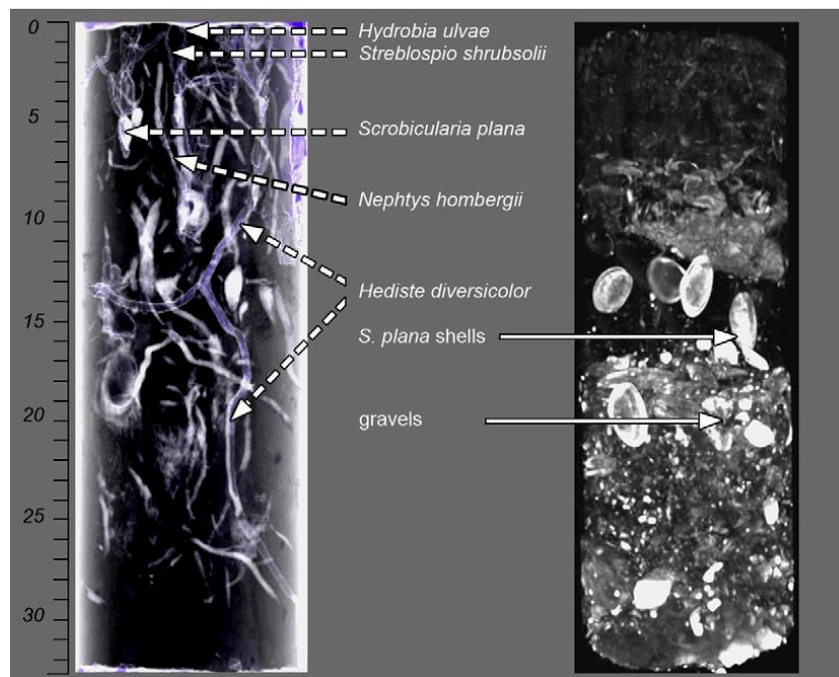

Figure 72. 3D images of the biogenic structures obtained by axial tomography (left) and corresponding vertical distribution of macrofaunal species (right). From Bouchet et al. (2009).

Microhabitats, burrows and cavities of infaunal species can therefore be reconstructed as 3D images after scanning successive thin sections of a sediment core (Fig. 72; Fossing et al. 1995, Schulz et al. 1996). For instance, sediment cores containing living *Amphiura filiformis* (brittle star) were successively scanned 57, 80 and 128h after the addition of alumina (i.e. particle tracer). Results showed that the biologically-induced advective transport mainly occur within 80h after tracers were introduced (Rosenberg et al. 2008). Hence, in addition to allow the investigation of biogenic structures, computing tomography may help to assess the temporal evolution of particle transport in the sediment. Similarly, time-lapse assessment coupled with luminophores (e.g. Solan et al. 2004, Maire et al. 2006, Bernard et al. 2016) allow one to visualise, characterise and quantify sediment reworking process at different time and spatial scales. For instance, *Abra ovata* and *Abra nitida* (bivalves) generated three main types of vertical luminophore profiles depending on their activity in the sediment (Fig. 73; Maire et al. 2006). Biologically-induced sediment reworking was maximal immediately after the food addition then either decreased or increased with time for *A. nitida* and *A. ovata* respectively (Maire et al. 2006). Such experiments are therefore of interest to further understand the behavioural ecology of infaunal organisms.

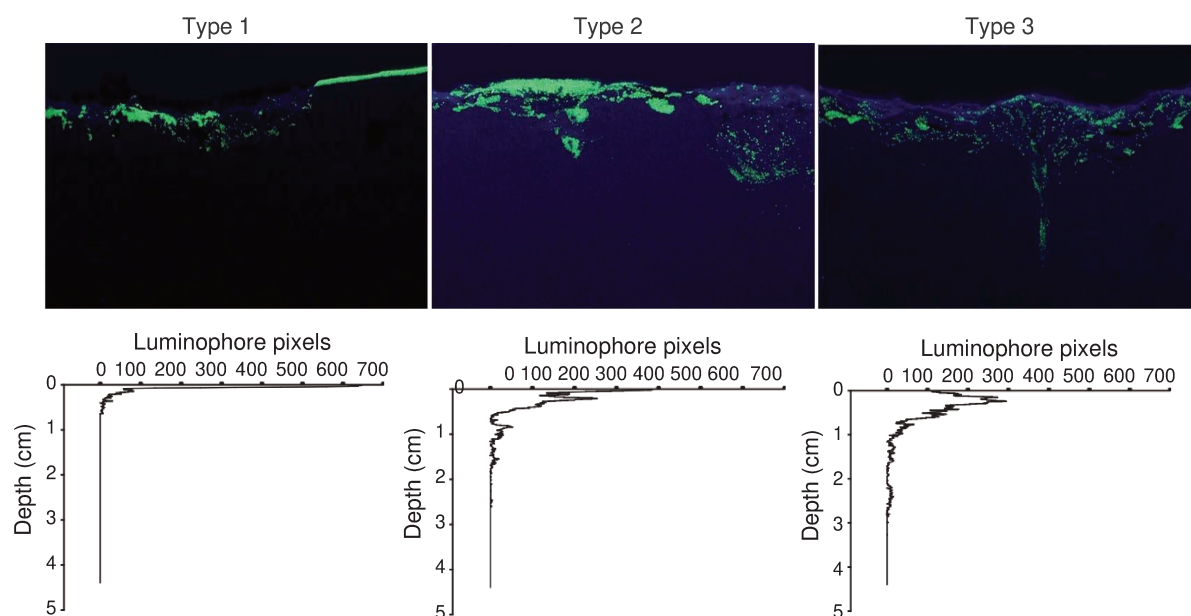

Figure 73. *Abra ovata*. Presentation of the three main types of luminophores vertical profiles: upper panes are original images; lower panels are the corresponding vertical profiles. From Maire et al. (2006).

It would be interesting to implement such techniques on *Haynesina germanica*. It may allow a deeper understanding of the kinetics of the species contribution to vertical sediment mixing. Such experiment could be performed under different food concentration as organic matter mediates the foraging activity of *H. germanica* (Chapter II, Part 2, p. X-X). In addition, supplementary experiments in the presence of other bioturbators species such as copepods, nematode or larger invertebrates may be relevant to (1) confirm the sustainability of one-end tubes generated by *H. germanica* and (2) its effect on sediment reworking mode and intensity.

May foraminifera be involved in bioirrigation in muddy sediment?

Water exchanges between the sediment and the water column result from the biologically-induced sediment reworking (Kristensen et al. 2012). Specifically, increasing water fluxes by infaunal organisms affect the distribution of dissolved element such as nitrate, oxygen, sulphide in the sediment column (Volkenborn et al. 2016). This has several consequences on organic matter mineralisation processes, deep microbial communities and microphytobenthic growth and production (Bertics & Ziebis 2009, Michaud et al. 2009, Quintana et al. 2015, Citadin et al. 2016, Koo et al. 2019). Importance and mode of bioirrigation may however differ between functional groups. Surficial-biodiffusor species have for instance, lower effects on water exchanges, nutrient release and microbial activity than gallery-biodiffusors as the latest are burrowed deeper in the sediment (Mermillod-Blondin et al. 2004).

To assess how the activity of infaunal organism affects bioirrigation processes, several techniques exist and are widely applied on macrofaunal species. More recently, they were successfully carried out with meiofauna both to evaluate their effect on oxygen penetration depth (e.g. Bonaglia et al. 2020), nutrient fluxes (e.g. Piot et al. 2013), carbon mineralisation and methane flux (e.g. Nascimento et al. 2012, Bonaglia et al. 2014).

Noticeably, the exchange of solutes across the sediment-water interface is typically estimated through successive measurements of dissolved elements in the water column. When starting experiment, water sample can be collected for initial measurements of

dissolved elements concentration such as oxygen, ammonium or nitrate. Then the concentrations can be continuously (e.g. dissolved oxygen concentration) or periodically (e.g. nitrate, ammonium) measured (e.g. Mermillod-Blondin et al. 2003, Piot et al. 2013, Pascal et al. 2019). The porewater exchange, corresponding to the volumetric flux of water and associated dissolved element between the water column and the sediment (Na et al. 2008), can be quantified using transport tracer method (Pascal et al. 2019). A fluororimetric probe can be used to continuously record the tracer concentration e.g. uranine in the overlaying water (Fig. 74). The decrease in tracer concentration with time therefore indicates a water exchange across the sediment water interface resulting from faunal bioturbation (Fig. 74).

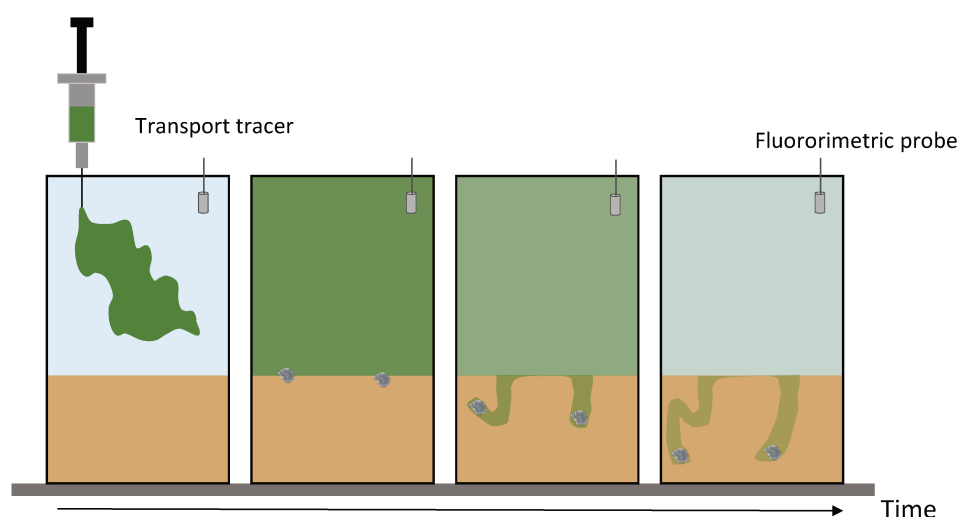

Figure 74. Experimental set-up to assess the effect of foraminifera on porewater exchange using continuous record of tracer concentration in the water column.

In addition, meiofauna was recently described having a both positive effect on the oxygen concentration and a negative effect on the sulphide flux in oxygen depleted environment (Bonaglia et al. 2020). Increase in oxygen concentration however provide a more energetically favourable electron acceptor that stimulate microbial degradation of the organic matter (Volkenborn et al. 2016). Sediment microprofiles with microsensors can be used to measure the evolution of the oxygen and sulphide concentrations within the sediment in the presence of meiofaunal species (Bonaglia et al. 2020). Oxygen and sulphides fluxes were then estimated using Fick's first law. The oxygen penetration depth increased by 85%, 59% and 62% after 5, 14 and 22 days in

the presence of high meiofaunal density (Fig. 75). This may structure microbial diversity and therefore the organic matter mineralisation rate.

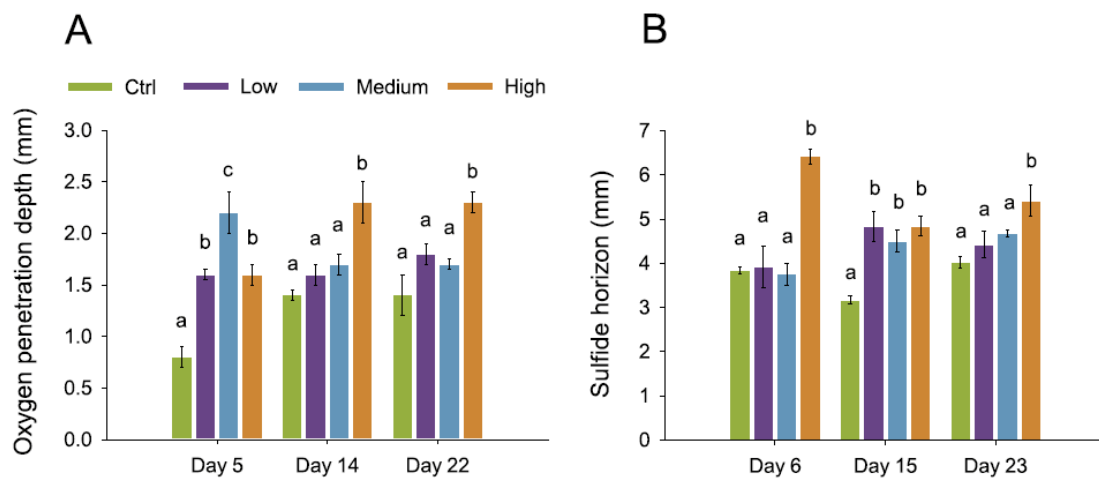

Figure 75. (A) Oxygen penetration depths (OPDs) and (B) depth of sulfide horizons measured with microsensors in the four treatments. Different letters on top of each bar indicate significant differences among density treatments. Bars represent average values \pm SD (n=9 replicates). From Bonaglia et al. (2020).

Such experiments were performed with meiofaunal community but there is no mention of foraminifera. Such techniques could be however applied on foraminifera and in particular *H. germanica* as the infaunal character of the species potentially affect the exchange of water and dissolved fluxes between the water column and the sediment. In the context of the research project COFFEE in which I am involved, our preliminary experiments suggest that benthic foraminifera eventually enhance the oxygen penetration depth (Langlet et al. in prep.)

May interspecific facilitation by benthic foraminifera favour microbial communities?

Studying bioturbation processes is a useful way to evaluate the interaction between biotic compartments. Indeed, faunal activity control the rates and pathways of mineralisation in marine sediment hence the intensity of bacterial mineralisation (Kristensen 2000, Kristensen & Mikkelsen 2003, Marinelli & Waldbusser 2005, Meysman et al. 2006). Such interspecific facilitation was described in a study that

measured the mineralisation of a ^{14}C -labeled diatom bloom in sediment together with the production of $^{14}\text{CO}_2$ in the presence/absence of meiofauna (Fig. 76; Nascimento et al. 2012). They showed that meiofauna positively affect the bacterial community which thereby enhance the organic mineralisation rate (Fig. 76).

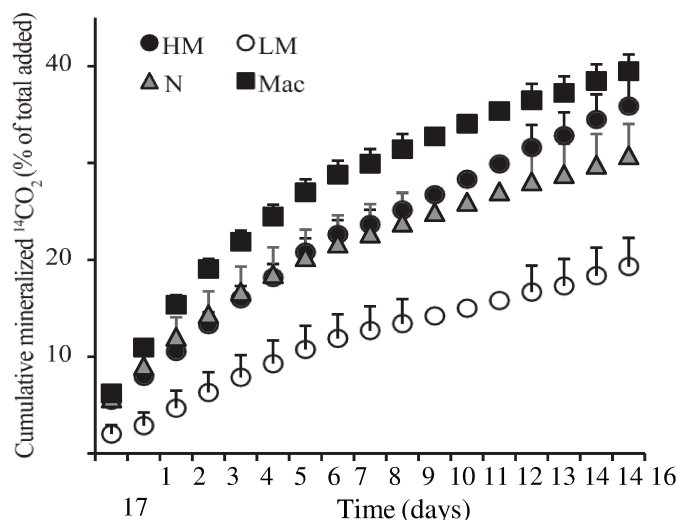

Figure 76. Cumulative amount of mineralized ^{14}C in the three treatments. HM= High Meiofauna; LM = Low Meiofauna; Mac = treatment with *Macoma balthica* (bivalve) and high meiofauna; N = unmanipulated treatment. Values are means \pm SE (n=7). From Nascimento et al. (2012).

Similarly, it has been recently shown that meiofauna may have a bottom-up effect on the macrofaunal diversity and their role in benthic ecosystem functioning (Piot et al. 2013). This stresses the need to consider meiofauna with greater attention in studies dealing with the bioturbation of marine ecosystems.

End note

The central objective of my PhD thesis was to improve our understanding of foraminiferal bioturbation through the characterization of their role in sediment reworking process. The present study results open new perspectives on the ecology of intertidal benthic foraminifera and their unsuspected role in sediment reworking. Here, the perspectives that are presented, only constitute a small view of what we can further do to improve our understanding on the motion behaviour of intertidal foraminifera and their effect on bioturbation processes as a whole.

REFERENCES

A

- Abdullah M, Lee S (2016) Meiofauna and crabs in mangroves and adjoining sandflats: is the interaction physical or trophic? *Journal of Experimental Marine Biology and Ecology* 479:69–75.
- Adkins S, Marsden I, Pirker J (2014) Variation in population structure and density of *Austrovenus stutchburyi* (Veneridae) from Canterbury, New Zealand. *Journal of Shellfish Research* 33:343–354.
- Adl S et al. (2007) Diversity, nomenclature, and taxonomy of protists. *Systematic Biology* 56:684–689.
- Alkemade R, Wielemaker A, Hemminga M (1992) Stimulation of decomposition of *Spartina anglica* leaves by the bacterivorous marine nematode *Diplolaimelloides brucei* (Monohysteridae). *Journal of Experimental Marine Biology and Ecology* 159:267–278.
- Aller RC (1982) The effect of macrobenthos on chemical properties of marine sediments and overlying water. In: *Animal-sediment relations*, McCall PL, Tevesz MJS. Plenum Press, New York, 53–102.
- Aller RC (1994) Bioturbation and remineralization of sedimentary organic matter: effects of redox oscillation. *Chemical Geology* 114:331–345.
- Aller RC (2014) Sedimentary diagenesis, depositional environments, and benthic fluxes. In: *Treatise on geochemistry, 2nd edn*, Holland HD, Turekian KK. Elsevier, Oxford, 293–334.
- Aller RC, Aller JY (1992) Meiofauna and solute transport in marine muds. *Limnology and Oceanography* 37:1018–1033.
- Aller RC, Benninger LK, Cochran JK (1980) Tacking particles-associated processes in nearshore environments by use of $^{234}\text{Th}/^{238}\text{U}$ disequilibrium. *Earth and Planetary Science Letters* 47:161–178.
- Allison N et al. (2010) Culture studies of the benthic foraminifera *Elphidium williamsoni*: evaluating pH, $\Delta[\text{CO}_3^{2-}]$ and inter-individual effects on test Mg/Ca. *Chemical Geology* 274:87–93.
- Altenbach AV (1992) Short term processes and patterns in the foraminiferal response to organic flux rates. *Marine Micropaleontology* 19:119–129.

- Altenbach AV et al. (1993) *Miliolinella subrotunda* (Montagu), a miliolid foraminifer building large detritic tubes for a temporary epibenthic lifestyle. *Marine Micropaleontology* 20:293–301.
- Alvarez MF et al. (2015) Combined engineering effects of clams and crabs on infaunal assemblages and food availability in intertidal systems. *Marine Ecology Progress Series* 540:57–71.
- Alve E (1995) Benthic foraminiferal distribution and recolonization of formerly anoxic environments in Drammensfjord, southern Norway. *Marine Micropaleontology* 25:169–186.
- Alve E (1999) Colonization of new habitats by benthic foraminifera: a review. *Earth-Science Reviews* 46:167–185.
- Alve E, Murray JW (1994) Ecology and taphonomy of benthic foraminifera in a temperate mesotidal inlet. *Journal of Foraminiferal Research* 24:18–27.
- Alve E, Bernhard JM (1995) Vertical migratory response of benthic foraminifera to controlled oxygen concentrations in an experimental mesocosm. *Marine Ecology Progress Series* 116:137–152.
- Alve E, Murray JW (1999) Marginal marine environments of the Skagerrak and Kattegat: a baseline study of living (stained) benthic foraminiferal ecology. *Palaeogeography, Palaeoclimatology, Palaeoecology* 146:171–193.
- Alve E, Murray JW (2001) Temporal variability in vertical distributions of live (stained) intertidal foraminifera, Southern England. *Journal of Foraminiferal Research* 31:12–24.
- Alve E, Goldstein ST (2003) Propagule transport as a key method of dispersal in benthic foraminifera (Protista). *Limnology and Oceanography* 48:2163–2170.
- Alve E, Goldstein ST (2010) Dispersal, survival and delayed growth of benthic foraminiferal propagules. *Journal of Sea Research* 63:36–51.
- Amara R et al. (2007) Growth and condition indices in juveniles sole *Solea solea* measured to assess the quality of essential fish habitat. *Marine Ecology Progress Series* 351:201–208.
- Andersen T et al. (2002) Enhanced erodibility of fine-grained marine sediments by *Hydrobia ulvae*. *Journal of Sea Research* 48:51–58.
- Angell R (1990) Observations on reproduction and juvenile test building in the foraminifer *Trochammina inflata*. *Journal of Foraminiferal Research* 20:246–247.

- Angilletta MJ (2009) Looking for answers to questions about heat stress: researchers are getting warmer. *Functional Ecology* 23:231–232.
- Armstrong H, Brasier M (2005) *Microfossils* (2nd edition). Blackwell publishing. Oxford, USA.
- Armynot du Châtelet E et al. (2016) Environmental control on a land–sea transitional setting: integrated sedimentological, geochemical and faunal approaches. *Environmental Earth Sciences* 75:123.
- Armynot du Châtelet E, Francescangeli F, Frontalini F (2018) Definition of benthic foraminiferal bioprovinces in transitional environments of the Eastern English Channel and the Southern North Sea. *Revue de Micropaléontologie* 61:223–234.
- Ashley G (1990) Classification of large-scale subaqueous bedforms: a new look at an old problem. *Journal of Sedimentary Research* 60:160–172.
- Austin H, Austin W, Paterson D (2005) Extracellular cracking and content removal of the benthic diatom *Pleurosigma angulatum* (Quekett) by the benthic foraminifera *Haynesina germanica* (Ehrenberg). *Marine Micropaleontology* 57:68–73.

B

- Balsamo M et al. (2012) Meiofauna as a tool for marine ecosystem biomonitoring. *Marine Ecosystems* 4:77–104.
- Banerjee O, Crossman N, de Groot R (2013) Ecological processes, functions and ecosystem services. In: *Ecosystem Services in Agricultural and Urban Landscapes*, Wratten S, Sandhu H, Cullen R and Costanza R. John Wiley & Sons, Ltd, Oxford, 16–27.
- Banta GT et al. (1999) Effects of two polychaete worms, *Nereis diversicolor* and *Arenicola marina*, on aerobic and anaerobic decomposition in a sandy marine sediment. *Aquatic Microbial Ecology* 19:189–204.
- Barahona M, Navarrete S (2010) Movement patterns of the seastar *Heliaster helianthus* in central Chile: relationship with environmental conditions and prey availability. *Marine Biology* 157:647–661.

- Barmawidjaja DM et al. (1992) Microhabitat selection by benthic foraminifera in the Northern Adriatic Sea. *Journal of Foraminiferal Research* 22:297–317.
- Barrow M, Wells R (1982) Ventilation and oxygen extraction in an arenicolid polychaete. *Comparative Biochemistry and Physiology - Part A* 73:491–495.
- Bates D et al. (2007) The lme4 Package. R Package Version 2, 74.
- Beaumont N et al. (2007) Identification, definition and quantification of goods and services provided by marine biodiversity: implications for the ecosystem approach. *Marine Pollution Bulletin* 54:253–265.
- Beck M et al. (2001) The identification, conservation and management of estuarine and marine nurseries for fish and invertebrates. *BioScience* 51:633–641.
- Bell W (1991) *Searching behaviour: the behavioural ecology of finding resources*. Springer. Berlin.
- Benthuisen JA et al. (2018) Extreme marine warming across tropical australia during austral summer 2015-2016. *Journal of Geophysical Research: Oceans* 123:1301–1326.
- Berkeley A et al. (2007) A review of the ecological and taphonomic controls on foraminiferal assemblage development in intertidal environments. *Earth-Science Reviews* 83:205–230.
- Berkenbush K, Rowden A (1999) Factors influencing sediment turnover by the burrowing ghost shrimp *Callinassa filholi* (Decapoda: Thalassinidea). *Journal of Experimental Marine Biology and Ecology* 238:283–292.
- Bernard G et al. (2016) Experimental assessment of the effects of temperature and food availability on particle mixing by the bivalve *Abra alba* using new image analysis techniques. *PLoS ONE* 11:e0154270.
- Bernhard JM (1993) Experimental and field evidence of Antarctic foraminiferal tolerance to anoxia and hydrogen sulfide. *Marine Micropaleontology* 20:203–213.
- Bernhard JM, Bowser SS (1999) Benthic foraminifera of dysoxic sediments: chloroplast sequestering and functional morphology. *Earth-Science Reviews* 46:149–165.
- Bernhard JM et al. (1997) Benthic foraminiferal proxy to estimate dysoxic bottom-water oxygen concentrations: Santa Barbara basin, US Pacific continental margin. *Journal of Foraminiferal Research* 27:301–310.

- Bernhard JM et al. (2006) Comparison of two methods to identify live benthic foraminifera: a test between Rose Bengal and CellTracker Green with implications for stable isotope paleoreconstructions. *Paleoceanography and Paleoclimatology* 21:PA4210.
- Bernhard JM et al. (2009) Tolerance of allogromid Foraminifera to severaly elevated carbon dioxide concentrations: implications to future ecosystem functioning and paleoceanographic interpretations. *Global and Planetary Change* 65:107–114.
- Bernhard JM, Goldstein S, Bowser S (2010) An ectobiont-bearing foraminiferan, *Bolivina pacifica*, that inhabits microxic pore waters: cell-biological and paleoceanographic insights. *Environmental Microbiology* 12:2107–2199.
- Bernhard JM, Tsuchiya M, Nomaki H (2018) Ultrastructural observations on prokaryotic associates of benthic foraminifera: food, mutualistic symbionts, or parasites? *Marine Micropaleontology* 138:33–45.
- Bertics VJ, Ziebis W (2009) Biodiversity of benthic microbial communities in bioturbated coastal sediments is controlled by geochemical microniches. *The ISME Journal* 3:1269–1285.
- Beukema J, De Vlas J (1979) Population parameters of the lugworm, *Arenicola marina*, living on tidal flats in the Dutch Wadden Sea. *Netherlands Journal of Sea Research* 13:331–353.
- Bhaud M (1988) Influence of temperature and food supply on development of *Eupolymnia nebulosa* (Montagu, 1818) (Polychaeta: Terebellidae). *Journal of Experimental Marine Biology and Ecology* 118:103–113.
- Biles C et al. (2002) Bioturbation, ecosystem functioning and community structure. *Hydrology and Earth System Sciences* 6:999–1005.
- Bird C et al. (2020) Heterotrophic foraminifera capable of inorganic nitrogen assimilation. *Frontiers in Microbiology* 11:604979.
- Blanchard G et al. (1997) Kinetics of tidal resuspension of microbiota: testing the effects of sediment cohesiveness and bioturbation using flume experiments. *Marine Ecology Progress Series* 151:17–25.
- Boerema A, Meire P (2017) Management for estuarine ecosystem services: a review. *Ecological Engineering* 98:172–182.
- Bolnick DI et al. (2011) Why intraspecific trait variation matters in community ecology. *Trends in Ecology & Evolution* 26:183–192.

- Boltovskoy E (1966) Depth at which foraminifera can survive in sediments. *Contribution from the Cushman Foundation for Foraminiferal Research* 17:43–45.
- Bonaglia S et al. (2014) Meiofauna increases bacterial denitrification in marine sediments. *Nature Communications* 5:5133.
- Bonaglia S et al. (2019) Sulfide oxidation in deep Baltic Sea sediments upon oxygenation and colonization by macrofauna. *Marine Biology* 166:149.
- Bonaglia S et al. (2020) Meiofauna improve oxygenation and accelerate sulfide removal in the seasonally hypoxic seabed. *Marine Environmental Research* 159:104968.
- Bond NA et al. (2015) Causes and impacts of the 2014 warm anomaly in the NE Pacific. *Geophysical Research Letters* 42:3414–3420.
- Bornmalm L, Corliss BH, Tedesco K (1997) Laboratory observations of rates and patterns of movement of continental margin benthic foraminifera. *Marine Micropaleontology* 29:175–184.
- Bouchet VMP, Seuront L (2020) Strength may lie in numbers: intertidal foraminifera non-negligible contribution to surface sediment reworking. *Open Journal of Marine Science* 10:131–140.
- Bouchet VMP et al. (2007) Effects of short-term environmental disturbances on living benthic foraminifera during the Pacific oyster summer mortality in the Marennes-Oléron Bay (France). *Marine Environmental Research* 64:358–383.
- Bouchet VMP et al. (2009) Influence of the mode of macrofauna-mediated bioturbation on the vertical distribution of living benthic foraminifera: first insight from axial tomodesitometry. *Journal of Experimental Marine Biology and Ecology* 371:20–33.
- Bouchet VMP et al. (2018) Can benthic foraminifera serve as proxies for changes in benthic macrofaunal community structures? Implications for the definition of reference conditions. *Marine Environmental Research* 137:24–36.
- Bouchet VMP et al. (2020) Benthic foraminifera to assess ecological quality statuses: the case of salmon fish farming. *Ecological Indicators* 117:106607.
- Boudreau B (1986a) Mathematics of tracer mixing in sediments: I. Spatially-dependent, diffusive mixing. *American Journal of Science* 286:161–198.

- Boudreau BP (1986b) Mathematics of tracer mixing in sediments. II. Non-local mixing and biological conveyor-belt phenomena. *American Journal of Science* 286:199–238.
- Bradshaw J (1961) Laboratory experiments on the ecology of foraminifera. *Contribution from the Cushman Foundation for Foraminiferal Research* 12:87–106.
- Bradshaw C, Kumblad L, Fagrell A (2006) The use of tracers to evaluate the importance of bioturbation in remobilising contaminants in Baltic sediments. *Estuarine, Coastal and Shelf Science* 66:123–134.
- Braeckman U et al. (2010) Role of macrofauna functional traits and density in biogeochemical fluxes and bioturbation. *Marine Ecology Progress Series* 399:173–186.
- Braeckman U et al. (2013) Meiofauna metabolism in suboxic sediments: currently overestimated. *PLoS ONE* 8:e59289.
- Buffan-Dubau E, Carman K (2000) Diel feeding behaviour of meiofauna and their relationships with microalgal resources. *Limnology and Oceanography* 45:381–395.
- Buzas MA (1965) The distribution and abundance of foraminifera in Long Island. *Smithsonian Miscellaneous Collections* 149:1–89.
- Buzas MA (1978) Foraminifera as prey for benthic deposit feeders: results of predator exclusion experiments. *Journal of Marine Research* 36:617–625.

C

- Cadée G (1976) Sediment reworking by *Arenicola marina* on tidal flats in the Dutch Wadden Sea. *Netherlands Journal of Sea Research* 10:440–460.
- Caputi N et al. (2016) Management adaptation of invertebrate fisheries to an extreme marine heatwave event at a global warming hot spot. *Ecology and Evolution* 6:3583–3593.
- Caputi N et al. (2019) Factors affecting the recovery of invertebrates stocks from the 2011 Western Australian extreme marine heatwave. *Frontiers in Marine Sciences* 6:484.

- Caralp MH (1989) Size and morphology of the benthic foraminifer *Melonis barleeaanum*: relationship with marine organic matter. *Journal of Foraminiferal Research* 19:235–245.
- Cardinale BJ et al. (2011) The functional role of producer diversity in ecosystems. *American Journal of Botany* 98:572–592.
- Cavalier-Smith T, Chao E-Y (2003) Phylogeny and classification of phylum Cercozoa (Protozoa). *Protist* 154:341–358.
- Cearreta A (1988) Population dynamics of benthic foraminifera in the Santona Estuary, Spain. *Revue de Paléobiologie* 2:721–724.
- Cearreta A et al. (2002) Environmental transformation of the Bilbao estuary, N. Spain: microfaunal and geochemical proxies in the recent sedimentary record. *Marine Pollution Bulletin* 44:487–503.
- Cedhagen T (1996) Foraminiferans as food for cephalaspideans (Gastropoda: Opisthobranchia), with notes on secondary tests around calcareous foraminiferans. *Phuket Marine Biological Center Special Publication* 16:279–290.
- Cesbron F et al. (2016) Vertical distribution and respiration rates of benthic foraminifera: contribution to aerobic remineralization in intertidal mudflats covered by *Zostera noltei* meadows. *Estuarine, Coastal and Shelf Science* 179:23–38.
- Cesbron F et al. (2017) Sequestered chloroplasts in the benthic foraminifer *Haynesina germanica*: cellular organization, oxygen fluxes and potential ecological implications. *Journal of Foraminiferal Research* 47:268–278.
- Chandler GT (1989) Foraminifera may structure meiobenthic communities. *Oecologia* 81:354–360.
- Chandler GT, Fleeger J (1984) Tube-building by a marine meiobenthic harpacticoid copepod. *Marine Biology* 82:15–19.
- Chapman M (2000a) A comparative study of differences among species and patches of habitat on movements of three species of intertidal gastropods. *Journal of Experimental Marine Biology and Ecology* 244:181–201.
- Chapman M (2000b) Poor design of behavioural experiments gets poor results: examples from intertidal habitats. *Journal of Experimental Marine Biology and Ecology* 250:77–95.

- Chapperon C, Seuront L (2011a) Variability in the motion behaviour of intertidal gastropods: ecological and evolutionary perspectives. *Journal of the Marine Biological Association of the United Kingdom* 91:237–244.
- Chapperon C, Seuront L (2011b) Behavioral thermoregulation in a tropical gastropod: links to climate change scenarios. *Global Change Biology* 17:1740–1749.
- Chapperon C, Seuront L (2012) Keeping warm in the cold: on the thermal benefits of aggregation behaviour in an intertidal ectotherm. *Journal of Thermal Biology* 37:640–647.
- Choquel C et al. (2021) Total nitrate uptake by an invasive benthic foraminifer in marine sediments. *Biogeosciences* 18:327–341.
- Chronopoulou P-M et al. (2019) Metabarcoding insights into the trophic behavior and identity of intertidal benthic foraminifera. *Frontiers in Microbiology* 10:1169.
- Ciacci C et al. (2019) Nanoparticle-biological interactions in a marine benthic foraminifer. *Scientific Reports* 9:19441.
- Citadin M, Costa T, Netto S (2016) The response of meiofauna and microphytobenthos to engineering effects of fiddler crabs on a subtropical intertidal sandflat. *Austral Ecology* 41:572–579.
- Cohen-Shacham E et al. (2014) Using the ecosystem services concept to analyse stakeholder involvement in wetland management. *Wetlands Ecology and Management* 22:1–19.
- Coll M et al. (2008) Ecosystem overfishing in the ocean. *PLoS ONE* 3:e3881.
- Corliss B (1985) Microhabitats of benthic foraminifera within deep-sea sediments. *Nature* 314:435–438.
- Corliss B (1991) Morphology and microhabitat preferences of benthic foraminifera from the northwest Atlantic Ocean. *Marine Micropaleontology* 17:195–236.
- Costanza R et al. (1993) Modeling complex ecological economic systems: toward an evolutionary, dynamic understanding of people and nature. *BioScience* 43:545–555.
- Costanza R et al. (1997) The value of the world's ecosystem services and natural capital. *Nature* 387:253–260.
- Coull BC (1999) Role of meiofauna in estuarine soft-bottom habitats. *Austral Ecology* 24:327–343.

- Couturier C et al. (2007) Effects of water viscosity upon ventilation and metabolism of a flatfish, the common sole *Solea solea* (L.). *Marine Biology* 152:803–814.
- Covich AP et al. (2004) The role of biodiversity in the functioning of freshwater and marine benthic ecosystems. *BioScience* 54:767–775.
- Cozzoli F et al. (2019) A process based model of cohesive sediment resuspension under bioturbators' influence. *Science of the Total Environment* 670:18–30.
- Crutsinger GM (2006) Plant genotypic diversity predicts community structure and governs an ecosystem process. *Science* 313:966–968.
- Cullen DJ (1973) Bioturbation of superficial marine sediments by interstitial meiobenthos. *Nature* 242:323–324.
- Culver SJ (1993) Foraminifera. In: *Fossil prokaryotes and protists*, Blackwell Scientific Publications, Oxford, 203-247.

D

- Daily G et al. (1997) Ecosystem services: benefits supplied to human societies by natural ecosystems. *Issues in Ecology* 1:1–18.
- Dale S et al. (2005) Information and its use by animals in evolutionary ecology. *Trends in Ecology and Evolution* 20:187–193.
- Dame R (2012) *Ecology of marine bivalves: an ecosystem approach*, 2nd ed. CRC Press, Taylor and Francis Group, London.
- Danovaro R et al. (2001) Small-scale distribution of bacteria, enzymatic activities, and organic matter in coastal sediments. *Microbial Ecology* 42:177–185.
- Danovaro R et al. (2008) Exponential decline of deep-sea ecosystem functioning linked to benthic biodiversity loss. *Current Biology* 18:1–8.
- Danovaro R et al. (2010) Deep-sea biodiversity in the Mediterranean Sea: the known, the unknown, and the unknowable. *PLoS ONE* 5: e11832.
- Dauwe B, Herman P, Heip C (1998) Community structure and bioturbation potential of macrofauna at four North Sea stations with contrasting food supply. *Marine Ecology Progress Series* 173:67–83.
- Davies MS, Blackwell J (2007) Energy saving through trail following in a marine snail. *Proceedings of the Royal Society: Biological Sciences* 274:1233–1236.

- Davis R (1993) The role of bioturbation in sediment resuspension interaction with physical shearing. *Journal of Experimental Marine Biology and Ecology* 171:187–200.
- De Backer A et al. (2009) Remote sensing of biologically reworked sediments: a laboratory experiment. *Estuaries and Coasts* 32:1121–1129.
- De Backer A et al. (2010) Behaviour and time allocation of the mud shrimp, *Corophium volutator*, during the tidal cycle. *Helgoland Marine Research* 64:63–67.
- De Backer A et al. (2011) Bioturbation effects of *Corophium volutator*: importance of density and behavioural activity. *Estuarine, Coastal and Shelf Science* 91:306–313.
- De Deckere E, Tolhurst T, De Brouwer J (2001) Destabilization of cohesive intertidal sediments by infauna. *Estuarine, Coastal and Shelf Science* 53:665–669.
- De Mesel I et al. (2004) Top-down impact of bacterivorous nematodes on the bacterial community structure: a microcosm study. *Environmental Microbiology* 6:733–744.
- De Rijk S, Troelstra S (1999) The application of a foraminiferal actuo-facies model to saltmarsh cores. *Palaeogeography, Palaeoclimatology, Palaeoecology* 149:59–66.
- Debenay J-P, Guillou J-J (2002) Ecological transitions indicated by foraminiferal assemblages in paralic environments. *Estuaries* 25:1107–1120.
- Debenay JP et al. (2000) Distributional trends of foraminiferal assemblages in paralic environments - A base for using foraminifera as bioindicators. In: *Environmental micropaleontology*, Martin, RE, Kluwer Academic/Plenum Publishers. New York, 39–67.
- Debenay J-P et al. (2006) Spatio-temporal distribution of benthic foraminifera in relation to estuarine dynamics (Vie estuary, Vendée, W France). *Estuarine, Coastal and Shelf Science* 67:181–197.
- Decho A (1990) Microbial exopolymer secretions in ocean environments: their role(s) in food webs and marine processes. *Oceanography and Marine Biology: An Annual Review* 28:73–153.
- de Goeij JM et al. (2013) Surviving in a marine desert: the sponge loop retains resources within coral reefs. *Science* 342:108–110.

- Degré D et al. (2006) Comparative analysis of the food webs of two intertidal mudflats during two seasons using inverse modelling: Aiguillon Cove and Brouage Mudflat, France. *Estuarine, Coastal and Shelf Science* 69:107–124.
- Deldicq N et al. (2020) Assessing behavioural traits of benthic foraminifera: implications for sediment mixing. *Marine Ecology Progress Series* 643:21–31.
- Deldicq N et al. (2021) Effects of temperature on the behaviour and metabolism of an intertidal foraminifera and consequences for benthic ecosystem functioning. *Scientific Reports* 11:4013.
- Della-Marta P et al. (2007) Doubled length of western European summer heatwaves since 1880. *Journal of Geophysical Research* 112:D15103.
- Deschênes J et al. (2005) Environmental influence on activity levels and behavioural allocation in the polychaete *Nereis virens* (Sars). *Journal of Experimental Marine Biology and Ecology* 317:203–212.
- Dessandier PA et al. (2015) Lateral and vertical distributions of living benthic foraminifera off the Douro River (western Iberian margin): impact of the organic matter quality. *Marine Micropaleontology* 120:31–45.
- D'Hondt A-S et al. (2018) Nematodes stimulate biomass accumulation in a multispecies diatom biofilm. *Marine Environmental Research* 140:78–89.
- Di Bella L et al. (2015) Benthic foraminiferal assemblages in active volcanic area of the Azores Islands (North Atlantic Ocean). *Italian Journal of Geosciences* 134:50–59.
- Diaz JA, Cabezas-Diaz S (2004) Seasonal variation in the contribution of different behavioural mechanisms to lizard thermoregulation. *Functional Ecology* 18:867–875.
- Diz P, Francés G (2008) Distribution of live benthic foraminifera in the Ria de Vigo (NW Spain). *Marine Micropaleontology* 66:165–191.
- Dolbeth M, Raffaelli D, Pardal M (2014) Patterns in estuarine macrofauna body size distribution: the role of habitat and disturbance impact. *Journal of Sea Research* 2014:404–412.
- Dong S, Lei Y, Li T, Jian Z (2019) Responses of benthic foraminifera to changes of temperature and salinity: results from a laboratory culture experiment. *Science China Earth Sciences* 62:459–472.
- Dorgan KM (2015) The biomechanics of burrowing and boring. *The Journal of Experimental Biology* 218:176–183.

- Dorgan KM et al. (2005) Burrow extension by crack propagation. *Nature* 433:475–475.
- Dorgan KM et al. (2006) Macrofaunal burrowing: the medium is the message. *Oceanography and Marine Biology: An Annual Review* 44:85–121.
- Dorgan KM, Arwade SR, Jumars PA (2007) Burrowing in marine muds by crack propagation: kinematics and forces. *The Journal of Experimental Biology* 210:4198–4212.
- Dorgan KM, Arwade SR, Jumars PA (2008) Worms as wedges: effects of sediment mechanics on burrowing behavior. *Journal of Marine Research* 66:219–254.
- Dubois Y et al. (2009) Thermoregulation and habitat selection in wood turtles *Glyptemys insculpta*: chasing the sun slowly. *Journal of Animal Ecology* 78:1023–1032.
- Duchemin G et al. (2008) Seasonal variability of living benthic foraminifera from the outer continental shelf of the Bay of Biscay. *Journal of Sea Research* 59:297–319.
- Duijnste IAP, Ernst SR, Van Der Zwaan GJ (2003) Effect of anoxia on the vertical migration of benthic foraminifera. *Marine Ecology Progress Series* 246:85–94.
- Duport E et al. (2006) Effects of population density on the sediment mixing induced by the gallery-diffuser *Hediste (Nereis) diversicolor*, O.F. Müller, 1776. *Journal of Experimental Marine Biology and Ecology* 336:33–41.
- Duport E et al. (2007) Benthic macrofauna and sediment reworking quantification in contrasted environments in the Thau Lagoon. *Estuarine, Coastal and Shelf Science* 72:522–533.
- Dupuy C et al. (2010) Predation of mudflat meio-macrofauna metazoans by a calcareous foraminifer, *Ammonia tepida* (Cushman, 1926). *Journal of Foraminiferal Research* 40:305–312.

E - F

- Elliott M, Quintino V (2007) The estuarine quality paradox, environmental homeostasis and the difficulty of detecting anthropogenic stress in naturally stressed areas. *Marine Pollution Bulletin* 54:640–645.
- Elliott M, Whitfield A (2011) Challenging paradigms in estuarine ecology management. *Estuarine, Coastal and Shelf Science* 94:306–314.

- Ernst S, Duijnste IAP, Van Der Zwaan B (2002) The dynamics of the benthic foraminiferal microhabitat: recovery after experimental disturbance. *Marine Micropaleontology* 46:343–361.
- Fatela F et al. (2009) Environmental constraints of foraminiferal assemblages distribution across a brackish tidal marsh (Caminha, NW Portugal). *Marine Micropaleontology* 70:70–88.
- Filipsson HL (2008) Culturing of benthic foraminifera for improved paleoceanographic reconstructions. *Palaios* 23:1–2.
- Fontanier C et al. (2002) Live benthic foraminiferal faunas from the Bay of Biscay: faunal density, composition, and micro-habitats. *Deep-Sea Research I* 49:751–785.
- Forster S, Graf G (1995) Impact of irrigation on oxygen flux into the sediment: intermittent pumping by *Callianassa subterranea* and ‘piston-pumping’ by *Lanice conchilega*. *Marine Biology* 123:335–346.
- Fossing H et al. (1995) Concentration and transport of nitrate by mat-forming sulphur bacterium *Thioploca*. *Nature* 374:713–715.
- Frail-Gauthier JL et al. (2019) Mesocosm and microcosm experiments on the feeding of temperate salt marsh Foraminifera. *Journal of Foraminiferal Research* 49:259–274.
- Francescangeli F (2017) Spatio-temporal distribution of benthic foraminifera in intertidal areas of Hauts-de-France: environmental applications and implications. PhD thesis, Université de Lille, 203 pp.
- Francescangeli F et al. (2016) Palaeo-ecological quality status based on foraminifera of Boulogne-sur-Mer harbour (Pas-de-Calais, Northeastern France) over the last 200 years. *Marine Environmental Research* 117:32–43.
- Francescangeli F et al. (2020) Multidisciplinary study to monitor consequences of pollution on intertidal benthic ecosystems (Hauts de France, English Channel, France): comparison with natural areas. *Marine Environmental Research* 160:105034.
- François F et al. (1997) A new approach for the modelling of sediment reworking induced by a macrobenthic community. *Acta Biotheoretica* 45:295–319.
- François F et al. (2001) A new model of bioturbation for a functional approach to sediment reworking resulting from macrobenthic communities. In: *Organism-*

sediment interactions, Aller JY, Woodin SA, Aller RC. University of South Carolina Press, Columbia, 75–88.

François F, Gérino M, Stora G, Durbec J, Poggiale J (2002) Functional approach to sediment reworking by gallery-forming macrobenthic organisms: modeling and application with the polychaete *Nereis diversicolor*. *Marine Ecology Progress Series* 229:127–136.

Fraser KPP, Clarke A, Peck LS (2002) Low-temperature protein metabolism: seasonal changes in protein synthesis and RNA dynamics in the Antarctic limpet *Nacella concinna* Strebel 1908. *The Journal of Experimental Biology* 205:3077–3086.

Frölicher T, Fischer E, Gruber N (2018) Marine heatwaves under global warming. *Nature* 560:360–376.

Frontalini F, Coccioni R (2011) Benthic foraminifera as bioindicators of pollution: a review of Italian research over the last three decades. *Revue de Micropaléontologie* 54:115–127.

G

Gagic V et al. (2015) Functional identity and diversity of animals predict ecosystem functioning better than species-based indices. *Proceedings of the Royal Society B: Biological Sciences* 282:20142620.

Gaillard J et al. (2010) Habitat-performance relationships: finding the right metric at a given spatial scale. *Philosophical Transactions of the Royal Society B* 365:2255–2265.

Garrabou J et al. (2009) Mass mortality in Northwestern Mediterranean rocky benthic communities: effects of the 2003 heatwave. *Global Change Biology* 15:1090–1103.

Garten L (2016) The coastal zone management act: a mixed success. *Consilience: The Journal of Sustainable Development* 16:1–13.

Gee J (1985) Seasonal aspects of the relationship between temperature and respiration rate in four species of intertidal harpacticoid copepod. *Journal of Experimental Marine Biology and Ecology* 93:147–156.

Gérino M (1990) The effects of bioturbation on particle redistribution in Mediterranean coastal sediment. Preliminary result. *Hydrobiologia* 207:251–258.

- Gérino M, Stora G, Durbec J (1994) Quantitative estimation of biodiffusive and bioadvective sediment mixing: in situ experimental approach. *Oceanologica Acta* 17:547–554.
- Gérino M et al. (1998) Comparison of different tracers and methods used to quantify bioturbation during a spring bloom: ²³⁴-thorium, luminophores and chlorophyll *a*. *Estuarine, Coastal and Shelf Science* 46:531–547.
- Gérino M et al. (2003) Macro-invertebrate functional groups in freshwater and marine sediments: a common mechanistic classification. *Vie Milieu* 53:221–231.
- Gérino M et al. (2007) Bioturbation in the Venice Lagoon: rates and relationship to organisms. *Acta Oecologica* 32:14–25.
- Gerlach S (1978) Food-chain relationships in subtidal silty sand marine sediments and the role of meiofauna in stimulating bacterial productivity. *Oecologia* 33:55–69.
- Geslin E et al. (2004) Migratory responses of deep-sea benthic foraminifera to variable oxygen conditions: laboratory investigations. *Marine Micropaleontology* 53:227–243.
- Geslin E et al. (2011) Oxygen respiration rates of benthic foraminifera as measured with oxygen microsensors. *Journal of Experimental Marine Biology and Ecology* 396:108–114.
- Giere O (1993) *Meiobenthology: the microscopic fauna in aquatic sediments*, Springer, Berlin.
- Giere O (2009) *Meiobenthology: the microscopic motile fauna of aquatic sediments*, 2nd edn. Springer, Berlin.
- Gilbert F, Stora G, Bertrand J (1996) *In situ* bioturbation and hydrocarbon fate in an experimental contaminated Mediterranean coastal ecosystem. *Chemosphere* 33:1449–1458.
- Gilbert F et al. (2003) 2-D optical quantification of particle reworking activities in marine surface sediments. *Journal of Experimental Marine Biology and Ecology* 285–286:251–263.
- Gilbert F et al. (2007) Sediment reworking by marine benthic species from the Gullmar Fjord (Western Sweden): importance of faunal biovolume. *Journal of Experimental Marine Biology and Ecology* 348:133–144.
- Gilbert C et al. (2010) One for all and all for one: the energetic benefits of huddling in endotherms. *Biological Reviews* 85:545–569.

- Gilbertson WW, Solan M, Prosser JI (2012) Differential effects of microorganism-invertebrate interactions on benthic nitrogen cycling. *FEMS Microbiology Ecology* 82:11–22.
- Glock N et al. (2013) The role of benthic foraminifera in the benthic nitrogen cycle of the Peruvian oxygen minimum zone. *Biogeosciences* 10:4767–4783.
- Glud RN et al. (1994) Diffusive and total oxygen uptake of deep-sea sediments in the eastern South Atlantic Ocean: in situ and laboratory measurements. *Deep-Sea Research I* 41:1767–1788.
- Glud RN et al. (2009) Nitrogen cycling in a deep ocean margin sediment (Sagami Bay, Japan). *Limnology and Oceanography* 54:723–734.
- Goineau A et al. (2011) Live (stained) benthic foraminifera from the Rhône prodelta (Gulf of Lion, NW Mediterranean): environmental controls on a river-dominated shelf. *Journal of Sea Research* 65:58–75.
- Goldstein ST, Watkins GT, Kuhn RM (1995) Microhabitats of salt marsh foraminifera: St. Catherines Island, Georgia, USA. *Marine Micropaleontology* 26:17–29.
- Gooday AJ, Alve E (2001) Morphological and ecological parallels between sublittoral and abyssal foraminiferal species in the NE Atlantic: a comparison of *Stainforthia fusiformis* and *Stainforthia* sp. *Progress in Oceanography* 50:261–283.
- Gooday AJ et al. (1992) The role of benthic foraminifera in deep-sea food webs and carbon cycling. In: *Deep-sea food chains and the global carbon cycle*. Rowe GT, Pariente V. Springer, Dordrecht, 63–91.
- Gooday AJ et al. (2018) Five new species and two new genera of xenophyophores (Foraminifera: Rhizaria) from part of the abyssal equatorial Pacific licensed for polymetallic nodule exploration. *Zoological Journal of the Linnean Society* 183:723–748.
- Gordon JE (1991) *The new science of strong materials*. Penguin Adult, USA.
- Gosling E (2004) *Bivalve Molluscs biology, ecology and culture*. Wiley-Blackwell, Oxford, UK.
- Gothland M et al. (2014) Biological traits explain the distribution and colonisation ability of the invasive shore crab *Hemigrapsus takanoi*. *Estuarine, Coastal and Shelf Science* 142:41–49.

- Gouletquer P et al. (1998) Summer mortality of the Pacific cupped oyster *Crassostrea gigas* in the Bay of Marennes-Oléron (France). *Mariculture Committee CM* 1998/CC:14.
- Green A, Chandler GT (1994) Meiofaunal bioturbation effects on the partitioning of sediment-associated cadmium. *Journal of Experimental Marine Biology and Ecology* 180:59–70.
- Grémare A et al. (2004) Feeding behaviour and functional response of *Abra ovata* and *A. nitida* compared by image analysis. *Marine Ecology Progress Series* 267:195–208.
- Grill S, Dorgan KM (2015) Burrowing by small polychaetes - mechanics, behavior and muscle structure of *Capitella* sp. *Journal of Experimental Biology* 218:1527–1537.
- Gross O (2000) Influence of temperature, oxygen and food availability on the migrational activity of bathyal benthic foraminifera: evidence by microcosm experiments. *Hydrobiologia* 426:123–137.
- Gross O (2002) Sediment interactions of foraminifera: implications for food degradation and bioturbation processes. *Journal of Foraminiferal Research* 32:414–424.
- Guarini J et al. (1997) Modelling the mud surface temperature on intertidal flats to investigate the spatio-temporal dynamics of the benthic microalgal photosynthetic capacity. *Marine Ecology Progress Series* 153:25–36.
- Guarini J et al. (2000) Dynamic model of the short-term variability of microphytobenthic biomass on temperate intertidal mudflats. *Marine Ecology Progress Series* 195:291–303.
- Gudmundsson G, von Schmalensee M, Svavarsson J (2000) Are foraminifers (protozoa) important food for small isopods (Crustacea) in the deep sea? *Deep-Sea Research I* 47:2093–2109.
- Guidetti R, Altiero T, Rebecchi L (2011) On dormancy strategies in tardigrades. *Journal of Insect Physiology* 57:567–576.
- Guinasso N, Schink D (1975) Quantitative estimates of biological mixing rates in abyssal sediments. *Journal of Geophysical Research* 80:3032–3043.
- Gustafsson M, Nordberg K (2001) Living (stained) benthic foraminiferal response to primary production and hydrography in the deepest part of the Gullmar Fjord, Swedish West Coast, with comparisons to Høglund's 1927 material. *Journal of Foraminiferal Research* 31:2–11.

Gustafsson M, Nordberg K (2002) The impact of climate and shore-level displacement on the late-holocene environmental development of Havstens Fjord and Koljö Fjord, Swedish west coast. *The Holocene* 12:325–338.

Gutiérrez JL, Jones CG (2006) Physical ecosystem engineers as agents of biogeochemical heterogeneity. *BioScience* 56:227–236.

H

Hallock P (1981) Light dependence in *Amphistegina*. *Journal of Foraminiferal Research* 11:40–46.

Hallock P (1985) Why are larger foraminifera large? *Paleobiology* 11:195–208.

Hallock P, Hansen HJ (1979) Depth adaptation in *Amphistegina*: change in lamellar thickness. *Bulletin of the Geological Society of Denmark* 27:99–104.

Hallock P et al. (1986) Population biology and sediment production of *Archaias angulatus* (Foraminiferida) in Largo Sound, Florida. *Journal of Foraminiferal Research* 16:1–8.

Harley CDG et al. (2006) The impacts of climate change in coastal marine systems. *Ecology Letters* 9:228–241.

Harrison S, Phizacklea A (1987) Vertical temperature gradient in muddy intertidal sediments in the Forth estuary, Scotland. *Limnology and Oceanography* 32:954–963.

Hattam C et al. (2014) Marine ecosystem services: linking indicators to their classification. *Ecological Indicators* 49:61–75.

Hayward BW et al. (2004) Morphological distinction of molecular types in *Ammonia* - Towards a taxonomic revision of the world's most commonly misidentified foraminifera. *Marine Micropaleontology* 50:237–271.

Heinz P (1999) Response of deep-sea benthic foraminifera to simulated phytodetritus pulses under laboratory conditions. *Tübinger Mikropaläontologische Mitteilungen* 20:126pp.

Heinz P, Geslin E, Hemleben C (2005) Laboratory observations of benthic foraminiferal cysts. *Marine Biology Research* 1:149–159.

- Heip C, Vincx M, Vranken G (1985) The ecology of marine nematodes. *Oceanography and Marine Biology: An Annual Review* 23:399–489.
- Hemleben C, Kitazato H (1995) Deep-sea foraminifera under long time observation in the laboratory. *Deep-Sea Research I* 42:827–832.
- Henry F et al. (2004) Heavy metals in four fish species from the French coast of the Eastern English Channel and Southern Bight of the North Sea. *Environmental International* 30:675–683.
- Henseler C et al. (2019) Coastal habitats and their importance for the diversity of benthic communities: a species- and trait-based approach. *Estuarine, Coastal and Shelf Science* 226:106272.
- Herbert D (1991) Foraminiferivory in a *Puncturella* (Gastropoda: Fissurellidae). *Journal of Molluscan Studies* 57:127–140.
- Higgins R, Thiel H (1988) Introduction to the study of meiofauna, Smithsonian Institution Press. Washington, D.C.
- Hippensteel SP, Martin RE, Nikitina D, Pizzuto JE (2000) The formation of holocene marsh foraminiferal assemblages, Middle Atlantic Coast, U.S.A: implications for holocene sea-level change. *Journal of Foraminiferal Research* 30:272–293.
- Hobday AJ et al. (2016) A hierarchical approach to defining marine heatwaves. *Progress in Oceanography* 141:227–238.
- Hobday AJ et al. (2018) Categorizing and naming marine heatwaves. *Oceanography* 31: 162-173.
- Høgslund S et al. (2008) Denitrification, nitrate turnover, and aerobic respiration by benthic foraminiferans in the oxygen minimum zone off Chile. *Journal of Experimental Marine Biology and Ecology* 359:85–91.
- Hohenegger J (2006) The importance of symbiont-bearing foraminifera for West Pacific carbonate beach environments. *Marine Micropaleontology* 61:4–39.
- Holbrook N et al. (2019) A global assessment of marine heatwaves and their drivers. *Nature Communications* 10:2624.
- Hollertz K, Duchêne J-C (2001) Burrowing behaviour and sediment reworking in the heart urchin *Brissopsis lyrifera* Forbes (Spatangoida). *Marine Biology* 139:951–957.

- Horton B (1999) The distribution of contemporary intertidal foraminifera at Cowpen Marsh, Tees Estuary, UK: implications for studies of Holocene sea-level changes. *Palaeogeography, Palaeoclimatology, Palaeoecology* 149:127–149.
- Horton B, Murray JW (2007) The roles of elevation and salinity as primary controls on living foraminiferal distributions: Cowpen Marsh, Tees Estuary, UK. *Marine Micropaleontology* 63:169–186.
- Hottinger L (1982) Larger foraminifera, giant cells with a historical background. *Naturwissenschaften* 69:361–371.
- Hottinger L (2006) The “face” of benthic foraminifera. *Bollettino della Societa Paleontologica Italiana* 45:75–89.
- Hov Ø et al. (2013) Extreme weather events in Europe preparing for climate change adaptation. Norwegian Meteorological Institute, Oslo, Norway.
- Hubas C et al. (2010) Bacterivorous nematodes stimulate microbial growth and exopolymer production in marine sediment microcosms. *Marine Ecology Progress Series* 419:85–94.
- Hughes T (1975) The sorting of food particles by *Abra* sp. (Bivalvia: Tellinacea). *Journal of Experimental Marine Biology and Ecology* 20:137–156.
- Hulings N, Gray J (1971) A manual for the study of meiofauna. *Smithsonian Contributions to Zoology* 78:1–84.
- Humphries N et al. (2010) Environmental context explains Lévy and Brownian movement patterns of marine predators. *Nature* 465:1066–1069.
- Hunter R, Elder H (1989) Burrowing dynamics and energy cost of transport in the soft-bodied marine invertebrates *Polyphysia crassa* and *Priapulius caudatus*. *The Zoological Society of London* 218:209–222.
- Hymel S, Plante C (2000) Feeding and bacteriolytic responses of the deposit-feeder *Abarenicola pacifica* (Polychaeta: Arenicolidae) to changes in temperature and sediment food concentration. *Marine Biology* 136:1019–1027.

I - J

- Ingalls A et al. (2000) The influence of deposit-feeding on chlorophyll *a* degradation in coastal marine sediments. *Journal of Marine Research* 58:631–651.

- Ingels J et al. (2014) Interactions between multiple large macrofauna species and nematode communities — Mechanisms for indirect impacts of trawling disturbance. *Journal of Experimental Marine Biology and Ecology* 456:41–49.
- Jackson J et al. (2001) Historical overfishing and the recent collapse of coastal ecosystems. *Science* 293:629–637.
- Jauffrais T et al. (2016a) Effect of light on photosynthetic efficiency of sequestered chloroplasts in intertidal benthic foraminifera (*Haynesina germanica* and *Ammonia tepida*). *Biogeosciences* 13:2715–2726.
- Jauffrais T et al. (2016b) Locomotion speed of the benthic foraminifer *Ammonia tepida* exposed to different nitrogen and carbon sources. *Journal of Sea Research* 118:52–58.
- Jauffrais T et al. (2017) Ultrastructure and distribution of kleptoplasts in benthic foraminifera from shallow-water (photic) habitats. *Marine Micropaleontology* 138:46–62.
- Jauffrais T et al. (2019) Response of a kleptoplastidic foraminifer to heterotrophic starvation: photosynthesis and lipid droplet biogenesis. *FEMS Microbiology Ecology* 95:fiz046.
- Jepps M (1942) Studies on *Polystomella Lamarck* (Foraminifera). *Journal of the Marine Biological Association of the United Kingdom* 25:607–666.
- Johansen P-O et al. (2018) Temporal changes in benthic macrofauna on the west coast of Norway resulting from human activities. *Marine Pollution Bulletin* 128:483–495.
- Joint I, Smale DA (2017) Marine heatwaves and optimal temperatures for microbial assemblage activity. *FEMS Microbiology Ecology* 93:fiw243.
- Jorissen FJ et al. (1992) Vertical distribution of benthic foraminifera the Northern Adriatic Sea: the relation with the organic flux. *Marine Micropaleontology* 19:131–146.
- Jorissen FJ, de Stigter HC, Widmark JGV (1995) A conceptual model explaining benthic foraminiferal microhabitats. *Marine Micropaleontology* 26:3–15.
- Jumars P, Nowell A (1984) Effects of benthos on sediment transport: difficulties with functional grouping. *Continental Shelf Research* 3:115–130.

K

- Karlson K et al. (2005) Experimental recolonisation of Baltic Sea reduced sediments: survival of benthic macrofauna and effects on nutrient cycling. *Marine Ecology Progress Series* 294:35–49.
- Karlson K, Bonsdorff E, Rosenberg R (2007) The impact of benthic macrofauna for nutrient fluxes from Baltic sea sediments. *AMBIO* 36:161–167.
- Kennett J (1982) *Marine Geology*, Prentice-Hall, USA.
- Kitazato H (1981) Observation of behaviour and mode of life of benthic foraminifers in laboratory. *Geoscience Reports of Shizuoka University* 6:61–71.
- Kitazato H (1988) Locomotion of some benthic foraminifera in and on sediments. *Journal of Foraminiferal Research* 18:344–349.
- Kitazato H (1994) Foraminiferal microhabitats in four marine environments around Japan. *Marine Micropaleontology* 24:29–41.
- Kogure K, Wada M (2005) Impacts of macrobenthic bioturbation in marine sediment on bacterial metabolic activity. *Microbes and Environments* 20:191–199.
- Kölzsch A et al. (2015) Experimental evidence for inherent Lévy search behaviour in foraging animals. *Proceedings of the Royal Society: Biological Sciences* 282:20150424.
- Koo BJ, Kim S-H, Hyun J-H (2019) Feeding behavior of the ocypodid crab *Macrophthalmus japonicus* and its effects on oxygen-penetration depth and organic-matter removal in intertidal sediments. *Estuarine, Coastal and Shelf Science* 228:106366.
- Kristensen E (1983) Ventilation and oxygen uptake by three species of *Nereis* (Annelida: Polychaeta). I. Effects of hypoxia. *Marine Ecology Progress Series* 12:289–297.
- Kristensen E (2000) Organic matter diagenesis at the oxic/anoxic interface in coastal marine sediments, with emphasis on the role of burrowing animals. *Hydrobiologia* 426:1–24.
- Kristensen E (2008) Mangrove crabs as ecosystem engineers; with emphasis on sediment processes. *Journal of Sea Research* 59:30–43.

- Kristensen E, Mikkelsen O (2003) Impact of the burrow-dwelling polychaete *Nereis diversicolor* on the degradation of fresh and aged macroalgal detritus in a coastal marine sediment. *Marine Ecology Progress Series* 265:141–153.
- Kristensen E, Kostka JE (2005) Macrofaunal burrows and irrigation in marine sediment: microbiological and biogeochemical interactions. In: *Macro- and Microorganisms in Marine Sediments. Coastal and Estuarine Studies* 60. Kristensen E, Haese RR, Kostka JE, American Geophysical Union, Washington, D.C, 125–157.
- Kristensen E et al. (2012) What is bioturbation? the need for a precise definition for fauna in aquatic sciences. *Marine Ecology Progress Series* 446:285–302.

L

- Langer MR (2008) Assessing the contribution of foraminiferan protists to global ocean carbonate production. *Journal of Eukaryotic Microbiology* 55:163–169.
- Langer MR, Gehring CA (1993) Bacteria farming: a possible feeding strategy of some smaller, motile foraminifera. *Journal of Foraminiferal Research* 23:40–46.
- Langer MR, Hottinger L, Huber B (1989) Functional morphology in low-diverse benthic foraminiferal assemblages from tidal flats of the North Sea. *Senckenbergiana Maritima Frankfurtam-Main* 20:81–99.
- Langer MR, Silk M, Lipps J (1997) Global ocean carbonate and carbon dioxide production: the role of reef foraminifera. *Journal of Foraminiferal Research* 27:271–277.
- Langezaal A et al. (2005) Foraminiferal selectivity towards bacteria: an experimental approach using cell-permeant stain. *Journal of Sea Research* 54:256–275.
- Langlet D et al. (2013) Foraminiferal survival after long-term in situ experimentally induced anoxia. *Biogeosciences* 10:7463–7480.
- Langlet D et al. (2014) Foraminiferal species responses to *in situ*, experimentally induced anoxia in the Adriatic Sea. *Biogeosciences* 11:1775–1797.
- Langlet D et al. (2020a) Motion behavior and metabolic response to microplastic leachates in the benthic foraminifera *Haynesina germanica*. *Journal of Experimental Marine Biology and Ecology* 529:151395.

- Langlet D et al. (2020b) Foraminiferal ecology and role in nitrogen benthic cycle in the hypoxic Southeastern Bering sea. *Frontiers in Marine Science* 7:582818.
- Lardies MA et al. (2001) Effects of environmental variables on burial depth of two infaunal bivalves inhabiting a tidal flat in southern Chile. *Journal of the Marine Biological Association of the United Kingdom* 81:809–816.
- Laverock B et al. (2011) Bioturbation: impact on the marine nitrogen cycle. *Biochemical Society Transactions* 39:315–320.
- Le Hir P, Monbet Y, Orvain F (2007) Sediment erodability in sediment transport modelling: can we account for biota effects? *Continental Shelf Research* 27:1116–1142.
- Le Kieffre C et al. (2018) Inorganic carbon and nitrogen assimilation in cellular compartments of a benthic kleptoplastic foraminifer. *Scientific Reports* 8:10140.
- Lebreton B et al. (2012) Food sources used by sediment meiofauna in an intertidal *Zostera noltii* seagrass bed: a seasonal stable isotope study. *Marine Biology* 159:1537–1550.
- Lecerf A, Chauvet E (2008) Intraspecific variability in leaf traits strongly affects alder leaf decomposition in a stream. *Basic and Applied Ecology* 9:598–605.
- Lee JJ et al. (1966) Tracer experiments in feeding littoral foraminifera. *The journal of Protozoology* 13:659–670.
- Lencioni V (2004) Survival strategies of freshwater insects in cold environments. *Journal of Limnology* 63:45–55.
- Lennon JT, Jones SE (2011) Microbial seed banks: the ecological and evolutionary implications of dormancy. *Nature Reviews Microbiology* 9:119–130.
- Levin LA et al. (2001) The function of marine critical transition zones and the importance of sediment biodiversity. *Ecosystems* 4:430–451.
- Levinton J (1979) The effect of density upon deposit-feeding populations: movement, feeding, and floating of *Hydrobia ventrosa* Montagu (Gasteropoda: Prosobranchia). *Oecologia* 43:27–39.
- Levinton J (1985) Complex interactions of a deposit feeder with its resources, roles of density, a competitor, and detrital addition in the growth and survival of the mudsnail *Hydrobia totteni*. *Marine Ecology Progress Series* 22:31–40.

- Levinton J (1990) Variable feeding behavior in three species of *Macoma* (Bivalvia: Tellinacea) as a response to water flow and sediment transport. *Marine Biology* 110:375–383.
- Levinton J, Stewart S (1988) Effects of sediment organics, detrital input, and temperature on demography, production, and body size of a deposit feeder. *Marine Ecology Progress Series* 49:259–266.
- Levri E, Lively C (1996) The effects of size, reproductive condition, and parasitism on foraging behaviour in a freshwater snail, *Potamopyrgus antipodarum*. *Animal Behaviour* 51:891–901.
- Li M, Lei Y, Li T, Jian Z (2019) Impact of temperature on intertidal foraminifera: results from laboratory culture experiment. *Journal of Experimental Marine Biology and Ecology* 520:151224.
- Lima FP, Wethey DS (2012) Three decades of high-resolution coastal sea surface temperatures reveal more than warming. *Nature Communications* 3:704.
- Linke P, Lutze GF (1993) Microhabitat preferences of benthic foraminifera—a static concept or a dynamic adaptation to optimize food acquisition? *Marine Micropaleontology* 20:215–234.
- Linke P et al. (1995) Response of deep-sea benthic foraminifera to a simulated sedimentation event. *Journal of Foraminiferal Research* 25:75–82.
- Lipps J, Valentine J (1970) The role of foraminifera in the trophic structure of marine communities. *Lethaia* 3:279–286.
- Lipps J, Ronan T (1974) Predation on foraminifera by the polychaete worm, *Diopatra*. *Journal of Foraminiferal Research* 4:139–143.
- Lipps JH (1983) Biotic interactions in benthic foraminifera. In: *Biotic interactions in recent and fossil benthic communities*. Plenum Press, New York and London, 331–376.
- Liquete C et al. (2013) Current status and future prospects for the assessment of marine and coastal ecosystem services: a systematic review. *PLoS ONE* 8:e67737.
- Lissman H (1945) The mechanism of locomotion in gastropod molluscs I. Kinematics. *Journal of Experimental Biology* 21:58–69.
- Lohrer AM, Thrush SF, Gibbs MM (2004) Bioturbators enhance ecosystem function through complex biogeochemical interactions. *Nature* 431:1092–1095.

- Lohrer AM et al. (2005) Rapid reworking of subtidal sediments by burrowing spatangoid urchins. *Journal of Experimental Marine Biology and Ecology* 321:155–169.
- Lombard F et al. (2009) Modelling the temperature dependent growth rates of planktic foraminifera. *Marine Micropaleontology* 70:1–7.
- Longo E et al. (2015) Inter- and intra-specific variation in movement behaviour of benthic macroinvertebrates from a transitional habitat: a laboratory experiment. *Rendiconti Lincei* 27:281–290.
- Lopez E (1979) Algal chloroplasts in the protoplasm of three species of benthic foraminifera: taxonomic affinity, viability and persistence. *Marine Biology* 53:201–211.
- Lou F, Gao T, Han Z (2019) Transcriptome analyses reveal alterations in muscle metabolism, immune responses and reproductive behavior of Japanese mantis shrimp (*Oratosquilla oratoria*) at different cold temperature. *Comparative Biochemistry and Physiology Part D: Genomics and Proteomics* 32:100615.

M

- Maes J et al. (2016) An indicator framework for assessing ecosystem services in support of the EU Biodiversity Strategy to 2020. *Ecosystem Services* 17:14–23.
- Mahaut M, Graf G (1987) A luminophore tracer technique for bioturbation studies. *Oceanologica Acta* 10:323–328.
- Maire O et al. (2006) Effects of food availability on sediment reworking in *Abra ovata* and *A. nitida*. *Marine Ecology Progress Series* 319:135–153.
- Maire O et al. (2007a) A comparison of sediment reworking rates by the surface deposit-feeding bivalve *Abra ovata* during summertime and wintertime, with a comparison between two models of sediment reworking. *Journal of Experimental Marine Biology and Ecology* 343:21–36.
- Maire O et al. (2007b) Linking feeding activity and sediment reworking in the deposit-feeding bivalve *Abra ovata* with image analysis, laser telemetry, and luminophore tracers. *Marine Ecology Progress Series* 351:139–150.

- Maire O et al. (2007c) Activity patterns in the terebellid polychaete *Eupolyornia nebulosa* assessed using a new image analysis system. *Marine Biology* 151:737–749.
- Maire O et al. (2008) Quantification of sediment reworking rates in bioturbation research: a review. *Aquatic Biology* 2:219–238.
- Maire O et al. (2016) How does macrofaunal bioturbation influence the vertical distribution of living benthic foraminifera? *Marine Ecology Progress Series* 561:83–97.
- Maltagliati F et al. (2006) Morphological differentiation in the ragworm, *Hediste diversicolor* (Polychaeta, Nereididae), as revealed by variation of paragnath number and distribution. *Italian Journal of Zoology* 73:255–262.
- Mare M (1942) A study of a marine benthic community with special reference to the micro-organisms. *Journal of the Marine Biological Association of the United Kingdom* 25:517–554.
- Marinelli R, Waldbusser GG (2005) Plant–animal– microbe interactions in coastal sediments: closing the ecological loop. In: *Interactions between macro- and microorganisms in marine sediments*. Marinelli RL, Waldbusser GG, American Geophysical Union, 233–249.
- Marinelli R et al. (2002) Experimental investigation of the control of bacterial community composition in macrofaunal burrows. *Marine Ecology Progress Series* 235:1–13.
- Martins MVA et al. (2011) The response of benthic foraminifera to pollution and environmental stress in Ria de Aveiro (N Portugal). *Journal of Iberian Geology* 37:231–246.
- Martins MVA et al. (2013) Assessment of the health quality of Ria de Aveiro (Portugal): Heavy metals and benthic foraminifera. *Marine Pollution Bulletin* 70:18–33.
- Martins MVA et al. (2015) Environmental quality assessment of Bizerte lagoon (Tunisia) using living Foraminifera assemblages and a multiproxy approach. *PLoS ONE* 10:e0137250.
- Massé C et al. (2019) Feeding ethology and surface sediment reworking by the ampharetid polychaete *Melinna palmata* Grube, 1870: effects on sediment characteristics and aerobic bacterial community composition. *Journal of Experimental Marine Biology and Ecology* 512:63–77.

- Matera N, Lee J (1972) Environmental factors affecting the standing crop of foraminifera in subltoral and psammotoral communities of a Long Island salt marsh. *Marine Biology* 14:89–103.
- McFarland D (1977) Decision making in animals. *Nature* 269:15–21.
- McLusky D, Elliott M (2004) *The estuarine ecosystem: ecology, threats and management*, Oxford University Press.
- Meire P et al. (2005) The Scheldt estuary: a description of a changing ecosystem. *Hydrobiologia* 540:1-11.
- Mendes I et al. (2012) Distribution of living benthic foraminifera on the Northern Gulf of Cadiz continental shelf. *Journal of Foraminiferal Research* 42:18–38.
- Mermillod-Blondin F (2011) The functional significance of bioturbation and biodeposition on biogeochemical processes at the water–sediment interface in freshwater and marine ecosystems. *Journal of the North American Benthological Society* 30:770–778.
- Mermillod-Blondin F, Rosenberg R (2006) Ecosystem engineering: the impact of bioturbation on biogeochemical processes in marine and freshwater benthic habitats. *Aquatic Sciences* 68:434–442.
- Mermillod-Blondin F et al. (2003) Assessment of the spatial variability of intertidal benthic communities by axial tomodesitometry: importance of fine-scale heterogeneity. *Journal of Experimental Marine Biology and Ecology* 287:193–208.
- Mermillod-Blondin F et al. (2004) Influence of bioturbation by three benthic infaunal species on microbial communities and biogeochemical processes in marine sediment. *Aquatic Microbial Ecology* 36:271–284.
- Mestre NC, Brown A, Thatje S (2013) Temperature and pressure tolerance of larvae of *Crepidula fornicata* suggest thermal limitation of bathymetric range. *Marine Biology* 160:743–750.
- Meysman FJR, Galaktionov OS, Middelburg JJ (2005) Irrigation patterns in permeable sediments induced by burrow ventilation: a case study of *Arenicola marina*. *Marine Ecology Progress Series* 303:195–212.
- Meysman FJR et al. (2006) Bio-irrigation in permeable sediments: an assessment of model complexity. *Journal of Marine Research* 64:589–627.
- Meysman FJR et al. (2007) Quantifying biologically and physically induced flow and tracer dynamics in permeable sediments. *Biogeosciences* 4:627–646.

- Meysman FJR et al. (2010) Oxygen penetration around burrows and roots in aquatic sediments. *Journal of Marine Research* 68:309–336.
- Michaud E et al. (2005) The functional group approach to bioturbation: the effects of biodiffusers and gallery-diffusers of the *Macoma balthica* community on sediment oxygen uptake. *Journal of Experimental Marine Biology and Ecology* 326:77–88.
- Michaud E et al. (2006) The functional group approach to bioturbation: II. The effects of the *Macoma balthica* community on fluxes of nutrients and dissolved organic carbon across the sediment-water interface. *Journal of Experimental Marine Biology and Ecology* 337:178–189.
- Michaud E et al. (2009) Spatial interactions in the *Macoma balthica* community control biogeochemical fluxes at the sediment-water interface and microbial abundances. *Journal of Marine Research* 67:43–70.
- Michaud E, Aller RC, Stora G (2010) Sedimentary organic matter distributions, burrowing activity, and biogeochemical cycling: natural patterns and experimental artifacts. *Estuarine, Coastal and Shelf Science* 90:21–34.
- Middelburg JJ, Meysman FJR (2007) Burial at sea. *Science* 316:1294–1295.
- Millennium Ecosystem Assessment (2005) Chapter 19: coastal systems. In: *Ecosystems and human well being: current state & trends*. Island Press, Washington D.C, 513–549.
- Millers S (1974) Adaptive design of locomotion and foot form in prosobranch gastropod. *Journal of Experimental Marine Biology and Ecology* 14:99–156.
- Miron G et al. (1991) Dispersion and prospecting behaviour of the polychaete *Nereis virens* (Sars) as a function of density. *Journal of Experimental Marine Biology and Ecology* 145:65–77.
- Miron G et al. (1992) Variation in time budget of the Polychaete *Nereis virens* as a function of density and acclimation to a new borrow. *Marine Biology* 114:41–48.
- Moens T, Vincx M (2000) Temperature, salinity and food thresholds in two brackish-water bacterivorous nematode species: assessing niches from food absorption and respiration experiments. *Journal of Experimental Marine Biology and Ecology* 243:137–154.
- Moens T et al. (2005) Do nematode mucus secretions affect bacterial growth? *Aquatic Microbial Ecology* 40:77–83.

- Moens T et al. (2013) Ecology of free-living marine nematodes. In: *Handbook of Zoology: Gastrotricha, Cycloneuralia and Gnathifera, Vol. 2: Nematoda*, De Gruyter. Berlin, 109–152.
- Mojtahid M, Zubkov MV, Gooday AJ (2011) Grazing of intertidal benthic foraminifera on bacteria: assessment using pulse-chase radiotracing. *Journal of Experimental Marine Biology and Ecology* 399:25–34.
- Montagna P (1984) In situ measurement of meiobenthic grazing rates on sediment bacteria and edaphic diatoms. *Marine Ecology Progress Series* 18:119–130.
- Moodley L et al. (1998) Tolerance of benthic foraminifera (Protista: Sarcodina) to hydrogen sulphide. *Marine Ecology Progress Series* 169:77–86.
- Moodley L et al. (2002) Bacteria and Foraminifera: key players in a short-term deep-sea benthic response to phytodetritus. *Marine Ecology Progress Series* 236:23–29.
- Morad M et al. (2010) Quantification of pumping rate of *Chironomus plumosus* larvae in natural burrows. *Aquatic Ecology* 44:143–153.
- Morvan J et al. (2006) Patchiness and life cycle of intertidal foraminifera: implication for environmental and paleoenvironmental interpretation. *Marine Micropaleontology* 61:131–154.
- Mouret A et al. (2010) Oxygen and organic carbon fluxes in sediments of the Bay of Biscay. *Deep-Sea Research I* 57:528–540.
- Mugnai C et al. (2003) Bioturbation experiments in the Venice Lagoon. *Hydrobiologia* 494:245–250.
- Murphy EAK, Reidenbach MA (2016) Oxygen transport in periodically ventilated polychaete burrows. *Marine Biology* 163:208.
- Murray JW (1963) Ecological experiments on Foraminiferida. *Journal of the Marine Biological Association of the United Kingdom* 43:621–642.
- Murray JW (1983) Population dynamics of benthic foraminifera: results from the Exe estuary, England. *Journal of Foraminiferal Research* 13:1–12.
- Murray JW (2006) *Ecology and applications of benthic foraminifera*. Cambridge University Press, Cambridge.
- Murray JW, Alve E (2000) Major aspects of foraminiferal variability (standing crop and biomass) on a monthly scale in an intertidal zone. *Journal of Foraminiferal Research* 30:177–191.

Myers E (1936) The life cycle of *Spirillina vivipara* Ehrenberg, with notes on morphogenesis, systematics and distribution in the foraminifera. *Journal of the Royal Microscopical Society* 56:120–146.

Myers E (1943) Life activities of foraminifera in relation to marine ecology. *Proceedings of the American Philosophical Society* 86:439–458.

N

Nardelli MP et al. (2014) Experimental evidence for foraminiferal calcifications even under anoxia. *Biogeosciences* 11:4029–4038.

Nascimento FJA, Näslund J, Elmgren R (2012) Meiofauna enhances organic matter mineralization in soft sediment ecosystems. *Limnology and Oceanography* 57:338–346.

Näslund J, Nascimento FJA, Gunnarsson JS (2010) Meiofauna reduces bacterial mineralization of naphthalene in marine sediment. *The ISME Journal* 4:1421–1430.

Needham HR et al. (2010) Habitat dependence in the functional traits of *Austrohelice crassa*, a key bioturbating species. *Marine Ecology Progress Series* 414:179–193.

Nehring S (1993) Tube-dwelling meiofauna in marine sediments. *Internationale Revue der gesamten Hydrobiologie* 78:521–534.

Nehring S, Jensen P, Lorenzen S (1990) Tube-dwelling nematodes: tube construction and possible ecological effects on sediment-water interfaces. *Marine Ecology Progress Series* 64:123–128.

Ng TPT et al. (2013) Snails and their trails: the multiple functions of trail-following in gastropods. *Biological Reviews* 88:683–700.

Nogaro G et al. (2008) Food supply impacts sediment reworking by *Nereis diversicolor*. *Hydrobiologia* 598:403–408.

Nomaki H et al. (2008) Benthic foraminifera as trophic links between phytodetritus and benthic metazoans: carbon and nitrogen isotopic evidence. *Marine Ecology Progress Series* 357:153–164.

Nomaki H et al. (2011) Differing utilization of glucose and algal particulate organic matter by deep-sea benthic organisms of Sagami Bay, Japan. *Marine Ecology Progress Series* 431:11–24.

Nordhaus I, Diele K, Wolff M (2009) Activity patterns, feeding and burrowing behaviour of the crab *Ucides cordatus* (Ucididae) in a high intertidal mangrove forest in North Brazil. *Journal of Experimental Marine Biology and Ecology* 374:104–112.

Norkko A et al. (2013) Size matters: implications of the loss of large individuals for ecosystem function. *Scientific Reports* 3:2646.

O

Officer C, Lynch D (1982) Interpretation procedures for the determination of sediment parameters from time-dependent flux inputs. *Earth and Planetary Science Letters* 61:55–62.

Oliver ECJ et al. (2018) Longer and more frequent marine heatwaves over the past century. *Nature Communications* 9:1324.

Oliver ECJ et al. (2019) Projected marine heatwaves in the 21st century and the potential for ecological impact. *Frontiers in Marine Sciences* 6:734.

d'Orbigny A (1826) *Tableau méthodique de la classe des Céphalopodes*. Crochard.

Orvain F, Sauriau P-G (2002) Environmental and behavioural factors affecting activity in the intertidal gastropod *Hydrobia ulvae*. *Journal of Experimental Marine Biology and Ecology* 272:191–216.

Orvain F, Hir PL, Sauriau P (2003) A model of fluff layer erosion and subsequent bed erosion in the presence of the bioturbator, *Hydrobia ulvae*. *Journal of Marine Research* 61:823–851.

Orvain F et al. (2004) Interacting effects of *Hydrobia ulvae* bioturbation and microphytobenthos on the erodibility of mudflat sediments. *Marine Ecology Progress Series* 278:205–223.

Orvain F, Sauriau P-G, Bacher C, Prineau M (2006) The influence of sediment cohesiveness on bioturbation effects due to *Hydrobia ulvae* on the initial erosion of intertidal sediments: a study combining flume and model approaches. *Journal of Sea Research* 55:54–73.

- Orvain F, Sauriau P-G, Lefebvre S (2012) Modelling the effects of macrofauna on sediment transport and bed elevation: application over a cross-shore mudflat profile and model validation. *Estuarine, Coastal and Shelf Science* 108:64–75.
- Oswald E, Rood R (2014) A trend analysis of the 1930–2010 extreme heat events in the Continental United States. *Journal of Applied Meteorology and Climatology* 53:565–582.
- Ouellette D et al. (2004) Effects of temperature on in vitro sediment reworking processes by a gallery biodiffusor, the polychaete *Neanthes virens*. *Marine Ecology Progress Series* 266:185–193.

P

- Papaspyrou S, Kristensen E, Cox RP (2006) Microbial reaction rates and bacterial communities in sediment surrounding burrows of two nereidid polychaetes (*Nereis diversicolor* and *N. virens*). *Marine Biology* 148:541–550.
- Parry M et al. (2007) IPCC. 2007: Climate Change 2007: impacts, adaptation and vulnerability. Contribution of working group II to the Fourth Assessment report of the intergovernmental panel on climate change. Cambridge University Press, Cambridge.
- Pascal L et al. (2019) Linking behaviours, sediment reworking, bioirrigation and oxygen dynamics in a soft-bottom ecosystem engineer: the mud shrimp *Upogebia pusilla* (Petagna 1792). *Journal of Experimental Marine Biology and Ecology* 516:67–78.
- Pascal P-Y, Dupuy C, Richard P, Niquil N (2008) Bacterivory in the common foraminifer *Ammonia tepida*: isotope tracer experiment and the controlling factors. *Journal of Experimental Marine Biology and Ecology* 359:55–61.
- Pawlowski J et al. (1995) DNA analysis of “*Ammonia beccarii*” morphotypes: one or more species? *Marine Micropaleontology* 26:171–178.
- Pemberton S et al. (2008) Biogenic chaos: cryptobioturbation and the work of sedimentologically friendly organisms. *Palaeogeography, Palaeoclimatology, Palaeoecology* 270:273–279.
- Peng C et al. (2016) Effects of anthropogenic sound on digging behavior, metabolism, $\text{Ca}^{2+}/\text{Mg}^{2+}$ ATPase activity, and metabolism-related gene expression of the bivalve *Sinonovacula constricta*. *Scientific Reports* 6:24266.

- Penha-Lopes G et al. (2009) Are fiddler crabs potentially useful ecosystem engineers in mangrove wastewater wetlands? *Marine Pollution Bulletin* 58:1694–1703.
- Perez K et al. (1999) Application of computer-aided tomography (CT) to the study of estuarine benthic communities. *Ecological Applications* 9:1050–1058.
- Pérez-Asensio JN, Aguirre J, Rodríguez-Tovar FJ (2017) The effect of bioturbation by polychaetes (Opheliidae) on benthic foraminiferal assemblages and test preservation. *Palaeontology* 60:807–827.
- Petersen J et al. (2016) Improved methodology for measuring pore patterns in the benthic foraminiferal genus *Ammonia*. *Marine Micropaleontology* 128:1–13.
- Peterson C, Andre S (1980) An experimental-analysis of interspecific competition among marine filter feeders in a soft-sediment environment. *Ecology* 61:129–139.
- Pike J et al. (2001) Microbiorrigation of marine sediments in dysoxic environments: implication for early sediment fabric formation and diagenetic processes. *Geology* 29:923–926.
- Pillet L, Vargas CD, Pawlowski J (2011) Molecular identification of sequestered diatom chloroplasts and kleptoplastidy in foraminifera. *Protist* 162:394–404.
- Piña-Ochoa E et al. (2010) Survival and life strategy of the foraminiferan *Globobulimina turgida* through nitrate storage and denitrification. *Marine Ecology Progress Series* 417:39–49.
- Pinckney J, Sandulli R (1990) Spatial autocorrelation analysis of meiofaunal and microalgal populations on intertidal sandflat: scale linkage between consumers and resources. *Estuarine, Coastal and Shelf Science* 30:341–353.
- Pinko D, Abramovich S, Titelboim D (2020) Foraminiferal holobiont thermal tolerance under climate change – Roommates problems or successful collaboration? *Biogeosciences* 17:2341–2348.
- Piot A, Nozais C, Archambault P (2013) Meiofauna affect the macrobenthic biodiversity – ecosystem functioning relationship. *Oikos* 123:1–11.
- Pörtner HO (2001) Climate change and temperature-dependent biogeography: oxygen limitation of thermal tolerance in animals. *Naturwissenschaften* 88:137–146.
- Pörtner HO (2012) Integrating climate-related stressor effects on marine organisms: unifying principles linking molecule to ecosystem-level changes. *Marine Ecology Progress Series* 470:273–290.

- Pörtner HO, Farrell AP (2008) Physiology and Climate Change. *Nature* 322:690–692.
- Pörtner HO, Peck L, Somero G (2007) Thermal limits and adaptation in marine Antarctic ectotherms: an integrative view. *Philosophical Transactions of the Royal Society B; Biological Sciences* 362:2233–2258.
- Prast M et al. (2007) Effect of ciliates on nitrification and nitrifying bacteria in Baltic Sea sediments. *Marine Ecology Progress Series* 350:55–61.
- Prazeres M, Roberts TE, Pandolfi JM (2017) Variation in sensitivity of large benthic Foraminifera to the combined effects of ocean warming and local impacts. *Scientific Reports* 7:45227.
- Price R, Warwick RM (1980) The effect of temperature on the respiration rate of meiofauna. *Oecologia* 44:145–148.
- Przeslawski R, Zhu Q, Aller R (2009) Effects of abiotic stressors on infaunal burrowing and associated sediment characteristics. *Marine Ecology Progress Series* 392:33–42.
- Pusceddu A et al. (2003) Enzymatically hydrolyzable protein and carbohydrate sedimentary pools as indicators of the trophic state of detritus sink systems: a case study in a Mediterranean coastal lagoon. *Estuaries* 26:641–650.
- Pyke GH (1984) Optimal foraging theory: a critical review. *Annual Review of Ecology and Systematics* 15:523–575.
- Pyke GH (2015) Understanding movements of organisms: it's time to abandon the Lévy foraging hypothesis. *Methods in Ecology and Evolution* 6:1–16.
- Pyke GH (2019) Animal movements - an optimal foraging theory approach. *Encyclopedia of Animal Behaviour* 2:149–156.

Q - R

- Quintana CO, Tang M, Kristensen E (2007) Simultaneous study of particle reworking, irrigation transport and reaction rates in sediment bioturbated by the polychaetes *Heteromastus* and *Marenzelleria*. *Journal of Experimental Marine Biology and Ecology* 352:392–406.
- Quintana CO et al. (2015) Carbon mineralization pathways and bioturbation in coastal Brazilian sediments. *Scientific Reports* 5:16122.

- R Core Team (2018) R: a language and environment for statistical computing. R Foundation for Statistical Computing, Vienna, Austria.
- R Core Team (2019) R: a language and environment for statistical computing. R Foundation for Statistical Computing, Vienna, Austria.
- Ramsing N, Gundersen J (1994) Seawater and gases-tabulated physical parameters of interest to people working with microsensors in marine systems. Unisense Internal Report.
- Reichardt W (1988) Impact of bioturbation by *Arenicola marina* on microbiological parameters in intertidal sediments. Marine Ecology Progress Series 44:149–158.
- Reichelt A (1991) Environmental effects of meiofaunal burrowing. In: *The environmental impact of burrowing animals and animal burrows*. Meadows PS, Meadows A Zoological Symposium, Clarendon Press, Oxford, 33–52.
- Reise K (1983) Biotic enrichment of intertidal sediments by experimental aggregates of the deposit-feeding bivalve *Macoma balthica*. Marine Ecology Progress Series 12:229–236.
- Reiss J et al. (2009) Emerging horizons in biodiversity and ecosystem functioning research. Trends in Ecology and Evolution 24:505–514.
- Reiss J et al. (2011) Testing effects of consumer richness, evenness and body size on ecosystem functioning. Journal of Animal Ecology 80:1145–1154.
- Reiss J, Schmid-Araya J (2010) Life history allometries and production of small fauna. Ecology 91:497–507.
- Revsbech NP (1989) An oxygen microsensor with a guard cathode. Limnology and Oceanography 34:474–478.
- Reynolds A (2015) Liberating Lévy walk research from the shackles of optimal foraging. Physics of Life Reviews 14:59–83.
- Reynolds A (2018) Current status and future directions of Lévy walk research. Biology Open 7:1–6.
- Rhoads D (1963) Rates of sediment reworking by *Yoldia limatula* in Buzzards Bay, Massachusetts, and Long Island Sound. Journal of Sedimentary Petrology 33:723–727.
- Rhoads D (1974) Organism-sediment relations on the muddy sea floor. Oceanography and Marine Biology: An Annual Review 12:263–300.

- Rhoads D, Young D (1970) The influence of deposit-feeding organisms on sediment stability and community trophic structure. *Journal of Marine Research* 28:150–178.
- Richirt J et al. (2019) Morphological distinction of three *Ammonia* phylotypes occurring along European Coasts. *Journal of Foraminiferal Research* 49:76–93.
- Richirt J et al. (2020) Foraminiferal community response to seasonal anoxia in Lake Grevelingen (the Netherlands). *Biogeosciences* 17:1415–1435.
- Richter G (1964) Zur ökologie der Foraminiferida II: lebensraum und lebensweise von *Nonion depressulum*, *Elphidium excavatum* und *Elphidium selseyense*. *Natur und Museum* 94:421–430.
- Richter G (1965) Zur Ökologie der Foraminiferen. III. Verdriftung und Transport in der Gezeitenzone. *Natur und Museum* 95:51–62.
- Riemann F, Schrage M (1978) The mucus-trap hypothesis on feeding of aquatic nematodes and implications for biodegradation and sediment texture. *Oecologia* 34:75–88.
- Riera P, Hubas C (2003) Trophic ecology of nematodes from various microhabitats of the Roscoff Aber Bay (France): importance of stranded macroalgae evidenced through $\delta^{13}\text{C}$ and $\delta^{15}\text{N}$. *Marine Ecology Progress Series* 260:151–159.
- Riisgård H, Banta GT (1998) Irrigation and deposit feeding by the lugworm *Arenicola marina*, characteristics and secondary effects on the environment. A review of current knowledge. *Vie Milieu* 48:243–257.
- Risgaard-Petersen N et al. (2006) Evidence for complete denitrification in a benthic foraminifer. *Nature* 443:93–96.
- Rönnbäck P, Crona B, Ingwall L (2007) The return of ecosystem goods and services in replanted mangrove forests: perspectives from local communities in Kenya. *Environmental Conservation* 34:313–324.
- Rosenberg R (1993) Suspension feeding in *Abra alba* (Mollusca). *Sarsia* 78:119–121.
- Rosenberg R et al. (1997) Density-dependent migration in an *Amphiura filiformis* (Amphiuridae, Echinodermata) infaunal population. *Marine Ecology Progress Series* 159:121–131.
- Rosenberg R et al. (2007) Application of computer-aided tomography to visualize and quantify biogenic structures in marine sediments. *Marine Ecology Progress Series* 331:23–34.

- Rosenberg R et al. (2008) 3D visualization and quantification of marine benthic biogenic structures and particle transport utilizing computer-aided tomography. *Marine Ecology Progress Series* 363:171–182.
- Ross BJ, Hallock P (2016) Dormancy in the Foraminifera: a review. *Journal of Foraminiferal Research* 46:358–368.
- Roy H, Huettel M, Jorgensen B (2002) The role of small-scale sediment topography for oxygen flux across the diffusive boundary layer. *Limnology and Oceanography* 47:837–847.
- Roy H, Huettel M, Jorgensen B (2005) The influence of topography on the functional exchange surface of marine soft sediments, assessed from sediment topography measured *in situ*. *Limnology and Oceanography* 50:106–112.
- Ruddiman W et al. (1980) Tests for size and shape dependency in deep-sea mixing. *Sedimentary Geology* 25:257–276.
- Russi D et al. (2013) *The Economics of Ecosystems and Biodiversity for Water and Wetlands*. IEEP: London and Brussels.
- Rysgaard S et al. (2000) Marine meiofauna, carbon and nitrogen mineralization in sandy and soft sediments of Disko Bay, West Greenland. *Aquatic Microbial Ecology* 21:59–71.

S

- Saad SA, Wade CM (2016) Biogeographic distribution and habitat association of *Ammonia* genetic variants around the coastline of Great Britain. *Marine Micropaleontology* 124:54–62.
- Saffert H, Thomas E (1998) Living foraminifera and total populations in salt marsh peat cores: Kelsey Marsh (Clinton, CT) and the Great Marshes (Barnstable, MA). *Marine Micropaleontology* 33:175–202.
- Salami M (1976) Biology of *Trochammina cf. quadriloba* (Höglund), an agglutinating foraminifer. *Journal of Foraminiferal Research* 6:142–153.
- Sandnes J et al. (2000) Influence of particle type and faunal activity on mixing of di(2-ethylhexyl) phthalate (DEHP) in natural sediments. *Marine Ecology Progress Series* 197:151–167.

- Schindelin J et al. (2012) Fiji : an open-source platform for biological-image analysis. *Nature Methods* 9:676–682.
- Schmidt C et al. (2011) Temperature-induced stress leads to bleaching in larger benthic foraminifera hosting endosymbiotic diatoms. *Limnology and Oceanography* 56:1587–1602.
- Schönfeld J et al. (2012) The FOBIMO (FOraminiferal Bio-MONitoring) initiative-towards a standardised protocol for soft-bottom benthic foraminiferal monitoring studies. *Marine Micropaleontology* 94–95:1–13.
- Schratzberger M (2012) On the relevance of meiobenthic research for policy-makers. *Marine Pollution Bulletin* 64:2639–2644.
- Schratzberger M, Ingels J (2018) Meiofauna matters: the roles of meiofauna in benthic ecosystems. *Journal of Experimental Marine Biology and Ecology* 502:12–25.
- Schulz H et al. (1996) Community structure of filamentous, sheat-building sulfur bacteria, *Thioploca* spp., off the coast of Chile. *Applied and Environmental Microbiology* 62:1855–1862.
- Scott DB, Medioli FS, Schafer C (2001) Monitoring in coastal environments using foraminifera and thecamoebian indicators. Cambridge University Press. Oxford, UK.
- Seitaj D et al. (2015) Cable bacteria generate a firewall against euxinia in seasonally hypoxic basins. *PNAS* 112:13278–13283.
- Sen Gupta BK (1999) Systematics of modern Foraminifera. In: *Modern Foraminifera*. Kluwer Academic Publishers, Dordrecht, 7–36.
- Seuront L (2005) Hydrodynamic and tidal controls of small-scale phytoplankton patchiness. *Marine Ecology Progress Series* 302:93–101.
- Seuront L (2010a) Fractals and multifractals in ecology and aquatic science. CRC P, Boca Raton, FL.
- Seuront L (2010b) How does salinity influence the swimming speed of the estuarine calanoid copepod *Eurytemora affinis*? *Journal of Plankton Research* 31:1223–1225.
- Seuront L (2011a) Behavioral fractality in marine copepods: endogenous rhythms versus exogenous stressors. *Physica A: Statistical Mechanics and its Applications* 390:250–256.

- Seuront L (2011b) Hydrocarbon contamination decreases mating success in a marine planktonic copepod. *PLoS ONE* 6:e26283.
- Seuront L (2015a) When complexity rimes with salinity: loss of fractal and multifractal behavioural complexity as an indicator of sub-lethal contaminations in zooplankton. In: *Marine Productivity: perturbation and resilience of socio-ecosystems*. Ceccaldi H-J, Hénocque Y, Koike Y, Komatsu T, Stora G, Tusseau-Vuillemin M-H. Springer, New York, 129–137.
- Seuront L (2015b) On uses, misuses and potential abuses of fractal analysis in zooplankton behavioral studies: a review, a critique and a few recommendations. *Physica A: Statistical Mechanics and its Applications* 432:410–434.
- Seuront L, Spilmont N (2002) Self-organized criticality in intertidal microphytobenthos patch patterns. *Physica A* 313:513–539.
- Seuront L, Leterme S (2006) Microscale patchiness in microphytobenthos distributions: evidence for a critical state. In: *Functioning of microphytobenthos in estuaries*. Kromkamp JC, de Brouwer JFC, Blanchard GF, Forster RM, and Créach V. Royal Netherlands Academy of Arts and Sciences, 167-186.
- Seuront L, Stanley HE (2014) Anomalous diffusion and multifractality enhance mating encounters in the ocean. *Proceedings of the National Academy of Sciences of the United States of America* 111:2206–2211.
- Seuront L, Bouchet VMP (2015) The devil lies in details: new insights into the behavioural ecology of intertidal foraminifera. *Journal of Foraminiferal Research* 45:390–401.
- Seuront L, Cribb N (2017) Fractal analysis provides new insights into the complexity of marine mammal behavior: a review, two methods, their application to diving and surfacing patterns, and their relevance to marine mammal welfare assessment. *Marine Mammal Sciences* 33:847–879.
- Seuront L et al. (2004) Individual variability in the swimming behavior of the subtropical copepod *Oncaea venusta* (Copepoda: Poecilostomatoida). *Marine Ecology Progress Series* 283:199–217.
- Seuront L et al. (2019) Decreased thermal tolerance under recurrent heat stress conditions explains summer mass mortality of the blue mussel *Mytilus edulis*. *Scientific Reports* 9:17498.
- Severin KP (1987) Laboratory observations of the rate of subsurface movement of a small milioli foraminifer. *Journal of Foraminiferal Research* 17:110–116.

- Severin KP, Erskian MG (1981) Laboratory experiments on the vertical movement of *Quinqueloculina impressa* Reuss through sand. *Journal of Foraminiferal Research* 11:133–136.
- Severin KP, Culver SJ, Blanpied C (1982) Burrows and trails produced by *Quinqueloculina impressa* Reuss, a benthic foraminifer, in fine-grained sediment. *Sedimentology* 29:897–901.
- Sheppard C (2006) The muddle of ‘Biodiversity’. *Marine Pollution Bulletin* 52:123–124.
- Shull DH, Yasuda M (2001) Size-selective downward particle transport by cirratulid polychaetes. *Journal of Marine Research* 59:453–473.
- Sims D (2015) Intrinsic Lévy behaviour in organisms - searching for mechanism Comment on “Liberating Lévy walk research from the shackles of optimal foraging” by A.M. Reynolds. *Physics of Life Reviews* 14:111–114.
- Sinutok S et al. (2014) Ocean acidification and warming alter photosynthesis and calcification of the symbiont-bearing foraminifera *Marginopora vertebralis*. *Marine Biology* 161:2143–2154.
- Smale DA, Wernberg T, Vanderklift MA (2017) Regional-scale variability in the response of benthic macroinvertebrate assemblages to a marine heatwave. *Marine Ecology Progress Series* 568:17–30.
- Snelgrove PVR et al. (2014) Real world biodiversity-ecosystem functioning: a seafloor perspective. *Trends in Ecology & Evolution* 29:398–405.
- Snelgrove PVR et al. (2018) Global carbon cycling on a heterogeneous seafloor. *Trends in Ecology & Evolution* 33:96–105.
- Solan M, Wigham BD (2005) Biogenic particle reworking and bacterial–invertebrate interactions in marine sediments. In: *Interactions between macro- and microorganisms in marine sediments. Coastal and estuarine studies 60*. Kristensen E, Haese RR, Kostka JE. American Geophysical Union, Washington, D.C, 105–124.
- Solan M et al. (2004) In situ quantification of bioturbation using time-lapse fluorescent sediment profile imaging (f-SPI), luminophore tracers and model simulation. *Marine Ecology Progress Series* 271:1–12.
- Solan M et al. (2008) How biodiversity affects ecosystem processes: implications for ecological revolutions and benthic ecosystem function. *Aquatic Biology* 2:289–301.

- Somero GN (2002) Thermal physiology and vertical zonation of intertidal animals: optima, limits, and costs of living. *Integrative and Comparative Biology* 42:780–789.
- Specht D, Lee H (1989) Direct measurement technique for determining ventilation rate in the deposit feeding clam *Macoma nasuta* (Bivalvia, Tellinaceae). *Marine Biology* 101:211–218.
- Spilmont N et al. (2011) There's more to the picture than meets the eye: sampling microphytobenthos in a heterogeneous environment. *Estuarine, Coastal and Shelf Science* 95:470–476.
- Stamhuis E, Videler J (1998) Burrow ventilation in the tube-dwelling shrimp *Callinassa subterranea* (Decapoda: Thalassinidea). III. Hydrodynamic modelling and the energetics of pleopod pumping. *Journal of Experimental Biology* 201:2171–2181.
- Stead RA, Thompson RJ (2006) The influence of an intermittent food supply on the feeding behaviour of *Yoldia hyperborea* (Bivalvia: Nuculanidae). *Journal of Experimental Marine Biology and Ecology* 332:37–48.
- Stillman JH, Somero GN (1996) Adaptation to temperature stress and aerial exposure in congeneric species of intertidal porcelain crabs (genus *Petrolisthes*): correlation of physiology, biochemistry and morphology with vertical distribution. *The Journal of Experimental Biology* 199:1845–1855.
- Stillman JH, Somero GN (2000) A comparative analysis of the upper thermal tolerance limits of Eastern Pacific porcelain crabs, genus *Petrolisthes*: influences of latitude, vertical zonation, acclimation, and phylogeny. *Physiological and Biochemical Zoology* 73:200–208.
- Stock W et al. (2014) Interactions between benthic copepods, bacteria and diatoms promote nitrogen retention in intertidal marine sediments. *PLoS ONE* 9:e111001.
- Straub SC et al. (2019) Resistance, extinction, and everything in between – The diverse responses of seaweeds to marine heatwaves. *Frontiers in Marine Sciences* 6:763.
- Stuhr M et al. (2018) Variable thermal stress tolerance of the reef-associated symbiont-bearing foraminifera *Amphistegina* linked to differences in symbiont type. *Coral Reefs* 37:811–824.
- Sun M et al. (1999) Enhancement degradation of algal lipids by benthic macrofaunal activity: effect of *Yoldia limatula*. *Journal of Marine Research* 57:775–804.

Sunday JM, Bates AE, Dulvy NK (2012) Thermal tolerance and the global redistribution of animals. *Nature Climate Change* 2:686–690.

T

Tankersley R (1989) The effect of trail-following on the locomotion of the marsh periwinkle *Littorina irrorata* (Mesogastropoda: Littorinidae). *Marine Behaviour and Physiology* 15:89–100.

Tendal O, Gooday AJ (1981) Xenophyophoria (Rhizopodia, Protozoa) in bottom photographs from the bathyal and abyssal NE Atlantic. *Oceanologica Acta* 4:415–422.

Tessier B, Delsinne N, Sorrel P (2010) Holocene sedimentary infilling of a tide dominated estuarine mouth. The example of the macrotidal Seine estuary (NW France). *Bulletin de la Société Géologique de France* 181:87–98.

Thomas S et al. (2021) Does the size structure of venerid clam populations affect ecosystem functions on intertidal sandflats. *Estuaries and Coasts* 44:242–252.

Thomsen L, Altenbach AV (1993) Vertical and areal distribution of foraminiferal abundance and biomass in microhabitats around inhabited tubes of marine echinurids. *Marine Micropaleontology* 20:303–309.

Thrush S et al. (2006) Functional role of large organisms in intertidal communities: community effects and ecosystem function. *Ecosystems* 9:1029–1040.

Tietjen JH, Lee JJ (1973) Life history and feeding habits of the marine nematodes, *Chromadora macrolaimoides* Steiner. *Oecologia* 12:303–314.

Tobin R et al. (2005) Infaunal benthic foraminifera in some North American marshes and their influence on fossil assemblages. *Journal of Foraminiferal Research* 35:130–147.

Trevor JH (1978) The dynamics and mechanical energy expenditure of the polychaetes *Nephtys cirrosa*, *Nereis diversicolor* and *Arenicola marina* during burrowing. *Estuarine and Coastal Marine Science* 6:15.

Tsubokura T, Goshima S, Nakao S (1997) Seasonal horizontal and vertical distribution patterns of the supralittoral amphipod *Trinorchestia trinitatis* in relation to environmental variables. *Journal of Crustacean Biology* 17:674–686.

Turner RK, Schaafsma M (2015) Coastal zones ecosystem services. From science to values and decision making, Turner RK, Schaafsma M. Springer, Switzerland.

U - V

Underwood GJC, Kromkamp J (1999) Primary production by phytoplankton and microphytobenthos in estuaries. *Advances in Ecological Research* 29:93–139.

Underwood GJC, Chapman M (2000) Variation in abundances of intertidal populations: consequences of extremities of environment. *Hydrobiologia* 426:25–36.

Underwood GJC, Paterson D, Parkes RJ (1995) The measurement of microbial carbohydrate exopolymers from intertidal sediments. *Limnology and Oceanography* 40:1243–1253.

Urban-Malinga B et al. (2013) Species-specific effect of macrobenthic assemblages on meiobenthos and nematode community structure in shallow sandy sediments. *Marine Biology* 161:195–212.

Valdemarsen T et al. (2011) Exclusion of seagrass by benthic invertebrates; burial of eelgrass seeds and seedlings by the lugworm (*Arenicola marina*). *Journal of Experimental Marine Biology and Ecology* 410:45–52.

van Dam JW et al. (2012) Additive pressures of elevated sea surface temperatures and herbicides on symbiont-bearing foraminifera. *PLoS ONE* 7:e33900.

van Oevelen D et al. (2006) Carbon flows through a benthic food web: integrating biomass, isotope and tracer data. *Journal of Marine Research* 64:453–482.

van Prooijjen B, Montserrat F, Herman P (2011) A process-based model for erosion of *Macoma balthica*-affected mud beds. *Continental Shelf Research* 31:527–538.

Venturini N et al. (2011) Polychaete response to fresh food supply at organically enriched coastal sites: repercussion on bioturbation potential and trophic structure. *Journal of Marine Systems* 88:526–541.

Verdelhos T, Marques JC, Anastácio P (2015) Behavioral and mortality responses of the bivalves *Scrobicularia plana* and *Cerastoderma edule* to temperature, as indicator of climate change's potential impacts. *Ecological Indicators* 58:95–103.

- Vernberg W, Vernberg F (1972) Environmental physiology of marine organisms. Springer-Verlag, New-York, USA.
- Vianna B da S et al. (2020) Effects of temperature increase on the physiology and behavior of fiddler crabs. *Physiology & Behavior* 215:112765.
- Violle C et al. (2007) Let the concept of trait be functional! *Oikos* 116:882–892.
- Viswanathan GM et al. (1999) Optimizing the success of random search. *Nature* 401:911–914.
- Viswanathan GM et al. (2011) The physics of foraging: an introduction to random searches and biological encounters. Cambridge University Press, New York.
- Volkenborn N et al. (2012) Hydraulic activities by ghost shrimp *Neotrypaea californiensis* induce oxic-anoxic oscillations in sediments. *Marine Ecology Progress Series* 455:141–156.
- Volkenborn N et al. (2016) Bioirrigation in marine sediments. In: *Reference module in earth systems and environmental sciences*. Scott A. Elsevier, 1–9.

W

- Ward J, Pond DW, Murray JW (2003) Feeding of benthic foraminifera on diatoms and sewage-derived organic matter: an experimental application of lipid biomarker techniques. *Marine Environmental Research* 56:515–530.
- Weinberg JR (1991) Rates of movement and sedimentary traces of deep-sea foraminifera and Mollusca in the laboratory. *Journal of Foraminiferal Research* 21:213–217.
- Wernberg T et al. (2016) Climate-driven regime shift of a temperate marine ecosystem. *Science* 353:169–172.
- Wetmore K (1988) Burrowing and sediment movement by benthic foraminifera, as shown by time-lapse cinematography. *Revue de Paléobiologie* 2:921–927.
- Wheatcroft RA (1992) Experimental tests for particle size-dependent bioturbation in the deep ocean. *Limnology and Oceanography* 37:90–104.
- Wheatcroft RA, Jumars PA (1987) Statistical re-analysis for size dependency in deep-sea mixing. *Marine Geology* 77:157–163.

- Wheatcroft RA et al. (1990) A mechanistic view of the particulate biodiffusion coefficient: Step lengths, rest periods and transport directions. *Journal of Marine Research* 48:177–207.
- Widdows J et al. (2000) Temporal changes in intertidal sediment erodability: influence of biological and climatic factors. *Continental Shelf Research* 20:1275–1289.
- Wieser W (1973) Temperature Relations of Ectotherms: A Speculative Review. In: *Effects of temperature on ectothermic organisms: ecological implications and mechanisms of compensation*. Wieser W. Springer, Berlin, 1–23.
- Willows RI, Widdows J, Wood RG (1998) Influence of an infaunal bivalve on the erosion of an intertidal cohesive sediment: a flume and modeling study. *Limnology and Oceanography* 43:1332–1343.
- Wohlgemuth D, Solan M, Godbold JA (2017) Species contributions to ecosystem process and function can be population dependent and modified by biotic and abiotic setting. *Proceedings of the Royal Society: Biological Sciences* 284:20162805.
- Woodin SA, Wethey DS, Volkenborn N (2010) Infaunal hydraulic ecosystem engineers: cast of characters and impacts. *Integrative and Comparative Biology* 50:176–187.
- Woodin SA et al. (2016) Same pattern, different mechanism: locking onto the role of key species in seafloor ecosystem process. *Scientific Reports* 6:26678.
- Woulds C et al. (2007) Oxygen as a control on seafloor biological communities and their roles in sedimentary carbon cycling. *Limnology and Oceanography* 52:1698–1709.
- Wu F et al. (2017) Effects of seawater pH and temperature on foraging behavior of the Japanese stone crab *Charybdis japonica*. *Marine Pollution Bulletin* 120:99–108.
- Wukovits J et al. (2017) Increased temperature causes different carbon and nitrogen processing patterns in two common intertidal foraminifera (*Ammonia tepida* and *Haynesina germanica*). *Biogeosciences* 14:2815–2829.
- Wukovits J et al. (2018) Food supply and size class depending variations in phytodetritus intake in the benthic foraminifer *Ammonia tepida*. *Biology Open* 7:bio030056.

Y - Z

Yawata Y et al. (2020) Constrained optimal foraging by marine bacterioplankton on particulate organic matter. PNAS 117:25571–25579.

Zar J (2009) Biostatistical analysis, fifth edition, Pearson. Upper Saddle River.

Zorn M et al. (2006) Microscale oxygen distribution in various invertebrate walls. Geobiology 4:137–145.

PUBLICATIONS DURING MY PHD WORK

FROM THIS PHD WORK

Assessing behavioural traits of benthic foraminifera: implications for sediment mixing

Noémie Deldicq^{1,*}, Laurent Seuront^{1,2,3,4}, Dewi Langlet¹, Vincent M. P. Bouchet¹

¹Univ. Lille, CNRS, Univ. Littoral Côte d'Opale, UMR 8187, LOG, Laboratoire d'Océanologie et de Géosciences, 62930, Wimereux, France

²CNRS, Univ. Lille, Univ. Littoral Côte d'Opale, UMR 8187, LOG, Laboratoire d'Océanologie et de Géosciences, 62930, Wimereux, France

³Department of Marine Resources and Energy, Tokyo University of Marine Science and Technology, 4-5-7 Konan, Minato-ku, Tokyo 108-8477, Japan

⁴Department of Zoology and Entomology, Rhodes University, Grahamstown, 6140, South Africa

ABSTRACT: The assessment of behavioural traits of marine organisms is increasingly recognized as a key issue to understanding their role in ecosystem processes such as bioturbation and nutrient cycling. The movement ability of intertidal foraminifera suggest that they may have a role, yet to be quantified, in benthic–pelagic coupling through their movement on the sediment surface, at the sediment–water interface and within the sediment. In this context, we investigated the behavioural traits of 5 benthic foraminiferal species typical of European temperate mudflats under standardized trophic light and temperature conditions. Behavioural traits related to motion of *Ammonia tepida*, *Haynesina germanica*, *Cibicides williamsoni*, *Miliammina fusca* and *Quinqueloculina seminula* were assessed through their travelled distance, velocity, tortuosity of the path, position in the sediment and activity index. By analogy with macrofauna bioturbation functional groups, we describe the studied foraminifera as biodiffusor species with 3 sub-groups defined according to their vertical position in the sediment. *C. williamsoni* belongs to the epifaunal-biodiffusors, *A. tepida* and *H. germanica* belong to the surficial-biodiffusors, and *Q. seminula* and *M. fusca* are considered gallery-biodiffusors. Our results further suggest that features such as velocity, activity and tortuosity may mediate sediment-mixing intensity. Therefore, *Q. seminula*, *H. germanica* and *C. williamsoni*, which are the most active species, would have a larger effect on particle reworking rates than the less active *A. tepida* and *M. fusca*. Our results suggest that benthic foraminifera may play an underestimated role in bioturbation processes.

KEY WORDS: Benthic foraminifera · Intertidal · Motion behaviour · Functional trait · Bioturbator groups

Resale or republication not permitted without written consent of the publisher

1. INTRODUCTION

Trait-based studies have largely been implemented to describe ecosystem functioning, especially over the last decade (Braeckman et al. 2010, Cardinale et al. 2011, Gothland et al. 2014). Specifically, traits—defined as 'the morphological, physiological or phenological features measurable at the individual level, from the cell to the whole-organism level' (Violle et al. 2007, p. 884)—can either be demographical (e.g. birth, mortality), biological (e.g. size, growth), eco-

physiological (e.g. nutrient assimilation, resource uptake) or behavioural (e.g. locomotion, species interactions). These features determine the role of a species in the ecosystem and hence allow definition of functional traits (Violle et al. 2007, Gagic et al. 2015).

A comprehensive assessment of species-specific behavioural traits associated with locomotion is one way to understand the role of species in the structure and functioning of coastal ecosystems. Specifically in soft-sediment environments, the behavioural traits related to faunal motion are intrinsically considered

*Corresponding author: noemie.deldicq@outlook.fr



OPEN

Effects of temperature on the behaviour and metabolism of an intertidal foraminifera and consequences for benthic ecosystem functioning

Noémie Deldicq¹✉, Dewi Langlet¹, Camille Delaeter¹, Grégory Beaugrand^{1,2}, Laurent Seuront^{1,3,4} & Vincent M. P. Bouchet¹

Heatwaves have increased in intensity, duration and frequency over the last decades due to climate change. Intertidal species, living in a highly variable environment, are likely to be exposed to such heatwaves since they can be emerged for more than 6 h during a tidal cycle. Little is known, however, on how temperature affects species traits (e.g. locomotion and behaviour) of slow-moving organisms such as benthic foraminifera (single-celled protists), which abound in marine sediments. Here, we examine how temperature influences motion-behaviour and metabolic traits of the dominant temperate foraminifera *Haynesina germanica* by exposing individuals to usual (6, 12, 18, 24, 30 °C) and extreme (high; i.e. 32, 34, 36 °C) temperature regimes. Our results show that individuals reduced their activity by up to 80% under high temperature regimes whereas they remained active under the temperatures they usually experience in the field. When exposed to a hyper-thermic stress (i.e. 36 °C), all individuals remained burrowed and the photosynthetic activity of their sequestered chloroplasts significantly decreased. Recovery experiments subsequently revealed that individuals initially exposed to a high thermal regime partially recovered when the hyper-thermic stress ceased. *H. germanica* contribution to surface sediment reworking substantially diminished from 10 mm³ indiv⁻¹ day⁻¹ (usual temperature) to 0 mm³ indiv⁻¹ day⁻¹ when individuals were exposed to high temperature regimes (i.e. above 32 °C). Given their role in sediment reworking and organic matter remineralisation, our results suggest that heatwaves may have profound long-lasting effects on the functioning of intertidal muddy ecosystems and some key biogeochemical cycles.

Over the last decades, anthropogenic pressures such as industrial activity, intensive agriculture, pollution, deforestation and overfishing have altered the terrestrial and marine biosphere^{1–3}. Greenhouse gas emissions have risen substantially, affecting the global climate and the frequency and magnitude of extreme weather or climatic events such as storms, floods, droughts and heatwaves^{2,4–9}. Over the period 1982–2010, extremely hot days have been more frequent along 38% of the world's coastlines¹⁰ and a recent study suggests that 50% of the ocean surface may suffer from a permanent marine heatwave state by the late twenty-first century³. Marine heatwaves, which result from the warming of both air and seawater temperature^{11,12}, have caused unprecedented mass mortalities of a wide range of intertidal species such as mussels and limpets^{13–17}. In the intertidal environment, sessile and slow-moving invertebrates are more likely to be exposed to extreme temperature events. Noticeably, in temperate ecosystems, surface soft-sediment temperature (i.e. within the first centimetre) can frequently reach up to 30 °C¹⁸ and sometimes even 40 °C at low tide^{19,20} during spring and summer. Typically, in European Atlantic mudflats, organisms can experience daily rise in sediment temperature up to 20 °C in 2 h at emersion¹⁹. Consequently, intertidal species are more eurytherm than their subtidal counterparts^{21–23}. However, these organisms often live

¹Laboratoire d'Océanologie et de Géosciences, Univ. Lille, CNRS, Univ. Littoral Côte d'Opale, UMR 8187, LOG, 59000 Lille, France. ²The Laboratory, Marine Biological Association, The CPR Survey, Citadel Hill, Plymouth, UK. ³Department of Marine Resources and Energy, Tokyo University of Marine Science and Technology, 4-5-7 Konan, Minato-ku, Tokyo 108-8477, Japan. ⁴Department of Zoology and Entomology, Rhodes University, Grahamstown 6140, South Africa. ✉email: noemie.deldicq@outlook.fr

OTHER

Research Article

History of the introduction of a species resembling the benthic foraminifera *Nonionella stella* in the Oslofjord (Norway): morphological, molecular and paleo-ecological evidences

Noémie Deldicq^{1,2,*}, Elisabeth Alve², Magali Schweizer^{3,4}, Irina Polovodova Asteman^{5,6}, Silvia Hess², Kate Darling^{4,7} and Vincent M.P. Bouchet¹

¹Univ. Lille, CNRS, Univ. Littoral Côte d'Opale, UMR 8187, LOG, Laboratoire d'Océanologie et de Géosciences, F 62930, Wimereux, France

²Department of Geosciences, University of Oslo, P.O. Box 1047 Blindern, 0316 Oslo, Norway

³LPG-BIAF, UMR-CNRS 6112, University of Angers, 2 Bd Lavoisier, 49045 Angers Cedex, France

⁴School of Geosciences, University of Edinburgh, James Hutton Road, Edinburgh EH9 3FE, UK

⁵Department of Marine Sciences, University of Gothenburg, Carl Skottsbergsgata 22B, 41319 Gothenburg, Sweden

⁶Currently at: Marine Mätteknik (MMT) Sweden AB, Sven Källfelts gatan 11, SE-426 71 Gothenburg, Sweden

⁷School of Geography and Sustainable Development, University of St Andrews, Fife KY169AL, UK

*Corresponding author

E-mail: noemie.deldicq@outlook.fr

Citation: Deldicq N, Alve E, Schweizer M, Polovodova Asteman I, Hess S, Darling K, Bouchet VMP (2019) History of the introduction of a species resembling benthic foraminifera *Nonionella stella* in the Oslofjord (Norway): morphological, molecular and paleo-ecological evidences. *Aquatic Invasions* 14(2): 182–205, <https://doi.org/10.3391/ai.2019.14.2.03>

Received: 22 August 2018

Accepted: 17 February 2019

Published: 3 May 2019

Handling editor: Thomas Therriault

Thematic editor: Stelios Katsanevakis

Copyright: © Deldicq et al.

This is an open access article distributed under terms of the Creative Commons Attribution License ([Attribution 4.0 International - CC BY 4.0](https://creativecommons.org/licenses/by/4.0/)).

OPEN ACCESS

Abstract

Specimens resembling the benthic foraminifera *Nonionella stella* (Cushman and Moyer, 1930), a morphospecies originally described from the San Pedro Basin, California, USA, were observed for the first time in the Oslofjord (Norway) in 2012. This study investigates the Oslofjord *Nonionella* population in order to confirm its non-indigenous species (NIS) status and assess its introduction time. Morphological characterisation based on SEM imaging complemented by molecular identification using small subunit (SSU) rDNA sequencing and assessment of the recent past record (sediment core), were performed on material collected in the Oslofjord in 2016. Examination of the dead fauna showed that specimens resembling *N. stella* only appeared recently in the Oslofjord, confirming the NIS status of this population. Moreover, DNA results indicate that the Oslofjord specimens differ genetically from *N. stella* sampled in the Santa Barbara Basin (California USA). Hence, we propose to use the name *Nonionella* sp. T1 for the specimens sampled in the Oslofjord for the time being. In the southern part of the Skagerrak, specimens morphologically similar to *Nonionella* sp. T1 were reported as NIS in the Gullmar fjord (Sweden) in 2011 and in the Skagerrak in 2015. Molecular data indicate that the two populations from Gullmar- and Oslofjords are identical, based on their SSU rDNA sequences. In addition, analyses of foraminiferal dead assemblages suggest that the population from the Gullmar fjord settled prior to the Oslofjord population, *i.e.* ~ 1985 and about 2010, respectively. This implies that *Nonionella* sp. T1 may have been transported from Sweden to Norway by northward coastal currents.

Key words: non-indigenous species, benthic foraminifera, morphological criteria, molecular identification

Introduction

Introduction of non-indigenous species (NIS) is one of the major threats to biodiversity and ecosystem functioning in coastal waters (Butchart et al. 2010; Pyšek and Richardson 2010). One of the main vectors of NIS

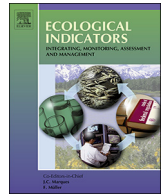

Benthic foraminifera to assess ecological quality statuses: The case of salmon fish farming

Vincent M.P. Bouchet^{a,*}, Noémie Deldicq^a, Noémie Baux^{b,c}, Jean-Claude Dauvin^b, Jean-Philippe Pezy^b, Laurent Seuront^{d,e,f}, Yann Méar^c

^a Univ.Lille, CNRS, ULCO, UMR8187, Laboratoire d'Océanologie et de Géosciences F-62930 Wimereux, France

^b NormandieUniv., UNICAEN, Laboratoire Morphodynamique Continentale et Côtière, UMR6143M2C, 24 rue des Tilleuls, F-14000 Caen, France

^c Normandie univ., UNICAEN, Laboratoire des Sciences Appliquées de Cherbourg, EA 4253 and Conservatoire National des Arts et Métiers, INTECHMER, 50100 Cherbourg, France

^d CNRS, Univ. Lille, ULCO, UMR8187, Laboratoire d'Océanologie et de Géosciences F-62930 Wimereux, France

^e Department of Marine Resource and Energy, Tokyo University of Marine Science and Technology, 4-5-7 Konan, Minato-ku, Tokyo 108-8477, Japan

^f Department of Zoology and Entomology, Rhodes University, Grahamstown 6140, South Africa

ARTICLE INFO

Keywords:

Fish aquaculture
English Channel
Environmental monitoring
Benthic foraminifera
Biotic index
Macrofauna

ABSTRACT

The “Rade de Cherbourg” (RdC, Cotentin) hosts the only marine salmon fish farm along the French coasts. High hydrodynamic regime would limit, there, organic matter (OM) accumulation directly under the cages, and enhance the transport of OM in the surrounding of the cages. This study was aiming at (1) monitoring the impact of a salmon fish farm on ecological quality statuses (EcoQs) of the RdC based on a benthic foraminiferal biotic index, (2) comparing EcoQs assessment results between foraminifera and macrofauna, and (3) *in fine* assessing the potential for benthic foraminifera to become an alternate biological quality element. In 2014 and 2015, bottom sediments of the RdC were sampled at 13 stations under and outside the farm for sedimentary (grain size and OM), and living foraminiferal and macrofaunal analyses. For benthic foraminifera, Exp(H_{b,c}) was used to determine EcoQs, while H', AMBI and BO2A indices were used for benthic macrofauna. Rank-frequency distributions (RFDs) were calculated for both groups. Ecological quality statuses based on foraminifera and macrofauna indicated a moderate degradation of the environmental conditions, shifting from excellent outside the farm to poor under the cages for foraminifera and from excellent to moderate for macrofauna. This study showed that benthic foraminifera are as reliable as macrofauna to assess EcoQs in the RdC. It offers interesting perspectives to monitor the health of marine systems based on benthic foraminifera. Furthermore, results obtained with RFDs suggested that this approach should be considered in the assessment of the good environmental status within the European marine strategic framework directive. Finally, diversity proved to be efficient in monitoring the health of the RdC, suggesting that it should not be set aside for the benefit of sensitivity-based indices.

1. Introduction

During the last 30 years, aquaculture in marine waters has greatly increased partly driven by the need for greater self-sufficiency in marine food production (Holmer, 2010). However, it is now widely acknowledged that activities related to aquaculture cause environmental disturbances (Bouchet and Sauriau, 2008; Carvalho et al., 2006; Chamberlain et al., 2001). Numerous studies have demonstrated that aquaculture degrades both sedimentary characteristics and benthic communities (Bouchet and Sauriau, 2008; Karakassis et al., 2002; La Rosa et al., 2004; Mazzola et al., 2000; Dauvin et al., 2020), which ultimately leads to decreased ecological quality statuses (Bouchet and

Sauriau, 2008; Muxika et al., 2005). Previous studies show that the impacts of fish farms are essentially localised and depend mainly on aquaculture and environmental factors such as fish density, start date of activities, water depth, initial sea bottom site characteristics and hydrodynamic regime (Black, 2001; Karakassis et al., 2002; Yokoyama et al., 2006; Dauvin et al., 2020).

The Rade de Cherbourg (RdC), the second largest artificial roadstead in the world, is located on the north coast of the Cotentin Peninsula (Normandy, France) and hosts the only open marine water French salmon farm since the beginning of 1990 s. Sediments directly below the cages are characterized by a moderated and localized increase in mud, organic carbon and nitrogen content (Kempf et al., 2002;

* Corresponding author.

E-mail address: vincent.bouchet@univ-lille.fr (V.M.P. Bouchet).

Résumé

L'objectif de cette thèse est de décrire le rôle des foraminifères benthiques dans les processus de bioturbation en caractérisant le comportement de déplacement à l'interface eau-sédiment des espèces dominantes des vasières intertidales des côtes Est de la Manche pour notamment les classer dans les groupes fonctionnels de bioturbation, (ii) de quantifier le remaniement sédimentaire de surface de ces espèces, (iii) de comprendre comment les facteurs biotiques et abiotiques vont moduler le mode et l'intensité du remaniement sédimentaire de l'espèce *Haynesina germanica*, enfin, (iv) de décrire la dynamique du déplacement verticale, des structures biogéniques et de quantifier le taux de bioturbation de *H. germanica*. Pour cela, les paramètres suivants ont été mesurés : la distance parcourue, la vitesse de déplacement, la position, l'indice d'activité et la complexité de la trajectoire. La dynamique du déplacement a été étudiée sur les espèces suivantes : *Haynesina germanica*, *Criboelphidium williamsoni*, *Quinqueloculina seminulum*, *Ammonia tepida* et *Miliammina fusca*. Bien que toutes identifiées comme appartenant au groupe fonctionnel des biodiffuseurs, les espèces occupent des positions verticales distinctes dans la colonne sédimentaire. Ainsi, *C. williamsoni* est un biodiffuseur épifaune, *Q. seminulum*, *M. fusca* et *H. germanica* sont des biodiffuseurs de galeries tandis que *A. tepida* est un biodiffuseur de surface. Ceci suggère ainsi des effets différents sur la redistribution spatiale des particules. L'intensité du remaniement sédimentaire est contrôlée par les traits spécifiques ainsi que par les facteurs biotiques et abiotiques. En effet, la distance parcourue, la vitesse, le niveau d'activité et la complexité de la trajectoire varient à la fois entre et au sein des espèces. Par conséquent, les taux de remaniement sédimentaire varient aux échelles spécifiques, individuelles et fonctionnelles. Spécifiquement, l'étude d'*H. germanica* montre que la taille du test, la densité, la température et la concentration en matière organique sont des éléments clefs structurant son activité de bioturbation. Ce travail illustre la capacité des foraminifères benthiques à contribuer au processus de remaniement sédimentaire à l'interface eau-sédiment mais également en profondeur. Il ouvre de nouvelles perspectives sur la compréhension de l'écologie des foraminifères et leur rôle non négligeable dans la bioturbation des écosystèmes intertidaux.

Abstract

The aim of this PhD is to describe the role of benthic foraminifera in bioturbation processes focusing on particulate fluxes at the sediment-water interface. Specifically, the objectives are fourfold: (i) characterising the motion behaviour of key benthic foraminiferal species inhabiting intertidal mudflats from the Eastern English Channel at the sediment water interface to further classify them into functional groups of bioturbation, (ii) quantifying surface sediment reworking rates of the above-mentioned species, (iii) understanding how biotic and abiotic parameters may drive the mode and the intensity of surface sediment reworking of the dominant species *Haynesina germanica*, and (iv) further describing the vertical burrowing dynamics and the biogenic structures built by *Haynesina germanica* to quantify its bioturbation rates. To do so, the following parameters are described: the travelled distance, the velocity, the vertical position, the activity level and the tortuosity of the path. The motion-behaviour is described for the following species: *Haynesina germanica*, *Criboelphidium williamsoni*, *Quinqueloculina seminulum*, *Ammonia tepida* and *Miliammina fusca*. Although they are all classified in the functional group of biodiffusors, these species differ in their preferential vertical position within the sediment. Specifically, *C. williamsoni* is an epifaunal-biodiffusor, *Q. seminulum*, *M. fusca* and *H. germanica* are gallery-biodiffusors while *A. tepida* is a surficial biodiffusor. This therefore means that the mode of sediment reworking is species-specific in benthic foraminifera. Its intensity is mediated by specific traits as well as biotic and abiotic factors. Indeed, travelled distance, velocity, activity level and tortuosity of the path would vary between and within species. As a consequence, the rate and the mode of sediment reworking are species-, individual- and functional group-dependant. Specifically, the surface area of the test, the species density, the temperature and the organic matter concentration are key parameters that control the bioturbation activity of *H. germanica*. The present work highlights the role of benthic foraminifera in sediment reworking processes taking place at the sediment-water interface and in the sediment column. It opens new perspectives on the understanding of the ecology of foraminifera and their putative non-negligible role in bioturbation processes in intertidal ecosystems.