



HAL
open science

Analysing content and language integrated learning (CLIL) and English as an additional language (EAL) interactions and exploring representations in a plurilingual context

Zehra Gabillon

► **To cite this version:**

Zehra Gabillon. Analysing content and language integrated learning (CLIL) and English as an additional language (EAL) interactions and exploring representations in a plurilingual context. Education. Université de la Polynésie française, 2020. tel-03725623

HAL Id: tel-03725623

<https://theses.hal.science/tel-03725623>

Submitted on 18 Jul 2022

HAL is a multi-disciplinary open access archive for the deposit and dissemination of scientific research documents, whether they are published or not. The documents may come from teaching and research institutions in France or abroad, or from public or private research centers.

L'archive ouverte pluridisciplinaire **HAL**, est destinée au dépôt et à la diffusion de documents scientifiques de niveau recherche, publiés ou non, émanant des établissements d'enseignement et de recherche français ou étrangers, des laboratoires publics ou privés.



Université de la Polynésie française

EASTCO – EA 4241
Équipe d'accueil sociétés traditionnelles et
contemporaines en Océanie

Analysing content and language integrated learning (CLIL) and English as an additional language (EAL) interactions and exploring representations in a plurilingual context

Dossier présenté en vue d'une habilitation à diriger des recherches

(HDR)

16 décembre 2020

Volume I : note de synthèse

Zehra Ergüdenler Gabillon

Enseignante-chercheure à l'Université de la Polynésie française (section 11)

2020

Jury de soutenance

Jean-Paul NARCY-COMBES, Professeur émérite des Universités, DILTEC (EA2288), Université de la Sorbonne nouvelle – Paris 3 (*Garant scientifique*) (section CNU 07)

Peter BROWN, Professeur des universités, membre du FAHA (Fellow, Australian Academy of the Humanities), Laboratoire EASTCO EA4241, Université de la Polynésie française (*président du jury*) (section CNU 11)

John HAJEK, Professeur des universités, membre du FAHA (Fellow, Australian Academy of the Humanities), Directeur de l'unité de recherche « Multilingualism and Cross-Cultural Communication (RUMACCC) », School of Languages and Linguistics, Université de Melbourne (*rapporteur*) (section CNU 07)

Andrea YOUNG, Professeur des universités, INSPÉ, unité de recherche 1339, LILPA, Université de Strasbourg (*rapporteur*) (section CNU 11)

Claire CHAPLIER, Maître de conférences, Habilitée à Diriger des Recherches, UMR EFTS, (Education, Formation, Travail, Savoirs), Université Toulouse Jean-Jaurès, Département LVG-FSI, Université de Toulouse III (*rapporteur*) (section CNU 11)

ACKNOWLEDGEMENTS

I would like to express my sincere thanks to Professor Jean-Paul Narcy-Combes, my HDR supervisor (*Garant scientifique*), for sharing his insightful viewpoints with me. Without his comments and his extensive knowledge in the field of applied linguistics, it would have been difficult to give this HDR thesis the current epistemological dimension.

I also thank Professor Peter Brown, my *Réfèrent HDR* and the *President of the jury*, who helped me overcome administrative obstacles throughout this adventure.

I would also like to thank my '*Rapporteurs*', Professor John Hajek, Professor Andrea Young and Claire Chaplier, for agreeing to participate in this hard work of reading so many pages and assessing my work.

My thanks also go to my colleagues Jacques Vernaudon, Rodica Ailincăi, Goenda Reea, Mirose Paia, with whom I have worked on several research projects and participated in field work on French Polynesian islands.

I would also like to thank my colleagues from other institutions, Frédéric Anciaux (University of French West Indies), Yvette Slaughter (Melbourne University), Séverine Ferrière (University of New Caledonia) with whom I conduct research projects.

In addition, I would like to thank professor Patrick Capolsini (president of the Université de la Polynésie française [UPF]), Professor Nabila Gaertner-Mazouni (vice-president of research, UPF) for their time and support in implementing the administrative decisions and authorizing my defense.

I thank French Polynesian educational authorities and teachers. Without their cooperation my research activities would not have been realized.

Finally, thanks to Alban and Cyrus, my dear husband, and my dear son, who supported me throughout my work and enabled me to see that life goes on outside the HDR work.

PREFACE

The aim of this *Habilitation à Diriger des Recherches* (HDR)¹ dissertation is to present a summary of the research activities I have carried out since the completion of my PhD studies with the prospect of obtaining the accreditation to supervise research activities.

This HDR dissertation consists of four volumes:

- *Volume I*² contains a synopsis of my research activities which includes (i) a presentation of my epistemological position, (ii) a description of the research context, (iii) a review of the fundamental concepts and definition of key concepts, (iv) a summary of the studies I have conducted (I use only selected papers to present as examples with some minor modifications; other research papers are included in Volume III), and (v) a statement of conclusions and perspectives.
- *Volume II* presents a detailed curriculum vitae with information on the research projects in which I have participated and a list of publications.
- *Volume III* includes my research papers (i.e., empirical studies and state-of-the-art papers) and book chapters.
- *Volume IV* contains an unpublished manuscript. This manuscript is written in French and is meant as a tool to help teachers and students to understand CLIL and plurilingualism in the light of recent research in applied linguistics.

¹ The *Habilitation à Diriger les Recherches* (HDR) is the highest qualification in French higher education and confers (i) scientific level recognition and (ii) recognition of the ability to supervise doctoral research.

² This document conforms to Oxford English, a variant British English that uses the suffix -ize (e.g., organization, privatize, and recognizable, instead of organisation, private, and recognisable) alongside -yse: (e.g., analyse, paralyse etc.).

Table of Contents

<i>Acknowledgements</i>	<i>ii</i>
<i>Preface</i>	<i>iii</i>
<i>Glossary of main acronyms</i>	<i>xiii</i>
<i>Introduction</i>	<i>1</i>
Overview of Volume I	1
<i>Part I: Overview of my research, language learning experience and context</i>	<i>11</i>
<i>Chapter One</i>	<i>12</i>
<i>Overview of my research and language learning experience</i>	<i>12</i>
<i>1 Introduction</i>	<i>12</i>
1.1 Summary of my research activities and interests	12
1.1.1 Studies on EAL and CLIL pedagogies	14
1.1.2 Studies on beliefs and social representations.....	15
1.1.3 Overview of research methodologies used	16
1.1.4 Combining teacher education and research	17
1.1.5 Past research projects (2011-2020).....	17
1.2 My personal experience with AL learning and plurilingual contexts	20
1.3 Conclusion	25
<i>Chapter Two</i>	<i>26</i>
<i>French Polynesian educational context and language ecology</i>	<i>26</i>
<i>Introduction</i>	<i>26</i>
1.4 French Polynesian educational context	26
1.5 French Polynesian linguistic, social, and cultural ecology	29
1.6 Research on plurilingualism	31
1.7 Conclusion	34
<i>Part II: Theoretical foundations and key terminology</i>	<i>35</i>

Introduction	35
<i>Chapter Three.....</i>	36
<i>Current applied linguistic context</i>	36
<i>Introduction.....</i>	36
1.8 Current linguistic transformations and applied linguistics context	37
1.8.1 Transdisciplinary growth.....	40
1.8.2 Inclusion of autochthonous, heritage, and regional language learning in applied linguistics.....	41
1.8.3 Epistemological shifts.....	42
1.9 Conclusion.....	43
<i>Chapter Four.....</i>	45
<i>Epistemological position</i>	45
<i>Introduction.....</i>	45
1.10 From monoglossic bilingualism towards heteroglossic dynamic bilingualism	46
1.11 My conceptualization of bilingualism, multilingualism, and plurilingualism	50
1.12 Some notions related to bilingualism, multilingualism, plurilingualism.....	53
1.13 Conceptualization of language, language use, and language learning	57
1.14 My conceptualization of language-learning context.....	61
1.15 Conclusion.....	64
<i>Chapter Five</i>	66
<i>Canons of the theoretical stance in instructed AL learning.....</i>	66
<i>Introduction.....</i>	66
1.16 Sociocultural and interactionist theoretical positions	67
1.16.1 The sociocultural perspective in learning and AL development.....	68
1.16.2 Interactionist perspective in AL development.....	74
1.17 Discussion and conclusion.....	81

<i>Chapter Six</i>	83
<i>Current AL teaching approaches</i>	83
<i>Introduction</i>	83
1.18 Competency-based approaches	85
1.19 Task-based language teaching (TBLT)	88
1.20 Action-oriented approach (AOA)	90
1.21 Content-based instruction (CBI)	92
1.22 Conclusion	95
 <i>Chapter Seven</i>	 96
<i>CLIL as an educational approach</i>	96
<i>Introduction</i>	96
1.23 CLIL background	97
1.24 CLIL inception	98
1.25 CLIL experimentations	99
1.26 What is CLIL?	100
1.27 Different CLIL models or different CLIL practices?	102
1.27.1 Do contextual differences count as different CLIL models?	104
1.28 Epistemological underpinnings	105
1.28.1 Current philosophical influence on CLIL.....	105
1.29 Theoretical foundations	107
1.29.1 Sociocultural perspective.....	107
1.29.2 Cognitivist views and CLIL	108
1.29.3 CLIL frameworks and their underlying theoretical stance	109
1.29.4 Is CLIL a language teaching approach?	112

1.29.5	Is CLIL same as CBI?	113
1.30	Discussion and conclusion.....	114
<i>Chapter Eight</i>		
	<i>beliefs and social representations</i>	<i>116</i>
	<i>Introduction.....</i>	<i>116</i>
1.31	Social representation	117
1.31.1	Anchoring.....	121
1.31.2	Objectification	122
1.32	Learner beliefs	123
1.32.1	Metacognitive knowledge.....	124
1.32.2	Self-beliefs.....	125
1.32.3	Attribution theory	128
1.33	Belief formation as a progressive process (Gabillon, 2005).....	131
1.34	Conclusion.....	135
<i>Part III: CLIL and EAL studies (2011-2020)</i>		
	<i>Introduction</i>	<i>136</i>
<i>Chapter Nine.....</i>		
	<i>Research methodologies and techniques used in CLIL and EAL studies</i>	<i>138</i>
	<i>Introduction.....</i>	<i>138</i>
1.35	Classroom interaction analysis.....	139
1.36	Segmenting (framing) data	140
1.36.1	Key terms	141
1.37	Coding technique.....	142
1.38	SLA terms and taxonomies.....	143
1.38.1	Labels used during coding.....	144

1.39	Data analysis tools	146
1.40	Data collection instruments	146
1.40.1	Video-recordings and transcriptions.....	147
1.40.2	Observation notes	148
1.40.3	Descriptive notes	148
1.41	Conclusion.....	148
<i>Chapter Ten</i>		<i>150</i>
<i>CLIL studies</i>		<i>150</i>
<i>Introduction.....</i>		<i>150</i>
<i>CLIL: Study I.....</i>		<i>151</i>
1.42	Introduction	151
1.43	Aim of the study.....	152
1.44	Theoretical stance and pedagogical principles	153
1.45	Procedure	154
1.46	Data collection.....	156
1.47	Analysis and results.....	157
1.47.1	Phase 1: CLIL Lesson for Group A.....	158
1.47.2	Phase 1: Subject Lesson for Group B	163
1.47.3	Phase 2: CLIL Lesson for Group B	165
1.47.4	Phase 2: Subject Lesson for Group A.....	166
1.48	Discussion and conclusion.....	168
<i>CLIL: Study II.....</i>		<i>170</i>
1.49	Introduction	170
1.50	Theoretical stance.....	170

1.51	Methodology.....	171
1.51.1	Data collection instruments	171
1.51.2	Analysis	172
1.52	Results.....	173
1.53	Discussion and conclusion.....	176
	<i>CLIL study III</i>	<i>178</i>
1.54	Introduction	178
1.55	CLIL as part of the Maeha'a Nui project	180
1.55.1	CLIL Study III (work package 1)	183
1.55.2	CLIL Study III (work package2)	185
1.56	Discussion and conclusion.....	188
	<i>Conclusion</i>	<i>190</i>
	<i>Chapter Eleven</i>	<i>192</i>
	<i>EAL studies</i>	<i>192</i>
	<i>Introduction</i>	<i>192</i>
	<i>EAL: Study I</i>	<i>194</i>
1.57	Introduction	194
1.58	Participants	194
1.59	Analysis methods and procedures.....	194
1.60	Results.....	195
1.60.1	Summary of Results	196
1.61	Discussion and conclusion.....	208
	<i>EAL: Study II</i>	<i>209</i>
1.62	Introduction	209

1.63	Methodology.....	209
1.64	Analysis procedures.....	211
1.65	Results.....	213
1.65.1	Main interaction types observed.....	214
1.65.2	Exchanges with low learner involvement.....	216
1.65.3	Exchanges with high learner involvement.....	218
1.65.4	Exchanges with average learner involvement.....	221
1.65.5	Summary of results.....	222
1.66	Discussion and conclusion.....	224
	<i>Conclusion.....</i>	<i>226</i>
	<i>Chapter Twelve.....</i>	<i>227</i>
	<i>Teacher education and research.....</i>	<i>227</i>
	<i>Introduction.....</i>	<i>227</i>
1.67	Teacher training projects and activities.....	227
1.68	Discussion and conclusion.....	230
	<i>Part IV: Studies on social representation and beliefs.....</i>	<i>231</i>
	Introduction.....	231
	<i>Chapter Thirteen.....</i>	<i>232</i>
	<i>Introduction.....</i>	<i>232</i>
1.69	Research methodologies.....	232
1.69.1	Grounded theory method.....	233
1.69.2	Data analysis tools.....	236
1.70	Discussion and conclusion.....	237
	<i>Chapter Fourteen.....</i>	<i>238</i>
	<i>Belief and social representation studies.....</i>	<i>238</i>
	<i>Introduction.....</i>	<i>238</i>

<i>Social representations: Study I</i>	240
1.71 Introduction	240
1.72 Brief literature survey on representations and technology use	241
1.73 Methodology	242
1.73.1 Sampling and participants	244
1.73.2 Corpus coding and analysis	245
1.73.3 Results	247
1.74 Discussion and conclusion	253
<i>Beliefs: Study II</i>	254
1.75 Introduction	254
1.76 Methodology	254
1.77 Results	255
1.77.1 Participants' attributions for 'I don't like English'	255
1.77.2 Participants' attributions for 'I like English but ...'	257
1.77.3 Participants' attributions for 'I like English'	260
1.78 Conclusion and discussion	262
<i>Representations: Study III</i>	264
1.79 Introduction	264
1.80 Methodology	264
1.81 Results	267
1.81.1 The participants' beliefs about the English language and English language learning	267
1.81.2 The participants' motives for learning English.....	271
1.81.3 The participants' beliefs about AL skill/component difficulty	272
1.81.4 The participants' beliefs about AL skill/component significance	274

1.81.5	The participants' beliefs about using the L1	276
1.82	Discussion and conclusion.....	277
	<i>Conclusion.....</i>	<i>279</i>
	<i>Part V: Ongoing research studies and projects.....</i>	<i>280</i>
	<i>Chapter Fifteen.....</i>	<i>281</i>
	<i>Ongoing research studies and projects.....</i>	<i>281</i>
	<i>Introduction:.....</i>	<i>281</i>
1.83	Ongoing research.....	281
1.83.1	EMILE 2 ^D (CLIL 2 ^D) project (2019-2023).....	281
1.83.2	Identity texts project (2020-2023)	284
1.83.3	EMILE 1 ^D project (2020-2022)	287
1.84	Conclusion.....	288
	<i>Discussion and conclusion.....</i>	<i>289</i>
	<i>Introduction.....</i>	<i>289</i>
1.85	The CLIL research processes and framework	290
1.86	Socially mediated activity (SMA) framework.....	291
1.87	Conclusion.....	299
	<i>References.....</i>	<i>303</i>
	<i>I. Table of figures.....</i>	<i>349</i>
	<i>II. Table of tables.....</i>	<i>352</i>
	<i>III. Table of extracts</i>	<i>354</i>
	<i>IV. Appendices.....</i>	<i>356</i>

GLOSSARY OF MAIN ACRONYMS

A&G: Artefacts and gestures

AL: Additional language

AOA: Action-oriented approach

BICS: Basic interpersonal communicative skills

CALP: Cognitive academic language proficiency

CBI: Content-based instruction

CLIL: Content and language integrated learning

CBLT: Competency based language teaching

CLT: Communicative language teaching

CUP: Common underlying proficiency

EAL: English as an additional language

EASTCO: Sociétés traditionnelles et contemporaines en Océanie

EMILE: Enseignement d'une matière par l'intégration d'une langue étrangère

ESPE: Écoles supérieures du professorat et de l'éducation

DGEE: Direction générale de l'éducation et des enseignements

DNL: Discipline non-linguistique (disciplines dites non linguistiques [DdNL]).

GT: Grounded theory

HDR: Habilitation à diriger des recherches

IH: Interaction hypothesis

IUFM: *Instituts universitaires de formation des maîtres*

LI: Initial socialization language

NLD : Non-linguistic discipline

PAS: Potentially acquisitional sequences (fr. *séquence potentiellement acquisitionnelle* [SPA])

PrEEPP: Pratiques Éducatives, Enseignantes et Parentales en Polynésie' (PrEEPP)

SLA: *Second language acquisition (research)*

SMA: *Socially mediated activity*

STT: *Student talking time*

TBLT: Task based language teaching

TTT: Teacher talking time

UBL: Usage-based linguistics

UPF: *Université de la Polynésie français*

ZPD: Zone of proximal development

INTRODUCTION

Overview of Volume I

This HDR dissertation (*note de synthèse*) presents a summary of the research activities I have carried as a member of the research unit *Équipe d'Accueil Sociétés Traditionnelles et Contemporaines en Océanie* (EASTCO; EA 4241) at the University of French Polynesia (*Université de la Polynésie Française* [UPF]). Currently, I am a member of the 'languages and learning' (*langues et apprentissages*) research team, a sub-unit of EASTCO. The languages and learning team conducts research on Polynesian languages and collaborative action-research activities on the teaching of Tahitian and English as additional languages (EAL) in partnership with the educational authorities of French Polynesia (Gabillon, 2019, 2021; Gabillon & Ailincal, 2015a, 2016, 2017).³ I am an EAL teacher, and my research focuses on content and language integrated learning (CLIL;⁴ '*enseignement d'une matière par l'intégration d'une langue étrangère*' [EMILE⁵]), EAL teaching, and beliefs (i.e., social representations and belief systems).

My doctoral studies focused primarily on learner and teacher beliefs about EAL learning and teaching. After completing my doctoral studies, I adapted my research orientation to the linguistic context and needs of French Polynesia (see [Chapter 2](#)).

In this document, I use the term 'additional language' (AL) to refer to either a foreign language (e.g., English), an autochthonous language (e.g., Tahitian), a heritage language (e.g., Chinese), or a community or regional language learned as an AL at school. I use the term 'foreign language' when I need to distinguish between different languages with different status, such as foreign, autochthonous, heritage, or other languages, or when the term is a direct quote from an author in a

³ The references in this document follow the format of the American Psychological Association (APA) 6th Edition and generated by Mendeley reference manager.

⁴ Content and language integrated learning (CLIL) is a dual educational approach that uses an AL to teach both content and language. This approach will be described in detail in [Chapter 7](#).

⁵ In some texts EMILE is referred to as '*enseignement d'une matière intégré à une langue étrangère*'.

citation (see also the epistemological position taken by the Doulas Fir Group [Atkinson et al., 2016] and M.-F. Narcy-Combes et al. [2019]). I also use the term initial socialization language (L1⁶), which has traditionally been called ‘mother tongue’ or ‘first Language’. ‘L1’ in this document is used to refer to any language, such as an autochthonous, regional, heritage, or official language that the individual learns as their⁷ initial language in their family or immediate socialization environment. It should be noted that in today's multilingual world, many children use a language other than their ‘mother tongue’ as their L1 and may be exposed to more than one L1 at a time (which is the case for many French Polynesian children; see also M.-F. Narcy-Combes et al., 2019).

Part I of my HDR dissertation presents a brief overview of my research activities in the French Polynesian context (see [Chapter 1](#)). My epistemological position on ‘languages’ and ‘language learning’ is based on the principles of plurilingualism, which is supported by pluralistic approaches that recognize and respect the choice of language and the language rights of bilingual people (see [Chapter 4](#)). In this HDR dissertation, bilingualism, which literally means being able to speak two languages, is used as a generic term to mean speaking one or more languages in addition to one's initial language of socialization. However, in some cases, different terms are used to identify different types of bilingualism when further clarification is needed. In this document, I also make a distinction between plurilingualism and multilingualism.⁸ Multilingualism means the coexistence of several languages in parallel without interacting with each other (e.g., in a community, region, or country). In this manuscript plurilingualism refers to the individual's ability to use more than one language in an interconnected manner (with varying degrees of linguistic skills in each of these languages) to communicate with each other in multi/plurilingual and pluri/multicultural

⁶ In this dissertation, the acronym L1 does not refer to a linear order of language acquisition. In today's multilingual societies, many people can learn more than one language as a language of first socialization (e.g., L1a, L1b, L1c.). See also explanations given by M.-F. Narcy-Combes et al. (2019).

⁷ Throughout this document the singular ‘they’, a generic third-person singular pronoun, will be used as a gender-neutral pronoun in conformity with APA and many leading publishers’ publication guidelines.

⁸ Publications in English often do not identify between these two concepts, with multilingualism being used as a generic term to cover the concept of plurilingualism.

environments (Castellotti, 2006; Conseil de l'Europe, 2001, 2018; M.-F. Narcy-Combes et al., 2019).

Chapter Two of Part I provides a detailed description of the French Polynesian context, highlighting its plurilingual linguistic ecology, and explains how my research is situated within this framework (Gabillon & Ailinc̃ai, 2015b). In French Polynesia different languages coexist, and these languages (see [Section 2.2](#)) are most often used interchangeably or in an enmeshed way by the local people. Most of my studies have been conducted within this linguistic landscape as part of plurilingual and multidisciplinary research projects doing field work in cooperation with other researchers (Gabillon, 2019, 2021; Gabillon, Vernaudo, Marchal, Ailinc̃ai, & Paia, 2016). Although my research focuses on EAL and CLIL (English) practices (Gabillon, 2019, 2020b, 2021; Gabillon & Ailinc̃ai, 2013, 2015a, 2017, 2020, 2021), beliefs and other linguistic and social components are also incorporated into my research and teaching approaches (Gabillon, 2012a, 2012b, 2013a, 2013b).

Present-day French Polynesia, located in the centre of the 'Polynesian triangle' that unites New Zealand, Hawaii, and the Easter Islands (Rapa Nui), is the region of origin of the Polynesian people. In this plurilingual linguistic landscape, the English language has a special status. In this region English is used as a lingua franca in research, cultural, educational, and economic cooperation. In this context, my research goes beyond the analysis of AL practices within the classroom setting⁹ (micro-context; see Gabillon, 2019; Gabillon & Ailinc̃ai, 2013, 2016a, 2020) and focuses on social representations (belief systems) and ideologies (macro-context) embedded in languages and culture (see Ailinc̃ai & Gabillon, 2018b, 2018a; Ailinc̃ai, Gabillon, & Ferriere, 2018; Ailinc̃ai, Gabillon, Vernaudo, Paia, & Alì, 2016; Gabillon, 2012b, 2012a, 2013a, 2013b; see also [Section 1.1.2](#) and [Chapter 14](#)). My personal experience with languages, as a plurilingual speaker and as an EAL teacher and teacher educator, and my position as a researcher and lecturer on second-language acquisition (SLA) and AL didactics, puts me in the right position to conduct research in such a

⁹ In this dissertation, I use the terms 'classroom context', 'classroom setting', and 'classroom environment' interchangeably to refer to the micro-context which includes learners, peers, teachers, the physical classroom setting (i.e., the classroom and social artefacts), and affect (e.g., emotions and learner beliefs; Atkinson et al., 2016).

plurilingual context (see [Section 1.2](#) for my ‘language learner identity text’ and my CV for my professional experience).

[Part II](#) highlights the transdisciplinary aspect of applied linguistics and explains how other disciplines relate and inform this research field (see [Section 3.1.1](#)). In [Part II](#), I offer general information on recent developments that have shaped the applied linguistics field and how these developments have been reflected in my epistemological position (see [Chapter 3](#) and [Chapter 4](#)). I also provide a comprehensive account of recent transformations in the applied linguistics field by addressing the philosophical and societal influences that have been behind the paradigm shifts in this discipline. Often, we treat the historical narratives of a field superficially in a brief manner, thereby leading to an incomplete understanding of the underlying philosophies and pioneering ideas. What transformed applied linguistics was global. In this dissertation, I attempt to present the impact of these dynamic global transformations, which have had considerable repercussions on language teaching approaches and epistemological conceptualizations around the world. As my analysis will reveal, these global transformations also had an impact on local linguistic ecologies and language policies. My theoretical position (i.e., theoretical, methodological, and pedagogical) has been influenced by these complex transformations.

[Part II](#) also provides a detailed account of the theoretical and pedagogical concepts that underpinned my research (i.e., conceptualization, methodology, and implementation; see [Chapters 3, 4, 5, 6, and 7](#)). As I previously mentioned, my pedagogical view of AL learning is based on pluralistic approaches. Pluralistic approaches¹⁰ value the linguistic and cultural resources of bi/plurilingual children and enable them to make effective use of their plurilingual/pluricultural identities, experiences, cognitive resources, and linguistic repertoire (Candelier, 2016; Candelier et al., 2012; Conseil de l’Europe, 2018: see also [Chapter 4](#)). Linguistic repertoire, which includes knowledge of all the languages that a bilingual speaker knows, is considered inseparable and contributes to language learning (Grosjean, 2008). The learners’ linguistic repertoire, which contains the learners’ cultural identities and general knowledge of the world, which are rooted in their culture and the languages they know, contributes to their AL development. Analysis of the

¹⁰ ‘The term “pluralistic approaches to languages and cultures” refers to didactic approaches that use teaching/learning activities involving several (i.e. more than one) varieties of languages or cultures’(Candelier et al., 2012, p. 5).

interactional exchanges of learners recorded during CLIL and EAL lessons has shown that this repertoire is used as a resource for peer support and as a pedagogical tool by teachers (Gabillon, 2019; Gabillon & Ailincăi, 2013, 2017, 2020).

My overall conceptualizations of bilingualism, language learning, and ALs are in keeping with the emergentist accounts (see also [Chapter 4](#)), which emphasize that language learning is not innate¹¹ but that it emerges from complex interactions between learners' cognitive mechanisms (biological) and social interactions (environment; for emergentist accounts of AL learning, see complexity theories [Larsen-Freeman, 2011a, 2012], connectionisms [N. C. Ellis, 1998, 2019], dynamic systems theories [Larsen-Freeman, 2004] and usage-based linguistics [UBL]; Atkinson, 2011, 2019). This emergentist view also implies that the fluent language use is the result of a massive collection of knowledge databases that are accumulated through frequent practice and exposure in social interactions. Emergentist theories underline the importance of frequency of use and engaging in interactional exchanges with others in AL learning.

Embedded in the theoretical epistemologies mentioned above, the main theoretical notions that underlie my research are rooted in sociocultural and interactionist perspectives (see [Chapter 5](#)). These two perspectives view language use, thinking, and language development as inseparable and interacting entities. My research focuses on the microgenetic analysis¹² of interactional exchanges by observing how language learners interact with each other and make use of social tools (i.e., social artefacts, body movements, other languages they know, and other non-verbal elements) in specific situations to construct their AL collaboratively in classroom settings. These two perspectives provide my research with the fundamental premises underlying my conceptual, methodological (i.e., research design and analysis), and pedagogical epistemologies. This section also details my pedagogical position in CLIL and AL learning by providing a brief review of recent

¹¹ Research in the field of neuroscience maintains that infants are born with the ability to learn, but that different parts of their brains specialize (different modular networks are formed) as they are exposed to the environment (for further information on research in neuroscience/neurolinguistics see García, 2011; García & Wei, 2014; J.-P. Narcy-Combes & M.-F. Narcy-Combes, 2019; M.-F. Narcy-Combes et al., 2019).

¹² The microgenetic interaction analysis method is used to examine how language development takes place during a course of interactional exchanges in a social setting by obtaining detailed data about changes at the moment the changes are taking place (e.g., during classroom interactions; R. Ellis, 2015a; see also [Section 9.1](#)).

bilingual language teaching approaches, highlighting how sociocultural and interactionist perspectives have shaped AL and CLIL teaching.

Part II also provides a brief overview of the theoretical concepts used in my belief and social representations studies. This section presents the language learner belief model I propose (Gabillon, 2005). A slightly modified version of my state-of-the-art article (Gabillon, 2005) constitutes a section in [Chapter 8](#) (see [Section 8.3](#)). My state-of-the-art papers and the model I propose are cited as references by some of the leading researchers in SLA and belief research (e.g., Cook & Singleton, 2014; Kalaja & Maria Ferreira Barcelos, 2013; Singleton, 2014; B. Turnbull, 2018).

Part II contains six long chapters. This is due to the fact that (i) in France, to my knowledge,¹³ the field I am researching has not yet been the subject of much research; (ii) my research involves a multitude of theoretical, pedagogical, and contextual elements, and this complexity is required to be presented in a connected manner; (iii) my research is highly influenced by recent transformations in the applied linguistics field and many of the concepts that have emerged via these transformations are still new to many researchers in the field; and (iv) some of my state-of-the-art papers, which present the synthesis of my theoretical position, are also integrated in some chapters and sections to describe my theoretical position (e.g., Gabillon, 2005, 2012b, 2013a, 2020b).

[Part III](#) describes my research studies on CLIL and AL, using sample studies to present the evolution of my work and illustrate how my epistemological position and theoretical underpinnings are reflected in my research. This section is presented to highlight how the results obtained in each study are used as a starting point for the study that followed (Gabillon, 2019; Gabillon & Ailincal, 2013, 2015a, 2016, 2017). The original versions of these studies and the studies that are not included in this volume are presented in Volume III of my HDR dossier. The final chapter of Part III devotes a section to a description of the teacher education activities that took place as part of the action-research activities during CLIL studies (see [Chapter 12](#)). This chapter is brief. Although teacher education is crucial for the success of plurilingualism and the effective application of the CLIL approach, this HDR dissertation provides brief information on this topic. The teacher

¹³ This knowledge is acquired by searching selected scientific research databases.

education domain is vast and needs to be examined from many angles, which is beyond the scope of this HDR dissertation.

[Part IV](#) presents some sample papers from my belief and social representations studies and describes the procedures and analysis methods used. At present I am working on a CLIL project that extends its focus to social/cultural belief systems (Project EMILE 2^D; see [Section 15.1](#)). This project aims at investigating learners, teachers, and parents' social representations on languages and AL learning in the French Polynesian context. This project has not yet yielded any publications, but the transcribed interviews are available in the Mendeley data (see Gabillon 2020c).

[Part V](#) describes ongoing research activities and projects that have begun but have not yet produced publications.

The [Conclusion and Discussion](#) part ends this first volume. This last section provides readers with a synthesis of the results of my research on CLIL and EAL and the models that have emerged from my nine years of research work in the context of French Polynesia. CLIL (primary and secondary education) and AL (primary education) practices, represent an innovation for teachers, as well as for learners and parents. This final section details my research agenda on CLIL, AL, and beliefs—which involves not only learners but also teachers' and parents—outlines some questions for prospective research. This last section also includes an informative paragraph on a book I have written in French, which summarizes my theoretical orientations by giving examples drawn from my observations in CLIL and EAL classes. This monograph, in addition to international views, also focuses on some fundamental notions from the point of view of French researchers and concludes my synthesis by integrating general (global) perspectives and explanations from French Polynesia and the French language.

About Volume I

This first volume contains four parts and 15 chapters. As I have already mentioned, the research orientations and the epistemological position I adopt in my research work have been influenced by the educational context in French Polynesia, research on SLA, and recent developments in applied linguistics. These points will be clarified and detailed in different sections of this HDR dissertation. In order to show the links between my research work and my epistemological position, I will present samples of my research papers by highlighting how my research studies are related to one another and how my theoretical position is reflected in my work.

The research publications cited in this manuscript are international in nature. My research is situated and conducted in the context of French Polynesia, and the results of my research can only be interpreted in relation to the contextual realities specific to this setting. However, it should be noted that in today's world, an applied linguistic context cannot be isolated from the global linguistic ecology. We live in an interconnected world where the symbiotic dynamics of global language ecology have overarching effects on language and social ecologies in other contexts.

In this manuscript, I selected my references on the basis of (i) their relevance to my research field and themes (i.e., EAL, CLIL, beliefs, and social representations), (ii) their representativeness of plurilingual learning approaches and situations, (ii) their relevance to my theoretical and methodological positioning, and (iii) their quality. This manuscript is longer than

As an EAL teacher, an applied linguist, and a plurilingual person, I am against any discrimination between languages, regardless of their status. This dissertation is written in English, which is my research field, my teaching subject, my teacher education domain, and one of the languages in my language repertoire. My choice of language was also influenced by the fact that English is used as the language of academic/scientific publications, allowing researchers from various educational settings to share their work. Most of my publications are in English, and this can also be counted as a valid reason why this HDR dissertation is in English.¹⁴

Outline of Volume I

The [Introduction](#) provides information on the content of this HDR dissertation.

[Part I](#) contains two chapters:

- [Chapter One](#) provides a concise overview of my research career and the activities that followed my doctoral studies and presents my personal experience with languages as a learner.

¹⁴ According to Article 5 of the decree of 11 July 2018 concerning the procedure for registration on the qualification lists for university professorships, HDR dissertations written in a language other than French is allowed (Legifrance.gouv.fr, 2018). My section (CNU 11) also recommends research publications in English and allows HDR dissertations written in English.

- [Chapter Two](#) presents a synopsis of the education system in French Polynesia and the educational research activities that have been conducted by other researchers. This section also shows how EAL is embedded in the linguistic landscape of French Polynesia and the role my research plays in this educational framework.

[Part II](#) provides an overview of the fundamental notions and theoretical concepts that correspond to my epistemological positioning:

- [Chapter Three](#) presents recent paradigm shifts that have transformed applied linguistics and links these transformations to the epistemological stance I take.
- [Chapter Four](#) explains my epistemological position in relation to recent developments in applied linguistics and provides a concise overview of current conceptualizations of fundamental concepts and key terms relating to language, language use, bilingualism, multilingualism, and plurilingualism.
- [Chapter Five](#) outlines the theories that formed the epistemological basis and research framework for the studies I conducted on EAL and CLIL.
- [Chapter Six](#) provides an overview of current AL teaching approaches that have influenced the pedagogical and epistemological perspectives in my research.
- [Chapter Seven](#) describes CLIL as an educational approach in detail. The CLIL approach has been my major pedagogical focus and although it is briefly mentioned in Chapter Six as an AL approach, Chapter Seven provides a comprehensive overview of CLIL, focusing on its historicity, its ideological and theoretical underpinnings, and the points that have been the subject of confusion and debate in the literature.
- [Chapter Eight](#) defines the main concepts and terminology that I used in my belief and social representations studies, which examined learner, teacher, and parent beliefs and social representations of AL learning.

[Part III](#) contains four chapters. This section (i) presents the research methodologies used in CLIL and EAL studies, (ii) presents the CLIL and EAL studies, and (iii) provides an overview of the teacher education activities that were carried out as part of CLIL and EAL studies.

- [Chapter Nine](#) reviews the research methodologies used in CLIL and EAL studies.

- [Chapter Ten](#) presents examples from CLIL studies.
- [Chapter Eleven](#) presents examples from the EAL studies.
- [Chapter Twelve](#) gives an overview of the teacher education activities that took place as sub-projects in conjunction with CLIL and EAL research activities.

[Part IV](#) describes the belief and social representations studies after a succinct overview of the major research methodologies used in these studies.

- [Chapter Thirteen](#) provides a brief description of the primary research techniques used in the belief and representation studies I conducted.
- [Chapter Fourteen](#) presents an overview of my belief and representations studies.

[Part V](#) contains one chapter, [Chapter Fifteen](#), which presents my ongoing research projects and concludes with prospective research activities.

The [Discussion and Conclusion](#) section ends Volume I of my HDR dissertation with a brief discussion and conclusion providing the overall results and the models that emerged from my studies.

PART I: OVERVIEW OF MY RESEARCH, LANGUAGE LEARNING EXPERIENCE AND CONTEXT

Part I is divided into two chapters:

- Chapter One presents an overview of my research activities since the completion of my doctoral studies and describes my personal experience with different languages both as a plurilingual speaker and an AL learner.
- Chapter Two is presented via three main sections: (i) the first section provides a synopsis of the education system in French Polynesia, (ii) the second section describes the linguistic landscape and presents an overview of research on plurilingualism in French Polynesia, and (iii) the last section situates my research within the French Polynesian context and explains the role my research activities play within this educational setting.

CHAPTER ONE

OVERVIEW OF MY RESEARCH AND LANGUAGE LEARNING EXPERIENCE

1 Introduction

The first section of this chapter presents a concise overview of the research activities I have carried out in the French Polynesian education context since the end of my doctoral studies. This section also provides a brief presentation of the plurilingual and multidisciplinary research projects in which I have been involved since my integration into the research unit EASTCO.

The second section of this chapter includes an introspective analysis of my personal experience in plurilingualism. This introspection, while telling the story of my language learning experience from a learner's perspective, also reflects my insights as a teacher, teacher educator, and researcher in the field of SLA.

1.1 Summary of my research activities and interests

My research studies are encapsulated under three research areas: (i) mainstream EAL teaching, (ii) CLIL, and (iii) social representations and beliefs concerning educational issues (e.g., AL learning, CLIL, and educational technology; see Figure 1). In my research these three domains are intrinsically connected, and they inform one another. My research findings in these three areas have contributed to the understanding of issues related to (i) EAL and CLIL pedagogies (Gabillon, 2019, 2020b, 2021; Gabillon & Ailincăi, 2013, 2016, 2017, 2020); (ii) learner beliefs, representations, and attitudes (Gabillon, 2005, 2007b, 2012a; Gabillon & Ailincăi, 2017); (iii) teacher beliefs and teacher training (Ailincăi & Gabillon, 2018a; Ailincăi et al., 2018; Gabillon, 2012a, 2013a); and (iv) social and educational context (Ailincăi et al., 2016; Gabillon & Ailincăi, 2015a, 2015b; Gabillon et al., 2016).

The videotaped corpora collected from CLIL and EAL classrooms were analysed using interaction analysis procedures and mainly used microgenetic interaction analysis methodologies (see [Section 9.1](#) for microgenetic analysis). The data obtained from these studies helped me develop the 'socially mediated activity' (SMA) framework, which is based on interactionist and sociocultural

principles of language learning (Gabillon, 2019, 2020a; see also [Section 16.2](#) for socially mediated activity framework). The data about learners, teachers, and parents' representations were collected via interviews and questionnaires. The interview corpora were analysed using discourse analysis procedures (using a series of coding techniques) and questionnaires using descriptive statistics techniques (see [Section 14.3](#) for research methodologies used).

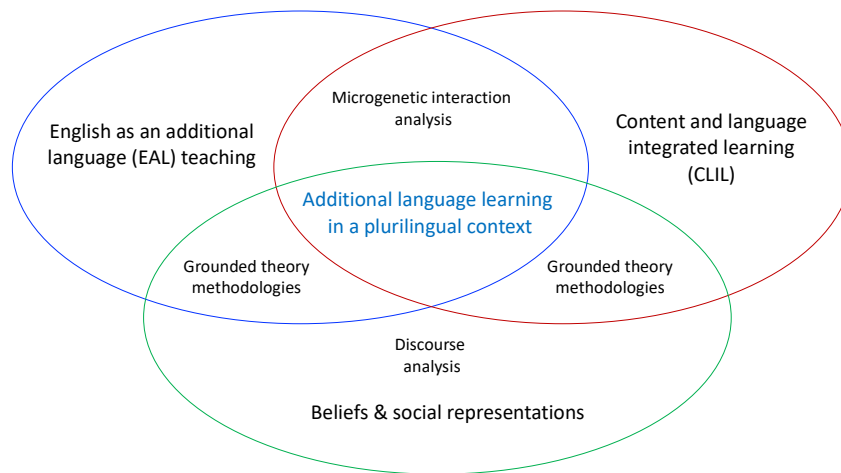

Figure 1. Overview of my research domains.

Research in these areas requires not only knowledge and research skills in the field of SLA but also knowledge in other neighbouring disciplines, such as educational sciences, educational psychology, sociolinguistics, linguistics, social psychology, psychology, and sociology (Candel & J.-P. Narcy-Combes, 2018; Douglas Fir Group, 2016¹⁵; Duff & Byrnes, 2019; Liddicoat, 2018; M.-F. Narcy-Combes, 2018; see also [Section 3.1.1](#)). The fundamental theories that influence applied linguistics, my field of research, have their origins in these disciplines. The transdisciplinary character of my field is reflected in all aspects of my research work. My ideological, theoretical,

¹⁵ The Douglas Fir Group is composed of 15 leading applied linguists: Dwight Atkinson, University of Arizona; Heidi Byrnes, Georgetown University; Meredith Doran, The Pennsylvania State University; Patricia Duff, University of British Columbia; Nick C. Ellis, University of Michigan; Joan Kelly Hall, The Pennsylvania State University; Karen E. Johnson, The Pennsylvania State University; James P. Lantolf, The Pennsylvania State University; Diane Larsen-Freeman, University of Michigan and University of Pennsylvania; Eduardo Negueruela, University of Miami; Bonny Norton, University of British Columbia; Lourdes Ortega, Georgetown University; John Schumann, UCLA; Merrill Swain, The Ontario Institute for Studies in Education of the University of Toronto; and Elaine Tarone, University of Minnesota.

methodological, and pedagogical orientations and the references I use in this HDR dissertation fully reflect the transdisciplinary character of my field.

1.1.1 Studies on EAL and CLIL pedagogies

I am interested in research studies that focus on interactional exchanges in AL learning settings. Most of my studies aimed at acquiring data on AL and CLIL teaching practices by collecting lesson samples via video recordings. These research inquiries include experimental studies that have investigated CLIL pedagogies and exploratory studies that have examined interactional exchanges obtained in mainstream EAL classes (Gabillon, 2019; Gabillon & Ailincăi, 2013, 2015b, 2015a, 2016a, 2017; Gabillon, et al., 2016).

The studies I have conducted in CLIL were carried out as part of a longitudinal study that contained several work packages (from 2011 to present). Each work package has been designed on the basis of the results obtained in the previous module (see [Section 16.1](#) and Figure 80 for CLIL research cycle). This gradual way of proceeding, by planning, collecting data, analysing, revising, and re-implementing research activities, has enabled me to gain an in-depth understanding of how CLIL was implemented. As a result of these implementations, I have drawn out some principles that could be applied to other CLIL settings (see Gabillon & Ailincăi, 2013, 2016). These studies aimed at (i) exploring learning and teaching actions (Gabillon & Ailincăi, 2015a, 2016), (ii) identifying efficient pedagogies (Gabillon & Ailincăi, 2013, 2017), and (iii) providing first-hand contextualized training data for primary and pre-service teachers (Gabillon et al., 2016).

The research work I carried out in mainstream AL learning situations investigated issues concerning peer support, teacher strategies and scaffolding techniques (e.g., corrective feedback strategies and input presentation styles), task types used (e.g., that enable active learner participation and cognitive engagement), and the effects these actions produced on learners (Gabillon, 2019). To analyse the effects of teaching strategies and the task types used on student learning, I focused on classroom exchanges with foremost emphasis on learner productions (e.g., I

measured the degree of learner involvement, the use of AL, and task types that enabled peer support¹⁶).

In my CLIL and EAL studies, I used video recordings as the primary source of data. The video-recorded data were transcribed, and the analysis was carried out using a series of coding and microgenetic interaction analysis techniques (see [Chapter 9](#) for analysis techniques).

1.1.2 Studies on beliefs and social representations

The second research domain, beliefs and social representations¹⁷ (most commonly referred to as beliefs in the general belief literature), stretches my research interests out to the social-psychological dimension of learning and teaching. Belief as a construct¹⁸ and Moscovici's social representations theory (Abric, 2001; Moscovici, 2000a; Moscovici & Markovà, 2006) constituted the primary theoretical framework of my doctoral thesis, and I continued to publish in this area after the completion of my PhD studies. I am especially interested in collecting and analysing learners', teachers', and parents' beliefs and social representations on educational issues to gain insights into their perceptions and conceptualizations of languages and language learning (e.g., bilingualism, EAL learning, CLIL, and the use of educational technology; Ailincăi & Gabillon, 2018b, 2018a; Ailincăi et al., 2018; Gabillon, 2005, 2007a, 2007b, 2012b, 2012a, 2013a, 2013b). The data for my belief and social representations studies have been collected via individual and focus-group interviews, and I analysed the corpora through discourse analysis procedures. Some of my representation studies also used questionnaires to complement interview data (Gabillon, 2007b, 2013b).

¹⁶ In this document, peer correction, peer feedback, peer mediation, peer scaffolding, and peer support refer to the help provided by learners to support the language development of their peers.

¹⁷ The social representations notion will be explained in detail in [Chapter 8](#). For the time being I will use this term interchangeably with the belief concept to cover a large group of belief-related notions such as cognitions, images, perceptions, and metacognitive knowledge.

¹⁸ In psychology, a construct is a hypothesized cause (e.g., motivation, beliefs, representations, and affect) for a certain behaviour. They are the individual's interpretations or perceptions of the world around them. 'They are ways of construing the world. They are what enables man, ... to chart a course of behaviour ...' (G. Kelly, 2003, p. 7).

Recently, I have been involved in projects that have included some researchers from other universities (The University of New Caledonia, the University of the French West Indies, and the University of Melbourne; see [Chapter 15](#) for ongoing research projects) and have reinvested in research on the representations construct. At present, I am co-supervising a PhD thesis that aims to explore parents' and teachers' representations of the role of school in the French Polynesian context involving social representations on school; language; learning; bi-, multi-, and plurilingualism; and so forth.

1.1.3 Overview of research methodologies used

The studies mentioned above were mainly qualitative but were augmented with quantitative data using descriptive analysis procedures. In these research studies, the methods I principally employed were (i) data exploration techniques using coding and inductive analysis procedures (qualitative/comprehensive), and (ii) descriptive statistics techniques to present occurrences, frequencies, and percentages (quantitative/summative). Figure 2 presents an overview of my research domains and the research methodologies used.

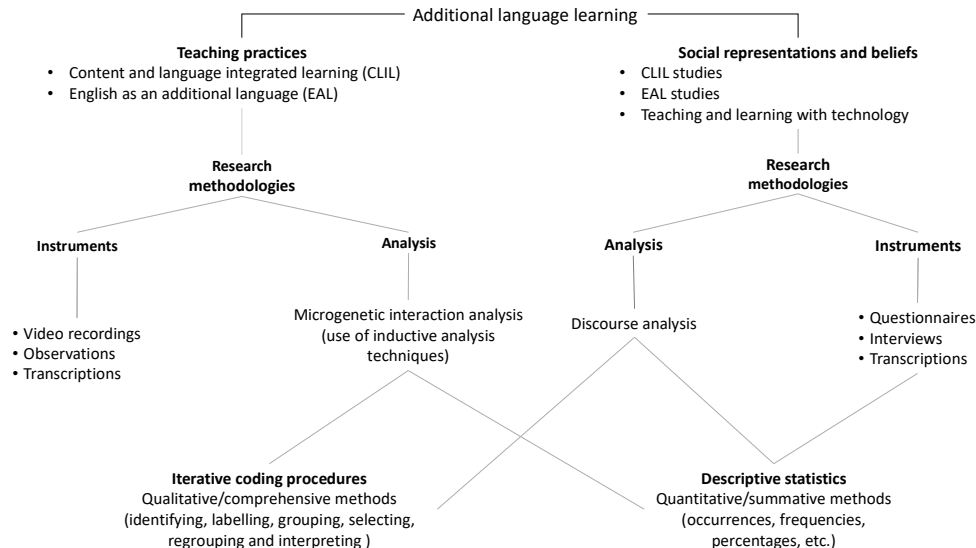

Figure 2. Overview of my research topics and methodologies used.

The data exploration techniques and interpretations were used to analyse the content of the discourse obtained via audio-recorded interviews and the content of the interactions obtained via video recordings in language classrooms. These qualitative analysis procedures consisted of a

range of reflexive iterative coding techniques (i.e., identifying, labelling, grouping, selecting, regrouping, and interpreting). The earlier interaction analysis studies, which took place from 2012-2015, were analysed manually, but the more recent research activities, from 2015 onwards, used the computer-assisted qualitative data analysis software (CAQDAS) Atlas.ti (Gabillon, 2019; Gabillon & Ailincal, 2016, 2017).

1.1.4 Combining teacher education and research

The CLIL and EAL projects I have implemented involved collaboration of elementary teachers (Gabillon & Ailincal, 2013, 2015a, 2016, 2020; Gabillon et al., 2016). The contribution of these research activities to teacher education can be summarized as (i) experiential education through direct involvement in research practices, (ii) teaching seminars and workshops using research outcomes to build awareness, (iii) authentic material for the research seminar courses designed for master's students (future teachers), and (iv) communication of research findings to other professionals in education and policymakers. Collaboration with teachers through research activities and teacher training seminars and courses has also provided valuable feedback to my research.

The CLIL research activities were based on collaborative research principles. Each cycle was planned and implemented in collaboration with the participant teachers (see Figure 64). After each lesson, I organized post-implementation discussions through which I received feedback from the teachers. At the end of each CLIL cycle, I provided the teachers with feedback. I also communicated the outcomes of these research projects during teacher education sessions at the university (especially in research and methodology courses), and this information was used to build awareness in EAL and CLIL pedagogies in practising, novice, and pre-service teachers (see [Chapter 12](#) for teacher education and research).

1.1.5 Past research projects (2011-2020)

The educational corpora used in my studies were gathered via several educational projects that are described below. The research projects I describe in this section have been the source of several publications, which I present in this document. The first three projects, CLIL Project 1, 'Pratiques Éducatives Enseignantes et Parentales en Polynésie' (PrEEPP; 'teachers and parents' educational practices in Polynesia'), and the Meaha'a Nui project, have been finalized, and the NumériProf

project has completed its first research cycle. Other ongoing projects, which have not yet been the subject of any publications, will be described in [Chapter 15](#) (all projects will also be described in detail in my CV).

CLIL project 1 (2011-2014)

The first CLIL study (consisting of two work packages) was integrated into a small longitudinal project initiated in 2011 in collaboration with a researcher and with a group of schoolteachers in two primary schools in Tahiti (see Gabillon, 2013b; Gabillon & Ailincal, 2016).

PrEEPP project (2014-2017)

The PrEEPP project was a large project. It was initiated in 2014 and carried out by a multidisciplinary and multi-institutional research team. The aim of this teamwork was to collect data samples in elementary schools across the five French Polynesian archipelagos (Society Islands, Tuamotu Archipelago, Marquesas Islands, Gambier Islands, and Austral Islands) of (i) video-recorded lessons on several school subjects (i.e., science, mathematics, English, and Tahitian), (ii) video-recorded parent-child interactions during school support, (iii) video-recorded parent interviews, and (iv) parent questionnaires. The project was extensive and required travelling long distances. This work was made possible by the financial contributions of the following organizations: the Ministry of Overseas France (Ministère des Outre-Mer), the University of French Polynesia (Université de la Polynésie Française [UPF]), the Directorate General for Education and Teaching of French Polynesia (Direction Générale de l'Éducation et des Enseignements [DGEE]), the Vice Rector (Vice-rectorat),¹⁹ and the education school (Écoles Supérieures du Professorat et de l'Éducation [ESPE²⁰]) of the l'Académie de Guadeloupe. The research described in this HDR dissertation used the video recordings obtained from EAL classes only.

¹⁹ An appointed French State official, represents the French Ministry of National Education, Higher Education, and Research (*Ministre de l'éducation nationale, de l'enseignement supérieur et de la recherche*)

²⁰ Since 2019, in France and in all its territories, all ESPEs have been renamed INSPEs except for French Polynesia and New Caledonia.

Maeha'a Nui project (2015-2016)

We conducted the third project, Maeha'a Nui (2015-2016), in collaboration with some teaching professionals in primary education and researchers from UPF. The overarching objective of this cooperative work was to create a dynamic multilingual space (using Tahitian, English, and French) within a state school situated in Tahiti. The project contained both research and non-research activities and involved various teaching professionals, parents, and the school staff who were the potential users of the Tahitian language. We implemented my CLIL research as a sub-project within this all-encompassing multilingual project. I obtained BQR²¹ funding for this CLIL project. The project aimed to experiment and identify effective methodologies for CLIL teaching and to train teachers and colleague mentors on the use of innovative techniques in foreign (English) and heritage (Tahitian) language teaching (see Gabillon & Ailincal, 2015b, 2015a; Gabillon et al., 2016).

'NumériProf' research project (2017-2020)

The project is ongoing in French Polynesia since 2017. In 2018 the project was extended to the New Caledonian education system with the contributions of the researchers from the University of New Caledonia (UNC), and now the UNC is a partner on the project. The objectives of my research are to carry out under the same conditions a series of about 20 semi-structured interviews in order to gather representations of teachers on their practices concerning digital technology in French Polynesia and New Caledonia (see Ailincal & Gabillon, 2018b, 2018a; Ailincal et al., 2018; Gabillon & Ailincal, 2016). During the second phase of the study, we intend to carry out a comparative study on the data obtained in French Polynesia and New Caledonia, and the third phase will be devoted to classroom observations and comparison of these with the data collected via interviews.

²¹ Bonus Qualité Recherche (BQR) is research funding given to individual researchers by their university.

1.2 My personal experience with AL learning and plurilingual contexts

This HDR dissertation concerns language learning, teaching, and research on language learning. It includes not only a summary of my research activities,²² but also my reflections, introspection, and representations of language learning. I would therefore like to present my own language learner ‘identity text’²³ in addition to my research.

I am a trilingual person. I have always lived, studied, and worked in plurilingual milieus. I speak Turkish, English, and French (if I do not count some commonly used everyday expressions that I know in Greek, such as ‘Γεια σας? Μιλάς αγγλικά?’ ‘Αντιο σας’, ‘Καλημέρα’, and ‘Καληνυχτα’ and a few words in Tahitian, such as ‘Ia ora na!’ ‘Māuruuru’, and ‘Nānā!’). Learning and teaching languages have been two significant endeavours in my life. I am a member of a plurilingual, multinational family and I have operated in plurilingual milieus at home with my family in day-to-day situations and at work with my students in formal educational settings. I was born in Cyprus, a country that has had a very complex multilingual and multicultural background since ancient times (Steele, 2013). During British rule,²⁴ Greek, Turkish, and English constituted the languages of schooling, social, political, legislative, and administrative modes of communication. Until recent history, the island had three official languages (Greek, Turkish, and English), and it has also been a home for many small communities such as Cypriot Maronites, Armenians, and Romani, who also spoke their own languages in addition to the official languages (Merrillees, 1993; Worldatlas, 2019). Within this plurilingual context, I had my schooling in a language other than my initial socialization language (L1).

The educational and career path that I have pursued always carried me to plurilingual educational settings. After I had had my secondary education in a full immersion bilingual school, I chose to

²² Please refer to my CV for detailed information on my teaching experience as a language teacher.

²³ The identity text studies were initiated by Cummins and Early (2011) in the 2000s. Identity texts are used as pedagogical tools to help learners infuse their identities into literacy practices in plurilingual environments (Cummins & Early, 2011).

²⁴ Cyprus was under the dominion of the British Empire from 1878 to 1914 as a British protectorate, from 1914 to 1922 as a unilaterally annexed military occupation, and from 1922 to 1960 as a Crown colony.

become an EAL teacher. I graduated from university with a bachelor's degree²⁵ in English language teaching (ELT). A year after my graduation, I started working in an English-medium university with international students and multinational academic staff in Cyprus. This environment, in which people spoke different varieties of English (at the academic level) and other languages (at the social level), was a small plurilingual community that gathered people from different places, cultures, and nationalities. I worked with colleagues from Scotland, England, Russia, the United States, South Africa, Ireland, India, Turkey, France, and others. These teachers all had multilingual, multicultural, and multinational experiences. The diverse experiences of this pluricultural teaching force generated synergy in teaching and cooperation. At this university, I worked as an EAL teacher and a teacher educator. I met my husband, who is French at this university. He did not know Turkish, and I did not know French. We used English as our home language.

I was 35 years old when we decided to move to France, where I started a new language-learning venture. This novel language learning experience was not the same as the former one. This new experience, more complex and demanding than my previous AL acquisition, took me by surprise and out of my comfort zone.²⁶ The scientific literature provides us with a long list of factors such as (i) age,²⁷ (ii) cognition,²⁸ (iii) exposure (Cummins, 1980), (iv) frequency of use,²⁹ (v) motivation,³⁰ and (vi) self-efficacy, self-perception, and self-concept (see Bandura, 2010, among others, for factors that influence the learning of an AL). The introspection of my personal

²⁵ I attended a four-year teacher education college programme (three years focusing on the discipline courses in English, literature, civilization, linguistics, SLA, and teaching methodology and a year focusing on educational courses such as testing and evaluation and educational psychology and a practicum).

²⁶ 'Comfort zone' is a notion that refers to a psychological condition in which the individual feels safe and in control of their environment and lives familiar experiences with steady performance and low anxiety (Mälkki, 2010).

²⁷ See Bialystok and Hakuta (1999), J.-P. Narcy-Combes and M.-F. Narcy-Combes (2019), J.-P. Narcy-Combes et al. (2008).

²⁸ See Bialystok (1991), J.-P. Narcy-Combes and M.-F. Narcy-Combes (2019).

²⁹ See N. C. Ellis (2002).

³⁰ See Dörnyei (2005), Gardner (2007), Weine (1985).

experience with languages makes me feel strongly about the influence of the factors I have mentioned above. I have learned an AL1 (English) and an AL2 (French) in different temporal spaces and different cultural milieus. I acquired the AL1 at a young age in a bilingual school and the AL2 when I was an adult in a country where the language is spoken. My experience with learning French has illustrated that we might not acquire an AL1 and AL2 (and AL3, AL4, etc.) the same way or have the same attitude, aptitude, motivation, and emotions. My personal experience indicated that age factor is an important matter, not only because of biological reasons related to memory and other cognitive issues that SLA researchers often cite,³¹ but also because of social and emotional reasons. When I arrived in France, I was an adult, a teacher, a teacher trainer, and a person with professional knowledge and a high level of communication skills. My new language experience resembled moving back to the starting line and rebuilding what I had already constructed. It was as if I was being stripped of my self-image and my intellectual abilities. I believe that these concerns were not merely language related. They were the result of the interaction between much more complex and dynamic systems and multiple dimensions of consciousness.³² They were partly related to self-concept and partly to age. Still, they were also directly linked to other social, cultural (e.g., habitus and cultural capital; see Bourdieu, 1979, 1986), and psychological concerns. According to Monceri (2003), ‘being confronted with a radical difference implies an identity problem for the *Self*, because in this case he cannot rely upon unconsciously elaborated frameworks within which the flowing everyday life experiences are “properly” collocated’ (p. 111). The notion of transculturing (transcultural behaviour) involves this complex mixture of dynamic influence engulfing not only the language but also other interacting elements.³³ I currently use AL1 and AL2 regularly both at work and at home. I am used to alternating from one language to another, and I am aware of the countless advantages (social, cultural, and educational) of speaking several languages can have for a plurilingual person. As a plurilingual person, I identify that the role of affect, self-beliefs, and representations of language learning are factors influencing

³¹ See Gass and Selinker (2008), M.-F. Narcy-Combes, et al. (2019), Selinker (1972).

³² See transculturing in Baena (2005), Monceri (2003, 2009), J.-P. Narcy-Combes (2019a), J.-P. Narcy-Combes and Narcy-Combes (2019).

³³ See J.-P. Narcy-Combes (2019b, 2019a).

AL development. I have an assortment of feelings and sentiments associated with each of the languages I have learned.

My experience with languages has revealed that language transfer is not a one-way process (from L1 → AL).³⁴ Cross-linguistic influence³⁵ is much more dynamic than what I was taught in university when I was doing my bachelor's and master's degrees. I sometimes transfer some structures from my L1 to the AL1 and AL2, from the AL1 to the AL2, from the AL2 to the AL1, or even from the AL1 and AL2 to the L1 subconsciously.³⁶

In situations where I know that my interlocutor understands both my AL1 and AL2, I often move back and forth between these two languages by alternating language codes. This mode of communication is more expressive as alternating codes offer more variety, choice, and precision. Each word feels different in each language. I often think that from one language to another, words do not carry exactly the same meanings. The feelings and experiences that we associate with them are not the same. Their explanatory or illustrative features, their emotional and affective properties, and their register in some way do not feel the same. In situations where I cannot find precise associations, multilingual strategies such as translanguaging, code-switching, and code-meshing offer me the possibility to refine, adapt, and clarify ideas (see [Chapter 4](#) for plurilingualism).

Is there such a thing as a 'balanced bilingual'? Is it possible to have the same skills in all the languages we learn? If we do not have the competence of a native speaker, can we still be considered as being a maximal-bilingual?

As a person who had her schooling in English from a young age onwards, my academic lexical competence in English exceeds that of my mother tongue. However, in situations when I need to express my emotions, I feel that the words I use have more meaning in my L1. I can understand all

³⁴ See Gass and Selinker (1994).

³⁵ Recent studies refer to the linguistic transfer as cross-linguistic influence to emphasize the bi-directional use of linguistic transfer between languages (Cenoz, Hufeisen, & Jessner, 2001).

³⁶ See Cenoz, Hufeisen, and Jessner (2001) for cross-linguistic influence in third language acquisition.

standard forms³⁷ of the three languages I speak, and I am also used to some non-standard dialectal variations in my L1 and AL1.

The competencies we acquire in each AL are highly dependent on the individual experiences we accumulate through social interaction in diverse settings. And, of course, the availability of the ‘diversity of authentic³⁸ experiences’ in different environments is fundamental in acquiring ‘authentic AL competencies’.³⁹ It is possible to have high proficiency levels in more than one language; however, it is unlikely to have the same experiences twice and develop precisely the same competences in both languages. Although it is still widely believed that balanced bilingualism is possible, SLA research sustains that it does not exist (Grosjean, 2008; García & Wei, 2014; Grosjean, 2008). The SLA research literature provides us with definitions of different kinds of bilingualisms such as compound, coordinate, early, late, balanced, additive, subtractive, maximal, and minimal bilingualism (see the list provided by Wei, 2000). Bilingualism is complex, each AL situation is different, and individuals have varied experience in each of them. J.-P. Narcy-Combes and M.-F. Narcy-Combes (2014) explained this phenomenon from an emergentist perspective, positing that language development is a system in which the interaction between the components instigates a global change resulting from the interaction between biological and environmental processes causing each experience to be new, irreducible, and unpredictable.

The issues concerning instructed AL learning and bilingual education (e.g., code-switching, translanguaging, and transculturing) have been part of my daily life since my childhood. I have been reflecting on issues concerning bilingualism and language learning not only at the professional level as a teacher or researcher, but also at the personal level as a language learner. For the last 20 years, SLA books have been my bedtime reading not only to develop my professional knowledge for research or teaching purposes but also to satisfy my curiosity in the search for explanations for my own experience with languages. Am I an early or late bilingual?

³⁷ I speak a vernacular form of Turkish, but I am also proficient in standard Turkish.

³⁸ I use the phrase ‘authentic experience’ to mean experience gained through natural, meaningful, and purposeful interaction with others.

³⁹ I use the phrase ‘authentic L2 competencies’ to mean competencies that are acquired through, natural, meaningful, and purposeful interaction with others.

Can I be both? Am I a compound or coordinate or dominant bilingual? Can I count the languages in which I can say hello and goodbye as my ALs? There are many questions that need to be answered by researching the practices of others and reflecting on my personal experiences.

1.3 Conclusion

In this section, I have tried to present a brief overview of my research and professional experience since I started working at the University of French Polynesia as a researcher, EAL teacher, teacher trainer, and researcher in applied linguistics. My nine years of research activity in the context of French Polynesia have contributed to the understanding of issues related to the learning of ALs and have complemented the results of existing research on plurilingualism. To set the scene for my readers, I have also sketched my own AL learning experience from the perspective of a learner by providing my AL learning ‘identity text’ or ‘language learning biography’.⁴⁰

⁴⁰ See Cummins and Early (2011); D. Moore, Oyama, and Pearce (2020).

CHAPTER TWO

FRENCH POLYNESIAN EDUCATIONAL CONTEXT AND LANGUAGE ECOLOGY

Introduction

The linguistic and social ecology of the French Polynesian context has contributed to the reorientation of my research and my epistemological perspectives on AL learning and plurilingualism. In order to understand the relationship between my epistemological position and the research context, a detailed description of this particular setting is necessary. In this section, I will (i) describe the French Polynesian educational context, (ii) highlight the specificities regarding its linguistic landscape and language ecology, and (iii) present an overview of previous research on plurilingualism and how my research relates to research on plurilingualism in this context.

French Polynesia has its rightful place among the countries that have made efforts to achieve plurilingualism in their communities (see Nocus et al., 2012; Paia, Cummins, Nocus, Salaün, & Vernaudon, 2015; Vernaudon, 2015; Vernaudon & Fillool, 2009). In French Polynesia, struggles for the revitalization and recognition of autochthonous languages have always persisted within the local community, but did not receive attention from the central government until the late 1970s (Vernaudon, 2015). Since the early 2000s, both regional and foreign language teaching practices have gained a significant impetus in France (Deyrich, 2007; Tardieu, 2006). This revolutionary change in language-learning policies in France gave the long-awaited impetus to the teaching of local and ALs in French Polynesia.

1.4 French Polynesian educational context⁴¹

French Polynesia is an overseas collectivity of the French Republic (*collectivité d'outre-mer*) located in the South Pacific. In this territory, education falls under the combined responsibility of the local authorities and the French government. The 2004 law relating to the statute of autonomy of French Polynesia provided for the transfer to French Polynesia of several powers, including in

⁴¹ This section is an updated version of a journal article I published (Gabillon & Ailincal, 2015b).

the field of education (organization of teaching, allocation of resources, and control of facilities and examinations), that were previously the domain of the French State (*Loi organique* N° 2004-192).

The *Vice-Recteur* (Vice-Rector) has authority over the management of teaching, education, teacher training, and administrative and technical personnel; chairs the local joint executive committees representing State officials; makes decisions on their advancement and promotion; and ensures that these decisions are consistent with service obligations.

The Directorate-General for Education and Teaching (*Direction Générale de l'Éducation et des Enseignements [DGEE]*), which was created in 2014 (*Arrêté n° 895 CM du 12 juin 2014*), is the local authority responsible for ensuring the implementation of general educational policies in French Polynesia. This authority is also in charge of monitoring and ensuring the organization and administrative and financial management of primary and secondary education. The missions of this service consist of coordination and management of educational policies and teaching practices in accordance with the country's jurisdiction and the administrative and financial responsibilities in the field of education and training that fall within the competence of the country.

In French Polynesia, the official language is French, and it is the medium of schooling⁴². However, since 2019, some bilingual public schools offer partial immersion programmes. Primary and secondary education implement the French national curriculum with some adjustments to adapt to the local context and needs. The law on autonomy and some official texts on education assign the local educational institution responsibility and authority to adapt the national curriculum to the needs of the local community (*Loi du Pays n° 2017-15, 2017*). These official texts recommend that the historic, geographic, social, economic, and cultural realities of the country be taken into account in the implementation of the local school curricula.

In 2013, teacher training and recruitment systems underwent a complete transformation in France and, a year later, this educational reform package was also adopted in French Polynesia. Following this reform, the then-existing teacher education colleges, *instituts universitaires de formation des maîtres (IUFM)* were replaced by the new teacher education schools, *écoles supérieures du*

⁴² Recently several bilingual primary school projects (partial French-Tahitian immersion with EAL) have been initiated and these projects are gradually expanding. I am a member of the committee in charge of these projects.

professorat et de l'éducation (ESPE).⁴³ This teacher education structure is now part of the French Polynesian education system. The ESPE of French Polynesia is part of the Université de la Polynésie Française (UPF). This school offers a two-year master's program for pre-service teachers. As part of this teacher training programme, the achievement of level B2 (upper-intermediate level) in English, corresponding to the reference scale of the Common European Framework of Reference for Languages (CEFRL; Council of Europe, 2003), is required for all primary and secondary school teachers to start their teaching profession. These master programs also incorporate EAL pedagogy modules as part of their pre-service primary teacher education curriculum.

To become a teacher in a kindergarten or elementary school, applicants must obtain the *concours de recrutement de professeurs des écoles (CRPE)* qualification. The CRPE is a national competitive examination, which candidates can prepare within the framework of an ESPE (or INSPE in France). This national competitive examination includes a compulsory test in the most commonly used Polynesian language, Tahitian, and since 2019 there has been an EAL pedagogy option as part of this competitive examination.

Primary education includes both pre-schools and elementary schools, and schooling is compulsory from the ages of 5 to 16. French Polynesia consists of 118 islands, 76 of which are inhabited islands and atolls, and almost all of them have elementary schools. There are 172 elementary schools on five archipelagos, and the fact that these schools are scattered over large geographical areas in the Pacific Ocean makes them difficult to manage.

Secondary education also offers the teaching of both modern languages (e.g., English, Spanish, and Chinese). Recently, other Polynesian languages have also been integrated into the secondary school curriculum. To teach in a public secondary school or high school, candidates must pass the examination called *certificat d'aptitude au professorat de l'enseignement du second degré (CAPES)*. The CAPES is a national competitive examination that teachers can prepare for in an ESPE (now INSPE in France).

⁴³ In 2019 all ESPEs in France were reformed again and their name was changed to *instituts nationaux supérieurs du professorat et de l'éducation (INSPE)*. This change has not yet been promulgated in French Polynesia.

1.5 French Polynesian linguistic, social, and cultural ecology

French Polynesia has always been a multilingual society where seven local languages⁴⁴ have co-existed in the five French Polynesian archipelagos. Many French Polynesians speak one of these seven local languages and dialectal variants of these languages as their socialization language at home. These languages are Tahitian (Reo Mā`ohi or Reo Tahiti), spoken in the Society Islands; Pa'umotu (Reo Pa'umotu), spoken in Tuamotu archipelagos; North Marquesan ('Eo Nu'uhiva or 'Eo'enana) and South Marquesan ('Eo'enata), spoken in the Marquesas Islands; Austral and Rapa, spoken in the Austral Islands; and Mangareva (or Mangarevan), spoken in the Gambier islands (see Charpentier & François, 2015; Paia et al., 2015; Peltzer, 2009). Although all these seven languages are used, Reo Mā`ohi is the main local language used throughout French Polynesia (see Paia et al., 2015; Paia & Vernaudon, 2002; Vernaudon, 2015). The language skills of individuals in these autochthonous languages vary greatly. According to some statistical data, people '15 and older (56% of the total population and 73% of this age group) reported that they could understand, speak, read and write a Polynesian language' (Paia et al., 2015, p. 150).⁴⁵

In French Polynesia, many children are bilingual (generally a Polynesian language and French), with some being plurilingual speakers (e.g., French, a Polynesian language, and Chinese). Although many Polynesian children understand and speak standard French, the majority of them also use non-standard local French by meshing local words and expressions with French expressions or by alternating linguistic codes in conversation. This plurilingual and pluricultural aspect of the French Polynesian context is an inherent part of my epistemological and pedagogical approach and is reflected in my conceptualization of AL learning and my research (see [Chapter 4](#)).

My research, including my doctoral studies, has always considered AL learning to be closely related to educational, psychological, and social issues (e.g., learner and teacher beliefs and social

⁴⁴ Stressing the imprecise criterion of mutual understanding on which the distinction between languages and dialects is based, Charpentier and François (2015) cautiously point out that 'the exact number of "different languages" traditionally spoken in French Polynesia ranges from five to eight' (p. 22).

⁴⁵ However, the validity of this figures is disputed (Paia et al., 2015). See also Paia and Vernaudon (2002) and Vernaudon (2015).

representations, ideologies, educational policies, and other educational issues [e.g., parental involvement]; see Ailincal et al., 2016; Gabillon, 2005, 2012b, 2012a; Gabillon et al., 2016). My most recent research (see [Chapter 15](#) for ongoing research) has focused on studying EAL and CLIL learning by situating these practices in the social, cultural, and linguistic ecosystem of French Polynesia.

Using Bronfenbrenner's concept of the 'ecology of human development' (1979) and the ideas expressed by the Douglas Fir Group on the ecology of AL learning (Douglas Fir Group, 2016), I adapt the concept of language ecology to the context of French Polynesia (see [Section 4.5](#)).

This ecological perspective supports equitable plurilingualism and presents the symbiotic relationship between the learner, languages, language learning, and other social systems to which the individual belongs. This vision links my research both to global social ecology, and to the language ecology of French Polynesia. This symbiosis has led to a chain of transformations on a universal scale. French Polynesia, in addition to these global influences, has also been affected by the dynamic interaction between its own local social, linguistic and cultural elements. (see [Figure 3](#)).

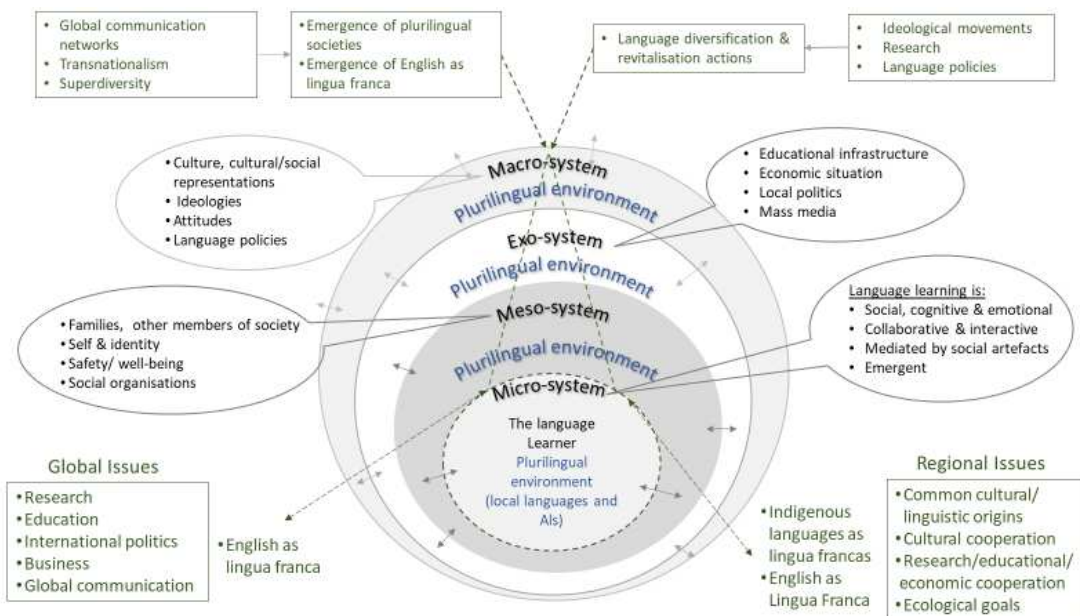

Figure 3. Social and language ecology of French Polynesia.

The English language has also a specific place in French Polynesian linguistic ecology. With the globalization process at both the micro- and macro-levels, demand for learning English has

increased worldwide. The situation in French Polynesia is no different. French Polynesia is situated in the South Pacific and the official language (or one of the official languages) of most of the neighbouring Pacific countries/islands is English (e.g., New Zealand, Australia, Cook Islands, Kiribati, Marshall Islands, Nauru, Samoa, Tokelau, Tonga, Tuvalu, and Vanuatu). French Polynesia and many of these islands share common concerns. Many of these Pacific islands (i) have a dialect of a Polynesian language as the language of initial socialization at home (e.g., Cook Islands, Niue, Samoa, and Solomon Islands); (ii) are linguistically superdiverse communities, with many autochthonous languages originating from the region being on UNESCO's list of endangered languages; (iii) have educational concerns related to linguistic diversity; and (iv) have similarities in other ecological concerns such as climate change and marine life. In the Polynesian context English is used as a lingua franca in transnational communication, education, research, environmental issues, science, business, and cultural/regional cooperation with the other South Pacific islands (e.g., PIURN⁴⁶). This special place of English as a lingua franca puts emphasis on the learning and teaching of this language, as well as on its use as a language for research publications.

1.6 Research on plurilingualism

Since 2005, several French Polynesian elementary schools have participated in various experimental studies and pilot projects both in autochthonous and EAL teaching contexts. Since 2011, I have been one of the active researchers who participated in these experimental studies, which aimed at improvement and innovation in additional and autochthonous language teaching (i.e., English and Polynesian languages). The research projects I conducted in this educational setting were continuations of previous research activities conducted before me. This period was also marked by the intensification of teacher training seminars and workshops on EAL and

⁴⁶ The Pacific Islands Universities Research Network (PIURN) is a partnership of 13 universities from Pacific island countries and territories (PICT) established in 2012 to facilitate collaboration among researchers in the network through research, development and innovation on issues concerning social priorities, economic growth, and environmental challenges.

autochthonous language teaching. I also participated in the organization of these seminars and workshops on several occasions as a specialist and researcher in applied linguistics.

The plurilingual education schemes in the French Polynesian educational context are an extension of the early childhood plurilingual language education provision started in the 2000s in France (Gabillon & Ailincal, 2013). In France, this period was marked by an improvement in language policy and planning efforts in modern foreign language teaching practices (Deyrich, 2007; Tardieu, 2006) and the inclusion of the teaching of autochthonous, regional, and heritage languages (Conseil de l'Europe, 2001, 2018). This change in language learning policy in France also affected the French Polynesian education system and language learning policy and gave a long-awaited boost to the teaching of autochthonous and additional modern languages in primary education (Gabillon & Ailincal, 2013). This important change in language policies, which has led to the adoption of pluralistic approaches, has been the result of complex linguistic and social transformations worldwide, which have led to paradigm shifts in applied linguistics at all levels (e.g., epistemological, philosophical, ideological, and pedagogical; see [Chapter 4](#)). My pedagogical and epistemological orientations are fully in line with the approaches that highlight this plurilingual state of mind in the teaching of ALs.

From 2005 to 2012, two research projects investigated the effects of bilingual education (French and Tahitian) on Polynesian children's speaking, reading, and writing skills at elementary school level. These two research projects, *école plurilingue outre-mer (ECOLPOM)*, which means 'plurilingual overseas schools', were funded by the National Agency for Research (*l'Agence Nationale de la Recherche*; Nocus, Vernaudon, & Paia, 2014). The first project took place from 2005 to 2008 (Nocus, Vernaudon, & Paia, 2014), and the second phase of the project was implemented from 2009 to 2012 (Nocus, Paia, Vernaudon, Guimard, & Florin, 2014).

In addition to the research projects that examined bilingual programs (Tahitian/French), French Polynesian elementary schools also participated in other national, experimental, and exploratory school projects that focused on EAL learning at the primary education level. The first pedagogical pilot project in EAL was initiated by the local educational authorities in 2006 in six schools at the preschool level (5 year olds) and involved seven teachers. During this EAL project, the same pupils were taught and observed for three years. During this three-year experimentation period, many elementary school teachers attended in-service programs and were informed about the recent

developments in EAL teaching (information obtained via a personal interview with the head of the English Language Unit [*Cellule d'Anglais*] in May 2011).

In French Polynesia, EAL teaching became part of the primary school curriculum in 2011. The addition of EAL to the school curriculum was accomplished progressively by first beginning the integration from the *CM2* level (*Cours Moyen 2* [pupils aged 10-11]) and gradually introducing it to lower levels until the *Grande Section* level (pupils aged 5-6). My involvement in research in primary education began when I volunteered to teach English in a primary school for an hour a week, which also involved teacher training,⁴⁷ at the request of a primary school principal in Tahiti (my intervention as a teacher lasted three years on a one-hour-a-week basis).

Secondary education offers the teaching of both modern languages (e.g., English, Spanish, and Chinese) and Tahitian as part of the school curriculum. Some high schools also offer European classrooms⁴⁸ (*sections européennes*), where selected students study a subject or two in English. In France these classrooms are sometimes referred to as non-linguistic discipline (NLD; in French, *discipline non-linguistique* [DNL] or *disciplines dites non linguistiques*⁴⁹ [DdNL]). One of my recent research projects aims at investigating NLD (DdNL) classes as part of my CLIL research (see project EMILE 2^D in [Section 15.1.1](#)). This new research project combines pedagogical, social psychological (i.e., beliefs about and social representations of languages and bilingual education), and ideological (e.g., local language policies) aspects of such bilingual programmes.

⁴⁷ My involvement as an EAL teacher and teacher educator came at a time when the teaching of EAL in primary education was in its infancy and teacher training was an urgent necessity.

⁴⁸ European classrooms (*sections européennes*) are language and culture immersion programmes in France and the United Kingdom (Fontecha, 2009). In France they are amalgamated with the *discipline non-linguistique* (DNL) courses.

⁴⁹ Some French speaking academics do not find the term '*discipline non-linguistique*' (DNL) appropriate in the context of CLIL. They argue that bilingual education must be considered at the intersection of linguistic and disciplinary issues and within the framework of a didactics of plurilingualism. They assert that no disciplinary content can be devoid of linguistic content (Gajo, 2009), and they sometimes refer to it as '*disciplines dites non linguistiques*' (DdNL).

1.7 Conclusion

The research work that I have carried out since the end of my doctoral studies has been in the context of the French Polynesian educational system, and my research activities have their place in this plurilingual language ecology. Over the last two decades, the teaching of AL that includes English and Polynesian languages has undergone significant expansion in primary and secondary schools. During this period of growth, language pedagogies and pedagogical tools and methods have been progressively evaluated and revised. My research has had an influence on these pedagogical innovations (Gabillon, 2013b, 2019, 2020b, 2021; Gabillon & Ailincal, 2013, 2015a, 2015b, 2016; Gabillon et al., 2016).

The research projects in which I have participated in this educational framework have established a continuity with previous research on plurilingualism that was carried out before I joined the EASTCO research unit. In my research, which has been based on plurilingual ideologies, pluralistic language activities, EAL and CLIL teaching, and the role of English as a global lingua franca are interrelated and treated as constitutive of the French Polynesian language and social ecology.

PART II: THEORETICAL FOUNDATIONS AND KEY TERMINOLOGY

Introduction

[Part II](#) is presented under six chapters. The aim of Part II is to briefly present the current global transformations in applied linguistics and the changing conceptualizations of language, language use and language learning. In this paradigm shift and evolving linguistic ecology, I situate my epistemological position and present the theories that have underpinned my research. To reflect these global paradigm shifts, which have affected both global linguistic ecology and local linguistic ecologies around the world, I have used references from international publications. These references have been selected to reflect the pedagogical and epistemological impact that these global transformations have exerted on applied linguistics worldwide, which has strongly influenced local linguistic ecologies.

Outline of Part II:

- [Chapter Three](#) describes recent developments in the field of applied linguistics and how these paradigm shifts have influenced the epistemological position I adopt.
- [Chapter Four](#) presents my epistemological position and provides an updated review of the fundamental concepts, constructs, and definitions that relate to bi-, multi-, and plurilingual education.
- [Chapter Five](#) reviews the theoretical underpinnings on which my EAL and CLIL research activities are based.
- [Chapter Six](#) presents an overview of the current AL teaching approaches in relation to the theoretical, ideological, and epistemological influences that have shaped them.
- [Chapter Seven](#) introduces CLIL as an educational approach and provides a critical overview by presenting background information on its creation and highlighting some of the most frequently raised issues.
- [Chapter Eight](#) presents the social representations and belief constructs as well as the terminology used in my studies, which were designed to explore the beliefs and social representations of students, teachers, parents, and stakeholders.

CHAPTER THREE

CURRENT APPLIED LINGUISTIC CONTEXT

Introduction

My epistemological position has been strongly influenced by the current philosophical and epistemological orientations of applied linguistics, which have evolved out of the global linguistic transformations and research in neighbouring disciplines (e.g., SLA, psycholinguistics, **sociolinguistics, and neuroscience**). **I think that in order to understand the current situation of applied linguistics** in its broader context, it is necessary to present brief background information on the global transformations that have shaped current views.

In applied linguistics, the conceptualization of bilingualism, language, language use, and AL learning has evolved with the global social and linguistic transformations that started in the 1980s and have accelerated since the 1990s.⁵⁰ These linguistic transformations have been the result of societal and ideological changes that were triggered by technological developments and transnationalism⁵¹ (Duff, 2015; Vertovec, 2009). These complex phenomena have affected the linguistic ecology worldwide and, with it, language practices at all levels (Blommaert, 2013).

I will explain these transformations, which have inspired my viewpoints, by looking at (i) their influences on social and linguistic ecology worldwide, (ii) their impact on applied linguistics research and AL practice, and, finally, (iii) their consequent influence on the conceptualization of language, language use, and instructed AL learning.

⁵⁰ See Blommaert (2013), Brown (2002), Douglas Fir Group (2016), Kumaravadivelu (1994), Larsen-Freeman (2011a), Pennycook (2006, 2017a), Vertovec (2015), and Vertovec and Posey (2003).

⁵¹Transnationalism is the spread and diffusion of social, political, and economic movements between and across the borders of individual nation-states (Vertovec, 2009).

1.8 Current linguistic transformations and applied linguistics context

These linguistic and societal transformative changes have had symbiotic but diverse effects on language ecology worldwide: (i) Transnationalism has created superdiversity⁵² and linguistically diverse societies (Blommaert, 2013; Vertovec, 2015; Vertovec & Posey, 2003); (ii) ideological pursuits such as post-structuralist, post-nationalist, post-modern, and post-colonial philosophies (see Kramsch, 2018) have focused on issues relating languages such as ‘linguistic diversity’, ‘language rights’ (e.g., mother tongue, heritage, and autochthonous language rights), and AL language learning practices; (iii) global technological developments such as mass media, global interconnectivity, communication systems, and virtual social environments have accelerated the globalization process and have led to the emergence of English as a global lingua franca in domains such as science, education, research, and international business; and (iv) recent research (e.g., in sociology, anthropology, and sociolinguistics) has explored the role of language and language use in the changing global social ecology and has led to new conceptualizations of language, language use, and language learning.

It is difficult to isolate these symbiotically related phenomena, such as transnationalism, superdiversity, global interconnectivity, and ideological revolution, and to describe their precise trajectories. However, as far as language practices are concerned, we observe that each of these phenomena has diverse consequences while continuing to influence each other.

The first phenomenon, transnationalism and mass movement, created superdiverse societies all around the world and has given rise to the emergence of diverse linguistic landscapes (Blommaert, 2013; Vertovec, 2015; Vertovec & Posey, 2003). Although bilingualism and multilingualism⁵³ have always existed (e.g., in Africa, Asia, and South America), this linguistic and cultural diversity was new to most present-day European countries,⁵⁴ which were mainly monolingual societies (one-

⁵² Superdiversity is a complex social, cultural, and economic diversity in societies: ‘diversity within diversity, a tremendous increase in the texture of diversity in societies’ (Blommaert, 2013, p. 4).

⁵³ Ability to speak several languages. Several language communities may co-exist within society without interacting with each other (Council of Europe, 2003).

⁵⁴ It should be noted that in the Middle Ages, many European countries were plurilingual (Braunmüller & Ferraresi, 2003; Picardo, 2018).

nation-one-language). This exceptional situation compelled linguists, educators, and politicians worldwide to reflect on this emerging phenomenon and adopt corresponding language policies.⁵⁵ The reflection of these new paradigms in AL pedagogies, language policies, and philosophical and ideological views is evident in documents published by the Council of Europe from the 1990s onwards.⁵⁶

At the global level, new ideological aspirations have focused on issues of language and language rights (Canagarajah, 2016; Kubota, 2004, 2016; D. Moore & Gajo, 2009; Pennycook, 2006). The main ideological movements that affected applied linguistics were (i) post-structuralism, which postulates that language is a social and cognitive phenomenon that is created and appropriated by language users, as opposed to traditional views that saw language as a system of discrete structures based on rules (García & Wei, 2014; Kramersch, 2018); (ii) postmodernism, which emphasizes plurality of thought and the situated nature of learning; and (iii) post-national/post-colonial ideologies, which focus on language rights and respect for cultural diversity in applied linguistics and seek to unearth suppressed alternative knowledge⁵⁷ (García & Wei, 2014; Kramersch, 2018; Pennycook, 2006). Since the early 1990s, motivated by the ideological aspirations mentioned above, various actions⁵⁸ have been launched. The promotion of linguistic diversity (i.e., foreign, regional heritage, and autochthonous language teaching) was seen as essential to promoting cross-cultural understanding and communication and economic cooperation among communities. These

⁵⁵ See Blake and Kramersch (2007); Breidbach (2003); Brown (2002); Byrnes (2007); Coste, D. Moore, and Zarate (2009); European Commission (1989); European Commission (2006); D. Moore and Gajo (2009); D. Moore and Py (2008); Pennycook (2006); Williams (2005); and Zarate, Lévy, and Kramersch (2008).

⁵⁶ See Beacco, Bouquet, and Porquie (2003); Breidbach (2003); Byram and Planet (2000); Conseil de l'Europe (2001, 2018); and Zarate, Gohard-Radenkovic, Lussier, and Pens (2004).

⁵⁷ This movement has initiated the revitalization of many endangered languages, such as the Polynesian languages in the South Pacific. French Polynesia, like many South Pacific island countries, has actively participated in these actions.

⁵⁸ Some examples for these actions targeted at promoting language diversity are (i) UNESCO's activities and publications concerning revitalization of minority languages to empower culturally and linguistically diverse communities, which were suppressed during the colonization periods (see intangible cultural heritage texts <https://ich.unesco.org/en/basic-texts-00503>), and (ii) the language policies adopted by the European Commission to promote linguistic diversity, intercultural understanding, and economic cooperation between European citizens.

linguistic diversification actions, although they took place worldwide (Blake & Kramersch, 2007; Byrnes, 2007), have been strongly supported within the European context by the joint efforts of the European Commission and the Council of Europe (Beacco, Bouquet, & Porquier, 2003; Council of Europe, 2003; Lorenzo & Moore, 2009). With this movement, many cultural groups and governments belonging to endangered language communities across the world started actions to reverse the trend and revitalize their heritage languages, such as Polynesian languages, which are spoken in the South Pacific region (Paia et al., 2015; Paia & Vernaudon, 2002). Similar efforts have also been undertaken to revitalize regional languages in France (Castellotti, 2006). This new linguistic and cultural awareness has led to greater cooperation among communities that share the same cultural and linguistic origins.

During actions to promote linguistic diversity and AL teaching to enhance intercultural communication and understanding, the English language spread out and grew to become the dominant AL, establishing itself as a global lingua franca in many domains worldwide (e.g., in global communication networks, education, science, research, and international business and politics; Breidbach, 2003; Héran, 2013). Although the position of English as a lingua franca has been the subject of some debate, the current situation of the English language is mostly seen as a natural consequence of the globalization phenomenon, unrelated to cultural imperialism or linguisticism (Breidbach, 2003).

Under the influence of these dynamic and complex ecological linguistic phenomena, applied linguistics has also undergone profound changes (D. Brown, 2002; Canagarajah, 2016; Douglas Fir Group, 2016; Kumaravadivelu, 1994; Larsen-Freeman, 2004; Pennycook, 1989; Prabhu, 1990). In applied linguistics, the epistemological change process was the continuation of the postmodernist movement, which began to affect the field in the 1980s (see [Chapter 6](#)). The global transformations of the 1990s provided the impetus and motivation to implement this change process, which can be summarized under five main axes:

1. The transdisciplinary growth of the field (see Atkinson et al., 2016; M.-F. Narcy-Combes, 2018; Stern, 2011; van Lier, 2004)
2. The integration of the study and teaching of autochthonous, regional, and heritage languages into the field (see Atkinson et al., 2016)

3. The epistemological shift in the conceptualization of bilingualism, language, language use, and the learning context, which led to:
 - a) the adoption of a plurilingual mindset (see Canagarajah, 2011b, 2011a, 2016; Cenoz & Gorter, 2019; Duff, 2015; García & Wei, 2014; Hajek & Slaughter, 2015; Hall, 2019; Hornberger & Link, 2012; MacSwan, 2017; Pennycook, 2017b)
 - b) the ‘social turn’⁵⁹ in applied linguistics, which represents (i) a shift towards a more sociocultural theoretical orientation, (ii) the emergence of new conceptualizations embedding the cognitive and emotional within the social, and (iii) the integration of contextual elements and local specificities (i.e., cultural, historical, and educational; see Atkinson et al., 2016; La Scotte & Tarone, 2019; Lantolf, J., Thorne, S. L., & Poehner, 2015; Lantolf & Pavlenko, 1995; Schinke-Llano, 1993).

1.8.1 Transdisciplinary growth

The applied linguistics field has always been a multidisciplinary field that has had close connections with psychology and linguistics and SLA research, which is one of the sub-fields of applied linguistics (Larsen-Freeman, 2000). These global transformations have led to further transdisciplinary cooperation and the emergence of new epistemological frameworks (Douglas Fir Group, 2016). The transdisciplinary approach implies that experts/researchers integrate their own knowledge and practices by working together to develop solutions to critical problems (Atkinson, 2019). According to M.-F. Narcy-Combes (2018) the transdisciplinary approach⁶⁰ posits that the knowledge developed in each discipline is combined towards the creation of new information. This transdisciplinary action involves the integration and cooperation of other disciplines and their sub-fields such as education (e.g., educational linguistics and educational psychology), anthropology (e.g., anthropological linguistics), sociology (e.g., sociolinguistics and social psychology), and

⁵⁹ The expression ‘social turn’ is used by many leading applied linguists to underline the recent epistemological shift in applied linguistics (Atkinson, 2011; Douglas Fir Group, 2016; Duff, 2019; N. C. Ellis, 2019; Kramsch & Whiteside, 2007; Larsen-Freeman, 2007).

⁶⁰ See M.-F. Narcy-Combes (2018) for definitions and distinctions between pluri-multidisciplinary, interdisciplinary, and transdisciplinary approaches.

neurosciences (Douglas Fir Group, 2016; Duff & Byrnes, 2019; Hult, 2019; K. E. Johnson, 2019; M.-F. Narcy-Combes, 2018). This transdisciplinary aspect of applied linguistics is strongly reflected in my research work at all levels: conceptualization, methodological, and pedagogical.

1.8.2 Inclusion of autochthonous, heritage, and regional language learning in applied linguistics

The emergence of plurilingual ideologies and pluralistic approaches and the inclusion of autochthonous, regional, and heritage languages in the applied linguistics field are interrelated and have influenced one another. Applied linguistics was conventionally involved in ‘foreign’ and ‘second’ languages, which were primarily modern European languages. The new linguistic movement of the 1980s and 1990s stressed the importance of grassroots plurilingualism and the plurilingualism of relegated communities, which rarely received attention in second language acquisition research (Ortega, 2019). As a result of changes in the global linguistic ecology and with the support of recent ideological movements, endangered autochthonous, heritage, and regional languages have found their place in AL learning spaces (e.g., French Polynesian languages). The promotion of linguistic diversity, and thus the inclusion of autochthonous, heritage, and regional languages in the field of applied linguistics, has been supported by various national and transnational organizations (e.g., Council of Europe, United Nations Educational, Scientific and Cultural Organization [UNESCO], Languages Other Than English [LOTE⁶¹]). However, the teaching of these languages has required different epistemological positions, research perspectives, and pedagogical approaches. Universal prescriptive normative methods with monoglossic ideologies would not meet the needs of the learners of these languages. French Polynesia is a perfect example for such a plurilingual context in which autochthonous languages are taught as ALs at school among ‘foreign languages’ such as English.

⁶¹ LOTE programmes are used as part of multilingual education programmes to teach minority languages in various countries where English is used as the majority language (especially in Australia).

1.8.3 Epistemological shifts

Current conceptualizations posit that language is not simply a system of static linguistic structures and norms. This post-structuralist viewpoint holds that language is embedded in the personal histories and identities of individuals and constantly evolves through social interactions and meaning-making processes.

Global transformations have also altered how languages are used. Today, in multilingual/plurilingual environments, speakers make use of various semiotic resources from the language repertoires they have (e.g., different dialects, varieties, and registers) in response to specific social demands (García, 2011). Today ‘language use’ in AL settings is seen as a plurilingual and multimodal act involving the use of different languages, cultures, and personal histories of individuals. With the evolution of language use and the increased awareness of pluricultural/plurilingual interaction, alternating from one language to another, which was once considered a ‘bad language habit’, is now accepted as a language tool commonly used by bilinguals. In today’s language-learning contexts these tools are not only used for communication but also for pedagogical purposes (Canagarajah, 2016; García & Lin, 2017; García & Wei, 2014; Vogel & García, 2017).

The new language practices that increasingly take place in plurilingual environments have changed the conceptualization of AL learning (May, 2019). Current views describe language learners as having diverse and unequal experiences with each of the languages they speak (D. Moore, 2019). In today’s AL classrooms, pluralistic views have replaced the monoglossic view of AL learning. In short, current conceptualizations, which emphasize plurilingual skills, have a more flexible view. This position accepts that bilingualism can have various forms and degrees of competency levels varying from minimal (A level: basic user) to maximal (C: proficient user) levels (see CEFRL, Council of Europe, 2003).

With these new conceptualizations, new epistemological positions have also been taken. Applied linguistics, which has traditionally had cognitive orientations, has shifted its paradigms towards a more sociocultural perspective.

1.9 Conclusion

As a researcher in applied linguistics and as an EAL teacher, I have strongly felt the impact of these transformations in my field. The ideological shifts and new conceptualizations in applied linguistics, which are the subsequent effect of these transformations, have also influenced the epistemological and methodological position I adopt in my research studies. My major research area, CLIL, is the result of these new plurilingual ideologies (see Gabillon, 2020c), and my research on beliefs and social representations reflects this transdisciplinary approach (Gabillon, 2005, 2012a, 2013a).

This ‘new world order’⁶² (Douglas Fir Group, 2016) that has affected the global linguistic ecology has not left French Polynesia unaffected. The ideological movements concerning language rights of plurilingual communities, integration of autochthonous languages into school curriculums, the importance of learning ALs, and the shift in pedagogical approaches in AL didactics have all affected the French Polynesian linguistic ecology. Since 2005, French Polynesian educational authorities have funded several plurilingual/pluridisciplinary projects in which I have been involved since 2013.

The recognition of the applied linguistics field as a generic discipline with sub-fields has allowed researchers in applied linguistics such as myself to feel more comfortable when supplementing their research data by using research in one of these ‘neighbouring’ disciplines.⁶³ My studies investigate CLIL and AL learning, and my research in these areas is complemented by beliefs and social representation studies. Each of these areas are informed by diverse disciplines.

Last but not least, the ‘social turn’ in applied linguistics, which conceptualizes language learning as a social interactional activity involving cognitive, contextual, and individual elements that are

⁶² The term ‘new world order’ is used by many historians and sociologists to refer to the global transformations from the 1990s onwards in relation to the two different forces that emerged at the same time: (i) the mass movement corresponding to the end of the Cold War and (ii) the technology boom leading to global interconnectedness (Blommaert, 2013; Vertovec & Posey, 2003).

⁶³ This transdisciplinary aspect of applied linguistics is often not well known, and applied linguists are seen as trespassers doing research in a field that is not theirs. I should also note that applied linguistics is not recognized as a discipline by the National Council of French Universities (*Conseil National des Universités [CNU]*).

unique to the situation, provides the perfect framework for my research. My primary theoretical framework is grounded on sociocultural and (socio)interactionist perspectives in AL learning. The following chapter, Chapter Four, presents the key concepts underlying my epistemological position.

CHAPTER FOUR

EPISTEMOLOGICAL POSITION

Introduction

Over the last three decades, basic notions such as bilingualism, multilingualism, plurilingualism, language, language use, and AL learning have been revised in the light of research in second-language acquisition, developmental psychology, sociolinguistics, and psycholinguistics.⁶⁴ These new developments are consistent with recent sociological and linguistic transformations and have been supported by current philosophies which include postmodernist (Pennycook, 2006, 2010), post-structuralist, and post-nationalist philosophies (García & Leiva, 2014).

My epistemological position concerning language; language use; language learning; and bi-, multi-, and plurilingualism notions has been strongly influenced by recent research findings and global linguistic transformations, which have led to important paradigm shifts in applied linguistics.⁶⁵ These new trends and conceptual reorientations in applied linguistics provide my research with a consistent epistemological framework. The objective of this chapter is to situate my epistemological position with regard to these current conceptualizations and the constantly evolving linguistic ecology.

This section will start with a brief overview of research on bilingualism. This brief background information will form the basis on which my epistemological position has been built by following the evolution of applied linguistics. I will then present the concepts that have underpinned my epistemological position.

⁶⁴ See García and Wei (2014), J.-P. Narcy-Combes and M.-F. Narcy-Combes (2014, 2019), and Pennycook (2006, 2010).

⁶⁵ See Atkinson (2019), Castellott (2006), Douglas Fir Group (2016), Duff (2015), Duff and Byrne (2019), García (2011), García and Wei (2014), D. Moore (2019), D. Moore and Gajo (2009), D. Moore and Py (2008), M.-F. Narcy-Combes (2018), M.-F. Narcy-Combes et al. (2019), and Picardo (2018).

1.10 From monoglossic bilingualism towards heteroglossic dynamic bilingualism

Although mastering more than one language has historically been a common feature in many societies, bilingualism has not always been promoted and considered an important asset. Early studies on bilingualism, which took place between the early 1920s to 1960s, purported the superiority of monolingual children over bilingual ones, claiming that bilingualism was detrimental to children's intellectual ability (e.g., Jones & Stewart, 1951; Lewis, 1959; Saer, 1922, 1923; Smith, 1923). Today the literature on bilingualism provides us with hundreds of empirical studies attesting positive associations with bilingualism (Bialystok, 2010; Bialystok, Luk, & Kwan, 2005; Cenoz, 2003; Cummins, 1977, 1998, 2001b). The majority of these studies suggest that a child who has had a bilingual schooling compared to a child who has had only monolingual schooling benefits from considerable advantages (see reviews in C. Baker, 2001; Bialystok, 2003, 2007, 2011; Bialystok et al., 2005; Cummins, 1998, 2001b; Cummins & Swain, 2014). Cognitive advantages have been observed on a wide range of tasks, including both the verbal and nonverbal domains (Bialystok, 2010; Bialystok et al., 2005). Several studies have also suggested that there is an additive effect of bilingualism on third language acquisition (Cenoz, 2003; Cummins, 2001a). The list of advantages of bilingualism is long (see reviews provided by C. Baker, 2001; Cummins & Swain, 2014). Recent research in developmental psychology, psycholinguistics, sociolinguistics, and neurosciences has also supported these positive assertions about the benefits of bilingualism on child development.

Until recently, the use of the learner's L1 in AL learning settings was seen as a threat. The significant contributions concerning the importance of L1 use in bilingual contexts came from research done on immersion programmes in the Canadian context. Bilingual studies that investigated the role of L1 on a child's development in dual language education programmes have suggested correlations between a child's level of L1 competence and their second-language development (J. Ball, 2010; Cummins, 2001a). Cummins (1980) and Lambert (1981) made distinctions between two language learning situations: (1) *additive bilingualism* (language enrichment model), where a child's first language and culture continue to develop at home in addition to a second language that the child is learning at school, and (2) *subtractive bilingualism* (language shift model), where the second language (schooling language) replaces the child's first

language. Cummins (1980, 2001a) maintained that additive bilingualism minimizes the difficulty of learning a second language. He supported additive bilingualism and claimed that when a child has a good mastery of their first language they will encounter less difficulty retaining and labelling notions/concepts in a second language (see also Cummins & Swain, 2014). Cummins' common underlying proficiency (CUP) model suggests that the experiences and skills that bilingual children acquire through L1 and AL promote the development of competencies underlying both languages (Cummins, 1980, 1981). Cummins maintained that these skills (e.g., general, communicative, social, linguistic, and academic) and knowledge (e.g., educational, linguistic, metalinguistic, conceptual, and cultural) are stored as competences (underlying proficiency) common to both the L1 and the AL that can be easily accessed to and transferred from one to another. This model holds that although on the surface L1 and AL look different, there is a cognitive interdependence of linguistic practices. The model suggests that the expansion of the CUP would support learning other languages and offers a theoretical base to explain why bilingualism facilitates the learning of ALs. The CUP model is also related to the concepts of basic interpersonal communicative skills (BICS) and cognitive academic language proficiency (CALP) (Cummins, 1981). BICS develops through the use of language in social interactions and it is context embedded. The concept of CALP is specific to the context of schooling and is related to the mastery of oral and written academic knowledge (knowledge of content and language). BICS is meaningful, cognitively undemanding and requires non-specialized language. CALP, on the other hand requires not only interpersonal communication skills, but also high-level thinking skills such as comparison, analysis, evaluation, hypothesis formulation, inference and synthesis.

Cummins' CUP linguistic model and other transdisciplinary research findings (e.g., in child development research, psycholinguistics, sociolinguistics, and neuroscience) have led to a paradigm shift in the way bilingualism is understood. These new points of view initiated a break with monoglossic ideologies and opened up the prospect of pluralist bilingualism. Today, the conceptualization of bilingualism emphasizing the 'principle of monolingualism' has been challenged by some SLA researchers (Cummins, 2001a, 2008; Dicamilla & Antón, 2012; Gallagher & Colohan, 2014; Levine, 2014; Swain & Lapkin, 2000). Earlier forms of bilingualism

(e.g., subtractive⁶⁶ and additive bilingualism⁶⁷) were influenced by the monolingual ideology. The monolingual ideology, based on the structuralist perspective, holds that L1 and AL are separate parallel entities with their standardized and rule-based systems and that monolingualism and cultural homogeneity are necessary for national unity (Pennycook, 2006). Bilingual education models based on this ideology insist that the L1 and AL(s) should be kept separate and that interference should be avoided. From this monoglossic perspective, bilingualism is perceived as the ability to acquire equal language competences in two (or more) languages. In order to achieve ‘perfect bilingualism’, learners are expected to achieve the norms and standards of a native speaker (e.g., perfect pronunciation and acquisition of standard grammar rules).

Recent neurolinguistic research has confirmed Cummins’s CUP model and taken his hypotheses further (García & Wei, 2014). Most recent views of bilingualism are based on⁶⁸ bilingual ideologies (García & Wei, 2014; Pavlenko, 2006). These current views tend to conceptualize bilingualism as a dynamic system and not an additive system with two autonomous linguistic systems, an L1 and an L2 (AL) or two separate interdependent dual systems, operating as one (García, 2011; García & Lin, 2017; Vogel & García, 2017). These current viewpoints, supported by some psycholinguistic, sociolinguistic, and neuropsychological research data, adopt a plurilingual mindset (for psycholinguistic, sociolinguistic, and neuropsychological research, see Blommaert, 2013; García, 2011; García & Wei, 2014; J.-P. Narcy-Combes & M.-F. Narcy-Combes, 2019; M.-F. Narcy-Combes et al., 2019).

Current views have led to basic concepts such as bilingualism, language, language use and language learning being reviewed, and several new concepts in line with these points of view have been introduced. Some of these conceptualizations include heteroglossia (Lutz & Abu-Lughod,

⁶⁶ Subtractive bilingualism is based on language shift to the dominant language. This practice results in developing a feeling that children’s home language is worthless (García, 2011).

⁶⁷ Additive bilingualism is based on language maintenance or language enrichment and aims to achieve a high level of proficiency that conforms with monolingual standards in both languages. The most recent forms of North American immersion programs can be given as an example for this group of bilingual education programs (García, 2011).

⁶⁸ Heteroglossic bilingualism is based on the concept of heteroglossia. The term was first used by Bakhtin and describes hybrid utterances or the coexistence of different speech varieties in a ‘language plurality’ used by a single speaker (Blackledge & Creese, 2014).

1990; Pavlenko, 2006), multilingualism, plurilingualism (Council of Europe, 2003), translanguaging (Cen Williams cited in C. Baker, 2001; García, 2011), transculturing (Monceri, 2003), and code-meshing (Canagarajah, 2006).

García (2011) makes a distinction between the traditional, the linguistic interdependence model (i.e., CUP), and the more recent dynamic models of bilingualism. This dynamic bilingualism perspective sees bilingualism as a blend of two or more languages in a common language system with integrated linguistic features that are intertwined with each other (García, 2011). This viewpoint reinforces Grosjean’s (2008) conceptualization of bilingualism, which postulates that bilinguals have a ‘unique linguistic repertoire’ from which they select language features (see Figure 4).

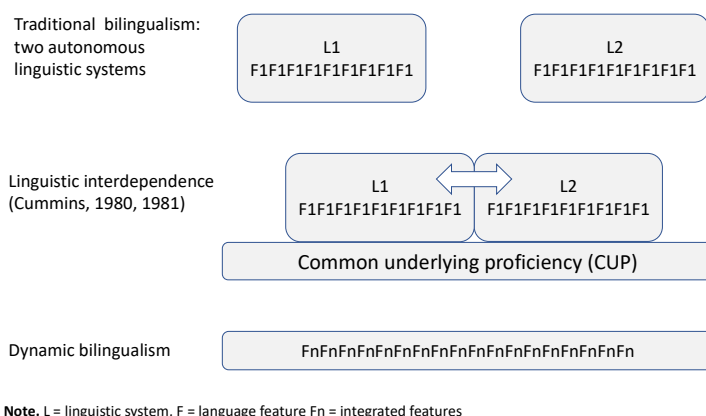

Figure 4. Difference between traditional bilingualism, linguistic interdependence model, and dynamic bilingualism (adapted from García & Wei, 2014, p. 14).

According to the heteroglossic viewpoint, the language skills that an individual possesses are greater than the sum of all the skills in each of the languages the individual speaks (Douglas Fir Group, 2016; García, 2011; Grosjean, 2008, 2010). This system is dynamic and aims to build a developing language repertoire (Council of Europe, 2018). This heteroglossic competence is characterized by a high degree of flexibility and capacity that uses an evolving and adaptable set of linguistic resources (Castellotti, 2006; García, 2011). It has been postulated that this repertoire contains representations and strategies for mobilizing linguistic resources and enabling their diverse uses in a variety of contexts (M.-F. Narcy-Combes et al., 2019). Heteroglossic bilingualism has a pluralistic orientation and aims to help learners develop a pluricultural and plurilingual repertoire by using all the available language resources at their disposal. This type of bilingualism

accommodates different levels of language proficiency and gives priority to the development of effective plurilingual communication skills (Council of Europe, 2018). My EAL and CLIL research activities focus on the role of these languages, especially during peer support and teacher scaffolding episodes, to understand how these resources are used by the learners (Gabillon, 2019; Gabillon & Ailincai, 2013, 2017).⁶⁹

1.11 My conceptualization of bilingualism, multilingualism, and plurilingualism

The literature on bilingualism indicates conclusively that a common definition cannot encompass all the distinct contextual characteristics of bilingualism (i.e., bilingual, multilingual, and plurilingual contexts) (Cummins & Swain, 2014; García, 2011) and that bilingualism cannot be defined as a unified concept describing a single phenomenon (i.e., monoglossic, heteroglossic, and dynamic bilingualism). Bilingualism can take different forms (e.g., compound vs coordinate bilingualism) and different levels of proficiency (e.g., maximal vs minimal bilingualism; see the long list provided by Wei, 2000, pp. 6–7). In this HDR dissertation, in some cases I use the term ‘bilingualism’ as a generic term to cover all forms of bilingualism, and in some other cases I use specific terms to provide further clarification.

I make a distinction between plurilingualism and multilingualism.

‘Plurilingualism’ underlies many epistemological positions of current bilingualism. The term emerged in the 1990s in the European context and appeared for the first time in Council of Europe publications. In this dissertation, in the broadest sense, I use the term plurilingualism to refer to the interconnected knowledge and use of several languages (Council of Europe, 2003). I also use the term to cover concepts such as dynamic bilingualism and heteroglossia, which underline the existence of a unique language system that includes the skills, knowledge, experience, culture, and other languages that the learner has acquired. Plurilingualism in this sense implies that the learner

⁶⁹ Our observations have shown that French Polynesian children rarely use Polynesian languages in the classroom but use them during their break time. However, it should be noted this was not the aim but rather the result of our observations, and we are not in a position to make any further comments on this subject.

makes use of this knowledge dynamically (skills, culture, and languages) to communicate and learn other languages creatively.

By multilingualism I mean the individual's knowledge of a certain number of languages or the coexistence of different languages in a given society without interference with one another (Beacco et al., 2003; Conseil de l'Europe, 2001, 2018). For instance, if we take the classroom setting as an example, a multilingual context would represent a learning setting in which children speak several languages or different L1s but only one language is used as the medium of school instruction. Although French Polynesia is a plurilingual society, where different languages are used in the daily context, the separation of languages is still the dominant practice in the majority of schools. However, it should be noted that in French Polynesia, in some primary and nursery schools, plurilingual practices are gaining in importance and teachers use this linguistic diversity to develop learners' plurilingual skills. In some schools, plurilingual approaches are also integrated into some subject teaching courses (e.g., CLIL; Gabillon & Ailincal, 2013, 2020a; Gabillon et al., 2016).

The concept of plurilingualism, an important element of my overall philosophical viewpoint, is a cornerstone notion on which my epistemological position is based. The theoretical foundations of my research work and my pedagogical position regarding AL, and CLIL in particular, are grounded on this plurilingual perspective. My vision of plurilingualism has a 'positive human connotation'; it implies acceptance and openness and pluriculturalism (Conseil de l'Europe, 2018; D. Moore, 2019; Zarate, Gohard-Radenkovic, Lussier, & Penz, 2004). This view, in order to be operational, requires the adoption of a plurilingual mindset and plurilingual/pluralistic approaches that place particular emphasis on the language choice and rights of bi/multi/plurilinguals (Hajek & Slaughter, 2015). Paia and Vernaudo (2002) noted that many Polynesians still remember a time when they were banned from speaking their language at school.⁷⁰ Adopting a plurilingual perspective may help value local languages and help learners use all their linguistic resources to learn an AL.

My position also questions the underlying conceptions of the monolingual ideology of 'native speakerism', which aim at achieving native-speaker standards and norms that expect learners to attain native speaker-like proficiency (Douglas Fir Group, 2016; García, 2011; García & Wei, 2014; Roy & Galiev, 2011). Although in many AL learning situations neither local needs nor

⁷⁰ Many Polynesian children use Tahitian during playtime but speak French during classes.

available teaching time meet this idealized standard, the ideal of ‘perfect AL proficiency’ persists to the extent that much valuable learning time is wasted by focusing on language ‘impurities’ and neglecting communication needs. It is not uncommon still to see teachers, even at the elementary level, insisting on learner productions with so-called⁷¹ standard form and ideal pronunciation. Extract 1 below is an example for such normative interactional exchanges.

Extract 1. Normative interactional exchanges

T: Where is the ball, Herenui?

S7: On the table.

T: Full sentence, Herenui. ((T snaps her fingers to signal that the student has to hurry))

S7: The ball is on the table.

T : Good!

Note. T = teacher, S = student

Within this plurilingual framework, my viewpoint concerning ‘language proficiency’ is influenced by the context and the time available for language exposure. My vision of AL learning varies from the minimum to the maximum level of bilingualism. From this stance, I consider plurilingual competence partial, plural, and inherently heterogeneous at all proficiency levels.

I am especially interested in the dynamic, holistic, and the multimodal aspects of language use. My research focuses in particular on the multimodal aspect of language use and how social artefacts, translanguaging, and non-verbal elements contribute to both communication and the acquisition of an AL (see Gabillon, 2019; Gabillon & Ailincăi, 2013, 2016). In my research context, learners and teachers often use plurilingual and pluricultural tools to provide scaffolding. The analysis of these code alternations (e.g., code-switching and translanguaging practices) is part of the objectives of my interactional analysis procedures (e.g., analysis of their functions, purpose, and frequency of use) (Gabillon, 2019, 2021; Gabillon & Ailincăi, 2013, 2017). Extract 2, below, from an EAL lesson in which children worked in groups to describe a Tahitian dish, shows how the learners use

⁷¹ Most of the time, the insistence on adhering to these idealized ‘native-speaker norms’ (e.g., the use of entirely grammatical statements and perfect pronunciation) misleads teaching and leads to unnatural linguistic productions with little communicative value, as in the situation presented in Extract 1.

their language repertoire (French, Tahitian, and English) to build EAL knowledge collaboratively (see Extract 2).

Extract 2. Plurilingual exchanges during a group work task

L1 : Je connais ce mot.... Tu te souviens ?... On l'a appris quand on a préparé le « raw fish ». C'est... ((elle mime l'action de couper))	L1: I know this word... Do you remember? ... We learned it when we prepared the raw fish. It's... ((she mimes the action of cutting))
L2 : Eh bien couper ?... C'est « cut ». N'est-ce pas ? ((elle se tourne vers L3 et attend sa confirmation)).	L2: Well, cut? It's 'cut'. Isn't it? ((she turns to L3 and waits for confirmation))
L1 : Oui, cut ! Donc, 'Cut the fish et Carrot...'	L1: Yes, cut! So, 'cut the fish and ... carrot'.
L2 : Comment on dit « put l'uru dans l'ahima'a »? ((elle se tourne vers L3))	L2: How do you say put the <i>uru</i> in the <i>ahima'a</i> ? ((she turns to L3 again))
L3 : L'uru est « breadfruit » ... mais je sais pas comment on dit l'ahima'a. ((ahima'a : four traditionnel tahitien))	L3: The <i>uru</i> is 'breadfruit' ... but I don't know how we say <i>ahima'a</i> . ((ahima'a : traditional Tahitian oven))
Note. L = learner (e.g., L1 = Learner 1)	

My view emphasizes that bilinguals do not simply transfer the experiences, general skills (e.g., general, communicative, social, linguistic, and academic skills), and knowledge (e.g., educational, linguistic, metalinguistic, conceptual, and cultural) that they have acquired in L1 and AL, but by using this knowledge they build new knowledge and skills by comparing and mixing and matching what they have acquired in any of these languages (e.g., L1, AL1, AL2,). See Extract 3 for the exchanges between two elementary school pupils (aged 10) during a pairwork task.

Extract 3. Learners' language choice

L1: Can I have two aubergine? ((pronounces 'aubergine' as /obɛʁʒin/, does not use the plural form)) ((she places the card on the table)).	L1: Can I have two aubergine? ((pronounces aubergine as /obɛʁʒin/)) ((she places the card on the table)).
L2: Aubergine n'est pas de l'anglais ? C'est 'eggplant' en anglais.	L2: 'Aubergine' is not English? It is 'eggplant' in English.
L1: Si ! la maitresse l'a dit. C'est de l'anglais, pas de l'anglais américain.	L1: Yes! The teacher said it. It's English not American English.
L2: Tu es sûr ? Sûr ?	L2: Are you sure? Sure?
L1: ((L1 fait un signe de tête)) Sûr !	L1: ((L1 nods))
L2: Eh bien, je dirai la même chose la prochaine fois. C'est plus facile. Mais j'aime « eggplant ». C'est drôle. Comme un oeuf tu sais ((she giggles and takes another card))	L2: Well! I will say the same next time ((takes another card)) But I like 'eggplant'. It's funny. Like an egg you know ((she giggles and takes another card)).
Note. L = Learner (e.g., L1 = Learner 1)	

1.12 Some notions related to bilingualism, multilingualism, plurilingualism

The concepts of code-switching, code-mixing, code-meshing, and translanguaging, which are related notions are associated with bilingual practices. They all mean using more than one language during communication in a multilingual/plurilingual context. In my earlier papers I have used the

terms ‘code-switching’, or ‘code alternation’ as cover terms to refer to discourse involving two or more languages during an interaction. Recently, I have included concepts such as translanguaging, code-meshing, and transculturing as part of my epistemological viewpoint. Now, I prefer to use the term translanguaging to cover various forms of pedagogical techniques and practices of using the learners’ AL. In this section, I will review these concepts and present my epistemological position.

Code-switching: Code-switching is commonly defined as the alternating use of more than one language in the same stretch of language exchanges. It is the shift to another language (or languages) at a word, phrase, or expression level (i.e., at the inter- and intra-sentential levels; Grosjean, 2008). According to M.-F. Narcy-Combes et al. (2019), code-switching represents the external point of view that perceives bilinguals as two monolinguals.

Code-switching can serve several purposes, such as managing communication in plurilingual learning environments (e.g., clarifying meaning). See Extract 4 recorded during an elementary level AL lesson where three languages (French, Tahitian, and English) are used.

Extract 4. Code-switching to clarify meaning (code-switching for scaffolding purposes)

T: What is this?

Ss (some students): Tortue! ((‘Tortoise!’ in French))

T: Yes, but ‘tortue’ in the sea!

T: ((She mimes the action swimming))

Ss (some students): Honu! ((‘Turtle’—The students say the word ‘turtle’ in Tahitian))

T: On est en anglais. On parle pas tahitien. Tell me in English. ((We are in (an) English (class). We do not speak Tahitian.))

Code-switching is also used for (i) signalling group membership (e.g., ethnicity), (ii) eliminating embarrassment and frustration, (iii) indicating a pause/break in conversation (e.g., switching to another topic—mostly at the inter-sentential level), and many other reasons (Huabin, 2018). Extract 5 below is an example of code-switching that caused an interruption in the conversation to answer/respond/address an issue unrelated to the ongoing exchange.

Extract 5. Code-switching following an interruption during plurilingual interactions

S1: Un animal préféré ? ((A favorite animal?)) I like dogs.

S2: (some): Non, deux animaux ((No, two animals)).

S1: I like dogs and pigs ((he mimics a pig and laughs)) ((The student behind pushes his chair)).

Code-switching (to provide peer support)

S1: ((He turns to him.)) Arrête de me secouer pu'aa. ((Stop shaking me *pu'aa*—Pu'aa means 'pig' in Tahitian)).

code-switching (to react or to respond to a situation/event)

Note. S = student (e.g., S1 = Student 1)

Code-mixing: Simple definitions of code-mixing describe this action as the inclusion of more than one language in the same utterance (i.e., intra-sentential level). Code-mixing has also been defined as 'borrowing' and replacing a word or expression by a word or expression from another language; rather, it involves the unconscious use or absence of awareness of the difference in the use of the language feature in these languages.

Code-meshing: According to Canagarajah (2011b), code-meshing treats languages as part of a unique linguistic system. He posits that unlike code-switching or translanguaging, code-meshing makes use of diverse semiotic tools including symbols. Code-meshing is often described as a writing strategy that integrates different varieties of the same language (or different languages) for the benefit of the learner to help them in their meaning-making (Lee, 2014).

I consider code-meshing a writing technique that uses multimodal means to help learners express themselves freely. This tool can be used to help learners discover their own feelings related to the languages they know (e.g., what they think about different languages) and skills in different languages (e.g., metacognitive knowledge) and to assess their own language development. As a pedagogical tool, code-meshing can help teachers to get to know their students better and to identify their language needs.

Translanguaging: I will be using the term translanguaging as a cover term. This term is in line with general epistemological position on plurilingualism. The term translanguaging was first used in Welsh bilingual education in the 1980s. The term was coined by Cen Williams in the 1990s in Welsh (C. Baker, 2001; Conteh, 2018; G. Lewis, Jones, & Baker, 2012a; M.-F. Narcy-Combes et al., 2019; Vogel & García, 2017). Colin Baker (2001) translated the term into English as translanguaging, and now this term is widely accepted by SLA scholars (Vogel & García, 2017, p. 4). Translanguaging is often compared to code-switching and code-mixing; however, the use of

translanguaging often goes beyond the traditional uses of code-switching and code-mixing practices (García, 2011), and there is a growing tendency to replace these two terms with the former (Cenoz, 2017; García, 2011; Hornberger & Link, 2012; G. Lewis, Jones, & Baker, 2012b; Mazak & Herbas-Donoso, 2015; Probyn, 2015). The original term describes practices of alternating between languages for pedagogical purposes (García & Wei, 2014; Mazak & Herbas-Donoso, 2015). However, the term has been extended to refer to complex language practices through the use of more than one language to make meaning and communicate in bi/plurilingual contexts. (Canagarajah, 2011b, 2011a; García & Wei, 2014; Vogel & García, 2017).

In this HDR dissertation, I will use the term ‘translanguaging’ to refer both to the pedagogical (i.e., scaffolding) tools used by teachers to help facilitate learners' language learning processes and to the complex plurilingual interactions that learners use in the meaning-making processes during their language development.

Transculturating: Byram defines transculturating as the ‘readiness to suspend disbelief and judgment with respect to others' meanings, beliefs and behaviours’ and a ‘willingness to suspend belief in one's own meanings and behaviours, and to analyse them from the viewpoint of the others with whom one is engaging’ (Byram, 1997, p. 34).

However, according to some scholars, transculturating is not always associated with admission and acceptance. It can also involve culture shock that produces uneasiness and conflicts with the AL culture and can cause feelings of stress, anxiety, or disorientation because of the differences between the individual's culture and the AL culture (C. Baker, 2001; Cummins & Early, 2011). J.-P. Narcy-Combes posited that activating a behaviour in an unusual situation or when the stakes are high is always complicated, and the situation can become even be more complex when the individual has pluricultural references (J.-P. Narcy-Combes, 2019a).

J.-P. Narcy-Combes (2019b) sustained that translanguaging and transculturating are two interconnected notions and that transculturating is at the level of thought, but less conscious than thought. He explained that transculturating is what leads individuals to interpret events and to (re)act and that translanguaging is related to the production of discourse: the expression of this thought according to the situation (J.-P. Narcy-Combes, 2019b). In some plurilingual situations, interlocutors may communicate in a unilingual mode. According to J.-P. Narcy-Combes (2019b), this uniqueness of the code does not mean that there is a cultural uniqueness, because individuals

may live pluricultural experiences but react transculturally. He explained that transculturing is a complex phenomenon, and it is not easy to access this complexity, which is linked to the history of the individual.

In this HDR dissertation, transculturing is considered an integral part of the translanguaging process. It refers to the activation of complex cultural, emotional, social, and linguistic knowledge that learners have acquired. Although translanguaging is widely acclaimed and considered a useful psychological tool in plurilingual practices, some researchers have noted that the uncritical promotion of translanguaging could lead to overuse of the L1 replacing the use of the AL and leading to its minimal use (Cenoz & Gorter, 2019). It should also be noted that translanguaging is a complex bilingual or pedagogical practice and should not be equated with translation practices. Our observations have also shown that EAL or CLIL instruction based on decontextualized translation practices that have no pedagogical foundation may not have much pedagogical value. In some learning situations, the unprincipled (and decontextualized) use of translation practices can be an obstacle to the development of strategies for guessing meaning from context, which are useful for functioning in both real-life and academic settings (Gabillon et al., 2016). However, it should be noted that the advantages of translanguaging practices outweigh its disadvantages and that these practices go hand in hand with plurilingual ideologies.

1.13 Conceptualization of language, language use, and language learning

Consistent with recent research and epistemological frameworks, I view language as a social and emergent phenomenon resulting from the dynamic interactions between the social (i.e., interaction with others), cognitive, and emotional aspects and the physical context (i.e., social artefacts and non-verbal elements such as body movements and gestures) within a linguistic ecosystem (e.g., belief systems, culture, and other languages the individual knows; Douglas Fir Group, 2016). This view supports the idea that language is a multimodal social semiotic tool that uses signs, social artefacts, and senses (i.e., visual, auditory, tactile, olfactory, and gustatory) to express and construct emergent thoughts.

The above-mentioned conceptualization of language and its functions have also led to reformulations of “what language development is”. language development is a complex and

dynamic act, and it is the result of the interactions between the social, cognitive, emotional and the physical context.

How I conceptualize language development is influenced by recent research, my theoretical underpinnings and the Douglas Fir Group's (2016) ideas. This epistemological position is supported by Emergentist, sociocultural and socio-interactionist theories, and the notions of plurilingualism and translanguaging, which constitute the major theoretical underpinnings in my research. This view can be summarized as follows (see Figure 5).

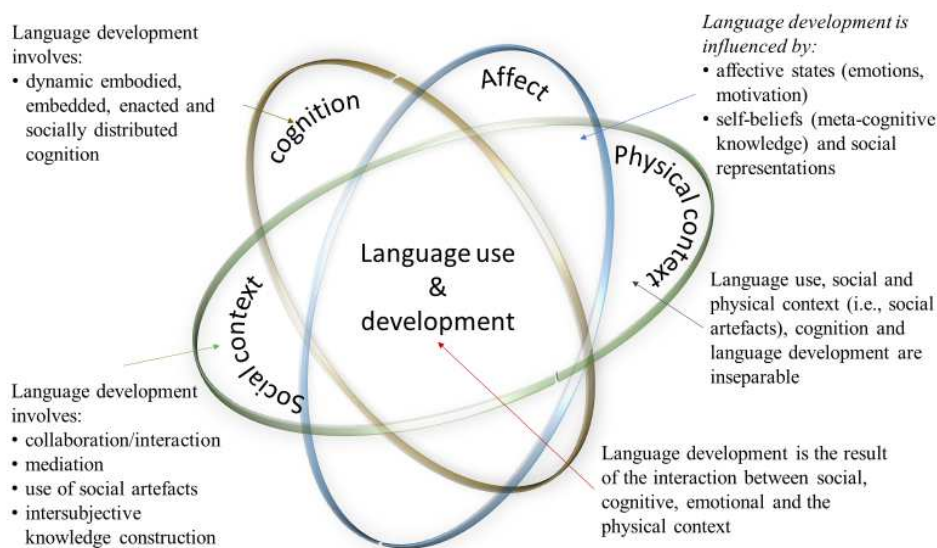

Figure 5. The major constituents of AL development (created by the author)

1. Language development is embodied. It is shaped by learners' identities and personal histories (e.g., their cognitive mechanisms and personal experiences – the languages they know and the knowledge they have previously acquired, etc.).
2. Language development is socially embedded. It is the result of collaborative interactions and collaborative knowledge creation.
3. Language development is enacted. It is inseparable from the activity, context and actions which contribute to its development.
4. Language development is enculturated. It is a socially distributed cognition. It bears the benchmarks of the cultures, social representations and languages with which learners are familiar.

5. Language development is strongly influenced by affect such as emotions, self-beliefs, attitudes and motivation.

Applied linguistics has been historically dominated by the cognitive approach. Since the 1990s,⁷² the conceptualizations of language development have taken a ‘social turn’, and this stance evolved and continued into the 21st century. The sociocultural perspective, which dominates current research on AL acquisition, provides a plausible explanation of the nature of the language learning process (Cross, 2010; De Guerrero & Villamil, 2000; Lantolf, 2006; N. Mercer, 2004; Swain & Lapkin, 2013; Vygotsky, 1986; Wood, Bruner, & Ross, 1976).

My research is founded on sociocultural epistemologies. This sociocultural stance (see [Section 15.1.1](#)), which is at the heart of my conceptualization of language development, stresses the social nature of learning and the important roles that language plays in the learning process, both as a tool and as an object of learning. According to this view, learners develop their AL through interaction with others using the social artefacts provided in this linguistic and social space. This epistemological position holds that knowledge, cognition, and culture are embedded in language and accessing knowledge is not possible without using the language (Coyle, Hood, & Marsh, 2010). From this position, communication, reflection, language use, and learning are seen as inseparable and interdependent processes. The sociocultural position emphasizes that language learning is incidental and that it emerges as the by-product of social activity through collaborative interactional exchanges. This conceptualization of language learning underpins the key principles of current AL teaching approaches (Gabillon, 2019, 2020b, 2021; Gabillon & Ailincăi, 2013, 2016)

The emergentist perspective, which originally focused solely on the cognitive aspects of language development, has evolved. These current epistemologies blend well with sociocultural philosophies (N. C. Ellis, 2019). According to this view, language as a social phenomenon is the essence and result of distributed cognition, and language cognition is shared through culturally constructed communicative exchanges (N. C. Ellis, 2019). The complex relationship between dialogical exchanges and social, cognitive, emotional and the distributed nature of human cognition (e.g., through beliefs and social representations) recapitulates the essence of my research.

⁷² The SLA paradigm wars began in the early 1990s (Lantolf, 1994), escalated in the late 1990s (Firth & Wagner, 1997, 1998), and continued into the 21st century (Douglas Fir Group, 2016; Duff, 2019; Firth & Wagner, 2014).

Emergentist accounts (e.g., complexity theory, connectionism, and the dynamic systems theory), which describe language and language learning as dynamic complex systems involving a multitude of interacting factors, articulate my views on AL learning entirely (Larsen-Freeman, 2004, 2011a; S. Mercer, 2013; J.-P. Narcy-Combes & M.-F. Narcy-Combes, 2019).

The explanations provided from current emergentist viewpoints correspond to my general view on AL development. The emergentist approach to SLA emphasizes that language learning is not innate (top-down) but emerges from interactions between learners' cognitive mechanisms and social interactions (bottom-up). Emergentism views language as primarily exemplar-based rather than rule-based. This implies that fluent language use is not the result of the knowledge of grammar rules but a massive collection of knowledge database that is accumulated through frequent practice and exposure in social interactions. This emergentist view underlies the key principles of current approaches to AL teaching (e.g., especially TBLT; see [Section 6.2](#), and it constitutes an important position in my pedagogical stance. Language learning is now understood more as 'a complex adaptive system, which emerges bottom-up from interactions of multiple agents in speech communities ... than a static system composed of top-down grammatical rules or principles' (Larsen-Freeman, 2011a, p. 49). This viewpoint holds that the amount of language development is proportional to previously experienced utterances (i.e., frequency of use) during social interactions (N. C. Ellis, 1998).

This view also supports the concept of usage-based linguistics (UBL), which emphasizes that language development emerges with communication and evolves over time, along with the speakers themselves (May, 2013). UBL is in line with emergentist, interactionist, sociocultural, and complexity theory perspectives. UBL, like emergentist orientations, holds that increasing and frequent experience of usage leads to language development. This development process is data-driven and emerges from linguistic systematicities. This view also holds that because of collaborative exchange, languages are dynamic and in constant change: 'Usage affects learning and it affects languages, too.' (N. C. Ellis, 2019, p. 40). This aspect of UBL is highly consistent with sociocultural philosophies that consider language a socially constructed artefact that takes shape through collaborative use.

The fundamental elements underlying the above-mentioned epistemologies are observable in all aspects of my research: at the epistemological, pedagogical, methodological, and implementation

levels (see [Chapter 5](#), and [Chapter 7](#)). My research focuses on the social and interactional aspects of language development and how AL is constructed collaboratively during these interactions. The sociocultural epistemological position is also reflected in my conceptualization of language learning and in the analysis processes I use in my research. My interactional analysis procedures aim to obtain detailed data on the nature of learners' interactional exchanges (language use and the use of extra-linguistic tools) and to capture the changes that occur during these interactions and exchanges (see Gabillon, 2019, 2020a; Gabillon & Ailincăi, 2013, 2016, 2017).

1.14 My conceptualization of language-learning context

As I have already mentioned in this manuscript, my view of AL learning extends beyond the classroom and the cognitive abilities of the individual to other people, to the other languages the learner speaks, to the community, to the culture, and to social and cultural belief systems. Each of these elements has connections with each other and understanding AL learning requires an awareness of the relationships between these different aspects.

My research, which is conducted in a plurilingual context, integrates these elements into its framework. In an AL learning framework, the learners' knowledge of other languages, culture, emotions, and belief systems are all integrated into their linguistic repertoire. This repertoire is not constructed by the individual alone: It accumulates over the course of life experiences in different social, temporal, and physical spaces. Thus, what constitutes AL learning cannot be limited merely to the classroom environment (micro-context; Gabillon, 2005, p. 259).

My conceptualization of context, inspired by Bronfenbrenner's (1979) ecology of human development model, encompasses the micro-context, meso-context, exo-context, and macro-context (see also [Section 2.2](#) for French Polynesian linguistic ecology). In this model, like all environmental systems, social systems, such as humans and their activities, are considered to be symbiotically linked and part of an ecological system (Bronfenbrenner, 1979; Vertovec & Posey, 2003). This model provides a consistent framework for my research by holistically integrating my work on belief systems with AL and CLIL learning. These belief systems, which are rooted in culture, languages, and language learning, are embedded in this linguistic and social ecology. This ecological perspective integrates the fundamental elements of my research such as language,

culture, identity, social representations, language policies, and physical, temporal, social, and symbolic spaces, and provides a contextualized and holistic approach to AL learning.

The ecology of human development proposed by Bronfenbrenner (1979) describes the progressive mutual accommodation between an individual (in our case the language learner) and the changing properties of their immediate settings (micro-system, meso-system, exo-system, and macro-system). The settings to which the individual belongs are affected by interactions between these settings and other larger settings (e.g., macro-settings) that surround them (Bronfenbrenner, 1979). In Figure 6, I bring together the most relevant elements that form a linguistic ecosystem. This schematic representation is influenced by the global transformations that have led to the emergence of the present-day global linguistic ecology and the linguistic context of French Polynesia (see also Figure 3 in Section 2.2).

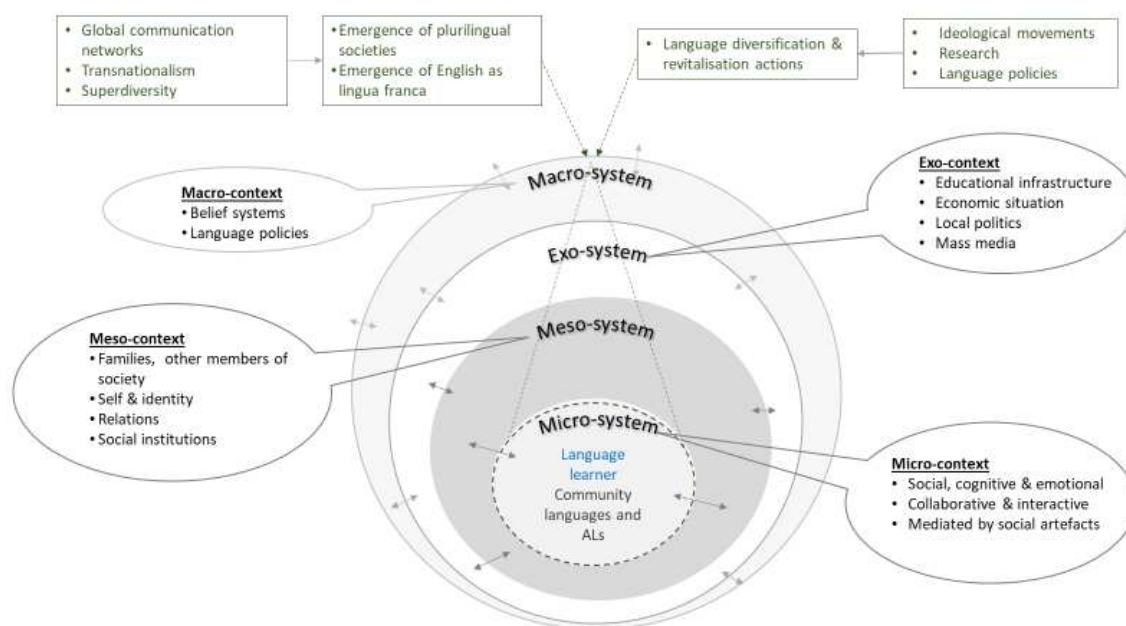

Figure 6. Ecological representation of language learning context (created by the author)

The micro-system is the immediate social environment within and with which the learner interacts and develops. This system involves a certain pattern of activities, roles, and interpersonal relations that occur in the learner's immediate physical environment. The micro-context, in our case the AL learning context, includes learners, peers, teachers, the physical classroom setting (i.e., the classroom and social artefacts), and affect (e.g., emotions and beliefs; Douglas Fir Group, 2016).

The meso-system, a system of micro-systems, contains the learner's parents, friends, home, and school. This system interacts with the micro-system and the other larger systems and has a direct influence on the learner's development. The meso-system extends the learning environment to society, including the school, families, neighbours, social relationships, and lifestyles. The exo-system contains fundamental systems and facilities such as mass media, educational infrastructure, and economic situation. Although the learner never has direct interaction with the exo-system, the actions that take place in this system affect the learner directly. Finally, the all-embracing macro-system, which encompasses the other lower order systems (micro-, meso-, and exo-systems), contains the ideologies that underlie the subcultures and the culture as a whole and regulates their coherence (Bronfenbrenner, 1979). The macro-context contains the foundations of social and cultural belief systems and language policies and permeates all levels of this ecological system (Bronfenbrenner, 1979; Duff & Byrnes, 2019; K. E. Johnson, 2019; see also [Section 2.2](#) for French Polynesian language ecology). My studies link the macro-context to the micro-context by integrating beliefs and social representations in my research on EAL and CLIL.

My research primarily focuses on actions that take place in micro- and meso-contexts and extends to belief systems. Belief systems are influenced by different sources at different levels of the social ecosystem (in different temporal, social, and physical spaces), and they have the power to influence individual beliefs and the belief system as a whole (see the belief formation model proposed by Gabillon, 2005, in [Section 8.3](#)). In my studies, in addition to AL learning, beliefs and social representations of languages, language learning, and bilingualism are explored using data collected through micro- and meso-systems, and this information is used to complement the data obtained in the micro-context (classroom setting).

1.15 Conclusion

My research takes place in the French Polynesia's language learning context. I view my research context as part of the French Polynesia's linguistic ecology. I view French Polynesia's social systems (culture and belief systems) and its languages to be symbiotically linked and part of an ecological system. My research situates EAL and CLIL learning in this ecological system. The language landscape in French Polynesia is pluricultural and plurilingual, and my studies take this plurality into consideration (Gabillon & Ailincai, 2015b; Gabillon et al., 2016).

My conceptualization of bilingualism is based on the heteroglossic view. This view has a pluralistic orientation and aims to help learners develop a pluricultural and plurilingual repertoire by using all available language resources at their disposal. My view of bilingualism accommodates different levels of language proficiency and gives priority to the development of effective plurilingual communication skills.

I conceptualize language as a social phenomenon that emerges from interactions between the individual's cognitive capacities and their environment (i.e., with others, social artefacts, culture, beliefs, and the other languages the individual knows). This viewpoint encompasses fundamental epistemological viewpoints expressed by emergentist, complexity, UBL, sociocultural, and interactionist perspectives. This epistemological position is consistent with my pedagogical stance and research framework.

My position regarding AL development also parallels these theoretical views mentioned above. According to this conceptualization, AL development takes place through inputs that emerge from communicative interactions (e.g., during problem solving tasks in classroom settings; J.-P. Narcy-Combes & Narcy-Combes, 2019). My conceptualization also holds that social interaction, collaboration, and frequent use are essential elements of language development. The language development process is complex and cannot be reduced to teaching explicit grammar rules, vocabulary, pronunciation, and language conventions separately by taking them out of their context and breaking them down into manageable teaching units in isolation. Language learning is a process of constant reflection, problem solving, and creative meaning making that can take various forms in different situations with different individuals.

I have a pluralistic vision of language learning, and code-switching is an integral part of my vision of plurilingual learning environments. However, pedagogical decisions regarding bilingual,

plurilingual, and plurilingual practices are context specific. Decisions regarding the integration of translanguaging practices should be adapted to the context (e.g., time of exposure and type of AL programme, such as immersion, partial immersion, or CLIL) and the status of the AL (e.g., autochthonous, heritage, regional, or foreign). Pedagogical translanguaging practices that are meaningful and effective in one AL learning context may not produce the same outcomes in another learning context. The use of translanguaging (e.g., code-switching, code-meshing) is a sensitive issue and requires understanding the learning context and making sound pedagogical decisions.

CHAPTER FIVE

CANONS OF THE THEORETICAL STANCE IN INSTRUCTED AL LEARNING

Introduction

This chapter describes the theories that provide explanations for my research actions and methodological choices. The current epistemological state of applied linguistics (see [Chapter 4](#)), which underlines the multidimensional nature of AL teaching and learning, is one of the fundamental epistemological positions of this HDR dissertation. It is now commonly believed that applied linguistic issues are complex (Larsen-Freeman, 2004) and cannot be explained from a single theoretical perspective (Atkinson, 2019). The multiplicity of factors ranging from the micro-context (e.g., social activity involving learners, teachers, and social artefacts) to the meso (e.g., parents, families, relations, social/cultural institutions, and relations), the exo-context (e.g., social and institutional infrastructures), and the macro-context (i.e., ideological structures, beliefs/social representations, and language policies) require transdisciplinary cooperation and multiple and complementary epistemological perspectives. My research attempts to grasp the transdisciplinary nature of my domain and multiple epistemological perspectives.

My overall epistemological vision of applied linguistic research encompasses various interrelated research perspectives including epistemologies proposed by emergentist and complexity theories and UBL perspectives (see [Section 4.4](#) for details concerning my overall epistemological stance). Although the perspectives cited above provide me with an overall epistemological ground, my conceptualization of AL development and my research methodologies draw predominantly on sociocultural and interactionist epistemologies (Gabillon, 2019, 2021; Gabillon & Ailincăi, 2013, 2016, 2017, 2020).

My research work investigates microgenetic interactional activities that take place in the classroom setting (Gabillon, 2019; Gabillon & Ailincăi, 2013, 2016, 2020). The overall objective of my CLIL and EAL research is to study interactional productions in AL situations (i.e., changes that occur in learners' productions using mediation strategies, artefacts and gestures, and L1) that take between learners and teachers (i.e., learner[s] \leftrightarrow learner[s] and teacher \leftrightarrow learner[s]). Sociocultural and interactionist perspectives provide the necessary theoretical framework at the conceptual,

methodological, and pedagogical levels and provide guidance for the design, implementation, and analysis of dialogic interactions. These two perspectives are thus particularly well suited to microgenetic analysis designs that study interactional exchanges within the same social learning setting (repeatedly) in order to observe significant elements and changes in detail. My studies on CLIL and EAL, as can be seen in my research publications, base their theoretical orientations mainly on these two perspectives in an associated manner (Gabillon, 2019; Gabillon & Ailincăi, 2013, 2015a, 2016, 2017, 2020; Gabillon et al., 2016).

1.16 Sociocultural and interactionist theoretical positions

The ideas expressed about interactionist and sociocultural perspectives in this section highlight the theoretical underpinnings on which my research on EAL and CLIL are grounded. Although the sociocultural and interactionist perspectives have emerged from two different research traditions, the interactionist perspective has taken a ‘social turn’, and these two perspectives now share similar key characteristics and principles with regard to AL development (see Figure 7).

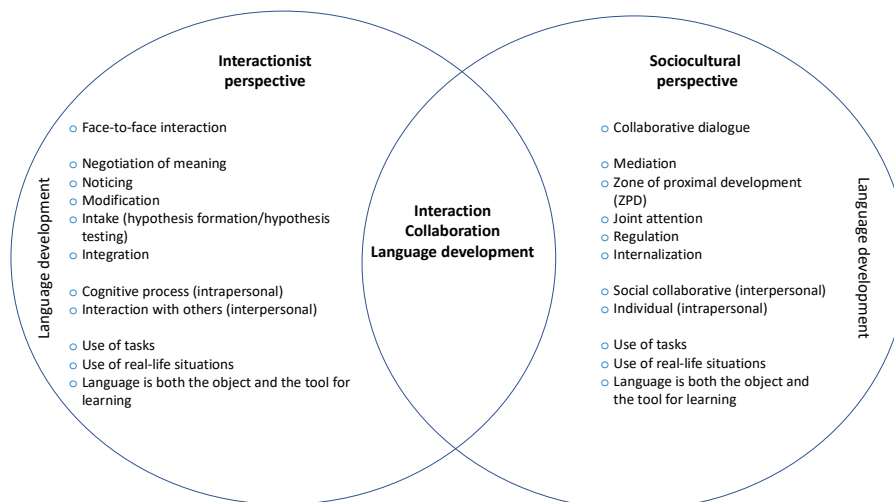

Figure 7. Sociocultural and interactionist perspectives (translated from Gabillon, 2019, p. 75).

The shared key features of these two perspectives constitute the major principles in my research paradigm. Both sociocultural and interactionist perspectives (i) see language use, thinking, and language development as inseparable and interacting entities; (ii) stress the importance of face-to-face (dialogic) interaction in language development; (iii) lay emphasis on the help given by others and the role of collaboration in language development; (iv) underline the importance of tasks in

intersubjective language production and authentic communication; and (v) value the primacy of the communication of meaning over the production of correct language forms.

These two traditions complement one another and provide a comprehensive view of both learning school subjects and learning an AL. A wide range of papers on AL learning and CLIL show tendencies towards an approach combining sociocultural and socio-interactionist perspectives (Anton, 1999; Foster & Ohta, 2005; Gabillon & Ailincăi, 2016; Gutierrez, 2008; Pica, 1987; Sato, 2017; Swain, 2000; Swain, Brooks, & Tocalli-Beller, 2002; Thompson, 2013; van Lier, 2008).

1.16.1 The sociocultural perspective in learning and AL development

Sociocultural philosophies are influenced by Vygotsky's work (Vygotsky, 1978, 1986). The sociocultural perspective considers communication, thinking, and learning as related processes in knowledge construction and AL development (Bruner, 1978; Lantolf, 2006; Mercer, 2004; Swain & Lapkin, 2013; Vygotsky, 1986; Wood, Bruner, & Ross, 1976). This inseparable aspect of learning, reflection, and communication underpins my research on both EAL and CLIL. Current approaches to teaching ALs (e.g., action-oriented approaches, task-based language teaching, and CLIL) are all based on this principle. This principle is reflected in classroom pedagogies that use tasks. Using tasks enable learners to use AL creatively through problem-solving activities that engage them in interaction and communication that lead to the emergence of AL productions. These tasks are not only AL related: They focus on acquiring knowledge through cognitive involvement, the use of artefacts, and other multimodal tools (e.g., other languages and non-verbal elements; Gabillon, 2019; Gabillon & Ailincăi, 2013, 2016, 2017).

Vygotsky's work is characterized by three elements: (i) the way in which human cognition develops and evolves, (ii) the link between cognitive functions and social activity, and (iii) the importance of social signs and tools in the mediation of cognitive functions. The sociocultural theory provides an ideal framework for the conceptualization of language and analysing interactions in instructed learning settings. One of the fundamental principles of this epistemological stance is that cognitive development originates in a social context. According to Lantolf (2004b) and Lantolf and Thorn (2006), the sociocultural theory is primarily a theory of mind that focuses on how social relationships and culturally constructed artefacts shape the human mind, thinking, and creations. From this stance, language development is studied through microgenetic analysis (Vygotsky, 1978, 1986) by observing how the language learner interacts with others and makes use of social tools in

specific situations to construct their AL (see Gabillon, 2019; Gabillon & Ailincăi, 2013, 2016, 2017, for microgenetic analysis processes focusing on interactions between learners and their environment). This perspective holds that ‘individuals and environments mutually constitute one another’ (Foster & Ohta, 2005, p. 403). Vygotsky explained that any function during the child’s development occurs twice. First between people in the social plane, as an interpersonal (interpsychological) category, and then in the personal plane (psychological), as an intrapersonal (intrapsychological) category. Vygotsky’s view considers these interpersonal and intrapersonal processes as connected and interdependent (Vygotsky, 1986).

Vygotsky used the term ‘*obuchenie*’ to explain knowledge construction during a child’s development. This concept is often translated as either ‘instruction’ (i.e., the actions performed by the teacher to facilitate learning) or ‘learning’ (i.e., cognitive involvement and development of the learner). Both translations describe the learning and teaching acts as one-sided processes. This term, as used by Vygotsky, involves both the teacher and the learner and refers to an active collaboration that takes place during knowledge construction (Wertsch, James, & Sohmer, 1995). The collaborative nature of learning between teacher and learner is highlighted in the socially mediated activity (SMA) framework that I propose (see Gabillon, 2019; Gabillon & Ailincăi, 2015a). This task model highlights the collaborative engagement of all participants in tasks, including the teacher and puts emphasis on collaborative thinking and the construction of intersubjective knowledge, of which language is a part (Gabillon, 2019; Gabillon & Ailincăi, 2015a, 2016; see also [Section 16.2](#)).

In this collaborative social setting, language is used to regulate the individual’s cognitive activities and answer the demands of social activity. During this social interaction, language has three functions: It is used as a tool for thought to regulate internal cognitive processes, a tool for learning to acquire information and skills, and it is an object of learning (Lantolf & Pavlenko, 1995; Lantolf & Thorne, 2006; Vygotsky, 1986). This threefold function of language is particularly highlighted in the conceptualization of the CLIL approach (see Gabillon, 2020b; see also [Chapter 7](#) and [Section 7.7.1](#)).

Sociocultural research does not aim to produce generalizable results. These studies, in general, focus on small groups of subjects and are aimed at painting a complete picture of learning processes through the accumulation of small studies (Foster & Ohta, 2005). The sociocultural perspective

considers learning a social activity in which language functions as a tool for reflection, communication (and language learning), and construction of knowledge (Engeström, 1999, 2001, 2014; Engeström & Miettinen, 1999; Lantolf, 2006). Sociocultural philosophies stress the importance of the social context and its vital influence in any type of learning. My research activities are based on the principle of the accumulation of interdependent studies, which follow a progressive process of data construction and interpretation (Gabillon, 2019; Gabillon & Ailincăi, 2013, 2016, 2017; see also [Chapter 9](#)).

Vygotsky viewed knowledge construction as a socially shared cognition that individuals develop through social collaboration. The concepts ‘zone of proximal development’ (ZPD; Vygotsky, 1978, 1986), mediation, (Vygotsky, 1978), social artefacts (Vygotsky, 1978), scaffolding (Bruner, 1978; Wood et al., 1976), joint attention (Bruner, 1974, 2014), intersubjectivity, and activity (Engeström, 2014; Engeström & Miettinen, 1999; Leontiev, 2006) are some key concepts in sociocultural theory. These concepts form the main foundations of my CLIL and SLA research and form the backbone of the SMA framework that I have developed (Gabillon, 2019; Gabillon & Ailincăi, 2015a, 2016).

Zone of proximal development: Vygotsky's ZPD concept is explained as ‘the distance between the actual development level as determined by independent problem solving and the level of potential development as determined through problem solving under adult guidance or in collaboration with more capable peers’ (Vygotsky, 1978, p. 86). According to Lantolf, ZPD also implies joint effort and learning: ‘People working jointly are able to co-construct contexts in which expertise emerges as a feature of the group’ (Lantolf, 2004a, p. 16). In an educational context, the ‘zone’ metaphor is commonly used to define learning processes in collaboration with others. In the school context, the ZPD may vary according to the school subject (Gabillon & Ailincăi, 2016). This means that for each learner the required level of help may vary depending on the school subject taught. Today, educators are trying to bridge the possible gap between the different levels of competence of learners in the different school subjects by encouraging interdisciplinary teaching in order to create a synergistic learning dynamic. CLIL, which involves both subject-based content learning and language development, is particularly well suited to creating this dynamic and to providing learners with the opportunity to integrate a variety of skills and knowledge into their learning situation (Gabillon & Ailincăi, 2016). According to J.-P. Narcy-Combes and M.-F. Narcy-Combes (2019), language expresses a certain form of content, and mastery of content leads to a better mastery of

discourse structures. In instructed learning settings this learning dynamic is often created by assigning learners collaborative group tasks in order to increase peer support (see Figure 8).

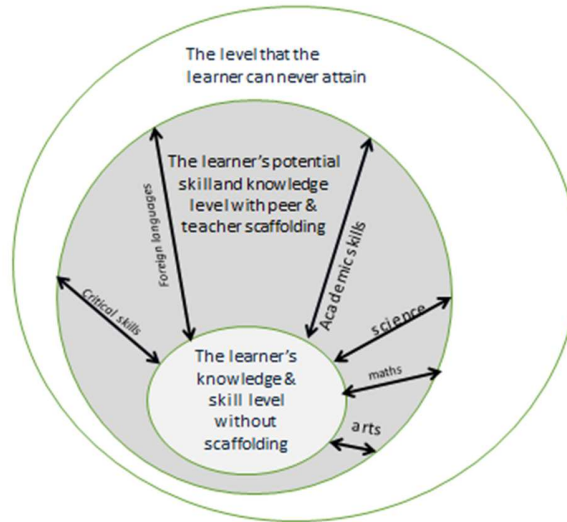

Figure 8. ZPD and the school context (Gabillon & Ailincal, 2016, p. 28).

Mediation and social artefacts: The term ‘mediation’ was introduced into the literature by Vygotsky (1978) and refers to interpersonal interactions through the use of social artefacts that support children's intrapersonal processes. In sociocultural theory, interaction contexts, artefacts, and the use of symbolic tools are inseparable from affective/volitional and cognitive elements (Vygotsky, 1978). According to this view, artefacts play an essential role in transforming material forms of activity into forms of mental, psychological, and physical activity (Engeström, 2014; Engeström & Miettinen, 1999; Leontiev, 2006). The role of artefacts in AL learning has been a focus of attention in my CLIL and EAL research studies.⁷³ Likewise, experiential learning activities that emphasize communication, reflection, and action promote cognitive and participatory involvement of learners. Without learning tasks that encourage free and creative use of language and that allow for opportunities for negotiation and the creation of intersubjective knowledge, we cannot speak of the availability of high levels of learner engagement. In a nutshell, the success of our SMA framework depends highly on how well the tasks are designed and how well each component is aligned (e.g., small group activity, experiential and naturalistic learning

⁷³ See Section 16.2 for the synthesis concerning the use of artefacts and gestures as an outcome of the microgenetic analysis procedures.

tasks, the use of social artefacts, and the maintenance of joint attention; see [Section 16.2](#) and Gabillon, 2019).

Some of my publications specifically examine the role of artefacts and gestures in interactive exchanges (Gabillon, 2019; Gabillon & Ailincăi, 2013, 2015a, 2016; Gabillon et al., 2016).

Vygotsky, Rieber, and Wollock, (1997) explain that during social mediation, human beings use various sorts of psychological tools to master their mental processes. The sociocultural theory considers all human-made objects and signs (e.g., language, gestures, body movements, and books) artefacts. According to Vygotsky (1978), social artefacts are ‘directed toward the mastery of [mental] processes’, and these psychological tools modify ‘the entire course and structure of mental functions’ (p. 85). Vygotsky theorized that ‘the application of psychological tools enhances and immensely extends the possibilities of behaviour making the results of the work of geniuses available to everyone’ (Vygotsky et al., 1997, p. 87). He also claimed that success in the child’s development primarily relates to the type of instrumental method used. He posited that this act differs from instinctive stimulus-response (subject-object relations in the form of reflex). Vygotsky’s notion of mediation (1978, 1986) is symbolized by Vygotsky’s triangular model, commonly referred to as the ‘object, subject, and mediating artefact’ (see Figure 9).

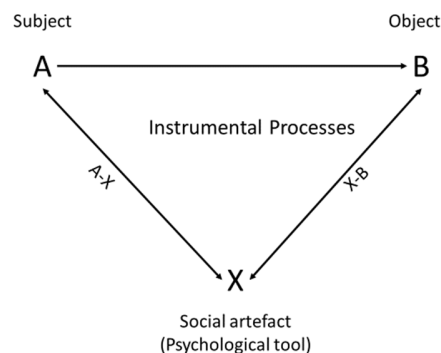

Figure 9. Vygotsky’s instrumental processes (adapted by the author).

Scaffolding: The term ‘scaffolding’ was introduced in the sociocultural literature with the work of Jerome Bruner (1974) and his colleagues David Wood and Gail Ross in 1976 (Wood et al., 1976). Later, the concept was developed by Bruner, and the concept is now associated with him. In educational settings, the term scaffolding is often defined as a supportive dialogue that draws learners’ attention to the main characteristics of learning (De Guerrero & Villamil, 2000; Duff, 2007). According to Wood, Bruner, and Ross (1976), scaffolding is distinguished by six important

actions: (i) recruitment, involving enlisting interest and adhering to the requirements of the task; (ii) reduction of degrees of freedom, where the task is simplified temporarily; (iii) direction maintenance, where learners' focus is kept on a particular objective; (iv) marking critical features, where the defining features of the task are signalled; (v) frustration control, where the existence of a tutor creates a less stressful situation than doing the task without one; and (vi) demonstration, where possible solutions to the task are modelled (Wood et al., 1976, p. 98). My studies associate the notion of ZPD with scaffolding processes. The roles played by the scaffolding processes and ZPD during interactional exchanges have received special attention in my microgenetic analysis procedures (see Gabillon, 2019; Gabillon & Ailincăi, 2013, 2015a, 2016; Gabillon et al., 2016) and clearly highlighted in my SMA framework (see SMA activity design in [Section 16.2](#)).

Joint attention and intersubjective knowledge creation: The concept of joint attention emerged from sociocultural philosophies and was the subject of sustained attention in psychology and education (C. Moore & Dunham, 2014). The term took shape with the work of Bruner and his colleagues. Technically speaking, joint attention means the simultaneous engagement of two or more people in a mental activity by focusing on the same object (e.g., a task) to achieve a goal (Baldwin, 2014; Tomasello, 2014). Bruner (2014) defined the notion of joint attention as a 'meeting of minds' (p. 6). He maintained that joint attention depends not only on a joint focus but also on a shared context and presupposition (Bruner, 2014, p. 6). In the same vein, Tomasello (2014) added that joint attention is not just about attention, but about joint participation in a common culture and the search for intersubjectivity. According to him, without joint attention, we cannot build and coordinate common social realities that make up everyday life. Bruner (1974) pointed out that joint attention also plays a crucial role in the acquisition of a language. He studied the role of joint attention in joint adult-child activities and observed how mutual activity functioned as a tool for the development of formal language structures (Bruner, 1974). Joint attention and thinking leads to the creation of intersubjective knowledge, which is constructed collaboratively. Our experimental CLIL studies and our observations in EAL classrooms have shown that in order to increase opportunities for joint attention and collaborative work, the types of tasks and group sizes used need to be carefully considered (see [Section 16.2](#) for the synthesis).

Activity: In sociocultural theory, activity is described as a purposeful social interaction between actors and artefacts (the world and its objects). The role of activity is detailed in activity theory. This theory provides a sound theoretical framework for task design, which constitutes an important

element of AL teaching and my SMA framework (see [Chapter 16](#)). Activity theory was introduced to the sociocultural theory through the works of Vygotsky, Leontiev, and Luria (Leontiev, 2006; Luria, 1976; Vygotsky, 1978, 1986). A large number of contemporary scholars have expanded and updated the concept of activity introduced by Vygotsky and his colleagues (Chaiklin & Lave, 1996; Engeström, 1999, 2001, 2014; Engeström & Miettinen, 1999; Lave, 1996). Vygotsky maintained that individuals alone cannot provoke a change in their physical world. The activity theory holds that all kinds of collaborative learning using artefacts is an activity. In order to change the world around them and to regulate the circumstances, individuals need to participate in a collective activity (Lantolf, 2004b, 2004a). During this social activity, there is always a change. Lantolf (2004a) explained that each generation ‘reworks its cultural inheritance’, and from generation to generation, these physical and psychological signs are reshaped to suit individuals’ daily lives (p. 2). Participating in such cultural activities (e.g., schooling) results in the restructuring of one’s mental system, including one’s self-concept. In this social activity, the individual’s role changes as they gain more control in action. As children develop (move from one stage to another), they acquire more control over the mediational means available (e.g., language) in their environment for interpersonal (social interaction) and intrapersonal (cognitive) purposes (Lantolf, 2004a). Vygotsky defined these stages as ‘object-, other- and self-regulation’ (Vygotsky, 1978, 1986). This viewpoint considers the activity as situated and relating to both the social world and the mind.

The underlying principles of the sociocultural perspective provide a framework for my research on how social artefacts, mind (cognitive engagement), language and other signs (including non-verbal), and social artefacts interact with each other and lead to the emergence of negotiated language (trial by trial) during these interactions. This perspective also provides my research with the necessary tools to understand, analyse, and explain, in a coherent way, the role of interactional exchanges in language development.

1.16.2 Interactionist perspective in AL development

The interactionist perspective assumes that person-to-person interaction facilitates the acquisition of an AL and that the development of an AL will occur when a learner engages in social interaction with others. The central role of social interactional exchange in the development of ALs is a view common to all current epistemological positions in applied linguistics. Emergentist theories offer us explanations of the ‘why’: why social interactional exchange is necessary and the conditions

required to assimilate the knowledge acquired through these exchanges. Complexity theory emphasizes the existence of a multitude of factors involved in language acquisition and parallels the explanations offered by emergentist theories on how learners deal with complexity in a systematic way. UBL, like the emergentist orientations, also argues that increased and frequent experience of use leads to language development. Sociocultural theories offer us explanations about the nature of the components of social interactional exchanges that lead to successful knowledge acquisition. Finally, the interactionist perspective raises the question of ‘how’ and offers explanations about what actually happens during these interactional exchanges and how these exchanges contribute to language development. AL instruction is primarily concerned with the nature of social interactions and how the development of AL occurs during these interactional exchanges. My research focuses on the nature of social interactions and how AL development takes place over the course of these interactional exchanges (which I analyse using microgenetic analysis procedures).

Some SLA researchers view the interactionist perspective of SLA as part of the cognitivist view and refer to it as ‘cognitive-interactionist SLA theory’ (see Norris & Ortega, 2008). However, some others place the interactionist view within sociocultural theories and refer to it as ‘social interactionist’ (or socio-interactionist; Gass, 2010; Gass, Mackey, & Pica, 1998; Mackey, 1999; Mackey, Abbuhl, & Gass, 2012; Swain, 2000; Swain et al., 2002). My overall epistemological position evolved with the developments in applied linguistics (see [Chapter 3](#)). This position combines both sociocultural and interactionist views. Early formulations of interactionist approaches presented language development as consisting of processes that function as linear steps (i.e., input, meaning negotiation, and output), whereas recent conceptualizations have situated these processes in a more complex (non-linear) social and psychological context. It should be also noted that earlier interactionist perspective had monoglossic views and analysed AL interactions based on native speaker norms. Recent interactionist perspectives highlight both social and pluralistic aspects of AL interactional exchanges. My theoretical orientation is grounded in the latter perspective.

In order to understand the notions behind the concept of face-to-face interaction and the interactionist perspective, I will first provide readers with some basic notions and then in the conclusion section present a model that combines these notions with my view of the interactional exchanges that are part of AL learning.

Some of the critical concepts that describe the interactionist perspective are comprehensible input, interaction hypothesis, comprehended input, attention and noticing, negotiation of meaning, output, negative feedback, comprehensible output, collaborative interaction/dialogue, hypothesis testing, modified output, and intake.

Comprehensible input: The concept ‘comprehensible input’ was first added to SLA literature by Stephen Krashen’s input hypothesis⁷⁴ (see Krashen, 1979, 1982). This hypothesis holds that the only condition for acquiring a language is the provision of comprehensible input (understanding messages; Krashen, 1979, 1982). According to Gass (1997), Krashen’s conceptualization of input assumes a central role in AL acquisition, and comprehensible input alone cannot be a sufficient condition to promote AL development (Pica, Holliday, & Lewis, 1989). My position concerning input is influenced by my conceptualisation of ‘language’ (see [Section 4.4](#)). My position regarding input is influenced by the current conceptualization of ‘language development’, which considers the notion of ‘comprehensible input’ as a phenomenon that takes place during language tasks through interactional exchanges (incidental learning).

Interaction hypotheses (IH): IH postulates that acquisition occurs when learners focus primarily on communication (incidental acquisition—with or without awareness). According to Long (1981, 1983), this process consists of a communication breakdown followed by restructuring and the modification of input. Long claimed that such a process of restructuring and modification facilitates AL learning. The IH is consistent with my general conceptualization of language development and underpins my pedagogical vision of task design.

Negotiation of meaning (negotiated interactions): According to Long, the best way to render input comprehensible is through interactional adjustments made during conversational exchanges (Long, 1981, 1983). He explained that these conversational adjustments are made during negotiations, which take place when the learner encounters problems of comprehending the meaning. He posited that comprehensible input is gained through these negotiated exchanges and that adjustments are central to AL development. He referred to this interactive act between interlocutors (teacher-learner

⁷⁴ Krashen’s compressible input hypothesis (Krashen, 1979, 1982) relates to acquisition and learning. This hypothesis, which is based on a nativist view, is no longer a relevant concept in current SLA research. However, the concept is important because it has been instrumental in the emergence of the interactionist approach in SLA.

or peers), which attempts to resolve a communication breakdown through language modifications, as the 'negotiation of meaning'. However, later Long himself also pointed out (1985) that interactional modifications, cannot be the only mechanism behind the learner's AL development. The notion of negotiation of meaning is an important concept that explains how and why linguistic exchanges take place. However, the initial form of this concept does not reflect the complexity of the interaction process. In my conceptualization, I combine this concept with peer and teacher support and Vygotsky's ZPD concept.

Negotiation of form: The claim that learners use negotiation of meaning to render their communication comprehensible received some criticisms because in instructed AL settings learners also negotiate the form to make their language grammatically accurate. In instructed AL settings, during an interactional sequence, learners (or teachers) may focus their attention on the form even if there is no communication problem. Although such events are not common in L1 interactional sequences, they occur very often in classroom settings (R. Ellis & Shintani, 2014). Thus, many specialists consider the negotiation of form as part of the processes of negotiation of meaning. Recent conceptualizations also emphasize the importance of the use of metalanguage in these negotiation processes. My vision of negotiation covers all three concepts and goes further. My conception of negotiation in plurilingual environments using interdisciplinary content (e.g., CLIL situations) covers the negotiation of 'meaning', 'form', and 'content' using multimodal means (e.g., using verbal and non-verbal means and scaffolding and translanguaging techniques).

Hypothesis testing: Hypothesis testing is an important part of the negotiation of meaning processes, but it is not an observable part of these processes. This cognitive aspect of interactional exchanges will not be the focus of my research (although I agree that it exists). Gass (1997) argued that when learners produce language, they test their hypotheses at the same time through the negotiation of meaning and the feedback they receive. In order for input to be internalized, processing input and integrating it into already existing knowledge is necessary. Gass (1997) explained that when the learner receives new input data, they either use this data to confirm and strengthen their hypothesis about particular knowledge or they reject their original hypothesis (in this case they modify their original hypothesis and wait for new input data to confirm this new hypothesis). She also explained that in some cases, such as when the learner has some level of understanding but has not fully mastered certain linguistic items, they store the information (create a hypothesis) and wait for new information (input) to confirm (or disconfirm) their hypothesis.

Output (comprehensible output, pushed output) hypothesis: The output hypothesis was first formulated by Swain (Swain, 1985, cited in Gass, 1997, and Swain & Lapkin, 1995). This hypothesis holds that output, which refers to the language that learners produce, is a crucial element of AL development (Gass, Behney, & Plonsky, 2013). Swain (1985) argued that comprehensible input could not fully explain the processes involved in AL acquisition. She hypothesized that comprehensible output helps learners ‘notice the gap’ in their language productions – ‘what they do not know or know partially’ (1995, p. 129)—and pushes them to reflect on their output and produce the correct language forms. Swain postulated that during the collaborative dialogue, the learner does not only respond to the ‘comprehensible input’, but they also produce the language. She postulated that learners also learn from their output (Swain, 2000; Swain & Lapkin, 1995). Gass (1997) claimed that output helps the development of fluency and automaticity of processing and that it requires more cognitive effort than the input (Swain, 2000). Swain (2000) claimed that the output entails both cognitive and communicative activity, and during a negotiation process, learners try to make their language productions comprehensible to their interlocutors and this effort pushes them to produce comprehensible output or ‘pushed output’. The output produced by learners during learning tasks can also provide comprehensible input to their peers (to improve learners’ output [oral and written], various modalities have recently been proposed, such as providing interactional feedback [Nassaji, 2020], performing textual enhancement activities, using visual input [S. Izumi, 2002, 2003; Y. Izumi & Izumi, 2004], and so forth).

Negative evidence: Negative evidence is a form of input that provides the learner with evidence that their output is erroneous (Long, 1996). The negative evidence can either be performed directly (i.e., explicit evidence, through provision of a correct formulation)⁷⁵ or indirectly (i.e., implicit evidence, using prompting to indicate an ungrammatical part of the learner’s discourse).⁷⁶ Any reformulation of the learner’s erroneous phrase using recasts, clarification requests, explicit

⁷⁵ In classroom practices the term ‘direct repair’ is most often used to refer to the teacher’s direct correction (reformulation of) the learner’s faulty language productions.

⁷⁶ In classroom practices the term ‘guided repair’ is commonly used to refer to the teacher’s guided correction through the use of various techniques such as recasting and elicitation, the use of questions, repetition of the mistake, and other similar techniques that guide learners towards self-correction.

correction, elicitation, repetition, and metalinguistic feedback can help the learner notice their error (Lyster, 1997; Lyster & Ranta, 1997) (see Figure 10).

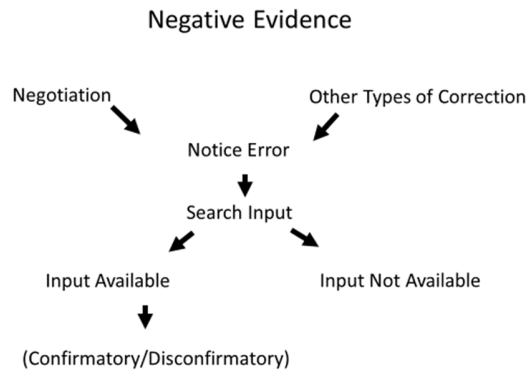

Figure 10. The function of negative evidence (Polio & Gass, 1998, p. 310)

Noticing the error can in turn activate cognitive mechanisms (e.g., hypothesis formation, hypothesis testing, and revision) and may result in modified output (Gass et al., 1998). Polio and Gass (1998) provide us with a model describing the function of negative evidence. J.-P. Narcy-Combes (2006) connects this phenomenon to ‘potentially acquisitional sequences’ (PAS) (*séquence potentiellement acquisitionnelle* [SPA]). PAS is a dialogical sequence in which processing of meaning, noticing, and negotiation are observed (De Pietro, Matthey, & Py, 1989). Early interpretations of the interactionist perspective focused only on the interactional exchanges that took place solely in the AL. According to J.-P. Narcy-Combes (2006), a plurilingual approach will increase attention and will help learners to anchor newly formed concepts (linguistic features, lexicon, or cultural elements) to internal criteria. This process will allow PAS to be achieved and the use of a plurilingual experience will generate more substantiated intercultural and metalinguistic reflection.

Positive evidence: The earlier versions of the interaction hypothesis viewed the negotiation of meaning processes as offering only positive evidence (comprehensible input) by providing the learner with grammatically correct and acceptable meaningful models of language.

Intake: Intake refers to the language features internalized by the learner (Gass et al., 2013). Corder (1967) made a distinction between input and intake: input is what is available to the learner, while intake is what is internalized or what is taken in by the learner (cited in Gass & Selinker, 2008).

Noticing Hypothesis (attention & awareness): The noticing hypothesis was proposed by Schmidt (1990, 2010, 2012). He asserted that ‘subliminal language learning is impossible, and that noticing is the necessary and sufficient condition for converting the input to intake’ (Schmidt, 1990, p. 129). According to Schmidt, attention and awareness are necessary conditions for noticing (the degree of attention can vary from low-level automatic attention to high-level controlled attention), and in order to acquire any particular aspect of the AL, the learner must first notice it (Tomlin & Villa, 1994). According to Schmidt, regardless of whether learning is intentional (e.g., a purposeful action such as reading a book to learn academic concepts) or incidental (e.g., during a conversational act), it requires conscious attention (see also Tomlin & Villa, 1994). Schmidt claimed that conscious attention helps the learner to notice the gap in their performance (compared to other speakers, e.g., peers and teachers). N.C. Ellis, who emphasizes the importance of implicit learning, notes that after identification, most language learning occurs implicitly without conscious attention (N. C. Ellis, 2002). J.-P. Narcy-Combes (2009) reminds us that language development takes place through the accumulation of models (exemplars), with a progressive awareness through the detection of regularities within the examples offered by the input. This type of treatment takes into account the context of the discourse and the intention of the interlocutor. He explains that as soon as there is explicitness, we are in the field of metacognition. Initially, this information may have been based on instances (exemplar-based information), but over time, through observation, reflection, and integration, this knowledge may take an explicit form (metacognitive knowledge). J.-P. Narcy-Combes points out that although language development is largely an implicit process, there are moments that attention allows explicit reflection (metacognitive awareness; J.-P. Narcy-Combes, 2009).

Since its inception, the interactionist perspective has been elaborated by the works of several SLA researchers (Mackey, 1999; Mackey & Polio, 2009; Pica, Doughty, & Young, 1990; Varonis & Gass, 1994). Progressively, the interactionist approach, through reflection and investigation, has moved away from its initial nativist assumptions and the monoglossic standards of the ‘native speaker’, and has increasingly integrated social elements into its framework. My theoretical position is inspired by this socially oriented interactionist perspective based on heteroglossic views and the principles of dynamic bilingualism (see [Chapter 4](#)). My research studies look into interactional exchanges by taking into account the social context and learners’ linguistic repertoires. My analysis does not only focus on learners’ AL productions but also how

translanguaging/transculturating processes are used during negotiation processes and collaborative interactions (among other modalities, including non-verbal aspects; see Gabillon, 2019; Gabillon & Ailincăi, 2013, 2016, 2017).

1.17 Discussion and conclusion

I conceptualize negotiation of meaning, modified output, and other related elements such as intake as consisting of episodes of complex collaborative social interactions. During the language learning process, prior knowledge, knowledge of other languages, cognition, emotions, social/cultural representations, attention (individual and joint), and social artefacts interact with each other. Hypothesis testing is also explained by the use of Bayesian inferences (J.-P. Narcy-Combes and M.-F. Narcy-Combes, 2019). According to this explanation, the individual's brain calculates the most likely interpretation (unconscious/implicit learning). According to this view, language learning requires an understanding of associative learning of representations that reflect the probabilities of occurrence of form-function relationships. Such a hypothesis-testing approach explains that learners discover language by calculating the probability of an interpretation using language cues in a particular context by linking form to meaning conditioned by the context (Mackey & Polio, 2009).

In my conceptualization of language learning, input emerges during task-based learning activities and is inseparable from the content, language, and objectives of the task. Negotiation processes are therefore not only language related (e.g., meaning and form) but also cover content and pragmatic elements. From my standpoint, the modalities used in the negotiation process also include mediational means, such as artefacts, body movements, and other extralinguistic resources. This multimodal (e.g., L1, artefacts, and gestures) interactional process leads to the creation of intersubjective knowledge, which is constructed collaboratively. In short, this co-constructed intersubjective knowledge (output) cannot solely belong to the individual who produces it. This view is presented in Figure 11.

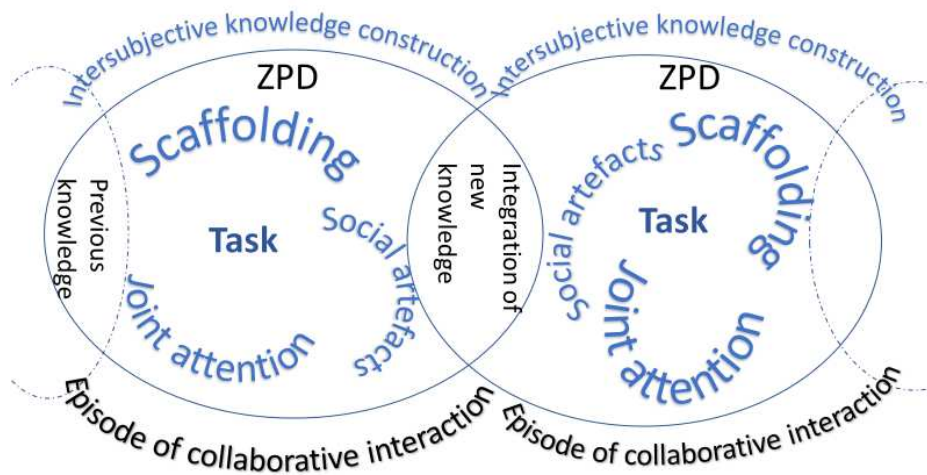

Figure 11. Episodes of collaborative social interactions in AL development (proposed by the author).

Language development is modelled on the identity of its creators (in our case learners) and is shaped by their personal (cognitive and social) histories. Language development is socially embedded, and it is the outcome of collaborative interactions and intersubjective knowledge creation. Language development is situated and inseparable from the activity, context (i.e., collaborative actions, physical movements, manipulations, and social artefacts), and content (i.e., language(s) and knowledge). Language development bears the imprint of the cultures and languages with which learners are familiar (transculturing and translanguaging) and their language productions bear the reference values of the society in which they live.

CHAPTER SIX

CURRENT AL TEACHING APPROACHES

Introduction

In parallel with the ideological and sociological changes that have affected the ecology of languages around the world, approaches to language learning and teaching have also been reformed. These new generation approaches share similar pedagogical principles but may differ slightly in terms of philosophical concerns. The pedagogical principles that have guided my studies are based on these new generation approaches to language teaching, with particular emphasis on the CLIL approach (which I detail in [Chapter 7](#)). In order to situate these approaches in today's social and linguistic ecology, as well as in my position regarding language pedagogy, it is important to present a brief update on current approaches to language teaching and the theories and ideologies that have influenced them. The theories and ideological positions that have influenced the development of these new generation approaches are in line with my epistemological position and pedagogical vision of complementary language teaching.

The complex and dynamic social, political, and ideological paradigm shifts that started affecting the applied linguistics field from the early 1980s led applied linguistics to move from the 'method' ⁷⁷ to the 'post-method' ⁷⁸ condition (e.g., Brown, 2002; Kumaravadivelu, 1994; Pennycook, 1989; Prabhu, 1990). These changes in language teaching approaches were mainly influenced by the postmodernist movement (see Table 1).

Table 1. Modernist vs. postmodernist views of applied linguistics.

Modernist (positivist) definitions of applied linguistics	Postmodernist (relativist) definitions of applied linguistics
Focus on:	Focus on:

⁷⁷ D. Brown, defined method as '... a theoretically unified classroom technique thought to be generalizable across a variety of contexts and audiences ...' (D. Brown, 2002, p.9).

⁷⁸ D. Brown (2002) defined the post-method approach to instructed AL teaching as 'dynamic' (p. 11) 'principled' based on 'research-based principles' (p.12).

- prescribed solutions to problems	- specificity, and a multiplicity of perspectives
- general and universal	- the contextual and the locally specific aspects of knowledge
- enlightenment	- pragmatism
- the value of scientific progress for the common good	
Represents the positivist (universal) view that experience can be understood in a similar way	Represents the relativist (situated) belief that contexts are different
One size fits all	It is unacceptable to assume that one size fits all
Note. Views taken from Davies and Elder (2004, 2005) and Weideman (2007, p. 559).	

This postmodernist movement was primarily motivated by observations that teachers are confronted with the complexity of language and language learning situations, and no predefined universal method or explanation could answer their needs (Kumaravadelu, 1994; Larsen-Freeman, 2004). This new epistemological position led to the departure from modernist (positivist) language practices that emphasized the general and universal aspects of knowledge and language development regardless of context. This new stance emphasized the constructive functions of language and the contextual and locally specific aspects of knowledge (Davies & Elder, 2005, 2008; Kramsch, 2018; Weideman, 2007).

The post-method attitude in language teaching has challenged methods that were based on prescriptive procedures and static sets of principles, regardless of context. From the early 1980s onwards, the notion of approach, which includes language theory and language learning, became the norm in applied linguistics worldwide (D. Brown, 2000, 2002). An approach, in contrast to a method, is defined as having ‘core sets of principles but no specific set of prescriptions and classroom techniques’ (Bell, 2003, p. 327). The major philosophies that support the post-method view in language teaching are emergentist theories such as complexity theory (Larsen-Freeman, 2004, 2011a; S. Mercer, 2013) and sociocultural theory (Vygotsky, 1986). The flexible and situated nature of its practices and the avoidance of rigid and prescriptive teaching procedures can be justified from nonlinear systems dynamics such as emergentism, connectionism (N. C. Ellis, 1998), and complexity theory (Larsen-Freeman, 2011a, 2012). These theories emphasize the social, dynamic, unpredictable, creative, and unique nature of the language learning process and its variability in different contexts (Larsen-Freeman, 2004, 2011a; S. Mercer, 2013; J.-P. Narcy-Combes & M.-F. Narcy-Combes, 2019). These epistemological perspectives are complementary to each other and explain different aspects of AL acquisition.

1.18 Competency-based approaches

Today, AL instruction is not based on prescribed teaching models, which dictate predetermined procedures to be followed. The influence of post-method condition and post-structuralist views in applied linguistics has led AL pedagogies to abandon prescriptive teaching based on rigid methodological practices. Today's language pedagogies are guided by approaches that base their principles on research and theories of language learning.

It is therefore difficult today to make a clear distinction between the pedagogical principles used by many current approaches to language teaching, such as task-based language teaching (TBLT), the action-oriented approach (AOA), content-based instruction (CBI) and CLIL, because almost the same underlying principles are used to define these approaches. These approaches share similar sets of assumptions and theoretical underpinnings. Depending on the teaching context, these approaches are implemented differently. These four approaches consider language learning a compiling of skills (language, life, academic, and cognitive skills) through integrating sets of behaviours that are learned through practice. They are task- or performance-oriented approaches and put the emphasis on what learners can do using the language to achieve the objectives of the task in question rather than how well they produce discrete linguistic features. All these approaches emphasize the importance of incidental learning through repeated practise⁷⁹ and view language skills development through engagement in tasks. This view is supported by emergentist perspectives and usage-based approaches, which emphasize that the vast majority of our cognitive processes are unconscious and that learning emerges from automatic associations between different elements of the input learners are processing during language use (which is called implicit learning⁸⁰).

These four approaches can be considered the descendants of the communicative approach that have taken different paths. Current language teaching approaches overlap in significant ways, and sometimes it is impossible to distinguish between TBLT from AOA or CLIL from CBI. Moreover,

⁷⁹ Repeated practise (repeated skills or skill components) is different from the audiolingual approach, which was based on earlier forms of behaviouristic theory and behaviour conditioning.

⁸⁰ The influence of implicit cognition on implicit learning is now widely accepted in applied linguistics (N. C. Ellis, 2019).

actual implementations of these four approaches may borrow from one another. All four of these approaches share the same underlying principles and theoretical underpinnings, and they can be grouped under competency-based language teaching (CBLT; Celce-Murcia, 2014). CBLT is an umbrella term used to refer to this current group of communicative approaches, which emphasize the construction of competencies (skills) that are required of individuals to function in society (Auerbach, 1986; Findley & Nathan, 1980; Pérez-Cañado, 2013). ‘So one could say, paradoxically, that indefinability has become one of the defining characteristics of all approaches to language teaching ...’ (Littlewood, 2011, p. 542).

From the CBLT perspective, successful language performance and skill acquisition depend upon repeated opportunities for practice through the use of real-life tasks (Nunan, 2007; Richards & Rodgers, 2014; see Figure 12).

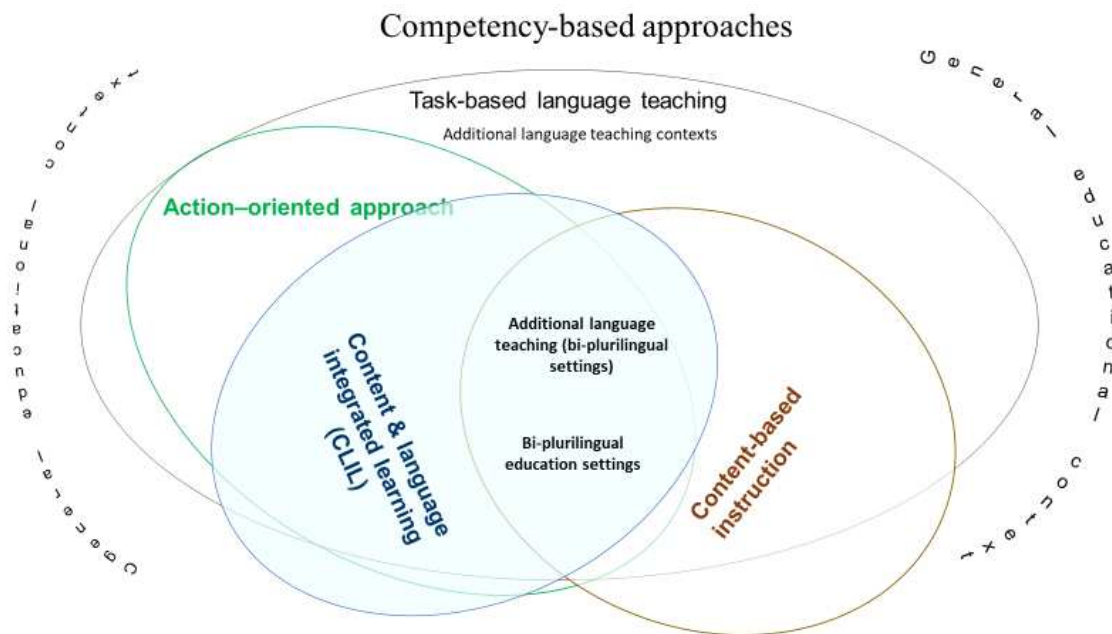

Figure 12. Current AL teaching approaches.

Auerbach (1986) summarized the key features of CBLT as follows:

- A focus on successful functioning in society: The primary aim of learning is to build in skills that enable learners to cope with the demands of society autonomously.
- A focus on life skills: Auerbach (1986) describes this feature as, ‘rather than teaching language in isolation’, teaching language using concrete tasks.

- Task or performance-centred orientation: This feature emphasizes the importance of what learners can do (overt behaviours) rather than the ability to talk ‘about language’.
- Modularized instruction: language teaching is broken into sub-objectives (micro-tasks) to allow both learners and teachers to get a clear sense of progress. Outcomes are made explicit a priori: They are specified in terms of behavioural objectives and agreed upon by both by learners and teachers.
- Continuous and ongoing assessment: Learners’ skill levels are pre- and post-tested, and they are expected to work until they master the skills in question.
- Demonstrated mastery of performance objectives: Assessment is based on the ability to demonstrate pre-specified behaviours rather than measuring learners’ language ability via paper-and-pencil tests.
- Individualized student-centred instruction: The curriculum is designed to take into account learners’ prior knowledge and individual needs (Auerbach, 1986, pp. 414-415).

The learning approaches that are part of CBLT consider AL learning to be the compiling of skills (language, life, academic, and cognitive skills) through integrating sets of behaviours that are learned through repeated practise. This view of skill formation through the process of ‘knowledge compilation’, which involves storing information as chunks (instances, implicit knowledge, formulaic expressions, or exemplar-based information), takes its grounds from the emergentist (N. C. Ellis, 1998; J.-P. Narcy-Combes & M.-F.Narcy-Combes, 2019) and complexity perspectives. This view assumes that when skills are performed repetitively, knowledge is fully automatized and can be easily and quickly accessed during task performance (Ellis R 2003, p. 348). Researchers who have looked at competency-based language learning from a complexity perspective, on the other hand, emphasize the importance of fluency practice by providing learners with contextualized complex real-life tasks.⁸¹ These two perspectives are complementary and compatible with sociocultural and interactionist perspectives.

⁸¹ See Foster and Skehan (1996); Larsen-Freeman (2011a); Skehan (2014); Skehan and Foster (1997).

1.19 Task-based language teaching (TBLT)

TBLT is viewed as the strong version of communicative language teaching (CLT), a non-interventionist approach, which holds that language is acquired through real-life communication (Brinton, Celce-Murcia, Brinton, & Snow, 2014; R. Ellis, 2005b, 2005a; Skehan, 2014). The principal underpinning of the task-based approach is incidental learning. ‘Incidental learning refers to any learning that is unplanned or unintended. It develops while engaging in a task or activity and may also arise as a by-product of planned learning’ (S. W. Kelly, 2012, p. 1517). TBLT is based on the principle that activities, which involve real-world communication, allow learners to carry out meaningful tasks and that meaningful tasks promote language learning (R. Ellis, 2003, 2005a; R. Ellis & Barkhuizen, 2005; Larsen-Freeman, 2011b; J.-P. Narcy-Combes & Walski, 2004; Richards & Rodgers, 2014). TBLT emphasizes the primacy of meaning over accuracy; however, it also accepts that learners need to attend to form.

In TBLT, the emphasis is not merely on the language itself. Learners are required to communicate using their own linguistic and non-linguistic resources (e.g., gestures and social artefacts) to complete tasks. This approach makes use of unfocused communicative tasks in which the teacher and learners attend to forms while performing tasks (incidentally) or take time out to deal with specific language forms the learners need to use in a specific context (R. Ellis, 2003).

In TBLT tasks constitute the core element of syllabus planning and instruction, and these tasks aim to engage learners in authentic communication in AL learning environments (Celce-Murcia, 2014; Larsen-Freeman, 2011b; Richards & Rodgers, 2014). According to Ellis (2003), tasks used in language instruction need to be ‘situationally authentic’ (i.e., they need to employ same communicative characteristics as real-world activities), and they should aim to achieve ‘interactional authenticity’ (e.g., negotiation of meaning, problem solving, shared understanding, asking questions, and clarifying meaning). Although the tasks used in TBLT emphasize primarily the development of oral skills, this approach does not exclude reading, writing, and listening skills (R. Ellis, 2003).

Design of tasks in TBLT is informed by different approaches such as humanistic teaching and interactionist, cognitivist, and sociocultural theories. Tasks from the humanistic perspective emphasize the importance of the affective dimension and cognitive development for the full potential of growth. Humanistic tasks also aim at increasing self-esteem and motivation (see R.

Ellis, 2003, for task design based on humanistic principles). The focus in TBLT is on *how* learners will learn rather than *what* learners will learn (R. Ellis, 2003). This view is based on the assumption that learning is incidental and is the outcome of social interaction, which is carried out via problem-solving tasks. According to J.-P. Narcy-Combes and Walski (2004), the task triggers the learning process that is specific to each learner. They posited that the task is not an end in itself but a means for learners to interact with the language by continually asking questions and actively engaging in their learning by trying to understand their own learning processes (J.-P. Narcy-Combes & Walski, 2004). Tasks offer learners the possibility of establishing a direct link with the context and the type of language used (Beacco et al., 2003; Rosen, 2009).

TBLT draws commonly on an interactional view of learning and views language development as the result of dialogic interaction and collaborative meaning-making. This view emphasizes language acquisition processes that consist of communication breakdown, restructuring, and the modification of input through PAS (De Pietro et al., 1989). According to this perspective, AL development occurs when learners are primarily focusing on communication (incidental acquisition—with or without awareness), and tasks provide opportunities for learners to notice the gap in their AL productions and possibilities for negotiation of meaning (Beglar & Hunt, 2002; Richards & Rodgers, 2014).

The current implementations of tasks have been primarily explained using sociocultural premises. From a sociocultural standpoint, the task is viewed as social activity providing learners with opportunities for optimizing their AL development through the use of both peer- and teacher-mediated help. Tasks, as such, create the necessary conditions for collaboration and joint learning opportunities. During this assisted process, the discourse is created jointly, and less-able learners feel less threatened. Gradually less-able learners develop their skills and knowledge and take more responsibilities in their learning (see ZPD in [Section 5.1](#); Richards & Rodgers, 2014).

In TBLT learners' cognitive engagement in problem-solving tasks is paramount. This approach aims at involving learners in real-life communication through problem-solving tasks. TBLT uses tasks for different purposes, such as to encourage spontaneous communication, to help fine-tune learners' language performance (e.g., hypothesis testing/hypothesis confirmation), to develop learning strategies, to improve self-esteem, and so forth. Tasks are fundamentally different from

traditional language exercises. To show the distinction between tasks and exercises, R. Ellis (2003) provided some definitions (see Table 2).

Table 2. Distinctions between tasks and exercises (R. Ellis 2003, p. 3)

Tasks	Exercises
Tasks are activities that call for primarily meaning-focused language use.	Exercises are activities that call for primarily form-focused language use.
Tasks are concerned with ‘pragmatic meaning’, i.e., the use of the language in context, while an exercise is concerned with ‘semantic meaning’.	Exercises focus on language structures, i.e., the systematic meaning that specific forms can convey irrespective of context.
Tasks require the participants to function primarily as ‘language users’.	Exercises require the participants to function primarily as ‘learners’.

Contrary to traditional approaches (or methods) to language teaching, TBLT rejects the use of synthetic syllabi, which are organized around linguistic units (Larsen-Freeman, 2011b; Larsen-Freeman & Anderson, 2016). Instead, the syllabi used in TBLT are analytic. That is, the content of a task-based syllabus comprises tasks without any specification of the language forms (or functions or notions) to be taught (see R. Ellis 2003; Richard & Rodgers 2001). Recent proponents of TBLT emphasize the use of an analytic syllabus that employs a noninterventionist experiential approach (Beglar & Hunt, 2002). Tasks which are designed using this non-interventionist approach allow learners to function primarily as language users who learn through experiential learning activities. It should be noted, however, that language forms and lexicon that emerge through these tasks (input) and the forms and lexicon that learners seek to use (language needs) are dealt with either in the feedback or follow-up tasks.

1.20 Action-oriented approach (AOA)

Language teaching methodology experts often refer to the action-oriented approach (AOA) as a competency-based (or skill-based, standard-based) approach that uses tasks (Celce-Murcia, 2014; Richards & Rodgers, 2014). This approach is the collaborative creation of the language experts who worked together in the elaboration of the language policies within the Council of Europe (Council of Europe, 2003; Little, 2005). AOA is very often considered the same as TBLT because of its similar pedagogical and theoretical foundations (theory of language, SLA research and theories, and related learning theories). Both TBLT and AOA describe tasks as activities having more than one solution (answer) and require learners to solve a problem, express their personal

opinion, and produce, request, and obtain information (Council of Europe, 2003; R. Ellis, 2003; Long, 2015). However, it should be noted that AOA includes not only language-related theoretical underpinnings but also philosophical, societal, and political issues.

The Council of Europe included these philosophies in the CEFRL, and they are reflected in AOA distinctly (Byrnes, 2007; Little, 2007). AOA, and communicative competence (i.e., linguistic, sociolinguistic, and pragmatic; see Figure 13), integrates individual general competences into its framework (see Figure 14).

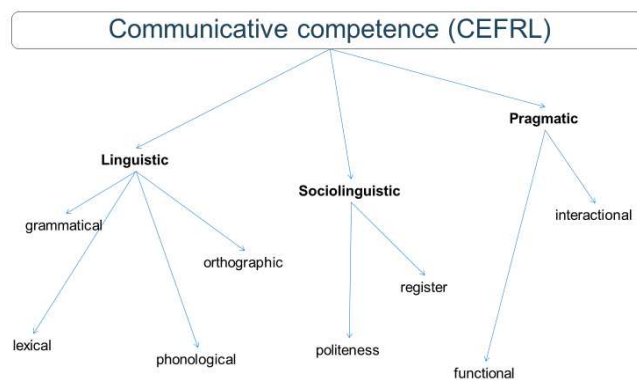

Figure 13. Communicative competence as part of the AOA framework.

This framework has components similar to the communicative competence notion proposed by Savignon (2002, p. 8). However, the conceptualization of AL includes skills that are not always related to language, which are crucial for effective functioning in today's society. Tasks proposed by AOA require technical, pragmatic, academic, intercultural, and plurilingual skills as well as social and linguistic skills. These skills are integrated in individual general competencies (i.e., knowledge, know-how, existential, and ability to learn into its framework; see Figure 14).

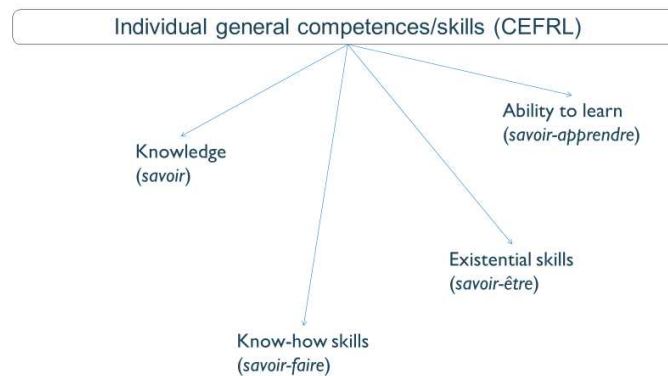

Figure 14. Individual general competences as part of AOA framework

Although TBLT implies the inclusion of general skills in its practices, it does not explicitly mention these as part of its theoretical framework. The definition of tasks in the AOA extends the definition of tasks proposed by the proponents of TBLT. This approach incorporates the plurilingualism and pluriculturalism inherent in the overly complex educational issues of today's postmodernist world. Pedagogies that emphasize the plurilingual aspect of language learning constitute the heart of this approach (J.-P. Narcy-Combes & M.-F. Narcy-Combes, 2014).

1.21 Content-based instruction (CBI)

The content-based language instruction (CBI) approach is a prototypical model that originated with the inauguration of the Canadian immersion programmes in the 1960s, but its pedagogical innovations took place in the 1970s, and the approach was fully developed in the 1980s to meet the changing educational demands of society (Leaver & Stryker, 1989; Stryker & Leaver, 1997b). Since the 1980s, CBI has gained considerable credibility as an alternative to traditional approaches. Initially CBI was intended for foreign/ second language and content teaching in bilingual education contexts (Stryker & Leaver, 1997b), but today it is also used to teach heritage and autochthonous languages as well (Lyster & Ballinger, 2011).

The principles and learning theories that CBI draws on are in line with the principles of communicative approaches (Leaver & Stryker, 1989). CBI posits that 'people do not learn a language and then use it; instead, they learn language by using it' (Genesee & Lindholm-Leary, 2013, p. 3). In the same vein, Stryker and Leaver (1997) posited that CBI 'encourages students to learn a new language by playing real pieces actually using that language, from the very first class, as a real means of communication' (p. 3). CBI has various models and applications depending on the contextual demands and curriculum constraints varying from total immersion (the teaching of all disciplinary subjects in the target language) to language classes that focus on content learning. Lyster and Ballinger (2011) adapted Met's (1998, cited in Lyster & Ballinger, 2011) description of different CBI models to present the range of CBI settings (see Figure 15).

Stryker, 1989; Stryker & Leaver, 1997a, 1997b). SLA research has been supportive of the principles that characterize CBI. The principles that characterize recent CBI practices are:

1. *Rich and authentic AL context*: CBI holds that language acquisition takes place in a rich and authentic AL context. R. Ellis (2000, 2003, 2005a, 2005b) argued that rich and extensive AL input enables learners to learn more and faster. Thus, CBI aims to provide learners with a rich context in which authentic, meaningful communication can occur.
2. *The relevance of content to learner needs*: It has been widely stated that learners learn better if the content is meaningful and relevant to their needs. CBI holds that content that is directly linked to the learners' needs and interests promotes language acquisition.
3. *Learning by doing*: CBI is based on the principle that people learn by doing. It holds that linguistic ability develops through active engagement in a communicative activity. Hence, CBI emphasizes creating opportunities for the active involvement of learners in communicative AL activities (e.g., tasks encouraging the use of face-to-face interactions, problem-solving activities, comparing, analysing, and working in groups/pairs, all of which involve experiential learning).
4. *Negotiation of meaning*: CBI provides learners with communicative language tasks, which encourage negotiation of meaning.
5. *Use of tasks*: Tasks are viewed as an essential part of authentic and experiential language learning; thus, TBLT is considered to be an integral part of CBI.

CBI emphasizes the importance of providing learners with opportunities to interact with authentic, contextualized, and linguistically challenging materials in a communicative context, and it views AL development as a social and cognitive activity. Within this social and cognitive activity, prior knowledge and strategy use are regarded as critical to the learner's AL development. CBI is a formal approach with theoretical underpinnings (Kasper 2000), and it is grounded in the theory that (i) people learn an AL more successfully if they use the language as a means of acquiring information, (ii) people learn best if the teaching is based on their prior experiences, and (iii) people learn best if the instruction addresses their needs, interests, and goals (see Richards and Rodgers 2014).

1.22 Conclusion

Current approaches to AL teaching are all based on the same theoretical orientations and research findings. However, their pedagogical implications can be influenced by curricular constraints, local language policies, philosophical concerns, values, social/cultural representations and ideological orientations, and contextual variations (e.g., age, allocated teaching hours, and whether the language is an additional modern language or an autochthonous language), and these differences in turn have an impact on other parameters and principles of the AL implementations (e.g., the L1 use and other related practices such as translanguaging, code-switching, and code-meshing). Thus, a difference in learning settings will directly influence the pedagogical considerations and consequently the learning outcomes. For instance, teacher and learner roles, activities used (task or exercises), the use of the L1 (e.g., code-switching and translanguaging practices), and many other parameters would necessitate different theoretical positioning depending on a given situation. My research and pedagogical practices make flexible use of the relevant elements of these approaches.

CHAPTER SEVEN

CLIL AS AN EDUCATIONAL APPROACH

Introduction

A modified version of this chapter has been published as a journal paper (Gabillon, 2020b). This article reflects my conceptualization of CLIL and provides an overview of the evolution of this approach through research and practice to meet current needs.

CLIL studies have been the main part of my research activities since I completed my doctoral studies. Although CLIL is briefly mentioned as part of current AL teaching approaches in the previous section, in this section CLIL is described in detail as an educational approach. This chapter provides a comprehensive updated overview of CLIL, focusing on its historicity, its ideological and theoretical underpinnings, and the points that have been the subject of confusion and debate in the literature. CLIL is an educational approach that integrates AL learning and disciplinary content learning. It is a dynamic approach that is in constant interaction with various research domains, educational contexts, and disciplines to adapt to current social and language needs.

Content and language integrated learning (CLIL; *enseignement d'une matière par l'intégration d'une langue étrangère [EMILE]*) is an educational approach that integrates language learning and disciplinary content learning. The term CLIL was coined by European language experts and educators within the European educational setting in the 1990s (Beacco et al., 2003; Béliard & Gravé-rousseau, 2009; Coyle, 2008; Coyle et al., 2010; Cross, 2016; Pérez-Cañado, 2012), which was the period when multilingualism and language education became a crucial issue in the European context (Pérez-Cañado, 2012). In the early 1990s, the CLIL approach was known to solely a small group of European language experts and language teaching practitioners who were involved in the bi-/plurilingual education provision prompted by the European Commission (Castellotti, 2006; Coyle, 2007; Dalton-Puffer, 2011; Gravé-Rousseau, 2011; D. Moore & Gajo, 2009; Pérez-Cañado, 2012). This movement in bi-/multilingual education was not unique to the European educational context. For the last three decades, the research studies that have been carried on bilingualism using content-based language instruction in the North American context and the research on CLIL practices in diverse educational contexts have indicated that integrating content

and language teaching not only helps the acquisition of linguistic and academic competencies, but it also has various cognitive and motivational benefits (Coyle et al., 2010; Cummins, 1980; Cummins & Swain, 2014; Grabe & Stoller, 1997; Griva & Mattheoudaki-sayegh, 2017; Lazaruk, 2007; Leaver & Stryker, 1989; Stryker & Leaver, 1997b; Van de Craen, Mondt, Ceuleers, & Migom, 2010).

CLIL is not only about using an AL (e.g., foreign, autochthonous, heritage, and second languages) as a medium to teach subject content. The approach also aims to build and reinforce learners' knowledge of other disciplines while using the language to solve problems and develop critical thinking. The approach was conceived to enable learners to improve their communicative (i.e., person-to-person and intercultural) and cognitive skills while they are building knowledge of norms and conventions specific to both the language and content they are studying (Coyle, 2007, 2008, 2013; Coyle et al., 2010; Cross, 2013, 2016; Dalton-Puffer, 2007b; Mehisto, Marsh, & Frigols, 2008). Since the 1990s, an increasing number of European institutions have incorporated CLIL into their curriculum. At the same time in other parts of the world, multiliteracy education has increasingly become a norm. In parallel with this increase in CLIL practices, research in this area has been growing. This increase in CLIL implementations and international exchanges through various research projects have contributed to the development of the CLIL approach.

This chapter reviews the literature on CLIL by providing background information on its creation, describing the approach and highlighting some of the most commonly raised issues. The creation of CLIL was marked by a multitude of factors such as (i) the historical, political, epistemological, and societal influences of the 1980s; (ii) research on second language acquisition (ESL); (iii) current theories of learning; and (iv) educational philosophies on linguistic diversity and approaches to language teaching that drew on postmodernist views that emerged in the 1980s.

1.23 CLIL background

The European Commission and the Council of Europe were instrumental in the inception of CLIL (Beacco et al., 2003; Council of Europe, 2003; Coyle, 2007; European Commission, 1989; Findley & Nathan, 1980; Little, 2007; Marsh, Mehisto, Wolff, & Frigols, 2012). CLIL was not originally intended as a content and language teaching approach. Rather, the original aim was 'the

development of an innovative foreign language teaching method'⁸² that could (i) respond to changing demands and needs in language learning, (ii) promote plurilingualism, and (iii) create synergy for the economic development of a plurilingual Europe. This search for a 'foreign language teaching method' that would increase exposure to AL instruction and diversify the linguistic landscape in the European educational context was also inspired by the success of bilingual immersion programs in Canada and the results of research on content-supported bilingualism (Cenoz, 2003; Cummins, 1980, 1981, 1998, 2001b, 2001a; R. K. Johnson & Swain, 1997; Swain & Lapkin, 1983).

1.24 CLIL inception

In the 1980s, at the international level, overall observations were revealing that the AL teaching pedagogies in practice were not answering the changing needs of learners (D. Brown, 2002; Kumaravadivelu, 1994, 2003). These ubiquitous observations initiated an extensive review of existing AL teaching methods. In the European language teaching context, similar observations were also made (Coyle et al., 2010; Marsh, 2002). Starting from the mid-1980s,⁸³ the Council of Europe and the European Commission organized a series of actions to promote the acquisition of at least two foreign or community languages from an early age. Following consultation and expert opinion, the European Parliament brought forward the issues concerning promoting community languages and plurilingualism (Coyle, 2002; European Commission, 1989; Marsh, 2002). These preliminary undertakings gave rise to the formulation of the following resolutions:

6. increase opportunities for the teaching and learning of foreign languages,
7. encourage the teaching and learning of the less widely used languages of the Community,

⁸² I use the term 'method' to refer to the exact term used in the 1980s-1990s by some CLIL promoters. The term method is now viewed as restricting and prescriptive and not adapted to the conceptualization of languages and language learning of the 21st century. The term 'approach', which is based on principles instead of prescriptions, replaced the term 'method' (Bell, 2003; D. Brown, 2002; Kumaravadivelu, 1994).

⁸³ The issue of foreign language learning received recognition by the department of education in the Council of Europe as early as the 1960s; however, the actions which led to the inception of the CLIL approach started in the mid-1980s (see Marsh, 2002).

8. promote innovation in foreign language pedagogies and training (Official Journal of the European Commission, 1989, p. 2).

This new European scheme required synergizing intercultural communication and creating ‘opportunities to use language/s in a variety of settings and contexts in order to enable them [students] to operate successfully in a plurilingual and pluricultural Europe’. (Marsh, 2002, p. 52). The language experts who collaborated in the workshops organized by the Council of Europe and the European Commission stressed the importance of (i) the development of diverse language-related competencies (e.g., academic, intercultural, communicative, and cognitive), (ii) the development of authentic language use, and (iii) the opportunities for active language use to attain sustainable learning outcomes (Coyle, 2002; Marsh, 2002; Ruiz de Zarobe, 2013). Achieving better linguistic and communicative competences, using authentic language situations, increasing learner motivation, and providing more exposure to AL learning could not be accomplished without allocating more teaching hours to the school curriculum (Cenoz, 2015; Gabillon & Ailincăi, 2013; Marsh, 2002). However, allocating extra time for AL learning on the existing school curricula was not possible. Thus, integrating AL learning with school subject learning was considered as a possible solution (Gabillon & Ailincăi, 2013; Lasagabaster & Sierra, 2009b; Marsh, 2002). As a result of these reflections, an innovative approach combining content teaching with AL teaching emerged as a new educational approach.

1.25 CLIL experimentations

The CLIL approach was proposed during the workshops organized within the ‘language learning for European citizenship’ scheme, which was carried out between the years 1983-1996 under the supervision and participation of multinational policymakers, researchers, teachers, and learners (Coyle, 2007; Coyle et al., 2010; Marsh, 2002). As a result of these workshops, a large-scale exploratory project was initiated. The project took place between the years 1993-2000 (Marsh, Maljers, & Hartiala, 2001) and a group of language experts were assigned the task of profiling practices that combined content and language teaching in European schools (Coyle, 2002; Coyle et al., 2010; Eurydice, 2006; Marsh, 2002, 2008; Marsh et al., 2001).

These classroom experiments, which began with the search for an ‘innovative pedagogy in the teaching of foreign languages’, revealed that this new approach had a much wider scope than just

innovating foreign language teaching (Eurydice, 2006). The profiles obtained during this period of experimentation pointed to the existence of various CLIL implementations (Coyle et al., 2010; Eurydice, 2006; Marsh & Hartiala, 2001; Marsh et al., 2001). This first research-driven project, which aimed to observe how teachers integrated content and language teaching (see Marsh et al., 2001), indicated that contextual variations shaped the type of focus and procedures used. Coyle et al. (2010), Marsh and Hartiala (2001), and Marsh et al. (2001) explained that contextual variations arose from factors such as the time allocated for teaching, the availability of trained teachers, content learning objectives, language input, intercultural communication, and other learning objectives. It should be noted that at the time these profiling explorations began, the term ‘CLIL’ had not yet been used. Following the recommendations and decisions taken by the European network of language administrators, researchers, and experts on the integration of subject and language teaching, this dual-focused, multi-faceted approach was formally endorsed and the term CLIL was coined in 1994 (Coyle et al., 2010; Marsh & Frigols, 2007; Marsh et al., 2001; Pérez-Cañado, 2012; Pinner, 2013a).

1.26 What is CLIL?

Coyle described CLIL as ‘a fusion of subject didactics, leading to an innovation’ (Coyle et al., 2010, p. ix). Combining content teaching with AL teaching had existed for a long time. Immersion programmes in Canada had been using content-based instruction (CBI) successfully, and they had already accumulated positive research results supporting the benefits of integrating content teaching with AL teaching. What then was innovative about CLIL? According to Marsh (2002), CLIL comprised ‘any activity in which a foreign language is used as a tool in the learning of a non-language subject’ (p. 58). How then can we differentiate CLIL from other approaches that integrate content and language teaching? In the years that followed CLIL’s adoption, the above-mentioned and other similar definitions caused ambiguity and launched the debate about what CLIL and what it is not (Cenoz, Genesee, & Gorter, 2014; Cenoz & Ruiz de Zarobe, 2015; Dalton-Puffer, Llinares, Lorenzo, & Nikula, 2014; Lasagabaster & Sierra, 2009a; Pérez-Cañado, 2011, 2013; Pérez Cañado, 2018; Somers & Surmont, 2012; Ting, 2011).

The most commonly cited definitions describe CLIL as a generic umbrella term that represents a dual-focussed, flexible educational approach with multiple dimensions and applications in which

an additional language is used for learning both content and language (Coyle et al., 2010; Eurydice, 2006; Marsh, 2002, 2008).

The literature provides us with many definitions. However, many of these definitions are too general and could easily be confused with other definitions describing other practices that integrate content and language. For example, CLIL and immersion programmes are often compared. The definitions used by CLIL experts promote CLIL as an educational approach, a generic umbrella term with a variety of practices, which can be implemented in various curriculum models (Marsh, 2002). Table 3 presents the key expressions and terms that are frequently used to define CLIL.

Table 3. Key expressions that are used to define CLIL (Gabillon, 2000b)

Umbrella or generic term	<p>'generic umbrella' (Marsh, 2002, 2008; Ruiz de Zarobe, 2008)</p> <p>'an umbrella term' (Aguilar & Muñoz, 2014; Alcaraz-Mármol, 2018; Banegas, 2016; Cenoz et al., 2014; Coyle, 2007, 2008; Cross, 2014; Dalton-Puffer, 2017; Darn, 2009; García-Mayo & Lázaro Ibarrola, 2015; Ikeda, 2013; Ioannou Georgiou, 2012; Lasagabaster & Doiz, 2015; Lasagabaster & Sierra, 2009a; Lorenzo, Casal, & Moore, 2010; Merino & Lasagabaster, 2018; Otto, 2019; Pladevall-Ballester, 2016; Ruiz de Zarobe, 2008, 2013; Sylvén, 2013)</p> <p>'a generic term' (Agustín-Llach & Canga Alonso, 2016; Cenoz et al., 2014; Eurydice, 2006; Gabillon & Ailincai, 2013; Merino & Lasagabaster, 2018)</p>
Dual-focused approach	<p>'dual-emphasis on both content and language', 'a dual focus on language and content', 'having 'dual-focused aims' (Cendoya & Di Bin, 2010; Cross, 2014; Dafouz & Hibler, 2013; Dalton-Puffer, 2011; Lin, 2015; Lorenzo, 2007; Mehisto, 2008; Otto, 2019; Pinner, 2013b; Pladevall-Ballester, 2016; W. Yang & Gosling, 2013)</p> <p>'refers to a dual-focused approach' (Alcaraz-Mármol, 2018; Ioannou Georgiou, 2012; Reitbauer, Fürstenberg, Kletzenbauer, & Marko, 2018; Ruiz de Zarobe, 2013; Soler, González-Davies, & Iñesta, 2016; Sylvén, 2013; Turner & Cross, 2016)</p> <p>'a "dual-focused" educational approach' (Coyle et al., 2010; Gierlinger, 2015; Pérez-Cañado, 2018; Ruiz de Zarobe, 2008, 2013; Sasajima, 2013; Soler et al., 2016; Zhyrun, 2016)</p> <p>'Integrating language with non-language content, in a dual-focused learning environment, emerged as a solution....' (Coyle, 2002, p. 10)</p> <p>'This approach requires the use of dual-focused language-sensitive methodologies....' (Marsh, 2008, p. 244)</p> <p>'refers to any dual-focused educational context in which an additional language, thus not usually the first foreign language of the learners involved, is used as a medium in the teaching and learning of non-language content' (Coyle, 2008, p. 97)</p> <p>'is a dual-focused educational approach in which an additional language is used for the learning and teaching of both content and language' (Cenoz et al., 2014, p. 244)</p>
Flexible approach with diverse applications	<p>'refers to several teaching approaches' (Merino & Lasagabaster, 2018, p. 19)</p> <p>'CLIL is defined as a developing, flexible concept' (Coyle, 2013, p. 245)</p> <p>'CLIL is flexible, and there are many different models depending on a range of contextual factors....' (Coyle, 2005, p. 2)</p> <p>'integrates language and content along a continuum, in a flexible and dynamic way' (Pérez-Cañado, 2012, p. 318)</p> <p>'inclusive and flexible. It encompasses a variety of teaching methods and curriculum models and can be adapted to the age, ability, needs and interests of the learners....' (Coyle, Holmes, & King, 2009, p. 6)</p> <p>'CLIL-based programs can take a variety of forms....' (Cross, 2014, p. 24)</p>

‘underpinned by a set of flexible but theoretically robust principles that support teacher practices across a range of different contexts’ (Cross, 2013, p. 6)
‘includes a variety of approaches to bilingual education or content-based language teaching differing in their intensity and frequency of exposure and continuity’ (Pladevall-Ballester, 2016, p. 54)
‘includes many variants. Some of these may be considered as primarily for language teaching. Some can be seen as mainly content teaching.’ (Marsh, 2008, p. 244)
‘The real potential of CLIL lies in the flexibility it offers as an approach to produce the optimum conditions for languages learning across a wide range of teaching contexts.’ (Cross, 2014, p. 23)

CLIL is different from concepts such as immersion programmes,⁸⁴ European classrooms, and non-linguistic discipline (NLD, *discipline non-linguistique* [DNL]), which describe different types of educational programmes,⁸⁵ which may or may not use the CLIL approach. CLIL is not a programme. It is first and foremost an educational approach. CLIL is also often used interchangeably with CBI (see [Section 6.4](#) for CBI). While CLIL and CBI share some common features in terms of pedagogies and theories of language learning, they differ in their historicity and philosophical perspectives on bilingualism and plurilingualism (The difference between CLIL and CBI is detailed in [Section 7.7.5](#)).

1.27 Different CLIL models or different CLIL practices?

Observations of CLIL practices have revealed that the programme models⁸⁶ used in CLIL practices can vary considerably depending on the context and outcome expectations. In some CLIL implementations, the subject teacher may use an AL that is either a second official language, a foreign language, an autochthonous language, a heritage language, or any other community language to teach a school subject. For instance, the mathematics teacher may use an AL to teach their course. NLD classes, which are used in European classrooms to teach regional or minority languages in France, can be considered this type of CLIL (Tardieu & Dolitsky, 2012). Some CLIL implementations may be carried out on irregular bases. They may take the form of occasional

⁸⁴ A programme is defined as an ‘organised system of services and activities’ (Cambridge online dictionary).

⁸⁵ ‘Coherent set or sequence of educational activities designed and organized to achieve pre-determined learning objectives or accomplish a specific set of educational tasks over a sustained period’ (<http://uis.unesco.org/en/glossary-term/educational-programme>)

⁸⁶ ‘Model’ refers to a way of doing something that has specific characteristics distinguishing it from other practices.

showers to diversify subject teaching or AL teaching practices (Gabillon & Ailincăi, 2013). For instance, disciplines such as physical education, science, geography, and technology, which combine content and language learning practices with action-oriented, task-based, experiential, and hands-on activities can be implemented in CLIL as occasional showers to diversify teaching methodologies. These types of classes can either be used as part of a language-enriched subject classes or content-based AL instruction (Gabillon & Ailincăi, 2013, 2016). The following examples, obtained from the CLIL literature, show some possible applications of CLIL practices (see also Coyle et al., 2010; Eurydice, 2006):

1. All or some of the school subjects can be taught using CLIL (e.g., bilingual education programmes such as full or partial immersion programmes).
2. One or more school subjects may be taught in an AL (e.g., International or European classes or NLD classes that use a heritage, regional, community, or autochthonous language to teach one or more school subjects).
3. A subject can be taught in tandem by two teachers who use different languages. (e.g., initial socialization language [L1] and an AL).
4. Some sequences of lessons in some school subjects can be taught in the L1 and in an AL.
5. CLIL can be implemented as part of an interdisciplinary project, an international collaborative project, or an extracurricular learning project using an AL (either as part of a school subject or a language course).
6. CLIL can be integrated into a teaching sequence in AL classes as to diversify the pedagogical approach used or as part of an interdisciplinary school project based on a theme.
7. CLIL can be introduced into a vocational programme in which learners develop domain-specific knowledge of both content and language through task-based activities. Such programmes usually require language and content teachers to work in tandem.

The examples mentioned above may take different forms and applications, but they always use the key principles inherent in the CLIL approach. Often these variations in CLIL implementations are described as different models. For example, P. Ball (2009) situated CLIL practices in bilingual education and presented them on a continuum to highlight the changing emphasis on content learning. He then labelled the opposing ends as ‘strong version’ (full immersion programs) and ‘weak version’ of CLIL (content-based language classes; P. Ball, 2009; see Figure 16).

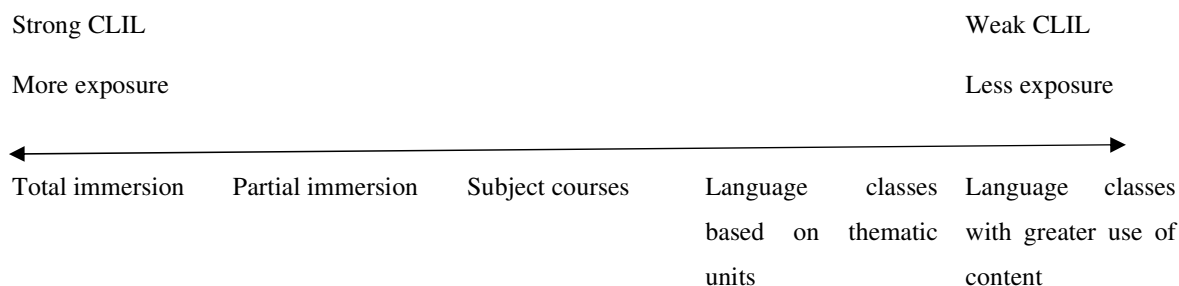

Figure 16. CLIL continuum proposed by P. Ball (adapted from P. Ball, 2009, p. 37).

An extensive review of the relevant literature indicates a significant influence of immersion on CLIL design and implementation. The continuum suggested by P. Ball (2009, p. 37) is similar to the continuum proposed by Met (1998, cited in Lyster & Ballinger, 2011, p. 280) to illustrate variations in CBI employed in immersion programmes in Canada (see also Figure 15 in [Section 6.4](#)).

1.27.1 Do contextual differences count as different CLIL models?

Several researchers have studied CLIL practices in a variety of contexts and have compiled contextual differences such as age, programme duration, intensity, entry requirements, language level of learners, programme status, and emphasis on content or language. Based on these contextual differences, some researchers have reported the existence of different ‘types of CLIL’ (Grin, 2005; Clegg, 2003, cited in Coyle, 2008, p. 100). From these examples (not models or not necessarily programmes), we can infer that CLIL can be implemented in different situations and programmes, for different purposes, with different expectations, with different age groups, and with learners with different needs (see Table 4).

Table 4. Contextual differences which lead to diverse CLIL implementations

Intensity	- Different amount of language exposure varying from occasional language showers to intensive bilingual programmes (e.g., varying from a foreign language project to full immersion; P. Ball, 2009; Cenoz, 2015; Cenoz et al., 2014; Coyle, 2002, 2008; Eurydice, 2006; Gabillon & Ailincăi, 2013; Lorenzo et al., 2010; Marsh, 2000, 2002; Marsh et al., 2001; Pladevall-Ballester & Vallbona, 2016)
Objectives (five dimensions)	- Context related (e.g., to answer local needs and curricular demands) - Content related (e.g., to build academic skills and conventions in the AL) - Language related (e.g., to improve target language competences and communication skills) - Learning related (e.g., to diversify teaching methods and to provide naturalistic learning opportunities; Coyle et al., 2010; Marsh & Hartiala, 2001) - Culture related (e.g., introducing wider cultural context, developing cultural awareness and intercultural communication, and understanding)

Programme type	- Different programmes varying from full or partial bilingual programmes (e.g., Immersion programmes and international classes in Europe) to less intensive language programmes such as NLD classes (teaching of one or more school subjects using an AL) and occasional language enriched instruction or interdisciplinary or AL teaching projects (Eurydice, 2006)
Language proficiency level	- Different language proficiency expectations varying from maximal bilingualism (which aims to build native-like competences in learners) to functional bilingualism with plurilingual objectives (which aims to construct operational skills in two or more languages that enable learners to communicate with or without full fluency)
Age and educational Context	- Different age groups varying from pre-primary to primary, secondary, vocational, and tertiary school contexts - Diverse contexts varying from foreign language learning in monolingual to AL learning in bilingual, multilingual, and plurilingual learning settings (e.g., heritage, regional, or autochthonous languages; Coyle et al., 2010)
Language of instruction	- Different CLIL implementations may use different ALs with different statuses (e.g., foreign, second, heritage, autochthonous, or community languages)

However, these are contextual differences that lead to curriculum variations in the implementation of CLIL, which would not influence the theoretical principles underlying the approach. Such contextual variations are common to all educational subjects and are usually defined as different practices or implementations rather than models or variations.

1.28 Epistemological underpinnings

In this chapter, through a review of the CLIL literature, I have studied the evolution and traced the epistemological origins of the CLIL approach. Often CLIL implementations have been guided by practical maxims, and its theoretical underpinnings have been left implicit. As I mentioned earlier, CLIL was not created from scratch. Its creation was influenced by current philosophical and theoretical orientations in education, research on second language acquisition and current approaches to language teaching, which are based on research and sound theoretical foundations. In many academic publications, these theoretical foundations are regarded as common knowledge and the maxims derived from these conceptual paradigms are used to guide teachers in their CLIL practices with little or no reference to their sources.

1.28.1 *Current philosophical influence on CLIL*

A closer look at CLIL highlights the influence of the postmodernist movement of the early 1980s, which influenced the way language teaching was perceived (Pennycook, 2006; Weideman, 2007; see [Chapter 6](#) and Table 1 for postmodernism). In the face of the societal changes and technological developments of the 1980s, language teaching pedagogies could no longer respond to the specific

needs of learners. It was time for change. This period of change was fuelled by different ideologies (e.g., postmodernist, post-nationalist, post-structuralist; Kramsch, 2018). Table 5 highlights the influence of postmodernist views on CLIL.

Table 5. Influence of postmodernist views on CLIL

Postmodernist (relativist) views in applied linguistics	CLIL and its underlying postmodernist viewpoints
Period: the 1980s	Period: the 1990s
'It is unacceptable to assume that one size fits all ...' Davies and Elder (2005, p. 797)	'One size does not fit all—there is no one model for CLIL ...' (Coyle et al., 2010)
Emphasizes the importance of maintaining cultural and linguistic pluralism (Pennycook, 2006)	'In Europe, CLIL has emerged in response to the need to raise levels of plurilingualism ...' (Marsh, 2008, p. 243)
Characterized by 'a sensitivity to the social and political impact of the plans that we make to solve language problems' (Weideman, 2007, p. 590)	'social, economic, cultural and ecological advantages to be gained through promoting plurilingualism through language learning right across our societies' (Marsh, 2000, p. 10)
Emphasizes (i) the influence of global dynamic changes, (ii) new technologies and their subsequent consequences on everyday life, (iii) mass mobility and its impact on educational and societal issues, etc. (Best & Kellner, 2003)	'Since the 1990s, Europe, among other continents, has witnessed a knowledge revolution in education, resulting mainly from increasingly widespread access to the Internet and the new technologies.' (Marsh, 2008, p. 236)
The contextual and locally specific aspects of knowledge (C. Baker, 2001; Pennycook, 1989; Weideman, 2007)	'... bilingual education must take account of situational and context variables so that developments are interpreted through a sociocultural lens ...' (Coyle, 2007, p. 543)
Represents the relativist (situated) view that contexts are different (Weideman, 2007) 'favours situated knowledge ... knowledge, value, and action are always specifically situated' (Pennycook, 2006, p. 63)	'CLIL is flexible, and there are many different models depending on a range of contextual factors ...' (Coyle, 2005, p. 2)
Specificity and a multiplicity of perspectives (Davies & Elder, 2008; Pennycook, 1989, 2006; Weideman, 2007)	Applications of CLIL are multifarious depending on educational level, environment, and the specific approach adopted (Marsh, 2008, p. 233)
A shift from a single ideal 'method' to the post-method condition (e.g., Brown, 2002; Kumaravadivelu, 1994; Pennycook, 1989; Prabhu, 1990)	CLIL is 'inclusive and flexible. It encompasses a variety of teaching and curriculum models and can be adapted to the age, ability, needs and interests of the learners ...' (Coyle, Holmes, & King, 2009, p. 6)

Although CLIL has never been explicitly specified as coming from the postmodernist perspective, some statements used by some CLIL experts suggest underlying postmodernist influence. The postmodernist view highlights the situatedness of teaching contexts and welcomes various curriculum models and implementations in language teaching. These relativist philosophies explain the reasons for some characteristics of CLIL, such as the multidimensionality and variability of its implementation.

1.29 Theoretical foundations

An extensive review of the CLIL literature allows us to establish a clear link between cognitive and sociocultural theories of learning and the CLIL approach. Cognitivist theories (e.g., emergentist, connectionist, and complexity perspectives) and sociocultural theories are complementary to each other and support the CLIL approach by providing tangible explanations. The literature provides us with some CLIL publications that have made some reference to sociocultural and cognitive perspectives in relation to CLIL (see Table 6).

Table 6. Publications that have referred to the underlying theories of CLIL

Sociocultural theories	Banegas, 2012, 2016; Cenoz, 2015; Cenoz & Ruiz de Zarobe, 2015; Coyle, 2007; Coyle et al., 2010; Cross, 2012, 2016; Dalton-Puffer, 2007a; Dalton-Puffer & Nikula, 2014; Gabillon & Ailincăi, 2013, 2015a, 2016; Gabillon et al., 2016; Ioannou Georgiou, 2012; Llinares, 2015; Moate, 2010; Nikula, 2015; Pinner, 2013b
- (Socio)-interactionist theories	Azkarai & Imaz Agirre, 2016; Coyle, 2008; Dafouz & Hibler, 2013; Evnitskaya & Morton, 2011; Gabillon & Ailincăi, 2013, 2016; García-Mayo & Lázaro Ibarrola, 2015
- Socio-constructivist	Cross, 2012; Moate, 2010; Pistorio, 2010
Cognitivist perspective	
- Emergentism	Coyle et al., 2010; Pinner, 2013a
- Connectionism	
- Bloom's taxonomy	Coyle et al., 2010; Leal, 2016; Várkuti, 2010
- BICS & CALP	Coyle et al., 2010

This section provides a brief overview of these perspectives in relation to their influence on the conceptualization of the CLIL approach.

1.29.1 Sociocultural perspective

The theory most cited by CLIL researchers is sociocultural theory. Fostering language development through scaffolding is one of the maxims of CLIL pedagogies. In sociocultural perspective, mediation (Vygotsky, 1978) and scaffolding (Wood et al., 1976), in other words, help and guidance, are considered crucial (see also [Section 5.1](#) for sociocultural approaches). Table 7 summarizes the main features of sociocultural philosophies.

Table 7. Influence of sociocultural perspective on the CLIL approach.

Sociocultural theories	<ul style="list-style-type: none"> - Important components - Zone of proximal development (ZPD) - Mediation - Scaffolding
------------------------	--

	- Social interaction /dialogic learning
	- Activity
	- Artefacts
	- Social and cultural context
- Socio-constructivist	- Collaborative language construction
	- Other-regulated learning towards self-regulated learning
	- Student-led learning
	- (Co-)construction of knowledge (and intersubjectivity)
- Socio-interactionist	- Importance of interaction
	- Scaffolded learning
	- Help given by more experienced other (teacher, parents, peers etc.)
	- Learning through language
	- Using language to learn
	- Learning while interacting

As the child develops (moves from one stage to another), they acquire more control over the mediational means available (e.g., language) in their environment for interpersonal (social interaction) and intrapersonal (cognitive) purposes (Lantolf, 2004a). Learning through mediation, social artefacts, collaboration and real-life tasks in naturalistic learning environments, which are fundamental features of sociocultural theories, are essential elements of CLIL.

1.29.2 Cognitivist views and CLIL

The cognitivist theoretical orientation is inherent in the tasks proposed by CLIL. The aim of the CLIL approach is to create a learning space that can enable learners to acquire new content knowledge and the target language through cognitive engagement. The cognitivist models that have influenced the CLIL approach are the emergentist perspective⁸⁷ (e.g., complexity theory, connectionism, and dynamic systems theory; N.C. Ellis, 1998; Larsen-Freeman, 2012) and the revised version of Bloom’s taxonomy (Krathwohl, 2002).

The cognitive involvement of learners in their own learning is fundamental to CLIL. Bloom's revised taxonomy (Krathwohl, 2002) provides a framework for the necessary cognitive skills that learners need to develop in order to master their own knowledge construction. Table 8 provides an overview of cognitivist theories that have influenced the CLIL approach.

⁸⁷ See [Section 4.4](#) for emergentist theories.

Table 8. Current cognitivist theories that have influenced the CLIL approach.

Emergentist theories	
Connectionism (N.C. Ellis, 1998)	<ul style="list-style-type: none"> - Language learning is exemplar based rather than rule based - Language learning is effective when: <ul style="list-style-type: none"> • associations are repeated and plentiful, • associations are connected with other associations and form larger and more connections, and • there is regular processing (frequency of use) to strengthen these associations.
Complexity theory (Larsen-Freeman, 2011a)	<ul style="list-style-type: none"> - Language learning is unpredictable, complex, and creative and it varies in relation to different contexts.
Cognition and learning	<ul style="list-style-type: none"> - Learning should promote cognitive involvement of learners.
Revised version of Bloom's taxonomy (Krathwohl, 2002)	<ul style="list-style-type: none"> - <i>Cognitive process dimension</i>: lower-order processing (i.e., remembering, understanding, and applying) and higher-order processing (i.e., analysing, evaluating, and creating) - <i>The knowledge dimension</i>: factual knowledge, conceptual knowledge, procedural knowledge, and metacognitive knowledge
BICS & CALP (Cummins, 1981)	<ul style="list-style-type: none"> - Importance of the development of everyday interpersonal communication skills - Importance of the development of higher-level thinking skills

Cummins's concepts of BICS, which describes the development of conversational fluency in the AL, and CALP, which describes the specific use of language in academic situations, are also relevant to CLIL. In CLIL classes, learners need language for formal academic situations that covers not only language for basic everyday interpersonal communication, but also to develop higher level thinking skills such as comparison, analysis, evaluation, hypothesis testing, deduction and synthesis.

1.29.3 CLIL frameworks and their underlying theoretical stance

Although there have been some references to the theoretical orientations mentioned above, the literature has rarely reported a direct link to the theory and conceptualization of CLIL as an approach. The ideas expressed by the most commonly used maxims, such as 'language of learning, language for learning, and language through learning' and 'content, communication, cognition, and culture', which provide guidance to CLIL teachers, evoke epistemological constructs based on sociocultural and cognitivist theories. These ideas are expressed through the concept of Coyle's language triptych and the 4Cs curriculum (Coyle et al., 2010). Both models are well designed and have been widely accepted by CLIL practitioners.

4Cs framework

Coyle's (2005) 4Cs framework contains four guiding principles that teachers can use as a basis for developing their CLIL curriculum (see Figure 17).

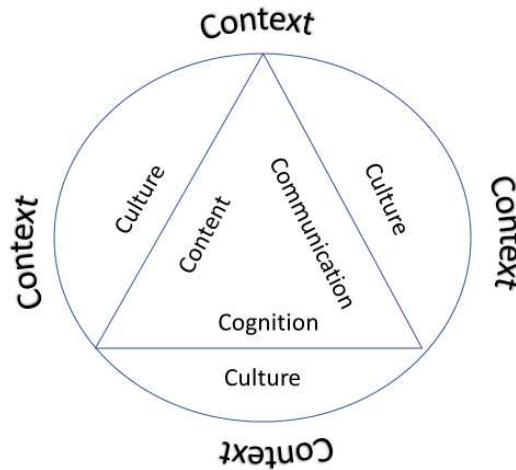

Figure 17. The 4Cs Framework (adapted from Coyle et al., 2010, p. 41).

The *4Cs framework* integrates content, communication, cognition, culture, and context in CLIL. The framework emphasizes the importance of the development of cognitive skills, creative learning and collaborative social interaction.

Content: Content provides a means of reflection and interpretation that enables the development of cognitive skills. From this point of view, disciplinary content knowledge does not imply the accumulation of knowledge but rather the creative construction of knowledge through generation, planning, and production of ideas. The study of the subject content fosters the use and development of lower-order (i.e., remember, understand, and apply) and higher-order (i.e., analyse, evaluate, and create) skills proposed by a revised version of Bloom's taxonomy (Krathwohl, 2002). The acquisition of content knowledge also emphasizes the development of metacognitive skills and personalized learning. Linguistic content is integrated with content knowledge, and linguistic forms and meanings are also reflected upon and analysed by plurilingual means (e.g., through translanguaging).

Communication: Language use is understood as both social (i.e., interpersonal interaction that uses scaffolding, mediation, and negotiation of meaning and form) and personal (i.e., intrapersonal interaction that mobilizes cognitive processing skills).

Cognition: Learning (both language and content learning) is conceptualized as the development of lower-order processing skills (i.e., remembering, understanding, and applying) and higher-order processing skills (i.e., analysing, evaluating, and creating) through the use of tasks that can enable learners to reflect, analyse, and create.

Culture: The integration of content and language is seen as inseparable from cultural elements. CLIL aims to develop cultural understanding and awareness of the conventions that are embedded in the language of the subject content.

Context: Context is conceptualized as encompassing the other three components (i.e., content, communication and cognition). The framework recognizes that there is a complex relationship among these four components, each of which has a role to play in learning.

Language Triptych

In CLIL *language* and its *functions* play a critical role. The CLIL approach holds that knowledge and culture are embedded in language and accessing knowledge is not possible without using the language (Coyle et al., 2010). The role of language in CLIL is materialized in Coyle's 'language triptych' concept (see Figure 18).

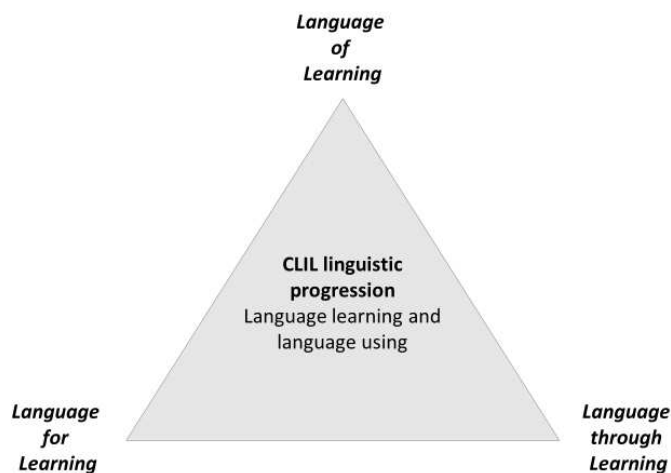

Figure 18. Coyle's language triptych (Coyle et al., 2010 p. 36)

CLIL requires learners to use language for different purposes: (i) to learn the language, (ii) to learn the content, (iii) to operate effectively in tasks and other classroom activities, and (iv) to connect thinking skills with the language, content, and language learning (Coyle, 2007). This multifunctional aspect of language (as a social artefact and as the product of social activity) is

parallel with sociocultural and interactionist theories of learning. The idea that language is ‘a tool for learning’ and ‘an object of learning’ originates from Vygotsky’s ideas.

The language triptych concept was explained by Coyle as follows:

- *Language of learning*: Learners need to reflect on and analyse the language specific to the subject and thematic content they are learning (i.e., building awareness of different genres and variations in language use—language as an object of learning [Vygotsky, 1978, 1986]).
- *Language for learning*: Learners need the language to operate in the classroom setting effectively, and they need to understand and do classroom tasks using the language (e.g., peer scaffolding, asking questions, giving explanations—language as a tool for learning [Vygotsky, 1978, 1986]).
- *Language through learning*: Learners learn the language and content through active involvement and simultaneous use and reflection (Coyle et al., 2010; i.e., the synergistic use of language [as an object of learning and a tool for learning] and content to build new knowledge through reflection [Vygotsky, 1978, 1986]). ‘Language through learning is predicated on the sociocultural tenet that learning cannot take place without the active involvement of language and thinking ...’ (Coyle, 2007, p. 553).

The integrated nature of cognition, social interaction, and language use is the core idea in CLIL. Research in bilingualism has obtained highly supportive results backing language implementations combining content, cognition, and language integration (Cummins, 1981; Lazaruk, 2007). Coyle’s language triptych concept and 4Cs model synthesize the key theoretical concepts concerning the role of language, content, cognition, communication, and culture and integrate them into the CLIL approach successfully.

1.29.4 Is CLIL a language teaching approach?

CLIL is often referred to as a language teaching approach (Celce-Murcia, 2014; Doughty & Long, 2005; Larsen-Freeman, 2011b; Richards & Rodgers, 2014; Richards & Schmidt, 2010). Although initially CLIL was intended to be an innovative ‘foreign language method’, with the influence of diverse sources and implementations it has evolved into an educational approach that integrates both language teaching and content teaching. In some contexts, CLIL is used by teachers who are specialized in subject teaching other than language teaching and in some other contexts CLIL is

used as part of AL teaching classes. Nevertheless, the approach draws highly on current language teaching pedagogies that view language conventions, language development, cognitive engagement, and content learning as inseparable and influencing one another. It should also be noted that CLIL was conceived to promote AL learning. Indeed, the practices and pedagogies used in CLIL draw heavily on current approaches to language teaching, which are influenced by similar epistemological sources and the key pedagogical principles. CLIL's inception coincides with the period during which TBLT was burgeoning out from the communicative approach as an innovative approach. TBLT is highly compatible with CLIL and it can provide CLIL implementations with the required pedagogical framework.

1.29.5 Is CLIL same as CBI?

Because of their above-mentioned common epistemological origins CLIL is often compared with CBI. The CBI approach is a prototypical model that originated with the inauguration of the Canadian immersion programmes in the 1960s (Stryker & Leaver, 1997b). Originally, CBI was developed for the Canadian bilingual context to teach French to the English-speaking minority in Quebec. The recent forms of CBI, like CLIL, have various applications depending on the contextual demands and curriculum constraints. The approach has now been adapted to teach not only French and English but also other ALs such as heritage, and autochthonous languages (Lyster & Ballinger, 2011).

In the relevant literature, some descriptions of CBI share significant similitude with CLIL (see Costabile-Heming et al., 1997). Some scholars consider CLIL and CBI related (Dalton-Puffer, 2011; Richards & Rodgers, 2014), and some experts in applied linguistics consider them the same approach with different names (Cenoz, 2015; Larsen-Freeman, 2011b; Larsen-Freeman & Anderson, 2016). As I illustrated earlier, Met's description of different CBI models to present various CBI settings (see Figure 15; Met, 1998, cited in Lyster & Ballinger, 2011) shares great similarities with the model proposed by P. Ball (2009) for CLIL (see also Figure 16).

Although CLIL and CBI are both educational approaches that integrate content and language and share similar theoretical and pedagogical foundations, they do not share the same historicity and political, contextual, and ideological background. CBI, as used in immersion programs, aims to develop a high level of AL competence and language skills proportional with expectations regarding the learner's age and abilities (Richards & Rodgers, 2014).

CLIL, on the other hand, aims to promote plurilingualism (at least two ALs) as a response to globalizations. In CLIL, outcome expectations regarding language skills vary from maximal bilingualism with high AL competence to functional bilingualism with plurilingual objectives that aim to construct operational skills in two or more languages that enable learners to communicate with or without full fluency. In CLIL, learners' active participation, cognitive skills development (i.e., critical thinking and problem solving), content acquisition, and language skills development are all considered equally important (Coyle et al., 2010). In CLIL's conceptualization, intercultural awareness is fundamental, and culture, language, context, and content are viewed as inseparable and influencing one another.

1.30 Discussion and conclusion

CLIL has come a long way since its inception in the 1990s. It has been strongly influenced by global social and linguistic transformations, which began in the 1980s and have accelerated since the 1990s (Blommaert, 2013; Vertovec, 2009; Vertovec & Posey, 2003). It has grown out of ideologies that support plurilingualism and cultural awareness and has developed from research findings and the success of other content-based bilingual practices. The development of CLIL has also been influenced by recent research (e.g., in sociology, anthropology, and sociolinguistics), which has explored the role of language and language use in the changing global social ecology caused by transnationalism and superdiversity (Blommaert, 2013; Duff, 2015; Vertovec, 2009). Current research in sociolinguistics, sociology, and anthropology has enabled CLIL to develop a new understanding of language, its use, and its role in the classroom and in society. From this new perspective, language is no longer seen as a standardized entity with well-defined national borders, but as a multimodal tool, a resource for social practice (see Atkinson et al., 2016, for new conceptualizations of language, language use, and language learning). CLIL aims to combine language cognition, content, and learning with a plurilingual mindset (see Castellotti, 2006; Coste et al., 2009; Moore, 2019, for plurilingualism). CLIL's difference is that it considers bilingual education as part of the wider context of plurilingual education. It does not see the development of bilingualism as a parallel to monolingual education.

CLIL has drawn on a variety of theoretical sources and adapted its methodologies to meet the needs of 21st century learners. CLIL is an ecological approach that integrates cultural, political, and societal factors and the changing needs of learners, as well as language and content teaching, into

its framework. Although it shares some common features with other bilingual programmes, language teaching approaches, and content-based language instruction, there are identifiable features that characterize CLIL as a distinct approach.

As the literature makes clear, CLIL is an educational approach, a generic umbrella that covers a variety of applications in different educational contexts with different objectives and learners with different needs and in different age groups. This variety and flexibility in its application is inherent in CLIL as an approach that rejects the prescriptive methods of the previous century. However, it should be noted that CLIL is an approach whose well-defined key principles distinguish it from other practices. CLIL aims to (i) respect plurilingual teaching philosophies; (ii) consider language, content, communication, context, and cognition as an inseparable unified entity; (iii) create naturalistic learning environments; (iv) provide tasks that promote cognitive engagement and creativity; (v) allow collaborative knowledge building; (vi) promote dialogical interaction; and (vii) develop awareness of self and others. However, it should also be noted that the CLIL approach is an evolving educational approach and its practice is not without problems and controversies (Bruton, 2011, 2015; Dalton-Puffer, 2011; Dalton-Puffer & Smit, 2013). One of the critical issues related to CLIL is the recruitment and training of teachers. This issue is at the heart of CLIL and needs to be addressed carefully by uncovering teachers' social representations of CLIL teaching and their beliefs about their needs.

CHAPTER EIGHT

BELIEFS AND SOCIAL REPRESENTATIONS

Introduction

For my doctoral thesis and my research activities that followed my graduation I used the term ‘belief’ as a general notion that also comprises the ‘social representation’ construct of Moscovici (Gabillon, 2005, 2007b, 2012a, 2012b, 2013b, 2013a). In my recent publications, however, I have referred to the ‘belief’ and ‘social representation’ notions as separate constructs. In my recent research and research projects I examine teachers’, learners’, and parents’ representations in the French Polynesian educational context (Ailincal & Gabillon, 2018a; Ailincal et al., 2018). In my conceptualization of AL learning and the learning context (for French Polynesian language ecology, see [Section 2.2](#)), social representations, as part of belief systems, play an important role. My most recent research aims to examine the social representations of parents, teachers, and learners regarding languages, language learning, and bilingual education in the French Polynesian context. This research is in progress and has not yet resulted in any publications. (see [Section 15.1.1](#) and Mendeley dataset; Gabillon, 2020b).

Some of my ‘belief research’ activities have focused on different aspects of the belief concept under different labels. In some specific situations, I have used ‘belief’ or ‘social representations’ (Gabillon, 2012a, 2012b, 2013a) or other more specific terminology such as ‘metacognitive knowledge’ (Gabillon, 2005), ‘learner attributions’ (Gabillon, 2013b) to identify learners’ lived experiences and beliefs about their own learning and the attributions they make to interpret their experiences. My conceptualization of belief construction is influenced by both cognitive and social theories and I have used the explanations provided in different theories in a complementary way (Gabillon, 2005).

In this literature review, I present a review of some of the definitions that underpinned my research. First I will provide a brief overview of these constructs and theories, such as the social representation theory (Moscovici, 2000b, 2000a), the metacognitive theory (Flavell, 1979), the self-efficacy theory (Bandura, 2010) and the attribution theory (Weiner, 1985). In the last section

I will present a version⁸⁸ of one of my state-of-the art articles, which sums up my conceptualization of beliefs about languages and language learning (Gabillon, 2005).

1.31 Social representation

The term ‘social representation’, which originates from Moscovici’s social representation theory, has been widely referred to (mainly by French scholars) in numerous epistemological and empirical works that have looked into beliefs about AL learning (Castellotti & Moore, 2002; Zarate, 1993; Zarate, Gohard-Radenkovic, Lussier, & Pens, 2004). The theory of social representation informs and connects individuals to the world around them and bears the marks of the group (society) to which they belong (Duveen & Lloyd, 1990; Moscovici, 1984, 1986, 1997). A widely accepted characterization of the concept of representation is that it is a form of knowledge that is socially elaborated and shared and has a practical aim that contributes to the construction of a reality common to a particular group of people (Duveen & Lloyd, 1990; Moscovici, 1991).

Representations are rooted in society and internalized by the individual (Gabillon, 2005; Moscovici, 1991). J.-P. Narcy-Combes (2005) emphasized both the individuality and collectivity of representations. He argued that, although the internal organization of representations is primarily individual, social representations involve sharing and transmission. He added that collective preservation of representations is sustained in the form of knowledge, or tradition, or in the form of collective beliefs. Social representations should not be understood as judgments about the truth or error of a cognitive and moral system, but as means that guide a given group (Moscovici, 1991). According to Moscovici (1991), a social representation is an image of reality and can never be exactly the same as the object it represents. Castellotti and Moore (2002) posited that the term ‘representation’ has often been used to refer to common knowledge or cultural beliefs such as stereotypes, attitudes, prejudices, and images.

Moscovici’s (2000b) theory of social representation is concerned with the process through which knowledge (beliefs, images, and ideas) is produced, transformed, and transmitted into the social world. According to Moscovici (2000b), the fact that representations are produced collaboratively

⁸⁸ This paper is modified to avoid redundance. The original paper is included in Volume III of this HDR dossier.

in society was a known concept, but the structure or inner dynamics of representations received little attention.

One of my state-of-the-art papers that looked into teacher belief systems employed the explanations given by Moscovici's (1984) 'belief appropriation process' and Abric's (1993, 2001) 'central kernel hypothesis'⁸⁹ to explain how teachers' belief change mechanisms function (Gabillon, 2012b).

Moscovici (2000b) claimed that often representations are perceived as stable forms of collective understanding. He maintained that a static conception of representations would not be relevant to modern and dynamic societies that are in constant change. Moscovici explained that social representations are networks of beliefs (ideas, metaphors, images, and so forth) that are connected to one another around a 'core belief' (a prototype which represents a class). Moscovici maintained that although representations take different shapes with different values, there is always a core belief that connects them all to one another, and that these core beliefs are recognized by individuals who are the members of the same society (see Figure 19).

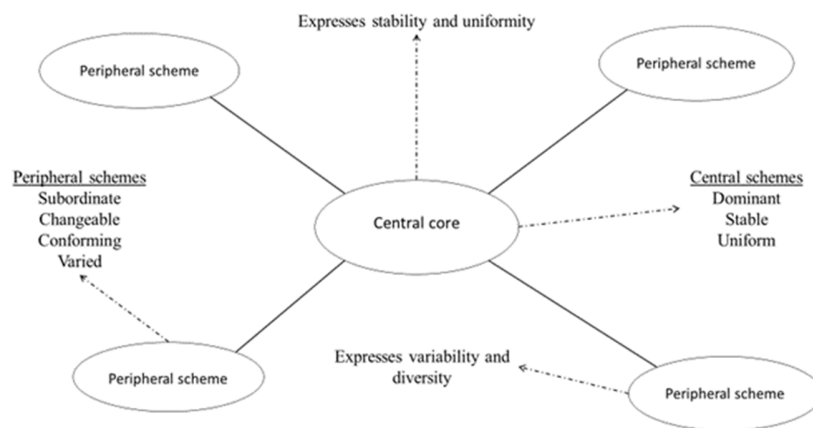

Figure 19. Central kernel hypothesis (Gabillon, 2012b, p. 198).

Moscovici and Vignaux (2000) acknowledged that according to the 'central kernel' hypothesis, each social representation is composed of 'cognitive elements' or 'relatively stable schemes' and

⁸⁹ The idea of central beliefs was first introduced by Moscovici (1986), but his ideas were developed into 'central kernel hypothesis' by Abric (1993, 2001).

other cognitive elements and peripheral schemes are formed around these central kernels (this description bears similarities with schemata⁹⁰ theory). Moscovici and Vignaux (2000) explained that according to this hypothesis, the central elements dominate the meaning of the peripheral elements and that the central kernels (or core beliefs, central cognitive schemes, or prototypes) have a stronger forbearance to change than the newly formed peripheral schemes. Moscovici and Vignaux (2000) stated that ‘the former (stable elements) expresses the permanence and uniformity of the social, while the latter (peripheral schemes) expresses its variability and diversity’ (p. 159).

Duveen (2000) asserted that social representations, which are produced in society, are part of individuals’ everyday worlds and circulate in the media they watch and read and in everyday discussions they have with their friends, families, colleagues, and so forth. In short, these representations constitute the realities of individuals’ everyday lives and are sustained by social influences of communication. He explained that social representation theory views representations as a ‘classification system of assigning categories and names’. According to Moscovici, comparing objects, ideas, individuals, events, and so forth leads people to create these classifications and to link them to a prototype, which represents a class. He considered this classification system more than just a simple means of grading and labelling discrete entities (e.g., persons, objects, events, and people’s actions). Moscovici (2000b) asserted that the main purpose of representations is to facilitate interpretations and to form opinions.

Moscovici’s social representation theory holds that knowledge is always produced through interaction and communication (Duveen, 2000). Moscovici (2000a) explained this phenomenon as follows:

We have no reason to exclude totally individual experience and perception.
But...we must remember that nearly everything a person knows they have
learned from another, either through their accounts, or through the
language, which is acquired, or the objects which are used. (p. 126)

⁹⁰ Schemata refer to categorical rules and cognitive structures or scripts, which all individuals are assumed to possess, used to interpret the world. The concept of a schema was first introduced by Bartlett (1958) and later developed and used by Piaget (1970), Bruner (1973), Ausubel (1980), and other cognitive psychologists.

From this perspective, Moscovici's social representation theory shares similarities with constructivist and sociocultural trends in psychology (Duveen & Lloyd, 1990). The idea that knowledge is treated as correlative and co-constitutive is also the major element in constructivist and sociocultural trends. However, Moscovici's social representation theory is not primarily concerned with the interpersonal sources of self-knowledge like in Vygotsky's social development theory or intra-personal knowledge construction like in Piaget's theory of learning (Cole & Wertsch, James, 1996; Piaget, 1937; Piaget viewed knowledge acquisition as a process of continuous self-construction). Moreover, social representations cannot be viewed merely as self-knowledge, which is the product of an individual's cognitive processes, as described in Flavell's (1979) metacognition theory, which views knowledge as the product and property of the individual mind. Moscovici (2000b) explained that the primary aim of social representation theory is to discover how individuals and groups, who have diverse views, ideas, attitudes, and so forth, can construct a stable and predictable world out of such diversity.

Moscovici claimed that the function of all representations is to make something unfamiliar familiar. Moscovici sustained that interpreting an unfamiliar idea requires categories (e.g., names and references) so that it can be integrated into a group of concepts. Moscovici (2000b) maintained that the fear of the unknown is 'deep-rooted'. He asserted that despite this fear, the unknown attracts individuals (and communities). According to Moscovici, individuals perceive the unknown as a threat to the sense of continuity, and this fear forces individuals to make the unknown explicit. Moscovici sustained that in such cases, individuals' beliefs, images, ideas, and the language they share are used to integrate the unfamiliar into their mental and physical world. Moscovici explained that the conflict between the familiar and the unfamiliar is always resolved in favour of the familiar. In other words, the unknown, after having been enriched and transformed, is always absorbed into an already known category.

Moscovici (2000b) stated that it is necessary to activate the cognitive mechanisms in order to start the appropriation process (integrating the unknown, unfamiliar, unusual, and implicit into the known, familiar, customary, and explicit). According to Moscovici, this process is composed of two complementary and interdependent mechanisms: anchoring and objectification. Moscovici's

conception of the belief appropriation process has been an important theoretical notion in my beliefs research (Ailincăi & Gabillon, 2018a; Gabillon, 2005, 2007b, 2012b).

1.31.1 Anchoring

The first mechanism aims to ‘anchor’ the unknown, to reduce it to an ordinary category and image, and to put it into a familiar context. In other words, this is a process whereby the unfamiliar is absorbed into a known category that is shared by members of the same group/society so that it can be interpreted by the individual (Duveen & Lloyd, 1990; Jodelet, 1984). To anchor is thus to classify and name something new and unknown. Moscovici (2000b) emphasized that things that are unclassified and unnamed are strange, non-existent, and at the same time threatening. The object of representation then becomes a familiar object inserted into a category of pre-existing knowledge (Moliner, 1996). This process of integrating a new concept is not smooth and leads to transformations both at the level of the integrated object and at the level of prior knowledge (Jodelet, 1984; see Figure 20).

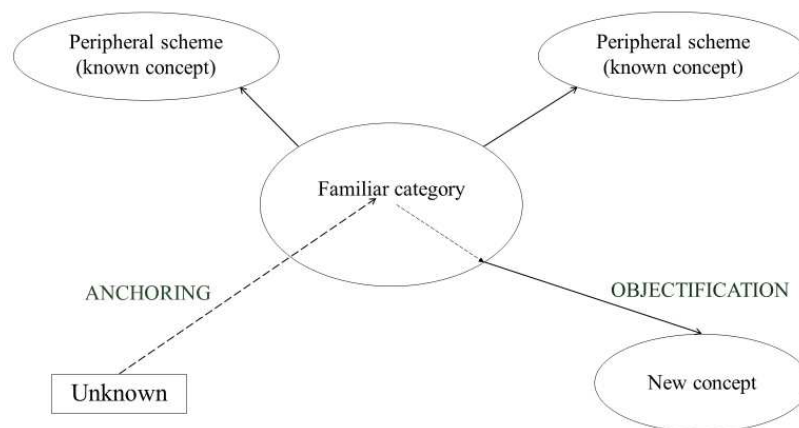

Figure 20. Schematic representation of the appropriation process (Gabillon, 2012b, p. 197).

The information about the object of representation is interpreted according to the group to which it belongs (Guimelli, 1994; Jodelet, 1984; Moliner, 2001; Moscovici, 1961). Thus, the same object will be anchored differently depending on the social group and its system of values and beliefs.

1.31.2 Objectification⁹¹

The second mechanism aims to ‘objectify’ the unknown, that is, to transform something abstract into something almost concrete that already exists in the physical world of the individual (Moscovici, 1984). In other words, it is a process by which the individual (or group) transforms the unknown into a more meaningful and easily understandable image. Moscovici (2000b) argues that such a process reassures and comforts individuals and restores a sense of continuity.

Moscovici (2000a) stressed that any new/strange/unknown idea is always anchored to an already existing social representation, and this new idea is modified by the anchoring and objectification process. However, he asserted that during this process, the familiar mostly remains unchanged. He explained that ‘[s]earching for the familiar means that these representations tend towards conservatism, towards the confirmation of their significant content’ (p. 150).

Regarding the knowledge construction processes involved, Moscovici’s social representation theory also shares some similarities with Piaget’s (1964) cognitive development theory⁹² and Ausubel’s (1980) assimilation theory.⁹³ Although each of these theories has different conceptualizations of knowledge, they all emphasize the dynamic act of processing information (e.g., assimilating, transforming, adapting, and modifying) and incorporating something new (e.g., information and idea) into something already known.

Gremmo (1993) emphasized the role played by culture and society and claimed that the aggregate of representations that learners hold about languages and learning (e.g., the idea that languages are

⁹¹ The term *objectification* has also been referred to as *objectivation* by some scholars (e.g., Castellotti & Moore 2002).

⁹² According to Piaget, cognitive development consists of a constant effort to adapt to the environment in terms of assimilation and accommodation: Assimilation is the process of incorporation of new information to the existing schemes or thought patterns people already have, and accommodation is the process of adapting/modifying existing schemes to account new information. Equilibration, which covers both assimilation and accommodation, is the process to establish the balance between assimilation and accommodation (Miller, 2011).

⁹³ According to Ausubel (1980), meaningful learning is a process through which the learner connects the new piece of information to information they already know. In other words, new information is anchored into existing cognitive structures.

learned through imitation, memorization, and so forth) constitute their 'language learning culture', which, in return, guides learners' language learning behaviours.

Zarate et al. (2004) stressed the influence of positive and negative representations on learners' behaviours. They explained that 'positive representations lead to xenophile attitudes which are generally expressed by a behaviour and practice of openness to the 'Other', while negative representations lead to behaviour that is displayed through xenophobic rejection and refusal of the Other' (p. 27). Castellotti and Moore (2002) asserted that representations are neither 'wrong', 'correct', nor 'permanent'. They sustained that representations vary depending on the macro-context (curricular options, teaching orientations, and relationships between languages in society as a whole and in the classroom) and micro-context (directly related to learning activities and attitudinal and classroom dynamics).

1.32 Learner beliefs

In mainstream language learner belief research, the term 'AL learner beliefs' has been used as a generic terminology to encompass and take in various definitions and labels that originate from diverse disciplines. Some such terms that are dealt with under the rubric of AL learner beliefs are language learners' perceptions, expectations (Gabillon, 2007b; White, 1999), attitudes (Gabillon, 2013b; Sakui & Gaies, 1999), language strategies (N.-D. Yang, 1999), conceptions of language and language learning (Benson & Lor, 1999), attributions (Gabillon, 2013b) and so forth.

However, despite conceptual differences and theoretical perspectives, most researchers have described beliefs as psychologically held views about the world that individuals feel to be true. A review of the learner belief literature indicates that learner beliefs are 'context based'; therefore, they should not be viewed independently of the context in which they were formed (Alanen, 2003; Dufva, 2003; Wenden, 1998, 1999; White, 1999). It has also been maintained that learners' beliefs are shaped by their 'prior experiences' (Benson & Lor, 1999; White, 1999). According to Wenden (1999) beliefs are 'value related' and are 'held tenaciously' (Wenden, 1999, p. 436). However, some research studies that have examined AL learner beliefs from sociocultural perspectives have shown that learner beliefs can also be 'flexible; therefore, they can be mediated' (e.g., Alanen, 2003; Dufva, 2003).

1.32.1 Metacognitive knowledge

The metacognitive theory has constituted an important element in my belief research, and the ideas expressed in this theory are integrated into the belief formation model I have proposed (see Gabillon, 2005). The term ‘metacognitive knowledge’, which originates from Flavell’s (1979) metacognitive theory, refers to the individual’s beliefs or knowledge about their or others’ cognitive processes. Pintrich (2002) described metacognitive knowledge as involving ‘knowledge about cognition in general, as well as awareness of and knowledge about one’s own cognition’ (p. 219).

According to Flavell (1979), metacognitive knowledge, which can be both conscious and unconscious, is used by the individual to guide their cognitive activities (i.e., to engage in or to abandon a particular cognitive activity). Flavell proposed three categories of metacognitive knowledge: person variables, task variables, and strategy variables (see Figure 21).

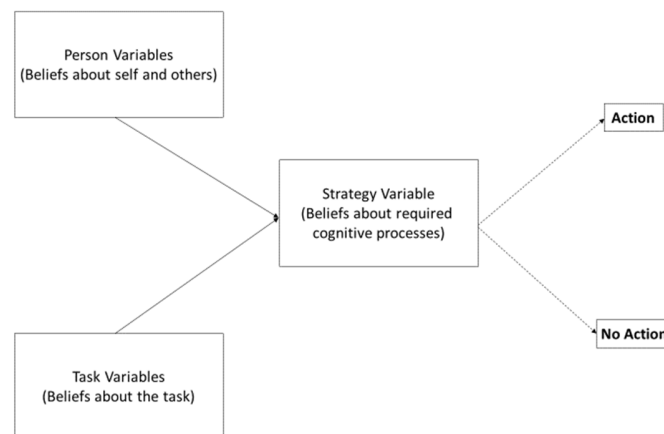

Figure 21. Flavell’s (1979) metacognitive knowledge model (Gabillon, 2007a).

Person variables are an individual’s beliefs about themselves and other people (e.g., that they can learn better by memorizing vocabulary items or that their friends can learn languages better because they have a better memory). Task variables are an individual’s beliefs (knowledge) about a given task (e.g., whether the task is interesting or familiar or whether it is within the capabilities of the individual to accomplish). Strategy variables involve the learner’s self-regulation of their learning: the selection of cognitive processes that the individual believes to be appropriate to fulfil a task (e.g., belief about whether the task requires summarizing, analysing, or expressing personal opinion or whether the individual needs to ask for further clarification).

Some scholars have explained self-knowledge acquisition through social constructivist accounts. They have claimed that self-knowledge is a progressive construction of meaningful units, which are linked to one another by a process of inclusion of lower and less powerful meaningful units into higher and more powerful ones as part of both individual and social processes. In this respect, metacognitive theory bears some theoretical similarities with Piaget's constructivist theory, Moscovici's social representation theory and the sociocultural model of Vygotsky. Pintrich (2002) maintained that regardless of their theoretical perspectives—sociocultural Vygotskian or cognitive constructivist Piagetian—researchers now agree that with development learners become more aware of their own thinking and cognition in general and this knowledge (metacognitive knowledge) guides them in their learning.

The term metacognitive awareness has been one of the most commonly used terms in SLA. Metacognitive knowledge has been in the SLA literature since the 1980s (Wenden, 1998). Since then the term has been widely referred to in various belief studies in the SLA literature (Alanen, 2003; Barcelos, 2003; Dufva, 2003; Gabillon, 2005; Victori & Lockhart, 1995; Wenden, 1998).

1.32.2 Self-beliefs

Concepts related to self-beliefs have been widely used in my research (see Gabillon, 2005, 2007b, 2013a, 2013b). Bandura's self-efficacy theory and his self-referent belief terminologies such as self-perception, self-conception, and self-efficacy beliefs, have been widely referred to by many SLA scholars (Bandura, 1994; Ertmer & Ottenbreit-Leftwich, 2010; Gabillon, 2005, 2013b; Wang, Ertmer, & Newby, 2004).

In SLA, self-beliefs such as self-perception, self-conception, and self-efficacy beliefs have been used to refer to learner's judgments about their AL abilities. However, slightly differently from self-perception and self-conception, self-efficacy beliefs are often viewed as an integral part of learners' self-regulatory systems, which also cover self-assessment and self-management. Most of the time, self-efficacy beliefs are investigated in relation to the learners' use of learning strategies and their attributional styles. In some cases, the terms 'perceived control' and 'self-efficacy beliefs' are both used to refer to perceived ease or difficulty in performing a language activity. In some other cases, self-efficacy beliefs are used to refer to the learner's perceived AL competence.

Self-efficacy beliefs

Bandura (1994, 2010, 2012) postulated self-efficacy beliefs as the foundation of human agency.⁹⁴ Simply defined, self-efficacy ‘beliefs’ refer to personal beliefs (judgments) about one's capabilities to engage in an activity or perform a task (Bandura, 1986). ‘Self-efficacy beliefs’ revolve around the question of ‘can’. (Pajares & Schunk 2002, p. 20). Bandura (2010) maintains that the individual's belief in their efficacy is the foremost personal resource in ‘self-development’, ‘successful adaptation’, and ‘change’. He also claimed that efficacy beliefs shape individuals’ motivations, goals, outcome expectations (i.e., whether they expect their efforts to produce favourable or unfavourable outcomes), ways of thinking, and emotions and their determination when faced with difficulties. According to social cognitive theory, self-efficacy beliefs affect individuals’ functioning in various ways (Bandura, 1994, 2010).

Choice behaviour

Bandura (1986) maintained that people choose to engage in tasks/activities that they believe they have high efficacy and avoid the ones that they perceive to be beyond their capabilities.

Effort and persistence

When people perceive strong self-efficacy, they exert more effort and are more persistent and resilient in face of failure. ‘People who regard themselves as highly efficacious act, think, and feel differently ... They produce their own future, rather than simply foretell it.’ (Bandura, 1986, p. 395).

Emotional reactions

According to self-efficacy theory, an individual with low self-efficacy beliefs perceives tasks to be fulfilled more difficult than they actually are. Thus, this belief restrains them from performing their best. Individuals with high self-efficacy beliefs, on the other hand, direct their attention and effort on task requirements and exert more effort in the face of difficulty or failure (Bandura, 1986). Bandura (2006b) maintained that ‘a strong sense of coping efficacy reduces vulnerability to stress and depression in taxing situations and strengthens resiliency to adversity’ (Bandura, 2006b, p. 56).

⁹⁴ To be an agent means to have the power to influence one's own functioning and life circumstances (Bandura 1997).

Attributions

Perceived self-efficacy has also been reported to influence the attributions individuals make of their performance (Gabillon, 2013b). Individuals with high self-efficacy belief are assumed to attribute their failure to insufficient effort (i.e., people with high self-efficacy possess a success orientation and exert more effort when engaged in a similar task another time). However, individuals who believe that they have low self-efficacy attribute their failure to lack of necessary skills and ability (i.e., people with low self-efficacy belief avoid engaging in similar tasks). Another scenario is that individuals with low self-efficacy belief attribute their success to external factors rather than their own capabilities (i.e., a learner with low self-efficacy belief might attribute his success to a teacher who gives high grades or to an easy exam; Bandura, 1986).

Goals, expectations, and motivation

Bandura (2006b) asserted that self-efficacy beliefs play a significant role in the regulation of motivation. He maintained that people feel motivated to undertake challenges on the basis of their outcome expectations. The likelihood that people will act greatly depends on whether they believe they can produce the required performance.

According to Bandura's social cognitive model, self-efficacy beliefs are influenced by four main sources (Bandura 1986):

Mastery experience

Mastery experience is considered a key source for self-efficacy belief (Bandura 1997). Bandura (2006b) acknowledged that an individual's successes help them develop strong sense of self-efficacy. On the other hand, an individual's failures, especially when experienced in the early stages of efficacy development, weaken the individual's self-efficacy beliefs. Mastery experiences are considered the most powerful sources of self-efficacy belief. Tschannen-Moran, Hoy, and Hoy (1998) asserted that an individual's perception that their performance has been successful increases their efficacy, and also contributes to their expectation that they will be able to accomplish a similar performance in the future (see Figure 28).

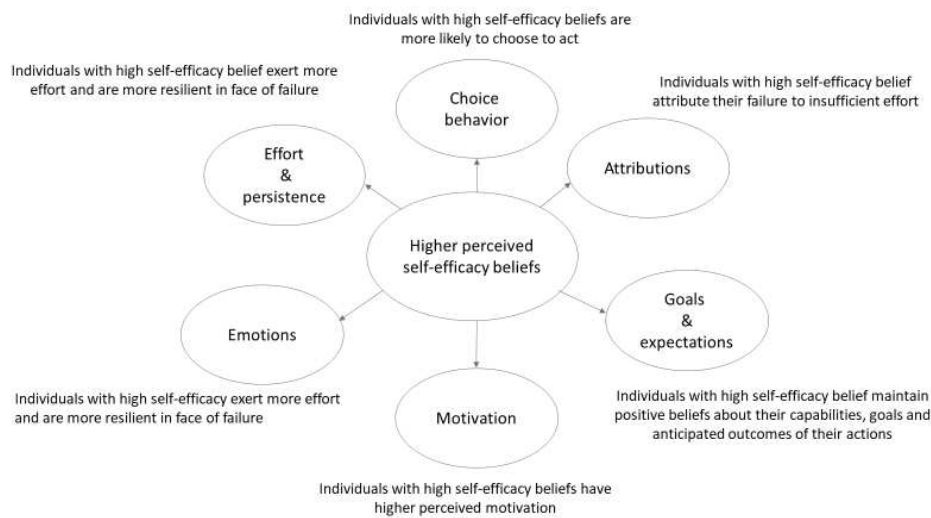

Figure 22. The influence of high self-efficacy on individuals.

1.32.3 Attribution theory

Attribution theory (Weiner, 1980, 2010a) assumes that people are motivated to look for meaning in their own behaviour, as well as in the world around (and about) them (Ross, 1976). This theory is used as part of my learner belief studies to analyse how learners evaluate their learning experiences (see Gabillon, 2013b). Heider (1958) claimed that people act on the basis of their beliefs and maintained that psychologists could learn a great deal from people's explanations and understandings of events and behaviours. He stressed the importance of taking ordinary people's beliefs seriously, whether these beliefs are valid or not, and suggested that beliefs must be taken into account if psychologists were to deal with human behaviour (Heider, 1958)(Heider, 1958)(Heider, 1958)(Heider, 1958)(Heider, 1958)(Heider, 1958)(Heider, 1958)(Heider, 1958). An individual's explanations of their experiences and the attributions they make, therefore, are considered to be important because they are the inferences (self-attribution) the individual uses to understand and interpret the causes that they believe to be responsible for their own behaviour, feelings, and attitudes (Ross, 1976).

Attribution theory deals with the processes of explaining events and the behavioural and emotional consequences of those explanations (Ross, 1976). Simply put, the theory assumes that individuals try to determine why people, including themselves, do what they do. According to the theory, individuals naturally seek to understand people's behaviours and attribute a cause or causes to

explain those behaviours (Weiner, 1986). ‘Attribution’ (causal ascription) is the key term in attribution theory, and it refers to individuals’ interpretations of the causes of events that happen to themselves and others (Weiner, 1986). Attribution theory was seen as relevant to the study of the acquisition of self-knowledge, person perception, attitude change, motivation, event perception, and much more (Weiner, 2010b). A simple conceptualization of attributional theory describes four main causes—ability, task difficulty, effort, and luck—for individuals’ behaviours, explains their dimensional properties as locus and stability, and links these properties to affect and individuals’ expectancies (see Figure 23).

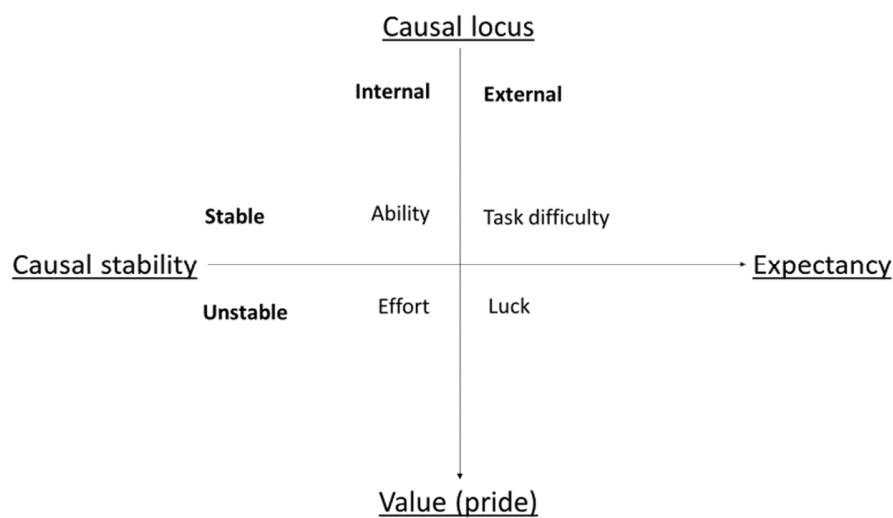

Figure 23. Representations of the four main causes of behaviour, their properties and linkages to affect and expectancy (Weiner, 2010b, p. 32).

The theoretical framework that Weiner developed (Weiner, 1979, 1980, 1985, 1986, 2000, 2010a) has become a major research paradigm in achievement and motivation research. This theory postulates expectancy and affect as key elements that guide motivated behaviour. According to Weiner’s (2010a) attributional theory of achievement motivation, individuals use attributions to interpret and predict the outcomes of their actions.

Weiner’s (2000) attribution theory aims at explaining the difference in motivational orientations and motivational levels between high and low achievers (Weiner 2000). According to Weiner, ability, effort, task difficulty, and luck are the key factors that influence attributions people ascribe for their achievements. The theory is grounded on three underlying causal properties, which can be

located within a three-dimensional causal space: (i) locus, (ii) stability, and (iii) controllability (see Figure 24 for different scenarios).

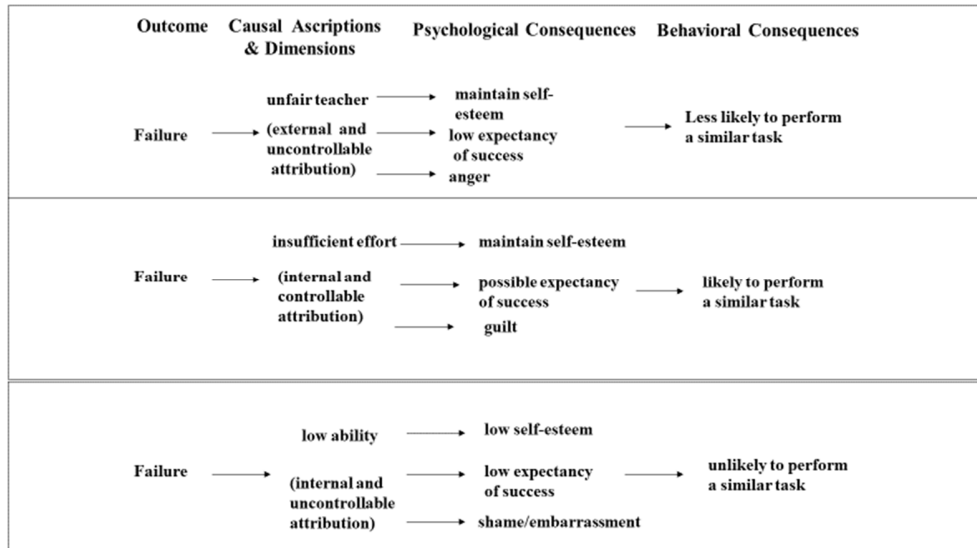

Figure 24. Locus, controllability, emotions, and expectancies (Weiner 2000).

According to Weiner (2000) locus refers to the location of a cause, internal or external. Internal attribution ascribes causality to a factor or factors within the person. It is the inference that a person is behaving in a certain way because of something about the person, such as attitude or personality. In other words, an internal attribution claims that the person perceives themselves as directly responsible for the event (Weiner, 2008, 2010b, 2010a). For instance, success that is attributed to ability and effort, or failure that is attributed to an individual's perceived lack of ability are considered to be the functions of internal causes. When the cause is attributed to an outside factor or factors, the attribution is considered to be an external attribution. In other words, an external attribution is an assumption that a person is behaving a certain way because of something about the situation they are in (not because of something within them or because of them). For instance, students who are attributing their failure in AL learning to the conditions of learning, not having a good/fair teacher, or not finding the methods used appropriate to their needs are considered to be making external attributions.

The stability (or causal stability) dimension of causes designates whether causes change over time or not (e.g., language aptitude and lower perceived ability are considered to be constant and durable; Weiner, 2000). However, teaching/learning conditions can change over time (e.g., different teachers with different approaches to teaching).

Weiner (2000) explained controllability as the degree of control an individual feels over a cause. That is, in some cases individuals feel that they can control causes (e.g., succeeding by working harder). However, some causes cannot be changed by personal volition and/or effort (e.g., lack of aptitude, lower perceived ability).

Weiner (2000) asserted that the three properties of causes, locus, stability, and controllability, play a significant role in shaping the two key determinants of motivation: expectancy, the subjective likelihood of future success, and value, the degree of emotions attached to attainment or non-attainment of a goal. Weiner (2000) explained that when the cause is stable (or perceived as stable) people anticipate the same outcome. For instance, if the individual perceives that they lack the ability (which is internal, stable, and uncontrollable) to perform a task that is similar to one that they have already experienced a failure with, they then will anticipate failure again. If, for example, a failure is attributed to a teacher who is perceived as unfair, which is external locus, stable (while the course lasts), and uncontrollable, then attending the same teacher's classes will cause failure to be anticipated again.

According to Weiner's attributional theory of achievement motivation, locus and controllability relate to the state of feelings, which in turn affects the value of achievement outcomes (Weiner, 2008, 2010b). Weiner (2000) asserts that locus influences individuals' feelings of pride and self-esteem positively in cases of success. However, in cases of failure, individuals are likely to experience feelings of shame, deprecation, embarrassment, and low self-esteem. Weiner (2000) maintained that both controllability and locus following a failure (non-attainment of a goal) determine whether guilt or shame is experienced. He claimed that ascribing failure to insufficient effort (which is internal and controllable) often elicits a feeling of guilt. While attributing failure to a perceived lack of ability (which is internal but uncontrollable) often leads to feelings of shame, embarrassment, and humiliation. Weiner also stated that the expectation of success and the emotions felt (pride, shame, guilt, etc.) determine subsequent behaviour.

1.33 Belief formation as a progressive process (Gabillon, 2005)

The content of this section is an adapted version of one of my state-of-the art articles (see Gabillon, 2005). In this article drawing upon Moscovici's social representation theory, Flavell's (1979) metacognitive theory, and SLA belief research studies, I proposed a model for language learners'

belief formation. This model highlights my conceptualization of belief formation. The model views belief formation as a progressive process through anchoring and objectivation (Gabillon, 2005). This view posits that beliefs are (co)constructed, reconstructed, and appropriated (fine-tuned) through gaining experience (i.e., through going up from one phase to another) and are internalized as part of individuals' language-learning belief repertoire.

In this conceptualization of belief formation, I consider three phases, (i) the social/cultural context, (ii) the general educational context, and the (iii) AL learning context(s), to be the social environments where learners (co)construct their identity and their beliefs through interaction with others (parents, friends, teachers, etc.) and with social artefacts (e.g., media, textbooks, and learning activities) provided with/within these social environments. Throughout this progressive process of belief formation, in each phase, the learner's intra-personal mechanisms operate simultaneously, in parallel to their inter-personal interactions and the social activities they are experiencing.

Phase One: Society at large and learners' cultural representations and cultural beliefs

Cultural representations or cultural beliefs (such as values, prejudices, attitudes, and stereotypes) constitute the substructure (Phase One) in the learners' belief hierarchy and serve as a kind of reference to learners when shaping their beliefs about language learning. In other words, these collectively created beliefs, which reflect views of the society the learner has been brought up in, form a kind of base on which the learner further constructs other beliefs (anchoring and objectivation processes). These cultural beliefs often precede the learner's experience in language learning. Before the learner starts learning an AL, they already possess some of these (culturally/socially constructed or collectively created) ready-made beliefs about languages and, perhaps, beliefs about how ALs are/should be learned. However, these cultural beliefs might not always appear to have direct links with AL learning itself. In some cases, beliefs about a particular AL, and the learner's interest in learning it, seem to originate from other socially/culturally shared beliefs about that specific culture, its people, and its economic and political status (Csizér & Dörnyei, 2005). The learner's knowledge about the shared historical past and political relations between the target AL culture and their own might also contribute to shaping their beliefs about and their attitudes towards learning that particular language, most often even before starting to learn it.

These representations can also be considered core beliefs that the learner may acquire unconsciously and accept as ‘truths’ before having any personal experience in language learning (Alanen, 2003). Later, through gaining experiences in general educational and language-learning contexts, these cultural beliefs might be reinterpreted, fine-tuned, and internalized to become part of the learner’s personal AL learning belief repertoire.

Differentiating between functional and dysfunctional representations and encouraging functional cultural representations can help learners develop positive attitudes toward the target language(s) in question (see Zarate, 1993). This issue, therefore, concerns language policymakers. These cultural representations, which circulate in society, need to be uncovered, and dysfunctional beliefs need to be detected so that policymakers can adopt appropriate AL learning policies. Large-scale surveys, questionnaires, interviews, and text/discourse analysis can be employed to detect these dysfunctional beliefs (Zarate, 1993; Zarate, Gohard-Radenkovic, Lussier, & Pens, 2004). To mediate these beliefs, cultural awareness-raising activities and programs have been found to be useful (Byram & Planet, 2000).

Phase Two: The general educational context and learners’ beliefs about learning

Learners' beliefs about learning are the second phase in the learner belief formation process. There is now ample evidence that learning/teaching traditions can vary according to cultural contexts (e.g., learning can be conceived as a process of reproduction whereby learners store knowledge and reproduce it when necessary, and teacher-centred approaches can be favoured over learner-centred learning/teaching). From an early age, learners are exposed to the educational traditions of their social environment and, consciously or unconsciously, they develop certain beliefs about what learning and teaching are or should be and about the roles of learners and teachers. In addition, at this stage, learners have a daily experience of learning and (re)construct beliefs based on these experiences and internalize them, integrating them with other relevant beliefs in their belief repertoires.

Phase Three: The AL context(s) and learners’ beliefs about AL

The language learning context(s) and learners’ past and present experiences in AL learning form Phase Three in the learners’ belief formation process. Like general teaching/learning traditions, AL learning traditions may vary in different educational contexts. In this phase, learners have direct

contact (experience) with AL learning. The learners' cultural beliefs (i.e., attitudes towards and beliefs about the target language) and their past learning experiences in general and in AL learning in particular all contribute to shaping their beliefs about the AL and their conceptions of AL learning. In this phase, learners start to have well-established beliefs about how efficient they are in AL learning, what their roles and their teachers' roles in AL learning settings should be, and how AL should be learned.

Teachers' approaches to teaching, testing types used, learners' past experiences, and course expectations are all said to be factors influencing the approaches learners adopt to learning (Prosser & Trigwell, 1999). Like language learners, language teachers also have some conceptions of AL learning, and they often modify the 'espoused' theory (the 'official' theory; see Gabillon, 2013a) and adopt approaches that are compatible with their beliefs. That is, the espoused theory becomes the theory in use and it guides both the teacher and the learners in the teaching/learning process (Biggs, 1994; Gabillon, 2013a).

The Intra-personal plane and metacognitive knowledge

Beliefs that have been (co)constructed in social planes through interactions between others and social tools (artefacts) are appropriated and internalized in the learner's psychological plane to become part of the learner's metacognitive knowledge (Alanen, 2003). This knowledge reservoir is used as a resource by the learner to guide their AL learning activities. Learners, drawing upon their metacognitive knowledge (belief repertoire), make some judgements regarding self, others, and AL learning tasks and activate self-regulatory mechanisms to choose the strategies they believe to be suitable to fulfil the required language tasks. Attributing learners' beliefs solely to their AL learning experience and attempting to investigate these beliefs without referring to the learner's past experiences and the broader social contexts that surround them is inadequate.

To conclude, this progressive view of language learner belief formation assumes that learners' beliefs come into being in society in different contexts (society, general educational context, and AL learning context) and are reshaped and internalized in learners' intra-personal planes as language learning beliefs. Figure 25 summarises this belief formation process.

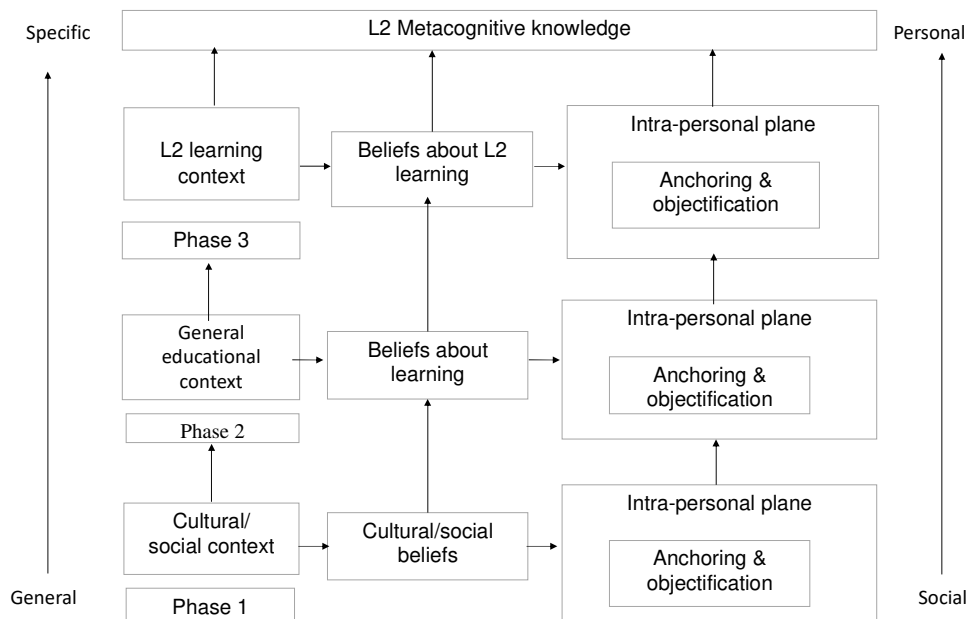

Figure 25. Language learner belief formation (adapted from Gabillon, 2005, p. 259).

We can also assume that through this process each belief is fine-tuned and reshaped from distant to closer, general to specific, social to individual, less relevant to relevant, unconscious to conscious, and stable to more variable forms.

1.34 Conclusion

My research on beliefs and social representations is complementary and indispensable to my research studies on CLIL and AL learning. Beliefs and social representations about language and language learning are dynamic and in symbiotic relationship with the different elements that constitute them: (i) the social and cognitive (the inter- and intra-personal), (ii) the emotional and affective, (iii) the conscious (metacognitive) and subconscious (social and other related), and (iv) within and between different contexts (micro-, meso-, exo-, and macro-contexts).

Understanding beliefs and social representations and their potential influence on learners and learning actions is necessary to have a comprehensive view of learning and other related actions. This literature review has attempted to include perspectives that cover these diverse aspects of belief and social representation.

PART III: CLIL AND EAL STUDIES (2011-2020)

Introduction

The main objective of the third part is to present samples of my CLIL and EAL studies and to provide an analytical summary of my activities in these areas. The studies that I have chosen to present in this section aim to (i) present samples of my research that show the links between my epistemological, pedagogical and research orientations, and (ii) illustrate how my microgenetic analysis procedures have progressively gathered information and how each research cycle builds on the previous one. The CLIL and EAL studies are presented together because they are grounded on the same epistemological viewpoints and research orientations. In addition, the data obtained from these studies are used to make comparisons and inferences.

My CLIL and EAL studies are informed by transdisciplinary research and diverse epistemological sources. Figure 26 presents a schematic representation of the major neighbouring disciplines that influence my CLIL and EAL research.

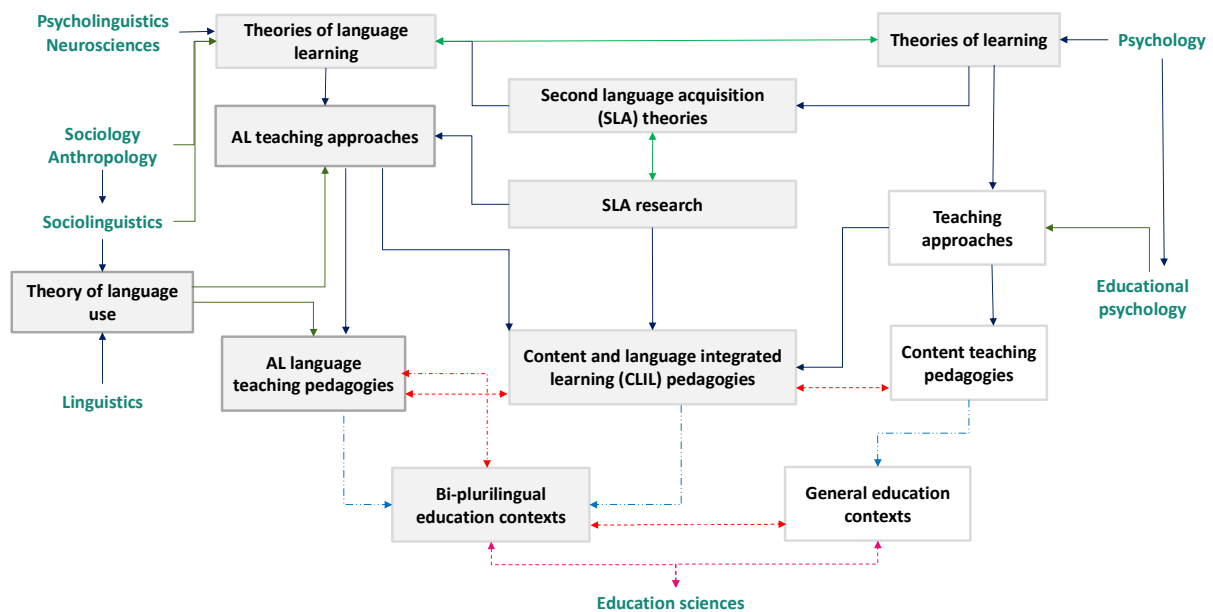

Note. —→ = uni-directional influence, ↔ = bi-directional influence, - - -> = in the context of, - - -> = related to

Figure 26. Neighbouring disciplines and my research.

In the first part of this section I describe the research methodologies I have used in my CLIL and EAL studies. The CLIL and EAL studies that I have conducted have used interactional analysis methods and examined classroom discourse, focusing not only on verbal interactions but also on learner participation, cognitive involvement and other multimodal means such as translanguaging, the use of A&G, intersubjective knowledge construction, and various forms of non-verbal elements used by learners to communicate. These studies were based on the principles of plurilingualism and dynamic bilingualism and most of them were conducted as part of plurilingual and pluridisciplinary research projects.

Outline of Part III

Part III contains four chapters.

- Chapter Nine describes the research methods and techniques used in CLIL and EAL studies and defines the key terms.
- Chapter Ten presents an overview of the CLIL studies I have conducted since 2011.
- Chapter Eleven presents the studies that I have carried out in mainstream EAL learning settings.
- Chapter Twelve gives brief information on how my research activities contributed to teacher development.

CHAPTER NINE

RESEARCH METHODOLOGIES AND TECHNIQUES USED IN CLIL AND EAL STUDIES

Introduction

This section will briefly describe the research methods used in my studies. The CLIL and mainstream EAL learning studies used qualitative methods; however, in some studies the qualitative data are augmented using descriptive statistics to present the data in a more synthetic way (e.g., using histograms or charts to show occurrences of salient elements). See Figure 27 for a summary of the research methodologies used in my studies.

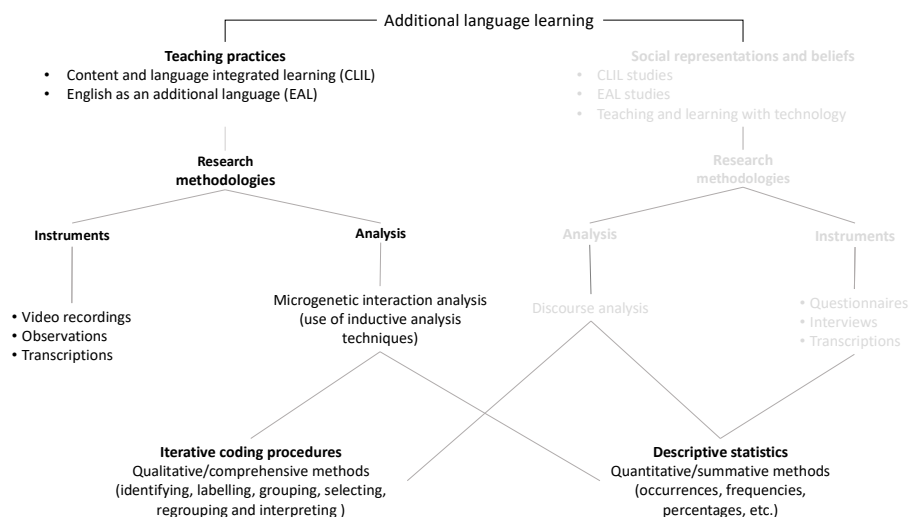

Figure 27. Research methodologies used in CLIL and EAL studies.

My research on CLIL and AL learning relied heavily on sociocultural and interactionist perspectives both on the pedagogical and methodological level (see Gabillon, 2019; Gabillon & Ailincăi, 2013, 2016, 2020). My studies used interactional analysis methods that used recorded data from AL classrooms—both EAL and CLIL. To analyse the interactions, I used various techniques and drew inspiration from different models used in the SLA literature. I analysed the transcribed interactions (verbal and non-verbal) using a series of iterative coding and inductive analysis procedures.

1.35 Classroom interaction analysis

My studies used ‘microgenetic’ interaction analysis (Vygotsky, 1986; Vygotsky et al., 1997) approaches during the treatment of the corpus obtained from CLIL and EAL studies. A microgenetic approach involves the observation of moment-to-moment changes in learners’ interactional exchanges (behaviour) while learners (and the teacher) work on collaborative tasks in a social setting. This notion was first introduced by Vygotsky (1978, 1986).⁹⁵ This analysis method is in line with my general epistemological position concerning AL development that emphasizes the role of interactional exchanges (see [Section 9.1](#)). The analysis aims to obtain detailed data about language use and changes at the moment the interactions are taking place (R. Ellis, 2015a). The theoretical basis of the method is that ‘individuals and environments mutually constitute one another’ (Foster & Ohta, 2005, p. 403), and the development of interactional exchanges and cognitive activity evolve mutually leading to a change both in the dialogic exchange and the individual.

According to R. Ellis (2015a), interaction analysis ‘involves the use of a system of categories to record and analyse the different ways in which teachers and students use language’ (p. 967). In the same vein, Kumaravadivelu (1999) characterized interaction analysis as involving ‘the use of an observation scheme consisting of a finite set of preselected and predetermined categories for describing certain verbal behaviours of teachers and students as they interact in the classroom’ (p. 455). The descriptions of interaction analysis given by R. Ellis and Kumaravadivelu do not correspond to the interaction analysis approach I use. These two descriptions emphasize the use of predetermined analysis schemes (or models) based on the researcher’s assumptions on what is to be observed. In my interaction analysis studies I do not use predetermined categories. Although some of the terms that I use to label concepts originate in the SLA literature and the models used in diverse SLA studies, in my research all categories, theoretical concepts, and ideas emerge from the data during the analysis process (although I sometimes label the emerging categories using the concepts commonly used in interactional analysis studies).

⁹⁵ See also De Guerrero and Villamil (2000) and Gutierrez (2008).

My analysis procedures also go beyond conventional classroom discourse and interaction analysis techniques. I interpret actions that take place in the classroom setting as social activities and do not only focus on language-related features. My analysis is based on the study of how language learners interact with each other using AL and make use of social tools (e.g., artefacts) to communicate and negotiate meaning (Gabillon & Ailincăi, 2013, 2016). In my research, interaction is a multimodal activity that encompasses all forms of dialogic exchanges including elements, such as social artefacts, gestures, and translanguaging, that play a role in this collaborative act (e.g., language learning, knowledge building, communicating, problem-solving, and socializing; Gabillon, 2019, 2020a; Gabillon & Ailincăi, 2016, 2017; Gabillon et al., 2016).

Depending on my research inquiries, although I do not use predetermined categories, I use some initial questions (coding filters) to help me maintain the coherence in my analysis. I search for analysis methodologies and models that correspond my objectives, and in some cases I borrow models and hybrid analysis methods originating from other disciplines (e.g., sociology, educational sciences, and psychology). The definition of interaction analysis that describes my stance is ‘an interdisciplinary method for the empirical investigation of the interaction of human beings with each other and with objects in their environment. It investigates human activities, such as talk, nonverbal interaction, and the use of artefacts’ (Jordan & Handersen, 1995, p. 39). The theoretical assumptions that underpin this type of interaction analysis emphasize the social origin and the situated nature of the action—this perspective of analysis is also in line with my epistemological position on language learning.

1.36 Segmenting (framing) data

In some CLIL studies, I based my segmentation on an adapted version of Kerbrat-Orecchioni’s interactional analysis model (Kerbrat-Orecchioni, 1998b, 1998a; Kerbrat-Orecchioni & Traverso, 2004). This model is about identifying exchanges (or different exchange types), sequences, and turns and then segmenting data into meaningful discourse units. First, the data are segmented into sequences (a unit [or block] of exchanges that are linked by a high degree of semantic and/or pragmatic coherence). Within each sequence, exchanges are then identified (e.g., restricted exchanges, extended exchanges, and truncated exchanges). The identification of exchanges then in turn helps to identify the interventions and the speech turns (see Gabillon & Ailincăi, 2016).

1.36.1 Key terms

Segmentation technique, which is also called framing, is the procedure of cutting discourse into a block of meaningful discourse sequences.

Exchange is the smallest dialogue unit, made up of verbal and/or non-verbal interventions.

Limited exchange (LE) is a short exchange of a maximum of two moves that contain either two verbal interventions or a verbal and a non-verbal intervention, which indicates that the message has been understood and the learner is responding to it.

Truncated exchange (TE) demonstrates that the learner has not understood the message and is unable to respond. A truncated exchange consists of an opening move and a failed move that results in closure of the exchange.

- *Relaunched exchange* (RE) describes an exchange type that attempts to restart a truncated exchange.
- *Truncated-relaunched-failed exchange* (T-R-FE) is an exchange type which fails after an attempt to relaunch a truncated exchange.
- *Extended exchange* (EE) is an exchange type that contains more than two learner moves on the same topic, which indicates that the interlocutors are able to communicate on the subject.
- *Truncated-relaunched-extended exchange* (T-R-EE) describes an extended exchange type that is successfully relaunched after it is truncated.
- *Initiation response feedback (IRF) pattern* contains an opening move (initiation), responding move (response), and a follow-up move (feedback). In some cases, it can be in the IR or IF forms as well (Sinclair & Coulthard, 1992). Originally IRF exchanges aimed at reinforcing the learning of the grammatical structures in the AL. They were mechanical exchanges, which were almost always initiated and directed by the teacher. However, this interaction scheme, once contextualized, can be used (i) as a scaffolding technique to present a new language feature, (ii) to practice language features that the learners have already seen, or (iii) as a tool for performing real communication.
- An *utterance* is a unit of speech produced by an individual (Sinclair & Coulthard, 1992).

1.37 Coding technique

To analyse transcribed data, I employ several coding techniques and procedures. Corbin and Strauss describe coding as ‘assigning essence-capturing conceptual labels’ to a portion of language-based or visual data (Corbin & Strauss, 1990a; Strauss & Corbin, 1997, 1998). A coding process is an inductive method involving iterative processes that necessitate going through the data; comparing ideas, interactions, events, and so forth for similarities and differences; linking; and assigning conceptual labels.

By using ‘inductive iterative methods’, researchers revisit the data over several rounds as new ideas (e.g., categories and themes) emerge and try to establish connections between newly emerged material with the previously discovered groups of ideas. This iteration is a highly reflexive task and an essential element of inductive meaning-making processes (see Charmaz, 1996; Strauss & Corbin, 1998).

‘Open’ and ‘axial’ coding are two most commonly used coding methods (Corbin & Strauss, 1990b). Open coding, an interpretive process, is mainly used at the initial stages of the inquiry processes. It involves going through the data and assigning salient labels during this discovery process (Charmaz, 1996; Strauss & Corbin, 1997). In axial coding, categories are linked to their sub-categories, and the relationships tested against data (Corbin & Strauss, 1990b; see Figure 28).

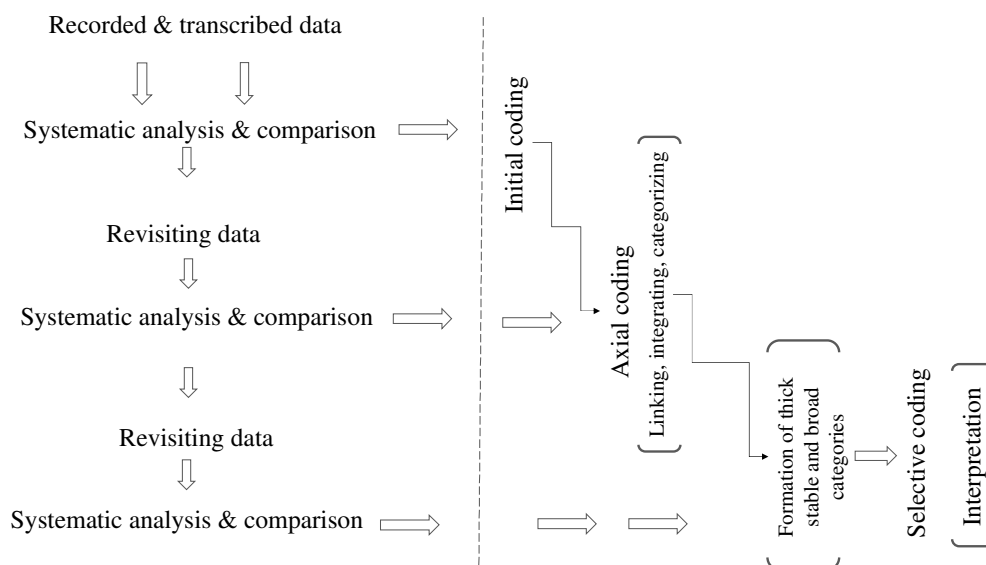

Figure 28. Coding procedures used in the CLIL and EAL studies.

Analysis methods employing coding do not use any hypotheses or rigid pre-determined categories. Coding is a qualitative enquiry technique based on exploratory processes through analysis and interpretation. However, using coding filters such as ‘Does the lesson involve active learner participation?’ ‘Do the tasks allow learner productions?’ or ‘Are the learner productions communicative (or mechanical)?’ can help the researcher to have a more focused analytical lens (Charmaz, 1996).

1.38 SLA terms and taxonomies

My studies are exploratory studies, and the research outcomes emerge from the data through iterative microgenetic analysis processes. However, to label the concepts that materialized from the data, I mostly use the terms that are commonly used in the interaction analysis literature. I also refer to these terms during the analysis procedures to interpret my data. Most of these terms were introduced into the literature via error analysis and negotiation of meaning studies mostly conducted in the 1990s (Lyster & Ranta, 1997; Mackey & Philp, 1998). The terminology in this area is vast and versatile. Early SLA interaction analysis studies were conducted using a monolingual mindset and examined SLA interactions using native speaker norms and structuralist perspectives. They rarely focused on non-verbal elements. In my research, although I use some of the terminology used in these studies, I analyse the data using techniques that are recommended in the interactionist and sociocultural perspectives (see [Section 9.4](#)).

Here I will only present some of the terms that have guided my coding and analysis procedures. Most of these terms are presented in taxonomies, and they are proposed to analyse teacher feedback or scaffolding strategies, negotiation of meaning processes, learner-teacher interactions, and so forth in AL learning settings. See Table 9 and Table 10.

Table 9. A taxonomy of CF strategies (R. Ellis, 2009, p. 8)

Input-providing	Implicit	Explicit
Output-prompting	Recast	Explicit correction
	Repetition	Metalinguistic explanation
	Clarification request	Elicitation
		Paralinguistic signal

Table 10. A taxonomy of CF strategies (R. Ellis, 2009, p. 9)

CF strategies	Definition	Example
Recast	The corrector incorporates the content words of the immediately preceding incorrect utterance and changes and corrects the utterance in some way (e.g., phonological, syntactic, morphological, or lexical).	L: I went there two times. T: You've been. You've been there twice as a group?
Repetition	The corrector repeats the learner utterance highlighting the error by means of emphatic stress.	L: I will <i>showed</i> you. T: I will <i>SHOWED</i> you. L: I'll show you.
Clarification request	The corrector indicates that he/she has not understood what the learner said.	L: What do you spend with your wife? T: What?
Explicit correction	The corrector indicates an error has been committed, identifies the error, and provides the correction.	L: On May. T: Not on May, In May. We say, 'It will start in May.'
Elicitation	The corrector repeats part of the learner utterance but not the erroneous part and uses rising intonation to signal the learner should complete it.	L: I'll come if it will not rain. T: I'll come if it?
Paralinguistic signal	The corrector uses a gesture or facial expression to indicate that the learner has made an error.	L: Yesterday I go cinema. T: (gestures with right forefinger over left shoulder to indicate past)

These two taxonomies were designed to analyse interactions in which the teacher provides learners with corrective feedback (CF). I used some of the terms proposed by R. Ellis (2009) to label the codes and to interpret the outcomes. However, I did not use them as predefined taxonomies. I used these labels to identify the different functions of learner(s) \leftrightarrow learner (s) (peer scaffolding/mediation) and learner(s) \leftrightarrow teacher exchanges (teacher scaffolding/mediation) when negotiating form and content, as well as meaning (Gabillon, 2021; Gabillon & Ailincai, 2013, 2016, 2017, 2020).

1.38.1 Labels used during coding

Corrective feedback is also referred to as guided repair (implicit correction) and direct repair (explicit correction). In the SLA literature the term is mainly used to refer to teacher feedback.

Extra-linguistic element refers all sorts of elements other than the language such as signs, objects, and gestures. To designate these extra-linguistic elements, I use the term social artefacts as a generic term—which corresponds to my general epistemological orientation. However, in some cases, for the sake of precision, I use one of the above names.

Asking for information refers to an exchange through which the learner requests some information.

Asking for clarification refers to situations in which the learner or teacher requests clarification or explanation (e.g., in situations when there is a communication breakdown or to draw the learner's attention to a faulty language production).

Free language use refers to the use of the AL in communicative situations, mostly during group tasks done independently of the teacher. It also involves the individual learner's free language choice.

Giving explanation refers to either the teacher providing conceptual information or providing supplementary information or explanations/information given by learners either to each other or to the teacher—this can be the result of a misunderstanding that requires clarification, or it can be performed as part of the usual information exchange processes.

Peer correction, peer feedback, peer mediation, peer scaffolding, and peer support: In my studies, I did not make a distinction between these four commonly used SLA terms. They all refer to the explanations or clarifications given or corrections made by learners to support their peers' language development.

Elicitation refers to a teaching technique through which the teacher obtains information from the learners. It is often used as a scaffolding and guided-repair technique.

Learner-initiated exchange refers to an exchange initiated by the learner. It is one of the indicators of free language use and choice.

Repetition (learner) refers to identical productions of what others say. It can be used as a mechanical exercise or as a self-talk related to inner speech.

Repetition (corrective feedback) refers to a CF strategy in which the listener (learner or teacher) repeats the erroneous statement they have heard, highlighting the error.

Responding refers to learners' responses to questions and requests from the teacher. The length and nature of the learner's answers may be indicative of the level of the learner, their interest in the topic, or the type of approach used by the teacher.

Self-correction (self-repair) refers to a correction done by a learner who has committed an error. It also indicates a learner's awareness of the correct formulation.

1.39 Data analysis tools

From 2015 onwards, to analyse the corpora collected via interviews and CLIL and AL learning settings, I used a qualitative data analysis software called ATLAS.ti. This software is specially designed to employ a systematic approach to qualitative inquiry. The software offers tools for coding, extracting, comparing, exploring, and (re)grouping information systematically and comprehensively. The software is adapted to use different types of coding procedures (e.g., initial and axial). Codes can be attributed to audio, text, or video quotations and can be organized under different code families and groups. The software also enables the user to print codes and quotations or to obtain code relations, code groundedness, and code (co)occurrences, among others. Figure 29 displays a screenshot obtained from ATLAS.ti.

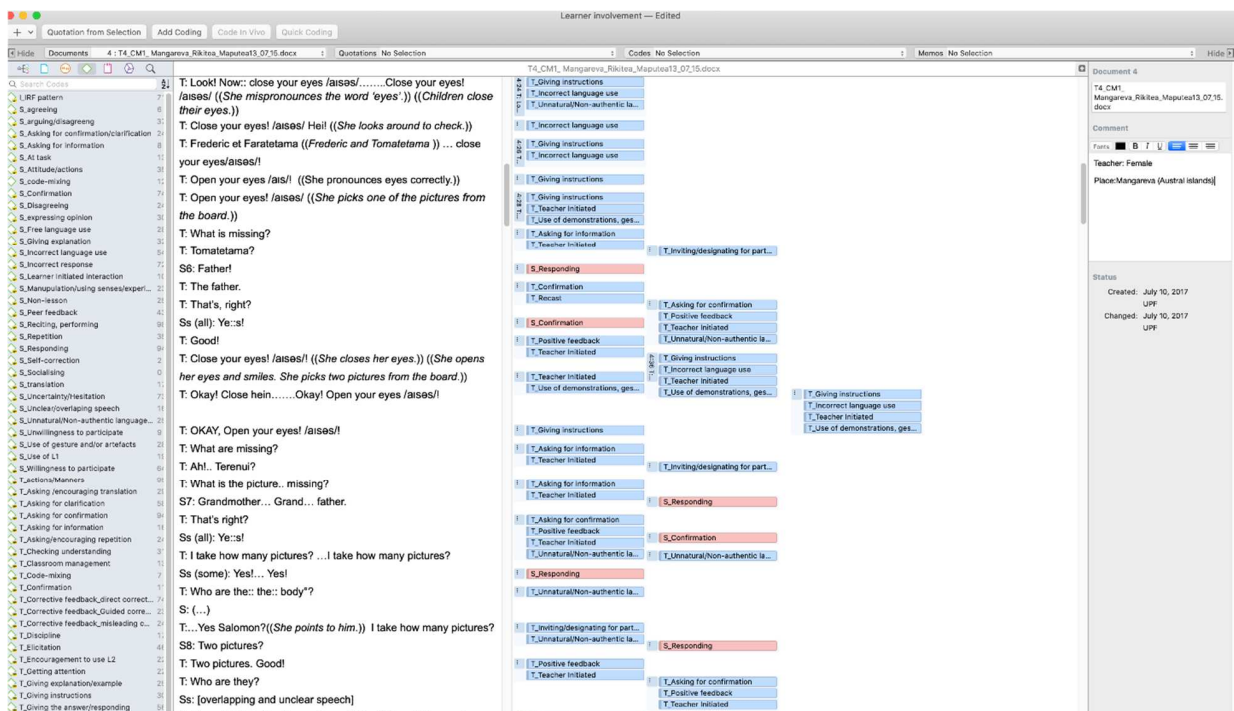

Figure 29. A snapshot from ATLAS.ti showing concept labelling and coding.

1.40 Data collection instruments

The main data collection instrument I used in my CLIL and AL learning studies was video recording, and these recordings were later transcribed in full, verbatim, with comments indicating the use of extralinguistic elements such as use of artefacts, gestures, physical movements, and other

observable elements. I also supplemented transcriptions with observation notes and descriptive notes.

1.40.1 Video-recordings and transcriptions

AL classes involve a variety of actions, and face-to-face exchanges and such incidents could not be easily captured and understood. Classroom-based research requires capturing linguistic, extra-linguistic, and social aspects of classroom discourse (Dufon, 2002; Swann, 2001). My studies used video recording as the major research instrument. When used as a research instrument, video recording provides researchers with a replicate of actual classroom happenings. Video-recordings can (i) capture both linguistic and social cues such as the language, turn-taking, voice, intonation, and extra-linguistic elements such as gestures, body language, and so forth; (ii) provide permanent data which can repeatedly be replayed and studied; (iii) help to distinguish different speakers; (iv) provide visual information that contributes to clarifying verbal messages; (v) help to identify observable emotions such as enjoyment, boredom, excitement, anger, and so forth; (vi) provide contextual information concerning the physical setting such as space, facilities, learning arrangements, teacher movements, posture, and so forth; and (vii) provide researchers with the complete account of the exchanges (i.e., every word uttered and every action made is recorded).

The transcripts, which were made between 2011-2015, were recorded manually using an adapted version of a notation system proposed by Jefferson (2004; see Appendix). The transcripts made after 2015 were edited using an application called Subtitle Edit Pro (still using Jefferson's notation system). Subtitle Edit Pro is an app to create subtitles which provides start and end timecodes on transcripts. The application is intuitive and easy to use and provides the opportunity to view the video with the subtitles—which can be used for teacher education purposes as well. The text files can also be easily exported as SRT (plain text) files and converted into MS Word or Excel documents. The recording of timecodes is also a supplementary utility that can be used for research purposes. These documents were then uploaded to ATLAS.ti for analysis (see Figure 30).



Figure 30. Recordings with transcriptions (with comments) added as subtitles

1.40.2 Observation notes

The recorded data were also supplemented with ‘anecdotal records’, a direct observation technique that consists of the recording of significant events chronologically as they occurred. These anecdotal notes provided us with complementary information about some salient events that occurred during the lessons (e.g., a change of the ambiance due to an event and conduct problems). The primary objective of these anecdotal notes was to complement the video recordings and provide information in cases when the video recording fails to capture a significant event.

1.40.3 Descriptive notes

Each recording was also supplemented with descriptive information, such as the number of students (number of boys and girls) in each class, their age groups, their number of years of EAL learning, information about the school and the teachers (their years of teaching experience, gender, etc.), and other background information about the context.

1.41 Conclusion

In this section, I have sought to provide an overview of the research methodologies that I used in the CLIL and EAL studies. My research activities involved various data collection and analysis

procedures. In this dissertation, I have not included detailed information on commonly used quantitative research methodologies, such as descriptive statistics techniques, nor did I discuss some basic research protocols that I followed. I have provided an overview of the procedures by highlighting the main research methods and data analysis techniques that I have employed. I have sometimes explained certain lesser-known techniques or research methodologies that follow complex procedures in a more detailed manner, and I have briefly mentioned others.

CHAPTER TEN

CLIL STUDIES

Introduction

The launch of my first CLIL research project corresponded to the period when CLIL research in mainstream AL classrooms with young learners had not yet been tested (Gabillon & Ailincăi, 2013). This period also coincides with the beginning of the teaching of EAL in primary schools in French Polynesia. My CLIL studies started in 2011 when there was a need for research in AL learning and demand for collaboration in teacher development. Since then, we have completed several CLIL work packages at the primary level, and we have some research activities in progress (Gabillon, 2019; Gabillon & Ailincăi, 2013, 2015a, 2017, 2020a; Gabillon et al., 2016; see also [Section 15.1](#) for ongoing projects).

I analysed CLIL studies using the interaction analysis methods that I detailed in the previous section. CLIL research constitutes a significant part in my research and is interconnected with the studies I conduct on EAL teaching and beliefs and social representations. The CLIL studies are grounded on sociocultural and interactionist epistemologies (see [Chapter 5](#)). The pedagogical philosophies employed in these studies are plurilingual (see [Chapter 4](#)). These studies draw on classroom pedagogies and techniques offered by competency-based approaches more specifically CLIL, AOA and TBLT (see [Chapter 6](#)).

CLIL: Study I

1.42 Introduction

CLIL Study I⁹⁶ took place from 2011 to 2013 during a CLIL project in a primary school in Tahiti (Gabillon & Ailincal, 2013). This first CLIL work package plays a crucial role because the results obtained from this study informed the other studies that followed (Gabillon, 2019; Gabillon & Ailincal, 2016, 2017; Gabillon et al., 2016). This first study was conducted in a primary school where I volunteered one hour of English teaching per week to help teachers become familiar with EAL teaching approaches. In addition to the mainstream EAL lessons, I proposed introducing CLIL as a complementary approach. The idea was to enable learners to transfer and use the features and language skills they had acquired in their EAL lesson to CLIL.

In this first study, we⁹⁷ used CLIL to teach a science lesson to a group of young beginner-level⁹⁸ primary school children (see Gabillon & Ailincal, 2013). The part I describe in this section constitutes the first two phases of a longitudinal CLIL research. When I conceived this first CLIL project, there was substantial empirical evidence to support the benefits and effectiveness of high-exposure CLIL practices (covering about 40-50 % of the curriculum; Ruiz de Zarobe, 2008; Ruiz de Zarobe & Jiménez Catalán, 2009). However, there had not been sufficient evidence-based support on the effectiveness of CLIL practices as short irregular language showers with young learners. Thus, in this study, I investigated if CLIL could be applied effectively with young beginner-level learners with occasional EAL showers to teach content knowledge.

The subjects of this first study were 16 primary school pupils (9 girls and 7 boys) between the ages of 10-11 who lived in Tahiti, French Polynesia. They all spoke French (L1a), the language of

⁹⁶ This study is published in Gabillon and Ailincal (2013). In this section I am presenting a shorter version. The published article is included in Volume III of this HDR dossier.

⁹⁷ I sometimes use the pronoun 'we' to also refer to people I have collaborated with during the CLIL studies (e.g., teachers, inspectors, and other researchers involved in CLIL research in other ALs [e.g., Tahitian]).

⁹⁸ Beginner level corresponds to level A1, the first level of the six reference levels described in Common European Framework of Reference for Languages (CEFR). The six reference levels are accepted as the global standard for grading an individual's language proficiency.

instruction and the official language, and some Tahitian, the language of home (L1b). These learners had had approximately a year of EAL experience and could use basic language structures, simple phrases, and everyday vocabulary about themselves and their immediate environment⁹⁹ (i.e., home and school).

1.43 Aim of the study

This first study aimed to explore (i) if CLIL was feasible with young beginner-level learners, (ii) if there would be any notable differences in the outcome between teaching a science lesson using the L1 (French) and CLIL using the AL (English),¹⁰⁰ and (iii) if CLIL could be applied effectively with young beginner-level learners using occasional ‘CLIL showers’.

The study used four 25- to 30-minute identical science lessons in the learners’ mother tongue (French/L1) and the target AL (English/AL). The science lesson required the pupils to experiment to see if the given substances were soluble or insoluble in water and provide a description of the liquid they had obtained. This science subject topic was on the curriculum, but the pupils had not done an experiment of solubility in their science classes before.

Although the study aimed at exploring the corpus without any formulation of a hypothesis, I needed to set some parameters to analyse the corpus in a more focused manner. The following questions provided me with the guidance I needed:

- How does the teacher use the language (L1 or AL) to help learners understand the new concepts?
- What strategies did the teacher use to compensate for the learners’ lower AL competence?
- Did the learners’ use the L1 during the CLIL lessons? How often? Why?
- Did the CLIL teacher use strategies different from those of the science teacher?
- Were there significant differences between the learners’ behaviours and participation during CLIL and regular science lessons?

⁹⁹ Beginner-level users (level A1) according to the Common European Frame of Reference for Languages (CEFR)

¹⁰⁰ It should be noted that we did the same lessons both in French and English for research purposes only.

1.44 Theoretical stance and pedagogical principles

My conceptualization of this CLIL study was anchored in the philosophies expressed by sociocultural and interactionist theories of learning. From this perspective, any learning (i.e., content learning and AL learning) is perceived as co-construction of knowledge through interaction with others (e.g., with the help of others) by using social artefacts. In this study, I specifically focused on the following ideas expressed by the sociocultural perspective:

- Learning (i.e., language and content) is a socially situated activity (interpersonal) rather than merely being an individual activity (cognitive/intrapersonal) and is co-constructed collaboratively during a social activity.
- Scaffolding received from others (i.e., from peers and the teacher) helps the learner learn what they cannot learn alone.
- Tasks (actions) are concrete goal-directed activities that use social artefacts to allow manipulation and experiential learning. The use of artefacts and experiential learning practices enables the transformation of these concrete external processes into cognitive internal processes.
- Learning involves a gradual shift from object-oriented to other-regulated and finally to self-regulated activity.

I designed my first CLIL study using a hybrid research methodology that combined an experimental research framework with qualitative data analysis techniques. When developing this methodology, I aligned the CLIL focus with the curriculum requirements and chose a school subject and theme from the school curriculum. I worked jointly with the class teacher on the selection of the theme and the disciplinary subject to use in CLIL. Then we prepared the lessons in collaboration considering the suitability of the topic for (i) the learners' AL competence, (ii) instructional scaffolding, and (iii) the learning of both the disciplinary content and the AL. The children had beginner-level EAL skills, which rendered some concepts difficult to explain using the AL. Thus, we designed the activity using the principles advocated by CLIL and sociocultural philosophies of learning. These principles are summarized as follows:

- Enable the learners to learn a school subject on their curriculum using the AL they are learning at school.
- Select the school subject content taking into account their ability in the AL (the learners had necessary background knowledge on certain vocabulary and structures they needed for this activity).
- Provide instructional scaffolding to support the learning of both the AL and the disciplinary content.
- Promote the use of learner strategies and cognitive skills.
- Provide the learners with experiential learning and hands-on experience to help them learn by doing.
- Provide learners with authentic learning settings (e.g., doing a science experiment using lab equipment and everyday substances).
- Enable the learners to learn skills that they can transfer and use in other similar contexts (e.g., know-how skills to complete tasks and solve problems that involve cognitive skills) and practical skills (e.g., employment of manual skills and methods, materials, tools, and instruments; Coyle, 2002; Coyle et al., 2010; Marsh & Frigols, 2007).

1.45 Procedure

The class ($N = 16$) was divided into two groups, Group A ($n = 8$), and Group B ($n = 8$), and each group received the same lesson both in English (CLIL science) and in French (science). The study comprised two phases. In Phase 1, Group A received the lesson in English and Group B in French. In Phase 2, the teachers swapped the groups and did the same science experiment, this time in French with Group A and in English with Group B. Each lesson took 24 to 27 minutes (see Figure 31).

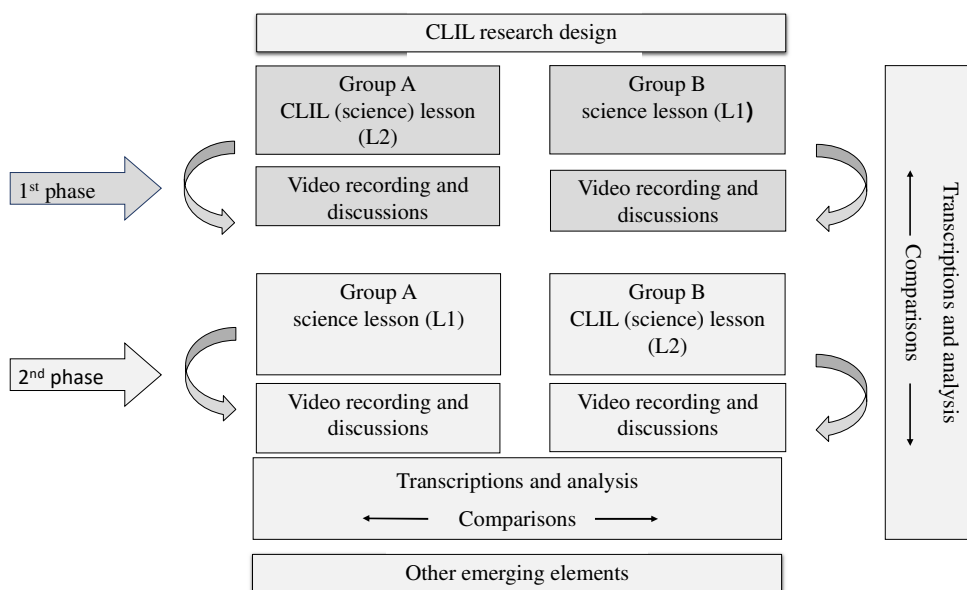

Figure 31. The phases of the CLIL study.

We designed the lessons as science experiments, which required learners to handle the objects manually and acquire the content knowledge via the use of AL (English). In order to obtain comparable results from the lessons, both teachers (CLIL and science lesson) used the same experiment and followed similar procedures with both groups. However, each teacher used different varieties of the same substances (e.g., insoluble coffee grains instead of soluble instant coffee; powdered sugar instead of sugar cubes, and large-grained salt crystals instead of refined table salt). By using different varieties of the same substance, my aim was to give a reason to the learners to do the same experiment and keep their curiosity and interest high since the same lesson was done both in English and in French, with a week between two experiences.

During the experiment, eight pupils were put around a table and provided with the substances and lab equipment that were needed for the experiment. The setting enabled the use of extra-linguistic artefacts (e.g., lab tools and substances). The natural environment provided the learners with a variety of sensory input (e.g., seeing, touching, and smelling) that could enable multiple memory traces and connections. Both the teacher-led activity that took place during the presentation of the new concepts and the learner-directed group activity occurred in small groups, which enabled joint attention and collaborative learning (see Figure 32).

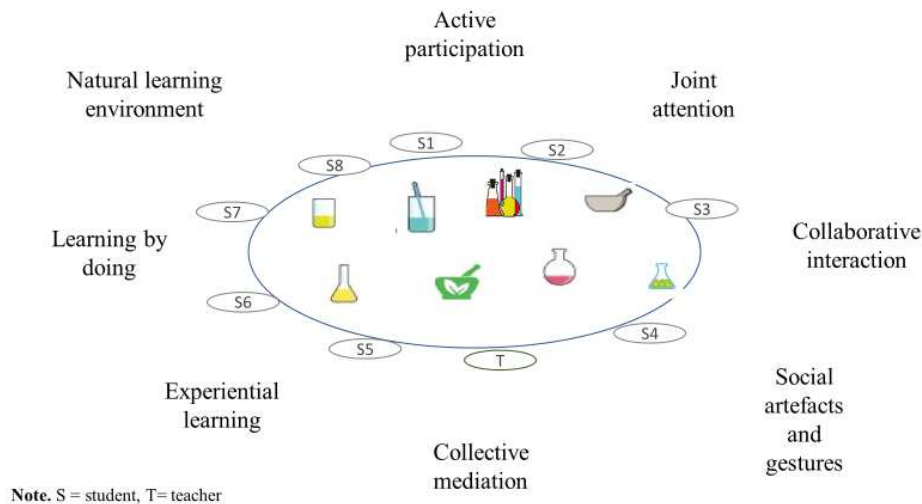

Figure 32. A naturalistic science experiment setting

After each lesson, the class teacher tested the learners' content knowledge via the use of concept questions, and then I made comparisons between the content acquired during CLIL and regular science lessons in the light of the answers given by the learners.

1.46 Data collection

We used video recordings to gather data. The recorded material was then transcribed in full, verbatim; that is grammatical errors, repetitions, hesitations, and so on were included in the transcripts. The transcripts also contained comment sections to include non-verbal elements such as emotions (observable elements), behaviour, and the use of gestures and social artefacts. We observed the children's behaviour during the activities, such as their involvement, interests towards the activities, attention, group dynamics, and so forth. Using video recordings as a means to collect data allowed me to have more flexibility than I could have with real-time observation. This method helped me to do retrospective analysis to re-examine the data as much as required. The videotaped material also enabled me to identify and analyse not only the linguistic data, but also non-verbal elements of the phenomena observed. Due to the small group size, I was able to obtain an uninterrupted view of every single student in the video recordings. Having an uninterrupted view of the entire group enabled me to view how each learner experienced the learning instances at each stage of the lesson, and how differently each individual learner reacted to the same circumstances.

To supplement recorded data, I used grids on which I tallied occurrences of the exchanges and the interaction patterns used during the lessons.

Each recording was also supplemented with some descriptive information such as the number of students (number of boys and girls) in each class, their age group, their number of years of EAL learning, and information about the school and the teachers (their years of experience in teaching, gender, etc.).

1.47 Analysis and results

Right after each lesson, I analysed the recorded lessons. In these analysis procedures, I primarily focused on the functions of the interactions used during the exchanges (verbal and non-verbal), rather than merely focusing on the linguistic accuracy of the language used.

This study used a microgenetic interactional analysis method to analyse the video-recorded corpus. The codes were generated by studying both transcripts and video recordings simultaneously. The initial coding was performed through the use of open codes. We studied each transcript closely and labelled the exchanges according to the functions they played in the exchange. After the identification and labelling of concepts, the related ideas were linked and grouped. We continued studying, linking, and comparing processes until I formed consistent concept groups. Finally, the labelled concepts were reintegrated into higher-level categories. The data were also analysed quantitatively using descriptive statistics by focusing on the occurrences of significant features. We presented the results by using both qualitative and quantitative data presentation methods. Knowledge gained through coding and inductive analysis was presented using excerpts of live examples to support my explanations, and descriptive data were presented using histograms or charts to present the synthesis of the results.

Once I obtained the preliminary results from the first phase, I applied the same analysis procedures to the lessons during the second phase. Upon the completion of the cycle, I compared all the results obtained and drew out conclusions using comprehensive methods. We repeated the same procedures in Phase 2 and then compared the data collected in Phase 2 with the data obtained in Phase 1. In Phase 2, the groups were taught the same subject content by swapping the language of instruction (Group A in French and Group B in English – see also Figure 31). Table 11 presents the categories obtained during this first CLIL study.

Table 11. The major categories observed during both CLIL and regular science lessons

	Interaction types used by the <u>teacher</u> in CLIL science lessons	Interaction types used by the <u>teacher</u> in regular science lessons	Interaction types used by the <u>learners</u> in CLIL science lessons	Interaction types used by the <u>learners</u> in regular science lessons
The use of artefact and gestures	Giving explanation	Giving explanation	Giving explanation	Giving explanation
	Confirmation	Confirmation	Repetition (self, individual or group)	
The use of L1 (code-switching, translanguaging, etc.)	Giving instructions	Giving instructions	Indication of comprehension	Indication of comprehension
	Scaffolding	Scaffolding	Peer scaffolding	Peer scaffolding
	Correction (direct or guided)	Correction (direct or guided)	Peer-correction	Peer correction
	Asking for information	Asking for information	Self-correction	Self-correction
			Asking for information	Asking for information

1.47.1 Phase 1: CLIL Lesson for Group A

In *Phase 1*, the first lesson was in English with Group A. The first CLIL lesson took 27 minutes and comprised of 123 interventions (T-Ls¹⁰¹ 27%, L-T 28%, T-L 21%, Ls-T 15%, and Ls-Ls 5%, Self-Talk 4%). The lesson was designed to emphasize teacher-learner exchanges and teacher scaffolding because of the learners' lower English level. Most of the exchanges that took place during the lesson were teacher-led (in a small group –ZPD) and in the form of teacher-learner and learner-teacher interactions. The learners' lower level of English required the teacher to scaffold learning with care, using short exchanges and other means of communication (e.g., gestures, objects, and demonstrations). In the first CLIL lesson, most of the teacher talk was aided with social artefacts (demonstrations, use of realia, gestures etc.) (see Figure 33). It should be noted that in most of the interventions the teacher used more than one scaffolding strategy. Thus, the occurrences of the strategy used by the teacher should not be interpreted as equal to the number of teacher interventions.

¹⁰¹ T=teacher, Ls= learners

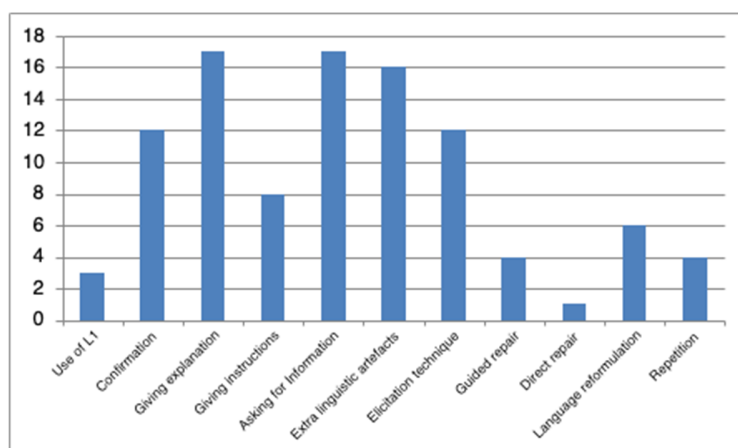

Figure 33. CLIL lesson 1: Occurrences of teacher scaffolding strategies

The teacher talk was primarily used for (i) giving explanation, (ii) asking for information, (iii) confirmation (e.g., learner answers and language use), (iv) elicitation techniques (a means of scaffolding that is used to guide learners to give the correct answer), (v) language reformulation (e.g., simplification of language and varying language forms and vocabulary), (vi) guided repair (a way of scaffolding that is used to help learners correct their own mistakes), and (vii) repetition (e.g., to make confirmation or to indicate an error). The majority of the exchanges (teacher-learner and learner-learner) in the CLIL lesson took place in the AL (92 %). The teacher used the L1 only on rare occasions and for short exchanges.¹⁰² During the lesson, I observed some examples of self-regulation. On several occasions, I spotted some learners engaging in self-talk (private speech) in English, repeating some phrases and words on their own. I also observed other forms of self-regulation, such as self-repair (self-correction). The learners were able to use the AL to cope with the demands of the lesson (see Figure 34).

¹⁰² In the CLIL lessons, the aim was to maximize the use of AL without prohibiting the use of L1. It was explained to the learners that they could use their L1 whenever they needed it, and they were also told that if they could, they should try to use the AL.

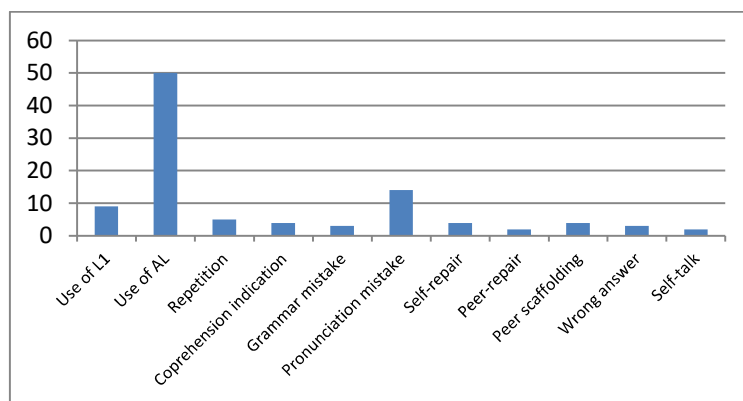

Figure 34. CLIL lesson 1: Types and occurrences of learner interactions

The majority of the mistakes were of phonetic origin (e.g., /sɔlybl/ instead of /sɔljɔbəl/). Learner-learner exchanges mainly took place in L1 except for a few that were in the form of code-mixing (e.g., *Il est 'clear' /kliʁ'/*; *C'est ne pas 'cloudy' /'klav.di/*; see Extract 6 **Error! Not a valid bookmark self-reference.**). In some cases, learners used translanguaging. These translanguaging practices were mostly related to the task the learners were performing and had the purpose of peer scaffolding. Extract 6 illustrates how Pupils 2 and 3 (students are hereafter referred to by their codes, in this case, P2 and P3) use the L1 to explain to each other the solubility notion.

Extract 6. Teacher scaffolding.

T: Look! Can you see the sugar? ((Points the bottom of the jar)).

Ps: Yes—((some)) Yes, I do.

T: Now I ... ((some children do not know the word 'stir')) ... stir it ((The teacher demonstrates it)). Stir it...stir it...stir it... ((Teacher's repetition of the word 'stir' makes children laugh)). Where's the sugar? Can you see it?

Ps: No.

T: It is ... Sugar is...

Ps: Soluble ((some of them pronounce it as /sɔljɔbəl/ and some as /sɔlybl/)).

T: In...

Ps: Water.

T: Excellent! Sugar is soluble /sɔljɔbəl/ in water. ((The children start whispering to each other in French.))

P2: *On le voit plus parce qu'il est soluble dans l'eau.* ((We cannot see it because it is soluble in water.))

P3 *Mais, il est là en fait. Même s'il est soluble. Il est mélangé avec l'eau.* ((But, it is there in fact. Even if we do not see it. It is mixed with water.))

Note. P = pupil Ps = pupils T = teacher

The dialogic exchanges between the teacher and learners helped the learners to acquire new concepts and words, to use the target language in a natural setting, and to self-repair their errors.

The setting also enabled the use of A&G. The availability of A&G in the learning environment facilitated both teacher and peer scaffolding and concept formation (see Extract 6 and Extract 7).

Extract 7. Use of A&G while scaffolding.

T: Let us test another substance ((The teacher models the activity)). ((She puts some sand in water)) We stir it...stir it...stir it again...and...

Ps: Insoluble ((several pupils at the same time))

T: Why?

Ps: ((No answer)).

T: Look at the bottom of the jar ((She holds the jar up and points the bottom of the jar with a spoon)).

P2: I see sand.

T: Yes, it doesn't mix with water. It falls to the bottom of the jar. Can you see it? Here... ((Shows it)).

Note. P = pupil T = teacher

Most of the English terms used in the experiment were similar to their French equivalents (e.g., soluble, insoluble, and liquid) and this seemed to have contributed to the learners' understanding of the new concepts but the differences in pronunciation created some confusion. The learners tended to insist on French pronunciation. The teacher used guided-repair techniques such as repeating the answer with the correct pronunciation or asking another question that required the learner to repeat the correct pronunciation (see Extract 8).

Extract 8. Guided repair.

P7: The flour and water. Flour and water...soluble /sɔlybl/... ((She hesitates)).

T: Is the flour soluble /sɔljɔbəl/ ...?

P7: Flour is soluble /sɔlubl/ ... soluble /sɔljubl/ in water.

T: Is the flour soluble /sɔljɔbəl/ in the water? Look at the bottom of the jar.

P7: No, No... the flour is insoluble /ɔnsɔlybl/ in water.

Note. P = pupil T = teacher

The dialogic exchanges also demonstrated that the learners were able to articulate their understanding of the topic by using both L1 and AL and other means, such as artefacts, and gestures. Pupil 5's (P5) exchange with the teacher displays how he used the A&G to demonstrate the teacher that he understood the concepts of soluble and insoluble see Extract 9).

Extract 9. Learners' use of A&G to supplement verbal interactions.

((P5 could not decide whether the soap was soluble or insoluble in water because pieces of soap were floating on the surface of the water.))

T: Ok. Do the experiment again! ((passes the jar to P5)) Take some soap. ((some finely grated soap this time)) Put it in water. Stir it..., stir it very well. ((P5 stirs energetically.)) Oh!! We can see some bubbles (hhh). What do you think? Is soap soluble or insoluble?

P5: Soluble

T: Why?

P5: I can't see the soap. ((shows the bottom of the jar)) I can't see the soap. ((shows the surface of the water))

Note. P = pupil T = teacher

The feedback given by the learners at the end of the experiment indicates that they were able to differentiate between soluble and insoluble substances, give simple descriptions, and explain why some substances were soluble/insoluble using simple English (see Extract 10).

Extract 10 Learner exchanges during the group feedback.

P1: Sand is insoluble in water and the liquid is clear, transparent.

P2: Rice is insoluble in the water ... the liquid /likid/ is hmm white and cloudy? ((pronounces liquid in French. She is not sure))

P4: Salt. Salt is soluble, and the water is clear.

P6: Coffee. Coffee is soluble /sɒləbel/ ((instant coffee)) in water and the liquid /likid/ is brown. ((pronounces liquid in French))

Note. P = pupil T = teacher

The learners used simple language forms, in general, correctly; however, there were minor problems concerning the grammar (e.g., articles and word order) and pronunciation. Issues regarding linguistic accuracy were not the principal focus in this lesson.

In this study, we analysed dialogic exchanges (microgenetic analysis) only for an indication of increased understanding (knowledge gaining). During this first CLIL lesson, I observed that the learners were able to gain knowledge through dialogic exchanges. The science topic and the experiment I selected did not require complex language structures, and the CLIL teacher used short and simple dialogic exchanges, gestures, realia, and modelling to scaffold understanding and to build concepts. This experiment provided a necessary framework for efficient instructional scaffolding in a natural setting. The natural environment, created by the experiment, enabled the integration of both the content and AL, providing the learners with a variety of sensory input (e.g.,

seeing, touching, and smelling). In brief, this first lesson suggested that successful CLIL is possible with breakthrough-level learners.

1.47.2 Phase 1: Subject Lesson for Group B

Group B received their first lesson in French. The class teacher followed more or less the same procedures as the CLIL teacher. There were 118 turn-takings, and the lesson took 25 minutes. In this lesson, the teacher used fewer extra-linguistic elements (e.g., A&G) than the CLIL teacher. Because of the use of L1, the interactions were richer. The teacher used various pedagogical scaffolding methods such as the use of realia, identification of objects by means of touching, seeing, smelling, and so on. To assist learners in the construction of their knowledge, the teacher asked for language precisions and helped the learners relate new knowledge to their prior knowledge (see Figure 35 and Extract 11).

Extract 11. Concept building during a science lesson in L1.

T: Ma question est: Est-ce que ces éléments sont solubles dans l'eau ? Qu'est-ce que cela veut dire soluble dans l'eau ? Qui va m'expliquer le mot soluble ? ((My question is: Are these substances soluble in water? What does 'soluble in water' mean? Who will explain what the word 'soluble' is?))

P3: Quelque chose est soluble quand il peut se dissoudre. ((Something is soluble when it dissolves.))

T: Ah! 'Dissoudre' m'intéresse. Qu'est-ce que ça veut dire 'dissoudre' ? ((Ah! 'Dissolve' interests me. What does 'dissolve' mean?))

P5: Fondre? ((Melt?))

T: Tu n'es pas sûre ? Pour toi, Qu'est-ce que ça veut dire soluble ? ((You are not sure? What does 'soluble' mean to you?))

P6: Je ne sais pas. ((I don't know.))

P5: Qui disparaît ((something that disappears))

T: Disparaît ? Où ? ((Disappears? Where?))

P1: Dans l'eau ((In water))

P4: Quand quelque chose se dissout et se mélange avec de l'eau ((Very willing)) ((when something dissolves and mixes with water))

T: Très bien ((Very good))

Note. P= pupil T= teacher

The teacher-learner interactions were mainly in the form of asking for information (teacher) and providing information (learners) (see Figure 35 and Figure 36).

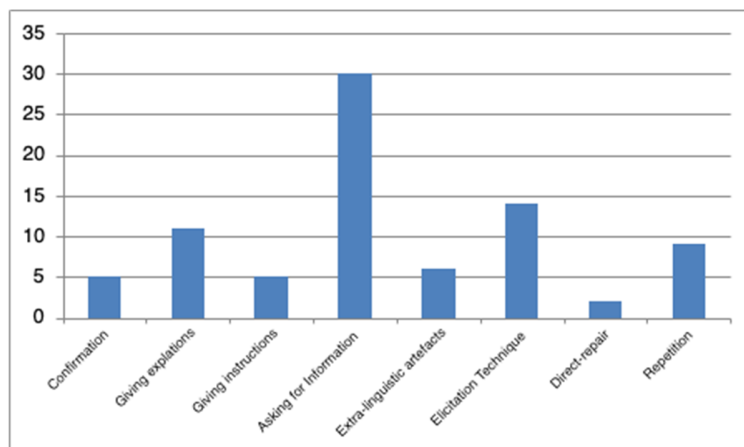

Figure 35. Subject lesson 1: Occurrences of teacher scaffolding strategies

Compared to Group A (who had their first lesson in English), Group B seemed to be more willing to participate and was perhaps a little more dynamic than Group A. This could be attributed to the fact that the children were using their L1 or simply to the difference between two groups of children. However, overall both groups shared more similarities than differences concerning their behaviours and the interest they showed to the tasks.

In this first subject lesson (French), dialogic exchanges between the teacher and learners were in the form of verbal scaffolding (L1). The CLIL lesson (English), on the other hand, used A&G to compensate for the learners' lower level of AL competence. Our observations indicate that both lessons (CLIL and subject lesson) attained their aims within approximately the same length of time using similar procedures.

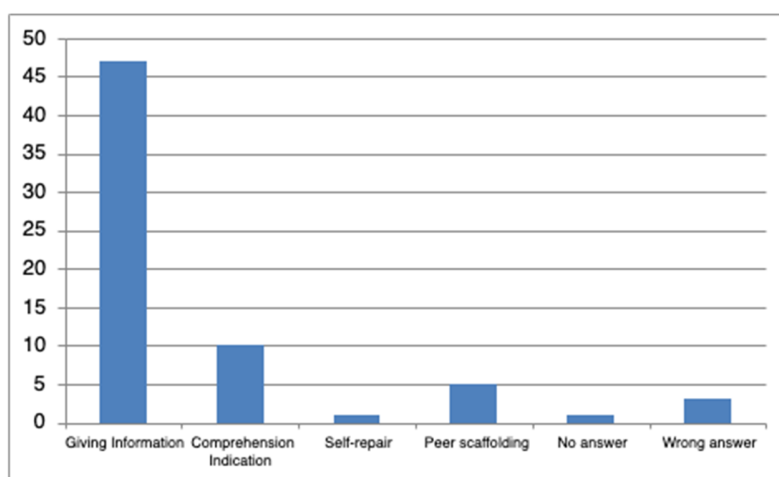

Figure 36. Subject lesson 1: Types and occurrences of learner interactions

1.47.3 Phase 2: CLIL Lesson for Group B

Group B did the experiment in CLIL a week after they had the same lesson in French. The lesson comprised 119 turn-takings and took 25 minutes. The interaction patterns used in this lesson were similar to the previous two lessons. The learners already knew what type of experiment they were going to do, but they still seemed interested and willing to participate. This group was slightly more dynamic than Group A in their subject lesson as well. The analysis of interactions showed that in this CLIL lesson, the teacher gave fewer explanations and had less recourse to extra-linguistic artefacts (see Figure 37).

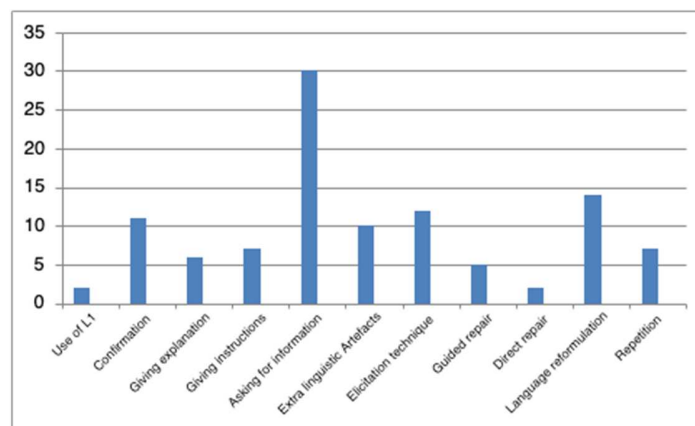

Figure 37. CLIL lesson 2: Frequency of teacher scaffolding strategies

Instead, the teacher demanded more explanations and clarifications from the learners themselves. Concerning the use of English, although there was not a noticeable difference qualitatively, the quantitative data analysis indicated that Group B had the slightly fewer grammar and pronunciation mistakes compared to Group A. In both groups, the pupils made similar types of errors such as liquid /'lik.wɪd/, which the learners pronounced as /likid/, or soluble as /sɔlybl/. The learners effortlessly used the contextual clues to understand and respond to the task requirements even though some expressions were not previously taught in their English classes (see Figure 38).

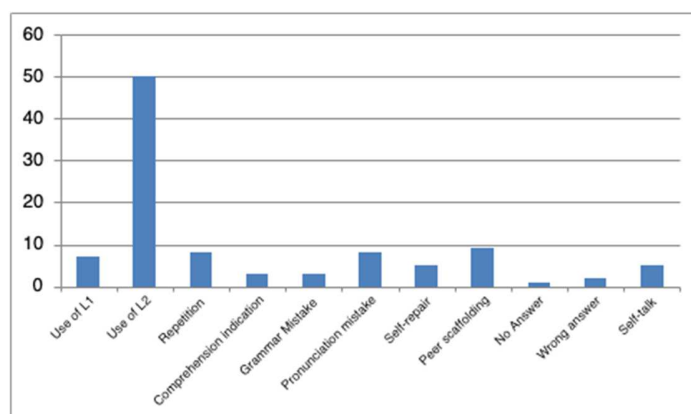

Figure 38. CLIL lesson 2: Types and occurrences of learner interactions

1.47.4 Phase 2: Subject Lesson for Group A

Group A's second lesson was the subject lesson in French (L1). This subject lesson had 124 interventions and took 24 minutes. In this lesson, the learners provided most of the information concerning the content of the lesson. The teacher used questions and elicitation techniques to help learners to give information. As it was the case with the previous subject lesson, the teacher used the extra-linguistic context less than the CLIL teacher did. The learners' L1 was used to construct concepts through dialogic exchanges and language precisions (see Figure 39 and Figure 40).

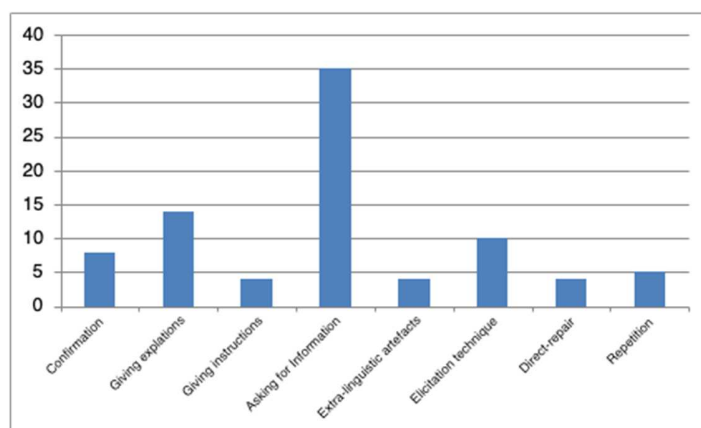

Figure 39. Subject lesson 2: Frequency of teacher scaffolding strategies

The learners did not show any sign of disinterest. On the contrary, I observed that the children readily used their knowledge on the topic. They seemed to have more self-confidence. The children's explanations in French indicated that they acquired the intended content knowledge in their previous CLIL lesson.

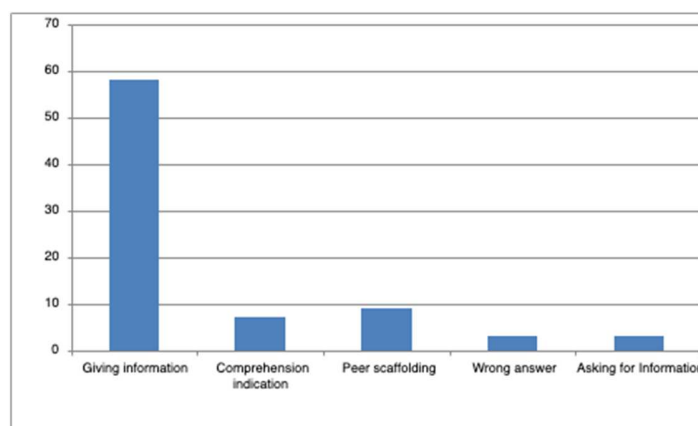

Figure 40. Subject lesson 2: Types and occurrences of learner interactions

In *Phase 2*, (both in the subject lesson and in the CLIL lesson), I observed more examples of peer scaffolding than I did in *Phase 1*. This could be explained by the fact that the learners were already familiar with the topic and had enough information to share with their peers. We observed that the learners transferred their knowledge from one experience to another.

I also observed that the children translated some of the explanations used in their CLIL lesson (in English) to French during their science lesson (in French). See the translation in Extract 12 below in which we observe that the student P1 uses the exact translation of what the teacher used during *CLIL lesson 1*: T: ‘... does not fall to the bottom of the jar...’ ‘... mixes with water...’ (taken from Extract 7 see [Section 10.6.1](#) above) during *Subject lesson 2* P1: ‘*Quand un élément est soluble il ne tombe pas au fond du bocal. Il se mélange avec l’eau.*’

Extract 12. Concept transfer from CLIL to science lesson in L1.

T: Savez-vous ce que nous allons faire? ((Do you know what we are going to do?))

Ps: Oui! ((Yes !))

P1: On va regarder si ces éléments sont solubles ou non-solubles. ((We’ll see if these substances are soluble or insoluble.)) (shows the substances on the table)

T: Qu’est-ce que ça veut dire soluble?((What does ‘soluble’ mean?))

P2 : Ça veut dire qu’on peut mélanger un élément avec un liquide ((It means that we can mix a substance with a liquid.))

T: Comment peut-on savoir si un élément est soluble ou non? ((How can we know that a substance is soluble?)) ((She does not respond to the learner and addresses the other students.))

P1: Quand un élément est soluble il ne tombe pas au fond du bocal. Il se mélange avec l’eau. ((When a substance is soluble, it does not fall to the bottom of the jar. It mixes with water.))

Note. T = teacher, P = pupil, Ps = pupils

1.48 Discussion and conclusion

Our experimentations during the first CLIL work package indicated that the classroom arrangement used in the lessons was also contributed to the success of the experiments. The fact that the learners were asked to complete a real task (i.e., a task that they would do during subject lessons in L1) by using real laboratory utensils created a natural learning setting with concrete goals. The activities were done in small groups (teacher-directed and autonomous group work) in which each member (including the teacher) focused on one objective. This small-group configuration, rather than a whole class activity, encouraged joint attention and collaboration. Our observations during this first work package indicated that the use of A&G played an essential role during teacher-learner and learner-learner exchanges. We noted that, in addition to language simplifications, the use of A&G (i) contributed to both language development and content learning, (ii) created a naturalistic learning setting, and (iii) facilitated learning operations. The overall results obtained from this research can be summarized as follows:

1. CLIL was possible with beginner-level young learners. The lessons made use of extra-linguistics artefacts to complement the AL and help the learners understand new concepts. During the CLIL lessons, the teacher tried to make the AL input comprehensible by employing input simplification and through the use of linguistic and extra-linguistic context. The data obtained from this experience suggested that CLIL with young beginner-level learners requires a rich extra-linguistic setting and socially mediated activity designs.
2. The disciplinary content learning objectives were attained. In the CLIL lessons, the children mainly used the AL as a tool for communication and responded to the task requirements. They answered the teacher willingly and were able to cope with all the task requirements without any observable difficulty. The learners used L1 for peer scaffolding during group work.
3. The dialogic exchanges mostly occurred between the teacher and the learners, and these exchanges were used to scaffold learning (AL or content learning). This practice took place in the ZPD and corresponded to the scaffolding steps suggested by Bruner (Bruner, 1974; Wood et al., 1976). The scaffolding theory holds that providing supportive dialogue in

successive steps¹⁰³ maintains learners' attention to the main features of learning (Bruner, 1978; Duff, 2007; Wood et al., 1976). This idea suggests that with beginner-level CLIL learners, activities need to evolve gradually from teacher-learner-mediated activity to peer-mediated activity patterns.

4. Overall, I did not notice any significant observable differences in the learners' behaviours regarding subject and CLIL lessons. However, the learners seemed more confident during the subject lessons, in which they used their L1. Overall, learners demonstrated a willingness to participate in all four lessons.

The most salient feature of this study was the observable mediating effect of the use of A&G. Our study indicates that the use of artefacts contributed to the construction of concepts, facilitated teacher scaffolding, and created authentic patterns of interaction. This finding prompted us to design a second study to examine the role of A&G in more detail.

¹⁰³ Important steps to follow during scaffolding practices: (i) enlist interest and adhere to the requirements of the task, (ii) simplify the task, (iii) keep learners focused on a particular objective, (iv) signal the defining features of the task, (v) control frustration and build confidence, and (vi) demonstrate (Bruner, 1978; Wood et al., 1976).

CLIL: Study II

1.49 Introduction

CLIL Study II¹⁰⁴ constituted a continuation of the CLIL Study I and was designed based on the result obtained in the first study (Gabillon & Ailincal, 2016). The second CLIL work package took place from 2012 to 2014 in two elementary state schools in Tahiti. The study was carried out with the participation of two primary school teachers. The results I obtained from the first CLIL work package suggested that CLIL was possible with young beginner-level learners but required a rich extra-linguistic context and socially mediated activity designs (see Gabillon & Ailincal, 2013). Following the results obtained from the first study, in this second CLIL experimentation I aimed to discover how A&G mediated learning (Gabillon & Ailincal, 2016, 2021).

Thirty children participated in this study. The participants were 9- and 10-year-old children with beginner-level English (corresponds to CEFRL A1 level). The learners had a maximum of two years of English language learning experience. For this study, we designed three science laboratory lessons like the ones we implemented during the first work package. To facilitate scaffolding, we worked with small groups of 9 to 11 children. The duration of the recorded lessons varied from 25 to 30 minutes.

The study focused on the observation and analysis of the use of A&G in CLIL. Our foremost aim was to observe the role played by A&G during dialogic exchanges. The filtering questions used were: (1) How do A&G mediate learning? (2) How does the use of A&G influence dialogic exchanges?

1.50 Theoretical stance

This second study, like the previous CLIL study based its theoretical stance on the sociocultural and interactionist perspectives (see [Chapter 5](#)). The study analysed the actions and interactions that took place in the learners' ZPD, focusing on the scaffolding techniques used by teachers through

¹⁰⁴ CLIL Study II was published as a journal article (see Gabillon & Ailincal, 2016). In this section I provide readers a short version of the article.

the use of A&G. The use of artefacts is one of the central notions of Vygotsky's sociocultural theory (see [Section 7.7.1](#)). In Vygotsky's conceptualization of child development, artefacts play a crucial role. This conceptualization posits that interactions through the use of social artefacts support children's intrapersonal processes and help them to both improve their cognitive abilities and enhance their knowledge. According to the sociocultural theory of learning, interaction, mediation, artefacts, and the activity are inseparable from cognitive elements, and the child's cognitive development depends on how effectively artefacts are used in social mediation (Vygotsky, 1978). This mediating role of artefacts was the focus of my second CLIL study.

1.51 Methodology

The study employed video recordings and observations to gather data, which were then analysed qualitatively using interaction analysis. The discourse was split into meaningful segments and studied by focusing on the role that A&G played during dialogic exchanges. The analysed data indicated that socially mediated activity designs that enabled the use of A&G facilitated the mediation of learning, extended dialogic exchanges, and improved the communicative quality of interactions (see Gabillon & Ailincăi, 2016a).

In this study, as in my previous CLIL study, I considered actions that took place in the classroom as a social activity where learning is mediated through collaborative dialogue and social artefacts. The science experiments were designed to create a naturalist learning environment and included social artefacts and manipulations that enabled the use of a variety of sensory inputs. These activities also focused on experiential learning to help learners make sense of their learning. The CLIL teachers used simplified language forms and vocabulary, and they used A&G to scaffold learning.

1.51.1 Data collection instruments

The corpus for this study was collected from three identical 25-to-30-minute CLIL lessons from three different groups of learners. The data obtained from the previous CLIL study were also integrated into the data obtained in this research work and reanalysed with this new focus.

The data were collected using video recordings. The small size of the groups (9 to 11 students each) made it possible to have a continuous view of each learner and to record not only language data

but also the use of non-verbal elements (e.g., the use of A&G and body movements, manipulations etc.) of the observed phenomena.

1.51.2 Analysis

The study used microgenetic interaction analysis to examine the data obtained from the CLIL classes I observed. Interaction analysis has been exponentially applied to the analysis of exchanges in order to understand student learning and the role of dialogic exchanges in AL settings (see [Chapter 9](#); Coulthard, 1992; R. Ellis, 2012; R. Ellis & Barkhuizen, 2005; Sinclair & Coulthard, 1992). I completed my analysis with descriptive statistics and presented the occurrences of certain elements to provide a synthesis of the results.

The transcribed data were examined and re-examined to look for patterns within and across interactional exchanges in order to understand how, how often and why A&G were used and the consequences they produced. During the data conceptualization phase, after careful evaluation of the transcribed data, I observed certain patterns and links between the use of A&G and the processes of concept-building and negotiating meaning.

After the identification of persisting patterns, I coded the data into categories. In these categories, I focused on the occurrences of A&G, how they were used and the effects they produced. Then I split the exchanges on the transcripts into smaller, manageable meaningful segments.

We defined the boundaries of discourse segments through the identification of an opening move, which marked the beginning of a topic or a new action, and through the identification of a framing move, which indicated the end of an exchange (Coulthard, 1992; Sinclair & Coulthard, 1992). We re-grouped and labelled the data segments utilising a conversation analysis model similar to the one offered by Kerbrat-Orecchioni (1998). Although the analysis model proposed by Kerbrat-Orecchioni views conversation analysis as probing only linguistic components, the analysis model that I employed also integrated extra-linguistic elements such as A&G (Kerbrat-Orecchioni, 1998a, 1998b). After splitting and re-grouping the data, I labelled the data segments using the following categories (adapted from Kerbrat-Orecchioni, 1998b): (i) limited exchange (LE), (ii) truncated exchange (TE), (iii) relaunched exchange (RE), (iv) truncated-relaunched-failed exchange (T-R-FE), (v) extended exchange (EE), and (vi) truncated-relaunched-extended exchange (T-R-EE; see [Section 9.2](#)).

1.52 Results

The results obtained indicated that A&G helped exchanges to continue without a break and added a communicative quality to the dialogic exchanges. Learners, despite their moderate AL level, used the language to express their intentions sincerely and for communication purposes. Extract 13 illustrates how using A&G (both by the learners and the teacher) mediated learning, contributed to carrying out of tasks and extended the exchange. In this extract, which I had previously analysed during the first CLIL research, we observe that A&G mediated collaborative exchange through providing scaffolding during the moments of instruction giving (Moves 1 and 3) and comprehension checks (Move 5). This extract also illustrates how learners utilized A&G to provide scaffolding during their explanations to clarify and justify the meaning of their utterances (Move 8). The explanations given by the learner in Move 8 could probably not have been possible without the use of the artefacts available within the vicinity of the learner (see Extract 13).

Extract 13. The role of artefacts in extending exchanges.

Extended exchange (EE)

EE	T: Ok. Do the experiment again (passes the jar to P5). Take some soap. Put it in water.	}	-(A&G) scaffolding during instruction giving
	P5: (Takes a jar and puts some powdered soap in it)	}	-(A&G) non-verbal response
	T: Stir it... (shows it), stir it very well.....	}	-(A&G) scaffolding during instruction giving
	T: Oh we can see bubbles (Children laugh).	}	-(A&G) comprehension check
	T: What do you think? Is soap soluble or insoluble? (shows the jar)	}	-(A&G) responding
	P5: (Stirs) Soluble. (Holds the jar up).	}	-(A&G) explanation giving
	T: Why?	}	-(A&G) scaffolding during clarification request
	P5: We can't see it here (shows the bottom of the jar). We can't see it here (shows the middle of the jar).	}	-(A&G) scaffolding during clarification request
	T: (Laughs) we don't see it anywhere. Look at it. (shows the jar) Can you see any soap?	}	-(A&G) scaffolding during elicitation
	P4: Yes, soluble.		
	T: OK? (Hand gestures to invite children to talk).		
	Ps: Soap is soluble in water.		
	T: Thank you very much.		
	Ps: You're welcome.		

Note. T = teacher, P5 = Pupil 5, Ps = pupils, EE = extended exchange, A&G = artefacts and gestures.

Extract 14 below has a clear pattern where a teacher is encouraging a shy learner to take part in a classroom activity. This short exchange is a good example to illustrate how a truncated exchange (TE) could be extended using A&G. In this particular example, the learner was unable to respond to the teacher's question because of a language structure that the pupil had difficulty understanding. The teacher relaunched the exchange by modifying her language and supporting linguistic modification with the use of A&G (see Move 3).

Extract 14. The role of artefacts in relaunched truncated exchanges.

Truncated-relaunched-extended exchange (T-R-EE)

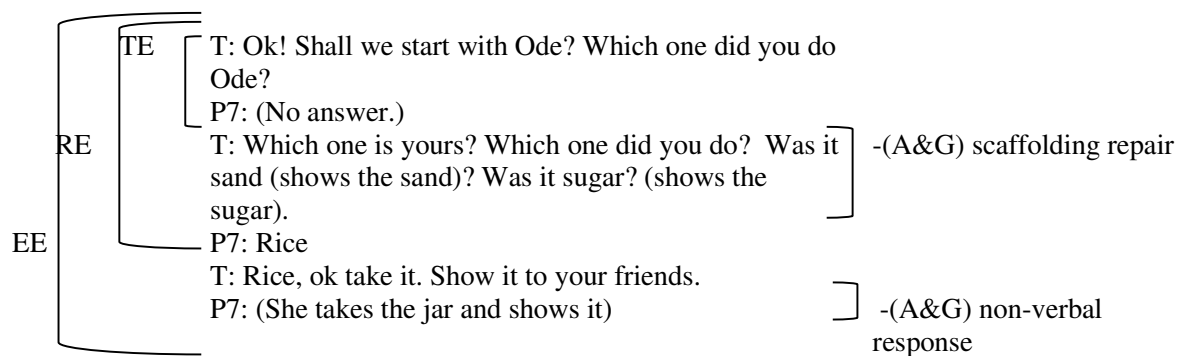

Note. T = teacher, P7 = Pupil 7, TE = truncated exchange, RE = relaunched exchange, EE = extended exchange, A&G = artefacts and gestures.

The videotaped data clearly illustrated that the teacher's constant recourse to the objects and gestures contributed to the learner's comprehension and the natural flow of the dialogic exchange. The time interval between the teacher's and the learner's moves was natural, and the learner's reaction was free from any frustration. Although the exchange was short and the linguistic content (lexical and grammatical) modest, the exchange was linguistically appropriate and corresponded to the maxims of social interaction. This simple exchange in Extract 14 illustrates how the robust pragmatic dimension of an exchange could make up for linguistic simplicity. The situation was appropriate for the use of short language forms and pragmatic strategies, both functional and interactional.

Throughout this concept-building stage, the teacher used the artefacts to help compensate for the learners' lower-level English. In this particular exchange, the teacher used A&G not only to present a new concept but also to mediate student learning and to encourage learner participation while clarifying the 'solubility' concept. Although the interactional exchanges were simple and the learners' abilities to converse in the AL were highly limited (e.g., the use of non-verbal elements

and one-word utterances), the evaluation of the video material, both during the teacher scaffolding and the autonomous task stage, indicates that the interactional exchanges were natural and that the learners seemed interested throughout the lesson. When we look at the transcripts in isolation, without viewing the video recording, we observe traditional teacher-led IRF exchanges. However, in the actual learning process, the activities took place in the ZPD with the support of the teacher who engaged the learners' interest and simplified the tasks through the use of artefacts, demonstrations, and modelling (see Extracts 13 and 14 above extract 15 below).

Extract 15. The role of A &G in teacher scaffolded dialogue

Extended exchange (EE)

EE	<p>T: We'll mix them (with water) and you'll tell me if they are soluble or insoluble. Now look at me. (takes a spoon), (takes some sugar) ... (invites Ps with a hand gesture to talk)</p>	} -(A&G) scaffolding during elicitation
	<p>Ps: sugar</p> <p>T: and then I put it in a ... (touches the jar)</p>	} -(A&G) scaffolding during elicitation
	<p>Ps: jar</p> <p>T: Look! Can you see any sugar? (Points the bottom of the jar).</p> <p>Ps: (some Ps) Yes-- (some Ps) Yes, I do. (some Ps) nod</p>	} -(A&G) scaffolding during concept building
	<p>T: Now I... stir it (demonstrates it). Stir it ... stir it ... stir it... (Teacher's repetition of the word 'stir' makes children laugh) .</p>	} -(A&G) scaffolding during instruction giving
	<p>T: Where's the sugar? Can you see it? (shows the jar)</p>	} -(A&G) scaffolding during elicitation/concept building
	<p>T: it is ... Sugar is ...</p> <p>Ps: Soluble</p> <p>T: in ... (points at the jar)</p>	} -(A&G) scaffolding during elicitation
	<p>Ps: water.</p> <p>T: Sugar is soluble in water. Good.</p>	

Note. T = teacher, Ps = pupils, EE = extended exchange, A&G = artefacts and gestures.

Extract 15 exemplifies how the teacher used supportive dialogue to direct the learners' attention to the key concepts of learning using A&G in successive steps. Throughout this concept-building stage, the teacher used the artefacts to help compensate for the learners' lower-level English. In this particular exchange, the teacher used A&G not only to present a new concept but also to mediate student learning and to encourage learner participation while clarifying the solubility

concept even though the interactional exchanges were simple and the learners' abilities to converse in the AL was highly limited (e.g., the use of non-verbal elements and one-word utterances). The evaluation of the discourse using Grice's maxims illustrated that the exchanges complied perfectly well with the cooperative principles of discourse. The evaluation of the video material, both during the teacher scaffolding and the autonomous task stage, indicates that the interactional exchanges were natural and that the learners seemed interested throughout the lesson.

The overall results obtained from this CLIL research data indicate that the activity design that we used contributed to fostering meaningful use of A&G, which in return (i) provided scaffolding for learning, (ii) extended dialogical exchanges, and (iii) contributed to the amelioration of communicative quality and the fluency of the dialogic exchanges.

The post-task discussions with the learners in their L1 plainly indicated that the learners understood the scientific concepts conveyed through collaborative exchanges, regardless of their breakthrough level English. The tasks were executed almost without any need for recourse to the L1, and this gap was filled with the extensive use of A&G. My overall data analysis has demonstrated that 62% of the collaborative dialogue (478 moves) in three CLIL lessons observed was in the form of EE.

Whenever there was a communication break, the exchange was relaunched through the use of A&G. The analysis of the data clearly indicates that without the use of A&G, the majority of the exchanges would have been truncated exchanges with constant communication breaks. Although the learners' target language level was low, the activities were carried out via natural dialogic exchanges, and new concepts were constructed using successive scaffolding techniques with an extensive A&G support.

1.53 Discussion and conclusion

Close data analysis indicates that the learners being surrounded by artefacts during the science experiment provided them with rich and easily accessible scaffolding opportunities. In some cases, although the learners did not have the necessary language skills, they were able to respond to the demands of the exchange by simply giving a non-verbal response, for example, by demonstrating with objects such as filling the jar or following the teacher's instructions and mixing the ingredients or by simply pointing and nodding their heads.

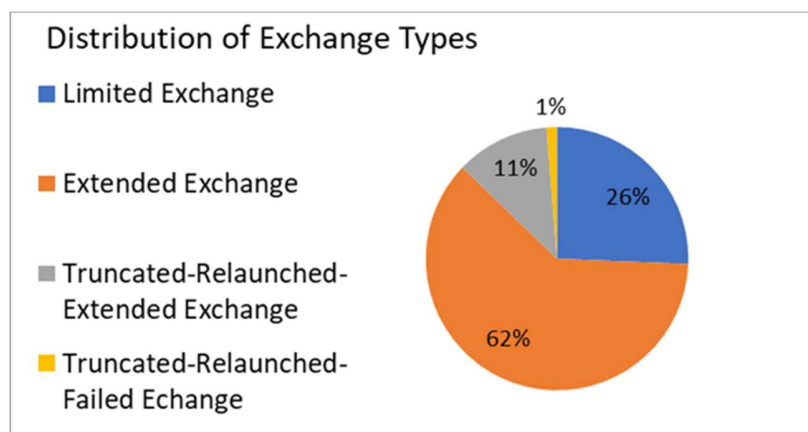
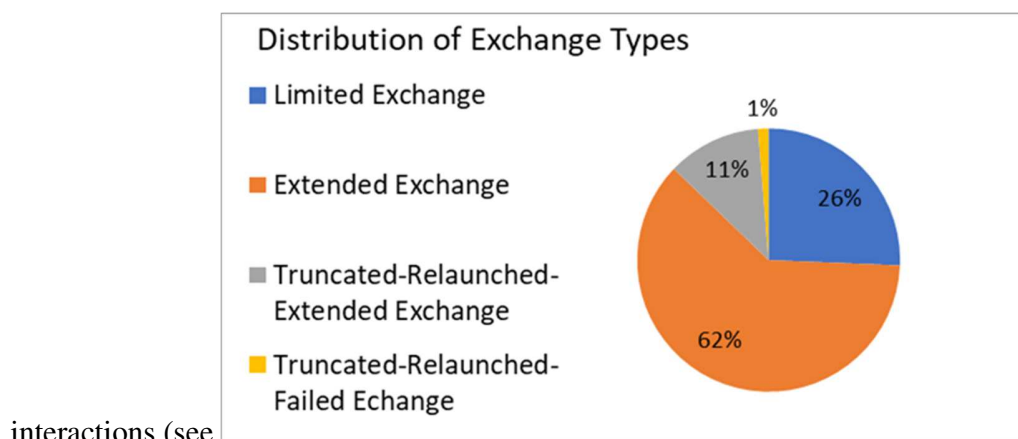

Figure 41. Learners' use of A&G to scaffold dialogic exchanges in CLIL.

The discourse analysis that I carried out displayed that the learners used A&G to make their meanings clear and to give and receive help. The results I obtained via this research study indicate that the use of A&G can (i) extend dialogic exchanges and improve the communicative quality of



interactions (see

Figure 41), (ii) scaffold learning efficiently, (iii) elicit learner responses, (iv) help teaching instructions, (v) contribute to building new concepts, (vi) provide experiential learning and hands-on experience, and (vii) sustain joint attention during learning tasks. This research study confirmed my previous observations and suggested that the use of A&G is an area I should focus more on.

CLIL study III

1.54 Introduction

Study III¹⁰⁵ (two work packages) was conducted as part of the Maeha'a Nui project (2015-2016) in collaboration with some teaching professionals in primary education and researchers from UPF. The overarching objective of this cooperative work was to create a dynamic multilingual space (using Tahitian, English, and French) within a state school situated in Tahiti. The project contained both research and non-research activities and involved various teaching professionals, parents, and the school staff, who were the potential users of the Tahitian language.

The non-research activities were in the form of extra-curricular activities that aimed at providing the pupils with additional exposure to both their L1b (Tahitian) and the AL (English) as out-of-class activities (see Figure 42).

¹⁰⁵ The content of this section is a shortened and slightly modified version of one of my published articles (see (Gabillon et al., 2016))

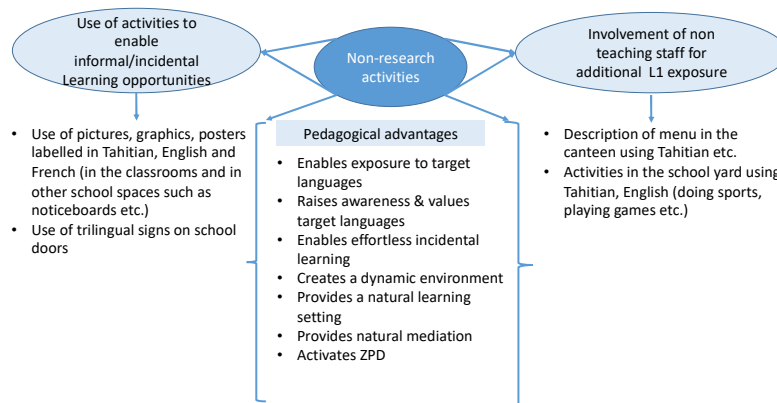

Figure 42. Non-research activities implemented during the project.

The first type of activity included the use of posters, signs, pictures and so forth labelled in Tahitian (L1a – the first socialization and home language for many students), English (AL) and French (L1b –the language of instruction and the official language). These kinds of activities, although simple in nature, provide informal peripheral learning opportunities that favour effortless incidental learning (Hulstijn, 2013; Lave & Wenger, 1991) and contribute to the dynamism of the learning environment (see also Kusyk & Sockett, 2012; Sockett, 2011; Sockett & Toffoli, 2012; Toffoli, 2020 for informal learning environments).

The second type of non-research activities included the school staff such as canteen workers, cleaners, and the caretaker to engage in interactions with the pupils in their first language (i.e., Tahitian). For instance, an MA student (as part of her MA project) worked together with a pedagogical advisor to guide the canteen workers on how to announce the menu in Tahitian and then they observed the worker’s interactions with the children. In the same vein, the project proposed activities involving the school staff speaking to children only in their first language while the food was served or playing games in the schoolyard during the playtime. Using activities in such natural settings provided social mediation and effortless learning opportunities (Chaiklin & Lave, 1996; Engeström, 1999; Lave & Wenger, 1991).

The third activity concerned parents’ involvement in their children’s language learning development (see Figure 43).

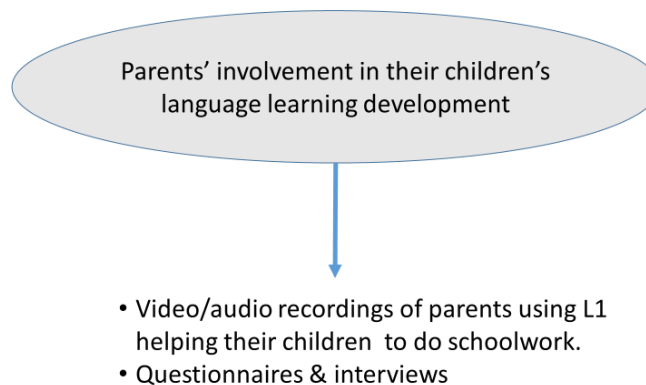

Figure 43. Parents' involvement.

Before the project, a pedagogical inspector and some pedagogical advisors had a meeting with the parents. The objective of this first meeting was to inform the parents about the project and to raise awareness about the positive effects of plurilingualism. During this meeting, the parents were encouraged to communicate with their children using Tahitian. The parents were also interviewed for research purposes. The fourth activity concerned training activities for the participant teachers, parents, and the school staff. One of the objectives of the project was to provide the participating teaching professionals and other school staff with training on plurilingualism (see [Section 12.1](#) for teacher training projects and activities). My role within this multilingual project, among other learning-related plurilingual activities, concerned primarily CLIL research and teacher training. In this new project, I wished to continue building on the previous CLIL studies. After each CLIL lesson, post-implementation discussions were held with the teachers during which the teachers made an analysis of their experiences and discussed their ideas with us. Then the content of these lessons, the results of the discussions, the interactions, and the learners' reactions were compared.

1.55 CLIL as part of the Maeha'a Nui project

I implemented my CLIL research as a sub-project within this all-encompassing multilingual project.¹⁰⁶ The study aimed (i) to experiment and identify effective methodologies for CLIL teaching and (ii) to train teachers and pedagogical advisors on the use of innovative techniques in

¹⁰⁶ I obtained Bonus Qualité Recherche (BQR) funding for this CLIL project. BQR is research funding given to individual researchers by their university.

foreign (English) and heritage (Tahitian) language teaching. I contributed to the data collection at all levels but analysed and reported only on CLIL (English).

The study took place between 2015-2017 and consisted of two work packages (see Gabillon & Ailincal, 2015a; Gabillon et al., 2016). This time the learners were younger and had almost no prior EAL experience. The study used the CLIL approach to teach science and mathematics lessons using English.¹⁰⁷ The overall objectives of this CLIL project were as follows:

- To identify effective teaching methods suitable for CLIL practices within a primary school context.
- To observe the role of different types of interactions/exchanges used in the lessons observed.
- To study the balance between content teaching and language teaching (i.e., English/Tahitian).
- To train teachers on effective implementations of the CLIL approach within a French Polynesian context.

This project involved a plurilingual research design including both English, the AL, Tahitian, the autochthonous language (i.e., home language), and French, the language of schooling and the wider community. The children who attended the school were bilingual¹⁰⁸ (French and Tahitian) and learned English as an AL in school. Within this plurilingual language learning context, the role of Tahitian had a different status because many children were not proficient in Tahitian. This multilingual project based its principles on solid theoretical standpoints that included (i) sociocultural theories, (ii) Cummins's common underlying proficiency (CUP) model (Cummins, 1980), (iii) the notions of additive and subtractive bilingualism, and (iv) the literature concerning AL pedagogies (see also [Chapters, 4, 5, 6, and 7](#)). These principles are summarized in Figure 44.

¹⁰⁷ CLIL using Tahitian was also part of the project. The study was conducted by other researchers and is not described in this manuscript.

¹⁰⁸ The learners had varying degrees of proficiency in Tahitian.

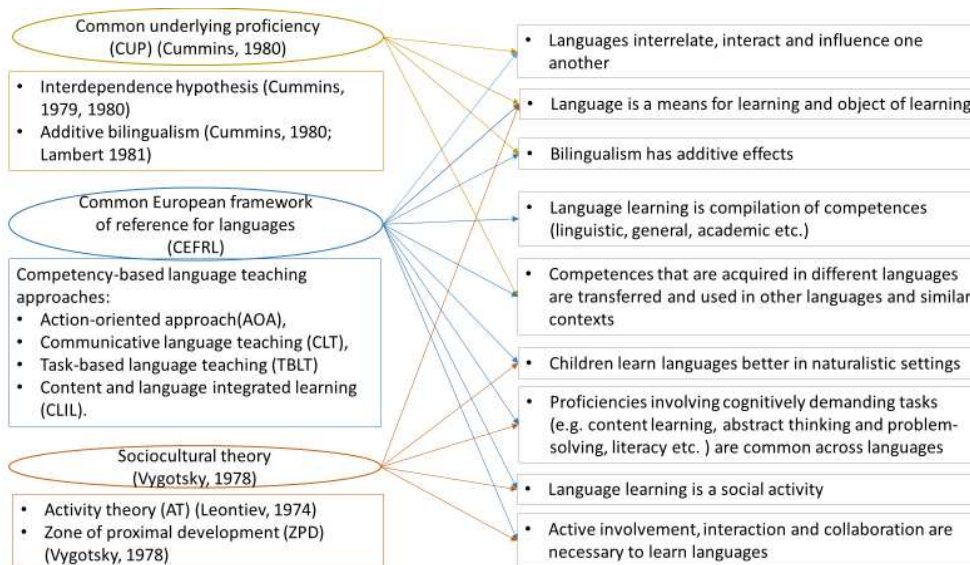

Figure 44. The theoretical underpinnings and principles which supported the project.

1.55.1 CLIL Study III (work package 1)

During this study I worked with two volunteer elementary school teachers and their pupils. Both teachers were female. Teacher 1 (T1) had five years of primary school and a year of English language teaching experience. She did not receive any formal training on AL teaching and perceived her level of English as adequate but added that she was not always at ease when she used it with native speakers. She believed that learning English was important for her pupils. Teacher 2 (T2) had seven years of teaching and five years of English language teaching experience. She stated that she had a sufficient level of English to teach at the primary school level. She also stated that she did not receive any training on any approaches specific to AL teaching.

In the first work package, two groups of 26 pupils ($N = 52$) participated in the study. The students were 7- and 8-year-old French Polynesian children. The children were much younger than the children we had in the previous CLIL implementations. Identical CLIL lessons (in science and mathematics) were repeated in both English and Tahitian. The CLIL sessions were prepared by the teachers in collaboration with the pedagogical counsellors (for Tahitian and English). Figure 45 represents the action plan that I followed in this first work package.

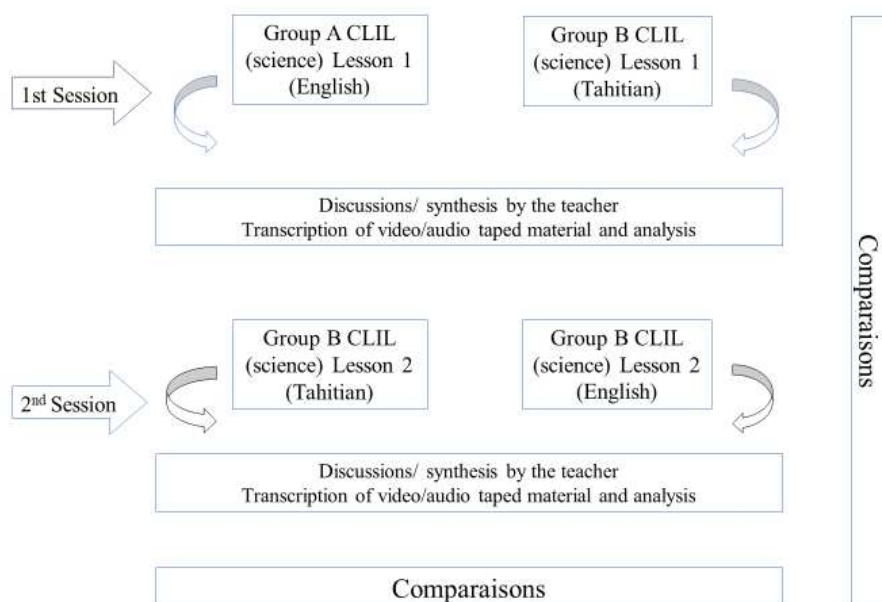

Figure 45. CLIL experimentation cycles in English and Tahitian.

The data were analysed using both qualitative and quantitative data analysis methods. The exchanges, which were recorded and then transcribed using an adapted version of Jefferson's

transcription notation system (Jefferson, 2004). The transcribed data were then analysed using inductive iterative coding procedures. The results were presented using qualitative interpretive methods and descriptive statistics (e.g., histograms, charts, tables using percentages and mean scores).

In my previous CLIL studies, I was able to apply the principles of CLIL pedagogies and build these principles into a consistent framework. During this project, I observed that the CLIL research results (English and Tahitian) were less satisfactory than those of the previous studies that I conducted. In the beginning, I attributed this to the teachers not being proficient in English (and Tahitian) and not having had enough experience in AL teaching nor any in-service training on AL teaching and the participating pupils being younger (7-8 years of age) and having had very little (almost no) experience with English before the CLIL project.

The sessions (English and Tahitian) of the first research cycle were about healthy eating, on which the teachers had already started a sequence in French, and the learners had some prior knowledge regarding the language structures and the vocabulary items in English. The activity aimed to ask pairs to compose their plate with different food types and explain what they had on their plates (e.g., 'on our plate we have a ...') and why they had chosen them: 'We like papaya but we don't like ...'. My further analysis indicates that the activities used in these lessons did not follow the principles that I proposed via my socially mediated activity model. The problems encountered can be summarized as follows:

1. The activities were based on traditional exercise models (e.g., the use of flash cards labelled with names of objects).
2. No collaborative tasks involving learner participation were used when they were preparing their plates (e.g., asking learners to choose fruits and vegetables together by expressing what they like and dislike 'I like apples, I don't like bananas')
3. Interactional exchanges were not in conformity with natural social exchanges. The teachers used mechanical IRF patterns based on traditional teacher-learner exchanges followed by feedback (corrections etc.).
4. Learners were asked to raise their hands before speaking, which hindered authentic communicative exchanges and active participation of learners and discouraged shy learners from taking risks.

5. The learners were not given purposeful tasks with clear objectives that required reflection, manipulation, and language use. They simply put the flashcards on their plates.
6. There was an imbalance between the content and language teaching. The lessons were rather traditional AL lessons with mechanical exercises. During the feedback children simply read the names of the fruits and vegetables on their plates and repeated mechanically for instance ‘On my plate I have apples. I like apples.’

These two sessions did not succeed in creating a natural/authentic learning environment and did not promote natural exchanges based on the real communicational needs that I observed in CLIL experiments. One of the teachers’ instructions were based on constant translation that hindered learner reflection and strategy use (e.g., guessing meaning from context). Both teachers preferred lengthy explanations in French rather than scaffolding techniques with successive stages of concept building that could help learners think about language and concepts. However, the practice of translanguaging between learners to mediate each other’s learning was not allowed by the teachers. My observation of these translation practices led me to reflect on the difference between the use of pedagogical translanguaging for reflection and mediation and the use of translation to move things forward without much reflection.

1.55.2 CLIL Study III (work package2)

I have continued the project with the same group of learners and the same teachers, but I have strengthened my collaboration with the teachers. I organized workshops and feedback sessions with teachers and relaunched the CLIL cycles. This time I decided to do a CLIL mathematics lesson with the pupils. Learning the names of numbers in English was part of the curriculum. I wanted to contextualize the learning by introducing both numbers and mathematical operations such as

addition, subtraction, multiplication and division, which learners are used to doing as part of their school ritual'¹⁰⁹ every day.

During this second cycle, I adapted my CLIL framework for mathematics lessons by following the common conventions used in mathematics lessons. The teachers used authentic measuring tools and other authentic objects available in the classroom that were commonly used with young children during mathematics lessons. Simple artefacts such as an abacus or cards with mathematical symbols, counting beans, and so forth were suitable enough to replicate the conventions used in mathematics lessons. The results were satisfactory. We obtained sessions with active learner participation with natural and meaningful exchanges. During this second cycle, I was able to observe motivated learners who were able to have meaningful exchanges with their peers and the teacher and carry out autonomous tasks.

Extract 16 is a short episode of interactions taking place between the teacher and the learners in a small group (12 students aged 7-8). We observe that during the activity, the learners are attentive and even are able to correct the teacher's slipups. At first glance, these exchanges seem to be part of a mechanical IRF pattern through which the learners answer the teacher's questions and in return the teacher provides them with corrective feedback. However, in the actual learning setting the situation is the opposite. The learners and the teacher are sitting together in a circle. The group consists of 12 participants. Asking questions is not reserved for the teacher. Both the teacher and the learners ask and answer questions. The teacher is both the participant and the more experienced other who acts as a referee, a resource person, and a knower (if necessary). In Extract 16, we see that a learner corrected the teacher's mistake when the teacher gave an incorrect answer to one of the questions asked by a student.

Extract 16. A teacher-led activity in a small group of 12 students.

S1 : Eight plus...two [Unclear overlapping speech]. ((Other students are speaking in French in the background.))

¹⁰⁹ This is the direct translation of the French expression '*rituel à l'école*', which refers to a repeated moment of activities of short duration at the beginning of each day (5 to 10 minutes) on topics/subjects that learners need practice frequently until they master certain skills that they need to use regularly at school or to function in society (the date in English, French, and Tahitian; mathematical operations; important events; etc.).

S4 : Two? ((asks if the last number is two))

T : Is... ((the teachers requests the student to use 'eight plus two is...'))

S1 : Ten.

T : ...Is ten. Very good!

S6 : Perfect. ((behaves like the teacher))

T : Perfect ! Good. Qui à dit 'perfect'? ((S6 raises his hand.)) I like... ((The teacher shows the students another flashcard.))

S7 : Four plus five is...errr:::

T : Is twelve ((the teacher answers the student's question)).

S6 : Nine! [S4: Nine! S2: Nine, Ss: Nine!]

T : It's nine.

S3 : Twelve? ((asks the teacher if the answer is twelve as the teacher said earlier))

T : Twelve? It's not correct? It's not correct? Twelve? ((The teacher corrects her slipup))

S6 : Yes.

T : It's correct 'twelve'?

S6 : No. [Ss : No!]

T : No, no it's not. Yes, Yes ((Teacher points to S6 in agreement.)) You're right.

S6 : C'est moi qui a dit 'nine'. C'est elle qui a dit 'twelve'. ((S6: 'It's me who said nine and she (teacher) said twelve'. Indicating that the teacher made a mistake.))

T : It's me. ((Teacher giggles loudly, accepting that she made a mistake.))

The transcribed data provided us with interesting episodes of negotiation of meaning (and form) and purposeful translanguaging practices used during peer mediation (peer scaffolding). Extract 17 presents a short excerpt which illustrates how learners (7-8 years of age) do mathematical operations in a playful manner during an independent group task (in a group of 8). In this excerpt, we can also observe the extent to which learners listen attentively to their peers' productions and support their learning (see Extract 17).

Extract 17. An episode from a student-led CLIL mathematics activity.

S6 : Eight times two...((Looks around and ...))

S2 : Is...((Reminds that he should use 'is' and let his peer complete the sentence. This is what the teacher often does))

S6 : Is...

S6 : Teanua (Addresses S1 by calling out her name.)

S1 : Sixteen?

S6 : Yes, very GOOD!!! ((Imitates his teacher.)). ((We do not see the teacher, but we hear her giggles.))

S2 : Elle a dit six...((She said six...))

S6 : Teen:: ((He confirms that she (S1) said sixTEEN and not six.))

S2 : Teen? ((Asking for confirmation.))

S6 : (Nods his head in agreement and S2 seems to be accepting)

Ss: ...[Unclear overlapping speech]

S6 : Tiens! ((Take!)) (Passes the box of flashcards to S1.)

S6: ((Turns to the camera.)) One plus one! ((He smiles amusingly))

1.56 Discussion and conclusion

The results obtained in the second cycle of CLIL 3 were consistent with the results of my previous CLIL studies. In the second phase of this study, I was able to observe the applications of socially mediated activities and improve the SMA framework that gradually emerged over the course of my CLIL studies (see [Section 16.2](#)).

The results of the study suggested that the activities used would promote better learning conditions if the classroom organization allowed learners to see each other and do tasks jointly. This experience has shown that when there are more than 12 participants in the group, establishing joint attention and collaborative work becomes difficult. Teacher-led activities, if they are performed in small groups, can become powerful scaffolding tools. In such small-group activities in which the teacher is present, the teacher can have different roles, such as a participant or an expert who provides scaffolded help. Our observations have demonstrated that these teacher-led activities work best when the group size is 10 to 12 participants at most. In classrooms of 25-30 pupils this can be done by dividing the class into two or three groups: one teacher-led activity and one or two independent group or groups. Such small-group tasks are suitable for creating an environment for natural interactional exchanges (without raising hands), manipulating objects within their reach and use, and sustaining joint attention. Regarding L1 use, my observations indicate that learners should be encouraged to use the AL, but L1s should not be prohibited, and the learners should be

Conclusion

The CLIL studies helped me to develop the SMA framework which applied the principles expressed by the sociocultural and socio-interactionist perspectives (Gabillon, 2019). Our experiments with young beginner-level learners indicate that teaching a school subject in mainstream AL classes can work best if the activity designs and implementations (i) are adapted to the learners' language proficiency levels, (ii) correspond to the learners' needs and ages, (iii) are aligned with the characteristics of real-life activities that require a task to be accomplished in collaboration with others, and (iv) are accompanied with A&G that help mediate learning (Gabillon, 2019; Gabillon & Ailincăi, 2015a, 2016, 2017, 2020, 2021; Gabillon et al., 2016). Table 12 summarizes these principles.

Table 12. Socially mediated activity (SMA) framework.

Collective mediation	Learning is an active and constructive process where learners (and the teacher) collectively construct new information through collaborative interaction and joint attention.
Joint attention	Activities are goal-directed and require learners to work together to fulfil tasks.
Collaborative interaction	Activities encourage natural face-to-face pair/group interactions. This type of collaborative interaction uses language as a means to exchange information and construct knowledge.
Social artefacts & gestures	Activities use A&G to mediate learning.
Experiential learning	Activities provide learners with hands-on activities to enable learning through direct experience (e.g., laboratory experience, and gardening).
Naturalistic learning environment	Activities allow learning to take place in naturalistic learning settings (e.g., laboratory experiments in labs, and gardening outside).
Active involvement	Activities enable each individual learner's active participation to complete tasks.

During the CLIL studies in which I participated from 2011 to 2018, I experimented with and improved the SMA framework. The results obtained from these studies have shown that learner participation and cognitive engagement can be enhanced if all of these above mentioned elements

are integrated into the design and implementation of CLIL lessons (Gabillon, 2019; Gabillon & Ailincăi, 2013, 2015a, 2016, 2017; Gabillon et al., 2016).

CHAPTER ELEVEN

EAL STUDIES

Introduction

The research work that I have carried out in mainstream EAL settings took place between 2014 to 2018 (see Gabillon, 2019; Gabillon & Ailincăi, 2017). These studies used video-recorded corpora gathered via the PrEEPP project (see Section 1.1.5 for information on the PrEEPP project). The studies conducted in mainstream EAL classes aimed to explore learning and teaching actions and to identify effective EAL teaching pedagogies used by elementary school teachers. The research methodologies used in EAL studies are similar to those of CLIL studies (see Chapter 9 for research methodologies used). Figure 46 summarizes the research methodologies used in EAL studies.

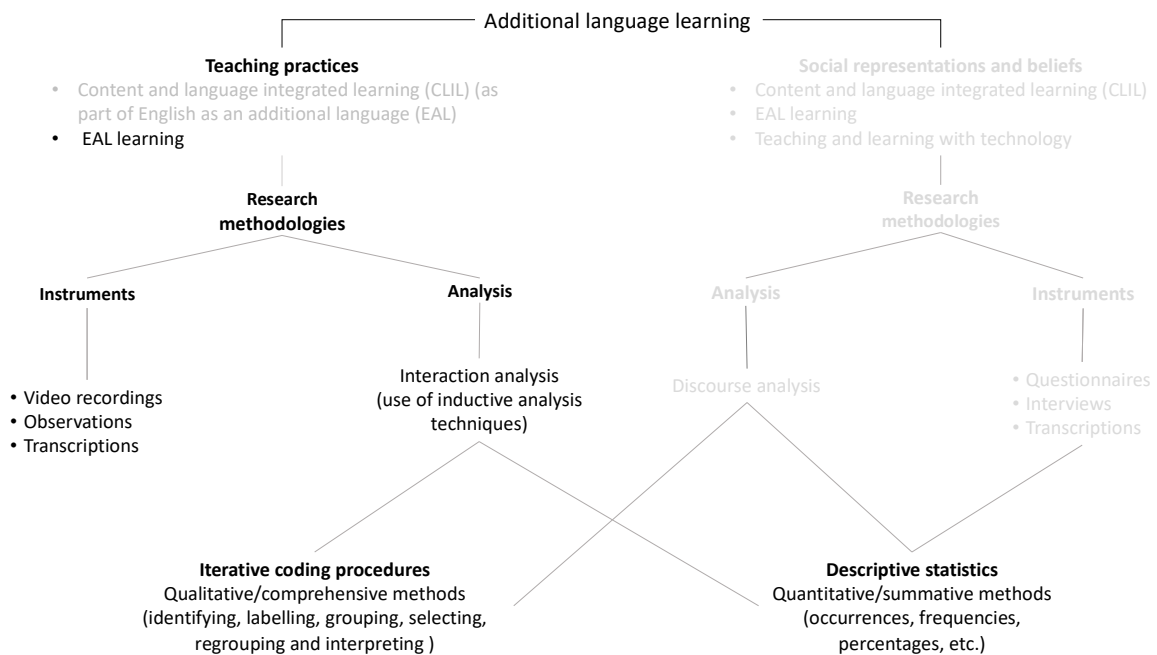

Figure 46. Research methodologies used in EAL studies.

The EAL studies, like those of CLIL, are based on theoretical positions that draw on sociocultural and interactionist perspectives (see Chapter 5). My studies on mainstream EAL have focused on issues related to cognitive learner involvement, learner participation, scaffolding techniques (e.g., corrective feedback strategies, input presentation styles, and peer support), the tasks and types of

classroom organization used, and the observable links between all of these elements. These studies have also examined the effects that the abovementioned elements had on learners. To analyse the different effects of the teaching strategies and task types used, I focused on exchanges with a particular emphasis on learner outputs; for example, I measured the degree of learner involvement, the use of AL, and the types of tasks that allowed for peer scaffolding. We used videotaped data as the primary source of data collection instruments and transcribed and analysed them using coding techniques. These studies employed primarily inductive qualitative methods, but in some cases, they were augmented with summative qualitative methods, such as descriptive statistics, to synthesize results. The data obtained from these studies are also used in my didactic courses to provide first-hand contextualized training data to pre-service teachers.

EAL: Study I

1.57 Introduction

This section presents a shorter version of a published journal article (Gabillon & Ailincăi, 2017). The corpus used in this study was collected from six AL lessons from six different primary schools. This interaction analysis study aimed to (i) discover the common teaching strategies and techniques that primary school teachers employed, (ii) explore the effects teachers' actions produced on learners, and (iii) determine whether teachers' teaching methods were consistent with the principles of current AL teaching approaches. The study employed microgenetic interaction analysis techniques. The transcribed data were examined focusing on both verbal and non-verbal interventions using the qualitative data analysis software ATLAS.ti. The codes were generated by studying both the transcribed data and video recordings. Results were presented using (i) excerpts and interpretations (qualitatively) and (ii) occurrences and percentages on histograms and charts (quantitatively).

1.58 Participants

The study used data obtained from six EAL lessons. The subjects involved in this study were four female and two male elementary school teachers with ages ranging from 32 to 45. These teachers had 8 to 20 years of teaching experience. The video-recorded data contained corpora from 121 elementary school students' interactions. The number of pupils in each class varied from 21 to 27 students. Participants were children between the ages of 7 and 11 with 1 to 3 years of English language learning experience.

1.59 Analysis methods and procedures

The transcriptions were made manually using a transcription notation adapted from the notation system offered by Jefferson (2004). The transcriptions were then imported to ATLAS.ti software for analysis. The initial coding was performed through the use of open codes. After intensive comprehensive and inductive analysis processes (i.e., repeated viewing of the video-recorded material via iterating, coding, linking, comparing, and grouping), I grouped all the exchanges into three main categories: 'teachers', 'learners' and 'types of activities.' All other sub-categories were

grouped under these three broad groups, and the overall results utilized these groups to explain the outcome of this research. I closely examined each transcript and labelled the exchanges according to the functions they performed in each exchange. I tagged the codes primarily using terms from the SLA literature or created the tags myself. I used excerpts to show examples and to support explanations. In addition to qualitative comments and inductive interpretations, a synthesis of the results was presented using the code occurrences (e.g., using histograms).

1.60 Results

Teacher exchanges were grouped into five categories according to their functions. These categories are scaffolding strategies, corrective feedback strategies, EAL proficiency issues, L1 use, and types of activities. Table 13 presents the categories and sub-categories grouped under the label ‘*teacher*’. Other lower-level concepts that represented similar notions have been grouped under these headings.

Table 13. The code group ‘teacher’

Scaffolding strategies	Corrective feedback strategies	Problems related to teachers’ EAL proficiency	Use of L1
Checking understanding	Direct repair	Unattended problem	Operational (e.g., giving instructions, and establishing discipline)
Use of gesture and artefacts	Guided repair	Inauthentic language use	
Asking for repetition	Misleading correction	Incorrect language use	Social
Asking for confirmation			Scaffolding
Asking for information			
Giving explanation			

I grouped the categories that were linked to the learners’ actions under the label ‘learners.’ The concepts that emerged from the coding process formed three categories: (i) active involvement, (ii) passive involvement, and (iii) the use of L1. Other subgroups that are related to these concepts were also gathered as part of these three higher level abstractions. See Table 14 for the codes grouped under the label ‘learners’.

Table 14. The code group ‘learners’

Active Learner Involvement		L1 use			Passive Learner Involvement
T←→S S←→T Teacher-led communicative tasks in small groups	S←→S Learner-led tasks in groups	T←→S S←→T S←→S All types of activities	T←→S S←→T Teacher-led mechanical whole-class activity		
AL/L1		L1			AL
Asking for confirmation Asking for clarification Asking for information Giving explanation Agreeing/disagreeing Giving feedback		Peer scaffolding	Other	Operational	Social Reciting/performing Repeating
Free language use					Mechanical practice

The ‘activity type’ code group organized the various classroom activities along a communicativeness continuum from mechanical to real-life tasks. The analysis has revealed links between the activity types and the seating arrangements used (see Table 15).

Table 15. The code group activity types

Activity Types	Observations	Sitting arrangements	Group size
Whole class	Mechanical or pre-communicative activities	Mostly in rows	25-30
Teacher-led group work (communicative or real-life activity)	Communicative or real-life activities	Circle, or around a table	10-12
Learner-led group/pair work	Varied from mechanical to pre-communicative, communicative, and real-life tasks	Circle, or around a table	2-12

1.60.1 Summary of Results

In this study, the analysed exchanges were mainly in the form of simple repetitions or short question-answer type utterances. Very few of the exchanges were learner initiated. Figure 47 presents the total number of exchanges that occurred in each teacher’s lesson and the duration of each experience. This type of exchange is known as ‘initiation response feedback’ (IRF; Sinclair & Coulthard, 1992; see also Chapter 9). The transcribed corpus and video recordings illustrated that the language exchanges used in these six lessons were short utterances through which the teachers initiated an exchange, asked a student to respond, and then followed up.

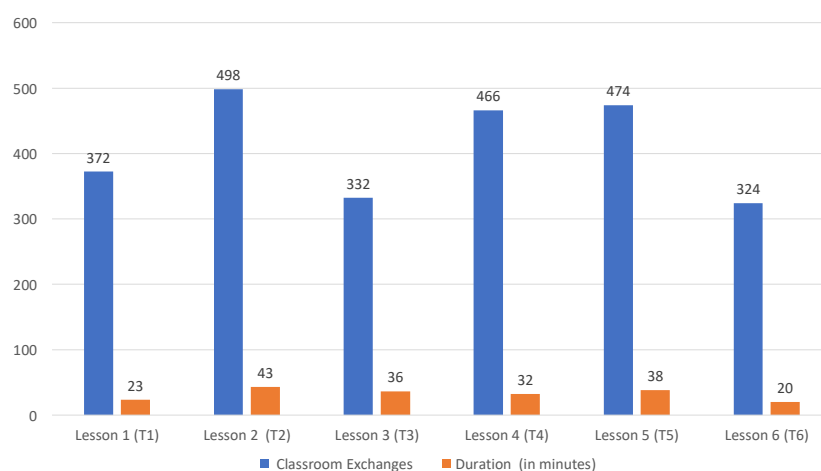

Figure 47. The number of exchanges and duration per lesson (T=Teacher)

Extract 18 illustrates a series of repetition drill exchanges between *Teacher1* (T1) and the students. Extract 19 is also an example of an IRF exchange. In this particular example, the teacher attempts to elicit the correct language form using an IRF pattern. The teacher tries to involve other students in the corrective feedback procedures, but she does not encourage the student to self-correct. She simply asks the student to repeat the correct language form (see Extract 19).

Extract 18. Repetition drill exchanges

T: Ball!
 Ss: Ball! [Ball]
 T: Bicycle!
 Ss: Bicycle! [Bicycle]
 T: KITE!
 Ss: Kite! [KITE]
 T: Doll!
 ((continues)) ...

Extract 19. Mechanical IRF exchanges.

T: Is right? The ball is in the table?
 Ss: Yes
 T: The ball is in? ((She uses a gesture to indicate the position 'in' and looks at the students))
 Ss: On!
 T: The ball is on! Stevens? Repeat!
 S1: The ball is on the table!
 T: Is good ::::: !
 T: ((The teacher shows another picture.)) ...

Note. T = teacher, Ss = students S = student

The use of L1 & AL language exposure

In today's plurilingual AL learning contexts a consensus has formed on the legitimacy of L1 in AL learning environments (Cummins, 2001a, 2008; Dicomilla & Antón, 2012; García & Wei, 2014; Swain & Lapkin, 2000). At the same time, SLA research indicates that successful language learning

requires extensive and frequent AL input (N. C. Ellis, 1998). Thus, many applied linguistic researchers draw our attention to the importance of principled use of L1 in AL classrooms. Figure 48 illustrates the occurrences of L1 utilized both by the teachers and the students. Analysis of the corpus of six participating teachers showed that four out of six teachers maintained the use of the AL throughout their lessons and used the learners' L1 for short exchanges to resolve misunderstandings, give instructions or explanations, and make a joke and on other occasions when needed.

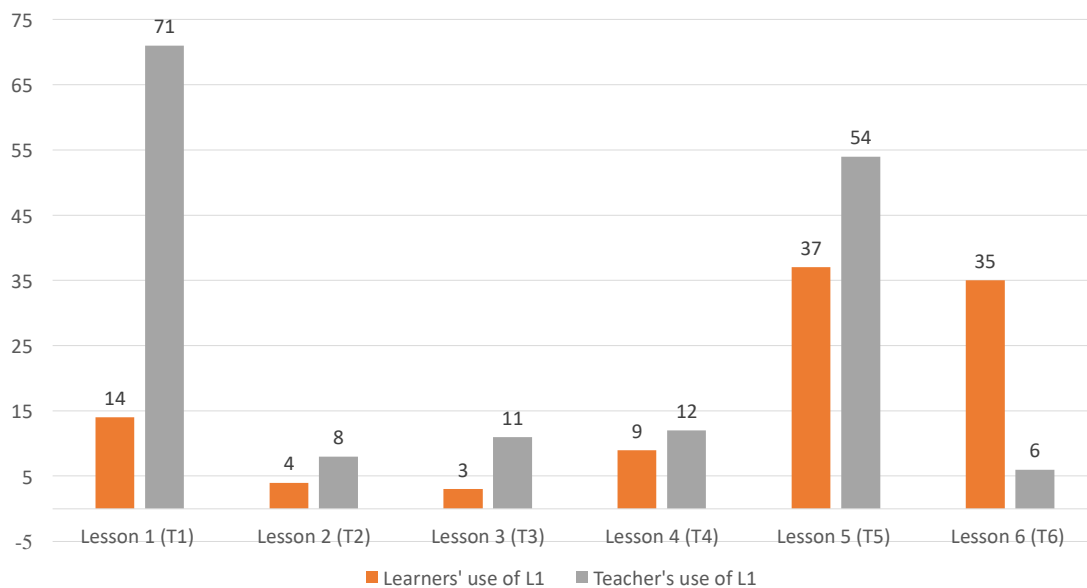

Figure 48. The use of L1 (teacher & learners) (T=Teacher)

The analysis of the exchanges indicates that T1 and T5 both used the L1 extensively during their lessons. In many occasions, T1's use of the L1 did not seem to be necessary, and on some occasions the teacher's interventions in L1 were particularly lengthy. T1's whole lesson was based on translating language items from English to French or vice versa (see Extract 20 and Extract 21).

Extract 20. Mechanical translation.

S2: Sac, bag!
 T: Sac ((bag)), the bag. Tout le monde est d'accord ? ((Does everyone agree?)) ((The teacher writes the words in French and in English.))
 Ss: Oui! ((Yes !))
 T: Tout le monde répète ((Everybody repeat)): bag !
 Ss: Bag!
 T: Autre chose peut-être ! ((Perhaps another thing!))
 T: Kahea? ((The teacher points to Kahea))

Extract 21. Mechanical translation

T: Bien! Poupée ((Well! Doll)), a doll! A vous! ((You!))
 Ss: A doll!
 T: On passera à la prononciation ensuite. ((We will then proceed to pronunciation.))
 T: Alors ! Yo:::yo? Alors ça pourrait être quoi ? Je ne fais pas le niveau difficile normalement le matin. ((Well! Yo:::Yo! What could it be? Normally, I do not do the difficult level in the morning.))

S9: °°° (Unclear speech)
T: Plus fort ma puce. ((Louder))	T: Allez ! On fait un petit rappel, ce ne seront pas long, on va voir si vous vous en rappelez. ((Come on, we (will) do a little revision, it will not be long, we'll see if you remember.))
S9: Table...	T: C'était une des premières séances de l'année. ((It was one of the first sessions of the year.))
T: Table! Est ce que c'est bon ? (('Table'! Is it correct?))	T: En français Yo-yo en anglais yo-yo. ((In French, it is yo-yo. In English, it is yo-yo.)) ((The teacher writes the words on the board.))
Ss: Oui! ((Yes!))	T: En français puzzle en anglais puzzle. ((In French, it is puzzle. In English, it is puzzle.))
((Some students keep their hands up. They are waiting for the teacher to ask them to speak.))	T: En français robot en anglais robot. ((In French, it is robot. In English, it is robot.))
T: Répétez ! Table! ((Repeat ! 'table'))	T: En français table en anglais table ! ((In French, it is table. In English, it is table.))
Ss: Table!	

Note. T = teacher, Ss = students, S = student

However, T5 used translanguaging moving between L1 and AL to help learners to understand complex instructions, to explain the purpose of the task, to check understanding, to socialize with her students and to manage the class. When using complex language forms and vocabulary in English, she encouraged students to respond in French to check their understanding of the instructions (see Extract 22 and Extract 23).

Extract 22. Bilingual instruction giving

T: You will write the message to them. So, let's try today.
T: Qui a compris là ce que je viens de dire ? ((Who has understood what I've just said?))
Ss (some): En fait on va écrire une lettre. ((In fact, we will write a letter.))
T: By computer.
Ss (some): On va écrire une lettre ! ((We will write a letter.))
T: By computer! ... [S: J'ai déjà vue. ((I have already seen it.))]
Ss (some): On va écrire un mail. ((We will write an e-mail.))
T: Can you repeat (Canny)? Listen!
T: Calyssa, repeat, please?
S: On va leur envoyer un mail. ((We will send them an email.))
T: On va leur envoyer un mail. ((We will send them an email.))

Note. T = teacher, Ss = students, S = student

Extract 23. Translanguaging

T: So... Who is ready to write? Who is ready to write? ((She mimes meaning that they should write.))
T: Qui est prêt? Qui est prêt, déjà ? ((Some students raise their hands.)) Are you sure?
T: Sûr? Sûr? [Unclear and overlapping speech.]
S: Moi!° Moi!° [Me! Me!]
T: Wait a minute...prêts ? (ready?) Can you.... Yes? Can you give me some example?`
Ss (some): Cochone ((Pig))?
T: (hhh) aii aie non !
T: So...
Ss (some): On va regarder dans le dictionnaire ! ((We will look it up in a dictionary.))

The corpus indicates that during T5's and T6's lessons the learners used the L1 more than the students in other teachers' classes (except T5's class; see Figure 48). In T6's lesson, the students were engaged in a group activity (the students were 7 years old, and most of the time the teacher was not present with the students). Analysis of learners' interactions showed that the learners were 'at task' most of the time and used the L1 mainly to negotiate meaning, to give explanations to their classmates, and to show agreement or disagreement. The L1 was also used by learners as a tool to help them make sense of what they were doing. The interactional exchanges that took place were all related to the task (see Extract 24 below).

Extract 24. Learner translanguaging

S4: Sais pas comment on dit les grands nombres. ((She does not know how we say big numbers.))

S6: (Addresses S1 by calling out her name.)

S1: Sixteen?

S6: Yes, very good. ((Imitates his teacher.)) ((We do not see the teacher but we hear her giggle.))

S2: Elle a dit 'six' ((She said six....))

S6: Teen:: ((He confirms that she (S1) said sixteen and not six.))

S2: Teen? ((Asking for confirmation.))

S6: (Nods his head in agreement.)

Ss: ... [Unclear overlapping speech]

S6: Tiens! ((Take!)) (Passes the box of flashcards to S1.)

Note. S = student, Ss = students

Scaffolding strategies used by the teachers

The results obtained illustrated that the teachers mainly used the following scaffolding strategies: asking for clarification, asking for confirmation, asking for repetition, giving explanation, asking for information, and use of artefacts.

Asking for clarification refers to a strategy that the teacher employs to help learners make their meaning clear. The teacher may also use this strategy to check learners' understanding. The primary function of this strategy is to make sure that the learners have understood the phenomenon in question. When used efficiently, the asking for clarification strategy can promote active cognitive learner engagement. The analysis indicated that, except for T4 and T5, the teachers did not use this strategy frequently.

In this study asking for confirmation refers to the teacher's request for confirmation to make sure that learners mean what they intend to say. In some cases, this strategy may be used as a recast (guided repair), which is employed to direct the learner's attention to a mistake, and by asking for confirmation the teacher gives them the opportunity to correct themselves. These two functions are interrelated, and sometimes it is difficult to separate one from the other.

In this study, the term asking for confirmation is used to refer to these two functions. The analysis revealed that this strategy was primarily used as a repair strategy to indicate to learners that they committed an error. In AL learning settings, these teaching strategies may differ depending on the requirements of the situation and the intended purposes. For instance, asking for repetition may take diverse forms such as rote repetitions of words, clarification requests to resolve misunderstandings, and asking for repetition to hear better. In the lessons I observed, the asking for repetition function was used as a rote learning technique that was performed mechanically. The corpus illustrated that some teachers employed this strategy frequently (e.g., T1 and T3).

Giving explanations is the most commonly used and known teaching strategy. However, when it is used frequently and interminably this technique can lead to minimizing useful student talking time (STT). Some examples from T1's and T2's lessons illustrated frequent and lengthy explanations, many of which could have been avoided through the use of examples, contextualizing, and the use of A&G.

The category labelled asking for information refers to any form of a request to obtain information or response from the students. Asking for information can be in the form of a simple question, elicitation, or brainstorming that necessitates a response from the learner. In the lessons I examined, this strategy was predominantly used to get either mechanical or controlled responses from the students. These responses were mostly in the form of short or one-word answers (most often used by T1 and T2).

The A&Gs were exploited by all the teachers observed. Mostly the teachers used this strategy to teach vocabulary items through the employment of flashcards, PowerPoint slides, pictures, and objects. We did not observe other creative use of A&G. Activities such as real-life tasks, the use

of total physical response (TPR)¹¹⁰ and A&G to supplement instructions was not observed in the analysed lessons (see Figure 49).

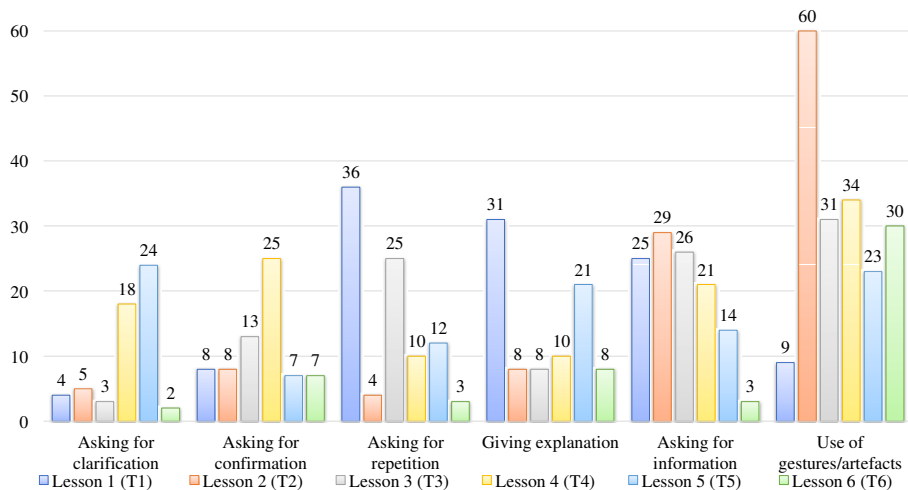

Figure 49. Scaffolding strategies used by the teachers (T = teacher)

Results also indicated that learners were not encouraged to use A&G to help them communicate. They were encouraged to respond to the teacher only verbally, and the non-verbal aspect of expression was limited (or not accepted).

Corrective feedback strategies used by the teachers

Corrective feedback, that is, how teachers ‘repair’ their students’ language errors, has been one of the most-researched SLA topics (R. Ellis, 2009). Corrective feedback is an integral part of AL learning. It is a technique that teachers use to engage their students in the process of negotiation of meaning and form during interactional exchanges. Research on AL learning has shown that repair (error correction) can be used as a learning tool if it is done effectively. A recast that draws the learner’s attention to a faulty language output is viewed as an effective strategy to help learners notice the gap between their language production and the target language form. This strategy is known as an implicit error correction technique through which the teacher encourages the learner to self-repair. The recast technique may also be used to encourage peer correction if the student

¹¹⁰ TPR is a demonstration-based AL teaching method first introduced in the applied linguistics literature by James Asher (1969; cited in Richards & Rodgers, 2014).

cannot manage to self-repair. The direct correction technique, which was widely used in former AL teaching methodologies (the audio-lingual method, which was based on the behaviouristic approach), is no longer recommended by current AL teaching pedagogies. This type of correction strategy does not allow learners to reflect on their mistakes and understand what their mistake is and why there is a mistake. During corrective feedback, it is also important that the purpose of the correction is understood by the learner (that the correction should not be misleading).

The results I obtained through the analysis of the video recordings and the transcriptions indicate that the participant teachers had a tendency to use guided repair strategies (see Figure 50). In some other circumstances, the repair strategies the teachers employed were not clear because the teachers seemed not to be sure about what exactly the error was or how to repair it, which resulted in misleading corrections.

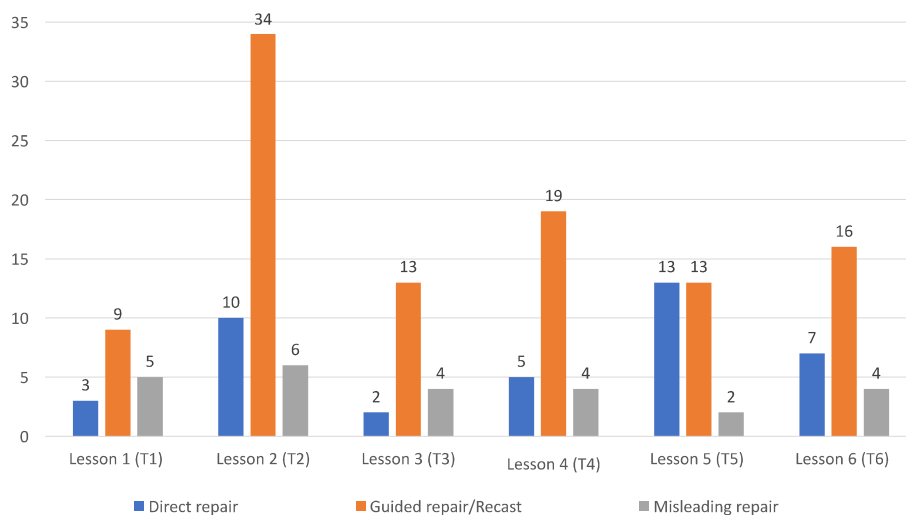

Figure 50. Corrective feedback strategies used by the teachers (T=Teacher, E=Exchanges)

Problems related to the teachers' AL competence

As mentioned earlier, in French Polynesia, elementary school teachers are generalist teachers, and they do not receive specialized primary level AL teacher education as part of their qualification. However, all elementary school teachers are expected to have B2 level¹¹¹ EAL proficiency. The

¹¹¹ B2 corresponds to an upper intermediate level according to the scales offered by the Common European Framework of Reference for Languages (CEFRL).

results obtained from this study indicated that some teachers had some difficulties in EAL (see Extract 25 & Extract 26).

Extract 25. Teachers' language needs

T: Look! Now::: close your eyes /aisəs/.....Close your eyes! /aisəs/ ((She mispronounces the word 'eyes'.))
((Children close their eyes.))

T: Close your eyes! /aisəs/ Hei! ((She mispronounces the word 'eyes'. She looks around to check.))

T: Frederic et Faratetama ((Frederic and Faratetama)) ... close your eyes /aisəs/!

T: Open your eyes /ais/! ((She pronounces eyes correctly.))

T: Open your eyes! /aisəs/ ((She mispronounces the word 'eyes'. She picks one of the pictures from the board.))

Note. T=Teacher

These EAL related problems were grouped under the following headings: (i) incorrect language use (e.g., mispronunciation, wrong word choice, and incorrect use of language structures), (ii) leaving the problem unattended (not knowing how to correct an error or how to respond to a student's answer), and (iii) inauthentic AL use, which refers to language use that does not comply with authentic/natural language use.

Extract 26. Unauthentic language use.

T: Ehhhm....The other... you please...will make an exercise, okay? ((He uses the wrong verb 'make' with the word exercise))

Ss (some): Exercice?? ((Exercise?)) [Unclear and overlapping speech.]

T: Tumuhai, Miranda (Unclear speech). You work with me okay? The others... You make... You will make an exercise. ((He uses the wrong verb 'make' with the word exercise))

Ss: On va faire un exercice. [We will do an exercise.] [Unclear and overlapping speech.]

Note. S = student, T = teacher

Inauthentic language use could be linked to language cross-linguistic influence or other cultural contextual influences. In general, these detected problems were minor and did not seem to be causing any harm to the learners' EAL development. However, the same types of mistakes were observed in most of the teachers' discourse. Thus, teachers' EAL proficiency, despite its trivial nature, reveals itself to be an issue to consider in elementary school teachers' initial teacher education (see Figure 51).

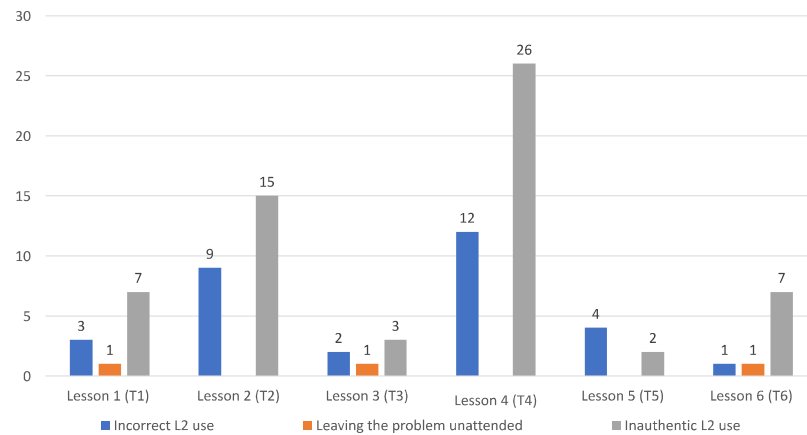

Figure 51. Problems linked to the teachers' AL competence (T = teacher)

Learner involvement

Issues concerning learner engagement in AL learning have been a central topic in SLA research. Research in this area has focused both on issues concerning learner participation, teacher talking time (TTT), student talking time (STT), teacher and learner interaction types, learners cognitive engagement, learner autonomy, and task types (Ellis, 2012; Lier, 2007; Long, 1981,1983; Swain, 2001; Van Lier, 2008). It is now a common belief that active learner engagement is the key to AL learning. However, participation of learners using purely mechanical IRF interactions and repetition exercises may not result in active learner engagement. Language productions based on teacher-learner interactions using non-contextualized question-and-answer exchanges would also fail to engage learners cognitively. The results obtained from these six elementary school teachers' lessons indicate that these teachers (except T6) involved their learners in IRF type interactions based on short oral teacher-learner exchanges or mechanical repetition drills (see Figure 52).

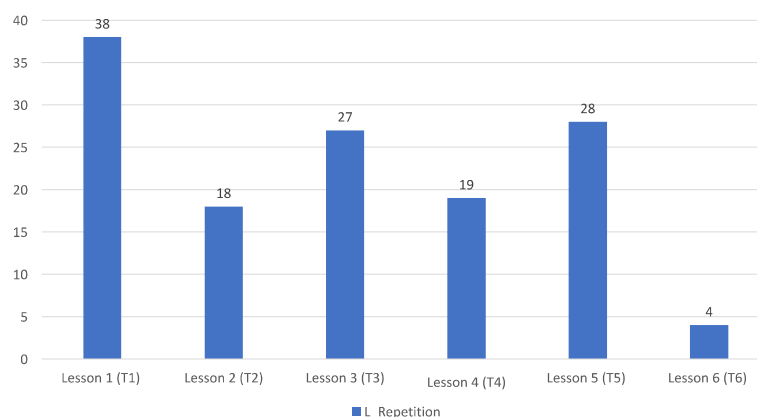

Figure 52. Passive learner involvement (T=Teacher, L=Learners)

T6's lesson contained some elements that favoured active learner engagement (see Figure 53 and Figure 54). The results from the interaction and video-recorded material analysis illustrated that the students in T6's class were more actively involved than the students in the other teachers' lessons (see Extract 27). In this lesson, the students had opportunities to collaborate and engage in negotiation of meaning (i.e., asking for confirmation, asking for clarifications, giving explanations, disagreeing, giving feedback). The students were arranged in a group of seven students and the task provided the learners with the possibility of active engagement.

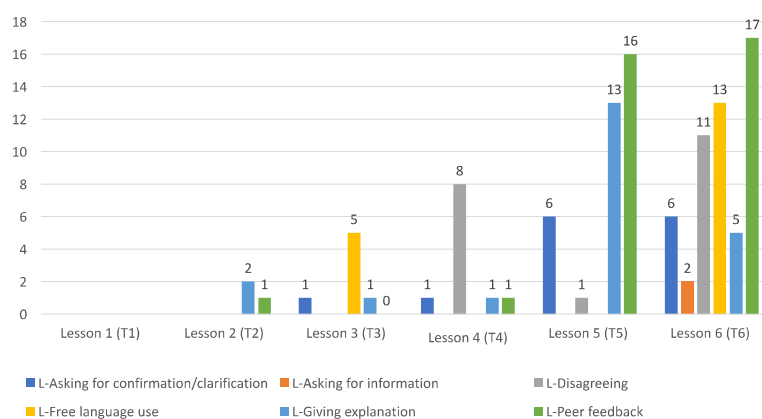

Figure 53. Active learner involvement (T=Teacher, L=Learners).

Extract 27 represents an example of the negotiation of meaning taking place between three students in T6's class. These students were 7 years old and had only 1 year of AL learning experience. Their task was to take cards from a box, read maths operations to their classmates, and ask them to answer.

Extract 27. Autonomous activities.

S2 : Eh Maitresse, comment déjà on dit 'fois'? ((Eh ! Teacher how do we say 'times'))

T: Times.

S2: Times ((repeats)). Ok six times five ((shows six and five))

S3: Mais non c'est nine ((no, its nine))

S2: ((Looks at the card)) Oui, nine times five.

S1: uhhh [S3 :forty:::::five. FORTY FIVE!]

S2: ((thinks)) Yes, very good.

Note. S = student, T = teacher

Several studies have reported that working in small groups helps learners produce not only a more significant amount of language, but also better-quality productions compared to activities in traditional teacher-oriented learning environments (Ellis, 2003, 2012; Lier, 2007; Long 1981,1983). Group work also provides learners with the opportunities to negotiate for meaning when a communication problem arises. Figure 54 shows that the five teachers out of six favoured non-communicative activities (i.e., mechanical activities) over activities based on real-life needs.

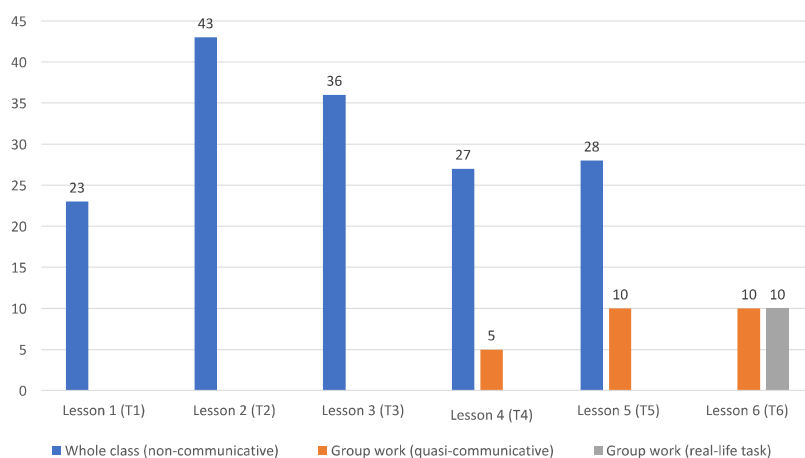

Figure 54. Activity types used in minutes (T = teacher).

These studies have shown that independent learner activities in small groups can provide interactional conditions that better facilitate the learning of AL compared to AL situations involving only teacher-student exchanges. The results have also show that the teachers (except T6) mainly used whole-class IRF rather than group activities.

1.61 Discussion and conclusion

Several studies have reported that understanding messages conveyed by the teacher or engaging in controlled teacher-fronted mechanical activities (e.g., repetition drills or question-answer exercises) are not favourable conditions for learning an AL. It has been repeatedly reported that face-to-face small group interactions through which learners engage in cognitive activities provide the necessary conditions to use and improve AL learning. The summary of the results showed that among these six teachers, only T6 used group-work activities through which the learners could engage in negotiation of meaning and learner-initiated language production.

In this study, the analysis of the learners' and teacher's interactions displayed that, although the teachers used various forms of scaffolding and feedback strategies, the following points required consideration:

- The learner roles were predominantly passive.
- There were minimal real-life exchanges and group-work activities.
- The activities that the learners were provided with did not encourage problem-solving tasks, which favour cognitive involvement.
- The learners were primarily provided with IRF situations.
- The majority of the exchanges were in the form of simple repetitions or short question-answer type exchanges.
- Few of the interactions were learner initiated.

These EAL studies were exploratory studies. I only examined collected data (video-recorded material, anecdotal notes, and transcribed data). The aim of these studies was to explore learning and teaching actions through the use of interactional analysis. During my analysis procedures, I focused on the most salient observations and sometimes I reanalysed the same material by focusing some specific points through the methods of iteration. In this first EAL study I obtained broader categories which provided me with some paths to follow in my future studies.

EAL: Study II

1.62 Introduction

This second study built on the previous research we had conducted in mainstream EAL settings in a French Polynesian context (see Gabillon, 2019 for the published version of the study). In this second study I accumulated more data to work on. My previous analysis indicated that many teachers were not sufficiently using (i) activities that promote learners' cognitive involvement and participation, (ii) interactional models that enable authentic dialogical exchanges, and (iii) classroom configurations that maximize learner involvement, and (iv) adapted scaffolding techniques to promote learning.

By adopting the idea that maximizing active participation and cognitive involvement of learners is conducive to learning, this second EAL study examined how primary teachers, by their choice of task types, optimized or hindered active learner participation. This research study focused on learning and learners rather than teaching and the teacher. However, in the majority of situations, these two acts were inseparable, and one could not be discussed without referring to the other. With this in mind, issues such as teacher talking time (TTT), student talking time (STT), the types of learning activities used, and peer support, which were closely related to the objective of the research, were examined.

1.63 Methodology

The objective of this research work was to explore the types of interactions used and investigate their roles. The purpose of the study was therefore to see whether the proposed activities and approaches:

- encourage the learner to communicate and collaborate (e.g., interact, (re)act, express opinions, ask for explanations, and ask questions),
- enable peer scaffolding (e.g., provide information, give explanations, correct, and translate),
- favour the development of cognitive skills (e.g., classify, explain, recognize, apply, analyse, evaluate, and create),

- enable the use of pragmatic strategies to learn and communicate in the AL (e.g., use of gestures and artefacts [teacher and students] and manipulation of objects), and
- employ group and pair work in order to maximize the participation of learners.

The corpus used in this study was collected from 11 different primary schools from the five French Polynesian archipelagos (see Table 16 for details).

Table 16. Information on data and other contextual information.

N° lessons	Recording date	Duration (Minutes)	Archipelago /Island	N° teachers	N° students	Age of students	Level of students
L1	27/05/2015	23 :24	SI/Tahiti	F	24	9 to 10	Beginner
L2	30/11/2015	43 :06	TA/Rangiroa	H	16	10 to 11	Beginner
L3	01/12/2015	36 :28	TA/Rangiroa	F	21	8 to 9	Beginner
L4	13/07/2015	32 :00	GI/Rikitea	F	24	9 to 10	Beginner
L5	03/12/2015	38 :25	TA/Fakarava	F	24	10 to 11	Beginner
L6	09/06/2015	35 :00	AI/Rurutu	F	16	10 to 11	Beginner
L7	23/03/2016	18 :00	SI/Tahiti	F	17	7 to 8	Beginner
L8	02/06/2014	28 :00	SI/Tahiti	F	12	10 to 11	Beginner
L9	18/01/2016	35 :00	MI/Nuku Hiva	F	13	4 to 11	Beginner
L10	11/06/2015	35 :00	AI/Tubuai	H	26	10 to 11	Beginner
L11	20/01/2016	39 :00	MI/Nuku Hiva	F	25	8 to 11	Beginner

Note. SI = Society Islands, AT = Tuamotu Archipelago, GI = Gambier Islands, AI = Austral Islands,

MI = Marqueses Islands, Beginner level = A1¹¹²

¹¹² Beginner level corresponds to Level A1, the first level of the six reference levels described in the Common European Framework of Reference for Languages (CEFR). The six reference English levels are accepted as the global standard for grading an individual's language proficiency.

This research work, like the previous one, consisted of microgenetic interaction analysis and used video recordings collected during the PrEPPP and Maeha’a Nui projects (see [Section 10.14](#)). The videotaped corpora were transcribed in full, including both verbal and non-verbal elements of the corpus samples by using an adapted version of Jefferson's (2004) transcription notation. The data were also analysed using descriptive statistics to provide a synthesis of the outcomes obtained.

1.64 Analysis procedures

To analyse the corpus, we used an inductive approach that involved a constant search for themes and a grouping of these themes into coherent categories (Charmaz, 1995). I looked for recurring themes, consistent structures, and patterns when examining the data. I gradually developed conceptual categories and was able to restructure and explain the data by identifying coherent relationships within the corpus. The initial codes were grouped into the categories ‘L1 use’ and ‘extra-linguistic support’. Analysis of these two categories provided additional information regarding how, why, and in what situations the codes and sub-categories within these groups were used. [Table 17](#) contains the sub-categories within the code groups ‘learner’ and ‘teacher’.

Table 17. The categories ‘L1 use’ and ‘extra-linguistic support’.

The code groups ‘learners’ and ‘teacher’			
Label	Concept	Categories	Observations
E&A-Tr	Translation	L1 use O=196 Learners O=448 Teachers	As a tool for scaffolding (teacher and learners)
	Code alternations		As a compensation strategy due to learners’ lower level in the AL (e.g., indicating understanding, clarify the meaning, and giving additional information)
	Translanguaging		
E&A-AltC			As a tool for collaboration
			As a tool for facilitating classroom management and social relationships
E&A-UG	Use of gestures	Extra-linguistic support O=159	As a compensation strategy due to learners’ lower level in the AL
E&A-UA	Use of artefacts		As a tool for scaffolding (teacher and learners)

E&A-MLO	Manipulation of objects		As a means for providing multiple traces and cognitive connections (e.g., seeing, smelling, tasting, manipulating, and creating)
			As a tool for contextualizing learning
			As a tool for sustaining joint attention
			As a tool for facilitating creative AL use
			As a tool for improving learner involvement
Note. O= Occurrences, number of student interventions =1,632, number of teacher interventions=2472			

Table 18 contains the categories that have emerged in the code group ‘learner’. The table shows the initial concepts (open codes), how these initial concepts are grouped (axial coding) and how the final categories (selective coding) are formed. These categories show the links between the interaction types proposed by the teacher and the degree of cognitive involvement of the learner.

Table 18. Categories within the code group ‘learners’, obtained via open, axial and selective coding.

Learners										
Label	Concept	Categories					Major categories			
A-EO	Expressing an opinion O=63	The type of exchange	Initiated by the learner	Group work (3 to 12 learners)	The use of AL is encouraged (but L1 is not forbidden)	Autonomous learner activity	High number of learner exchanges	Communicative activity	Suitable for learner scaffolding	High learner involvement
A-Agr	Agreeing O=61									
A-Dis	Disagreeing O=30									
A-ACC	Asking for confirmation/clarification O=32									

A-AI	Asking for information O=11	Initiated by the learner/or teacher Whole class or group work	Whole class activity	L1 is not allowed	IRF (teacher-led activity)	Low number of learner exchanges	Quasi-mechanical to communicative activity	Suitable for teacher scaffolding	High to medium learner involvement
A-GE	Giving explanation O=44								
A-RQ	Responding a question O=941								
A-Rct	Reciting O=98								
A-Rpt	Repeating O=352								
Note. O = occurrences, number of student turn-takings = 1,632									

1.65 Results

In this study, first, we measured learner participation quantitatively by comparing the STT with the TTT in minutes (see Figure 55). This information provided insight into the amount of learner participation, as well as the types of exchanges that took place during the lessons. In all the recorded lessons, the number of teacher exchanges and TTT eclipsed the number of learner exchanges and STT except for lesson 7. Most of the recorded exchanges took place during whole-class activities and mostly between the teacher and the learners. The exchanges were short and fast, 2 to 5 seconds per sequence.

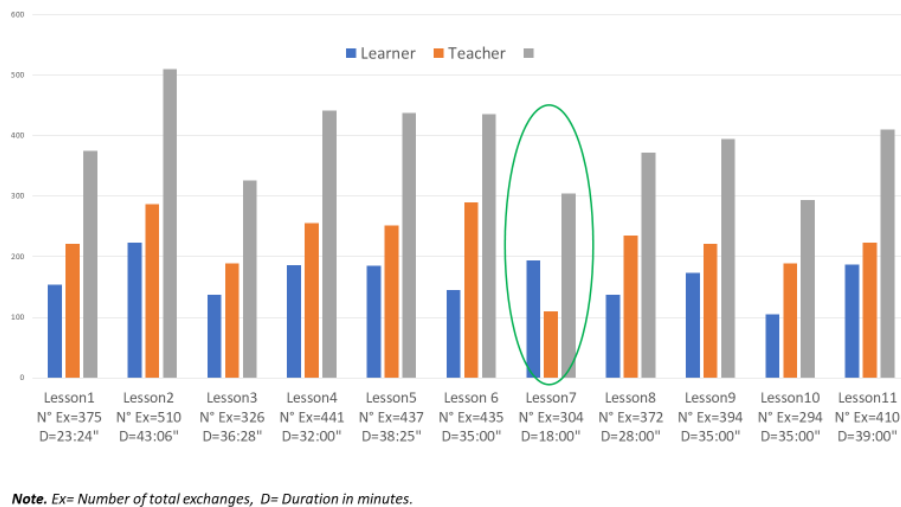

Figure 55. Distribution of teacher and learner exchanges.

1.65.1 Main interaction types observed

After coding, we selected the categories having direct links with the learner involvement (see Table 18 above and Figure 56 below). The analysis of the exchanges indicated that the majority of the recorded exchanges took place during whole-class activities and that they occurred in IRF interactions (Sinclair & Coulthard, 1992). These IRF interactions were composed of short exchanges that started with a question (mainly from the teacher), followed by the learner's response, then brief feedback from the teacher (R. Ellis, 2015b, 2015a; R. Ellis & Shintani, 2014). Most of the time, the interactions were initiated and directed by the teacher. These IRF exchanges ranged from mechanical exchanges (non-contextualized) to pre-communicative exchanges (little contextualized) to communicative exchanges (contextualized).

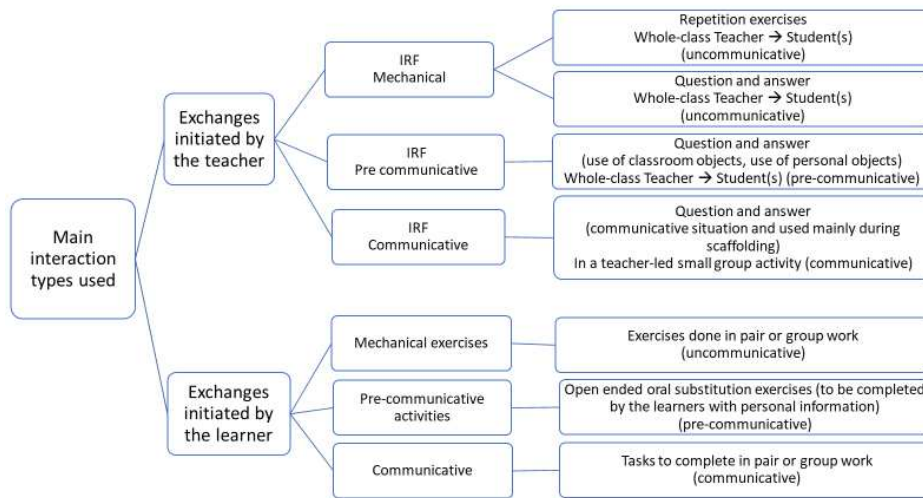

Figure 56. Theoretical frame chart showing main interaction types used.

The in-depth analysis of IRF exchanges provided some paths to follow. I used the initially formulated questions as coding filters (see the objectives in Section 11.7) to guide my analysis procedures to obtain more inclusive and coherent categories. By performing further analysis, I obtained the following categories (see Figure 57). In the light of what I discovered, I re-examined the lessons through the lens of these new categories.

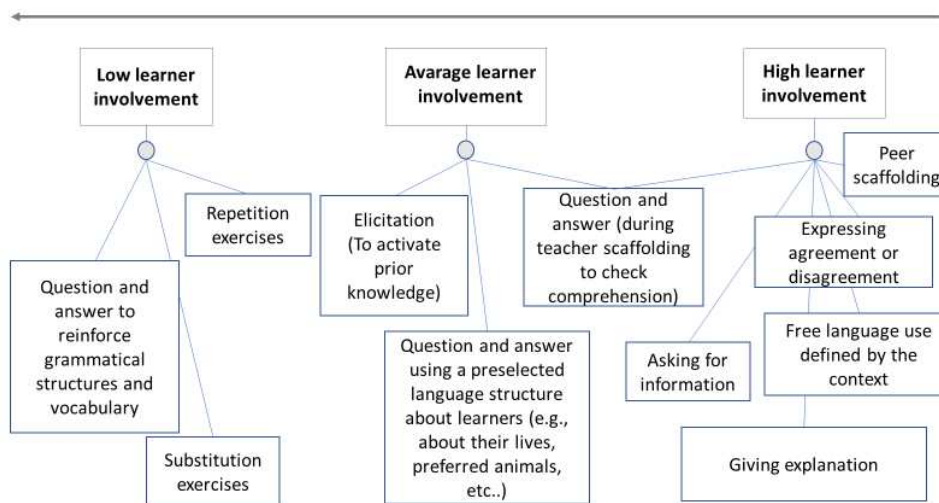

Figure 57. The degree of learner involvement: categories and sub-categories.

Analysis of the interactions and the filmed material showed that the students were actively involved in Lessons 5, 7, and 8 (see Figure 58). During these three lessons, the students had the opportunity to collaborate with each other and to engage in the negotiation of meaning (e.g., asking for

confirmation, asking for clarification, giving explanations, express disagreement, and give feedback to their peers).

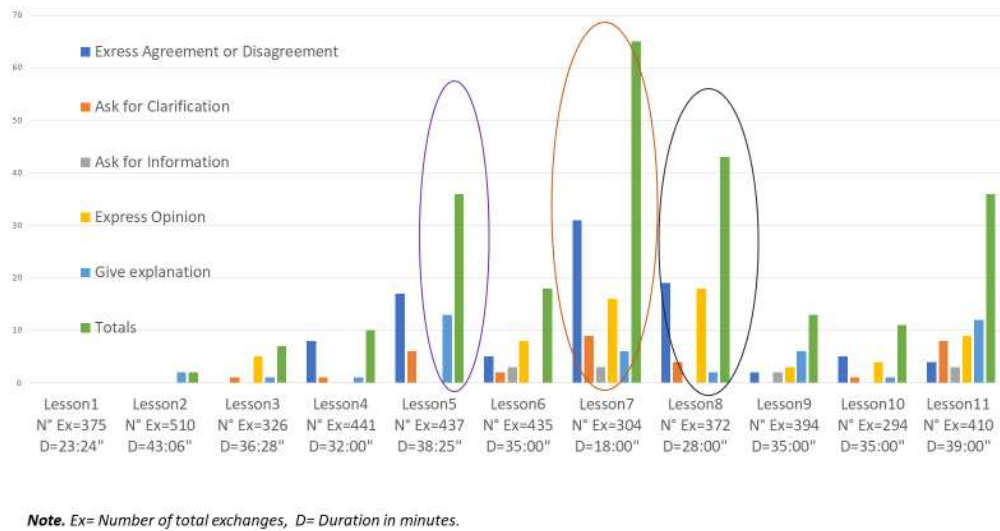

Figure 58. Learner involvement during class activities.

1.65.2 Exchanges with low learner involvement

Extract 28 is an example illustrating mechanical IRF exchanges. There are 16 children in the class. The tables are lined up one behind the other, the learners face the board and the teacher stands in front of the board. The teacher is active and goes from one student to another, showing pictures and asking the same question ‘What is it?’. Students respond based on what they see in the image. Most of the time, learners do not respond naturally because they are reminded that they should answer using full sentences (which is not the case when the language is used in a real context). The teaching technique we observe does not allow the exchange of ideas between learners but exclusively promotes the mechanical teacher-student dialogue. In 5 minutes, the teacher goes around the class and quickly exchanges with all the learners. Certainly, there is energy and action during the lesson. Each learner has the opportunity to have their turn, but there is little communication and little cognitive involvement on the part of the learners. Such an approach, if used as the main pedagogical approach, does not seem to enable learners to develop the necessary skills they need to express themselves in an AL. As can be seen in Extract 28 the exchanges are mechanical and do not allow learners to think about or use the language creatively.

Extract 28. Non-contextualized IRF exchanges

-
- 451 [00:37:21.15] T: What...What is this? ((*He shows the flashcard to other students.*)) [00:37:25.10]
- 452 [00:37:25.10] S: Eraser /e'rai.zər/ ((*Pronunciation problem.*)) [00:37:28.25]
- 453 [00:37:28.25] T: It is an eraser /e'rai.zər/. ((*Pronunciation problem.*)) ((*The teacher looks at other students and repeats.*)) [00:37:30.11]
- 454 [00:37:30.11] Ss: It is an eraser /e'rai.zər/, eraser /e'rai.zər/. Good! [00:37:35.23]
- 455 [00:37:35.23] T: Okay! Good! ((*Teacher shows another flashcard.*)) [00:37:38.15]
-

Note. T = teacher, S = student, Ss = students

Extract 29 gives us an overview of an interaction pattern in which learners recite numbers, on a poster placed on the board, pointed out by the teacher. The learners repeat the numbers one by one, in order, stopping once the number 11 is reached. The teacher sees that the learners can no longer repeat the numbers stops the activity abruptly (see Extract 29).

Extract 29. Mechanical IRF exchanges based on rote learning and repetition.

-
- 10 [00:00:37.11] E: OKAY! Today we count OKAY? ((*A question ... with a rising intonation*)) ... and what is this number? [00:00:44.04] ((*The teacher shows the numbers on a poster placed above the board and the students recite them one by one, in order.*)) [00:00:44.13]
- 11 [00:00:44.15] Ss (all): One, [*T: One!*] [00:00:45.28]
- 12 [00:00:46.00] Ss (all): Two, [00:00:46.23]
- 13 [00:00:46.23] Ss (all): Three, [00:00:47.13]
- 14 [00:00:47.13] Ss (all): Four, [00:00:48.03]
- 15 [00:00:48.03] Ss (all): Five [00:00:48.21]
- 16 [00:00:48.21] Ss (all): Six, [00:00:49.07]
- 17 [00:00:49.07] Ss (all): Seven, [00:00:49.27]
- 18 [00:00:49.27] Ss (all): Eight, [00:00:50.13]
- 19 [00:00:50.13] Ss (all): Nine, [00:00:51.00]
- 20 [00:00:51.00] Ss (all): Ten, [00:00:51.16]
- 21 [00:00:51.16] Ss (some): ((*Some students hesitate*)) Eleven. [*Twelve*] ((*Some students say something else, some mumble.*)). [00:00:52.06]

22 [00:00:52.06] E: ((*Hesitation*)) ... Eleven Okay:::? .. Stop ! [00:00:55.21] ((*She stops the activity abruptly.*))

Note. Ss = students

1.65.3 Exchanges with high learner involvement

Extract 30, offers a different scenario compared to the examples given above. Like the students in Extract 29 above, the students in Extract 30¹¹³ are learning the numbers in English. This group of learners is much younger (7-8 years old) and attend a school located in Tahiti. They had started learning English just a few months before for an hour and a half a week. In this episode, the learners are sitting in a circle and working together. They are not asked to recite the numbers in the correct order, but to use them to perform mental calculations.

Extract 30. A 28-second exchange during an autonomous CLIL maths activity.

-
- 101 [00:06:11.07] S7: ((*She takes a card from the box.*)) Fifty-one minus nine. [00:06:14.02]
102 [00:06:14.02] S1: Is... ((*Indicating that she should say 'fifty-one minus nine IS...?'*)) [00:06:15.18]
103 [00:06:15.18] S7: Je sais! ((*She raises her hand, turns her head and looks for the teacher. The teacher is busy with another group*)) [00:06:18.17]
104 [00:06:18.17] S3: ... Sixty... [00:06:20.28]
105 [00:06:23.28] S6: Mais non! Moins! On a dit moins ((*No, said minus*))[00:06:25.10]
106 [00:06:26.10] S4: On n'a pas dit 'plus'! ((*Shed id not say plus*))[00:06:28.13]
107 [00:06:28.13] S3: Fifty ... Fifty-two! Fifty-two! ((*He jumps on his chair.*)) [00:06:31.13]
108 [00:06:32.13] S1: Quarante! ... Quarante! ... ((*He shouts, indicating that the number should not be fifty but forty something.*)) [00:06:34.08]
109 [00:06:34.08] S6: Forty-two! ((*Gives the correct answer.*)) [00:06:35.23]
110 [00:06:35.23] S2: No, FORTY-TWO! Forty-two! ((*Gives the correct answer right after the S6 but louder.*)) Aa: [*Incomprehensible speech*] [00:06:39.13]
111 [00:06:39.13] S6: J'ai dit AVANT toi. [00:06:45.07]
-

Note. S=Student

¹¹³ Extract taken from a CLIL lesson.

The examination of the filmed document and the transcription provided additional information on the contextual elements of the extract. This extract was taken from a CLIL lesson that had two sections: (i) a teacher-led introduction and (ii) a group activity in which students worked independently. The autonomous group activity was a 10-minute activity on mental calculations. There were 12 learners (7-8 years of age) who were seated in a circle. They were expected to take turns, pick cards, put the numbers and signs together, read aloud a mathematical operation, and then chose a classmate and ask them to answer. In the excerpt, we see that the use of the L1, although discouraged by the teacher, helped learners to perform peer scaffolding. During this activity, students drew their classmates' attention to the mistakes they had made. This cooperative process promoted the sharing of knowledge between peers and the active participation of each learner. Line 105 shows how the child detected the source of his classmate's error and corrected it by explaining the reason for his error (see Extract 30).

In order to understand the situation in this episode, it is necessary to provide the following details: Before Line 101, the learners performed a series of mental calculations on additions, and there was a passage to subtractions. Seeing that his classmate responded 'sixty' to an operation of 'fifty-one minus nine', the student (A6) guessed that his classmate had made an addition. We observe that, during this independent group activity, the learners had no difficulty understanding what their classmates meant and were able to detect the causes of the problems instantly. During this activity, the learners used their general and communicative skills to facilitate the learning of their peers and to establish congruence in their knowledge.

Exchanges with medium to high learner involvement Extract 31 and Extract 32, taken from Lesson 8,¹¹⁴ show that IRF exchanges can be contextualized. These extracts give an overview of a science lesson in English in which the teacher is part of a group of learners (12 pupils aged 10 to 11) who are carrying out a science experiment. The learners are standing around a table. There are objects on the table in front of them. The teacher has the role of mediator and helps learners understand and participate in the activity. As a mediator, she tries to optimize the understanding of learners and their interactions using a maximum of social artefacts, demonstrations, gestures, and other contextual elements. The teacher refers to the objects by pointing to them and accompanying her

¹¹⁴ A CLIL lesson.

words with gestures to compensate for the lower AL level of the learners. The teacher encourages students to guess the nature of each substance by inviting them to touch, smell, and taste (e.g., coffee, sugar, salt etc.). The 12 students carefully follow the teacher's instructions and explanations and respond by communicating naturally. Learners touch, manipulate, observe, and use these objects to communicate, showing them, describing them, and naming them.

Extract 31. Example of contextualized IRF exchanges during teacher scaffolding.

162	[00:05:50.02] T: Another... ((The teacher takes an envelope that contains sand which she pours in a goblet.)) [00:05:52.12]
163	[00:05:53.03] T: It's not an ingredient... ((Children stretch their heads and watch this new substance. Some try to touch it.)) [00:05:55.12]
164	[00:05:55.12] Ss (Some): It's SAND! [<i>Ss (Some): Stone</i>] [<i>Ss (Some): sable, c'est du sable</i>]. [00:05:56.38]
165	[00:05:56.38] T: It's a little bit of... ((She encourages the learners to finish her sentence)) [00:05:57.08]
166	[00:05:57.08] Ss (some): It's stone. [<i>Ss (Some): SAND! It's sand</i>] [00:05:58.02]
167	[00:05:58.02] T: Sand, we've got a little bit of stone in there... ((The teacher tries to show the difference between sand and stone by showing the pebbles in the sand.)) ... but it's sand. [00:06:04.38]

Note. T = teacher, S = student, Ss = students

In Extract 32, like in Extract 28 and Extract 29, the teacher asks a question, the students answer, and the teacher gives them feedback. However, in this episode, there are no mechanical exchanges or the repetition of the AL structures. The teacher does not require learners to raise their hands. The exchanges take place naturally. During this task, learners are negotiating, agreeing, opposing, and helping each other. The attention of the learners and the teacher is focused on the task they are doing together. The level of the language used is modest (A1 CEFRL). Language is rather a tool and not the main learning objective. The use of the AL is encouraged, but the L1 is not prohibited either. Learners are motivated enough to use the AL when they can. They use the L1 to show their understanding of the concepts and contribute to the pursuit of exchanges and communication.

Extract 32. Example of a small teacher-led group activity.

-
- 365 [00:21:34.01] T: The liquid is... ((The teacher shows a jar with a liquid mixed with certain substances and asks learners to describe it.)) [00:21:35.21]
- 366 [00:21:35.21] Ss: Yellow, yellow. [*Some students: It's yellow*] [00:21:37.15]
 [00:21:37.15] S2: The liquid is yellow. ((*He finishes the sentence that the teacher has started*)) [00:21:39.04]
- 367 [00:21:39.04] T: and...? ((The teacher asks for more descriptive elements)). [00:21:40.00]
- 368 [00:21:40.00] Ss: (*Some Ss*) Cloudy, cloudy [(*Some Ss*) Trouble] [00:21:42.01]
- 369 [00:21:42.01] Ss: (*Some Ss*) Clear [*Some Ss: It's clear*] [00:21:44.21]
- 370 [00:21:44.21] S3: No! no, no! Yellow and cloudy. ((*She disagrees*)) [00:21:47.15]
- 371 [00:21:47.15] S4: No, it's clear ((*He insists that the liquid is clear.*)) [00:21:48.19]
- 372 [00:21:48.19] S1: It's clear ((*She agrees with her classmate*)) [00:21:50.19]
- 373 [00:21:50.19] T: Ok let's have a look ((*The teacher raises the pot and asks for consensus*)) [00:21:54.04]
- 374 [00:21:54.04] S5: C'est bizarre il y a des bulles ((*The child shows the bubbles*)) [00:21:58.21]
- 375 [00:21:58.21] T: 'Bulles'? ((The teacher seems surprized that the learner uses French)) [00:22:00.00]
- 376 [00:22:00.00] Ss: Bubble, bubble ((*They all repeat at the same time*)). [00:22:04.05]

Note. T = teacher, S = student, Ss = students

1.65.4 Exchanges with average learner involvement

Lessons 6, 9, 10, and 11 mainly consisted of IRF exchange models. These lessons contained certain elements that allowed learners to speak about themselves using the language forms and structures provided by the teacher (see Extract 33).

Extract 33. Example of a teacher-led pre-communicative whole-class activity.

-
- 314 [00:20:50:27] T: What do you like? ((Asks a student by pointing)) [00:20:52:10]
- 315 [00:20:54:05] S14: (I like dancing but) ° I don't like... football! ((The other students speak at the same time)) [00: 20:58:17]
- 316 [00:20:58:17] T: ... playing football and you Tamatoa? ((Asks another student by pointing)) [00:21:01:09]
-

317	[00:23:50:29] S13: I like basketball ... [We hear other students in the background – unclear and overlapping speech] [00:27:10:13]
318	[00:27:10:13] T: Yes? [Unclear and overlapping speech] [00:30:19:29]
319	[00:30:19:29] S13: ...but I don't like (playing) football [Unclear and overlapping speech] [00:34:39:05]

Note. T = teacher, S = student, Ss = students

1.65.5 Summary of results

The following sections summarize the results of the analysis of the 11 videotaped lessons and the major pedagogical characteristics associated with them.

General characteristics of teacher-led whole-class activities

At first glance, the teacher-led whole-class activities have a dynamic outlook because they consist of rapid exchanges or well-orchestrated repetitions. The exchanges are predominantly initiated and conducted by the teacher. They are in the form IRF exchanges that start with a teacher question, are followed by the learner's answer, and are often closed by short feedback from the teacher. These types of exchange patterns foster high control and permanent intervention of the teacher. These are mostly mechanical interactions and are marked by the dominant role of the teacher. Usually, learners are allowed to take part only when they raise their hands or when the teacher points to them. Learner errors are not welcome and are corrected immediately. Most of the time, learners are not allowed to use their mother tongue and are scolded if they do. In short, learners rarely have the opportunity to express an opinion, to check their understanding, to use the language freely or to help their classmates. In such a teaching model, although the learners all seem to be participating, the teacher talking time (TTT) always exceeds that of the learners (STT). Figure 59 summarizes the main elements of such teacher-led activities.

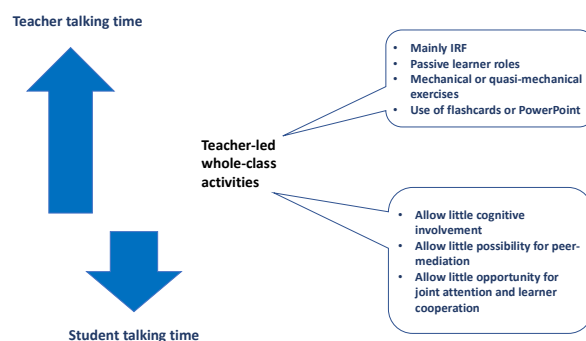

Figure 59. Main characteristics of teacher-led whole-class activities.

General characteristics of teacher-led small group activities

Teacher-led activities in small groups of 8-12 students in which teachers work in collaboration with learners are conducive to promoting the active participation of the learner. This type of activity offers opportunities for teacher and peer scaffolding (see Figure 60). The activities used in this type of configuration encourage the active participation and cognitive involvement of learners. The teacher plays the role of a participant, a mediator, and a resource person who facilitates learning and communication. During the presentation of new language features and other concepts, the teacher is present within the group. They collaborate with the students by introducing social artefacts. They highlight problematic elements by giving examples, providing resources, encouraging communication between learners, and clarifying the concepts studied. These types of interactions are similar to what children are generally accustomed to in their social milieu. The use of multimodal means (verbal and social artefacts) to support learning through linguistic simplifications and experimentation through manipulation and demonstration are consistent with Bruner's (1978) scaffolding practices and Vygotsky's ZPD notion (1978, 1986). In general, in this type of teaching, the STT is much higher than in whole-class activities.

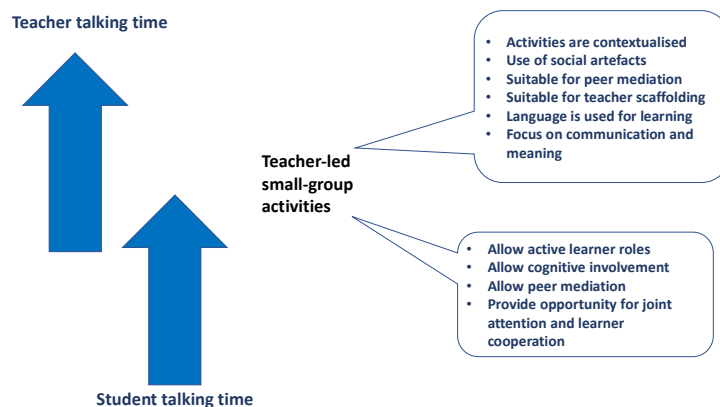

Figure 60. Main characteristics of teacher-led small group activities.

General characteristics of learner-led group activities

The third type of interactions take place in autonomous small-group activities (see Figure 61). During these activities, learners use the AL to accomplish the tasks given to them, but they can also use the L1 to perform peer scaffolding or to ask for help or information from their classmates. In this type of group activity, joint attention and motivation remain vivid. Learners actively participate and use the target language to complete the tasks, even if their command of the language is modest.

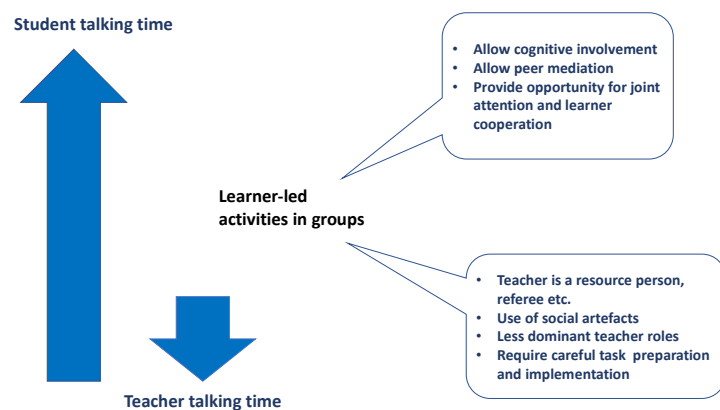

Figure 61. Main characteristics of autonomous small group activities.

1.66 Discussion and conclusion

What I uncovered during EAL studies provided me with some data to compare exploratory EAL data with experimental CLIL data. My analysis and observations suggested that learner

participation and cognitive engagement can be enhanced if teachers (i) minimize whole-class instruction, (ii) work in small groups during the teacher-led concept building phases, (iii) provide learners with more authentic tasks that enable communicative interactional patterns with natural turn-taking practices, and (iv) use tasks based on learning-by-doing and problem-based learning activities. These observations were in line with the insights I gained during the CLIL lessons. During the EAL studies, I also observed the important role played by teacher-led small group tasks. I have noted that such a configuration maximizes the effectiveness of scaffolding techniques and the expansion of the learners' ZPD. In the early stages of AL learning, especially with beginner learners, a small group led by a teacher can help the teacher to offer learners more care and attention. Such a configuration unifies as many elements of successful scaffolding as possible, such as joint attention, task simplification, frustration control and interaction.

Conclusion

The results obtained from the EAL studies are consistent with the results obtained from my CLIL studies (Gabillon and Ailincal, 2013, 2015, 2016, 2017; Gabillon et al., 2016). They indicate that learners' participation and cognitive involvement can be improved if teachers incorporate the following elements into their practice:

7. A pedagogical framework that allows active learner participation
8. Optimal group size that facilitates collaborative work and promotes joint attention: My observations indicate that the optimal learner-led autonomous group size varies according to the type of activity used (3-8 students). The optimal size for activities led by the teacher is between 8 and 12 students per group.
9. Task configurations that allow the use of artefacts and other extra-linguistic elements: The use of A&G helps young learners to compensate for their lower AL level and to maintain the continuity of their communication in the AL. The use of A&G promotes both teacher and peer scaffolding (see Gabillon & Ailincal, 2016).
10. Inclusion of contextualized activities which simulate experiences relating to everyday life (e.g., the use of authentic tasks directed by an objective and open to different possibilities and activities related to the learners' lives, environment, and culture)
11. Integration of the content of other school subjects with the AL (e.g., a science experiment using laboratory objects and a mathematics course with tools to measure, calculate, and explain)

In light of these observations, I have made a few adjustments to improve the SMA framework. With these new insights I have reflected on the role played by different classroom configurations and added these as an extension to the SMA framework (see [Section 16.2](#)).

CHAPTER TWELVE

TEACHER EDUCATION AND RESEARCH

Introduction

During the CLIL projects, I have had a great deal of contact with school administrations, learners, and especially cooperating teachers. As a researcher, who is also involved in teacher training at the university level, I have been in permanent contact with the French Polynesian educational authorities and have been actively involved in teacher training in the field of AL teaching (EAL and Polynesian languages). The research activities I have carried out have also provided my students (i.e., teachers in training and novice teachers) with primary sources of information from schools in French Polynesia. I have used the research corpora and results to improve the professional thinking skills of my students during my methodology and research courses.

1.67 Teacher training projects and activities

Our CLIL studies were collaborative research activities that involved the participation of elementary teachers both in the planning and conception of the content of the CLIL lessons. We communicated the outcomes of these research projects during teacher education sessions (especially in research and methodology courses), and this information was used to build awareness in EAL and CLIL pedagogies in practising, novice, and pre-service teachers. The contribution of these research activities to teacher education can be summarized as (i) experiential training through direct involvement in research practices, (ii) teaching seminars and workshops using research outcomes to build awareness in issues concerning AL practices, (iii) course material for the research seminar courses designed for master's students (future teachers), and (iv) communication of research findings to professionals and policymakers.

The Maeha'a Nui project, had both research and non-research contributions (see also [Section 10.14](#) for the *Maeha'a Nui* project). One of the objectives of the project was to provide the participating teaching professionals and other school staff with training on plurilingualism (see Figure 62).

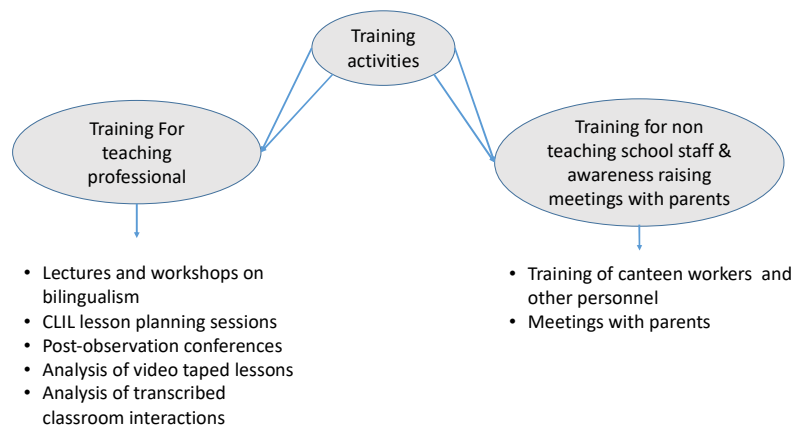

Figure 62. Training activities used in the project.

For teaching professionals, various forms of training sessions were offered. Prior to the commencement of the project, all participant teaching professionals attended a week-long training programme (i.e., workshops and lectures). The aim of this week-long training was to inform the teaching professionals about the objectives of the project and to sensitize them to both the challenges and opportunities of creating a multilingual school environment. As part of the teachers' CLIL training, I also presented a workshop during the pre-project training week. During the implementation of the CLIL project, regular meetings, discussion sessions, and sessions to analyse recorded CLIL lessons were also organized with the participating teachers.

My role within this multilingual project, among teacher training and other non-research activities, primarily involved CLIL research. The CLIL projects (EAL and Tahitian) enabled us to have direct contact with the class teachers. These studies can be described as collaborative research activities because they accommodated and benefited both the researchers and teachers alike and the action plans were determined collectively. During the Maeha'a Nui project, we had a great deal of contact with the school administration and learners and especially with the cooperating teachers. Before launching the project, the pedagogical inspector of the district organized lectures and workshops on CLIL and plurilingualism. We started the project with meetings (with the inspector of the school district, pedagogical counsellors, principals, and teachers) and scheduled sets of actions to complete. We planned and implemented the research activities taking into account the school curriculum and the teachers' workload. Figure 63 provides an overview of my contribution to the CLIL research activities and the teacher training activities, which were an integral part of this CLIL project.

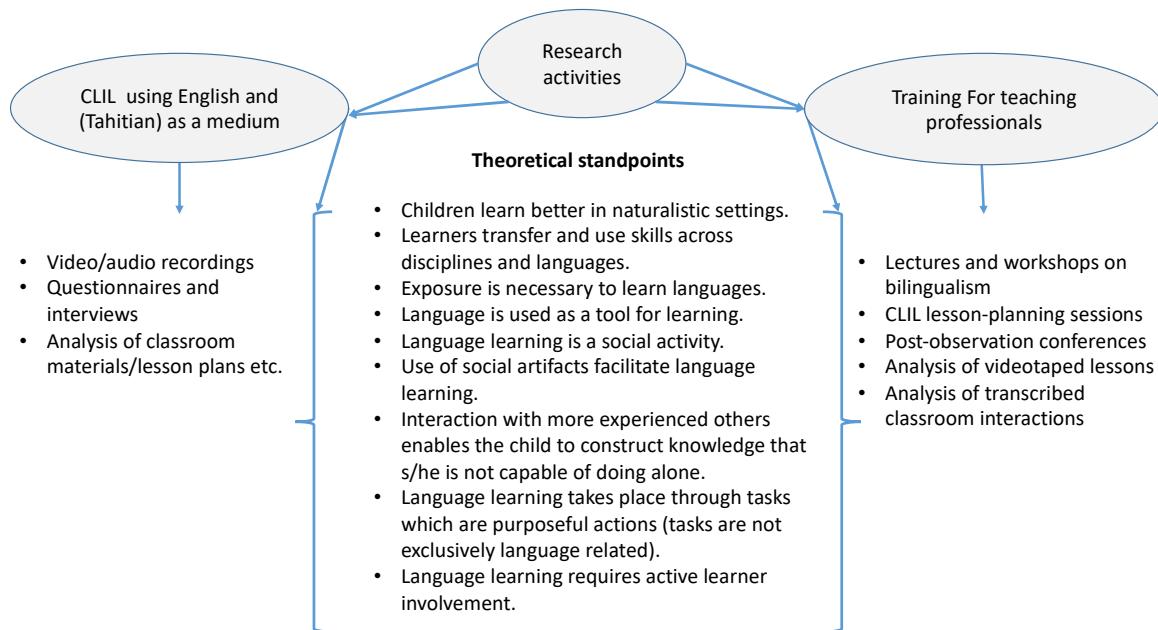

Figure 63. The overview of the CLIL and teacher training activities.

The CLIL research cycle started with the CLIL lesson planning sessions with the participant teachers. Then we implemented these sessions and recorded the lessons. After the lessons, we organized the post-implementation discussions. Depending on their availability of the teachers these post-implementation sessions were organized either immediately after the lessons or postponed to a later date. I recorded, transcribed, and analysed the recordings and provided the teachers with feedback by giving them concrete examples and explanations. After discussions, I adjusted and re-implemented the lessons (see Figure 64 for my action plan).

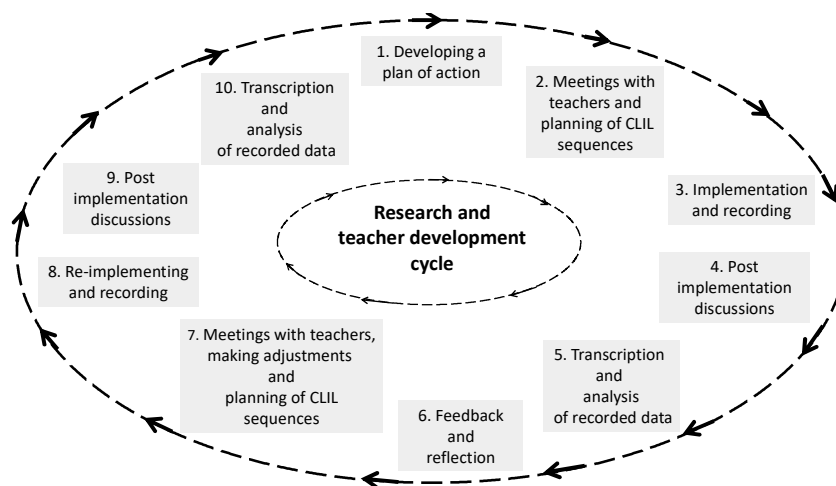

Figure 64. Research and teacher development action plan.

During the PrEEPP project, which aimed to collect data samples from primary school settings, we had minimal contact with the teachers. However, the data obtained from this project was used during the ESPE master's courses for the pre-service teachers and novice teachers' education. For instance, some transcriptions were used during the research seminar courses to train future teachers on how to analyse interactions. Some videos, excerpts and transcriptions were also used during methodology courses to build in teachers' professional critical analysis skills. These excerpts and transcriptions obtained from French Polynesian schools gave the novice teachers the opportunity to examine learning/teaching events in a realistic context. The earlier results obtained from this research project were also communicated to some pedagogical counsellors during a training seminar.

1.68 Discussion and conclusion

Integrating research with teacher education has various advantages. Classroom-based research requires the class teacher's collaboration and offers an invaluable experiential teacher development opportunity, which enables the teacher to grow professionally. During my CLIL projects I was able to provide teachers with experiential learning to test an innovation. Both the teachers and I gained functional knowledge during the pre-observation workshops and post-observation discussions.

Our research projects did not involve the participation of the teachers in the data analysis procedures. I believe that the recorded data and transcriptions could have been used to fulfil diverse teacher education objectives. Recorded data can provide a mirror image of learning/teaching practices and enable data analysis using multiple perspectives and focuses. Lesson recordings and transcripts can also be used as training tools to help teachers reflect on and critically analyse their own teaching. These tools can be combined with guidelines to encourage them to (i) observe their own lessons and analyse a critical moment encountered during their teaching, (ii) determine whether their teaching needs further innovation (e.g., adjusting CLIL teaching techniques), and (iii) observe and analyse other teaching- and learning-related issues (e.g., to explore the use of instructions, the L1, teacher questions, and learning tasks and investigate learners' oral productions). My intent for future projects is to continue bridging AL research with teacher education and contribute to teacher development by integrating research and teacher training cycles.

PART IV: STUDIES ON SOCIAL REPRESENTATION AND BELIEFS

Introduction

The belief construct, and Moscovici's social representations theory constituted the primary theoretical framework of my doctoral thesis, and I continued to publish in this area after the completion of my PhD studies. The first study presented in this section took place in the French Polynesian context and investigated teachers' representations on the use of digital technology in the primary education. The study was conducted by a multidisciplinary theme and concerned not only EAL but other subjects, as well. The outcomes of the study indicated some global categories to focus on and the following stages target at re-examine these areas in a more in-depth manner in each discipline (Ailincai & Gabillon, 2018a; Ailincai et al., 2018).

At present I am working on another interdisciplinary and multi-institutional project (see [Section 15.1.1](#)). This ongoing project has already collected some data on parents' social representations through interviews (see Mendeley dataset; Gabillon, 2020b), and my aim is to collect and analyse learners', teachers', and parents' beliefs/representations about languages, language learning, and bilingual education, combining disciplinary subject and AL learning.

In my belief and social representation studies I have used various research methodologies and data collection procedures such as individual and focus group interviews, mind-showering activities, group discussions, and questionnaires, and I have analysed the data using several research techniques and procedures.

[Part IV](#) provides an overview of my studies that explored beliefs and social representations. This section contains two chapters.

- [Chapter Thirteen](#) presents the research methodologies used in my belief and social representation studies.
- [Chapter Fourteen](#) provides a review of my studies on beliefs and social representations.

CHAPTER THIRTEEN

Introduction

My work on beliefs and social representations, although mostly remained in the AL domain, focuses on learners, teachers and parents' beliefs on topics varying from CLIL, EAL learning, and teaching and the use of educational technology. The features that unite the representations/beliefs notions and CLIL and EAL are the social context and school setting and their links with learning. In this HDR dissertation my work on representations comprises three studies, two of which were conducted right after the completion my doctoral studies and represent the continuation of my doctoral studies.

1.69 Research methodologies

In my beliefs and social representations studies, the data were primarily analysed by employing qualitative methodologies such as iterative coding techniques and grounded theory (GT) methods. However, I have also used some commonly known descriptive statistics methods (percentages, occurrences, etc.) that utilized data obtained through instruments such as questionnaires. The research methodologies used in my belief and social representation research are summarized below (see Figure 65).

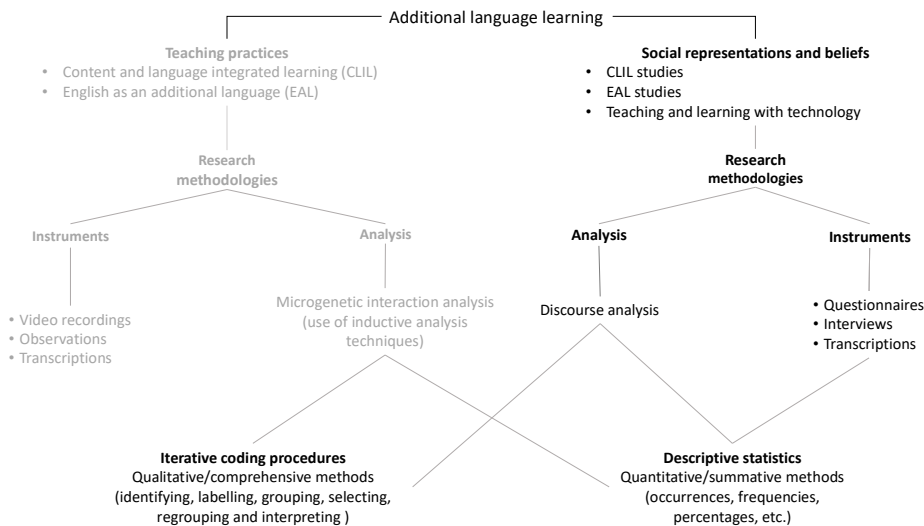

Figure 65. Beliefs and social representations and their link with other research topics.

Although I have used various data collection and analysis methods in my studies, in this methodology section I do not describe the commonly used techniques (e.g., questionnaires) and analysis procedures (e.g., descriptive statistics). This chapter focuses mainly on GT techniques that are used to examine social and socio-psychological phenomena.

GT commonly uses interviews to collect and examine primary data. The interview technique allows the collection of discursive content from the members of a given group relating to an object. Most of the time, these interviews are semi-structured or open. During the interview, the interviewer establishes a climate of trust and acts as a facilitator and stimulator. The interviewer should be neutral and show interest and understanding to the interviewee (Charmaz, 1996, 2014; Guimelli, 1995; Moliner & Guimelli, 2015). The interviewer repeats and reformulates the respondent's statements and makes sure that the interviewee's statements reflect what they intend to convey. This casual exchange also allows the interviewer to check whether they understand what the interviewee is saying.

Most of the data in my studies on representations were collected through semi-structured interviews (individuals or focus groups¹¹⁵) and questionnaires. The data collected from the interviews were analysed using procedures offered by the GT approach (Glaser & Strauss, 1967, 2006; Strauss & Corbin, 1990, 1998). All interviews were audio recorded and after transcription, the content was verified by the respondents for validity. All transcriptions were complete verbatim transcripts and contained contextual elements and comments. Comments were only used when notable events such as anger, hesitation, expression of strong opinion, and passion occurred.

1.69.1 Grounded theory method

The GT approach was formulated by sociologists Glaser and Strauss in the late 1960s. This qualitative research approach bases its theoretical stance on pragmatism and symbolic interactionism (Corbin & Strauss, 1990b). GT employs observations, interviews, video and audio recordings, or written documents to collect data, and it is applied to generate a comprehensive theory to understand social and psychological phenomena (see Glaser & Strauss, 1994; Strauss &

¹¹⁵ The researcher may interview a group of people who share similar characteristics at the same time (the questions can be semi-structured or open).

Corbin, 1990, 1997). The research traditions used in this school of inquiry share similarities with practices employed in social constructionism and social psychology (Strauss & Corbin, 1997). The symbolic interactionist perspective assumes that people are motivated to look for meaning in their behaviour and that they act following their subjective understanding of the situations in which they find themselves (Serpe, 1987; Serpe & Stryker, 2011). GT is used in disciplines that aim to discover significant aspects of human experiences, and it is employed to capture, understand, and explain people's lived experiences (P. Baker, 2006; Charmaz, 1996, 2014). GT provides researchers with a series of logically consistent research techniques and strategies to conduct rigorous qualitative research studies. These interpretive research methods are especially suitable for studies that aim at discovering participants' meanings, perceptions, emotions, attitudes, beliefs, and so forth. GT is an, inductive, iterative and an interactive inquiry that necessitates entering the participants' world and gathering accounts that are as complete as possible (Charmaz, 2014).

In GT, the analysis starts as soon as the data is collected. The terms which are associated with GT are 'coding', 'theoretical sampling', 'theoretical saturation', 'purposeful sampling', (e.g., open and axial coding), 'modelling' (i.e., formation of thick, stable, and broad categories), and 'theorising'. 'Coding' is the central inquiry process used in GT. Coding involves going through the data, comparing ideas, interactions, events, and so forth for similarities and differences and assigning conceptual labels. 'Open' and 'axial' coding are two most commonly used coding methods (Corbin & Strauss, 1990b). Open coding, an interpretive process, is mainly used at the initial stages of the inquiry processes. It involves going through the data and assigning labels during this discovery process (Charmaz, 1996; Strauss & Corbin, 1997). In axial coding, concepts that pertain to the same phenomenon are grouped together to form categories (not all concepts become categories). Then, after several cycles of a systematic search of meaning, linking, and interpreting, these groups are connected to their sub-categories, and the relationships tested against the data (Corbin & Strauss, 1990b).

Using 'inductive iterative' methods, the researcher revisits the data over several rounds as new ideas (e.g., categories, themes) emerge, and they try to establish connections between newly emerged material with the previously discovered groups of ideas. This iteration is a highly reflexive task and an essential element of inductive meaning-making processes. See Figure 66 for the schematic representation of the GT model.

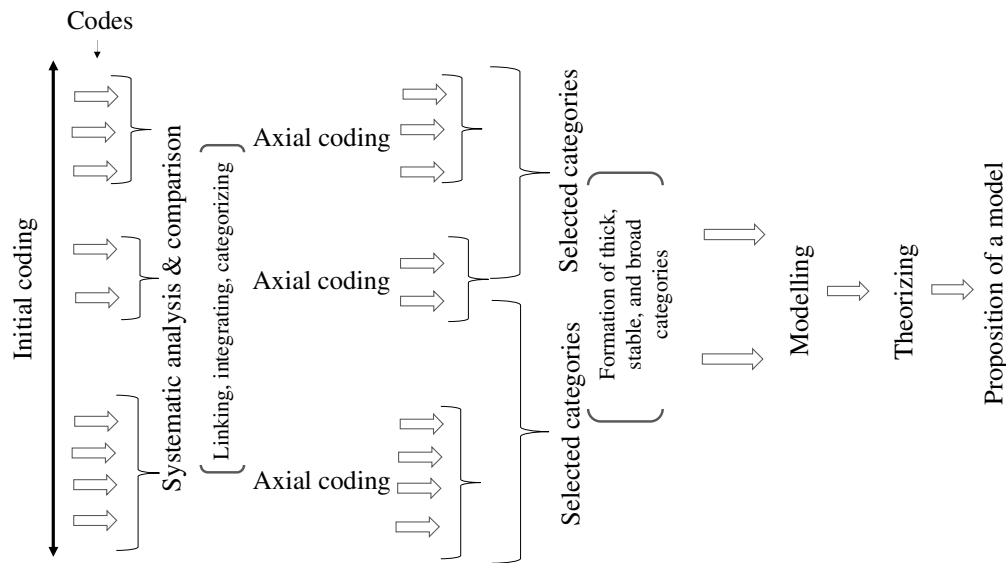

Figure 66. Schematic representation of a grounded theory method model.

In GT, sampling is carried out using specific procedures. The samplings methods used in GT are ‘theoretical sampling’, ‘similarities principle’, ‘maximum variation principle’, and ‘theoretical saturation’. Theoretical sampling is one of the central concepts of GT. The term was introduced into the literature when GT was devised by the sociologists Glaser and Strauss (1967, 2006). Sampling procedures should not be confounded with theoretical sampling, which is ‘... sampling for theory construction, not for representativeness of a given population, to check and refine the analyst's emerging conceptual categories.’ (Charmaz, 1996, p.28). Theoretical sampling is an iterative data collection process with a primary objective of generating theory. During this iterative process, the researcher carries out a series of concurrent data collection and analysis procedures and decides what data to collect next. This process involves collecting, coding, comparing, linking, and integrating data into relevant categories. This iteration is a loop-like a process with multiple rounds that directs the researcher’s attention to the emerging themes and what to look for next (Glaser & Strauss, 1967, 2006; Paillé, 1994; Strauss & Corbin, 1990, 1998).

When a research project begins, based on the phenomenon the researcher intends to investigate, representative groups of individuals are selected. In GT, researchers go to groups from whom they can obtain rich information about issues crucial to the purpose of the research (Corbin & Strauss, 1990; Strauss & Corbin, 1990). A ‘purposeful’ sampling is usually based on similarities or/and maximum variation principles with an aim of obtaining the maximum amount of information on

the phenomenon in question and maximizing the representativeness of the primary data (Charmaz, 1996; Corbin & Strauss, 1998; Glaser & Strauss, 2006; Strauss & Corbin, 1990, 1997, 1998). ‘Initial sampling’ is usually based on similarities principle, and the researcher selects a group that has characteristics that are shared by all members (e.g., social identity, occupation, and educational background) and that are representative of the phenomenon in question (Glaser & Strauss, 2006). ‘Maximum variation’ is used when researchers desire to maximize the variation (e.g., age, gender, and class) within the sample. The aim of maximum variation is to ensure the presence of maximum variability within the primary data (Charmaz, 1996; Glaser & Strauss, 2006).

Data collection, concurrent comparative analysis, and category formation procedures continue until each category is saturated. In other words, the theoretical sampling processes end when the data collection procedures can no longer obtain new information, and the analysis procedures cease to generate new categories (Charmaz, 1996). This stage is referred to as theoretical saturation, and this saturation point determines the definitive sample size (Charmaz, 2014; Strauss & Corbin, 1998).

1.69.2 Data analysis tools

Beginning in 2015, I used a qualitative data analysis software called ATLAS.ti to analyse the corpora collected via interviews. This software is specially designed to employ a systematic approach to the analysis of qualitative data and is compatible with GT methodologies.¹¹⁶ The software offers tools to manage, extract, compare, explore, and regroup meaningful information in masses of data systematically and comprehensively. The software is adapted to using different types of coding procedures (e.g., initial and axial), which can be attributed to different data segments (quotations). Codes can be attributed to audio, text, or video quotations and can be organized under different code families and groups. The software also enables us to obtain code relations, code groundedness, and code (co)occurrences, among others.

¹¹⁶Many recent software packages for qualitative data analysis (e.g., ATLAS.ti, NVivo, and MAXQDA) offer different levels of coding and note-writing (memo) techniques that make it possible to use iterative inductive analysis methods compatible with GT techniques.

1.70 Discussion and conclusion

The chapter presented succinct information on the research methodologies and analysis procedures used in my belief and social representation research. Although I have used various data collection and analysis methods in my studies, I have not described commonly known techniques (e.g., questionnaires) and analysis procedures (e.g., descriptive statistics) in this methodology section. I focused mainly on describing GT techniques that are interpreted and applied differently by different researchers depending on their theoretical position. In my recent research on beliefs and social representations, I have used the original GT method that was created and developed by Glaser and Strauss (1967). I have explained in detail the steps used in this method in order to differentiate it from other grounded theory methods that have various names and applications.

CHAPTER FOURTEEN

BELIEF AND SOCIAL REPRESENTATION STUDIES

Introduction

Beliefs play an essential role in education. It is widely accepted that the beliefs that learners develop and hold true about their abilities and skills have an immediate impact on their learning behaviour (Pajares, 2001; Wenden, 1995). It has often been argued that social representations, which are produced in society, are part of people's everyday world and circulate in the media they watch and read and in the daily discussions they have with friends, family, and colleagues (Duveen, 2000; Moscovici, 2000a). These representations constitute the realities of people's lives that facilitate the formation of opinions about the world around them. They influence the daily decisions and actions of individuals, groups, and societies as well as how they perceive their own and others' roles.

My earlier publications on belief and social representations focused on learners' and teachers' beliefs in EAL contexts (Gabillon, 2007b, 2012a, 2012b, 2013b). My most recent publications have investigated elementary school teachers' social representations of digital technologies (Ailincăi & Gabillon, 2018a; Ailincăi et al., 2018).

My most recent projects investigate social representations and beliefs about languages, language learning, and bilingualism (See [Chapter 15](#)). These ongoing projects aim to complement research on EAL and CLIL learning by investigating parents', teachers', and learners' social representations and beliefs in the French Polynesian context. Analysis of the unpublished dataset on parents' representations regarding language, language use, and AL learning (research in progress) suggests that French Polynesians consider AL learning to be indispensable to their community and are in favour of a bilingual (plurilingual) education (French, English, and Tahitian, in order of preference; see Gabillon, 2020b, for Mendeley dataset). My research activities aim to explore these social perspectives and explore the links between beliefs/social representations and language learning. Figure 67 illustrates how CLIL, EAL and other educational issues intersect with beliefs and social representations.

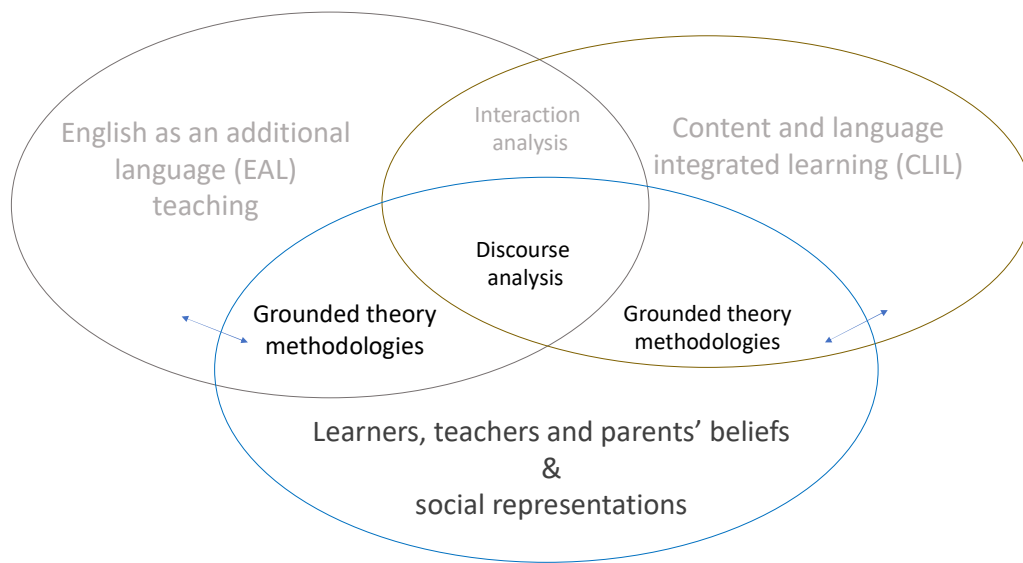

Figure 67. Beliefs and social representations research and their link with CLIL and EAL.

The three research areas of CLIL, EAL, and beliefs/social representations are intrinsically connected, and they inform one another. Research findings in these three areas contribute to insights into issues related to AL pedagogies, learning behaviours, attitudes, social context, and social cognition. These studies provide useful information on personal, social, and cultural levels about language learning, languages, and language use. This chapter presents three examples from my belief and social representation studies.

Social representations: Study I

1.71 Introduction

This study presents the results of exploratory research that focused on the social representations of French Polynesian elementary school teachers about digital technology and its uses in teaching and learning. This study was carried out as part of the *NumériProf* research project (2017-2020; Ailincal & Gabillon, 2018a; Ailincal et al., 2018). The project has been ongoing in French Polynesia since 2017. In 2018 the project was extended to the New Caledonian education system with the contributions of researchers from the University of New Caledonia (UNC), and now the UNC is a partner on the project. The objectives of our research are to carry out (under the same conditions) a series of semi-structured interviews to gather representations of teachers on their practices concerning digital technology in French Polynesia and New Caledonia (see Ailincal & Gabillon, 2018a; Ailincal et al., 2018). During the second phase of the study, we intend to carry out a comparative study on the data obtained in French Polynesia and New Caledonia, and the third phase will be devoted to classroom observations and comparison of these with the data collected via interviews.

The exponential development of digital technologies and their subsequent integration in learning environments has exerted pressure on teacher education programs to incorporate technical, didactic, and pedagogical training in their curricula, which was also our case as researchers and teacher educators at the ESPE in French Polynesia. Today, more and more French Polynesian schools are equipped with digital tools. Since 2010, with the installation of the underwater fibre optic communication cable, which connects French Polynesia to Hawaii, the broadband internet is omnipresent in French Polynesian society. The *DigiWorld Yearbook 2017* report, which was published by the association We Are Social (2017), states that 65% of the French Polynesian population are active internet users.

In 2015, an educational project called the Digital Plan for Education, was launched by the French Ministry of Education. This project reinforced the French Polynesians' wish for the creation of a 'digital school'. In recent years, the French Polynesian Ministry of Education has demonstrated a genuine desire to integrate digital technology into schools and has made significant efforts to equip schools with digital materials. The French Polynesian Ministry of Education aims at endowing all

middle school students with personal mobile equipment by the year 2019 and generalizing the implementation of digital technology in all middle school classes. This endowment program can also include the primary schools upon their submission of a project. Since donations are often submitted upon presentation of a pedagogical project, information and communication technology in education (ICTE) counsellors have the task of training their colleagues in the realization of such projects.

This new endowment program is also backed up with a large project that aims at providing teachers with training on the pedagogical implementation of digital technology. The permanent and efficient use of digital tools, which corresponds to official educational texts and recent ministerial recommendations, requires technical skills and pedagogical knowledge. Lasting and effective use of digital technology can only be promoted by adapting the content of teacher training to the current needs of the teachers and their teaching contexts. Such teacher education programs can only be efficient if firm theoretical stands and research-based findings constitute their foundation.

1.72 Brief literature survey on representations and technology use

Research done on the use of digital technology in school settings suggests that there are correlations between teachers' representations and their practices. Teachers' representations, skills, and attitudes are seen as interdependent (Summers, 1990). Negative representations due to lack of knowledge of digital tools and their use are said to have direct consequences on teachers' attitudes, triggering fears and consequently influencing their confidence in using these tools. In contrast, positive representations have been shown to be positively correlated with teachers' attitudes and actions (Berney & Pochon, 2000).

Teachers' representations and skills concerning the use of digital technology are of foremost importance in curriculum design. Nevertheless, learning and teaching are situated processes, and many other contextual factors also influence teachers' commitment to or choice of including digital tools in their teaching (Lave & Wenger, 1991). These factors can be grouped at the macro-level, such as social, cultural, and organizational contexts (at the local or departmental level), and at the micro-level, which are immediate factors such as daily obligations, teaching routines, institutional projects, parental requirements, and so forth (Bronfenbrenner, 1979). Simply put, the initiative for the use of digital technology is determined at the macro-level by an overall systemic dynamic and

at the micro-level by the teacher's professional values. These reflections, and research in this area, have led us to consider social representation as a necessary construct to be studied in terms of its subsequent impact on teachers' behaviours. This aspect of social representation was relevant to our theoretical stance, and throughout this study we have attempted to provide additional elements to contribute to the existing literature.

1.73 Methodology

Our study aimed to investigate how digital technology is perceived and used by elementary teachers in French Polynesia. During the first work package, we explored teachers' representations (i.e., elementary teachers and teaching advisors) using face-to-face interviews. The second work package of this study is an ongoing project, and we aim at maximizing the variation of participants by extending the face-to-face interviews to educational inspectors and trainee teachers at the ESPE. In the last work package, our objective is to carry out classroom visits to observe the teachers' actual practices. Figure 68 illustrates the steps followed in all these three work packages.

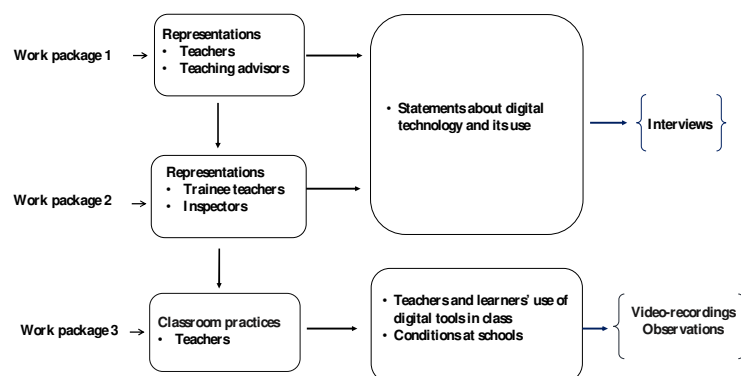

Figure 68. Research plan and work packages

This first study deals only with the first part of the Work Package 1. The study focuses on 16 teachers' representations and their reported teaching practices regarding digital technology. During the first part of Work Package 1, we aimed to answer the following research questions: (i) To what extent do French Polynesian teachers know about digital technology? (ii) How do teachers make use of digital technology in their teaching? and (iii) How do teachers feel about using digital tools in their teaching? To answer these questions, we carried out an exploratory study based on face-to-face interviews with 16 primary school teachers. The primary objective was to collect a group of

teachers' representations of digital technology and their statements concerning the employment of digital tools in their teaching. The study also aimed at gathering these teachers' representations related to the impact of digital technology on learning. Table 19 summarizes the characteristics of the teachers who agreed to be interviewed.

Table 19. General characteristics of the participants and the length of the interviews.

Primary teachers						Pedagogical counsellors					
Gender	Teacher number	Age	Teacher number	Age	Teacher number	Age	Teacher number	Age	Teacher number	Age	Teacher number
Male	T1	43	T1	43	T1	43	T1	43	T1	43	T1
	T2	40	T2	40	T2	40	T2	40	T2	40	T2
	T3	44	T3	44	T3	44	T3	44	T3	44	T3
	E4	35	E4	35	E4	35	E4	35	E4	35	E4
Female	T5	42	T5	42	T5	42	T5	42	T5	42	T5
	T6	33	T6	33	T6	33	T6	33	T6	33	T6
	T7	37	T7	37	T7	37	T7	37	T7	37	T7
	T8	45	T8	45	T8	45	T8	45	T8	45	T8

The study was based on a GT approach (Charmaz, 1996; Corbin & Strauss, 1990b; Strauss & Corbin, 1990). The sample size selection was carried out according to the theoretical sampling model offered by GT research inquiry. This comprehensive research model, which used inductive corpus analysis schemes, suited the aims and the theoretical stance of this study. Respecting GT research traditions, we started the analysis procedures as early as the first interview at the outset of the study. The data gathered through interviews were analysed by applying simultaneous analysis schemes such as coding, sorting, linking, forming categories, and integrating new ideas into new categories (Corbin & Strauss, 1990a; Glaser & Strauss, 1967). The data were triangulated using the following methods: (i) theoretical saturation, to ensure that the data represent all facets of the investigated phenomenon, and (ii) double-checking the content of the transcribed corpus with the interviewees themselves.

The data for the study were gathered by conducting semi-structured face-to-face interviews, and the data gathering procedures took place from April until the end of June 2017. Sixteen elementary school teachers from Tahiti, French Polynesia, participated in the research. The rich, contextualized, and in-depth information that interviews provide induced us to choose this research technique over other forms of qualitative inquiry. The face-to-face interview technique is

considered the most suitable data collection instrument in GT research. GT is an inductive, iterative, and interactive inquiry that necessitates entering into the participants' world and gathering accounts that are as complete as possible (Charmaz, 1996, 2014). The interviewing technique also provides the researcher with synchronous communication both in time and place. Interviews are also rich in discourse features such as emphasis, choice of vocabulary, repetition, and social cues such as voice, intonation, body language, and so forth. As such, interviews provide a great deal of extra information that adds value to this qualitative research technique.

The interview questions were conceived using the literature on representations and digital technologies for learning (Baron & Drot-Delange, 2016; Karsenti, 2005). We tested the initial set of questions with two teachers. Following these two interviews, we transcribed and analysed the interview data and readjusted the questions through consultation with other researchers. These two preliminary interviews were not included in the actual research corpus. After the modifications, the final set of questions were formed and used with the other participants. The analysis was done by two different researchers and the categories obtained were compared.

1.73.1 Sampling and participants

We looked for characteristics that were shared by all participants and that were representative of the phenomenon (i.e., elementary school teachers who lived in French Polynesia and who had a French Polynesian identity). The sample group size was determined by employing the theoretical sampling criteria used in GT. We carried out purposive sampling by applying the 'similarities and differences' criteria and the empirical saturation principle to determine the number of participants. The sampling procedures were carried out at three levels. Taking the abovementioned principles into consideration, we designed the sampling model (see Figure 69).

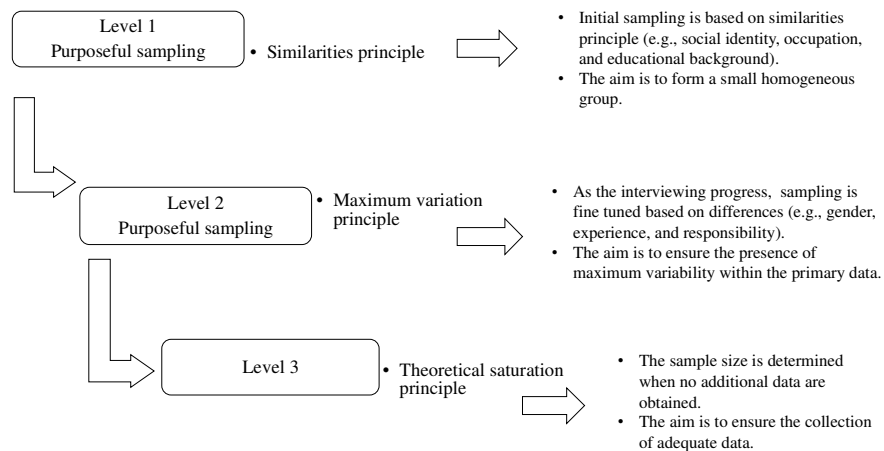

Figure 69. Three-level sampling model used in the study.

The first level is concerned with constituting a group of subjects who were the most representative of the phenomenon in question. The researchers thus used a purposive sampling method focusing on the similarities that constituted the major characteristics of the sample. After defining the characteristics regarding similarities, we looked for differences within this uniform group by applying the principle of maximum variation. Thus, we selected a sample to observe differences regarding intra-personal and inter-personal levels (e.g., experience, gender, age, and responsibilities). The sampling was done to include eight men and eight women, eight teachers and eight teaching advisors, teachers with ages ranging from 33 to 50, and teachers with 11 to 23 years of teaching experience.

1.73.2 Corpus coding and analysis

The analysis of the data was based on GT proposed by Glaser and Strauss (1967) and comprised five steps: codification, categorization, linking, integration, and theorization. In this research work, we employed procedures similar to those suggested by Glaser and Strauss (1967) with minor adaptations. The phases used in this study were also inspired by the anchored theorization model of Paillé (1994), which was also shaped by Strauss and Corbin's (1990) GT.

GT provides researchers with some key strategies and procedures on how to code and identify categories and how to discover properties to establish links between emerging groups (Charmaz, 2014). Some of these key strategies are constant comparative analysis, iterative inductive data processing, theoretical sampling, and theoretical coding (Corbin & Strauss, 1990a; Strauss &

Corbin, 1998). We followed the steps suggested in GT. We started the analysis procedures as early as the collection of the first interview data. After the collection and transcription of the interview corpus, using the ecological triangulation method, we double-checked the transcribed the corpus with the interviewees. In the initial stages we used simple coding techniques to form lower-level abstractions (two researchers analysed the data at the same time). As the analysis progressed, we started using iterative inductive processes using axial coding to make higher-level abstractions. At this stage, we began forming different levels of categories. The abstraction and categorizing processes continued until the saturation point, meaning that the process continued until the properties became redundant and we were unable to form any new categories. Figure 70 illustrates the processes we followed in the study.

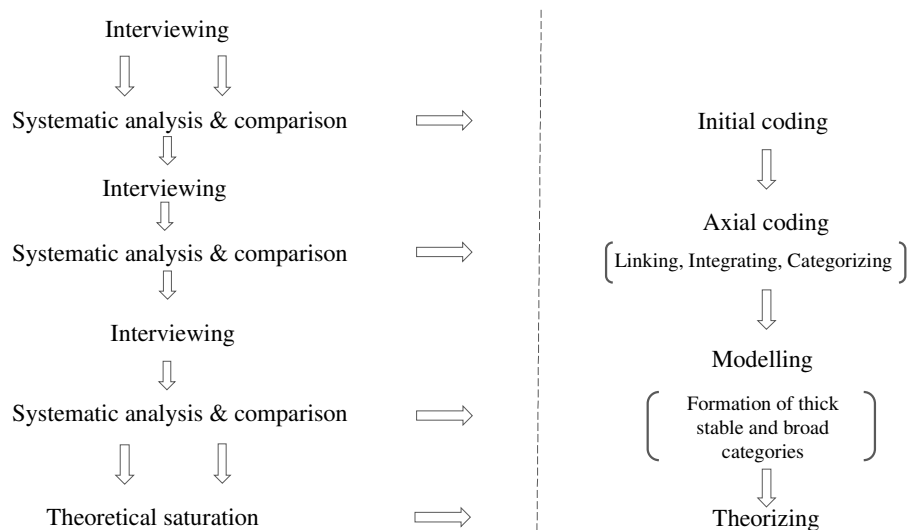

Figure 70. The research protocols followed in the study.

We identified initial categories from the most frequent occurrences. Finally, we grouped all these categories under themes, which initially constituted the main ideas in the interview questions: (i) the teachers' representations of the notion of digital technology, (ii) the teachers' statements about the use of digital technology in their practices (i.e., their and their students' use of digital technology tools), and (iii) the teachers' statements related to the perceived instrumental value of digital technology (this item emerged as a category under 'student use').

1.73.3 Results

This section presents the preliminary results of a study that comprises three work packages. The results we present here have an exploratory character, and we do not attempt to theorize the categorized phenomena.

a) The teachers' representations regarding the notion of digital technology

Research Question 2 aimed at gathering information on the teachers' representations of the notion of digital technology. The interview corpus (from Question 2 and from other questions) that belonged to this category was coded and examined through systematic comparison and analysis procedures (iterative inductive processes). Throughout the interviewing, the data properties falling into this category were sorted, linked, and integrated into different levels of abstraction. As the last step, the responses obtained were organized into four hierarchical categories. The transcribed data revealed that the respondents did not have the same level of familiarity with digital technology. Some teachers developed and refined their ideas with precise descriptions of digital tools, while some others gave short responses in the form of keywords without developing their answers. The analysed corpus indicated that some teachers had limited notions of digital technology both at personal and professional levels. It should be noted that the concepts that were cited most (grounded) were commonly used materials and tools. A few teachers referred to some technical tools, materials, applications, and some other more sophisticated technical notions that are reserved to more competent users (e.g., web browsers, operating systems, Unix, HTML, and programming tools). However, since the comprehensive interviewing method was not based on the number of occurrences, even a single incident was taken into account and considered a category (see Figure 71).

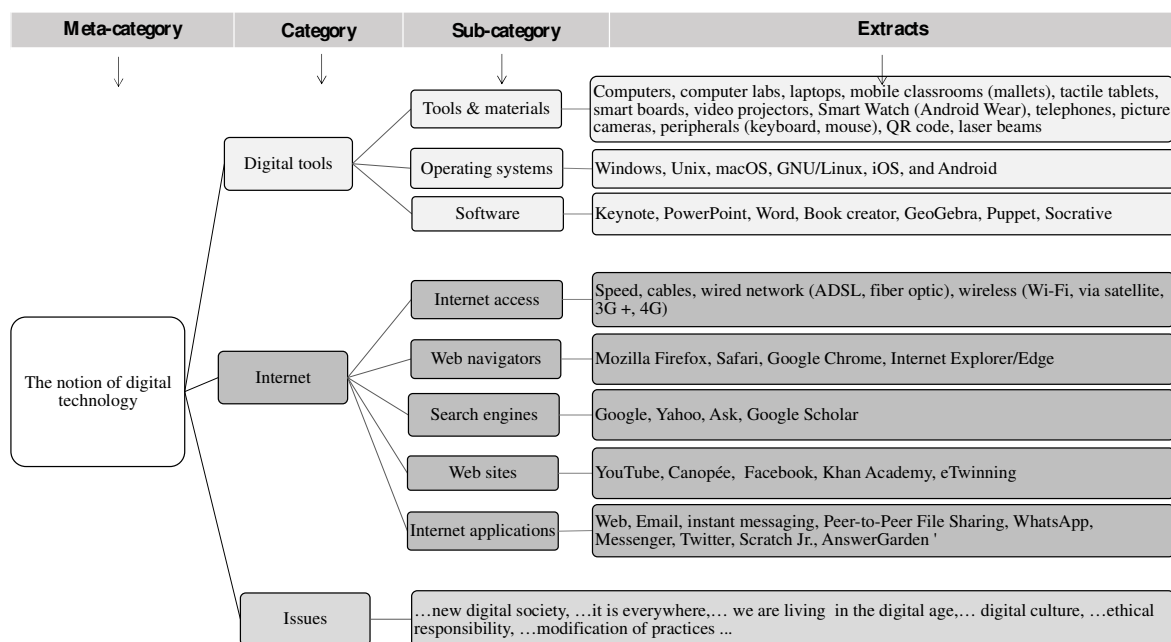

Figure 71. The teachers' representations regarding the notion of 'digital technology.'

More than half of the interviewees associated the notions related to digital technology with pedagogical approaches and the use of tools for a purpose: 'in the notion of digital I include all sorts of computer hardware', 'behind each material, there is also an approach that must be used while teaching', 'cannot use it as you do in traditional teaching', 'the approach allows taking a professional stance with digital technology...without also forgetting the whole ethical responsibility part about these uses.'

b) The teachers' statements about the use of digital technology in their practices

In this macro-category, we grouped the comments about the use of digital tools and the perceived impact on learning practices. This mega-category also included categories about teaching activities using digital tools. Figure 72 summarizes the statements regarding the teachers' discourse concerning the use of digital technology in their teaching.

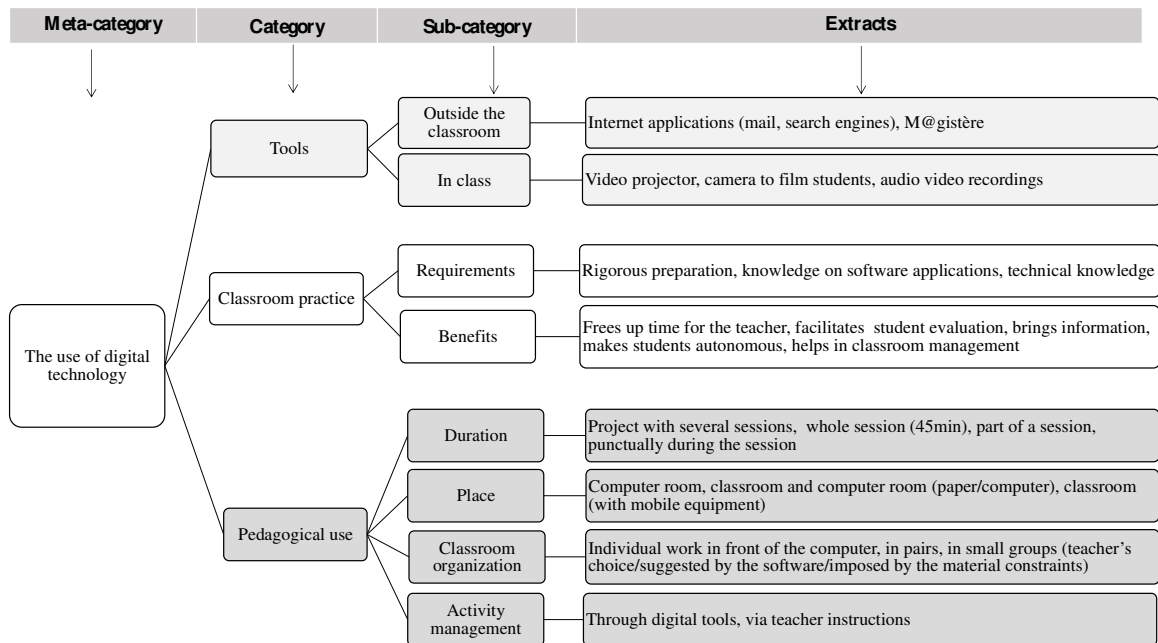

Figure 72. teachers' statements about their use of digital technology.

The majority of the interviewees emphasized that the integration of digital technology in teaching practices requires both technical and pedagogical knowledge and laborious work that demands extra preparation time. They repeatedly stressed the necessity of detailed preparation and foreseeing in advance: 'The preparation time of an activity is quite huge ... everything has to be fixed and done in advance.' 'In the computer room, if I do not think about everything previously, they [pupils] will drop the activity because they will not know how to use such software ...' '[For us it is important that] pupils are at ease when they start the tasks ... it is necessary that the students are in full activity and maintain their attention during the duration of the chosen activity.'

Some teachers also indicated that when teachers are in class, they have to manage their students' pedagogical needs and other requirements about tasks and tools simultaneously: 'That's why if we do not give instructions before they arrive in the computer room, it goes in every way.' 'While in class...I act according to what the pupils are demanding from me; there are things that I may not have thought of in advance. I try my best to respond to the children ...'

The teachers maintained that the wise use of digital tools necessitates modification of common teacher-learner interactions and teaching practices: 'Besides, many [students] believe that they can take the information like that on the Internet, and then they use it without adapting, without

appropriating really what they are going to read.’ ‘... but afterwards, you have to know how to use them, and the teacher has to teach the pupils, the children how to use these tools.’

The teachers also added that the teacher's presence is indispensable: ‘Digital tools will never replace the teacher ... It is a tool, there is no relationship between the tool and the learner, the teacher and the pupil ... if there's no teacher to show him/her how to do it, the digital tool will not do it alone.’

c) The teachers’ statements about the learners’ use of digital technology in their teaching practices

We have distinguished a meta-category regarding the learners’ use of digital tools in learning settings. In the corpus, the statements referring to the uses of digital technology by pupils, involving things such as tools, activities, projects, tasks that are used in class, and the added value of digital tools and their benefits for pupils, were gathered under a distinct mega-category (see Figure 73).

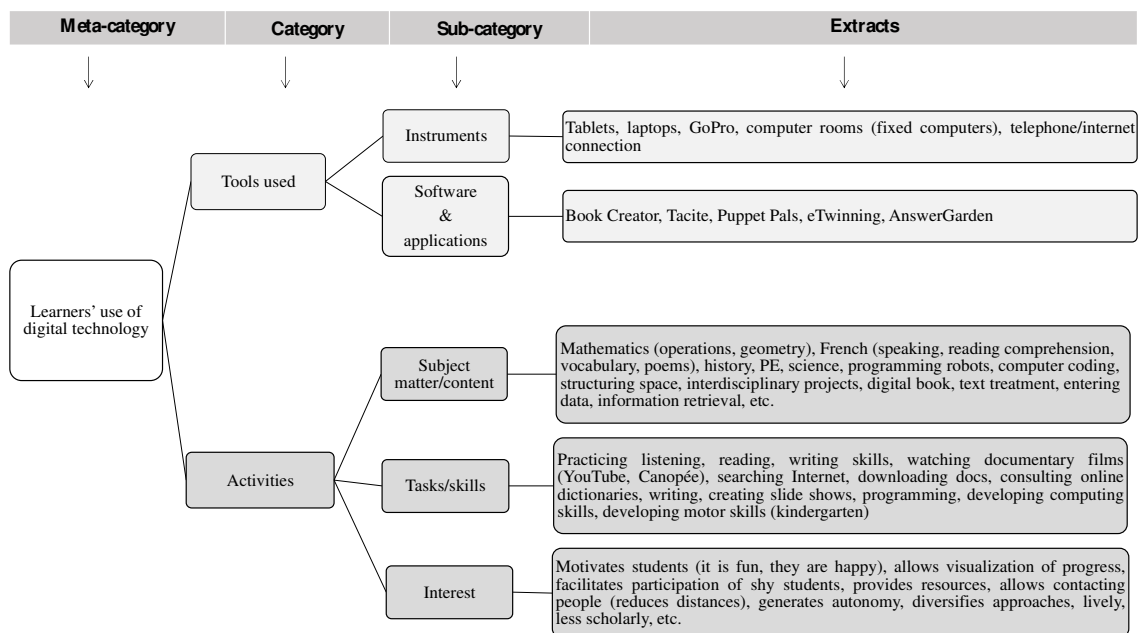

Figure 73. Teachers’ statements about the learners’ use of digital technology in learning.

Almost all of the teachers stated that digital tools have advantages and benefits for students: ‘They [students] love it. They love it, ...but because it's not academic ... it's fun. They do not have computers at home ... they have phones, but they do not have an iPad, not often ... and in any case no junk and no internet ... So, coming to class and having a computer, it's game time. Such tools

will be beneficial for the students in difficulty’. Table 20 provides the teachers’ statements describing how they used these tools in their teaching practices.

Table 20. Examples of teachers’ statements which describe how they use digital tools in teaching practices.

Reading, comprehension, & vocabulary	‘The digital device is used during the practice phase...on a notion that they have already seen ...’ ‘... with 6th graders, we do comprehension activities using an application called “Tacitus”; ... it is an application ... for vocabulary practice with children, but they have to go online ... to improve comprehension skills.’
History	‘... the films in history classes ...’ ‘...They searched for the kings of France. So, they had a guide sheet, and they had to navigate to answer the questions...’
Mathematics	‘... with GeoGebra they do geometry...’
Computer coding	‘... we used the laptop ... to be able to do computer coding ... this computer coding serves to move small robots, ...playful ...’
Physical education	‘... the use of video in PE. Pupils are put in a situation of a game, ...a student video records, then, in autonomy, the students re-watch the film. ... you do a lot of work with them, ... you observe the role of each person. ... we improve learning as well, gestures or techniques or tactics of the game, which is done precisely through video ...’

Some of the statements of the teachers were directly linked to the positive aspects of such tools regarding learner errors: ‘... because they are no longer blocked by fear of making an error. With digital tools precisely, being able to self-correct and to go back without leaving any trace, favours enormously the students with learning difficulties.’ ‘Collaborative writing, ... with computer ... when one makes corrections, one produces a clean piece of work.’ ‘There is no erasure, barring, erasing ... for children, it still has another value to produce a clean piece of work ..., very nice.’ ‘I would like to mention it as regards its connection with children's self-esteem. ... on tablets, I see that they are not afraid to be wrong.’ ‘When they write on a piece of paper, and when there is a mark, they have difficulty in erasing it, they do not want to give their work anymore, there is really a written trace that is marked somewhere, and they have trouble with ... so they prefer not to write anything because they are not sure of their answers. While on the tablet it is easily done, eh.’ ‘When it is wrong, neither seen nor known, they erase everything, and they can go back and revise.’

d) Teachers' negative and positive representations regarding the use of digital technology in class

The teachers also described in which situations they used digital tools. The teachers' statements indicated that they made use of some applications in teaching certain school subjects. After forming general categories, we also regrouped the abstractions obtained under two broader areas and presented these broader categories as positive and negative representations. The stages of linking and integration revealed several levels of discourse: 36% of the participants expressed favourable opinion towards digital technology, while 64% of the participants' discourse contained elements highlighting difficulties. These statements, however, were mainly expressed either as difficulties that needed to be resolved or as reasons for non-use. We have not recorded any statements 'against' digital technology. Although the positive impact of digital technology on learning was apparent in all interviews, these positive ideas were balanced by arguments about the difficulties teachers face in using it in the classroom (see Table 21).

Table 21. Negative and positive representations about the use of digital technology in class

Positive representations	Negative representations
Improves the dynamic of the course	Additional preparation and time
Brings openness to the world and resources teachers use (M@gistère and MOOCs)	Difficulty of catching up with it due to the rapid evolution
Reduces teaching time (evaluations, correction of the notebooks, etc.)	Complexity of its use and its rapid evolution
Increases learner self-esteem, motivating	Lack of appropriate user-friendly material
Allows autonomous work and scaffolding by software	Gap between pupil-teacher competencies (students are more competent)
Motivates	Difficulties regarding classroom management
Has an added value for the course	Reluctance related to time and additional work to prepare an activity
Meets student expectations	Unwillingness to change
Encourages collaborative learner work	Desire to keep to usual practices
Provides help for learners with learning difficulties	Difficulty of getting tailor-made training to answer personal needs (relevant, useful training)
Helps diversify learning approaches	Denial of use due to lack of skills or bad experience
	Non-availability of permanent technical maintenance

To sum up, in all the interviewed teachers expressed positive ideas towards the use of digital technology in education. However, they also mentioned that they encountered many difficulties such as not being able to catch up with the constant evolution of digital tools, not having an updated teacher education, not having technical staff available at schools, and additional preparation time.

1.74 Discussion and conclusion

This study described only with the first work package, which explored eight teachers and eight teaching advisors' discourse concerning digital technology in the French Polynesian elementary school context. The results obtained revealed that the teachers used digital technology both for personal and professional purposes (100%). They all stated that they used digital tools for lesson preparation and some basic tools such as video projectors and computers for their teaching practices. However, the data indicated that there was a gap between the students' active use of technological tools in class (19%), and the teachers' use for personal purposes and professional use for lesson preparation (100%). Regarding feelings, 36% of respondents said they felt positive about digital technology. However, no teacher expressed any direct refusal or rejection relating to the use of digital technology in learning. The negative arguments expressed during the interviews were in the form of explanations for non-use. The corpus revealed a balance between female and male participants regarding the classroom use: four women and four men stated that they used digital technology in their classrooms (five occasionally and three regularly); three men and four women participants stated that they rarely used digital tools with their students. One female participant revealed that she never utilized any digital tools in her classes. The majority of the teachers stated that they did not use digital technology, and their arguments were mainly difficulty oriented. The three most involved teachers had 25 to 35 years of experience. These three teachers expressed that they used digital technology regularly in their classrooms.

The study is still in progress, and the phenomena under investigation have not yet fully considered. Thus, the modelling and theorising of this analysis remain to be completed.

Beliefs: Study II

1.75 Introduction

The second study, a synthetic report published as a journal article, is a qualitative study, which was conducted with a small group of learners using Weiner's attribution model as part of my learner belief studies (see Gabillon, 2013b). The study aimed to analyse eight learners' stated beliefs about English and English language learning based on the data collected via semi-structured interviews. The study drew also on Bandura's self-efficacy theory and Weiner's (1985) attribution theory of achievement motivation (See [Sections 8.2.3.](#) and [8.2.2.](#)). The novel aspect of this research is the employment of an attributional analysis framework to study and explain the learners' stated beliefs about English and English language learning.

1.76 Methodology

The study addresses attributions and self-referent beliefs, such as self-efficacy beliefs and self-concept beliefs. The aim was to (i) elicit the causes the learners ascribed to their perceived like or dislike of English language learning, (ii) examine the nature of these attributions, and (iii) look into the relationships between the learners' attributions, self-referent beliefs, perceived value of English language learning, and the marks they obtained in English. The participants in the study were eight adult male science students who had had 8 to 10 years of English language learning experience. They were selected according to the scores they obtained in English (below average, average, and above average), The scores they had obtained were the average of the marks obtained in all four skills (speaking, reading, writing, and listening).

The study used semi-structured interviews as a research tool. I prepared a set of questions but also allowed flexibility to ask other questions whenever it was necessary. The interviews were done in French, and each individual learner's discourse items were transcribed and then translated into English. Weiner's (1985) attribution theory was applied to see the attributions each learner ascribed for their like or dislike of English and English language learning. The learner interviews were analysed by focusing on whether the learners stated a like or a dislike of learning English and the types of attributions they ascribed as causes. Based on the model proposed by Weiner (1985,

2010a), I also tried to establish links between the learners' beliefs and possible consequences of these stated beliefs on future learning.

1.77 Results

Three students out of eight stated that they did not like the English language and/or English language learning (Students 1, 2, and 3). Two out of eight were hesitant. These two students (Students 4 and 5) indicated that their past learning experiences had had a negative impact on their AL learning. Students 6, 7, and 8 all expressed positive feelings about English and English language learning.

1.77.1 Participants' attributions for 'I don't like English'

Student 1 explained that he did not like learning English (see Table 22). He attributed his perceived dislike for English language learning—to his lower perceived AL self-concept 'I am not a good language learner' (an internal, stable and uncontrollable cause).

Table 22. Analysis of Student 1's discourse

(Do you like learning English?)	<i>Student 1's stated belief: 'I don't like learning English'</i>	
<u>Causal ascription</u> Lower perceived ability in L2 learning (properties of cause: negative, present, internal, stable/uncontrollable)	"I am not a good language learner."	Attributes his dislike of English to his perceived lack of L2 ability and low L2 self-concept
<u>Causal ascription</u> Perceived task difficulty (properties of cause: negative, present, internal, stable/uncontrollable)	"I find English difficult. I can understand when I read the texts given in the class, without much difficulty, but I cannot speak and understand English-speaking people well"	Attributes his perceived L2 difficulty to his lower perceived self-efficacy in English
<u>Goal/Expectation</u> (What is 'being good at English' for you?)	"Being able to speak and understand English-speaking people well"	
Outcome	English mark obtained:9/20	Fail
Expectancy of future success (Do you think you will get a better mark next time?)	"No, I don't think I can"	The student has a low expectancy of success in his next English test

The learner was convinced that he could not learn English because he perceived that he lacked the required AL ability to learn this language. He attributed his perceived AL difficulty (or lower

perceived AL competence) as the consequence of his lack of ability to learn English. When the learner was asked what he meant by ‘being good at English’, he responded as: ‘Being able to speak and understand English.’ For this learner, ‘understanding and speaking English’ represented a core belief, an implicit goal/expectation of learning English. The learner’s discourse analysis indicated that the learner believed that he failed to achieve this goal because he perceived that he lacked the ability to learn this language. The reason for this learner’s negative attitude towards learning English seemed to originate from his negative self-referent beliefs (i.e., lower perceived AL competence and negative self-concept), which have internal, stable, and uncontrollable causal properties.

Student 2, like Student 1, attributed the causes for his dislike of English language learning to his lower perceived AL competence and his lower perceived AL progress, which the learner believed to be beyond his control. Student 2, like Student 1, attributed his dislike of learning English to his lack of ability to learn this language. Student 1’s perception of the importance of listening and speaking skills was also shared by Student 2. (see Table 23).

Table 23. Analysis of Student 2’s discourse

(Do you like learning English?)	<i>Student 2’s stated belief: ‘I don’t like learning English.’</i>	
<u>Causal ascription</u> Lower perceived L2 competence (properties of cause: negative, present, internal, stable/uncontrollable)	“My English is not good.”	Attributes his dislike of English to his lower perceived L2 competence
<u>Causal ascription</u> Perceived repetitive failure (properties of cause: negative, past/present, internal, stable/uncontrollable)	“I have been learning English for more than eight years, yet I don’t know much English.”	Attributes his lower perceived L2 competence and his lack of progress as a cause for his non-achievement
<u>Goal/Expectation</u> (What is ‘being good at English’ for you?)	“Having good speaking and listening competence.”	
<u>Outcome</u>	English mark obtained:8/20	Fail
Expectancy of future success (Do you think you will get a better mark next time?)	“I don’t think I will.”	The student does not expect to succeed in his next English test

In short, he also perceived speaking and understanding as being the goal of language learning and was convinced that he failed to achieve this goal: ‘I cannot speak it [English] well; I do not think I will get better now.’ Both Student 2’s and Student 1’s discourses showed that these learners did not expect to get a better mark in their next English test. Bandura (2006a) asserted that learners

who perceive that they do not have the required competence believe that they cannot produce desired effects by their actions and are not willing to participate in learning activities. Students 1 and 2 considered their lower perceived AL competence (their perceived lack of ability, perceived AL difficulty, and lower perceived AL progress) the primary cause for their negative feelings towards AL learning.

The case of *Student 3* (see Table 24) appeared to be slightly different from the first two learners, whose beliefs were directly related to their lower perceived AL competence and AL self-concept.

Table 24. Analysis of Student 3's discourse

(Do you like learning English?)	<i>Student 3's</i> stated belief: 'I don't like learning English.'	
<u>Causal ascription</u> Perceived dislike for English and English language learning (properties of cause: negative, present, internal, stable)	"I don't like English because It sounds strange."	Attributes his dislike of learning English to his dislike of this language
<u>Causal ascription</u> Perceived value for another foreign language (properties of cause: positive, present, internal, stable)	"I prefer learning Spanish."	Ascribes his lack of interest in learning English to his preference for Spanish
<u>Causal ascription</u> Perceived insignificance of English course (properties of cause : negative, present, internal, stable)	"...and also I really don't think that I'll need English after I finish school. I already have a lot of other important school subjects to worry about."	Attributes his lack of interest in learning English to his perceived insignificance of learning English
<u>Expectation/Goal</u> (What is 'being good at English' for you?)	(Not relevant)	
<u>Outcome</u>	English mark obtained:10/20	Pass
<u>Expectancy of future success</u> (Do you think you will get a better mark next time?)	"Perhaps, I will. I don't know. It depends on the test."	The student has some expectancy of success. He expresses that the test (task difficulty) will determine whether he will be successful or not

Student 3 attributed his dislike of learning English to the nature of the English language. This learner expressed an explicit negative attitude towards the English language. His discourse also revealed that he did not perceive English as being relevant to his goals and future expectations. This learner stated that he could get a better mark in his next English test if the test was easy (external, uncontrollable causal ascription). The data obtained indicated that the behavioural consequence of Student 3's AL beliefs would probably be non-participation in the AL activities.

1.77.2 Participants' attributions for 'I like English but ...'

Students 4 and 5 expressed dual feelings about English and English language learning and attributed their non-achievement to an external cause. They both described their past AL learning situations as unfavourable and attributed their previous experiences with AL both to their lower

perceived proficiency in AL and to the fact that they did not like learning English (having difficulty learning it because of inadequate language-teaching approaches). Student 4's discourse revealed that he perceived English language learning as instrumental to achieving his goals. He believed that learning English would be useful for getting a good job and for his school achievement (see Table 25).

Table 25. Analysis of Student 4's discourse

(Do you like learning English?)	<i>Student 4's stated belief: '(I think) I like English but...'</i>	
<u>Causal ascription</u> Perceived L2 value (properties of cause: positive, present, internal/external, stable)	"I believe English is an important language ...for my future career, for my studies etc."	Perceives English as a significant language to learn (for his studies/ future career) and attributes this as a cause for his interest in English
<u>Causal ascription</u> Previous L2 situation (properties of cause: negative, past, external, unstable/ uncontrollable)	"But I didn't have good teachers at lycée (high school)". I have problems with English. "They mostly taught grammar...not useful....not enjoyable"	Attributes his low L2 competence in English to his teachers' teaching in his past L2 learning situation (i.e. not having good teachers)
<u>Goal/Expectation</u> (What is 'being good at English' for you?)	"knowing grammar and speaking well"	
Outcome	English mark obtained:12/20	Satisfactory
Expectancy of future success (Do you think you will get a better mark next time?)	"I don't know. Well! I don't think. I have never learnt English well. Perhaps it's a little late now."	The student has a low expectancy of getting a better mark. He attributes it to his lower perceived L2 self-concept.

Student 4 believed that his AL learning experience at high school was the major reason for his dislike of English classes (past, external, uncontrollable cause). He stated that at high school his teachers focused mainly on the teaching of grammar, which he did not find useful and enjoyable to learn. In short, he attributed his teachers' language teaching approach at high school as a cause for his low AL competence.

Although previously he attributed his teachers' emphasis on grammar teaching as a cause for his non-attainment, when the learner was asked what he considered as 'being good at English', he explained that for him knowing English meant 'being good at grammar and speaking.' When it was pointed out to him that he considered the emphasis on grammar learning/teaching as one of the causes for his dislike of English, he responded as follows: 'I don't like doing grammar exercises. I never felt that I learned English when we did grammar lessons. But I know that I need

to know grammar well to speak and understand English. Now we speak a lot and the teacher corrects our grammar mistakes after. It's better' (see Table 26).

Table 26. Analysis of Student 5's discourse.

(Do you like learning English?)	<i>Student 5's</i> stated belief: 'I like English but...'	
<u>Causal ascription</u> Lack of interest (properties of cause: negative, past, internal, stable/ uncontrollable)	"I was not interested in English when I was in secondary/high school."	Attributes his perceived lack of interest in his previous English classes as a cause for his lower perceived L2 competence.
<u>Causal ascription</u> Perceived L2 significance(properties of cause: positive, present, external/internal)	"I know that learning English is important.	Perceives English as a significant language to learn.
<u>Causal ascription</u> Lower perceived L2 competence (properties of cause: negative, present, internal)	"But my English is not good. My speaking is not good, at all."	Attributes his lower perceived L2 competence to his previous lack of interest
<u>Causal ascription</u> Intrinsic interest in L2 activities (dimension: positive, present, external/internal)	But I like the activities we do in class now. I even feel that my English is getting better	Attributes his appreciation of English and his progress in English classes to the nature of the classroom activities used in his present L2 classes
<u>Goal/Expectation</u> (What is 'being good at English' for you?)	"Speaking with English people fluently"	
<u>Outcome</u> Expectancy of future success (Do you think you will get a better mark next time?)	English mark obtained:12/20 I don't know...It is possible	Satisfactory Low expectancy of getting a better mark

Student 5 ascribed internal self-referent causes for his lower perceived AL achievement. He explained that he was not interested in learning English when he was a high school student. He perceived his previous lack of interest to be the primary reason for his lower perceived AL competence. However, he added that he perceived learning English as being necessary for his future career and his studies. Student 5, along with Students 1, 2, 4, equated 'being good at English' to being able to speak the language. Like the other participants, this learner considered his lower perceived competence as an obstacle for his AL enjoyment. However, this particular learner, despite his lower perceived competence, expressed a positive attitude towards his present AL situation. He stated that he liked the activities he did in his current English classes. He also maintained that he made progress in his English. This change in Student 5's learning conditions, seems to have led him to conciliate his attitude towards learning English and see it more positively. However, his speech was still cautious and uncertain.

1.77.3 Participants' attributions for 'I like English'

Students 6, 7, and 8 expressed positive attitudes towards English language learning. Student 8 expressed high intrinsic interest in the English language itself as well as in English language learning. Student 6's and 7's discourses followed more or less the same thematic pattern (see Table 27 and Table 28).

Table 27. Analysis of Student 6's discourse

(Do you like learning English?)	<i>Student 6's</i> stated belief: I like English	
<u>Causal ascription</u> Perceived intrinsic interest in L2 learning. (properties of cause: positive, present, internal)	"I think I like learning English."	Attributes his interest in this language to his liking for learning this language
<u>Causal ascription</u> Favourable L2 conditions. (properties of cause: positive, present, external)	"English classes are different from other classes. We are active. We talk, we do things."	Attributes his liking for learning English to his active involvement in-class activities
<u>Causal ascription</u> Favourable L2 conditions. (properties of cause: positive, present, external)	"I like the listening and speaking activities that we do. They are mostly fun."	Attributes his liking for learning English to doing listening and speaking activities in his L2 class
<u>Goal/Expectation</u> (What is 'being good at English' for you?)	"Understanding people when they talk and speaking well"	
Outcome	English mark obtained:14/20	Good
Expectancy of future success (Do you think you will get a better mark next time?)	Ohm... I hope.	The student has the expectancy of a better achievement in English.

Student 6 and *Student 7's* opening remarks acknowledged their positive perceptions of English language learning. The data revealed that both *Student 6* and *Student 7*, like all the other learners, recognized language learning primarily for oral communication. The data obtained from *Student 6* and *Student 7* indicated that external factors such as the activities used in their English classes had an influence on these learners' motivations and consequently on their interest in the EAL tasks used in their English classes. The interview data also indicated that the learning activities used in their present English classes correlated with their expectations and goals (see Table 28).

Table 28. Analysis of Student 7's discourse

(Do you like learning English?)	<i>Student 7's stated belief: 'I like English'</i>	
<u>Causal ascription</u> Perceived intrinsic interest in L2 learning (properties of cause: positive, present, internal, stable, uncontrollable)	"I enjoy English classes a lot."	Attributes his interest in this language to enjoying L2 classes.
<u>Causal ascription</u> Favorable L2 situation (properties of cause: positive, present, external, unstable, uncontrollable)	"We use computers... for example, we listen to activities using the internet, we use internet dictionaries ... we do other activities, for example, we record our voices if we want and listen..."	Attributes his liking for learning English to his liking for the learning activities in his present L2 learning situation.
<u>Causal ascription</u> Favorable L2 situation (properties of cause: positive, present, external, unstable, uncontrollable)	"I love talking in English ... we have the opportunity to talk in our English classes. We did not do such things at lycée."	Attributes his liking for learning English to having opportunities to talk in L2 classes.
Goal/Expectation (What is 'being good at English' for you?)	Speaking without an accent	
Outcome	English mark obtained: 15/20	Good
Expectancy of future success (Do you think you will get a better mark next time?)	I think with our new teacher I will.	The student has the expectancy of a better achievement in English.

Student 8, among all the participants, was the one with the highest positive attitude towards the AL. This student expressed a wholesome intrinsic interest in both the English language and English language learning (see Table 29). He attributed his interest in this language to his strong liking of this language. He maintained that he especially enjoyed talking in English. He also stated that he perceived English as a language with high international status, and he expressed willingness to participate in tasks in his English lessons. Student 8, like the other participants, equated knowing English to the ability to communicate in this language well. However, this learner's goals and expectations concerning the learning of English indicated differed from the other participants' in that his standards were much higher. This learner's discourse indicated that his higher perceived incentive value for this AL motivated him towards achieving a native speaker level of English. This learner had the highest mark in the English course, and his discourse suggested that he was also the one with the highest intrinsic (and integrative) motivation.

Table 29. Analysis of Student 8's discourse

(Do you like learning English?)	<i>Student 8's stated belief: 'I like English (I like the English language)'</i>	
<u>Causal ascription</u> The perceived value of English (properties of cause: positive, present, internal, stable, uncontrollable)	"English is a nice language."	Attributes his interest in this language to a higher perceived value for this language (high intrinsic interest in the L2)
<u>Causal ascription</u> Perceived intrinsic interest in L2 (properties of cause: positive, present, internal, unstable, uncontrollable)	"I like talking in English. I sometimes chat on the net (internet) when I play games. I like learning English."	Attributes his willingness to communicate in English to his liking for this language (high intrinsic interest in the L2)
<u>Causal ascription</u> Intrinsic interest in L2 learning (properties of cause: positive, present/past, internal, stable, uncontrollable)	"Yes, I enjoyed learning English when I was at lycée, as well."	Ascribes his enjoyment of learning English to his liking for this language
<u>Causal ascription</u> Perceived L2 significance (properties of cause: positive, present, internal/external)	"Learning English is a must for everybody. It's an international language."	Perceives English as a language with high incentive value
Goal/Expectation (What is 'being good at English' for you?)	Being able to communicate well in English	
Outcome	English mark obtained: 17/20	Very Good
Expectancy of future success (Do you think you will get a better mark next time?)	"I don't know... I already have a good mark. Well, it's possible I think."	The student has the expectancy of a better achievement in English.

1.78 Conclusion and discussion

The learners' attributions indicated that these learners' perceived like or dislike of English language learning was influenced by their beliefs about (i) their AL competence and self, (ii) their AL learning situation and AL goals and expectations, and (iii) their perceived value of the English language. These learners, in general, had a tendency to attribute failure either to uncontrollable external factors such as teachers and teaching/learning situations or to uncontrollable internal factors such as low ability and low self-efficacy. The learners' interview data suggested that their lower perceived self-concept and lower perceived AL proficiency were ascribed as principal causes for their lack of interest in learning English. The students' grades also correlated with their perceived AL proficiency, self-concept beliefs, and likes or dislikes about learning English.

Favourable AL learning situation was one of the main factors that the learners attributed as a cause for their enjoyment of learning English and their attainment in English classes. During the interviews, the students expressed that they liked English classes mainly because of their present favourable AL learning situation. They attributed this positive feeling to external factors such as relevant, interesting, and useful AL activities their present English classes offered (e.g., use of

internet, speaking activities, and variety of activities that encourage student participation). The activities that corresponded to their expectations and goals seemed to have a significant influence on their interest in learning. This study suggested that belief and attitude change could be possible with a change of conditions and methods used in language learning settings: 'Now we speak a lot and the teacher corrects our grammar mistakes after. It's better.' '...but I like the activities we do in class now...I feel that my English is getting better.'

Representations: Study III

1.79 Introduction

This small-scale exploratory study investigated a group of university students' beliefs about English and English language learning, and the possible impact these beliefs might have had on the learners' EAL attitudes and motivation (Gabillon, 2007b). The study employed a three-phased research paradigm. The first phase consisted of a mind-showering activity and group discussions, which aimed to elicit the initial information. The second phase comprised a questionnaire whose items were formulated by using the information elicited during the first phase. Finally, focus-group interviews were employed to provide in-depth information and, explain and cross-check the questionnaire data. The data obtained indicated that, although these learners had fairly negative dispositions towards the English language and English language learning, the great majority perceived English as a requisite for their studies and their future careers. The findings also suggested that the participants mostly had lower perceived AL competence and lower perceived willingness to communicate in the AL.

1.80 Methodology

The study consisted of three phases: (i) Phase One contained a mind-showering (similar to brainstorming) activity, and group discussions. Twenty-eight students participated in the mindshowering and discussion activities (these 28 students also agreed to participate in Phases Two and Three); (ii) Phase Two consisted of a questionnaire. Sixty-two participants (including the 28 students from phase one) participated in phase two; (iii) Phase Three consisted of group interviews. The 28 students who were also members of Phases One and Three also participated in this last phase.

The participants, except for one female, were all male students who were studying at a 2-year technical university program to become technicians. The participants' ranged from 18 to 22 years of age, from 6 to 9 years of English language learning experience, and from lower-intermediate (B1 on CEFRL) to intermediate (B2 on CEFRL) levels of English. No special selection procedures were applied. Participation in the group activities was on a voluntary basis.

Phase One: Mind-showering activity and group discussions (n = 28)

This phase aimed at eliciting initial information on the participants' beliefs about the English language and English language learning. The data obtained in this phase were used to construct the belief questionnaire used in this study. At this stage, the participants were asked to write, either in French or English, anything they thought would be relevant to the topic. The activity continued as long as the learners had something to write about.

Right after the mind-showering activity, during the same session, the group discussions took place. The participants were set into smaller groups (4-5 participants) and were asked to express their opinions and feelings about learning English and the English language (a tape recorder was placed by each group). The data gathered through the mind-showering activity and group discussions were analysed qualitatively. A coding technique was used to organize the data into categories. That is, the group discussions were transcribed and the recurring themes (at least four occurrences) were grouped under categories. A similar procedure was applied to the written data gathered via the mind-showering activity. The information obtained through the mind-showering activity and the group discussions provided the initial data on some beliefs the learners had. After the coding, the following broad categories emerged:

- The participants' beliefs about the English language
- The participants' beliefs about English language learning
- The participants' motives for learning English
- The participants' beliefs about the AL language skills (speaking, listening, reading, and writing) and the other components of AL learning (vocabulary and grammar)
- The participants' beliefs about using the L1 in the AL settings

Phase Two: Questionnaire (n = 62)

In the second phase, a 23-item Likert-type scale questionnaire was designed by using the previously elicited data. That is, the themes obtained during the mind-showering activity and the group discussions were formulated, and the final scale items were selected from this pool to devise the questionnaire.

Although the questionnaire used in this study kept to the participant's stated beliefs and the themes obtained from these beliefs (see Phase One above), the format and content of Horwitz's (1999) beliefs about language learning inventory (BALLI) was also studied before constructing the questionnaire. Thus, the relevant items from the BALLI (the items that shared similarities with the participant learners' stated beliefs) were adapted and included in the questionnaire. The questionnaire was piloted to check whether the format and the items of the questionnaire were clear to the participants. After the piloting, the revised final copy of the questionnaire was administered. The questionnaires were distributed to 62 students who had agreed to be the respondents. The students filled out the questionnaires in class. I was present to answer any questions and collect questionnaires (all 23 items were responded to by all). The data obtained through the questionnaires were analysed with the aid of descriptive statistics. The total percentages of responses to the items were calculated and the results were presented as bar charts.

Phase Three: Focus-group interviews (n = 28)

Glesne (2006) asserted that using focus-group interviews (interviewing more than one person at a time) provides more in-depth information and offers significantly greater coverage than an interview with one individual. She maintained that topics such as perceptions, beliefs, and attitudes are better discussed in smaller groups of people who know each other. Focus-group interviews were conducted after the questionnaire data were analysed. For the focus-group interviews, the participants were arranged into small groups (5-6 participants). The focus-group interviews used the themes obtained during the mind-showering activity and group discussions (the questionnaire used the same themes). During the interviews, further on-the-spot questions were asked to elicit in-depth information, clarify points, and understand what each belief meant to different individuals and how these beliefs related to one another. During these focus-group interviews, I asked questions, encouraged participation, and took notes (the interviews were also recorded). I also let the discussions continue as long as the participants had something to say and interfered only when she needed further clarification or information on the topic or to encourage group dynamics and to keep the pace when there was a pause. From time to time she also checked whether all the group members shared the same beliefs and whether these beliefs meant the same to different individuals. The data gathered through the focus-group interviews were analysed qualitatively. The focus group interviews were transcribed and the recurring themes (at least four occurrences) were grouped

under relevant categories. The same data was then reorganized under subcategories (such as ‘perceived significance of different AL skills’ and ‘perceived AL competence’). The focus-group interviews served a threefold purpose: (i) to cross-check and explain the questionnaire data, b) to provide in-depth information on these learners’ stated beliefs, and (ii) to understand what each belief might mean to different individuals.

1.81 Results

The overall data—the written records from the mind-showering activity, the explanations given by the participants during the group discussions and the focus-group interviews, and the questionnaire data—were used to interpret the results.

1.81.1 *The participants’ beliefs about the English language and English language learning*

The responses to the questionnaire overtly indicated that the great majority of the participants (92%) believed that spending some time in an English-speaking country (Figure 74-Question 1) would contribute to the betterment of their English. The focus-group interview data revealed that the underlying reason for this positive-sounding belief was actually linked to the learners’ perceptions that the formal learning setting (i.e., the classroom) is not adequate for language learning (see Extract 34):

Extract 34. The participants’ beliefs about English and English language learning.

Translation	Original transcription
S1: I’ve been learning English for eight years, and I still can’t speak it. Some people spend a year or two in a foreign country and master the language completely.	S1 : Cela fait huit ans que j’apprends l’anglais, et je ne le parle toujours pas. Certaines personnes passent un an ou deux dans un pays étranger et maîtrisent parfaitement la langue.
S2: When you live in a foreign country you can learn the language even in the streets. The language is everywhere.	S2 : Lorsque vous vivez dans un pays étranger, vous pouvez apprendre la langue même dans la rue. La langue est partout.
S3: For us, English is not as important as other subjects. To learn it, we need to go to the country where it is spoken.	S3 : Pour nous, l’anglais n’est pas aussi important que d’autres matières. Pour l’apprendre, nous devons aller dans le pays où il est parlé.
S4: English for one or two hours a week!! Not enough to learn it.	S4 : L’anglais pendant une ou deux heures par semaine !! Ce n’est pas suffisant pour l’apprendre.

Many participants stated that one could learn an AL well only in a country where the language is spoken. The statements in Figure 74 (the original statements were in French), which were taken from the focus-group interviews, may help explain what this belief represented to some participant learners.

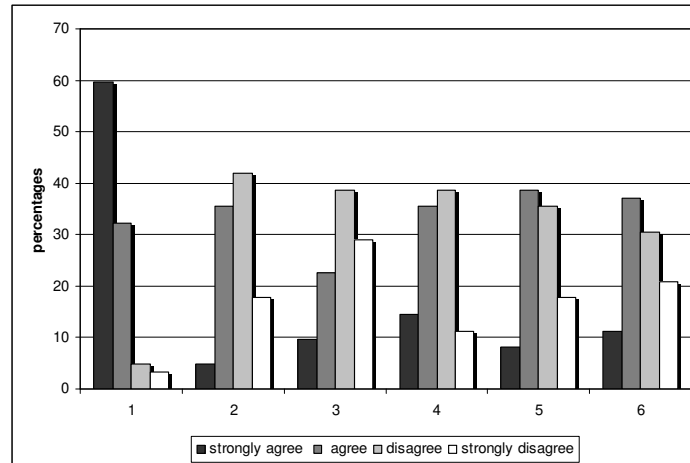

Note. Questions: 1) Spending some time in an English speaking country would be useful for me. 2) English sounds nice to the ear. 3) I learn English because it is a compulsory part of my school's curriculum. 4) Speaking to an English speaking person is a pleasure. 5) Speaking in English is a pleasure. 6) Learning English is a pleasure.

Figure 74. Participants' beliefs about the English and English language learning (n= 62)

The questionnaire data indicated that among these learners, many did not perceive English as a nice language (60%; English pronunciation, rhythm, sounds, etc.; see Figure 74, Question 2). Some participants presented this belief as a reason for their dislike for English language learning. Some others, on the other hand, expressed their preference for other ALs (see (see Table 30).

Table 30. The participants' beliefs about the English language (n= 28)

Perceived indisposition	Perceived difficulty
English doesn't sound nice (n= 10)	The English accent (rhythm) is difficult to understand (n= 8)
The English language sounds strange (n= 4)	(I don't like the English language) I find the pronunciation very difficult (n= 4)
I don't like English. I prefer Spanish, Italian, (French) etc. (n= 5)	

However, 68% of the participants asserted that they were not learning English just because it was a compulsory part of their school curriculum (Figure 74-Question 3). During the focus group interviews, the majority of the participants claimed that learning English was not a matter of choice, but a matter of necessity for them. Many expressed extrinsic interest and maintained that English is an international language, and it would be useful for them to succeed in their studies and to find a job. A few students also expressed intrinsic interest in the English language itself and a few others expressed intrinsic interest in the AL learning tasks used in their classes (see Table 31).

Table 31. The participants' positive beliefs about learning English (n = 28)

Extrinsic interest	Intrinsic interest in the AL
English will be useful for my career. (n = 10)	I like talking in English. (n = 4)
English is useful for my studies. (n = 10)	I want to be able to talk in English. (n = 5)
English is an international language. (n = 6)	I want to understand English songs. (n = 6)
Learning English is a must for everybody. (n = 4)	I want to understand English-speaking people. (n = 7)
English is the language of technology. (n = 9)	Intrinsic interest in AL learning tasks
	We do computer-assisted language learning activities (e.g., the internet, online dictionaries, online activities etc.). (n = 7)
	We have the opportunity to talk in English. (n = 6)

The questionnaire data illustrated that more than half of the participants (52%) had fairly negative dispositions and attitudes towards English language learning (Figure 74, Question 7). Different participants attributed these negative beliefs to different reasons. The most significant attributions centred mainly on perceived AL difficulty, lower perceived AL competence, AL task enjoyment, and perceived lack of task relevance (see Table 32).

Table 32. The participants' negative beliefs about learning English (N = 28)

Perceived difficulty	Perceived lack of competence
English is difficult to understand. (n = 5)	I make a lot of mistakes. (n = 6)
English is difficult to speak. (n = 7)	I'm not good at English. (n = 8)
English pronunciation is difficult. (n = 8)	My pronunciation is awful etc. (n = 9)
Lower perceived AL learning task enjoyment	Perceived lack of relevance
Learning English is not interesting, enjoyable, etc. (n = 7)	Languages can be better learned in a country where they are spoken. (n = 4)
I don't like learning English. (n = 4)	Technical school students need technical English. (n = 6)
I don't like speaking in English. (n = 5)	Our major subjects are more important than English. (n = 4)
Perceived lack of progress	
I have been learning English for more than eight years and my English has not progressed much. (n = 6)	

Heavy course load	I don't think I'll really need English after I finish school (I'll work and live in France). (<i>n</i> = 4)
- We have a lot of courses and just not enough time to learn English. (<i>n</i> = 4)	- There are not many English-speaking people in France (we don't really need to use English very often). (<i>n</i> = 4)

Heavy course load and progress also appeared to be important factors contributing to these negative beliefs. Questions 4 and 5 asked about the participants' willingness to communicate in English (Figure 74, Question 4, 'speaking to English-speaking people is a pleasure' [71%]; Figure 74, Question 5, 'speaking in English is a pleasure' [47%]). The focus-group interviews revealed that these participants believed that speaking to a native speaker of English (outside of the classroom) would be more enjoyable (although only five out of 28 had ever talked to a native speaker of English).

The data obtained during the focus-group interviews suggested that formal language learning context, perceived difficulty, perceived AL anxiety, lower perceived AL competence, and perceived importance of correct AL performance are interconnected and interacting features contributing to the learners' lower perceived AL enjoyment and their decreased AL willingness to communicate (WTC; see Extract 35 and also Table 32).

Extract 35. The participants' explanations for their non-involvement in speaking tasks.

Translation	Original transcription
S1: (I don't like talking in English) ...because I cannot. I cannot say what I want to say. I don't know enough vocabulary. My grammar is awful. [Group agreement]	S1 : (Je n'aime pas parler en anglais) ...parce que je ne peux pas. Je ne peux pas dire ce que j'ai envie de dire. Je ne connais pas assez de vocabulaire. Ma grammaire est affreuse. [Accord de groupe]
S2: When I talk others make fun of my pronunciation.	S2 : Quand je parle, les autres se moquent de ma prononciation.
S1: Me, as well ... I sound funny too.	S1 : Moi aussi... Je suis drôle aussi.
S3: I don't like talking in the classroom.	S3 : Je n'aime pas parler en classe.
R: Why?	R : Pourquoi ?
S3: I make a lot of mistakes. I care less about my mistakes when I talk to someone elsewhere.	S3 : Je fais beaucoup de fautes. Je me soucie moins de mes erreurs quand je parle à quelqu'un d'autre.
S4: I always try to use the vocabulary and grammar I am sure of, but I still sound stupid.	S4 : J'essaie toujours d'utiliser le vocabulaire et la grammaire dont je suis sûr, mais j'ai toujours l'air stupide.

The focus-group interviews also revealed that this group of learners had strong inclinations towards risk avoidance. Many of the interviewed participants explained that they did not feel comfortable when they made mistakes. In the light of the findings, we can assume that, combined with other

factors, risk avoidance might cause hindrance in learners' advancement and enjoyment of language learning (Oxford & Shearin, 1994). Thus, these learners' risk avoidance can also be considered a dysfunctional AL attitude affecting the learners' AL performance and enjoyment. Ely (1986) observed that risk taking positively affected learner participation. Empirical studies have also illustrated that risk takers, in terms of language learning, progress more quickly.

1.81.2 The participants' motives for learning English

In the previous section, more than half of the participant learners appeared to have fairly negative beliefs regarding the English language and English language learning (e.g., not liking English and not enjoying English classes and talking in English; see Figure 74). However, in this section, the great majority of the participants perceived learning English as useful for their studies (98%; Figure 75, Question 1) and for their future careers (90%; Figure 75, Question 2). Some of the participants attributed their lower perceived motivation mainly to having a lot of courses to study, not having enough time to learn English, and perceived lack of task relevance (not studying enough technical learning materials) and significance of learning this language. Some participants explained that, although in most cases English is a prerequisite to get a job, after admission to a post the language is rarely used (e.g., 'I will rarely use English in the future').

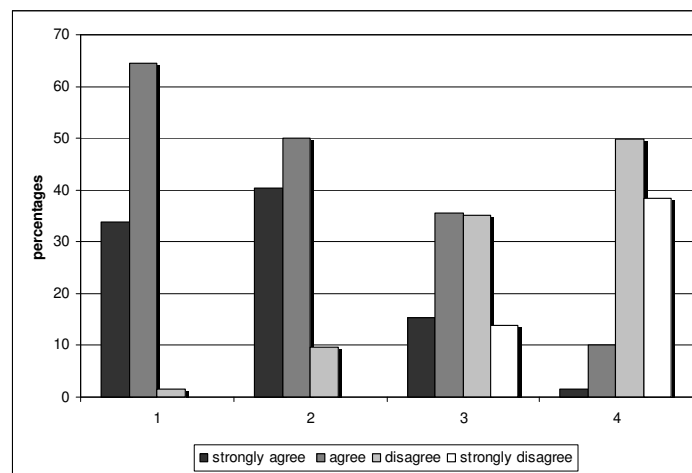

Note. Questions: 1) English is useful for my studies. 2) English will be useful for my future career. 3) English might be useful during my travels. 4) English is important to me because I would like to know about English-speaking people.

Figure 75. The participants' motives for learning English (n = 62)

Half of the participants claimed that English might be useful during their travels (Figure 75, Question 3). However, focus-group interviews revealed that none of the participants perceived this as a significant motive to learn English (e.g., ‘Well! Yes, it [English] is, of course, useful [when you travel], but no one wants to learn English just because of this.’ ‘Yes, it’s very useful...but I want to learn English because it’s difficult to get a job if you don’t know English.’). Very few (12%) appeared to be interested in English because they wanted to know more about the English-speaking people (Figure 75, Question 4).

The findings suggest that despite the lack of intrinsic interest in their English language classes the majority of the participants strongly perceived that learning English was important for them. This may be explained by the fact that this particular group of learners, who were preparing to finish their studies and to start work in a year or two, perceived English as an instrument to achieve their future goals (e.g., succeeding in their studies, getting a job etc.) rather than anything else. Ryan and Deci (2000) claimed that, especially after early childhood, social demands necessitate that individuals assume responsibility for tasks that might not be intrinsically interesting for them. They maintained that learners might choose to fulfil school tasks for their instrumental value rather than because they find them interesting and/or enjoyable.

1.81.3 The participants’ beliefs about AL skill/component difficulty

The data obtained from this section illustrated that 78% of the participants found understanding written English (reading) easier than understanding spoken English (listening). Seventy-six percent of the participants stated that writing in English is easier than speaking in English. Fifty-seven percent of the participants stated that English grammar was difficult to learn. Fifty-six percent of the students maintained that the English language was difficult to pronounce. Fifty-one percent perceived the English language as being a difficult language to learn (see Figure 76).

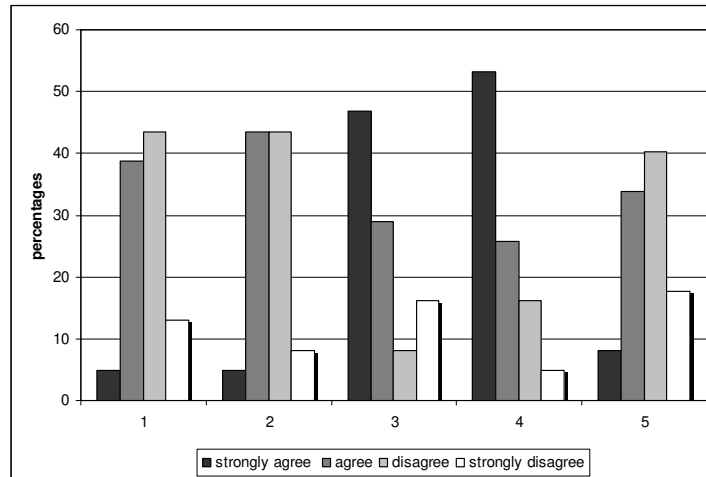

Note. Questions: 1) English is easy to pronounce. 2) English is easy to learn. 3) Writing in English is easier than speaking in English. 4) Reading comprehension is easier than listening comprehension. 5) English grammar is easy to learn.

Figure 76. The participants' beliefs about AL skill/component difficulty (n= 62)

Regarding the outcomes on the learners' perceived AL skill/component difficulty, parallel results were also obtained via the focus-group interviews. The focus-group interview results also emphasized that speaking and listening skills were perceived as difficult skills to master compared to other language skills (such as reading and writing). During the focus-group interviews, one of the participants said that in some cases, although he was familiar with all the language elements, he still had great difficulty understanding the listening tasks (see Extract 36 and Table 33).

Extract 36. The participants' perceived AL skill/component difficulty.

Translation	Original transcription
S: I find it very difficult to understand the listening tasks we do in the multimedia room (CALL lab). I listen to the recordings several times and try to understand. I understand almost nothing. Then I read the text script and see that I know all the vocabulary. Then I understand everything.	S: Je trouve très difficile de comprendre les tâches de compréhension orale que nous faisons dans la salle multimédia (CALL lab). J'écoute les enregistrements plusieurs fois et j'essaie de comprendre. Je ne comprends presque rien. Ensuite, je lis le texte et je vois que je connais tout le vocabulaire. Ensuite, je comprends tout.

Related research in SLA has demonstrated that listening skills are difficult skills to acquire in an AL (Graham 2006). Research on speech segmentation has illustrated that adult listeners are language-specific perceivers, thus when the target AL language uses a different rhythmic structure, listening skills are the most difficult to acquire (see Cutler, Murty, & Otake, 2003; Field, 2003; Goh, 1997). Cutler et al. (2003) maintained that listeners have a tendency to apply native language

procedures to a non-native speech during listening. Because rhythmic units differ across languages, using an L1 strategy can lead to inefficiency in listening to an AL (e.g., English uses stress-based rhythm whereas French uses syllable-based rhythm).

Table 33. The participants' beliefs about AL skill/component difficulty (n = 28)

Perceived ease	Perceived difficulty
Reading is not difficult. (n = 11)	Listening and speaking skills are the most difficult. (n = 11)
Reading is easier than, listening, speaking, and writing. (n = 10)	I cannot understand English-speaking people. (n = 10)
	I find listening very difficult to understand. (n = 10)
	Grammar is difficult to learn. (n = 5)

1.81.4 The participants' beliefs about AL skill/component significance

The participants' responses to this section confirmed how strongly the learners perceived the importance of listening and speaking skills and vocabulary learning in their AL lessons (see Figure 77).

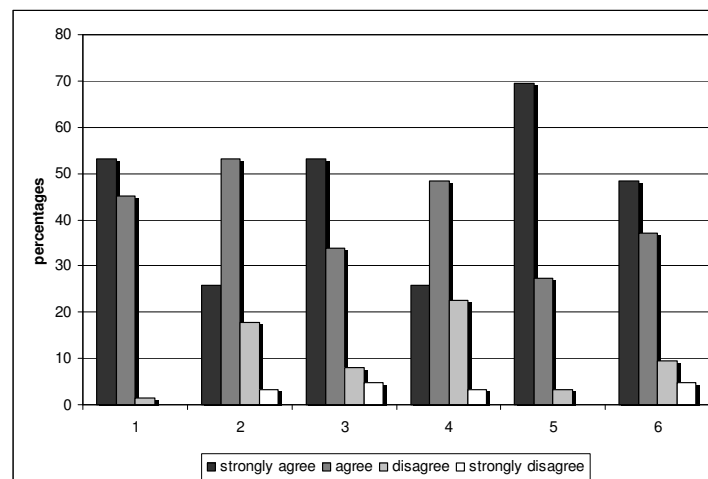

Note. Questions: 1) Vocabulary learning is very important. 2) Grammar learning is very important. 3) Speaking is very important. 4) Writing is very important. 5) Listening comprehension is very important. 6) Reading is very important.

Figure 77. The participants' beliefs about AL skill/component significance (n = 62)

Although the overall agreement on the importance of vocabulary learning (53% *strongly agree* and 45% *agree*) slightly exceeded the perceived importance of listening, the highest percentage of the participants chose to strongly agree on the importance of listening skills. In short, with a high

percentage of strong agreement (69% *strongly agree* and 27% *agree*), the importance of listening was emphasized (97%) in this section as well. The responses to the questionnaire also indicated that the learners had a tendency to express strong agreement concerning the importance of speaking (53% *strongly agree* and 34% *agree*). Reading, with 85% of perceived importance, was considered to be the fourth most important AL learning component (see also Table 34).

Table 34. The participants' beliefs about AL skill/component significance (n= 28)

Perceived significance/usefulness	Perceived lack of significance/usefulness
- Listening and speaking are the most important skills. (n = 12)	- Grammar is not as useful/important as vocabulary, listening comprehension, and speaking. (n = 7)
- Understanding native speakers is very important. (n = 6)	- Writing is not very important. (n = 4)
- Vocabulary is important. (n = 11)	
- Vocabulary is more useful than grammar. (n = 10)	
- Learning technical vocabulary is necessary. (n = 10)	

The data obtained during different stages of the study revealed different and conflicting beliefs regarding the perceived importance of grammar learning. During the focus-group interviews (and also during the group discussions), the learners expressed negative beliefs about grammar learning, claiming that they had repeatedly received grammar teaching in their past AL learning contexts and perceived this procedure to be unsuccessful and not to be contributing to their AL learning. Some participants also attributed their lower (perceived) AL proficiency (especially in listening and speaking skills) to the overemphasis on grammar teaching during their past AL learning experiences (see Extract 37).

Extract 37. The participants' stated beliefs about grammar.

Translation	Original transcription
S1: We think learning grammar does not contribute much to learning English.	S1: Nous pensons qu'apprendre la grammaire ne contribue pas beaucoup à l'apprentissage de l'anglais.
S2: We did a lot of grammar exercises (activities) when we were at the lycée (high school). Most of us still don't know how to use tenses correctly.	S2: Nous avons fait beaucoup d'exercices de grammaire lorsque nous étions au lycée. La plupart d'entre nous ne savent toujours pas utiliser les temps correctement.
S1: We don't want to say that it is not important, but it is not the most important. We have been learning English for more than eight years, and we still cannot speak it correctly and have a lot of difficulty in understanding it.	S1: Nous ne voulons pas dire que ce n'est pas important, mais ce n'est pas le plus important. Nous apprenons l'anglais depuis plus de huit ans, et nous

ne le parlons toujours pas correctement et nous
avons beaucoup de difficultés à le comprendre.

However, the questionnaire results illustrated that the learners perceived grammar learning/teaching as being significant in AL learning (79% of the participants agreed on the importance of grammar learning). Perhaps this conflict was the result of the general belief in the importance of grammar learning and at the same time an expression of discontent towards the way these learners had experienced grammar learning/teaching. However, the results indicate that the majority of the participants avoided expressing strong agreement regarding the significance of grammar learning (26% *strongly agree* and 53% *agree*). A similar tendency for choosing *agree* rather than *strongly agree* was also observed regarding writing skill. The data indicated that the participants perceived this skill as the least important among the six AL learning/teaching components.

1.81.5 The participants' beliefs about using the L1

The questionnaire data illustrate that the majority of the participants believed that English could be better learned when explanations were given in French (see Figure 78, Question 1). The results also indicate that the participants valued translation exercises (see Figure 78, Question 2). Thus, the findings pointed out that the majority of the learners favoured their mother tongue in their AL classes. The data obtained during the focus-group interviews also suggested the existence of similar tendencies for L1 reliance (see Table 35).

Table 35. The participants' beliefs about using the L1 in AL lessons (n = 28)

Perceived usefulness of the L1
I learn/understand better when teachers give explanations, definitions, etc. in French. (n = 9)
English language teachers should understand French. (n = 7)
I always think in French, and then I speak, write, etc. in English. (n = 6)
Translating texts (English to French and French to English) is useful and helps to learn. (n = 4)

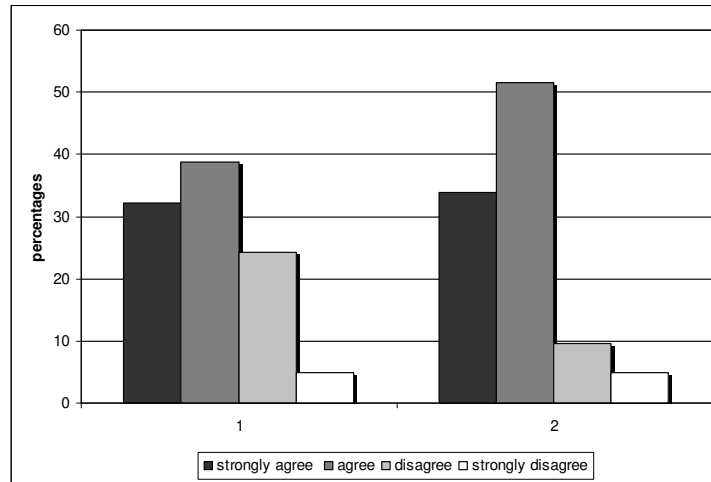

Note. Questions: 1) It is easier to learn English when explanations are given in French. 2) Translating texts helps to learn English.

Figure 78. The participants' beliefs about using the L1 (n 62).

Sociocultural and plurilingual approaches, which are increasingly establishing new paradigms in SLA research, argue for L1 use in AL learning settings. The scholars taking the sociocultural, social-psychological, and socio-cognitive standpoints claim that learners use their culture and L1 as a point of reference when learning an AL (Antón & DiCamilla, 1998; Blackledge & Creese, 2014; Cummins, 2001a, 2008; Dicamilla & Antón, 2012; García & Wei, 2014; Lin, 2015; Swain & Lapkin, 2013).

1.82 Discussion and conclusion

The data in this study suggest that these learners' attitudes and orientations of motivation were directly linked with their beliefs (perceived goals, expectations, etc.). Learners who had specific goals and expectations regarding learning English (such as its instrumental value to succeed in their studies and to get a job) tended to have beliefs regarding course expectations, course content, and goals for studying English that appeared to be factors that influenced their attitudes towards learning the language and, therefore, their levels of motivation and motivational orientations.

One significant outcome of this study is the common belief among the participants about the importance of listening and speaking skills, which they also perceived as difficult skills to acquire. When the students claimed that they could not understand listening despite their complete familiarity with the language items involved in these tasks, they were perhaps partly referring to

the problem they were facing with speech segmentation. However, lack of both sufficient AL exposure (both in and outside of the classroom) and appropriate listening skill training might also be contributing factors.

The results also indicate that the participants perceived language learning as mainly for communication, which is indicated by the perceived importance of listening and speaking skills. However, this perception appears to contradict the fact that in general these learners had decreased AL WTC. The data obtained suggest that perceived AL difficulty, lower perceived competence, perceived importance of correct performance, and task relevance appear to be interconnected and interacting features contributing to the learners' lower perceived AL enjoyment and decreased WTC.

In short, the overall data indicate that these learners see language learning as a means rather than as an end itself. Thus, on the basis of the findings obtained, I suggest that the curriculum be designed in collaboration between the subject matter teachers and the language teachers to include content relevant to these learners' subjects of study and interests (CBI or CLIL). It has commonly been argued that having prior knowledge about a topic promotes better comprehension (e.g., listening) and also provides useful input before fulfilling a task (e.g., speaking). A theme-based approach (see CBI in Richards & Rodgers, 2001) might help these learners to get the necessary input and preparation (relevant to their needs and interests) before they get engaged in a speaking/listening task. Thus organizing language instruction around themes relevant to these learners' needs (and interests) and introducing listening/speaking tasks on the same topics may help these learners to (i) understand listening content better, (ii) get the necessary input before speaking and consequently, and (iii) increase their willingness to communicate. Communicative language tasks (see Ellis, 2003) and problem-solving tasks (related to students' subjects of study, e.g., resolving technical problems or giving technical advice) might also be used within a CBI or CLIL framework to help the learners develop necessary communication strategies.

Conclusion

In this section I presented my studies that have focused on social representations and beliefs. My research activities during my PhD used ‘stated beliefs’ as an umbrella term to study learner and teacher statements from the metacognitive, social representation, attributional, and motivational perspectives. My research work after my doctoral studies have refined the distinction between (i) beliefs, which are socially (co)constructed (inter-personal) and individually appropriated (intra-personal) phenomena shaped by the personal histories of individuals, and (ii) social representations, a notion that refers to a social phenomenon, which, simply defined, ‘is a way of seeing an aspect of the world through the eyes of a given group’.

My recent studies on social beliefs and representations are intended to complement my studies on CLIL and EAL by giving them a sociolinguistic dimension. My most recent research (the ongoing EMILE 2D research project; see [Section 15.1.1](#)) aims to extend the learning framework to a broader social context in order to trace the possible links between language policies, language ideologies, social and individual expectations and their respective influences on learning.

PART V: ONGOING RESEARCH STUDIES AND PROJECTS

[Part V](#) contains only one chapter ([Chapter Fifteen](#)) and describes my research activities and projects that have begun but have not yet resulted in publications. The data obtained from some of these projects are in the analysis and reporting phases.

CHAPTER FIFTEEN

ONGOING RESEARCH STUDIES AND PROJECTS

Introduction:

My research activities (almost all) have been part of longitudinal projects and comprised a series of one or two yearlong research work packages. After the completion of each work package I sometimes (i) repeated the same research pattern to verify the results obtained in another similar setting, or (ii) reinvested in the results that emerged in order to gain an in-depth understanding of the issue, and (iii) applied the same procedures in different settings to observe the influence of changing parameters.

1.83 Ongoing research

At present, I am involved in three ongoing projects.

*1.83.1 EMILE 2^D (CLIL 2^D) project (2019-2023)*¹¹⁷

EMILE 2^D stands for CLIL for secondary education. I am the coordinator of EMILE 2^D (CLIL 2^D) project. The project involves the collaboration of researchers from two research units, EASTCO (EA 4241), UPF, and CRREF (EA-4538) the University of French West Indies-. In this project, we are interested in exploring CLIL implementations in English, Tahitian, and Creole in the context of secondary education in French Polynesia and the French West Indies. The project comprises a 4-year research work that aims to explore different CLIL practices such as non-linguistic disciplines (NLD), CLIL in AL classes, and interdisciplinary, multidisciplinary, extracurricular, and intercultural projects. This project also aims to investigate representations of parents, teachers, and learners about languages in general (i.e., French, Tahitian and AL and the learning of these languages) and their representations of a bilingual education using CLIL. In addition to research, the overall objective of this project is to (i) provide teachers with training experience by

¹¹⁷ Because of COVID-19, we are behind schedule.

experimenting with innovative language teaching pedagogies, and (ii) sensitize them to effective CLIL learning pedagogies.

Objectives

The main objectives of this new research project are to (i) explore the representations (beliefs) of parents, teachers, and learners on CLIL practices; (ii) experiment with innovative CLIL practices in collaboration with secondary school teachers; and (iii) contribute to the training of teachers in CLIL practices.

Specific objectives of the project:

- *Parents*: exploration of the representations of parents on bilingual education via interviews and questionnaires
- *Teachers*: (i) exploration of teachers' representations of bilingual education and (ii) collection of lived experiences, feelings, opinions, etc. of teachers regarding their CLIL practices (via interviews)
- *Learners*: (i) exploration of learners' representations of bilingual education and (ii) gathering of lived experiences, feelings, opinions, etc. of learners regarding CLIL lessons (via interviews)
- *Experimental lessons*: observation of types of interactions used and their roles in learning to see whether (i) the proposed pedagogies encourage the learners to participate in activities; (ii) the proposed pedagogies encourage peer mediation (peer scaffolding); (iii) the proposed pedagogies favour the development of cognitive skills, such as classifying, explaining, discussing, recognizing, applying, analysing, evaluating, and creating; (iv) the situations and conditions are favourable to CLIL teaching, for instance, are they contextualized, authentic, and respectful of the conventions and culture of the discipline taught; and (v) CLIL teaching is accompanied by artefacts such as the use of gestures and artefacts by the teacher and students and what their role is and how they are used.
- *Exploration of CLIL practices*: observations of different types of implementations, such as in NLD, in interdisciplinary projects, as part of a school subject teaching, and in AL classes.
-

Research methodology

This study uses a mixed-methods approach to research and consists of several work packages. Each research cycle uses various research instruments and procedures using both qualitative and quantitative methodologies. In this research work, I use (i) iterative reflexive coding techniques (qualitative/comprehensive) and (ii) descriptive statistics methods (quantitative/summative; see Figure 79).

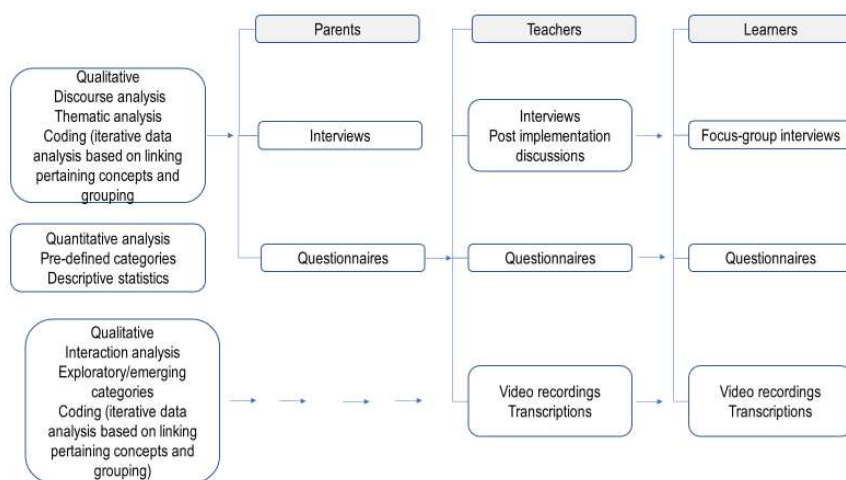

Figure 79. Research protocols.

Research instruments

The data collection instruments are (i) interviews (parents, teachers, and learners), (ii) questionnaires (parents, teachers, and learners), (iii) post-implementation conferences with teachers to discuss events that have taken place in the classroom, and (iv) video recordings, which will be full verbatim transcripts that will include contextual elements (verbal and non-verbal), translations, and comments.

Research procedures

Our research will begin with semi-structured interviews.¹¹⁸ The sampling size will be established according to the principle of empirical data saturation. According to this principle, data analysis

¹¹⁸ I have already interviewed nine parents and analysed the data. These interviews are accessible via Mendeley data (see Gabillon, 2020b).

starts as soon as the first interview data is transcribed. The second interview will be carried out after the analysis of the first, and the third interview will start after the analysis of the second and so forth. The data collection procedures will come to a halt when the interview data can no longer provide any new information (when the data reach saturation). The analysis of the data will be based on the GT and will include five stages: coding, categorization, linking, integration, and theorization.

The questionnaires will be designed and distributed once the interviews are over. The categories obtained from the interviews will be used to design the questionnaire items. The questionnaire items will be tested with a small sample of participants and, after probable modifications, paper copies and an online copy will be distributed to participants.

Collaborative research activities will begin in the second year of the project. Activities will begin with meetings with the participant teachers (see Figure 79). Research activities will be planned and implemented taking into account the curriculum and the workload of the teachers. The CLIL research cycle will begin with workshops during which CLIL sequences will be planned with the teachers.

1.83.2 Identity texts project (2020-2023)

This project takes place with the participation of two researchers from the University of Melbourne – Melbourne Graduate School of Education (MSGÉ). The long title of the project is ‘Challenging discourses of deficit: Understanding the vibrancy and complexity of multilingualism through identity texts’. This project concerns EAL and modern languages. It aims to explore pre-service and in-service teachers’ linguistic repertoires on their language practices and resources and linguistic experiences. Through the use of identity texts (Cummins & Early, 2011), this project aims to develop in teachers:

1. a deeper understanding of their own language practices and the connections that can be made between language practices inside and outside of the education context and
2. a stronger understanding of how they can leverage this linguistic knowledge when developing learning activities for their students.

Key questions

What role can identity texts play in developing a deeper understanding, in teachers, of their multilingual, multimodal language practices?

- How is the teacher positioning towards languages other than English?
- How can the use of identity texts inform changes in teacher practice?

Research design

This research project will be situated within a transformative paradigm that problematizes practice (i.e., to question the status quo) and engages in reflexivity through narrative analysis and dialogue. The research will involve teacher educators facilitating the use of identity texts in language methodology subjects at MSGE and at the ESPE of French Polynesia. Participants will be pre-service and in-service teachers.

Data collected will include the identity texts that are created in class or for assessment (once the marking process is complete) and follow-up interviews with a 5 to 10 students from each class whereby students will explain and analyse their identity texts and their possible extrapolation for pedagogical use.

Background

The ‘multilingual turn’ has opened up a variety of creative, participatory methods for researchers and educators to explore language learners’ linguistic repertoires, language practices and resources, and linguistic experiences. It seeks to challenge monolingual biases with ‘... a range of theoretical lenses that help us to examine language and what it means to individuals and societies.’ (Conteh & Meier, 2014, p. 3). These multimodal, speaker-centred methods can be captured visually (through photographs, hand-drawn body portraits and maps, and Lego blocks) and explained narratively, allowing researchers and educators to explore lived linguistic experiences of language learners.

As part of this work, ‘identity’ has emerged as a critical component of research and teaching, with Cummins et al. arguing that ‘identity negotiation, investment, and affirmation are directly related to patterns of achievement and underachievement among social groups’ and that any language teaching and learning needs to address issues of identity as well as language as a system (Cummins, Hu, Markus, & Kristiina Montero, 2015). However, in looking at identity texts to explore the

complexity and vibrancy of learners' linguistic repertoires, Dutton et al. argue that when students are not able to understand and recognize their own linguistic resources, they 'may internalize deficit views of their own skills'. It is crucial, therefore, for teachers to facilitate the development of this knowledge as students move through schooling (Dutton, D'warte, Rossbridge, & Rushton, 2018, p. 31).

Significance of this research

Recent research using identity texts has explored the intersections of multilinguals' lived experiences with their language learning journeys both within (D'warte, 2014a, 2014b) and outside of formal education contexts, as well as issues of multilingualism and pedagogy from the language teacher perspective (De Laurentiis Brandão, 2018). Little of this research, however, has focused on developing the pedagogical skills of pre-service teachers and of teachers undertaking professional development, and the integration of identity texts into curricula in order to recognize and develop the breadth of students' language practices, both from within and outside of school lives. This research aims to fill this gap.

Data/material collection technique(s)

Over a 2-year period, this research will be undertaken in the subjects listed above at MGSE. This project involves the following data collection techniques:

Identity texts

As part of a class activity, students will be asked to develop their own identity texts. Identity texts are not limited to just visual representations but can include oral, written and visual texts to explore the intersections of multilinguals' lived experiences with their language learning journeys both within (Cummins & Early, 2011; Serpe, 1987; Serpe & Stryker, 2011). The student materials collected may, therefore, be in paper or multimodal formats.

Interviews

Participants can also volunteer to participate in one-to-one interviews to discuss their texts. Interviews will last for about 20 minutes. Each student will be asked to narrate their text. Some guiding questions will be used to initiate and maintain the discussion as well as to seek elaboration and clarification from the participants. Each interview will be audio-recorded for subsequent

transcribing and verification purposes. The interview will be conducted at MGSE and at their convenience.

Data Analysis

This study adopts thematic analysis (Lapadat, 2010) to look for common themes that come through the identity texts and transcripts from the audio recordings. We will then use a narrative structure to make sense of students' texts and the 'small stories' (Barkhuizen, 2009) they share during the activity, in order to understand the affordances of such devices in opening up space for teachers and learners to critically reflect on the complexities and vibrancy of contemporary multilingual language journeys and to recognize situational factors that influence dispositions towards language, language learning, and identity.

1.83.3 EMILE 1^D project (2020-2022)

EMILE 1^D stands for CLIL for primary education. I am the coordinator of this small project. This new project is the continuation of the previous CLIL studies I have conducted in the French Polynesian primary education context. The project involves the participation of a primary teacher (female) and her students. The project starts in January 2020 in a primary school in Tahiti. This study aims to apply a framework that will enable CLIL and EAL classes to go in parallel in order to (i) increase the occurrences of use of the language features practised, (ii) to support the transfer of skills from one learning situation to another, and (iii) diversify the context of AL use. I posit that by enabling learners to use the AL by repeating the language structures, vocabulary, and idioms that they have learned recently and increasing their frequency of use in different learning situations (e.g., in mathematics, science, etc.) would help learners to make diverse associations and would contribute to their language development.

EMILE 1^D is the continuation of the CLIL studies that have been carried out since 2011. This research project will follow up on the outcomes obtained during these studies using the same iterative methodologies. The research methodologies and the teacher training activities will follow similar patterns but allow emergence of new research trajectories.

1.84 Conclusion

The abovementioned projects, although each has a different focus and objectives, have a global aim of drawing a research based linguistic landscape on AL learning and situate it in the French Polynesian language ecology. Through these projects I also aim to compare and contrast the data and research outcomes with other researchers, who do similar research in other social systems.

DISCUSSION AND CONCLUSION

Introduction

The final part of my HDR dissertation provides an overview of the knowledge I have gained from my CLIL, EAL, and belief studies. It also includes a discussion of my future research prospects and how novice researchers can benefit from my experience in AL pedagogy, as both teacher and teacher educator, and how my theoretical knowledge in applied linguistics can be a benefit to them.

Research in the field of applied linguistics requires (i) theoretical knowledge in a variety of disciplines, (ii) a thorough understanding of pedagogical issues related to both general educational fields and AL learning pedagogies, (iii) knowledge of diverse research methodologies, (iv) the conduct of fieldwork such as classroom observations and recordings and the viewing and transcribing of large amounts of recorded data, (v) the analysis of pages of transcripts, and much more. In short, research in this field requires a considerable amount of time and commitment. My CLIL, EAL, and belief/representation studies are the result of such a commitment.

CLIL and EAL studies have constituted a major part of my research work after my doctoral studies. My research has sought to link AL learning (CLIL and EAL) and other educational issues to notions of beliefs and social representations. These two areas are interrelated and influence each other. The majority of my studies were conducted in French Polynesia, a plurilingual community where people have a complex cultural and linguistic background and are very concerned about language learning issues (Paia et al., 2015; Paia & Vernaudo, 2002). Thus, understanding their beliefs and social representations about languages and language learning is a part of my research objective. So far, I have only investigated CLIL within the mainstream AL learning context and mainly in primary education settings. I am currently engaged in a multi-institutional¹¹⁹ research project on CLIL in secondary education (e.g., DdNL and mainstream AL contexts).¹²⁰

¹¹⁹ I have started a research project in collaboration with the research unit, *Centre de Recherches et de Ressources en Éducation et Formation* (CRREF; EA-4538) at the University of French West Indies (see [Section 15.1.1](#) for the CLIL project).

¹²⁰ See [Section 15.1.1](#) for CLIL/EMILE 2^D project, which was conceived for secondary education.

1.85 The CLIL research processes and framework

My CLIL studies have had their theoretical underpinnings based on interactionist and sociocultural perspectives and have had pedagogical principles applied that inspired competency-based approaches (i.e., TBLT and AOA) and CLIL teaching. Table 36 presents these principles.

Table 36. The principles on which CLIL and EAL observations were based

	CLIL/EMILE and EAL (Competency-based approach)
Learning	Social and situated activity Emerges with the use of social artefacts (objects), cognition, content, and language Compilation of pragmatic, linguistic, and academic skills Social and individual/cognitive Emerges through collaborative interactions Experiential/naturalistic Learner oriented Incidental/outcome of the task Collaborative, intersubjective, and emergent; shaped by learners and their needs
Language	Learning tool Inseparable from content and cognition Object of learning Tool for reflection Learning outcome (by-product of the learning activity)
Learners	Social agents/active participants
Tasks	Authentic Goal driven Complex Open to different possibilities Collaboratively performed
Skills	Social, cognitive, communicative, linguistic, academic, pragmatic, and intercultural
Interaction	Collaborative (between pairs/in groups) Takes place in the ZPD (peer or teacher scaffolding) Interaction with objects (social artefacts) and teaching material
Input	Emerges from interactional exchanges during the task Elaborated via mediated help

In my initial research studies, I simply sought to determine whether CLIL teaching could be possible with beginner-level young learners by applying these theoretical and pedagogical orientations. Then, in each study that followed, I progressively shifted my focus and orientation depending on the outcomes obtained in each of these studies. In CLIL studies, I followed a series of iterative phases: inquiry, experimentation, research results, emergence of a new inquiry, reformulation, integration of the new inquiry, verification of previous results, new research results, and so on. Figure 80 presents a schematic representation of this inquiry process.

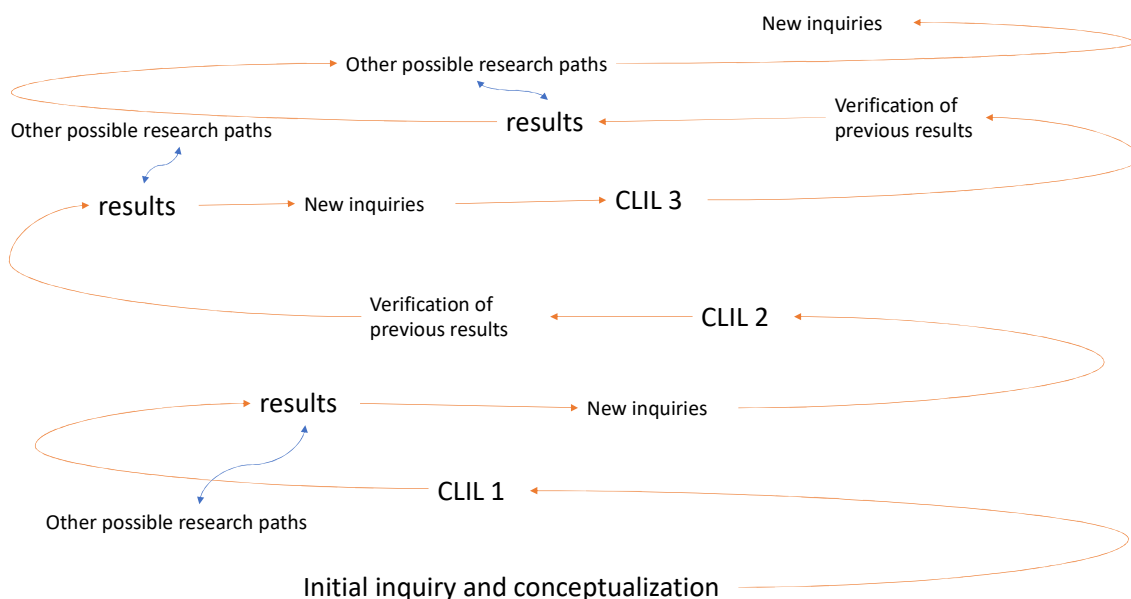

Figure 80. CLIL research cycle.

These cyclic processes followed in my CLIL studies have guided us on what to focus on and how to reorient my subsequent research projects. This progressive shift in focus has allowed us to (i) move forward by unfolding a new phenomenon, (ii) cross-check my previous research outcomes, (iii) re-examine and re-analyse previous data and to establish links with newly emerging phenomena, and (iv) progress in my exploration with a continuous spiral pattern (through verification and progress).

1.86 Socially mediated activity (SMA) framework

During my CLIL experimentations, through trial and observation, we¹²¹ have tested and elaborated a framework that I named ‘socially-mediated activity’ (SMA) framework. This framework’s theoretical underpinnings are based on a set of principles conveyed via sociocultural theories of learning, the interactionist perspective in SLA, and competency-based AL pedagogies (CLIL,

¹²¹ This framework was elaborated via observation and practice with the contribution of the teachers who were involved in the CLIL projects.

TBLT¹²², and AOA). This framework is based on the observations that (i) language is a tool for learning and that language skills cannot be fully developed without active participation and reflection; (ii) learning occurs in learners' ZPD, where help is given during collaborative activity; (iii) learning takes place through social interactional exchanges and is observable during a joint activity in which mediational tools and joint actions are used to perform the activity, and (iv) the combination of all the above-mentioned elements contributes to the creation of a motivating learning environment with low affective filters.

This framework is suitable for combining content and AL teaching both in mainstream AL learning and CLIL settings. I have only tested my model with young learners, and the application of this framework with young learners presented satisfactory results. However, we are confident that this framework can also be operational with CLIL for middle and high school students (e.g., teaching science experiments, geography, and the arts). The constituent components of the framework are ZPD, mediation (scaffolding), joint attention, active involvement, experiential learning, naturalistic learning setting, real-life activities using problem-solving tasks, collaborative dialogue, and the use of social artefacts (see Figure 81).

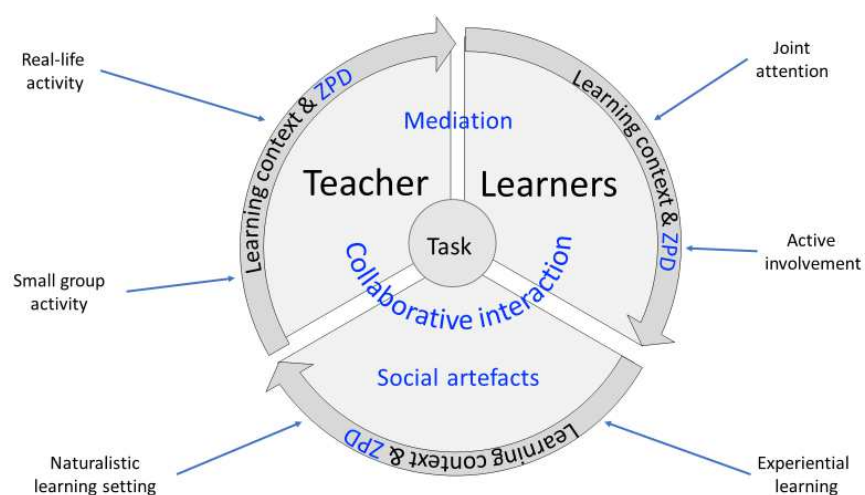

Figure 81. Socially mediated activity framework (translated and adapted from Gabillon, 2019, p. 93).

¹²² Task-based language teaching (TBLT) is considered the most recent version of communicative language teaching (CLT).

ZPD, mediation, and collaborative interaction

Three notions are in the heart of the SMA framework: (i) ‘ZPD’, the interpersonal zone where learners interact with each other (and the teacher) and receive help via peer support and teacher scaffolding, (ii) ‘mediation’, consisting of peer support and teacher scaffolding that uses successive steps of strategic instruction to facilitate learning, and (iii) ‘collaborative interaction’. These three elements are also central elements of sociocultural theory (see [Section 5.1](#)). The concepts of ZPD and scaffolding point out that learning takes place in learners’ ZPD, in the interpersonal space, through collaborative interaction. In this framework, the interpersonal learning space where collaborative interaction takes place influences all other parameters of the framework. The expansion of this zone is often equated with the increase in knowledge and the acquisition of skills that are required for self-regulated learning (gaining autonomy).

Joint attention

In my CLIL observations, joint attention¹²³ plays an essential role and the activities that I propose are designed to promote this feature. Simply defined joint attention means concerted reflection and action during language learning. This collaboration involves both the learners and the teacher. Joint attention connects all participants to the task and learning objectives and creates collaborative thinking (leading to the creation of intersubjective knowledge). In the framework joint attention is facilitated by group tasks in which learners are required to work collaboratively to achieve a goal. To increase the potential for joint attention, the task types are carefully selected and, based on the requirements of the task, the optimal group size is determined to allow for joint effort and reflection.

From the cognitivist SLA perspective, concepts such as noticing and attention are viewed as psycholinguistic processes (Kunitz, 2018). From a sociocultural perspective, noticing and attention are seen as social processes that take place during interactional collaborative tasks. The concept of joint attention (see also [Section 5.1.1](#) for joint attention), which stems from sociocultural theories,

¹²³To measure joint attention, we use observable features such as interactional exchanges and non-verbal elements: We observe whether what learners do is directly relevant to the task; whether they participate in the group task (interact and do manipulations); whether they agree, disagree, or express opinion while performing the tasks; whether they look focused and alert during group work; whether they work together and create something jointly; and so forth.

is an alternative concept for Schmidt's (1990, 2010) noticing hypothesis. Some scholars consider joint attention a crucial concept in language development (Baldwin, 2014; Bruner, 2014; Dunham & Moore, 2014; Kasper & Wagner, 2018; Tomasello, 2014). Joint attention is often described as moments of mutual attention for the regulation of the problem and the construction of a shared meaning during the negotiation of communicative intentions (Dunham & Moore, 2014). My observations with the children have indicated that without joint attention, no social interaction, reflective observation, or meaningful learner production can take place.

Experiential learning and hands-on activities

Most of our CLIL tasks (e.g., scientific experiments) offer excellent opportunities for experiential and practical activities. These activities allow learners to make multiple associations with the language they are learning with objects, actions, and sensory inputs (i.e., seeing, touching, smelling and, in some cases, tasting) and their productions. The inclusion of experiential learning activities is paramount to the success of the SMA approach. According to Piaget, learning is neither solely cognitive (intrinsic) or the result of environmental influence (an external influence, e.g., parents). Piaget pointed out that learning is the result of the child's interactions with their environment and that learning is shaped by experience (Miller, 2011; Piaget, 1937, 1959). In the same vein, language development, which used to be considered an innate internal characteristic of the individual, is now seen as the product of lived experience (Kolb, 1984) emerging as a product of the interaction between the individual and their environment (between others and social artefacts). Experiential learning is learning through active experimentation (by doing), the use of analytical skills (reflecting), and the creation of meaning from experience (through reflective observation). The use of hands-on activities and social artefacts (especially with young learners) supports this process of meaning making by providing concrete elements to assist in abstract conceptualization.

Creation of natural learning environments

When designing activities, we take care to create a natural environment that represents the authentic situation and respects the conventions used in this particular situation. I have observed that the success of the activities also depends on the inclusion of (i) real-life tasks (i.e., tasks that are contextualized, authentic, with clear objectives and well-defined outcomes, and open to different possibilities) that help learners relate their learning to real situations they face every day at school (e.g., a scientific experiment using laboratory objects, a mathematics lesson with tools for

measuring or calculating and explaining, physical education lessons, food technology lessons, and art lessons) and (ii) the use of social artefacts and language that represents the actual convention of the context (e.g., using lab tools and respecting scientific norms and language when doing a science experiment).

The role of artefacts and gestures

In my CLIL and EAL research, A&G have played an important role. In my microanalysis, I observed how A&G were used by the teacher and learners. Our observations have indicated that the use of social A&G was the key to creating a naturalistic learning environment.

The creation of a naturalistic learning environment would not be possible without the use of social artefacts and other non-verbal elements (gestures, body movements, etc.). The use of social artefacts interacts with all the other components of the framework and influences the functioning of the entire system (see Figure 82).

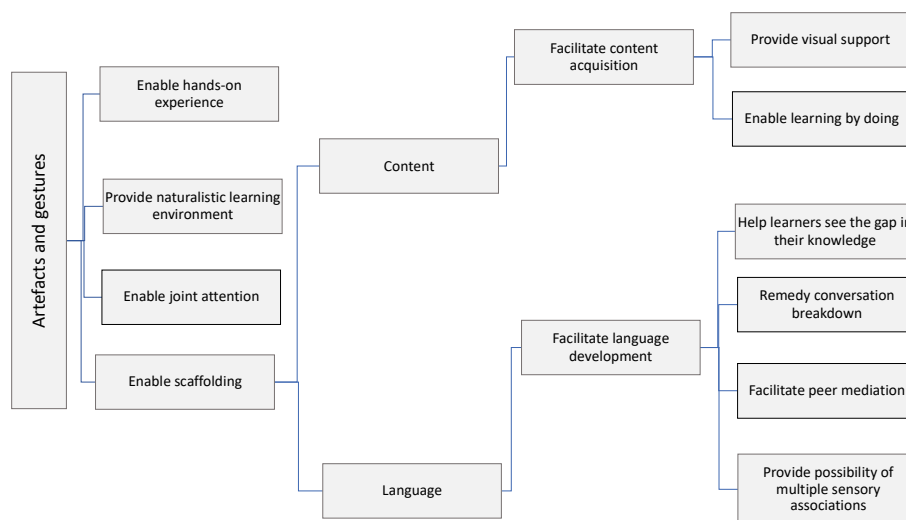

Figure 82. Our observations concerning the use of A&G during CLIL lessons.

Our observations show that the use of social artefacts serves several purposes. The inclusion of artefacts in AL task design (see my SMA design) enhances both cognitive and communicative aspects of task outcomes. I have formulated the role of social artefacts into six hypotheses based on my research findings:

Hypothesis 1: The use of A&G helps compensate for learners' lower-level AL competence (e.g., during presentation of new concepts, communication) and helps avoid communication breakdowns by substituting these for unknown language items.

Hypothesis 2: Artefacts can serve as powerful tools in the formation of not only concrete but also abstract concepts.

Hypothesis 3: The use of A&G enables multiple memory traces (e.g., touching, seeing, smelling, manipulating, thinking, and conceptualizing), which could help the retention of newly learned concepts and language items through their use.

Hypothesis 4: The use of artefacts enables the creation of a naturalistic learning environment and real-life situations.

Hypothesis 5: The use of artefacts enables experiential learning and hands-on experience that are conducive to AL development.

Hypothesis 6: The use of artefacts constitutes and sustains joint attention during learning tasks.

Of all the uses of A&G mentioned above, the most crucial function is the assistance provided by A&G to compensate for the low level of AL learners and the maintenance of continuity of communication, which in turn supports the joint attention that interacts with other elements (see Gabillon & Ailincai, 2016).

SMA frame and classroom arrangements

Based on my observations, I can assert that in order to generate interest and maintain joint attention, it is important to pay attention to the size of the group. Experiential learning tasks typically consist of a teacher-led interactive concept-building phase, a student-directed independent task, and a feedback phase (Gabillon, 2019). Teacher-directed tasks take place in small groups (usually half the class), in which the teacher (i) generates interest in the task, (ii) simplifies the task, (iii) keeps learners focused on a goal, (iv) highlights essential characteristics of the task and new concepts, (v) tries to keep 'affective filters' low and to control frustrations about the task, and (vi) shows possible ways and solutions for the task. In autonomous group tasks, learners can experiment and help each other. In the feedback phase, learners meet and share the results of their experiences with each other. The optimal size for independent group work varies according to the type of activity used (5-12 students). The optimal size for teacher-led activities varies between 8 and 15 students

per group. A larger group would not allow the teacher to provide a successful scaffold, generate interest, control learner frustration, maintain learner concentration, and create a natural collaborative learning environment (see Wood et al., 1976, p. 98).

Our observations have shown that small-group teacher-led activities are better suited to creating a naturalistic learning environment and natural social exchanges and maintaining joint attention than whole-class activities. In these activities, the teacher is a member of the group and provides scaffolding and helps to support the active participation of the learner. Such a classroom setting increases learner participation, student talking time, and assistance provided by the teacher and peers as compared to the whole-class organization. This configuration is also better suited for teachers and learners working together to optimize the ZPD (see Figure 83).

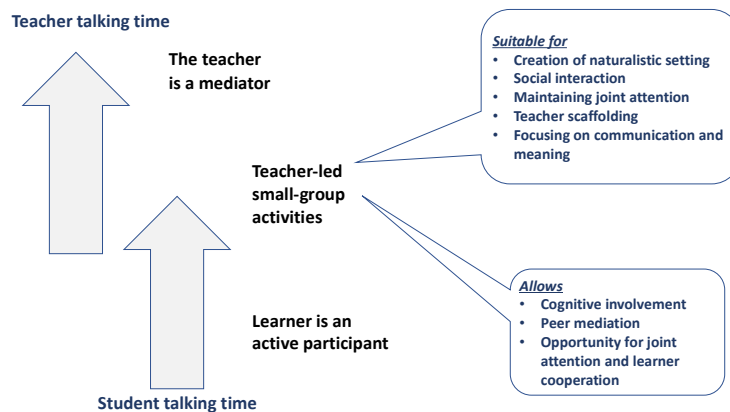

Figure 83. Teacher-led small group activity.

In SMA, autonomous small-group activities are an integral part of the task cycle. The success of these group tasks is highly dependent on the quality of the task design. The tasks proposed in these small-group activities are mostly open-ended and generally focus on experiential learning. If the objectives are well defined with explicit expectations, if the task is adapted to the levels and interests of the learners, and if the task focuses on problem solving through the use of content knowledge, then the learners' involvement, cognitive engagement, language use, and talking time can be expected to be high. This configuration is highly suitable for peer mediation, allowing students to use their plurilingual competences and multimodal communication skills (see Figure 84).

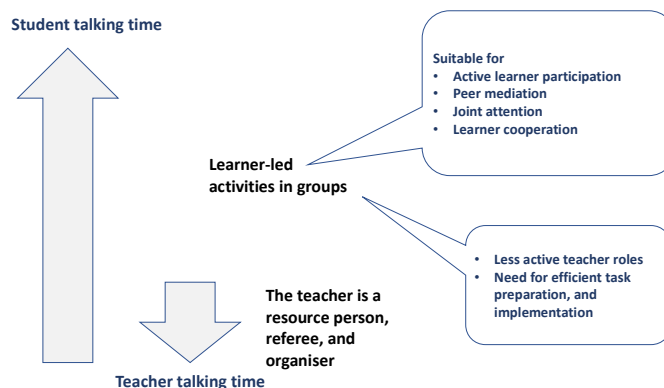

Figure 84. Autonomous group-work activity.

Our observations suggest that in these independent small-group activities, even with a minimal AL level, if the task is well designed, learners participate more, are more motivated, and scaffold the learning of their peers (content and language—lexical, grammatical etc.), and their language productions are of much better quality than in conventional AL classes.

Factors promoting high learner involvement

In my SMA framework, there is a symbiotic relationship between the different elements. The deletion of one component can influence all other components. For example, high learner engagement (both participative and cognitive), which is the main goal of current AL/CLIL implementations, cannot be achieved if all the parameters are not aligned (see Figure 85).

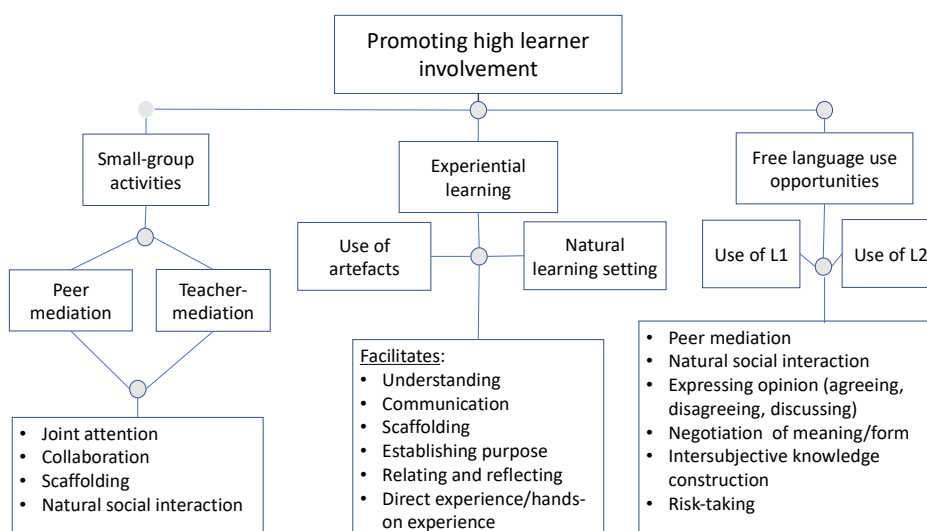

Figure 85. Factors promoting high learner engagement.

Small-group activities, which increase learners' opportunities for collaborative interaction, support high levels of learner participation. Likewise, experiential learning activities that emphasize communication, reflection, and action promote cognitive and participatory involvement of learners. Without learning tasks that encourage free and creative use of language and that allow for opportunities for negotiation and the creation of intersubjective knowledge, we cannot speak of the availability of high levels of learner engagement. In a nutshell, the success of my SMA framework depends highly on how well the tasks are designed and how well each component is aligned (e.g., small group activity, experiential and naturalistic learning tasks, the use of social artefacts and the maintenance of joint attention).

1.87 Conclusion

Our observations in primary EAL/CLIL classrooms enabled us to have an overview of EAL implementations in the French Polynesian primary education context. Our results illustrate that the learners were more motivated and active and used the AL willingly and purposefully in CLIL lessons much more than in mainstream EAL lessons. Our CLIL experimentations have not come to an end. In my future projects, I intend to apply a framework that will enable CLIL and EAL classes to go in parallel (i) to increase the frequency of use of the language items practised (i.e., by recycling the language items used in AL classes and reusing them in CLIL lessons and by varying the context of their use), (ii) to support the transfer of skills from one learning situation to another, and (iii) to diversify the context of AL use. I hypothesize that (i) enabling learners to recycle the language features they have learned by repeating the same language features and their use in different situations and (ii) helping them make diverse associations (connections) will contribute to their language development (i.e., retention of AL features and the ability to use the AL in different contexts).

CLIL practices, in the French Polynesian context, represent innovation to both learners and teachers. Therefore, supplementing research data with learner, teacher, and parent interviews and obtaining both the learners and the teachers' opinions on their CLIL experiences would provide richer data and widen perspectives.

The study of social representations and beliefs has significant potential for gaining valuable knowledge about learning and teaching that could be used to enhance AL and CLIL pedagogies. I

need to make closer links with classroom practices and individuals' beliefs and social representations. I therefore intend to pursue research that explores (i) the relationships between beliefs/representations, teaching, and learning; (ii) classroom practices; and (iii) the links between teaching and assessment techniques used. I therefore intend to focus on the following questions:

- (a) Cultural beliefs about AL/CLIL issues: What are they? How are they expressed?
- b) Beliefs about AL/CLIL learning: What are the learners' conceptions of their L1 and its use in AL/CLIL classes? How do learners perceive their role and that of their teachers in AL classes?
- c) Beliefs about the teaching of AL/CLIL: How do teachers perceive their role and that of their learners in AL/CLIL classes?
- d) What approaches do teachers take to the teaching of AL? What types of assessment methods and tasks are used? How do teachers approach the use of L1 in AL/CLIL classes?
- e) Personal beliefs: What types of attributions do learners face in terms of failure/success? What are learners' personal interests/expectations regarding the AL/CLIL they are learning? How do learners regulate their language learning? What strategies do they use? What beliefs encourage the use of these strategies?

AL learning is at the crossroads of issues relating to language learning and subject content learning. The teaching of ALs today requires teacher education programmes on plurilingual didactic approaches (Gajo, 2009). Although some efforts have been made in teacher education, this issue remains one of the main obstacles to the development of plurilingualism. In the minds of many teachers plurilingual approaches are merely based on considerations of the linguistic dimension and sometimes compromise the notion of teaching a school subject, which may hinder the development of knowledge of subject content (Gajo, 2009). The teaching and use of plurilingual and pluralistic approaches require collaboration between teachers and tandem teaching. Improving collaboration and tandem teaching approaches can only be achieved through teacher education. Encouraging teachers to participate in pluralistic teaching also requires formal recognition of career development, which involves both political and financial concerns.

This HDR dissertation did not elaborate on the issues of teacher education concerning plurilingualism in relation to AL and CLIL teaching. Teacher training is a crucial issue in actions

to promote plurilingualism. This area involves many interrelated issues such as language policies, financial resources, time, and availability of teacher educators and requires detailed analysis.

So far, my research has not elaborated on research actions in this area. I intend to focus my future research projects on this area. Language identity texts from language learners and teachers about AL/CLIL can be used as sources of information for teaching and teacher training.

Overall, in this HDR dissertation, I have included issues directly linked to my research. I have attempted to situate my research on AL learning in the current global linguistic context by drawing parallels with the situation in French Polynesia. I have placed particular emphasis on the plurilingual language ecology of French Polynesia and have situated AL learning in this landscape.

This HDR dossier focuses on language learning and teaching in plurilingual contexts and aims to reflect this plurilingual aspect of my work as a researcher and teacher and my experience as a language learner. To conform to this plurilingual aspect of my work, this dossier is presented in two ALs that I have acquired: English and French. In addition to this dissertation, written in English, the last volume of my dossier includes a book written in French that also highlights the current views expressed by French researchers on certain fundamental issues. This book is addressed to teachers and covers the epistemological and pedagogical positions conveyed by this HDR dissertation. It is based on examples drawn from the French Polynesian context and is intended for readers who wish to be informed about issues related to plurilingualism and the integration of disciplinary content teaching with ALs. Much of the literature on language learning is practical in nature and based on the principles of language didactics. However, the concepts expressed by these principles are not always well understood and are interpreted in different ways by different individuals depending on their personal history in language learning or teaching (see Gabillon, 2012b). These different interpretations can lead to practices that do not correspond to the fundamental ideas underlying these principles. The book establishes links between research, theory, and pedagogy in AL teaching and aims to provide information on recent paradigm shifts in the field of language didactics.

In French Polynesia, being a plurilingual society, members of this community show a great interest in issues related to plurilingualism and bilingual education. As part of my ongoing research, preliminary analysis of my interviews with parents indicates that all parents without exception emphasize the importance of bilingualism and stress the importance of learning English and

Tahitian as ALs (see Gabillon, 2020b for Mendeley dataset). Currently, I am co-supervising a doctoral student who is studying the social representations of parents and teachers on education in the context of French Polynesia. This novice researcher's work concerns the representations of parents and teachers on language learning and bilingual education, as well as their social representations on general educational issues.

I also see this HDR work as a step in the supervision of novice researchers who wish to conduct research in schools. Plurilingualism and plurilingual approaches require further research for the successful implementation of pluralistic approaches and CLIL. This dissertation provides an overview of both the research methodology and theoretical knowledge that junior researchers would need. My goal would be to help them equip themselves with the knowledge and skills to conduct research for the benefit of learners and their communities. Language teaching pedagogy and research in AL are vast fields with multiple dimensions. My research work aims to explore these different dimensions in an integrated manner by combining SLA research findings, local specificities, plurilingual and pluralistic pedagogies, individual beliefs, and social representations. I believe that my knowledge of applied linguistics (pedagogy and research), combined with the collaboration of novice researchers, would be beneficial to the local community and would contribute to research in applied linguistics.

REFERENCES

- Abric, J.-C. (1993). Central system, peripheral system: Their functions and roles in the dynamics of social representations. *Papers on Social Representations*, 2(2), 75–78. Retrieved from <http://psr.iscte-iul.pt/index.php/PSR/article/download/126/90>
- Abric, J.-C. (2001). L'approche structurale des représentations sociales : Développements récents. *Psychologie & Société*, 4, 81–103.
- Aguilar, M., & Muñoz, C. (2014). The effect of proficiency on CLIL benefits in engineering students in Spain. *International Journal of Applied Linguistics (United Kingdom)*, 24(1), 1–18. <https://doi.org/10.1111/ijal.12006>
- Agustín-Llach, M. P., & Canga Alonso, A. (2016). Vocabulary growth in young CLIL and traditional EFL learners: evidence from research and implications for education. *International Journal of Applied Linguistics (United Kingdom)*, 26(2), 211–227. <https://doi.org/10.1111/ijal.12090>
- Ailincăi, R., & Gabillon, Z. (2018a). Analysing teachers' representations of digital technology using a grounded theory approach. *EURASIA Journal of Mathematics, Science and Technology Education*, 14(10), online. <https://doi.org/10.29333/ejmste/93380>
- Ailincăi, R., & Gabillon, Z. (2018b). Corpus: Entretiens semi-directifs avec des enseignants du primaire en Polynésie française 2017.
- Ailincăi, R., Gabillon, Z., & Ferrière, S. (2018). Des éléments de corpus pour comprendre les représentations sur le numérique en contexte polynésien : préalables à la conception d'un dispositif de formation des enseignants du 1er degré. *Contextes et Didactiques*, 11, 35–68. <https://doi.org/10.4000/ced.1003>
- Ailincăi, R., Gabillon, Z., Vernaudeau, J., Paia, M., & Alì, M. (2016). School and family involvement in educational practices in French Polynesia. In *The Hawaiian Conference on Education 2016* (pp. 199–215). Honolulu, Hawaii: © The International Academic Forum. Retrieved from <https://halshs.archives-ouvertes.fr/halshs-01309812/>
- Alanen, R. (2003). A sociocultural approach to young language learners' beliefs about language learning. In P. Kalaja & A. M. F. Barcelos (Eds.), *Beliefs about SLA: New research approaches*.

Netherlands: Kluwer Academic Publishers.

- Alcaraz-Mármol, G. (2018). Trained and non-trained language teachers on CLIL methodology: Teachers' facts and opinions about the CLIL approach in the primary education context in Spain. *Latin American Journal of Content & Language Integrated Learning*, 11(1), 39–64. <https://doi.org/10.5294/lacilil.2018.11.1.3>
- Anton, M. (1999). The discourse of a learner-centered classroom: Sociocultural perspectives on teacher-learner interaction in the second-language classroom. *Modern Language Journal*, 83(3), 303–318. <https://doi.org/10.1111/0026-7902.00024>
- Antón, M., & DiCamilla, F. (1998). Socio-cognitive functions of L1 collaborative interaction in the L2 classroom. *Canadian Modern Language Review*, 54(3), 314–342. <https://doi.org/10.3138/cmlr.54.3.314>
- Atkinson, D. (2011). *Alternative approaches to second language acquisition*. (D. Atkinson, Ed.). New York, USA: Routledge.
- Atkinson, D. (2019). Second language acquisition beyond borders? The Douglas Fir Group searches for transdisciplinary identity. *Modern Language Journal*, 103, 113–121. <https://doi.org/10.1111/modl.12530>
- Auerbach, E. (1986). Competency-based ESL: One step forward or two steps back? *TESOL Quarterly*, 20(3), 411–429.
- Ausubel, D. P. (1980). Schemata, cognitive structure, and advance organizers: A reply to Anderson, Spiro, and Anderson. *American Educational Research Journal*, 17(3), 400–404. <https://doi.org/10.3102/00028312017003400>
- Azkarai, A., & Imaz Agirre, A. (2016). Negotiation of meaning strategies in child EFL mainstream and CLIL settings. *TESOL Quarterly*, 50(4), 844–870. <https://doi.org/10.1002/tesq.249>
- Baena, R. (2005). Transculturing: Auto/biography. *Prose Studies*, 27(3), 211–216. <https://doi.org/10.1080/01440350500223792>
- Baker, C. (2001). *Foundations of bilingual education and bilingualism* (3rd ed.). Bristol, UK: Multilingual Matters.
- Baker, P. (2006). *Using corpora in discourse analysis*. London, UK: Continuum.

<https://doi.org/10.1007/9781139764377.013>

- Baldwin, D. A. (2014). Understanding the link between joint attention and language. In C. Moore & P. Dunham (Eds.), *Joint attention: It's origin and role in development* (pp. 131–158). New York: Routledge.
- Ball, J. (2010). *Enhancing learning of children from diverse language backgrounds: Mother tongue-based bilingual or multilingual education in early childhood and early*. Victoria, Canada.
- Ball, P. (2009). Does CLIL work? In D. A. Hill & A. Pulverness (Eds.), *The best of both worlds? International Perspectives on CLIL* (pp. 32–43). Norwich: Norwich Institute for Language Education.
- Bandura, A. (1986). *Social foundations of thought and action: A social cognitive theory* (Eaglewood). New Jersey: Prentice-Hall, Inc.
- Bandura, A. (1994). Self-efficacy. In V. Ramachaudran (Ed.), *Encyclopedia of human behavior* (pp. 71–81). New York, USA: Academic Press, 1998. <https://doi.org/10.5860/choice.36-0036>
- Bandura, A. (2010). Self-efficacy. In B. Weiner & E. W. Craighead (Eds.), *The Corsini Encyclopedia of Psychology* (pp. 1–3). John Wiley & Sons, Inc. <https://doi.org/10.9780470479216>.
- Bandura, A. (2012). Going global with social cognitive theory: From prospect to paydirt. In *Applied psychology* (pp. 65–92). Psychology Press.
- Banegas, D. L. (2012). Integrating content and language in English language teaching in secondary education : Models , benefits , and challenges. *Studies in Second Language Learning and Teaching*, 2(1), 111–136. <https://doi.org/10.14746/ssllt.2012.2.1.6>
- Banegas, D. L. (2016). Teachers develop CLIL materials in Argentina: A workshop experience. *Latin American Journal of Content & Language Integrated Learning*, 9(1), 17–36. <https://doi.org/10.5294/laclil.2016.9.1.2>
- Barcelos, A. M. F. (2003). Researching eliefs about SLA: A critical review. In P. Kalaja & A. M. F. Barcelos (Eds.), *Beliefs about SLA: New reserch approaches*. Netherlands: Kluwer Academic Publishers.

- Barkhuizen, G. (2009). Topics, aims, and constraints in English teacher research: A Chinese case study. *TESOL Quarterly*, 43(1), 113–125.
- Baron, G.-L., & Drot-Delange, B. (2016). L'informatique comme objet d'enseignement à l'école primaire française? Mise en perspective historique. *Revue Française de Pédagogie*, (2), 51–62.
- Bartlett, F. C. (1958). (1958). *Thinking*. New York: Basic books.
- Beacco, J.-C., Bouquet, S., & Porquier, R. (2003). *Cadre européen commun de référence pour les langues: apprendre, enseigner, évaluer*. Council of Europe. Strasbourg. Retrieved from <https://rm.coe.int/16802fc3a8>
- Beglar, D., & Hunt, A. (2002). Implementing task-based language teaching. In J. C. Richards & W. A. Renandya (Eds.), *Methodology in language teaching: An anthology of current practice* (pp. 96–106). Cambridge, UK: Cambridge University Press.
- Béliard, J., & Gravé-rousseau, G. (2009). *Les programmes EMILE : principes , objectifs et mise en œuvre*. Commission européenne. Retrieved from http://www.ienmaroc.org/site_ien/wp-content/uploads/2018/12/Les-programmes-EMILE-principes-objectifs-et-mise-en-oeuvre-1.pdf
- Bell, D. M. (2003). Method and postmethod: Are they really so incompatible? *TESOL Quarterly*, 37(2), 325. <https://doi.org/10.2307/3588507>
- Benson, P., & Lor, W. (1999). Conceptions of language and language learning. *System*, 27(4), 459–472.
- Berney, J., & Pochon, L.-O. (2000). *L'internet à l'école: analyse du discours à travers la presse*. Neuchâtel: IRDP.
- Best, S., & Kellner, D. (2003). Contemporary youth and the postmodern adventure. *Review of Education, Pedagogy, and Cultural Studies*, 25(2), 75–93. <https://doi.org/10.1080/10714410390198949>
- Bialystok, E. (1991). *Language processing in bilingual children*. Cambridge, UK: Cambridge University Press. <https://doi.org/10.1017/CBO9780511620652>
- Bialystok, E. (2003). *Bilingualism in development: Language, literacy and cognition*. Cambridge,

UK: Cambridge University Press.

- Bialystok, E. (2007). Cognitive effects of bilingualism: How linguistic experience leads to cognitive change. *International Journal of Bilingual Education and Bilingualism*, *10*(3), 210–223. <https://doi.org/10.2167/beb441.0>
- Bialystok, E. (2010). Global-local and trail-making tasks by monolingual and bilingual children: Beyond inhibition. *Developmental Psychology*, *46*(1), 93–105. <https://doi.org/10.1037/a0015466>
- Bialystok, E. (2011). Reshaping the mind: The benefits of bilingualism. *Canadian Journal of Experimental Psychology*, *65*(4), 229–235. <https://doi.org/10.1037/a0025406>
- Bialystok, E., & Hakuta, K. (1999). Confounded age: Linguistic and cognitive factors in age differences for second language acquisition. In D. Birdsong (Ed.), *Second language acquisition and critical period hypothesis* (pp. 161–181). New Jersey, USA: Lawrence Erlbaum Associates.
- Bialystok, E., Luk, G., & Kwan, E. (2005). Bilingualism, biliteracy, and learning to read: Interactions among languages and writing systems. *Scientific Studies of Reading*, *9*(1), 43–61. https://doi.org/10.1207/s1532799xssr0901_4
- Biggs, J. (1994). Student learning research and theory-Where do we currently stand? In G. Gibbs (Ed.), *Improving student learning: Theory and practice* (pp. 1–19). Oxford, UK: Oxford Center for Staff Development.
- Blackledge, A., & Creese, A. (2014). *Heteroglossia as practice and pedagogy*. New York: Springer.
- Blake, R., & Kramsch, C. (2007). The issue: National language educational policy. *Modern Language Journal*, *91*(2).
- Blommaert, J. (2013). *Ethnography, superdiversity and linguistic landscapes: Chronicles of complexity*. New York, USA: Multilingual Matters.
- Bourdieu, P. (1979). Les trois états du capital culturel. *Actes de La Recherche En Sciences Sociales*, *30*(1), 3–6. <https://doi.org/10.3406/arss.1979.2654>
- Bourdieu, P. (1986). Habitus, code et codification. *Actes de La Recherche En Sciences Sociales*,

64(1), 40–44. <https://doi.org/10.3406/arss.1986.2335>

- Braunmüller, K., & Ferraresi, G. (2003). *Aspects of multilingualism in European language history*. Amsterdam: John Benjamins Publishing Company. <https://doi.org/10.1017/CBO9781107415324.004>
- Breidbach, S. (2003). *Plurilingualism, democratic citizenship in Europe and the role of English. Council of Europe*. Strasbourg. Retrieved from http://www.coe.int/T/E/Cultural_Cooperation/education/Languages/Language_Policy/Policy_development_activities/Studies/BreidbachEN.pdf?L=E
- Brinton, D. M., Celce-Murcia, M., Brinton, D. M., & Snow, M. A. (2014). *Teaching English as a second or foreign language*. (D. M. Brinton, M. Celce-Murcia, & M. A. Snow, Eds.) (4th ed.). Boston, USA: Sherrise Roehr.
- Bronfenbrenner, U. (1979). *The ecology of human development. Experiments by nature an design*. Harvard University Press.
- Brown, D. (2000). *Principles of language learning and teaching*. UK, London: Pearson Longman.
- Brown, D. (2002). English language teaching in the “post-method” era: Toward better diagnosis, treatment, and assessment. In J. C. Richards & W. A. Renandya (Eds.), *Methodology in language teaching: An anthology of current practice* (1st ed., pp. 9–18). Cambridge, UK: Cambridge University Press.
- Bruner, J. (1973). *Going beyond the information given*. New York: Norton.
- Bruner, J. (1974). The ontogenesis of speech acts. *Journal of Child Language*, 2, 1–19.
- Bruner, J. (1978). The role of dialogue in language acquisition. *The Child Conception of Language*, 2(3), 241–256.
- Bruner, J. (2014). From joint attention to the meeting of minds: An introduction. In C. Moore & P. Dunham (Eds.), *Joint attention: Its origin and role in development* (pp. 1–14). New York: Routledge.
- Bruton, A. (2011). Is CLIL so beneficial, or just selective? Re-evaluating some of the research. *System*, 39(4), 523–532. <https://doi.org/10.1016/j.system.2011.08.002>
- Bruton, A. (2015). CLIL: Detail matters in the whole picture. More than a reply to J. Hüttner and

- U. Smit (2014). *System*, 53, 119–128. <https://doi.org/10.1016/j.system.2015.07.005>
- Byram, M. (1997). *Teaching and assessing intercultural communicative competence*. Toronto, CA: Multilingual Matters.
- Byram, M., & Planet, M. T. (2000). *Social identity and European dimension: Intercultural competence through foreign language learning*. (M. Byram & M. T. Planet, Eds.). Graz: Council of Europe Publication.
- Byrnes, H. (2007). Perspectives. *Modern Language Journal*, 91(4), 641–644.
- Canagarajah, S. (2006). The place of world Englishes in composition: Pluralization continued. *College Composition and Communication*, 57(4), 586–619.
- Canagarajah, S. (2011a). Codemeshing in academic writing: Identifying teachable strategies of translanguaging. *Modern Language Journal*, 95(3), 401–417. <https://doi.org/10.1111/j.1540-4781.2011.01207.x>
- Canagarajah, S. (2011b). Translanguaging in the classroom: Emerging issues for research and pedagogy. *Applied Linguistics Review*, 2((online)), 1–28. <https://doi.org/10.1515/9783110239331.1>
- Canagarajah, S. (2016). Crossing borders, addressing diversity. *Language Teaching*, 49(3), 438–454. <https://doi.org/10.1017/S0261444816000069>
- Candel, D., & Nancy-Combes, J. P. (2018). Complémentarité des disciplines en linguistique appliquée. Introduction. *Ela*, 190(2), 139–142. <https://doi.org/10.3917/ela.190.0139>
- Candelier, M. (2016). Activités métalinguistiques Pour une didactique intégrée des langues. *Le Français Aujourd'hui*, 192(1), 107–116. Retrieved from <https://www.cairn.info/revue-informations-sociales-2005-3-page-48.htm>
- Candelier, M., Camilleri-Grima, A., Castellotti, V., De Pietro, J.-F., Lőrincz, I., Meißner, F.-J., ... Schröder-Sura, A. (2012). *FREPA: A framework of reference for pluralistic approaches to languages and cultures*. Graz: Council of Europe Publishing.
- Castellotti, V. (2006). Une conception plurielle et intégrée de l'enseignement des langues – principes, modalités, perspectives. *Recherches En Didactique Des Langues et Des Cultures. Les Cahiers de l'Acedl*, 2, 1–10.

- Castellotti, V., & Moore, D. (2002). *Représentations sociales des langues et enseignements. Guide pour l'élaboration des politiques linguistiques éducatives en Europe — De la diversité linguistique à l'éducation plurilingue*. Strasbourg: Conseil de l'Europe. Retrieved from <http://www.coe.int/T/DG4/linguistic/Source/CastellottiMooreFR.pdf>
- Celce-Murcia, M. (2014). An overview of language teaching methods and approaches. In M. Celce-Murcia, D. M. Brinton, & M. A. Snow (Eds.), *Teaching English as a second or foreign language* (4th ed., pp. 2–13). Boston, USA: Sherrise Roehr.
- Cendoya, A. M., & Di Bin, M. V. (2010). A CLIL experience based on the use of tasks and different genre types. *Latin American Journal of Content and Language Integrated Learning*, 3(1), 11–17. <https://doi.org/10.5294/lacil.2010.3.1.2>
- Cenoz, J. (2003). The additive effect of bilingualism on third language acquisition: A review. *International Journal of Bilingualism*, 7(1), 71–87. <https://doi.org/10.1177/13670069030070010501>
- Cenoz, J. (2015). Content-based instruction and content and language integrated learning: the same or different? *Language, Culture and Curriculum*, 28(1), 8–24. <https://doi.org/10.1080/07908318.2014.1000922>
- Cenoz, J. (2017). Translanguaging in school contexts: International perspectives. *Journal of Language, Identity and Education*, 16(4), 193–198. <https://doi.org/10.1080/15348458.2017.1327816>
- Cenoz, J., Genesee, F., & Gorter, D. (2014). Critical analysis of CLIL: Taking stock and looking forward. *Applied Linguistics*, 35(3), 243–262. <https://doi.org/10.1093/applin/amt011>
- Cenoz, J., & Gorter, D. (2019). Multilingualism, translanguaging, and minority languages in SLA. *Modern Language Journal*, 103, 130–135. <https://doi.org/10.1111/modl.12529>
- Cenoz, J., Hufeisen, B., & Jessner, U. (2001). *Cross-linguistic influence in third language acquisition: Psycholinguistic perspectives*. Clevedon, UK: Multilingual Matters.
- Cenoz, J., & Ruiz de Zarobe, Y. (2015). Learning through a second or additional language: content-based instruction and CLIL in the twenty-first century. *Language, Culture and Curriculum*, 28(1), 1–7. <https://doi.org/10.1080/07908318.2014.1000921>

- Chaiklin, S., & Lave, J. (1996). *Understanding practice: Perspectives on activity and context*. Cambridge, UK: Cambridge University Press.
- Chapple, L., & Curtis, A. (2000). Content-based instruction in Hong Kong: student responses to film. *System*, 28, 419–433.
- Charmaz, K. (1996). The search for meanings-grounded theory. In J. A. Smith, R. Harré, & L. Van Langenhove (Eds.), *Rethinking methods in psychology* (pp. 27–49). London: Sage Publications.
- Charmaz, K. (2014). *Constructing grounded theory*. Thousand Oaks, CA: Sage Publications.
- Charpentier, J., & François, A. (2015). *Linguistic atlas of French Polynesia*. Degruyter. <https://doi.org/https://doi.org/10.1515/9783110260359>
- Cole, M., & Wertsch, James, V. (1996). Beyond the individual-social antinomy in discussions of Piaget and Vygotsky. *Human Development*, 39, 250–256. Retrieved from <http://ro.uow.edu.au/cgi/viewcontent.cgi?article=1002&context=llrg>
- Conseil de l'Europe. (2001). *Un cadre européen commun de référence pour les langues: apprendre, enseigner, évaluer*. Paris, France: Didier.
- Conseil de l'Europe. (2018). *Cadre européen commun de référence pour les langues : apprendre, enseigner, évaluer. Volume complémentaire du nouveaux descripteurs*. Strasbourg.
- Conteh, J. (2018). Translanguaging. *ELT Journal*, 72(4), 445–447. <https://doi.org/10.1093/elt/ccx030>
- Conteh, J., & Meier, G. (2014). *The multilingual turn in languages education: Opportunities and challenges* (Vol. 40). Multilingual Matters.
- Cook, V., & Singleton, D. (2014). *Key topics in second language acquisition*. Bristol, UK: Multilingual matters.
- Corbin, J., & Strauss, L. A. (1990a). Grounded theory research: Procedures, canons, and evaluative criteria. *Qualitative Sociology*, 13(1), 3–21. <https://doi.org/10.1007/BF00988593>
- Corbin, J., & Strauss, L. A. (1990b). Grounded theory research: Procesures, canons and evaluative criteria. *Zeitschrift Fuer Soziologie*, 19(6), 418–427. <https://doi.org/http://dx.doi.org/10.1007/BF00988593>

- Corbin, J., & Strauss, L. A. (1998). *Basics of qualitative research: Techniques and procedures for developing grounded theory*. *Basics of qualitative research: Techniques and procedures for developing grounded theory* (2nd ed.). SAGE Publications.
- Coste, D., Moore, D., & Zarate, G. (2009). *Plurilingual and pluricultural competence*. Strasbourg: Council of Europe Publication.
- Coulthard, M. (1992). *Advances in spoken discourse analysis*. *Advances in Spoken Discourse Analysis*. New York, USA: Routledge. <https://doi.org/10.4324/9780203200063>
- Council of Europe. (2003). *Common European framework of reference for languages: Learning, teaching, assessment (CEFR)*. Cambridge: Cambridge University Press. Retrieved from <https://rm.coe.int/16802fc1bf>
- Council of Europe. (2018). *Common european framework of reference for languages: Learning, teaching, assessment. Companion volume with new descriptors*. Strasbourg.
- Coyle, D. (2002). Relevance of CLIL to the European Commission's language learning objectives. In D. Marsh (Ed.), *CLIL/EMILE. The European dimension: Actions, trends and foresight potential* (pp. 27–28). Jyväskylä: University of Jyväskylä, Finland.
- Coyle, D. (2005). *CLIL: Planning tools for teachers*. Nottingham.
- Coyle, D. (2007). Content and language integrated learning: Towards a connected research agenda for CLIL pedagogies. *International Journal of Bilingual Education and Bilingualism*, 10(5), 543–562. <https://doi.org/10.2167/beb459.0>
- Coyle, D. (2008). CLIL—A pedagogical approach from the European perspective. In J. Cenoz & N. H. Hornberger (Eds.), *Encyclopedia of language and education* (2nd ed., pp. 97–111). Boston, MA: Springer US. https://doi.org/10.1007/978-0-387-30424-3_92
- Coyle, D. (2013). Listening to learners: An investigation into “successful learning” across CLIL contexts. *International Journal of Bilingual Education and Bilingualism*, 16(3), 244–266. <https://doi.org/10.1080/13670050.2013.777384>
- Coyle, D., Holmes, B., & King, L. (2009). *Towards an integrated curriculum – CLIL national statement and guidelines*. The Languages Company. <https://doi.org/10.1371/journal.pone.0085878>

- Coyle, D., Hood, P., & Marsh, D. (2010). *CLIL: Content and language integrated learning*. Cambridge, UK: Cambridge University Press.
- Cross, R. (2010). Language teaching as sociocultural activity: Rethinking language teacher practice. *Modern Language Journal*, 94(3), 434–452. <https://doi.org/10.1111/j.1540-4781.2010.01058.x>
- Cross, R. (2012). Creative in finding creativity in the curriculum: The CLIL second language classroom. *Australian Educational Researcher*, 39(4), 431–445. <https://doi.org/10.1007/s13384-012-0074-8>
- Cross, R. (2013). *Research and evaluation of the content and language integrated learning (CLIL) approach to teaching and learning languages in Victorian schools*. Melbourne, Australia. Retrieved from <http://hdl.handle.net/11343/55778>
- Cross, R. (2014). *Best-evidence synthesis: Current approaches to language education*. Melbourne, Australia. Retrieved from <http://hdl.handle.net/11343/55777>
- Cross, R. (2016). Language and content ‘integration’: the affordances of additional languages as a tool within a single curriculum space. *Journal of Curriculum Studies*, 48(3), 388–408. <https://doi.org/10.1080/00220272.2015.1125528>
- Csizér, K., & Dörnyei, Z. (2005). (2005). The internal structure of language learning motivation and its relationship with language choice and learning effort. *Modern Language Journal*, 89, 19–36.
- Cummins, J. (1977). *The cognitive development of bilingual children: A review of recent research*. Edmonton, Canada. Retrieved from <https://eric.ed.gov/?id=ED145727>
- Cummins, J. (1980). The construction of language proficiency in bilingual education. In J. E. Alatis (Ed.), *Current issues in bilingual education* (pp. 81–103). Washington, D.C.: Georgetown University Press.
- Cummins, J. (1981). Empirical and theoretical underpinnings of bilingual education. *Journal of Education*, 163(1), 16–29. <https://doi.org/10.1177/002205748116300104>
- Cummins, J. (1998). Immersion education for the millennium: What have we learned from 30 years of research on second language immersion? In *Learning through two languages: Research*

- and practice. Second Katoh Gakuen International Symposium on Immersion and Bilingual Education* (pp. 34–47). Katoh Gakuen, Japan.
- Cummins, J. (2001a). Bilingual children's mother tongue: Why is it important for education? *Sprogforum*, 7(19), 15–20.
- Cummins, J. (2001b). *Language, power and pedagogy: Bilingual children in the crossfire*. Clevedon, UK: Multilingual Matters.
- Cummins, J. (2008). Teaching for transfer: challenging the two solitudes assumption in bilingual education. In *Encyclopedia of language and education* (2nd ed., Vol. 5, pp. 65–75). Springer. https://doi.org/10.1007/978-0-387-30424-3_116
- Cummins, J., & Early, M. (2011). *Identity texts: The collaborative creation of power in multilingual schools*. Staffordshire, UK: Trentham books limited.
- Cummins, J., Hu, S., Markus, P., & Kristiina Montero, M. (2015). Identity texts and academic achievement: Connecting the dots in multilingual school contexts. *TESOL Quarterly*, 49(3), 555–581. <https://doi.org/10.1002/tesq.241>
- Cummins, J., & Swain, M. (2014). *Bilingualism in education: Aspects of theory, research and practice* (6th ed.). London, UK: Routledge.
- D'warte, J. (2014a). Exploring linguistic repertoires: Multiple language use and multimodal literacy activity in five classrooms. *Australian Journal of Language and Literacy*, 37(1), 21–30.
- D'warte, J. (2014b). Linguistic Repertoires: Teachers and Students Explore Their Everyday Language Worlds. *Language Arts*, 91(5), 352–362. Retrieved from <http://www.jstor.org/stable/24575546>
- Dafouz, E., & Hibler, A. (2013). “Zip your lips” or “Keep quiet”: Main teachers' and language assistants' classroom discourse in CLIL settings. *Modern Language Journal*, 97(3), 655–669. <https://doi.org/10.1111/j.1540-4781.2013.12026.x>
- Dalton-Puffer, C. (2007a). *Discourse in content and language integrated learning (CLIL) classrooms*. Amsterdam, The Netherlands: John Benjamins Publishing.
- Dalton-Puffer, C. (2007b). Outcomes and processes in content and language integrated learning

- (CLIL): current research from Europe. *Future Perspectives for English Language Teaching*, (May).
- Dalton-Puffer, C. (2011). Content-and-language integrated learning: From practice to principles? *Annual Review of Applied Linguistics*, 31, 182–204. <https://doi.org/10.1017/S0267190511000092>
- Dalton-Puffer, C. (2017). Putting CLIL into practice. *ELT Journal*, 72(1), 109–111. <https://doi.org/10.1093/elt/ccx063>
- Dalton-Puffer, C., Llinares, A., Lorenzo, F., & Nikula, T. (2014). “You can stand under my umbrella”: Immersion, CLIL and bilingual education. A response to Cenoz, Genesee & Gorter (2013). *Applied Linguistics*, 35(2), 213–218. <https://doi.org/10.1093/applin/amu010>
- Dalton-Puffer, C., & Nikula, T. (2014). Content and language integrated learning. *The Language Learning Journal*, 42(2), 117–122. <https://doi.org/10.1080/09571736.2014.891370>
- Dalton-Puffer, C., & Smit, U. (2013). Content and language integrated learning: A research agenda. *Language Teaching*, 46(4), 545–559. <https://doi.org/10.1017/S0261444813000256>
- Darn, S. (2009). Teaching other subjects through English, cross-curricular resources for young learners, uncovering CLIL. *ELT Journal*, 63(3), 275–277. <https://doi.org/10.1093/elt/ccp042>
- Davies, A., & Elder, C. (2005). Validity and validation in testing. In E. Hinkel (Ed.), *Handbook of research in second language teaching and learning* (pp. 795–814). Mahwah, New Jersey: Lawrence Erlbaum Associates.
- Davies, A., & Elder, C. (2008). *The handbook of applied linguistics*. (A. Davies & Eld, Eds.), *The Handbook of Applied Linguistics*. Victoria, Australia: Blackwell Publishers. <https://doi.org/10.1002/9780470757000>
- De Guerrero, M. C. M., & Villamil, O. S. (2000). Activating the ZPD: Mutual scaffolding in L2 peer revision. *Modern Language Journal*, 84(1), 51–68. <https://doi.org/10.1111/0026-7902.00052>
- De Laurentiis Brandão, A. C. (2018). Visualizing EFL teacher identity (re)construction in materials design and implementation. *Applied Linguistics Review*, 9(2–3), 249–271. <https://doi.org/10.1515/applirev-2016-1060>

- De Pietro, J.-F., Matthey, M., & Py, B. (1989). Acquisition et contrat didactique : les séquences potentiellement acquisitionnelles dans la conversation exolingue. In D. Weil & H. Fougier (Eds.), *Actes du 3e Colloque Régional de Linguistique* (pp. 99–124). Strasbourg.
- Deyrich, M.-C. (2007). *Enseigner les langues à l'école*. Paris, France: Ellipses.
- Dicamilla, F. J., & Antón, M. (2012). Functions of L1 in the collaborative interaction of beginning and advanced second language learners. *International Journal of Applied Linguistics (United Kingdom)*, 22(2), 160–188. <https://doi.org/10.1111/j.1473-4192.2011.00302.x>
- Dörnyei, Z. (2005). *The psychology of the language learner: Individual differences in second language acquisition*. Mahwah, NJ: Lawrence Erlbaum Associates. <https://doi.org/10.1017/S0272263107310061>
- Doughty, C. J., & Long, M. H. (2005). *The handbook of second language acquisition*. Oxford, UK: Blackwell Publishing.
- Douglas Fir Group. (2016). A transdisciplinary framework for SLA in a multilingual world. *Modern Language Journal*, 100, 19–47. <https://doi.org/10.1111/modl.12301>
- Duff, P. A. (2007). Second language socialization as sociocultural theory: Insights and issues. *Language Teaching*, 40(4), 309–319. <https://doi.org/10.1017/S0261444807004508>
- Duff, P. A. (2015). Transnationalism, multilingualism, and identity. *Annual Review of Applied Linguistics*, 35, 57–80. <https://doi.org/10.1017/S026719051400018X>
- Duff, P. A. (2019). Social dimensions and processes in second language acquisition: Multilingual socialization in transnational contexts. *Modern Language Journal*, 103, 6–22. <https://doi.org/10.1111/modl.12534>
- Duff, P. A., & Byrnes, H. (2019). SLA across disciplinary borders: Introduction to the special issue. *Modern Language Journal*, 103(1), 3–5. <https://doi.org/10.1111/modl.12537>
- Dufva, H. (2003). Beliefs in dialogue: A Bakhtinian View. In P. Kalaja & A. M. F. Barcelos (Eds.), *Beliefs about SLA: New reserch approaches* (pp. 131–151). Netherlands: Kluwer Academic Publishers. https://doi.org/10.1007/978-1-4020-4751-0_6
- Dunham, P., & Moore, C. (2014). Current themes in research on joint attention. In C. Moore & P. Dunham (Eds.), *Joint attention: It's origin and role in development*. New York: Routledge.

- Dutton, J., D'warte, J., Rossbridge, J., & Rushton, K. (2018). *Tell me your story: confirming identity and engaging writers in the middle years*. Primary English Teachers' Association (PETAA).
- Duveen, G. (2000). *Social representations: Explorations in social psychology*. (G. Duveen, Ed.). Cambridge: Polity Press.
- Duveen, G., & Llyod, B. (1990). *Social representations and the development of knowledge*. Cambridge: Cambridge University Press. <https://doi.org/10.1017/cbo9780511659874>
- Ellis, N. C. (1998). Emergentism , connectionism and language learning. *Language Learning Journal*, 48(4), 631–664.
- Ellis, N. C. (2002). Frequency effects in language processing: A Review with implications for theories of implicit and explicit language acquisition. *Studies in Second Language Acquisition*, 24, 143–188.
- Ellis, N. C. (2019). Essentials of a theory of language cognition. *Modern Language Journal*, 103, 39–60. <https://doi.org/10.1111/modl.12532>
- Ellis, R. (2003). *Task-based language learning and teaching*. Oxford, UK: Oxford University Press.
- Ellis, R. (2005a). *Instructed second language acquisition a literature review*.
- Ellis, R. (2005b). Principles of instructed language learning. *System*, 33(2), 209–224. <https://doi.org/10.1016/j.system.2004.12.006>
- Ellis, R. (2009). Corrective feedback and teacher development. *L2 Journal*, 1(1), 3–18. <https://doi.org/10.5070/l2.v1i1.9054>
- Ellis, R. (2012). *Language teaching research and language pedagogy*. Oxford, UK: Wiley-Blackwell.
- Ellis, R. (2015a). *The study of second language acquisition* (2nd ed.). Oxford, UK: Oxford University Press.
- Ellis, R. (2015b). *Understanding second language acquisition* (2nd ed.). Oxford, UK: Oxford University Press.

- Ellis, R., & Barkhuizen, G. (2005). *Analysing learner language*. Oxford, UK: Oxford University Press.
- Ellis, R., & Shintani, N. (2014). *Exploring language pedagogy through second language acquisition research*. New York, USA: Routledge. <https://doi.org/10.4324/9780203796580>
- Ely, C. M. (1986). An analysis of discomfort, risktaking, sociability, and motivation in the L2 classroom. *Language Learning*, 36(1), 1–25.
- Engeström, Y. (1999). Activity theory and individual and social transformation. In Y. Engeström, R. Miettinen, & R.-L. Punamäki (Eds.), *Perspectives on activity theory* (pp. 19–38). Cambridge, Massachusetts: Cambridge University.
- Engeström, Y. (2001). Expansive Learning at Work: Toward an activity theoretical reconceptualization. *Journal of Education and Work*, 14(1), 133–156. <https://doi.org/10.1080/13639080020028747>
- Engeström, Y. (2014). *Learning by expanding: An activity-theoretical approach to developmental research, second edition* (2nd ed.). Cambridge, UK: Cambridge University Press.
- Engeström, Y., & Miettinen, R. (1999). Introduction. In Y. Engeström, R. Miettinen, & R.-L. Punamäki (Eds.), *Perspectives on activity theory* (pp. 1–19). Cambridge, UK: Cambridge University Press.
- Ertmer, P. A., & Ottenbreit-Leftwich, A. T. (2010). Teacher technology change: How knowledge, confidence, beliefs, and culture intersect. *Journal of Research on Technology in Education*, 42(3), 255–284. <https://doi.org/10.1080/15391523.2010.10782551>
- European Commission. Proposal for a council decision establishing the Lingua programme to promote training in foreign languages in the European Community, Pub. L. No. 07, 7 (1989). EU: Official Journal of the European Commission.
- European Commission. (2006). *Promoting Language Learning and Linguistic Diversity: An Action Plan 2004-06*. Retrieved from <http://scholar.google.com/scholar?hl=en&btnG=Search&q=intitle:Promoting+Language+Learning+and+Linguistic+Diversity:+An+Action+Plan+2004+--+2006#0>
- Eurydice. (2006). *Content and language integrated learning (CLIL) at school in Europe*.

- Eurydice.org*. Brussels, Belgium. <https://doi.org/10.1080/09571730685200121>
- Evnitskaya, N., & Morton, T. (2011). Knowledge construction, meaning-making and interaction in CLIL science classroom communities of practice. *Language and Education*, 25(2), 109–127. <https://doi.org/10.1080/09500782.2010.547199>
- Faber, G. (2019). Longitudinal effects of task performance and self-concept on preadolescent efl learners' causal attributions of grammar success and failure. *Studies in Second Language Learning and Teaching*, 9(4), 633–656. <https://doi.org/10.14746/ssl.t.2019.9.4.4>
- Findley, C. A., & Nathan, L. A. (1980). Functional language objectives in a competency based ESL curriculum. *TESOL Quarterly*, 14(2), 221. <https://doi.org/10.2307/3586316>
- Firth, A., & Wagner, J. (1997). On discourse, communication, and (some) fundamental concepts in SLA research. *Modern Language Journal*, 81(3), 285–300. <https://doi.org/10.2307/329302>
- Firth, A., & Wagner, J. (1998). SLA Property: No Trespassing! *Modern Language Journal*, 82(1), 91–94.
- Firth, A., & Wagner, J. (2014). Second / foreign language learning as a social accomplishment : Elaborations on a reconceptualized SLA, *91*(1997), 800–819.
- Flavell, J. H. (1979). Metacognition and cognitive monitoring: A new area of cognitive-developmental inquiry. *American Psychologist*, 34(10), 906–911. <https://doi.org/10.1037/0003-066X.34.10.906>
- Floss, G., & Alpha, T. Arrêté n° 895 CM du 12 juin 2014 portant création, organisation et fonctionnement de la direction générale de l'éducation et des enseignements (DGEE), Pub. L. No. 48, Journal Officiel de la Polynésie Française 1 (2014). French Polynesia: Lexpol. Retrieved from <http://lexpol.cloud.pf/LexpolAfficheTexte.php?texte=442386>
- Fontecha, A. F. (2009). Spanish CLIL: Research and official actions. In Y. Ruiz de Zarobe & R. M. Jiménez Catalán (Eds.), *Content and language integrated learning: Evidence from research in Europe* (pp. 3–21). Bristol, UK: Multilingual Matters.
- Foster, P., & Ohta, A. S. (2005). Negotiation for meaning and peer assistance in second language classrooms. *Applied Linguistics*, 26(3), 402–430. <https://doi.org/10.1093/applin/ami014>
- Foster, P., & Skehan, P. (1996). The influence of planning and task type on second language

- performance. *Studies in Second Language Acquisition*, 18(3), 299–323.
<https://doi.org/10.1017/S0272263100015047>
- Gabillon, Z. (2005). L2 learner's beliefs: An overview. *Journal of Language and Learning*, 3(2), 233–260.
- Gabillon, Z. (2007a). *L2 learners' and L2 teachers' stated L2 beliefs*. Université Nancy-II. Retrieved from <http://www.opengrey.eu/item/display/10068/806867>
- Gabillon, Z. (2007b). Learner beliefs on L2 attitudes and motivation: an exploratory study. *Lingua et Linguistica*, 1(1), 68–90.
- Gabillon, Z. (2012a). Discrepancies between L2 teacher and L2 learner beliefs. *English Language Teaching*, 5(12), 94–99. <https://doi.org/10.5539/elt.v5n12p94>
- Gabillon, Z. (2012b). Revisiting foreign language teacher beliefs. In *Frontiers of language and teaching* (Vol. 3, pp. 190–203). Online: Universal Publishers. Retrieved from Universal Publishers
- Gabillon, Z. (2013a). A Synopsis of L2 teacher belief research. In *Belgrade International Conference on Education 2013* (pp. 1–15). Belgrade. Retrieved from <https://halshs.archives-ouvertes.fr/halshs-00940593>
- Gabillon, Z. (2013b). Language learner beliefs from an attributional perspective. *Procedia - Social and Behavioral Sciences*, 106, 1697–1711. <https://doi.org/10.1016/j.sbspro.2013.12.193>
- Gabillon, Z. (2019). Analyse des interactions dans la classe d'anglais à l'école élémentaire : une étude sur l'implication des apprenants. *Contextes et Didactiques*, 14, 72–98. <https://doi.org/10.4000/ced.1417>
- Gabillon, Z. (2020a). Project CLIL 2D parent interviews. Mendeley dataset. <https://doi.org/10.17632/cr67yjwt9hs.1>
- Gabillon, Z. (2020b). Revisiting CLIL : Background, pedagogy , and theoretical underpinnings. *Contextes et Didactiques*, 15, 88–116. <https://doi.org/10.4000/ced.1836>
- Gabillon, Z. (2021). Bridging the gap between additional language learning research and classroom practices. In P. Brown & N. Gaertner-Mazouni (Eds.), *Small islands, big issues. Pacific perspectives on the ecosystem of knowledge* (p. (to appear)). Oxford: Peter Lang.

- Gabillon, Z., & Ailincal, R. (2013). CLIL: A science lesson with breakthrough level young EFL learners. *Education*, 3(3), 168–177. Retrieved from <http://article.sapub.org/10.5923.j.edu.20130303.05.html>
- Gabillon, Z., & Ailincal, R. (2015a). Content and language integrated learning: In search of a coherent conceptual framework. In *The European Conference on Language Learning (ECLL)* (pp. 311–324). Brighton, UK: IAFOR. <https://doi.org/10.13140/RG.2.1.4027.6963>
- Gabillon, Z., & Ailincal, R. (2015b). Multilingual primary education initiative in French Polynesia. *Procedia - Social and Behavioral Sciences*, 174, 3595–3602. <https://doi.org/10.1016/j.sbspro.2015.01.1077>
- Gabillon, Z., & Ailincal, R. (2016). The role of artefacts and gestures in CLIL lessons. *TESOLANZ Journal*, 24(Special edition, CLESOL 2014), 26–37. Retrieved from <https://www.tesolanz.org.nz/publications/tesolanz-journal/volume-24-2016-se/>
- Gabillon, Z., & Ailincal, R. (2017). Using video recorded corpus to analyze classroom interactions in elementary school EFL classes. *TOJET*, (Special Issue for ITEC 2017), 949–969.
- Gabillon, Z., & Ailincal, R. (2020). L’approche “EMILE” dans le contexte de l’apprentissage à l’école primaire. In B. Marin & D. Berger (Eds.), *La recherche en éducation : des enjeux partagés. Le printemps de la recherche en éducation 2016* (pp. 272–290). Paris, France: Éditions Le Réseaux des INSPÉ.
- Gabillon, Z., & Ailincal, R. (2021). Le rôle des artefacts et des gestes dans l’apprentissage de l’anglais. In J. Bisault, R. LE Bourgeois, J.-F. Thémines, M. Le Mentec, & C. Chanoine (Eds.), *Objets pour apprendre, objets à apprendre* (p. (to appear)). Paris: Éditions ISTE.
- Gabillon, Z., Vernaudeau, J., Marchal, E., Ailincal, R., & Paia, M. (2016). Maeha’a Nui: A multilingual primary school project in French Polynesia. In *The IAFOR International Conference on Language Learning* (pp. 137–152). Honolulu, Hawaii: IAFOR. Retrieved from <https://papers.iafor.org/submission21845/>
- Gajo, L. (2009). De la DNL à la DdNL: principes de classe et formation des enseignants: Enseignants de DNL et de LV: à armes égales? *Les Langues Modernes*, 103.(4), 15–24.
- Gallagher, F., & Colohan, G. (2014). T (w) o and fro : Using the L1 as a language teaching tool in the CLIL classroom. *The Language Learning Journal*, 45(4), 485–498.

<https://doi.org/10.1080/09571736.2014.947382>

- García-Mayo, M. del P., & Lázaro Ibarrola, A. (2015). Do children negotiate for meaning in task-based interaction? Evidence from CLIL and EFL settings. *System*, 54, 40–54. <https://doi.org/10.1016/j.system.2014.12.001>
- García, O. (2011). *Bilingual education in the 21st century: A global perspective*. New York, USA: Wiley-Blackwell.
- García, O., & Leiva, C. (2014). Theorizing and enacting translanguaging for social justice. In A. Blackledge & A. Creese (Eds.), *Heteroglossia as practice and pedagogy* (pp. 199–216). New York: Springer. https://doi.org/10.1007/978-94-007-7856-6_11
- García, O., & Lin, A. M. Y. (2017). Translanguaging in bilingual education. In O. García, A. M. Y. Lin, & S. May (Eds.), *Bilingual and multilingual education, encyclopedia of language and education* (pp. 117–130). New York: Springer.
- García, O., & Wei, L. (2014). *Translanguaging: Language, bilingualism and education*. New York, USA: Palgrave Macmillan.
- Gardner, R. C. (2007). Motivation and second language acquisition. *Porta Linguarum*, 8(04), 9–20. <https://doi.org/10.1017/S0272263102224067>
- Gass, S. M. (1997). *Input, interaction, and the second language learner*. Mahwah, NJ: Lawrence Erlbaum Associates.
- Gass, S. M. (2010). Interactionist perspectives on second language acquisition. In R. B. Kaplan (Ed.), *The Oxford handbook of applied linguistics* (2nd ed., pp. 170–181). Oxford, UK: Oxford University Press. <https://doi.org/10.1093/oxfordhb/9780195384253.013.0015>
- Gass, S. M., Behney, J., & Plonsky, L. (2013). *Second language acquisition: An introductory course* (4th ed.). New York, USA: Routledge.
- Gass, S. M., Mackey, A., & Pica, T. (1998). The role of input and interaction in second language acquisition introduction to the special issue. *Modern Language Journal*, 82(3), 299–307. <https://doi.org/10.1111/j.1540-4781.1998.tb01206.x>
- Gass, S. M., & Selinker, L. (1994). *Language transfer and language learning*. Philadelphia, USA: John Benjamins Publishing.

- Gass, S. M., & Selinker, L. (2008). *Second language acquisition: An introductory course* (3rd ed.). New York, USA: Taylor & Francis. <https://doi.org/10.1002/9781118791844.ch32>
- Genesee, F., & Lindholm-Leary, K. (2013). Two case studies of content-based language education. *Journal of Immersion and Content-Based Language Education*, 1(1), 3–33. <https://doi.org/10.1075/jicb.1.1.02gen>
- Gierlinger, E. (2015). ‘You can speak German, sir’: on the complexity of teachers’ L1 use in CLIL. *Language and Education*, 29(4), 347–368. <https://doi.org/10.1080/09500782.2015.1023733>
- Glaser, B., & Strauss, L. A. (1967). *The discovery of grounded theory: Strategies for qualitative research*. California, USA: Aldine Transaction.
- Glaser, B., & Strauss, L. A. (2006). *Strategies for qualitative research*. New Jersey: Aldine Transaction.
- Glesne, C. (2006). *Becoming qualitative researchers: An introduction*. New York: Longman.
- Grabe, W., & Stoller, F. L. (1997). Content-based instruction: Research Foundations. *The Content-Based Classroom: Perspectives on Integrating Language and Content*.
- Gravé-Rousseau, G. (2011). *L’EMILE d’hier à aujourd’hui: une mise en perspective de l’apprentissage d’une discipline en langue étrangère. Charte européenne du plurilinguisme*. Retrieved from http://www.emilangues.education.fr/files/par-rubriques/L_EMILE_d_hier_a_aujourd'hui_G_Grave-Rousseau.pdf
- Griva, E., & Mattheoudaki-sayegh, M. (2017). CLIL implementation in foreign language contexts: Exploring challenges and perspectives - Part II. *Research Papers in Language Teaching and Learning*, 8(2), 63–73.
- Grosjean, F. (2008). *Studying bilinguals*. Oxford, UK: Oxford University Press.
- Grosjean, F. (2010). *Bilingual: Life and reality*. Cambridge, Massachusetts: Harvard University Press.
- Guimelli, C. (1994). Introduction. In C. Guimelli (Ed.), *Structures et transformations des représentations sociales* (pp. 11–24). Paris: Delachaux et Niestlé.
- Guimelli, C. (1995). Valence et structure des représentations sociales. *Bulletin de Psychologie*, 49(422), 58–72.

- Gutierrez, A. G. (2008). Microgenesis, method and object: A study of collaborative activity in a Spanish as a foreign language classroom. *Applied Linguistics*, 29(1), 120–148. <https://doi.org/10.1093/applin/amm032>
- Hajek, J., & Slaughter, Y. (2015). *Challenging the monolingual mindset*. Bristol, UK: Multilingual Matters.
- Hall, J. K. (2019). The contributions of conversation analysis and interactional linguistics to a usage-based understanding of language: Expanding the transdisciplinary framework. *Modern Language Journal*, 103, 80–94. <https://doi.org/10.1111/modl.12535>
- Heider, F. (1958). *The psychology of interpersonal relations* (3rd ed.). New York, USA: John Wiley & Sons, Inc. <https://doi.org/10.2307/2089062>
- Héran, F. (2013). L'anglais hors la loi? Enquête sur les langues de recherche et d'enseignement en France. *Population & Sociétés*, 501(6), 1–4.
- Hornberger, N. H., & Link, H. (2012). Translanguaging and transnational literacies in multilingual classrooms: a biliteracy lens. *International Journal of Bilingual Education and Bilingualism*, 15(3), 261–278. <https://doi.org/10.1080/13670050.2012.658016>
- Horwitz, E. K. (1999). Cultural and situational influences on foreign language learners' beliefs about language learning: a review of BALLI studies. *System*, 27, 557–576. <https://doi.org/10.1016/j.chemosphere.2011.10.040>
- Huabin, W. (2018). Interpersonal meaning of code-switching: An analysis of three TV series. *Australian Journal of Applied Linguistics*, 1(1), 3–19.
- Hulstijn, J. H. (2013). Incidental learning in second language acquisition. In C. A. Chapelle (Ed.), *The Encyclopedia of Applied Linguistics* (pp. 1–5). New York, USA: John Wiley & Sons, Inc. <https://doi.org/10.1002/9781405198431.wbeal0530>
- Hult, F. M. (2019). Toward a unified theory of language development: The transdisciplinary nexus of cognitive and sociocultural perspectives on social activity. *Modern Language Journal*, 103, 136–144. <https://doi.org/10.1111/modl.12527>
- Ikeda, M. (2013). Does CLIL work for Japanese secondary school students? *International CLIL Research Journal*, 2(1), 31–43.

- Ioannou Georgiou, S. (2012). Reviewing the puzzle of CLIL. *ELT Journal*, 66(4), 495–504. <https://doi.org/10.1093/elt/ccs047>
- Izumi, S. (2002). Output, input enhancement, and the noticing hypothesis. *Studies in Second Language Acquisition*, 24(4), 541–577. <https://doi.org/10.1017/s0272263102004023>
- Izumi, S. (2003). Comprehension and Production Processes in Second Language Learning: In Search of the Psycholinguistic Rationale of the Output Hypothesis. *Applied Linguistics*, 24(2), 168-196+268. <https://doi.org/10.1093/applin/24.2.168>
- Izumi, Y., & Izumi, S. (2004). Investigating the effects of oral output on the learning of relative clauses in English: Issues in the psycholinguistic requirements for effective output tasks. *Canadian Modern Language Review*, 60(5), 587–609. <https://doi.org/10.3138/cmlr.60.5.587>
- Jefferson, G. (2004). Glossary of transcript symbols with an introduction. In G. H. Lerner (Ed.), *Conversation Analysis: Studies from the first generation* (pp. 13–31). Amsterdam: John Benjamins Publishing.
- Jodelet, D. (1984). Réflexions sur le traitement de la notion de représentation sociale en psychologie sociale. *Communication Information Médias Théories*, 6(2), 14–41.
- Johnson, K. E. (2019). The relevance of a transdisciplinary framework for SLA in language teacher education. *Modern Language Journal*, 103, 167–174. <https://doi.org/10.1111/modl.12524>
- Johnson, R. K., & Swain, M. (1997). *Immersion education: International perspectives*. Cambridge, UK: Cambridge University Press.
- Jones, W. R., & Stewart, W. A. C. (1951). Bilingualism and verbal intelligence. *British Journal of Statistical Psychology*, 4(1), 3–8. <https://doi.org/10.1111/j.2044-8317.1951.tb00300.x>
- Jordan, B., & Handersen, A. (1995). Interaction analysis: Foundations and practice. *The Journal of Learning Sciences*, 4(1), 39–103. <https://doi.org/10.1207/s15327809jls0401>
- Kalaja, P., & Maria Ferreira Barcelos, A. (2013). Beliefs in second language acquisition: Learner. In C. A. Chapelle (Ed.), *The Encyclopedia of Applied Linguistics*. Blackwell Publishing. <https://doi.org/10.1002/9781405198431.wbeal0082>
- Karsenti, T. (2005). *L'intégration pédagogique des TIC dans le travail enseignant: recherches et pratiques*. Québec: PUQ.

- Kasper, G., & Wagner, J. (2018). Epistemological reorientations and L2 interactional settings: A postscript to the special issue. *Modern Language Journal*, 102, 82–90. <https://doi.org/10.1111/modl.12463>
- Kelly, G. (2003). *The psychology of personal constructs. volume1: Theory and personality*. London, UK: Routledge.
- Kelly, S. W. (2012). Incidental learning. In *Encyclopedia of the sciences of learning* (2012th ed., pp. 1517–1518). Springer. https://doi.org/10.1007/978-1-4419-1428-6_366
- Kerbrat-Orecchioni, C. (1998a). La notion d' interaction en linguistique : origine , apports , bilan. *Langue Française*, 117, 51–67. <https://doi.org/doi> : <https://doi.org/10.3406/lfr.1998.6241>
- Kerbrat-Orecchioni, C. (1998b). *Les interactions verbales* (Tome 1). Paris: Armand Colin.
- Kerbrat-Orecchioni, C., & Traverso, V. (2004). Types d ' interactions et genres de l ' oral. *Languages*, (153), 41–51.
- Kolb, D. (1984). *Experiential learning*. Eaglewood Cliffs: Prentice Hall.
- Kramersch, C. (2018). Is there still a place for culture in a multilingual FL education ? *Language and Education and Multilingualism-The Landscape Journal*, 1, 16–33.
- Kramersch, C., & Whiteside, A. (2007). Three fundamental concepts in second language acquisition and their relevance in multilingual contexts. *Modern Language Journal*, 91(SUPPL. 1), 907–922. <https://doi.org/10.1111/j.1540-4781.2007.00677.x>
- Krashen, S. (1979). A response to McLaughlin, “The monitor model: Some methodological considerations.” *Language Learning*. <https://doi.org/10.1111/j.1467-1770.1979.tb01056.x>
- Krashen, S. (1982). *Principles and practice in second language acquisition*. New York, USA: Pergamon.
- Krathwohl, D. R. (2002). A revision of Bloom's taxonomy: An overview. *Theory Into Practice*, 41(4), 212–218. <https://doi.org/10.1207/s15430421tip4104>
- Kubota, R. (2004). The politics of cultural differences in second language education. *Critical Inquiry in Language Studies*, 1(1), 21–39. <https://doi.org/10.1207/s15427595cils0101>
- Kubota, R. (2016). The Multi/Plural Turn, Postcolonial Theory, and Neoliberal Multiculturalism:

- Complicities and Implications for Applied Linguistics. *Applied Linguistics*, 37(4), 474–494. <https://doi.org/10.1093/applin/amu045>
- Kumaravadivelu, B. (1994). The postmethod condition: (E)merging strategies for second/foreign language teaching. *TESOL Quarterly*, 28(1), 27. <https://doi.org/10.2307/3587197>
- Kumaravadivelu, B. (1999). Critical classroom discourse analysis. *Tesol Quartely*, 33(3), 453–484. <https://doi.org/10.1017/CBO9781107415324.004>
- Kumaravadivelu, B. (2003). Forum critical language pedagogy: A postmethod perspective on English language teaching. *World Englishes*, 22(4), 539–550.
- Kunitz, S. (2018). Collaborative attention work on gender agreement in Italian as a foreign language. *Modern Language Journal*, 102, 64–81. <https://doi.org/10.1111/modl.12458>
- Kusyk, M., & Sockett, G. (2012). From informal resource usage to incidental language acquisition: Language uptake from online television viewing in English. *ASp. La Revue Du GERAS*, (62), 45–65.
- La Scotte, D., & Tarone, E. (2019). Heteroglossia and constructed dialogue in SLA. *Modern Language Journal*, 103(Supplement), 95–112. <https://doi.org/10.1111/modl.12533>
- Lambert, W. E. (1981). Bilingualism and language acquisition. *Annals of the New York Academy of Sciences*, 379(1), 9–22. <https://doi.org/10.1111/j.1749-6632.1981.tb41993.x>
- Lantolf, J., Thorne, S. L., & Poehner, M. (2015). Sociocultural Thory and Second Language Development., 8(January), 207–226.
- Lantolf, J. P. (1994). Sociocultural theory and second language learning. *Modern Language Journal*, 78(4), 418–420. <https://doi.org/10.1163/15718034-12341309>
- Lantolf, J. P. (2004a). Introducing sociocultural theory. *Sociocultural Theory and Second Language Learning*, 1–26. <https://doi.org/10.1007/978-0-387-46301-8>
- Lantolf, J. P. (2004b). Sociocultural theory and second and foreign language learning: An overview of sociocultural theory. In K. van Esch & O. St. John (Eds.), *New insights into foreign language learning and teaching* (pp. 13–34). Frankfurt am Main: Peter Lang.
- Lantolf, J. P. (2006). Sociocultural theory and L2: State of the art. *Studies in Second Language Acquisition*, 28(01), 67–109. <https://doi.org/10.1017/S0272263106060037>

- Lantolf, J. P., & Pavlenko, A. (1995). Sociocultural theory and second language acquisition. *Annual Review of Applied Linguistics*, 15(04), 108–124. <https://doi.org/10.1017/S0267190500002646>
- Lantolf, J. P., & Thorne, S. L. (2006). *Sociocultural theory and the genesis of second language development*. Oxford, UK: Oxford University Press.
- Lapadat, J. C. (2010). Thematic analysis. *Encyclopedia of Case Study Research*, 2, 925–927.
- Larsen-Freeman, D. (2000). Second language acquisition and applied linguistics. *Annual Review of Applied Linguistics*, 20, 165–181. <https://doi.org/10.1017/s026719050020010x>
- Larsen-Freeman, D. (2004). Chaos/complexity, science and second language acquisition. *Applied Linguistics*, 18(2), 141–165. <https://doi.org/10.1093/applin/18.2.141>
- Larsen-Freeman, D. (2007). Reflecting on the cognitive–social debate in second language acquisition. *Modern Language Journal*, 91, 773–787. <https://doi.org/10.1111/j.1540-4781.2007.00668.x>
- Larsen-Freeman, D. (2011a). A complexity theory approach to second language development/acquisition. In D. Atkinson (Ed.), *Alternative approaches to second language acquisition* (pp. 48–72). New York, USA: Routledge.
- Larsen-Freeman, D. (2011b). *Technique and principles in language teaching* (3rd ed.).
- Larsen-Freeman, D. (2012). Complexity theory. In S. M. Gass & A. Mackey (Eds.), *The Routledge handbook of second language acquisition* (1st ed., pp. 73–87). London, UK: Routledge.
- Larsen-Freeman, D., & Anderson, M. (2016). *Techniques and principles in language teaching*. Oxford, UK: Oxford University Press.
- Lasagabaster, D., & Doiz, A. (2015). A longitudinal study on the impact of CLIL on affective factors. *Applied Linguistics*, 38(5), 688–712. <https://doi.org/10.1093/applin/amv059>
- Lasagabaster, D., & Sierra, J. M. (2009a). Immersion and CLIL in English: More differences than similarities. *ELT Journal*, 64(4), 367–375. <https://doi.org/10.1093/elt/ccp082>
- Lasagabaster, D., & Sierra, J. M. (2009b). Language attitudes in CLIL and traditional EFL classes. *International CLIL Research Journal*, 1(2), 4–17.

- Lave, J. (1996). The practice of learning. In S. Chaiklin & J. Lave (Eds.), *Understanding practice: Perspectives on activity and context* (pp. 3–32). Cambridge, UK: Cambridge University Press.
- Lave, J., & Wenger, E. (1991). *Situated learning: Legitimate peripheral participation*. Cambridge, UK: Cambridge University Press.
- Lazaruk, W. (2007). Linguistic, academic, and cognitive benefits of French immersion. *Canadian Modern Language Review*, 63(5), 605–627. <https://doi.org/10.3138/cmlr.63.5.605>
- Leal, J. P. (2016). Assessment in CLIL: Test development at content and language for teaching natural science in English as a foreign language. *Latin American Journal of Content & Language Integrated Learning*, 9(2), 293–317. <https://doi.org/10.5294/laclil.2016.9.2.3>
- Leaver, B. Lou, & Stryker, S. B. (1989). Content-based instruction for foreign language classrooms. *Foreign Language Annals*, 22(3), 269–275. <https://doi.org/10.1111/j.1944-9720.1989.tb02746.x>
- Lee, M. E. (2014). Shifting to the world Englishes paradigm by way of the translingual approach: Code-meshing as a necessary means of transforming composition pedagogy. *TESOL Journal*, 5(2), 312–329. <https://doi.org/10.1002/tesj.121>
- Legifrance.gouv.fr. Arrêté du 11 juillet 2018 relatif à la procédure d’inscription sur les listes de qualification aux fonctions de maître de conférences ou de professeur des universités (2018). République Française. Retrieved from <https://www.legifrance.gouv.fr/affichTexte.do?cidTexte=JORFTEXT000037308181&dateTexte=20180904>
- Leontiev, A. (2006). Sign and Activity. *Journal of Russian & East European Psychology*, 44(3), 17–29. <https://doi.org/10.2753/rpo10610405440302>
- Levine, G. S. (2014). Principles for code choice in the foreign language classroom: A focus on grammaring. *Language Teaching*, 47(3), 332–348. <https://doi.org/10.1017/S0261444811000498>
- Lewis, D. G. (1959). Bilingualism and non-verbal intelligence: A further study of test results. *British Journal of Educational Psychology*, 29(1), 17–22. <https://doi.org/10.1111/j.2044-8279.1959.tb01470.x>

- Lewis, G., Jones, B., & Baker, C. (2012a). Translanguaging: developing its conceptualisation and contextualisation. *Educational Research and Evaluation*, 18(7), 655–670. <https://doi.org/10.1080/13803611.2012.718490>
- Lewis, G., Jones, B., & Baker, C. (2012b). Translanguaging: Origins and development from school to street and beyond. *Educational Research and Evaluation*, 18(7), 641–654. <https://doi.org/10.1080/13803611.2012.718488>
- Liddicoat, A. J. (2018). Language teaching and learning as a transdisciplinary endeavour. *AILA Review*, 31, 14–28. <https://doi.org/10.1075/aila.00011.lid>
- Lin, A. M. Y. (2015). Conceptualising the potential role of L1 in CLIL. *Language, Culture and Curriculum*, 28(1), 74–89. <https://doi.org/10.1080/07908318.2014.1000926>
- Little, D. (2005). The common European framework and the European language portfolio: Involving learners and their judgements in the assessment process. *Language Testing*, 22(3), 321–336. <https://doi.org/10.1191/0265532205lt311oa>
- Little, D. (2007). The common European framework of reference for languages: Perspectives on the making of supranational language education policy. *Modern Language Journal*, 91(4), 645–655. https://doi.org/10.1111/j.1540-4781.2007.00627_2.x
- Littlewood, W. (2011). Communicative language teaching: An expanding concept for a changing world. In E. Hinkel (Ed.), *Handbook of research in second language teaching and learning: Volume II* (pp. 541–557). New York, USA: Routledge.
- Llinares, A. (2015). Integration in CLIL: a proposal to inform research and successful pedagogy. *Language, Culture and Curriculum*, 28(1), 58–73. <https://doi.org/10.1080/07908318.2014.1000925>
- Loi du Pays n° 2017-15. La charte de l'éducation de la Polynésie française. (2017). Polynésie Française: Journal officiel de la Polynésie française.
- Loi organique n° 2004-192 du 27 février 2004 (2004). Legifrance. Retrieved from <https://www.legifrance.gouv.fr/affichTexte.do?cidTexte=JORFTEXT000000435515>
- Long, M. H. (1981). Input, interaction, and second language acquisition. *Annals of the New York Academy of Sciences*, 379(1), 259–278. <https://doi.org/10.1111/j.1749-6632.1981.tb42014.x>

- Long, M. H. (1983). Native speaker / non-native speaker conversation in the second language classroom. *On TESOL '82: Pacific Perspectives on Language Learning and Teaching*, 207–225.
- Long, M. H. (1996). The role of the linguistic environment in second language acquisition. In W. C. Ritchie & T. K. Bhatia (Eds.), *Handbook of second language acquisition* (pp. 413–468). New York, USA: Academic Press inc.
- Long, M. H. (2015). *Second language acquisition and task-based teaching*. Oxford, UK: Wiley-Blackwell.
- Lorenzo, F. (2007). An analytical framework of language integration in L2 content-based courses: The European dimension. *Language and Education*, 21(6), 502–514. <https://doi.org/10.2167/le708.0>
- Lorenzo, F., Casal, S., & Moore, P. A. T. (2010). The effects of content and language integrated learning in European education: Key findings from the Andalusian bilingual sections evaluation project. *Applied Linguistics*, 31(3), 418–442. <https://doi.org/10.1093/applin/amp041>
- Lorenzo, F., & Moore, P. (2009). European language policies in monolingual southern Europe: Implementation and outcomes. *European Journal of Language Policy*, 1(2), 121–135. <https://doi.org/10.3828/ejlp.2009.3>
- Luria, A. R. (1976). *Cognitive development: Its cultural and social foundations*. Cambridge, Massachusetts: Harvard University Press.
- Lutz, C. A., & Abu-Lughod, L. (1990). *Language and the Politics of Emotion: Language and the Politics of Emotion*. Cambridge, UK: Cambridge University Press. <https://doi.org/10.1525/jlin.1991.1.1.115>
- Lyster, R. (1997). Negotiation of form, recasts, and explicit correction in relation to error. Retrieved from <http://web.ebscohost.com/ehost/pdfviewer/pdfviewer?vid=3&sid=819b99d6-6575-4e61-adc9-90e513ede173@sessionmgr10&hid=112>
- Lyster, R., & Ballinger, S. (2011). Content-based language teaching: Convergent concerns across divergent contexts. *Language Teaching Research*, 15(3), 279–288. <https://doi.org/10.1177/1362168811401150>

- Lyster, R., & Ranta, L. (1997). Corrective feedback and learner uptake: Negotiation of form in communicative classrooms. *Studies in Second Language Acquisition*, 20, 37–66. <https://doi.org/10.1017/s0272263197001034>
- Mackey, A. (1999). Input, interaction, and second language development: An empirical study of question formation in ESL. *Studies in Second Language Acquisition*, 21(4), 557–587. [https://doi.org/10.1016/S1060-3743\(99\)80112-X](https://doi.org/10.1016/S1060-3743(99)80112-X)
- Mackey, A., Abbuhl, R., & Gass, S. M. (2012). Interactionist approach. In *The Routledge handbook of second language acquisition* (pp. 7–23). New York, USA: Routledge.
- Mackey, A., & Philp, J. (1998). Conversational interaction and second language development: recasts, responses, and red herrings? *Modern Language Journal*, 82(3), 338–356. <https://doi.org/10.1111/j.1540-4781.1998.tb01211.x>
- Mackey, A., & Polio, C. (2009). *Multiple perspectives on interaction: Second language research in honor of Susan M. Gass. Multiple Perspectives on Interaction: Second Language Research in Honor of Susan M. Gass.* New York, USA: Routledge. <https://doi.org/10.4324/9780203880852>
- MacSwan, J. (2017). A Multilingual Perspective on Translanguaging. *American Educational Research Journal*, 54(1), 167–201. <https://doi.org/10.3102/0002831216683935>
- Mälkki, K. (2010). Building on Mezirow's theory of transformative learning: Theorizing the challenges to reflection. *Journal of Transformative Education*, 8(1), 42–62. <https://doi.org/10.1177/1541344611403315>
- Marsh, D. (2000). Using languages to learn and learning to use languages. *TIE-CLIL*, 1–16. Retrieved from <http://www.tieclil.org/html/products/pdf/1UK.pdf>
- Marsh, D. (2002). *CLIL/EMILE European dimension: Actions, trends and foresight.* Jyväskylä: University of Jyväskylä, Finland.
- Marsh, D. (2008). Language awareness and CLIL. In J. Cenoz & N. H. Hornberger (Eds.), *Encyclopedia of language and education* (2nd ed., Vol. 6, pp. 233–246). Boston, MA: Springer.
- Marsh, D., & Frigols, M. J. (2007). CLIL as a catalyst for change in languages education.

- Babylonia*, 15(3), 33–37. <https://doi.org/http://dx.doi.org/10.1038/375567a0>
- Marsh, D., & Hartiala, A.-K. (2001). Dimensions of content and language integrated learning. In D. Marsh, A. Maljers, & A.-K. Hartiala (Eds.), *Profiling European CLIL classrooms* (pp. 15–53). Jyväskylä, Finland: University of Jyväskylä.
- Marsh, D., Maljers, A., & Hartiala, A.-K. (2001). *Profiling European CLIL classrooms*. Jyväskylä, Finland: University of Jyväskylä.
- Marsh, D., Mehisto, P., Wolff, D., & Frigols, M. J. (2012). *European framework for CLIL teacher education: A framework for the professional development of CLIL teachers*. Strasbourg: Council of Europe Publication.
- May, S. (2013). *A cognitivist theoretical orientation is inherent in the tasks offered by CLIL. The aim of the CLIL approach is to create a learning space that could enable learners to learn new content and the target language through cognitive engagement*. London, UK: Routledge.
- May, S. (2019). Negotiating the multilingual turn in SLA. *Modern Language Journal*, 103, 122–129. <https://doi.org/10.1111/modl.12531>
- Mazak, C. M., & Herbas-Donoso, C. (2015). Translanguaging practices at a bilingual university: a case study of a science classroom. *International Journal of Bilingual Education and Bilingualism*, 18(6), 698–714. <https://doi.org/10.1080/13670050.2014.939138>
- Mehisto, P. (2008). CLIL counterweights: Recognising and decreasing disjuncture in CLIL. *International CLIL Research Journal*, 1(1), 93–119.
- Mehisto, P., Marsh, D., & Frigols, M. J. (2008). *Uncovering CLIL content and language integrated learning in bilingual and multilingual education*. New York, USA: Macmillan Education.
- Mercer, N. (2004). Sociocultural discourse analysis: Analysing classroom talk as a social mode of thinking. *Journal of Applied Linguistics*, 1(2), 137–168. <https://doi.org/10.1558/japl.v1i2.137>
- Mercer, S. (2013). Towards a complexity-informed pedagogy for language learning. *Revista Brasileira de Linguística Aplicada*, 13(2), 375–398. <https://doi.org/10.1590/s1984-63982013005000008>
- Merino, J. A., & Lasagabaster, D. (2018). The effect of content and language integrated learning programmes' intensity on English proficiency: A longitudinal study. *International Journal of*

- Applied Linguistics (United Kingdom)*, 28(1), 18–30. <https://doi.org/10.1111/ijal.12177>
- Merrillees, R. S. (1993). The Languages of Cyprus. *Cahiers Du Centre d'Etudes Chypriotes*, 20(2), 3–17. <https://doi.org/10.3406/cchyp.1993.1267>
- Miller, P. H. (2011). Piaget's theory: Past, present, and future. In U. Goswami (Ed.), *The Wiley-Blackwell handbook of childhood cognitive development* (pp. 649–672). New York: Wiley-Blackwell.
- Moate, J. (2010). The integrated nature of CLIL: A sociocultural perspective. *International CLIL Research Journal*, 1(3), 38–45.
- Moliner, P. (1996). *Images et représentations sociales*. Grenoble: Presses universitaires de Grenoble.
- Moliner, P. (2001). Formation et stabilisation des représentations sociales. In P. Moliner (Ed.), *La dynamique des représentations sociales* (pp. 15–41). Grenoble: Presses universitaires de Grenoble.
- Moliner, P., & Guimelli, C. (2015). *Les représentations sociales. Fondements historiques et développements récents*. Grenoble: Presses universitaires de Grenoble.
- Monceri, F. (2003). The transculturing self: A philosophical approach. *Language and Intercultural Communication*, 3(2), 108–114. <https://doi.org/10.1080/14708470308668094>
- Monceri, F. (2009). The transculturing self II. Constructing identity through identification. *Language and Intercultural Communication*, 9(1), 43–53. <https://doi.org/10.1080/14708470802444282>
- Moore, C., & Dunham, P. (2014). *Joint attention: Its origin and role in development*. New York: Routledge.
- Moore, D. (2019). Conversations autour du plurilinguisme. Théorisation du pluriel et pouvoir des langues. *Cahiers de l'ILOB*, 10, 43–64. <https://doi.org/10.18192/olbiwp.v10i0.3828>
- Moore, D., & Gajo, L. (2009). Introduction—French voices on plurilingualism and pluriculturalism: Theory, significance and perspectives. *International Journal of Multilingualism*, 6(2), 137–153. <https://doi.org/10.1080/14790710902846707>
- Moore, D., Oyama, M., & Pearce, D. R. (2020). Biographies langagières et EMILE , quand tous

- les chemins mènent ... au plurilinguisme , même au Japon ! *Contextes et Didactiques*, 15, 13–31.
- Moore, D., & Py, B. (2008). Discours sur les langues et représentations sociales. In G. Zarate, D. Lévy, & C. Kramsch (Eds.), *Précis du plurilinguisme et du pluriculturalisme* (pp. 275–283). Paris: Éditions des archives contemporaines Paris.
- Moscovici, S. (1961). *La psychanalyse, son image, son public*. Paris: PUF.
- Moscovici, S. (1984). Introduction : le domaine de la psychologie sociale. *Psychologie Sociale*, 2, 60–78.
- Moscovici, S. (1986). L'ère des représentations sociales. In W. Doise & A. Palmonari (Eds.), *L'étude des représentations sociales* (pp. 34–80). Paris: Delachaux et Niestlé.
- Moscovici, S. (1991). La fin des représentations sociales ? In V. Aebischer, J.-P. Debonchy, & E. M. Lipiansky (Eds.), *Idéologies et représentations sociales* (pp. 65–84). Suisse: Les Éditions Delval.
- Moscovici, S. (1997). Social Representations Theory and Social Constructionism.
- Moscovici, S. (2000a). The history and actuality of social representations. In G. Duveen (Ed.), *Social representations: Explorations in social psychology* (pp. 120–155). Cambridge: Polity Press.
- Moscovici, S. (2000b). The phenomenon of social representations. In G. Duveen (Ed.), *Social Representations: Explorations in Social Psychology* (pp. 18–77). Cambridge: Polity Press.
- Moscovici, S., & Markovà, I. (2006). *The making of modern social psychology: The hidden story of how an international social science was created*. Cambridge, UK: Polity Press. <https://doi.org/10.1192/bjp.111.479.1009-a>
- Moscovici, S., & Vignaux, G. (2000). The concept of Themata. In *Social representations: Explorations in social psychology* (pp. 156–183). Cambridge: Polity Press.
- Narcy-Combes, J.-P. (2005). *Didactique des langues et TIC: Vers une recherche-action responsable*. Paris, France: Ophrys.
- Narcy-Combes, J.-P. (2009). La correction dans l'enseignement/apprentissage des langues: Un problème malaisé à construire. *Cahiers de l'APLIUT*, 28(3), 26–38.

- Narcy-Combes, J.-P. (2019a). Comment la réflexion sur le transculturing conduit à repenser la compétence interculturelle. *Neofilolog*, 52(2), 353–371. <https://doi.org/10.14746/n.2019.52.2.10>
- Narcy-Combes, J.-P. (2019b). Le transculturing : un construit pour découvrir les ressorts du translanguaging. *Language Education and Multilingualism – The Langscape Journal*, 1, 52–65.
- Narcy-Combes, J.-P., & Narcy-Combes, M.-F. (2014). Formations hybrides en milieu pluriculturel: comment concilier théories, pratiques et contraintes. In D. Abendroth-Timmer & E.-M. Hennig (Eds.), *Plurilingualism and multiliteracies: International research on identity construction in language education* (pp. 211–226). Frankfurt: Peter Lang.
- Narcy-Combes, J.-P., & Narcy-Combes, M.-F. (2019). *Cognition et personnalité dans l'apprentissage des langues: Relier théories et pratiques*. Paris, France: Didier.
- Narcy-Combes, J.-P., Tardieu, C., Le Bihan, J.-C., Aden, J., Delasalle, D., Larreya, P., & Raby, F. (2008). L' anglais à l' école élémentaire. *Les Langues Modernes*, 4, 2–10.
- Narcy-Combes, J.-P., & Walski, J. (2004). Le concept de tâche soumis au crible de nouvelles questions. *Recherche et Pratiques Pédagogiques En Langues de Spécialité - Cahiers de l' APLIUT*, 23(1), 27–44. <https://doi.org/10.4000/apliut.3431>
- Narcy-Combes, M.-F. (2018). La transdisciplinarité dans l'intervention en linguistique appliquée. *ELA*, 190(2), 183–193.
- Narcy-Combes, M.-F., Narcy-Combes, J.-P., McAlister, J., Leclère, M., & Miras, G. (2019). *Language learning and teaching in a multilingual world*. Bristol, UK: Multilingual Matters.
- Narcy-Combes, J.-P. (2006). La didactique de L2 à la croisée des chemins. *Recherches En Didactique Des Langues et Des Cultures*, 2, 1–16. <https://doi.org/10.4000/rdlc.5746>
- Nassaji, H. (2020). Assessing the effectiveness of interactional feedback for L2 acquisition: Issues and challenges. *Language Teaching*, 1–26. <https://doi.org/10.1017/S0261444819000375>
- Nikula, T. (2015). Hands-on tasks in CLIL science classrooms as sites for subject-specific language use and learning. *System*, 54, 14–27. <https://doi.org/10.1016/j.system.2015.04.003>
- Nocus, I., Guimard, P., Vernaudo, J., Paia, M., Cosnefroy, O., & Florin, A. (2012). Effectiveness

- of a heritage educational program for the acquisition of oral and written French and Tahitian in French Polynesia. *Teaching and Teacher Education*, 28(1), 21–31. <https://doi.org/10.1016/j.tate.2011.07.001>
- Nocus, I., Paia, M., Vernaudo, J., Guimard, P., & Florin, A. (2014). Etude longitudinale de l'impact du dispositif d'enseignement renforcé du tahitien sur le développement des compétences des élèves (CP-CE1). In *L'école plurilingue en Outre-mer : Apprendre plusieurs langues, plusieurs langues pour apprendre* (pp. 129–154). Rennes: Press Universitaires de Rennes.
- Nocus, I., Vernaudo, J., & Paia, M. (2014). *L'école plurilingue en Outre-mer : Apprendre plusieurs langues, plusieurs langues pour apprendre*. Rennes: Press Universitaires de Rennes. Retrieved from <https://hal.archives-ouvertes.fr/hal-01914932/>
- Norris, J., & Ortega, L. (2008). Defining and measuring SLA. In *The Handbook of Second Language Acquisition* (pp. 717–761). New York, USA: Blackwell Publishing.
- Nunan, D. (2007). Standards-based approaches to the evaluation of ESL instruction. In J. Cummins & C. Davison (Eds.), *International handbook of English language teaching* (pp. 421–434). Boston, MA: Springer.
- Ortega, L. (2019). SLA and the study of equitable multilingualism. *Modern Language Journal*, 103, 23–38. <https://doi.org/10.1111/modl.12525>
- Otto, A. (2019). Assessing language in content and language Integrated learning: A review of the literature towards a functional model. *Latin American Journal of Content & Language Integrated Learning*, 11(2), 308–325. <https://doi.org/10.5294/laclil.2018.11.2.6>
- Oxford, R., & Shearin, J. (1994). Language learning motivation: Expanding the theoretical framework. *The Modern Language Journal*, 78(1), 12–28.
- Paia, M., Cummins, J., Nocus, I., Salaün, M., & Vernaudo, J. (2015). Intersections of language ideology, power, and identity. In W. E. Wright, S. Boun, & O. García (Eds.), *The handbook of bilingual and multilingual education* (pp. 145–163). Sussex, UK: Blackwell Publishers.
- Paia, M., & Vernaudo, J. (2002). Le Tahitien: plus de prestige, moins de locuteurs. *Hermès*, 32–33, 395–402.

- Paillé, P. (1994). L'analyse par théorisation ancrée. *Cahiers de Recherche Sociologique*, (23), 147. <https://doi.org/10.7202/1002253ar>
- Pavlenko, A. (2006). *Emotions and Multilingualism. Emotions and Multilingualism*. Cambridge, UK: Cambridge University Press.
- Peal, E., & Lambert, W. E. (1962). The relationship of bilingualism to intelligence. *Psychological Monographs: General and Applied*, 76(27), 1–23.
- Peltzer, L. (2009). Le cas du tahitien et des langues polynésiennes en Polynésie française. *Tréma*, 31, 97–106.
- Pennycook, A. (1989). The concept of method, interested knowledge, and the politics of language teaching. *TESOL Quarterly*, 23(4), 589. <https://doi.org/10.2307/3587534>
- Pennycook, A. (2006). Postmodernism in language policy. In T. Ricento (Ed.), *An introduction to language policy: Theory and method* (pp. 60–76). Victoria, Australia: Blackwell Publishing.
- Pennycook, A. (2010). Critical and alternative directions in applied linguistics. *Australian Review of Applied Linguistics*, 33(2), 1–16. <https://doi.org/10.2104/ara11016>
- Pennycook, A. (2017a). *The cultural politics of English as an international language*. (A. Pennycook, Ed.), *TESOL matters* (Vol. 13). New York, USA: Routledge.
- Pennycook, A. (2017b). Translanguaging and semiotic assemblages. *International Journal of Multilingualism*, 14(3), 269–282. <https://doi.org/10.1080/14790718.2017.1315810>
- Pérez-Cañado, M. L. (2012). CLIL research in Europe : past , present , and future. *International Journal of Bilingual Education and Bilingualism*, 15(3), 315–341. <https://doi.org/10.1080/13670050.2011.630064>
- Pérez-Cañado, M. L. (2013). *Competency-based language teaching in higher education*. New York, USA: Spr.
- Pérez-Cañado, M. L. (2018). CLIL and pedagogical innovation: Fact or fiction? *International Journal of Applied Linguistics (United Kingdom)*, 28(3), 369–390. <https://doi.org/10.1111/ijal.12208>
- Piaget, J. (1937). *La construction du réel chez l'enfant*. Oxford, England: Delachaux & Niestlé.

- Piaget, J. (1959). *The language and thought of the child*. (M. Gabain & R. Gabain, Eds.) (3rd ed.). New York: Routledge. <https://doi.org/10.2307/1415214>
- Piaget, J. (1964). Development and learning. In *Piaget rediscovered* (pp. 7–20). <https://doi.org/10.1016/B978-0-08-097086-8.92013-0>
- Pica, T. (1987). Second language acquisition, social interaction, and the classroom. *Applied Linguistics*, 8(1), 1–25. <https://doi.org/10.1093/applin/8.1.3>
- Pica, T., Doughty, C., & Young, R. (1990). Making input comprehensible: Do interactional modifications help? *Penn Working Papers in Educational Linguistics*, 2(1), 121–145.
- Pica, T., Holliday, L., & Lewis, N. (1989). Comprehensible output as an outcome of linguistic demands on the learner. *Studies in Second Language Acquisition*, 11, 63–90.
- Picardo, E. (2018). Plurilingualism: Vision, conceptualization, and practices. In P. P. Trifonas & T. Aravossitas (Eds.), *Handbook of research and practice in heritage language education* (pp. 207–225). Toronto: Springer.
- Pinner, R. (2013a). Authenticity and CLIL: Examining authenticity from an international CLIL perspective. *International CLIL Research Journal*, 2(1), 44–54.
- Pinner, R. (2013b). Authenticity of purpose: CLIL as a way to bring meaning and motivation into EFL contexts. *Asian EFL Journal*, 15(4), 138–159.
- Pintrich, P. R. (2002). The role of metacognitive knowledge in learning, teaching and assessing. *Theory Into Practice*, 41(4), 219–225.
- Pistorio, M. I. (2010). A blend of CLIL and cooperative learning creates a socially constructed learning environment. *Latin American Journal of Content and Language Integrated Learning*, 3(1), 1–10. <https://doi.org/10.5294/laclil.2010.3.1.1>
- Pladevall-Ballester, E. (2016). CLIL subject selection and young learners' listening and reading comprehension skills. *International Journal of Applied Linguistics (United Kingdom)*, 26(1), 52–74. <https://doi.org/10.1111/ijal.12079>
- Pladevall-Ballester, E., & Vallbona, A. (2016). CLIL in minimal input contexts: A longitudinal study of primary school learners' receptive skills. *System*, 58, 37–48. <https://doi.org/10.1016/j.system.2016.02.009>

- Polio, C., & Gass, S. M. (1998). The role of interaction in native speaker comprehension of nonnative speaker speech. *Modern Language Journal*, 82(3), 308–319. <https://doi.org/10.1111/j.1540-4781.1998.tb01208.x>
- Prabhu, N. S. (1990). There is no best method-why? *TESOL Quarterly*, 24(2), 161. <https://doi.org/10.2307/3586897>
- Probyn, M. (2015). Pedagogical translanguaging: bridging discourses in South African science classrooms. *Language and Education*, 29(3), 218–234. <https://doi.org/10.1080/09500782.2014.994525>
- Prosser, M., & Trigwell, K. (1999). *Understanding learning and teaching: The experience in higher education*. London: McGraw-Hill Education.
- Reitbauer, M., Fürstenberg, U., Kletzenbauer, P., & Marko, K. (2018). Towards a cognitive-linguistic turn in CLIL: Unfolding integration. *Latin American Journal of Content & Language Integrated Learning*, 11(1), 87–108. <https://doi.org/10.5294/laclil.2018.11.1.5>
- Richards, J. C., & Rodgers, T. (2014). *Approaches and methods in language teaching*. UK, Cambridge: Cambridge University Press.
- Richards, J. C., & Schmidt, R. (2010). *Longman dictionary of language teaching and applied linguistics. Most* (4th ed.). London, UK: Pearson-Longman.
- Rosen, E. (2009). Perspective actionnelle et approche par les tâches en classe de langue. *Le Française Dans Le Monde / Recherches et Applications*, 45, 487–498. Retrieved from <https://www.utpjournals.press/doi/abs/10.3138/cmlr.66.4.487>
- Ross, M. (1976). The self-perception of intrinsic motivation. In J. H. Harvey, W. J. Ickes, & R. F. Kidd (Eds.), *New directions in attribution research* (pp. 121–167). New Jersey: Lawrence Erlbaum Associates.
- Roy, S., & Galiev, A. (2011). Discourses on bilingualism in Canadian French immersion programs. *Canadian Modern Language Review*, 67(3), 351–376. <https://doi.org/10.3138/cmlr.67.3.351>
- Ruiz de Zarobe, Y. (2008). CLIL and foreign language learning: A longitudinal study in the Basque Country. *International CLIL Research Journal*, 1(1), 60–73. Retrieved from <http://www.icrj.eu/11/article5.html>

- Ruiz de Zarobe, Y. (2013). CLIL implementation: from policy-makers to individual initiatives. *International Journal of Bilingual Education and Bilingualism*, 16(3), 231–243. <https://doi.org/10.1080/13670050.2013.777383>
- Ruiz de Zarobe, Y., & Jiménez Catalán, R. M. (2009). *Content and language integrated learning: Evidence from research in Europe*. Bristol, UK: Multilingual Matters.
- Saer, D. J. (1922). An inquiry into the effect of bilingualism upon the Intelligence of young children. *Journal of Experimental Pedagogy & Training College Record*, 6, 232–240.
- Saer, D. J. (1923). The effect of bilingualism on intelligence. *British Journal of Psychology*, 14(1), 25–38. <https://doi.org/10.1111/j.2044-8295.1923.tb00110.x>
- Sakui, K., & Gaies, S. J. (1999). Investigating Japanese learners' beliefs about language learning. *System*, 27(4), 473–492.
- Sasajima, S. (2013). How CLIL can impact on EFL teachers' mindsets about teaching and learning : An exploratory study on teacher cognition. *International CLIL Research Journal*, 2(1), 55–66.
- Sato, M. (2017). Interaction mindsets, interactional behaviors, and L2 development: An affective-social-cognitive model. *Language Learning*, 67(2), 249–283. <https://doi.org/10.1111/lang.12214>
- Savignon, S. J. (2002). Communicative language teaching: Linguistic theory and classroom practice. In S. J. Savignon (Ed.), *Interpreting communicative language teaching: Contexts and concerns in teacher education* (pp. 1–27). New Haven, USA: Yale University Press.
- Schinke-Llano, L. (1993). On the value of a Vygotskian framework for SLA theory and research. *Language Learning*, 43(1), 121–129. <https://doi.org/10.1111/j.1467-1770.1993.tb00175.x>
- Schmidt, R. W. (1990). The role of consciousness in second language learning. *Applied Linguistics*, 11(2), 129–158. <https://doi.org/10.1093/applin/11.2.129>
- Schmidt, R. W. (2010). Attention, awareness, and individual differences in language learning. In W. M. Chan, S. Chi, K. N. Cin, J. Istanto, M. Nagami, J. W. Sew, ... I. WALKER (Eds.), *Proceedings of CLaSIC 2010 sof CLaSIC 2010* (Vol. 4, pp. 721–737).
- Schmidt, R. W. (2012). Attention, awareness, and individual differences in language learning.

Perspectives on Individual Characteristics and Foreign Language Education, 4, 27–50.

Selinker, L. (1972). Interlanguage. *IRAL*, 10(3), 209–232.

Serpe, R. T. (1987). Stability and change in self: A structural symbolic interactionist explanation. *Social Psychology Quarterly*, 50(1), 44–55.

Serpe, R. T., & Stryker, S. (2011). The symbolic interactionist perspective and identity theory. In *Handbook of identity theory and research* (pp. 225–248). Springer. https://doi.org/https://doi.org/10.1007/978-1-4419-7988-9_10

Sinclair, J., & Coulthard, M. (1992). Towards an analysis of discourse. In M. Coulthard (Ed.), *Advances in spoken discourse analysis* (pp. 1–34). New York, USA: Routledge.

Singleton, D. (2014). How do attitude and motivation help in learning a second language. In V. Cook & D. Singleton (Eds.), *Key topics in second language acquisition* (pp. 89–107). Bristol: Multilingual Matters.

Skehan, P. (2014). *Processing perspectives on task performance. Task-based language teaching*. Amsterdam, The Netherlands: John Benjamins Publishing Company. <https://doi.org/http://dx.doi.org/10.1075/tblt.5>

Skehan, P., & Foster, P. (1997). Task type and task processing conditions as influences on foreign language performance. *Language Teaching Research*, 1(3), 185–211. <https://doi.org/10.1177/136216889700100302>

Smith, F. (1923). Bilingualism and mental development. *British Journal of Psychology*, 13(3), 271–282. <https://doi.org/10.1111/j.2044-8295.1923.tb00101.x>

Snow, M. A. (2014). Content-based instruction and immersion models of second and foreign language teaching. In M. Celce-Murcia, D. M. Brinton, & M. A. Snow (Eds.), *An overview of language teaching methods and approaches* (pp. 438–454). Boston, USA: Sherrise Roehr.

Sockett, G. (2011). From the cultural hegemony of English to online informal learning: Cluster frequency as an indicator of relevance in authentic documents. *ASp. La Revue Du GERAS*, (60), 5–20.

Sockett, G., & Toffoli, D. (2012). Beyond learner autonomy: A dynamic systems view of the informal learning of English in virtual online communities. *ReCALL*, 24(2), 138–151.

- Soler, D., González-Davies, M., & Iñesta, A. (2016). What makes CLIL leadership effective? A case study. *ELT Journal*, 71(4), 478–490. <https://doi.org/10.1093/elt/ccw093>
- Somers, T., & Surmont, J. (2012). Clil and immersion: How clear-cut are they? *ELT Journal*, 66(1), 113–116. <https://doi.org/10.1093/elt/ccr079>
- Steele, P. M. (2013). *A Linguistic history of ancient Cyprus. A Linguistic History of Ancient Cyprus*. Cambridge, UK: Cambridge University Press. <https://doi.org/10.1017/cbo9781107337558>
- Stern, H. H. (2011). *Fundamental concepts of language teaching*. Oxford, UK: Oxford University Press.
- Strauss, L. A., & Corbin, J. (1990). *Basics of qualitative research: grounded theory procedures and techniques*. Thousand Oaks, CA: Sage.
- Strauss, L. A., & Corbin, J. (1997). *Grounded theory in practice*. Thousand Oaks, CA: SAGE Publications.
- Strauss, L. A., & Corbin, J. (1998). Grounded theory methodology: An overview. *Handbook of Qualitative Research*. <https://doi.org/10.1007/BF00988593>
- Stryker, S. B., & Leaver, B. Lou. (1997a). Content-based instruction: from theory to practice. In C. A. Costabile-Heming, S. B. Stryker, & B. Lou Leaver (Eds.), *Content-based instruction in foreign language education: Models and methods* (p. 328). Georgetown, USA: Georgetown University Press.
- Stryker, S. B., & Leaver, B. Lou. (1997b). *Content-based instruction in foreign language education: Models and methods. Content-based instruction in foreign language education*. Georgetown, USA: Georgetown University Press.
- Summers, M. (1990). New student teachers and computers: an investigation of experiences and feelings. *Educational Review*, 42(3), 261–271. <https://doi.org/10.1080/0013191900420304>
- Swain, M. (2000). The output hypothesis and beyond: Mediating acquisition through collaborative dialogue. In J. P. Lantolf (Ed.), *Sociocultural theory and second language learning* (3rd ed., pp. 97–114). Oxford, UK: Oxford University Press.
- Swain, M., Brooks, L., & Tocalli-Beller, A. (2002). Peer-peer dialogue as a means of second

- language learning. *Annual Review of Applied Linguistics*, 22, 171–185.
<https://doi.org/10.1017/S0267190502000090>
- Swain, M., & Lapkin, S. (1983). *Evaluating bilingual education: A Canadian case study*. Clevedon, UK: Multilingual Matters.
- Swain, M., & Lapkin, S. (1995). Problems in output and the cognitive processes they generate: A step towards second language learning. *Applied Linguistics*, 16(3), 371–391.
<https://doi.org/10.1093/applin/16.3.371>
- Swain, M., & Lapkin, S. (2000). Task-based second language learning: The uses of the first language. *Language Teaching Research*, 4(3), 251–274.
<https://doi.org/10.1177/136216880000400304>
- Swain, M., & Lapkin, S. (2013). A Vygotskian sociocultural perspective on immersion education: The L1/L2 debate. *Journal of Immersion and Content-Based Language Education*, 1(1), 101–129. <https://doi.org/10.1075/jicb.1.1.05swa>
- Sylvén, L. K. (2013). CLIL in Sweden—why does it not work? A metaperspective on CLIL across contexts in Europe. *International Journal of Bilingual Education and Bilingualism*, 16(3), 301–320.
- Tardieu, C. (2006). *Se former pour enseigner les langues à l'école primaire*. Paris, France: Ellipses.
- Tardieu, C., & Dolitsky, M. (2012). Integrating the task-based approach to CLIL teaching. In *Teaching and Learning English through Bilingual Education*, (pp. 3–35). Cambridge, UK: Cambridge Scholars Publishing.
- Thompson, I. (2013). The mediation of learning in the zone of proximal development through a co-constructed writing activity. *Research in the Teaching of English*, 47(3), 247–276.
 Retrieved from <http://www.jstor.org/stable/24397856> <http://about.jstor.org/terms>
- Ting, Y. L. T. (2011). CLIL... not only not immersion but also more than the sum of its parts. *ELT Journal*, 65(3), 314–317. <https://doi.org/10.1093/elt/ccr026>
- Toffoli, D. (2020). Students Outside the System: Informal Learning. In *Informal Learning and Institution-wide Language Provision* (pp. 125–161). Springer.
- Tomasello, M. (2014). Joint attention as social cognition. In C. Moore & P. Dunham (Eds.), *Joint*

- attention: It's origin and role in development* (pp. 103–130). New York: Routledge.
- Tomlin, R. S., & Villa, V. (1994). Attention in cognitive science and second language acquisition. *Studies in Second Language Acquisition*, 16(2), 183–203. <https://doi.org/10.1017/S0272263100012870>
- Tschannen-Moran, M., Hoy, A. W., & Hoy, W. K. (1998). Teacher efficacy: Its meaning and measure. *Review of Educational Research*, 68(2), 202–248.
- Turnbull, B. (2018). The potential impact of cultural and educational background on foreign language teachers' use of the L1. *The Journal of Language Teaching and Learning*, 8(1), 53–70.
- Turner, M., & Cross, R. (2016). Making space for multilingualism in Australian schooling. *Language and Education*, 30(4), 289–297. <https://doi.org/10.1080/09500782.2015.1114627>
- Van de Craen, P., Mondt, K., Ceuleers, E., & Migom, E. (2010). EMILE a douze ans. Douze ans d'enseignement de type immersif en Belgique. Résultats et perspectives. *Synergies Monde*, 7, 127–140.
- van Lier, L. (2004). *The ecology and semiotics of language learning: A sociocultural perspective*. New York, USA: Kluwer Academic Publishers.
- van Lier, L. (2008). Agency in the classroom. *Sociocultural Theory and the Teaching of Second Languages*, 163–186.
- Várkuti, A. (2010). Linguistic benefits of the CLIL approach: Measuring linguistic competences. *International CLIL Research Journal*, 1(3), 67–79.
- Varonis, E. M., & Gass, S. M. (1994). Input, interaction, and second language production. *Studies in Second Language Acquisition*, 16(3), 283–302. <https://doi.org/10.1017/S0272263100013097>
- Vernaudon, J. (2015). Linguistic ideologies: Teaching Oceanic languages in French Polynesia and New Caledonia. *Contemporary Pacific*, 27(2), 434–462.
- Vernaudon, J., & Fillol, V. (2009). *Vers une école plurilingue dans les collectivités françaises d'Océanie et de Guyane*. Paris, France: Harmattan. Retrieved from <http://books.google.fr/books?id=VZHQdX0MKVMC>

- Vertovec, S. (2009). *Transnationalism*. New York, USA: Routledge.
- Vertovec, S. (2015). *Routledge international handbook of diversity studies*. New York, USA: Routledge.
- Vertovec, S., & Posey, D. (2003). *Globalization, globalism, environments, and environmentalism: Consciousness of connections*. Oxford, UK: Oxford University Press.
- Victori, M., & Lockhart, W. (1995). Enhancing metacognition in self-directed language learning. *System*, 23(2), 223–234. [https://doi.org/10.1016/0346-251X\(95\)00010-H](https://doi.org/10.1016/0346-251X(95)00010-H)
- Vogel, S., & García, O. (2017). Translanguaging. In G. Noblit & L. Moll (Eds.), *Oxford research encyclopedia of education* (pp. 1–21). Oxford, UK.
- Vygotsky, L. (1978). *Mind in society: The development of higher psychological processes*. (M. Cole, V. John-Steiner, S. Scribner, & E. Souberman, Eds.). Cambridge, Massachusetts: Harvard University Press.
- Vygotsky, L. (1986). *Thought and language*. (A. Kozulin, Ed.). Cambridge, Massachusetts: MIT Press.
- Vygotsky, L., Rieber, R., & Wollock, J. (1997). *Problems of the theory and history of psychology*. (R. W. Rieber & J. L. Wollock, Eds.), *The collected works of L. S. Vygotsky* (Vol. 3). <https://doi.org/DOI 10.1007/978-1-4615-5893-4>
- Wang, L., Ertmer, P. A., & Newby, T. J. (2004). Increasing preservice teachers' self-efficacy beliefs for technology integration. *Journal of Research on Technology in Education*, 36(3), 231–250. <https://doi.org/10.1080/15391523.2004.10782414>
- Wei, L. (2000). Dimensions of bilingualism. In L. Wei (Ed.), *The bilingualism reader* (pp. 3–25). New York, USA: Routledge.
- Weideman, A. (2007). The redefinition of applied linguistics: Modernist and postmodernist views. *Southern African Linguistics and Applied Language Studies*, 25(4), 589–605. <https://doi.org/10.2989/16073610709486483>
- Weiner, B. (1979). A theory of motivation for some classroom experiences. *Journal of Educational Psychology*, 71(1), 3–25. <https://doi.org/10.1037/0022-0663.71.1.3>
- Weiner, B. (1980). *Human motivation*. Hillsdale, NJ: Associates, Lawrence Erlbaum.

- Weiner, B. (1985). An Attributional Theory of Achievement Motivation and Emotion. *Psychological Review*, 92(4), 548–573. <https://doi.org/10.1037/0033-295X.92.4.548>
- Weiner, B. (1986). An attributional theory of motivation and emotion. In B. Weiner (Ed.), *An attributional theory of motivation* (pp. 159–190). New York, USA: Springer-Verlag.
- Weiner, B. (2000). Intrapersonal and interpersonal theories of motivation from an attributional perspective. *Educational Psychology Review*, 12(1), 1–14. <https://doi.org/10.1023/A:1009017532121>
- Weiner, B. (2008). Reflections on the history of attribution theory and research: People, personalities, publications, problems. *Social Psychology*, 39(3), 151–156. <https://doi.org/10.1027/1864-9335.39.3.151>
- Weiner, B. (2010a). Attribution Theory. *International Encyclopedia of Education*, 6, 558–563. <https://doi.org/10.1002/9780470479216.corpsy0098>
- Weiner, B. (2010b). The development of an attribution-based theory of motivation: A history of ideas. *Educational Psychologist*, 45(1), 28–36. <https://doi.org/10.1080/00461520903433596>
- Wenden, A. L. (1998). Metacognitive knowledge and language learning. *Applied Linguistics*, 19(4), 515–537. <https://doi.org/10.1093/applin/19.4.515>
- Wenden, A. L. (1999). An introduction to metacognitive knowledge and beliefs in language learning: Beyond the basics. *System*, 27(4), 435–441.
- Wertsch, James, V., & Sohmer, R. (1995). Vygotsky on learning and development. *Human Development*, 38(6), 332–337. <https://doi.org/10.1159/000278339>
- White, C. (1999). Expectations and emergent beliefs of self-instructed language learners. *System*, 27(4), 443–457.
- Williams, G. (2005). *Sustaining language diversity in Europe: Evidence from the Euromosaic project*. New York: Palgrave Macmillan. <https://doi.org/10.1525/jsae.2006.6.1.17>
- Wood, D., Bruner, J. S., & Ross, G. (1976). The role of tutoring in problem-solving. *Journal of Child Psychology and Psychiatry*, 17, 89–100. <https://doi.org/10.1111/j.1469-7610.1976.tb00381.x>
- Worldatlas. (2019). What languages are spoken in Cyprus. Retrieved from

<https://www.worldatlas.com/articles/what-languages-are-spoken-in-cyprus.html>

- Yamano, Y. (2013). Utilizing the CLIL approach in a Japanese primary school: A comparative study of CLIL and EFL lessons. *Asian EFL Journal*, 15(4), 160–183.
- Yang, N.-D. (1999). The relationship between EFL learners' beliefs and learning strategy use. *System*, 27(4), 515–535.
- Yang, W., & Gosling, M. (2013). National appraisal and stakeholder perceptions of a tertiary CLIL program in Taiwan. *International CLIL Research Journal*, 2(1), 67–81.
- Zarate, G. (1993). *Représentations de l'étranger et didactique des langues*. Paris, France: Didier.
- Zarate, G., Gohard-Radenkovic, A., Lussier, D., & Pens, H. (2004). *Cultural mediation and language learning and teaching*. Kapfenberg: Council of Europe publishing. Kapfenberg: Council of Europe publishing.
- Zarate, G., Gohard-Radenkovic, A., Lussier, D., & Pens, H. (2004). *Cultural mediation in language learning and teaching*. *Cultural mediation in language learning and teaching*. Strasbourg: Council of Europe Publishing.
- Zarate, G., Lévy, D., & Kramsch, C. (2008). *Précis du plurilinguisme et du pluriculturalisme*. Paris: Éditions des archives contemporaines.
- Zhyrun, I. (2016). Culture through comparison: creating audio-visual listening materials for a CLIL course. *Latin American Journal of Content & Language Integrated Learning*, 9(2), 345–373. <https://doi.org/10.5294/laclil.2016.9.2.5>

I. Table of figures

Figure 1. Overview of my research domains.	13
Figure 2. Overview of my research topics and methodologies used.....	16
Figure 3. Social and language ecology of French Polynesia.....	30
Figure 4. Difference between traditional bilingualism, linguistic interdependence model, and dynamic bilingualism (adapted from García & Wei, 2014, p. 14).....	49
Figure 5. The major constituents of AL development (created by the author)	58
Figure 6. Ecological representation of language learning context (created by the author).....	62
Figure 7. Sociocultural and interactionist perspectives (translated from Gabillon, 2019, p. 75)....	67
Figure 8. ZPD and the school context (Gabillon & Ailincui, 2016, p. 28).	71
Figure 9. Vygotsky’s instrumental processes (adapted by the author).	72
Figure 10. The function of negative evidence (Polio & Gass, 1998, p. 310).....	79
Figure 11. Episodes of collaborative social interactions in AL development (proposed by the author).	82
Figure 12. Current AL teaching approaches.	86
Figure 13. Communicative competence as part of the AOA framework.....	91
Figure 14. Individual general competences as part of AOA framework	91
Figure 15. Range of CBI settings (Met, 1998, cited in Lyster & Ballinger, 2011, p. 280).....	93
Figure 16. CLIL continuum proposed by P. Ball (adapted from P. Ball, 2009, p. 37).	104
Figure 17. The 4Cs Framework (adapted from Coyle et al., 2010, p. 41).	110
Figure 18. Coyle’s language triptych (Coyle et al., 2010 p. 36)	111
Figure 19. Central kernel hypothesis (Gabillon, 2012b, p. 198).....	118
Figure 20. Schematic representation of the appropriation process (Gabillon, 2012b, p. 197).....	121
Figure 21. Flavell’s (1979) metacognitive knowledge model (Gabillon, 2007a).	124

Figure 22. The influence of high self-efficacy on individuals.	128
Figure 23. Representations of the four main causes of behaviour, their properties and linkages to affect and expectancy (Weiner, 2010b, p. 32).....	129
Figure 24. Locus, controllability, emotions, and expectancies (Weiner 2000).....	130
Figure 25. Language learner belief formation (adapted from Gabillon, 2005, p. 259).....	135
Figure 26. Neighbouring disciplines and my research.	136
Figure 27. Research methodologies used in CLIL and EAL studies.	138
Figure 28. Coding procedures used in the CLIL and EAL studies.	142
Figure 29. A snapshot from ATLAS.ti showing concept labelling and coding.	146
Figure 30. Recordings with transcriptions (with comments) added as subtitles.....	148
Figure 31. The phases of the CLIL study.....	155
Figure 32. A naturalistic science experiment setting	156
Figure 33. CLIL lesson 1: Occurrences of teacher scaffolding strategies	159
Figure 34. CLIL lesson 1: Types and occurrences of learner interactions.....	160
Figure 35. Subject lesson 1: Occurrences of teacher scaffolding strategies	164
Figure 36. Subject lesson 1: Types and occurrences of learner interactions.....	164
Figure 37. CLIL lesson 2: Frequency of teacher scaffolding strategies.....	165
Figure 38. CLIL lesson 2: Types and occurrences of learner interactions.....	166
Figure 39. Subject lesson 2: Frequency of teacher scaffolding strategies	166
Figure 40. Subject lesson 2: Types and occurrences of learner interactions.....	167
Figure 41. Learners' use of A&G to scaffold dialogic exchanges in CLIL.	177
Figure 42. Non-research activities implemented during the project.	179
Figure 43. Parents' involvement.	180
Figure 44. The theoretical underpinnings and principles which supported the project.	182
Figure 45. CLIL experimentation cycles in English and Tahitian.	183

Figure 46. Research methodologies used in EAL studies.....	192
Figure 47. The number of exchanges and duration per lesson (T=Teacher).....	197
Figure 48. The use of L1 (teacher & learners) (T=Teacher).....	198
Figure 49. Scaffolding strategies used by the teachers (T = teacher)	202
Figure 50. Corrective feedback strategies used by the teachers (T=Teacher, E=Exchanges)	203
Figure 51. Problems linked to the teachers' AL competence (T = teacher).....	205
Figure 52. Passive learner involvement (T=Teacher, L=Learners)	206
Figure 53. Active learner involvement (T=Teacher, L=Learners).....	206
Figure 54. Activity types used in minutes (T = teacher).....	207
Figure 55. Distribution of teacher and learner exchanges.....	214
Figure 56. Theoretical frame chart showing main interaction types used.	215
Figure 57. The degree of learner involvement: categories and sub-categories.....	215
Figure 58. Learner involvement during class activities.	216
Figure 59. Main characteristics of teacher-led whole-class activities.....	223
Figure 60. Main characteristics of teacher-led small group activities.....	224
Figure 61. Main characteristics of autonomous small group activities.....	224
Figure 62. Training activities used in the project.....	228
Figure 63. The overview of the CLIL and teacher training activities.....	229
Figure 64. Research and teacher development action plan.	229
Figure 65. Beliefs and social representations and their link with other research topics.	232
Figure 66. Schematic representation of a grounded theory method model.....	235
Figure 67. Beliefs and social representations research and their link with CLIL and EAL.....	239
Figure 68. Research plan and work packages	242
Figure 69. Three-level sampling model used in the study.	245

Figure 70. The research protocols followed in the study.	246
Figure 71. The teachers' representations regarding the notion of 'digital technology.'	248
Figure 72. teachers' statements about their use of digital technology.	249
Figure 73. Teachers' statements about the learners' use of digital technology in learning.	250
Figure 74. Participants' beliefs about the English and English language learning (n= 62)	268
Figure 75. The participants' motives for learning English (n = 62).....	271
Figure 76. The participants' beliefs about AL skill/component difficulty (n= 62).....	273
Figure 77. The participants' beliefs about AL skill/component significance (n = 62)	274
Figure 78. The participants' beliefs about using the L1 (n 62).	277
Figure 79. Research protocols.	283
Figure 80. CLIL research cycle.	291
Figure 81. Socially mediated activity framework (translated and adapted from Gabillon, 2019, p. 93).....	292
Figure 82. Our observations concerning the use of A&G during CLIL lessons.	295
Figure 83. Teacher-led small group activity.	297
Figure 84. Autonomous group-work activity.	298
Figure 85. Factors promoting high learner engagement.	298

II. Table of tables

Table 1. Modernist vs. postmodernist views of applied linguistics.	83
Table 2. Distinctions between tasks and exercises (R. Ellis 2003, p. 3).....	90
Table 3. Key expressions that are used to define CLIL (Gabillon, 2000b).....	101
Table 4. Contextual differences which lead to diverse CLIL implementations.....	104
Table 5. Influence of postmodernist views on CLIL	106
Table 6. Publications that have referred to the underlying theories of CLIL.....	107

Table 7. Influence of sociocultural perspective on the CLIL approach.....	107
Table 8. Current cognitivist theories that have influenced the CLIL approach.....	109
Table 9. A taxonomy of CF strategies (R. Ellis, 2009, p. 8).....	143
Table 10. A taxonomy of CF strategies (R. Ellis, 2009, p. 9).....	144
Table 11. The major categories observed during both CLIL and regular science lessons.....	158
Table 12. Socially mediated activity (SMA) framework.....	190
Table 13. The code group ‘teacher’	195
Table 14. The code group ‘learners’	196
Table 15. The code group activity types	196
Table 16. Information on data and other contextual information.....	210
Table 17. The categories ‘L1 use’ and ‘extra-linguistic support’	211
Table 18. Categories within the code group ‘learners’, obtained via open, axial and selective coding.....	212
Table 19. General characteristics of the participants and the length of the interviews.....	243
Table 20. Examples of teachers’ statements which describe how they use digital tools in teaching practices.....	251
Table 21. Negative and positive representations about the use of digital technology in class	252
Table 22. Analysis of Student 1’s discourse	255
Table 23. Analysis of Student 2’s discourse	256
Table 24. Analysis of Student 3’s discourse	257
Table 25. Analysis of Student 4’s discourse	258
Table 26. Analysis of Student 5’s discourse.....	259
Table 27. Analysis of Student 6’s discourse	260
Table 28. Analysis of Student 7’s discourse	261
Table 29. Analysis of Student 8’s discourse	262

Table 30. The participants' beliefs about the English language (n= 28).....	268
Table 31. The participants' positive beliefs about learning English (n = 28)	269
Table 32. The participants' negative beliefs about learning English (N = 28)	269
Table 33. The participants' beliefs about AL skill/component difficulty (n = 28)	274
Table 34. The participants' beliefs about AL skill/component significance (n= 28).....	275
Table 35. The participants' beliefs about using the L1 in AL lessons (n = 28)	276
Table 36. The principles on which CLIL and EAL observations were based	290

III. Table of extracts

Extract 1. Normative interactional exchanges.....	52
Extract 2. Plurilingual exchanges during a group work task.....	53
Extract 3. Learners' language choice	53
Extract 4. Code-switching to clarify meaning (code-switching for scaffolding purposes).....	54
Extract 5. Code-switching following an interruption during plurilingual interactions	54
Extract 6. Teacher scaffolding.	160
Extract 7. Use of A&G while scaffolding.	161
Extract 8. Guided repair.	161
<i>Extract 9. Learners' use of A&G to supplement verbal interactions.</i>	<i>162</i>
Extract 10 Learner exchanges during the group feedback.	162
Extract 11. Concept building during a science lesson in L1.	163
Extract 12. Concept transfer from CLIL to science lesson in L1.....	167
Extract 13. The role of artefacts in extending exchanges.	173
Extract 14. The role of artefacts in relaunching truncated exchanges.	174
Extract 15. The role of A &G in teacher scaffolded dialogue.....	175
Extract 16. A teacher-led activity in a small group of 12 students.	186

Extract 17. An episode from a student-led CLIL mathematics activity.....	187
Extract 18. Repetition drill exchanges	197
Extract 19. Mechanical IRF exchanges.....	197
Extract 20. Mechanical translation.....	198
Extract 21. Mechanical translation.....	198
Extract 22. Bilingual instruction giving	199
Extract 23. Translanguaging	199
Extract 24. Learner translanguaging	200
Extract 25. Teachers' language needs	204
Extract 26. Unauthentic language use.	204
Extract 27. Autonomous activities.	207
Extract 28. Non-contextualized IRF exchanges.....	217
Extract 29. Mechanical IRF exchanges based on rote learning and repetition.	217
Extract 30. A 28-second exchange during an autonomous CLIL maths activity.....	218
Extract 31. Example of contextualized IRF exchanges during teacher scaffolding.....	220
Extract 32. Example of a small teacher-led group activity.	220
Extract 33. Example of a teacher-led pre-communicative whole-class activity.	221
Extract 34. The participants' beliefs about English and English language learning.....	267
Extract 35. The participants' explanations for their non-involvement in speaking tasks.	270
Extract 36. The participants' perceived AL skill/component difficulty.....	273
Extract 37. The participants' stated beliefs about grammar.....	275

IV. Appendices

Appendix A

Transcription notation system used in the study (adapted from Jefferson, 2004)

Symbol	Name	Use
[<i>italic text</i>]	Square brackets	Indicates the start and endpoints of overlapping speech.
((<i>italic text</i>))	Double Parentheses	Indicates comments, translation, or annotation of non-verbal activity.
(<i>italic text</i>)	Parentheses	Indicates speech which is unclear or in doubt in the transcript.
...	Ellipsis	Short pause.
°	Degree symbol	Indicates whisper or reduced volume speech.
ALL CAPS	Capitalized text	Indicates shouted or increased volume speech.
underline	Underlined text	Indicates the speaker is emphasizing or stressing the speech.
:::	Colon(s)	Indicates prolongation of an utterance/ indicates a stretched sound.
(hhh)	Parentheses	Indicates laughter in the conversation/speech.
--	Dash	Indicates a break within a word.
=	Equal Sign	Indicates the break and subsequent continuation of a single interrupted utterance.