



**HAL**  
open science

# Evaluation of muscle aging using high density surface electromyography

Loubna Imrani Sallak

► **To cite this version:**

Loubna Imrani Sallak. Evaluation of muscle aging using high density surface electromyography. Bio-engineering. Université de Technologie de Compiègne, 2021. English. NNT : 2021COMP2647 . tel-03770245

**HAL Id: tel-03770245**

**<https://theses.hal.science/tel-03770245>**

Submitted on 6 Sep 2022

**HAL** is a multi-disciplinary open access archive for the deposit and dissemination of scientific research documents, whether they are published or not. The documents may come from teaching and research institutions in France or abroad, or from public or private research centers.

L'archive ouverte pluridisciplinaire **HAL**, est destinée au dépôt et à la diffusion de documents scientifiques de niveau recherche, publiés ou non, émanant des établissements d'enseignement et de recherche français ou étrangers, des laboratoires publics ou privés.

Par Loubna IMRANI SALLAK

*Evaluation of muscle aging using high density surface electromyography*

Thèse présentée  
pour l'obtention du grade  
de Docteur de l'UTC

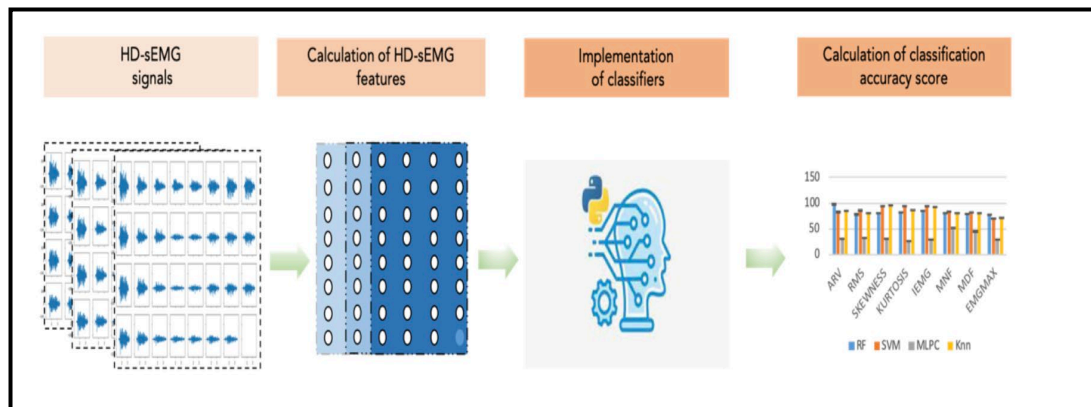

Soutenu le 29 novembre 2021

**Spécialité :** Bioingénierie : Unité de Recherche en Biomécanique et Bioingénierie (UMR-7338)

D2647

# Evaluation of muscle aging using High Density Surface Electromyography

Thesis report by:

**Loubna IMRANI SALLAK**

Submitted to :

Sorbonne University, Université de Technologie de Compiègne (UTC)  
Doctoral school « Sciences pour l'ingénieur »

for the Degree of **Doctor** in **Bioengineering**

**Spécialité : Bioingénierie**

Jury members :

Emmanuel Fournier	PU-PH, Faculté de Médecine Sorbonne Université, Paris, France.	Reviewer.
Jérôme Boudy	PU, Institut Mines Télécoms, Paris, France.	Reviewer.
Agathe Raynaud-Simon	PU-PH, Faculté de Médecine Université de Paris, Paris, France.	Examiner.
Christine Boutet-Rixe	MD, CEO, IUIS, Sorbonne Université, Paris, France.	Examiner.
Catherine Marque	PU, Université de Technologie de Compiègne, Compiègne, France.	Examiner.
Dan Istrate	ECC, Université de Technologie de Compiègne, Compiègne, France.	Examiner.
Kiyoka Kinugawa Bourron	PU-PH, Faculté de Médecine Sorbonne Université, Paris, France.	Co-Supervisor.
Sofiane Boudaoud	PU, Université de Technologie de Compiègne, Compiègne, France.	Supervisor.

**November 29, 2021**

*"The only source of knowledge is experience."*  
— **Albert Einstein**







# Résumé

Avec le vieillissement de la population, préserver la fonction musculaire est important pour éviter la perte de mobilité et d'autonomie. De nos jours, la prévention de la maladie musculaire, la sarcopénie, est une préoccupation majeure et des facteurs de risque importants tels que l'âge avancé ainsi que des facteurs modifiables, notamment une faible activité physique et une alimentation déséquilibrée ont été identifiés. Compte tenu de la croissance des populations plus âgées et de la diminution de l'activité physique, qui touche également les jeunes citoyens, la sensibilisation à la qualité musculaire peut être cruciale pour promouvoir un vieillissement en bonne santé dans nos sociétés. Les besoins en évaluations fonctionnelles musculaires ont été exprimés par les chercheurs et les cliniciens. Le groupe de travail européen sur la sarcopénie chez les personnes âgées (EWGSOP) recommande de définir la sarcopénie comme la présence à la fois d'une faible masse musculaire et d'une faible fonction musculaire (force et performance physique).

Pour cela, nous avons développé une méthode d'évaluation du vieillissement musculaire, en utilisant une technologie ambulatoire et non invasive, appelée technologie d'électromyographie de surface haute densité (HD-sEMG), à travers un projet de recherche clinique sur cinq catégories d'âge (25 à 74 ans), actifs et sédentaires. Nous avons réalisé une étude comparative avec une analyse complète et multimodale du rectus femoris (RF), muscle impliqué dans les mouvements de la vie quotidienne, pour dévoiler le potentiel prometteur de la technique HD-sEMG, par rapport aux techniques cliniques classiques, l'objectif étant de détecter les changements précoces de la qualité de la fonction musculaire impactée par le vieillissement et le niveau d'activité physique. La partie clinique de ce projet de thèse a été financée par une subvention européenne, EIT Health.

En analysant principalement la dynamique de contraction musculaire et l'intensité du rectus femoris, nos résultats ont montré que la technique HD-sEMG, était capable de discriminer entre les cinq catégories d'âge de sujets sains physiquement actifs. Plus intéressant encore, les scores HD-sEMG proposés discriminaient entre les participants actifs et sédentaires, de la même catégorie d'âge (45-54 ans), contrairement aux paramètres cliniques et aux autres techniques couramment utilisées (absorptiométrie biphotonique par rayons X, DXA et échographie). De plus, ces scores pour les participants sédentaires de cette catégorie

d'âge étaient significativement plus proches de ceux des participants actifs des catégories d'âge supérieures (55-64 ans et 65-74 ans).

Cela suggère fortement qu'un mode de vie sédentaire semble accélérer le processus de vieillissement musculaire au niveau anatomique et fonctionnel, et ce processus accéléré subtil peut être détecté par la technique HD-sEMG. Ces résultats préliminaires prometteurs pourraient contribuer au développement d'un outil intéressant aux cliniciens pour améliorer à la fois la précision et la sensibilité de l'évaluation musculaire utile pour les programmes de prévention et de réadaptation afin d'éviter ou de retarder la sarcopénie, problème de santé publique actuel alerté par l'Organisation Mondiale de la Santé (OMS) et promouvoir un vieillissement en bonne santé.

# Abstract

With the aging of the population, preserving muscle function is important to prevent loss of mobility and autonomy. Nowadays, the prevention of the muscle disease, sarcopenia, is a major concern and important risk factors such as older age as well as modifiable factors including low physical activity and unhealthy diet have been identified. Considering the growth of older populations and the decreased physical activity, which also includes young citizens, muscle quality awareness can be crucial in promoting a healthy aging process in our societies. Muscle functional assessments needs were expressed by researchers and clinicians, The European Working Group on Sarcopenia in Older People (EWGSOP) recommends defining sarcopenia as the presence of both low muscle mass and low muscle function (strength, and physical performance).

For this purpose, we have developed a method for muscle aging evaluation, using an ambulatory and non-invasive technology, called high-density surface electromyography (HD-sEMG), through a clinical research project on five age categories (25 to 74 yrs.). We performed a comparative study with a complete and multimodal analysis of the rectus femoris, muscle involved in daily life motions, in order to reveal the promising potential of the HD-sEMG technique, compared to conventional clinical techniques, to detect early changes in the quality of muscle function impacted by aging and physical activity level. The clinical part of this thesis project was funded by a European grant, EITH Health.

By analyzing both muscle contraction dynamics and intensity of the rectus femoris, our results showed that the HD-sEMG technique, was able to discriminate between the five age categories of healthy physically active subjects. More interestingly, the proposed HD-sEMG scores discriminated between active and sedentary participants, from the same age category (45-54 yrs.), in contrary to clinical parameters and others usual techniques (dual-energy x-ray absorptiometry, DXA and ultrasonography). In addition, these scores for sedentary participants from this age category were significantly closer to those of active participants from higher age categories (55-64 yrs. and 65-74 yrs.).

This strongly suggests that sedentary lifestyle seems to accelerate the muscle aging process at both anatomical and functional level, and this subtle accelerated process can be detected by the HD-sEMG technique. These promising preliminary results can contribute to the development of an interesting tool for clinicians to improve both accuracy and sensitivity of functional muscle evaluation useful for prevention and rehabilitation to avoid the effects of unhealthy lifestyle that can potentially lead to sarcopenia. This can support also the actual public health concern alerted by World Health Organization (WHO) regarding aging and sarcopenia, to promote healthy aging.

# Publications

## International journal

- **L.Imrani**, S.Boudaoud, J.Laforêt, K.Kinugawa. Ageing Effect Evaluation on HD-sEMG Signals Using CCA Approach. IRBM 2021. <https://doi.org/10.1016/j.irbm.2021.05.002>
- **Under submission:**
- **L.Imrani**, S.Boudaoud, C.Lahaye, C. Moreau, M. Ghezal, S. Ben Manaa, M. Doulazmi, J. Laforêt, F. Marin, K. Kinugawa. High-density surface electromyography as biomarker of early muscle aging induced by physical inactivity. Under submission to Journal of Gerontology: Biological Sciences.

## International conferences

- **Imrani L.**, Boudaoud S., Lahaye C., Ghezal M., Ben Manaa S., Doulazmi M., Kinugawa K., Does physical inactivity induce muscle ageing? High-density surface electromyography study. EUGMS2021. Athens, Greece. 11-13 October, 2021.
- C. Lahaye, **L. Imrani**, M. Ghezal, S. BenManaa, M. Doulazmi, S. Boudaoud, K. Kinugawa. Assessment of muscle aging by quadricipital ultrasound. EUGMS2019.Krakow, Poland. 25-27 September 2019.
- **L. Imrani**, S. Boudaoud, K. Kinugawa, J. Laforêt. Wireless evaluation of muscle abilities with aging using CCA approach. IEEE JETSAN2019. Paris, France. 23-24 Mai 2019.
- S. Banerjee, **L. Imrani**, K. Kinugawa, J. Laforet, S. Boudaoud. Analysis of HD-sEMG signals using Non-Negative Matrix Factorization and Time Domain Features for functional assessment with aging. BIOCUM2018. London, United Kingdom,30-31 October 2018.
- **L. Imrani**, S. Boudaoud, K. Kinugawa, K. Lepetit, J. Laforêt , F. Marin. Evaluation of motor abilities with aging using HD-sEMG and IMU data. EUGMS 2018. Berlin, Germany, 10,12 October 2018.
- **L. Imrani**, S. Boudaoud, K. Kinugawa, K. Lepetit, J. Laforêt, F. Marin. Étude de l'effet de l'âge sur des capacités motrices en utilisant les données HD-sEMG et IMU. JASFGG 2018.Paris 26-28 November 2018.
- **L. Imrani**, S. Xeres, K. Lepetit ,M. Al Harrach, S. Boudaoud, K. Kinugawa, F. Marin. Evaluation of motor abilities in young and older subjects using HD-sEMG and IMU data. EUGMS 2017. Nice, France. 20-22 September 2017

*"To my son Yacine & my husband Mohamed  
thank you for making me the happiest mom on  
earth"*



# Contents

LIST OF FIGURES.....	13
LIST OF TABLES.....	16
GENERAL INTRODUCTION.....	17

## CHAPTER 1 : GENERAL CONTEXT..... 20

1.1	INTRODUCTION .....	21
1.2	PROBLEMATIC OF AGING.....	22
1.2.1	<i>Aging statistics.....</i>	22
1.2.2	<i>Chronological age versus Motor Functional Age.....</i>	23
1.3	PHYSIOLOGICAL AND ANATOMICAL BASES OF NEURO MUSCULOSKELETAL SYSTEM .....	24
1.3.1	<i>Anatomy of skeletal muscle.....</i>	24
1.3.2	<i>Muscle fiber types.....</i>	30
1.3.3	<i>Motor units .....</i>	33
1.3.4	<i>Muscle contraction.....</i>	35
1.4	AGING OF MUSCULOSKELETAL SYSTEM .....	39
1.4.1	<i>Effect of age on muscle mass and typology.....</i>	40
1.4.2	<i>Effect of age on motor unit recruitment.....</i>	43
1.4.3	<i>Effect of age on muscle contraction (Excitation-contraction coupling) .....</i>	43
1.4.4	<i>Environmental factors responsible of muscle decline during aging.....</i>	45
1.5	SARCOPENIA.....	47
1.6	EVALUATION OF MUSCLE FUNCTIONAL ABILITIES BY USING MULTIMODAL DATA ANALYSIS.....	48
1.6.1	<i>Measurements of muscle function in clinical routine.....</i>	48
1.6.2	<i>Techniques used to evaluate muscle mass .....</i>	50
1.6.3	<i>Research state techniques.....</i>	53
1.6.4	<i>Sit-To-Stand motion .....</i>	56
1.7	PROBLEMATIC DESCRIPTION AND THESIS WORK .....	60
1.8	CONCLUSION.....	62

## CHAPTER 2 : HD-SEMG SIGNAL RECORDING AND ANALYSIS FOR THE CLINICAL ASSESSMENT OF MUSCLE AGING..... 65

2.1	INTRODUCTION .....	66
2.2	EXPERIMENTAL PROTOCOL AND DATA PROCESSING.....	67
2.2.1	<i>General overview .....</i>	67
2.2.2	<i>Experimental setup .....</i>	68
2.2.3	<i>Statistical analysis for multimodal data comparison .....</i>	85
2.3	CLINICAL STUDY RESULT .....	86
2.3.1	<i>Preliminary studies .....</i>	86
2.3.2	<i>Multimodal clinical comparative study (CHRONOS).....</i>	88
2.4	DISCUSSION.....	97
2.5	STRENGTHS AND LIMITATIONS.....	100
2.6	CONCLUSION.....	102

<b>CHAPTER 3 : ANALYSIS AND CLASSIFICATION OF HD-SEMG SIGNALS WITH MUSCLE AGING AND SEDENTARY LIFESTYLE.....</b>	<b>104</b>
3.1 INTRODUCTION .....	105
3.2 ANALYSIS OF HD-SEMG SIGNALS .....	106
3.2.1 <i>Aging effect evaluation on HD-sEMG signals using CCA approach</i> .....	106
3.2.2 <i>Time-Frequency analysis of HD-sEMG signals with aging</i> .....	115
3.3 PREDICTION OF MUSCLE AGING BASED ON HD-SEMG FEATURES CLASSIFICATION .....	121
3.3.1 <i>Introduction</i> .....	121
3.3.2 <i>Features from HD-sEMG signal</i> .....	122
3.3.3 <i>Classifiers</i> .....	124
3.3.4 <i>Experiments &amp; Methodology</i> .....	128
3.3.5 <i>Results and discussion</i> .....	135
<b>GENERAL CONCLUSION .....</b>	<b>147</b>
<b>BIBLIOGRAPHY.....</b>	<b>151</b>

# List of figures

Figure 1.1: Organization of skeletal muscle .....	25
Figure 1.2: Skeletal muscle shapes photo created by © Benjamin Cummings, Addison Wesley Longman, Inc 2001).....	26
Figure 1.3: Skeletal muscle shapes photo created by © Benjamin Cummings, Addison Wesley Longman, Inc 2001).....	27
Figure 1.4: Structure of the muscle fiber [15].....	28
Figure 1.5: Representation of the sarcoplasmic reticulum and the tubular system transverse [16]. .....	29
Figure 1.6: Classification of muscle fibers on the staining of myofibrillar ATPase after Eriksson 1982 [19].....	30
Figure 1.7: Representation of muscle fiber types conforming to their types [20].....	31
Figure 1.8: Action potential (image from © Pearson prentice Hall, Inc 2005). .....	33
Figure 1.9: Representation of Motor unit (image from © Pearson Education, Inc, 2013).....	34
Figure 1.10: The theory of sliding filaments: behavior of actin filaments in relation to the myosin filaments during relaxation (top), partially contracted (in the middle), and fully contracted (at the bottom) After (Huxley, 1956) [23].....	35
Figure 1.11: The component of muscle contraction (image from © Pearson Education, Inc, 2013).....	36
Figure 1.12: Types of muscle contraction [26].....	38
Figure 1.13: The several factors responsible of age age-related changes. Diagram by Tim Goheen,.....	39
Figure 1.14: The potential muscle gain and loss during our lifetime [38].....	40
Figure 1.15: Histological sections stained for myosin-ATPase obtained from the vast lateral for a 25-year-old subject (C) and a 75-year-old subject (D) with type I (dark spots) and type II fibers (light spots) [50] .....	42
Figure 1.16: Relationship between total number of motor units and age for men aged 18 to 82 [31].....	43
Figure 1.17 : Illustration of DXA technique .....	50
Figure 1.18: Examples of ultrasound images of RF of (A) Young participant. (B) Old participant [113]. .....	51
Figure 1.19: Schematic representation of surface EMG signal generation [125]. .....	53
Figure 1.20: Representation of High-Density Surface Electromyography (HD-sEMG) technique (Refa and Mobita devices, TMSi ©).....	54
Figure 1.21: Inertial Measurement Unit (IMU).....	55
Figure 1.22: Number of Pubmed publications per year for “gait analysis” and “Sit To Stand”. .....	57
Figure 1.23: The four phases of the human Sit-Stand-Motion. In phase 1, humans flex their upper body to generate momentum and initiate the Sit-To-Stand motion. In phase 2, they raise their hip from the chair and transfer momentum. In phase 3, humans extend their whole body upward. In phase 4, they move their body backward to stabilize their posture [150]. available via license: Creative Commons Attribution 4.0 International .....	58
Figure 1.24: General overview of the thesis.....	62

Figure 2.1: The experimental setup up for CHRONOS study. ....	68
Figure 2.2 : Flow diagram of the participants .....	70
Figure 2.3: Example of ultrasound image recording during CHRONOS study. A: Ultrasound image from a young woman aged 25 years with BMI=19kg/m <sup>2</sup> . B: Ultrasound image from older woman aged 70 years with BMI=20kg/m. ....	71
Figure 2.4: Acquisition of HD-sEMG signals during CHRONOS clinical study.....	72
Figure 2.5: EMG electrode configurations and the corresponding recorded signal from one Motor Unit [157]......	74
Figure 2.6 : Methodological issues in the processing of surface electromyogram.....	75
Figure 2.7: Set up of HD-sEMG score calculation .....	76
Figure 2.8: Above: Raw EMG signal, below: EMG signal after band-pass filter with rest period to calculate SNR.....	77
Figure 2.9: Acquisition interface using Polybench software by TMSI Netherland. A: Wireless connection for Mobita® (TMSi, Oldenzaal, Netherlands). B: high-pass filter with Fc=5 Hz (recommended for Mobita device). C: visualization of EMG channels. D: visualization of acceleration acquisition.....	77
Figure 2.10: Automatic segmentation algorithm using Hilbert transform .....	80
Figure 2.11: Automatic segmentation of EMG signal using Hilbert transform .....	81
Figure 2.12: Alarm vector obtained from automatic segmentation .....	81
Figure 2.13: Averaged MCD heat map (32 channels) for the 5 age categories yrs (category1=25-34yrs ,category2=35-44yrs, category3=45-54yrs, category4=55-64yrs, category5=65-74yrs.), and sedentary group 45-54 yrs group (up, proximal, down distal, left, lateral and right distal part of the grid). ....	82
Figure 2.14 : Averaged HD-sEMG signals for the 5 age categories and sedentary category, A=(Category1:25-34yrs),B= (Category2:35-44yrs),C=(Category3:45-54yrs),D=(Category4:55-64yrs),E= Category5:65-74yrs),and F=(sedentary category:45-54yrs).....	85
Figure 2.15: Optimization of HD-sEMG acquisition chain from REFA amplifier (A) to Mobita ambulatory device (B). ....	86
Figure 2.16: Box plot for the maximum amplitude (left) and the maximum acceleration (Right) for three age categories (Imrani et al 2018) [191]. See (Annex 4Annex 5).....	88
Figure 2.17: Linear regression with aging of FT score (A) and MT score(B). Where R is determinant coefficient R= (0.4,0.52) respectively.....	91
Figure 2.18: A linear regression with aging of MCD score (A) and MCI score (B). Where R is determinant coefficient R= (0.8,0.58) respectively.....	92
Figure 2.19 linear model of maximum acceleration with determinant coefficient R=0.6 .....	96
Figure 3.1: Representation of canonical components (estimated sources) for one subject during STS motion.....	110
Figure 3.2 Obtained CCA correlation coefficients for the 31 estimated sources for young (H1) "up" and older -(H2) "down" groups.....	112
Figure 3.3: Boxplot of the mean correlation coefficient of the estimated sources for H1 (young) and H2 (older) groups. ....	113
Figure 3.4: Boxplot of standard deviation of CCA correlation coefficients for the estimated sources for H1 (young) and H2 (older)groups. ....	114
Figure 3.5: Focus for Time-Frequency map for one channel of young subject (up) and senior (down) subject during sit to stand motion.....	117
Figure 3.6 : Time-Frequency cartography for representative Young subject 25 yrs.....	118
Figure 3.7 : Time-Frequency cartography for representative Young subject 52 yrs.....	119

Figure 3.8: Time-Frequency cartography for representative Young subject 63 yrs.....	119
Figure 3.9 : <i>The overview of classification set up</i> .....	122
Figure 3.10: the decision function for a linearly separable problem, with three samples on the margin boundaries [242]. .....	126
Figure 3.11: Random forest setup.....	127
Figure 3.12 : Neuronal network [248].....	128
Figure 3.13: Classification process .....	130
Figure 3.14: Feature extraction for MFA prediction.....	132
Figure 3.15: Grid Search method.....	133
Figure 3.16: Cross validation (K-fold) method.....	134
Figure 3.17: Accuracy percentage of HD-sEMG features from the averaged channels channels (Feature Extraction Methodology 1) .....	136
Figure 3.18: Accuracy percentage of HD-sEMG features from 31 channels (Feature extraction methodology 2) .....	137
Figure 3.19: the three segments of EMG contraction during STS motion.....	138
Figure 3.20: Accuracy percentage of HD-sEMG features from the 1st segment of all channels .....	139
Figure 3.21: Accuracy percentage of HD-sEMG features from the 2nd segment of all channels .....	140
Figure 3.22: Accuracy percentage of HD-sEMG features from the 3rd segment of all channels .....	140
Figure 3.23: Representative confusion matrix for the four classifiers with methodology 1, using ARV feature.....	141
Figure 3.24: MFA Prediction by majority voting of sedentary representative subject 2 using logistic regression .....	144
Figure 3.26: MFA Prediction by majority voting of sedentary representative subject 2 using Knn.....	145

## List of tables

Table 1: General description of the CHRONOS active population (n=82) .....	89
Table 2. Statistical testing of clinical scores of the active population with aging (n=82).....	90
Table 3: Statistical testing of the ultrasound scores of the active population with aging (n=82) .....	91
Table 4 Statistical testing of HD-sEMG scores of the active population according to age (n=82) .....	92
Table 5: Correlation coefficients of HD-sEMG scores, ultrasound scores, and age (n=82) ..	93
Table 6 : multivariate variance analysis (MANOVA) to assess the robustness of the HD-sEMG scores to MT, FT, Gender, and BMI parameters .....	93
Table 7 Statistical testing for comparing clinical scores between active and sedentary subjects .....	94
Table 8. Statistical testing for comparing HD-sEMG and ultrasound scores between active and sedentary subjects .....	95
Table 9. Cohort description (BMI: Body Mass Index).....	107
Table 10. t-test results for H1 and H2 groups.....	111
Table 11. Dataset description .....	129
Table 12. Summary of the best classifiers and features (accuracy performances in %)......	142
Table 13. Summary of MFA prediction using Knn and LR methods .....	144

# General introduction

The aging of the population is a major public health concern, according to the world report on aging and health, from World Health Organization (WHO, 2015), the proportion of people aged 60 and over will almost double between 2015 and 2025 [1,2]. There are many effects of aging such as the loss of autonomy and increased risk of falling [3]. These generate a very important economic, social and psychological costs [4].

The current clinical examinations are not enough accurate and robust to assess the muscle status of older people as mentioned in the recently updated recommendations of the European Working Group on Sarcopenia of Older People EWGSOP [5]. Indeed, the way of aging is different from one individual to another; it is a function of many factors such as the biological and physiological changes of the organs, the environmental conditions as well as the lifestyle of the person.

The consequences of these factors can divide the older population into two categories; the first is a population with a healthy aging mode, and the second is a category that suffers from a pathological aging with a decrease in autonomy, caused in part by the loss of motor capacity of the muscles, which causes discomfort to perform simple physical tasks during daily life.

Consequently, it would be interesting to exploit the new technologies dedicated to the functional evaluation of the musculoskeletal system such as the high-density surface electromyography technique (HD-sEMG), a recent multichannel recording technique, to develop device able to assess motor decline and to serve as an indicator in a prevention approach or in functional rehabilitation.

The work of this thesis is a part of "CHRONOS" project (<http://www.chronos-eithealth.eu>), a European project founded by EIT Health. This work will modestly launch a first study to evaluate a new innovative technology used in research in order to construct the first basis for a portable precise device able to assess motor decline with aging. Indeed, this work will be divided into three parts. The **first chapter** will introduce the musculoskeletal system, basic notions about muscle aging, and the problematic treated in this thesis, and the new concept of motor functional age (MFA). **The second chapter** will unveil the materials and

methods used for the implementation of the instrumental protocol including clinical examination, the HD-sEMG and accelerometer sensors combined in the same portable device. It will also cover the preprocessing of the data and statistical analysis to evaluate the sensitivity of various parameters from HD-sEMG technique compared to current clinical examinations with aging and the variation of physical activity level. **The third chapter** will be devoted to advanced analysis of HD-sEMG signals divided in two subparts: firstly, the evaluation of aging effect using blind source separation technique, namely, canonical correlation analysis [6], and time frequency analysis using short time Fourier transform to analyze the non-stationarity of the signals. The last subpart of the chapter will explore classification possibilities to estimate motor functional age from basics features extracted from HD-sEMG signals. Several classifiers from machine learning approaches will be evaluated in term of classification accuracy according to each feature, segmentation techniques, number of channels, with aging and physical activity level. Finally, after discussing the strengths and limitations of the thesis work, envisaged perspectives will be exposed concerning clinical application.





# CHAPTER 1 : General Context

1.1	INTRODUCTION .....	21
1.2	PROBLEMATIC OF AGING.....	22
1.2.1	<i>Aging statistics</i> .....	22
1.2.2	<i>Chronological age versus Motor Functional Age</i> .....	23
1.3	PHYSIOLOGICAL AND ANATOMICAL BASES OF NEURO MUSCULOSKELETAL SYSTEM .....	24
1.3.1	<i>Anatomy of skeletal muscle</i> .....	24
-	Architecture of skeletal muscle .....	24
-	Structure of the muscle fiber.....	28
1.3.2	<i>Muscle fiber types</i> .....	30
-	Classification of muscle fibers .....	30
-	Generation and propagation of fiber action potential.....	32
1.3.3	<i>Motor units</i> .....	33
1.3.4	<i>Muscle contraction</i> .....	35
-	Mechanism of muscle contraction .....	35
-	Types of muscle contraction.....	37
1.4	AGING OF MUSCULOSKELETAL SYSTEM .....	39
1.4.1	<i>Effect of age on muscle mass and typology</i> .....	40
1.4.2	<i>Effect of age on motor unit recruitment</i> .....	43
1.4.3	<i>Effect of age on muscle contraction (Excitation-contraction coupling)</i> .....	43
1.4.4	<i>Environmental factors responsible of muscle decline during aging</i> .....	45
-	Physical activity.....	45
-	Nutritional diet .....	46
1.5	SARCOPENIA.....	47
1.6	EVALUATION OF MUSCLE FUNCTIONAL ABILITIES BY USING MULTIMODAL DATA ANALYSIS.....	48
1.6.1	<i>Measurements of muscle function in clinical routine</i> .....	48
-	Handgrip strength .....	48
-	Gait Speed Time.....	48
-	Short Physical Performance Battery (SPPB).....	49
1.6.2	<i>Techniques used to evaluate muscle mass</i> .....	50
-	Dual energy X-ray absorptiometry (DXA).....	50
-	Computer tomography (CT)/Magnetic resonance imaging (MRI) .....	50
-	Ultrasound imaging .....	51
-	Bio electrical impedance analysis (BIA) .....	52
-	Electromyography technique .....	52
1.6.3	<i>Research state techniques</i> .....	53
-	High density surface electromyography (HD-sEMG) technique .....	53
-	Inertial Measurement Unit (IMU) .....	54
-	Diffusion Weighted Magnetic Resonance Imaging.....	55
1.6.4	<i>Sit-To-Stand motion</i> .....	56
1.7	PROBLEMATIC DESCRIPTION AND THESIS WORK .....	60
1.8	CONCLUSION .....	62

## 1.1 Introduction

The aging of the population is a major public health concern, according to the world report on aging and health, from World Health Organization (WHO, 2015), the proportion of people aged 60 and over will almost double between 2015 and 2025 [1,2]. There are many effects of aging such as the loss of autonomy and increased risk of falling [3]. These generate a very important economic, social and psychological costs [4]. The current clinical examinations are not enough accurate and robust to assess the muscle status of older people as mentioned in the recently updated recommendations of the European Working Group on Sarcopenia of Older People EWGSOP [5]. Consequently, it would be interesting to exploit the new technologies dedicated to the functional evaluation of the musculoskeletal system such as the high-density surface electromyography technique (HD-sEMG), to develop device able to assess motor decline and to serve as an indicator in a prevention approach or in a functional rehabilitation.

This is why we propose to show at first the aging statistic and the difference between chronological age and functional age in order to justify the motivation behind this thesis, then we will introduce the physiological and anatomical elements on muscle contraction in order to understand muscle aging. We will highlight the characteristics of muscles that seem essential to maintain the autonomy and care of the older population, and finally we will discuss the main elements to clarify how muscle is implemented in the quality of life from its structure until the impact of environmental factors on its performance and quality. The keys elements of this chapter are: firstly, we will introduce the aging statistics, physiological and anatomical bases of neuromusculoskeletal system, then age-related changes in muscles, we progress to the environmental factors responsible for aging, and the advantages and limitations of recent clinical examinations in terms of the accessibility to functional information of muscle.

Finally, we will illustrate how to explore neuro-musculoskeletal system using High Density Surface Electromyography (HD-sEMG) and others new innovative devices such as Inertial Measurement Unit (IMU), Motor unit magnetic resonance imaging. Once all the key elements have been cited, we will show the general objective of this thesis work and our strong motivation to get involved in the improvement of clinical tools to guide aging to a positive,

healthy and active way. Keeping in mind during all this work that the objective is to help clinical routine being more accurate and well-rounded to assess the muscle quality with aging and other factors such as physical activity.

## 1.2 Problematic of aging

### 1.2.1 Aging statistics

According to the Eurostat report, the population of the European on 1 January 2020 Union (EU) was estimated at 446.8 million people. Young people (0 to 14 years old) made up 15.2% of the population of the EU, while people considered to be of working age (15 to 64 years old) represented 64.6% of the population, and the older (65 years and over) 20.3% (i.e. 0.3 percentage point more than the previous year and 2.9 percentage points more than ten years ago) [2]. Among the Member States of the EU-27, the highest proportion of young people in the total population in 2019 was observed in Ireland (20.5%), France (18.0%) and Sweden (17.8%), while the lowest shares were recorded in Italy (13.2%), Germany (13.6%), Malta and Portugal (13.7% each). Regarding the proportion of older people (65 years and over) in the total population, Italy (22.8%), Greece (22.0%), Portugal, Finland (21.8% each) and France (20.4%) recorded the highest shares, and Ireland (14.1%) and Luxembourg (14.4%) the lowest [2]. With aging, the major public health problem is the development of dependence of older population. As a result, we can introduce the notion of dependency rates. Age dependency ratios can be used to study the level of care for young and / or the older people by the working-age population [2].

These rates are expressed in terms of the relative size of the young and / or old populations compared to the working-age population. The old-age dependency ratio of the EU stood at 31.4% as of January, 2019. There were therefore just over three people of working age for every person aged 65 or over. The old-age dependency ratio varied from one EU Member State to another, ranging from 20.7% in Luxembourg to 21.6% in Ireland (See Eurostat report for more details), with nearly five people of working age per year for each person aged 65 or over. This ratio reached 35.7% in Italy, 35.1% in Finland, 34.6% in Greece, and 33.1% in France with less than three people of working age taking care for each person aged 65 and over. From this statistical data analysis given by Eurostat the conclusion is that in

2020, more than one fifth (20.6 %) of the EU population was aged 65 and over. For these reasons, we are interested in the mode of aging of the population with the objective of helping the older to live this part of their life in the best conditions while maintaining a healthy aging. The benefits of being interested in leading active aging for this population are multiple: first, the well-being of the older will reduce their dependencies, and then the costs of the consequences of pathological (unhealthy) aging will be reduced [1]. Finally, the psychological and societal impacts are very important; keeping a good mental and psychological health during this step can avoid several health complications. Euro statistics show a real need for real-time monitoring of the living conditions of the older, particularly the impact of physical activity.

Our main motivation in this thesis work is to provide precise studies based on muscle activity from signals using High Density surface Electromyography technology (HD-sEMG) to be able to provide a device that allows to monitor muscle conditions based on aging and physical activity. This seems very important to us to warn early the citizen about the impact on the muscle of the lack of physical activity through life, in order to maintain muscle health.

## 1.2.2 Chronological age versus Motor Functional Age

The way of aging is different from one individual to another; it is a function of many factors such as the biological and physiological changes of the organs, the environmental conditions as well as the way of life of the person [7,8]. The consequences of these factors can divide the older population into two categories; the first is a population with a healthy aging mode, and the second is a category that suffers from a pathological aging with a decrease in autonomy, caused partly by the loss of motor capacity of the muscles, which causes difficulty to perform physical tasks during the daily life. According to the recent European report "Population structure and ageing" [2], difficulties of movement (27%) combined with the loss of strength, endurance (27%) represent the main symptoms of aging and the main limitation in older population.

Because the chronological age taken alone is rarely a reliable index of the motor efficiency of a person to make a physical effort, the assessment of motor capacity is virtually related to the functional age, different from the chronological age. That mean, our chronological age does not reflect precisely our muscular abilities, because there may be

young people in physical inactivity who also suffer from defined motor loss as early aging [9]. Based on that, it is becoming more important to find out solution to slow down the pathological or premature aging process by improving the lifestyle, such as diet, activities, life choices [9,10]. One proposition is the design of the Motor Functional Age (MFA) concept by S. Boudaoud & K. Kinugawa to provide Intuitive metric to evaluate possible early muscle aging for preventing sarcopenia.

## 1.3 Physiological and anatomical bases of neuro musculoskeletal system

### 1.3.1 Anatomy of skeletal muscle

#### - *Architecture of skeletal muscle*

The human body has more than 650 muscles attached to the skeleton [6]. They provide a pulling force that allows movement. These muscles make up about 40% of the total weight of the body. Each end of the muscle is attached by a point called origin or insertion and has a contractile fleshy portion called the muscular body (Figure 1.1).

The origin corresponds to the point of attachment of the muscle to the bone, which remains fixed. Insertion is the point attaching the muscle to the bone it sets in motion. These muscles are attached to the bones either directly, or indirectly (by tendons), and work to produce the movements of the body; the muscles work together to produce the movement of a articulation, to stabilize a joint and to prevent any movement in the direction opposite to that desired [11].

The shortening of the muscle during its contraction brings both bones. As a rule, only the bone including the insertion is put into action while the bone to which the origin of the muscle is attached remains firmly in place. Skeletal muscles always have a fatigability often linked to a continuous contraction and therefore require rest phases [11].

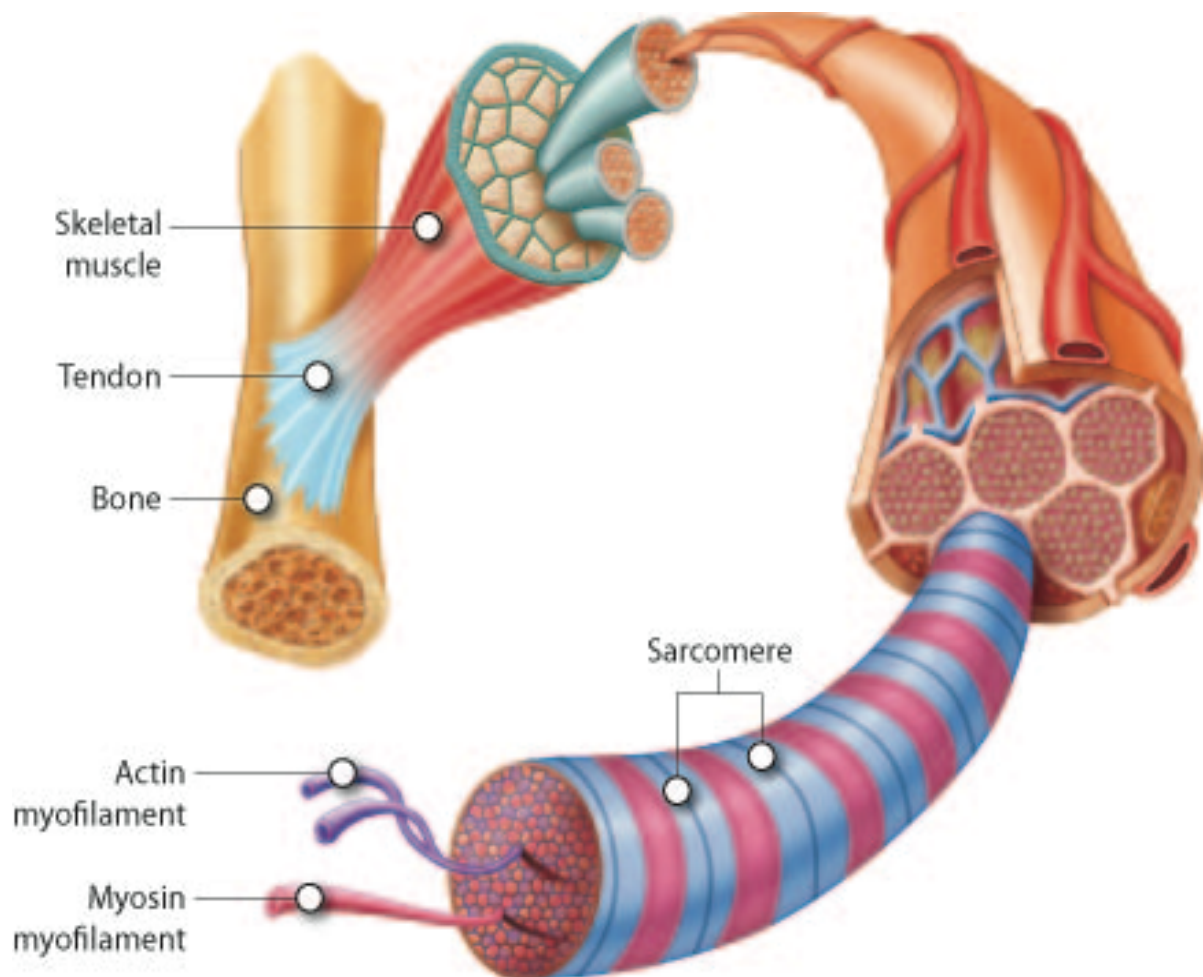

Figure 1.1: Organization of skeletal muscle

Source : <https://courses.lumenlearning.com/cuny-csi-ap-1/chapter/muscular-levels-of-organization/>

The skeletal muscles in the human body possess a diversity of shapes according to the fiber orientation whether it is in the direction of the tendon (fusiform) or at a certain angle from the tendon (pennate). In the case of a pennate muscle, the fibers are connected to the aponeurosis of the muscle [11]. Thus, the muscle fiber types vary from: fusiform, parallel, unipennate, bipennate, multipennate, circular and convergent as illustrated in Figure 1.2 where every shape has its own conveniences.

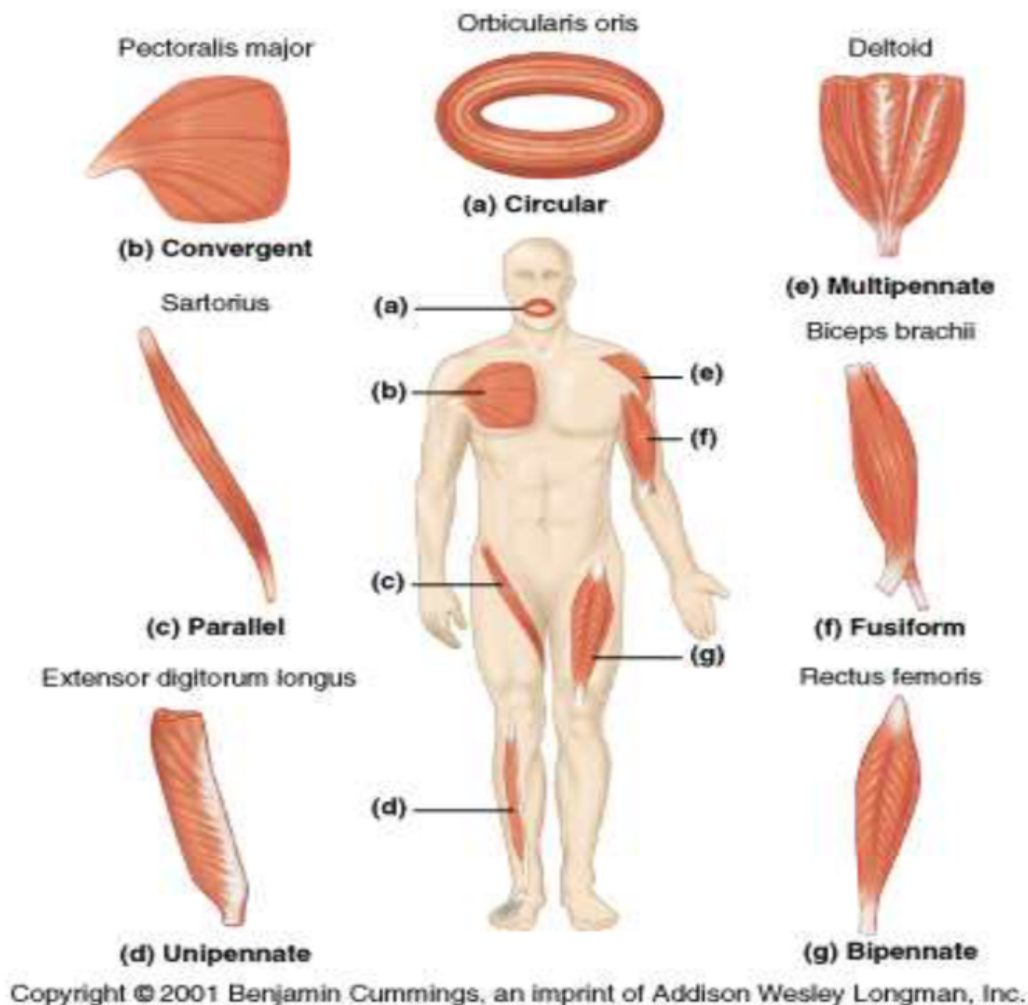

Figure 1.2: Skeletal muscle shapes photo created by © Benjamin Cummings, Addison Wesley Longman, Inc 2001).

Skeletal muscles have four essential properties:

- **Excitability:** is the property of a muscle to respond to stimulation by the production of electrical phenomena associated with ionic movements.
- **Contractility:** is the property of muscle tissue to be able to shorten following a stimulus so as to mobilize the bone elements to which it is attached; the contractions lead to shortening, thickening and hardening of the muscle.
- **Elasticity:** is the property of muscle tissue to resume its original form when the contraction stops.
- **Tonicity:** is the property of the muscle to be in a permanent state of tension (Muscle tone).



All skeletal muscles are attached to two bones by tendons, except for facial muscles. Tendons are tough band of fibrous connective tissues whose strong collagen fibers firmly attach muscles to bones. Tendons are able to withstand tension. They are put under extreme stress when muscles pull on them, so they are strong and are interlaced into the covering of both muscles and bones.

In this thesis, our interest will be focused on the skeletal muscles and more precisely the evaluation of Rectus femoris muscle (RF) abilities with aging and physical activities by analyzing our designed protocol containing multimodal data from clinical routine and research innovative tools.

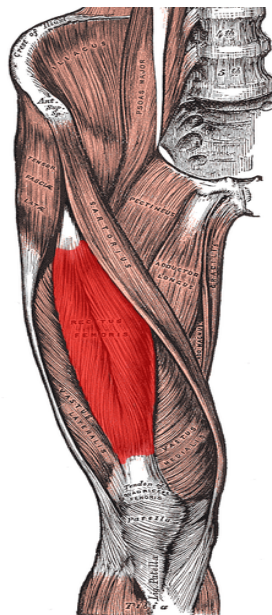

Figure 1.3: Skeletal muscle shapes photo created by © Benjamin Cummings, Addison Wesley Longman, Inc 2001).

Rectus femoris (RF) illustrated in Figure 1.3 is part of the quadriceps group. The RF is innervated by the femoral nerve. It is a bulk of muscle located in the superior, anterior middle compartment of the thigh and is the only muscle in the quadriceps group that crosses the hip [12]. It is a biarticulated muscle that contributes to 90° of knee flexion and assists iliopsoas in hip flexion, originates from anterior inferior iliac spine (AIIS) and the part of alar of ilium superior to the acetabulum. Rectus Femoris together with vastus medialis, vastus lateralis and vastus intermedius joins the quadriceps tendon to insert at the patella and tibial tuberosity (via patellar ligament). The rectus femoris is also the more superficial muscle of the quadriceps group. This helps in providing reliable electrical activity measurements using HD-sEMG technique.

- Structure of the muscle fiber

The basic unit of skeletal muscle tissue is the muscle fiber. These fibers resemble long cylindrical forms containing nuclei, mitochondria, reticulum endoplasmic and myofibrils [11]. The fibers are arranged in parallel. They measure from 10 to 100  $\mu\text{m}$  in diameter and can reach 30 cm in length [13]. Each muscle fiber is located in a membrane transparent thin called sarcolemma (Figure 1.4).

Myofibrils, occupying about 80% of the volume of the muscle fiber, are cylindrical elements, with a diameter of 1 to 2  $\mu\text{m}$  [14]. Each myofibril has a regular alternation of dark bands (A, anisotropic) and bands clear (I, isotropic), whose perfect correspondence from one myofibrilla to another gives muscle its transverse striation (Figure 1.4). In the middle of each band A, there is one more band clear: zone H (Figure 1.4). In the middle of this zone H, there is a darker streak: the band M (Figure 1.4).

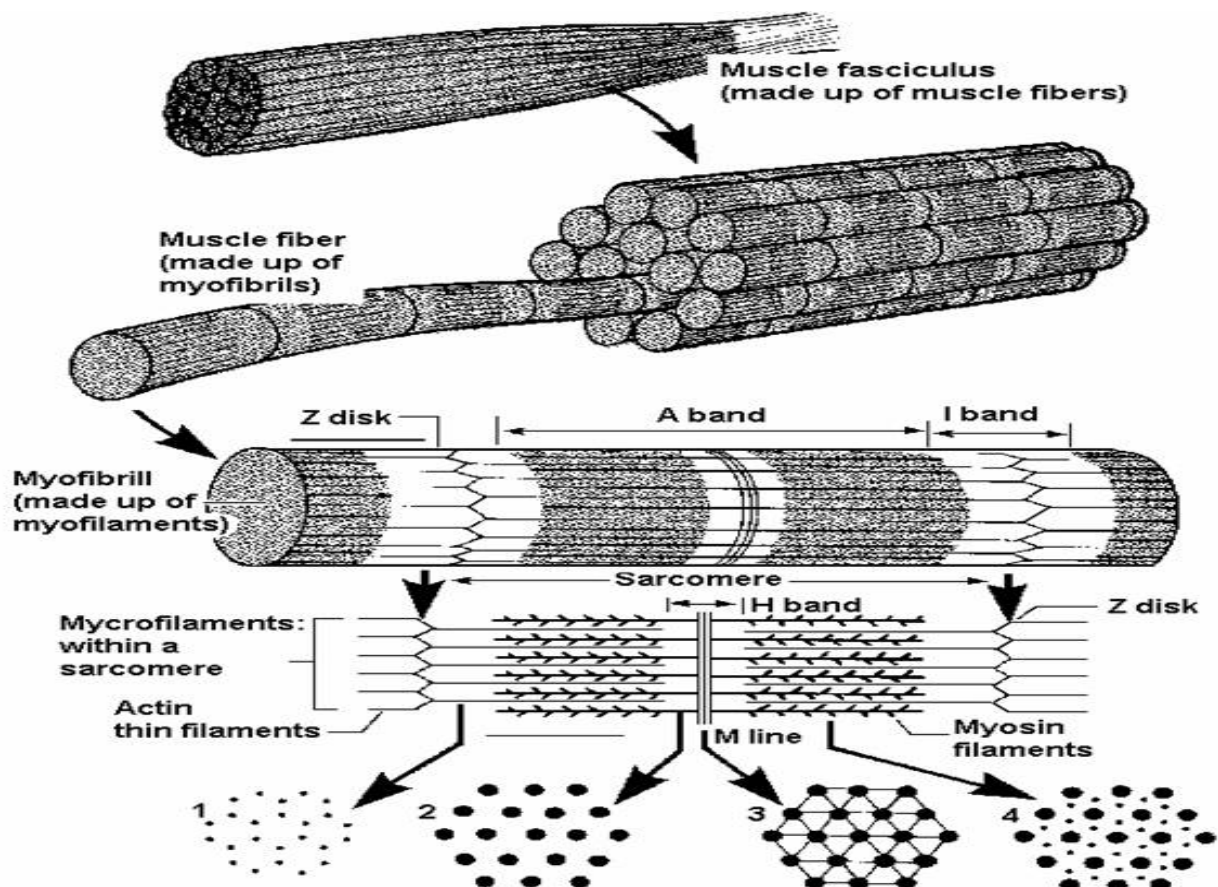

Figure 1.4: Structure of the muscle fiber [15].

In the middle of each band I, is a darker band, the line Z. Space cylindrical delimited by two consecutive Z lines is called sarcomere: this is the unit anatomo-physiological muscle. Studied under the electron microscope, the sarcomeres have two types of filaments: thick filaments and fine filaments. Filaments thick, consisting of a protein called myosin, are located at the center of the sarcomere and correspond to band A. The fine filaments, composed of a protein called actin, are attached to each end of the sarcomere at the Z-lines and arranged throughout the bands I. Bridges connecting thick filaments to fine filaments, actin-myosin bridges, are responsible for changes in muscle length to develop tension (Figure 1.4).

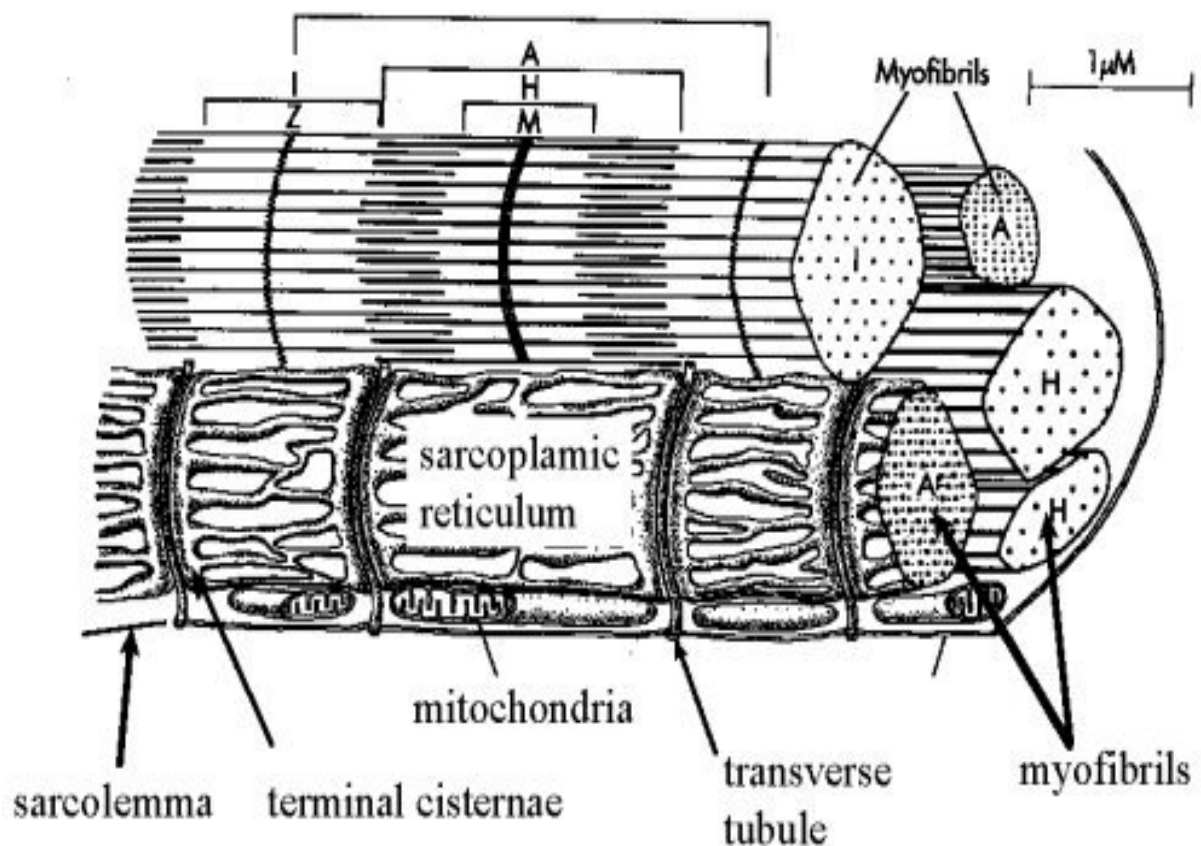

Figure 1.5: Representation of the sarcoplasmic reticulum and the tubular system transverse [16].

A network of cannulas (sarcoplasmic reticulum) travels the fiber in the direction of the length. Above each junction between the bands A and I, there is another structure tubular positioned transversely to the axis of the fiber (transverse tubule), and in contact with which the reticulum transforms into a tube (Figure 1.5). These structures contain calcium that plays an inhibitory role at the level of contraction muscular.

Several layers of connective tissue separate and protect the components of skeletal muscles. The endomysium separates each muscle fiber, the perimysium organizes 10 to 100

muscle fibers in bundles and epimysium is the outer layer that envelops all the muscle. These membranes provide collagen fibers to tissues connective tissue that attaches muscle to other structures (muscle, bone, tendons) (Figure 1.2).

### 1.3.2 Muscle fiber types

#### - *Classification of muscle fibers*

Muscles are heterogeneous organs that have great abilities adaptation. They are composed of muscular fibers of several types that are classified according to two main characteristics: their maximum speed of contraction that mean the speed at which the myosin heads are detached from the actin, and their preferential metabolism used to resynthesize ATP molecules.

In humans, the simplest and most widely used classification is that proposed by Engel [16] which is based on the staining of myofibrillar ATPase after incubation at a pH of 10.4. Due to the basic value of their pH, type I (or S, "Slow") fibers appear clear, while type II (or F, "Fast") fibers become dark due to their acidic pH (Figure 1.6).

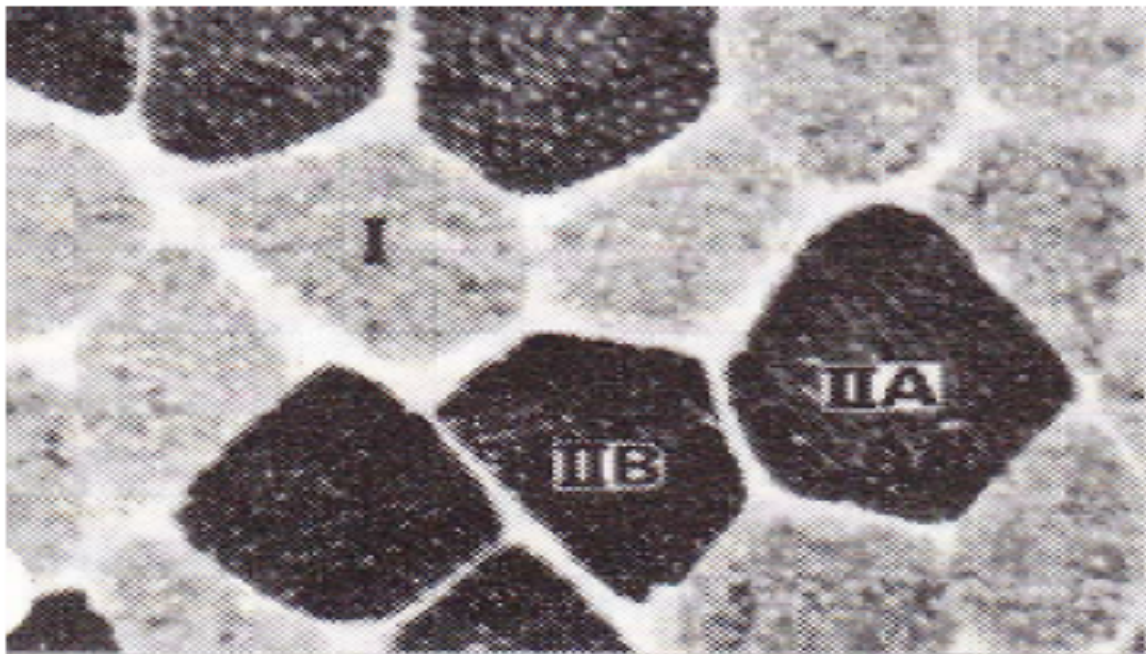

Figure 1.6: Classification of muscle fibers on the staining of myofibrillar ATPase after Eriksson 1982 [19]

Fibers II and I are in fact the old name red and white due to the presence in greater or lesser amounts of myoglobin in these fibers. Myoglobin is the equivalent of red blood cell hemoglobin muscular it allows local storage of oxygen to produce energy to/from aerobic metabolism. Type II muscle fibers are themselves subdivided into two large subgroups: the IIa (or FR, "Fast Resistable") and the IIb (or FF, "Fast Fatigable"), always at from their relative pH sensitivity [17].The existence of a third subgroup, the IIc fibers, is sometimes established through the combination of different pH of incubation. These latter have intermediate characteristics between type I fibers and type II fibers. They represent, in any case, only a very low quota (2 to 5%) of the fibers.

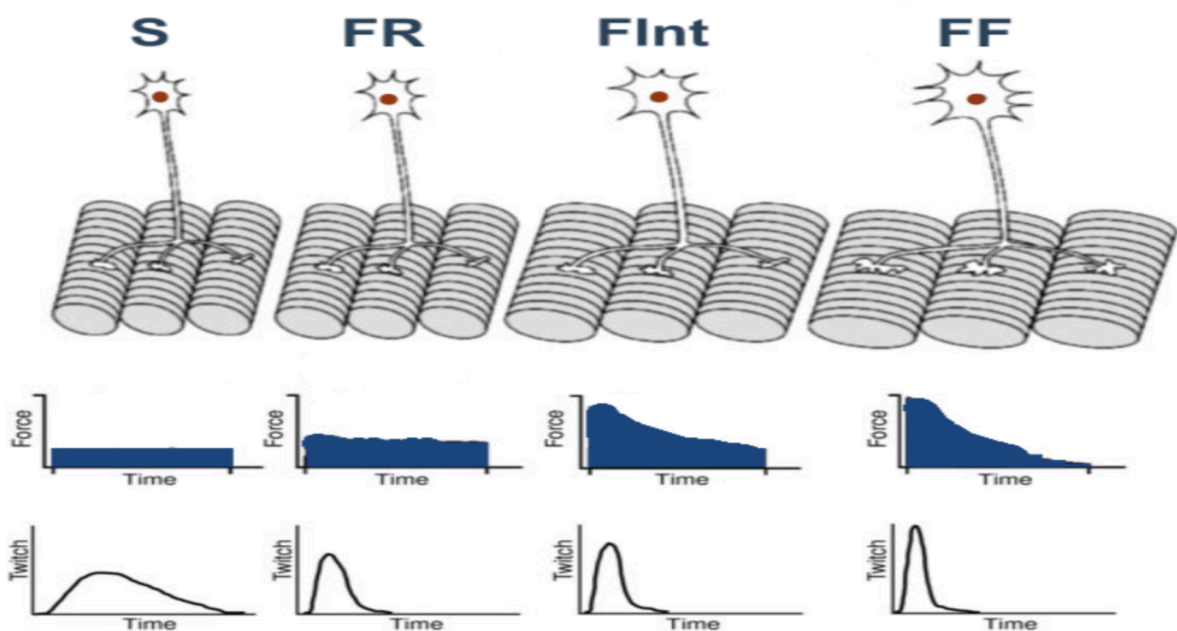

Figure 1.7: Representation of muscle fiber types conforming to their types [20]

The different characteristics of muscle fibers can be summarized below (Figure 1.7):

- **I fibers** are very slow (sarcoplasmic reticulum not very developed, so weaker capacity to transmit the action potential), very weak at the force level (weak number of myofibrils), but also more enduring (preferential use of metabolism aerobic because they have many capillaries, mitochondria and myoglobin).
- **IIa Fibers** are intermediate fibers between types I and IIb, therefore moderately fatigable, moderately strong and moderately enduring. The muscle, undergoing sustained training, undergoes modifications of the fiber type which relate to its

structure and its metabolism. Whatever the training modality adopted, the effects relate only to the muscular groups in particular need and, for a given muscle, they are particularly interested in the fibers that are particularly involved.

- **IIb fibers** are extremely fast and strong (large diameter and reticulum highly sarcoplasmic, large number of myofibrils) and very fatiguing (because essentially glycolytic).

Moreover, the modifications of muscle fibers typology obtained depend on the intensity of the exercise. In addition, with aging, there is a loss of muscle, associated with a decrease in the type of fibers II, which may be due partly to less physical activity [10,18].

- *Generation and propagation of fiber action potential*

The excitation of muscle fiber can be explained by the model of a semi-permeable membrane describing the electrical properties of sarcolemma [19]. The balance ionic between the inside and outside of a muscle cell produces a potential, said resting potential, for the muscle fiber membrane (approximately -70 to -80 mV). This potential difference, which is maintained by physiological processes (ion pump) leads to a negative intracellular charge compared to the external medium. The Activation of an alpha motor neuron (induced by the central nervous system or by reflex) causes conduction of excitation along the motor nerve. After release of transmitters at the motor plate, a motor plate potential is formed on the muscle fibers innervated by this motor unit. The diffusion characteristics of the membrane of muscle fibers are briefly changed, and Na<sup>+</sup> ions enter. If a threshold level is exceeded, depolarization of the membrane causes an action potential (AP) and the potential difference changes rapidly from - 80 mV to +40 mV (Figure 1.8). It is a monopolar electrical burst that is immediately followed by a repolarization phase, then a period of hyperpolarization of the membrane by return of ions thanks to the active ion pump mechanism.

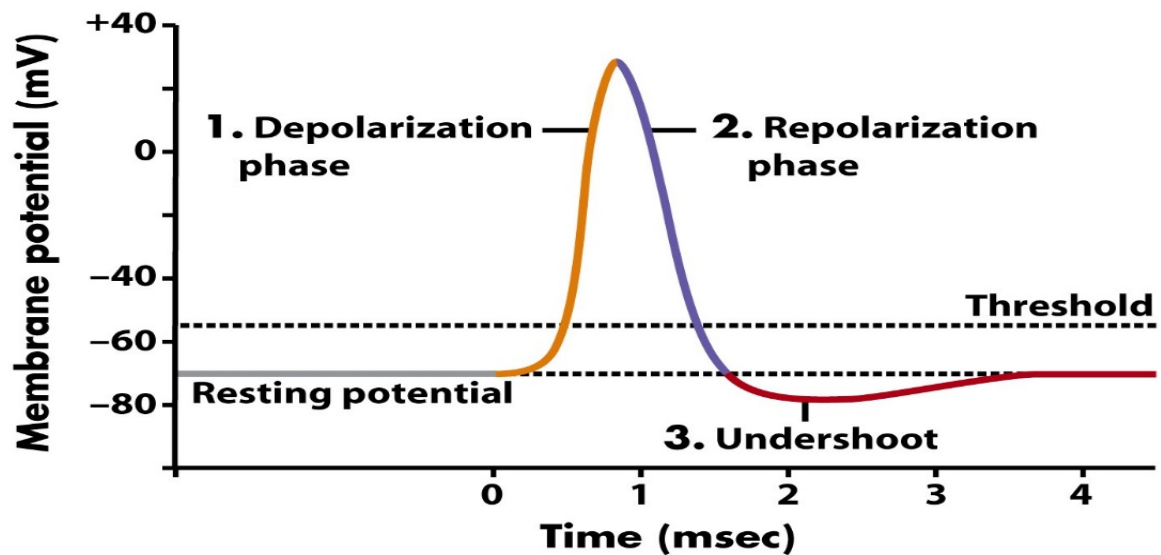

Figure 45-5 Biological Science, 2/e  
© 2005 Pearson Prentice Hall, Inc.

Figure 1.8: Action potential (image from © Pearson prentice Hall, Inc 2005).

### 1.3.3 Motor units

All the muscle fibers of a muscle are innervated by the axons of the nerve motors emanating from the anterior part of the spinal cord. Every motor nerve or motor neuron innervates several muscle fibers. On the other hand, a muscle fiber is innervated only by a single motor neuron. The set formed by a motor neuron and fibers that it innervates is called the motor unit (UM) (Figure 1.9). It is the smallest muscular functional unit because the smallest muscle contraction result in fact from the activation of a single motor unit. The connections between Axonal endings of motoneurons and muscle fibers, called the junctions neuromuscular or motor plaques, usually occur in the middle of the muscle, and all these junctions form the driving point [20]. MUs vary among themselves by:

- **their fiber type:** an UM contains a single type of fiber muscle (I, IIa, IIb); this will have an influence on both the speed of contraction of the UM but also on its ability to resist fatigue;
- **their number of muscle fibers:** more the motor neuron innervates muscular fibers, more the strength that UM can develop will be important;
- **the size of the motor neuron that innervates muscle fibers:** its diameter is important, the faster the conduction velocity of the impulse, but the more sensitive it is to the nerve impulse is weak (it will take a higher intensity of discharge to succeed in excite it because its sheath of myelin, an insulator made of fat, is thicker).



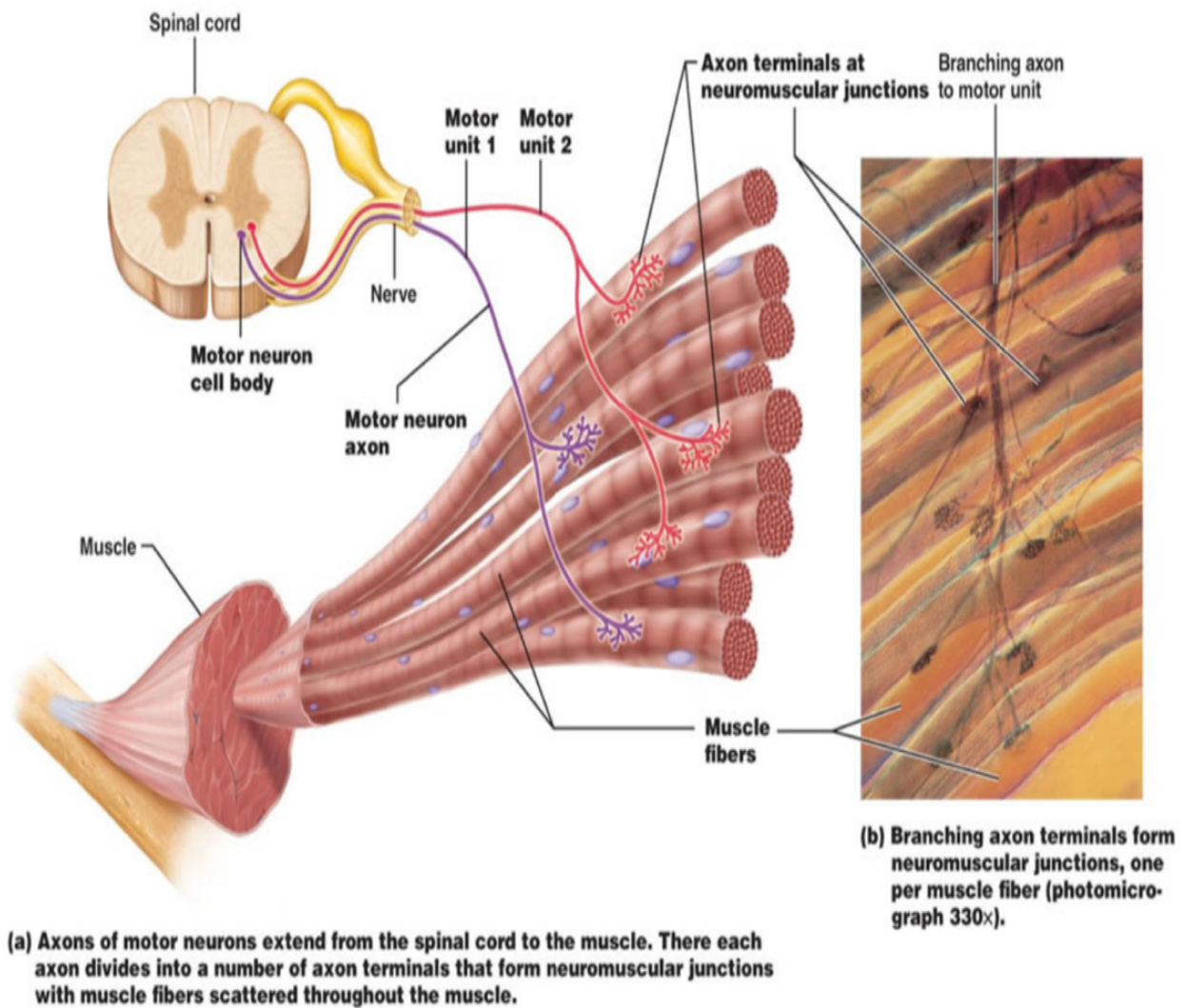

© 2013 Pearson Education, Inc.

Figure 1.9: Representation of Motor unit (image from © Pearson Education, Inc, 2013).

There are therefore several types of motor units which characteristics are related to both the number and the quality of the muscle fibers that compose them. Thus, the same nomenclature used for muscle fibers can be used as Type I motor units and Type II motor units. During the stimulation of a motor neuron, the totality of the fibers of a UM is excited and the fibers therefore contract all at the same time ("all or nothing" law) [20,21]. This organization allows, instead of the total contraction of a muscle, a progressive and successive activation of muscle fibers, motor unit per motor unit, and thus the adjustment of the force necessary for the activity.



### 1.3.4 Muscle contraction

- *Mechanism of muscle contraction*

The mechanism of muscle contraction is based on two theories: the “sliding filament” theory and “the cross-bridge theory” to the production and propagation of action potential (AP) in the fibers (Figure 1.10).

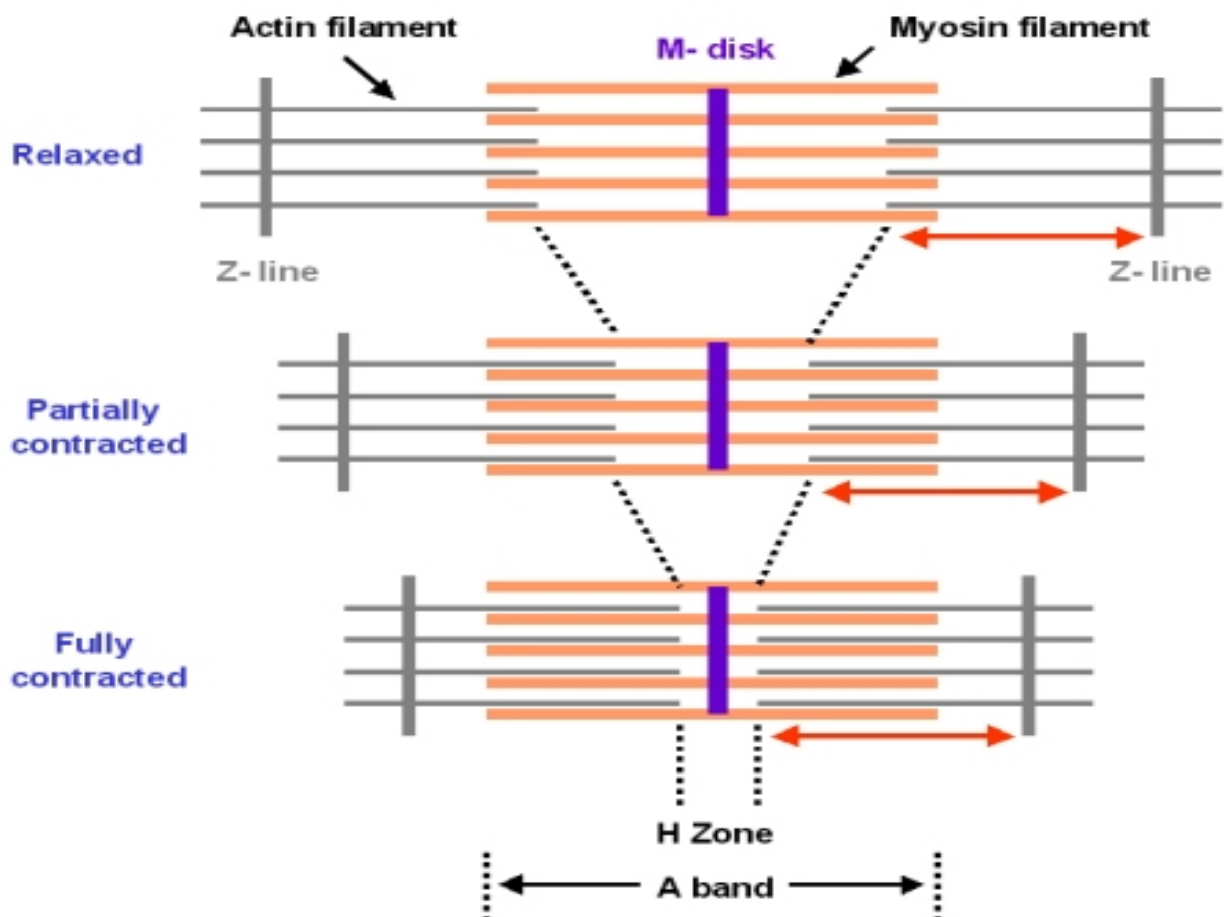
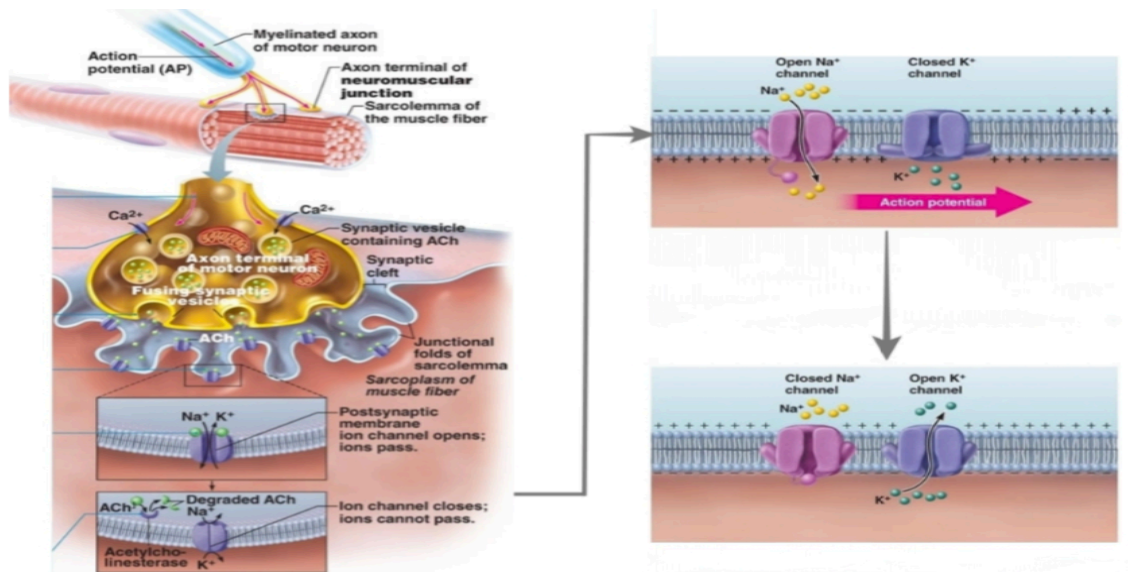

Figure 1.10: The theory of sliding filaments: behavior of actin filaments in relation to the myosin filaments during relaxation (top), partially contracted (in the middle), and fully contracted (at the bottom) After (Huxley, 1956) [23].

The muscle fiber excitation phase begins by the arrival of AP at the axon’s terminal which causes the release of Acetylcholine (ACh) following the penetration of  $\text{Ca}^{2+}$  ions in the axon’s terminal (Figure 1.11). Then, the ACh binds to the sarcolemma receptors which induces the opening of ion channels. Then, Sodium ( $\text{Na}^{2+}$ ) ions enters and Potassium ( $\text{K}^{+}$ ) ions exits the muscle fiber. This variation in the ions concentrations changes the membrane potential (end plate potential) which causes the depolarization of the membrane and the propagation of the AP at the sarcolemma. The second phase of muscle contraction, the excitation-

contraction phase, Following the propagation of the AP along the sarcolemma, the AP travels down the T tubule where the voltage sensitive proteins lead to the opening of  $\text{Ca}^{2+}$  channels and the releasing of  $\text{Ca}^{2+}$  in the sarcoplasmic reticulum. Thus, the  $\text{Ca}^{2+}$  ions concentration in the sarcoplasmic reticulum increases and the  $\text{Ca}^{2+}$  ions start to bind to the troponin of the actin filaments. When the  $\text{Ca}^{2+}$  binds to the troponin, it causes it to change shape exposing binding sites for myosin and the sliding filaments phenomenon responsible for muscle contraction begins (Figure 1.11) [22].



(a) The calcium dynamics at the terminal-sarcolemma border.

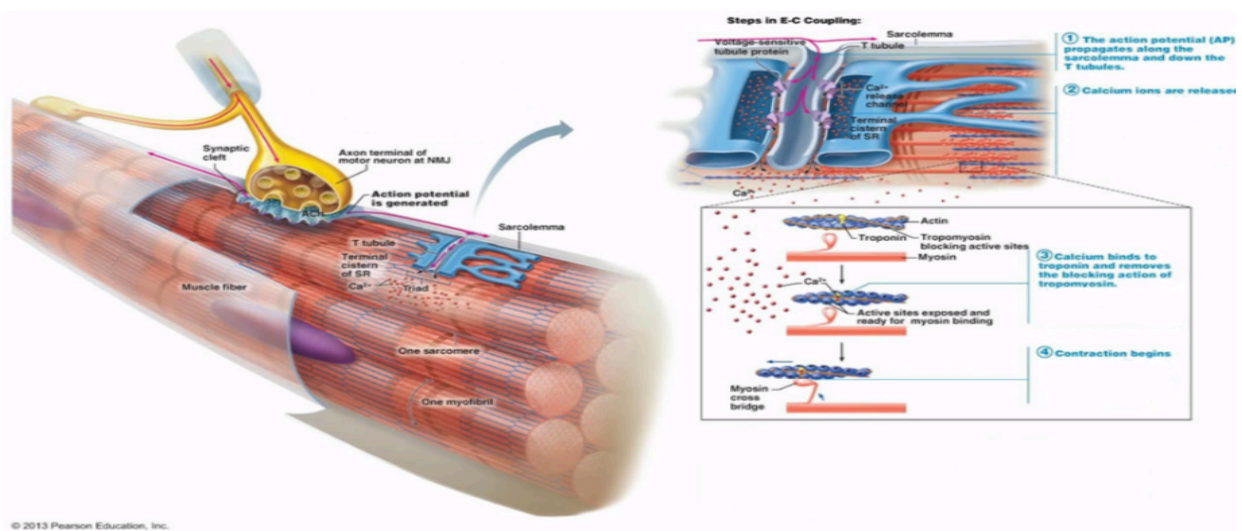

(b) The dynamic of AP propagation in the fiber.

Figure 1.11: The component of muscle contraction (image from © Pearson Education, Inc, 2013).

The current theory of how muscles create internal tensions (forces) is the "sliding filaments" developed by Huxley, and based on Hanson and Huxley's model [23]. She stipulates that, during muscle contraction, the actin filaments slip between the myosin filaments (Figure 1.11).

When a myosin head attaches to an actin filament, forming an actine/myosin bridge, and move, the two filaments slide on one another. Myosin heads and bridges thus formed undergo a change of spatial configuration, as soon as the heads Myosin binds to the active sites of the actin filaments. The bridge arm thus established and the myosin head exert a very strong molecular attraction that brings the head of myosin to tilt towards the center of the sarcomere, thus causing the actin filament [23].

This oscillation is at the origin of the power generation by the muscle. Immediately after the oscillation of the myosin head, it leaves the active site, returns to its original position and attaches to the next active site on the actin filament. These successive bonding and the generated power allow the filaments to slide one on the other, hence the name slippery filament theory.

This process continues until the distal ends of the myosin filaments reach the Z streaks. During this phase of sliding and contraction, the opposite actin filaments of the same sarcomere come closer together from each other and enter Zone H until they overlap at the ultimate stage. When this occurs, zone H is no longer visible.

When the muscle fibers are at rest, the head of myosin remains near an active site of actin but the molecular binding is inhibited by tropomyosin. This sliding is the result of the formation of bridges of union between the heads of myosin and some actin filament sites, with a chemical reaction (hydrolysis of adenosine triphosphate, ATP) which releases the energy necessary for the attachment of the heads of myosin and, therefore, makes it possible to exert traction on the fine filaments for slide between the thick filaments. So, it occurs in the muscle a transformation from chemical energy to mechanical energy.

#### - *Types of muscle contraction*

The muscle contraction type can be divided according to the variation of muscle length or the produced force (Figure 1.12).

Based on muscle length variation the muscle contraction is usually divided into two main classes [15]:

- **Isometric contraction**, during which the muscle length does not change when the muscle generates tension. However, we can also observe changes in the muscle shape due to the shortening of the contractile element.
- **Anisometric contraction** also called dynamic contraction, implies that the muscle length changes during the contraction causing also a deformation of the muscle shape due to both length variation of the contractile element and the tendons. This type can be further broken down into two subtypes:
  - **Anisometric eccentric contraction**: described by a lengthening of the muscle during contraction.
  - **Anisometric concentric contraction**: distinguished by a shortening of the muscle during contraction.

Based on the force produced, we can distinguish between:

- **Isotonic contraction**: which is the type of contraction obtained when the generated force does not change along the contraction time.
- **Anisotonic contraction**: which is attained when the generated force changes all along the contraction.

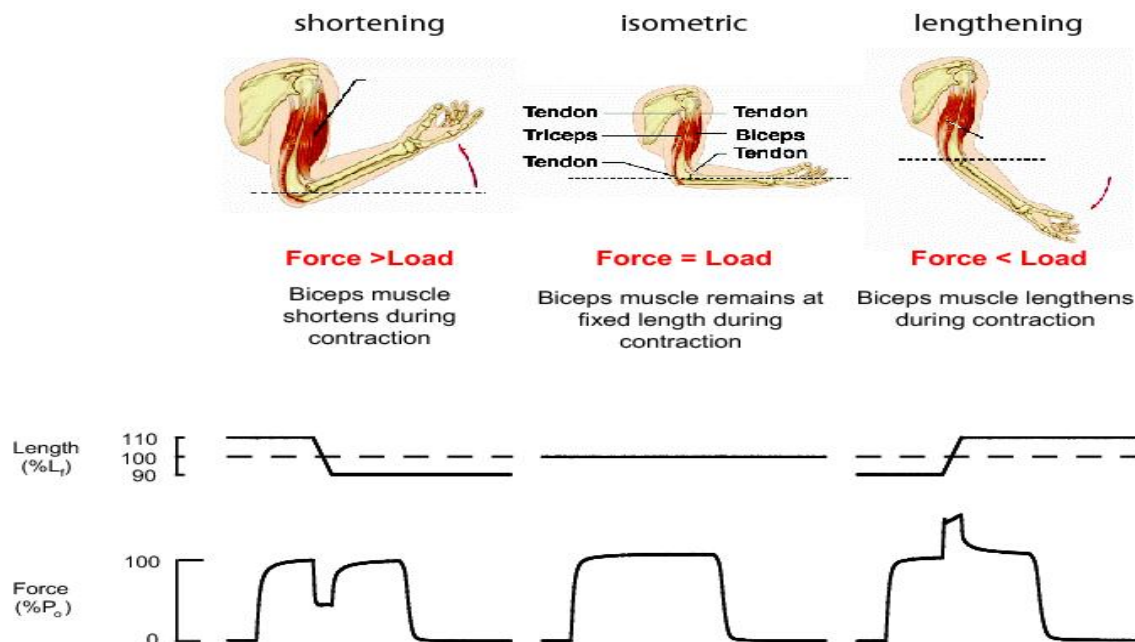

Figure 1.12: Types of muscle contraction [26].

In this thesis work, the proposed study will concern dynamic contraction from Rectus Femoris muscle during Sit To Stand motion (STS).

## 1.4 Aging of musculoskeletal system

The origins of skeletal muscle aging are multifactorial and common to all mammals, especially at the cellular level [24]. Other factors contribute to the loss of muscle tissue, such as a decrease in anabolic function and, possibly, a concomitant increase in catabolism [25]. Hormonal, metabolic, immunological, genetic, circulatory and nutritional factors all have important effects on the inherent alterations of the molecular factors that regulate muscle protein balance [26]. A reduction of the muscular mass implies at the same time a decrease in the size of the muscular fibers thus an atrophy, and a decrease of their number thus a hypoplasia [27,28]. This observed hypoplasia impacts all the muscle fibers. Thus, there is a decrease in the overall quality of cells but also in the structure and function of muscle proteins. This mainly affects fast fibers, which tends to reduce the quality of muscle tissue [29]. The aging in human body can be evaluate in different levels and sites, depending the aim of our assessment, the Figure 1.13 below resume the various factors responsible for changes with aging.

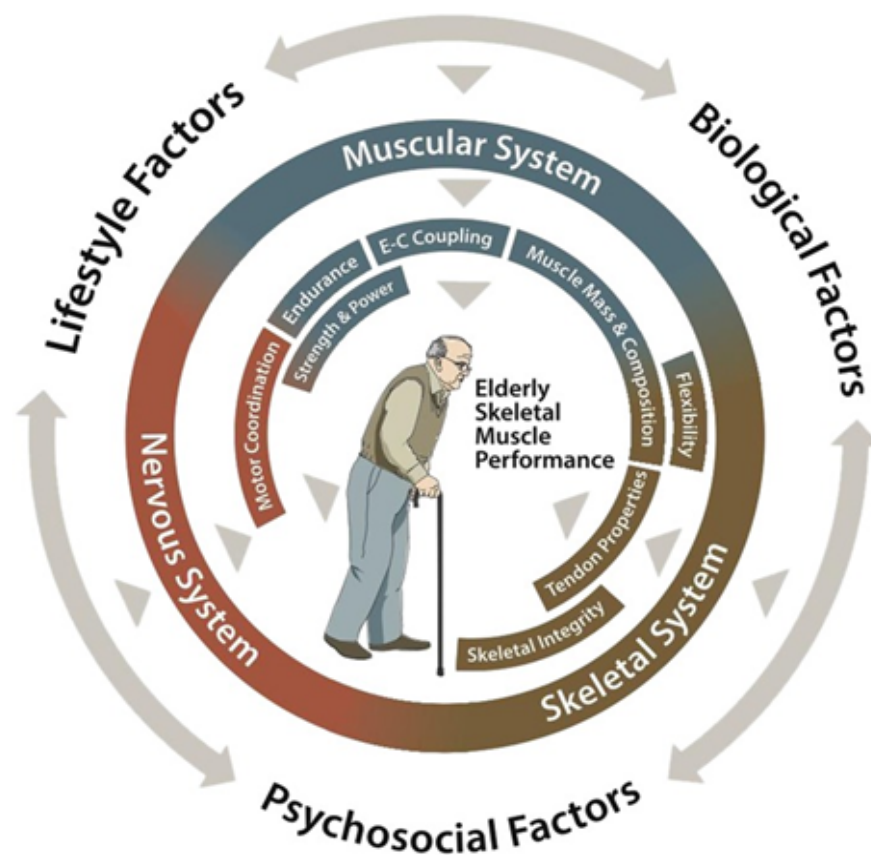

Figure 1.13: The several factors responsible of age age-related changes. Diagram by Tim Goheen,

Source : <https://www.ncbi.nlm.nih.gov/pmc/articles/PMC5803609/figure/jcsm12238-fig-0001/>

### 1.4.1 Effect of age on muscle mass and typology

The aging has been associated with a loss of muscle mass. According to longitudinal studies in people aged 75 years or over [30], muscle mass decreased by 0.64–0.70% per year in women and 0.80–0.98% per year in men.

The literature agrees that the decrease in muscle mass would be accentuated from the 4th decade [31–33]. Some authors suggest that 50% of muscle mass can be lost in 4 decades from age 40 [34,35]. It has also been suggested a decrease from the 3rd decade but this becomes substantial from the age of 50 [36]. Age-dependent changes in muscle mass have been proposed by creating periods for mass increase, maintenance, and decrease (Figure 1.14). The authors also specify in this figure the interindividual differences in this evolution [37] according to diet and lifestyle. The lower line (Figure 1.14) represents the early muscle loss that can occur with poor diet, disease, and lack of physical activity. The upper line shows how we can maintain the independence and function as you achieve 60 years old and beyond if you work at it. Indeed, there may be huge disparities in peak muscle mass in adulthood, around 25 years of age [38].

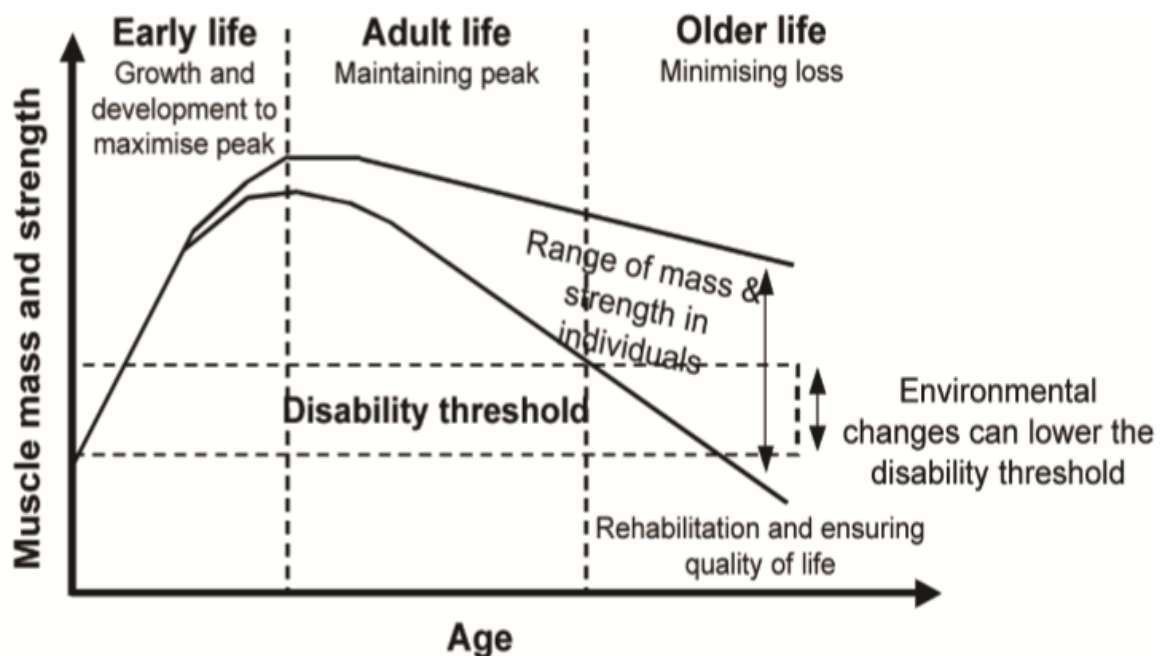

Figure 1.14: The potential muscle gain and loss during our lifetime [38]

The loss of muscle mass does not appear to reach all muscles in the same way [39,40]. Indeed, by observing the entire body of 468 people aged 18 to 88 years, the decrease in muscle mass is greater in the lower limbs [41]. A 12-year longitudinal follow-up of 9 men aged 65.4 years at the start of the study shows that the muscle section area of the flexors and extensors of the knee and elbow decreased by approximately 15% under effect of time [42]. Indeed, the decrease in muscle mass is greater in men compared to women with aging. A study comparing 148 women and 136 men shows that skeletal muscle mass is halved for men compared to women [43]. However, men generally have a greater muscle mass and a shorter life span than women do [2]. This implies that women will be more impacted by aging on their muscular mass particularly after menopause and therefore on their quality of life [44]. Men will live a constant decline in their muscle mass while women may have a sudden decline after menopause [45,46].

These remarks are to put into perspective because a recent Australian study shows no difference between men and women. In fact, of 8582 adults aged 25 to 91, the percentages of muscle loss are about 11 to 15% for both gender [22]. The knee extensors were the main affected muscles. Thus, a longitudinal follow-up of 8.9 years involving 12 people aged 71 at the beginning of the experiment, shows a significant decrease of 5.7% in the muscular section area of the quadriceps [29]. It has nevertheless been observed that the decrease in muscle area is the same for the 3 large muscles of the quadriceps [47]. Indeed, during a longitudinal follow-up of healthy older people, the sectional area of the lateral vastus muscle had not decreased [48]. The study of the decline in muscle mass depends on the population and muscles studied and the techniques used.

The size of the muscular fibers as well as the evolution of the number or the proportion by type of fibers that can be observed are parameters evolving with the age [30]. The size of muscle fibers appears to be affected by age in cross-sectional studies comparing young and old populations, with 10–40% smaller type II fibers observed in the older as compared with young adults [49]. In contrast, type I muscle fiber size seems to be largely sustained with aging. Many studies have indicated a preferential loss of type II fast-twitch fibers and age-related remodeling [27,50,51].

A recent studies has performed biopsies and histological differences between young and older persons [52,53]. An example is shown in Figure 1.15, it is clear that the older person has less Type II muscle fibers and more Type I fibers than the young person.



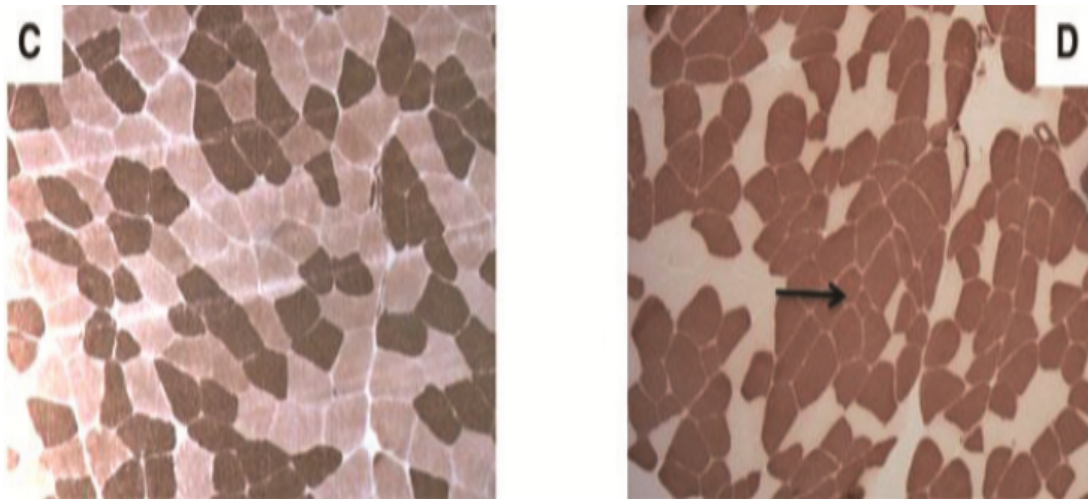

Figure 1.15: Histological sections stained for myosin-ATPase obtained from the vast lateral for a 25-year-old subject (C) and a 75-year-old subject (D) with type I (dark spots) and type II fibers (light spots) [50]

The primary cause of skeletal muscle loss is the disorder in the regulation of skeletal muscle protein turnover, leading to a negative balance between muscle protein synthesis and muscle protein breakdown [54]. In addition to changes in the protein turnover processes, there are several other physiological contributors to reduced muscle quality such as changes in the muscle architectural structure [55], including the change in the elastic fibers system and an increase in fat infiltration of skeletal muscle [56]. The intermuscular adipose tissue was observed to increase 30% in the mid-thigh for women and nearly 50% for men, in a five-year longitudinal study of older adults between 70 and 79 years. It should be noted that large variation of standard deviations over time were noted [57]. Interestingly intermuscular adipose tissue has been shown to be associated with the loss of physical performance and limited mobility in older adults [18,58]. Indeed, the aging changes in the grip strength is a key component of the sarcopenia and frailty phenotypes, a study from 60,803 observations from 49,964 participants (26,687 female) of 12 general population studies in Great Britain demonstrated three overall periods: an increase to peak in early adult life, maintenance through to midlife, and decline from midlife onwards [59]. Moreover, the loss of muscle mass has been related to several chronic affections, including insulin resistance and arthritis, osteoporosis [60]. Indeed, the loss of muscle fibers number is the principal cause of sarcopenia, although fibers atrophy particularly among type II fibers appears to be more pronounced than that of Type I fibers [61,62,49,52].



## 1.4.2 Effect of age on motor unit recruitment

The reduction in the number of motor units is one of the most cited processes among all the processes undergoing the effects of age. A motor unit is defined by a motor neuron associated with several muscle fibers. The discharge frequency of a motor neuron is a reflection of all the discharges of action potentials that reach it [63–65]. The variation of the number of motor units with age is visible in Figure 1.16. There is a decrease beginning in the 5th decade. Associated with this decrease in the number of motor units, incomplete re-innervation is observed [52,63,64,66]. The decreases in the number of motor neurons and in the number of motor units in older people compared with younger adults have a similar magnitude [67]. Despite this agreement, no cause effect relationship between the loss in the number of axons in motor nerves and the loss in the number of motor units or muscle fibers has been established in human [20].

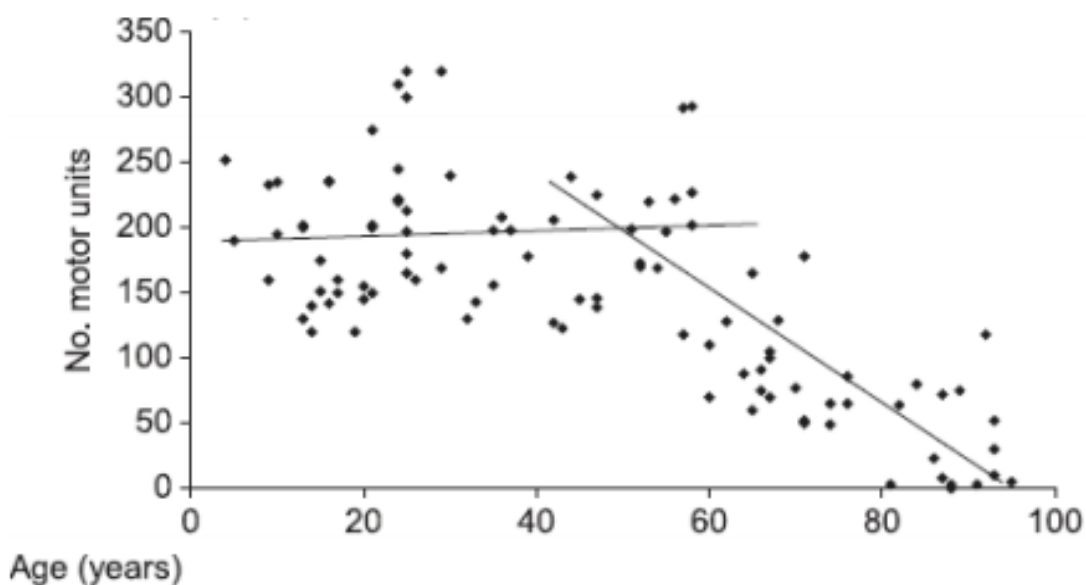

Figure 1.16: Relationship between total number of motor units and age for men aged 18 to 82 [31]

## 1.4.3 Effect of age on muscle contraction (Excitation-contraction coupling)

Excitation–contraction coupling (E-CC) is implicated in the physiological processes that convert the neural signal for muscle activation (i.e. the muscle fibers action potential) into muscle contraction and therefore into force development. To observe a failure of the corticospinal motor pathway with age, electrical stimulation of the corresponding nerve or

muscle is used while the subject performs a maximal voluntary contraction to evaluate the "added force" [68]. It has been repeatedly found that the level of voluntary activation decreases with age and also with the level of frailty of people [69–72]. The measurement of motor potentials evoked by transcranial magnetic stimulation (TMS) is a tool for stimulating neurons in a specific brain region under the cranial box. This technique quantifies intracortical responses via electroencephalography and spinocorticals via electromyography to a stimulus [73].

Studies using this technique suggest that with advancing age intracortical or corticospinal communications would be less and less excitable [74–76]. The studies in this area suggest that with advanced age the corticospinal pathway is likely to have less ability to stimulate motoneurons or optimize synchronization of a motoneuron pool [52,76]. All of this information tends to show that there is a reduction of the signal from the main driving path from a qualitative or quantitative point of view towards the motor units. This results in a decrease in the number of motoneurons recruited in the spinal cord and a reduction in their speed of stimulation.

These findings assume that excitation–contraction uncoupling contributes significantly to the reduction in muscle contraction quality observed with advancing age and highlights the processes in the E-CC pathway as a potential therapeutic target. In addition to changes in the E-CC processes, there are several other physiological contributors to reduced muscle contraction quality taking account muscle energetics, the vast majority of studies have focused on the effects of aging on mitochondrial function (i.e. aerobic metabolism). Mitochondria are important cellular organelles that are responsible for the production of energy by both aerobic and anaerobic respiration and oxidative phosphorylation.

Cross-sectional evidence from 74 healthy men and women aged 18–90 years indicates that age is negatively correlated with vastus lateralis mitochondrial DNA. There is clear that aerobic capacity, measured by the peak treadmill oxygen consumption (peak VO<sub>2</sub>) [77], which is the maximal ability to use oxygen to meet the energy needs of physical activity, may decline at an accelerated rate already after the age of 20, with a rate up to >20% per decade in community-dwelling men and women over 70 [77].

This decline may result in lower mitochondrial muscle protein synthesis rates in older adults [78]. Not only the mitochondrial content is important for older skeletal muscle performance, the mitochondrial function (i.e. the ability to produce ATP) is important as well

[79,80]. Furthermore, almost of these studies were performed in healthy older subjects, whereas no data are accessible on frail older. More research is recommended to illustrate the impact of aging on the mitochondrial capacity in the older and their impact on muscle contraction performance.

#### 1.4.4 Environmental factors responsible of muscle decline during aging

##### - *Physical activity*

Functional muscles abilities gradually decline with age, resulting in the decrease ability to perform physical activities such as walking or cycling.

A longitudinal observational study reported a significantly decrease in 6 min walking distance (-11%) in healthy older after 3 years of follow up, indicating a decrease in aerobic capacity [81]. The practice of physical activity also influences the amount of muscle mass [10,18]. A study of 2425 people aged 63 years on average shows that there is a positive relationship between the amount of aerobic exercise and the muscle mass index of non-obese people [82]. Practice of physical activities across the life course has many advantages, including increased longevity. Resistance-type exercise training is currently the most effective intervention to initiate muscle hypertrophy and to improve muscle strength and physical performance [10,25]. A total of 49 randomized intervention studies showed that after an average of 20.5 weeks of resistance-type exercise training, older people gained 1.1 kg of lean body mass [83]. Although resistance exercise is effective in maintaining, and in many cases improving, muscle mass and strength, aerobic exercise is also important in maintaining optimal skeletal muscle performance.

Furthermore, physical activity has multiple other benefits in older age. These include improving physical and mental capacities (for example, by maintaining muscle strength and cognitive function, reducing anxiety and depression, and improving self-esteem); preventing disease and reducing risk (for example, of coronary heart disease, diabetes and stroke); and improving social outcomes (for example, by increasing community involvement, and maintaining social networks and intergenerational links) [1]. In addition, the exercised muscles become more sensitive to nutrients, allowing more of the available amino acids to be synthesized into muscle protein [82]. In sedentary older subjects, however, the sensitivity of skeletal muscle tissue to anabolic stimuli such as physical activity or protein intake might be

reduced [84]. It could be speculated that a sedentary lifestyle is responsible for the anabolic resistance to physical activity and protein intake in frail older people [85].

Indeed, during physical inactivity, skeletal muscle atrophy is substantially accelerated. It has been demonstrated that the immobilization and bed rest experiments induced a substantial muscle mass loss of 1 kg in 10 days [86,87]. This substantial loss of skeletal muscle mass is led by a major decline in strength ranged between 0.3% and 4.2% per day [88,89]. As a consequence, multiple episodes of prolonged muscle disuse atrophy accelerate the degradation of muscle performance and physical performance and, as such, increase the risk for physical disability at later life. The common effects observed among the older: decreased strength and power contribute to the high incidence of accidental falls and can compromise quality of life.

- *Nutritional diet*

The aging process is accompanied with a decline in appetite and food intake known as anorexia of aging [90]. Anorexia is defined as eating disorder characterized by an abnormally low body weight [90]. The progressive loss of vision and hearing, as well as osteoarthritis, may limit mobility and affect older people's ability to shop for food and prepare meals. Along with these physiological changes, aging may also be associated with profound psychosocial and environmental changes, such as isolation, loneliness, depression and inadequate finances, which may also have significant impacts on diet. Malnutrition is strongly related to a decline of dietary protein intake and micronutrient intake.

Adequate dietary protein intake is a key factor for maintaining skeletal muscle mass in the older [90]. The amount of protein intake, the distribution, and the source of protein intake are all important to maximally stimulate postprandial muscle protein synthetic response and muscle mass accretion in the older [91]. Indeed, the Health ABC study showed that older people consuming a daily protein intake of 0.8 g/kg-body weight/day lost a dramatic 40% more muscle mass compared with older who consumed 1.2 g/kg-bw/day of protein [92].

Tieland et al [91] observed that habitual dietary protein intake is between 0.8 and 1.1 g/kg-bw/day in older, demonstrating the lowest intakes in institutionalized and hospitalized older people. Recent consensus statements recommended that protein intakes between 1.2 and 1.5 g/kg-bw/day may be necessary to slow down the loss of muscle capacities in the older [88,93–95].

In addition, several studies suggest that malnutrition was between 11% and 19%, and found that it was accompanied by deficiencies of vitamins C and D, and low levels of carotenoids [88,94,96].

## 1.5 Sarcopenia

Sarcopenia defined progressive and generalized skeletal muscle disorder with accelerated muscle mass loss and function, associated with a negative prognostic effect on falls and declining physical performance, disability and mortality risk [97]. Sarcopenia is highly prevalent among older subjects [37]. Age-related muscle loss is the result of a progressive atrophy and loss of type II muscle fibers, motor neurons and muscle lipid infiltration. Further, poor diet and reduced physical activity accelerate age-related muscle loss, and the frequency and severity of sarcopenia increase dramatically in the presence of several co-morbidities, such as osteoporosis, type 2 diabetes, advanced organ failure, and chronic inflammatory states [98]. Due to the high risk of serious negative health outcomes, including disability and death, sarcopenia is considered a major contributor to healthcare costs and even a small reduction of its prevalence might be expected to produce relevant savings in health-care resources [36].

The European Working Group on Sarcopenia in Older People (EWGSOP) developed a clinical definition and consensus criteria for the diagnosis of sarcopenia, relying on specific and easily identifiable parameters (EWGSOP2 definition) [97]. The variables to be measured to this purpose are muscle mass, strength, and physical performance. The EWGSOP recommends defining sarcopenia as the presence of both low muscle mass and low muscle function.

For these reasons, in the last decade an increasing number of clinical trials have tested the ability of a variety of interventions, including physical exercise, dietary supplementation, and pharmacological treatments to reduce sarcopenia, with promising but still limited evidence of efficacy [97]. One of the major issues that must be faced to obtain stronger evidence, to be ultimately translated into clinical practice, is the availability of a consensus on sarcopenia definition and case finding, as well as of reliable, valid, non-injurious, and affordable measures of muscle mass for the diagnosis of sarcopenia [99].

## 1.6 Evaluation of muscle functional abilities by using multimodal data analysis

### 1.6.1 Measurements of muscle function in clinical routine

#### - *Handgrip strength*

Hand grip strength is the widely used method to evaluate muscle strength in clinical practice [100]. The measurement of handgrip is performed with 3 types of dynamometer: hydraulic dynamometer (e.g. Jamar®, considered as the best reference of this evaluation) as mentioned in Landy study [101], pneumatic [e.g. Martin vigorimeter with units in millimeters of mercury (mmHg) or pounds per square inch (psi)] which measure grip pressure, mechanical [e.g. Harpenden dynamometer with units in kg or lbf] and strain dynamometer [with units in Newtons of force (N)]. Dynamometers have to be calibrated appropriately by manufacturer prior using it [100,102]. It is recommended to use standardized measurement protocols such the Southampton protocol, proposed by Roberts et al [102], the standardization include seating the subject in a standard chair with forearms resting flat on the chair arms. The testing nurse or physician should demonstrate the use of the dynamometer and show that gripping very tightly registers the best score. Six measures should be taken, 3 with each arm. Ideally, the patients should be encouraged to squeeze as hard and as tightly as possible during 3–5 s during each of the 6 trials; usually the highest reading of the 6 measurements is reported as the final results [100,102]. The measurement is easy to perform, the device is portable, with an acceptable cost, and does not require a specialist trained user. Because of the ease of its application, grip strength measurement can be used in clinical practice, and thus, can be applied in a large sample of older adults, symptomatic or asymptomatic, to identify those with low muscle strength [100].

#### - *Gait Speed Time*

The gait speed measurement is probably one of the most widely used tools in clinical practice for the assessment of physical performance. Two main types of gait speed tests exist; the short-distance walk tests (2.4-m distance, 4-m distance, 6-m distance and 10-m distance) and the long-distance walk tests (400-m walk test and 6-min walk test). Long-distance walk

tests require a corridor of at least 20 m as well as a minimum time for execution of 15 min. Gait Speed Time is generally measured in a short distance (2.4-m distance, 4-m distance, 6-m and 10-m distance) with the 4-m distance as being the most commonly used short-walk test validated in older adults [101,103].

The short-walk test has been shown to be highly predictive of the ability to perform the 400-m walk test in older adults [101,104]. Added to measuring physical performance in older adults, these tests also evaluate endurance of the subjects a short distance.

- *Short Physical Performance Battery (SPPB)*

The Short Physical Performance Battery is the most used test to evaluate the physical performance in the clinical daily practice and research setting. The SPPB is developed by the National Institute on Aging for use in the Established Population for the Epidemiologic Studies of the Elderly (EPESE)[3,105].

The SPPB includes three tests:

- balance tests: the subject should to keep balance in standing position with three different challenges during 10 seconds for each: (1) side by side stand; (2) semi-tandem stand; (3) tandem stand.
- Walking speed test: the subject walk at his spontaneous pace over 4-m.the timing begins when the starting command is given, in order to record the time duration in seconds needed to complete the 4-m distance.
- Repeated chair stand test: firstly, we evaluate the ability of subject to perform STS by asking him/her to stand from sitting position without using arms. Then, the subject is asked to stand up and sit down five times successively, as fast as possible. The time to perform five stands is recorded.

The summary score is calculated from the three physical tests, each test is scored from 0 to 4, where 4 indicates the best performance, and 0 is the bad performance. Then the summary score for the 3 tests realized in SPPB ranging from 0 (bad performers) to 12 (best performers), calculated by adding the sub scores from each SPPB test.

## 1.6.2 Techniques used to evaluate muscle mass

- *Dual energy X-ray absorptiometry (DXA)*

DXA allows the body composition assessment using the relative attenuation of two different energy X rays by the body (Figure 1.17) [106]. This technique is a clinically applicable and greatly tolerated [106]. Radiation exposure is minimal and measurement time is short. It derives a three-component model of body composition, comprising fat, bone mineral, and lean tissue. It also allows regional analysis, particularly limb lean tissue and body fat distribution, thus allowing the measure of both total muscle mass and appendicular muscle mass. Recent study shows that the calculation of percentage of skeletal muscle mass (total muscle mass/weight  $\times 100$ ) provides a higher estimate of sarcopenia prevalence and is more associated with obesity status in comparison with appendicular muscle mass [107]. The main advantage of this technique is less costly than CT and MRI, however DXA is still relatively expensive, requires patients to visit a center and must be applied by specialized staff: therefore, so far it cannot to be considered a routine test in clinical practice, whereas it is highly appropriate for a research setting [106,108].

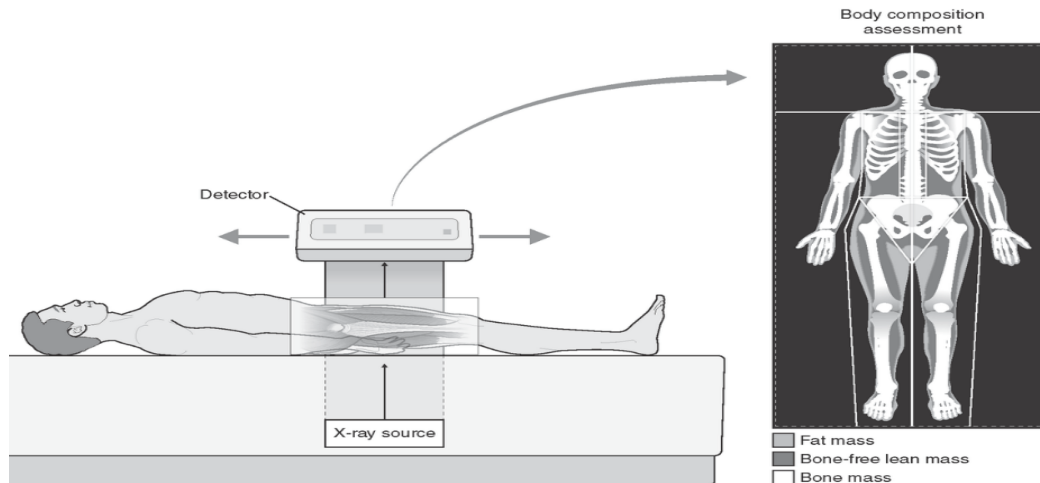

Figure 1.17 : Illustration of DXA technique

Source : <https://i2.wp.com/humankinetics.me/wp-content/uploads/2019/04/DXA-body-composition-test-2.png?w=940&ssl=1>

- *Computer tomography (CT)/Magnetic resonance imaging (MRI)*

CT and MRI scanning can be used to assess skeletal muscle volume in particular, and provide anatomical details. The main advantage of these techniques is that they are the only techniques that can directly assess abdominal visceral fat content. They allow calculation of



segmental and total muscle mass, and assessment of fat infiltration in the muscle, which impacts on muscle quality and force development [109]. But as limitation, these methods are very expensive, are not easily accessible, and are not routinely indicated to study muscle mass. But, they have been used mainly for research purposes [106]. They require a highly specialized staff, specific software, and a relatively large amount of time. A further major limitation of CT includes radiation exposure. CT and MRI are the gold standard imaging modalities to assess muscle mass and quality, but no clear cutoff values have been reported to identify sarcopenia, limiting the application of these modalities to research purposes.

- *Ultrasound imaging*

Ultrasound is simple, easily applied in clinical practice or large population surveys. It is widely available equipment and useful for bedridden or mobility impaired individuals. Ultrasound evaluates muscle mass and also its quality, as enhanced echo intensity represents changes caused by increased intramuscular fibrous and adipose tissue (Figure 1.18) [110]. Recently, some research groups have used computer-aided gray scale analysis to evaluate the quality of skeletal muscle. There is limited experience in sarcopenia studies [106,111]. The emerging field of ultrasound assessment of muscle mass only highlights the need for a standardization of measurement technique. In this article [111], guidelines are updated and broadened to provide standardization instructions for a large number of muscles.

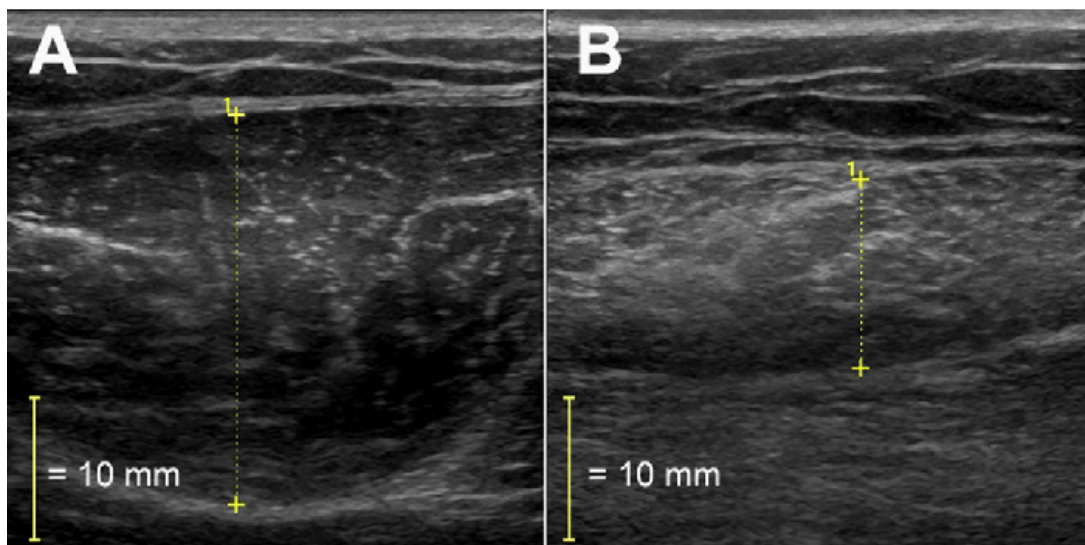

Figure 1.18: Examples of ultrasound images of RF of (A) Young participant. (B) Old participant[112].

- *Bio electrical impedance analysis (BIA)*

The bioelectrical impedance analysis is widely used in clinical assessment of the muscle, is a noninvasive, portable, quick, and inexpensive method for measuring body composition [113]. BIA is based on the relation between the volume of a conductor and its electrical resistance.

The BIA is based on the electrical properties of the tissues, these properties are described since 1871 [114]. BIA is defined with 3 parameters: the electrical Resistance (R) of the tissue, the length (L) of the tissues and (A) the cross-sectional area [114].

The body is not a uniform cylinder and its conductivity is not constant, an empirical relationship can be established between the impedance quotient ( $L^2/R$ ) and the volume of water, which contains electrolytes that conduct the electrical current through the body [115]. In practice, it is easier to measure height ( $H$ ) than the conductive length, which is usually from wrist to ankle. Therefore, the empirical relationship is between lean body mass (typically 73% water) and ( $H^2/R$ ).

However, due to the inherent field inhomogeneity in the body, the term  $H^2/R$  describes an equivalent cylinder, which must be matched to the real geometry by an appropriate coefficient. This coefficient depends on various factors, among them also the anatomy of the segments under investigation, this is still a big limitation of this method.

- *Electromyography technique*

This technique consists in sensing the electrical activity generated by muscle fibers (MFs) during a voluntary muscle contraction effort. The fundamental principle of electromyography is based on measuring the electrical manifestations of muscle cell excitability. Indeed, the surface EMG signal corresponds to the sum of the action potentials (AP) produced by the active motor units (MUs) and detected on the surface of the skin [116,117].

The action potential of fiber (APF) comes from the propagation of an AP along the excitable membrane of a muscle fiber (MF). The APs of an active MU (MUAPs) correspond to the spatiotemporal summation of the APs of each MF that compose it (Figure 1.19) [14,116].

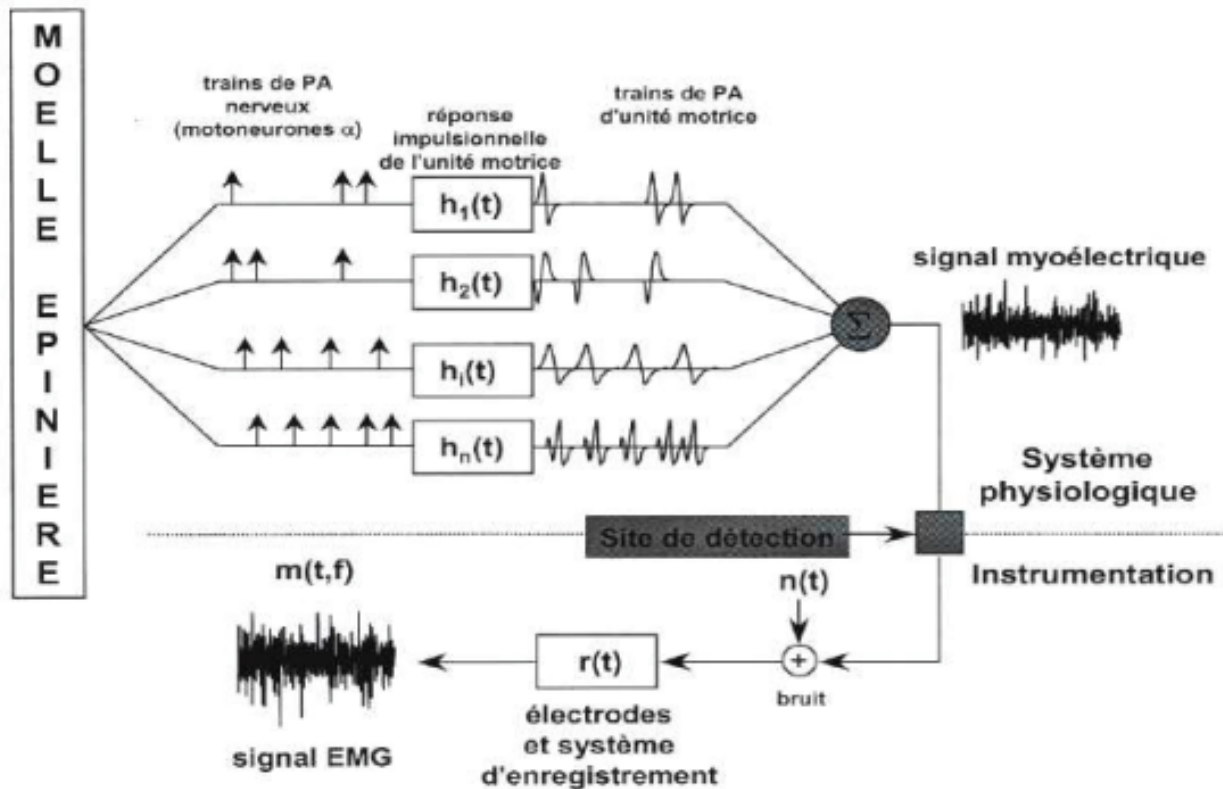

Figure 1.19: Schematic representation of surface EMG signal generation [125].

The HD-sEMG is a non-invasive technique with high spatial precision due to the large number of electrodes in the grid, making it possible to analyze the muscular contraction over a large area. This technique is already used in research studies [116,118–123] to explore functional muscle abilities and evaluate several phenomenon related to the quality and performance of musculoskeletal muscle.

### 1.6.3 Research state techniques

- *High density surface electromyography (HD-sEMG) technique*

HD-sEMG technique is a novel sEMG recording technique, based on a multi-channel electrode recording system (Figure 1.20). It is composed of a two dimensional array of electrodes called a HD-sEMG grid that is characterized by being a spatiotemporal variant of the usual single channel sEMG techniques [124]. The HD-sEMG technique exceeds the classical electromyography by considering aspects of spatial distribution of electrical potentials [112] and by overcoming their basic limitations such as the electrode placement problem, the representability of the recorded signal, the auto-cancellation phenomenon and the spatial

resolution. The HD-sEMG recording technique has become widespread in the last few years, which is due to multiple reasons. This HD-sEMG technology is currently used only for research purposes to assess muscle functionality in different applications such as electromyography/force relationship analysis [125,126], muscle aging evaluation [118,123,127], muscle disease monitoring [27], and prosthesis monitoring [128]. However, there is no integrated solution using this HD-sEMG technology able to analyze muscle changes in routine clinical practice.

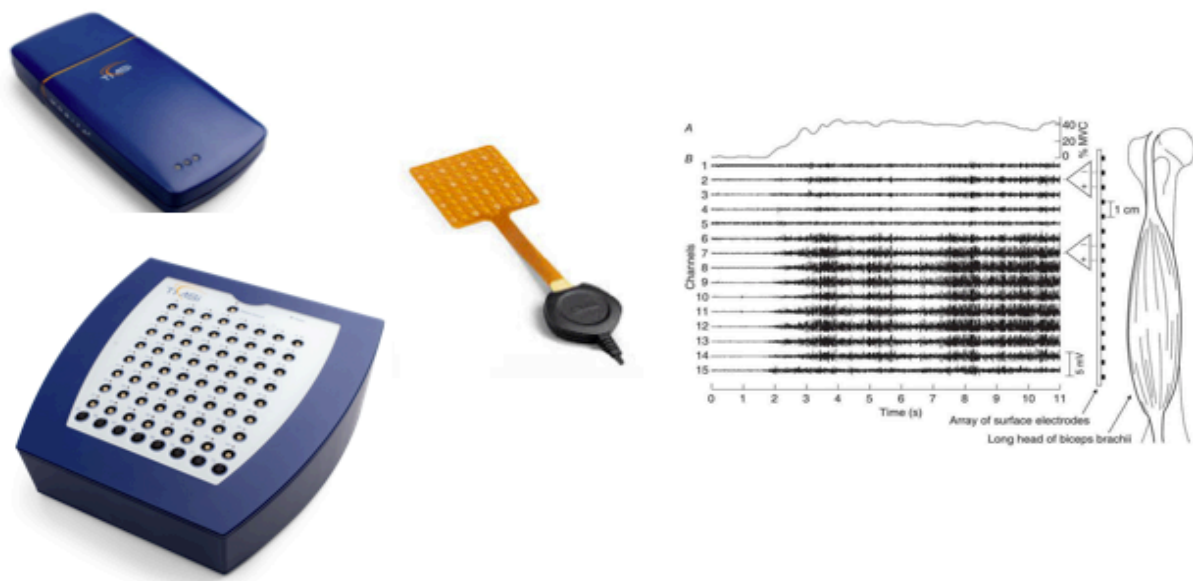

Figure 1.20: Representation of High-Density Surface Electromyography (HD-sEMG) technique (Refa and Mobita devices, TMSi ©).

- *Inertial Measurement Unit (IMU)*

An Inertial Measurement Unit, also known as IMU (Figure 1.21), is an electronic device that measures and reports acceleration, orientation, angular rates, and other gravitational forces. There are different types of IMU sensors: the one based on FOG (Fiber Optic Gyroscope), the RLG IMUs (Ring Laser Gyroscope), and lastly, IMU based on MEMS technology (Micro Electro-Mechanical Systems) [129]. This technology allows lower costs and low power requirements while ensuring performance. MEMS-based systems therefore combine high performance and ultra-low power consumption in a smaller unit.

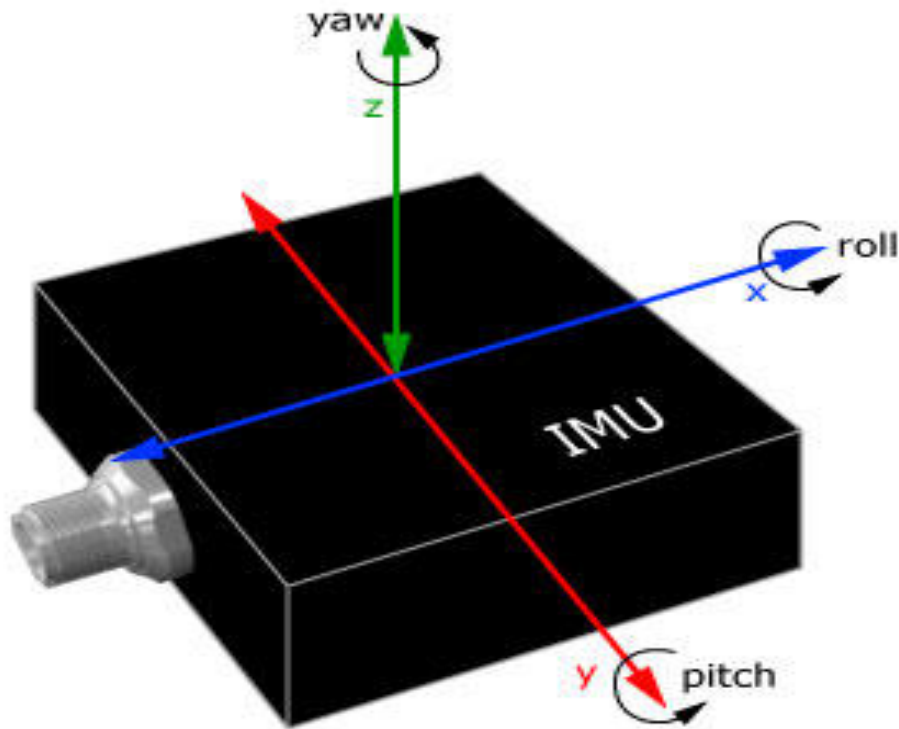

Figure 1.21: Inertial Measurement Unit (IMU)  
 Source: usgs.gov/media/images/inertial-measurement-unit-imu

Inertial units offer the opportunity to quantify clinical testing in older population. They are light, ambulatory and non-invasive tools. The kinematic data evaluated by this type of unit during tests such as Sit To Stand (STS) test were recently evaluated in K. Lepetit et al. (2019) study [130] in order to differentiate between healthy young and healthy senior subjects as well as healthy senior and frail subjects. The recent development of magneto-inertial sensors has made it possible new opportunities for clinical measurement of STS [131,132]. For example, quantifications of the rising of chair from inertial unit data have already been investigated to diagnose frailty [133], or the risk of falls [131]. However, in the context of aging population, the effects of the loss of muscle tone or sedentary lifestyle impact should be monitored to identify the first signs in order to prevent pathology such as frailty, sarcopenia and adverse outcomes such as falls. These specifications require a simple tool and specific protocol. For this purpose, an accelerometer is embedded in the proposed HD-sEMG device used in this thesis work.

- *Diffusion Weighted Magnetic Resonance Imaging*

Diffusion MRI is a magnetic resonance imaging (MRI) method allowing the mapping of the process of molecules, mainly water, in biological tissues, in vivo non-invasively. Molecular

diffusion in tissues is not free, and is impacted by obstacles, such as macromolecules, fibers, and cell membranes. This technique is usually used to study brain diseases; a recent study presents this technique in order to understand the changes of neuromuscular system associated with aging, sarcopenia and other neuromuscular diseases. In this context the technique based on diffusion weighted magnetic resonance imaging (DWMRI) is called "motor unit magnetic resonance imaging (MUMRI) [134].

Diffusion-weighted MRI sequences can be designed to be sensitive to diffusion in a single direction or many. It is not yet known how the choice of diffusion sensitivity direction affects the contrast observed in MUMRI images. It's suggested that when the direction of the fiber and diffusion sensitivity are the same, then the observed contrast will be greatest. We therefore propose that MUMRI can be extended to a diffusion tensor imaging approach. Diffusion tensor imaging exploits the anisotropy of diffusion in tissue and can provide information about the orientation of muscle fibers, and on spatio-temporal patterns of motor unit activity in multiple muscles simultaneously. It also suggests that MUMRI may provide useful biomarkers in the detection of neuromuscular disease.

#### 1.6.4 Sit-To-Stand motion

In this thesis work, the "Sit-To-Stand" (STS) motion was chosen to assess muscle aging using HD-sEMG. This motion was chosen because it is a daily life gesture and a good indicator of autonomy/frailty [130,135,136]. It consists of rising from a chair without help. This motion is also already included in some geriatric clinical tests as Short Physical Performance Battery (SPPB) [137].

The STS motion is defined as the function frequently used to change from a sitting position to a standing position [138]. The STS motion can be described using kinematic or kinetic variables, with definitions supplied for phases and events during this motion [138]. Among the indication that led us to choose the STS in this protocol (in addition to its simplicity because it is a daily life gesture) is that the amount of research on STS has been more recent and smaller than research on gait (Figure 1.22). Recent studies have suggested that reducing prolonged sitting demonstrates the importance of maintaining the ability to stand up from a sitting position, it's may improve glucose metabolism and could represent an

important public health and clinical intervention strategy for reducing cardiovascular risk [139,140] and mortality [141] with aging.

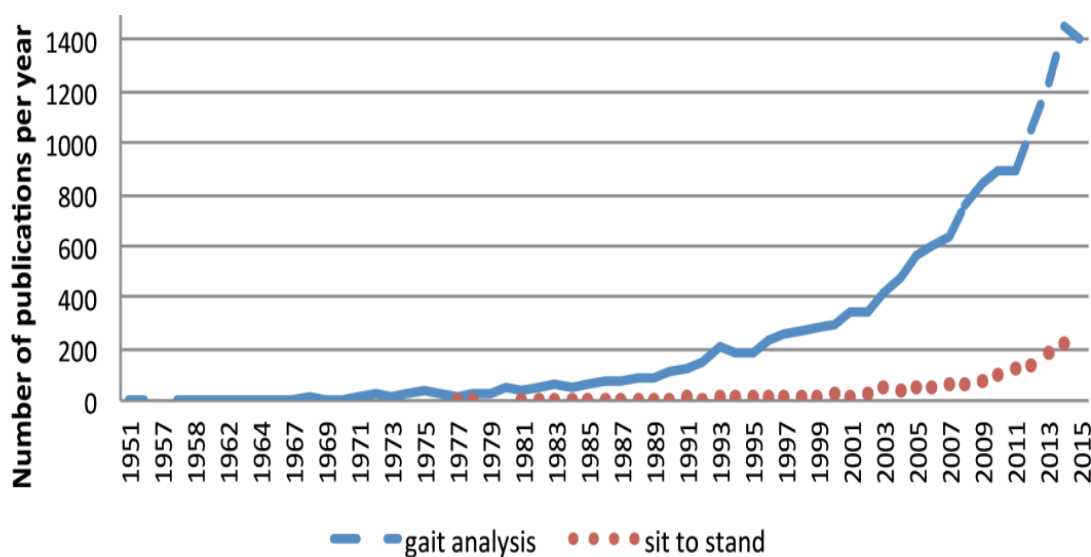

Figure 1.22: Number of Pubmed publications per year for "gait analysis" and "Sit To Stand".  
source: <http://www.ncbi.nlm.nih.gov/pubmed/?term=gait+analysis> and [term=sit+to+stand](http://www.ncbi.nlm.nih.gov/pubmed/?term=sit+to+stand) (28-08-2016).

Secondly, another important STS justification is related to aging, risk of falling and fear of falling, those are common causes of becoming inactive at older age. A German study on more than 70,000 falls from residents of Bavarian nursing homes, demonstrates a severe fall resulting from walking and standing up, in particular during the morning hours. An important cause of falls in the morning might find its origin in dizziness. Actually, dizziness is a potential side effect of blood pressure control medication leading to lower blood pressure in the morning with orthostatic hypotension. Further, unsuccessful transfers from sitting to standing accounted for 41% of all falls [142].

Thirdly, the relationship between strength and STS is crucial in the modifications of STS with aging. The rates of decline in isokinetic strength in older adults averaged 14% per decade for knee extensors [143]. This decline in muscle strength is faster than the loss of muscle mass, advancing decline in muscle quality [144]. Consequently, improving muscle strength is a vigorous means to improve STS capacity in older adults by training, such as resistance exercise training, effective to improve strength among older adults, particularly with higher intensity training [145]. Therefore, the resistance exercise may be considered a viable strategy to prevent generalized muscular weakness associated with aging. However, strength decline of

the lower limbs is not the only responsible of STS performance decrease in older adults, as is evident from the fact that strength parameters only explain part of the variance of the duration of the STS task [146]. STS performance is influenced by multiple physiological and functional processes, and represents a specific skill, rather than a proxy measure of lower limb strength [135,147]. For these reasons, we suggested in our experimental protocol, the use of STS test to evaluate more precisely the functional abilities of the lower extremity (Rectus Femoris muscle) using HD-sEMG technique for a better understanding of the relationship between aging, strength and functional abilities.

Finally, the chair rise strategies are important criterion in STS modifications with aging. Several strategies of standing up have been analyzed using camera systems, inertial measurement unit (IMU) and force platform [130,135,136,138,146]. However, there are 4 main STS phases in STS rise strategies (Figure 1.23):

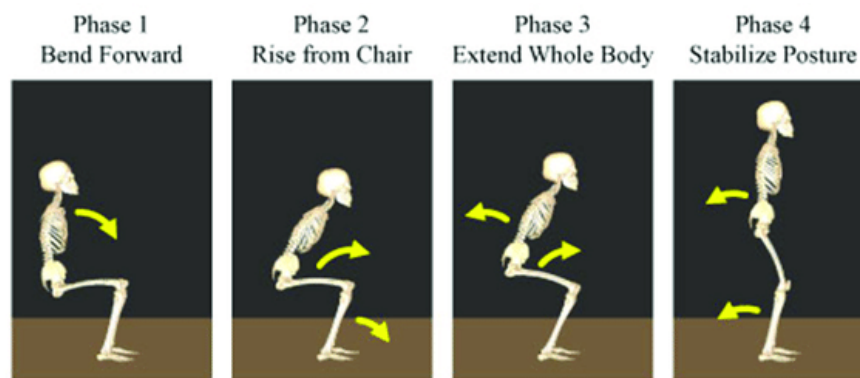

Figure 1.23: The four phases of the human Sit-Stand-Motion. In phase 1, humans flex their upper body to generate momentum and initiate the Sit-To-Stand motion. In phase 2, they raise their hip from the chair and transfer momentum. In phase 3, humans extend their whole body upward. In phase 4, they move their body backward to stabilize their posture [148]. available via license: Creative Commons Attribution 4.0 International

- Flexion momentum: begins at the initiation of the movement of flexion of the trunk and ends with loss of contact with the seat. During this phase, the authors notice a flexion movement of the trunk, which has an increasing angular speed.
- The momentum transfer: the second phase corresponds to a short period of unloading the seat; it is detected by a rapid change in the level of the component vertical reaction force of the soil. During this phase, the flexion of the trunk reaches its maximum and the movement of extension of the trunk appears.
- Extension: this phase begins when dorsiflexion of the ankle is at its maximum and ends when the hip has completed its extension. The main movements during this phase are



hip extension and knee extension. The angular velocities of hip and knee extension reach their maximum during this phase, then they decrease and become zero.

- Stabilization: this phase begins at the end of the previous phase, that is, at the end of the hip extension. According to the authors, the end of this phase, which is the end of the action, is difficult to determine [138,148,149].

In the STS strategies, the balance control is crucial. For young healthy people standing up is current and automatic motion, which does not need a lot of mental attention. For older adults with a failing vestibular system, less muscle strength, pain, impaired vision, comorbidities, restrictions in the joints or a combination of these difficulties, the momentum transfer strategy becomes less suitable or even impossible. With the flexion strategy, the horizontal and the vertical phase of the STS are more separated in time.

The horizontal displacement of the center of mass is realized by bending the trunk more forward during the flexion phase [135]. Consequently, the center of mass approaches the base of support. During the extension phase, trunk angular velocity is increased to support vertical displacement. Because the upper body is much more massive than the thigh, the upper body must contribute more to center of mass vertical momentum than the thigh [150]. In healthy older, at the momentum transfer, hip flexion angular velocity was shown to increase with decreased seat height [149].

The motion transmission in STS strategy suggests that functionally impaired older person attempts to increase their momentum while rising by increasing their hip flexion velocity [151]. It is not evident to what extent this knowledge has helped to improve clinical practice, the measurement methods as used in the lab are not applicable in clinical routine practice. The set-up, the data collection and the data analysis of most laboratory studies are intricate and time consuming [135].

The instrumentation is expensive and there is a need for engineering expertise. Moreover, the patient has to visit the lab, which is also costly and time consuming. For the clinical applications of functional and motion assessment, these methods have to be easy to use, efficient and has to yield useful and relevant data. As we propose in this thesis, we thought that HD-sEMG technique used in portable device including an accelerometer could be more useful in clinical practices to evaluate STS strategies changes with aging.

## 1.7 Problematic description and thesis work

As illustrated in this chapter, there are several effects of aging such as the loss of autonomy and increased risk of falling. This generates very important economic, social and psychological costs. The way of aging is different from one individual to another; it is a function of many factors such as the biological and physiological changes of the organs, the environmental conditions as well as the lifestyle of the person.

The consequences of these factors can divide the older population into two categories; the first is a population with a healthy aging mode, and the second is a category that suffers from a pathological aging with a decrease in autonomy, caused in part by the loss of motor capacity of the muscles, which causes discomfort to perform physical tasks during daily life.

This is why we introduce the concept of Motor Functional Age (MFA). The assessment of motor capacity is related to motor functional age, this age being different from chronological age. The MFA assesses the motor skills of a person, because the chronological age taken alone is rarely a reliable index of the motor efficiency of a person to make a physical effort. That mean, our chronological age does not reflect precisely our muscular capacity, because there may be young people in physical inactivity who also suffer from defined motor loss as early aging.

The current clinical examinations are not accurate and robust enough to assess the muscle-status of older people. Unfortunately, there are no specific methods for assessing functional age, which is associated with muscular strength and part of the musculoskeletal system. Therefore, it would be interesting to exploit the new technologies dedicated to the functional evaluation of the musculoskeletal system such as the high-density surface electromyography technique (HD-sEMG) and the kinematic motion for the motor functional age evaluation.

The work of this thesis is a part of "CHRONOS" project, a European project funded by EIT Health. This work will modestly build a first knowledge to exploit a new innovative technology used in research in order to elucidate the first basis for a tool able to assess motor decline and to serve as an indicator in a prevention approach or in a functional rehabilitation.

We are interested in studying the contraction of Rectus Femoris (RF) muscle during Sit To Stand test (STS), recorded using the HD-sEMG technique. We start on the assumption that: the MFA might be different from the Chronological Age (CA), depending on lifestyle, physical

activity, and medical condition. Therefore, the difference between CA and MFA should give indication on the motor functional status. The aim of this study is to introduce the motor functional age by developing a precise quantitative device measuring the “Motor Functional Age” (MFA) of young, middle-aged and old people, thus preventing future functional motor loss for healthy aging.

The main objective of this work is the development of a tool able to evaluate functional age based on the muscular activity data from the HD-sEMG technique, and the kinematic data obtained from the accelerometer, combined in the same device called Mobita from TMSI Company (Netherland).

This work will be divided into three parts; we have described in this first chapter the musculoskeletal system and basic notions about aging. The second chapter will unveil the materials and methods used for the implementation of the experimental protocol. The first part includes clinical examination and experimental protocol design, for obtaining reliable data (HD-sEMG and accelerometer signals) combined in the same ambulatory device, the second part contains the preprocessing of the data and statistical analysis to evaluate the sensitivity of various parameters from HD-sEMG technique and current clinical examinations with aging and the variation of physical activity levels. The third chapter will contain the features extractions or parameters extracted from HD-sEMG signals to test classification approach using classifiers from machine learning approaches to evaluate the power of discrimination for each feature with aging and physical activity level, for MFA estimation, and finally the perspectives envisaged following the presented work.

The main elements of this work are illustrated in Figure 1.24; namely the standard goal which is the study of the motor efficiency, that could support in the future the prevention and the reduction of the motor decline. In this thesis work, the technique which will be used is represented mainly in the technique of the high-density surface electromyography (HD-sEMG), the experimental protocol will be defined to acquire multimodal data, the preprocessing steps and the multimodal data analysis will be detailed in the next chapters as illustrated in the figure below.

# General overview of the thesis

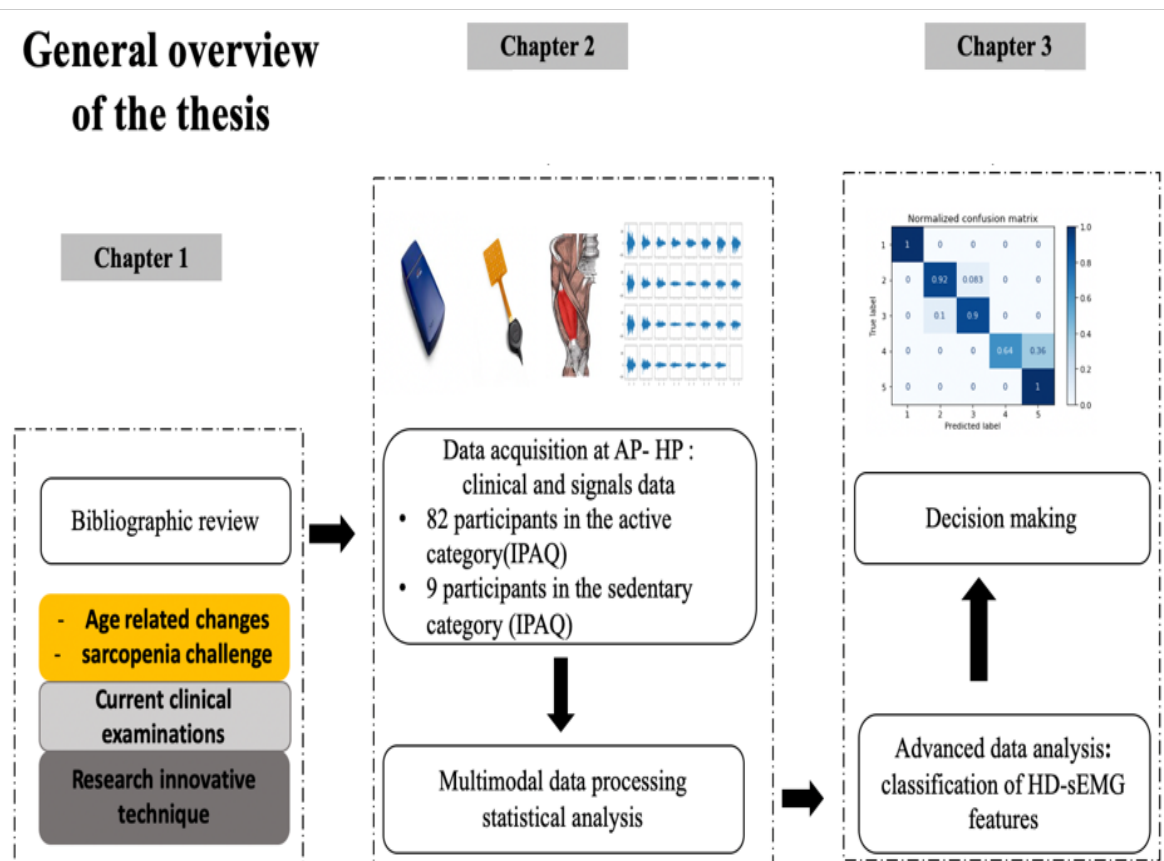

Figure 1.24: General overview of the thesis

## 1.8 Conclusion

After recalling the anatomy and physiology of neuromuscular system related to aging, this chapter exposed the state of the art about musculoskeletal system and age-related changes. Indeed, a new concept of motor functional age different from chronological age has been introduced to intuitively monitoring of functional muscle abilities with aging.

This allowed us to unveil the potential of our research approach on the change of muscular abilities with age, starting from the idea of helping prevention and treatment of sarcopenia, thus preventing its adverse outcomes in the older population. However, the amount of information directly related at the muscular aging is still insufficient, because the studies are based on clinical scores and physical tests not enough sensitive at early stage as shown in the last section. In order to concretize the concept of the functional evaluation of muscles through aging, we are interested in using the technique of high-density surface electromyography (HD-sEMG) to detect the electrical activity of rectus femoris muscle during Sit to Stand test (STS). The assessment of muscle quality/abilities with aging will be presented

in the next chapters, not solely in the older population but also young and middle age categories, to analyze aging through life and evaluate the impact of physical activities, then giving more efficiency to the keys of the sarcopenia prevention. During next chapters, we will analyze deeply the data from the CHRONOS project that proposed a complete and multimodal analysis of the muscle (using techniques mentioned in section V.2), in view to evaluate possible promising potential of the HD-sEMG technique to monitor early changes in muscle function affected with aging and physical activity level.



# CHAPTER 2 : HD-sEMG signal recording and analysis for the clinical assessment of muscle aging

2.1	INTRODUCTION .....	66
2.2	EXPERIMENTAL PROTOCOL AND DATA PROCESSING.....	67
2.2.1	General overview.....	67
2.2.2	Experimental setup .....	68
-	Clinical setup of the "CHRONOS" study.....	68
-	Clinical evaluations .....	70
-	Dual-energy X-ray absorptiometry .....	71
-	Muscle Ultrasonography .....	71
-	HD-sEMG signals recording .....	72
-	Processing of HD-sEMG signals .....	75
-	HD-sEMG score analysis .....	82
2.2.3	Statistical analysis for multimodal data comparison .....	85
2.3	CLINICAL STUDY RESULT .....	86
2.3.1	Preliminary studies .....	86
2.3.2	Multimodal clinical comparative study (CHRONOS).....	88
-	Results of the aging effect on clinical, ultrasound and HD-sEMG scores.....	89
-	Results of the physical activity level effect on clinical, ultrasound and HD-sEMG scores .....	93
-	Maximum Trunk acceleration .....	95
2.4	DISCUSSION.....	97
2.5	STRENGTHS AND LIMITATIONS.....	100
2.6	CONCLUSION.....	102

## 2.1 Introduction

As previously mentioned in the first chapter, the aging process is a combination of many factors such as the biological and physiological changes of the organs, the environmental conditions as well as the lifestyle of the person; especially a sedentary lifestyle and unhealthy diet that can affect muscle quality [152]. There is as yet no method that evaluates simultaneously muscle mass, muscle strength, and physical performance, while diagnosis of sarcopenia calls for the measurement of a combination of these 3 muscle parameters [153]. Various clinical scores and tools evaluate separately these different muscle parameters i.e.- imaging techniques including dual-energy X-ray absorptiometry (DXA) or magnetic resonance imaging (MRI). In addition, these techniques are laborious and painstaking to perform in everyday clinical practice. In this context, specifications must include providing an ambulatory, precise and non-invasive device to monitor muscle quality and functionality. Recent non-invasive technologies dedicated to the functional evaluation of the musculoskeletal system such as the high-density surface electromyography technology (HD-sEMG) offers new applications [154] as described in the previous chapter. This HD-sEMG technology is currently used only for research purposes to assess muscle functionality in different applications such as electromyography/force relationship analysis [155,156], muscle aging evaluation [157,158], muscle disease monitoring [159] and prosthesis monitoring [128]. However, there is no integrated solution with this HD-sEMG technology able to analyze muscle changes in routine clinical practice.

This chapter is focused mainly on the "CHRONOS" project (<http://www.chronos-eithealth.eu/>), funded by the European Institute of Innovation and Technology (EIT) Health, aimed to develop such a non-invasive, wireless portable medical device using this innovative approach based on the HD-sEMG technique combined with an embedded accelerometer to get more precision about the orientation of Sit To Stand gesture (STS), and finally to develop muscle aging assessment. This chapter aims to carry out a multimodal analysis of muscle aging assessment in healthy individuals, both physically active and sedentary, in order to demonstrate the ability of the HD-sEMG technique to detect both healthy muscle aging and accelerated muscle aging related to sedentary lifestyle in clinical environment.



The objective is to compare HD-sEMG data with methods of muscle measurement currently used in clinical practice: muscle mass using dual-energy X-ray absorptiometry (DXA), muscle thickness using ultrasonography, handgrip strength, and physical performance.

## 2.2 Experimental protocol and data processing

### 2.2.1 General overview

According to the bibliography study, the change in muscle capacity is evident with age [31,152,160]; different methods and protocols were discussed to evaluate the evolution of motor functions. However, the amount of information directly related to the muscular aging is still insufficient since the studies are mainly based on not enough precise clinical scores and physical tests such as (autonomy in daily life (ADL), SPPB, grip strength...etc.). In order to concretize the concept of the functional evaluation of physical performance from young to older people, we are interested in using the technique of HD-sEMG to detect the electrical activity of rectus femoris muscle during STS test. The recorded data set obtained from HD-sEMG signals and clinical modalities is used to extract relevant information from multimodal data analysis of each subject of a cohort with different age categories. The parameters from HD-sEMG signals will be evaluated and compared to others techniques throughout the chapter, in order to evaluate their power of discrimination in term of functional aspect of the muscle according to aging (5 age categories divided in decade from 25 yrs. to 74 yrs.) and physical activity levels (i.e. active vs sedentary).

The aim of the study was two-fold:

1) To assess the ability of the HD-sEMG technique to detect age-related muscle changes (anatomical and functional) among physically active people, divided into five age categories (25-34 years., 35-44 years., 45-54 years., 55-64 years., and 65-74 years.); we advance the hypothesis that we will observe a modification with aging.

2) To assess the ability of the HD-sEMG technique to detect muscle changes related to sedentary lifestyle, by comparing a group of sedentary individuals, aged 45-54 years old with the active ones in the same age category. In addition, by comparing this group of sedentary 45-54 years old individuals with older active individuals (55-64 yrs. and 65-74 yrs.), we advance the hypothesis that we will observe a modification with sedentary lifestyle.

The Figure 2.1 below explains the whole process realized in this experimental study:

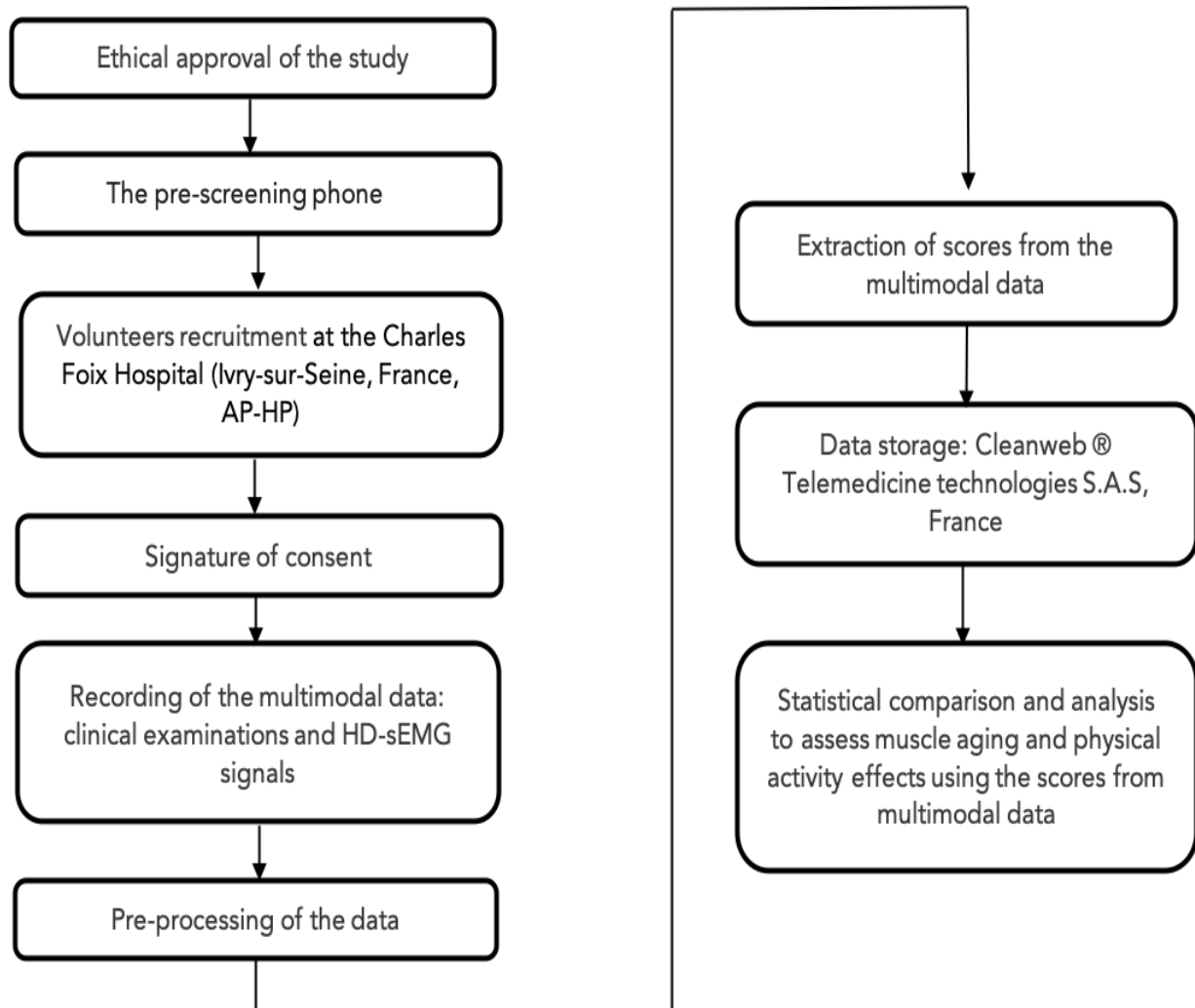

Figure 2.1: The experimental setup up for CHRONOS study.

## 2.2.2 Experimental setup

### - Clinical setup of the "CHRONOS" study.

During the CHRONOS study, we recruited, with the help of Dr. K. Kinugawa and her team, healthy volunteers from July 2018 to January 2019. The recruitment was done through various advertising means: posters / ads and online mailing list through associations, universities, hospitals (AP-HP) and on social networks (Facebook, Twitter). The pre-screening phone interview enabled us to check the inclusion criteria (25 to 74 years old, walking without

help,) and non-inclusion criteria, and to evaluate their physical activity level (active population or sedentary category) according to the International Physical Activity Questionnaire (IPAQ, long version) [161], affiliation to a social security scheme (excluding AME). Non-inclusion criteria were: body mass index (BMI)  $<18.5$  or  $\geq 30$  kg/m<sup>2</sup>, professional or elite sportsman/woman, any history of neurological, endocrinal (including diabetes), rheumatological and recent cancer pathologies, heart failure, severe broncho pneumopathy, myopathy, fracture or trauma affecting the hip and lower limb, active smoking, pregnancy, taking medication affecting muscle function (corticosteroids, statin, fibrate, insulin...), dermatological pathology and allergy to adhesive dressings. Subjects under guardianship or curatorship, imaging examination with or without the use of contrast media in the 7 days preceding inclusion, contraindication to performing DXA, and pacemaker.

A total of 325 volunteers were interested in participating in the study and contacted the CHRONOS team. Among these volunteers, 46 were excluded relating to exclusion criteria and 188 were qualified for the study but were kept on a waiting list for a future extension of this pilot study. Finally, a total of 91 volunteers aged 25 to 74 years old were included in the pilot clinical study with experimental data recording sessions (Figure 2.2), on a nearly 50/50 basis of women and men, evenly distributed across age groups. The participants were divided into two distinct groups according to their level of physical activity from IPAQ: "active subjects" group = "high" or "moderate" physical activity (n=82) in five age categories from 25 to 74 divided into 5 decades, and "sedentary subjects" group = "low" physical activity (n=9, age group 45-54 years old) see Annex 1. Physical activity levels were estimated through energy expenditure in MET-minutes per week (Metabolic equivalent task = MET level x number of minutes of activity/day x number of days/week) in accordance with IPAQ guidelines: low physical activity if  $< 600$  MET-min/week, moderate activity if between 600 and 3000 MET-min/week, and high activity if  $\geq 3000$  MET-min/week. The MET level was weighted according to the type of activity (walking, cycling, gardening etc.).

The inclusion of participants took place at the Charles Foix Hospital (Ivry-sur-Seine, France, AP-HP) for half a day, where their clinical and para-clinical data were collected. After their hospital visit, participants were asked to complete a nutritional questionnaire on 3 weekdays to estimate their mean daily energy and protein/carbohydrate/lipid intake. All participants provided written informed consent. Institutional review boards approved the CHRONOS study (Patient Protection Committee, project number 2018/31). The study was

registered in ClinicalTrials.gov ID: NCT03560648. The database was declared to the French National Commission for Data Protection and Liberty (CNIL, France).

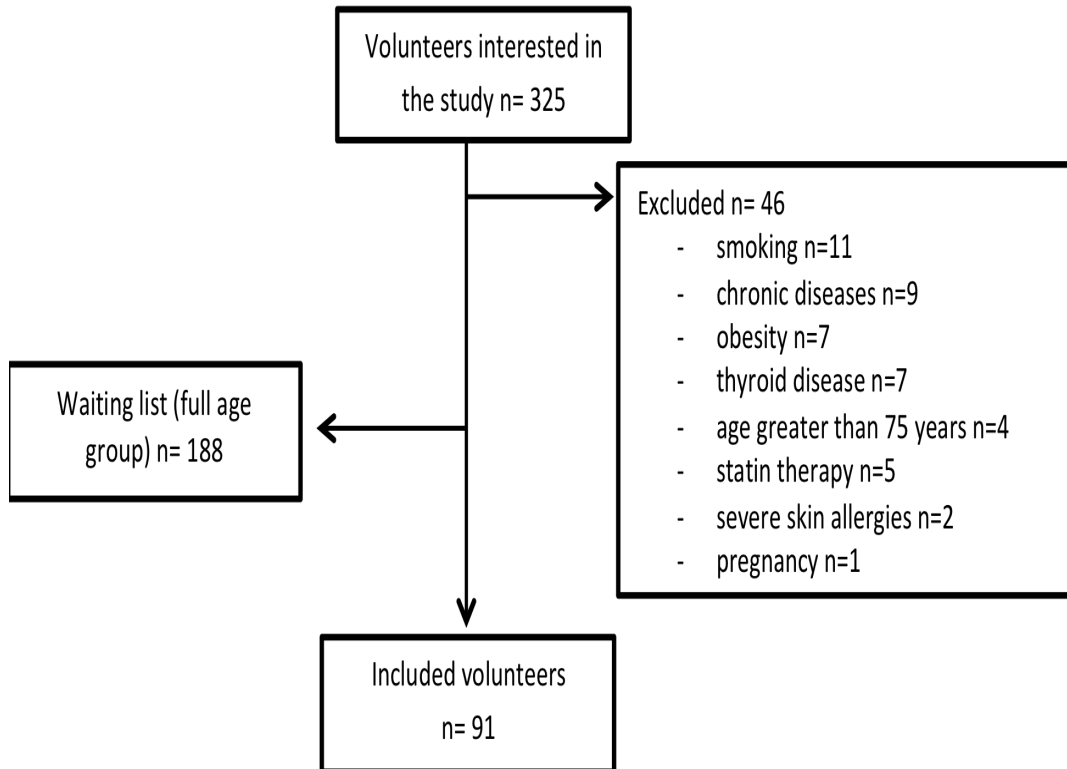

Figure 2.2 : Flow diagram of the participants

- Clinical evaluations

All clinical data collected during the CHRONOS project were entered into an electronic case report (Cleanweb®, Telemedicine technologies S.A.S, France) to guarantee the accessibility and quality of the collected data. The following information for each participant was collected: age, gender, physical activity level scored by IPAQ, BMI, medical history, medications and their number, comorbidities assessed using the Charlson score, frailty using the Rockwood score, cognition (Mini mental State Examination MMSE), depression (Geriatric Depression Scale GDS), handgrip strength using Jamar® hydraulic hand dynamometer (dominant hand, averaging over 3 trials), physical performance assessed using the Short Physical Performance Battery (SPPB) used for both research and clinical practice [3,97,98], and distance of 6-minute walk test (reflecting also muscle strength of the lower limbs) [162].

- *Dual-energy X-ray absorptiometry*

Muscle mass was assessed using dual-energy X-ray absorptiometry (DXA, GE Lunar Prodigy), a widely used device in both research and clinical practice. This well-established, low-radiation technique is recommended by the European Working Group on Sarcopenia on Older People EWGSOP [97]. We collected skeletal muscle index SMI ( $\text{kg}/\text{m}^2$ ), appendicular muscle mass AMM (kg), total lean mass LM (%) and total fat mass FM (%).

- *Muscle Ultrasonography*

We analyzed muscle thickness MT (mm) and fat thickness FT (mm) of the rectus femoris muscle on the dominant side (Figure 2.3). A B-mode ultrasound (Siemens, Acuson Antares 5.0, Ultrasound System) with 40mm linear array probe (5-13MHZ) was used to evaluate MT and FT. Cross-sectional images of the rectus femoris were obtained at 30% proximal zone of the rectus femoris in the iliac spine line located between the iliac crest and the middle of the patella. Participants were lying on the examination table with their thigh relaxed. The MT was measured at the midpoint of the rectus femoris. The FT was defined as the distance between the dermis and fascia of the rectus femoris muscle [163]. These parameters were measured in millimeters. The probe was coated with water-soluble transmission gel to provide acoustic contact and reduce pressure. The pressure was reduced while scanning by suspending the linear probe on the skin surface and keeping it perpendicular to the bed to achieve a clear image [163]. To obtain precise measurements of muscle parameters, the same sonographer was performed all measurements.

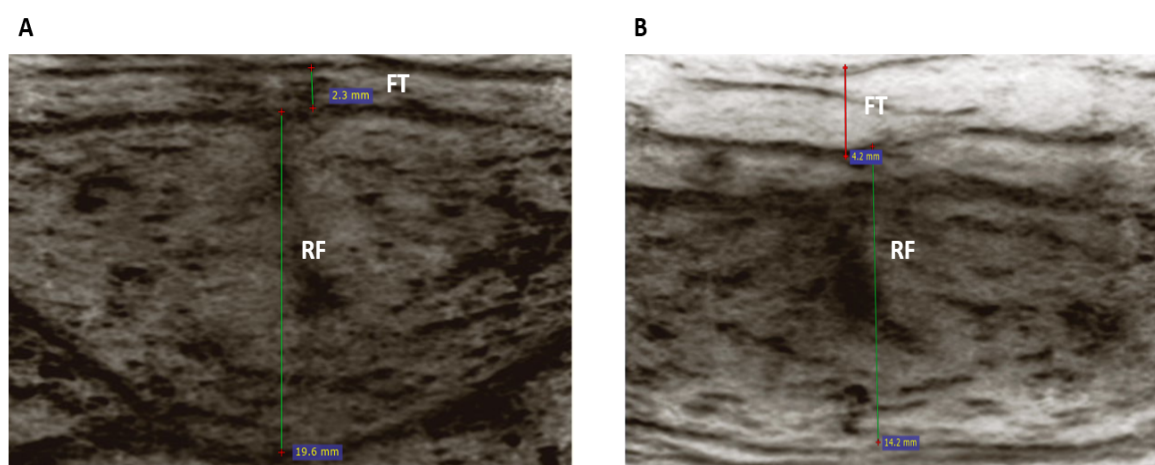

Figure 2.3: Example of ultrasound image recording during CHRONOS study. A: Ultrasound image from a young woman aged 25 years with  $\text{BMI}=19\text{kg}/\text{m}^2$ . B: Ultrasound image from older woman aged 70 years with  $\text{BMI}=20\text{kg}/\text{m}^2$ .

- HD-sEMG signals recording

Let recall that HD-sEMG is a non-invasive technique with high spatial precision due to the large number of electrodes in the grid, making it possible to analyze the muscular contraction over a large area.

In this protocol (see Figure 2.4), the 3-times sit to stand (STS, chair rising) motion was analyzed. This daily life motion is already employed in clinical routine as mentioned in the “STS justification” section, as in SPPB test. The rectus femoris muscle was studied, because of its superficial positioning in the quadriceps muscle group, and moreover, being the muscle the most involved in the STS motion [1]. The positioning of the HD-sEMG grid on the rectus femoris after skin preparation by cleaning the surface of muscle with alcohol is done according to anatomical considerations [166]. In fact, the grid was positioned in the proximal region of the rectus femoris (precisely at 30% proximal zone of the rectus femoris in the iliac spine line located between the iliac crest and the middle of the patella). The choice of the proximal zone were motivated by recent studies showing the sensitivity of the proximal region to aging [157,158,160].

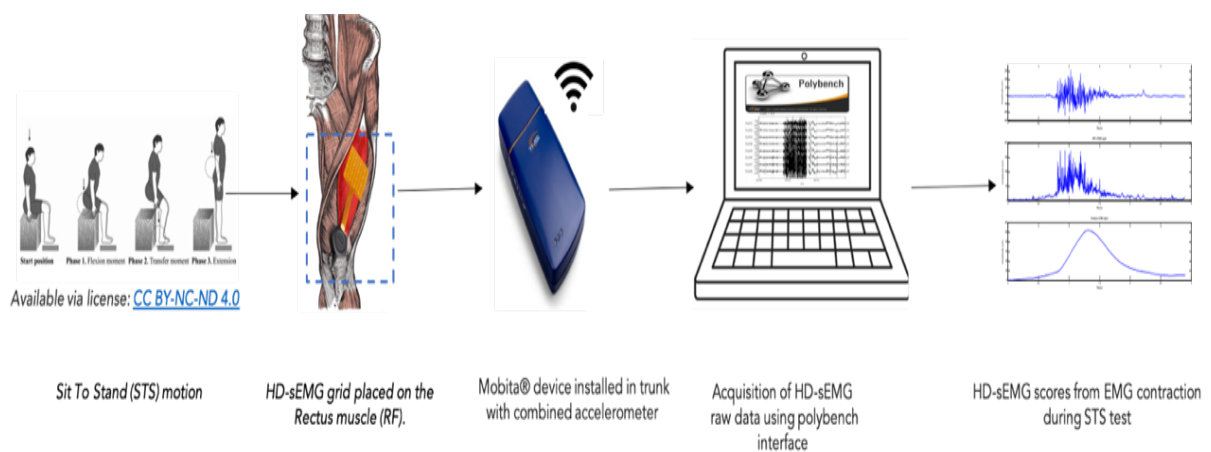

Figure 2.4: Acquisition of HD-sEMG signals during CHRONOS clinical study

To reduce background noise during sEMG recording, it is important to know the possible sources of noise [124,167], and to try to minimize it. The electrode-skin interface is the potentially cause of the source of noise. When the impedance is high the signal to noise Ratio (SNR) is greater [167]. Then, the contact surface from one gate to the other changes and therefore the impedance of the electrodes also changes. However, this difference in impedance

can be neglected because of the large input impedance of the device (of the order of 100 MΩ). This contributes to obtaining a good Signal-to-Noise Ratio (mean SNR (dB)=21.35 ±4.38). It is not necessary to perform impedance measurements, which facilitates the clinical use of the device. The SNR was calculated using the following formula [168]:

$$SNR_j = 20 \log_{10} \left( \frac{\sum_{i=1}^N |EMG_j(i)|}{N} \times \frac{P}{\sum_{i=1}^P |b_j(i)|} \right) \quad \text{Eq. 1}$$

Where  $EMG_j(i)$  represents the  $i$ th sample of the  $j$ th sEMG channel,  $b_j(i)$  the corresponding noise obtained from the first 0.5 s rest period without muscle contraction ( $N$ ,  $P$  are sample numbers for EMG signal during contraction and without muscle contraction respectively with sampling frequency  $F_s = 1\text{kHz}$ ).

The HD-sEMG system includes the TMSi Polybench® processing software for customizing the configuration of the measurement interface. The sampling frequency is 1000 Hz on a 12-bit resolution. The device is CE marked and belongs to the Class II.

In order to make a conventional sEMG recording, three electrodes are needed: two of them will take charge of the differential measurement as such, and a third will connect the patient to the mass of the system (patient ground). There are two main modes of reception: monopolar reception and bipolar reception.

The monopolar reception (*Figure 2.5*) involves an electrode located in an electrically active zone containing the signal to be measured and a reference electrode located in an electrically inert zone (bone, lobe of the ear, etc.). The differential calculus will be realized between the wanted signal and an artificial "zero". The monopolar configuration has the largest detection volume compared to the others electrode configurations.

The bipolar configuration (*Figure 2.5*) corresponds to two electrodes connected to the differential amplifier and placed on the skin over the muscle (*Figure 2.5*). The bipolar installation of the acquisition system has a high pass filtering effect on the obtained sEMG signals [169]. This filtering effect causes a reduction of the detection volume by altering the spatial selectivity of the electrode system [170,171].

Other electrodes configurations are used such as double differential and Laplacian configurations. Laplacian configuration has the advantage to better filter the signal and the Non-Propagating Component (NPC) of the motor unit action potential (MUAPs) than the bipolar arrangement. This NPC arises from the extinction of the action potential of fiber (APF)

it the myotendinous junction. Its principal limitation is a reduced detection volume. It is important to remark that the detection volume of the electrode arrangement is dependent to the electrode setup. In fact, increasing the filtering order reduces the detection volume as well as the signal amplitude. In the CHRONOS study, monopolar recording is applied to maximize the detection volume and capture the maximum muscle activity from the rectus femoris during the short duration of the STS motion. This electrode arrangement will guarantee the best quality and representability of the recorded signal [172].

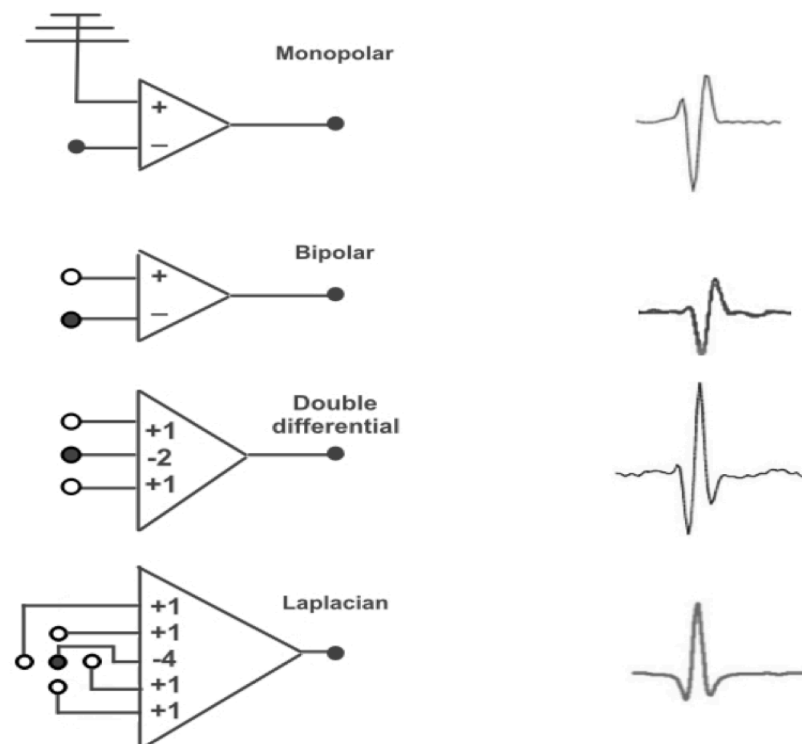

Figure 2.5: EMG electrode configurations and the corresponding recorded signal from one Motor Unit [155].

All used electrode cables are shielded with the electrode signal itself (active shielding). The active shielding ensures that disturbances such as cable movement artefacts and mains interference (50/60 Hz) are reduced to a minimum. The transmission of the signals during the acquisition is done by WIFI protocol.

The high-density surface electromyography HD-sEMG signals were acquired with a semi-disposable square adhesive grid (32 electrodes, 4x8) characterized by 4 mm diameter electrodes and an inter-electrode distance of 8.57 mm, with a wireless connected ambulatory system Mobita® (TMSi, Oldenzaal, Netherlands).



Half of a (8x8) grid is currently used to make 32 channel acquisitions since the final design of the grid (with 32 channels) is being finalized. This technique consists in sensing the electrical activity generated by muscle fibers (MFs) during a voluntary muscle contraction effort. The acceleration of the trunk was measured thanks to the combined accelerometer in the device Mobita® (TMSi, Oldenzaal, Netherlands).

- Processing of HD-sEMG signals

The muscle activity was quantified in the clinical study using two specific scores from HD-sEMG signal analysis and related to the contraction dynamics and intensity of the rectus femoris: Muscular Contraction Intensity MCI score ( $\mu V$ ), and Muscle Contraction Dynamics MCD score (Sec) related to contraction duration. These scores were obtained after preprocessing steps (Figure 2.6) such as: signal denoising by using a band pass filter in (4-400Hz) range [173], segmentation of muscle contractions from the HD-sEMG signal then signal averaging over channels and trials (3 trials to assess the reproducibility, See Annex 2Annex 3).

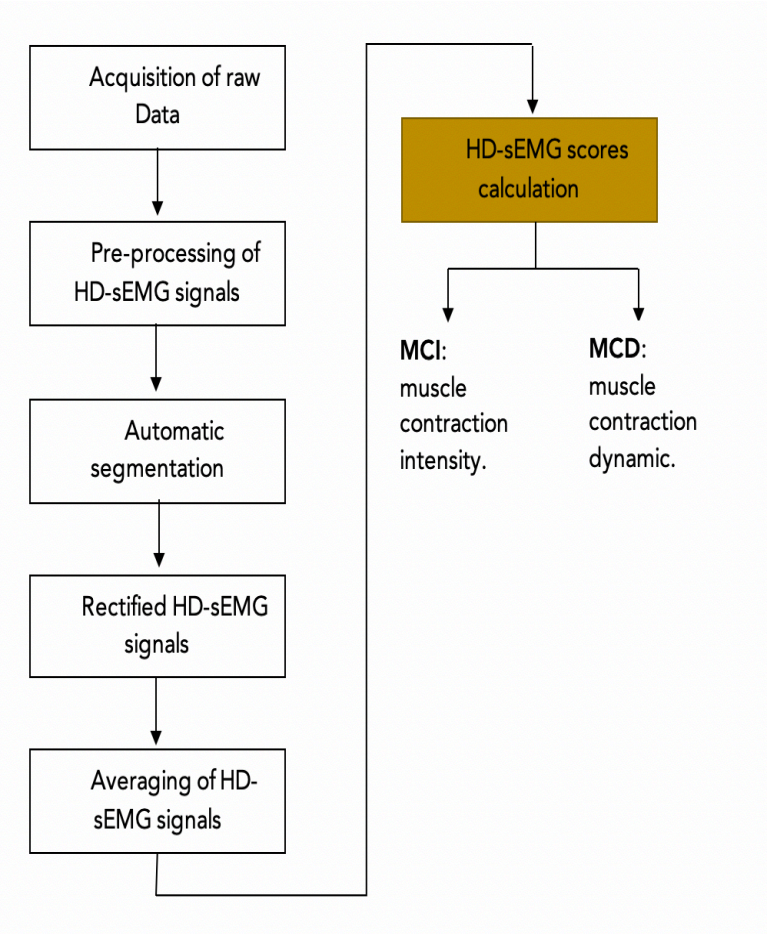

Figure 2.6 : Methodological issues in the processing of surface electromyogram

Finally, the MCI and MCD scores are computed (see Figure 2.7) and compared statistically between the age categories, physical activity level, and ultrasound scores. Both scores exhibited acceptable reproducibility among the three trials for all the age categories.

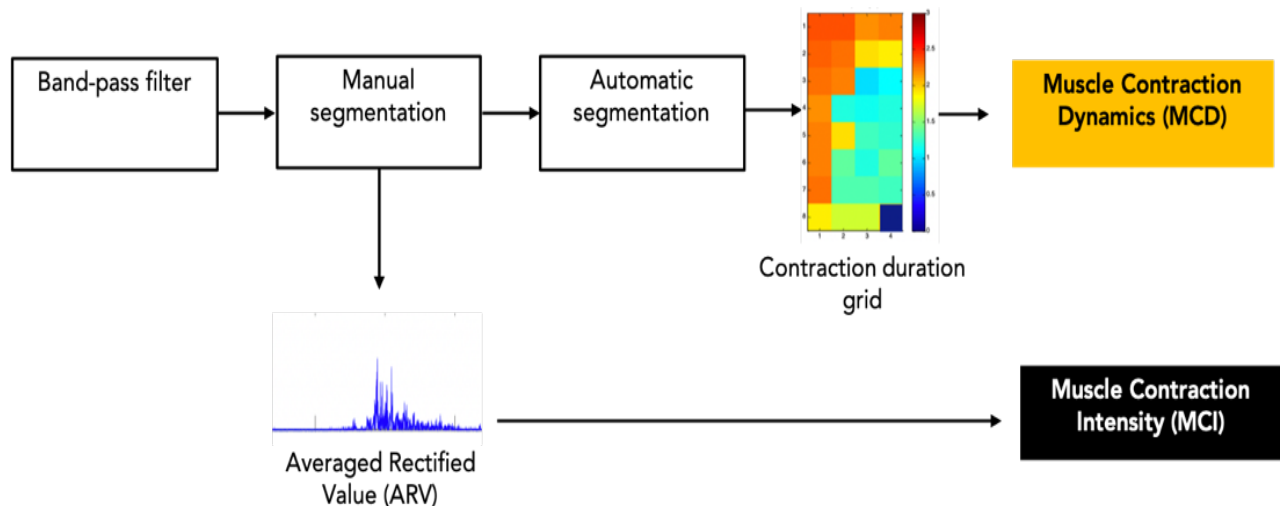

Figure 2.7: Set up of HD-sEMG score calculation

### Band-pass filter

The surface HD-sEMG signals has a spectral content from 4 Hz to 400 Hz [173]. When analog signals are sampled at rates smaller than twice of their highest frequency (for example less than 800 samples/s for the surface EMG signals), sinusoids with frequencies above this threshold are superimposed on the low frequency sinusoids. This phenomenon, known as aliasing, is suppressed with the use of low-pass analog filters [173].

Removing undesired components from the HD-sEMG signals is also possible after its digitization, with the use of digital filters. The power line interference, for example, is not attenuated with digital notch filters, that create a hole in the Power Spectral Density, but it's can be done with spectral interpolation techniques or blind source separation approaches [174,175].

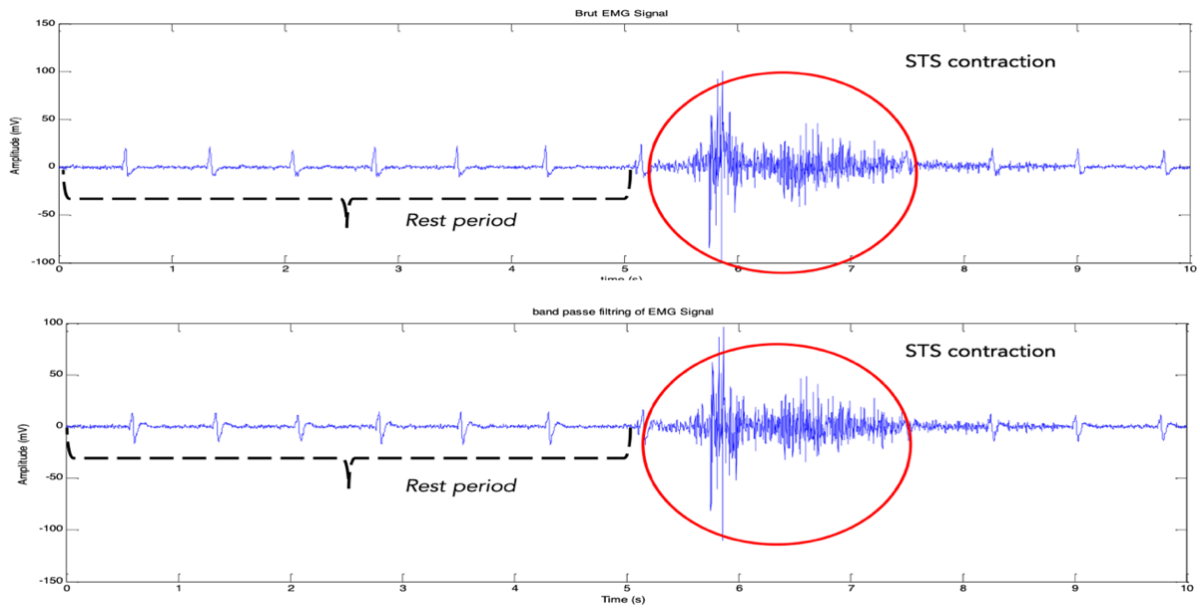

Figure 2.8: Above: Raw EMG signal, below: EMG signal after band-pass filter with rest period to calculate SNR.

Similarly, the movement artifacts appearing can be removed from the surface EMGs with a high-pass filter (included in the Mobita® device). Usually, band-pass filters with cutoff frequencies set at 4 Hz and 400 Hz are recommended for the filtering of surface EMG signals [176] (Figure 2.8). These pre-processing and data visualization steps can be done using Polybench® software provided with the Mobita® device (see Figure 2.9).

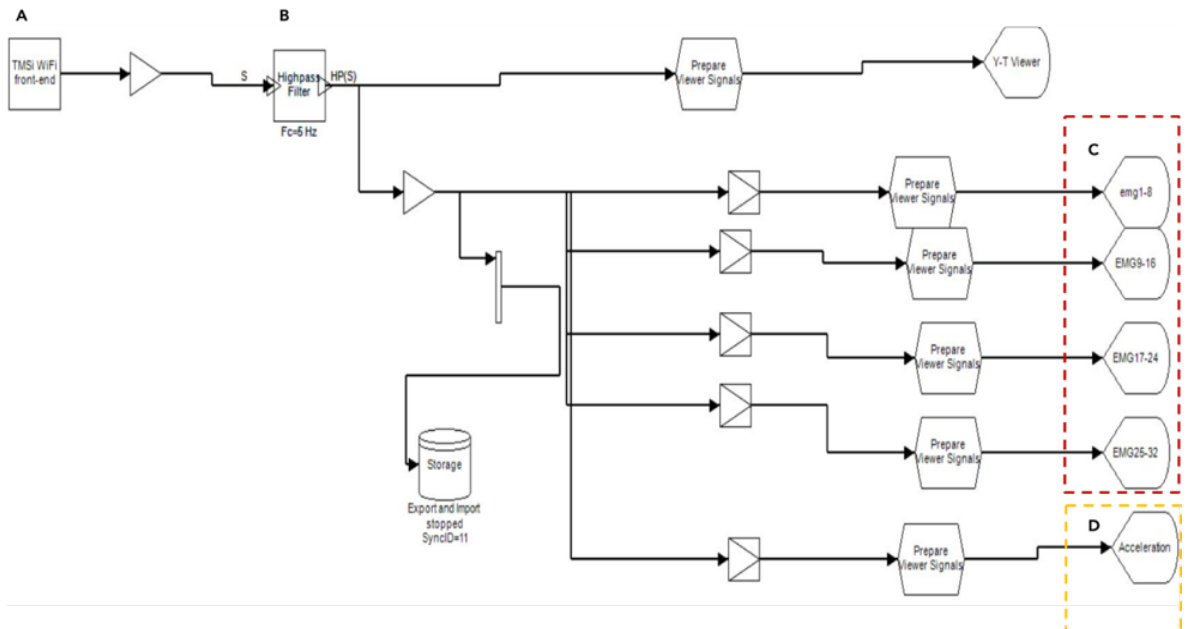

Figure 2.9: Acquisition interface using Polybench software by TMSI Netherland. A: Wireless connection for Mobita® (TMSi, Oldenzaal, Netherlands). B: high-pass filter with  $F_c=5$  Hz (recommended for Mobita device). C: visualization of EMG channels. D: visualization of acceleration acquisition.

### Manual segmentation

After having carried out the filtering block, we dealt with visual check and a manual segmentation to avoid the part which does not concern the signal of interest, we recall that the acquisitions of these data during the "CHRONOS" study concerned 91 participants including 82 active and 9 sedentary according to IPAQ. In fact, we set up the preprocessing approach at the same time as the acquisition sessions are done, so to be sure about the quality of the data that is entered into the automatic segmentation algorithm. Indeed, it was essential for us to carry out a visual checking as well as a manual segmentation. Now, with this hindsight that we have on these acquisitions we will be able to offer recommendations at the end of this manuscript in order to avoid this step, namely that manual segmentation done by an expert is always recommended by clinicians. One strength of our study is that all the steps (protocol, interface development, acquisition, pretreatment, analysis) were carried out by the same person, with help of supervisors. Communicating with the experts in the field of all related challenges, and recommendations deducted from this study (particularly manual segmentation) have strongly helped in designing automatic procedure (see next section).

### Automatic segmentation using Hilbert envelope

We processed the automatic segmentation using Hilbert transform. This method of segmentation is recommended for non-stationary and dynamic signals such as HD-sEMG signals during STS test [177]. The Hilbert transform overcomes the difficulties like choosing basic function for wavelet transform [178]. Empirical Mode Decomposition (EMD) has into its advantages that with a low level of SNR of the processed signal [179], it provides the best surface EMG de-noising performance compared to other methods. This offers the most successful results for attenuation of specific noises of sEMG signals, especially in cases of power-line noises, white Gaussian noise, baseline wandering and artifacts [179,180]. In case of short and clean signals such as our clinical database, EMD can lead to the loss of useful information in the contraction [179]. The Canonical Correlation Analysis (CCA) is also a relevant method for denoising signals. It has been already used to denoise HD-sEMG signals during isometric contraction [174,181,182]. This method will be evaluated in the next chapter for extracting meaningful features to discriminate age categories as we will show later.

In 1996, Norden E. Huang proposed the Hilbert Huang Transform (HHT), that can be used for processing non-stationary and non-linear signals, such as noise filtering and segmentation [183]. Is an empirically based data-analysis method. We can extract important features from this method such as contraction duration related to MCD score; extracted from the Hilbert envelope. Its basis of expansion is adaptive, so that it can produce physically meaningful representations of the data from non-linear and non-stationary processes [177,180]. In our project, we have chosen the Hilbert transform, the choice of Hilbert transform for automatic segmentation is made because it is the method which segments better both the nonstationary and dynamic signals (the case of ours signals). The other methods are relevant for isometric signals as well as the signals with long duration, in our case we will have a loss of information as a disadvantage using these methods.

The Hilbert transform theory is defined with these equations [177,180]:

We consider the signal  $z(t)$  as an analytic signal, where  $x(t)$  is the real part and  $y(t)$  is the imaginary component.

$$\mathbf{z}(t) = \mathbf{x}(t) + i\mathbf{y}(t) = \mathbf{a}(t)e^{j\theta t} \quad \text{Eq. 2}$$

Then we obtain the amplitude and phase:

Amplitude:

$$\mathbf{a}(t) = \sqrt{\mathbf{x}^2(t) + \mathbf{y}^2(t)} \quad \text{Eq. 3}$$

Phase:

$$\mathbf{arctg}\left(\frac{\mathbf{y}(t)}{\mathbf{x}(t)}\right) \quad \text{Eq. 4}$$

Whit this  $\theta(t)$  function, we obtain the instantaneous frequency, by applying the derivation to it:

$$\mathbf{w} = \frac{d\theta}{dt} \quad \text{Eq. 5}$$

The original data can be expressed as the real part Re in the following form:

$$\mathbf{x}(t) = \mathbf{Re} \sum_{j=1}^n \mathbf{a}_j(t)e^{j \int \mathbf{w}_j dt} \quad \text{Eq. 6}$$

Equation above shows that HHT (Hilbert-Huang Transform) is an extended form of Fourier Transform.

$$x(t) = \text{Re} \sum_{j=1}^n a_j(t) e^{i w_j(t) t} \quad \text{Eq. 7}$$

The contrast between equations 6 and 7 represents a generalized Fourier expansion. The variable amplitude and the instantaneous frequency have not only greatly improved the efficiency of the expansion, but also enabled the expansion to accommodate nonlinear and non-stationary data [177].

We calculate the analytical signal with the help of Hilbert transform function in Matlab [184] (Figure 2.10 & Figure 2.11), taking the envelope and smoothing the signal (smooth window=50ms, correlated to  $F_s=1\text{KHz}$ , this is the window length used for smoothing HD-sEMG signal).

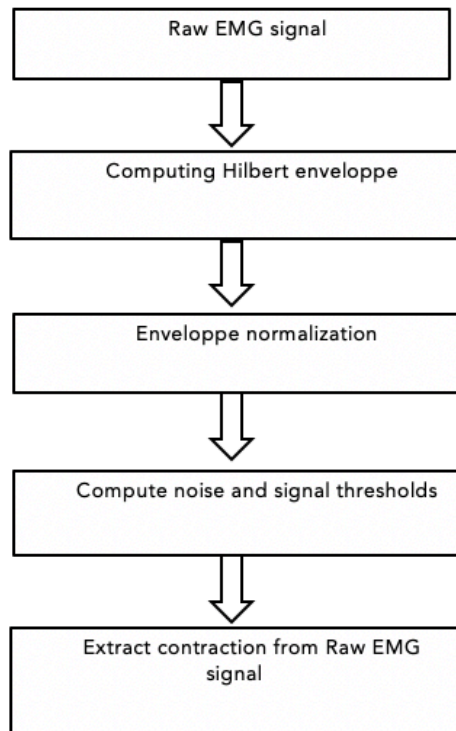

Figure 2.10: Automatic segmentation algorithm using Hilbert transform

Then, with the help of an adaptive threshold algorithm, we detect the muscle activity in the signal where at least a minimum number of samples with the length of duration samples (250ms) should stay above the noise threshold. This threshold is obtained from computation of signal noise and sEMG activity level and updated online (Figure 2.11).

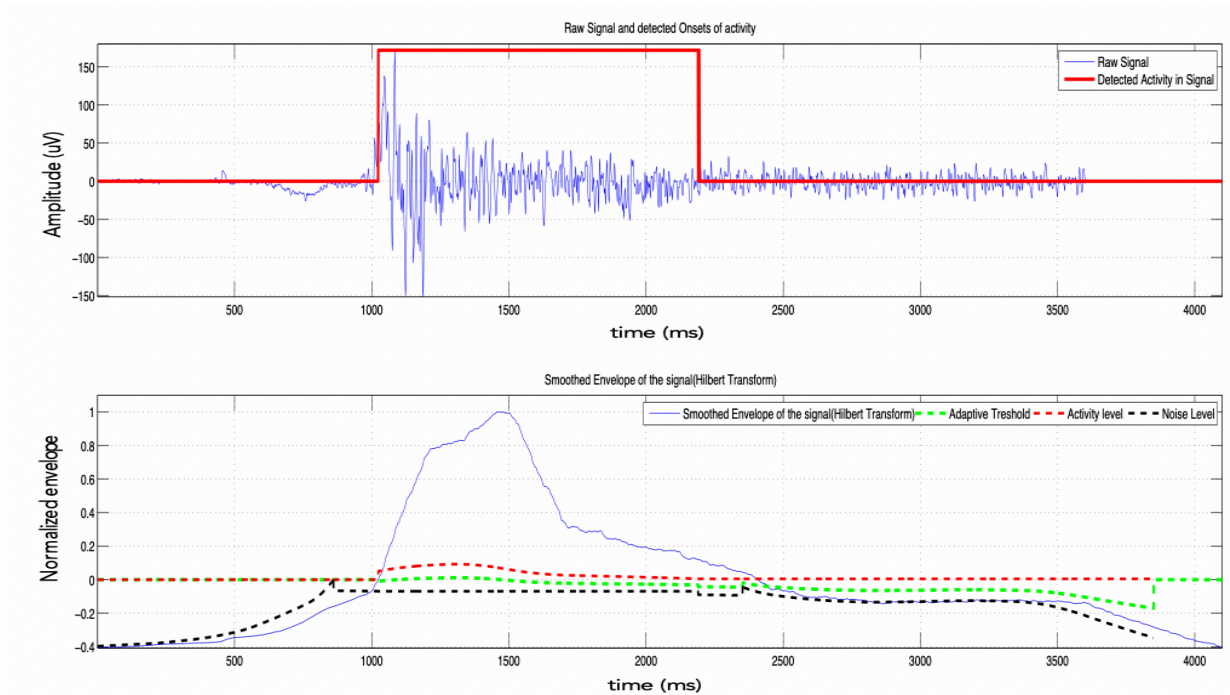

Figure 2.11: Automatic segmentation of EMG signal using Hilbert transform

The outputs obtained from the segmentation process are: the alarm vector (see Figure 2.12) containing the muscle activity window, the start and the end of contraction from the Alarm vector and the calculated contraction duration.

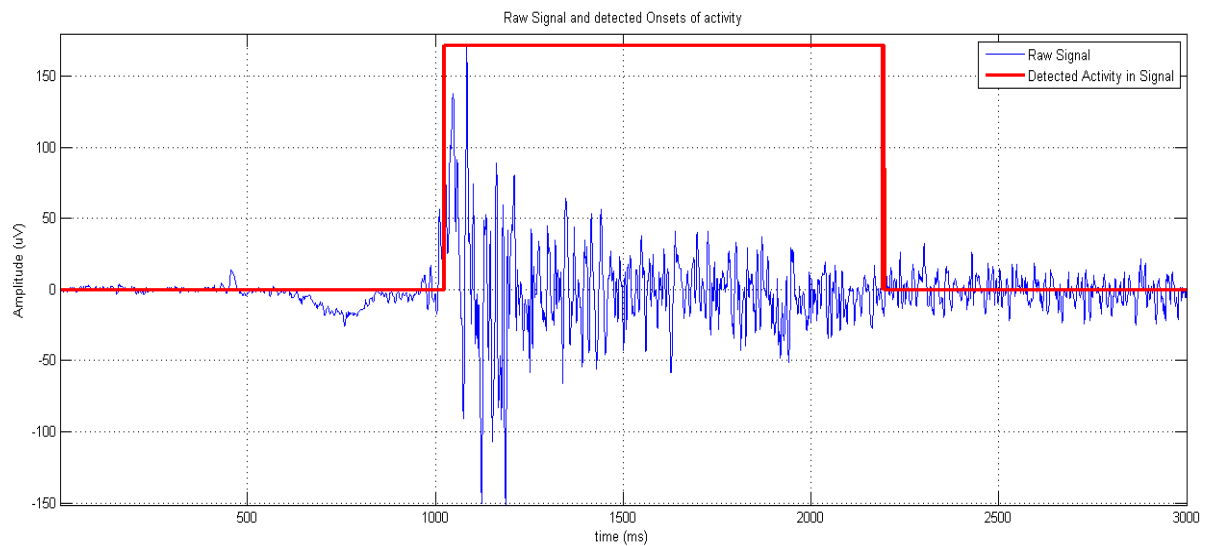

Figure 2.12: Alarm vector obtained from automatic segmentation

Finally, we match the alarm vector (Figure 2.12) with the active part in original signal in order to recover the contraction part, the beginning of contraction, the end of contraction serve as to compute the contraction duration defined as MCD score.

- HD-sEMG score analysis

Muscle Contraction Dynamics (MCD) score :

From the contraction duration matrix, we obtained the following averaged heat maps of the MCD scores (see Figure 2.13) for the 5 age categories and the sedentary group. For the younger category (25-34 yrs.), the blue color indicates small MCD values related to short contraction duration and fast STS motion. As the age increases, the color becomes warmer indicating longer contraction duration and slower STS motion.

The sedentary heat map is particularly interesting. One can observe two regions. One dominated by slow contraction dynamics and the other with faster ones. The sedentary category seems to share both behavior of the same active age (45-54 yrs.; i.e. category 3) and the one of older ones (categories 4 and 5). These observations are useful for discrimination purposes as exposed in the next chapter. The averaged MCD score from the 32 channels will show also a good discrimination in statistical analysis in CHRONOS study results (see next sections).

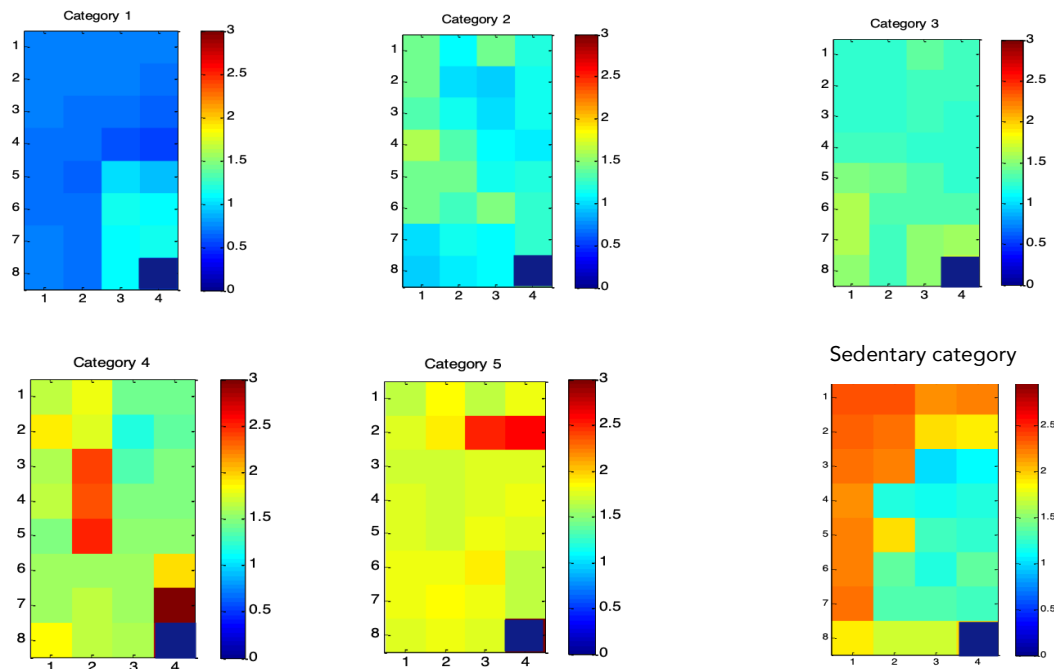

Figure 2.13: Averaged MCD heat map (32 channels) for the 5 age categories yrs (category1=25-34yrs ,category2=35-44yrs, category3=45-54yrs, category4=55-64yrs, category5=65-74yrs.), and sedentary group 45-54 yrs group (up, proximal, down distal, left, lateral and right distal part of the grid).



Muscle Contraction Intensity (MCI) score:

The MCI score refers to the maximum amplitude from the Averaged Rectified Value (ARV) that corresponds as its name reveals to the average of the rectified values of a sEMG signal  $x$  during a segment of time corresponding to total number of samples in the signal ( $N_{tot}$ ). It is expressed by the following equation, where  $i$  is the sample index:

$$ARV = \frac{1}{N_{tot}} \sum_{i=1}^{N_{tot}} x^2_i \quad \text{Eq. 8}$$

We obtain the following shapes of ARV signals and smoothed envelope for the 5 age categories and sedentary group (chosen from one channel of the grid and one representative subject for each category, exposed on Figure 2.14). We can observe, in this figure, the rise strategy changes with aging (up to down: the 5 age categories 25-34 yrs., 35-44yrs, 45-54yrs, 55-64yrs, 65-74yrs, and finally the sedentary group 45-54 yrs.). In fact, the muscle activity seems to be more compact in time for younger category (with one peak in the signal envelope corresponding to one compact sEMG activity) and begins to enlarge with age, increase to reach a double peak (corresponding to two separated sEMG activity) in the older category (65-74 yrs.). It is interesting to observe that the sedentary category exhibits an envelope shape (Figure 2.14 F) that is closer to higher age categories (Figure 2.14 D,E) than its active age category (Figure 2.14 C). However, these results are preliminary and should be confirmed in term of reproducibility (channel and subject) in further work. Indeed, one can notice that these preliminary results agree with the multimodal clinical study CHRONOS, presented in the next sections.

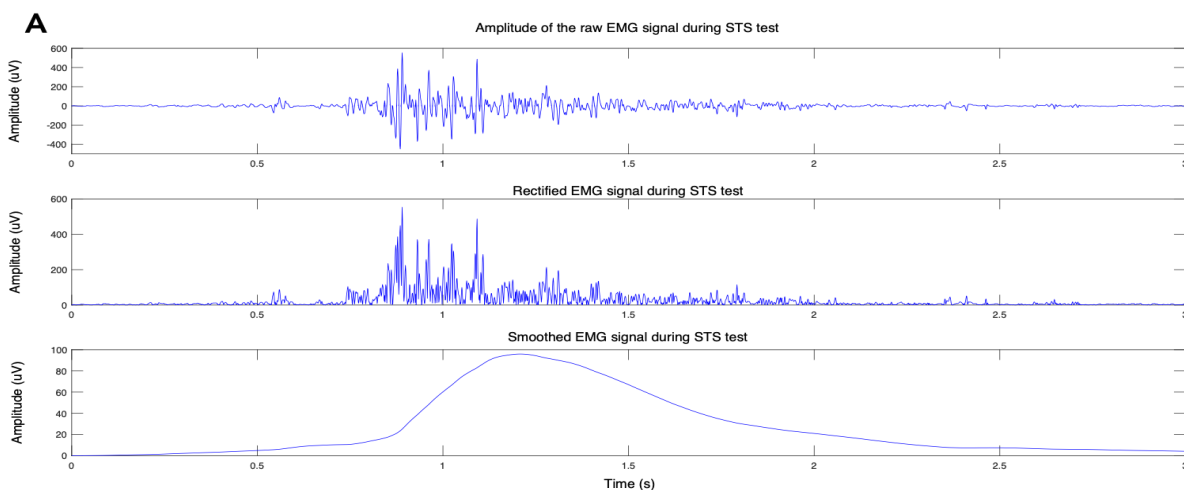

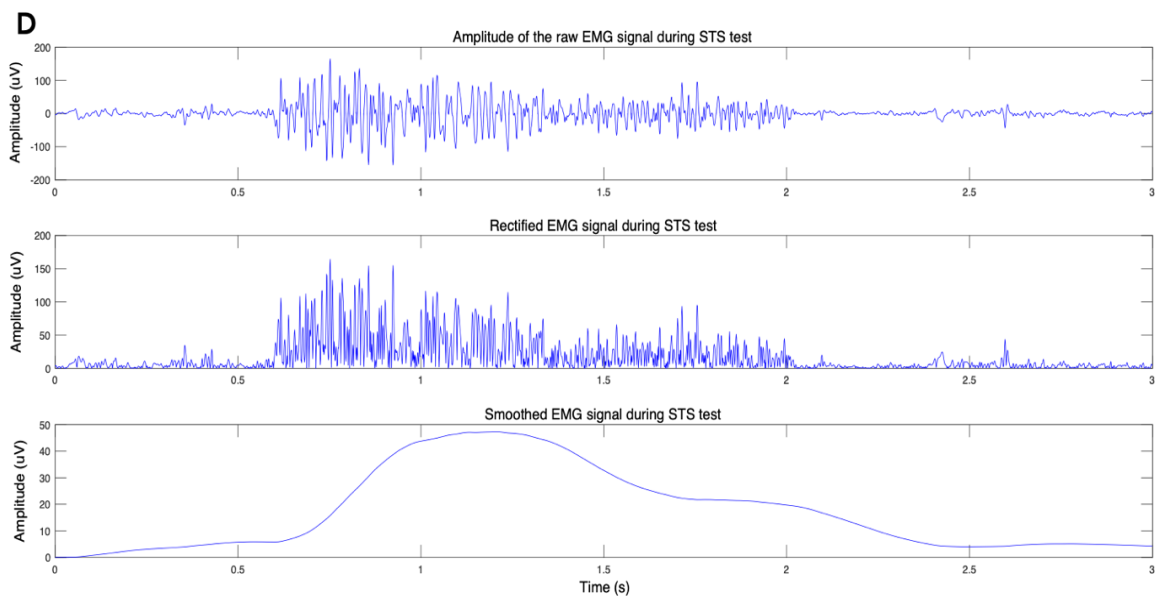
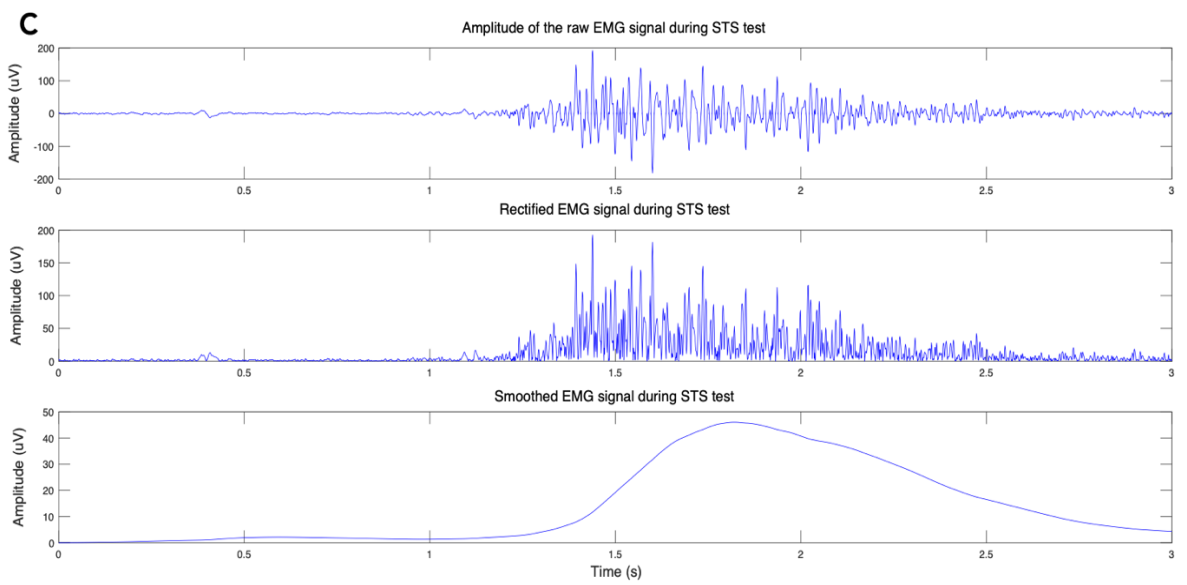
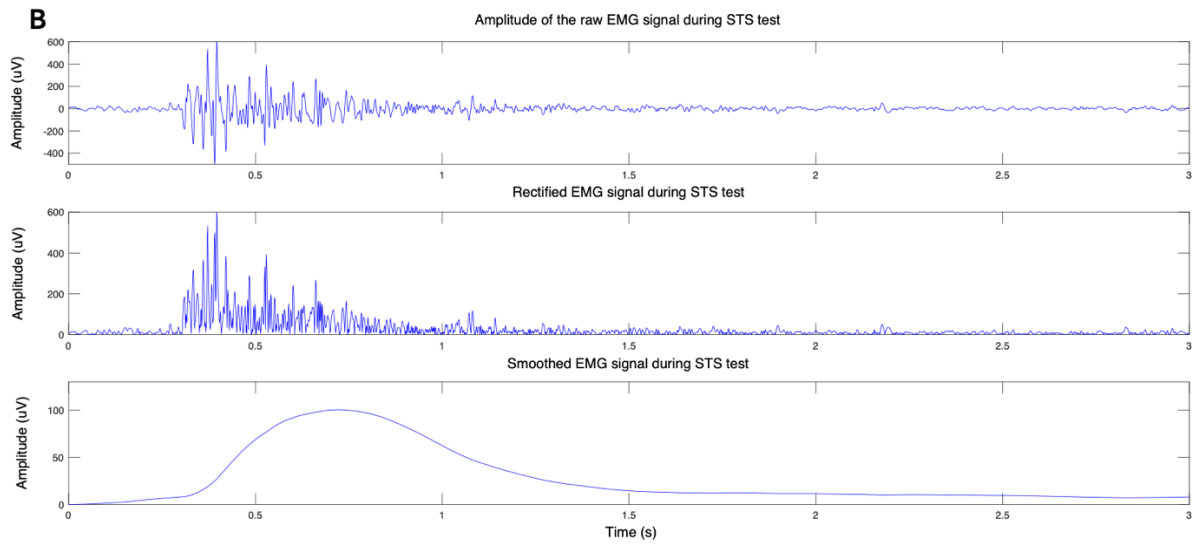

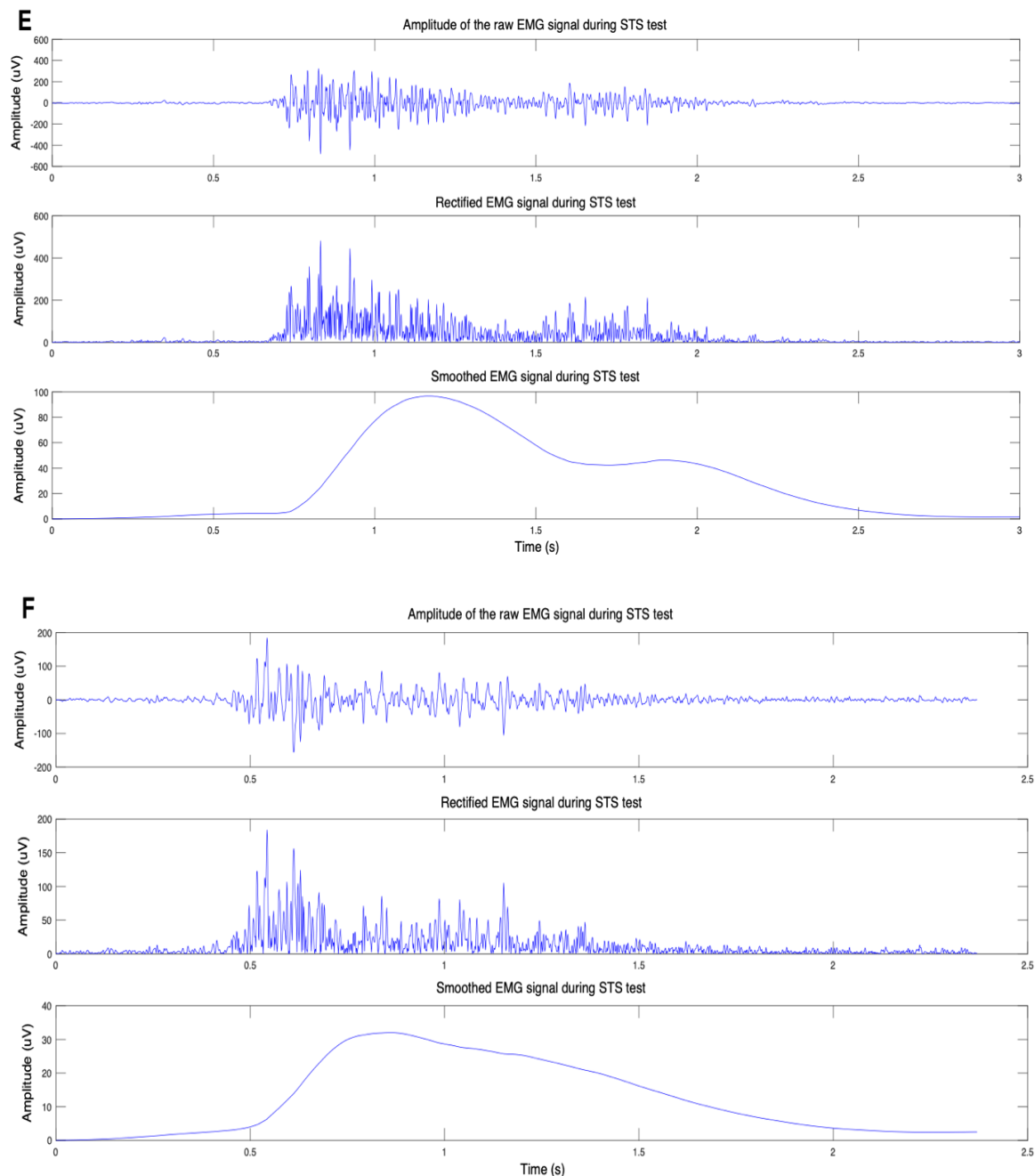

Figure 2.14 : Averaged HD-sEMG signals for the 5 age categories and sedentary category, A=(Category1:25-34yrs),B= (Category2:35-44yrs),C=(Category3:45-54yrs),D=(Category4:55-64yrs),E= Category5:65-74yrs),and F=(sedentary category:45-54yrs).

### 2.2.3 Statistical analysis for multimodal data comparison

The clinical data obtained in the presented studies were analyzed and statistically compared to the HD-sEMG scores, to age and to physical activity level using statistical hypothesis tests with Matlab software (R2014, Mathworks©). In addition, correlation coefficient between pairs of scores and multivariate analysis (MANOVA) was computed according to age,

sex, and BMI of the subjects. The quantitative variables were analyzed using parametric tests (ANOVA analysis of variance followed by post hoc Tukey HSD tests when there were more than two groups). Variables that do not meet the validity conditions for parametric tests (normality of the distribution, equality of variances) were analyzed with non-parametric tests (Kruskal-Wallis test followed by post hoc Nemenyi test) [185]. The results are considered to be statistically significant at a critical threshold of 1% ( $p < 0.01$ ) [185–187].

## 2.3 Clinical study result

### 2.3.1 Preliminary studies

Before starting the recording campaign for CHRONOS study, we did some previous preliminary studies in order to optimize the experimental protocol (Figure 2.15).



Figure 2.15: Optimization of HD-sEMG acquisition chain from REFA amplifier (A) to Mobita ambulatory device (B).

The aim of our first preliminary study [188] was to characterize the motor abilities of young compared to older subjects by combining a recent electromyography technique, the HD-sEMG (high density surface electromyography), and the Inertial Measurement Unit (IMU) to estimate muscle activation and motion efficiency during the Sit-to-stand test (STS). Twelve subjects participated in the STS test. Seven of which were healthy young subjects ( $25 \pm 5.7$

years), and five were older subjects ( $80 \pm 7.8$  years). All subjects performed sit-to-stand (STS) motion 5 times at spontaneous pace.

The muscle activity was quantified using specific descriptors such as contraction timing and intensity. Two  $8 \times 8$  HD-sEMG grids were placed on the right and left femoral muscles. Simultaneously, the trunk maximum acceleration during STS test was measured using an IMU. The results showed that the HD-sEMG descriptors related to muscular activity, and the trunk maximum acceleration were discriminant with the age ( $p < 0.001^{***}$ ) [189]. Also, this study demonstrated the potential of the combination of HD-sEMG signals and IMU data for evaluating functional motor abilities.

However, our acquisition chain was based on the Refa (TMSi) equipment (Figure 2.15) and this acquisition chain was not suitable for clinical use. Then, we thought about optimizing the acquisition chain by using another innovative device (Mobita®, TMSi), notably advantageous in terms of combination of acceleration data and HD-sEMG signals. The wireless facilities and also its low weight and the easiness of setting up the acquisition chain was a strong and motivating point for testing this new device in the muscle aging monitoring task.

So, the aim of the second preliminary study is to characterize the motor abilities with aging, including middle-aged subjects and using new descriptors, by combining both techniques, embedded in a recent ambulatory portable device (Mobita®). Nine subjects participated in this study [189]. Three were aged  $25 \pm 2$  years, four were aged  $34.75 \pm 3.09$  years, and two were aged  $57 \pm 7.07$  years. All of them performed sit-to-stand motion 3 times at spontaneous pace. New features from HD-sEMG signals such as Skewness and Kurtosis were also tested in addition to previous descriptors such as contraction timing and intensity, in order to check their efficiency.

For this purpose,  $4 \times 8$  HD-sEMG grids were placed on the quadriceps muscle. Simultaneously, the trunk maximum acceleration was also measured [189]. Thus, the results for the three age categories were statistically evaluated. The results showed that the statistical descriptors have a significant sensitivity to the motor efficiency with aging in the STS test ( $p < 0.001^{***}$ ) [189].

Contraction timing and intensity related to muscular activity, and the trunk maximum acceleration are also discriminant with the age ( $p < 0.001^{**}$ ), in agreement with the previous obtained results in [188].

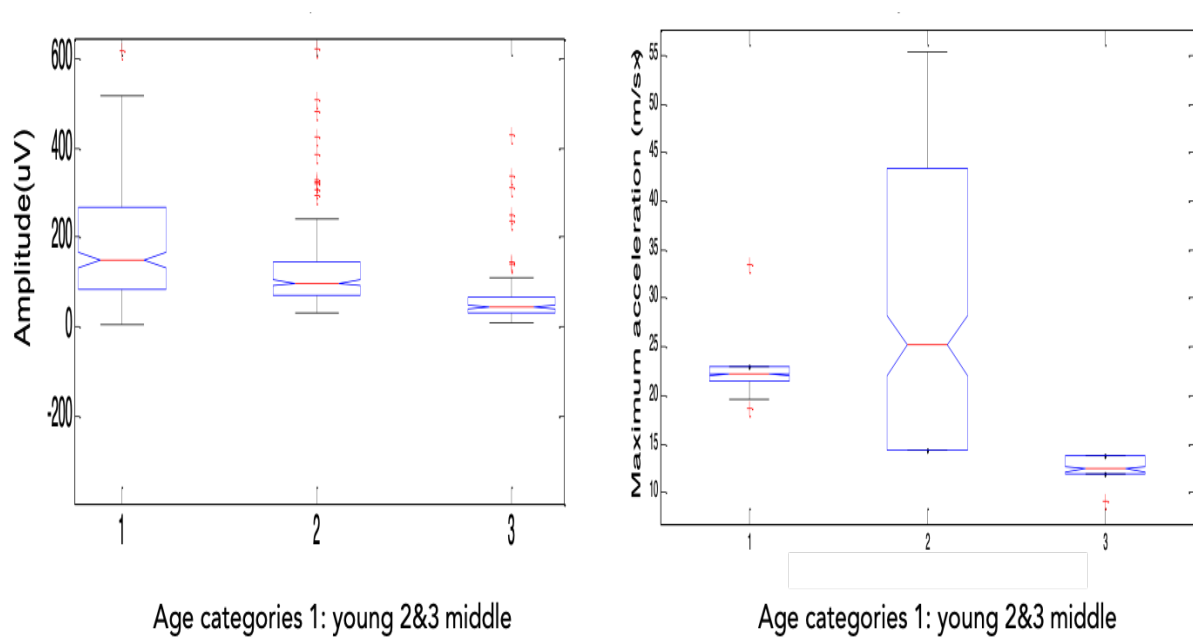

Figure 2.16: Box plot for the maximum amplitude (left) and the maximum acceleration (Right) for three age categories (Imrani et al 2018) [189]. See (Annex 4Annex 5)

In fact, the obtained results (Figure 2.16) demonstrated the potential of statistical and previous descriptors from HD-sEMG signals and IMU data recorded by an ambulatory device for evaluating functional motor abilities with aging. Consequently, we decided to use Mobita® device in the CHRONOS clinical study taking account the several advantages regarding clinical use. Other preliminary results were obtained during the CHRONOS study, with intermediate data, before obtaining the final database (see the next section). These results also demonstrated that HD-sEMG signals descriptors have a significant sensitivity to the motor efficiency with aging (posters presented in congresses JASFGG 2018, ICSFR 2019)

### 2.3.2 Multimodal clinical comparative study (CHRONOS)

The 91 recruited healthy volunteers were 49% females, with a mean age of  $49 \pm 14$  years and a mean body mass index (BMI) of  $23.7 \pm 2.7$  kg/m<sup>2</sup>. Firstly, a comparative study between classical clinical and imaging scores was performed to show the ability of the HD-sEMG technique to detect muscle manifestations of healthy aging in a precise manner. Secondly, a specific age category (45-54 years old) was scrutinized to evaluate the effect of sedentary lifestyle on muscle aging. For this purpose, the active group was compared to the sedentary group.

- Results of the aging effect on clinical, ultrasound and HD-sEMG scores

Among the 91 volunteers included, 82 were physically active according to the IPAQ. The scores evaluating muscle changes were compared according to age group (five categories, from 25 to 74 years old divided into 5 decades). It is important to note that the 82 physically active volunteers did not show any significant difference in BMI, food ratio in kilocalories/kg/day and protein intake (g/kg/day), level of physical activity, comorbidities assessed using the Charlson score, frailty using the Rockwood score, cognition (MMSE), depression (GDS), and number of medications (Table 1)

Table 1: General description of the CHRONOS active population (n=82)

Variables	25-34 yrs. (n=16) Mean (±SD)	35-44 yrs. (n=16) Mean (±SD)	45-54 yrs. (n=17) Mean (±SD)	55-64 yrs. (n=17) Mean (±SD)	65-74 yrs. (n=16) Mean (±SD)	P-value
Females (%)	50	50	47	47	50	
BMI (kg/m <sup>2</sup> )	23.88 (±2.80)	23.63 (±2.90)	23.53 (±2.32)	24.0 (±3.24)	23.63 (±2.83)	0.987
IPAQ (Met-min/week)	3986.55 (±2651.45)	4544.83 (±3339.39)	4433.61 (±3244.17)	5004.07 (±4128.19)	3107.31 (±1792.13)	0.559
Charlson score	0.00 (±0.00)	0.00 (±0.00)	0.12 (±0.49)	0.00 (±0.00)	0.3 (±0.34)	0.241
Rockwood score	1.25 (±0.45)	1.31 (±0.70)	1.12 (±0.33)	1.12 (±0.33)	1.25 (±0.68)	0.824
MMSE	29.44 (±0.89)	29.31 (±1.49)	29.65 (±0.49)	29.06 (±1.03)	28.69 (±1.35)	0.076
Mini GDS	0.1875 (±0.40)	0.19 (±0.54)	0.41 (±1.00)	0.18 (±0.39)	0.13 (±0.50)	0.868
Number of medications	0.62 (±0.62)	0.38 (±0.50)	0.24 (±0.44)	0.59 (±0.87)	0.31 (±0.87)	0.149
Food ratio (kcal/kg/day)	26.67 (±7.40)	27.48 (±7.13)	28.35 (±5.21)	27.48 (±7.13)	25.53 (±7.38)	0.719
Protein intake (g/kg/day)	1.07 (±0.36)	1.19 (±0.38)	0.99 (±0.16)	1.19 (±0.38)	1.04 (±0.23)	0.823

BMI: body mass index; IPAQ: International physical Activity Questionnaire, MMSE: Mini Mental State Examination; GDS: Geriatric Depression Scale.

According to the results obtained (see table 2), the classical clinical muscle parameters (handgrip strength, distance of 6-minute walk test, SPPB, and DXA) did not significantly differ across age categories. These clinical parameters were not able to discriminate, in a significant manner, between young, middle-aged or old healthy active volunteers.

Table 2. Statistical testing of clinical scores of the active population with aging (n=82)

Variables	25-34 yrs. (n=16) Mean ( $\pm$ SD)	35-44 yrs. (n=16) Mean ( $\pm$ SD)	45-54 yrs. (n=17) Mean ( $\pm$ SD)	55-64 yrs. (n=17) Mean ( $\pm$ SD)	65-74 yrs. (n=16) Mean ( $\pm$ SD)	P-value
Handgrip Strength(kg)	38.06 ( $\pm$ 10.74)	41.69 ( $\pm$ 11.81)	40.53 ( $\pm$ 11.88)	35.29 ( $\pm$ 8.18)	36.06 ( $\pm$ 10.29)	0.398
Distance of 6 minute walk (m)	528.94 ( $\pm$ 56.74)	540.00 ( $\pm$ 88.17)	513.53 ( $\pm$ 50.28)	494.47 ( $\pm$ 56.56)	488.31 ( $\pm$ 88.14)	0.179
SPPB	11.69 ( $\pm$ 1.01)	12.00 ( $\pm$ 0.00)	11.88 ( $\pm$ 0.33)	12.00 ( $\pm$ 0.00)	11.81 ( $\pm$ 0.40)	0.228
SMI (kg/m <sup>2</sup> )	7.36 ( $\pm$ 1.02)	7.90 ( $\pm$ 1.14)	7.48 ( $\pm$ 1.45)	7.29 ( $\pm$ 1.38)	7.09 ( $\pm$ 1.22)	0.465
AMM (kg)	22.51 ( $\pm$ 4.91)	23.7 4( $\pm$ 5.12)	21.89 ( $\pm$ 5.77)	21.73 ( $\pm$ 5.54)	20.56 ( $\pm$ 4.99)	0.424
Total LM (%)	66.54 ( $\pm$ 8.77)	70.81 ( $\pm$ 8.45)	70.28 ( $\pm$ 7.63)	67.89 ( $\pm$ 9.51)	66.93 ( $\pm$ 7.51)	0.484
Total FM (%)	30.57 ( $\pm$ 9.28)	26.06 ( $\pm$ 8.99)	26.76 ( $\pm$ 8.13)	29.39 ( $\pm$ 10.08)	30.46 ( $\pm$ 7.84)	0.464

AMM: appendicular muscle mass; LM: lean mass; FM: fat mass; SMI: skeletal muscle index; SPPB: Short Physical Performance Battery

Muscle thickness evaluated using ultrasonography showed discriminant results ( $p < 0.001^{***}$ ) with aging: the muscle thickness decreased with age from  $19.97 \pm 2.38$  mm between 25–34 years to  $15.86 \pm 1.13$  mm between 65–74 years ( $p < 0.001$ ). In contrast, fat thickness increased between 25–34 years and 65–74 years ( $3.99 \pm 1.15$  vs.  $6.22 \pm 1.44$ ,  $p < 0.001$ ) (Table 3, Figure 2.17).



Table 3: Statistical testing of the ultrasound scores of the active population with aging (n=82)

Variables	25-34 yrs. (n=16) Mean ( $\pm$ SD)	35-44 yrs. (n=16) Mean ( $\pm$ SD)	45-54yrs. (n=17) Mean ( $\pm$ SD)	55-64yrs. (n=17) Mean( $\pm$ SD)	65-74yrs. (n=16) Mean ( $\pm$ SD)	P-value
MT (mm)	19.97 ( $\pm$ 2.38)	18.87 ( $\pm$ 2.41)	17.43 ( $\pm$ 2.03)	17.76 ( $\pm$ 3.12)	15.86 ( $\pm$ 1.13)	<b>P&lt;0.001</b> <b>***</b>
FT (mm)	3.99 ( $\pm$ 1.15)	4.62 ( $\pm$ 1.38)	4.21 ( $\pm$ 1.08)	5.66 ( $\pm$ 1.65)	6.22 ( $\pm$ 1.44)	<b>P&lt;0.001</b> <b>***</b>

FT: fat thickness; MT: muscle thickness. \*\*\*  $p < 0.001$

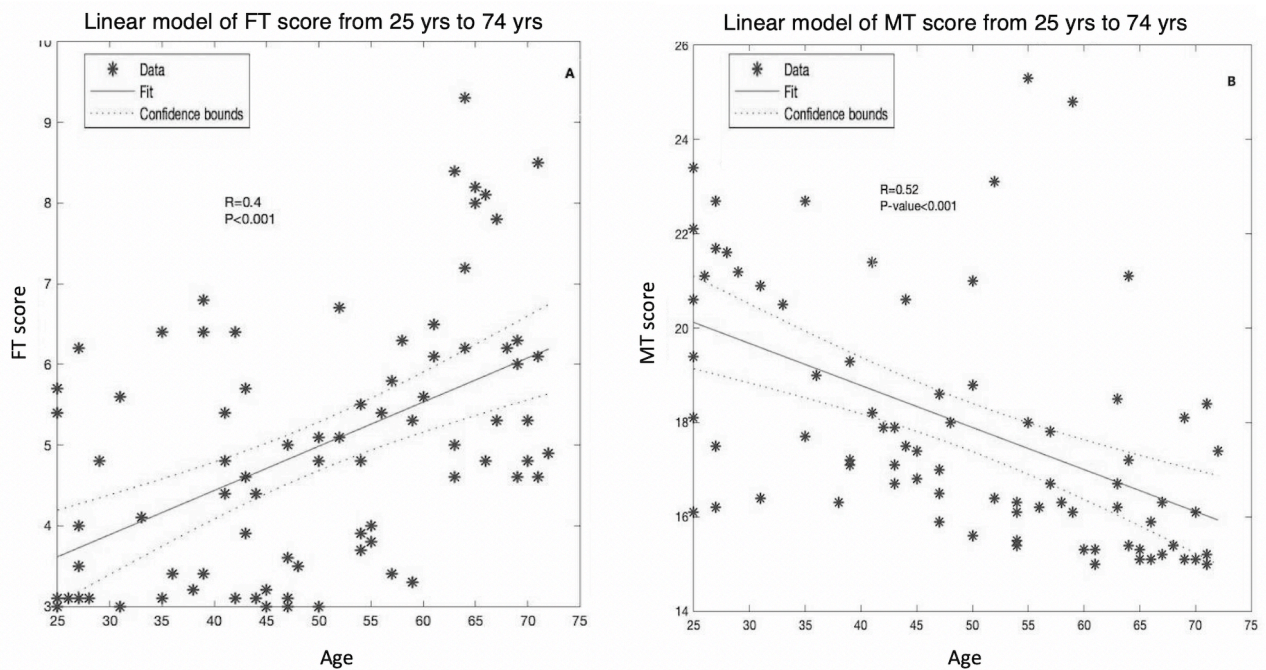

Figure 2.17: Linear regression with aging of FT score (A) and MT score(B). Where R is determinant coefficient R= (0.4,0.52) respectively.

The HD-sEMG scores (MCD, MCI) demonstrated a significant discrimination (respectively  $p < 0.001^{***}$ ,  $P < 0.01^{**}$ ) between the age categories of the active subjects (Table 4). There was a monotonic increase for MCD scores indicating different muscle activation strategies with aging. A linear regression analysis was performed and depicted in Figure 2.18. A high correlation value of MCD was obtained indicating this clear monotonic and linear behavior. This increase was also observable on MCI scores for some decades but with a decrease for the last decade indicating decrease in strength and muscle contraction intensity.

However, the age relationship of the MCI score was not as clear at this level as for the MCD score (see Table 4, Figure 2.18 for details).

Table 4 Statistical testing of HD-sEMG scores of the active population according to age (n=82)

Variables	25-34 yrs. (n=16) Mean ( $\pm$ SD)	35-44 yrs. (n=16) Mean ( $\pm$ SD)	45-54 yrs. (n=17) Mean ( $\pm$ SD)	55-64 yrs. (n=17) Mean ( $\pm$ SD)	65-74 yrs. (n=16) Mean ( $\pm$ SD)	P-value
MCI ( $\mu$ V)	199.32 ( $\pm$ 224.60)	155.75 ( $\pm$ 81.54)	183.30 ( $\pm$ 136.51)	291.95 ( $\pm$ 164.63)	260.15 ( $\pm$ 119.43)	P<0.01 **
MCD (Sec)	1.60 ( $\pm$ 0.63)	1.64 ( $\pm$ 0.43)	1.84 ( $\pm$ 0.35)	2.00 ( $\pm$ 0.34)	2.13 ( $\pm$ 0.71)	P<0.001 ***

MCD: Muscle Contraction Dynamic score; MCI: Muscular Contraction Intensity score.

\*\* p<0.01; \*\*\* p<0.001

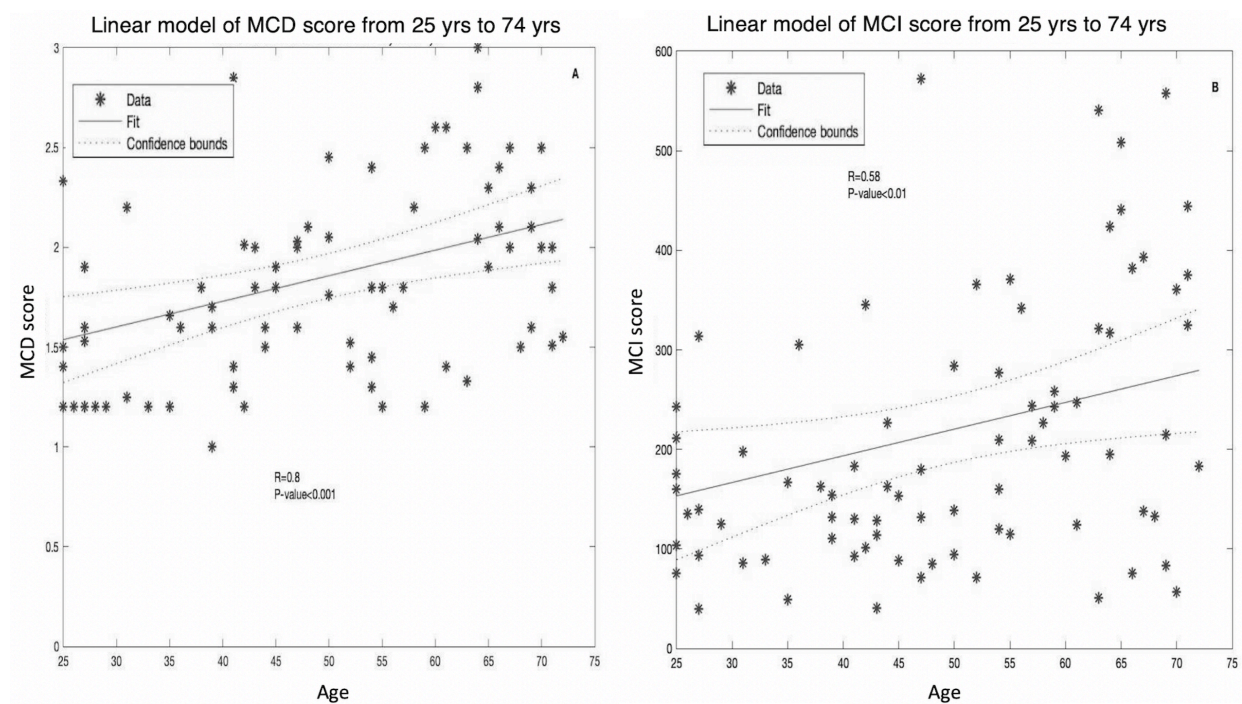

Figure 2.18: A linear regression with aging of MCD score (A) and MCI score (B). Where R is determinant coefficient R= (0.8,0.58) respectively.

Interestingly, a significant correlation coefficient was observed between HD-sEMG scores and muscle thickness evaluated using ultrasonography (Table 5). Adipose tissue thickness was significantly different with aging (p<0.001\*\*\*) but not significantly different with

HD-sEMG scores (Tables 3 and 6). Furthermore, both HD-sEMG scores were correlated to age with a correlation coefficient of 0.58 and 0.81 for MCI and MCD score respectively (Table 5).

Table 5: Correlation coefficients of HD-sEMG scores, ultrasound scores, and age (n=82)

	Age	MCI (uV)	MCD (S)	MT (mm)	FT (mm)
Age	1	<b>0.59</b>	<b>0.81</b>	-0.40	0.52
MCI (uV)	<b>0.59</b>	1	0.18	-0.22	0.09
MCD (Sec)	<b>0.81</b>	0.18	1	<b>-0.58</b>	0.40
MT (mm)	-0.40	-0.22	<b>-0.58</b>	1	-0.47
FT (mm)	0.52	0.09	0.40	-0.47	1

FT: fat thickness; MCD: Muscle Contraction Dynamic score; MCI: Muscular Contraction Intensity score; MT: muscle thickness.

A MANOVA analysis was performed to assess the robustness of the HD-sEMG scores of several parameters (Table 6). In this study, the HD-sEMG score sensitivity to muscle aging manifestations were significantly independent of BMI, gender or fat thickness effects ( $P>0.02$ ) in the five active age categories. These observations further demonstrated the reliability of the results related to HD-sEMG technique.

Table 6 : multivariate variance analysis (MANOVA) to assess the robustness of the HD-sEMG scores to MT, FT, Gender, and BMI parameters

	MCI (uV)	MCD (Sec)	MT (mm)	FT (mm)
Age (yrs.)	$P>0.05$	$P<0.001$ ***	$P<0.001$ ***	$P<0.001$ ***
Gender	$P=0.025$	$P>0.05$	$P>0.05$	$P>0.05$
BMI (kg.m-2)	$P>0.05$	$P>0.05$	$P>0.05$	$P>0.05$
FT (mm)	$P>0.05$	$P>0.05$		

BMI: Body Mass Index; FT: fat thickness; MCD: Muscle Contraction Dynamic score; MCI: Muscular Contraction Intensity score; MT: muscle thickness.

- *Results of the physical activity level effect on clinical, ultrasound and HD-sEMG scores*

The clinical muscle parameters (handgrip strength, distance of 6-minute walk test, SPPB, and DXA) did not significantly differ across physical activity level (Table 7): in healthy subjects, these clinical parameters were not able to discriminate, in a significant manner, between sedentary and active subjects of the same decade (45-54 yrs.)

Table 7 Statistical testing for comparing clinical scores between active and sedentary subjects

	Sedentary	Active			Sedentary vs active P-value		
		45-54 yrs. (n=9) Mean(±SD)	45-54 yrs. (n=17) Mean (±SD)	55-64 yrs. (n=17) Mean (±SD)	65-74 yrs. (n=16) Mean (±SD)	45-54 yrs. vs 45-54 yrs.	45-54 yrs. vs 55-64 yrs.
Females (%)	55	47	47	50			
BMI (kg/m <sup>2</sup> )	24.33 (±2.60)	23.53 (±2.32)	24.0 (±3.24)	23.63 (±2.83)	0.53	0.40	0.64
IPAQ (MET- min/week)	333.97 (±183.81)	4433.61 (±3244.17)	5004.07 (±4128.19)	3107.31 (±1792.13)	<b>0.001*</b>	<b>0.002*</b>	<b>0.0001*</b>
Charlson score	0.0 (±0.00)	0.12 (±0.49)	0.00 (±0.00)	0.3 (±0.34)	0.86	-	0.73
Rockwood score	2 (±0.00)	1.12 (±0.33)	1.12 (±0.33)	1.25 (±0.68)	0.96	<b>0.001</b>	<b>0.003</b>
MMSE	28.88 (±1.16)	29.65 (±0.49)	29.06 (±1.03)	28.69 (±1.35)	0.81	0.92	0.16
Mini GDS	0.33 (±0.70)	0.41 (±1.00)	0.18 (±0.39)	0.13 (±0.50)	0.43	0.65	0.54
Number of medications	0.11 (0.33)	0.24 (±0.44)	0.59 (±0.87)	0.31 (±0.87)	0.89	0.59	0.44
Food ratio (kcal/kg/day )	22.88 (±6.52)	28.35 (±5.21)	26.58 (±7.13)	25.53 (±7.38)	0.08	0.78	0.16
Protein intake (g/kg/day)	0.90 (±0.20)	0.99 (±0.16)	1.17 (±0.31)	1.04 (±0.23)	0.16	0.50	0.11
<b>Muscle strength and physical performance</b>							
Handgrip strength (kg)	30.58 (±6.31)	40.53 (±11.88)	35.29 (±8.18)	36.06 (±10.29)	0.3341	0.925	0.641
Distance of 6 minute walk (m)	545.78 (±85.53)	513.53 (±50.28)	494.47 (±56.56)	488.31 (±88.14)	0.235	0.1951	0.127
SPPB	12.00 (±0.00)	11.88 (±0.33)	12.00 (±0.00)	11.81 (±0.40)	0.2936	-	0.488
<b>DXA parameters</b>							
SMI (kg/m <sup>2</sup> )	7.07 (±1.03)	7.48 (±1.45)	7.29 (±1.38)	7.09 (±1.22)	0.4187	0.850	0.954
AMM (kg)	21.21 (±4.82)	21.89 (±5.77)	21.73 (±5.54)	20.56 (±4.99)	0.517	0.726	0.496
Total LM (%)	63.19 (±5.16)	70.28 (±7.63)	67.89 (±9.51)	66.93 (±7.51)	0.02	0.183	0.199
Total FM (%)	34.2 (±5.53)	26.76 (±8.13)	29.39 (±10.08)	30.46 (±7.84)	0.022	0.1987	0.219

AMM: appendicular muscle mass; IPAQ: International physical Activity Questionnaire; LM: lean mass; FM: fat mass; SMI: skeletal muscle index; SPPB: Short Physical Performance Battery \*\*  $p < 0.01$ ; \*\*\*  $p < 0.001$ ; \*\*\*\*  $p < 0.0001$

Muscle thickness evaluated by ultrasonography showed discriminant results ( $p < 0.001$ \*\*\*\*) with aging but not a significant difference with physical activity level (Table 8). However, the HD-sEMG scores significantly discriminate sedentary subjects from active ones of the same decade under study ( $p < 0.0001$ \*\*\*\*,  $p < 0.01$ \*\*). Indeed, the sedentary subjects HD-sEMG scores were not significantly different from those of older active subjects (two last decades: 55-64 years old or 65-74 years old) (Table 8).

Table 8. Statistical testing for comparing HD-sEMG and ultrasound scores between active and sedentary subjects

Variables	Sedentary	Active			Sedentary vs Active P-value		
	45-54 yrs. (n=9) Mean( $\pm$ SD)	45-54 yrs. (n=17) Mean ( $\pm$ SD)	55-64 yrs. (n=17) Mean ( $\pm$ SD)	65-74 yrs. (n=16) Mean ( $\pm$ SD)	45-54 yrs. vs 45-54 yrs.	45-54 yrs. vs 55-64 yrs.	45-54 yrs vs 65-74 yrs.
MCI ( $\mu$ V)	323.69 ( $\pm$ 144.47)	183.30 ( $\pm$ 136.50)	291.95 ( $\pm$ 164.63)	260.15 ( $\pm$ 119.43)	<b>P&lt;0.01**</b>	0.242	0.634
MCD (Sec)	1.91 ( $\pm$ 0.58)	1.84 ( $\pm$ 0.35)	2.00 ( $\pm$ 0.34)	2.13 ( $\pm$ 0.71)	<b>P&lt;0.0001</b> <b>****</b>	0.423	0.601
MT (mm)	16.38 ( $\pm$ 2.71)	17.43 ( $\pm$ 2.06)	17.76 ( $\pm$ 3.12)	15.86 ( $\pm$ 1.13)	0.244	0.318	0.266
FT (mm)	5.41 ( $\pm$ 1.57)	4.22 ( $\pm$ 1.08)	5.66 ( $\pm$ 1.65)	6.22 ( $\pm$ 1.44)	0.449	0.714	0.173

- FT: fat thickness; MCD: Muscle Contraction Dynamic score; MCI: Muscular Contraction Intensity score; MT: muscle thickness
- Maximum Trunk acceleration

During this thesis work the analysis of trunk acceleration will not be approached in depth because this thesis is focused on HD-sEMG technique, the acceleration will be detailed in the future research works. In fact, in this preliminary study, we only used the maximum value of the acceleration during STS provided by the Mobita® Device. Then, we evaluated the maximum acceleration with aging and sedentary lifestyle. The aim was to clarify the Sit To Stand strategies by analyzing the relationship between the trunk motion (maximum acceleration) and rectus femoris activation during Sit To Stand motion (MCI, MCD). The

acceleration of trunk decreased clearly with the age with a correlation coefficient equal to -0.62 (Figure 2.19).

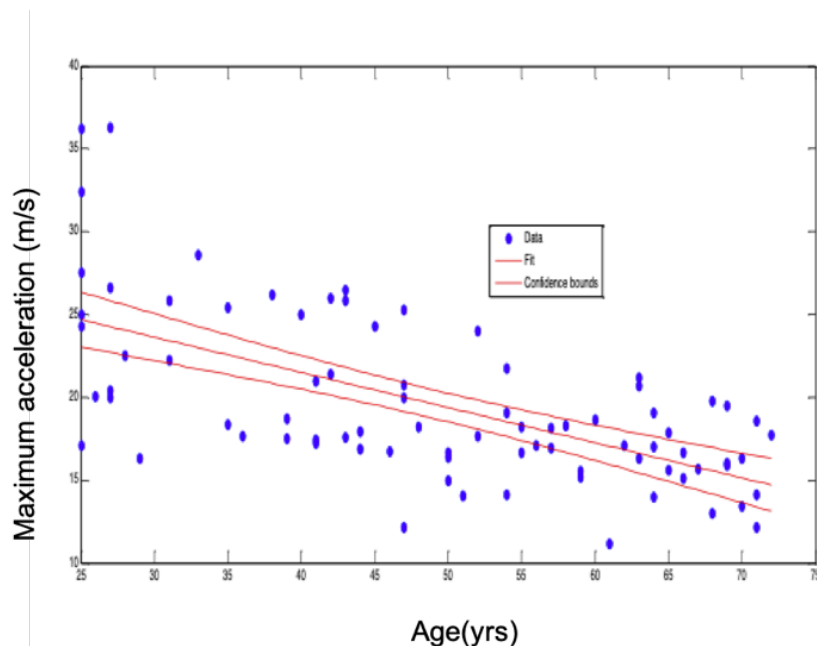

Figure 2.19 linear model of maximum acceleration with determinant coefficient  $R=0.6$

Inversely the maximum acceleration of trunk was decreased when the contraction duration increased with a correlation coefficient (-0,37). The acceleration reduced during aging probably because, the lower limb (Rectus femoris muscle) request more time to execute the STS exercise to maintain the balance, consequently the MCD increased. The MCI score showed a negative correlation (-0.41) with the maximum acceleration. With this present study we cannot analyze deeply these relationship between MCI/MCD and trunk acceleration. Because, finding a relationship between duration based on an averaged electrode grid and a single acceleration value from an on-board system is not very consistent. But, it can probably be linked to the aging related changes of STS strategy to maintain the balance posture during daily motion in healthy subjects [135,147]. Indeed, the maximum acceleration of trunk showed significant results for the sedentary category comparing to the same active category ( $P<0.001^{**}$ ). The maximum acceleration did not differ between the two last actives categories (55-64 yrs, 65-74 yrs.) and the sedentary category ( $p>0.05$ ). The maximum acceleration was significantly independent of BMI, gender or fat thickness effects ( $P>0.05$ ) in the five active age categories.

## 2.4 Discussion

Firstly, results from preliminary studies and especially from CHRONOS study showed that the HD-sEMG and ultrasound scores were able to evaluate healthy muscle aging, unlike clinical parameters (handgrip strength, DXA, SPPB, 6 min walking test). These clinical parameters used routinely to monitor the motor decline or sarcopenia in older patients, failed to discriminate between the five age categories of healthy physically active subjects. It confirmed the lack of sensitivity of these clinical parameters to detect subtle changes in motor functional abilities and muscle anatomy of healthy and active subjects from 25 to 74 years old [97]. The HD-sEMG scores were able to discriminate between the 5 age decades regarding healthy muscle aging, and similarly muscle and fat thicknesses assessed by ultrasonography of the rectus femoris, from a structural point of view. It attested a good sensitivity of this imaging approach to structural muscle changes even during healthy aging. Secondly, the HD-sEMG scores were not only able to discriminate this healthy muscle aging but also to discriminate between active and sedentary participants. Thirdly, the HD-sEMG scores of sedentary participants were significantly closer to those of older active subjects (two last decades: 55-64 yrs. or 65-74 yrs.), suggesting that the sedentary lifestyle would tend to accelerate the muscle aging process, according to the proximity of the MCD and MCI scores of the sedentary category with those of the two last decades of the active category.

Data throughout the life course showed the underlying concept of a life course approach to sarcopenia [153]. Muscle mass and strength generally increase with growth in youth and young adulthood (maximal levels reached up to ~40 years of age), are maintained in midlife and then decrease with aging. Beyond the age of 50 years, loss of leg muscle mass (1–2% per year) and loss of strength (1.5–5% per year) have been reported [190]. Also, it has been shown that the lower limbs are more seriously affected by aging than the upper limbs [191,192]. The HD-sEMG results obtained suggest that, the increase in the signal intensity is related to the decrease of muscle strength or an increased muscle solicitation, and that the slowing of contraction dynamics is associated with a strategy for rising from a chair with aging. In our study, the HD-sEMG signal intensity decreased in the 65 -74 years age group. This can be explained maybe by the muscle atrophy linked to the modification of the muscular typology. Adding the decrease in the strength with aging generates the disability to perform the contraction level (MCI) requested even the contraction duration (MCD) increased. Indeed,

DXA were not able to detect the subtle muscle atrophy. This change can be due to the modification of muscle composition and structure, and more generally muscle plasticity, related also to muscle control, which could explain the modifications with aging only observed by the HD-sEMG technique. Moreover, reducing the number of motor units is one of the processes most cited among all the processes undergoing the effects of age [31] and the muscular typology modifications with aging. Plasticity is a reorganization of the remaining motoneuron function towards damaged muscle fibers [193–195]. This leads to a qualitative decrease in motor function [192,196–200]. It is often stated that type II muscle fibers are de-innervated by fast, large diameter motoneurons and re-innervated by slow small diameter motoneurons [165,200–204]. These type II motor units are highly involved in the muscle explosiveness abilities during short and intense motions such as STS [31,165].

According to the results of the present study and considering the type of sit to stand motion which is a dynamic test, it would be interesting to discuss the effect of aging on motion efficiency. In other terms, the strategy of rising from a seated position without using arms during STS tests is modified with aging. Indeed, the reduced motor abilities would indicate incapacity to generate, as observed on MCI and MCD scores, an efficient muscle contraction (intensity and temporal dynamics) for faster rising and consequently slowing down the generation of the STS movement. This could be also explained by a possible balance disorder when the center of mass is outside the support polygon combined with muscular deficit of the extensors making the extension of the knees and hips difficult [204,205]. In fact, the angular velocity profiles of the trunk and the knee differ between young and old people: in young people, the profile is regular while in old people oscillations appear at different times of rising to ensure the maintenance of posture [37,205]. Recent observations have shown the discriminative power of scores relating to STS kinematics comparing young healthy subjects with old healthy subjects using a magneto-inertial measurement unit [130]. Furthermore, these scores were able to discriminate between young healthy subjects and older and frailer subjects. In agreement with the CHRONOS project, this confirms the usefulness of STS analysis for precise monitoring of the effect of muscle aging on lower limbs.

The CHRONOS study demonstrated that the rising strategy from a chair is modified with aging and impacted by the level of physical activity as demonstrated by the proposed HD-sEMG scores. Physical activity influences muscle condition [71]. Therefore, knowing how to earlier quantify and characterize its impact on muscle function, throughout life, is a primary



need and is indeed the interest of our study. An interesting observation from the results obtained is the effect of a sedentary lifestyle. To date, few studies [9,10,191] have compared functional and anatomical performances of different age categories including active and sedentary lifestyle. These previous studies have demonstrated that regular physical activity is safe for healthy and for frail older people and the risks of developing major cardiovascular and metabolic diseases, obesity, falls, cognitive impairments, osteoporosis and muscular weakness are decreased by regularly completing activities ranging from low intensity walking through to more vigorous sports and resistance exercises, in consistent with our perspectives. The proposed study demonstrated a clear and adverse effect of a sedentary lifestyle on muscle function even in healthy participants, detected earlier and more precisely with HD-sEMG scores than classical clinical scores. In fact, the 45-54 years-old sedentary participants differed significantly from the active participants of the same age category. Subtle differences related to both muscle structure and function were detected only by the HD-sEMG technique, according to muscle contraction intensity and dynamics scores.

Moreover, the HD-sEMG scores sensitivity to muscle aging manifestations were independent from BMI, gender or fat thickness. Furthermore, both scores were correlated to aging with a correlation coefficient of 0.58 and 0.81 for MCI and MCD scores respectively. These observations confirm the reliability and the robustness of our results relating to muscle aging.

In this study, the classical and widely used clinical parameters (grip strength, 6-minute walking distance, muscle mass using DXA and SPPB) were not discriminant between the five age groups of healthy active individuals. However, according to the literature, there has been a decline in muscle strength [206,207], and physical performance [207] from the age of 40 in the general population. Indeed, according to the previously reported normative data [59], in men, the grip strength varied from  $48.8 \pm 8.7$  kg to  $51.6 \pm 10.1$  kg between 25-35 years and from  $48.8 \pm 10.3$  kg to  $46.2 \pm 9.8$  kg between 45 -55 years old then decreased from  $42.3 \pm 8.6$  kg to  $35.6 \pm 7.6$  kg between 65-74 years. For women, the grip strength ranged from  $30.6 \pm 5.6$  kg to  $31.3 \pm 6.2$  kg between 25-35 years, then from  $29.9 \pm 6.4$  kg to  $27.5 \pm 6.4$  kg between 45-55 years and declined from  $25.3 \pm 6.0$  kg to  $21.4 \pm 5.4$  kg between 65-74 years [59]. In our study, grip strength declined after 45 years, but not in a significant way in healthy participants as reported previously [206]. Also, a linear decrease was observed in the performance of STS test from SPPB (6.2 vs 9.4 seconds between 18-19 years and 80 years and

over respectively) in both genders [206]. This can be partly explained by the small size of the CHRONOS database. The database size justified the women and men mixing for the statistical studies in order to strengthen the statistical power of the CHRONOS results. For these clinical scores, the CHRONOS study results differ from those of the literature mainly because the participants were homogeneously selected according to strict inclusion criteria (without particular comorbidities, physically active according to the IPAQ and a maximum age of 72 years), contrary to the previously reported data found in the general population. It seems that the physical activity level and the consideration of gender mixed population are the principal factors justifying these differences.

The MT evaluated by ultrasonography exhibited significant correlation with HD-sEMG scores. Indeed, the scores of these two modalities are negatively correlated with age, demonstrating also the sensitivity of the HD-sEMG scores to muscle anatomical modifications in addition to functional ones. The study of Zhu et al. [208] showed, in limb muscles, the interest of choosing muscle thickness as a discriminant parameter between young and older populations rather than the pennation angle and echogenicity parameters. In the CHRONOS study, the MT decreased with age from  $20.0 \pm 2.4$  mm at 25–34 years to  $15.9 \pm 1.1$  mm at 65–74 years. In contrast, fat thickness increased between 25–34 years and 65–74 years ( $4.0 \pm 1.1$ mm vs  $6.2 \pm 1.4$ mm). These values are consistent with the literature [191,209,210]. However, it is important to note that the impact of physical activity or its lack was detected only by HD-sEMG scores whereas ultrasonography could not.

## 2.5 Strengths and limitations

Sarcopenia has long been associated with aging and older people, but the onset of sarcopenia is now recognized as being earlier in life [37]. Because the aging process and muscle function are intertwined throughout life, a tool that can monitor this muscle functional decline deserves special attention. These insights are important to consider for interventions that prevent or delay development of sarcopenia. This also has the potential to enable public health messages to reach young people encouraging healthy lifestyle changes such as increasing physical activity with immediate to lifelong benefits for muscle health. Therefore, to prevent or delay the onset of sarcopenia, the aim is to maximize muscle in youth and young adulthood, maintain muscle in middle age and minimize loss in older age [97]. However, the evidence to date supporting this approach is largely observational and trials of life course

interventions are needed, with the use of efficient methodologies and accurate, non-invasive, ambulatory and large-scale use techniques. The strength of the CHRONOS study is that the HD-sEMG technique was able to detect not only healthy aging, but also the effect of sedentary lifestyle on the muscle function contrary to other routinely used techniques or clinical parameters.

Sarcopenia is associated with low muscle quantity and quality/functionality, and these parameters are technically difficult to measure accurately with one device [97]. Firstly, the HD-sEMG technique recorded during the sit to stand (STS) motion, a daily life motion, thus integrating this physical performance aspect, defined as the ability to carry out physical tasks in order to function independently in daily life. Secondly, HD-sEMG scores were based on contraction intensity and dynamics, reflecting muscle functionality. Thirdly, HD-sEMG scores were significantly correlated with muscle thickness measured by ultrasonography, reflecting the muscle mass. Thus, the HD-sEMG technique should represent an innovative approach for a comprehensive and complete muscle assessment.

The monocentric character and the relatively small sample size of this study limit the generalization of our results, and larger samples are definitively needed. However, this was a pilot study, and it demonstrated the promising capacity of this innovative technology. The HD-sEMG technique exhibits usefulness for non-invasive, comprehensive muscle mass and functionality assessment for diagnosis of both chronological and pathological/accelerated muscle aging, potentially precursor to sarcopenia. Another limitation is that, although the HD-sEMG scores were independent of BMI or fat thickness, the study was conducted in selected healthy participants without obesity. It cannot be ruled out that the higher fat thickness in obese participants could prevent accurate muscle measurements with the surface electromyography. Finally, further studies, related to larger and heterogeneous populations, are needed to definitively assess these complex physiological mechanisms related to muscle aging and validate the assumptions we have presented in this preliminary study.

## 2.6 Conclusion

This chapter proposed a complete and multimodal analysis of muscle aging, during daily life motion (STS), in view to unveiling the promising potential of the HD-sEMG technique to monitor early changes in muscle function impacted with aging and physical activity level. The results obtained showed that the HD-sEMG technique on the rectus femoris was able to discriminate between the five age categories of healthy physically active subjects, and more interestingly, to discriminate between active and sedentary participants contrary to the clinical parameters and others routinely used techniques (DXA and ultrasonography). The observed modifications, related to sedentary subjects, are not sufficiently significant to be detected yet by other techniques such as muscle atrophy state evaluated by ultrasound. The most interesting point is that these differences were reduced compared to older active age categories: HD-sEMG scores of 45-54 years-old sedentary participants were comparable with the scores of active participants, aged older than 55 years old. This strongly suggests that sedentary lifestyle seems to accelerate the muscle aging process at both anatomical and functional level, and this subtle accelerated process can be detected by the HD-sEMG technique. These promising preliminary results can help to provide an interesting tool for clinicians to improve both accuracy and sensitivity of functional assessment. We will introduce in the next chapter the main elements, covering advanced signal processing and machine learning, to build the first estimator device of Motor Functional Age (MFA) that will be predicted for sedentary subject.



# CHAPTER 3 : Analysis and classification of HD-sEMG signals with muscle aging and sedentary lifestyle

3.1	INTRODUCTION .....	105
3.2	ANALYSIS OF HD-sEMG SIGNALS .....	106
3.2.1	<i>Aging effect evaluation on HD-sEMG signals using CCA approach</i> .....	106
-	Introduction.....	106
-	Materials and methods .....	107
-	Results and discussions.....	111
-	Conclusion.....	114
3.2.2	<i>Time-Frequency analysis of HD-sEMG signals with aging</i> .....	115
-	Introduction.....	115
-	Materials and methods .....	115
-	Results and discussion .....	117
-	Conclusion.....	120
3.3	PREDICTION OF MUSCLE AGING BASED ON HD-sEMG FEATURES CLASSIFICATION .....	121
3.3.1	<i>Introduction</i> .....	121
3.3.2	<i>Features from HD-sEMG signal</i> .....	122
-	Temporal domain [226]: .....	122
-	Frequency domain: .....	123
-	High order statistic (HOS) domain [228,229]: .....	124
3.3.3	<i>Classifiers</i> .....	124
-	Support Vector Machines (SVM).....	125
-	Random Forest (RF) .....	126
-	Multi Layers Perceptron Couche (MLP).....	127
-	K Nearest Neighbors (Knn) .....	128
3.3.4	<i>Experiments &amp; Methodology</i> .....	128
-	Dataset description.....	129
-	Classification methodology.....	130
3.3.5	<i>Results and discussion</i> .....	135
-	Results of HD-sEMG features from the averaged channels (Features Extraction Methodology 1).....	135
-	Results of HD-sEMG features from 31 channels (Feature extraction methodology 2).....	136
-	Results of HD-sEMG features from the segmented HD-sEMG signals for 31 channels (Feature extraction methodology 3).....	138
-	Results of MFA prediction.....	142
-	Conclusion.....	145

## 3.1 Introduction

Throughout this manuscript, it is recalled that the way of muscle aging differs from one individual to another. Indeed, the aging process is a combination of many factors such as the biological and physiological changes of the organs, the environmental conditions as well as the lifestyle of the person. That generates costly consequences as mentioned in previous chapters. In this context, developing new non-invasive approaches for early evaluation of sarcopenia is a major challenge [5]. Our objective in this chapter, focused on giving the main elements to develop a wireless medical device based on high-definition surface electromyography (HD-sEMG) technology, a non-invasive and portable technology, for the diagnosis of muscle aging by introducing muscle functional age (MFA). It will allow advances not only for clinical practice in terms of diagnosis to implement appropriate management, but also as a judgment criterion of therapeutic trials for anti-sarcopenic drugs and nutritional supplements.

Other interventions that slow down the effects of muscle aging with a view for sarcopenia prevention and functional rehabilitation can be monitored using HD-sEMG technique. The scientific issues of this study are twofold: 1- Clinical by the evaluation of muscle aging and methodological through development of a diagnostic tool, compatible with E-health platform, based on the analysis of HD-sEMG signals. 2- Research and development by giving more qualitative and accurate information linked to muscle aging changes to interpret deeply the physiological observations related to muscle aging.

Preliminary study obtained in young and older patients [189] by using the HD-sEMG techniques have shown that HD-sEMG descriptors related to muscular activity are discriminant with the age. Experimental results depicted in Chapter 2 demonstrated this assertion. This main result encouraged us to explore the usefulness of integrating advanced signal processing methods and classifiers from machine learning theory in this thesis in order to estimate the MFA score and discriminate different age categories.

Thus, we will perform three kinds of studies:

The first preliminary study consists on applying a recent Blind Source Separation (BSS) technique, the Canonical Correlation Analysis (CCA) approach, to analyze the estimated

sources from the HD-sEMG recordings obtained from CHRONOS project, and their possible modifications with aging.

The second preliminary study is based on exploring time frequency analysis on the 32 channels of the grid with aging. The aim is to evaluate if the muscle activation regions, obtained from the analysis of the nonstationary HD-sEMG signals, differ with aging in time and frequency during the STS motion. Both studies 1 and 2 were tested on small number of patients from CHRONOS database due to the complex signal processing task which is time consuming. However, optimized processing procedure is definitively needed to enlarge this study on bigger database in the future work.

The third study will be more complete and will address the classification of CHRONOS database according to age categories, by using the basic descriptors, frequently used in the analysis of experimental and simulated HD-sEMG data and containing temporal, frequency and statistical information. The objective is to evaluate the discriminative power of HD-sEMG parameters with aging, as demonstrated by the statistical study in the second chapter of the averaged descriptors MCD and MCI.

The final goal of this chapter is to propose an MFA estimator based on machine learning approaches. Another goal is to demonstrate the usefulness of these approaches in a better assessment of muscle aging, in order to develop remote monitoring tools of muscle capacities by using simplified, automatic, and non-invasive acquisition procedure, which guarantees acceptability by a maximum of patients.

## 3.2 Analysis of HD-sEMG signals

### 3.2.1 Aging effect evaluation on HD-sEMG signals using CCA approach

#### - *Introduction*

The objective of the proposed study is to exploit the technology of high-density surface electromyography (HD-sEMG), in order to evaluate the muscle activation in young and older subjects during a daily life gesture, namely, Sit To Stand (STS), using wireless connected ambulatory equipment (TMSi©) and Blind Source Separation (BSS) approach with Canonical Correlation Analysis (CCA). Sixteen subjects from CHRONOS database participated (50%



females) divided into two categories ('H1': young (30.62 yrs  $\pm$ 5.92, 23.95 kg/m<sup>2</sup>  $\pm$ 3.08), versus 'H2':old (61.87 yrs  $\pm$ 7.98, 23.4 kg/m<sup>2</sup>  $\pm$ 3.38)), in the recording of HD-sEMG signals, using 32-electrodes square grids (4x8), during Sit To Stand (STS) motion, three times at spontaneous speed (as described in the previous chapter). The studied muscle is the Rectus Femoris (RF) muscle.

The recorded HD-sEMG signals were analyzed with CCA approach to extract correlation coefficient sets according to two age categories (young versus old), in order to evaluate its discriminating power with aging. Statistical tests (t-test) were used to evaluate the discrimination for these two categories. The calculation of CCA correlation coefficients showed a significant difference between young and old category concerning the mean CCA correlation coefficient ( $P < 0.001^{***}$ ) and also the standard deviation of the CCA correlation coefficients ( $P < 0.0001^{****}$ ).

- *Materials and methods*

Participants

In this study, sixteen subjects participated in the recording of the experimental signals, divided into two categories (H1 & H2) with the following characteristics:

Table 9. Cohort description (BMI: Body Mass Index)

<b>Category</b>	<b>H1</b>	<b>H2</b>
<b>Gender</b>	4M/4F	4M/4F
<b>Range of age (years)</b>	30.62 $\pm$ 5.92	61.87 $\pm$ 7.98
<b>BMI (Kg/m<sup>2</sup>)</b>	23.95 $\pm$ 3.08	23.46 $\pm$ 3.38

As described in the previous chapter, all participants provided their written informed consent. Institutional review boards approved the clinical study (Patient Protection Committee, project number 2018/31). The study was registered on ClinicalTrials.gov ID: NCT03560648. The database was declared to the French National Commission for Data Protection and Liberty (CNIL, France). The subjects presented in Table 9 did not have any history of muscular or neurological disorder.

## Age effect evaluation using CCA Algorithm

The CCA is a statistical multivariate method that correlates linear relationships between two multidimensional variables. It is used frequently to denoise HD-sEMG signals[174]. The CCA algorithm attempts to extract the original sources, in a BSS paradigm, having maximum autocorrelation values (at a specific time delay) and minimum intercorrelation values with each other [181].

This method has the main advantage of ranking the estimated sources according to a correlation coefficient and allowing the construction of a pertinent thresholding paradigm. It has been successfully used for HD-sEMG signal analysis [174,175,181]. It suggests the use of the source vector as the first multidimensional variable and its temporally delayed version as the second [174].

In addition, it proposes to solve the BSS problem by finding the base vectors so that the projections of the variables onto these vectors are mutually maximized [174]. The CCA algorithm attempts to extract the original sources having a maximum autocorrelation value (at a specific time delay) and minimum intercorrelation value with each other.

We assume that a multidimensional random variable:

$$\mathbf{X} = [\mathbf{X}_1, \mathbf{X}_2, \dots, \mathbf{X}_n] \quad \text{Eq. 9}$$

With n being the number of sensors

X is the result of an unknown mixture of unknown source signals:

$$\mathbf{S} = [\mathbf{S}_1, \mathbf{S}_2, \dots, \mathbf{S}_n] \quad \text{Eq. 10}$$

The mixing is assumed to be linear, Therefore, reducing the mixing to a matrix multiplication allows to write [181]:

$$\mathbf{X} = \mathbf{A} \cdot \mathbf{S} \quad \text{Eq. 11}$$

Where S, X,  $\mathbf{S}$ ,  $\mathbf{X}$  are respectively the source and the grid signals matrixes of dimension (n×m) with n being the number of sensors and m the number of samples, and A is the mixing matrix of dimension (n×n).

The aim is to retrieve the original source signals  $S$  by estimating the mixing matrix  $A$  with  $A$  is the estimated mixing matrix equal to the inverse of the estimated demixing matrix  $W$ . This can be achieved by introducing the demixing matrix  $W$  such that:

$$\mathbf{Z} = \mathbf{w} \cdot \mathbf{X} \quad \text{Eq. 12}$$

Where the matrix  $Z$  approximates the source matrix  $S$  by a scaling factor.

Let  $Y$  be the delayed version of the source matrix  $X$  such that:

$$\mathbf{Y}(k) = \mathbf{X}(k - 1) \quad \text{Eq. 13}$$

Where  $k$  represents the sample number. The one sampling period delay was chosen after multiple denoising trials using different delays between  $X$  and  $Y$ . The CCA algorithm obtains two sets of basis vectors, one for  $X$  and the other for  $Y$ , such that the correlations between the projections of the variables onto these basis vectors are mutually maximized. The mean value of each row from the data matrices  $X$  and  $Y$  is removed, then by considering:  $u = w_x^T \cdot X$  and  $v = w_y^T \cdot Y$ . The linear combinations of the elements in  $X$  and  $Y$ , respectively, the correlation between  $u$  and  $v$ , called the variates or the canonical components, can be represented by [9]:

$$\rho = \frac{E[uv]}{\sqrt{E[u^2]E[v^2]}} = \frac{w_x^T C_{xy} w_y}{\sqrt{(w_x^T C_{xx} w_x)(w_y^T C_{yy} w_y)}} \quad \text{Eq. 14}$$

where  $C_{xx}$  and  $C_{yy}$  represent the autocovariance matrices of  $X$  and  $Y$ , respectively.

$C_{xy}$  represents the cross-covariance matrix of  $X$  and  $Y$ , and  $w_x$  and  $w_y$  are the corresponding weight vectors. Then, the maximization problem will be solved by setting the derivative of  $\rho$ , with respect to  $w_x$  and  $w_y$ , equal to zero which leads to the Eq.15.

$$C_{xx}^{-1} C_{xy} C_{yy} w_x = \rho^2 w_x \quad C_{yy}^{-1} C_{yx} C_{xx} w_y = \rho^2 w_y \quad \text{Eq. 15}$$

With  $\rho$  is the square root of the eigenvalue,  $w_x$  and  $w_y$  are Eigen vectors of  $C_{xx}^{-1} C_{xy} C_{yy}$  and  $C_{yy}^{-1} C_{yx} C_{xx}$ , respectively.

The first variates obtained by CCA are, maximally correlated with each other [8]. The next pair of weight vectors is obtained likewise by finding variates, which are maximally correlated with each other and uncorrelated with the variates of the first pair.

All the variates are found in an iterative manner [120,175]. Consequently, these variates are considered as the sources having maximal autocorrelation and are uncorrelated with each other. Thus, when CCA algorithm is applied on the raw HD-sEMG signals matrix, we obtain the sources (estimated canonical components) ranked from the higher to the lower delayed autocorrelation. The algorithm therefore extracts the original sources of the signal having a maximum autocorrelation value and a minimum inter-correlation value between them [182].

The advantage of this separation is that the sources are sorted according to their correlation coefficient value. Thus, the first source will have the highest autocorrelation approximately equal to one and the last source will have the lowest autocorrelation close to 0.

We propose to evaluate the obtained correlation coefficient set according to two age categories (young versus old) to evaluate its discriminating power. For each participant in each category (H1 and H2), we computed the averaged correlation coefficients of 31 sources (the channel 32 is the reference) (Figure 3.1) and the standard deviation (std) of these sources, then we compute the average of these two parameters (mean and std) in each category. Finally, we compare the data of young and old category by using statistical tests (t-test) to evaluate the discrimination for these two categories.

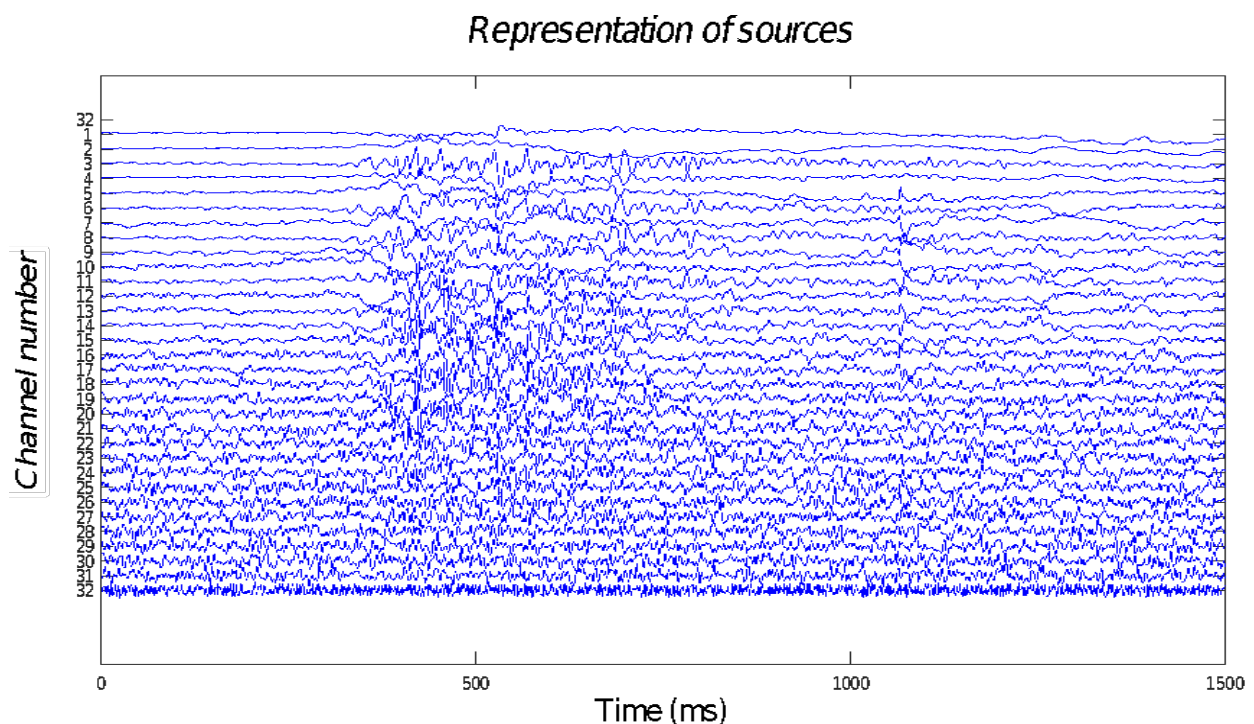

Figure 3.1: Representation of canonical components (estimated sources) for one subject during STS motion.

- *Results and discussions*

The calculation of CCA correlation coefficients showed a significant difference between young and old category concerning the mean CCA correlation coefficient ( $P < 0.001^{***}$ ) and also the standard deviation of the CCA correlation coefficients ( $P < 0.0001^{****}$ ) as exposed in Table 10.

Table 10. t-test results for H1 and H2 groups

	<i>H1</i> <i>(young)</i>	<i>H2</i> <i>(older)</i>	<b>t-test</b> <i>(P-value)</i>
<b>SNR (dB)</b>	$18.13 \pm 4.59$	$18.12 \pm 4.86$	
<b>Mean Correlation coefficient</b>	$0.86 \pm 0.07$	$0.90 \pm 0.08$	$P < 0.001^{***}$
<b>Std of correlation coefficient</b>	$0.16 \pm 0.04$	$0.091 \pm 0.06$	$P < 0.0001^{****}$

A higher correlation coefficient observed in the older group can be related directly to spectral contain of the muscle electrical activity; because of the SNR goodness, we assume that these modifications in the correlation of sources can be related to muscle activity changes with aging and generating differences with the young category.

Indeed, we explain this higher autocorrelation values in old population by the presence of more sources with narrower spectral bands (related to larger autocorrelation functions) in contrary to the young category. This should be linked to the modifications of muscle fibers typology; older people have more MUs of type I (slow velocity) and less type II (fast velocity) compared to young people [211]. Type I fibers are characterized by a low force, power and speed production but an important endurance. These fibers have slow contraction and a slow fatigability. They are used in low force level requiring activities like walking, posture maintaining and in daily activities such as STS motion used in the present study.

The motor units that contains these types of fibers are called slow motor units [14,124]. That is why the muscle fibers Type I are more dominant with aging. In contrary Type II fibers are described by having a high force production but low resistance to fatigue and bigger diameter than the type I fibers [14,124]. Type II MU electrical activity exhibits larger spectral contain and narrower autocorrelation function. They are present in the young category. This

could also explain the rapid decay of the CCA correlation coefficient trend in young category (H1) compared to the old category (H2) as depicted in Figure 3.2.

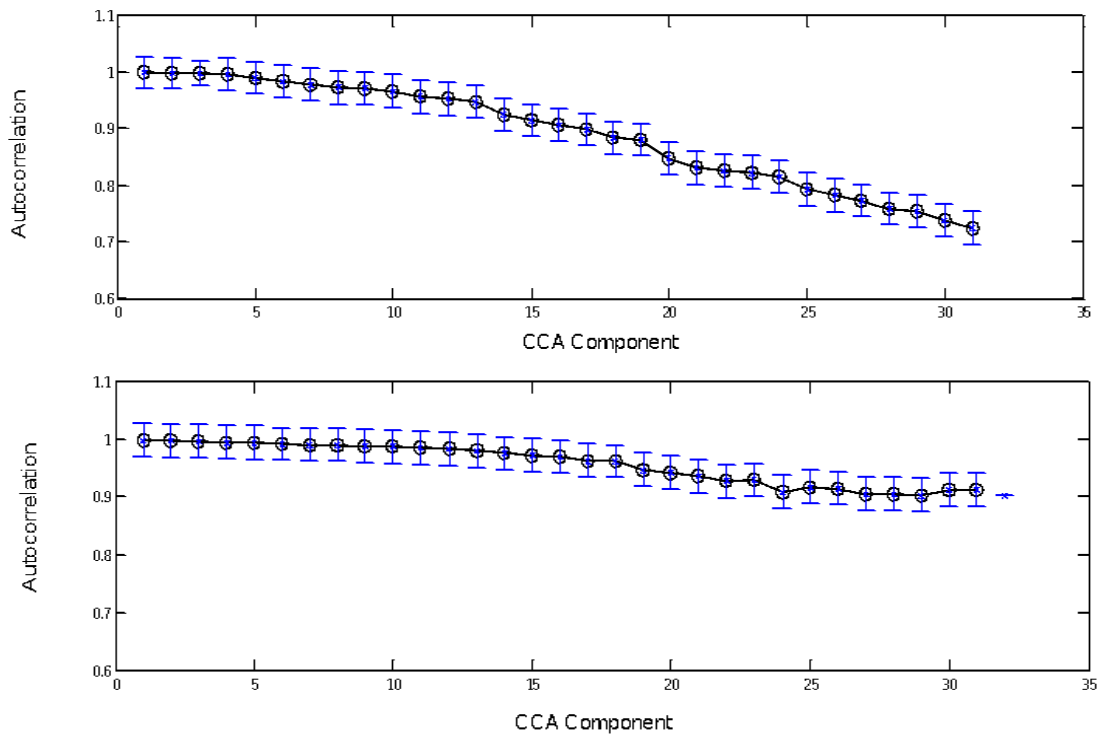

Figure 3.2 Obtained CCA correlation coefficients for the 31 estimated sources for young (H1) “up” and older (H2) “down” groups.

In fact, this figure shows the trends of the average correlation coefficients, for each source and each age category; this result is complementary with the t-test and validate the utility of CCA approach not only in the aim of signal denoising but also in order to extract new features sensitive to muscle changes with aging.

This will be exploited in future work, combined to classification approaches, to better separate age categories. In addition, these autocorrelation trends will be also investigated using middle-age category in a next study. In addition, it is planned to extend this preliminary study to analysis the CHRONOS database.

The study of Watanabe et al. on the relationships between muscle strength and multi-channel surface EMG parameters in eighty-eight older shows also a high correlation of HD-sEMG parameters in the older subjects [123]. This high correlation is supposed to be linked to the modulation of muscle structure with aging and not only to the atrophy. This result agrees with our study and notably with the result of Figure 3.3, which also shows clear modifications with aging. These modifications can be functionally evaluated by HD-sEMG parameters such as correlation coefficient from CCA proposed in the present study.

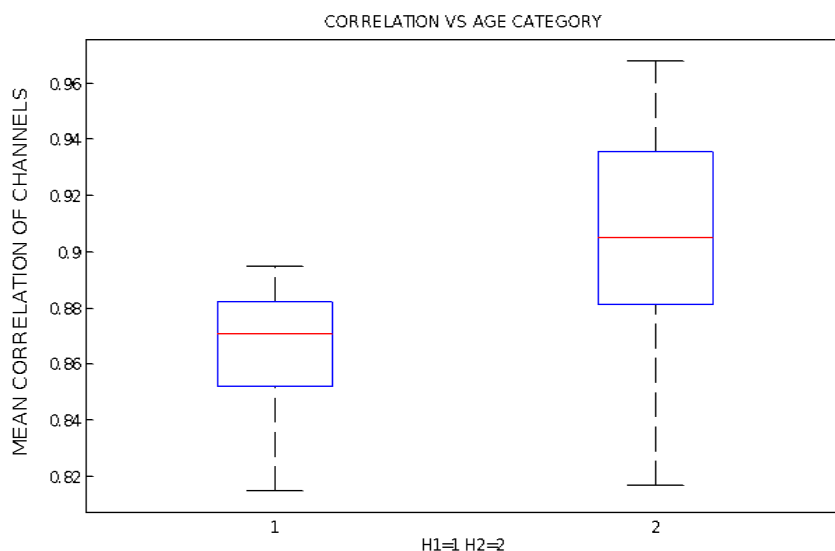

Figure 3.3: Boxplot of the mean correlation coefficient of the estimated sources for H1 (young) and H2 (older) groups.

We observed also that the standard deviation of the autocorrelation coefficient (Figure 3.4) significantly decreases in old category compared to young category. This can be also related to the variation in muscle architecture and thickness which are modified with aging and can be assessed using ultrasonography imaging [212]. Note also that the standard deviation disperses even more in the older than in the young. This is possibly due to the heterogeneity of the muscular structure and electrical activity that seems to increase with aging, among subjects, as shown in a recent study [213]. It is important to note that the BMI index is similar in both age categories (Table 9) to avoid signal filtering effects due to the adipose tissue that could bias the result interpretation.

The present study aims at exploiting the advantages of combining the HD-sEMG technique and CCA approach, using autocorrelation coefficients (mean and standard deviation of the sources) and statistical test (t-test) to evaluate aging effect throughout life using classification of CCA sources.

We observed a trend of sources that clearly differentiates each category (young and old). This could be related to anatomical and functional modifications related to aging and not solely to the atrophy process [123]. However, gender difference analysis has not been addressed in this study in order to keep the power of the statistical testing according to the small database size. The database will be increased in size with further clinical studies assessing gender differences.

The main aim of this study is to give objective and intuitive information, using few parameters, to the clinician related to muscle decline and to contribute in finding solutions for standardization of aging effect evaluation as previously mentioned [5].

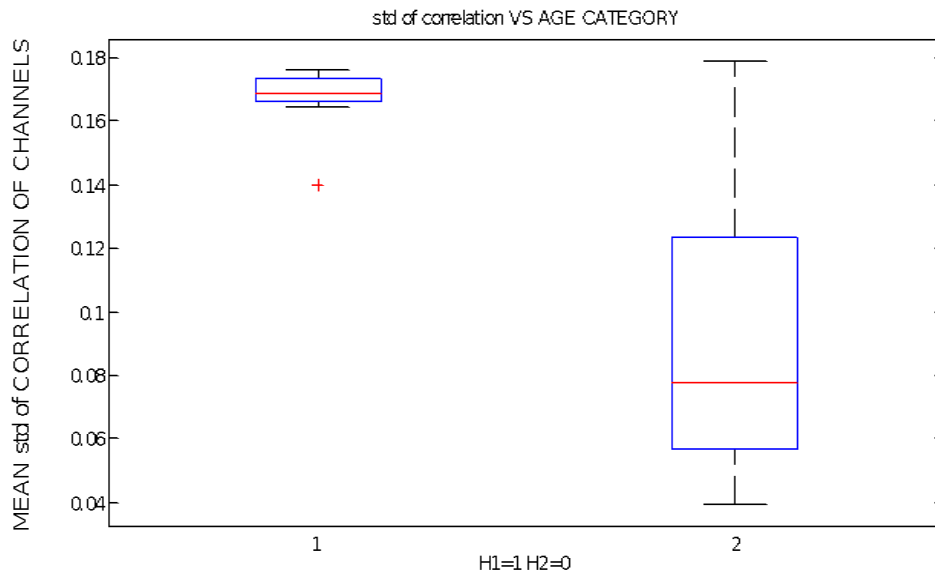

Figure 3.4: Boxplot of standard deviation of CCA correlation coefficients for the estimated sources for H1 (young) and H2 (older) groups.

Further studies are needed to better explain the complex mechanisms underlying muscle aging. This study is relevant to introduce new parameters from HD-sEMG signal processing, in order to demonstrate some differences in muscle activity linked to age-related changes in clinical routine. To make easier the implementation of this study in clinical applications, the information chain from clinical investigators to engineers and analysts was already successfully tested in clinical environment during the data acquisition process. Indeed, thanks to the data management tools set up in the clinical environment and in the research laboratory, the data communication is practical. The frequency of the measurements will depend on the needs of the clinicians for patients' follow-up.

- *Conclusion*

The obtained results are promising and indicate a clear difference between the obtained source variability using CCA method between the young and the old tested subjects during daily life motion. This study allowed us to unveil the potential of the CCA approach in a deeper screening of muscular modifications with aging, starting from the idea to support therapeutic and prevention approach of sarcopenia in the older population. The results indicated clear modifications in the electrical activity, measured by HD-sEMG technique, related to muscle



activity during STS motion. These modifications should be linked to both anatomical and/or functional changes and be better investigated in future works on bigger cohorts like CHRONOS database.

### 3.2.2 Time-Frequency analysis of HD-sEMG signals with aging

#### - Introduction

In this study we aim to evaluate the possible changes in regions activation of the Rectus Femoris muscle during STS motion that implies several short dynamic contractions and the generation of non-stationary HD-sEMG signals. To overcome the limitations of the Fourier transform in the analysis of non-stationary sEMG signals as mentioned in chapter 2, time-frequency transforms have been applied to signals acquired during dynamic contractions. Each segment has been transformed using the Short Time Fourier Transform (STFT), the simplest of the Time-Frequency transforms and the easiest to be interpreted. However, with this method, it is not possible to have a good resolution simultaneously in time and frequency domain [214].

#### - Materials and methods

The short time Fourier transform (STFT) is a linear Time-Frequency Representation (TFR) that was used to study fatigue during isometric and isotonic muscle contractions. These studies showed that the frequency content of the sEMG signal slides to lower frequencies with increased fatigue [215,216]. In case it is not possible to consider the signal as stationary, the STFT assumes that the sEMG signal is stationary over a short-windowed signal segment and then analyzes each segment with the Fourier transform [217,218]. TFRs represent signals in both time and frequency. Thus, the STFT with analysis window  $h(t)$  is given by [217,219]:

$$S_x(t, f; h) = \int_{\tau} e^{-j2f\pi\tau} x(\tau)h(\tau - t) d\tau, \quad \text{Eq. 16}$$

Where  $x$  is the analyzed signal weighted by the sliding time widow  $h$  by time shift  $t$ .

The STFT preserves time-frequency shifts on the signal [217,219],

$$y(t) = x(t - t_o)e^{j2\pi f_o t} \Rightarrow S_y(t, f; h) = S_x(t - t_o, f - f_o; h)e^{-j2\pi t_o(f - f_o)} \quad \text{Eq. 17}$$

With  $t_0$  is a time shift and  $f_0$  a frequency shift Introduced by the modulation with the complex harmonic at  $f_0$ . However, the STFT does not preserve energy information and it is limited by assumption of signal stationarity over the length of the window [217,219]]. Following the uncertainty inequality, given as:

$$\Delta T \Delta \omega \geq \frac{1}{2} \quad \text{Eq. 18}$$

where  $\omega = 2\pi f$ , if the window is chosen to have a narrow bandwidth to increase frequency resolution, then the time resolution decreases since the window has long duration. This trade off presents a problem in dynamics analysis since the desirable use is to detect changes in the frequency content; if the changes are small, the high frequency resolution is needed but at the cost of low time resolution.

Wavelet based methods were also used to study frequency changes for fatigue analysis [177]. The STFT and continuous wavelet transform (CWT) were used to analyze mechanomyography (MMG) and sEMG signals collected from the vastus lateralis and rectus femoris muscles during isometric ramp contractions [220,221].

A Hamming window of 0.6s was used by the STFT, with an overlap of 0.1 s, and the resulting TFR was used to estimate the mean power frequency (MPF) at each time. Frequency shifting to lower frequencies was not observed in this experiment. The wavelet is only useful for multiresolution analysis, desiring different frequency resolutions at different times, and this was not shown to be needed for STS analysis. Note, also, that the wavelet transform also uses windowing and thus still has Time-Frequency resolution trade off. For this analysis, a resolution of  $\Delta f=3,9$ , Hz and  $\Delta t=0,2560$  seconds was used.

The segmented part of the data was transformed by multiplying the signal by a Hamming window, then, after computing the discrete Fourier transform and shifting the window along the HD-sEMG recordings (31 channels), we obtained a new spectrum each 256 ms for each electrode and for each segment (three segments of STS of each patient). After, the spectrogram has been calculated between 0 Hz and 50 Hz. This choice is justified by the fact that main modifications with aging of the MU recruitment and firings are supposed to be in this frequency bandwidth. For illustration purposes, an image of all the channel spectrograms has been constructed to show the spatial distribution of the electrical energy, between 0 Hz

and 50 Hz, of the RF muscle activity and see the difference between the power distribution in RF region during STS.

Many limitations are found with this protocol, starting with the fact that it is unknown where the several STS steps take place (as explained in section "STS justification"), because no camera was used during this protocol. To solve this, the point of maximum extension has been approximated with the time location of the maximum power value in the time frequency domain.

- *Results and discussion*

According to the obtained results, one can observe that, for a young person, at the time considered as short-isometric contraction of the femoral muscle (between 1300 and 1600 ms), the time frequency plane is richer in frequency and energy (approximately 20 decibels (dB)). However, for a senior, the energy the spectrum is twice as low compared to young people (about 10 decibels) with less frequency and larger time support. In fact, for an older person, the contraction time is greater compared to a young person. This could be explained by the fact that the aged muscle contains more slow than fast motor units. Indeed, the muscle develops strength in a longer duration of time than in the young. However, the muscle of a young privileges the use of fast motor units in order to quickly execute the STS motion which explains the important energy and the frequency richness during shorter period (*Figure 3.5*).

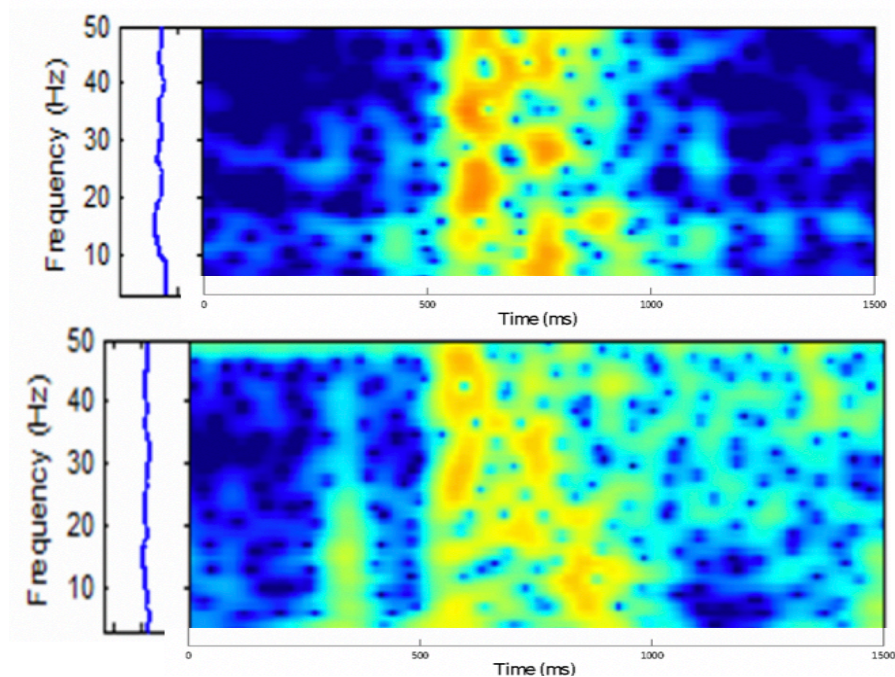

Figure 3.5: Focus for Time-Frequency map for one channel of young subject (up) and senior (down) subject during sit to stand motion

This observed result with aging is in agreement with the MCD score increase presented in the previous chapter. This preliminary result using Time-Frequency analysis will be exploited to develop new descriptors to discriminate between the two young and old populations.

A precise subject-to-subject analysis is still not possible with the followed experimental protocol with no use of camera recordings for possible synchronization. In fact, it is not possible to compare between STS phases (flexion/ extension duration) because the speed inter-variability. Thus, the signal length is different between patients and between segments. One can roughly approximate the maximum muscle contraction that corresponds approximately to the middle of the stand phase. But from the 31 channel cartography, we observed that the muscle activation it is concentrated in the proximal part of the grid (See Figure 3.6, Figure 3.7 and Figure 3.8) and in the beginning of the distal part according to our grid of electrodes (which is located in the 70% away from the top of the patella). All the subjects tested have almost this observed spatial distribution (more activation in proximal part).

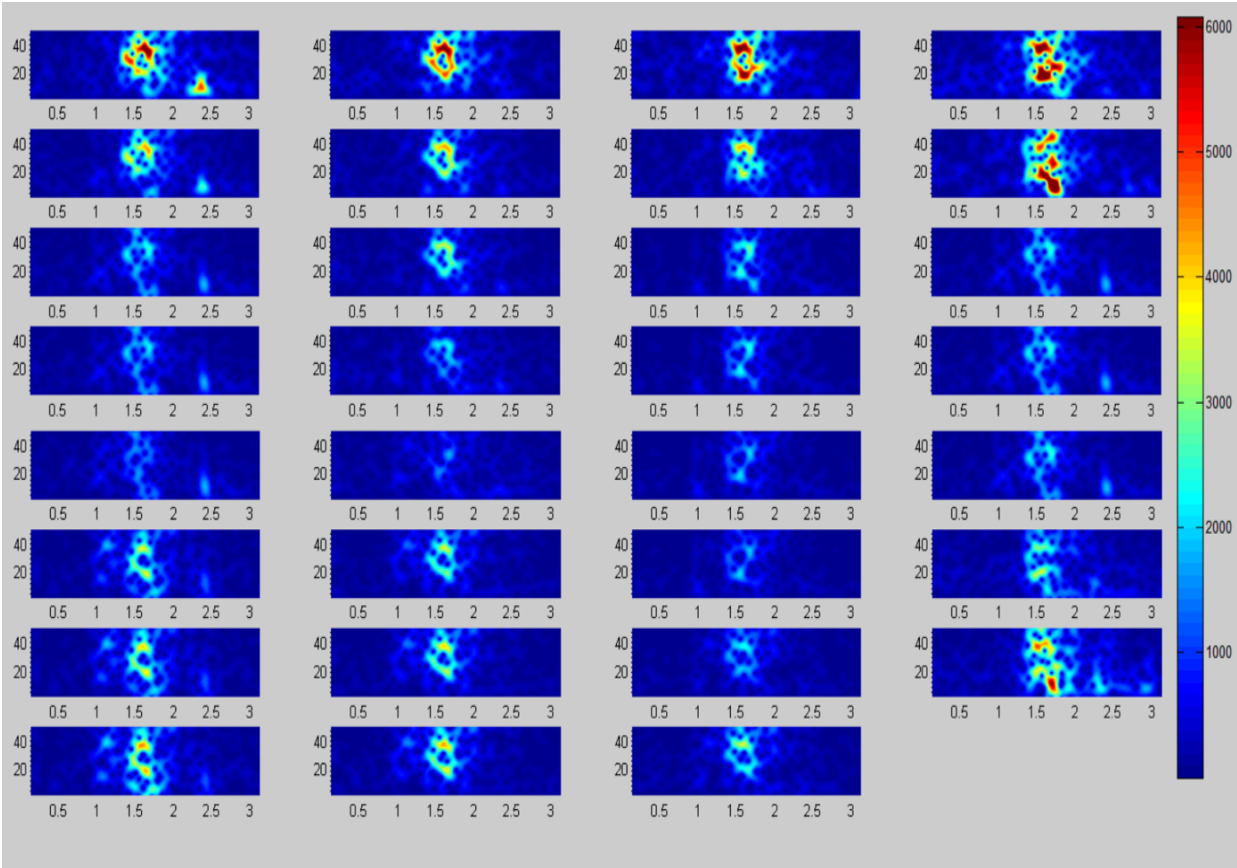

Figure 3.6 : Time-Frequency cartography for representative Young subject 25 yrs.

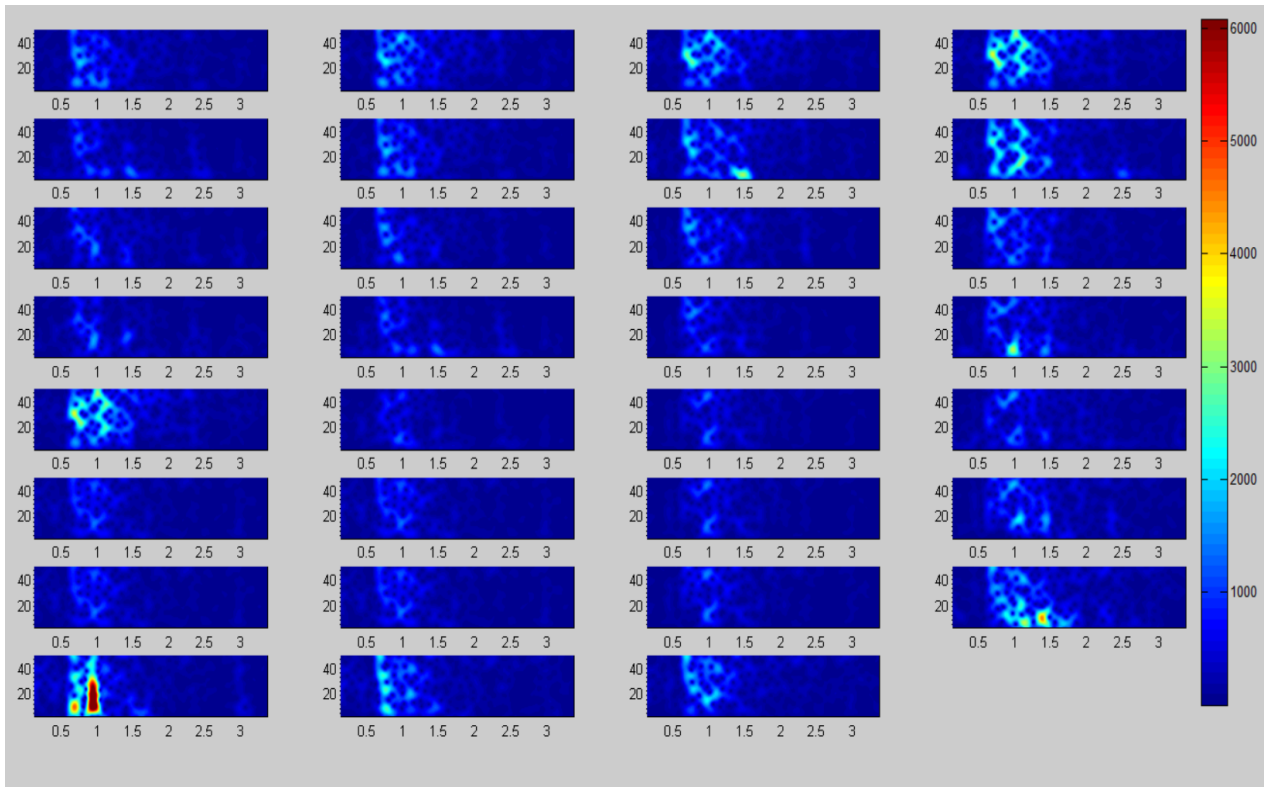

Figure 3.7 : Time-Frequency cartography for representative Young subject 52 yrs.

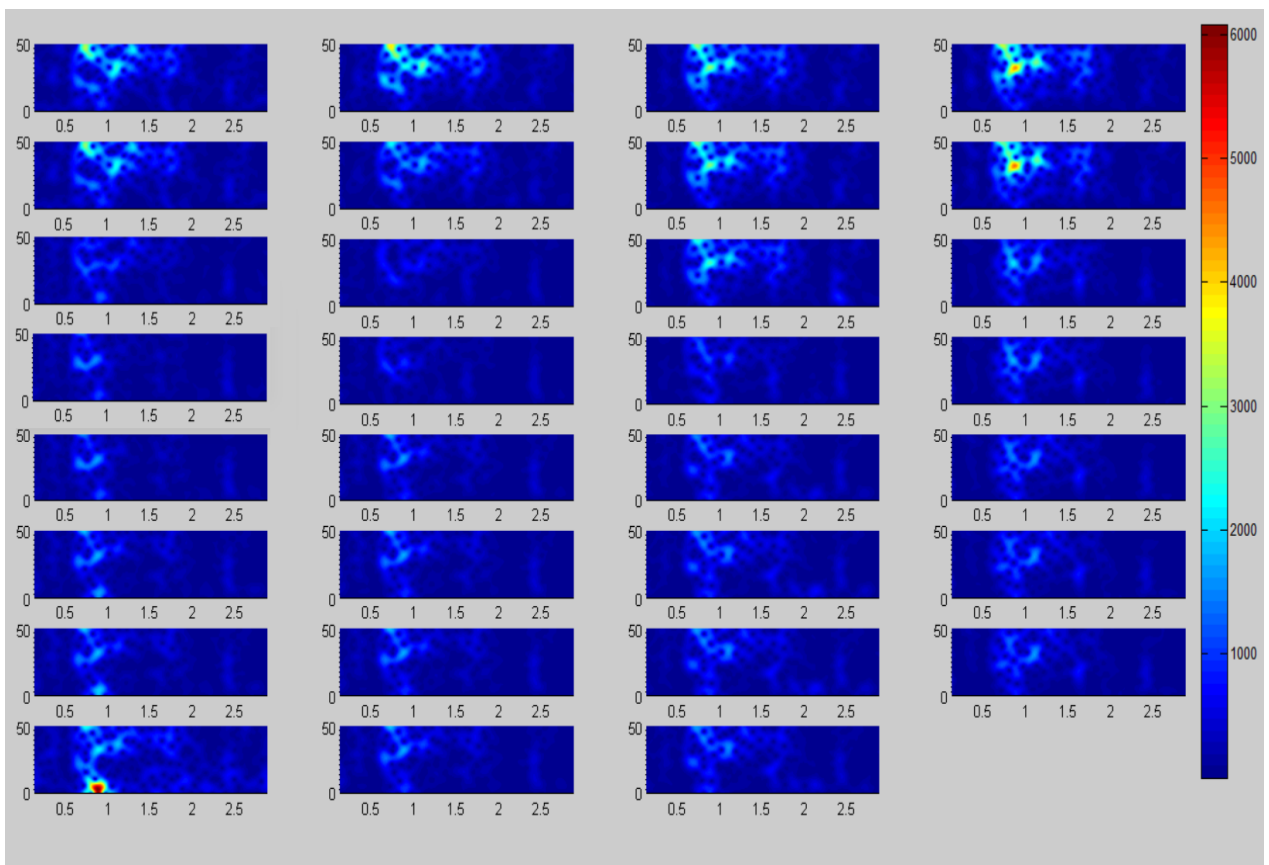

Figure 3.8: Time-Frequency cartography for representative Young subject 63 yrs.

The observed spatial distribution can be explained in part by the fact that two motor nerve branches innervate the human RF muscle. In [118], the femoral triangle area was dissected to identify the branches of the femoral nerve. It was observed that the motor branch of the RF was divided into 2 sub-branches just before it reached the 20% of muscle length from the hip. Based on this anatomical evidence, it can be estimated that the boundaries of the neuromuscular compartment are located at 20–33% of the RF muscle length from the hip. Previous studies using mfMRI have shown that during isokinetic knee extension exercises, the level of activation between the proximal and distal regions of the RF muscle is different [222].

Based on this finding, it is admitted that there are proximal and distal neuromuscular compartments in the RF muscle, and they are supposed to be independently regulated. Since the beginning of the electrode grid is located in the proximal third (30%) length of the RF muscle, the proximal grid area in this study can be divided into proximal neuromuscular compartments, while the middle and distal grid areas can be classified into distal neuromuscular compartment. Another study showed that the proximal part is more activated during the hip flexion, and the distal part is more activated during knee extension [223]. In [223] during knee extension, normalized RMS value at the distal region was significantly higher than the proximal region at 80% of MVC ( $p < 0.05$ ). On the other hand, during hip flexion, normalized RMS values at the proximal region were significantly higher than middle and distal regions at 60% of MVC ( $p < 0.05$ ). During STS motion, both hip flexion and knee extension are present and could explain the observed spatial distribution in the Time-Frequency domain. However, one can observe the aging effect in time spreading of the Time-Frequency representation. In fact, it is clear that further analysis is needed to better understand underlying processes related to STS motion with aging.

- *Conclusion*

In conclusion, we investigated the spatial activation pattern in the RF muscle during STS motion in the Time-Frequency domain. This first study, to our knowledge, can provide a better understanding of the characteristics and functional roles of RF muscle and its neuromuscular compartments. Indeed, the hypothesis of possible different RF region activation with aging seems to hold. According to these preliminary results, we observed significant differences with aging from young subject to older one (young person (25 yrs.), middle age person (52 yrs.) and old person (63 yrs.) in spatial distribution, timing and power intensity in the Time-Frequency

domain. The validity of the suggested hypotheses has to be demonstrated in future works on larger database. It is planned to extend this preliminary to the whole CHRONOS database. For this purpose, computing time of Time-Frequency maps need to be optimized.

## 3.3 Prediction of muscle aging based on HD-sEMG features classification

### 3.3.1 Introduction

The goal of this section is to give a first insight about prediction the aging effect in RF muscle and the impact of a sedentary lifestyle. Indeed, for this sake, we use a conventional automated recognition system, using machine learning methods, which can be divided into two main basic tasks, feature extraction and classification (Figure 3.9). It should be noted that we would give a special focus to the evaluation of the discrimination power of the extracted features.

Despite the ability of recorded HD- sEMG signals to give useful information, they are not always captured in ready and adequate format for analysis and interpretation, which clearly shows the need to address the problem of information extraction and interpretation. Therefore, relevant and discriminative features are of critical and fundamental importance to achieve high performances.

Feature extraction is of extreme importance in order to evaluate muscle aging effects. It seeks to transform and fix the dimensionality of an initial input raw data to generate a new set of features containing meaningful information contributing to assign the observations to the correct corresponding class either on training samples or new unseen data class (See Figure 3.9). Unfortunately, doing this correctly and completely represents a continuous challenging problem, which took the effort and attention of researchers in signal processing and computer science communities. Actually, the extracted features from the raw signals are used to feed up various machine learning classifiers techniques. Before delving to the details of the obtained results, we give hereafter a general overview of the different extracted features as well as the tested classifiers.

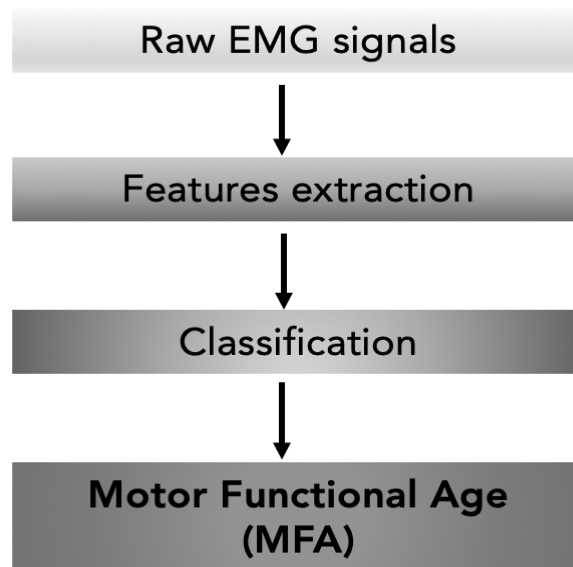

Figure 3.9 : The overview of classification set up

Let recall that, the chronological age taken alone is rarely a reliable index of the motor efficiency of a person to make a physical effort. The assessment of motor capacity is virtually related to the functional age, different from the chronological age. That mean, our chronological age does not reflect precisely our muscular abilities, because there may be young people in physical inactivity who also suffer from defined motor loss as early aging [9]. Based on that, we propose to evaluate the Muscle Functional Age (MFA) in this section, because it is becoming more important to find out solution to slow down the aging process by improving the lifestyle, such as diet, activities, life choices [9,10]. Based on that, we propose to predict the Muscle Functional Age (MFA), proposed by S. Boudaoud and K. Kinugawa, using different machine learning architectures compared in term of accuracy performances on active subjects and tested on unseen sedentary subjects to evaluate their MFA.

### 3.3.2 Features from HD-sEMG signal

- Temporal domain [224]:

In the time domain, the parameters allowing quantification of the activation level are:

- integrated EMG (iEMG) represents the integral of a rectified digitized signal  $x_i$  during a period of time corresponding to  $N_{tot}$  samples [224]:



$$iEMG = \sum_{i=1}^{N_{tot}} |x_i| \quad \text{Eq. 19}$$

- Averaged Rectified Value (ARV) corresponds to the average of the rectified values of a sEMG signal  $x_i$  during a segment of time corresponding to  $N_{tot}$  samples. It is expressed by [224]:

$$ARV = \frac{1}{N_{tot}} \sum_{i=1}^{N_{tot}} |x_i| \quad \text{Eq. 20}$$

- Root Mean Squared (RMS) correlates with the signal power. It is computed using the following equation [224]:

$$RMS = \sqrt{\frac{1}{N_{tot}} \sum_{i=1}^{N_{tot}} x_i^2} \quad \text{Eq. 21}$$

- Frequency domain:

In the frequency domain, the spectral parameters are based on the Power Spectral Density (PSD) of the sEMG signal by [224]:

$$S(e^{jk\omega}) = \sum_{\tau=-\infty}^{+\infty} r(\tau) \cdot e^{-jk\omega} \quad \text{Eq. 22}$$

Where  $e^{-jk\omega}$  ( $\omega = 2\pi f$ ) is the  $k^{th}$  sinusoidal harmonic and  $r(k)$  is the autocorrelation function expressed by the expected value:  $r(\tau) = E[x(k + \tau)x(k)]$ .

The power of the sEMG signal is generally between 5 and 500 Hz with the primary energy contained in the 50 -150 Hz portion [225]. The change in the spectral content of the EMG signal is usually tested using frequency parameters such as:

- The median frequency ( $f_{med}$ ) corresponds to the frequency that breaks up the PSD total energy in two equal power parts given by [217]:

$$\sum_{k=1}^{f_{med}} S_k = \sum_{k=f_{med}}^{F_{tot}} S_k \quad \text{Eq. 23}$$

With  $F_{tot}$  is the total number of samples in the frequency domain.

- The mean frequency ( $f_{mean}$ ) stands for the ratio of the first spectral moment normalized by total energy. It is computed using the following equation [217]:

$$f_{mean} = \frac{\sum_{k=1}^{F_{tot}} f_k S_k}{\sum_{k=1}^{F_{tot}} S_k} \quad \text{Eq. 24}$$

With  $f_i$  is the frequency value at the  $i^{th}$  sample.

- High order statistic (HOS) domain [226,227]:

The HOS parameters, the skewness (asymmetry) and the kurtosis (flatness), track indirectly the Power density function (PDF) shape modifications of the sEMG signal as used in Ayachi et al, [228]. We recall briefly the definitions of both normalized parameters in the following equations for the sEMG amplitude:

$$Skew(sEMG) = \frac{E[(sEMG - \mu)^3]}{(E[(sEMG - \mu)^2])^{3/2}} \quad \text{Eq. 25}$$

$$Kur(sEMG) = \frac{E[(sEMG - \mu)^4]}{(E[(sEMG - \mu)^2])^2} - 3 \quad \text{Eq. 26}$$

Where  $E(.)$  is defined as the expectation operator, and  $\mu$  is the mean value of the sEMG signal amplitude. It is important to note, that these high moments are invariant to the mean value and variance variability. These parameters were computed for STS dynamics contraction by averaging the values obtained over ten epochs of 0.2 seconds (sampling frequency,  $f_s$ , fixed at 1000 Hz) in order to minimize the bias of the used HOS estimators that employ empirical formula.

### 3.3.3 Classifiers

Machine learning is a branch of computer science, it represents an application of artificial intelligence (AI) providing systems the ability to automatically learn and improve from experience without being explicitly programmed [229]. Machine learning (ML) learns models from previous (the past knowledge) data in order to predict the new data (future knowledge). The key process is the learning that mimics human intelligences. Classification is the process of predicting the class of given data points. Classes are sometimes called targets/ labels or categories. Predictive classification predictive modeling is the task of approximating a mapping function ( $f$ ) from input variables ( $X$ ) to discrete output variables ( $y$ ). Many different statistical, probabilistic, and optimization techniques can be implemented as the learning

methods such as the logistic regression, artificial neural networks (ANN), K-nearest neighbor (KNN), decision trees (DT) and Naive Bayes [230]. There are two main types of ML learning - supervised learning and unsupervised learning.

The supervised learning builds a model by learning from known classes (labeled training data) [230]. In contrast, unsupervised learning methods learn the common features from unknown class data (unlabeled training data) [230]. The strength of ML methods is the ability to detect hard-to-discern patterns from large, noisy or complex data sets. This capability is particularly well-suited to complex medical data. Namely, genomic data especially in cancer studies [231]. The ML methods is also used in ambulatory devices for electrophysiological monitoring such as HD-sEMG and EHG techniques to predict premature delivery [232,233], to select the feature-channels pairs that best classify the hand postures at different limb positions [234], also to do pattern recognition based on HD-sEMG spatial features extraction for an efficient proportional control of a robotic arm [235] and more applications in biomedical field related to EEG or ECG signal analysis [236]. In our work we will test four classifiers from machine learning library in Python: Support Vector machines, Random forest, K Nearest Neighbors (Knn), and Multi Layers Perceptron (MLP).

- *Support Vector Machines (SVM)*

Support vector machines (SVMs) are a set of supervised learning methods, used for classification analysis introduced by Vapnik [237]. It is based on statistical learning theory [237]. Given a set of training examples, each marked as belonging to one of two categories, an SVM training algorithm builds a model that assigns new examples into one category or the other, making it a non-probabilistic binary linear classifier. A support vector machine constructs a hyper-plane or set of hyper-planes in a high or infinite dimensional space, which can be used for classification, regression or other tasks. Intuitively, a good separation is achieved by the hyper-plane that has the largest distance to the nearest training data points of any class (so-called functional margin), since in general the larger the margin the lower the generalization error of the classifier [238,239]. The Figure 3.10 below shows the decision function for a linearly separable problem, with three samples on the margin boundaries, called "support vectors":

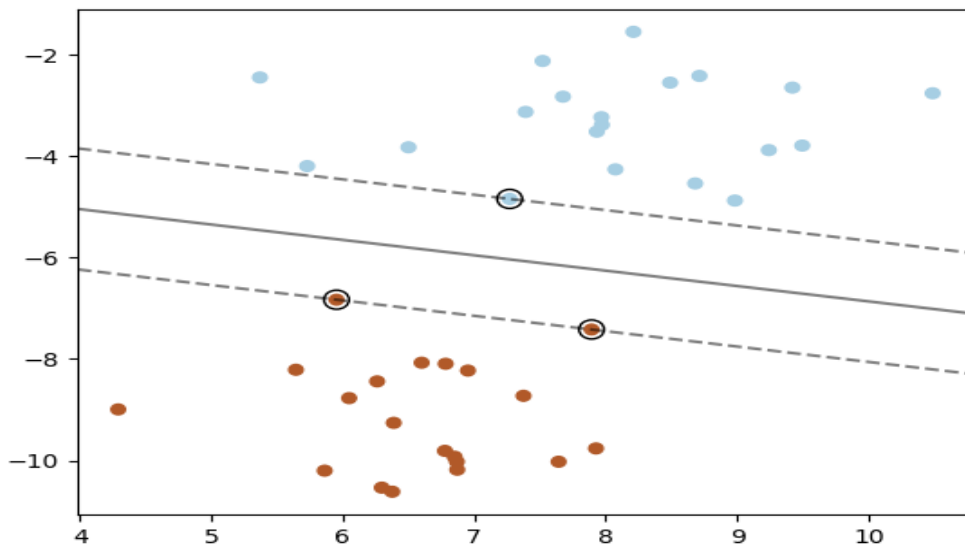

Figure 3.10: the decision function for a linearly separable problem, with three samples on the margin boundaries [240].

The support vector machines has several advantages listed hereafter [240]:

- Performs well in high dimensional spaces when the number of dimensions is greater than the number of samples.
- Uses a subset of training points in the decision function (called support vectors), so it is also memory efficient.
- Different kernel functions can be specified for the decision function. Common kernels are provided, but it is also possible to specify custom kernels.

The choice of the optimal parameters for SVM to get optimal accuracy scores will be done thanks to Hyper parameters optimization.

- *Random Forest (RF)*

Random forest (RF) is an essential machine learning algorithm, proposed by Leo Breiman in 2001 [241]. It is easy to interpret, stable with generally good accuracy and can be used for classification or regression tasks. It therefore covers a large part of Machine Learning issues [242]. It is an algorithm based on the assembly of decision trees by constructing a multitude of decision trees at training time. As its name suggests, a decision tree helps to make a decision through a series of tests whose answer (yes / no) will lead to the final decision [243], see Figure 3.11. On the tree, each question corresponds to a node, that is, a place where a branch splits into two branches. Depending on the answer to each question, we will orient

ourselves towards a particular branch of the tree to finally arrive on a leaf of the tree (or end) which will contain the answer to our question [242].

Random Forests can be made up of several dozen or even hundreds of trees, each tree is trained on a subset of the dataset and gives the result. The results of the selected decision trees are then combined to give a final answer. Each tree "votes" and the final answer is the one that had the majority vote [242,243].

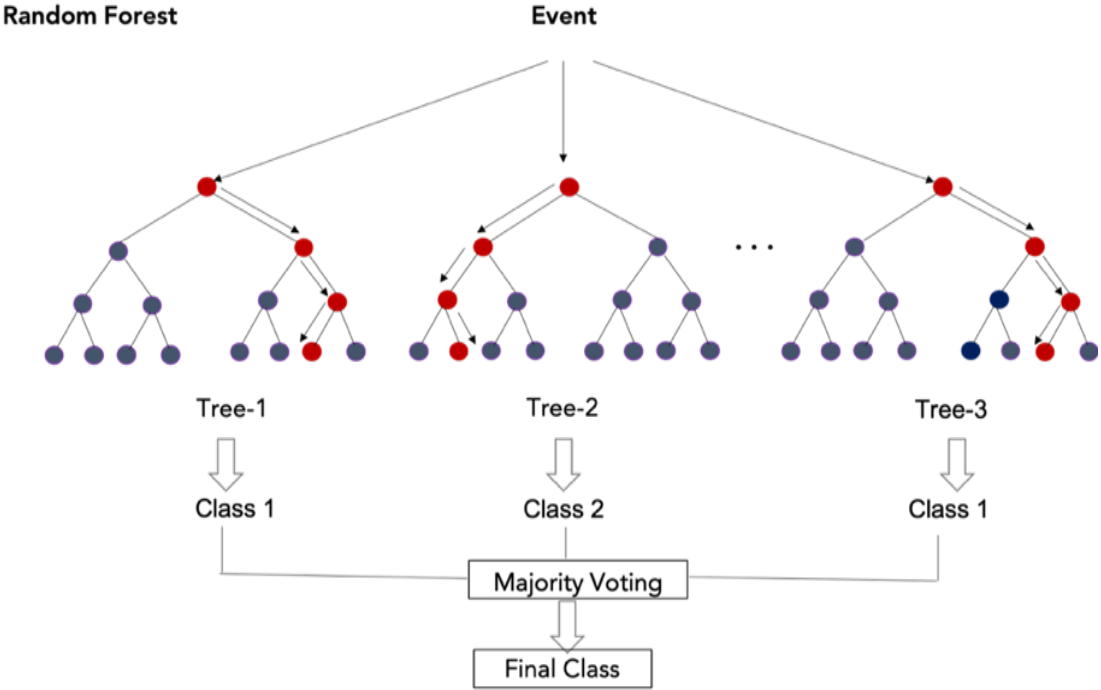

Figure 3.11: Random forest setup

- Multi Layers Perceptron Couche (MLP)

A multilayer perceptron (MLP) is a class of feedforward Artificial Neural Network (ANN) [244,245]. MLP utilizes a supervised learning technique called backpropagation for training. Its multiple layers and non-linear activation distinguish MLP from a linear perceptron. It can distinguish data that is not linearly separable. A multi-layer neural network consists of a large number of units (neurons) joined together in a pattern of connections (Figure 3.12) [245]. Units in a net are usually segregated into three classes: input units, which receive information to be processed; output units, where the results of the processing are found; and units in between known as hidden units. Feed-forward ANNs (Figure 3.12) allow features to travel one way only, from input to output.

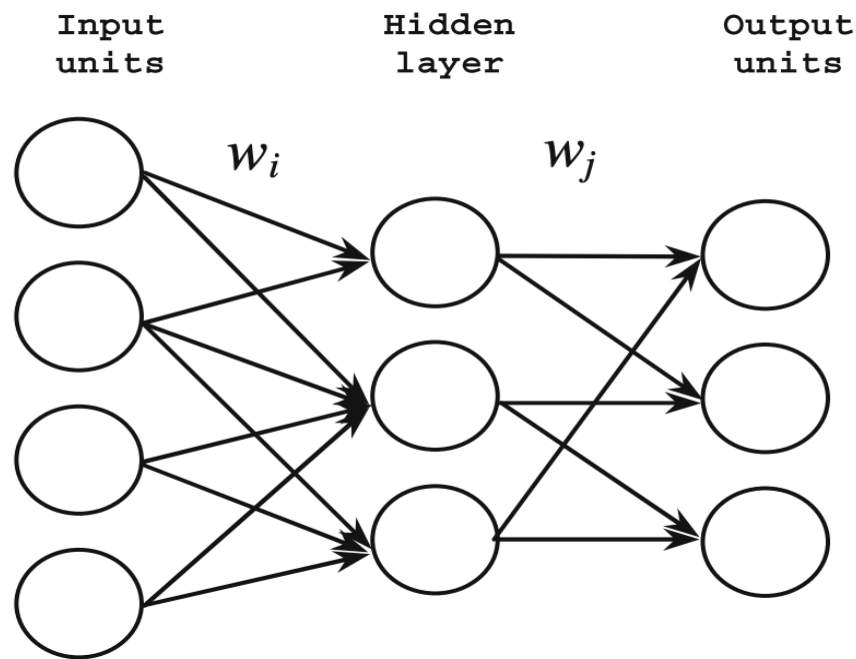

Figure 3.12 : Neuronal network [246].

- *K Nearest Neighbors (Knn)*

The k-Nearest-Neighbors (Knn) method of classification is one of the simplest methods in machine learning. It seeks to find the most similar data points in the training data, and make a guess based on their classifications [229,247]. Although very simple to understand and implement, this method has seen wide application in many domains, such as in recommendation systems, semantic searching, and anomaly detection [247]. Unlike most other methods of classification, Knn falls under lazy learning [230] (i.e. there is no explicit training phase before classification). While we can immediately begin classifying once we have our data, there are some inherent problems with this type of algorithm. Indeed, we must be able to keep the entire training set in memory unless we apply some type of reduction. It should be noted that performing classifications could be computationally expensive as the algorithm parses through all data points for each classification. For these reasons, Knn tends to work best on smaller datasets with a limited number of features [230].

### 3.3.4 Experiments & Methodology

Performing a classification mainly consists of several steps: (a) choosing an experiment scheme, (b) choosing a set of features or attributes according to maximized discriminative

power (feature selection); (c) training the classifier; (d) validating the classifier; and finally (e) evaluating potential errors in the classification scheme by analyzing confusion matrix (well classified versus misclassified data statistics).

In this work, we suggest to evaluate several experimental designs to classify features according to age categories. Firstly, we will describe the dataset architecture, the implementation of classifiers, and we will present and discuss the accuracy of the classification according to each feature and experimental design.

- *Dataset description*

As described before, the CHRONOS dataset contains 82 active subjects (49% females) according to IPAQ (as described in the chapter 2), with a mean age of  $49 \pm 14$  years and a mean body mass index (BMI) of  $23.7 \pm 2.7$  kg/m<sup>2</sup>, divided into 5 age categories (from 25 years to 74 years) as depicted on Table 11. Each subject provides 3 Sit To Stand trials combined to HD-sEMG signal recording.

Table 11. Dataset description

Age categories	Females (%)	Number of subjects	Age range (yrs)	BMI(Kg/m <sup>2</sup> ) (mean(( $\pm$ sd))
Class 1	50	16	25-34	23.88( $\pm$ 2.80)
Class 2	50	16	35-44	23.63( $\pm$ 2.90)
Class 3	47	17	45-54	23.53( $\pm$ 2.32)
Class 4	47	17	55-64	24.0( $\pm$ 3.24)
Class 5	50	16	65-74	23.63( $\pm$ 2.83)

The aforementioned extracted features from HD-sEMG signals for the classification stage are extracted from the CHRONOS database. The HD-sEMG signals were detected from a restricted area of the skin over the muscle (in the proximal zone of the Rectus Femoris muscle) using HD-sEMG electrode grid according to the experimental protocol. These 2D array electrodes are organized in 8 rows and 4 columns. The recorded HD-sEMG data was preprocessed using band-pass filtered at 20-450 Hz, automatically segmented to extract muscle contraction using Hilbert envelope and finally sampled at 1000 Hz.

For each STS trial, 31 channels were recorded (the 32 channel is the reference). Each HD-sEMG dataset was recorded separately and refers to the original file containing others information of patients in order to make data exploration easier. This permits to have a

flexibility in data management to allow several studies such as a comparison between clinical data and HD-sEMG data, adding new features, etc. During this thesis, the standardization of this data was done starting from HD-sEMG raw data to feature extraction. The main goal of this standardization is to make the whole process from data recording (with all details about experimentation) to feature extraction, across processing of HD-sEMG signals, traceable, archived, and reusable for future advanced studies. Thus, this will facilitate the reuse of codes for similar studies whether for data from the CHRONOS project or from other studies and avoiding redundancy. From another point of view, it will also facilitate the communication of all users involved in the projects.

- *Classification methodology*

The muscle functional age (MFA) estimation based on the classification of the extracted features from the recorded HD-sEMG data is summarized in Figure 3.13.



Figure 3.13: Classification process

In this section, we decided to test three feature extraction methodologies from HD-sEMG signals. In the first methodology, we extract the features from the averaged signals over channels for each trial. The objective of this architecture is to evaluate if the signal averaging is an exploratory and promising possibility to be considered in the final device, which will predict the motor functional age (MFA).



Then for each subject we have one value per feature and per trial (3 values for each subject). The advantage of using the averaged signals is the simplicity of its integration into the final software dedicated to clinical applications, considering the fast computation time of the features and also all the processing steps before the calculation of the features.

This methodology will also allow us to compare the classification results of these features with the statistical results of basic scalar parameters such as MCI and MCD, shown in chapter 2. In contrast, the averaged data architecture makes hard to obtain a precise and spatial information on the changes in muscle activity over the grid. Another critical point is the discriminant vector construction combining different features.

This is why we decided to test each feature separately for the averaged feature methodology, and also for the other methodologies, in order to avoid the design of a complete black box system where we cannot extract some physiological interpretations from the used features.

The second methodology consists on the classification of the features using 31 channels per trial and per subject in order to evaluate the muscle aging changes related to spatial muscle activation changes observed on the HD-sEMG grid.

And finally, in the third methodology, we keep the 31 channel per trial and per subject but in this time will divided the complete STS contraction into three-time segments, to consider the STS phases (as described in chapter 1). Then, we compute features for each time segment in order to evaluate the changes linked to the several STS phases. Finally, we will propose a classification procedure, based on channel majority voting, to predict the MFA on the sedentary subject group.

The proposed three feature extraction methodologies are exposed in Figure 3.14:

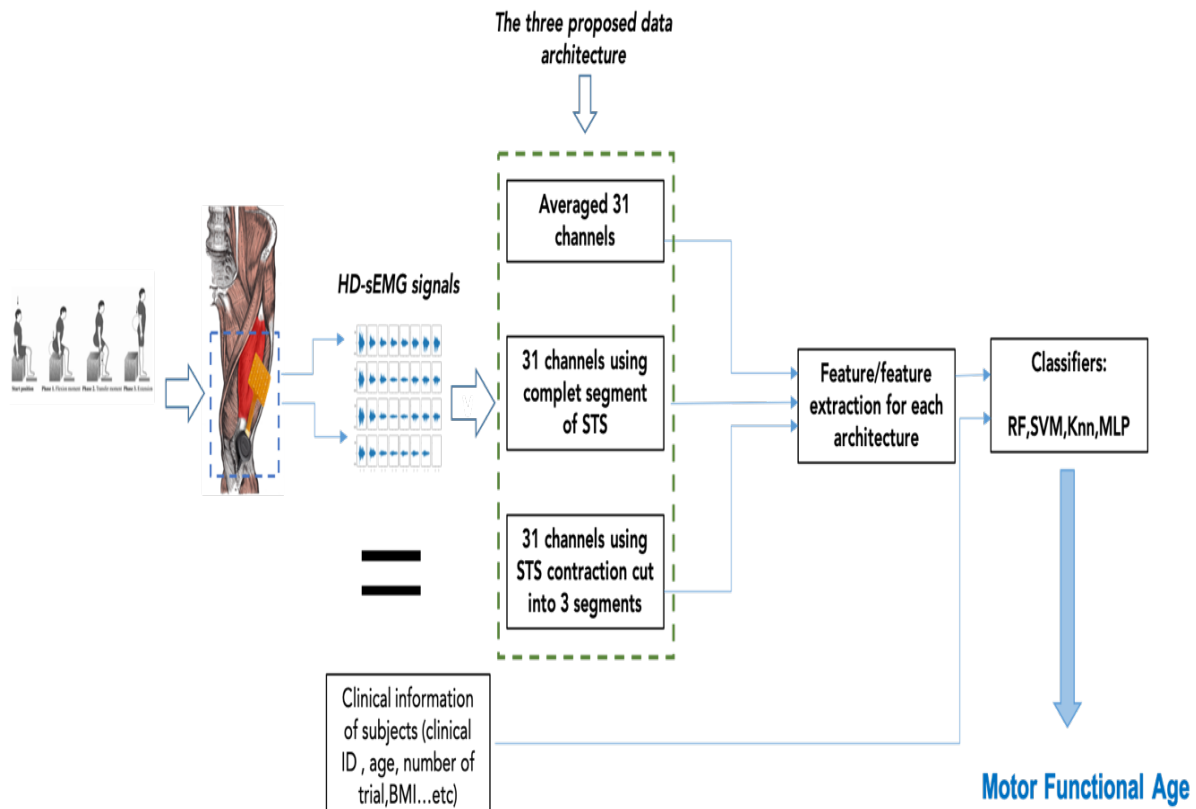

Figure 3.14: Feature extraction for MFA prediction

During the implementation of the classifiers, it was necessary to think about the best calibration parameter values. For this sake, we refer the reader to the literature regarding the choice of these hyper-parameters [229]. In statistics, this step is called hyper-parameter optimization; it represents a parameter from a prior distribution which captures the prior belief before data is observed [247]. In any machine learning algorithm, hyper-parameters are important because they directly control the behavior of the training algorithm and have a significant impact on the performance of the trained model.

Choosing appropriate hyper-parameters plays a crucial role in the success of our classification approaches since it makes a huge impact on the learned model performances [248]. Choosing good hyper-parameters gives two benefits: a). Efficient search in the space of possible hyper-parameters. b). Management simplicity of a large set of experiments for hyper-parameter tuning.

The common algorithms to find the most optimal hyper-parameters include: Grid Search, Random Search, Bayesian Optimization. In this study, we have chosen the grid search method (Figure 3.15). It is a classical technique for calibrating hyper-parameters. It tries all the

possible hyper-parameter combinations and then provides the best combination giving the best accuracy score [249].

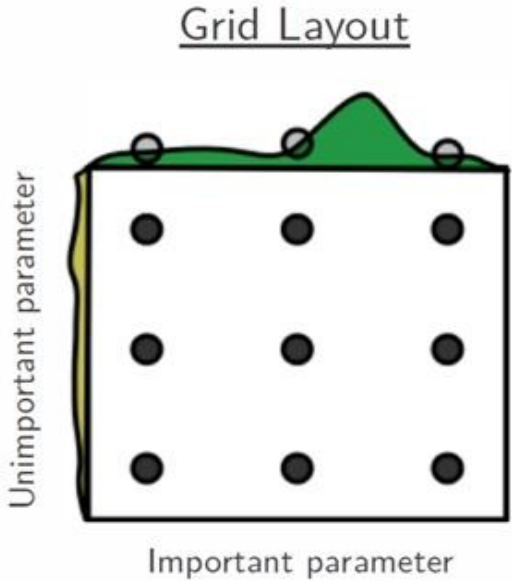

Figure 3.15: Grid Search method

Source: <https://blog.floydhub.com/guide-to-hyperparameters-search-for-deep-learning-models/>

The Grid search method is a simple algorithm to use but it suffers from complexity increase related to high dimensional space namely called the curse of dimensionality. For more generalization ability (new knowledge ability) and in order to avoid possible dependence to a special training/testing set (past knowledge dependence), we have performed a 10-fold cross validation scheme (see Figure 3.16). Indeed, each time, 9-folds have been used for training (90%) and the remaining one (10%) for testing. The performance is measured by the classification accuracy given by [247,250]:

$$Accuracy = \frac{True\ Positive + True\ Negative}{Total\ Sample} \tag{Eq. 27}$$

We repeat the operation 10-times, and the final accuracy is given by the mean accuracies and its corresponding the standard deviation (see Figure 3.16)

Validating a classifier involves testing it on a set of subjects (the test set) that is independent of the training set. When the dataset is large, one can simply divide it into a training and test set (hold-out method). But in case of smaller database, we used cross

validation such as an effective and statistically justified validation method that can be used in this case [247].

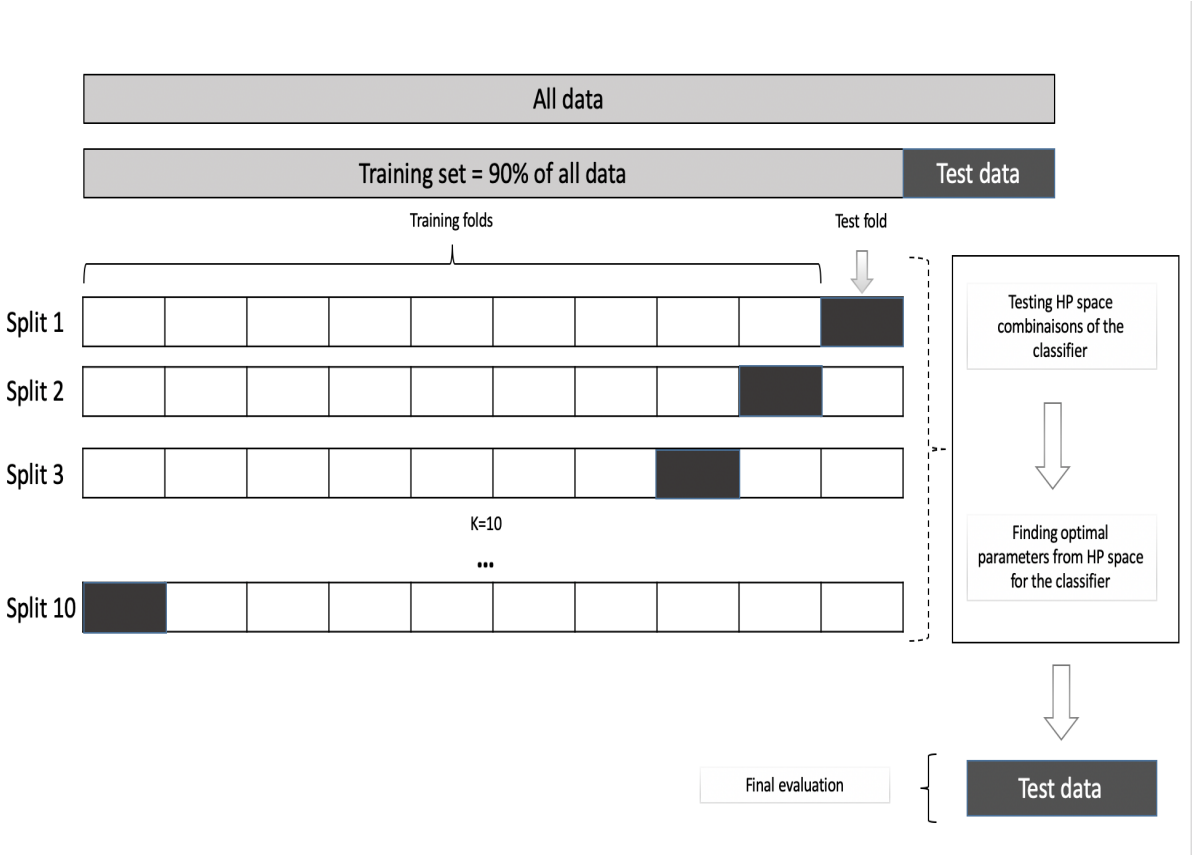

Figure 3.16: Cross validation (K-fold) method

In this approach, combined to hyper-parameter tuning process, one sample (10% of the database) is removed from the training set (Figure 3.16). The classifier is trained using the remaining training set, and then evaluated using the hold-out sample as a test (Figure 3.16). This process is repeated in turn for each member of the training set. Other validation methods can be used instead the proposed one and are computationally less intensive, and some machine learning techniques combine training and validation of classifiers in one process [238,247]. The performance of tested classifiers to separate the 5 age classes using each feature is compared according to the accuracy scores. Because our database is well equilibrated in term of samples per class, the accuracy is supposed to be a good performance indicator.

We will complete this analysis by giving the confusion matrix in order to evaluate which classes will be confused in the classification. This would provide some observations and interpretations correlated to the statistical results obtained in the CHRONOS clinical study in Chapter 2.

Finally, we will test the ability of the most relevant features to ensure the MFA prediction on new data from the sedentary group (low activity level according to IPAQ). It is important to keep in mind that for these sedentary subjects are not labeled with a known MFA. Their classification, trained on active subjects, to a younger or older age category will constitute the MFA prediction and can be considered as a generalization process of the selected classifiers.

### 3.3.5 Results and discussion

- *Results of HD-sEMG features from the averaged channels (Features Extraction Methodology 1)*

To verify that the averaged features from HD-sEMG signals allow the recognition of aging changes through ages categories for active subjects, we compared the four classifiers (RF, SVM, MLP, Knn) accuracy for each of the height features depicted in the previous sections (input dimension: 1 averaged feature from 31 channels x 3 trials).

The highest recognition accuracy was  $92\%, \pm 0.06$ ,  $90\%, \pm 0.05$ , for ARV and RMS feature respectively with SVM classifier. this classifier demonstrates a high recognition ability for HD-sEMG data in other application, such as gesture recognition [251]. Also, the higher accuracy for RF and Knn classifiers was observed:  $96\%, \pm 0.04$ ,  $94\%, \pm 0.05$  respectively for ARV feature see Figure 3.17.

The other features demonstrate a very good accuracy with RF, SVM and Knn (see Figure 3.17 for more details). For example, IEMG feature performed with an accuracy of  $85\%, \pm 0.23$ ,  $94\%, \pm 0.03$ ,  $93\%, \pm 0.07$  for RF, SVM, and Knn respectively. In contrast, the MLP classifier performed not well. It may be because this classifier is not adapted to our proposal configurations taking account the complexity and the dimension of neuronal network. The complexity of the model is based on the architecture, which is determined here by the number of hidden: it is the first parameter used to control the network.

To preserve convergence properties, some restrictions have to be respected, particularly concerning the dimension [252]. Since we used the hyper parameters optimization process, we assume maybe for the eventual data, the input layer dimension was small and not enough adapted to MLP classifier. The aim of testing this classifier is to give an idea about

several kind of classifiers from statistical learning such as SVM, RF and Knn and also from neuronal technique such as MLP [253].

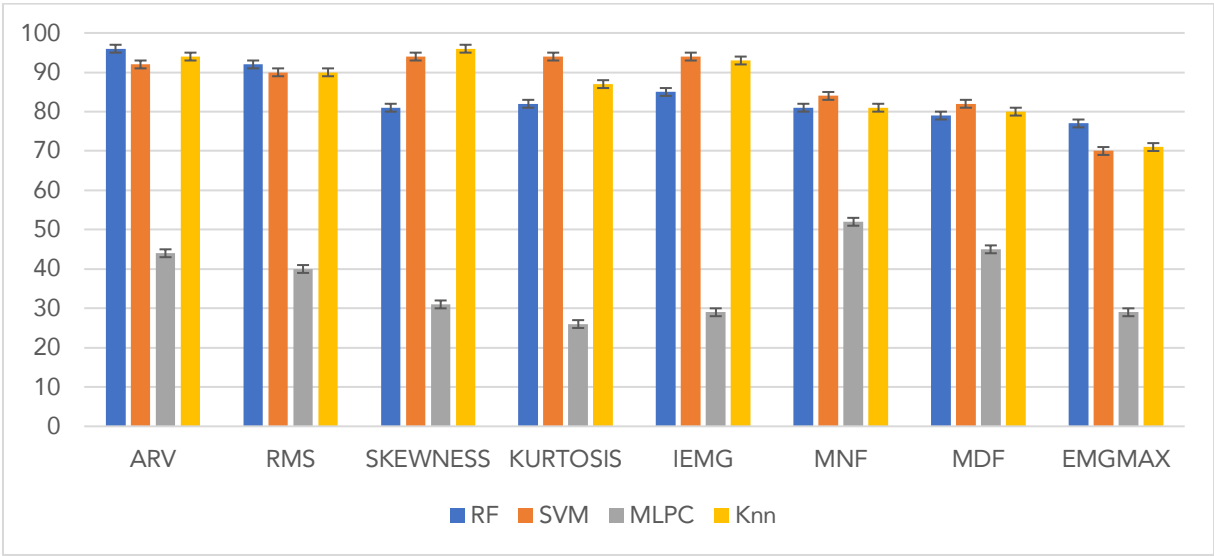

Figure 3.17: Accuracy percentage of HD-sEMG features from the averaged channels channels (Feature Extraction Methodology 1)

Indeed, the averaged feature methodology seems to be robust for the recognition of muscle changes based on HD-sEMG features. This data input architecture has many advantageous such as an easier implementation in clinical device after choosing the best feature with the best classifier and a better robustness against clinical variability. However, the spatial information from the grid is missed and more precise analysis on the spatial muscle activation becomes impossible.

- *Results of HD-sEMG features from 31 channels (Feature extraction methodology 2)*

The second feature extraction methodology evaluates the ability of each feature ((input dimension: 1 feature x 3 trials x 31 channels).The classification results are showed in the Figure 3.18 below the classifiers performed a considerable accuracy score for ARV, RMS, IEMG and EMGMAX (71%,±0.1 , 89%,±0.23, 88,±0.05, 74%,±0.05) using RF classifiers, we observe that the accuracy score globally decrease using this methodology especially for some features such as ARV, skewness, kurtosis ,MNF and MDF with RF. This is clearly due to the increasing of the variability in the dataset including now all the 31 channels. In contrast, an interesting performance was obtained by MLP (64%,±0.13 for ARV, 74%,±0.12 for Skewness) comparing

to the first architecture with averaged features (Figure 3.18), that confirm that MLP work better with large input layer dimension as mentioned before [252].

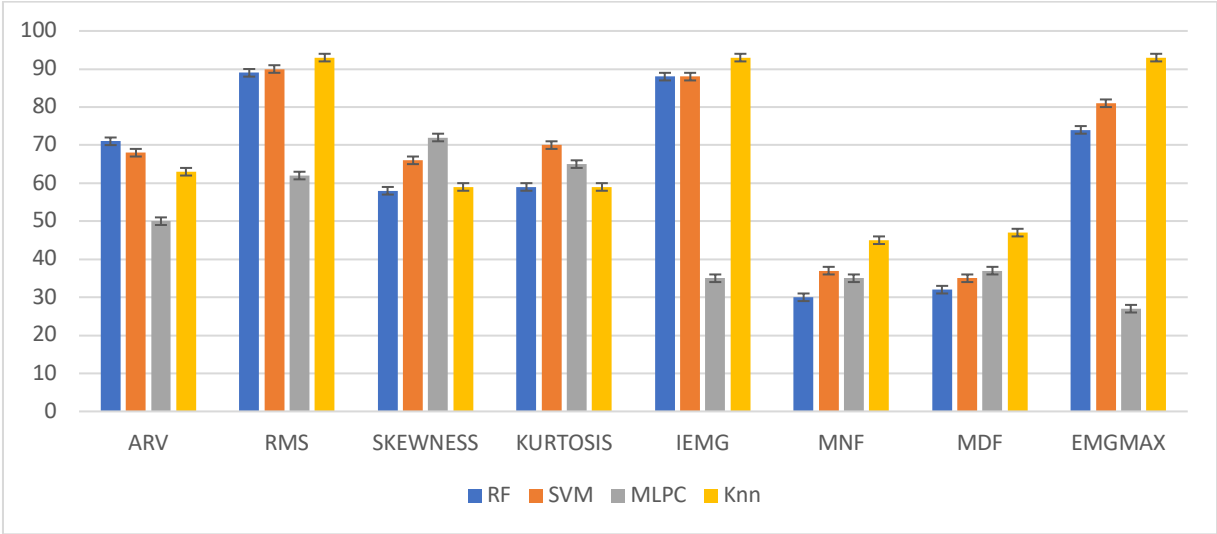

Figure 3.18: Accuracy percentage of HD-sEMG features from 31 channels (Feature extraction methodology 2)

This feature extraction methodology based on 31 channels gave us a better overview about how to explore classification approaches to study the contribution of each feature in the muscle functional changes including spatial activation information over the grid. Thanks to this methodology, we can also analyze the possible region activation by observing how each feature contribute in the surface of the grid, and interpret more the activation behavior of RF muscle during STS test. This can provide more precise knowledge on muscle activation strategies, piloted by the peripheral nervous system. However, the proposed methodology could also be combined to channel selection procedure to better assess the considered regions.

An interesting future study could be considering the fusion of the 31 channels with other clinical data to evaluate muscle functional age such as ultrasound images or other electrophysiological signals. A recent study for motion classification strategy based on sEMG-EEG signal combination for upper limb amputees prosthesis control showed that the classification performance achieved by the fusion of sEMG and EEG signals was significantly better than that obtained by using either sEMG or EEG signals alone [254].

- Results of HD-sEMG features from the segmented HD-sEMG signals for 31 channels (Feature extraction methodology 3)

This last feature extraction methodology was proposed to evaluate the behavior of the studied features and the classification performances if we analyze the HD-sEMG signals during STS separately and according to three-time segments or windows (Figure 3.19). The objective is to take into account the dynamic nature of the recorded signals following the STS phases as illustrated in the figure below.

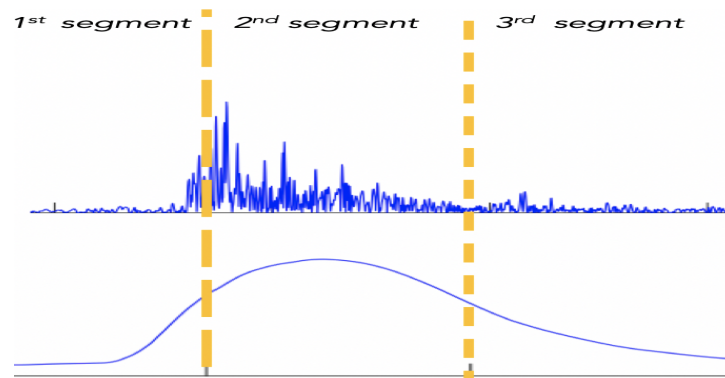

Figure 3.19: the three segments of EMG contraction during STS motion

Unfortunately, during the data recording sessions, due to regulatory issue, we could not have a camera for recording STS motion for precise identifying all STS phases within HD-sEMG signals. However, to initiate a first preliminary study, an arbitrary segmentation is proposed for evaluation the classification performances by taking into account the dynamic nature of the HD-sEMG signals. For this purpose, we will evaluate the performance using the three segments. Future work will concern the improvement of this methodology using camera to identify precisely the phases of STS to analyze deeply the motion modification with aging changes based on HD-sEMG signals.

The obtained results for the 1<sup>st</sup> segment (that we consider matching with the initiation of hip flexion) from the HD-sEMG contraction illustrate the increase in the accuracy comparing to the previous architecture based on the 31 channels analyzing the entire contraction. This increase concerns particularly in Skewness and Kurtosis features for all classifiers. For example, for RF method, they increase from 58%, $\pm$ 0.2, 59%, $\pm$ 0.14 respectively in the previous architecture (Figure 3.18) to 87%, $\pm$ 0.05, 87%, $\pm$ 0.07 in the classification results related to the



first segment (Figure 3.20). Indeed, the Skewness and Kurtosis already showed high sensitivity to the probability density function shape of HD-sEMG signals and were helpful to classify the muscle force [121,227]. In contrary, The MNF and MDF features showed worse performances using all classifiers for example with SVM, the accuracy is  $30\%, \pm 0.12$ ,  $35\%, \pm 0.16$ , this bad accuracy is related to the shortness of signals that affects spectrum estimation [215].

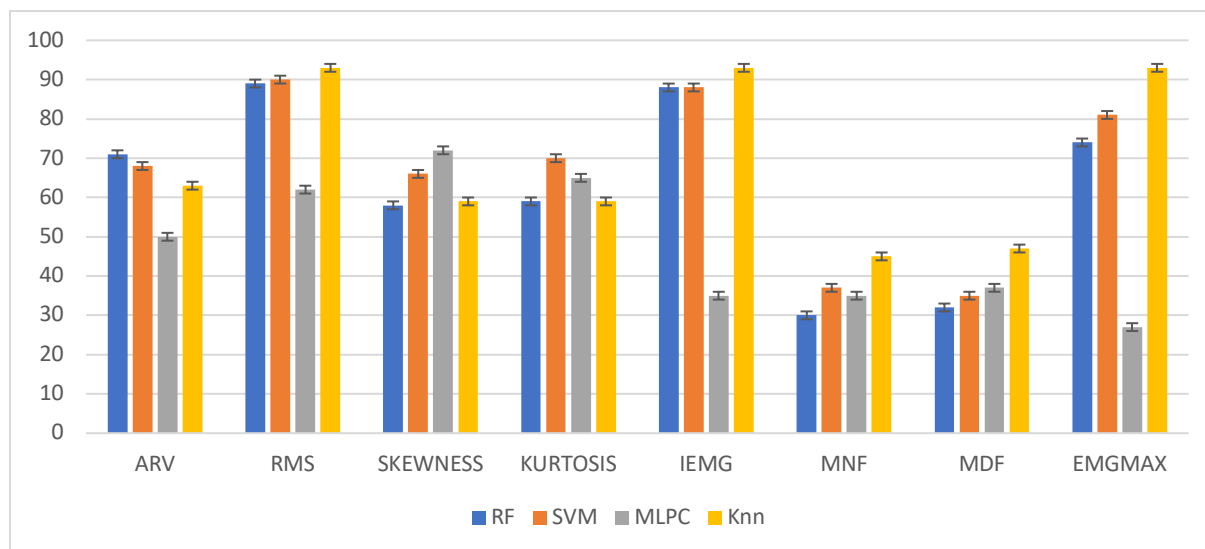

Figure 3.20: Accuracy percentage of HD-sEMG features from the 1st segment of all channels

The 2<sup>nd</sup> segment, refers to the middle part of the contraction containing the rising phase (Figure 3.19). In fact, this segment is related to the phase of the transition from sitting to standing. This phase in STS motion is critical in term of energy request-(we obtain the maximum amplitude of sEMG activity during this step). This step bears on the coherence between the acceleration of the trunk and the contraction of the muscle in lower limb particularly the RF muscle. Generally, during this phase, the risk of failing increases in older population. We observe that the performance of classifiers is higher and recognize better the age categories of the active subjects (Figure 3.21). For illustration, the Knn demonstrated a good performance with ARV by  $93\% \pm 0.07$ , with Skewness and Kurtosis  $93\%, \pm 0.06$ ,  $95\%, \pm 0.08$  respectively.

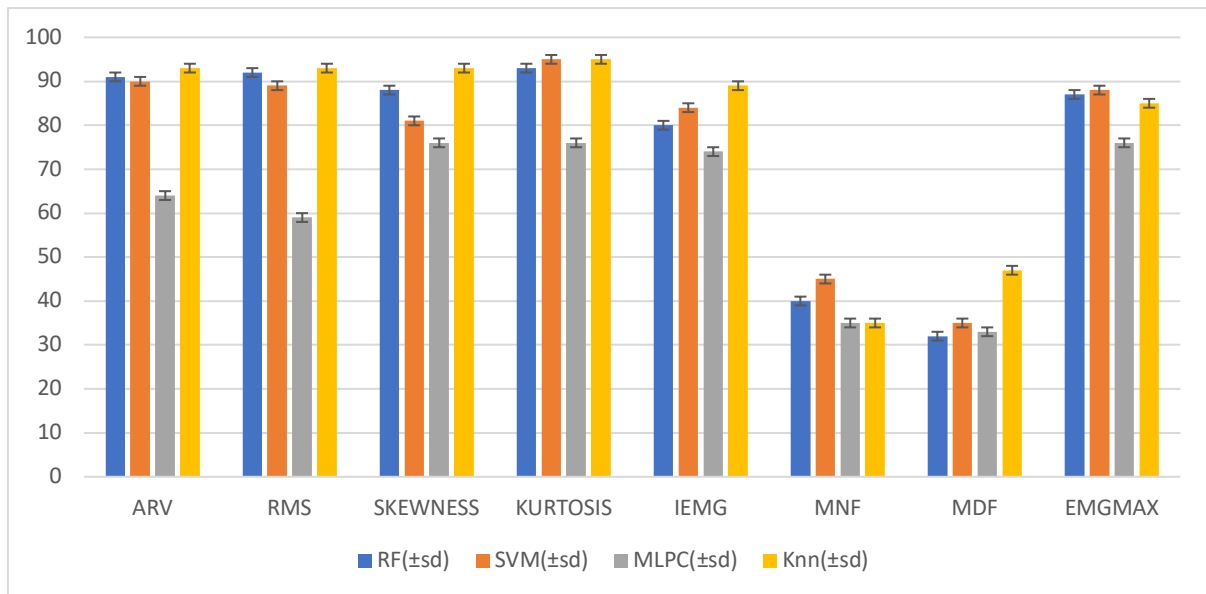

Figure 3.21: Accuracy percentage of HD-sEMG features from the 2nd segment of all channels

The final tested segment in this architecture refers to the step of the stabilization of the posture during STS motion. The accuracy performance given by this segment is higher with Knn classifier and SVM for the ARV (Knn: 94%, $\pm 0.07$ , SVM: 89%, $\pm 0.09$ ), RMS (Knn: 93%, $\pm 0.09$ , SVM: 87%, $\pm 0.08$ ), Skewness (Knn: 96%, $\pm 0.08$ , SVM: 96%, $\pm 0.06$ ), and Kurtosis (Knn: 95%, $\pm 0.07$ , SVM: 96%, $\pm 0.05$ ) respectively (Figure 3.22).

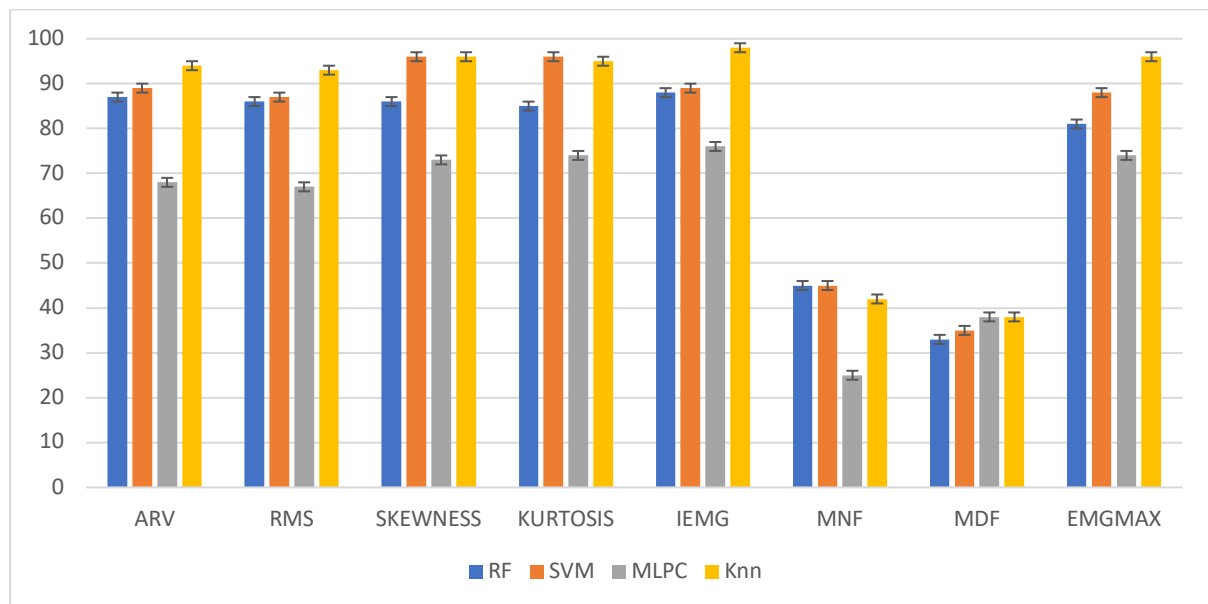

Figure 3.22: Accuracy percentage of HD-sEMG features from the 3rd segment of all channels

We analyzed the confusion matrices of each feature and classifier for each methodology (3 methodologies X 8 features X 4 classifiers). For illustration purpose, we present a

representative confusion matrix (Figure 3.23). We observed that all classifiers confused between two neighbors' classes (1 with 2, 2 with 3 or 4 with 5). This observation is in agreement with the fact that muscle aging is a time evolving process. Subjects can be lie in the borderline inducing possible misclassification.

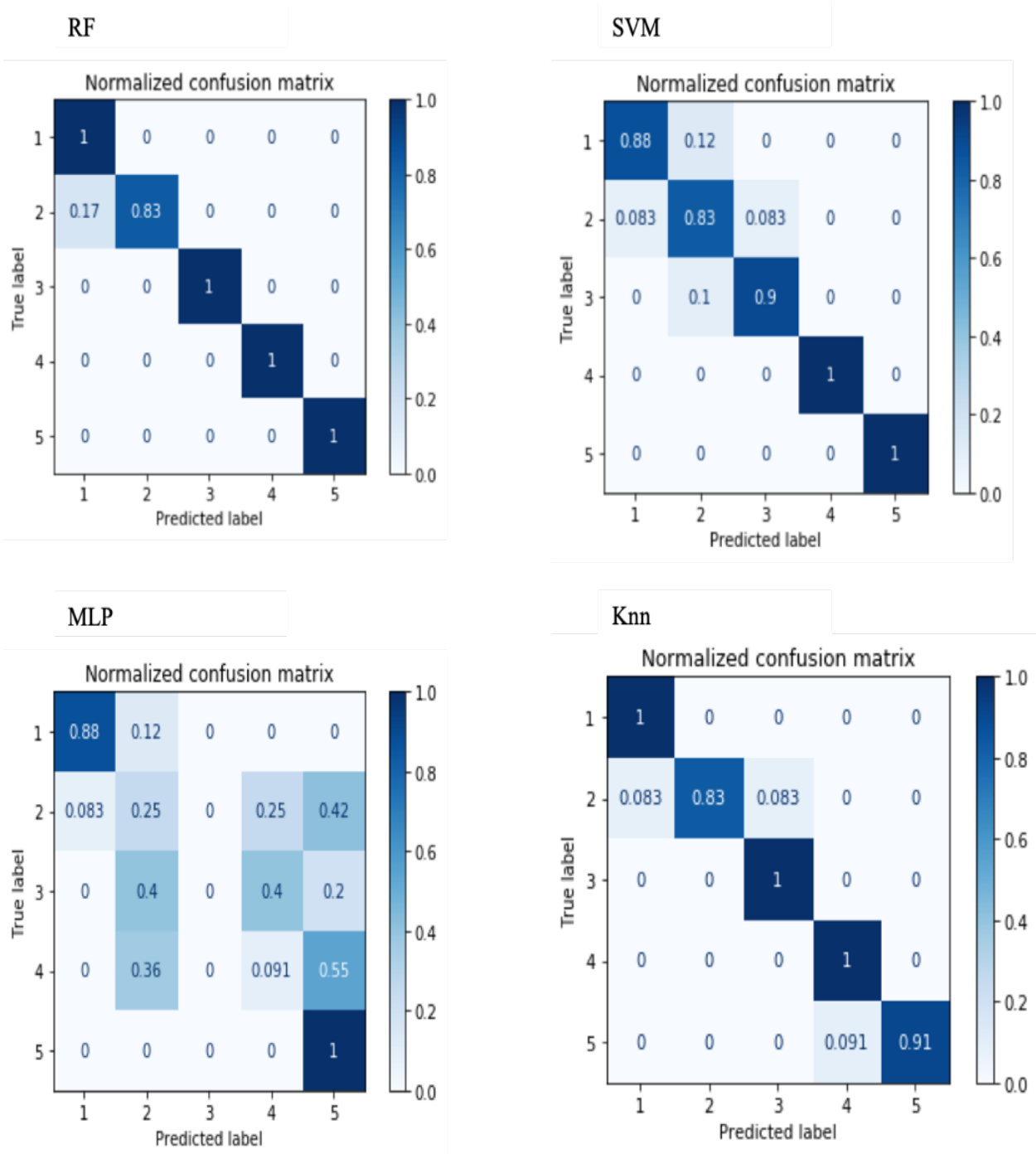

Figure 3.23: Representative confusion matrix for the four classifiers with methodology 1, using ARV feature.

The following tables shows the top classifiers, which provided interesting performance in all three methodologies, including Knn, SVM and RF with the features: RMS, EMGMAX, Skewness and Kurtosis. We observe that the results of Knn were the most stable throughout the three methodologies. This is why we choose these features with this classifier in the MFA prediction (see next section). One can also observe that the dynamic of contraction according to the three analyzed time segments has an impact and will better explored in future works. Furthermore, introducing spatial Information with all the channels during the whole contraction seems to degrade the classification performances due to greater variability (time and spatial).

Table 12. Summary of the best classifiers and features (accuracy performances in %)

Summary of methodology 1					Summary of methodology 2				
Averaged channels					Total channels				
	Skewness	Kurtosis	EMGMAX	RMS		Skewness	Kurtosis	EMGMAX	RMS
Knn	96(±0.15)	87(±0.15)	93(±0.06)	90(±0.08)	Knn	59(±0.08)	59(±0.05)	93(±0.06)	93(±0.07)
SVM	94(±0.1)	94(±0.1)	81(±0.03)	90(±0.05)	SVM	66(±0.05)	70(±0.14)	81(±0.11)	68(±0.06)
RF	81(±0.25)	92(±0.15)	88(±0.23)	92(±0.21)	RF	58(±0.2)	59(±0.14)	74(±0.05)	71(±0.23)
Summary of methodology 3									
1 st segment					2 st segment				
	Skewness	Kurtosis	EMGMAX	RMS		Skewness	Kurtosis	EMGMAX	RMS
Knn	96(±0.08)	94(±0.05)	93(±0.06)	65(±0.07)	Knn	96(±0.07)	95(±0.08)	93(±0.11)	85(±0.07)
SVM	95(±0.05)	95(±0.14)	81(±0.05)	60(±0.06)	SVM	90(±0.05)	95(±0.05)	81(±0.07)	88(±0.06)
RF	87(±0.2)	87(±0.15)	88(±0.11)	68(±0.23)	RF	91(±0.11)	93(±0.09)	88(±0.05)	87(±0.11)
3 rd segment									
	Skewness	Kurtosis	EMGMAX	RMS					
Knn	96(±0.08)	95(±0.07)	96(±0.07)	93(±0.08)					
SVM	96(±0.06)	96(±0.05)	88(±0.16)	87(±0.09)					
RF	86(±0.18)	85(±0.16)	81(±0.11)	86(±0.15)					

- *Results of MFA prediction*

Finally, we aim to test the prediction of the MFA giving new data from sedentary subjects. We recall our hypothesis that muscle aging occurs earlier and/or in the sedentary subjects than the active ones. As a result, their muscle activity properties will be more similar to the older categories than their own chronological category (as mentioned and statistically evaluated in the Chapter2). Indeed, the aim of this section is to take benefits of the presented classification approaches studied before for predicting which age class belongs to the sedentary subjects. Our objective is to confirm the statistical results obtained in the clinical study with machine learning prediction, in order to give an application overview about the

innovative tool dedicated to muscle aging monitoring with physical activity combined to MFA concept and HD-sEMG analysis.

The prediction is performed using two algorithms recommended for the prediction of new experimental data: Logistic regression and Knn, using the features showed a high accuracy to discriminate the five age, such as: RMS, Skewness, Kurtosis, and the maximum amplitude (EMGMAX). The logistic regression is a binomial regression model, that provides a simple mathematical model with many real observations [255]. It is associated with a vector of random variables. it is widely used in prediction based on real data such as features extracted from experimental signals [255]. Finally, for both methods, a majority voting is performed over the three trials to obtain the final predicted age class (integer between 1 and 5).

The aim of testing particularly this methodology ((input dimension: 4 features x 31 channels x 3 trials) is to evaluate the dispersion of the MFA prediction in the grid. The classification accuracy obtained by Knn and LR methods using this classification methodology is  $95\% \pm 0.08$  and  $92\% \pm 0.01$ , respectively for active category classification as in previous sections. The Knn and LR both demonstrate that the sedentary lifestyle impact considerably the chronological age class by predicting an MFA, for the majority of the nine tested sedentary subjects, equal to age class 4 (55-64 yrs.).

It seems for us that the earlier aging caused by a reduced physical activity, attested by the IPAQ questionnaire, can be detected thanks to HD-sEMG feature classification depicted in table 13. It is interesting to note that the older tested subject (subject 7) has been associated to a predicted MFA of age class 5 by Knn (65-74 yrs.). One can note also that the subject 9, even with a low physical activity remains with a predicted MFA that is equal to his chronological age category (age class 3). This can be explained by possible imprecision in filling the IPAQ or a favorable genetical background. It has been observed, during the experiment, that this subject responded to the protocol as an active subject of age class 3. However, a larger cohort of sedentary subjects is definitively needed to refine the discussed observations.

Table 13. Summary of MFA prediction using Knn and LR methods

	age class (45-54yrs.)	BMI (kg/m <sup>2</sup> )	gender	IPAQ class	MFA class	
					Knn	LR
Subject1	3 (46 yrs.)	23	Male	Low	Class 4	Class 4
Subject2	3 (51 yrs.)	22	Female	Low	Class 4	Class 4
Subject3	3 (46 yrs.)	25	Female	Low	Class 4	Class 4
Subject4	3 (51 yrs.)	30	Female	Low	Class 4	Class 4
Subject5	3 (51 yrs.)	25	Female	Low	Class 4	Class 4
Subject6	3 (46 yrs.)	25	Male	Low	Class 4	Class 4
Subject7	3 (54 yrs.)	21	Female	Low	Class 5	Class 4
Subject8	3 (51 yrs.)	25	Male	Low	Class 4	Class 4
Subject9	3 (50 yrs.)	23	Male	Low	Class 3	Class 3

Class 4 =55-64yrs.Class 5=65-74yrs.

We explored also the channel classification over the grid, to assess possible regionalization of early muscle aging using the two prediction methods. For the LR method, we observe clearly for a representative subject that the grid is predominantly predicted in class 4 see Figure 3.24 indicating a homogeneous classification according to channels.

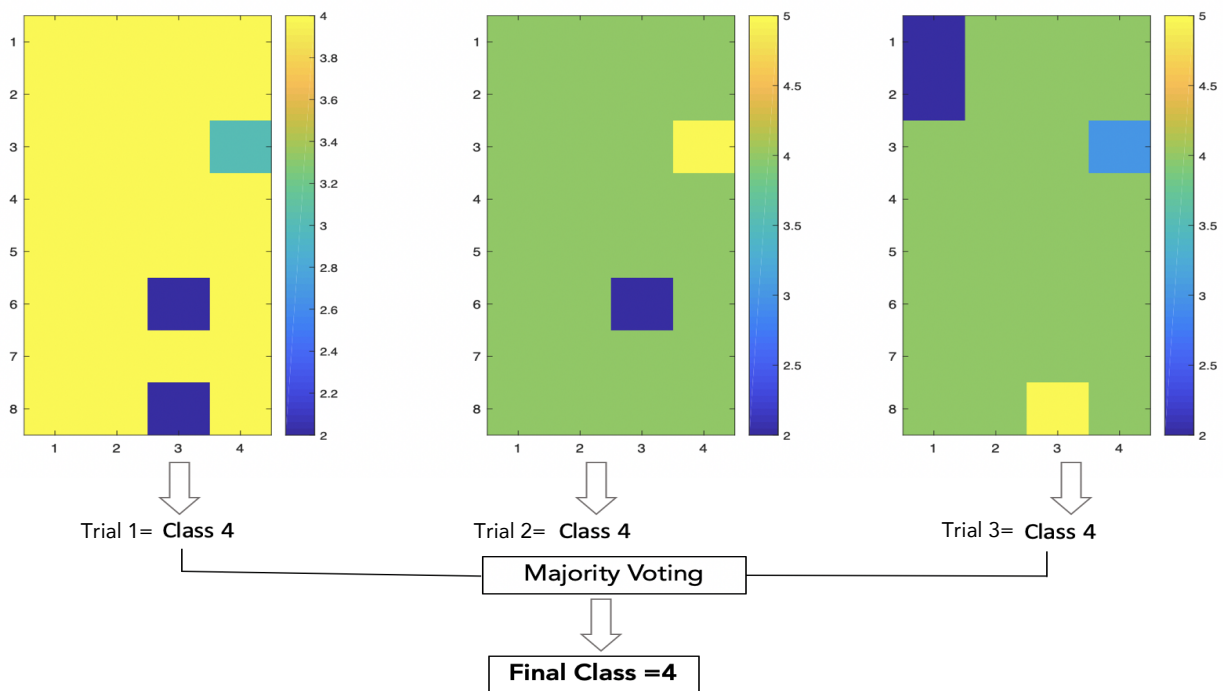

Figure 3.24: MFA Prediction by majority voting of sedentary representative subject 2 using logistic regression

However, for the Knn method in Figure 3.25, the obtained results are different with a real regionalization of the classification results, in a heterogeneous manner, according to channel and trial. Further effort is needed to better assess, on larger number of subjects, this suspected early aging regionalization.

All these prediction results are promising. They refine the early aging estimation compared to the statistical testing presented in chapter 2 by providing an MFA for each tested sedentary subject. However, Knn method seems to provide results more related to physiological aspects of RF activation in comparison to LR method. However, both methods predicted an older age for the majority of sedentary subjects that confirms the strong predictive potential of the proposed tool for early muscle aging evaluation.

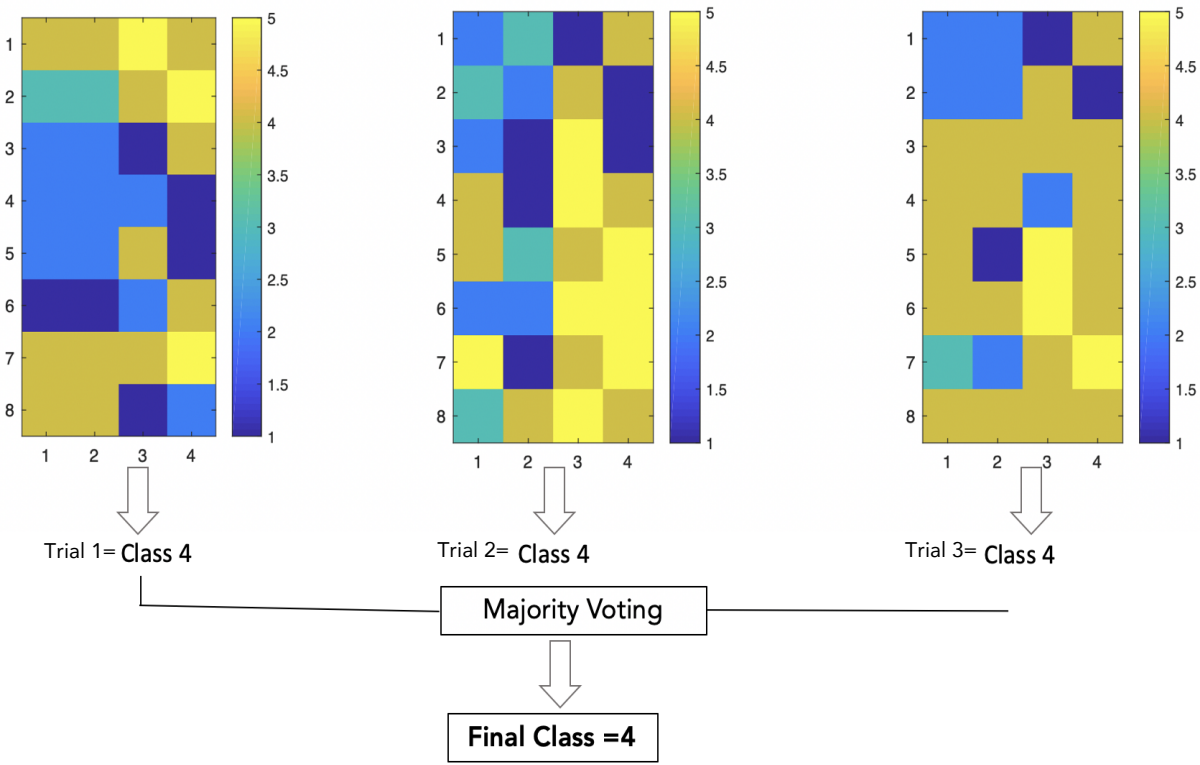

Figure 3.26: MFA Prediction by majority voting of sedentary representative subject 2 using Knn.

- Conclusion

Through this section based on MFA prediction, by using machine learning approaches, we strongly suggested that the HD-sEMG ambulatory used device, coupled to a classification software, demonstrated its usefulness in rapid and wireless evaluation of muscle capacities, showing a promising accuracy to discriminate age categories, and to predict early muscle aging related sedentary lifestyle using MFA concept. This opens the door for clinical applications related to E-Health and personalized medicine. Expected benefits are not only for the older, but also for the young, to alert them about future dangers related to accelerated aging as sarcopenia. Thus, physiotherapists and clinicians could routinely employ the proposed device for muscle assessment through life in a near future.





# General conclusion

This thesis had the main objective to unveil the potential of the proposed research approach, based on assessing changes of muscular capacity with age using a recent high-density electromyography technique, namely HD-sEMG. The starting clinical goal is to support prevention strategies of muscle pathology frequently encountered in older people. The technological outcome will be a complete portable solution that combines HD-sEMG recording device and associated machine learning software for predicting the people at risk of sarcopenia.

Our applicative context is not only for the older population, but also for the young, to alert them about the impact on muscle health of sedentary life style and to avoid the future dangers that can be engendered with aging such sarcopenia.

For this purpose, we introduced in this work the concept of Motor Functional Age (MFA), proposed by PhD directors: S. Boudaoud and K. Kinugawa. The MFA is suspected to be different (higher) from the Chronological Age (CA) in case of early muscle aging, induced by some factors such as sedentary life style.

To explore this early muscle aging, under the scope of the CHRONOS project (EIT Health funding), we started by the conception of a multimodal experimental protocol, including clinical examinations and HD-sEMG technique. Then, we dealt with segmentation and processing of the HD-sEMG signals to extract precisely the contraction information of the Rectus Femoris during STS. After the subject screening process, I recorded and constructed, during a heavy schedule of 6 months in clinical environment (Hôpital Charles Foix, AP-HP), a HD-sEMG database from 91 subjects of different age category and physical activity level.

All the obtained data (HD-sEMG signals, clinical examinations, questionnaires...etc.) were saved in eCRF platform to keep traceability and ensure ethical protection of the data. In fact, this data organization allowed us to provide a statistical analysis, in order to deduce the first assumptions related to muscle functional changes with aging and physical activity level.

After these essential steps to provide a complete documented database, we started with the evaluation of simple and easily usable scores in clinical evaluation of muscle functional aging, namely MCI (intensity of muscle contraction) and MCD (dynamics of muscle contraction) taken from the averaged electrical activity of the HD-sEMG grid. The statistical results obtained from the 91 studied subjects over 5 age decades and 2 physical activity levels, comparing between the HD-sEMG scores and the clinical scores, showed the potential of this technique to better assess the muscle quality (anatomy and function) than the usual methods. We did not observe significant difference in their BMI, dietary intake, DXA skeletal muscle mass index, handgrip strength, walking distance and SPPB according to age and physical activity. However, we observed that:

- The HD-sEMG scores significantly discriminated the 5 age categories among active subjects (MCI,  $p < 0.01$  and MCD  $p < 0.001$ ),
- The HD-sEMG scores significantly discriminated sedentary subjects from active subjects aged 45-54 years (MCI,  $p < 0.01$  and MCD  $p < 0.0001$ ),
- The HD-sEMG scores for sedentary subjects was not significantly different from those of older active subjects (>55 years) suggesting possible early aging.
- Muscle thickness (MT) assessed by ultrasound imaging showed no significant difference with physical activity for the 45-54 yrs age category.

After this complete clinical study, we wanted to enrich the knowledge around early muscle aging and MFA by carrying out advanced processing and classification studies on the available database. For this purpose, we evaluated first, a Blind Source Separation (BSS) technique, the CCA algorithm to discriminate the young population from the old population according to the coefficient of their correlation canonical components. This approach is often used in signal denoising by separating the noise and the useful signals into different sources. The objective of our study was to evaluate if aging has an impact on this source estimation. The answer seems to be affirmative with significant statistical results for both mean correlation values and their standard deviation. This promising result indicates possible anatomical, physiological and neural modifications with aging that affects the signals from the grid and their decomposition into several sources. After that, we explored the grid signature of time-frequency maps. In fact, the HD-sEMG signals recorded from STS are nonstationary. The goal is to better analyze this nonstationary behavior with time-frequency analysis. For this purpose, spectrogram using Short Time Fourier Transform (STFT) was tested on specific frequency

range (0-50 Hz) that corresponds to Motor Unit firing rate range. Again, the obtained results on few subjects showed a difference in the time distribution of the spectral power in the young / middle and old subject according also to specific regions of the grid (proximal or distal). These preliminary results will serve to enrich physiological interpretations in terms of regional activation of the muscle according to the motion realized. In the literature, this kind of studies showed interesting results in coherence with our preliminary time frequency analysis related to the spatial distribution of electrical activity in the proximal area of the Rectus Femoris muscle.

In the last part of this thesis, thanks to the results found in the chapter 2, we thought about proposing classification architectures (methodology1, 2 and 3), using HD-sEMG features with several methodologies (averaging the features over the grid, keeping all channels, introducing time segmentation following STS phases) using Machine Learning algorithms. For this purpose, four classifiers were tested with the three proposed methodologies. In addition, eight HD-sEMG features were analyzed. The testing was done first on classifying the five age categories of active subjects. Promising results were obtained especially for Knn classifier and a reduced set of five HD-sEMG features reaching the best classification accuracy of 96%. It was also observed the influence of the three methodologies on the classification results indicating the importance of respecting a compromise between classification robustness (averaging over the grid) and physiological outcomes (using all the channels of the grid).

Finally, Knn and another prediction method, namely Logistic Regression, were used with the best five HD-sEMG features for predicting MFA on a small database of nine sedentary subjects from the age range of 45-54 yrs. (class 3). The majority of the subjects were classified in class 4 corresponding to an older active class [55-64 yrs.] indicating an early muscle aging. Furthermore, the older sedentary subject (54 yrs.) was classified in class 5 [65-74 yrs.] by Knn classifier indicating probable monotonic behavior of the observed early muscle aging predicted by MFA. These results agree and refine those obtained by statistical testing in chapter 2.

As a limitation of this thesis work, we can note the relatively small size (91 subjects) of the database. In fact, presented studies might be validated on larger number of subjects of both active and sedentary subjects. Indeed, further studies are needed to enrich the normative database (active subjects) with the same inclusion/exclusion criteria. Creating new databases with more flexible inclusion/exclusion criteria (ex: BMI) to test the generalization of the

obtained results will be also interesting. In the future, it would be important to study if MFA may be used as a sarcopenia risk among people and to develop also HD-sEMG software as a medical device allowing to diagnose sarcopenia.

The choice of the studied muscle can be criticized. The choice of the Rectus Femoris muscle as the muscle of interest was motivated by literature reviews that mentioned RF as highly faced to aging changes, among other quadriceps muscle, even with its relatively small size. However, one has to keep in mind the complex architecture of the RF (bipennate and biarticulated muscle) that complicates the physiological interpretation of the recorded HD-sEMG signals. Nevertheless, in contrary to other quadriceps muscles, the RF is the most superficial one. This important property maximizes the HD-sEMG signal quality by reducing possible crosstalk interference. Despite the complicated anatomy, it has been possible to observe specific HD-sEMG maps during STS motion that are different with aging in term of intensity, dynamic and spatial repartition. Further studies are planned in the team that will concern other muscles like the Biceps Brachii under isometric conditions. Even with complicated muscle anatomy and dynamic short motion like STS, we have been able to manage the inter-subject variability to provide robust and reproducible metrics (ex: MCD, MCI and MFA) for muscle aging monitoring.

To conclude, this thesis provided the essential experimental, methodological and numerical elements to accurately assess muscle functionality and quality with aging and physical activity using HD-sEMG technique. The overall objective is to support the evolution of clinical practice while respecting the needs and recommendations suggested by practitioners by providing innovative prediction tools for muscle evaluation. Our hope is to make the HD-sEMG technology and the power of computations (signal processing and classification) supporting patients and public health to promote healthy and active aging through life.

# Bibliography

- [1] WHO | World report on ageing and health. WHO n.d. <http://www.who.int/life-course/publications/2015-ageing-report/en/> (accessed September 28, 2020).
- [2] Population structure and ageing - Statistics Explained n.d. [https://ec.europa.eu/eurostat/statistics-explained/index.php/Population\\_structure\\_and\\_ageing](https://ec.europa.eu/eurostat/statistics-explained/index.php/Population_structure_and_ageing) (accessed September 24, 2020).
- [3] Beaudart C, McCloskey E, Bruyère O, Cesari M, Rolland Y, Rizzoli R, et al. Sarcopenia in daily practice: assessment and management. *BMC Geriatr* 2016;16:170. <https://doi.org/10.1186/s12877-016-0349-4>.
- [4] Harper S. Economic and social implications of aging societies. *Science* 2014;346:587–91. <https://doi.org/10.1126/science.1254405>.
- [5] Correa-de-Araujo R, Harris-Love MO, Miljkovic I, Fragala MS, Anthony BW, Manini TM. The Need for Standardized Assessment of Muscle Quality in Skeletal Muscle Function Deficit and Other Aging-Related Muscle Dysfunctions: A Symposium Report. *Front Physiol* 2017;8. <https://doi.org/10.3389/fphys.2017.00087>.
- [6] Imrani L, Boudaoud S, Laforêt J, Kinugawa K. Ageing Effect Evaluation on HD-sEMG Signals Using CCA Approach. *IRBM* 2021. <https://doi.org/10.1016/j.irbm.2021.05.002>.
- [7] Brunner F, Schmid A, Sheikhzadeh A, Nordin M, Yoon J, Frankel V. Effects of Aging on Type II Muscle Fibers: A Systematic Review of the Literature n.d.:13.
- [8] Soto-Perez-de-Celis E, Li D, Yuan Y, Lau YM, Hurria A. Functional versus chronological age: geriatric assessments to guide decision making in older patients with cancer. *The Lancet Oncology* 2018;19:e305–16. [https://doi.org/10.1016/S1470-2045\(18\)30348-6](https://doi.org/10.1016/S1470-2045(18)30348-6).
- [9] Wyke S, Bunn C, Andersen E, Silva MN, Nassau F van, McSkimming P, et al. The effect of a programme to improve men’s sedentary time and physical activity: The European Fans in Training (EuroFIT) randomised controlled trial. *PLOS Medicine* 2019;16:e1002736. <https://doi.org/10.1371/journal.pmed.1002736>.
- [10] McPhee JS, French DP, Jackson D, Nazroo J, Pendleton N, Degens H. Physical activity in older age: perspectives for healthy ageing and frailty. *Biogerontology* 2016;17:567–80. <https://doi.org/10.1007/s10522-016-9641-0>.
- [11] Shaffer F, Neblett R. *Practical Anatomy and Physiology: The Skeletal Muscle System*. *Biofeedback* 2010;38:47–51. <https://doi.org/10.5298/1081-5937-38.2.47>.
- [12] Gray’s anatomy for students (Livre, 2010) [WorldCat.org] n.d. <https://www.worldcat.org/title/grays-anatomy-for-students/oclc/265657274> (accessed February 2, 2021).
- [13] Bouisset S, Maton B. *Muscles, posture et mouvement: base et applications de la méthode électromyographique*. Hermann; 1996.
- [14] Basmajian JV, Luca CJ de. *Muscles Alive: their functions revealed by electromyography*. Baltimore: Williams & Wilkins; 1985.
- [15] Human Physiology - Muscle n.d. <http://people.eku.edu/ritchisong/301notes3.htm> (accessed January 21, 2021).
- [16] Engel AG. Chapter 33 - Diseases of the Neuromuscular Junction. In: Dyck PJ, Thomas PK, editors. *Peripheral Neuropathy (Fourth Edition)*, Philadelphia: W.B. Saunders; 2005, p. 831–67. <https://doi.org/10.1016/B978-0-7216-9491-7.50036-3>.

- [17] Brooke MH, Kaiser KK. Muscle fiber types: how many and what kind? *Arch Neurol* 1970;23:369–79. <https://doi.org/10.1001/archneur.1970.00480280083010>.
- [18] Bh G, P C, Bk W, A R, Nw G, Mj D, et al. Effects of physical activity on strength and skeletal muscle fat infiltration in older adults: a randomized controlled trial. *J Appl Physiol* (1985) 2008;105:1498–503. <https://doi.org/10.1152/jappphysiol.90425.2008>.
- [19] Arnold WD, Sheth KA, Wier CG, Kissel JT, Burghes AH, Kolb SJ. Electrophysiological Motor Unit Number Estimation (MUNE) Measuring Compound Muscle Action Potential (CMAP) in Mouse Hindlimb Muscles. *J Vis Exp* 2015. <https://doi.org/10.3791/52899>.
- [20] al FB et. Morphologic studies of motor units in normal human muscles. - PubMed - NCBI 2018. <https://www.ncbi.nlm.nih.gov/pubmed/14349537> (accessed April 19, 2018).
- [21] Eriksson PO. Muscle-fibre composition of the human mandibular locomotor system. Enzyme-histochemical and morphological characteristics of functionally different parts. *Swed Dent J Suppl* 1982;12 Suppl:1–44.
- [22] Physiologie Humaine Troisieme Edition par Vander, A.J.; Sherman, J.H.; Luciano, D.S. and Briere, Richard: Good Soft cover (1995) | Bay Used Books n.d. <https://www.abebooks.fr/Physiologie-Humaine-Troisieme-Edition-Vander-A.J/9912491753/bd> (accessed January 11, 2021).
- [23] Huxley HE, Hanson J. The structural basis of the contraction mechanism in striated muscle. *Ann N Y Acad Sci* 1959;81:403–8. <https://doi.org/10.1111/j.1749-6632.1959.tb49323.x>.
- [24] Demontis F, Piccirillo R, Goldberg AL, Perrimon N. Mechanisms of skeletal muscle aging: insights from *Drosophila* and mammalian models. *Disease Models & Mechanisms* 2013;6:1339–52. <https://doi.org/10.1242/dmm.012559>.
- [25] Paterson DH, Jones GR, Rice CL. Ageing and physical activity: evidence to develop exercise recommendations for older adults. *Can J Public Health* 2007;98 Suppl 2:S69–108.
- [26] Huxley H, Hanson J. Changes in the Cross-Striations of Muscle during Contraction and Stretch and their Structural Interpretation. *Nature* 1954;173:973–6. <https://doi.org/10.1038/173973a0>.
- [27] Wilkinson DJ, Piasecki M, Atherton PJ. The age-related loss of skeletal muscle mass and function: Measurement and physiology of muscle fibre atrophy and muscle fibre loss in humans. *Ageing Research Reviews* 2018;47:123–32. <https://doi.org/10.1016/j.arr.2018.07.005>.
- [28] Miljkovic N, Lim J-Y, Miljkovic I, Frontera WR. Aging of Skeletal Muscle Fibers. *Ann Rehabil Med* 2015;39:155–62. <https://doi.org/10.5535/arm.2015.39.2.155>.
- [29] Frontera WR, Reid KF, Phillips EM, Krivickas LS, Hughes VA, Roubenoff R, et al. Muscle fiber size and function in elderly humans: a longitudinal study. *J Appl Physiol* (1985) 2008;105:637–42. <https://doi.org/10.1152/jappphysiol.90332.2008>.
- [30] Mitchell WK, Williams J, Atherton P, Larvin M, Lund J, Narici M. Sarcopenia, Dynapenia, and the Impact of Advancing Age on Human Skeletal Muscle Size and Strength; a Quantitative Review. *Front Physiol* 2012;3. <https://doi.org/10.3389/fphys.2012.00260>.
- [31] Faulkner JA, Larkin LM, Claflin DR, Brooks SV. Age-related changes in the structure and function of skeletal muscles. *Clin Exp Pharmacol Physiol* 2007;34:1091–6. <https://doi.org/10.1111/j.1440-1681.2007.04752.x>.
- [32] Metter EJ, Conwit R, Tobin J, Fozard JL. Age-associated loss of power and strength in the upper extremities in women and men. *J Gerontol A Biol Sci Med Sci* 1997;52:B267–276. <https://doi.org/10.1093/gerona/52a.5.b267>.

- [33] Cederholm TE, Bauer JM, Boirie Y, Schneider SM, Sieber CC, Rolland Y. Toward a Definition of Sarcopenia. *Clinics in Geriatric Medicine* 2011;27:341–53. <https://doi.org/10.1016/j.cger.2011.04.001>.
- [34] Ling SM, Conwit RA, Ferrucci L, Metter EJ. Age-Associated Changes in Motor Unit Physiology: Observations From the Baltimore Longitudinal Study of Aging. *Archives of Physical Medicine and Rehabilitation* n.d.;90:1237–40.
- [35] Siparsky PN, Kirkendall DT, Garrett WE. Muscle Changes in Aging. *Sports Health* 2014;6:36–40. <https://doi.org/10.1177/1941738113502296>.
- [36] Janssen I. Evolution of sarcopenia research. *Appl Physiol Nutr Metab* 2010;35:707–12. <https://doi.org/10.1139/H10-067>.
- [37] Sayer AA, Syddall H, Martin H, Patel H, Baylis D, Cooper C. The developmental origins of sarcopenia. *J Nutr Health Aging* 2008;12:427–32.
- [38] Strugnell C, Dunstan DW, Magliano DJ, Zimmet PZ, Shaw JE, Daly RM. Influence of age and gender on fat mass, fat-free mass and skeletal muscle mass among Australian adults: the Australian diabetes, obesity and lifestyle study (AusDiab). *J Nutr Health Aging* 2014;18:540–6. <https://doi.org/10.1007/s12603-014-0464-x>.
- [39] Kadhiresan VA, Hassett CA, Faulkner JA. Properties of single motor units in medial gastrocnemius muscles of adult and old rats. *J Physiol* 1996;493:543–52.
- [40] Klein CS, Marsh GD, Petrella RJ, Rice CL. Muscle fiber number in the biceps brachii muscle of young and old men. *Muscle Nerve* 2003;28:62–8. <https://doi.org/10.1002/mus.10386>.
- [41] Janssen I, Heymsfield SB, Wang Z, Ross R. Skeletal muscle mass and distribution in 468 men and women aged 18–88 yr. *Journal of Applied Physiology* 2000;89:81–8. <https://doi.org/10.1152/jappl.2000.89.1.81>.
- [42] Frontera W, Hughes V, Fielding R, Fiatarone M, Evans W, Roubenoff R. Aging of skeletal muscle: A 12-yr longitudinal study. *Journal of Applied Physiology (Bethesda, Md : 1985)* 2000;88:1321–6. <https://doi.org/10.1152/jappl.2000.88.4.1321>.
- [43] Gallagher D, Visser M, De Meersman RE, Sepúlveda D, Baumgartner RN, Pierson RN, et al. Appendicular skeletal muscle mass: effects of age, gender, and ethnicity. *J Appl Physiol (1985)* 1997;83:229–39. <https://doi.org/10.1152/jappl.1997.83.1.229>.
- [44] Roubenoff R, Hughes VA. Sarcopenia: current concepts. *J Gerontol A Biol Sci Med Sci* 2000;55:M716-724. <https://doi.org/10.1093/gerona/55.12.m716>.
- [45] Rolland Y, Czerwinski S, Abellan Van Kan G, Morley JE, Cesari M, Onder G, et al. Sarcopenia: its assessment, etiology, pathogenesis, consequences and future perspectives. *J Nutr Health Aging* 2008;12:433–50. <https://doi.org/10.1007/BF02982704>.
- [46] Ostan R, Monti D, Guerresi P, Bussolotto M, Franceschi C, Baggio G. Gender, aging and longevity in humans: an update of an intriguing/neglected scenario paving the way to a gender-specific medicine. *Clin Sci (Lond)* 2016;130:1711–25. <https://doi.org/10.1042/CS20160004>.
- [47] Trappe TA, Lindquist DM, Carrithers JA. Muscle-specific atrophy of the quadriceps femoris with aging. *J Appl Physiol (1985)* 2001;90:2070–4. <https://doi.org/10.1152/jappl.2001.90.6.2070>.
- [48] Reid KF, Pasha E, Doros G, Clark DJ, Patten C, Phillips EM, et al. Longitudinal decline of lower extremity muscle power in healthy and mobility-limited older adults: influence of muscle mass, strength, composition, neuromuscular activation and single fiber

- contractile properties. *Eur J Appl Physiol* 2014;114:29–39. <https://doi.org/10.1007/s00421-013-2728-2>.
- [49] Porter MM, Vandervoort AA, Lexell J. Aging of human muscle: structure, function and adaptability. *Scandinavian Journal of Medicine & Science in Sports* 2007;5:129–42. <https://doi.org/10.1111/j.1600-0838.1995.tb00026.x>.
- [50] Hepple RT, Rice CL. Innervation and neuromuscular control in ageing skeletal muscle. *J Physiol* 2016;594:1965–78. <https://doi.org/10.1113/JP270561>.
- [51] Larsson L. Morphological and functional characteristics of the ageing skeletal muscle in man. A cross-sectional study. *Acta Physiol Scand Suppl* 1978;457:1–36.
- [52] Piasecki M, Ireland A, Jones DA, McPhee JS. Age-dependent motor unit remodelling in human limb muscles. *Biogerontology* 2016;17:485–96. <https://doi.org/10.1007/s10522-015-9627-3>.
- [53] McPhee JS, Hogrel J-Y, Maier AB, Seppet E, Seynnes OR, Sipilä S, et al. Physiological and functional evaluation of healthy young and older men and women: design of the European MyoAge study. *Biogerontology* 2013;14:325–37. <https://doi.org/10.1007/s10522-013-9434-7>.
- [54] Holloszy JO, Nair KS. Muscle Protein Turnover: Methodological Issues and the Effect of Aging. *J Gerontol A Biol Sci Med Sci* 1995;50A:107–12. [https://doi.org/10.1093/gerona/50A.Special\\_Issue.107](https://doi.org/10.1093/gerona/50A.Special_Issue.107).
- [55] Narici MV, Maganaris CN. Adaptability of elderly human muscles and tendons to increased loading. *J Anat* 2006;208:433–43. <https://doi.org/10.1111/j.1469-7580.2006.00548.x>.
- [56] Structural, biochemical, cellular, and functional changes in skeletal muscle extracellular matrix with aging - PubMed n.d. <https://pubmed.ncbi.nlm.nih.gov/22092924/> (accessed January 26, 2021).
- [57] Delmonico MJ, Harris TB, Visser M, Park SW, Conroy MB, Velasquez-Mieyer P, et al. Longitudinal study of muscle strength, quality, and adipose tissue infiltration. *Am J Clin Nutr* 2009;90:1579–85. <https://doi.org/10.3945/ajcn.2009.28047>.
- [58] Marcus RL, Brixner DI, Ghate S, LaStayo P. Fat Modulates the Relationship between Sarcopenia and Physical Function in Nonobese Older Adults. *Curr Gerontol Geriatr Res* 2012;2012. <https://doi.org/10.1155/2012/216185>.
- [59] Dodds RM, Syddall HE, Cooper R, Benzeval M, Deary IJ, Dennison EM, et al. Grip Strength across the Life Course: Normative Data from Twelve British Studies. *PLOS ONE* 2014;9:e113637. <https://doi.org/10.1371/journal.pone.0113637>.
- [60] Larson DJ. Sarcopenia: How To Keep Muscle While Aging. *Larson Sports and Orthopaedics* 2020. <https://larsonsportsortho.com/sarcopenia-keep-muscle-while-aging/> (accessed January 21, 2021).
- [61] Lexell J, Henriksson-Larsén K, Winblad B, Sjöström M. Distribution of different fiber types in human skeletal muscles: Effects of aging studied in whole muscle cross sections: Aging and Skeletal Muscle Morphology. *Muscle Nerve* 1983;6:588–95. <https://doi.org/10.1002/mus.880060809>.
- [62] Andersen JL. Muscle fibre type adaptation in the elderly human muscle. *Scand J Med Sci Sports* 2003;13:40–7. <https://doi.org/10.1034/j.1600-0838.2003.00299.x>.
- [63] Dalton BH, McNeil CJ, Doherty TJ, Rice CL. Age-related reductions in the estimated numbers of motor units are minimal in the human soleus. *Muscle Nerve* 2008;38:1108–15. <https://doi.org/10.1002/mus.20984>.



- [64] McNeil CJ, Doherty TJ, Stashuk DW, Rice CL. Motor unit number estimates in the tibialis anterior muscle of young, old, and very old men. *Muscle Nerve* 2005;31:461–7. <https://doi.org/10.1002/mus.20276>.
- [65] Gandevia SC. Spinal and Supraspinal Factors in Human Muscle Fatigue. *Physiological Reviews* 2001;81:1725–89. <https://doi.org/10.1152/physrev.2001.81.4.1725>.
- [66] Galea V. Changes in motor unit estimates with aging. *J Clin Neurophysiol* 1996;13:253–60.
- [67] Gordon T, Hegedus J, Tam SL. Adaptive and maladaptive motor axonal sprouting in aging and motoneuron disease. *Neurol Res* 2004;26:174–85. <https://doi.org/10.1179/016164104225013806>.
- [68] Interaction between muscle fibres in a twitch n.d. <https://www.ncbi.nlm.nih.gov/pmc/articles/PMC1366269/> (accessed January 11, 2021).
- [69] Cannon J, Kay D, Tarpenning KM, Marino FE. Comparative effects of resistance training on peak isometric torque, muscle hypertrophy, voluntary activation and surface EMG between young and elderly women. *Clin Physiol Funct Imaging* 2007;27:91–100. <https://doi.org/10.1111/j.1475-097X.2007.00719.x>.
- [70] De Serres SJ, Enoka RM. Older adults can maximally activate the biceps brachii muscle by voluntary command. *J Appl Physiol* (1985) 1998;84:284–91. <https://doi.org/10.1152/jappl.1998.84.1.284>.
- [71] Harridge SDR, Bottinelli R, Canepari M, Pellegrino MA, Reggiani C, Esbjörnsson M, et al. Whole-muscle and single-fibre contractile properties and myosin heavy chain isoforms in humans. *Pflügers Arch* 1996;432:913–20. <https://doi.org/10.1007/s004240050215>.
- [72] Klass M, Baudry S, Duchateau J. Voluntary activation during maximal contraction with advancing age: a brief review. *Eur J Appl Physiol* 2007;100:543–51. <https://doi.org/10.1007/s00421-006-0205-x>.
- [73] Rossini PM, Rossini L, Ferreri F. Brain-behavior relations: transcranial magnetic stimulation: a review. *IEEE Eng Med Biol Mag* 2010;29:84–95. <https://doi.org/10.1109/MEMB.2009.935474>.
- [74] Kossev AR, Schrader C, Däuper J, Dengler R, Rollnik JD. Increased intracortical inhibition in middle-aged humans; a study using paired-pulse transcranial magnetic stimulation. *Neurosci Lett* 2002;333:83–6. [https://doi.org/10.1016/s0304-3940\(02\)00986-2](https://doi.org/10.1016/s0304-3940(02)00986-2).
- [75] McGinley M, Hoffman RL, Russ DW, Thomas JS, Clark BC. Older adults exhibit more intracortical inhibition and less intracortical facilitation than young adults. *Exp Gerontol* 2010;45:671–8. <https://doi.org/10.1016/j.exger.2010.04.005>.
- [76] Oliviero A, Profice P, Tonali PA, Pilato F, Saturno E, Dileone M, et al. Effects of aging on motor cortex excitability. *Neurosci Res* 2006;55:74–7. <https://doi.org/10.1016/j.neures.2006.02.002>.
- [77] Fleg JL, Morrell CH, Bos AG, Brant LJ, Talbot LA, Wright JG, et al. Accelerated longitudinal decline of aerobic capacity in healthy older adults. *Circulation* 2005;112:674–82. <https://doi.org/10.1161/CIRCULATIONAHA.105.545459>.
- [78] Chen W-T, Chou K-H, Liu L-K, Lee P-L, Lee W-J, Chen L-K, et al. Reduced cerebellar gray matter is a neural signature of physical frailty. *Hum Brain Mapp* 2015;36:3666–76. <https://doi.org/10.1002/hbm.22870>.
- [79] Russ DW, Lanza IR. The impact of old age on skeletal muscle energetics: supply and demand. *Curr Aging Sci* 2011;4:234–47. <https://doi.org/10.2174/1874609811104030234>.

- [80] Kaczor JJ, Ziolkowski W, Antosiewicz J, Hac S, Tarnopolsky MA, Popinigis J. The effect of aging on anaerobic and aerobic enzyme activities in human skeletal muscle. *J Gerontol A Biol Sci Med Sci* 2006;61:339–44. <https://doi.org/10.1093/gerona/61.4.339>.
- [81] Lima GA, Vilaça KHC, Lima NKC, Moriguti JC, Ferriolli E. Balance and aerobic capacity of independent elderly: a longitudinal cohort study. *Brazilian Journal of Physical Therapy* 2011;15:272–7. <https://doi.org/10.1590/S1413-35552011000400003>.
- [82] Morris MS, Jacques PF. Total protein, animal protein and physical activity in relation to muscle mass in middle-aged and older Americans. *Br J Nutr* 2013;109:1294–303. <https://doi.org/10.1017/S0007114512003133>.
- [83] Peterson MD, Sen A, Gordon PM. Influence of resistance exercise on lean body mass in aging adults: a meta-analysis. *Med Sci Sports Exerc* 2011;43:249–58. <https://doi.org/10.1249/MSS.0b013e3181eb6265>.
- [84] Breen L, Stokes KA, Churchward-Venne TA, Moore DR, Baker SK, Smith K, et al. Two weeks of reduced activity decreases leg lean mass and induces “anabolic resistance” of myofibrillar protein synthesis in healthy elderly. *J Clin Endocrinol Metab* 2013;98:2604–12. <https://doi.org/10.1210/jc.2013-1502>.
- [85] Burd NA, Wall BT, van Loon LJC. The curious case of anabolic resistance: old wives’ tales or new fables? *J Appl Physiol* (1985) 2012;112:1233–5. <https://doi.org/10.1152/jappphysiol.01343.2011>.
- [86] Ferrando AA, Paddon-Jones D, Hays NP, Kortebein P, Ronsen O, Williams RH, et al. EAA supplementation to increase nitrogen intake improves muscle function during bed rest in the elderly. *Clinical Nutrition* 2010;29:18–23. <https://doi.org/10.1016/j.clnu.2009.03.009>.
- [87] Kortebein P, Ferrando A, Lombeida J, Wolfe R, Evans WJ. Effect of 10 days of bed rest on skeletal muscle in healthy older adults. *JAMA* 2007;297:1772–4. <https://doi.org/10.1001/jama.297.16.1772-b>.
- [88] Wall BT, van Loon LJC. Nutritional strategies to attenuate muscle disuse atrophy. *Nutr Rev* 2013;71:195–208. <https://doi.org/10.1111/nure.12019>.
- [89] Verdijk LB, Snijders T, Drost M, Delhaas T, Kadi F, van Loon LJC. Satellite cells in human skeletal muscle; from birth to old age. *Age (Dordr)* 2014;36:545–57. <https://doi.org/10.1007/s11357-013-9583-2>.
- [90] Morley JE. Anorexia of aging: a true geriatric syndrome. *J Nutr Health Aging* 2012;16:422–5. <https://doi.org/10.1007/s12603-012-0061-9>.
- [91] Tieland M, Borgonjen-Van den Berg KJ, van Loon LJC, de Groot LCPGM. Dietary protein intake in community-dwelling, frail, and institutionalized elderly people: scope for improvement. *Eur J Nutr* 2012;51:173–9. <https://doi.org/10.1007/s00394-011-0203-6>.
- [92] Houston DK, Nicklas BJ, Ding J, Harris TB, Tylavsky FA, Newman AB, et al. Dietary protein intake is associated with lean mass change in older, community-dwelling adults: the Health, Aging, and Body Composition (Health ABC) Study. *Am J Clin Nutr* 2008;87:150–5. <https://doi.org/10.1093/ajcn/87.1.150>.
- [93] Morley JE, Argiles JM, Evans WJ, Bhasin S, Cella D, Deutz NEP, et al. Nutritional recommendations for the management of sarcopenia. *J Am Med Dir Assoc* 2010;11:391–6. <https://doi.org/10.1016/j.jamda.2010.04.014>.
- [94] Deutz NEP, Bauer JM, Barazzoni R, Biolo G, Boirie Y, Bosy-Westphal A, et al. Protein intake and exercise for optimal muscle function with aging: recommendations from the ESPEN Expert Group. *Clin Nutr* 2014;33:929–36. <https://doi.org/10.1016/j.clnu.2014.04.007>.

- [95] Barazzoni R, Bischoff SC, Boirie Y, Busetto L, Cederholm T, Dicker D, et al. Sarcopenic obesity: Time to meet the challenge. *Clinical Nutrition* 2018. <https://doi.org/10.1016/j.clnu.2018.04.018>.
- [96] Risonar MGD, Rayco-Solon P, Ribaya-Mercado JD, Solon JAA, Cabalda AB, Tengco LW, et al. Physical activity, energy requirements, and adequacy of dietary intakes of older persons in a rural Filipino community. *Nutr J* 2009;8:19. <https://doi.org/10.1186/1475-2891-8-19>.
- [97] Cruz-Jentoft AJ, Bahat G, Bauer J, Boirie Y, Bruyère O, Cederholm T, et al. Sarcopenia: revised European consensus on definition and diagnosis. *Age and Ageing* 2019;48:16–31. <https://doi.org/10.1093/ageing/afy169>.
- [98] Cruz-Jentoft AJ, Baeyens JP, Bauer JM, Boirie Y, Cederholm T, Landi F, et al. Sarcopenia: European consensus on definition and diagnosis Report of the European Working Group on Sarcopenia in Older People A. J. Cruz-Gentoft et al. *Age Ageing* 2010;39:412–23. <https://doi.org/10.1093/ageing/afq034>.
- [99]: Correa-de-Araujo R, Hadley E. Skeletal muscle function deficit: a new terminology to embrace the evolving concepts of sarcopenia and age-related muscle dysfunction. *J Gerontol A Biol Sci Med Sci*. 2014 May;69(5):591-4. doi: 10.1093/gerona/glt208. PMID: 24737562; PMCID: PMC3999854. - Recherche Google n.d. [https://www.google.com/search?q=%3A+Correa-de-Araujo+R%2C+Hadley+E.+Skeletal+muscle+function+deficit%3A+a+new+terminology+to+embrace+the+evolving+concepts+of+sarcopenia+and+age-related+muscle+dysfunction.+J+Gerontol+A+Biol+Sci+Med+Sci.+2014+May%3B69\(5\)%3A591-4.+doi%3A+10.1093%2Fgerona%2Fglt208.+PMID%3A+24737562%3B+PMCID%3A+PMC3999854.&oq=%3A+Correa-de-Araujo+R%2C+Hadley+E.+Skeletal+muscle+function+deficit%3A+a+new+terminology+to+embrace+the+evolving+concepts+of+sarcopenia+and+age-related+muscle+dysfunction.+J+Gerontol+A+Biol+Sci+Med+Sci.+2014+May%3B69\(5\)%3A591-4.+doi%3A+10.1093%2Fgerona%2Fglt208.+PMID%3A+24737562%3B+PMCID%3A+PMC3999854.&aqs=chrome..69i57.367j0j7&sourceid=chrome&ie=UTF-8](https://www.google.com/search?q=%3A+Correa-de-Araujo+R%2C+Hadley+E.+Skeletal+muscle+function+deficit%3A+a+new+terminology+to+embrace+the+evolving+concepts+of+sarcopenia+and+age-related+muscle+dysfunction.+J+Gerontol+A+Biol+Sci+Med+Sci.+2014+May%3B69(5)%3A591-4.+doi%3A+10.1093%2Fgerona%2Fglt208.+PMID%3A+24737562%3B+PMCID%3A+PMC3999854.&oq=%3A+Correa-de-Araujo+R%2C+Hadley+E.+Skeletal+muscle+function+deficit%3A+a+new+terminology+to+embrace+the+evolving+concepts+of+sarcopenia+and+age-related+muscle+dysfunction.+J+Gerontol+A+Biol+Sci+Med+Sci.+2014+May%3B69(5)%3A591-4.+doi%3A+10.1093%2Fgerona%2Fglt208.+PMID%3A+24737562%3B+PMCID%3A+PMC3999854.&aqs=chrome..69i57.367j0j7&sourceid=chrome&ie=UTF-8) (accessed June 11, 2021).
- [100] Beaudart C, Rolland Y, Cruz-Jentoft AJ, Bauer JM, Sieber C, Cooper C, et al. Assessment of Muscle Function and Physical Performance in Daily Clinical Practice : A position paper endorsed by the European Society for Clinical and Economic Aspects of Osteoporosis, Osteoarthritis and Musculoskeletal Diseases (ESCEO). *Calcif Tissue Int* 2019;105:1–14. <https://doi.org/10.1007/s00223-019-00545-w>.
- [101] Landi F, Calvani R, Tosato M, Martone AM, Fusco D, Sisto A, et al. Age-Related Variations of Muscle Mass, Strength, and Physical Performance in Community-Dwellers: Results From the Milan EXPO Survey. *Journal of the American Medical Directors Association* 2017;18:88.e17-88.e24. <https://doi.org/10.1016/j.jamda.2016.10.007>.
- [102] Roberts HC, Denison HJ, Martin HJ, Patel HP, Syddall H, Cooper C, et al. A review of the measurement of grip strength in clinical and epidemiological studies: towards a standardised approach. *Age Ageing* 2011;40:423–9. <https://doi.org/10.1093/ageing/afr051>.

- [103] Working Group on Functional Outcome Measures for Clinical Trials. Functional outcomes for clinical trials in frail older persons: time to be moving. *J Gerontol A Biol Sci Med Sci* 2008;63:160–4. <https://doi.org/10.1093/gerona/63.2.160>.
- [104] Rolland YM, Cesari M, Miller ME, Penninx BW, Atkinson HH, Pahor M. Reliability of the 400-m usual-pace walk test as an assessment of mobility limitation in older adults. *J Am Geriatr Soc* 2004;52:972–6. <https://doi.org/10.1111/j.1532-5415.2004.52267.x>.
- [105] Cornoni-Huntley J, Ostfeld AM, Taylor JO, Wallace RB, Blazer D, Berkman LF, et al. Established populations for epidemiologic studies of the elderly: study design and methodology. *Aging (Milano)* 1993;5:27–37. <https://doi.org/10.1007/BF03324123>.
- [106] Rubbieri G, Mossello E, Di Bari M. Techniques for the diagnosis of sarcopenia. *Clin Cases Miner Bone Metab* 2014;11:181–4.
- [107] Lee W-J, Liu L-K, Peng L-N, Lin M-H, Chen L-K. Comparisons of Sarcopenia Defined by IWGS and EWGSOP Criteria Among Older People: Results From the I-Lan Longitudinal Aging Study. *Journal of the American Medical Directors Association* 2013;14:528.e1-528.e7. <https://doi.org/10.1016/j.jamda.2013.03.019>.
- [108] Cruz-Jentoft AJ, Bahat G, Bauer J, Boirie Y, Bruyère O, Cederholm T, et al. Sarcopenia: revised European consensus on definition and diagnosis. *Age Ageing* 2019;48:16–31. <https://doi.org/10.1093/ageing/afy169>.
- [109] Woodrow G. Body composition analysis techniques in the aged adult: indications and limitations. *Curr Opin Clin Nutr Metab Care* 2009;12:8–14. <https://doi.org/10.1097/MCO.0b013e32831b9c5b>.
- [110] Watanabe Y, Yamada Y, Fukumoto Y, Ishihara T, Yokoyama K, Yoshida T, et al. Echo intensity obtained from ultrasonography images reflecting muscle strength in elderly men. *Clin Interv Aging* 2013;8:993–8. <https://doi.org/10.2147/CIA.S47263>.
- [111] Perkisas S, Bastijns S, Baudry S, Bauer J, Beaudart C, Beckwée D, et al. Application of ultrasound for muscle assessment in sarcopenia: 2020 SARCUS update. *Eur Geriatr Med* 2021;12:45–59. <https://doi.org/10.1007/s41999-020-00433-9>.
- [112] Berger J, Bunout D, Barrera G, de la Maza MP, Henriquez S, Leiva L, et al. Rectus femoris (RF) ultrasound for the assessment of muscle mass in older people. *Arch Gerontol Geriatr* 2015;61:33–8. <https://doi.org/10.1016/j.archger.2015.03.006>.
- [113] Janssen I, Heymsfield SB, Baumgartner RN, Ross R. Estimation of skeletal muscle mass by bioelectrical impedance analysis. *Journal of Applied Physiology* 2000;89:465–71. <https://doi.org/10.1152/jappl.2000.89.2.465>.
- [114] Sillanpää E, Cheng S, Häkkinen K, Finni T, Walker S, Pesola A, et al. Body composition in 18- to 88-year-old adults--comparison of multifrequency bioimpedance and dual-energy X-ray absorptiometry. *Obesity (Silver Spring)* 2014;22:101–9. <https://doi.org/10.1002/oby.20583>.
- [115] Kyle UG, Bosaeus I, De Lorenzo AD, Deurenberg P, Elia M, Gómez JM, et al. Bioelectrical impedance analysis—part I: review of principles and methods. *Clinical Nutrition* 2004;23:1226–43. <https://doi.org/10.1016/j.clnu.2004.06.004>.
- [116] Farina D, Merletti R, Enoka RM. The extraction of neural strategies from the surface EMG. *J Appl Physiol* 2004;96:1486–95. <https://doi.org/10.1152/jappphysiol.01070.2003>.
- [117] De Luca CJ. The Use of Surface Electromyography in Biomechanics. *Journal of Applied Biomechanics* 1997;13:135–63. <https://doi.org/10.1123/jab.13.2.135>.

- [118] Watanabe K, Kouzaki M, Moritani T. Effect of aging on regional neuromuscular regulation within human rectus femoris muscle during stair ascent and descent. *Gait & Posture* 2017;52:26–32. <https://doi.org/10.1016/j.gaitpost.2016.11.011>.
- [119] Bingham A, Arjunan SP, Jelfs B, Kumar DK. Normalised Mutual Information of High-Density Surface Electromyography during Muscle Fatigue. *Entropy* 2017;19:697. <https://doi.org/10.3390/e19120697>.
- [120] Al Harrach M, Boudaoud S, Carriou V, Laforet J, Letocart AJ, Grosset J-F, et al. Investigation of the HD-sEMG probability density function shapes with varying muscle force using data fusion and shape descriptors. *Computers in Biology and Medicine* 2017;89:44–58. <https://doi.org/10.1016/j.combiomed.2017.07.023>.
- [121] Al Harrach M, Boudaoud S, Gamet D, Grosset JF, Marin F. Evaluation of HD-sEMG Probability Density Function deformations in ramp exercise. *Conf Proc IEEE Eng Med Biol Soc* 2014;2014:2209–12. <https://doi.org/10.1109/EMBC.2014.6944057>.
- [122] Farina D, Jiang N, Rehbaum H, Holobar A, Graimann B, Dietl H, et al. The extraction of neural information from the surface EMG for the control of upper-limb prostheses: emerging avenues and challenges. *IEEE Trans Neural Syst Rehabil Eng* 2014;22:797–809. <https://doi.org/10.1109/TNSRE.2014.2305111>.
- [123] Watanabe K, Kouzaki M, Ogawa M, Akima H, Moritani T. Relationships between muscle strength and multi-channel surface EMG parameters in eighty-eight elderly. *Eur Rev Aging Phys Act* 2018;15:3. <https://doi.org/10.1186/s11556-018-0192-z>.
- [124] Merletti R, Afsharipour B, Piervirgili G. High Density Surface EMG Technology. In: Pons JL, Torricelli D, Pajaro M, editors. *Converging Clinical and Engineering Research on Neurorehabilitation*, Springer Berlin Heidelberg; 2013, p. 1205–9.
- [125] Al Harrach M, Carriou V, Boudaoud S, Laforet J, Marin F. Analysis of the sEMG/force relationship using HD-sEMG technique and data fusion: A simulation study. *Computers in Biology and Medicine* 2017;83:34–47. <https://doi.org/10.1016/j.combiomed.2017.02.003>.
- [126] Cao H, Boudaoud S, Marin F, Marque C. Surface EMG-force modelling for the biceps brachii and its experimental evaluation during isometric isotonic contractions. *Comput Methods Biomech Biomed Engin* 2014. <https://doi.org/10.1080/10255842.2013.867952>.
- [127] Watanabe K, Kouzaki M, Ogawa M, Akima H, Moritani T. Relationships between muscle strength and multi-channel surface EMG parameters in eighty-eight elderly. *Eur Rev Aging Phys Act* 2018;15:3. <https://doi.org/10.1186/s11556-018-0192-z>.
- [128] Farina D, Lorrain T, Negro F, Jiang N. High-density EMG E-textile systems for the control of active prostheses. *Conf Proc IEEE Eng Med Biol Soc* 2010;2010:3591–3. <https://doi.org/10.1109/IEMBS.2010.5627455>.
- [129] Lepetit K. Evaluation biomécanique des capacités musculo-squelettiques lors de la transition assis / debout au moyen d'une centrale inertielle. Université de Technologie de Compiègne, 2018.
- [130] Lepetit K, Mansour KB, Letocart A, Boudaoud S, Kinugawa K, Grosset J-F, et al. Optimized scoring tool to quantify the functional performance during the sit-to-stand transition with a magneto-inertial measurement unit. *Clinical Biomechanics* 2019;69:109–14. <https://doi.org/10.1016/j.clinbiomech.2019.07.012>.
- [131] Montesinos L, Castaldo R, Pecchia L. Wearable Inertial Sensors for Fall Risk Assessment and Prediction in Older Adults: A Systematic Review and Meta-Analysis. *IEEE*

- Transactions on Neural Systems and Rehabilitation Engineering 2018;PP:1–1. <https://doi.org/10.1109/TNSRE.2017.2771383>.
- [132] K L, K BM, S B, K K-B, F M. Evaluation of the kinetic energy of the torso by magneto-inertial measurement unit during the sit-to-stand movement. *J Biomech* 2017;67:172–6. <https://doi.org/10.1016/j.jbiomech.2017.11.028>.
- [133] Mugueta-Aguinaga I, Garcia-Zapirain B. Is Technology Present in Frailty? Technology a Back-up Tool for Dealing with Frailty in the Elderly: A Systematic Review. *Aging Dis* 2017;8:176–95. <https://doi.org/10.14336/AD.2016.0901>.
- [134] Birkbeck MG, Blamire AM, Whittaker RG, Sayer AA, Dodds RM. The role of novel motor unit magnetic resonance imaging to investigate motor unit activity in ageing skeletal muscle. *J Cachexia Sarcopenia Muscle* 2020. <https://doi.org/10.1002/jcsm.12655>.
- [135] van Lummel R. Assessing Sit-to-Stand for Clinical Use n.d.:194.
- [136] Manckoundia P, Mourey F, Pfitzenmeyer P, Papaxanthis C. Comparison of motor strategies in sit-to-stand and back-to-sit motions between healthy and Alzheimer's disease elderly subjects. *Neuroscience* 2006;137:385–92. <https://doi.org/10.1016/j.neuroscience.2005.08.079>.
- [137] Guralnik JM, Simonsick EM, Ferrucci L, Glynn RJ, Berkman LF, Blazer DG, et al. A short physical performance battery assessing lower extremity function: association with self-reported disability and prediction of mortality and nursing home admission. *J Gerontol* 1994;49:M85-94. <https://doi.org/10.1093/geronj/49.2.m85>.
- [138] Janssen WG, Bussmann HB, Stam HJ. Determinants of the Sit-to-Stand Movement: A Review. *Physical Therapy* 2002;82:866–79. <https://doi.org/10.1093/ptj/82.9.866>.
- [139] Benatti FB, Ried-Larsen M. The Effects of Breaking up Prolonged Sitting Time: A Review of Experimental Studies. *Med Sci Sports Exerc* 2015;47:2053–61. <https://doi.org/10.1249/MSS.0000000000000654>.
- [140] Dunstan DW, Kingwell BA, Larsen R, Healy GN, Cerin E, Hamilton MT, et al. Breaking up prolonged sitting reduces postprandial glucose and insulin responses. *Diabetes Care* 2012;35:976–83. <https://doi.org/10.2337/dc11-1931>.
- [141] Stamatakis E, Gale J, Bauman A, Ekelund U, Hamer M, Ding D. Sitting Time, Physical Activity, and Risk of Mortality in Adults. *Journal of the American College of Cardiology* 2019;73:2062–72. <https://doi.org/10.1016/j.jacc.2019.02.031>.
- [142] Büchele G, Becker C, Cameron ID, König H-H, Robinovitch S, Rapp K. Predictors of serious consequences of falls in residential aged care: analysis of more than 70,000 falls from residents of Bavarian nursing homes. *J Am Med Dir Assoc* 2014;15:559–63. <https://doi.org/10.1016/j.jamda.2014.03.015>.
- [143] Hughes VA, Frontera WR, Wood M, Evans WJ, Dallal GE, Roubenoff R, et al. Longitudinal muscle strength changes in older adults: influence of muscle mass, physical activity, and health. *J Gerontol A Biol Sci Med Sci* 2001;56:B209-217. <https://doi.org/10.1093/gerona/56.5.b209>.
- [144] Goodpaster BH, Park SW, Harris TB, Kritchevsky SB, Nevitt M, Schwartz AV, et al. The Loss of Skeletal Muscle Strength, Mass, and Quality in Older Adults: The Health, Aging and Body Composition Study. *The Journals of Gerontology Series A: Biological Sciences and Medical Sciences* 2006;61:1059–64. <https://doi.org/10.1093/gerona/61.10.1059>.
- [145] Yoshiko A, Kaji T, Sugiyama H, Koike T, Oshida Y, Akima H. Effect of 12-month resistance and endurance training on quality, quantity, and function of skeletal muscle in older adults requiring long-term care. *Exp Gerontol* 2017;98:230–7. <https://doi.org/10.1016/j.exger.2017.08.036>.

- [146] Van Lummel RC, Evers J, Niessen M, Beek PJ, Van Dieën JH. Older Adults with Weaker Muscle Strength Stand up from a Sitting Position with More Dynamic Trunk Use. *Sensors* 2018;18:1235. <https://doi.org/10.3390/s18041235>.
- [147] Lord SR, Murray SM, Chapman K, Munro B, Tiedemann A. Sit-to-stand performance depends on sensation, speed, balance, and psychological status in addition to strength in older people. *J Gerontol A Biol Sci Med Sci* 2002;57:M539-543. <https://doi.org/10.1093/gerona/57.8.m539>.
- [148] Schenkman M, Berger RA, Riley PO, Mann RW, Hodge WA. Whole-body movements during rising to standing from sitting. *Phys Ther* 1990;70:638–48; discussion 648-651. <https://doi.org/10.1093/ptj/70.10.638>.
- [149] Schenkman M, Riley PO, Pieper C. Sit to stand from progressively lower seat heights -- alterations in angular velocity. *Clin Biomech (Bristol, Avon)* 1996;11:153–8. [https://doi.org/10.1016/0268-0033\(95\)00060-7](https://doi.org/10.1016/0268-0033(95)00060-7).
- [150] Riley PO, Schenkman ML, Mann RW, Hodge WA. Mechanics of a constrained chair-rise. *J Biomech* 1991;24:77–85. [https://doi.org/10.1016/0021-9290\(91\)90328-k](https://doi.org/10.1016/0021-9290(91)90328-k).
- [151] Hughes MA, Schenkman ML. Chair rise strategy in the functionally impaired elderly. *J Rehabil Res Dev* 1996;33:409–12.
- [152] Distefano G, Goodpaster BH. Effects of Exercise and Aging on Skeletal Muscle. *Cold Spring Harb Perspect Med* 2018;8:a029785. <https://doi.org/10.1101/cshperspect.a029785>.
- [153] Cruz-Jentoft AJ, Sayer AA. Sarcopenia. *The Lancet* 2019;393:2636–46. [https://doi.org/10.1016/S0140-6736\(19\)31138-9](https://doi.org/10.1016/S0140-6736(19)31138-9).
- [154] Merletti R, Rainoldi A, Farina D. Surface electromyography for noninvasive characterization of muscle. *Exerc Sport Sci Rev* 2001;29:20–5.
- [155] Al Harrach M, Carriou V, Boudaoud S, Laforet J, Marin F. Analysis of the sEMG/force relationship using HD-sEMG technique and data fusion: A simulation study. *Computers in Biology and Medicine* 2017;83:34–47. <https://doi.org/10.1016/j.compbiomed.2017.02.003>.
- [156] Boudaoud S, Allouch S, Harrach MA, Marin F. On the benefits of using HD-sEMG technique for estimating muscle force. *Computer Methods in Biomechanics and Biomedical Engineering* 2015;18:1890–1. <https://doi.org/10.1080/10255842.2015.1070578>.
- [157] Watanabe K. Region-specific modulation of tendon reflex along human rectus femoris muscle. *Human Movement Science* 2018;58:224–30. <https://doi.org/10.1016/j.humov.2018.02.013>.
- [158] Watanabe K, Kouzaki M, Moritani T. Regional neuromuscular regulation within human rectus femoris muscle during gait in young and elderly men. *Journal of Biomechanics* 2016;49:19–25. <https://doi.org/10.1016/j.jbiomech.2015.11.010>.
- [159] Wilkinson DJ, Piasecki M, Atherton PJ. The age-related loss of skeletal muscle mass and function: Measurement and physiology of muscle fibre atrophy and muscle fibre loss in humans. *Ageing Research Reviews* 2018;47:123–32. <https://doi.org/10.1016/j.arr.2018.07.005>.
- [160] Watanabe K, Kouzaki M, Moritani T. Effect of aging on region-specific functional role and muscle geometry along human rectus femoris muscle. *Muscle & Nerve* 2017;56:982–6. <https://doi.org/10.1002/mus.25556>.

- [161] Hagströmer M, Oja P, Sjöström M. The International Physical Activity Questionnaire (IPAQ): a study of concurrent and construct validity. *Public Health Nutr* 2006;9:755–62. <https://doi.org/10.1079/PHN2005898>.
- [162] Pradon D, Roche N, Enette L, Zory R. Relationship between lower limb muscle strength and 6-minute walk test performance in stroke patients. *Journal of Rehabilitation Medicine : Official Journal of the UEMS European Board of Physical and Rehabilitation Medicine* 2012;45. <https://doi.org/10.2340/16501977-1059>.
- [163] Ye X, Wang M, Xiao H. Echo intensity of the rectus femoris in stable COPD patients. *Int J Chron Obstruct Pulmon Dis* 2017;12:3007–15. <https://doi.org/10.2147/COPD.S143645>.
- [164] Clark BC, Taylor JL. Age-related changes in motor cortical properties and voluntary activation of skeletal muscle. *Curr Aging Sci* 2011;4:192–9. <https://doi.org/10.2174/1874609811104030192>.
- [165] Deschenes MR. Effects of Aging on Muscle Fibre Type and Size. *Sports Med* 2004;34:809–24. <https://doi.org/10.2165/00007256-200434120-00002>.
- [166] Merletti R, Hermens H. Introduction to the special issue on the SENIAM European Concerted Action. *Journal of Electromyography and Kinesiology* 2000;10:283–6. [https://doi.org/10.1016/S1050-6411\(00\)00019-5](https://doi.org/10.1016/S1050-6411(00)00019-5).
- [167] Hewson D, Duchêne J, Hogrel J-Y. Changes in impedance at the electrode-skin interface of surface EMG electrodes during long-term EMG recordings. vol. 4, 2001, p. 3345–8 vol.4. <https://doi.org/10.1109/IEMBS.2001.1019543>.
- [168] DeFreitas JM, Beck TW, Stock MS. Comparison of methods for removing electromagnetic noise from electromyographic signals. *Physiol Meas* 2012;33:147–58. <https://doi.org/10.1088/0967-3334/33/2/147>.
- [169] Sinderby C, Weinberg J, Sullivan L, Lindström L, Grassino A. Electromyographical evidence for exercise-induced diaphragm fatigue in patients with chronic cervical cord injury or prior poliomyelitis infection. *Spinal Cord* 1996;34:594–601. <https://doi.org/10.1038/sc.1996.106>.
- [170] Farina D, Rainoldi A. Compensation of the effect of sub-cutaneous tissue layers on surface EMG: a simulation study. *Medical Engineering & Physics* 1999;21:487–97. [https://doi.org/10.1016/S1350-4533\(99\)00075-2](https://doi.org/10.1016/S1350-4533(99)00075-2).
- [171] Farina D, Cescon C, Merletti R. Influence of anatomical, physical, and detection-system parameters on surface EMG. *Biological Cybernetics* 2002;86:445–56. <https://doi.org/10.1007/s00422-002-0309-2>.
- [172] Merletti R, Botter A, Cescon C, Minetto MA, Vieira TMM. Advances in surface EMG: recent progress in clinical research applications. *Crit Rev Biomed Eng* 2010;38:347–79. <https://doi.org/10.1615/critrevbiomedeng.v38.i4.20>.
- [173] Merletti R, Botter A, Troiano A, Merlo E, Minetto MA. Technology and instrumentation for detection and conditioning of the surface electromyographic signal: State of the art. *Clinical Biomechanics* 2009;24:122–34. <https://doi.org/10.1016/j.clinbiomech.2008.08.006>.
- [174] Al Harrach M, Boudaoud S, Hassan M, Ayachi FS, Gamet D, Grosset JF, et al. Denoising of HD-sEMG signals using canonical correlation analysis. *Medical & Biological Engineering & Computing* 2017;55:375–88. <https://doi.org/10.1007/s11517-016-1521-x>.
- [175] Hassan M, Boudaoud S, Terrien J, Karlsson B, Marque C. Combination of Canonical Correlation Analysis and Empirical Mode Decomposition Applied to Denoising the



- Labor Electrohysterogram. *IEEE Transactions on Biomedical Engineering* 2011;58:2441–7. <https://doi.org/10.1109/TBME.2011.2151861>.
- [176] Mello RGT, Oliveira LF, Nadal J. Digital Butterworth filter for subtracting noise from low magnitude surface electromyogram. *Computer Methods and Programs in Biomedicine* 2007;87:28–35. <https://doi.org/10.1016/j.cmpb.2007.04.004>.
- [177] Altamirano AA. EMG Pattern Prediction for Upper Limb Movements Based on Wavelet and Hilbert-Huang Transform n.d.:134.
- [178] Hussain M s., Reaz M b. i., Mohd-Yasin F, Ibrahimy M i. Electromyography signal analysis using wavelet transform and higher order statistics to determine muscle contraction. *Expert Systems* 2009;26:35–48. <https://doi.org/10.1111/j.1468-0394.2008.00483.x>.
- [179] Andrade AO, Nasuto S, Kyberd P, Sweeney-Reed CM, Van Kanijn FR. EMG signal filtering based on Empirical Mode Decomposition. *Biomedical Signal Processing and Control* 2006;1:44–55. <https://doi.org/10.1016/j.bspc.2006.03.003>.
- [180] Huang NE, Shen Z, Long SR, Wu MC, Shih HH, Zheng Q, et al. The empirical mode decomposition and the Hilbert spectrum for nonlinear and non-stationary time series analysis. *Proceedings of the Royal Society of London Series A: Mathematical, Physical and Engineering Sciences* 1998;454:903–95. <https://doi.org/10.1098/rspa.1998.0193>.
- [181] De Clercq W, Vergult A, Vanrumste B, Van Paesschen W, Van Huffel S. Canonical Correlation Analysis Applied to Remove Muscle Artifacts From the Electroencephalogram. *IEEE Transactions on Biomedical Engineering* 2006;53:2583–7. <https://doi.org/10.1109/TBME.2006.879459>.
- [182] M. Al Harrach, S. Boudaoud, M.Hassan, F.S. Ayachi,, D.Gamet, J.F. Grosset, F. Marin. Denoising of HD-sEMG Signals Using Canonical Correlation Analysis n.d.
- [183] Chen L, Hao Y. Feature Extraction and Classification of EHG between Pregnancy and Labour Group Using Hilbert-Huang Transform and Extreme Learning Machine. *Computational and Mathematical Methods in Medicine* 2017;2017:1–9. <https://doi.org/10.1155/2017/7949507>.
- [184] Automatic activity detection in noisy signals with Hilbert transform n.d. <https://ww2.mathworks.cn/matlabcentral/fileexchange/46139-automatic-activity-detection-in-noisy-signals-with-hilbert-transform> (accessed May 10, 2021).
- [185] Velleman, P. F, D. C. Hoaglin. *Application, Basics, and Computing of Exploratory Data Analysis*. CA: Duxbury Press, 1981. Pacific Grove: n.d.
- [186] Peritz E. Book Reviews: *Multiple Comparison Procedures* Y. Hochberg and A. C. Tamhane New York: Wiley, 1987. xxii + 450 pp. *Journal of Educational Statistics* 1989;14:103–6. <https://doi.org/10.3102/10769986014001103>.
- [187] Conover WJ. *Practical Nonparametric Statistics*. John Wiley & Sons; 1998.
- [188] Masson E. Poster presentations. EM-Consulte n.d. <https://www.em-consulte.com/article/1143350/article/poster-presentations> (accessed September 16, 2021).
- [189] L. Imrani, S. Boudaoud, K. Kinugawa, K. Lepetit, J. Laforêt, F. Marin. Evaluation of Motor Abilities with aging using HD-sEMG and IMU data 2018.
- [190] Keller K, Engelhardt M. Strength and muscle mass loss with aging process. Age and strength loss. *Muscles Ligaments Tendons J* 2013;3:346–50.
- [191] Ikezoe T, Mori N, Nakamura M, Ichihashi N. Age-related muscle atrophy in the lower extremities and daily physical activity in elderly women. *Archives of Gerontology and Geriatrics* 2011;53:e153–7. <https://doi.org/10.1016/j.archger.2010.08.003>.

- [192] Aagaard P, Suetta C, Caserotti P, Magnusson SP, Kjaer M. Role of the nervous system in sarcopenia and muscle atrophy with aging: strength training as a countermeasure. *Scand J Med Sci Sports* 2010;20:49–64. <https://doi.org/10.1111/j.1600-0838.2009.01084.x>.
- [193] McComas AJ, Fawcett PRW, Campbell MJ, Sica REP. Electrophysiological estimation of the number of motor units within a human muscle. *J Neurol Neurosurg Psychiatry* 1971;34:121–31.
- [194] Novotny SA, Warren GL, Hamrick MW. Aging and the Muscle-Bone Relationship. *Physiology (Bethesda)* 2015;30:8–16. <https://doi.org/10.1152/physiol.00033.2014>.
- [195] Midrio M. The denervated muscle: facts and hypotheses. A historical review. *Eur J Appl Physiol* 2006;98:1–21. <https://doi.org/10.1007/s00421-006-0256-z>.
- [196] Kaya RD, Nakazawa M, Hoffman RL, Clark BC. Interrelationship between muscle strength, motor units, & aging. *Exp Gerontol* 2013;48:920–5. <https://doi.org/10.1016/j.exger.2013.06.008>.
- [197] Chalmers GR, Knutzen KM. Recurrent inhibition in the soleus motor pool of elderly and young adults. *Electromyogr Clin Neurophysiol* 2004;44:413–21.
- [198] Kido A, Tanaka N, Stein RB. Spinal reciprocal inhibition in human locomotion. *J Appl Physiol* 2004;96:1969–77. <https://doi.org/10.1152/jappphysiol.01060.2003>.
- [199] Laidlaw DH, Bilodeau M, Enoka RM. Steadiness is reduced and motor unit discharge is more variable in old adults. *Muscle Nerve* 2000;23:600–12. [https://doi.org/10.1002/\(sici\)1097-4598\(200004\)23:4<600::aid-mus20>3.0.co;2-d](https://doi.org/10.1002/(sici)1097-4598(200004)23:4<600::aid-mus20>3.0.co;2-d).
- [200] Doherty TJ, Komori T, Stashuk DW, Kassam A, Brown WF. Physiological properties of single thenar motor units in the F-response of younger and older adults. *Muscle & Nerve* 1994;17:860–72. <https://doi.org/10.1002/mus.880170805>.
- [201] Carmeli E, Reznick AZ. The physiology and biochemistry of skeletal muscle atrophy as a function of age. *Proc Soc Exp Biol Med* 1994;206:103–13. <https://doi.org/10.3181/00379727-206-43727>.
- [202] Erim Z, Beg MF, Burke DT, de Luca CJ. Effects of aging on motor-unit control properties. *J Neurophysiol* 1999;82:2081–91. <https://doi.org/10.1152/jn.1999.82.5.2081>.
- [203] Roos MR, Rice CL, Vandervoort AA. Age-related changes in motor unit function. *Muscle Nerve* 1997;20:679–90. [https://doi.org/10.1002/\(sici\)1097-4598\(199706\)20:6<679::aid-mus4>3.0.co;2-5](https://doi.org/10.1002/(sici)1097-4598(199706)20:6<679::aid-mus4>3.0.co;2-5).
- [204] Scaglioni G, Narici MV, Maffiuletti NA, Pensini M, Martin A. Effect of ageing on the electrical and mechanical properties of human soleus motor units activated by the H reflex and M wave. *The Journal of Physiology* 2003;548:649–61. <https://doi.org/10.1111/j.1469-7793.2003.00649.x>.
- [205] Millington PJ, Myklebust BM, Shambes GM. Biomechanical Analysis of the Sit-to-Stand Motion in Elderly Persons 1992:9.
- [206] Landi F, Calvani R, Tosato M, Martone AM, Fusco D, Sisto A, et al. Age-Related Variations of Muscle Mass, Strength, and Physical Performance in Community-Dwellers: Results From the Milan EXPO Survey. *J Am Med Dir Assoc* 2017;18:88.e17-88.e24. <https://doi.org/10.1016/j.jamda.2016.10.007>.
- [207] Gross MM, Stevenson PJ, Charette SL, Pyka G, Marcus R. Effect of muscle strength and movement speed on the biomechanics of rising from a chair in healthy elderly and young women. *Gait & Posture* 1998;8:175–85. [https://doi.org/10.1016/S0966-6362\(98\)00033-2](https://doi.org/10.1016/S0966-6362(98)00033-2).

- [208] Zhu S, Lin W, Chen S, Qi H, Wang S, Zhang A, et al. The correlation of muscle thickness and pennation angle assessed by ultrasound with sarcopenia in elderly Chinese community dwellers. *Clin Interv Aging* 2019;14:987–96. <https://doi.org/10.2147/CIA.S201777>.
- [209] Minetto MA, Caresio C, Menapace T, Hajdarevic A, Marchini A, Molinari F, et al. Ultrasound-Based Detection of Low Muscle Mass for Diagnosis of Sarcopenia in Older Adults. *PM&R* 2016;8:453–62. <https://doi.org/10.1016/j.pmrj.2015.09.014>.
- [210] Strasser EM, Draskovits T, Praschak M, Quittan M, Graf A. Association between ultrasound measurements of muscle thickness, pennation angle, echogenicity and skeletal muscle strength in the elderly. *Age (Dordr)* 2013;35:2377–88. <https://doi.org/10.1007/s11357-013-9517-z>.
- [211] Brunner F, Schmid A, Sheikhzadeh A, Nordin M, Yoon J, Frankel V. Effects of aging on Type II muscle fibers: a systematic review of the literature. *J Aging Phys Act* 2007;15:336–48.
- [212] Lahaye C, Imrani L, Ghezal M, Manaa S, Doulazmi M, Boudaoud S, et al. Évaluation du vieillissement musculaire par échographie quadricipitale. *Nutrition Clinique et Métabolisme* 2020;34:38. <https://doi.org/10.1016/j.nupar.2020.02.240>.
- [213] Tavares JMRS, Dey N, Joshi A, editors. *Biomedical Engineering and Computational Intelligence: Proceedings of The World Thematic Conference—Biomedical Engineering and Computational Intelligence, BIOCOM 2018*. vol. 32. Cham: Springer International Publishing; 2020. <https://doi.org/10.1007/978-3-030-21726-6>.
- [214] Karlsson S, Yu J, Akay M. Time-frequency analysis of myoelectric signals during dynamic contractions: a comparative study. *IEEE Transactions on Biomedical Engineering* 2000;47:228–38. <https://doi.org/10.1109/10.821766>.
- [215] Allison GT, Fujiwara T. The relationship between EMG median frequency and low frequency band amplitude changes at different levels of muscle capacity. *Clinical Biomechanics* 2002;17:464–9. [https://doi.org/10.1016/S0268-0033\(02\)00033-5](https://doi.org/10.1016/S0268-0033(02)00033-5).
- [216] Arjunan SP, Kumar DK, Naik G. Computation and Evaluation of Features of Surface Electromyogram to Identify the Force of Muscle Contraction and Muscle Fatigue. *BioMed Research International* 2014. <https://doi.org/10.1155/2014/197960>.
- [217] Clancy EA, Bertolina MV, Merletti R, Farina D. Time- and frequency-domain monitoring of the myoelectric signal during a long-duration, cyclic, force-varying, fatiguing hand-grip task. *Journal of Electromyography and Kinesiology* 2008;18:789–97. <https://doi.org/10.1016/j.jelekin.2007.02.007>.
- [218] Merletti R, Knaflitz M, DeLuca CJ. Electrically evoked myoelectric signals. *Crit Rev Biomed Eng* 1992;19:293–340.
- [219] Welch P. The use of fast Fourier transform for the estimation of power spectra: A method based on time averaging over short, modified periodograms. *IEEE Transactions on Audio and Electroacoustics* 1967;15:70–3. <https://doi.org/10.1109/TAU.1967.1161901>.
- [220] Akataki K, Mita K, Watakabe M, Itoh K. Mechanomyogram and force relationship during voluntary isometric ramp contractions of the biceps brachii muscle. *Eur J Appl Physiol* 2001;84:19–25. <https://doi.org/10.1007/s004210000321>.
- [221] Bilodeau M, Cincera M, Arsenaault AB, Gravel D. Normality and stationarity of EMG signals of elbow flexor muscles during ramp and step isometric contractions. *Journal of Electromyography and Kinesiology* 1997;7:87–96. [https://doi.org/10.1016/S1050-6411\(96\)00024-7](https://doi.org/10.1016/S1050-6411(96)00024-7).

- [222] Akima H, Takahashi H, Kuno S, Katsuta S. Coactivation pattern in human quadriceps during isokinetic knee-extension by muscle functional MRI. *Eur J Appl Physiol* 2004;91:7–14. <https://doi.org/10.1007/s00421-003-0942-z>.
- [223] Task-dependent spatial distribution of neural activation pattern in human rectus femoris muscle | Kohei Watanabe; Motoki Kouzaki; Toshio Moritani | download n.d. <https://ur.booksc.eu/book/16978310/2d0036> (accessed September 21, 2021).
- [224] Merletti R, Farina D. Surface EMG processing: Introduction to the special issue. *Biomedical Signal Processing and Control* 2008;3:115–7. <https://doi.org/10.1016/j.bspc.2008.01.001>.
- [225] Merletti R, Lo Conte LR. Surface EMG signal processing during isometric contractions. *Journal of Electromyography and Kinesiology* 1997;7:241–50. [https://doi.org/10.1016/S1050-6411\(97\)00010-2](https://doi.org/10.1016/S1050-6411(97)00010-2).
- [226] Chua KC, Chandran V, Acharya UR, Lim CM. Application of higher order statistics/spectra in biomedical signals--a review. *Med Eng Phys* 2010;32:679–89. <https://doi.org/10.1016/j.medengphy.2010.04.009>.
- [227] Naik G. Evaluation of higher order statistics parameters for multi channel sEMG using different force levels. *Proceedings of the Annual International Conference of the IEEE Engineering in Medicine and Biology Society, EMBS* n.d.
- [228] Ayachi FS, Boudaoud S, Marque C. Evaluation of muscle force classification using shape analysis of the sEMG probability density function: a simulation study. *Med Biol Eng Comput* 2014;52:673–84. <https://doi.org/10.1007/s11517-014-1170-x>.
- [229] Sammut C, Webb GI. *Encyclopedia of Machine Learning*. Springer Science & Business Media; 2011.
- [230] Pedregosa F, Varoquaux G, Gramfort A, Michel V, Thirion B, Grisel O, et al. Scikit-learn: Machine Learning in Python. *Journal of Machine Learning Research* 2011;12:2825–30.
- [231] Huang S, Cai N, Pacheco PP, Narrandes S, Wang Y, Xu W. Applications of Support Vector Machine (SVM) Learning in Cancer Genomics. *Cancer Genomics & Proteomics* 2018;15:41–51.
- [232] Fergus P, Cheung P, Hussain A, Al-Jumeily D, Dobbins C, Iram S. Prediction of Preterm Deliveries from EHG Signals Using Machine Learning. *PLoS ONE* 2013;8:e77154. <https://doi.org/10.1371/journal.pone.0077154>.
- [233] Alamedine D, Khalil M, Marque C. Comparison of Different EHG Feature Selection Methods for the Detection of Preterm Labor. *Computational and Mathematical Methods in Medicine* 2013;2013:1–9. <https://doi.org/10.1155/2013/485684>.
- [234] Al-Angari HM, Kanitz G, Tarantino S, Cipriani C. Distance and mutual information methods for EMG feature and channel subset selection for classification of hand movements. *Biomedical Signal Processing and Control* 2016;27:24–31. <https://doi.org/10.1016/j.bspc.2016.01.011>.
- [235] Nougrou F, Campeau-Lecours A, Massicotte D, Boukadoum M, Gosselin C, Gosselin B. Pattern recognition based on HD-sEMG spatial features extraction for an efficient proportional control of a robotic arm. *Biomedical Signal Processing and Control* 2019;53:101550. <https://doi.org/10.1016/j.bspc.2019.04.027>.
- [236] Foster KR, Koprowski R, Skufca JD. Machine learning, medical diagnosis, and biomedical engineering research - commentary. *BioMedical Engineering OnLine* 2014;13:94. <https://doi.org/10.1186/1475-925X-13-94>.
- [237] Vapnik V. *The Nature of Statistical Learning Theory*. 2nd ed. New York: Springer-Verlag; 2000. <https://doi.org/10.1007/978-1-4757-3264-1>.

- [238] Bishop CM. Pattern recognition and machine learning. New York: Springer; 2006.
- [239] Smola AJ, Schölkopf B. A tutorial on support vector regression. 2004.
- [240] 1.4. Support Vector Machines — scikit-learn 0.24.2 documentation n.d. <https://scikit-learn.org/stable/modules/svm.html#svm-outlier-detection> (accessed May 31, 2021).
- [241] Breiman L, Friedman J, Olshen R, Stone CJ. Classification and Regression Trees, 1983. <https://doi.org/10.2307/2530946>.
- [242] Schonlau M, Zou RY. The random forest algorithm for statistical learning. *The Stata Journal* 2020;20:3–29. <https://doi.org/10.1177/1536867X20909688>.
- [243] What is Random Forest? 2021. <https://www.ibm.com/cloud/learn/random-forest> (accessed July 16, 2021).
- [244] Hu YH, Hwang J-N. Handbook of Neural Network Signal Processing. CRC Press; 2001.
- [245] Karayiannis N, Venetsanopoulos AN. Artificial Neural Networks: Learning Algorithms, Performance Evaluation, and Applications. Springer Science & Business Media; 2013.
- [246] What is a Neural Network? - Databricks n.d. <https://databricks.com/fr/glossary/neural-network> (accessed September 21, 2021).
- [247] Asiri S. Machine Learning Classifiers. Medium 2018. <https://towardsdatascience.com/machine-learning-classifiers-a5cc4e1b0623> (accessed July 12, 2021).
- [248] Grid Search for model tuning. A model hyperparameter is a... | by Rohan Joseph | Towards Data Science n.d. <https://towardsdatascience.com/grid-search-for-model-tuning-3319b259367e> (accessed July 12, 2021).
- [249] Yu T, Zhu H. Hyper-Parameter Optimization: A Review of Algorithms and Applications. ArXiv:200305689 [Cs, Stat] 2020.
- [250] Moslem B, Karlsson B, Diab MO, Khalil M, Marque C. Classification performance of the frequency-related parameters derived from uterine EMG signals. 2011 Annual International Conference of the IEEE Engineering in Medicine and Biology Society, Boston, MA: IEEE; 2011, p. 3371–4. <https://doi.org/10.1109/IEMBS.2011.6090913>.
- [251] Parul Sinha, Poonam Sinha, BUIT. Comparative Study of Chronic Kidney Disease Prediction using KNN and SVM. *IJERT* 2015;V4:IJERTV4IS120622. <https://doi.org/10.17577/IJERTV4IS120622>.
- [252] Gaudart J, Giusiano B, Huiart L. Comparison of the performance of multi-layer perceptron and linear regression for epidemiological data. *Computational Statistics and Data Analysis* 2004;44:547–70.
- [253] Nazmi N, Abdul Rahman MA, Yamamoto S-I, Ahmad SA, Zamzuri H, Mazlan SA. A Review of Classification Techniques of EMG Signals during Isotonic and Isometric Contractions. *Sensors* 2016;16:1304. <https://doi.org/10.3390/s16081304>.
- [254] Li X, Samuel OW, Zhang X, Wang H, Fang P, Li G. A motion-classification strategy based on sEMG-EEG signal combination for upper-limb amputees. *J NeuroEngineering Rehabil* 2017;14:2. <https://doi.org/10.1186/s12984-016-0212-z>.
- [255] Chen B, Chen X, Li B, He Z, Cao H, Cai G. Reliability estimation for cutting tools based on logistic regression model using vibration signals. *Mechanical Systems and Signal Processing* 2011;25:2526–37. <https://doi.org/10.1016/j.ymssp.2011.03.001>.



# Annexes

**Annex 1.** Questionnaire de l'activité physique IPAQ (version longue, française, interview téléphonique)

**LIRE :** Je vais vous interroger sur le temps que vous avez passé à être actif physiquement ces 7 derniers jours. Merci de répondre à chaque question même si vous ne vous considérez pas comme une personne physiquement active. Pensez aux activités que vous faites au travail, à domicile et dans votre jardin, pour vos déplacements d'un endroit à l'autre et pendant votre temps libre pour les loisirs, l'exercice ou le sport.

## **1<sup>ERE</sup> PARTIE : ACTIVITE PHYSIQUE LIEE AU TRAVAIL**

**LIRE :** Les premières questions portent sur votre travail. Par travail on entend les emplois payés, le travail agricole, le travail bénévole, les études, les stages et tout autre type de travail non payé que vous avez effectué en dehors du domicile. Ne tenez pas compte du travail non payé que vous effectuez à domicile, comme faire le ménage, le jardinage, entretenir la maison ou vous occuper de votre famille. Je vous interrogerai sur ces activités plus tard.

Avez-vous actuellement un emploi ou faites-vous un travail payé ou non payé en dehors de votre domicile ? [Travail ; Oui = 1, Non = 0 ; 8,9]

- \_\_\_ Oui
- \_\_\_ Non [Passez à la 2<sup>ème</sup> Partie]
- 8. Ne sait pas / Pas sûr [Passez à la 2<sup>ème</sup> Partie]
- 9. N'a pas répondu

[**Clarification de l'enquêteur :** Cela comprend aussi les cours, les études et les stages. Cela comprend aussi le travail bénévole et le temps passé à chercher un emploi. Cela ne comprend pas le travail non payé fait à la maison ou dans votre jardin, ni le temps passé à s'occuper d'une personne à charge. Ceci fera l'objet de questions plus tard.]

**LIRE :** Les questions suivantes portent sur toutes les activités physiques que vous avez faites au travail qu'il soit payé ou non. Cela ne comprend pas les trajets entre votre domicile et votre travail.

**LIRE :** Tout d'abord, pensez aux activités *intenses* qui vous ont demandé un gros effort physique au travail. Les activités intenses font respirer beaucoup plus fort que d'habitude. Il peut s'agir d'activités comme porter des charges lourdes, creuser, faire de la maçonnerie ou monter des escaliers. Pensez seulement aux activités physiques intenses qui ont duré au moins dix minutes d'affilée.

Ces 7 derniers jours, pendant combien de jours avez-vous fait des activités physiques intenses au travail ? [De 0 à 7, 8, 9]

\_\_\_ Jours par semaine [Si la personne répond 0, passez à la question 4]

Ne sait pas/pas sûr [Passez à la question 4]

N'a pas répondu [Passez à la question 4]

**[Clarification de l'enquêteur :** Pensez seulement aux activités physiques de ce type qui ont duré au moins 10 minutes d'affilée.]

**[Clarification de l'enquêteur :** Le travail comprend le travail payé et non payé ainsi que les études et les stages. Tenez compte de tous les emplois et du travail bénévole.]

Quand vous avez fait des activités physiques **intenses** au travail au cours d'un de ces jours, combien de temps y avez-vous consacré en moyenne ?

\_\_\_ Heures par jour [De 0 à 16]

\_\_\_ Minutes par jour [De 0 à 960, 998, 999]

Ne sait pas / Pas sûr

N'a pas répondu

**[Clarification de l'enquêteur :** Pensez seulement aux activités physiques de ce type qui ont duré au moins 10 minutes d'affilée.]

**[Précision pour l'enquêteur :** On recherche une durée moyenne par jour. Si la personne interrogée ne peut pas répondre parce que le temps consacré aux activités varie beaucoup d'un jour à l'autre ou bien parce qu'il y a une grande variété de travaux payés ou non, demandez : « Quelle a été la durée totale de vos activités physiques intenses au travail **ces 7 derniers jours** ? »

\_\_\_ Heures par semaine [De 0 à 112]

\_\_\_ Minutes par semaine [De 0 à 6720, 9998, 9999]

9998. Ne sait pas/pas sûr

9999. N'a pas répondu

**LIRE : Maintenant pensez aux activités qui vous ont demandé un effort physique modéré au travail. Les activités physiques modérées font respirer un peu plus fort que d'habitude et peuvent comprendre des activités comme porter des charges légères. N'incluez pas la marche. Là encore, pensez seulement aux activités physiques modérées qui ont duré au moins 10 minutes d'affilé.**

Ces **7 derniers jours**, pendant combien de jours avez-vous fait des activités physiques **modérées au travail** ? [De 0 à 7, 8, 9]

\_\_\_ Jours par semaine [Si la personne répond 0, passez à la Question 6]

Ne sait pas / pas sûr [Passez à la question 6]

N'a pas répondu [Passez à la question 6]



[**Clarification de l'enquêteur** : Pensez seulement aux activités physiques de ce type qui ont duré au moins 10 minutes d'affilée.]

[**Clarification de l'enquêteur** : Le travail comprend le travail payé et non payé ainsi que les études et les stages. Tenez compte de tous les emplois et du travail bénévole.]

Quand vous avez fait des activités physiques **modérées** au travail au cours d'un de ces jours, combien de temps y avez-vous consacré en moyenne ?

\_\_\_ \_\_\_ Heures par jour [De 0 à 16]

\_\_\_ \_\_\_ \_\_\_ Minutes par jour [De 0 à 960, 998, 999]

Ne sait pas / pas sûr

N'a pas répondu à la question

[**Clarification de l'enquêteur** : Pensez seulement aux activités physiques de ce type qui ont duré au moins 10 minutes d'affilée.]

[**Précision pour l'enquêteur** : On recherche une durée moyenne par jour. Si la personne interrogée ne peut pas répondre parce que le temps consacré aux activités varie beaucoup d'un jour à l'autre ou bien parce qu'il y a une grande variété de travaux payés ou non, demandez : « Quelle a été la durée totale de vos activités physiques modérées au travail **ces 7 derniers jours** ? »

\_\_\_ \_\_\_ Heures par semaine [De 0 à 112]

\_\_\_ \_\_\_ \_\_\_ Minutes par semaine [De 0 à 6720, 9998, 9999]

9998. Ne sait pas/Pas sûr

9999. N'a pas répondu

**LIRE : Maintenant, pensez au temps que vous passez à marcher pendant au moins 10 minutes au travail. Ne tenez pas compte de la marche entre votre domicile et votre lieu de travail.**

Ces **7 derniers jours**, pendant combien de jours avez-vous **marché au travail** ? [De 0 à 7, 8, 9]

\_\_\_ Jours par semaine [Si la personne répond 0, passez à la 2<sup>ème</sup> partie]

8. Ne sait pas/Pas sûr [Passez à la 2<sup>ème</sup> partie]

9. N'a pas répondu [Passez à la 2<sup>ème</sup> partie]

[**Clarification de l'enquêteur** : Pensez seulement à la marche qui a duré au moins 10 minutes d'affilée.]

[**Clarification de l'enquêteur** : Tenez compte de tous les types de travail.]

Quand vous avez **marché** au travail au cours d'un de ces jours, combien de temps y avez-vous consacré en moyenne?

\_\_\_ \_\_\_ Heures par jour [De 0 à 16]

\_\_\_ \_\_\_ \_\_\_ Minutes par jour [De 0 à 960, 998, 999]

998. Ne sait pas/Pas sûr

999. N'a pas répondu

[**Clarification de l'enquêteur** : Pensez seulement à la marche qui a duré au moins 10 minutes d'affilée.]

[**Précision pour l'enquêteur** : On recherche une durée moyenne par jour. Si la personne interrogée ne peut pas répondre parce que le temps consacré aux activités varie beaucoup d'un jour à l'autre ou bien parce qu'il y a une grande variété de travaux payés ou non, demandez : « Quelle a été la durée totale de votre marche au travail **ces 7 derniers jours** ? »]

\_\_\_ Heures par semaine [De 0 à 112]

\_\_\_ \_\_\_ \_\_\_ Minutes par semaine [De 0 à 6720, 9998, 9999]

9998. Ne sait pas/Pas sûr

9999. N'a pas répondu

## **2<sup>ème</sup> PARTIE : ACTIVITE PHYSIQUE LIEE AUX DEPLACEMENTS**

**LIRE** : Maintenant, pensez à la manière dont vous vous êtes déplacé d'un endroit à un autre, notamment pour vous rendre au travail, dans des magasins, au cinéma, etc.

Ces **7 derniers jours**, pendant combien de jours vous êtes-vous **déplacé en véhicule motorisé** comme le train, le bus, la voiture ou le tramway ? [De 0 à 7, 8, 9]

\_\_\_ Jours par semaine [Si la personne interrogée répond 0, passez à la question 10]

Ne sait pas / Pas sûr [Passez à la question 10]

N'a pas répondu [Passez à la question 10]

Quand vous vous êtes **déplacé** dans un véhicule à moteur (comme un train, un autobus, une voiture ou un tram) au cours d'un de ces jours, combien de temps cela a-t'il duré en moyenne ?

\_\_\_ Heures par jour [De 0 à 16]

\_\_\_ \_\_\_ \_\_\_ Minutes par jour [De 0 à 960, 998, 999]

998. Ne sait pas / Pas sûr

999. N'a pas répondu

[**Précision pour l'enquêteur** : On recherche une durée moyenne par jour. Si la personne interrogée ne peut pas répondre parce que le temps consacré aux activités varie beaucoup d'un jour à l'autre, demandez : « Quelle a été la durée totale de vos déplacements en véhicule motorisé **ces 7 derniers jours** ? »]

\_\_\_ Heures par semaine [De 0 à 112]

\_\_\_ \_\_\_ \_\_\_ Minutes par semaine [De 0 à 6720, 9998, 9999]

9998. Ne sait pas / Pas sûr

9999. N'a pas répondu

**LIRE : Maintenant, pensez à vos déplacements à vélo entre votre domicile et votre travail, pour faire des courses ou pour aller d'un endroit à un autre. Ne tenez compte que des trajets à vélo qui ont duré au moins 10 minutes d'affilée.**

Ces 7 **derniers jours**, pendant combien de jours avez-vous fait du vélo pour aller d'un endroit à un autre ? [De 0 à 7, 8, 9]

\_\_\_ Jours par semaine [Si la personne répond 0, passez à la question 12]

Ne sait pas/Pas sûr [Passez à la question 12]

N'a pas répondu [Passez à la question 12]

[**Clarification de l'enquêteur** : Pensez à vos déplacements à vélo qui ont duré au moins 10 minutes d'affilée.]

Quand vous avez fait du **vélo** au cours d'un de ces jours, combien de temps y avez-vous consacré en moyenne ?

\_\_\_ Heures par jour [De 0 à 16]

\_\_\_ Minutes par jour [De 0 à 960, 998, 999]

998. Ne sait pas/Pas sûr

999. N'a pas répondu

[**Clarification de l'enquêteur** : Pensez à vos déplacements à vélo qui ont duré au moins 10 minutes d'affilée.]

[**Précision pour l'enquêteur** : On recherche une durée moyenne par jour. Si la personne interrogée ne peut pas répondre parce que le temps consacré aux activités varie beaucoup d'un jour à l'autre, demandez : « Quelle a été la durée totale de vos déplacements à vélo pour aller d'un endroit à un autre **ces 7 derniers jours** ? »]

\_\_\_ Heures par semaine [De 0 à 112]

\_\_\_ Minutes par semaine [De 0 à 6720, 9998, 9999]

9998. Ne sait pas/Pas sûr

9999. N'a pas répondu

**LIRE : Maintenant, pensez au temps que vous avez passé à marcher pour vous déplacer entre votre domicile et votre travail, pour faire des courses ou pour aller d'un endroit à un autre. Incluez seulement la marche qui a duré au moins 10 minutes d'affilée. Ne tenez pas compte de la marche de loisir qui n'avait pas pour but le déplacement d'un endroit à un autre.**

Ces 7 **derniers jours**, pendant combien de jours vous êtes-vous **déplacé à pied** ? [De 0 à 7, 8, 9]

\_\_\_ Jours par semaine [Si la personne répond 0, passez à la 3<sup>ème</sup> partie]

Ne sait pas/Pas sûr [Passez à la 3<sup>ème</sup> partie]

9. N'a pas répondu [Passez à la 3<sup>ème</sup> partie]

[**Clarification de l'enquêteur** : Pensez seulement à la marche qui a duré au moins 10 minutes d'affilée.]

Quand vous avez marché **pour vos déplacements** au cours d'un de ces jours, combien de temps y avez-vous consacré en moyenne ?

\_\_\_ Heures par jour [De 0 à 16]

\_\_\_ Minutes par jour [De 0 à 960, 998, 999]

998. Ne sait pas/Pas sûr

999. N'a pas répondu

[**Clarification de l'enquêteur** : Pensez seulement à la marche qui a duré au moins 10 minutes d'affilée.]

[**Précision pour l'enquêteur** : On recherche une durée moyenne par jour. Si la personne interrogée ne peut pas répondre parce que le temps consacré aux activités varie beaucoup d'un jour à l'autre, demandez : « Quelle a été la durée totale de vos déplacements à pied pour aller d'un endroit à un autre **ces 7 derniers jours** ? »]

\_\_\_ Heures par semaine [De 0 à 112]

\_\_\_ Minutes par semaine [De 0 à 6720, 9998, 9999]

9998. Ne sait pas/Pas sûr

9999. N'a pas répondu

### **3<sup>ème</sup> PARTIE : MENAGE, ENTRETIEN DE LA MAISON, TEMPS PASSE A S'OCCUPER DE SA FAMILLE**

**LIRE** : Maintenant pensez aux activités physiques que vous avez faites ces 7 derniers jours à l'intérieur et à l'extérieur de votre domicile comme faire le ménage, le jardinage, faire des travaux d'entretien et vous occuper de votre famille.

**LIRE** : Pensez d'abord aux activités *intenses* qui demandent un *gros effort physique* et que vous avez faites dans votre jardin ou votre cour. Les activités intenses font respirer beaucoup plus fort que d'habitude et comprennent des activités comme soulever des charges lourdes, couper du bois, déblayer la neige ou bêcher. Encore une fois, pensez seulement aux activités physiques intenses qui ont duré au moins 10 minutes d'affilée.

Ces 7 derniers jours, pendant combien de jours avez-vous fait des activités physiques **intenses dans votre jardin ou votre cour** ? [De 0 à 7, 8, 9]

\_\_\_ Jours par semaine [Si la personne répond 0, passez à la question 16.]

Ne sait pas / pas sûr [Passez à la question 16]

N'a pas répondu [Passez à la question 16]

[**Clarification de l'enquêteur** : Pensez seulement aux activités physiques de ce type qui ont duré au moins 10 minutes d'affilée.]

Quand vous avez fait des activités physiques **intenses** dans votre jardin ou votre cour au cours d'un de ces jours, combien de temps y avez-vous consacré en moyenne?

\_\_\_ Heures par jour [De 0 à 16]

\_\_\_ Minutes par jour [De 0 à 960, 998, 999]

998. Ne sait pas / pas sûr

999. N'a pas répondu

[**Clarification de l'enquêteur** : Pensez seulement aux activités physiques de ce type qui ont duré au moins 10 minutes d'affilée.]

[**Précision pour l'enquêteur** : On recherche une durée moyenne par jour. Si la personne interrogée ne peut pas répondre parce que le temps consacré aux activités varie beaucoup d'un jour à l'autre, demandez : « Quelle a été la durée totale de vos activités physiques intenses dans votre jardin ou votre cour **ces 7 derniers jours** ? »]

\_\_\_ \_\_\_ Heures par semaine [De 0 à 112]

\_\_\_ \_\_\_ \_\_\_ \_\_\_ Minutes par semaine [De 0 à 6720, 9998, 9999]

9998. Ne sait pas / Pas sûr

9999. N'a pas répondu

**LIRE : Maintenant pensez aux activités dans votre jardin ou votre cour qui vous ont demandé un effort physique modéré. Les activités physiques modérées font respirer un peu plus fort que d'habitude et comprennent des activités comme soulever des charges légères, balayer, nettoyer les vitres et ratisser. Encore une fois, ne tenez compte que des activités physiques modérées qui ont duré au moins 10 minutes d'affilée.**

Ces **7 derniers jours**, pendant combien de jours avez-vous fait des activités **modérées dans votre jardin ou votre cour** ? [De 0 à 7, 8, 9]

\_\_\_ Jours par semaine [Si la personne interrogée répond 0, passez à la question 18]

8. Ne sait pas / Pas sûr [Passez à la question 18]

9. N'a pas répondu [Passez à la question 18]

[**Clarification de l'enquêteur** : Pensez seulement aux activités physiques de ce type qui ont duré au moins 10 minutes d'affilée]

Quand vous avez fait de l'activité physique **modérée** dans votre jardin ou votre cour au cours d'un de ces jours, combien de temps y avez-vous consacré en moyenne?

\_\_\_ \_\_\_ Heures par jour [De 0 à 16]

\_\_\_ \_\_\_ \_\_\_ Minutes par jour [De 0 à 960, 998, 999]

998. Ne sait pas / Pas sûr

999. N'a pas répondu

[**Clarification de l'enquêteur** : Pensez seulement aux activités physiques de ce type qui ont duré au moins 10 minutes d'affilée.]

[**Précision pour l'enquêteur** : On recherche une durée moyenne par jour. Si la personne interrogée ne peut pas répondre parce que le temps consacré aux activités varie beaucoup d'un jour à l'autre, demandez : « Quelle a été la durée totale de vos activités physiques modérées dans votre jardin ou votre cour **ces 7 derniers jours** ? »]

\_\_\_ \_\_\_ \_\_\_ Heures par semaine [De 0 à 112]

\_\_\_ \_\_\_ \_\_\_ Minutes par semaine [De 0 à 960, 998, 999]

9998. Ne sait pas / Pas sûr

9999. N'a pas répondu

**LIRE : Maintenant pensez aux activités à l'intérieur de votre domicile qui vous ont demandé au moins un effort physique modéré. Cela comprend des activités comme soulever des charges légères, nettoyer le sol ou les vitres et balayer. Ne tenez compte que des activités physiques modérées qui ont duré au moins 10 minutes d'affilée.**

[Clarification de l'enquêteur : Les activités modérées font respirer un peu plus fort que d'habitude.]

Ces **7 derniers jours**, pendant combien de jours avez-vous fait des activités **modérées à l'intérieur de votre domicile** ? [De 0 à 7, 8, 9]

\_\_\_ Jours par semaine [Si la personne interrogée répond 0, passez à la 4<sup>ème</sup> partie]

8. Ne sait pas / pas sûr [Passez à la 4<sup>ème</sup> partie]

9. N'a pas répondu [Passez à la 4<sup>ème</sup> partie]

[Clarification de l'enquêteur : Pensez seulement aux activités physiques de ce type qui ont duré au moins 10 minutes d'affilée.]

[Clarification de l'enquêteur : Ces **7 derniers jours**, combien de jours avez-vous fait des activités qui demandent **au moins un effort modéré** à l'intérieur de votre domicile ?]

Quand vous avez fait de l'activité physique **modérée** à l'intérieur votre maison au cours d'un de ces jours, combien de temps y avez-vous consacré en moyenne?

\_\_\_ Heures par jour [De 0 à 16]

\_\_\_ Minutes par jour [De 0 à 960, 998, 999]

998. Ne sait pas / Pas sûr

999. N'a pas répondu

[Clarification de l'enquêteur : Pensez seulement aux activités physiques de ce type qui ont duré au moins 10 minutes d'affilée.]

[Précision pour l'enquêteur : On recherche une durée moyenne par jour. Si la personne interrogée ne peut pas répondre parce que le temps consacré aux activités varie beaucoup d'un jour à l'autre, demandez : « Quelle a été la durée totale de vos activités physiques modérées à l'intérieur de votre domicile **ces 7 derniers jours** ? »]

\_\_\_ Heures par semaine [De 0 à 112]

\_\_\_ Minutes par semaine [De 0 à 6720, 9998, 9999]

9998. Ne sait pas / Pas sûr

9999. N'a pas répondu

**4<sup>ème</sup> PARTIE : ACTIVITE PHYSIQUE LIEE AUX LOISIRS, AU SPORT ET AU TEMPS LIBRE**

**LIRE : Maintenant, pensez à toutes les activités physiques que vous avez faites ces 7 derniers jours seulement dans le cadre de votre temps libre, de vos activités sportives ou de vos loisirs. Ne tenez pas compte des activités que vous avez déjà mentionnées.**

Sans compter la marche que vous avez déjà mentionnée, ces **7 derniers jours**, combien de jours avez-vous **marché** pendant au moins 10 minutes **pendant votre temps libre** ? [De 0 à 7, 8, 9]

\_\_\_ Jours par semaine [Si la personne répond 0, passez à la question 22]

8. Ne sait pas / pas sûr [Passez à la question 22]

9. N'a pas répondu [Passez à la question 22]

[**Clarification de l'enquêteur** : Pensez seulement à la marche qui a duré au moins 10 minutes d'affilée.]

Quand vous avez marché au cours de votre temps libre au cours d'un de ces jours, combien de temps y avez-vous consacré en moyenne ?

\_\_\_ Heures par jour [De 0 à 16]

\_\_\_ Minutes par jour [De 0 à 960, 998, 999]

998. Ne sait pas/Pas sûr

999. N'a pas répondu

[**Clarification de l'enquêteur** : Pensez seulement à la marche qui a duré au moins 10 minutes d'affilée.]

[**Précision pour l'enquêteur** : On recherche une durée moyenne par jour. Si la personne interrogée ne peut pas répondre parce que le temps consacré aux activités varie beaucoup d'un jour à l'autre, demandez : « Quelle a été la durée totale de votre marche pendant votre temps libre **ces 7 derniers jours** ? »]

\_\_\_ Heures par semaine [De 0 à 112]

\_\_\_ Minutes par semaine [De 0 à 6720, 9998, 9999]

9998. Ne sait pas / Pas sûr

9999. N'a pas répondu

**LIRE : Maintenant, pensez aux autres activités physiques que vous avez faites pendant votre temps libre pendant au moins 10 minutes d'affilée.**

**LIRE : Tout d'abord, pensez aux activités *intenses* qui demandent un gros effort physique et que vous avez faites pendant votre temps libre. Il peut s'agir d'activités comme courir, faire du vélo ou nager vite ou faire de la gym type aérobic.**

[**Clarification de l'enquêteur** : Les activités intenses font respirer plus fort que d'habitude.]

Ces **7 derniers jours**, pendant combien de jours avez-vous fait des activités physiques **intenses pendant votre temps libre** ? [De 0 à 7, 8, 9]

\_\_\_ Jours par semaine [Si la réponse est 0, passez à la question 24]

8. Ne sait pas / pas sûr [Passez à la question 24]

9. N'a pas répondu [*Passez à la question 24*]

[**Clarification de l'enquêteur** : Pensez seulement aux activités physiques **intenses** qui ont duré au moins 10 minutes d'affilée.]

Quand vous avez fait des activités physiques **intenses** au cours de votre temps libre au cours d'un de ces jours, combien de temps y avez-vous consacré en moyenne ?

\_\_\_ Heures par jour [De 0 à 16]

\_\_\_ Minutes par jour [De 0 à 960, 998, 999]

998. Ne sait pas / Pas sûr

999. N'a pas répondu

[**Clarification de l'enquêteur** : Pensez seulement aux activités physiques de ce type qui ont duré au moins 10 minutes d'affilée.]

[**Précision pour l'enquêteur** : On recherche une durée moyenne par jour. Si la personne interrogée ne peut pas répondre parce que le temps consacré aux activités varie beaucoup d'un jour à l'autre, demandez : « Quelle a été la durée totale de vos activités physiques intenses pendant votre temps libre **ces 7 derniers jours** ? »]

\_\_\_ Heures par semaine [De 0 à 112]

\_\_\_ Minutes par semaine [De 0 à 6720, 9998, 9999]

9998. Ne sait pas / Pas sûr

9999. N'a pas répondu

**LIRE : Maintenant, pensez aux activités qui demandent un effort physique modéré et que vous avez faites pendant votre temps libre. Il peut s'agir d'activités comme faire du vélo ou nager à un rythme tranquille ou jouer au tennis en double. Encore une fois, ne tenez compte que des activités modérées qui ont duré au moins 10 minutes d'affilée.**

[**Clarification de l'enquêteur** : les activités physiques modérées font respirer un peu plus fort que d'habitude.]

Ces **7 derniers jours**, pendant combien de jours avez-vous fait des activités physiques **modérées pendant votre temps libre** ? [De 0 à 7, 8, 9]

\_\_\_ Jours par semaine [*Si la personne répond 0, passez à la 5<sup>ème</sup> partie*]

Ne sait pas / pas sûr [*Passez à la 5<sup>ème</sup> partie*]

N'a pas répondu [*Passez à la 5<sup>ème</sup> partie*]

[**Clarification de l'enquêteur** : Pensez seulement aux activités physiques de ce type qui ont duré au moins 10 minutes d'affilée.]

Quand vous avez fait des activités physiques modérées pendant votre temps libre au cours d'un de ces jours, combien de temps y avez-vous consacré en moyenne ?

\_\_\_ Heures par jour [De 0 à 16]

\_\_\_ Minutes par jour [De 0 à 960, 998, 999]

998. Ne sait pas/Pas sûr



999. N'a pas répondu

[**Clarification de l'enquêteur** : Pensez seulement aux activités physiques de ce type qui ont duré au moins 10 minutes d'affilée.]

[**Précision pour l'enquêteur** : On recherche une durée moyenne par jour. Si la personne interrogée ne peut pas répondre parce que le temps consacré aux activités varie beaucoup d'un jour à l'autre, demandez : « Quelle a été la durée totale de vos activités physiques modérées pendant votre temps libre **ces 7 derniers jours** ? »]

\_\_\_ \_\_\_ Heures par semaine [De 0 à 112]

\_\_\_ \_\_\_ \_\_\_ \_\_\_ Minutes par semaine [De 0 à 6720, 9998, 9999]

9998. Ne sait pas/Pas sûr

9999. N'a pas répondu

## 5<sup>ème</sup> PARTIE : TEMPS PASSE ASSIS

**LIRE** : La dernière question porte sur le temps que vous avez passé assis ces 7 derniers jours. Incluez le temps passé au travail, à la maison, le temps passé à étudier ou en stage et le temps de loisirs. Cela peut comprendre le temps passé assis à votre bureau, assis lors d'une visite chez des amis, le temps passé à lire ou bien le temps passé assis ou allongé à regarder la télé. N'incluez pas le temps passé assis dans un véhicule motorisé que vous avez déjà mentionné.

En moyenne, ces 7 **derniers jours**, combien de temps avez-vous passé **assis pendant un jour de semaine** ?

\_\_\_ \_\_\_ Heures par jour [De 0 à 16]

\_\_\_ \_\_\_ \_\_\_ Minutes par jour [De 0 à 960, 998, 999]

998. Ne sait pas/Pas sûr

999. N'a pas répondu

[**Clarification de l'enquêteur** : Incluez le temps passé allongé sans dormir en plus du temps passé assis.]

[**Précision pour l'enquêteur** : On recherche une durée moyenne par jour. Si la personne interrogée ne peut pas répondre parce que le temps consacré aux activités varie beaucoup d'un jour à l'autre, demandez : « Au total, combien de temps avez-vous passé assis **mercredi dernier** ? »

\_\_\_ \_\_\_ Heures le mercredi [De 0 à 16]

\_\_\_ \_\_\_ \_\_\_ \_\_\_ Minutes le mercredi [De 0 à 960, 998, 999]

9998. Ne sait pas/Pas sûr

9999. N'a pas répondu

En moyenne, le week-end dernier, combien de temps avez-vous passé **assis au cours d'une journée** ?

\_\_\_ \_\_\_ Heures par jour [De 0 à 16]

\_\_\_ \_\_\_ \_\_\_ Minutes par jour [De 0 à 960, 998, 999]

998. Ne sait pas / pas sûr

999. N'a pas répondu

[**Clarification de l'enquêteur** : Incluez le temps passé allongé sans dormir en plus du temps passé assis.]

[**Précision pour l'enquêteur** : On recherche une durée moyenne par jour. Si la personne interrogée ne peut pas répondre parce que le temps consacré aux activités varie beaucoup d'un jour à l'autre, demandez : « Au total, combien de temps avez-vous passé assis **samedi dernier** ? »

\_\_\_ \_\_\_ Heures le samedi [De 0 à 16]

\_\_\_ \_\_\_ \_\_\_ \_\_\_ Minutes le samedi [De 0 à 960, 998, 999]

9998. Ne sait pas/Pas sûr

9999. N'a pas répondu

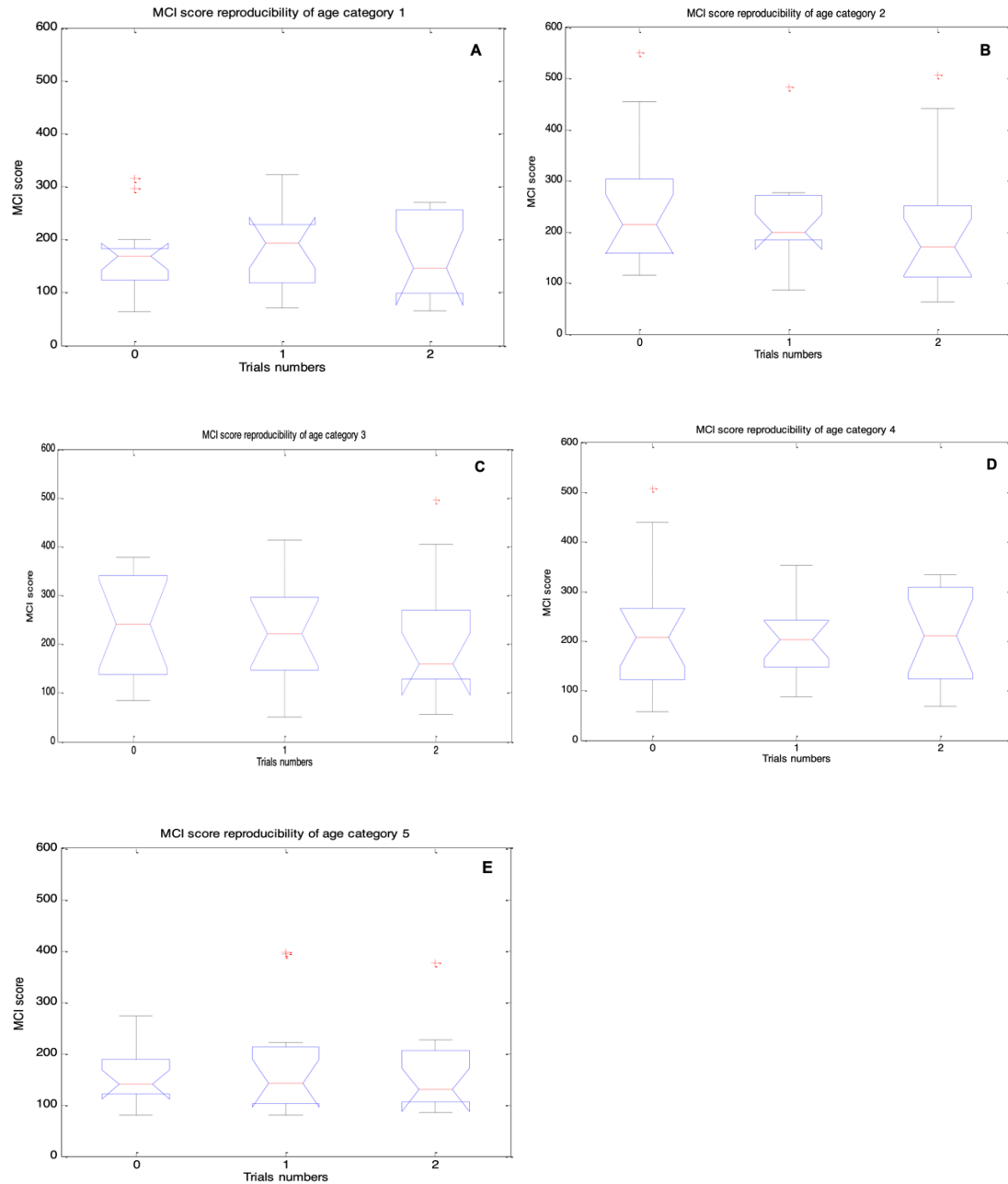

**Annex 2.** Reproducibility of the HD-sEMG Muscular Contraction Intensity MCI score ( $\mu\text{V}$ ) among the 3 sit to stand trials according to age categories (A: 25-34 yr.; B: 25-44 yr.; C: 45-54 yr.; D: 55-64 yr.; E = 65-74 yr.)

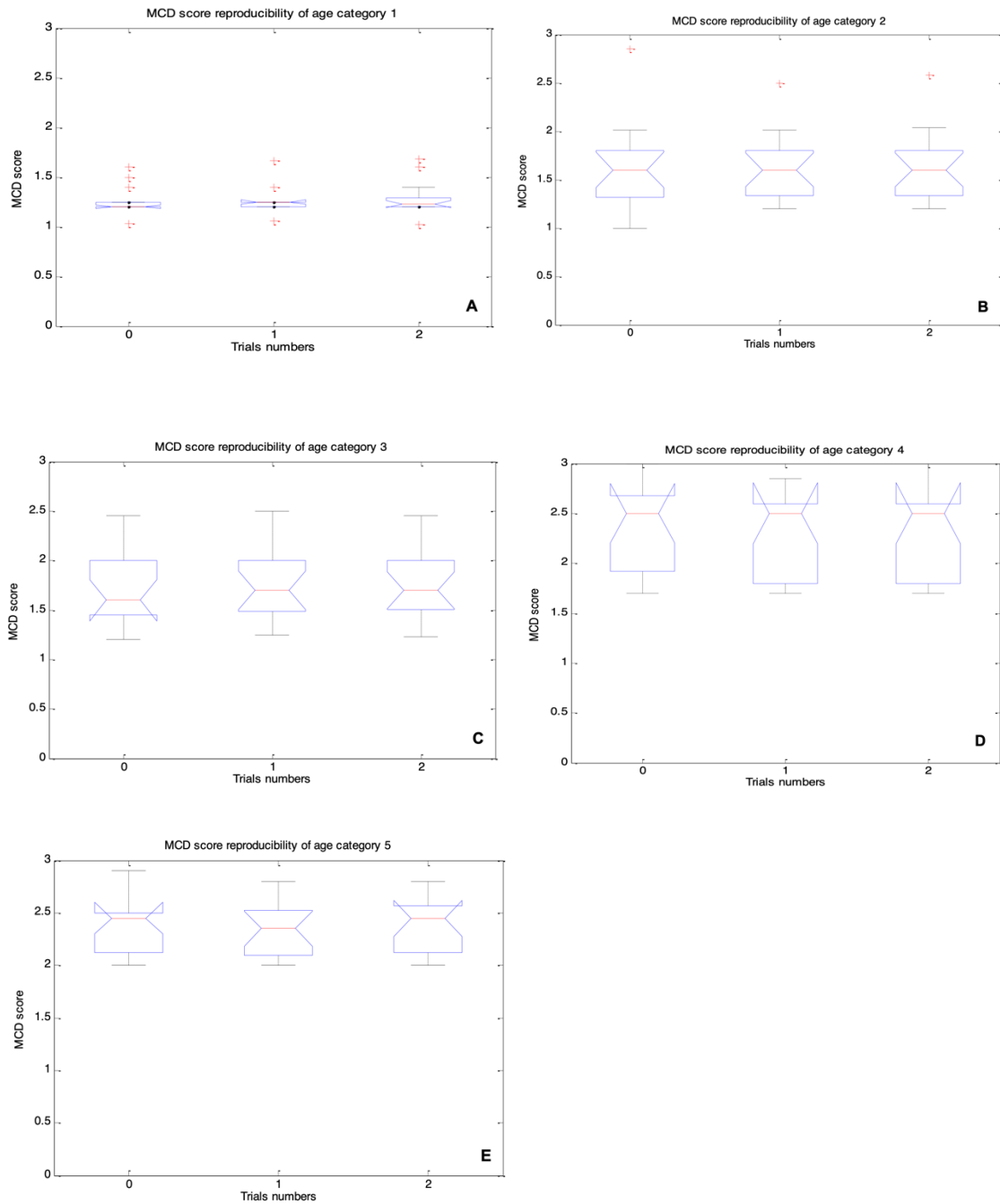

**Annex 3.** Reproducibility of the HD-sEMG Muscle Contraction Dynamics MCD score (Sec) among the 3 sit to stand trials according to age categories (A: 25-34 yr.; B: 25-44 yr.; C: 45-54 yr.; D: 55-64 yr.; E = 65-74 yr.)



## Annex 4. Poster of EUGMS congress 2017

### Evaluation of Motor Abilities in young and elderly subjects using HD-sEMG and IMU data

L. Imrani(1), S. Xeres(1), K. Lepetit(1), M. Al Harrach(1), S. Boudaoud(1), K. Kinugawa-Bourron(2,3), F. Marin(1).

1. Sorbonne Universités, Université de technologie de Compiègne, UMR CNRS 7338, Compiègne, France  
 2. Hôpital Pitié salpêtrière - Charles Foix(AP-HP), Ivry-sur-Seine, France





### Introduction

The aim of this study is to characterize the motor abilities of young compared to elderly subjects by combining a recent electromyography technique, the HD-sEMG (high density surface electromyography), and the Inertial Measurement Unit (IMU) to estimate muscle activation and motion efficiency during the sit-to-stand test (STS).

### Materials and Methods

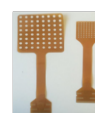
Twelve subjects participated in the STS test. Seven were healthy young subjects (25 ± 5.7 years), and five were elderly subjects (80 ± 7.8 years). All subjects performed sit-to-stand motion 5 times at spontaneous pace. The muscle activity was quantified using specific descriptors; contraction timing and intensity. Two 8 x 8 HD-sEMG grids were placed on the right and left femoral muscle. Simultaneously, the trunk maximum acceleration obtained by the IMU during STS test was measured.



Inertial Measurement Unit (IMU) 8 x 8 HD-sEMG grids

### Results

The results between young/elderly and men/women were compared. In addition, the statistical correlation was computed for age, sex, and body mass index (BMI) of the subjects.

Variables	Duration of a rising	intensity difference	Maximum acceleration
<b>Sexe</b>	N.S s=0.29 P>0.05	N.S s=0.13 P>0.05	
<b>Age</b>	S s=0.022 P<0.01**	V.S s=3.344* -05 P<0.001***	V.S s=0.011* -07 P<0.001***
<b>BMI</b>	N.S s=0.4 P>0.05	S s=0.0014 P<0.01**	

BMI : body mass index. N.S : not significant. V.S: Very significant. S: significant

### Conclusion

- the sex did not have a significant influence on the motor efficiency (p>0.05) in the STS test.
- HD-sEMG descriptors related to muscular activity, and the trunk maximum acceleration are discriminant with the age (p<0.001\*\*\*).
- The BMI has also significant impact on specific parameters (P<0.01\*\*).

→ The obtained results demonstrated the potential of the combination of HD-sEMG and IMU data processing for functional motor ability assessment. Further developments are promising for the evaluation of motor aging and sarcopenia in clinical routine.

*Acknowledgements : This work has received support from "Agence Nationale de Recherche" ANR-11-IDEX-0004-02 under Idex "Sorbonne Universités" in the investments for the future program*

## Annex 5. Poster of EUGMS congress 2018



### Evaluation of Motor Abilities with aging using HD-sEMG

L. Imrani(1), S. Boudaoud(1), K. Kinugawa(2,3), K. Lepetit(1), J. Laforêt(1), F. Marin(1).

1. Sorbonne Universités, Université de technologie de Compiègne, UMR CNRS 7338, Compiègne, France

2. Hôpital Pitié salpêtrière - Charles Foix(AP-HP), Ivry-sur-Seine, France



#### Introduction

Preliminary study obtained in older patients [1] by using the HD-sEMG and IMU techniques have shown that HD-sEMG descriptors related to muscular activity and the trunk maximum acceleration are discriminant with the age. The aim of this study is to characterize the motor abilities with aging, including middle-aged subjects and using new descriptors, by combining both techniques, embedded in a recent ambulatory portable device.

#### Materials and Methods

Nine subjects participated. Three were aged  $25 \pm 2$  years, four were aged  $34.75 \pm 3.09$  years, and two were aged  $57 \pm 7.07$  years. All of them performed sit-to-stand motion 3 times at spontaneous pace. New features, the high order statistics, were also tested in addition to previous descriptors [1] such as contraction timing and intensity, in order to check their efficiency. For this purpose, 4 x 8 HD-sEMG grids were placed on the quadriceps muscle. Simultaneously, the trunk maximum acceleration was also measured. Thus, the results for the three age categories were statistically evaluated.

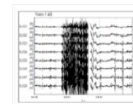

Acquisition of HD\_sEMG signals

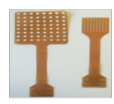

HD-sEMG grids

#### Results

The results showed that the statistical descriptors, tested on the three categories with ANOVA test, have a significant sensitivity to the motor efficiency with aging in the STS test ( $p < 0.001^{***}$ ). Contraction timing and intensity related to muscular activity, and the trunk maximum acceleration are also discriminant with the age ( $p < 0.001^{**}$ ), tested on three categories with ANOVA test, in agreement with obtained results in [1].

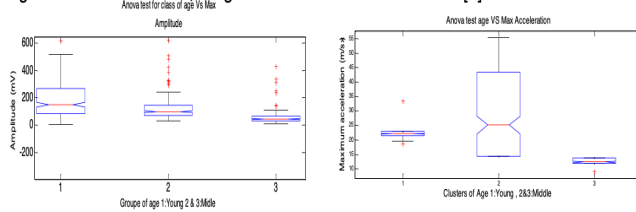

#### Conclusion

- The obtained results demonstrated the potential of statistical and previous descriptors from HD-sEMG and IMU data recorded by an ambulatory device for evaluating functional motor abilities with aging.

*Acknowledgements : This work has received support from EIT Health BP2018.*

#### Reference :

[1] EUGMS 2017 Congress, «Evaluation of Motor Abilities in young and older subjects using HD-sEMG and IMU data», IMRANI et al.