



HAL
open science

Causal and logical loops from quantum theory

Hippolyte Dourdent

► **To cite this version:**

Hippolyte Dourdent. Causal and logical loops from quantum theory. Quantum Physics [quant-ph]. Université Grenoble Alpes [2020-..], 2022. English. NNT: 2022GRALY006 . tel-03771904

HAL Id: tel-03771904

<https://theses.hal.science/tel-03771904v1>

Submitted on 7 Sep 2022

HAL is a multi-disciplinary open access archive for the deposit and dissemination of scientific research documents, whether they are published or not. The documents may come from teaching and research institutions in France or abroad, or from public or private research centers.

L'archive ouverte pluridisciplinaire **HAL**, est destinée au dépôt et à la diffusion de documents scientifiques de niveau recherche, publiés ou non, émanant des établissements d'enseignement et de recherche français ou étrangers, des laboratoires publics ou privés.

THÈSE

Pour obtenir le grade de

DOCTEUR DE L'UNIVERSITÉ GRENOBLE ALPES

Spécialité : Physique Théorique

Arrêté ministériel : 25 mai 2016

Présentée par

Hippolyte DOURDENT

Thèse dirigée par **Cyril BRANCIARD**, Chargé de Recherche,
Université Grenoble Alpes
et codirigée par **Jean-Philippe POIZAT**, Université Grenoble Alpes

préparée au sein du **Laboratoire Institut Néel**
dans l'**École Doctorale Physique**

Boucles causales et logiques de la théorie quantique

Causal and Logical Loops from Quantum Theory

Thèse soutenue publiquement le **10 février 2022**,
devant le jury composé de :

Monsieur CASLAV BRUKNER

Professeur, Universität Wien, Rapporteur

Monsieur PABLO ARRIGHI

Professeur des Universités, UNIVERSITE PARIS- SACLAY, Rapporteur

Madame ANA BELEN SAINZ

Docteur en sciences, Uniwersytet Gdanski, Examinatrice

Monsieur AURELIEN DREZET

Chargé de recherche HDR, CNRS DELEGATION ALPES, Examinateur

Monsieur MNACHO ECHENIM

Professeur des Universités, GRENOBLE INP, Président

Madame LIDIA DEL RIO

Docteur en sciences, Ecole Polytechnique Fédérale de Zurich,
Examinatrice



Causal and Logical Loops from Quantum Theory

Hippolyte Dourdent¹

¹Univ. Grenoble Alpes, CNRS, Grenoble INP, Institut Néel, 38000 Grenoble, France ;
hippolyte.lazourenko-dourdent@neel.cnrs.fr

Cette thèse est dédiée à Paulette Lazourenko.

Time is the means by which God realized the inconceivable that P and non- P are both true.
Kurt Gödel



*Causal and Logical Loops from Quantum Theory (in the style of Van Gogh) ,
VQGAN+CLIP.*

Abstract

The fundamental nature of causality has been challenged by quantum theory. In particular, recent developments have shown that by relaxing the standard assumption that quantum events are embedded in a fixed background causal structure, a new kind of causal relations, indefinite, can emerge. These indefinite causal structures have been interpreted as causal loops allowing for the violation of a form of causality without paradoxes. On the other hand, quantum contextuality shows that any attempt to extend quantum theory such that classical logic holds in the extended domain fails due to the rise of inconsistent logical loops. There has been increasing evidence that it is a key feature in the understanding of quantum paradoxes. This thesis aims at improving our understanding of indefinite causal orders and quantum paradoxes in order to address the question: “Could the non-fundamental nature of causality be related to a form of contextuality ?”

The process matrix formalism is a mathematical framework which, in analogy with entanglement and the violation of Bell inequalities (nonlocality), offers new tools — witnesses of causal nonseparability and the violation of causal inequalities with noncausal correlations — to study and identify indefinite causal orders. In a bottom-up approach, I have studied a large class of physically implementable processes, the quantum circuits with quantum control of causal order (QC-QCs), that includes causally nonseparable processes such as the celebrated “quantum switch”. However these circuits cannot be used to violate causal inequalities. Nevertheless, in another work, I have proposed a significant relaxation of assumptions to certify the causal nonseparability of many processes, showing that it can be done in a semi-device-independent scenario with untrusted local operations and trusted quantum inputs. In particular, I have shown that the quantum switch can generate noncausal correlations in this kind of scenario.

In order to refine my understanding of quantum contextuality, I have investigated the origins of the Kochen-Specker theorem and I have analysed how the Hardy paradox entails a form of logical contextuality. I have identified that the two possible intermediate measurements involved in a pre-post-selection version of the paradox differ causally from each other. This analysis might be useful to study the Frauchiger-Renner paradox, a “meta-version” of the Hardy paradox. On a more metaphysical aspect, I have argued for a “Gödelian hunch” from quantum theory, the idea that quantum paradoxes emerge from a lack of distinction between theoretical and metatheoretical objects.

Finally, in order to establish a link between indefinite causal orders and contextuality, I have proposed a new causal game, in which the grandfather paradox is formalized in terms of a logical inequality. Some process matrices can violate the causal inequality without violating the logical one. I suggest that the emergence of logical inconsistencies induced by the violation of a logical inequality might be interpreted as a form of contextuality.

Résumé

La nature fondamentale de la causalité a été remise en cause par la théorie quantique. En particulier, des développements récents ont montré qu'en abandonnant l'hypothèse standard selon laquelle les événements quantiques sont intégrés dans une structure causale fixe, un nouveau type de relations causales, indéterminées, peut émerger. Ces structures causales indéterminées ont parfois été interprétées comme des boucles causales permettant de violer une forme de causalité sans paradoxes. D'autre part, la contextualité quantique montre que toute tentative d'extension de la théorie quantique de sorte que la logique classique s'applique dans le domaine étendu échoue en raison de l'émergence de boucles logiques incohérentes. Il y a de plus en plus de preuves que cette caractéristique constitue un élément clé dans la compréhension des paradoxes quantiques. Cette thèse vise à améliorer notre compréhension des ordres causaux indéterminés et des paradoxes quantiques afin de répondre à la question : "La nature non fondamentale de la causalité pourrait-elle être liée à une forme de contextualité ?"

Le formalisme des matrices de processus est un cadre mathématique qui, par analogie avec l'intrication et la violation d'inégalités de Bell (non-localité), offre de nouveaux outils - témoins de non-séparabilité causale et violation d'inégalités causales avec des corrélations non-causales - permettant d'étudier et d'identifier les ordres causaux indéterminés. Dans une approche ascendante (bottom-up), nous avons identifié une grande famille de processus physiquement implémentables, les circuits quantiques avec contrôle quantique d'ordres causaux (QC-QCs), qui incluent des processus causalement non-séparables tels que le célèbre "quantum switch". Cependant, ces circuits ne peuvent pas être utilisés pour violer des inégalités causales. Néanmoins, dans un autre travail, en assouplissant significativement les hypothèses permettant de certifier la non-séparabilité causale de nombreux processus, j'ai montré que cette certification pouvait être réalisée dans un scénario "semi-device-independent" avec des opérations locales non fiables et des entrées quantiques fiables. En particulier, j'ai montré que le quantum switch peut générer des corrélations non-causales dans ce type de scénario.

Afin d'affiner ma compréhension de la contextualité quantique, j'ai enquêté sur les origines du théorème de Kochen-Specker et j'ai analysé comment le paradoxe de Hardy implique une forme de contextualité logique. J'ai identifié que les deux mesures intermédiaires possibles impliquées dans une version "pré-post-sélection" du paradoxe diffèrent causalement l'une de l'autre. Cette analyse pourrait être utile à l'étude du paradoxe de Frauchiger-Renner, une "méta-version" du paradoxe de Hardy. Sur un aspect plus métaphysique, j'ai plaidé en faveur d'une "intuition gödelienne" issue de la théorie quantique, l'idée que les paradoxes quantiques émergent d'un manque de distinction entre objets théoriques et méta-théoriques.

Enfin, afin d'établir un lien possible entre les ordres causaux indéterminés et la contextualité, j'ai proposé un jeu causal original, dans lequel le paradoxe du grand-père est formalisé en termes d'inégalité logique. Certaines matrices de processus peuvent violer l'inégalité causale sans violer l'inégalité logique. J'ai suggéré que l'émergence d'incohérences logiques issue de la violation d'une inégalité logique pourrait être interprétée comme une forme de contextualité.

Remerciements

Je souhaiterais avant tout commencer par remercier mon directeur de thèse, Cyril Branciard: merci d’avoir accepté d’encadrer mes travaux pendant ces trois années, de m’avoir fait confiance en me laissant définir ce sujet de thèse qui me tenait tant à coeur, de m’avoir à la fois donné la liberté dont j’avais besoin mais également d’avoir répondu à la moindre de mes sollicitations, et de m’avoir soutenu dans les moments difficiles. Ce fut à la fois un plaisir et une fierté d’apprendre et travailler à tes côtés.

Merci à Jean-Philippe Poizat d’avoir accepté le rôle de co-directeur. Je souhaite également remercier Alexei Grinbaum, pour ses conseils avisés et pour m’avoir initié au domaine des fondements quantiques il y a de cela cinq ans.

Je suis profondément reconnaissant envers l’ensemble des personnes avec lesquelles j’ai collaboré et auprès desquelles j’ai tant appris: mes “partenaires” Julian Wechs et Alastair Abbott (que j’ai énormément embêtés au cours de ma première année) ; Mehdi Mhalla, Aurélien Drezet et Dominic Horsman qui ont suivi ma thèse et m’ont conseillé tout au long de son élaboration ; Alexia Auffèves (qui partage mon amour pour les restaurants et la philosophie), Cristian Mariani (pour l’organisation du meilleur journal club de tous les temps), Ivan Šupić et Nicolas Brunner (pour leur précieuse collaboration), Vilasini, Eleftherios Tselentis et Amin Baumeler (pour les discussions passionnantes que nous avons eu à Zurich).

Je souhaite ensuite remercier l’ensemble des trublions de la feue F218: Hippo-Marco, Laurie (pour avoir eu, à trois reprises, la folle idée de me laisser tenter de convertir ses étudiants à l’anti-réalisme), “my Badminton sensei” Samyak, mes partenaires de danse Patrice et Maria, mon “successeur” Raphaël, Léa, Juliette et Richard. Merci également aux “PLUMs” Alexandra, Pierre, Smail, Augustin, sans oublier les membres adoptifs Guillian, Marie et Juan, pour tous les moments passés à vos côtés.

Merci à mes amis qui m’ont accompagné tout au long de cette thèse. Les “Grenoblois”: les “Vrais”, mon irremplaçable “psy” Morgane, Pedro, Jovanie et Clothilde pour leur inestimable soutien, ma binôme d’oreille Cyrielle, Lucie, Jean et Yann pour nos innombrables sorties cinés et pour avoir assisté à mes côtés à la chute d’une grande série ; et les “Parisiens”: “Bibi” Cyprien, Sarah, Camille, Agathe et Arlequin, les team “Passage d’Informations Participatif et Interactif (P.I.P.I.)” et “Come si faaa ?”.

Merci à Alexandra Elbakyan, Ponce, les Croute et Kevin Penkin qui ne me connaissent pas mais ont été d’une aide précieuse.

Enfin, merci à ma famille, mes parents et mes frères, pour tout.

Contents

Introduction	11
0.1 General Remarks	14
0.1.1 Disciplinary identity of the dissertation	14
0.1.2 Goals and results	17
0.1.3 Outline	20
0.2 Philosophy of this dissertation	21
I Quantum Causality	23
1 Causality and Quantum Theory	25
2 Preliminaries	30
2.1 From Operational Quantum Theory to the Process Matrix Formalism . . .	30
2.2 Local Quantum Operations	31
2.3 Process Matrices	33
2.4 Causal nonseparability	34
2.4.1 Device-Dependent Certification: Causal Witnesses	36
2.4.2 Device-Independent Certification: Non-causal correlations	39
2.5 Physical Indefinite Causal Orders: the Quantum Switch	42
2.6 What are process matrices ?	45
3 Beyond the Quantum Switch: Quantum Circuits with Quantum Control of causal orders	49
3.1 Quantum Circuits and Process Matrices as Quantum Supermaps	50
3.2 Quantum Circuits with Fixed Causal Order	52
3.3 Quantum Circuits with Classical Control of causal order	55
3.4 Quantum Circuits with Quantum Control of causal order	63
3.4.1 A new implementation of the quantum switch	68
3.4.2 The “quantum N -switch” and other simple generalisations	71
3.4.3 New examples of causally nonseparable QC-QCs	72
3.5 Applications	78
3.5.1 Probabilistic quantum circuits	78
3.5.2 Discrimination task and advantages	80
3.6 All QC-QCs admit a causal model	80
3.7 Take Away and Perspectives	81
4 Witnessing Causal Nonseparability with Quantum Inputs	83
4.1 Analogous Characterisations of Non-Locality and Non-Causality	83
4.2 Semi-device independent certification of entanglement with quantum inputs	86

4.2.1	Bell nonlocality, a brief reminder	87
4.2.2	Buscemi nonlocality and Measurement-DI entanglement witnesses	88
4.3	Post-quantum Buscemi nonlocality and D-POVMs	90
4.4	Causal scenario with quantum inputs	91
4.5	Causally separable D-POVMs	92
4.6	SDIQI certification of causal nonseparability	97
4.6.1	Witnesses of causal nonseparability for D-POVMs	97
4.6.2	Causally nonseparable D-POVM from noncausal process matrices	99
4.6.3	Causally nonseparable D-POVM from a Werner-like process matrix	100
4.6.4	Causally nonseparable D-POVM from the quantum switch	103
4.7	Certifying all bipartite causally nonseparable process matrices with trusted quantum inputs	104
4.8	One-sided device independent certification of causal nonseparability with trusted quantum inputs	106
4.8.1	TTU-noncausal process matrices	106
4.8.2	MDCI-MDCI-DI certification of TTU-noncausal process matrices	107
4.9	Take Away and Perspectives	110
II	Quantum Contextuality	111
5	Contextualisation	113
6	Infuturabilia: the Kochen-Specker theorem	114
6.1	Introduction	114
6.2	Specker’s logical inspiration: “Is logic empirical ?”	117
6.3	Specker’s scholastic inspiration: “Infuturabilia”	118
6.4	Contextuality and the Jonah paradox	120
7	Contextuality from the Hardy Paradox	122
7.1	The Hardy Paradox	123
7.2	Logical Contextuality	125
7.2.1	Topological approach	125
7.2.2	Hypergraph approach	128
7.3	A Logical Pre-Post-Selection Paradox	135
7.3.1	The two-time state formalism	136
7.3.2	Anomalous weak values	136
7.3.3	The three-box paradox	137
7.3.4	The LPPS Hardy paradox	138
7.4	Take Away and Perspectives	142
8	Meta-Contextuality: a neo-Copenhagen approach to quantum theory	143
8.1	Introduction: Is Physics Paradoxical ?	143
8.2	“It’s Meta”: a “Gödelian Hunch” from Contextuality	147
8.3	The Measurement Problem as a Self-Referential Paradox	149
8.4	What is it like to be a Schrödinger cat ?	154
8.5	Wigner’s Friendifications	157
8.6	The Heirs of Copenhagen	161
8.7	Take Away and Perspectives	164

III “Time-Travel without Paradoxes”	166
9 Disclaimer and Introduction	168
10 A Gödelian Hunch from Time	169
11 Relating Quantum Contextuality and Noncausality ?	172
11.1 A hypergraph representation of noncausality?	174
11.2 A relation between noncausality and anomalous weak values?	175
12 Violation of Causal and Logical Inequalities in a causal game	177
12.1 Related Work	178
12.2 From the Grandfather paradox to Liar games.	178
12.3 The Paradoxical Game G	180
12.4 The Contingent Strengthened Liar subgame G_0	180
12.5 The Contingent Strengthened Liar subgame G_1	181
12.6 Causal inequality and its violation in game G	182
12.7 Logical inequality and its violation in game G	183
12.8 Take Away and Perspectives	186
Conclusion and Perspectives	188
Résumé synthétique	190
Appendix	199
A Graphical Calculus for Open Quantum Systems	199
A.1 Quantum Diagrams	199
A.2 Graphical representation of the Choi-Jamiolkowski isomorphism	201
A.3 The Link Product	203
B Construction of MDIEW for all entangled states	204
C A Contextuality Tale	206
D A Yu-Oh-like Proof	208

Introduction

In his novel “*Le Voyageur imprudent*” (“*Future Times Three*”, 1944) [1], French author René Barjavel tells the story of a misfortunate time traveler, Pierre Saint-Menoux, who accidentally kills his ancestor in the past. This is the first appearance of the *grand-father paradox*, a scenario in which an effect suppresses its own cause. In a 1958 post-scriptum entitled “*To be and not to be*” (1958), Barjavel writes:

“However, for Pierre Saint-Menoux there can be no end. Think about it: he killed his ancestor before the latter had time to marry and have children. So he disappears, that’s understood. He doesn’t exist, he never existed. There never was a Pierre Saint-Menoux. Good ... But if Saint-Menoux does not exist, if he never existed, he could not have killed his ancestor! ...” “*To be or not to be ? Hamlet wondered. To be and not to be, replies Saint-Menoux. [...] I do not know what to tell you. It is impossible for me to imagine his condition. For our human mind, limited, crippled, only the “or” of Hamlet is apprehensible. It is already, alas, enough anguish. The “and” of Saint-Menoux makes us lose our balance. We are at the extreme edge of our rational universe. One more step, one more word, and this is the beginning of abysses, the logic of the absurd, and the proven evidence of the possibility of the impossible.* ([1], personal translation)¹”

This could be waved aside as a mere science-fiction fantasy, irrelevant for physicists. However, in 1949, Kurt Gödel discovered solutions of general relativity containing closed time-like curves (CTCs), objects that would theoretically allow an observer to travel back into her own past [2]. Despite the hypothetical nature of their existence, CTCs have thus lead physicists to consider the possibility of “time-travel paradoxes” such as the grandfather inconsistency, and lead them to find solutions to avoid it [3, 4].

Furthermore, interestingly, Barjavel refers to quantum theory as a possible loophole allowing to “vaguely” understand the paradox:

“No metaphor can help us. His quality of being is unknowable to us. Only the great physicists of our time, specialists of the constituent particles of the atom, could perhaps have a very vague idea about it. ([1], personal translation)²”

Let us take Barjavel’s intuition “seriously”, and use it as a guideline to this thesis, asking ourselves:

How can the grand-father paradox be related to quantum theory ?

¹*“Pourtant, pour Pierre Saint-Menoux il ne saurait y avoir de fin. Réfléchissez: il a tué son ancêtre avant que celui-ci ait eu le temps de prendre femme et d’avoir des enfants. Donc il disparaît, c’est entendu. Il n’existe pas, il n’a jamais existé. Il n’y a jamais eu de Pierre Saint-Menoux. Bon... Mais si Saint-Menoux n’existe pas, s’il n’a jamais existé, il n’a pas pu tué son ancêtre!... [...] Être ou ne pas être ? se demandait Hamlet. Être et ne pas être, réplique Saint-Menoux. Je ne sais que vous dire. Il m’est impossible d’imaginer son état. Pour notre esprit humain, limité, infirme, seul le « ou » d’Hamlet est préhensible. C’est déjà, hélas, bien assez d’angoisse. Le « et » de Saint-Menoux nous fait perdre l’équilibre. Nous sommes à l’extrême bord de notre univers rationnel. Un pas de plus, un mot de plus, et c’est le commencement des abîmes, la logique de l’absurde, et l’évidence démontrée de la possibilité de l’impossible.”*

²*“Aucune métaphore ne peut nous aider. Sa qualité d’être nous est inconnaisable. Seuls pourraient peut-être s’en faire une très vague idée les grands physiciens de notre temps, spécialistes des particules constituantes de l’atome.”*

- A first track is to look at what quantum theory has to say about causality.

Causality is the idea that events in the present are caused by events in the past and act as causes for events in the future. An event cannot be influenced by events in its future. This is considered as one of the most fundamental concepts in science. However the stability of this pillar of physics has been threatened by the counter-intuitive features of quantum theory. Facing quantum indeterminacy, which prevent from “know[ing] the present in detail” [5] and thus from “predicting the future”, Bohr proposed to overcome the “failure of causality” by replacing it with his concept of *complementarity* [6], as a new relationship between events to account for phenomena. The nonlocal correlations of quantum theory [7, 8] also put the fundamental nature of causality in a difficult position. In fact, they can only satisfy the very natural *Reichenbach’s principle of a common cause* - “according to which correlations among events that are not related as cause and effect are explained by a common cause in their joint past that screens off the correlation” [9] - at the cost of exotic characteristics such as superluminal or retrocausal signalling [10]. These considerations motivate the first question of this thesis:

Is causality fundamental ?

To tackle this issue, one can for example consider relaxing an assumption from the standard formulation of quantum theory that quantum events are embedded in a fixed background causal structure. One can then imagine extending quantum indeterminacy - which applies to physical quantities such as the position, the momentum or the spin of a particle - to the causal relations between events themselves. Intuitively, for two events A and B in a causal relation with each other, in addition to the well defined causal relations “ A is in the causal past of B .” and “ B is in the causal past of A .”, this relation may now also be indeterminate.

In 2005, Lucien Hardy paved the way for this new quantum approach of causality by introducing formalisms in which the causal orders were not fixed a priori [11, 12]. Seven years later, among other alternatives [13, 14], Oreshkov, Costa and Brukner also proposed a framework that relies on relaxing the traditional assumption of predefined global causal order, while parties in distinct laboratories can still perform arbitrary local quantum operations: the *process matrix formalism* [15]. While it provides a unified description of standard quantum resources compatible with a definite causal order, such as entangled states and quantum channels, the process matrix formalism also allowed to identify a new kind of objects (process matrices) with *indefinite causal orders*. New conceptual tools were developed to study and identify these indefinite causal orders: causal nonseparability, which can be certified in a device-dependent way by constructing causal witnesses [16, 17], and noncausality, a device-independent certification based on the violation of causal inequalities [15, 18]. These are direct analogies to the famous quantum entanglement (also sometimes called quantum nonseparability) and famous violation of Bell’s inequalities by quantum correlations, which discriminates correlations that fulfil the condition of local causality from those that do not [7, 8, 19].

An important and simple example of a causally nonseparable quantum resource, i.e. incompatible with a definite causal order, is the ‘quantum switch’ [13], a causal variation of Schrödinger’s cat in which the order of two quantum operations (instead of the “life or death” state of a cat) is entangled with a quantum system. Despite being causally nonseparable and allowing for the realization of new information tasks which are impossible

with standard quantum circuits [16, 20], this process cannot generate noncausal correlations that violate a causal inequality [16, 21]. The new formalism suggests that certain mathematical solutions may allow to do so [15, 18, 22]. However, the question of the physical realization of such processes remains open [23].

Remarkably, process matrices were shown to correspond to a specific kind of CTC based on post-selection and quantum teleportation [24, 25]. They are thus sometimes said to be *causal loops* allowing one to “send information backward in time without paradoxes” [15, 26]. The logical inconsistencies are in fact avoided by a consistency principle, imposing that processes generate non-negative and normalized probabilities under any choice of the parties’ operations. Logical consistency arises then as a more fundamental notion than causality [27].

- Another path is to interpret the grandfather paradox as a (speculative) physical realization of a self-contradiction, and highlight how quantum theory might be characterized by a similar logical structure.

Quantum indeterminacy is often presented as the fact that “the result of a quantum measurement depends on the experimental context.” This vague adage inspired by Bohr’s philosophical concept of complementarity [6], finds strong mathematical grounds from the Kochen-Specker theorem [28]. The latter shows that quantum theory is incompatible with the view that physical observables possess pre-existing values independent of the measurement context, a feature called *quantum contextuality*. After various works consisting in simplifying the proof of the theorem [29, 30, 31, 32, 33, 34, 35], increasing evidence have highlighted that contextuality might be a central notion that captures precisely what makes quantum theory fundamentally different from classical physics ; a witness of quantum weirdness [36]. Quantum contextuality has for example been identified as an important ingredient in the quest for the recipe that will allow to reach the Holy Grail of universal quantum computation [37, 38]. Furthermore, recent results suggest that contextuality may be more fundamental than Bell nonlocality, which can be seen, in some sense, as a particular case of contextuality. Graphical generalisations of the Kochen-Specker result have allowed to established connections between nonlocal and contextual correlations [39], and identify how nonlocality can be expressed in a contextuality scenario [40]. Another approach initiated by Robert Spekkens [41], generalises the notion of measurement contextuality from the Kochen-Specker theorem to any kind of experimental procedure (preparations, transformations) in a theory-independent way, allowing to directly compare this “universal” contextuality with Bell’s assumption of local causality [8]. Finally, contextuality and its relation with nonlocality have also been studied in topological approaches [42, 43, 44]. In [45], contextuality emerges when data are locally consistent, but globally inconsistent, and it shares a similar logical structure with famous semantic paradoxes such as the Liar paradox. This brings us to another main issue motivating this thesis:

Is physics paradoxical ?

In other words, does Nature entail logically inconsistent phenomena ? The Kochen-Specker theorem has shown that quantum theory is not only counter-intuitive, but goes against our own logic: any attempt to extend it such that classical logic holds in the extended domain fails due to the rise of inconsistent *logical loops*. Recent new quantum

paradoxes [46, 47], that involve these quantum logical loops as well as observers who can perform a quantum measurement on other observers who measure themselves quantum systems, have been interpreted as showing that “quantum theory cannot consistently describe the use of itself” [47]. These bring up to date previous analyses [48, 49, 50, 51, 52] of the famous measurement problem, which asks whether a quantum state is projected or not during a measurement. In such analyses, the problem arises from a self-reference, a mere logical error in which the observer is both an object and a user of the theory.

- Finally, we can examine the interplay between quantum causality and contextuality.

As Bell nonlocality may be seen as a kind of contextuality, and because of the analogy between nonlocality and noncausality, one could expect the existence of a link - yet to be explored - between indefinite causal relations and contextuality in quantum theory, thus raising the question:

Could the non-fundamental nature of causality be related to a form of contextuality ?

0.1 General Remarks

0.1.1 Disciplinary identity of the dissertation

This dissertation belongs to the field of Quantum Foundations. This field aims at better understanding what quantum theory means, or as Wheeler puts it:

“*Why the Quantum ?*” [53]

Quantum physics is “strange”. At least, that is how it seems to be perceived by society, the popular science press, and most of the scientific community. While physics usually aims to describe the world and to dissolve its strangeness, or at least to familiarize with it, quantum theory is surrounded by a certain aura of complexity and stupor. Penrose has declared that “*Quantum mechanics doesn’t make any sense.*” ; Feymann observed that “*nobody really understands quantum mechanics*” ; Bohr would have advocated that “*Those who are not shocked when they first come across quantum theory cannot possibly have understood it.*” [54] and finally Greenberger likes to say that “*Quantum mechanics is magic.*” [55]. Why is quantum theory so strange ? After the (very often decontextualized as above) authority argument, come the examples. An anthology of “quantum phenomena”, each one more fantastic and bizarre than the others, are invoked: the elusive nature of light and matter, “sometimes waves, sometimes corpuscles”; Schrödinger’s “undead” cat, or the facetious “hidden and conspiratorial influences” from quantum nonlocality.

The uncanny (“*Unheimliche*”) feeling of weirdness that may shine out from quantum theory is often attenuated by relegating its scope to “the world of the infinitely small”. This conveys the ambiguous idea that as strange as quantum theory may be, we would never have to be directly confronted with its fantasies. In short, something occult, invisible to our gaze. Could quantum magic be reduced to a matter of scale ? Are there effectively two worlds - a classical macroscopic one, the one we live in, and the microscopic “quantum world” - connected with each other by a secret bridge, hidden on the intermediate mesoscopic scale ? Some alternative quantum-based theories, e.g. the “spontaneous-collapse” ones [56, 57], argue for this kind of scission. However the wall separating the quantum

world from our own may seem porous. While quantum theory was born in an atomistic context, its formalism does not explicitly discriminate microscopic from macroscopic objects. It does not indicate either which objects shall be treated as quantum, and which cannot. This was the reason for the trouble of Schrödinger, who seemed to deplore that a quantum state could be associated with a cat as well as a radioactive atom [58, 59]. On the contrary, Bohr was wary of this scale-based distinction, and advocated looking for the border in “the use of ordinary language terms to describe the properties of an object.” [54]

Our ordinary classical concepts do not seem to apply to quantum objects. Worse, quantum theory seems still desperately silent when it comes to extract meaning from its equations, even though its mathematical grounds have been fixed almost a century ago by von Neumann [60]. As pointed out by Mermin,

“[Q]uantum theory is the most useful and powerful theory physicists have ever devised. Yet today, nearly 90 years after its formulation, disagreement about the meaning of the theory is stronger than ever. New interpretations appear every day. None ever disappear.” ([61] as cited in [62])

Roughly, two opposite interpretative factions can be identified:

- the “*realists*” (associated with the terms “strong”, “intrinsic”, or “naive” realism), who believe that quantum mechanics must, like any other physical theory, describe a world independent of any observer. If it cannot manage to do so, it means that quantum theory is either incomplete or false. Bohmian mechanics [63], spontaneous collapse theories [57] or again the Many-Worlds interpretation [64, 65] belong to this category;
- the “(*neo-*)*Copenhagen*” interpretations (associated with the terms “anti-realism”, “weak” or “participatory realism” [66]), in which quantum theory describes the state of knowledge (or belief, or information) of an observer who “participates” in the studied experimental implementations. Copenhagen interpretations (e.g. those of Bohr, Heisenberg and Pauli), the relational interpretation of Carlo Rovelli [67, 68], the information-based interpretations of Jeff Bub [69] and Brukner [70, 71], or QBism [72] fall into this class.

Metaphysical investigations, discussing the ontology (literally aiming at giving a discourse (λόγος) on the Being (ὄντος), what *is*) and the nature of quantum theory are a first line of work in quantum foundations. In fact, while quantum foundations was inextricably born with quantum theory, it has been relegated to a lower priority by physicists as a field dealing with mere philosophical issues. This status lasted for a long period of time after the elaboration of the theory, with some exceptions, such as Bohm’s [63] and Everett’s [64], and the Bohr-Einstein debate [73, 6]. The area of research was revived by Bell’s work [7] and Aspect’s experiments [74] on quantum entanglement and nonlocality.

On the one hand, their works have sparked a renewed interest in quantum foundations and understanding the weird phenomena of quantum theory. Beyond the (sometimes vain) metaphysical debates, some have attempted to rebuild the foundations of the theory by deriving its unsympathetic mathematical axioms from physical principles based on the notion of “information” [75, 67]. Hardy has for instance identified a set of postulates specific to quantum theory and classical probability theory. In order to distinguish clearly

quantum theory, i.e. what differentiates it from other theories, one “just needs” to add any quantum principle that is inconsistent with classical probability theory to the list [76, 77]. Such principles may be identified by exploring generalisations or alternatives of quantum theory, foil theories [78]. These “science-fiction mathematics” are not physical theories in the sense that they are not empirically valid. However, if such an alternative theory shares a set of features with quantum theory, then this set is not sufficient to completely characterize the axioms of quantum theory. For instance, Spekkens has shown that a large number of supposedly “strange” quantum characteristics - non-commutativity, coherence, collapse, interference, teleportation, post-selection effects, no-cloning theorem and many others - could emerge from classical statistical theories to which an epistemological restriction condition has been added, i.e. a restriction on the ability to know the state of the studied system [79]. These “epistricted” theories are however unable to reproduce quantum nonlocality [7] and contextuality [28], which may hint at the fact that these features are more fundamental, more “specific” to quantum theory than the others. Other important results have led to clarify what type of ontology is adequate with quantum theory, such as the Pusey-Barrett-Rudolph (PBR) theorem, that shows under natural assumptions that “[ontological] models in which the quantum state is interpreted as mere information about an objective physical state of a system cannot reproduce the predictions of quantum theory.” [80]; and other lines of work have focused on the development of the understanding of strange quantum phenomena, such as quantum nonlocality [19, 81], contextuality [36, 82] or causality [26]. Note that the meaning of quantum theory is not the only issue at stake. The field of research is also oriented towards a final goal, hoping that a better understanding of quantum theory might be a crucial step towards the elaboration of a theory of quantum gravity [83].

On the other hand, note that any breakthrough and result in quantum foundations is (very often) Janus-faced. While quantum foundations, as being a part of foundations of physics, lies at the interplay between physics and philosophy of science, it also has a deep impact on the field of quantum information. Indeed, by better understanding what makes quantum theory so strange and special, we pave the way for using its “weirdness”. Bell and Aspect’s works have for instance led to consider quantum entanglement and nonlocality as resources for various information protocols such as quantum teleportation [84, 19]. The atomistic occultness of quantum theory has become a source of computing power. Its nonclassicity is no longer seen as a mere restriction on our ability to apprehend an hypothetical “quantum world”. It has become a catalyst for extraordinary new computing possibilities, tasks that cannot be carried out classically. Of course, the influence is dual, as quantum information raises foundational issues such as “What physical principles of quantum theory allow for such advantages?” or “Is quantum theory the only theory from which emerge these advantages?” These are questions that now drive not only researchers, but also industrialists, competing in the quest of new quantum technologies in communications, cryptography, metrology and computing [85].

This dissertation subscribes to all the stakes and lines of work presented above. While my main motivation is to understand and study the strange phenomena of quantum theory, focusing here on quantum causality and contextuality, this cannot be done without taking a mathematical step back (e.g. studying generalisations of the theory like the process matrix formalism [15]), as well as taking some metaphysical distance in order to give meaning and truly understand our results, and finally reflecting on the possible pragmatical impact of some of our results as useful tools for quantum information.

0.1.2 Goals and results

The goal of this thesis is to contribute in answering the three issues given above.

Firstly, “Is causality fundamental?”. While various results have been obtained in understanding processes with indefinite causal orders, the question of which processes are effectively physical and whether these processes can violate causal inequalities is still open. Identifying and characterizing these processes will not only improve our comprehension of causal nonseparability, but it can also suggest how to use it in quantum information. The first objective of my project was then to investigate the possible causal relations between events that can exist in the quantum world, and see how they differ from classical relations. In particular, the objective was to contribute to characterise the processes (building e.g. on the “quantum switch” mentioned above) that can be realised experimentally, to study how these processes differ from processes with a well-defined causal structure (i.e. standard quantum circuits), and whether the generated correlations might violate causal inequalities. From these results, the goal was then to explore if these new causal relations can yield new possibilities in information processing tasks.

This topic constituted the vast majority of my thesis. I have participated in developing a new class of physically implementable quantum processes that includes the quantum switch as a special case: quantum circuits with quantum control of causal orders. In particular, I have characterized the quantum switch as such a circuit, and I have proposed a new implementation of this process, which require fewer degrees of freedom than previous realizations. The new class also allows one to design new kinds of indefinite causal structures, and I have studied new examples of physically implementable and causally nonseparable processes beyond the quantum switch based on an original idea from Cyril Branciard. Furthermore, Julian Wechs and I have found several examples of tasks for which quantum circuits with quantum control of causal orders provide an advantage over circuits with definite causal order. However, like the quantum switch, our class of quantum processes cannot generate noncausal correlations. Nonetheless, resorting to the analogy with entanglement and Bell nonlocality, I have explored a form of certification of causal nonseparability in a semi-device-independent scenario where the involved parties receive trusted quantum inputs, but whose operations are otherwise uncharacterised. To do so, I have defined, with my coauthors, the notion of causally nonseparable distributed measurements, paving the way for a resource theory of causal nonseparability. I have shown that certain causally nonseparable processes which cannot violate any causal inequality, such as the quantum switch, can generate noncausal correlations in such a scenario. Moreover, by further imposing some natural structure to the untrusted operations, I have shown that all bipartite causally nonseparable process matrices can be certified with trusted quantum inputs.

This first part of the thesis is based on the papers associated with these results. It comprises (but does not reduce to) literal excerpts from the following works that have already been published or submitted for publication:

- J. Wechs, **H. Dourdent**, A. A. Abbott, and C. Branciard, “*Quantum Circuits with Classical Versus Quantum Control of Causal Order*,” PRX Quantum 2 (2021) 030335. [86]
- **H. Dourdent**, A. A. Abbott, N. Brunner, I. Šupić, and C. Branciard, “*Semi-device-independent Certification of Causal Nonseparability with Trusted Quantum Inputs*,” arXiv:2107.10877 [quant-ph] (*submitted*) [87]

These manuscripts have been reworked to a varying extent, in order to embed them into a coherent whole. That is, some modifications have been made in order to avoid repetitions, some relevant details, explanations and remarks as well as new figures have been added, where appropriate, for the sake of contextualisation and clarification. A note is included at the beginning of each of these chapters, describing the precise correspondence between its content and the respective publication.

In the prospect of establishing a possible link between indefinite causal orders and contextuality by resorting to the analogies between noncausal, Bell and Kochen-Specker correlations, the study of quantum contextuality - guided by the issue “Is physics paradoxical ?” - constitutes a natural intermediate step.

To this end, an objective is to explore new generalisations and results [42, 40] concerning the Kochen-Specker theorem [28], in the light of personal intuitive evidences that contextuality might also be the key to understand how quantum causal relations differ from classical ones, and how some processes can violate causal inequality and avoid at the same time causal loops and paradoxes. One intuition behind the connection to be established is that it appears that contextuality arises when there is local consistency and global inconsistency of data [42], while the process framework is built on a similar idea that one may not obtain a well-defined global causal structure from local ones [15]. Another reason that suggests a link between contextuality and the process matrix framework is that process matrices are equivalent to particular class of pre- and post-selected quantum states [88], while it has been shown [89] that anomalous weak values (quantities accessed through quantum experiments involving weak measurements and post-selection that lie beyond the eigenvalue range of the corresponding operator [90]) arising from pre- and post-selection are a proof of a generalised notion of contextuality [41]. Finally, it should be possible to extend the direct analogy between causal inequalities and Bell inequalities to contextuality tests, building on the recent result that a Bell scenario is a specific product of contextuality scenarii, involving the union of the edges of one-way signalling (i.e. fixed causal structure) hypergraphs [40]. On a more conceptual level, another objective is to understand how a notion of contextuality might be related with the fundamental issues of quantum theory such as the measurement problem [60] and the Wigner’s friend thought experiment [91], as well as recent variants such as Brukner’s “no-go theorem for observer-independent facts” [46] and the Frauchiger-Renner paradox [47].

While most of my PhD thesis was dedicated to quantum causality, I have nevertheless kept an interest for contextuality, which started during my Master studies and the writing of a bibliographical review on the matter [36]. On the one hand, in the light of the intuitions enunciated above, I have carefully analysed the Hardy paradox [92], as a canonical example of a quantum scenario at the crossroads of distinct approaches

of contextuality [42, 40]. I have identified three derivations of the logical contradiction underlying the logical contextuality of the paradox. Two arguments are based on Liar cycles, and one is a combination of both. Using a connection between contextuality and pre-post-selection paradoxes [93, 94, 95, 89], I have given a hypergraph depiction of a post-selection version of the paradox [96], and I have shown how it is related to the causal relations of intermediate measurements. I have identified how a combination of the Liar cycles underlying the paradox is directly related to the emergence of an anomalous weak value. On the other hand, inspired by the works of Szangolies [97], Brukner [70, 46] and Grinbaum [98, 99], I have identified how quantum contextuality, Wigner’s friend and their variations are related with self-contradictory logical loops, and I have defined the notion of *meta-contextuality* as the main characteristic of neo-Copenhagen interpretations of quantum theory. I have analysed the Frauchiger-Renner paradox [47] as a hybrid scenario, merging the contextuality of the Hardy paradox with the meta-contextuality underlying Wigner’s friend.

This work gave rise to a published essay which won the third prize in the FQXi 2020 Essay Contest “Undecidability, Uncomputability, and Unpredictability”.

- **H. Dourdent**, “*A Gödelian Hunch from Quantum Theory*,” pp. 97–113, In: Aguirre A., Merali Z., Sloan D. (eds) *Undecidability, Uncomputability, and Unpredictability*. The Frontiers Collection. Springer, Cham., 2021. [100]

The version of this essay presented in this manuscript has been extended and modified, based on an introductory lecture on “Anti-realist interpretations of quantum theory” that I gave to Bachelor students in philosophy.

Finally, the final objective of this PhD was to give some answers to the endgame question “Could the non-fundamental nature of causality be related to a form of contextuality?” Despite the fact that I did not produce any published nor pre-published paper on the matter, a work in progress akin to it. In particular, I have formalized a grandfather-Liar-like paradox in terms of a causal game with causal and logical inequalities. I have shown that the causal inequality is violated by some process matrices without logical paradoxes nor strong pathologies, and I have speculated that a violation of the logical inequality, which might be interpreted as an empirical test of classical logic, would imply a form of contextuality.

- **H. Dourdent** and C. Branciard, “*Violation of causal and logical inequalities in a causal game*,” (in preparation)

This work has been presented in ETH Zurich 2021 Workshop: “Time in Quantum Theory: from mathematical foundations to operational characterization” and in the 20th European Conference on Foundations of Physics (Paris, 2021).

0.1.3 Outline

This dissertation is divided in three parts³, following my three motivation issues. Their lengths are unequal, as they reflect the amount of time that I dedicated to each one of them during my PhD. A take-away and perspectives are given at the end of most of the chapters.

In “Part I: Quantum Causality”, I present my work on indefinite causal orders. In Chapter 2, I start by introducing the process matrix formalism. This framework allows to describe the most general standard quantum communication resources - the so-called quantum channels with memory - and more: some solutions - like the quantum switch - were shown to be incompatible with a definite causal order. Could we go beyond the quantum switch, and find other examples of processes incompatible with a definite causal order that are not mathematical chimeras ? In Chapter 3, I present our new class of physically implementable quantum processes that includes the quantum switch as a special case: quantum circuits with quantum control of causal order [86]. These allow one to imagine and conceive new kind of indefinite causal structures beyond the quantum switch. However, like the quantum switch, they cannot generate noncausal correlations. Nonetheless, I show in chapter 4 that certain causally nonseparable processes which cannot violate any causal inequality, such as the quantum switch, can generate noncausal correlations in a semi-device-independent scenario where the involved parties receive trusted quantum inputs, but whose operations are otherwise uncharacterised [87].

“Part II: Quantum Contextuality”, is dedicated to my work on the Kochen-Specker theorem, the Hardy paradox and meta-contextuality. I start by introducing the Kochen-Specker theorem (Chapter 6) and a personal investigation on its origins. In Chapter 7, I show how the Hardy paradox [92, 101] can be seen as a canonical example at the crossroads of distinct approaches of contextuality [42, 40]. I analyze how contextuality emerges from a formulation of the paradox with post-selection [96], based on [93, 94, 89, 95]. In Chapter 8, I present the notion of *meta-contextuality* as the main characteristic of neo-Copenhagen interpretations of quantum theory, based on my essay “A Gödelian Hunch from Quantum Theory” [100].

Finally, “Part III: “Time-Travel without Paradoxes” ” is dedicated to work in progress and speculations on a possible relation between (non)causality and contextuality. In Chapter 10, I extend my “Gödelian hunch from quantum theory” to a specific notion of time, based on an analysis of the grandfather paradox. In Chapter 11, I speculate on a possible relation between quantum causality and contextuality and propose some line of thoughts for future investigations. In Chapter 12, I present an original causal game that quantifies a Novikov-like consistency principle in terms of a logical inequality in addition to a causal inequality. I show that the maximal probability of success with indefinite causal orders lies between the causal and logical bounds, thus illustrating that noncausality does not imply logical inconsistency. In the end, I speculate on the idea that the violation of a logical inequality might be interpreted as a form of contextuality.

³Four illustrations, generated by VQGAN+CLIP (Vector Quantized Generative Adversarial Network + Contrastive Language-Image Pre-training), are attached to each part of this thesis, and I would like to credit Katherine Crowson and Somewhere Systems for the open source code that I used to generate them. The illustrations of Alice and Bob were drawn by myself, and were inspired by the characters of *Hollow Knight* by Ari Gibson.

0.2 Philosophy of this dissertation

The uncanniness of quantum theory is the main reason that led me to study quantum foundations. I have always been fascinated by the absurd, the paradoxical, by stories that push us to the edge of the precipice of rationality and lead us to question our reassuring preconceived ideas. The complementarity and the interplay between physics and philosophy is also a crucial motivation in my work [102]. While most of the chapters of this PhD are rather “metaphysically-free”, Chapters 8 and 10 come within the scope of my affinity towards the neo-Copenhagen interpretations of quantum theory. In Sections 8.1 and 8.2 in particular, I develop the idea that fundamental quantum paradoxes might emerge from a desperate mathematical attempt of the physicists to “break the fifth wall”.

Quantum undecidability is a metaphysical warning for physicists: you cannot take a transcendent position with respect to Nature and at the same time ignore the fact that you are yourself part of It and mechanically include yourself in your theoretical description. In other words: “You are not Gods, don’t get cocky.” Either you decide to look from outside, and cut yourself from the world, giving up the desire to be able to describe everything ; or you decide to look from inside, a perspective from which you can study everything, but everything is not fully accessible experimentally. In both cases, some questions will necessary remain unanswered.

Trying to break the fifth wall exposes you to self-referential structure, i.e. logical loops and thus logical paradoxes. If two observers, Alice and Bob, include each others in their respective descriptions, they may end up describing themselves. One needs to “cut the logical loop”, i.e. to meticulously choose one perspective, and avoid asking about what the other has to say, in this context. Imagine now two parties, Alice and Bob, trapped in a causal loop. Are they not facing an analogous situation ? Inside the loop, any notion of order is undefinable. Nevertheless, you may “cut the causal loop” and define a perspectival causal relation: in one context (one position of the cut), Alice precedes Bob, while in the other, Bob precedes Alice.

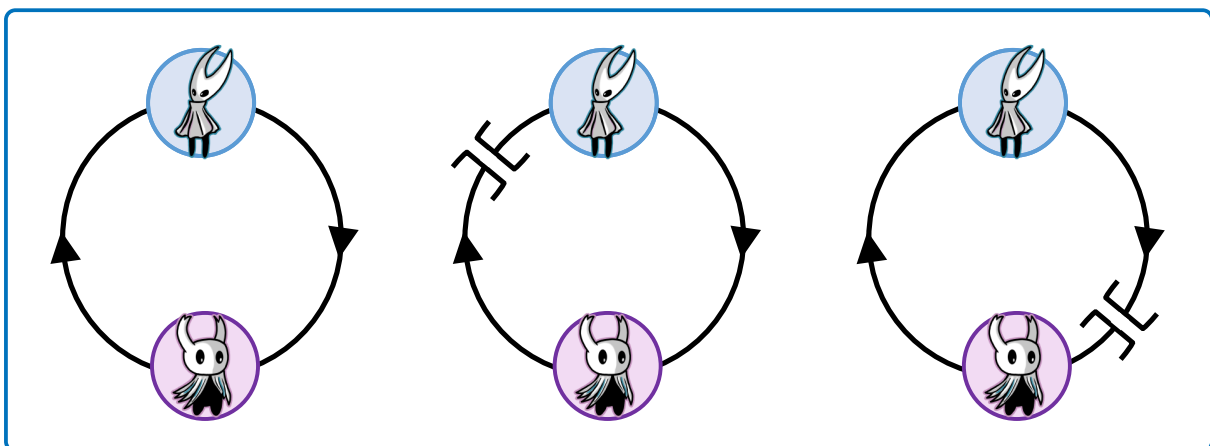

Whether Alice and Bob are trapped in a causal or a logical loop, a similar solution appears. This analogy makes me wonder about the nature of the blurred line between logical and causal relations. It gives me a hunch that they might be two sides of the same

coin. Remarkably, Gödel, as the father of the incompleteness theorem and one of the discoverers of closed time-like curves, appears as a guide in both cases. His statement

“Time is the means by which God realized the inconceivable that P and non- P are both true.” [103]

is the motto of this PhD thesis.

Part I
Quantum Causality

I don't see how he can ever finish, if he doesn't begin. Alice [104]

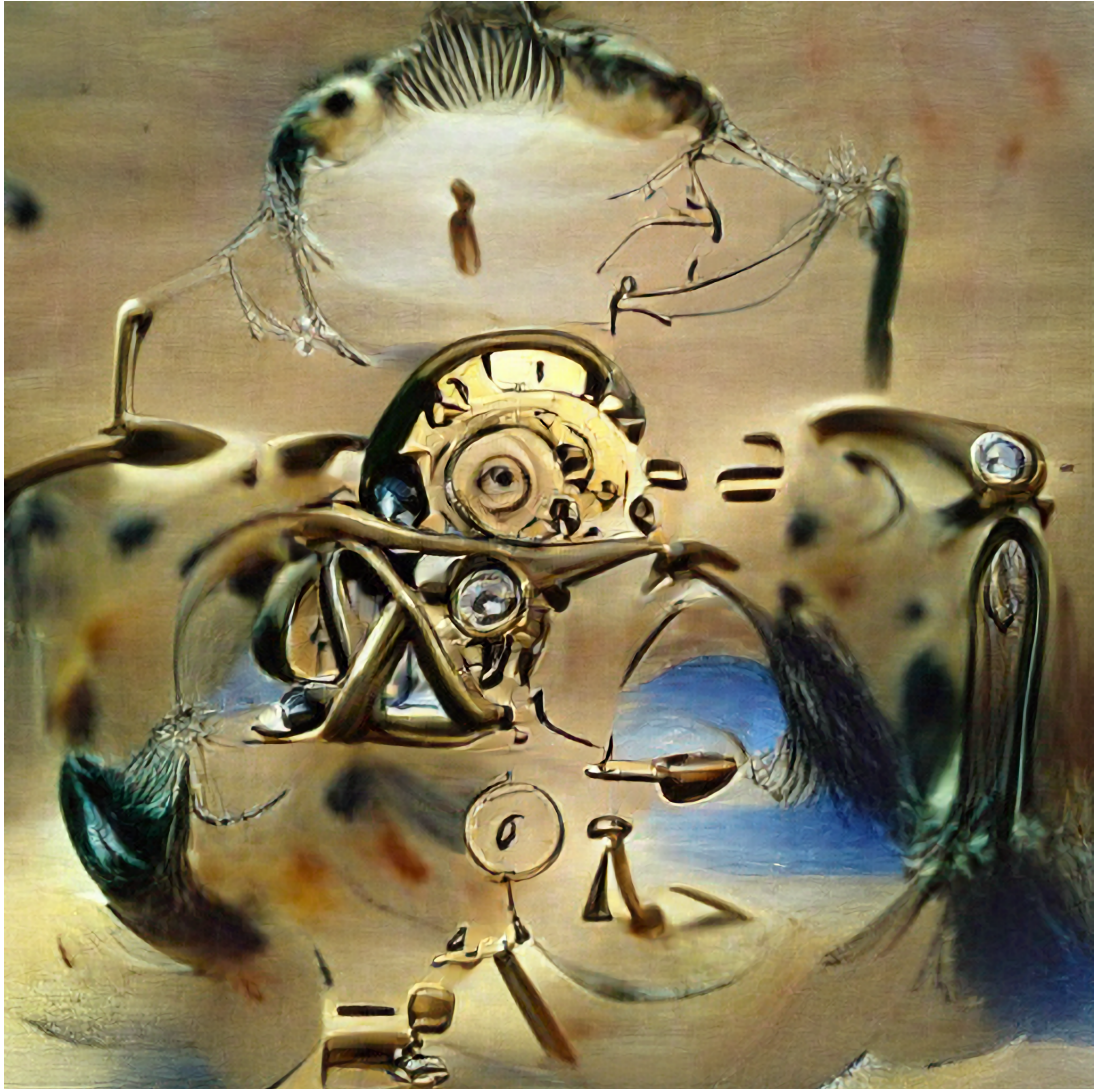

Quantum Causality (in the style of Dali), VQGAN+CLIP.

Chapter 1

Causality and Quantum Theory

The law of causality, I believe, like much that passes muster among philosophers, is a relic of a bygone age, surviving, like the monarchy, only because it is erroneously supposed to do no harm. Bertrand Russel [105]

Causality is arguably a primitive concept for physics: explaining a phenomenon amounts to finding “what causes it”. Historically, causality was thus often intertwined with the notion of *determinism*, the fact that given an initial state for a physical system, there is one and only one possible evolution for this system. The chimerical dream of classical physics that any event is caused by an earlier one according to the laws of nature culminates in Leibniz’s *principle of sufficient reason* that stipulates that “nothing happens without it being possible for one who knows things enough to give a reason which is sufficient to determine why it is so, and not otherwise.” [106] To illustrate his principle, Leibniz imagined a scientist who has become a prophet, being able to predict the future from a complete knowledge of the present:

“We see [...] that everything is mathematical, that is to say, that everything happens infallibly in the vast whole world, so that, if someone could have a sufficient view of the interior parts of things and at the same time sufficient memory and understanding, he would be a prophet and would see the future in the present as in a mirror. (personal translation)”¹

Leibniz’s prophet will later be taken up by Pierre-Simon Laplace, and will enter into posterity under the name of “*Laplace’s demon*”, a being able to have access with infinite precision to the current state of the world, and is thus able to compute its evolution for any time in the future or the past:

“The present events have, with the preceding ones, a connection founded on the evident principle, that a thing cannot begin to be, without a cause that produces it. This axiom, known as the principle of sufficient reason, extends to the very actions that are considered irrelevant [...]. We must therefore consider the present state of the universe, as the effect of its previous state, and as the cause of the one to follow. An intelligence which, for a given moment, would know all the forces with which nature is animated, and the respective situation

¹Originally in French: “*On voit [...] que tout est mathématique, c’est-à-dire, que tout arrive infailliblement dans le vaste monde tout entier, de telle sorte que, si quelqu’un pouvait avoir une vue suffisante des parties intérieures des choses et en même temps suffisamment de mémoire et de compréhension, il serait un prophète et verrait le futur dans le présent comme dans un miroir.*” [107]

of the beings which compose it, if moreover it were large enough to submit these data to analysis, would embrace in the same formula the motions of the largest bodies in the universe and those of the lightest atom: nothing would be uncertain for her, and the future, like the past, would be present to her eyes. (personal translation)²

This standard deterministic approach of causality lead to the well-known *causality principle*: every event has a cause, and the cause of an event is necessarily prior to the event itself. Causality acts underground in all things and before any event, so that there is no space left for contingency (i.e. uncertain conditional dependence). Even if an event cannot be assigned with an identifiable cause, it still, necessarily, has one, which is hidden. This statement has been formalized in 1956 by Hans Reichenbach, through his *Common Cause Principle* [109]: If there is a correlation between two events A and B and a direct causal connection between the correlated events is excluded then there exists a common cause C of the correlation such that the probability for events A and B to occur conditioned on C is given by $p(A, B|C) = p(A|C)p(B|C)$.

However, during the XXth century, quantum theory has been said to have delivered a decisive blow to this deterministic approach of causality. For instance, the “*failure of causality*” was highlighted by Heisenberg, in the light of his *indeterminacy principle* :

“In all cases in which relations exist in classical theory between quantities which are really all exactly measurable, the corresponding exact relations also hold in quantum theory (laws of conservation of momentum and energy). But what is wrong in the sharp formulation of the law of causality, “When we know the present precisely, we can predict the future,” it is not the conclusion but the assumption that is false. Even in principle we cannot know the present in all detail. For that reason everything observed is a selection from a plenitude of possibilities and a limitation on what is possible in the future. [...] Because all experiments are subject to the laws of quantum mechanics, [...], it follows that quantum mechanics establishes the final failure of causality.” [5]

The noncommutativity of quantum observables translates the inexhaustibility of information [110]: “even when we have gathered maximum information about an object it is still possible to learn something unexpected about it. The future is not determined by the past.” Bohr proposed his concept of *complementarity* has a new relationship to account for phenomena, and bury the old fashioned causality [6]. It might nevertheless be premature to argue that Bohr and Heisenberg have definitively slayed Laplace’s demon, since their arguments mainly relies on metaphysical ground. One might also argue that what Bohr and Heisenberg are targeting should rather be called causal determinism, leaving a more operational notion of causality untamed, in line with Hermann’s position:

²Originally in French: “*Les événements actuels ont, avec les précédents, une liaison fondée sur le principe évident, qu’une chose ne peut pas commencer d’être, sans une cause qui la produise. Cet axiome, connu sous le nom de principe de la raison suffisante, s’étend aux actions mêmes que l’on juge indifférentes [...]. Nous devons donc envisager l’état présent de l’univers, comme l’effet de son état antérieur, et comme la cause de celui qui va suivre. Une intelligence qui, pour un instant donné, connaîtrait toutes les forces dont la nature est animée, et la situation respective des êtres qui la composent, si d’ailleurs elle était assez vaste pour soumettre ces données à l’analyse, embrasserait dans la même formule les mouvemens des plus grands corps de l’univers et ceux du plus léger atome : rien ne serait incertain pour elle, et l’avenir comme le passé, serait présent à ses yeux.*” [108]

“The theory of quantum mechanics forces us [...] to drop the assumption of the absolute character of knowledge about nature, and to deal with the principle of causality independently of this assumption. Quantum mechanics has therefore not contradicted the law of causality at all, but has clarified it and has removed from it other principles which are not necessarily connected to it.” [111]

Nevertheless the apparent tension between causality and quantum theory still remains. In particular, Bell’s theorem [7, 8], which relies on correlations between two observers’s choices and results, has been analyzed in the light of causality. Wiseman and Cavalcanti [112] have argued that the violation of Bell inequalities can be explained by the incompatibility between “*relativistic causality*, according to which an event’s causal past is its past lightcone; *free choice*, which states that measurement settings can be freely chosen and, hence, have no causes within the system under consideration; and *Reichenbach’s principle of a common cause*, according to which correlations among events that are not related as cause and effect are explained by a common cause in their joint past that screens off the correlation.” [9] Maintaining causality is still possible, but at the cost of superluminal and/or retrocausal signalling, which entails a form of fine-tuning, i.e. the fact that some causal dependence might not imply a probabilistic dependence, as shown by Wood and Spekkens [10].

These studies do not necessarily spell “the end of causality”. However they hint at the fact that a classical standard approach of causality might be challenged when it is put in perspective with quantum phenomena. This motivates the study of more general causal structures, quantum causal models [113], or theoretical framework in which causal relations are themselves subject to quantum indeterminacy [26].

In 2005, Lucien Hardy paved the way for this new quantum approach of causality in the context of quantum gravity, by introducing formalisms in which the causal orders were not fixed a priori, unlike in standard quantum theory [11, 12]. He introduced a new mathematical object, the “causaloid”, which encapsulates information about the causal structure that interconnects different space–time regions. “Since then, researchers, particularly in Pavia [13], Vienna [15] and the Perimeter Institute [14], have applied the powerful tools and concepts of quantum information to shed new light on the relation between the nature of time, causality and the formalism of quantum theory.”[26] The process matrix formalism, developed in [15] and mainly used in this thesis, is one of these frameworks for quantum causality.

A simple illustration which might give an intuitive picture of these “*indefinite causal orders*” is to imagine two parties, Alice and Bob, trapped inside a *causal loop*. “... Alice who is in the causal past of Bob who is in the causal past of Alice ...” In such loop, notions like causality and time cannot be properly defined. The loop needs to be “cut” in order to defined a consistent causal relation between Alice and Bob. Indeed, the cut provides an entrance point (the “global past P ”) and an exit point (the “global future F ”) to the loop. Its position is directly correlated with the causal relation between Alice and Bob’s operations, cf. Fig.1.1. Imagine now that the position of the cut is subject to quantum indeterminacy. The causal ordering of Alice and Bob’s operations would become indefinite.

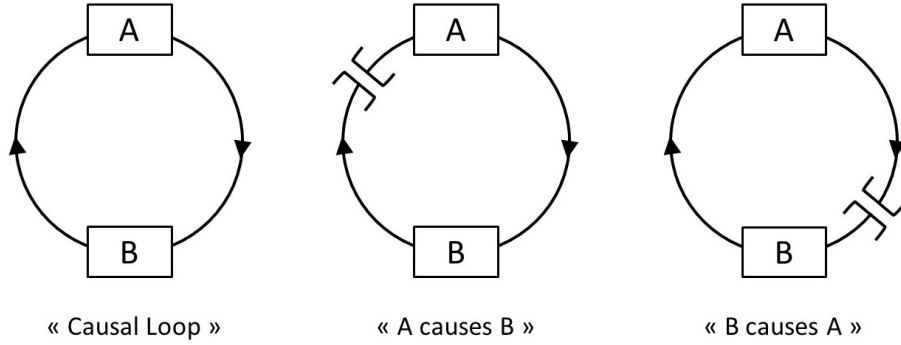

Figure 1.1: A causal loop model: Trapped inside a causal loop, Alice and Bob’s operations cannot be causally ordered. The introduction of a cut defines a global past and a global future, and thus a well-defined causal relation between Alice and Bob. If the cut is put between Bob’s output space and Alice’s input space, the causal order “Alice is in the causal past of Bob” is defined. If it is put between Alice’s output space and Bob’s input space, the causal order “Bob is in the causal past of Alice” is defined. Making the position of the cut undetermined leads to an indefinite causal relation.

The study of indefinite causal orders raises new challenging and exciting questions. For instance, what would be the consequences of having indefinite causal orders? could they be the “missing link” between quantum theory and gravity? what kind of new phenomenology would they give rise to, and could they be related with already known quantum phenomena like nonlocality and contextuality? do they give any advantages in information processing? and finally, are they physical, i.e. do they exist in Nature, or are they merely mathematical artefacts?

In this first part of the thesis, I will present work that aimed at answering such questions. In chapter 2, I will start by introducing the process matrix formalism, a generalisation of standard quantum theory that relies on relaxing the traditional assumption of predefined global causal order, while parties in distinct laboratories can still perform arbitrary local quantum operations. This framework allows to describe the most general standard quantum communication resources - the so-called quantum channels with memory - and more: some solutions were shown to be incompatible with a definite causal order. Noteworthy, the tools introduced to identify this causal indefiniteness - causal nonseparability [15, 16] and causal inequalities [15, 18] - have been developed by analogy with quantum entanglement and Bell inequalities. So-far, the only known physically implementable example of a process matrix with indefinite causal structure was the “quantum switch” [13], a process in which the causal order between two quantum operations is coherently controlled by a qubit. While this process is causally nonseparable, it cannot generate noncausal correlations, i.e. correlations that violate a causal inequality. Could we go beyond the quantum switch, and find other examples of processes incompatible with a definite causal order that are not mathematical chimeras? In chapter 3, I will present a new class of physically implementable quantum processes that includes the quantum switch as a special case: quantum circuits with quantum control of causal order [86]. These allow one to imagine and conceive new kind of indefinite causal structures beyond the quantum switch. However, like the quantum switch, they cannot generate noncausal correlations. Although noncausal mathematical solutions have been found [15, 18], the question of the physical realization of such a process remains open. Nonetheless, I will

show in chapter 4 that certain causally nonseparable processes which cannot violate any causal inequality, such as the quantum switch, can generate noncausal correlations in a semi-device-independent scenario where the involved parties receive trusted quantum inputs, but whose operations are otherwise uncharacterised [87]. To do so, we define the notion of causally nonseparable distributed measurements, paving the way for a resource theory of causal nonseparability.

Chapter 2

Preliminaries

In this chapter, I introduce the basic concepts and mathematical tools that I used in my study of quantum scenarii with indefinite causal orders. For simplification purposes, I will start by considering bipartite scenarii. I will present the process matrix framework (Section 2.1, Section 2.2, Section 2.3), and two certifications of causal nonseparability (Section 2.4), i.e. the incompatibility with a definite causal order: the construction of a causal witness in a device-dependent scenario, and the generation of noncausal correlations in a device-independent scenario. I then present a canonical example of an implementable causally nonseparable process, the quantum switch (Section 2.5). Finally, I will conclude by speculating on the nature of process matrices, based on recent advances in the literature (Section 2.6).

2.1 From Operational Quantum Theory to the Process Matrix Formalism

In what follows, the notions of causality and events considered will be employed in a purely operational sense, without any reference to a space-time structure.

In an operational theory, primitive concepts, the *events*, are procedures of preparation, transformation, and measurement, each understood as a list of instructions that an experimenter must follow. The theory gives a mathematical algorithm that fixes the probability distribution on the results of a given measurement, for all possible preparations and transformations. Various operational theories are then distinguished by the type of experimental statistics that they allow. Thus, one can, in such an operational framework, study generalizations of quantum theory by analyzing conditions on probability distributions and the obtained correlations. Intuitively, the information related to the correlations between the observer's chosen inputs and the obtained outputs is assumed to be carried by physical systems. These are often represented by “*wires*”, connecting “*boxes*” symbolizing various operations performed by observers on available information.

Quantum theory can be formalized in such a framework¹, (cf. Appendix A). In 1925, Heisenberg performed a revolution in the history of physics: he developed a theory solely

¹It is important to emphasize that the operationalization of a theory is not related to a philosophical interpretation, but it is an explanatory mode of the theory. An operational theory is therefore not the equivalent of an instrumentalist interpretation of the type "Shut up and calculate".

based on variables which can be observed, “observables”. These physical variables were mathematically formalized as matrices. A matrix formalism, where physics is anchored in tables of numbers. Few years later, Dirac and Von Neumann establish the Hilbert-space-based formalism of quantum theory that physicists still use to this date. However the development and understanding of formalizing quantum theory did not remain stagnant. Following Von Neumann’s “immoral confession” in a letter to Birkhoff that he did not “believe absolutely in Hilbert space no more” [114] various attempts have been made to revisit the mathematical structure of quantum theory. Mathematical tools from computer science have been particularly useful to do so. As an example, the linear algebra of finite dimensional Hilbert spaces strongly relates to the pictorial representation of monoidal category theory, which allows one to describe all kind of processes [115, 116].

In fact, the operationalisation of quantum formalism has enabled to study information theory in the light of quantum theory. Classically, computer circuits consist of wires, used to carry information around the circuit, and logic gates, which perform manipulations of the information. By analogy, quantum circuits are made of wires and elementary quantum gates which respectively carry around and manipulate quantum information.

Intrinsically, quantum circuits do not allow for feedback from one part to another: the quantum gates are causally ordered, i.e. a certain quantum gate is always applied either before or after another gate. In an operational framework, *causality* is thus simply the ordering of events, and can be encapsulated in (non)signalling constraints. Relaxing this fundamental characteristic allows to go beyond the standard quantum theory, and study its relation with causality.

The process matrix formalism was developed by Oreshkov, Costa and Brukner [15] as a framework allowing to describe processes - i.e. resources relating local quantum events with each other - that are not necessarily compatible with a definite causal order. As mentioned above, the standard quantum processes are either no-signalling (entangled state) or one-way-signalling (quantum channel) resources, only compatible with scenarii with a definite global causal structure. One typically prepares quantum states, applies some quantum operations (or “quantum gates”) in a well-defined order, and then makes a measurement. The process matrix formalism allows to study all these standard causal scenarii. However, by relaxing the assumption that there is a definite global causal structure *a priori*, it also opens the possibility to find new causal resources which might be themselves subject to quantum indeterminacy.

2.2 Local Quantum Operations

For the sake of clarity, we will introduce the formalism by focusing on the bipartite case. We consider two parties, Alice (A) and Bob (B), who each resides in a closed laboratory. In a single run of the experiment, the entrance of the laboratories opens to let a physical system enter in. The parties perform a local operation on it, during which the laboratories are closed again, i.e. have no interaction with any other object. They only reopen to let a physical system go out after the operations. Alice and Bob’s operations produce an *outcome*, denoted by classical bits a and b respectively.

We assume that Alice and Bob perform local quantum operations. We consider some

input Hilbert spaces $\mathcal{H}^{A_I}, \mathcal{H}^{B_I}$ (for some quantum system entering their laboratory) and some outputs Hilbert spaces $\mathcal{H}^{A_O}, \mathcal{H}^{B_O}$ (for some quantum system exiting their laboratory). In addition, we allow Alice and Bob’s operations to also act on some auxiliary systems with Hilbert spaces $\mathcal{H}^{\tilde{A}}$ and $\mathcal{H}^{\tilde{B}}$, and have access to some auxiliary (potentially entangled) quantum state $\tilde{\rho}^{\tilde{A}\tilde{B}} \in \mathcal{L}(\mathcal{H}^{\tilde{A}} \otimes \mathcal{H}^{\tilde{B}})$ (where $\mathcal{L}(\mathcal{H})$ denotes the space of linear operators acting on \mathcal{H})².

The most general description of a quantum operation is given by a *quantum instrument*: a set of *completely positive* (CP) maps $\mathcal{M}_a^{\tilde{A}\tilde{A}} : \mathcal{L}(\mathcal{H}^{\tilde{A}} \otimes \mathcal{H}^{A_I}) \rightarrow \mathcal{L}(\mathcal{H}^{A_O})$ associated to all measurement outcomes a , whose sums $\sum_a \mathcal{M}_a$ are *completely positive trace preserving* (CPTP) maps. Quantum instruments can be seen as a generalization of the notion of Positive Operator-Valued Measure (POVM)³ which captures more general scenarii than detection, such as transformations of the system. A convenient representation of these operations is given by the Choi-Jamiołkowski (CJ) isomorphism [117, 118].

Intuitively, The CJ isomorphism simply consists in “turning a bra into a ket” [119]:

$$|i\rangle \langle k| \equiv |k\rangle \otimes |i\rangle$$

Therefore, it allows to express linear operators as pure states⁴, and maps as density matrices, the “Choi matrices”. For a given linear map $\mathcal{M} : \mathcal{L}(\mathcal{H}^X) \rightarrow \mathcal{L}(\mathcal{H}^Y)$, its Choi matrix can be defined as

$$\begin{aligned} M^{XY} &:= (\mathcal{I}^X \otimes \mathcal{M})(|\mathbb{1}\rangle\rangle\langle\langle \mathbb{1}|^X) \\ &= \sum_{i,i'} |i\rangle\langle i'|^X \otimes \mathcal{M}(|i\rangle\langle i'|^X) \in \mathcal{L}(\mathcal{H}^{XY}) \end{aligned} \quad (2.1)$$

where \mathcal{I}^X is the identity map on $\mathcal{L}(\mathcal{H}^X)$, $|\mathbb{1}\rangle\rangle^X := \sum_i |i\rangle^X \otimes |i\rangle^X$ and $\{|i\rangle^X\}_i$ is a fixed (so-called “computational”) basis of \mathcal{H}^X .⁵ A linear map $\mathcal{M} : \mathcal{L}(\mathcal{H}^X) \rightarrow \mathcal{L}(\mathcal{H}^Y)$ is completely positive if and only if its Choi matrix $M^{XY} \in \mathcal{L}(\mathcal{H}^{XY})$ is positive semidefinite; it is trace-preserving if and only if its Choi matrix satisfies $\text{Tr}_Y M^{XY} = \mathbb{1}^X$ (where Tr_Y denotes the partial trace over \mathcal{H}^Y).

Thus, a quantum instrument $\{\mathcal{M}_a^{\tilde{A}\tilde{A}}\}_a$ can be represented as a set of matrices $\{M_a^{\tilde{A}\tilde{A}}\}_a$ such that

$$M_a^{\tilde{A}\tilde{A}} \geq 0, \quad \text{Tr}_{A_O} \sum_a M_a^{\tilde{A}\tilde{A}} = \mathbb{1}^{\tilde{A}A_I} \quad (2.2)$$

Another important tool that I will use in this section is the so-called “link product”, who was originally introduced in [120, 121] to describe the composition of linear maps in

²**Notations:** for some Hilbert space \mathcal{H}^X , $\mathcal{L}(\mathcal{H}^X)$ denotes the space of linear operators on \mathcal{H}^X . For two Hilbert spaces \mathcal{H}^X and \mathcal{H}^Y , we write $\mathcal{H}^{XY} = \mathcal{H}^X \otimes \mathcal{H}^Y$. For brevity we also write $\mathcal{H}^A = \mathcal{H}^{A_I A_O}$, $\mathcal{H}^B = \mathcal{H}^{B_I B_O}$. Superscripts are typically used (when useful) to clarify the spaces on which the operators act; e.g., $\mathbb{1}^X$ denotes the identity operator on \mathcal{H}^X .

³A POVM can be seen as a special case of quantum instrument with a trivial output Hilbert space, i.e. its dimension is $d(\mathcal{H}^{A_O}) = 1$.

⁴This isomorphism corresponds to the *vectorization* of a matrix (cf. Appendix A).

⁵Note that the version of the Choi isomorphism that we use here differs from that originally used in the process matrix framework [15] by a transpose.

the Choi matrix representation. This product is particularly convenient and elegant, since it can be intuitively interpreted as linking “quantum boxes” (quantum operations) with each other by connecting their “wires” labeled with the same Hilbert space (cf. Appendix A).

Consider two composite Hilbert spaces $\mathcal{H}^{XY} = \mathcal{H}^X \otimes \mathcal{H}^Y$ and $\mathcal{H}^{YZ} = \mathcal{H}^Y \otimes \mathcal{H}^Z$ that share the same (possibly trivial) space factor \mathcal{H}^Y (while \mathcal{H}^X and \mathcal{H}^Z do not overlap). The link product of two matrices $M^{XY} \in \mathcal{L}(\mathcal{H}^{XY})$ and $N^{YZ} \in \mathcal{L}(\mathcal{H}^{YZ})$ is then defined as [120, 121, 86]

$$\begin{aligned} M^{XY} * N^{YZ} &:= \text{Tr}_Y[(M^{XY} \otimes \mathbb{1}^Z)^{T_Y}(\mathbb{1}^X \otimes N^{YZ})] \\ &= (\mathbb{1}^{XZ} \otimes \langle\langle \mathbb{1}^Y | \rangle\rangle)(M^{XY} \otimes N^{YZ})(\mathbb{1}^{XZ} \otimes |\mathbb{1}\rangle\rangle^Y) \in \mathcal{L}(\mathcal{H}^{XZ}) \end{aligned} \quad (2.3)$$

where T_Y is the partial transpose over \mathcal{H}^Y (defined in the computational basis).

Up to reordering of the Hilbert spaces, the link product is commutative. Moreover, it is also associative, provided each Hilbert space involved in a multiple link product appears at most twice in all factors. Noteworthy, the product simplifies to a full trace

$$M^Y * N^Y := \text{Tr}[(M^Y)^T N^Y]$$

when \mathcal{H}^X and \mathcal{H}^Z are trivial, and to a mere tensor product

$$M^X * N^Z := M^X \otimes N^Z$$

when \mathcal{H}^Y is trivial. It is also useful to note that

$$M^{XY} * \mathbb{1}^Y = \text{Tr}_Y M^{XY},$$

and that the link product of two positive semidefinite matrices is also positive semidefinite (or a nonnegative scalar for trivial \mathcal{H}^X and \mathcal{H}^Z). Thus, Eq.(2.4) can be rewritten as

$$M_a^{\tilde{A}\tilde{A}} \geq 0, \quad \sum_a M_a^{\tilde{A}\tilde{A}} * \mathbb{1}^{A_o} = \mathbb{1}^{\tilde{A}A_I} \quad (2.4)$$

2.3 Process Matrices

The physical “process” of such scenario is entirely encapsulated in the probability distribution $P(a, b)$ established by Alice and Bob, usually referred to as *correlations*. Assuming that Alice and Bob perform local quantum operations which can be described as probabilistic mixtures of quantum instruments, this imposes that the probabilities should be bilinear functions of these operations [15]. Moreover, the probabilities should be non-contextual: the correlations should only depend on Alice’s and Bob’s CP maps rather than on the whole instruments. Within the process matrix framework, these correlations are given by the “generalised Born rule”

$$P(a, b) = \text{Tr} [(M_a^{\tilde{A}\tilde{A}} \otimes M_b^{\tilde{B}\tilde{B}})^T(\rho^{\tilde{A}\tilde{B}} \otimes W^{AB})], \quad (2.5)$$

where $W^{AB} \in \mathcal{L}(\mathcal{H}^{AB})$ is a Hermitian operator, the so-called *process matrix*. It can be interpreted as a multipartite resource that encapsulates the notion of quantum state and

quantum channel but also extends to describe more general causal structures (cf. Section 2.6 for a discussion on the nature of process matrices).

Valid process matrix

To ensure that Eq. (2.5) always defines valid probabilities (non-negative summing up to 1), even when Alice and Bob shares auxiliary input states, a valid W^{AB} must

- be positive semidefinite ($W \geq 0$),
- satisfy the normalisation $\text{Tr}(W) = d_{A_O} d_{B_O}$, where we used the notation $d_X = d(\mathcal{H}^X)$ for the dimension,
- belong to the nontrivial subspace \mathcal{L}_V of $\mathcal{L}(\mathcal{H}^{AB})$ [15] defined by the constraints:

$$[1-A_O]_{B_I B_O} W = 0 \quad (2.6)$$

$$[1-B_O]_{A_I A_O} W = 0 \quad (2.7)$$

$$[1-A_O][1-B_O] W = 0 \quad (2.8)$$

where we use the “trace-and-replace” notation of [16],

$${}_X W = \frac{\mathbb{1}^X}{d_X} \otimes \text{Tr}_X W, \quad [1-X] W = W -_X W \quad (2.9)$$

Eq. (2.6) means that after tracing out Bob’s input B_I and output B_O Hilbert spaces, the reduced process matrix carries out an identity operator on Alice’s output space A_O . This can be interpreted as “ignoring Bob’s operations, the reduced process on Alice’s systems is still valid: Alice’s input precedes her output, i.e. the reduced process is compatible with Alice performing a quantum operation from the input space A_I to the output space A_O , and thus avoids “post-selection” and “local loops” on Alice’s systems. Similarly, Eq. (2.7) checks if after ignoring Alice’s operations, the reduced process on Bob’s systems is valid and thus compatible with quantum operations from B_I to B_O , avoiding “post-selection” and “local loops” on Bob’s systems. Finally, Eq. (2.8) checks that the process matrix is not post-selecting on the output space $A_O \otimes B_O$, nor it is a global loop on $A_I \otimes A_O \otimes B_I \otimes B_O$. Hence, satisfying Eq. (2.6)-(2.8) amounts to avoiding paradoxical processes (cf. Part 3 “Time-Travel without Paradoxes”).

2.4 Causal nonseparability

A process is said to be compatible with the causal order where Alice acts before Bob (noted $A \prec B$) if it does not allow Bob to signal to Alice. It can be shown [16] that a valid process matrix $W^{A \prec B}$ compatible with this order is necessarily of the form

$$W^{A \prec B} = W^{A \prec B_I} \otimes \mathbb{1}^{B_O}.$$

Analogously, a valid process matrix compatible with the causal order $B \prec A$ is of the form $W^{B \prec A} = W^{B \prec A_I} \otimes \mathbb{1}^{A_O}$.

Causally separable bipartite process matrix

Definition 1. A bipartite process matrix is said to be *causally separable* if it is compatible with a fixed causal order $A \prec B$ or $B \prec A$, or a probabilistic mixture of both, i.e. if it is compatible with a well-defined causal structure. Such a process can be described as a convex mixture

$$W^{\text{sep}} = qW^{A \prec B_I} \otimes \mathbb{1}^{B_O} + (1 - q)W^{B \prec A_I} \otimes \mathbb{1}^{A_O} \quad (2.10)$$

with $q \in [0, 1]$, and with $W^{A \prec B_I}, W^{B \prec A_I} \geq 0$ valid causally-ordered process matrices, hence satisfying

$${}_{[1-A_O]B_I}W^{A \prec B_I} = 0, \quad {}_{[1-B_O]A_I}W^{B \prec A_I} = 0. \quad (2.11)$$

It can be shown that the set of (non-normalised) causally separable process matrices defines a closed convex cone, noted \mathcal{W}^{sep} . There exist valid processes that do not satisfy Eq. (2.10), and thus are not included in \mathcal{W}^{sep} . Such processes are called *causally nonseparable*. They are incompatible with any definite causal structure.

The notion of causal nonseparability has been generalised to multipartite scenarios, where more than two parties are involved. The simplest generalisation is to consider a specific tripartite scenario, noted $(2 + F)$, that involves Alice, Bob, and third party Fiona (F), who is always last. Her output Hilbert space is trivial, $d_{F_O} = 1$, such that we will note her input space $F = F_I$, which can be interpreted as a global future with respect to Alice and Bob's operations. Hence, only two fixed causal orders are involved $A \prec B \prec F$ and $B \prec A \prec F$. In such scenario, causal (non)separability is defined as follows.

Causally separable $(2 + F)$ -partite process matrix

Definition 2. A $(2 + F)$ -partite process matrix is said to be *causally separable* if it is compatible with some well-defined causal structure. Such a process can be described as a convex mixture

$$W^{\text{sep}} = qW^{A \prec B \prec F} + (1 - q)W^{B \prec A \prec F} \quad (2.12)$$

with $q \in [0, 1]$, $W^{A \prec B \prec F}, W^{B \prec A \prec F} \geq 0$ and such that after tracing out Fiona's space F , the reduced process matrices on Alice and Bob is valid and compatible with a well-defined causal order, $\text{Tr}_F W^{A \prec B \prec F} = W^{A \prec B}$ and $\text{Tr}_F W^{B \prec A \prec F} = W^{B \prec A}$.

Beyond this simple scenario, the generalisation is less trivial. In fact, the multipartite notion of causal nonseparability also needs to encapsulate the possibility of a dynamical construction of the causal order. For example, imagine a general tripartite scenario, with Alice, Bob, and Charlie. One can imagine a scenario where Alice performs her operation first, and, depending on the produced outcome, the system either goes first to Bob and then Charlie, or vice-versa. A definition and characterisation of causal (non)separability is given for the N -partite case in [21, 122]. In the general tripartite case, a causally separable process matrix is characterized as the following:

Causally separable tripartite process matrix

Characterisation 3. A 3-partite process matrix is causally separable if and only if it can be decomposed as

$$\begin{aligned} W^{sep} &= W_{(A)} + W_{(B)} + W_{(C)} \\ &= \overbrace{W_{(ABC)} + W_{(ACB)}} + \overbrace{W_{(BCA)} + W_{(BAC)}} + \overbrace{W_{(CAB)} + W_{(CBA)}} \end{aligned} \quad (2.13)$$

where, for each permutation of the three parties (X, Y, Z) , $W_{(X,Y,Z)}$ and $W_{(X)} := W_{(X,Y,Z)} + W_{(X,Z,Y)}$ are positive semidefinite matrices satisfying

$$[1-X_O]YZW_{(X)} = 0 \quad [1-Y_O]ZW_{(X,Y,Z)} = 0, \quad [1-Z_O]W_{(X,Y,Z)} = 0 \quad (2.14)$$

Note that I did not write the weights explicitly. Instead, for convenience, W^{sep} is decomposed in terms of three nonnormalised process matrices $W_{(X)}$, which can be interpreted as a process compatible with “the party X acts first”. Note also that the $W_{(X,Y,Z)}$ are not necessarily valid process matrices. Thus, a causally nonseparable tripartite process matrix is the convex mixture of the three valid process matrices each associated with a different first party.

2.4.1 Device-Dependent Certification: Causal Witnesses

In analogy with entanglement witnesses, the notion of *causal witness* (or *witnesses of causal nonseparability*) was introduced [16, 17] in order to identify if a given process matrix is causally separable or not. This certification is *device-dependent*, i.e., it requires to perfectly trust the implementation of the operations to be performed by Alice and Bob. The set of causal witnesses is the set of Hermitian operators which define the dual cone (which we denote using an asterisk) of the cone of \mathcal{W}^{sep} , i.e.

$$(\mathcal{W}^{sep})^* = \{S \mid \forall W \in \mathcal{W}^{sep}, \text{Tr}(S^T W) \geq 0\} \quad (2.15)$$

Since the set of causally separable process matrices \mathcal{W}^{sep} is convex, according to the separating hyperplane theorem [123], there exists a hyperplane that separates any causally nonseparable process matrix from all causally separable process matrices. In other words, there exists a “witness” $S \in (\mathcal{W}^{sep})^*$ for any causally nonseparable process matrix $W^{ns} \notin \mathcal{W}^{sep}$ such that, $\langle S \rangle = \text{Tr}(S^T W^{ns}) < 0$. By characterizing the set of all causal witnesses in terms of linear constraints on a convex cone, a witness can be found by solving a semidefinite program⁶ (SDP) [16].

A witness can be measured on a given process by combining the statistics of a set of quantum operations. In fact, it can be decomposed in terms of various operations $M_{a|x}^A, M_{b|y}^B \geq 0$ (we don’t need \tilde{A}, \tilde{B} here),

$$S = \sum_{x,y,a,b} \gamma_{x,y,a,b} M_{a|x}^A \otimes M_{b|y}^B \quad (2.16)$$

for some real coefficients $\gamma_{x,y,a,b}$, where x and y can be interpreted as classical inputs given to Alice and Bob indicating which instruments $M_{|x}^A = \{M_{a|x}^A\}_a$ and $M_{|y}^B = \{M_{b|y}^B\}_b$,

⁶Semidefinite programs are a specific type of convex optimisation problem which can be solved efficiently in various cases of interest (cf. Annex A of [124] for a nice introduction).

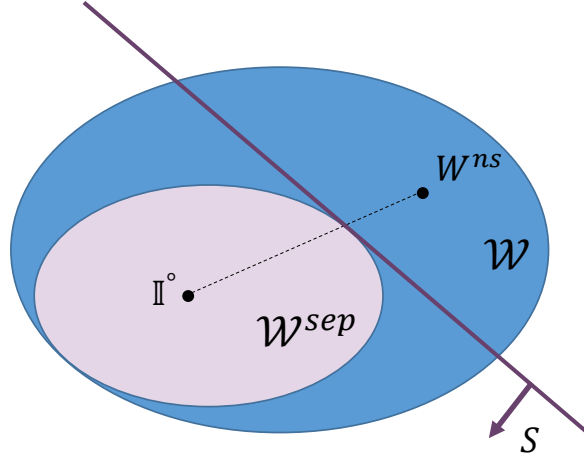

Figure 2.1: The set of causally separable processes \mathcal{W}^{sep} is a closed convex cone (represented by the purple inner cone). The separating hyperplane theorem guarantees that for any causally nonseparable process W^{ns} in the larger (blue) set of valid process matrices \mathcal{W} , there is a hyperplane that separates it from \mathcal{W}^{sep} . In other words, there always exists a witness certifying the causal nonseparability of any $W^{ns} \notin \mathcal{W}^{sep}$.

with classical outputs a, b , they should perform. By implementing the corresponding instruments $M_{|x}^A$ and $M_{|y}^B$, one can measure the expectation value $\langle S \rangle$, which can be expressed as a combination of the joint probabilities of obtaining outcomes a and b from these operations, conditioning on the choice of instrument made explicit by the labels x and y ,

$$\text{Tr}(S^T W) = S * W = \sum_{x,y,a,b} \gamma_{x,y,a,b} P(a, b | M_{|x}^A, M_{|y}^B) \quad (2.17)$$

For a given process matrix W , we typically investigate the causal nonseparability of the unnormalized⁷ noisy process

$$W(r) = W + r\mathbb{1}^\circ \quad (2.18)$$

with $\mathbb{1}^\circ = \mathbb{1}^{AB}/d_{A_I B_I}$ the process matrix that can be interpreted as a “white noise”, since it amounts to completely “ignore” (trace out) both Alice and Bob’s incoming systems.

One can define the following optimisation problem that consists in minimizing the amount of white noise added to the process such that the noisy process is causally separable:

$$\begin{aligned} \min r \\ \text{s.t. } W + r\mathbb{1}^\circ \in \mathcal{W}^{sep} \end{aligned} \quad (2.19)$$

Using the definition Def.(1) and noting that for $W \in \mathcal{L}_V$, $W + r\mathbb{1}^\circ$ is automatically in \mathcal{L}_V , one can see that this is a SDP problem, i.e. it can be expressed with explicit positive

⁷The normalization $W(r) = \frac{1}{1+r}(W + r\mathbb{1}^\circ)$ is irrelevant in order to check whether the process is in the convex cone \mathcal{W}^{sep} .

semidefinite constraints in the bipartite⁸ case:

$$\begin{aligned}
& \min r \\
& \text{s.t. } W + r\mathbb{1}^\circ = W^{A\prec B} + W^{B\prec A}, \\
& W^{A\prec B} \geq 0, \quad [1-B_O]W^{A\prec B} = 0, \\
& W^{B\prec A} \geq 0, \quad [1-A_O]W^{B\prec A} = 0 \\
& r \geq 0
\end{aligned} \tag{2.20}$$

One can show that the constraints $[1-A_O]_{B_I B_O} W^{A\prec B} = 0$ and $[1-B_O]_{A_I A_O} W^{B\prec A} = 0$ can be omitted if W is already assumed to be valid, i.e. to be part of \mathcal{L}_V .

This primal SDP problem is intimately linked to its dual problem:

$$\begin{aligned}
& \min \text{Tr}(S^T W) \\
& \text{s.t. } S \in (\mathcal{W}^{sep})^*, \quad \text{Tr}(S^T \cdot \mathbb{1}^\circ) \leq 1
\end{aligned} \tag{2.21}$$

which can also be expressed with positive semidefinite constraints:

$$\begin{aligned}
& \min \text{Tr}(S^T W) \\
& \text{s.t. } S = S^P + S^\perp \\
& {}_{B_O}S^P \geq 0, \quad {}_{A_O}S^P \geq 0, \quad L_V(S^\perp) = 0 \\
& \text{Tr}(S^T \mathbb{1}^\circ) \leq 1
\end{aligned} \tag{2.22}$$

where L_V is the projector onto the linear subspace $\mathcal{L}_V (= \{S | L_V(S) = S\})$ ⁹.

The optimal solutions of the primal and dual problems, r^* and S^* , are related by the duality theorem for SDP problems [125]:

$$r^* = -\text{Tr}(S^* W) \tag{2.23}$$

where r^* can be interpreted as the *random robustness* [16, 17], i.e. a quantifier of the robustness of the process W with respect to white noise. In particular, $r^* > 0$ implies that the process W is causally nonseparable. Thus, the optimal solution of the dual problem S^* , in the case where $\text{Tr}(S^* \cdot W) < 0$, provides a witness of causal nonseparability of W .

The first causally nonseparable process matrix formulated in the literature by Oreshkov, Costa and Brukner (OCB) [15], is

$$W_{OCB} = \frac{1}{4} \left(\mathbb{1}^{AB} + \frac{1}{\sqrt{2}} (\mathbb{1}^{A_I} Z^{A_O} Z^{B_I} \mathbb{1}^{B_O} + Z^{A_I} \mathbb{1}^{A_O} X^{B_I} Z^{B_O}) \right) \tag{2.24}$$

with the Pauli operators $Z = \begin{pmatrix} 1 & 0 \\ 0 & -1 \end{pmatrix}$ and $X = \begin{pmatrix} 0 & 1 \\ 1 & 0 \end{pmatrix}$.

⁸The constraints are similar in the $(2 + F)$ -partite case, with W replaced by ${}_F W$, cf. [16, 17].

⁹It can be written as $L_V(W) = [1-[1-B_O]_{A_I A_O} - [1-A_O]_{B_I B_O} - [1-A_O][1-B_O]] W$.

Up to a certain amount of white noise added to the process W_{OCB} , quantified by r^* , the noisy process becomes causally separable, i.e. compatible with a definite causal order:

$$\frac{1}{r^* + 1}(W_{OCB} + r^* \mathbb{1}^\circ) = \frac{1}{2}W^{A \prec B} + \frac{1}{2}W^{B \prec A} \quad (2.25)$$

with $r^* = \sqrt{2} - 1$; $W^{A \prec B} = \mathbb{1}^\circ + \frac{1}{4}\mathbb{1}^{A_I} Z^{A_O} Z^{B_I} \mathbb{1}^{B_O}$ and $W^{B \prec A} = \mathbb{1}^\circ + \frac{1}{4}Z^{A_I} \mathbb{1}^{A_O} X^{B_I} Z^{B_O}$

2.4.2 Device-Independent Certification: Non-causal correlations

The compatibility of a process with indefinite causal order can also be demonstrated in a *device-independent* manner. In this setting, the instruments performed are identified only by their labels x, y , but we make no assumption about which physical instruments these labels correspond to. This certification relies on the correlations established by Alice and Bob, described by the joint probability distribution $P(a, b|x, y)$, after multiple runs of the experiment.

If Alice's operation precedes Bob's in each run so that Bob cannot signal to Alice, the correlations are compatible with the causal order $A \prec B$ and satisfy

$$\forall x, y, y', a \quad \sum_b P^{A \prec B}(a, b|x, y) = \sum_b P^{A \prec B}(a, b|x, y') \quad (2.26)$$

Similarly, correlations compatible with the causal order $B \prec A$ satisfy the no-signalling constraint

$$\forall x, x', y, b \quad \sum_a P^{B \prec A}(a, b|x, y) = \sum_a P^{B \prec A}(a, b|x', y) \quad (2.27)$$

Causal and noncausal correlations

Definition 4. Following [15], bipartite correlations are called *causal* if they can be written as a convex mixture of probability distributions compatible with $A \prec B$ or $B \prec A$, with $q \in [0, 1]$:

$$P(a, b|x, y) = qP^{A \prec B}(a, b|x, y) + (1 - q)P^{B \prec A}(a, b|x, y) \quad (2.28)$$

Correlations that cannot be written as in Eq. (2.28) are said to be *noncausal*. In analogy with nonlocal correlations and Bell inequalities, the noncausality of correlations can be guaranteed via the violation of *causal inequalities*.

A causal inequality is an inequality that is satisfied by any causal correlations, i.e. of the form Eq. (2.28). They can be written as a linear combination of correlations $p(a, b|x, y)$, constrained by the “rules” of a *causal game*, a scenario in which two parties must perform a task that involves communication (unlike Bell scenarios, where the parties cannot signal to each other).

From the seminal paper [15], the violation of a causal inequality implies the incompatibility of the three following assumptions, meaning that at least one of them should be discarded:

- *Causal Structure (CS)*: Alice and Bob’s operations are localized in a causal structure.
- *Free Choice (FC)*: each input bit can only be correlated with events in its causal future.
- *Closed Laboratories (CL)*: the outcome a (resp. b) can be correlated with the input y (resp. x) only if the latter is generated in the causal past of the system entering Alice (resp. Bob)’s laboratory.

As shown in [18], the set of causal correlations forms a polytope, whose non-trivial facets define causal inequalities, in analogy with the local polytope and Bell inequalities.

Clearly, the correlations obtained from a causally separable process matrix are necessarily causal. Hence, within the process matrix framework a violation of a causal inequality certifies that the process involved is causally nonseparable. A causally nonseparable process matrix that can generate noncausal correlations is a *noncausal process matrix*. This is the case for the “OCB process” in Eq. (2.24). However, importantly, there are causally nonseparable process matrices which can never generate non-causal correlations [16, 15, 126, 86, 127].

Example: The *Guess Your Neighbour Input* game

A simple example of a causal inequality can be obtained from the *Guess Your Neighbour Input* (GYNI) game [18]. In this scenario, Alice and Bob have both a binary input, respectively x and y , uniformly distributed ($p(x) = p(y) = 1/2$), according to which they chose their respective operation, as well as a binary output, respectively a and b . The task of each player is to guess the input of the other player. For example, let us assume that Alice is in the past of Bob. Thus, Alice can signal to Bob, and Bob cannot signal to Alice. Assuming Alice signals the value of her input to Bob, Bob’s guess will always be right in this particular case, and he can always output Alice’s input: $b = x$. However, because Bob’s input is random, Alice’s guess will always succeed with probability $1/2$. The overall success probability for the parties to win the game is thus bounded by $1/2$. The same is true in the case of Bob being in the past of Alice, or for a probabilistic mixture of the two cases. Thus, Alice and Bob’s probability of winning is bounded by the *causal inequality*:

$$P^{causal}(a = y, b = x) = \frac{1}{4} \sum_{x,y,a,b} \delta_{a,y} \delta_{b,x} P(a, b|x, y) \leq 1/2 \quad (2.29)$$

It was shown in [18] that given the causally nonseparable process matrix:

$$W_{GYNI} = \frac{1}{4} \left(\mathbb{1}^{AB} + \frac{1}{\sqrt{2}} (Z^{A_I} Z^{A_O} Z^{B_I} \mathbb{1}^{B_O} + Z^{A_I} \mathbb{1}^{A_O} X^{B_I} X^{B_O}) \right) \quad (2.30)$$

and the instruments:

$$M_{0|0}^A = M_{0|0}^B = 0 \quad (2.31)$$

$$M_{1|0}^A = M_{1|0}^B = |\mathbb{1}\rangle\langle\mathbb{1}| \quad (2.32)$$

$$M_{0|1}^A = M_{0|1}^B = |0\rangle\langle 0| \otimes |0\rangle\langle 0| \quad (2.33)$$

$$M_{1|1}^A = M_{1|1}^B = |1\rangle\langle 1| \otimes |0\rangle\langle 0| \quad (2.34)$$

one finds

$$P(a = y, b = x) = \frac{5}{16} \left(1 + \frac{1}{\sqrt{2}} \right) \approx 0.5335 > 1/2 \quad (2.35)$$

thus violating the causal inequality.

Such non-causal correlations exist theoretically. However, so far, no physically implementable resource able to generate them without a “trivial” violation of one of the assumptions (CS, FC, CL) - e.g. via post-selection [20, 21], two-way signalling [128] - has been found. Whether causal-inequality-violating processes can indeed be realized in practice remains an open question.

Maximum violation of causal inequalities

Based on Appendix B of [18].

One may wonder what is the maximum violation of causal inequalities by correlations generated from the action of local quantum operations on a process matrix. To answer this question, we follow the method of [18], itself inspired by [129].

As explained in [18], “maximizing the violation of a causal inequality over the process matrix and the instruments is a nonlinear problem, which makes it intractable directly.” To optimize the process matrix correlations for some $\mathcal{H}_{A_I}, \mathcal{H}_{A_O}, \mathcal{H}_{B_I}, \mathcal{H}_{B_O}$ of a given dimension, the idea is to perform the following *see-saw algorithm*.

Let $I(W, \{M_{a|x}^A\}_a, \{M_{b|y}^B\}_b)$ be the value taken by the combination of probabilities in the causal inequality (e.g., in the GYNI game, $I(W, \{M_{a|x}^A\}_a, \{M_{b|y}^B\}_b) = P^{process}(a = y, b = x)$), a function of the process matrix and Alice and Bob’s instruments.

Assume first that Alice and Bob’s operations are fixed: we generate some random sets of instruments $\{M_{a|x}^A\}_a^\circ$ and $\{M_{b|y}^B\}_b^\circ$. Then, $I(W, \{M_{a|x}^A\}_a^\circ, \{M_{b|y}^B\}_b^\circ)$ is a linear function of the process matrix W , and its maximization is the SDP problem

$$\begin{aligned} \max I(W, \{M_{a|x}^A\}_a^\circ, \{M_{b|y}^B\}_b^\circ) \\ \text{s.t. } W \in \mathcal{W}^{sep} \end{aligned} \quad (2.36)$$

which can be solved efficiently.

The next step is to fix the process matrix with the optimal solution W° found previously, as well as one of the parties’ operations (e.g. Alice’s). This time $I(W^\circ, \{M_{a|x}^A\}_a^\circ, \{M_{b|y}^B\}_b)$ is a linear function of Bob’s instruments $\{M_{b|y}^B\}_b$, and its maximization is the SDP problem

$$\begin{aligned} \max I(W^\circ, \{M_{a|x}^A\}_a^\circ, \{M_{b|y}^B\}_b) \\ \text{s.t. } \forall y, b \quad M_{b|y}^B \geq 0, \quad \sum_b M_{b|y}^B * \mathbb{1}^{B_O} = \mathbb{1}^{B_I}. \end{aligned} \quad (2.37)$$

The last step consists in fixing both W° and $\{M_{b|y}^B\}_b^\circ$. $I(W^\circ, \{M_{a|x}^A\}_a, \{M_{b|y}^B\}_b^\circ)$ is a linear function of Alice’s instruments $\{M_{a|x}^A\}_a$, and its maximization is the SDP problem

$$\begin{aligned} \max I(W^\circ, \{M_{a|x}^A\}_a, \{M_{b|y}^B\}_b^\circ) \\ \text{s.t. } \forall x, a \quad M_{a|x}^A \geq 0, \quad \sum_a M_{a|x}^A * \mathbb{1}^{A_O} = \mathbb{1}^{A_I}. \end{aligned} \quad (2.38)$$

This three steps are repeated - using the optimal W° , $\{M_{a|x}^A\}_a^\circ$ and $\{M_{b|y}^B\}_b^\circ$ to initialize the next iteration - until the solution converges.

Importantly, “note that because the optimization problem is nonconvex, the algorithm is not guaranteed to converge to a global maximum” [18]. Nevertheless, at least for small enough dimensions (e.g. qubits), we can conjecture that the global maximum can be found by repeating the see-saw algorithm for different random initializations multiple times.

2.5 Physical Indefinite Causal Orders: the Quantum Switch

A canonical example of a physical quantum process incompatible with a definite causal order is the so-called quantum switch [13] (its implementation is discussed in Section 3.4.1). The considered scenario involves $(2 + F)$ parties: Alice, Bob and Fiona. Alice and Bob can perform respectively a unitary operation U_A and U_B on a “target qubit” $|\psi\rangle_t$. The order of their operations is coherently controlled by another degree of freedom, the so-called “control qubit” $|\phi\rangle_c$. Fiona recovers the global compound system of the target and the control, and can perform measurements on it. Therefore, the order in which the gates are performed is coherently controlled by a quantum system. Initially, the description of the global system {control-target} takes the form: $|\phi\rangle_c \otimes |\psi\rangle_t$. If the control qubit is in the initial state $|0\rangle_c$, Alice applies an operation on the target before Bob, and Fiona recovers the final state: $|0\rangle_c \otimes U_B U_A |\psi\rangle_t$. If the control qubit is in the initial state $|1\rangle_c$, Bob applies an operation on the target before Alice, and Fiona recovers the final state: $|1\rangle_c \otimes U_A U_B |\psi\rangle_t$. If the control qubit is in the superposed initial state $|+\rangle_c = \frac{1}{\sqrt{2}}(|0\rangle_c + |1\rangle_c)$, Fiona recovers the final state:

$$|+\rangle_c \otimes |\psi\rangle_t \rightarrow \frac{1}{\sqrt{2}} (|0\rangle_c \otimes U_B U_A |\psi\rangle_t + |1\rangle_c \otimes U_A U_B |\psi\rangle_t) \quad (2.39)$$

In this case, Alice and Bob’s operations are often referred as being in a “*superposition of orders*”. Note that this is a misnomer: the causal order is entangled with / coherently controlled by a quantum system, rather than being itself in superposition¹⁰. Furthermore, a no-go theorem shows that a pure superposition of causal orders is not possible for a broad class of processes [130].

The causal structure underlying the quantum switch can be expressed in the process matrix formalism. Alice and Bob’s operations are associated with Hilbert spaces

¹⁰Note that the same misnomer commonly appears when the Schrödinger’s cat is said to be in a superposition of “alive” and “dead”. One should rather say that the state of the cat is entangled with / coherently controlled by a quantum system.

$\mathcal{H}^{A_I}, \mathcal{H}^{A_O}$ and $\mathcal{H}^{B_I}, \mathcal{H}^{B_O}$, and Fiona's measurement with the input Hilbert spaces \mathcal{H}^{F^t} (for the target) and \mathcal{H}^{F^c} (for the control).

The Quantum Switch

The process matrix of the quantum switch is conveniently considered to be the reduced tripartite process matrix:

$$W_{switch}^{ABF^c} = \text{Tr}_{F^t} |w\rangle \langle w|^{ABF^t F^c} \quad (2.40)$$

with the process vector^a:

$$\begin{aligned} |w\rangle^{ABF^t F^c} &= \frac{1}{\sqrt{2}} \left(|w\rangle^{A \prec B \prec F^t F^c} + |w\rangle^{B \prec A \prec F^t F^c} \right) \\ &= \frac{1}{\sqrt{2}} \left(|\psi\rangle^{A_I} |\mathbb{1}\rangle^{A_O B_I} |\mathbb{1}\rangle^{B_O F^t} |0\rangle^{F^c} + |\psi\rangle^{B_I} |\mathbb{1}\rangle^{B_O A_I} |\mathbb{1}\rangle^{A_O F^t} |1\rangle^{F^c} \right) \end{aligned} \quad (2.41)$$

with implicit tensor products. The unnormalized Bell state $|\mathbb{1}\rangle^{X_O Y_I} = \sum_i |i\rangle^{X_O} \otimes |i\rangle^{Y_I}$, for a fixed orthonormal basis $\{|i\rangle^X\}_i$ (the computational basis of \mathcal{H}^X) represents an identity channel between party X 's output Hilbert space X_O and party Y 's input Hilbert space Y_I .

^a"In some cases, the process matrix turns out to be a rank-one projector. If the CJ operators representing the local operations are also rank-one projectors, as is the case for unitaries and projective measurements followed by pure re-preparations, it is convenient to work at the level of vectors and of probability amplitudes." [16], cf. Definition 6.

In fact, a process vector of the form

$$|w\rangle^{A \prec B \prec F^t F^c} = |\psi\rangle^{A_I} |\mathbb{1}\rangle^{A_O B_I} |\mathbb{1}\rangle^{B_O F^t} |0\rangle^{F^c} \quad (2.42)$$

can naively be understood as the following: the target qubit $|\psi\rangle_t$ enters Alice's laboratory (and thus evolves in the space \mathcal{H}^{A_I}). After Alice's operation, it leaves her laboratory and is sent to Bob's without intermediate transformation: hence the identity channel from Alice's output space to Bob's input space $|\mathbb{1}\rangle^{A_O B_I}$. Bob performs in turn an operation on the target, and, finally, the system is sent to Fiona, without intermediate transformation, $|\mathbb{1}\rangle^{B_O F^t}$. This process is correlated with the control qubit in state $|0\rangle_c$. Being unaltered and unseen by Alice and Bob during the process, one can consider that the latter is directly sent to Fiona. It thus evolves in the Hilbert space \mathcal{H}^{F^c} .

Therefore, Eq.(2.40) can be written as:

$$\begin{aligned} W_{switch}^{ABF^c} &= \frac{1}{2} \text{Tr}_{F^t} (W^{A \prec B \prec F^t F^c} + W^{B \prec A \prec F^t F^c} \dots \\ &\dots + |w\rangle^{A \prec B \prec F^t F^c} \langle w|^{B \prec A \prec F^t F^c} + |w\rangle^{B \prec A \prec F^t F^c} \langle w|^{A \prec B \prec F^t F^c}) \end{aligned} \quad (2.43)$$

with $W^{A \prec B \prec F^t F^c} = |w\rangle^{A \prec B \prec F^t F^c} \langle w|^{A \prec B \prec F^t F^c}$ and $W^{B \prec A \prec F^t F^c} = |w\rangle^{B \prec A \prec F^t F^c} \langle w|^{B \prec A \prec F^t F^c}$, corresponding to well defined causal orders. Intuitively, Eq. (2.43) can thus be interpreted as the sum of two causally ordered process matrices, $W^{A \prec B \prec F^t F^c}$ and $W^{B \prec A \prec F^t F^c}$, and two

“interference” / coherence terms, $|w\rangle^{A \prec B \prec F^t F^c} \langle w|^{B \prec A \prec F^t F^c}$ and $|w\rangle^{B \prec A \prec F^t F^c} \langle w|^{A \prec B \prec F^t F^c}$. Because this process matrix is a rank-1 projector (it is “pure”, cf. Definition 6), it cannot be decomposed as a convex mixture of nontrivial process matrices. Thus it follows that the process matrix W is causally nonseparable.

The causal nonseparability of the quantum switch can be certified by constructing a causal witness, with a random robustness [16, 17]

$$r^* \approx 1,576. \quad (2.44)$$

Nevertheless, it cannot violate a causal inequality, as shown in [16, 21]. In fact, the last party, Fiona, cannot signal to Alice nor Bob. Therefore, the correlation generated by the process matrix W of the quantum switch takes the form:

$$\begin{aligned} p(a, b, f|x, y, z) &= \sum_{f'} p(a, b, f'|x, y, z) \frac{p(a, b, f|x, y, z)}{\sum_{f''} p(a, b, f''|x, y, z)} \\ &= ((M_{a|x}^A \otimes M_{b|y}^B \otimes \sum_{f'} M_{f'|z}^F) * W^{ABF}) p(f|a, b, x, y, z) \\ &= ((M_{a|x}^A \otimes M_{b|y}^B \otimes \mathbb{1}^F) * W^{ABF}) p(f|a, b, x, y, z) \\ &= (M_{a|x}^A \otimes M_{b|y}^B) * (\text{Tr}_F W^{ABF}) p(f|a, b, x, y, z) \\ &= p(a, b|x, y) p(f|a, b, x, y, z) \end{aligned} \quad (2.45)$$

where the probability distribution $p(a, b|x, y)$ is generated by the causally separable process matrix

$$\text{Tr}_F W^{ABF} = \frac{1}{2} (W^{A \prec B} + W^{B \prec A}) \quad (2.46)$$

with $W^{A \prec B} = \text{Tr}_{F^t F^c} W^{A \prec B \prec F^t F^c}$ and $W^{B \prec A} = \text{Tr}_{F^t F^c} W^{B \prec A \prec F^t F^c}$. In fact, the “interference” terms that were responsible of the causal nonseparability of the quantum switch are killed when the control Hilbert space \mathcal{H}^{F^c} is traced out. Therefore, the reduced process generates causal correlations.

Causal and noncausal correlations - $(2 + F)$ scenario

Definition 5. Following [16, 17], $(2 + F)$ correlations are called *causal* if they can be written as a convex mixture of probability distributions compatible with $A \prec B \prec F$ or $B \prec A \prec F$, with $q \in [0, 1]$:

$$P(a, b|x, y) = qP^{A \prec B \prec F}(a, b|x, y) + (1 - q)P^{B \prec A \prec F}(a, b|x, y) \quad (2.47)$$

Correlations that cannot be written as in Eq. (2.47) are *noncausal*.

It follows that the probability distribution $p(a, b, f|x, y, z)$ of Eq. (2.45) is causal as well. Thus, the correlations generated by the quantum switch cannot violate a causal inequality, although the process matrix is causally nonseparable. This is analogous with certain entangled states that, although being nonseparable, cannot violate a Bell inequality [131] (cf. Chapter 4).

As we will see in more details in Section 3.5, processes with indefinite causal orders can achieve some computational advantages over processes with a fixed causal order. A simple example of such advantage can be obtained with the quantum switch. Assume that Alice and Bob’s unitary operations¹¹ on the target either commute $[U_A, U_B] = U_A U_B - U_B U_A = 0$, or anticommute, $\{U_A, U_B\} = U_A U_B + U_B U_A = 0$. The goal of the task is to determine which one is true. Writing the output state of the quantum switch Eq.(2.39) with the control qubit in the diagonal basis $\{|\pm\rangle = \frac{1}{\sqrt{2}}(|0\rangle \pm |1\rangle)\}$, we have

$$|+\rangle_c \otimes |\psi\rangle_t \rightarrow \frac{1}{2} (|+\rangle_c \otimes \{U_A, U_B\} |\psi\rangle_t - |-\rangle_c \otimes [U_A, U_B] |\psi\rangle_t) \quad (2.48)$$

If the control is found in state $|+\rangle_c$, then Alice and Bob’s operations commute with certainty. If it is found in state $|-\rangle_c$, Alice and Bob’s operations anticommute with certainty. Thus, only one application of each operation is necessary to realize the task. This is not possible when U_A and U_B are implemented in a quantum circuit with a fixed causal order [16, 20]. Therefore, the causal nonseparability of the quantum switch can be used as a new quantum computational resource¹².

2.6 What are process matrices ?

In this section, I present some personal reflections on the nature of process matrices based on the literature.

Process matrices were constructed based on mathematical considerations. A process matrix can be seen as a multipartite resource that encapsulates the notion of quantum state and quantum channel with memory, but also extends to describe more general causal structures. In the seminal paper by Oreshkov, Costa and Brukner [15], it is defined as a functional on quantum instruments such that the generated correlations are well-defined for all instruments, including situations in which the parties share entangled auxiliary systems, and thus do not generate logical paradoxes (cf. Part III “Time Travel without Paradoxes”). The process matrix can also be seen as a “supermap”, mapping the local quantum operations of the parties into a CPTP map from a past Hilbert space \mathcal{H}^P into a future Hilbert space \mathcal{H}^F [86, 132] (cf. Section 3.1). A process matrix is thus a map from the past \mathcal{H}^P and *output* Hilbert spaces $\mathcal{H}^{A_o}, \mathcal{H}^{B_o}$ to the future \mathcal{H}^F and the *input* Hilbert spaces $\mathcal{H}^{A_i}, \mathcal{H}^{B_i}$.

But beyond their mathematical formulation, what *are* process matrices ? Can they all be realized in a laboratory ? Are they all *physical* ? Are there physical processes that could violate a causal inequality ?

The process matrix formalism goes beyond the quantum formalism in the sense that, by relaxing the assumption of a predefined causal order between Alice and Bob’s operations, it allows the description of resources which can go beyond definite causal order. For instance, the quantum switch is such a resource, incompatible with a definite causal order. But, the quantum switch is, as its name suggests, *quantum*: it is compatible with quantum theory,

¹¹Note that the quantum switch can be defined for operations that are not unitaries.

¹²In fact, it was shown in [16] that this task could be used to construct a causal witness in order to certify the causal nonseparability of the quantum switch.

and thus does not require to be expressed in the process matrix formalism. The latter is convenient -not to say essential- to study its causal indefiniteness, i.e. to define and certify causal nonseparability. However, while all quantum operations can occur inside Alice and Bob’s laboratories, not all quantum transformations have a representation in the process matrix formalism. This is the case for example for the “half switch”, which describes the evolution

$$|+\rangle_c \otimes |\psi\rangle_t \rightarrow \frac{1}{\sqrt{2}} (|0\rangle_c \otimes U_A |\psi\rangle_t + |1\rangle_c \otimes U_B |\psi\rangle_t) \quad (2.49)$$

This transformation is ill-defined in the process matrix formalism because only one of Alice or Bob’s operation is performed. They do not “both act once and only once”.

De facto, the process matrix does not generalise quantum theory at the level of quantum operations, but at a higher level of abstraction, at the level of the (causal) resources relating quantum events with each other. It is a theory of higher-order multipartite operations. In a sense, the process matrix formalism should arguably be presented as a meta-theory of quantum theory rather than a generalisation of it: a process matrix is a meta-theoretical object rather than an object of quantum theory (cf. Chapter 8).

Which processes can be implemented in a laboratory and which are mere mathematical artefacts is a non-trivial question. For instance, it was shown that all process matrices can be realized under a suitable post-selection [133, 88, 134]. The set of process matrices was also found to be equivalent with the set of linear post-selection-closed-timelike curves (P-CTC) [25, 24] (cf. Chapter 12). However the fact that all processes matrices can be *simulated* with an experimental post-selection, or could be found in hypothetical exotic systems involving a fundamental post-selection (cf. Section 7.3), does not answer the question about their “physicality” in a satisfactory way. In fact, some post-quantum resources such as the Popescu-Rohrlich (PR) boxes [135, 81] - known to be maximally non-local (they allow to win the CHSH game with certainty)- can be simulated with a post-selection [136, 137, 138, 139]. Nevertheless, this does not suggest that they can be realizable in Nature *without cheating*.

The notion of *purifiability* (also called *unitary extendibility*) has been proposed as a criterion of physicality for processes [23]. Purifiable processes are those than can be obtained from some pure processes after tracing out on some involved Hilbert spaces. A pure process is defined as being compatible with the reversibility of the parties’ operations. In other words, if unitary operations are applied in the local laboratories, then the global induced map from the past P to the future F is also a unitary transformation.

Pure process matrix

Definition 6. A bipartite process matrix W^{PABF} is *pure* if, for all auxiliary Hilbert spaces $\mathcal{H}^{A'_I}, \mathcal{H}^{A'_O}, \mathcal{H}^{B'_I}, \mathcal{H}^{B'_O}$ (with dimensions satisfying $d_{A_I} d_{A'_I} = d_{A_O} d_{A'_O}$, $d_{B_I} d_{B'_I} = d_{B_O} d_{B'_O}$ and $d_P d_{A'_I} d_{B'_I} = d_F d_{A'_O} d_{B'_O}$) and all unitaries $U_A : \mathcal{H}^{A_I A'_I} \rightarrow \mathcal{H}^{A_O A'_O}$, $U_B : \mathcal{H}^{B_I B'_I} \rightarrow \mathcal{H}^{B_O B'_O}$, the resulting transformation is a unitary channel $\mathcal{G} : \mathcal{H}^{P A'_I B'_I} \rightarrow \mathcal{H}^{F A'_O B'_O}$ with the Choi representation

$$G^{P A' B' F} = W^{P A B F} * (|U_A\rangle\rangle \langle\langle U_A|^{A A'} \otimes |U_B\rangle\rangle \langle\langle U_B|^{B B'}) \quad (2.50)$$

with $|U_A\rangle\rangle \langle\langle U_A|^{A A'}$ and $|U_B\rangle\rangle \langle\langle U_B|^{B B'}$ the Choi representations of the unitaries.

Pure processes can be characterized as the processes that can be written as a rank-1 projector $W = |U_w\rangle\rangle \langle\langle U_w|$ for some unitary $U_w : \mathcal{H}^{PA_0B_0} \rightarrow \mathcal{H}^{FA_1B_1}$, e.g. the quantum switch. However, in contrast with the purification of mixed state and the dilation of quantum channel into a unitary channel, there exist processes that do not admit a unitary extension. The OCB process of Eq. (2.24) [15], the GYNI process of Eq. (2.30) [18], as well as all bipartite causally nonseparable process matrices are not purifiable [23, 140]. If the notion of purifiability is accepted as a necessary or at least a reasonable notion for physicality “because the irreversibility that occurs within them can be interpreted as arising from forgetting degrees of freedom in a fundamentally reversible process” [141], then physical examples of causally nonseparable processes do not exist in the bipartite case.

This negative result does not mean that the violation of causal inequality is not physical. In fact, a tripartite noncausal process found by Araújo and Feix and then published and further studied by Baumeler and Wolf [142, 24, 22], called the *Lugano process*, was shown to be purifiable. Interestingly, this process matrix is “classical”, in the sense that it is diagonal in the computational basis. This suggests that causal nonseparability is *not* uniquely a quantum feature, as it can also manifest in classical processes. The Lugano process can be written as

$$\begin{aligned} W^{ABC} &= \sum_{a,b,c} |a, b, c\rangle \langle a, b, c|^{A_0B_0C_0} \otimes |\neg b \wedge c, \neg c \wedge a, \neg a \wedge b\rangle \langle \neg b \wedge c, \neg c \wedge a, \neg a \wedge b|^{A_1B_1C_1} \\ &= \sum_{a,b,c} |\neg b \wedge c\rangle \langle \neg b \wedge c|^{A_1} \otimes |a\rangle \langle a|^{A_0} \otimes |\neg c \wedge a\rangle \langle \neg c \wedge a|^{B_1} \otimes |b\rangle \langle b|^{B_0} \dots \\ &\quad \dots \otimes |\neg a \wedge b\rangle \langle \neg a \wedge b|^{C_1} \otimes |c\rangle \langle c|^{C_0} \end{aligned} \quad (2.51)$$

Its purified extension is given by

$$W_L^{PABCF} = |w_L\rangle \langle w_L| \quad (2.52)$$

with the process vector

$$\begin{aligned} |w_L\rangle &= \sum_{a,b,c,i,j,k} |i, j, k\rangle^P \otimes |i \oplus \neg b \wedge c\rangle^{A_1} \otimes |a\rangle^{A_0} \otimes |j \oplus \neg c \wedge a\rangle^{B_1} \otimes |b\rangle^{B_0} \dots \\ &\quad \dots \otimes |k \oplus \neg c \wedge a\rangle^{C_1} \otimes |c\rangle^{C_0} \otimes |a, b, c\rangle^F \end{aligned} \quad (2.53)$$

In this process, the state observed by each party - Alice, Bob and Charlie - depends non-trivially on the states prepared by all the others. All of them can verify to be both in the past and the future of each other, without any restriction on the local operations they can perform and without logical paradoxes. This process has been formalised and generalised in a classical version of the process matrix formalism [143, 144, 145].

Physical processes with indefinite causal orders have also been interpreted in terms of timedelocalized subsystems [146] and observer-dependent local events [141]. It was shown that there is a one-to-one correspondence between pure processes and consistent causal reference frames, which are the processes that allow a description in terms of a quantum system evolving in time. In such approaches, the operation of a party can be taken as reference and is always localised. For causally separable (pure) processes, the other parties’ operations are also localised, independently of the reference. But in the case of causally

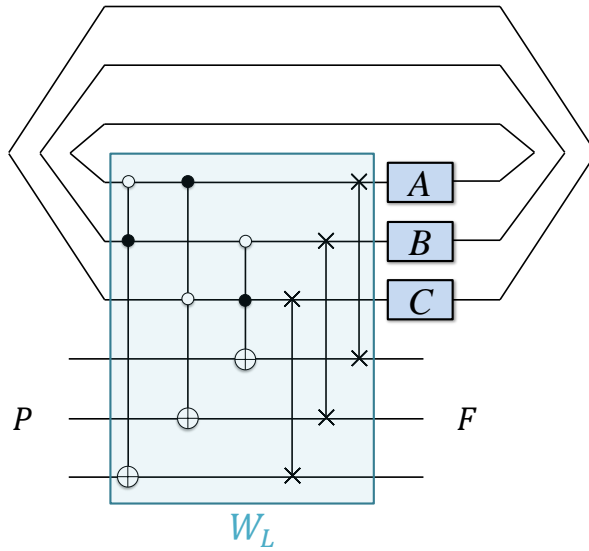

Figure 2.2: Circuit representation of the purified Lugano process W_L , from [25].

nonseparable (pure) processes, the other parties' operations are “smeared out” in the future and in the past” [141]. Furthermore, these processes - including the “noncausal” ones that violate a causal inequality, like the Lugano process - admit a causal explanation in terms of cyclic causal models [140].

Chapter 3

Beyond the Quantum Switch: Quantum Circuits with Quantum Control of causal orders

This chapter is taken from and based on our publication [86]. A similar presentation was made by Julian Wechs in his PhD thesis [147]. In particular, I have characterized the quantum switch as a quantum circuits with quantum control of causal orders (QC-QC) (Section 3.4), as well as straightforward generalisations (Section 3.4.2). I have proposed a new implementation of the quantum switch, which require fewer degrees of freedom than previous realizations (Section 3.4.1). I have also studied new examples of QC-QCs based on an original idea from Cyril Branciard (Section 3.4.3). Finally, Julian Wechs and I have found several examples of tasks for which QC-QCs provide an advantage over circuits with definite causal order (Section 3.5).

One of the main open questions in the field of quantum causality is to identify which causally nonseparable process matrices have a physical realization, and more specifically if there exist physical causally nonseparable processes able to violate a causal inequality. This question can be studied in a *top-down* approach, i.e. answering directly the question “Which process matrices are physical?”. The main difficulty of this task is to find a satisfactory criterion for physicality. In [23], a purification postulate is proposed: “process matrices are physical only if they are purifiable”, and some processes, like the OCB process of Eq. (2.24) [15] and the GYNI process of Eq. (2.30), do not satisfy the associated conditions (cf. Section 2.6).

The question can also be studied in a *bottom-up* approach. Process matrices that can be realized with a quantum circuit as quantum supermaps (Section 3.1) are straightforwardly physical. Thus the question: “What kind of quantum circuits are incompatible with a definite causal order?”.

Standard quantum circuits are compatible with a fixed causal order (QC-FO) (Section 3.2). They correspond to the so-called *quantum combs*, in which open slots into which variable external operations can be inserted in a fixed order [148, 120, 121]. Building on the idea, we introduce a new class of quantum circuits where the causal order is established dynamically, controlled by the classical inputs and outputs of the external operations as they are performed on the fly: *quantum circuits with classical control* (QC-CC) (Section

3.3). However these are all compatible with a definite causal order, i.e. the corresponding process matrices are all causally separable.

So far, the quantum switch - with some rather straightforward multipartite generalisations [149, 150] or combinations [151, 152] - was the only practical example of a causally nonseparable process that has been proposed in the literature. It is a quantum circuit in which the causal order is coherently controlled. Building on this canonical example, we proposed new classes of experimentally realisable process matrices, corresponding to *quantum circuits with quantum control of causal orders* (QC-QC) (Section 3.4). This new type of circuits, for which some are incompatible with a definite causal order) offers advantages over QC-FOs and QC-CCs in some specific information processing tasks (Section 3.5). However, despite the fact that some QC-QCs are causally nonseparable, they are all causal, i.e. they cannot generate noncausal correlations (Section 3.6).

3.1 Quantum Circuits and Process Matrices as Quantum Supermaps

In analogy with how a classical computer is based on an electrical circuit made of wires connecting logical gates, quantum computation can be modeled by *quantum circuits*, made of wires - systems carrying around quantum information - and quantum operations - that manipulate them. In such a circuit, some operations might be interpreted as being “external”, as they can freely chosen. The quantum circuit is thus built on the other, “internal” operations, with empty slots containing pins, on which the free operations are plugged in. From such perspective, a quantum circuit can be seen as a higher-order operation, mapping external quantum operations (CP maps) into a global CP map: a so-called *quantum supermap*.

Process matrices as previously defined, i.e. as higher-order operations transforming CP maps into probabilities - CP maps with trivial (1-dimensional) input and output spaces - can be interpreted as such quantum supermaps. Previously presented in the bipartite case, here we will consider the multipartite generalisation of process matrices as quantum supermaps taking N external locally quantum operations, CP maps $\mathcal{A}_k : \mathcal{L}(\mathcal{H}^{A_k^I}) \rightarrow \mathcal{L}(\mathcal{H}^{A_k^O})$ (with input and output Hilbert spaces $\mathcal{H}^{A_k^I}$ and $\mathcal{H}^{A_k^O}$ with finite dimensions $d_{A_k^I}$ and $d_{A_k^O}$ respectively, and $k \in \mathcal{N} := \{1, \dots, N\}$) into a global CP map \mathcal{M} operating from some “global past space” \mathcal{H}^P to a “global future space” \mathcal{H}^F , cf. Fig. 3.1. These global spaces can be interpreted respectively as a space where an input system is prepared and a space where a final measurement might be performed on the output system, respectively.

Note that we impose that the considered quantum supermaps should be completely CP-preserving (CCP) [132, 120]. The supermaps should be linear, i.e. if a given operation \mathcal{A}_k is obtained as a probabilistic mixture of some operations $\mathcal{A}_k^{(j)}$, then the resulting map \mathcal{M} should also be obtained as the corresponding probabilistic mixture. Moreover, if the local CP maps \mathcal{A}_k shall be extended with some auxiliary spaces $\mathcal{H}^{A_k^{I'}}$ and $\mathcal{H}^{A_k^{O'}}$ into extended maps $\mathcal{A}'_k : \mathcal{L}(\mathcal{H}^{A_k^I A_k^{I'}}) \rightarrow \mathcal{L}(\mathcal{H}^{A_k^O A_k^{O'}})$, we impose that the application of the quantum supermap on such operations should still give valid CP maps. This imposes that the process matrix W should be positive semidefinite (cf. Section 2.3).

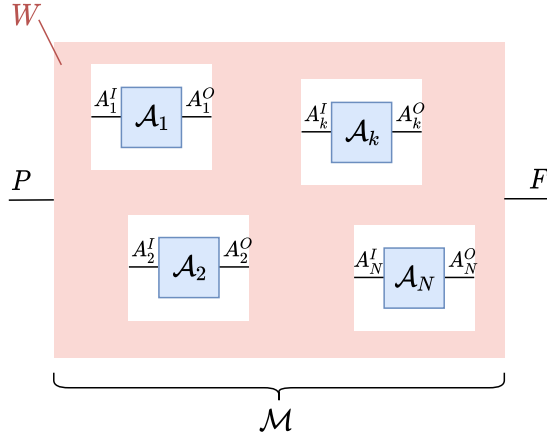

Figure 3.1: A CP map \mathcal{M} from the “global past” \mathcal{H}^P to the “global future” \mathcal{H}^F is induced by the action of a completely CP-preserving quantum supermap that takes N quantum operations as inputs—i.e., CP maps— \mathcal{A}_k (for $k = 1, \dots, N$) with input and output Hilbert spaces $\mathcal{H}^{A_k^I}$ and $\mathcal{H}^{A_k^O}$ [15, 23]. The Choi representation M of the global map \mathcal{M} is obtained from the Choi representations A_k of the maps \mathcal{A}_k according to Eq. (3.1), in terms of the *process matrix* W (represented by the salmon-coloured area).

Like in the process matrix formalism introduced previously, the local CP maps \mathcal{A}_k should be trace-nonincreasing, but not necessarily trace-preserving (TP): indeed in the general case, these external operations are part of some quantum instruments (sets of CP maps summing up to a CPTP map) and generate some classical outcome.

In this thesis, I will focus on the seminal case where the internal circuit is a *deterministic* supermap, such that if all CP maps \mathcal{A}_k are trace-preserving (TP), then so must be the induced map \mathcal{M} (they have thus sometimes been called *superchannels* [153, 127]). As explained above, this condition imposes some “validity constraints” on the allowed process matrices W —namely, that they must belong to some particular subspace \mathcal{L}_V of $\mathcal{L}(\mathcal{H}^{PA_N^IOF})$, and be normalised such that $\text{Tr } W = d_P(\prod_{k \in \mathcal{N}} d_k^O)$ [15, 16, 23, 21].

Note that in our work [86], we also consider *probabilistic* process matrices which turn TP maps into a trace-nonincreasing induced map, and which may be part of a so-called *quantum superinstrument* [154]—namely, sets of probabilistic process matrices summing up to a deterministic one. I will briefly introduce these in Section 3.5.

Using the link product, the Choi representation $M \in \mathcal{L}(\mathcal{H}^{PF})$ of the induced global map \mathcal{M} is the composition of the Choi representations A_k of the N local operations \mathcal{A}_k on the process matrix W :

$$M = (A_1 \otimes A_2 \otimes \dots \otimes A_N) * W \quad (3.1)$$

In what follows, I will present three specific classes of generalised quantum circuits (represented in Fig. 3.2), i.e. three types of CCP quantum supermaps, into which the free, “external” operations A_k can be “plugged in” in either a fixed, a classically-controlled, or a coherently controlled causal order, with the last two being new families of quantum supermaps. Remarkably, the latter can lead to causally nonseparable process matrices,

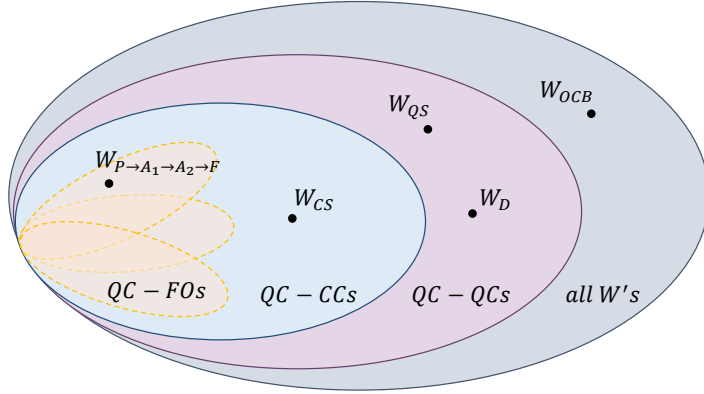

Figure 3.2: Venn diagram of the classes of quantum supermaps studied in [86]. QC-FOs are quantum circuits compatible with a single, fixed, causal order (Sec. 3.2), such as the process $W_{P \rightarrow A_1 \rightarrow A_2 \rightarrow F}$ described in Eq. (3.8). These circuits form a non-convex set since a mixture of QC-FOs compatible with different orders is, in general, not compatible with any single order. QC-CCs are quantum circuits with classical control of causal order (Sec. 3.3), such as the “classical switch” W_{CS} (Eq. (3.19)); all QC-CCs are causally separable processes. QC-QCs are quantum circuits with quantum control of causal order (Sec. 3.4), such as the quantum switch W_{QS} (Eq. (3.37)) and the new quantum process W_D that we describe in Eq. (3.47), both of which are causally nonseparable. QC-QCs are a strict subset of all quantum supermaps: those violating causal inequalities, such as the W_{OCB} of Eq. (2.24) [15] cannot be described as QC-QCs.

defining a broad new class of such supermaps which, by construction, can be meaningfully interpreted.

3.2 Quantum Circuits with Fixed Causal Order

A quantum circuit is generally represented as a sequence of quantum operations performed in a well defined causal order, i.e. each one applied one after the other. These are the so-called *quantum combs* [120, 121], quantum supermaps transforming a fixed set of ordered external operations into a global CP map, that we call here *quantum circuits with fixed causal order (QC-FO)*. Indeed, these circuits can be represented in the shape of a “comb”, with an ordered sequence of slots.

Consider a quantum circuit with N “open slots” into which the CP maps $\mathcal{A}_1, \dots, \mathcal{A}_N$ are placed in a fixed order (so as to define the global map \mathcal{M} , as described above). We will denote, for example, the ordering in which \mathcal{A}_1 is applied first, then \mathcal{A}_2 , etc., as $(\mathcal{A}_1, \mathcal{A}_2, \dots, \mathcal{A}_N)$. The building blocks of the QC-FO are internal operations $\mathcal{M}_1, \dots, \mathcal{M}_{N+1}$ that take the output of each external map to the input of the following one, as shown in Fig. 3.3.

Because we consider deterministic circuits, the internal operations \mathcal{M}_k must preserve the trace of their input states, i.e. they are *CPTP maps*. Note that these internal operations may also act upon some “memories”, additional auxiliary systems living in Hilbert spaces \mathcal{H}^{α_k} that are entangled with the “target systems” that the external CP maps act

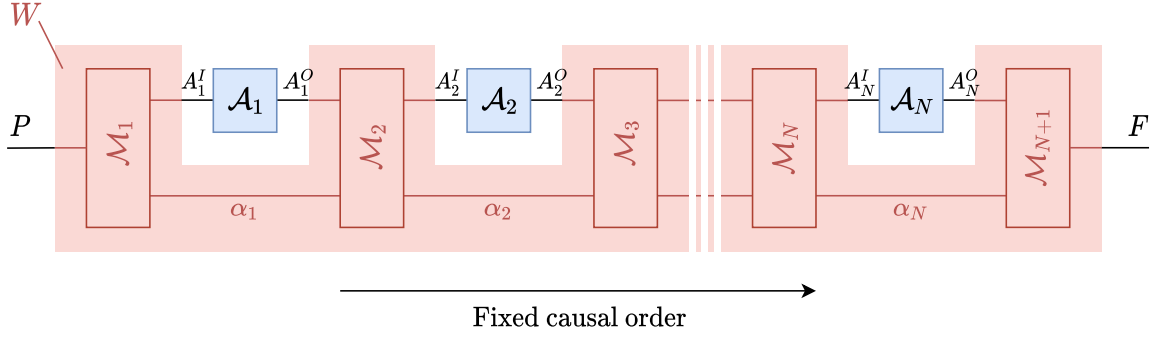

Figure 3.3: Quantum circuit with fixed causal order (“quantum comb”), here with the order of operations $(\mathcal{A}_1, \mathcal{A}_2, \dots, \mathcal{A}_N)$. Its process matrix representation (salmon-coloured area) is given by Eq. (3.5).

upon. The most general case of QC-FO is in fact often referred to as “quantum channel with memory” [121, 120, 155].

The maps \mathcal{M}_1 , \mathcal{M}_{n+1} , and \mathcal{M}_{N+1} above have Choi representations $M_1 \in \mathcal{L}(\mathcal{H}^{PA_1^I \alpha_1})$, $M_{n+1} \in \mathcal{L}(\mathcal{H}^{A_n^O \alpha_n A_{n+1}^I \alpha_{n+1}})$, and $M_{N+1} \in \mathcal{L}(\mathcal{H}^{A_N^O \alpha_N F})$, respectively.

A QC-FO is built as the following:

- a first CPTP map $\mathcal{M}_1 : \mathcal{L}(\mathcal{H}^P) \rightarrow \mathcal{L}(\mathcal{H}^{A_1^I \alpha_1})$ starts the circuit by acting on the global past \mathcal{H}^P and outputs a state in the input Hilbert space $\mathcal{H}^{A_1^I}$ of the first operation \mathcal{A}_1 (the target system), which in general may be entangled with an auxiliary system in some Hilbert space \mathcal{H}^{α_1} , the corresponding TP condition in the Choi representation being

$$\text{Tr}_{A_1^I \alpha_1} M_1 = \mathbb{1}^P, \quad (3.2)$$

- then, for $1 \leq n \leq N - 1$, a CPTP map $\mathcal{M}_{n+1} : \mathcal{L}(\mathcal{H}^{A_n^O \alpha_n}) \rightarrow \mathcal{L}(\mathcal{H}^{A_{n+1}^I \alpha_{n+1}})$ is performed on the output state of each external CP map \mathcal{A}_n in the Hilbert space $\mathcal{H}^{A_n^O}$ and the auxiliary system in \mathcal{H}^{α_n} , and outputs a state in the the input Hilbert space $\mathcal{H}^{A_{n+1}^I}$ of \mathcal{A}_{n+1} and an auxiliary system in some Hilbert space $\mathcal{H}^{\alpha_{n+1}}$. it can be shown [86] that the corresponding TP condition is:

$$\forall n = 1, \dots, N-1, \text{Tr}_{A_{n+1}^I \alpha_{n+1}} (M_1 * \dots * M_n * M_{n+1}) = \text{Tr}_{\alpha_n} (M_1 * \dots * M_n) \otimes \mathbb{1}^{A_n^O} \quad (3.3)$$

- finally, after the last internal operation \mathcal{A}_N , the last internal CPTP map of the QC-FO, $\mathcal{M}_{N+1} : \mathcal{L}(\mathcal{H}^{A_N^O \alpha_N}) \rightarrow \mathcal{L}(\mathcal{H}^F)$, drives the output state of \mathcal{A}_N in $\mathcal{H}^{A_N^O}$, together with the auxiliary state in \mathcal{H}^{α_N} , to the global output state of the full circuit in the global future \mathcal{H}^F , with the TP condition¹

$$\text{Tr}_F (M_1 * \dots * M_N * M_{N+1}) = \text{Tr}_{\alpha_N} (M_1 * \dots * M_N) \otimes \mathbb{1}^{A_N^O} \quad (3.4)$$

¹Note that the TP conditions Eq. (3.3)-(3.4) are weaker than (and indeed implied by) the TP assumptions applied to the full input spaces of the operations \mathcal{M}_n (which can be written as $\text{Tr}_{A_{n+1}^I \alpha_{n+1}} M_{n+1} = \mathbb{1}^{A_n^O \alpha_n}$ for $n = 1, \dots, N-1$, and $\text{Tr}_F M_{N+1} = \mathbb{1}^{A_N^O \alpha_N}$). Indeed, we only require trace-preservation for the inputs spaces of the internal operations for the subspace of $\mathcal{L}(\mathcal{H}^{A_{n-1}^O \alpha_{n-1}})$ that can actually be populated following the internal and external circuit operations previously applied.

QC-FO as a process matrix

The QC-FO, being a specific CCP quantum supermap, have a representation as a process matrix.

Process matrix description of QC-FOs

Proposition 7. *The process matrix corresponding to the quantum circuit of Fig. 3.3, with the fixed causal order $(\mathcal{A}_1, \mathcal{A}_2, \dots, \mathcal{A}_N)$, is*

$$W = M_1 * M_2 * \dots * M_N * M_{N+1} \in \mathcal{L}(\mathcal{H}^{PA_N^{IO}F}). \quad (3.5)$$

Proof. Recall firstly that the Choi matrix of the sequential composition of quantum operations is obtained by link-multiplying the composite operations. Using the commutativity and associativity of the link product, and the fact that it reduces to tensor products for non-overlapping Hilbert spaces, we can write the Choi matrix $M \in \mathcal{L}(\mathcal{H}^{PF})$ of the induced global map $\mathcal{M} : \mathcal{L}(\mathcal{H}^P) \rightarrow \mathcal{L}(\mathcal{H}^F)$ as

$$\begin{aligned} M &= M_1 * A_1 * M_2 * \dots * M_N * A_N * M_{N+1} \\ &= (A_1 \otimes \dots \otimes A_N) * (M_1 * M_2 * \dots * M_N * M_{N+1}) \end{aligned} \quad (3.6)$$

Recalling Eq. (3.1), this allows us to identify the process matrix W as the unique operator corresponding to the second term in parentheses above. This is illustrated in Fig.3.3. \square

Characterisation

The previous description of QC-FO allows us to obtain a characterisation in terms of constraints on process matrices, i.e. given a process matrix, if it satisfies the relevant constraints, one can infer that it describes a QC-FO.

Characterisation of QC-FOs

Proposition 8. *For a given matrix $W \in \mathcal{L}(\mathcal{H}^{PA_N^{IO}F})$, let us define the reduced matrices (for $1 \leq n \leq N$, and relative to the fixed order $(\mathcal{A}_1, \mathcal{A}_2, \dots, \mathcal{A}_N)$) $W_{(n)} := \frac{1}{d_n^O d_{n+1}^O \dots d_N^O} \text{Tr}_{A_n^O A_{\{n+1, \dots, N\}}^O} W \in \mathcal{L}(\mathcal{H}^{PA_{\{1, \dots, n-1\}}^I A_n^I})$.*

The process matrix $W \in \mathcal{L}(\mathcal{H}^{PA_N^{IO}F})$ of a quantum circuit with the fixed causal order $(\mathcal{A}_1, \mathcal{A}_2, \dots, \mathcal{A}_N)$ is a positive semidefinite matrix such that its reduced matrices $W_{(n)}$ just defined satisfy

$$\begin{aligned} \text{Tr}_{A_1^I} W_{(1)} &= \mathbb{1}^P, \\ \forall n = 1, \dots, N-1, \quad \text{Tr}_{A_{n+1}^I} W_{(n+1)} &= W_{(n)} \otimes \mathbb{1}^{A_n^O}, \\ \text{and} \quad \text{Tr}_F W &= W_{(N)} \otimes \mathbb{1}^{A_N^O}. \end{aligned} \quad (3.7)$$

Conversely, any positive semidefinite matrix $W \in \mathcal{L}(\mathcal{H}^{PA_N^{IO}F})$ whose reduced matrices $W_{(n)}$ satisfy the constraints of Eq. (3.7) is the process matrix of a quantum circuit with the fixed causal order $(\mathcal{A}_1, \mathcal{A}_2, \dots, \mathcal{A}_N)$.

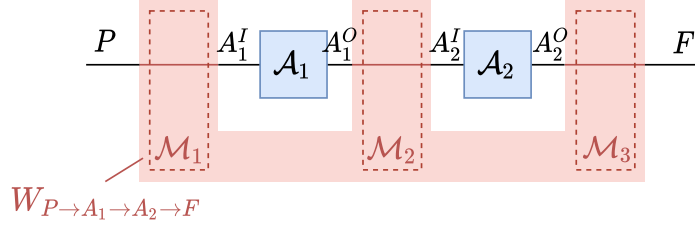

Figure 3.4: In the QC-FO $W_{P \rightarrow A_1 \rightarrow A_2 \rightarrow F}$, the CP maps \mathcal{A}_1 and \mathcal{A}_2 are applied successively to a system initially provided in the global past \mathcal{H}^P . The internal operations $\mathcal{M}_1, \mathcal{M}_2, \mathcal{M}_3$ are simply identity channels between the respective (isomorphic) Hilbert spaces (cf. Fig. 3.3).

A self-contained proof² is given in [86, 148, 120, 121].

Note that the set of (process matrices of) QC-FO's, for a given order, is convex. Furthermore, one can write a SDP problem and, in the same spirit as causal witnesses, one can obtain “witnesses for non-QC-FO's”, allowing to directly verify that a given process is not a QC-FO for a given, fixed causal order.

Example

For the sake of clarity, we give a simple, canonical example of bipartite QC-FO compatible with the causal order $(\mathcal{A}_1, \mathcal{A}_2)$, corresponding to a composition of identity channels (without memory) sending an input system from a global past through two successive external operations \mathcal{A}_1 and \mathcal{A}_2 , and outputting a system in a global future. With isomorphic Hilbert spaces \mathcal{H}^P and $\mathcal{H}^{A_1^I}$, $\mathcal{H}^{A_1^O}$ and $\mathcal{H}^{A_2^I}$, and $\mathcal{H}^{A_2^O}$ and \mathcal{H}^F , and the Choi matrix of an identity channel $\mathcal{I} : \mathcal{L}(\mathcal{H}^X) \rightarrow \mathcal{L}(\mathcal{H}^Y)$ of the form $|\mathbb{1}\rangle\rangle\langle\langle\mathbb{1}|^{XY}$, the corresponding process matrix, as per Proposition 7, is

$$W_{P \rightarrow A_1 \rightarrow A_2 \rightarrow F} = |\mathbb{1}\rangle\rangle\langle\langle\mathbb{1}|^{PA_1^I} \otimes |\mathbb{1}\rangle\rangle\langle\langle\mathbb{1}|^{A_1^O A_2^I} \otimes |\mathbb{1}\rangle\rangle\langle\langle\mathbb{1}|^{A_2^O F}, \quad (3.8)$$

with $M_1 = |\mathbb{1}\rangle\rangle\langle\langle\mathbb{1}|^{PA_1^I}$; $M_2 = |\mathbb{1}\rangle\rangle\langle\langle\mathbb{1}|^{A_1^O A_2^I}$ and $M_3 = |\mathbb{1}\rangle\rangle\langle\langle\mathbb{1}|^{A_2^O F}$.

The circuit is represented in Fig.3.4.

3.3 Quantum Circuits with Classical Control of causal order

The family of QC-FO is a well-known class of quantum supermaps. However it does not entail the totality of causally separable supermaps. In fact, one could imagine a quantum circuit corresponding to a probabilistic mixture of QC-FO with different causal orders ; or a quantum circuit compatible with a well-defined causal order, but in which the latter is established dynamically, i.e. where the application of internal operations might depend

²Note that the necessary condition of the proof follows trivially from Eq.(3.2)-(3.4), as for a QC-FO as defined above, the reduced process matrices are $W_{(n)} = \text{Tr}_{\alpha_n}(M_1 * \dots * M_n)$.

on the previous implemented ones. Inspired by a preliminary formulation in Ref. [21], we present a circuit model encompassing such prospects. We introduce the new class of *quantum circuits with classical control of causal order* (QC-CCs), in which the causal order it can be established dynamically, with the operations in the past determining the causal order of the operations in the future. Note however that it is still unclear if this new class is equivalent with the full set of causally separable supermaps.

Consider a quantum circuit with N “open slots” at different time slots t_n ($1 \leq n \leq N$). At each time slot, one (and only one) external operation \mathcal{A}_k will be applied (and each operation \mathcal{A}_k can *a priori* be applied at any time slot t_n). In a QC-FO, the internal operations \mathcal{M}_n were used to link the external operations with each other in a predefined order. In order to now allow for dynamical orders, the internal operations of the QC-CC determine which external operation should be applied next before the first time slot t_1 , and between each pair of consecutive time slots t_n, t_{n+1} (for $1 \leq n \leq N - 1$), while also transforming its input state and, potentially, additional auxiliary systems. Thus, instead of CPTP maps, we now consider internal operations that produce a classical outcome, indicating which is the subsequent external operation to be applied. The internal operations are thus described by *quantum instruments* $\mathcal{M}_{(k_1, \dots, k_{n-1})}^{\rightarrow k_n}$, sets of CP maps with one outcome k_n for each possible operation that may come next that sums up to a CPTP map, given that the previous external operations $(\mathcal{A}_{k_1}, \dots, \mathcal{A}_{k_{n-1}})$ have been applied. Indeed, the internal circuit operations should somehow “know” (and depend on) which external operations have been applied before, so as to avoid picking, as the next operation, one that has been applied already. Note that QC-FOs are a special case of QC-CCs as the internal CPTP maps of a QC-FO can be seen as instruments with only one non-trivial classical output.

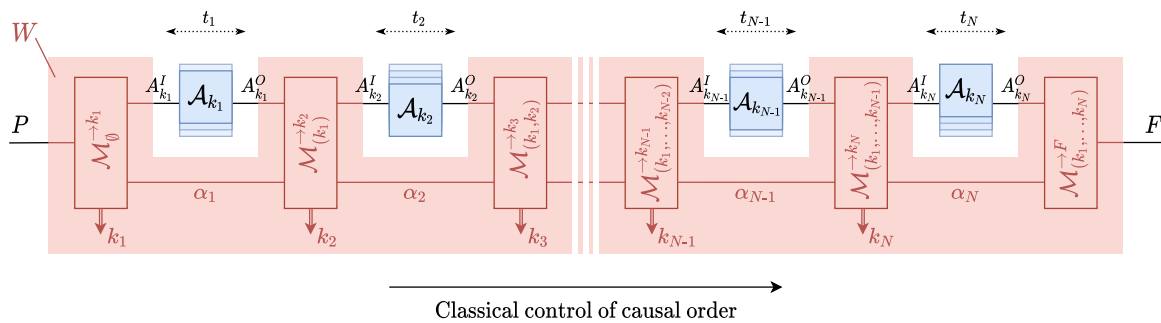

Figure 3.5: Quantum circuit with classical control of causal order (QC-CC) leading to a final causal order $(k_1, k_2, \dots, k_{N-1}, k_N)$. This causal order is established dynamically, controlled by the outcomes k_n of the internal operations $\mathcal{M}_{(k_1, \dots, k_{n-1})}^{\rightarrow k_n}$. In a QC-CC, any external operation \mathcal{A}_k can *a priori* be applied at any time slot t_n . This is illustrated by superimposed boxes \mathcal{A}_{k_n} at each time slot. The salmon-coloured area represents the process matrix W , which corresponds to a (classical) combination of the different contributions associated with the various (dynamically established) orders (k_1, \dots, k_N) . It is given by Eq. (3.12).

More precisely, a QC-CC is built as the following:

- the circuit starts by applying some internal quantum instrument $\{\mathcal{M}_{\emptyset}^{\rightarrow k_1}\}_{k_1 \in \mathcal{N}}$, where each operation $\mathcal{M}_{\emptyset}^{\rightarrow k_1} : \mathcal{L}(\mathcal{H}^P) \rightarrow \mathcal{L}(\mathcal{H}^{A_{k_1}^I \alpha_1})$, attached to the classical output

k_1 that “controls” which external operation shall be applied at the first time slot t_1 maps the circuit’s input in \mathcal{H}^P to the incoming space $\mathcal{H}^{A_{k_1}^I}$ of the operation \mathcal{A}_{k_1} and (possibly) also to some auxiliary system in some Hilbert space \mathcal{H}^{α_1} , with the corresponding TP condition in the Choi representation:

$$\sum_{k_1} \text{Tr}_{A_{k_1}^I \alpha_1} M_{\emptyset}^{\rightarrow k_1} = \mathbb{1}^P, \quad (3.9)$$

- then, for the time slots t_n and t_{n+1} , for $1 \leq n \leq N - 1$, a quantum instrument $\{\mathcal{M}_{(k_1, \dots, k_n)}^{\rightarrow k_{n+1}}\}_{k_{n+1} \in \mathcal{N} \setminus \{k_1, \dots, k_n\}}$ is performed, given the sequence (k_1, \dots, k_n) of operations that have already been performed. Each operation $\mathcal{M}_{(k_1, \dots, k_n)}^{\rightarrow k_{n+1}} : \mathcal{L}(\mathcal{H}^{A_{k_n}^O \alpha_n}) \rightarrow \mathcal{L}(\mathcal{H}^{A_{k_{n+1}}^I \alpha_{n+1}})$, attached to the classical output k_{n+1} indicating the next operation to apply, is performed on the output system of the last external operation \mathcal{A}_{k_n} , together with the auxiliary system in \mathcal{H}^{α_n} , and output a state in the incoming space $\mathcal{H}^{A_{k_{n+1}}^I}$ of some yet unperformed operation $\mathcal{A}_{k_{n+1}}$ (hence with $k_{n+1} \in \mathcal{N} \setminus \{k_1, \dots, k_n\}$) and an auxiliary system in some Hilbert space $\mathcal{H}^{\alpha_{n+1}}$. The corresponding TP condition in the Choi representation is:

$$\begin{aligned} & \forall n = 1, \dots, N-1, \forall (k_1, \dots, k_n), \\ & \sum_{k_{n+1}} \text{Tr}_{A_{k_{n+1}}^I \alpha_{n+1}} (M_{\emptyset}^{\rightarrow k_1} * \dots * M_{(k_1, \dots, k_{n-1})}^{\rightarrow k_n} * M_{(k_1, \dots, k_n)}^{\rightarrow k_{n+1}}) \\ & = \text{Tr}_{\alpha_n} (M_{\emptyset}^{\rightarrow k_1} * \dots * M_{(k_1, \dots, k_{n-1})}^{\rightarrow k_n}) \otimes \mathbb{1}^{A_{k_n}^O}, \end{aligned} \quad (3.10)$$

- finally, before the last external operation \mathcal{A}_{k_N} at the time slot t_N , the instruments $\{\mathcal{M}_{(k_1, \dots, k_{N-1})}^{\rightarrow k_N}\}$ only have one possible outcome k_N driving the system to the latter. After t_N all external operations \mathcal{A}_k have been performed exactly once. A CPTP map $\mathcal{M}_{(k_1, \dots, k_N)}^{\rightarrow F} : \mathcal{L}(\mathcal{H}^{A_{k_N}^O \alpha_N}) \rightarrow \mathcal{L}(\mathcal{H}^F)$ ends the circuit, taking the output system of \mathcal{A}_{k_N} , together with the auxiliary state in \mathcal{H}^{α_N} , to the global output space \mathcal{H}^F , with the TP condition:

$$\begin{aligned} & \forall (k_1, \dots, k_N), \\ & \text{Tr}_F (M_{\emptyset}^{\rightarrow k_1} * \dots * M_{(k_1, \dots, k_{N-1})}^{\rightarrow k_N} * M_{(k_1, \dots, k_N)}^{\rightarrow F}) \\ & = \text{Tr}_{\alpha_N} (M_{\emptyset}^{\rightarrow k_1} * \dots * M_{(k_1, \dots, k_{N-1})}^{\rightarrow k_N}) \otimes \mathbb{1}^{A_{k_N}^O}. \end{aligned} \quad (3.11)$$

QC-CC as a process matrix

The QC-CC, being a specific CCP quantum supermap, have a representation as a process matrix.

Process matrix description of QC-CCs

Proposition 9. *The process matrix corresponding to the quantum circuit with classical control of causal order depicted in Fig. 3.5 is*

$$W = \sum_{(k_1, \dots, k_N)} W_{(k_1, \dots, k_N, F)} \quad (3.12)$$

where

$$W_{(k_1, \dots, k_N, F)} := M_{\emptyset}^{\rightarrow k_1} * M_{(k_1)}^{\rightarrow k_2} * M_{(k_1, k_2)}^{\rightarrow k_3} * \dots * M_{(k_1, \dots, k_{N-1})}^{\rightarrow k_N} * M_{(k_1, \dots, k_N)}^{\rightarrow F} \in \mathcal{L}(\mathcal{H}^{PA_N^{IO}F}). \quad (3.13)$$

Proof. In the case where the internal operations $\mathcal{M}_{\emptyset}^{\rightarrow k_1}$, $\mathcal{M}_{(k_1)}^{\rightarrow k_2}$, $\mathcal{M}_{(k_1, k_2)}^{\rightarrow k_3}$, \dots , $\mathcal{M}_{(k_1, \dots, k_{N-1})}^{\rightarrow k_N}$ and $\mathcal{M}_{(k_1, \dots, k_N)}^{\rightarrow F}$ are applied in between the external operations A_k —which thus end up being applied in the dynamically established order (k_1, k_2, \dots, k_N) —the Choi matrix of the global CP map induced by the circuit is obtained as the link product

$$\begin{aligned} & M_{\emptyset}^{\rightarrow k_1} * A_{k_1} * M_{(k_1)}^{\rightarrow k_2} * A_{k_2} * M_{(k_1, k_2)}^{\rightarrow k_3} * \dots * M_{(k_1, \dots, k_{N-1})}^{\rightarrow k_N} * A_{k_N} * M_{(k_1, \dots, k_N)}^{\rightarrow F} \\ &= (A_1 \otimes \dots \otimes A_N) * (M_{\emptyset}^{\rightarrow k_1} * M_{(k_1)}^{\rightarrow k_2} * M_{(k_1, k_2)}^{\rightarrow k_3} * \dots * M_{(k_1, \dots, k_{N-1})}^{\rightarrow k_N} * M_{(k_1, \dots, k_N)}^{\rightarrow F}), \end{aligned} \quad (3.14)$$

where we used in particular the fact that each operation A_k appears once and only each in $A_{k_1} * A_{k_2} * \dots * A_{k_N}$ to reorder these terms. This induced map is conditioned on the causal order ending up being (k_1, k_2, \dots, k_N) .³ In order to not “post-select” on this order, we need to sum Eq. (3.14) above over all possible orders (k_1, k_2, \dots, k_N) to obtain the induced global map:

$$M = \sum_{(k_1, \dots, k_N)} M_{\emptyset}^{\rightarrow k_1} * A_{k_1} * M_{(k_1)}^{\rightarrow k_2} * \dots * M_{(k_1, \dots, k_{N-1})}^{\rightarrow k_N} * A_{k_N} * M_{(k_1, \dots, k_N)}^{\rightarrow F} \in \mathcal{L}(\mathcal{H}^{PF}). \quad (3.15)$$

Noting that the sum can be applied only to the second term in parentheses in Eq. (3.14) (which, for each (k_1, \dots, k_N) , belongs to the same space $\mathcal{L}(\mathcal{H}^{PA_N^{IO}F})$), and that the induced map is then written in the form of Eq. (3.1), we can directly identify the process matrix W . \square

Characterisation

The previous description of QC-CC allows us to obtain a characterisation in terms of constraints on process matrices, i.e. given a process matrix, if it satisfies the relevant constraints, one can infer that it describes a QC-CC.

³Note that this induced map is not TP; instead, the trace of its output equals the trace of its input, multiplied by the probability that the causal order of operations indeed ends up being (k_1, \dots, k_N) .

Characterisation of QC-CCs

Proposition 10. *The process matrix $W \in \mathcal{L}(\mathcal{H}^{PA_N^IOF})$ of a quantum circuit with classical control of causal order can be decomposed in terms of positive semidefinite matrices $W_{(k_1, \dots, k_n)} \in \mathcal{L}(\mathcal{H}^{PA_{\{k_1, \dots, k_{n-1}\}}^IO} A_{k_n}^I)$ and $W_{(k_1, \dots, k_N, F)} \in \mathcal{L}(\mathcal{H}^{PA_N^IOF})$, for all nonempty ordered subsets (k_1, \dots, k_n) of \mathcal{N} (with $1 \leq n \leq N$, $k_i \neq k_j$ for $i \neq j$), in such a way that*

$$W = \sum_{(k_1, \dots, k_N)} W_{(k_1, \dots, k_N, F)} \quad (3.16)$$

and $\sum_{k_1} \text{Tr}_{A_{k_1}^I} W_{(k_1)} = \mathbb{1}^P$,

$$\forall n = 1, \dots, N-1, \forall (k_1, \dots, k_n), \sum_{k_{n+1}} \text{Tr}_{A_{k_{n+1}}^I} W_{(k_1, \dots, k_n, k_{n+1})} = W_{(k_1, \dots, k_n)} \otimes \mathbb{1}^{A_{k_n}^O},$$

$$\forall (k_1, \dots, k_N), \text{Tr}_F W_{(k_1, \dots, k_N, F)} = W_{(k_1, \dots, k_N)} \otimes \mathbb{1}^{A_{k_N}^O}. \quad (3.17)$$

Conversely, any Hermitian matrix $W \in \mathcal{L}(\mathcal{H}^{PA_N^IOF})$ that admits a decomposition in terms of positive semidefinite matrices $W_{(k_1, \dots, k_n)} \in \mathcal{L}(\mathcal{H}^{PA_{\{k_1, \dots, k_{n-1}\}}^IO} A_{k_n}^I)$ and $W_{(k_1, \dots, k_N, F)} \in \mathcal{L}(\mathcal{H}^{PA_N^IOF})$ satisfying Eqs. (3.16)–(3.17) above is the process matrix of a quantum circuit with classical control of causal order.

A self-contained proof⁴ is given in [86].

Note that the set of (process matrices of) QC-CC's is convex. Furthermore, one can write a SDP problem and, in the same spirit as causal witnesses, one can obtain “witnesses for non-QC-CC's”, allowing to directly verify that a given process is not a QC-CC.

Note also that if W is a well-defined process matrix, the individual matrices $W_{(k_1, \dots, k_N, F)}$ in Proposition 10 may or may not be valid (deterministic) process matrices. If they are valid (up to normalisation), i.e. each corresponding to a process matrix compatible with the fixed causal order (k_1, \dots, k_N) respectively, then W is simply a probabilistic mixture of quantum circuits with different fixed causal orders. Moreover, if the sum only contains one term, the circuit is a QC-FO. If the $W_{(k_1, \dots, k_N, F)}$'s are not valid process matrices, then the causal order is established “dynamically”: it depends, at least in part, on the input state of the circuit (in the global past space \mathcal{H}^P) and on the external operations \mathcal{A}_n inserted in the slots of the QC-CC. Finally, if the global past and future Hilbert spaces \mathcal{H}^P and \mathcal{H}^F are trivial ($d_P = d_F = 1$), i.e. if we consider the “original” version of process matrices as supermaps that take linear CP maps to probabilities [15]—then the characterisation of Proposition 10 coincides precisely with the sufficient condition for the causal separability of general N -partite process matrices obtained in Ref. [122]. Hence, unsurprisingly, all QC-CCs (even if \mathcal{H}^P and \mathcal{H}^F are nontrivial) define causally separable processes.

⁴Note that the necessary condition of the proof follows trivially from Eq.(3.9)-(3.11), as for a QC-CC as defined above, the reduced process matrices are $W_{(n)} = \text{Tr}_{\alpha_n}(M_1 * \dots * M_n)$.

Example: the classical switch

A canonical example of QC-CC is the “classical switch” [13], in which the causal order of two external operations \mathcal{A}_1 and \mathcal{A}_2 performed on a “target system” is incoherently controlled by a “classical control system”, cf. Fig. 3.6. The initial systems are prepared in the global past $\mathcal{H}^P = \mathcal{H}^{P_t} \otimes \mathcal{H}^{P_c}$, with P_t the target space, and P_c the control space. After a measurement on the control system, depending on the classical measurement outcome, the target is sent-via identity channels- first to \mathcal{A}_1 and then \mathcal{A}_2 (outcome “1”) or vice-versa (“outcome 2”). The causal order is not fixed *a priori*, but is established on the fly, through the preparation of the control system in the global past. Finally, the target and control systems are sent to the global future $\mathcal{H}^F = \mathcal{H}^{F_t} \otimes \mathcal{H}^{F_c}$.

The classical switch can be described as a QC-CC, by taking the following internal circuit operations (in the Choi representation):

$$\begin{aligned} M_{\emptyset}^{\rightarrow k_1} &= |\mathbb{1}\rangle\rangle\langle\langle\mathbb{1}|^{P_t A_{k_1}^I} \otimes |k_1\rangle\langle k_1|^{P_c}, \\ M_{(k_1)}^{\rightarrow k_2} &= |\mathbb{1}\rangle\rangle\langle\langle\mathbb{1}|^{A_{k_1}^O A_{k_2}^I}, \\ M_{(k_1, k_2)}^{\rightarrow F} &= |\mathbb{1}\rangle\rangle\langle\langle\mathbb{1}|^{A_{k_2}^O F_t} \otimes |k_1\rangle\langle k_1|^{F_c}. \end{aligned} \quad (3.18)$$

We can give an intuitive interpretation to these operations: $\mathcal{M}_{\emptyset}^{\rightarrow k_1}$ is an identity channel sending the initial target system in \mathcal{H}^{P_t} to the input space of the first operation \mathcal{A}_{k_1} , post-selected on the outcome k_1 of the measurements on \mathcal{H}^{P_c} ; $\mathcal{M}_{(k_1)}^{\rightarrow k_2}$ is an identity channel sending the target from the output of \mathcal{A}_{k_1} to the input of \mathcal{A}_{k_2} ; and $\mathcal{M}_{(k_1, k_2)}^{\rightarrow F}$ sends the output of the second operation to the global future, while preparing the control system in \mathcal{H}^{F_c} in the appropriate state, $|k_1\rangle\langle k_1|$. These operations satisfy the TP conditions of Eqs. (3.9)–(3.11).

The associated process matrix $W_{\text{CS}} \in \mathcal{L}(\mathcal{H}^{P_c P_t A_1^I O A_2^I O F_t F_c})$ describing the classical switch defined by the operations (3.18) is thus

$$\begin{aligned} W_{\text{CS}} &= M_{\emptyset}^{\rightarrow 1} * M_{(1)}^{\rightarrow 2} * M_{(1,2)}^{\rightarrow F} + M_{\emptyset}^{\rightarrow 2} * M_{(2)}^{\rightarrow 1} * M_{(2,1)}^{\rightarrow F} \\ &= |1\rangle\langle 1|^{P_c} |\mathbb{1}\rangle\rangle\langle\langle\mathbb{1}|^{P_t A_1^I} |\mathbb{1}\rangle\rangle\langle\langle\mathbb{1}|^{A_1^O A_2^I} |\mathbb{1}\rangle\rangle\langle\langle\mathbb{1}|^{A_2^O F_t} |1\rangle\langle 1|^{F_c} \\ &\quad + |2\rangle\langle 2|^{P_c} |\mathbb{1}\rangle\rangle\langle\langle\mathbb{1}|^{P_t A_2^I} |\mathbb{1}\rangle\rangle\langle\langle\mathbb{1}|^{A_2^O A_1^I} |\mathbb{1}\rangle\rangle\langle\langle\mathbb{1}|^{A_1^O F_t} |2\rangle\langle 2|^{F_c} \end{aligned} \quad (3.19)$$

(where the tensor products are implicit).

Indeed, W_{CS} satisfies the characterisation of Proposition 10, with $W_{(k_1)} = M_{\emptyset}^{\rightarrow k_1}$, $W_{(k_1, k_2)} = M_{\emptyset}^{\rightarrow k_1} \otimes M_{(k_1)}^{\rightarrow k_2}$, and $W_{(k_1, k_2, F)} = M_{\emptyset}^{\rightarrow k_1} \otimes M_{(k_1)}^{\rightarrow k_2} \otimes M_{(k_1, k_2)}^{\rightarrow F}$.

QC-CC, Mark 2

Note that the above description of QC-CCs can be revisited so as to include the control more explicitly as a physical system. In particular, the dependency of each internal quantum instrument on the order (k_1, \dots, k_n) of the previously applied external operations \mathcal{A}_k , as well as the dependency of which external operation \mathcal{A}_{k_n} is applied at time t_n with respect to the outcome of the previous internal instrument, can be included in the description of the internal quantum operations building the circuit. Indeed, we can

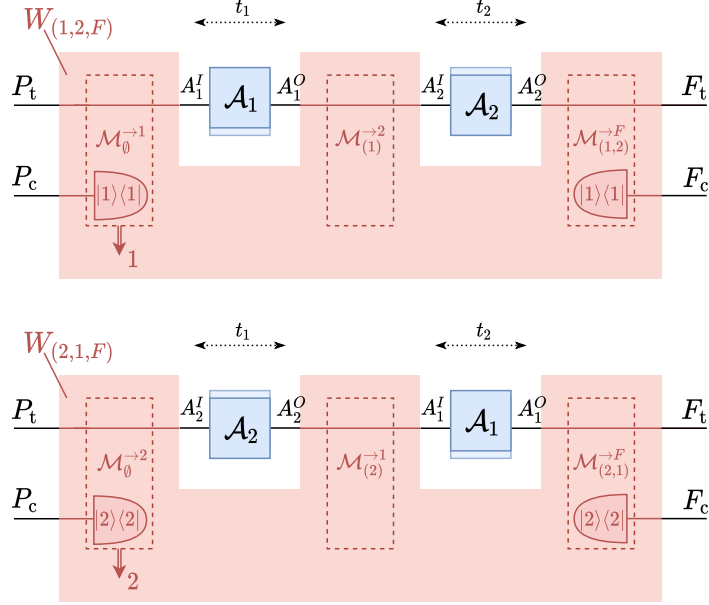

Figure 3.6: The two possible realisations of the classical switch. In this QC-CC, the order of the two CP maps \mathcal{A}_1 and \mathcal{A}_2 is controlled incoherently through a “control system” in \mathcal{H}^{P_c} , which is measured as part of the first internal circuit operation. The process matrix is the sum of the contributions $W_{(1,2,F)}$ and $W_{(2,1,F)}$ corresponding to the two possible orders (cf. Eq. (3.19)).

introduce some “control system” C_n living in some Hilbert space \mathcal{H}^{C_n} that stores on the fly the dynamically established causal order in some state

$$|((k_1, \dots, k_n))\rangle^{C_n} \quad (3.20)$$

The full order of the preceding (and currently applied) external operations is thus encoded in the computational basis states $|((k_1, \dots, k_n))\rangle^{C_n}$ of some Hilbert space \mathcal{H}^{C_n} (for $1 \leq n \leq N$). For convenience it is useful to define the following notation:

$$\llbracket (k_1, \dots, k_n) \rrbracket^{C_n} := |((k_1, \dots, k_n))\rangle \langle ((k_1, \dots, k_n))|^{C_n}. \quad (3.21)$$

At each time slot t_n (for $1 \leq n \leq N$), the external operations \mathcal{A}_{k_n} can be embedded into some “larger” conditional operations $\tilde{\mathcal{A}}_n$ which use the control system to apply the correct one:

$$\tilde{\mathcal{A}}_n := \sum_{(k_1, \dots, k_n)} \mathcal{A}_{k_n} \otimes \pi_{(k_1, \dots, k_n)}^{C_n \rightarrow C'_n} : \mathcal{L}(\mathcal{H}^{\tilde{\mathcal{A}}_n^I C_n}) \rightarrow \mathcal{L}(\mathcal{H}^{\tilde{\mathcal{A}}_n^O C'_n}), \quad (3.22)$$

where $\pi_{(k_1, \dots, k_n)}^{C_n \rightarrow C'_n}$ is the (classical) map that projects the control system onto the state $\llbracket (k_1, \dots, k_n) \rrbracket^{C_n}$, while re-labelling the control system C_n to C'_n which denotes the control system just after the external operation \mathcal{A}_{k_n} . The corresponding Choi matrix of $\tilde{\mathcal{A}}_n$ is

$$\tilde{\mathcal{A}}_n = \sum_{(k_1, \dots, k_n)} \mathcal{A}_{k_n} \otimes \llbracket (k_1, \dots, k_n) \rrbracket^{C_n} \otimes \llbracket (k_1, \dots, k_n) \rrbracket^{C'_n} \in \mathcal{L}(\mathcal{H}^{\tilde{\mathcal{A}}_n^I C_n \tilde{\mathcal{A}}_n^O C'_n}). \quad (3.23)$$

Similarly, the internal circuit operations $\mathcal{M}_{(k_1, \dots, k_n)}^{\rightarrow k_{n+1}}$ can be embedded into some “larger”

operations that also involve the control systems, as shown in Fig. 3.7, by defining

$$\tilde{\mathcal{M}}_{n+1} := \sum_{(k_1, \dots, k_n, k_{n+1})} \mathcal{M}_{(k_1, \dots, k_n)}^{\rightarrow k_{n+1}} \otimes \pi_{(k_1, \dots, k_n), k_{n+1}}^{C'_n \rightarrow C_{n+1}} : \mathcal{L}(\mathcal{H}^{\tilde{A}_n^O \alpha_n C'_n}) \rightarrow \mathcal{L}(\mathcal{H}^{\tilde{A}_{n+1}^I \alpha_{n+1} C_{n+1}}), \quad (3.24)$$

where $\pi_{(k_1, \dots, k_n), k_{n+1}}^{C'_n \rightarrow C_{n+1}} : \mathcal{L}(\mathcal{H}^{C'_n}) \rightarrow \mathcal{L}(\mathcal{H}^{C_{n+1}})$ is the (classical) map that projects the control system onto $\llbracket (k_1, \dots, k_n) \rrbracket^{C'_n}$ and updates it to $\llbracket (k_1, \dots, k_n, k_{n+1}) \rrbracket^{C_{n+1}}$. The corresponding Choi representation $M_{n+1} \in \mathcal{L}(\mathcal{H}^{\tilde{A}_n^O \alpha_n C'_n \tilde{A}_{n+1}^I \alpha_{n+1} C_{n+1}})$ is:

$$\tilde{M}_{n+1} = \sum_{(k_1, \dots, k_n, k_{n+1})} M_{(k_1, \dots, k_n)}^{\rightarrow k_{n+1}} \otimes \llbracket (k_1, \dots, k_n) \rrbracket^{C'_n} \otimes \llbracket (k_1, \dots, k_n, k_{n+1}) \rrbracket^{C_{n+1}} \quad (3.25)$$

$$\text{with } \tilde{M}_1 = \sum_{k_1} M_{\emptyset}^{\rightarrow k_1} \otimes \llbracket (k_1) \rrbracket^{C_1} \in \mathcal{L}(\mathcal{H}^{P \tilde{A}_1^I \alpha_1 C_1})$$

$$\tilde{M}_{N+1} = \sum_{(k_1, \dots, k_N)} M_{(k_1, \dots, k_N)}^{\rightarrow F} \otimes \llbracket (k_1, \dots, k_N) \rrbracket^{C'_N} \in \mathcal{L}(\mathcal{H}^{\tilde{A}_N^O \alpha_N C'_N F})$$

for the first and last internal operations respectively.

Note that there is in fact an abuse of notation in the equations Eq. (3.22)-(3.25), as the input and output spaces of the internal and external operations are a priori not the same for the different values of the control. This can however be made more rigorous by artificially increasing all dimensions and trace out some unused systems. This way, we can introduce “target system” input and output (tilde) Hilbert spaces, isomorphic with the external operations spaces (cf. [86]).

Note also that the extended operations $\tilde{\mathcal{M}}_{n+1}$ and \tilde{A}_n are CPTP maps, so that the global circuit defines a CPTP map \mathcal{M} whenever all external operations \mathcal{A}_k are CPTP maps.

The Choi matrix $M \in \mathcal{L}(\mathcal{H}^{PF})$ of the global map \mathcal{M} can then be obtained by link-multiplying all these operations:

$$\begin{aligned} M &= \tilde{M}_1 * \tilde{A}_1 * \tilde{M}_2 * \dots * \tilde{M}_N * \tilde{A}_N * \tilde{M}_{N+1} \\ &= \sum_{(k_1, \dots, k_N)} \tilde{M}_{\emptyset}^{\rightarrow k_1} * \tilde{A}_{k_1} * \tilde{M}_{(k_1)}^{\rightarrow k_2} * \dots * \tilde{M}_{(k_1, \dots, k_{N-1})}^{\rightarrow k_N} * \tilde{A}_{k_N} * \tilde{M}_{(k_1, \dots, k_N)}^{\rightarrow F} \\ &= \sum_{(k_1, \dots, k_N)} M_{\emptyset}^{\rightarrow k_1} * A_{k_1} * M_{(k_1)}^{\rightarrow k_2} * \dots * M_{(k_1, \dots, k_{N-1})}^{\rightarrow k_N} * A_{k_N} * M_{(k_1, \dots, k_N)}^{\rightarrow F} \end{aligned} \quad (3.26)$$

We thus recover Eq. (3.15) from the previous description of QC-CCs, and consequently the same process matrix description of our QC-CC as in Proposition 9, as well as the same characterisation of QC-CC process matrices as in Proposition 10.

Intuitively, as explained above, this classical control of causal order driven by a physical system cannot lead to interesting exotic causal structures, i.e. causally nonseparable processes. To obtain an instance of “quantum causality”, let’s make the control system quantum, and make the different possible causal orders interfere.

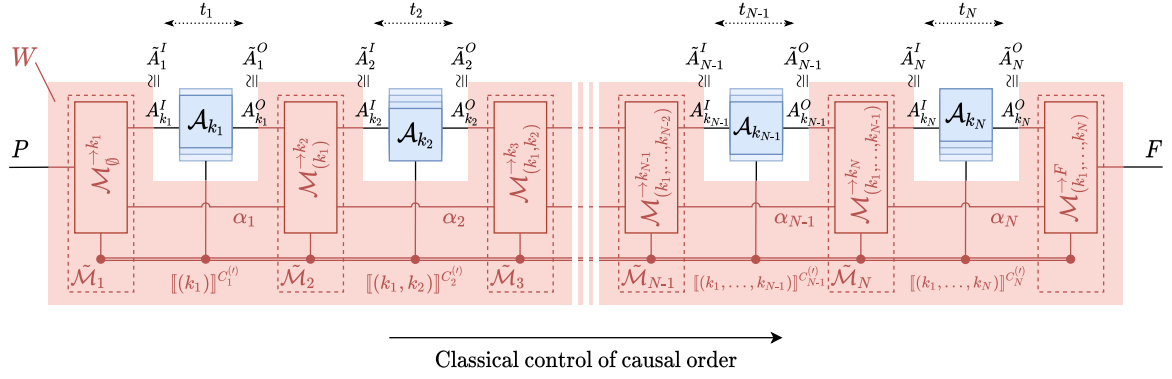

Figure 3.7: Quantum circuit with classical control of causal order, alternative version (equivalent to Fig. 3.5). In this other formulation, the transmission of the classical information about the causal order is made explicit (double-stroke lines). It is established dynamically and stored on the fly in the states $|(k_1, \dots, k_n)\rangle_{C_n^{(i)}}$ of some control system. It allows to control which external operation \mathcal{A}_{k_n} is to be applied at each time slot t_n . One can thus embed this operation in a joint operation $\tilde{\mathcal{A}}_n$ of Eq. (3.22) on the target and control systems. The classical control is also used to decide which internal circuit operations $\mathcal{M}_{(k_1, \dots, k_n)}^{\rightarrow k_{n+1}}$ is implemented, defining the joint operations $\tilde{\mathcal{M}}_{n+1}$ of Eq. (3.24) on the target, auxiliary and control systems.

3.4 Quantum Circuits with Quantum Control of causal order

In order to simplify going from circuits with classical to quantum control of causal order, we consider the following “purification” of the internal operations. Because no specific assumption is made on the auxiliary Hilbert spaces \mathcal{H}^{α_n} (e.g. on their dimension), they can be used to “purify”⁵ all the internal operations $\mathcal{M}_0^{\rightarrow k_1} : \mathcal{L}(\mathcal{H}^P) \rightarrow \mathcal{L}(\mathcal{H}^{A_{k_1}^I \alpha_1})$ and $\mathcal{M}_{(k_1, \dots, k_{n-1})}^{\rightarrow k_n} : \mathcal{L}(\mathcal{H}^{A_{k_{n-1}}^O \alpha_{n-1}}) \rightarrow \mathcal{L}(\mathcal{H}^{A_{k_n}^I \alpha_n})$ for $1 \leq n \leq N$. Similarly, for the final operations $\mathcal{M}_{(k_1, \dots, k_N)}^{\rightarrow F}$, one can introduce an auxiliary Hilbert space \mathcal{H}^{α_F} so as to purify these operations before tracing out the auxiliary system α_F .

Without loss of generality, we can thus assume they consist of the application of just one Kraus operator, which we shall denote $V_{(k_1, \dots, k_{n-1})}^{\rightarrow k_n} : \mathcal{H}^{A_{k_{n-1}}^O \alpha_{n-1}} \rightarrow \mathcal{H}^{A_{k_n}^I \alpha_n}$ (so that $\mathcal{M}_{(k_1, \dots, k_{n-1})}^{\rightarrow k_n}(\varrho) = V_{(k_1, \dots, k_{n-1})}^{\rightarrow k_n} \varrho V_{(k_1, \dots, k_{n-1})}^{\rightarrow k_n \dagger}$); the Choi representations of the operations are then simply

$$M_{(k_1, \dots, k_{n-1})}^{\rightarrow k_n} = |V_{(k_1, \dots, k_{n-1})}^{\rightarrow k_n}\rangle\rangle\langle\langle V_{(k_1, \dots, k_{n-1})}^{\rightarrow k_n} |, \quad (3.27)$$

$$M_{(k_1, \dots, k_N)}^{\rightarrow F} = \text{Tr}_{\alpha_F} |V_{(k_1, \dots, k_N)}^{\rightarrow F}\rangle\rangle\langle\langle V_{(k_1, \dots, k_N)}^{\rightarrow F} | \quad (3.28)$$

where $|V_{(k_1, \dots, k_{n-1})}^{\rightarrow k_n}\rangle\rangle \in \mathcal{H}^{A_{k_{n-1}}^O \alpha_{n-1} A_{k_n}^I \alpha_n}$ (or $|V_0^{\rightarrow k_1}\rangle\rangle \in \mathcal{H}^{P A_{k_1}^I \alpha_1}$ for $n = 1$), $|V_{(k_1, \dots, k_N)}^{\rightarrow F}\rangle\rangle \in \mathcal{H}^{A_{k_N}^O \alpha_N F \alpha_F}$ are the Choi vector representation of $V_{(k_1, \dots, k_{n-1})}^{\rightarrow k_n}$ and $V_{(k_1, \dots, k_N)}^{\rightarrow F}$.

⁵In particular, according to Stinespring’s dilation theorem [156], for any CP map $\mathcal{M} : \mathcal{L}(\mathcal{H}^X) \rightarrow \mathcal{L}(\mathcal{H}^Y)$ there exists an auxiliary Hilbert space \mathcal{H}^α and a linear operator $V : \mathcal{H}^X \rightarrow \mathcal{H}^{Y\alpha}$ such that $\mathcal{M}(\rho) = \text{Tr}_\alpha(V\rho V^\dagger) \forall \rho$. In the case of the generalised quantum circuits we consider here, the auxiliary “purifying” systems can be carried through the circuit via the auxiliary systems \mathcal{H}^{α_n} before being traced out at the very end.

It will similarly be convenient to assume that the external operations $\mathcal{A}_k : \mathcal{L}(\mathcal{H}^{A_k^I}) \rightarrow \mathcal{L}(\mathcal{H}^{A_k^O})$ correspond to the application of a single Kraus operator $A_k : \mathcal{H}^{A_k^I} \rightarrow \mathcal{H}^{A_k^O}$ (with a slight but unambiguous enough conflict of notation) so that $\mathcal{A}_k(\rho) = A_k \rho A_k^\dagger$. In the Choi representation, the Kraus operator is represented by the Choi vector $|A_k\rangle\rangle \in \mathcal{H}^{A_k^I A_k^O}$, so that the Choi matrix of the map \mathcal{A}_k is $|A_k\rangle\rangle\langle\langle A_k| \in \mathcal{L}(\mathcal{H}^{A_k^I A_k^O})$.

These simplifications will allow to make the calculation of the induced global map \mathcal{M} significantly easier. More importantly it will allow us to directly study a pure global map $V : \mathcal{H}^P \rightarrow \mathcal{H}^{F\alpha_F}$, with Choi vector $|V\rangle\rangle \in \mathcal{H}^{P F\alpha_F}$ as a function of all pure external and internal operations (and only trace out the \mathcal{H}^{α_F} auxiliary system at the very end).

We can now turn the classical control of the QC-CCs into a quantum control, and thus define a new class of processes, the *quantum circuits with quantum control of causal order* (QC-QCs). Similarly with the previous case, we need to assume that each operation is applied once and only once, so that the circuit define valid quantum supermaps. Thus, like in the classical case, the control system needs to remember which operations has already been applied. However, in order to obtain “interferences” between the causal orders (k_1, \dots, k_{n-1}) and (k'_1, \dots, k'_{n-1}) corresponding to the same unordered set $\mathcal{K}_{n-1} = \{k_1, \dots, k_{n-1}\} = \{k'_1, \dots, k'_{n-1}\}$, and thus make the causal order indefinite, we don't want the control system C_n to record the whole causal order (k_1, \dots, k_n) anymore. We do not require that it keep track of the order in which the previous operations were applied, but only need it to register the minimal information of the unordered set $\mathcal{K}_{n-1} = \{k_1, \dots, k_{n-1}\}$ of operations already applied. Hence, at each time slot t_n and in each coherent “branch” of the computation, an operation is applied that has not previously been used in that branch. We thus now consider a control system of the form $|\mathcal{K}_{n-1}, k_n\rangle^{C_n}$, defining the computational basis of \mathcal{H}^{C_n} , which encode which operation A_{k_n} should be applied next and the unordered set \mathcal{K}_{n-1} of already applied ones.

We can now construct QC-QCs by generalising QC-CCs as follows, cf. Fig.3.8.

- before the time slot t_1 , the circuit transforms the input state into a state that is sent coherently to all operations A_{k_1} and, possibly, also to some auxiliary system in \mathcal{H}^{α_1} , while accordingly attaching the control state $|\emptyset, k_1\rangle^{C_1}$ to each component of the superposition. That is, instead of the operation \mathcal{M}_1 in the QC-CC case, the circuit now applies a (pure) operation of the form

$$\tilde{V}_1 := \sum_{k_1} \tilde{V}_{\emptyset, \emptyset \rightarrow k_1} \otimes |\emptyset, k_1\rangle^{C_1} : \quad \mathcal{H}^P \rightarrow \mathcal{H}^{\bar{A}_1^{\alpha_1 C_1}}. \quad (3.29)$$

- between the time slots t_n and t_{n+1} , for $1 \leq n \leq N - 1$, the internal operations are applied coherently on the target, auxiliary, and control systems. The circuit coherently controls the operation $V_{\mathcal{K}_{n-1}, k_n}^{\rightarrow k_{n+1}}$ to apply depending on the state $|\mathcal{K}_{n-1}, k_n\rangle^{C_n}$ of the control system, before coherently sending the target system to all remaining $A_{k_{n+1}}$'s (with $k_{n+1} \notin \mathcal{K}_{n-1} \cup k_n$) and, possibly, an auxiliary system in $\mathcal{H}^{\alpha_{n+1}}$, while updating the control system to $|\mathcal{K}_{n-1} \cup k_n, k_{n+1}\rangle^{C_{n+1}}$, thereby encoding the next operation to apply, k_{n+1} and erasing the information about the specific previous operation k_n (among all the previously applied operations) by just recording the whole set of previously applied operations $\mathcal{K}_n := \mathcal{K}_{n-1} \cup k_n$. Formally, the circuit

applies the operation

$$\begin{aligned} \tilde{V}_{n+1} &:= \sum_{\substack{\mathcal{K}_{n-1}, \\ k_n, k_{n+1}}} \tilde{V}_{\mathcal{K}_{n-1}, k_n}^{\rightarrow k_{n+1}} \otimes |\mathcal{K}_{n-1} \cup k_n, k_{n+1}\rangle^{C_{n+1}} \langle \mathcal{K}_{n-1}, k_n |^{C'_n} : \\ &\mathcal{H}^{\tilde{A}_n^O \alpha_n C'_n} \rightarrow \mathcal{H}^{\tilde{A}_{n+1}^I \alpha_{n+1} C_{n+1}}, \end{aligned} \quad (3.30)$$

- finally, after time slot t_N , the application of the operations $V_{\mathcal{K}_{N-1}, k_N}^{\rightarrow F}$ (with $\mathcal{K}_{N-1} = \mathcal{N} \setminus k_N$) is coherently controlled on the control system, taking the output of A_{k_N} , together with the auxiliary state in \mathcal{H}^{α_N} , to the global output of the circuit in \mathcal{H}^F and, possibly, an auxiliary system in \mathcal{H}^{α_F} . The circuit thus applies the operation

$$\tilde{V}_{N+1} := \sum_{k_N} \tilde{V}_{\mathcal{N} \setminus k_N, k_N}^{\rightarrow F} \otimes \langle \mathcal{N} \setminus k_N, k_N |^{C'_N} : \mathcal{H}^{\tilde{A}_N^O \alpha_N C'_N} \rightarrow \mathcal{H}^{F \alpha_F}. \quad (3.31)$$

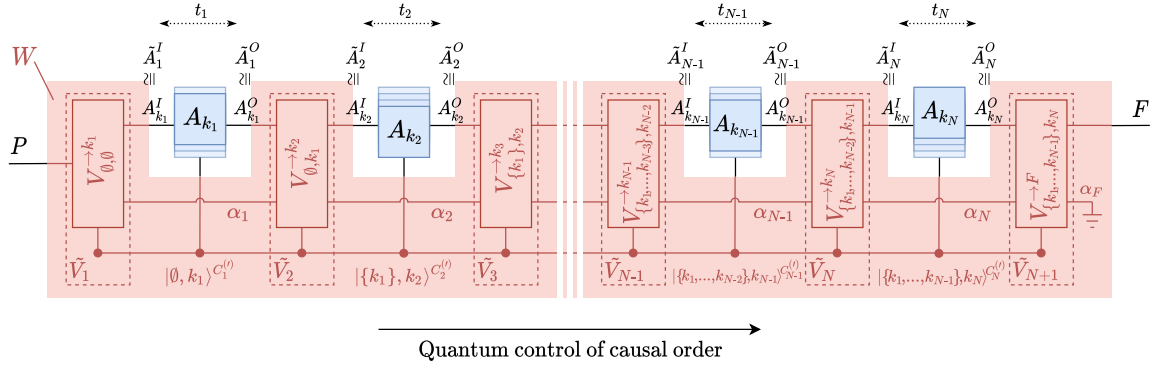

Figure 3.8: Quantum circuit with quantum control of causal order (QC-QC). We replaced the classical control system of Fig. 3.7 by a quantum control system with basis states $|\{k_1, \dots, k_{n-1}\}, k_n\rangle^{C'_n}$, which only store information about which operations ($\{k_1, \dots, k_{n-1}\}$) have already been applied (but not about their order) and the currently performed operation (k_n). (Note that in contrast to the previous figures, the “boxes” are labelled by linear operators, rather than linear CP maps). We illustrate here the component $|w_{(k_1, \dots, k_N, F)}\rangle$ of the process, corresponding to the order (k_1, \dots, k_N) —which is coherently superposed with other components, corresponding to different orders, in order to obtain the process matrix W from the internal operations $V_{\mathcal{K}_{n-1}, k_n}^{\rightarrow k_{n+1}}$ of the circuit; see Proposition 11.

Note that because we require these operators to act as isometries, they shall satisfy some TP conditions (cf. [86]).

QC-QC as a process matrix

The QC-QC, being a specific CCP quantum supermap, have a representation as a process matrix.

Process matrix description of QC-QCs

Proposition 11. *The process matrix corresponding to the quantum circuit with quantum control of causal order depicted on Fig. 3.8 is*

$$W = \text{Tr}_{\alpha_F} |w_{(\mathcal{N},F)}\rangle\langle w_{(\mathcal{N},F)}|$$

$$\text{with } |w_{(\mathcal{N},F)}\rangle := \sum_{(k_1, \dots, k_N)} |w_{(k_1, \dots, k_N, F)}\rangle \quad (3.32)$$

and with

$$|w_{(k_1, \dots, k_N, F)}\rangle := |V_{\emptyset, \emptyset}^{\rightarrow k_1}\rangle * |V_{\emptyset, k_1}^{\rightarrow k_2}\rangle * |V_{\{k_1\}, k_2}^{\rightarrow k_3}\rangle * \dots$$

$$\dots * |V_{\{k_1, \dots, k_{N-2}\}, k_{N-1}}^{\rightarrow k_N}\rangle * |V_{\{k_1, \dots, k_{N-1}\}, k_N}^{\rightarrow F}\rangle \in \mathcal{H}^{PA_{\mathcal{N}}^{IO}F\alpha_F}. \quad (3.33)$$

Proof. We proceed analogously to the previous sections. Indeed, note that as in the previous cases, the operations \tilde{V}_n and \tilde{A}_n are applied in a well-defined order. The global operation $V : \mathcal{H}^P \rightarrow \mathcal{H}^{F\alpha_F}$ induced by the circuit (prior to tracing out \mathcal{H}^{α_F}) when the external operations A_k are applied is obtained by composing all these operations \tilde{V}_n and \tilde{A}_n in that well-defined order. Its Choi vector $|V\rangle\rangle \in \mathcal{H}^{PF\alpha_F}$ is obtained by link-multiplying the Choi vectors⁶ of all these operations:

$$|V\rangle\rangle = |\tilde{V}_1\rangle\rangle * |\tilde{A}_1\rangle\rangle * |\tilde{V}_2\rangle\rangle * \dots * |\tilde{V}_N\rangle\rangle * |\tilde{A}_N\rangle\rangle * |\tilde{V}_{N+1}\rangle\rangle$$

$$= \sum_{(k_1, \dots, k_N)} |\tilde{V}_{\emptyset, \emptyset}^{\rightarrow k_1}\rangle\rangle * |\tilde{A}_{k_1}\rangle\rangle * |\tilde{V}_{\emptyset, k_1}^{\rightarrow k_2}\rangle\rangle * \dots * |\tilde{V}_{\{k_1, \dots, k_{N-2}\}, k_{N-1}}^{\rightarrow k_N}\rangle\rangle * |\tilde{A}_{k_N}\rangle\rangle * |\tilde{V}_{\{k_1, \dots, k_{N-1}\}, k_N}^{\rightarrow F}\rangle\rangle$$

$$= \sum_{(k_1, \dots, k_N)} (|A_1\rangle\rangle \otimes \dots \otimes |A_N\rangle\rangle) * |w_{(k_1, \dots, k_N, F)}\rangle$$

$$= (|A_1\rangle\rangle \otimes \dots \otimes |A_N\rangle\rangle) * |w_{(\mathcal{N}, F)}\rangle \in \mathcal{H}^{PF\alpha_F} \quad (3.34)$$

We can identify $|w_{(\mathcal{N}, F)}\rangle$ as a “process vector” describing the QC-QC in the pure Choi representation prior to \mathcal{H}^{α_F} being discarded. \square

Note that unlike the process matrix description of a QC-CC, here W is obtained by coherently superposing different terms corresponding to different orders (k_1, \dots, k_n) rather than by summing them in an incoherent manner. In fact, this reflects the quantum behavior of the control system in a QC-QC. However, if the control systems decoheres, —e.g. if some information about the full order leaks to the environment via the auxiliary system α_{N+1} and is traced out—then the QC-QC reduces to a QC-CC.

Characterisation

The previous description of QC-QC allows us to obtain a characterisation in terms of constraints on process matrices, i.e. given a process matrix, if it satisfies the relevant

⁶The link product of any two vectors $|a\rangle \in \mathcal{H}^{XY}$ and $|b\rangle \in \mathcal{H}^{YZ}$ is defined (with respect to the computational basis $\{|i\rangle^Y\}_i$ of \mathcal{H}^Y) as $|a\rangle * |b\rangle := (\mathbb{1}^{XZ} \otimes \langle\langle \mathbb{1}^{YY} \rangle\rangle)(|a\rangle \otimes |b\rangle) = \sum_i |a_i\rangle^X \otimes |b_i\rangle^Z \in \mathcal{H}^{XZ}$ with $|a_i\rangle^X := (\mathbb{1}^X \otimes \langle i|^Y) |a\rangle \in \mathcal{H}^X$ and $|b_i\rangle^Z := (\langle i|^Y \otimes \mathbb{1}^Z) |b\rangle \in \mathcal{H}^Z$ (so that $|a\rangle = \sum_i |a_i\rangle^X \otimes |i\rangle^Y$ and $|b\rangle = \sum_i |i\rangle^Y \otimes |b_i\rangle^Z$).

constraints, one can infer that it describes a QC-QC.

Characterisation of QC-QCs

Proposition 12. *The process matrix $W \in \mathcal{L}(\mathcal{H}^{PA_{\mathcal{N}}^{IO}F})$ of a quantum circuit with quantum control of causal order is such that there exist positive semidefinite matrices $W_{(\mathcal{K}_{n-1}, k_n)} \in \mathcal{L}(\mathcal{H}^{PA_{\mathcal{K}_{n-1}}^{IO}A_{k_n}^I})$, for all strict subsets \mathcal{K}_{n-1} of \mathcal{N} and all $k_n \in \mathcal{N} \setminus \mathcal{K}_{n-1}$, satisfying*

$$\begin{aligned} \sum_{k_1 \in \mathcal{N}} \text{Tr}_{A_{k_1}^I} W_{(\emptyset, k_1)} &= \mathbb{1}^P, \\ \forall \emptyset \subsetneq \mathcal{K}_n \subsetneq \mathcal{N}, \quad \sum_{k_{n+1} \in \mathcal{N} \setminus \mathcal{K}_n} \text{Tr}_{A_{k_{n+1}}^I} W_{(\mathcal{K}_n, k_{n+1})} &= \sum_{k_n \in \mathcal{K}_n} W_{(\mathcal{K}_n \setminus k_n, k_n)} \otimes \mathbb{1}^{A_{k_n}^O}, \\ \text{and} \quad \text{Tr}_F W &= \sum_{k_N \in \mathcal{N}} W_{(\mathcal{N} \setminus k_N, k_N)} \otimes \mathbb{1}^{A_{k_N}^O}. \end{aligned} \quad (3.35)$$

Conversely, any Hermitian matrix $W \in \mathcal{L}(\mathcal{H}^{PA_{\mathcal{N}}^{IO}F})$ such that there exist positive semidefinite matrices $W_{(\mathcal{K}_{n-1}, k_n)} \in \mathcal{L}(\mathcal{H}^{PA_{\mathcal{K}_{n-1}}^{IO}A_{k_n}^I})$ for all $\mathcal{K}_{n-1} \subsetneq \mathcal{N}$ and $k_n \in \mathcal{N} \setminus \mathcal{K}_{n-1}$ satisfying Eq. (3.35) is the process matrix of a quantum circuit with quantum control of causal order.

A self-contained proof is given in [86].

Note that the set of (process matrices of) QC-QC's is convex. Furthermore, one can write a SDP problem and, in the same spirit as causal witnesses, one can obtain “witnesses for non-QC-QC's”, allowing to directly verify that a given process is not a QC-QC.

Example: The quantum switch as a QC-QC

The canonical example of a QC-QC incompatible with a definite causal order is the quantum switch, already presented in Section 2.5. Let us recall that it consists in a quantum circuit in which the causal order of two external operations \mathcal{A}_1 and \mathcal{A}_2 (corresponding to Alice and Bob's operations A and B , I will use the two notations interchangeably) applied on some target system coherently controlled by a qubit system. As explained in Section 3.1, process matrices were first introduced as higher-order operations transforming CP maps into probabilities, but can be seen as quantum supermaps, transforming CP maps into a global CP map from a global past to a global future. Thus, the process matrix of the quantum switch introduced in Section 2.5 can be reformulated as such a quantum supermap. To do so, we introduce the global past Hilbert spaces \mathcal{H}^{P_t} and \mathcal{H}^{P_c} , in which the target system and control qubit are prepared, respectively. The circuit thus coherently sends via identity channels the target system to A_1 and then A_2 if the “control qubit” is in state $|1\rangle^{P_c}$, and to A_2 and then A_1 if it is in state $|2\rangle^{P_c}$.

Importantly, what is generally referred to as the “control qubit” in the literature - i.e. the state prepared in \mathcal{H}^{P_c} and later recovered in \mathcal{H}^{F_c} , is distinct from what we call the control system in the Hilbert spaces $\mathcal{H}^{C_n^{(t)}}$ in the description of a QC-QC, even though in the special case of the quantum switch, their roles might be effectively equivalent.

The quantum switch can be described as a QC-QC, by taking the following internal operations (in their Choi representation):

$$\begin{aligned}
|V_{\emptyset, \emptyset}^{\rightarrow k_1}\rangle\rangle &= |\mathbb{1}\rangle\rangle^{P_t A_{k_1}^I} \otimes |k_1\rangle^{P_c}, \\
|V_{\emptyset, k_1}^{\rightarrow k_2}\rangle\rangle &= |\mathbb{1}\rangle\rangle^{A_{k_1}^O A_{k_2}^I}, \\
|V_{\{k_1\}, k_2}^{\rightarrow F}\rangle\rangle &= |\mathbb{1}\rangle\rangle^{A_{k_2}^O F_t} \otimes |k_1\rangle^{F_c}.
\end{aligned} \tag{3.36}$$

These can be interpreted intuitively: $V_{\emptyset, \emptyset}^{\rightarrow k_1}$ is an identity channel sending the initial target system in \mathcal{H}^{P_t} to the input space of A_{k_1} when the state in \mathcal{H}^{P_c} is $|k_1\rangle$; $V_{\emptyset, k_1}^{\rightarrow k_2}$ is an identity channel sending the output of A_{k_1} to the input of A_{k_2} ; and $V_{\{k_1\}, k_2}^{\rightarrow F}$ sends the output of A_{k_2} to the global future \mathcal{H}^{F_t} , while recording coherently $|k_1\rangle$ in \mathcal{H}^{F_c} , thereby completing the transmission of the control qubit initially provided in \mathcal{H}^{P_c} (and whose state is transferred via the enlarged operations \tilde{V}_1 and \tilde{V}_2 , as these update the control systems to $|\emptyset, k_1\rangle^{C_1}$ and $|\{k_1\}, k_2\rangle^{C_2}$).

From Eq.(3.32) and (3.33), the process matrix of the quantum switch is thus

$$\begin{aligned}
W_{QS} &= |w_{QS}\rangle\rangle \langle w_{QS}| \quad \text{with} \quad |w_{QS}\rangle\rangle = \sum_{(k_1, k_2)} |w_{(k_1, k_2, F)}\rangle\rangle \langle w_{(k_1, k_2, F)}| \\
\text{where } |w_{(k_1, k_2, F)}\rangle\rangle &= |V_{\emptyset, \emptyset}^{\rightarrow k_1}\rangle\rangle * |V_{\emptyset, k_1}^{\rightarrow k_2}\rangle\rangle * |V_{\{k_1\}, k_2}^{\rightarrow F}\rangle\rangle \text{ given in Eq. (3.36)}
\end{aligned} \tag{3.37}$$

We see clearly that we have a coherent superposition of terms corresponding to different causal orders, in contrast to the incoherent mixture in the process matrix W_{CS} of the classical switch in Eq. (3.19). Indeed, one recovers the classical switch W_{CS} by projecting the systems in \mathcal{H}^{P_c} and/or \mathcal{H}^{F_c} onto the basis $\{|1\rangle, |2\rangle\}$, or, similarly, by decohering the control system on the QC-QC.

3.4.1 A new implementation of the quantum switch

The first proposal of a physical implementation of the quantum switch made in [149] and realised experimentally in [157, 158] is a photonic circuit, in which the target system is encoded in an internal degree of freedom of a photon, and the control system is copied (coherently) from the polarisation to the path degrees of freedom of the same photon, cf. Fig.3.9.

Nevertheless, this copy of the control induces a redundancy in the implementation. In fact, with the control systems encoded in the path of the photons (such that $|\emptyset, k_1\rangle^{C_1} = |k_1\rangle^{C_1^{\text{path}}}$ and $|\{k_1\}, k_2\rangle^{C_2} = |k_2\rangle^{C_2^{\text{path}}}$), the implementations of [149, 157, 158] could be written as QC-QCs by taking (instead of Eq. (3.36) above)

$$\begin{aligned}
|V_{\emptyset, \emptyset}^{\rightarrow k_1}\rangle\rangle &= |\mathbb{1}\rangle\rangle^{P_t A_{k_1}^I} \otimes |k_1\rangle^{P_c} \otimes |k_1\rangle^{\alpha_1}, \\
|V_{\emptyset, k_1}^{\rightarrow k_2}\rangle\rangle &= |\mathbb{1}\rangle\rangle^{A_{k_1}^O A_{k_2}^I} \otimes |k_1\rangle^{\alpha_1} \otimes |k_1\rangle^{\alpha_2}, \\
|V_{\{k_1\}, k_2}^{\rightarrow F}\rangle\rangle &= |\mathbb{1}\rangle\rangle^{A_{k_2}^O F_t} \otimes |k_1\rangle^{F_c} \otimes |k_1\rangle^{\alpha_2}
\end{aligned} \tag{3.38}$$

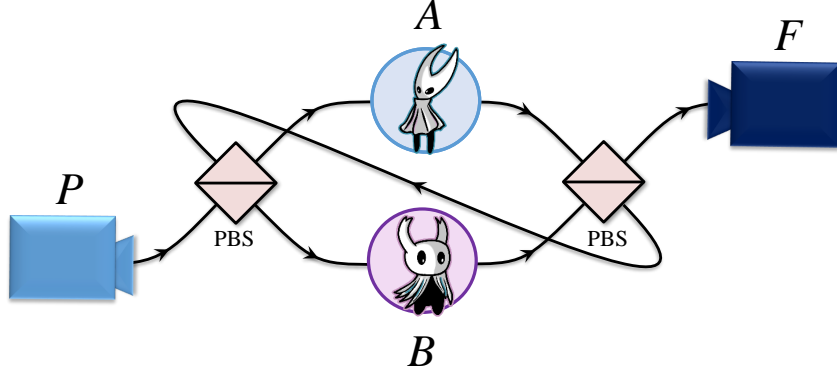

Figure 3.9: Standard optical implementation of the quantum switch. The target system is encoded in, for example, the orbital angular momentum of a photon, on which Alice and Bob perform an operation. The control qubit system is encoded in the polarisation of the photon, such that the system can be routed via polarising beam splitters (PBS). If the photon is prepared in a horizontally polarized state $|0\rangle_c = |H\rangle_c$, the photon is transmitted by the PBSs. The photon is then first transmitted to Alice’s, and then transmitted back to Bob, $A \prec B$. A vertically polarized photon $|1\rangle_c = |V\rangle_c$ is reflected by both PBS, leading to the causal order $B \prec A$. If the photon is initially diagonally polarized $|+\rangle_c = (|H\rangle_c + |V\rangle_c)/\sqrt{2}$, the quantum switch is realized.

with $|k_1\rangle^{P_c/\alpha_n/F_c} = |H\rangle$ for $k_1 = 1$, or $|V\rangle$ for $k_1 = 2$. Here, the control system gets redundantly copied onto and transferred through the auxiliary systems α_n , encoding the polarisation of the photons. Thus most of the implementations of the quantum switch [159, 151, 160, 157, 158, 161, 162] display such redundancy, illustrating the fact that the same process can be given different descriptions in terms of a QC-QC.

We propose an implementation that actually realize the QC-QC description of the quantum switch given in Eq. (3.36), involving only two degrees of freedom, and thus ensuring that the internal operations are applied to photons in the same spatial modes (although at different times), and thus ensuring that the applications of each A_k at different time slots are truly indistinguishable.

The “philosophy” of this new implementation can be understood as following our intuition on “indefinite causal orders” in Section 1. Assume that Alice and Bob’s laboratories are put inside a “closed global causal loop”: Alice’s output space is connected to Bob’s input space, and vice-versa, so that the exchanged information is trapped. In such loop, notions like causality and time cannot be defined. The loop needs to be “cut” in order to define a consistent causal relation between Alice and Bob. Note that the causal loop and the cut can be interpreted as primitives, making the notions of causality and time emergent. Indeed, the cut introduces a temporality, giving an entrance point (the “global past P ”) and an exit point (the “global future F ”) to the loop. The position of the cut defines the causal relation between Alice and Bob’s operations, cf. Fig.1.1. If the position of the cut is undetermined, the causal ordering of Alice and Bob’s operations becomes indefinite.

In a photonic circuit, the cut could be physically implemented by fast-switching removable mirrors, which are momentarily removed between the application of Alice and Bob’s operations, such that both are applied, cf. Fig.3.10. In such new implementa-

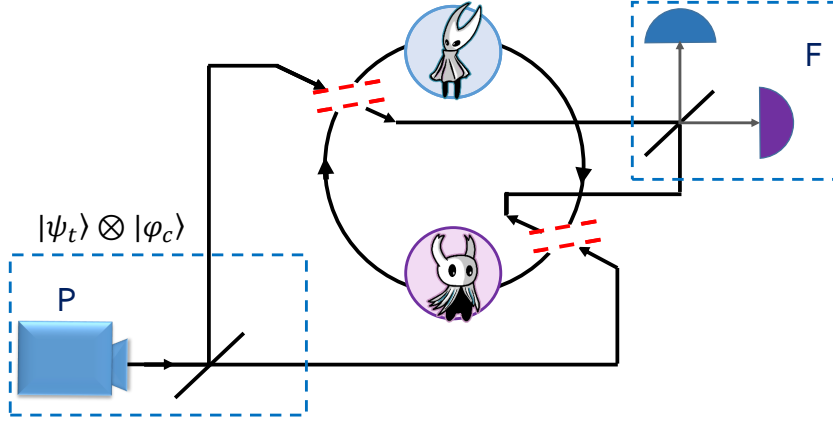

Figure 3.10: A new possible photonic implementation of the quantum switch, in which the control qubit gets encoded in the path degree of freedom, and the target system in an internal degree of freedom of the photon. The dashed optical elements (\vdash) are reflecting mirrors, which are momentarily removed between the time slots t_1 and t_2 (i.e., between the applications of the operations A and B , in either order). Example operations in the global past P (the preparation of an initial target state $|\psi_t\rangle^{P_t}$ and the control qubit in a superposition state $|\varphi_c\rangle^{P_c}$, see Sec. 2.5) and future F (the measurement of the final control system in F_c in a superposition basis) are shown in grey for clarity.

tion, the external operations are thus implemented in different spatial locations. They are applied on a target system that gets encoded in an internal degree of freedom of the photon. The control qubit gets encoded in the path degree of freedom cf. Fig.3.10. In the general N -partite case, the control systems can thus be taken to be of the form $|\mathcal{K}_{n-1}, k_n\rangle^{C_n} = |\mathcal{K}_{n-1}|k_n\rangle^{C_n^{\text{past ops.}}} \otimes |k_n\rangle^{C_n^{\text{path}}}$, where $|k_n\rangle^{C_n^{\text{path}}}$ denotes the path k_n of the carrier that undergoes operation A_k at time t_n , and $|\mathcal{K}_{n-1}|k_n\rangle^{C_n^{\text{past ops.}}}$ is the state of some complementary control system that records the required information about the previously applied operations \mathcal{K}_{n-1} (which, in general, may be encoded differently for different k_n). Note however that here, in the $N = 2$ case, the latter is not needed, so that the control can be taken to be $|k_n\rangle^{C_n^{\text{path}}}$. The internal circuit operations \tilde{V}_n routes the photon while performing the operations $V_{\mathcal{K}_{n-1}, k_n}^{\rightarrow k_{n+1}}$, i.e., act jointly on the path and internal degrees of freedom of the photon, so as to recover Eqs. (3.29)–(3.31).

Note that one could avoid using fastswitching elements by introducing an additional system that acts as a “timer” (of dimension at most $N + 1$), to be “incremented” at every time slot t_n , and which also controls (in an essentially classical manner) the application of the correct internal circuit operation. Here for instance, the polarisation could be used as such a “timer” by initially preparing it in the state $|V\rangle_c$ replacing the removable mirrors in the setup by PBS and adding wave plates at the exit ports of A and B that switch the polarisation, $|V\rangle_c \leftrightarrow |H\rangle_c$ (so as to “increment” the timer), cf. Fig.3.11. We then simply have a passive optical circuit as in [149, 157, 158], although in a structurally different manner.

The question of whether the experiments [159, 151, 160, 157, 158, 161, 162] are actual implementation of the quantum switch or mere simulations, has been debated [163, 146,

141, 164, 165, 166]. In fact, one could argue that such experiments can be described with a space-time diagram that involves two events per party rather than one. In my opinion, this debate is based on semantics differences. If causality and events are understood in the “(operational) quantum way”, i.e. independent of space-time structure, one might argue that the timedelocalized nature [146, 141] of the quantum switch has been effectively realised. However, if events are defined as space-time points and are thus embedded in a space-time structure, then, one can argue that a genuine implementation of the quantum switch would need to involve specific gravitational features [165].

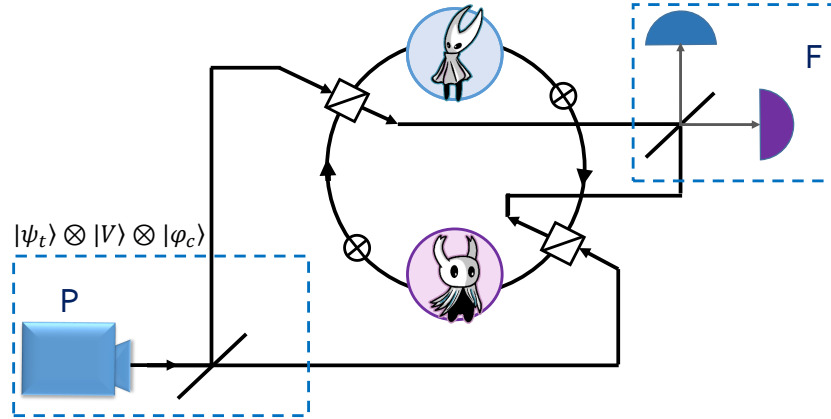

Figure 3.11: Photonic implementation of the quantum switch based on the “causal loop model” of Fig.1.1, where the potential cuts are realized by PBS and the polarization of a photon is taken as a “timer”, initially prepared in the state $|V\rangle_c$, and “incremented” by waveplates (represented by “ \oplus ”) after each external operation applied on a internal degree of freedom of a photon. After the first operation, at time t_1 , a first “ \oplus ” leads to $|V\rangle_c \rightarrow |H\rangle_c$, such that the photon is transmitted by the second PBS and thus sent to the other external operation without exiting the loop. After the second operation, at time t_2 , a second “ \oplus ” leads to $|H\rangle_c \rightarrow |V\rangle_c$ such that the photon exits the loop and is sent to the global future, ensuring that Alice and Bob’s operations are both applied once and only once. The control is simply encoded on the path: if the loop is entered from the PBS preceding Alice, the causal order $A \prec B$ is realised. If the loop is entered from the PBS preceding Bob, the causal order $B \prec A$ is realised. Finally, if the loop is entered by “both” in superposition, the quantum switch is realised.

3.4.2 The “quantum N -switch” and other simple generalisations

The quantum switch admits a “trivial generalisation”, involving N operations A_k (all with isomorphic d_t -dimensional input and output Hilbert spaces, for simplicity) instead of two, the so called “quantum N -switch” [167, 149, 168, 150, 169, 170, 171, 172, 173, 174]. This circuit requires, in general, a control system of dimension $N!$ so as to encode each of the possible $N!$ permutations $\pi := (k_1, \dots, k_N)$ of orders of the N operations (or some subset thereof).

The N -switch can be obtained as a QC-QC, for instance by introducing d_t -dimensional Hilbert spaces \mathcal{H}^{P_t} and \mathcal{H}^{F_t} (for the “target” systems in the global past and future) and $N!$ -dimensional isomorphic Hilbert spaces \mathcal{H}^{P_c} , \mathcal{H}^{F_c} and \mathcal{H}^{α_n} (for the global past/future

“control” and for the auxiliary systems) with orthonormal bases $\{|\pi\rangle\}_{\pi\in\Pi_{\mathcal{N}}}$, with $\Pi_{\mathcal{N}}$ denoting the set of all permutations $\pi = (\pi(1), \dots, \pi(N)) = (k_1, \dots, k_N)$ of \mathcal{N} , and by taking

$$\begin{aligned}
\forall k_1, \quad |V_{\emptyset, \emptyset}^{\rightarrow k_1}\rangle\rangle &= |\mathbb{1}\rangle\rangle^{P_t A_{k_1}^I} \otimes \sum_{\substack{\pi\in\Pi_{\mathcal{N}}: \\ \pi(1)=k_1}} |\pi\rangle^{P_c} \otimes |\pi\rangle^{\alpha_1} \\
\forall \mathcal{K}_{n-1}, k_n, k_{n+1}, \quad |V_{\mathcal{K}_{n-1}, k_n}^{\rightarrow k_{n+1}}\rangle\rangle &= |\mathbb{1}\rangle\rangle^{A_{k_n}^O A_{k_{n+1}}^I} \otimes \sum_{\substack{\pi\in\Pi_{\mathcal{N}}: \\ \{\pi(1), \dots, \pi(n-1)\}=\mathcal{K}_{n-1}, \\ \pi(n)=k_n, \pi(n+1)=k_{n+1}}} |\pi\rangle^{\alpha_n} \otimes |\pi\rangle^{\alpha_{n+1}} \\
\forall k_N, \quad |V_{\mathcal{N}\setminus\{k_N, k_N\}}^{\rightarrow F}\rangle\rangle &= |\mathbb{1}\rangle\rangle^{A_{k_N}^O F_t} \otimes \sum_{\substack{\pi\in\Pi_{\mathcal{N}}: \\ \pi(N)=k_N}} |\pi\rangle^{\alpha_N} \otimes |\pi\rangle^{F_c}
\end{aligned} \tag{3.39}$$

The corresponding process matrix is given by $W_{\text{QS}}^{(N)} = |w_{\text{QS}}^{(N)}\rangle\rangle\langle\langle w_{\text{QS}}^{(N)}| \in \mathcal{H}^{P_c P_t A_{\mathcal{N}}^I O F_t F_c}$ with

$$|w_{\text{QS}}^{(N)}\rangle\rangle := \sum_{(k_1, \dots, k_N)=:\pi} |\pi\rangle^{P_c} |\mathbb{1}\rangle\rangle^{P_t A_{k_1}^I} |\mathbb{1}\rangle\rangle^{A_{k_1}^O A_{k_2}^I} \dots |\mathbb{1}\rangle\rangle^{A_{k_{N-1}}^O A_{k_N}^I} |\mathbb{1}\rangle\rangle^{A_{k_N}^O F_t} |\pi\rangle^{F_c} \tag{3.40}$$

according to Proposition 11.

Note that in the quantum N -switch, while the causal order is indeed controlled coherently (“quantumly”), and thus give rise to an indefinite causal order, the latter is not established “dynamically”, but is fixed from the beginning, as the full order $\pi := (k_1, \dots, k_N)$ corresponding to each component $|\pi\rangle^{P_c} |\mathbb{1}\rangle\rangle^{P_t A_{k_1}^I} \dots |\mathbb{1}\rangle\rangle^{A_{k_{N-1}}^O A_{k_N}^I} |\pi\rangle^{F_c}$ of $|w_{\text{QS}}^{(N)}\rangle\rangle$ is already encoded in the state of the control system at the start of the circuit (and, with the choice of Eq. (3.39), is transmitted, untouched, throughout the circuit by the auxiliary states $|\pi\rangle^{\alpha_n}$).

Similarly with the case for the quantum switch (i.e., when $N = 2$), tracing out the “control qubit”, i.e. the system in \mathcal{H}^{F_c} , from the quantum N -switch, $\text{Tr}_{F_c} W_{\text{QS}}^{(N)}$, leads to a “classical N -switch”, i.e. an incoherent mixture of terms corresponding to the $N!$ different orders.

The quantum N -switch is not the only straightforward generalisation of the quantum switch. Another simple possibility, which also give QC-QCs, is for example to replace all the identity channels in the quantum N -switch (i.e., the $|\mathbb{1}\rangle\rangle$ ’s in Eq. (3.39) or (3.40)) applied to the target system by any, potentially different, arbitrary unitaries (or even, taking the external operations to have non-isomorphic input and output Hilbert spaces, isometries), as was considered, for instance, for the case of $N = 2$ in [175, 176]. One could also introduce further auxiliary systems α'_n to act as “memory channels” across the different time slots.

Like the quantum N -switch, these generalisations do not exhibit any form of really dynamical causal order. Instead, they only exploit coherent control conditioned on some quantum system, the causal order thus being fixed from the start of the process.

3.4.3 New examples of causally nonseparable QC-QCs

So far, the quantum switch - and trivial generalisations presented above - was the only known example of a physically achievable implementation of indefinite causal orders. Our

characterisation of the whole class of realisable quantum circuits with quantum control of causal order enables the investigation of new feasible causally nonseparable processes. Here, we present a new type of implementable QC-QC for $N = 3$ external operations, distinct from the 3-switch: it allows for the causal order to be established “dynamically”, depending (coherently) on the output of external operations, and not only a subsystem of \mathcal{H}^P . Remarkably, its process matrix remains causally nonseparable, with no well-defined “final” operation, despite having only a trivial global future \mathcal{H}^F .

A new family of causally nonseparable and dynamical QC-QCs

We consider QC-QCs with $N = 3$ operations A_1, A_2, A_3 . Assume, for simplicity, that all input and output Hilbert spaces $\mathcal{H}^{A_k^I}$ and $\mathcal{H}^{A_k^O}$ are of the same dimension d_t . We consider a nontrivial global past $P := P_t P_c$ (with corresponding Hilbert space $\mathcal{H}^P := \mathcal{H}^{P_t P_c}$, $d_{P_t} = d_t$ and $d_{P_c} = 3$) and global future $F := F_t F_\alpha F_c$ (with corresponding Hilbert space $\mathcal{H}^F := \mathcal{H}^{F_t F_\alpha F_c}$, $d_{F_t} = d_t$, $d_{F_\alpha} \geq 2$ and $d_{F_c} = 3$).

Consider a QC-QC built on operators $V_{\emptyset, \emptyset}^{\rightarrow k_1}$, $V_{\mathcal{K}_{n-1}, k_n}^{\rightarrow k_{n+1}}$ and $V_{\mathcal{N} \setminus \{k_N, k_N\}}^{\rightarrow F}$ of the form

$$V_{\emptyset, \emptyset}^{\rightarrow k_1} := \mathbb{1}^{P_t \rightarrow A_{k_1}^I} \otimes \langle k_1 |^{P_c}, \quad (3.41)$$

$$V_{\emptyset, k_1}^{\rightarrow k_2} := (\mathbb{1}^{A_{k_2}^I} \otimes \langle \sigma_{(k_1, k_2)} |^\alpha) \mathcal{V}_{k_1}, \quad (3.42)$$

$$V_{\{k_1\}, k_2}^{\rightarrow k_3} := \mathcal{V}'_{k_3} (\mathbb{1}^{A_{k_2}^O} \otimes |\sigma_{(k_1, k_2)} \rangle^{\alpha'}), \quad (3.43)$$

$$V_{\{k_1, k_2\}, k_3}^{\rightarrow F} := \mathbb{1}^{A_{k_3}^O \rightarrow F_t} \otimes \mathbb{1}^{\alpha_3 \rightarrow F_\alpha} \otimes |k_3 \rangle^{F_c}. \quad (3.44)$$

for some isometries⁷ $\mathcal{V}_{k_1} : \mathcal{H}^{A_{k_1}^O} \rightarrow \mathcal{H}^{A_{k_2}^I \alpha}$, where we introduced a 2-dimensional auxiliary Hilbert space \mathcal{H}^α with orthonormal basis $\{|0\rangle^\alpha, |1\rangle^\alpha\}$, which encodes the “signature” of the order (k_1, k_2) in such a way that $\sigma_{(k_1, k_2)} := 0$ if $k_2 = k_1 + 1 \pmod{3}$, and $\sigma_{(k_1, k_2)} := 1$ if $k_2 = k_1 + 2 \pmod{3}$ (and such that $\forall k_1, \sum_{k_2} |\sigma_{(k_1, k_2)} \rangle \langle \sigma_{(k_1, k_2)} |^\alpha = \mathbb{1}^\alpha$); and for some isometries $\mathcal{V}'_{k_3} : \mathcal{H}^{A_{k_2}^O \alpha'} \rightarrow \mathcal{H}^{A_{k_3}^I \alpha_3}$, where we similarly introduced a 2-dimensional auxiliary Hilbert space $\mathcal{H}^{\alpha'}$, as well as an auxiliary (d_{F_α} -dimensional) system α_3 .

Intuitively, these internal operations can be interpreted as follows:

- $V_{\emptyset, \emptyset}^{\rightarrow k_1}$ sends some “target” system prepared in the global past to the first A_{k_1} operation via an identity channel when the state in \mathcal{H}^{P_c} is in $|k_1\rangle$ (Eq. (3.41));
- $V_{\emptyset, k_1}^{\rightarrow k_2}$ performs an isometry \mathcal{V}_{k_1} on the target after the first external operation and coherently routes it to the next operation based on the auxiliary state $|\sigma_{(k_1, k_2)} \rangle^\alpha$ (Eq. (3.42)). For example, assuming that $A_{k_1} = A_1$, if $|\sigma_{(k_1, k_2)} \rangle^\alpha = |0\rangle^\alpha$, the system is routed to A_2 (and then A_3); if $|\sigma_{(k_1, k_2)} \rangle^\alpha = |1\rangle^\alpha$, the system is routed to A_3 (and then A_2). This “signature” allows the causal order to be established dynamically;

⁷ $\mathcal{V}_{k_1} : \mathcal{H}^{A_{k_1}^O} \rightarrow \mathcal{H}^{A_{k_2}^I \alpha}$ may depend, as indicated by its subscript, on k_1 , but it must have the same form for both values of $k_2 \neq k_1$ (recall that all $\mathcal{H}^{A_{k_2}^I}$ ’s are isomorphic). Similarly below, $\mathcal{V}'_{k_3} : \mathcal{H}^{A_{k_2}^O \alpha'} \rightarrow \mathcal{H}^{A_{k_3}^I \alpha_3}$ may depend on k_3 , but for a given k_3 it must have the same form for both initial orders (k_1, k_2) (with all $\mathcal{H}^{A_{k_2}^O}$ ’s being isomorphic).

- $V_{\{k_1\},k_2}^{\rightarrow k_3}$ performs an isometry \mathcal{V}'_{k_3} on the target and routs it coherently to the last external operation, where the auxiliary $|\sigma_{(k_1,k_2)}\rangle^{\alpha'}$ ensures that each operation is applied once and only once (Eq. (3.43));
- $V_{\{k_1,k_2\},k_3}^{\rightarrow F}$ drives the system output by the last operation in $\mathcal{H}^{A_{k_3}^O}$ and the auxiliary living in \mathcal{H}^{α_3} to the global future spaces \mathcal{H}^{F_t} and \mathcal{H}^{F_α} respectively, while recording coherently $|k_3\rangle$ in \mathcal{H}^{F_c} (Eq. (3.44)).

According to Proposition 11, the process matrix corresponding to the choice of operators above is then $W = |w\rangle\langle w|$ with $|w\rangle := \sum_{(k_1,k_2,k_3)} |w_{(k_1,k_2,k_3,F)}\rangle$ and

$$\begin{aligned}
|w_{(k_1,k_2,k_3,F)}\rangle &= |V_{\emptyset,\emptyset}^{\rightarrow k_1}\rangle \otimes |V_{\emptyset,k_1}^{\rightarrow k_2}\rangle \otimes |V_{\{k_1\},k_2}^{\rightarrow k_3}\rangle \otimes |V_{\{k_1,k_2\},k_3}^{\rightarrow F}\rangle \\
&= |k_1\rangle^{P_c} \otimes |\mathbb{1}\rangle^{P_t A_{k_1}^I} \otimes (|\mathcal{V}_{k_1}\rangle^{A_{k_1}^O A_{k_2}^I \alpha} * |\sigma_{(k_1,k_2)}\rangle^\alpha) \\
&\quad \otimes (|\mathcal{V}'_{k_3}\rangle^{A_{k_2}^O \alpha' A_{k_3}^I \alpha_3} * |\sigma_{(k_1,k_2)}\rangle^{\alpha'} * |\mathbb{1}\rangle^{\alpha_3 F_\alpha}) \otimes |\mathbb{1}\rangle^{A_{k_3}^O F_t} \otimes |k_3\rangle^{F_c}.
\end{aligned} \tag{3.45}$$

Referring to the same argument as for the ‘‘pure’’ quantum switch [16, 21] (cf. Section 2.5), because $W = |w\rangle\langle w|$ is a rank-1 process matrix and there exists some preparation of states in the global past such that the induced process is not compatible with any given operation being applied first, then it follows that the process matrix W is causally nonseparable.

Example

Several examples of new QC-QCs incompatible with a definite and fixed causal order can be now found based on the construction above by fixing the preparation of some particular global past state and/or trace out some systems in the global future. The causal nonseparability of the process matrix will then depend on this choice of initial state as well as the choice of isometries \mathcal{V}_{k_1} and \mathcal{V}'_{k_3} .

For example, one can choose the initial input state $|\psi\rangle^{P_t} \otimes \frac{1}{\sqrt{3}} \sum_{k_1} |k_1\rangle^{P_c}$, where $|\psi\rangle^{P_t}$ is an arbitrary qubit state ; choosing $\mathcal{V}_{k_1} = V_{\text{COPY}}$ and $\mathcal{V}'_{k_3} = V_{\text{CNOT}}$ and tracing out F completely, which indeed results in a causally nonseparable process.

The QC-QC realisation of this circuit is given by:

$$\begin{aligned}
V_{\emptyset, \emptyset}^{\rightarrow k_1} &= \frac{1}{\sqrt{3}} |\psi\rangle^{A_{k_1}^I}, \\
V_{\emptyset, k_1}^{\rightarrow k_2} &= \begin{cases} |0\rangle^{A_{k_2}^I} \langle 0|^{A_{k_1}^O} & \text{if } k_2 = k_1 + 1 \pmod{3} \\ |1\rangle^{A_{k_2}^I} \langle 1|^{A_{k_1}^O} & \text{if } k_2 = k_1 + 2 \pmod{3} \end{cases}, \\
V_{\{k_1\}, k_2}^{\rightarrow k_3} &= \begin{cases} |0\rangle^{A_{k_3}^I} |0\rangle^{\alpha_3} \langle 0|^{A_{k_2}^O} + |1\rangle^{A_{k_3}^I} |1\rangle^{\alpha_3} \langle 1|^{A_{k_2}^O} & \text{if } k_2 = k_1 + 1 \pmod{3} \\ |0\rangle^{A_{k_3}^I} |1\rangle^{\alpha_3} \langle 0|^{A_{k_2}^O} + |1\rangle^{A_{k_3}^I} |0\rangle^{\alpha_3} \langle 1|^{A_{k_2}^O} & \text{if } k_2 = k_1 + 2 \pmod{3} \end{cases}, \\
V_{\{k_1, k_2\}, k_3}^{\rightarrow F} &= \mathbb{1}^{A_{k_3}^O \alpha_3 \rightarrow \alpha_F^{(1)}} \otimes |k_3\rangle^{\alpha_F^{(2)}}, \tag{3.46}
\end{aligned}$$

where we introduced an auxiliary 2-dimensional system α_3 (but no α_1, α_2), a 4-dimensional system $\alpha_F^{(1)}$ and a 3-dimensional system $\alpha_F^{(2)}$, defining $\alpha_F := \alpha_F^{(1)} \alpha_F^{(2)}$ (with corresponding Hilbert spaces $\mathcal{H}^{\alpha_F} := \mathcal{H}^{\alpha_F^{(1)}} \alpha_F^{(2)}$), and $|\psi\rangle$ is an arbitrary qubit state.

These operations can be interpreted as follows. $V_{\emptyset, \emptyset}^{\rightarrow k_1}$ sends the state $|\psi\rangle$ to A_{k_1} (and to each choice of k_1 with equal weight, in a superposition). $V_{\emptyset, k_1}^{\rightarrow k_2}$ sends the output of A_{k_1} to one of the remaining operations A_{k_2} (for $k_2 \neq k_1$) dynamically and coherently depending on the state of said output: the component in the state $|0\rangle^{A_{k_1}^O}$ is sent to $A_{k_1+1 \pmod{3}}$, while the component in the state $|1\rangle^{A_{k_1}^O}$ is sent to $A_{k_1+2 \pmod{3}}$. $V_{\{k_1\}, k_2}^{\rightarrow k_3}$ then sends the output of A_{k_2} to the remaining operation A_{k_3} and attaches an auxiliary state $|0\rangle^{\alpha_3}$ if $k_2 = k_1 + 1 \pmod{3}$ or $|1\rangle^{\alpha_3}$ if $k_2 = k_1 + 2 \pmod{3}$, that is then flipped if $A_{k_3}^I$ is in the state $|1\rangle^{A_{k_3}^I}$ (i.e., a controlled NOT gate is applied).⁸ Finally, $V_{\{k_1, k_2\}, k_3}^{\rightarrow F}$ sends the output of A_{k_3} along with the system in \mathcal{H}^{α_3} to $\alpha_F^{(1)}$, while $|k_3\rangle$ is sent to $\alpha_F^{(2)}$.

The (tripartite) process matrix of this QC-QC, according to Proposition 11, is

$$\begin{aligned}
W &= \text{Tr}_{\alpha_F} |w\rangle\langle w| \\
\text{with } |w\rangle &= \sum_{(k_1, k_2, k_3)} |V_{\emptyset, \emptyset}^{\rightarrow k_1}\rangle * |V_{\emptyset, k_1}^{\rightarrow k_2}\rangle * |V_{\{k_1\}, k_2}^{\rightarrow k_3}\rangle * |V_{\{k_1, k_2\}, k_3}^{\rightarrow F}\rangle. \tag{3.47}
\end{aligned}$$

Using the technique of causal witnesses [16, 17, 122], one can check, for any fixed but arbitrary state $|\psi\rangle$, that this process matrix is causally nonseparable⁹.

⁸Note that introducing the auxiliary system α_3 in such a nontrivial way—in particular, with its state depending on whether $k_2 = k_1 + 1 \pmod{3}$ or $k_2 = k_1 + 2 \pmod{3}$ —is indeed necessary (despite the fact that α_3 is ultimately discarded) to ensure the internal operation \tilde{V}_3 acts as an isometry on its input spaces.

⁹We investigated the causal nonseparability of such QC-QCs by solving SDP problems numerically with CVX [177]. More specifically, we computed the random robustness [16, 17, 122] for 1000 random qubit states $|\psi\rangle$ via SDP, and always found values in the interval [0.51, 0.53], which indeed certifies causal nonseparability.

Note again that here the global future F is completely traced out. Moreover, tracing out α_F (or even just $\alpha_F^{(2)}$) turns W into an (incoherent) sum of three matrices (one for each value of k_3), these three matrices are not themselves valid process matrices, i.e. the reduced process is not a QC-QC. Unlike the “3-switch”, here W is not simply a convex mixture of 3 tripartite process matrices, each compatible with one operation A_{k_3} being applied last. This is due to the fact that the causal order here is established dynamically: in fact, which operation is applied last is not predetermined (even probabilistically), but depends on the operations A_1, A_2, A_3 .

Again, note that the causal nonseparability of the reduced process $\text{Tr}_F W$ depends crucially on the choice of isometries \mathcal{V}'_{k_1} and \mathcal{V}'_{k_3} . With the same initial state preparation and the same \mathcal{V}'_{k_1} but removing the CNOT gates, i.e. choosing for instance $\mathcal{V}'_{k_3} = \mathbb{1}^{A_{k_2}^O \rightarrow A_{k_3}^I} \otimes \mathbb{1}^{\alpha' \rightarrow \alpha_3}$, the resulting process matrix after tracing out F would have become causally separable.

Our general description of the QC-QC class thus allowed us to present here a new class of causally nonseparable quantum supermaps with concrete interpretations that go beyond the well-studied quantum switch and its generalisations. This new family exhibit a range of different behaviours, as it combines both a coherent and dynamical control of causal order. One can imagine yet further generalisations, for example by introducing further auxiliary systems in a nontrivial way. Exploring such possibilities and completely new families of causally nonseparable QC-QCs provides an important direction for future research.

Possible implementation

The previous implementation procedure presented for the quantum switch can be generalized and apply to this new QC-QCs examples. We propose a possible photonic circuit depicted in Fig. 3.12-3.13 in which a 2-dimensional target system (initially in the state $|\psi\rangle^t$, in the generic target space \mathcal{H}^t) is encoded in some internal degree of freedom of a photon (e.g., its orbital angular momentum). The control systems C_1 and C_3 are encoded in the path of the photon, such that $|\emptyset, k_1\rangle^{C_1} = |k_1\rangle^{C_1^{\text{path}}}$ and $|\{k_1, k_2\}, k_3\rangle^{C_3} = |k_3\rangle^{C_3^{\text{path}}}$. In order to define the control system C_2 on the other hand, we encode the system α in the polarisation of the photon (with basis states $|0\rangle^\alpha = |V\rangle, |1\rangle^\alpha = |H\rangle$), such that $|\{k_1\}, k_2\rangle^{C_2} = |0\rangle^\alpha \otimes |k_2\rangle^{C_2^{\text{path}}}$ if $k_2 = k_1 + 1 \pmod{3}$, $|\{k_1\}, k_2\rangle^{C_2} = |1\rangle^\alpha \otimes |k_2\rangle^{C_2^{\text{path}}}$ if $k_2 = k_1 + 2 \pmod{3}$. The auxiliary system α_3 is also taken to be the polarisation.

The dynamical construction of the causal order is particularly made explicit in this implementation: after the first operation A_{k_1} , the corresponding output is “copied” onto the polarisation of the photon (in the $\{|0\rangle, |1\rangle\}$ basis) by V_{COPY} . the photon is then routed to the next operation A_{k_2} based on this polarisation state (with $|V\rangle$ being reflected, $|H\rangle$ being transmitted at the polarising beam-splitters (PBS)), whose configuration guarantees that each operation is applied once and only once on each path. Note that the figures Fig. 3.12 and 3.13 depict the same circuit. In Fig. 3.12, the circuit is “unfolded”, for clarity. As in the “folded” one (Fig. 3.13), each external operation is applied once and only once. Each box depicted in this circuit is thus identified as a single timedelocalized operation [21].

While the realisation of this QC-QC in the lab would undoubtedly be a major chal-

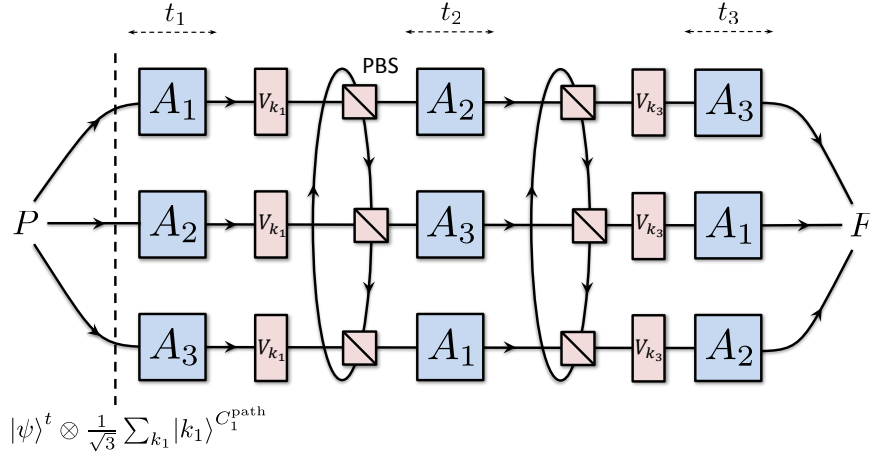

Figure 3.12: Unfolded scheme of our new implementable QCQC for $N=3$. The system is sent to the first operation based on the state of the control system, i.e. the path of the photon. The operations A_1, A_2, A_3 act (once and only once) on the target qubit, some internal degree of freedom of a photon. The V_{k_1} and V_{k_3} gates implement the isometries \mathcal{V}'_{k_1} and \mathcal{V}'_{k_3} . In the specific example given above a “COPY” and “CNOT” gates implement the operations $V_{\text{COPY}} = \sum_{i=0,1} |i\rangle^t |i\rangle^\alpha \langle i|^t$ and $V_{\text{CNOT}} = \sum_{i,j=0,1} |i\rangle^t |i \oplus j\rangle^\alpha \langle i|^t \langle j|^\alpha$ (with \oplus denoting addition modulo 2), respectively. Based on the state of the polarisation, the system is then routed to the second operation by polarizing beam splitters (PBS’s). It is reflected if $|V\rangle$, and transmitted if $|H\rangle$. After the second operation, PBS’s finally rout the system to the last unitaries and the third operation.

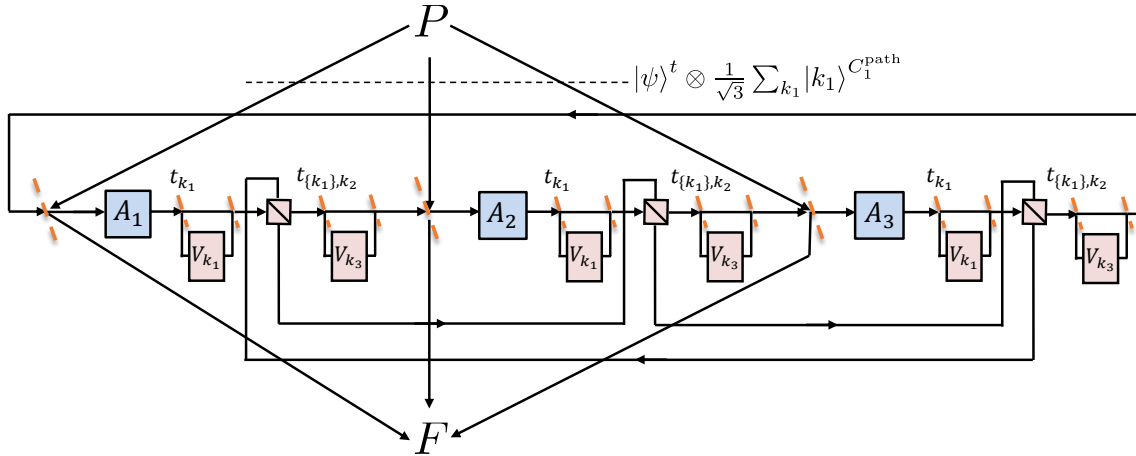

Figure 3.13: Folded scheme of the new example of QC-QC, based on the implementation of the quantum switch presented in Section 3.4.1. The structure of the photonic is the same: A_1, A_2 and A_3 are “inside a loop”, entered by the photon via fast switching mirrors. The photon is also routed to the isometries, applied at specific time (after A_{k_1} , at “ t_{k_1} ” for \mathcal{V}'_{k_1} ; before A_{k_3} , at “ $t_{\{k_1\},k_2}$ ” for \mathcal{V}'_{k_3}), using such fastswitching mirrors. A “cascade” of PBS allows to rout the photon dynamically and coherently to one operation to another, while making sure that each operation is applied once and only once.

lence, it would represent a major step towards showing that more general QC-QCs exploiting dynamical, coherent control of causal order can be realised and, eventually, exploited

in the laboratory, and we challenge experimental groups to the task.

3.5 Applications

In addition to the fundamental interest in the study of new features of Nature, another motivation for investigating quantum causal structures is the prospect that indefinite causal orders could offer new advantages in quantum information processing tasks. This way, causal nonseparability can be exploited as a new information processing resource [13].

Indeed, the quantum switch and the N -switch have been shown to enable new advantages in regard for instance to quantum query complexity [20, 167, 149, 168, 170], quantum communication complexity [178, 179] and other information processing tasks [180, 181, 182, 183, 184, 150, 185, 186, 187, 188, 169, 189, 190, 191, 172, 173]. The identification of new physical causally nonseparable processes beyond the quantum switch enabled by our characterisation of QC-QCs allows to broaden the search for new advantageous uses of causal nonseparability, by finding, more systematically, tasks for which QC-QCs provide an advantage over circuits with definite causal order.

The canonical example of perfect discrimination between commuting and anticommuting unitaries enabled by the quantum switch considered above (cf. Section 2.5) is an example of a “higher-order quantum computation” problem among others, such as the cloning [120], the storage and retrieval [120], or the replication of the inverse or transpose [192, 193, 127] of some undisclosed, black-box operation of which one or multiple copies are available. In fact, it is natural to study this type of information processing tasks in the context of higher-order maps such as the studied quantum supermaps i.e. involving transformation of transformations.

The performance of a given class of circuit for a given task can be quantified by optimising over the corresponding higher order transformations and find the “best” circuit, i.e. the one that maximises some figure of merit, e.g. the success probability of the task. This circuit can be efficiently found using the characterisations of QC-FO, QC-CC, QC-QC presented above, by exploiting, in many cases of interest, semidefinite programming (SDP) techniques for optimisation. In particular, the performances of all these classes can be compared for a given task.

3.5.1 Probabilistic quantum circuits

In order to quantify the advantage of our new circuits in terms of probabilities of succeeding in such discrimination task, we need to consider a probabilistic version of these quantum circuits, generalising the concept of “quantum testers” [121] or “quantum superinstruments” [193] providing some classical outcome (e.g., ‘success’ or ‘fail’). A detailed description and characterisation of these probabilistic quantum circuits is given in our paper [86].

The generalisation consists in replacing each internal CPTP map in the above descriptions by a quantum instrument, i.e. set of (trace non-increasing) CP maps (each

corresponding to a given outcome) that sum up to a CPTP map. Without loss of generality, one can note that the classical outcomes can always be encoded onto suitable orthogonal states of the auxiliary systems, and the post-selection can be performed at the end as part of the last internal operation (before F). This way all the internal operations can remain deterministic except for the last one. One can thus define, from [86]:

- *Probabilistic QC-FO*: here, The CPTP map \mathcal{M}_{N+1} is replaced by an instrument $\{\mathcal{M}_{N+1}^{[r]}\}_r$, such that the probabilistic process matrix describing the specific realisation of such a pQC-FO, corresponding to the classical outcome r , is

$$W^{[r]} = M_1 * M_2 * \dots * M_N * M_{N+1}^{[r]} \in \mathcal{L}(\mathcal{H}^{PA_N^{IO}F}) \quad (3.48)$$

The entire pQC-FO is described by the set $\{W^{[r]}\}_r$ of all such probabilistic process matrices, for all classical outcomes r ;

- *Probabilistic QC-CC*: the last internal operation of a QC-CC probabilistic $\mathcal{M}_{(k_1, \dots, k_N)}^{\rightarrow F} \rightarrow \{\mathcal{M}_{(k_1, \dots, k_N)}^{\rightarrow F[r]}\}_r$ to define a pQC-CC. The probabilistic process matrix describing the specific realisation of such a pQC-CC, corresponding to the classical outcome r , is given by

$$W^{[r]} = \sum_{(k_1, \dots, k_N)} W_{(k_1, \dots, k_N, F)}^{[r]} \quad (3.49)$$

$$\text{with } W_{(k_1, \dots, k_N, F)}^{[r]} := M_{\emptyset}^{\rightarrow k_1} * M_{(k_1)}^{\rightarrow k_2} * M_{(k_1, k_2)}^{\rightarrow k_3} * \dots * M_{(k_1, \dots, k_{N-1})}^{\rightarrow k_N} * M_{(k_1, \dots, k_N)}^{\rightarrow F[r]} \quad (3.50)$$

The entire pQC-CC is described by the set $\{W^{[r]}\}_r$ of all such probabilistic process matrices, for all classical outcomes r ;

- *Probabilistic QC-QC*: the last operation \tilde{V}_{N+1} is replaced by a set of operators

$$\tilde{V}_{N+1}^{[r]} := \sum_{k_N} \tilde{V}_{\mathcal{N} \setminus k_N, k_N}^{\rightarrow F[r]} \otimes \langle \mathcal{N} \setminus k_N, k_N |^{C'_N}, \quad (3.51)$$

each associated with the classical outcome r of the circuit. The probabilistic process matrix describing the specific realisation of such a pQC-QC, corresponding to the classical outcome r , is given by

$$W^{[r]} = \text{Tr}_{\alpha_F} |w_{(\mathcal{N}, F)}^{[r]}\rangle \langle w_{(\mathcal{N}, F)}^{[r]}| \text{ with}$$

$$|w_{(\mathcal{N}, F)}^{[r]}\rangle := \sum_{(k_1, \dots, k_N)} |V_{\emptyset, \emptyset}^{\rightarrow k_1}\rangle * |V_{\emptyset, k_1}^{\rightarrow k_2}\rangle * |V_{\{k_1\}, k_2}^{\rightarrow k_3}\rangle * \dots$$

$$\dots * |V_{\{k_1, \dots, k_{N-2}\}, k_{N-1}}^{\rightarrow k_N}\rangle * |V_{\{k_1, \dots, k_{N-1}\}, k_N}^{\rightarrow F[r]}\rangle. \quad (3.52)$$

The entire pQC-QC is described by the set $\{W^{[r]}\}_r$ of all such probabilistic process matrices, for all classical outcomes r .

3.5.2 Discrimination task and advantages

For example, we have identified a discrimination task¹⁰ for which the performance of general causally nonseparable process matrices surpasses the one of QC-QCs which itself surpasses the QC-CCs. This task is a natural variant of an equivalence determination task studied in [194], in which two reference boxes implement some black-box unitary operations U_1 and U_2 respectively, and a target box U_i is promised to perform, with probability $1/2$, one of these operations. The goal is to determine which operation is implemented by the target box, with the constraint that each one of the three boxes shall be used once. In our variant, instead of implementing U_1 or U_2 , the target is promised to implement two different functions of the reference boxes, i.e. either $U_i = f_1(U_1, U_2)$ or $U_i = f_2(U_1, U_2)$. For simplicity (as in [194]) we shall consider the case where the boxes all implement qubit unitaries, with the reference boxes chosen randomly according to the Haar measure on $SU(2)$. Denoting $\mathcal{H}^{A_j^I}$ and $\mathcal{H}^{A_j^O}$ the input and output spaces of the reference boxes for $j \in 1, 2$ and the target box for $j = 3$; $\{W^{[i]}\}_{i=1,2}$ the quantum instrument at disposal, with $W^{[i]} \in \mathcal{L}^{A_1^O A_2^O A_3^I O}$, and where $i \in \{1, 2\}$, the outcome of the superinstrument, denotes the outcome to our guess of which black box operation is implemented. The figure of merit is given by the probability of success:

$$p_{U_1, U_2} = \frac{1}{2} \sum_{i=1,2} W^{[i]} * (|U_1\rangle\rangle \langle\langle U_1| \otimes |U_2\rangle\rangle \langle\langle U_2| \otimes |U_i\rangle\rangle \langle\langle U_i|) \quad (3.53)$$

The problem consists then in maximizing this probability of success for a given class of circuit. For each class presented above, this optimisation task is a SDP problem, and can thus be solved efficiently. Some examples of functions (when averaging numerically over a large number of Haar random unitaries) for which each class of circuit gives a distinct probability of success for such task are given in Table 3.1.

$f_1(U_1, U_2)$	$f_2(U_1, U_2)$	QC-FO	QC-CC	QC-QC	IND
$U_1 U_2 U_1^\dagger$	$U_2 U_1 U_2^\dagger$	0.6681	0.6681	0.6854	0.6868
$U_1 U_1$	$U_2 U_2$	0.6814	0.6856	0.6926	0.6932
$U_1 U_2 U_1$	$U_1 U_2 U_2$	0.7070	0.7070	0.7133	0.7138

Table 3.1: Success probabilities for the discrimination task between two functions $f_1(U_1, U_2)$ and $f_2(U_1, U_2)$ implemented by the target box. QC-FO is the maximum of the success probabilities for the possible fixed order configurations (i.e., with the target box before, between or after the reference boxes), QC-CC and QC-QC denote the class of superinstruments with classical and quantum control of causal order, respectively, and IND stands for general quantum superinstruments (defined as a set of positive semidefinite matrices $\{W^{[r]}\}_r$ whose sum $W := \sum_r W^{[r]}$ is a valid process matrix.)

3.6 All QC-QCs admit a causal model

The definition of the class of quantum circuits with quantum control of causal order is an important step in the study of causal indefiniteness, as it allows to identify new causally nonseparable process matrices - beyond the quantum switch and trivial generalisations -

¹⁰Other examples of discrimination tasks are given in ([86, 147]).

that admit a physical implementation. A key question to tackle is whether some QC-QC might be able to violate a causal inequality, and thus manifest, in a sense, a stronger form of incompatibility with definite causal orders than the quantum switch. This would also be an important breakthrough, as it would give the first example of a physical process able to generate noncausal correlations. Nevertheless, the answer to this question is negative. Generalizing the proof for the quantum switch, we have shown the following result:

QC-QCs are causal.

Proposition 13. *Quantum circuits with quantum control of order can only generate causal correlations, and are therefore unable to violate causal inequalities.*

By coincidence, another paper independent from our work [86] has also shown that causal inequalities cannot be violated in some similar circuit-like quantum models [195].

3.7 Take Away and Perspectives

Take Away

- In a bottom-up approach, we have tackled the question: “What kind of quantum circuits are incompatible with a definite causal order?”.
- Beyond standard quantum circuits with a fixed causal order (QC-FO, also known as quantum combs), we introduce the class of quantum circuits with classical control of causal order (QC-CC) in which the causal order is established on the fly, dynamically.
- We have then generalised this class by making the control “quantum”, leading to define the class of quantum circuits with quantum control of causal order (QC-QC).
- The class of QC-QCs include circuits incompatible with a definite causal order, such as the quantum switch, but also new examples of causally nonseparable process matrices, in which the causal order is both dynamically established and indefinite.
- I have proposed a new implementation of the quantum switch, based on the idea that a definite causal order emerges from the position of a cut in a causal loop. If the position of the cut is indefinite, the causal order is, by “entanglement”, also indefinite.
- QC-QCs offer new information processing advantages for some discrimination tasks with respect to quantum circuits with a definite causal order (whether it is fixed (QC-FO) or not (QC-CC)).
- All causally nonseparable QC-QCs are causal, i.e. they cannot be used to violate causal inequalities.

Perspectives

- The question of how quantum supermaps outside the QC-QC class can be given a physical interpretation is open.
- One could try to generalise the QC-QC, for example by relaxing some validity constraints on the processes, restricting the set of allowed instruments, and by only imposing that valid probabilities should be produced.
- Experimental realisations and study of new QC-QCs beyond the quantum switch, and whether they lead to new advantages for quantum information tasks should be investigated.

Chapter 4

Witnessing Causal Nonseparability with Quantum Inputs

This chapter is taken from and based on our pre-publication [87]. This work has been one of the central part of my thesis, and I have contributed to all parts of the research presented in this chapter.

4.1 Analogous Characterisations of Non-Locality and Non-Causality

The notion of causal nonseparability in the process matrix formalism was introduced in analogy with entanglement in standard quantum theory. Given such specific non-trivial theoretical features, the questions of how they can be characterized, experimentally certified, and which underlying assumptions are necessary to do so, are fundamental issues.

For example, a universal way to characterize causal nonseparability and entanglement is via the measurement of *causally nonseparable* and *entanglement witnesses*, respectively. These certifications however have an important experimental drawback, as they crucially require the correct calibration of the devices to be measured. Indeed, from Eq. (2.16) and Eq. (2.17), to define (and measure) a witness, one needs to perfectly *trust* that the experimental devices effectively implement the operations $M_{a|x}$ and $M_{b|y}$. This type of certification, so-called *device-dependent (DD)*, are in general laborious to implement, as even small alignment errors, difficult to estimate, can lead to false positives.

However, other types of certification exist, which involve fewer assumptions. In fact, it is the case for the first certification of entanglement, proposed by Bell. The violation of a Bell inequality is a *theory independent*¹ result, as it can be inferred at the operational level by only relying on observable probabilities $P(a, b|x, y)$. Moreover, if one “trusts” quantum theory, it implies that Alice and Bob share an entangled state. In analogy, within the process matrix formalism, the violation of a causal inequality allows to certify in a device-independent way that Alice and Bob have access to a causally nonseparable process matrix. This type of characterization is particularly powerful, in the sense that it only requires a minimal set of assumptions on the devices, and do not rely on their detailed characterization: it is *device-independent (DI)*. For example the violation of Bell

¹Unlike causal nonseparability and entanglement, which are *theory dependent* concepts.

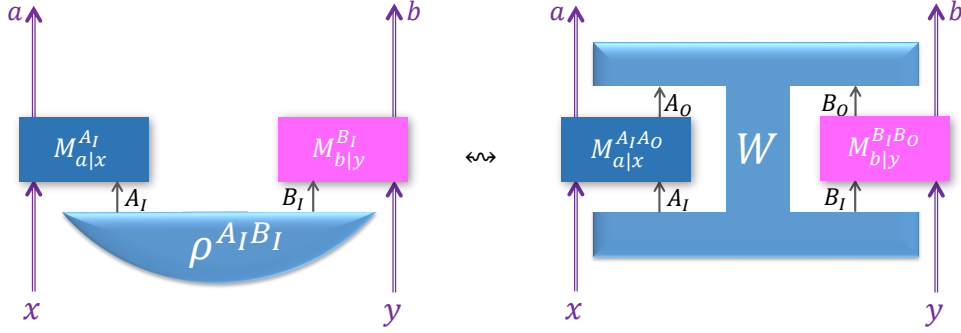

Figure 4.1: Analogous scenarios for the certification of the entanglement of quantum state $\rho^{A_I B_I}$ (left) and the causal nonseparability of a process matrix W^{AB} (right).

inequalities certifies entanglement independently of any implementation details, in a way robust to any experimental imperfection. Alice and Bob’s devices are treated as *black boxes*, receiving classical inputs x and y and yielding classical outputs a and b . Thus, the internal mechanisms of the boxes are completely untrusted: their physics is solely captured in the generated observable probabilities $P(a, b|x, y)$.

Device independent certifications have then a genuine pragmatical interest in the experimental detection of entanglement and causal nonseparability. Moreover, they have a straightforward application in communication protocols and cryptography, in which untrusted devices can be interpreted as being prepared by malicious eavesdroppers. In fact, the terminology was first introduced by Mayers and Yao [196], who paved the way to device-independent quantum cryptography with imperfect sources. Device-independent protocols have since then been developed for randomness generation [197, 198], quantum key distribution [199], estimation of the states of unknown systems via self-testing [200], certification of multipartite entanglement [201], and distrustful cryptography [202].

Nevertheless, although several experimental device-independent certification of entanglement have been reported [74, 203, 204, 205], device-independent implementations are usually experimentally challenging (especially for protocols involving large multipartite scenarios), as they generally require high visibilities and high detection efficiencies for example. Moreover, there are entangled states that can be certified in a device-dependent way, but cannot violate Bell inequalities, e.g. (some of) the Werner states [131]. In the case of causal nonseparability, as explained in Chapter 2, despite that causally nonseparable process matrices can be characterized with causal witnesses, it remains unclear if any physically realisable process can violate a causal inequality. Furthermore, causal models have recently been formulated for a large class of quantum-realizable processes [86, 195].

To find a compromise between device-dependent (“complete trust”) and device-independent (“complete distrust”) certifications, one can study intermediate approaches, *semi-device-independent* certifications. These correspond to a variety of characterisations where only few specific assumptions are made on the devices: for example, only trusting that the dimension of the input/output systems is bounded [206], or only trusting the characterisation of some of the devices. In a bipartite scenario, the latter is often coined as a *one-sided device-independent* certification of entanglement, also known as *quantum*

*steering*² [207, 124, 208]. Interestingly, it was shown that all quantum states displaying steering are entangled states, but the converse is not true, i.e. entanglement is necessary but not sufficient for steering. Moreover all entangled state violating a Bell inequality, i.e. generating nonlocal correlations display quantum steering, but some steerable entangled states admit a local model. Hence, quantum steering is sometimes said to be “a novel form of nonseparability, intermediate between entanglement and nonlocality” [19].

In fact, beyond the pragmatical interest, the fact that there exist distinct manifestations of “nonseparability”, and crucially that not all entangled states can manifest “nonseparability” in all these forms (entanglement, steering, nonlocality), might motivate a phenomenological interpretation of the various characterisations of entanglement. Some entangled states only display “entanglement”, i.e. can only be characterized in a DD way. Some can also display “steering”, and thus be characterized in a one-sided-DI way, and finally some can generate non-local correlations, i.e. display “non-locality” and be characterized, straightforwardly, in a DI way.

This phenomenological distinction needs however to be interpreted with caution, as different types of resources (states, steering assemblages, boxes) are involved. Hence, as explained in [209], the fact that some entangled state cannot violate Bell inequalities is not necessarily surprising: “whether or not a given state can be converted to a nonlocal box is certainly an interesting question, but it is not a necessary condition for the state to be deemed nonclassical.” Indeed, the device-independent certification of entanglement, i.e. a certification by “conversion [of an entangled state] into a process with only classical inputs and outputs”, does not necessarily imply to “convert the state into a box”, i.e. certify entanglement via the violation of a Bell inequality. In fact, “as soon as one considers converting states into other sorts of processes, it becomes possible to certify entangled states that could not be certified by boxes” [209]. All entangled states can be certified in a device-independent way, for example by combining self-testing technique with a specific semi-device-independent certification with quantum inputs, that I will present in the next section.

As it transpires in the DD and DI cases, there is a clear analogy between the characterisations of quantum nonlocality and indefinite causal orders. Inspired by this parallel, the analogous of quantum steering for causal nonseparability has been studied, i.e. a certification in scenarii where some of the devices are trusted and others are not [210]. By abuse of language, these are also called *one-sided device-independent (OSDI)* scenarii (even for the multipartite cases) [208]. This characterization of causal nonseparability will be succinctly introduced in Section 4.8.1.

In analogy with the fact that some entangled state admit a local model, i.e. cannot generate nonlocal correlations violating a Bell inequality, some causally nonseparable process matrices admit a causal model, i.e. cannot generate noncausal correlations violating a causal inequality. In the case of the characterisation of entanglement, it was nevertheless shown that all entangled states can generate nonlocal correlations in a specific scenario, where parties receive inputs in the form of trusted quantum systems (instead of classical

²Remarkably, quantum steering was introduced by Schrödinger in 1935 [58, 59] as an attempt to formalize the essence of the EPR paradox [73]. The concept was then “rediscovered” and modernized by Wiseman, Jones and Doherty in 2007 [207].

ones), but are otherwise untrusted [211]. This so-called Buscemi nonlocality corresponds to a semi-device-independent certification of entanglement with trusted quantum inputs (SDIQI). Furthermore, it was also shown that one could construct a measurement-device-independent entanglement witness for all entangled states in such scenario [212] (Section 4.2). Moreover, in analogy with Bell nonlocality and post-quantum correlations, a post-quantum generalisation of Buscemi nonlocality was introduced in [213], based on effective joint operators, called *distributed measurements* [213, 214] (Section 4.3).

Pursuing the analogy between nonlocality and noncausality, we explored how causal nonseparability could be characterized in a scenario where untrusted devices receive trusted quantum inputs (Section 4.4), cf. Table 4.1. Defining a notion of causal (non)separability for distributed measurements (Section 4.5). We show that certain causally nonseparable processes which cannot violate any causal inequality, such as the quantum switch [13], can generate non-causal correlations in our *semi-DI with quantum inputs* scenario. Moreover, under a weak additional constraint on the uncharacterised operations, we show that all bipartite causally nonseparable process matrices can be certified in this way.

Note however that the analogy remains limited. In fact the mathematical translations of the concepts of entanglement and causal nonseparability, are not equivalent. For example, determining whether a quantum state is entangled or not is in general a notoriously hard problem [215] —which, contrary to the case of causal nonseparability cannot be solved via SDP. Moreover, while all pure entangled state can violate a Bell inequality, and only some mixed entangled state admit a local model [131, 19], there are pure process matrix, such as the quantum switch, which cannot violate a causal inequality. As we show in [87], while all entangled states can be certified in a SDIQI way, it does not seem to be the case for all causally nonseparable process matrices. Finally, recall that while the violation of Bell inequalities has become a successful experimental achievement, the physicality of the violation of a causal inequality remains unclear (cf. Section 2.6).

To conclude, I would like to point out that beyond their pragmatism and phenomenological interests, the notions of device-independence and trusts could provide food for thought on a metaphysical perspective. What does it mean to do physics without trusting your devices? Replacing the malicious eavesdropper from quantum cryptography protocols, what if untrusted devices were prepared by evil demons, and are there any epistemological consequences? This is a subject that I would like to explore (or at least to see being explored) in more details. Alexei Grinbaum paved the way to such metaphysics of black boxes in [216], where he suggests that “device-independent methods convert the usually implicit trust of the observer into a theoretical problem. By doing so, they erase one of the main dogmas of quantum theory: that it deals with systems.”

4.2 Semi-device independent certification of entanglement with quantum inputs

Before introducing our semi-device-independent certification of causal nonseparability with quantum inputs, let us succinctly present the work it was inspired by: a Bell scenario with quantum inputs, a semi-quantum nonlocal game [211, 212].

DD	Entangled states	\longleftrightarrow	Causally nonseparable process matrices
	Entanglement witnesses	\longleftrightarrow	Causal witnesses
DI	(Non-)local correlations	\longleftrightarrow	(Non-)causal correlations
	Local polytope	\longleftrightarrow	Causal polytope
	Bell inequalities	\longleftrightarrow	Causal inequalities
OSDI	Quantum steering	\longleftrightarrow	[Bavaresco et al., Quantum 3, 176, 2019 [210]]
SDIQI	Entangled state admitting a local model	\longleftrightarrow	Causally nonseparable process matrices admitting a causal model
	Buscemi non-locality	\longleftrightarrow	?
	Measurement-device-independent entanglement witnesses	\longleftrightarrow	?

Table 4.1: Analogies between non-locality and non-causality in different regimes of certification: device-dependent (DD) ; device-independent (DI) ; one-sided device-independent (OSDI) ; semi-device-independent with quantum inputs (SDIQI). In [87] and this section, we address precisely the question marks of this table, i.e. we investigate the causal analogies of Buscemi non-locality and measurement-device-independent entanglement witnesses.

4.2.1 Bell nonlocality, a brief reminder

Consider the following Bell scenario involving two players, Alice and Bob. Each of them receives (from some external referee) an input x and y respectively, which can take the bit values $x, y \in \{0, 1\}$ with equal probabilities. Each yield an output a and b respectively, with bit values $a, b \in 0, 1$. Alice and Bob thus produce correlations, described by the conditional probability distribution of the outputs given their inputs, which is generically denoted by $P(a, b|x, y)$. In a Bell scenario, Alice and Bob are not allowed to communicate after they receive their inputs. Hence, Alice cannot signal to Bob, *and* Bob cannot signal to Alice. This means that on the one hand Alice’s marginal probability distribution $P(a|x, y) = \sum_b P(a, b|x, y)$ cannot depend on Bob’s input y :

$$\forall x, y, y', a \quad P(a|x, y) = \sum_b P(a, b|x, y) = \sum_b P(a, b|x, y') = P(a|x) \quad (4.1)$$

This constraint corresponds to a *no-signalling condition from Bob to Alice*, that we already encountered in (2.26), satisfied by correlations compatible with the causal order $A \prec B$. On the other hand, Bob’s marginal probability distribution $P(b|x, y) = \sum_a P(a, b|x, y)$ cannot depend on Alice’s input x :

$$\forall x, x', y, b \quad P(b|x, y) = \sum_a P(a, b|x, y) = \sum_a P(a, b|x', y) = P(b|y) \quad (4.2)$$

a *no-signalling condition from Alice to Bob*, satisfied by correlations compatible with the causal order $B \prec A$ (2.27).

In a Bell-local model, Alice and Bob are also allowed to share a common strategy beforehand, denoted λ . This variable can be seen as some “past factor” [19]: it has a joint causal influence on both outcomes, and it fully accounts for the dependence between a and b , following some probability distribution $\rho(\lambda)$. If the past factors λ have a classical

description (e.g. they can be written as a list of bits) and are used locally by Alice and Bob, then their respective response functions are of the form $P(a|x, \lambda)$ and $P(b|y, \lambda)$. Finally, their joint conditional probability distribution is

$$P(a, b|x, y) = \int d\lambda \rho(\lambda) P(a|x, \lambda) P(b|y, \lambda) \quad (4.3)$$

Eq.(4.3) is the so-called *local causality*, or “*locality*”, condition.

If the correlations yielded by Alice and Bob do not satisfy (4.3), as shown by violating a bound characterizing this condition - a Bell inequality-, then they are *nonlocal*. Some entangled quantum states $\rho^{A_I B_I} \in \mathcal{H}^{A_I B_I}$, for some sets of quantum measurements $\{M_{a|x}^{A_I}\}_{a,x}$ and $\{M_{b|y}^{B_I}\}_{b,y}$, can generate correlations³

$$P(a, b|x, y) = \left(M_{a|x}^{A_I} \otimes M_{b|y}^{B_I} \right) * \rho^{A_I B_I} \quad (4.4)$$

that do not satisfy (4.3), thus certifying the entanglement of $\rho^{A_I B_I}$ in a *device-independent* way.

4.2.2 Buscemi nonlocality and Measurement-DI entanglement witnesses

Despite the fact that some entangled state cannot violate Bell inequalities, it was shown by Buscemi that all entangled states can generate nonlocal correlations in a scenario where Alice and Bob receive quantum inputs instead of classical ones. Instead of receiving classical input bits x and y , Alice and Bob are given some quantum states $\rho_x^{\tilde{A}} \in \mathcal{L}(\mathcal{H}^{\tilde{A}})$ and $\rho_y^{\tilde{B}} \in \mathcal{L}(\mathcal{H}^{\tilde{B}})$ respectively, that can be measured jointly with their shared entangled state $\rho^{A_I B_I}$. We shall explicitly write the dependency on the quantum inputs in the correlations $P(a, b|\rho_x^{\tilde{A}}, \rho_y^{\tilde{B}})$ obtained according to Eq. (4.4). For some quantum measurements $\{M_a^{\tilde{A}A_I}\}_a$ and $\{M_b^{\tilde{B}B_I}\}_b$, the parties can thus generate correlations

$$P(a, b|\rho_x^{\tilde{A}}, \rho_y^{\tilde{B}}) = \left(M_a^{\tilde{A}A_I} \otimes M_b^{\tilde{B}B_I} \right) * \left(\rho_x^{\tilde{A}} \otimes \rho_y^{\tilde{B}} \otimes \rho^{A_I B_I} \right) \quad (4.5)$$

In such scenario, Alice and Bob’s operations are still untrusted, as above. However, we trust that they receive quantum inputs in some given states. Thus, the scenario is not fully device-independent anymore. It is a *semi-device-independent with trusted quantum inputs* or *measurement-device-independent* scenario.

It can be easily shown that all entangled state $\rho^{A_I B_I}$ violating a Bell inequality for some POVMs $\{M_{a|x}^{A_I}\}_{a,x}$ and $\{M_{b|y}^{B_I}\}_{b,y}$, i.e. such that the correlations $P(a, b|x, y)$ given by Eq.(4.4) cannot be written as Eq.(4.3), can also generate nonlocal correlations in a scenario with quantum inputs. Assume that Alice and Bob performs joint operations $\{M_a^{\tilde{A}A_I}\}_a$ and $\{M_b^{\tilde{B}B_I}\}_b$ such that

$$\begin{aligned} M_a^{\tilde{A}A_I} &= \sum_x |x\rangle\langle x|^{\tilde{A}} \otimes M_{a|x}^{A_I} \\ M_b^{\tilde{B}B_I} &= \sum_y |y\rangle\langle y|^{\tilde{B}} \otimes M_{b|y}^{B_I} \end{aligned} \quad (4.6)$$

³For convenience, we use the link product introduced in Eq. 2.3. Note that Eq. 4.4 is equivalent to the “standard” Born rule, up to a transpose.

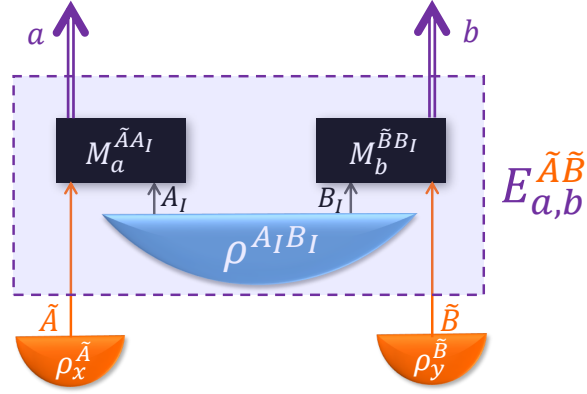

Figure 4.2: Semi-device-independent scenario with trusted quantum inputs for the certification of entanglement.

Moreover assume that they receive orthonormal quantum states $\rho_x^{\tilde{A}} = |x\rangle\langle x|^{\tilde{A}}$ and $\rho_y^{\tilde{B}} = |y\rangle\langle y|^{\tilde{B}}$ respectively, such that Eq.(4.5) gives

$$\begin{aligned}
P(a, b | \rho_x^{\tilde{A}}, \rho_y^{\tilde{B}}) &= \left(\sum_{x', y'} |x'\rangle\langle x'|^{\tilde{A}} \otimes M_{a|x'}^{A_I} \otimes |y'\rangle\langle y'|^{\tilde{B}} \otimes M_{b|y'}^{B_I} \right) * \left(|x\rangle\langle x|^{\tilde{A}} \otimes |y\rangle\langle y|^{\tilde{B}} \otimes \rho^{A_I B_I} \right) \\
&= \left(\sum_{x', y'} P(a, b | x', y') |x'\rangle\langle x'|^{\tilde{A}} \otimes |y'\rangle\langle y'|^{\tilde{B}} \right) * \left(|x\rangle\langle x|^{\tilde{A}} \otimes |y\rangle\langle y|^{\tilde{B}} \right) \\
&= P(a, b | x, y)
\end{aligned} \tag{4.7}$$

where we used the fact that $|x'\rangle\langle x'| * |x\rangle\langle x| = \delta_{x', x}$.

The correlations $P(a, b | \rho_x^{\tilde{A}}, \rho_y^{\tilde{B}})$ are thus straightforwardly nonlocal.

Remarkably, this is also the case for all entangled state, even if they cannot violate Bell inequalities in the standard scenario with classical inputs. In fact, while the joint operations (4.6) allow Alice and Bob to discriminate their quantum input states $\rho_x^{\tilde{A}} = |x\rangle\langle x|^{\tilde{A}}$ and $\rho_y^{\tilde{B}} = |y\rangle\langle y|^{\tilde{B}}$, leading to the generation of correlations identical to the case where they receive classical inputs (4.7); a scenario with quantum inputs may not, in general, let such discrimination occur: Alice and Bob only know which ensembles $\{\rho_x^{\tilde{A}}\}_x$ and $\{\rho_y^{\tilde{B}}\}_y$ quantum inputs are drawn from. As shown in [212], this fundamental difference allows to construct an explicit witness for all entangled state in a scenario with quantum inputs, a “*measurement-device-independent entanglement witness* (MDIEW)” (cf. Appendix B).

Several developments on Buscemi nonlocality and MDIEWs have been made. For example, it was shown that a universal witness [217] can be found given multiple copies of the studied state, allowing to certify the entanglement of arbitrary states. With a single copy, it is nevertheless possible to show that unlike the certification of entanglement in a device-dependent scenario, which is a hard problem, the certification with quantum inputs can be cast as a semidefinite programming (SDP) optimization problem [218]. MDIEWs were also used for instance to estimate the amount of entanglement and certify randomness in a quantum network [214], and various experimental implementations of MDIEWs have been realized (cf. e.g. [219, 220, 218]).

4.3 Post-quantum Buscemi nonlocality and D-POVMs

In analogy with Bell nonlocality and the existence of post-quantum correlations, e.g. correlations able to maximally violate Bell inequalities when yielded by PR boxes, Hoban and Sainz have introduced a post-quantum generalisation to Buscemi nonlocality [213]. To do so, they identify, as in [214], that the correlations (4.5) can be written as the application of an effective joint operator on the quantum inputs,

$$P(a, b | \rho_x^{\tilde{A}}, \rho_y^{\tilde{B}}) = E_{a,b}^{\tilde{A}\tilde{B}} * (\rho_x^{\tilde{A}} \otimes \rho_y^{\tilde{B}}) \quad (4.8)$$

with

$$E_{a,b}^{\tilde{A}\tilde{B}} = \left(M_a^{\tilde{A}A_I} \otimes M_b^{\tilde{B}B_I} \right) * \rho^{A_I B_I}. \quad (4.9)$$

The set of joint operators $\{E_{a,b}^{\tilde{A}\tilde{B}}\}_{a,b}$ constitutes an effective POVM, as each element is positive semidefinite, and the sum over the distributed outcomes a and b gives the identity operator. One can thus define the notion of *distributed measurement (D-POVM)*⁴:

D-POVM

Definition 14. Given a set of classical outcomes $\{a, b\}$, a *distributed measurement*, or *D-POVM*, is a set of operators $\{E_{a,b}^{\tilde{A}\tilde{B}} \in \mathcal{L}(\mathcal{H}^{\tilde{A}\tilde{B}})\}_{a,b}$ such that $E_{a,b}^{\tilde{A}\tilde{B}} \geq 0$ and $\sum_{a,b} E_{a,b}^{\tilde{A}\tilde{B}} = \mathbb{1}^{\tilde{A}\tilde{B}}$.

The set of distributed measurements that result from the set of local operations and shared randomness, called *local D-POVM*, is defined as follows:

Definition 15. A *D-POVM* is *local* if there exist a separable state $\sigma^{A_I B_I} = \sum_k p_k \sigma_k^{A_I} \otimes \sigma_k^{B_I}$, with $\forall k, p_k \geq 0$ and $\sum_k p_k = 1$, and some POVMs $\{M_a^{\tilde{A}A_I}\}_a$ and $\{M_b^{\tilde{B}B_I}\}_b$ such that

$$E_{a,b}^{\tilde{A}\tilde{B}} = \left(M_a^{\tilde{A}A_I} \otimes M_b^{\tilde{B}B_I} \right) * \sigma^{A_I B_I} = \sum_k p_k E_{a,k}^{\tilde{A}} \otimes E_{b,k}^{\tilde{B}} \quad (4.10)$$

with⁵ $E_{a,k}^{\tilde{A}} = M_a^{\tilde{A}A_I} * \sigma_k^{A_I} \geq 0$ and $E_{b,k}^{\tilde{B}} = M_b^{\tilde{B}B_I} * \sigma_k^{B_I} \geq 0$.

When Alice and Bob share a quantum resource, the generated D-POVM is quantum:

Definition 16. A *D-POVM* is *quantum* if it is generated from a quantum state $\rho^{A_I B_I}$ as in Eq.(4.9), in a Buscemi nonlocality experiment.

In such a framework, Buscemi's result can be reformulated as follows: for every entangled state $\rho^{A_I B_I}$ there exists measurements $\{M_a^{\tilde{A}A_I}\}_a$ and $\{M_b^{\tilde{B}B_I}\}_b$ such that the generated quantum D-POVM $\{E_{a,b}^{\tilde{A}\tilde{B}}\}_{a,b}$ is not local. As pointed out by Hoban and Sainz, a corollary is that the set of local D-POVMs is strictly contained in the set of quantum D-POVMs

⁴In [213], distributed measurement are defined in a more general N-partite case. I have decided to stay in the bipartite scenario for the sake of clarity and simplify notations. The generalisation is straightforward.

⁵Note that because the dimension of the Hilbert spaces \mathcal{H}^{A_I} and \mathcal{H}^{B_I} are finite but not constrained, the local measurements $\{M_a^{\tilde{A}A_I}\}_a$ and $\{M_b^{\tilde{B}B_I}\}_b$ can be taken to be projective without loss of generality.

[213]. Moreover, they define the set of *nonsignalling D-POVMs*, i.e. the most general set of D-POVMs that do not permit superluminal signalling:

Nonsignalling D-POVM

Definition 17. A *D-POVM* is a *nonsignalling D-POVM* if there exist POVMs $\{E_a^{\tilde{A}} \in \mathcal{L}(\mathcal{H}^{\tilde{A}})\}_a$ and $\{E_b^{\tilde{B}} \in \mathcal{L}(\mathcal{H}^{\tilde{B}})\}_b$ such that

$$\sum_b E_{a,b}^{\tilde{A}\tilde{B}} = E_a^{\tilde{A}} \otimes \mathbb{1}^{\tilde{B}}, \quad (4.11)$$

$$\sum_a E_{a,b}^{\tilde{A}\tilde{B}} = \mathbb{1}^{\tilde{A}} \otimes E_b^{\tilde{B}} \quad (4.12)$$

In fact, Eq.(4.11) and Eq.(4.12) can be interpreted as nonsignalling conditions. Eq.(4.11) is a nonsignalling condition from Bob to Alice, as it implies that Alice's marginal probability distribution is independent of Bob's quantum input, and vice-versa. Eq.(4.11) and Eq.(4.12) imply the generalisation of (4.1) and (4.2) (respectively) with quantum inputs:

$$\forall \rho_x^{\tilde{A}}, \rho_y^{\tilde{B}}, \rho_{y'}^{\tilde{B}}, a \quad P(a|\rho_x^{\tilde{A}}, \rho_y^{\tilde{B}}) = \sum_b P(a, b|\rho_x^{\tilde{A}}, \rho_y^{\tilde{B}}) = \sum_b P(a, b|\rho_x^{\tilde{A}}, \rho_{y'}^{\tilde{B}}) = P(a|\rho_x^{\tilde{A}}) \quad (4.13)$$

$$\forall \rho_y^{\tilde{B}}, \rho_x^{\tilde{A}}, \rho_{x'}^{\tilde{A}}, b \quad P(b|\rho_x^{\tilde{A}}, \rho_y^{\tilde{B}}) = \sum_a P(a, b|\rho_x^{\tilde{A}}, \rho_y^{\tilde{B}}) = \sum_a P(a, b|\rho_{x'}^{\tilde{A}}, \rho_y^{\tilde{B}}) = P(b|\rho_y^{\tilde{B}}) \quad (4.14)$$

Remarkably, given a tomographically complete set of quantum inputs, the D-POVM $\{E_{a,b}^{\tilde{A}\tilde{B}}\}_{a,b}$ can be explicitly reconstructed via Eq. (4.8)-(4.9). It can be characterized by only looking at the generated correlations $P(a, b|\rho_x^{\tilde{A}}, \rho_y^{\tilde{B}})$.

We will see in the next sections how these nonsignalling conditions can be used to define a notion of causal nonseparability for D-POVMs.

4.4 Causal scenario with quantum inputs

Using the analogy between non-locality and non-causality described above, we now go from a Bell scenario with quantum inputs to a causal scenario with quantum inputs. Alice and Bob are still provided with additional quantum inputs $\rho_x^{\tilde{A}}$ and $\rho_y^{\tilde{B}}$, respectively, indexed by the labels x and y . Instead of applying POVMs $\{M_a^{\tilde{A}A_I}\}_a$ and $\{M_b^{\tilde{B}B_I}\}_b$, we consider that Alice and Bob can perform more general quantum operations, the quantum instruments $\{M_a^{\tilde{A}A}\}_a$ and $\{M_b^{\tilde{B}B}\}_b$ respectively, i.e. operations with a non-trivial output space ($d_{A_O}, d_{B_O} \neq 1$) in general, satisfying (2.4). Each party outputs the classical results of their instrument, a and b , respectively. Alice and Bob are assumed to be in closed laboratories, and can communicate with each other only through a shared resource, a process matrix W^{AB} (instead of sharing a quantum state $\rho^{A_I B_I}$). We shall explicitly write the dependency on the quantum inputs in the correlations $P(a, b|\rho_x^{\tilde{A}}, \rho_y^{\tilde{B}})$ obtained according to Eq. (2.5), which can then be written as

$$\begin{aligned}
P(a, b | \rho_x^{\tilde{A}}, \rho_y^{\tilde{B}}) &= \left(M_a^{\tilde{A}A} \otimes M_b^{\tilde{B}B} \right) * \left(\rho_x^{\tilde{A}} \otimes \rho_y^{\tilde{B}} \otimes W^{AB} \right) \\
&= E_{a,b}^{\tilde{A}\tilde{B}} * \left(\rho_x^{\tilde{A}} \otimes \rho_y^{\tilde{B}} \right) = \text{Tr} \left[\left(E_{a,b}^{\tilde{A}\tilde{B}} \right)^T \left(\rho_x^{\tilde{A}} \otimes \rho_y^{\tilde{B}} \right) \right]
\end{aligned} \tag{4.15}$$

with

$$E_{a,b}^{\tilde{A}\tilde{B}} = \left(M_a^{\tilde{A}A} \otimes M_b^{\tilde{B}B} \right) * W^{AB}. \tag{4.16}$$

According to Eq. (4.15), the family $\mathbb{E}^{\tilde{A}\tilde{B}} := \{E_{a,b}^{\tilde{A}\tilde{B}}\}_{a,b}$ defines a D-POVM⁶ [214, 213] on the quantum inputs, cf. Definition 14.

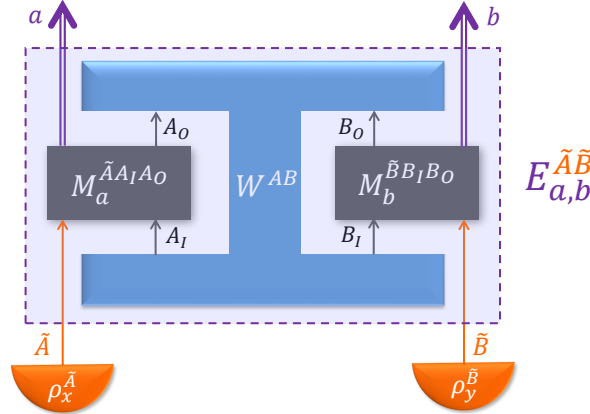

Figure 4.3: Semi-device-independent scenario with trusted quantum inputs for the certification of causal nonseparability.

In this scenario, the quantum inputs $\rho_x^{\tilde{A}}, \rho_y^{\tilde{B}}$ and their respective spaces are taken to be trusted. However, we do not trust the (fixed) instruments $\{M_a^{\tilde{A}A}\}_a$ and $\{M_b^{\tilde{B}B}\}_b$, and make no assumptions about the spaces $\mathcal{H}^{A_I}, \mathcal{H}^{A_O}, \mathcal{H}^{B_I}$ and \mathcal{H}^{B_O} . As in the case of certifying entanglement with quantum inputs, provided we can use a tomographically complete set of trusted quantum inputs, the D-POVM elements $E_{a,b}^{\tilde{A}\tilde{B}}$ can be explicitly reconstructed via Eq. (4.15).

4.5 Causally separable D-POVMs

The fundamental question we wish to tackle here is: if the process matrix W^{AB} is causally nonseparable, can one certify its causal nonseparability by just looking at the generated D-POVM elements $E_{a,b}^{\tilde{A}\tilde{B}}$'s? To address this question, we ask conversely whether assuming that W^{AB} is causally separable imposes any specific constraints on the $E_{a,b}^{\tilde{A}\tilde{B}}$'s.

Assume that Alice and Bob are given a process compatible with the causal order

⁶One can show that the validity constraints of the instruments and of W^{AB} imply that $\{E_{a,b}^{\tilde{A}\tilde{B}}\}_{a,b}$ is a valid POVM.

$A \prec B$, $W^{AB} = W^{A \prec B} = W^{A \prec B_I} \otimes \mathbb{1}^{B_O}$ with $W^{A \prec B_I} \geq 0$ and $_{[1-A_O]B_I} W^{A \prec B_I} = 0$. Then

$$\begin{aligned}
\sum_b E_{a,b}^{\tilde{A}\tilde{B}} &= \sum_b (M_a^{\tilde{A}A} \otimes M_b^{\tilde{B}B}) * (W^{A \prec B_I} \otimes \mathbb{1}^{B_O}) \\
&= (M_a^{\tilde{A}A} \otimes \sum_b \text{Tr}_{B_O} M_b^{\tilde{B}B}) * W^{A \prec B_I} \\
&= (M_a^{\tilde{A}A} \otimes \mathbb{1}^{\tilde{B}B_I}) * W^{A \prec B_I} \\
&= E_a^{\tilde{A}} \otimes \mathbb{1}^{\tilde{B}}
\end{aligned} \tag{4.17}$$

with $E_a^{\tilde{A}} = M_a^{\tilde{A}A} * \text{Tr}_{B_I} W^{A \prec B_I} \geq 0$ defining a (single-partite) POVM $\{E_a^{\tilde{A}}\}_a$.

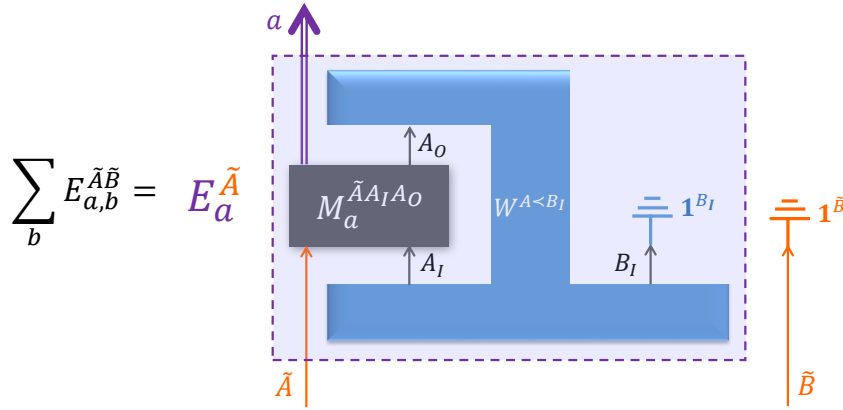

Figure 4.4: Illustration of Alice's marginalisation of the D-POVM elements $E_{a,b}^{\tilde{A}\tilde{B}}$, resulting in an effective POVM element $E_a^{\tilde{A}}$ and the identity operator on Bob's auxiliary space $\mathcal{H}^{\tilde{B}}$.

Thus, the D-POVM generated from a process matrix compatible with $A \prec B$ satisfies the no-signalling constraint Eq.(4.11). We say that a D-POVM $\{E_{a,b}^{\tilde{A}\tilde{B}}\}_{a,b}$ satisfying Eq.(4.11) (or, using the trace-and-replace notation of Eq. (2.9), $_{[1-\tilde{B}]}(\sum_b E_{a,b}^{\tilde{A}\tilde{B}}) = 0$) for all a is compatible with the order $\tilde{A} \prec \tilde{B}$. We generically denote such a POVM as $\{E_{a,b}^{\tilde{A} \prec \tilde{B}}\}_{a,b}$.

Similarly, starting with a process matrix $W^{AB} = W^{B \prec A} = W^{B \prec A_I} \otimes \mathbb{1}^{A_O}$ that is compatible with the order $B \prec A$, we find that the resulting D-POVM obtained from Eq. (4.16), satisfies Eq. (4.12), i.e., is compatible with the order $\tilde{B} \prec \tilde{A}$ (generically denoted $\{E_{a,b}^{\tilde{B} \prec \tilde{A}}\}_{a,b}$).

Because the compatibility of process matrices with a well-defined causal structure imposes constraints on the generated D-POVMs, and in analogy with the definition of causal (non)separability for process matrices Eq. (2.10), we define a notion of causal (non)separability for D-POVMs:

Causally separable bipartite D-POVM

Definition 18. A bipartite D-POVM $\mathbb{E}^{\tilde{A}\tilde{B}} = \{E_{a,b}^{\tilde{A}\tilde{B}}\}_{a,b}$ that can be decomposed as a convex mixture of D-POVMs compatible with the causal orders $\tilde{A} \prec \tilde{B}$ and $\tilde{B} \prec \tilde{A}$, i.e., of the form

$$\mathbb{E}^{\tilde{A}\tilde{B}} = q \mathbb{E}^{\tilde{A} \prec \tilde{B}} + (1-q) \mathbb{E}^{\tilde{B} \prec \tilde{A}} \quad (4.18)$$

with $q \in [0, 1]$ and where the D-POVMs $\mathbb{E}^{\tilde{A} \prec \tilde{B}} = \{E_{a,b}^{\tilde{A} \prec \tilde{B}}\}_{a,b}$ and $\mathbb{E}^{\tilde{B} \prec \tilde{A}} = \{E_{a,b}^{\tilde{B} \prec \tilde{A}}\}_{a,b}$ satisfy $\sum_b E_{a,b}^{\tilde{A} \prec \tilde{B}} = E_a^{\tilde{A}} \otimes \mathbb{1}^{\tilde{B}}$ for all a and $\sum_a E_{a,b}^{\tilde{B} \prec \tilde{A}} = \mathbb{1}^{\tilde{A}} \otimes E_b^{\tilde{B}}$ for all b , for some local POVMs $(E_a^{\tilde{A}})_a$ and $(E_b^{\tilde{B}})_b$ — is said to be *causally separable*. Otherwise, we say that it is *causally nonseparable*.

In the $(2+F)$ -partite scenario

No physical interpretation is currently known for any bipartite causally nonseparable processes (cf. Section 2.6). A more practically relevant scenario is the one of the quantum switch, a “ $(2+F)$ -partite scenario”, cf. Eq. (2.12), Section 2.5). As a reminder, the only relevant causal orders in this scenario are $A \prec B \prec F$ and $B \prec A \prec F$ [16]. Moreover, generalisations of Eq. (2.5), as well as the definitions of causally separable process matrices (cf. Eq. (2.12)) are straightforward.

In a scenario where Alice, Bob and Fiona are given quantum inputs, Eqs. (4.15) and (4.16) generalise easily to the $(2+F)$ -partite case, so that one is led to consider the D-POVM $\mathbb{E}^{\tilde{A}\tilde{B}\tilde{F}} = \{E_{a,b,f}^{\tilde{A}\tilde{B}\tilde{F}}\}_{a,b,f}$ with

$$E_{a,b,f}^{\tilde{A}\tilde{B}\tilde{F}} = \left(M_a^{\tilde{A}\tilde{A}} \otimes M_b^{\tilde{B}\tilde{B}} \otimes M_f^{\tilde{F}\tilde{F}} \right) * W^{ABF}. \quad (4.19)$$

Similarly with the bipartite case, if $W^{ABF} = W^{A \prec B \prec F}$ is compatible with the order $A \prec B \prec F$, then the induced D-POVM $\mathbb{E}^{\tilde{A}\tilde{B}\tilde{F}}$ is compatible with the causal order $\tilde{A} \prec \tilde{B} \prec \tilde{F}$, and satisfies $\sum_f E_{a,b,f}^{\tilde{A}\tilde{B}\tilde{F}} = E_{a,b}^{\tilde{A} \prec \tilde{B}} \otimes \mathbb{1}^{\tilde{F}}$ for all a, b and for some bipartite D-POVM $\{E_{a,b}^{\tilde{A} \prec \tilde{B}}\}_{a,b}$ compatible with $\tilde{A} \prec \tilde{B}$; we generically denote such a D-POVM $\mathbb{E}^{\tilde{A} \prec \tilde{B} \prec \tilde{F}} = \{E_{a,b,f}^{\tilde{A} \prec \tilde{B} \prec \tilde{F}}\}_{a,b,f}$ (and similarly for the order $\tilde{B} \prec \tilde{A} \prec \tilde{F}$).

We then define:⁷

⁷Note that the structure of the space in which the D-POVM $\mathbb{E}^{\tilde{A}\tilde{B}\tilde{F}}$ is defined does not reflect the fact that Fiona’s output Hilbert space is trivial, and therefore does not by itself imply that \tilde{F} is taken to come last; hence the clarification in Definition 19.

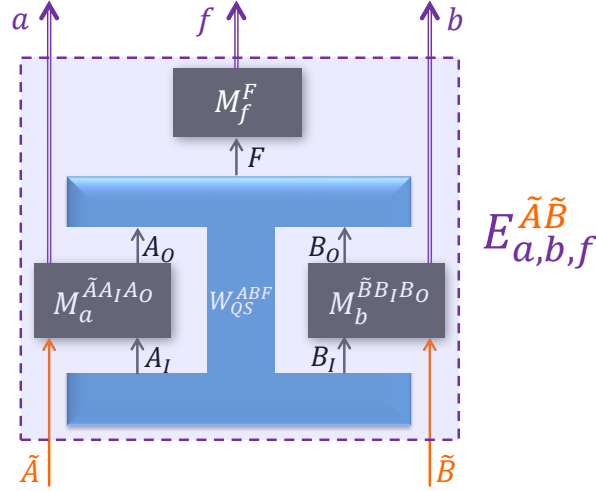

Figure 4.5: Semi-device-independent scenario with trusted quantum inputs for the certification of causal nonseparability of a $(2+F)$ -partite process matrix, with no quantum inputs for Fiona (in general she could also receive one, cf. Definition 19).

Causally separable $(2 + F)$ -partite D-POVM

Definition 19. A $(2+F)$ -partite D-POVM $\mathbb{E}^{\tilde{A}\tilde{B}\tilde{F}}$ (where \tilde{F} comes last) that can be decomposed as a convex mixture of D-POVMs compatible with the causal orders $\tilde{A} \prec \tilde{B} \prec \tilde{F}$ and $\tilde{B} \prec \tilde{A} \prec \tilde{F}$, i.e., of the form

$$\mathbb{E}^{\tilde{A}\tilde{B}\tilde{F}} = q \mathbb{E}^{\tilde{A} \prec \tilde{B} \prec \tilde{F}} + (1-q) \mathbb{E}^{\tilde{B} \prec \tilde{A} \prec \tilde{F}} \quad (4.20)$$

with $q \in [0, 1]$ is said to be *causally separable*.

One clearly sees from the above observations that a causally separable process matrix can only generate causally separable D-POVMs. We show in [87] that the converse also holds: any causally separable D-POVM can be realised by local operations on a causally separable process matrix.

In a general tripartite scenario

Beyond our work [87] and based on the multipartite causal (non)separability [122], we can define a tripartite notion of causal (non)separability for D-POVMs.

For example, consider the general tripartite scenario involving Alice, Bob and Charlie, and consider the non-valid process matrix $W_{(ABC)} = W_{(ABC_I)} \otimes \mathbb{1}^{C_O}$ of Eq.(2.13)-(2.14). Then one has

$$\begin{aligned} \sum_c E_{a,b,c}^{\tilde{A}\tilde{B}\tilde{C}} &= \sum_c (M_a^{\tilde{A}A} \otimes M_b^{\tilde{B}B} \otimes M_c^{\tilde{C}C}) * (W_{(ABC_I)} \otimes \mathbb{1}^{C_O}) \\ &= (M_a^{\tilde{A}A} \otimes M_b^{\tilde{B}B} \otimes \text{Tr}_{C_O} \sum_c M_c^{\tilde{C}C}) * W_{(ABC_I)} \\ &= (M_a^{\tilde{A}A} \otimes M_b^{\tilde{B}B} \otimes \mathbb{1}^{\tilde{C}C_I}) * W_{(ABC_I)} = E_{a,b}^{\tilde{A}\tilde{B}} \otimes \mathbb{1}^{\tilde{C}} \end{aligned} \quad (4.21)$$

with $E_{a,b}^{\tilde{A}\tilde{B}} = (M_a^{\tilde{A}A} \otimes M_b^{\tilde{B}B}) * \text{Tr}_{C_I} W_{(ABC_I)} \geq 0$.

Moreover, using $\text{Tr}_{C_I} W_{(ABC_I)} = \frac{1}{d_{B_O}} \text{Tr}_{B_O C_I} W_{(ABC_I)} \otimes \mathbb{1}^{B_O}$ we also obtain

$$\sum_{b,c} E_{a,b,c}^{\tilde{A}\tilde{B}\tilde{C}} = \sum_b E_{a,b}^{\tilde{A}\tilde{B}} \otimes \mathbb{1}^{\tilde{C}} = E_a^{\tilde{A}} \otimes \mathbb{1}^{\tilde{B}\tilde{C}} \quad (4.22)$$

with $E_a^{\tilde{A}} = \frac{1}{d_{B_O}} \text{Tr}_{B_C I} W_{(ABC_I)} * M_a^{\tilde{A}\tilde{A}} \geq 0$. Eq.(4.21)-(4.22) can be interpreted as no-signalling conditions [213], meaning respectively that Charlie cannot signal to Bob nor Alice, and Bob cannot signal to Alice. Note however that because $W_{(ABC)}$ is not a valid process matrix in general (cf. Eq.(2.13)-(2.14)), $\{E_a^{\tilde{A}}\}_a$ (and thus $\{E_{a,b}^{\tilde{A}\tilde{B}}\}_{a,b}$ and $\{E_{a,b,c}^{\tilde{A}\tilde{B}\tilde{C}}\}_{a,b,c}$) is not a POVM, $\sum_a E_a^{\tilde{A}} \neq \mathbb{1}^{\tilde{A}}$ in general.

We need to consider the complementary $(\tilde{A}, \tilde{C}, \tilde{B})$ such that, defining

$$E_{a,b,c}^{(\tilde{A})} := E_{a,b,c}^{(\tilde{A},\tilde{B},\tilde{C})} + E_{a,b,c}^{(\tilde{A},\tilde{C},\tilde{B})},$$

the set $\{E_{a,b,c}^{(\tilde{A})}\}$ is a D-POVM:

$$\begin{aligned} \sum_{a,b,c} E_{a,b,c}^{(\tilde{A})} &= \sum_a M_a^{\tilde{A}\tilde{A}} * \left(\frac{1}{d_{B_O}} \text{Tr}_{B_C I} W^{(ABC_I)} + \frac{1}{d_{C_O}} \text{Tr}_{C_B I} W^{(ACB_I)} \right) \otimes \mathbb{1}^{\tilde{B}\tilde{C}} \\ &= \sum_a M_a^{\tilde{A}\tilde{A}} * (\rho^{A_I} \otimes \mathbb{1}^{A_O}) \otimes \mathbb{1}^{\tilde{B}\tilde{C}} \\ &= \mathbb{1}^{A_I} * \rho^{A_I} \cdot \mathbb{1}^{\tilde{A}\tilde{B}\tilde{C}} = \mathbb{1}^{\tilde{A}\tilde{B}\tilde{C}} \end{aligned} \quad (4.23)$$

with ρ^{A_I} such that $\frac{1}{d_{B_O} d_{C_O}} \text{Tr}_{BC} W_{(A)} = \frac{1}{d_{B_O} d_{C_O}} \text{Tr}_{BC} (W_{(ABC)} + W_{(ACB)}) = \rho^{A_I} \otimes \mathbb{1}^{A_O}$. Thus, we can extend the notion of causal (non)separability for bipartite D-POVM to a general tripartite case.

Causally separable tripartite D-POVM

Definition 20. A tripartite D-POVM $\mathbb{E}^{\tilde{A}\tilde{B}\tilde{C}}$ that can be decomposed as a convex mixture of D-POVMs compatible with “A first”, “B first” and “C first”, i.e., of the form

$$\mathbb{E}^{\tilde{A}\tilde{B}\tilde{C}} = \mathbb{E}^{(\tilde{A})} + \mathbb{E}^{(\tilde{B})} + \mathbb{E}^{(\tilde{C})} \quad (4.24)$$

is said to be causally separable.

Each D-POVM $\mathbb{E}^{(\tilde{X})}$ decomposes as a sum of sets of positive semidefinite matrices (but whose elements do not sum up to $\mathbb{1}^{\tilde{X}}$ in general) $\mathbb{E}^{(\tilde{X}\tilde{Y}\tilde{Z})} + \mathbb{E}^{(\tilde{X}\tilde{Z}\tilde{Y})}$. For each permutation of $(\tilde{A}, \tilde{B}, \tilde{C})$, the elements $E_{x,y,z}^{(\tilde{X}\tilde{Y}\tilde{Z})}$ and $E_{x,y,z}^{(\tilde{X})} := E_{x,y,z}^{(\tilde{X}\tilde{Y}\tilde{Z})} + E_{x,y,z}^{(\tilde{X}\tilde{Z}\tilde{Y})}$ are positive semidefinite matrices satisfying

$$\sum_{x,y,z} E_{x,y,z}^{(\tilde{X})} = \mathbb{1}^{\tilde{X}\tilde{Y}\tilde{Z}} \quad (4.25)$$

$$[1-\tilde{Y}\tilde{Z}] \sum_{y,z} E_{x,y,z}^{(\tilde{X}\tilde{Y}\tilde{Z})} = 0 \quad (4.26)$$

$$[1-\tilde{Z}] \sum_z E_{x,y,z}^{(\tilde{X}\tilde{Y}\tilde{Z})} = 0 \quad (4.27)$$

The question of whether any tripartite causally separable D-POVM be obtained from a tripartite causally separable process matrix is an open problem.

4.6 SDIQI certification of causal nonseparability

If a causally nonseparable process matrix can generate a causally nonseparable D-POVM, its causal nonseparability can thus be certified without trusting the parties' instruments (but only their quantum inputs); i.e., in an SDQI manner. The follow-up question is then: for which process matrices is this possible?

To tackle this question, we can start by noting that one can verify whether a given D-POVM is causally nonseparable with a semi-definite program (SDP).

4.6.1 Witnesses of causal nonseparability for D-POVMs

Indeed, in the bipartite scenario (and straightforwardly, in the $(2 + F)$ -scenario), one can define the closed convex cone of causally separable (non-normalized) D-POVMs as the Minkowski sum

$$\mathcal{E}^{\text{sep}} = \mathcal{E}^{\tilde{A} \prec \tilde{B}} + \mathcal{E}^{\tilde{B} \prec \tilde{A}}, \quad (4.28)$$

of the cones $\mathcal{E}^{\tilde{A} \prec \tilde{B}}$ and $\mathcal{E}^{\tilde{B} \prec \tilde{A}}$ of D-POVMs compatible with the orders $\tilde{A} \prec \tilde{B}$ and $\tilde{B} \prec \tilde{A}$, resp. The cone $\mathcal{E}^{\tilde{A} \prec \tilde{B}}$ of (nonnormalised) causally ordered D-POVMs $\mathbb{E}^{\tilde{A} \prec \tilde{B}} = \{E_{a,b}^{\tilde{A} \prec \tilde{B}}\}_{a,b}$ with n_A and n_B possible outputs a and b can be written as

$$\mathcal{E}^{\tilde{A} \prec \tilde{B}} = \mathcal{P}^{n_A n_B} \cap \mathcal{L}^{\tilde{A} \prec \tilde{B}}, \quad (4.29)$$

where \mathcal{P} generically denotes the cone of positive semidefinite matrices of appropriate dimensions (taken here to the Cartesian power $n_A n_B$) and where $\mathcal{L}^{\tilde{A} \prec \tilde{B}}$ is the linear space

$$\mathcal{L}^{\tilde{A} \prec \tilde{B}} = \{\{E_{a,b}^{\tilde{A} \prec \tilde{B}}\}_{a,b} | \forall a, \sum_b E_{a,b}^{\tilde{A} \prec \tilde{B}} = E_a^{\tilde{A}} \otimes \mathbb{1}^{\tilde{B}}; \sum_a E_a^{\tilde{A}} \propto \mathbb{1}^{\tilde{A}}\}. \quad (4.30)$$

The cone of D-POVMs $\mathbb{E}^{\tilde{B} \prec \tilde{A}}$ is obtained in a similar, symmetric manner.

In analogy with the causal (non)separability of process matrices, we can show that the dual cones of causally separable D-POVMs contain the ‘‘witness of causal nonseparability’’. These dual cones (which we denote with an asterisk $*$ or with the ‘‘orthogonal’’ symbol \perp in the case of linear spaces) are typically obtained by using the following duality relations that hold for any of the closed convex cones $\mathcal{K}_1, \mathcal{K}_2$:

$$(\mathcal{K}_1 + \mathcal{K}_2)^* = \mathcal{K}_1^* \cap \mathcal{K}_2^*, \quad (\mathcal{K}_1 \cap \mathcal{K}_2)^* = \mathcal{K}_1^* + \mathcal{K}_2^*. \quad (4.31)$$

Thus, we have

$$(\mathcal{E}^{\text{sep}})^* = (\mathcal{E}^{\tilde{A} \prec \tilde{B}})^* \cap (\mathcal{E}^{\tilde{B} \prec \tilde{A}})^* \quad (4.32)$$

In order to characterize $(\mathcal{E}^{\tilde{A} \prec \tilde{B}})^*$ (and resp. $(\mathcal{E}^{\tilde{B} \prec \tilde{A}})^*$), we consider the scalar product inherited from the link product

$$\mathbb{S}^{\tilde{A} \tilde{B}} * \mathbb{E}^{\tilde{A} \tilde{B}} = \sum_{a,b} \text{Tr} \left[(S_{a,b}^{\tilde{A} \tilde{B}})^T E_{a,b}^{\tilde{A} \tilde{B}} \right] \quad (4.33)$$

for $\mathfrak{S}^{\tilde{A}\tilde{B}} = \{S_{a,b}^{\tilde{A}\tilde{B}}\}_{a,b}$ and $\mathbb{E}^{\tilde{A}\tilde{B}} = \{E_{a,b}^{\tilde{A}\tilde{B}}\}_{a,b}$, so that the dual of a cone \mathcal{E}^{sep} is the cone

$$(\mathcal{E}^{\text{sep}})^* = \{\mathfrak{S}^{\tilde{A}\tilde{B}} | \forall \mathbb{E}^{\tilde{A}\tilde{B}} \in \mathcal{E}^{\text{sep}}, \mathfrak{S}^{\tilde{A}\tilde{B}} * \mathbb{E}^{\tilde{A}\tilde{B}} \geq 0\} \quad (4.34)$$

It is easily verified that $\mathcal{P}^{n_A n_B}$ is self-dual, and that $(\mathcal{L}^{\tilde{A}\tilde{B}})^* = (\mathcal{L}^{\tilde{A}\tilde{B}})^\perp = \{(S_{a,b}^{\tilde{A}\tilde{B}} = S_a^{\tilde{A}\tilde{B}} + S_a^{\tilde{A}\tilde{B}})_{a,b} | \forall a, \text{Tr}_{\tilde{B}}[S_a^{\tilde{A}\tilde{B}}] = 0; \text{Tr}[S^{\tilde{A}\tilde{B}}] = 0\}$. We thus obtain

$$\begin{aligned} (\mathcal{E}^{\tilde{A}\tilde{B}})^* &= \mathcal{P}^{n_A n_B} + (\mathcal{L}^{\tilde{A}\tilde{B}})^\perp, \\ &= \{(S_{a,b}^{\tilde{A}\tilde{B}} = S_{\text{PSD};a,b}^{\tilde{A}\tilde{B}} + S_a^{\tilde{A}\tilde{B}} + S_a^{\tilde{A}\tilde{B}})_{a,b} | \forall a, b, S_{\text{PSD};a,b}^{\tilde{A}\tilde{B}} \geq 0, \text{Tr}_{\tilde{B}}[S_a^{\tilde{A}\tilde{B}}] = 0, \\ &\quad \text{Tr}[S^{\tilde{A}\tilde{B}}] = 0\} \end{aligned} \quad (4.35)$$

and similarly for $(\mathcal{E}^{\tilde{B}\tilde{A}})^*$.

Any set of operators $\mathfrak{S}^{\tilde{A}\tilde{B}} = \{S_{a,b}^{\tilde{A}\tilde{B}}\}_{a,b}$ in the dual cone \mathcal{E}^{sep} acts as a ‘‘witness of causal nonseparability’’ for D-POVMs, in the sense that by definition all causally separable D-POVMs satisfy $\mathfrak{S}^{\tilde{A}\tilde{B}} * \mathbb{E}^{\tilde{A}\tilde{B}} \geq 0$ —hence, if one gets a value $\mathfrak{S}^{\tilde{A}\tilde{B}} * \mathbb{E}^{\tilde{A}\tilde{B}} < 0$, this certifies that the D-POVM is causally nonseparable. Note, furthermore, that since the set of causally separable D-POVMs is closed and convex, then by the separating hyperplane theorem [123], for any causally nonseparable D-POVM there exists a witness that certifies it.

Thus, for any causally nonseparable distributed measurement $\{E_{a,b}^{\tilde{A}\tilde{B}}\}_{a,b} \notin \mathcal{E}^{\text{sep}}$, there exists a witness of causal nonseparability $\{S_{a,b}^{\tilde{A}\tilde{B}}\}_{a,b} \in (\mathcal{E}^{\text{sep}})^*$ such that $\sum_{a,b} S_{a,b}^{\tilde{A}\tilde{B}} * E_{a,b}^{\tilde{A}\tilde{B}} < 0$. By using the characterization of $(\mathcal{E}^{\text{sep}})^*$ above, a witness can be found by solving a SDP program asking how much noise can be added before the distributed measurement becomes causally separable. For example, we can consider⁸ the case of a ‘‘white noise’’ D-POVM with uniform elements, all equal to $\mathbb{1}^\circ = \frac{1}{n_A n_B}$, with n_A and n_B the numbers of different values for a and b . For a given D-POVM $\{E_{a,b}^{\tilde{A}\tilde{B}}\}_{a,b}$, we investigate the causal nonseparability of the non-normalized⁹ noisy distributed measurement $\{E_{a,b}^{\tilde{A}\tilde{B}}(r)\}_{a,b}$ defined as

$$E_{a,b}^{\tilde{A}\tilde{B}}(r) = E_{a,b}^{\tilde{A}\tilde{B}} + r \mathbb{1}^\circ. \quad (4.36)$$

The SDP problem thus consists in minimizing the amount of white noise added to the distributed measurement such that the noisy distributed measurement becomes causally separable:

$$\begin{aligned} \min r \\ \text{s.t. } \{E_{a,b}(r) + r \mathbb{1}^\circ\}_{a,b} \in \mathcal{E}^{\text{sep}}, \quad r \geq 0. \end{aligned} \quad (4.37)$$

The primal problem is intrinsically linked with the dual problem:

$$\begin{aligned} \min \sum_{a,b} S_{a,b} * E_{a,b} \\ \text{s.t. } \{S_{a,b}\}_{a,b} \in (\mathcal{E}^{\text{sep}})^*, \quad \sum_{a,b} S_{a,b} * \mathbb{1}^\circ \leq 1, \end{aligned} \quad (4.38)$$

⁸In [87], we take the more general case of a noise as some random object \mathbb{E}° taken to be in the interior of \mathcal{E}^{sep} .

⁹The normalization is irrelevant in order to check whether the D-POVM is in the convex cone \mathcal{E}^{sep} .

The optimal value of noise is related with the witness $\{S_{a,b}^{\tilde{A}\tilde{B}}\}_{a,b}$ following the duality theorem (cf., e.g., Theorem 8 in Appendix E of [16]),

$$r^* = - \sum_{a,b} S_{a,b}^{\tilde{A}\tilde{B}} * E_{a,b}^{\tilde{A}\tilde{B}} \quad (4.39)$$

where r^* can be interpreted as the *random robustness*, i.e., a quantifier of the robustness of the distributed measurement $\{E_{a,b}^{\tilde{A}\tilde{B}}\}_{a,b}$ with respect to white noise. In particular, $r^* > 0$ implies that the distributed measurement is causally nonseparable. The witness of the causal nonseparability of the obtained distributed measurement is then a *semi-device-independent with trusted quantum inputs (SDIQI) causal witness* of W^{AB} . This witness can be measured in practice. Indeed, given $\{\rho_x^{\tilde{A}}\}_x$ and $\{\rho_y^{\tilde{B}}\}_y$ to be tomographically complete sets and writing $S_{a,b}^{\tilde{A}\tilde{B}} = \sum_{x,y} s_{a,b}^{(x,y)} \rho_x^{\tilde{A}} \otimes \rho_y^{\tilde{B}}$, one can thus reconstruct the witness from the correlations $P(a, b | \rho_x^{\tilde{A}}, \rho_y^{\tilde{B}})$ and certify the causal nonseparability of $\mathbb{E}^{\tilde{A}\tilde{B}}$ by observing

$$\sum_{a,b} S_{a,b}^{\tilde{A}\tilde{B}} * E_{a,b}^{\tilde{A}\tilde{B}} = \sum_{a,b,x,y} s_{a,b}^{(x,y)} P(a, b | \rho_x^{\tilde{A}}, \rho_y^{\tilde{B}}) < 0. \quad (4.40)$$

In order to certify the causal nonseparability of a process matrix in a SDIQI manner, one thus needs to find some auxiliary systems $\mathcal{H}^{\tilde{A}}, \mathcal{H}^{\tilde{B}}$ and some instruments $\{M_a^{\tilde{A}\tilde{A}}\}_a$ and $\{M_b^{\tilde{B}\tilde{B}}\}_b$ such that the D-POVM $\mathbb{E}^{\tilde{A}\tilde{B}}$ induced via Eq. (4.16) is causally nonseparable.

4.6.2 Causally nonseparable D-POVM from noncausal process matrices

It is fairly easy to see that if W^{AB} can violate a causal inequality, then it can indeed generate a causally nonseparable D-POVM. Indeed, if W^{AB} generates noncausal correlations $P(a, b | x, y)$ with some instruments $M_{|x}^A = \{M_{a|x}^A\}_a$ and $M_{|y}^B = \{M_{b|y}^B\}_b$, then one obtains a causally nonseparable D-POVM by introducing auxiliary spaces $\mathcal{H}^{\tilde{A}}$ and $\mathcal{H}^{\tilde{B}}$ with computational bases $\{|x\rangle^{\tilde{A}}\}_x$ and $\{|y\rangle^{\tilde{B}}\}_y$, and taking the instruments (similarly to Eq. (4.6) for Buscemi nonlocality)

$$\begin{aligned} M_a^{\tilde{A}\tilde{A}} &= \{M_a^{\tilde{A}\tilde{A}} = \sum_x |x\rangle\langle x|^{\tilde{A}} \otimes M_{a|x}^A\}_a \\ M_b^{\tilde{B}\tilde{B}} &= \{M_b^{\tilde{B}\tilde{B}} = \sum_y |y\rangle\langle y|^{\tilde{B}} \otimes M_{b|y}^B\}_b \end{aligned} \quad (4.41)$$

With this choice, the induced D-POVM elements, obtained from Eq. (4.16), are

$$\begin{aligned} E_{a,b}^{\tilde{A}\tilde{B}} &= \sum_{x,y} (|x\rangle\langle x|^{\tilde{A}} \otimes M_{a|x}^A \otimes |y\rangle\langle y|^{\tilde{B}} \otimes M_{b|y}^B) * W^{AB} \\ &= \sum_{x,y} P(a, b | x, y) |x\rangle\langle x|^{\tilde{A}} \otimes |y\rangle\langle y|^{\tilde{B}}, \end{aligned} \quad (4.42)$$

so that $P(a, b | x, y) = E_{a,b}^{\tilde{A}\tilde{B}} * (|x\rangle\langle x|^{\tilde{A}} \otimes |y\rangle\langle y|^{\tilde{B}})$ (similarly to Eq. (4.7) for Buscemi nonlocality). These correlations being noncausal, it implies that the D-POVM $\{E_{a,b}^{\tilde{A}\tilde{B}}\}_{a,b}$ is causally nonseparable.

Note that this argument also holds for “non-extensibly causal” process matrices, i.e. processes that admit a causal model, but can still violate a causal inequality by generating noncausal correlations $p(a, b|x, y)$ when extended with a shared entangled state on auxiliary spaces $\mathcal{H}^{\dot{A}}$ and $\mathcal{H}^{\dot{B}}$, $|\phi^+\rangle\langle\phi^+|^{\dot{A}\dot{B}} = \frac{1}{\sqrt{d}} |\mathbb{1}\rangle\langle\mathbb{1}|^{\dot{A}\dot{B}}$, with some instruments $\{M_{a|x}^{\dot{A}\dot{A}}\}_a$ and $\{M_{b|y}^{\dot{B}\dot{B}}\}_b$. By introducing auxiliary spaces $\mathcal{H}^{\tilde{A}}$ and $\mathcal{H}^{\tilde{B}}$ and taking instruments defined as

$$\begin{aligned} M_a^{\tilde{A}\dot{A}\dot{A}} &= \sum_x |x\rangle\langle x|^{\tilde{A}} \otimes M_{a|x}^{\dot{A}\dot{A}} \\ M_b^{\tilde{B}\dot{B}\dot{B}} &= \sum_y |y\rangle\langle y|^{\tilde{B}} \otimes M_{b|y}^{\dot{B}\dot{B}}. \end{aligned} \quad (4.43)$$

we can also show, with a similar argument as before, that the D-POVM $\{E_{a,b}^{\tilde{A}\tilde{B}}\}_{a,b}$ is causally nonseparable.

4.6.3 Causally nonseparable D-POVM from a Werner-like process matrix

Nevertheless, as mentioned previously, in analogy with some entangled states admitting a local model, such as the so-called Werner states [131], there exist causally nonseparable processes that can never generate causal correlations. In the bipartite case, this is the case for example for a family of processes presented in [126]. Note that these processes are not unitarily extendible, i.e. they are not purifiable (cf. Section 2.6). Let us present and analyze them and show how can one find adapted instruments in order to generate a causally nonseparable D-POVM.

The processes are of the form

$$\begin{aligned} W_{\text{FAB}}(q, \epsilon) &= \mathbb{1}^\circ + \frac{q}{12} (\mathbb{1}^{A_I} Z^{A_O} Z^{B_I} \mathbb{1}^{B_O} + \mathbb{1}^{A_I} X^{A_O} X^{B_I} \mathbb{1}^{B_O} + \mathbb{1}^{A_I} Y^{A_O} Y^{B_I} \mathbb{1}^{B_O}) \\ &\quad + \frac{1-q+\epsilon}{4} Z^{A_I} \mathbb{1}^{A_O} X^{B_I} Z^{B_O} \end{aligned} \quad (4.44)$$

with X, Y, Z the Pauli matrices, implicit tensor products between each spaces,

$\mathbb{1}^\circ = \mathbb{1}^{AB}/4$, $q \in [0, 1]$ and $|1-q+\epsilon| \leq \sqrt{\frac{(1-q)(q+3)}{3}}$ so as to ensure that $W_{\text{FAB}}(q, \epsilon)$ is positive semidefinite (as required for a valid process matrix).

It was shown in [126] that $W_{\text{FAB}}(q, \epsilon)$ is causally nonseparable for $\epsilon > 0$, in which case its random robustness [16, 17] is ϵ . In the following we will take the values $q = \sqrt{3} - 1$ and $\epsilon = \frac{4}{\sqrt{3}} - 2$, which give the maximal random robustness $\epsilon = \frac{4}{\sqrt{3}} - 2 \simeq 0.309$, and simply write $W_{\text{FAB}} = W_{\text{FAB}}(q, \epsilon)$ for those values. Note a characteristic of such processes is that ignoring the input space of Bob \mathcal{H}^{B_I} leads to a fully depolarized process: ${}_{B_I}W_{\text{FAB}} = \mathbb{1}^\circ$.

Mixing this process matrix with fully white noise, described by the process matrix $\mathbb{1}^\circ$, we then define

$$W_{\text{FAB}}(r) = \frac{1}{1+r} (W_{\text{FAB}} + r \mathbb{1}^\circ) \quad (4.45)$$

for $r \geq 0$. The largest value of r such that $W_{FAB}(r)$ is causally nonseparable defines the random robustness of W_{FAB} [16, 17]: as just recalled, $W_{FAB}(r)$ is thus causally nonseparable for all $r \leq \frac{4}{\sqrt{3}} - 2 \simeq 0.309$.

Let us try to find instruments such that the D-POVM from W_{FAB} is causally nonseparable. First of all, let us note that W_{FAB} is causal, i.e. it cannot generate noncausal correlations. In fact, one can check that the process $W_{FAB}^{T_B}$ - with $(\cdot)^{T_B}$ the partial transpose on \mathcal{H}^B - is causally separable. Thus it can only produce causal correlations with valid instruments. Because W_{FAB} and instruments $\{M_a^A\}_a, \{M_b^B\}_b$ give the same correlations as $W_{FAB}^{T_B}$ and instruments $\{M_a^A\}_a, \{(M_b^B)^{T_B}\}_b$ - which is also a valid instrument because the transpose is positive - we can conclude that W_{FAB} is also causal. However this argument does not imply that W_{FAB} cannot lead to causally nonseparable D-POVMs, since $(M_b^{\tilde{B}B})^{T_{\tilde{B}}} \not\geq 0$ in general, and is thus not valid in general.

Indeed, because $W_{FAB}^{T_B}$ is causally separable, it can only generate causally separable D-POVMs. Moreover, because $\{(M_b^{\tilde{B}B})^{T_{\tilde{B}}}\}_b$ is a valid instrument (because the full transpose is positive), the D-POVM generated by $W_{FAB}^{T_B}$ can be written $W_{FAB}^{T_B} * (M_a^{\tilde{A}A} \otimes (M_b^{\tilde{B}B})^{T_{\tilde{B}}}) = E_{a,b}^{\tilde{A} \prec \tilde{B}} + E_{a,b}^{\tilde{B} \prec \tilde{A}}$, and is thus equal to $(E_{a,b}^{\tilde{A} \tilde{B}})^{T_{\tilde{B}}} = W_{FAB} * (M_a^{\tilde{A}A} \otimes (M_b^{\tilde{B}B})^{T_{\tilde{B}}})$. If $(M_b^{\tilde{B}B})^{T_{\tilde{B}}} \geq 0$, then $\{E_{a,b}^{\tilde{A} \tilde{B}}\}$ is causally separable. Thus, the D-POVM $\{E_{a,b}^{\tilde{A} \tilde{B}}\}_{a,b}$ generated by W_{FAB} might be causally nonseparable only if at least one element of the pseudo-instrument $\{(M_b^{\tilde{B}B})^{T_{\tilde{B}}}\}_b$ is not semidefinite positive $(M_b^{\tilde{B}B})^{T_{\tilde{B}}} \not\geq 0$. Following the *positive partial transpose criterion* [221, 222], it follows that the \mathcal{H}^B and $\mathcal{H}^{\tilde{B}}$ spaces shall be entangled for at least one element $(M_b^{\tilde{B}B})^{T_{\tilde{B}}} \not\geq 0$.

From (4.44), we obtain

$$\sum_b E_{a,b}^{\tilde{A} \tilde{B}} = (\mathbb{1}^\circ + \frac{1-q+e}{4} Z^{A_I} \mathbb{1}^{A_O} X^{B_I} Z^{B_O}) * (M_a^{\tilde{A}A} \otimes \sum_b M_b^{\tilde{B}B}) \quad (4.46)$$

with $\frac{q}{12}(\mathbb{1}ZZ\mathbb{1} + \mathbb{1}XX\mathbb{1} + \mathbb{1}YY\mathbb{1}) * \sum_b M_b^{\tilde{B}B} = \frac{q}{12}(\mathbb{1}ZZ + \mathbb{1}XX + \mathbb{1}YY) * \mathbb{1}^{B_I} \otimes \mathbb{1}^{\tilde{B}} = 0$, with implicit spaces and tensor products.

Note that if $[\mathbb{1}_{-B_I}] \sum_b M_b^{\tilde{B}B} = 0$, because $(Z^{A_I} \mathbb{1}^{A_O} X^{B_I} Z^{B_O} * \mathbb{1}^{B_I}) = 0$ we obtain

$$\sum_b E_{a,b}^{\tilde{A} \tilde{B}} = \mathbb{1}^\circ * (M_a^{\tilde{A}A} \otimes \sum_b M_b^{\tilde{B}B}) = \frac{1}{2} \text{Tr}_A(M_a^{\tilde{A}A}) \otimes \mathbb{1}^{\tilde{B}} \quad (4.47)$$

and thus the D-POVM is causally separable, compatible with $\tilde{A} \prec \tilde{B}$.

On the other hand, we have

$$\sum_a E_{a,b}^{\tilde{A} \tilde{B}} = (\mathbb{1}^\circ + \frac{q}{12}(\mathbb{1}ZZ\mathbb{1} + \mathbb{1}XX\mathbb{1} + \mathbb{1}YY\mathbb{1})) * (\sum_a M_a^{\tilde{A}A} \otimes M_b^{\tilde{B}B}) \quad (4.48)$$

Note that if $[\mathbb{1}_{-A_O} A_I] \sum_a M_a^{\tilde{A}A} = 0$, we obtain

$$\sum_a E_{a,b}^{\tilde{A} \tilde{B}} = \mathbb{1}^\circ * (M_b^{\tilde{B}B} \otimes \sum_a M_a^{\tilde{A}A}) = \frac{1}{2} \text{Tr}_B(M_b^{\tilde{B}B}) \otimes \mathbb{1}^{\tilde{A}} \quad (4.49)$$

and thus the D-POVM is causally separable, compatible with $\tilde{B} \prec \tilde{A}$.

Hence, in order to obtain a causally nonseparable D-POVM, we must thus find instruments such that

$$\exists b \text{ s.t. } (M_b^{\tilde{B}B})^{T_{\tilde{B}}} \not\geq 0, \quad \sum_{[1-B_I]} M_b^{\tilde{B}B} \neq 0, \quad \sum_{[1-A_O]A_I} M_a^{\tilde{A}A} \neq 0 \quad (4.50)$$

We have found several sets of instruments satisfying Eq. (4.50) that lead to a causally nonseparable D-POVM when applied to W_{FAB} . For example, I have found the instruments (with a 1-qubit input space $\mathcal{H}^{\tilde{A}}$ for Alice and a 2-qubit input space $\mathcal{H}^{\tilde{B}} = \mathcal{H}^{\tilde{B}_I} \otimes \mathcal{H}^{\tilde{B}_O}$ for Bob)

$$\begin{aligned} M_a^{\tilde{A}A} &= |a\rangle\langle a|^{A_I} \otimes |\mathbb{1}\rangle\langle\mathbb{1}|^{\tilde{A}A_O}, \\ M_0^{\tilde{B}B} &= \Pi_{Hardy}^{\tilde{B}_I B_I} \otimes |\mathbb{1}\rangle\langle\mathbb{1}|^{\tilde{B}_O B_O} \\ M_1^{\tilde{B}B} &= (\mathbb{1}^{\tilde{B}_I B_I} - \Pi_{Hardy}^{\tilde{B}_I B_I}) \otimes |X\rangle\langle X|^{\tilde{B}_O B_O} \end{aligned} \quad (4.51)$$

with $\Pi_{Hardy} = |v_{Hardy}\rangle\langle v_{Hardy}|$ the projector associated with the Hardy state $|v_{Hardy}\rangle = \frac{1}{\sqrt{3}}(|00\rangle + |01\rangle + |10\rangle)$, for which the process can generate a causally nonseparable D-POVM for all $r \lesssim 0.0125$. A stronger example, as it allows to generate a causally nonseparable D-POVM for all $r \lesssim 0.113$, is

$$\begin{aligned} M_a^{\tilde{A}A} &= |a\rangle\langle a|^{A_I} \otimes |\mathbb{1}\rangle\langle\mathbb{1}|^{\tilde{A}A_O}, \\ M_0^{\tilde{B}B} &= |\psi\rangle\langle\psi|^{\tilde{B}_I B_I} \otimes (|0,0\rangle\langle 0,0| + |1,1\rangle\langle 1,1|)^{\tilde{B}_O B_O}, \\ M_1^{\tilde{B}B} &= \mathbb{1}^{\tilde{B}_I B_I} \otimes (|0,0\rangle\langle 0,0| + |1,1\rangle\langle 1,1|)^{\tilde{B}_O B_O} \\ &\quad - |+\rangle\langle +|^{\tilde{B}_I} \otimes |-\rangle\langle -|^{B_I} \otimes Z^{\tilde{B}_O} \otimes Z^{B_O} - M_0^{\tilde{B}B} \end{aligned} \quad (4.52)$$

with $|\psi\rangle = (|+, +\rangle + \delta |-, 0\rangle) / \sqrt{1 + \delta^2}$ and $\delta \simeq 0.01$.

Recall however that W_{FAB} was found in [126] not to be “extensibly causal”: that is, extended with some entangled state, W_{FAB} allows for some causal inequality violation. Hence, the approach and instruments of Eq. (4.43) could also be used to generate a causally nonseparable D-POVM from W_{FAB} . This non-extensible-causality was however not found to be very robust to noise: such “activation” of noncausality by entanglement was only found for noise values much smaller than the robustness $r \simeq 0.113$ found above,¹⁰ so that our approach above to certify the causal nonseparability of W_{FAB} , with our choice of instruments in Eq. (4.52) (and even in Eq. (4.51)), is much more robust to noise than via its non-extensible-causality.

Like any bipartite causally nonseparable process, Feix *et al.*’s process, however, has no known physical interpretation. It is even more interesting to look at an example that could have a practical implementation.

¹⁰More specifically, [126] considered the noisy “extended” process $(1-\kappa)W_{FAB} \otimes \rho^{A'B'} + \kappa \mathbb{1}^{ABA'B'}/64$, for some maximally entangled 2-quart auxiliary state $\rho^{A'B'}$, and only found causal inequality violations with this process matrix for $\kappa \lesssim 3.3 \times 10^{-4}$. From this, one may expect $W_{FAB}(r)$ to also exhibit non-extensible-causality for r of the order of $10^{-4} - 10^{-3}$ only.

4.6.4 Causally nonseparable D-POVM from the quantum switch

As explained before, a causally nonseparable process that has received significant interest is the “quantum switch” [13], as a tripartite process in the “(2+ F)-partite scenario” with a clear physical interpretation.

The quantum switch W_{QS} is known to be causally nonseparable but to only generate causal correlations [16, 21], even when extended with entanglement. So far, its causal nonseparability was only certified experimentally in a device-dependent way [151, 157]. Despite being extensively causal, we find that this important process can be certified in an SDQI way. Indeed, I have found that for a qubit target system and with qubit auxiliary systems (quantum inputs) for Alice and Bob, and without any quantum input for Fiona, the instruments

$$\begin{aligned} M_a^{\tilde{A}A} &= |a\rangle\langle a|^{A_I} \otimes |\mathbb{1}\rangle\langle\mathbb{1}|^{\tilde{A}A_O}, & M_{\pm}^F &= |\pm\rangle\langle\pm|^F, \\ M_b^{\tilde{B}B} &= |b\rangle\langle b|^{B_I} \otimes |\mathbb{1}\rangle\langle\mathbb{1}|^{\tilde{B}B_O}, \end{aligned} \quad (4.53)$$

give a causally nonseparable D-POVM. These instruments can be interpreted as Alice and Bob performing computational basis measurements on the untrusted systems they receive from the process (in \mathcal{H}^{A_I} and \mathcal{H}^{B_I} , resp.) while sending their quantum inputs (in $\mathcal{H}^{\tilde{A}}$ and $\mathcal{H}^{\tilde{B}}$, resp.) to the process (in \mathcal{H}^{A_O} and \mathcal{H}^{B_O} , resp.) via identity channels; Fiona then measures in the diagonal basis $\{|\pm\rangle = \frac{1}{\sqrt{2}}(|0\rangle \pm |1\rangle)\}_{\pm}$.

To understand how robust this certification is, we can consider the “noisy” quantum switch

$$W_{\text{QS}}(r) = \frac{1}{1+r}(W_{\text{QS}} + r \mathbb{1}^{ABF}/8) \quad (4.54)$$

parameterised by $r \geq 0$.

It is known that $W_{\text{QS}}(r)$ is causally nonseparable for $r \lesssim 1.576$ [17]. With the instruments (4.53) it is readily checked that $W_{\text{QS}}(r)$ generates a causally nonseparable D-POVM for $r \lesssim 0.367$ ¹¹. Despite extensive numerical searches, we were unable to find instruments allowing us to certify the causal nonseparability of $W_{\text{QS}}(r)$ for $0.367 \lesssim r \lesssim 1.576$. It could be that some better choice of instruments would allow one to partially close this gap¹². Still, we conjecture that for a certain range of values r , $W_{\text{QS}}(r)$ is causally nonseparable but that this cannot be certified in a SDQI manner, i.e. our SDQI approach cannot certify all causally nonseparable processes, in contrast to the MDI certification of entanglement.

Nevertheless, the fact our approach provides a noise robust SDQI certification of the quantum switch is of significant relevance, given that it is responsible for most known applications of causal nonseparability and yet cannot be certified in a fully DI manner.

¹¹This value was initially found via a SDP program using CVX [177], which also gave a witness of causal nonseparability for the generated D-POVM. In [87], we also construct this witness explicitly and give an analytical expression.

¹²We will see in Section 4.8.2 that this gap can be reduced (but not completely closed) by making additional assumptions on the structure of Alice and Bob’s instruments.

4.7 Certifying all bipartite causally nonseparable process matrices with trusted quantum inputs

Whether there exists a general recipe to obtain a causally nonseparable D-POVM from any causally nonseparable process matrix - in analogy with the study of entanglement where one can construct MDI entanglement witnesses (MDIEWs) [211, 212] for all entangled states - remains an open question in the general case presented above. However, if one is willing to commit to some natural assumptions on the structure of Alice and Bob's operations, we can show that the answer is positive for all bipartite causally nonseparable process matrices.

Let us assume that Alice and Bob's (trusted) auxiliary Hilbert spaces have a bipartite tensor product structure of the form $\mathcal{H}^{\tilde{A}} = \mathcal{H}^{\tilde{A}_I \tilde{A}_O}$ and $\mathcal{H}^{\tilde{B}} = \mathcal{H}^{\tilde{B}_I \tilde{B}_O}$, and that their operations are of the form:

$$M_a^{\tilde{A}A} = M_a^{\tilde{A}_I A_I} \otimes M^{\tilde{A}_O A_O} \quad M_b^{\tilde{B}B} = M_b^{\tilde{B}_I B_I} \otimes M^{\tilde{B}_O B_O}, \quad (4.55)$$

with $\sum_a M_a^{\tilde{A}_I A_I} = \mathbb{1}^{\tilde{A}_I A_I}$ and $\text{Tr}_{A_O} M^{\tilde{A}_O A_O} = \mathbb{1}^{\tilde{A}_O}$, and similarly for Bob.

These can be interpreted as follows: Alice performs a joint POVM $\{M_a^{\tilde{A}_I A_I}\}_a$ on the subsystem of her trusted quantum input living in $\mathcal{H}^{\tilde{A}_I}$ and the untrusted system in \mathcal{H}^{A_I} she receives from the process matrix; and she sends the subsystem of her trusted quantum input living in $\mathcal{H}^{\tilde{A}_O}$ to the process matrix in the untrusted output space \mathcal{H}^{A_O} via a quantum channel (i.e. a CPTP map), and similarly for Bob¹³. These new constraints define a “measurement device and channel independent” scenario (with trusted quantum inputs), in which no assumption is made about the implemented measurements and quantum channels, that can be treated as black boxes, cf. Fig.4.6. The additional constraint concerns the structure of the instruments alone. It is a natural assumption in a situation where the quantum input is provided as two physically distinct systems (e.g., in two separate fibres) and distinct operations can be performed on these inputs.

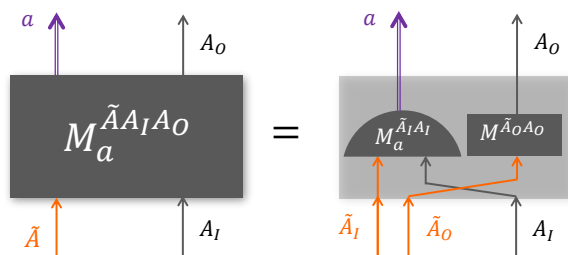

Figure 4.6: Additional assumption of the structure of the instruments (here Alice's).

Similarly with the previous general case, we can ask how assuming a causally separable

¹³Note that the structure of Eq. (4.55) implies in particular that

$$\text{Tr}_{A_O} M_a^{\tilde{A}A} = M_a^{\tilde{A}_I A_I} \otimes \mathbb{1}^{\tilde{A}_O}, \quad \text{Tr}_{B_O} M_b^{\tilde{B}B} = M_b^{\tilde{B}_I B_I} \otimes \mathbb{1}^{\tilde{B}_O} \quad (4.56)$$

for all a, b , with $\sum_a M_a^{\tilde{A}_I A_I} = \mathbb{1}^{\tilde{A}_I A_I}$ and $\sum_b M_b^{\tilde{B}_I B_I} = \mathbb{1}^{\tilde{B}_I B_I}$. These constraints, for the particular values of a, b under consideration, are in fact sufficient to prove our result.

process matrix W^{AB} impose any specific constraints on the generated D-POVM elements $\{E_{a,b}^{\tilde{A}\tilde{B}}\}_{a,b}$.

Assuming that Alice and Bob share a process matrix $W^{A\prec B} = W^{A\prec B_I} \otimes \mathbb{1}^{B_O}$ compatible with the order $A \prec B$ and using Eq. (4.56), one then has, for any fixed a, b

$$\begin{aligned} E_{a,b}^{\tilde{A}\prec\tilde{B}} &= (M_a^{\tilde{A}A} \otimes M_b^{\tilde{B}B}) * (W^{A\prec B_I} \otimes \mathbb{1}^{B_O}) \\ &= (M_a^{\tilde{A}A} \otimes \text{Tr}_{B_O} M_b^{\tilde{B}B}) * W^{A\prec B_I} \\ &= (M_a^{\tilde{A}A} \otimes M_b^{\tilde{B}_I B_I} \otimes \mathbb{1}^{\tilde{B}_O}) * W^{A\prec B_I} \\ &= E_{a,b}^{\tilde{A}\prec\tilde{B}_I} \otimes \mathbb{1}^{\tilde{B}_O} \end{aligned} \quad (4.57)$$

with $E_{a,b}^{\tilde{A}\prec\tilde{B}_I} = (M_a^{\tilde{A}A} \otimes M_b^{\tilde{B}_I B_I}) * W^{A\prec B_I} \geq 0$. Similarly for a process matrix $W^{B\prec A} = W^{B\prec A_I} \otimes \mathbb{1}^{A_O}$ compatible with $B \prec A$, one gets $E_{a,b}^{\tilde{B}\prec\tilde{A}} = E_{a,b}^{\tilde{B}\prec\tilde{A}_I} \otimes \mathbb{1}^{\tilde{A}_O}$ with $E_{a,b}^{\tilde{B}\prec\tilde{A}_I} = (M_a^{\tilde{A}_I A_I} \otimes M_b^{\tilde{B}B}) * W^{B\prec A_I} \geq 0$.

Starting with a causally separable process matrix W^{AB} as in Eq. (2.10), one finds that $E_{a,b}^{\tilde{A}\tilde{B}}$ necessarily decomposes as

$$E_{a,b}^{\tilde{A}\tilde{B}} = q E_{a,b}^{\tilde{A}\prec\tilde{B}_I} \otimes \mathbb{1}^{\tilde{B}_O} + (1-q) E_{a,b}^{\tilde{B}\prec\tilde{A}_I} \otimes \mathbb{1}^{\tilde{A}_O} \quad (4.58)$$

for some $E_{a,b}^{\tilde{A}\prec\tilde{B}_I}, E_{a,b}^{\tilde{B}\prec\tilde{A}_I} \geq 0$. If the D-POVM elements $E_{a,b}^{\tilde{A}\tilde{B}}$ cannot be decomposed in such a way, then one can conclude that the process matrix W^{AB} is causally nonseparable.

Remarkably, in analogy with the construction of MDIEWs, one only needs to consider some fixed outcomes, say $a = b = 0$, and thus only look at a single D-POVM element $E_{0,0}^{\tilde{A}\tilde{B}}$ to certify the causal nonseparability of W^{AB} in this scenario.

Proposition 21. *For any causally nonseparable process $W^{AB} \notin \mathcal{W}^{sep}$, one can find instruments such that the generated distributed measurement element $E_{00}^{\tilde{A}\tilde{B}}$ cannot be decomposed as Eq. (4.58).*

Proof. Consider auxiliary quantum input spaces $\mathcal{H}^{\tilde{A}_I}, \mathcal{H}^{\tilde{A}_O}, \mathcal{H}^{\tilde{B}_I}$ and $\mathcal{H}^{\tilde{B}_O}$ that are isomorphic to $\mathcal{H}^{A_I}, \mathcal{H}^{A_O}, \mathcal{H}^{B_I}$ and \mathcal{H}^{B_O} , resp., and consider the operations

$$\begin{aligned} M_0^{\tilde{A}A} &= |\Phi^+\rangle\langle\Phi^+|^{\tilde{A}_I A_I} \otimes |\mathbb{1}\rangle\langle\mathbb{1}|^{\tilde{A}_O A_O}, \\ M_0^{\tilde{B}B} &= |\Phi^+\rangle\langle\Phi^+|^{\tilde{B}_I B_I} \otimes |\mathbb{1}\rangle\langle\mathbb{1}|^{\tilde{B}_O B_O}. \end{aligned} \quad (4.59)$$

We find that $E_{0,0}^{\tilde{A}\tilde{B}}$ is (up to normalisation) formally the same as the process matrix W^{AB} under consideration, written in the spaces $\mathcal{H}^{\tilde{A}_I}, \mathcal{H}^{\tilde{A}_O}, \mathcal{H}^{\tilde{B}_I}$ and $\mathcal{H}^{\tilde{B}_O}$ instead of $\mathcal{H}^{A_I}, \mathcal{H}^{A_O}, \mathcal{H}^{B_I}$ and \mathcal{H}^{B_O} . The process matrix is in a sense “teleported” from the untrusted input and output spaces into the trusted spaces of the quantum inputs.

Consider now that W^{AB} is causally nonseparable, which means that it *cannot* be decomposed as Eq. (2.10). Note, further, that a causally nonseparable process matrix can also not be decomposed as in Eq. (2.10), even if we do not impose Eq. (2.11) *a priori*.¹⁴

Translating this onto $E_{0,0}^{\tilde{A}\tilde{B}}$, this means that $E_{0,0}^{\tilde{A}\tilde{B}}$ cannot be written as in Eq. (4.58), for any $E_{0,0}^{\tilde{A}\prec\tilde{B}_I}, E_{0,0}^{\tilde{B}\prec\tilde{A}_I} \geq 0$, which proves our claim above. \square

Thus, any (bipartite) causally nonseparable process matrix can be certified in the scenario with trusted quantum inputs, as long as we trust the fact that the instruments are of the form considered in Eq. (4.55). This is independently from the measurement devices used to implement the POVMs $\{M_a^{\tilde{A}_I A_I}\}_a$ and $\{M_b^{\tilde{B}_I B_I}\}_b$ on systems $\tilde{A}_I A_I$ and $\tilde{B}_I B_I$, resp., and independent from the devices that implement the channels from \tilde{A}_O to A_O and from \tilde{B}_O to B_O —although not fully independently from the instruments $\{M_a^{\tilde{A}A}\}_a$ and $\{M_b^{\tilde{B}B}\}_b$, which are required to satisfy Eq. (4.55). We can thus construct *measurement-device-and-channel-independent (MDCI) causal witnesses* for all bipartite causally nonseparable processes.

4.8 One-sided device independent certification of causal nonseparability with trusted quantum inputs

Surprisingly, Proposition 21 cannot be generalised straightforwardly to a $(2+F)$ -scenario¹⁵.

Nonetheless, I have shown that the partial-device-independent certification of causal nonseparability of [210], in which some parties are trusted and others are not, can be generalised with our MDCI approach. For example, all causally nonseparable process matrices whose causal nonseparability can be certified with trusted operations from Alice and Bob and an untrusted measurement by Fiona—so-called “TTU-noncausal” process matrices—can also be certified in a MDCI manner for Alice and Bob, and fully DI for Fiona.

4.8.1 TTU-noncausal process matrices

As defined in Ref. [210], a “TTU-assemblage” is a set of positive semidefinite matrices $\{w_{f|z}^{AB}\}_{f,z}$, with each $w_{f|z}^{AB} \in \mathcal{L}(\mathcal{H}^{AB})$, such that the sum over outcome f of these operators is a valid bipartite process matrix¹⁶ W^{AB} ,

$$\sum_f w_{f|z}^{AB} = W^{AB} \quad \forall z. \quad (4.60)$$

Such TTU-assemblage is typically realized by the application of Fiona’s measurement $\{M_{f|z}^F\}_{f,z}$ - where z is a classical input and f a classical outcome of Fiona - on a process

¹⁴This can be seen by noting that Eq. (2.11) follows from the validity of W^{AB} (which satisfies in particular ${}_{[1-A_O]B}W^{AB} = 0$) and the decomposition of Eq. (2.10): e.g., $q({}_{[1-A_O]B_I}W^{AB_I}) \otimes \mathbb{1}^{B_O} = {}_{[1-A_O]B}(qW^{AB_I} \otimes \mathbb{1}^{B_O}) = {}_{[1-A_O]B}[W^{AB} - (1-q)W^{BA_I} \otimes \mathbb{1}^{A_O}] = {}_{[1-A_O]B}W^{AB} - (1-q){}_{[1-A_O]B}(W^{BA_I} \otimes \mathbb{1}^{A_O}) = 0$, which indeed implies (for $q > 0$) that ${}_{[1-A_O]B_I}W^{AB_I} = 0$.

¹⁵This is due to the fact that the decomposition of Eq. (2.12) along with the validity of W^{ABF} does not by itself imply that $W^{A\prec B\prec F}$ and $W^{B\prec A\prec F}$ are themselves valid process matrices

¹⁶thus, a TTU-process assemblage can be interpreted as a set of *probabilistic process matrices* [86], which (for each z) sum up to a deterministic process.

matrix W^{ABF} such that

$$w_{f|z}^{AB} = M_{f|z}^F * W^{ABF} \quad \forall f, z. \quad (4.61)$$

It is said to be ‘‘causal’’ if it can be decomposed as a convex mixture (for some $q \in [0, 1]$)

$$w_{f|z}^{AB} = q w_{f|z}^{A \prec B} + (1-q) w_{f|z}^{B \prec A} \quad \forall f, z, \quad (4.62)$$

in terms of positive semidefinite matrices $w_{f|z}^{A \prec B}, w_{f|z}^{B \prec A} \geq 0$ satisfying

$$\begin{aligned} \sum_f w_{f|z}^{A \prec B} &= W^{A \prec B_I} \otimes \mathbb{1}^{B_O} \quad \forall z, \\ \sum_f w_{f|z}^{B \prec A} &= W^{B \prec A_I} \otimes \mathbb{1}^{A_O} \quad \forall z, \end{aligned} \quad (4.63)$$

for some causally ordered (valid) process matrices $W^{A \prec B_I}$ and $W^{B \prec A_I}$.

If no such decomposition exists, then the TTU-assembly is noncausal. As in the bipartite case, we note that a noncausal TTU-assembly can also not be decomposed as in Eqs. (4.62) and (4.63) above, even if we don’t assume *a priori* that $W^{A \prec B_I}$ and $W^{B \prec A_I}$ are valid process matrices (as their validity condition would anyway be implied by Eqs. (4.60)–(4.63), as in Footnote 14).

A process matrix that can generate a noncausal TTU-assembly in such a way is said to be ‘‘TTU-noncausal’’ [210]. Note that only causally nonseparable process matrices can generate noncausal process TTU-assemblies, so that certifying TTU-noncausality implies a certification of causal nonseparability. Furthermore, note that one can construct witness-assemblies $\{S_{f|z}\}_{f,z}$ of noncausality for TTU-assemblies. These correspond to a set of matrices $\{S_{f|z}\}_{f,z}$ such that $\sum_{f,z} S_{f|z} * w_{f|z} \geq 0$ for all causal TTU-assembly. Because the set of causal TTU-assemblies is closed and convex, then according to the separating hyperplane theorem, the noncausality of a TTU-assembly $\{w_{f|z}\}_{f,z}$ can always be certified by the existence of a witness-assembly such that $\sum_{f,z} S_{f|z} * w_{f|z} < 0$, which can be constructed using a SDP program.

The noisy quantum switch (4.54) is an example of a TTU-noncausal process [210], whose TTU-noncausality—and hence, whose causal nonseparability—can thus be certified in this partial-device-independent way for $r \lesssim 1.319$ (or in terms of the noise parameter used in [210], for $\eta = \frac{r}{1+r} \lesssim 0.5687$). We note that for this example Fiona can apply a single, fixed POVM $\{M_f^F\}_f$, with no classical input z , as the non-causal TTU-assembly studied in [210] is induced when Fiona measures her qubit in the diagonal basis $\{|\pm\rangle\}$

$$\{w_{f=\pm}^{AB} = |\pm\rangle\langle\pm|^F * W_{\text{QS}}(r)\}_{f=\pm}. \quad (4.64)$$

4.8.2 MDCl-MDCI-DI certification of TTU-noncausal process matrices

In a $(2 + F)$ -scenario where Alice and Bob’s instruments are of the form Eq. (4.55) with fixed outcomes $a = b = 0$ and Fiona is given a classical input z , the causal separability of W^{ABF} implies that the generated D-POVM elements are

$$E_{0,0,f|z}^{\tilde{A}\tilde{B}} = q E_{0,0,f|z}^{\tilde{A} \prec \tilde{B}} + (1 - q) E_{0,0,f|z}^{\tilde{B} \prec \tilde{A}} \quad \forall f, z, \quad (4.65)$$

$$\begin{aligned}
\sum_f E_{0,0,f|z}^{\tilde{A}\prec\tilde{B}} &= E_{0,0}^{\tilde{A}\prec\tilde{B}_I} \otimes \mathbb{1}^{\tilde{B}_O} & \forall z, \\
\sum_f E_{0,0,f|z}^{\tilde{B}\prec\tilde{A}} &= E_{0,0}^{\tilde{B}\prec\tilde{A}_I} \otimes \mathbb{1}^{\tilde{A}_O} & \forall z,
\end{aligned} \tag{4.66}$$

for some $E_{0,0,f|z}^{\tilde{A}\prec\tilde{B}}, E_{0,0,f|z}^{\tilde{B}\prec\tilde{A}}, E_{0,0}^{\tilde{A}\prec\tilde{B}_I}, E_{0,0}^{\tilde{B}\prec\tilde{A}_I} \geq 0$.

In such a scenario for TTU-noncausal process matrices, we can show a similar result to the bipartite case:

Proposition 22. *For any TTU-noncausal process matrix W^{ABF} , one can find instruments such that the induced distributed measurement $\{E_{0,0,f|z}^{\tilde{A}\tilde{B}}\}_{0,0,f|z}$ cannot be decomposed as in Eqs. (4.65)–(4.66).*

Proof. Consider, as in the bipartite case, some quantum input spaces $\mathcal{H}^{\tilde{A}_I}, \mathcal{H}^{\tilde{A}_O}, \mathcal{H}^{\tilde{B}_I}$ and $\mathcal{H}^{\tilde{B}_O}$ that are isomorphic to $\mathcal{H}^{A_I}, \mathcal{H}^{A_O}, \mathcal{H}^{B_I}$ and \mathcal{H}^{B_O} , resp., and the CP maps $M_0^{\tilde{A}A}$ and $M_0^{\tilde{B}B}$ of Eq. (4.59) for Alice and Bob. The induced D-POVM elements

$$E_{0,0,f|z}^{\tilde{A}\tilde{B}} = (M_0^{\tilde{A}A} \otimes M_0^{\tilde{B}B} \otimes M_{f|z}^F) * W^{ABF} = (M_0^{\tilde{A}A} \otimes M_0^{\tilde{B}B}) * w_{f|z}^{AB} \tag{4.67}$$

are formally the same, up to a normalisation factor $\frac{1}{d_{A_I} d_{B_I}}$, as the matrices $w_{f|z}^{AB}$ of the TTU-assemblage generated by the process matrix W^{ABF} and Fiona’s POVMs $\{M_{f|z}^F\}_f$, but written in the quantum input spaces. In other words, the TTU-assemblage is teleported from the process matrix spaces $\mathcal{H}^{A_I}, \mathcal{H}^{A_O}, \mathcal{H}^{B_I}$ and \mathcal{H}^{B_O} into the quantum input spaces $\mathcal{H}^{\tilde{A}_I}, \mathcal{H}^{\tilde{A}_O}, \mathcal{H}^{\tilde{B}_I}$ and $\mathcal{H}^{\tilde{B}_O}$.

Suppose that the process TTU-assemblage $\{w_{f|z}^{AB}\}_{f,z}$ is noncausal, i.e., cannot be decomposed as in Eqs. (4.62)–(4.63) for any $w_{f|z}^{A\prec B}, w_{f|z}^{B\prec A}, W^{A\prec B_I}, W^{B\prec A_I} \geq 0$. Recalling from the remark above that such a decomposition remains impossible even if we don’t require $W^{A\prec B_I}, W^{B\prec A_I} \geq 0$ to be valid process matrices *a priori*, then it implies that the set of D-POVM elements $\{E_{0,0,c|z}^{\tilde{A}\tilde{B}}\}_{c,z}$ can also not be decomposed as in Eqs. (4.65)–(4.66). \square

Hence, any TTU-noncausal $(2+F)$ -partite process matrix W^{ABF} can generate some subsets of D-POVM elements $\{E_{0,0,f|z}^{\tilde{A}\tilde{B}}\}_{f,z}$ that cannot be decomposed¹⁷ as in Eqs.(4.65)–(4.66). Here, we don’t need to trust Fiona’s measurements. However, unlike the TTU scenario, we don’t need to fully trust Alice and Bob’s operations either. We only trust that their instruments are of the form of Eq. (4.55), so that this certification of causal nonseparability is MDCI for Alice and Bob, but fully DI for Fiona (“MDCI-MDCI-DI”).

As explained above, because the noisy quantum switch $W_{\text{QS}}(r)$ of Eq. (4.54) is TTU-noncausal for $r \lesssim 1.319$ [210], it is also *MDCI-MDCI-DI-noncausal* for the same amount of noise. This is notably a significant improvement over the noise tolerance obtained above for SDQI certification ($r \lesssim 0.367$) without the additional MDCI assumption, showing how robustly the quantum switch can be certified with only rather weak assumptions about

¹⁷Note that once again, verifying that such a decomposition is impossible can be done with similar techniques to the use of “witnesses of causal nonseparability” [16, 17], which can be measured in practice.

the performed operations. Nonetheless, there remains a gap (for $1.319 \lesssim r \lesssim 1.576$, cf. Fig. 4.7) where it is still unknown whether the noisy quantum switch can be certified with trusted quantum inputs¹⁸.

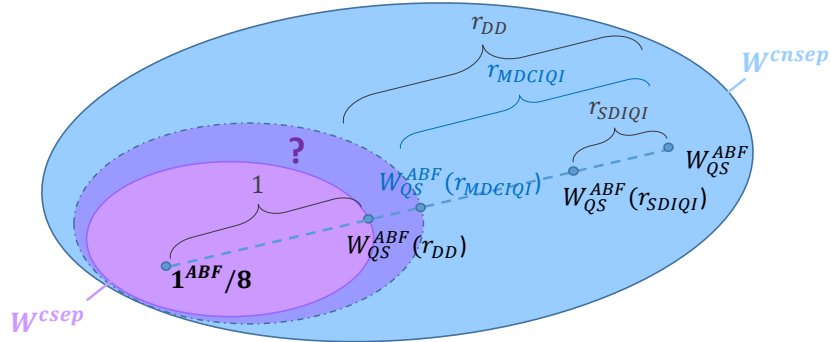

Figure 4.7: Venn diagram illustrating the various certifications of the noisy quantum switch. The process matrix of the quantum switch W_{QS}^{ABF} belongs to the set of causally nonseparable processes (blue). When an amount $r_{DD} > 1.576$ is added to it, it becomes causally separable (dark pink area). The noise tolerance obtained for the SDIQI certification might be smaller: in such scenario, for $r_{SDIQI} > 0.367$, we have not found instruments allowing to certify the causal nonseparability of the noisy quantum switch. The gap is reduced with the additional MDCI assumption, as we have found instruments such that $W_{QS}(r)$ is TTU-noncausal for $r_{MDCI} \leq 1.319$. Nevertheless, a gap remains between the causally nonseparable noisy quantum switch which can be certified in a device-dependent manner and with quantum inputs (purple area), i.e. for $r_{MDCI} \lesssim r \lesssim r_{DD}$.

¹⁸Note that the noisy quantum switch was also shown to be *TUU*-noncausal in [210], i.e. with trusted operations for Alice, untrusted operations for Bob and Fiona. With a similar argument, I have shown that all *TUU*-noncausal process matrices are also *MDCI* – *DI* – *DI*-noncausal.

4.9 Take Away and Perspectives

Take Away

- We have made a significant relaxation of assumptions to certify the causal nonseparability of many processes. Causal nonseparability can be certified in a scenario with untrusted local operations with trusted quantum inputs, a semi-device-independent scenario with quantum inputs (SDIQI).
- We have defined the notion of causal (non)separability for (bipartite, $(2 + F)$ -partite and tripartite) distributed measurements.
- The quantum switch can generate noncausal correlations in a SDIQI scenario.
- The analogy with the certification of entanglement with quantum inputs is limited. All bipartite causally nonseparable process matrices can be certified in a measurement-device-and-channel -independent (MDCI) manner.
- All one-sided device independent certifications of causal nonseparability in a “TTU” scenario can be generalised in a “MDCI-MDCI-DI” scenario.

Perspectives

- The understanding of which causally nonseparable processes can be certified in a SDIQI way remains an open problem.
- Our result could be generalised for multipartite scenarios. For example, one could define the notion of causal nonseparability for N -partite distributed measurements. This way, beyond the study of the quantum switch in a SDIQI scenario, one could try to verify if other QC-QCs can generate noncausal correlations with quantum inputs.
- The study of causally nonseparable D-POVMs might be a topic of interest on its own. In the same spirit, one could try to define causal nonseparability for other types of objects, and develop a resource theory of causal nonseparability.
- Pursue of the analogy nonlocality/noncausality: Entanglement can be certified for all entangled states in a device-independent way [223] by combining measurement-device-independent entanglement witnesses and self-testing, “a method to infer the underlying physics of a quantum experiment in a black box scenario” [224], A natural follow-up would then be to investigate if an analogous combination of our SDIQI certification of causal nonseparability with self-testing could lead to a device-independent certification of causal nonseparability for some processes.

Part II

Quantum Contextuality

*Le réel ne peut s'exprimer que par l'absurde*¹⁹. Paul Valéry



Quantum Contextuality (in the style of Kandinsky), VQGAN+CLIP.

¹⁹Reality can only be expressed through the absurd.

Chapter 5

Contextualisation

What is a context ? Is it “the situation within which something exists or happens, and that can help explain it” ? Or “the text or speech that comes immediately before and after a particular phrase or piece of text and helps to explain its meaning” ? It depends on the context. My interest for quantum contextuality takes root in a specific context. During my Master studies, I was led to establish a bibliography review of recent development on this feature. I discovered that quantum contextuality does not reduce to Bohr’s philosophical notion of complementarity [6], nor a vague Copenhagenish adage: “The result of a quantum measurement depends on the experimental context.” It has a precise definition and meaning in the field of quantum foundations. My review [36] aimed at introducing the Kochen-Specker theorem [28] and its recent generalisations to the French reading community (researchers, students). For instance, it has been used by science journalists [225, 226]. Since then, more recent reviews have been proposed [82], with one based on my work [227].

While most of my PhD thesis was dedicated to quantum causality, I have nevertheless kept feeding my interest for contextuality, as my first main motivation was initially to study a possible relation between indefinite causal orders and contextuality. Partial results and ideas on this will be presented in Part III “Time-Travel without Paradoxes”. In this Part II, I will present some personal studies and reflections carried out during the last three years with the idea of sharpening my view of contextuality as a fundamental feature of “quantum weirdness”, and the perspective of establishing a possible link with quantum causality. I will start by introducing the Kochen-Specker theorem (Chapter 6) and a personal investigation on its origins. I will then show how the Hardy paradox [92, 101] can be seen as a canonical example at the crossroads of distinct approaches of contextuality [42, 40] (Chapter 7). I will also analyze how contextuality emerges from a formulation of the paradox with post-selection [96], based on [93, 94, 89, 95]. Finally, I will define the notion of *meta-contextuality* as the main characteristic of neo-Copenhagen interpretations of quantum theory, based on my essay “A Gödelian Hunch from Quantum Theory” [100] (Chapter 8).

Chapter 6

Infuturabilia: the Kochen-Specker theorem

The future is inevitable, but it may not occur. Jorge Luis Borges

This introduction is based on the review I realised during my Master studies [36]. However it has been since then processed and extended: in particular, I have speculated that a connection between Specker's scholastic motivation, his interest for the Jonah narrative and the so-called "Jonah paradox" might be established and offer a key in understanding the origins of the Kochen-Specker theorem [28].

6.1 Introduction

In 1961, Ernst Specker, then professor of mathematics at the ETH Zurich for six years, took a sabbatical year at Cornell University (Ithaca, New York). During a mathematics colloquium, he gave a lecture on one of his recently published articles, entitled "Die Logik nicht gleichzeitig entscheidbarer Aussagen" [228] (translated as "The logic of propositions not simultaneously decidable" [229]), that points out, inter alia, that classical logic does not hold for values associated to non co-mesurable observables. More striking, the quantum formalism cannot be extended through the introduction of additional variables in such a way that classical (Boolean) logic holds in the extended domain.

"Is it possible to extend the description of a quantum mechanical system through the introduction of supplementary — fictitious — propositions in such a way that in the extended domain the classical propositional logic holds (whereby, of course, for simultaneously decidable proposition negation, conjunction and disjunction must retain their meaning)? The answer to this question is negative, except in the case of Hilbert spaces of dimension 1 and 2." [229]

His presentation caught the attention of Simon Kochen, a Canadian mathematician, and they collaborated for several years on the study of quantum logic and the problem of hidden variables, both in Ithaca and in Zurich. Their work culminated in an enriched reformulation of Specker's result, adapted to quantum formalism, which will be known as the Kochen-Specker theorem [28].

This theorem can be stated as the following:

Consider two commuting observables, A and B , associated to Hilbert spaces of any dimension: $[A, B] = 0$. Thus, they share a common decomposition basis of projectors $\{\Pi_k\}_k$ such that

$$A = \sum_j a_j \Pi_j \quad B = \sum_j b_j \Pi_j \quad (6.1)$$

The product and the sum of these observables can also be decomposed in the same basis :

$$AB = \sum_j a_j b_j \Pi_j \quad A + B = \sum_j (a_j + b_j) \Pi_j \quad (6.2)$$

Two fundamental assumptions are made:

- **(P)** : *predetermination* (or *outcome determinism*): the values of an observable are assumed to be predefined, regardless of its measurement. In other words, even if the observable is not measured, it has a well-defined value. A value-assignment function $v(*)$ can then be defined, such that for each observable, one can associate the value 1 to exactly one of the eigenvectors, and the value 0 with the others. This function allows to assign a predefined value to any observable

$$v(A) = \sum_j a_j v_A(\Pi_j) \quad (6.3)$$

such that $\exists! k$ with $v_A(\Pi_k) = 1$, else $\forall j \neq k, v_A(\Pi_j) = 0$.

- **(NC)** : *non-contextuality*: the value assignment is assumed to be context independent, i.e. in every decomposition, the same eigenvector will therefore be assigned the same value.

$$\forall k, \quad v_A(\Pi_k) = v_B(\Pi_k) = v(\Pi_k) \quad (6.4)$$

As a result, from (6.2):

$$v(AB) = v(A)v(B) \quad v(A + B) = v(A) + v(B) \quad (6.5)$$

The Kochen-Specker theorem stipulates that in a Hilbert space of dimension greater than or equal to 3, the predictions of quantum mechanics are logically incompatible with these two assumptions. It is logically necessary

- either to give up on predetermination and save non-contextuality, meaning that the values of an observable are not predefined ;
- either to give up on non-contextuality and save predetermination, meaning that the value-assignment function is not distributive on both the sum and the product, i.e. the assigned value is context-dependent. This position can be labeled as “*contextuality*¹” ;
- or give up on both.

¹The term “contextuality” is often abusively used to refer to the Kochen-Specker theorem rather than being exclusively associated with the solution “giving up on non-contextuality”.

Therefore, the common sentence: “In quantum mechanics, the result of a measurement depends on the experimental context.” finds a mathematical ground here, in the sense that one cannot in general assign a pre-defined value to an observable independently of which compatible observable might be measured alongside. On the one hand, the sentence can be interpreted as meaning that “A measurement does not reveal a pre-existing value of the measured property. The outcome is “brought into being” by the act of measurement itself. This way, counterfactual “facts” seems incompatible with quantum mechanics.” This is generally the operationalist point of view. On the other hand, one can argue that it means that “A measurement does reveal a pre-existing value of the measured property, but the value assignment depends on the measurement context.” A position defended by Bell and Bohmian mechanics.

In fact, the latter takes part in one of the contexts of birth of the theorem. In 1952, David Bohm [63] brought up to date a hidden variables theory issued thirty-two years earlier by Louis de Broglie, which the French physicist had quickly abandoned because of its nonlocal character. A decade later, in 1963, John Bell attended a lecture by Joseph Maria Jauch at CERN [230] on the “proof of impossibility” for the validity of hidden variables theories demonstrated by John von Neumann in 1932 [60]. Von Neumann’s “proof” seems to be in obvious contradiction with the existence of the de Broglie-Bohm hidden variable theory. This is “the problem of hidden variables”. In their discussions, Jauch draws Bell’s attention on a 1957 theorem by Gleason. Bell will use a corollary of this work in a 1964 paper entitled “On the problem of hidden variables in quantum mechanics”, in which he derives the same result as Kochen and Specker. Despite the fact that they share the same title - the 1967 paper by Kochen and Specker is entitled “The Problem of Hidden Variables in Quantum Mechanics” [28] - their work - communicated by Gleason himself - was carried out independently from Bell’s. Note that Kochen and Specker also knew that their theorem could be derived from Gleason’s: “This result first stated in Specker [228], can be obtained more simply either by a direct topological argument or by applying a theorem of Gleason [231].”

Moreover, the two papers give opposite conclusions: while Bell argue that the theorem proves that von Neumann’s result is “foolish” and of “limited relevance” [232], Kochen and Specker conclude that on the contrary the theorem strengthens it [28]. The same result therefore seems to be used by its authors to defend a thing and its opposite. A misunderstanding about the nature of von Neumann’s proof might be the cause of this paradoxical situation (cf. [232]).

However, unlike Bell, the hidden variables problem was not the primary motivation of Specker’s seminal 1960 work [228]. In fact, Specker took inspiration in one of his former teachers’s - Ferdinand Gonseth - philosophy on logics, as well as in an eternal scholastic debate which he named “Infutabilia”.

6.2 Specker's logical inspiration: "Is logic empirical?"

In the late 1940s, Ernst Specker, then assistant in mathematics at the ETH Zurich, attended a seminar organized by Ferdinand Gonseth² - his teacher - and Wolfgang Pauli. The seminar focused on "the foundations of quantum theory", and especially on von Neumann's work. Shortly after, inspired by the heated and passionate debates which occurred during the seminar, Specker sketched the proof of a theorem that would be published only ten years later. When he was asked for the reason for postponing publication, he replied that "some people like to be told to publish."^[233]³

In 1960, Gonseth encouraged him ^[235] to publish his ideas in a special issue of the journal *Dialectica*⁴ in honor of his seventieth birthday. Specker dedicated the article ^[228] to Gonseth in the epigraph and the introduction of the article:

"La logique est d'abord une science naturelle.

F. Gonseth (Logic is in the first place a natural science.)

The motto attached to this work is the subtitle of the chapter La physique de l'objet quelconque from the book Les mathématiques et la réalité; this physics shows itself to be essentially a form of classical propositional logic, by which, on the one hand, it obtains a typical realization, and, on the other hand, it is, in an almost obvious way, deprived of its claim to absoluteness, with which it is occasionally dressed up. The following remarks concur to this view and can be understood in this same empirical sense." ^[229]

According to Gonseth, "logic should take on the aspect of a natural science of a very primitive character, which may perhaps be called the 'physics of any object whatsoever'." ^[236] Logic supposes the existence of objects on which the propositions relate. They are to the objects of the real world what the mathematical line is to "stretched wire, the top of a roof, the edge of a drawing rule ...", i.e. a schematic image, consistent with our experience of reality and its evolution. From this "open realism" - in the sense that abstract objects are not identified with the immutable and eternal Ideas of Plato, but are constructed from real empirical facts - Gonseth draws three empirical laws:

- Every object is or it is not.
- An object cannot be and at the same time not be.
- Every object is identical to itself.

²Ferdinand Gonseth (1890-1975) was a Swiss mathematician and philosopher. He developed with Gaston Bachelard a "non-Cartesian method" of research that does not impose any principle before knowledge itself. Like science, this method must be *open* and be able to change its fundamentals according to experimentation.

³In introduction to this collection of Ernst Specker's publications, one can find a biography of Specker, by a "friend" named Jonas Meon, which is nothing but an autobiography written under a pseudonym ^[234], Jonas referring to the Biblical prophet, and Meon could be interpreted as "on me" or referred to the Ancient Greek μή-ὄν, "non-being".

⁴*Dialectica* is a quarterly magazine, mainly devoted to publish works in philosophy of science and epistemology. It was founded in 1947 by Gaston Bachelard, Paul Bernays and Ferdinand Gonseth. Between 1942 and 1945, Ernst Specker was a pupil of these last two, and he seemed to have a particular admiration for them ^[233].

He sees in these three laws of the ‘physics of any object whatsoever’ the primitive forms of the principle of the excluded third, of the principle of non-contradiction, and of the principle of identity, which are the three pillars of classical logic, introduced by Aristotle. However Gonsseth noticed that these laws seemed to be put to the test by quantum theory. As commented by Bachelard:

"What strikes me is that the properties of the object whatsoever agree with the principles of the experiences of locality. Anything that would disturb the principles of locality -and I believe that these principles of locality are indeed disturbed in microphysics - should thus lead to a division of logic." [237]

The idea that logic is an empirical science and should be revised in accordance with our physical theories will later radiate in the famous debate “Is Logic Empirical ?” opposing Hilary Putnam [238] and Michael Dummett [239] (see also [240]). It questions the status of logic, and more specifically quantum logic. Note that while quantum contextuality and its modern development seems to precisely target the principle of identity (e.g. Spekkens’s notion of contextuality violates a form of Leibnizian identity of indiscernibles [41, 241, 242]), one might argue that the principle of non-contradiction is threatened by the Many-Worlds interpretation, while the principle of the excluded third would be violated by many-valued logics and anti-“substantialism” interpretations (e.g. the Bachelardian interpretation [243]).

In [228] (cf. [229] for an English translation), Specker focuses on the problems arising from “non-simultaneously decidable propositions”, which can be both found in contingent statements of classical logic as well as in quantum propositions:

“The difficulties that arise from propositions that are together not decidable emerge very clearly from propositions about quantum mechanical systems. In accordance to the there commonly used terminology [i.e., in that field], we would like to call the collection of such propositions as not-simultaneously decidable [...].”

6.3 Specker’s scholastic inspiration: “Infuturabilia”

“He [Specker] explained to me how the Kochen– Specker theorem (which he had first published by himself five years before the usually cited joint paper) arose from a theological question. At the time, he really wanted to know whether God could know what the world would have been like if Hitler were never born.” C. Fuchs [244]

“The story of how Specker first started down the road which led to this result is quite wonderful. It shows that even in an era where “shut up and calculate” is the mantra of many researchers, deep philosophical questions can still lead to great advances in our understanding of the world. It is a story that will warm the heart of anyone who believes that physics should be pursued in a romantic style. [...] [H]e was led to the critical question: could God know what outcome would have occurred had a different quantum measurement been done to the one that was actually done, without getting into contradiction ? ”
R. Spekkens [235]

Aristotle himself had already observed that the stability of the pillars of logic seems to be severely threatened when statements are made about facts that did not happen yet.

Assume for example that there will be a sea battle tomorrow. If it were true, it was also true yesterday, and the days, the months, the years before. All past truths being necessarily true today, we can conclude that the statement "There will be a sea battle tomorrow" is necessarily true. But what if we had assumed that there will not be a sea battle tomorrow ? Using the same arguments, we can demonstrate that the previous statement is necessarily false, which contradicts our first conclusion.

Aristotle's solution to this contradiction was to introduce the modality of *contingency*: statements about the future only become either true or false when they emerge from potential to actual. Whenever a statement is made on the existence of unmeasured properties or non-actual facts, i.e. whenever there is contingency, *counterfactual* propositions such as "If it were that *A*, then it would be that *B*." are used (cf. [245]). Problems such as "the sea battle tomorrow" are called "future contingents", and they have been widely studied over the centuries (see for example [246] for a review). During the Middle Ages, *the problem of future contingents* was discussed by the Scholastics, who attempted to conciliate Aristotelian philosophy and biblical theology. For example, in Aquinas's *Summa Theologica*, one can find an analysis of the following question:

Does God know future contingent things ?

This question was at the heart of Specker's process (cf. [244], [235]), and was certainly the prime motivation of his 1960 precursor article, in which he refers to future contingents as "Infuturabilia":

"The difficulties that arise from propositions that are together not decidable emerge very clearly from propositions about quantum mechanical systems. [...] In a certain sense the scholastic speculations about the "Infuturabilien" also belong here, that is, the question whether the omniscience of God also extends to events that would have occurred in case something would have happened that did not happen. (cf. e.g. [3], Vol. 3, p.363.)" [229]

Interestingly, the reference "(cf. e.g. [3], Vol. 3, p.363.)" in [228] leads to an introduction to Jesuit theologian Pedro da Fonseca's concept of *scientia media* (in Solana's "Historia de la filosofia espanola"), which will be fully developed by his disciple, Luis de Molina. *Scientia Media*, also called *middle knowledge*, is a form of knowledge attributed to God in order to explain compatibilism, the compability of God's "foreknowledge"⁵, i.e. knowledge regarding future events, and the "free will" (cf. e.g. [247, 248]) of an agent. It corresponds to God's knowledge of counterfactuals. According to Molina, *before* knowing the actual ontology of the world, God has knowledge about counterfactual facts. This way, if God knows what a free agent is about to do, it may nevertheless be in the power of the agent to do something such that if she were to do it, God would have known something else. God's knowledge of counterfactuals preceding His knowledge of actual facts, there is still room for "free will", despite His omniscience (ability to know everything).

⁵Note that "God" is interchangeable with "foreknowledge" here. Beings gifted with foreknowledge do not necessarily have to be interpreted as divine. The study of the science of God, the question of the extent of his omniscience might be reduced to - or at least is in some extent analogous with - the philosophical question of what the scientist can say about Nature.

Such incompatibility has been illustrated by Specker in his seminal article [228] through a simple example of non-classical correlations which he emphasized using a parable⁶ about a seer who sets an impossible prediction task to his daughter’s suitors. In Appendix C, I propose to illustrate how the notion of contextuality can be related with Specker’s Infuturabilia with a personal narrative inspired by a counterfactual version of the Newcomb problem [250].

6.4 Contextuality and the Jonah paradox

In the prelude of Specker’s parable, the seer is said to originate from Nineveh. Ernst Specker was known for his taste for enigma and hidden messages [235]. Thus, this detail cannot be innocuous. In fact, a famous prophet was charged by God to deliver a message to the inhabitants of Nineveh: Jonah⁷. Specker was fascinated by this biblical character, to the extent that he wrote an autobiographical article under the pseudonym “Jonas Meon” (cf. Footnote 3) [233, 234]. Interestingly, it is possible to forge a link between this interest and “Infuturabilia”.

One may assume that the Specker’s seer might represent Jonah, but it is not the case [235]. Nevertheless, it is possible that Specker’s passion for Jonah could be intimately linked with the motivations that led him to his theorem. I believe he could have been inspired by this biblical narrative in his reflection on “Infuturabilia”⁸.

The Book of Jonah tells the story of a Hebrew prophet sent by God to prophesy the destruction of Nineveh to its inhabitants, but tries to escape his divine mission. After being punished by spending three days and three nights in the belly of a giant fish, Jonah finally resolves to accomplish his mission. He enters the city of Nineveh, crying “In forty days Nineveh shall be overthrown.” The Ninevites fast and repent, and God changes his mind and spares the city. Jonah, angry, explains why he tried to flee in the first place : he feared that God would show mercy and accept the repentance of the Nineveh.

This narrative can be interpreted as displaying the same difficulties emerging with “future contingents”. On the one hand, Jonah’s prophecy “In forty days Nineveh shall be overthrown.” is a divine communication, so it should be necessarily true, and it can be assigned a definite truth value. On the other hand, this statement involves future events, and, therefore, it should be contingent. This apparent contradiction raises the scholastic question of God’s knowledge of counterfactuals and compatibilism : if divine statements are necessarily true, then Nineveh must be overthrown. However, because the prophecy deals with future contingents, the Ninevites still have the freedom to repent, and their action leads to the non-achievement of God’s previous necessary truth. Thus, foreknowledge and free will seem incompatible. The solution offered by the narrative can be seen as a molinist argument. The truth value of God’s statement can be contextualized: it is true in the context of the Nineveh non-action (non-repentance) and it is false in the context of the Nineveh repentance. People and God can both change their minds, and

⁶This parable has been studied and revisited in the context of modern quantum foundations by Liang, Spekkens and Wiseman [249].

⁷Jonas in Latin /Jonah (Yona in Hebrew), Biblically transliterated Yonah.

⁸Note that the Jonah narrative is not limited to the problem of future contingents. A reflection about morality and responsibility - that I do not use in my analysis - is also at the core of the narrative.

are therefore each endowed with a form of free will. There is therefore a place for human free will, compatible with divine foreknowledge.

Accordingly, the Jonah narrative has been read as an inspiring illustration to reflect on the difficulties emerging with counterfactual futures. For instance, French philosopher Jean-Pierre Dupuy has given the name of “Jonah” - in reference to the biblical prophet and to German philosopher Hans Jonas - to paradoxes where a prediction of doom is made in order to avoid the catastrophe itself [251]. Dupuy highlights the paradoxical nature of the mission assigned to a prophet of doom: “He must foretell an impending catastrophe as though it belonged to an ineluctable future, but with the purpose of ensuring that, as a result of his doing just this, the catastrophe will not occur.” Once again, a solution to avoid the paradox is to commit to a molinist position: if God had predicted that you will make a certain choice A , it may nevertheless have been in your power to do something, such that were you to do it, God would not have predicted this peculiar choice A . In a sense, God’s omniscience and human free will can co-exist at the condition that the former is *contextualized* by the latter.

Finally, let us remark that some might be tempted to take seriously Specker’s theological inspiration and the analogies between the extent of God’s omniscience and scientific knowledge (Footnote 5) and between quantum contextuality and the molinist solution [252, 253]. I prefer to remain extremely cautious, and avoid jumping to conclusions. Specker’s romantic process is particularly fascinating and I find the idea that a scholastic reading of a Biblical narrative might have inspired him to establish one of the most fundamental results of quantum theory profoundly thrilling. Analogies, myths and narratives can be used as a “medium that combines strangeness and beauty” [254] and are both powerful sources of inspiration and popularisation. Nevertheless, this is not incompatible with a careful examination of the scope of the studied field and of the limits of these analogies. The Kochen-Specker theorem and quantum contextuality can be clearly explained without any reference to God’s knowledge of counterfactuals.

Chapter 7

Contextuality from the Hardy Paradox

In this chapter, I present an analysis of the contextuality underlying the Hardy paradox based on topological [42] and hypergraphical approaches [40]. I give an original (unpublished) study inspired by the works of Aharonov, Leifer and Spekkens, showing how contextuality is related with a pre-post-selection reformulation of the paradox.

The notoriety of quantum nonlocality and Bell’s theorem [7, 8] contrasts with the unpopularity of the Kochen-Specker result, totally obscured by the shine of his “little brother”¹. Even today, despite particularly significant conceptual breakthroughs, quantum contextuality remains for the most part (with the exception of quantum foundations experts) unknown, in the shadow of nonlocality.

David Mermin pointed out that this “comparative obscurity” may derive from the fact that unlike Bell’s theorem, which has a device-independent formulation, the Kochen-Specker theorem and its assumptions are anchored in the quantum formalism [61]. The original proof was also “less transparent”, as it “entails a moderately elaborate exercise in geometry” [61]. This argument has become obsolete since the 1990s, when new simpler proofs of the Kochen-Specker theorem (e.g. requiring fewer observables and/or fewer contexts than the original proof of Kochen and Specker) have been discovered, notably by Mermin [61], Peres [30, 31] and Cabello [32]. This search for simplification continued over the last two decades (cf. [36, 82]). However conceptual progress in the understanding of contextuality have also been made. For example, several approaches tackle the question of how nonlocality is, at the mathematical level, a particular case of contextuality. These are based on different mathematical tools, such as graphs [39], hypergraphs [40], and topology [42, 44]. Another important breakthrough is Spekkens’ “universal” notion of contextuality [41], that generalises the concept on (non)-contextuality to all kind of experimental procedures (preparation, transformation, measurement).

The Hardy paradox [92, 101], first introduced as a proof of quantum nonlocality with-

¹Even if the Bell [255] and Kochen-Specker’s papers [28] are posterior to the 1964 article [7], the fact remains that the first buds of contextuality were already deeply rooted in people’s minds (von Neumann [60], Bohr [6], Gleason [231] and the 1960 article by Specker [228]). Note also that Bell’s contextuality paper [255] should have been published before the nonlocality one. In fact, before showing that hidden variables theories are necessarily nonlocal, Bell aimed at demonstrating that von Neumann’s impossibility proof was erroneous. [255] is even cited in [7]. However, because the paper was lost by the editor, it will end up published two years later [256, 257].

out inequalities, was also shown to entail a form of contextuality² [42, 259, 260] (Section 7.1). In this chapter, I present two distinct ways to present this paradox as a proof of contextuality. The first one is due to Abramsky and Brandenburger’s topological study of contextuality [42, 43, 45], and highlights how the Hardy paradox can be compared to so-called “Liar cycles³” (Section 7.2). The second one is an original representation of the paradox, based the Acin-Fritz-Leverrier-Sainz (AFLS) hypergraphical approach [40] which clarifies how the Hardy paradox can be interpreted as a logical pre-post-selection paradox, and illustrates how these paradoxes can be used as proofs of contextuality, as shown by Leifer and Spekkens [93, 94] (Section 7.3). Finally, in Appendix D, I derive a new proof of contextuality from the paradox, based on an analogy with the Yu-Oh inequality [34].

7.1 The Hardy Paradox

In the Hardy paradox scenario [92, 101] two agents, Alice and Bob, share a two-qubit system in a specific entangled state. Each agent can choose to measure their respective qubit in a computational $\{|0\rangle, |1\rangle\}$ or a diagonal basis $\{|+\rangle, |-\rangle\}$ with $|\pm\rangle = \frac{1}{\sqrt{2}}(|0\rangle \pm |1\rangle)$. The initial entangled state can thus be written in four different bases, each corresponding to a measurement context. For example, in the computational-computational bases, the state is: $|\psi\rangle = \frac{1}{\sqrt{3}}(|00\rangle + |10\rangle + |11\rangle)$. Pragmatically, this state can be prepared in a bipartite EPR-Bohm bomb scenario [261, 101]. Two particles are each sent in a Mach-Zehnder-interferometer-like circuit, each belonging to Alice and Bob respectively. Each branch of each interferometer is labeled with a quantum state: if a particle takes the left branch, it is in state $|1\rangle$, if it takes the right branch, it is in state $|0\rangle$. The scenario is such that Alice’s right branch and Bob’s left branch crosses each other. Assume that the crossing corresponds to a “bomb”, such that the particles can never be observed in state $|01\rangle$ (for example, Alice and Bob could share antiparticles: if they meet each other, they annihilate each other, cf. Fig. 7.1). Then, the expression of the global state (before measurements) of the compound system in the distinct bases depends on Alice and Bob’s choice of measurements, i.e. their choice to put a beam splitter (measuring in the diagonal basis and actually implementing an interferometer) are not (measuring in the computational basis) at the end of their circuit (cf Fig. 7.1).

Assuming that a predefined value can be associated to a measured property when a result can be predicted with certainty, one can infer the four following sentences, each associated to a measurement context:

- (1) • In the diagonal-computational basis, the state before measurements is:

$$|\psi\rangle = \sqrt{\frac{2}{3}} | +0\rangle + \frac{1}{\sqrt{6}} | +1\rangle - \frac{1}{\sqrt{6}} | -1\rangle$$

²In fact, the Hardy paradox can be seen as an example of a recent theorem that shows that any multiqubit state “that can yield a statistical proof of the Kochen-Specker theorem with a finite set of unentangled projective measurements can violate a Bell inequality with local projective measurements.” [258].

³The relation between the Hardy paradox and the Liar paradox will be relevant in Chapter 8.

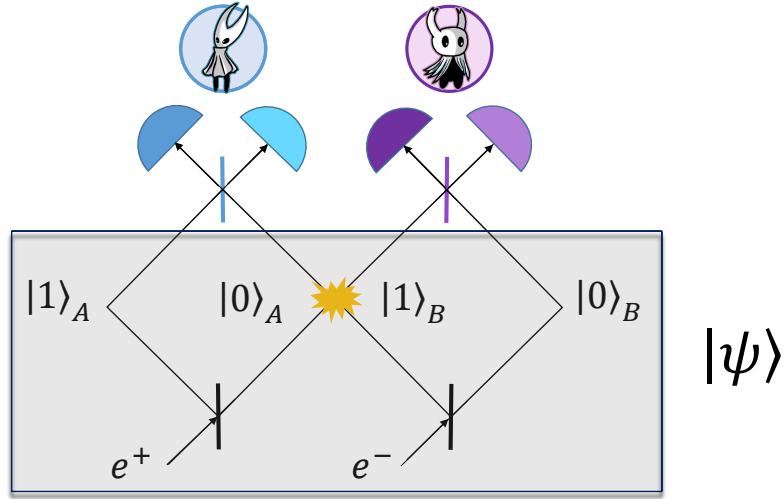

Figure 7.1: Example of an experimental set-up for the Hardy paradox. Alice and Bob share a pair of antiparticles, a positron and an electron respectively. Each particle goes through a Mach-Zehnder-like experiment. The left path of each interferometer is labeled $|1\rangle$; the right path is labeled $|0\rangle$. In order to obtain the initial state $|\psi\rangle = \frac{1}{\sqrt{3}}(|00\rangle + |10\rangle + |11\rangle)$, the right path of Alice’s set-up, denoted $|0\rangle_A$, crosses with the left path of Bob’s set-up $|1\rangle_B$, such that the particles annihilate each other if they are in the global state $|01\rangle$. The state of interest, $|\psi\rangle$, is the state of the global system exiting the preparation quantum box. Alice and Bob can then each choose to measure their respective subsystem in the the computational basis (no second beam-splitter) or the diagonal basis (add colored beam-splitter), thus corresponding to four distinct measurement contexts.

Sentence S1 : “If Alice obtains ‘-’, then Bob obtains ‘1’.”

(2) • In the computational-computational basis, the state before measurements is:

$$|\psi\rangle = \frac{1}{\sqrt{3}}(|00\rangle + |10\rangle + |11\rangle)$$

Sentence S2 : “If Bob obtains ‘1’, then Alice obtains ‘1’.”

(3) • In the computational-diagonal basis, the state before measurements is:

$$|\psi\rangle = \sqrt{\frac{2}{3}}|1+\rangle + \frac{1}{\sqrt{6}}|0+\rangle + \frac{1}{\sqrt{6}}|0-\rangle$$

Sentence S3 : “If Alice obtains ‘1’, then Bob obtains ‘+’.”

(4) • In the diagonal-diagonal basis, the state before measurements is:

$$|\psi\rangle = \frac{3}{\sqrt{12}} |++\rangle + \frac{1}{\sqrt{12}} |+-\rangle - \frac{1}{\sqrt{12}} |-+\rangle + \frac{1}{\sqrt{12}} |--\rangle$$

Sentence S4 : “Alice and Bob can both obtain ‘−’ with a probability 1/12.”

Assuming locality means that the outcome of a measurement on one qubit does not depend on the choice of measurement on the other qubit. In other terms, it implies here that one can build inferences from these different sentences. Note that on a logical level, this can also be interpreted as a non-contextuality assumption (each sentence being associated with a measurement context). For instance, from $(S1, S2, S3)$, one can construct the sentence: “If Alice obtains ‘−’, then Bob obtains ‘+’”. However, this sentence is incompatible with $S4$. Hence, the logical contradiction between the four sentences $(S1, S2, S3, S4)$ shows that one cannot associate predefined values to quantum observables assuming locality (“quantum nonlocality”), and that one cannot associate predefined values to quantum observables independently of the measurement context (“quantum contextuality”).

The interplay between contextuality and nonlocality is explicit in this scenario. Indeed, nonlocality seems to be easily understandable as a form of “remote contextuality”, a special case of contextuality where the measurement contexts can be locally separated. Note however that this is a particularity of the Hardy paradox. In fact, the relation between nonlocality and contextuality is less trivial for other proofs of nonlocality that are not based on a purely logical argument, like the violation of Bell inequalities [43, 41].

7.2 Logical Contextuality

7.2.1 Topological approach

In a topological approach of contextuality by Abramsky et al. [42, 43, 45] based on sheaf theory and cohomology, contextuality emerges when “a family of data is locally consistent but globally inconsistent”. As pointed out by Abramsky [262], “An immediate impression of how this situation might arise is given by impossible figures such as the Penrose tribar [263]. If we take each leg of the tribar, and the way each pair of adjacent legs are joined to each other, this gives a family of locally consistent data, where consistency here refers to realizability as a solid object in 3-space. However, the figure as a whole is inconsistent in this sense.” In fact, one can illustrate this definition of contextuality with famous undecidable figures such as the Penrose tribar, or the Penrose pentagone⁴ (Fig.7.2). In this construction, each pair of bars can be isolated and visualized without paradoxes. It is only when one tries to interpret the figure globally that a visual obstruction emerges.

Topologically, given a set X of variables labeling measurements (e.g. $X = \{A, A', B, B'\}$ in Fig.7.3), one can identify

- a base space of contexts, i.e. a family $\mathcal{M} = \{C_i\}_i$ of subsets of X which are comesurable (in Fig.7.3, $\mathcal{M} = \{\{A', B\}, \{A, B\}, \{A, B'\}, \{A', B'\}\}$);

⁴Warning: this is a figurative illustration which has a didactic purpose. However, note that a proof of contextuality, the violation of the KCBS inequality [264], shares a similar structure.

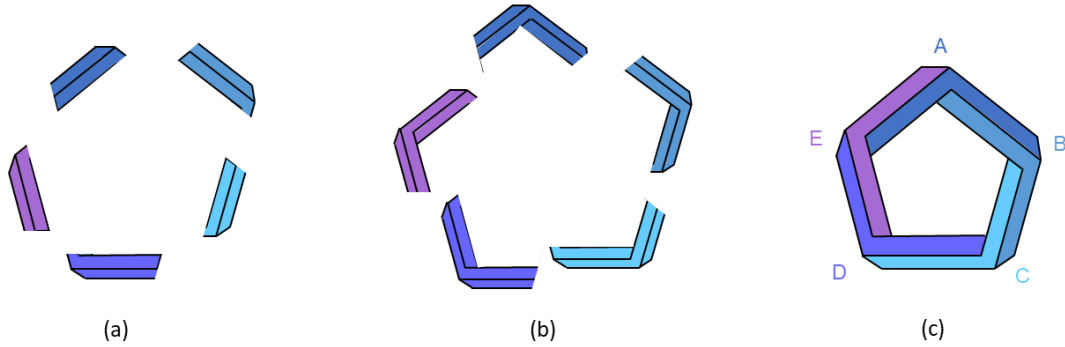

Figure 7.2: (a) Each corner of an individual bar represents an observable to which one assign a truth-value. (b) Each observable is compatible with two other ones separately, and thus two local contexts can be defined per observable. The truth values assigned to observables in a context are logically consistent. (c) Each corner from $\{A, B, C, D, E\}$ is mutually compatible with its two neighbours. However, the global picture of all bars glued together is an undecidable figure, the Penrose pentagon. One cannot define a global context in which no truth-value assignment leads to a contradiction.

- a space of data, fibred - with the same fibre O of outcomes - over the space of contexts ;
- a family of local sections, values assignment to variables in a context, in the fibres.

The set $\langle X, \mathcal{M}, O \rangle$ defines a measurement scenario. For such a scenario, one can associate an empirical model, a specific value assignment to the variables given the considered contexts. Such a model can be represented in a probability table - listing the probabilities to assign some values to variables in a context - and a possibility table - each entry with a positive probability (possible) is assigned the outcome 1, otherwise it is assigned the outcome 0 (impossible). The latter can then be used to construct a *contextuality bundle*.

Topological hierarchy of contextuality

Abramsky et al. distinguishes the following hierarchy of contextuality:

- *probabilistic contextuality*, only manifests itself at the probabilistic level, but cannot be certified from a possibility table (e.g. the nonlocal correlations of the CHSH model);
- *logical contextuality*, for which consistent global sections exist, but there is a local value assignment that cannot be extended globally (e.g. the Hardy paradox);
- *strong contextuality* can be certified when no global section defined on all the variables can reconcile all the local data (e.g. proofs of the Kochen-Specker theorem, the PR box model [135] which forms a discrete Möbius strip [262])

Let us make explicit how the Hardy paradox manifests contextuality in this framework. Consider four variables $X = \{A, A', B, B'\}$, corresponding to Alice and Bob measurements, e.g. A corresponds to Alice's measurement in the computational basis, A' to Alice's measurement in the diagonal basis, and similarly for Bob's. Four contexts can

be constructed from them, each associated with a sentence S_i : $\mathcal{M} = \{S_1, S_2, S_3, S_4\}$. In a given context, each variable can be assigned a value in $O = \{0, 1\}$. From the four decomposition of the global state $\{(1), (2), (3), (4)\}$, we obtain the possibility table of the Hardy paradox Tab.7.1.

$C \setminus O$	00	01	10	11
$S_1 : A'B$	1	1	0	1
$S_2 : AB$	1	0	1	1
$S_3 : AB'$	1	1	1	0
$S_4 : A'B'$	1	1	1	1

Table 7.1: Possibility table of the Hardy paradox. An entry 1 (resp. 0) means that the corresponding outcomes in O can (resp. cannot) be obtained in the associated context S_i .

To make the topological structure explicit, we construct a contextuality bundle Fig.7.3. Each variable is associated with a vertex of the support, and compatible variables are linked with each other, each edge corresponding to a specific measurement context/sentence. A fibre is drawn from each vertex, with the values (0 or 1) that can be assigned to it. When a joint outcome is possible (entry 1 in the possibility table) the two corresponding values of adjacent fibres are connected (local section). For example, for the possible result $AB \rightarrow 00$, the point “0” of the fibre from A and the point “0” of the fibre from B are connected. After transposing the possibility table into the bundle, one can look if any global assignment are possible, i.e. closed univocal (as a unique value is assigned to each variable) path traversing all the fibres exactly once. This is the case here, for example for the assignment: $\{A \rightarrow 0, B \rightarrow 0, A' \rightarrow 0, B' \rightarrow 0\}$. Thus the Hardy paradox is not strongly contextual. However, one can easily check that every path involving the local section $\{A' \rightarrow 1, B' \rightarrow 1\}$ cannot be closed and univocal. Thus the Hardy paradox is *logically contextual*.

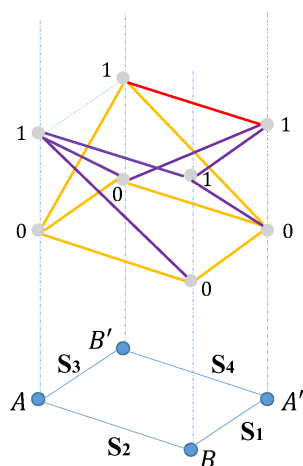

Figure 7.3: Contextuality Bundle of the Hardy paradox following [42, 43]. In orange and purple, sections that can lead to a closed univocal path. However, all paths involving the red edge cannot be closed. Hence, the Hardy paradox entails a logical contextuality.

Liar cycles in the Hardy paradox

Interestingly, as noticed in [45], there is a direct connection between contextuality and classical semantic paradoxes called “Liar cycles”, defined as sequences of statements of the form : $[\{S_1, S_2\} \text{ true} ; \dots ; \{S_{N-1}, S_N\} \text{ true} ; \{S_N, S_1\} \text{ false}]$ with S_i the i^{th} assertion, and $\{S_{i-1}, S_i\}$ and $\{S_i, S_{i+1}\}$ the two “local” contexts associated to this assertion. For the Hardy paradox, the following probabilistic (because the contradiction only occurs with a probability $1/12$) Liar cycles can be formulated, assuming that both Alice and Bob obtained ‘-’ (cf. Fig.7.4):

- (*Liar cycle 1*) either Bob obtains ‘-’ and Alice obtains ‘-’ \rightarrow Bob obtains ‘1’ \rightarrow Alice obtains ‘1’ \rightarrow Bob obtains ‘+’, contradicting the first assignment;
- (*Liar cycle 2*) or Alice obtains ‘-’ and Bob obtains ‘-’ \rightarrow Alice obtains ‘0’ \rightarrow Bob obtains ‘0’ \rightarrow Alice obtains ‘+’, contradicting the first assignment.

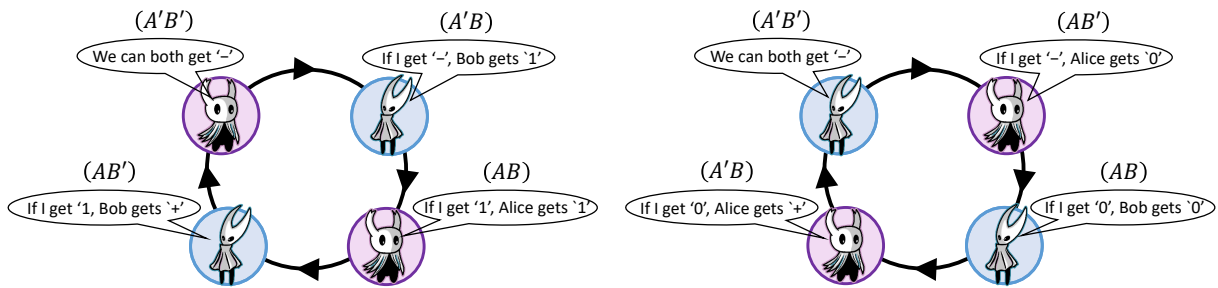

Figure 7.4: Liar cycles 1 (left) and 2 (right) of the Hardy paradox. Each sentence is associated with the measurement context from which it can be inferred.

Note that Liar cycle 1 corresponds to the logical contradiction between (S_1, S_2, S_3, S_4) presented above. Another incompatible set of four statements can be inferred from the four quantum propositions of the scenario, corresponding to Liar cycle 2 (cf. Fig. 7.4).

In [40], a Bell scenario is shown to be a specific product of contextuality scenarios in a hypergraph framework, involving the union of the edges of one-way signalling (i.e. fixed causal structure) hypergraphs. Let us present this result succinctly. I will then represent the possibilistic Hardy model and its logical contextuality in this hypergraph approach.

7.2.2 Hypergraph approach

This introduction is based on [40, 265].

A contextuality scenario is defined as a hypergraph $H = (V, E)$ whose vertices $v \in V$ correspond to the events of the scenario, i.e. the possible answers to the questions that can be asked to the system in a particular experimental setup. Each *event* represents an outcome obtained from a chosen operation given some classical input. Every hyperedge $e \in E$ is a collection of events representing all the possible outcomes given a specific measurement choice. Every measurement set is assumed to be complete, i.e. if the measurement corresponding to the hyperedge e is performed, then exactly one of the outcomes corresponding to $v \in e$ is always obtained. The notion of operational equivalence between

two outcomes is represented by the appearance of an event in more than one hyperedge.

A *probabilistic model* $p \in \mathcal{G}(H)$ (where $\mathcal{G}(H)$ denotes the set of probabilistic models on H) on a contextuality scenario is an assignment of a probability to each event, $p : V \rightarrow [0, 1]$. Because we consider complete measurements, every probabilistic model p over the contextuality scenario H satisfies the normalisation condition $\sum_{v \in e} p(v) = 1$ for every hyperedge $e \in E$. The hyperedges also define the notion of orthogonal events: v and w are orthogonal whenever there exists a hyperedge e that contains both. These can be interpreted as contradictory counterfactual possibilities.

On the one hand, we can define the notion of *classical model* $p \in \mathcal{C}(H)$, as an assignment of probabilities $p : V(H) \rightarrow [0, 1]$ such that $p(v) = \sum_{\lambda} q_{\lambda} p_{\lambda}(v)$, with $p_{\lambda} \in \mathcal{G}(H)$ and $q_{\lambda} \in [0, 1]$ satisfying $\sum_{\lambda} q_{\lambda} = 1$ and $p_{\lambda}(v) \in \{0, 1\} \forall v, \lambda$. A classical model is a convex mixture of deterministic models. On the other hand, a *quantum model* $p \in \mathcal{Q}(H)$ is defined as an assignment of probabilities $p : V(H) \rightarrow [0, 1]$ such that there exists a Hilbert space \mathcal{H} upon which live some positive semidefinite quantum state ρ and positive semidefinite projection operators P_v associated to every $v \in V$ such that $1 = \text{tr}(\rho)$, $p(v) = \text{tr}(\rho P_v) \forall v \in V(H)$, $\sum_{v \in e} P_v = \mathbb{1}_{\mathcal{H}} \forall e \in E(H)$.

Note that here only projective measurements are considered. Furthermore, note also that in this framework, the Kochen-Specker theorem can be interpreted as showing that there exist scenarios that admit quantum models but no classical models, i.e. $\mathcal{C}(H) \subsetneq \mathcal{Q}(H)$ for some scenario H . In the case of Bell scenarios, a global measurement can consistently be expressed as a product of local projectors, one for each party, such that the projectors for different parties commute and are properly normalised. For instance, in a bipartite Bell scenario $P_{ab|xy} = P_{a|x} P_{b|y}$ where $[P_{a|x}, P_{b|y}] = 0$ for all a, b, x, y and $\sum_a P_{a|x} = \sum_b P_{b|y} = \mathbb{1}_{\mathcal{H}}$.

Bell scenario as a contextuality scenario

The Bell scenario $\mathcal{B}_{n,k,m}$ consists of n parties having access to k local measurements each, each of which has m possible outcomes. At the single-party level, the outcomes form a contextuality scenario $\mathcal{B}_{1,k,m}$. $\mathcal{B}_{n,k,m}$ is obtained as the Foulis-Randall product of n $\mathcal{B}_{1,k,m}$ scenarios:

$$\mathcal{B}_{n,k,m} := \mathcal{B}_{1,k,m} \otimes \dots \otimes \mathcal{B}_{1,k,m}$$

For example, for the CHSH scenario, $\mathcal{B}_{2,2,2} = \mathcal{B}_{1,2,2} \otimes \mathcal{B}_{1,2,2}$, represented in Fig.11.1.

Foulis-Randall product

The Foulis-Randall product is the scenario $H_A \otimes H_B$ with

$$V(H_A \otimes H_B) = V(H_A) \times V(H_B) \text{ and } E(H_A \otimes H_B) = E_{A \rightarrow B} \cup E_{B \rightarrow A}$$

where

$$E_{A \rightarrow B} := \left\{ \bigcup_{a \in e_A} \{a\} \times f(a) : e_A \in E(H_A), f : e_A \rightarrow E(H_B) \right\}$$

$$E_{B \rightarrow A} := \left\{ \bigcup_{b \in e_B} f(b) \times \{b\} : e_B \in E(H_B), f : e_B \rightarrow E(H_A) \right\}$$

Following [40], $E_{A \rightarrow B}$ and $E_{B \rightarrow A}$ corresponds to “signalling hyperedges” from Alice to Bob and from Bob to Alice respectively, while elements that are common to both sets are of the form $e_A \times e_B$ and can be interpreted as simultaneous measurements (cf. Fig.7.5): “Intuitively, an element of $E_{A \rightarrow B}$ is the following: first, an edge $e_A \in E(H_A)$ representing a measurement conducted by Alice; second, a function $f : e_A \rightarrow E(H_B)$ which determines the subsequent measurement of Bob as a function of Alice’s outcome. This function f maps each vertex $a \in e_A$ to an edge $f(a) \in E(H_B)$. This defines a joint measurement in which we think of Alice measuring first and communicating her outcome to Bob, who then chooses his measurement as a function of Alice’s outcome. This is a feasible way to operate on the joint system and therefore should be considered as a measurement conductible on the joint system. Its outcomes are pairs (a, b) with $a \in e_A$ and $b \in f(a)$, so that the set of all these outcomes is $\bigcup_{a \in e_A} \{a\} \times f(a)$. [...] The resulting product contextuality scenario may be interpreted as describing a temporal succession of operating on H_B after having operated on H_A .” [40]

For example, in the CHSH scenario, consider Alice’s edge e_{A_0} associated with her measurement $x = 0$. This edge contains two vertices denoted $0|0$ and $1|0$, corresponding to the outcome $a = 0$ and $a = 1$ respectively. Consider the function $f : e_A \rightarrow E(H_B)$ such that $f(a) = a$. This function maps each Alice’s outcome $a \in e_{A_0}$ into Bob’s measurement choice, $y = f(a)$, and thus the edges $e_{B_{y=f(a)}}$. The resulting joint measurement is described by the edge containing the events $ab|0y = ab|0a$, i.e. the edge $e_{ab|0a} = \{00|00, 01|00, 10|01, 11|01\}$. This is a “signalling” hyperedge. It is an element of $E_{A \rightarrow B}$ ⁵. It corresponds to a situation in which Alice acts first and Bob’s choice of operation depends on her outcome. Thus Alice can signal to Bob and, importantly, Bob cannot signal to Alice.

In fact, it can be shown (cf. [40]) that all the probabilistic models on the Foulis-Randall product scenario $H_A \otimes H_B$ are precisely the non-signalling models on the direct product scenario $H_A \times H_B$, with non-signalling model being such that

$$\sum_{w \in e} p(v, w) = \sum_{w \in e'} p(v, w) \quad \forall v \in V(H_A), e, e' \in E(H_B) \quad (7.1)$$

⁵Note that in order to obtain the other elements of $E_{A \rightarrow B}$, one needs to consider all the edges of Alice (i.e. also e_{A_1}) and all the functions f of the outcomes (for each edge). Even though each e_A is of the form (x, a) as it is labeled by x and contains the outcomes a , the functions f are defined for all x and thus only depends on a .

$$\sum_{v \in e} p(v, w) = \sum_{v \in e'} p(v, w) \quad \forall w \in V(H_B), e, e' \in E(H_A) \quad (7.2)$$

These are the non-signalling conditions Eq.(2.26) and Eq.(2.27) that defines the notions of causal order $A \prec B$ and $B \prec A$.

As mentioned in [40], this also applies for the case of unidirectional nonsignalling, i.e. all the probabilistic models compatible with $A \prec B$ (resp. $B \prec A$) and thus satisfy Eq.(7.1) - Eq.(2.26) (resp. Eq.(7.2) - Eq.(2.27)) are the probabilistic models on the hypergraph with vertices $V(H_A) \times V(H_B)$ and the “signalling” hyperedges $E_{A \rightarrow B}$ (resp. $E_{B \rightarrow A}$). This equivalence is particularly interesting as it gives a graphical representation of our notion of causal order, that could be helpful in the future (cf. Perspectives 7.4).

Let us show the equivalence between a probabilistic distribution satisfying the nonsignalling condition associated with “ $A \prec B$ ” and a probabilistic model on the hypergraph “ $A \rightarrow B$ ”.

Let us first recall the definitions.

We denote $A \prec B$ the notion of causal order defined as a non-signalling condition from Bob to Alice, and we denote $p(a|x, y) = \sum_b p(a, b|x, y)$ for all x, y, a . We obtain

$$p(a|x, y) = p(a|x, y') = p(a|x) \quad \forall x, y, y', a \quad (7.3)$$

The notation $A \rightarrow B$ refers to the set of signalling hyperedges describing events in which Alice acts first and Bob’s choice of operation depends on her outcome ; Alice can signal to Bob, but not vice-versa. For a probabilistic model on this hyperedge, the normalisation condition gives

$$\sum_a p(a|x, f(a)) = \sum_{a,b} p(a, b|x, f(a)) = 1 \quad \forall x, f \quad (7.4)$$

For simplicity, we consider the CHSH scenario, i.e. we restrict our proof to a bipartite scenario with binary inputs and outputs. Thus, $f(a) = a$ or $f(a) = 1 - a$ or $f(a)$ is constant ($f(a) = 0$ or $f(a) = 1$).

- $A \prec B$ implies $A \rightarrow B$

Assuming $A \prec B$ (Eq.(7.3)), we have

$$\sum_a p(a|x, f(a)) = \sum_a p(a|x) = 1 \quad \forall x, f \quad (7.5)$$

i.e. $A \rightarrow B$.

- $A \rightarrow B$ implies $A \prec B$

From $A \rightarrow B$ (Eq.(7.4)),

– for $f(a) = 0$,

$$\forall x, \quad p(a = 0|x0) + p(a = 1|x0) = 1, \quad (7.6)$$

– for $f(a) = 1$,

$$\forall x, \quad p(a = 0|x1) + p(a = 1|x1) = 1, \quad (7.7)$$

– for $f(a) = a$,

$$\forall x, \quad p(a = 0|x0) + p(a = 1|x1) = 1. \quad (7.8)$$

From Eq.(7.6) and Eq.(7.8), we obtain

$$\forall x, \quad p(a = 1|x0) = p(a = 1|x1) = p(a = 1|x). \quad (7.9)$$

From Eq.(7.7) and Eq.(7.8), we obtain

$$\forall x, \quad p(a = 0|x0) = p(a = 0|x1) = p(a = 0|x). \quad (7.10)$$

The same result is obtained if $f(a) = 1 - a$. Hence $A \prec B$.

The signalling hyperedges $E_{A \rightarrow B}$ and $E_{B \rightarrow A}$ involved in the CHSH scenario are represented in Fig.7.5. Their Foulis-Randall product, corresponding to the hypergraph representation of this scenario, is given in Fig.11.1, These edges are the following:

- For simultaneous measurements, the f are constant, and the joint measurements (represented by blue hyperedges in Fig.7.5) are:

$$\begin{aligned} e_{ab|00} &= \{00|00, 01|00, 10|00, 11|00\} \\ e_{ab|01} &= \{00|01, 01|01, 10|01, 11|01\} \\ e_{ab|10} &= \{00|10, 01|10, 10|10, 11|10\} \\ e_{ab|11} &= \{00|11, 01|11, 10|11, 11|11\} \end{aligned}$$

- If $A \prec B$, the events are of the form $ab|xf(a)$, Consider the case where f is not a constant. Thus we have two possibilities (represented by red hyperedges in Fig.7.5): $f(a) = a$, giving the edges

$$\begin{aligned} e_{ab|0a} &= \{00|00, 01|00, 10|01, 11|01\} \\ e_{ab|1a} &= \{00|10, 01|10, 10|11, 11|11\} \end{aligned}$$

or $f(a) = 1 - a$, giving the edges

$$\begin{aligned} e_{ab|0(1-a)} &= \{00|01, 01|01, 10|00, 11|00\} \\ e_{ab|1(1-a)} &= \{00|11, 01|11, 10|10, 11|10\} \end{aligned}$$

- If $B \prec A$, then the events are of the form $ab|f(b)y$. Consider the case where f is not a constant. the measurements (represented by green hyperedges in Fig.7.5) are, with either $f(b) = b$ or $f(b) = 1 - b$:

$$\begin{aligned} e_{ab|b0} &= \{00|00, 01|10, 10|00, 11|10\} \\ e_{ab|b1} &= \{00|01, 01|11, 10|01, 11|11\} \\ e_{ab|(1-b)0} &= \{00|10, 01|00, 10|10, 11|00\} \\ e_{ab|(1-b)1} &= \{00|11, 01|01, 10|11, 11|01\} \end{aligned}$$

On the one hand, one can verify that all classical model on the CHSH scenario are local: they can be obtained from local boxes i.e. such that the normalisation condition $\sum_{v \in e} p(v) = 1$ is satisfied for every $e \in E$ in both H_A and H_B , hence such that $p(a, b|x, y) = p(a|x)p(b|y)$. On the other hand, the Bell and PR model, represented in Table 7.2 and 7.3, do not satisfy this constraint: they are non-local.

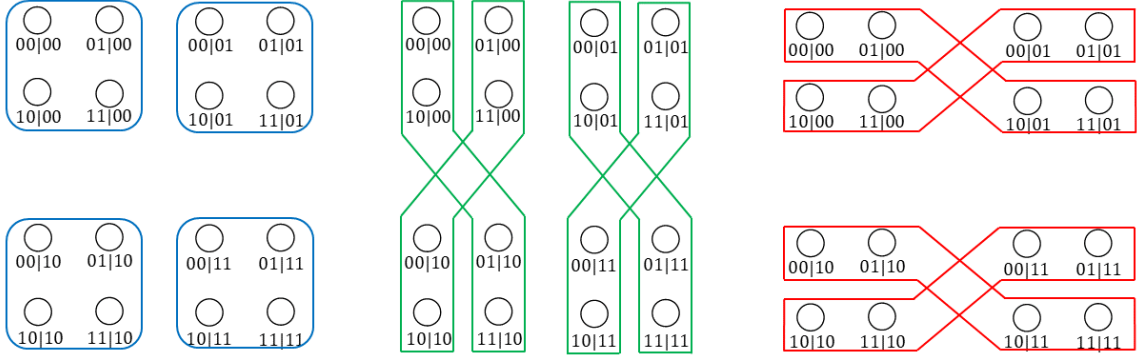

Figure 7.5: Hyperedges of $E_{A \rightarrow B}$ and $E_{B \rightarrow A}$. In blue, hyperedges corresponding to simultaneous measurements. In green, Alice’s measurement choice depends on Bob’s outcome. In red, Bob’s measurement choice depends on Alice’s outcome.

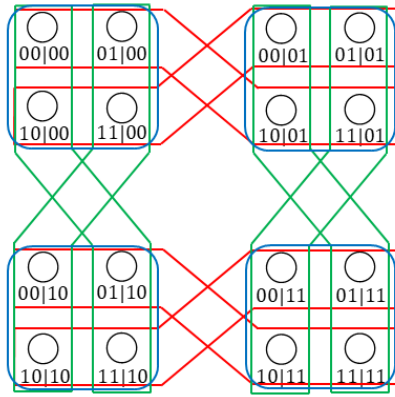

Figure 7.6: Hypergraph of the CHSH scenario as the Foulis-Randall product $\mathcal{B}_{1,2,2} \otimes \mathcal{B}_{1,2,2}$. In blue, hyperedges corresponding to simultaneous measurements. In green, Alice’s measurement choice depends on Bob’s outcome. In red, Bob’s measurement choice depends on Alice’s outcome.

$(x,y) \setminus (a,b)$	00	01	10	11
00	1/2	0	0	1/2
01	3/8	1/8	1/8	3/8
10	3/8	1/8	1/8	3/8
11	1/8	3/8	3/8	1/8

Table 7.2: Probability table of the Bell model [42]. Each entry corresponds to the probability $p(ab|xy)$ in a Bell model, i.e. a model which can be realised by Alice and Bob if they share a maximally entangled state and perform appropriate quantum measurements, allowing them to violate a (logical) Bell inequality [266, 262].

A representation of the Hardy paradox in a possibility hypergraph

Inspired by the AFLS hypergraphical approach [40] that focuses on probabilistic models, I propose a hypergraph representation of the logical (and strong) contextuality underlying the Hardy paradox based on the possibilistic models of [42, 43]⁶. I will call “possibility

⁶Note that a graphical analysis of logical contextuality was made in another graphical approach [39]. In [268], it is shown that a model is logically contextual if and only if a graphical invariant- the minimal

$(x,y)\backslash(a,b)$	00	01	10	11
00	1/2	0	0	1/2
01	1/2	0	0	1/2
10	1/2	0	0	1/2
11	0	1/2	1/2	0

Table 7.3: Probability table of the PR model [135] corresponds to the probability $p(ab|xy)$ in a Bell model, i.e. a model in which Alice and Bob are given PR boxes that allow them to maximally violate the CHSH inequality [267].

hypergraph” $H = (V, E)$ a contextuality scenario associated with a possibility table. Each vertex $v \in V$ corresponds to an entry 1 of the possibility table. They can be interpreted as “possible events”: the possible yielding of outcomes given a measurement context. This differs from the original hypergraph approach [40] in which all the events of a scenario are represented, independently of the considered empirical model. In other words, in [40], the contextuality hypergraph is model-independent, while here it is built from the possibility table of a specific empirical model. As a consequence, if an outcome is impossible in the edge of a (standard) contextuality hypergraph for the considered empirical model, i.e. if it has an entry 0 in the possibility table of the model, then this outcome will not be represented in the corresponding edge of the associated possibility hypergraph. In order to distinguish these two representations, I will denote the possible events referring to Table 7.1 as $(ab|S_i)$ (instead of $ab|xy$ in the standard contextuality hypergraph approach [40]).

Similarly with the AFLS framework, we consider the signalling hyperedges $E_{A \rightarrow B}$ and $E_{B \rightarrow A}$, and distinguish three types of edges, corresponding to:

- simultaneous measurements, or “context measurement” (blue edges), associated with events of the form $ab|S_i$, in which x and y are constant;
- “ $A \prec B$ measurements” associated with events of the form $ab|xf(a)$ with $f(a)$ that is not constant (red edges);
- “ $B \prec A$ measurements” associated with events of the form $ab|f(b)y$ with $f(b)$ that is not constant (green edges).

We consider a deterministic value assignment that associates a value 0 or 1 to each possible (those with entry 1 in the possibility table) event in the studied model. Associating value 1 with a vertex $(ab|S_i)$ means that if the measurements of context S_i are performed, the outcomes (a, b) will be obtained with certainty. This corresponds to “coloring” the vertex $(ab|S_i)$. Uncolored vertices then correspond to possible events that may have occurred (while those that are not represented are ignored, as they are considered to be “impossible” in the studied scenario). For example, assigning value 1 to the local section $\{A' \rightarrow 1, B' \rightarrow 1\}$ amounts to coloring the vertex $(11|A'B')$. In every hyperedge, exactly one of the outcomes corresponding to $v \in e$ is always obtained, and thus shall be colored. Indeed, when a joint measurement is performed, one and only one event should occur⁷. If no coloring is possible following this rule, then the corresponding model is *strongly contextual*. If no consistent coloring is possible given the coloring of a specific

independence number- is smaller than the number of contexts.

⁷...among only events with entry 1 in the possibility table, which justifies why we only represent them.

vertex, the model is *logically contextual*.

In the case of the Hardy paradox (Fig. 7.7), from the possibility Table 7.1, coloring the vertex $(11|A'B')$

- (*Liar cycle 1*) either imposes the coloring of $(11|A'B)$, which leads to the coloring of $(11|AB)$, that itself gives the coloring of $(10|AB')$, in contradiction with the initial coloring of $(11|A'B')$;
- (*Liar cycle 2*) or imposes the coloring of $(01|AB')$, which leads to the coloring of $(00|AB)$, that itself gives the coloring of $(00|A'B)$, in contradiction with the initial coloring of $(11|A'B')$.

This is a graphical representation of the Liar cycles presented above. No global consistent coloring is possible if $(11|A'B')$ is colored: the Hardy paradox is logically contextual⁸.

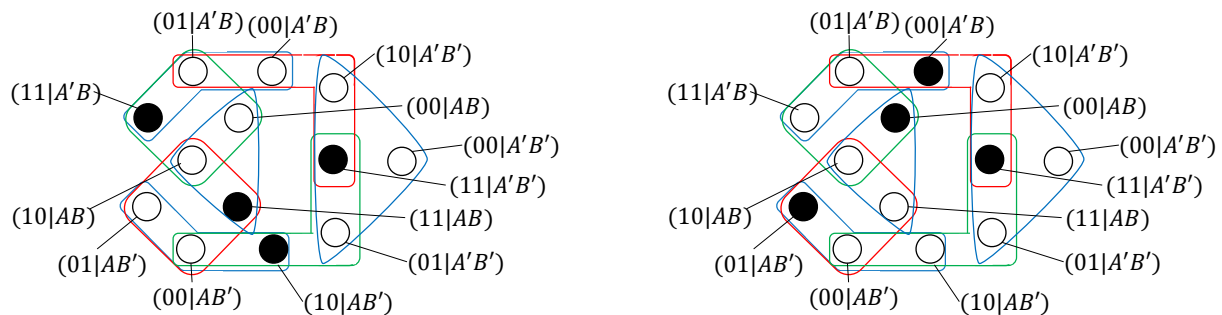

Figure 7.7: Possibility hypergraph of the Hardy paradox, with the coloring associated with the Liar cycles 1 (left) and 2 (right). In blue, the hyperedges corresponding to “context measurements”. In red, signalling hyperedges $e \in E_{A \rightarrow B}$ corresponding to the case where causal order $A \rightarrow B$ and Bob’s measurement choice depends on Alice’s outcome. In green, signalling hyperedges $e \in E_{B \rightarrow A}$ corresponding to the case where $B \rightarrow A$ and Alice’s measurement choice depends on Bob’s outcome. If the vertex $(11|A'B')$ is colored and following the rule that one vertex and only one shall be colored in every hyperedge, then no global consistent coloring is possible.

7.3 A Logical Pre-Post-Selection Paradox

Progress through paradox. Y. Aharonov

In [96], Aharonov *et al.* give a reformulation of the Hardy paradox [92, 101] as a *pre-post-selection (PPS) paradox*. These paradoxes (like the three-box paradox [269, 93], the quantum Cheshire cat [270], the quantum pigeonhole effect [271] or the mean king’s problem [272, 273]) emerge from the possibility of selecting both the initial state *and* the final state of a experimental procedure, which was developed by Aharonov, Bergmann and Lebowitz (ABL) in the *two-time state formalism* [274, 275]. The question of whether PPS paradoxes and other strange features of the pre-post-selection such as *anomalous*

⁸It is not strongly contextual. For example, coloring the vertices $(00|AB), (00|A'B), (00|AB'), (00|A'B')$ is not contradictory.

weak values are truly paradoxical and non-classical has been a matter of debate. Remarkably, Leifer and Spekkens [93, 94] have established a direct link between a specific set of PPS paradoxes - termed “logical pre-post-selection (LPPS) paradoxes”- and quantum contextuality. Later, Leifer and Pusey have shown that every LPPS paradox is a proof of Spekkens’s universal contextuality [95]. Finally, Pusey [89] has also shown that anomalous weak values are themselves proofs of Spekkens contextuality [95, 90]). Thus, using quantum contextuality as a witness of quantum weirdness, it was possible to establish that (at least some of) the PPS paradoxes are in fact logically paradoxical. In this section, I propose a graphical representation of the Hardy paradox as a LPPS paradox, illustrating the connection between these paradoxes and logical contextuality.

7.3.1 The two-time state formalism

Let us present succinctly the two-time state formalism (for more details, cf. e.g. [275]).

Assume that Alice prepares at a time t_0 a quantum system in the initial state $|\psi\rangle$, corresponding to the “pre-selection”. At an intermediate time t , she performs some projective measurement⁹ $\{P_a\}_a$. Finally, she performs a final measurement at time t_1 , and “post-selects” the final state $|\phi\rangle$. Note that this post-selection can be either experimental, i.e. the procedure is repeated multiple times and the results are discarded if the final state is not $|\phi\rangle$, or fundamental, i.e. Alice has already access to the statistics corresponding to the PPS at the intermediate times t because of some exotic phenomenon. The probability to obtain the outcome a , conditioned on the PPS is given by the “ABL rule”:

$$P(a|\psi, |\phi\rangle) = \frac{|\langle\phi|P_a|\psi\rangle|^2}{\sum_{a'}|\langle\phi|P_{a'}|\psi\rangle|^2} \quad (7.11)$$

7.3.2 Anomalous weak values

Without going into details, one can consider that instead of an intermediate projective measurement, Alice performs a *weak measurement*, i.e. a minimally disturbing quantum measurement that can be realised by coupling a quantum system to a one-dimensional continuous variable pointer device with momentum p via a von Neumann-type interaction $H = gP_a \otimes p$, with P_a the observable to be measured and g the coupling constant, such that for a duration of interaction t and the initial position uncertainty of the pointer Δx , $gt \ll \Delta x$. This way, a small amount of information is imprinted in the pointer at the cost of a small disturbance on the system.

In a PPS scenario, with an intermediate weak measurement, the position of the pointer has shifted by an amount $gtw(P_a|\psi, |\phi\rangle)$ at the first order in gt , with $w(P_a|\psi, |\phi\rangle)$ the “result” of the weak measurement, called the *weak value* of P_a , such that

$$w(P_a|\psi, |\phi\rangle) = \text{Re} \left(\frac{\langle\phi|P_a|\psi\rangle}{\langle\phi|\psi\rangle} \right) \quad (7.12)$$

Remarkably, a weak value¹⁰ can lie outside the eigenvalue range of P_a , and is then termed *anomalous weak value*.

⁹Note that a generalisation in which the intermediate measurement is a POVM exists [276].

¹⁰Note that here we only consider the real part of weak values. Nonetheless the Pusey theorem showing

7.3.3 The three-box paradox

In [94], Leifer and Spekkens show that the mathematical structure of some pre-post-selection (PPS) paradoxes is sufficient to construct a proof of contextuality. These PPS are called “logical PPS paradoxes”: they correspond to PPS paradoxes for which all the PPS probabilities are 0 or 1 and the pre- and post-selected states are non-orthogonal. For all logical PPS paradoxes, there is an associated proof of contextuality. “The key to the proof is that measurements that are treated as temporal successors in the PPS paradox are treated as counterfactual alternatives in the proof of contextuality.” [93] Instead of a pre-selection (t_0), an intermediate measurement (t_1) and a post-selection (t_2); one considers alternative possible measurements at a single time. As an example, it is shown that a proof of the Kochen-Specker theorem by Clifton [277] can be converted into a canonical logical PPS paradox named *the 3-box paradox* [269] and vice-versa.

In the 3-box paradox, the system is prepared (pre-selected) in the qutrit state $|\psi\rangle = |0\rangle + |1\rangle + |2\rangle$ and post-selected in the state $|\phi\rangle = -|0\rangle + |1\rangle + |2\rangle$. At an intermediate time, one of two possible measurements is performed. The first possibility is $M_1 = \{P_1, P_1^\perp\}$ with $P_1 = |1\rangle\langle 1|$ and $P_1^\perp = |0\rangle\langle 0| + |2\rangle\langle 2|$ which can be decomposed into a sum of projectors onto the vectors $|0\rangle + |2\rangle$ and $|0\rangle - |2\rangle$. The other possibility is $M_2 = \{P_2, P_2^\perp\}$ with $P_2 = |2\rangle\langle 2|$ and $P_2^\perp = |0\rangle\langle 0| + |1\rangle\langle 1|$ which can be decomposed into a sum of projectors onto the vectors $|0\rangle + |1\rangle$ and $|0\rangle - |1\rangle$. The paradox emerges from the fact that if one performs M_1 to see whether the system is in state $|1\rangle$, one finds that, from the ABL rule, it is with certainty; and if one performs M_2 to see whether the system is in state $|2\rangle$, one finds that it also is with certainty. Thus the “paradox”.

It can be easily seen that, by considering the PPS and the possible intermediate projective measurements counterfactually, one obtains Clifton’s proof of contextuality, represented in Fig.7.8. Moreover, as explained in [89], it can easily be checked that if the ABL probabilities $P(a|\psi, |\phi\rangle)$ are 0 or 1 as in a logical PPS paradox, then the weak value of P_a is equal to the ABL probability associated with P_a [278], i.e. $w(P_a|\psi, |\phi\rangle) = P(a|\psi, |\phi\rangle)$. This implies that there is always a projector with an anomalous weak value in the weak version of a LPPS paradox. In the considered three-box paradox, it corresponds to $w(P_3|\psi, |\phi\rangle) = -1$. This anomalous weak value can easily be identified from a hypergraphical depiction of the paradox (cf. Fig.7.8): in the measurement hyperedge containing the contradiction, i.e. in which more than one outcome is assigned value 1 / more than one vertex is colored, the remaining outcome(s) are assigned anomalous values such that the sum of assigned value in the measurement hyperedge is 1. One could thus interpret anomalous weak values as instances of contextuality¹¹, “compensating¹²” the logical contradiction. These LPPS paradoxes are thus directly connected with quantum contextuality¹³ in both strong and weak versions.

that anomalous (real) weak values are proof of Spekkens generalized contextuality [95] was extended to weak values with nonzero imaginary part [90].

¹¹To be rigorous, anomalous weak values are instances of Spekkens contextuality [89]

¹²Note however that weak values should be interpreted with caution. They should be considered as “small shifts in the distribution of the pointer position” [89], rather than probabilities.

¹³One may be tempted to directly infer that LLPS paradoxes are proofs of Kochen-Specker contextuality. However, as explained by Pusey and Leifer in [89], this is not possible, because the intermediate measurements may eventually disturb the quantum state, and thus change the probability of success of the post-selection. Nevertheless, they have established a direct link between LPPS paradoxes and Spekkens’s generalised contextuality which include preparation and POVMs, and allows to study the

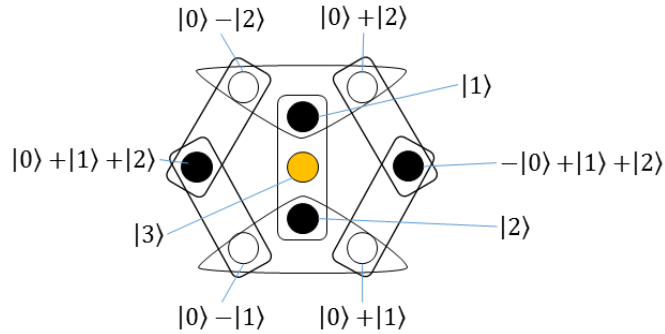

Figure 7.8: Hypergraph of Clifton’s probabilistic proof of the Kochen-Specker theorem. This depiction does not follow the AFLS hypergraph approach, but is a simple depiction of the proof. The vertices correspond to the vectors of the projectors involved in the proof, and the hyperedges correspond to orthogonality relations. The KS coloring rules imply that two orthogonal vertices cannot both be assigned value 1 (color black), and that inside a triangle (complete measurement with three outcomes), one and only one vertex is assigned value 1. One can see that if the vertices $|0\rangle + |1\rangle + |2\rangle$ and $-|0\rangle + |1\rangle + |2\rangle$ are given value 1, then the orthogonal vertices $|1\rangle$ and $|2\rangle$ are also given value 1, leading to a logical contradiction. Moreover if we consider weak intermediate measurements, one can associate the weak value -1 to $|3\rangle$, “solving” the logical contradiction.

7.3.4 The LPPS Hardy paradox

As mentioned above, the Hardy paradox was reformulated as a PPS paradox. For example, this can be done with the preselection¹⁴ $|\psi\rangle = \frac{1}{\sqrt{3}}(|00\rangle + |10\rangle + |11\rangle)$ and the post-selection $|--\rangle$. At an intermediate time, one of two possible measurements is performed. The first one asks “Is the system in state $|00\rangle$?”, i.e. $M_{00} = \{P_{00}, P_{00}^\perp\}$ with $P_{00} = |00\rangle\langle 00|$ and $P_{00}^\perp = |10\rangle\langle 10| + |11\rangle\langle 11| + |01\rangle\langle 01|$ which can be decomposed into a sum of projectors onto the vectors $|10\rangle + |11\rangle = |1+\rangle$, $|10\rangle - |11\rangle = |1-\rangle$ and $|01\rangle$. The second one asks “Is the system in state $|11\rangle$?”, i.e. $M_{11} = \{P_{11}, P_{11}^\perp\}$ with $P_{11} = |11\rangle\langle 11|$ and $P_{11}^\perp = |00\rangle\langle 00| + |10\rangle\langle 10| + |01\rangle\langle 01|$ which can be decomposed into a sum of projectors onto the vectors $|00\rangle + |10\rangle = |+0\rangle$, $|00\rangle - |10\rangle = |-0\rangle$ and $|01\rangle$. Like in the three-box paradox, from the ABL rule, one obtains positive answers with certainty for both measurements. Thus, the PPS paradox.

First, we can note that because the pre- and post-selection states are not orthogonal $\langle\phi|\psi\rangle \neq 0$, and because the considered probabilities are 0 or 1, the PPS Hardy paradox is a logical PPS paradox. Hence, like the three-box paradox and Clifton’s probabilistic proof of the Kochen-Specker theorem, there exists a proof of contextuality associated with the LPPS Hardy paradox¹⁵.

amount of disturbance of the intermediate measurements.

¹⁴In the original paper [96], the preselection was $|\psi\rangle = \frac{1}{\sqrt{3}}(|01\rangle + |10\rangle + |11\rangle)$.

¹⁵In [32], Cabello et al. present a similar Hardy-like probabilistic proof of the Kochen-Specker theorem (with $|\psi\rangle = \frac{1}{\sqrt{3}}(|00\rangle - |01\rangle - |10\rangle)$ and $|\phi\rangle = |++\rangle$). In [279], it is shown that the Clifton-three-box proof and the “Hardy paradox” (in fact its pre-post-selection version) share a similar “pentagram” logical structure. However, in my knowledge, neither the relation with Aharonov’s revisited Hardy paradox with PPS [96] nor the fact that it is a logical PPS paradox using Spekkens and Leifer’s result [93] were emphasized. Furthermore, a “simple Hardy’s like proof of the quantum contextuality” is given in [280]. This proof is actually a 3-box paradox. The authors also show that the set of projectors used in the proof

Similarly with the depiction of the three-box paradox Fig.7.8, we can construct a hypergraph of the LPPS Hardy paradox that does not follow the AFLS approach nor the possibility hypergraph, but in which each vertex corresponds to a projector (represented as vectors in the figures) involved in the scenario, and each hyperedge translates their orthogonality relations (Fig.7.9 (left)). We can distinguish the preselection and postselection hyperedges (in black), and the intermediate measurements

$$\begin{aligned} M_{00} &= \{|00\rangle, |1+\rangle, |1-\rangle, |01\rangle\} \\ M_{11} &= \{|11\rangle, |+0\rangle, |-0\rangle, |01\rangle\} \end{aligned}$$

as well as the edge

$$\{|00\rangle, |01\rangle, |10\rangle, |11\rangle\}$$

In Fig.7.9 (left), coloring (i.e. associating value 1 to) the vertices that correspond to the preselection $|\psi\rangle$ and the postselection $|--\rangle$ leads to coloring the projectors onto $|00\rangle$ and $|11\rangle$. Thus in the LPPS Hardy paradox, if M_{00} is performed, the answer is always “ $|00\rangle$ ”; if M_{11} is performed, the answer is always “ $|11\rangle$ ”. If the measurements are treated as “counterfactual alternatives”, we obtain a proof of the Kochen-Specker theorem: a logical contradiction occurs if we ask what event occurs in the computational-computational basis, because both “ $|00\rangle$ ” and “ $|11\rangle$ ” would happen with certainty. In the LPPS paradox, if the intermediate measurements are weak, this contradiction manifests itself in the anomalous weak value -1 associated with $|10\rangle$.

Note that all the vectors involved in the LPPS Hardy paradox - apart from the pre-selected state $|\psi\rangle$ - are factorisable. This way, one can associate a “quantum event” to each vertex, i.e. the yielding of outcomes $a, b \in \{0, 1\}$ from Alice and Bob joint quantum measurements, where A and B correspond to measurements in the computational basis $\{|0\rangle, |1\rangle\}$ and A' and B' correspond to measurements in the diagonal basis $\{|+\rangle, |-\rangle\}$. For example, the projector onto $|1+\rangle$ corresponds to the quantum event $(10|AB')$.

Interestingly, the two hyperedges representing the intermediate measurements are signalling hyperedges. On the one hand, M_{00} can be interpreted as an intermediate measurement in which $A \prec B$ and Bob’s measurement choice depends on Alice’s outcome (who performed a measurement A in the computational basis, $x = 0$), $y = a$ (red edge in Fig.7.9), i.e. $M_{00} = e_{ab|0a}$. On the other hand, M_{11} can be interpreted as an intermediate measurement in which $B \prec A$ and Alice’s measurement choice depends on Bob’s outcome (who performed a measurement B in the computational basis, $y = 0$), $x = 1 - b$ (green edge in Fig.7.9), i.e. $M_{11} = e_{ab|(1-b)0}$. Furthermore, the logical contradiction occurs in a “context hyperedge”, and correspond to the simultaneous measurement in which both Alice and Bob measure in the computational basis, $e_{ab|00}$. If we consider weak intermediate measurements M_{00} and M_{11} , one can compensate the logical contradiction by associating a weak value to the quantum event $(10|AB)$.

To sum up: given the preselection $|\psi\rangle$ and the postselection $|--\rangle$, the two intermediate questions of the LPPS paradox causally differs from each other.

allows to violate (but not maximally) the a famous contextuality inequality [34]. A variant of the proof with an extra-projector orthogonal with the pre and post-selected ones is given in [281].

On the one hand, asking “Is the system in state $|00\rangle$?” amounts to Alice asking “Is my part of the system in state $|0\rangle$ or $|1\rangle$?”, to which she always obtains the answer “ $|0\rangle$ ”. She informs Bob about her outcome. If she obtains $|0\rangle$ (resp. $|1\rangle$), he performs a measurement in the computational (resp. diagonal) basis. Thus, he asks “Is my part of the system in state $|0\rangle$ or $|1\rangle$?”, to which he always obtains the the answer “ $|0\rangle$ ”.

On the other hand, asking “Is the system in state $|11\rangle$?” amounts to Bob asking “Is my part of the system in state $|0\rangle$ or $|1\rangle$?”, to which he always obtains the answer “ $|1\rangle$ ”. He informs Alice about his outcome. If he obtains $|1\rangle$ (resp. $|0\rangle$), she performs a measurement in the computational (resp. diagonal) basis. Thus, she asks “Is my part of the system in state $|0\rangle$ or $|1\rangle$?”, to which she always obtains the the answer “ $|1\rangle$ ”.

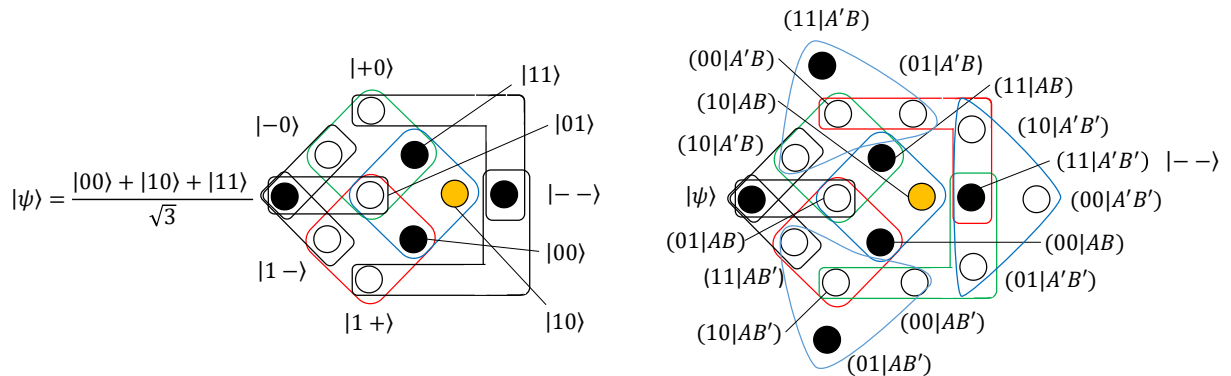

Figure 7.9: (Left) Hypergraph of the proof of the Kochen-Specker theorem associated with the LPPS Hardy paradox. Black hyperedges correspond to the orthogonal relations due to the pre- and post-selections. In red, signalling hyperedges $e \in E_{A \prec B}$; in green signalling hyperedges $e \in E_{B \prec A}$; in blue, context hyperedge. Only the vertices involved in the LPPS paradox are depicted. Assigning value 1 to a projector is represented by coloring a vertex in black. The yellow vertex corresponds to the anomalous weak value -1 from the LPPS version. (Right) New hypergraph of the Hardy paradox. All the vertices involved in the LPPS and the standard Hardy paradoxes are depicted. If the PPS $|\psi\rangle$ and $|\phi\rangle = (11|A'B')$ are assigned value 1, the events $(11|AB)$, $(00|AB)$ (as well as $(11|A'B)$ and $(01|AB')$) are assigned value 1, leading to a logical contradiction in the measurement context $\{A, B\}$. If we consider weak intermediate measurements in the LPPS version, one can associate the anomalous weak value -1 to $(10|AB)$, “solving” the logical contradiction that emerge from the two incomplete Liar cycles of the standard Hardy paradox.

This analysis offers a new insight on the relation between the anomalous weak value of the LPPS Hardy paradox and the logical contextuality of the Hardy paradox. Let us complete the hypergraph of the LPPS Hardy paradox Fig.7.9 (left) with the events of the Hardy paradox (Fig.7.7) that are not represented. We obtain a new hypergraph¹⁶ for the Hardy paradox (Fig.7.9 (right)) that illustrates how the anomalous weak values of the LPPS version is related to the two Liar cycles in the standard version.

¹⁶Note that this depiction still differs from the more general AFLS representation as the introduction of the quantum preselection and postselection vertices reduces the study of the contextuality scenario to quantum models (and thus quantum events). It also differs from the possibility hypergraph of Fig.7.7 as it represents impossible vertices that are not needed to demonstrate the logical contextuality of the Hardy model but are useful to understand the LPPS version of the paradox.

In Fig.7.9 (right), given that the system is prepared in the initial state $|\psi\rangle$, and post-selected in the final state $|--\rangle$,

- Assume that Alice and Bob both perform a joint simultaneous measurement in the diagonal basis and both obtain the state $|-\rangle$, i.e. the quantum event $(11|A',B')$ happens with certainty. In the context hyperedge $e_{ab|11}$ (corresponding to $S_4 = \{A',B'\}$, the corresponding vertex is colored.
- If instead of simultaneous measurements in $\{A',B'\}$, Alice would have signalled to Bob, $A \prec B$, and sent him her result, and if Bob had performed a computational basis, then he would have obtain the state $|1\rangle$. In fact, from the red hyperedge containing $(11|A'B')$, the events $(00|A'B)$ and $(01|A'B)$ cannot occur (if Alice has obtained $|-\rangle$, she cannot have obtained $|+\rangle$). From the preselection state, the event $(10|A'B)$ cannot occur either. Thus, if the joint simultaneous measurement $\{A',B\}$ would have been performed instead, the quantum event $(11|A'B)$ would have occurred. In the Liar cycle 1, this would correspond to “Alice obtains ‘-’ \rightarrow Bob obtains ‘1.’” The green signalling $B \prec A$ hyperedge associated with the intermediate measurement M_{11} in the PPS version leads to conclude that given that $(11|A'B)$ would have occurred, if instead of measuring A' Alice would have measured A , she would have obtained the state $|1\rangle$ and thus the quantum event $(11|AB)$ would have occurred, i.e. in Liar cycle 1, “Bob obtains ‘1.’ \rightarrow Alice obtains ‘1.’”
- Similarly, if instead of simultaneous measurements in $\{A',B'\}$, Bob would have signalled to Alice, $B \prec A$, following the same reasoning with the corresponding signalling hyperedges, one can conclude that the quantum event $(01|AB')$ - “Bob obtains ‘-.’” \rightarrow Alice obtains ‘0.’” would have occurred. And assuming that the latter would have occurred, and that Alice would have signalled to Bob, then, following Liar cycle 2, the event $(00|AB)$ - “Alice obtains ‘0.’” \rightarrow Bob obtains ‘0.’” - would have occurred. Thus (counterfactually), both events $(11|AB)$ and $(00|AB)$ are assigned a predefined value 1. Because these events are incompatible with each other, this is a logical contradiction, and thus a proof of contextuality. Here, instead of the full Liar cycles 1 and 2, the logical contradiction is derived from a combination of both, without “closing” them (i.e. without inferring that “Alice obtains ‘1’ \rightarrow Bob obtains ‘+.’” in Liar cycle 1 and that “Bob obtains ‘0’ \rightarrow Alice obtains ‘+.’” in Liar cycle 2).
- If instead of counterfactual alternatives, one consider temporal successive measurements, one obtains the LPPS version of the paradox. Assume that Alice and Bob prepare the system in the initial state $|\psi\rangle$, post-select the final state $|--\rangle$, and performs one of the two intermediate weak joint measurements M_{00} or M_{11} . We have shown previously that the events $(11|AB)$ and $(00|AB)$ occur with certainty depending on the causal order in which the Alice and Bob’s intermediate operations are implemented. This gives a new insight on the emergence of the anomalous weak value, that comes from the combination of two “opened” Liar cycles, without closing the arguments, i.e. without counterfactually inferring that “Bob obtains ‘0’ \rightarrow Alice obtains ‘+’ ” and “Alice obtains ‘1’ \rightarrow Bob obtains ‘+’ ”.

7.4 Take Away and Perspectives

Take Away

- The Hardy paradox entails a form of logical contextuality that can be depicted in a contextuality bundle or a (hyper)graph.
- There is a logical pre-post-selection version of the paradox, in which the state $|\psi\rangle = \frac{1}{\sqrt{3}}(|00\rangle + |10\rangle + |11\rangle)$ is preselected and the state $|--\rangle$ is postselected. The intermediate questions M_{00} =“Is the system in state $|00\rangle$?” and M_{11} =“Is it in state $|11\rangle$?” are always answered “yes” with certainty. However, using a hypergraph representation, we have shown that these questions corresponds to distinct signalling measurements, $A \prec B$ and $B \prec A$ respectively. If the intermediate measurements are weak, an anomalous weak value - which is a proof of (generalised) contextuality - emerges.
- Three derivations of the logical contradiction underlying the logical contextuality of the Hardy paradox can be identified. Two arguments are based on Liar cycles, and one is a combination of both. The latter is directly related with the emergence of the anomalous weak value in the (weak) LPPS version of the paradox.

Perspectives

- Clarify the apparent relation between (partial) Liar cycles and the emergence of anomalous weak values (in a LPPS paradox).
- Is the causal distinction between M_{00} and M_{11} a mere coincidence attached with the Hardy scenario, or is there a deeper meaning ?
- The Yu-Oh inequality [34] is a state-independent proof of contextuality based on a combination of three-box paradoxes. By analogy, I propose to construct a new proof of the Kochen-Specker theorem by combining Hardy paradoxes (cf. Appendix D).

Chapter 8

Meta-Contextuality: a neo-Copenhagen approach to quantum theory

This chapter is based on my essay “A Gödelian Hunch from Quantum Theory” [100] which won the third prize in the FQXi 2021 Essay Contest, and on an introductory lecture on “Anti-realist interpretations of quantum theory” that I gave to undergraduate students in philosophy.

8.1 Introduction: Is Physics Paradoxical ?

Le silence éternel ~~de ces espaces infinis~~ des espaces de Hilbert m’effraie¹.

almost B. Pascal

We have seen how the vague adage “The result of a quantum measurement depends on the experimental context.”, despite being often associated with “the Copenhagen interpretation”, finds strong mathematical grounds from the Kochen-Specker theorem independently of Niels Bohr philosophical concept of complementarity. However, like Bell’s theorem, this result does not impose any positive inference on the nature of quantum theory or the world it is supposed to model: it is a *no-go theorem*, imposing constraints on the ontology that one may wish to associate with the formalism. Thus, depending on one’s interpretation of quantum theory, and more specifically on how this interpretation deals with the concept of measurement, distinct conclusions can be drawn. In Bohmian mechanics, the theorem implies that hidden variables are contextual [282], embracing the paradox ontologically. In the many-worlds interpretations, the logical contradiction seems to be avoided by arguably giving up on the principle of non-contradiction: a measurement does not yield a single outcome. However some interpretations of quantum theory - the so-called “anti-realist” interpretations - do not give an explicit ontology of the formalism, and even seem quite relentless to avoid giving one. I argue that this family of interpretations, all characterized by a fundamental distinction between “observer” and “observed” objects, most efficiently, i.e. without resorting to additional ontological baggage, draw the main lesson of the Kochen-Specker theorem, that quantum propositions cannot be extended in such way to be described by Boolean logic. In fact, mirroring Gonsseth and Specker’s interrogation: “Is logic empirical?”, one of my main obsessions is the question:

¹The eternal silence of ~~these infinite spaces~~ Hilbert spaces terrifies me.

“*Is physics paradoxical ?*”

A first way to interpret it is to rephrase it as: “*Is the quest for understanding (and taking control of) Nature absurd ?*”. If we put aside the pragmatical repercussions and focus on the pursuit of knowledge, I am tempted to answer that “yes, this quest is absurd.”

Physics is arguably about giving the most accurate representation of the world we live in. It is generally expected to offer us a λόγος, a reasoned and rational speech, about the world, *independently of our story-teller’s point of view*. However, the quantum formalism has remained, for nearly a century, desperately silent. While representations and images evolve with theories, the advent of quantum physics has profoundly changed the way we “talk” about the world. Classical language no longer manages to contain concepts that escape its logic. The expression “wave-particle duality”, still used in most introductory quantum mechanics courses, has always been obsolete: a quantum particle is neither a wave nor a particle, and certainly not “both at a time” (it might be in a very special way, like in Bohmian mechanics). Faced with these two contradictory representations, several solutions are available to us, “storytellers”: develop a new language adapted to quantum phenomena, i.e. redraft our logic and/or update our vocabulary based on empirical facts; invoke exotic ontological representations ; or revise our concept of knowledge and acknowledge our position of “story-tellers”, striving for an *epistemological modesty* [99].

I do not mean that looking for an ontology is vain nor unfruitful. This would be presumptuous and stupid, since two of the most important features of quantum theory, non-locality and contextuality, were discovered following this path. My position is not pessimistic, nor cynical. I love hearing and telling stories. But physicists should sometimes not forget their position, and avoid being blinded by their romantic Faustian dream. The world can only be apprehended with images, and these have a limit. Thus, “absurd” can be understood following Camus’s essay “Le Mythe de Sisyphe”, as being “born of this confrontation between the human need and the unreasonable silence of the world.” (L’absurde naît de cette confrontation entre l’appel humain et le silence déraisonnable du monde.)” “You explain this world to me with a picture. I recognize then that you have come to poetry: I will never know. (Vous m’expliquez ce monde avec une image. Je reconnais alors que vous en êtes venus à la poésie: je ne connaîtrai jamais.)”

The silence of the world facing Camus seems to echo the silence of the equations of quantum mechanics. Whether they are metaphors for educational purposes, or a philosophical interpretation, an image remains an image and while it allows, most of the time, reality to be told, it does not allow it to be apprehended. The awareness of such a “treachery of images”, recalls the pictorial works of Magritte on the limits of our representations. Anti-realist interpretations do not offer an ontology about the world, or at least a particularly scarce one. They do not offer a tale about the world, which is not their direct subject of interest. Rather they aim at aspiring to understand what is quantum theory. In the end, is it not what the field of quantum foundations is working towards ?

Some indignant reactions have blamed this paradigm change of being a “betrayal of the ideal of science” [283] ; that it spells “the end of physics as a science” (as Einstein might have said to Bohr [284]), reducing it to the cold maxim “Shut up and calculate”. In fact, Einstein believed that Heisenberg’s approach of only describing observable quantities

was in fact “absurd”².

The (neo-)Copenhagen interpretations are thus sometimes perceived as the end of a form of scientific ideal with romantic overtones, depriving the researcher of the illusion of being able to extract himself from Nature and aim for a form of transcendent omniscience; confronting him with his latent Icarus complex that made him believe he could fly over and out of the world. They would have brought him down to Earth, in a cold and essentially calculative pragmatism. However, one only has to read the actors of the (neo-) Copenhagen camp to see that their objective is not simply operational, and that their philosophy is not without horizon.

In chapter 17 of *Physics and Beyond* [54], Heisenberg reports a discussion he had with Bohr and Pauli about *positivism*. As a reminder, positivists stipulated that only statements verifiable by direct observation or by logical proof made sense. They refused any form of metaphysics, and sought to re-establish the bases of philosophy on logic and science. According to Heisenberg, they would say that “to understand means to be able to calculate in advance.” Bohr is first of all puzzled that after explaining his interpretation of quantum theory to the positivists, they were in no way surprised. Indeed, he expected that the sacrifice of a realistic and objective description of the world would “horrify” anyone in the first place:

“I tried to explain to these (positivist) philosophers the interpretation of quantum theory. After my presentation, there were no objections or difficult questions; but I must admit that this is precisely what shocked me the most. *Because if, at first glance, you are not horrified by quantum theory, you certainly did not understand it.* Probably my presentation was so bad that no one understood what it was about. (p.352) [...] I obviously agree with the requirement that all concepts be defined with extreme precision. But I cannot accept the interdiction on thinking about general questions, an interdiction made on the pretext that there are no such precise concepts there; if one complied with such a interdiction, one would indeed not be able to understand quantum theory. (p.356)”

Thus, Bohr does not deny the existence of a metaphysical reality. He does not deny all form of objectification either, nor the possibility of being interested in “the major correlations”. Neo-Copenhagen interpretations are not limited to “Shut up and calculate”. Nevertheless, one cannot speak of these “great correlations” without precautions either. The investigation of our experience of the world is not free: it is preconditioned by an epistemic constraint, the cut between the observer and the observed, the story-teller and story-objects.

There are other ways to interpret our driven question. If “paradox” is to be taken in its etymological meaning, i.e. παρά-δόξα, “what goes against the common opinion”, then it can be rephrased as: “Do physical theories go against our common sense?”. One could easily argue that physics, and even science in general, is indeed paradoxical in this sense. Scientific research is driven by such “paradoxes”, puzzling phenomena and observations that we wish to apprehend. Sometimes, the theories and model building from these re-

²Despite the fact that Einstein himself applied such philosophy when he developed special relativity, by stipulating that one cannot speak about an absolute time because one cannot measure such absolute time.

main profoundly counter-intuitive, going beyond the scope of what can be intuited from our immediate empirical experience. A physicist is led to “think against their own brain” [285]. For example, Galileo conceptualized an ideal motion (the inertial motion) far from our immediate experience in order to understand the motions that we observe in our everyday life.

This is also the case for quantum theory. But quantum weirdness does not only go against our common opinion. As shown by Kochen and Specker, it also seems to go against our own logic. Thus we could also narrow down the meaning of “paradox” to the logical ones, e.g. self-contradictory statements such as the Liar paradox, and ask: “Is physics, and even more Nature itself, logically paradoxical?”. Does the world really feature intrinsically strange phenomena that cannot be captured with our words, whether it is a non-local behaviour or parallel worlds? In [97], Szangolies points out that “an intriguing connection between fundamental features of quantum mechanics and the phenomena of self-reference” might be established. He coined the expression “Gödelian hunch” to describe “the idea that the origin of the peculiarities surrounding quantum theory lie in phenomena related, or at least similar, to that of incompleteness in formal systems.” Wheeler might have been one of the first to investigate this idea³:

“Physics is not machinery. Logic is not oil occasionally applied to that machinery. Instead, everything, physics included, derives from two parents, and is nothing but cathode-tube image of the interplay between them. One is the “participant”. The other is the complex of undecidable propositions of mathematical logic.” [66]

In my essay [100], I argue for such a quantum Gödelian hunch. I defend the idea that quantum paradoxes are not physical, but emerge from *a lack of metaphysical distancing*: on the one hand the Liar-like structure of quantum propositions enlightened by the Kochen-Specker theorem already invites to give up on considering quantum objects as entities with intrinsic properties independently of the questions asked by a meta-theoretical object, i.e. an object that is not described by quantum theory but belongs to a higher order level of abstraction, an “observer”. On the other hand, I propose the notion of “meta-contextuality” to explain how neo-Copenhagen interpretations avoid the measurement problem [60, 70] and Wigner’s friend-based paradoxes [47, 46] by analyzing them as logical errors. Meta-contextuality consists in acknowledging the need for an undiscriminating cut between meta-theoretical and theoretical objects when one uses quantum theory. Any question that ignores this transcendental distinction loses its operational significance and becomes physically undecidable. Thus, quantum paradoxes might just be instances of a fundamental undecidability, contributing to a quantum Gödelian hunch⁴.

In what follows, I will present the main arguments presented in my essay, answering the question: *What if the paradoxical nature of quantum theory could find its source in some undecidability analogous to the one emerging from the Liar?* I will first justify the use of the prefix “meta-” and recontextualize the expression “Gödelian Hunch” by introducing

³A famous anecdote tells that Wheeler was thrown out of Gödel’s office for asking him if there was a connection between his incompleteness theorem and Heisenberg’s uncertainty principle. [97]

⁴A very recent result [286] also contributes to the quantum Gödelian hunch. Using a modified proof of quantum contextuality, the authors proved that the class MIP* of problems that can be decided by a polynomial-time referee interacting with quantum agents sharing entanglement contains Liar-like undecidable problems.

succinctly and without going into details the Liar paradox and the lessons of Gödel's theorems, reinterpreting quantum contextuality in the light of this philosophy (Section 8.2). I will give an overview of previous works arguing that the measurement problem is a self-referential paradox (Section 8.3). I will then analyze the Wigner's friend paradox and show how the notion of meta-contextuality solves it (Section 8.4). I will present how it can also be applied to hybrid paradoxes based on the Wigner's friend thought experiment and contextuality scenarii (Section 8.5), in particular the Frauchiger-Renner paradox, a "Wigner's Friendification" of the Hardy paradox, that I will analyse and compare with our previous work on the latter. Finally, I will argue that meta-contextuality is the main feature common to all "anti-realist" or "neo-Copenhagenian" interpretations of quantum theory (Section 8.6).

8.2 "It's Meta": a "Gödelian Hunch" from Contextuality

The prefix "meta-" comes from the Ancient Greek $\mu\epsilon\tau\alpha$, which can mean "beyond", "after" or "with". Metaphysics is thus the branch of philosophy that studies "what is beyond physics"⁵. It deals with what is not said or treated by physics, such as additional ontologies or the study of knowledge (epistemology). These are part of "meta-sciences" (history, philosophy, sociology of physics) whose object of study is physics itself. Indeed, a modern use of the prefix is to design a higher degree of abstraction: a "meta-X" is "an X about X". For example metamathematics (mathematical logic) is the mathematical study of mathematics. A meta-theory is a theory about another theory, that deals with its foundations, methods, forms. A meta-statement a statement about another statement... The idea of a hierarchy of levels is fundamental in the prefix, and can be extended beyond two levels of abstraction. A meta-meta-object lives in a level higher than the one of a meta-object which lives itself in a level higher than the one of an object.

Douglas Hofstadter has participated to the popularisation of the prefix with his book "*Gödel, Escher, Bach*" [288]. In the narrative *Little Harmonic Labyrinth*, the protagonists, Achilles and the Tortoise, are granted three wishes by a Genie. Their first wish is to have a hundred wishes, to which the Genie answers that he cannot grant meta-wishes, i.e. wishes about wishes. In order to "temporary suspend all type-restrictions on wishes", the Genie has to contact a meta-Genie, who has to refer to a meta-meta-Genie... etc. ... who has to refer to "GOD", who resides at the "end" of this infinite regression.

I have always been fascinated by this kind of structure, by stories within stories, characters breaking the fifth wall and self-referencing narratives like "If on a winter's night a traveler" [289] (*Se una notte d'inverno un viaggiatore*) by Italo Calvino, which tells the story of the Reader and his attempt to read the book "If on a winter's night a traveler". "Meta-narratives" provoke a metaphysical vertigo by sending us back to our own condition of observer, of being rooted in the insides of Nature but trying desperately to watch it from an hypothetical, transcendental and absurd outside. They convey a form of "absurd",

⁵Originally, the word might come from Aristotle's book "Metaphysics", entitled this way because it followed the book "Physics". Thus "Metaphysics" would be literally what is "after Physics" [287].

as trying to watch the universe from outside despite being inside, we are ineluctably led to a self-reference and eventual logical inconsistencies.

In fact, in classical logic, self-referring propositions can lead to pathologies such as the well-known Liar paradox:

“This sentence is false.”

Because it features self-reference and contradiction, it leads to an over-determination - if the sentence is true then it is false, if it is false then it is true - i.e. the “Liar” leads to undecidability, the impossibility to decide whether the sentence is true or false. The paradox has numerous variations (cf. also Chapter 12), such as the “Strengthened Liar”, that involves two propositions:

Alice: “Bob’s sentence is false.” Bob: “Alice’s sentence is true.”

Again, the propositions refer to each other, and are contradictory. For example if Alice’s sentence is true, then Bob’s sentence is false, thus Alice’s sentence is false. Another version is the Liar cycle, presented above (Section 7.2), that underlies contextuality.

Analogies of the Liar have been famously used in the foundations of mathematical logic, from Russell’s paradox to Gödel’s incompleteness theorem, that stipulates that “who realizes a proof of the consistency of a well-behaved scientific theory, must be ‘external’ with respect to the theory (in the sense that he cannot use only the proof theoretical tools allowed by the theory)” [48]. A theory sufficient to demonstrate the basic theorems of arithmetic is necessarily incomplete, i.e. there are statements which are neither demonstrable nor refutable, undecidable statements. Moreover, a theory is consistent only if there are undecidable statements. Another fundamental result is the Tarski and Gödel undefinability theorem, showing that “who ‘grasps’ the concept of truth for a well-behaved theory cannot speak only the language of the theory” [48]. Any description of the truth of a proposition must be in a richer metalanguage than the language in which the proposition itself is stated. This hierarchy of languages arises then as a solution of the Liar.

In [97], Szangolies argues that *epistemic horizons*, which are “limitations on the amount of information simultaneously available in a consistent way” identified as part of the information-theoretic axiomatic basis of quantum theory [290], arise due to restrictions of paradoxical self-reference. Pointing at this “intriguing connection between fundamental features of quantum mechanics and the phenomena of self-reference”, he coined the expression “Gödelian hunch” to “the idea that the origin of the peculiarities surrounding quantum theory lie in phenomena related, or at least similar, to that of incompleteness in formal systems.”

Applied to quantum contextuality, this Gödelian hunch manifests itself as follows. The Kochen-Specker theorem shows that quantum theory is based on intertwined Boolean algebra that cannot be embedded in a global Boolean algebra. The quantum formalism cannot be extended in such a way that Boolean logic holds in the extended domain. In the light of the Gödelian hunch, we can conclude that if meta-theoretical statements, i.e. the value-function $v : |\Pi_k\rangle \rightarrow \{0, 1\}$ (or equivalently the sentence H_k) are attached to a quantum proposition Π_k (a quantum state / projector), they cannot be embedded in a global Boolean proposition in general. If you try to associate a truth value to quantum

propositions, the meta-propositions will then be infected by the logical structure of the quantum ones and will then become globally undecidable, potentially leading to logical contradictory loops analogous to Liar cycles.

8.3 The Measurement Problem as a Self-Referential Paradox

“[We] are not angels, who view the universe from the outside. Instead, we and our models, are both part of the universe we are describing. Thus a physical theory, is self referencing, like in Gödel’s theorem. One might therefore expect it to be either inconsistent, or incomplete.” S. Hawking [291]

As expressed in the literature, there exist different measurement problems [69, 292, 293].

The one we wish to tackle addresses “the question of what makes a measurement a measurement. [...] There is nothing in the theory to tell us which device in the laboratory corresponds to a unitary transformation and which to a projection !” [70]. It is a “What’s in the box ?” problem. On the one hand, quantum theory is applied to the studied quantum system. Thus, only the latter lies inside the “quantum box”. On the other hand, quantum theory is applied to both the studied quantum system *and* the measurement device, which in this case is also contained inside the quantum box. The problem arises from the fact that depending on the frontiers of the quantum box, the measurement process is mathematically described in different ways, leading to different final states.

The “What’s in the box ?” measurement problem

This measurement problem can be formalized as follows. Assume that a quantum system is in the state $|\psi\rangle = \alpha|0\rangle + \beta|1\rangle \in \mathcal{H}_S$ and is measured in the computational basis $\{|0\rangle, |1\rangle\}$. On the one hand, following the projection postulate, the system will either be projected onto state $|0\rangle$ with probability $|\alpha|^2$, or state $|1\rangle$ with probability $|\beta|^2$ after the measurement. On the other hand, if the “observer” (e.g. the measuring device) is a physical system, then one could argue that it shall also be described by quantum theory. One associates a Hilbert space \mathcal{H}_O to this observing system. The initial observer state is defined as $|M\rangle$, corresponding to “ready to perform a measurement”. Thus, the initial state of the compound system in $\mathcal{H}_S \otimes \mathcal{H}_O$ is $(\alpha|0\rangle + \beta|1\rangle) \otimes |M\rangle$. In this case, the measurement process is described as a quantum interaction between the system and the device, and thus as a unitary transformation U , resulting in $U[(\alpha|0\rangle + \beta|1\rangle) \otimes |M\rangle] \rightarrow \alpha|0\rangle \otimes |M_0\rangle + \beta|1\rangle \otimes |M_1\rangle$. This entangled state differs from the projected ones when the observer is not described by quantum theory. Because these two final states are physically distinct, there seems to be a tension between the postulates of quantum theory that lead to this apparent contradiction, raising questions such as whether or not one can describe the observer quantumly, and thus how should a measurement process be described.

In Bohmian mechanics and the Many-Worlds interpretation, the object of quantum theory is the “wave-function of the universe”. There is no “collapse of the wavefunction”. Hence, all objects are included inside the quantum box, and the measurement process is

a unitary evolution⁶. In objective collapse theories, the measurement is described as a projection and is considered as a genuine physical process. Thus, all realist “interpretations” of quantum theory give an ontological (Bohmian mechanics and Many-Worlds) or nomological (Spontaneous collapse theories) solution to this measurement problem.

On the other hand, the “anti-realist” interpretations arguably “dissolve” the problem, rather than solving it. In fact, this measurement problem can be metaphysically analyzed as a “logical error” emerging from a lack of distinction between theoretical and meta-theoretical objects. Thus, the problem originates from a self-referential pathology, and is comparable (but not identical) to fundamental results from mathematical logic such as the Gödel and Tarski theorems. Acknowledging this Gödelian hunch, the problem disappears.

For example, Dalla Chiara investigated the measurement problem of quantum theory as a “characteristic question of semantical closure⁷ of a theory” [48], asking “to what extent can a consistent theory (in this case quantum mechanics) be *closed* with respect to the *objects* and the *concepts* which are described in its metatheory ?” She compares it with set theory and its paradoxes. “As it well known, the *limitative* theorems of logic and the paradoxes of set theory teach us that there are some definite limits to the semantical closure of any consistent theory (which satisfies some standard formal requirements). In particular, such theories can never express and prove *all* that is expressed and proved in their metatheories; further , they cannot generally describe (up to certain limitations) their universe as their *own object*. From an intuitive point of view one can recall a number of arguments which justify why a well-behaved scientific theory cannot be logically *self-sufficient*. However, we cannot help finding a much more disagreeable situation when a given physical theory (quantum mechanics), owing to purely *logical* reasons, turns out to be subject to some limitations concerning its capacity of describing and expressing certain specific *physical* objects and concepts.” [48]

She argues that if the standard axioms of quantum theory are accepted, then the problem can be derived from two assumptions, which are very similar to those used in set theory to derive the Russell paradox:

- (a) - Some “strange” objects of the metatheory of the considered theory (set theory and quantum theory) are also *objects* of the theory, i.e. belong to its *universe*.
- (b) - All axioms of the theory hold in the same way for *all* objects of the theory.

From the paradoxes (Russell antinomy and the measurement problem), one concludes that at least one of this two assumptions shall be rejected. In the case of set theory:

- I) Refusing only (a): the “strange” objects are not objects of the theory (“Zermelo’s solution”),

⁶In Bohmian mechanics, a hidden variable contains the information on whether $|0\rangle \otimes |M_0\rangle$ or $|1\rangle \otimes |M_1\rangle$ is obtained in the end, while in Many-Worlds, the interaction leads to a branching: each outcome occurs in a distinct world.

⁷A theory is “semantically closed” if it contains its own metatheories, and thus does not need to refer to a higher level of abstraction to define its objects and concepts.

- II) Refusing only (b): the axioms do not hold, generally, for strange objects, but only for normal ones (“Von-Neumann-Bernays-Gödel solution”),
- III) Refusing both (a) and (b): limits the universe of objects, and at the same time, relativizes the axioms to specific classes of objects.

According to Dalla Chiara, in the case of quantum theory, we obtain

- I) Bohr’s solution: “strange objects” such as the measurement device, the observer, “are *essentially only metatheoretical*, since they represent *classical* and not *quantum systems*,
- II) Von Neumann’s solution: the “strange object” is a “legitimate object of the theory”. However, the evolution of the compound system made of the normal and a strange object, i.e. a quantum system and a measurement device, the measurement process is not described by the Schrödinger equation. Hence, “if the observer is an object of the theory then [it] *cannot realize* the reduction of the wave function. This is possible only to another [observer], which is ‘external’ with respect to the universe of the theory.” Thus any observer, as a physical system, can be an object of the theory. Nevertheless, “*any [observer] which realizes the reduction of the wave function is necessarily only a meta-theoretical object.*”
- III) Solutions that take Von Neumann’s purely logical solution and reformulate it such that the measurement process is given a physical explanation. Dalla Chiara refers for example to “quantum macrodynamics, which includes an adequate theory of the measurements processes and is included in the metatheory of [quantum theory]”. We could imagine that such metatheory could also give a physical criterion to identify which objects can play the role of the observer.

The Von Neumann’s solution corresponds exactly to our Gödelian Hunch. As Dalla Chiara pointed out, this solution seems “to be very close to some similar limitative results that we have accepted in logic such as the Gödel theorem or the Tarski theorem.” [48]

Peres and Zurek also argue that “[quantum theory’s] inability to completely describe the measurement process appears to be not a flaw of the theory but a *logical necessity* which is analogous to Gödel’s undecidability theorem” [50]. According to them, an ideal theory should fulfil three assumptions, which are nonetheless always incompatible:

- “Determinism”: The outcome of an ideal perfectly controlled experiment should be predictable. This might not be the case in practice, but the underlying reality is assumed to be well-determined: “The system has no choice.”
- “Verifiability”: An experimenter can “freely” choose which experiment she is going to make. “The observer has a choice.”
- “Universality”: The theory apply to any object. “The observer is also a system.”

A solution, they argue is to acknowledge that quantum theory is universal, any observer *can* be described by quantum theory, “but under the condition that they lose their

status of observers and have to be observed by something or someone else. [...] Thus although quantum theory is universal, it is not *closed*. Anything can be described by it, but something must remain unanalyzed. [...] Although it can describe anything, a quantum description cannot include *everything*.” [50]

Zwick, in a paper entitled “Quantum Measurement and Gödel’s Proof” [51], argues that the measurement problem might be “an instance of a general limitation of formal languages”, and is thus comparable with Gödel’s incompleteness theorem. The parallel between physics and mathematics suggests that “the measurement process is self-referential as was Gödel’s special formula, and that the measurement may be undecidable within the dynamics, occurring only at a meta-level of the formalism. [...]” Thus, quantum theory from outside introduces another level, a meta-level, in which lives the object outside the description: the observer. The measurement, associated with the projection postulate and the Born rule, is thus taken as a meta-level statement, while the dynamics following the Schrödinger’s equation is left “incomplete”.

Breuer proved a theorem showing that, independently of the considered theory, “an internal observer cannot distinguish all states of a system in which she is contained” [294]. This is due to self-referential issues. Indeed, a measurement on a system in which the observer is contained yields information about the observer herself: a self-measurement. This is also defended by Mittelstaedt [52], who argues that universality implies semantical completeness, i.e. the associated language contains both semantic concepts and expressions referring to its own propositions, meta-theoretical concepts, which thus implies self-referentiality. In order to avoid logical paradoxes and be consistent, this self-measurement has to be constrained. In a later work, entitled “John Von Neumann met Kurt Gödel: undecidable statements in quantum mechanics.” [49], Breuer speculates that an encounter between Gödel and Von Neumann in 1930 might have inspired the formulation of the quantum measurement problem in 1932 by the latter (which would not only make him the first advocate of the quantum Gödelian hunch, but also would mean that the origin of the measurement problem is the Gödelian hunch itself!). “Is Gödel’s incompleteness theorem related in any way to the quantum measurement problem? Is perhaps self-reference at the heart of both?” [49] Thus, self-reference problems might be the reason why quantum mechanics is not applicable to the observer. In fact, due to self-referential issues, a theory cannot be universally valid and experimentally fully accessible: no observer can distinguish all states of the universe, since she is also part of the universe herself. One can then see the measurement problem as the incompatibility between two uses of quantum theory, corresponding to two distinct positions of the observer, giving up either on universality or full measurability (cf. Fig.8.1):

The two uses of quantum theory

- *Quantum theory from inside* (also termed “*endophysics*” by Primas [295]): the observer cannot be separated from the observed system. The studied object is a closed system, e.g. the universe, and is observed from inside. It is thus universal, but full measurability fails: this is the case of the Many-Worlds interpretation.
- *Quantum theory from outside* (“*exophysics*” [295]): the observer is cut from the observed systems, which are described as open systems. The observed systems are always (ideally) fully experimentally accessible, but the theory is not universal, since an object (the observer) is always out of the description. This is the point of view taken by the “anti-realists”, “(neo-)Copenhagen”, “operationalists”.

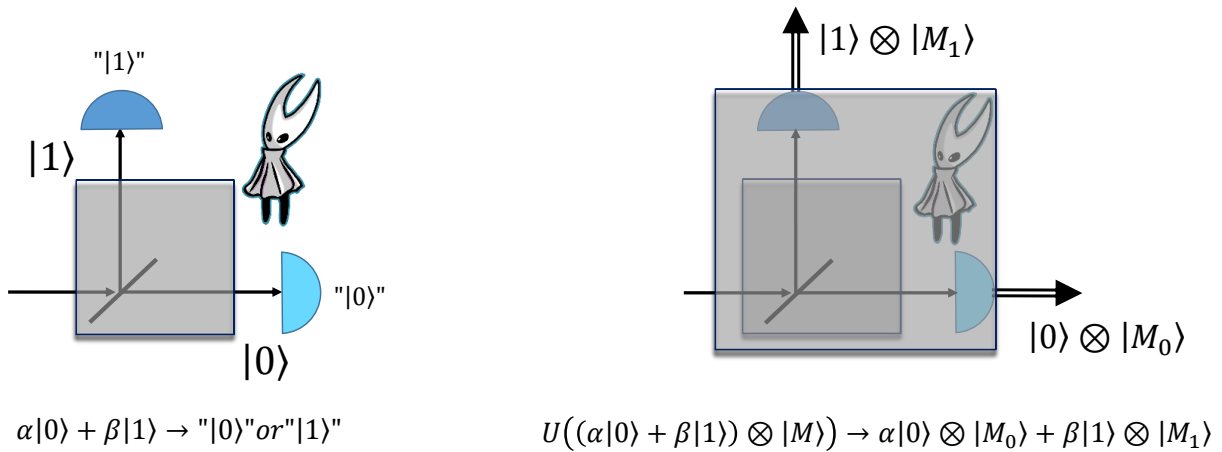

Figure 8.1: The measurement problem as the incompatibility between two perspectives. A qubit $|0\rangle + |1\rangle$ is prepared inside a quantum box, by sending a photon on a beam splitter. We denote $|0\rangle$ and $|1\rangle$ the right and left paths after the beam splitter. The position of the photon is measured by an observer, Alice, who collects the particle on one of her two detectors at the end of each path. Two positions of the observer can be considered. (Left) *Quantum theory from outside*. Alice is “out of the quantum box”, and the measurement process is described by a projection. (Right) *Quantum theory from inside*. Alice is “inside the quantum box”, her interaction with her own quantum box is described “quantumly”, by the unitary evolution of a higher-order quantum box which contains both Alice and her quantum box.

Thus, following Dalla Chiara, Peres and Zurek, Breuer concludes that “from an operational point of view, theories [and thus quantum theory] can at most be universally valid in a relative, observer dependent sense.” [49] A similar distinction will be formalised by Baumann and Wolf [296], who identify two inequivalent quantum formalisms (a “relative-state” one corresponding to quantum theory from inside, and a “standard” one corresponding to quantum theory from outside).

Finally, Grinbaum established the enlightening concept of *loop of existences*, which allows to give a representation for deriving the measurement problem from “a logical

error”. Representing all the scientific descriptions as a loop, “any particular theoretical description is achieved by cutting the loop at some point and thus separating the target object of the theory from the theory’s presuppositions. It is impossible to give a theoretical description of the loop of existences as a whole. [...] With the position of the cut being fixed, some elements of the loop will be object of the theory, while other elements will fall into the domain of meta-theory of this theory. At another loop cut these elements may exchange roles: those that were explanans become explanandum and those that were explanandum become explanans. The reason why one cannot get rid of the loop cut and build a theory of the full loop is that the human venture of knowing needs a basis on which it can rely; at another time, this basis itself becomes the object of scientific inquiry, but then a new basis is unavoidably chosen.” [98]

8.4 What is it like to be a Schrödinger cat ?

Wigner’s friend

“Wigner’s friend” is a thought experiment proposed by E. Wigner in 1961 [91], that originally aimed at showing that quantum measurement requires a conscious observer. The thought experiment is often presented as a variant of Schrödinger’s cat, where the “cat” is an observer, Wigner’s friend, who performs a measurement on a qubit living in a Hilbert space \mathcal{H}_S in her laboratory, while Wigner, another observer outside her laboratory, can associate a quantum state to the compound system $\mathcal{H}_S \otimes \mathcal{H}_O$, where \mathcal{H}_O is a Hilbert space associated to Wigner’s friend, e.g. a memory qubit $|M_i\rangle$ which can be interpreted as “Wigner’s friend observes a projection on state $|i\rangle$ ”. The problem arises from the fact that while Wigner’s friend observes a collapse of the qubit, Wigner describes this process as the interaction between two quantum systems, i.e. a unitary evolution ending up in an entangled state. However both descriptions should be valid. This can be seen as a meta-illustration of the measurement problem, which asks: what happens when an observer observes another observer observing a quantum system ?

Based on the analysis of the measurement problem as a self-referential paradox, I will rely on the following terminology. The quantum system is an *object*, since it is described by quantum theory. Wigner’s friend is an observer, and as a user of quantum theory, is a meta-theoretical object, in short a *meta-object*. Wigner is an observer who can perform a measurement on systems of the form *object* \otimes *meta-object*, and is thus a meta-meta-object, or *meta-observer*. The problem can be thus reformulated as the fact that an observer and a meta-observer are led to describe the same event - the observer’s measuring process - in contradictory ways. I introduce the notion of *meta-context* as a set of the form {meta-object,object}. This set is defined by a movable *cut* between theoretical objects studied in the language of the theory, and meta-theoretical objects which are out of the range of the theory. In other words, the meta-context imposes the frontiers of the “quantum box”, defining what is inside and outside of it. In the Wigner’s friend paradox, two meta-context are involved: {Wigner’s friend, objects in \mathcal{H}_S } and {Wigner, objects in $\mathcal{H}_S \otimes \mathcal{H}_O$ }.

Inspired by previous works [46, 49, 48], I argue that the problem can be understood

as the incompatibility between (at least⁸) the three following assumptions:

Assumptions underlying the Wigner’s friend paradox

- Universality (Q): Quantum theory is assumed to be correct and can be applied to *any* object whatsoever (but not necessarily *all* objects).
- Non-Meta-Contextuality (NMC): truth values given by the propositions associated with an object are independent of the meta-context, i.e. whether they are given from inside or outside the quantum box. this assumption is equivalent with Brukner’s “observer-independent facts” [46], and can also be compared with Cavalcanti’s “Absoluteness of Observed Events” [297].
- Measurement (M): The interaction between a meta-theoretical object and an object which shall be in principle fully experimentally accessible, i.e. the measurement process, is described by a projection yielding a single outcome.

The incompatibility can be derived by the following argument. Maintaining (Q) and (NMC) leads to an absolute form of universality: *all* objects, everything can be described by the theory, irrespective of the meta-context: no cut is needed. But imagine an infinite chain of observers observing observers observing a quantum system. Then, meta- ... -meta-observers are invoked, *ad infinitum*. This is the so-called “Von Neumann chain”, analogous with “the hierarchy of object theory, meta-theory, meta-metatheory etc. enforced by problems of self-reference.” [49]. One could argue that the ultimate meta[∞]-object is God, or some Laplacian demon⁹. In [299], Rothstein introduces the idea of “physical demonology”. The idea is that “if a demon is defined as an hypothetical entity capable of doing things humans cannot do because of some natural law, then one can invent a demon capable of deciding a physically undecidable question, and the undecidability is tantamount to outlawing such a demon.” [300] Let us assume that such an entity exists, and that it is able to perform an ideal measurement on the Universe, i.e. the latter is fully experimentally accessible. If this is the case, then the demon is necessarily excluded from the Universe in order to avoid Liar-like inconsistencies, independently of the considered theory, following Breuer’s theorem [49]. There is a tension between absolute universality (Q,NMC), in which the measuring process might be treated theoretically, and quantum theory is used from inside, and *measurement* (M) as a meta-theoretical process for observer from outside.

Spontaneous collapse theories, which modify Schrödinger’s equation, give up on (Q). The Many-Worlds interpretation, as being “quantum theory from inside”, give up on (M). Note that it is not trivial to analyze the Broglie-Bohm solution from this set of assumptions. One could argue that it is an extension of quantum theory from inside, and thus also gives up on (M). In the next section, I will argue that it might also be interpreted as giving up on (NMC) in a particular way.

⁸I do not claim that the set is complete. For example, one could add assumptions on the completeness of the theory, or highlight assumptions of “freedom of choice” or “Single outcome”. However, I argue that the proposed assumptions are sufficient to analyse the Wigner’s friend problem as a self-referential paradox.

⁹Note that this demon was already invoked by Popper [298], to give an argument in favour of “indeterminism” and show that no physical system can ever perfectly predict its own behaviour.

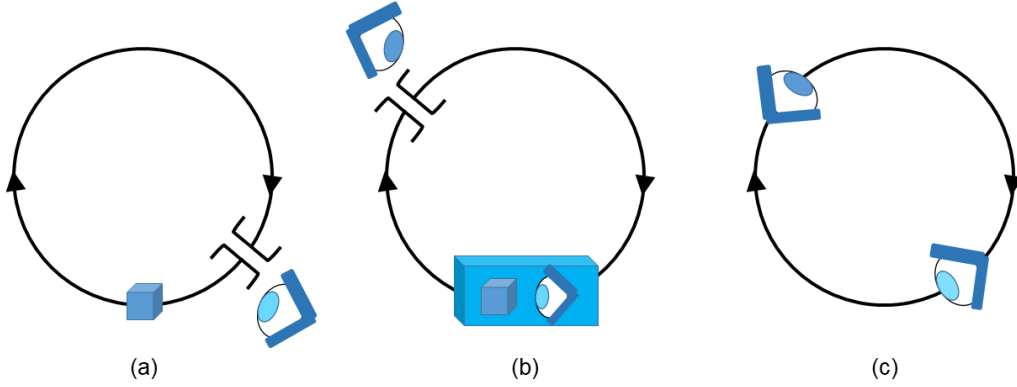

Figure 8.2: Inspired by Grinbaum’s epistemic loops [99], let us represent all theoretical objects by a loop. Cutting the loop sends objects in the meta-theoretical domain. (a) Meta-Context $\{\text{Wigner’s friend, } \mathcal{H}_S\}$. (b) Meta Context $\{\text{Wigner, } \mathcal{H}_S \otimes \mathcal{H}_O\}$. (c) Maintaining (Q) and (MNC) leads to ignoring the relative cuts, i.e. the meta-contexts. Wigner and Wigner’s friend are put at the same level, and self-referential inconsistencies may occur.

In the light of analysing the measurement problem as a logical error, I argue that the most appealing solution is to drop (NMC) and acknowledge the observer for what it is: a meta-object. This way, the notion of meta-observer becomes obsolete, and the logical inconsistencies are avoided (cf. Figure 8.2). The universality of the theory is maintained, but becomes *relative*. Any object can be cut and become a meta-object. However, once the cut is fixed, any out-of-meta-context question is *undecidable*. Every description is consistent inside and only inside a given meta-context.

This solution is equivalent to the “Von Neumann’s logical solution (II)” presented by Dalla Chiara [48]. It has the advantage of (dis)solving the paradox without resorting to the addition of exotic ontologies, nor a nomological modification of the theory. However, despite being based on a metaphysical analysis, one could argue that this solution, since it does not give any physical explanation of the measurement process nor explain where to put the cut, leaves a bitter taste. Indeed, quantum theory does not provide any physical criterion to identify whether an object is an observer or not. The cut is purely functional, not ontological: it does not discriminate between microscopic and macroscopic objects, only what is described by the theory and what is beyond the theory. Thus one cannot infer from quantum theory alone if the observer is a human being, an artificial intelligence, a cat or the Universe. “As emphasized by Wheeler, this makes it extraordinarily difficult to state clearly where “the community of observer-participators” begins and where it ends [301].” [302]. On a purely logical aspect, quantum theory does not say anything more on what an observer should be. Should we associate with it the ability to know, to bet or at least to store information and communicate it? I will discuss this matter further in Section 8.6.

To conclude, I argue that the terminology “observer” should be used with caution. It should only be applied to a meta-object, thus an object outside the theoretical description. From Wigner’s perspective, his friend is *not* an observer, even though he can acknowledge that she is one from *her* perspective. In the light of this analysis, being Wigner’s friend, or a Schrödinger cat, is nothing special. The friend inside Wigner’s quantum box will observe

a definite outcome, despite being entangled with a qubit from Wigner’s perspective. Inside the box, the cat is dead *or* alive, despite being entangled with a qubit from the perspective of Schrödinger.

8.5 Wigner’s Friendifications

Recently, there has been a renewed interest in Wigner’s thought experiment in the field of quantum foundations. This resurgence is due to the appearance of new hybrid paradoxes which rely on a “Wigner’s Friendification”¹⁰, a transformation of previous quantum “paradoxes” where one allows meta-objects to be described as objects of the theory, and allows meta-observers to measure compound systems of the type “object \otimes meta-object”. Remarkably all the “Wigner’s friendified” paradoxes so far entail some form of contextuality. Brukner has proposed a “no-go theorem for observer-independent facts” [46], extended in [304], based on the violation of the CHSH inequality that entails probabilistic contextuality. Frauchiger and Renner have proposed a meta-version of the Hardy paradox involving logical contextuality (cf. Sections 7.1 and 7.2) [47]. These have been given experimental proof-of-principle realisations in [305]. Regarding strong contextuality, several examples have been formalised. In an appendix of [46], Brukner presents another proof of his no-go theorem based on the GHZ paradox. Szangolies has proposed a Wigner’s friendification of the Mermin-Peres proof of the Kochen-Specker theorem, that he named “the quantum Rashomon effect” [306] in reference to Kurosawa’s film in which the same event is presented in various, sometimes contradictory, ways from distinct perspectives. Finally, Vilasini, Nurgalieva and del Rio have introduced a way to generalize Wigner’s friendification to arbitrary physical theories, and in particular generalized probabilistic theories [307]. As an example, they have formalised a Wigner’s friendification of the PR box paradox, which is a canonical example of a scenario characterized by strong contextuality. Their result shows that, similarly with the fact that there exist post-quantum scenarii like the PR box one that entail a form of contextuality, “multi-agent paradoxes” are not specific to quantum theory. I fully agree with their hunch (also presented in [308]) that “multi-agent paradoxes are closely linked to the notion of contextuality”.

In fact, a sceptic could argue that there is no fundamental contradiction in the Wigner’s friend paradox: the final *physical* states given by both descriptions (Wigner’s and his friend’s) are not necessarily different. For example, in a hidden variable theory like de-Broglie-Bohm’s, they are the same. The apparent contradiction would come from the fact that the standard quantum formalism is ontologically incomplete. Thus, Wigner and his friend do not seem to necessarily contradict each other. If they use a completed quantum theory, it seems that their respective representations would agree. Nevertheless, it is possible to obtain a logical contradiction from quantum scenarii involving a form of contextuality, and thus Liar cycles¹¹, that hidden variables models cannot avoid. One can in fact update the quantum scenarii at the meta-level, so that the logical contradiction,

¹⁰In my knowledge, this terminology was first used by Aaronson in a blog post (“It’s hard to think when someone Hadamards your brain.” [303]) in order to describe the Frauchiger-Renner paradox with respect to the Hardy Paradox.

¹¹One could argue that no logical contradiction arises from probabilistic contextuality. However, this is not the case. Indeed, as expressed in [262] “in [266] it is shown that every Bell inequality (i.e. every inequality satisfied by the “local polytope”) is equivalent to a logical Bell inequality, based on purely logical consistency conditions.”

instead of being counterfactual, would come from the meta-statements of observers and meta-observers. In [307], it is shown that the replacement of counterfactual measurements by actual ones can be realized in the most general case (i.e. any physical theories) by an information-preserving model for physical measurements. Here I will only focus on the standard quantum way to do so, following the example of the Frauchiger-Renner paradox [47] that we present in a simplified version below. Hence, one can formalize a multi-level scenario *à la Wigner* with a genuine logical contradiction. In the case of hidden variables theories, the paradox is solved because of the Kochen-Specker theorem: these theories are contextual and thus, as will we see, *a fortiori* meta-contextual.

As mentioned above, the main recipe of Wigner’s friendification is to introduce some “meta-meta-objects” that treat meta-objects, their “friends”, as objects of the theory. A two-level scenario like the Hardy paradox, which only involves objects and meta-objects, is upgraded into a three-level scenario: instead of a couple of measurements among four counterfactual possibilities, four actual measurements are performed. Alice and Bob’s friend, the meta-objects, measure their qubits, living in Hilbert spaces \mathcal{H}^{S_A} and \mathcal{H}^{S_B} respectively, in the computational $\{|0\rangle, |1\rangle\}$ basis. Regarding Alice and Bob, the meta-meta-objects, the former computational basis is transformed into a meta-computational basis corresponding to an “observer basis”: it corresponds to a meta-observer asking her friend in which state has the qubit been projected: $\{|0\rangle_{S_A} \otimes |0\rangle_{F_A}, |1\rangle_{S_A} \otimes |1\rangle_{F_A}\}$, where the Hilbert spaces \mathcal{H}^{F_A} and \mathcal{H}^{F_B} are associated with Alice and Bob’s friends respectively. For example, if Alice’s friend finds her qubit in state $|0\rangle_{S_A}$, then her associated quantum proposition will be $|0\rangle_{F_A}$ and Alice will find the global system in the state $|0\rangle_{S_A} \otimes |0\rangle_{F_A}$. The diagonal basis of the standard observation becomes a meta-diagonal basis corresponding to a “meta-observer basis”, where the meta-observers actually perform a quantum measurement on the compound system of their respective friend and their object, living in a Hilbert space \mathcal{H}^A and \mathcal{H}^B , resulting in a quantum proposition associated to the meta-observer: $\{|+\rangle_A, |-\rangle_A\}$, with $|\pm\rangle_A = \frac{1}{\sqrt{2}}(|0\rangle_{S_A} \otimes |0\rangle_{F_A} \pm |1\rangle_{S_A} \otimes |1\rangle_{F_A})$.

The Frauchiger-Renner paradox

Applying this Wigner’s Friendification to the four quantum propositions of the Hardy paradox (cf. Section 7.1), one obtains four new assertions:

- (1) • In the metaobserver-observer basis, the state before measurements is:

$$|\psi\rangle_{tot} = \sqrt{\frac{2}{3}} |+\rangle_A |0\rangle_{S_B} |0\rangle_{F_B} + \frac{1}{\sqrt{6}} |+\rangle_A |1\rangle_{S_B} |1\rangle_{F_B} - \frac{1}{\sqrt{6}} |-\rangle_A |1\rangle_{S_B} |1\rangle_{F_B}$$

Sentence FR1: “If Alice finds the outcome ‘-’, she knows that Bob’s friend obtained outcome ‘1’.”

- (2) • In the observer-observer basis, the state before measurements is:

$$|\psi\rangle_{tot} = \frac{1}{\sqrt{3}} (|0\rangle_{S_A} |0\rangle_{F_A} |0\rangle_{S_B} |0\rangle_{F_B} + |1\rangle_{S_A} |1\rangle_{F_A} |0\rangle_{S_B} |0\rangle_{F_B} + |1\rangle_{S_A} |1\rangle_{F_A} |1\rangle_{S_B} |1\rangle_{F_B})$$

Sentence FR2: “If Bob’s friend finds the outcome ‘1’, he knows that Alice’s friend obtained outcome ‘1’.”

(3) • In the observer-metaobserver basis, the state before measurements is:

$$|\psi\rangle_{tot} = \sqrt{\frac{2}{3}} |1\rangle_{S_A} |1\rangle_{F_A} |+\rangle_B + \frac{1}{\sqrt{6}} |0\rangle_{S_A} |0\rangle_{F_A} |+\rangle_B + \frac{1}{\sqrt{6}} |0\rangle_{S_A} |0\rangle_{F_A} |-\rangle_B$$

Sentence FR3: “If Alice’s friend finds the outcome ‘1’, she knows that Bob obtained outcome ‘+’.”

(4) • In the metaobserver-metaobserver basis, the state before measurements is:

$$|\psi\rangle_{tot} = \frac{3}{\sqrt{12}} |+\rangle_A |+\rangle_B + \frac{1}{\sqrt{12}} |+\rangle_A |-\rangle_B - \frac{1}{\sqrt{12}} |-\rangle_A |+\rangle_B + \frac{1}{\sqrt{12}} |-\rangle_A |-\rangle_B$$

Sentence FR4: “Alice and Bob both find the outcome ‘−’ with a probability of $\frac{1}{12}$.”

The four meta-statements (F1,F2,F3,F4) share the same logical structure as (S1,S2,S3,S4). Like the Hardy paradox (cf. Section 7.2), this set of statements forms a probabilistic Liar cycle: either Bob obtains ‘−’ and Alice obtains ‘−’ → Bob’s friend obtains “1” → Alice’s friend obtains “1” → Bob obtains “+”, contradicting the first assignment. And like the Hardy paradox, another set of meta-statements can be inferred from the quantum propositions, and forms another Liar cycle: Alice obtains ‘−’ and Bob obtains ‘−’ → Alice’s friend obtains ‘0’ → Bob’s friend obtains ‘0’ → Alice obtains ‘+’, contradicting the first assignment.

In [47], the authors analyze this paradox as an incompatibility between three assumptions:

- Quantum theory (Q): quantum theory is correct and can be applied to systems of any complexity,
- Consistency (C): observers and meta-observers claims should be consistent with each other,
- Single outcome (S): a measurement yields a single outcome.

(Q) is equivalent to (U), and thus is given up by spontaneous collapse theories. (S) is given up by the Many-Worlds interpretation. (C) has been widely discussed in the literature (cf. for example [46, 309, 310]). I argue that this assumption contains a redundancy, and can be reformulated into two assumptions: non-contextuality (NC) and non-meta-contextuality, which is here formalised as the Wigner’s friend-version of non-contextuality. Thus, I argue that (NMC) is dropped by both neo-Copenhaguians and Bohmians, but not for the same reason. The neo-Copenhaguians’s argument is based on the logical analysis of the Wigner’s friend-like multi-level paradoxes as self-referential antinomies, resulting in a metaphysical and logical incompleteness. Bohmians¹² acknowledge the incompleteness, but interpret it straightforwardly as ontological. From the Kochen-Specker theorem, they give up on (NC), and since (NMC) is built on this assumption in a Wigner’s friend-type scenario, they also give up on (NMC). It would be interesting to compare this proposition

¹²For a Bohmian take on the Frauchiger-Renner paradox, cf. [311].

with the fact that the Bohmian mechanics is “more” contextual than what is imposed by quantum theory¹³ [282].

Because it has the same logical structure as the Hardy paradox, the Frauchiger-Renner paradox also entails logical contextuality. Note that it has already been analyzed as applying classical logic to quantum propositions, which is forbidden by the non-Boolean structure of quantum theory [46, 309, 310, 307]. Thus the contradiction might occur from assuming non-contextuality (NC). However, unlike the Hardy paradox, which is counterfactual, here each meta-statement can be associated to one agent: one for each observer (FR1 and FR3), and one for each meta-observer (FR2 and FR4). In fact, like in the original Wigner’s friend experiment meta-objects (the friends) are described in the language of the theory, i.e. at the level of objects. As seen previously, this is equivalent to the (NMC) assumption, which associated with (Q), can lead to self-referential inconsistencies when statements made in different meta-contexts are compared. Giving up on (NMC), consistency is restored, but only inside a meta-context among $\{\text{Alice, Alice’s Friend} \otimes \text{qubit } S_A\}$; $\{\text{Bob, Bob’s Friend} \otimes \text{qubit } S_B\}$; $\{\text{Alice’s Friend, qubit } S_A\}$; $\{\text{Bob’s Friend, qubit } S_B\}$ (cf. Fig. 8.3). Under such analysis, the fact that “a self-referential use of the theory yields contradictory claims” [47] is not especially surprising, if one acknowledges that quantum theory can only be consistently used in a meta-context, i.e. that *the use of quantum theory is (meta-)contextual*.

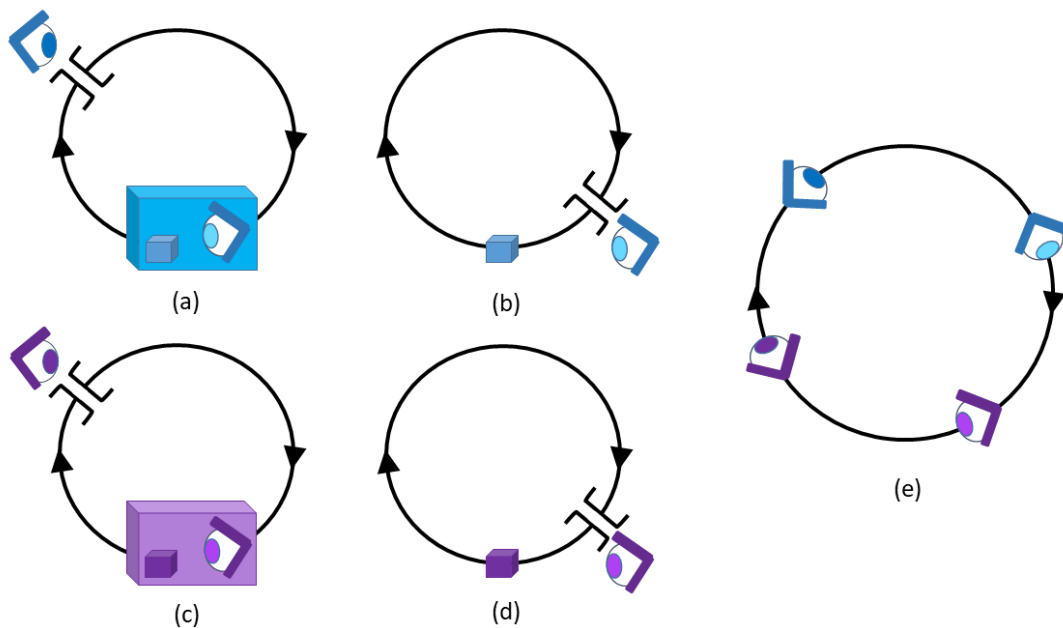

Figure 8.3: (a) Meta-context: $\{\text{Alice, Alice’s Friend} \otimes \text{qubit } S_A\}$. (b) Meta-context: $\{\text{Alice’s Friend, qubit } S_A\}$. (c) Meta-context: $\{\text{Bob, Bob’s Friend} \otimes \text{qubit } S_B\}$. (d) Meta-context: $\{\text{Bob’s Friend, qubit } S_B\}$. (e) Maintaining (Q) and (NMC), i.e. comparing the results from different meta-contexts, leads to logical inconsistencies.

¹³In fact, as exposed by Hardy [282], Bohmian mechanics is contextual even for quantum systems of dimension two, while the Kochen-Specker theorem only applies to quantum systems of dimension equal or higher than three.

8.6 The Heirs of Copenhagen

Analyzing the measurement problem and its meta-versions as self-reference and escaping the logical inconsistency by introducing a *cut*¹⁴ complies with various “neo-Copenhagen” interpretations of quantum theory. These interpretations, often labelled as “anti-realist” or “operationalist” are related with anti-realist philosophical school of thought such as pragmatism, instrumentalism or phenomenology. They are strongly inspired by the Copenhagen school of Bohr, Heisenberg, Von Neumann and Pauli. Leifer (in a talk entitled “What are Copenhagenish interpretations and should they be Perspectival ?”) proposed four criteria to characterize them:

- *Universality*: Quantum theory is a physical theory. Any object can be described by it. There is no intrinsically “classical” nor “quantum” objects.
- *Observation*: When an observer performs a measurement, it yields an outcome, a *fact* (phenomenon) occurs. The observers acknowledge the existence of other observers. Thus these interpretations cannot be reduced to solipsism. However, a fact might be observer-dependent.
- *Anti-ontology*: Quantum states are not ontological. They do not correspond to some intrinsic property of a quantum system. They are actual state of knowledge/belief/information belonging to a given observer.
- *Completeness*: Quantum theory is complete. It does not invoke some “hidden” ontology.

However these criteria are not exclusive to neo-Copenhagen interpretations (for example the Many-Worlds interpretation is also compatible with Completeness). I argue that the fundamental criterion, specific to these neo-Copenhagen interpretations, is the *Cut*, or as formalized above, *Meta-Contextuality*. Indeed, all neo-Copenhagen interpretations are perspectival¹⁵, i.e. solve the Wigner’s friend paradox and its variations by given up on non-meta-contextuality / observer-independent facts / absoluteness of observed events, i.e. with a “shifty split”. All agree on this fundamental distinction between the meta-theoretical and theoretical object. This metaphysical cut is “*functional*” [70], not ontological. It does not discriminate a macroscopic classical world from a microscopic quantum one, because every object can be treated by the theory (Q) or not. It does not rely on a specific physical criterion to distinguish meta-objects from objects. The position of the cut goes in pair with defining what an “observer” is... and standard quantum theory does not give any information on what it is.

So what is an observer ? Again, if we should stick to quantum theory, then one can only say that it is a meta-object, i.e. a higher-order object not described by the theory. Everett, in his relative-state interpretation, argued that observers are physical systems with memory, “parts... whose states are in correspondence with past experience of the observers” [64]. Grinbaum called this “a universal observer hypothesis: any system with certain information-theoretic properties can serve as quantum mechanical observer,

¹⁴Sometimes called the von Neumann or Heisenberg cut (“Schnitt”).

¹⁵One might argue that it might not be the case for the old Copenhagen school, for which there might be an objective, observer independent fact after each measurement. If it is indeed the case, this point of view would be ruled out by Wigner’s friendified quantum paradoxes.

independently of its physical constituency, size, presence or absence of conscious awareness and so forth.” [98] Rovelli [67, 68] argues for such a universally discriminative cut in his relational quantum mechanics (RQM), “making Copenhagen democratic”, putting all systems on equal grounds and ascribing them only relative states. However some might argue that the word “observer” and “measurement” are not adapted to the interaction between, for example, two electrons. This echoes in Bell’s critic of the Copenhagen interpretation, in his paper “Against Measurement” [312]:

“It would seem that the theory is exclusively concerned about ‘results of measurement’, and has nothing to say about anything else. What exactly qualifies some physical systems to play the role of ‘measurer’? Was the wave-function of the world waiting to jump for thousands of millions of years until a single-celled living creature appeared? Or did it have to wait a little longer, for some better qualified system . . . with a PhD? [...] The first charge against ‘measurement’, in the fundamental axioms of quantum mechanics, is that it anchors there the shifty split of the world into ‘system’ and ‘apparatus’. A second charge is that the word comes loaded with meaning from everyday life, meaning which is entirely inappropriate in the quantum context. When it is said that something is ‘measured’ it is difficult not to think of the result as referring to some pre-existing property of the object in question. This is to disregard Bohr’s insistence that in quantum phenomena the apparatus as well as the system is essentially involved.”

Recently, Brukner has proposed a no-go theorem showing “that in RQM the physical description of a system relative to an observer cannot represent knowledge about the observer in the conventional sense of this term. The problem lies in the ambiguity in the choice of the basis with respect to which the relative states are to be defined in RQM.” [313] This preferred basis problem would not arise in other neo-Copenhagen interpretations in which a quantum state is relative to some measurement contexts [70]. This is made particularly explicit in the “Context, System, Modality (CSM)”, interpretation, in which a “modality” - an element of reality - can only be assigned to a “system” with respect to a “context¹⁶”, i.e. to a set $\{context, system\}$ [314, 315, 316]. QBism [72] also avoids the preferred basis problem. According to QBists, the “observer” is a Bayesian agent, a user of the theory who uses it to make bets and update her beliefs. Thus, the state is relative to the beliefs of this agent. But it would not be the case in RQM, which makes the cut absolutely democratic. More specifically, Brukner points out that the maximally entangled state $|\phi^+\rangle$, that can describe “the entangled state between an observer $[F]$ and an spin-1/2-particle $[S]$ ”, can be written in different bases:

$$|\phi^+\rangle_{SF} = \frac{1}{\sqrt{2}} (|0\rangle_S |0\rangle_F + |1\rangle_S |1\rangle_F) = \frac{1}{\sqrt{2}} (|+\rangle_S |+\rangle_F + |-\rangle_S |-\rangle_F) \quad (8.1)$$

Thus, what is the state of S relative to F : the one in the computational basis or the diagonal one? According to Brukner, this is avoided by most of the neo-Copenhagen interpretations, in which this underdetermination is avoided by the choice of measurement

¹⁶The notion of “context” in the CSM interpretation corresponds to the “observer” / her experimental apparatus, but is stronger than our definition of meta-object. Indeed in CSM, the cut is not only functional, but also ontological: quantum objects (systems) and classical objects (contexts) are separated by nature, “based on empirical evidence”. Thus, unlike RQM, some objects (e.g. a photon) cannot be treated as a “context”.

made by the observer / agent. However “RQM does not seem to give any prescription on how to resolve this ambiguity.” I argue nonetheless that this ambiguity can be diffused, if we acknowledge that in RQM, an “observer” *is* and only is a meta-object. Thus, we cannot interpret the Hilbert space F as being associated with an “observer”: as Brukner’s concludes, “Qubits are not observers.” In other words, the state $|\phi^+\rangle_{SF}$ does not describe an interaction between a system and an observer. It is a state from Wigner’s point of view, who describes the interaction between two quantum systems, not from his friend. If F is an actual observer, then she would simply associate a state $|\psi\rangle_S$ to the system she “measures” or, rather interact with. A terminology more adapted to RQM might be: if we want to know how a the spin/1/2 of a particle is *determined relative to the perspective of* another system F , the correct description is a state $|\psi\rangle_S$. If we want to know how they *co-determine each other as interacting quantum systems*, we describe them with the global state $|\phi^+\rangle_{SF}$. Hence, Brukner’s no-go theorem do not challenge RQM, but allows to highlight an important aspect of it¹⁷. Finally, Grinbaum [302, 98] has proposed to overcome the apparent tension between the universal cut of RQM with the more epistemological-based one of others (neo-)Copenhagen interpretations by giving a definition of an “observer” in the light of the information-theoretic reformulation of quantum theory: the observer is “a system identification algorithm” and is “characterized by its Kolmogorov complexity.”

To conclude, meta-contextuality is especially made explicit in Rovelli’s relational interpretation: “As soon as we realize that any physical system can play the role of a Copenhagen’s ‘observer’, we fall into relational quantum mechanics. Relational quantum mechanics is Copenhagen quantum mechanics made democratic by bringing all systems onto the same footing.” [68], as well as in a recent QBist analysis of the Frauchiger-Renner paradox, which rests on a: “quantum Copernican principle; when two agents take actions on each other, each agent has a dual role as a physical system for the other agent” [318]. Meta-contextuality resonates with the footsteps of Bohr: “There is no quantum world. There is only an abstract quantum physical description. It is wrong to think that the task of physics is to find out how nature *is*. Physics concerns what we can *say* about nature. We depend on our words, our task is to communicate experience and ideas to others. We are suspended in language ...” [319] ; and Wittgenstein, who wrote in his *Tractatus*: “(5.632) The subject does not belong to the world: rather it is a limit of the world.” I am sympathetic towards phenomenological readings of these neo-Copenhagen interpretations [320]. Absolute universality has a God-like flavour and leads to paradoxical features that cannot be *said*. On the contrary, one can acknowledge the transcendental status of the meta-theoretical object: a classical (Boolean) description made at the meta-level by the meta-object is the condition of possibility for the rendering of quantum (non-Boolean) events.

Quantum theory is then only “a general procedure for anticipating probabilistically the replies to context-dependent experimental solicitations. [It does] not even offer a hint in the quest of a faithful representation of some independent reality out there, behind phenomena.” [320] This non-representational status does not reduce it to solipsism, or

¹⁷While I was writing this thesis, Di Biago and Rovelli have finally addressed Brukner’s no-go theorem, and have answered with a similar argument: “ The quantum state of a composite system relative to an external system is not an account or record of relative events between the subsystems of the composite system. It is only a mathematical tool useful for predicting probabilities of events relative to the external system. Assuming that the quantum state is more than this is the misunderstanding leading to the apparent contradictions.” [317]

mutism. After an ἐποχή, a “suspension of one judgement about a presumably external domain of objects”, i.e. acknowledging that “no symbol of quantum mechanics *refers* to objects or *denotes* predicates of objects”, an ontological reconstruction is possible. This ontology would not be based on objects, rather it would be “an ontology in which we are not onlookers of a nature given out there, but rather intimately intermingled with nature, somewhere in the midst of it [...] This *endo-ontology* is therefore an ontology of the participant *in* Being, rather than an ontology of the observer *of* beings.” [320]

“Quantum physics does not put all truths on the side of the ‘subjective’, which would maintain the idea of an inaccessible objectivity. It rather challenges the very principle of this division and brings the contact between the observer and the observed in its very definition of ‘reality’.” (quoted [321] in [320])

In a nutshell, as advocated by Paulette Destouches-Février [322], and later John Wheeler and Chris Fuchs [66], the logical paradoxical loops raised by the careless interplay of quantum theory and its meta-theory supports a form of *participatory realism*.

8.7 Take Away and Perspectives

Take Away

- I argue for a Gödelian hunch from quantum theory, the idea that quantum paradoxes emerge from a lack of metaphysical distancing, i.e. a lack of distinction between the level of the studied object (quantum theory), and the level of the meta-theoretical object (observer).
- Quantum contextuality can be interpreted as the fact that meta-propositions (truth values) associated to quantum propositions are infected by the logical structure of the latter. They can then become globally undecidable, and lead to logical contradictions analogous with the Liar paradox.
- The measurement problem, the Wigner’s friend problem can be analyzed as logical errors emerging from a lack of distinction between theoretical and meta-theoretical objects.
- Hybrid paradoxes combining contextuality and Wigner’s friend highlight that the use of quantum theory is meta-contextual, i.e. it is consistent if and only if a well-defined distinction is made between objects and meta-objects.
- Metacontextuality is the fundamental criterion underlying neo-Copenhagen interpretations such as QBism or Relational Quantum Mechanics.

- (A LPPS Frauchiger-Renner Paradox) It would be interesting to investigate further the fact that the Hardy and Frauchiger-Renner paradoxes share a common logical structure. In particular, in the light of our analysis (Section 7.3.4) one could for example speculate on a LPPS formulation for the Frauchiger-Renner paradox, based on the logical argument previously presented (Fig.7.9). For example, the pre-selection at time t_1 would correspond to the preparation of a Hardy state shared between Alice and Bob’s friends. At a later time t , Alice and Bob’s friends perform a joint weak measurement asking either if their qubits is in the state $|00\rangle$ or $|11\rangle$. At time t_2 , Alice and Bob perform a global measurement in the “meta-observer basis”, and the state $|--\rangle_{AB}$ is post-selected (experimentally or fundamentally). This, of course, would need a proper mathematical formalisation. However, one could expect that the friends’ intermediate weak measurement would always answer that the state is in $|00\rangle$ with certainty, and that it is in $|11\rangle$ with certainty, like in the Hardy paradox. The apparent logical paradox would then be “solved” with the anomalous weak value -1 associated with the state $|10\rangle$. In Section 11.2, I propose furthermore to exploit the idea that the occurring of “obtaining $|00\rangle$ with certainty” and “obtaining $|11\rangle$ with certainty” depends on the causal order of Alice and Bob’s friends operations. What would happen if this causal order was controlled by a quantum switch ? or if Alice and Bob’s friends could both signal to each other via a non-causal process matrix ?

Part III

“Time-Travel without Paradoxes”

“Time is a consequence of every attempt to provide a comprehensive description of the universe from within. Thus, time is not related to the universe itself but to the attempt to describe it.” A. Kull [323] on *Laws of Forms* (1969) by Spencer-Brown [324].

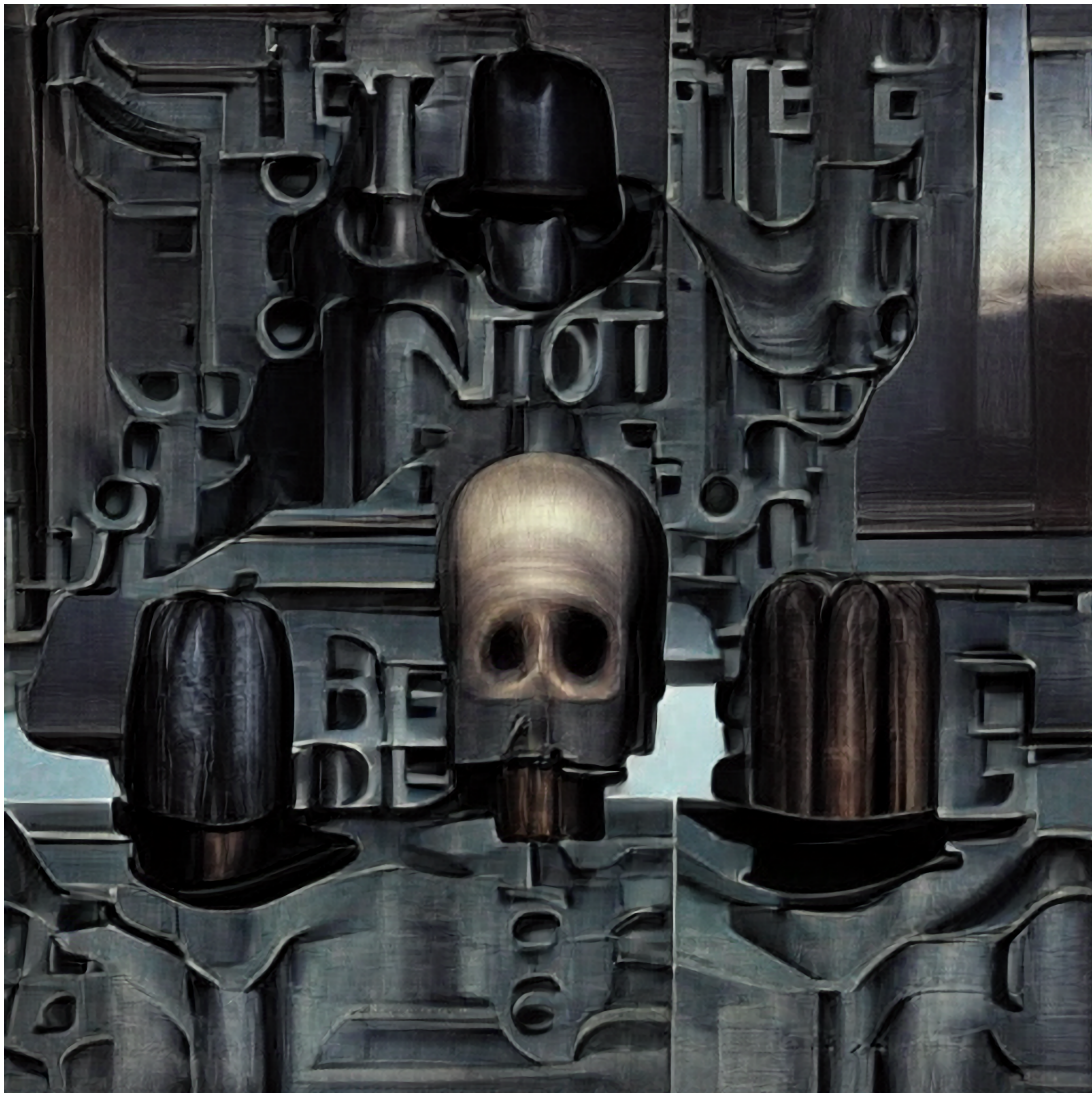

To be and not to be (in the style of Magritte), VQGAN+CLIP.

Chapter 9

Disclaimer and Introduction

This last part aims at giving some reflections on the main motivation of the thesis: to establish a link between quantum causality and contextuality. It does not rely on any published nor pre-published work. Rather, it mainly contains work in progress and speculations on perspectives beyond this PhD thesis, that I wish to explore in the future.

In Chapter 10, I will extend my “Gödelian hunch from quantum theory” (cf. Chapter 8) to a specific notion of time, based on an analysis of the grandfather antinomy¹ as a Liar-like paradox. In Chapter 11, I will speculate on a possible relation between quantum causality and contextuality and propose some line of thoughts for future investigations. In Chapter 12, I will present an original causal game that quantifies a Novikov-like consistency principle in terms of a logical inequality in addition to a causal inequality. I will show that the maximal probability of success with indefinite causal orders lies between the causal and logical bounds, thus illustrating that noncausality does not imply logical inconsistency. Finally, I will speculate on the idea that the violation of a logical inequality might be interpreted as a form of contextuality.

¹I will use the terms “antinomy” and “paradox” interchangeably. Etymologically, anti-nomy (from Ancient Greek ἀντί - νόμος, “against - the law”) can be interpreted as the mutual incompatibility between two laws or as a paradox that emerges from a logical contradiction, i.e. against the laws of logic.

Chapter 10

A Gödelian Hunch from Time

The grandfather paradox

In 1949, Gödel discovered solutions of general relativity containing closed time-like curves (CTCs), which theoretically would allow an observer to travel back in her own past [2]. However, the existence of such closed causal loops seems to imply the possibility for a traveller to interact with her own past-self, and for example prevent her own time-travel. This paradox, known as the grandfather antinomy, appeared for the first time in the science-fiction novel *Le Voyageur imprudent*, written by René Barjavel, which tells the story of a time-traveller who went back into the past and accidentally killed his ancestor. (cf. introduction of the thesis). Remarkably, it shares the same logical structure as the Liar paradox (cf. Chapter 8). It can arguably be interpreted as a (speculative) *physical realization* of a self-contradiction.

By analogy with the previously introduced scholastic debate on the tension between God's knowledge of counterfactuals and "free will" (Section 6.3), the grandfather paradox can be understood as the tension between events that already happened and the ability to decide whether these "physically-already-determined" facts can be changed or not. Here, the role of God or the omniscient demon is played by *time* itself. One can also defend a "superdeterministic" solution, where the traveler has no free will, or conclude with Stephen Hawking that time-travel is impossible: in fact, a "chronology protection conjecture" could prevent the existence of CTCs, in order to "make the universe safe for historians" [3]. The most popular solution in science-fiction is a "many-worlds-like" one: there is no contradiction because when the traveler interacts with her past, different consistent worlds are created. David Lewis' proposal [325] is one of such solution, but is more subtle. He analyzed the paradox in the light of his modal realism philosophy, where possible worlds are as real as the actual one. His solution is based on a Leibnizian notion of "compossible facts": "What I can do, relative to one set of facts, I cannot do, relative to another, more inclusive, set." This preservation of consistency might be interpreted as a form of "fine-tuning". In the case of a single world, Igor Novikov has formulated a similar self-consistency principle that stipulates that "[e]vents on a closed timelike curve are already guaranteed to be self-consistent" [326]. Thus only events that would not lead to a grandfather antinomy could be part of a CTC. The traveler would still be free, but her choices of actions are limited by some "time police / fine-tuning" principle such that consistency is preserved.

Finally, one could deny time its fundamental aura, and argue instead that it is emer-

gent. In fact, inside a closed loop, “time” is undefinable, as “time is an order and nothing else. And all order is a time.”[327] Following the notion of contextuality introduced prece-
 dently, when one faces a global inconsistency, one can cut the loop, and recover logical
 consistency by introducing “local” contexts of logically consistent and well-defined se-
 quences of events cf. Fig. 10.1. These “contexts of ordered events” are locally consistent,
 but globally inconsistent. This way, time emerges from cutting self-referential paradoxes.
 As Gödel wrote: “*Time is the means by which God realized the inconceivable that P and
 $non-P$ are both true [...].*” [103] The flow of time allows to associate truth values to both
 a proposition and its negation. Noticing that this cut might be epistemic, one could fi-
 nally speculate that “*Time is a consequence of every attempt to provide a comprehensive
 description of the universe from within. Thus, time in this sense is not related to the
 universe itself but to the attempt to describe it.*”[323]

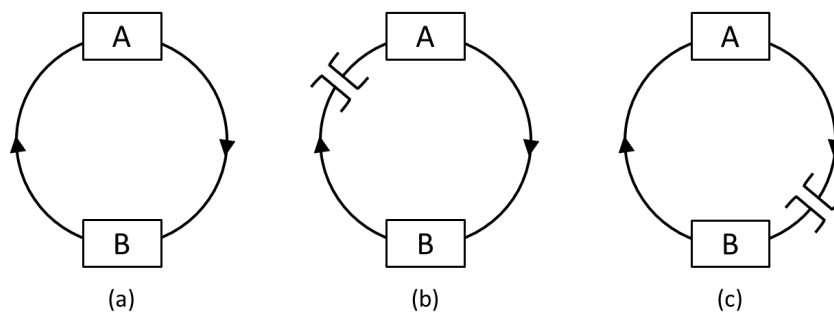

Figure 10.1: (a) Events A and B in a closed loop. The order is undefinable. If the loop
 is cut, an order emerges. Depending on the position of the cut, the “context”, either A
 precedes B (b), or the opposite (c).

In fact, according to Gödel, the hypothetical existence of CTCs reaffirmed his idea
 that time is not an intrinsic and primitive variable of the Universe. Rather, it only exists
 in a relative sense: it does not have any objective reality independently of the observer.
 In a CTC, observers should have an experience of the flow of time, while there is no flow
 of time strictly speaking, as past and future are completely indistinguishable. Hence, “if
 the experience of a flow of time can exist without an objective flow of time, there is no
 longer any reason to admit an objective flow of time.” ([328] vol.II, p.206)

Regarding the grandfather paradox itself, Gödel wrote:
 “This state of affairs seems to imply an absurdity. For it enables one e.g. to travel into
 the near past of those places where he has himself lived. There he would encounter a
 person which would be himself so and so many years ago. Now he could do something
 to this person which he knows by his own memory has not happened to him. This and
 similar contradictions, however, presuppose not only the practical feasibility of the trip
 into the past (velocities very close to that of light would be necessary for it) but also
 certain decision[s] on the part of the traveler; whose possibility one concludes only from
 vague conviction of the freedom of the will. Practically the same inconsistencies (again
 by neglecting certain “practical” difficulties) can be derived from the assumption of strict
 causality and the freedom of the will in the sense just indicated. Hence, as far as the
 paradoxical situation under consideration is concerned, an R-world [rotating] is not any
 more absurd than any world subject to strict causality.” ([329], p.560-561)

According to Gödel, the Universe is intrinsically independent from time. However, it is built on causal relations and a logical notion of causality, that “do not change in time and do not imply any change.” ([103] p.342) Baptiste Le Bihan’s analysis echoes this intuition: “the hypothesis of time travel of the temporal teleportation type amounts precisely to introducing a phase shift between external time and personal time, or to put it another way, to dissociate personal time and causality on the one hand and external time on the other hand. [...] Personal time is thus based on the existence of causal relations, and the hypothesis of the possibility of time travel amounts to postulating that causal relations can be dissociated from temporal relations.” ([330], p.89-90, personal translation) I argue that the notions of causality and time involved in this PhD thesis, i.e. in the process matrix formalism, concur with this view.

Chapter 11

Relating Quantum Contextuality and Noncausality ?

There is increasing evidence that contextuality is a central notion that captures precisely what makes quantum theory fundamentally different from classical physics, and that it is one of the key resources that enables many quantum advantages for information processing. Along this line, one can explore and clarify some emerging intuitive evidences that contextuality might also be the key to understanding how quantum causal relations differ from classical ones, and how some processes can violate causal inequalities and avoid at the same time pathological causal loops and paradoxes.

A first intuition is that it appears that, in a sheaf-theoretic approach, contextuality arises when there is local consistency and global inconsistency of data [42], while the process framework is built on a similar idea that one may not obtain a well-defined global causal structure from local ones [15]. In fact, even though no direct connexion between contextuality and noncausality was established, a recent extension of the sheaf-theoretic framework to (in)definite causal order has been proposed, and the “Lugano process” [24, 22] (cf. Section 2.6) has been analysed in this approach [331].

Another reason that suggests a link between contextuality and the process matrix framework is that it should be possible to extend the direct analogy between causal inequalities and Bell inequalities to contextuality tests, building on the recent result that a Bell scenario is a specific product of contextuality scenarii, involving the union of the edges of one-way signalling (i.e. fixed causal structure) hypergraphs [40]. In Section (11.1) we speculate on a hypergraph representation of a causal scenario and the emergence of noncausality from a specific contextuality scenario. Moreover a recent work [145] establishes a striking connection between parity local games, i.e. “a game where the parity of the parties’s outputs must equal a function of their inputs”, and causal games. In fact, it was proposed to translate such local games into causal ones by asking *each* party separately (instead of both, jointly) to guess the function value of the game. A canonical example with the CHSH game is given. Instead of having to satisfy the relation $a \oplus b = xy$ for a given binary random variable x and y , and produced outcomes a and b , the parties are asked to produce outcomes such that $a = xy$ and $b = xy$. The resulting causal game is the lazy-guess-your-neighbour input [18], in which Alice and Bob’s task is to guess each other’s input only when their respective input is 1. This game is known to have a causal bound of $3/4$, which thus coincides with the local bound of the CHSH game.

Finally, process matrices are known to be equivalent to a particular class of pre- and post-selected multipartite quantum states [88], while it has been shown [95] that anomalous weak values arising from pre- and post-selection are a proof of a generalised notion of contextuality from Spekkens [41], that extends the concept to any kind of experimental procedures (preparations, measurements, transformations).

On the one hand, one could thus speculate that a connection between contextuality and noncausality might be established in the light of Spekkens contextuality. This was for example explored by Shrapnel and Costa [332], who have shown, by extending Spekkens (non)contextuality to instruments and processes, that quantum contextuality cannot be explained by ontological models with an indefinite causal structure. “[One cannot construct] an ontological model that is both instrument and process non-contextual and also accords with the predictions of quantum mechanics.” In other words, quantum contextuality is not the apparent signature of a non-contextual model with indefinite causal relations. Note however that my motivation takes the opposite view to the Shrapnel-Costa theorem: rather than asking if noncausality can explain contextuality - which was shown not to be the case - I ask if a form of contextuality could underlie noncausality.

On the other hand, one could also look for such a relation in the multi-time state framework [276, 88]. Our previous analysis of the Hardy paradox as a LPPS paradox (cf. Chapter 7) aimed at being a starting point for exploring this line of thought. In Section (11.2), I speculate that using a meta-version of the paradox, i.e. in a Frauchiger-Renner-type scenario, an hypothetical connection between noncausal correlations and anomalous weak values could be investigated.

Finally I would like to mention another potential preliminary line of research, based on the analogy between Schrödinger’s cat and the quantum switch. In fact, the quantum switch can be interpreted as a form of causal Schrödinger’s cat: instead of the cat’s state, the causal order between two local operations is coherently controlled by a qubit. Thus one could imagine a Wigner’s friendification of the quantum switch in which, inside a closed laboratory, a party, Fiona, performs a measurement of the quantum control of a quantum switch - that quantumly controls the order of Alice and Bob’s operations U_A and U_B on the target $|\psi\rangle_t$ in the computational basis, i.e. project the state of the joint system either on $|0\rangle_c \otimes U_B U_A |\psi\rangle_t$ or $|1\rangle_c \otimes U_A U_B |\psi\rangle_t$. From her point of view, the causal order is well-defined: either $A \prec B$ or $B \prec A$: a reduced causally separable process matrix. However, outside Fiona’s closed laboratory, Ursula describes her measurement by a unitary evolution. The final state of the joint system from Ursula’s point of view is $\frac{1}{\sqrt{2}} \left(|0\rangle_c \otimes |0\rangle_f \otimes U_B U_A |\psi\rangle_t + |1\rangle_c \otimes |1\rangle_f \otimes U_A U_B |\psi\rangle_t \right)$, with $|0\rangle_f$ and $|1\rangle_f$ corresponding to the quantum description of Fiona’s state. Thus, from the point of view of Ursula, the causal order is still coherently controlled by quantum states; the process is still causally nonseparable. This hints at the idea that causal nonseparability, like quantum events, might be observer-dependent.

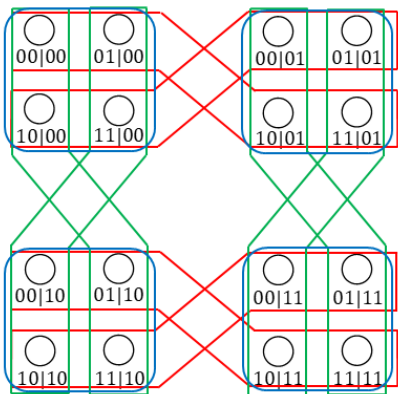

Figure 11.1: Hypergraph of the CHSH scenario as the Foulis-Randall product $\mathcal{B}_{1,2,2} \otimes \mathcal{B}_{1,2,2}$, cf. Section 7.2.2. In blue, hyperedges corresponding to simultaneous measurements. In green, Alice’s measurement choice depends on Bob’s outcome. In red, Bob’s measurement choice depends on Alice’s outcome.

11.1 A hypergraph representation of noncausality?

In the CHSH scenario depicted in Fig. 11.1, one can easily check that a signalling probabilistic model, for example associated with the strategy $\{a = xy, b = 0\}$ such that $p(00|00) = p(00|01) = p(00|10) = p(10|11) = 1$, is compatible with the signalling hyperedges $E_{B \rightarrow A}$ but is incompatible with the considered contextuality scenario¹. The normalisation condition $\sum_{v \in e} p(v) = 1$ cannot be satisfied for every hyperedge $e \in E$ of the hypergraph H . In a sense, one could argue that a signalling probabilistic model might be thus “contextual” with respect to a non-signalling scenario.

One could thus ask how we could represent causal scenarii in this hypergraph framework (cf. Section 7.2.2). I speculate that one might consider the two signalling hypergraphs associated with the hyperedges $E_{A \rightarrow B}$ and $E_{B \rightarrow A}$ respectively. One would then need to define a notion of *process model*, maybe as an assignment of probabilities $p : V(H) \rightarrow [0, 1]$ such that there exists Hilbert spaces \mathcal{H}^{AB} upon which live some valid process matrix W and valid local operations $M_{a|x}$ and $M_{b|y}$ associated to every vertex $v = (a, b|x, y) \in V$ such that $p(v) = \text{tr}(W M_v)$ with $M_v = M_{a|x} \otimes M_{b|y} \forall v \in V(H)$ (this is of course non-trivial, I am only speculating here).

For example, let us take the example of the GYNI game ($a = y, b = x$). A two-way signalling probabilistic model that allows to win the game with certainty is such that $p(00|00) = p(10|01) = p(01|10) = p(11|11) = 1$. One can easily check (cf. Fig. 11.2) that this model is inconsistent with the considered signalling hyperedges. Intuitively, two-way signalling is incompatible with both one-way signalling from Alice to Bob and one-way signalling from Bob to Alice respectively. Thus, in a sense, one could argue that such two-signalling model might be “contextual” with respect to a causal scenario. The same conclusion might be formulated for process models that allows to violate the GYNI causal inequality.

¹This is trivial. In fact, this signalling probabilistic model is incompatible with signalling from Alice to Bob, and thus the hyperedges $E_{A \rightarrow B}$.

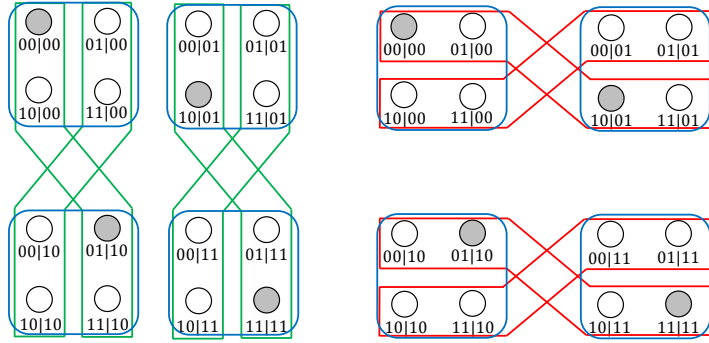

Figure 11.2: Hypergraph of the GYNI game with a probabilistic model winning the game with certainty, i.e. all events such that $a = y$ and $b = x$ happens with certainty. The violation of the GYNI causal inequality seems to imply a “contextual” (paradoxical) coloring of the two hypergraphs associated respectively with the signalling hyperedges $A \prec B$ (right) and $B \prec A$ (left). Thus a form of contextuality might underly noncausal correlations.

11.2 A relation between noncausality and anomalous weak values?

As analysed in Section 7.3.4, the LPPS-Hardy paradox, i.e. the fact that one can “obtain $|00\rangle$ with certainty” and also “obtain $|11\rangle$ with certainty”, actually depends on the causal order of Alice and Bob’s operations: the question “is the system in state $|00\rangle$?” is answered “yes” with certainty whenever Alice’s intermediate weak measurement precedes Bob’s ; while the question “is the system in state $|11\rangle$?” is answered “yes” with certainty whenever Bob’s intermediate operation precedes Alice’s. As suggested in Section 8.7, one could try to define a logical-pre-post-selection version of the Frauchiger-Renner paradox, since it has the same logical structure as the Hardy paradox. In this case, the pre-selection would consist in preparing a Hardy state, that would be given to Alice and Bob’s friends who would then apply intermediate weak measurements (in the computational basis) on it. Later, Alice and Bob would measure the compound system of the Hardy state and their friends in a meta-diagonal basis, and post-select the state $|-\rangle_A |-\rangle_B$. Thus, in this hypothetical 4-partite Frauchiger-Renner-type scenario, one could ask: what would happen if Alice and Bob’s friends could communicate via a quantum channel ? what if the causal order between the friends’ intermediate operations was controlled by a quantum switch ? what if Alice and Bob’s friends could both signal to each other via a non-causal process matrix ?

This might be an interesting set-up to explore. I speculate that one could expect that in the case where the friend’s operations are controlled with a quantum switch: if the control is in state $|0\rangle$ then the result of Alice and Bob’s friends joint weak measurement would always be $|00\rangle$, as Alice’s friend could signal to Bob’s. If the control is in state $|1\rangle$ then the result of Alice and Bob’s friends joint weak measurement would always be $|11\rangle$, as Bob’s friend could signal to Alice’s. On the other hand, if Alice and Bob’s friends share a non-causal process matrix instead, would they then actually obtain weak values $w(00|AB) = w(11|AB) = 1$ and $w(10|AB) = -1$?

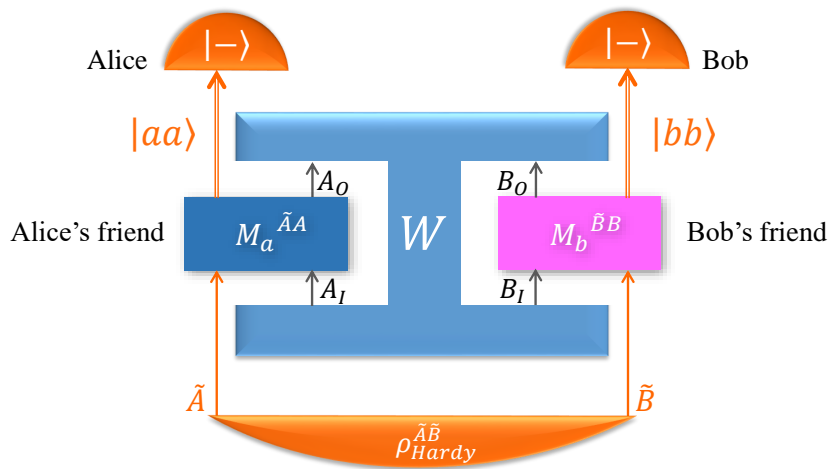

Figure 11.3: Hypothetical LPPS version of the Frauchiger-Renner scenario where the causal order between intermediate weak measurements of Alice and Bob's friends is given by a process matrix. The post-selection would correspond to the preparation of a Hardy state $\rho_{Hardy}^{\tilde{A}\tilde{B}}$ sent to Alice and Bob's friends, on which they would perform a weak measurement. Their closed laboratories would be linked with each other via a process matrix W . From Alice and Bob's point of view, their friends' operations might be described as unitaries, and they would receive the joint system made of the initial one and their friends' memories. They would then post-select the joint states $|-\rangle_A |-\rangle_B$.

Chapter 12

Violation of Causal and Logical Inequalities in a causal game

This chapter is based on a work in progress.

Several “quantum-based” models of CTCs were proposed in the 1990s, to formulate Novikov’s principle [4] and thus give an operational solution to the grandfather paradox. On the one hand, David Deutsch proposed a model (Deutsch CTCs, “D-CTCs”) [333] inspired by the Many-Worlds interpretation [334], that could be interpreted as a Many-Worlds-like take on Barjavel’s “To be *and* not to be”: the time-traveller still exists in a world, while she does not in another one. On the other hand, another model, proposed by various authors [335, 336, 337], is based on (post-selected) quantum teleportation: as the time-traveler teleported into the past if and only if it does not lead to a grandfather paradox. This can be done by preparing a maximally entangled state such that one part undergoes a joint unitary evolution with a causality respecting system. After the evolution, the causality violating system is teleported into the past by post-selection, resulting in the realisation of a post-selection CTC (“P-CTCs”). However, D-CTCs and P-CTCs are strongly pathological, as they allow post-quantum phenomena such as perfect cloning or perfect discrimination of non-orthogonal quantum states [24, 25]. Thus one could legitimately wonder whether a quantum-based model of CTC without logical paradox nor strong pathology exists. This is the case of process matrices. In fact, it was shown that the set of process matrices is equivalent to a specific (linear) subset of P-CTCs, meaning that every process matrix can be realized with a P-CTC¹ (Fig. 12.1) [24, 25].

Moreover, process matrices, which can be written as maps from a global past and the parties’ output Hilbert spaces $P \otimes A_O \otimes B_O$ to a global future and the parties’ input Hilbert spaces $F \otimes A_I \otimes B_I$, are sometimes interpreted as allowing to send information backwards in time without paradoxes: some can violate causal inequalities, without generating a grandfather paradox. In fact, the process matrix framework was precisely conceived so that it only generates valid probabilities and does not lead to any paradox. Thus, non-causality does not imply logical inconsistency. In what follows, I will illustrate this feature with an example of a new kind of causal game that, in addition to a causal inequality, quantifies a consistency principle in terms of a logical inequality. I will show that the maximal probability of success with indefinite causal orders lies between the causal and logical

¹In a P-CTC, the post-selection introduces a renormalization that depends in general on the input state of the evolution, thus introducing a non-linearity in the evolution of the causally-violating and causally-respecting systems. This is not the case for process matrices, which are linear P-CTCs.

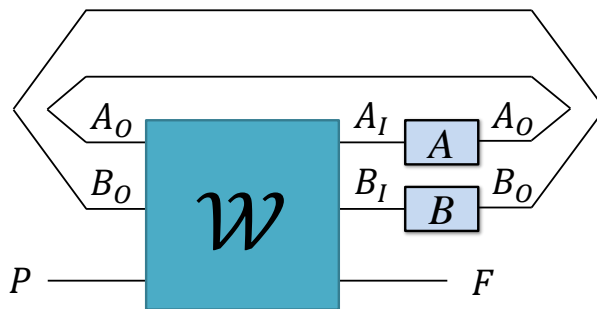

Figure 12.1: Representation of a process matrix as a supermap from $P \otimes A_O \otimes B_O$ to $F \otimes A_I \otimes B_I$ in the form of a P-CTC.

bounds. Finally, I will speculate on the meaning of the violation of a logical inequality, and how it might be interpreted as a form of contextuality.

12.1 Related Work

The grandfather paradox has already been studied and formulated for classical process matrices, i.e. process matrices which are diagonal in the computational basis. In the classical case, the antinomy would arise if the process has no fixed point ; i.e. if there exists a choice of operations for the parties such that no consistent assignment of values to some input bits exist. For example, a simple instance of the paradox can be realised with a NOT gate, trapped inside a trivial classical loop [326]. If, before the NOT gate, the bit takes value a , then it takes value $\neg a$ after. It is then looped back, meaning that it takes value $\neg a$ before the NOT gate, and thus $a = \neg a$, a logical contradiction occurs. Nevertheless, valid classical processes are the ones with exactly one fixed point, and thus always avoid the logical inconsistency by definition. Moreover, there are examples of classical process matrices that can generate noncausal correlations and thus violate a causal inequality, e.g. the Lugano process. Thus “noncausality does not imply logical inconsistency.”

Note that formulating the grandfather paradox in a cyclic quantum causal structure remains an open question, since the notion of fixed point is not straightforwardly generalisable to the quantum case [326]. In what follows, I will not tackle this issue directly. Rather, I will try to formulate an instance of the grandfather paradox against which both classical and quantum processes can be tested.

12.2 From the Grandfather paradox to Liar games.

I propose a theory-independent formulation of the grandfather paradox in terms of a game, based on the idea that this antinomy shares a similar logical structure with the Liar paradox. This formulation is inspired by various works in formal logic, in which semantic paradoxes are reformulated as Boolean equations. In such frameworks, a statement is represented by a variable in a system of Boolean equations. A paradox is defined as a statement or a set of statements for which there is no solution [338].

The Liar paradox

The simplest, canonical example of semantic paradox is “the Liar”: “This sentence is false.” One can associate the variable a with the statement, that can then be written by making its self-referential structure more explicit:

$$a = \text{The sentence } a \text{ is false.}$$

Finally, the negation relation “is false” is translated into the negation logical operator “ \neg ”, such that the Boolean equation associated with the Liar is

$$\text{Liar : } a = \neg a$$

Two instances of “truth” are involved here. On the one hand, “truth” is represented at the operational level, in the form of logical operators. “ $= a$ ” corresponds to “The sentence a is true.”, while “ $= \neg a$ ” means “The sentence a is false.” On the other hand, “truth” is also pictured at the interpretational level, in the form of truth values assigned to the statements/variables, 0 and 1 meaning “false” and “true” respectively. In the case of the Liar, if “ a is true”, $a = 1$, then, from the equation, “ a is false”, $a = \neg a = 0$, and vice-versa. Thus the equation has no solution: it is a paradox.

The Liar paradox has many variations. For example, it can be “strengthened” by adding a layer, i.e. it can be expressed with two statements rather than one. The “Strengthened Liar” can be realized with two players, contradicting each other. Alice declares that “Bob’s sentence is true.” while Bob says that “Alice’s sentence is false.” One can associate two variables a and b to Alice and Bob statements respectively.

$$a = \text{The sentence } b \text{ is true. } b = \text{The sentence } a \text{ is false.}$$

In order to distinguish the “referrer” from the “referred”, the variables are always written on the left-side of the equations, while the statements they refer to and their logical relations are on the right-side. For the Strengthened Liar, one thus obtains the following system of Boolean equations:

$$\text{Strengthened Liar : } \begin{cases} a = b \\ b = \neg a \end{cases}$$

One can easily check that this system has no solutions.

Finally, the Strengthened Liar paradox can be made *contingent*, if (at least) one of the variables refers to an “external” variable, e.g. x , out of the referential loop.

$$a = \text{The sentence } b \text{ is true. } b = \text{The sentence } x \text{ is true and the sentence } a \text{ is false.}$$

This way, a Contingent Strengthened Liar may or may not lead to a paradox, depending on the truth value associated with the external statement. Given the semantic equations:

$$\text{Contingent Strengthened Liar : } \begin{cases} a = b \\ b = x \wedge \neg a \end{cases}$$

If x is “false”, $x = 0$, then Bob’s sentence is false $b = x \wedge \neg a = 0$, as well as Alice’s, $a = b = 0$. The system has a well defined solution, there is no paradox. However, if x is “true”, $x = 1$, then the system is equivalent to a Strengthened Liar paradox.

I propose to interpret the Boolean systems as guessing games. The variables a and b are interpreted as guesses, classical outcomes produced by Alice and Bob respectively. In what follows, external variables, e.g. x and y , will be interpreted as classical inputs. Note moreover that I assume that a party’s statement/guess only refers to statements associated with the other party. Thus, from $b = x \wedge \neg a$, Bob has to guess the product of Alice’s input x and the negation of her outcome $\neg a$. A guessing game associated with a paradoxical system of equations will be called a *Liar game*.

12.3 The Paradoxical Game G

Assume that Alice and Bob are given uniformly distributed classical inputs x and y , according to which they chose their operations, and produce some classical outcomes a and b . The correlation that Alice and Bob establish in such an experiment is described by the joint conditional probability distribution $p(a, b|x, y)$. Another random bit γ gives the rules that should be satisfied by the correlations in order to win the game G .

The paradoxical game G

If $\gamma = 0$,

$$G_0 := \begin{cases} (\alpha_0) : a = \neg(y \wedge b) \\ (\beta_0) : b = x \wedge a \end{cases}$$

If $\gamma = 1$

$$G_1 := \begin{cases} (\alpha_1) : a = \neg((\neg y) \wedge (\neg b)) \\ (\beta_1) : b = (\neg x) \wedge (\neg a) \end{cases}$$

The probability of winning the game G is given by:

$$p_{win}(G) = \frac{1}{2}(p(G_0|\gamma = 0) + p(G_1|\gamma = 1))$$

Based on their available shared resources, Alice and Bob can elaborate a *strategy*, i.e. a map $(x, y) \rightarrow (a, b)$, in order to maximize their probability to win the game. I will start by presenting the two subgames G_0 and G_1 , from which I will derive causal and logical inequalities for G , and analyse their violations.

12.4 The Contingent Strengthened Liar subgame G_0

$$G_0 := \begin{cases} (\alpha_0) : a = \neg(y \wedge b) \\ (\beta_0) : b = x \wedge a \end{cases}$$

The probability of winning the subgame G_0 is given by:

$$p_{win}(G_0) = \frac{1}{4} \sum_{a,b,x,y} \delta_{\alpha_0} \delta_{\beta_0} p(a, b|x, y)$$

where δ_{α_0} and δ_{β_0} are Kronecker deltas associated with Alice's and Bob's guesses (α_0) and (β_0) respectively. The semantic translation of G_0 is:

$$\begin{aligned} (\alpha_0) \ a &= \text{At least one of the statements } y \text{ and } b \text{ is false.} \\ (\beta_0) \ b &= \text{Both statements } x \text{ and } a \text{ are true.} \end{aligned}$$

This game is a *Contingent Strengthened Liar game*: if $(x, y) = (1, 1)$, the game becomes a "Strengthened Liar":

$$G_{0|11} := \begin{cases} (\alpha_0|11) : a = \neg b \\ (\beta_0|11) : b = a \end{cases}$$

If the inputs are $(x, y) = (1, 1)$, a paradox arises due to the *self-referential* structure of the game: a is defined according to b and b is defined according to a ; so a and b are respectively defined according to themselves. The game can only be won "logically" (i.e. following Boolean logic) with a set of inputs $(x, y) \neq (1, 1)$. Defining a logical bound as the best Boolean strategy, we obtain the *logical inequality*:

$$p^{\text{logic}}(G_0) \leq \frac{3}{4} \quad (12.1)$$

This logical inequality is saturated for the strategy $\{a = 1, b = x\}$.

Let's now assume that Alice and Bob can communicate with each other in a well-defined order.

- If $A \prec B$, the previous strategy holds, and the game can be won 3 times out of 4 (whenever $(x, y) \neq (1, 1)$, $p^{A \prec B}(G_0) \leq 3/4$).
- If $B \prec A$, the previous strategy does not hold. Even if $a = 1$ (like in the previous strategy), Bob only has a probability 1/2 of correctly guessing Alice's input x , e.g. $b = 0$ if $y = 1$ and $b = \text{rand}$ if $y = 0$. One can verify that $p^{B \prec A}(G_0) \leq 1/2$.

To sum up, the causal bound is equal to the logical bound, but can only be saturated with a causal order $A \prec B$:

$$p^{A \prec B}(G_0) = p^{\text{logic}}(G_0) \leq \frac{3}{4} \quad (12.2)$$

12.5 The Contingent Strengthened Liar subgame G_1

$$G_1 := \begin{cases} (\alpha_1) : a = \neg((\neg y) \wedge (\neg b)) \\ (\beta_1) : b = (\neg x) \wedge (\neg a) \end{cases}$$

The probability of winning the game is given by:

$$p_{\text{win}}(G_1) = \frac{1}{4} \sum_{a,b,x,y} \delta_{\alpha_1} \delta_{\beta_1} p(a, b|x, y)$$

where δ_{α_1} and δ_{β_1} are Kronecker deltas associated with Alice's and Bob's guesses (α_1) and (β_1) respectively. Note that G_1 structure is similar with G_0 's, but refers to the negations

of the reference statements from G_0 . Moreover, (α_1) can be simplified as $a = y \vee b$. The semantic translation of G_1 is then:

$$\begin{aligned} (\alpha_1) \ a &= \text{At least one of the statements } y \text{ and } b \text{ is true.} \\ (\beta_1) \ b &= \text{Both statements } x \text{ and } a \text{ are false.} \end{aligned}$$

This game is a Contingent Strengthened Liar game: if $(x, y) = (0, 0)$, the game becomes a ‘‘Strengthened Liar’’:

$$G_{1|00} := \begin{cases} (\alpha_1|00) : a = b \\ (\beta_1|00) : b = \neg a \end{cases}$$

If the inputs are $(x, y) = (0, 0)$, a paradox arises due to the *self-referential* structure of the game. Similarly with G_0 , we obtain the logical inequality

$$p^{\text{logic}}(G_1) \leq \frac{3}{4} \quad (12.3)$$

saturated with the strategy $\{a = y, b = 0\}$.

Assuming that Alice and Bob share a causal resource, we obtain the inequalities $p^{A \prec B}(G_1) \leq 1/2$ and $p^{B \prec A}(G_1) \leq 3/4$.

To sum up, the causal bound is equal to the logical bound, but can only be saturated with a causal order $B \prec A$:

$$p^{B \prec A}(G_1) = p^{\text{logic}}(G_1) \leq \frac{3}{4} \quad (12.4)$$

12.6 Causal inequality and its violation in game G

Remember that the probability of winning G is :

$$p_{\text{win}}(G) = \frac{1}{2}(p(G_0|\gamma = 0) + p(G_1|\gamma = 1))$$

The possible outcomes of G can be represented in the following table:

(x, y)	$G_0 : (a, b)$	$G_1 : (a, b)$
(0,0)	(1,0)	\emptyset
(0,1)	(1,0)	(1,0)
(1,0)	(1,1)	(0,0)
(1,1)	\emptyset	(1,0)

Because a strategy with a well-defined order, e.g. $A \prec B$ (resp. $B \prec A$) wins 3 times out of 4 for the subgame G_0 (resp. G_1), but randomly wins for the other subgame G_1 (resp. G_0), we obtain:

$$\begin{aligned} p_{\text{win}}^{A \prec B}(G) &= \frac{1}{2}[p^{A \prec B}(G_0|\gamma = 0) + p^{A \prec B}(G_1|\gamma = 1)] \\ &= \frac{1}{2}\left[\frac{3}{4} + \frac{1}{2}\right] = \frac{5}{8} \end{aligned} \quad (12.5)$$

and similarly with $B \prec A$. Thus, the causal inequality

$$p^{causal}(G) \leq \frac{5}{8} = 0,625 \quad (12.6)$$

I have found the largest possible violation of the causal inequality by a valid process by using a *see-saw algorithm* (cf. Section 2.4.2). Note however that because the optimization problem is nonconvex, the algorithm is not guaranteed to converge to a global maximum. From my numerical result, using a semidefinite program, I conjecture that the maximal violation of my causal inequality achievable with qubits is

$$p_G^{max,d=2} = \frac{1}{4}(2 + \frac{1}{\sqrt{2}}) \approx 0.6768 > 0.625 = \frac{5}{8} \quad (12.7)$$

Interestingly other processes known to violate other causal inequalities also reach this bound. This is the case for example for a process known to violate the causal inequality of the GYNI game (cf. [18]):

$$W_{GYNI} = \frac{1}{4} \left(\mathbb{1}\mathbb{1}\mathbb{1}\mathbb{1} + \frac{ZZZ\mathbb{1} + Z\mathbb{1}XX}{\sqrt{2}} \right) \quad (12.8)$$

with the instruments

$$M_{a|x,\gamma}^A = \frac{\gamma}{2} (x|a\rangle\langle a| + (1-x)a\mathbb{1}) \otimes \mathbb{1} \dots \\ \dots + (1-\gamma)a((1-x)(|01\rangle\langle 01| + |10\rangle\langle 10|) + x(|00\rangle\langle 00| + |11\rangle\langle 11|)) \quad (12.9)$$

$$M_{b|y,\gamma}^B = \frac{\gamma}{2}(1-b)(\mathbb{1}\mathbb{1} + (-1)^y XX) + \frac{1-\gamma}{2}(y(1-b)\mathbb{1} + (1-y)|\neg b\rangle\langle \neg b|) \otimes \mathbb{1} \quad (12.10)$$

Inter alia, one can note that, if $\gamma = 0$, i.e. G_0 is played, then Alice always outputs $a = 1$, while if G_1 is played ($\gamma = 1$), then Bob always returns $b = 0$.

12.7 Logical inequality and its violation in game G

Independently of whether G_0 or G_1 is played, only 3 out of 4 of the outcomes are “possible”. The logical inequality associated with game G is thus

$$p^{logic}(G) \leq \frac{6}{8} = \frac{3}{4} \quad (12.11)$$

Thus, finally

$$p_{win}^{causal}(G) \approx 0.625 < p_{win}^{process}(G) \approx 0.6768 < p_{win}^{logic}(G) = 0.75 < 1 \quad (12.12)$$

Noncausal processes can violate a causal inequality without violating a logical inequality, i.e. without logical paradoxes.

Note that two fundamental assumptions were made in the derivation of the causal and logical inequalities:

- No dynamical causal order: γ cannot be used by a previous party P to influence the causal structure between Alice and Bob's operations. If it was possible, then the logical bound would be saturated by valid causal processes of the form

$$W = \gamma W_{\gamma=1}^{B \prec A} + (1 - \gamma) W_{\gamma=0}^{A \prec B}$$

where $W_{\gamma=1}^{B \prec A}$ and $W_{\gamma=0}^{A \prec B}$ are valid causal processes. In other words, the causal bound would be the same as the logical bound,

$$p^{causal}(G) = p^{logic}(G) \leq \frac{3}{4} \quad (12.13)$$

- Knowing the rules: Alice and Bob have access to γ . If not, the best logical strategy would be to answer $a = (1, 0)$ if $(x, y) \neq (1, 0)$ and $a = b = rand$ if $(x, y) = (1, 0)$. Alice and Bob would have to randomly guess the value of γ . One can then verify that the logical bound would be the same as the causal one,

$$p^{logic}(G) = p^{causal}(G) \leq \frac{5}{8} \quad (12.14)$$

I speculate that the violation of the logical bound in this specific case might also arise with a logically consistent strategy that features the so-called *information* or *bootstrap paradox*, for which the corresponding semantic system of equations would have more than one solution.

The logical inequality Eq.(12.11) can be violated by the non-valid classical process

$$W = \frac{1}{4}(\mathbb{1}\mathbb{1}\mathbb{1}\mathbb{1} + \mathbb{1}ZZ\mathbb{1} + Z\mathbb{1}\mathbb{1}Z + ZZZZ) \quad (12.15)$$

with the valid classical operations

$$M_{a|x,\gamma}^A = a(\gamma(|01\rangle\langle 01| + |10\rangle\langle 10|) + (1 - \gamma)(x(|00\rangle\langle 00| + |11\rangle\langle 11|)) \dots \\ \dots + (1 - x)(|01\rangle\langle 01| + |10\rangle\langle 10|)) \quad (12.16)$$

$$M_{b|y,\gamma}^B = \gamma(y(1 - b)(|01\rangle\langle 01| + |10\rangle\langle 10|) + (1 - y)\frac{1}{4}\mathbb{1} \otimes \mathbb{1}) \dots \\ \dots + (1 - \gamma)(y(1 - b)(|01\rangle\langle 01| + |10\rangle\langle 10|)) \dots \\ \dots + (1 - y)\frac{1}{2}((1 - b)(|01\rangle\langle 01| + |10\rangle\langle 10|) + b(|00\rangle\langle 00| + |11\rangle\langle 11|)) \quad (12.17)$$

that gives a probability of success of 1.

However the violation of a logical inequality can only be realised with non-valid probabilities (negative or non-normalised)². Such pathology might be interpreted in the following operational way: the correlations $p(a, b|x, y)$ are *meaningless*. This would be in line with the QBist take on correlations: “Quantum correlations refers only to [...] the acquisition of experiences by any single agent. One cannot assign correlations, spooky or otherwise, to space-like separated events, since they cannot be experienced by any single agent.” [339]

²Here, the violation involves non-normalised probabilities. In fact, because W is positive semidefinite and the instruments are valid, the probabilities are always non-negative.

Moreover, the violation of the logical inequalities involved in G_0 , G_1 and G might be interpreted as a violation of the Novikov consistency principle, i.e. the emergence of logical inconsistencies similar with the structure of the grandfather and the Liar paradoxes. In the light of the similarities between Liar-like paradoxes and contextuality (cf. part 2 “Quantum Contextuality” of this thesis), one could speculate that a form contextuality might emerge from the violation of a logical inequality. In fact, in each subgame G_γ , the local statements (α_γ) and (β_γ) are locally consistent, but globally inconsistent. In other words, the guesses of each player are locally consistent but lead to logical inconsistencies when embedded in correlations. For example, when $(x, y) = (1, 1)$, the game G_0 can intuitively be won with certainty by realizing a logical paradox in a simple classical closed causal loop. However, the global inconsistency can be avoided with logically consistent local “contexts”, by cutting the loop. Remarkably, the position of the cut defines both a “party of reference” and a causal order (Fig. 12.2).

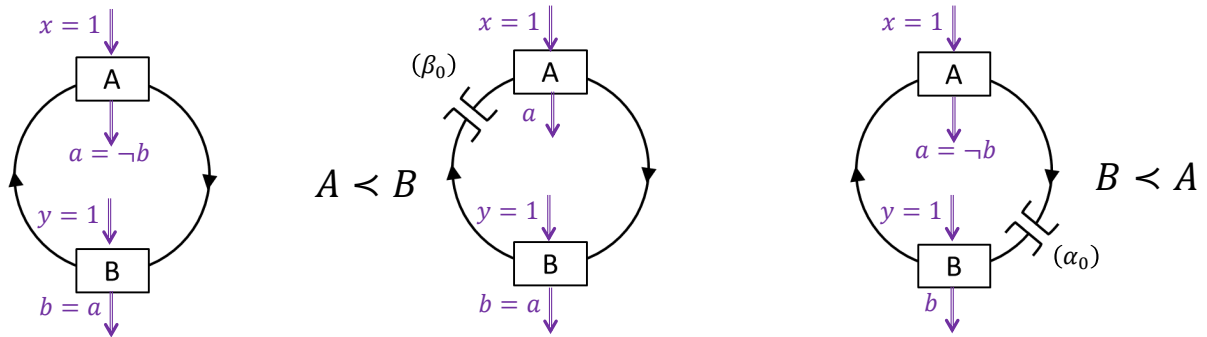

Figure 12.2: Representation of the emergence of contextuality from the violation of the game G_0 when $(x, y) = (1, 1)$. In a closed causal loop, the paradox is realised, and a global inconsistency arises. By cutting the loop, one can then focus on the realisation of only one of the statement, given in a context. Either the statement (β_0) can be realised without contradiction, i.e. Alice outputs the statement a without any reference and sends it to Bob, who outputs $b = a$, introducing the causal order $A \prec B$; or the statement (α_0) can be realised without contradiction, i.e. Bob outputs the statement b without any reference and sends it to Alice, who outputs $a = \neg b$, introducing the causal order $B \prec A$.

12.8 Take Away and Perspectives

Take Away

- Noncausality does not imply logical inconsistency.
- I have formalized a grandfather-Liar-like paradox in terms of a causal game with causal and logical inequalities, with the following bounds:

$$p_{win}^{causal}(G) \approx 0.625 < p_{win}^{process}(G) \approx 0.6768 < p_{win}^{logic}(G) = 0.75 < 1$$

The causal inequality is violated by some process matrices without logical paradoxes nor strong pathologies, i.e. without violating the logical inequality, which might be interpreted as an empirical test of classical logic.

Perspectives

- The emergence of logical inconsistencies from the violation of a logical inequality might be interpreted as a form of contextuality, the guesses of each player being locally consistent but leading to inconsistencies when embedded globally in correlations. This remains to be clarified.
- I could test the performance of other kinds of processes in the game, e.g. classical process matrices, non-linear P-CTCs, D-CTCs...
- One could try to find other examples of such paradoxical causal games, in particular a tripartite game in which Lugano-like processes could be tested.

Conclusion and Perspectives

Using the grandfather paradox as a source of inspiration, the initial motivation of this thesis was to improve our understanding of causal nonseparability, noncausality and quantum paradoxes in order to address the question: “Could the non-fundamental nature of causality be related to a form of contextuality ?”

I started this exploration by tackling the question “What kind of quantum circuits are incompatible with a definite causal order ?” (Chapter 3) We have identified a large class of physically implementable processes, the quantum circuits with quantum control of causal order (QC-QCs), which includes causally nonseparable processes such as the quantum switch. I have proposed a new implementation of the quantum switch, based on one of the motto of this thesis: the idea that a definite causal order emerges from the position of a cut in a causal loop. If the position of the cut is indefinite, the causal order is, by “entanglement”, also indefinite. I have studied a new example of causally nonseparable QC-QC in which the causal order is both dynamically established and indefinite, and I have identified new information processing advantages offered by the QC-QCs for some discrimination tasks with respect to quantum circuits with a definite causal order. The experimental realisations and study of new causally nonseparable QC-QCs, beyond the quantum switch, and whether they lead to new advantages for quantum information tasks should be investigated in the future.

QC-QCs cannot be used to violate causal inequalities. The question of whether a physically implementable process allowing to do so exists or not remains open. This could be explored by relaxing some validity constraints on the processes, restricting the set of allowed instruments, and by only imposing that valid probabilities should be produced.

My main contribution in the understanding of noncausality was to make a significant relaxation of assumptions to certify the causal nonseparability of many processes, showing that it can be done in a semi-device-independent scenario with untrusted local operations and trusted quantum inputs (Chapter 4). I have shown in particular that the quantum switch can generate noncausal correlations in this kind of scenario. With additional natural assumptions on the operations, I have shown that it is also the case of all bipartite causally nonseparable, as well as all “TTU-noncausal” processes. A deeper understanding of which causally nonseparable processes can be certified in this way remains an open problem. Our definition of causal nonseparability for distributed measurements could be generalised for multipartite scenarios, paving the way to develop a resource theory of causal nonseparability. One could try to verify if other QC-QCs can generate noncausal correlations with quantum inputs. Finally we plan to pursue the analogy between non-locality and noncausality: inspired by [223, 224], we are investigating if an analogous combination of our semi-device independent certification of causal nonseparability with self-testing could lead to a device-independent certification of causal nonseparability for some processes.

In order to refine my understanding of quantum contextuality, I have studied how the Hardy paradox entails a form of logical contextuality (Chapter 7). The logical contradiction manifests itself in the form of two Liar cycles, and a combination of both. The latter is directly related with the emergence of the anomalous weak value in the weak logical pre-post-selection version of the paradox. Furthermore, I have shown that the two possible intermediate measurements involved in this pre-post-selection version differ causally from each other, one being associated with $A \prec B$, while the other corresponds to $B \prec A$. Is this distinction a mere coincidence of the Hardy scenario or is there a deeper

meaning ? The apparent relation between the combination of the Liar cycles underlying the paradox and the emergence of anomalous weak values needs further investigation. This analysis might be useful to the study of the Frauchiger-Renner paradox, which can be seen as a “Wigner’s friendification” of the Hardy paradox. In particular, one could try to develop a logical pre-post-selection of it. I propose furthermore to exploit the fact that the intermediate measurements differs causally from one another. What would happen if this causal order was indefinite ?

On a more metaphysical aspect, I have argued that physics might not be paradoxical (Chapter 8). I have defended the idea of a Gödelian hunch from quantum theory, the idea that quantum paradoxes are not ontological, but emerge from a lack of metaphysical distancing, i.e. a lack of distinction between the level of the studied object (quantum theory), and the level of the meta-theoretical object (observer). Quantum contextuality can be interpreted as the fact that meta-propositions (truth values) associated to quantum propositions are infected by the logical structure of the latter. The measurement problem can be analyzed as a logical error emerging from a lack of distinction between theoretical and meta-theoretical objects. I have defined the notion of meta-contextuality as the fundamental criterion underlying neo-Copenhagen interpretations which allow them to (dis)solve these paradoxes.

I have suggested some ideas to directly face the question of a possible link between noncausality and contextuality. In Chapter 11, I have proposed to explore a speculative hypergraph representation of noncausality in a contextuality scenario. I have also suggested to look into an hypothetical link between noncausality and anomalous weak values. In Chapter 12, I have proposed an original causal game, which highlights the fact that noncausality does not imply logical inconsistency. In this game, the grandfather paradox is formalized in terms of a logical inequality which might be interpreted as an empirical test of classical logic. I have shown that some process matrices can violate the causal inequality without violating the logical one. I also plan to test the performance of other kinds of processes (such as classical process matrices, non-linear P-CTCs and D-CTCs) in the game. One could try to find other examples of such paradoxical causal games, in particular a tripartite game in which Lugano-like processes - which I find particularly interesting - could be tested. Finally, the emergence of logical inconsistencies from the violation of a logical inequality might be interpreted as a form of contextuality, the guesses of each player being locally consistent but leading to inconsistencies when embedded globally in correlations. This logical contradiction would be stronger than the one emerging from quantum contextuality, which relies on a counterfactual contradiction. This remains to be clarified, but might be in line with our philosophical motivation (Section 0.2), our Gödelian hunch from time (Chapter 10) and the motto of this PhD thesis:

“Time is the means by which God realized the inconceivable that P and $non-P$ are both true.”
K. Gödel

Résumé synthétique

Introduction

Dans son roman “Le Voyageur imprudent”, René Barjavel raconte l’histoire d’un voyageur temporel qui tue accidentellement son ancêtre dans le passé. Il s’agit de la première apparition du paradoxe du grand-père, un scénario dans lequel un effet supprime sa propre cause. Dans un post-scriptum de 1958 intitulé “Être et ne pas être.” (1958), Barjavel émet l’hypothèse que seul les physiciens spécialistes de la théorie quantique pourraient peut-être se faire “une très vague idée” du caractère indéfinissable du voyageur. Utilisons l’intuition de l’auteur comme fil rouge de cette thèse et demandons-nous : “Comment le paradoxe du grand-père peut-il être lié à la théorie quantique ?” Cette thèse est divisée en trois grands axes, explorant chacun une piste de réflexion autour de cette question.

La première piste vise à étudier comment la théorie quantique interroge le caractère fondamental de la causalité. Celle-ci - qui se définit par l’idée qu’un événement ne peut pas être influencé par des événements futurs - est considérée comme un des concepts fondamentaux de la physique. Néanmoins, on pourrait envisager d’assouplir l’hypothèse standard selon laquelle les événements quantiques sont intégrés dans une structure causale fixée, et ainsi étendre l’indétermination quantique aux relations causales elles-mêmes. Le formalisme des matrices de processus, un cadre théorique dans lequel l’ordre causal global n’est pas prédéfini, mais des joueurs (Alice et Bob) peuvent tout de même effectuer des opérations quantiques locales et arbitraires, au sein de leurs laboratoires respectifs. Ce formalisme a permis d’identifier une nouveau types d’objets (matrices de processus) aux ordres causaux indéterminés. Ces objets se sont avérés correspondre à un type spécifique de courbe de temps fermée (CTC), basée sur la post-sélection et la téléportation quantique, parfois interprétés comme des *boucles causales* permettant de “renvoyer de l’information dans le passé sans paradoxe”.

La seconde piste consiste à interpréter le paradoxe du grand-père comme une réalisation physique (hypothétique) d’une auto-contradiction, et à mettre en évidence comment la théorie quantique pourrait être caractérisée par une structure logique similaire. De fait, il se trouve que l’adage “le résultat d’une mesure quantique dépend du contexte de la mesure” trouve de solides fondements mathématiques au sein du théorème de Kochen-Specker, qui montre que la théorie quantique est incompatible avec l’idée que les observables physiques possèdent des valeurs préexistantes indépendantes du contexte de mesure. Cette caractéristique appelée contextualité quantique montre que toute tentative d’étendre la logique quantique de telle sorte que la logique classique soit rétablie dans le domaine étendu échoue en raison de l’apparition de *boucles logiques* paradoxales. Ceci nous amène à nous interroger sur la nature même des “paradoxes” quantiques.

Enfin, nous pouvons examiner l'interaction entre la causalité quantique et la contextualité. La non-localité de Bell pouvant être considérée comme une sorte de contextualité, et du fait d'une profonde analogie entre la non-localité et la non-causalité, on pourrait s'attendre à l'existence d'un lien - encore à explorer - entre les relations causales indéterminées et la contextualité en théorie quantique, invoquant la principale problématique de cette thèse: "*Le caractère non fondamental de la causalité pourrait-il être lié à une forme de contextualité ?*"

Partie I: Causalité Quantique

De nouveaux outils conceptuels furent développés au sein du formalisme des matrices de processus pour étudier et identifier les ordres causaux indéterminés: la non-séparabilité causale, qui peut être démontrée de manière "device-dependent" en construisant des témoins causaux ; et la non-causalité, une certification "device-independent" basée sur la violation d'inégalités causales. Celles-ci sont des analogies directes avec l'intrication quantique et la violation des inégalités de Bell.

Le "quantum switch" est un exemple important de ressource quantique causalement non-séparable. Il peut être vu comme une variante causale du chat de Schrödinger dans laquelle l'ordre de deux opérations quantiques (plutôt que l'état de "vie ou de mort" d'un chat) est intriqué avec un système quantique. Malgré sa non-séparabilité causale et le fait qu'il permette de réaliser de nouvelles tâches en traitement de l'information qui sont impossibles avec des circuits quantiques standards, ce processus ne peut pas générer de corrélations non causales qui violeraient une inégalité causale.

Le premier objectif de mon projet de thèse était de contribuer à caractériser les processus à ordres causaux indéterminés réalisables expérimentalement, au-delà du quantum switch, dans le but d'étudier en quoi ces processus diffèrent des processus ayant une structure causale bien définie et si les corrélations générées pourraient violer des inégalités causales. À partir de ces résultats, l'objectif était alors d'explorer si ces nouvelles relations causales pouvaient offrir de nouvelles possibilités dans le domaine du traitement de l'information.

Au-delà du Quantum Switch: Circuits Quantiques avec Contrôle Quantique d'Ordres Causaux

L'une des principales questions ouvertes dans le domaine de la causalité quantique est d'identifier quelles matrices de processus causalement non-séparables ont une réalisation expérimentale, et si certains de ces processus sont capable de violer une inégalité causale.

Nous avons initié cette exploration dans une approche ascendante ("bottom-up"), en abordant la question "Quels types de circuits quantiques sont incompatible avec un ordre causal déterminé ?" Nous avons identifié une grande classe de processus physiquement implémentables, les circuits quantiques avec contrôle quantique d'ordre causaux (QC-QCs), qui inclut des processus causalement non séparables tels que le "quantum switch". J'ai proposé une nouvelle implémentation du quantum switch, basée sur l'idée qu'un ordre causal défini émerge de la position d'une coupure dans une boucle causale. Si la position

de la coupure est indéterminée, l'ordre causal est, par "intrication", également indéterminé. J'ai également étudié un nouvel exemple de QC-QC causalement non-séparable au-delà du quantum switch, dans lequel l'ordre causal est à la fois établi dynamiquement et indéterminé. Enfin, nous avons identifié de nouveaux avantages offerts par les QC-QCs pour certaines tâches de traitement informationnel par rapport aux circuits quantiques avec un ordre causal déterminé. Néanmoins, comme le quantum switch, aucun QC-QC causalement non-séparable ne peut générer de corrélations non-causales permettant de violer une inégalité causale.

Certification de la Non-Séparabilité Causale à l'aide d'Entrées Quantiques

La notion de non-séparabilité causale dans le formalisme matriciel de processus a été introduite par analogie avec l'intrication dans la théorie quantique standard. Compte-tenu de l'aspect contre-intuitif de ces caractéristiques, la question de savoir comment elles peuvent être caractérisées, certifiées expérimentalement et quelles hypothèses sous-jacentes sont nécessaires pour le faire est fondamentale.

Une première méthode qui permet de détecter la non-séparabilité causale de tout processus à ordre causaux indéterminés est de mesurer des témoins causaux. Cette certification présente cependant un inconvénient expérimental important, car elle repose sur le calibrage parfait des appareils de mesure. Ce type de certification, dit "device-dependent", est en général laborieux à mettre en œuvre, car même de petites erreurs d'alignement, difficiles à estimer, peuvent conduire à des faux positifs. Cependant, d'autres types de certification existent, impliquant moins d'hypothèses. C'est le cas de la violation d'inégalité causale, qui permet de caractériser la non-séparabilité causale d'une manière particulièrement puissante, dans le sens où elle ne nécessite qu'un ensemble minimal d'hypothèses sur les dispositifs, et ne repose pas sur leur caractérisation détaillée : il s'agit d'une certification "device-independent". Cependant, comme expliqué précédemment, aucun des processus causalement non-séparables implémentables connus, les QC-QCs, ne peut violer d'inégalité causale.

En recourant à l'analogie avec l'intrication et la non-localité de Bell, j'ai exploré une forme de certification de la non-séparabilité causale dans un scénario "semi-device-independent" dans lequel les joueurs impliqués reçoivent des états quantiques fiables en entrée, mais pour dont les dispositifs ne sont autrement pas caractérisés. Pour ce faire, j'ai défini, avec mes coauteurs, la notion de "mesures distribuées causalement non-séparables". J'ai montré que certains processus causalement non-séparables qui ne peuvent violer aucune inégalité causale, comme le quantum switch, peuvent générer des corrélations non-causales dans un tel scénario. De plus, en faisant l'hypothèse d'une structure naturelle sur les dispositifs non fiables, j'ai montré que toutes les matrices de processus bipartites causalement non-séparables ainsi que tous les processus dits "TTU-non causaux" peuvent être certifiés avec des entrées quantiques fiables.

Partie II: Contextualité Quantique

Après divers travaux consistant à simplifier la démonstration du théorème de Kochen-Specker, de plus en plus de preuves ont mis en évidence que la contextualité pourrait

être une notion centrale qui capture précisément ce qui rend la théorie quantique fondamentalement différente de la physique classique ; un témoin de l'étrangeté quantique. La contextualité quantique a par exemple été identifiée comme un ingrédient important dans la quête de la recette de l'ordinateur quantique universel. De plus, des résultats récents suggèrent que la non-localité de Bell peut être considérée, dans un sens spécifique, comme un cas particulier de contextualité. Des généralisations graphiques du résultat de Kochen-Specker ont permis d'établir des liens entre les corrélations non locales et contextuelles, et d'identifier comment la non-localité peut être exprimée dans un scénario de contextualité. Une autre approche initiée par Robert Spekkens généralise la notion de contextualité de mesure du théorème de Kochen-Specker à tout type de procédure expérimentale (préparations, transformations) d'une manière indépendante de la théorie, permettant de comparer directement cette contextualité avec l'hypothèse de la causalité locale de Bell. Enfin, la contextualité et sa relation avec la non-localité ont également été étudiées dans une approche topologique, dans laquelle elles émergent lorsque des données sont localement cohérentes, mais globalement incohérentes. La contextualité partage ainsi une structure logique similaire à celle de célèbres paradoxes sémantiques tels que le paradoxe du menteur. Ceci nous amène à l'autre question principale motivant cette thèse: la physique est-elle paradoxale ?

Infutabilia: le théorème de Kochen-Specker

Dans ce chapitre, je présente le théorème de Kochen-Specker ainsi que l'histoire de ses origines. L'origine du théorème est en effet double. Un premier contexte est celui du "problème des variables cachées". Bell utilisera un corollaire du théorème de Gleason (1957) dans un article de 1964 intitulé "Sur le problème des variables cachées en mécanique quantique", dans lequel il démontre le même résultat que Kochen et Specker. Malgré le fait que leur article partage le même titre - "Le problème des variables cachées en mécanique quantique" (1967) - leur travail a été réalisé indépendamment de celui de Bell.

Cependant, contrairement à Bell, le problème des variables cachées n'était pas la motivation principale des travaux fondateurs de Specker en 1960, dans lequel le théorème apparaît pour la première fois. Specker s'est inspiré de la philosophie de l'un de ses anciens professeurs - Ferdinand Gonseth - sur la nature empirique de la logique, ainsi que d'un éternel débat scholastique qu'il a nommé "Infutabilia" : le problème des futurs contingents, et plus spécifiquement la question de savoir si l'omniscience divine s'étend aux énoncés contrefactuels. J'émet l'hypothèse que la passion qu'entretenait Specker pour le livre biblique de Jonas pourrait être un élément clé dans la compréhension des origines du théorème.

Contextualité dans le Paradoxe de Hardy

Afin d'affiner ma compréhension de la contextualité quantique, j'ai étudié comment le paradoxe de Hardy implique une forme de contextualité logique à travers une approche topologique et une représentation graphique. La contradiction logique se manifeste sous la forme de deux cycles de Menteur, et également sous la forme d'une combinaison des deux. Cette dernière preuve est directement liée à l'émergence de la valeur faible anormale (quantité accessible via des expériences quantiques impliquant des mesures faibles et une

post-sélection, qui se situe au-delà de la plage de valeurs propres de l'opérateur correspondant) dans la version "pré-post-sélection faible" du paradoxe logique. Par ailleurs, j'ai montré que les deux mesures intermédiaires possibles impliquées dans cette version "pré-post-sélection" sont différentes l'une de l'autre, et correspondent à des ordres causaux différents.

Meta-Contextualité: une approche néo-Copenhagienne de la théorie quantique

Dans un essai philosophique, j'ai défendu l'idée d'une intuition gödelienne de la théorie quantique, inspirée des travaux de Szangolies, Brukner et Grinbaum. D'après cette intuition, les paradoxes quantiques ne seraient pas ontologiques, mais émergeraient d'un manque de distanciation métaphysique, c'est-à-dire d'un manque de distinction entre le niveau d'abstraction de l'objet théorique étudié (théorie quantique), et le niveau d'abstraction de l'objet méta-théorique étudiant (observateur). La contextualité quantique peut ainsi être interprétée comme le fait que les méta-propositions (valeurs de vérité) associées aux propositions quantiques sont infectées par la structure logique de ces dernières. Le problème de la mesure, le problème de l'ami de Wigner ainsi que le paradoxe de Frauchiger-Renner (un "méta-paradoxe de Hardy") peuvent être analysés comme une erreur logique issue d'un manque de distinction entre objets théoriques et méta-théoriques. J'ai défini la notion de méta-contextualité comme le critère fondamental sous-jacent aux interprétations néo-Copenhague qui leur permettent de dissoudre ces paradoxes.

Partie III: "Voyages Temporels sans Paradoxes"

Cette dernière partie vise à donner quelques réflexions sur la motivation principale de la thèse : établir un lien entre causalité quantique et contextualité. Elle ne s'appuie sur aucun travail publié ou prépublié. Au contraire, elle contient principalement des travaux en cours et des spéculations sur des perspectives au-delà de cette thèse de doctorat, que je souhaiterais explorer à l'avenir.

Un lien entre contextualité et noncausalité ?

La contextualité est une notion centrale qui pourrait capturer précisément ce qui rend la théorie quantique fondamentalement différente de la physique classique. Dans cette optique, on peut explorer et clarifier certains indices laissant penser que la contextualité pourrait également être la clé pour comprendre en quoi les relations causales quantiques diffèrent des relations classiques, et comment certains processus peuvent violer une inégalité causale et éviter en même temps des formes pathologiques et paradoxales de boucles causales.

Un premier indice est le fait que dans une approche topologique, la contextualité survient lorsqu'il existe une cohérence locale et une incohérence globale des données, tandis que le formalisme des matrices de processus est construit sur une idée similaire selon laquelle on peut ne pas obtenir de structure causale globale bien déterminée à partir de structures causales locales. Une autre exemple d'indice est qu'il devrait être possible d'étendre l'analogie directe entre les inégalités causales et les inégalités de Bell aux tests de contextualité, en s'appuyant sur le résultat récent qu'un scénario de Bell est un produit

spécifique de scénarios de contextualité, impliquant l'union de sommets d'hypergraphes associés à des structures causales fixes. J'émet l'hypothèse d'une possible représentation hypergraphique d'un scénario causal et de l'émergence de la non-causalité à partir d'un scénario de contextualité spécifique.

D'autre part, on pourrait aussi rechercher une telle relation au sein du formalisme des "états à multi-temps". Notre analyse précédente du paradoxe de Hardy en tant que paradoxe logique de pré-post-sélection visait à être un point de départ pour explorer cette ligne de pensée. J'émet l'hypothèse qu'en utilisant une méta-version du paradoxe, c'est-à-dire dans un scénario de type Frauchiger-Renner, une connexion possible entre les corrélations non-causales et les valeurs anormales faibles pourrait être étudiée.

Violation d'inégalités causale et logique dans un jeu causal

Plusieurs modèles "quantiques" de CTC ont été proposés dans les années 1990 afin de donner une solution opérationnelle au paradoxe du grand-père. David Deutsch a proposé un modèle (Deutsch CTC, "D-CTC") inspiré de l'interprétation des mondes multiples, qui pourrait être vue comme une interprétation à la "mondes multiples" du « Être et ne pas être » de Barjavel : le voyageur temporel existe toujours dans un monde, alors qu'il n'existe pas dans un autre. Un autre modèle, proposé par divers auteurs, est basé sur la téléportation quantique post-sélectionnée (CTC de post-sélection, "P-CTC") : le voyageur temporel est téléporté dans le passé si et seulement si cela ne conduit pas au paradoxe du grand-père. Cependant, les D-CTCs et les P-CTCs sont fortement pathologiques, car elles permettent des phénomènes post-quantiques tels que le clonage parfait ou la discrimination parfaite d'états quantiques non orthogonaux. Ainsi, on pourrait légitimement se demander s'il existe un modèle quantique de CTC sans paradoxe logique ni pathologie forte. C'est le cas des matrices de processus. En fait, il a été montré que l'ensemble des matrices de processus est équivalent à un sous-ensemble (linéaire) spécifique de P-CTC, ce qui signifie que chaque matrice de processus peut être réalisée avec une P-CTC. Le formalisme des matrices de processus a été conçu précisément pour qu'il ne génère que des probabilités valides et ne conduise à aucun paradoxe. Ainsi, la non-causalité n'implique pas d'incohérence logique.

J'ai illustré cette caractéristique à l'aide d'un exemple d'un nouveau type de jeu causal qui, en plus d'une inégalité causale, quantifie un principe de cohérence logique en termes d'inégalité logique. J'ai montré que la probabilité maximale de succès avec des ordres causaux indéfinis se situe entre la borne causale et la borne logique. Enfin, j'ai émis l'hypothèse qu'une violation d'inégalité logique pourrait être interprétée comme une forme de contextualité.

Conclusion et Perspectives

En utilisant le paradoxe du grand-père comme source d'inspiration, la motivation initiale de cette thèse était d'améliorer notre compréhension de la non-séparabilité causale, de la non-causalité et des paradoxes quantiques afin de répondre à la question : "La nature non fondamentale de la causalité pourrait-elle être liée à une forme de contextualité ?" Comme indiqué ci-dessus, j'ai commencé cette exploration en abordant la question "Quels types de circuits quantiques sont incompatibles avec un ordre causal défini ?" Nous avons identifié

une grande classe de processus physiquement implémentables, les circuits quantiques avec contrôle quantique de l'ordre causal. Les réalisations expérimentales et l'étude de nouveaux QC-QCs causalement non-séparables, au-delà du quantum switch, et l'éventualité de nouveaux avantages en information quantique devraient être explorées à l'avenir. Les QC-QCs ne peuvent pas être utilisés pour violer les inégalités causales. La question de savoir s'il existe ou non un processus physiquement implémentable permettant de le faire reste ouverte. Cela pourrait être exploré en assouplissant certaines contraintes de validité sur les processus, en restreignant l'ensemble des instruments autorisés et en imposant uniquement que des probabilités valides soient produites.

J'ai montré que la non-séparabilité causale de nombreux processus peut être certifiée dans un scénario "semi-device-independent" avec des opérations locales non fiables et des entrées quantiques fiables. Une compréhension plus approfondie des processus causalement non-séparables qui peuvent être certifiés de cette manière reste à établir. On pourrait notamment vérifier si des QC-QCs autres que le quantum switch peuvent générer des corrélations non causales avec des entrées quantiques. Enfin, nous prévoyons de poursuivre l'analogie entre non-localité et non-causalité, en étudiant si une combinaison de notre certification semi-device-independent de la non-séparabilité causale avec un protocole de "self-testing" pourrait conduire à une certification "device-independent" de la non-séparabilité causale de certains processus.

Afin d'affiner ma compréhension de la contextualité quantique, j'ai étudié comment le paradoxe de Hardy implique une forme de contextualité logique. J'ai montré que les deux mesures intermédiaires possibles impliquées dans une version pré-post-sélection du paradoxe sont causalement différentes l'une de l'autre. Cette distinction est-elle une simple coïncidence du scénario de Hardy ou y a-t-il un sens plus profond ? La relation apparente entre la combinaison des cycles de Menteur sous-jacents dans le paradoxe et l'émergence de valeurs faibles anormales nécessite également une enquête plus approfondie. Cette analyse pourrait être utile à l'étude du paradoxe de Frauchiger-Renner, qui peut être considéré comme un "méta-paradoxe de Hardy". En particulier, on pourrait essayer d'en développer une version de type pré-post-sélection. Je propose en outre d'exploiter le fait que les mesures intermédiaires diffèrent causalement l'une de l'autre. Que se passerait-il si cet ordre causal était indéfini ?

Sur un aspect plus métaphysique, j'ai soutenu que la physique (quantique) pourrait ne pas être paradoxale. J'ai défendu l'idée d'une intuition gödelienne de la théorie quantique, selon laquelle les paradoxes quantiques émergent d'une erreur logique, d'un manque de distinction entre objets théoriques et méta-théoriques. J'ai défini la notion de méta-contextualité comme le critère fondamental sous-jacent aux interprétations néo-Copenhague qui leur permettent de dissoudre ces paradoxes.

J'ai suggéré quelques idées pour affronter directement la question d'un lien possible entre non-causalité et contextualité. J'ai notamment proposé un jeu causal original, qui met en évidence le fait que la non-causalité n'implique pas d'incohérence logique. Dans ce jeu, le paradoxe du grand-père est formalisé en termes d'inégalité logique qui pourrait être interprétée comme un test empirique de la logique classique. J'ai montré que certaines matrices de processus peuvent violer l'inégalité causale sans violer l'inégalité logique. Je prévois également de tester les performances d'autres types de processus (tels

que les matrices de processus classiques, les P-CTCs non-linéaires et les D-CTCs) au sein du jeu. On pourrait essayer de trouver d'autres exemples de tels jeux causaux paradoxaux, notamment un jeu tripartite dans lequel des "processus à la Lugano" - que je trouve particulièrement intéressants - pourraient être testés. Enfin, l'émergence d'incohérences logiques à partir de la violation d'une inégalité logique pourrait être interprétée comme une forme de contextualité, les résultats de chaque joueur étant localement cohérents mais conduisant à des incohérences lorsqu'ils sont intégrés globalement dans des corrélations. Cette contradiction logique serait plus forte que celle issue de la contextualité quantique, qui repose sur une contradiction contrefactuelle. Ceci reste à clarifier, mais pourrait être en accord avec la devise de cette thèse de doctorat :

"Le temps est le moyen par lequel Dieu a réalisé l'inconcevable que P et $non - P$ soient toutes les deux vraies." (K. Gödel)

Appendix

Appendix A

Graphical Calculus for Open Quantum Systems

In order to familiarize myself with the process matrix formalism, I used a graphical calculus for open quantum systems [340], which was useful throughout my PhD. Although I didn't use it explicitly in the present manuscript, I'd still like to present it here as an appendix, as it gives very intuitive representations of mathematical tools such as the CJ isomorphism and the link product.

Following Von Neumann's "immoral confession" that he did not "believe absolutely in Hilbert space no more" various attempts have been made to revisit the mathematical structure of quantum theory. Mathematical tools from computer science have been particularly useful to do so. As an example, the linear algebra of finite dimensional Hilbert spaces strongly relates to the pictorial representation of monoidal category theory, which allows to describe all kinds of processes [115, 116].

This leads to a diagrammatic approach of the quantum formalism, where physical systems become wires, connecting boxes symbolizing transformations, events, operations. Writing the equation describing the evolution of a physical system is replaced by a drawing of interconnecting boxes. Such reformulation is to be put in the light of the rise of quantum information, where quantum theory becomes a theory of quantum circuits, architecture of quantum logical gates, boxes processing quantum information.

In this annex, I will present the WBC graphical calculus for open quantum systems [340] based on tensor networks, that I used throughout my PhD and which revealed itself to be particularly helpful in my learning and use of the process matrix formalism.

A.1 Quantum Diagrams

This introduction is taken from [340], a graphical calculus for open quantum systems. Here is a summary of their graphical notations :

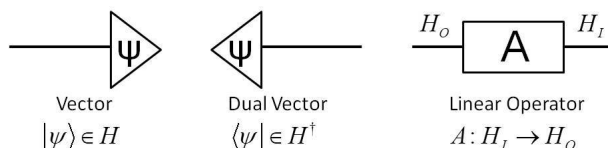

A vector is represented by an arrow, pointing to the right (by convention). Each wire, i.e. system, is indexed by the Hilbert space it evolves in. A linear operator is a diagram, which acts on an input system coming from the right, and outputs a system on the left.

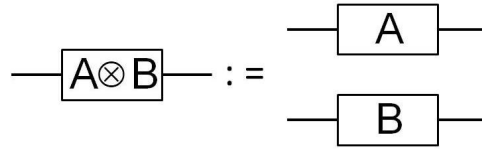

Parallel wires and diagrams correspond to a tensor network: the number of wires is then the order of the tensor. The mathematical rules of tensor network theory assert that the wires of tensors may be manipulated, with each manipulation corresponding to a specific transformation.

Thus, the transposition (in the computational basis) of a vector and of a dual vector is represented by a bending of the wire as follows:

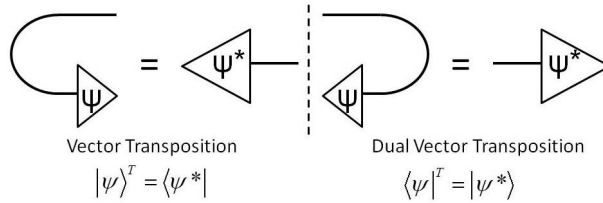

The transpose of a linear operator therefore consists in bending its wires, inverting the input and output Hilbert spaces, $A : H_I \rightarrow H_O$ becomes $A^T : H_O \rightarrow H_I$.

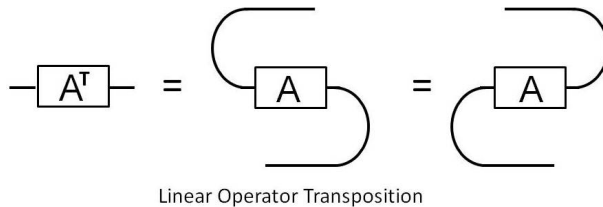

The trace of an operator A is depicted by connecting the corresponding left and right wires of a linear operator:

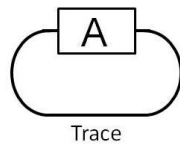

The identity is represented as a wire:

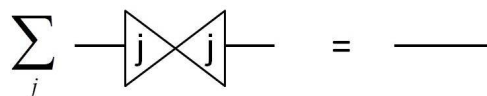

The unnormalized maximally entangled Bell-state $|\phi^+\rangle = \sum_{j=0}^{d-1} |j\rangle \otimes |j\rangle$ and its dual $\langle\phi^+|$ are represented as curves:

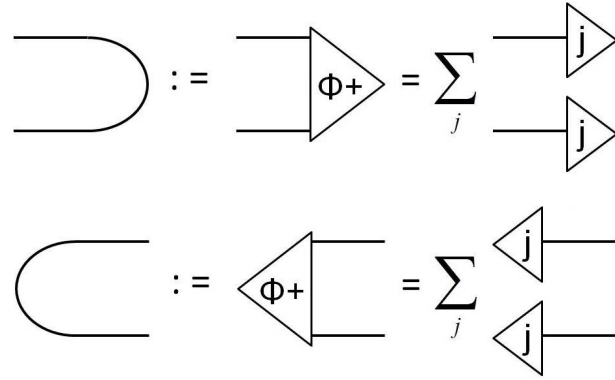

By composing the unnormalized Bell-state and its dual, one can form an identity element. This is known as the *snake equation* or *zig-zag equation* and is given by:

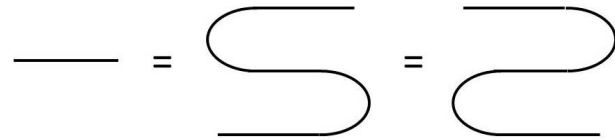

Anytime one has a curved wire with two bends we can “pull the wire” to straighten it out into an identity. Anytime we bend a wire, transforming between say a bra and a ket, we can bend the wire to transform back again.

A.2 Graphical representation of the Choi-Jamiolkowski isomorphism

The Choi-Jamiolkowski (CJ) isomorphism [117, 118] simply “turns a bra into a ket” [119] (cf. Section 2.2).

Vectorization of a matrix

Assume that a party A applies an operation $U_A : A_I \rightarrow A_O$, i.e. $U_A \in \mathcal{L}(A_I, A_O)$, to the state $|\psi\rangle$:



Using the wire-bending operation, we obtain :

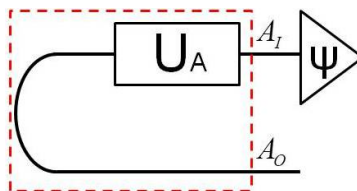

Due to the orientation of the wires, this graphical representation of the operator U_A is actually a (dual) vector, the CJ isomorphism consisting in $\mathcal{L}(A_I, A_O) \rightarrow A_I \otimes A_O : U_A \mapsto \langle\langle U_A^* |^1$

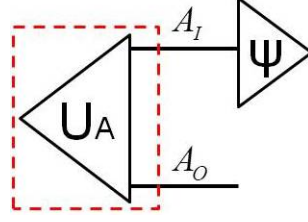

Note that the unnormalized Bell-state $|\phi^+\rangle$ is the vectorized identity operator $|\mathbb{1}\rangle\rangle$.

$$\mathcal{L}(A_I, A_O) \rightarrow A_I \otimes A_O : \mathbb{1} \mapsto \langle\langle \mathbb{1} | = \langle\phi^+ |$$

Thus

$$\langle\langle U_A^* |^{A_I A_O} = \langle\langle \mathbb{1} | (U_A \otimes \mathbb{1}) = \langle\phi^+ | (U_A \otimes \mathbb{1})$$

Finally

$$U_A |\psi\rangle = \langle\langle U_A^* |^{A_I A_O} (|\psi\rangle^{A_I} \otimes \mathbb{1}^{A_O})$$

This type of calculations illustrates the convenience of this graphical calculus.

Choi matrix of a linear map

Recall (Eq.(2.1)) that for a given linear map $\mathcal{M} : \mathcal{L}(\mathcal{H}^X) \rightarrow \mathcal{L}(\mathcal{H}^Y)$, we define its Choi matrix as

$$\begin{aligned} M^{XY} &:= (\mathcal{I}^X \otimes \mathcal{M})(|\mathbb{1}\rangle\rangle\langle\langle \mathbb{1} |^X) \\ &= \sum_{i, i'} |i\rangle\langle i'|^X \otimes \mathcal{M}(|i\rangle\langle i'|^X) \in \mathcal{L}(\mathcal{H}^{XY}) \end{aligned} \quad (\text{A.1})$$

where \mathcal{I}^X is the identity map on $\mathcal{L}(\mathcal{H}^X)$, $|\mathbb{1}\rangle\rangle^X := \sum_i |i\rangle^X \otimes |i\rangle^X$ and $\{|i\rangle^X\}_i$ is a fixed (so-called ‘‘computational’’) basis of \mathcal{H}^X (cf. Section 2.2). Graphically, we obtain

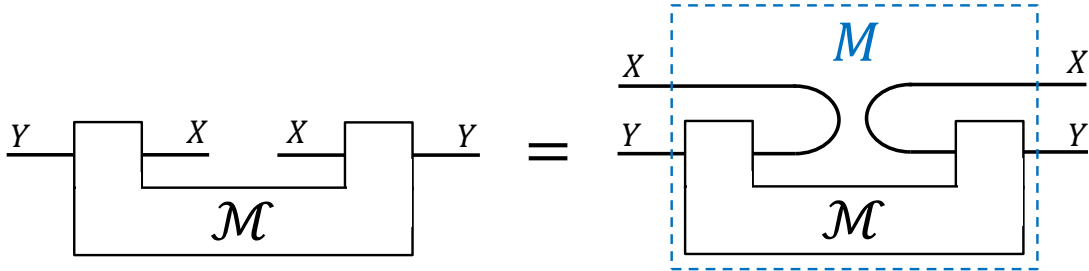

Again, the graphical calculus gives an intuitive representation of the CJ isomorphism.

¹This version of the CJ isomorphism slightly differs from the one presented before. Here, we rather ‘‘turn a ket into a bra’’, and represent the matrix U_A as a bipartite effect (instead of a bipartite state), in order to describe its application on $|\psi\rangle$.

A.3 The Link Product

As explained in Section 2.2, the link product (Eq.(2.3)) is defined as follows. Consider two composite Hilbert spaces $\mathcal{H}^{XY} = \mathcal{H}^X \otimes \mathcal{H}^Y$ and $\mathcal{H}^{YZ} = \mathcal{H}^Y \otimes \mathcal{H}^Z$ that share the same (possibly trivial) space factor \mathcal{H}^Y (while \mathcal{H}^X and \mathcal{H}^Z do not overlap). The link product of two matrices $M^{XY} \in \mathcal{L}(\mathcal{H}^{XY})$ and $N^{YZ} \in \mathcal{L}(\mathcal{H}^{YZ})$ is then defined as [120, 121, 86].

$$\begin{aligned} M^{XY} * N^{YZ} &:= \text{Tr}_Y[(M^{XY} \otimes \mathbb{1}^Z)^{T_Y}(\mathbb{1}^X \otimes N^{YZ})] \\ &= (\mathbb{1}^{XZ} \otimes \langle\langle \mathbb{1} |^Y \rangle\rangle)(M^{XY} \otimes N^{YZ})(\mathbb{1}^{XZ} \otimes |\mathbb{1}\rangle\rangle^Y) \quad \in \mathcal{L}(\mathcal{H}^{XZ}) \end{aligned} \quad (\text{A.2})$$

where T_Y is the partial transpose over \mathcal{H}^Y (defined in the computational basis).

The graphical calculus is particularly useful to apprehend this convenient product. In fact, the link product can be intuitively interpreted as linking “quantum boxes” (quantum operations and/or process matrices) with each other by connecting their “wires” labeled with the same Hilbert space.

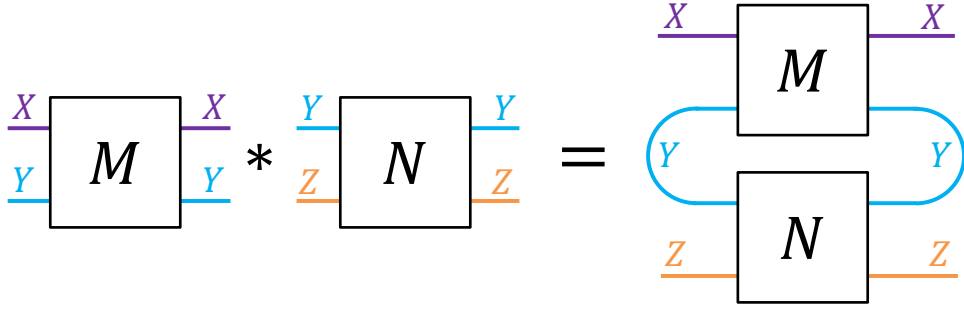

Appendix B

Construction of MDIEW for all entangled states

From [212]

First, assume that Alice and Bob share an entangled state $\rho^{A_I B_I}$. There exists an Hermitian operator $S^{A_I B_I} \in \mathcal{H}^{A_I B_I}$ such that $\text{Tr}((S^{A_I B_I})^T \rho^{A_I B_I}) < 0$ while for all separable state $\sigma^{A_I B_I}$, $\text{Tr}((S^{A_I B_I})^T \sigma^{A_I B_I}) \geq 0$, i.e. $S^{A_I B_I}$ is an *entanglement witness*. Suppose that Alice and Bob both have some tomographically complete sets of quantum inputs $\{\rho_x^{\tilde{A}_I}\}_x$ and $\{\rho_y^{\tilde{B}_I}\}_y$. The entanglement witness can then be decomposed as follows:

$$S^{A_I B_I} = \sum_{x,y} \alpha_{x,y} \rho_x^{A_I} \otimes \rho_y^{B_I} \quad (\text{B.1})$$

with some real coefficients $\alpha_{x,y}$. Assume that we consider fixed values a and b , e.g. $a = b = 0$, and that these outputs correspond to the case where Alice and Bob perform a projection on the maximally entangled states $|\Phi^+\rangle^{\tilde{A}A_I} = \frac{1}{\sqrt{d_{A_I}}} \sum_{i=1}^{d_{A_I}} |i\rangle^{\tilde{A}} |i\rangle^{A_I}$ and $|\Phi^+\rangle^{\tilde{B}B_I} = \frac{1}{\sqrt{d_{B_I}}} \sum_{i=1}^{d_{B_I}} |i\rangle^{\tilde{B}} |i\rangle^{B_I}$

$$\begin{aligned} M_0^{\tilde{A}A_I} &= |\Phi^+\rangle\langle\Phi^+|^{\tilde{A}A_I} \\ M_0^{\tilde{B}B_I} &= |\Phi^+\rangle\langle\Phi^+|^{\tilde{B}B_I} \end{aligned} \quad (\text{B.2})$$

on their shared entangled state $\rho^{A_I B_I}$ and their quantum inputs $\rho_x^{\tilde{A}}$ and $\rho_y^{\tilde{B}}$. Eq.(4.5) thus gives

$$\begin{aligned} P(0, 0 | \rho_x^{\tilde{A}}, \rho_y^{\tilde{B}}) &= \left(|\Phi^+\rangle\langle\Phi^+|^{\tilde{A}A_I} \otimes |\Phi^+\rangle\langle\Phi^+|^{\tilde{B}B_I} \right) * \left(\rho_x^{\tilde{A}} \otimes \rho_y^{\tilde{B}} \otimes \rho^{A_I B_I} \right) \\ &= \left(\rho_x^{A_I} \otimes \rho_y^{B_I} \right) * \rho^{A_I B_I} / (d_{A_I} d_{B_I}) \end{aligned} \quad (\text{B.3})$$

Finally,

$$\begin{aligned} \sum_{x,y} \alpha_{x,y} P(0, 0 | \rho_x^{\tilde{A}}, \rho_y^{\tilde{B}}) &= \sum_{x,y} \alpha_{x,y} \left(\rho_x^{A_I} \otimes \rho_y^{B_I} \right) * \rho^{A_I B_I} / (d_{A_I} d_{B_I}) \\ &= \text{Tr} \left(\sum_{x,y} \alpha_{x,y} (\rho_x^{A_I})^T \otimes (\rho_y^{B_I})^T \rho^{A_I B_I} \right) / (d_{A_I} d_{B_I}) \\ &= \text{Tr} \left((S^{A_I B_I})^T \rho^{A_I B_I} \right) / (d_{A_I} d_{B_I}) < 0 \end{aligned} \quad (\text{B.4})$$

Hence, the expression $\sum_{x,y} \alpha_{x,y} P(0,0|\rho_x^{\tilde{A}}, \rho_y^{\tilde{B}})$ takes negative values when Alice and Bob share the entangled state $\rho^{A_I B_I}$ under consideration. The proof that this constitute a valid entanglement witness with quantum inputs is not complete yet, as we need to make sure that this certification cannot lead to false-positive, i.e. we need to make sure that it cannot detect entanglement from a separable state.

Assume now that Alice and Bob share a separable state $\sigma^{A_I B_I} = \sum_k p_k \sigma_k^{A_I} \otimes \sigma_k^{B_I}$, with $\forall k, p_k \geq 0$ and $\sum_k p_k = 1$. Eq.(4.5) thus gives

$$\begin{aligned} P(0,0|\rho_x^{\tilde{A}}, \rho_y^{\tilde{B}}) &= \left(M_0^{\tilde{A}A_I} \otimes M_0^{\tilde{B}B_I} \right) * \left(\rho_x^{\tilde{A}} \otimes \rho_y^{\tilde{B}} \otimes \sum_k p_k \sigma_k^{A_I} \otimes \sigma_k^{B_I} \right) \\ &= \sum_k p_k \left(E_{0,k}^{\tilde{A}} \otimes E_{0,k}^{\tilde{B}} \right) * \left(\rho_x^{\tilde{A}} \otimes \rho_y^{\tilde{B}} \right) \end{aligned} \quad (\text{B.5})$$

with $E_{0,k}^{\tilde{A}} = M_0^{\tilde{A}A_I} * \sigma_k^{A_I} \geq 0$ and $E_{0,k}^{\tilde{B}} = M_0^{\tilde{B}B_I} * \sigma_k^{B_I} \geq 0$. We obtain

$$\begin{aligned} \sum_{x,y} \alpha_{x,y} P(0,0|\rho_x^{\tilde{A}}, \rho_y^{\tilde{B}}) &= \sum_{x,y} \alpha_{x,y} \sum_k p_k \left(E_{0,k}^{\tilde{A}} \otimes E_{0,k}^{\tilde{B}} \right) * \left(\rho_x^{\tilde{A}} \otimes \rho_y^{\tilde{B}} \right) \\ &= \sum_k p_k \text{Tr} \left(\sum_{x,y} \alpha_{x,y} (\rho_x^{\tilde{A}})^T \otimes (\rho_y^{\tilde{B}})^T E_{0,k}^{\tilde{A}} \otimes E_{0,k}^{\tilde{B}} \right) \\ &= \sum_k p_k \text{Tr} \left((S^{\tilde{A}\tilde{B}})^T E_{0,k}^{\tilde{A}} \otimes E_{0,k}^{\tilde{B}} \right) \end{aligned} \quad (\text{B.6})$$

Because $\sum_k p_k E_{0,k}^{\tilde{A}} \otimes E_{0,k}^{\tilde{B}}$ is (proportional to) a separable state, and because $S^{\tilde{A}\tilde{B}}$ is an entanglement witness, then $\sum_{x,y} \alpha_{x,y} P(0,0|\rho_x^{\tilde{A}}, \rho_y^{\tilde{B}}) \geq 0$. Thus one can construct “*measurement-device-independent entanglement witnesses* (MDIEWs)” for all entangled state, in a scenario where Alice and Bob’s operations are uncharacterized, but where they receive trusted quantum inputs.

Appendix C

A Contextuality Tale

In order to illustrate how the notion of contextuality can be related with Specker's In-futurabilia, I propose the following narrative, inspired by a counterfactual version of the Newcomb problem [250].

You are about to quietly continue your reading, when suddenly a demon appears before you. Expert in demonology, you recognize it immediately: it is the Laplace's demon, an entity whose predictions are known to be always perfectly accurate. This one submits you to the following game. The demon places three goblets in front of you. The first, transparent, contains a hundred thousand gold coins. The second, on the other hand, is completely opaque. The third, also transparent, is empty. Your goal: to discover the content of the opaque box, and survive. To do this you simply have to open it in a particular context, i.e. together with one of the two transparent boxes. Once a box is opened, you can collect its content. The demon then declares that he has previously determined the content of the mystery box as follows:

- If he has predicted with certainty that you are going to open the opaque box with the first transparent box (context 1) - the one containing the hundred thousand gold coins - it will place a bomb inside the mysterious box, which will be triggered at the opening.
- If he has predicted with certainty that you are going to open the opaque box with the empty transparent box (context 2), nothing will be placed in the mysterious box, and will let you go, safe and sound.

Despite the lure of profit, the game is not worth it, and you decide quickly enough to opt for context 2. To your relief, the demon's prediction was accurate : the mystery box is also empty. Your enthusiasm, however, is short-lived, because you notice that a gleam of mischief shines in the eyes of the evil genie. He approaches you, and whispers to your ear, "If you had made the other choice, what would have happened ?". Before disappearing in a cloud of smoke with a sneer.

At first, this question seems absurd to you. As the demon is never wrong in his predictions, if you had made the other choice, he would have predicted it too. You deduce that he would have placed a bomb in the opaque box, and that you would not be there to cogitate. In this scenario, the result, although determined, would depend on the measurement context you choose. We then speak of measurement contextuality. In this case, the omniscience of the demon cannot extend to counterfactuals, since it would deny that

his prediction is based on your choice.

But if you thought about it well, the content of the box was already determined before your choice. So if you had chosen the other context, it would not have changed the content of the opaque box. You would have gone away alive, and with a hundred thousand gold coins ! In this interpretation, the measurement would not depend on the context. On the other hand, the prediction of the demon would have been wrong ! Since its power is no longer absolute, his very existence could then be contested, so that the result might not have been pre-established, but would have been determined by your measurement.

These two counterfactual reasoning highlight a contradiction between two fundamental assumptions: *predetermination* and *measurement non-contextuality*.

Appendix D

A Yu-Oh-like Proof

Kochen and Specker’s first proof [28] of their theorem is a construction of 117 rays obtained by replicating fifteen times the eight rays ¹ of the Clifton-three-box proof.

In [34], Yu and Oh construct a state-independent proof of contextuality with 13 rays in dimension 3, which is based on six three-box paradoxes. This construction differs from standard proofs because the rays do not form a KS set². It was shown that regardless of the dimension of the Hilbert space, there exists no set of rays revealing state-independent contextuality with less than 13 rays [35]. This implies that the set proposed by Yu and Oh in dimension 3 is actually the minimal set to prove contextuality in quantum theory.

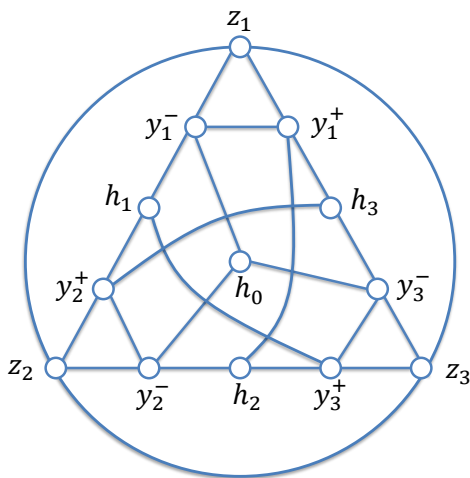

Figure D.1: The Yu-Oh set of 13 rays [34], composed with six Clifton-three-box proofs. The edges link orthogonal rays (vertices) with each other.

The Yu-Oh set is made of three kinds of rays:

- the computational basis rays: $z_1 = (1, 0, 0)$; $z_2 = (0, 1, 0)$; $z_3 = (0, 0, 1)$;

¹The arrangement of these rays with each other leads to identification of three of them with the same vector. Thus the proof contains 117 rays (instead of $15 \cdot 8 = 120$).

²A *KS set* is a set of rays which is “KS-uncolorable”, i.e. it is impossible to assign values 1 or 0 to each ray while respecting that two orthogonal rays cannot both have assigned 1, and 1 must be assigned to exactly one of d mutually orthogonal rays. The (proven) minimal proof of contextuality based on a KS set contains 19 rays in dimension 3, and 18 rays in dimension 4. [341]

- couples of rays $\{y_i^\pm\}$ forming a orthonormal basis (PVM) with a ray z_i : $y_1^+ = (0, 1, 1)$; $y_1^- = (0, 1, -1)$; $y_2^+ = (1, 0, 1)$; $y_2^- = (1, 0, -1)$; $y_3^+ = (1, 1, 0)$; $y_3^- = (1, -1, 0)$;
- pre-post-selection rays: $h_0 = (1, 1, 1)$; $h_1 = (-1, 1, 1)$; $h_2 = (1, -1, 1)$; $h_3 = (1, 1, -1)$

Note that four complete measurements are involved: $\{z_1, z_2, z_3\}$; $\{z_1, y_1^+, y_1^-\}$; $\{z_2, y_2^+, y_2^-\}$; $\{z_3, y_3^+, y_3^-\}$. The set is not a KS set because it is KS colorable. For example: $v(h_0, y_1^+, y_2^+, z_3) = (1, 1, 1, 1)$ is a consistent KS assignment of values. In fact, a contradiction only occurs when more than one h_i is colored. For example: the assignment $v(h_0, h_1) = (1, 1)$ leads to $v(z_2) = 1$ and $v(z_3) = 1$ (in other words, coloring the vertices h_0 and h_1 leads to coloring z_2 and z_3), thus leading to a contradiction since only one of the z_i can be assigned the value 1. This corresponds to a 3-box paradox, i.e. a logical PPS paradox. The set contains six 3-box paradoxes, corresponding to each couple $\{h_i, h_j\}$. Moreover, if the measurements are interpreted as weak measurements, then coloring two z_i leads to assigning the anomalous weak value -1 to the remaining one.

The minimal state-independent contextuality set in dimension 4 contains 14 rays, and can be obtained by extending Yu-Oh's proof, adding the vector $(0, 0, 0, 1)$ and rewriting the 13 rays in $d=4$. However such proof is trivially based on the three-box paradox. Based on our previous analysis, we propose a contextuality set inspired by the Yu-Oh construction, but relying on another logical PPS paradox. I propose a new proof that consists of 17 rays based on four Hardy paradoxes.

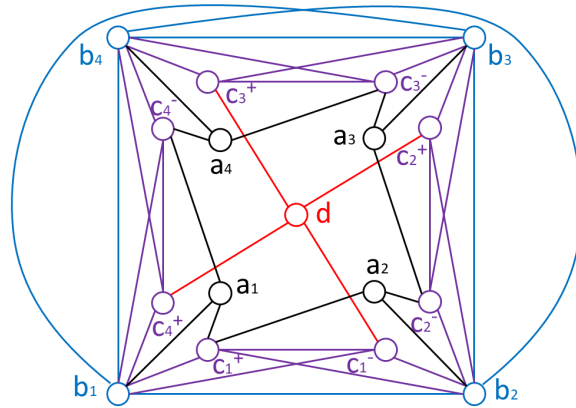

Figure D.2: Our set of 17 rays, composed with 4 Hardy paradoxes. It contains four “computational basis” rays (blue) ; four couples of rays forming a PVM with a two rays (purple), four pre-selection rays (black), one post-selection ray (red).

Like the Yu-Oh set, this construction is made of three kinds of rays:

- the computational basis rays: $b_1 = (0, 0, 0, 1)$; $b_2 = (0, 0, 1, 0)$; $b_3 = (1, 0, 0, 0)$; $b_4 = (0, 1, 0, 0)$;
- couples of rays forming a orthonormal basis (PVM) with two b_i : $c_1^+ = (1, 1, 0, 0)$; $c_1^- = (1, -1, 0, 0)$; $c_2^+ = (0, 1, 0, 1)$; $c_2^- = (0, 1, 0, -1)$; $c_3^+ = (0, 0, 1, 1)$; $c_3^- = (0, 0, 1, -1)$; $c_4^+ = (1, 0, 1, 0)$; $c_4^- = (1, 0, -1, 0)$;
- pre-post-selection rays: $a_1 = (1, 1, 1, 0)$; $a_2 = (1, 1, 0, 1)$; $a_3 = (0, 1, 1, 1)$; $a_4 = (1, 0, 1, 1)$; $d = (1, -1, -1, 1)$

Note that four measurements are involved: $\{b_1, b_2, b_3, b_4\}; \{b_1, c_1^+, c_1^-, b_2\}; \{b_2, c_2^+, c_2^-, b_3\}; \{b_3, c_3^+, c_3^-, b_4\}; \{b_4, c_4^+, c_4^-, b_1\}$.

The set is not a KS set because it is KS colorable. For example: $v(a_1, c_1^-, c_4^+, b_3) = (1, 1, 1, 1)$ is a consistent KS assignment of values. A contradiction occurs when a a_i vertex is colored with the vertex d . Let us assume that $v(a_i) = v(d) = 1$, i.e. that we color effectively the vertices a_i and b ; and consider the measurement $\{b_i, c_i^-, c_i^+, b_{i+1[4]}\}$. Because a_i is orthogonal to b_i and c_i^+ and d is orthogonal to c_i^- , we can only color the vertex $b_{i+1[4]}$, which is thus outcome that is supposed to occur with certainty when this measurement is performed. However, $b_{i+1[4]}$ is orthogonal to b_i , and thus both cannot be assigned value 1 at the same time; hence the logical contradiction.

Bibliography

- [1] R. Barjavel, *Le Voyageur Imprudent*. Denoël, Paris, 1958.
- [2] K. Gödel, “An Example of a New Type of Cosmological Solutions of Einstein’s Field Equations of Gravitation,” *Rev. Mod. Phys.* **21** (Jul, 1949) 447–450.
<https://link.aps.org/doi/10.1103/RevModPhys.21.447>.
- [3] S. W. Hawking, “Chronology protection conjecture,” *Phys. Rev. D* **46** (Jul, 1992) 603–611. <https://link.aps.org/doi/10.1103/PhysRevD.46.603>.
- [4] J. Friedman, M. S. Morris, I. D. Novikov, F. Echeverria, G. Klinkhammer, K. S. Thorne, and U. Yurtsever, “Cauchy problem in spacetimes with closed timelike curves,” *Phys. Rev. D* **42** (Sep, 1990) 1915–1930. <https://link.aps.org/doi/10.1103/PhysRevD.42.1915>.
- [5] W. Heisenberg, “Über den anschaulichen Inhalt der quantentheoretischen Kinematik und Mechanik,” *Zeitschrift für Physik* no. 43, (1927) 172–98.
- [6] N. Bohr, “Can Quantum-Mechanical Description of Physical Reality be Considered Complete?,” *Phys. Rev.* **48** (Oct, 1935) 696–702.
<https://link.aps.org/doi/10.1103/PhysRev.48.696>.
- [7] J. S. Bell, “On the Einstein Podolsky Rosen Paradox,” *Physics Physique Fizika* **1** (Nov, 1964) 195–200. <https://link.aps.org/doi/10.1103/PhysicsPhysiqueFizika.1.195>.
- [8] J. S. Bell and A. Aspect, *Speakable and Unsayable in Quantum Mechanics: Collected Papers on Quantum Philosophy*. Cambridge University Press, 2 ed., 2004.
- [9] M. Frisch, “Causation in Physics,” in *The Stanford Encyclopedia of Philosophy*, E. N. Zalta, ed. Metaphysics Research Lab, Stanford University, Fall 2020 ed., 2020.
<https://plato.stanford.edu/archives/fall2020/entries/causation-physics/>.
- [10] C. J. Wood and R. W. Spekkens, “The lesson of causal discovery algorithms for quantum correlations: causal explanations of bell-inequality violations require fine-tuning,” *New Journal of Physics* **17** no. 3, (Mar, 2015) 033002.
<http://dx.doi.org/10.1088/1367-2630/17/3/033002>.
- [11] L. Hardy, “Probability theories with dynamic causal structure: A new framework for quantum gravity,” [arXiv:gr-qc/0509120](https://arxiv.org/abs/gr-qc/0509120).
- [12] L. Hardy, “Towards quantum gravity: a framework for probabilistic theories with non-fixed causal structure,” *Journal of Physics A Mathematical General* **40** no. 12, (Mar., 2007) 3081–3099, [arXiv:gr-qc/0608043](https://arxiv.org/abs/gr-qc/0608043) [gr-qc].
- [13] G. Chiribella, G. M. D’Ariano, P. Perinotti, and B. Valiron, “Quantum computations without definite causal structure,” *Phys. Rev. A* **88** (Aug, 2013) 022318.
<https://link.aps.org/doi/10.1103/PhysRevA.88.022318>.

- [14] M. S. Leifer and R. W. Spekkens, “Towards a formulation of quantum theory as a causally neutral theory of Bayesian inference,” *Phys. Rev. A* **88** (Nov, 2013) 052130. <https://link.aps.org/doi/10.1103/PhysRevA.88.052130>.
- [15] O. Oreshkov, F. Costa, and Č. Brukner, “Quantum correlations with no causal order,” *Nature Communications* **3** (Oct., 2012) 1092, [arXiv:1105.4464](https://arxiv.org/abs/1105.4464) [quant-ph].
- [16] M. Araújo, C. Branciard, F. Costa, A. Feix, C. Giarmatzi, and Č. Brukner, “Witnessing causal nonseparability,” *New Journal of Physics* **17** no. 10, (Oct., 2015) 102001, [arXiv:1506.03776](https://arxiv.org/abs/1506.03776) [quant-ph].
- [17] C. Branciard, “Witnesses of causal nonseparability: an introduction and a few case studies,” *Scientific Reports* **6** (May, 2016) . <http://dx.doi.org/10.1038/srep26018>.
- [18] C. Branciard, M. Araújo, A. Feix, F. Costa, and C. Brukner, “The simplest causal inequalities and their violation,” *New Journal of Physics* **18** no. 1, (2016) 013008. <http://stacks.iop.org/1367-2630/18/i=1/a=013008>.
- [19] N. Brunner, D. Cavalcanti, S. Pironio, V. Scarani, and S. Wehner, “Bell nonlocality,” *Rev. Mod. Phys.* **86** (Apr, 2014) 419–478. <https://link.aps.org/doi/10.1103/RevModPhys.86.419>.
- [20] G. Chiribella, “Perfect discrimination of no-signalling channels via quantum superposition of causal structures,” *Phys. Rev. A* **86** (Oct, 2012) 040301. <https://link.aps.org/doi/10.1103/PhysRevA.86.040301>.
- [21] O. Oreshkov and C. Giarmatzi, “Causal and causally separable processes,” *New J. Phys.* **18** no. 9, (2016) 093020, [arXiv:1506.05449](https://arxiv.org/abs/1506.05449) [quant-ph].
- [22] A. Baumeler and S. Wolf, “The space of logically consistent classical processes without causal order,” *New Journal of Physics* **18** no. 1, (Jan, 2016) 013036.
- [23] M. Araújo, A. Feix, M. Navascués, and Č. Brukner, “A purification postulate for quantum mechanics with indefinite causal order,” *Quantum* **1** (Apr., 2017) 10. <https://doi.org/10.22331/q-2017-04-26-10>.
- [24] Ä. Baumeler, *Causal Loops: Logically Consistent Correlations, Time Travel, and Computation*. Phd, Università della Svizzera italiana, 2017.
- [25] M. Araújo, P. A. Guérin, and A. Baumeler, “Quantum computation with indefinite causal structures,” *Phys. Rev. A* **96** (Nov, 2017) 052315. <https://link.aps.org/doi/10.1103/PhysRevA.96.052315>.
- [26] C. Brukner, “Quantum causality,” *Nature Physics* **10** (2014) 259–263. <http://dx.doi.org/10.1038/nphys2930>.
- [27] Ä. Baumeler and S. Wolf, *Causality–Complexity–Consistency: Can Space-Time Be Based on Logic and Computation?*, pp. 69–101. Springer International Publishing, Cham, 2017. https://doi.org/10.1007/978-3-319-68655-4_6.
- [28] S. Kochen and E. Specker, “The Problem of Hidden Variables in Quantum Mechanics,” *Journal of Mathematics and Mechanics* **17** no. 1, (1967) 59–87.
- [29] N. D. Mermin, “Hidden variables and the two theorems of John Bell,” *Rev. Mod. Phys.* **65** (Jul, 1993) 803–815. <https://link.aps.org/doi/10.1103/RevModPhys.65.803>.

- [30] A. Peres, “Incompatible results of quantum measurements,” *Physics Letters A* **151** no. 3, (1990) 107–108.
<https://www.sciencedirect.com/science/article/pii/037596019090172K>.
- [31] A. Peres, “Two simple proofs of the Kochen-Specker theorem,” *Journal of Physics A: Mathematical and General* **24** no. 4, (Feb, 1991) L175–L178.
<https://doi.org/10.1088/0305-4470/24/4/003>.
- [32] A. Cabello, M. E. José, and G. García-Alcaine, “Bell-Kochen-Specker theorem: A proof with 18 vectors,” *Physics Letters A* **212** no. 4, (1996) 183 – 187.
<http://www.sciencedirect.com/science/article/pii/037596019600134X>.
- [33] A. Cabello, “How many questions do you need to prove that unasked questions have no answers ?” *International Journal of Quantum Information* **04** no. 01, (2006) 55–61,
<https://doi.org/10.1142/S021974990600161X>.
<https://doi.org/10.1142/S021974990600161X>.
- [34] S. Yu and C. H. Oh, “State-Independent Proof of Kochen-Specker Theorem with 13 Rays,” *Phys. Rev. Lett.* **108** (Jan, 2012) 030402.
<https://link.aps.org/doi/10.1103/PhysRevLett.108.030402>.
- [35] A. Cabello, M. Kleinmann, and J. R. Portillo, “Quantum state-independent contextuality requires 13 rays,” *Journal of Physics A: Mathematical and Theoretical* **49** no. 38, (Aug, 2016) 38LT01. <https://doi.org/10.1088/1751-8113/49/38/381t01>.
- [36] H. Dourdent, “Contextuality, Witness of Quantum Weirdness,” *"arXiv" e-prints* (Jan., 2018) , [arXiv:1801.09768](https://arxiv.org/abs/1801.09768) [quant-ph].
- [37] M. Howard, J. Wallman, V. Veitch, and J. Emerson, “Contextuality supplies the “magic” for quantum computation,” *Nature* **510** no. 7505, (Jun, 2014) 351–355.
<http://dx.doi.org/10.1038/nature13460>.
- [38] M. Frembs, S. Roberts, and S. D. Bartlett, “Contextuality as a resource for measurement-based quantum computation beyond qubits,” *New Journal of Physics* **20** no. 10, (Oct, 2018) 103011. <http://dx.doi.org/10.1088/1367-2630/aae3ad>.
- [39] A. Cabello, S. Severini, and A. Winter, “Graph-Theoretic Approach to Quantum Correlations,” *Phys. Rev. Lett.* **112** (Jan, 2014) 040401.
<https://link.aps.org/doi/10.1103/PhysRevLett.112.040401>.
- [40] A. Acín, T. Fritz, A. Leverrier, and A. B. Sainz, “A combinatorial approach to nonlocality and contextuality,” *Communications in Mathematical Physics* **334** no. 2, (Mar, 2015) 533–628. <https://doi.org/10.1007/s00220-014-2260-1>.
- [41] R. W. Spekkens, “Contextuality for preparations, transformations, and unsharp measurements,” *Phys. Rev. A* **71** (May, 2005) 052108.
<https://link.aps.org/doi/10.1103/PhysRevA.71.052108>.
- [42] S. Abramsky and A. Brandenburger, “The sheaf-theoretic structure of non-locality and contextuality,” *New Journal of Physics* **13** no. 11, (2011) 113036.
<http://stacks.iop.org/1367-2630/13/i=11/a=113036>.
- [43] S. Abramsky, S. Mansfield, and R. S. Barbosa, “The cohomology of non-locality and contextuality,” *EPTCS* **95** (2012) 1–14.
- [44] C. Okay and R. Raussendorf, “Homotopical approach to quantum contextuality,” *Quantum* **4** (Jan., 2020) 217. <https://doi.org/10.22331/q-2020-01-05-217>.

- [45] S. Abramsky, R. S. Barbosa, K. Kishida, R. Lal, and S. Mansfield, “Contextuality, Cohomology and Paradox,” in *24th EACSL Annual Conference on Computer Science Logic (CSL 2015)*, S. Kreutzer, ed., vol. 41 of *Leibniz International Proceedings in Informatics (LIPIcs)*, pp. 211–228. Schloss Dagstuhl–Leibniz-Zentrum fuer Informatik, Dagstuhl, Germany, 2015.
- [46] Č. Brukner, “A no-go theorem for observer-independent facts,” *Entropy* **20** no. 5, (2018) . <http://www.mdpi.com/1099-4300/20/5/350>.
- [47] D. Frauchiger and R. Renner, “Quantum theory cannot consistently describe the use of itself,” *Nature Communications* **9** (2018) 3711. <https://doi.org/10.1038/s41467-018-05739-8>.
- [48] M. Chiara, “Logical Self Reference, Set Theoretical Paradoxes and the Measurement Problem in Quantum Mechanics,” *Journal of Philosophical Logic* **6** no. 1, (1977) 331–347. <http://www.jstor.org/stable/30227134>.
- [49] T. Breuer, *John von Neumann Met Kurt Gödel: Undecidable Statements in Quantum Mechanics*, pp. 159–170. Springer Netherlands, Dordrecht, 1999. https://doi.org/10.1007/978-94-017-2043-4_15.
- [50] A. Peres and W. H. Zurek, “Is quantum theory universally valid?” *American Journal of Physics* **50** no. 9, (1982) 807–810, <https://doi.org/10.1119/1.13086>. <https://doi.org/10.1119/1.13086>.
- [51] M. Zwick, “Quantum measurement and Gödel’s proof,” *Speculations in Science and Technology* **1** no. 2, (1978) I978. https://works.bepress.com/martin_zwick/120/.
- [52] P. Mittelstaedt, *Universality and self-referentiality in quantum mechanics*, p. 103–124. Cambridge University Press, 1997.
- [53] A. Zeilinger, *Why the quantum? “It” from “bit”? A participatory universe? Three far-reaching challenges from John Archibald Wheeler and their relation to experiment*, p. 201–220. Cambridge University Press, 2004.
- [54] W. Heisenberg, *La Partie et le Tout*. Flammarion, 2016 (1969).
- [55] N. D. Mermin, “Is the Moon There When Nobody Looks? Reality and the Quantum Theory,” *Physics Today* **38** no. 4, (1985) 38–47, <https://doi.org/10.1063/1.880968>. <https://doi.org/10.1063/1.880968>.
- [56] G. C. Ghirardi, A. Rimini, and T. Weber, “Unified dynamics for microscopic and macroscopic systems,” *Phys. Rev. D* **34** (Jul, 1986) 470–491. <https://link.aps.org/doi/10.1103/PhysRevD.34.470>.
- [57] M. Carlesso and A. Bassi, “Current tests of collapse models: How far can we push the limits of quantum mechanics?” *Quantum Information and Measurement (QIM) V: Quantum Technologies* (2019) . <http://dx.doi.org/10.1364/QIM.2019.S1C.3>.
- [58] E. Schrödinger, “Discussion of probability relations between separated systems,” *Mathematical Proceedings of the Cambridge Philosophical Society* **31** no. 4, (1935) 555–563.
- [59] E. Schrödinger, “Probability relations between separated systems,” *Mathematical Proceedings of the Cambridge Philosophical Society* **32** no. 3, (1936) 446–452.

- [60] J. von Neumann, *Mathematical Foundations of Quantum Mechanics: New Edition*. Princeton University Press, 2018. <https://doi.org/10.1515/9781400889921>.
- [61] N. D. Mermin, “Quantum mechanics: Fixing the shifty split,” *Phys. Today* **65** (2012) 8–10.
- [62] A. Cabello, “Interpretations of Quantum Theory: A Map of Madness,” *What is Quantum Information?* 138–144. <http://dx.doi.org/10.1017/9781316494233.009>.
- [63] D. Bohm, “A Suggested Interpretation of the Quantum Theory in Terms of "Hidden" Variables. I,” *Phys. Rev.* **85** (Jan, 1952) 166–179. <https://link.aps.org/doi/10.1103/PhysRev.85.166>.
- [64] H. Everett, “"Relative state" formulation of quantum mechanics,” *The Many Worlds Interpretation of Quantum Mechanics* (2015) 141–150.
- [65] L. Vaidman, “Many-Worlds Interpretation of Quantum Mechanics,” in *The Stanford Encyclopedia of Philosophy*, E. N. Zalta, ed. Metaphysics Research Lab, Stanford University, Fall 2021 ed., 2021. <https://plato.stanford.edu/archives/fall2021/entries/qm-manyworlds/>.
- [66] C. A. Fuchs, *On Participatory Realism*, pp. 113–134. Springer International Publishing, Cham, 2017. https://doi.org/10.1007/978-3-319-43760-6_7.
- [67] C. Rovelli, “Relational quantum mechanics,” *International Journal of Theoretical Physics* **35** no. 8, (Aug, 1996) 1637–1678. <https://doi.org/10.1007/BF02302261>.
- [68] C. Rovelli, “Space is blue and birds fly through it,” *Philosophical Transactions of the Royal Society A: Mathematical, Physical and Engineering Sciences* **376** (May, 2018) . <https://doi.org/10.1098/rsta.2017.0312>.
- [69] J. Bub and I. Pitowsky, “Two dogmas about quantum mechanics,” *Many worlds* (2010) 433–459.
- [70] Č. Brukner, *On the Quantum Measurement Problem*, pp. 95–117. Springer International Publishing, Cham, 2017. https://doi.org/10.1007/978-3-319-38987-5_5.
- [71] Č. Brukner and A. Zeilinger, “Quantum physics as a science of information,” in *Quo Vadis Quantum Mechanics?*, pp. 47–61. Springer, 2005.
- [72] C. A. Fuchs and B. C. Stacey, “Qbism: Quantum theory as a hero’s handbook,” in *Proceedings of the International School of Physics “Enrico Fermi*, vol. 197, pp. 133–202. 2019.
- [73] A. Einstein, B. Podolsky, and N. Rosen, “Can Quantum-Mechanical Description of Physical Reality Be Considered Complete?,” *Phys. Rev.* **47** (May, 1935) 777–780. <https://link.aps.org/doi/10.1103/PhysRev.47.777>.
- [74] A. Aspect, P. Grangier, and G. Roger, “Experimental Realization of Einstein-Podolsky-Rosen-Bohm Gedankenexperiment: A New Violation of Bell’s Inequalities,” *Phys. Rev. Lett.* **49** (Jul, 1982) 91–94. <https://link.aps.org/doi/10.1103/PhysRevLett.49.91>.
- [75] C. A. Fuchs, “Quantum Mechanics as Quantum Information (and only a little more),” *eprint "arXiv":quant-ph/0205039* (2002) , [quant-ph/0205039](https://arxiv.org/abs/quant-ph/0205039).
- [76] L. Hardy, “Quantum theory from five reasonable axioms,” *"arXiv" e-prints* (2001) , [arXiv:quant-ph/0101012](https://arxiv.org/abs/quant-ph/0101012). <https://arxiv.org/abs/quant-ph/0101012>.

- [77] L. Hardy, *Why Quantum Theory?*, pp. 61–73. Springer Netherlands, Dordrecht, 2002. https://doi.org/10.1007/978-94-010-0385-8_4.
- [78] G. Chiribella and R. W. Spekkens, *Introduction*, pp. 1–18. Springer Netherlands, Dordrecht, 2016. https://doi.org/10.1007/978-94-017-7303-4_1.
- [79] R. W. Spekkens, “Evidence for the epistemic view of quantum states: A toy theory,” *Phys. Rev. A* **75** (Mar, 2007) 032110. <https://link.aps.org/doi/10.1103/PhysRevA.75.032110>.
- [80] M. F. Pusey, J. Barrett, and T. Rudolph, “On the reality of the quantum state,” *Nature Physics* **8** no. 6, (May, 2012) 475–478. <http://dx.doi.org/10.1038/nphys2309>.
- [81] S. Popescu, “Nonlocality beyond quantum mechanics,” *Nature Physics* **10** (Apr, 2014) 264–270.
- [82] C. Budroni, A. Cabello, O. Gühne, M. Kleinmann, and J. Åke Larsson, “Quantum contextuality,” [arXiv:2102.13036](https://arxiv.org/abs/2102.13036) [quant-ph].
- [83] L. Hardy and R. Spekkens, “Why Physics Needs Quantum Foundations,” *Physics in Canada* **66** (2010) 73–76, [arXiv:1003.5008](https://arxiv.org/abs/1003.5008) [quant-ph].
- [84] C. H. Bennett, G. Brassard, C. Crépeau, R. Jozsa, A. Peres, and W. K. Wootters, “Teleporting an unknown quantum state via dual classical and Einstein-Podolsky-Rosen channels,” *Phys. Rev. Lett.* **70** (Mar, 1993) 1895–1899. <https://link.aps.org/doi/10.1103/PhysRevLett.70.1895>.
- [85] O. Ezratty, *understanding Quantum Technologies*. le lab quantique, 2021. <https://www.oezratty.net/wordpress/2021/understanding-quantum-technologies-2021/>.
- [86] J. Wechs, H. Dourdent, A. A. Abbott, and C. Branciard, “Quantum Circuits with Classical Versus Quantum Control of Causal Order,” *PRX Quantum* **2** (Aug, 2021) 030335. <https://link.aps.org/doi/10.1103/PRXQuantum.2.030335>.
- [87] H. Dourdent, A. A. Abbott, N. Brunner, I. Šupić, and C. Branciard, “Semi-device-independent Certification of Causal Nonseparability with Trusted Quantum Inputs,” [arXiv:2107.10877](https://arxiv.org/abs/2107.10877) [quant-ph].
- [88] R. Silva, Y. Yelena Guryanova, A. Short, P. Skrzypczyk, N. Brunner, and N. Popescu, “Connecting processes with indefinite causal order and multi-time quantum states,” *New Journal of Physics* **19** no. 10, (2017) 103022. <http://stacks.iop.org/1367-2630/19/i=10/a=103022>.
- [89] M. F. Pusey and M. S. Leifer, “Logical pre- and post-selection paradoxes are proofs of contextuality,” *Electronic Proceedings in Theoretical Computer Science* **195** (Nov, 2015) 295–306. <http://dx.doi.org/10.4204/EPTCS.195.22>.
- [90] R. Kunjwal, M. Lostaglio, and M. F. Pusey, “Anomalous weak values and contextuality: Robustness, tightness, and imaginary parts,” *Phys. Rev. A* **100** (Oct, 2019) 042116. <https://link.aps.org/doi/10.1103/PhysRevA.100.042116>.
- [91] E. P. Wigner, “Remarks on the Mind-Body Question,” in *The Scientist Speculates*, I. J. Good, ed. Heineman, 1961.
- [92] L. Hardy, “Quantum mechanics, local realistic theories, and Lorentz-invariant realistic theories,” *Phys. Rev. Lett.* **68** (May, 1992) 2981–2984. <https://link.aps.org/doi/10.1103/PhysRevLett.68.2981>.

- [93] M. S. Leifer and R. W. Spekkens, “Pre- and Post-Selection Paradoxes and Contextuality in Quantum Mechanics,” *Phys. Rev. Lett.* **95** (Nov, 2005) 200405. <https://link.aps.org/doi/10.1103/PhysRevLett.95.200405>.
- [94] M. S. Leifer and R. W. Spekkens, “Logical Pre- and Post-Selection Paradoxes, Measurement-Disturbance and Contextuality,” *Int J Theor Phys* **44** (2005) 1977–1987.
- [95] M. Pusey, “Anomalous Weak Values Are Proofs of Contextuality,” *Phys. Rev. Lett.* **113** (Nov, 2014) 200401. <https://link.aps.org/doi/10.1103/PhysRevLett.113.200401>.
- [96] Y. Aharonov, A. Botero, S. Popescu, B. Reznik, and J. Tollaksen, “Revisiting hardy’s paradox: counterfactual statements, real measurements, entanglement and weak values,” *Physics Letters A* **301** no. 3, (2002) 130 – 138. <http://www.sciencedirect.com/science/article/pii/S0375960102009866>.
- [97] J. Szangolies, “Epistemic Horizons and the Foundations of Quantum Mechanics,” *"arXiv" e-prints* (May, 2018) , [arXiv:1805.10668](https://arxiv.org/abs/1805.10668) [quant-ph].
- [98] A. Grinbaum, *The Significance of Information in Quantum Theory*. Theses, Ecole Polytechnique X, Oct., 2004. <https://pastel.archives-ouvertes.fr/tel-00007634>.
- [99] A. Grinbaum, “On epistemological modesty,” *Philosophica* **83** (2010) 139–150.
- [100] H. Dourdent, *A Gödelian Hunch from Quantum Theory*, pp. 97–113. Springer International Publishing, Cham, 2021. https://doi.org/10.1007/978-3-030-70354-7_7.
- [101] L. Hardy, “Nonlocality for two particles without inequalities for almost all entangled states,” *Phys. Rev. Lett.* **71** (Sep, 1993) 1665–1668. <https://link.aps.org/doi/10.1103/PhysRevLett.71.1665>.
- [102] C. Rovelli, “Physics Needs Philosophy. Philosophy Needs Physics,” *Foundations of Physics* **48** no. 5, (May, 2018) 481–491. <http://dx.doi.org/10.1007/s10701-018-0167-y>.
- [103] P. Cassou-Noguès, *Les Démons de Gödel. Logique et folie: Logique et folie*. Le Seuil, 2015.
- [104] L. Carroll, *Alice’s Adventures in Wonderland*. Princeton University Press, 1963.
- [105] B. Russell, “On the Notion of Cause,” *Proceedings of the Aristotelian Society* **13** (1912) 1–26. <http://www.jstor.org/stable/4543833>.
- [106] G. W. Leibniz, *Principes de la nature et de la grâce fondés en raison (L’Europe savante, nov., art. VI)*, vol. tome premier. Félix Alcan, 1900.
- [107] G. W. Leibniz, *Dans le labyrinthe : nécessité, contingence et liberté chez Leibniz : Cours 2009 et 2010*, vol. tome premier. Collège de France, 2013.
- [108] P. Laplace, *Théorie analytique des probabilités*. Courcier, Paris, 1812. <http://gallica.bnf.fr/ark:/12148/bpt6k88764q>.
- [109] C. Hitchcock and M. Rédei, “Reichenbach’s Common Cause Principle,” in *The Stanford Encyclopedia of Philosophy*, E. N. Zalta, ed. Metaphysics Research Lab, Stanford University, Summer 2021 ed., 2021. <https://plato.stanford.edu/archives/sum2021/entries/physics-Rpcc/>.
- [110] C. Rovelli, *Helgoland*. Allen Lane, 2021.

- [111] G. Hermann and D. Lumma, “The Foundations of Quantum Mechanics in the Philosophy of Nature,” *The Harvard Review of Philosophy* **7** no. 1, (1999) 35–44.
- [112] H. Wiseman and E. Cavalcanti, “Causarum Investigatio and the Two Bell’s Theorems of John Bell,” *arXiv e-prints* (Mar., 2015) , [arXiv:1503.06413](https://arxiv.org/abs/1503.06413) [quant-ph].
- [113] J. Barrett, R. Lorenz, and O. Oreshkov, “Quantum causal models,” [arXiv:1906.10726](https://arxiv.org/abs/1906.10726) [quant-ph].
- [114] J. von Neumann, *John von Neumann: selected letters*, vol. 27 of *History of Mathematics*. 2005.
- [115] B. Coecke, “Quantum picturalism,” *Contemporary Physics* **51** no. 1, (Jan, 2010) 59–83. <http://dx.doi.org/10.1080/00107510903257624>.
- [116] B. Coecke and A. Kissinger, *Picturing Quantum Processes: A First Course in Quantum Theory and Diagrammatic Reasoning*. Cambridge University Press, 2017.
- [117] A. Jamiolkowski, “Linear transformations which preserve trace and positive semidefiniteness of operators,” *Reports on Mathematical Physics* **3** (1972) 275–278.
- [118] M.-D. Choi, “Completely positive linear maps on complex matrices,” *Linear Algebra and its Applications* **10** (1975) 285–290.
- [119] M. Leifer, “The Choi-Jamiolkowski Isomorphism: You’re Doing It Wrong!,” <http://mattleifer.info/2011/08/01/the-choi-jamiolkowski-isomorphism-youre-doing-it-wrong/>.
- [120] G. Chiribella, G. M. D’Ariano, and P. Perinotti, “Quantum circuit architecture,” *Phys. Rev. Lett.* **101** (Aug, 2008) 060401. <https://link.aps.org/doi/10.1103/PhysRevLett.101.060401>.
- [121] G. Chiribella, G. M. D’Ariano, and P. Perinotti, “Theoretical framework for quantum networks,” *Phys. Rev. A* **80** (Aug, 2009) 022339. <https://link.aps.org/doi/10.1103/PhysRevA.80.022339>.
- [122] J. Wechs, A. A. Abbott, and C. Branciard, “On the definition and characterisation of multipartite causal (non)separability,” *New Journal of Physics* **21** no. 1, (Jan, 2019) 013027. <https://doi.org/10.1088/1367-2630/aaf352>.
- [123] R. T. Rockafellar, *Convex Analysis*. Princeton University Press, 1970. <http://www.jstor.org/stable/j.ctt14bs1ff>.
- [124] D. Cavalcanti and P. Skrzypczyk, “Quantum steering: a review with focus on semidefinite programming,” *Reports on Progress in Physics* **80** no. 2, (Dec, 2016) 024001. <https://doi.org/10.1088/1361-6633/80/2/024001>.
- [125] Y. Nesterov and A. Nemirovskii, *Interior-Point Polynomial Algorithms in Convex Programming*. Society for Industrial and Applied Mathematics, 1994. <https://epubs.siam.org/doi/pdf/10.1137/1.9781611970791>. <https://epubs.siam.org/doi/abs/10.1137/1.9781611970791>.
- [126] A. Feix, M. Araújo, and C. Brukner, “Causally nonseparable processes admitting a causal model,” *New Journal of Physics* **18** no. 8, (Aug, 2016) 083040. <http://dx.doi.org/10.1088/1367-2630/18/8/083040>.

- [127] M. T. Quintino, Q. Dong, A. Shimbo, A. Soeda, and M. Murao, “Probabilistic exact universal quantum circuits for transforming unitary operations,” *Phys. Rev. A* **100** (Dec, 2019) 062339, [arXiv:1909.01366](https://arxiv.org/abs/1909.01366) [quant-ph].
<https://link.aps.org/doi/10.1103/PhysRevA.100.062339>.
- [128] F. Del Santo and B. Dakić, “Two-way communication with a single quantum particle,” *Phys. Rev. Lett.* **120** (Feb, 2018) 060503.
<https://link.aps.org/doi/10.1103/PhysRevLett.120.060503>.
- [129] R. F. Werner and M. M. Wolf, “Bell inequalities and entanglement,” *Quantum Inf. Comput.* **1** (2001) 1–25. <https://arxiv.org/abs/quant-ph/0107093>.
- [130] F. Costa, “A no-go theorem for superpositions of causal orders,” [arXiv:2008.06205](https://arxiv.org/abs/2008.06205) [quant-ph].
- [131] R. F. Werner, “Quantum states with einstein-podolsky-rosen correlations admitting a hidden-variable model,” *Phys. Rev. A* **40** (Oct, 1989) 4277–4281.
<https://link.aps.org/doi/10.1103/PhysRevA.40.4277>.
- [132] G. Chiribella, G. M. D’Ariano, and P. Perinotti, “Transforming quantum operations: Quantum supermaps,” *EPL (Europhysics Letters)* **83** no. 3, (Jul, 2008) 30004.
<https://doi.org/10.1209/2F0295-5075/2F83/2F30004>.
- [133] O. Oreshkov and N. J. Cerf, “Operational quantum theory without predefined time,” *New Journal of Physics* **18** no. 7, (Jul, 2016) 073037.
<https://doi.org/10.1088/1367-2630/18/7/073037>.
- [134] S. Milz, F. A. Pollock, T. P. Le, G. Chiribella, and K. Modi, “Entanglement, non-markovianity, and causal non-separability,” *New Journal of Physics* **20** no. 3, (Mar, 2018) 033033. <https://doi.org/10.1088/1367-2630/aaafee>.
- [135] S. Popescu and D. Rohrlich, “Quantum nonlocality as an axiom,” *Foundations of Physics* **24** (Mar, 1994) 379–385.
- [136] A. Cabello, “Violating Bell’s Inequality Beyond Cirel’son’s Bound,” *Phys. Rev. Lett.* **88** (Jan, 2002) 060403. <https://link.aps.org/doi/10.1103/PhysRevLett.88.060403>.
- [137] S. Marcovitch, B. Reznik, and L. Vaidman, “Quantum-mechanical realization of a Popescu-Rohrlich box,” *Phys. Rev. A* **75** (Feb, 2007) 022102.
<https://link.aps.org/doi/10.1103/PhysRevA.75.022102>.
- [138] W.-J. Chu, X.-L. Zong, M. Yang, G.-Z. Pan, and Z.-L. Cao, “Optical simulation of a Popescu-Rohrlich Box,” *Scientific Reports* **6** (Jun, 2016) 28351.
<https://doi.org/10.1038/srep28351>.
- [139] M. Plávala and M. Ziman, “Popescu-Rohrlich box implementation in general probabilistic theory of processes,” *Physics Letters A* **384** no. 16, (2020) 126323.
<https://www.sciencedirect.com/science/article/pii/S0375960120301274>.
- [140] J. Barrett, R. Lorenz, and O. Oreshkov, “Cyclic causal models,” *Nature Communications* **12** (Feb., 2021) .
- [141] P. A. Guérin and Č. Brukner, “Observer-dependent locality of quantum events,” *New Journal of Physics* **20** no. 10, (Oct, 2018) 103031.
<https://doi.org/10.1088/1367-2630/aae742>.

- [142] A. Baumeler, A. Feix, and S. Wolf, “Maximal incompatibility of locally classical behavior and global causal order in multiparty scenarios,” *Phys. Rev. A* **90** (Oct, 2014) 042106. <https://link.aps.org/doi/10.1103/PhysRevA.90.042106>.
- [143] Ämin Baumeler, F. Costa, T. C. Ralph, S. Wolf, and M. Zych, “Reversible time travel with freedom of choice,” *Classical and Quantum Gravity* **36** no. 22, (Oct, 2019) 224002. <https://doi.org/10.1088%2F1361-6382%2Fab4973>.
- [144] G. Tobar and F. Costa, “Reversible dynamics with closed time-like curves and freedom of choice,” *Classical and Quantum Gravity* **37** no. 20, (Sep, 2020) 205011. <https://doi.org/10.1088%2F1361-6382%2Faba4bc>.
- [145] Ämin Baumeler, A. S. Gilani, and J. Rashid, “Unlimited non-causal correlations and their relation to non-locality,” [arXiv:2104.06234](https://arxiv.org/abs/2104.06234) [quant-ph].
- [146] O. Oreshkov, “Time-delocalized quantum subsystems and operations: on the existence of processes with indefinite causal structure in quantum mechanics,” *Quantum* **3** (Dec., 2019) 206. <https://doi.org/10.22331/q-2019-12-02-206>.
- [147] J. Wechs, *Relations causales multipartites en théorie quantique*. PhD thesis, 2020. <http://www.theses.fr/2020GRALY008>. Thèse de doctorat dirigée par Branciard, Cyril et Auffeves-Garnier, Alexia et Mhalla, Mehdi Physique théorique Université Grenoble Alpes 2020.
- [148] G. Gutoski and J. Watrous, “Toward a general theory of quantum games,” in *Proceedings of the Thirty-Ninth Annual ACM Symposium on Theory of Computing, STOC '07*, p. 565–574. Association for Computing Machinery, New York, NY, USA, 2007. <https://doi.org/10.1145/1250790.1250873>.
- [149] M. Araújo, F. Costa, and Č. Brukner, “Computational advantage from quantum-controlled ordering of gates,” *Phys. Rev. Lett.* **113** (Dec, 2014) 250402. <https://link.aps.org/doi/10.1103/PhysRevLett.113.250402>.
- [150] L. M. Procopio, F. Delgado, M. Enríquez, N. Belabas, and J. A. Levenson, “Communication enhancement through quantum coherent control of n channels in an indefinite causal-order scenario,” *Entropy* **21** no. 10, (Oct, 2019) 1012. <http://dx.doi.org/10.3390/e21101012>.
- [151] J. Rubino, L. Rozema, A. Feix, M. Araújo, J. Zeuner, L. Procopio, C. Brukner, and P. Walther, “Experimental verification of an indefinite causal order,” *Science Advances* **3** no. 3, (2017) . <http://www.ncbi.nlm.nih.gov/pmc/articles/PMC5365250/>.
- [152] M. Zych, F. Costa, I. Pikovski, and Č. Brukner, “Bell’s theorem for temporal order,” *Nature Communications* **10** no. 1, (Aug, 2019) . <http://dx.doi.org/10.1038/s41467-019-11579-x>.
- [153] G. Gour, “Comparison of quantum channels by superchannels,” *IEEE Trans. Inf. Theory* **65** (2019) 5880, [arXiv:1808.02607](https://arxiv.org/abs/1808.02607) [quant-ph].
- [154] G. Chiribella, A. Toigo, and V. Umantà, “Normal completely positive maps on the space of quantum operations,” *Open Syst. Inf. Dyn.* **20** no. 01, (2013) 1350003, [arXiv:1012.3197](https://arxiv.org/abs/1012.3197) [quant-ph]. <https://doi.org/10.1142/S1230161213500030>.
- [155] D. Kretschmann and R. F. Werner, “Quantum channels with memory,” *Physical Review A* **72** no. 6, (Dec, 2005) . <http://dx.doi.org/10.1103/PhysRevA.72.062323>.

- [156] W. F. Stinespring, “Positive Functions on C*-Algebras,” *Proceedings of the American Mathematical Society* **6** no. 2, (1955) 211–216. <http://www.jstor.org/stable/2032342>.
- [157] K. Goswami, C. Giarmatzi, M. Kewming, F. Costa, C. Branciard, J. Romero, and A. G. White, “Indefinite causal order in a quantum switch,” *Phys. Rev. Lett.* **121** (Aug, 2018) 090503, [arXiv:1803.04302](https://arxiv.org/abs/1803.04302) [quant-ph].
<https://link.aps.org/doi/10.1103/PhysRevLett.121.090503>.
- [158] K. Goswami, Y. Cao, G. A. Paz-Silva, J. Romero, and A. G. White, “Increasing communication capacity via superposition of order,” *Phys. Rev. Research* **2** (Aug, 2020) 033292, [arXiv:1807.07383](https://arxiv.org/abs/1807.07383) [quant-ph].
<https://link.aps.org/doi/10.1103/PhysRevResearch.2.033292>.
- [159] L. Procopio, A. Moqanaki, M. Araújo, F. Costa, I. Alonso Calafell, E. Dowd, D. Hamel, L. Rozema, C. Brukner, and P. Walther, “Experimental superposition of orders of quantum gates,” *Nature Communications* **6** no. 7913, (2015) .
<http://dx.doi.org/10.1038/ncomms8913>.
- [160] G. Rubino, L. A. Rozema, F. Massa, M. Araújo, M. Zych, Č. Brukner, and P. Walther, “Experimental entanglement of temporal orders,” [arXiv:1712.06884](https://arxiv.org/abs/1712.06884) [quant-ph].
- [161] K. Wei, N. Tischler, S.-R. Zhao, Y.-H. Li, J. M. Arrazola, Y. Liu, W. Zhang, H. Li, L. You, Z. Wang, Y.-A. Chen, B. C. Sanders, Q. Zhang, G. J. Pryde, F. Xu, and J.-W. Pan, “Experimental quantum switching for exponentially superior quantum communication complexity,” *Phys. Rev. Lett.* **122** (2019) 120504, [arXiv:1810.10238](https://arxiv.org/abs/1810.10238) [quant-ph].
- [162] Y. Guo, X.-M. Hu, Z.-B. Hou, H. Cao, J.-M. Cui, B.-H. Liu, Y.-F. Huang, C.-F. Li, G.-C. Guo, and G. Chiribella, “Experimental transmission of quantum information using a superposition of causal orders,” *Phys. Rev. Lett.* **124** (Jan, 2020) 030502, [arXiv:1811.07526](https://arxiv.org/abs/1811.07526) [quant-ph].
<https://link.aps.org/doi/10.1103/PhysRevLett.124.030502>.
- [163] J.-P. W. MacLean, K. Ried, R. W. Spekkens, and K. J. Resch, “Quantum-coherent mixtures of causal relations,” *Nature Communications* **8** no. 1, (May, 2017) .
<http://dx.doi.org/10.1038/ncomms15149>.
- [164] K. Ried, M. Agnew, L. Vermeyden, D. Janzing, R. W. Spekkens, and K. J. Resch, “A quantum advantage for inferring causal structure,” *Nature Physics* **11** no. 5, (Mar, 2015) 414–420. <http://dx.doi.org/10.1038/nphys3266>.
- [165] N. Paunković and M. Vojinović, “Causal orders, quantum circuits and spacetime: distinguishing between definite and superposed causal orders,” *Quantum* **4** (May, 2020) 275. <http://dx.doi.org/10.22331/q-2020-05-28-275>.
- [166] F. Costa, “(Talk:) Indefinite causal order from quantum spacetime to the lab,” *Indefinite Causal Structure Conference, Perimeter Institute, PIRSA 19120034* (2019) .
<https://pirsa.org/19120034>.
- [167] T. Colnaghi, G. M. D’Ariano, S. Facchini, and P. Perinotti, “Quantum computation with programmable connections between gates,” *Phys. Lett. A* **376** no. 45, (2012) 2940–2943, [arXiv:1109.5987](https://arxiv.org/abs/1109.5987) [quant-ph].
- [168] S. Facchini and S. Perdrix, “Quantum circuits for the unitary permutation problem,” in *Theory and Applications of Models of Computation*, R. Jain, S. Jain, and F. Stephan, eds., pp. 324–331. Springer International Publishing, Cham, 2015. [arXiv:1405.5205](https://arxiv.org/abs/1405.5205) [quant-ph].

- [169] L. M. Procopio, F. Delgado, M. Enríquez, N. Belabas, and J. A. Levenson, “Sending classical information via three noisy channels in superposition of causal orders,” *Phys. Rev. A* **101** (Jan, 2020) 012346, [arXiv:1910.11137](https://arxiv.org/abs/1910.11137) [quant-ph]. <https://link.aps.org/doi/10.1103/PhysRevA.101.012346>.
- [170] M. M. Taddei, J. Cariñe, D. Martínez, T. García, N. Guerrero, A. A. Abbott, M. Araújo, C. Branciard, E. S. Gómez, S. P. Walborn, L. Aolita, and G. Lima, “Computational advantage from the quantum superposition of multiple temporal orders of photonic gates,” *PRX Quantum* **2** (2021) 010320, [arXiv:2002.07817](https://arxiv.org/abs/2002.07817) [quant-ph].
- [171] M. Wilson and G. Chiribella, “A diagrammatic approach to information transmission in generalised switches,” [arXiv:2003.08224](https://arxiv.org/abs/2003.08224) [quant-ph].
- [172] S. Sazim, M. Sedlak, K. Singh, and A. K. Pati, “Classical communication with indefinite causal order for n completely depolarizing channels,” *Phys. Rev. A* **103** (Jun, 2021) 062610, [arXiv:2004.14339](https://arxiv.org/abs/2004.14339) [quant-ph]. <https://link.aps.org/doi/10.1103/PhysRevA.103.062610>.
- [173] M. Wilson, H.-F. Chau, and G. Chiribella, “Quantum communication through completely depolarising channels in a superposition of causal orders,” [arXiv:2005.00618](https://arxiv.org/abs/2005.00618) [quant-ph].
- [174] N. Pinzani and S. Gogioso, “Giving operational meaning to the superposition of causal orders,” [arXiv:2003.13306](https://arxiv.org/abs/2003.13306) [quant-ph].
- [175] M. M. Taddei, R. V. Nery, and L. Aolita, “Quantum superpositions of causal orders as an operational resource,” *Phys. Rev. Research* **1** (2019) 033174, [arXiv:1903.06180](https://arxiv.org/abs/1903.06180) [quant-ph].
- [176] W. Yokojima, M. T. Quintino, A. Soeda, and M. Murao, “Consequences of preserving reversibility in quantum superchannels,” *Quantum* **5** (2021) 441, [arXiv:2003.05682](https://arxiv.org/abs/2003.05682) [quant-ph].
- [177] M. Grant and S. Boyd, “CVX: Matlab software for disciplined convex programming, v2.1,”. <http://cvxr.com/cvx>.
- [178] A. Feix, M. Araújo, and Č. Brukner, “Quantum superposition of the order of parties as a communication resource,” *Phys. Rev. A* **92** (Nov, 2015) 052326, [arXiv:1508.07840](https://arxiv.org/abs/1508.07840) [quant-ph].
- [179] P. A. Guérin, A. Feix, M. Araújo, and Č. Brukner, “Exponential communication complexity advantage from quantum superposition of the direction of communication,” *Phys. Rev. Lett.* **117** (Sep, 2016) 100502, [arXiv:1605.07372](https://arxiv.org/abs/1605.07372) [quant-ph]. <https://link.aps.org/doi/10.1103/PhysRevLett.117.100502>.
- [180] D. Ebler, S. Salek, and G. Chiribella, “Enhanced communication with the assistance of indefinite causal order,” *Phys. Rev. Lett.* **120** (Mar, 2018) 120502, [arXiv:1711.10165](https://arxiv.org/abs/1711.10165) [quant-ph]. <https://link.aps.org/doi/10.1103/PhysRevLett.120.120502>.
- [181] S. Salek, D. Ebler, and G. Chiribella, “Quantum communication in a superposition of causal orders,” [arXiv:1809.06655](https://arxiv.org/abs/1809.06655) [quant-ph].
- [182] G. Chiribella, M. Banik, S. S. Bhattacharya, T. Guha, M. Alimuddin, A. Roy, S. Saha, S. Agrawal, and G. Kar, “Indefinite causal order enables perfect quantum communication with zero capacity channel,” *New J. Phys.* **23** (2021) 033039, [arXiv:1810.10457](https://arxiv.org/abs/1810.10457) [quant-ph].

- [183] C. Mukhopadhyay, M. K. Gupta, and A. K. Pati, “Superposition of causal order as a metrological resource for quantum thermometry,” [arXiv:1812.07508 \[quant-ph\]](#).
- [184] C. Mukhopadhyay and A. K. Pati, “Superposition of causal order enables quantum advantage in teleportation under very noisy channels,” *J. Phys. Commun.* **4** no. 10, (Oct, 2020) 105003, [arXiv:1901.07626 \[quant-ph\]](#).
<https://doi.org/10.1088%2F2399-6528%2Fabb77>.
- [185] M. Frey, “Indefinite causal order aids quantum depolarizing channel identification,” *Quantum Inf. Process.* **18** (2019) 96.
- [186] N. Loizeau and A. Grinbaum, “Channel capacity enhancement with indefinite causal order,” *Phys. Rev. A* **101** (Jan, 2020) 012340, [arXiv:1906.08505 \[quant-ph\]](#).
<https://link.aps.org/doi/10.1103/PhysRevA.101.012340>.
- [187] M. Caleffi and A. S. Cacciapuoti, “Quantum switch for the quantum internet: Noiseless communications through noisy channels,” *IEEE J. Sel. Areas Commun* **38** no. 3, (2020) 575–588, [arXiv:1907.07432 \[quant-ph\]](#).
- [188] M. K. Gupta and U. Sen, “Transmitting quantum information by superposing causal order of mutually unbiased measurements,” [arXiv:1909.13125 \[quant-ph\]](#).
- [189] X. Zhao, Y. Yang, and G. Chiribella, “Quantum metrology with indefinite causal order,” *Phys. Rev. Lett.* **124** (2020) 190503, [arXiv:1912.02449 \[quant-ph\]](#).
- [190] D. Felce and V. Vedral, “Quantum refrigeration with indefinite causal order,” *Phys. Rev. Lett.* **125** (Aug, 2020) 070603, [arXiv:2003.00794 \[quant-ph\]](#).
<https://link.aps.org/doi/10.1103/PhysRevLett.125.070603>.
- [191] T. Guha, M. Alimuddin, and P. Parashar, “Thermodynamic advancement in the causally inseparable occurrence of thermal maps,” *Phys. Rev. A* **102** (Sep, 2020) 032215, [arXiv:2003.01464 \[quant-ph\]](#).
<https://link.aps.org/doi/10.1103/PhysRevA.102.032215>.
- [192] G. Chiribella and D. Ebler, “Optimal quantum networks and one-shot entropies,” *New J. Phys.* **18** no. 9, (2016) 093053, [arXiv:1606.02394 \[quant-ph\]](#).
<http://stacks.iop.org/1367-2630/18/i=9/a=093053>.
- [193] M. T. Quintino, Q. Dong, A. Shimbo, A. Soeda, and M. Murao, “Reversing unknown quantum transformations: Universal quantum circuit for inverting general unitary operations,” *Phys. Rev. Lett.* **123** (Nov, 2019) 210502, [arXiv:1810.06944 \[quant-ph\]](#).
<https://link.aps.org/doi/10.1103/PhysRevLett.123.210502>.
- [194] A. Shimbo, A. Soeda, and M. Murao, “Equivalence determination of unitary operations,” [arXiv:1803.11414 \[quant-ph\]](#).
- [195] T. Purves and A. J. Short, “Quantum theory cannot violate a causal inequality,” *Phys. Rev. Lett.* **127** (Sep, 2021) 110402.
<https://link.aps.org/doi/10.1103/PhysRevLett.127.110402>.
- [196] D. Mayers and A. Yao, “Quantum cryptography with imperfect apparatus,” in *Proceedings 39th Annual Symposium on Foundations of Computer Science (Cat. No.98CB36280)*, pp. 503–509. 1998.
- [197] R. Colbeck, “Quantum and relativistic protocols for secure multi-party computation,” [arXiv:0911.3814 \[quant-ph\]](#).

- [198] S. Pironio, A. Acín, S. Massar, A. B. de la Giroday, D. N. Matsukevich, P. Maunz, S. Olmschenk, D. Hayes, L. Luo, T. A. Manning, and et al., “Random numbers certified by Bell’s theorem,” *Nature* **464** no. 7291, (Apr, 2010) 1021–1024. <http://dx.doi.org/10.1038/nature09008>.
- [199] J. Barrett, L. Hardy, and A. Kent, “No signaling and quantum key distribution,” *Phys. Rev. Lett.* **95** (Jun, 2005) 010503. <https://link.aps.org/doi/10.1103/PhysRevLett.95.010503>.
- [200] C.-E. Bardyn, T. C. H. Liew, S. Massar, M. McKague, and V. Scarani, “Device-independent state estimation based on Bell’s inequalities,” *Phys. Rev. A* **80** (Dec, 2009) 062327. <https://link.aps.org/doi/10.1103/PhysRevA.80.062327>.
- [201] J.-D. Bancal, N. Gisin, Y.-C. Liang, and S. Pironio, “Device-Independent Witnesses of Genuine Multipartite Entanglement,” *Phys. Rev. Lett.* **106** (Jun, 2011) 250404. <https://link.aps.org/doi/10.1103/PhysRevLett.106.250404>.
- [202] N. Aharon, S. Massar, S. Pironio, and J. Silman, “Device-independent bit commitment based on the CHSH inequality,” *New Journal of Physics* **18** no. 2, (Feb, 2016) 025014. <http://dx.doi.org/10.1088/1367-2630/18/2/025014>.
- [203] M. Giustina, M. A. M. Versteegh, S. Wengerowsky, J. Handsteiner, A. Hochrainer, K. Phelan, F. Steinlechner, J. Kofler, J.-A. Larsson, C. Abellán, W. Amaya, V. Pruneri, M. W. Mitchell, J. Beyer, T. Gerrits, A. E. Lita, L. K. Shalm, S. W. Nam, T. Scheidl, R. Ursin, B. Wittmann, and A. Zeilinger, “Significant-Loophole-Free Test of Bell’s Theorem with Entangled Photons,” *Phys. Rev. Lett.* **115** (Dec, 2015) 250401. <https://link.aps.org/doi/10.1103/PhysRevLett.115.250401>.
- [204] L. K. Shalm, E. Meyer-Scott, B. G. Christensen, P. Bierhorst, M. A. Wayne, M. J. Stevens, T. Gerrits, S. Glancy, D. R. Hamel, M. S. Allman, K. J. Coakley, S. D. Dyer, C. Hodge, A. E. Lita, V. B. Verma, C. Lambrocco, E. Tortorici, A. L. Migdall, Y. Zhang, D. R. Kumor, W. H. Farr, F. Marsili, M. D. Shaw, J. A. Stern, C. Abellán, W. Amaya, V. Pruneri, T. Jennewein, M. W. Mitchell, P. G. Kwiat, J. C. Bienfang, R. P. Mirin, E. Knill, and S. W. Nam, “Strong Loophole-Free Test of Local Realism,” *Phys. Rev. Lett.* **115** (Dec, 2015) 250402. <https://link.aps.org/doi/10.1103/PhysRevLett.115.250402>.
- [205] B. Hensen, H. Bernien, A. E. Dréau, A. Reiserer, N. Kalb, M. S. Blok, J. Ruitenberg, R. F. L. Vermeulen, R. N. Schouten, C. Abellán, W. Amaya, V. Pruneri, M. W. Mitchell, M. Markham, D. J. Twitchen, D. Elkouss, S. Wehner, T. H. Taminiau, and R. Hanson, “Loophole-free Bell inequality violation using electron spins separated by 1.3 kilometres,” *Nature* **526** no. 7575, (Oct., 2015) 682–686. <http://dx.doi.org/10.1038/nature15759>.
- [206] Y.-C. Liang, T. Vértesi, and N. Brunner, “Semi-device-independent bounds on entanglement,” *Phys. Rev. A* **83** (Feb, 2011) 022108. <https://link.aps.org/doi/10.1103/PhysRevA.83.022108>.
- [207] H. M. Wiseman, S. J. Jones, and A. C. Doherty, “Steering, entanglement, nonlocality, and the einstein-podolsky-rosen paradox,” *Phys. Rev. Lett.* **98** (Apr, 2007) 140402. <https://link.aps.org/doi/10.1103/PhysRevLett.98.140402>.
- [208] R. Uola, A. C. S. Costa, H. C. Nguyen, and O. Gühne, “Quantum steering,” *Rev. Mod. Phys.* **92** (Mar, 2020) 015001. <https://link.aps.org/doi/10.1103/RevModPhys.92.015001>.

- [209] D. Schmid, T. C. Fraser, R. Kunjwal, A. B. Sainz, E. Wolfe, and R. W. Spekkens, “Understanding the interplay of entanglement and nonlocality: motivating and developing a new branch of entanglement theory,” [arXiv:2004.09194](https://arxiv.org/abs/2004.09194) [quant-ph].
- [210] J. Bavaresco, M. Araújo, Č. Brukner, and M. T. Quintino, “Semi-device-independent certification of indefinite causal order,” *Quantum* **3** (Aug., 2019) 176. <https://doi.org/10.22331/q-2019-08-19-176>.
- [211] F. Buscemi, “All entangled quantum states are nonlocal,” *Phys. Rev. Lett.* **108** (May, 2012) 200401. <https://link.aps.org/doi/10.1103/PhysRevLett.108.200401>.
- [212] C. Branciard, D. Rosset, Y.-C. Liang, and N. Gisin, “Measurement-device-independent entanglement witnesses for all entangled quantum states,” *Phys. Rev. Lett.* **110** (Feb, 2013) 060405. <https://link.aps.org/doi/10.1103/PhysRevLett.110.060405>.
- [213] M. J. Hoban and A. B. Sainz, “A channel-based framework for steering, non-locality and beyond,” *New J. Phys.* **20** no. 5, (May, 2018) 053048, [arXiv:1708.00750](https://arxiv.org/abs/1708.00750) [quant-ph]. <https://doi.org/10.1088/1367-2630/aabea8>.
- [214] I. Šupić, P. Skrzypczyk, and D. Cavalcanti, “Measurement-device-independent entanglement and randomness estimation in quantum networks,” *Phys. Rev. A* **95** (Apr, 2017) 042340, [arXiv:1702.04752](https://arxiv.org/abs/1702.04752) [quant-ph]. <https://link.aps.org/doi/10.1103/PhysRevA.95.042340>.
- [215] L. Gurvits, “Classical deterministic complexity of edmonds’ problem and quantum entanglement,” in *Proceedings of the Thirty-Fifth Annual ACM Symposium on Theory of Computing*, STOC ’03, p. 10–19. Association for Computing Machinery, New York, NY, USA, 2003. <https://doi.org/10.1145/780542.780545>.
- [216] A. Grinbaum, “How device-independent approaches change the meaning of physical theory,” *Studies in History and Philosophy of Science Part B: Studies in History and Philosophy of Modern Physics* **58** (May, 2017) 22–30. <http://dx.doi.org/10.1016/j.shpsb.2017.03.003>.
- [217] A. Mallick and S. Ghosh, “Witnessing arbitrary bipartite entanglement in a measurement-device-independent way,” *Phys. Rev. A* **96** (Nov, 2017) 052323. <https://link.aps.org/doi/10.1103/PhysRevA.96.052323>.
- [218] E. Verbanis, A. Martin, D. Rosset, C. C. W. Lim, R. T. Thew, and H. Zbinden, “Resource-Efficient Measurement-Device-Independent Entanglement Witness,” *Phys. Rev. Lett.* **116** (May, 2016) 190501. <https://link.aps.org/doi/10.1103/PhysRevLett.116.190501>.
- [219] P. Xu, X. Yuan, L.-K. Chen, H. Lu, X.-C. Yao, X. Ma, Y.-A. Chen, and J.-W. Pan, “Implementation of a Measurement-Device-Independent Entanglement Witness,” *Phys. Rev. Lett.* **112** (Apr, 2014) 140506. <https://link.aps.org/doi/10.1103/PhysRevLett.112.140506>.
- [220] Z. Tang, K. Wei, O. Bedrova, L. Qian, and H.-K. Lo, “Experimental measurement-device-independent quantum key distribution with imperfect sources,” *Phys. Rev. A* **93** (Apr, 2016) 042308. <https://link.aps.org/doi/10.1103/PhysRevA.93.042308>.
- [221] A. Peres, “Separability Criterion for Density Matrices,” *Phys. Rev. Lett.* **77** (Aug, 1996) 1413–1415. <https://link.aps.org/doi/10.1103/PhysRevLett.77.1413>.

- [222] M. Horodecki, P. Horodecki, and R. Horodecki, “Separability of mixed states: necessary and sufficient conditions,” *Physics Letters A* **223** no. 1, (1996) 1–8.
<https://www.sciencedirect.com/science/article/pii/S0375960196007062>.
- [223] J. Bowles, I. Šupić, D. Cavalcanti, and A. Acín, “Device-independent entanglement certification of all entangled states,” *Phys. Rev. Lett.* **121** (Oct, 2018) 180503,
[arXiv:1801.10444 \[quant-ph\]](https://arxiv.org/abs/1801.10444).
<https://link.aps.org/doi/10.1103/PhysRevLett.121.180503>.
- [224] I. Šupić and J. Bowles, “Self-testing of quantum systems: a review,” *Quantum* **4** (Sep, 2020) 337. <http://dx.doi.org/10.22331/q-2020-09-30-337>.
- [225] M. Fontez, “Au-delà du quantique: la découverte d’un nouveau monde,” *Science et Vie* **1220** (May, 2019) . <https://www.science-et-vie.com/science-et-culture/au-dela-du-quantique-la-decouverte-d-un-nouveau-monde-49225>.
- [226] A. Roupioz, “Interprétation de la quantique : questionner ses fondements, in: Quantique, le nouvel âge d’or,” *Science et Vie, Hors Série* **292** (Oct, 2020) .
<https://www.science-et-vie.com/archives-par-numero/n-292>.
- [227] G. Masse, “From the problem of future contingents to peres-mermin square experiments: An introductory review to contextuality,” [arXiv:2105.13821 \[quant-ph\]](https://arxiv.org/abs/2105.13821).
- [228] E. Specker, “Die Logik Nicht Gleichzeitig Entscheidbarer Aussagen,” *Dialectica* **14** no. 2/3, (1960) 239–246.
- [229] M. P. Seevinck, “E. Specker: "The logic of non-simultaneously decidable propositions" (1960),” [arXiv:1103.4537 \[physics.hist-ph\]](https://arxiv.org/abs/1103.4537).
- [230] A. Whitaker, *John Stewart Bell and Twentieth-Century Physics: Vision and Integrity*. Oxford University Press, 2016.
<https://oxford.universitypressscholarship.com/view/10.1093/acprof:oso/9780198742999.001.0001/acprof-9780198742999>.
- [231] A. Gleason, “Measures on the closed subspaces of a hilbert space,” *Indiana Univ. Math. J.* **6** (1957) 885–893.
- [232] D. Dieks, “Von Neumann’s Impossibility Proof: Mathematics in the Service of Rhetorics,” <http://philsci-archive.pitt.edu/12443/>. From a talk at HQ4, San Sebastian 2015; preprint for a special issue of SHPMP.
- [233] E. Specker, *Ernst Specker Selecta*. Birkhäuser Basel, 1990.
- [234] E. Engeler, N. Hungerbühler, and M. J., “Remembering Ernst Specker (1920–2011),” *Elem. Math.* **67** (2012) 89–115.
- [235] R. W. Spekkens, “Ernst Paul Specker (1920-2011),” *Mind and Matter* **9** no. 2, (2011) 121–128.
- [236] F. Gonseth, “Les mathématiques et la réalité,” *Dialectica* **29** no. 1, (1975) 25–38.
<http://www.jstor.org/stable/42968610>.
- [237] G. Bachelard, *L’Engagement rationaliste*. Presses universitaires de France, Paris, 1972.
- [238] H. Putnam, “Is logic empirical?” in *Boston studies in the philosophy of science*, pp. 216–241. Springer, 1969.
- [239] M. Dummett, *Is Logic Empirical?*, pp. 45–68. London: Allen and Unwin, 1976.

- [240] G. Bacciagaluppi, “Is logic empirical?”. <http://philsci-archive.pitt.edu/3380/>. To appear in: D. Gabbay, D. Lehmann and K. Engesser (eds), Handbook of Quantum Logic (Elsevier Science Publications).
- [241] R. W. Spekkens, “Noncontextuality: how we should define it, why it is natural, and what to do about its failure, PIRSA:17070035, <http://pirsa.org/17070035/>,” *PIRSA:17070035* . <http://pirsa.org/17070035/>.
- [242] D. Schmid, J. H. Selby, and R. W. Spekkens, “Unscrambling the omelette of causation and inference: The framework of causal-inferential theories,” [arXiv:2009.03297](https://arxiv.org/abs/2009.03297) [quant-ph].
- [243] C. De Ronde and V. Bontems, “La notion d’entité en tant qu’obstacle épistémologique. Bachelard, la mécanique quantique et la logique.,” *Bulletin des Amis de Gaston Bachelard* (2011) 12–12.
- [244] C. A. Fuchs, M. Schlosshauer, and B. C. Stacey, “My Struggles with the Block Universe,” *"arXiv" e-prints* (May, 2014) , [arXiv:1405.2390](https://arxiv.org/abs/1405.2390) [quant-ph].
- [245] L. Vaidman, “Counterfactuals in quantum mechanics,” [arXiv:0709.0340](https://arxiv.org/abs/0709.0340) [quant-ph].
- [246] P. Öhrström and P. Hasle, “Future Contingents,” in *The Stanford Encyclopedia of Philosophy*, E. N. Zalta, ed. Metaphysics Research Lab, Stanford University, 2015. <https://plato.stanford.edu/archives/win2015/entries/future-contingents/>.
- [247] M. McKenna and D. J. Coates, “Compatibilism,” in *The Stanford Encyclopedia of Philosophy*, E. N. Zalta, ed. Metaphysics Research Lab, Stanford University, Fall 2021 ed., 2021. <https://plato.stanford.edu/archives/fall2021/entries/compatibilism/>.
- [248] T. O’Connor and C. Franklin, “Free Will,” in *The Stanford Encyclopedia of Philosophy*, E. N. Zalta, ed. Metaphysics Research Lab, Stanford University, Spring 2021 ed., 2021. <https://plato.stanford.edu/archives/spr2021/entries/freewill/>.
- [249] Y.-C. Liang, R. W. Spekkens, and H. M. Wiseman, “Specker’s parable of the overprotective seer: A road to contextuality, nonlocality and complementarity,” *Physics Reports* **506** no. 1, (2011) 1 – 39. <http://www.sciencedirect.com/science/article/pii/S0370157311001517>.
- [250] R. Nozick, “Newcomb’s problem and two principles of choice,” in *Essays in Honor of Carl G. Hempel*, N. Rescher, ed., pp. 114–146. Reidel, 1969.
- [251] J. Dupuy, *Pour un catastrophisme éclairé*. Paris : Seuil, 2002.
- [252] A. Suarez, “All-possible-worlds: Unifying many-worlds and copenhagen, in the light of quantum contextuality,” [arXiv:1712.06448](https://arxiv.org/abs/1712.06448) [quant-ph].
- [253] A. Suarez, “The limits of quantum superposition: Should "Schrödinger’s cat" and "Wigner’s friend" be considered "miracle" narratives?,” *"arXiv" 1906.10524 preprint* (2019) , [arXiv:1906.10524](https://arxiv.org/abs/1906.10524) [quant-ph].
- [254] A. Grinbaum, “Narratives of quantum theory in the age of quantum technologies,” *Ethics and Information Technology* **19** no. 4, (Dec, 2017) 295–306. <https://doi.org/10.1007/s10676-017-9424-6>.
- [255] J. S. Bell, “On the Problem of Hidden Variables in Quantum Mechanics,” *Rev. Mod. Phys.* **38** (Jul, 1966) 447–452. <https://link.aps.org/doi/10.1103/RevModPhys.38.447>.

- [256] M. Jammer, *The Philosophy of Quantum Mechanics the Interpretations of Quantum Mechanics in Historical Perspective*. Wiley & Sons, 1974.
- [257] M. Jammer, “John Stewart Bell and his work—on the occasion of his sixtieth birthday,” *Foundations of Physics* **20** no. 10, (Oct, 1990) 1139–1145.
<https://doi.org/10.1007/BF01889462>.
- [258] V. J. Wright and R. Kunjwal, “Contextuality in composite systems: the role of entanglement in the Kochen-Specker theorem,” [arXiv:2109.13594](https://arxiv.org/abs/2109.13594) [quant-ph].
- [259] S. Mansfield and T. Fritz, “Hardy’s non-locality paradox and possibilistic conditions for non-locality,” *Foundations of Physics* **42** no. 5, (May, 2012) 709–719.
<https://doi.org/10.1007/s10701-012-9640-1>.
- [260] A. W. Simmons, J. J. Wallman, H. Pashayan, S. D. Bartlett, and T. Rudolph, “Contextuality under weak assumptions,” *New Journal of Physics* **19** no. 3, (Mar, 2017) 033030. <https://doi.org/10.1088/1367-2630/aa5f72>.
- [261] A. C. Elitzur and L. Vaidman, “Quantum mechanical interaction-free measurements,” *Foundations of Physics* **23** no. 7, (Jul, 1993) 987–997.
<http://dx.doi.org/10.1007/BF00736012>.
- [262] S. Abramsky, “Contextuality: At the Borders of Paradox,” [arXiv:2011.04899](https://arxiv.org/abs/2011.04899) [quant-ph].
- [263] R. Penrose, “On the cohomology of impossible figures,” *Leonardo* **25** no. 3/4, (1992) 245–247. <http://www.jstor.org/stable/1575844>.
- [264] A. A. Klyachko, M. A. Can, S. Binicioğlu, and A. S. Shumovsky, “Simple Test for Hidden Variables in Spin-1 Systems,” *Phys. Rev. Lett.* **101** (Jul, 2008) 020403.
<https://link.aps.org/doi/10.1103/PhysRevLett.101.020403>.
- [265] T. Gonda, R. Kunjwal, D. Schmid, E. Wolfe, and A. B. Sainz, “Almost Quantum Correlations are Inconsistent with Specker’s Principle,” *Quantum* **2** (Aug., 2018) 87.
<https://doi.org/10.22331/q-2018-08-27-87>.
- [266] S. Abramsky and L. Hardy, “Logical Bell inequalities,” *Phys. Rev. A* **85** (Jun, 2012) 062114. <https://link.aps.org/doi/10.1103/PhysRevA.85.062114>.
- [267] J. F. Clauser, M. A. Horne, A. Shimony, and R. A. Holt, “Proposed Experiment to Test Local Hidden-Variable Theories,” *Phys. Rev. Lett.* **23** (Oct, 1969) 880–884.
<https://link.aps.org/doi/10.1103/PhysRevLett.23.880>.
- [268] N. de Silva, “Graph-theoretic strengths of contextuality,” *Phys. Rev. A* **95** (Mar, 2017) 032108. <https://link.aps.org/doi/10.1103/PhysRevA.95.032108>.
- [269] D. Z. Albert, Y. Aharonov, and S. D’Amato, “Curious New Statistical Prediction of Quantum Mechanics,” *Phys. Rev. Lett.* **54** (Jan, 1985) 5–7.
<https://link.aps.org/doi/10.1103/PhysRevLett.54.5>.
- [270] Y. Aharonov, S. Popescu, D. Rohrlich, and P. Skrzypczyk, “Quantum Cheshire Cats,” *New Journal of Physics* **15** no. 11, (Nov, 2013) 113015.
<http://dx.doi.org/10.1088/1367-2630/15/11/113015>.
- [271] Y. Aharonov, F. Colombo, S. Popescu, I. Sabadini, D. C. Struppa, and J. Tollaksen, “Quantum violation of the pigeonhole principle and the nature of quantum correlations,” *Proceedings of the National Academy of Sciences* **113** no. 3, (2016) 532–535,

- <https://www.pnas.org/content/113/3/532.full.pdf>.
<https://www.pnas.org/content/113/3/532>.
- [272] L. Vaidman, Y. Aharonov, and D. Z. Albert, “How to ascertain the values of σ_x , σ_y , and σ_z of a spin-1/2 particle,” *Phys. Rev. Lett.* **58** (Apr, 1987) 1385–1387.
<https://link.aps.org/doi/10.1103/PhysRevLett.58.1385>.
- [273] B.-G. Englert and Y. Aharonov, “The mean king’s problem: prime degrees of freedom,” *Physics Letters A* **284** no. 1, (2001) 1–5.
<https://www.sciencedirect.com/science/article/pii/S0375960101002717>.
- [274] Y. Aharonov, P. G. Bergmann, and J. L. Lebowitz, “Time symmetry in the quantum process of measurement,” *Physical Review* **134** no. 6B, (1964) B1410.
- [275] Y. Aharonov and L. Vaidman, *The Two-State Vector Formalism: An Updated Review*, pp. 399–447. Springer Berlin Heidelberg, Berlin, Heidelberg, 2008.
https://doi.org/10.1007/978-3-540-73473-4_13.
- [276] R. Silva, Y. Guryanova, N. Brunner, N. Linden, A. J. Short, and S. Popescu, “Pre- and postselected quantum states: Density matrices, tomography, and Kraus operators,” *Phys. Rev. A* **89** (Jan, 2014) 012121.
<https://link.aps.org/doi/10.1103/PhysRevA.89.012121>.
- [277] R. Clifton, “Getting contextual and nonlocal elements-of-reality the easy way,” *American Journal of Physics* **61** no. 5, (1993) 443–447, <https://doi.org/10.1119/1.17239>.
<https://doi.org/10.1119/1.17239>.
- [278] Y. Aharonov and L. Vaidman, “Complete description of a quantum system at a given time,” *Journal of Physics A: Mathematical and General* **24** no. 10, (1991) 2315.
- [279] P. Badziąg, I. Bengtsson, G. H. Cabello, A., and J.-L. Larsson, “Pentagrams and paradoxes,” *Found Phys* **41** (2011) 414 – 423.
- [280] A. Cabello, P. Badziąg, M. Terra Cunha, and M. Bourennane, “Simple Hardy-Like Proof of Quantum Contextuality,” *Phys. Rev. Lett.* **111** (Oct, 2013) 180404.
<https://link.aps.org/doi/10.1103/PhysRevLett.111.180404>.
- [281] P. Kurzyński and D. Kaszlikowski, “Contextuality of almost all qutrit states can be revealed with nine observables,” *Phys. Rev. A* **86** (Oct, 2012) 042125.
<https://link.aps.org/doi/10.1103/PhysRevA.86.042125>.
- [282] L. Hardy, “Contextuality in Bohmian mechanics,” in *Bohmian mechanics and quantum theory: An appraisal*, pp. 67–76. Springer, 1996.
- [283] I. Stengers, *Cosmopolitiques 4: Mécanique quantique, la fin du rêve*. La Découverte, Paris, 1997.
- [284] L. Ponomarev, *The Quantum Dice*. Institute of Physics Publishing, 1993.
- [285] G. Bachelard, *La Formation de l’esprit scientifique*. Vrin, Paris, 1999 (1938).
- [286] Z. Ji, A. Natarajan, T. Vidick, J. Wright, and H. Yuen, “Mip* \rightarrow re,” [arXiv:2001.04383](https://arxiv.org/abs/2001.04383) [quant-ph].
- [287] S. M. Cohen and C. D. C. Reeve, “Aristotle’s Metaphysics,” in *The Stanford Encyclopedia of Philosophy*, E. N. Zalta, ed. Metaphysics Research Lab, Stanford University, Winter 2020 ed., 2020.
<https://plato.stanford.edu/archives/win2020/entries/aristotle-metaphysics/>.

- [288] D. R. Hofstadter, *Gödel, Escher, Bach: An Eternal Golden Braid*. Basic Books, Inc., New York, NY, USA, 1979.
- [289] I. Calvino, *Si une nuit d'hiver un voyageur*. (traduction de Martin Rueff), Collection Folio de Gallimard, Paris, 2015.
- [290] A. Grinbaum, “Elements of information-theoretic derivation of the formalism of quantum theory,” *International Journal of Quantum Information* **01** no. 03, (2003) 289–300, <https://doi.org/10.1142/S0219749903000309>.
<https://doi.org/10.1142/S0219749903000309>.
- [291] S. Hawking, “Gödel and the end of physics.”
- [292] I. Pitowsky, “Quantum mechanics as a theory of probability,” in *Physical theory and its interpretation*, pp. 213–240. Springer, 2006.
- [293] T. Maudlin, “Three measurement problems,” *Topoi* **14** no. 1, (1995) 7–15.
- [294] T. Breuer, “The Impossibility of Accurate State Self-Measurements,” *Philosophy of Science* **62** no. 2, (1995) 197–214. <http://www.jstor.org/stable/188430>.
- [295] H. Primas, “Endo- and exo-theories of matter,”
<http://philsci-archive.pitt.edu/950/>.
- [296] V. Baumann and S. Wolf, “On Formalisms and Interpretations,” *Quantum* **2** (Oct., 2018) 99. <https://doi.org/10.22331/q-2018-10-15-99>.
- [297] E. G. Cavalcanti, “The view from a Wigner bubble,” *Foundations of Physics* **51** no. 2, (2021) 1–31.
- [298] K. R. Popper, “Indeterminism in quantum physics and in classical physics. part ii,” *The British Journal for the Philosophy of Science* **1** no. 3, (1950) 173–195.
- [299] J. Rothstein, “Physical Demonology,” *Methodos* **XI** no. 42, (1950) 94.
- [300] J. Rothstein, “Thermodynamics and some undecidable physical questions,” *Philosophy of Science* **31** no. 1, (1964) 40–48. <http://www.jstor.org/stable/186745>.
- [301] J. A. Wheeler, ““On recognizing ‘law without law,’” Oersted Medal Response at the joint APS–AAPT Meeting, New York, 25 January 1983,” *American Journal of Physics* **51** no. 5, (1983) 398–404, <https://doi.org/10.1119/1.13224>.
<https://doi.org/10.1119/1.13224>.
- [302] A. Grinbaum, “Quantum observer and Kolmogorov complexity: a model that can be tested,” [arXiv:1007.2756 \[quant-ph\]](https://arxiv.org/abs/1007.2756).
- [303] S. Aaronson, “It’s hard to think when someone Hadamards your brain.”
<https://www.scottaaronson.com/blog/?p=3975>.
- [304] K.-W. Bong, A. Utreras-Alarcón, F. Ghafari, Y.-C. Liang, N. Tischler, E. G. Cavalcanti, G. J. Pryde, and H. M. Wiseman, “A strong no-go theorem on the Wigner’s friend paradox,” *Nature Physics* **16** no. 12, (2020) 1199–1205.
- [305] M. Proietti, A. Pickston, F. Graffitti, P. Barrow, D. Kundys, C. Branciard, M. Ringbauer, and A. Fedrizzi, “Experimental test of local observer independence,” *Science Advances* **5** no. 9, (Sep, 2019) . <http://dx.doi.org/10.1126/sciadv.aaw9832>.

- [306] J. Szangolies, “The Quantum Rashomon Effect: A Strengthened Frauchiger-Renner Argument,” [arXiv:2011.12716](https://arxiv.org/abs/2011.12716) [quant-ph].
- [307] V. Vilasini, N. Nurgalieva, and L. del Rio, “Multi-agent paradoxes beyond quantum theory,” *New Journal of Physics* **21** no. 11, (Nov, 2019) 113028. <https://doi.org/10.1088/2F1367-2630%2Fab4fc4>.
- [308] P. Fraser, N. Nurgalieva, and L. del Rio, “Fitch’s knowability axioms are incompatible with quantum theory,” [arXiv:2009.00321](https://arxiv.org/abs/2009.00321) [quant-ph].
- [309] J. Bub, “In defense of a “single-world” interpretation of quantum mechanics,” *Studies in History and Philosophy of Science Part B: Studies in History and Philosophy of Modern Physics* (2018) . <http://www.sciencedirect.com/science/article/pii/S1355219817301788>.
- [310] S. Fortin and O. Lombardi, “Wigner and his many friends: A new no-go result?” [arXiv:1904.07412](https://arxiv.org/abs/1904.07412) [quant-ph].
- [311] A. Drezet, “About Wigner Friend’s and Hardy’s paradox in a Bohmian approach: a comment of ‘Quantum theory cannot’ consistently describe the use of itself,” [arXiv:1810.10917](https://arxiv.org/abs/1810.10917) [quant-ph].
- [312] J. Bell, “Against ‘measurement’,” *Physics World* **3** no. 8, (Aug, 1990) 33–41. <https://doi.org/10.1088/2058-7058/3/8/26>.
- [313] Č. Brukner, “Qubits are not observers – a no-go theorem,” [arXiv:2107.03513](https://arxiv.org/abs/2107.03513) [quant-ph].
- [314] A. Auffèves and P. Grangier, “Contexts, Systems and Modalities: A New Ontology for Quantum Mechanics,” *Foundations of Physics* **46** no. 2, (Sep, 2015) 121–137. <http://dx.doi.org/10.1007/s10701-015-9952-z>.
- [315] A. Auffèves and P. Grangier, “Extracontextuality and extravalence in quantum mechanics,” *Philosophical Transactions of the Royal Society A: Mathematical, Physical and Engineering Sciences* **376** no. 2123, (May, 2018) 20170311. <http://dx.doi.org/10.1098/rsta.2017.0311>.
- [316] P. Grangier and A. Auffèves, “What is quantum in quantum randomness?” *Philosophical Transactions of the Royal Society A: Mathematical, Physical and Engineering Sciences* **376** no. 2123, (May, 2018) 20170322. <http://dx.doi.org/10.1098/rsta.2017.0322>.
- [317] A. D. Biagio and C. Rovelli, “Relational Quantum Mechanics is about Facts, not States: A reply to Pienaar and Brukner,” [arXiv:2110.03610](https://arxiv.org/abs/2110.03610) [quant-ph].
- [318] J. B. DeBroda, C. A. Fuchs, and R. Schack, “Respecting One’s Fellow: QBism’s Analysis of Wigner’s Friend,” *arXiv* 2008.03572 preprint (2020) , [arXiv:2008.03572](https://arxiv.org/abs/2008.03572) [quant-ph].
- [319] A. Petersen, “The Philosophy of Niels Bohr,” *Bulletin of the Atomic Scientists* **19** no. 7, (1963) 8–14, <https://doi.org/10.1080/00963402.1963.11454520>. <https://doi.org/10.1080/00963402.1963.11454520>.
- [320] M. Bitbol, “A phenomenological ontology for physics: Merleau-ponty and qbism,” in *Phenomenological Approaches to Physics*, pp. 227–242. Springer, 2020.
- [321] M. Merleau-Ponty, *Le visible et l’invisible*. Gallimard., 1964.

- [322] P. Destouches-Février, *La structure des théories physiques*. PUF, 1951.
- [323] A. Kull, *Self-Reference and Time According to Spencer-Brown*, pp. 71–79. Springer Berlin Heidelberg, Berlin, Heidelberg, 1997. https://doi.org/10.1007/978-3-642-60707-3_6.
- [324] G. Spencer-Brown, *Laws of Form*. New York: Julian Press, 1972.
- [325] D. Lewis, “The Paradoxes of Time Travel,” *American Philosophical Quarterly* **13** no. 2, (1976) 145–152. <http://www.jstor.org/stable/20009616>.
- [326] A. Baumeler and E. Tselentis, “Equivalence of Grandfather and Information Antinomy Under Intervention,” *Electronic Proceedings in Theoretical Computer Science* **340** (Sep, 2021) 1–12. <http://dx.doi.org/10.4204/EPTCS.340.1>.
- [327] G. Bachelard, *L’Intuition de l’instant*. Le Livre de Poche, Paris, 1994.
- [328] S. Feferman, *Kurt Gödel, Collected Works*. Oxford University Press, 1995.
- [329] K. Gödel, *A Remark About the Relationship Between Relativity Theory and Idealistic Philosophy*. Harper & Row, 1949.
- [330] B. L. Bihan, *Qu’est-Ce Que le Temps ?* Paris: Vrin, 2019.
- [331] S. Gogioso and N. Pinzani, “The sheaf-theoretic structure of definite causality,” *Electronic Proceedings in Theoretical Computer Science* **343** (Sep, 2021) 301–324. <http://dx.doi.org/10.4204/EPTCS.343.13>.
- [332] S. Shrapnel and F. Costa, “Causation does not explain contextuality,” *Quantum* **2** (May, 2018) 63. <https://doi.org/10.22331/q-2018-05-18-63>.
- [333] D. Deutsch, “Quantum mechanics near closed timelike lines,” *Phys. Rev. D* **44** (Nov, 1991) 3197–3217. <https://link.aps.org/doi/10.1103/PhysRevD.44.3197>.
- [334] D. Deutsch, “Quantum theory as a universal physical theory,” *International Journal of Theoretical Physics* **24** no. 1, (Jan, 1985) 1–41. <https://doi.org/10.1007/BF00670071>.
- [335] H. D. Politzer, “Path integrals, density matrices, and information flow with closed timelike curves,” *Phys. Rev. D* **49** (Apr, 1994) 3981–3989. <https://link.aps.org/doi/10.1103/PhysRevD.49.3981>.
- [336] C. H. Bennett and B. Schumacher, “Teleportation, simulated time travel, and how to flirt with someone who has fallen into a black hole,” *Talk in QUPON* (2005) . <http://web.archive.org/web/20060207123032/http://www.research.ibm.com/people/b/bennetc/QUPONBshort.pdf>.
- [337] G. Svetlichny, “Time travel: Deutsch vs. teleportation,” *International Journal of Theoretical Physics* **50** no. 12, (Dec, 2011) 3903–3914. <https://doi.org/10.1007/s10773-011-0973-x>.
- [338] M. Walicki, “Reference, paradoxes and truth,” *Synthese* **171** no. 1, (Sep, 2008) 195. <https://doi.org/10.1007/s11229-008-9392-9>.
- [339] C. A. Fuchs, N. D. Mermin, and R. Schack, “An introduction to QBism with an application to the locality of quantum mechanics, journal = American Journal of Physics,” <https://doi.org/10.1119/1.4874855>. <https://doi.org/10.1119/1.4874855>.

- [340] C. J. Wood, J. D. Biamonte, and D. G. Cory, “Tensor Networks and Graphical Calculus for Open Quantum Systems,” *Quantum Info. Comput.* **15** no. 9-10, (July, 2015) 759–811. <https://arxiv.org/abs/1111.6950>.
- [341] A. Cabello, “Minimal proofs of state-independent contextuality,” [arXiv:1201.0374](https://arxiv.org/abs/1201.0374) [quant-ph].