



HAL
open science

Dynamic Thermal Ratings of Power Transformers : Modelling, Concepts, and Application case

Ildar Daminov

► **To cite this version:**

Ildar Daminov. Dynamic Thermal Ratings of Power Transformers : Modelling, Concepts, and Application case. Electric power. Université Grenoble Alpes [2020-..]; Université polytechnique de Tomsk (Russie), 2022. English. NNT : 2022GRALT036 . tel-03772184

HAL Id: tel-03772184

<https://theses.hal.science/tel-03772184v1>

Submitted on 8 Sep 2022

HAL is a multi-disciplinary open access archive for the deposit and dissemination of scientific research documents, whether they are published or not. The documents may come from teaching and research institutions in France or abroad, or from public or private research centers.

L'archive ouverte pluridisciplinaire **HAL**, est destinée au dépôt et à la diffusion de documents scientifiques de niveau recherche, publiés ou non, émanant des établissements d'enseignement et de recherche français ou étrangers, des laboratoires publics ou privés.

THÈSE

Pour obtenir le grade de

DOCTEUR DE L'UNIVERSITE GRENOBLE ALPES

**préparée dans le cadre d'une cotutelle entre
l'Université Grenoble Alpes et l'Université
Polytechnique de Tomsk**

Spécialité : **Génie Électrique**

Arrêté ministériel : 25 mai 2016

Présentée par

Ildar DAMINOV

Thèse dirigée par **Raphael CAIRE** et **Anton PROKHOROV**
codirigée par **Marie-Cécile ALVAREZ-HERAULT**

préparée au sein des **Laboratoire de Génie Electrique de
Grenoble, G2Elab** et **l'Ecole d'ingénierie énergétique, PES**

dans **École Doctorale Electronique, Electrotechnique,
Automatique, Traitement du Signal, EEATS**

Dynamic Thermal Rating of Power Transformers: Modelling, Concepts, and Application case

Thèse soutenue publiquement le **23 mai 2022**,
devant le jury composé de :

Monsieur, Nicolas RETIERE

Professeur, Univ. Grenoble Alpes, G2Elab, Président du jury

Monsieur, Evgeny SOLOMIN

Professeur, Université d'État du Sud de l'Oural, Examineur

Monsieur, Andrea MICHIORRI

Enseignant chercheur, MINES ParisTech, Examineur

Monsieur, Matti LEHTONEN

Professeur, Université Aalto, Rapporteur

Monsieur, Hans EDIN

Professeur, Institut royal de technologie KTH, Rapporteur

Monsieur, Raphael CAIRE

Maître de Conférences, Univ. Grenoble Alpes, G2Elab, Directeur de thèse

Monsieur, Anton PROKHOROV

Maître de Conférences, Univ. Polytechnique de Tomsk TPU, Directeur de thèse

Madame, Marie-Cécile ALVAREZ-HERAULT

Maître de Conférences, Univ. Grenoble Alpes, G2Elab, Co-Encadrante de thèse



Ildar Daminov

Dynamic Thermal Rating of Power Transformers: Modelling, Concepts, and Application Case

PhD thesis

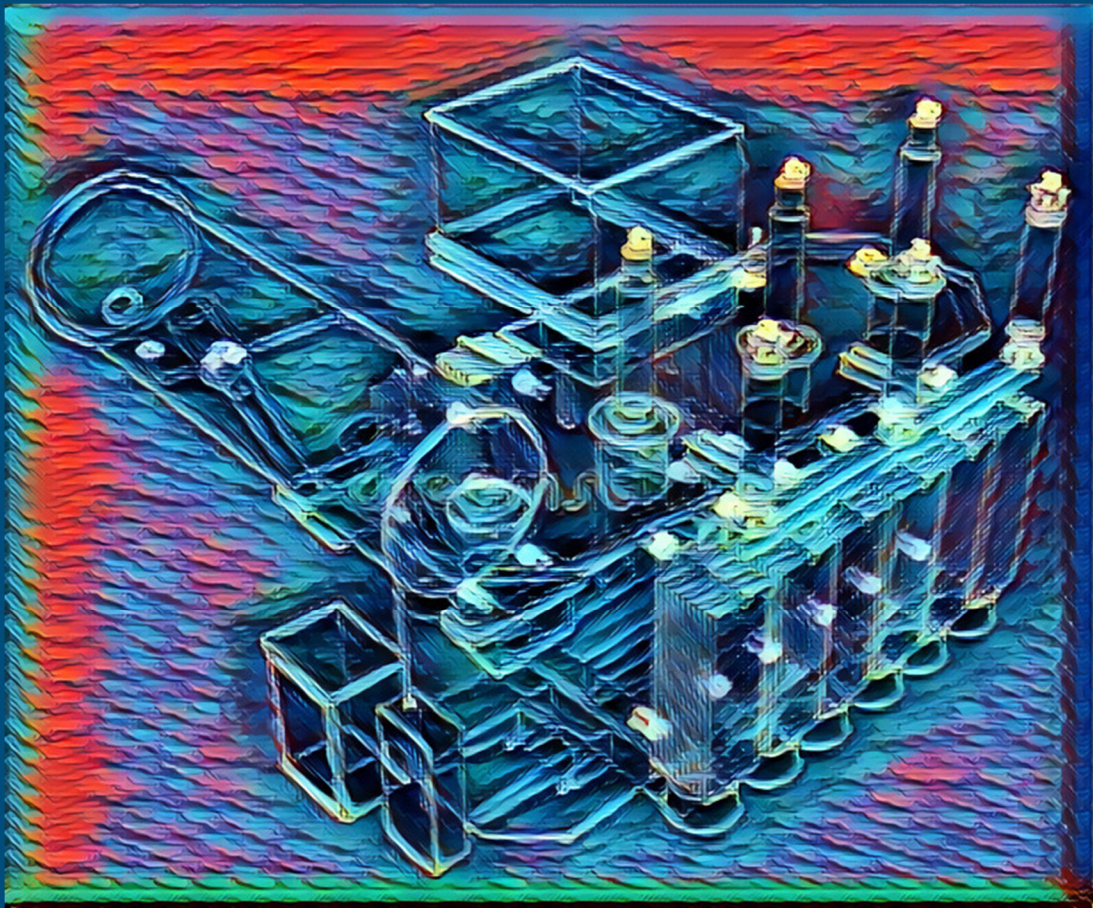

May 2022

To my family and friends

Abstract of thesis

This thesis investigates a promising and mature technology: Dynamic Thermal Ratings (DTR) of mineral-oil-filled transformers. In short, DTR represents a thermal limit that varies in time as a function of external (ambient) and internal (winding, oil) temperatures of transformers. Considerations of the transformer's thermal state may allow operating the transformers above their nameplate ratings and thus better utilizing their capacities.

The thesis describes a global context, identifies the incentives appearing worldwide, and explains why transformers were chosen as a research object. Next, the reader may find the state of the art on the thermal performance of power transformers, answering the questions:

- What are the current and temperature limits of the transformer's winding and oil?
- Why is it necessary to operate the transformers below these limits?
- Which factors may affect the permissible loading of power transformers?

Furthermore, the reader may find a review explaining how the vision of the transformer's thermal limits was evaluated from the early 20th century and up to nowadays.

As an output of this discussion, we formulate the **main hypothesis** stating that transformer capacity is still underutilized per IEC and IEEE loading guides despite recent advances. Therefore, **three main tasks** were set to enhance the utilization of transformer capacities. **First**, it was decided to reassess DTR using current and temperature limitations per IEC standard. This implies using the intermittent limit of winding temperature (120 or 140 °C) instead of its continuous limit (98 or 110 °C) as done in similar studies. **Second**, it was decided to investigate how much load can be connected to power transformers if using DTR alone and with flexibilities (on the example of Demand Response). The latter allows modifying the load profile of the transformer and thus optimizing its utilization from the thermal state perspective. **Third**, it was decided to find a maximal energy transfer through a transformer, i.e. an energy limit. Also, we investigate optimal ageing considering the remaining time of the transformer's operation and the remaining life of winding insulation.

As the **main methods**, we rely on the thermal modelling of transformers through IEC 60076-7 standard (a difference method), widely used in industry and academia. Also, we use heuristic and optimization techniques from MATLAB to optimize the utilization of transformer capacities. Statistics methods were applied for processing the data and results.

Our **main results** demonstrate that power transformers may have around 30-35% more capacity (compared to DTR based on continuous temperature limits) if using DTR based on intermittent temperature limits. It was also shown that the reserve capacity of the power transformer has significant headroom for load connections (compared to a business-as-usual approach). Furthermore, a small amount of demand response may boost this headroom even far more. Finally, we introduced a new concept – the energy limit of the power transformer. Moreover, we suggested using the variable optimal ageing limit, depending on the remaining insulation life of the transformer and its expected calendar life.

MATLAB code and the initial data used in this thesis is **available in open access** on GitHub.

Acknowledgement

During this thesis, I had a chance to meet great people to whom I am grateful for their contributions. First, I would like to thank my supervisors - Dr Raphael CAIRE, Dr Marie-Cecile ALVAREZ- HERAULT and Dr Anton PROKHOROV for guiding and supporting me through this journey. In addition, I would like to say un grand merci to Dr Raphael CAIRE for his enormous support in the laboratory and conferences and for inviting academic and industry experts to this research. Our discussions allowed me to identify my blind spots and therefore become a better scientist. Dr Marie-Cecile ALVAREZ- HERAULT, I am thankful for all feedback, discussions, and support with the organization of the thesis defence. It was also my pleasure to teach the students with you. I would like to say special thanks to Dr Anton PROKHOROV for seeing the potential in me back in the days of my master's studies which later were transformed into a PhD. Moreover, thank you a lot for the opportunity to work on real industry projects, and for your help in organizing collaboration with the Distribution System Operator.

This thesis would not be possible without financial support from many organizations and people. First, I wish to express my gratitude to Conference des Grandes écoles for supporting us through the research grant "Bernard Sutter". This support gave rise to the cotutelle agreement (a cotutelle is a joint PhD program in France) and therefore stands as a foundation for this international research. Besides, I appreciate Tomsk Polytechnic University and University Grenoble Alpes for providing PLUS scholarships and IDEX grants. Specifically, I am expressing my gratitude to Dr Igor STEPANOV, TPU vice-rector on research and innovation at that time, and his colleagues from the administration team who helped to resolve administrative issues even working extra hours (sometimes our meetings were held around 21:00-22:00). I am very grateful to Dr Alexander MATVEEV, Director of the Power Engineering School for standing strongly for his employees. Similarly, I would thank the entire administration team of G2Elab for their numerous support during this thesis. I am also very grateful for the time of working as an assistant professor at Grenoble INP and Tomsk Polytechnic University which allowed me to partially finance this PhD thesis. Large gratitude must be also attributed to Dr Egor GLADKIKH, CEO of TOPPLAN start-up with whom I had a chance to work as an engineer. The flexible and friendly ambience of working with Dr Egor GLADKIKH allowed me to manage my engineer's duties, PhD and assistant professorship and as result to finance a year of my PhD.

I wish to thank experts whose contributions allowed me to improve this research. First, I wish to thank a lot Dr Rémy RIGOMARIANI (Senior Researcher at CNRS, G2Elab) with whom I had a chance of working together on the optimization problems. I very much appreciate our discussions and sharing best practices in world-leading universities. I am also very thankful to Christophe KIENY, a transformer expert with large experience at ENEDIS, who provided us with a detailed feedback and remarks on our articles as well as assisted at the pre-defence. I would like to thank Tatiana MOISEEVA, the head of the TRK department responsible for a load connection, for her valuable support in conducting this research. I also appreciate all article reviewers and experts with whom I had the pleasure to discuss during conferences, as well the thesis jury for their comments and especially remarks.

The thesis would not be accomplished without ensuring deep (focused) work. In this regard, I have special thanks to Dr Delphine RIU (Director of Ense3 school) and Dr Benoit DELINCHANT (Professor at Ense3 school). Thanks to your flexible work conditions during ATER, it became literally possible to be focused on the thesis and as a result to prepare 3 research articles in Q1-Q2 journals. Besides, while working with Dr Benoit DELINCHANT on the course for OMEGAAlpes software, I learned a lot about open science. This motivated me later to share a MATLAB code, used in this PhD thesis, in open access on GitHub. During my final year of PhD, I was able to finalize a thesis manuscript thanks to working as a postdoc on the CELT4Wind project with Dr Anne BLAVETTE (Senior Researcher at CNRS, ENS Rennes, SATIE laboratory) and Dr Salvy BOURGUET (Associate professor at Nantes University, IREENA laboratory). Merci enormement for this postdoc opportunity, which not only helped me to finance the last year of PhD but also provided a friendly and flexible ambience. Thanks to these great conditions I could efficiently manage my time without diving into multitasking (which would inevitably cause a low efficiency) but actually keeping my focus on deep work (focused and efficient).

I express my gratitude to Dr Bertrand RAISON, Dr Lauric GARBUIO and Dr Laurent GERBAUD who oversaw the thesis progress over the years. Special thanks to Dr Jumana BOUSSEY, Director of Doctoral School and her team who did a great job for keeping the cotutelle. The same gratitude I would like to express to Dr Anna BARSKAYA, Head of Postgraduate and Doctoral Office, and her team for ensuring it on the TPU side. Also, I am thanking International Student Department and especially Marina TAYURSKAYA for her assistance with the cotutelle agreement. I have large gratitude to MeteoBlue company which provided us meteo data for conducting our research and later shared our results on their website. Special thanks to my colleagues (both academic and administrative), PhD students and students whom I had the pleasure to meet during the thesis. I learned a lot from you all.

My very special gratitude is reserved for my family. I am infinitely thankful to my grandfather, Khamit DAMINOV whose lifelong hard work in the mines laid the foundations for our family growth. My mother - Nuriya DAMINOVA, though she is far in Kazakhstan but at the same time, she has been always near as we all could feel her support. Thank you for cherishing my love for the pursuit of new knowledge. My dear wife, Dr Ekaterina DAMINOVA 😊 thank you for your support during these years and for sharing these both good and hard times. My brother and sisters, uncles and aunts also supported me despite long distances. My pug, Frank, thank you for distracting me and providing us with the cosy atmosphere. My friends, although some of you are very far, still remain inspiring examples for me, pushing towards great achievements like this thesis.

Table of content

Abstract of thesis	2
Acknowledgement	4
Table of content	5
List of figures	7
List of tables	10
List of abbreviations	11
List of symbols	13
Chapter I State of the art, Motivation, and Contributions	16
1. Introduction of a global context.....	17
1.1 Historical transformation: electricity becomes a primary energy carrier	17
1.2 Rising costs of electrical networks.....	18
1.3 Global warming as a risk for electrical networks.....	23
2. Thermal performance of power transformers: state of the art.....	23
2.1 Thermal performance of power transformers: background	25
2.2 Thermal limits of power transformers: review	36
3. Research tasks and motivation	46
3.1 Task 1: DTR assessment considering current and temperature limitations.....	46
3.2 Task 2: Estimation of transformer reserve capacity for load connection	47
3.3 Task 3: Investigating the energy and ageing limits of transformer	48
4. Contributions.....	49
5. Full list of publications.....	51
6. Thesis outline	52
Chapter II Assessment of Dynamic Transformer Rating considering C&T limitations.....	53
1. Introduction.....	54
2. Feasible region of transformer loadings	56
2.1 Examples of feasible regions with different limiting factors	62
3. Assessment of dynamic transformer ratings	64
4. Recommendations for transformer overloading	70
5. Conclusions.....	74
Chapter III Reserve capacity of transformers for a load connection	76
1. Introduction.....	77
1.1 Problem: low loadings of the electrical network in Russia.....	78
1.2 The mechanism as a solution for low-loaded network	83

1.3	Headroom for increasing the reserve capacities.....	86
2	Existing DSO approach in Russia for evaluating a reserve capacity.....	89
3	Estimation of reserve capacity using C&T limitations.....	91
3.1	Consideration of ambient temperature uncertainty.....	92
3.2	Consideration of new consumer load profile uncertainty.....	94
3.3	Algorithm for substation reserve determination	95
3.4	Case study	96
3.5	Conclusions	99
4	Coupling DTR with DR to increase a transformer reserve capacity	100
4.1	Literature review on using DR and DTR for transformer reserve capacity.....	100
4.2	End-users side flexibility for grid upgrades deferral.....	101
4.3	Integrated Design and Management of Demand Response.....	108
4.4	Results and discussion	110
5	Conclusions	115
Chapter IV Investigating the energy limit and ageing limit of transformers		117
Part I Energy limit of oil-immersed transformers.....		118
1.	Introduction.....	118
1.1	Context of modern power systems.....	118
1.2	Motivation for investigation of energy limits	118
1.3	Section goals	121
2.	Determination of energy limit: a concept.....	122
3.	Quantification of energy limits in different climates	127
3.1	Historical ambient temperature in Tomsk and Grenoble.....	127
3.2	Results: Metrics of energy limit in each city.....	129
3.3	Study limitations	131
4.	Conclusion	132
Part II Optimal ageing limit of oil-immersed transformers.....		134
1.	Introduction.....	134
2.	Methodology: Determination of the optimal ageing limit.....	136
2.1	Optimal energy transfer through transformers.....	136
2.2	Optimal ageing limit of oil-immersed transformers	138
3.	Conclusions.....	142
Thesis conclusions		143
References.....		146

List of figures

- Figure 1 World final energy demand in EJ/year: before and after COVID-19 [1]. 17
- Figure 2 World final energy demand by the carrier. Source DNV GL and IEA 18
- Figure 3 Energy demand by primary energy carrier as a function of time. Source: DNV GL data.
..... 18
- Figure 4 Global network cost by the driver. Source: DNV GL [4] 19
- Figure 5 CAPEX and OPEX of the electrical network in Billion \$/ year. Source: DNV GL [4].... 19
- Figure 6 Global network costs in 2020 and 2050 by voltage levels . Data: [2],[5]..... 20
- Figure 7 Power line capacity by voltage levels. Source: DNV GL [5]..... 21
- Figure 8 Global number of transformers by voltage levels and time. Data: DNV GL [5]..... 21
- Figure 9 Traditional and new electricity system architecture. Redrawn from [4]..... 22
- Figure 10 Temperature limits of different power equipment in normal and emergency mode
..... 24
- Figure 11 External and internal view of a power transformer. Figure is redrawn by author from
power transformers 1000-6300 kVA, 35 kV [64] 25
- Figure 12 Structural formula of cellulose. Source: IEC standard [91] 30
- Figure 13 Correlation between DP and tensile strength. Source: IEC standard [91]..... 30
- Figure 14 Transformer loadings equal to HST and TOT limits as a function of T_{amb} 57
- Figure 15 Limiting factors in the range of T_{amb} 58
- Figure 16 Feasible region (the yellow area) for given C&T limits 59
- Figure 17 The same feasible region, but showing the loadings with normal ageing (green area)
..... 59
- Figure 18 Interrelations between transformer loading and temperatures 60
- Figure 19 Feasible region limited by the current only 62
- Figure 20 Feasible region limited by the TOT only..... 63
- Figure 21 Feasible region limited by current and HST 63
- Figure 22 Hourly T_{amb} from 1985 to 2019 in Tomsk, Russia and Grenoble, France. Source:
MeteoBlue 64
- Figure 23 Estimation of feasible regions during 34 years 65
- Figure 24 Mean DTR with maximum and minimum deviations during 34 years..... 66
- Figure 25 Mean DTR with maximum and minimum deviations in each month 67
- Figure 26 DTR duration curves of the same ONAF transformer in Tomsk and Grenoble..... 68
- Figure 27 Share of limiting factors: based on 34 years analysis (% are rounded) 69
- Figure 28 Exponential dependencies of AAF on HST. Y-axis has a log scale..... 71
- Figure 29 Black lines: transformer loadings correspond to HST1%. Orange and blue bars:
histogram of T_{amb} in Tomsk and Grenoble based on 34-years history 72
- Figure 30 Loadings, which can be used for compensation of accelerated LoL (based on T_{amb})
..... 73
- Figure 31 Biggest obstacles faced by firms. Source: World Bank [379]..... 77
- Figure 32 Top performers on Getting Electricity in the world. Source: World Bank [379]..... 77
- Figure 33 Loadings of a distribution network in 2012-2015. Source: Rosseti [381]. Translated
from Russian by the author 78
- Figure 34 Costs of load connections in Russia. Exchange rate: 85 RUB = 1 EUR. The source:
Rosseti. Translated from Russian by the author 79
- Figure 35 Operation of wholesale and retail markets in Russia. Source: [390]. Translated from
Russian by the author..... 80
- Figure 36 The composition of prices for electrical energy. Source: [390] 81

Figure 37 Utilization of distribution network capacity 35 kV and above in 2015. Source: [381]. Translated from Russian by the author.....	83
Figure 38 Composition of final electricity prices in Russia for 2017 and 2020. Source: [387]	83
Figure 39 Hidden transformer capacity and the limitation of mechanism.....	86
Figure 40 Deficit of transformer capacity in Russia and a number of substations unavailable for new load connection. Source: [425]	88
Figure 41 Share of closed substation and the share of the capacity deficit in Russia. Source: [425]	88
Figure 42 Historical T_{amb} in Tomsk over 30 years. Source: MeteoBlue.....	92
Figure 43 Histogram of T_{amb} in September since 1985	93
Figure 44 Reference annual maximal T_{amb} for use in thermal modelling	93
Figure 45 Assumed load profile of new consumer during the year.....	94
Figure 46 Initial load profile of primary substation and reference T_{amb} graph in Tomsk	96
Figure 47 Initial load profile (blue) and the same load profile after adding reserve (orange)	97
Figure 48 Annual HST profile and corresponding LoL.....	98
Figure 49 Reaching the HST limit subject to the increased load profile	98
Figure 50 Case study—(a) outdoor secondary substation; (b) hourly load in kilovolt ampere (kVA) and monthly maximum ambient temperature (θ_{ta}) in Grenoble, France.....	102
Figure 51 Preliminary results for yearly simulation: load growing from 1% to 100% of nominal rating (reserve in pu). The initial loading of the studied distribution transformer is 86% (see the y-axis of the central figure).	104
Figure 52 Number of days where thermal limits are reached.	106
Figure 53 The procedure for finding the necessary volume of Demand Response (DR) to interconnect the studied reserve.....	107
Figure 54 Validation run with “energy shifting”: (a) transformer loadings; (b) temperatures.	110
Figure 55 Validation run with “energy shedding”: (a) transformer loadings; (b) temperatures	111
Figure 56 Validation run with “energy shedding” and ageing: (a) transformer loadings; (b) temperatures.....	111
Figure 57 One-week profiles in January, comparison of the base case and Dynamic Thermal Rating (DTR)/DR in “energy-shedding mode”	112
Figure 58 Obtained results for different reserve margins and DR in “energy-shedding” mode: (a) DR rated power; (b) DR power share compared to the added load; (c) DR rated energy; (d) DR energy share compared to the total energy of load.	113
Figure 59 Power shedding over the year—75% reserve in “energy-shedding” mode.....	114
Figure 60 Yearly temperature duration curves: 75% reserve in “energy-shedding” mode leading to less than 1% energy curtailment, as seen in Figure 57.....	114
Figure 61 Results: DR modelled with or without payback effect, i.e. the energy conservation: (a) DR power in kW; (b) DR energy in kWh.	115
Figure 62 Transformer, limiting an energy transfer between two zones	119
Figure 63 Maximization of the energy generation using flexibilities by RES operators	120
Figure 64 Criteria of thermal ratings for DER interconnection in different countries [30] ...	121
Figure 65 Case study for investigating the highest energy transfer through transformers ..	122
Figure 66 Optimal transformer loading, $S(t)$, with corresponding HST and TOT.....	125
Figure 67 Heating of winding conductors based on [474]	125
Figure 68 Energy limit (loading profiles) in cold T_{amb}	127

Figure 69 Hourly T_{amb} in Tomsk and Grenoble from 1985 to 2019. Source: MeteoBlue..... 128

Figure 70 Duration curves of T_{amb} s in Tomsk, Russia and Grenoble, France 128

Figure 71 Loading duration for all transformers in Tomsk, Russia and Grenoble, France 129

Figure 72 Maximal, minimal and mean loadings of energy limits in each month..... 130

Figure 73 Maximal energy transfer through transformers in comparison with energy delivered at a constant nominal rating 131

Figure 74 The general case showing the remaining insulation life calendar life of transformers 134

Figure 75 Arbitrary load profiles having the same LoL (1 pu) but different energy transfer. The load profile is given in 1-min resolution but assumed constant over 1-hour step..... 135

Figure 76 Top figure: optimal load profile (the black line) ensuring the highest energy transfer and thus the optimal utilization of insulation. Bottom figure: a cumulative ageing (the blue line) and a hot spot temperature (the red line), corresponding to the black line..... 136

Figure 77 Optimized load profile (the black line) ensuring the highest energy transfer for one week at rated $T_{amb} = +20\text{ }^{\circ}\text{C}$: (two top figures) and real T_{amb} in Grenoble, France (two bottom figures)..... 137

Figure 78 Situations when various ageing limits (LoL in the figure) maximize the energy transfer at the remaining calendar life of the transformer 139

Figure 79 Energy transfer as a function of ageing limits for 3 cases. % on the y-axis is related to each case alone and not intended to compare shown cases..... 140

Figure 80 Insulation and calendar lives in the case of new transformer..... 141

Figure 81 Dependency: an ageing limit-a remaining calendar life-a maximal energy transfer. 141

List of tables

- Table 1 C&T limits for transformers below 100 MVA designed per IEC 60076-2..... 32
- Table 2 Analyzed publications on DTR-related issues sorted by years since 1990..... 40
- Table 3 Description of contributions..... 49
- Table 4 Main publications with thesis contributions..... 50
- Table 5 STR of power transformer as a function of daily mean T_{amb} 54
- Table 6 C&T limitations in IEC/IEEE and national standards of Russia 54
- Table 7 Thermal characteristics of ONAF power transformer (≤ 100 MVA)..... 56
- Table 8 Numerical data from Figure 23..... 66
- Table 9 Worst-case LoL in pu or the number of days 70
- Table 10 Number of days per year for overloading and compensating the accelerated ageing 71
- Table 11 Contribution of this chapter and the journal where it was published..... 75
- Table 12 Expenses of Network company used to calculate TRR 82
- Table 13 Transformer thermal parameters used in the case study..... 96
- Table 14 Results of the algorithm at steps 1-2 97
- Table 15 Contribution of this chapter and the conference where it was presented 99
- Table 16 Limits for distribution transformers applicable for different types of loadings [90]. 103
- Table 17 Thermal characteristics of ONAN distribution transformer..... 108
- Table 18 Contribution of this chapter and the journal where it was published..... 116
- Table 19 Thermal characteristics of transformers: ONAN, ONAF, OF, OD [14]..... 123
- Table 20 Contribution of this chapter and the journal where it was published..... 133
- Table 21 Specific values of green and blue bars in Figure 77 140
- Table 22 Contribution of this chapter and the journal where it was published..... 142
- Table 23 GitHub links to initial code for each contribution 145

List of abbreviations

AAF	Ageing Acceleration Factor
ABB	Asea Brown Boveri
AC	Alternating Current
ACSR	Aluminium-Conductor Steel-Reinforced
AEQ	Ageing EQuivalent or Annual Equivalent Ageing
ANSI	American National Standards Institute
C&T	Current and Temperature
CAPEX	CAPital Expenditures
CFD	Computational Fluid Dynamics
COVID-19	COronaVirus Disease
DC	Direct Current
DER	Distributed Energy Resources
DG	Distributed Generation
DNV GL	Det Norske Veritas и Germanischer Lloyd.
DP	Degree of Polymerization
DR	Demand Response
DSO	Distrbution System Operator
DTCR	Dynamic Thermal Circuit Rating
DTR	Dynamic Thermal Rating
EHV	Extra-High Voltage, the average voltage level of 350 kV
EJ	Exajoule, 1.0E+18 J
ENTSO-E	European Network of Transmission System Operators for Electricity
EU	European Union
FEM	Finite Element Method
FERC	Federal Energy Regulatory Commission
GDP	Gross domestic product
GIC	Geomagnetically Induced Current
GOERLO	State Commission for Electrification of Russia. In Russian ГОЭРЛО.
GOST	ГОсударственный СТАндарт State standard
GW	GigaWatt
HST	Hot Spot Temperature
HV	High Voltage, the average voltage level of 130 kV
IEA	International Energy Agency
IEC	International Electrotechnical Commission
IEEE	Institute of Electrical and Electronics Engineers
km	Kilometre
KPI	Key Performance Indicator
kV	KiloVolt
kVA	KiloVolt Ampere
kW	KiloWatt
kWh	KiloWatt hour, 1.0E+3 Wh
LoL	Loss of Life
LV	Low Voltage, the average voltage level of 0.4 kV
LILCO	Long Island Lighting Company
MATLAB	Matrix Laboratory
MISO	Midcontinent Independent System Operator

MV	Medium Voltage, the average voltage level of 20 kV
MVA	MegaVolt Ampere
MW	MegaWatt
MWh	MegaWatt hours, 1.0E+6 Wh
NEMA	National Electrical Manufacturers Association
NYPA	New York Power Authority
OD	Oil Directed (Either ODAN, ODAF, or ODWF cooling)
OF	Oil Forced (Either OFAN, OFAF, or OFWF cooling)
OFAF	Oil Forced Air Forced
OFWF	Oil Forced Water Forced
OLTC	On-Load Tap Changer
ONAF	Oil Natural Air Forced
ONAN	Oil Natural Air Natural
OPEX	Operational Expenditure
PJM	Pennsylvania New Jersey Maryland Interconnection
PSEG	Public Service Electric and Gas Company
PTLOAD	Power Transformer LOADING
pu	Per Units
PWh	PetaWatt Hour, 1.0E+15 Wh
RES	Renewable Energy System
RTTR	Real-Time Thermal Rating
RUB	Ruble
RUSAL	RUSSian ALuminum
SAIDI	System Average Interruption Duration Index
SAIFI	System Average Interruption Frequency Index
SOC	State Of Charge
SQP	Sequential Quadratic Programming
STO	Стандарт Организации Standard of Organization
STR	Static Thermal Rating
THD	Total Harmonic Distortion
TOT	Top-Oil Temperature
TRR	Total Revenue Requirement
TSO	Transmission System Operator
TUP	Thermally-Upgraded Paper
TW	TerraWatt, 1.0E+12 W
TWh	TerraWatt hour, 1.0E+12 Wh
UHV	Ultra-High Voltage, the average voltage level of 800 kV
USA	United States of America
USD	United States Dollar
USSR	Union of Soviet Socialist Republics
VAR	Volt-Ampere Reactive
VRES	Variable Renewable Energy Source/System
Wh	Watt Hour
XLPE	Cross-Linked PolyEthylene

List of symbols

Chapter 1

Symbol	Description	Units
LoL	Loss of insulation life	h,min or pu
N	Total number of intervals during the studied period	-
n	Number of each time interval	-
t_n	n^{th} time interval	-
T_{amb}	Ambient temperature	$^{\circ}\text{C}$
V	The relative ageing rate during a period	pu
V_n	The relative ageing rate during a period n	pu
θ_h	Hot spot temperature of windings	$^{\circ}\text{C}$

Chapter 2

Symbol	Description	Units
$\text{HST}_{1\%}$	Hot spot temperature which causes 1 % of ageing	$^{\circ}\text{C}$
k_{11}	Thermal constant	-
k_{21}	Thermal constant	-
k_{22}	Thermal constant	-
LoL	Loss of insulation life	h or min or pu
N	The numerical order of y-data	-
R	Loss ratio, no unit	-
T_{amb}	Ambient temperature	$^{\circ}\text{C}$
T	Duration of studied period (1 day).	min
x	Oil exponent	-
y	Winding exponent, no unit	-
Δ	Any small number (used in the algorithm)	-
$\Delta\theta_{hr}$	Hot-spot to the top-oil gradient at rated current	K
$\Delta\theta_{or}$	Top-oil temperature rise	K
θ_a	Design ambient temperature	$^{\circ}\text{C}$
θ_h	Design hot spot temperature	$^{\circ}\text{C}$
τ_o	Oil time constant	min
τ_w	Winding time constant	min

Chapter 3

Symbol	Description	Units
AEQ	Ageing EQuivalent or Annual Equivalent Ageing	pu
b	Coefficient applied if the interruption of load may have ecological, economic, or social consequences	-
C_{operat}	Fees for maintaining the 20 kV electrical network in a given region (defined by special commissions in charge of tariff)	$\text{€}/\text{MW}$ month
E_{losses}^{actual}	Actual losses of electrical energy in the reported year	kWh
E^{DRr}	DR flexibility rated energy	kWh
E_{losses}^{norm}	Losses of electrical energy at substation or outgoing feeders in a reported year if keeping losses within the normative level	kWh

$E_{year}^{transfer}$	Annual transfer from a primary substation in the year	kWh
HST_{max}	Maximal hot spot temperature	°C
K	Reducing coefficient for each year	%
k_{11}	Thermal constant	-
k_{21}	Thermal constant	-
k_{22}	Thermal constant	-
K_{cont}	The coefficient for continuous loading of the transformer	pu
K_{lr}	Coefficient for load reduction at the studied primary substation for keeping the losses within normative levels	pu
K^{trR}	Transformer rated power	kW
LoL	Loss of insulation life	h or min or pu
P_{actual}	Actual load of the consumer	MW
p_t^{DR}	DR flexibility power	kW
p^{DRr}	DR flexibility rated power	kW
p_t^l	Load to supply at time t	kW
P_{max}	Maximal load of a consumer in the application for technological connection	MW
$P_{reserved}$	Reserved power of consumer	MW
$P_{reserved_paid}$	Reserved capacity which a consumer should pay	MW
p^{tr}	Transformer loading	pu
p_t^{tr}	Transformer loading	pu
R	Loss ratio, no unit	-
$S_{reserve}^{actual}$	Reserve capacity of the primary substation	MVA
$S_{admissible}$	Steady-state permissible loading of the transformer	pu
S_{nom}^{fact}	Actual nominal rating of transformer per a documentation	MVA
S_{load}	Up-to-date loading of power transformer	MVA
$S_{losses\ reduction}$	Power reduced to keep the losses of electrical energy corresponding to normative levels	MVA
$S_{load\ max}$	Maximal load of substation	pu
S_{N-1}	The lowest transformer capacity in N-1 mode	pu
SOC^{DR}	Lower/upper state of charge	%
SOC_0^{DR}	Initial flexibility state of charge	%
$SOC_{t=T}^{DR}$	Final flexibility state of charge	%
$S_{reserve}$	Reserve capacity in the algorithm	MVA, pu
$S_{reserve}$	Reserve capacity of the substation	pu
$S_{reserved}$	Final payment for reserved capacity	EUR
$S_{transfer}$	Power, which may be transferred to other substations in N-1 mode if the LV-MV network allows doing that	MVA
$S_{unloading}$	Power, which may be transferred to other substations after emergency mode using the network 6-35 kV	MVA
t	Time in 1 h...8760h	min, hour
$t \in T$	A generic set of time steps (1 min)	min
T_{amb}	Ambient temperature	°C
$T_{amb\ Sloadmax}$	Ambient temperature during the peak load	°C
$t^d \in T^D$	Set of the time steps for dispatch (1 h)	hour

x	Oil exponent	-
y	Winding exponent, no unit	-
$\delta_{reserved}$	Fraction of $P_{reserved}$ in P_{max}	%
$\Delta\vartheta_t^{h1}, \Delta\vartheta_t^{h2}$	Hot-spot to top oil gradients at t	K
$\Delta\theta_{hr}$	Hot-spot to the top-oil gradient at rated current	K
$\Delta\theta_{or}$	Top-oil temperature rise	K
θ_a	Design ambient temperature	°C
ϑ_t^a	The ambient temperature at time t	°C
θ_h	Design hot spot temperature	°C
ϑ^h	Hot spot temperature	°C
ϑ_t^h	The hot-spot temperature at time t	°C
ϑ^o	Top-oil temperature	°C
ϑ_t^o	Top oil temperature at time t	°C
τ_o	Oil time constant	min
τ_w	Winding time constant	min

Chapter 4

Symbol	Description	Units
AAF	Ageing Acceleration Factor	pu
D	Difference operator, in difference equations	-
E_{TR}	Energy transfer through a transformer	MWh, puh
k_{11}	Thermal constant	-
k_{21}	Thermal constant	-
k_{22}	Thermal constant	-
LoL	Equivalent loss of life on the studied period	pu
N	The numerical order of y-data	-
R	Loss ratio, no unit	-
$S_{(t)}$	Transformer loading at time t	°C
T_{amb}	Ambient temperature	°C
x	Oil exponent	-
y	Winding exponent, no unit	-
$\Delta\theta_{h1}$	The first term of hot-spot temperature rise	K
$\Delta\theta_{h2}$	The second term of hot-spot temperature rise	K
$\Delta\theta_{hr}$	Hot-spot to the top-oil gradient at rated current	K
$\Delta\theta_{or}$	Top-oil temperature rise	K
θ_a	Design ambient temperature	°C
$\theta_{a(t)}$	The ambient temperature at time t	°C
θ_h	Design hot spot temperature	°C
$\theta_{h(t)}$	The hot-spot temperature at time t	°C
$\theta_{0(t)}$	The top-oil temperature at time t	°C
τ_o	Oil time constant	min
τ_w	Winding time constant	min
S	Vector of size $1 \times T_1$ representing the transformer loading curve	pu

Chapter I

State of the art, Motivation, Contributions

In less than 15 years, electricity will become the primary energy carrier worldwide. With the increasing share of electricity, electrical networks should face a double load by 2050. Together with the integration of Distributed Energy Resources, this will require three times more annual investments in the future electrical network than is spent nowadays. Furthermore, while electrical demand increases, the ambient temperatures get warmer due to global warming. Thus, it is expected that less current-carrying capabilities of network elements may be available to transfer electrical energy. A detailed overview of this global context is presented in sections 1.1-1.3.

Similar to doubled electrical demand by 2050, distribution networks may need the doubled quantity of transformers. However, these transformer needs were estimated when a load did not exceed their nominal rating. This assumption may be conservative as transformers can often sustain the load above their nameplate rating. This fact leads our discussion to another reason, explaining why transformers were chosen as a research object for this thesis. Specifically, IEC and IEEE standards allow transformers to exceed their design temperatures in normal operation. The safe operation above the transformer's nameplate rating is achieved by Dynamic Thermal Ratings (DTR).

Although IEC/IEEE standards permit operating the transformers above their nominal ratings, DSO usually sets transformers limits more conservatively. Even nowadays, it is usually based on static ratings which are either equal to a nominal rating or a bit higher/less than it. Therefore, a transformer capacity still is not fully used as it can be per industrial standards (based on temperature). As a result, a significant transformer capacity remains hidden, which many publications have already revealed. However, the existing literature on DTR may still have imprecisions in their modelling and thus underestimate permissible loadings of power transformers. Precisely, DTR may be calculated for a continuous (design) temperature as a limit of permissible loadings. However, a continuous temperature is not a temperature limit for normal cyclic loadings per industrial standards. Hence, this thesis estimates permissible loadings for the intermittent temperature as per IEC/IEEE standards. Thus, DTR considers a full transformer capacity.

To better understand DTR of transformers, section 2 introduces the background on their thermal performance and provides state of the art on their thermal limits. Section 2 also explains our assumptions and limitations on the safe loadability of power transformers. Further, section 3 describes our motivation and tasks formulated for this thesis. Next, section 4 summarizes the contributions of this thesis and relevant publications. The complete list of all publications (also considering non-included papers or those done in parallel with the thesis) is provided in section 5. Finally, section 6 gives a thesis outline for better navigating through different chapters.



1. Introduction of a global context

This section introduces a global context where electric power systems may operate in the middle-term future. It is expected that electric energy will overtake oil and gas and become the main energy carrier in the future world. As a result, it will be necessary to spend 3 times more annual investments on electrical networks than today. At the same time, global warming will cause the ambient temperature to rise further. With increasing electric demand, this will lead to less current-carrying capacity of network components available to transfer power.

1.1 Historical transformation: electricity becomes a primary energy carrier

Our world passes through historical events, revealing the fundamental changes in energy systems. For example, in 2014, a coal consumption reached a historical peak, marking the end of its age [1]. Nowadays, we witness the peak of oil production, which was likely in 2019, and according to DNV GL,¹ it will never recover to pre-pandemic levels [1]. DNV GL also estimates that a primary energy supply in the world will reach its maximum in 2032 and global final energy demand in 2034 [1]. However, their predicted peaks will be a few percentages greater than what the modern world supplies and consumes today. This is mainly due to the COVID-19 outbreak spread worldwide in 2020. Figure 1 shows that COVID-19 caused an 8 % drop in final energy demand this year. This drop has long-term effects as forecasts [1] estimate that the energy demand will not recover to pre-pandemic levels (see the dashed line in Figure 1).

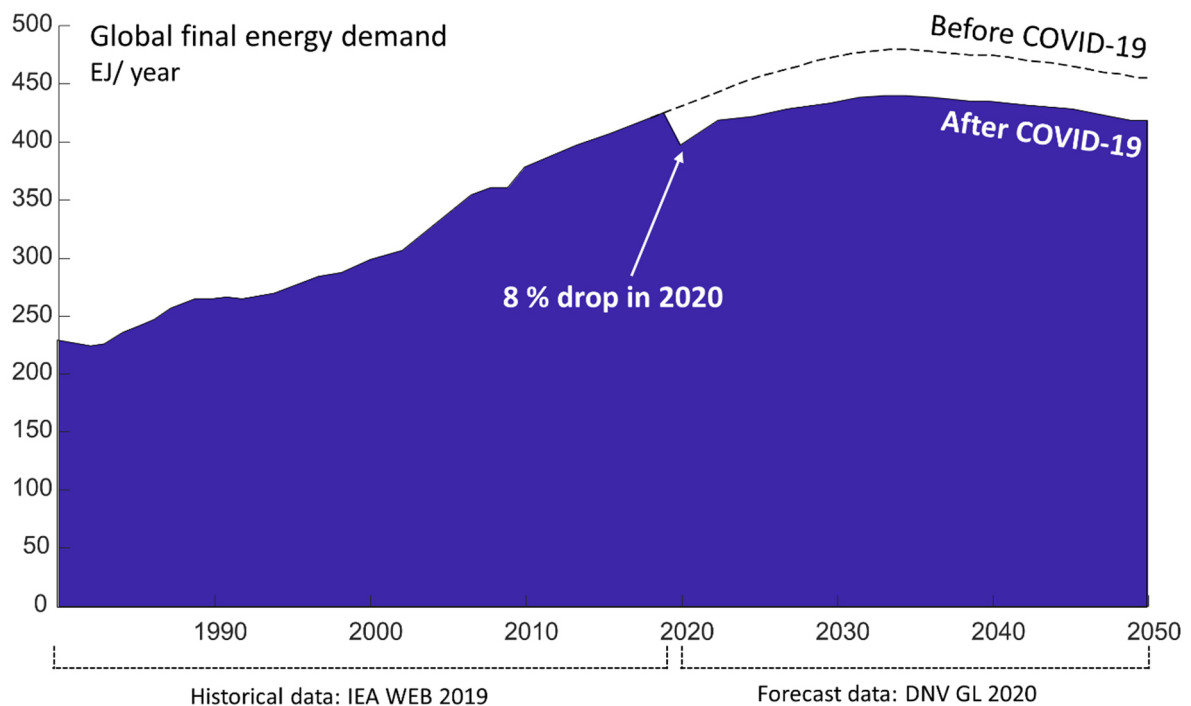

Figure 1 World final energy demand in EJ²/year: before and after COVID-19 [1].

Although the final energy consumption should continue decreasing after 2034, the global electricity demand, on the opposite, should double: from 24 PWh³/year in 2019 to 48 PWh/year in 2050 [2]. These numbers might be even higher: from 26 PWh/year in 2019 to 56

¹ DNV GL is company providing the services on testing, certification and technical advisory for the energy industry including renewables, oil and gas, and energy management. Site: <https://www.dnv.com/>

² EJ stands for ExaJoule, and equal to 1.0E+18 Joule

³ PWh stands for PetaWatt Hour and equals to 1.0E+15 Wh

PWh/year in 2050 if considering power-to hydrogen as well as a self-consumption from local generators and storage [2]. Figure 2 shows that the electric demand should grow from 20 % of final energy demand in 2019 to 41% in 2050 [2]. If this scenario continues, electricity should become a dominant energy carrier in 2033, leaving oil in second place that year and natural gas in third place (see Figure 3) [2].

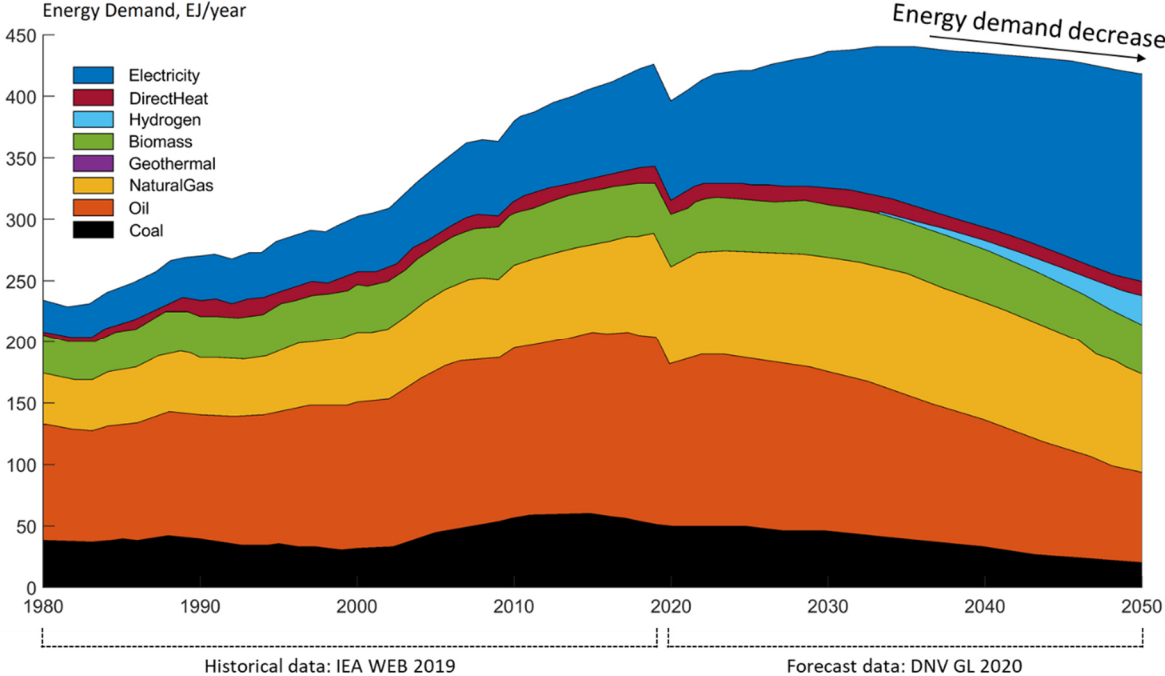

Figure 2 World final energy demand by the carrier. Source DNV GL and IEA

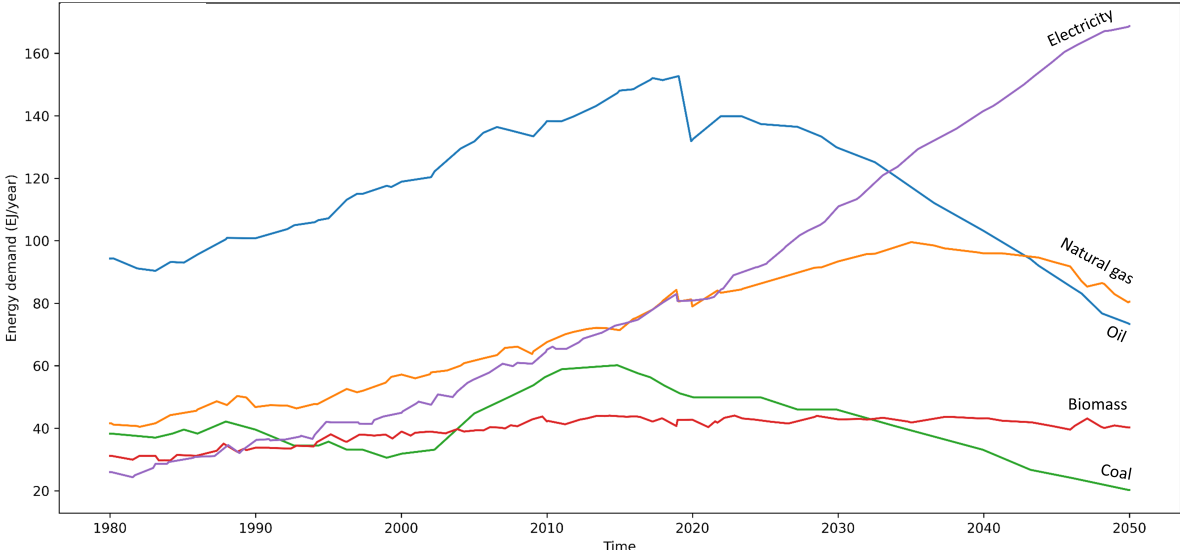

Figure 3 Energy demand by primary energy carrier as a function of time. Source: DNV GL data.

1.2 Rising costs of electrical networks

As electricity becomes a dominant energy carrier, the total energy demand in the world should decrease (see Figure 2) thanks to the efficient use of electric energy. Consequently, the share of energy-system expenditures in GDP is expected to reduce from 5.5% nowadays to 3.1 % in 2050 [3]. Despite these positive effects on the energy industry, accommodating the rising electric demand may become a challenge for the electric power industry. For instance, DNV GL estimates that worldwide annual expenditures into electrical networks will rise from USD

0.49 trillion/year in 2016 to USD 1.5 trillion/year in 2050 [4]. Apart of electric demand, it would also be necessary to spend high costs on the integration of supply and renewables since 2025 [4]. Nevertheless, grid investments related to renewables or supply will be about 2 times less than investments needed to meet the electric demand (see Figure 4) [4]. Hence, the electric demand always remains the primary cause of these grid⁴ expenditures.

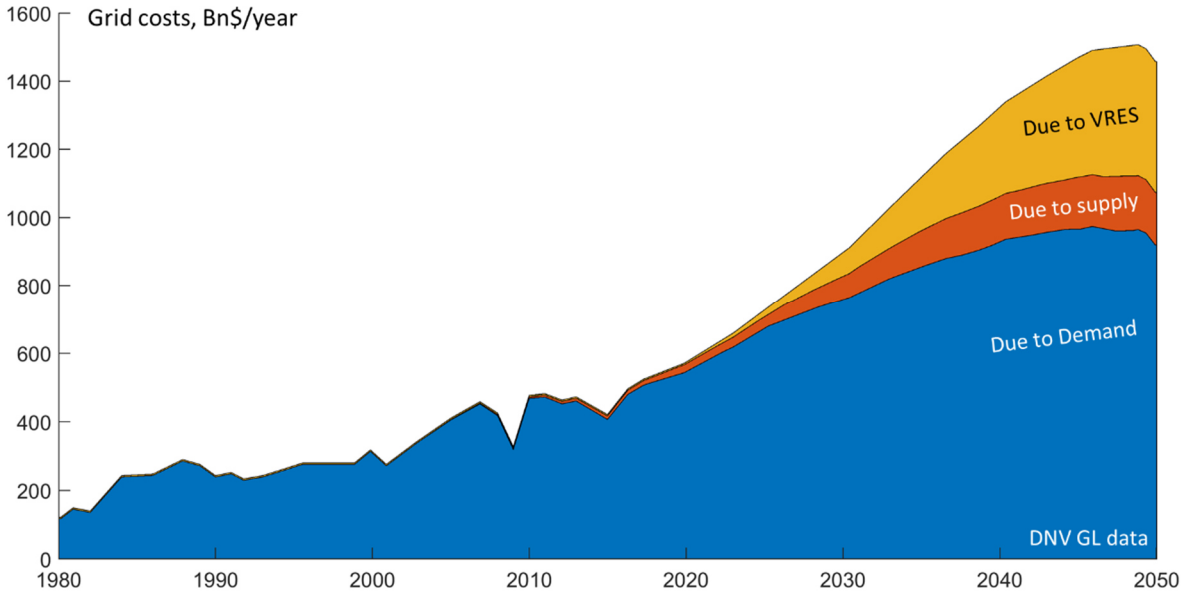

Figure 4 Global network cost by the driver. Source: DNV GL [4]

For general information, Figure 5 shows grid costs as a function of main network equipment. This figure shows that power lines will require most investments, while substations and transformers require much less.

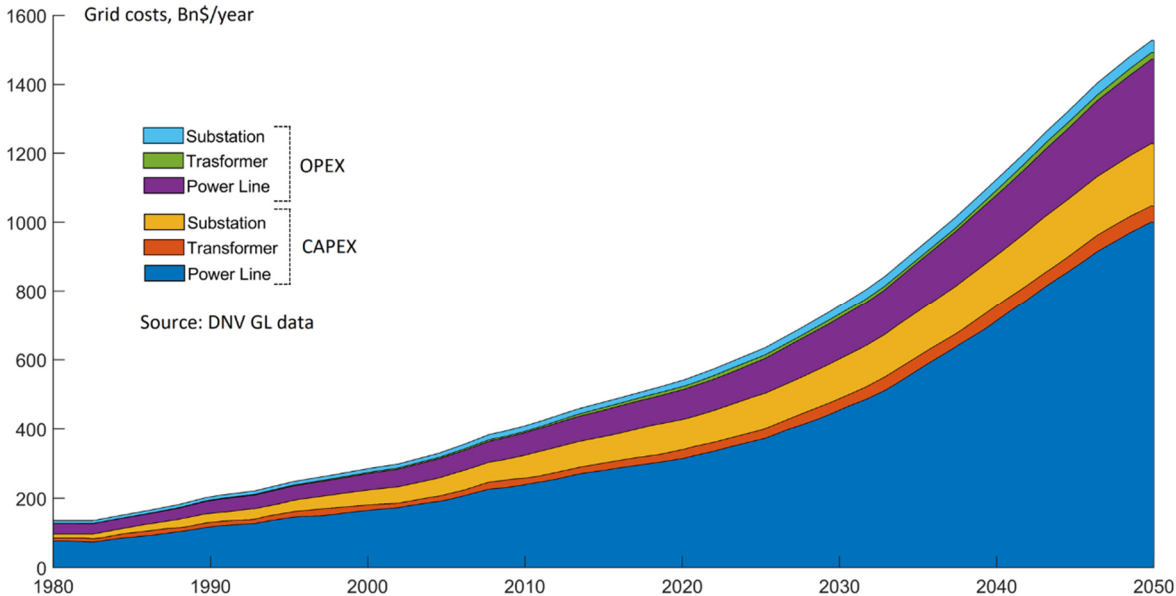

Figure 5 CAPEX and OPEX of the electrical network in Billion \$/ year. Source: DNV GL [4]

⁴ In the report of DNV GL, the term “grid” is a synonym of electrical network. However, other publications, especially from USA, may also use the term “grid” as synonym of a power system. That is why it is necessary to clarify that in this thesis, the terms “grid” and “electrical network” are used interchangeably.

For the last 5 years, about 67% of grid costs have been allocated for the distribution network and around 33% for the transmission network [2],[5]. Likewise, the future distribution network would require the most financial resources (see bottom plot at Figure 6).

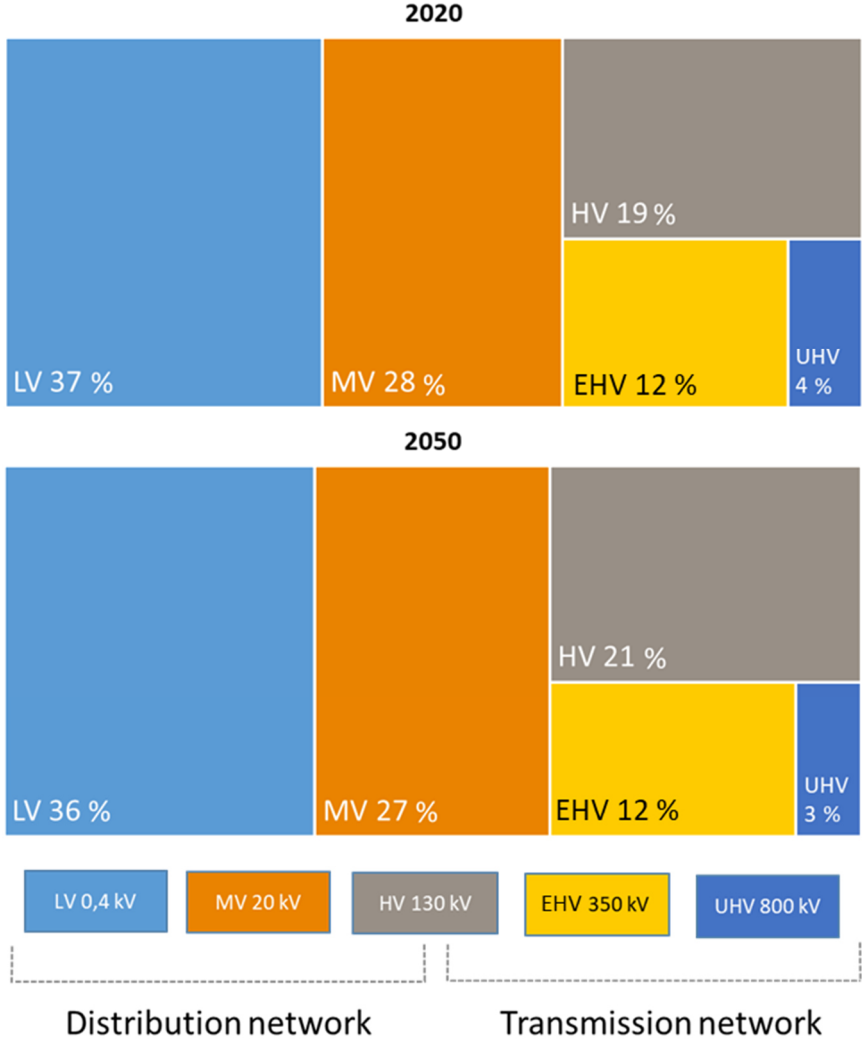

Figure 6 Global network costs in 2020 and 2050 by voltage levels ⁵. Data: [2],[5]

As most investments are traditionally required for distribution networks, it was decided to focus the scope of this thesis on the distribution network. Our choice of research object in distribution networks was limited to transformers and/or overhead lines/cables. However, the capacity of power lines in TW-km⁶ tends to EHV level (see Figure 7), so it is rather relevant for the transmission network. Meanwhile, the annual rate of transformers installations in distribution networks may double by 2050 (Figure 8 below) [4]. As this seemed for us more relevant for distribution networks, we decided to choose transformers rather than power lines for studying in this thesis (other reasons are discussed in section 2). Nowadays, 92 % of transformers are oil-immersed [6]. Among all oil types, mineral oil holds the largest share at

⁵ DNV GL applies following dimensions to power lines, transformers and substations:
 LV: power lines with average voltage level of 0.4 kV. Refers to LV/LV transformers
 MV: power lines with average voltage level of 20 kV. Refers to MV/MV and MV/LV transformers
 HV: power lines with average voltage level of 130 kV. Refers to HV/HV and HV/MV transformers
 EHV: power lines with average voltage level of 350 kV. Refers to EHV/EHV and EHV/HV transformers
 UHV: power lines with average voltage level of 800 kV. Refers to UHV/UHV and UHV/EHV transformers

⁶ TW-km means a power rating multiplied by a line length. Details on power-distance parameter are in [487]

least up to 2030 [7]. Hence, we focus on mineral-oil-immersed transformers only. At the same time, the thesis’s results may still be applicable for transformers in transmission networks and even in offshore grids [8]–[12]. This is because engineers in both grids refer to the same transformer loading guides. For instance, IEEE/IEC standard [13] on wind farms transformer addresses the same IEC guidelines [14], widely used in transmission and distribution networks.

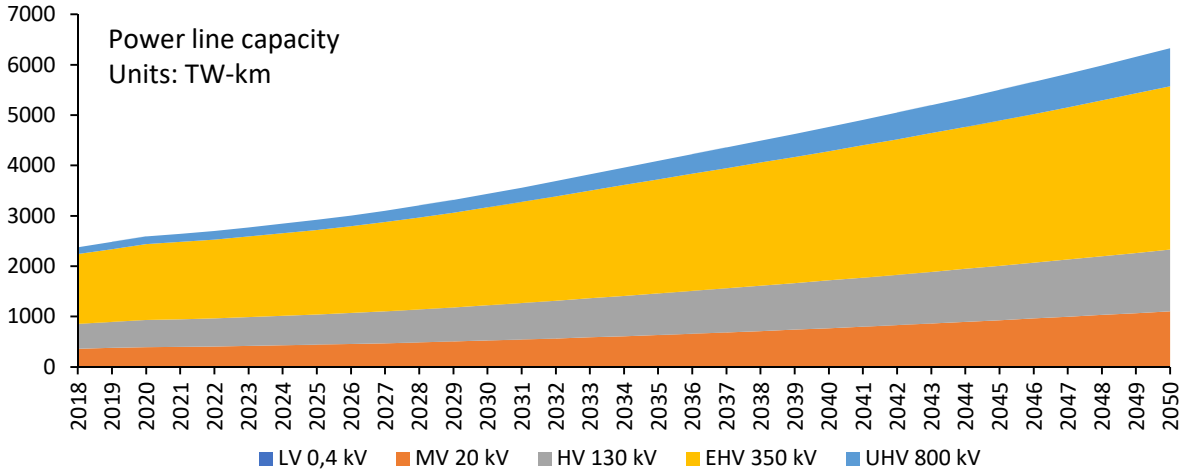

Figure 7 Power line capacity by voltage levels. Source: DNV GL [5]

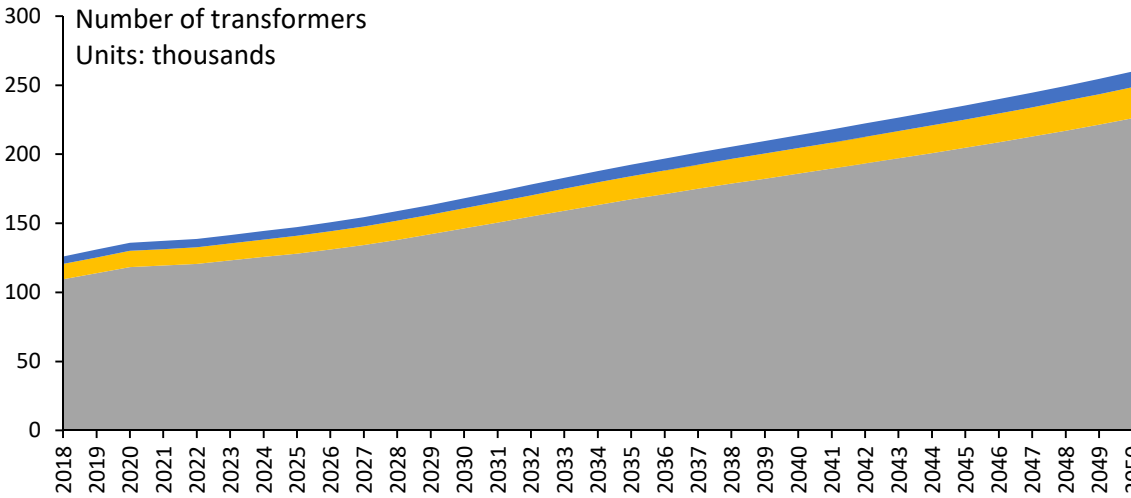
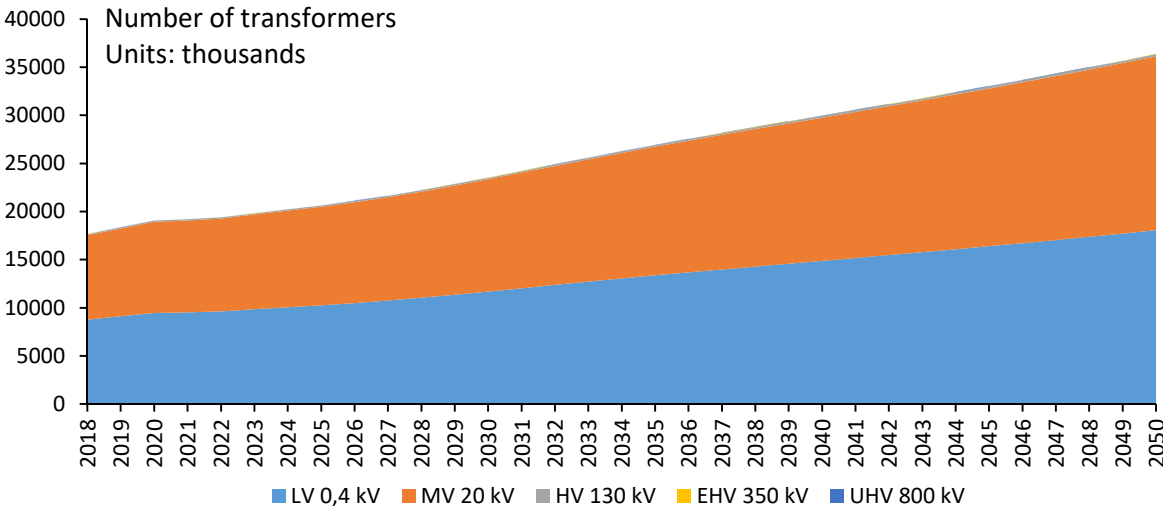

Figure 8 Global number of transformers by voltage levels and time. Data: DNV GL [5]

Two main factors cause the increasing number of transformers in distribution networks: the intensive electrification of energy demand [4] and the connection of distributed generators and electric vehicles at the LV-MV level [15]–[21]. In the Netherlands, for example, the growth of load and new generating facilities may overload 87 % of distribution transformers by 2040 [22]. Around 12 000 distribution transformers in Sacramento, USA may be overloaded and replaced due to EV integration [23]. So far, the installation rate of Distributed Energy Resources (DER) has already overtaken the installation rate of centralized generation in the world [24]. In accordance with [25], the global market of DER is currently growing by 6-9 % per year. International Energy Agency (IEA) estimates that if such dynamics continue, then already in 2025, the installation rate of DER will be three times higher than the centralized generation [25]. As a result, transformers may face reverse power flows, leading to their congestions [26], because of the variable and intermittent output of some DER (Figure 9).

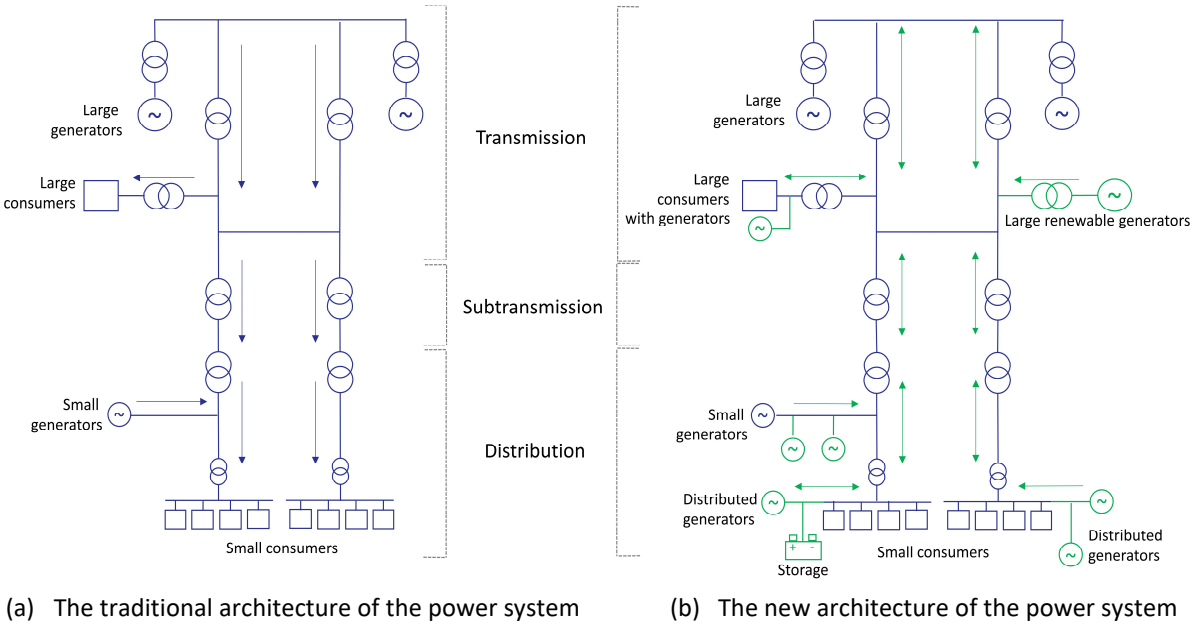

Figure 9 Traditional and new electricity system architecture. Redrawn from [4]

According to [27], power transformers may *thermally* withstand a reverse power flow the same way they cope with a power flow in normal directions. However, DER integration may also lead to voltage problems [28],[29], but this is out of the scope of this thesis. In particular cases of reverse power flows, transformers may face congestions [27], [30], [31]. For instance, a transformer with OLTC based on the single resistor bridging may transfer the reverse power for only 30 – 70 % of the nominal rating [27], [30]. Also, in the case of split-winding transformers, DER may cause the power to flow from one LV winding to another LV winding which is forbidden [31]. As a result, an intensive leakage field may occur in this operating regime of a split-winding transformer, leading to the local overheating of the core and winding’s middle part. This may lead to transformer failure, as it seems to have happened with a 110 kV/10 kV/10 kV transformer located at a thermal power plant in Minsk, Belarus [31].

Excluding these two cases [27], [30], [31], we assume that no special considerations are needed for the thermal performance of transformers. As the electric demand remains the primary driver of network reinforcement (shown in Figure 4), we assume that transformer congestions should be under the normal direction of power flows. As our thesis focuses on the issues of electric demand growth, we do not consider reverse power flows further.

1.3 Global warming as a risk for electrical networks

According to recent forecasts [4], electricity should become a primary energy carrier in less than 15 years. As a result, power industries should allocate significant investments (shown earlier in Figure 5) to meet the rising electricity demand. However, recent climate studies state the mean ambient temperature (T_{amb}) in the world will likely rise to $2.3\text{ }^{\circ}\text{C}$ ⁷ [1]. The $2.3\text{ }^{\circ}\text{C}$ rise does not comply with the Paris agreement, which considered a $2\text{ }^{\circ}\text{C}$ rise (or even $1.5\text{ }^{\circ}\text{C}$ rises) by the end of the century as the necessary target to avoid significant and catastrophic changes to our planet. Thus, it seems that more investments are needed to mitigate the $2.3\text{ }^{\circ}\text{C}$ rise.

However, if global warming follows its worst scenario, electrical networks may be exposed to serious risks [32]. Many studies [33], [34], [43], [35]–[42] found that the thermal capacities of network components are going to decrease due to global warming. Depending on applied methodology, capacities of electrical network may reduce from 1.5 % and up to 20% [33], [37], [38], [41]. Apart from reduced capacities, warmer temperatures could require unplanned investments to reinforce the electrical network. For instance, the study [44] found that rising T_{amb} by the end of the century may increase network investments in the USA up to 25%: from \$95 billion per year (without climate change) up to \$119 billion per year. This amount seems quite important for one year, especially if reminded that the present value of all existing electricity assets in the USA is estimated at around \$800 billion [42].

Apart from economic concerns, many studies [40], [45],[46] also highlight that climate change may jeopardize the reliability of electric networks. For instance, the increasing number of heat waves⁸ [47] due to climate change may lead to the failures of network components, as this already happened with power transformers in the USA during the summer of 2006 [40], 2007 [48], 2018 [41]. Specifically, the heat wave of July 2006 caused more transformer failures (469) than for the rest year of 2006 (440) [48]. Another study [39] estimates that the frequency of transformers outages may increase by 22-33 for each additional $^{\circ}\text{C}$ degree.

As global warming cannot be avoided but only mitigated, electrical networks will inevitably operate in warmer conditions than nowadays. This means that less current-carrying capability of network components will be available for system operators. At the same time, this coincidence with doubling of electric demand. Hence, the electrical network will be under high thermal stress, which requires better utilizing the network capacities [49]–[51].

2. Thermal performance of power transformers: state of the art

As discussed in sections 1.1-1.3, electrical networks should face a rising electric demand and ambient temperatures. Therefore, operators may strive to better utilize network capacities and prolong their asset life. This could be especially relevant during the next 5 years for reducing the costs, increasing the reliability, and meeting electric demand [2]. This may be achieved via advanced utilization of network components from an electro-thermal perspective [49],[50]. In general, a better utilization of capacities may encompass many fields: the thermal modelling of network components, setting their thermal limits, controlling and monitoring their electro-thermal parameters (loading, temperature, ageing). As it is a quite

⁷ Even small rises in mean ambient temperatures may cause serious changes in Earth's climate. For instance, the Nature study [488] emphasizes that the difference between a mean temperature of nowadays and global Ice age (20 000 years ago) was $6\text{ }^{\circ}\text{C}$ only. Another source [36] states about $4\text{ }^{\circ}\text{C}$ difference with the ice age.

⁸ Heat wave is a period of several days or even weeks with abnormally hot ambient temperatures, which often coincidence with high humidity [40].

large field for the one thesis, it was decided to focus mainly on thermal limits while using the present knowledge on thermal modelling.

Although thermal limits of both lines and transformers deserve thorough investigations, we focus on power transformers because of two reasons. First, the number of the transformers should double in future, as discussed in the previous section (Figure 8). This would require additional financial resources from DSO, especially because transformers are among the most expensive and critical components [52]. Furthermore, the transformer replacements have a long lead time, e.g. it may require 3-12 months to replace a damaged transformer with the new one [52]. Moreover, installed capacities of transformers may be 10 fold higher than the generating capacity of power plants (because of many voltage levels within a power delivery) [53]. Therefore, we believe that the better utilization of transformer capacities represents relevant and timely subject.

Second, we believe that transformers may still have a hidden capacity that is not utilized due to conservative assumptions. For instance, DNV GL in their estimations on doubled needs in transformers assumed that the transformer should be reinforced if the load exceeds the nominal rating of transformers in N-1 mode [4]. However, this is conservative as loading above the nominal rating can still be managed without damaging the transformers. This leads us to the second reason explaining why transformers have a scientific interest in conducting this research. In contrast to other network components, oil-immersed transformers can exceed their continuous (design) temperatures⁹ in normal operation¹⁰. For instance, Figure 10 shows temperature limits for different network components in normal operation (and emergency).

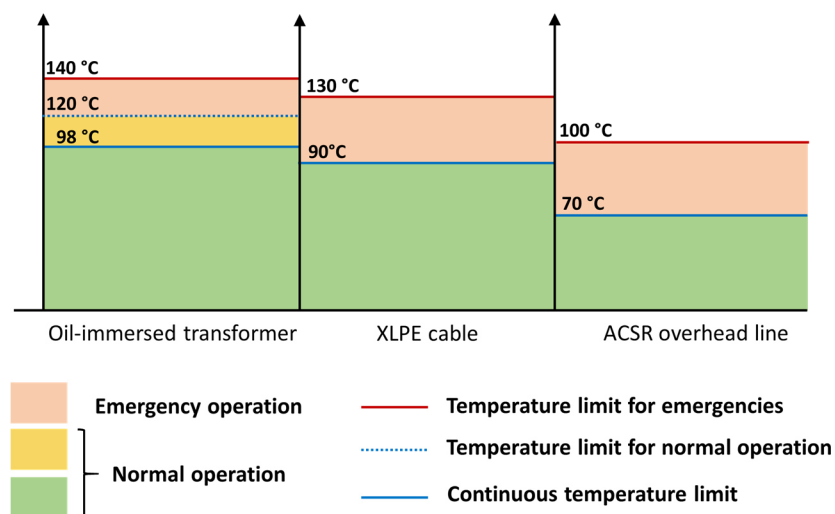

Figure 10 Temperature limits of different power equipment in normal and emergency mode

⁹ Continuous (design) temperature is a maximal temperature at which it is possible to continuously operate the transformers during the full design life without causing the accelerated ageing.

¹⁰ Although it may be allowed [489] to operate *lines* above their continuous temperatures in the normal operation, international standards accept it only in emergencies. In normal mode, such standards usually permit operating the lines up to their maximal allowable temperature. In the case of overhead line, this is a temperature minimizing the loss of conductor strength and limiting the sag to maintain adequate electrical clearances along the lines. In the case of cables, this is usually a maximum allowable temperature of XLPE (cross-linked polyethylene) or other insulations. In both cases, power lines may operate at these temperatures permanently. Therefore, a maximal allowable temperature applicable to lines represents a continuous temperature (blue line in Figure 10).

The attention should be drawn to the yellow area¹¹ (at the left), where transformers can operate for a limited time above their design temperature (98 °C in Figure 10). However, the modelling of this yellow zone in terms of power limits is not evident. Depending on the effective ambient temperature, a top line of this yellow area may be limited by different factors: a current or a temperature of winding and/or oil. Hence, it is not evident which element may be the most restrictive for a given moment, and thus what power limit should be selected. This problem is discussed in detail and then solved in Chapter II.

The operation above the continuous limits for *transformers* became possible after a unique discussion among transformer specialists in the 1930-70s [54]–[56]. Based on this discussion, industrial standards approved a short-term operation above continuous temperatures (based on an intermittent temperature limit) for normal cyclic loadings [55]. A similar debate on the possibility to exceed continuous temperatures [57]–[59] for power lines is ongoing among cable and line specialists. However, to the best of the author's knowledge, it is not still accepted in industrial standards on overhead lines and cables [60]–[63]. Hence, this makes transformers the unique network equipment whose continuous temperatures may be exceeded from time to time.

2.1 Thermal performance of power transformers: background

From a thermal point of view, the most critical components of a transformer are windings, core, and oil (see a general construction of transformer on Figure 11).

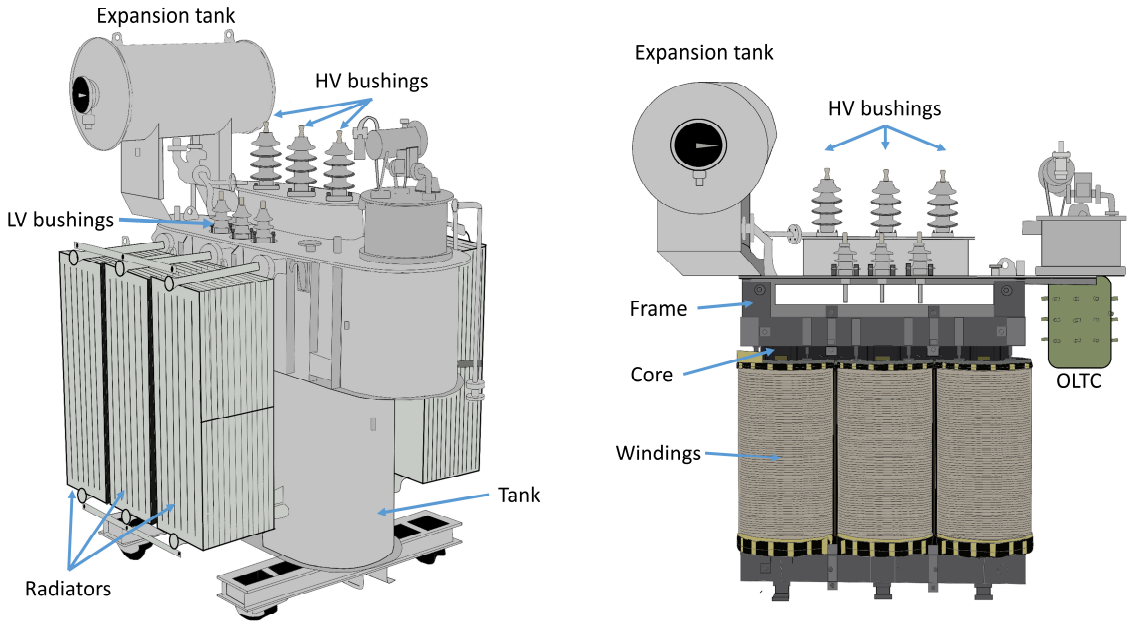

Figure 11 External and internal view of a power transformer. Figure is redrawn by author from power transformers 1000-6300 kVA, 35 kV [64]

While almost all transformer elements can be replaced in case of their damage [65], it may not be always possible to replace windings and magnetic core as a special firms should be engaged [66]. This is rather rare event e.g. rewind transformer capacity is less than 2% of all refurbished capacity [66]. At the same time, all refurbished transformer capacity (including

¹¹ This zone is shown only for the case if winding temperature is a limiting factor. However, a current or oil temperature may also limit the admissible loadings of transformers. This is discussed in Chapter II.

rewound transformers) per year may represent around 1% of in-service transformers capacities [66]. On the other hand, the oil may be treated and even totally renewed during the lifetime of a transformer [67].

Suppose that the appropriate maintenance of transformers is timely conducted. In that case, engineers can control most vital transformer parameters except a degree of polymerization and a short-circuit impedance [65]. The degree of polymerization has an essential impact on the thermal performance of transformers. Thus, it is discussed in section 2.1.2 in more detail. Meanwhile, a short circuit impedance affects a voltage drop in transformers and an amplitude of short-circuit currents. Thus, it has an implicit impact on the thermal performance of transformers in normal operation¹². Hence, we do not discuss the impedance further, albeit some considerations on voltage and frequency should be recognized (see section 4.2 in IEEE standard [68])

Once a transformer is in operation, it is widespread [69], [70], [79]–[85], [71]–[78] to monitor the temperatures of windings and oil. Specific temperature limits are also set for the magnetic core¹³ and other metallic parts of the transformer in contact with oil, aramid paper, glass fibre materials. However, loading guides, albeit imposing these restrictions, do not provide models to calculate these temperatures. This is probably why many scientists [69], [70], [79]–[85], [71]–[78], except few studies [77], do not consider these components in their research while calculating the thermal state of the transformer. Nevertheless, it is possible to consider these limitations by using sophisticated methods of thermal modelling as the computational fluid dynamics (CFD) or finite element method (FEM) or other models [77], [86]–[89]. To better understand temperature limitations, it is necessary to discuss an immediate and cumulative damage for transformers.

2.1.1 Immediate damage of power transformers

The immediate damage represents a situation when some process may instantly jeopardize the transformer after exceeding particular temperatures. The most common example of such a process is the formation of gas bubbles at the interface between windings and oil [90]. The gas bubbles, usually represented by water vapour or nitrogen, typically occur if the winding temperature exceeds 140 °C. Initially developed in the areas with low electrical stress, some gas bubbles move to the areas of high electrical stress, i.e. windings and leads [91]. Once arrived in the area of high electrical stress or being directly generated there, gas bubbles may reduce the dielectric strength¹⁴ of the transformer. This happens because the dielectric strength of gas bubbles is much lower than those of oil or winding insulations. With reduced dielectric strength, the oil or winding insulation does not fully accomplish their insulating

¹² Equal impedances of two transformers working in parallel is a necessary condition among others to avoid circulating currents (which do not supply loads but heat up the transformers) [329]. However, investigating the transformer operation in such abnormal mode remains out of focus of this thesis as such operation should be avoided at the design stage.

¹³ Usually, the core does not impose any problem as long as voltages remain below limits stated in IEC 60076-1, Clause 4. In this case, no over excitation of magnetic core occurs and therefore no overheating happens. As an example, the study [255] shows that a limit of core flux (1.9 Tesla) was never reached at load 1.2 pu. However, stray losses cannot be negligible anymore in case of abnormal situations as unbalanced voltage supply (due to increased leakage flux). As a result, it may be necessary to reduce a transformer load for 4-9 % [88].

¹⁴ Dielectric strength is a maximal electric field that the insulation or oil can withstand while keeping its insulating properties.

function. This may cause a flashover, leading to an immediate internal fault [92]. That is why it is necessary to limit a windings temperature to avoid such instantaneous faults.

Note that the bubble inception temperature of windings (140 °C) may not be universal [90], [93], [94]. It depends on other factors, such as moisture content in the paper-oil system (see details [94]). For instance, the bubble inception temperature of 140 °C usually corresponds to 2% moisture content, typical for new transformers, whereas 120 °C corresponds to 5 % for old ones. However, there was evidence [95] that gas bubbles may appear even at 100 °C and 3.1% of water content in the insulation. In general, free-breathing transformers increase their moisture content by 0.1 % each year. Therefore, 3 % moisture content may be expected in such transformers after 30 years in service [96]. Nowadays, IEC and IEEE standard [97], [91] suggest 120 °C¹⁵ as a winding's temperature limit for normal cyclic loadings, whereas 140 °C is recommended for emergencies. Apart from well-known temperature limits, other restrictions may be applied to avoid a bubble formation: rate of winding temperature change (2 °C/min), internal/external pressures ratios, etc. [98].

Similar temperature restrictions on ultimate temperature exist for oil. If the oil temperature increases very high, it may reach a flashpoint (130...150 °C [99]). Beyond these temperatures, the oil may inflame due to hydrocarbons and eventually damage a transformer. Under local heating, the oil may decompose, which may significantly reduce the flashpoint temperature.

Besides, once the oil becomes hot, it starts expanding inside the tank, which may cause mechanical damage¹⁶ to the transformer [100]. The expanded oil may also increase the internal pressure inside bushings which may blow out gaskets or result in their leakage [101],[102]. To avoid such adverse effects, the oil temperature should not exceed 105 °C, also known as a maximum continuous operating temperature [103],[104]. New oils, whose flashpoint exceeds 145 °C, may reach 115 °C. In general, a 30°C margin (below the flashpoint temperature) is usually kept to allow the emergency load to be higher than the forecasted load [104]. However, some standards recommend limiting oil temperature even far down to 95 °C, and some article mentions 80 °C [105]. Usually, oil temperature corresponds to the winding insulation class [106]. Depending on the class, winding insulation should not exceed 95 °C or 105 °C. That is why the same limit is also set for the hottest oil, usually located at the top of the transformer tank.

As windings and oil may have different temperature limits (e.g. 120 °C for winding's hot spot and 105 °C for top oil), it may be non-evident which power limit corresponds to them. Moreover, this may be less obvious as each temperature limit could be more or less restrictive under various ambient temperature conditions. Thus, this thesis studies the interdependency between the permissible loading of transformers and their temperature limits. A detailed discussion on this topic is presented in Chapter II.

¹⁵ In accordance with CIGRE survey [90] on a safe maximal temperature, the limit of 120 °C was chosen after measuring the mechanical and chemical condition of insulation after 1-year tests. Depending on oil types, it was found that the remaining tensile strength of insulation was around 20 % - 45 % of initial values. Hence, it was decided that it cannot be sufficient to withstand short-circuit currents. Thus, it is necessary to limit the temperature to 120 °C in emergency case.

¹⁶ Transformer tanks are supposed to withstand a 25% overpressure [217]

2.1.2 Cumulative effects leading to damage of power transformers

In contrast to immediate damage, cumulative damage happens when some processes degrade the insulation integrity over time. For example, even if the transformer never exceeded temperature limits, it may still face a failure within a few years after commissioning. The most common example of cumulative damage is a degradation of winding insulation under the effects of temperatures, moisture, oxidation, and acids. The mechanisms of cumulative insulation ageing are well known and described in the literature [91], [107], [108]. Hence, in the following paragraphs, we provide only a general overview of these mechanisms.

In general, three mechanisms govern the degradation of winding insulation: hydrolysis (water), oxidation (oxygen), and pyrolysis (heat) [107]. It is considered that the oxidation process dominates at a lower temperature [91]. Oxygen firstly appears in the transformer from air ingress and after some time turns into water. As transformer insulation paper is more hygroscopic than oil, the substantial water/moisture will migrate from the oil into the insulation [109],[98]. In general, it is believed that the insulation contains around 95% of all moisture [110]. As a result, the insulation paper will undergo the hydrolysis process. Hydrolysis represents a chemical reaction of breaking the cellulose down due to contact with water. The hydrolysis effects may be mitigated if the transformer is sealed or dehydrating measures are in place. However, the oil degradation may increase the content of acids, which act as a catalyst for hydrolysis. Thus, hydrolysis may auto accelerate as both water and acids are products of cellulose ageing. Pyrolysis is a process that can occur even without water and/or oxygen. At normal operating or overload temperatures (i.e., < 140 °C), it is assumed that pyrolysis has no significant effects.

In practice, all these processes – hydrolysis, oxidation, and pyrolysis – act simultaneously in a transformer. This makes it challenging to use a single model, which should fully describe the process of paper degradation [111]. In fact, the winding temperature, a content of water, oxygen, and acid predetermine which ageing mechanism should dominate. However, many transformers are equipped with oil preservation systems. With appropriate maintenance and monitoring programs, they allow minimizing the effects of moisture and oxidation. For instance, it is believed [65] that in the presence of oil preservation systems and maintenance programs, the degradation of winding insulation depends for 98-99% on current and the initial degree of polymerization (discussed in 2.1.3) and only for 1-2 % on other factors. Thus, the winding temperature is often assumed a unique operating variable causing the thermal degradation of insulation [112]. However, other factors may be seen as a catalyst, and therefore they should also be considered in particular situations [111].

As the winding temperature is assumed a single operating variable affecting the insulation ageing, one should understand how they are linked. First, it is necessary to introduce the background on the material from which the insulation is fabricated. The winding insulation is generally produced from unbleached softwood pulp using the sulfate process [91]. This sulfating process is also known as a Kraft process. That is why the paper of winding insulation took its name - Kraft paper.

Kraft paper is also known as a non-thermally-upgraded paper [91]. This means that Kraft paper can continuously withstand 98 °C without jeopardizing the designed life of paper corresponding to 105 class (or Class A – usually used for oil-filled transformers). Note that 98 °C corresponds to the hottest spot of winding insulation. Although first indicators of winding temperature have been in service since 1918 [113], it was challenging to measure the accurate

hot spot temperature until the optical sensing was implemented in early 1980 [114],[95]. However, engineers could measure the average winding temperature in the past by evaluating a change in resistance above some reference temperature [115]. After conducting tests with naturally cooled transformers, scientists found that their hot spot temperature was typically 13 K¹⁷ higher than the average winding temperature [115]. Hence, it is possible to calculate the hot spot temperature empirically if knowing the average temperature of windings:

$$\text{Hot spot temperature} = T_{amb} + \text{average winding temperature rise} + 13 K \quad (1)$$

$$98 \text{ }^\circ\text{C} = 20 \text{ }^\circ\text{C} + 65 \text{ }^\circ\text{C} + 13 K \quad (2)$$

IEC-rated transformers assume that a mean T_{amb} is 20 °C, and the average winding temperature rise should be 65 K according to IEC 60076-2. As a Kraft paper is considered non-thermally upgraded, improved paper types exist, called thermally upgraded paper (TUP). In contrast to Kraft paper, TUP may withstand higher temperatures – 110 °C. Such better properties of TUP are achieved, e.g. by adding nitrogen-based compounds in the content of 1% to 4% or by other techniques [91]. As a result, such processing stabilises chemical bonds which otherwise would be broken under exposure to a high temperature [116] (see details on glycosidic rings in the next section). This also prevents the production of acids from hydrolysis during the transformer's lifespan, among others.

Although both types of paper can be found worldwide, Kraft paper is more used in Europe. In contrast, TUP has been more often utilized in North America since 1980th [111]. European transformers are designed per IEC standards [91]. In contrast, North American ones are designed with IEEE, ANSI, NEMA [97]. In North America, transformer specialists calculate the continuous temperature of 110 °C differently. Specialists use 30 °C as a reference T_{amb} , 65 K¹⁸ as hottest average winding temperature rise, and 15 K as a hot spot difference:

$$\text{Hot spot temperature} = T_{amb} + \text{average winding temperature rise} + 15 K \quad (3)$$

$$110 \text{ }^\circ\text{C} = 30 \text{ }^\circ\text{C} + 65 \text{ }^\circ\text{C} + 15 K \quad (4)$$

Note that 98 °C and 110 °C are assumed when the insulation paper is used with mineral oil. However, using the same papers but in combination with another oil, e.g. ester, may allow the transformers to operate at higher admissible winding temperatures [117]. For instance, the combination of Kraft paper and ester oil increases the design HST to 110 °C (while using 98 °C for mineral oil) [117]. Likewise, if the ester oil is combined with TUP, the design HST may increase up to 130°C (while it is 110 °C for mineral oil) [117]. This thesis focuses on mineral-oil-immersed transformers only as the latter still represent most transformers in electrical networks. However, ester-based oils may replace mineral oil in the future due to their advantages [118]–[122].

2.1.3 IEC criteria for evaluating the end of transformer life

It was often demonstrated that the transformer insulation does not deteriorate electrically until it loses its mechanical strength [113]. Furthermore, the dielectric strength may even increase until the insulation cracks [113]. Consequently, the mechanical strength remains the

¹⁷ IEC 60076-7:2005 (page 47) states that units of K are traditionally used for temperature differences (i.e. rises) and °C are for temperatures. In the text, such convention helps to easier understand either given number represents a temperature rise (K) or absolute temperature (°C).

¹⁸ In USA, transformers with 55 K average winding rise were replaced as a standard suggesting in early 1960s. In 1977 the transformers with unique 65 K average winding temperature rise became the industry standard [490].

unique parameter for evaluating the insulation integrity. The most important criterion of the mechanical strength is the tensile strength of the paper, which describes how the insulation may resist shear stresses from short-circuits [91].

However, the problem of using a tensile strength in practice is that, engineers cannot directly measure it due to paper's folded geometry [91]. Therefore, specialists use a chemical parameter - a degree of polymerization (DP), which allows them to evaluate a tensile strength implicitly [123]. Chemical parameter DP has a physical meaning: a number of glycosidic rings in cellulose macromolecule (see Figure 12). As the mechanical strength of cellulose depends on the length and condition of such fibres, DP is considered an appropriate measure of the remained functionality of insulation material [112].

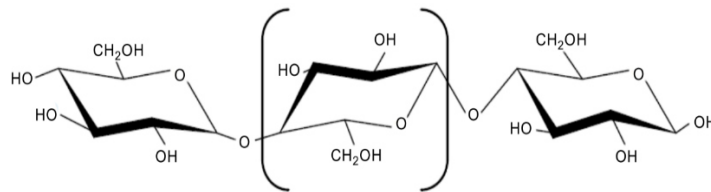

Figure 12 Structural formula of cellulose. Source: IEC standard [91]

The mean number of glycosidic rings in unbleached soft wood is typically between 1100 and 1400 before any processing was applied. When the transformer is dried, DP in unbleached soft wood reduces to 1000-1200 [111] depending on the technique. While the transformer is in service, the paper exposure to temperatures breaks these rings. Once rings are broken, this becomes irreversible. Therefore, paper ageing is also considered an irreversible process. As the number of such rings reduces over time, the paper loses its tensile strength. The correlation between DP and tensile strength is shown in Figure 13.

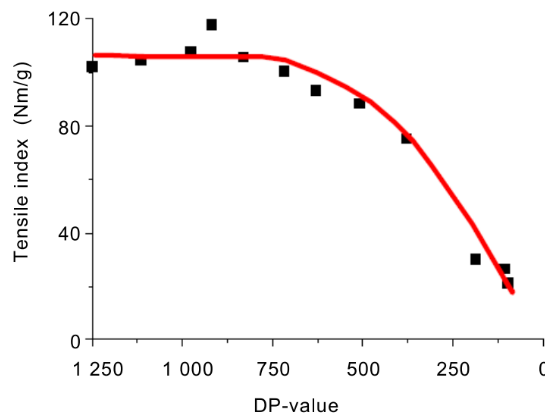

Figure 13 Correlation between DP and tensile strength. Source: IEC standard [91]

Once DP reaches 200 (35 % retained tensile strength), specialists assume that the mechanical strength is insufficient to resist short-circuits. Therefore, this is considered as the end of insulation life. However, even with such low DP, a transformer may operate for weeks and even years until the next short-circuit occurs and jeopardizes the insulation integrity [55]. Note that the insulation life and transformer life are usually seen as synonyms. However, the scientific community still discusses other criteria for the end of life [124],[104].

To consider the insulation ageing in this thesis, it was decided to use IEC and IEEE industrial standards [97],[91] and consequently their assumptions and limitations. In these industrial standards, transformer life is equal to a life of windings insulation. Therefore, insulation ageing is usually considered as a function of temperature only. As discussed earlier, this may be

justified if oil preservation systems and appropriate maintenance and monitoring procedures are in place. Note that windings are not uniformly heated. Hence, the most significant deterioration of the insulation paper will be at the hottest spot of the windings. Thus, a temperature at the hottest spot of windings should be used to evaluate a relative ageing rate.

Equations (5)-(6) are corresponding formulas for the relative ageing rate for Kraft and TUP paper. Equation (5) is obtained empirically by Monstsinger based on a heat test with varnished cambric tape insulation placed inside a series of oil-filled test tubes [68]. These tests were conducted in the 1920s (but reported in 1930), and their results are used in European standards [125]. The equation (6) represents the Dakin-Arrhenius model based on the chemical law of thermal degradation. In 1948 Dakin demonstrated that Arrhenius' chemical reaction rate theory could be applied to estimate the insulation ageing (it was shown that Monstsinger's results also fit this theory). Nowadays, the Dakin-Arrhenius model is widely accepted among transformer specialists [68]. The reader may refer to Annex I in [68], presenting the review on the vision of insulation life from a historical perspective.

$$V = 2^{(\theta_h - 98)/6} \quad (5)$$

$$V = e^{\left(\frac{15\,000}{110+273} - \frac{15\,000}{\theta_h+273}\right)} \quad (6)$$

V is a parameter relative to rated conditions at a given time moment. However, it does not represent the cumulative effect yet. Cumulative impacts can be considered by loss of insulation life over a certain period (LoL):

$$LoL = \int_{t_1}^{t_2} V dt \text{ or } LoL \approx \sum_{n=1}^N V_n \cdot t_n \quad (7)$$

Where V_n is a relative ageing rate during the time n per (5)-(6); θ_h is a hot spot temperature of the windings; t_n is a n^{th} time interval; n is the number of each time interval; N is a total number of intervals during the studied period

NB: the length of the longest time step should be at least 2 times less than a time constant of transformer windings (4-10 minutes) to obtain an accurate computation with IEC 60076-7.

2.1.4 Current and temperature limitations from IEC 60076-7

To avoid both immediate and cumulative damage, IEC / IEEE standards [97], [91] determined current and temperature (C&T) limits, ensuring the safe operation of oil-immersed transformers. Table 1 shows C&T and ageing limits for distribution (up to 2.5 MVA) and medium power transformers (up to 100 MVA). For large power transformers (> 100 MVA), IEC standards prescribe stricter C&T limits.

In contrast to small and medium power transformers, large power transformers are more vulnerable to loadings above their nominal ratings [91]. This vulnerability is a consequence of factors inherited for large transformers: the increased leakage flux density and short-circuit forces, the greater mass of insulation, which should withstand high electric stress, as well as a more difficult determination of hot-spot temperatures [91]. Besides, large power transformers have severe consequences if they fail¹⁹ [91]. As the distribution network usually

¹⁹ In accordance with [215], around 34 large power transformers fail each year worldwide [215]. This is around 0.28 % of total fleet - 12 000 large power transformers in the world. The replacement cost is 5 mln. \$ in average.

consists of transformers whose nominal rating is less than 100 MVA, then large power transformers are not initially considered in this thesis. Nevertheless, we believe that thesis results may also be relevant for large transformers but subject to verifications on their thermal modelling and C&T limits.

Table 1 C&T limits for transformers below 100 MVA designed per IEC 60076-2

Limits	Loading Type		
	Normal Cyclic	Long-Term Emergency	Short-Term Emergency
Current	1.5 pu	1.8 pu	2 pu
Winding hot-spot temperature and metallic parts in contact with cellulosic insulation material	120 °C	140 °C	180 °C
Other metallic hot-spot temperatures in contact with oil, aramid paper, glass fibre materials	140 °C	160 °C	Not specified
Inner core hot spot temperature	130 °C	140 °C	Not specified
Top-oil temperature	95/105 °C	115 °C	Not specified
Loss of insulation life	≤1 pu	>1 pu possible	Not specified

These C&T limits are not intended to be valid simultaneously. For example, the current may be limited to a lower value to meet a requirement of temperature limitations. Conversely, the temperature may be limited to a lower value than that shown in Table 1 to meet the current limitation requirement.

Although IEC and IEEE standards tables usually do not present LoL values, LoL remains hidden inside loading type’s definitions. For example, the IEC standard defines normal cyclic loadings (also known as a normal life expectancy loading in the USA) as loadings when

“higher ambient temperature or a higher-than-rated load current is applied during part of the cycle. However, from the point of view of relative thermal ageing rate, this loading is equivalent to the rated load at normal ambient temperature” [91].

In other words, LoL for normal cyclic loadings by its definition must not exceed 1 pu. At the same time, the IEC standard states that long-term emergency loadings may persist for weeks or even months and thus can lead to considerable ageing. Therefore, LoL under such emergencies may exceed 1 pu. No LoL limits are applied for short-term emergencies due to their temporal durations, but C&T limitations must be met to avoid imminent damage. IEEE standards [97] also distinguish a planned loading above nameplate rating. For such loading type, winding and oil temperatures can rise to 130 °C and 110 °C correspondingly. This makes “planned loading above nameplate rating” from IEEE something intermediate between IEC normal cyclic and IEC long-term emergency loadings.

Note that the associated equipment such as circuit breakers, current transformers, and other branch elements can lower the current limit further than in Table 1. In addition, auxiliary equipment such as bushings [126], tap-changing devices, cable-end connections, and leads may also restrict a current limit [101], [102], [127],[128]. For example, an analysis of the permissible loading of 48 power transformers conducted in the United States [80] showed that in 60% of cases, the permissible loading of the transformer was limited by the rating of OLTC or bushings. In this study, OLTC or bushing ratings are at least 99.97% of the rated power and up to 215%. Another source [107] indicates that the OLTC rating of old transformers was about 1.2 pu of nominal rating, whereas new designs have 1.5 pu. In accordance with [67],

however, OLTC is typically tested to withstand the loading 200% above the nameplate rating. Still, in actual operation, transformer loadings may be limited to lower values.

At the same time, the study [129] showed that under realistic operating conditions in Canada, loading limits of oil-immersed transformers in Ontario could be increased up 1.8-1.9 pu without jeopardizing the normal life expectancy or supply reliability. Transformer loadings 1.8 pu and 1.9 pu may already seem significant, but the degree of this significance may depend on the design issues and application context. For instance, the particular design of a large transformer may withstand a short-term overloading of 2.5 pu [95]. On the other hand, in railway systems, the locomotive transformer may be overloaded even up to 3 pu [130]. Hence, the final value of the current limit of transformers may be drastically different in various situations.

2.1.5 Factors affecting the permissible loadings of transformer

Many factors may affect permissible transformer loadings, and therefore they should be shortly discussed for general understanding.

Air temperature [14],[68] around the transformer is a main environmental factor that affects its capacity. The air temperature and ambient temperature are usually used as synonyms for most transformers in electrical networks. Note, however, that the ambient temperature may also correspond to the other ambient environment. For instance, in the offshore industry, some transformers are installed undersea where the ambient temperature is the temperature of the seawater [131],[132]. Moreover, onshore transformers having a water-cooling system should also consider a water temperature as an ambient temperature.

Suppose the transformer is placed above the design altitude (i.e., 1000 m above the sea). In that case, this may reduce the efficiency of its cooling systems and thus decrease the permissible load [68]. This happens because, with altitude, the solar irradiation increases and the air density decreases [133]. As the air becomes less dense, it reduces heat removal from the transformer leading to higher winding temperatures. There are also some nuances if transformers are located in closed rooms, manholes, vaults or if transformers are used with deadening walls [134]–[136]. The heat removal from such transformers is less efficient due to the constrained ventilation [137] and accumulative heat effects [138]. Thus, the permissible transformer loading for enclosed spaces must be derated per the effective air temperature.

As mentioned in previous paragraphs, the cooling system determines the heat dissipation efficiency from the transformer and thus the permissible load [139]. For example, suppose OFAF or OFWF cooling system is operable between 33 % and 100 %. In that case, the permissible transformer load may vary between 50 % and 100 % of the rated power [68]. At the same time, additional external cooling, such as water spray²⁰ or ice cubes, may enhance the cooling performance of the transformer [140].

Mechanical impurities in oil: dust, fibres, products of materials used in the transformer (a paint, a varnish), carbonized particles (products of overheated locations, such as carbon) can contaminate the oil in the form of sludge or suspended substances [99]. Sludge depositions

²⁰ Despite positive effect of water spray on cooling, IEEE standard [68] does not recommend to use this technique for normal loading beyond the nameplate ratings because of build up on the cooling equipment (due to minerals in water) over the long run. Under condition of additional precautions, water spray may be used for emergencies. Nevertheless, measures should be taken to avoid any flashover between different phases (at bushings).

on insulation deteriorate its dielectric properties and reduce heat transfer, leading to accelerated ageing. Oil oxidation may produce acids and alkalis, which can also cause sludge and metal corrosion, leading again to accelerated wear of the insulation. The cooling system's performance may also be affected by contamination of the radiator's tubes and clogging of the oil filters [141],[139]. Due to the fouling of coolers, the thermal characteristics of the transformer may vary [139]. This may eventually reduce its permissible loadings.

In addition, mechanical impurities having good conductivity as carbon can overlap the insulated elements and reduce the electrical strength of the oil. Internal damages of the transformer as ingress of foreign objects in the channel may increase transient resistance of contacts. Swelling of insulation may reduce a channel cross-section and eventually cause the abnormal heating of oil and metal structures [141]. If abnormal heating of oil (not related to current) is detected, the transformer must be taken out of service [141]

Besides, cold air may make oil viscose [142]. As the oil becomes more viscose, it starts circulating slowly in the tank and radiators, which may damage oil pumps and OLTC [99]. Moreover, the slower oil circulation decreases the heat dissipation from transformer windings, leading to their higher temperatures [143]. To avoid such negative consequences, it is necessary to gradually increase the transformer load to warm up the oil. As oil becomes warmer, it restores the normal flow and its cooling capabilities. This is called a cold start of the transformer²¹. However, the cold start can impose temporary restrictions on the permissible transformer load. Hence, it should be considered for transformer overloading at low ambient temperatures [144].

Some studies also consider the impact of wind speed and its direction [145]–[148] precipitations [146], solar irradiation [128], [147], [149]–[151] especially in the tropical area [152],[86]. Besides, solar radiation also impacts the paint colour of the transformer tank [150]. Specifically, the radiative properties of the paint may affect how fast the transformer may absorb the solar energy and emit the heat losses to the atmosphere [150]. However, the IEC standard states that although wind, sunshine, and rain may affect the loading capacity of transformers, their unpredictable nature makes it impracticable to consider these factors. This seems discussable, especially because of recent PV development and their power forecasts where solar irradiation plays a key role. Moreover, wind and irradiation effects are already considered in the DTR of overhead lines.

Other studies consider geomagnetically induced currents (GIC)²² [86],[122]. Such GIC may reach as few amperes and hundreds of amperes depending on the magnitude and duration of magnetic disturbances, grid topology, and soil conductivity. Nevertheless, according to [100],

²¹ The cold start of transformer may be especially important during a cold-load pick up [491]– the situation when transformer is reenergized after long-lasting outage. The loading during the a cold-load pickup may be much greater than a pre-outage loading because all loads turns on simultaneously (diversity loss and high inrush currents of motor load etc). If not controlled, this could damage the transformer especially if high loadings coincidence with very low ambient temperatures making the oil viscous, preventing the efficient heat removal from a transformer. For instance, in field studies of cold-load pick up, a bushing's temperature reached 300 °C [491]. Hence, step-by-step restoration of power supply, maximizing the use of transformer capacity is needed [492] .

²² GIC in transformers happens as consequences of magnetic disturbances on the sun: solar winds or sunspots. When geo-magnetic field of Earth varies, this creates a DC current flowing from the transformer's grounded neutral to HV windings. Transformers, located in countries close to Earth's magnetic poles (especially at high latitudes), may be more exposed to GIC.

GIC, even high ones, usually have a short duration. Therefore, it is believed that GIC does not lead to inadmissible overheating of windings or other structural parts for most transformers. However, another study [122] demonstrates that GIC may restrict a permissible capacity of 400 MVA transformers, especially at high loadings. Note that GIC usually happens for transformers used with long lines or intermeshed networks. This is not common for distribution networks, historically having a radial topology and relatively short feeder distances from substations.

Other studies show that harmonics are sources of additional losses in transformers [117], [153]–[156]. Therefore, they cause the increased cumulative ageing of insulation [155]. An interesting example is described in [157], where a 9-years-old transformer suddenly failed after small short circuits, which it should typically sustain. However, the post-damage analysis showed that the DP value was deficient, and no tensile strength remained. It is interesting to note that the temperature gauges of this damaged transformer never reached alarm set points. This again testifies that cumulative ageing may occur even if the temperature never reaches its limits. After investigations, it was found that this transformer was connected with a rectifier whose THD²³ was not correctly considered [157],[158]. As a result, harmonics led to a fast deterioration of the given transformer and 19 similar transformers. Eventually, a transformer owner had to replace them all. As many small generators are connected to the distribution network, the potential sources of harmonics should grow. As a result, harmonics become essential factors defining the transformer capacity. A similar effect on the insulation ageing may happen due to phase imbalances, which also can occur from the increased number of small generators or storage [68], [159],[86].

In the case of short circuits, winding turns may be deformed due to electrodynamic forces of the short-circuit current. Usually, the winding deformation should not exceed 3% of its initial state [65]. Because of winding deformation, there is a risk of inter-turn faults and thus a risk of transformer failure. At the same time, a temporary deterioration of mechanical properties at higher temperatures may reduce the short-circuit strength. Therefore, transformers during or directly after operation at load beyond nameplate rating may not comply with thermal short-circuit requirements of IEC 60076-5 (based on a short-circuit duration of 2 seconds). However, in practice, the effective duration of short-circuit is usually much less than 2 seconds. Hence, we do not consider the issue of short-circuits further.

Fulfilling the N-1 criterion in mode planning can reduce the allowable transformer load, e.g., 50% of its rated capacity [160]. For example, suppose one of two transformers in the substation fails. In that case, the transformer remaining in operation must ensure a continuous load supply. In this case, part of the transformer capacity in normal operation cannot be used due to the requirements to fulfil the N-1 criterion. Other factors, except thermal aspects, can be grouped as follows: economical [161]–[165]; probabilistic [69], [76], [166]–[172] statistical [69], [74], [129], [173]–[179].

This list of factors is not exhaustive, but it demonstrates that a transformer's capacity is a complex multifactorial characteristic. Moreover, researchers continuously improve the thermal modelling of oil-immersed transformers leading to the development of more accurate

²³ Total Harmonic Distortion (THD) is a parameter that shows how much the current and/or voltage sinusoids are distorted due to presence of harmonics. Usually, THD should not exceed 5% [71],[158] but if considering actual winding temperature, it may be acceptable to operate the transformer during the most of the time even at higher THD e.g. 23% and 54% [117].

and multifactorial thermal models [86], [180]–[182]. Attempting to account for all factors in one thesis would require much work and time as well as validated data. Besides, it may not be relevant considering all these factors simultaneously as the specific factor may be appropriate only in a particular situation. In general, as a literature review has shown, the physical limitation of the transformer capacity is often reduced to C&T limits of winding and oil as well as limits of insulation ageing. Hence, we decided to follow this practice and admit all limitations of this approach [183].

In general, C&T limitations may be considered a necessary condition for safe transformer operation, but it should be kept in mind that sometimes they may be insufficient. For instance, the study [184] shows that despite complying with all temperature limitations, the relative saturation of oil exceeds the permissible limit of 60% (in this case, authors assume that the risk of breakdown becomes inadmissible). In another study [185], authors control a tank's pressure and voltage limits together with temperature limitations. Finally, in [98], researchers control the rate of temperature change and internal/external pressure as well as a bubble inception temperature, among others.

Thus, it is necessary to emphasize that some specific situations may indeed require additional limitations. However, C&T limits are usually applied in the literature in common cases. As this thesis targets rather general concerns than special ones, we assume that C&T limitations are necessary and sufficient conditions for the safe operation of the transformer. This may be justified if oil preservation systems and appropriate practices of monitoring, diagnostics and maintenance are in place. Hence, the following section 2.2 shortly review the existing research on the thermal limit of transformers.

2.2 Thermal limits of power transformers: review

First of all, it should be highlighted that the subject of transformer's thermal limits and its related issues has a vast and long history. The bibliography on this issue (a heat transfer and transformer loadings) contains 220 pages for 1895-2016 [186]. According to its author – a transformer specialist and researcher, Pierce L. W. [186], the earliest publication on this subject is dated back to 1895 by W. L. R. Emmet, who conducted heat run tests of the dry transformer, which were widespread at that time. Nowadays, however, 92 % of all transformers worldwide represent oil-immersed transformers [6]. Therefore, we remind that they are the focus of this thesis.

Nowadays, we may distinguish two main approaches on a thermal limit of power transformers. The first approach [187] assumes that the limit of transformer loading should correspond to its continuous (design) temperature. In contrast, the second approach is based on the “intermittent” temperature limit, set above the design temperature [54].

In 1928, Norris suggested that the transformer should operate below a continuous (rated) temperature limit (typically 95°C or 105 °C at that time) [187]. This allows avoiding acceleration of insulation ageing, i.e. without sacrificing the transformer's design life [188]. Also, it was found that operating the transformer at their continuous temperature should not damage internal connections of transformers (even old ones²⁴). As a result, first loading

²⁴ Concerning this issue, there is an interesting example [104]. Specialists at New England Electric System asked the transformer manufacturer if it is possible to load their old transformers up to the guaranteed temperature limit 95 °C. Preliminary, manufacturer responded yes but its specialists were not sure about internal connections

guides, e.g., BS 171 1936, adopted Norris's approach on continuous temperature limit [55]. It was axiomatic to use it for rating purposes in the first half of the 20th century [56]. For operation purposes, the 105 °C limit was lowered to 85-95°C depending on the accuracy of winding monitoring sensors at that time or other reasons [189].

Nevertheless, scientists discussed the possibility of operating the transformer above the continuous temperature limit. For instance, we may find a discussion of 1913 [190] on ratings of electrical apparatus where it was argued for continuous versus intermittent temperature limit. In 1930, Montsinger supposed that in the future, the continuous limit of 105 °C for transformers might be temporarily exceeded for periodical loadings [113]. However, Montsinger and other researchers [189] agreed that it might be better to adopt a lower continuous (95°C) limit from the conservative side and keep 105 °C for periodical loadings[113]. But already in 1934, Montsinger and Dann [191] published a vision of the transformer committee on permissible temperature limits for short-term operation of the transformer above the design (continuous) limits.

In 1944, Sealey and Hodtum [54] discussed overloading cases non covered by general rules. Specifically, the authors stated that it is possible to temporarily exceed the rated temperature if, at other time intervals, the temperature would be sufficiently below its rated value. In such a case, the accelerated insulation ageing caused by above-rated temperatures should be compensated by a slow insulation ageing at below-rated temperatures. This was based on numerous tests conducted in 1921 [189], showing that for each 6-8 °C²⁵ change in operating temperature, the rate of insulation ageing doubles or halves [189],[192]. Thus, it should be still possible to operate transformers without sacrificing a design life even if their rated temperature is violated from time to time. That is why, nowadays, the IEC loading guide [14] allows the normal overloading of transformers up to 120 °C, while a rated winding temperature can be 98 °C for non-thermally upgraded insulation (or 110 °C for TUP insulation). Despite the acceptance of this approach in industrial standards, transformer experts also apply the practice of continuous temperature for thermal limits.

Later in the second half of the 20th century, transformer ratings were discussed in industry and academia as the one of forefront subjects. Special attention was drawn to the operation of transformers above their nameplate ratings as it provides economic effects [102], [104], [149], [193] but also because of emerging computer-based solutions. Specifically, during the early 50s, engineers and scientists started to apply the first computer programs²⁶ for transformer design and operations [104], [194], [195]. Followed by computers development, the implementation of the first monitoring systems allowed utilities to significantly increase the transformers limits [193]. For instance, after implementing such a monitoring system, Consumers Power Company in the USA increased loading limits of residential transformers (less 10 kVA) from 225% to 300% and for 10 kVA and larger from 165% to 250% above the nameplate loading [193].

of transformers. After additional verifications, they found that the risk for such loading of old transformer remains reasonable and it does not warrant to investigate each transformer for operating them at 95 °C.

²⁵ For temperature higher than 120 °C (or 115°C per [192]) the ageing doubling/halving occurs for each 8 °C change whereas for temperatures from 100°C to 110 °C the rule of 6 °C is used. However, it is also believed that 10 °C rule should be applied. (See discussion in [192],[68]).

²⁶ Computer programs, once appeared, allowed to reduce the computation times of transformer ratings by 70 %, which before were calculated by hand [104].

Before the early 1970s, the average winding temperature rise was used to define the thermal rating of transformers [196]. Its measurement was done via winding temperature indicators which monitor the change in a winding resistance. However, in the late 1970s, utilities recognized that such conventional winding indicators do not represent real hot spots [197](their temperature is 13-15 K higher than the average temperature of windings). Thus, efforts were made towards direct measurements of temperature at hot spot locations through fibre optic sensors. The latter became possible thanks to the creation of Fluoroptic® technology in 1978 [197]. In the early 1980s series of tests held in General Electric, PSE&G, and Luxtron confirmed the feasibility of this technology which remained almost the same up to nowadays.

In parallel with the development of fiber optic technology and with further development of monitoring systems [198], new concepts on thermal limits of network components started emerging [199]. In the late 1960s - early 70s, researchers suggested adjusting thermal ratings according to real-time environmental conditions [200]. Such ratings were later called Dynamic Thermal Rating (DTR) or Real-Time Thermal Ratings (RTTR) [201]. Hence, in contrast to pre-calculated ratings, DTR allows releasing the unused capacities of power equipment thanks to online monitoring systems.

In the 1970s, the first-ever demonstration project on DTR - “Cable Monitoring and Rating System” (CMARS) was launched at PSE&G, USA [202]. In the middle of 1980, the first commercial project, UPRATE, was set up at Boston Edison and later in LILCO, PSE&G, Con Edison and NYPA [202]. Although these projects were on DTR of underground cables, their success enabled the expansion of DTR technology for overhead lines and transformers [179], [200], [203]–[207]. According to [200], the first DTR system for oil-immersed transformers was placed in 1989 at LILCO and the second one in 1990. In the UK, a prototype for providing online ratings based on real-time data was developed in the 1980s and later used by National Grid [208]. As a course of technology development, DTR has been actively investigated for online-monitoring systems of transformers [165], [209]–[216] and their relay protection [171], [205], [225]–[228], [217]–[224].

The feasibility of RTTR technology was verified in 1987 [229]. It was concluded that DTR is inexpensive and relatively easy to implement in practice. Moreover, DTR technology may provide up to 15% more capacity than classical rating methods [229]. In 1996-1997, Douglass et al. [229], [230] presented results of field investigations in Philadelphia on DTR of overhead lines, cables, transformers and other network equipment: buses, disconnectors, line traps. As one of the results from this project, special DTR software²⁷ such as DTCR (Dynamic Thermal Circuit Rating) and PTLOAD (Power Transformer LOADing) were developed [231].

In the 1990s and 2000s, the development of DTR coincided with the paradigm shift in how power systems operate [232]. After the successful market liberalization in Chili in the 1980s, many countries started transforming their vertically-integrated utilities towards liberalized electricity markets [232]. As a result, this leads to load flows never planned before [210] and incentives to reduce the power system’s operating costs. Hence, the utilization of network assets as much as possible becomes paramount in market conditions, and it remains relevant up to nowadays. DTR is considered a perspective and timely option to reduce costs and

²⁷ Computer programs considering thermal limits of transformers were already used since 1960, e.g. in New England (but not in real time as DTCR or PTLOAD do) [104]. Moreover, first practices of transformer’s overload were implemented much earlier, e.g. in the same Philadelphia, they were performed since 1938 [104].

increase supply reliability in new market conditions. In 2016, around 2000 projects on DTR (both lines and/or transformers) had been deployed in 50 countries [233]. Nowadays, DTR is found to be especially efficient together with flexibilities from generation, storage and load [137], [206], [234]–[241] as well as for RES integration in the onshore and offshore grids [8], [9], [12], [242]–[244].

Table 2 briefly reviews advances in the field of DTR of oil-immersed transformers for the past 30 years. Note that these publications do not represent a complete list of articles on this subject. However, with a comprehensive bibliography from Pierce [186], this overview may be useful for DTR specialists and those who only start their investigations of this subject.

Table 2 Analyzed publications on DTR-related issues sorted by years since 1990.

1990	
[150]	Alegi and Black developed a real-time thermal model, considering detailed weather impact for application to the load management of transformers
1993	
[242]	El-gasseir et al. demonstrated that DTR with PV arrays might defer or reduce network upgrades even if PV generation does not match the peak load.
[173]	Kartas et al. estimated the admissible overloading of transformers in Greece.
1994	
[129]	Wong found that it is possible to increase the loading limits of transformers up to 1.9 pu if considering their thermal performance. In this case, savings in NPV are estimated around \$4 500 000 for 3 years or a CAPEX reduction of \$ 10 million per year
[245]	Pierce presented new loading equations and the computer program, which was later adopted in IEEE standards
1995	
[174]	Jardini et al. suggested a methodology allowing to evaluate the loadability of residential transformers based on their typical load profiles
[208]	Simonson et Lapworth described how the UK system operator maximises the thermal capacity of power transformers without sacrificing reliability
1996	
[246]	Saied et al. suggested the generalized method for simulating the dynamic thermal behaviour of power system components, including the power transformers
[229]	Douglass et Edris discussed the results of the EPRI project on flexible transmission systems, which avoid using the direct measurements of component temperatures (instead, thermal models are used).
1997	
[230]	Douglass et al. described a field data management in the EPRI project on DTR (including transformers).
1999	
[200]	Walldorf et al. provided a short historical overview of DTR technology and described some benefits of the DTR system for transformers
2000	
[223]	Galdi et al. suggested a neural algorithm to identify dynamic thermal overloading of power transformers. This neural algorithm was later enhanced in 2001 by incorporating local memory [221]
[196], [247]	Tripathy et Lakervi estimated the overloading capability of transformers for a certain percentage of the time. Also, investigations on the impact of the winding time constant during the emergency loading are presented.
2001	
[224]	Galdi et al. applied the genetic algorithm to identify the parameters of the thermal model used for the transformer protection.
[165]	Chenier et Aubin performed the cost-benefit evaluation of transformer overloading with the online monitoring system. It was shown that online-monitoring systems could payback for a few months.
[212]	Yasuoka et al. suggested a Transformer Allowable <i>Power</i> Predictor, calculating an admissible MVA rating for a few hours ahead.
[210]	Tenbohlen et al. presented the method for online calculation of transformer's overloading capacity.
[217]	Swift et al. presented approaches for adaptive thermal protection of power transformers
[172]	Weihui et al. proposed a risk-based probabilistic approach considering time series of load and ambient temperature for assessing the transformer capacity
2002	

[248]	Park et al. developed general recommendations for overloading distribution transformers in South Korea for the summer and winter seasons.
[249]	Lehtonen et al. developed a state estimation model for distribution networks. In this model, the temperatures of power transformers and cables were monitored and verified against their limits.
[211]	Pudlo et al. presented online monitoring systems enabling the calculation of overload capacity
2003	
[92]	Lachman et al. presented a historical introduction into loading guide development. Furthermore, the authors developed a comprehensive DTR approach considering various factors (temperature and ageing limits.).
2004	
[225], [250]– [252]	Ippolito et al. focus on a fuzzy and neural model to simulate the thermal response of mineral-oil transformer for relay protection
[77]	Weekes et al. developed an algorithm of relay protection based on the thermal model of the power transformer. Interestingly, the hot spot temperature in this study does not belong to winding but to lockplate. Moreover, it was shown that the transformer, even loaded far higher than the manufacturer limits, did not violate predicted temperatures. The lack of furans in oil testified that the ageing was within the norms.
2005	
[253]	Villacci et al. proposed a grey-box approach for thermal modelling power transformers for forecast purposes.
[69]	Li et al. proposed a methodology to define peak-load limits of transformers during winter and summer
[254]	Nuijten et al. presented the vision on DTR technology (including power transformers) in Nuon (Netherland's electricity utility)
[255]	Nuijten et Geschiere estimated the loadability of HV/MV transformers in the Netherlands. It was found that during the winter it is possible to load the transformer up to 1.2 pu. However, in summer, loadings should be restricted to 1.1 pu. It was also shown that core flux never reaches its limit (1.9 Tesla). As a remark, it was reported that 18 MVA transformers could not deliver 10.5 kV in particular conditions. Nevertheless, the possibility of such situation is very low so that the risk can be tolerable.
2007	
[256]	Lee et al. developed a dispatch strategy, maximizing the remaining life of transformers in case of emergencies.
2008	
[257]	Ishak et Wang showed that IEEE Annex G better models the hot spot temperature than IEEE Clause 7
2009	
[178]	Michiorri et al. evaluated the benefits of RTTR (including transformers) from the perspective of distributed generation integration. Authors found that the average power transformer capacity is around 6% -10% higher than their static rating.
2010	
[258]	Kuss et al. studied the overloading scenarios for distribution transformers due to the charging of electric vehicles.
[205]	Yip et al. described the project on control of active distribution network considering the thermal ratings of lines and transformers

[259]	Jupe presented a PhD thesis where a thermal vulnerability of network components (including transformers) was assessed, among many others
[260], [261]	Cheema et al. described the architecture of their DTR system and discussed its development and benefits.
2011	
[127]	Rashid evaluated the IEC thermal model performance for short-term overloading of transformers.
2012	
[219]	Lloyd et al. presented results of field tests for evaluation of extra capacity from DTR. Concerning a power transformer, it was found that DTR ensures almost 6% of additional capacity. (the 98 °C limit was chosen)
[262]	Bochenski et al. presented a computer program calculating normal and emergency ratings of 800 transformers in Canada.
[263]	Josue et al. Modified IEC 60076-7 model to consider the oil viscosity during dynamic loadings
[228]	Castillo et al. presented an automation controller that may calculate the loading rating according to the IEEE standard.
2013	
[264]	Hazra et al. proposed an optimizer that can choose admissible overloading from the risk/profit ratio.
[265]	Yun et al. described a decision system used in Korea for overloading of distribution transformers
[266]	Hilber et al. described the possibilities and benefits of reliability-centred asset management (including DTR)
[267]	Rosenlind presented a PhD thesis on lifetime modelling and operation of power transformers. Concerning DTR, Rosenlind studied a probabilistic feature of transformer capacity among others.
2014	
[203]	Feng et Mousavi evaluated the overloading capacity of transformers and power lines. For transformers, the 120 °C limit was chosen. The loading-temperature relation for the power transformer is given as a result.
[20]	Su et al. suggested the design of distribution transformer used with PEV.
[268]	Huang et al. used a failure rate limit and the winding temperature limit (140 °C) to define the safe overloading of transformers.
[74]	Yang et Strickland estimated potential gains from transformer DTR compared to STR. Authors found that DTR (the 110 °C limit) may ensure up to 20% of additional capacity in the winter months. However, during the summer, DTR may be lower than STR.
[269]	Degefa et al. quantified RTTR benefits of lines and transformers for DG integration. It was shown that RTTR enables a 40% margin in loading and DG integration.
[237]	Degefa et al. investigated the framework for day-ahead thermal state previsions of distribution network components (including transformers).
[270]	Wallnerstrom et al. presented the perspectives of using DTR in Sweden
2015	
[146]	Yang et al. found safety margins for transformer DTR using 90%, 95%, 99% confidence intervals of day/ week –ahead forecasts. Specifically, for 95% confidence, 0.03 pu margin is required for day-ahead forecast, and 0.04 pu margin would be needed for week-ahead forecasts.

[271]	Esmaeeli et al. considered transformers operation above its nameplate rating while defining transformer size, placement and costs.
[206]	Safdarian et al. discussed the DTR benefits for the operation of the distribution network in Finland.
[272]	Degefa presented a PhD thesis where RTTR of transformer and lines were estimated. The thesis encompasses [237], [269], among others
[234], [273]	Humayun et al. used DR with DTR to enhance the utilization of transformers during the contingencies. Specifically, the proposed method allows choosing the best combination between a power curtailment, DR or a load transfer to adjacent substations to keep transformer temperature below the limit (120-130 °C).
[274]	Humayun et al. suggested the optimization model, which incorporates the HST of transformers and demand response
2016	
[162], [275]	Humayun et al. developed an optimization model of transformer capacity management at long-term horizons.
[276]	Humayun presented a PhD thesis encompassing previous publications [162],[234],[273]
[235]	Ali et al. used DTR of oil-immersed transformer together with DR to balance the output of wind farms from the side of the DR aggregator
[84]	Zhou et al. suggested an algorithm for dynamic load adjustment based on winding temperature and ageing limit.
[71]	Das et al. suggested modifications of IEC 60076-7 models (both exponential and difference methods) considering the unbalancing and harmonic effect. The proposed method is to be used in DTR applications in New Zealand.
[277]	Chittock et al. explain how it is possible to obtain the parameters of IEEE/IEC models for DTR
[278]	Dorostkar-Ghamsari et al. maximized a load transfer through a substation with two transformers if one of them failed.
[241]	Weisshaupt et al. applied DTR to increase the hosting capacity of a distribution network for PV connections
[22]	Haque et al. proposed a method for real-time congestion management considering the thermal overloading of MV/LV transformers
[279]	Gao presented a PhD thesis where the impact of EV integration on distribution transformers was estimated.
2017	
[240]	Haque et al. extended their previous study [22] by incorporating an intelligent computation in a multi-agent environment.
[280]	Haque presented a PhD thesis suggesting a smart congestion management of LV network (including thermal overloading of MV/LV transformers).
[186]	Pierce published a comprehensive bibliography on the issues of heat transfer in transformers and their loadings for 1895 - 2016
[73]	Elders et al. proposed an approach to tune the parameters of the IEC thermal model. After analyzing the measured and modelled temperatures, the authors suggest using a 8.5 °C margin for the hot spot temperature calculated with IEC 60076-7
[281], [282]	Karlsson et al. investigated the power system performance (reliability, voltage stability and active power losses) with a DTR of 63 MVA transformer connected to a wind farm.
[283]	Gao et al. developed a methodology to enhance an IEC thermal model for better assessing the transformer capacity of distribution transformers
2018	
[169]	Sousa et al. suggested the risk-based strategy for emergency operation of power transformers with interruptible load contracts.
[284]	El-Bayeh et al. suggested a Transformer's Critical Power Limit as a function of ambient temperature and ageing factors
[285]	Djamali et al. proposed a method to compute the real-time loading capability of indoor transformers.

[286]	Turnell et al. evaluated the risk and economic performance of using a DTR-based transformer (16 MVA) versus the non-DTR transformer (19.4 MVA) coupled with the wind farm.
[287]	Stefanou studied the impact of moisture on insulation degradation from a DTR perspective.
[171]	Bracale et al. suggested a probabilistic approach based on monitoring of electrical and ambient conditions to forecast DTR of power transformer
2019	
[170]	Bracale et al. developed a non-parametric stress-strength model to evaluate the stress probability (i.e., the transformer loading current) to be less than the strength (i.e. DTR).
[288]	Bracale et al. proposed a risk-based procedure that allows operating the power transformer with DTR
[11]	Kazmi et al. reviewed dynamic thermal models from the perspective of their application for offshore wind farms' transformers and cables.
[12]	Kazmi et al. estimated the loadability of offshore transformers at Anholt wind farm in N-1 condition.
[98]	de Carvalho Sousa et al. developed an innovative method to estimate the quality of the transformer rating (from unacceptable to excellent grade) as a function of bubble-related restrictions: a relative saturation, a bubble inception temperature, rate of winding temperature change etc.
[128]	Wang et al. evaluated the transformer capacity, considering the solar radiation and auxiliary equipment ratings, for normal cyclic and emergency situations (short and long term). It was found that the admissible loadings of transformer may exceed the nominal rating by 15%. Ageing limit is considered as a limiting factor for nominal cyclic loadings whereas auxiliary equipment restricts the transformer capacity for long-term emergencies. For short-term emergency, inner temperatures of transformer are limiting factors.
[289]	Viafora et al. developed the DTR to optimize the utilization of transformer life.
[290]	Viafora et al. combined the DTR of transformer and lines in day-ahead dispatch optimization.
[9]	Viafora presented a PhD thesis where he applied DTR for the integration of wind power plants
[291]	Fang et al. proposed a DTR application in the optimal power flow problem to maximize a lead time before the next contingency.
[156]	McBee et al. studied the effects of demand-side management on the capacity limits of an oil-immersed transformer, including the harmonic impact.
[292], [293]	Zarei et al. investigated the reliability and economic effects of a DTR-based transformer with a wind farm.
[294]	Ariza Rocha et al. studied how DTR of transformers could allow connecting the additional wind turbines to existing wind farms
[295]	Alvarez et al. proposed a DTR algorithm for short-term and long-term horizons
[296]	Rashid presented a PhD thesis where a predictive rating tool was developed for transformers and lines in a distribution network.
2020	
[297]	Bracale et al. presented a comprehensive tool, "SmarTransfo", allowing to estimate a DTR from a probabilistic point of view.
[298]	Bracale et al. proposed a procedure based on probabilistic forecasts of DTR
[299]	Zhou et al. suggested a computational approach for the OPF problem considering thermal models of overhead lines, cables and transformers.
[184]	Lupandina et al. studied the DTR by considering additional factors, e.g. a relative saturation of oil
[300]	Talpur et al. combining DTR with centralized battery systems allows maximising the utilization of power transformers and improving the voltage nearby consumers.
[301], [302]	Molina Gómez et al. applied DTR for the short-term and long-term planning of onshore wind farms.
[243]	Morozovska presented a thesis on using the DTR for renewables applications.

[23]	Andrianesis et Caramanis incorporated the transformer's thermal model in the AC-OPF of radial distribution networks with DER
2021	
[105]	Lei et al. Authors suggested the strategy of load transfer in a distribution network. The objective function minimizes the switching cost and keeps the appropriate headroom for reactive power exchange with the transmission network. The proposed thermal model considers two external cooling modes: air-assisted water sprays and ice cubes. It is also interesting to note that authors use HST limit = 105 °C and TOT limit = 80 °C
[238]	Li et al. used DTR of oil-immersed transformers into a dispatch problem of active distribution network with a high share of PV and flexibility
[303]	Kopperud estimated the DTR of 300-MVA power transformer under various ambient temperature conditions
[304]	Danylov et al. experimentally evaluated the impact of DTR (i.e. different heating cycles) on the insulation ageing of oil-immersed transformers
[241]	Fatima et al. used DTR among other techniques to connect more PV to the distribution network
[305]	Kazmi et al. presented a PhD thesis where he suggested how a transformer can be utilised by DTR to design the export system of offshore wind farms optimally
[306]	Dong proposed a data-based approach for assessing the annual DTR of oil-immersed transformers from the long-term perspective
[307]	Andrianesis et al. Evaluated the impact of transformer and cable's ageing on locational marginal prices in active distribution networks
2022	
[308]	Andrianesis et al. considered the transformer thermal model as [23]. They suggested novel improvements in AC-OPF of distribution networks with DER.
[309]	Li et al. suggested a method for selecting the capacity of power transformer considering the wake losses and thermal limits
[310]	Lai et Teh conducted literature review on DTR (including transformers) for sustainable electric power systems
[311]	Wang et al. proposed a control strategy considering the dynamic safety margin of power transformers in emergency situations

* Table 2 was updated by 23 March 2022.

3. Research tasks and motivation

The **main hypothesis** of this thesis is that a transformer capacity still is not fully used as it can be per industrial standards (i.e. C&T limits). As a result, a significant transformer capacity remains hidden from system operators. Therefore, it was decided to reveal the transformer's hidden capacity and to demonstrate how it can be better used on the example of a relevant problem. Hence, Task 1 and 2 are dedicated to this problem, targeting practical applications. Apart from practical applications, we are interested in finding the integral limits of transformer capacity utilization. Thus, Task 3 is set to investigate this theoretical question.

3.1 Task 1: DTR assessment considering current and temperature limitations

As explained in section 2.1, many papers on transformer DTR still do not consider an intermittent temperature limit (i.e. a permissible exceedance of continuous temperatures). Even though the concept of intermittent temperature limit was discussed in first half of 20th century [54] and later adopted in industrial standards [97], [91], many researchers [146], [176], [179], [238], [292], [312] continue considering continuous temperatures as a temperature limit. However, as discussed in section 2, a continuous temperature should not be considered a temperature limit. At the same time, studies [177], considering intermittent temperature limits, do not consider a current limit. Therefore, DTR estimations remain incomplete compared with C&T limitations of industrial standards [97], [91]. As a result, DTR based on continuous temperatures may underestimate DTR capability. This may be crucial for our understanding of transformer capacity. Also, specialists promoting DTR [313], asset operators, policymakers may underestimate DTR benefits compared to other technologies.

The literature review showed that DTRs are often based on typical load profile [76], [80], [315], [316], [85], [167], [173], [176], [177], [185], [295], [314]. This means that researchers take a typical load profile and then proportionally scale it through coefficient /factor until temperature or ageing limits are reached. For instance, in 1995, Nguyen [314] proposed an optimization formulation with a load multiplier to find normal cyclic and long-term emergency loadings. In 2008 Savaghebi et al.[85] and Shahbazi et al. [76] applied a dynamic loading factor (i.e., a load multiplier) for given load profiles. In 2012, Zhang et al. [315] scaled a shape of load profile until temperature limits were reached. In 2015, Pasricha and Crow [80] used a load multiplier for power limit determination, considering transformer bushings and the OLTC limit. In 2019 Alvarez et al. [295] used load multipliers (both constant and dynamic) to reach a top-oil limit. In the same year (2019), Bunn et al. [185] used a similar principle of load multiplier for a given shape of load profile to increase the utilization of transformers. Such scaled load profile is then used to determine the DTR. Dong used a similar scaling approach in [306] to determine DTR over long-term horizons. Although using a typical load profile for scaling was indeed realistic in the past, future load profiles may be drastically different because of a growing number of DER at the distribution level [22], [205], [235], [237], [269], [317]. Besides, typical load profiles of transformers are changing due to the recent COVID-19 outbreak [318]. Therefore, using a typical load profile may converge to non-optimal DTR for distribution networks.

Besides, novel strategies of active network operation [22], [205], [235], [237], [269], [317] and aggregators providing flexibility allow changing the shape of load profile [319],[320],[156]. For instance, such strategies or services are known in the literature as load/peak shaving [284], [321], [322] and valley filling [323]. Thus, DSO may not only face a new shape of loads but also

control them with available flexibility. Altogether, DTR estimations require using many shapes of load profile and not the typical one.

According to the IEC standard [91], C&T limits are not intended to be valid simultaneously. Furthermore, the IEC standard [91] specifies that limiting factors may shift from current to temperature and vice versa. However, no other clarifications are given in the IEC standard [91] or other sources, e.g., which factor is dominant, and occurrence. Besides, in face-to-face discussions with colleagues and some literature sources [324]–[326], we met an opinion that winding temperature is always a limiting factor for transformer loading. Although this is often true, our numerical investigations showed that this could also be false in particular ambient temperature ranges and different C&T limits.

Because of all these issues, it was decided that **the first task** of the thesis should be an assessment of DTR considering C&T limitations. The new assessment, in contrast to previous studies, should estimate permissible loadings, considering the following:

- (1) Intermittent temperature limit (above the continuous temperature) should be considered. Otherwise, the transformer capacity may be significantly underutilised.
- (2) DTR estimation should encompass as many load profiles as possible and not only any single one. In other words, DTR should not depend on the shape of the load profile. Otherwise, the DTR may ignore the part of transformer capacity.
- (3) Limiting factor of transformer loadings and its occurrence should be defined for better understanding a transformer capacity.

3.2 Task 2: Estimation of transformer reserve capacity for load connection

It was found that the electric demand should remain (up to 2050) a primary factor driving the reinforcement of distribution networks. Furthermore, the existing DSO approach [327] do not use C&T limitations but a nominal rating of the smallest transformer in N-1 mode. Therefore, we made a hypothesis that there is a hidden transformer capacity, which DSO currently underutilizes because of very conservative assumptions of power ratings. Thus, the **second task** of our thesis is to investigate how much load can be connected to transformers if using C&T limits from the IEC standard [91]. From a transformer perspective, this task should prove the significant reserve capacity of a power transformer [327] for a load connection.

The problem of reserve capacity is illustrated in Russia because its energy and business community actively discuss this problem of reserve capacity. Briefly, consumers in Russia may soon be obliged to pay a reserved power maintained by DSO for them. These payments may reach a few billion euros in the next few years. Thus, the actual reserve capacity was one of the points of such debates. Details of this situation in Russia are provided in Chapter III.

At the same time, DSOs worldwide have started taking advantage of flexibility in their electrical network [328]. That is why, we were interested in how much flexibility is needed to interconnect the given load, especially if DSO uses the flexibility with DTR? After preliminary evaluating the costs of different flexibilities, it was found that the demand response (DR) is considered as the low-cost technology. Therefore, DR will be reference flexibility for the problem of reserve determination. However, although there are many works on maximizing transformer utilization with DR and DTR [169], [234], [334]–[337], [273]–[275], [329]–[333], the issue of reserve capacity determination is studied only in a few works [276], [338]–[340]

(details are given in section 4.1 of Chapter III). This gave us additional motivation for conducting the research on the second task of the thesis.

3.3 Task 3: Investigating the energy and ageing limits of transformer

As already mentioned, system operators would be prone to maximize the utilization of transformer capacities. Literature review showed that transformer limits might be considered in various forms: power [284], failure rate [268], temperature [113], tank pressure [185], relative saturation [184], economic [165],[341] or risk-profit limits [286]. In practice, however, the main technical problem is usually related to a power flow constraint. Nevertheless, active operation strategies [22], [205], [235], [237], [269], [280], [317] as peak shaving for example, may mitigate power constraints and prolong transformer's operation. Assuming that DSO has enough flexibility to mitigate any power constraint, we posed the theoretical question: up to what physical limit is it possible to operate a power transformer?

To answer this question, we made the hypothesis: if any power constraint may be mitigated, then the physical limit in such a situation should have some integral nature. Thus, it can be supposed that the physical limitations should be a maximal amount of energy transfer without violating temperature and current constraints. This energy transfer limit should represent the unique transformer's loading profile, ensuring the highest energy transfer under a given ambient temperature. Once a transformer reaches the energy limit, its reinforcement becomes an inevitable option, even if earlier it was deferred by active operation strategies or load transfers to another substation. Therefore, it was decided to investigate the concept of energy limit in this thesis to understand its characteristics better. Since energy limit changes as a function of ambient temperature, we decided to quantify the energy limit in different climate conditions: Tomsk, Russia, and Grenoble, France.

Apart from the energy limit, it was decided to investigate the ageing limit. As a reminder, IEC and IEEE standard [97], [91] states that normal cyclic loadings are loadings, which cause the normal ageing of insulation ($\text{Loss of insulation life} \leq 1 \text{ pu}$). Such assumption should ensure that transformers could operate an entire design life as predefined by the manufacturer. However, we believe that this may also be a conservative assumption, especially confirmed by recent tests. For example, in 2018, network companies in Russia investigated the actual state of power equipment after being many years in operation [342]. It was found that the insulation system and other vital parameters of existing transformers remain in a good state (physical ageing is only 24 %). This is especially notable as 50-70% of transformers in Russia stay in service beyond their design lifetime. Therefore, some studies [289] already suggest increasing the existing transformer ageing limit higher than the normal limit if considering their remaining insulation life. However, we suppose that the remaining insulation life should not be used alone to choose the ageing limit. Therefore, we propose considering the remaining calendar life with the remaining insulation life.

Hence, this thesis's **third task will focus** on three issues: (1) the development of the concept of energy limits (2) its quantification for ambient temperatures in Tomsk and Grenoble. (3) the investigation of optimal ageing limit while considering various combinations of the remaining insulation life and the remaining calendar life.

4. Contributions

Contributions of this thesis represent the solutions of the abovementioned tasks. Each contribution provides the added value for a particular domain related to DTR (modelling, concepts or application case). Hence, all contributions are summarized below.

Table 3 Description of contributions

Contributions	
DTR modelling – C1	
C1	<p>It is suggested to model DTR using a feasible region. In contrast to other techniques, this method allows considering the permissible operation of the transformer within C&T limits. As a result, it becomes possible to consider about 30-35 % of hidden transformer capacity, ignored in similar studies. Furthermore, no load profile is required to model DTR, thanks to a feasible region. This allows avoiding converging to lower DTR shapes. Besides, a feasible region considers variations of power limit as a function of limiting factor between C&T limitations. This is mentioned in the IEC standard, but no further explanation was provided. Thus, this numerical study fills this gap.</p> <p>As a new modelling technique was proposed, it was necessary to reassess DTR. In contrast to other studies, DTR is assessed for multiple C&T limits. This allows identifying the limiting factors of power limits (among given C&T). On the one hand, this confirmed the commonly accepted vision that the winding temperature is a primary limiting factor of DTR. On the other hand, it was shown that winding temperatures might be less or totally unrestrictive for DTR at particular C&T limits.</p> <p>Finally, the recommendations for transformer overloading using C&T limitations were formulated. Specifically, it was explicitly shown that transformers may still be loaded up to 89 % while exposed to negligible ageing. In addition, the number of days of permissible operation above the design temperature but within C&T limits is evaluated. This complements the approach based on the intermittent temperature limit, which is currently adopted by IEC and IEEE standards.</p>
DTR application – C2,C3	
C2	<p>It was demonstrated that transformers have a substantial reserve capacity even under restrictive assumptions on load growth and T_{amb}. With restrictive assumptions, we applied DTR to estimate the reserve capacity on the example of a primary substation in Russia. The DTR-based reserve was evaluated against DSO approach. In contrast to the DSO approach based on static power limits, the proposed DTR approach is based on C&T and ageing limits. To formalise the approach, we formulated an algorithm that integrates restrictive assumptions on load and T_{amb}. Thus, it is ensured that the obtained reserve is located on the conservative side from a thermal point of view.</p>
C3	<p>It was demonstrated that coupling DTR with DR might further increase the reserve capacity of transformers. To ensure the given reserve margin, we estimated the required amount of DR in terms of kW and kWh. The methodology was formalized in an algorithm and then solved. Moreover, it was shown that while keeping the same ageing limit, the intermittent temperature limit (120 °C) is more advantageous for DTR than a continuous temperature (98 °C). This complements the C1 contribution for DTR modelling, stating that the intermittent temperature limit should be considered.</p>

DTR concept – C4,C5

C4	For the first time, the limit of energy transfer was introduced as a theoretical concept and modelled through existing techniques. This study identified typical characteristics of energy limits such as loading amplitudes and their durations for the city of Tomsk, Russia and Grenoble, France. Furthermore, the highest energy output was estimated for main transformers types per the IEC standard: ONAN, ONAF, OD, and OF. It was revealed that maximal energy transfer corresponds to a specific thermal state of the transformer. Moreover, we showed that thermal inertias have a limited impact on the maximal energy transfer through a transformer. Thus, they can be ignored for the estimation of energy limits.
C5	It was demonstrated that the optimal ageing limit should be determined as the ratio between the remaining insulation life of transformers and their remaining calendar life. Hence, the main situations with different ratios are generalized. Besides, it was shown that a transformer operating at low ageing limits has a relatively higher energy transfer increment in percentage versus high ageing limits. This allows transferring much more energy through the transformer at long term-horizons. Finally, a maximal energy transfer through the transformer is estimated as a function of an ageing limit and calendar life.

Each contribution was presented to the scientific community in journal articles (C1, C3 and C4) and/or conference papers (C2, C4 and C5). Table 4 shows relevant publications where each contributions were published.

Table 4 Main publications with thesis contributions

No	Name of publication	Journal/Conference	Link
C1	Assessment of dynamic transformer rating, considering current and temperature limitations	<i>International Journal of Electrical Power & Energy Systems</i> (IF: 3,588, Q1), 2021	[343]
C2	Application of dynamic transformer ratings to increase the reserve of primary substations for new load interconnection	CIREN conference in Madrid, Spain 2019	[344]
C3	Demand response coupled with a dynamic thermal rating for increased transformer reserve and lifetime	<i>Energies</i> (IF: 2.702, Q2), 2021	[345]
C4	Energy limit of oil-immersed transformers: A concept and its application in different climate conditions	<i>IET Generation, Transmission & Distribution</i> (IF: 2,862, Q1), 2021	[346]
C4, C5	Optimal ageing limit of oil-immersed transformers in flexible power systems	CIREN conference in Geneva, Switzerland 2021	[347]

5. Full list of publications

In total, 5 journal articles and 6 conference papers were prepared during the thesis.

Journal articles:

1. **Ildar Daminov**, Anton Prokhorov, Raphael Caire, Marie-Cécile Alvarez-Herault, "Assessment of dynamic transformer rating, considering current and temperature limitations" in *International Journal of Electrical Power & Energy Systems* (IF: 3,588, Q1), **2021**, <https://doi.org/10.1016/j.ijepes.2021.106886>
2. **Ildar Daminov**, Anton Prokhorov, Raphael Caire, Marie-Cécile Alvarez-Herault, "Energy limit of oil-immersed transformers: A concept and its application in different climate conditions" in *IET Generation, Transmission & Distribution* (IF: 2,862, Q1), **2021**, <https://doi.org/10.1049/gtd2.12036>
3. **Ildar Daminov**, Rémy Rigo-Mariani, Raphael Caire, Anton Prokhorov, Marie-Cécile Alvarez-Herault, "Demand response coupled with a dynamic thermal rating for increased transformer reserve and lifetime" in *Energies* (IF: 2.702, Q2), **2021**, <https://doi.org/10.3390/en14051378>
4. Anne Blavette, Charles-Henri Bonnard, **Ildar Daminov**, Salvy Bourguet, Thomas Soulard, "Upgrading wave energy test sites by including overplanting: a techno-economic analysis" in *IET Renewable Power Generation* (IF: 3.894, Q2), **2021**, <https://doi.org/10.1049/rpg2.12220> [Research was done in parallel with the thesis]
5. **Ildar Daminov**, Anne Blavette, Salvy Bourguet, Hamid Ben Ahmed, Thomas Soulard, Pierre Warlop, "Quantifying the revenue of overplanted offshore wind farms allowing dynamic rating under several production commitment strategies" in *Applied Energy* (IF: 9.746, Q1), **2022**. Under review [Research was conducted in parallel with the thesis]

Conference papers:

1. **Ildar Daminov**, Alexander Sazonov, "Two-stage algorithm to solve the economic dispatch problem with dynamic transformer ratings", in *EGM*, Irkutsk, Russia, **2019**. [Not included in the thesis]
2. **Ildar Daminov**, Anton Prokhorov, Raphael Caire, Marie-Cécile Alvarez-Herault, "Application of dynamic transformer ratings to increase the headroom of primary substations for new load interconnection," in *CIGRE conference*, Madrid, Spain, **2019**.
3. **Ildar Daminov**, Anton Prokhorov, Raphael Caire, Marie-Cécile Alvarez-Herault, "Receding horizon control application for dynamic transformer ratings in a real-time economic dispatch," *IEEE PES Powertech*, Milan, Italy, **2019**. [Not included in the thesis]
4. Charles-Henri Bonnard, Anne Blavette, Salvy Bourguet, **Ildar Daminov** and Thomas Soulard, "Increasing the energy production of a MRE farm considering thermal and techno-economic aspects" in *Symposium de Génie Electrique*, Nantes, France, **2021** [Research was conducted in parallel with the thesis]
5. **Ildar Daminov**, Anton Prokhorov, Raphael Caire, Marie-Cécile Alvarez-Herault, "Optimal ageing limit of oil-immersed transformers in flexible power systems", in *CIGRE conference*, Geneva, Switzerland (held online), **2021**.
6. **Ildar Daminov**, Anne Blavette, Salvy Bourguet, Didier Trichet, Guillaume Wasselynck, Laurent Dupont, Hamid Ben Ahmed, Thomas Soulard, and Pierre Warlop, "Optimal energy management of offshore wind farms considering the combination of overplanting and dynamic rating" in *CIGRE Session, Accepted*, Paris, France, **2022** [Research was done in parallel with the thesis]

6. Thesis outline

The thesis outline is as follows:

- Chapter II: In this chapter, the problem of DTR assessment considering C&T limitations is described. Existing scientific works on this topic are reviewed, and their advantages and drawbacks are discussed. Then, we present a new modelling method for DTR called a feasible region. This feasible region allows modelling the DTR of the transformer without the drawbacks of existing methods. In contrast to existing approaches, the feasible region allows considering the intermittent temperature limit (above the continuous temperature) and multiple shapes of (net) load profiles. We quantify the transformer capacity based on historical ambient temperatures in Tomsk, Russia and Grenoble, France as the case study. Thanks to this analysis, DTR is reassessed against C&T limitations. Also, main limiting factors of transformer loading and their occurrence are identified. Results of such assessment are discussed, and new recommendations for transformer overloading are suggested.
- Chapter III: In this chapter, we introduce the problem of reserve determination and describe the existing methodology of Russian DSO, which traditionally uses power ratings. The methodology is then discussed, and its advantages and drawbacks are identified. Further, we propose a methodology that considers C&T limitations of transformers instead of power ratings. The methodology is then compared with the business-as-usual approach on the example of two primary substations located in Tomsk, Russia. Finally, the results of this simulation are discussed, and relevant conclusions are drawn.

Further, we present the detailed literature review on maximizing transformer utilization using DTR and Demand Response (DR). The drawbacks of existing solutions were analyzed, and research gaps were identified. Next, we introduce the case study, problem statement, and the proposed methodology. The formulation takes the form of an integrated optimization problem for simultaneous DR sizing and management. The proposed methodology represents the algorithm that solves this integrated optimization problem. The simulation of solving this integrated problem was shown on the example of fictional MV/LV substations in Grenoble, France. Simulation results were assessed and discussed.

- Chapter IV: In the first part of this chapter, we answer the question of the physical limit of transformer utilization. In its second part, we discuss the optimal ageing limit of transformers. The first part of the chapter introduces the energy limit of oil-immersed transformers and explains the motivation and future application. Next, we demonstrate how the energy limit could be modelled and quantified in the climates of Tomsk, Russia and Grenoble, France.

In the second part of this chapter, we explain why the ageing limit of oil-immersed transformers may vary as a function of insulation and calendar life. Thus, main combinations of insulation and calendar life are generalized. Once generalization is made, we conduct simulations to determine the optimal ageing limit on the example of a new distribution transformer. Simulations results are then discussed, and relevant conclusions are drawn.

Chapter II

Assessment of Dynamic Transformer Ratings considering C&T limitations

The main hypothesis of this thesis is that the transformer capacity is not fully utilised as it could be per industrial standards. Moreover, the chapter showed that even advanced rating techniques such as DTR have drawbacks that make some available capacity non-utilized. Therefore, it was decided to reassess DTR as the first task of this thesis. Hence, section 1 reminds key findings of Chapter I and especially drawbacks of existing techniques. Further, section 2 suggests a method called “feasible region” to estimate transformer capacity that overcomes identified disadvantages. Altogether, this chapter shows how much transformer capacity may be available for DSO.

The first difference with the existing techniques is that we do not use a continuous winding temperature as a temperature limit of DTR. Instead, we use the C&T limitations given in the IEC loading guide. This allows modelling a DTR based on intermittent temperature limit, which is only partially considered or ignored in similar studies. As a result, this allows us to evaluate the part of transformer capacity, which represents the allowable operation above the design temperatures. Second, a feasible region allows modelling a DTR without using a typical (net) load profile or any load profile at all, as the latter may be different due to massive electrification and DER integration. Thus, a feasible region represents an improved solution for better modelling of DTR, which permits better assessing the transformer capacity.

As a case study, DTR is assessed in different climates: one in Russia (Tomsk city in Siberia) with a cold continental climate and another in France (Grenoble city in the Alps) with a warm temperate climate. In contrast to existing studies, we used multiple combinations of C&T limitations to evaluate the permissible transformer loadings. This allows us to identify the limiting factors of transformer capacity for each C&T limitation. Thus, section 3 presents the results of this analysis and holds a discussion. Finally, DTR reassessment allows formulating recommendations for transformer overloading using C&T limitations. They are summarized in section 4 of this chapter.

Following the philosophy of open science, MATLAB code and data used in DTR modelling are available in open access at GitHub repository.



1. Introduction

Nowadays, the assessment of thermal rating is a relevant problem for engineers and researchers dealing with power system operation and planning. Thermal ratings have a substantial impact on the optimal solution of a power system scheduling [348], a wind power integration [292], [305], [349], a hosting capacity of substations [326], [30],[350] and asset management [351], among many others [352]. Recently, system operators have started managing a power system with a large share of DER [353]. To avoid congestions caused by new DER, system operators have to know the actual thermal ratings of the existing network. This is especially relevant since the lead time of DER is much less than that of network reinforcement [354].

For many years, thermal ratings have been defined in practice as Static Thermal Ratings (STR) [269],[355]. STR is a constant limit, expressed in units of current or power (or their per units) [356] and usually calculated for daily-mean ambient temperature (T_{amb}). For instance, Table 5 shows the STR of power transformers used in Russia [357]. Similar STRs are used in other countries.

Table 5 STR of power transformer as a function of daily mean T_{amb}

Mean T_{amb} , °C	-20	-10	0	+10	+20	+30	+40
STR, pu	1.2	1.2	1.15	1.08	1	0.91	0.82

Despite the long history of using STR, it has been repeatedly proven that STR is only a rough approximation of true thermal ratings [290], [292], [358], [359]. This is explained by the fact that STR does not consider both the shapes of T_{amb} and load profile. Consequently, many scientists investigated Dynamic Thermal Rating (DTR) [171], [229], [290], [292], [360]–[362]. DTR represents a daily profile of admissible loadings, expressed either by current or power limits (or their per units). DTR is usually higher than STR, but DTR can be set lower than STR for hot ambient conditions to avoid the network equipment overheating and/or mechanical damage.

So far, DTR is investigated for all network equipment [179]: power and distribution transformers [171], overhead lines [356], [363], [364] and power cables [365]. Nevertheless, we focus on the DTR of oil-immersed transformers because, unlike other network elements, the transformer may exceed their continuous temperatures during a normal operation. To ensure safe operation, especially above nominal rating, the transformer must meet its C&T limitations [91]. As mentioned in chapter I, these limitations are usually set for the current, hot spot temperature (HST) of a winding and top-oil temperature (TOT) in the tank. For instance, Table 6 shows C&T limitations for normal cyclic loading (i.e. without accelerated ageing) in international and Russian standards.

Table 6 C&T limitations in IEC/IEEE and national standards of Russia

Limiting parameters	International		National (Russian)		
	IEC [91]	IEEE [68]	STO [357]	GOST [366]	GOST [367]
Current, pu	1.5	2	-	1.5	1.5
HST, °C	120	120	138	140	140
TOT, °C	105	105	105	95	105

Although industrial standards adopted C&T limitations long ago, many scientists still define DTR using a continuous HST as a temperature limit [146], [176], [179], [312],[238], [292]. As mentioned in chapter I, the continuous HST equals 98 °C for non-thermally upgraded paper and 110 °C for TUP. As a reminder, using continuous temperatures as a temperature limit was axiomatic in the first half of the 20th century. However, since the second half of the 20th century, loading guides have allowed transformers to exceed these continuous temperatures for a short time [55]. However, to prevent the immediate fault of transformers, it is necessary to keep the operating HST below the HST limit. Thus, two visions of DTR exist in the transformer community, one based on the continuous HST [187] and another based on the intermittent HST limit [54].

Although two visions on DTR exist, none of the papers above estimates DTR following them simultaneously. Mainly all papers [146], [176], [179], [312] consider DTR based on continuous HST only, whereas DTR based on HST limit is omitted. In other words, many papers do not consider the intermittent temperature limit. Therefore, it can be concluded that an actual DTR capability is not fully revealed. Meanwhile, the papers [177], [173] estimating DTR based on temperature limit does not consider current limitations. The lack of a current limit makes the DTR estimation incomplete from an industrial standards point of view. The study [306] uses the normal ageing limit as a criterion for DTR determination but not temperature limitations. Thus, no study mentioned above investigates DTR per C&T limitations simultaneously.

The use of not-complete C&T limits (e.g. only HST limits but not those of current or oil) may lead to the inaccurate estimation of DTR. This is because the limiting factor of DTR can shift between C&T limits. For example, the following extract from IEC 60076-7:2005 describes this problem:

“Current and temperature limits are not intended to be valid simultaneously. The current may be limited to a lower value to meet the temperature limitation requirement. Conversely, the temperature may be limited to a lower value in order to meet the current limitation requirement”.

Consequently, DTR estimation (in power units) from a C&T perspective may be challengeable and not evident. Furthermore, it is less obvious if various C&T limitations are used (Table 6). Thus, in this chapter, DTR is estimated for different C&T limitations because multiple C&T limitations ensure various permissible loadings. Hence, DTR is assessed for various C&T limits as the first problem in this chapter.

To ensure that DTR estimation is representative, it is necessary to use long-term data (not a few days or weeks) encompassing various ambient temperature conditions. However, only a few studies estimate transformer limits over a long-term period but not all C&T are considered there. For instance, the authors of [176] estimate the loadability of the ONAF power transformer for a typical load profile and 30-year monthly-mean T_{amb} in Turkey. Another study [173] evaluates the permissible overloading of power transformers in Greece. In [146], the authors estimate DTR for ONAN power transformer based on the annual T_{amb} in the United Kingdom. The one-year DTR benefits are studied in [179] for ONAN and OFAF power transformers in Milton Keynes, United Kingdom. The paper [167] assesses peak-load transformer capability based on three months hour T_{amb} and load data in Manitoba, Canada. The data-driven approach is suggested in [177] to estimate residential transformer overloading based on a two-year T_{amb} in West Canada. The same authors [306] applied a data-driven approach to determine DTR based on 5-years data in Canada. In addition, the paper

[312] investigates the loadability of the ONAN power transformer in Egypt based on the mean-daily T_{amb} at each month.

The second problem of this chapter is the role of a typical load profile in estimating DTR. Many papers [76], [80], [85], [167], [176], [177], [185], [295], [314], [315] assume a typical load profile shape and upscale this shape until temperature limits are met. The upscaled shape of the load profile is then considered as DTR. We believe that the assumption of a typical load profile becomes outdated in the era of smart grids. In the past, typical load profiles were relevant since DSO could not actively control the shape of the load profile, and DER share could not affect this load shape. However, the fast integration of DER into the distribution network changes the shape of typical load profiles. Thus, a load profile of consumers is not a reference for transformers anymore but a net load profile, whose shape is determined by DER and load.

Whatever a (net) load profile is given, DSO may change the shape of (net) load profile, using controllable DER: distributed generation, storage and demand response [22], [205], [235], [237], [269], [317]. Aggregators, a new market player, already provide such services to DSO [319],[320]. This poses another problem for the estimation of DTR: DTR should not target a single typical (net) load profile but multiple possible (net) load profiles. Next section suggests a solution considering both intermittent temperature limit and many load profiles for DTR assessment.

2. Feasible region of transformer loadings

The term “feasible region” is introduced to consider admissible loadings per C&T limitations. It is taken from the mathematical optimization area [368]. Generally, the feasible region represents a set of all possible solutions of an optimization problem satisfying all given constraints. In the case of a daily transformer loading, these constraints are C&T limitations (Table 6). However, drawing a DTR feasible region in one x-y axis is impossible because their limitations are given in different physical units: pu (or A) for current and °C for temperature. Thus, temperature limitations should also be presented in A/MVA or pu. Before harmonizing the units, it is necessary to know the thermal characteristics of the given transformer. In this study, the thermal characteristics of the ONAF transformer are taken from the IEC standard [91],[369] (see Table 7).

Table 7 Thermal characteristics of ONAF power transformer (≤ 100 MVA)

Oil exponent, no unit	x	0.8	Design ambient temperature, °C	θ_a	20
Winding exponent, no unit	y	1.3	Hot-spot to the top-oil gradient at rated current, K	$\Delta\theta_{hr}$	35
Loss ratio, no unit	R	8	Top-oil temperature rise, K	$\Delta\theta_{or}$	45
Oil time constant, min	τ_o	150	Thermal constant, no unit	k_{11}	0.5
Winding time constant, min	τ_w	7	Thermal constant, no unit	k_{21}	2
Design hot spot temperature, °C	θ_h	98	Thermal constant, no unit	k_{22}	2

To convert temperature limitations into equivalent loading limits, it is necessary to build dependencies between the steady-state loading and T_{amb} (Figure 14). For constructing this dependency, we use 120 °C/140 °C as HST limit and 95 °C/105 °C as TOT limit because many industrial standards suggest these values. Keeping the temperatures within these limits ensures the safe operation of power transformer as discussed in section 2.1.1 of Chapter I.

Also, we keep always 1.5 pu as a current limit because the IEC standard suggests it for medium and small transformers. These transformers are usually installed in distribution networks where our attention is focused. In general, it is believed [196] that mechanical forces in the windings remain acceptable for the current limit of 1.5 pu. However, note that the current limit may be reduced if associated or auxiliary equipment has more restrictive limitations than the transformer

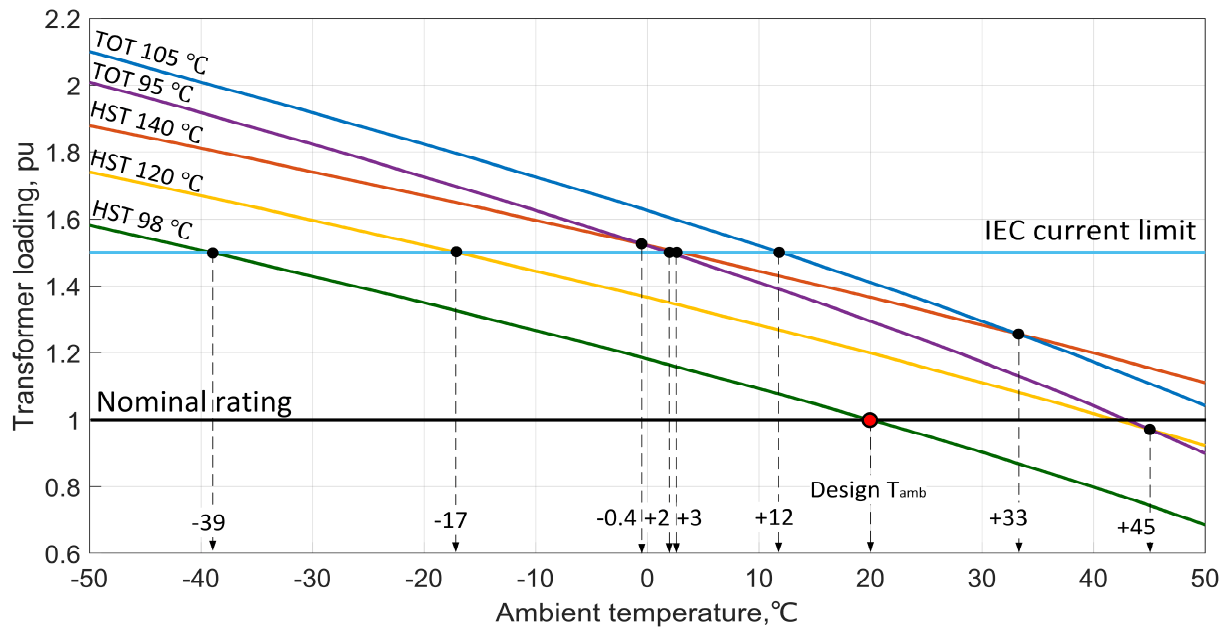

Figure 14 Transformer loadings equal to HST and TOT limits as a function of T_{amb}

To draw each line in Figure 14, one can use an algorithm shown below:

Algorithm: Building the dependencies between loading and T_{amb} :

Input:

- 1) Vector of T_{amb} [-50 °C...+50 °C];
- 2) Transformer thermal characteristics (Table 7);
- 3) HST limits [98°C 120 °C 140 °C] and TOT limits [95 °C 105 °C];
- 4) Horizon = 24 hours;

% The drawing the Loading – T_{amb} dependency:

for each value from T_{amb} vector [-50 °C ...+50 °C]

set T_{amb} = const and Loading = 0.01 pu during 24 hours;

% Calculating the Loading breaking the temperature limit

while $HST \leq HST$ limit and $TOT \leq TOT$ limit

 Loading = Loading + Δ , where Δ is any small value;

calculate HST and TOT by IEC 60076-7 (difference method) for given Loading and T_{amb} ;

end

save Loading reaching the temperature limit;

end

plot (Vector of T_{amb} as x-axis and Loadings as y-axis)

The reader may note that lines, representing the temperature limitations, cross each other at different T_{amb} (see black dots in Figure 14). Depending on the chosen HST and TOT limits, the transformer's loading at given T_{amb} range would be limited by the lowest line belonging either to the current or to the temperature of winding or oil. Figure 15 shows limiting factors using horizontal bars plotted as a function of T_{amb} (x-axis in Figure 15). The colour of each bar represents a limiting factor (the lowest line) at a given T_{amb} range.

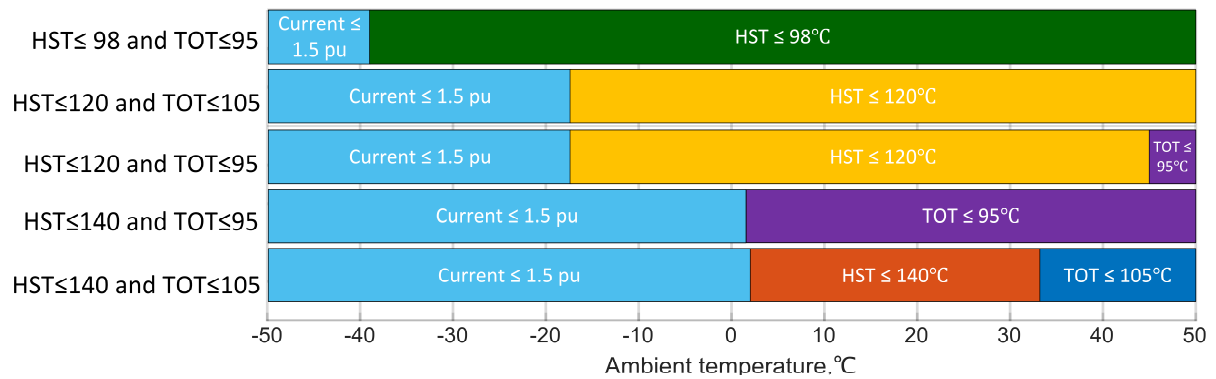

Figure 15 Limiting factors in the range of T_{amb}

For instance, let us understand how the third section (horizontal bars for $HST \leq 120^\circ C$ & $TOT \leq 95^\circ C$) is constructed. First, it is necessary to see how in Figure 14 the yellow line ($HST = 120^\circ C$) crosses the current limit (at $T_{amb} -17^\circ C$) and $TOT = 95^\circ C$ (at $T_{amb} +45^\circ C$). The lowest line between two crossing ones corresponds to the limiting factor at the given T_{amb} range. This means that:

- for $T_{amb} \in [-50^\circ C; -17^\circ C]$, the current limit of 1.5 pu is the limiting factor (a blue bar at the left of Figure 15)
- for $T_{amb} \in [-17^\circ C; +45^\circ C]$, the $HST = 120^\circ C$ is the limiting factor (yellow bar in the middle of Figure 15)
- for $T_{amb} \in [+45^\circ C; +50^\circ C]$, the $TOT = 95^\circ C$ is the limiting factor (purple bar at the right of Figure 15).

It is essential to highlight that Figure 14 and Figure 15 are drawn for a studied ONAF power transformer (whose characteristics are given in Table 7). Due to other design variations, ONAF transformers can have distinct critical T_{amb} (black dots). For a studied ONAF transformer, it is possible to build a feasible region for a given T_{amb} profile (explanations will be discussed later in section 2). Figure 16 shows a feasible region calculated for a T_{amb} profile shown in the same figure. Loading limits of this feasible region correspond to C&T limits [91] for medium transformers: $Current \leq 1.5$ pu, $HST \leq 120^\circ C$ & $TOT \leq 105^\circ C$.

To build a feasible region, it is necessary to independently plot loadings limits corresponding to chosen C&T limitations. This means that for each given value of the T_{amb} profile in Figure 16, one should find a loading corresponding to given HST and TOT limits in Figure 14. For example, let us take a $9^\circ C$ - a T_{amb} at midnight in Figure 16. Hence, the transformer loading for $T_{amb} = 9^\circ C$ equals 1.5 pu, 1.3 pu, and 1.53 pu (estimated from Figure 14) for current, HST and TOT limitations correspondingly. Once such loading is found for each T_{amb} in Figure 16, it is possible to finally plot three power lines corresponding to C&T limits during the whole day. The lowest values (fully corresponding to the HST line in this example) are considered the feasible region's top line. This is because the HST limit is reached earlier than the current and TOT limit. Thus, the HST limit is a limiting factor for DTR for the given T_{amb} profile.

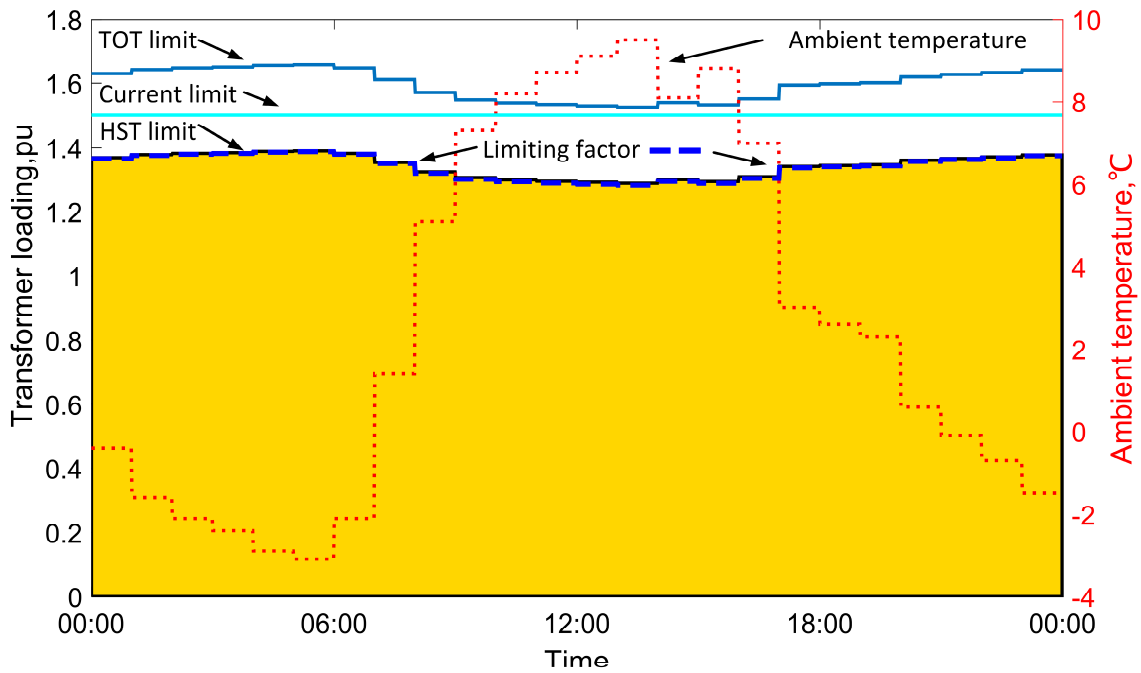

Figure 16 Feasible region (the yellow area) for given C&T limits

It would be useful to define a part of this feasible region that causes the normal insulation ageing (i.e. DTR based on continuous HST). Therefore, a line (loadings) corresponding to the continuous HST = 98 °C was added (its calculation is similar to the HST limit). The green colour shows the area below this new line. The part above this new line remains yellow (Figure 17).

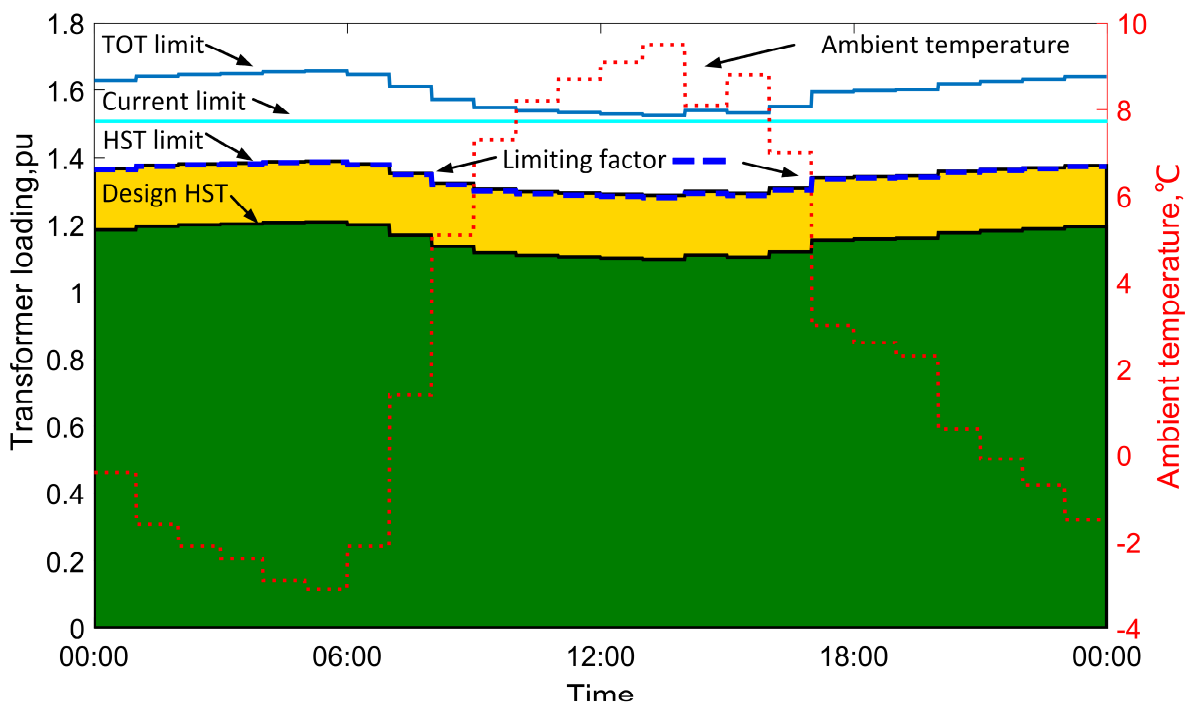

Figure 17 The same feasible region, but showing the loadings with normal ageing (green area)

Thus, the green area represents DTR based on a continuous HST. In contrast, the yellow area represents DTR based on the HST limit. In this example, the difference between two DTRs is always around 0.2 pu, i.e. 20 % of the nominal rating. In other words, DTR based on the continuous HST neglects about 20 % of actual transformer capacity for this example.

Once the construction of the feasible region is explained, it is necessary to discuss the insulation ageing issue in the feasible region. As the reader may note, a feasible region is based on C&T limitations only, i.e. amplitudes limits. This means accelerated ageing is possible if transformer loadings exceed the green area (the continuous HST). Nevertheless, the IEC standard clarifies accelerated ageing as follows:

“This is not serious if there are otherwise long periods (usually the case) at relatively low hot-spot temperatures”.

This quote refers to the example given in the IEC standard, where cumulative ageing during 2 hours exceeds the normal ageing 74 times! In other words, for two calendar hours, a transformer has lost the insulation resource equivalent to 6 days of normal operation ($=\frac{2h \times 74}{24h}$). Indeed, such a high ageing rate in one day can be compensated by low ageing rates in other days, weeks or months.

Note that IEC suggested this assumption when DSO cannot actively control the shape of load profiles. However, nowadays, DSO may maintain a necessary loading profile thanks to flexibility. Therefore, this IEC assumption becomes even more realistic. Thus, the proposed feasible region is explicitly determined for C&T limitations and implicitly for ageing. More details on dealing with accelerated ageing are presented in Section 4.

Once ageing effects are explained, it is necessary to justify the borders of the feasible region, which are based on steady-state loadings (Figure 14). To do that, the reader should address Figure 18, showing the interrelations (circles 1-4) between representative loadings (left side) and their temperatures (right side).

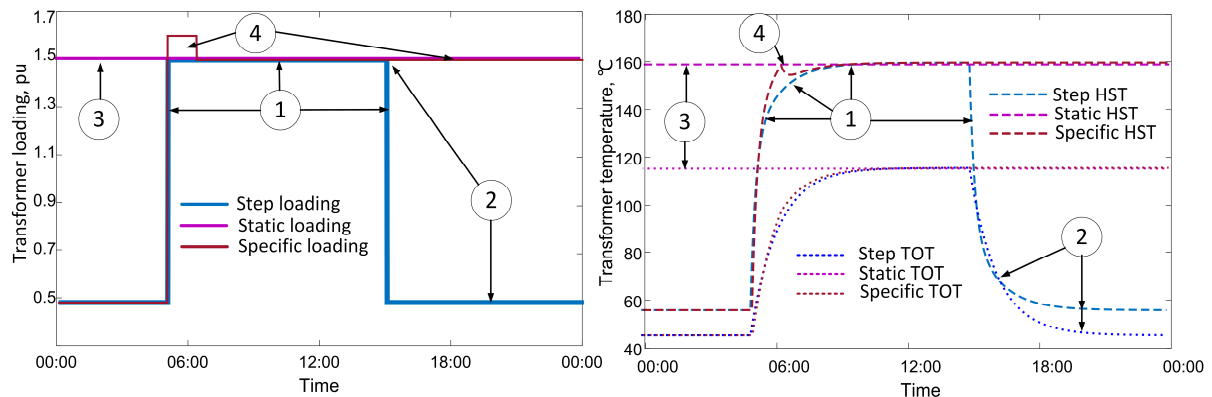

Figure 18 Interrelations between transformer loading and temperatures

The reader may notice that while the blue load steps up, the transient blue temperatures (circle 1) reach a steady-state value (purple lines, circle 3) without exceeding it. This interrelation allows us to formulate a meaningful conclusion. If loadings are consistently below the steady-state loading, then transient temperatures are also below their steady-state temperature. Therefore, load profiles should not exceed the continuous HST if located in the green area as steady-state limits bound the latter. Similarly, a load profile does not violate the HST limit if its loadings are located in the yellow area.

However, the green area in Figure 17 should be considered without accelerated ageing only for the load profiles entirely located within the green zone. Otherwise, suppose a part of a load profile is located in the yellow area. In that case, the green area may not be referred to as the area without accelerated ageing. Let us explain why: circle 2 in Figure 18 shows that

even if the load may be instantaneously reduced, the temperatures take time to reduce to a new steady-state value. Thus, the transient temperature could be still in yellow areas even if a loading had already returned to the green area. While the temperature is reducing to a steady-state value, the ageing will be accelerated because the temperature would be still higher than the continuous temperature. Although this interrelation affects ageing, it should be highlighted that it does not affect the feasible region of the current or HST limit. Therefore, the suggested feasible region is still valid for C&T limitations.

There is a specific load profile(s) whose loading may be higher than steady-state DTR (brown line in Figure 18). However, transient temperatures of such load profiles still remain below the steady-state temperature (see circle 4). Therefore, it can be concluded that the feasible region, obtained earlier in Figure 17, can be even higher in terms of loadings. Nevertheless, it seems that such a load profile can exist only under thorough control of transformer loadings. For instance, it is necessary to reduce a transformer loading just after its HST reaches its steady-state limit. Therefore, such load profiles are advantageous for short-term planning [370],[371]. Thus, they can be neglected in the suggested feasible region. Moreover, this neglecting reduces a feasible region that allows estimating the DTR with margin.

Previous paragraphs concluded that the feasible region encompasses multiple load profiles, not only one single load profile as done in other studies. This means that the feasible region approximately considers various load profiles, especially those exceeding continuous temperatures. However, note that the amplitude of unique load profiles may theoretically exceed the top line of feasible region (see point 4 in Figure 18). This allows considering the feasible region as a conservative estimation. It would also be essential to highlight that the permissible loading of some load profiles may be less than the top line of the feasible region. This may be due to ageing, but this accelerated ageing can be compensated later or earlier whose vision is currently adopted in industrial standards. Therefore, such load profiles remain always feasible from an amplitude point of view.

Summarizing above-mentioned results:

- ❖ All load profiles located in the green area only are always feasible for both normal ageing and C&T limitations.
- ❖ All load profiles located only in the yellow area are always not feasible for normal ageing but feasible for C&T limitations.
- ❖ Some load profiles, located in green and yellow area, could be either feasible or infeasible from ageing point of view but always feasible for C&T limitations.
- ❖ Some load profiles, exceeding the top line of feasible region, may still be feasible for C&T limitation and potentially feasible for ageing.

Thus, a feasible region always complies with C&T limitations.

2.1 Examples of feasible regions with different limiting factors

In this section, feasible regions with different limiting factors are described. At least six possible combinations of limiting factors can be identified: 1. Current only; 2. HST only; 3. TOT only; 4. Current + HST; 5. HST + TOT; 6. Current + TOT. Case 2 (HST only) was already presented in Figure 17. Thus, the main examples of feasible regions in this section are presented (case 1, 3, 4).

Current limit only: Figure 19 shows a feasible region built for C&T limitations: Current ≤ 1.5 pu, HST ≤ 120 °C & TOT ≤ 105 °C and for T_{amb} profile on January 11, 2019, in Tomsk, Russia.

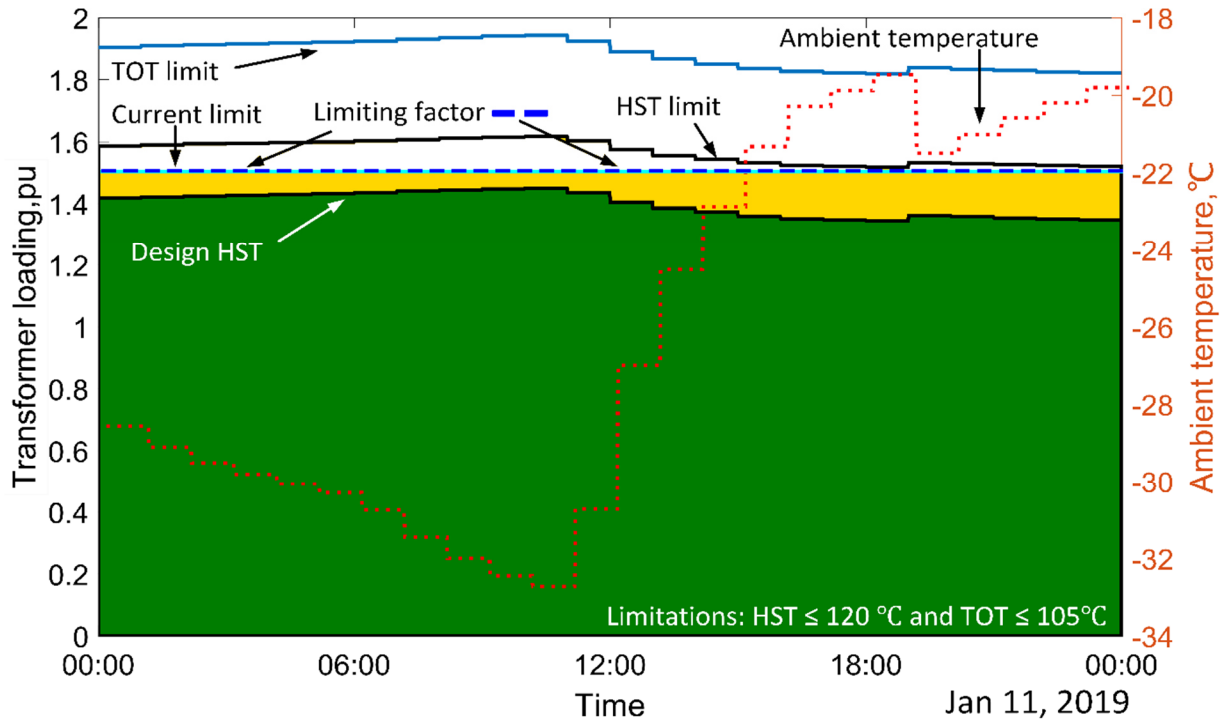

Figure 19 Feasible region limited by the current only

The top line of the feasible region (the dashed line) corresponds to the current limit. To explain why the current is a limiting factor, the reader should compare the given T_{amb} profile with the range of the T_{amb} (x-axis in Figure 14) corresponding to current and HST limit = 120 °C. In Figure 14, we see that the current limit remains a limiting factor for T_{amb} below -17 °C. At the same time, given T_{amb} profile (varying between -19 °C and -33 °C) remains lower than this critical T_{amb} . That is why the current limit remains a limiting factor for the given T_{amb} profile all day long.

TOT limit only: Figure 20 shows a feasible region for limitations HST ≤ 140 °C & TOT ≤ 95 °C and T_{amb} profile on July 07, 2018, in Grenoble, France. For the given C&T limitations, the TOT limit (95 °C) is a limiting factor for $T_{amb} > +2$ °C (see Figure 14). At the same time, the T_{amb} profile in Figure 20 varies between $+10$ °C and $+18$ °C, which is higher than this critical T_{amb} . Thus, this explains why TOT is a limiting factor.

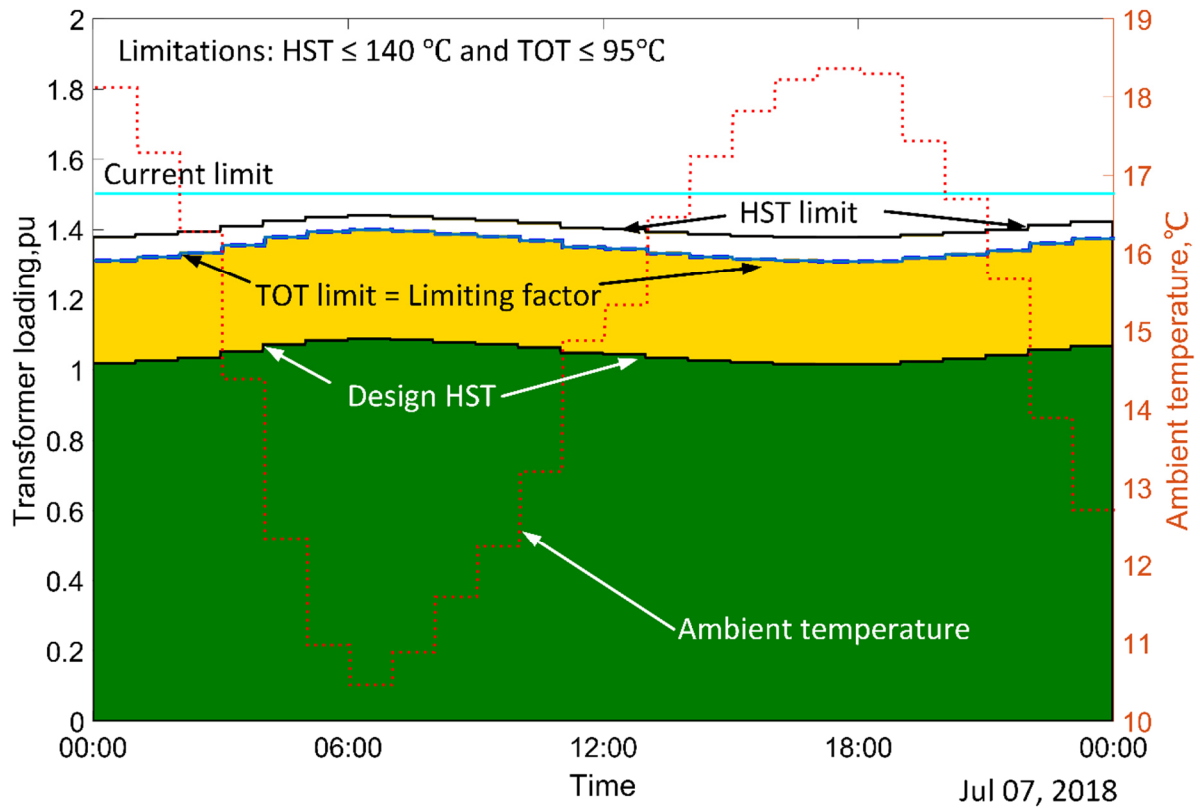

Figure 20 Feasible region limited by the TOT only

Current+HST limit: Figure 21 shows a feasible region for HST limit $\leq 120^{\circ}\text{C}$ & TOT limit $\leq 105^{\circ}\text{C}$ and T_{amb} profile in Tomsk on January 15, 2019. Figure 21 shows that once T_{amb} crosses the critical $T_{\text{amb}} = -17^{\circ}\text{C}$ (Figure 14), the limiting factor shifts from current = 1.5 pu to HST limit = 120°C .

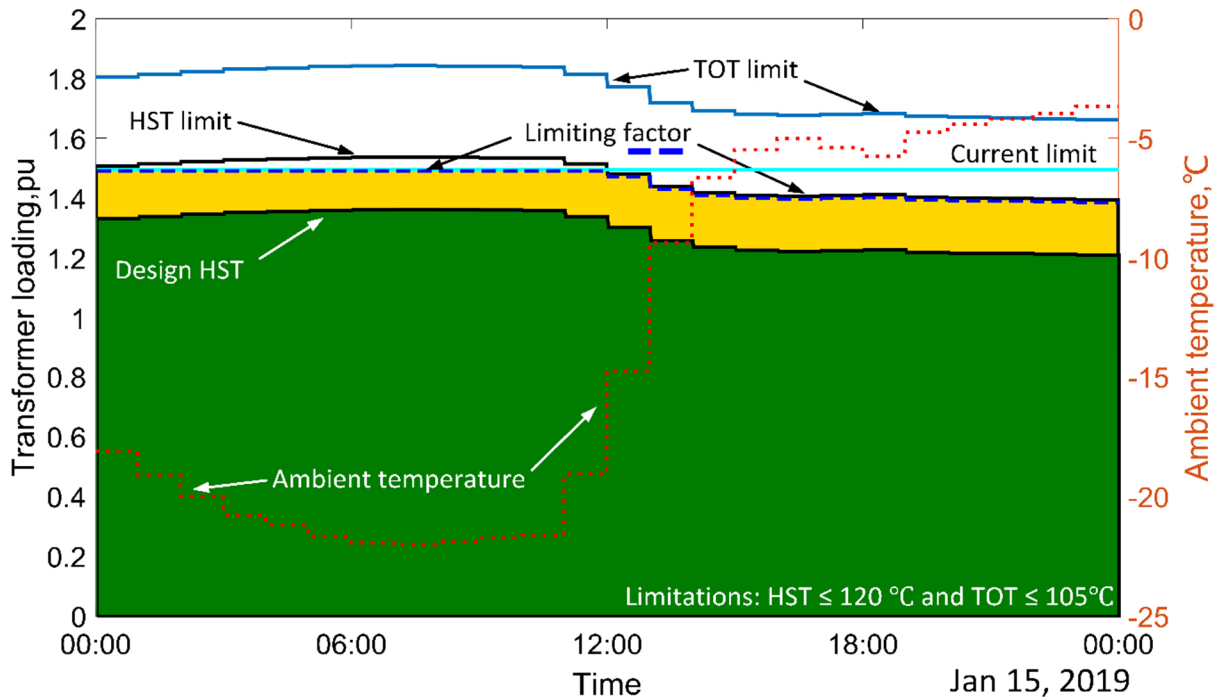

Figure 21 Feasible region limited by current and HST

3 Assessment of dynamic transformer ratings

This section provides the results of the DTR assessment in Tomsk and Grenoble. As mentioned in section 1, DTR estimations should be based on long-term data of T_{amb} in each geographical area. For instance, climate science recommends considering at least a 30-year-long interval to obtain representative results [372]. Therefore, the case study is based on the hour T_{amb} for the 34 years from January 01, 1985 (the data availability) to March 29, 2019 (the time of data downloading) in Tomsk, Russia and Grenoble, France (Figure 22) [373].

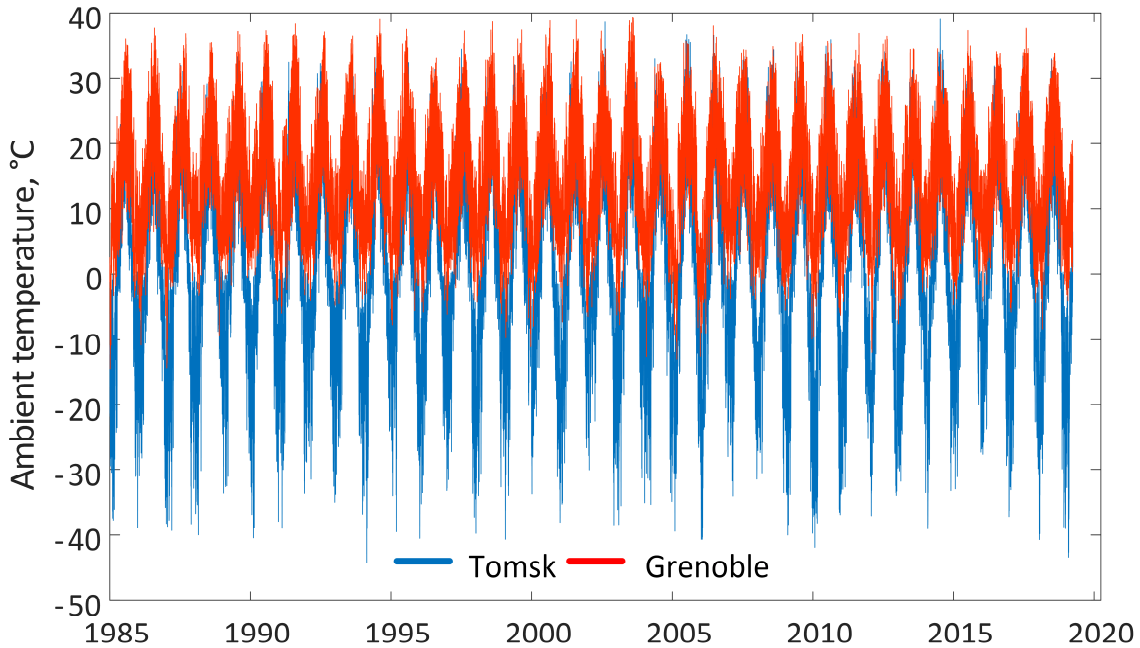

Figure 22 Hourly T_{amb} from 1985 to 2019 in Tomsk, Russia and Grenoble, France. Source: MeteoBlue

Figure 22 encompasses 12 506 daily T_{amb} profiles with an hour resolution in each city. For these T_{amb} profiles, it is possible to define 12 506 daily feasible regions corresponding to different combinations of C&T limitations (Figure 23). In Figure 23, the yellow area is reserved for the HST limit only as in Figure 17. In contrast, the top line of the feasible region in Figure 23 corresponds to the black line. Figure 23 allows seeing that the black line shape (a limiting factor) of these feasible regions is variable. To quantify this DTR variability, mean DTR and its maximum and minimum deviations are estimated for the given (the most common) formulations of C&T limitations. (Figure 24).

■ TOT limit
 ■ HST limit
 ■ Design HST
 — Current limit
 — Limiting factor

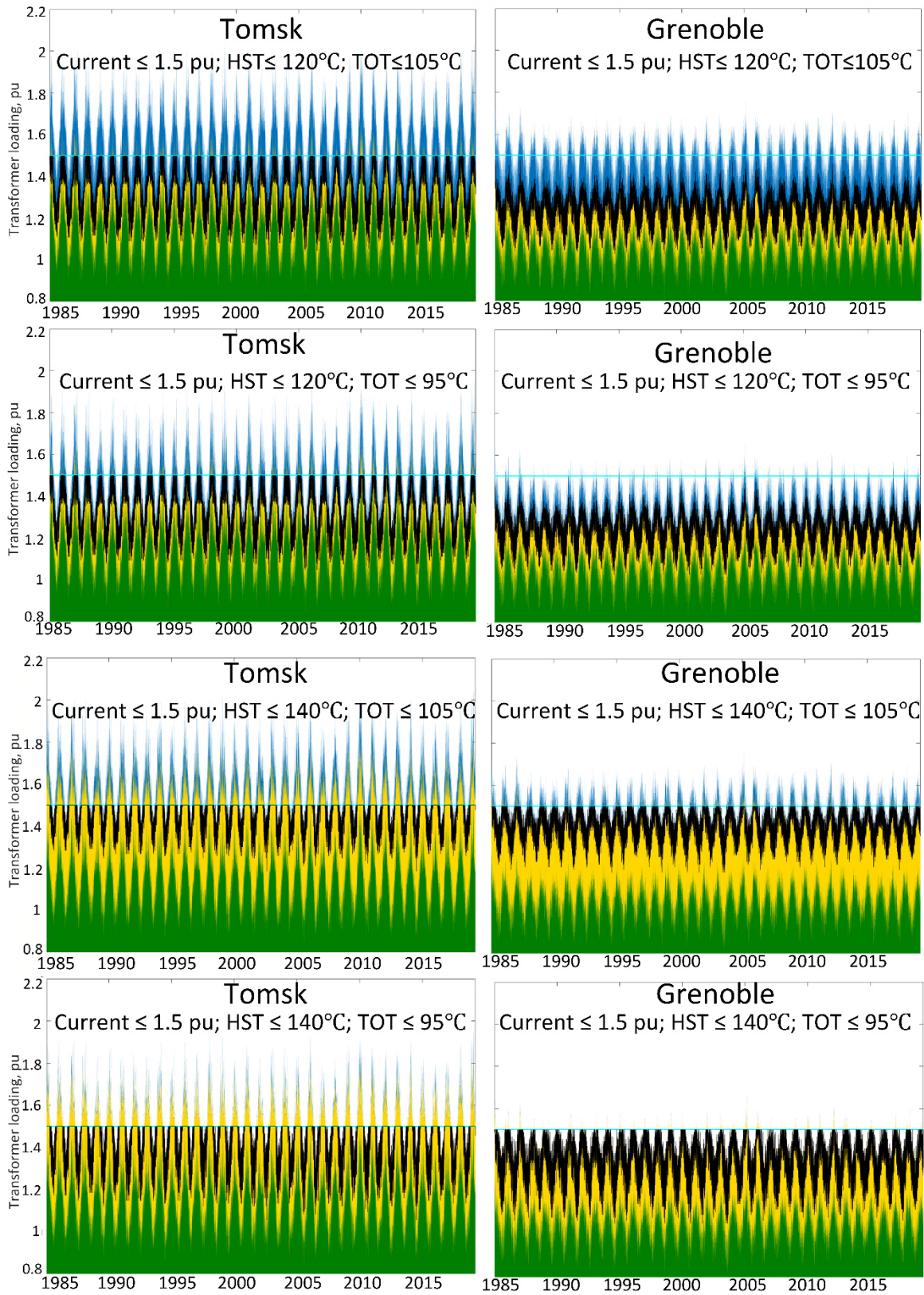

Figure 23 Estimation of feasible regions during 34 years

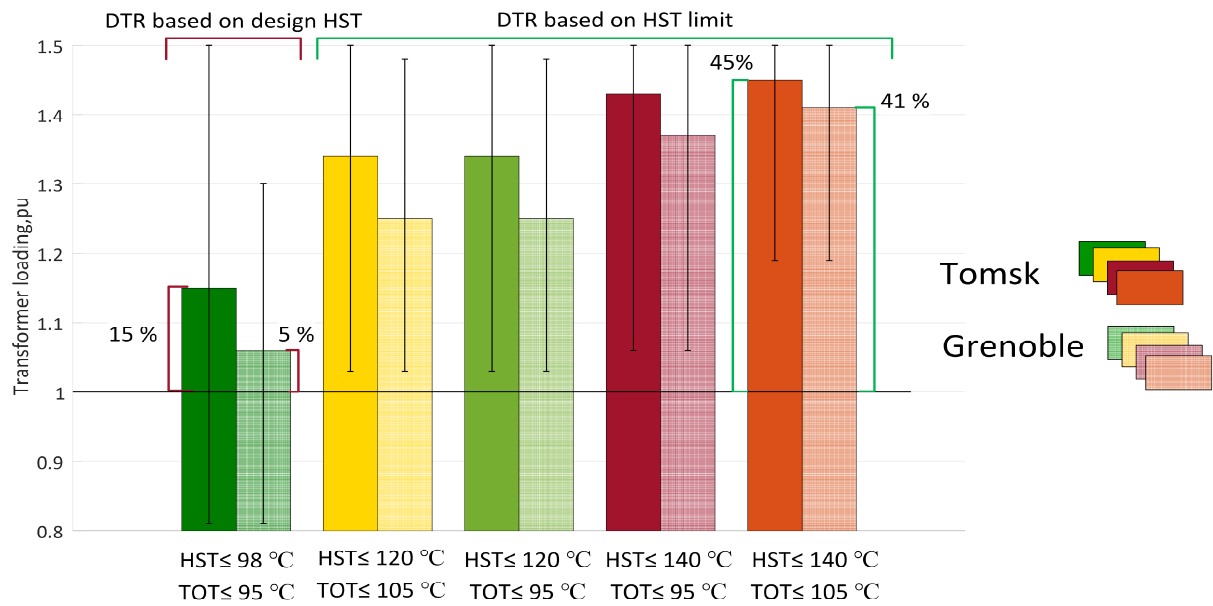

Figure 24 Mean DTR with maximum and minimum deviations during 34 years

Table 8 Numerical data from Figure 24

Loadings	C&T limitations									
	Load ≤ 1.5 pu									
	HST ≤ 98 °C		HST ≤ 120 °C		HST ≤ 120 °C		HST ≤ 140 °C		HST ≤ 140 °C	
	TOT ≤ 95 °C	TOT ≤ 105 °C	TOT ≤ 105 °C	TOT ≤ 95 °C	TOT ≤ 95 °C	TOT ≤ 95 °C	TOT ≤ 95 °C	TOT ≤ 95 °C	TOT ≤ 105 °C	TOT ≤ 105 °C
High	1.5	1.3	1.5	1.48	1.5	1.48	1.5	1.5	1.5	1.5
Mean	1.15	1.06	1.34	1.25	1.34	1.25	1.43	1.37	1.45	1.41
Low	0.81	0.81	1.03	1.03	1.03	1.03	1.06	1.06	1.19	1.19
City*	T	G	T	G	T	G	T	G	T	G

* T- Tomsk and G - Grenoble

The bars in Figure 24 estimate DTR, based on continuous or design HST (the dark green bar) and DTR, based on C&T limits (other bars). Note that many papers estimate DTR using the continuous HST only (dark green bars). This allows scientists to avoid problems with accelerated ageing, which is an advantage. However, as a drawback, they ignore a substantial part of DTR, confined by C&T limitations. For instance, in [146], [179], [219], authors estimated that DTR provides 6%-10% additional transformer capacity in the United Kingdom. This correlates with our dark green bars, showing that the mean DTR delivers 15 % of extra power over nominal rating in Tomsk Russia and 6% in Grenoble France. Similar results are obtained in [178],[303], where the capacity of power transformers is estimated up to 10% above the nameplate rating.

Nevertheless, as shown in Figure 24, using C&T limits can ensure up to 45 % of additional transformers capacity in Tomsk and 41% in Grenoble. This is around 30-35 % more power than DTR, based on the continuous HST (dark green bars). Our estimation is also higher than the similar evaluation for Greece (using 140 °C-HST limit and a typical load profile), where permissible overloading was from 21 to 29 % above nameplate ratings [173].

It is noteworthy that this additional power leads to transformer operation at the increased HST. However, DSO may use the flexibility from DER to control this load amplitude and

duration. Hence, DTR coupled with DER management provides additional freedom for system operators in power systems operation. At the same time, this degree of freedom may change during a year following DTR seasonal variations. Therefore, it was decided to estimate DTR for all C&T limitations per month (Figure 25)

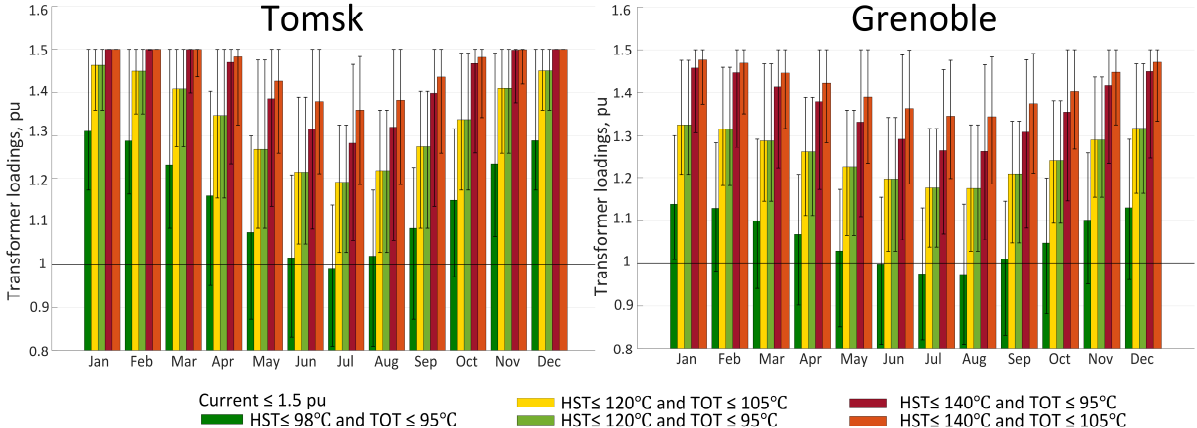

Figure 25 Mean DTR with maximum and minimum deviations in each month

Figure 25 shows that dark green bars (DTR based on the continuous HST) exceed the nominal rating of the transformer during almost all months. However, in the summer months, such DTR should be set lower than the nominal rating to avoid the violation of the continuous HST. As mentioned earlier, the dark green bars are a classic example of DTR, studied in many papers [146], [179]. However, these papers do not consider other bars shown in Figure 25. This leads to a very conservative estimation of DTR.

It is necessary to explain some particular bars in Figure 25. For instance, yellow and light green bars are always equal in both cities. This means that the HST limit = 120 °C is always reached before the TOT limit (95 °C or 105 °C) in both climates. This happens since the T_{amb} in studied cities is always below than critical $T_{amb} + 45$ °C shown in Figure 14. Hence, HST remains the unique limiting factor for these two C&T limitations.

Moreover, the reader can notice that red and orange bars in Tomsk do not have any deviations in the winter months. This means that the current limit is always reached earlier than temperature limits. Thus, bars whose loading equals 1.5 pu are current-limited, and bars below 1.5 pu are temperature-limited. Therefore, Figure 25 is an example showing how the limiting factor may shift between current to temperature during the year. Thus, Figure 25 represents an example of how different C&T limits pre-define the amplitude of DTR.

In addition to DTR amplitude (bars in Figure 25), it is necessary to estimate DTR duration. Typical DTR duration curves in Tomsk and Grenoble are presented in Figure 26. Therefore, Figure 26 shows how different C&T limits pre-define the duration of DTR.

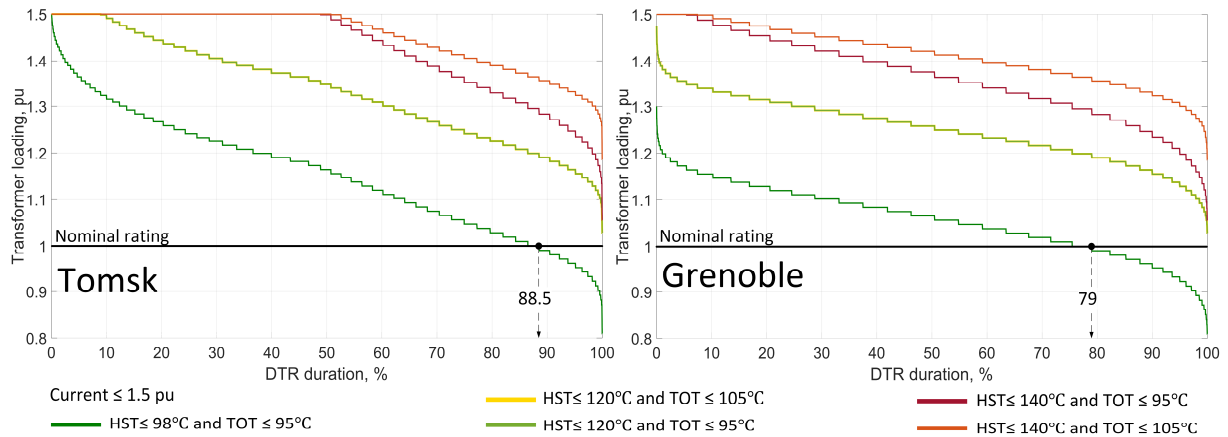

Figure 26 DTR duration curves of the same ONAF transformer in Tomsk and Grenoble

To find such a duration curve, it is necessary to sort all values of the DTR profile in descending order. This gives us the y-data of Figure 26. DTR duration (x-axis) is obtained as follows:

$$Duration(1: end) = \frac{N(1: end)}{N(end)} \times 100\% \quad (8)$$

Where N – a numerical order of y-data (DTR sorted in descending order).

X-axis shows the amount of time (in %) when DTR exceeds the value selected on the duration curve. For instance, the classical DTR (dark green curve) exceeds a nominal rating of a transformer for 88,5 % of the time in Tomsk and 79 % of the time in Grenoble. However, this also means that the classical DTR is below the nominal rating during 11.5% and 21 % of the time. This result correlates with the conclusions of many authors, stating that DTR can be below the nominal rating for a short period [146], [179]. Meanwhile, duration curves of DTRs based on the HST limit remain higher than the nominal rating for 100 % of the time in both cities. These results quantify DTR duration based on C&T limits, which is often ignored in similar studies.

Finally, the main limiting factor of DTR can be identified for Tomsk, Russia and Grenoble, France. The easiest way to do that is to take a T_{amb} history in each city and see the limiting factor for each T_{amb} range in Figure 14. For instance, let us assume that T_{amb} is $-10\text{ }^{\circ}\text{C}$, and DTR formulation is $\text{current} \leq 1.5\text{ pu}$, $\text{HST} \leq 120\text{ }^{\circ}\text{C}$ and $\text{TOT} \leq 105\text{ }^{\circ}\text{C}$. For this T_{amb} , the limiting factor is the $\text{HST} = 120\text{ }^{\circ}\text{C}$ (see Figure 14). Figure 27 shows limiting factors and their occurrence expressed in % of the studied period. Pie chart colours correspond to the colours of lines in Figure 14.

Let us come back to our discussion that some papers [324]–[326] assume HST as a primary limiting factor. For instance, Figure 27 shows that DTR based on the continuous temperature has HST as a limiting factor 99,9 % of the time in Tomsk and 100% in Grenoble. Indeed, current or TOT limits do not affect the limiting factor of a studied ONAF transformer, whatever the climate is chosen. However, suppose one uses a higher (intermittent) HST and TOT limit. In that case, the current becomes a primary limiting factor from 9% to 51 % in Tomsk.

It is necessary to emphasize that the HST is no longer a limiting factor for formulation: $\text{current} \leq 1.5\text{ pu}$, $\text{HST} \leq 140\text{ }^{\circ}\text{C}$ and $\text{TOT} \leq 95\text{ }^{\circ}\text{C}$. Therefore, the assumption that HST is always a limiting factor can be fully and partially valid for other formulations but also very wrong for $\text{current} \leq 1.5\text{ pu}$, $\text{HST} \leq 140\text{ }^{\circ}\text{C}$, and $\text{TOT} \leq 95\text{ }^{\circ}\text{C}$. Therefore, it is necessary address a limiting factor

cautiously as the latter depends on chosen C&T limits, T_{amb} in a given location, and the thermal characteristics of the transformer.

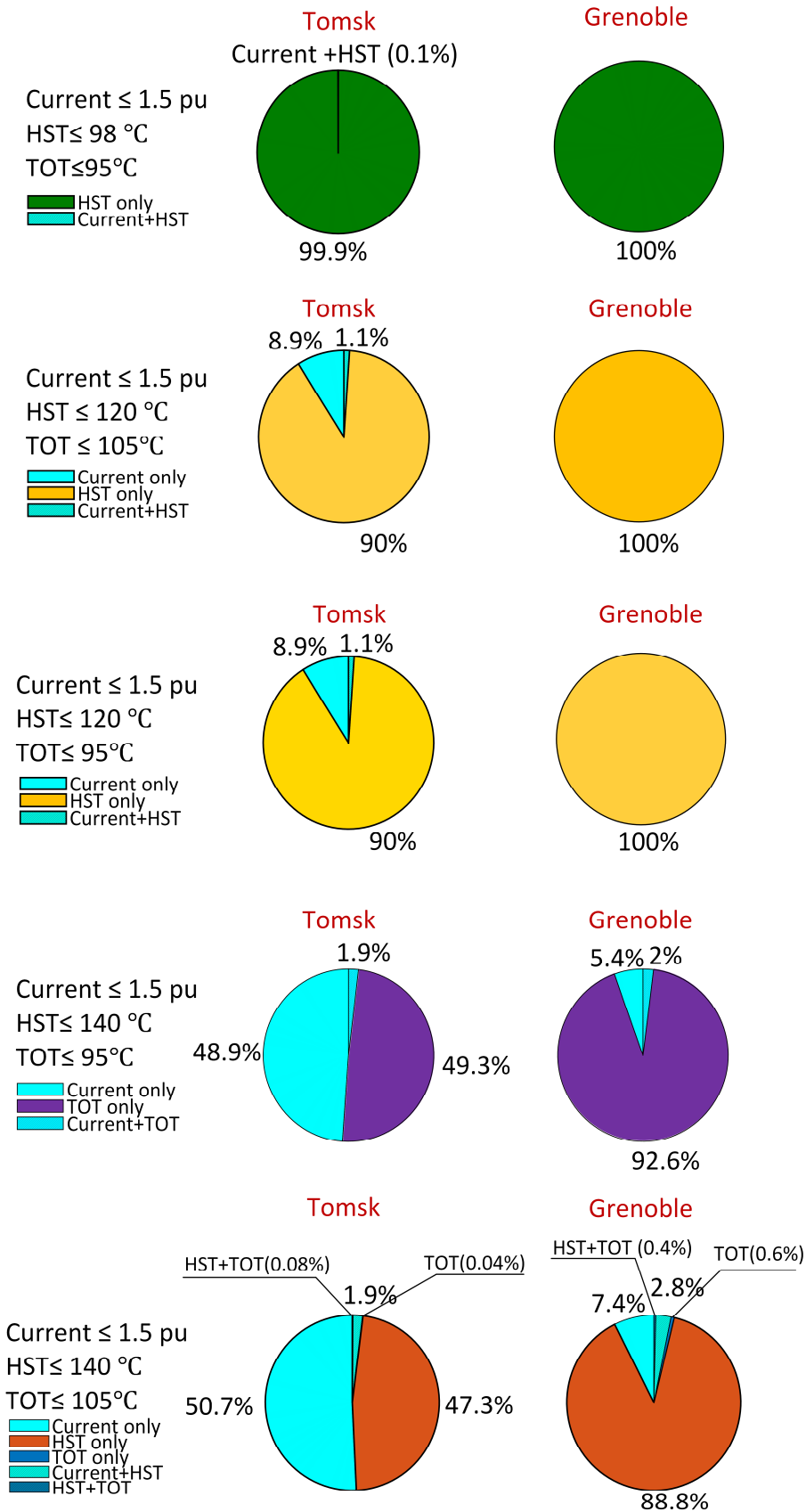

Figure 27 Share of limiting factors: based on 34 years analysis (% are rounded)

4 Recommendations for transformer overloading

This section proposes recommendations for transformer overloading based on a feasible region.

First, the green area of the feasible region in Figure 17, Figure 19, Figure 20 and Figure 21 can be a reference for a system operator to avoid any accelerated LoL. Thus, system operators can always keep the transformer loading within the green area and prevent any accelerated LoL. As found in Figure 24, the green area provides 6 % over nominal rating in Grenoble and 15 % in Tomsk. Secondly, the yellow area can be a reference to keep the transformer loading within temperature limits. The yellow area provides up to 41 % of additional capacity in Grenoble and 45 % in Tomsk.

However, the system operator should be aware that the operation in the yellow area may cause the accelerated LoL. Therefore, it may be useful to quantify the worst-case LoL, which can happen if the system operator keeps the loading within the yellow area. To do that, it is necessary to define the worst case of overloading (the amplitude and duration). The worst overloading from LoL perspective should happen if the loading is equal to the top border of the yellow area during the whole day. Hence, the worst case would be if the loading remains equal to the top line of HST limit (120 °C or 140 °C depending on DTR formulation). In such a case, LoL will be the most severe since the transformer operates at the maximum allowable HST. Thus, the most severe LoL can be estimated by formulas (9)-(10):

$$LoL = \begin{cases} \frac{1}{T} \cdot \int_0^T 2^{\frac{HST(t)-98}{6}} dt & \text{if design HST} = 98 \text{ }^\circ\text{C} & (9) \\ \frac{1}{T} \cdot \int_0^T e^{\frac{15000}{110+273} - \frac{15000}{HST(t)+273}} dt & \text{if design HST} = 110 \text{ }^\circ\text{C} & (10) \end{cases}$$

Where T is the duration of the studied period (1 day).

Equation (9) corresponds to the case if insulation paper is Kraft paper. To remind, the Kraft paper has a continuous HST= 98 °C which was assumed for studied ONAF transformer. However, a new ONAF transformer can be equipped with TUP having the continuous HST =110 °C. In this case, equation (10) should be used. Table 9 shows a LoL estimation by (9)-(10) for HST limit = 120 °C and 140 °C correspondingly.

Table 9 Worst-case LoL in pu or the number of days

The worst LoL		HST limit	
		120 °C	140 °C
Continuous HST	98 °C	12.7 pu	128 pu
	110 °C	2.7 pu	17.2 pu

Results in Table 9 can be converted to overloading occurrence expressed in approximate days per year. To do that, we suggest using our own formula (11).

$$(LoL + 1) \cdot x \leq 365 \quad (11)$$

Where x – unknown, meaning the occurrence, days per year

The meaning of this formula is that the sum of the overloading days and “compensating” days is less or equal to the number of days in the year. Thus, Table 10 shows the admissible occurrence of overloading calculated by equation (11). The number of compensating days is calculated as the difference between 365 days and overloading days.

Table 10 Number of days per year for overloading and compensating the accelerated ageing

Overloading days		HST limit	
		120 °C	140 °C
Continuous HST	98 °C	≈ 26 days	≈ 2 days
	110 °C	≈ 98 days	≈ 20 days

Compensating days		HST limit	
		120 °C	140 °C
Continuous HST	98 °C	≈ 339 days	≈ 363 days
	110 °C	≈ 267 days	≈ 345 days

Depending on the insulation paper, the worst day operating at C&T limits may be equivalent to 2.7 to 128 days running transformer at the design (continuous) HST. Therefore, such overloading may be tolerated from 98 days to 2 days per year (Table 10). Hence, the number of days necessary to compensate for accelerated ageing varies from 267 days to 363 days.

These results do not necessarily mean that transformer should be out of service during “compensating” days. Following our next estimations, the studied transformer ONAF can still be loaded on average for 64-89% from a nominal rating. This non-evident result can be explained by the exponential interrelation between HST and Ageing Acceleration Factor (AAF) shown in Figure 28 (y-axis has a log scale). Figure 28 shows that AAF exponentially reduces (see log y-axis) while HST linearly decreases (see x-axis).

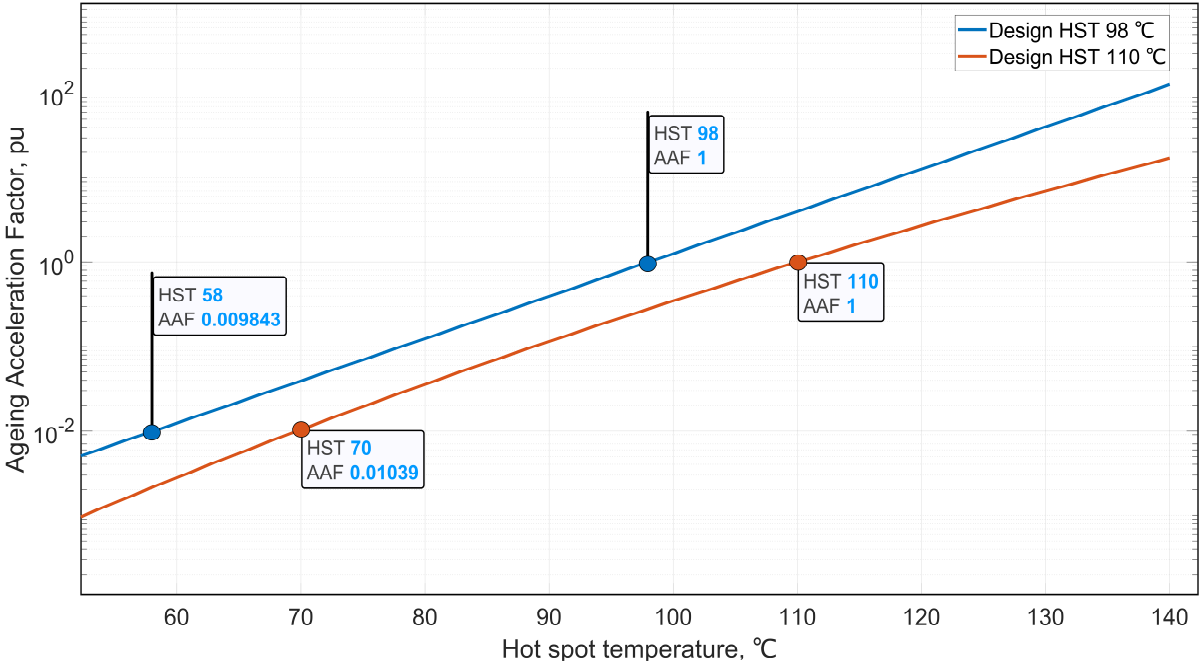

Figure 28 Exponential dependencies of AAF on HST. Y-axis has a log scale.

System operators may benefit from HST-AAF dependency by operating the transformers at low HST during some days to compensate for the accelerated LoL during another day. As mentioned earlier, transformers can still operate at 64-89% from their nominal rating for such compensating days. To explain how 64-89% are calculated, let us assume that the transformer operation during compensating days should not exceed 1 % of normal ageing (% could be set lower to make the ageing negligible). Although a little excessive ageing is possible at the end of the year (as it is not totally 0 % during compensating days), 1 % value demonstrates the principal idea of mutual ageing compensations. Also, DSO may adjust overloading allowances during the next period to consider a small excessive ageing from 1% value at previous periods.

If 1% ageing is assumed for the compensating days, it is necessary to choose such HST when LoL would be 1 % of normal LoL (see flags in Figure 28). In accordance with equations (9)-(10) for the continuous HST = 98 °C such HST_{1%} = 58 °C²⁸ and for the continuous HST = 110 °C such HST_{1%} = 70 °C correspondingly. Note that the loading corresponding to these HST_{1%} would vary as a function of T_{amb}. That is why if knowing the historical T_{amb} in Tomsk and Grenoble (shown in Figure 22), it is possible to find loadings corresponding to these HST_{1%}. To do that, a similar algorithm, presented in section 2, can be used. However, instead of a temperature limit, it is necessary to use HST_{1%}.

Figure 29 shows loadings (black lines) corresponding to HST_{1%} = 58 °C and 70 °C in the range of T_{amb} from -50°C to +50 °C (x-axis in Figure 29). These black lines are relevant for the given ONAF transformer. Still, its admissible loadings may differ in each geographical location as the latter has particular T_{amb} conditions. For instance, Figure 29 shows the histogram of T_{amb} in Tomsk and Grenoble.

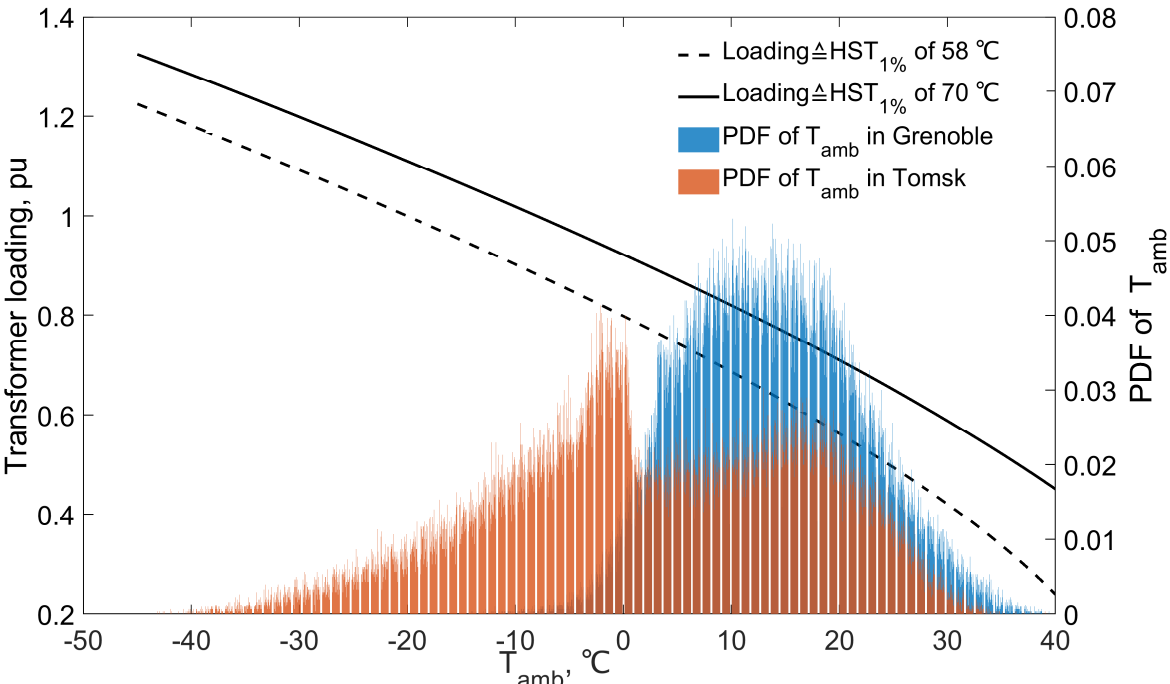

Figure 29 Black lines: transformer loadings correspond to HST1%. Orange and blue bars: histogram of T_{amb} in Tomsk and Grenoble based on 34-years history

²⁸ Note that AAF formula in equation (9) is based on Montsinger’s model. It is recommended to use this model in the temperature range from 80°C to 140°C [125],[247]. At the same time no temperature restrictions are applied to equation (10) – based on Dakin – Arrhenius model [125].

Figure 29 shows that a histogram of T_{amb} tends to some particular loadings. To calculate a similar histogram of transformer loadings, it is sufficient to take each T_{amb} (on Figure 29) and find the corresponding loading (on the black curve in Figure 29). Figure 30 shows the resulting histogram of transformer loadings in Tomsk and Grenoble.

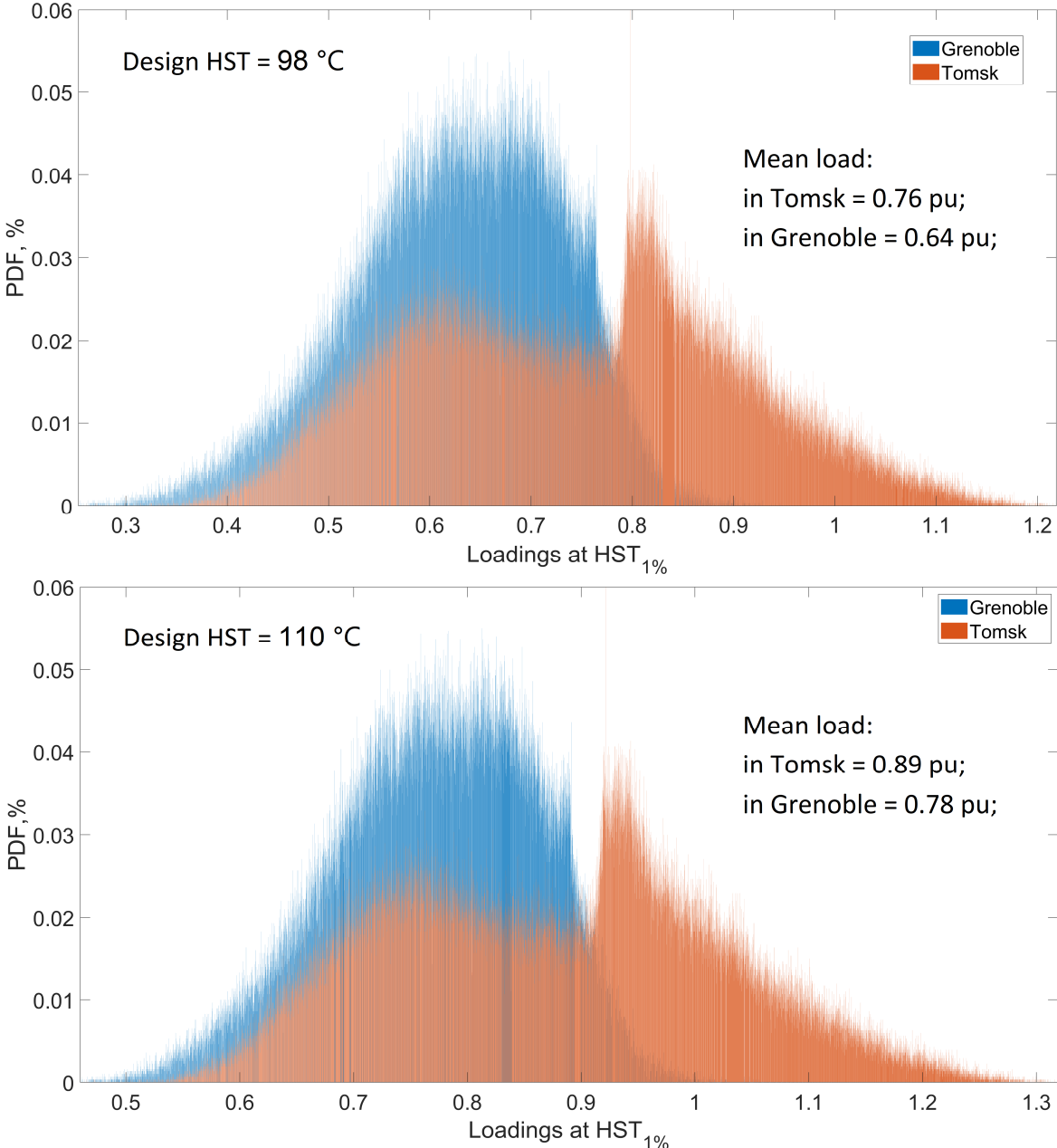

Figure 30 Loadings, which can be used for compensation of accelerated LoL (based on T_{amb})

Two observations can be found from histograms shown in Figure 30. First, the shape of histograms always remains the same, whatever the insulation paper is used. It seems that histograms of T_{amb} in each climate predetermine the form of loadings histograms. The only difference between the two types of insulation paper is a mean loading: 0.76 pu (0.64 pu) for Kraft paper and 0.89 pu (0.78 pu) for TUP. The second observation is that a mean loading at HST_{1%} can be higher than a nominal rating (at least for Tomsk). It seems that the reason for such increased admissible loadings is a cold climate in Tomsk. Generally, Figure 30 proves that system operators can compensate the accelerated LoL even if operating a transformer at

loadings close to the nominal rating. For such “compensating” days, a system operator can redraw the feasible region using $HST_{1\%}$ as the temperature limit.

In addition to recommendations already presented in this section, it may be useful to discuss recommendations from other papers, which can be linked to the feasible region. For instance, system operators could update feasible regions at each hour. This would allow them to consider the actual loading and T_{amb} at past intervals to increase/decrease the feasible region at the following intervals. The general logic of such DTR updating can be based on receding horizon control [179], also known as model predictive control [374]. It would also be valuable to develop the advanced ageing model linking the LoL and failure effect. For instance, as it was done in [375],[376] for DTR of overhead lines or in [268] for transformers. The probabilistic nature of a feasible region can be enhanced based on [170], [171], [297]. Moreover, system operators should reduce the current limit of a feasible region to the rating of tap changer or bushings if some limit transformer loadings, as shown in [80]. The effect of harmonics, unbalancing, moisture in the oil-insulation system, oil viscosity should be carefully assessed since they can significantly reduce the thermal rating of transformers [159],[156].

5 Conclusions

In summary, DTR for various C&T limitations was assessed for better modelling of DTR. In contrast to similar studies, all limiting factors (current, HST and TOT) and their combinations were considered. This allowed assessing DTR parts, which were usually omitted in similar studies. At the same time, our results showed that this omitted DTR represents a large transformer capacity in the range from 25% to 45 % nominal rating. Moreover, DTR duration curves prove that this additional DTR capacity is higher than the nominal rating during 100 % of the time in contrast to classical DTR, which is 88,5% in Tomsk and 79 % in Grenoble correspondingly.

The attention should be paid to the fact that this additional capacity is operated at increased HST. Nevertheless, modern DSO may use DER to control the shape of transformer loadings. This allows controlling the amplitude and duration of transformer loadings, making them feasible from both sides: C&T limitations and ageing. Furthermore, this provides more freedom for system operators to manage the power systems. This additional capacity can be especially relevant if one recalls that the HV/MV substation cost can vary from 500 k€ to 1.5 M€. Therefore, DSO may take an advantage of DTR and DER to defer significant investments into the transformer reinforcement.

Another result of this chapter is that using a typical (net) load profile can be avoided for DTR determination. Instead, it is possible to build a feasible region of load profiles based on T_{amb} only. Thus, multiple shapes of load profiles can be considered and not only typical ones.

Moreover, the DTR assessment showed that the main limiting factor is sensitive to the chosen formulation of C&T limitations. For instance, HST partially or fully remains a limiting factor for most formulations. However, HST does not affect DTR for the formulation: $HST \leq 140$ °C and $TOT \leq 95$ °C. At the same time, many papers considered HST as the main limiting factor, which is not necessarily true as results showed.

Finally, the recommendation is formulated to consider the entire feasible region of loadings. The worst LoL is quantified, and the number of overloading days per year is calculated. Moreover, it was shown that the compensation of accelerated LoL can be ensured at loading

around 64-89% of the nominal rating. Thus, system operators can still use transformers at relatively high loadings and at the same time compensate for the accelerated LoL.

Following the philosophy of open science [377], it was decided to make available MATLAB scripts, functions and the initial data used in this thesis. Thus, the MATLAB code used in this chapter is available in open access at the GitHub repository [378].

Table 11 Contribution of this chapter and the journal where it was published

No	Contribution of this chapter
C1	<p>It is suggested to model DTR using a feasible region. In contrast to other techniques, this method allows assessing the permissible operation of the transformer above their design temperatures. Thus, it becomes possible to consider about 30-35 % of hidden transformer capacity, ignored in similar studies. Moreover, no load profile is required to model DTR with a feasible region. This allows avoiding converging to lower DTR shapes. Besides, a feasible region considers variations of power limit as a function of C&T limitations. This is mentioned in the IEC standard, but no explanation was provided. Thus, this contribution fills this gap.</p> <p>As a new modelling technique was proposed, it was necessary to reassess DTR. In contrast to other studies, DTR is assessed for multiple C&T limits. This allows to determine power limits and to identify their limiting factors. On the one hand, this confirmed the commonly accepted vision that the winding temperature is a primary limiting factor of DTR. On the other hand, it was shown that winding temperature might be less or totally unrestrictive for DTR for particular C&T limits.</p> <p>Finally, recommendations for transformer overloading using C&T limitations were formulated. Specifically, it was explicitly shown that transformers may still be loaded up to 89 % while exposed to negligible ageing. In addition, the number of days of permissible operation above the design temperature but within C&T limits is calculated. This complements approach on the intermittent temperature limit, which is currently adopted by IEC and IEEE standards.</p>
<p>Journal: <i>International Journal of Electrical Power & Energy Systems</i> IF: 3,588, Q1</p>	<p>MATLAB code and data at GitHub [378]</p>

Chapter III

Reserve capacity of transformers for a load connection

In the coming years, the massive electrification and the development of DER may require a heavy reinforcement of distribution networks. As a result, transformers in distribution networks may double their number by 2050. If this prediction sustains, it would require significant investments from electric network companies but eventually from final consumers. The latter pay all costs of network reinforcement through various tariffs. However, such predictions assume that the transformer should be updated once a load exceeds its nominal rating. This is a conservative assumption as our investigations in chapter II showed that transformers, if using C&T limitations, still have a significant capacity above nominal rating. Hence, this chapter answers the question: how much load can be connected to transformers if using C&T limitations instead of conservative power ratings.

To better understand the studied challenge, section 1 describes the problem of reserve capacity in Russia. Russia is chosen as a reference country in this thesis because it is considered one of the top performers showing best practices in load connections. Moreover, Russian industry nowadays actively discusses the topic of reserved power. Briefly, in Russia, consumers may have to pay for the reserved power they requested during technological connection but did not use it during operation. Sections 1.1-1.3 explains the reasons for this problem, solutions proposed by industries and especially the data on how many substations lack the reserve capacity.

Nowadays, a few thousand primary substations in Russia already cannot connect more load. To better understand this situation, section 2 gives the overview of the existing DSO approach in Russia used to evaluate the reserve capacity of a substation. Once the existing approach based on power ratings is introduced, section 3 presents our proposed method based on C&T limitations. Using the example of real substations in Russia, it was found that C&T limitations might unblock the significant capacity for a load connection. Hence, DSO may continue connecting more consumers to existing substations without violating the C&T limits of transformers.

Developments of DER and aggregators services enable DSO to mitigate power constraints. This flexibility might be merged with the existing practice of DSO when it is used to connect more consumers if load-shedding automatics were in place. Similarly, we believe that DSO may connect more consumers to existing substations if having enough flexibility in place. Thus, in this chapter we extend our investigations on reserve capacity by coupling DTR together with demand response (DR). The specific question of this section was formulated as how much DR is needed to connect the given load if using DTR? To answer it, the reader may first see the literature review on using DR together with DTR (section 4.1). Then, the next sections 4.2-4.3, explain DR modelling and the formulation of the optimization problem. Finally, section 4.4 presents validation results and the approbation on the MV/LV substation. Results showed that coupling DTR with a small volume of DR significantly increases the reserve capacity of transformers. The latter may operate far beyond their nameplate ratings.

Following the philosophy of open science, MATLAB code and data used in this chapter are available in open access at GitHub repository.



1. Introduction

Nowadays, companies worldwide consider getting electricity the fifth-biggest obstacle for business (see Figure 31) [379]. That is why “getting electricity” was used as one of the principal criteria in World Bank’s annual report “Doing business” to evaluate business conditions worldwide. In this report, the criterion “getting electricity” consists of two main components: a technological connection²⁹ to substations and supply reliability. Hence, the problem of a load connection has the special attention of DSO and business communities all over the world.

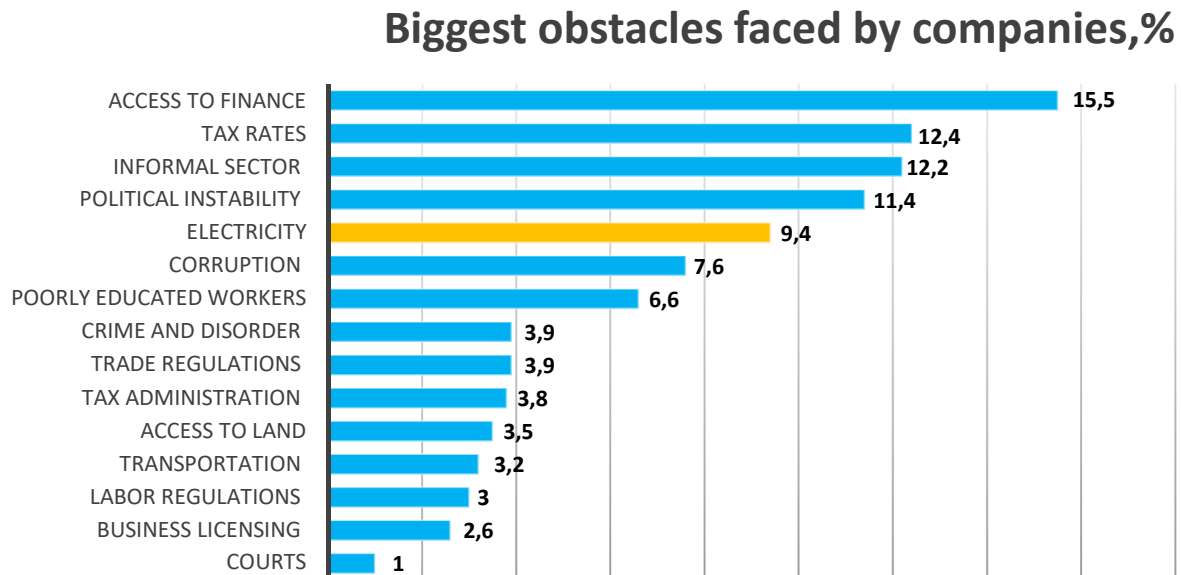

Figure 31 Biggest obstacles faced by firms. Source: World Bank [379]

To be more specific in this thesis, the case of Russia will be the focus of this chapter. On the one hand, Russia is chosen because World Bank considers it one of the top countries demonstrating the best practices for load connections (measured in the number of procedures, time and costs and reliability indexes, see Figure 32) [379]. On the other hand, the Russian energy community currently discusses a reserved network capacity. This is an integral part of a load connection problem where transformer capacities play a major role.

Top performance	Score	Procedures (number)	Time (days)	Cost (% GNI per cap.)	Reliability index (0-8)
United Arab Emirates	100,00	2,00	10,00	0	8,00
South Korea	99,89	3,00	13,00	35,20	8,00
Hong Kong SAR, China	99,34	3,00	22,00	1,30	8,00
Malaysia	99,27	3,00	27,00	6,00	8,00
Germany	98,79	3,00	28,00	38,50	8,00
Thailand	98,57	3,00	52,00	40,40	8,00
United Kingdom	96,45	3,00	5,00	23,90	8,00
Taiwan,China	96,32	3,00	31,00	38,60	7,00
Sweden	96,21	3,00	79,00	30,20	8,00
Czech Republic	95,36	3,00	83,00	24,10	8,00
Switzerland	94,41	3,00	39,00	58,10	7,00
Russian Federation	94,00	2,00	73,00	5,70	8,00
Iceland	92,24	4,00	22,00	9,30	7,00
China	92,01	3,00	34,00	0	6,00
France	92,01	4,00	53,00	5,80	8,00

Figure 32 Top performers on Getting Electricity in the world. Source: World Bank [379]

²⁹ Technological connection is a comprehensive service provided by grid companies to businesses and individuals for connection of their electric power installations to grid facilities [493].

1.1 Problem: low loadings of the electrical network in Russia

Like many other countries, Russia has been facing the problem of a low-loaded electrical network. For instance, the electrical network in the USA may be loaded for 25 % of its nominal capacity [380]. In 2015, Russia had almost the same average loadings - 26,8 % [381]. For example, Figure 33 shows loadings of network equipment in Russia during 2012-2015 estimated by the main network company Rosseti³⁰. As can be seen, the network loading in Russia was constantly reducing during these three years.

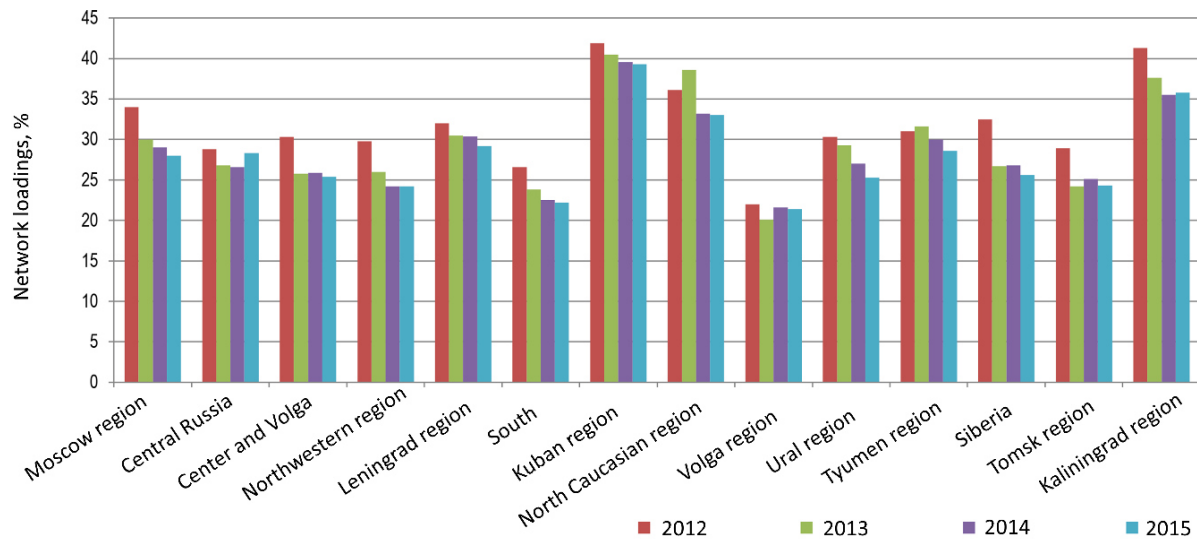

Figure 33 Loadings of a distribution network in 2012-2015. Source: Rosseti [381]. Translated from Russian by the author

In accordance to Rosseti [381], low loadings during 2012-2015 were caused by:

1. Manifold overvaluation by consumers of their maximal load during a technological connection
2. The rapid decline in the net energy output of Rosseti's subsidiaries in comparison with the general reduction in the electrical consumption
3. Errors in the forecasting of future loads
4. The concentration of consumer applications in areas lacking transformer capacity instead of sites with abundant transformer capacity.

Among these reasons, the main cause of low loadings was referred to a consumer's overvaluation of their maximal load during a technological connection [381]. This happened because consumers had no financial responsibility if their requested maximal load³¹ at the stage of a technical connection would really be consumed during the operation. Therefore, consumers were prone to ask for more network capacity than they actually needed. As a result, Rosseti claimed that they had to build large network capacities, which consumers do not utilize for the mid-term. For instance, from 2011 to 2018, Rosseti built 88 GW of network infrastructure at the request of consumers while the actual load for the same period increased only by 8 GW [382]–[385]. Rosseti also estimates that they commission 14 GW of “non-used”

³⁰ Rosseti or Russian grids is an operator of transmission and distribution networks in Russia. The company maintains 2.37 million km of power transmission lines, 517,000 substations with transformer capacity of more than 802 GW.

³¹ The requested maximal load is a maximal load which consumer indicates in his application while asking DSO for technological connection. It is forbidden to consume more load than it is indicated in the application.

network capacity each year [386]. Suppose one estimates the CAPEX needed to construct these capacities. In that case, one can get costs, which may be avoided since existing network reserves should be sufficient to connect new consumers.

In general, Rosseti estimates that around 60% of existing network capacities, i.e. more than 100 GW, are not utilized [387]. According to an analysis held in 72 regions of Russia [388], the reserved capacity in Russia reaches 133 GW in 2019. Another study, held in 2020 in over 65 regions in Russia, showed that only 35 % (55 GW) of network capacity was utilized, whereas 65 % (101 GW) represents the unused reserved capacity [385]. This unused capacity is typical for both small and large consumers. It is distributed as follows: 58 % (59 GW) belong to small consumers (below 670 kW), whereas 42 % (43 GW) belong to large consumers (higher 670 kW) [385] (44% per [389]).

Another reason why consumers request more network capacity than they really need is that connection fees do not include actual costs, especially for residential and small commercials. For instance, if a connecting load is below 15 kW (typical for residential consumers), the consumer should pay around €6³². In contrast, actual costs may reach €5 700 on average (see Figure 34). [381].

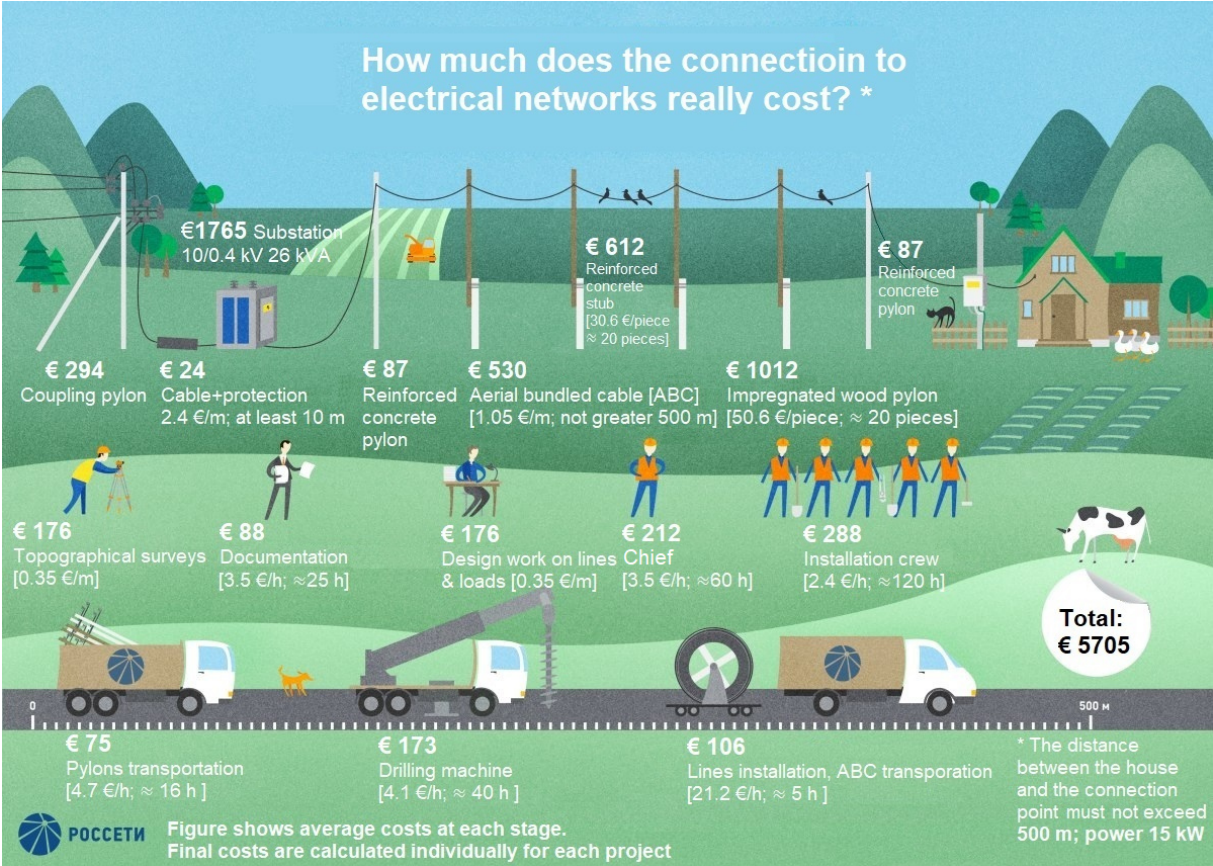

Figure 34 Costs of load connections in Russia. Exchange rate: 85 RUB = 1 EUR. The source: Rosseti. Translated from Russian by the author

³² The exchange rate RUB/EUR is 85 RUB per 1 EUR as it was on September 29, 2021. Standardized connection fees are equal to 550 RUB

Moreover, in 2017 CAPEX for construction of new network capacities was excluded³³ from connection fees for loads below 150 kW (typical for the small and medium business) [386]. As a result, the number of applications and CAPEX doubled in particular regions in 2018 [386]. Still, the capacity provided on preferential fees for such consumers is generally used only for 15-20%, i.e. 80-85 % are not utilized [388]. For example, for 2010-2016, DSO built 17 GW capacity after residential and small consumers request while only 3.3 GW was used [385].

Since consumers pay only negligible fees for their connection to the electrical network, most real costs are included in a tariff for electrical energy consumption. This means that actual costs of the connection for one consumer are distributed among all existing consumers while they pay electrical bills. Such a state of a thing is financially beneficial for the particular consumer because other consumers pay real costs, which are spent to connect his facilities. However, despite such an already beneficial situation, some consumers may manipulate their applications for the technological connection to minimize their connection costs even more [386]. For instance, an applicant may need to connect 1 MW of load. However, consumer may split 1 MW into several 150-kW parts to benefit favourable fees for 150 kW (where CAPEX is excluded). Hence, such companies pay a few dozen euros instead of € 350 000 for their technological connection [386]. This allows such companies to reduce their connection fees significantly by increasing a tariff for all consumers. The following paragraphs provide a short overview of how a tariff for electrical energy consumption is calculated in Russia to understand this mechanism better.

First, it is necessary to highlight that Russia has wholesale and retail markets like many other countries. Figure 35 shows the main interactions between principal buyers and sellers at both markets [390].

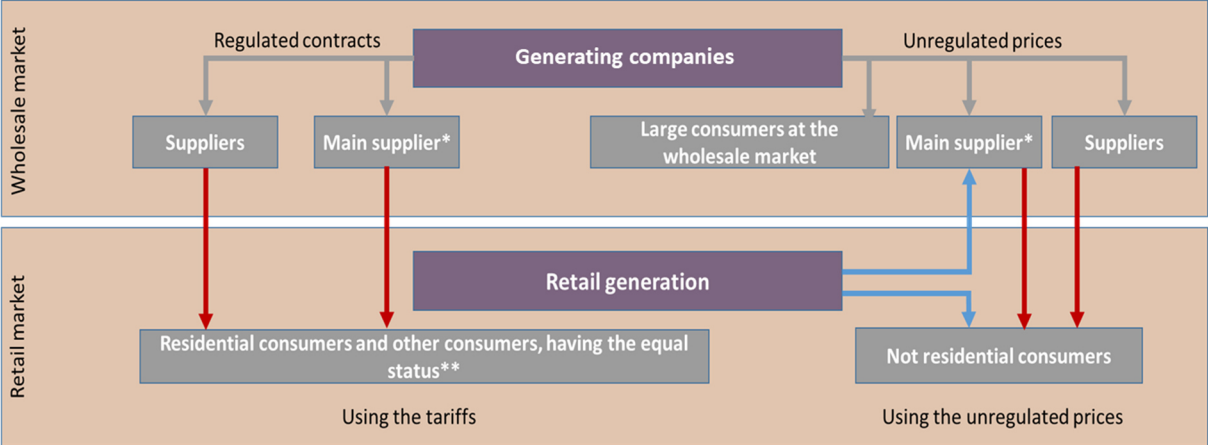

Figure 35 Operation of wholesale and retail markets in Russia. Source: [390]. Translated from Russian by the author

Generating companies (sellers) trade the produced energy with suppliers and large consumers at the wholesale market. They mainly use either regulated contracts (the left arrow) or unregulated prices (the right arrow). Further, suppliers and retail generation sell this energy at the retail market for final consumers. There are two principal categories of consumers (excluding particular cases): a population and those who have equal status and all other

³³ This was done in the framework of new guidelines from Federal Antimonopoly Service on a determination of connection fees for technological connections [494]

consumers. Population and those with equal status use the electricity for household needs, i.e., not creating profit [391]. Some non-residential premises also belong to the "population": private garages, bathhouses, barns and cellars. Non-residential premises, used for commercial purposes (pharmacies, offices, stores, salons, etc.), are included in the "other consumers" tariff group. The prices for "other consumers" are markedly higher than the tariff for households and differentiated: by voltage level, price rates (day-night; peak- off-peak- semi peak, hours), day-ahead planning of consumption, a grid tariff (one rate or two rates) among others. Figure 36 shows that residential consumers in Russia buy electrical energy using regulated tariffs. In contrast, all other consumers buy electrical energy based on unregulated energy prices. For each case, it is possible to see the composition of the final price (see Figure 36)

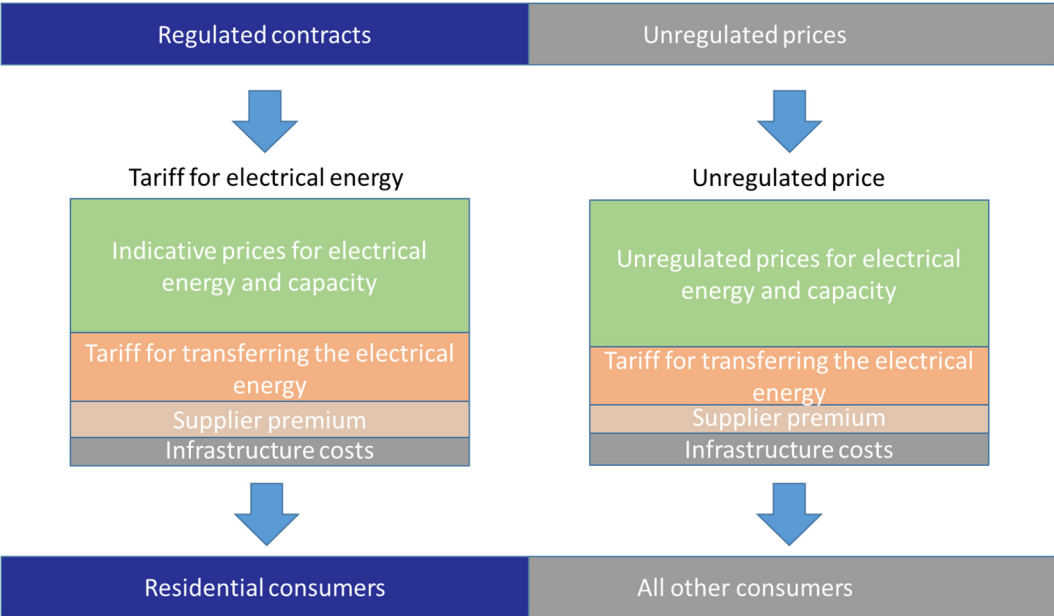

Figure 36 The composition of prices for electrical energy. Source: [390]

In both cases, the final price contains:

1. The indicative price³⁴ (defined by a regulator) or the unregulated price.
2. The tariff for transferring the electrical energy through electrical networks³⁵,
3. The supplier premium³⁶,
4. Infrastructure costs³⁷

As a technological connection is related to the tariff for transferring electrical energy, the next paragraphs will explain how this tariff is formed. Note that tariffs for transferring the electrical energy for various tariff groups may be calculated differently and sophisticatedly. To keep our explanation simple, it was decided to focus only on the basics. If interested, the reader may

³⁴ Indicative price is a weighted average price per MWh calculated used to determine regulated tariffs for electric power (capacity) on retail markets for the relevant regulation period;
³⁵ This is the price of the electric grid company's services for the delivery of electricity.
³⁶ The price for the services of supplier companies. The share of this price usually 2-4%.
³⁷ This is a small fee for the services of System Operator of the Unified Energy System, Administrator of Trading System and Financial Settlement Center. The share of these payments in the structure of the final price is 0.1%.

see a full methodology with particular cases in the normative documentation [392] and the market Council's presentation [393].

As nowadays, an activity of network companies in Russia remains regulated, it is necessary to address a notion of a total revenue requirement (TRR). TRR is the economically justified amount of financial resources needed for the network company to carry out its activity during the reference period. In a simplified way, TRR is a sum of the following costs for the given year:

Table 12 Expenses of Network company used to calculate TRR

Nature of expenses	Types
Controllable expenses	<ul style="list-style-type: none"> ❖ Raw materials and supplies ❖ Salary and social security ❖ Maintenance program
Non-controllable expenses	<ul style="list-style-type: none"> ❖ Payments for the energy transfer through an upstream transmission network ❖ Amortization ❖ Taxes ❖ Rent payments ❖ Costs of technological connections
The investment program of DSO	<ul style="list-style-type: none"> ❖ Construction of new facilities and reconstruction

Once TRR is calculated for the next reference period, usually six months ahead, network companies send TRR to a local authority regulating the tariffs (a regulator). This regulator is either a committee on prices and tariffs or a regional energy commission. The local regulator should totally or partially approve the TRR of network companies. The regulator will define tariffs for electrical energy consumption for the next calendar year in the given region. While determining the tariff, the local regulator cannot exceed the range established for each region by the Federal Antimonopoly Service of the Russian Federation. To calculate the grid tariff, it is necessary to sum up all expenses (this gives TRR) and divide it for the net energy output from the electrical network to consumers:

$$Grid\ tariff = \frac{Controllable\ expenses + Non - controallable\ expenses + Investment\ program}{Net\ energy\ output} \quad (12)$$

Once the mechanism of tariff calculations is defined, it is necessary to return to our discussion on connection fees. To remind, it was mentioned that consumers pay only a tiny fraction of the real costs needed to connect their facilities. The network company includes remaining costs into TRR, which the local regulator then uses to calculate the tariff for energy consumption in the given region. Thus, consumers whose requested maximal load matches the actual load have to pay the construction and maintenance of network capacities requested by other consumers. At the same time, the scale of unused power in an electrical network can be measured in many GW [385], [387], [388]. For instance, Figure 37 shows how the network capacity 35 kV and above (in total, 292.4 GW) was utilized by the end of 2015.

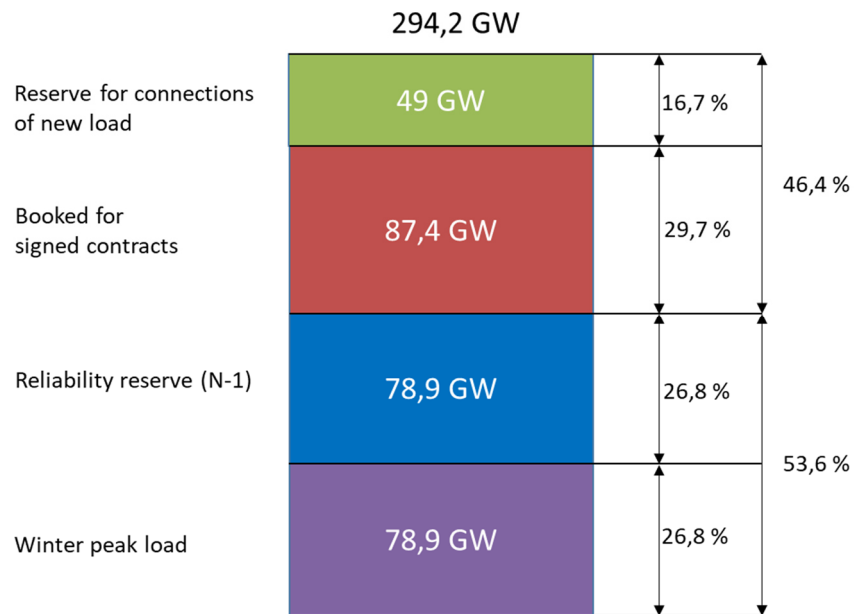

Figure 37 Utilization of distribution network capacity 35 kV and above in 2015. Source: [381]. Translated from Russian by the author

Although in 2015, a peak load of existing consumers was reaching 78.9 GW, the booked (non-used) capacity was 87.4 GW. Such a share of non-used capacity may be a reason, among many others explaining the large percentage of the grid tariff in Russia's final price of electrical energy. For instance, the share of a grid tariff at the cheapest HV level reaches 20% and up to 55% at the LV level. In comparison, the similar share in other countries usually remains at the level of 10-15% [394]. Figure 38 shows the composition of final electricity prices in Russia in 2017 and 2020 following [387].

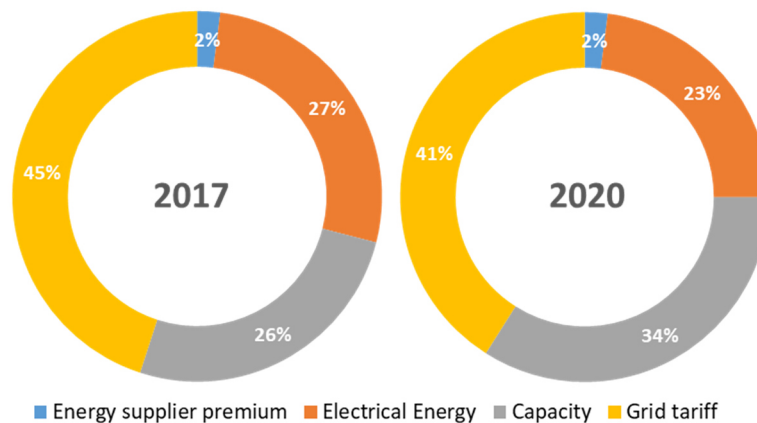

Figure 38 Composition of final electricity prices in Russia for 2017 and 2020. Source: [387]

1.2 The mechanism as a solution for low-loaded network

For more than 8 years, the Russian government has been developing a mechanism to solve the problem of reserved capacity. Specifically, such a mechanism should establish consumers' obligation to pay for electric power transmission services, considering the payment for reserved capacity [395], [396]. Efforts to introduce this payment mechanism started in 2012 when the Rules for Retail Markets [381] suggested specific solutions for the reserved capacity. In April 2013, the Russian Government approved the "Strategy for the Development of the Electric Grid Sector of the Russian Federation until 2030". This strategy sets the development

of a procedure for reserve payments by consumers, deadlines for introducing the payment mechanism and categories of consumers to whom this procedure will apply [395].

In 2018, the Ministry of Energy prepared a first draft of the project establishing the new payment mechanism for electricity transmission services, taking into account the payment of the reserved capacity [381]. The project was supposed to be approved in 2019, but discussions with the energy community continued during 2019. However, some media [384] already claimed (apparently mistakenly) that the Russian government took the favourable decision on its approval. In September 2019, the Ministry of Energy returned with the new project. Some fees were adjusted for consumers with distributed generation and consumers complying with increased reliability requirements [386]. But again, the project did not find support from many energy community members. Thus, in April 2021 [397], the Ministry of Energy decided to update the project draft, taking into account new remarks and suggestions from the energy community. Eventually, the Ministry of Energy returned in July 2021, with the revised project having reduced some requirements for consumers. Up to the moment of writing this text (summer 2021), the government portal [381] indicated that the project was at the new round of discussions.

The main suggestions of the Ministry of Energy concerning reserved capacity [389]:

1) Consumers whose maximum load is higher than 670 kW must pay the reserved capacity if the following conditions coincide:

(a) Actual load in each month of the previous year did not exceed 60% of the consumer's maximum load declared in connection agreement;

AND

(b) Actual load in the accounting month of the current calendar year does not exceed 60% of the maximum load (defined in a connection agreement);

2) The fraction of maximum load, which should be paid, is calculated as a difference between maximum load and actual load considering the payment coefficient (K). It was planned to avoid rapid financial pressure on consumers. Therefore, K shall gradually increase during three years from 0.05 to 0.6. (see illustrative example in following paragraphs).

3) Payments for the reserved capacity are determined according to the tariff for the maintenance of electric networks;

4) Consumers with a distributed generation, for which the external network serves as a reserve power source, should pay grid maintenance costs to the grid companies.

1.2.1 The numerical example of reserved capacity

To better understand the payments for reserved capacity, let us see how the project calculates it on the simplified example [398], [399]. Let us take a Tomsk region in January 2021 and a consumer (not a population category!) who is connected to a 20 kV distribution network with the following initial data:

The requested maximal load of the consumer during the application: $P_{\max} = 10 \text{ MW}$

The measured peak load of the consumer in January 2021: $P_{\text{actual}} = 2 \text{ MW}$;

The value of the reserved power for January is then calculated as:

$$P_{reserved} = P_{max} \cdot b - P_{actual} \quad (13)$$

$$P_{reserved} = 10 \text{ MW} \cdot 1 - 2 \text{ MW} = 8 \text{ MW} \quad (14)$$

Note that b is a coefficient applied if the load interruption may have ecological, economic or social consequences. Otherwise, $b = 1$ as it was assumed in our simplified case.

The consumer will pay the reserved power at the end of the year if $\delta_{reserved}$ was exceeding 40 % each month. In other words, the consumer must pay the reserve capacity if the following condition is true:

$$\delta_{reserved} = \frac{P_{reserved}}{P_{max}} \cdot 100 \% \geq 40 \% \quad (15)$$

Let us calculate $\delta_{reserve}$ for the given example:

$$\delta_{reserved} = \frac{8 \text{ MW}}{10 \text{ MW}} \cdot 100\% = 80 \% \geq 40 \% \text{ true} \quad (16)$$

The condition (15) is true, and then the consumer must pay for the reserved capacity. The general formula for the payment of reserved capacity is determined as follows:

$$P_{reserved_paid} = P_{reserved} \cdot K \quad (17)$$

Where K is coefficient:

$$K = \begin{cases} 100 \% & \text{if application is submitted after 01.07.2019} \\ 5\% - 60 \% & \text{if application is submitted before 01.07.2019} \end{cases} \quad (18)$$

If the consumer submitted its application before July 1 2019, the consumer should pay only part of the reserved capacity. In such case, K is defined depending the current year: in 2020 – 5%, in 2021 – 10%, in 2022– 15%, in 2023 – 20% and in 2024 – 60 % [400]. Otherwise, if the consumer applied after July 1 2019, the project requires paying 100 % of reserved power. Let us assume in our simplified example that the consumer was connected before July 1, 2019. In this case, the coefficient K for 2021 equals 10%. Thus, the reserved power to be paid is calculated as follows:

$$P_{reserved_paid} = 8 \text{ MW} \cdot \frac{10\%}{100\%} = 0.8 \text{ MW} \quad (19)$$

The final payment for the reserved capacity is calculated as follows:

$$S_{reserved} = P_{reserved_paid} \cdot C_{operat} \quad (20)$$

$$S_{reserved} = 0.8 \text{ MW} \cdot 18\,093 \text{ €/MW} \cdot \text{month} = 14\,475 \text{ €} \quad (21)$$

Where C_{operat} are fees in €/MW·month for maintaining the 20 kV electrical network in a given region (defined by special commissions in charge of tariff). In Tomsk region $C_{operat} = 18\,093 \text{ €/MW} \cdot \text{month}$ for the first 6 months of 2021 [401].

1.2.2 Discussion on suggested mechanism in industry

For consumers, the introduction of this mechanism is expected to reduce the tariff³⁸. This should be thanks to payments for a reserved power of those consumers who decided to keep it. Notably, the project obliges DSO to inform the regulator about received payments for a reserved power. At the end of each regulatory period, the regulator excludes these payments from TRR (explained in the previous section) and thus reducing the tariffs for energy transfer services for all consumers. In such a case, consumers (whose requested and actual power vary less than 40%) should pay less, whereas consumers who keep the reserved power should pay more. In general, Rosseti estimates that the suggested mechanism will bring around €588.2 million per year [386]. On the other hand, under a pessimistic scenario of the consumer community, only large consumers should pay €3.8 billion [386]. At the same time, the Ministry of Economic Development estimates that cumulative payments of the industry should be around €4.6 billion for four years after introducing such a mechanism [402]. Meanwhile, the Ministry of Energy states that payment will be at the level of €5.15 billion for 2021-2024 [402].

Due to impact on many companies, much attention is drawn in Russia. On the one hand, Rosseti and the Ministry of Energy have actively supported the project [384], [389], [403]–[408]. On the other hand, the project was vigorously criticized by the consumer community, Ministry of Economics, Ministry of Construction, Housing and Utilities, Federal Antimonopoly Service, and Generating companies [384], [385], [412]–[416], [395], [396], [402], [404], [405], [409]–[411]. The discussion between project authors and their opponents is available in [417].

1.3 Headroom for increasing the reserve capacities

On the one hand, this mechanism should increase the reserve (not reserved!) capacity of existing substations either by motivating new consumers to request a capacity close to what they actually need or by encouraging the existing consumers to cede their unused power to DSO or other consumers. The latter option already exists in Russia [418], [419]. On the other hand, this mechanism may be applied only within the requested capacity (see Figure 39).

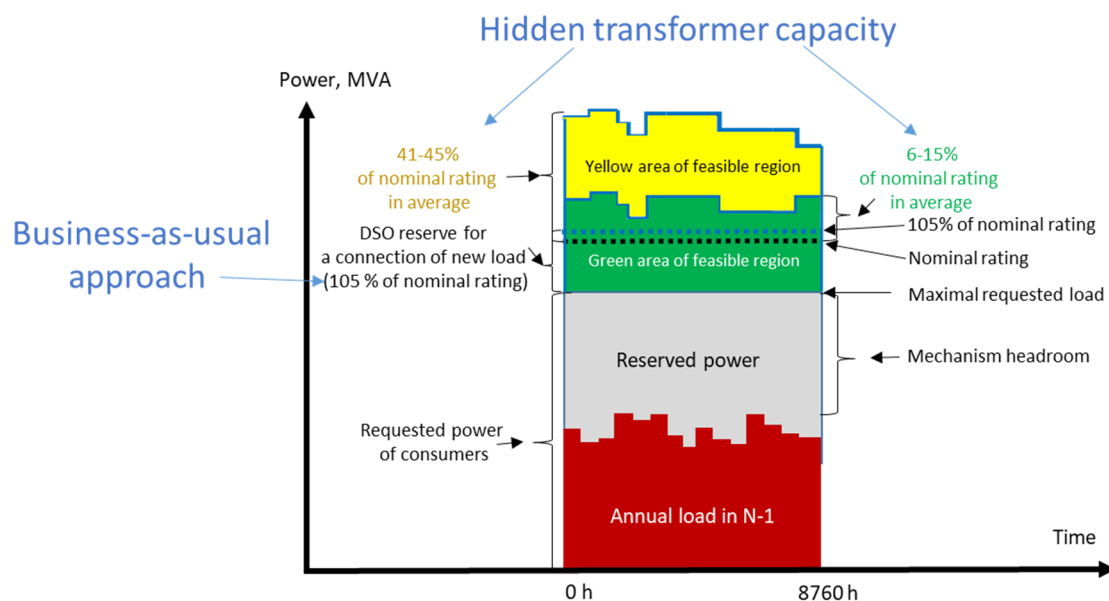

Figure 39 Hidden transformer capacity and the limitation of mechanism

³⁸ Some sources [412], [386] state, however, that introduction of this mechanism may actually increase tariffs for energy service and not reduce it

Indeed, we believe that the reserve capacity may be still underutilized due to conservative assumptions of DSO. Looking ahead, DSO applies the coefficients 1.05 or 1.3 to the nominal rating to calculate the reserve capacity (more details are in section 2). To increase a reserve capacity beyond these coefficients, it is necessary to unblock hidden transformer capacity (see Figure 39). As shown in Chapter II, the application of C&T limitations can unblock the hidden capacity of transformers. Specifically, it was demonstrated that the permissible loading of the ONAF transformer in Tomsk was 15% higher than its nominal rating (the first bar in Figure 24). Moreover, the permitted overloading of such transformer (represented by the yellow area in Figure 16) allows expanding the transformer capacity even more: on average up to 45 % greater than the nominal rating. Hence, it may be concluded that the existing approach of DSO may be indeed conservative and thus underutilize a transformer capacity for load connections.

Instead of using 1.05 and 1.3 loading limits, DSO may use C&T limitations per IEC and IEEE guides while evaluating the reserve capacity of transformers. To assess the benefits of such an approach, we apply DTR to the problem of reserve determination. This research may be especially relevant because, for many years, Rosseti has targeted KPI for increasing network loadings [420]. Moreover, following the recent report of Rosseti [421], increasing the loading of the existing network remains the relevant task in 2020.

Another concept of optimizing transformer capacities [422] cites recent Rosseti data (albeit without giving the particular source) that actual transformer loadings are 47.8 % in N-1 mode. The same report [422] states that this loading corresponds to the average loading of transformers worldwide in 2019. Therefore, it may be concluded that the situation with low network loading by 2015 in Russia remains unchangeable nowadays. Moreover, it seems that if loadings in N-1 are around 48 %, then in N mode, they should tend to 24%, which is even less than 26% in 2015. However, the final loading value may depend on the methodology of how loading is calculated. For instance, the consumer community (<https://en.np-ace.ru/>) recently argued that the actual loading of transformers in Russia is already approaching 48% and not 26 %³⁹ [423],[396].

Although the data on transformer loadings in Russia should be published in open access, in practice, it is not always available as it is supposed. Without having the complete datasets on actual transformer loadings, conducting the holistic analysis was impossible. So, we decided to assume Rosseti data on 26% as actual network loadings in Russia and admit remarks from consumer communities. Anyway, the application of C&T limits may allow connecting more load to transformers in both cases, especially in closed substations as described in the following paragraphs.

Although average transformer loadings in Russia by 2015 were reported around 26 almost 17 % of primary substations% in the same year lacked the power for the connection of new consumers (see Figure 40 and Figure 41). In Russia, such primary substations are called “closed

³⁹ Consumer community states that network loadings in Russia are not 26-35 % as Rosseti reports them but actually around 48% [423]. In accordance with [396] 26-35% loadings are calculated from the arithmetic sum of the full rated capacities of transformers. These values include significant transformer capacity, not directly related to the connection of specific consumers, but to the operation issues of electrical systems. Such as ensuring the transit and intersystem flows, including the power delivery schemes of large power plants; ensuring the power flow from adjacent substations, long lines, providing reliability (N-1) etc. Without taking into account the aforementioned capacity, which do not imply continuous use and are not subject to full loadings, but taking into account the N-1 criterion, the actual load of Rosseti network is 2 to 3 times higher than the loading 26-35%.

[meaning a congested] substations”. The closed substation is a substation where it would be impossible to keep the required level of reliability and quality of transmitted energy in case of additional load growth [424].

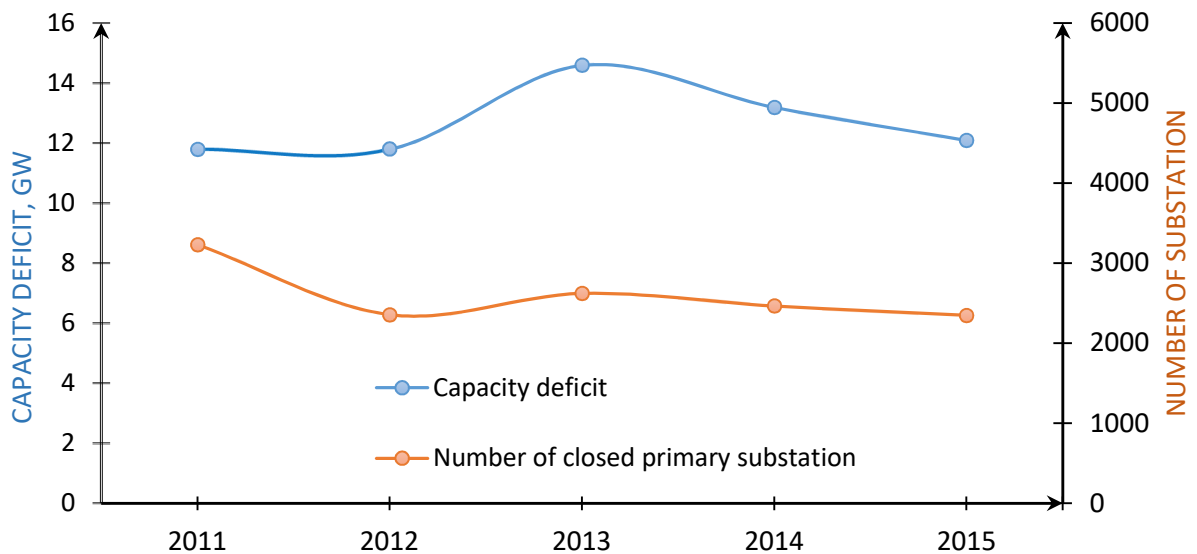

Figure 40 Deficit of transformer capacity in Russia and a number of substations unavailable for new load connection. Source: [425]

The number of closed substations during 2011-2015 stabilized around 2350 (see Figure 40), whereas the capacity deficit converges to around 12 GW. Such a situation may be typical for the downtowns of large cities (>1 million people) such as Moscow or Saint Petersburg. Building new network capacities in such megapolises is problematic due to high building density, urban protection requirements, and difficulties in obtaining approvals for the works [400].

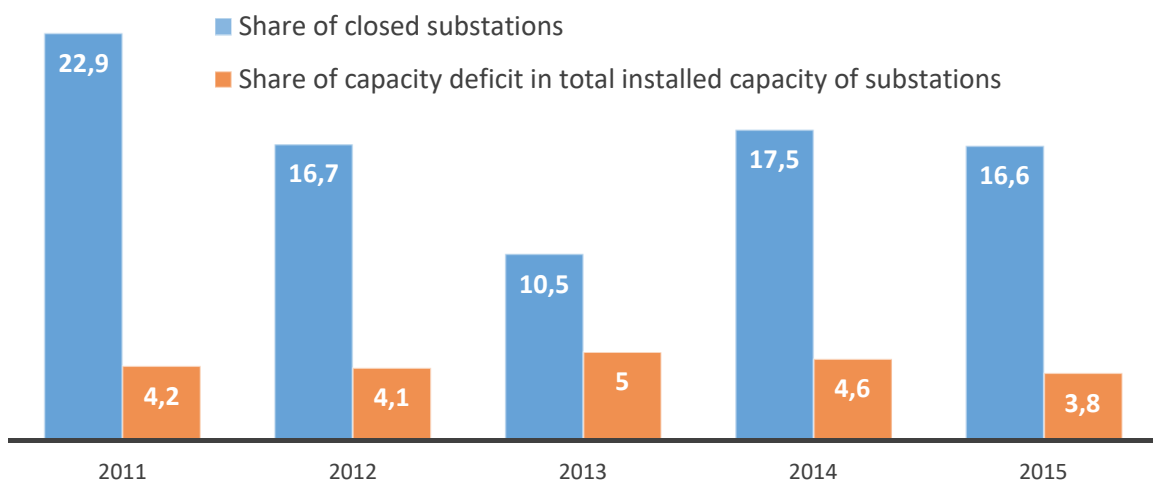

Figure 41 Share of closed substation and the share of the capacity deficit in Russia. Source: [425]

From data of Figure 40 and Figure 41, it may be concluded that Russia has a significant number of closed substations (despite low loadings of the electrical network in general). For these substations, it may be relevant to unblock the transformer’s hidden capacity for new load connections. However, before applying C&T limitations, it is necessary to present the existing DSO approach for evaluating the reserve capacity based on power ratings of transformers.

2 Existing DSO approach in Russia for evaluating a reserve capacity

The reserve determination procedure is available in the plan of power system development of the Tver region (the region nearby Moscow) [426]. Let us understand main stages involved in the procedure of reserve determination. Firstly, DSO collects and prepares the following input data:

- ❖ Nominal rating of power transformers located in existing primary substations 35-110 kV and new transformers capacities installed after construction, reconstruction and expansion of primary substations, which may increase the reserve capacity per the plan of power system development.
- ❖ Normal scheme of substation layout for the present year in N mode (no emergency or maintenance)
- ❖ Up-to-date typical loading of transformers at existing primary substation 35-110 kV obtained from load measurement at winter for the last reported year or the maximal load during the previous three years.⁴⁰
- ❖ The data on consumer applications for connections to primary substations 35-110 kV obtained after the last load measurement was taken.
- ❖ The data on contracts of technological connection, which are not finished yet.
- ❖ The load, which may be transferred to an adjacent substation through the MV-LV network 6-10-20-35 kV after an emergency or maintenance situation. Studies of AC load flows must be conducted to determine the permissible load transfer without special switching. If such a load flows analysis is absent, the load transfer must not be considered a technical possibility. In addition, if topology of network 6(10)-35 kV between adjacent substations 110 kV is normally open, then the load transfer is not applied.

Let us discuss essential assumptions taken by DSO while evaluating the reserve capacities. Following DSO guidelines, it is sufficient to use the expert method of reserve assessment (discussed below). If, however, a more accurate calculation of the reserve capacity is required, DSO will conduct AC load flows. In such a case, DSO will iteratively or simultaneously increase the load in buses of studied primary substations until any technological limitations are met.

- ❖ DSO assumes that all consumers connected previously to studied primary substations should be seen as the second reliability category for power supply. This means that the load supply must be ensured via two independent power sources or network branches.
- ❖ DSO does not consider the transfer capacity of line 35 kV and 110 kV while evaluating the reserve capacity of the primary substation.
- ❖ DSO does not consider the maximal power of consumers declared in existing contracts for electrical energy transfer
- ❖ DSO assumes that up-to-date loading of substations 35-110 kV does not change within the year.
- ❖ Suppose some loads are to be connected to the studied primary substation. In that case, DSO assumes that they are already connected for the date of reserve evaluations.

⁴⁰ DSO must ensure that the measured load is typical. In other words, no emergency or maintenance situation must be in place while conducting load measurements at primary substation. Apart of that, the studied substation must not be under increased load due to a load transfer from adjacent substations, operating in emergency or in maintenance mode. If, however, such non-typical situation is in place, DSO should use typical load obtained from the most recent load measurements.

At least once per 3 months, DSO must evaluate the reserve capacity of primary substation 35 kV and above. DSO evaluates the reserve capacity for each voltage level of primary substations while considering the reserve of other voltage levels. For instance, DSO should consider all contracts for technological connections to substations 35 kV and 10(6) kV supplied from primary substation 110/35/10(6).

If the substation has only one transformer, DSO will evaluate the reserve capacity in N mode. The loading of a one-transformer substation up to its continuous loading limit is considered permissible. If the substation is equipped with two and more transformers, DSO will evaluate the reserve capacity in N-1 mode.

The existing reserve capacity of the primary substation with one transformer is calculated as:

$$S_{reserve}^{actual} = K_{cont} \cdot S_{nom}^{fact} - S_{load} \quad (22)$$

Where K_{cont} - a coefficient for continuous loading of transformer per [427]. For oil-immersed transformer: K_{cont} is 1.05 pu in emergency mode if no load-shedding scheme is available or K_{cont} is 1.30 if load-shedding scheme is implemented. For dry transformers: If no load shedding is possible, K_{cont} should be within limits set by manufacturer. If a load-shedding scheme is in place, the K_{cont} is 1.2 pu in emergency mode.

S_{nom}^{fact} - is the actual nominal rating of transformer in accordance with technical documentation, MVA

S_{load} - up-to-date loading of power transformer, MVA. DSO usually use winter load measurements for the last year while preparing the report/plans for distribution network development. However, if DSO prepares the information for publishing in open access, they also use the winter load measurement but for the last three years. Note that the summer load peak in some power systems may be significantly higher than the winter load peak. In such a case, DSO uses a summer load peak for evaluating the reserve capacity, and the T_{amb} must be imperatively considered.

The existing reserve capacity of the primary substation with two transformers or more and if they have the capability of mutual reservation in N-1 mode⁴¹ is calculated as:

$$S_{reserve}^{actual} = K_{cont} \cdot S_{nom}^{fact} + S_{transfer} + S_{unloading} + S_{losses\ reduction} - S_{load} \quad (23)$$

Where K_{cont} - a coefficient for continuous loading of the transformer

S_{nom}^{fact} - the actual nominal power of transformer (windings) in N-1 mode, MVA. Note that for N-1 mode, DSO considers the outage of the largest transformer. In contrast, outage of overhead line or bus system is not considered.

$S_{transfer}$ - a power, which may be transferred to other substations in N-1 mode if the LV-MV network allows doing that in normal layout without performing the special switching, MVA. DSO must perform AC load flows to define $S_{transfer}$. Suppose DSO can transfer the load to adjacent substations. In that case, the permissible loading of transformers can be increased

⁴¹ If bus is not connected at MV and LV voltage i.e. there is no circuit breaker or there is no transformer between 6 and 10 kV then DSO considers such two-transformer substation as two one- transformer substations.

for the value of load transfer but not greater than 30% of the nominal power of the primary substation in N-1 mode. However, if AC load flows were not performed, then $S_{transfer} = 0$.

$S_{unloading}$ – a power, which may be transferred to other substations after emergency mode using the network 6-35 kV, MVA. The permissible load of transformer for defining $S_{unloading}$ is assumed equal to 1.05 pu.

S_{load} – Up-to-date loading of power transformer, MVA

$S_{losses\ reduction}$ – reducing the primary substation's load to keep the electrical energy losses corresponding to normative levels. In such a case, DSO assumes that the reduction of the maximal load is proportional to the decrease of annual energy transfer through the substation. The normative levels for electricity losses are given in [427].

$$\begin{aligned} \text{if } K_{lr} > 0 \text{ then } S_{losses\ reduction} &= K_{lr} \cdot S_{load} \\ \text{otherwise } S_{losses\ reduction} &= 0 \end{aligned} \quad (24)$$

K_{lr} – a coefficient for load reduction at the studied primary substation for keeping the losses within normative levels:

$$K_{lr} = \frac{E_{losses}^{actual} - E_{losses}^{norm}}{E_{year}^{transfer}} \quad (25)$$

E_{losses}^{actual} – actual losses of electrical energy at substation or outgoing feeders in the reported year, kWh

E_{losses}^{norm} – losses of electrical energy at substation or outgoing feeders in the reported year if keeping losses within a normative level, kWh

$E_{year}^{transfer}$ – annual transfer from the primary substation in the reported year, kWh

3 Estimation of reserve capacity using C&T limitations

In contrast to DSO approach based on power ratings 1.05 pu and 1.3 pu, we propose using C&T limitations from IEC/IEEE standards. As it is already shown in chapter II, this can allow permanently operating the transformers up to 15% higher (in average) than nominal rating and up to 45 % if the intermittent temperature limit is considered. However, using C&T limitations instead of STR would require reconsidering some assumptions. For instance, additional overload capacity was obtained based on historical (i.e. deterministic) T_{amb} . Even though DSO may have access to historical T_{amb} , future T_{amb} may not correspond to historical ones, especially under global warming. As it is already found in several researches, global warming eventually reduces the available capacity for load connection⁴². Therefore, DSO should operate the probabilistic forecasts [428] in such or another way.

Apart from T_{amb} changes, the shape of load profiles may vary significantly in future as more DER may connect to the distribution network or due to the high share of temperature-sensitive loads, microgrids among others. On the one hand, this requires DSO to consider probabilistic variations of load and T_{amb} over year. However, on the other hand, probabilistic techniques may not be available at DSO at the early stages. Therefore, it was decided to focus

⁴² As many studies consider only green area of feasible region, it is necessary to conduct the additional research, which would define the impact of climate change on the total feasible region of transformers. This is kept for future research

on a quasi-robust approach, which would avoid probabilistic methods at the early stages. After that, however, it is necessary to consider them in further steps.

Thus, this section aims to improve the existing method for a reserve determination to consider uncertainties of load and T_{amb} variation over the year. To manage these uncertainties, we decided to use security margins instead of probabilistic forecasts. These security margins should ensure that effects from particular uncertainties in thermal modelling would be reduced or overshoot with the high-security margin. Moreover, we would like to show that even under restrictive assumptions on load and T_{amb} variations, the application of DTR may significantly increase the reserve capacity of transformers.

As mentioned in previous paragraphs, the transformer overloading could happen due to underestimating input data – actual T_{amb} and/or irregularity of load profile. Therefore, it is necessary to ensure that reference input data (T_{amb} and load profile), used for reserve determination, have enough margins over their actual values. To achieve this goal, the approach is proposed to consider the T_{amb} and load profile of new consumers. In addition, the algorithm is developed to define a reserve of the congested primary substation with consideration of transformer’s C&T limitations.

3.1 Consideration of ambient temperature uncertainty

As shown in chapter II, the T_{amb} may substantially impact the permissible transformer loading. Thus, it is necessary to consider the annual variation of T_{amb} for reserve estimation. For achieving this goal, the a quasi-robust but simple approach is proposed. In particular, it is suggested to use worse (the highest) historical T_{amb} at each month as the reference value *over the whole month*. This approach allows obtaining the worse HST and LoL of a power transformer against actual T_{amb} variations during a year. As initial data for worse T_{amb} calculations, the hour T_{amb} for the last 30 years (Figure 42) is taken from [429].

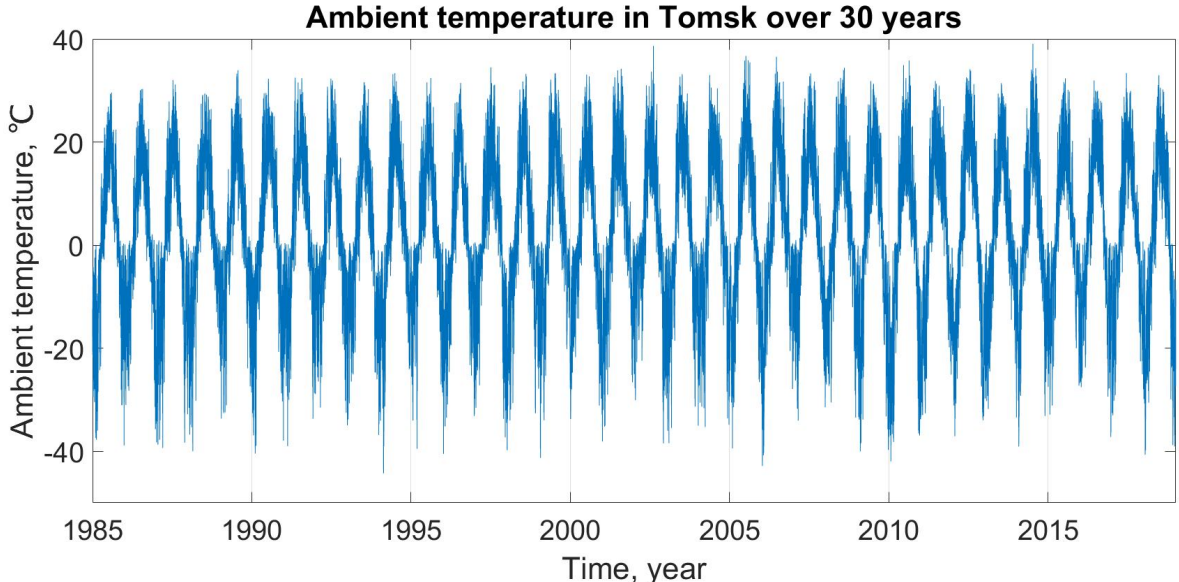

Figure 42 Historical T_{amb} in Tomsk over 30 years. Source: MeteoBlue

After analysing historical data, it is possible to build the T_{amb} histogram for each month (Figure 43 below). A conservative confidence interval of 100% is used to choose the highest T_{amb} from the given histogram. In the given example, the highest T_{amb} ever registered in September is +33°C – which provides a 100 % confidence interval. As an alternative, it is possible to use

other confidence intervals – 99%, 95% or 90%. However, it was decided not to study this opportunity and focus only on the conservative (the highest) T_{amb} in this thesis. Figure 44 shows the highest T_{amb} obtained correspondingly for each month. T_{amb} profile from Figure 44 will be assumed as T_{amb} nearby transformer.

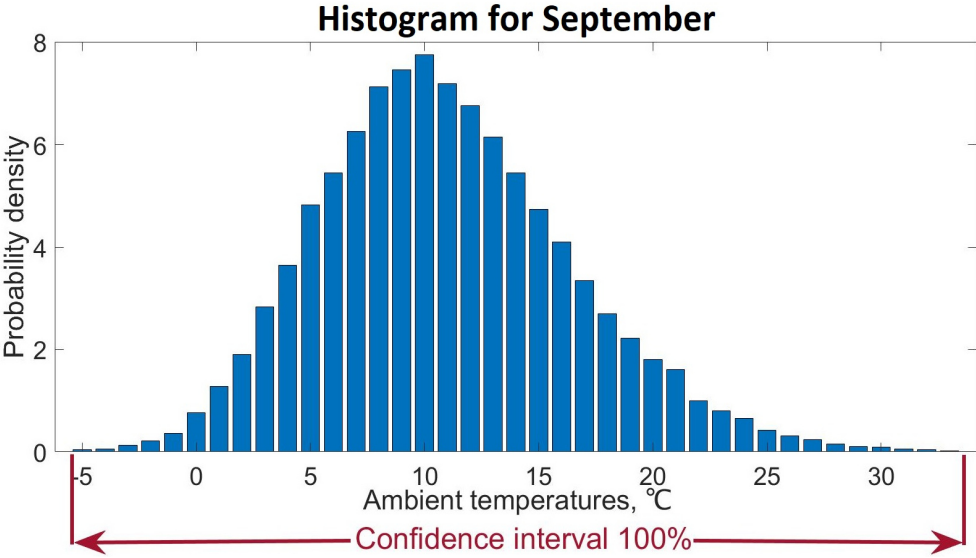

Figure 43 Histogram of T_{amb} in September since 1985

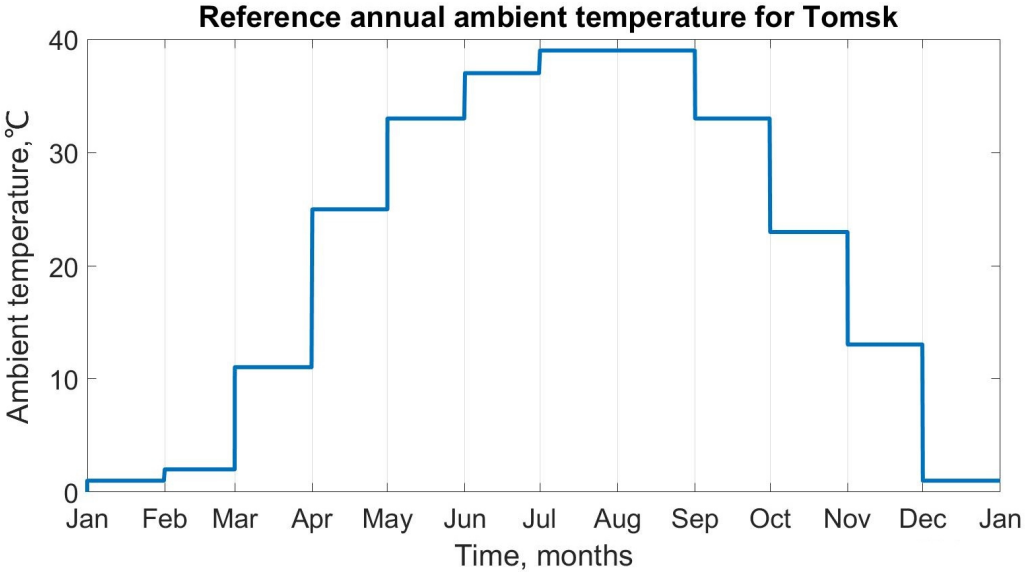

Figure 44 Reference annual maximal T_{amb} for use in thermal modelling

However, suppose DSO would like to model temperature sensitive loads. In that case, it may be better to use the actual forecast of T_{amb} over one year. Thus, DSO may assume the T_{amb} profile from Figure 44 nearby transformer (still keeping the secure margin) and the actual T_{amb} profile for temperature-sensitive loads. Of course, from the physical point of view, such a situation is over-hedging. But this will allow us demonstrating that even under such restrictive assumption, the reserve capacity may remain significant. Moreover, this allows using the security margins in thermal modelling of transformer against variations of real T_{amb} in the future due to possible climate changes.

This security margin appears for two reasons: (1) assuming the highest historical temperature of the given month and (2) assuming a permanent duration of the highest T_{amb} over the whole month. Thus, even if future T_{amb} is higher than those assumed in thermal modelling, their negative effect should be compensated. This is because the historical temperature was assumed constant over the whole month. In contrast, actual temperature will have a variable form by nature. At the same time, such an approach allows considering seasonal variations of ambient temperatures. The advantages for such T_{amb} consideration are following:

1. As the highest T_{amb} is set constant over the whole month, this allows considering the variation of future T_{amb} . Therefore, even if the real T_{amb} would be higher than the assumed one in thermal modelling, such a method reduces the adverse effect. Furthermore, real T_{amb} would not rise for a long time over assumed temperature but only for a short time. Thus, the negative effect from such underestimation will be negligible compared to the impact of using the historical peaks of T_{amb} during the whole month. Hence, it is possible to add a security margin against the effects of T_{amb} uncertainty on the HST and LoL of the transformer.
2. DSO may calculate the highest T_{amb} only once and then use it for all primary substations located in the same city or maybe region if possible. If new peaks of T_{amb} appear, then DSO could quickly correct the existing profile used in thermal modelling.

3.2 Consideration of new consumer load profile uncertainty

The load profile of *new* consumers may have various irregularities (i.e. a shape) during the year. Hence, it may be problematic to accurately define the final irregularity of load profiles at the stage of a reserve determination. As a result, the thermal states of the transformer, which heavily depends on a load profile, are also uncertain. This uncertainty does not allow to correctly define the accurate reserve of a primary substation through thermal modelling. Idem if DSO would like to consider C&T limitations.

Thus, this section presents a simple approach to consider all possible load profile irregularities of new consumers. To do that, we propose to use a constant load profile (equal to its peak load) as the reference load profile of the new consumer (see Figure 45). Such assumption allows obtaining the worse temperature and ageing concerning any other load profiles with equal peak load. Hence, it is possible to define the reserve capacity for a worse case.

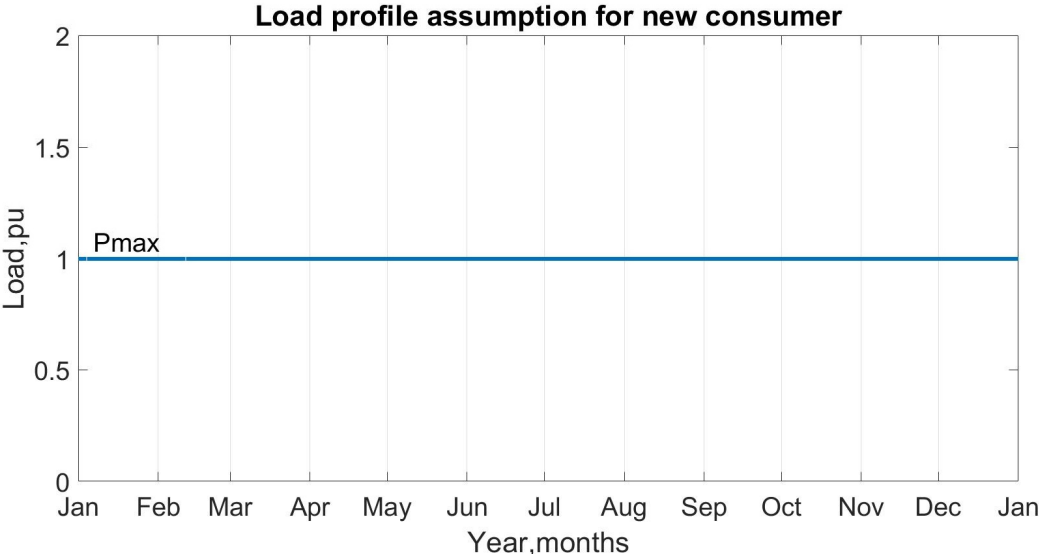

Figure 45 Assumed load profile of new consumer during the year

The advantages of the proposed approach for load profile consideration of new consumers are following:

1. The proposed approach can be easily adapted in practice since the existing application has information about the peak load of the new consumer. Thus, it is a sufficient condition (together with the reference T_{amb} and the initial load profile) to estimate the worse HST_{max} and LoL.
2. The constant load profile of the new customer allows obtaining the worse HST and LoL compared to HST and LoL of any other load profiles with the same peak load. However, DSO may need to model the existent loads, which are temperature-sensitive (out of scope of this thesis).

3.3 Algorithm for substation reserve determination

The goal of this section is to present the algorithm for reserve determination with HST_{max} and LoL consideration:

Main steps	Algorithm for a reserve determination considering C&T limitations
Step 1	% Input: hourly load profile and reference T_{amb} over a year; $S_{load}(t)$ and $T_{amb}(t)$ where $t = 1 \text{ h} \dots 8760 \text{ h}$
Step 2	% Estimate preliminary reserve as: $S_{reserve} = S_{admissible}(T_{amb} \text{ at } t_{max}) - \max(S_{load}(t_{max}))$
Step 3	% Increase the annual load profile by $S_{reserve}$: $S_{load}(t) = S_{load}(t) + S_{reserve}$
Step 4	% Calculate HST_{max} and LoL after adding $S_{reserve}$; $[HST_{max}, LoL] = IEC_60076 (S_{load}(t), T_{amb}(t))$
Step 5	% Adjusting the reserve value: if $\max(S_{load}(t)) > 1.5 \text{ pu}$ or $HST_{max} > 120 \text{ }^\circ\text{C}$ or $LoL > 8760 \text{ h}$ display ('Preliminary reserve is overestimated'). % Decreasing the reserve value using while cycle: while $\max(S_{load}(t)) > 1.5 \text{ pu}$ or $HST_{max} > 120 \text{ }^\circ\text{C}$ or $LoL > 8760 \text{ h}$ (a) % Decrease reserve by 0.01 pu: $S_{reserve} = S_{reserve} - 0.01 \text{ pu}$ (b) % Recalculate annual load profile with new $S_{reserve}$: $S_{load}(t) = S_{load}(t) + S_{reserve}$ (c) % Calculate HST_{max} and LoL: $[HST_{max}, LoL] = IEC_60076 (S_{load}(t), T_{amb}(t))$ Otherwise save $S_{reserve}$ and finish End % end of while cycle elseif $\max(S_{load}(t)) < 1.5 \text{ pu}$ and $HST_{max} < 120 \text{ }^\circ\text{C}$ and $LoL < 8760 \text{ h}$ display ('Preliminary reserve is underestimated') % Increasing the reserve value using while cycle: while $\max(S_{load}(t)) < 1.5 \text{ pu}$ and $HST_{max} < 120 \text{ }^\circ\text{C}$ and $LoL < 8760 \text{ h}$ (a) % Decrease reserve by 0.01 pu: $S_{reserve} = S_{reserve} - 0.01$ (b) % Recalculate annual load profile with new $S_{reserve}$: $S_{load}(t) = S_{load}(t) + S_{reserve}$ (c) % Calculate HST_{max} and LoL: $[HST_{max}, LoL] = IEC_60076 (S_{load}(t), T_{amb}(t))$ Otherwise save $S_{reserve}$ and finish End % end of while cycle End % end of If $\max(S_{load}(t)) > 1.5 \text{ pu}$ or $HST_{max} > 120 \text{ }^\circ\text{C}$ or $LoL > 8760 \text{ h}$

3.4 Case study

3.4.1 Initial data

To verify the proposed approach, it is necessary to compare its results with similar results of the conventional DSO approach. To do that, we investigate the real congested primary substation. This primary substation has two ONAF power transformers, 25 MVA, located in Tomsk, Siberia, Russia. Transformer parameters, used for their thermal modelling, are taken from [14] and presented in Table 13 below.

Table 13 Transformer thermal parameters used in the case study

Parameter	Value	Parameter	Value
x	0.8	$\Delta\vartheta_{hr}$	26
y	1.3	$\Delta\vartheta_{or}$	52
R	6	k_{11}	0.5
τ_o	150	k_{21}	2
τ_w	7	k_{22}	2

Note that the values of Table 13 are conservative since IEC 60076-7 was intended to represent the whole transformer fleet by using the same set of thermal characteristics [369]. Generally, the thermal characteristics of transformers are obtained by performing so-called non-truncated heat run tests [71]. Non-truncated heat run tests mean a situation when a constant load is applied to the transformer until reaching the steady-state (constant) temperatures of an oil and a winding [430]. The reader can see [369],[71],[283] for more details on thermal characteristics and the equations of IEC 60076-7 [91].

Figure 46 shows the initial load profile of the primary substation and the reference T_{amb} profile. The reference T_{amb} graph for Tomsk is taken from Figure 44. The reference load profile is synthesized by taking the maximal measured load for the previous five years at each time step.

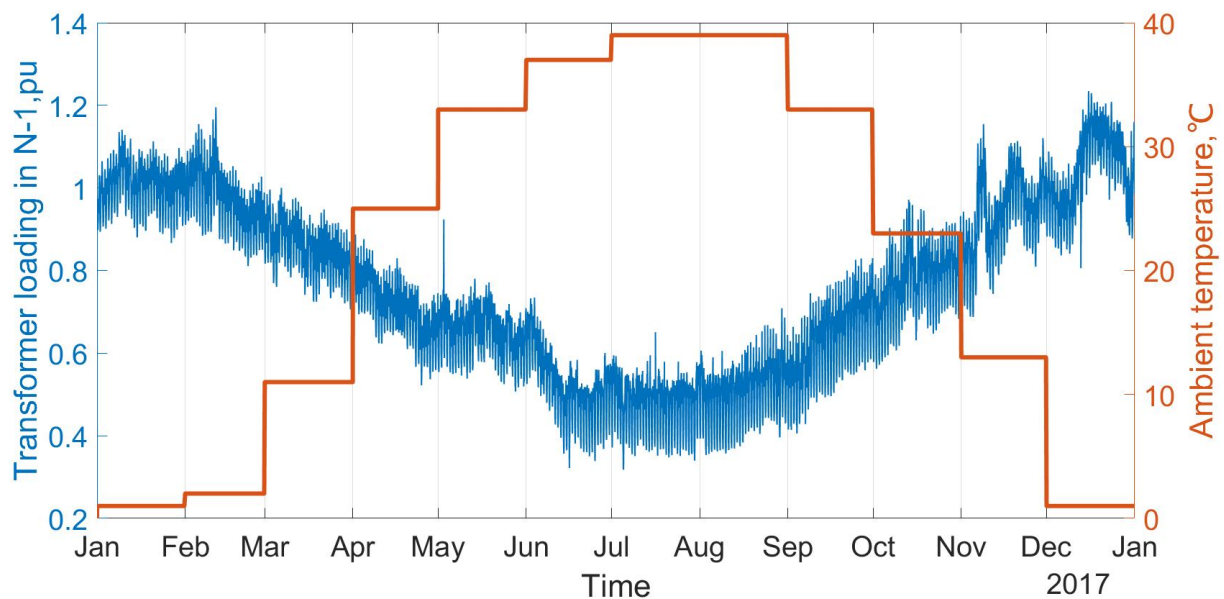

Figure 46 Initial load profile of primary substation and reference T_{amb} graph in Tomsk

3.4.2. Estimating the transformer reserve with a conventional approach

The conventional DSO approach determines a reserve as the difference between the lowest transformer capacity with 5% overloading in N-1 mode (in this case $S_{N-1} = 1.05 \text{ pu} = 26.25 \text{ MVA}$) and the peak load of the primary substation (according to Figure 46, $S_{\text{load max}} = 1.2344 \text{ pu}$):

$$S_{\text{reserve}} = 1.05 \cdot S_{N-1} - S_{\text{Load max}} \quad (26)$$

$$S_{\text{reserve}} = 1,05 \cdot 1 - 1,2344 = -0.1844 \text{ pu} = -4 \text{ 610 kVA} \quad (27)$$

According to the conventional approach DSO does not have any reserve at this primary substation. Thus, any load connection would be restricted to this substation. Moreover, the reserve is negative (- 4 610 kVA). This means that a power supply capability of the given primary substation could be limited for almost 5 MVA load in N-1 mode. Therefore, it implies that DSO plans large capital expenditures to reinforce two 25-MVA transformers at this primary substation.

3.4.3. Estimating a transformer reserve with C&T limitations

To assess the proposed approach, it is necessary to determine the reserve of the above-considered primary substation using C&T limitations. To do that, the algorithm mentioned above is applied.

At steps 1-2 of the algorithm, it is necessary to estimate the transformer reserve, corresponding to the difference between a peak load and the admissible transformer loading, corrected to T_{amb} . The calculation results of these parameters are presented in Table 14 below:

Table 14 Results of the algorithm at steps 1-2

$S_{\text{load max}}$	$T_{\text{amb}} S_{\text{load max}}$	$S_{\text{admissible}}$	S_{reserve}
1,234 pu	+1 °C	1,317 pu	0,083 pu

At step 3 of the algorithm, it is required to increase all values of load profile (Figure 47) for this reserve value (0.083 p.u.), calculated at the previous step. In other words, a reserve value is added to each value of the initial load profile.

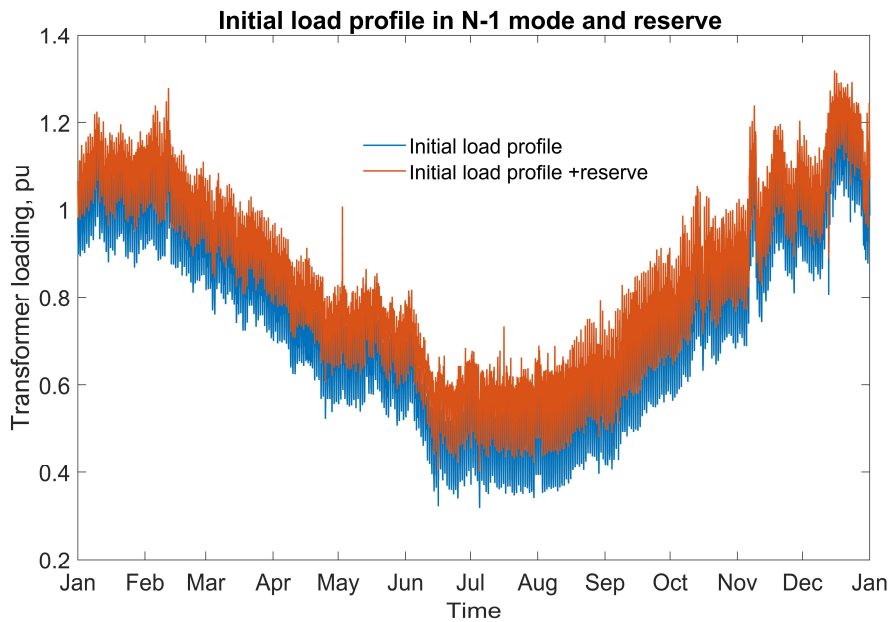

Figure 47 Initial load profile (blue) and the same load profile after adding reserve (orange)

Further, at step 4 of the algorithm, it is necessary to estimate the transformer HST_{max} and LoL for the new load profile (the orange profile in Figure 47). Figure 48 shows the obtained HST of transformer windings over the year and the corresponding LoL by the end of the year.

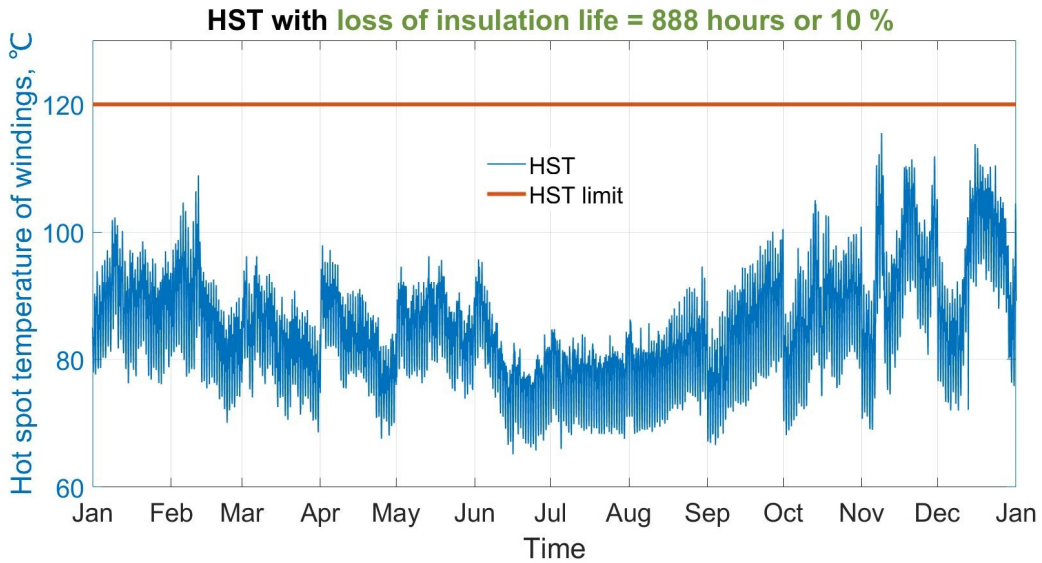

Figure 48 Annual HST profile and corresponding LoL

Results show that transformer HST and LoL do not exceed their permissible values:

$$HST_{max} = 115,5 \text{ }^{\circ}\text{C} \leq 120 \text{ }^{\circ}\text{C} \quad (28)$$

$$LoL = 888 \text{ h} \leq 8 \text{ 760 h} \quad (29)$$

From obtained HST_{max} and LoL, it can be seen that both HST and LoL have margins against their limits. Thus, these margins could be used to connect a more load. To quantify this additional load, it is necessary to iteratively increase the reserve by 0.01 pu until HST_{max} or LoL is reached. After three iterations, the constraint – HST_{max} reaches its permissible value (see Figure 49):

$$HST_{max} = 119 \text{ }^{\circ}\text{C} \leq 120 \text{ }^{\circ}\text{C} \quad (30)$$

$$LoL = 1 \text{ 410 h} \leq 8 \text{ 760 h} \quad (31)$$

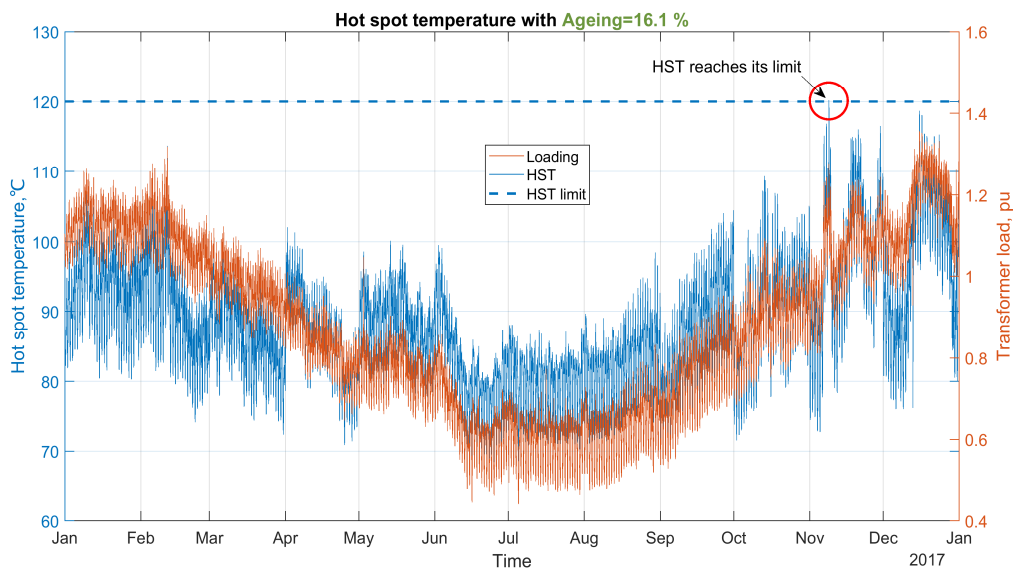

Figure 49 Reaching the HST limit subject to the increased load profile

Although the HST limit is reached, another constraint - LoL is less than 15% from its permissible limit, and the load is still below its current limit (1.5 pu) as well as the oil temperature. Hence, the transformer operates within all C&T limitations. Therefore, the substation reserve can be increased from 0.083 p.u. (preliminary computed) to 0.113 p.u (finally computed). In other words, the supposedly congested primary substation can actually connect 2825 kVA of new consumers with any load profile.

3.5 Conclusions

The case study showed that using C&T limitations instead of power ratings allows connecting 2 825 kVA of new consumers. In contrast, using power ratings at the same substation restricts any load connections at all. Moreover, according to a conventional DSO approach, the primary substation capacity lacks 4 610 kVA for reliable power supply of existing consumers in N-1 mode, whereas no load shedding would need in case of C&T limitations. Note that in case of C&T limitations, a reserve capacity of 2 825 kVA is calculated for the worst-case scenario on T_{amb} and load growth. If, however, DSO would like to use probabilistic techniques on load growth and T_{amb} , we believe that more load can be connected to existing substations.

Even without such probabilistic methods, DSO can already defer significant investments in transformer reinforcement thanks to a quasi-robust approach. This is again possible due to exploiting a hidden capacity of power transformers. These results testify that despite our restrictive assumptions on load and T_{amb} , transformers may have a significant reserve capacity for connecting the loads with any power profiles. Moreover, we draw the attention that C&T limitations were chosen for normal cyclic loadings, albeit N-1 mode was investigated. In theory, we may use C&T limitations of long-term emergency loadings for N-1 mode which are less restrictive (see Table 6 in Chapter II). This would increase the reserve capacity further. But again, C&T limitations for normal cyclic loading were intentionally chosen together with restrictive assumption on load growth and T_{amb} to demonstrate the significant reserve capacity of power transformers.

Following the philosophy of open science [377], it was decided to make available MATLAB scripts, functions and the initial data used in this thesis. Thus, the MATLAB code used in this chapter is available in open access at the GitHub repository [431].

Table 15 Contribution of this chapter and the conference where it was presented

Contribution of this chapter	
C2	It was demonstrated that transformers have a substantial reserve capacity even under restrictive assumptions on load growth and T_{amb} . With restrictive assumptions, we applied DTR to estimate the reserve capacity on the example of a primary substation in Russia. The DTR-based reserve was evaluated against DSO approach. In contrast to the DSO approach based on static power limits, the proposed DTR approach is based on C&T and ageing limits. To formalise the approach, we formulated an algorithm that integrates restrictive assumptions on load and T_{amb} . Thus, it is ensured that the obtained reserve is located on the conservative side from a thermal point of view.
CIRED conference in Madrid, Spain 2019	MATLAB code at GitHub [431]

4 Coupling DTR with DR to increase a transformer reserve capacity

Previous section 3.4 demonstrated that using C&T limitations instead of a 1.05-pu rating could significantly increase a reserve capacity. However, it is necessary to pay attention to a stopping criterion of (C&T based) algorithm from the previous section. To remind, the augmenting the transformer load (i.e. a reserve capacity) stopped because HST may start violating its limit in N-1 condition. However, this violation of the HST limit would happen only once per year (see red circle in Figure 48). Moreover, this is supposed to occur under very conservative assumptions: on T_{amb} , load growth and C&T limitations. Suppose DSO manages to mitigate this violation. In that case, more consumers can be connected.

As mentioned in previous sections, DSO may already connect consumers beyond than 1.05-pu ratings of transformers (up to 1.3 ratings) if an automatic load-shedding scheme is in place. Thus, we believe that the same practice can be extended if using C&T limitations with DER flexibility. Indeed, flexibilities may be provided from controllable distributed generation, storage, demand-side management [432]. Such DER should grow 6-9% per year, and by 2025 their installation rate will be three times higher than the installation rate of a centralized generation [25]. Therefore, it seems that DER will provide a technical possibility to manage the distribution network more actively. Consequently, it was decided to investigate the problem of a reserve capacity if using DTR together with flexibilities. Furthermore, after preliminary analysis of many possible flexibility options, it was agreed to investigate the Demand Response (DR) because DR is considered the low-cost technology [433]. The following paragraphs present the literature review on using DTR together with DR.

4.1 Literature review on using DR and DTR for transformer reserve capacity

The researchers investigating DR usually consider a conservative thermal rating of network equipment. Thus, this confirms that the network capacity can be underused. For instance, Martínez Ceseña et al. [434] demonstrated that small end-users could support the network capacity without sacrificing comfort levels. In [435], the same authors suggested a methodology, estimating a business case of DR for a small multi-energy district to support a distribution network's capacity. Celli et al. [436] proposed a model of flexibility aggregation with a particular focus on DR to address network contingencies. In another study [437], Esmat and Usaola developed an algorithm allowing to minimize the total cost of congestion management with consideration of payback effects. Jiang et al. [438] incorporated interruptible loads into substation capacity planning. Mullen [439] investigated the essential interactions between demand-side response, load recovery, peak pricing, and network capacity margins. Weckx et al. [440] performed a multi-agent EV charging considering transformer limits and voltage constraints. Once again, the thermal rating in these studies is considered conservatively.

At the same time, the researchers considering DTR/thermal modelling do not consider the possibility of using flexibilities. For example, Elmakis et al. [166],[441] developed a probabilistic approach for defining a transformer capacity based on its loss of life. Sen et al. [78] suggested a methodology for sizing a new oil-immersed transformer to replace the existing equipment. In another study [185], Bunn et al. estimated the capacity of a distribution transformer to accommodate additional demand without impacting reliability indexes. Finally, Kostin et al. [324] estimated urban transformers' reserve capacity (allowable loading) considering a minimum of relative annual electric power losses. Once again, these studies consider DTR without taking advantage of flexibilities.

Finally, the researchers who apply DTR and DR do not explicitly explain how much load can be interconnected to a substation [329]. For example, Sousa et al. [169] investigate the use of interruptible contracts for mitigating the emergency operation of power transformers. Teja and Yemula [330] prolonged the transformer life by controlling heating/cooling systems in buildings. Davison et al. [331] estimated the number of consumer connections considering the DR, temperature-sensitive load behaviour, and DTR of overhead lines (but not for transformers). Zhou et al. [332] proposed bi-level multi-house energy management to coordinate the residential DR and a transformer ageing. Van Der Klauw et al. [333] proposed smart charging strategies of electric vehicles and a neighbourhood's load profile to mitigate transformer ageing. Liu et al. [334] suggested a DR strategy to balance household benefits and the transformer lifespan. Soleimani and Kezunovic [335] proposed a method that defines a charging schedule of electric vehicles that eventually mitigates the transformer ageing and reduces risks of failure. Mohsenzadeh et al. [336] developed smart home management strategies to mitigate transformer loss of insulation life. Brinkel et al. [337] found that transformer reinforcement could lead to higher emissions than operating the existing transformer with lower ratings. Humayun et al. presented a series of papers [234], [273]–[275] dedicated to the joint application of DTR and DR to increase transformer utilization. Specifically, in [234],[274], the authors proposed an optimization model for the maximal utilization of transformer capacity during contingencies. In [275],[273], the authors expanded the scope of network automation (load transfer on near substations). The authors also included all the costs occurring along the transformer lifetime.

Some early studies estimated the transformer reserve without considering DR or DTR. For instance, Salehi and Haghifam [338] applied a genetic algorithm to define the reserve capacity of a substation. In [339], Kannan and Au suggested a probabilistic approach for sizing the distribution transformers. Finally, Helmi et al. [340] used the power factor correction capacitors to increase the reserve capacity of power transformers. Thus, the scope of this study establishes the intersection between three domains: Demand Response, Dynamic Thermal Rating, and the problem of reserve estimations. Although substantial efforts were made in each field, there is still a gap in their intersections.

The existing DSO methodology already allows connecting more consumers if the load shedding scheme is in place. Therefore, similar to load shedding, it is possible to increase reserve margins if DR is in place. However, suppose DTR is coupled with DR. In that case, a question is posed: how much and when is it necessary to have DR to ensure the different reserve margins? Sections 4.2-4.4 will answer this principal question.

4.2 End-users side flexibility for grid upgrades deferral

The reader may start reading from Section 4.2.1, presenting the case study of this section. Moreover, this section explains the choice of assumptions allowing us to consider that the calculated DR has safety margins to mitigate the thermal constraints of transformers. Further, section 4.2.2 explains at what reserve margins it would be sufficient to use DTR only and from what moment it is necessary to apply DR and DTR. Finally, in Section 4.2.3, the reader can see an overview of the proposed methodology to find the required DR.

4.2.1 Case study

The case study (Figure 50a) is an outdoor MV/LV substation with two 500 kVA distribution transformers equipped with an ONAN cooling system (Oil Natural Air Natural). Figure 50b

shows the annual load profile at MV/LV substation at 1-h resolution. This load profile represents an aggregated consumption of one hundred houses simulated by physical and behaviour approaches [442].

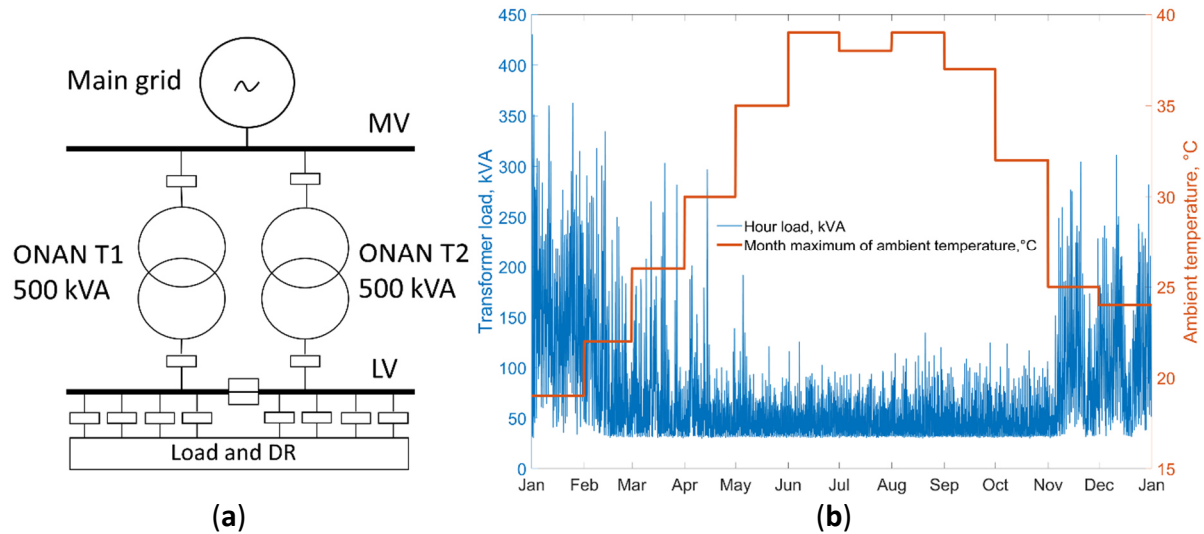

Figure 50 Case study—(a) outdoor secondary substation; (b) hourly load in kilovolt ampere (kVA) and monthly maximum ambient temperature (θ_t^a) in Grenoble, France.

To extract the load profile, it is necessary to use a MATLAB application “House load” [443] with all default parameters except the T_{amb} profile (ϑ_t^a). The updated hourly ϑ_t^a in 2019 was provided by MeteoBlue for Grenoble, France [444]. To obtain the conservative reserve values, only the historical maximum of T_{amb} for each month was used in thermal simulations (Figure 50b) [344]. These historical maximums of ϑ_t^a are assumed as a safety margin when simulating the worst thermal state of the transformer for different reserve values. This is especially relevant for global warming with expected constantly rising T_{amb} . Moreover, this margin can mitigate other errors in thermal characteristics/modelling.

An additional margin in the study comes from the reserve computation that assumes a N-1 condition with the loss of one transformer in the given substation. Thus, if one transformer is out of service, the remaining distribution transformer 500 kVA can supply all load alone. This is possible because the existing peak load is only 430 kVA (86% of nominal rating, 500 kVA). Therefore, the reserve for load connection (in a traditional DSO approach) would be estimated as the difference between the nominal rating (here without permissible 5% overloading) and the peak load, i.e., $500 - 430 = 70$ kVA (i.e., 14% of nominal rating).

Instead of the nominal rating (with the 1.05 coefficient or without), the DSO can also apply other approaches as STR [289],[269], seasonal ratings [269], or emergency ratings [445]. Nevertheless, the method for reserve determination does not change in its nature. It still represents a simple difference between admissible constant rating and the peak load without consideration of the actual thermal state of transformers. To focus on the thermal aspects of transformer operation, it was decided to consider only the thermal and ageing constraints of transformers. Note that other limiting factors (e.g., voltage) are ignored. This seems quite reasonable to practice as the paper [446] shows that 78%–83% of real network constraints are related to thermal restrictions.

Moreover, conventional DTR approaches assume a winding temperature limit of 98 °C, which is actually a design temperature of winding rather than a temperature limit. On the other

hand, the actual temperature limit per loading guide is higher, e.g., 120 °C or 140 °C [91]. The question of using design temperature or a temperature limit for transformer loadings was actively discussed in [54], [55], [187]. Hence, the approach based on the conventional design temperature will be considered a reference case (for DTR) in this section.

Once thermal modelling is applied, the transformer temperatures (i.e., oil temperature ϑ_t^o and hot spot temperature ϑ_t^h) and Ageing EQuivalent (AEQ) over the year can be calculated explicitly using the loading profile P_t^{tr} (in pu) and T_{amb} . As any variable representing the physical state, current, temperature, and ageing have corresponding limits. The choice of those limits can be again used to set substantial safety margins for thermal modelling. For instance, Table 16 provides C&T limits for various loading types: normal cyclic loadings and two emergency modes—long-term overloading and short-term overloading.

To remind, normal cyclic loading is when a transformer is subject to a high T_{amb} or higher-than-rated load. However, the ageing remains the same as for nominal conditions. Long-term emergency loading is when a transformer is subject to elevated temperatures for days or even months. Short-term emergency loading of transformers is the heavy overloading for less than 30 min. Due to the temporal nature of emergencies, the IEC standard [91] allows increasing their C&T limits.

Table 16 Limits for distribution transformers applicable for different types of loadings [91].

Limits	Loading Type		
	Normal Cyclic	Long-Term Emergency	Short-Term Emergency
P^{tr} (p.u.)	1.5	1.8	2
ϑ^h (°C)	120	140	180
ϑ^o (°C)	105	115	Not specified
AEQ (p.u.)	1	>1 possible	Not specified

In this section, it was decided to use the normal cyclic loading as the strictest limits in the N-1 condition. However, DSO could choose the long-term emergency limits as an alternative for N-1 conditions. This would allow releasing more transformer capacity at the cost of higher risks of overheating and accelerated loss of life. This alternative is not considered in this thesis but could be easily integrated without changing the proposed methodology and algorithms.

As stated in previous section 3, the problem of reserve determination is that the load profile of a new consumer cannot be definitely known in advance. Therefore, the transformer’s load profile after the connection of new consumers is also unknown. Furthermore, in addition to the renewable production, leading to the famous duck curve from California [447], the electrification of the heating and transport sector may change the typical shapes of existing load profiles. Hence, the existing shape of a load profile is not increased proportionally in this study to add a further “safety margin”. Instead, the reserve is considered while adding a constant load to the existing load profile throughout the representative year [344]. Adding the constant load profile ensures a worse thermal mode of operation than any other pattern with the same peak power.

Nevertheless, this assumption considers the peak increase only from new load connections. However, existing consumers, especially industry customers, can also increase the peaks. Regardless, DSO must guarantee that consumers could withdraw all power from the

distribution network, indicated in connection contracts (also known as firm capacity contracts [448]). As mentioned in section 1.1, consumers usually do not use their total requested power. Nevertheless, there is no guarantee that some industrial or commercial consumers will not expand production capacities and then boost the actual power demand up to the subscribed power indicated in connection contracts. In such a case, the assumption mentioned above can lead to errors in substation peak estimations and even emergencies. DSO may add a full-subscribed (i.e., not measured) power of large industrial and commercial consumers to the existing load profile to mitigate such risks.

4.2.2 Problem Statement

The problem statement is described in Figure 51 by conducting preliminary thermal studies. These initial studies investigate what would be ϑ^h , ϑ^o , and AEQ for different reserve margins without using DR (i.e., without taking any measures to decrease the temperatures of transformers). Figure 51 displays the state variables of the transformer as a function of the added constant load from 1% to 100% of a nominal rating of 500 kVA to the existing load profile shown in Figure 50b.

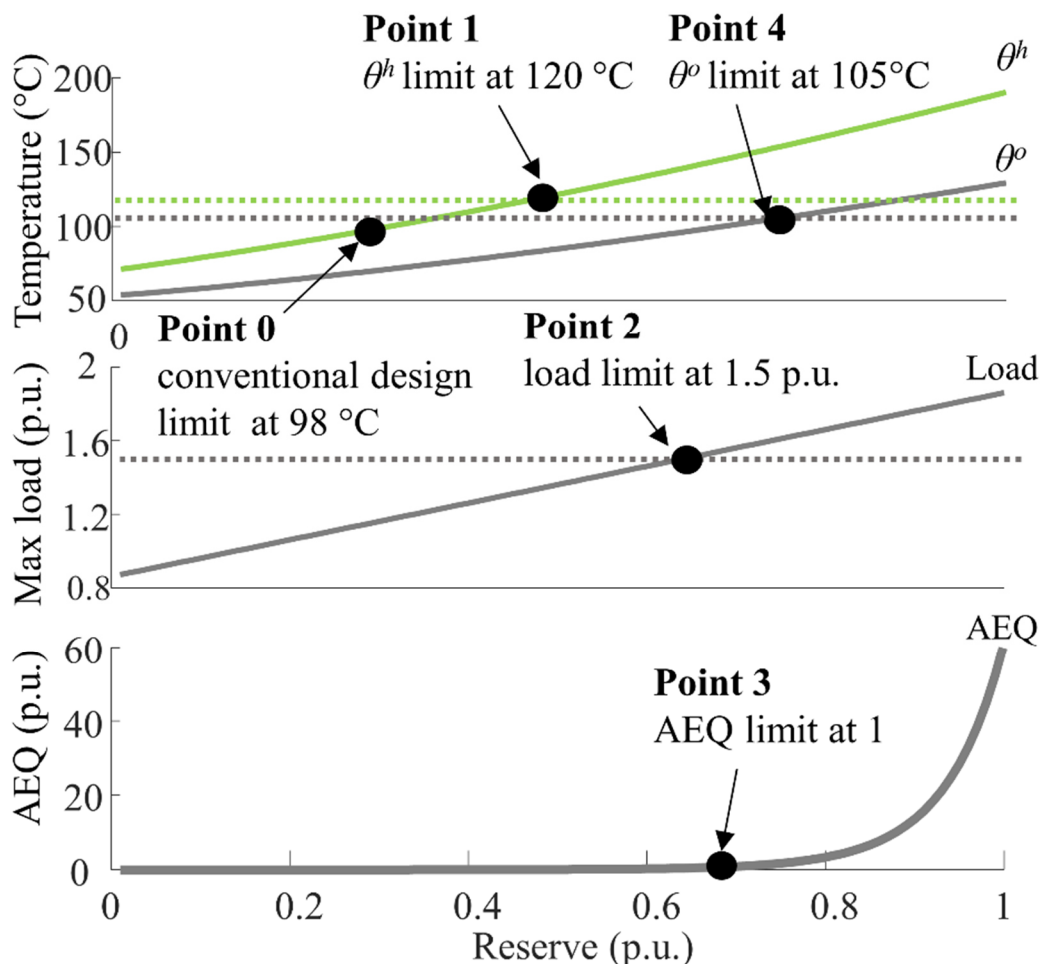

Figure 51 Preliminary results for yearly simulation: load growing from 1% to 100% of nominal rating (reserve in pu). The initial loading of the studied distribution transformer is 86% (see the y-axis of the central figure).

The maximal ϑ^h , ϑ^o during the year, and corresponding AEQ are estimated for the N-1 condition and computed using the IEC 60076-7 standard [91]. The IEC 60076-7 standard is an

internationally recognized loading guide that provides mathematical equations and thermal characteristics of oil-immersed transformers needed to calculate ϑ^h , ϑ^o , and AEQ. Specifically, it was decided to use the difference equations described in annexe E of the IEC 60076-7 standard. These equations are presented later in Section 4.3.1.

The preliminary thermal studies show that it is possible to connect a constant load of 240 kVA (=0.49 pu * 500 kVA) without violating the thermal constraints at 120 °C (see point 1). That 240-kVA reserve is 3.4 times higher than the reserve (70 kVA) calculated with a conventional approach—i.e., the transformer rated power (500 kVA) minus the peak consumption (430 kVA). The 240-kVA reserve is even more significant than the similar reserve obtained for DTR based on design temperature 98 °C (145 kVA, 0.29 pu at point 0). Although the use of design temperature in DTR is often claimed to avoid accelerated ageing, it could be observed that accelerated ageing occurs only if the reserve (a load growth) reaches significant values around 0.70 pu (see point 3). Thus, the consideration of the ϑ_t^h limit should be preferred over design temperature if the ageing limit is explicitly taken into account [344].

Suppose appropriate DR programs prevent the violation of temperature constraints. In that case, more load can be further connected to the transformer until the next limit is reached—the current limit at 1.5 p.u. (point 2 at 350 kVA in Figure 51). Starting from this point, DSO should use DR to avoid breaking both ϑ_t^h and current limits. Thus, from point 2 onward, the reserve can be further increased from 320 to 350 kVA until the next critical point is reached (see point 3 in Figure 51). Starting from this point 3, the AEQ may be higher than the normal annual loss of transformer life. Hence, it is necessary to reduce the ϑ_t^h even well below its limit to keep the AEQ less than 1 (as it will be shown in Section 4.4). The last critical point 4 in Figure 51 (reserve of 365 kVA) is when the transformer oil temperature violates its limit. At this moment, an appropriately designed and managed Demand Response should tackle three constraints at the same time—transformer thermal limits (ϑ_t^o , ϑ_t^h), current limit, and insulation ageing.

It is important to note that DR will be required only a few days per year (e.g., high load, high T_{amb} , or maintenance works). Thus, the DR design and management can be formulated only for the days when the transformer violates the thermal limits and not for the entire year. Hence, it is possible to avoid developing a largely intractable optimization problem. However, it is necessary to state that this idea remains valid as far as the longest interval does not exceed a few days. Figure 52 shows the longest interval with thermal violations considered in the DR optimization problem as a function of the reserve margin (added constant load on the x-axis).

Figure 52 shows that the longest interval increases exponentially. From a reserve value of 1.04 pu onward, the overheating occurs every day of the simulated year. Hence, nonlinear equations from IEC 60076-7 would lead to the intractability of the optimization problem. Therefore, in the paper [345], the authors suggested a linearization of the nonlinear equations of the transformer thermal model. However, it was decided to exclude the linearization from the thesis because this contribution firstly belongs to our colleague - Rémy Rigo-Mariani, with whom we get a chance to work on this article. The reader can still find this result in [345].

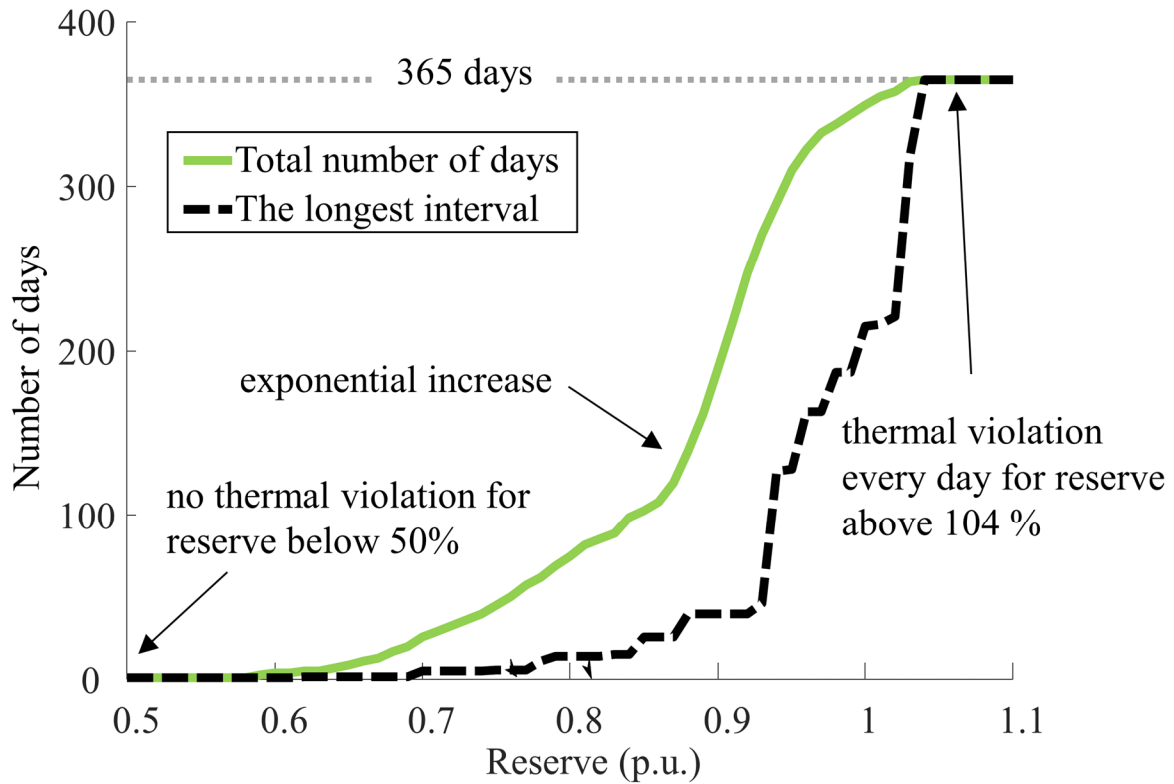

Figure 52 Number of days where thermal limits are reached.

4.2.3 Methodology

Figure 53 shows the algorithm to compute the necessary DR to ensure a given reserve level. The workflow consists of three main stages. At first, the annual transformer loading (without DR) is computed with the initial load profile increased by the given reserve margin. Next, the thermal state of the transformer is estimated with T_{amb} over the whole year. If there are no thermal violations, then no DR is needed, and the algorithm stops here. Hence, another reserve margin can be investigated.

If any overheating is detected, the second stage of the algorithm identifies the interval(s) where transformer temperatures ($\vartheta_t^o, \vartheta_t^h$) or current limits are violated. The algorithm extracts the loading profile (P_t^l) at every identified interval. Later, the load and T_{amb} profiles over a given interval are considered inputs for the integrated DR management and design. As outputs, the integrated DR management and design compute the minimum DR needs to fulfil the operating constraints (see Section 4.3).

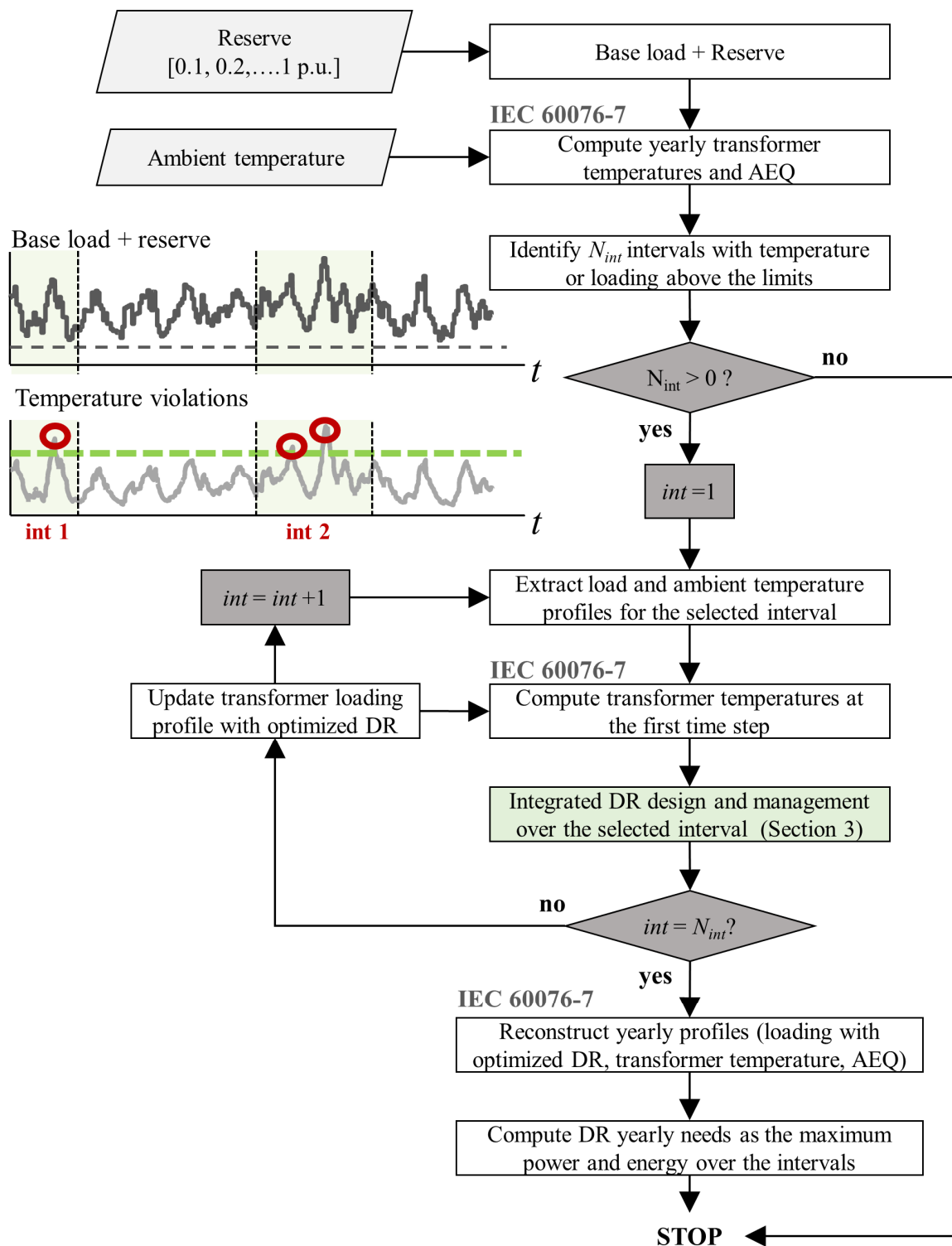

Figure 53 The procedure for finding the necessary volume of Demand Response (DR) to interconnect the studied reserve.

Note that the thermal model of the transformer requires initial values for the top-oil and hot-spot temperatures at the beginning of the extracted interval. To do that, the optimized transformer loading profile (with DR management) from the previous calculation is used to update the annual load profile from the start of the year until the beginning of the next

interval. This cycle repeats until all intervals are investigated and allows us to track the correct initial temperature every time an interval is simulated.

The last stage of the algorithm is needed once all intervals are studied, and the optimized annual load profile is entirely reconstructed. Finally, the algorithm defines the DR values in power and energy units.

4.3 Integrated Design and Management of Demand Response

To understand the thermal modelling of the chosen ONAN transformer, the reader can refer to Section 4.3.1. Section 4.3.2 suggests the problem formulation of integrated design and management for DR.

4.3.1 Transformer thermal model and ageing

The thermal model of oil-immersed transformers and the values for thermal characteristics are derived from the IEC 60076-7 standard [91]. The IEC model allows a discrete representation of the differential equations that govern the thermal behaviour of the transformer. The specific thermal characteristics of studied ONAN distribution transformers are given in Table 17.

Table 17 Thermal characteristics of ONAN distribution transformer.

γ	R	τ_o	τ_w	ϑ_a
1.6	5	180	4	20
$\Delta\vartheta^{hr}$	$\Delta\vartheta^{or}$	k_{11}	k_{21}	k_{22}
23	55	1	1	2

IEC model estimates the top oil and hot-spot temperatures over time, ϑ_t^o and ϑ_t^h , respectively. As already mentioned, those values depend on the time-series profiles for the T_{amb} (ϑ_t^a) and the transformer loading (P_t^{tr} in pu) as well as the transformer thermal characteristics (Table 17). Specifically, the model includes two nonlinear functions denoted f_t^1 and f_t^2 (1), which are used within equations for ϑ_t^o and ϑ_t^h . The equations of the IEC standard are ultimately summarized in (33) for $t > 1$ min and in (34) for the initialization step, i.e., $t = 1$ min.

$$f_t^1(P_t^{tr}) = \Delta\theta^{or} \times \left(\frac{1 + (P_t^{tr})^2 \times R}{1 + R} \right)^x \quad \text{and} \quad f_t^2(P_t^{tr}) = \Delta\theta^{or} \times (P_t^{tr})^y \quad (32)$$

$$\begin{cases} \theta_t^o = \theta_{t-1}^o + \frac{1}{k^{11} \times \tau^o} (f_t^1(P_t^{tr}) + \theta_{t-1}^o - \theta_t^o) \\ \Delta\theta_t^{h1} = \Delta\theta_{t-1}^{h1} + \frac{1}{k^{22} \times \tau^w} \times (k^{21} \times f_t^2(P_t^{tr}) - \Delta\theta_{t-1}^{h1}) \\ \Delta\theta_t^{h2} = \Delta\theta_{t-1}^{h2} + \frac{k^{22}}{\tau^o} \times ((k^{21} - 1) \times f_t^2(P_t^{tr}) - \Delta\theta_{t-1}^{h2}) \\ \theta_t^h = \theta_t^o + \Delta\theta_t^{h1} + \Delta\theta_t^{h2} \end{cases} \quad \forall t \in T \quad (33)$$

$$\begin{cases} \theta_{t=1}^o = f^2(P_{t=1}^{tr}) + \theta_{t=1}^a \\ \Delta\theta_{t=1}^{h1} = k^{21} \times f_{t=1}^2(P_{t=1}^{tr}) \\ \Delta\theta_{t=1}^{h2} = (k^{21} - 1) \times f_{t=1}^2(P_{t=1}^{tr}) \end{cases} \quad (34)$$

IEC thermal model returns the annual equivalent insulation ageing (denoted AEQ) for the given T_{amb} and power profiles. The insulation degradation is computed per (35) with the hot-spot temperature value over the simulated horizon (i.e., $t \in T$) at 1-min resolution. Note that the ageing is normalized with the period duration (the cardinal function $\#T$) and should remain below 1 pu. This number corresponds to a normal degradation of the transformer operating at the design temperature along its estimated lifetime.

$$AEQ = \frac{1}{\#T} \times \sum_{t \in T} 2^{\frac{\theta_t^h - 98}{6}} \leq 1 \quad (35)$$

4.3.2 Problem formulation

The characterization of the DR volume, which is necessary to avoid the transformer overheating, is expressed in a systemic optimization problem. In this optimization problem, the management strategy of the DR (i.e., load power profile modification) is considered along with DR design (sizing). Then, both sizing and management are variables of a single problem.

Moreover, dynamic constraints should be introduced due to the time dependency of temperature profiles. The overall problem consists of minimizing the DR needs in terms of rated power (P^{DRr} in kW) and the rated capacity (E^{DRr} in kWh). The DR should ultimately fulfil the transformer's thermal, ageing, and loading constraints (36). Additional constraints are introduced to represent the DR operation P_t^{DR} within its bounds (37). This management allows us to modify the transformer loading ($P_t^{tr} \times K^{tr}$) for a given load profile (P_t^l) following the power balance constraint in (38).

$$obj: \min \left(P^{DRr} + \frac{E^{DRr}}{1h} \right) \text{ s.t. } \begin{cases} \theta_t^o \leq \bar{\theta}^o & \forall t \in T \\ \theta_t^h \leq \bar{\theta}^h & \forall t \in T \\ P_t^{tr} \leq 1.5 \text{ p.u.} & \forall t \in T \\ AEQ \leq 1 \end{cases} \quad (36)$$

$$-P^{DRr} \leq P_t^{DR} \leq P^{DRr} \quad \forall t \in T \quad (37)$$

$$P_t^{tr} \times K^{tr} = P_t^l - P_t^{DR} \quad \forall t \in T \quad (38)$$

So far, no economic criteria are considered. No cost is attached to the capacity of the DR flexibility (e.g., cost for storage capacity) and its power (e.g., the cost for a battery inverter or backup generator). In practice, this DR flexibility could be of any form and provided by a set of controllable generators, loads, or storage equipment potentially coupled with renewable energy sources. In this work, the DR flexibility is exclusively described in a power and energy domain. It is modelled similarly to generic storage with a unitary efficiency. Then, additional constraints should be introduced to compute the "virtual state of charge" SOC_t^{DR} and keep it between the bounds (typically 0 and 100%) during the studied interval (39).

$$\begin{cases} SOC_t^{DR} = SOC_0^{DR} - \sum_{k=1}^t \frac{100 \times P_k^{DR} \times \Delta t}{E^{DRr}} & \forall t \in T \\ \underline{SOC}^{DR} \leq SOC_t^{DR} \leq \overline{SOC}^{DR} \\ SOC_{t=T}^{DR} = SOC_0^{DR} - \sum_{k=1}^T \frac{100 \times P_k^{DR} \times \Delta t}{E^{DRr}} \end{cases} \quad (39)$$

Two operating modes are envisioned for the designed DR. At first, when setting similar initial and final state-of-charge values (i.e., SOC_0^{DR} and $SOC_{t=T}^{DR}$ typically 50%), this DR is managed in an “energy-shifting” mode, with an energy conservation constraint. The “energy-shifting” mode ensures the conservation of the consumed energy, primarily through the constraints on the final values for the state of charge.

Apart from the “energy-shifting” mode, the section investigates another operating mode of DR - “energy shedding”. In the “energy shedding” mode, DR can be considered a curtailable load or its aggregation. Within the proposed problem formulation, “energy shedding” is modelled by setting $SOC_0^{DR} = 100\%$ at the beginning of the interval and $SOC_{t=T}^{DR} = 0\%$ at the end of the interval while $P_t^{DR} > 0$ (i.e. this is an equivalent of DR discharge).

Multiplying the state-of-charge constraints on both the left and right-hand side by the rated capacity E^{DRr} allows removing the nonlinearity (introduced by the division of operating variable by the design variable). Thus, it solves the integrated management and sizing problem [449].

4.4 Results and discussion

The reader could refer to Section 4.4.1 to see the validation runs for the integrated management and design of DR. Otherwise, the reader could pass directly to the obtained results presented in Section 4.4.2.

4.4.1 Validation runs for Integrated Management and Design of DR

Before investigating different reserve margins with the methodology introduced in Section 4.2.3, other validation runs are performed to understand better the DR optimization problem and the results of its solution. The first simulation is run over a single day interval. The objective is to validate the DR design and management block introduced in Section 4.3. At first, the DR flexibility is operated under “energy shifting” conditions. Note that the ageing constraint (i.e., $AEQ < 1$) is not considered here. Figure 54 shows the results without DR and with DR for a given value of reserve margin (i.e., with a given amount of surplus load).

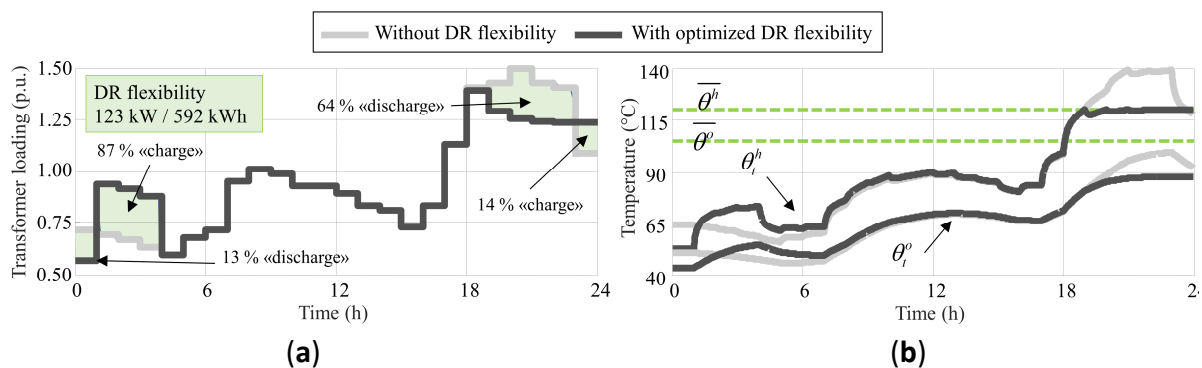

Figure 54 Validation run with “energy shifting”: (a) transformer loadings; (b) temperatures.

The reader can see in Figure 54 that adding a DR flexibility allows us to keep the hot-spot temperature below its limit. At the same time, the oil temperature always remains below the limit with or without the use of flexibility. To avoid the winding overheating during the evening, it is necessary to reduce the peak load after 18:00 and to transfer some load to the morning (Figure 54a). Note that the loading also decreases at the beginning of the simulation to reduce the temperature profiles before the DR flexibility is fully charged (to ensure the “energy conservation” constraints). This ultimately leads to higher temperatures at night, but

it is still far from the overheating limits. Finally, the DR flexibility follows a “charge/discharge/charge” pattern, and 64% of the estimated capacity (592 kWh here) is necessary to shave the peak loading. Note that DR flexibility cannot be fully “discharged” as the virtual state of charge should return to 50% at the end of the simulated period.

Given the same optimisation inputs, the second simulation is performed with a DR flexibility operating as a typical “energy shedding” and no AEQ constraints. Figure 55 displays results with the DR activated only in the evening to shave the peak transformer loading, similar to the previous simulation. Then, the loading and temperature profiles (Figure 55b) remain unchanged for the rest of the considered day. This load shaving is equal to 377 kWh. This shed energy corresponds to the optimized capacity of the installed DR flexibility in the “energy shedding” mode. This expected capacity is much lower than the one computed in the case of “energy shifting” since there is no need to recover the shed load during the day.

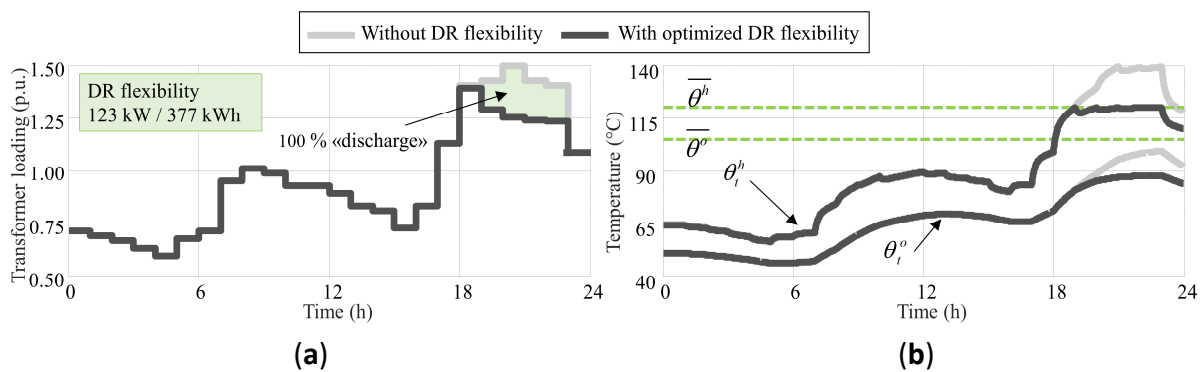

Figure 55 Validation run with “energy shedding”: (a) transformer loadings; (b) temperatures

Final validation runs consist of introducing the ageing constraint for the case of DR flexibility operated under “energy shedding”. Obtained results show that curtailed energy is more significant than in the previous runs (Figure 56a). However, the hot-spot temperature remains far below the limit, which would otherwise incur an excessive degradation of the winding insulation (Figure 56b). As a result, the oil temperature is reduced as expected. Note that the DR capacity of 637 kWh is almost twice as much as the case with no ageing constraint.

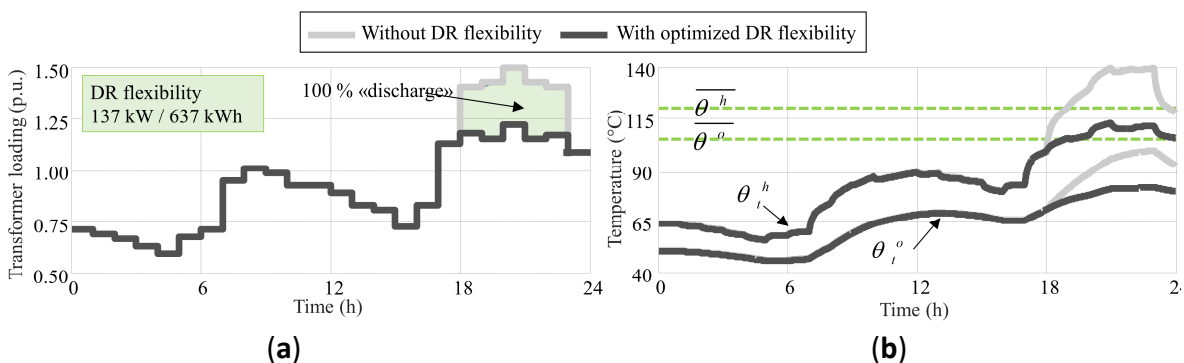

Figure 56 Validation run with “energy shedding” and ageing: (a) transformer loadings; (b) temperatures.

4.4.2 Results for different reserve margins

After performing the validation runs in Section 4.4.1, this subsection addresses results considering a full representative year obtained with the methodology introduced in Section 4.2.3. Figure 57 illustrates typical results while comparing three scenarios: the base case

scenario (i.e., baseload), the base case after adding a given reserve (75% here), and the last case considering the application of DTR/DR (“energy-shedding mode”).

Figure 57 shows that the total load has increased significantly after connecting a constant load (corresponding to reserve 75%) over the whole year. Although the current limit (1.5 p.u.) is not violated, adding that load leads to severe violations of the hot-spot temperature up to 140 °C (Figure 57). The curves are given for a week in January, corresponding to the peak load period. As previously mentioned and observed, the appropriate DR design and management allows adjusting the transformer loading. Hence, the hot-spot temperature remains well below the limit at 120 °C to fulfil the ageing constraints. As discussed further, the DR is activated almost every day, which is not the case for the rest of the year.

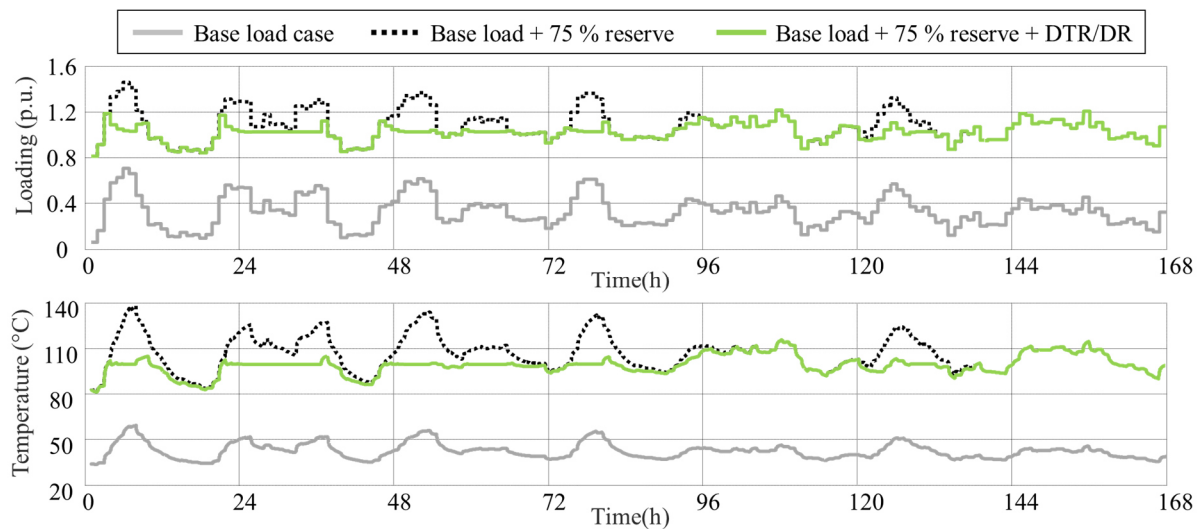

Figure 57 One-week profiles in January, comparison of the base case and Dynamic Thermal Rating (DTR)/DR in “energy-shedding mode”

Then, different reserve margins can be investigated and the yearly profile reconstructed with optimized DTR/DR in every case, following the methodology of Section 4.2.3. Figure 58 shows the main results obtained with a DR in “energy-shedding” mode. As expected, DR volumes in kW (Figure 58a) and kWh (Figure 58b) tend to increase with more significant reserve margins. Note that the optimization problem is not tractable for the reserve above 75% due to the length of the studied intervals (and consequent size of matrix constraints with over $3 \cdot 10^6$ variables).

Specifically, the green curve represents a complete optimisation problem formulation, i.e., with ageing, power and temperature constraints. The black curve shows the formulations with thermal and power constraints (i.e., without ageing constraint). Then, the green curve is higher or equal to the black line due to the higher DR required to mitigate ageing constraints.

Specific attention should be given to the grey curves in Figure 58a,c representing DR volumes calculated with a conventional DTR considering a design winding temperature (98 °C) as a temperature limit. As discussed earlier, a design winding temperature is often assumed as a temperature limit in the papers dealing with DTR. However, the design temperature is not a temperature limit and therefore should not be considered as such. The results prove that more DR in kW and kWh is required to keep the temperature below 98 °C. Moreover, fewer

reserve margins could be managed without DR, i.e., reserves 30% at 98 °C limit versus 50% with a 120 °C limit.

The reader can note that there is no need for DR for reserve margins below 45% (the green and black curves remain flat in Figure 58a,b). This means that the thermal capacity of one distribution transformer alone is sufficient to withstand the connected load (as mentioned earlier, without the need to apply DR). In other words, suppose any load corresponding to reserve margins below 45% is connected to transformers. In this case, the total transformer load will not violate any temperature or ageing limits (see Figure 51 for specific values of temperature and ageing).

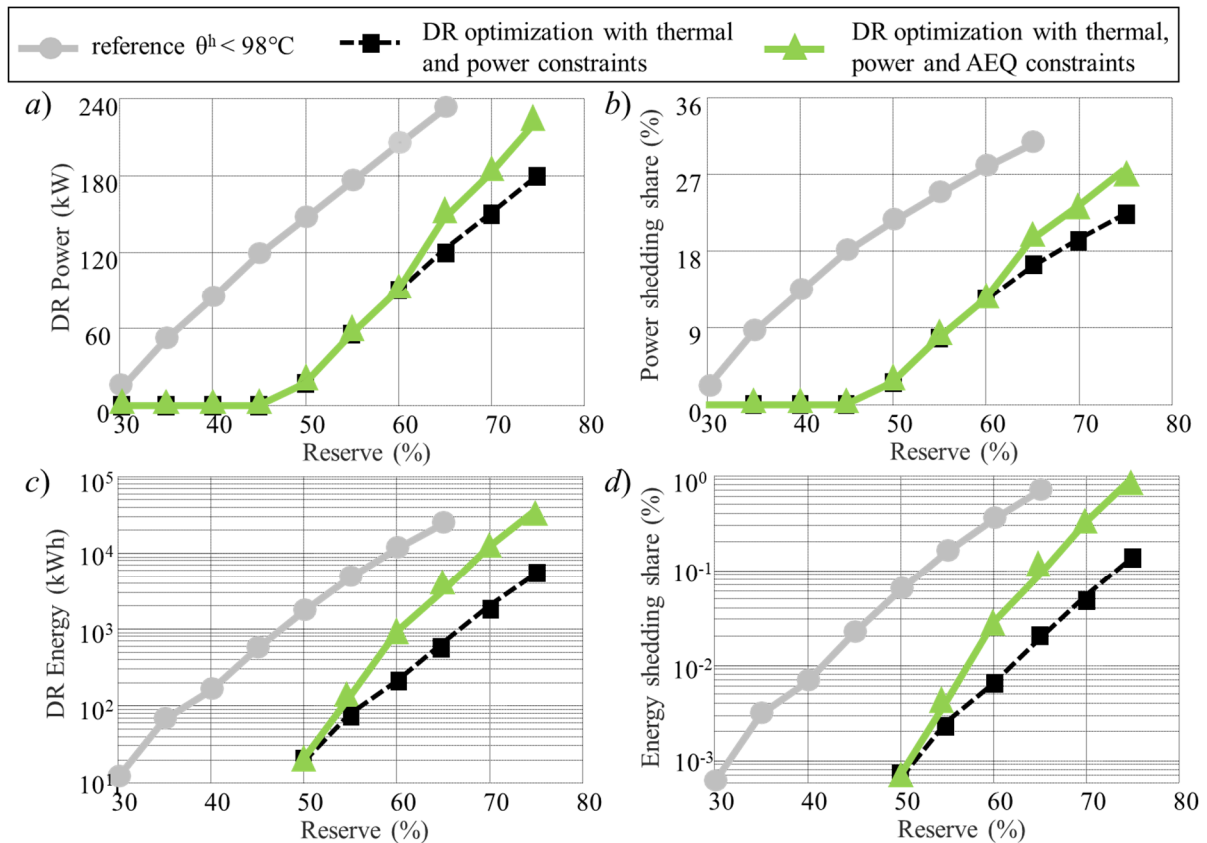

Figure 58 Obtained results for different reserve margins and DR in “energy-shedding” mode: (a) DR rated power; (b) DR power share compared to the added load; (c) DR rated energy; (d) DR energy share compared to the total energy of load.

One significant result of this study is presented in Figure 58d, which displays the total curtailed energy compared to the total consumption over the simulated year. Results show that only 1% of total consumption needs to be curtailed to connect up to 75% of the additional load (the transformer already loaded on 86% in N-1 mode). It is necessary to remind that results are obtained for a rigorous hypothesis: the constant load profile of new consumers, the maximum T_{amb} , and N-1 condition during the whole year. Even if it is necessary to shed almost 50% of the nominal power of the transformer (Figure 58a or around 30% of the peak load in Figure 58b), the curtailed energy remains marginal. The total DR capacity is activated only for a few hours of the year. DR operation is further depicted in the histograms of Figure 59.

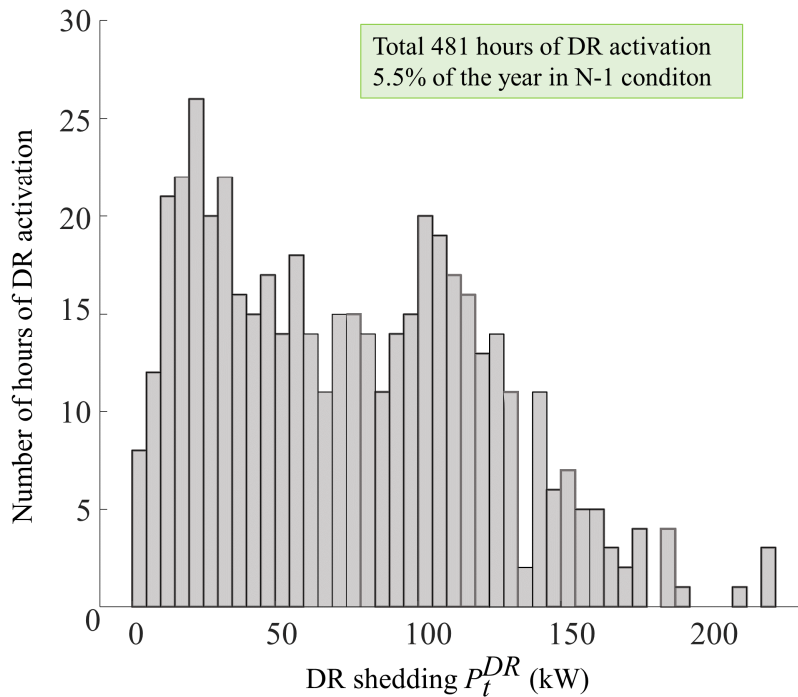

Figure 59 Power shedding over the year—75% reserve in “energy-shedding” mode.

The maximum DR shedding (the last bar at the right side) is only activated for 2–3 h per year. Thus, in total, the DR is required around 6% of the year if aggregating all the hours of activation. Once again, let us remind that DR application would be necessary only in the N-1 condition, which is unlikely to happen all year long.

Figure 60 displays the duration curves for the hot-spot temperature over the year and for different simulations with 75% of reserve (i.e., added 375 kVA to the 500-kVA transformer already loaded for 215 kVA in N mode and 430 kVA in N-1).

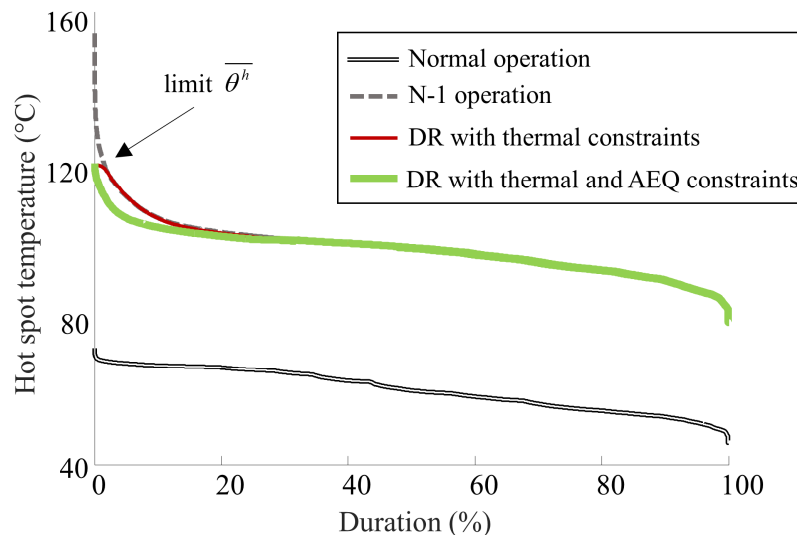

Figure 60 Yearly temperature duration curves: 75% reserve in “energy-shedding” mode leading to less than 1% energy curtailment, as seen in Figure 58

The temperature remains below the limit in a normal operation, and no power shedding is required. However, under the N-1 condition, significant overheating above 150 $^{\circ}\text{C}$ is observed and can be avoided with appropriate DR design and operation with regard to thermal

constraints. Suppose the ageing is considered in DR optimization. In that case, DSO should operate the transformer even at lower temperatures (see the green curve in Figure 60).

Another simulation is performed with the DR operating in “energy-shifting” mode. Results in Figure 61 show slightly higher DR capacities than the case with the “energy-shedding” mode. However, it is impossible to consider more than 60% reserve due to the energy conservation constraint. Therefore, any load shedding during the peak shall be shifted and compensated at other time steps. Furthermore, the thermal model of the transformer can be considered dependent on the integral of the loading. Thus, if substantial load energy is considered, overheating can no longer be avoided, even for different power profiles.

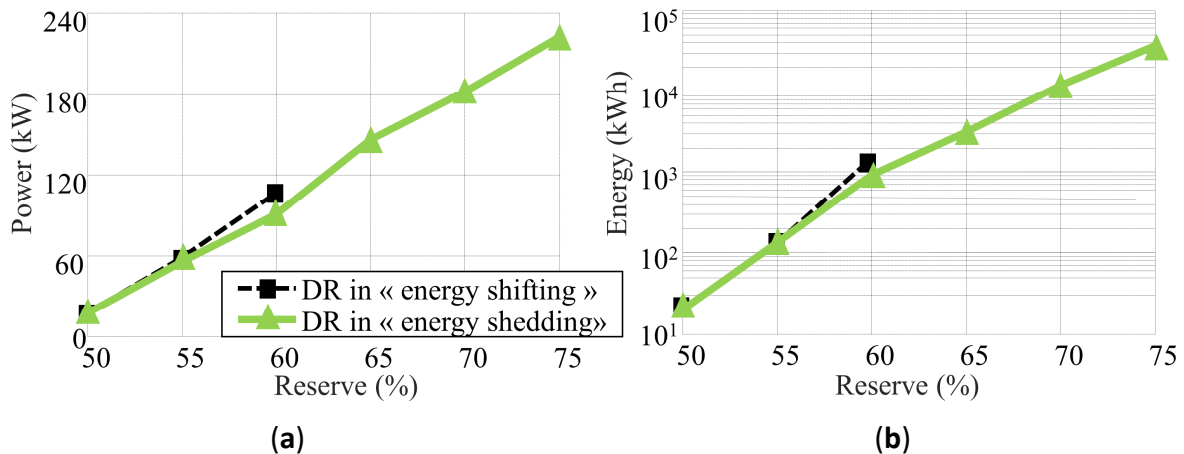

Figure 61 Results: DR modelled with or without payback effect, i.e. the energy conservation: (a) DR power in kW; (b) DR energy in kWh.

5 Conclusions

This chapter presents the methodology to increase the available reserve using Demand Response and DTR. The maximum reserve estimation relies on linear programming that simultaneously optimizes the DR volume and operation over a given time interval. The mathematical formulation accounts for the thermal limits of the transformer, the maximum power/current, and the ageing effects. The most noticeable result shows that relatively small DR volumes ($\leq 1\%$ of total energy consumption) could ensure high reserve margins of transformers. Although DR volumes in kW could reach 30% of peak loads, such high DR volumes will be needed only if the transformer operates in N-1 mode. Even in N-1, these DR volumes would be needed only for a few hours per year. In the N mode, no DR is required at all. No thermal stress of the transformer is observed even if high reserve margins are studied.

Additionally, those results are obtained despite rigorous hypotheses: the constant load profile of a new consumer, historical maximum T_{amb} over the whole month, and normal cyclic limits. Thus, suppose DSO adopts the methodology to assess the reserve considering the detailed load profile. Then it is possible to approve a more considerable increase of consumption (reserves) compared with the results obtained in this study.

Observed results are valuable for DSO and consumers since they could establish variable network access through “flexible network connection agreements” [450]. The general idea of such agreements is that the DSO does not provide a firm capacity all the time for certain consumers (or generators). Depending on different incentives (e.g., lower connections costs), the consumer agrees to have limited access to the distribution network during certain

times/events. Such agreements are already used in the United Kingdom for generators and tested in France [450]. For the considered test case, all consumers have access to the distribution network in the N mode, and no transformer overheating occurs. However, in the case of the N-1 mode, consumers could have limited access during 5–6% of the time, as earlier illustrated in Figure 58. Besides, other solutions may be used together with DR to mitigate the lack of transformer capacity: automation [446], load transfer and reconfiguration [278], volt-Var control [451], electric vehicles [335],[452],[18], and standby transformers [453]. Thus, the actual time of limited access for consumers could be further reduced.

Another legal possibility for implementing those DR operations is the introduction of interruptible contracts [438],[169],[446]. The interruptible contracts allow DSO to shed some consumer load in exchange for financial payment to consumers. Therefore, interruptible contracts and flexible network connection agreements may be a legal foundation to connect more load to existing transformers while deferring significant investments for reinforcements. Moreover, the recent study [337] shows that existing transformers (operated with electric vehicles) ensure less CO2 emission against reinforced transformers. This additionally justifies the utilization of the existing transformers instead of their reinforcement.

The results also showed that it is more beneficial for DR application to apply a DTR based on the HST limit (120 °C) rather than DTR based on the design HST (98 °C). The latter is widely used in other papers on DTR [146], [176], [179], [312]. Specifically, Figure 58 shows that DSO needs to apply less DR volumes both in power and energy terms for studied reserve margins if using the HST limit for DTR. The authors would like to point out that transformer capacity could be better utilised, thanks to using of the HST limit (120 °C) instead of the design HST (98 °C). This is because transformers, even in normal mode, can exceed a design HST (98 °C) for a short time (without exceeding the ageing).

In contrast, lines are not supposed to exceed their designed operating temperatures during normal operation [454]. From this point of view, DSO can better utilize a transformer capacity in normal mode and therefore have an additional degree of freedom. However, it is also true that the line’s DTR could be twice as great as the line’s static thermal rating in MVA [454], whereas a maximal MVA rating of transformers would be limited by a current limit of 1.5 pu from IEC standard and even lower current limits [80]. The reader could refer to [343] for details on the difference between the HST limit and the design HST. In addition, permission for lines to operate at higher maximum temperatures is discussed [58],[455]. However, to the author’s knowledge, exceeding the design temperature of lines is not yet approved for normal operation in the standards [61],[63] (in contrast to transformers standards [91]).

Following the philosophy of open science [377], it was decided to make available MATLAB scripts, functions and the initial data used in this thesis. Thus, the MATLAB code used in this chapter is available in open access at the GitHub repository [456].

Table 18 Contribution of this chapter and the journal where it was published

No	Contribution of this chapter	
C3	DTR is coupled with DR, and it was demonstrated that this coupling might further increase the reserve capacity of transformers. To ensure the given reserve margin, we estimated the required amount of DR. The methodology was formalized in an algorithm. Moreover, it was shown that the temperature limit (120 °C) has the advantage for DTR over a continuous temperature (98 °C).	
Journal: Energies IF: 2.702, Q2, 2021		MATLAB code at GitHub [456]

Chapter IV

Investigating the energy and ageing limits of power transformers

Part 1: This chapter continues our discussion on the maximal utilization of transformer capacity. To remind, chapter II showed that transformer capacity has a significant headroom above nominal rating if considering C&T limitations (especially yellow areas of feasible regions). Chapter III demonstrated that this hidden capacity alone allows connecting the significant amount of new loads while keeping the temperatures and ageing of transformers in the safe range. Moreover, it was found that using a small amount of demand response may increase the permissible connected load more than two times over the nominal rating of the transformer. Having these facts, the question was formulated: if DSO has enough flexibility to control transformer loadings, then up to what physical limitations may utilize the transformer?

The existing literature may provide different answers to this question. In particular, many scientific works expressed transformer limits in various forms: limits on power, failure rate, temperature, ageing, economic, efficiency or risk-profit, among others. However, there is still a gap in how much the transformer can transfer electrical energy. At the same time, a transformer remains a part of the electrical network whose primary goal is to transfer electrical energy. Thus, we made a hypothesis that a transformer, as any physical element, must have its limit of energy transfer, i.e. energy limit.

The energy limit was not investigated earlier because defining an energy limit requires explicitly controlling the shape of transformer loadings, which is problematic without flexibility. However, the context of modern power systems and smart grids allows reconsidering the role of flexibilities. The latter allows adjusting the load profile in a controllable way. Thus, the energy limit becomes more relevant. That is why section 1 presents the context of modern power systems in more detail and describes our motivation for investigating energy limits. Further, section 2 introduces the concept of energy limit and how it might be modelled using existing thermal models of transformers. Next, section 3 quantifies energy limits in Tomsk, Russia and Grenoble, France.

Part 2: this chapter reconsiders the role of the ageing limit. As mentioned in chapter I, IEC and IEEE loading guides suggest using a normal ageing limit while operating the transformers in normal mode. However, recent findings revealed that existing transformers still keep the insulation in good condition even after the end of the design life. For instance, 50-70% of transformers in Russia already overpassed their design life. Nevertheless, the physical ageing of all power (auto-)transformers was only 24 %. This state of transformers allowed us to formulate a question: how the calendar and insulation life may affect the choice of ageing limit? In other words, what is the optimal ageing limit for a given state of calendar and insulation life? Hence, part 2 of this chapter answers what the optimal ageing limit is. Under the optimal ageing limit, this chapter understands an ageing limit, which allows the transformer to transfer the maximal energy at the given insulation and calendar life. Specifically, section 2 explains how the ageing limit may vary as a function of calendar and insulation life. Moreover, it generalizes the main situations where different optimal ageing should be applied. The same section provides estimation results for energy transfer at various ageing limits and the calendar life of transformers.

Following the philosophy of open science, MATLAB code and data used in this chapter are available in open access at GitHub repository.



Part I Energy limit of oil-immersed transformers

1. Introduction

1.1 Context of modern power systems

In the coming years, congestion management becomes relevant due to the integration of Renewable Energy Systems (RES), aimed to address climate change. Even without RES, power equipment may be already loaded under normal operation close to the nominal rating [457]. Meanwhile, a traditional solution – network reinforcement, earlier used to mitigate congestions, becomes inefficient due to a high cost, long lead times and economic, environmental, political, social and regulatory issues [457]. Thus, system operators are forced to investigate other options to ensure RES integration and congestion management for short and middle-term horizons.

Nowadays, many researchers size transformers below RES installed capacity, using a thermal capacity of transformer with lower ratings and cost [286], [289], [292], [326], [349], [458]–[460]. In other words, a traditional sizing when transformer capacity is chosen per RES installed capacity is not cost-efficient. This is due to the high costs of transformers and intermittent output of RES [326]. A similar vision appears and actively develops for overhead lines and cables. Special IEC standards are being introduced for transformers operating with RES [13].

However, such an approach of transformer sizing can lead to congestions, e.g., if an interconnection of new RES facilities will exceed the initially planned capacity of RES. Even if transformers are not undersized, congestions are still possible. For instance, almost 90 % of distribution transformers will be overloaded in the Netherlands by 2040 due to load growth and new generating facilities [22]. Therefore, some share of RES generation must be curtailed during specific periods [243]. This leads to the underuse of RES installed capacity (i.e. reducing the efficiency of measures against climate change) and/or to the high cost of transformer replacement.

Active network operation [22], [205], [235], [237], [269], [317] implies the use of flexibilities [328] from generation, storage, and load which may minimize RES curtailments as well as transformer congestions. Thus, new RES facilities can be interconnected to “congested” transformers if flexibilities are applied. Therefore, modern power systems operate in a specific context: RES integration, new transformer sizing and active operation strategies (flexibilities).

1.2 Motivation for investigation of energy limits

Despite promising advantages of active operation strategies [22], [205], [235], [237], [269], [317], transformers should have a physical limit which *theoretically* makes further development of any active operation strategy inefficient. We suggest that this occurs when a transformer reaches its limit of energy transfer. This energy limit represents the unique transformer’s loading profile, ensuring the highest energy transfer under given T_{amb} conditions. Thus, transformer reinforcement becomes an inevitable option once a transformer reaches the energy limit. Even if earlier, the reinforcement was deferred by active operation strategies or load transfers to another substation [276].

It is worth explaining why the energy limit was not explored in the past and why it becomes relevant today and in the future. In the past, there was little technical possibility to reach an energy limit before a power limit. In other words, a loading profile of a transformer could not

be thoroughly controlled to match some theoretical and optimal loading profile, ensuring the highest energy transfer. That is why transformer limits are usually calculated per the shape of a given load. For instance, in [361], we found power limits to maximize the energy transfer through the transformer for a given load profile. However, the obtained power limits should not be considered as the energy limit since the energy transfer was maximized for a given load profile. For example, it can be another load profile, transferring more energy. Modifying a load profile can be performed by modern flexibilities from generation, load and storage. For instance, a transformer peak load can be shaved by increasing the power output of distributed generation located near consumers. Another way to reduce a substation load is to activate a demand response program or storage for valley filling [323]. New market players- aggregators already provide such system services in practice [319]. Thus, the loading profile of a transformer represents a controllable parameter in active power systems.

The interest of energy limits application can be found in problems where a transformer is a limiting element. For instance, [461] reports that transformers restrict the generators in West PJM⁴³ and East MISO⁴⁴ to supply loads in the PJM operating area. Specifically, the Cloverdale transformer was recognized as the second constraint among the top 25 constraints in PJM [462]. The congestion cost of one Cloverdale transformer in 2018 amounted to \$87.5 million or 6,7 % of PJM's total congestion cost [462]. Similarly to operating areas inside the country, transformers can reduce interconnection capacities among countries as it happened in Europe [463]. Such transformer congestions can affect cross border exchanges and generation scheduling in the power system. This is thus of great interest for system operators since a scheduling solution has a heavy impact on cost of energy generation. For instance, FERC estimated that 5% improvement of world-wide scheduling solution could save \$87 billion each year [464]. The general situation of congested transformers between operating areas or countries can be represented by the simple case shown in Figure 62.

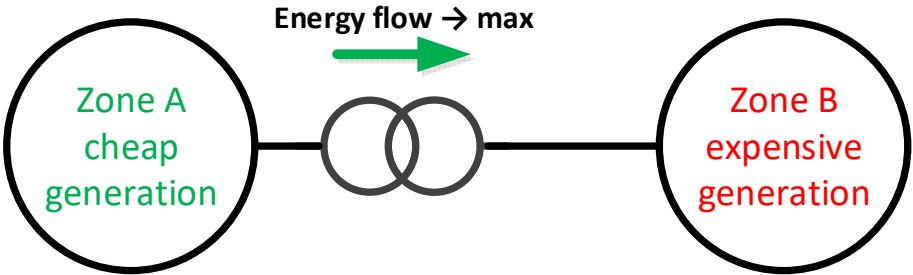

Figure 62 Transformer, limiting an energy transfer between two zones

European regulation [465] states that system operators should not limit the interconnection capacities (which can be restricted by transformers) to solve congestion inside of their operating area. In other words, cross border exchanges with other countries remain the priority for system operators, and it seems a maximization of energy transfer through them as well. Moreover, operating areas in Figure 62, zone A and zone B correspondingly, can be an MV distribution network and LV microgrid or vice versa. These networks can be seen as operating areas but at lower MV or LV levels if having enough flexibility. Whatever the voltage level is, the total energy cost can be reduced if one successfully transfers more energy from the low-cost zone to the zone with the expensive generation.

⁴³ PJM - Pennsylvania New Jersey Maryland Interconnection
⁴⁴ MISO - Midcontinent Independent System Operator

Due to climate change, the maximization of energy generation from RES becomes another fundamental problem. Furthermore, since RES projects have a lead time of many times less than a lead time of network reinforcement, it seems that RES curtailments will grow up each year. For instance, wind curtailment in Germany has already increased by 27 times (from 0.13 TWh to 3.53 TWh) as well as congestion management costs have increased 15 times (from 58.6 €m to 859.4 €m) [466]. At the same time, following the government decision, German system operators can tolerate up to 3 % of wind curtailment (wind energy produced) to decrease a reinforcement [466].

RES operators can use the energy limits and flexibilities of storage and generation to minimise RES curtailments. Scheduling the RES according to energy limits allows RES operators to maximize the energy transfer from their generating facilities. This is especially relevant if RES transformers are undersized and/or new RESs have to be installed in addition to initially planned RES capacity (known as an overplanting [467]). For instance, Figure 63 shows a case where RES operators can maximise the energy transfer to the power system using active operation strategies and energy limits.

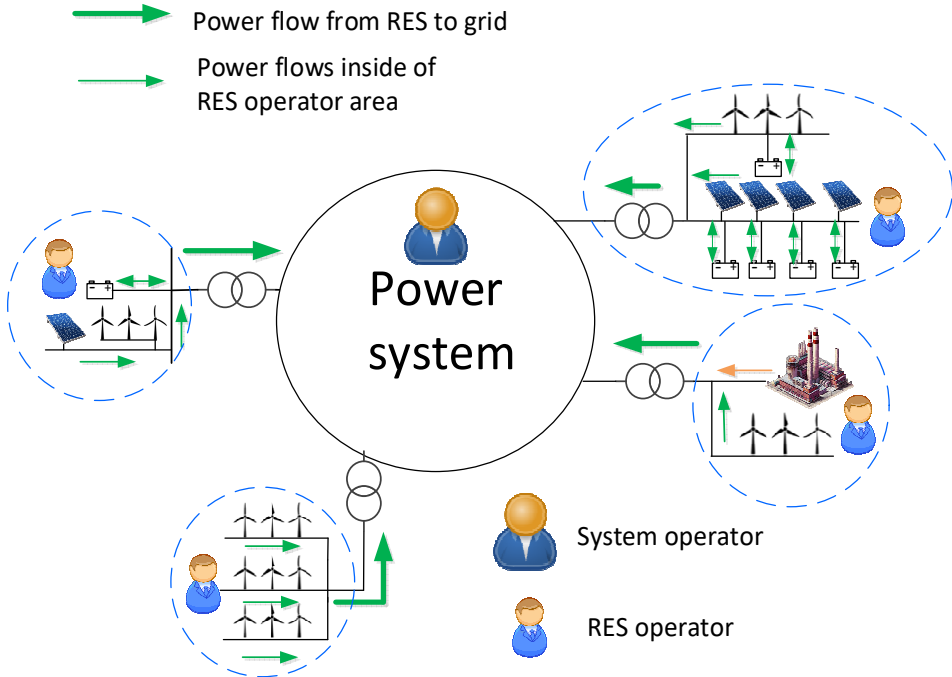

Figure 63 Maximization of the energy generation using flexibilities by RES operators

System operators usually validate all RES output and balance the remaining system load by fast ramping up generation facilities, storage or demand response if available. Otherwise, RESs are curtailed to keep a power balance or prevent congestions, among others. However, system operators strive to keep RES curtailments as a last resort to manage network constraints [466]. Therefore, it may be assumed that power flows from RES (and energy limits) should be kept unchanged as long as possible.

Another problem where energy limits can be applied may be determining the hosting capacity of distribution networks for interconnection of load and DER [241]. For DER interconnection, transformers capacity is traditionally used as one of the critical limitations (Figure 64).

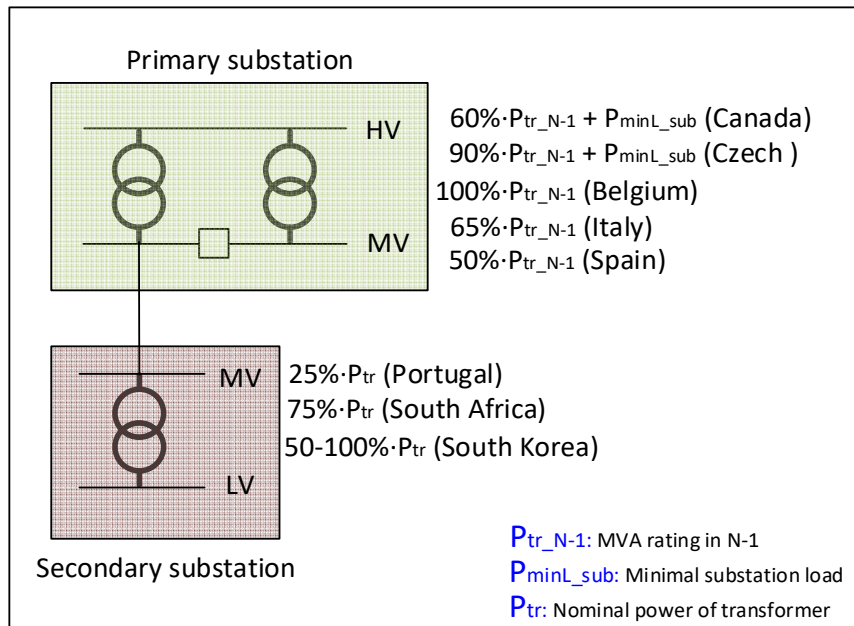

Figure 64 Criteria of thermal ratings for DER interconnection in different countries [30]

Moreover, real case studies [468] demonstrated that transformers remain the main limiting element of hosting capacity for DER interconnection because of their high CAPEX. However, other factors, e.g. voltage variations, voltage unbalance, flicker and harmonics, may limit the hosting capacity for DER interconnection [469],[350].

For load interconnection, the available transformer capacity is traditionally used as the primary criterion for decision making. In both situations (for load and DER), a transformer capacity is usually represented by power limit, corresponding to some % of the nominal rating given by the manufacturer. This approach seems very conservative since the DER power variation in time is not considered [470].

The application of active operation strategies should then increase the hosting capacity of the network if time-series profiles are taken into account. If so, the system operator could procure robust flexibility from DER to ensure a daily smart balancing of more Distributed Generation (DG) interconnections. At the same time, the energy limit is a final constraint that active operation strategies cannot overpass due to the physical limitations of a transformer to transfer additional energy. In such a case, the only option left is a reinforcement of transformers.

Knowing the energy limit and actual load profile, system operators may procure robust flexibilities to postpone the reinforcement of existing transformers. It is essential to highlight that the share of DER, i.e. available flexibilities, are growing very fast. The world installation rate of DER already surpasses the centralised generation's installation rate [471]. Meanwhile, a transformer remains in operation for 20-30 years and even more once installed. Thus, having some energy limit, a transformer can be a permanent constraint for developing active operation strategies and network hosting capacity.

1.3 Section goals

As mentioned in section 3 of Chapter I, a transformer limit has been considered in many forms: power, failure rate, temperature, insulation life, economic, efficiency or risk-profit limits but

never as the physical limit of energy transfer. The reason is that defining an energy limit requires explicitly controlling the shape of transformer loadings, which is not possible without flexibility. Thus, the problem has never been formulated regarding the energy limit of oil-immersed transformers. Moreover, the authors did not find any papers investigating the energy limit of other network equipment such as overhead lines or cables.

In Section 1.2, problems of power systems where the application of energy limits can be beneficial were identified. Despite relevant issues, no research has studied the energy limits of transformers yet. Due to its novelty, it is logical to firstly eliminate the theory gap on energy limits and further focus on their application for power systems problems. Nevertheless, brief explanations concerning the practical application are given in Section 1.2, and some comments are provided throughout this section.

Two goals are pursued: (1) in section 2, the energy limit of a transformer is studied, and its typical characteristics are defined. Following our definition, the energy limit depends on T_{amb} only. However, the shape and amplitude of T_{amb} profiles can vary within time and space. Therefore, (2) in section 3, we will estimate energy limits in various climate conditions. As in previous section 3, two types of climates are analysed: cold continental climate in Russia (Tomsk city in Siberia) and warm temperate climate in Europe (Grenoble city in France).

2. Determination of energy limit: a concept

In this section, the energy limit of oil-immersed transformers is modelled. We use a specific test case to find an actual energy limit, presented in Figure 65. It was intentionally decided to choose this simplified test to avoid any case-specific impact of other external factors on the energy limit of studied transformers.

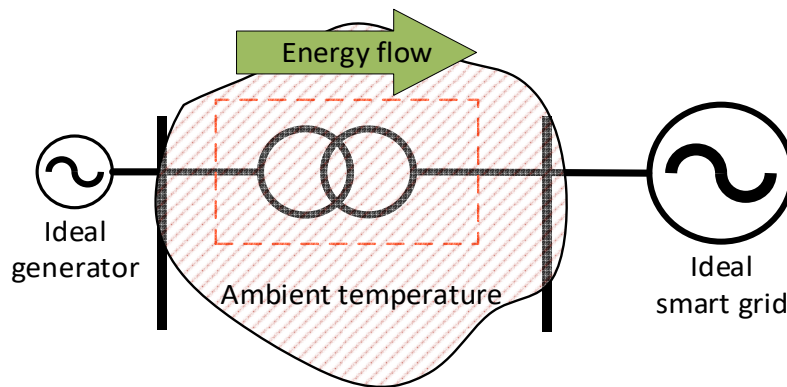

Figure 65 Case study for investigating the highest energy transfer through transformers

It was assumed that an ideal generator on the left side does not have any constraints. Also, the power system on the right side would absorb all the energy flow produced. Thus, this right side represents an ideal smart grid, able to deal with any internal constraints. Therefore, we avoid a situation when specific factors such as network topology, load distributions, voltage or angle stabilities, among others, can affect a transformer's energy limit. These imperfections of existing technologies can be overcome in the future, and situations with flexibility unavailability can be changed [472]. The assumption of the ideal generator and the ideal smart grid allows us to focus on transformer thermal constraints only. Despite the ideal generator and smart grid, the T_{amb} could not be controlled yet. This means that the shape of the energy limit depends on the T_{amb} only. Thus, it is necessary to determine an energy limit for given T_{amb} conditions.

The transformer is represented by the thermal model provided in the IEC standard [14]. IEC standard also provides typical characteristics (see Table 19) for a power transformer with ONAN⁴⁵, ONAF⁴⁶, OD⁴⁷, OF⁴⁸ cooling systems, and ONAN distribution transformers.

Table 19 Thermal characteristics of transformers: ONAN, ONAF, OF, OD [14]

Parameter, units		Distribution ONAN	Medium or large power transformer			
			ONAN	ONAF	OF	OD
Oil exponent, no unit	x	0,8	0,8	0,8	1	1
Winding exponent, no unit	y	1,6	1,3	1,3	1,3	2
Loss ratio, no unit	R	5	6	6	6	6
Oil time constant, min	τ_o	180	210	150	90	90
Winding time constant, min	τ_w	4	10	7	7	7
Ambient temperature, °C	θ_a	20	20	20	20	20
Hot-spot temperature, °C	θ_h	98	98	98	98	98
Hot-spot to top-oil gradient at rated current, °K	$\Delta\theta_{hr}$	23	26	26	22	29
Top-oil temperature rise, °K	$\Delta\theta_{or}$	55	52	52	56	49
Thermal constant, no unit	k_{11}	1	0,5	0,5	1	1
Thermal constant, no unit	k_{21}	1	2	2	1,3	1
Thermal constant, no unit	k_{22}	2	2	2	1	1

The objective is to find the optimal loading curve $S_{(t)}$ of given transformers, maximizing (under given T_{amb} conditions) the energy transfer through them, E_{TR} , as stated by equation (40).

$$\begin{aligned} & \max_S E_{TR}(S) \\ & S = \begin{bmatrix} S_{(1)} \\ \dots \\ S_{(T_1)} \end{bmatrix} \\ & E_{TR}(S) = \sum_{t=1}^{T_2} \frac{\sum_{i=(t-1) \times 60}^{t \times 60} S_{(i)}}{60} \end{aligned} \quad (40)$$

S is a vector of size $1 \times T_1$ representing a transformer loading in per unit with a time step Dt of 1 min over one day ($T_1 = 1440 \text{ min}$). As a time resolution of data may impact DTR [473], It was assumed that a transformer loading is constant during 1 hour. The 1-hour resolution has been actively used in power system planning and operation. Thus, the energy is computed with a time step of 1 hour over one day ($T_2=24$ hours). However, the input data of thermal models should be converted into a 1-minute resolution, as IEC thermal model requires it. Specifically, a time resolution for input data of the thermal model should be at least two times less than a winding time constant. As the smallest winding time constant of studied transformers is 4 minutes (see Table 19), it was decided to use a 1-minute resolution.

The solution of such an optimization problem is a loading profile of transformer, maximizing the energy transfer under given T_{amb} or, in other words, an energy limit which should be found.

⁴⁵ ONAN - Oil Natural Air Natural;

⁴⁶ ONAF - Oil Natural Air Forced;

⁴⁷ OD – Oil Directed;

⁴⁸ OF – Oil Forced;

This optimization problem is subjected to a set of constraints related to transformer loadings (41), temperature limitations (42) and (43) and equivalent loss of insulation life (44).

$$S_{(t)} \leq 1.5 \text{ pu}, \forall 0 \leq t \leq T_1 \quad (41)$$

$$\theta_{0(t)} \leq 105 \text{ }^\circ\text{C}, \forall 0 \leq t \leq T_1 \quad (42)$$

$$\theta_{h(t)} \leq 120 \text{ }^\circ\text{C}, \forall 0 \leq t \leq T_1 \quad (43)$$

$$\text{LoL} = \frac{\int_0^{T_1} 2^{\frac{\theta_{h(t)} - 98}{6}} dt}{T_1} \leq 1 \text{ pu} \quad (44)$$

Where $\theta_{0(t)}$, $\theta_{h(t)}$ are calculated using (45) – (48) for $t = 0$ and (49) - (52) for $t > 0$

$$\theta_{0(0)} = \left[\left[\frac{1 + S_{(0)}^2 R}{1 + R} \right]^x \cdot \Delta\theta_{or} + \theta_{a(0)} \right] \quad (45)$$

$$\theta_{h(0)} = \theta_{o(0)} + \Delta\theta_{h1(0)} - \Delta\theta_{h2(0)} \quad (46)$$

$$\Delta\theta_{h1(0)} = k_{21} \cdot \Delta\theta_{hr} \cdot S_{(0)}^y \quad (47)$$

$$\Delta\theta_{h2(0)} = (k_{21} - 1) \cdot \Delta\theta_{hr} \cdot S_{(0)}^y \quad (48)$$

$$\theta_{0(t)} = \theta_{0(t-1)} + \frac{Dt}{k_{11}\tau_o} \left[\left[\frac{1 + S_{(t)}^2 \cdot R}{1 + R} \right]^x \cdot \Delta\theta_{or} + [\theta_{o(t-1)} - \theta_{a(t)}] \right] \quad (49)$$

$$\begin{aligned} \theta_{h(t)} = & \theta_{0(t)} + \Delta\theta_{h1(t-1)} + \frac{Dt}{k_{22}\tau_w} [k_{21} \cdot \Delta\theta_{hr} \cdot S_{(t)}^y - \Delta\theta_{h1(t-1)}] - \\ & - \Delta\theta_{h2(t-1)} - \frac{Dt}{\left(\frac{1}{k_{22}}\right)\tau_o} [(k_{21} - 1) \cdot \Delta\theta_{hr} \cdot S_{(t)}^y - \Delta\theta_{h2(t-1)}] \end{aligned} \quad (50)$$

$$\Delta\theta_{h1(t)} = \Delta\theta_{h1(t-1)} \left(1 - \frac{Dt}{k_{22}\tau_w} \right) + \frac{Dt}{k_{22}\tau_w} k_{21} \cdot \Delta\theta_{hr} \cdot S_{(t)}^y \quad (51)$$

$$\Delta\theta_{h2(t)} = \left(1 - \frac{Dt}{\left(\frac{1}{k_{22}}\right)\tau_o} \right) \cdot \Delta\theta_{h2(t-1)} + \frac{Dt}{\left(\frac{1}{k_{22}}\right)\tau_o} (k_{21} - 1) \cdot \Delta\theta_{hr} \cdot S_{(t)}^y \quad (52)$$

With $S_{(t)}$, the transformer loading at time t , $\theta_{0(t)}$, the top-oil temperature at time t , $\theta_{a(t)}$, the T_{amb} at time t , $\theta_{h(t)}$, the hot-spot temperature at time t and LoL, the equivalent loss of life on the studied period.

The optimization problem (40)-(52) for each transformer cooling type was solved in MATLAB by fmincon (SQP algorithm). Preliminary tests showed that fmincon has the best performance and a much faster convergence time than global-search solvers: genetic algorithm, patternsearch available in MATLAB toolbox. At the same time, the SQP algorithm also demonstrated either the best or not worse performance compared to other fmincon algorithms (interior point method, trust-region-reflective etc.).

Figure 66 shows the optimal loading of transformers, depending on its technology and T_{amb} (input data), which maximizes the energy transfer through transformers. The values of constraints (hot-spot and top-oil temperatures) are also represented. In each case, LoL reached 1 pu exactly.

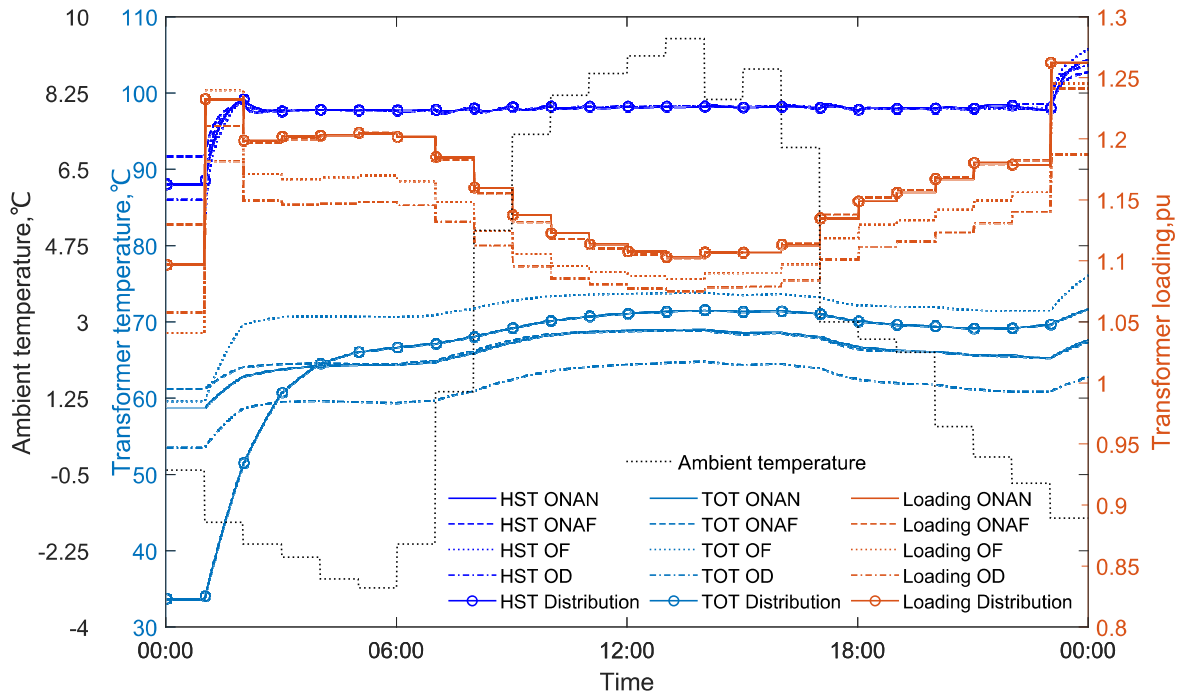

Figure 66 Optimal transformer loading, $S(t)$, with corresponding HST and TOT

Looking at Figure 66, one can notice an analytical regularity common for all types of transformers. At the beginning and the end, one can see a step rise in loadings, whereas loadings change smoothly in other time intervals. The step changes of loadings at the beginning and the end take advantage of winding thermal inertias to transfer the additional energy. Thermal inertia is a physical phenomenon explaining why a temperature does not change simultaneously with a current. When a current passes through winding conductors, it generates heat. This heat is then divided into two parts: one part goes for conductor heating, and another is released into surrounding oil. That is why a winding temperature has an asymptotic curve approaching steady-state temperature [474]. Suppose the heat would be used only for conductor heating. In that case, the temperature would (unrealistic case) change as a straight line, as shown in Figure 67.

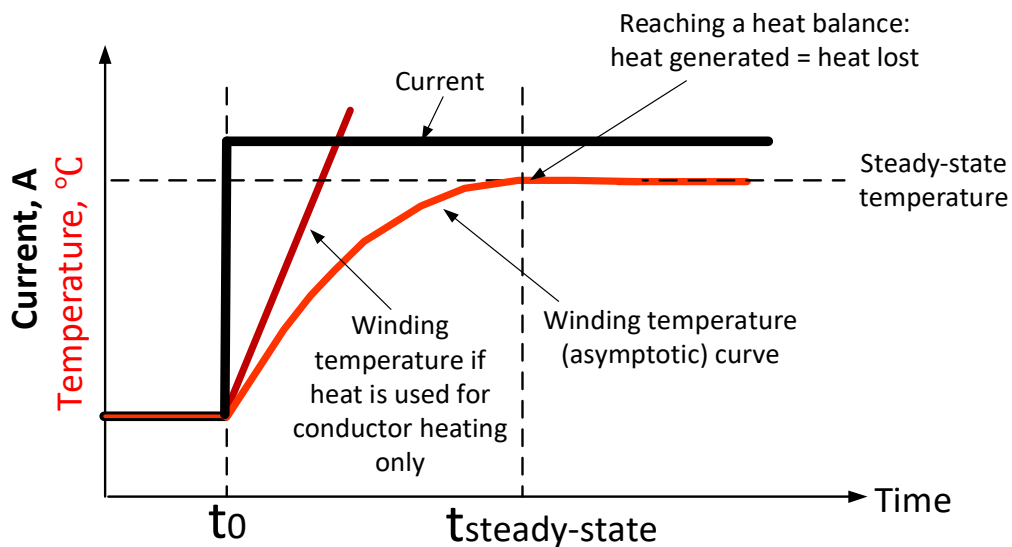

Figure 67 Heating of winding conductors based on [474]

Once the asymptotic curve reaches its steady-state value, the heat used for conductor heating, and heat, released to oil reach their balance. In the state of the heat balance, the winding temperature does not rise anymore. It remains constant until a current or a T_{amb} changes. Thanks to a time lag between C&T responses, transformers can transfer a little more energy than steady-state operations. Therefore, one can derive an analytical explanation of transformer energy limits. The energy limit is a loading profile, which usually keeps a heat balance (at the design HST). However, it may also get the advantages of thermal inertias to transfer additional energy.

From this analytical explanation (energy limits represent the operation at design HST most of the time), the energy limit tends to the form of temperature limit suggested by Norris [187] in 1928. To remind, Norris suggested limiting transformer loadings to avoid overpassing a continuous (design) HST. This continuous HST limit in °C can be expressed by a steady-state power limit [284] in power units (pu or MVA). The latter conclusion allows us to suppose that energy limits can be approximated by steady-state power limits [187],[284].

The steady-state power limits are well known in the industry [284]. Therefore, an energy limit, approximated by steady-state power limits, could be easily calculated. Many researchers already apply steady-state power limits [206], [285], [291], [292], [475]. However, steady-state power limits are not energy limits, even if they can approximate energy limits. Any power limit represents an absolute value of power at each time step. In contrast, the energy limit is an integral of all power limits at the whole time interval. Following these differences, one can deduce that power limits have *many* feasible loading profiles located below these power limits. However, the energy limit represents the *unique* loading profile of the transformer, which is equal to steady-state power limits. Thus, power limits are limits in their classical meaning: with many feasible loading profiles possible.

On the contrary, the energy limit is one single shape (trajectory) of loading, enabling the maximal energy transfer through a transformer. This fundamental difference affects the mathematical way in which transformer limits are formulated. For example, suppose one takes a power limit. In that case, it is necessary to formulate this constraint as an inequality (Power flow \leq Power limit). However, one should use an equality constraint for the energy limit (Power flow = Power limit). Once again, making power flow equal to the steady-state power limit became possible thanks to the development of active operation strategies (flexibilities) in the power system. These mathematical formulations explain why steady-state power limits (including DTR) are not the energy limit but can approximate the energy limit.

Although steady-state power limits can be used for energy limits approximations, under specific T_{amb} , this may be different. For instance, Figure 68 shows the optimized energy limit of the ONAN transformer for cold T_{amb} in Tomsk on February 1, 2019. The loss of insulation life is equal to 1pu.

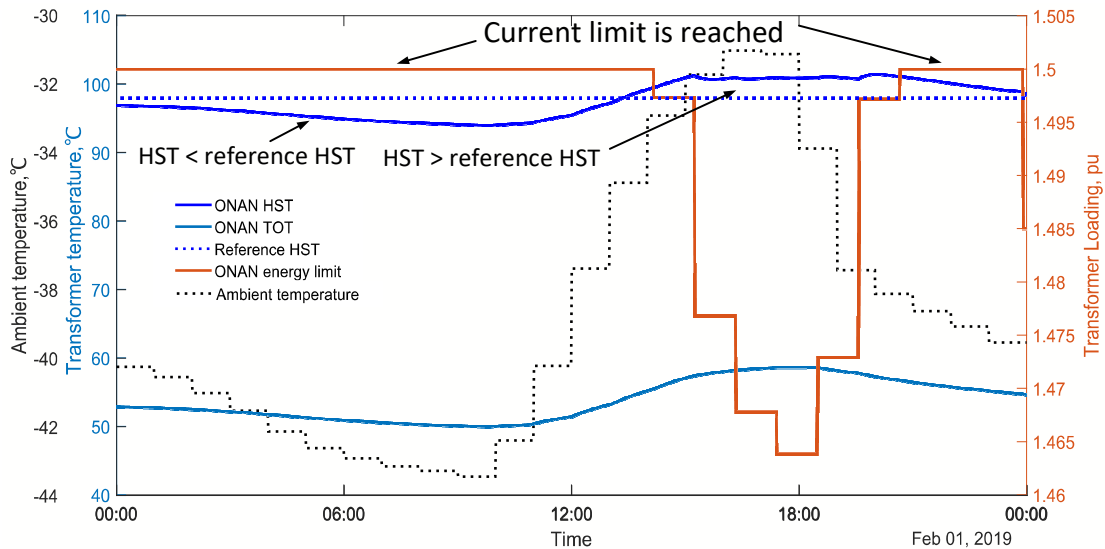

Figure 68 Energy limit (loading profiles) in cold T_{amb}

As seen from Figure 68, the optimized shape of the energy limit in cold T_{amb} does not correspond to the typical shape of steady-state power limits (where HST is quasi-constant). Instead, the energy limit conforms to the HST shape, which follows the logic of intermittent temperature limit – a short operation above rated HST. However, such extreme ambient conditions are rare. Therefore, typical characteristics of energy limit (expressed by steady-state power limits) should remain valid most of the time.

Whatever the shape of the energy limit is, the HST remains near rated HST, and TOT is much below the TOT limit. Thus, energy limits maximize the energy transfer and simultaneously avoid the high thermal stress of transformers. This brings a particular benefit of energy limits to power systems operation.

3. Quantification of energy limits in different climates

Estimating energy limits in different climates allows obtaining the characteristics of transformer loading profile if DSO applied active operation strategies (flexibilities). Thus, the energy limit, estimated in this section, should represent loadings of the transformer, operating at its physical limit in the context of smart grids. As mentioned in Section 1.2, such transformer operation can be beneficial for interconnections, the maximization of RES generation, and increasing the hosting capacity of distribution networks.

In this section, energy limits of oil-immersed transformers are estimated in the cold climate of Tomsk, Russia and the warm climate of Grenoble, France. Section 3.1 provides initial data and assumptions, whereas section 3.2 shows the results. Finally, section 3.3 provides a short discussion of limitations.

3.1 Historical ambient temperature in Tomsk and Grenoble

Firstly, a time horizon should be defined to investigate the impact of the climate on energy limits if the latter depends only on T_{amb} . The climate normal, used in climate science, states that all weather anomalies in a geographical area can be considered within the previous 30 years [372]. In other words, the studied period should be at least 30 years long. That is why Figure 69 shows a simulated mean-hourly T_{amb} from January 01, 1985, to March 29 2019 (day of data download) [373].

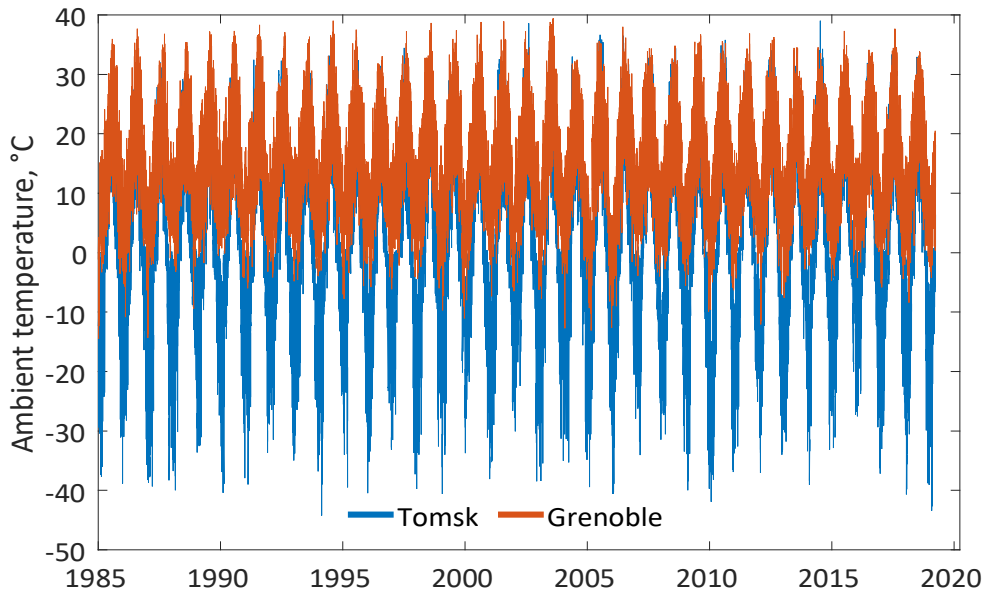

Figure 69 Hourly T_{amb} in Tomsk and Grenoble from 1985 to 2019. Source: MeteoBlue

To retrieve valuable information from Figure 69, it is necessary to convert it to T_{amb} duration curves (Figure 70). The duration curve can show how much time the T_{amb} was higher (or lower) than a design T_{amb} . (+20 °C for IEC transformers). For instance, in Figure 70, the real T_{amb} exceeded a design temperature during 12,4 % of the time in Tomsk, Russia and 22,6 % in Grenoble, France.

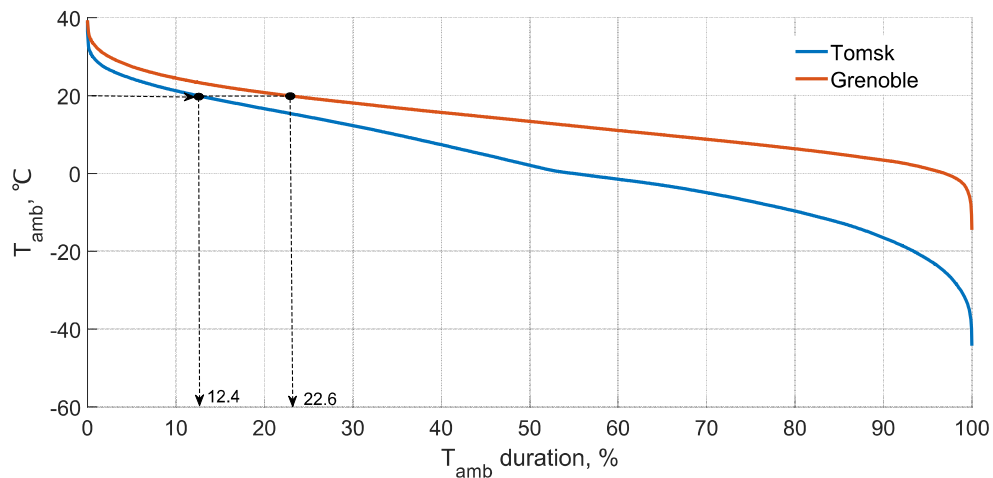

Figure 70 Duration curves of T_{amb} s in Tomsk, Russia and Grenoble, France

To plot a duration curve, one can sort the historical values of the T_{amb} in descending order. The T_{amb} duration (x-axis) is obtained as follows:

$$T_{amb} \text{ duration}(1: end) = \frac{N(1: end)}{N(end)} \times 100\% \quad (53)$$

Where N – the array representing a numerical order of T_{amb} values (sorted in descending order).

To compare energy limits in Tomsk and Grenoble, one should ensure equal conditions. Thus, it was assumed that new transformers were installed in 01.01.1985 in both cities. The

insulation life of these new transformers is assumed to be equal to 34 years, which is the period of T_{amb} data availability. All transformers have a Kraft paper with a rated HST of 98 °C.

From Figure 69, there are 12 506 daily T_{amb} profiles in hour resolution. For each daily temperature profile (or for 34 years), it is possible to solve an optimization problem using equations (40) - (52) and find 12 506 daily energy limits (or one energy limit for 34 years). However, solving the optimization problem with 12 506 days can take 10 days. Therefore, it was decided to approximate the energy limit by steady-state power limits [284], as they allow to obtain approximately the same energy transfer. The power limit for each hour during 34 years is adjusted to keep the transformer operation at rated HST (98 °C). Thus, it is possible to obtain a loading curve representing the energy limit of the transformer in each climate.

Energy limits represent a dynamic loading curve having: (1) maximum, (2) minimum, (3) mean value, as well as (4) duration and (5) energy transfer. Therefore, (1)-(5) are used as metrics to compare the energy limits in two climates. Metrics (1)-(3) are calculated for each month, and the energy transfer (5) is calculated for the whole period studied – 34 years.

3.2 Results: Metrics of energy limit in each city

The duration of energy limit loadings is obtained similarly to the curve of T_{amb} duration. Firstly, a loading was found corresponding to the rated HST for each T_{amb} during the 34-year history. Further, the obtained loading array was sorted in descending order. The resulting duration curves are of specific interest because they define how much time the loadings of energy limit are higher or less than particular loading. For instance, Figure 71 shows that loadings of energy limit are higher than the nominal loading of transformer for 79 % of the time in Grenoble and 88,6 % in Tomsk correspondingly.

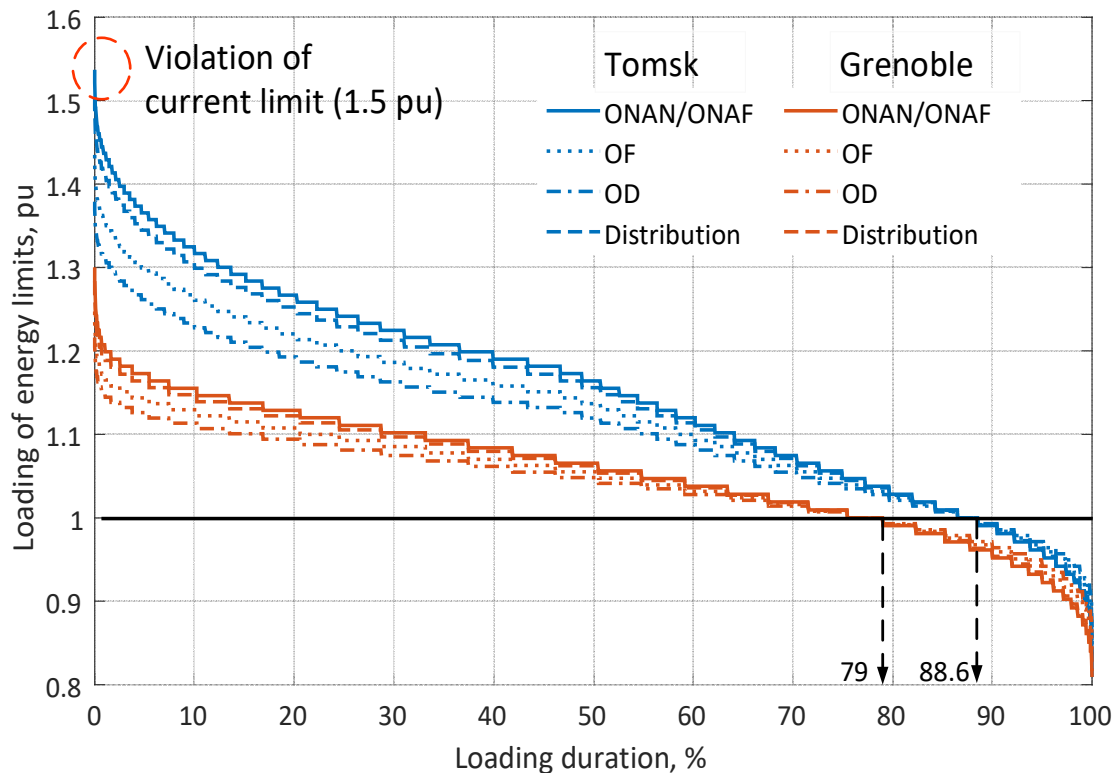

Figure 71 Loading duration for all transformers in Tomsk, Russia and Grenoble, France

From Figure 71, one can see that the current limit was violated in Tomsk for a small duration of time (because the approximation was used instead of optimization). This confirms our suggestion that cold T_{amb} rarely affects the typical shape of energy limits. Furthermore, no violation of the current limit is found for Grenoble. Moreover, no violation of TOT limits is detected in both cities. Thus, typical characteristics of energy limits (steady-state power limits) remain true for Grenoble and Tomsk most of the time.

Notably, the loading duration curve is very similar to the T_{amb} duration curves but twice reflected: horizontally and vertically. If so, the colder T_{amb} , the more significant difference between transformers in the energy transfer. The same conclusions can be found if a typical loading amplitude is quantified for each month. For example, Figure 72 shows maximal, minimal and mean loadings of energy limits in each month.

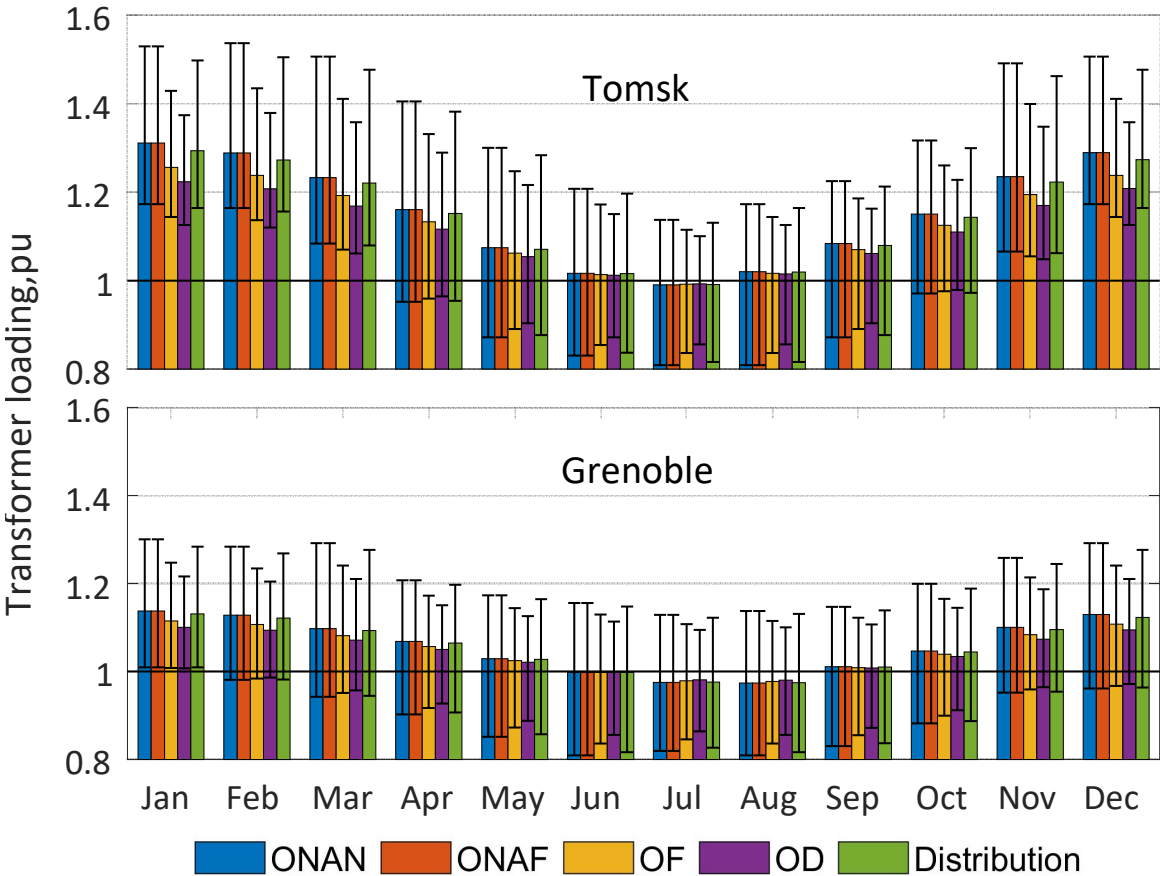

Figure 72 Maximal, minimal and mean loadings of energy limits in each month

Figure 72 shows that summer loadings of energy limit are relatively the same in both cities. However, in the winter months, the difference can be seen. For instance, in January, the mean loading of the energy limit reached 1.3 pu in Tomsk. In contrast, in Grenoble, it is only 1.15 pu. Thus, though the same transformers are used, the total energy transfer in both cities is different (see Figure 73).

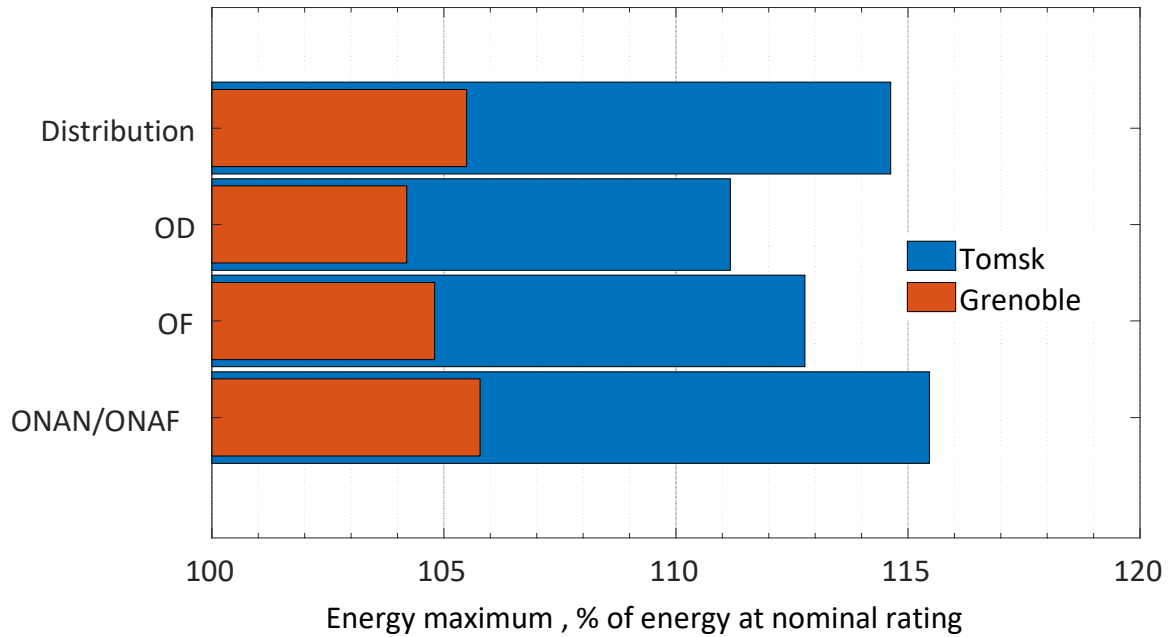

Figure 73 Maximal energy transfer through transformers in comparison with energy delivered at a constant nominal rating

The maximum energy transfer is computed as an integral of loading duration curves from Figure 70. The energy transfer was normalized relative to the energy transferred at the nominal rating of the transformer. Figure 73 shows that transformers can transfer up to 16 % more energy if the transformer loading is equal to the energy limits. Suppose transformers have the TUP (with rated HST = 110 °C). In that case, the total energy transfer can be higher than the nominal rating up to 25 %.

Such additional energy transfer (16-25 %) can be beneficial if a transformer restricts a low-cost generation. Hence, operating the transformer at the energy limit can transfer cheaper energy. This can significantly reduce energy costs in power systems since they are susceptible to incremental energy production at low-cost generators. Furthermore, RES operators and policymakers may take advantage of this additional energy transfer (16-25 %). Maximizing the energy transfer from RES may address climate change and contribute to the decarbonization of the power system operation. Energy limits can be especially relevant if RES-connected transformers are undersized and/or new RES are interconnected to the existing transformer.

Last but not least, a hosting capacity of a distribution network can be increased if knowing the typical characteristics of the energy limit (loading profile). The typical energy limit can be analyzed together with the existing load profile of the substation and available flexibility. From this analysis, an operator may decide on the interconnection of additional loads and DG and/or procurement of new flexibilities from aggregators to ensure a transformer operation at the energy limit.

3.3 Study limitations

This study is a first attempt to investigate energy limits, therefore, the impact of some factors was simplified. For instance, the scope of this study does not consider: harmonics, unbalancing, short-circuit impact, OLTC operation [68], [86], [159] as well as effects related to other natural issues as wind speed and direction [146], precipitations [146], solar irradiations

[86], [152], and GIC [86]. However, each of these factors may be considered in a relevant situation. For example, the fast integration of power electronics into the electrical network could increase harmonics, causing excessive heating in conductors and other parts. Thus, ignoring the harmonics can lead to underestimating winding and oil temperatures and thus overestimating energy limits.

Some improvements can be brought to the proposed model concept of energy limit presented in this study. For instance, in this study, the apparent energy transfer is maximized (i.e. MVAh), which does not necessarily maximize the useful energy transfer (i.e. MWh). However, the application of volt/VAR optimization in the distribution network [451] can keep power factors closer to unity and allow maximizing the active energy transfer (i.e. MWh).

In this study, the oil conditions, defined by viscosity, acidity, moisture and oxygen content etc., are assumed to be within normal values [476]–[479]. However, the deviation from their normal state can negatively affect the energy limits. For instance, the excessive moisture content in the insulation-oil system accelerates the insulation ageing [14] and therefore reduces the energy limit. Nevertheless, it is possible to consider the factors mentioned above if the appropriate transformer thermal model is used.

Thus, the additional research on energy limits may be planned further to consider the limitations of transformers and power systems. For instance, it is possible to include the modelling aspects of the transformer and distribution network, including the effect of losses and volt/VAR control.

4. Conclusion

In summary, the energy limit of the oil-immersed transformer is studied for the first time. Investigations revealed that the energy limit represents the unique loading profile for a given T_{amb} profile. The typical characteristic of this loading profile is that the transformer operates at quasi-rated winding temperature. At the beginning and the end, it may increase the energy transfer thanks to the thermal inertias of winding. However, the next part of this chapter will show that thermal inertias have a limited impact on the energy limit. Most of the time, however, the temperatures of the energy limit remain in the vicinity of a rated HST, making the operation of the transformer thermally beneficial. Therefore, the transformer transfers the maximal energy and avoids high thermal stress simultaneously. Typical characteristics of the energy limit: loading amplitudes and their durations are found.

Results demonstrated that cold climates might facilitate energy transfer through transformers. For instance, transformers in Tomsk, Russia, can transfer up to 10 % more energy than Grenoble, France. Moreover, it is revealed that current limits can be a constraint in cold climates. In contrast, no violation of the TOT limit occurs in both climates. Nevertheless, the TOT limit can also restrict the transformer capacity in a very hot environment ($> +40$ °C). Additional research is required.

Operating the transformer at their energy limits can transfer up to 25 % more energy through transformers. This additional energy transfer can be advantageous for maximising energy transfer between operating areas or even countries. Another promising application of energy limit consists in maximization of RES generation. Moreover, we believe that energy limits may increase the hosting capacity of distribution networks. That is why our future research will focus on applying energy limits to the abovementioned problems of a power system.

The scope of energy limits can be extended to other power system components such as overhead lines, cables, and synchronous generators. Their energy output also depends on T_{amb} .

Following the philosophy of open science [377], it was decided to make available MATLAB scripts, functions and the initial data used in this thesis. Thus, the MATLAB code used in this chapter is available in open access at the GitHub repository [480].

Table 20 Contribution of this chapter and the journal where it was published

No	Contribution of this chapter
C4	For the first time, the energy limit of oil-immersed transformers was investigated. First, the energy limit was introduced as a theoretical concept, modelled through the existing techniques and discussed for practical application. Moreover, the impact of ambient temperature on energy limits was studied. This study identified typical characteristics of energy limits such as loading amplitudes and their durations. Furthermore, the highest theoretical energy output was estimated through main transformers types: ONAN, ONAF, OD, and OF.
Journal: IET Generation, Transmission and Distribution IF: 2,862, Q1, 2021	MATLAB code at GitHub [480]

Part II Optimal ageing limit of oil-immersed transformers

1. Introduction

Nowadays, the energy industry faces an energy transition towards decarbonized power systems. However, while many countries upscale renewables to reduce greenhouse gas emissions, their electrical networks face high stress caused by congestions, voltage instabilities, and harmonics. Moreover, the ongoing electrification of the heating and transport sector will further increase the electrical load and, consequently, stress on a grid infrastructure. Meanwhile shares of DER continue growing fast, electrical networks cannot be reinforced at a similar pace. Nevertheless, new opportunities arise for system operators as power systems become flexible as never before. For instance, technologies such as controllable distributed generation, storage, demand-side management, and DTR reduce the stress on electrical networks. Thus, the challenge of system operators may be oriented to maximize grid infrastructure utilization.

The ageing limit is an integral constraint ensuring that a power equipment operates at variable temperatures whose cumulative effect does not exceed the normative ageing. For instance, the daily LoL of the transformer operating at variable temperatures must not exceed LoL if the same transformer would operate at the constant design temperature (usually 98°C or 110 °C). Such assumption of system operators/researchers ensures that transformers can operate an entire design life as predefined by the manufacturer. However, recent studies [289] testify that the ageing limit of existing transformers can be increased higher than the normal limit if considering their remaining insulation life. In fact, transformers have significant remaining life since they are operated below the normal ageing limit for a long time. For example, Figure 74 shows the generic explanation when the transformer has already operated its design calendar life. However, a transformer still keeps some insulation resources, allowing it to continue its operation.

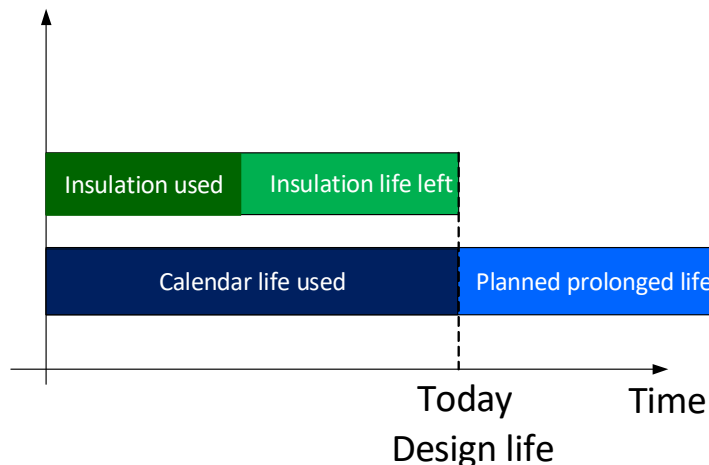

Figure 74 The general case showing the remaining insulation life calendar life of transformers

Nowadays, this situation is relevant in many countries: system operators continue to operate their old transformers beyond the calendar life. Comprehensive tests conducted by network companies showed that the insulation system and other vital parameters of existing transformers remain in a good state after the end of design life [342]. For instance, the calendar life of 50-70% of transformers in Russia already overpassed their design life. However, the physical ageing of all power (auto-) transformers is only 24 % on average [342]. In the UK, the thermal life expectancy of 185 transformers was estimated at around 83 years

[481], which is far longer than their calendar design life. Also, the calendar life of transformers may be legally restricted by some maximal value e.g. Swedish government prescribes 62 years as a the longest duration which transformers should operate [309]. This may be especially relevant as most of transformers in industrialized counties have been installed in the 1960s-70s [482]. So far, however, no study considers the choice of ageing limit as a function of the remaining insulation life and the remaining calendar life.

A choice of the optimal ageing limit of transformers is investigated here. Various combinations of the remaining insulation life (the green bar in Figure 74) are considered together with the remaining calendar life (the blue bar in Figure 74). Note that the exact duration of the remaining life is uncertain. For a long time, many specialists have been discussing the actual remaining life of the transformer [483]. This study assumes that the remaining life of insulation is known as given in IEC or IEEE standards [91],[68]. These standards consider a thermal deterioration of the winding insulation subject to hot spot temperatures. Thus, no mechanical or other deterioration of transformer components is considered here.

Nevertheless, this assumption remains realistic since the degradation of winding insulation depends for 98-99% on current and the initial degree of polymerization and only for 1-2 % on other factors (if oil preservation systems and appropriate maintenance is in place) [65]. Besides, nearly all vital parameters of transformers except for a degree of polymerization and a short circuit impedance can be controlled by conducting the appropriate maintenance programs or replacing damaged elements [65].

The winding insulation represents a resource that could be utilized with different energy efficiency. For instance, Figure 75 shows three arbitrary load profiles of a 1000-kVA distribution transformer, all having the same LoL at the end of the day (the normal LoL = 1 pu). Although all load profiles expose the transformer to the same ageing, they ensure a different energy transfer. T_{amb} during this day was assumed to be equal to the rated T_{amb} (+20 °C).

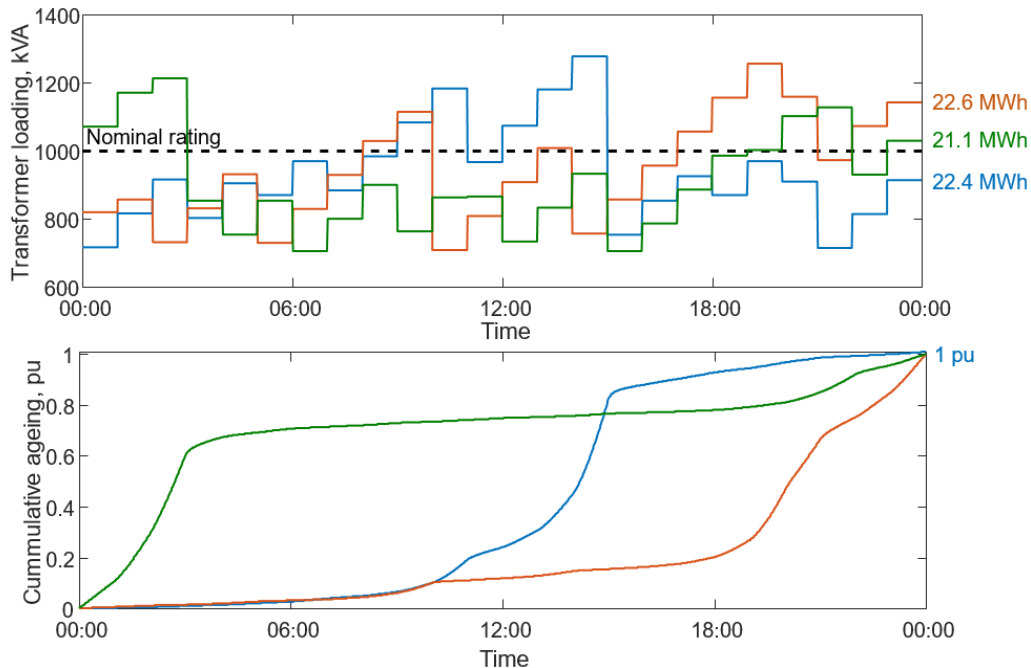

Figure 75 Arbitrary load profiles having the same LoL (1 pu) but different energy transfer. The load profile is given in 1-min resolution but assumed constant over 1-hour step.

Different energy volumes can be transmitted through transformers while using the same insulation resource. Note that flexible power systems allow system operators to modify a load profile. Thus, system operators could increase the energy transfer through transformers without increasing their ageing. To quantify this potential, a maximal energy transfer is used as the criterion for the optimality of insulation utilization. More details on how the maximal energy transfer of transformers may be calculated are given in section 2.1. Meanwhile, the choice of the ageing limit is explained in section 2.2.

2. Methodology: Determination of the optimal ageing limit

The reader can address section 2.1 to see the maximal energy transfer of transformers. In section 2.2, the reader can find a discussion on the optimal ageing limit.

2.1 Optimal energy transfer through transformers

As mentioned in the introduction, different energy transfers can be ensured while consuming the same insulation resource. Thus, it is logical to answer the question: what is the optimal utilization of insulation resources maximizing the energy transfer? Figure 76 briefly reminds the concept of maximal energy transfer as already shown in Part I.

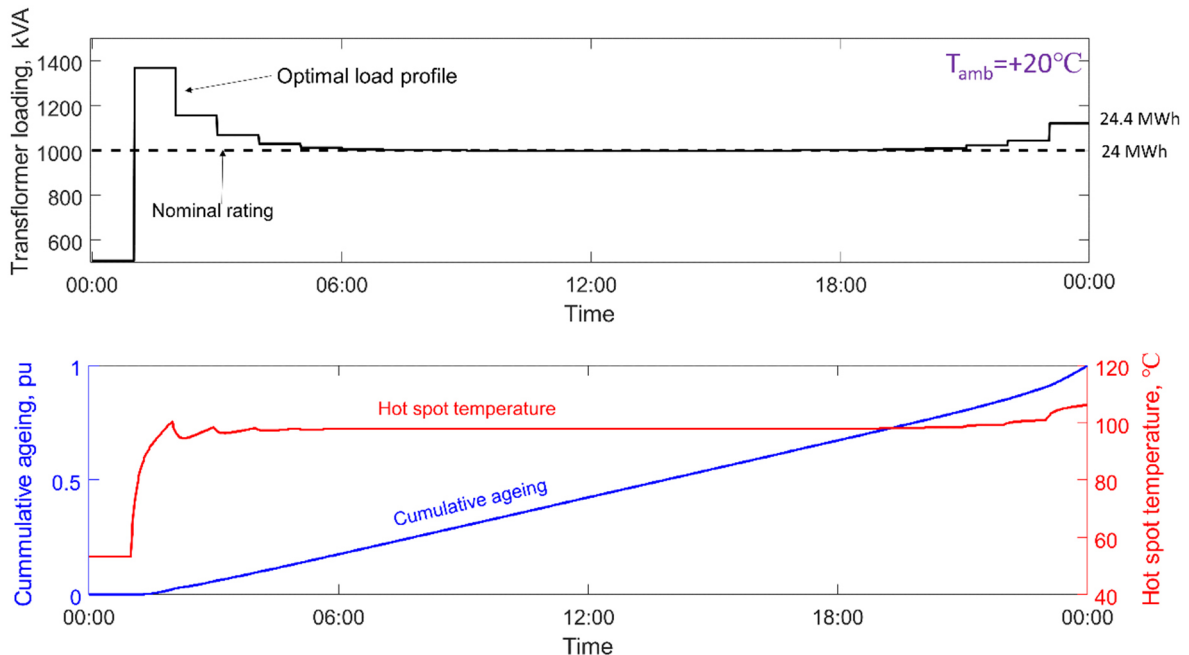

Figure 76 Top figure: optimal load profile (the black line) ensuring the highest energy transfer and thus the optimal utilization of insulation. Bottom figure: a cumulative ageing (the blue line) and a hot spot temperature (the red line), corresponding to the black line.

The optimisation problem was solved to obtain the optimal load profile (the black line). We apply a problem-based formulation [446] and the MATLAB solver `fmincon` with the SQP algorithm to solve this mathematical problem. The objective function was the maximization of energy transfer through a distribution transformer for one day. The constraints in the optimization problem were defined by normal cyclic limits on winding (120 °C) and oil temperatures (105 °C) as well as the ageing (1 pu). Corresponding temperatures were calculated with IEC 60076-7 (annexe E in IEC standard [91]). The complete mathematical formulation of such an optimization problem is given in section 2 of Part I. To compare the optimal load profile with arbitrary load profiles in Figure 75, T_{amb} was kept the same (+20 °C).

The optimal load profile transfers 24.36 MWh during the day. As expected, the optimal energy transfer is higher than the energy transfer of arbitrary load profiles from Figure 75 (21.1 - 22.6 MWh). However, the optimal transfer is higher for 0.36 MWh than the energy transfer (24 MWh) at rated conditions: the nominal power (1000 kVA) and T_{amb} (+20 °C). Such better energy transfer is physically possible due to the thermal inertia of the transformer. Due to thermal inertias of windings, their temperature changes slower than a current change. Thus, it is possible to transfer more energy while the temperature reaches its steady-state value.

Another important observation in Figure 76 is that the solution of the optimization problem is prone to keep the rated hot-spot temperature (98 °C) most of the time. Therefore, the insulation resource is consumed at the rated speed, also known as Ageing Acceleration Factor (AAF) [68]. Consequently, the optimal LoL curve (the blue line) increases gradually, not as LoL curves in Figure 75. Hence, the optimal utilisation of insulation resources maximizing the energy transfer happens if the insulation resource is equally consumed at each time moment. In other words, $AAF = \text{const}$ (if ignoring thermal inertias).

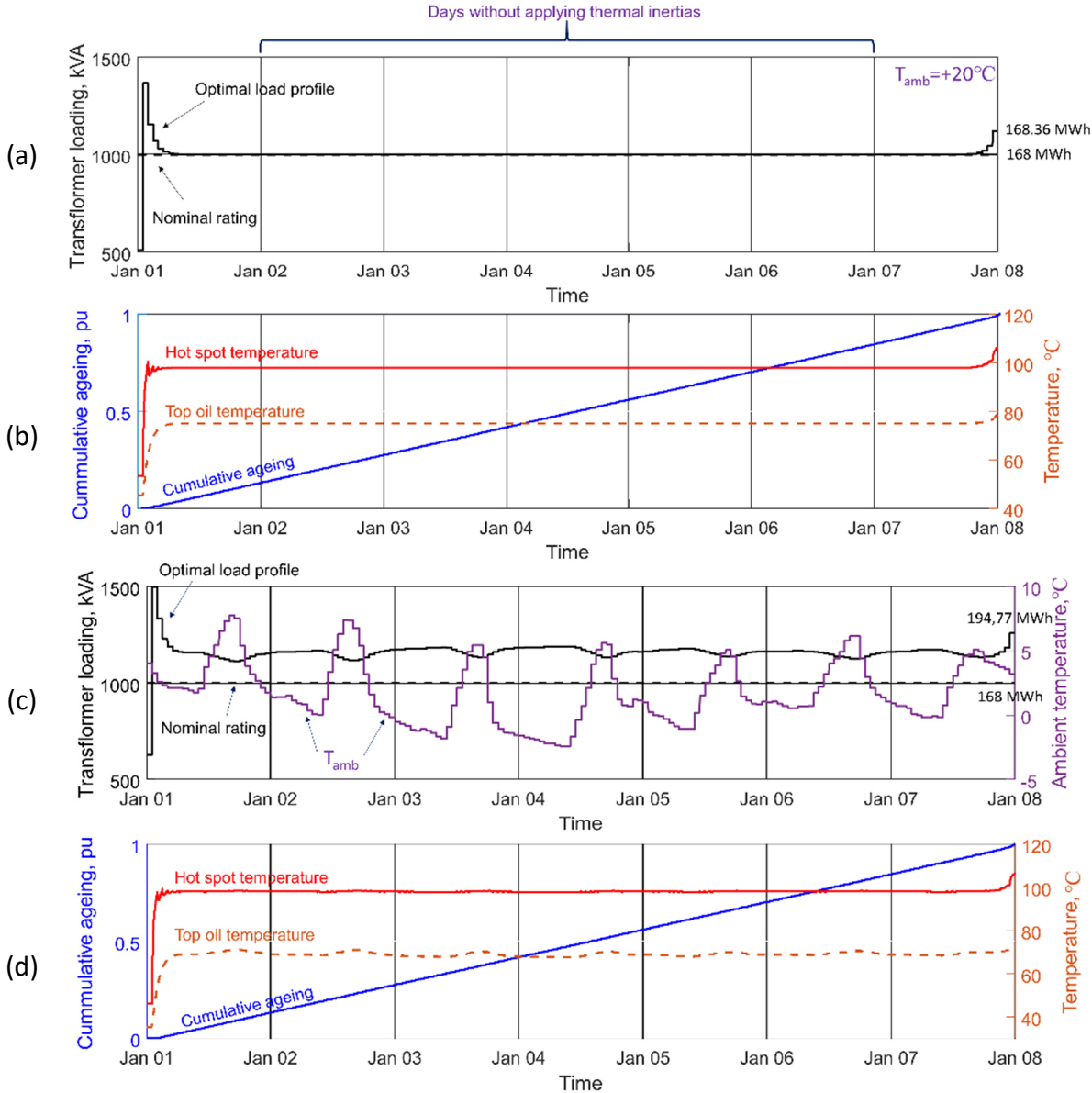

Figure 77 Optimized load profile (the black line) ensuring the highest energy transfer for one week at rated $T_{amb} = +20^{\circ}\text{C}$: (two top figures) and real T_{amb} in Grenoble, France (two bottom figures)

The question may be posed: if thermal inertias provide additional energy transfer, why they are ignored? The answer is that thermal inertias, despite their advantage, are applied only at the beginning and end of the studied horizon. For the rest of the studied horizon, the optimal solution keeps a rated hot spot temperature. This is especially evident if the horizon of the optimization problem would be increased from one day to one week (see Figure 77a above). The reader can see that during January 2-6, the optimal loading does not depend on thermal inertias (temperatures and loading are constant).

Moreover, suppose the reader would compare the energy transfer for horizons of 1 day and one week. In that case, it appears that thermal inertias ensure the same increment of energy transfer (0.36 MWh) over the energy transfer at nominal conditions. Hence, thermal inertias have limited impact, especially if a horizon becomes longer than one day. In this case, the energy transfer by thermal inertias remains the same while a total energy transfer increases.

The reader can notice that in Figure 77a, the constant T_{amb} (+20 °C) was assumed over the week. However, a real shape of T_{amb} does not affect the optimal thermal state of the transformer (bottom Figure 77a and bottom Figure 77b are almost the same). Nevertheless, it is possible to see that optimal loadings become variable at variable T_{amb} (Figure 77b). In contrast, at constant T_{amb} , loadings remain constant (Figure 77a). This happens because the optimal solution tends to keep the same profile of the hot spot temperature. Still, due to the variability of T_{amb} , it is necessary to adjust the load profile. Since the load is adjusted, the energy transfer becomes even higher (194,77 MWh) than if the transformer would operate at a nominal rating (168 MWh).

The most important observation in Figure 77 is that for different T_{amb} , the shape of optimal hot spot temperatures remains the same while the optimal top-oil temperature fluctuates negligibly. This confirms the statement that a maximal energy transfer tends to the same thermal conditions even under various T_{amb} (a constant +20 °C in Figure 77a versus the range [-2.5°C: +8 °C] in Figure 77b). Such a conclusion remains valid as long as a hot spot temperature remains a limiting factor of loadings (see T_{amb} ranges in [343] and [346] for an example where a current is a limiting factor).

We conclude that for an arbitrary T_{amb} profile, it is possible to calculate a quasi-maximal energy transfer without solving an optimization problem. To do that, it is necessary to reproduce the profile of rated hot spot temperature over the given horizon. For doing this, the reader can use the algorithm presented in section 2 of Chapter II. Briefly, this algorithm's principle consists of adjusting a transformer load for each value of T_{amb} until the rated hot spot temperature is reached. This algorithm can be especially useful for long horizons because the optimisation problem may become intractable for prolonged intervals (months and years) [345]. This happens due to the high time resolution of data required by the IEC thermal model. The increased time resolution at long intervals leads to a significant rise of state variables and constraints in the optimization problem [345]. Thus, such an algorithm can be used at long horizons to obtain a feasible solution close to the optimal maximum.

2.2 Optimal ageing limit of oil-immersed transformers

In previous section 2.1, the ageing limit was always equal to 1 pu at short-term horizons (a day or a week). As mentioned earlier, recent studies suggest increasing the ageing limit higher than 1 pu. At first glance, if the ageing limit would be increased, then the energy transfer should also increase (since the mathematical constraint in the optimization problem becomes

less restrictive). However, the not-evident result is that increasing the ageing limit can decrease the energy transfer over the remaining calendar life. Oppositely, the reduced ageing limit can actually increase the energy transfer through transformers over their remaining calendar life. Therefore, the increasing/ decreasing of the ageing limit should depend on the specific ratio between the remaining insulation life and the remaining calendar life. Figure 78 shows situations where a decision on ageing limit increasing/decreasing is different.

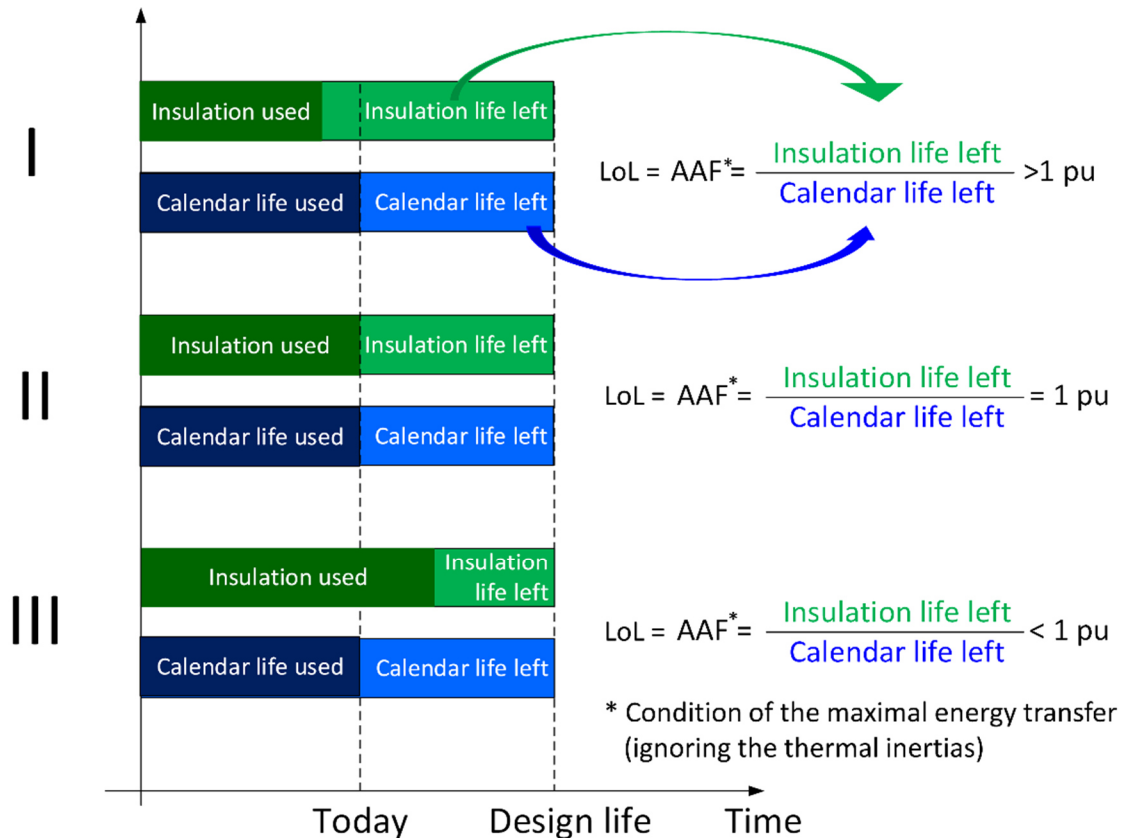

Figure 78 Situations when various ageing limits (LoL in the figure) maximize the energy transfer at the remaining calendar life of the transformer

The first case corresponds to the situation when the used insulation life (the dark green bar) is less than the used calendar life of the transformer (the dark blue bar). This is a typical example of network transformers located at primary substations [65]. As a rule of thumb, primary substations have two transformers, each able to carry a substation load alone in N-1 mode. Hence, such transformers are usually lightly loaded in N mode, i.e. most of the time. Light load often coincides with T_{amb} below the rated T_{amb} (+20 °C) of transformers. This leads to minor or even negligible ageing of insulation resources. For such transformers, it can be beneficial to increase the ageing limit, but the remaining calendar life must be considered.

The second case from Figure 78 corresponds to the situation when actual insulation ageing is equal (or close) to the time of transformer operation. For example, this situation can happen with a step-up (block) transformer of thermal power plants [65], working as baseload generation. In contrast to network transformers, such transformers are more often loaded close to their nominal rating. This is because baseload power plants should operate at maximal available capacity. Therefore, the normal ageing limit should be preferred for such situations.

The third case from Figure 78 corresponds to a situation when the actual insulation life exceeds the time of the transformer operation. Among possible reasons, this can happen due

to heavy overloading or if moisture and/or oxygen content in the insulation-oil system overpasses their permissible limits. For example, free-breathing transformers (in contrast to sealed transformers) are more exposed to moisture and oxygen ingress from the atmosphere [483]. For instance, the CIGRE survey [484] estimates that the yearly increase in moisture content is 0.03-0.06% for the sealed conservator and around 0.2% for the unsealed one [485]. This may accelerate the insulation ageing of the transformer even at a rated hot spot temperature. Furthermore, harmonics can also significantly accelerate the deterioration of winding insulation even if temperature gauges never achieve alarm setpoints [157]. As a result, the insulation life of the transformer is reduced faster than its calendar life. In such a situation, decreasing of ageing limit can prolong the time of transformer operation.

Let us assign specific numbers to green and blue bars from Figure 78 and find an energy transfer at the remaining calendar life for different ageing limits (see Table 21). Again, the $T_{amb} + 20\text{ }^{\circ}\text{C}$ will be held constant.

Table 21 Specific values of green and blue bars in Figure 78

Case	Insulation life		Calendar life	
	Used	Remaining	Used	Remaining
I	30 %	70 %	50 %	50 %
II	50 %	50 %		
III	70 %	30 %		

Figure 79 shows calculated energy transfers as a function of ageing limits.

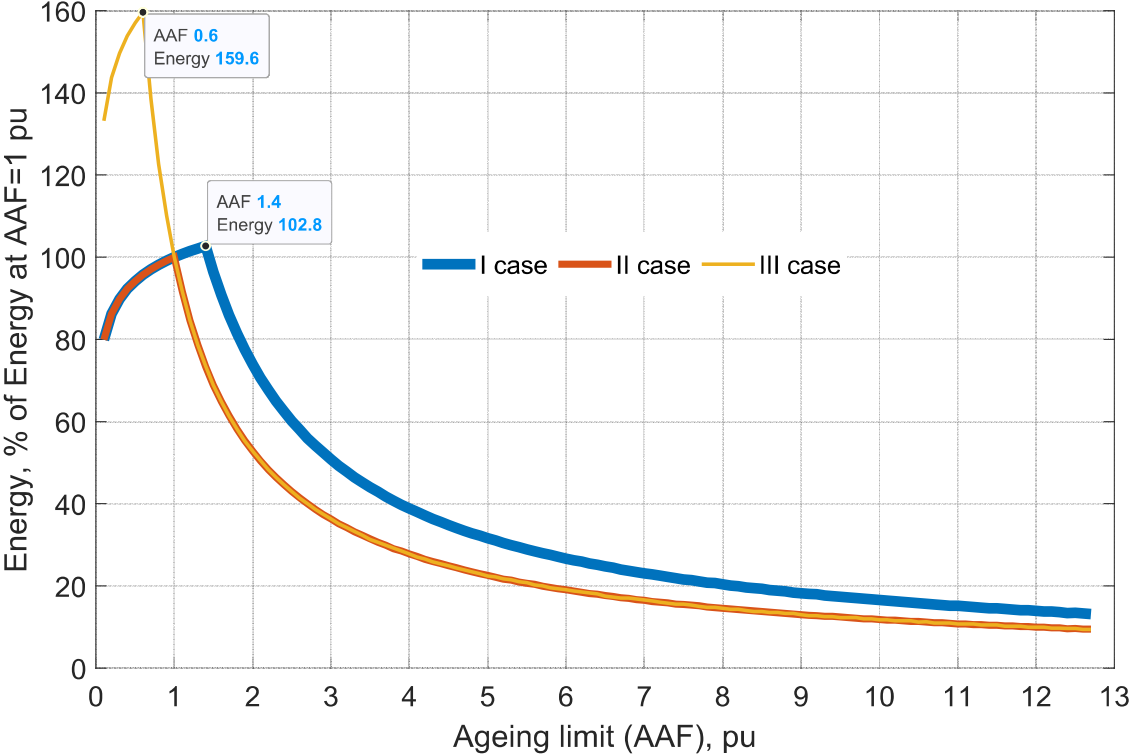

Figure 79 Energy transfer as a function of ageing limits for 3 cases. % on the y-axis is related to each case alone and not intended to compare shown cases.

Optimal energy transfers are achieved at low (case III), normal (case II), and high ageing limits (case I). Note that the optimal ageing limit increased by 40 % (1.4 pu) in the I case. However,

the energy transfer increased only by 2.8 % (see Energy value for I case in Figure 79). Whereas in the III case, the optimal ageing limit reduced to 40 % (0.6 pu), the energy transfer increased by 59,6 % (see Energy value for the III case). Thus, a reduced ageing limit may be more beneficial than increased ageing limits. This result can be explained by the exponential dependency between loadings and AAF (see section 4 of Chapter II for more details).

Figure 78 assumed that a calendar life (a blue bar) equals a transformer design life (on the x-axis). However, this is not always the case in practice: the actual calendar life of existing transformers can be longer than their design life (Figure 74).

The same situation may happen with new transformers (Figure 80). Two facts should be highlighted for the case of a new transformer: (1) the insulation resource of winding cannot be usually extended for a cost-efficient approach so far. Therefore, a green bar is assumed constant (i.e. not variable). However, (2) a calendar life (the blue bar) can have any duration depending on the planning priorities of the network company. Thus, a maximal energy transfer depends on the calendar life (the blue bar) and ageing limit. Figure 81 shows an energy transfer by varying a calendar life and an ageing limit.

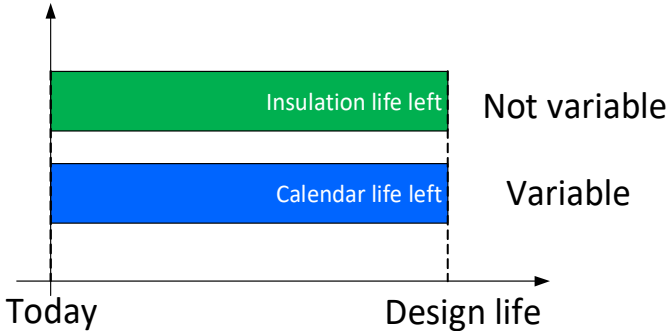

Figure 80 Insulation and calendar lives in the case of new transformer

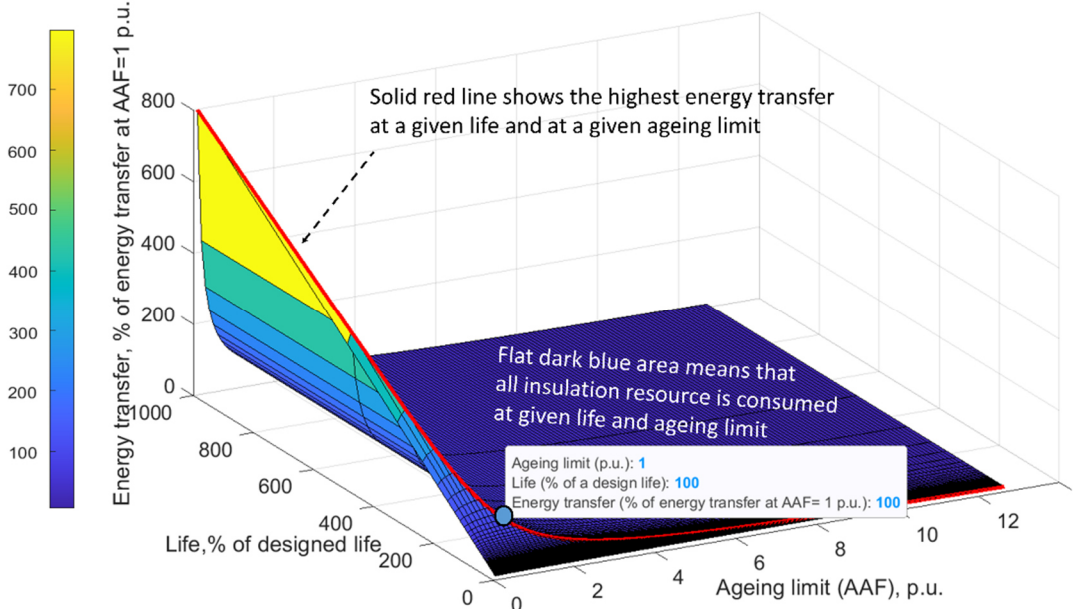

Figure 81 Dependency: an ageing limit-a remaining calendar life-a maximal energy transfer.

Figure 81 shows that low ageing limits allow transformers to operate longer and transfer up to 8 times more energy than at normal ageing limits. Despite these benefits, it is implausible that operation at an ageing limit below 0.5 pu is practically reasonable for maximising energy

transfer. At such low ageing limits, the transformer should operate for about 60-300 years. For such very long horizons, it is quite probable that advances in transformer manufacturing would make the operation of “old” transformers economically inefficient. For instance, this may happen due to the high losses of old transformers at such long periods. However, operation at ageing limits between 0.5 pu and 1 pu (i.e. up to 60 years) may represent a practical value. It may also be beneficial to operate transformers at an ageing limit >1 pu if the remaining insulation is sufficient. Note that the maximal AAF is limited by hot spot temperatures (120 °C for normal cyclic loadings). For 120 °C, the ageing limit equals 12.7 pu for Kraft paper and 2.7 pu for TUP. Note that high ageing limits lead to a small increment in energy transfer, as shown in Figure 79. Besides, high winding temperatures may cause a transformer failure. Thus, more economic and reliability studies are needed.

3. Conclusions

It was demonstrated that the optimal ageing limit should be chosen considering the ratio between the remaining insulation life and calendar life. Otherwise, system operators may underuse the insulation resource of windings at the remaining calendar life (omitted in other studies). Moreover, it may even damage transformers when the situation requires reducing the ageing limit. Main cases with different ratios (green and blue bars) are generalized.

Moreover, it was explained how it might be possible to utilize the winding insulation resource to maximize energy transfers. Specifically, it was revealed that maximal energy transfer tends to a particular thermal state which does not depend on T_{amb} . Furthermore, it was shown that thermal inertias have a limited impact on maximal energy transfer so they can be ignored. The case of the new transformer was studied by varying its calendar life and ageing limits. It seems that ageing limits between 0.5 pu and 1 pu could have a practical value in operation planning and should be studied in more detail. It is also shown that a low ageing limit has a relatively higher increment of energy transfer in % versus increased ageing limits.

Following the philosophy of open science [377], it was decided to make available MATLAB scripts, functions and the initial data used in this thesis. Thus, the MATLAB code used in this chapter is available in open access at the GitHub repository [486].

Table 22 Contribution of this chapter and the journal where it was published

№	Contribution of this chapter
C4	It was found that maximal energy transfer corresponds to a specific thermal state of the transformer. Furthermore, we showed that thermal inertias have a limited impact on the maximal energy transfer through a transformer. Thus, they can be ignored for the estimation of energy limits.
C5	It is explained how the optimal ageing limit should be chosen. Specifically, it was shown that the optimal ageing limit should be determined as the ratio between the remaining insulation life and the remaining calendar life of transformers. Hence, the main situations with different ratios are generalized. Besides, it was shown that operating at low ageing limits have a relatively higher increment of energy transfer in percentage versus high ageing limits. This allows transferring more energy through the transformer at long term-horizons. Finally, a maximal energy transfer through the transformer is estimated as a function of an ageing limit and calendar life.
CIRED conference in Geneva, Switzerland 2021	MATLAB code at GitHub [486]

Thesis conclusions

The first chapter of this thesis highlights historical transformations in modern power systems. Most of our attention was drawn to the transformation of electrical energy into the world's primary energy carrier. As a result, electrical demand should double in the next 30 years. This and DER integration should require significant investments into electrical networks. Traditionally, around 67 % of these network investments are allocated for distribution networks. A similar share is still expected in the near future. Hence, it was decided to focus this thesis on distribution networks and especially on oil-immersed transformers because of two reasons.

The first reason for choosing oil-immersed transformers is dictated by predictions: DSO will require twice more transformers as it nowadays due to massive electrification and a DER integration. The second reason is dictated by our scientific interest in transformers. In contrast to other network equipment, they may exceed their design (continuous) temperature during a normal operation. This creates a scientific problem of modelling their thermal rating because temperatures may be exceeded only in a short time. Even though standards permitted it a long time ago, existing techniques do not provide tools for thoroughly modelling/assessing this intermittent temperature limit as a power limit. Besides, the existing methods may have some drawbacks relative to initial assumptions on typical load profiles.

While calculating the thermal ratings of transformers, many techniques were based on the assumption of a typical load profile. However, in the era of smart grids, the shape of load profiles may vary due to DER integrations, making this assumption risky for calculating the actual thermal ratings. Moreover, it was discovered that existing papers do not always use C&T limitations given in IEC and IEEE standards. Some of them may use continuous temperature and temperature limits interchangeably. However, all C&T limitations (based on intermittent temperature limit) should be considered to comply with industrial standards. In our opinion, using continuous temperature as a temperature limit may be very conservative and not necessarily permit utilising the transformer capacity most efficiently. This may be especially relevant in the context of growing needs in transformers at distribution networks and due to global warming.

Besides, loading guides may use different C&T limitations. However, no study quantifies the power limits based on multiple C&T limits, especially considering the intermittent temperature limit. Because of such a gap, it may be non-evident how C&T limits may affect each other while defining the thermal rating of transformers. IEC standard states that these factors may limit each other to a lower value. Still, it does not explain how often it happens and how this affects the final power limit. Moreover, the impact of different climates (i.e. ambient temperatures) should be studied as the latter may impact the interdependency between power and temperature limits. Considering these facts, it was decided to reassess DTR, considering C&T limits as the **first task** of the thesis.

The primary factor driving the reinforcement of distribution networks will be electric demand. Therefore, our thesis's second task is to investigate how much load can be connected to transformers using C&T limitations. As a reference case, it was decided to choose Russia and the methodology of its DSO to evaluate the reserve capacity of substations. The case of Russia is especially interesting as nowadays, the topic of reserved capacity is highly discussed in the Russian industry. Besides, it was discussed that DSOs worldwide have started using flexibility

in their electrical network. That is why we were interested in how much flexibility (in our case, we focus on demand response) is needed to connect the given load while using the DTR of transformers. Hence, it was decided to extend the second task on coupling DTR with DR and apply it to the problem of reserve determination for load connections.

Apart from the first and second tasks, which are more practically oriented, it was decided to conduct theoretical investigations. Specifically, we had two theoretical hypotheses for utilising the transformer capacity more efficiently. The first hypothesis is that the transformer should have a limit of energy transfer as any physical object. The second hypothesis was that it is possible to apply different ageing limits as a function of the state of insulation and remaining calendar life to utilise the existing transformers better. Hence, **the third task** of this thesis will be investigating how the energy and ageing limit could allow better utilization of transformer capacity.

As a result of this research, it is possible to highlight five main contributions:

For DTR modelling:

C1. We propose a feasible region, the new technique for modelling the thermal rating of transformers. In contrast to existing methods, the feasible region allows modelling the intermittent temperature limit, not depending on the load profile. Moreover, the feasible region allows considering the mutual dependency between the power limit and C&T limitations. This mutual dependency was mentioned in the IEC standard but not explicitly explained yet. Hence, this thesis brings additional insights on this topic. For the first time, the transformer capacity was quantified for various C&T limits. This quantification allowed us to identify the limiting factors of transformer capacity in Tomsk and Grenoble. This, in turn, allowed us to reassess the impact of a winding temperature on the thermal rating, which has been usually considered a primary factor. On the one hand, our results confirm that for certain C&T limits, the winding temperature may be indeed always or partially the limiting factor of thermal rating. On the other hand, for other C&T limitations, the winding temperature may not affect the permissible loading at all. Finally, the recommendations for transformer overloading were formulated.

For DTR application:

C2. We integrated a DTR to determine transformer reserve capacity for connecting the new loads. In contrast to the existing DSO approach based on power ratings, the proposed approach is based on C&T limits. This allows unblocking of more transformer capacity and therefore connecting significantly more loads. To formalise the approach, we developed the algorithm based on quasi-robust consideration of uncertainties from load profile and ambient temperatures. Thus, it is ensured that the obtained reserve is located on the conservative side from the thermal point of view.

C3. We coupled DR with DTR and demonstrated that this coupling might further increase the reserve capacity of transformers. Specifically, we developed the methodology to estimate the required amount of DR to ensure the given reserve margin. The methodology was formalized in an algorithm whose primary problem was formulated as an integrated DR design and management problem. Moreover, the advantage of using a temperature limit instead of a continuous temperature was also shown.

For DTR concepts:

- C4.** We investigated the energy limit of oil-immersed transformers for the first time. The energy limit was introduced as a notion, modelled through the existing techniques and discussed from the possible practical application point of view. Moreover, we studied the impact of ambient temperatures in Tomsk and Grenoble on the energy limit. This study identified typical characteristics of energy limits such as loading amplitudes and their durations. Furthermore, we estimated the highest theoretical energy transfer through transformers ONAN, ONAF, OD, and OF. Moreover, it was revealed that maximal energy transfer corresponds to a specific thermal state of the transformer. Finally, we showed that thermal inertias have a limited impact on maximal energy transfer. Thus, they can be ignored for the estimation of energy limits.
- C5.** We developed general recommendations for the choice of the optimal ageing limit. Specifically, it was demonstrated that the optimal ageing limit should be chosen as the ratio between the remaining insulation life and the remaining calendar life of transformers. Thus, main situations with different ratios were generalized. Moreover, it was shown that low ageing limits have a relatively higher increment of energy transfer in percentage versus high ageing limits. Besides, a maximal energy transfer through the transformer is estimated as a function of an ageing limit and calendar life.

Following the philosophy of open science [377], we decided to make available MATLAB code and the initial data used in this thesis. Thus, everyone interested in our modelling and simulations may reproduce them. Besides, we hope that this MATLAB code could be helpful for specialists in conducting their research. Hence, Table 23 refers to a particular thesis's contribution and provides the link for the GitHub repository where one may download the source code in MATLAB. Finally, if any updates in the code will be made after the publication of this thesis, they can be tracked via GitHub repositories.

Table 23 GitHub links to initial code for each contribution

	Publication	Journal/Conference	Link	GitHub
C1	Assessment of dynamic transformer rating, considering current and temperature limitations	<i>International Journal of Electrical Power & Energy Systems</i> (IF: 3,588, Q1), 2021	[343]	[378]
C2	Application of dynamic transformer ratings to increase the reserve of primary substations for new load interconnection	CIREC conference in Madrid, Spain, 2019	[344]	[431]
C3	Demand response coupled with a dynamic thermal rating for increased transformer reserve and lifetime	<i>Energies</i> (IF: 2.702, Q2), 2021	[345]	[456]
C4	Energy limit of oil-immersed transformers: A concept and its application in different climate conditions	<i>IET Generation, Transmission & Distribution</i> (IF: 2,862, Q1), 2021	[346]	[480]
C4, C5	Optimal ageing limit of oil-immersed transformers	CIREC conference in Geneva, Switzerland 2021 (held online)	[347]	[486]

References

- [1] DNV GL, "Energy Transition Outlook 2020 - A global and regional forecast to 2050," 2020. [Online]. Available: <https://eto.dnvgl.com/2020/index.html>.
- [2] DNV GL, "Energy Transition Outlook 2020. Power Supply and Use," 2020. [Online]. Available: <https://eto.dnv.com/2020#ETO2020-top>.
- [3] "DNV GL's Energy Transition Outlook shows massive shift of investment from oil and gas into power lines - Energy Post." <https://energypost.eu/dnv-gls-energy-transition-outlook-shows-massive-shift-of-investment-from-oil-and-gas-into-power-lines/> (accessed Aug. 18, 2021).
- [4] DNV GL, "Energy Transition Outlook 2018: Power Supply, Forecast to 2050," no. September, p. 96, 2018, [Online]. Available: <https://eto.dnv.com/2018/>.
- [5] "Energy Transition Outlook 2021 dataset | Veracity by DNV." https://store.veracity.com/energy-transition-outlook?utm_source=web&utm_medium=microsite&utm_campaign=ds_ver_20q3_power_bi_dataset&utm_content=free (accessed Oct. 10, 2021).
- [6] Power Technology Research, "Global - Dry-Type Transformers Market - Renewables & Regulations Driving Growth," 2020. <https://www.coilwindingexpo.com/Articles/dry-type-transformers-market---renewables-reg> (accessed Feb. 11, 2022).
- [7] "Transformer Oil Market by Oil Type & Application - 2030," 2021. <https://www.marketsandmarkets.com/Market-Reports/transformer-oil-market-967.html> (accessed Feb. 18, 2022).
- [8] S. H. H. Kazmi, "Dynamic Rating based Design and Operation of Offshore Windfarm Export Systems," DTU, 2021.
- [9] N. Viafora, "Flexible Utilization of Transmission Grid Capacity for Wind Power Integration," 2020.
- [10] Pérez-Rúa and Juan-Andrés, "Electrical Network Design for Offshore Wind: Analysis, Mathematical Modelling, and Optimization," 2020.
- [11] S. H. Hasan Kazmi, J. Holboll, T. H. Olesen, and T. S. Sorensen, "Thermoelectric Modelling and Optimization of Offshore Windfarm Export Systems - State of the Art," in *2019 1st Global Power, Energy and Communication Conference (GPECOM)*, Jun. 2019, pp. 331–336, doi: 10.1109/GPECOM.2019.8778513.
- [12] S. H. H. Kazmi, J. Holbøll, T. H. Olesen, and T. S. Sørensen, "Dynamic Thermoelectric Modelling of Oil- filled Power Transformers for Optimization of Offshore Windfarm Export Systems," in *Symposium Aalborg, Denmark*, 2019, p. 11.
- [13] IEEE/IEC, "60076-16-2018 IEC/IEEE International Standard - Power transformers - Part 16: Transformers for wind turbine applications," 2018. [Online]. Available: <https://standards.ieee.org/standard/60076-16-2018.html>.
- [14] IEC, "Standard 60076-7 Loading guide for oil-immersed power transformers," 2005. [Online]. Available: <https://webstore.iec.ch/publication/605>.

- [15] M. R. Sarker, D. J. Olsen, and M. A. Ortega-Vazquez, "Co-Optimization of Distribution Transformer Aging and Energy Arbitrage Using Electric Vehicles," *IEEE Trans. Smart Grid*, 2017, doi: 10.1109/TSG.2016.2535354.
- [16] P. S. Moses, M. A. S. S. Masoum, and S. Hajforoosh, "Overloading of distribution transformers in smart grid due to uncoordinated charging of plug-in electric vehicles," *2012 IEEE PES Innov. Smart Grid Technol. ISGT 2012*, pp. 1–6, Jan. 2012, doi: 10.1109/ISGT.2012.6175689.
- [17] K. Kumar and G. B. Kumbhar, "A review on impact of distributed generation and electrical vehicles on aging of distribution transformer," in *3rd International Conference on Condition Assessment Techniques in Electrical Systems (CATCON)*, Nov. 2017, pp. 283–288, doi: 10.1109/CATCON.2017.8280229.
- [18] S. Powell, E. C. Kara, R. Sevlia, G. V. Cezar, S. Kiliccote, and R. Rajagopal, "Controlled workplace charging of electric vehicles: The impact of rate schedules on transformer aging," *Appl. Energy*, 2020, doi: 10.1016/j.apenergy.2020.115352.
- [19] R. Godina, E. M. G. Rodrigues, N. G. Paterakis, O. Erdinc, and J. P. S. Catalão, "Innovative impact assessment of electric vehicles charging loads on distribution transformers using real data," *Energy Convers. Manag.*, 2016, doi: 10.1016/j.enconman.2016.04.087.
- [20] C.-L. Su, C.-N. Lu, K.-E. Zheng, J.-H. Teng, R.-C. Leou, and K.-F. Huang, "Analysis of PEV charging impact on distribution transformer aging for charging station transformer design," in *IEEE Industry Application Society Annual Meeting*, Oct. 2014, pp. 1–8, doi: 10.1109/IAS.2014.6978491.
- [21] S. Qian, X. Zhang, C. Chen, H. Wang, J. Guo, and Y. Xu, "Ageing Evaluation of the Distribution Transformer under Varying Load due to Electric Vehicle Charging," in *2021 International Conference on Electrical Materials and Power Equipment (ICEMPE)*, Apr. 2021, pp. 1–4, doi: 10.1109/ICEMPE51623.2021.9509233.
- [22] A. N. M. M. Haque, D. S. Shafiullah, P. H. Nguyen, and F. W. Blied, "Real-time congestion management in active distribution network based on dynamic thermal overloading cost," in *2016 Power Systems Computation Conference (PSCC)*, Jun. 2016, pp. 1–7, doi: 10.1109/PSCC.2016.7540985.
- [23] P. Andrianesis and M. Caramanis, "Distribution Network Marginal Costs: Enhanced AC OPF Including Transformer Degradation," *IEEE Trans. Smart Grid*, vol. 11, no. 5, pp. 3910–3920, Sep. 2020, doi: 10.1109/TSG.2020.2980538.
- [24] Navigant Research, "Global DER Deployment Forecast Database 4Q," 2017. <https://www.navigantresearch.com/reports/global-der-deployment-database>.
- [25] G. S. Armashova, "Assessment of the potential of distributed energy technologies as a compensation for the need for generating capacities until 2035," *Proc. Vor. State Univ. Eng. Technol.*, vol. 82, no. 1, pp. 409–418, May 2020, doi: 10.20914/2310-1202-2020-1-409-418.
- [26] E. J. Aladesanmi and D. G. Dorrell, "Investigation and Assessment of the Impacts of Reverse Power Flow on Power System Network Loading under High Penetration of Wind Energy," *Proc. - 2019 South. African Univ. Power Eng. Conf. Mechatronics/Pattern*

- Recognit. Assoc. South Africa, SAUPEC/RobMech/PRASA 2019*, pp. 493–498, 2019, doi: 10.1109/RoboMech.2019.8704734.
- [27] L. M. Cipcigan, P. C. Taylor, and L.M. Cipcigan and P.C.Taylor, “Investigation of the reverse power flow requirements of high penetrations of small-scale embedded generation,” *Renew. Power Gener. IET*, vol. 3, no. 3, pp. 358–370, 2007, doi: 10.1049/iet-rpg.
- [28] R. Baetens *et al.*, “Assessing electrical bottlenecks at feeder level for residential net zero-energy buildings by integrated system simulation,” *Appl. Energy*, vol. 96, no. 2012, pp. 74–83, 2020, doi: 10.1016/j.apenergy.2011.12.098.
- [29] D. Q. Oliveira, A. C. Z. De Souza, and L. F. N. Delboni, “Optimal plug-in hybrid electric vehicles recharge in distribution power systems,” *Electr. Power Syst. Res.*, vol. 98, pp. 77–85, 2013, doi: 10.1016/j.epsr.2012.12.012.
- [30] CIGRE, “Capacity of Distribution Feeders for Hosting Distributed Energy Resources,” 2014. [Online]. Available: <https://www.cigreaustralia.org.au/assets/ITL-SEPT-2014/3.1-Capacity-of-Distribution-Feeders-for-hosting-Distributed-Energy-Resources-DER-abstract.pdf>.
- [31] А. Н. Гуминский, “Малая генерация» на предприятии – особенности реализации,” *Вестник гомельского государственного технического университета им. П.О. Сухого*, vol. 3, 2011, [Online]. Available: <https://cyberleninka.ru/article/n/malaya-generatsiya-na-predpriyatii-osobennosti-realizatsii/viewer>.
- [32] P. Davison, S. Blake, D. Greenwood, and N. Wade, “Climate change risks in electricity networks,” *Infrastruct. Asset Manag.*, vol. 2, no. 2, pp. 42–51, May 2015, doi: 10.1680/iasma.14.00035.
- [33] M. Bartos *et al.*, “Impacts of rising air temperatures on electric transmission ampacity and peak electricity load in the United States,” *Environ. Res. Lett.*, vol. 11, no. 11, p. 114008, Nov. 2016, doi: 10.1088/1748-9326/11/11/114008.
- [34] M. Hashmi, M. Lehtonen, and S. Hänninen, “Effect of Climate Change on Transformers Loading Conditions in the Future Smart Grid Environment,” *Open J. Appl. Sci.*, vol. 03, no. 02, pp. 24–29, 2013, doi: 10.4236/ojapps.2013.32b005.
- [35] V. V. Klimenko, E. V. Fedotova, and A. G. Tereshin, “Vulnerability of the Russian power industry to the climate change,” *Energy*, vol. 142, pp. 1010–1022, Jan. 2018, doi: 10.1016/j.energy.2017.10.069.
- [36] J. W. Stahlhut, G. T. Heydt, and N. J. Selover, “A preliminary assessment of the impact of ambient temperature rise on distribution transformer loss of life,” *IEEE Trans. Power Deliv.*, vol. 23, no. 4, pp. 2000–2007, 2008, doi: 10.1109/TPWRD.2008.2002848.
- [37] H. Chen *et al.*, “Estimating the impacts of climate change on electricity supply infrastructure: A case study of China,” *Energy Policy*, vol. 150, p. 112119, Mar. 2021, doi: 10.1016/j.enpol.2020.112119.
- [38] J. Sathaye, “Estimating risk to California energy infrastructure from projected climate change,” *Lawrence Berkeley Natl. Lab.*, 2011, [Online]. Available: <http://escholarship.org/uc/item/14r3v942.pdf>.

- [39] D. Burillo, M. Chester, and B. Ruddell, "Electric Grid Vulnerabilities to Rising Air Temperatures in Arizona," *Procedia Eng.*, vol. 145, pp. 1346–1353, 2016, doi: 10.1016/j.proeng.2016.04.173.
- [40] M. J. Simpson, "Global Climate Change Impacts in the United States," *J. Environ. Qual.*, vol. 40, no. 1, pp. 279–279, Jan. 2011, doi: 10.2134/jeq2010.0010br.
- [41] D. Burillo, M. V. Chester, S. Pincetl, and E. Fournier, "Electricity infrastructure vulnerabilities due to long-term growth and extreme heat from climate change in Los Angeles County," *Energy Policy*, vol. 128, pp. 943–953, May 2019, doi: 10.1016/j.enpol.2018.12.053.
- [42] S. N. Chandramowli and F. A. Felder, "Impact of climate change on electricity systems and markets – A review of models and forecasts," *Sustain. Energy Technol. Assessments*, vol. 5, pp. 62–74, Mar. 2014, doi: 10.1016/j.seta.2013.11.003.
- [43] ENA, "Climate Change Adaptation Report," 2015. Accessed: Feb. 23, 2022. [Online]. Available: https://assets.publishing.service.gov.uk/government/uploads/system/uploads/attachment_data/file/478927/clim-adrep-sse-power-distribution-2015.pdf.
- [44] C. Fant *et al.*, "Climate change impacts and costs to U.S. electricity transmission and distribution infrastructure," *Energy*, vol. 195, p. 116899, Mar. 2020, doi: 10.1016/j.energy.2020.116899.
- [45] N. Lu *et al.*, "Climate change impacts on residential and commercial loads in the Western U.S. grid," *IEEE Trans. Power Syst.*, vol. 25, no. 1, pp. 480–488, 2010, doi: 10.1109/TPWRS.2009.2030387.
- [46] N. Voisin *et al.*, "Vulnerability of the US western electric grid to hydro-climatological conditions: How bad can it get?," *Energy*, vol. 115, pp. 1–12, Nov. 2016, doi: 10.1016/j.energy.2016.08.059.
- [47] X. Ke, D. Wu, J. Rice, M. Kintner-Meyer, and N. Lu, "Quantifying impacts of heat waves on power grid operation," *Appl. Energy*, vol. 183, pp. 504–512, Dec. 2016, doi: 10.1016/j.apenergy.2016.08.188.
- [48] N. C. Abi-Samra, K. R. Forsten, and R. Entriken, "Sample Effects of extreme weather on power systems and components, part I: Sample effects on distribution systems," in *IEEE PES General Meeting*, Jul. 2010, pp. 1–3, doi: 10.1109/PES.2010.5589834.
- [49] "CELT4Wind Cable Electrothermal Management for Offshore Wind Farms." <https://www.weamec.fr/en/projects/celt4wind/> (accessed Oct. 07, 2021).
- [50] C.-H. Bonnard, A. Blavette, S. Bourguet, and A. Charmetant, "Modeling of a wave farm export cable for electro-thermal sizing studies," *Renew. Energy*, vol. 147, pp. 2387–2398, Mar. 2020, doi: 10.1016/j.renene.2019.09.135.
- [51] L. C. Cradden and G. P. Harrison, "Adapting overhead lines to climate change: Are dynamic ratings the answer?," *Energy Policy*, vol. 63, pp. 197–206, Dec. 2013, doi: 10.1016/j.enpol.2013.08.052.
- [52] J. Setreus, "Identifying critical components for system reliability in power transmission

- systems,” KTH, 2011.
- [53] D. D. Micu, A. G. Rusina, O. V. Naumov, and A. N. Gorlov, “Calculation of loading ability of power transformers taking into account electromechanical characteristics,” *E3S Web Conf.*, vol. 124, p. 02006, Oct. 2019, doi: 10.1051/e3sconf/201912402006.
- [54] W. C. Sealey and J. B. Hodtun, “Overloading of Transformers---Cases Not Covered by the General Rules,” *Trans. Am. Inst. Electr. Eng.*, vol. 63, no. 4, pp. 149–153, Apr. 1944, doi: 10.1109/T-AIEE.1944.5058912.
- [55] E. T. Norris, “Loading of power transformers,” *Proc. Inst. Electr. Eng.*, vol. 114, no. 2, p. 228, 1967, doi: 10.1049/piee.1967.0043.
- [56] E. T. Norris, “Power transformers—a proposed new standard rating,” *Electron. Power*, vol. 16, no. 8, p. 282, 1970, doi: 10.1049/ep.1970.0283.
- [57] J.-A. Pérez-Rúa, K. Das, and N. A. Cutululis, “Optimum sizing of offshore wind farm export cables,” *Int. J. Electr. Power Energy Syst.*, vol. 113, pp. 982–990, Dec. 2019, doi: 10.1016/j.ijepes.2019.06.026.
- [58] R. Olsen, “Dynamic Loadability of Cable Based Transmission Grids,” DTU, 2013.
- [59] Markus Heggås, “Dynamic Rating of Power Cables Based upon Transient Temperature Calculations,” NTNU, 2019.
- [60] IEC, *60287-1-1 Electric cables – Calculation of the current rating – Part 1-1: Current rating equations (100 % load factor) and calculation of losses*. Geneva, 2006.
- [61] IEC, *60287-2-1 Electric cables – Calculation of the current rating – Part 2-1: Thermal resistance – Calculation of thermal resistance*. 2006.
- [62] IEC, *60853-2 Calculation of the cyclic and emergency current rating of cables*. 1989.
- [63] IEEE, “Standard-738-2012 for Calculating the Current-Temperature Relationship of Bare Overhead Conductors,” 2012. doi: 10.1109/IEEESTD.2013.6692858.
- [64] Electroshield Samara, “Презентация силовых трансформаторов ТМ-СЭЩ и ТМН-СЭЩ,” 2015. <https://www.electroshield.ru/press-center/news/prezentatsiya-silovykh-transformatorov-tm-seshch-i-tmn-seshch/> (accessed Aug. 22, 2022).
- [65] A. Maiorov, M. Lvov, Y. Lvov, V. Komarov, and E. B., “Power transformers and autotransformers of electrical network life time prediction,” *Energetik*, 2018.
- [66] P. R. Barnes, J. W. Van Dyke, B. W. McConnell, S. M. Cohn, and S. L. Purucker, “The feasibility of replacing or upgrading utility distribution during routine maintenance,” 1994. [Online]. Available: <https://www.osti.gov/servlets/purl/10192710>.
- [67] E. Simonson, “Transformer ratings and transformer life,” in *IEE Colloquium Transformer Life Management*, 1998, vol. 1998, no. 510, pp. 7–7, doi: 10.1049/ic:19981011.
- [68] IEEE, “C57.91-2011 Guide for Loading Mineral- Oil-Immersed Transformers and Step-Voltage Regulators,” 2012. [Online]. Available: https://standards.ieee.org/standard/C57_91-2011.html.
- [69] X. Li, R. W. Mazur, D. R. Allen, and D. R. Swatek, “Specifying Transformer Winter and

- Summer Peak-Load Limits," *IEEE Trans. Power Deliv.*, vol. 20, no. 1, pp. 185–190, Jan. 2005, doi: 10.1109/TPWRD.2004.837680.
- [70] A. Mamizadeh and I. İskender, "Evaluation of Permissible Loading for Indoor Oil-Immersed Distribution Transformers," in *International Conference on Electrical and Electronics Engineering - ELECO*, 2009, pp. 216–220, doi: 10.1109/ELECO.2009.5355332.
- [71] B. Das, T. S. Jalal, and F. J. S. McFadden, "Comparison and extension of IEC thermal models for dynamic rating of distribution transformers," in *IEEE International Conference on Power System Technology (POWERCON)*, Sep. 2016, pp. 1–8, doi: 10.1109/POWERCON.2016.7753896.
- [72] M. Savaghebi, A. Gholami, and A. Jalilian, "Transformer dynamic loading capability assessment under nonlinear load currents," in *43rd International Universities Power Engineering Conference*, Sep. 2008, pp. 1–5, doi: 10.1109/UPEC.2008.4651612.
- [73] I. Elders, K. Bell, K. Smith, and A. Collinson, "Application of enhanced thermal ratings to primary substation transformers," *CIREC - Open Access Proc. J.*, vol. 2017, no. 1, pp. 37–41, Oct. 2017, doi: 10.1049/oap-cired.2017.1053.
- [74] J. Yang and D. Strickland, "Thermal modelling for dynamic transformer rating in low carbon distribution network operation," in *7th IET International Conference on Power Electronics, Machines and Drives (PEMD 2014)*, 2014, vol. 2014, no. 628 CP, p. 5.2.04-5.2.04, doi: 10.1049/cp.2014.0330.
- [75] R. Villarroel, Q. Liu, and Z. Wang, "Experimental study of dynamic thermal behaviour of an 11 kV distribution transformer," *CIREC - Open Access Proc. J.*, vol. 2017, no. 1, pp. 158–162, Oct. 2017, doi: 10.1049/oap-cired.2017.1102.
- [76] B. Shahbazi, M. Savaghebi, and M. Shariati, "A probabilistic approach for power transformer dynamic loading capability assessment," *Int. Rev. Electr. Eng.*, vol. 5, no. 3, pp. 952–960, 2010.
- [77] T. Weekes, T. Molinski, and G. Swift, "Transient Transformer Overload Ratings," *IEEE Electr. Insul. Mag.*, vol. 20, no. 2, pp. 32–35, Mar. 2004, doi: 10.1109/MEI.2004.1283260.
- [78] P. K. Sen, S. Pansuwan, K. Malmedal, O. Martinoo, and M. G. Simoes, "Transformer Overloading and Assessment of Loss-of-Life for Liquid-Filled Transformers," 2011. [Online]. Available: https://pserc.wisc.edu/wp-content/uploads/sites/755/2018/08/T-25_Final-Report_Feb-2011.pdf.
- [79] T. C. Raymond, "Power transformer thermal ratings-an overview," *2003 IEEE PES Transm. Distrib. Conf. Expo. (IEEE Cat. No.03CH37495)*, no. September, pp. 1017–1021, 1959, doi: 10.1109/TDC.2003.1335081.
- [80] A. Pasricha and M. L. Crow, "A method of improving transformer overloading beyond nameplate rating," *2015 North Am. Power Symp. NAPS 2015*, pp. 1–6, Oct. 2015, doi: 10.1109/NAPS.2015.7335148.
- [81] F. A. P. Aragao, S. dos Santos Lima, O. M. Almeida, A. P. de Souza Braga, K. Q. da Silva, and R. S. dos Anjos, "Dynamic loading of distribution transformers from models of

- dynamic thermal,” in *9th IEEE/IAS International Conference on Industry Applications - INDUSCON*, Nov. 2010, pp. 1–6, doi: 10.1109/INDUSCON.2010.5740062.
- [82] B. Bochenski, F. Mosinski, and T. Piotrowski, “Monitoring and forecasting of power transformer ratings using DTR computer program,” in *EUROCON 2007 - The International Conference on “Computer as a Tool,”* 2007, pp. 1373–1377, doi: 10.1109/EURCON.2007.4400358.
- [83] T. S. Jalal, “Case study: Implementation of Dynamic Rating for Transformers in a distribution network,” in *ISGT*, Feb. 2014, no. C, pp. 1–5, doi: 10.1109/ISGT.2014.6816414.
- [84] Xiang Zhou, Sixiang Zhao, Niya Chen, Haibao Mu, and GuanJun Zhang, “The dynamic load adjustment of power transformers based on the inner temperature,” in *International Conference on Condition Monitoring and Diagnosis (CMD)*, Sep. 2016, pp. 790–793, doi: 10.1109/CMD.2016.7757945.
- [85] M. Savaghebi, A. Jalilian, and A. Gholami, “A new approach for transformer loading capability assessment under non-linear load currents,” in *2008 IEEE International Conference on Industrial Technology*, Apr. 2008, no. October 2000, pp. 1–5, doi: 10.1109/ICIT.2008.4608354.
- [86] M. Djamali and S. Tenbohlen, “Hundred years of experience in the dynamic thermal modelling of power transformers,” *IET Gener. Transm. Distrib.*, vol. 11, no. 11, pp. 2731–2739, Aug. 2017, doi: 10.1049/iet-gtd.2016.1321.
- [87] L. Wang, L. Zhou, H. Tang, D. Wang, and Y. Cui, “Numerical and experimental validation of variation of power transformers’ thermal time constants with load factor,” *Appl. Therm. Eng.*, vol. 126, pp. 939–948, Nov. 2017, doi: 10.1016/j.applthermaleng.2017.07.167.
- [88] M. Mikha-Beyranvand, J. Faiz, B. Rezaeealam, A. Rezaei-Zare, and M. Jafarboland, “Thermal analysis of power transformers under unbalanced supply voltage,” *IET Electr. Power Appl.*, vol. 13, no. 4, pp. 503–512, Apr. 2019, doi: 10.1049/iet-epa.2018.5799.
- [89] Cigre WG A2.38, “Transformer Thermal Modelling,” 2016. [Online]. Available: <https://e-cigre.org/publication/659-transformer-thermal-modelling>.
- [90] CIGRE, “A survey of facts and opinions on the maximum safe operating temperature of power transformers under emergency conditions,” 1990. [Online]. Available: https://e-cigre.org/publication/ELT_129_4-a-survey-of-facts-and-opinions-on-the-maximum-safe-operating-temperature-of-power-transformers-under-emergency-conditions.
- [91] IEC, “Standard 60076-7 Loading guide for oil-immersed power transformers,” 2018. [Online]. Available: <https://webstore.iec.ch/publication/34351>.
- [92] M. F. Lachman, P. J. Griffin, W. Walter, and A. Wilson, “Real-time dynamic loading and thermal diagnostic of power transformers,” *IEEE Trans. Power Deliv.*, vol. 18, no. 1, pp. 142–148, Jan. 2003, doi: 10.1109/TPWRD.2002.803724.
- [93] M. Gao, Y. Ding, T. Wang, T. Wen, and Q. Zhang, “Study on bubble evolution in oil-paper insulation during dynamic rating in power transformers,” in *2016 IEEE International Power Modulator and High Voltage Conference, IPMHVC 2016*, 2017, pp. 341–344, doi:

10.1109/IPMHVC.2016.8012835.

- [94] J. Hill, Z. Wang, Q. Liu, C. Krause, and G. Wilson, "Analysing the power transformer temperature limitation for avoidance of bubble formation," *High Voltage*. 2019, doi: 10.1049/hve.2019.0034.
- [95] H. Nordman and M. Lahtinen, "Thermal overload tests on a 400-MVA power transformer with a special 2.5-p.u. Short time loading capability," *IEEE Trans. Power Deliv.*, vol. 18, no. 1, pp. 107–112, 2003, doi: 10.1109/TPWRD.2002.807747.
- [96] M. Koch, S. Tenbohlen, and M. Rösner, "Moisture ingress in free breathing transformers," *Proc. 2008 Int. Conf. Cond. Monit. Diagnosis, C. 2008*, pp. 646–650, 2008, doi: 10.1109/CMD.2008.4580369.
- [97] IEEE, "C57.91-1995 Guide for Loading Mineral- Oil-Immersed Transformers and Step-Voltage Regulators," 2011. [Online]. Available: https://standards.ieee.org/standard/C57_91-1995.html.
- [98] F. R. de Carvalho Sousa, C. de Jesus Ribeiro, A. Pereira Marques, and L. da Cunha Brito, "Method for Rating and Analyzing the Combined Effects of Moisture and Temperature on the Oil–Paper Insulation System of Power Transformers by Means of Load Variations," *J. Control. Autom. Electr. Syst.*, vol. 31, no. 5, pp. 1309–1321, Oct. 2020, doi: 10.1007/s40313-020-00607-7.
- [99] Г. Ф. Быстрицкий and Б. И. Кудрин, *Выбор и эксплуатация силовых трансформаторов*. Москва, 2003.
- [100] R. Girgis and K. Vedante, "Effects of GIC on power transformers and power systems," in *PES T&D 2012*, May 2012, pp. 1–8, doi: 10.1109/TDC.2012.6281595.
- [101] P. Fletcher *et al.*, "Dynamic Loading of transmission equipment. An overview," in *CIGRE Electra*, 2002, no. 202, p. 6, [Online]. Available: https://e-cigre.org/publication/ELT_202_5-dynamic-loading-of-transmission-equipment-an-overview.
- [102] B. Lahoti and D. Flowers, "Evaluation of Transformer Loading Above Nameplate Rating," *IEEE Trans. Power Appar. Syst.*, vol. PAS-100, no. 4, pp. 1989–1998, Apr. 1981, doi: 10.1109/TPAS.1981.316554.
- [103] J. Bentham, "A better life with a healthy planet. Pathways to net-zero emissions," *APPEA J.*, vol. 57, no. 3, 2017, doi: 10.1071/AJ16267.
- [104] J. Blake and E. Kelly, "Oil-Immersed Power Transformer Overload Calculations by Computer," *IEEE Trans. Power Appar. Syst.*, vol. PAS-88, no. 8, pp. 1205–1215, Aug. 1969, doi: 10.1109/TPAS.1969.292469.
- [105] C. Lei, Q. Wang, N. Zhou, L. Yang, X. Xiong, and S. Bu, "Load Transfer Optimization Considering Hot-spot and Top-oil Temperature Limits of Transformers," *IEEE Trans. Power Deliv.*, pp. 1–1, 2021, doi: 10.1109/TPWRD.2021.3106709.
- [106] A. Abu-Siada, *Power Transformer Condition Monitoring and Diagnosis*. Singapore: Institution of Engineering and Technology, 2018.
- [107] M. Van Harte, "Case Study - Permissible loading of transformers and Thermal limits for

- Oil and Winding temperature,” 2003. doi: 10.13140/RG.2.2.24529.53600.
- [108] D. H. Shroff and A. W. Stannett, “A review of paper aging in power transformers,” *IEE Proc. C Gener. Transm. Distrib.*, vol. 132, no. 6, p. 312, 1985, doi: 10.1049/ip-c.1985.0052.
- [109] D. Martin and T. Saha, “A review of the techniques used by utilities to measure the water content of transformer insulation paper,” *IEEE Electr. Insul. Mag.*, vol. 33, no. 3, pp. 8–16, May 2017, doi: 10.1109/MEI.2017.7906158.
- [110] PBSI, “Transformer refurbishment – why and what?” <http://www.pbsionthenet.net/article/87846/Transformer-refurbishment-why-and-what.aspx> (accessed Mar. 04, 2022).
- [111] CIGRE, “Ageing of cellulose in mineral-oil insulated transformers,” 2007. [Online]. Available: <https://e-cigre.org/publication/323-ageing-of-cellulose-in-mineral-oil-insulated-transformers>.
- [112] W. J. McNutt, “Insulation thermal life considerations for transformer loading guides,” *IEEE Trans. Power Deliv.*, vol. 7, no. 1, pp. 392–401, 1992, doi: 10.1109/61.108933.
- [113] V. M. Montsinger, “Loading Transformers By Temperature,” *Trans. Am. Inst. Electr. Eng.*, vol. 49, no. 2, pp. 776–790, Apr. 1930, doi: 10.1109/T-AIEE.1930.5055572.
- [114] J. Jiang and G. Ma, *Optical Sensing in Power Transformers*. Wiley, 2021.
- [115] C. R. Bayliss and B. J. Hardy, “Power Transformers,” in *Transmission and Distribution Electrical Engineering*, Elsevier, 2012, pp. 543–614.
- [116] J. O’Grady, “Overloading power transformers—a user’s views,” *Power Eng. J.*, vol. 4, no. 2, p. 87, 1990, doi: 10.1049/pe:19900019.
- [117] B. P. Das and Z. Radakovic, “Is Transformer kVA Derating Always Required Under Harmonics? A Manufacturer’s Perspective,” *IEEE Trans. Power Deliv.*, vol. 33, no. 6, pp. 2693–2699, Dec. 2018, doi: 10.1109/TPWRD.2018.2815901.
- [118] N. Zimmerman and R. Bass, “Consideration of Ester-Based Oils as Replacements for Transformer Mineral Oil Portland General Electric,” 2014. [Online]. Available: <https://www.nwppa.org/wp-content/uploads/PGE-FR3-report.pdf>.
- [119] D. M. Mehta, P. Kundu, A. Chowdhury, V. K. Lakhiani, and A. S. Jhala, “A review of critical evaluation of natural ester vis-a-vis mineral oil insulating liquid for use in transformers: Part II,” *IEEE Trans. Dielectr. Electr. Insul.*, vol. 23, no. 3, pp. 1705–1712, Jun. 2016, doi: 10.1109/TDEI.2016.005371.
- [120] D. M. Mehta, P. Kundu, A. Chowdhury, V. K. Lakhiani, and A. S. Jhala, “A review on critical evaluation of natural ester vis-a-vis mineral oil insulating liquid for use in transformers: Part 1,” *IEEE Trans. Dielectr. Electr. Insul.*, vol. 23, no. 2, pp. 873–880, Apr. 2016, doi: 10.1109/TDEI.2015.005370.
- [121] A. Sbravati, M. H. Oka, J. A. Maso, and J. Valmus, “Enhancing Transformers Loadability for Optimizing Assets Utilization and Efficiency,” *2018 IEEE Electr. Insul. Conf. EIC 2018*, no. June, pp. 144–149, 2018, doi: 10.1109/EIC.2018.8481063.

- [122] V. Vakhnina, A. Chernenko, D. Kretov, and O. Samolina, "The Method for Assessing the Permissible Overload Capacity of Power Transformers during High Geomagnetic Activity," in *2019 International Conference on Electrotechnical Complexes and Systems (ICOECS)*, Oct. 2019, pp. 1–5, doi: 10.1109/ICOECS46375.2019.8949917.
- [123] M. K. Pradhan and T. S. Ramu, "On the Estimation of Elapsed Life of Oil-Immersed Power Transformers," *IEEE Trans. Power Deliv.*, vol. 20, no. 3, pp. 1962–1969, Jul. 2005, doi: 10.1109/TPWRD.2005.848663.
- [124] M. M. Islam, G. Lee, and S. N. Hettiwatte, "A review of condition monitoring techniques and diagnostic tests for lifetime estimation of power transformers," *Electr. Eng. 2017 1002*, vol. 100, no. 2, pp. 581–605, Apr. 2017, doi: 10.1007/S00202-017-0532-4.
- [125] M. J. Resende, L. Pierrat, and J. Santana, "The transformer thermal loss of life: Part 1 - improved deterministic approach for thermal and ageing models," *Eur. Trans. Electr. Power*, vol. 13, no. 4, pp. 259–265, Jul. 2003, doi: 10.1002/etep.4450130408.
- [126] M. Akbari and A. Rezaei-Zare, "Transformer Bushing Thermal Model for Calculation of Hot-Spot Temperature Considering Oil Flow Dynamics," *IEEE Trans. Power Deliv.*, vol. 36, no. 3, pp. 1726–1734, Jun. 2021, doi: 10.1109/TPWRD.2020.3014064.
- [127] N. Rashid, "Short-time Overloading of Power Transformers," KTH, 2011.
- [128] C. Wang *et al.*, "Load Capacity Evaluation of Power Transformer via Temperature Rise Characteristics," in *2020 IEEE Conference on Electrical Insulation and Dielectric Phenomena (CEIDP)*, Oct. 2020, vol. 2020–Octob, pp. 512–515, doi: 10.1109/CEIDP49254.2020.9437520.
- [129] C. C. Wong, "Substation power-transformer-loading analysis and computer simulations of loadability under realistic operating conditions," *IEE Proc. - Gener. Transm. Distrib.*, vol. 141, no. 5, p. 413, 1994, doi: 10.1049/ip-gtd:19941220.
- [130] Zheng Dianchun, Lu Baomin, Yuan Li, and Zheng Dianwang, "Thermal aging behavior of the oil-impregnated paper at 160°C," in *Proceedings of 5th International Conference on Properties and Applications of Dielectric Materials*, 1997, vol. 1, pp. 256–258, doi: 10.1109/ICPADM.1997.617576.
- [131] ABB, "Power below the waves." Accessed: Jul. 31, 2021. [Online]. Available: <https://www.tdworl.com/grid-innovations/article/20964142/power-below-the-waves>.
- [132] A. Baudoin, C. Boström, and M. Leijon, "Thermal rating of a submerged substation for wave power," *IEEE Trans. Sustain. Energy*, vol. 7, no. 1, pp. 436–445, 2016, doi: 10.1109/TSTE.2015.2425045.
- [133] B. J. Conway, D. W. McMullen, A. J. Peat, and J. M. Scofield, "Loading of Substation Electrical Equipment with Emphasis on Thermal Capability Part I-Principles," *IEEE Trans. Power Appar. Syst.*, vol. PAS-98, no. 4, pp. 1394–1402, Jul. 1979, doi: 10.1109/TPAS.1979.319342.
- [134] J. Sandraz, F. De Leon, and J. Cultrera, "Validated transient heat-transfer model for underground transformer in rectangular vault," *IEEE Trans. Power Deliv.*, vol. 28, no. 3, pp. 1770–1778, 2013, doi: 10.1109/TPWRD.2013.2260183.

- [135] I. Iskender, A. Mamizadeh, I. Iskender, and A. Mamizadeh, "An improved nonlinear thermal model for MV/LV prefabricated oil-immersed power transformer substations," *Electr. Eng.* 2010 931, vol. 93, no. 1, pp. 9–22, Nov. 2010, doi: 10.1007/S00202-010-0186-Y.
- [136] M. R. Gouvea, E. J. Robba, J. R. S. Moreira, E. C. Belvedere, and P. A. Brunheroto, "Thermal simulation for distribution transformers in underground vaults," in *18th International Conference and Exhibition on Electricity Distribution (CIRED 2005)*, 2005, vol. 2005, no. 2005–11034, pp. v1-76-v1-76, doi: 10.1049/cp:20050952.
- [137] M. Z. Z. Degefa, R. J. J. Millar, M. Lehtonen, and P. Hyvonen, "Dynamic Thermal Modeling of MV/LV Prefabricated Substations," *IEEE Trans. Power Deliv.*, vol. 29, no. 2, pp. 786–793, Apr. 2014, doi: 10.1109/TPWRD.2013.2276941.
- [138] B. Zhou *et al.*, "Thermodynamic modelling of buried transformer substations for dynamic loading capability assessment considering underground heat accumulative effect," *Int. J. Electr. Power Energy Syst.*, vol. 121, p. 106153, Oct. 2020, doi: 10.1016/j.ijepes.2020.106153.
- [139] L. Paulhiac and R. Desquiers, "Dynamic Thermal Model for Oil Directed Air Forced Power Transformers with Cooling Stage Representation," *IEEE Trans. Power Deliv.*, pp. 1–1, 2022, doi: 10.1109/TPWRD.2022.3145003.
- [140] Z. Radakovic, D. Jacic, J. Lukic, and S. Milosavljevic, "Loading of transformers in conditions of controlled cooling system," *Int. Trans. Electr. Energy Syst.*, vol. 24, no. 2, pp. 203–214, Feb. 2014, doi: 10.1002/etep.1688.
- [141] О. Г. Широков, Д. И. Зализный, and Д. М. Лось, "Методика автоматического обнаружения ненормального нагрева силового трансформатора," *Вестник гомельского государственного технического университета им. П.О. Сухого*, no. 4, pp. 51–55, 2004, [Online]. Available: <https://elib.gstu.by/handle/220612/9771?locale-attribute=en>.
- [142] Y. Langhame and J. Aubin, "Effect of oil viscosity on transformer loading capability at ambient temperatures below 0 °C.," 1986. [Online]. Available: <https://www.scopus.com/inward/record.uri?eid=2-s2.0-0022854611&partnerID=40&md5=7e72f28840230932d7deb5eccedea378>.
- [143] В. И. Кобылин, "Повышение надежности и эффективности транспорта электроэнергии в условиях Севера," РАН Сибирское отделение Якутский научный центр Институт физико-технических проблем Севера, 2003.
- [144] J. Aubin and Y. Langhame, "Effect of oil viscosity on transformer loading capability at low ambient temperatures," *IEEE Trans. Power Deliv.*, vol. 7, no. 2, pp. 516–524, Apr. 1992, doi: 10.1109/61.127044.
- [145] Высоцкая В.М. and Гурченко А.А., "О некоторых особенностях поведения силовых трансформаторов в условиях интенсивного охлаждения," *Известия томского ордена трудового красного знамени политехнического института имени С.М. Кирова*, vol. 137, pp. 39–44, 1965, Accessed: Aug. 16, 2019. [Online]. Available: https://www.lib.tpu.ru/fulltext/v/Bulletin_TPU/1965/v137/07_bw.pdf.

- [146] C. Harrap, D. Strickland, J. Yang, and L. Chittock, "Predicting practical benefits of dynamic asset ratings of 33KV distribution transformers," in *IET International Conference on Resilience of Transmission and Distribution Networks (RTDN) 2015*, 2015, vol. 2015, no. CP668, p. 28 (6 .)-28 (6 .), doi: 10.1049/cp.2015.0898.
- [147] A. Doolgindachbaporn, G. Callender, P. Lewin, E. A. Simonson, and G. Wilson, "A Top-Oil Thermal Model for Power Transformers that Considers Weather Factors," *IEEE Trans. Power Deliv.*, pp. 1–1, 2021, doi: 10.1109/TPWRD.2021.3105459.
- [148] I. Arifianto, F. Josue, R. Saers, J. Rosenlind, and P. Hilber, "Investigation of Transformer Top-Oil Temperature Considering External Factors," *2012 IEEE Int. Conf. Cond. Monit. Diagnosis*, no. September, pp. 198–201, 2012, doi: 10.1109/CMD.2012.6416409.
- [149] I. S. Benko, D. E. Cooper, D. O. Craghead, and P. Q. Nelson, "Loading of Substation Electrical Equipment with Emphasis on Thermal Capability Part II-Application," *IEEE Trans. Power Appar. Syst.*, vol. PAS-98, no. 4, pp. 1403–1419, Jul. 1979, doi: 10.1109/TPAS.1979.319343.
- [150] G. L. Alegi and W. Z. Black, "Real-time thermal model for an oil-immersed, forced-air cooled transformer," *IEEE Trans. Power Deliv.*, vol. 5, no. 2, pp. 991–999, Apr. 1990, doi: 10.1109/61.53112.
- [151] B. Gorgan and P. V Notingher, "Influence of Solar Irradiation on Power Transformer Thermal Balance," *IEEE Trans. Dielectr. Electr. Insul.*, vol. 19, no. 6, pp. 1843–1850, 2012, doi: 10.1109/TDEI.2012.6396939.
- [152] J. Schlabbach, "Improvement of permissible loading of transformers," in *The IEEE Region 8 EUROCON 2003. Computer as a Tool.*, 2003, vol. 2, pp. 305–309, doi: 10.1109/EURCON.2003.1248205.
- [153] B. A. Thango, J. A. Jordaan, and A. F. Nnachi, "Selection and rating of the step-up transformer for renewable energy application," *SAIEE Africa Res. J.*, vol. 111, no. 2, pp. 50–55, Jun. 2020, doi: 10.23919/SAIEE.2020.9099492.
- [154] E. Cazacu, L. Petrescu, and V. Ionita, "Derating of power distribution transformers serving nonlinear industrial loads," in *2017 International Conference on Optimization of Electrical and Electronic Equipment (OPTIM) & 2017 Intl Aegean Conference on Electrical Machines and Power Electronics (ACEMP)*, May 2017, pp. 90–95, doi: 10.1109/OPTIM.2017.7974953.
- [155] A. Elmoudi, M. Lehtonen, and H. Nordman, "Effect of Harmonics on Transformers Loss of life," in *Conference Record of the 2006 IEEE International Symposium on Electrical Insulation*, pp. 408–411, doi: 10.1109/ELINSL.2006.1665344.
- [156] K. D. McBee, J. Chong, and P. Rudraraju, "Demand Side Management Effects on Substation Transformer Capacity Limits," *Appl. Sci.*, vol. 9, no. 16, p. 3266, Aug. 2019, doi: 10.3390/app9163266.
- [157] B. Sparling, "Managing existing transformers in the grid transition," *Transformers*, vol. 7, no. 2, 2020, [Online]. Available: <https://hrcak.srce.hr/236752>.
- [158] IEEE, "Recommended Practice for Establishing Liquid-Filled and Dry-Type Power and Distribution Transformer Capability When Supplying Nonsinusoidal Load Currents,"

2008. [Online]. Available: https://standards.ieee.org/standard/C57_110-2018.html.
- [159] R. Godina, E. Rodrigues, J. Matias, and J. Catalão, "Effect of Loads and Other Key Factors on Oil-Transformer Ageing: Sustainability Benefits and Challenges," *Energies*, vol. 8, no. 10, pp. 12147–12186, Oct. 2015, doi: 10.3390/en81012147.
- [160] J. Xiao, Buyun Su, Shisong Liu, and F. Li, "N-1 loadability for distribution systems," in *2015 IEEE Power & Energy Society General Meeting*, Jul. 2015, pp. 1–5, doi: 10.1109/PESGM.2015.7285921.
- [161] B. Shahbazi, M. Ashouri, M. R. Shariati, S. farzalizade, and M. Makhdoomi, "A New Approach For Transformer Overloading Considering Economic Terms," in *2007 Large Engineering Systems Conference on Power Engineering*, Oct. 2007, pp. 54–57, doi: 10.1109/LESCPE.2007.4437352.
- [162] M. Humayun *et al.*, "Optimal Capacity Management of Substation Transformers Over Long-Run," *IEEE Trans. Power Syst.*, vol. 31, no. 1, pp. 632–641, Jan. 2016, doi: 10.1109/TPWRS.2015.2396576.
- [163] L. Y. Li and R. Li, "Study on the Analysis Software of Economic Operation of Transformer," *Adv. Mater. Res.*, vol. 1008–1009, pp. 497–500, 2014, doi: 10.4028/www.scientific.net/AMR.1008-1009.497.
- [164] F. Edstrom, J. Rosenlind, K. Alvehag, P. Hilber, and L. Soder, "Influence of Ambient Temperature on Transformer Overloading During Cold Load Pickup," *IEEE Trans. Power Deliv.*, vol. 28, no. 1, pp. 153–161, Jan. 2013, doi: 10.1109/TPWRD.2012.2219079.
- [165] R. Chenier and J. Aubin, "Economic benefit and risk evaluation of power transformer overloading," in *2001 IEEE Power Engineering Society Winter Meeting. Conference Proceedings (Cat. No.01CH37194)*, 2001, vol. 2, no. C, pp. 459–462, doi: 10.1109/PESW.2001.916887.
- [166] D. Elmakis, A. Braunstein, and Y. Naot, "A probabilistic method for establishing the transformer capacity in substations based on the loss of transformer expected life," *IEEE Trans. Power Syst.*, vol. 3, no. 2, pp. 353–360, May 1988, doi: 10.1109/59.192884.
- [167] X. Li and G. Zielke, "A study on transformer loading in Manitoba - Peak-load ambient temperature," *IEEE Trans. Power Deliv.*, vol. 18, no. 4, pp. 1249–1256, 2003, doi: 10.1109/TPWRD.2003.817734.
- [168] Y. Zhang, Y. Cao, D. He, C. Guo, X. Du, and D. Bai, "A two-stage overload strategy of oil-immersed transformers considering operation risk," in *2017 IEEE Power & Energy Society General Meeting*, Jul. 2017, pp. 1–5, doi: 10.1109/PESGM.2017.8274403.
- [169] J. C. S. S. Sousa, O. R. Saavedra, and S. L. Lima, "Decision Making in Emergency Operation for Power Transformers With Regard to Risks and Interruptible Load Contracts," *IEEE Trans. Power Deliv.*, vol. 33, no. 4, pp. 1556–1564, Aug. 2018, doi: 10.1109/TPWRD.2017.2764466.
- [170] A. Bracale, G. Carpinelli, and P. De Falco, "A Predictive Stress-Strength Model Addressing the Dynamic Transformer Rating," in *2019 International Conference on Clean Electrical Power (ICCEP)*, Jul. 2019, pp. 611–616, doi: 10.1109/ICCEP.2019.8890172.

- [171] A. Bracale, G. Carpinelli, M. Pagano, and P. De Falco, "A Probabilistic Approach for Forecasting the Allowable Current of Oil-Immersed Transformers," *IEEE Trans. Power Deliv.*, vol. 33, no. 4, pp. 1825–1834, Aug. 2018, doi: 10.1109/TPWRD.2018.2791181.
- [172] W. Fu, J. D. McCalley, and V. Vittal, "Risk assessment for transformer loading," *IEEE Trans. Power Syst.*, vol. 16, no. 3, pp. 346–353, Aug. 2001, doi: 10.1109/59.932267.
- [173] A. Kartas, D. Tsanakas, and A. Sferides, "Power Transformers Overloading," in *Proceedings. Joint International Power Conference Athens Power Tech*, 1993, vol. 1, pp. 132–136, doi: 10.1109/APT.1993.686857.
- [174] J. A. Jardini, C. M. V. Tahan, S. U. Ahn, and E. L. Ferrari, "Distribution transformer loading evaluation based on load profiles measurements," *IEEE Trans. Power Deliv.*, vol. 12, no. 4, pp. 1766–1770, 1997, doi: 10.1109/61.634203.
- [175] V. M. Shiljkut and S. M. Maksimovich, "Determination of Critical Ambience Temperature by Power Transformers Loading," in *8th Mediterranean Conference on Power Generation, Transmission, Distribution and Energy Conversion (MEDPOWER 2012)*, 2012, pp. 36–36, doi: 10.1049/cp.2012.2019.
- [176] Y. Biçen and F. Aras, "Loadability of power transformer under regional climate conditions: The case of Turkey," *Electr. Eng.*, vol. 96, no. 4, pp. 347–358, 2014, doi: 10.1007/s00202-014-0301-6.
- [177] M. Dong, A. B. Nassif, and B. Li, "A Data-Driven Residential Transformer Overloading Risk Assessment Method," *IEEE Trans. Power Deliv.*, vol. 34, no. 1, pp. 387–396, Feb. 2019, doi: 10.1109/TPWRD.2018.2882215.
- [178] A. Michiorri, P. C. Taylor, S. C. E. Jupe, and C. J. Berry, "Investigation into the influence of environmental conditions on power system ratings," *Proc. Inst. Mech. Eng. Part M J. Eng. Marit. Environ.*, vol. 223, no. 4, pp. 743–757, 2009, doi: 10.1243/09576509JPE718.
- [179] J. Yang, X. Bai, D. Strickland, L. Jenkins, and A. M. Cross, "Dynamic Network Rating for Low Carbon Distribution Network Operation—A U.K. Application," *IEEE Trans. Smart Grid*, vol. 6, no. 2, pp. 988–998, Mar. 2015, doi: 10.1109/TSG.2015.2389711.
- [180] D. Susa, M. Lehtonen, and H. Nordman, "Dynamic thermal modelling of power transformers," *IEEE Trans. Power Deliv.*, 2005, doi: 10.1109/TPWRD.2004.835255.
- [181] D. Susa and M. Lehtonen, "Dynamic Thermal Modeling of Power Transformers: Further Development—Part II," *IEEE Trans. Power Deliv.*, vol. 21, no. 4, pp. 1971–1980, Oct. 2006, doi: 10.1109/TPWRD.2005.864068.
- [182] D. Susa and M. Lehtonen, "Dynamic Thermal Modeling of Power Transformers: Further Development—Part I," *IEEE Trans. Power Deliv.*, vol. 21, no. 4, pp. 1961–1970, Oct. 2006, doi: 10.1109/TPWRD.2005.864069.
- [183] V. Shiravand, J. Faiz, M. H. Samimi, and M. Djamali, "Improving the transformer thermal modeling by considering additional thermal points," *Int. J. Electr. Power Energy Syst.*, vol. 128, p. 106748, Jun. 2021, doi: 10.1016/j.ijepes.2020.106748.
- [184] I. Lupandina, W. Gawlik, M. Schrammel, A. Ilgevcicus, M. Kurten, and K. Viereck, "Evaluation of dynamic loading capability for optimal loading strategies of power

- transformers,” *Cigre e-Session*, pp. 1–17, 2020.
- [185] M. Bunn, B. P. Das, B.-C. Seet, and C. Baguley, “Empirical Design Method for Distribution Transformer Utilization Optimization,” *IEEE Trans. Power Deliv.*, vol. 34, no. 4, pp. 1803–1813, Aug. 2019, doi: 10.1109/TPWRD.2019.2926328.
- [186] L. W. Pierce, “Bibliography on transformer heat transfer and loading 1895-2016,” 2017. [Online]. Available: <https://grouper.ieee.org/groups/transformers/info/2017-Bibliography-TransfHeatTransfer&Loading-Pierce.pdf>.
- [187] E. T. Norris, “The thermal rating of transformers,” *J. Inst. Electr. Eng.*, vol. 66, no. 380, pp. 841–854, Aug. 1928, doi: 10.1049/jjee-1.1928.0095.
- [188] E. T. Norris, “Safe Loading of Oil-Immersed Transformers,” *Trans. Am. Inst. Electr. Eng.*, vol. 48, no. 4, pp. 1206–1212, 1929, doi: 10.1109/T-AIEE.1929.5055382.
- [189] W. M. Dann, “Operating transformers by temperature,” *J. A.I.E.E.*, vol. 49, no. 1, pp. 3–6, Jan. 1930, doi: 10.1109/JAIEE.1930.6535163.
- [190] W. L. Merrill, W. H. Powell, and C. Robbins, “Method of Rating Electrical Apparatus,” *Trans. Am. Inst. Electr. Eng.*, vol. XXXII, no. 1, pp. 91–152, Jan. 1913, doi: 10.1109/T-AIEE.1913.4765009.
- [191] V. M. Montsinger and W. M. Dann, “Overloading of power transformers,” *Electr. Eng.*, vol. 53, no. 10, pp. 1353–1355, Oct. 1934, doi: 10.1109/EE.1934.6539841.
- [192] T. W. Dakin, “Electrical Insulation Deterioration Treated as a Chemical Rate Phenomenon,” *Trans. Am. Inst. Electr. Eng.*, vol. 67, no. 1, pp. 113–122, Jan. 1948, doi: 10.1109/T-AIEE.1948.5059649.
- [193] A. Wurmlinger and D. Egly, “Distribution Transformer Load Management,” *IEEE Trans. Power Appar. Syst.*, vol. PAS-87, no. 7, pp. 1578–1587, Jul. 1968, doi: 10.1109/TPAS.1968.292244.
- [194] S. B. Williams, P. A. Abetti, and E. F. Magnusson, “Application of Digital Computers to Transformer Design,” *Trans. Am. Inst. Electr. Eng. Part III Power Appar. Syst.*, vol. 75, no. 3, pp. 728–735, 1956, doi: 10.1109/AIEEPAS.1956.4499359.
- [195] C. L. Moore, W. T. Duboc, and P. A. Zaphyr, “Application of a digital computer to the design of power transformers to specification,” *Trans. Am. Inst. Electr. Eng. Part I Commun. Electron.*, vol. 75, no. 2, pp. 134–138, 1956, doi: 10.1109/TCE.1956.6372502.
- [196] E. Lakervi, S. C. Tripathy, “Evaluation of Transformer Loading Above Nameplate Rating,” *Electr. Mach. Power Syst.*, vol. 28, no. 7, pp. 625–636, Jul. 2000, doi: 10.1080/073135600268090.
- [197] T. Lundquist and W. Knuth, “Finally fiber optic sensing of power transformer ‘hotspots’ is paying off,” *Proc. 2008 Int. Conf. Cond. Monit. Diagnosis, C. 2008*, pp. 819–824, 2008, doi: 10.1109/CMD.2008.4580410.
- [198] F. Bardiaux and M. Monseu, “Equipment for the thermal monitoring of overhead lines, underground cables and power transformers,” *Int Conf Large High-Voltage Electr Syst, 26th Sess*, 1976, [Online]. Available: <https://www.scopus.com/inward/record.uri?eid=2-s2.0->

85041983091&partnerID=40&md5=554c36f4e1f1ae2368981c8acc2958b7.

- [199] "Dynamic Thermal Line Rating - Summary and Status of the State-of-the-Art Technology Prepared by a Task Force of the Working Group on Calculation of Bare Overhead Conductor Temperatures, IEEE Towers, Poles and Conductors Subcommittee," *IEEE Power Eng. Rev.*, vol. PER-7, no. 7, pp. 65–66, Jul. 1987, doi: 10.1109/MPER.1987.5526995.
- [200] S. P. Walldorf, J. S. Engelhardt, and F. J. Hoppe, "The use of real-time monitoring and dynamic ratings for power delivery systems and the implications for dielectric materials," *IEEE Electr. Insul. Mag.*, vol. 15, no. 5, pp. 28–33, Sep. 1999, doi: 10.1109/57.793827.
- [201] M. W. W. Davis, "A new thermal rating approach: The real time thermal rating system for strategic overhead conductor transmission lines: Part I general description and justification of the real time thermal rating system," *IEEE Trans. Power Appar. Syst.*, vol. 96, no. 3, pp. 803–809, 1977, doi: 10.1109/T-PAS.1977.32393.
- [202] G. Lee *et al.*, "Progress in the Field Validation of the Cable Monitoring and Rating System," *IEEE Trans. Power Appar. Syst.*, vol. PAS-100, no. 3, pp. 1401–1409, Mar. 1981, doi: 10.1109/TPAS.1981.316615.
- [203] X. Feng and M. J. Mousavi, "Study of intelligent overloading in power delivery systems," in *IEEE PES General Meeting | Conference & Exposition*, Jul. 2014, vol. 2014–Octob, no. October, pp. 1–5, doi: 10.1109/PESGM.2014.6939089.
- [204] R. J. C. Hemparuva, S. P. Simon, S. Kinattungal, and N. P. Padhy, "Geographic information system and weather based dynamic line rating for generation scheduling," *Eng. Sci. Technol. an Int. J.*, vol. 21, no. 4, pp. 564–573, 2018, doi: 10.1016/j.jestch.2018.05.011.
- [205] H. T. Yip *et al.*, "Dynamic thermal rating and active control for improved distribution network utilisation," in *10th IET International Conference on Developments in Power System Protection, DPSP 2010*, 2010, vol. 2010, no. 558 CP, pp. 1–5, doi: 10.1049/cp.2010.0213.
- [206] A. Safdarian, M. Z. M. Z. Degefa, M. Fotuhi-Firuzabad, and M. Lehtonen, "Benefits of Real-Time Monitoring to Distribution Systems: Dynamic Thermal Rating," *IEEE Trans. Smart Grid*, vol. 6, no. 4, pp. 2023–2031, 2015, doi: 10.1109/TSG.2015.2393366.
- [207] D. Roberts, P. Taylor, and A. Michiorri, "Dynamic thermal rating for increasing network capacity and delaying network reinforcements," in *CIGRE Seminar 2008: SmartGrids for Distribution*, 2008, vol. 2008, no. 12380, pp. 61–61, doi: 10.1049/ic:20080466.
- [208] E. A. Simonson and J. A. Lapworth, "Thermal capability assessment for transformers," in *Second International Conference on the Reliability of Transmission and Distribution Equipment*, 1995, vol. 1995, no. 406, pp. 103–108, doi: 10.1049/cp:19950226.
- [209] T. Y. Wong, J. A. Findlay, and A. N. McMurtrie, "An on-line method for transmission ampacity evaluation," *IEEE Trans. Power Appar. Syst.*, vol. PAS-101, no. 2, pp. 309–315, 1982, doi: 10.1109/TPAS.1982.317108.
- [210] S. Tenbohlen, T. Stirl, and M. Stach, "Assessment of overload capacity of power transformers by on-line monitoring systems," in *2001 IEEE Power Engineering Society*

- Winter Meeting. Conference Proceedings (Cat. No.01CH37194)*, 2001, vol. 1, no. C, pp. 329–334, doi: 10.1109/PESW.2001.917057.
- [211] G. Pudlo, S. Tenbohlen, M. Linders, and G. Krost, “Integration of power transformer monitoring and overload calculation into the power system control surface,” in *IEEE/PES Transmission and Distribution Conference and Exhibition*, 2002, vol. 1, pp. 470–474, doi: 10.1109/TDC.2002.1178421.
- [212] J. Yasuoka, J. A. Jardini, J. L. P. Brittes, L. C. Magrini, P. S. D. Kayano, and J. Camargo, “Assessment of the allowable short-term overloads in power transformers including condition management,” in *18th International Conference and Exhibition on Electricity Distribution (CIRED 2005)*, 2005, vol. 2005, no. 3, pp. v3-10-v3-10, doi: 10.1049/cp:20051106.
- [213] R. Adapa and D. A. Douglass, “Dynamic thermal ratings: monitors and calculation methods,” in *Proceedings of the Inaugural IEEE PES 2005 Conference and Exposition in Africa*, 2006, pp. 163–167, doi: 10.1109/PESAfr.2005.1611807.
- [214] W. J. Liu, X. Wang, Y. H. Zheng, L. X. Li, and Q. S. Xu, “The Assessment of the Overload Capacity of Transformer Based on the Temperature Reverse Extrapolation Method,” *Adv. Mater. Res.*, vol. 860–863, pp. 2153–2156, Dec. 2013, doi: 10.4028/www.scientific.net/AMR.860-863.2153.
- [215] E. M. Cruz and A. Kulshrestha, “Dynamic Rating for Transformers using Analytics and Comprehensive Monitoring,” pp. 1–8, [Online]. Available: <https://offers.qualitrolcorp.com/dynamic-rating-for-transformers-using-analytics-and-comprehensive-monitoring>.
- [216] “DTR1 a software solution,” 2022. <https://www.dtr1tech.com/> (accessed Mar. 09, 2022).
- [217] G. W. Swift *et al.*, “Adaptive transformer thermal overload protection,” *IEEE Trans. Power Deliv.*, vol. 16, no. 4, pp. 516–521, 2001, doi: 10.1109/61.956730.
- [218] J. Perez, “Fundamental principles of transformer thermal loading and protection,” in *2010 63rd Annual Conference for Protective Relay Engineers*, Mar. 2010, pp. 1–14, doi: 10.1109/CPRE.2010.5469518.
- [219] G. Lloyd, R. G. R. G. G. Bouchet, L. Zou, and C. An, “Real-time thermal rating and active control improved distribution network utilisation,” in *Proceedings of the Universities Power Engineering Conference*, 2012, vol. 5, pp. 5–8, doi: 10.1109/UPEC.2012.6398636.
- [220] Z. Zhang, G. Swift, T. Molinski, and G. Wong, “Transformer overload with user-defined characteristic,” in *IEEE WESCANEX 93 Communications, Computers and Power in the Modern Environment - Conference Proceedings*, pp. 340–344, doi: 10.1109/WESCAN.1993.270525.
- [221] V. Galdi, L. Ippolito, A. Piccolo, and A. Vaccaro, “Application of local memory-based techniques for power transformer thermal overload protection,” *IEE Proc. - Electr. Power Appl.*, vol. 148, no. 2, p. 163, 2001, doi: 10.1049/ip-epa:20010086.
- [222] F. Gagliardi, L. Ippolito, and D. Villacci, “Loading control and thermal protection for power transformers using neural networks,” *Energ. Elettr.*, vol. 74, no. 2, p. 135–

- 143+152, 1997, [Online]. Available: <https://www.scopus.com/inward/record.uri?eid=2-s2.0-71249124040&partnerID=40&md5=8825e0266a26c8243c7dc84d0b81fbd6>.
- [223] V. Galdi, L. Ippolito, A. Piccolo, and A. Vaccaro, "Neural diagnostic system for transformer thermal overload protection," *IEE Proc. - Electr. Power Appl.*, vol. 147, no. 5, p. 415, 2000, doi: 10.1049/ip-epa:20000519.
- [224] V. Galdi, L. Ippolito, A. Piccolo, and A. Vaccaro, "Parameter identification of power transformers thermal model via genetic algorithms," *Electr. Power Syst. Res.*, vol. 60, no. 2, pp. 107–113, Dec. 2001, doi: 10.1016/S0378-7796(01)00173-0.
- [225] G. Acampora, V. Loia, L. Ippolito, and P. Siano, "Achieving transparency and adaptivity in fuzzy control framework: an application to power transformers predictive overload system," in *2004 IEEE International Conference on Fuzzy Systems (IEEE Cat. No.04CH37542)*, vol. 1, pp. 481–486, doi: 10.1109/FUZZY.2004.1375778.
- [226] K. Smith and S. Jain, "The necessity and challenges of modeling and coordinating microprocessor based thermal overload functions for device protection," in *2017 70th Annual Conference for Protective Relay Engineers (CPRE)*, Apr. 2017, pp. 1–22, doi: 10.1109/CPRE.2017.8090053.
- [227] D. J. Ventruella, "Transformer Fuse Sizing - The NEC is not the Last Word," in *2018 IEEE IAS Pulp, Paper and Forest Industries Conference (PPFIC)*, Jun. 2018, pp. 1–5, doi: 10.1109/PPIC.2018.8502224.
- [228] W. A. Castillo, R. T. Jagaduri, and P. K. Muralimanohar, "Implementation of a transformer monitoring solution per IEEE C57.91-1995 using an automation controller," in *2012 65th Annual Conference for Protective Relay Engineers*, Apr. 2012, pp. 442–448, doi: 10.1109/CPRE.2012.6201252.
- [229] D. A. Douglass and A.-A. Edris, "Real-time monitoring and dynamic thermal rating of power transmission circuits," *IEEE Trans. Power Deliv.*, vol. 11, no. 3, pp. 1407–1418, Jul. 1996, doi: 10.1109/61.517499.
- [230] D. A. Douglass, A. A. Edris, and G. A. Pritchard, "Field application of a dynamic thermal circuit rating method," *IEEE Trans. Power Deliv.*, vol. 12, no. 2, pp. 823–831, Apr. 1997, doi: 10.1109/61.584390.
- [231] R. Adapa and D. A. Douglass, "Dynamic Thermal Rating of Substation Terminal Equipment," in *Cigre Session 2004*, 2004, p. 8.
- [232] F. P. Sioshansi, *Evolution of Global Electricity Markets*. Elsevier, 2013.
- [233] НТС ЕЭС, "Протокол по рассмотрению программного комплекса оценки ограничений пропускной способности электрической сети в режиме реального времени с учетом краткосрочного прогнозирования SUMO," 2016. http://www.cigre.ru/research_commitets/ik_rus/b5_rus/materials/Протокол_09.02.2016_утв.pdf (accessed Jan. 23, 2022).
- [234] M. Humayun, M. Ali, A. Safdarian, M. Z. Degefa, and M. Lehtonen, "Optimal use of demand response for lifesaving and efficient capacity utilization of power transformers during contingencies," in *2015 IEEE Power & Energy Society General Meeting*, Jul. 2015,

- vol. 2015–Septe, pp. 1–5, doi: 10.1109/PESGM.2015.7285627.
- [235] M. Ali, M. Z. Z. Degefa, M. Humayun, A. Safdarian, and M. Lehtonen, “Increased utilization of wind generation by coordinating the demand response and real-time thermal rating,” *IEEE Trans. Power Syst.*, vol. 31, no. 5, pp. 3737–3746, 2016, doi: 10.1109/TPWRS.2015.2498899.
- [236] D. L. L. D. L. Alvarez, J. A. J. A. Rosero, F. Faria Da Silva, C. L. C. L. L. Bak, and E. E. E. E. Mombello, “Dynamic line rating - Technologies and challenges of PMU on overhead lines: A survey,” in *Proceedings - 2016 51st International Universities Power Engineering Conference, UPEC 2016*, 2017, vol. 2017–Janua, pp. 1–6, doi: 10.1109/UPEC.2016.8114069.
- [237] M. Z. Degefa, M. Koivisto, R. J. Millar, and M. Lehtonen, “Dynamic thermal state forecasting of distribution network components: For enhanced active distribution network capacity,” 2014, doi: 10.1109/PMAPS.2014.6960607.
- [238] Y. Li, Y. Wang, and Q. Chen, “Optimal Dispatch With Transformer Dynamic Thermal Rating in ADNs Incorporating High PV Penetration,” *IEEE Trans. Smart Grid*, vol. 12, no. 3, pp. 1989–1999, May 2021, doi: 10.1109/TSG.2020.3037874.
- [239] S. Almohaimeed, “Steady-state analysis of the impact of climate change on distribution transformer,” Colorado State University, 2016.
- [240] A. N. M. M. Haque, P. H. Nguyen, F. W. Bliet, and J. G. Slootweg, “Demand response for real-time congestion management incorporating dynamic thermal overloading cost,” *Sustain. Energy, Grids Networks*, vol. 10, pp. 65–74, Jun. 2017, doi: 10.1016/j.segan.2017.03.002.
- [241] M. J. Weisshaupt, B. Schlatter, P. Korba, E. Kaffe, and F. Kienzle, “Evaluation of Measures to Operate Urban Low Voltage Grids Considering Future PV Expansion,” *IFAC-PapersOnLine*, vol. 49, no. 27, pp. 336–341, 2016, doi: 10.1016/j.ifacol.2016.10.714.
- [242] M. M. El-Gasseir, M. A. Sayer, K. P. Alteneider, G. A. McCulla, and J. Bigger, “Enhancing transformer dynamic rating through grid application of photovoltaic arrays,” in *Conference Record of the Twenty Third IEEE Photovoltaic Specialists Conference - 1993 (Cat. No.93CH3283-9)*, pp. 1279–1284, doi: 10.1109/PVSC.1993.346936.
- [243] K. Morozovska, “Dynamic Rating with Applications to Renewable Energy,” KTH, 2020.
- [244] K. Morozovska, “Dynamic Rating of Power Lines and Transformers for Wind Energy Integration,” KTH, 2018.
- [245] L. W. Pierce, “Predicting liquid filled transformer loading capability,” *IEEE Trans. Ind. Appl.*, vol. 30, no. 1, pp. 170–178, 1994, doi: 10.1109/28.273636.
- [246] M. Saied, H. El-Shewy, and N. Fetih, “On the dynamic thermal behavior and the accelerated aging of power system components,” *Electr. Mach. Power Syst.*, vol. 24, no. 2, pp. 159–170, Mar. 1996, doi: 10.1080/07313569608955665.
- [247] S. C. Tripathy and E. Lakervi, “Evaluation of transformer overloading capability,” *Eur. Trans. Electr. Power*, vol. 15, no. 5, pp. 455–464, Sep. 2005, doi: 10.1002/etep.59.
- [248] C.-H. Park, J.-C. Kim, and S.-Y. Yun, “Overload criteria of mineral-oil-immersed

- distribution transformer rated 100 kVA and less using the characteristics of top-oil temperature rising," *IEEE Power Eng. Soc. Summer Meet.*, vol. 1, pp. 488–493, 2002, doi: 10.1109/PSS.2002.1043283.
- [249] M. Lehtonen, M. Jalonen, A. Matsinen, and J. Kuru, "A novel state estimation model for distribution systems," in *14th PSCC*, 2002, no. June, pp. 1–5.
- [250] L. Ippolito and P. Siano, "A power transformers' predictive overload system based on a Takagi-Sugeno-Kang fuzzy model," in *Proceedings of the 12th IEEE Mediterranean Electrotechnical Conference (IEEE Cat. No.04CH37521)*, 2004, pp. 301–306, doi: 10.1109/MELCON.2004.1346849.
- [251] L. Ippolito and P. Siano, "Identification of Tagaki–Sugeno–Kang fuzzy model for power transformers' predictive overload system," *IEE Proc. - Gener. Transm. Distrib.*, vol. 151, no. 5, p. 582, 2004, doi: 10.1049/ip-gtd:20040712.
- [252] L. Ippolito, A. Vaccaro, and D. Villacci, "The use of affine arithmetic for thermal state estimation of substation distribution transformers," *COMPEL - Int. J. Comput. Math. Electr. Electron. Eng.*, vol. 23, no. 1, pp. 237–249, Mar. 2004, doi: 10.1108/03321640410507671.
- [253] D. Villacci, G. Bontempi, A. Vaccaro, and M. Birattari, "The role of learning methods in the dynamic assessment of power components loading capability," *IEEE Trans. Ind. Electron.*, vol. 52, no. 1, pp. 280–290, 2005, doi: 10.1109/TIE.2004.841072.
- [254] J. M. A. Nuijten, A. Geschiere, J. C. Smit, G. J. Frijmersum, and N. Tecno, "Future Network Planning and Grid Control," in *2005 International Conference on Future Power Systems*, 2005, pp. 1–7, doi: 10.1109/FPS.2005.204303.
- [255] J. Nuijten and A. Geschiere, "Load capability of transformers: 'Experiences within an actual grid situation,'" in *CIGRE 2005*, 2005, p. 4, doi: 10.1049/cp:20050903.
- [256] C. Y. Lee, H. C. Chang, and C. C. Liu, "Emergency dispatch strategy considering remaining lives of transformers," *IEEE Trans. Power Syst.*, vol. 22, no. 4, pp. 2066–2073, 2007, doi: 10.1109/TPWRS.2007.907388.
- [257] M. T. Ishak and Z. Wang, "Transformer hotspot temperature calculation using IEEE loading guide," in *2008 International Conference on Condition Monitoring and Diagnosis*, 2008, pp. 1017–1020, doi: 10.1109/CMD.2008.4580455.
- [258] C. P. Steinmetz and B. G. Lamme, "Temperature and Electrical Insulation," *Trans. Am. Inst. Electr. Eng.*, vol. XXXII, no. 1, pp. 79–89, Jan. 1913, doi: 10.1109/T-AIEE.1913.4765008.
- [259] S. C. E. Jupe, "Active Management of Distributed Generation based on Component Thermal Properties," Durham university, 2010.
- [260] J. Cheema, A. Clark, J. Kilimnik, C. Pavlovski, D. Redman, and M. Vu, "Intelligent Rating Systems for the Smart Grid," *Proc. World Congr. Eng. Comput. Sci. (WCECS 2010)*, vol. vol.II, pp. 868–74, 2010.
- [261] J. Cheema *et al.*, "Towards Smart Grid Dynamic Ratings," in *AIP Conference Proceedings*, 2011, pp. 3–17, doi: 10.1063/1.3627190.

- [262] B. Bochenski, F. Mosinski, T. Piotrowski, and G. J. Anders, "A computer program for life-time management of power transformers," 2012, [Online]. Available: https://e-cigre.org/publication/A2-109_2012-a-computer-program-for-life-time-management-of-power-transformers.
- [263] F. Josue, I. Arifianto, R. Saers, J. Rosenlind, P. Hilber, and Suwarno, "Transformer hot-spot temperature estimation for short-time dynamic loading," *Proc. 2012 IEEE Int. Conf. Cond. Monit. Diagnosis, C. 2012*, no. September, pp. 217–220, 2012, doi: 10.1109/CMD.2012.6416414.
- [264] J. Hazra, K. Das, A. P. Kumar, B. Narayanaswamy, D. P. Seetharam, and N. Jespersen, "Optimal utilization of power transformers through virtual sensing," *2013 4th IEEE/PES Innov. Smart Grid Technol. Eur. ISGT Eur. 2013*, pp. 1–5, 2013, doi: 10.1109/ISGTEurope.2013.6695409.
- [265] S.-Y. Yun, C.-H. Park, and I.-K. Song, "Development of overload evaluation system for distribution transformers using load monitoring data," *Int. J. Electr. Power Energy Syst.*, vol. 44, no. 1, pp. 60–69, Jan. 2013, doi: 10.1016/j.ijepes.2012.07.006.
- [266] P. Hilber, S. Babu, J. Wallnerstrom, P. Westerlund, and J. Rosenlind, "Benefits of reliability centred asset management," in *22nd International Conference and Exhibition on Electricity Distribution (CIRED 2013)*, 2013, no. 0313, pp. 0313–0313, doi: 10.1049/cp.2013.0668.
- [267] J. Rosenlind, "Lifetime modeling and management of transformers," KTH, 2013.
- [268] Y. Huang, C. Guo, Y. Wen, Y. Wang, X. Zhang, and J. Zhang, "Overload strategy of transmission and transformation equipment for safety operation," in *IEEE PES General Meeting | Conference & Exposition*, Jul. 2014, pp. 1–5, doi: 10.1109/PESGM.2014.6939451.
- [269] M. Z. Degefa, M. Humayun, A. Safdarian, M. Koivisto, R. J. Millar, and M. Lehtonen, "Unlocking distribution network capacity through real-time thermal rating for high penetration of DGs," *Electr. Power Syst. Res.*, vol. 117, pp. 36–46, Dec. 2014, doi: 10.1016/j.eprsr.2014.07.032.
- [270] C. J. J. Wallnerstrom, P. Hilber, P. Soderstrom, R. Saers, and O. Hansson, "Potential of dynamic rating in Sweden," in *2014 International Conference on Probabilistic Methods Applied to Power Systems (PMAPS)*, Jul. 2014, pp. 1–6, doi: 10.1109/PMAPS.2014.6960605.
- [271] M. Esmaeeli, A. Kazemi, H.-A. Shayanfar, and M.-R. Haghifam, "Sizing and placement of distribution substations considering optimal loading of transformers," *Int. Trans. Electr. Energy Syst.*, vol. 25, no. 11, pp. 2897–2908, Nov. 2015, doi: 10.1002/etep.1998.
- [272] M. Z. Degefa, "Real-time thermal state and component loading estimation in active distribution networks," Aalto University, 2015.
- [273] M. Humayun, A. Safdarian, M. Z. Degefa, and M. Lehtonen, "Demand Response for Operational Life Extension and Efficient Capacity Utilization of Power Transformers During Contingencies," *IEEE Trans. Power Syst.*, vol. 30, no. 4, pp. 2160–2169, Jul. 2015, doi: 10.1109/TPWRS.2014.2358687.

- [274] M. Humayun, M. Z. Degefa, A. Safdarian, and M. Lehtonen, "Utilization improvement of transformers using demand response," *IEEE Trans. Power Deliv.*, 2015, doi: 10.1109/TPWRD.2014.2325610.
- [275] M. Humayun, A. Safdarian, M. Ali, M. Z. Degefa, and M. Lehtonen, "Optimal capacity planning of substation transformers by demand response combined with network automation," *Electr. Power Syst. Res.*, 2016, doi: 10.1016/j.epsr.2016.01.011.
- [276] M. Humayun, "Demand Response Benefits for Major Assets of High Voltage Distribution Systems Capacity Gain and Life Management," Aalto university, 2015.
- [277] D. Strickland, L. Chittock, J. Mourik, C. Harrap, and J. Yang, "Distribution network transformer thermal modelling parameter determination for dynamic rating applications," in *8th IET International Conference on Power Electronics, Machines and Drives (PEMD 2016)*, 2016, p. 6 -6 ., doi: 10.1049/cp.2016.0296.
- [278] M. R. Dorostkar-Ghamsari, M. Fotuhi-Firuzabad, A. Safdarian, A. S. Hoshyarzade, and M. Lehtonen, "Improve capacity utilization of substation transformers via distribution network reconfiguraion and load transfer," in *IEEE 16th International Conference on Environment and Electrical Engineering (EEEIC)*, Jun. 2016, pp. 1–6, doi: 10.1109/EEEIC.2016.7555777.
- [279] Y. Gao, "Assessment of Future Adaptability of Distribution Transformer Population Under EV Scenarios," University of Manchester, 2016.
- [280] A. N. M. M. Haque, "Smart Congestion Management in Active Distribution Networks," Technische Universiteit Eindhoven, 2017.
- [281] R. Karlsson, "Power system performance when implementing dynamic rating on a wind farm connected transformer," KTH, 2017.
- [282] K. Morozovska, R. Karlsson, and P. Hilber, "Dynamic rating of the wind farm transformer from the power system's perspective," in *2021 IEEE Madrid PowerTech*, Jun. 2021, pp. 1–6, doi: 10.1109/PowerTech46648.2021.9494902.
- [283] Y. Gao, B. Patel, Q. Liu, Z. Wang, and G. Bryson, "Methodology to assess distribution transformer thermal capacity for uptake of low carbon technologies," *IET Gener. Transm. Distrib.*, vol. 11, no. 7, pp. 1645–1651, May 2017, doi: 10.1049/iet-gtd.2016.0722.
- [284] C. Z. El-Bayeh, I. Mougharbel, D. Asber, M. Saad, A. Chandra, and S. Lefebvre, "Novel Approach for Optimizing the Transformer's Critical Power Limit," *IEEE Access*, vol. 6, pp. 55870–55882, 2018, doi: 10.1109/ACCESS.2018.2873077.
- [285] M. Djamali, S. Tenbohlen, E. Junge, and M. Konermann, "Real-Time Evaluation of the Dynamic Loading Capability of Indoor Distribution Transformers," *IEEE Trans. Power Deliv.*, vol. 33, no. 3, pp. 1134–1142, Jun. 2018, doi: 10.1109/TPWRD.2017.2728820.
- [286] A. V. Turnell *et al.*, "Risk and economic analysis of utilizing dynamic thermal rated transformer for wind farm connection," in *IEEE International Conference on Probabilistic Methods Applied to Power Systems (PMAPS)*, Jun. 2018, pp. 1–6, doi: 10.1109/PMAPS.2018.8440479.

- [287] C. Stefanou, "Investigation of the effect of moisture in transformers on the aging of the solid insulation for dynamic rating applications," KTH, 2018.
- [288] A. Bracale, G. Carpinelli, and P. De Falco, "Probabilistic risk-based management of distribution transformers by dynamic transformer rating," *Int. J. Electr. Power Energy Syst.*, vol. 113, pp. 229–243, Dec. 2019, doi: 10.1016/j.ijepes.2019.05.048.
- [289] N. Viafora, J. Holboll, S. H. H. Kazmi, T. H. Olesen, and T. S. Sorensen, "Load Dispatch optimization using Dynamic Rating and Optimal Lifetime Utilization of Transformers," in *2019 IEEE Milan PowerTech*, Jun. 2019, pp. 1–6, doi: 10.1109/PTC.2019.8811002.
- [290] N. Viafora, K. Morozovska, S. H. H. Kazmi, T. Laneryd, P. Hilber, and J. Holbøll, "Day-ahead dispatch optimization with dynamic thermal rating of transformers and overhead lines," *Electr. Power Syst. Res.*, vol. 171, pp. 194–208, Jun. 2019, doi: 10.1016/j.epr.2019.02.026.
- [291] D. Fang, J. Gunda, M. Zou, G. Harrison, S. Z. Djokic, and A. Vaccaro, "Dynamic Thermal Rating for Efficient Management of Post-Contingency Congestions," in *IEEE Milan PowerTech*, Jun. 2019, pp. 1–6, doi: 10.1109/PTC.2019.8810555.
- [292] T. Zarei, K. Morozovska, T. Laneryd, P. Hilber, M. Wihlén, and O. Hansson, "Reliability considerations and economic benefits of dynamic transformer rating for wind energy integration," *Int. J. Electr. Power Energy Syst.*, vol. 106, pp. 598–606, Mar. 2019, doi: 10.1016/j.ijepes.2018.09.038.
- [293] T. Zarei, "Analysis of reliability improvements of transformers after application of dynamic rating transformers after application of," KTH, 2017.
- [294] O. D. Ariza Rocha, "Dynamic transformers rating for expansion of expansion of existing wind farms," KTH, 2019.
- [295] D. L. Alvarez, S. R. Rivera, and E. E. Mombello, "Transformer Thermal Capacity Estimation and Prediction Using Dynamic Rating Monitoring," *IEEE Trans. Power Deliv.*, vol. 34, no. 4, pp. 1695–1705, Aug. 2019, doi: 10.1109/TPWRD.2019.2918243.
- [296] N. Rashid, "Development of a predictive asset rating tool for decision support in an electrical distribution network," University of Canterbury, 2019.
- [297] A. Bracale, P. Caramia, G. Carpinelli, and P. De Falco, "SmarTrafo: A Probabilistic Predictive Tool for Dynamic Transformer Rating," *IEEE Trans. Power Deliv.*, vol. 36, no. 3, pp. 1619–1630, Jun. 2021, doi: 10.1109/TPWRD.2020.3012180.
- [298] A. Bracale, P. Caramia, G. Carpinelli, and P. De Falco, "Probabilistic Management of Power Delivery Based on Dynamic Transformer Rating," *2020 Int. Conf. Probabilistic Methods Appl. to Power Syst. PMAPS 2020 - Proc.*, 2020, doi: 10.1109/PMAPS47429.2020.9183656.
- [299] S. Zhou, M. Wang, J. Wang, M. Yang, and X. Dong, "Time-Process Power Flow Calculation Considering Thermal Behavior of Transmission Components," *IEEE Trans. Power Syst.*, vol. 35, no. 6, pp. 4232–4250, Nov. 2020, doi: 10.1109/TPWRS.2020.2987945.
- [300] S. Talpur, T. Tjing Lie, R. Zamora, and B. Priyo Das, "Maximum Utilization of Dynamic

Rating Operated Distribution Transformer (DRoDT) with Battery Energy Storage System: Analysis on Impact from Battery Electric Vehicles Charging,” *Energies*, vol. 13, no. 13, p. 3411, Jul. 2020, doi: 10.3390/en13133411.

- [301] A. Molina Gómez, “Improved planning of wind farms using dynamic transformer rating,” KTH, 2020.
- [302] A. Molina Gómez, K. Morozovska, T. Laneryd, and P. Hilber, “Optimal sizing of the wind farm and wind farm transformer using MILP and dynamic transformer rating,” *Int. J. Electr. Power Energy Syst.*, vol. 136, p. 107645, Mar. 2022, doi: 10.1016/j.ijepes.2021.107645.
- [303] T. I. Kopperud, “Dynamic Current Rating of Power Transformers The effect of maximum temperature and thermal ageing,” NTNU, 2021.
- [304] D. Danylov *et al.*, “An experimental assessment of the intermittent heating and cooling operation effect on power transformer insulation,” 2021. Accessed: Jan. 25, 2022. [Online]. Available: <http://urn.kb.se/resolve?urn=urn:nbn:se:kth:diva-293055>.
- [305] S. H. H. Kazmi *et al.*, “Cost optimized dynamic design of offshore windfarm transformers with reliability and contingency considerations,” *Int. J. Electr. Power Energy Syst.*, vol. 128, p. 106684, Jun. 2021, doi: 10.1016/j.ijepes.2020.106684.
- [306] M. Dong, “A Data-driven Long-Term Dynamic Rating Estimating Method for Power Transformers,” *IEEE Trans. Power Deliv.*, vol. 36, no. 2, pp. 686–697, Apr. 2021, doi: 10.1109/TPWRD.2020.2988921.
- [307] P. Andrianesis, A. Michiorri, G. Kariniotakis, and M. Caramanis, “Impact of transformer and cable aging on distribution locational marginal costs in active distribution networks,” in *CIREC 2021 - The 26th International Conference and Exhibition on Electricity Distribution*, 2021, pp. 2237–2241, doi: 10.1049/icp.2021.1735.
- [308] P. Andrianesis, M. Caramanis, and N. Li, “Optimal Distributed Energy Resource Coordination: A Decomposition Method Based on Distribution Locational Marginal Costs,” *IEEE Trans. Smart Grid*, vol. 13, no. 2, pp. 1200–1212, Mar. 2022, doi: 10.1109/TSG.2021.3123284.
- [309] Z. Li, K. Morozovska, P. Hilber, T. Laneryd, and S. Ivanell, “Sizing Transformer Considering Transformer Thermal Limits and Wind Farm Wake Effect,” in *2021 IEEE PES Innovative Smart Grid Technologies - Asia (ISGT Asia)*, Dec. 2021, pp. 1–5, doi: 10.1109/ISGTAsia49270.2021.9715702.
- [310] C.-M. Lai and J. Teh, “Comprehensive review of the dynamic thermal rating system for sustainable electrical power systems,” *Energy Reports*, vol. 8, pp. 3263–3288, Nov. 2022, doi: 10.1016/j.egy.2022.02.085.
- [311] J. Wang, Y. Wan, Z. Xiong, X. Xiong, and J. Ouyang, “Cooperative overload control strategy of power grid-transformer considering dynamic security margin of transformer in emergencies,” *Int. J. Electr. Power Energy Syst.*, vol. 140, p. 108098, 2022, doi: 10.1016/j.ijepes.2022.108098.
- [312] M. M. M. Salama, D.-E. A. Mansour, S. M. Abdelmaksoud, and A. A. Abbas, “Impact of Long-Term Climatic Conditions on the Ageing and Cost Effectiveness of the Oil-Filled

- Transformer,” in *Twentieth International Middle East Power Systems Conference (MEPCON)*, Dec. 2018, pp. 494–499, doi: 10.1109/MEPCON.2018.8635184.
- [313] “CurrENT industry association,” 2021. <https://www.currenteurope.eu/> (accessed Sep. 17, 2021).
- [314] T. T. Nguyen, “Constrained optimisation procedure for evaluating cyclic loading of power transformers,” *IEE Proc. - Gener. Transm. Distrib.*, vol. 142, no. 3, p. 240, 1995, doi: 10.1049/ip-gtd:19951746.
- [315] M. Zhang, Y. Liu, and D. Tylavsky, “Dynamic loading of substation distribution transformers in a production grade environment,” *2012 North Am. Power Symp. NAPS 2012*, pp. 1–6, 2012, doi: 10.1109/NAPS.2012.6336380.
- [316] S. W. Heunis and R. Herman, “A Thermal Loading Guide for Residential Distribution Transformers Based on Time-Variant Current Load Models,” *IEEE Trans. Power Syst.*, vol. 19, no. 3, pp. 1294–1298, Aug. 2004, doi: 10.1109/TPWRS.2004.831293.
- [317] B. Swaminathan Prasanna, “Gestion prévisionnelle des réseaux actifs de distribution - relaxation convexe sous incertitude,” UGA, 2017.
- [318] K. D. McBee and I. Fareez, “Distribution Transformer Aging Due to COVID-19 Shelter-in-Place,” in *2021 IEEE PES/IAS PowerAfrica*, Aug. 2021, pp. 1–5, doi: 10.1109/PowerAfrica52236.2021.9543212.
- [319] IRENA, “Aggregators Innovation Landscape brief,” 2019. [Online]. Available: https://www.irena.org/-/media/Files/IRENA/Agency/Publication/2019/Feb/IRENA_Innovation_Aggregators_2019.PDF.
- [320] Z. Kaheh, R. Baradaran Kazemzadeh, and M. K. Sheikh-El-Eslami, “A trilevel programming model for flexiramp and reserve procurement in high penetration of wind farms and participation of a large industry and a DR aggregator,” *Int. Trans. Electr. Energy Syst.*, vol. 29, no. 7, Jul. 2019, doi: 10.1002/2050-7038.12105.
- [321] M. Uddin, M. F. Romlie, M. F. Abdullah, S. Abd Halim, A. H. Abu Bakar, and T. Chia Kwang, “A review on peak load shaving strategies,” *Renewable and Sustainable Energy Reviews*. 2018, doi: 10.1016/j.rser.2017.10.056.
- [322] D. M. D. M. Greenwood, N. S. N. S. Wade, P. C. P. C. Taylor, P. Papadopoulos, and N. Heyward, “A Probabilistic Method Combining Electrical Energy Storage and Real-Time Thermal Ratings to Defer Network Reinforcement,” *IEEE Trans. Sustain. Energy*, vol. 8, no. 1, pp. 374–384, 2017, doi: 10.1109/TSTE.2016.2600320.
- [323] L. Jian, Y. Zheng, and Z. Shao, “High efficient valley-filling strategy for centralized coordinated charging of large-scale electric vehicles,” *Appl. Energy*, vol. 186, pp. 46–55, Jan. 2017, doi: 10.1016/j.apenergy.2016.10.117.
- [324] V. N. Kostin, T. E. Minakova, and A. V. Kopteva, “Urban substations transformers allowed loading,” in *IEEE Conference of Russian Young Researchers in Electrical and Electronic Engineering (EIConRus)*, Jan. 2018, pp. 692–695, doi: 10.1109/EIConRus.2018.8317188.
- [325] M. Savaghebi, A. Gholami, A. Vahedi, and H. Hooshyar, “A fuzzy-based approach for

- transformer dynamic loading capability assessment,” in *43rd International Universities Power Engineering Conference*, Sep. 2008, pp. 1–5, doi: 10.1109/UPEC.2008.4651476.
- [326] O. Arguence and F. Cadoux, “Sizing power transformers in power systems planning using thermal rating,” *Int. J. Electr. Power Energy Syst.*, vol. 118, p. 105781, Jun. 2020, doi: 10.1016/j.ijepes.2019.105781.
- [327] ТРК, “Методические указания по определению резервов мощности на центрах питания ПАО «ТРК»,” Tomsk, 2018.
- [328] Ecosys, “Flexibility options in electricity systems,” 2014. [Online]. Available: <https://www.ourenergypolicy.org/wp-content/uploads/2014/06/Ecofys.pdf>.
- [329] S. N. G. Gourisetti, H. Kirkham, and D. Sivaraman, “A review of transformer aging and control strategies,” in *2017 North American Power Symposium (NAPS)*, Sep. 2017, pp. 1–6, doi: 10.1109/NAPS.2017.8107234.
- [330] C. Teja S and P. K. Yemula, “Architecture for demand responsive HVAC in a commercial building for transformer lifetime improvement,” *Electr. Power Syst. Res.*, vol. 189, p. 106599, Dec. 2020, doi: 10.1016/j.epr.2020.106599.
- [331] P. J. Davison, P. F. Lyons, and P. C. Taylor, “Temperature sensitive load modelling for dynamic thermal ratings in distribution network overhead lines,” *Int. J. Electr. Power Energy Syst.*, vol. 112, pp. 1–11, Nov. 2019, doi: 10.1016/j.ijepes.2019.03.071.
- [332] B. Zhou *et al.*, “Many-criteria optimality of coordinated demand response with heterogeneous households,” *Energy*, vol. 207, p. 118267, Sep. 2020, doi: 10.1016/j.energy.2020.118267.
- [333] T. van der Klauw, M. E. T. Gerards, and J. L. Hurink, “Using demand-side management to decrease transformer ageing,” in *IEEE PES Innovative Smart Grid Technologies Conference Europe (ISGT-Europe)*, Oct. 2016, pp. 1–6, doi: 10.1109/ISGTEurope.2016.7856205.
- [334] J. Liu, J. Xiao, B. Zhou, Z. Wang, H. Zhang, and Y. Zeng, “A two-stage residential demand response framework for smart community with transformer aging,” in *IEEE PES Asia-Pacific Power and Energy Engineering Conference (APPEEC)*, Nov. 2017, pp. 1–6, doi: 10.1109/APPEEC.2017.8308907.
- [335] M. Soleimani and M. Kezunovic, “Mitigating Transformer Loss of Life and Reducing the Hazard of Failure by the Smart EV Charging,” *IEEE Trans. Ind. Appl.*, pp. 1–1, Apr. 2020, doi: 10.1109/TIA.2020.2986990.
- [336] A. Mohsenzadeh, M. H. Kapourchali, Chengzong Pang, and V. Aravinthan, “Impact of smart home management strategies on expected lifetime of transformer,” in *2016 IEEE/PES Transmission and Distribution Conference and Exposition (T&D)*, May 2016, pp. 1–5, doi: 10.1109/TDC.2016.7519945.
- [337] N. B. G. Brinkel, W. L. Schram, T. A. AlSkaif, I. Lampropoulos, and W. G. J. H. M. van Sark, “Should we reinforce the grid? Cost and emission optimization of electric vehicle charging under different transformer limits,” *Appl. Energy*, vol. 276, p. 115285, Oct. 2020, doi: 10.1016/j.apenergy.2020.115285.

- [338] J. Salehi and M.-R. Haghifam, "Determining the optimal reserve capacity margin of Sub-Transmission (ST) substations using Genetic Algorithm," *Int. Trans. Electr. Energy Syst.*, vol. 24, no. 4, pp. 492–503, Apr. 2014, doi: 10.1002/etep.1707.
- [339] S. Kannan and Mau Teng Au, "Probabilistic approach in sizing distribution transformers," in *2010 IEEE 11th International Conference on Probabilistic Methods Applied to Power Systems*, Jun. 2010, pp. 599–603, doi: 10.1109/PMAPS.2010.5529012.
- [340] B. A. Helmi, M. D'Souza, and B. A. Bolz, "The application of power factor correction capacitors to reserve spare capacity of existing main transformers," in *Industry Applications Society 60th Annual Petroleum and Chemical Industry Conference*, 2013, pp. 1–6, doi: 10.1109/PCIcon.2013.6666047.
- [341] D. L. Levine and H. E. Smith, "Economic Loading of a Transformer System," *Trans. Am. Inst. Electr. Eng.*, vol. 68, no. 1, pp. 733–739, Jul. 1949, doi: 10.1109/T-AIEE.1949.5060004.
- [342] Ministry of Energy, "Technical state of electric power facilities (physical wear and tear) [In Russian]," 2018. <https://minenergo.gov.ru/node/11201>.
- [343] I. Daminov, A. Prokhorov, R. Caire, and M.-C. Alvarez-Herault, "Assessment of dynamic transformer rating, considering current and temperature limitations," *Int. J. Electr. Power Energy Syst.*, vol. 129, p. 106886, Jul. 2021, doi: 10.1016/j.ijepes.2021.106886.
- [344] I. Daminov, A. Prokhorov, T. Moiseeva, R. Caire, and M.-C. Alvarez-Herault, "Application of dynamic transformer ratings to increase the reserve of primary substations for new load interconnection," *Proceedings of the 25th International Conference on Electricity Distribution (CIRED 2019)*, 2019. <https://www.cired-repository.org/handle/20.500.12455/708?show=full> (accessed Feb. 21, 2020).
- [345] I. Daminov, R. Rigo-Mariani, R. Caire, A. Prokhorov, and M.-C. Alvarez-Hérault, "Demand Response Coupled with Dynamic Thermal Rating for Increased Transformer Reserve and Lifetime," *Energies*, vol. 14, no. 5, p. 1378, Mar. 2021, doi: 10.3390/en14051378.
- [346] I. Daminov, A. Prokhorov, R. Caire, and M. Alvarez-Herault, "Energy limit of oil-immersed transformers: A concept and its application in different climate conditions," *IET Gener. Transm. Distrib.*, vol. 15, no. 3, pp. 495–507, Feb. 2021, doi: 10.1049/gtd2.12036.
- [347] I. Daminov, M.-C. Alvarez-Herault, R. Caire, and A. Prokhorov, "Optimal ageing limit of oil-immersed transformers in flexible power systems," in *CIRED 2021 - The 26th International Conference and Exhibition on Electricity Distribution*, 2021, pp. 2823–2827, doi: 10.1049/icp.2021.1586.
- [348] M. Miura, T. Satoh, S. Iwamoto, and I. Kurihara, "Application of dynamic rating to increase the available transfer capability," *Electr. Eng. Japan*, vol. 166, no. 4, pp. 40–47, Mar. 2009, doi: 10.1002/eej.20537.
- [349] O. D. Ariza Rocha, K. Morozovska, T. Laneryd, O. Ivarsson, C. Ahlrot, and P. Hilber, "Dynamic rating assists cost-effective expansion of wind farms by utilizing the hidden capacity of transformers," *Int. J. Electr. Power Energy Syst.*, vol. 123, p. 106188, Dec. 2020, doi: 10.1016/j.ijepes.2020.106188.

- [350] S. Fatima, V. Püvi, and M. Lehtonen, "Review on the PV Hosting Capacity in Distribution Networks," *Energies*, vol. 13, no. 18, p. 4756, Sep. 2020, doi: 10.3390/en13184756.
- [351] W. I. Schmitz, D. L. P. Feil, L. N. Canha, A. R. Abaide, T. B. Marchesan, and R. Carraro, "Operational vulnerability indicator for prioritization and replacement of power transformers in substation," *Int. J. Electr. Power Energy Syst.*, vol. 102, pp. 60–70, Nov. 2018, doi: 10.1016/j.ijepes.2018.04.012.
- [352] M. Numan, D. Feng, F. Abbas, U. Rahman, and W. A. Wattoo, "Impact assessment of a co-optimized dynamic line rating and transmission switching topology on network expansion planning," *Int. Trans. Electr. Energy Syst.*, Jun. 2020, doi: 10.1002/2050-7038.12457.
- [353] A. Nawaz, H. Wang, Q. Wu, and M. Kumar Ochani, "TSO and DSO with large-scale distributed energy resources: A security constrained unit commitment coordinated solution," *Int. Trans. Electr. Energy Syst.*, 2020, doi: 10.1002/2050-7038.12233.
- [354] T. E. Hoff and C. Herig, "Managing Risk Using Renewable Energy Technologies," in *The Virtual Utility*, Boston, MA: Springer US, 1997, pp. 193–213.
- [355] A. N. M. M. Haque, P. H. Nguyen, T. H. Vo, and F. W. Bliet, "Agent-based unified approach for thermal and voltage constraint management in LV distribution network," *Electr. Power Syst. Res.*, vol. 143, pp. 462–473, Feb. 2017, doi: 10.1016/j.epsr.2016.11.007.
- [356] S. D. Kim and M. M. Morcos, "An Application of Dynamic Thermal Line Rating Control System to Up-Rate the Ampacity of Overhead Transmission Lines," *IEEE Trans. Power Deliv.*, vol. 28, no. 2, pp. 1231–1232, Apr. 2013, doi: 10.1109/TPWRD.2012.2234940.
- [357] FSK, "STO 56947007-29.180.01.116-2012 The guidance for transformer operation," 2014. [Online]. Available: https://www.fsk-ees.ru/about/management_and_control/test/STO-56947007-29.180.01.116-2012_izm_ot13.10.2014.pdf.
- [358] J. Teh *et al.*, "Prospects of Using the Dynamic Thermal Rating System for Reliable Electrical Networks: A Review," *IEEE Access*, vol. 6, pp. 26765–26778, 2018, doi: 10.1109/ACCESS.2018.2824238.
- [359] D. A. Douglass *et al.*, "A Review of Dynamic Thermal Line Rating Methods With Forecasting," *IEEE Trans. Power Deliv.*, vol. 34, no. 6, pp. 2100–2109, Dec. 2019, doi: 10.1109/TPWRD.2019.2932054.
- [360] D.-M. Kim, I.-S. Bae, and J.-O. Kim, "Determination of available transfer capability (ATC) considering real-time weather conditions," *Eur. Trans. Electr. Power*, vol. 21, no. 1, pp. 855–864, Jan. 2011, doi: 10.1002/etep.481.
- [361] I. Daminov, A. Prokhorov, R. Caire, and M.-C. Alvarez-Herault, "Receding horizon algorithm for dynamic transformer rating and its application for real-time economic dispatch," in *2019 IEEE Milan PowerTech*, Jun. 2019, pp. 1–6, doi: 10.1109/PTC.2019.8810511.
- [362] I. Daminov and A. Sazonov, "Two-stage algorithm to solve the economic dispatch problem with dynamic transformer ratings," in *EGM*, 2019, pp. 215–218, [Online].

Available: http://fondsmena.ru/media/EGM_publicationfiles_Article/том_1_1-2_секции.pdf.

- [363] S. Karimi, P. Musilek, and A. M. Knight, "Dynamic thermal rating of transmission lines: A review," *Renew. Sustain. Energy Rev.*, vol. 91, pp. 600–612, Aug. 2018, doi: 10.1016/j.rser.2018.04.001.
- [364] M. M. Saied, "Assessing the dynamic rating of overhead transmission lines," *Eur. Trans. Electr. Power*, vol. 17, no. 5, pp. 526–536, Sep. 2007, doi: 10.1002/etep.151.
- [365] R. Huang, J. A. A. Pilgrim, P. L. L. Lewin, and D. Payne, "Dynamic cable ratings for smarter grids," *2013 4th IEEE/PES Innov. Smart Grid Technol. Eur. ISGT Eur. 2013*, pp. 1–5, 2013, doi: 10.1109/ISGTEurope.2013.6695230.
- [366] GOST 14209 - 85, "General-purpose oil-immersed power transformers. Permissible loads," Moscow, 2009. [Online]. Available: <https://docs.cntd.ru/document/1200012414>.
- [367] GOST-14209-97, "Loading guide for oil-immersed power transformers." Moscow, p. 82, 1997, [Online]. Available: <https://meganorm.ru/Data2/1/4294847/4294847455.htm>.
- [368] B. Beavis and I. Dobbs, *Optimisation and Stability Theory for Economic Analysis*. Cambridge University Press, 1990.
- [369] D. Susa and H. Nordman, "IEC 60076-7 loading guide thermal model constants estimation," *Int. Trans. Electr. Energy Syst.*, vol. 23, no. 7, pp. 946–960, 2013, doi: 10.1002/etep.1631.
- [370] M. X. M.-X. Wang and X. S. X.-S. Han, "Study on electro-thermal coupling optimal power flow model and its simplification," in *IEEE PES General Meeting, PES 2010*, 2010, pp. 1–6, doi: 10.1109/PES.2010.5589644.
- [371] M. Wang, X. Han, H. Zhang, and Z. Jiang, "Advanced thermal rating and its application," in *1st International Conference on Sustainable Power Generation and Supply, SUPERGEN '09*, 2009, pp. 1–5, doi: 10.1109/SUPERGEN.2009.5348354.
- [372] World Meteorological Organization, "Guidelines on the Calculation of Climate Normals," 2017. Accessed: Nov. 02, 2019. [Online]. Available: https://library.wmo.int/doc_num.php?explnum_id=4166.
- [373] MeteoBlue, "history+ - Historical weather data since 1984," 2019. <https://www.meteoblue.com/en/historyplus> (accessed Nov. 05, 2019).
- [374] C. Straub, S. Olaru, J. Maeght, and P. Panciatici, "Robust MPC for temperature management on electrical transmission lines," *IFAC-PapersOnLine*, vol. 51, no. 32, pp. 355–360, 2018, doi: 10.1016/j.ifacol.2018.11.409.
- [375] J. Teh, "Uncertainty Analysis of Transmission Line End-of-Life Failure Model for Bulk Electric System Reliability Studies," *IEEE Trans. Reliab.*, vol. 67, no. 3, pp. 1261–1268, 2018, doi: 10.1109/TR.2018.2837114.
- [376] J. Teh, C.-M. Lai, and Y.-H. Cheng, "Impact of the real-time thermal loading on the bulk electric system reliability," *IEEE Trans. Reliab.*, vol. 66, no. 4, pp. 1110–1119, 2017, doi: 10.1109/TR.2017.2740158.

- [377] A.-S. Barthez and B. Larroutou, "Passport for open science," 2020. Accessed: Oct. 12, 2021. [Online]. Available: https://www.ouvirlascience.fr/wp-content/uploads/2020/11/Passport-for-Open-Science-A-Practical-Guide-For-PhD-Students_30-10-2020_WEB.pdf.
- [378] I. Daminov, "MATLAB code and data for IJEPES article," 2021. https://github.com/Ildar-Daminov/Assessment_Dynamic_Thermal_Rating_of_Transformers.git (accessed Oct. 11, 2021).
- [379] "Getting Electricity Indicator - What it measures, Why it matters, What are the results, and good practices? | World Bank Group." <https://olc.worldbank.org/content/getting-electricity-indicator-what-it-measures-why-it-matters-what-are-results-and-good-0> (accessed Jul. 25, 2021).
- [380] J. Shah and R. Gramlich, "Utilities aren't rewarded for saving money. FERC now has a chance to fix this | Utility Dive." <https://www.utilitydive.com/news/utilities-arent-rewarded-for-saving-money-ferc-now-has-a-chance-to-fix-th/585703/> (accessed Jun. 29, 2021).
- [381] Россети, "Динамика загрузки мощности электросетевого оборудования за последние годы и влияющие на нее факторы," 2016. Accessed: Jul. 25, 2021. [Online]. Available: https://www.eesk.ru/upload/site1/document_file/60MgpMzKIV.pdf.
- [382] "Мощный резерв: зачем нужна оптимизация энерготарифов | Статьи | Известия." <https://iz.ru/912584/mikhail-kalmatckii/moshchnyi-rezerv-zachem-nuzhna-optimizatsiia-energotarifov> (accessed Jun. 27, 2021).
- [383] "Начиная с 2020 г. Россети предлагают ввести плату за резерв мощности." <https://neftegaz.ru/news/powernetworks/291649-nachinaya-s-2020-g-rosseti-predlagayut-vvesti-platu-za-rezerv-moshchnosti/> (accessed Jun. 27, 2021).
- [384] "«Тюменьэнерго» возложила ответственность за растущий резерв мощности на нефтяников. «Россети» требуют обязать компании платить за введенные объекты | Правда УрФО." <https://pravdaurfo.ru/articles/173535-tyumenenergo-vozlozhila-otvetstvennost-za/> (accessed Jun. 27, 2021).
- [385] "Мощность про запас - Энергетика и промышленность России - № 08 (388) апрель 2020 года - WWW.EPRUSSIA.RU - информационный портал энергетика." <https://www.eprussia.ru/epr/388/7311900.htm> (accessed Jun. 30, 2021).
- [386] "Россети: Цифровая трансформация 2030 Проблемные точки финансирования." https://www.tadviser.ru/index.php/Статья:Россети:_Цифровая_трансформация_2030_Проблемные_точки_финансирования (accessed Jul. 03, 2021).
- [387] "Приложения: Последние новости России и мира – Коммерсантъ Энергетика (126427) - Затянуть сети потуже." <https://www.kommersant.ru/doc/4617286> (accessed Jun. 27, 2021).
- [388] Ю. В. Маневич, "Мощный резерв - Энергетическая политика," *Energy Policy*, 2019. <https://energypolicy.ru/moshchnyj-rezerv/business/2019/21/14/> (accessed Jun. 20, 2021).

- [389] CIGRE, “В Совете Федераций обсудили проблему резерва мощности и развитие интеллектуальных сетей,” Jan. 29, 2018. <http://cigre.ru/news/rnk/8589/> (accessed Jun. 20, 2021).
- [390] NP Market Council, *The modern market-based electrical energy industry of Russian Federation*, 2nd ed. Moscow 2015: Training center of NP Market Council, 2015.
- [391] “Из чего складывается тариф на электроэнергию, и почему он растёт | Коммунальные услуги Росквартал®.” <https://roskvartal.ru/kommunalnye-uslugi/9163/iz-chego-skladyvaetsya-tarif-na-elektroenergiyu-i-pochemu-on-rastyet> (accessed Sep. 28, 2021).
- [392] “Об утверждении Методических указаний по расчету регулируемых тарифов и цен на электрическую (тепловую) энергию на розничном (потребительском) рынке от 06 августа 2004 - docs.cntd.ru.” <https://docs.cntd.ru/document/901908404> (accessed Sep. 28, 2021).
- [393] НП Совет рынка, “Основные положения функционирования розничных рынков электрической энергии,” Москва, 2020. Accessed: Sep. 27, 2021. [Online]. Available: https://www.np-sr.ru/sites/default/files/2020_osnovnye_polozeniya_rre.pdf.
- [394] “‘Россети’ в поисках резервов / Экономика / Независимая газета.” https://www.ng.ru/economics/2019-09-16/4_7677_183916092019.html (accessed Jun. 27, 2021).
- [395] “Введение платы за резерв сетевой мощности: польза или зло?” https://zakon.ru/blog/2020/4/16/vvedenie_platy_za_rezerv_setevoj_moschnosti_pol_za_ili_zlo_83273 (accessed Jun. 30, 2021).
- [396] “«Проект по оплате сетевого «резерва» основан на заблуждениях.» <https://peretok.ru/opinion/22420/> (accessed Jun. 27, 2021).
- [397] “Минэнерго России ведёт доработку механизма оптимизации загрузки электросетевого комплекса | Министерство энергетики.” <https://minenergo.gov.ru/node/20509> (accessed Jul. 07, 2021).
- [398] “Резервируемая максимальная мощность (Часть 2).” <https://zen.yandex.ru/media/id/5e37ecea7ce67867350624e8/-rezerviruemaia-maksimalnaia-moschnost-chast-2--5e4e5d03f2bc623242236001> (accessed Jul. 03, 2021).
- [399] “Резервируемая максимальная мощность (Часть 3).” <https://zen.yandex.ru/media/id/5e37ecea7ce67867350624e8/-rezerviruemaia-maksimalnaia-moschnost-chast-3--5e4fb405cc6d233fd0f706ff> (accessed Jul. 03, 2021).
- [400] “За киловатты платят дважды. Когда в России введут плату за резерв сетевой мощности.” https://www.dp.ru/a/2020/03/17/Za_kilovatti_platjat_dvazhdi (accessed Jun. 27, 2021).
- [401] “Единые котловые тарифы на услуги по передаче электрической энергии по сетям территориальных сетевых организаций Томской области, поставляемой прочим потребителям на 2021 год.” 2020.

- [402] “Крупные производители попросили отменить плату за резерв мощности - Экономика и бизнес - ТАСС.” <https://tass.ru/ekonomika/10574121> (accessed Jun. 27, 2021).
- [403] Россети, “Опыт реализации технологических присоединений для проектов среднего бизнеса: технологии, малого и статистика, планы развития,” 2015. [Online]. Available: http://www.murmanexpo.ru/img/all/37_lebedev_kolenergo_vystuplenie_na_kruglom_stole.pdf.
- [404] А. Максимов, “Концепция Минэнерго России по сокращению неиспользуемых сетевых мощностей Начальник отдела развития нормативной базы отрасли Департамента развития электроэнергетики,” 2014. Accessed: Jul. 03, 2021. [Online]. Available: <https://docplayer.com/37523941-Koncepciya-minenergo-rossii-posokrashcheniyu-neispolzuemyh-setevyh-moshchnostey.html>.
- [405] “Слишком много мощности | Новости Иркутска, Иркутской области.” <https://snews.ru/reportag/slishkom-mnogo-moshchnosti> (accessed Jul. 03, 2021).
- [406] “Комитет по энергетике ГД поддерживает введение оплаты резерва сетевой мощности.” https://www.eskzgroup.ru/news/komitet_po_energetike_gd_podderzhivaet_vvedeniye_oplaty_rezerva_setevoy_moshchnosti/ (accessed Jul. 03, 2021).
- [407] “«О переходе к 100-процентной оплате сетевых резервов речи не идёт».” <https://peretok.ru/opinion/22385/> (accessed Jul. 03, 2021).
- [408] “Интервью Павла Сниккарса ‘Переток.ру’ | Министерство энергетики.” <https://minenergo.gov.ru/node/14122> (accessed Jul. 03, 2021).
- [409] “Промышленники просят Борисова сдержать энерготарифы - Ведомости.” <https://www.vedomosti.ru/business/articles/2020/08/11/836432-promishlenniki-borisova> (accessed Jun. 26, 2021).
- [410] “‘Мощный’ фейк.” <http://www.valeriyzhikharev.org/blog/мощный-фейк> (accessed Jun. 26, 2021).
- [411] “Борисов отправил на доработку энергореформу для промышленности .” <https://www.rbc.ru/business/27/06/2021/60d761329a794701df8db73b> (accessed Jun. 27, 2021).
- [412] “ДР: Энергетический шантаж: «Россети» против бизнеса.” <https://deloros.ru/energeticheskij-shantazh-rosseti-protiv-biznesa.html> (accessed Jun. 29, 2021).
- [413] “Плата за резерв мощности: законопроект должен справедливо распределить сетевые мощности, но ошибочно приравнивает «генераторов» к потребителям | Fortum.ru.” <https://www.fortum.ru/media/2020/10/plata-za-rezerv-moschnosti-zakonoproekt-dolzhen-spravedlivo-raspredelit-setevye-moschnosti-no-oshibochno-priravnivaet-generatorov-k-potrebitelyam> (accessed Jun. 30, 2021).
- [414] “Минэнерго возобновило борьбу за сетевые резервы / Экономика / Независимая газета.” https://www.ng.ru/economics/2020-08-11/100_232411082020.html

(accessed Jun. 30, 2021).

- [415] “Хочешь выйти — плати! «Совет рынка» ищет способ остановить уход промышленников из единой энергосистемы / Новости электротехники / Элек.ру.” <https://www.elec.ru/news/2020/11/30/hochesh-vyjti-plati-sovet-rynka-ishet-sposob-ostan.html> (accessed Jul. 03, 2021).
- [416] “Оплата «резерва» сетевой мощности. Оценка обоснованности проекта и достижимости заявленных целей 25 сентября 2018 года.”
- [417] “Проект о внесении изменений в некоторые акты Правительства Российской Федерации по вопросам определения обязательств потребителей по оплате услуг по передаче электрической энергии с учетом оплаты резервируемой максимальной мощности и взаимодействия субъектов розничных рынков электрической энергии.” <https://regulation.gov.ru/projects#npa=85369> (accessed Jul. 25, 2021).
- [418] “Перераспределение мощности | Министерство энергетики.” <https://minenergo.gov.ru/node/551> (accessed Jul. 25, 2021).
- [419] “Чем регулируется возможность технологического присоединения к электросетям посредством перераспределения мощности?” <http://kwexpert.ru/services/cost-of-ownership-electro-economy/tehprisoedinenie-k-setyam/chem-reguliruetsya-pereraspredelenie-elektricheskoy-moshchnosti.php> (accessed Jul. 25, 2021).
- [420] Россети, “Энергия для каждого,” 2016. Accessed: Jul. 25, 2021. [Online]. Available: <https://www.e-disclosure.ru/portal/FileLoad.ashx?Fileid=1362683>.
- [421] Россети, “Годовой отчет 2020,” 2021. [Online]. Available: http://www.rustocks.com/put.phtml/MRKH_2020_RUS.pdf.
- [422] “Концепция оптимизации экономичности использования трансформаторных мощностей электрических сетей ээс россии,” 2021.
- [423] “Сети достали из резерва – Газета Коммерсантъ № 121 (7083) от 14.07.2021.” <https://www.kommersant.ru/doc/4899715> (accessed Jul. 25, 2021).
- [424] “«Россети ФСК ЕЭС» | Проверка технической возможности технологического присоединения к открытым центрам питания.” https://www.fsk-ees.ru/consumers/service_engineering_connection/technological_connection_of_power_receivers/public_data/checking_the_technical_capability_of_technological_connection_to_open_feeding_centers/ (accessed Sep. 28, 2021).
- [425] Россети, “Доступность и эффективность использования электросетевой инфраструктуры,” 2015. [Online]. Available: https://www.rosseti.ru/press/presentation/doc/tehprisoedinenie2011_2015.pdf.
- [426] Правительство Тверской Области, “Схема и программа развития электроэнергетики Тверской области на 2020 – 2024 годы.” 2019.
- [427] “Приказ Министерства энергетики РФ от 13.01.2003 N 6 ‘Об утверждении Правил технической эксплуатации электроустановок потребителей’ (с изменениями и дополнениями) | ГАРАНТ.” <http://base.garant.ru/12129664/> (accessed Jul. 25, 2021).

- [428] A. F. Brandão, “Probability approach to installation studies of power transformers,” *Int. J. Electr. Power Energy Syst.*, vol. 5, no. 3, pp. 173–181, Jul. 1983, doi: 10.1016/0142-0615(83)90006-6.
- [429] MeteoBlue, “Ambient temperature history over 30 years for Tomsk,” 2019. https://www.meteoblue.com/en/weather/archive/export/tomsk_russia_1489425.
- [430] L. Wang, X. Zhang, R. Villarroel, Q. Liu, Z. Wang, and L. Zhou, “Top-oil temperature modelling by calibrating oil time constant for an oil natural air natural distribution transformer,” *IET Gener. Transm. Distrib.*, vol. 14, no. 20, pp. 4452–4458, Oct. 2020, doi: 10.1049/iet-gtd.2020.0155.
- [431] I. Daminov, “MATLAB code and data for CIREC 2019 paper,” 2022. <https://github.com/Ildar-Daminov/Reserve-capacity-of-transformer-for-load-connection.git> (accessed Oct. 11, 2021).
- [432] A. Esmat, J. Usaola, and M. A. Moreno, “Congestion management in smart grids with flexible demand considering the payback effect,” in *2016 IEEE PES Innovative Smart Grid Technologies Conference Europe (ISGT-Europe)*, Oct. 2016, pp. 1–6, doi: 10.1109/ISGTEurope.2016.7856233.
- [433] B. Pierpont, N. David, G. Andrew, and D. Posner, “Flexibility: the path to low-carbon, low-cost electricity grids,” 2017. [Online]. Available: <https://climatepolicyinitiative.org/wp-content/uploads/2017/04/CPI-Flexibility-the-path-to-low-carbon-low-cost-grids-April-2017.pdf>.
- [434] E. A. Martínez Ceseña, N. Good, and P. Mancarella, “Electrical network capacity support from demand side response: Techno-economic assessment of potential business cases for small commercial and residential end-users,” *Energy Policy*, vol. 82, no. 1, pp. 222–232, Jul. 2015, doi: 10.1016/j.enpol.2015.03.012.
- [435] E. A. Martinez Cesena and P. Mancarella, “Distribution network capacity support from flexible smart multi-energy districts,” in *2016 IEEE PES Transmission & Distribution Conference and Exposition-Latin America (PES T&D-LA)*, Sep. 2016, pp. 1–6, doi: 10.1109/TDC-LA.2016.7805605.
- [436] G. Celli, F. Pilo, and S. Ruggeri, “Flexibility model of integrated energy sources for the strategic planning of Distribution Networks,” in *CIREC Workshop*, 2018, p. 4, [Online]. Available: [http://www.cired.net/publications/workshop2018/pdfs/Submission_0525_Paper_\(ID-21419\).pdf](http://www.cired.net/publications/workshop2018/pdfs/Submission_0525_Paper_(ID-21419).pdf).
- [437] A. Esmat and J. Usaola, “DSO congestion management using demand side flexibility,” in *CIREC Workshop 2016*, 2016, vol. 2016, no. CP686, p. 197 (4 .)-197 (4 .), doi: 10.1049/cp.2016.0797.
- [438] S. Jiang *et al.*, “Substation Capacity Planning Method Considering Interruptible Load,” in *2018 International Conference on Power System Technology (POWERCON)*, Nov. 2018, pp. 496–500, doi: 10.1109/POWERCON.2018.8602045.
- [439] C. Mullen, “Interactions between demand side response, demand recovery, peak pricing and electricity distribution network capacity margins,” Newcastle University, 2018.

- [440] S. Weckx, R. D’Hulst, B. Claessens, and J. Driesensam, “Multiagent Charging of Electric Vehicles Respecting Distribution Transformer Loading and Voltage Limits,” *IEEE Trans. Smart Grid*, vol. 5, no. 6, pp. 2857–2867, Nov. 2014, doi: 10.1109/TSG.2014.2345886.
- [441] D. Elmakis, A. Braunstein, and Y. Naot, “A Probabilistic Method for Establishing the Transformer Capacity Reserve Criteria for HV/MV Substations,” *IEEE Trans. Power Syst.*, vol. 1, no. 4, pp. 158–164, 1986, doi: 10.1109/TPWRS.1986.4335032.
- [442] C. Sandels, J. Widén, and L. Nordström, “Forecasting household consumer electricity load profiles with a combined physical and behavioral approach,” *Appl. Energy*, 2014, doi: 10.1016/j.apenergy.2014.06.048.
- [443] Danbro, “House load electricity - File Exchange - MATLAB Central,” 2021. <https://fr.mathworks.com/matlabcentral/fileexchange/63375-house-load-electricity>.
- [444] MeteoBlue, “Ambient temperature history over 30 years for Grenoble region,” 2019. https://www.meteoblue.com/en/weather/archive/export/grenoble_france_3014728.
- [445] A. Watson and R. Weller, “Temperature correction factor applied to substation capacity analysis,” in *18th International Conference and Exhibition on Electricity Distribution (CIRED 2005)*, 2005, vol. 2005, no. June, doi: 10.1049/cp:20051335.
- [446] V. Turnham, S. M. Blair, C. D. Booth, and P. Turner, “Increasing Distribution Network Capacity using Automation to Reduce Carbon Impact,” in *12th IET International Conference on Developments in Power System Protection (DPSP 2014)*, 2014, vol. 2014, no. 626 CP, p. 6.1.2-6.1.2, doi: 10.1049/cp.2014.0040.
- [447] “The Duck Curve: A Review of California’s Daily Load Predictions - Aurora Solar.” <https://www.aurorasolar.com/blog/the-duck-curve-a-review-of-californias-daily-load-predictions/> (accessed Sep. 06, 2021).
- [448] A. N. M. M. Haque, M. T. Rahman, P. H. Nguyen, and F. W. Bliet, “Smart curtailment for congestion management in LV distribution network,” in *2016 IEEE Power and Energy Society General Meeting (PESGM)*, Jul. 2016, pp. 1–5, doi: 10.1109/PESGM.2016.7741936.
- [449] R. Rigo-Mariani, S. O. Chea Wae, and S. Mazzoni, “Impact of the Economic Environment Modelling for the Optimal Design of a Multi-Energy Microgrid,” in *IECON 2020 The 46th Annual Conference of the IEEE Industrial Electronics Society*, Oct. 2020, pp. 1837–1842, doi: 10.1109/IECON43393.2020.9254730.
- [450] CEDEC, EDSO for Smart Grids, Eurelectric, and GEODE, “Flexibility in the energy transition a toolbox for electricity dsos flexibility in the energy transition i a toolbox for electricity DSOs,” 2018. [Online]. Available: <https://www.edsoforsmartgrids.eu/wp-content/uploads/Flexibility-in-the-energy-transition-A-tool-for-electricity-DSOs-2018-HD.pdf>.
- [451] K. Kumar, S. Satsangi, and G. B. Kumbhar, “Extension of life of distribution transformer using Volt-VAr optimisation in a distribution system,” *IET Generation, Transmission and Distribution*. 2019, doi: 10.1049/iet-gtd.2018.5746.
- [452] R. Godina, E. M. G. Rodrigues, J. C. O. Matias, and J. P. S. Catalão, “Smart electric vehicle charging scheduler for overloading prevention of an industry client power distribution

- transformer,” *Appl. Energy*, 2016, doi: 10.1016/j.apenergy.2016.06.019.
- [453] Z. Xueqiang, Z. Pengfei, T. Haoyi, and Z. Sanshan, “Research and Practical Application of Transformer Emergency Standby Calculation and Assessment Method,” in *2018 International Conference on Power System Technology (POWERCON)*, Nov. 2018, pp. 3659–3666, doi: 10.1109/POWERCON.2018.8601744.
- [454] M. K. Metwaly and J. Teh, “Probabilistic Peak Demand Matching by Battery Energy Storage Alongside Dynamic Thermal Ratings and Demand Response for Enhanced Network Reliability,” *IEEE Access*, vol. 8, pp. 181547–181559, 2020, doi: 10.1109/ACCESS.2020.3024846.
- [455] A. S. Alghamdi and R. K. Desuqi, “A study of expected lifetime of XLPE insulation cables working at elevated temperatures by applying accelerated thermal ageing,” *Heliyon*, vol. 6, no. 1, Jan. 2020, doi: 10.1016/j.heliyon.2019.e03120.
- [456] I. Daminov, “MATLAB code and data for Energies article,” 2022. <https://github.com/Ildar-Daminov/Demand-response-coupled-with-DTR-of-transformers.git>.
- [457] H. L. Willis and R. R. Schrieber, *Aging Power Delivery Infrastructures*, 2nd ed. New York, NY: CRC Press, 2017.
- [458] T. Yip, M. Aten, B. Ferris, G. Lloyd, and Chang An, “Dynamic line rating protection for wind farm connections,” in *IET Conference Publications*, 2009, pp. 733–733, doi: 10.1049/cp.2009.0949.
- [459] K. Rajender, R. K. and Vallisaranya, “Transformer rating for solar PV plants based on overloading capability as per guidelines,” in *2014 IEEE Region 10 Humanitarian Technology Conference (R10 HTC)*, Aug. 2014, pp. 19–24, doi: 10.1109/R10-HTC.2014.7026318.
- [460] P. Pacheco, M. Cuesto, and M. Burgos, “Sizing Step-up Transformers for Solar Generation based on Load Profiles Predictability,” in *ARWtr 2019 - Proceedings: 2019 6th Advanced Research Workshop on Transformers*, Oct. 2019, pp. 37–41, doi: 10.23919/ARWtr.2019.8930196.
- [461] A. Rudkevich *et al.*, “Identification and Congestion Analysis of Transmission Corridors of the Eastern Interconnection,” in *2007 40th Annual Hawaii International Conference on System Sciences (HICSS’07)*, 2007, pp. 124–124, doi: 10.1109/HICSS.2007.254.
- [462] Monitoring Analytics, “2019 State of the Market Report for PJM,” 2019. [Online]. Available: <https://legalelectric.org/f/2020/03/2019-som-pjm-volume2.pdf>.
- [463] ENTSO-E, “Bidding zone configuration technical report,” 2018. [Online]. Available: https://eepublicdownloads.entsoe.eu/clean-documents/events/2018/BZ_report/20181015_BZ_TR_FINAL.pdf.
- [464] M. Cain, R. O’Neill, and A. Castillo, “History of Optimal Power Flow and Formulations,” 2012. [Online]. Available: <https://www.ferc.gov/sites/default/files/2020-05/acopf-1-history-formulation-testing.pdf>.
- [465] EU, “Regulation (EC) No 714/2009 of the European Parliament and of the Council on

- conditions for access to the network for cross-border exchanges in electricity and repealing Regulation (EC) No 1228/2003,” 2009. [Online]. Available: <https://eur-lex.europa.eu/legal-content/EN/TXT/PDF/?uri=CELEX:32009R0714&from=EN>.
- [466] M. Joos and I. Staffell, “Short-term integration costs of variable renewable energy: Wind curtailment and balancing in Britain and Germany,” *Renewable and Sustainable Energy Reviews*, vol. 86. Elsevier Ltd, pp. 45–65, Apr. 2018, doi: 10.1016/j.rser.2018.01.009.
- [467] A. Blavette, C. Bonnard, I. Daminov, S. Bourguet, and T. Soulard, “Upgrading wave energy test sites by including overplanting: a techno-economic analysis,” *IET Renew. Power Gener.*, vol. 15, no. 14, pp. 3176–3185, Oct. 2021, doi: 10.1049/rpg2.12220.
- [468] N. Etherden and M. H. J. Bollen, “Increasing the hosting capacity of distribution networks by curtailment of renewable energy resources,” in *2011 IEEE Trondheim PowerTech*, Jun. 2011, pp. 1–7, doi: 10.1109/PTC.2011.6019292.
- [469] S. Fatima, V. Püvi, and M. Lehtonen, “Comparison of Different References When Assessing PV HC in Distribution Networks,” *Clean Technol.*, vol. 3, no. 1, pp. 123–137, Feb. 2021, doi: 10.3390/cleantechnol3010008.
- [470] A. K. Jain, K. Horowitz, F. Ding, N. Gensollen, B. Mather, and B. Palmintier, “Quasi-Static Time-Series PV Hosting Capacity Methodology and Metrics,” in *2019 IEEE Power & Energy Society Innovative Smart Grid Technologies Conference (ISGT)*, Feb. 2019, pp. 1–5, doi: 10.1109/ISGT.2019.8791569.
- [471] Navigant Research, “Global DER Overview,” 2019. <https://www.navigantresearch.com/reports/global-der-overview> (accessed Feb. 21, 2020).
- [472] B. Pierpont, N. David, G. Andrew, and D. Posner, “Flexibility The path to low-carbon, low-cost electricity grids,” 2017.
- [473] J. Hosek, P. Musilek, E. Lozowski, and P. Pytlak, “Effect of time resolution of meteorological inputs on dynamic thermal rating calculations,” *IET Gener. Transm. Distrib.*, vol. 5, no. 9, p. 941, 2011, doi: 10.1049/iet-gtd.2011.0039.
- [474] S. Ananicheva and Y. Kotova, *Designing the electrical networks*. 2017.
- [475] P. M. Brown and J. P. White, “Determination of the maximum cyclic rating of high-voltage power transformers,” *Power Eng. J.*, vol. 12, no. 1, pp. 17–20, Feb. 1998, doi: 10.1049/pe:19980105.
- [476] N. Lelekakis, J. Wijaya, D. Martin, and D. Susa, “The effect of acid accumulation in power-transformer oil on the aging rate of paper insulation,” *IEEE Electr. Insul. Mag.*, vol. 30, no. 3, pp. 19–26, May 2014, doi: 10.1109/MEI.2014.6804738.
- [477] N. Lelekakis, D. Martin, and J. Wijaya, “Ageing rate of paper insulation used in power transformers Part 2: Oil/paper system with medium and high oxygen concentration,” *IEEE Trans. Dielectr. Electr. Insul.*, vol. 19, no. 6, pp. 2009–2018, Dec. 2012, doi: 10.1109/TDEI.2012.6396960.
- [478] N. Lelekakis, D. Martin, and J. Wijaya, “Ageing rate of paper insulation used in power transformers Part 1: Oil/paper system with low oxygen concentration,” *IEEE Trans.*

- Dielectr. Electr. Insul.*, vol. 19, no. 6, pp. 1999–2008, Dec. 2012, doi: 10.1109/TDEI.2012.6396958.
- [479] T. K. Saha and P. Purkait, *Transformer ageing : monitoring and estimation techniques*. Singapore: John Wiley & Sons Singapore Pte. Ltd.
- [480] I. Daminov, “MATLAB code and data for IET GTD article,” 2022. <https://github.com/Ildar-Daminov/Energy-limit-of-power-transformer.git> (accessed Oct. 11, 2021).
- [481] D. Y. Feng and Z. D. Wang, “Modeling Thermal Life Expectancy of the UK Transmission Power Transformers,” no. 3, pp. 540–543, 2012.
- [482] ABB, “Factory repair and refurbishment of transformers.” <https://search.abb.com/library/Download.aspx?DocumentID=3AJE000124-0015&LanguageCode=en&DocumentPartId=&Action=Launch> (accessed Mar. 04, 2022).
- [483] D. Feng, “Life expectancy investigation of transmission power transformers,” University of Manchester, 2013.
- [484] Cigre, “Moisture Equilibrium and Moisture Migration within Transformer Insulation Systems,” 2008. Accessed: Feb. 23, 2022. [Online]. Available: <https://e-cigre.org/publication/349-moisture-equilibrium-and-moisture-migration-within-transformer-insulation-systems>.
- [485] M. Ariannik, A. A. Razi-Kazemi, and M. Lehtonen, “Effect of cumulative moisture content on degradation of transformer paper insulation,” *IEEE Trans. Dielectr. Electr. Insul.*, vol. 24, no. 1, pp. 611–618, Feb. 2017, doi: 10.1109/TDEI.2016.006006.
- [486] I. Daminov, “MATLAB code and data for CIRED 2021 paper,” 2021. <https://github.com/Ildar-Daminov/MATLAB-code-for-CIRED-paper> (accessed Feb. 27, 2021).
- [487] NVE, “Computing the power distance parameter Commissioned by NVE THEMA Consulting Group,” 2019. Accessed: Oct. 17, 2021. [Online]. Available: https://publikasjoner.nve.no/eksternrapport/2019/eksternrapport2019_05.pdf.
- [488] J. E. Tierney, J. Zhu, J. King, S. B. Malevich, G. J. Hakim, and C. J. Poulsen, “Glacial cooling and climate sensitivity revisited,” *Nature*, vol. 584, no. 7822, pp. 569–573, Aug. 2020, doi: 10.1038/s41586-020-2617-x.
- [489] J. Hu, X. Xiong, J. Chen, W. Wang, and J. Wang, “Transient Temperature Calculation and Multi-Parameter Thermal Protection of Overhead Transmission Lines Based on an Equivalent Thermal Network,” *Energies*, vol. 12, no. 1, p. 67, Dec. 2018, doi: 10.3390/en12010067.
- [490] P. K. Sen and Sarunpong Pansuwan, “Overloading and loss-of-life assessment guidelines of oil-cooled transformers,” in *2001 Rural Electric Power Conference. Papers Presented at the 45th Annual Conference (Cat. No.01CH37214)*, 1887, p. B4/1-B4/8, doi: 10.1109/REPCON.2001.949516.
- [491] J. Aubin, R. Bergeron, and R. Morin, “Distribution transformer overloading capability

- under cold-load pickup conditions," *IEEE Trans. Power Deliv.*, vol. 5, no. 4, pp. 1883–1891, 1990, doi: 10.1109/61.103685.
- [492] C. Uçak and A. Pahwa, "Optimal step-by-step restoration of distribution systems during excessive loads due to cold load pickup," *Electr. Power Syst. Res.*, vol. 32, no. 2, pp. 121–128, Feb. 1995, doi: 10.1016/0378-7796(94)00902-G.
- [493] "Rosseti Centr - Technological connection." <https://www.mrsk-1.ru/en/clients/fitting/> (accessed Sep. 27, 2021).
- [494] "Приложение. Методические указания по определению размера платы за технологическое присоединение к электрическим сетям." <http://base.garant.ru/71792554/53f89421bbdaf741eb2d1ecc4ddb4c33/> (accessed Sep. 30, 2021).