



HAL
open science

Active Vision and Probabilistic Inference

Anna Montagnini

► **To cite this version:**

Anna Montagnini. Active Vision and Probabilistic Inference. Cognitive science. Aix-Marseille Université, 2018. tel-03779744

HAL Id: tel-03779744

<https://theses.hal.science/tel-03779744v1>

Submitted on 17 Sep 2022

HAL is a multi-disciplinary open access archive for the deposit and dissemination of scientific research documents, whether they are published or not. The documents may come from teaching and research institutions in France or abroad, or from public or private research centers.

L'archive ouverte pluridisciplinaire **HAL**, est destinée au dépôt et à la diffusion de documents scientifiques de niveau recherche, publiés ou non, émanant des établissements d'enseignement et de recherche français ou étrangers, des laboratoires publics ou privés.

Aix-Marseille Université
École Doctorale Sciences de la Vie et de la Santé

Active Vision and Probabilistic Inference

Anna MONTAGNINI

Habilitation à Diriger des Recherches

13 Novembre 2018



Aix-Marseille
université



Équipe Inference in Visual Behaviour (InViBe)
Institut de Neurosciences de la Timone
UMR 7289, CNRS et Aix-Marseille Université
27, Bd. Jean Moulin, 13385 Marseille Cedex 5, France
anna.montagnini@univ-amu.fr

Jury composé de :	
Prof. Thérèse Collins (Rapporteur)	Université Paris Descartes
Prof. Philippe Lefèvre (Rapporteur)	Université Catholique de Louvain
Dr. Mireille Bonnard (Rapporteur)	Aix-Marseille Université
Prof. Laurent Madelain (Examinateur)	Université de Lille III
Dr. Guillaume Masson (Examinateur)	Aix-Marseille Université
Prof. Jean-Louis Mège (Examinateur)	Aix-Marseille Université

Résumé

Ce manuscrit présente une synthèse de mon projet scientifique afin d'obtenir le diplôme d'Habilitation à Diriger des Recherches (HDR). Il est l'occasion de faire le point sur mon parcours scientifique, ainsi que de réfléchir aux projets de recherche collaborative que je souhaite mettre en place et coordonner au cours des prochaines années. Au sein de ces projets, j'espère pouvoir encadrer nombreux étudiants et jeunes chercheurs talentueux et motivés.

La première partie du manuscrit (introduction et chapitres 1 à 3) résume mon parcours de recherche de 2009 à 2017 (avec des références aux travaux de recherche antécédents), c'est à dire à partir du début de mon activité de chercheur statutaire au sein du CNRS.

La deuxième partie (chapitres 4 et 5) présente les perspectives de mes recherches dans le futur, aussi bien dans la continuité proche des projets en cours, que à l'égard des nouveautés et des idées originales que j'espère introduire dans les années à suivre. Dans la Conclusion (chapitre 6) je me permets quelques considérations personnelles, un petit *état de lieu* de mon sujet de recherche et mon point de vue sur son évolution.

Pour finir, en annexe je présente mon *curriculum vitae*, une liste complète de publications et communications scientifiques, la liste des projets collaboratifs financés par grants nationaux ou internationaux, ainsi que la liste des étudiants encadrés ou co-encadrés pendant mon parcours de recherche.

A l'exception de la section de remerciements, cette thèse est rédigée en Anglais.

Abstract

This manuscript presents a synthesis of my scientific work, in order to obtain the Habilitation à Diriger des Recherches (HDR) diploma. It is an opportunity, for me, to take stock of my scientific evolution so far, as well as to reflect about the collaborative research projects that I wish to set up and coordinate over the next few years. Within these projects, I hope to be able to supervise and mentor many talented and motivated students and young researchers.

The first part of the manuscript (introduction and chapters 1 to 3) summarizes my research from 2009 to 2017 (with references to some previous research work), i. e. from the beginning of my activity as a permanent researcher at the CNRS.

The second part (Chapters 4 and 5) presents the perspectives of my research in the future, either in the smooth continuity with the ongoing projects, or with regard to the novelties and original ideas that I hope to introduce in the years to come. In the Conclusion (Chapter 6) I allow myself some personal considerations, to sketch a brief *state of the art* of my research theme and express a point of view on its evolution.

Finally, in the Annexes, I present my *curriculum vitae*, a complete list of scientific publications and communications, the list of collaborative projects funded by national or international grants, as well as the list of students supervised or co-supervised during the past years.

Acknowledgements

Je souhaite exprimer mes remerciements les plus sincères aux personnes (et je ne vais nommer que certaines d'entre elles, mais beaucoup plus mériteraient de l'être) qui m'ont soutenue et aidée tout au long du parcours qui aboutit dans ce dossier de Habilitation à Diriger des Recherches. Je vais le faire en Français, car, si l'Anglais reste pour moi plus facile pour la rédaction scientifique, après toutes ces années le Français est devenu un peu la langue du coeur, quand-même.

Je remercie d'abord ceux qui, en *dirigeant mes recherches*, m'ont permis de grandir, apprendre énormément et acquérir mon autonomie dans le monde de la science. Je considère que la liste non exhaustive des mentors importants qui ont balisé ce chemin (aujourd'hui collègues et amis) comprend sans doute Paolo Grigolini, William Bialek, Leonardo Chelazzi, Guillaume Masson, Eric Castet et Pascal Mamassian.

La recherche étant une aventure collective, la presque totalité des études décrites dans ce manuscrit est le fruit de l'interaction avec de collaborateurs précieux: parmi eux je tiens à remercier tout particulièrement Laurent Perrinet, Laurent Madelain et Miriam Spering. Avec eux, ainsi que avec plusieurs autres *jeunes* collègues, j'ai l'espoir de continuer encore longtemps à m'amuser, en discutant de projets et idées plus ou moins farfelues.

Un grand merci aux jeunes chercheurs (masters, doctorants ou postdoc) que j'ai encadrés ou co-encadrés ces dernières années, et en particulier à Amar, Claudio, Sara, Mathieu, Kiana et Jean-Bernard. Ce sont effectivement la transmission et l'échange avec eux qui donnent du sens et du dynamisme à ce travail. D'ailleurs, qui sait si ce manuscrit aurait vu le jour, ou avec quels délais, si la soutenance de thèse de JB ne m'avait pas obligé à me dépêcher un peu...

Je suis très reconnaissante, enfin, aux membres de mon jury de HDR de me faire l'honneur d'évaluer ce manuscrit et de participer à la discussion qui suivra la soutenance. J'ai été presque émue de la rapidité et de l'enthousiasme avec lesquels les rapporteurs et examinateur externes, Thérèse Collins, Philippe Lefèvre et Laurent Madelain, aussi bien que les représentants AMU, Mireille Bonnard et Guillaume Masson, ont répondu positivement à cette charge ultérieure dans leur agenda déjà pleine. Au-delà de la formalité administrative et de l'occasion pour faire, au niveau personnel, un point sur le devenir de mon parcours de recherche, j'espère que cette HDR soit surtout l'occasion pour une discussion scientifique enrichissante.

Contents

I	General Presentation of my Research	6
1	Motion tracking and Bayesian Inference	10
1.1	Brief introduction to gaze-orienting and motion tracking eye movements	10
1.2	Brief introduction to Bayesian Inference in Vision and Sensorimotor research . .	12
1.3	Hierarchical Bayesian inference to explain visually-guided and predictive smooth pursuit	14
1.3.1	A visual Bayesian loop to explain oculomotor bias	15
1.3.2	Integrating multiple cues for smooth pursuit	17
1.3.3	Smooth Pursuit at low contrast	19
1.4	Generalization and limits of the Bayesian inference models for multisensory integration	20
1.5	Predicting and Anticipating Uncertain Motion Properties	22
2	Active Vision in a Complex Dynamic Environment	25
2.1	Brief Introduction to Active Vision	25
2.2	Presaccadic shift of attention	26
2.3	Fixational Eye Movements and Visual Processing	27
2.4	Role of the stimulus' spatiotemporal statistics for motion perception and oculomotor responses	30
2.5	Reinforcement and Eye Movements	32
3	The neuro-functional bases of visuomotor decisions	37
3.1	Modeling visuomotor decisions under conflict: behavior and electrophysiology . .	38
3.2	Physiological mechanisms underlying visuomotor decisions: information transfer between different effectors, behaviour and brain perturbations (TMS)	42
3.3	Non Invasive Transcranial Brain Stimulation during a visuo-oculomotor task . .	43
II	Future Research Developments	45
4	Probabilities and the Brain	48
4.1	Tracking probabilistic trajectories in space and time: behavioural analysis in humans and non-human primates	49
4.2	Representation and perturbation of behaviourally-relevant probabilities in the brain	51
4.3	Dynamic estimation of probabilities	52
4.4	Probability-based oculomotor anticipation across development and in pathological conditions	54
4.5	EEG-correlates of visuomotor adaptation in presence of sensory uncertainty . . .	55

5	New aspects in Active Vision	56
5.1	Oculomotor behavior as benchmark for Decision-Making models	56
5.2	Saccades and Information Maximization	58
5.3	Eye movements diversity across populations and across life span	59
5.4	Visual search in Natural scenes: testing the role of visual saliency	60
6	Conclusion end Perspectives	62
6.1	Vision and Eye movements, nice but...only that?	62
6.2	Vision and Eye movements, is this all about the brain?	63
6.3	Bayesian Inference Models: from the ideal observer to the human multitude . . .	64
6.4	Vision, Eye movements and Computational Models, will we save the world? . . .	65
III	Annexes	66
7	Curriculum Vitae	67
7.1	Short resume	67
7.2	Education	68
7.3	Previous Research Experience	69
7.4	List of Publications	72
7.5	Grants and Awards	78
7.6	Scientific animation	79
7.7	Training and Students' supervision	82

Part I

General Presentation of my Research

Preface

In October 2009, I was recruited as a permanent researcher in the Interdisciplinary Section "Modelling of Biological Systems" (CID 44) of the CNRS and affiliated to Section 27 (later 26), "Brain, Cognition and Behavior" of the CNRS. Since January 2012 I have joined the new Institut de Neurosciences de la Timone (INT, Joint Research Unit 7289 CNRS-Université de Aix-Marseille), headed by Dr Guillaume Masson, as part of the InVIBE team (Inference for Vision and Behaviour), co-led by Dr Frédéric Chavane and Dr Guillaume Masson. The research project I submitted for the CNRS selection call focused on the study of the human visuo-oculomotor system as an ideal model for decision-making under simple and well-controlled experimental conditions. This remains the central theme of my research, although new lines of research have emerged over time, through new ideas and/or collaborations with other researchers, and some of the initial projects have progressively been dropped.

My research project is characterized from the outset by an interdisciplinary approach, which involves on the one hand behavioral experimentation in human participants (psychophysical measurements, oculomotor recordings) and on the other hand the modelling of observed effects, mainly within the framework of probabilistic inference theory (Bayesian models) and Information Theory. More recently, in the context of collaborative projects, I have been interested in the neurofunctional bases of visuomotor control by means of electroencephalography, as well as in electrical and transcranial magnetic stimulation techniques, which allow to transiently facilitate or disrupt the functionality of a localized cerebral area in a transitory way. In addition I got interested in the analysis of visuo-oculomotor processes across different populations, including during development and in specific pathologies.

The research projects in which I have been involved since the beginning of my activity as a CNRS researcher is articulated along three main axes.

- Axis 1 consists of an extensive experimental study of the perception of motion and ocular tracking movements. This study is tightly coupled with the model-based analysis of the plausibility and role of Bayesian inferential processes in motion visual processing and oculomotor control. This work has started during my postdoc within the DyVA team (later InViBe) and it largely benefits of the collaboration with colleagues in the team, especially Guillaume Masson and Laurent Perrinet, as documented by the publication records. Several aspects have been addressed, such as the dynamic processing of ambiguous or degraded retinal information, the optimal integration of visual and non-visual information and the combination of several sources of sensory uncertainty for motion perception. These various aspects are discussed in several sections of chapter 1. The ability of our brain to extract regularities or principles of causality in the environment is reflected in the modulation of the motor response to sensory stimuli, but also in the progressive emergence of anticipatory behaviors: the analysis of this type of predictive motor control has been at the centre of my personal research interests for a while and in section 1.5 I present the most relevant results.
- With axis 2, I approach the complex forms of dynamic interaction between oculomotor control and a complex environment. Chapter 2 (with several independent studies) deals with issues raised within this axis over a long time period starting already during my postdoc, like for the study of the dynamic interaction between saccadic eye movements and visual selective attention (see section 2.2). The analysis of so-called fixational eye movements and of their functional role for perception has been a shared subject of interest and a true collective effort for the inViBe team: in section 2.3 I present the studies on this type of movements in which I was directly involved. The spatiotemporal statistical content of visual scenes plays a key role for vision and tracking eye movements and some of the recent collaborative works in the team have clearly demonstrated the interest of using ad-hoc complex visual stimuli with a controlled spectrum of spatiotemporal frequencies to investigate visuo-oculomotor control in depth (see section 2.4. More recently, a line of

research that has gradually emerged through the collaboration with Dr Laurent Madelain (University of Lille) is that of reinforcement-based adaptation and learning mechanisms that characterize voluntary eye movements (saccades and smooth pursuit) in their function of optimizing visual perception (see section 2.5).

From a theoretical point of view, there is no abrupt discontinuity between axis 1 and axis 2 (the categorization was mostly determined by the implementation of distinct sets of experiments and by historical reasons): several elements allow us to postulate that Bayesian inference mechanisms in their more complex version, including a hierarchical structure to account for the complete perception-action-cognition loop constitute a valid and interesting theoretical framework also for visuo-oculomotor tasks within a more complex and dynamic context. I will discuss some possible developments in this sense in chapter 4 and 5.

- Axis 3, illustrated in chapter 3 is the less elaborated one, as it is also the most recently addressed. It aims at understanding the neuronal bases of visuo-oculomotor decisions, using electrophysiology techniques (EEG, fMRI) and brain stimulation (TMS, tRNS). A collaborative study (described in Section 3.1) of the electromyographic (EMG) and electroencephalographic (EEG) signals during a visuomotor decision process allowed me to explore the potential of these electrophysiological measures to better constrain behavioral decision models. On the other hand, a second collaborative study on the use of single-pulse online TMS (briefly described in Section 3.2) allowed me to familiarize with this technique, but also to understand important limitations of it. The development of well-controlled experiments based on the use of non-invasive, magnetic or electrical brain stimulation techniques (TMS, tRNS) are the subject of a research line that has just opened up, thanks also to the scientific mobility (occurred in 2017) and an international collaboration with Lorella Battelli in Rovereto, Italy (see 3.3). I plan to further develop the investigation of the neuronal bases of sensorimotor decision making in uncertain, complex environments in the future, as I detail in chapter 4.

Chapter 1

Motion tracking and Bayesian Inference

1.1 Brief introduction to gaze-orienting and motion tracking eye movements

My whole research work develops around a common empirical core, which is constituted by those small rotations of the eyes that we make continuously and almost effortlessly to optimize the visual inspection of the environment, namely the voluntary orienting eye movements. Two main classes of these eye movements can be distinguished, saccades and smooth pursuit eye movements (illustrated in figure 1.1), and they both serve the purpose to *foveate* a selected part of the scene in order to process it in detail with the highest acuity part of the retina, the *fovea*, indeed.

Saccades are ballistic-like movements that allow to quickly re-orient the gaze towards a static or dynamic target region in the periphery of the visual field. Humans perform about three saccades per second, at any moment and during different tasks, like reading, exploring a new environment, manipulating tools, or doing sport, and the same holds, for very small saccades, while performing tasks demanding high visual acuity and high precision. Before, during and immediately after a saccade, visual perception undergoes very interesting dynamic modulations (described as distinct phenomena, such as the presaccadic shift of attention, saccadic suppression,

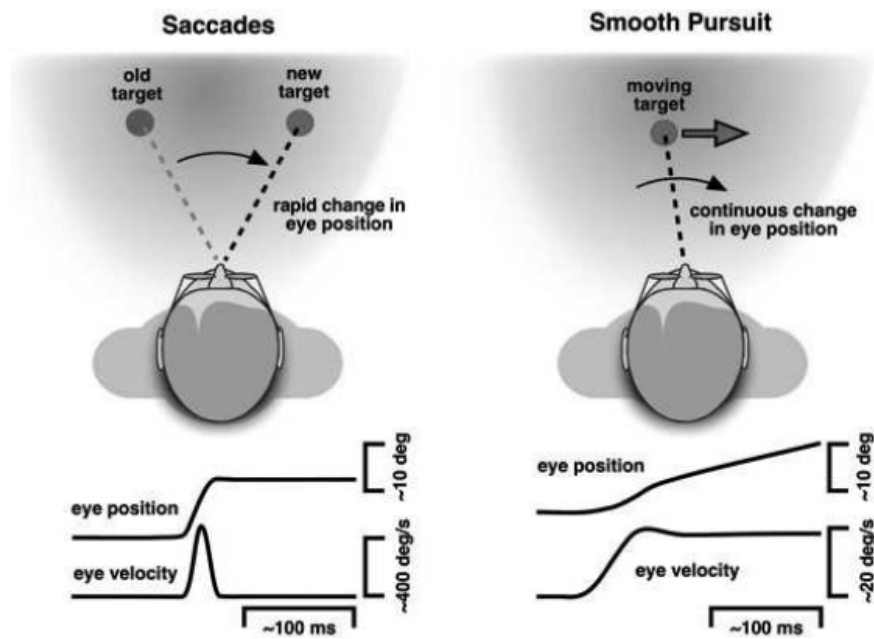

Figure 1.1: Adapted from Krauzlis (2008). Saccades (Left) shift the line of sight to place the retinal image of the visual target onto the fovea. They are characterized by rapid changes in eye position (upper deflection in eye position trace), involving very high velocities (brief pulses in eye velocity trace). Smooth pursuit eye movements (Right) continuously change the line of sight to minimize blurring of the target's retinal image. They are characterized by smooth and continuous changes in eye position (ramp in eye position trace) involving lower eye velocities (smooth step in eye velocity trace).

remapping...) that are the object of a vast literature in psychophysics and electrophysiology: I address some of these modulations to a very limited extent in section 2.2 of chapter 2. More space is devoted, in this manuscript, to the analysis of the early and late selection processes that determine saccadic orientation (see sections 2.5, 5.2, 5.4), as well as to the direct relation between specific eye movements and visual processing (e.g. section 2.3). Finally, saccades (and to a lesser extent smooth pursuit) have been extensively studied as the outcome of a sensorimotor decision, which takes into account several experimentally-controlled cognitive factors, such as expectancy or inhibition. My PhD thesis focused on the behavioral analysis of oculomotor decision-making (see section 7.3) and I plan to come back to this topic with a more model-based approach in the next future (e.g. section 5.1).

When an object of interest is moving at a relatively low speed, orienting saccades and smooth pursuit are interleaved, in order to align the fovea with the object, but also to stabilize it with respect to the eye, thus reducing its relative retinal velocity. During smooth pursuit eye movements, eye velocity changes more gradually and it typically stabilizes at the speed of the selected moving target. Despite the fact that we rarely perform smooth pursuit eye movements for a long time in real-life conditions, this type of eye movements is extremely interesting, for instance as it can inform us about how the brain integrates different motion signals and, conversely, how it segregates one particular moving object and precisely estimates this object's velocity under different conditions of visibility. These questions have been at the core of the InViBe team's and my own interests for years, as illustrated in this chapter. More recently, I got particularly interested in the analysis of anticipatory smooth pursuit, which can provide a time-continuous readout of the internal predictions about motion, including under conditions of uncertainty (see section 1.5 and the foreseen developments in chapter 4).

1.2 Brief introduction to Bayesian Inference in Vision and Sensorimotor research

When we perceive the physical world, make a decision or take an action to interact with it, our brain must deal with an ubiquitous property of it, uncertainty. Uncertainty can arise at

different levels and from different causes, e.g. from Heisenberg's principle in quantum physics to human emotional instability affecting the stock-market... During the past decades the modern science seems to have completed an epistemological transition, from struggling to reduce and neglect uncertainty to engaging in understanding it as a crucial constituent of the world. In the cognitive neurosciences and in particular in the field of behavioural analysis of sensory perception, this transition has been boosted, about fifty years ago, by the *Signal Detection Theory* (SDT, Green and Swets (1966)). Based on the assumption that a signal is always affected by noise, Signal Detection Theory provided a complete description of how the efficient process of signal detection has to appropriately account for the noise. More recently, the Bayesian framework of probabilistic inference has extended the scope of SDT and has become very popular as a benchmark of optimal behaviour in perceptual and sensorimotor tasks. Furthermore, plausible hypotheses about the implementation of Bayesian computations in the activity of neuronal populations have been proposed (Bastos et al., 2012; Fetsch et al., 2012; Ma et al., 2006).

The Bayesian theory relies on a single, very simple rule, positing that noisy sensory evidence (or *Likelihood*) is combined in a multiplicative way with noisy *Prior* knowledge (as illustrated in Figure 1.2) to provide the best possible probabilistic account (Posterior) of the current state of the world.

As a consequence of the Bayesian rule, the weight of the sensory data as well as that of experience-related (or innate) Prior is weighted by its reliability, or the inverse of the uncertainty associated to each of these sources of information. In practice, when the quality of the sensory evidence is poor, the Prior will more strongly affect the perceptual judgement (or any other sensorimotor outcome), possibly leading to a bias in the response. These types of behavioral biases, which may be interpreted like surprising *errors* at a first look, are actually explained in the Bayesian framework as the optimal readout of the available information taking into account its uncertainty. In this chapter, as well as at many other occasions in this thesis, I will illustrate examples of applications of this theoretical framework as a descriptive model of human sensorimotor behaviour.

In addition, the Bayesian multiplicative rule of combination of noisy information has been successfully applied to the analysis of multisensory integration, for instance to study the

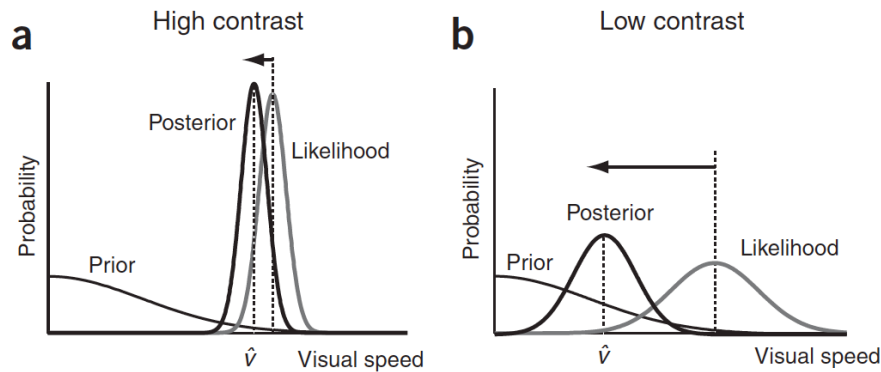

Figure 1.2: Adapted from Stocker and Simoncelli (2006). Illustration of the Bayesian framework applied to visual perception of motion speed at different stimulus contrast. (a) A stimulus with high luminance contrast leads to relatively precise measurements and thus a narrow Likelihood. Multiplication by a Prior probability favoring low speeds (the Prior density peaks in 0), for instance, induces only a small shift of the Posterior relative to the Likelihood and hence a small discrepancy between perception and the sensory input. (b) A low-contrast stimulus, conversely, is assumed to produce noisier measurements and thus a broader Likelihood. The combination with the same Prior induces a larger shift and thus low contrast stimuli are typically perceived as moving slower.

perception of events that are signaled simultaneously by visual, auditory and tactile cues. The idea of *Optimal Cue Combination* has been put forward (e.g. Ernst and Banks (2002)) which satisfactorily accounts for several phenomena observed experimentally (but see an example of the limits of the straightforward extension of this framework in some particular conditions in section 1.4).

1.3 Hierarchical Bayesian inference to explain visually-guided and predictive smooth pursuit

I became interested in the theoretical framework of probabilistic inference for visual motion processing and smooth tracking eye movements during my post-doc at the *Institut de Neurosciences Cognitives de la Mediterranee*, under the supervision of Guillaume Masson and in collaboration with Pascal Mamassian (ENS, Paris) (Montagnini, Mamassian, et al., 2007; Montagnini, Spering, and Masson, 2006) and throughout the first years after recruitment as

CNRS researcher (Bogadhi, Montagnini, Mamassian, et al., 2011; Bogadhi, Montagnini, and Masson, 2013; Simoncini et al., 2012).

Work by other groups as well my own work have highlighted three main factors that support a role for Bayesian inference in this context: first, the uncertainty (variability) in the sensory input affects motion perception and tracking eye movements in a significant and specific way, as illustrated in section 1.3.3 and 2.4; second, the role of long-term experience and innate Priors is suggested by perceptual and oculomotor biases 1.3.1; third, eye movements seem to result from a genuine decision process, whereby sensory and prior information are weighted taking into account their uncertainty and combined in order to select the optimal option for perception and/or movement 1.3.2 and 1.4.

1.3.1 A visual Bayesian loop to explain oculomotor bias

During my post-doc, I have developed a recurrent Bayesian model to describe the transient direction bias observed in motion perception and smooth pursuit initiation in the presence of ambiguous visual information (i.e. when only local motion information is available and the so called *aperture problem* -see figure 1.3 and its caption for explanation- prevents an unambiguous decoding of global motion direction (Lorenceanu et al., 1993; Masson and Stone, 2002)). This model was grounded on the hypothesis proposed by Weiss and collaborators (Weiss, Simoncelli, and Adelson, 2002) that the noisy and ambiguous sensory information about motion is combined with independent Prior information favouring low motion speed. We extended this idea to a dynamic context by introducing an optimal feedback to update the Prior in time, as illustrated in figure 1.3.

Subsequently, in collaboration with other members of the team and in particular with Amarender Bogadhi (whose PhD thesis was co-supervised by Guillaume Masson and myself), as well as with Pascal Mamassian (CNRS-ENS Paris), we developed a realistic and complete model of human open loop smooth pursuit while tracking an elongated tilted bar, which is typically affected by the aperture problem. To do this, we have taken into account important temporal parameters of neuronal activity of the MT-area in the Bayesian retinal-inferential loop and then we have cascaded the latter with a classical oculomotor model (Bogadhi, Montagnini,

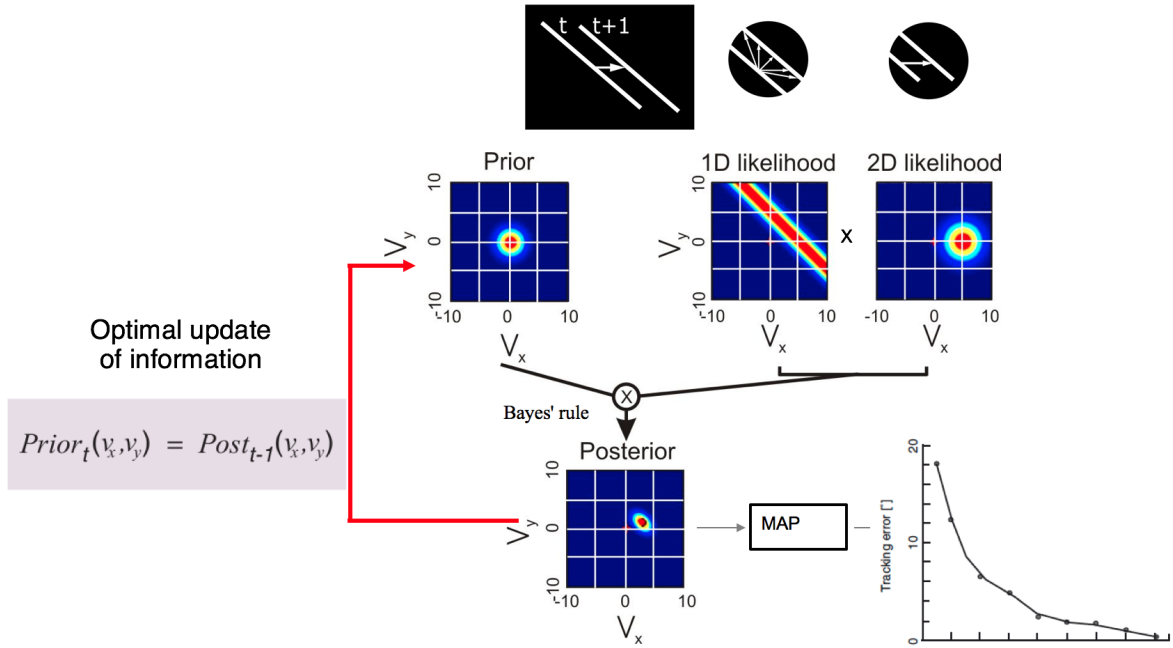

Figure 1.3: The *aperture problem* and Bayesian visual inference. The origin of the *aperture problem* is illustrated in the upper panels of the figure for a long tilted bar moving horizontally: the local information about the displacement of a moving edge (1D) is ambiguous as any point could have shifted to an infinity of other points across a time step. The Likelihood associated to this information is broad and elongated in the the velocity space (middle panels). Conversely, the motion information provided by a *line terminator* (2D) is non ambiguous and its Likelihood is narrow and peaked around the actual global velocity. Combining these motion cues with the low-speed Prior leads to a Posterior with a Maximum (MAP) which is offset from the veridical stimulus velocity, thereby introducing a perceptual bias. We proposed that an optimal, recurrent update of probabilistic information in this model is the mechanism that permits a quick correction of the *aperture*-induced bias. in perception and motion tracking (bottom-left panel).

Mamassian, et al., 2011). The simulated output of the model was able to mimic the initial, open-loop phase of human observers' smooth pursuit and reproduce the parametric modulations induced by a change in stimulus velocity or luminance contrast (see Figure 1.4)

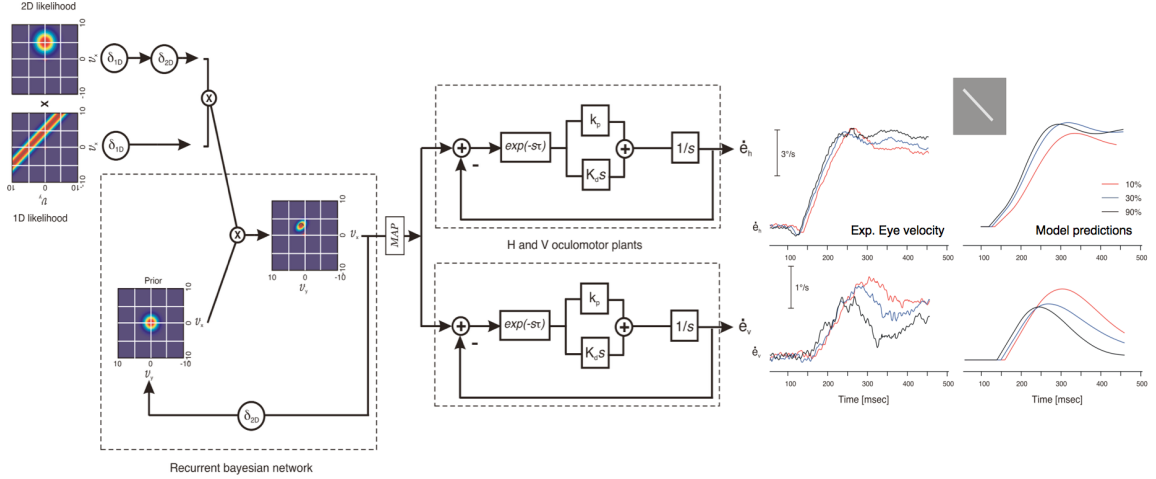

Figure 1.4: We cascaded the recurrent visual inference model of Figure 1.3 (here rotated in the leftmost part of the Figure) with a realistic linear-filter model of smooth pursuit eye movements (middle part). We also introduced some delays in the early visual processing, on the ground of neurophysiological findings in the non human primate. This model predicts eye velocity curves (rightmost part) that qualitatively reproduce the experimentally-observed ones for different values of luminance contrast and speed (not shown).

1.3.2 Integrating multiple cues for smooth pursuit

While the optimal dynamic integration (in the Bayesian sense) of visual information with a priori knowledge seems to reflect well certain illusory phenomena and oculomotor biases, such as the bias induced by the aperture problem, the modalities and limits of this integration remain little understood. For example, during my postdoc, I had shown that the experience accumulated through several trials of target presentation in motion with certain characteristics cannot help reduce the bias to initiate pursuit of a new test (Montagnini, Spering, and Masson, 2006). In collaboration with Amarender Bogadhi and Guillaume Masson, we addressed the issue of the dynamic integration of predictive information and visual input, as well as their relative weight, during different phases of motion processing and oculomotor tracking. To do this, we analysed smooth pursuit eye movements when a target with locally ambiguous motion characteristics (the horizontally moving tilted line) was hidden for a relatively short

time at different moments during a trial. We have thus demonstrated a dynamic interaction between retinal and extra-retinal information during smooth pursuit. From a theoretical point of view, these results open the way for interpretations that deviate from the original simple Bayesian model, which was not able to predict the observed behaviour. These interpretations use the concepts of Bayesian hierarchical inference, or equivalently the Kalman filter model (Orban de Xivry et al., 2013), that postulate a dynamic adjustment of the role of sensory and predictive information. It is interesting to note that this adjustment would take into account the relative reliability (inverse variance) of each source of information, as advocated by optimal cue combination models for multisensory integration (Ernst and Banks, 2002) as well as in other domains of adaptive sensorimotor control (Körding and Wolpert, 2004). We have indeed developed a recurrent and hierarchical (two-level) Bayesian model that is illustrated in figure 1.5 and which allows us to reproduce the experimental results fairly faithfully, with a single free parameter reflecting the persistence of inferential representations over time.

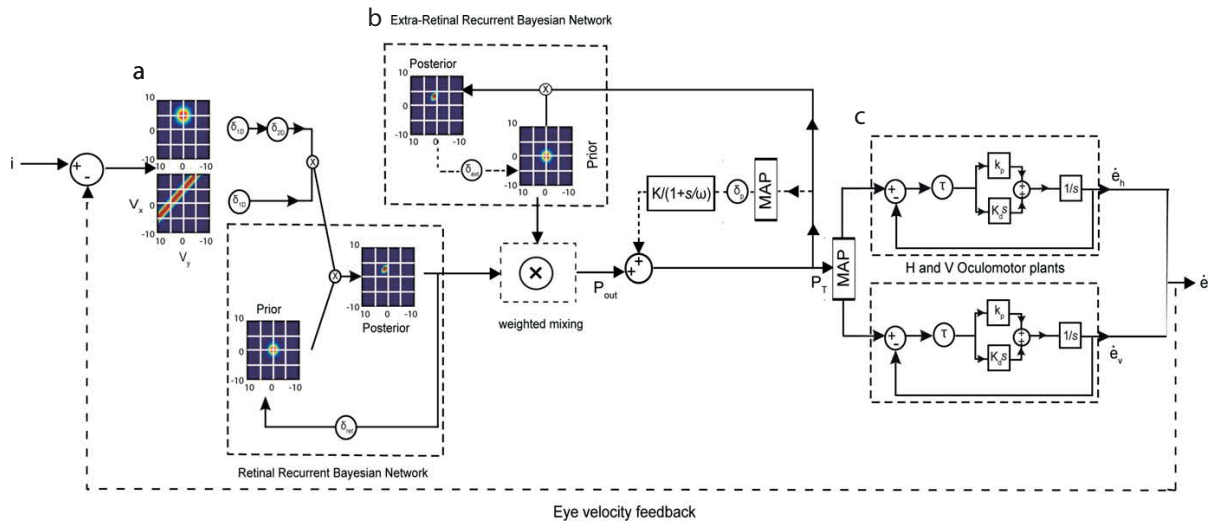

Figure 1.5: Two-stages hierarchical Bayesian model (with retinal and extra-retinal modules) for human visually-guided and predictive smooth pursuit. For the technical details, we refer to the original article (Bogadhi, Montagnini, and Masson, 2013). Briefly, the two inferential loops, grant the optimal combination of retinal and extra-retinal noisy motion information and the output is qualitatively in good agreement with the pattern of observed eye movements, including the transient aperture-bias and the velocity reduction during the transient occlusion of the moving target.

An original article describing these experimental results and the new model of optimal dynamic integration was published in 2013 in the Journal of Vision (Bogadhi, Montagnini, and

Masson, 2013). In addition, all the studies related to this theme and developed with Amarender Bogadhi were presented in his thesis with the title "An experimental and theoretical study of visual motion integration for smooth pursuit - A hierarchical recurrent Bayesian framework". Finally, a chapter entitled *Visual motion processing and human tracking behavior* (Montagnini, Perrinet, and Masson, 2015), which is a fairly comprehensive review of all the studies described in this section and previous work in this area, has been published in *Biologically-inspired Computer Vision* (Wiley).

1.3.3 Smooth Pursuit at low contrast

Some experiments in vision psychophysics have shown that the speed of a moving object is underestimated when the latter is characterized by a low contrast of luminosity (Thompson 1982). These results can be explained, within the Bayesian modeling framework, by the existence of *a priori* cues favoring low motion speed (low-speed Prior, Weiss, Simoncelli, and Adelson (2002), see also Figure 1.2), as already mentioned in the previous section. As a consequence of the Bayesian multiplicative rule for cue combination, this low-speed Prior would play an even more important role when sensory information is degraded (i.e. at low contrast of luminosity). However, these same results are controversial, since other studies have not replicated the same effects in perceptual motion discrimination tasks (Hammett et al., 2007). In collaboration with Laurent Madelain (University of Lille 3) and Guillaume Masson, we conducted a series of experiments to analyze the oculomotor response to a periodic or unpredictable change in contrast of a moving stimulus, during different phases of the ocular pursuit. We were able to confirm that a transient decrease in target contrast results in a systematic reduction in tracking speed, and we could precisely characterize its the dynamics. Overall our data are qualitatively and quantitatively in agreement with the predictions of the simple low-speed Prior inferential model. Importantly, we also observed that the absolute value of contrast induced pursuit velocity modulation depends on the context and history of stimulation: this confirms the idea, presented in the previous section, that sensory information (more or less reliable) is effectively and dynamically integrated with other information sources (such as prediction of uniform and repetitive motion). The results of these experiments were presented at several

international conferences (Madelain et al. 2012 (SfN), 2013 (VSS); Montagnini et al. 2014 (VSS)). An article is in preparation.

1.4 Generalization and limits of the Bayesian inference models for multisensory integration

Bayesian inference models postulate not only the important role of a priori knowledge (Montagnini, Mamassian, et al., 2007; Weiss, Simoncelli, and Adelson, 2002), but also the optimal, reliability-based integration of different sources of information (Bogadhi, Montagnini, and Masson, 2013; Ernst and Bühlhoff, 2004). This theoretical framework has demonstrated its flexibility and validity through several tasks in the fields of sensorimotor integration and perception. However, in the vast majority of cases, these models are applied under relatively simple experimental conditions, such as the integration of two coherent sources of sensory information. In collaboration with Anne Kavounoudias (NIA, University of Aix-Marseille) and her students, I was interested in analysing and modelling the illusory perception of one own hand's motion, which is induced when we stimulate the visual, tactile and/or proprioceptive modality independently or in combination (in a first phase we focused on the visual-tactile combination). Multisensory perception was tested in human subjects with a speed discrimination task, where the perceived velocity of their own hand was compared to the speed of a reference movement. In the case of bimodal stimulation (tactile and visual) the slope of the psychometric curves (related to uncertainty) were in good agreement with an optimal Bayesian model of cue integration (*Maximum Likelihood Estimate*, or MLE, illustrated in figure 1.6). In order to account for the very strong bias in speed perception (the *illusory gain* was actually very low, corresponding to the fact that the hand illusory motion was generally perceived as much slower than the reference), we included a Prior favoring the lowest speeds. This allowed us to account for perceptual bias (see figure 1.6), however, at the quantitative level, the model overestimates, in comparison with experimental data, the reduction of the point of subjective equality (PSE, namely the stimulation value for which the subject perceived hand velocity equals the reference velocity) obtained by combining two modalities in relation to uni-sensory stimuli.

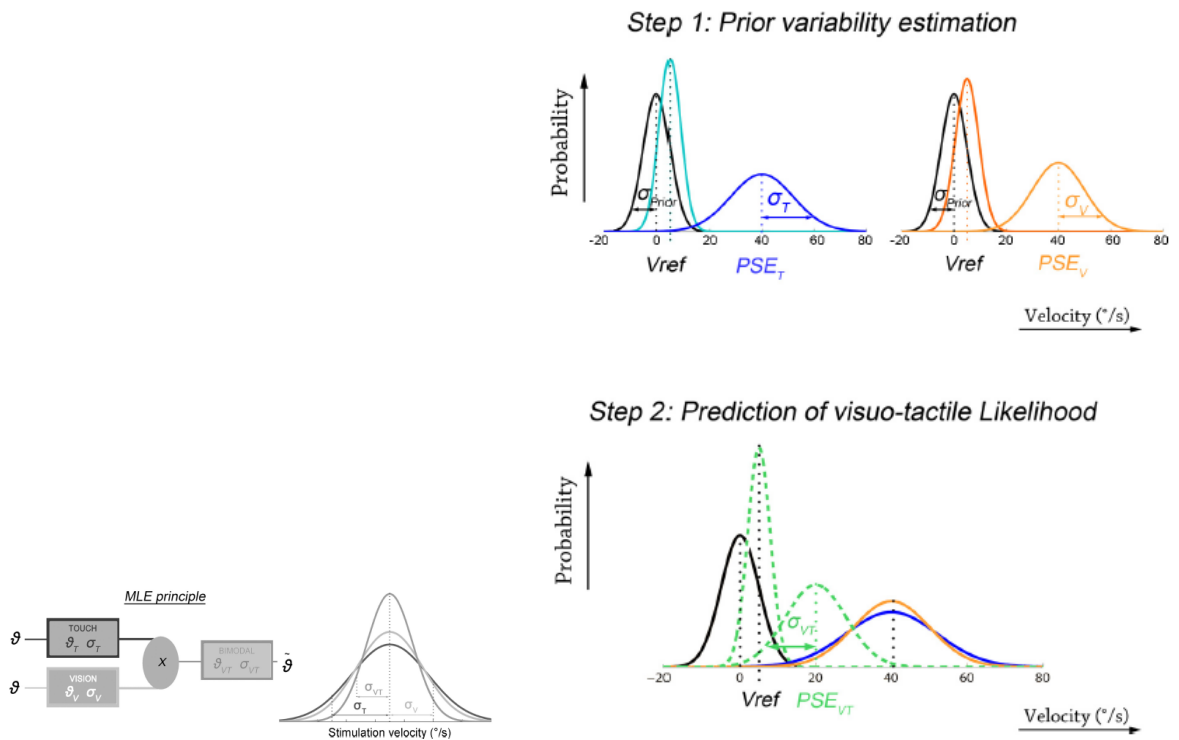

Figure 1.6: Illustration of the Bayesian framework applied to multisensory cue combination. The Maximum Likelihood Principle postulates a reliability-based combination of the unisensory Likelihood distribution, yielding a reduction of uncertainty for the multisensory percept (left panel). The observed perceptual bias, which depends on the number of sensory modalities tested, can be explained by the existence of a Prior favoring low-speeds, that is combined with the multisensory Likelihood.

We hypothesized that the lack of coherence between proprioceptive stimulation (theoretically absent, and nevertheless indicating immobility of the hand) and the other two sensory modalities (indicating a certain hand speed) could be an important factor in explaining these results. To test this hypothesis we have added a non informative proprioceptive stimulation (noisy condition). The psychometric curves obtained (particularly the PSE) in this condition were indeed closer to the model predictions, suggesting that by artificially reducing the reliability of the proprioceptive input, human behavior better matches the Bayesian integration of the two other sensory modalities plus the low-speed Prior. These results were published as original article in the *Journal of Neurophysiology* (2016), for which I shared the last-authorship, see Chancel et al. (2016). Chancel M., Blanchard C., Guerraz M., Montagnini A.*and Kavounoudias A.* (2016) Optimal visuo-tactile integration for velocity discrimination of self-hand movements. *Journal of Neurophysiology* 116,1522-1535.

1.5 Predicting and Anticipating Uncertain Motion Properties

The exploitation of statistical regularities in the sensory world ahead of a sensory event is a common trait of adaptive and efficient cognitive systems that can, on the basis of such predictive information, anticipate choices and actions. For instance, smooth pursuit eye movements do necessarily lag unpredictable visual target motion by a (short) time delay. In spite of this, many years ago, already, it was known that, when tracking regular periodic motion, pursuit sensorimotor delay can be nulled and a perfect synchronicity between target and eye motion is possible (see Barnes (2008) and Kowler, Aitkin, et al. (2014) for detailed reviews). Furthermore, when the direction of motion of a moving target is known in advance (for instance because motion properties are the same across many repeated experimental trials), anticipatory smooth eye movements are observed in advance of the target motion onset (Montagnini, Spring, and Masson, 2006). Remarkably, though, full predictability is not necessary to initiate anticipatory movements, as uncertainty seems to be efficiently taken into account by the system, in agreement with the proposed inferential framework. In the past years I got interested in the role of

probabilistic knowledge about target motion direction or speed, for the control of anticipatory smooth pursuit. In a first study (Montagnini, Souto, and Masson, 2010), human participants were asked to track the motion of a small target moving in one of two possible directions (Right vs Left) and the probability p of occurrence of each direction was manipulated across blocks. In a second companion task, the target moved always in one direction with one of two possible speeds and each speed's probability was manipulated. We have demonstrated that anticipatory smooth velocity is a close-to-linear monotonic function of the probability p of target motion direction (or speed) as illustrated in Figure 1.7. These results have been presented at several conferences, and they have been further replicated under different contexts by our team and other groups (e.g. Damasse et al. (2018) and Santos and Kowler (2017)). From a theoretical standpoint the relation between anticipatory eye movements and the environmental probabilistic structure opens the interesting possibility to estimate the *internal Prior* for motion and analyse its buildup across the time-scale of the experimental trials. The implications of these early findings have motivated several ongoing studies (see section 2.5 of the next chapter) and future research developments which I will describe in chapter 4.

Finally, in collaboration with Frederic Danion (INT Marseille) and others, I have recently addressed another form of permeability of the oculomotor system to predictive information and namely the one related to visually tracking the movement of one own's hand. It is a well-established fact that humans cannot generate smooth eye movements at will: for instance it is impossible to initiate and maintain at length a smooth tracking of an imaginary target with the eyes. However, an exception has been reported in the special condition in which an unseen target is self-moved through the smooth displacement of one's own finger (Gauthier and Hofferer, 1976). Correspondingly, when a visual target on the screen is artificially displaced by the finger's movement, the visuo-oculomotor delay can be practically canceled, suggesting that the finger movement control system can feed the oculomotor control system with predictive information. In this study we analysed what happens when the mapping between the hand and target motion becomes more complex and non-linear. In practice, the target moved on the screen as if it were placed at the end of a spring attached to the participant's fingers. In a very interesting way, the quality of the eye tracking in the condition controlled by one own's hand was initially

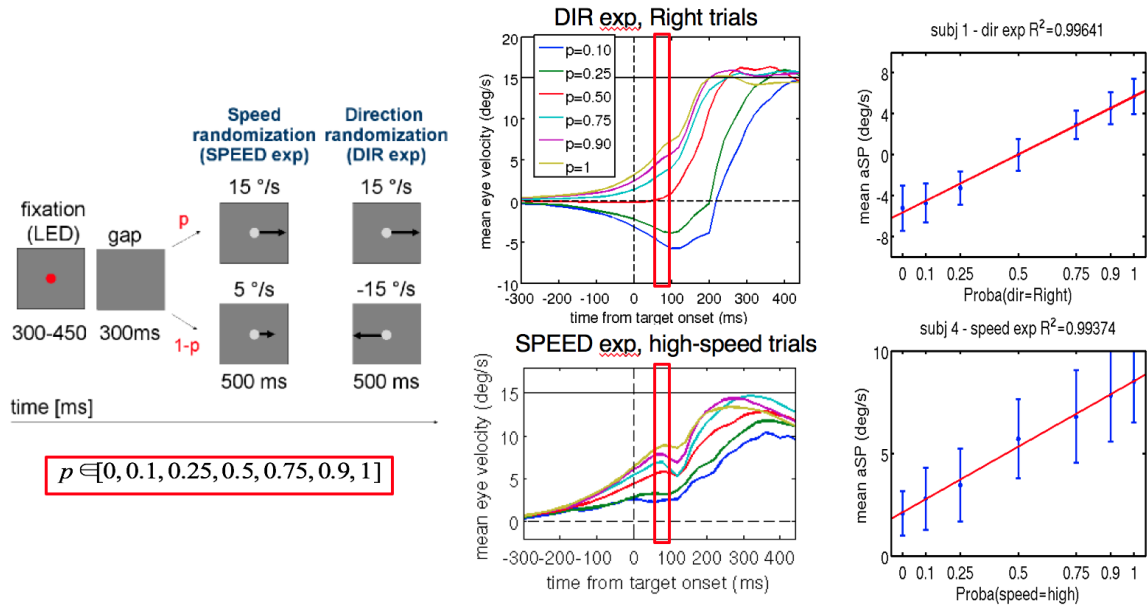

Figure 1.7: Motion probability bias and oculomotor anticipation. We manipulated the probability of direction or speed of a moving stimulus across different experimental blocks (left panel). The mean eye velocity curves for one representative participant show that the eyes start to rotate smoothly toward the expected direction well ahead of target motion onset (middle panels) and this anticipatory velocity scales linearly with the probability of direction or speed (upper and lower right panel respectively) of the moving target.

no better than with a completely unpredictable target. Nevertheless, after a few minutes of practice the performance improved significantly as a result of a modified internal representation. These results were published in the Journal of Neurophysiology in 2016, (Landelle et al., 2016). Landelle C., Montagnini A., Madelain L. and Danion F. (2016) Eye tracking a self-moved target with complex hand-target dynamics. Journal of Neurophysiology 116,1859-1870.

Chapter 2

Active Vision in a Complex Dynamic Environment

2.1 Brief Introduction to Active Vision

The interaction between eye movements, visual perception and cognitive processes is extremely rich and complex and has been the subject of numerous studies for over a century now (as reviewed by Findlay and Gilchrist (2003)). Primates' vision is neither static nor passive in its nature, and this is rather obvious to anyone. However, there is an intimate and complex link between visual perception and eye movements which goes beyond the immediate intuition. As mentioned in section 1.1, the physiology of primates' early visual system sets the constraints for voluntary eye movements, which become the functional dynamic tool to select and optimize visual information processing. This view corresponds to a feedforward model which takes the entire visual scene (and possibly other sensory cues) as input, then operates a filter and selects the areas of interest in the scene which become the targets of orienting eye movements, granting a more detailed analysis. Decades of research have now demonstrated that this one-way feedforward model explains only a part of the story and that a number of other mechanisms are at play during vision. First, exploring a visual scene with saccadic eye movements is not equivalent to be exposed to a sequence of photographs taken from different viewing angles, since dynamic modulations of visual perception take place before, during and after each saccade, as

partly illustrated in section 2.2. Second, even during the *pauses* between saccades, the so-called fixations, the interaction between very small eye movements and visual processing is extremely rich and its analysis and functional interpretation has recently gained the interest of the scientific community as well as of our team (see 2.3). Third, primates' eye movements seem to have a special relation with natural visual scenes: the use of oversimplified synthetic visual stimuli in the standard experiments has now shown its limits, and some evidence has emerged that it is only by using complex stimuli with a statistical structure similar to that of natural visual scenes that some mechanisms underlying visuomotor control can be investigated and understood, as illustrated in section 2.4. Finally, and again contrary to the notion of a mechanistic and hard-wired visuo-to-motor transformation, reinforcement contingencies have proven to have a dramatic effect on many different aspects of eye movements, as exemplified in section 2.5.

2.2 Presaccadic shift of attention

Visual stimuli presented during the preparation of a saccade are more accurately perceived when their location coincides with the saccadic target (Deubel and Schneider, 1996). In turn, when subjects are asked to perform a fine visual task at a given location, saccades toward that location have shorter latency compared to saccades directed elsewhere (Kowler, Anderson, et al., 1995). These phenomena have been interpreted in terms of a tight, mandatory link between oculomotor programming and the deployment of *selective visual attention*, or in other terms, of largely shared mechanisms underpinning selection for perception and selection for action. During my postdoc under the supervision of Eric Castet (at that time at INCM, Marseille), I got interested in the precise nature of this coupling and particularly in the quantitative characterization of any residual independent component of attention during saccadic preparation, both in the temporal and in the spatial domain. A first study of our group (Castet et al., 2006) has shown that visual performance improves dramatically at the saccadic target location and at locations nearby (within a 45deg amplitude cone) during the first 150-200ms after cue onset. A second study (Montagnini and Castet, 2007) has addressed more generally the spatiotemporal distribution of visual resources during saccadic preparation using a dual paradigm, with a primary saccadic task and a secondary perceptual task. The probability that the perceptual target would appear at the

same location of the saccadic target (congruency condition) was manipulated across blocks. We have replicated the finding that perceptual performance undergoes a dramatic spatially-selective improvement at the saccadic target across time during saccadic preparation. More importantly, we have found that the spatial distribution of attentional resources was significantly modulated by voluntary attention (i.e. by the congruency condition) during saccadic preparation. In particular, shortly after cue onset the perceptual performance was not affected by the position of saccadic target. Only with longer delays after cue onset (150ms), a strong bias in favour of the saccadic target location was consistently observed. These findings have been published in two articles in the *Journal of Vision* (Castet et al., 2006; Montagnini and Castet, 2007) and several successive studies by other groups have developed the original idea of a flexible dynamic coupling between oculomotor preparation and visual perception across space (Jonikaitis et al., 2013; Rolfs et al., 2011).

2.3 Fixational Eye Movements and Visual Processing

Our eyes are constantly in motion, even when we are carefully gazing at a detail in the visual image. For a long time, researchers have wondered what the role of these fixational eye movements (FEM) was, and their relationship to visual perception and cognitive performance is still widely debated. Recently I have been interested in these issues. The functional role of the FEM was also the theme of the interdisciplinary team project VISAFIX, which obtained funding from the ANR for the period 2011-2014, as well as the main topic of Sara Spotorno's postdoctoral fellowship that I supervised between 2013 and 2015.

Fixational saccades during fine visual perceptual tasks

In a first study, in collaboration with Sara Spotorno, I analysed the small fixational saccades of human participants during visual information gathering for perceptual detection and discrimination tasks. The results reported by a few studies in the past (e.g. Elsner and Deubel (1986), Hicheur et al. (2013), and Ko, Poletti, and Rucci (2010)) raise an important question: does the pattern of fixational saccades change in an adaptive and strategic way (even though probably

unconscious) according to the fine properties of visual stimulation (for instance its spatial frequency spectrum) but also according to the task, in order to optimize visual perception? To address this issue, we recorded fixational eye movements during the execution of two classical psychophysical tasks: 1) detection of a sinusoidal grating (at different spatial frequency and contrast) embedded in pixel luminance noise, and 2) spatial frequency discrimination of the grating (at different spatial frequency and fixed contrast). We also changed the luminance contrast of the noise. The initial working hypothesis was that saccadic amplitude would adapt to the spatial frequency of the grating (more precisely we predicted that the mean amplitude would approximate the half-period of the grating) in order to maximize the variation in luminosity on the retinal photoreceptors between two consecutive fixations, thus increasing the probability of detection of the network. Contrary to our expectations, our data show a very weak dependence of the participants' saccadic amplitude upon the spatial period of the grating. We also found a strong inter-individual variability. Even when some correlation between the grating's period and saccadic amplitude was present, the peak of the saccadic amplitude distribution did not correspond to the half-period of the network, or a fraction thereof. In addition, there was no systematic correlation between the number or amplitude of fixation saccades and perceptual performance. On the other hand, in the detection task, we observed a systematic effect, on the amplitude and number of fixation saccades, of the signal-to-noise ratio of luminance contrast (defined as the ratio between the Michelson's contrast of the grating divided by the root mean square of the noise contrast). An article reporting all of these results and concluding in favour of the evidence of adaptive visual modulations but no model-optimal adaptive strategy for fixational saccades was published in 2016 (S.Spotorno, G.S.Masson and A.Montagnini (2016) Fixational saccades during grating detection and discrimination, *Vision Research*, 118,105-118, (Spotorno, Masson, and Montagnini, 2016)).

Fixational saccades during the preparatory period

Within the framework of an international collaboration with Anders Ledberg (Pompeu Fabra University, Barcelona, European Brainscales network), I addressed the analysis of fixational eye movements during the time interval between a cue and the visual stimulus (*foreperiod*)

during a Go-NoGo visual discrimination task. The motivation for this analysis was based, on the one hand, on the observation that visual performance generally improves with the duration of the foreperiod and, on the other hand, that the fixational saccadic rate decreases during the foreperiod in several visual tasks (Rolfs, 2009). In our study we analyzed two parallel sets of results, including neuronal recordings in non-human primates and ocular movement records in human volunteers, obtained with the same behavioural task. We have shown that the variability of neuronal activity in the visual cortex is negatively correlated with the duration of the foreperiod as well as with the average reaction time in the discrimination task; at the same time we have observed that the variability of eye fixation decreases with the duration of the foreperiod. These results suggest that reducing visuomotor variability may be an effective multi-level strategy for optimizing visual performance when the timing of stimuli is at least partially predictable. All these results were the subject of an article published in the Journal Plos ONE. (A.Ledberg, A.Montagnini, R.Coppola, S.L.Bressler (2012) Reduced Variability of Ongoing and Evoked Cortical Activity Leads to Improved Behavioral Performance. PLoS ONE 7(8), e43166, (Ledberg et al., 2012).)

Visual symmetry and fixational eye movements

In collaboration with Andrew Meso, post-doc researcher in the team between 2012 and 2015 and now at Bournemouth University, Jason Bell (University of Western Australia) and Guillaume Masson, we have tried to understand whether a very prominent property of visual stimuli at the perceptual level, symmetry, could influence fixational eye movements. Participants observed black and white dot textures that were either completely randomly distributed or symmetrical with respect to an oriented axis of symmetry (horizontal, vertical or oblique). In two different experiments they had to either passively observe these textures or discriminate the orientation of the axis of symmetry. We observed a systematic bias in the direction of the small fixational saccades during the observation of symmetrical images, with a peak of the direction distribution matching the direction of the symmetry axis (see Figure 2.1). This bias is present both in passive observation and in the active discrimination task, it appears during the first 500ms of observation and persists throughout the fixation period, suggesting that this modulation

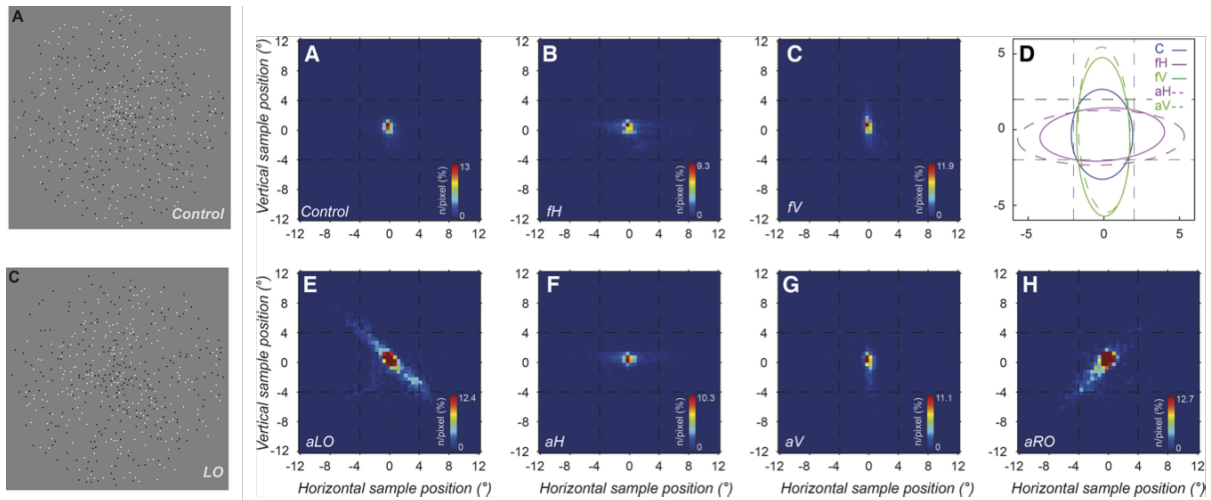

Figure 2.1: Left column: examples of non-symmetric control (above) and symmetric (below) random-dot textures. Heat-maps in panels A to C and E to H show the gaze position density for one representative subject during the passive observation (f, panels A to C) and the active discrimination task (a, panels E to H) and across different texture conditions (Control: asymmetric random texture; Orientation of the symmetry axis: H=horizontal;V=vertical;LO=left oblique;RO=right oblique). Panel D: best-fitting ellipses to the 2D-Gaussian distributions of gaze positions for the Control and the Horizontal and Vertical axis of symmetry (in both tasks).

is automatic in nature. A publication reporting this study was published in 2016 (A.I.Meso, A.Montagnini, J.Bell and G.S.Masson (2016) Looking for symmetry: fixational eye movements are biased by image mirror symmetry. Journal of Neurophysiology 116(3),1250-60., (Meso et al., 2016)).

2.4 Role of the stimulus' spatiotemporal statistics for motion perception and oculomotor responses

The properties of low-level visual processing are very often studied by means of highly simplified visual stimuli, like small circular patches or gratings. However, the optimal nature of natural scenes as visual stimuli has been highlighted several times in vision research (see for example Olshausen and Field (1996)). It therefore becomes interesting to study more complex stimuli, which share the rich structure of natural scenes while remaining well controlled from the point of view of visual characteristics and avoiding to deal with higher-level information processing (no object is represented in Motion Clouds). In the framework of Claudio Simoncini's doctoral

thesis (led by Guillaume Masson and co-supervised by myself), we have been interested in the characterization of visual perception and short latency reflex eye tracking response (Ocular Following Reflex -OFR) in function of the continuous modulation of the spatio-temporal frequency spectrum of complex moving stimuli (Motion Clouds, Leon et al. (2012)). The results obtained show an interesting dissociation (illustrated in Figure 2.2) between the perceptual performance (deterioration of speed discrimination) and OFR response (improved oculomotor gain and sensitivity) when the bandwidth of spatial frequencies present in the stimulus is enlarged. It is important to point out that this kind of dissociation, rather unintuitive, could

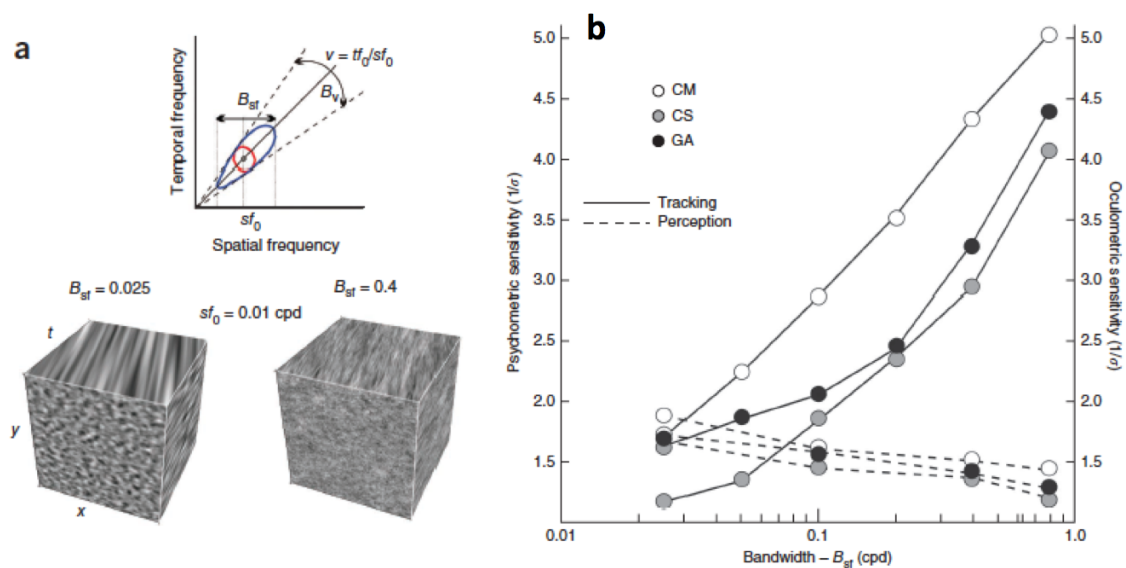

Figure 2.2: Motion Clouds stimuli for motion perception and tracking. (a) In the space representing temporal against spatial frequency, each line going through the origin corresponds to stimuli moving at the same speed. A simple drifting grating is a single point in this space. Our moving texture stimuli had their energy distributed in an ellipse elongated along a given speed line, keeping constant the mean spatial and temporal frequencies. The spatio-temporal bandwidth was manipulated by co-varying B_{sf} and B_{tf} , as illustrated by the (x, y, t) examples (the front face of the cube correspond to a single frame of the Motion Cloud). (b) A direct comparison between perceptual (dashed lines) and oculomotor (solid lines) performances represented by plotting normalized sensitivities against B_{SF} for three participants.

not have been highlighted by using classical, excessively simplified stimuli. In collaboration with Pascal Mamassian, we developed a model for decoding the neuronal activity of primary visual areas that would account for the differences between observed perceptual performance and oculomotor response. In particular, a gain control would be implemented differently depending

on whether the motion signal is used for the perception of speed or for its estimation in order to program a fast eye movement. These surprising results, as well as the simple adaptive gain model that qualitatively captures them, have been the subject of several presentations at international conferences and an article has been published in a very prestigious journal in our field (C. Simoncini, L. U. Perrinet, A. Montagnini, P. Mamassian and G. S. Masson. More is not always better: dissociation between perception and action explained by adaptive gain control. *Nature Neuroscience* 2012).

A first objective of Kiana Mansour-Pour's thesis (co-supervised by Guillaume Masson, Laurent Perrinet and myself) was to replicate and generalize these results for voluntary eye movements such as smooth pursuit eye movements. Kiana did indeed show results similar to those observed for the OFR response, but also an interesting interaction between the central frequency and the bandwidth. She is currently studying the role of local speed variability in Motion Clouds for motion perception and oculomotor tracking. The results indicate that both eye movements and perception depend in a non-linear way upon speed variability, and that extremely large values of this variability lead to a dramatic impairment in motion estimation, motion tracking and the transition to drastically different percepts (*transparent* motion). Kiana is currently probing the nature of motion perception across a large set of random textures with different speed components by implementing an original psychophysical task (*Maximum Likelihood Difference Scaling*). In parallel, in the framework of her PhD project we are also interested in the computational modeling of the experimental observations and in particular we aim at extending existing models of the cortical encoding of visual speed across spatiotemporally-tuned channels (Gekas et al., 2017) to the case of broad speed distribution. These results have already been presented in international conferences (EVCVP 2016 and 2017; SfN 2016) and a first paper is in preparation.

2.5 Reinforcement and Eye Movements

The oculomotor system has often been treated as a servo-mechanism controlled by the representation of a simple sensory input and the relative position (or velocity) error signal. For example, the appearance of a salient stimulus in the periphery triggers an ocular saccade with

a delay of about 200ms, which directs the fovea towards the stimulus minimizing the retinal position error. Even more stereotypically, smooth eye tracking was traditionally modeled, in its open-loop phase, by a linear filter that transforms the estimation of an object's speed into the acceleration of the eyes, with the aim of aligning the gaze and the moving object. However, several research groups over the past 30 years have shown that eye movements are controlled by highly efficient mechanisms, capable of a strong adaptivity in a complex and changing environment. Eye movements are indeed permeable to the influence of different types of cognitive processes (Barnes, 2008). Recently, several experimental paradigms manipulating reinforcement contingencies have demonstrated that voluntary eye movements (saccades, and to a lesser degree smooth pursuit) can be considered as operant behaviours (for a review, see Madelain, Paeye, and Darcheville (2011)). A collaborative project between researchers at INT (Frederic Danion, Laurent Perrinet and myself) and at Lille University (Laurent Madelain and Jeremie Jozefowicz) addressing this novel and fascinating framework has been funded between 2014 and 2017 by the ANR. I will illustrate here two of the studies conducted in collaboration with PhD students whose thesis has been funded by this grant. Interestingly this approach is tightly related to some of the topics of interest of my PhD thesis.

Role of postsaccadic visual perception for saccadic oculomotor programming

During my PhD under the supervision of Leonardo Chelazzi (University of Verona, Italy) I had demonstrated that by manipulating the objective probability to successfully perform a visual discrimination task after a saccade, it is possible to affect saccadic parameters such as latency and peak velocity (Montagnini and Chelazzi, 2005). This early result was suggestive of a strong flexibility of oculomotor programming (for similar findings, related to the mere visibility of the saccaded stimulus or the specific identity of it see also Collins (2012) and Xu-Wilson, Zee, and Shadmehr (2009)), presumably aimed at optimizing the perceptual performance across eye movements, and not compatible with an oversimplistic servo-system view. Somehow inspired by these findings, in collaboration with Laurent Madelain (University of Lille) and Sohir Ramouni, PhD-student in the same lab, I was more recently interested in a paradigm that investigates the

effect of post-saccadic visual perception on the planning of saccadic metrics, namely amplitude and direction. For this reason, we have set up an original task of adaptation. Instead of manipulating, as in the classic adaptation paradigm, the offset between the position of the visual target and the gaze after the saccade (obtained by means of a target jump during the saccade and typically unnoticed to the subject), we manipulated the probability of correctly discriminating a visual stimulus after the saccade. Such probability was determined depending on the amplitude or direction of the saccade. In other words, by means of a gaze-contingent procedure, we made the saccadic target disappear during the saccade and we made the perceptual *discriminandum* visible only when the amplitude of the saccade was small, for example, compared to the expected amplitude. In order to solicit a saccadic adaptation induced not by the target jump and consequent retinal error but by the visibility of the target. Different variants of the original task have been tested on a large pool of participants and, although inter-individual differences remain strong, positive results have been observed. These results have now been presented at several conferences (VSS meeting 2017, ECVF 2017) and an article is in preparation.

Role of reinforcement contingencies on anticipatory smooth pursuit

In section 1.5 I have described the dependence of anticipatory smooth pursuit upon target direction (or speed) probability. In the context of Jean-Bernard Damasse's PhD thesis (supervised by myself and Laurent Perrinet), we have built up on these empirical observations and addressed more in depth the characterisation of anticipatory smooth pursuit. In particular, we have tackled the possibility of influencing anticipatory smooth pursuit by manipulating its consequences at different levels. In a simple smooth tracking task where the probability of target direction was biased across experimental sessions, we used the on-line estimate of the anticipatory eye velocity (measured during the 100ms preceding the appearance of the target) to assign a reward (corresponding to the gain of 30 euro cents and signaled by the green color of the pursuit target) or a punishment (loss of 10 euro cents, red target) depending on the relationship between the estimated eye velocity and an adaptive velocity-criterion. In the first condition, for example, an estimated eye velocity above the criterion (defined as the median anticipatory eye velocity during the past 20 trials) was rewarded. With this gaze-contingent procedure we were able to

show a significant modulation of the anticipatory behaviour (see Figure 2.3), which suggests that even this very early phase of predictive oculomotor control remains very permeable to the behavioral context and in particular to reinforcement contingencies.

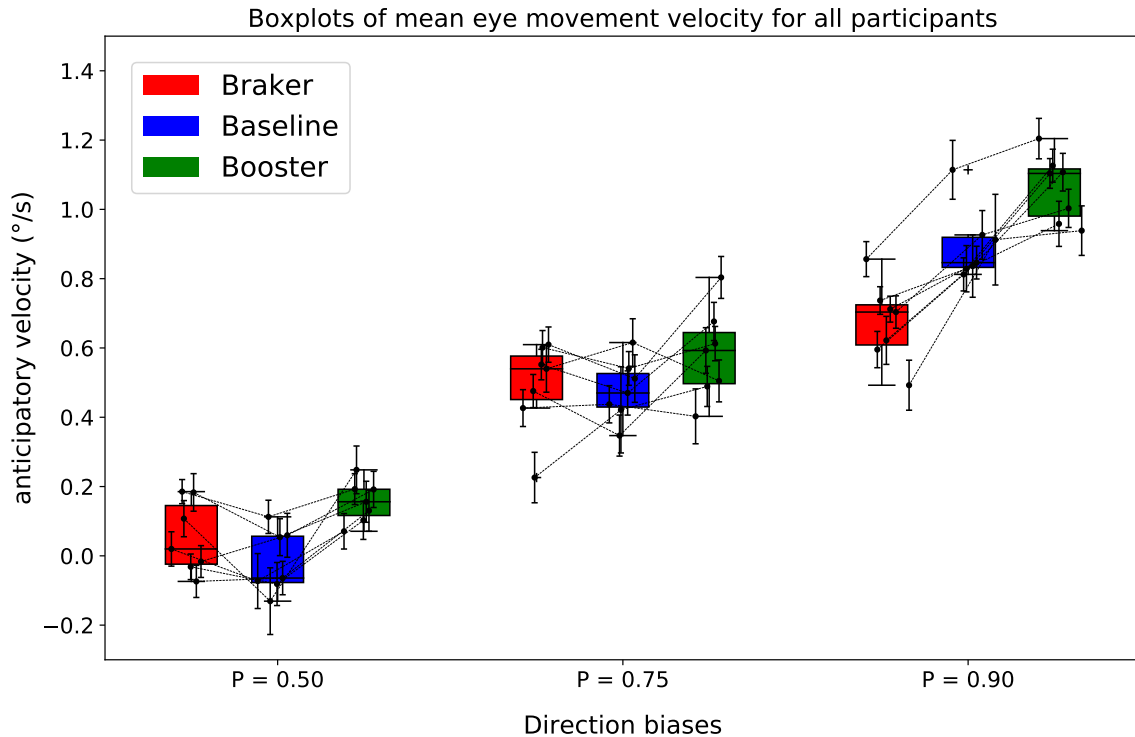

Figure 2.3: Effect of direction bias and reinforcement on anticipatory smooth pursuit. Boxplots of anticipatory eye velocity for the whole group of participants in all direction-bias sessions and reinforcement conditions. Individual mean velocities and 95% Confidence Intervals are also presented with black symbols connected by thin lines

Complementary experiences have highlighted the specificity of these effects, because in a "yoked" control group, the random attribution of rewards and punishments did not result in a systematic modulation of smooth pursuit anticipation. Furthermore, in a classical conditioning paradigm, the arbitrary association between direction of movement and expected reward, not contingent to the participants eye movements, has given rise to very limited modulations in anticipatory behaviour. Altogether these findings point to an *operant* nature for anticipatory smooth pursuit. Surprisingly, the experimental manipulation of visual or perceptual consequences of anticipatory smooth pursuit has failed to yield a similar modulation of eye movements in our study. All these observations have been presented at several international conferences and an article has recently been submitted for publication.

In a second study, Jean-Bernard Damasse and I have addressed the question of whether and how the expected reward associated to each of two moving targets affects different phases of human eye tracking, from the anticipatory epoch, through movement initiation and then target selection. The association between target-choice and reward has been defined according to an adapted version of the *Iowa Gambling Task* and different target properties (motion direction or color) could be associated to the monetary gain or loss in different experiments. Our results with young healthy participants highlight a very early tracking bias toward the selected target when the gain/loss schedule is associated to the target direction and to a lesser degree to the target color, in comparison to a baseline condition with no reward association. Surprisingly, target choice was most often suboptimal, with the exception of few participants, possibly indicating that high-level gain-optimization strategies can hardly permeate a quick sensorimotor decision, whereas a more immediate and instinctive reward related preference can affect it. Finally, during an in-doc visit to Miriam Spering's lab at the University of British Columbia, Jean-Bernard has administered an adapted version of this experiment to Parkinson's Disease (PD) patients, both on and off medication, as well as to age-matched control subjects. Beside a general impairment in oculomotor performance (both in PD patients and age-matched controls) results seem to indicate that the reward-schedule has a much weaker effect on early phases of smooth pursuit compared to young controls. The analysis of this study is almost complete and a manuscript is in preparation.

The two sets of experiments described in this section, together with a deeper computational analysis of sequential effects on anticipatory smooth pursuit (under different conditions of reinforcement and target direction probability), will constitute the original material of Jean-Bernard's PhD thesis, under the supervision of Laurent Perrinet and myself. Jean-Bernard is now writing the thesis manuscript and I expect him to defend before the summer 2018.

Chapter 3

The neuro-functional bases of visuomotor decisions

Introduction

The analysis of human visuomotor behavior in well controlled tasks has nourished a vast literature about sensory, motor and cognitive processes. The large majority of my research work consists in the design of ad-hoc controlled experiments and in the analysis of the recorded behavior of human participants, be this made of perceptual judgments or eye movements, and I remain a firm supporter of this approach (see some considerations in the Conclusion). Nonetheless, I think that it is exactly when the experimental analysis of behavior provides a solid ground for hypotheses about the underlying neuronal circuits and computational rules, that it is worth trying to have a closer look at what happens in the brain, by gathering different complementary measures. Within a long-term collaboration with Boris Burle (LNC Marseille) and with Mathieu Servant, a PhD student co-supervised by Boris and myself, we have addressed the analysis of visuomotor decisions in presence of conflictual information. In section 3.1 I review the three main studies that have constituted Mathieu's PhD thesis, relying on a behavioral, electrophysiological (EMG and EEG) and modelling (stochastic accumulation models of decision) approach.

Bayesian inference theory advocates an optimal combination of information associated with different signals (e. g. visual and auditory stimuli, see Ernst and Bühlhoff (2004), or sensory

and predictive information, Bogadhi, Montagnini, and Masson (2013) and Orban de Xivry et al. (2013)), where the contribution of each signal is weighted by its reliability (the inverse of its variance). However, in its simplest form, this very general model of integration does not take into account aspects that are important under natural and more complex conditions than the classical laboratory paradigms, such as possible differences in the dynamics of the neuronal population coding of each signal, or different motor responses, as well as the effects of context, which may, for example, facilitate or inhibit the processing of one signal over the other. As long as we do not understand with more detail how the different noisy signals affecting a sensorimotor decision are represented in the brain, we will not be able to formulate general predictions about their integration and the final outcome of a decision. On top of an extended literature in monkey neurophysiology which has largely addressed the oculomotor system, a few recent studies have attempted to analyse the activity of neuronal populations in the human brain during visuomotor decisions (O’Connell, Dockree, and Kelly, 2012). If one hopes to investigate the causal involvement of different neuronal populations for different specific processes in humans, non invasive brain perturbation techniques could provide a valid experimental tool, with the caveat that they rely on a relatively accurate localisation of the targeted brain areas. In section 3.2 and 3.3 I describe two recent attempts of mine to go into this direction, in collaboration with experts of these techniques. Neither of these attempts has been particularly successful, but yet, I envisage to further explore non invasive brain stimulation techniques in the near future (see chapter 4) in order to transiently and locally perturb target areas with clear hypotheses for their involvement in visuomotor decisions.

3.1 Modeling visuomotor decisions under conflict: behavior and electrophysiology

The Simon task is a well-known task in cognitive psychology, which studies the effect of interaction between two sources of visual information (e.g. colour and position of a stimulus) on visuomotor programming (illustrated in Figure 3.1, right panel). In general, in the Simon task, one of the two attributes (e.g. color) is defined as the task-relevant feature, while the other

attribute (position) has a neutral role (not relevant) in relation to the decision, but it implicitly shares some spatial compatibility or incompatibility with the response. The compatible condition is, for instance, when the stimulus position is to the right and the task requires a response with the right hand. The classic effect highlighted by the Simon task is an interference effect, which results in longer reaction times when the neutral attribute is incompatible with the response associated with the relevant attribute. Similarly, other classic experimental paradigms give rise to interference phenomena, such as, for instance, the Eriksen task (or flanker task, see Figure 3.1 left panel), where the perceptual target is surrounded by distractors which share (compatible condition) or not (incompatible condition) with the target the task-relevant attribute.

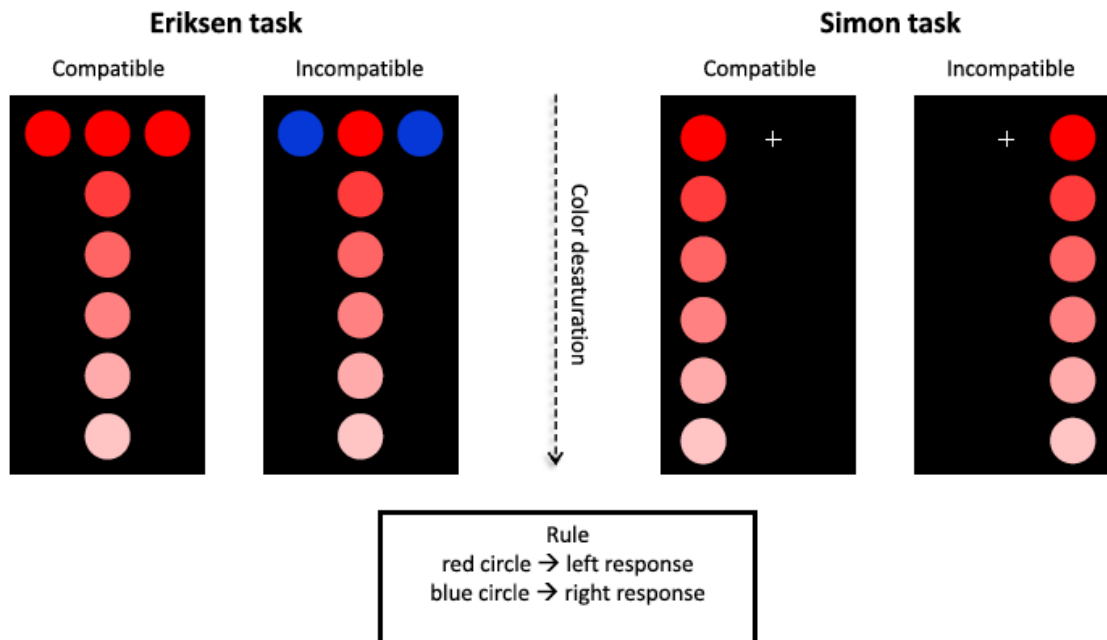

Figure 3.1: Illustration of two classical visuomotor tasks used to study the interference of task-irrelevant information, the Eriksen or *flanker* task (left panel) and the Simon task (right panel).

The standard models of decision-making based on the stochastic accumulation of sensory evidence to a response-triggering threshold (e.g. *Drift Diffusion Models*, DDM, Ratcliff and Rouder (1998), some schematic illustrations of variants of this model are presented in Figure 3.2), have generally proven successful in mimicking behavioural data (distribution of reaction times and response accuracy) under simple experimental conditions. The advantage of these models is that the critical parameters have been linked to well-identified perceptual and cognitive

variables, such as Prior expectancy, sensory salience or speed-accuracy tradeoff. However, these models are not able to capture the data observed during conflict tasks, including the dynamic interference effects. In collaboration with Boris Burle and Mathieu Servant, I addressed this kind of issues. In a first behavioural study we have implemented a flanker task where we manipulated the intensity of the visual input (the color saturation, as illustrated in Figure 3.1). We have analysed the participants' manual reaction time distributions and their choice accuracy across conditions of target salience and target-distractor compatibility. This has allowed us to highlight the limitations of drift diffusion models even in their most recent and dynamic version (i.e. the *time-varying Rate Diffusion Model*, Hübner, Steinhauser, and Lehle (2010) and White, Ratcliff, and Starns (2011)). An article reporting these results was published in the *Journal Cognitive Psychology* (Servant, Montagnini, and Burle, 2014). Neurophysiological research on the neuronal substrates of decision making has recently attracted considerable interest (e.g. Gold and Shadlen (2007) and Shadlen and Kiani (2013)), and the activity of certain neural populations in the parietal and frontal areas in awake monkeys has shown interesting correlations with functional predictions of diffusion models. Fewer electrophysiological studies in humans have been carried out, mainly based on functional magnetic resonance techniques (fMRI) or electroencephalography (EEG, O'Connell, Dockree, and Kelly (2012)). With the second study of Mathieu Servant's thesis, we have analyzed the electromyographic signals (EMG) of agonist muscles of both participants' hands while they were involved in the response to the flanker task. These signals were used to test and constrain the functional assumptions of time-varying drift diffusion models (Hübner, Steinhauser, and Lehle, 2010; White, Ratcliff, and Starns, 2011). In particular, the so-called *partial errors* (see Figure 3.2), where an EMG activity corresponding to the wrong response is detected before a correction process is put in place and the correct response is given, provide extremely interesting data for the validation of these models. In our study, the analysis of the partial errors did for instance challenge the notion of independence between decision making and motor execution. An article on experimental results and modeling of these data was published in the *Journal of Neuroscience* in 2015 (Servant, White, et al., 2015a). In a third study, the analysis of EEG recordings during the Simon task finally allowed us to corroborate (but also partially correct) a very recent model, proposed by Ulrich and

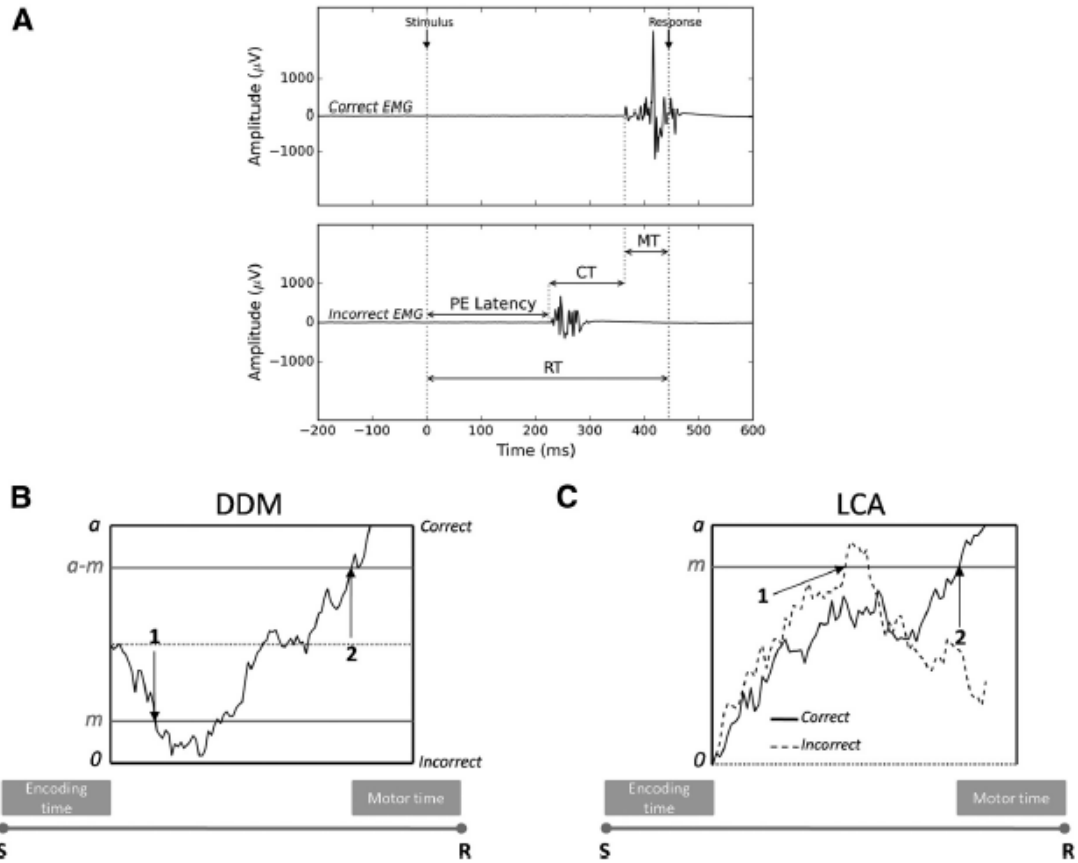

Figure 3.2: EMG partial errors and the sequential sampling model framework. (A) EMG activity (in μV) of the muscles involved (Correct EMG, top) and not involved (Incorrect EMG, bottom) in the required response as a function of time (in ms) from stimulus onset. Partial motor activity in the incorrect EMG channel precedes the correct response. RT, Reaction time (from stimulus onset to the mechanical response); PE, partial error; CT, correction time (from the incorrect EMG activation to the correct one); MT, motor time (from the correct EMG activation to the mechanical response). (B) Extended DDM scheme. EMG bounds were incorporated within the response selection accumulator at locations m (incorrect EMG activation) and $a-m$ (correct EMG activation). EMG bounds do not correspond to an actual choice. Evidence continues to accumulate until standard decision termination bounds are reached. Therefore, part of the MT overlaps with the decision time. The decision sample path represents a partial error trial. Arrows correspond to EMG events: 1 onset of the partial error, 2 onset of the correct EMG burst. S, Stimulus; R, mechanical response. (C) Extended LCA model (not described in this manuscript, we refer to the article - Servant, White, et al. (2015b)- for details).

colleagues (Ulrich et al., 2015) to account for the behavioural data characteristic of Simon’s task. This model is based on the accumulation - within the framework of a generalized DDM - of an evidence signal resulting from the dynamic superposition of an automatic and transient signal, essentially related to the position of the stimulus, and a signal that is more controlled and sensitive to several characteristics of the stimulus. Plausible correlates of these two components were indeed demonstrated in the EEG signals, in particular thanks to the identification of an early negative peak (MN150) in the primary motor area (M1) contralateral to the stimulus location and independent of its color. The predictions of Ulrich’s model, as well as certain variants of it, could be compared with all the experimental results (behaviour, EEG and EMG), thereby clarifying the value and limitations of the different models. This study was published in the Journal of Cognitive Neuroscience in 2016, (Servant, White, et al., 2016).

3.2 Physiological mechanisms underlying visuomotor decisions: information transfer between different effectors, behaviour and brain perturbations (TMS)

The ability to predict the sensory consequences of movements and to actively use this prediction has a huge importance for our brain: a typical example of this ability is the reduction of sensitivity to the relative visual motion of the environment when we move our eyes. Another function for which this prediction plays an important role is the coordination between different effectors: our eyes can precisely follow the movement of our own finger, almost without delay, and even in darkness. The hypothesis of the existence of an *efference copy* of the motor plan, which would transmit this kind of information, has been made long ago, but the exact nature of this signal is far from being understood and its physiological correlates remain poorly established. In collaboration with Frederic Danion (INT) and other colleagues, we focused on hand-eye coordination and investigated whether motor signals coming from the primary motor area M1 could play a role for the programming of an eye movement toward a visual target whose position was *artificially* linked to a hand movement. The subject was instructed to make an ocular saccade towards a visual target that was displaced on the screen. In the hand-movement-

contingent condition, the participant controlled voluntarily the target's displacement by means of a movement of her hand, connected to a force-sensor. In the stimulation condition, we have used a classic single-pulse TMS stimulation paradigm of the hand-related area of the primary motor cortex, which caused an involuntary hand movement to trigger the jump of the visual target on the screen, again by acting on a force sensor. Our working hypothesis was that the signals triggered by the stimulation on M1 could facilitate eye movements by reducing the saccade latency in the same way as the force sensor's voluntary compression: in the stimulation condition such facilitation would be coherent with the presence of an efference copy signal downstream of M1. This facilitation was indeed observed for all participants, in terms of a significant reduction of saccadic latency. Unfortunately, it was impossible to irrefutably distinguish this effect from a generic alert effect due to the acoustic noise or the mechanical vibration produced by the TMS on the skull, as shown by ad-hoc control experiments. This conclusion points to the risks and limitations of online TMS stimulation for the analysis of behavioural perturbations at the typical time scale of sensorimotor latencies. The careful monitoring of any unwanted warning and prediction cues will be necessary for future experiments.

3.3 Non Invasive Transcranial Brain Stimulation during a visuo-oculomotor task

In 2017, within the mobility-program of the CNRS and Aix-Marseille University, I spent four months as visiting scientist at the Center for Neuroscience and Cognitive Systems of the Italian Institute of Technology in Rovereto (Italy), within the group led by Dr Lorella Battelli, who is a world-leading expert in non-invasive brain stimulation in vision. Our collaborative project aimed at extending some of their recent findings on the facilitatory effects of online transcranial electrical stimulation in visual perceptual learning, to the framework of probabilistic learning and motion tracking. For this reason I have adapted the motion direction-bias paradigm described in section 1.5 in order to analyse visually-guided and predictive tracking eye movements under different conditions of visibility and of probabilistic direction-bias while applying transcranial Random Noise Stimulation (tRNS) to human volunteers. In particular, we probed the role of

key cortical areas for the control of predictive eye movements as well as for motion vision and, by applying tRNS over the frontal, parietal, and occipital cortex, plus a sham control condition with no stimulation, in separate sessions. In addition to the block-wise manipulation of target direction probability, in half the trials (blank-trials) the moving target was transiently occluded for 800ms during its motion. As expected, (a) robust anticipatory pursuit was observed before motion onset in the biased condition and (b) pursuit velocity was reduced during the target blank. Interestingly, the direction-biased condition, sustained predictive pursuit during blank was stronger in the more likely direction, suggesting the novel idea that information integrated over a long trial-sequence can be combined with the within-trial visuomotor memory. Somehow unexpected to us, tRNS over parietal cortex facilitated the occurrence of predictive saccades during the blank, whereas neither the visually-guided, nor the predictive pursuit before target onset was modulated by tRNS applied to any of the targeted areas. A possible explanation for this lack of effect on smooth pursuit is that the putative area related to predictive smooth-pursuit control is located quite deep in the Frontal Eye Fields and the tRNS technique might not allow to efficiently stimulate at that depth in the cortex. We plan to test this type of perturbation paradigm in the future (see section 4) with a more efficient technique, the transcranial magnetic stimulation, TMS, with a better constrained localisation of the perturbation site in the cortex. The results of the first experiments have been presented at the European Conference on Visual Perception in Berlin, 2017.

Part II

Future Research Developments

In this part I will outline some research lines that I wish to develop in the next years (say within 5 years from now, probably more...). All of these projects are clearly rooted in my past and ongoing research, but they also contain some important elements of novelty. I plan to refocus my research objectives around one central conceptual framework: modelling simple sensorimotor and perceptual decisions. In terms of experimental techniques and methodology I wish to acquire some advanced know-how in the modern non-invasive brain stimulation methods, as well as in functional magnetic resonance imaging. These measures will not substitute but rather complement the psychophysical and oculomotor recordings, which are the core of my expertise and which can provide a valuable online readout of ongoing perceptual and cognitive processes. I wish to pursue and strengthen the model-based approach to sensorimotor control and adaptive learning, which proves to be most fruitful when model predictions are directly tested with appropriate experiments and experimental results are fed back into the models to refine or refute them. The theoretical framework of probabilistic inference seems to provide a valid and interesting guideline to model sensorimotor control. Finally, I would like to broaden the scopus of the experimental analysis of eye movements to include pathological populations, with the aim, on the one hand, to pinpoint specific deficits in sensorimotor decision-making in patients and, on the other hand, to gain insight on the brain areas and functions which are necessary for specific inferential computations and for efficient performance in this kind of tasks. Taking advantage of the ongoing collaboration with researchers of the SCALP team (INT) and the Adolescent Psychiatry Unit of the Marseille Public Hospital, we aim at analysing in detail the oculomotor performance of young patients diagnosed with the Autistic Spectrum Disorder (ASD), as well as healthy adolescents as controls, during sensorimotor tasks in presence of sensory uncertainty and predictive cues. Another interesting development toward translational and clinical research on Parkinson's disease could stem from a recently established collaboration with researchers and clinicians at the University of British Columbia in Vancouver, Canada.

Some of the projects for future research are already defined in the context of ongoing collaborations (see sections 4.1, 4.3, 4.4, 4.5, 5.2) and all of them will involve, I hope, the contribution of young researchers (Master, PhD students or post-docs) that I will supervise. In chapter 4 I outline a big project on the brain encoding and representation of probabilistic

information for oculomotor (and other sensorimotor) tasks: this attempt will involve behavioral, computational, electrophysiological and brain-stimulation studies. A part of this project is currently the object of an application for funding as multi-approach collaborative research within the InViBe team. In chapter 5 I present some research projects sharing the common assumption that the visuo-oculomotor control is an ideal model system to study decision-making mechanisms (spanning sensory, motor and cognitive functions) across different time-scales in normotypical and pathological brains. In this vein, for instance, I wish to address across different populations, the efficacy of eye-movements as *information-foraging* tool, as well as the interaction with visual perception and selection mechanisms.

Chapter 4

Probabilities and the Brain

In the past decades many scientists have been attracted by the idea that probabilistic inference is a major function of the brain. On the one hand, the plausibility of a representation of probabilities in the activity of neural populations has been proposed and supported by computational models (Pouget et al., 2013). On the other hand, the elaboration and processing of such probabilistic information across a hierarchical structure has been put forward (Friston, Daunizeau, et al., 2010; Friston, Thornton, and Clark, 2012) to support general theoretical frameworks like predictive coding and active inference (Bastos et al., 2012; Rao and Ballard, 1999). Within the InViBe team, for some years now, we have proposed that dynamical probabilistic inference offers a powerful framework for understanding how the brain optimally keeps track of complex motion trajectories in both space and time and controls efficient predictive eye movements and visual perception (Bogadhi, Montagnini, Mamassian, et al., 2011; Bogadhi, Montagnini, and Masson, 2013; Perrinet, R. A. Adams, and Friston, 2014; Perrinet and Masson, 2012). By doing this, our recent empirical and theoretical works depart from the classical, linear control system approach that has historically dominated the theoretical approach to eye movements. We plan now to go a step further and exploit the advanced knowledge, and our expertise, as a team, of the behavioral and neurophysiological processes involved in visuo-oculomotor control to fully characterize the nature of dynamic probabilistic inference as implemented in the specific domain of this system. We aim at understanding the modalities and the limits, the *How*, *Where* and *When* of the hypothesized probabilistic representations and calculations, across species (humans and non-human primates) and different populations in humans.

4.1 Tracking probabilistic trajectories in space and time: behavioural analysis in humans and non-human primates

Recent studies in the InViBe team have illustrated the role of experience-based trajectory learning in motion tracking for non-human primates (Bourrelly et al., 2016) and humans (Bogadhi, Montagnini, and Masson, 2013; Damasse et al., 2018; Montagnini, Souto, and Masson, 2010). However, the difference in the experimental paradigms prevent us from having a general view of this adaptive function across primates. The idea is now to design and implement an extended common set of visuo-oculomotor experiments to be tested on human volunteers as well as on macaque monkeys in order to pinpoint the common and different ways to deal with uncertain, probabilistically-defined information about visual target motion and to learn from experience. Using anticipatory responses as a major behavioral probe, we will investigate how the tracking behavior changes with the probability of target position (or velocity, acceleration...) within motion trajectories of increasing complexity. We will focus on both pursuit initiation and steady-state tracking as anticipatory pursuit and saccade-pursuit coordination are efficient tools to probe predictive motor responses over different time scales. We will further investigate how they are elaborated through learning of probabilistic target motion trajectories. For instance, we have started by replicating with monkeys the experiment illustrated in section 1.5 of a probabilistic bias for target motion direction. Our preliminary data suggest that the buildup of anticipatory smooth pursuit toward the most expected direction is common to both species, although this behaviour is modulated by a much larger inter-individual variability in monkeys. The complexity of probabilistic motion trajectories will be manipulated, for instance by introducing a conditional dependence of target motion direction or speed upon a particular *turning point* in space, or on timing or, finally, on the properties of the previous segment of the trajectory (see a schematic representation of possible tasks in Figure 4.1).

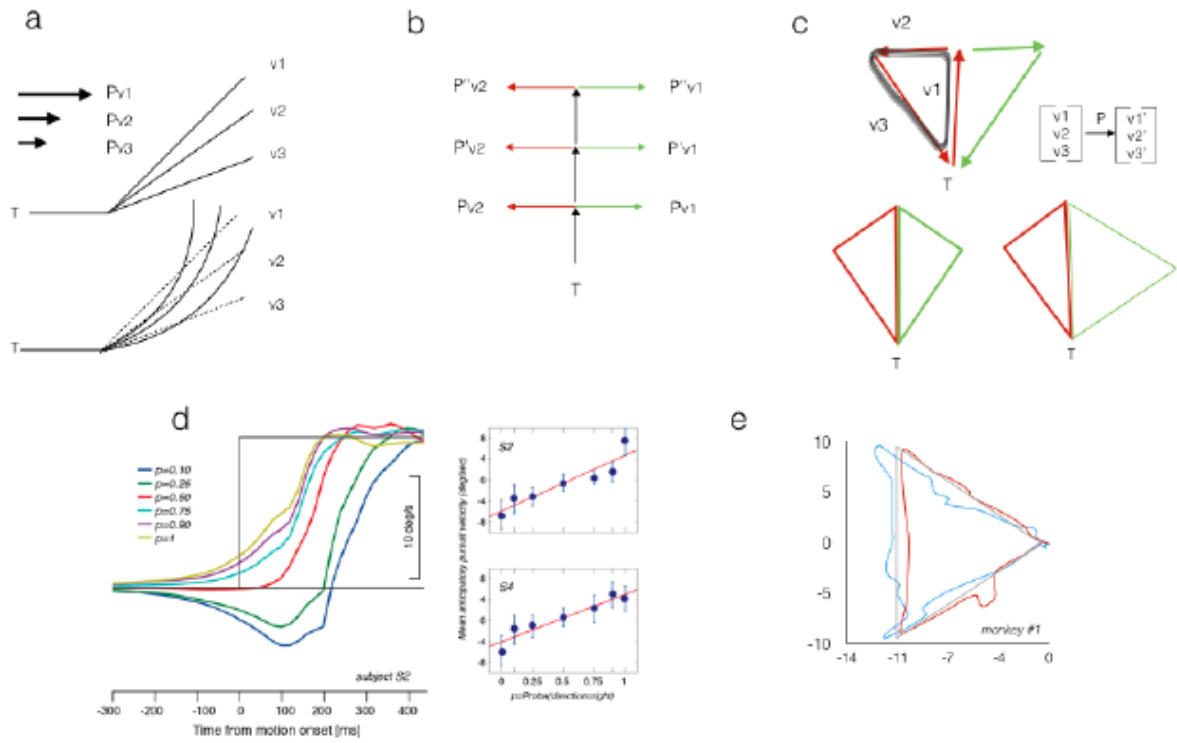

Figure 4.1: Schematic depictions of the three main levels of complexity for probabilistic target motion trajectories and preliminary human and monkey results. (a) Brief target motions with specific probability biases for different kinematic properties (velocity, acceleration) triggering anticipatory pursuit responses and saccades coherent with the expected target motion. (b) Probabilistic changes in target directions are presented at different target position/timing. (c) Complex triangular trajectories with different transition probability matrices and different target motion contexts. (d) Preliminary data for human anticipatory responses and its scaling with target direction probability. (e) Preliminary monkey data for tracking complex target motion shapes, contrasting the ocular tracking behavior before (blue) or after (red) unsupervised learning.

4.2 Representation and perturbation of behaviourally-relevant probabilities in the brain

A second big aim for the team's project is to investigate the neural bases of probabilistic representations in the context of visuomotor trajectories. Using complementary approaches in humans and monkeys, we hope to unveil which key cortical and sub-cortical neuronal populations encode position/motion information in a probabilistic, context-dependent manner to control saccadic and pursuit components of ocular tracking. I will be primarily involved in an fMRI investigation targeting prefrontal (FEF, SEF) cortical oculomotor networks as well as their major target brainstem premotor center, the superior colliculus. The goal is to scan human volunteers performing a previously defined and tested oculomotor paradigm (selected from the set illustrated in the previous section), in order to identify the functional network that implements the representation of motion-related probabilistic information and ideally to track its buildup across trials. This is an ambitious and somewhat risky project, which demands a collaborative effort by fellow expert colleagues and engineers of the fMRI center. I am confident that this project will provide exploitable novel data thanks to the high-quality imaging data now available in Marseille, the possibility to record high-resolution eye-movement in the scanner, and also on the ground of the recent techniques of analysis for functional imaging data, such as MVPA, together with system-identification methods to correlate BOLD-related sequences to oculomotor data and experimental manipulations across trials. In addition, I will address the causal involvement of specific cortical areas in probabilistic learning and in the control of anticipatory behavior. To do so, I will implement a transcranial brain stimulation study on human volunteers, in order to perturb target cortical areas with electrical (tRNS) or magnetic (low-frequency repeated TMS or single pulse TMS) at different time scales. In particular, I will test three working hypotheses: first, low-frequency rTMS applied on the Frontal Eye Fields slightly before an experimental session with a probabilistic bias for target motion should result in a reduced/altered buildup of probabilistic learning. Second, single pulse TMS locally delivered on this same region and/or on the Supplementary Eye Fields might lead to a facilitation for anticipatory behaviour towards predicted motion. Finally, on the basis of my

recent collaboration with the group led by Lorella Battelli in Rovereto (see section 3.3), I will apply transcranial random noise stimulation to the early visual cortex, and in particular the MT-complex specialized for motion vision, as this might result in a reduction of the sensory uncertainty propagated through the visuomotor network and hence a decrease of the weight of predictive information in oculomotor control (see section 1.3.2 for an illustration of these ideas), and of anticipatory eye movements.

4.3 Dynamic estimation of probabilities

By manipulating the probability for target motion direction we were able to bias the direction and mean velocity of anticipatory smooth eye movements (see section 1.5). This suggests that probabilistic information may be used to inform the internal representation of motion prediction for the initiation of efficient movements. However, such estimate may become particularly challenging in a dynamic context, where the probabilistic contingencies vary in time in an unpredictable way. In addition, whether and how the information processing underlying the control of probability-based anticipatory eye movements is linked to an explicit estimate of probabilities is still unknown. Finally, how does this form of probabilistic learning interact with the widely studied reinforcement-learning processes? These questions have recently attracted my own interest as well as the interest of my long-term collaborator Laurent Perrinet and we have started to address them (within a broader collaboration with Laurent Madelain as well). In collaboration with Chloe Pasturel we have implemented a pilot study by adapting the original direction-bias experiment (described in section 1.5), such that at the beginning of each trial participants had to adjust a cursor on an oriented line on the screen to say “How sure they felt that the target would go left or right in that trial”. Then they observed the target motion (to the right or the left) for 1s, and a new trial would start. Importantly, and different from the original direction-bias task, the probability of occurrence of a rightward target movement was itself a random variable that could change during the trial sequence depending on the occurrence of an unpredictable *switch*. The same participants took part, one day after, in a session of the original direction-bias eye-tracking experiment where we used the exact same sequence of trials (hence the same hidden sequence of switches and probability-bias values)

as for the first session. The first analyses suggest that a weak though significant correlation exist between the explicit estimates of direction bias (obtained in the first session) and the amplitude of the anticipatory smooth pursuit (measured in the second session), suggesting that a common process of probability-encoding could inform both responses. However, we aim to go beyond the correlational analysis of empirical data and we are now implementing an *ideal observer* model that assumes the possible existence of switches in the environment and estimates the likelihood of their occurrence at any moment in time, in order to optimise, in turn, the estimate of the current probability bias. The important novelty of this approach is that it goes beyond the classical approach to sequential analysis of perceptual and motor responses (see for instance Maus et al. (2015)) by including a hierarchical inference design which encompasses the environmental volatility (Meyniel and Dehaene, 2017). We are currently exploring the validity of a model adapted from R. P. Adams and Mackay (2007) and preliminary simulations are encouraging (see Figure 4.2). We plan to extend this theoretical approach to a number of well-established experimental findings in behavior, namely in the field of adaptation and learning (along the lines of research illustrated in section 2.5), in eye-hand coordination (e.g. 1.5), and in higher-level probability encoding.

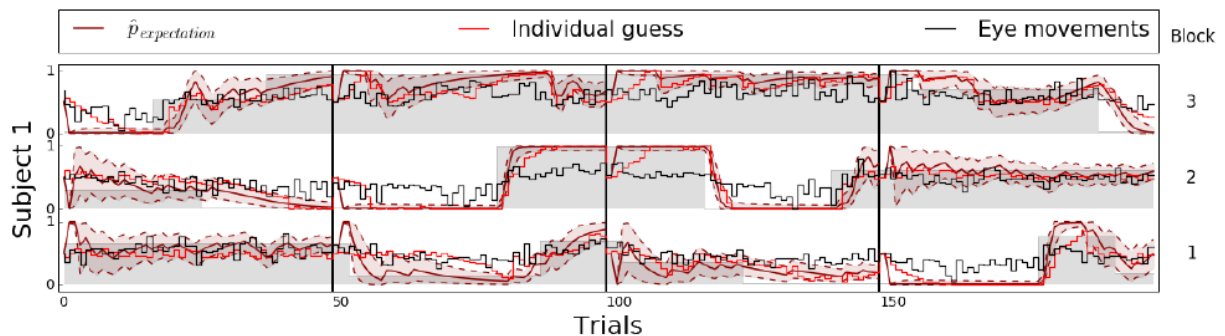

Figure 4.2: Comparison of anticipatory eye acceleration, explicit probability estimation and the *Bayesian Change Point* detection model. Our preliminary results suggest that the predictions of this model of optimal dynamical inference (dark red curve) mimic pretty well the individual guesses about the target direction probability (bright red) for a long random sequence of target motion trials (three block of 200 trials). For this particular subject, the anticipatory pursuit acceleration (black curve) seems to be less correlated with model predictions.

4.4 Probability-based oculomotor anticipation across development and in pathological conditions

In the framework of a collaboration with Guillaume Masson and Christine Deruelle, of the SCALP (Social Cognition across Lifespan and Pathologies) team of the INT, I got recently interested in analysing prediction-based anticipatory eye-movements in children and teen-agers. In perspective I also plan to extend this study to young participants diagnosed with developmental disorders of the Autistic Spectrum (ASD). The human capability to efficiently use predictive information for cognitive performance seems to be dependent on the correct functionality of the prefrontal cortex (Fuster, 2008) and the complete maturation of the latter is not accomplished before adulthood (Giedd et al., 1999). On the ground of these notions, we have asked whether even the encoding of simple probability biases in the sensorimotor context could be less advanced during childhood. Thus we have recently started to record eye movements in young participants belonging to different age-groups while they were performing an adapted version of the direction-biased smooth pursuit task described in section 1.5. Our preliminary results suggest that an efficient buildup of anticipatory smooth pursuit coherent with the direction bias is present already in the youngest participants, namely around six years of age. However, the sensitivity to the probability value is significantly reduced until young adulthood. In the next future I would like to corroborate these interesting findings and possibly try to correlate them to other measures of cognitive development. Furthermore, in order to test the recent proposal that some cognitive impairments in ASD could be explained in terms of a deficit in processing uncertain information to update internal models of the environment, we wish to extend our investigation on the adaptation and sensitivity to a probabilistic visuomotor bias to ASD patients.

A second collaborative study on predictive eye movements in patients, has recently started, targeting reward-related predictive information and Parkinson's Disease (PD) patients. With Miriam Spering at the University of British Columbia, we have since a long time been interested in the relations between eye movements and visual perception (Montagnini, Spering, and Masson, 2006; Spering and Montagnini, 2011; Spering, Montagnini, and Gegenfurtner, 2008) and more recently in the permeability of simple tracking eye movements to reward-based information

(see also section 2.5), even in the very early phases of motion. I have recently obtained a small grant to support international collaborative projects (PICS) to further develop the common projects with Dr Spering and the idea is to further study reward-related predictive processing for oculomotor control in PD patients and age-matched healthy controls. The first project developed in this framework has been carried out as part of the PhD thesis of Jean-Bernard Damasse and an article is in preparation.

4.5 EEG-correlates of visuomotor adaptation in presence of sensory uncertainty

To conclude this chapter, I will briefly mention a very recent idea for a collaborative study with Nicole Malfait, of the CoMCo (Cognitive and Motor Control) team at the INT, aiming at analysing the electrophysiological correlates (in terms of EEG oscillatory activity) of visuomotor adaptation when manipulating the uncertainty associated to the sensory (visual and proprioceptive) feedback and/or the the reliability of the internal mapping between a motor command and its consequences by means of motor perturbations. This idea stems conceptually from our recent interaction within the EU ITN Network PACE (for which Nicole Malfait and I act as coordinating team together with Guillaume Masson, as detailed in the Grants list in the annexes) that includes ten international partners in fundamental, applied and clinical research focusing on perception and action in complex environments. Despite the fact that we typically target different motor systems (hand-reaching and orienting eye movements respectively), this collaborative project offers a nice possibility to merge our approaches, namely the neurophysiological recordings during motor learning and the experimental test of sensorimotor Bayesian inference. In particular, we aim at testing the recent hypothesis that specific *beta*-oscillations observed in the EEG preparatory activity preceding a sensory-driven movement, are correlated with the perceived sensory uncertainty.

Chapter 5

New aspects in Active Vision

In this chapter I summarise some seemingly heterogeneous projects which are rooted in ongoing recent collaborations or novel ideas. The point in common among these projects is that they target different aspects of the complex relation between visual processing and eye movements (in addition to other forms of cognitive control), as suggested by the title of this chapter. Moreover, as the previous chapter 4 did mostly include studies addressing the relation between long-term probability learning, prediction and anticipatory eye movements, I decided to group here all the projects that tackle the functional visuo-oculomotor loop on different time scales, such as the very short ones of reflexive smooth tracking, or fast, saliency-driven saccadic orientation.

5.1 Oculomotor behavior as benchmark for Decision-Making models

Standard models of decision-making, referred to as Accumulation-To-Threshold (ATT) models, assume that an internal decision variable (proportional to the strength of the sensory input and affected by constant noise) is accumulated until a threshold is reached and the response initiated. ATT models can predict choice accuracy and reaction time (RT) distribution under many experimental conditions. A straightforward relationship has also been suggested between their parameters and critical cognitive factors affecting decisions, such as speed-accuracy tradeoff, sensory saliency or response bias. However, we have previously shown that these models fail to

account for the detailed pattern of behavioral and electrophysiological results in more complex conditions, such as when irrelevant sensory information interfere with the task instruction (Servant, White, et al., 2015a; Servant, Montagnini, and Burle, 2014; Servant, White, et al., 2016)). Importantly, two of the critical factors affecting human decisions have been embedded in an over simplistic form by ATT models, namely *uncertainty* (modeled as a fixed-variance noise in the decision variable) and *expectancy* (modeled as an offset of the starting point of accumulation). Some evidence has started to emerge against these simplistic assumptions (Madelain, Champrenaut, and Chauvin, 2007; Montagnini and Chelazzi, 2005) and there are now important theoretical reasons to question the generality of ATT models (Tajima, Drugowitsch, and Pouget, 2016). I plan to gather dynamic information about ongoing decision processes by analyzing different types of instructed and spontaneous eye movements, spanning across different spatiotemporal scales (from small fixational eye movements within tenths of ms, to learning effects lasting hours and days). These data will allow us to directly test some of the ATT models assumptions. In turn, the results will eventually lead to redefining alternative functional models of sensorimotor decision-making. A broad set of experimental tasks will be implemented, based on ad-hoc designed visual stimuli (with varying degree of complexity and a well-controlled dynamics and statistics) and different instructed choices, communicated by eye or hand movements. To illustrate a representative example of oculomotor decision task, I consider a variant of the random dot kinematogram (RDK) task, where a fraction of dots move coherently on the display towards the right or the left and the remaining dots move unpredictably (sensory uncertainty can be manipulated trial-by-trial along multiple dimensions, such as direction or speed). Thereafter, subjects are requested to provide a categorical response, for instance a saccade to the right or to the left, to signal the inferred direction of motion. In the standard RDK experiments, subjects have to strictly fixate the center of the screen before and during the RDK presentation and eye movements are not analyzed in that epoch. Here, on the contrary, spontaneous eye movements recorded during this epoch will be carefully scrutinized. First, under standard conditions the variability of early tracking eye movements constitute a reliable proxy of sensory variability, thus spontaneous smooth tracking movements will provide an online measure of the effective visual uncertainty (Osborne, Lisberger, and Bialek, 2005)

about the RDK stimulus that enters in the decision process. Second, anticipatory smooth eye movements before the onset of the RDK, will unveil the prior expectancy in favor of either direction of motion (Montagnini, Souto, and Masson, 2010; Santos and Kowler, 2017). Finally, we have previously reported under comparable experimental conditions the occurrence of partial errors, namely short-latency and short-amplitude saccades in the wrong direction. Saccadic partial-errors will provide information about late phases of decision, next-to-threshold, and the degree of control on possible errors.

5.2 Saccades and Information Maximization

The visual system needs to extract the most important elements of the external world from a large flux of information in a short time. Reasonably, in performing this task, it operates a strong data reduction at an early stage, by creating a compact summary of relevant information that can be handled by further levels of processing. It is also widely believed that the perceptual correlate of the early selection process is the *saliency* which is spontaneously attributed to specific local arrangement of luminance variations in a visual scene. The precise modalities of the data reduction process are still largely unknown, although numerous studies have addressed this question, and provided evidence that the statistical structure of natural images plays an important role (e.g. Olshausen and Field (1996)). In collaboration with Michela del Viva, at the Psychology department of the University of Florence, Italy, we have chosen to follow a purely Information-theory-driven approach to select the putative salient features in a visual scene, without any hypothesis on the visual system processing them. In other words, we chose a specific set of local features, predicted by a constrained maximum-entropy model to be optimal information carriers (Del Viva, Punzi, and Benedetti, 2013), as candidate salient features. These local patterns are spatial arrangements of 3-by-3 black and white pixels and the maximum-entropy model extracted them from a database of about 500 photographs of natural scenes. The idea is now to validate this model-based selection with behavioral experiments, investigating whether these selected features are indeed *salient*, and hence optimal for different perceptual and oculomotor tasks. A graduate-student of the university of Florence has recently joined my team at the INT for an Erasmus internship and she has implemented a set of oculomotor

experiments addressing whether the selected informative patterns attract the saccadic behavior of human participants in simple fast target-choice tasks but also in more complex visual search tasks. The first results will be presented this year at the annual meeting of the Vision Science Society and at the European Conference of Visual Perception.

5.3 Eye movements diversity across populations and across life span

Eye movements are at the core of vision and serve to optimize visual information foraging and processing. As illustrated by the studies reported in this manuscript, among many others, eye movements have been used as readout of bottom-up sensory processing (e.g. of saliency or sensitivity) and top-down cognitive functions (goal-directed selection, attention, inference and prediction...). Their properties are highly variable within and across individuals, and their malfunctioning impairs perception, cognitive abilities and well-being. Being controlled by a distributed and well-identified network of sub-cortical, cortical and cerebellar regions, eye movements are impaired in many visual, neurological, psychiatric and developmental pathologies, while showing specific age-related decline. For this reason, eye movements are probably a relevant gate to access a variety of normal and pathological behaviors, for which eye-tracking technologies are now mature. Current eye movement research in healthy individuals or in patients often concerns a single component of the rich eye movement repertoire, which includes fixational eye movements, saccades, pursuit, vergence, pupil activity and blinks. In addition very seldom studies have tested large samples of human subjects, as the standard experiments typically imply long recording sessions in the labs. Following an original and fascinating idea of Jean Lorenceau, CNRS senior researcher at the Institut de la Vision in Paris, I have joined a network of 13 teams across France, with the aim to design, implement and validate a package of short and entertaining eye-movements paradigms, the *Eye games*, that will be proposed to a large cohort of volunteers, by taking advantage of an ongoing epidemiological cohort-study (*Constances*). We are now validating a first version of the Eye Games, which are designed to elicit all kinds of eye movements (small fixational movements, oculomotor reflexes, pupil dilation and constriction,

voluntary orienting saccades, smooth tracking...) and in the next years we plan to record eye movements in several tens of thousands human volunteers across a large span of age and health conditions. The goal is twofold: first, on a short term we will be able to establish a sound empirical *norm* for the eye movement variability and the pattern of correlations among different types of eye movements. Second, on a longer time scale, we hope to be able to extract more interesting and possibly unexpected patterns of correlations between eye-movements properties and specific pathologies, opening the possibility, for the future, to use eye movements as a simple and non-invasive aid for clinical diagnosis.

5.4 Visual search in Natural scenes: testing the role of visual saliency

Several studies have shown that in visual search tasks with simple and well-controlled stimuli, the gaze is quickly and automatically drawn to the most salient areas of the scene, i.e. those characterized by a strong local gradient of one or more physical properties (luminosity, orientation, chromatic saturation etc.). If the information we look for requires a long and computationally expensive research, short latency eye movements will probably not be directed to the optimal location for information gathering. Saccades with longer latency, on the other hand, will be more likely to overlook the effect of salient distractors and will be directed towards the targets that maximize higher level information (e.g. Najemnik and Geisler (2005) and vanZoest and Donk (2006)). This rather logical and well-founded framework, however, is challenged by studies of visual search in natural scenes, where the importance of physical salience appears to be negligible with respect to the higher-level attributes of visual objects, linked to their semantic characterization and contextual relationships with the image (Henderson and Hollingworth, 1999; Tatler et al., 2011). Surprisingly, even at very short latency, the eye orientation movements seem to be guided predominantly by high level factors. In collaboration with Sara Spotorno, whose first work in the team has been described in section 2.3, I took an interest in this phenomenon and, as part of Claire Deshayes Master 1 research internship, we conducted a first study to understand whether an automatic facilitation related to visual saliency would be present also

for search in natural scenes, and eventually measurable at a finer level of analysis. Human volunteers were asked to look for two target objects in natural scenes (modified and balanced photographs according to certain salience criteria) that could appear in the same area of the scene (e.g., a plate and a glass on a kitchen table) or in two different areas (e.g., the plate on the table and slippers on the floor). We wanted to test two hypotheses: 1) whether, within a predefined subset of objects, the selection of the first target is modulated by its saliency; 2) whether the role of saliency is modulated by the fact that the target belongs to the same region (where the term region refers to physical and/or semantic properties) or to two different regions. Although the data collected are still preliminary, only the second hypothesis seems to be validated by our results. Several experiments have been programmed as part of this project and will be carried out in the coming months. The first results have been presented at the ESCOP meeting in 2017.

Chapter 6

Conclusion end Perspectives

I would like to conclude this manuscript with some considerations about my topic of research, its dynamic evolution within my own personal evolution, and its place in the more general framework of modern science, at the crossing point between the Neurosciences, the cognitive sciences and the computational models of physiology and behavior (would anyone still use the term *biocybernetics?*).

6.1 Vision and Eye movements, nice but...only that?

When I present a topic for lab-rotations or internships for students of the Neuroscience Master Program, I have sometimes this kind of questions: "Will you perform EEG recordings during your task?", "fMRI?", or "Will you use this eye movement task in autistic children?". The question students are implicitly asking is "Vision and eye movements, nice but only that?". It is a bit frustrating and despite my still firm conviction that Vision psychophysics and Eye movement analysis (together with modeling, I'll come back to this) is a huge, very meaningful and passionating question for modern science, I have abandoned the most extremistic position : Yes, I will do some electrophysiology and some imaging studies and I have already started performing some non-invasive brain stimulation. Somehow I feel that the opportunity has to be taken, now, to make a real move toward an integrated approach, where the rigorous framework of psychophysics and its theoretical background can scaffold the neurophysiological investigation.

The recent fast development of advanced techniques of analysis for large sets of imaging data, as well as the diffusion of data-sharing and code-sharing practices are very encouraging elements, in this sense.

6.2 Vision and Eye movements, is this all about the brain?

The visuo-oculomotor system in primates is a very privileged subsystem of the brain from the point of view of multidisciplinary research: to my knowledge, with no other high-level function of the brain it is conceivable to get back and forth between neuronal physiology and behavioural data, or to backup observed empirical data with established models of the underlying neural computations, as it occurs in this field. Does it mean that if we keep studying these tiny movements of the eyes in detail we will have understood the animal and the human brain ? It has also occurred to me to have this question, by highly-educated scientists from other fields, typically. Well, of course the answer is no. I think, however, that a deep, fully integrated (across spatial, temporal and epistemological scales) understanding of the visuo-oculomotor system does and will greatly contribute to the study of the brain. First, it will do so by providing well-grounded hypotheses to be tested elsewhere. An example is the model-based expected pattern of neuronal dynamics underlying sensory-to-motor transformation (e.g. FEF neuronal ramping activity related to accumulation to threshold models for saccade preparation, see Hanes and Schall (1996)). To my knowledge, scientists have struggled but not succeeded, so far, to find similar patterns in other brain areas implicated in other functions. The important point here is that in the case of the oculomotor system we have a relatively precise idea, compared to other systems, of *what to look for*, and *where*, when trying to link the neuronal activity to behavior. Second, the big contribution of this research field is in my view that of providing support for a category of brain scientists who are really genuinely multidisciplinary. There are not many other fields in the neurosciences where it is common, nowadays, to meet expert neurophysiologists who get inspiration from the old experimental psychology and psychophysics, plan their experiments taking into account the cognitive constraints (attention, prediction, etc)

and are able to propose new mathematical formulations (e.g. the *divisive normalization*) for the functional units of the targeted neuronal network.

6.3 Bayesian Inference Models: from the ideal observer to the human multitude

A valid theoretical hypothesis about the nature of computational rules in the brain (e.g. Bayesian Inference for visual processing) does not allow by itself to predict human behavior, as the latter is submitted to very specific constraints, for example a limited access to sensory evidence. Building up on the ideas of *Signal Detection Theory* (Green and Swets, 1966), the concept of *Ideal Observer* has been developed in Vision Science during the last twenty years of the past century. An Ideal Observer is a theoretical device that performs a given task in an optimal fashion given the available information and some specified constraints (Geisler, 2003). When dealing with uncertainty, the Ideal Observer is nothing like an errorless agent, it will rather make errors, and display a variable behavior. Yet, its behaviour is the optimal one, if one assumes that i) the implemented computational rule is valid and ii) the environmental uncertainty is correctly described. Given these premises, measured human behavior (e.g. perceptual threshold, eye movements' velocity etc) can only be equal or worse (in terms of performance in a specific task), statistically, than the Ideal Observer's behavior. This idea has allowed to compare experimental measures to a model-grounded quantitative benchmark, and thus obtain an estimate of the relative suboptimality of human subjects. However, one important factor has been left aside (or rather, just considered as random nuisance) in this framework so far: the human diversity. Inter-individual differences have recently re-gained interest in experimental psychology and vision science (Wilmer and Nakayama, 2007) as specific patterns of correlation across-subjects between different tasks have been highlighted. This suggests that the behavioral differences across individuals could be described, rather than as mere random noise, by systematic variations of the implemented neuronal algorithms (probably at the second, representational level of Marr's hierarchy, Marr (1982), underlying a particular task). Therefore, I think that one major challenge for the modeling approach to Vision science and sensorimotor decisions in the next

years will be that of extending the existing theoretical framework to address the computational bases of inter-individual differences.

6.4 Vision, Eye movements and Computational Models, will we save the world?

Yet another disturbing question for me, personally. Having missed the chance (when I was 20 years old, of course) to save the world, now I am left with the question: is this research worth it? Is this useful, helpful and important enough, given the large-scale constraints of social emergencies, global threatens and practical needs? (I guess that I have now clearly made explicit the fact that I consider it worth in terms of personal interest) Well, I don't know. And this is not the place to further discuss this issue either, luckily. However, a more focused question has its place here: does it still make sense to train young researchers and coordinate collaborative research projects on these research topics? My tentative answer is positive, with the caveat to remain attentive to what comes from just-outside the field (big data, artificial intelligence...what next?) and ready to close dead-end lines and to steer toward unforeseen ideas, especially if they come from young collaborators. I hope I will prove able to do so.

Part III

Annexes

Chapter 7

Curriculum Vitae

Anna Montagnini

born on January 10, 1973 in Milan, Italy

Current position: Chargé de Recherche (CR1, CNRS), Équipe Inference in Visual Behaviour (InViBe) - Institut de Neurosciences de la Timone (UMR 7289, CNRS et Aix-Marseille Université)

Address: 27, Bd. Jean Moulin, 13385 Marseille Cedex 5, France

E-mail: anna.montagnini@univ-amu.fr

Telephone: 04 91 32 40 43

7.1 Short resume

After a University Degree in Physics, with a Master research project on the statistics of complex dynamical systems which mimic the complexity of biological processes, I was selected for a PhD in Cognitive Neurosciences at the International School for Advanced Studies in Trieste. My PhD project focused initially on the computational analysis of the role of modularity in higher-level visual networks. However, after an In-Doc internship with Professor William Bialek's group at Princeton University, I got interested in the concept of efficiency and optimality of cognitive systems with respect to statistical uncertainty, thus I switched to a project on the role of dynamic probability changes for human saccadic goal-directed eye movements. I defended my

PhD under the supervision of Professor Leonardo Chelazzi in 2004. I was then enrolled in three successive EU-funded post-doc projects, including a MarieCurie individual fellowship, at the Institut de Neurosciences Cognitives de la Méditerranée, in Marseille, under the supervision of Guillaume Masson and Eric Castet. This postdoctoral experience allowed me to familiarize with visual selective attention, with the visual processing of motion information and with new paradigms in oculomotor research. In the meanwhile I continued to develop my original interest in the analysis of human behavior dealing with stochastic information about the environment; thanks to a collaboration with Pascal Mamassian (LPP, now LSP, Paris), I familiarized with the ideas of Bayesian inference applied to visual perception and I integrated this theoretical framework into the oculomotor experimental approach.

Keywords

Vision, Perception, Eye movements. Motion processing and prediction. Visual attention. Bayesian inference, natural scenes statistics, computational models of sensorimotor behaviour. Cognitive and computational neurosciences.

7.2 Education

Laurea (equivalent Master2) in Physics, *magna cum laude*, University of Pisa **1997**

Thesis: *Effects of temporal correlations on the properties of time series*,

Supervisor Prof. Paolo Grigolini, University of Pisa (Italy) and University of Denton, Texas-USA.

Master in Science Communication, SISSA-ISAS Trieste, Italy **2000**

Supervisors Dr Stefano Fantoni and Dr Pietro Greco, SISSA, Trieste, Italy

PhD in Cognitive Neurosciences, SISSA-ISAS Trieste, Italy **2004**

Thesis: *Decision making in the human saccadic eye movement system: effects of expectancy, conflict and motivation*

Supervisor Prof. Leonardo Chelazzi, University of Verona, Italy.

7.3 Previous Research Experience

Research assistant

1997-1998

Dynamical Systems Group of the Biophysics Institute of the Italian National Research Council (CNR), Pisa, Italy. Supervisors: Prof. Paolo Grigolini (University of Denton, Texas-USA) and Dr Santi Chillemi (CNR, Pisa-Italy)

I have developed numerical and analytical approaches for the statistical analysis of nonlinear dynamical processes which reproduce general properties of biological time-series (Buiatti, Grigolini, and Montagnini, 1999; Montagnini, Allegrini, et al., 1998)).

Graduate research position

1999-2001

Computational Neuroscience group of the Cognitive Neuroscience Sector at SISSA-ISAS Trieste, Italy. Supervisor Prof. Alessandro Treves.

I have developed numerical simulations of simple networks of linear-threshold neurons with a variable degree of modularity, to mimic the human performance in the perception of composite stimuli (e.g. faces). This work has been partly published as original article, (Montagnini and Treves, 2003)

Visiting doctoral internship

01/2002-05/2002

Biophysics Sector at Princeton University, Princeton, NJ, USA. Supervisor: Prof. William Bialek

I have developed an *ideal observer* model for the adaptation of saccadic latency to a probabilistic bias in target location.

Graduate research position

2002-2004

Neurological and Vision Sciences Department at the University of Verona, Verona, Italy. Supervisor: Prof. Leonardo Chelazzi

The work done has constituted the core of my PhD thesis, addressing the effects of expectancy, conflict and motivation on human saccadic eye movements. The ideas developed during my PhD have greatly inspired my subsequent research described in the present manuscript. Here, I provide only a short resume of the PhD thesis.

The aim of my PhD thesis was to investigate the isolated and synergistic influence of contextual factors, such as expectancy, conflict and motivation, on the latency distribution of saccades. The underlying hypothesis was that the analysis of the orienting eye movements recorded from human volunteers during simple saccadic tasks might provide a good insight into the decision-making mechanisms of our brain. The main focus was on a manipulation, to which we refer as the *probability-bias manipulation*, designed to study the effects, on the generation of saccades, of spatiotemporal uncertainty regarding the location of the saccade target. Uncertainty is likely to affect the *expectancy* for a given sensorimotor event and this is reasonably a crucial determinant for the decision-making process leading to a saccade. The first central question is whether and how probabilistic information about the location of the target is used (consciously or unconsciously) by the oculomotor system under different task demands. The probability-bias manipulation can also be seen as a particular instantiation of sequence-related effects, or, in other terms, of those effects resulting from the history of the past trials. Therefore, the effect of the main manipulation might interact with the local trial-sequence structure, i.e. the specific trials preceding the current one. My PhD thesis included several advanced analyses of this type of effects. The use of probabilistic information, and the corresponding adaptation of behaviour to the stimulus statistics, can be compared to the theoretical limits due to the finite size of the available sample of data. These limits can be defined in a mathematically precise form on the basis of the theory of probabilistic inference and of the Bayesian rule. We addressed the issue of how *efficiently*, with respect to the theoretical limits, the distribution of saccadic latency adapts to the probability-bias manipulation. The idea about this type of analysis came from several interesting discussions with professor William Bialek, at the University of Princeton, during a short-term visit which was part of my PhD program. The interaction of the probability-bias manipulation with the graded involvement of voluntary control in the generation of saccades was also a main focus of this thesis. For this reason we tested our subjects with a set of paradigms demanding a different degree of voluntary commitment. We analysed in particular the interaction of the probability bias with a decisional conflict, between the tendency to orient gaze to a visual onset and the required inhibition of the saccade (Montagnini and Chelazzi, 2009). Finally, if we assume that the mechanisms of sensorimotor integration are capable to efficiently

use the probabilistic information about the stimuli to optimise the behavioural performance, an interesting possibility is that such capability would maximally emerge when the target stimuli are associated to a strong motivational valence. This issue was examined at several points in the text of my thesis. In particular, we analysed the effect exerted by a manipulation of the valence *per se*, dissociating it from the probability bias manipulation. In other terms, we analysed the influence that the motivation to orient to the saccadic *goal* has on simple stimulus-elicited saccades (Montagnini and Chelazzi, 2005).

Postdoctoral research position

2004-2009

Equipe Dynamique de la Vision et de l'Action, Institut de Neurosciences Cognitives de la Méditerranée (INCM), CNRS-Marseille, France. Supervisors Eric Castet et Guillaume Masson. Funding: Marie Curie individual fellowship, then Marie Curie EU Training Networks (PRA,FACETS)

The research done during these years is partly described in chapters 1 and 2. It has given rise to several publications (Castet et al., 2006; Montagnini and Castet, 2007; Montagnini, Mamassian, et al., 2007; Montagnini, Spering, and Masson, 2006; Spering, Montagnini, and Gegenfurtner, 2008).

Mission longue

01/2017-05/2017

visiting Lorella Battelli's group at the Italian institute of Technology in Rovereto-Italy. Ongoing collaboration with Dr Battelli's group on the use of Transcranial electrical and magnetic stimulation as a perturbation technique during a sensorimotor learning task

7.4 List of Publications

Peer-reviewed articles

1. J-B. Damasse, L.U. Perrinet, L. Madelain and A. Montagnini (2018). Reinforcement effects in anticipatory smooth eye movements. *Journal of Vision*, in press.
2. C.Landelle, A.Montagnini, L.Madelain and F.Danion (2016) Eye tracking a self-moved target with complex hand-target dynamics. *Journal of Neurophysiology* 116:1859-1870
3. M .Chancel, C.Blanchard, M.Guerraz, A.Montagnini*, A.Kavounoudias* (2016) Optimal visuo-tactile integration for velocity discrimination of self-hand movements. *Journal of Neurophysiology* 116:1522-1535.
4. A.I.Meso, A.Montagnini, J.Bell and G.S.Masson (2016) Looking for symmetry: fixational eye movements are biased by image mirror symmetry. *Journal of Neurophysiology* 116(3):1250-60
5. M.Servant, C.White, A.Montagnini and B.Burle (2016). Linking theoretical decision-making mechanisms in the Simon task with electrophysiological data: a model-based neuroscience study in humans. *Journal of Cognitive Neuroscience* 28(10):1501-21
6. S.Spotorno, G.S.Masson and A.Montagnini (2016) Fixational saccades during grating detection and discrimination, *Vision Research*, 118:105-118.
7. M.Servant, C.White, A.Montagnini and B.Burle. (2015). Using covert response activation to test latent assumptions of formal decision-making models in humans. *The Journal of Neuroscience*, 35(28): 10371-10385.
8. M.Servant, A.Montagnini and B.Burle. (2014). Conflict tasks and the diffusion framework: Insight in model constraints based on psychological laws, *Cognitive Psychology*, 72: 162-195.
9. AR Bogadhi, A Montagnini and GS Masson (2013). Dynamic interaction between retinal and extra-retinal signals in motion integration for smooth pursuit, *Journal of Vision*, 13(13):5, 1-26.

10. C.Simoncini, L.U. Perrinet, A.Montagnini, P.Mamassian and G.S. Masson (2012) More is not always better: dissociation between perception and action explained by adaptive gain control. *Nature Neuroscience* 15(11):1596-603.
11. A.Ledberg, A.Montagnini, R.Coppola, S.L.Bressler (2012) Reduced Variability of Ongoing and Evoked Cortical Activity Leads to Improved Behavioral Performance. *PLoS ONE* 7(8): e43166.
12. A.R. Bogadhi, A.Montagnini, P.Mamassian, L.U. Perrinet and G.S. Masson (2011). Pursuing motion illusions: a realistic oculomotor framework for Bayesian inference. *Vision Research* 51: 867-880
13. M.Spering, and A. Montagnini (2011). Do we track what we see? Common versus independent processing for motion perception and smooth pursuit eye movements: A review. *Vision Research* 51: 836-852
14. A.Montagnini, and L.Chelazzi (2009). Dynamic interaction between Go and Stop signals in the saccadic eye movement system: New evidence against the functional independence of the underlying neural mechanisms. *Vision Research* 49: 1316-1328.
15. M.Spering, A. Montagnini, and K.R.Gegenfurtner (2008). Competition between color and luminance for target selection in smooth pursuit and saccadic eye movements. *Journal of Vision*,8(15):16,1-19, <http://journalofvision.org/8/15/16/>, doi:10.1167/8.15.16.
16. A.Montagnini, and E.Castet (2007). Spatiotemporal dynamics of visual attention during saccade preparation: Independence and coupling between attention and movement planning. *Journal of Vision*, 7(14):8, 1-16, <http://journalofvision.org/7/14/8/>, doi:10.1167/7.14.8.16.
17. A.Montagnini, P.Mamassian, L.Perrinet, Eric Castet and G. Masson (2007). Bayesian modeling of dynamic motion integration. *Journal of Physiology-Paris*, Vol 101(1-3):64-77.
18. A.Montagnini, M. Spering and G.S.Masson (2006). Predicting 2D target velocity cannot help 2D motion integration for smooth pursuit initiation. *Journal of Neurophysiology*, Vol. 96, p. 3545-3550.

19. E.Castet, S.Jeanjean, A.Montagnini, D.Laugier and G.S.Masson (2006). Dynamics of attentional deployment during saccadic programming. *Journal of Vision*, Vol 6 (3), p. 196-212.
20. A.Montagnini and L.Chelazzi (2005). The urgency to look: Prompt saccades for the benefit of perception. *Vision Research*, Vol 45 (27): p. 3391-3401.
21. Montagnini, A.Treves (2003). The evolution of mammalian cortex, from lamination to arealization. *Brain Research Bulletin*, Vol. 60 no.4, p.387.
22. M.Buiatti, P.Grigolini, A.Montagnini (1999). A dynamic Approach to the Thermodynamic of Superdiffusion. *Physical Review Letters*, Vol. 82-17.
23. A.Montagnini, P.Allegrini, S.Chillemi, A.Di Garbo, P.Grigolini (1998). Rescaling prescriptions: on the conflict between Hurst's analysis and the second moment prediction. *Physics Letters A*, 244, 237-244.

Peer-reviewed articles for international conference proceedings

1. A.Montagnini (2001). Statistical Learning of Human Faces. ICCM 2001 Proceedings, GMU Fairfax, VA, USA, July 26-28.
2. J.Drewes, G.S.Masson and A.Montagnini (2012). Shifts in reported gaze position due to changes in pupil size: ground truth and compensation. *Proceedings of the Symposium on Eye Tracking Research and Applications, ETRA 2012* (pp. 209-212).

Book Chapters

1. G.S.Masson, A.Montagnini and U.J.Ilg. When the brain meets the eye: tracking objects. From following edges to pursuing objects ? in Ilg UJ and Masson GS (2009) *Dynamics of visual motion processing*. Springer Verlag.
2. A.Montagnini, L.Perrinet and G.S.Masson. Visual motion processing and human tracking behavior (2015) In: *Biologically Inspired Computer Vision*, Wiley

Communications at international conferences

Co-author of more than 60 peer-reviewed abstracts published on international journals

Submitted articles and work in progress

1. J-B. Damasse, M. Spering and A. Montagnini. Reinforcement contingencies affect pursuit target selection in healthy and Parkinson's disease participants. *In preparation.*
2. A. Montagnini, G. Masson and L. Madelain. Contrast-dependent motion processing : insight from ocular tracking dynamics. *In preparation*
3. K. Mansour Pour, A. Montagnini, L. Perrinet and G. Masson. Role of local speed variability in motion perception and eye movements *In preparation*
4. A. Montagnini. Effects of motion predictability on anticipatory and visually-guided eye movements: a common prior for sensory processing and motor control? *In preparation*

Invited seminars at international conferences and academic institutions (selected)

1. Anticipatory Smooth Eye Movements are Modulated by Reinforcement Contingencies. Invited talk at the international meeting of the *Association for Behaviour Analysis*, Paris, November 14-15 2017.
2. Human Visual Tracking of Moving Objects, Illusions, and Probabilistic Guesses. Invited talk at the Gordon Research Conference on *The Oculomotor System as Model of Mind and Brain*, Bates College, Lewiston, MA USA, July 9-14 2017
3. Eye movements permeability to cognitive access. Brownbag seminar at the *Centro Interdipartimentale Mente e Cervello (CIMeC)*, Rovereto, Italy, 10-02-2017
4. Active sensing in visual processing - Eye movements and visual perception: the restless pas de deux. Invited talk the the 6th French-Israeli Neuroscience Conference *The power of Mathematics in Contemporary Neuroscience* Marseille, July 10-15 2016

5. Dynamic motion integration for tracking eye movements adaptive mixing of visual and predictive signals (28 January 2016) Invited Seminar at the EU-ITN network PACE international Workshop *Making a sense of a rich world*, INT, Marseille, France.
6. Visual tracking under uncertainty: Sensory and inferential contributions to human smooth eye movements. 19 May 2015 Invited Seminar at the 1st meeting of the *Club EyeMovements* -Société de Neurosciences Française, Montpellier, France.
7. Visual tracking under uncertainty: Sensory and inferential contributions to human smooth eye movements. 7 May 2015 Invited Seminar at the *Pisa Vision Lab*, Pisa, Italy.
8. Tracking objects, illusions and guesses with the eyes: Human smooth eye movements as a dynamical probe of visual and predictive information processing (December 2013). Invited seminar at the *Centre de Recherche Cerveau et Cognition*, Toulouse, France.
9. Pursuing objects, illusions and guesses: human ocular tracking as a dynamical probe of visual motion processing and predictive mechanisms (April 2013). Invited seminar at the *Laboratoire de Psychologie de la Perception*, Université Paris-Descartes, Paris-France.
10. Tracking objects, illusions and guesses with the eyes: Bayesian dynamic inference for smooth pursuit eye movements (March 2013). Invited seminar at the *Laboratoire de Neurosciences Integratives et Adaptatives*, CNRS and Aix-Marseille University, Marseille-France.
11. On the adaptivity of human eye movements to the visual constraints and the task requirements (December 2012). Invited seminar at the *General Psychology Department* of the University of Giessen, Germany
12. Adaptive Eye-Movements for optimal perception (2012). Invited seminar at the conference *Optimizing performance in dynamic environments* July 2-5 2012, Amsterdam, The Netherlands
13. The multiple roles of eye movements in understanding the visual brain (2011). Invited seminar at the *Center for Cognitive Neurosciences*, Lyon, France

14. Smooth Pursuit Eye-Movements: A Window Onto The Internal Representation and Processing of Uncertainty (2010). Invited seminar at the *Laboratoire de Psychologie et Neurocognition*, Grenoble, France
15. Temporal locking of visual attention to saccadic eye movements (2008) Invited seminar for the *Journée Oculomotricité* a Lille, France
16. Smooth pursuit eye movements and perception of motion (2007) Invited seminar for the *Kolloquium der Abteilung Allgemeine Psychologie*. Justus-Liebig-Universität Giessen, Germany.

7.5 Grants and Awards

- 2018-2022 ANR-Blanc, projet d'équipe InViBe PREDICTEYE (participant)
- 2018-2021 label FRM de l'équipe InViBe (participant)
- 2018 : Projet International de Cooperation Scientifique - 20000 euros, Individual grant to foster the collaboration with Miriam Spering's lab at the University of British Columbia, Vancouver, Canada
- 2017 : Prix de la Fondation Aix-Marseille Université pour l'aide à la Mobilité -4000 euros, Individual grant
- 2015-2019 : EU-Marie Curie ITN PACE (Perception and Action in Complex Environments) - member of the coordination team of 10 partner institutions (Academia, Clinics and Private Sector)
- 2014-2017 : ANR-REM (thématique Apprentissages) as PI of one of the member institutes
- 2013-2016 ANR-Blanc SPEED (participant)
- 2012-2016 ANR JCJC Kavounoudias (participant)
- 2011 Grant of the Institut Federatif de Recherche (Marseille) -11.000 euros, for a collaborative project with Boris Burle, LNC-CNRS Marseille)
- 2011-2014 ANR-Blanc VisaFix (participant):
- 2011-2014 EU IST-FET Network grant Brainscales (participant)
- 2008-2012 EU ITN network grant CODDE (participant)
- 2006-2008 EU Marie Curie Individual Fellowship for the project GEMME2
- 2005 Award of the town of Marseille: allocation *Accueil de chercheurs étrangers*: 2000 euros
- 2004 Women in Neuroscience award and travel grant for the 33rd SfN Meeting, San Diego, California

7.6 Scientific animation

Organization of scientific meetings and symposia

- 2018: International INT Workshop on: *Probabilities and Optimal Inference to Understand the Brain*. April 5-6, Marseille. Organizers: Paul Apicella, Frederic Danion, Nicole Malfait, Anna Montagnini and Laurent Perrinet.
- 2016: Selected Member-initiated symposium at the European Conference on Visual Perception, Barcelona, Spain, August 27-31: *New directions in Active Vision*. Organizers: Anna Montagnini and Eli Brenner (VU-Amsterdam)
- 2015: First Training Workshop of the EU-ITN network PACE: *Making a sense of a rich world*, INT, Marseille, France. Organizers: Anna Montagnini, Nicole Malfait, Laurent Perrinet, Frédéric Danion, Guillaume Masson and Sarah Mahir.
- 2013: 5th annual meeting of the *Reseau de Neurosciences Computationnelles de Marseille*, Marseille, France. Organizers: Anna Montagnini and Raoul Huys (INS, Marseille)
- 2011: annual meeting of of the *Groupement de Recherche en Vision (GDR Vision)*, Marseille, France. Organizers: Anna Montagnini and Frédéric Chavane (INT, Marseille)
- 2011: annual meeting of the Marie Curie Initial Training Network CODDE, Frejus, France *Coordination for Optimal decisions in Dynamic Environments*.
- 2011: Selected Member-initiated symposium at the European Conference on Eye Movements, Marseille, France: *Orienting the gaze toward predictions*. Organizers: Anna Montagnini and Laurent Madelain (Université de Lille)
- 2008: Selected Member-initiated symposium at the Vision Science Society meeting, Naples, FL-USA *Action for perception: functional significance of eye movements for vision*. Organizers: Anna Montagnini and Miriam Spering (Justus-Liebig University Giessen, Germany)

Peer-reviewing for articles and grants

- Invited peer review for scientific journals: Vision Research, Perception, Journal of Physiology, Journal of Vision, Journal of Neurophysiology, Neuropsychologia, Attention Perception and Psychophysics, The Journal of Neuroscience, Scientific Reports, PlosONE.
- International grant review: NWO -The Netherlands Organisation for Scientific Research, Agence Nationale pour la Recherche (ANR)
- Scientific board of international conferences: abstract peer-reviewing for the *European Conference on Eye Movements (ECEM)* in 2011,2013,2015; the *European Conference on Visual Perception (ECVP)* in 2011,2016,2017; the *Vision Science Society (VSS)* international conference, every year since 2014.

Science Communication and Outreach

- 2018: Participation to the *Brain Awareness Week - La semaine du cerveau* with two pedagogical presentations on the brain in the primary school
- 2016: Colloquium between neuroscientists and high-school professors of philosophy on the theme: *Le dualisme esprit-matière dans la science aujourd'hui*
- 2016: Participation to the European event *La nuit des chercheurs*, held in Marseille - Docks du Sud on September 30th 2016
- 2015: Participation to the project *Printemps des Chercheurs* with two interactive research-projects in high school and a public conference (at the Bibliothèque Alcazar) on the theme *La recherche en vision: du traitement de la lumière par l'oeil à l'interaction dynamique avec le monde visuel* in collaboration with Laurent Perrinet, Frédéric Chavane and the Association Tous Chercheurs
- 2013: Co-authorship of the article *La vision active* for a special issue of the magazine *Textes et documents pour la classe* (mostly for high school teachers) on the theme of Vision.

- 2007: Member of the communication and press office of the *European Conference on Visual Perception*, Arezzo, Italy
- 2003 Co-authorship of a textbook *Neuroscienze, per iniziare*, within the Brain Awareness Week project, Trieste, Italy.
- 2001: Co-authorship of the chapter *I meccanismi del pensiero*, included in the CD-rom *Il codice della vita* within the multimedia scientific encyclopaedia project Rizzoli-Larousse, Milano, Italy.
- 2000: Co-authorship and editing of the web site *La materia grigia* edited by INFMedia, Trieste, Italy

7.7 Training and Students' supervision

- since 2012, I am a member of the executive committee of the PhD Program in Integrative and Clinical Neuroscience of Aix-Marseille University. Main responsibilities: organization of specialistic courses on Computational Neuroscience, Biostatistics, Signal Processing and Programming; coordination of the mid-term PhD monitoring for PhD students; International relations, coordination with the European Federation of Neuroscience Society.

Supervision of PhD projects and Postdocs

- 2012-2014: Supervision of the postdoctoral stage of Sara Spotorno on the project *Functional instability during ocular fixation: perceptual and motor consequences* funded by the ANR
- Since October 2015: Co-supervision, with Dr Guillaume Masson, of the PhD thesis of Kiana Mansour Pour on the project: *Predicting sensory events and inference for visuomotor control* funded by the EU H2020-MSCA Program to the Network PACE that I also coordinate
- Since October 2014: Co-supervision, with Dr Laurent Perrinet, of the PhD thesis of Jean-Bernard Damasse on the project: *Reinforcement and Anticipatory Eye Movements* funded by the ANR for the collaborative research project REM (INT Marseille and Lille University). I am also coordinator of this project for Marseille.
- 2011-2015: Co-supervision, with Dr Boris Burle, of the PhD thesis of Mathieu Servant on the project: *Cognitive control and decision-making: an experimental and computational integrated account* funded by an ERC grant to Dr Boris Burle
- 2008-2013: Co-supervision, with Dr Guillaume Masson, of the PhD thesis of Claudio Simoncini on the project: *Intégration spatio-temporelle de l'information visuelle pour les mouvements oculaires et la perception* funded by EU-MCA Program CODDE
- 2008-2012: Co-supervision, with Dr Guillaume Masson, of the PhD thesis of Amarender Bogadhi on the project: *An experimental and theoretical study of Visual motion integration*

for Smooth pursuit - A hierarchical recurrent bayesian framework funded by EU-MCA Program CODDE

Supervision of Master projects and others

- May-June 2018: Supervision of the *stage de recherche Master 1* of Anne-Catherine Tomei on the project: Prédire et anticiper un événement probable: étude comportementale en oculomotricité.
- March-August 2018: co supervision of the *stage d'ingenieur* of Antoine Schwey on the project *Troubles du contrôle du mouvement dans la maladie de Parkinson : Analyse de séries chronologiques comportementales et électrophysiologiques*, in collaboration with Nicole Malfait.
- April-September 2017: co-supervision of the *stage d'ingenieur* of Baptiste Martin Chave on the project *Modeling goal directed and anticipatory eye movements*
- April 2017-June: 2018 co-supervision of the *CDD Ingenieur de Recherche* of Chloé Pasturel on the project *Pursuing and tracking motion probabilities*
- July 2017: Supervision of the *stage d'observation en milieu professionnel* of Ninon Freidel, high-school student in Waterloo Canada
- December 2015: Supervision of the *stage d'observation en milieu professionnel* of Mathilde Alli-Kauffmann, high-school student at the Collège Sylvain Menu, Marseille
- May-June 2014: Supervision of the *stage de recherche Master 1* of Claire Deshayes on the project: Role of visual saliency in visual search with natural scenes.
- April-May 2014: Supervision of the *stage de recherche Master 1* of Adrien Masson on the project: Saccadic adaptation by perceptual reinforcement.
- January-June 2012: Supervision of the *stage de recherche Master 2* of Jonathan Mirault on the project: Optimisation des stratégies oculomotrices : influences de la statistique des stimuli visuels?

- June-July 2011: Supervision of the *stage de recherche Master 1* of Jonathan Mirault on the project: Anticipatory eye-movements: influence of visual motion statistics on human smooth pursuit
- September 2011: supervision of a short-term visiting PhD student, Kurt Debono (University of Giessen, Germany) on the project: Bayesian modeling of the direction integration field during smooth pursuit eye movements
- June-July 2010: supervision of a short-term visiting PhD student, Céline Paeye (University of Lille), on the project: Effects of higher-order stimulus statistics on anticipatory eye movements

Bibliography

- Adams, R. P. and D. J. C. Mackay (2007). “Bayesian Online Changepoint Detection”. In: *ArXiv*. arXiv: arXiv:0710.3742v1 (cit. on p. 53).
- Barnes, G. R. (2008). “Cognitive processes involved in smooth pursuit eye movements”. In: *Brain and Cognition* 68.3, pp. 309–326 (cit. on pp. 22, 33).
- Bastos, A. M. et al. (2012). “Canonical microcircuits for predictive coding”. In: *Neuron* 76.4, pp. 695–711 (cit. on pp. 13, 48).
- Bogadhi, A. R., A. Montagnini, P. Mamassian, et al. (2011). “Pursuing motion illusions: A realistic oculomotor framework for Bayesian inference”. In: *Vision Research* 51.8, pp. 867–880 (cit. on pp. 15, 48).
- Bogadhi, A. R., A. Montagnini, and G. S. Masson (2013). “Dynamic interaction between retinal and extraretinal signals in motion integration for smooth pursuit”. In: *Journal of Vision* 13.13, pp. 5–5 (cit. on pp. 15, 18, 20, 38, 48, 49).
- Bourelly, C. et al. (2016). “Learning the trajectory of a moving visual target and evolution of its tracking in the monkey”. In: *Journal of Neurophysiology* 116.6, pp. 2739–2751 (cit. on p. 49).
- Buiatti, M., P. Grigolini, and A. Montagnini (1999). “Dynamic Approach to the Thermodynamics of Superdiffusion”. In: *Physical Review Letters* 82.17, pp. 3383–3387 (cit. on p. 69).
- Castet, E. et al. (2006). “Dynamics of attentional deployment during saccadic programming”. In: *Journal of Vision* 6.3, p. 2 (cit. on pp. 26, 27, 71).
- Chancel, M. et al. (2016). “Optimal visuotactile integration for velocity discrimination of self-hand movements.” In: *Journal of neurophysiology* 116.3, pp. 1522–1535 (cit. on p. 22).

- Collins, T. (2012). “Probability of Seeing Increases Saccadic Readiness”. In: *PLoS ONE* 7.11. Ed. by M. Lappe, e49454 (cit. on p. 33).
- Damasse, J.-B. et al. (2018). “Reinforcement effects in anticipatory smooth eye movement”. In: *submitted* (cit. on pp. 23, 49).
- Del Viva, M. M., G. Punzi, and D. Benedetti (2013). “Information and Perception of Meaningful Patterns”. In: *PLoS ONE* 8.7. Ed. by W. W. Lytton, e69154 (cit. on p. 58).
- Deubel, H. and W. X. Schneider (1996). “Saccade target selection and object recognition: evidence for a common attentional mechanism.” In: *Vision Research* 36.12, pp. 1827–37 (cit. on p. 26).
- Elsner, T. and H. Deubel (1986). “The effect of saccades on threshold perception—a model study.” In: *Biological cybernetics* 54.6, pp. 359–66 (cit. on p. 27).
- Ernst, M. O. and M. S. Banks (2002). “Humans integrate visual and haptic information in a statistically optimal fashion”. In: *Nature* 415.6870, pp. 429–433 (cit. on pp. 14, 18).
- Ernst, M. O. and H. H. Bühlhoff (2004). “Merging the senses into a robust percept”. In: *Trends in Cognitive Sciences* 8.4, pp. 162–169 (cit. on pp. 20, 37).
- Fetsch, C. R. et al. (2012). “Neural correlates of reliability-based cue weighting during multisensory integration”. In: *Nature Neuroscience* 15.1, pp. 146–154 (cit. on p. 13).
- Findlay, J. M. (M. and I. D. Gilchrist (2003). *Active vision : the psychology of looking and seeing*. Oxford University Press, p. 220 (cit. on p. 25).
- Friston, K. J., J. Daunizeau, et al. (2010). “Action and behavior: a free-energy formulation”. In: *Biological Cybernetics* 102.3, pp. 227–260 (cit. on p. 48).
- Friston, K. J., C. Thornton, and A. Clark (2012). “Free-energy minimization and the dark-room problem.” In: *Frontiers in psychology* 3, p. 130 (cit. on p. 48).
- Fuster, J. M. (2008). *The prefrontal cortex*. Academic Press/Elsevier, p. 410 (cit. on p. 54).
- Gauthier, G. M. and J. M. Hofferer (1976). “Eye tracking of self-moved targets in the absence of vision”. In: *Exp Brain Res* 26.2, pp. 121–139 (cit. on p. 23).
- Geisler, W. S. (2003). “Ideal Observer Analysis”. In: *The Visual Neurosciences*. Ed. by J. S. Chalupa, Leo M. and Werner. MIT Press, pp. 825–837 (cit. on p. 64).

- Gekas, N. et al. (2017). “A Normalization Mechanism for Estimating Visual Motion across Speeds and Scales.” In: *Current Biology* 27.10, 1514–1520.e3 (cit. on p. 32).
- Giedd, J. N. et al. (1999). “Brain development during childhood and adolescence: a longitudinal MRI study”. In: *Nature Neuroscience* 2.10, pp. 861–863 (cit. on p. 54).
- Gold, J. I. and M. N. Shadlen (2007). “The neural basis of decision making.” In: *Annual review of neuroscience* 30, pp. 535–74 (cit. on p. 40).
- Green, D. and J. Swets (1966). *Signal Detection Theory and Psychophysics*. New York: Wiley (cit. on pp. 13, 64).
- Hammett, S. T. et al. (2007). “Perceptual distortions of speed at low luminance: Evidence inconsistent with a Bayesian account of speed encoding”. In: *Vision Research* 47.4, pp. 564–568 (cit. on p. 19).
- Hanes, D. P. and J. D. Schall (1996). “Neural control of voluntary movement initiation.” In: *Science* 274.5286, pp. 427–30 (cit. on p. 63).
- Henderson, J. M. and A. Hollingworth (1999). “High-Level Scene Perception”. In: *Annual Review of Psychology* 50.1, pp. 243–271 (cit. on p. 60).
- Hicheur, H. et al. (2013). “Microsaccades are modulated by both attentional demands of a visual discrimination task and background noise”. In: *Journal of Vision* 13.13, pp. 18–18 (cit. on p. 27).
- Hübner, R., M. Steinhauser, and C. Lehle (2010). “A dual-stage two-phase model of selective attention.” In: *Psychological Review* 117.3, pp. 759–784 (cit. on p. 40).
- Jonikaitis, D. et al. (2013). “Allocation of attention across saccades”. In: *Journal of Neurophysiology* 109.5, pp. 1425–1434 (cit. on p. 27).
- Ko, H.-k., M. Poletti, and M. Rucci (2010). “Microsaccades precisely relocate gaze in a high visual acuity task”. In: *Nature Neuroscience* 13.12, pp. 1549–1553 (cit. on p. 27).
- Körding, K. P. and D. M. Wolpert (2004). “Bayesian integration in sensorimotor learning”. In: *Nature* 427.6971, pp. 244–247 (cit. on p. 18).
- Kowler, E., C. D. Aitkin, et al. (2014). “Davida Teller Award Lecture 2013: The importance of prediction and anticipation in the control of smooth pursuit eye movements”. In: *Journal of Vision* 14.5, pp. 10–10 (cit. on p. 22).

- Kowler, E., E. Anderson, et al. (1995). “The role of attention in the programming of saccades.” In: *Vision Research* 35.13, pp. 1897–916 (cit. on p. 26).
- Krauzlis, R. J. (2008). “Eye Movements”. In: *Fundamental Neuroscience*. Ed. by Squires, L.R. and Berg, D. 3rd. Amsterdam, NL: Elsevier (cit. on p. 11).
- Landelle, C. et al. (2016). “Eye tracking a self-moved target with complex hand-target dynamics.” In: *Journal of neurophysiology* 116.4, pp. 1859–1870 (cit. on p. 24).
- Ledberg, A. et al. (2012). “Reduced Variability of Ongoing and Evoked Cortical Activity Leads to Improved Behavioral Performance”. In: *PLoS ONE* 7.8. Ed. by O. Sporns, e43166 (cit. on p. 29).
- Leon, P. S. et al. (2012). “Motion clouds: model-based stimulus synthesis of natural-like random textures for the study of motion perception.” In: *Journal of neurophysiology* 107.11, pp. 3217–26 (cit. on p. 31).
- Lorenceau, J. et al. (1993). “Different motion sensitive units are involved in recovering the direction of moving lines.” In: *Vision Research* 33.9, pp. 1207–17 (cit. on p. 15).
- Ma, W. J. et al. (2006). “Bayesian inference with probabilistic population codes”. In: *Nature Neuroscience* 9.11, pp. 1432–1438 (cit. on p. 13).
- Madelain, L., L. Champrenaut, and A. Chauvin (2007). “Control of sensorimotor variability by consequences.” In: *Journal of neurophysiology* 98.4, pp. 2255–65 (cit. on p. 57).
- Madelain, L., C. Paeye, and J.-C. Darcheville (2011). “Operant control of human eye movements”. In: *Behavioural Processes* 87.1, pp. 142–148 (cit. on p. 33).
- Marr, D. (1982). *Vision: A Computational Investigation into the Human Representation and Processing of Visual Information*. New York: New York (cit. on p. 64).
- Masson, G. S. and L. S. Stone (2002). “From Following Edges to Pursuing Objects”. In: *Journal of Neurophysiology* 88.5, pp. 2869–2873 (cit. on p. 15).
- Maus, G. W. et al. (2015). “Different time scales of motion integration for anticipatory smooth pursuit and perceptual adaptation”. In: *Journal of Vision* 15.2, pp. 16–16 (cit. on p. 53).
- Meso, A. I. et al. (2016). “Looking for symmetry: fixational eye movements are biased by image mirror symmetry”. In: *Journal of Neurophysiology* 116.3, pp. 1250–1260 (cit. on p. 30).

- Meyniel, F. and S. Dehaene (2017). “Brain networks for confidence weighting and hierarchical inference during probabilistic learning”. In: *Proceedings of the National Academy of Sciences* 114.19, E3859–E3868 (cit. on p. 53).
- Montagnini, A., P. Allegrini, et al. (1998). “Rescaling prescriptions: On the conflict between Hurst’s analysis and the second moment prediction”. In: *Physics Letters A* 244.4, pp. 237–244 (cit. on p. 69).
- Montagnini, A. and E. Castet (2007). “Spatiotemporal dynamics of visual attention during saccade preparation: Independence and coupling between attention and movement planning”. In: *Journal of Vision* 7.14, p. 8 (cit. on pp. 26, 27, 71).
- Montagnini, A. and L. Chelazzi (2005). “The urgency to look: Prompt saccades to the benefit of perception”. In: *Vision Research* 45.27, pp. 3391–3401 (cit. on pp. 33, 57, 71).
- (2009). “Dynamic interaction between ”Go” and ”Stop” signals in the saccadic eye movement system: New evidence against the functional independence of the underlying neural mechanisms.” In: *Vision Research* 49.10, pp. 1316–28 (cit. on p. 70).
- Montagnini, A., P. Mamassian, et al. (2007). “Bayesian modeling of dynamic motion integration”. In: *Journal of Physiology-Paris* 101.1-3, pp. 64–77 (cit. on pp. 14, 20, 71).
- Montagnini, A., L. U. Perrinet, and G. S. Masson (2015). “Visual Motion Processing and Human Tracking Behavior”. In: *Biologically Inspired Computer Vision*. Wiley. Weinheim, Germany: Wiley-VCH Verlag GmbH & Co. KGaA, pp. 267–294 (cit. on p. 19).
- Montagnini, A., D. Souto, and G. S. Masson (2010). “Anticipatory eye-movements under uncertainty: a window onto the internal representation of a visuomotor prior”. In: *Journal of Vision* 10.7, pp. 554–554 (cit. on pp. 23, 49, 58).
- Montagnini, A., M. Spering, and G. S. Masson (2006). “Predicting 2D target velocity cannot help 2D motion integration for smooth pursuit initiation.” In: *Journal of neurophysiology* 96.6, pp. 3545–50 (cit. on pp. 14, 17, 22, 54, 71).
- Montagnini, A. and A. Treves (2003). “The evolution of mammalian cortex, from lamination to arealization.” In: *Brain research bulletin* 60.4, pp. 387–93 (cit. on p. 69).
- Najemnik, J. and W. S. Geisler (2005). “Optimal eye movement strategies in visual search”. In: *Nature* 434.7031, pp. 387–391 (cit. on p. 60).

- O’Connell, R. G., P. M. Dockree, and S. P. Kelly (2012). “A supramodal accumulation-to-bound signal that determines perceptual decisions in humans”. In: *Nature Neuroscience* 15.12, pp. 1729–1735 (cit. on pp. 38, 40).
- Olshausen, B. A. and D. J. Field (1996). “Emergence of simple-cell receptive field properties by learning a sparse code for natural images”. In: *Nature* 381.6583, pp. 607–609 (cit. on pp. 30, 58).
- Orban de Xivry, J.-J. et al. (2013). “Kalman filtering naturally accounts for visually guided and predictive smooth pursuit dynamics”. In: *Journal of Neuroscience* 33.44, pp. 17301–17313 (cit. on pp. 18, 38).
- Osborne, L. C., S. G. Lisberger, and W. Bialek (2005). “A sensory source for motor variation”. In: *Nature* 437.7057, pp. 412–416 (cit. on p. 57).
- Perrinet, L. U., R. A. Adams, and K. J. Friston (2014). “Active inference, eye movements and oculomotor delays.” In: *Biological cybernetics* 108.6, pp. 777–801 (cit. on p. 48).
- Perrinet, L. U. and G. S. Masson (2012). “Motion-based prediction is sufficient to solve the aperture problem”. In: pp. 1–24. arXiv: 1208.6471 (cit. on p. 48).
- Pouget, A. et al. (2013). “Probabilistic brains: knowns and unknowns”. In: *Nature Neuroscience* 16.9, pp. 1170–8 (cit. on p. 48).
- Rao, R. P. and D. H. Ballard (1999). “Predictive coding in the visual cortex: a functional interpretation of some extra-classical receptive-field effects.” In: *Nature Neuroscience* (cit. on p. 48).
- Ratcliff, R. and J. N. Rouder (1998). “Modeling Response Times for Two-Choice Decisions”. In: *Psychological Science* 9.5, pp. 347–356 (cit. on p. 39).
- Rolfs, M. (2009). “Microsaccades: Small steps on a long way”. In: *Vision Research* 49.20, pp. 2415–2441 (cit. on p. 29).
- Rolfs, M. et al. (2011). “Predictive remapping of attention across eye movements”. In: *Nature Neuroscience* 14.2, pp. 252–256 (cit. on p. 27).
- Santos, E. M. and E. Kowler (2017). “Anticipatory smooth pursuit eye movements evoked by probabilistic cues”. In: *Journal of Vision* 17.13, p. 13 (cit. on pp. 23, 58).

- Servant, M., C. White, et al. (2015a). “Using Covert Response Activation to Test Latent Assumptions of Formal Decision-Making Models in Humans”. In: *Journal of Neuroscience* 35.28, pp. 10371–10385 (cit. on pp. 40, 57).
- Servant, M., A. Montagnini, and B. Burle (2014). “Conflict tasks and the diffusion framework: Insight in model constraints based on psychological laws”. In: *Cognitive Psychology* 72, pp. 162–195 (cit. on pp. 40, 57).
- Servant, M., C. White, et al. (2015b). “Using Covert Response Activation to Test Latent Assumptions of Formal Decision-Making Models in Humans.” In: *Journal of neuroscience* 35.28, pp. 10371–85 (cit. on p. 41).
- (2016). “Linking Theoretical Decision-making Mechanisms in the Simon Task with Electrophysiological Data: A Model-based Neuroscience Study in Humans”. In: *Journal of Cognitive Neuroscience* 28.10, pp. 1501–1521 (cit. on pp. 42, 57).
- Shadlen, M. N. and R. Kiani (2013). “Decision Making as a Window on Cognition”. In: *Neuron* 80.3, pp. 791–806 (cit. on p. 40).
- Simoncini, C. et al. (2012). “More is not always better: adaptive gain control explains dissociation between perception and action.” In: *Nature Neuroscience* 15.11, pp. 1596–603 (cit. on p. 15).
- Spring, M. and A. Montagnini (2011). “Do we track what we see? Common versus independent processing for motion perception and smooth pursuit eye movements: a review”. In: *Vision Research* 51.8, pp. 836–852 (cit. on p. 54).
- Spring, M., A. Montagnini, and K. R. Gegenfurtner (2008). “Competition between color and luminance for target selection in smooth pursuit and saccadic eye movements.” In: *Journal of vision* 8.15, pp. 16.1–19 (cit. on pp. 54, 71).
- Spotorno, S., G. S. Masson, and A. Montagnini (2016). “Fixational saccades during grating detection and discrimination.” In: *Vision Research* 118, pp. 105–18 (cit. on p. 28).
- Stocker, A. A. and E. P. Simoncelli (2006). “Noise characteristics and prior expectations in human visual speed perception”. In: *Nature Neuroscience* 9.4, pp. 578–585 (cit. on p. 14).
- Tajima, S., J. Drugowitsch, and A. Pouget (2016). “Optimal policy for value-based decision-making.” In: *Nature communications* 7, p. 12400 (cit. on p. 57).

- Tatler, B. W. et al. (2011). “Eye guidance in natural vision: Reinterpreting salience”. In: *Journal of Vision* 11.5, pp. 5–5 (cit. on p. 60).
- Ulrich, R. et al. (2015). “Automatic and controlled stimulus processing in conflict tasks: Superimposed diffusion processes and delta functions”. In: *Cognitive Psychology* 78, pp. 148–174 (cit. on p. 42).
- vanZoest, W. and M. Donk (2006). “Saccadic target selection as a function of time”. In: *Spatial Vision* 19.1, pp. 61–76 (cit. on p. 60).
- Weiss, Y., E. P. Simoncelli, and E. H. Adelson (2002). “Motion illusions as optimal percepts.” In: *Nature Neuroscience* 5.6, pp. 598–604 (cit. on pp. 15, 19, 20).
- White, C., R. Ratcliff, and J. J. Starns (2011). “Diffusion models of the flanker task: Discrete versus gradual attentional selection”. In: *Cognitive Psychology* 63.4, pp. 210–238 (cit. on p. 40).
- Wilmer, J. B. and K. Nakayama (2007). “Two distinct visual motion mechanisms for smooth pursuit: evidence from individual differences”. In: *Neuron* 54, pp. 987–1000 (cit. on p. 64).
- Xu-Wilson, M., D. S. Zee, and R. Shadmehr (2009). “The intrinsic value of visual information affects saccade velocities”. In: *Experimental Brain Research* 196.4, pp. 475–481 (cit. on p. 33).