



**HAL**  
open science

# Relaxed homogeneity notions for finite-time and fixed-time stability analysis

Youness Braidiz

► **To cite this version:**

Youness Braidiz. Relaxed homogeneity notions for finite-time and fixed-time stability analysis. Automatic Control Engineering. Centrale Lille Institut, 2020. English. NNT: 2020CLIL0013. tel-03783760

**HAL Id: tel-03783760**

**<https://theses.hal.science/tel-03783760>**

Submitted on 22 Sep 2022

**HAL** is a multi-disciplinary open access archive for the deposit and dissemination of scientific research documents, whether they are published or not. The documents may come from teaching and research institutions in France or abroad, or from public or private research centers.

L'archive ouverte pluridisciplinaire **HAL**, est destinée au dépôt et à la diffusion de documents scientifiques de niveau recherche, publiés ou non, émanant des établissements d'enseignement et de recherche français ou étrangers, des laboratoires publics ou privés.

CENTRALE LILLE

THESE

Présentée en vue  
d'obtenir le grade de

**DOCTEUR**

Spécialité : **Automatique**

Par

**BRAIDIZ Youness**

DOCTORAT DELIVRE PAR CENTRALE LILLE

Titre de la thèse :

# Notions d'homogénéité détendues pour l'analyse de stabilité en temps-fini et en temps-fixe

Soutenue le 14 décembre 2020 devant le jury d'examen :

<b>Président</b>	Dorothée, NORMAND-CYROT, Directeur de recherche, CNRS
<b>Rapporteur</b>	Yacine, CHITOUR, Professeur, Université Paris-Saclay
<b>Rapporteur</b>	Jean-Pierre, BARBOT, Professeur, ENSEA
<b>Membre</b>	Jean-Michel, CORON, Professeur, Université Pierre et Marie Curie
<b>Membre</b>	Lionel, ROSIER, Professeur, ULCO
<b>Directeurs de thèse</b>	Wilfrid, PERRUQUETTI, Professeur, Ecole Centrale de Lille
<b>Co-Directeurs</b>	Denis, EFIMOV, Directeur de recherche, INRIA
<b>Co-Encadrant</b>	Andrey, POLYAKOV, Chargé de recherche HDR, INRIA

Thèse préparée dans le Laboratoire CRISAL

Ecole Doctorale SPI 072



CENTRALE LILLE

THESIS

Presented in order  
to become a

**DOCTOR**

Speciality : **Automatic**

By

**BRAIDIZ Youness**

DOCTORATE DELIVERED BY CENTRALE LILLE

Title of the thesis :

# Relaxed homogeneity notions for finite-time and fixed-time stability analysis

Defended on 14<sup>th</sup> December, 2020 before the examination board :

<b>Committee President</b>	Dorothee, NORMAND-CYROT, Senior Researcher, CNRS
<b>Referee</b>	Yacine, CHITOUR, Professor, University Paris-Saclay
<b>Referee</b>	Jean-Pierre, BARBOT, Professor, ENSEA
<b>Member</b>	Jean-Michel, CORON, Professor, University Pierre et Marie Curie
<b>Member</b>	Lionel, ROSIER, Professor, ULCO
<b>Supervisor</b>	Wilfrid, PERRUQUETTI, Professor, Ecole Centrale de Lille
<b>Co-Supervisor</b>	Denis, EFIMOV, Senior Researcher, INRIA
<b>Co-Monitor</b>	Andrey, POLYAKOV, HDR Junior Researcher, INRIA

Thesis prepared in the CRIStAL Laboratory

Ecole Doctorale SPI 072

Cette thèse a été préparée au sein du laboratoire

## CRIS<sup>t</sup>AL

Campus scientifique

Bâtiment ESPRIT

Avenue Henri Poincaré

Villeneuve d'Ascq

France

☎ (33)(0)3 28 77 85 41,

Site <https://www.cristal.univ-lille.fr>



To my loyal, supportive, and caring family. I am so appreciative to have it.  
To the extraordinary people that I had the chance to meet during the past three years in France.

# Acknowledgements

This work was supported by the Special Funds of Research ANR 15 CE23 0007 (Project Finite4SoS). This thesis was conducted at Inria-Lille Nord Europe, within the VALSE Team and at ESPRIT within the SHOC Team.

I want to express my sincere gratitude to my thesis supervisors Wilfrid PERRUQUETTI, Denis EFIMOV and Andrey POLYAKOV for allowing me to conduct this research under their auspices. I am especially grateful for their confidence and the freedom they gave me to do this work. They supported me in all stages of this work. They are the initiators of this project and they always gave me constant encouragement and advice, despite their busy agenda.

I would also like to thank the members of jury Dr. Dorothée NORMAND-CYROT, Pr. Jean-Michel CORON, Pr. Lionel ROSIER, Pr. Yacine CHITOUR and Pr. Jean-Pierre BARBOT for accepting to be members of my thesis jury, for generously offering their time, support, guidance and good will throughout the preparation and review of this document and for their valuable comments and corrections on the manuscript.

I would like to acknowledge the assistance of Dr. Nicolas ESPITIA who offered me valuable suggestions for the writing of thesis and for his helping hand.

I extend my sincere thanks to all members of Valse and SHOC Team, and all Ph.D students, post-docs, researchers and all my friends that I had met at INRIA, Ecole Centrale de Lille and ESPRIT.

I would especially like to express my gratitude to all members of my family, for their continuous and unparalleled love, help and support. I am forever indebted to my parents for giving me the opportunities and experiences that have made me who I am.



# Contents

<b>Acknowledgements</b>	<b>i</b>
<b>Contents</b>	<b>iii</b>
<b>Acronyms</b>	<b>v</b>
<b>Notation</b>	<b>vii</b>
<b>Résumé long</b>	<b>1</b>
<b>Long summary</b>	<b>5</b>
<b>Introduction</b>	<b>7</b>
<b>1 Finite-time stability and homogeneity theory: a brief review</b>	<b>13</b>
1.1 Finite-time stability property . . . . .	13
1.2 Homogeneity . . . . .	29
1.3 Applications of Finite-time stability and homogeneity . . . . .	42
<b>2 Problem statement and main tools</b>	<b>45</b>
2.1 Introduction . . . . .	45
2.2 Problem Statement . . . . .	46
2.3 Preliminaries on the main mathematical tools . . . . .	48
<b>3 Robustness and finite-time stability of homogeneous systems</b>	<b>61</b>
3.1 Finite-time strong iISS . . . . .	62
3.2 Robustness analysis of a homogeneous system and interconnections . . . . .	63
3.3 Application . . . . .	76



---

3.4	Conclusion . . . . .	79
<b>4</b>	<b>Finite-time stability analysis based on homogeneous extensions</b>	<b>81</b>
4.1	Introduction . . . . .	81
4.2	Homogeneous extension . . . . .	82
4.3	On stability analysis via homogeneous extensions . . . . .	83
4.4	A planar system example . . . . .	90
4.5	Conclusion . . . . .	93
<b>5</b>	<b>Finite-time stability analysis based on sup- and sub-homogeneity</b>	<b>95</b>
5.1	Introduction . . . . .	95
5.2	Model description . . . . .	96
5.3	Sub-homogeneous DI . . . . .	96
5.4	Sup-homogeneous DI . . . . .	103
5.5	FTS/FxTS of non-homogeneous systems . . . . .	106
5.6	Academic example . . . . .	107
5.7	Conclusion . . . . .	110
	<b>Conclusion and perspectives</b>	<b>111</b>
	<b>Bibliography</b>	<b>119</b>

# Acronyms

- FTS Finite-time stability/Finite-time stable
- GFTS Global Finite-time stability/Global Finite-time stable
- PDE Partial Differential Equation
- FT Finite-Time
- DI Differential Inclusions
- GAS Global Asymptotic Stability/Global Asymptotic Stable
- AS Asymptotic Stability/ Asymptotic Stable
- FxTS Fixed-Time Stability/Fixed-Time Stable
- FxT Fixed-Time
- ISS Input-to-State Stability/Input-to-State Stable
- LISS Local Input-to-State Stability/Local Input-to-State Stable
- iISS integral Input-to-State Stability/integral Input-to-State Stable
- FTISS Finite-time Input-to-State Stability/Finite-time Input-to-State Stable
- FTiISS Finite-time integral Input-to-State Stability/Finite-time integral Input-to-State Stable



# Notations

Some notations and preliminary definitions used throughout the thesis are as follows:

- $\mathbb{R}$  The set of real numbers.
- $|\cdot|$  The absolute value in  $\mathbb{R}$ .
- $\mathbb{R}_+ = \{x \in \mathbb{R} : x \geq 0\}$  The set of real and positive numbers.
- $\|\cdot\|$  The Euclidean norm in  $\mathbb{R}^n$ .
- $S = \{x \in \mathbb{R}^n : \|x\| = 1\}$  The unit sphere in  $\mathbb{R}^n$ .
- $[x]^\alpha = |x|^\alpha \text{sign}(x)$  for  $x \in \mathbb{R}$  and  $\alpha \in \mathbb{R}_+$ .
- $B(x_0, r) = \{x \in \mathbb{R}^n : \|x - x_0\| < r\}$  The open ball of radius  $r > 0$  centered at a point  $x_0$ .
- $\mathcal{M}_{m,n}$  The set of all  $m \times n$ -matrices over the field of real numbers. When  $m = n$  we write  $\mathcal{M}_n$  instead of  $\mathcal{M}_{n,n}$ .
- $\|\cdot\|_{\mathcal{M}_{m,n}}$  The matrix norm induced by  $\|\cdot\|$ .  $\|A\|_{\mathcal{M}_{m,n}} = \sup_{x \in S} \|Ax\|$ , where  $A \in \mathcal{M}_{m,n}$ .
- $\|d\|_{[t_0, t_1]} = \text{ess sup}_{t \in [t_0, t_1]} \|d(t)\|$  The essential supremum (the essential norm) of  $d \rightarrow \|d(t)\|$  for  $t \in [t_0, t_1]$  with  $d$  is a (Lebesgue) measurable function  $d : \mathbb{R}_+ \rightarrow \mathbb{R}^m$ .
- $\mathcal{L}_\infty$  The set of essentially bounded measurable functions  $d$  with  $\|d\|_\infty < +\infty$  and  $\|d\|_\infty = \|d\|_{[0, +\infty)}$ .
- $\mathcal{K}$  The set of functions  $\alpha : \mathbb{R}_+ \rightarrow \mathbb{R}_+$  with  $\alpha(0) = 0$  and  $\alpha(\cdot)$  is strictly increasing.
- $\mathcal{K}_\infty$  The set of functions  $\alpha : \mathbb{R}_+ \rightarrow \mathbb{R}_+$  with  $\alpha \in \mathcal{K}$  and  $\lim_{s \rightarrow +\infty} \alpha(s) = +\infty$ .
- $\mathcal{KL}$  The set of continuous functions  $\beta : \mathbb{R}_+ \times \mathbb{R}_+ \rightarrow \mathbb{R}_+$  with  $\beta(\cdot, t) \in \mathcal{K}_\infty$  for each fixed  $t \in \mathbb{R}_+$  and  $\beta(s, \cdot)$  is a strictly decreasing function in the second argument and  $\lim_{t \rightarrow +\infty} \beta(s, t) = 0$  for each fixed  $s \in \mathbb{R}_+$ .
- $\mathcal{GKL}$  The set of continuous functions  $\beta : \mathbb{R}_+ \times \mathbb{R}_+ \rightarrow \mathbb{R}_+$  with  $\beta(\cdot, 0) \in \mathcal{K}_\infty$  for  $\beta$  is a strictly decreasing function in its second argument  $t \in \mathbb{R}_+$  until  $T$  for any fixed first argument  $s \in \mathbb{R}_+ \setminus \{0\}$  and  $\beta(s, \tau) = 0, \forall \tau \geq T$  for each fixed  $s \in \mathbb{R}_+$  for some  $0 \leq T < +\infty$ .

- 
- $\nabla V(x) = \left( \frac{\partial V}{\partial x_1}(x), \dots, \frac{\partial V}{\partial x_n}(x) \right)^T$  The gradient of a continuously differentiable function  $V$  at point  $x$ .
  - $\langle \nabla V(x), f(x) \rangle = \sum_{i=1}^n \frac{\partial V}{\partial x_i}(x) f_i(x)$  The directional derivative of a continuously differentiable function  $V$  with respect to the vector field  $f$  evaluated at point  $x \in \mathbb{R}^n$ .
  - $\mathcal{C}^\infty(\mathbb{R}^n, \mathbb{R})$  The space of functions  $f : \mathbb{R}^n \rightarrow \mathbb{R}$  which are smooth.
  - $\mathcal{CL}^0(E, F)$  (respectively  $\mathcal{CL}^k(E, F)$ ) The set of continuous functions on  $E$ , locally Lipschitz on  $E \setminus \{0\}$  with value in  $F$  (respectively the set of continuous functions on  $E$ ,  $\mathcal{C}^k$  on  $E \setminus \{0\}$  with value in  $F$ ).
  - $\mathcal{D}(F)$  The domain of definition of the set-valued map  $F : \mathbb{R}^n \rightrightarrows \mathbb{R}^n$ .
  - $\partial \mathcal{A}$  The boundary of  $\mathcal{A}$ .

# Résumé long

Les comportements souhaités des systèmes dynamiques sont généralement définis par des modes d'objectifs: des ensembles admissibles de valeurs de l'état ou des équilibres appropriés (par exemple, les algorithmes de contrôle et d'estimation doivent garantir la décroissance des erreurs de régulation et d'observation à zéro). Dans ces scénarios, les performances (la qualité du contrôle et de l'estimation) peuvent être caractérisées par le temps de convergence des trajectoires vers les modes cibles, et par la quantité d'écarts des trajectoires par rapport à ces modes en présence de perturbations (fluctuations paramétriques, perturbations exogènes ou composants non modélisés), c'est-à-dire la robustesse du système. Un type de convergence populaire et difficile est le temps fini (**FTS**), où toutes les trajectoires doivent être attirées par l'équilibre (ou un ensemble) souhaité dans un temps fini proportionnel à l'écart initial. Un cas particulier de **FTS** est lorsque le temps de convergence est indépendant des conditions initiales et globalement borné, ce qui est appelé convergence à temps fixe (**FxTS**). Ces deux types de stabilité, **FTS** et **FxTS**, sont les principaux concepts étudiés dans ce travail.

Il existe deux méthodes pour étudier **FTS/FxTS**: la méthode des fonctions de Lyapunov et la théorie des systèmes homogènes. La première approche est puissante, mais il est difficile d'utiliser cet outil. Il n'y a pas de méthodologie pour trouver une fonction de Lyapunov nécessaire Pour un système dynamique stable (un inconvénient standard de cette approche). Ce dernier cadre est plus simple à utiliser, mais il présente également certaines limites. Et la principale est que la classe des systèmes homogènes est plutôt étroite. Cette lacune peut être évitée en considérant les systèmes dynamiques qui peuvent être localement approximés par des systèmes homogènes, et même dans ce cas, il y a encore une marge d'amélioration. Et c'est exactement le point d'investigation de la présente thèse: comment étendre et développer la théorie de l'homogénéité pour l'appliquer à des systèmes non linéaires non homogènes (n'admettant pas d'approximations homogènes) pour l'analyse de **FTS/FxTS** et les propriétés robustes de stabilité en temps fini.

Pour les systèmes de contrôle non linéaires, le problème de la robustesse par rapport aux perturbations et à l'incertitude du modèle est aussi ancien que le contrôle par rétroaction. La complexité des phénomènes non linéaires est problématique même en l'absence de perturbations et d'autres incertitudes. Par conséquent, cette théorie a mis du temps à être développée dans un sens clair pour certaines classes de systèmes non linéaires et elle devient un sujet central de la théorie du contrôle. L'une des propriétés de stabilité robustes les plus populaires, qui a été introduite dans [89], est le concept de stabilité entrée-état (**ISS**). Ce cadre est devenu indispensable pour diverses branches de la théorie du contrôle non linéaire, telles que conception d'observateurs non linéaires [4], stabilisation robuste des systèmes non linéaires [38], etc. Cependant, il est parfois impossible de garantir globalement le comportement **ISS** d'un système en boucle fermée, et sa variante locale (**LISS**) est fréquemment utilisé. De plus, une autre relaxation de l'**ISS** concept, connue sous le nom de stabilité d'entrée à l'état intégrale (**iISS**), a été proposée dans [88]. L'interprétation suivante de ces notions est possible: alors que l'état d'un système **ISS** est petit si les entrées sont petites, l'état d'un système **iISS**

est petit si les entrées ont une énergie finie. De plus, chaque système **ISS** est nécessairement **iISS**, mais l'inverse n'est pas vrai. Il a été montré que la propriété **ISS** (resp., **iISS**, **LISS**) équivaut à l'existence d'une fonction Lyapunov smoothISS (resp., **iISS**, **LISS**) [90], qui permet une large utilisation de ce cadre. L'étude de la propriété **ISS** pour les systèmes homogènes a également été considérée dans [10]. Ainsi, les auteurs ont montré qu'un système homogène, qui est globalement asymptotiquement stable (**GAS**) en l'absence de perturbation, permet d'obtenir une **ISS** ou **iISS** en ce qui concerne les propriétés de la dilatation et le signe de son degré d'homogénéité. L'étude de l'**ISS**/**iISS** à temps fini (**FTISS**/**FTiISS**) pour les systèmes homogènes a également été envisagée par Bernuau et al. dans [9]. Combinant les propriétés d'homogénéité et l'approche de Lyapunov, certaines questions se posent naturellement lorsque l'on réfléchit à la robustesse et au **FTS** des systèmes dynamiques avec ou sans perturbations:

- Est-il possible de garantir la **FTS** d'un système non linéaire perturbé? Si non, quelles sont les conditions qui doivent être réunies pour garantir la convergence **FT** des trajectoires du système en présence de perturbations?
- La preuve de la propriété **FTS** du système peut généralement être effectuée en trouvant une fonction de Lyapunov satisfaisant à des conditions nécessaires et suffisantes (c'est-à-dire la fonction **FT** Lyapunov). Cependant, il n'existe pas de méthode universelle pour le faire. Par conséquent, tant qu'un système est **GAS**, quelles sont alors les conditions que le champ vectoriel d'un tel système doit remplir pour garantir la propriété **FTS**?
- Est-il possible de trouver une nouvelle approche conduisant à l'établissement de **FTS** ou bien **FxTS** sans exiger l'existence de la fonction **FT** Lyapunov? la thèse vise à répondre aux questions ci-dessus. Présentons brièvement les principales contributions de cette thèse.

Cette thèse vise à répondre aux questions ci-dessus. Présentons brièvement les principales contributions de cette thèse.

## Contributions et structure de la thèse

La thèse est composée de 5 chapitres, et elle est organisée comme suit: Dans le chapitre 1, nous présentons brièvement une revue de **FTS**, les principaux outils qui ont été introduits pour étudier cette propriété pour les systèmes continus et discontinus, et certaines caractéristiques que ces systèmes présentent lorsqu'ils possèdent la propriété **FTS**. Nous présenterons également la notion d'homogénéité et comment elle a été développée dans le domaine de la théorie du contrôle. Le chapitre 2 présentera l'énoncé du problème, qui comprend les classes de systèmes à traiter, certains problèmes spécifiques (par exemple liés à la robustesse à toute entrée externe) et les principaux outils mathématiques utilisés dans le reste du manuscrit pour résoudre les questions ouvertes de la thèse. Plus précisément, nous divisons le problème comme suit:

La première contribution traite des problèmes d'analyse de la stabilité entrée-état (**ISS**) et son historique en temps fini (**FTISS**) des systèmes affinis non linéaires, c'est-à-dire:

$$\dot{x}(t) = f(x(t)) + g(x(t))\delta(t), \quad x \in \mathbb{R}^n, \quad \delta \in \mathbb{R}^m, \quad t \geq 0,$$

soumis à une perturbation  $\delta$  et il sera présenté au chapitre 3. Ce concept sera également considéré pour le cas général:

$$\dot{x}(t) = f(x(t), \delta(t)), \quad x \in \mathbb{R}^n, \quad \delta \in \mathbb{R}^m, \quad t \geq 0,$$

lorsque  $f$  est localement homogène. Par conséquent, ces résultats demandent la propriété **GAS** en l'absence de perturbations et nécessitent des conditions supplémentaires sur  $\delta$ . De plus, le problème de **FTS** et **FTISS** sera traité pour le système affine non linéaire lorsqu'il admet des perturbations dynamiques. Pour garantir de tels résultats, des conditions suffisantes que les perturbations dynamiques doivent satisfaire seront dérivées.

Le chapitre 4 traite du **FTS** des systèmes non linéaires, c'est-à-dire

$$\dot{x}(t) = f(x(t)), \quad x(0) = x_0 \in \mathbb{R}^n, \quad t \geq 0,$$

où  $f$  n'a pas d'approximation homogène. Quelques nouvelles extensions, avec des propriétés appropriées (extension homogène), sont introduites pour étudier les notions de **FT** et **FxTS** des systèmes non linéaires qui n'admet pas d'approximations homogènes à l'origine ni à l'infini. Dans ce chapitre, les résultats **FTS** et **presque FxTS** sont établis pour une classe de systèmes non linéaires (systèmes homogènes avec perturbation fonctionnelle multiplicative bornée). Ces résultats sont généralisés pour une somme finie de systèmes homogènes avec des fonctions multiplicatives bornées:

$$f(x) = \sum_{i=1}^{i=p} H_i(x) b_i(x), \quad p \in \mathbb{N},$$

où  $H_i$  sont des matrices homogènes et  $b_i$  sont des champs de vecteurs bornés. En particulier, on montre que si un système est globalement asymptotiquement stable admet une extension homogène, alors une fonction de Lyapunov homogène peut être construite pour l'extension, ce qui permet d'évaluer les taux de convergence et les propriétés de robustesse. **FTS** découle d'un degré d'homogénéité négatif de l'extension, comme dans le cas conventionnel.

Enfin, au chapitre 5, de nouveaux concepts assurant la symétrie des solutions pour les systèmes dynamiques, appelés **sur- ou sous-homogénéité**, sont introduits. Ces notions sont utilisées pour étudier **FTS** et **FxTS** d'inclusions différentielles. On étudie l'existence d'une fonction de Lyapunov homogène pour une inclusion différentielle, **sur-/sous-homogène** et globalement asymptotiquement stable. Ensuite, les notions d'extensions **sur- et sous-homogènes** sont introduites pour les systèmes dynamiques non linéaires, qui n'admettent pas d'extension homogènes. Par conséquent, cela conduit à établir des conditions suffisantes pour **FTS/FxTS** de systèmes asymptotiques stables avec la possibilité qu'ils ne soient pas localement homogènes. Un nouvel algorithme pour établir **FTS** et **FxTS** pour les systèmes non linéaires utilisant les notions d'extensions **sur/sous-homogènes** est présenté.

Long de la thèse, pour illustrer les résultats obtenus, des observateurs en temps fini sont conçus en utilisant les résultats développés pour les systèmes avec perturbations. Tous ces résultats sont dérivés sans construire une fonction de Lyapunov en temps fini ou en temps fixe. La robustesse vis-à-vis des perturbations exogènes est vérifiée à l'aide des propriétés **ISS** et **FTISS**.





# Long summary

The desired behaviors of dynamical systems are usually defined by goal modes: admissible sets of values of the state or suitable equilibria (*e.g.*, control and estimation algorithms have to ensure the decay of regulation and observation errors to zero). In these scenarios, the performances (the quality of control and estimation) can be characterized by the time of convergence of the trajectories to the goal modes, and by amount of deviations of the trajectories from these modes in the presence of perturbations (parametric fluctuations, exogenous disturbances or unmodeled components), *i.e.*, how robust is the system. A popular and challenging kind of convergence is the finite-time one (**FTS**), where all trajectories have to be attracted by the desired equilibrium (or a set) in a finite time proportional to the initial discrepancy. A special case of **FTS** is when the time of convergence is independent on initial conditions and globally bounded, which is called fixed-time convergence (**FxTS**). These two types of stability, **FTS** and **FxTS**, are the principal concepts investigated in this work.

There are two methods to investigate **FTS/FxTS**: the method of Lyapunov functions and the theory of homogeneous systems. The former approach is powerful, but it is difficult to use this tool since there is no methodology how to find a needed Lyapunov function in an application (a standard drawback of this approach). The latter framework is simpler to utilize, but it also has certain limitations, and the main one is that the class of homogeneous systems is rather narrow. This shortcoming can be avoided by considering the dynamical systems that can be locally approximated by homogeneous ones, and even in this case there is still a space for improvement. And this is exactly the point of investigation of the present thesis: how to extend and develop the theory of homogeneity in order apply it to nonlinear non-homogeneous systems (not admitting homogeneous approximations) for analysis of **FTS/FxTS**. The robust finite-time stability properties are examined.

This manuscript consists of five chapters as well as general introduction and conclusion. The state of the art on the theory of homogeneous systems, **FTS/FxTS** properties and related notions are presented in Chapter 1. The problem statement is introduced in Chapter 2, together with the mathematical tools and some recent results, which are used next in the main body of the thesis.

In Chapter 3, the problems of analysis of input-to-state stability (**ISS**) and its finite-time analogue (**FTISS**) are investigated for non-homogeneous systems obtained as a product of homogeneous matrix function and a multiplicative bounded state perturbation. Some sufficient conditions are formulated on the multiplicative part guaranteeing that **ISS/FTISS** properties are preserved. These results provide a generalization of that has been already proven for homogeneous systems (the case when the multiplicative part is a constant function). Two scenarios for the disturbances are treated: the case of bounded external signals, and the case when they are generated by another homogeneous autonomous dynamics.

In Chapter 4, the notion of homogeneous extensions is introduced. This concept provides a qualitative tool for studying robustness and convergence rates of nonlinear systems, which

do not admit homogeneous approximations at the origin nor at infinity. It is shown that if a globally asymptotically stable system admits a homogeneous extension, then a homogeneous Lyapunov function can be constructed for the extension, which allows the convergence rates and the robustness properties to be assessed. In particular, **FTS** follows from a negative degree of homogeneity of the extension, as in the conventional case.

Finally, in Chapter 5, new concepts ensuring the symmetry of solutions for dynamical systems, called sup- or sub-homogeneity, are introduced. These notions are used to investigate **FTS** and **FxTS** of differential inclusions. The existence of a homogeneous Lyapunov function for a differential inclusion, which is sup-/sub-homogeneous and globally asymptotically stable, is studied. Next, the notions of sup- and sub-homogeneous extensions are introduced for nonlinear dynamical systems, which do not admit homogeneous ones. A new algorithm to establish **FTS** and **FxTS** for nonlinear systems using the notions of sup/sub-homogeneous extensions is presented.

Along the thesis, for illustration of the obtained results, finite-time observer are designed by using the results developed for the systems wit disturbances. All these results are derived without constructing a finite-time or fixed-time Lyapunov function. Robustness with respect to exogenous perturbations is verified using **ISS** and **FTISS** properties.

# Introduction

Control theory and applications are widely omnipresent in engineering, in many areas such as aerospace control, manufacturing and robotics, active damping, climate control of buildings, process control in chemical plants, electrical power systems, bio-engineering, consumer products and engine timing in the car industry ... etc. Many researchers mentioned the gap between the control theory and engineering practice [93], indicating that this gap is increasing. From another side, the theory of control has strong relations with the theory of dynamical system finding applications in the modern problems of physics [37].

A fundamental problem in the theory of dynamical systems is the characterization of qualitative properties of solutions to a given differential equation. A basic notion is the stability property of an equilibrium point. Lyapunov stability is one of the classical concepts, which is at the center of interest for researchers. This concept guarantees the boundedness of solutions for bounded initial conditions. However, the behavior of the system trajectories around an equilibrium point may be significant. Therefore, researchers are interested in the *exponential* or *asymptotic stability* (**AS**). These properties characterize systems for which all trajectories converge to some equilibrium in a reasonable manner. Considering differential equations, the **AS** property combines stability in the sense of Lyapunov with an asymptotic attractivity property. The convergence of the trajectories to an equilibrium, of an asymptotic stable system, takes place in an infinite amount of time. Nevertheless, in many engineering problems, convergence time is a central issue which must be taken into account. Therefore, a qualitative theory of stability has been initiated recently for *finite-time* behaviours of dynamical systems.

## Motivation for finite-time stability

The need for a more practical concept of stability, than what is provided by the classical theory, drives scientists and engineers to develop a recent type of stability called *finite-time stability* (**FTS**) (see Zubov [31], Roxin [82] and Haimo [40]). Also, it becomes popular in many applications needed an accelerated convergence of the trajectories to the goal reference, and is studied by [82, 53, 11, 13, 19]. This new concept involves the existence of a scalar function of initial-condition  $T$ , which defines the time-convergence of all trajectories to an equilibrium. This function is frequently called the *settling-time* function. Hence, one of the key issues in **FTS** is the estimation of  $T$ . Accordingly, a more valuable problem is concerned, which is whether the time convergence of the solutions of a dynamical system can be realized within a fixed-time interval regardless of the initial conditions. To solve this problem, a uniform **FTS** with respect to the initial conditions called *fixed-time stability* (**FxTS**) was introduced by Polyakov [72]. This concept requires that the system is globally **FTS** and the settling-time is uniformly bounded with respect to initial conditions in the whole state domain. This property implies that for any initial condition, all trajectories of a nonlinear system will converge to the

equilibrium before a fixed and known time. Investigating **FTS** or **FxTS** can be done either by using *Lyapunov approach* or *homogeneity*.

In 1892, Alexander M. Lyapunov built a novel and effective technique to investigate the stability of nonlinear systems by using scalar functions similar to some "distance" to the equilibrium point. This modern stability theory is well-known under the name of "*Lyapunov approach*". Lyapunov analysis has been intensively developed for all types of stability including the above mentioned ones. This concept allows us to determine the stability of a dynamical system without linearizing it nor calculating the explicit form of its solutions. The aim of this approach is to find a continuous positive definite scalar function  $V$ , called *Lyapunov function*, such that its derivative along the trajectories of the dynamical system satisfies a particular differential inequality. However, the fact that there is no general procedure to find such a Lyapunov function is still an open problem from which the field of control theory suffers. Therefore, a notion, called *homogeneity*, which guarantees some invariant properties of the solution was defined and used in the control theory to specify the type of stability for a dynamical system.

## On homogeneity theory

*Homogeneity* is an inherent property of an object (a set, a function, a vector field, etc.), which operates in an invariant way with respect to a multiplicative dilation. In the classical sense, a function is homogeneous if it maps an argument scaled by a given constant to the image of that argument, scaled by the same constant at a fixed power, called a degree. Later, the classical homogeneity was generalized in control theory to a more general transformation, namely *weighted dilation*. In this concept, every coordinate is scaled by the same constant with different powers:

$$x \in \mathbb{R}^n \mapsto (\lambda^{r_1} x_1, \dots, \lambda^{r_n} x_n) \in \mathbb{R}^n,$$

for  $\lambda > 0$ , where  $r_i > 0$  are the weights (see [42, 95, 81]). In the control theory, this notion of homogeneity involves qualitative properties (e.g., symmetry-like property) for a system's trajectories and it is of particular interest in the light of stability. The advantage of homogeneous systems is that local properties can be extended globally (e.g., local asymptotic stability always implies the global one). Qualitative results not involving the computation of a Lyapunov function are therefore of a great interest. This is one of the reasons why, the *homogeneity* theory has been developed and used in control theory. It was introduced for ordinary differential equations (in [95, 52, 42, 49, 13]), time delay systems [33], discrete-time systems [85] and partial differential equations (in [76, 75]). In all these fields, this concept is considered as one of the main tools to establish **FTS** or **FxTS** of a given system. Indeed, in [94, page 110] it was shown that any asymptotically stable standard homogeneous system of negative degree is **FTS**. In [13], this result is extended to the most generalized concept of *homogeneity* called the *geometric homogeneity* (see [50, 80]). Notice that the same property holds for homogeneous differential inclusions [55, 8] and homogeneous evolution equations in Banach spaces [76]. One of the most important results in this context is the existence of a homogeneous Lyapunov function for any asymptotically stable homogeneous system [81].

This upshot is used to study the finite-time robustness of non-linear homogeneous systems with exogenous disturbances.

For non-linear control systems, the problem of achieving *robustness* with respect to disturbances and model uncertainty is as old as feedback control. The complexity of non-linear phenomena is problematic even in the absence of disturbances and other uncertainties. Therefore, this theory has taken some time to be developed in a clear sense for some classes of non-linear systems and it becomes a central topic in control theory. One of the most popular robust stability properties, which was introduced in [89], is the concept of input-to-state stability (**ISS**). This framework has become indispensable for various branches of non-linear control theory, such as design of non-linear observers [4], robust stabilization of non-linear systems [38], etc. However, sometimes it is impossible to ensure the **ISS** behavior of a closed loop system globally, and its local variant (**LISS**) is frequently used. Moreover, another relaxation of the **ISS** concept, known as integral input-to-state stability (**iISS**), has been proposed in [88]. The following interpretation of these notions is possible: while the state of an **ISS** system is small if inputs are small, the state of an **iISS** system is small if inputs have a finite energy. Moreover, every **ISS** system is necessarily **iISS**, but the converse is not true. It has been shown that **ISS** property (resp., **iISS**, **LISS**) are equivalent to the existence of a smooth **ISS** (resp., **iISS**, **LISS**) Lyapunov function [90], which allows this framework to be widely used. Investigating the **ISS** property for homogeneous systems has been also considered in [10]. Hence, the authors showed that a homogeneous system, which is *Globally asymptotically stable* (**GAS**) in the absence of disturbance, achieves **ISS** or **iISS** regarding the dilation's properties and the sign of its degree of homogeneity. Investigating finite-time **ISS**/**iISS** (**FTISS**/**FTiISS**) for homogeneous systems has been also considered by Bernuau et al. in [9].

Combining the properties of homogeneity and Lyapunov approach, some questions arise naturally when thinking about the robustness and **F****T****S** of dynamical systems either with or without perturbations:

- Is it possible to guarantee **F****T****S** of perturbed nonlinear system? If not, then what are the conditions that have to be held to guarantee the **F****T** convergence of the system trajectories in the presence of disturbances?
- Proving the **F****T****S** property of system can be usually done by finding a Lyapunov function satisfying a necessary and sufficient conditions (i.e., ***F****T** Lyapunov function*). However, there is no universal method to do so. Therefore, as long as a system is **GAS**, then what are the conditions that the vector field of such a system has to satisfy to guarantee the **F****T****S** property?
- Is it possible to find a new approach which leads to establishment of **F****T****S**/**F****x****T****S** without requiring the existence of **F****T** Lyapunov function?

This thesis aims at answering the above questions. Let us present briefly the main contributions of this thesis.

## Contributions and the structure of the thesis

The thesis is made up of 5 chapters, and it is organized as follows: In Chapter 1, we present briefly a review of **F<sub>T</sub>S**, the main tools that have been introduced to investigate this property for continuous and discontinuous systems, and some features that these systems exhibit when having **F<sub>T</sub>S** property. We will also present the notion of homogeneity and how it has been developed in field of control theory. Chapter 2 will introduce the problem statement, which include the classes of systems to deal with, some specific issues (e.g. related to the robustness to any external input), and the main mathematical tools used in the rest of the manuscript to solve the open questions in the thesis. More precisely, we split the problem as follows:

1. The first contribution deals with the problem of **F<sub>T</sub>S** robustness of nonlinear affine systems, i.e.,

$$\dot{x}(t) = f(x(t)) + g(x(t))\delta(t), \quad x \in \mathbb{R}^n, \quad \delta \in \mathbb{R}^m, \quad t \geq 0,$$

subject to a perturbation e.g.  $\delta$  and it will be presented in Chapter 3. This concept will also be considered for the general case:

$$\dot{x}(t) = f(x(t), \delta(t)), \quad x \in \mathbb{R}^n, \quad \delta \in \mathbb{R}^m, \quad t \geq 0,$$

when  $f$  is locally homogeneous. Hence, this results ask for the **GAS** property in the absence of disturbances and it requires additional conditions on  $\delta$ . Moreover, the problem of **F<sub>T</sub>S** and **F<sub>T</sub>ISS** will be treated for the nonlinear affine system when it admits dynamical disturbances. To guarantee such results, sufficient conditions that the dynamical perturbations has to satisfy, will be derived.

2. Chapter 4 deals with **F<sub>T</sub>S** of nonlinear systems, i.e.,

$$\dot{x}(t) = f(x(t)), \quad x(0) = x_0 \in \mathbb{R}^n, \quad t \geq 0,$$

where  $f$  may not have a homogeneous approximation.

Some new extensions, with suitable properties (e.g. *homogeneous extension*), are introduced to investigate the notions of **FT** and **F<sub>x</sub>T<sub>S</sub>**. In this chapter, **F<sub>T</sub>S** and **nearly F<sub>x</sub>T<sub>S</sub>** results are established for a class of nonlinear systems (homogeneous systems with multiplicative bounded functional perturbation). These results are generalized for a finite sum of homogeneous systems with multiplicative bounded functions, i.e.,

$$f(x) = \sum_{i=0}^{p-1} H_i(x)b_i(x), \quad p \in \mathbb{N},$$

where  $H_i$  are homogeneous matrices and  $b_i$  are bounded vector fields.

3. To enlarge the class of systems to which our method could apply, we need a new approach. We will call it (**sup- and sub-homogeneity**). These properties only apply for some classes of differential inclusions (**DI**) allowing to conclude **F<sub>T</sub>S** and **F<sub>x</sub>T<sub>S</sub>** properties of **DI**. Hence, this leads to establishing sufficient conditions for **F<sub>T</sub>S**/**F<sub>x</sub>T<sub>S</sub>** of asymptotic stable systems with possibility that they may not be locally homogeneous. The aforementioned contribution is discussed in Chapter 5.

## Publications

### Peer reviewed international journals

- Youness Braidiz, Denis Efimov, Andrey Polyakov, and Wilfrid Perruquetti. "*On robustness of finite-time stability of homogeneous affine nonlinear systems and cascade interconnections*". In **International Journal of Control (2020)**, pp. 1–22.
- Youness Braidiz, Andrey Polyakov, Denis Efimov and Wilfrid Perruquetti. "*On Finite/Fixed-time stability analysis based on sup- and sub-homogeneous extensions*", **Systems & Control Letters, 2020**.
- Youness Braidiz, Andrey Polyakov, Denis Efimov and Wilfrid Perruquetti. "*On finite-time stability analysis of homogeneous vector fields with multiplicative perturbations*", **International Journal of Robust and Nonlinear Control, 2020**.

### Peer reviewed international conferences

- Youness Braidiz, Denis Efimov, Andrey Polyakov, and Wilfrid Perruquetti. "*Robust finite-times tability of homogeneous systems with respect to multiplicative disturbances*". In 2019 18th European Control Conference (ECC), pages 668–673, June 2019.
- Youness Braidiz, Wilfrid Perruquetti, Andrey Polyakov, and Denis Efimov. "*On finite-time stability of homogeneous systems with multiplicative bounded function*". In 2019 18th European Control Conference (ECC), pages 645–649, 2019.
- Youness Braidiz, Andrey Polyakov, Denis Efimov, and Wilfrid Perruquetti. "*On fixed-time stability of a class of nonlinear time-varying systems*". In IFAC 2020-21st IFAC World Congress, 2020.
- Youness Braidiz, Denis Efimov, Andrey Polyakov, and Wilfrid Perruquetti. "*On finite-time stability of sub-homogeneous differential inclusions*". In IFAC 2020-21st IFAC World Congress, 2020.





# Finite-time stability and homogeneity theory: a brief review

---

## Contents

---

<b>1.1</b>	<b>Finite-time stability property</b>	<b>13</b>
1.1.1	Introduction	13
1.1.2	Finite-time and Fixed-time stability of continuous systems	16
1.1.3	Finite-time and Fixed-time stability of discontinuous systems	24
<b>1.2</b>	<b>Homogeneity</b>	<b>29</b>
1.2.1	Standard Homogeneity	30
1.2.2	Weighted Homogeneity	31
1.2.3	Geometric and Local Homogeneity	34
1.2.4	Stabilization in the light of homogeneity	37
<b>1.3</b>	<b>Applications of Finite-time stability and homogeneity</b>	<b>42</b>
1.3.1	Finite-time stabilizing control for robot manipulators	42
1.3.2	Finite-time Observer (Chua's Oscillator)	43

---

This chapter is made up of three parts. The first part introduces finite-time and fixed-time stability properties for nonlinear systems together with their Lyapunov analysis. The second part, after recalling some historical development of the homogeneity property, will focus on its use for asymptotic and finite-time stability analysis / stabilization of some nonlinear systems. Lastly, two examples show how the homogeneity property can be used in the controller/observer design to ensure the desired finite-time stability property for the target system (closed loop system/observer error system).

## 1.1 Finite-time stability property

### 1.1.1 Introduction

In the last century, a great effort has been spent to investigate the finite-time convergence property by a numerous researchers (starting from Erugin 1951 and Zubov 1957, followed by Roxin 1966, Korobov 1979 and then by many others).

This finite-time concept dates back to 1964, where Zubov studied the so called "*uniform attracting invariant set or equilibrium*" of nonlinear systems (see [94]). Latter in 1966, Roxin studied the notion of *finite stability* of time-varying systems [82]. 1982, Ryan presented several systems for which a **FT** optimal control has been designed [83]. One of these examples is the double integrator:

$$\begin{cases} \dot{x}(t) = y(t), & x(t), y(t) \in \mathbb{R}, \\ \dot{y}(t) = u(t) & t \geq 0. \end{cases}$$

which may arise, after eventually some simplifications, from many practical problems (mechanics, ...). For such systems (and, in general, for all linear systems), the **FT** convergence cannot be achieved using time-invariant linear state feedbacks. Therefore, nonlinear controls (sometimes discontinuous ones) or time-varying ones have been used to guarantee the **FTS** for these systems. However, discontinuous dynamics may lead to a complicated analysis [34] or to chattering [36] which in practice may destroy or at least damage the actuators. **FT** stabilization using time-varying feedback laws has also been considered by Coron in [28].

To introduce the notion of **FTS**, let us start with the following scalar system:

$$\begin{cases} \dot{x}(t) = -c[x(t)]^\alpha, \\ x(0) = x_0, \end{cases} \quad (1.1)$$

where  $[x]^\alpha = |x|^\alpha \text{sign}(x)$ ,  $x \in \mathbb{R}, x_0 \in \mathbb{R}, t \geq 0, c > 0$  and  $0 < \alpha < 1$ . This system has an equilibrium point at the origin, its right-hand side is continuous and locally Lipschitz everywhere except at the origin. Hence, for every initial condition from  $\mathbb{R} \setminus \{0\}$ , the system (1.1) has a unique solution in forward time. Solutions of (1.1) can be obtained by direct integration as

$$x(t, x_0) = \begin{cases} (|x_0|^{1-\alpha} - c(1-\alpha)t)^{\frac{1}{1-\alpha}} \text{sign}(x_0), & t \leq \frac{1}{c(1-\alpha)}|x_0|^{1-\alpha}; \\ 0, & t \geq \frac{1}{c(1-\alpha)}|x_0|^{1-\alpha}. \end{cases}$$

Since any trajectory will be exactly 0 for any  $t \geq \frac{1}{c(1-\alpha)}|x_0|^{1-\alpha}$ , we deduce that system (1.1) is **FTS** with the settling-time function<sup>1</sup> given by  $T(x_0) = \frac{1}{c(1-\alpha)}|x_0|^{1-\alpha}$ . Note that the settling-time function is continuous everywhere. In Figure 1.1, one can see the convergence speed of the solutions  $x(\cdot, x_0)$  of system (1.1) to zero: they are converging at least faster than the solutions  $y(\cdot, x_0)$  of the system  $\dot{y} = -y$  (which corresponds to system (1.1) with  $c = 1, \alpha = 1$ ).

This example exhibits **FT** convergence of the solutions to the origin. However this property was obtained by computing the solutions in closed form. To circumvent this difficulty in proving **FTS**, many results were developed in the last decades: Bhat and Bernstein obtained several **FTS** results for continuous autonomous systems [11]; then Moulay and Perruquetti gave **FTS** analysis and **FT** stabilization conditions for continuous autonomous systems [60] and for non-autonomous systems [61]. **FTS** has also been considered and treated for discontinuous systems. For example in 2004, Orlov studied **FTS** property of discontinuous switching

<sup>1</sup>The settling-time function provides the time for solutions to reach the origin starting from a given initial condition.

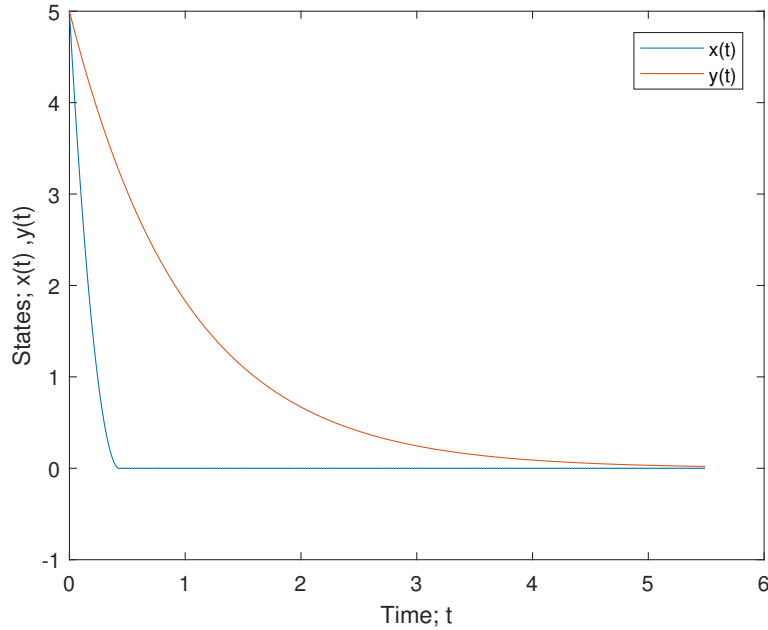

Figure 1.1: The solutions of the system (1.1) with  $c = 10$ ,  $\alpha = 0.5$  (blue) and  $c = 1$ ,  $\alpha = 1$  (red).

system [68]. Afterwards, in 2005, Moulay and Perruquetti established some **FTS** theorems for **DI** [62], which can be used to study discontinuous systems by considering their Filippov extensions. Here, we have just cited some of the most relevant results among the numerous obtained ones. More recently, such **FTS** studies were also devoted to infinite dimensional systems mainly time-delay systems and systems governed by partial differential equations. Meanwhile some robustness issues of **FTS** were considered: the so called **FTISS** was proposed for continuous systems by Hong et al. [45].

On the basis of **FTS**, another important concept called **FxTS** was introduced by Polyakov for **FTS** systems with uniformly bounded settling-time function (i.e., the bound does not depend on the initial states) [77, 72, 57, 56]. **FxTS** occurs frequently in many practical systems. For example in mechanics when dry friction acts in conjunction with non-linear damping or in power systems where **FxT** stabilization is used to guarantee excellent power supply quality and to avoid voltage collapses. Nowadays, more and more attention has been paid to these **FTS**/**FxTS** notions: the most relevant obtained properties can be found in [11, 69, 61, 70, 86].

Let us emphasize that more than half of the obtained results about **FTS** and **FxTS** are requiring Lyapunov functions. Researchers obtained necessary and sufficient Lyapunov conditions of **FTS**/**FxTS** for nonlinear dynamical systems. The existence of a universal method to construct a **FT** or **FxT** Lyapunov function has not been solved yet (similar for **AS**). Therefore, finding sufficient conditions ensuring either **FTS** or **FxTS** for a **GAS** nonlinear systems

is one of main goals of this thesis. In addition we will require that when testing the sufficient conditions, we do not need any specific construction of a Lyapunov function.

### 1.1.2 Finite-time and Fixed-time stability of continuous systems

**FTS** has been introduced and investigated for continuous, discontinuous, autonomous and non-autonomous systems. In the sequel, we will be interested in establishing the **FTS/FxTS** of continuous autonomous systems. To that end, we will introduce the definition of **FT/FxTS** properties and the main tools that have been developed, up to now, when studying and analysing these properties.

Let us now consider the following continuous system:

$$\begin{cases} \dot{x}(t) &= f(x(t)), \\ x(0) &= x_0 \in \mathbb{R}^n, \end{cases} \quad (1.2)$$

where  $x(t) \in \mathbb{R}^n$  is the state and  $x(t, x_0)$  is the corresponding solution for the initial condition  $x_0 \in \mathbb{R}^n$ . The right-hand side of (1.2)

$$f : \mathbb{R}^n \rightarrow \mathbb{R}^n, \quad f(0) = 0,$$

is considered such that a unique solution  $x(t, x_0)$  exists in forward time (forward uniqueness) and satisfies (1.2) for all  $x_0 \in \mathbb{R}^n$  and  $t \geq 0$ .

The following **FTS** definition is inspired by [11, 26, 78, 94]:

**Definition 1.1**

*The origin of the autonomous system (1.2) is:*

1. **Lyapunov stable:** if there exist a nonempty open neighborhood of the origin  $\mathcal{V} \subset \mathbb{R}^n$  and a function  $\alpha \in \mathcal{K}_\infty$  such that for all  $x_0 \in \mathcal{V}$  we have

$$\|x(t, x_0)\| \leq \alpha(\|x_0\|), \quad \forall t \geq 0.$$

2. **Asymptotically Lyapunov stable (AS):** if it is **Lyapunov stable** and  $\lim_{t \rightarrow +\infty} x(t, x_0) = 0$ ,  $\forall x_0 \in \mathcal{V}$ , i.e., there exists  $\beta \in \mathcal{KL}$  such that

$$\|x(t, x_0)\| \leq \beta(\|x_0\|, t), \quad \text{for all } x_0 \in \mathcal{V} \quad \text{and for all } t \geq 0. \quad (1.3)$$

3. **Finite-time (FT) attractive:** if there exists a function  $T : \mathcal{V} \rightarrow \mathbb{R}_+$  such that  $\forall x_0 \in \mathcal{V}$ ,

$$x(t, x_0) = 0, \quad \forall t \geq T(x_0).$$

*T is called a settling-time function.*

4. **Finite-time stable (FTS):** if it is **Lyapunov stable** and **FT attractive**.

In addition, if  $\mathcal{V} = \mathbb{R}^n$ , then all these properties hold globally.

Throughout the thesis,  $\mathcal{V}$  will always denote a neighborhood of the origin.

**Remark 1.1**

Let us stress that assertion 4. of Definition 1.1 holds if and only if there exists<sup>2</sup>  $\beta \in \mathcal{GKL}$  such that  $\|x(t, x_0)\| \leq \beta(\|x_0\|, t)$ ,  $\forall t \geq 0$ .

Note the following key property: if the origin of (1.2) is **FTS**, then (1.2) cannot possess unique solutions in backward time at the origin. Therefore, in particular, we assume that the vector field  $f$  is locally Lipschitz except at  $x = 0$  (this is true for the system (1.1)). In that case, for a nonlinear system, Lyapunov stability implies the uniqueness of solutions in forward-time.

The following proposition shows that, if the origin is a **FTS** equilibrium of (1.2), then the Cauchy problem associated to (1.2) has a unique solution on  $\mathbb{R}_+$  for every initial condition in an open neighborhood of the origin.

**Proposition 1.1** (Bhat & Bernstein. 2000 [11, Proposition 2.3])

Let  $f$  be locally Lipschitz except at the origin. Assume that the origin is a **FTS** equilibrium for (1.2). Let<sup>3</sup>  $\mathcal{V} \subset \mathbb{R}^n$  and  $T : \mathcal{V} \setminus \{0\} \rightarrow (0, +\infty)$  be the settling-time function (see Definition (1.1)). Then,  $x(\cdot, \cdot) : \mathbb{R}_+ \times \mathcal{V} \rightarrow \mathbb{R}^n$  is well defined and  $x(t, x_0) = 0$  for all  $t \geq T(x_0)$ ,  $x_0 \in \mathcal{V}$ , where  $T(x_0) \rightarrow 0$  as  $x_0 \rightarrow 0$ .

Due to Proposition 1.1, one comes out with very nice properties for the solutions and the settling-time function of a **FTS** system as highlighted in the next remarks.

**Remark 1.2**

Proposition 1.1 indicates that **FTS** guarantees  $x(\cdot, \cdot) : \mathbb{R}_+ \times \mathcal{V} \rightarrow \mathcal{V}$  is well defined and is a continuous function. In addition, it satisfies (semi-group properties)

$$x(0, x_0) = x_0, \quad x(t, x(h, x_0)) = x(t + h, x_0) \quad \text{and} \quad x(T(x_0) + t, x_0) = 0,$$

for every  $x_0 \in \mathcal{V}$  and for all  $t, h \in \mathbb{R}_+$ .

**Remark 1.3**

Proposition 1.1 shows also that it is reasonable to extend  $T$  to all points of  $\mathcal{V}$  by defining  $T(0) = 0$ . From definition of  $T$  on deduce that, for all  $x_0 \in \mathcal{V}$ ,

$$T(x_0) = \inf\{t \in \mathbb{R}_+ : x(t, x_0) = 0\}.$$

**FT** convergence is clearly link to the settling-time function which express the time for

---

<sup>2</sup> $\beta : \mathbb{R}_+ \times \mathbb{R}_+ \rightarrow \mathbb{R}_+$  is said to be a class  $\mathcal{GKL}$  function, if  $\beta(\cdot, t) \in \mathcal{K}_\infty$  for each fixed  $t \in \mathbb{R}_+$ ,  $\beta$  is a strictly decreasing function until  $T$  in its second argument  $t \in \mathbb{R}_+$  for any fixed first argument  $s \in \mathbb{R}_+ \setminus \{0\}$  and  $\beta(s, \tau) = 0$ ,  $\forall \tau \geq T$  for each fixed  $s \in \mathbb{R}_+$  for some  $0 \leq T < +\infty$ .

<sup>3</sup> $\mathcal{V}$  is a neighborhood of the origin

solution(s) starting from a given initial condition to reach exactly the origin. The following lemma, borrowed from [11], investigates the properties of this so called settling-time function.

**Lemma 1.1** (Bhat & Bernstein. 2000 [11])

Let  $f$  be locally Lipschitz everywhere except the origin. Assume that the origin of (1.2) is a **FTS** equilibrium. Then, the following statements hold:

- i) If  $x_0 \in \mathcal{V}$  and  $t \in \mathbb{R}_+$ , then  $T(x(t, x_0)) = \max\{T(x_0) - t, 0\}$ .
- ii)  $T$  is continuous on<sup>4</sup>  $\mathcal{V}$  if and only if  $T$  is continuous at 0.

As seen in Lemma 1.1, for **FTS** systems, continuity of the settling-time function  $T$  reduces to its continuity at the origin. But in general,  $T$  can be discontinuous as shown in the next example borrowed from [11] and where the settling-time function is discontinuous at the origin.

**Example 1.1** (Bhat & Bernstein. 2000 [11])

Let the vector field  $f : \mathbb{R}^2 \rightarrow \mathbb{R}^2$  be defined in the following four regions of the plane:

$$Q_I = \{x \in \mathbb{R} \setminus \{0\} : x_1 \geq 0, x_2 \geq 0\}, \quad Q_{II} = \{x \in \mathbb{R} \setminus \{0\} : x_1 < 0, x_2 \geq 0\},$$

$$Q_{III} = \{x \in \mathbb{R} \setminus \{0\} : x_1 \leq 0, x_2 < 0\}, \quad Q_{IV} = \{x \in \mathbb{R} \setminus \{0\} : x_1 > 0, x_2 < 0\}$$

as in Figure 1.2. Where  $f(0) = 0$  and  $x = (x_1, x_2) = (r \cos(\theta), r \sin(\theta))$ ,  $r > 0$ ,  $\theta \in [0, 2\pi)$ .

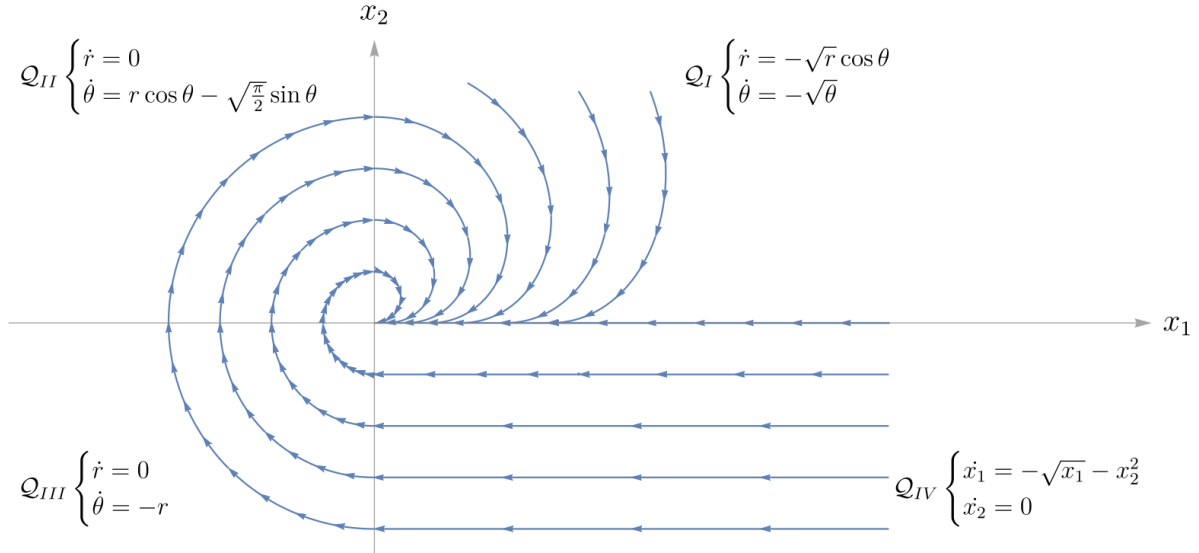

Figure 1.2: The trajectories show the behavior of a global **FTS** system with discontinuous settling-time function (Example from [13]).

It was shown in [13] that:

- $f$  is continuous on  $\mathbb{R}^2$  and Lipschitz everywhere except on the  $x_1$  and  $x_2$  axes;

---

<sup>4</sup> $\mathcal{V}$  is a neighborhood of the origin

- the system (1.2) has unique solutions in forward time and its origin is globally **FTS**;
- when solutions of (1.2) are initiated on the lower half line of the  $x_2$ -axis, the settling-time function  $T$  tends to infinity as the initial condition tends to zero.

Indeed, if we consider the sequence of initial conditions  $x_0^n = (0, -\frac{1}{n})$ ,  $n \in \mathbb{N} \setminus \{0\}$ , we have (see [13] for more details)

$$T(x_0^n) \rightarrow +\infty \text{ as } n \rightarrow +\infty.$$

Which means that  $\sup_{x_0 \in B(0,r)} T(x_0) = +\infty$ , for any  $r > 0$ . ■

Another extension of **FTS** concept, called **FxTS**, is related to uniform<sup>5</sup> boundedness of the settling-time function.

**Definition 1.2** (Polyakov, 2011 [72])

The origin of system (1.2) is

1. **FxTS**, if it is **FTS** (see Definition 1.1) and the settling-time function  $T$  is uniformly bounded.
2. **nearly FxTS**, if for any  $r > 0$ , there exists  $0 < T_r < +\infty$  such that  $x(t, x_0) \in B(0, r)$ ,  $\forall t \geq T_r$ ,  $\forall x_0 \in \mathbb{R}^n \setminus \{0\}$ .

If  $\mathcal{V} = \mathbb{R}^n$ , then all these properties hold globally.

The concept of **nearly FxTS** guarantees the convergence of the system trajectories to any ball of the origin in fixed-time (the ball radius can be made arbitrarily small). Consequently, the **nearly FxTS** systems behave "almost" like a **FxTS** system.

In the next chapters and in the following paragraphs, we investigate **FTS/FxTS**. Since these two properties are particular cases of the **AS** one, let us recall some known Lyapunov characterisation of it before looking at similar results for **FTS/FxTS** properties. Let us assume that the system (1.2) is **AS**. It has been proven (under some conditions to be given later on) that it is equivalent to the existence a Lyapunov function  $V$  for (1.2) such that its total derivative along the system trajectories is negative definite. Hence,  $V : \mathcal{V} \setminus \{0\} \rightarrow \mathbb{R}_+$  is asked to be continuously differentiable function on  $\mathcal{V} \setminus \{0\}$ , i.e.,

$$\dot{V}(x(t, x_0)) = \frac{dV \circ x(t, x_0)}{dt} = \langle \nabla V(x(t, x_0)), f(x(t, x_0)) \rangle, \forall x_0 \in \mathcal{V} \setminus \{0\}.$$

Moreover, according to Definition 1.1, the stability property of (1.2) holds globally if  $\mathcal{V} = \mathbb{R}^n$ . For that, the Lyapunov function will be required to be radially unbounded:

---

<sup>5</sup>Uniform with respect to initial conditions.



**Definition 1.3** (Bhat & Bernstein. 2005 [13])

A function  $V : \mathbb{R}^n \rightarrow \mathbb{R}_+$  is said to be radially unbounded if

$$\lim_{\|x\| \rightarrow +\infty} V(x) = +\infty.$$

The next theorem investigates **AS** of (1.2) using Lyapunov approach.

**Theorem 1.1** (Clarke et al. 1998 [26])

Let  $x = 0$  be an equilibrium of (1.2). Let  $\mathcal{V} \subset \mathbb{R}^n$  be neighborhood of the origin and let  $V : \mathcal{V} \subset \mathbb{R}^n \rightarrow \mathbb{R}^+$  and  $W : \mathcal{V} \setminus \{0\} \rightarrow \mathbb{R}^+$  be two continuous positive definite functions and  $V : \mathcal{V} \setminus \{0\} \subset \mathbb{R}^n \rightarrow \mathbb{R}^+$  be a continuously differentiable function such that

1.  $V(0) = 0$ ,  $V(x) > 0$  and  $W(x) > 0$  for all  $x \in \mathcal{V} \setminus \{0\}$ ,
2.  $\langle \nabla V(x), f(x) \rangle \leq 0$ ,  $\forall x \in \mathcal{V}$ .

Then the origin of (1.2) is **Lyapunov stable**. If condition 2. is replaced by

2bis.  $\langle \nabla V(x), f(x) \rangle \leq -W(x)$ ,  $\forall x \in \mathcal{V} \setminus \{0\}$ ,

then the origin of (1.2) is **AS**. Moreover, if  $\mathcal{V} = \mathbb{R}^n$ ,  $V$  is radially unbounded and condition 2bis. holds for all  $x \in \mathbb{R}^n$ , then the origin of (1.2) is **GAS**.

**Example 1.2**

The following system

$$\begin{cases} \dot{x} &= y + g(x), \\ \dot{y} &= u, \end{cases} \quad (1.4)$$

is globally asymptotically stable for  $g(x) = -x^{\frac{5}{3}}$  and  $u(x, y) = -x^{\frac{1}{3}} - y$ , as it is shown in Figure 3.5. Indeed, by using the following radially unbounded Lyapunov function

$$V(x, y) = \frac{3}{4}x^{\frac{4}{3}} + \frac{1}{2}y^2,$$

one gets

$$\langle \nabla V(x, y), f(x, y) \rangle = yx^{\frac{1}{3}} - x^{\frac{5}{3}}x^{\frac{1}{3}} - yx^{\frac{1}{3}} - y^2 = -(x^2 + y^2) < 0, \quad \forall (x, y) \neq (0, 0),$$

where  $f(x, y) = (y + g(x), u(x, y))^{\top}$ . Which, by using Theorem 1.1, proves that the origin of (1.4) is globally asymptotically stable.

**FTS** has also been considered and studied by using Lyapunov approach. Considering system (1.2) in one dimension, one can turn to [40] where Haimo builds up necessary and sufficient conditions on the right-hand side to guarantee the **FTS** property:

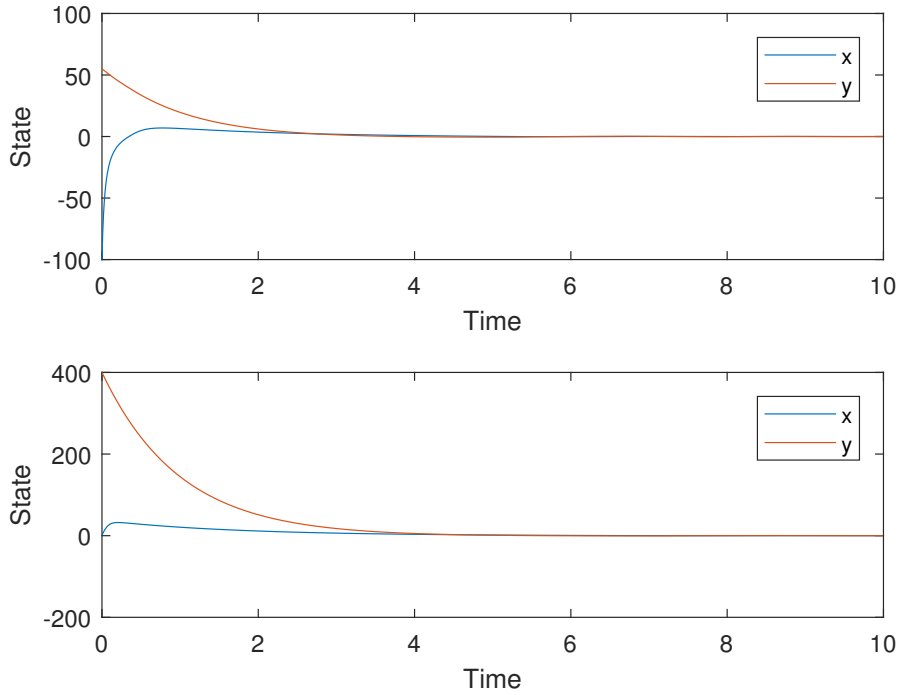

Figure 1.3: The solutions of the system (1.4) with different initial conditions.

**Proposition 1.2** (Haimo 1986 [40])

Assume that the origin is the unique equilibrium point of (1.2) with  $n = 1$ . The origin of (1.2) is **FTS** if and only if there exists a neighborhood  $\mathcal{V}$  of the origin such that

$$\forall x \in \mathcal{V} \setminus \{0\}, xf(x) < 0, \quad (1.5)$$

$$\int_x^0 \frac{dz}{f(z)} < +\infty. \quad (1.6)$$

Under the same assumptions of Proposition 1.2, one can prove a similar result for nonlinear differential inequalities through the use of comparison Lemma. Moreover, one may use Lyapunov theory to extend Proposition 1.2 to the multidimensional case. We shall see in particular that most of the approaches to investigate **FTS** of nonlinear systems, for any  $n \in \mathbb{N}$ , rely heavily on the Lyapunov function methods. Thus, we are going to emphasize the interest in a variety of theorems which state that, under minimal assumptions, **FTS** can be established if we guarantee the existence of Lyapunov functions with suitable properties.

Sufficient conditions using smooth or non-smooth Lyapunov function for **FTS**, have been introduced by Moulay et al. in [61]. Necessary conditions have also been presented in [61]. It has been mentioned in that paper that “for the moment, there is no necessary and sufficient condition for **FTS** of general continuous (even autonomous) systems”. However, when the settling time is continuous at the origin, necessary and sufficient conditions were obtained,

by Bhat & Bernstein in [13], for autonomous systems with uniqueness of solutions in forward time.

Before giving these necessary and sufficient conditions for **F**TS, let us start with a sufficient Lyapunov characterization of **F**TS for the continuous system (1.2).

**Proposition 1.3** (Moulay et al. 2008 [61, Proposition 4.1])

Let  $V : \mathcal{V} \rightarrow \mathbb{R}_+$  be a continuously differentiable and positive definite, where  $\mathcal{V}$  is a neighborhood of the origin. Let  $r \in \mathcal{K}$  be a continuous function which is locally Lipschitz in some neighborhood of the origin excluding the origin. If there exists  $\epsilon > 0$ , such that

$$\int_0^\epsilon \frac{ds}{r(s)} < +\infty \quad (1.7)$$

and

$$\langle \nabla V(x), f(x) \rangle \leq -r(V(x)), \quad \forall x \in \mathcal{V}. \quad (1.8)$$

then (1.2) is **F**TS. The existence of a Lyapunov function  $V$  such that (1.8) holds guarantees also that the settling-time function  $T$ , with respect to initial conditions of the system (1.2), satisfies the inequality:

$$T(x) \leq \int_0^{V(x)} \frac{dz}{r(z)}, \quad \forall x \in \mathcal{V}. \quad (1.9)$$

Moreover,  $T$  is continuous at the origin. If in addition  $\mathcal{V} = \mathbb{R}^n$ ,  $V$  is radially unbounded and (1.8) holds, then the origin is a globally **F**TS equilibrium of (1.2). The Lyapunov function  $V$  is called a **FT** Lyapunov function.

Proposition 1.3 presents sufficient conditions for **FT** Lyapunov function. Moreover, one can define necessary conditions as in [61]. These conditions require the existence of  $r \in \mathcal{K}$  such that, instead of (1.8), one has

$$\langle \nabla V(x), f(x) \rangle \geq -r(V(x)), \quad \forall x \in \mathcal{V}.$$

The above mentioned conditions have also been investigated for non-autonomous systems (see [61]). As it has been shown, **FT** Lyapunov function requires the existence of a couple  $(V, r)$ , which fulfills a specific inequality. The most common choice of the function  $r$  is  $r(V) = cV^\alpha$  for  $c > 0$  and  $\alpha \in [0, 1)$  for **F**TS (see [61, 11]) and  $\alpha > 1$  for **nearly FxTS** (see next Chapters). Therefore, we introduce the following **FT** different inequality to be used later for a function  $V : \mathcal{V} \subset \mathbb{R}^n \rightarrow \mathbb{R}_+$ ,

$$\langle \nabla V(x), f(x) \rangle \leq -c[V(x)]^\alpha, \quad \forall x \in \mathcal{V}. \quad (1.10)$$

The existence of a function  $V$ , such that (1.10) holds, guarantees also that the settling-time function  $T$ , with respect to initial conditions of the system (1.2), satisfies the following inequality:

$$T(x) \leq \int_0^{V(x)} \frac{dz}{r(z)} = \frac{[V(x)]^{1-\alpha}}{c(1-\alpha)}, \quad \forall x \in \mathcal{V}. \quad (1.11)$$

Moreover,  $T$  is continuous at the origin.

The following proposition, from [11], resumes the above discussion and provides some necessary and sufficient conditions for **FTS** using Lyapunov approach.

**Proposition 1.4** (Bhat & Bernstein. 2000 [11, Theorem 4.3])

Let  $\mathcal{V}$  be an open neighborhood of the origin. Then the two following assertions are equivalent:

- A)** the origin of (1.2) is **FTS** and the settling-time function is continuous at 0.
- B)** there exists a continuous function  $V : \mathcal{V} \rightarrow \mathbb{R}_+$  such that the following conditions are satisfied:
- $V$  is positive definite.
  - $\dot{V}$  is real valued and continuous on  $\mathcal{V}$  and there exist  $c > 0$  and  $0 < \alpha < 1$  such that (1.10) holds.

"A)  $\Leftarrow$  B)" was discussed before and "A)  $\Rightarrow$  B)" comes from the continuity of the settling-time function  $T : \mathcal{V} \rightarrow \mathbb{R}_+$ . Indeed, since  $T$  is assumed to be continuous, one gets that the function

$$V : x \in \mathcal{V} \mapsto V(x) = (T(x)) \cdot \frac{1}{1-\alpha} \in \mathbb{R}_+,$$

is continuous and well-defined. Moreover,  $V$  satisfies:

$$\begin{aligned} V(0) &= 0, \\ V(x) &> 0, \quad \forall x \neq 0, \\ \dot{V}(x) + c(V(x))^\alpha &= 0, \quad \forall x \in \mathcal{V} \text{ with } c = \frac{1}{1-\alpha}. \end{aligned}$$

This proves the **FTS** stability of (1.2).

Similarly to Propositions 1.4, Polyakov in 2011 [72] presented a Lyapunov sufficient condition for **FxTS** reported in the next proposition:

**Proposition 1.5** (Polyakov 2011 [72])

The origin of (1.2) is **FxTS** with a uniformly continuous and bounded settling-time function at the origin if and only if there exist a real numbers  $c_1, c_2 > 0$ ,  $\alpha \in (0, 1)$ ,  $\beta > 1$  and a Lyapunov function<sup>6</sup>  $V \in \mathcal{C}\mathcal{L}^\infty(\mathcal{V}, \mathbb{R}_+)$ ,  $0 \in \mathcal{V} \subset \mathbb{R}^n$  satisfying

$$\langle \nabla V(x), f(x) \rangle \leq -c_1[V(x)]^\alpha - c_2[V(x)]^\beta, \quad \forall x \in \mathcal{V}.$$

Then, the origin is a **FxTS** equilibrium of (1.2) and  $T$  is bounded by:

$$T(x) \leq \frac{1}{c_1(1-\alpha)} + \frac{1}{c_2(\beta-1)}. \quad (1.12)$$

If  $\mathcal{V} = \mathbb{R}^n$  and the function  $V$  is radially unbounded, then the origin of the system (1.2) is globally **FxTS**.

<sup>6</sup> $\mathcal{C}\mathcal{L}^\infty(\mathcal{V}, \mathbb{R}_+)$  denotes the set of continuous functions on  $\mathcal{V}$ ,  $\mathcal{C}^\infty$  on  $\mathcal{V} \setminus \{0\}$  with value in  $\mathbb{R}_+$ .  $\mathcal{V}$  is a neighborhood of the origin.

Proposition 1.5 shows sufficient condition for **FxTS** stability of an autonomous system. More elaborated Lyapunov analysis conditions for **FxTS** have been shown in the very recent work [56] which provides necessary and sufficient conditions for **FxTS** of an autonomous system. These results will be summarized in the next proposition.

**Proposition 1.6** (Lopez-Ramirez et al. 2019 [56])

Let  $\mathcal{V}$  be a neighborhood of the origin. Assume that there exists a continuously differentiable strict Lyapunov function  $V : \mathcal{V} \rightarrow \mathbb{R}_+$  for system (2.1) such that

- there exists a continuous positive definite function  $r : \mathbb{R}_+ \rightarrow \mathbb{R}_+$  that satisfies

$$\int_0^{\sup_{x \in \mathcal{V}} V(x)} \frac{dz}{r(z)} < +\infty,$$

- the inequality  $\dot{V}(x) \leq -r(V(x))$  holds for all  $x \in \mathcal{V}$ .

Then the origin of (1.2) is **FxTS** with continuous settling time function  $T : \mathcal{V} \rightarrow \mathbb{R}_+$  and

$$T(x) \leq \int_0^{\sup_{x \in \mathcal{V}} V(x)} \frac{dz}{r(z)} < +\infty.$$

A similar characterization to the one utilized in Proposition 1.6 was derived as a necessary condition for **FxTS** (see [56, Theorem 6]). This result is stated as follows: Consider system (1.2) and assume that the origin is **FxTS** on  $\mathcal{V}$ . Then there exist a strict Lyapunov function  $V$  and a class  $\mathcal{K}_\infty$  function  $q$  that satisfies

- $\int_0^{\sup_{x \in \mathcal{V}} V(x)} \frac{dz}{r(z)} < +\infty,$
- $\dot{V}(x) \leq -r(V(x))$  holds for all  $x \in \mathcal{V}$ .

Note that, as an example of the function  $r$ , one can refer to the results presented in Proposition 1.5, i.e.,  $r(s) = -c_1 s^\alpha - c_2 s^\beta$ , with  $c_1, c_2 > 0$ ,  $0 < \alpha < 1$  and  $\beta > 1$ .

### 1.1.3 Finite-time and Fixed-time stability of discontinuous systems

Stability of discontinuous systems is a required property (sometimes), which may arise in variety of disciplines (including various areas in engineering, physics, biological sciences, economics, etc). Indeed, some systems cannot be stabilized by regular static, time-invariant state feedback laws, e.g. Brockett's integrator [21]:

$$\begin{cases} \dot{x}_1 = u_1 \\ \dot{x}_2 = u_2 \\ \dot{x}_3 = x_2 u_1 - x_1 u_2, \end{cases}$$

where the state is given by  $x = (x_1, x_2, x_3)^\top \in \mathbb{R}^3$  and the control  $u = (u_1, u_2) \in \mathbb{R}^2$ . In addition, **FT** stabilization is sometimes required<sup>7</sup>. Therefore, in the control literature, many works concern this notion for **DI**s or discontinuous systems (see [68, 62, 84]). Lastly, as we will see in this thesis, **DI** extensions can be used to derive properties of the original ordinary differential equations (see chapter 4 & 5). These are all the motivations for recalling some results concerning **DI** and their stability properties (**AS**, **FTS**, **FxTS**).

The **DI**s appear in models of dynamical systems which do not satisfy the classical assumptions of regularity (i.e., systems with discontinuous vector field). Existence of the solution to (1.2) depends on the smoothness of function  $f$ . Therefore, the Cauchy problem (1.2) may not have a solution, and sometimes may have many solutions.

Accordingly, the study of system (1.2) when it has a discontinuous right-hand-side, (i.e., mechanical systems with friction, systems with relay, ...), is a multifaceted problem which embraces mathematical control theory and application aspects (see [34]). Regularization of system (1.2) proposed by Filippov [34] consists in replacing (1.2) with a suitable **DI**

$$\begin{cases} \dot{x}(t) \in F(x(t)), \forall t \geq 0, \\ x(0) = x_0 \in \mathbb{R}^n, \end{cases} \quad (1.13)$$

where  $F : \mathcal{D}(F) \subset \mathbb{R}^n \rightarrow 2^{\mathbb{R}^n}$ ,  $x \in \mathbb{R}^n$  is the state and  $x_0 \in \mathbb{R}^n$  is the initial condition. The notion of solution obtained in this way depends on the construction of the set-valued map  $F$ . For example, if

$$F(x) = \bigcap_{r>0} \bigcap_{\mu(N)=0} \overline{\text{co}} \{f(B(x, r) \setminus N)\},$$

then the **DI** (1.13) has an absolutely continuous function  $x : I \subset \mathbb{R}_+ \rightarrow \mathbb{R}^n$ , which is differentiable and satisfies  $\dot{x}(t) \in F(x(t))$  almost for all  $t \in I$ , and we say that the system (1.2) has a Filippov solution. Here  $\mu$  is the Lebesgue measure of  $\mathbb{R}^n$  and  $\overline{\text{co}}$  denotes the closure of the convex hull. One of the sufficient conditions, that  $F$  has to satisfy in order to guarantee the existence of the solutions for (1.13), is the property of upper-semi-continuity defined hereafter.

**Definition 1.4** (Filippov 1963 [35])

A set-valued map  $F$  is upper-semi-continuous at  $\bar{x} \in \mathcal{D}(F)$  if  $\forall \varepsilon > 0, \exists \delta > 0$  such that:

$$\forall x \in B(\bar{x}, \delta), \quad F(x) \subset B(F(\bar{x}), \varepsilon).$$

To investigate the existence of solutions for (1.13), the following theorem provides sufficient conditions to be satisfied by  $F$ .

**Theorem 1.2** (Filippov 1963 [35])

Assume that the set  $F(x)$  be non empty, compact and convex for all  $x \in \mathbb{R}^n$  and that the map  $F : x \mapsto F(x)$  be upper-semi-continuous. Then, there exists a solution to the Cauchy problem (1.13).

<sup>7</sup>Often AS is enough for many practical applications, but in some cases like rendez-vous problems **FTS**/**FxTS** should be used.

Assertions of Theorem 1.2 will be called the **classical conditions for a DI**. Now, let us give an example of a discontinuous system on which the Filippov extension will be applied.

**Example 1.3**

Consider the system

$$\dot{x} = Ax + bu(x), \quad \text{with } u(x) = \text{sign}(x_1) \in \mathbb{R},$$

where  $x = (x_1, x_2, \dots, x_n) \in \mathbb{R}^n$ ,  $A \in \mathcal{M}_n$ ,  $b \in \mathbb{R}^n$ . The Filippov **DI** extension is given by

$$\dot{x} \in \{Ax\} + \cup_{y \in \overline{\text{sign}(x_1)}} \{by\},$$

where

$$\overline{\text{sign}(s)} = \begin{cases} 1 & \text{if } s > 0, \\ -1 & \text{if } s < 0, \\ [-1, 1] & \text{if } s = 0. \end{cases}$$

Intensity of discontinuous control systems investigations has been always maintained on the high level in the entire history of the automatic control theory. Solutions of **DI**s possess many (but not all) properties similar to the ones for ordinary differential equations. In particular, if the set valued map  $F$  satisfies the classical conditions, then the set of solutions is compactum (a compact Hausdorff space). In addition, solutions of **DI** (1.13) satisfy a continuability property. Moreover, all the solutions of DI are equi-continuous.

For each  $\Omega \subseteq \mathbb{R}^n$ , we let  $\mathbf{S}(\Omega) \subset \mathcal{C}(\mathbb{R}_+ \times \mathbb{R}^n, \mathbb{R}^n)$  denotes the set of solutions of (1.13) satisfying  $x(0) \in \Omega$ . If  $\Omega$  is a singleton  $\{x_0\}$ , we will use the shorthand  $\mathbf{S}(x_0)$ . We denote  $\mathbf{S} = \mathbf{S}(\mathbb{R}^n)$  as the set of all solutions. The domain of a solution  $x(\cdot)$  will be denoted by  $\mathbb{R}_+$  if it is forward complete.

In the sequel, we will introduce the asymptotic stability, **F**TS, **F**xTS and **nearly F**xTS properties for **DI** (1.13) in the strong sens (for all solutions) and in the weak sens (for some solutions).

Let us now consider the system (1.13) where  $F$  is a set valued map such that  $0 \in F(0)$ . The next definition concerning the strong and weak uniform **GAS** of **DI**s.

**Definition 1.5** (Angeli et al. 2004 [3], Bernuau et al. 2014 [9])

The origin of the system (1.13) is

- **strongly uniformly AS** (i.e.,  $\mathbf{S}(x_0)$  is **strongly uniformly AS**) if there exist a nonempty open neighborhood of the origin  $\mathcal{V} \subset \mathbb{R}^n$  and  $\beta \in \mathcal{KL}$  such that

$$\|x(t, x_0)\| \leq \beta(\|x_0\|, t), \quad \forall t \geq 0, \quad \forall x_0 \in \mathbb{R}^n,$$

for any  $x(\cdot, x_0) \in \mathbf{S}(x_0)$ .

In addition, if  $\mathcal{V} = \mathbb{R}^n$ , then this property holds globally.

- **weakly uniformly GAS** if there exists a subset  $\hat{\mathbf{S}}$  of the set  $\mathbf{S}$  of solutions of (1.13), such that  $\hat{\mathbf{S}}(x_0)$  is uniformly GAS for all  $x_0 \in \mathbb{R}^n$ .

Lyapunov functions arise naturally in the analysis of the stability theory of **DI**s. Indeed, the origin of (1.13) is locally (resp., globally) uniformly Lyapunov stable if and only if there exists a locally (resp., globally) positive definite functional  $V : \mathcal{V}(\text{resp.}, \mathbb{R}^n) \rightarrow \mathbb{R}_+$  such that a specific inequality holds. Moreover, Lyapunov functions can be used to investigate the uniform asymptotic stability of **DI**s.

**Theorem 1.3**

Let  $\mathcal{V} \subset \mathbb{R}^n$  be a neighborhood of the origin. Let a function  $V : \mathcal{V} \rightarrow \mathbb{R}_+$  (resp.,  $V : \mathbb{R}^n \rightarrow \mathbb{R}_+$ ) be proper and positive definite, let a function  $W : \mathcal{V} \rightarrow \mathbb{R}_+$  (resp.,  $W : \mathbb{R}^n \rightarrow \mathbb{R}_+$ ) be continuous positive definite and such that

$$\sup_{h \in F(x)} \langle \nabla V(x), h \rangle \leq -W(x), \quad \forall x \in \mathcal{V},$$

(resp.,  $\sup_{h \in F(x)} \langle \nabla V(x), h \rangle \leq -W(x), \quad \forall x \in \mathbb{R}^n$ ). Then the origin of the system (1.13) is uniformly **AS** (resp., uniformly **GAS**).

Let us now give the following definition concerning **FTS** of **DI**s.

**Definition 1.6** (Bernuau et al. 2014 [9] )

The origin of (1.13) is said to be **FTS** if there exist a nonempty open neighborhood of the origin  $\mathcal{V} \subset \mathbb{R}^n$  and  $\beta \in \mathcal{GKL}$  such that

$$\|x(t, x_0)\| \leq \beta(\|x_0\|, t), \quad \forall t \geq 0, \quad \forall x_0 \in \mathcal{V},$$

for any  $x(\cdot, x_0) \in \mathbf{S}(x_0)$ . In addition, if  $\mathcal{V} = \mathbb{R}^n$ , then this property holds globally.

As seen for continuous systems, the use of Lyapunov function leads to some scalar differential inequality condition for **FTS**. Sufficient Lyapunov conditions for **FTS** of **DI**s were provided by Moulay et al. 2005 in [62]:

**Theorem 1.4** (Moulay et al. 2005 [62])

Let  $\mathcal{V} \subset \mathbb{R}^n$  be a neighborhood of the origin. Let a continuously differentiable function  $V : \mathcal{V} \rightarrow \mathbb{R}_+$  be positive definite and there exists a function  $r \in \mathcal{K}$ , which is continuous and locally Lipschitz in some neighborhood of the origin excluding the origin. If there exists  $\epsilon > 0$ , such that

$$\int_0^\epsilon \frac{ds}{r(s)} < +\infty, \tag{1.14}$$

and

$$\sup_{h \in F(x)} \langle \nabla V(x), h \rangle \leq -r(V(x)), \quad \forall x \in \mathcal{V}, \tag{1.15}$$

then (1.2) is **FTS**. If in addition  $\mathcal{V} = \mathbb{R}^n$ ,  $V$  is radially unbounded and (1.8) holds, then the origin is a globally **FTS** equilibrium of (1.2).

The existence of a Lyapunov function  $V$  such that (1.15) holds guarantees also that the settling-time function  $T$ , with respect to initial conditions of the system (1.2), satisfies the inequality (1.9) which implies its continuity at the origin.



**Example 1.4** (Moulay et al. 2005 [62])

Let us consider the set valued function

$$F(x) = \begin{cases} 1 + |x|^{\frac{1}{2}} & \text{if } x < 0 \\ [-1, 1] & \text{if } x = 0 \\ -1 - |x|^{\frac{1}{2}} & \text{if } x > 0, \end{cases}$$

associated to the **DI**  $\dot{x} \in F(x), x \in \mathbb{R}$ . Let  $x \mapsto V(x) = \frac{1}{2}x^2$ , one gets

$$\sup_{h \in F(x)} \langle \nabla V(x), h \rangle \leq -|x|^{\frac{3}{2}} = -2V(x)^{\frac{3}{4}}, \forall x \in \mathbb{R}.$$

The inequality (1.15) holds with the function  $r : \mathbb{R}_+ \rightarrow \mathbb{R}_+$  defined by  $r(s) = 2s^{\frac{3}{4}}$ . Then, the origin of  $\dot{x} \in F(x)$  is globally **FTS** and the settling-time function is estimated as follows:  $T(x) \leq 2^{\frac{3}{4}}|x|^{\frac{1}{2}}, \forall x \in \mathbb{R}$ .

Moulay et al. 2005 in [62], mentioned that function  $r$  in Theorem 1.4 can be chosen as  $r(s) = cs^\alpha$  with  $c > 0$  and  $\alpha \in [0, 1)$ . These results are stated in the following theorem (for more details see [62]).

**Theorem 1.5** (Moulay et al. 2005 [62])

Let  $\mathcal{V} \subset \mathbb{R}^n$  be a neighborhood of the origin. Let a function  $V : \mathcal{V} \rightarrow \mathbb{R}_+$  be continuously differentiable, positive definite and there exist  $c > 0$  and  $0 < \alpha < 1$  such that

$$\sup_{h \in F(x)} \langle \nabla V(x), h \rangle \leq -c[V(x)]^\alpha, \forall x \in \mathcal{V}.$$

If  $\mathcal{V} = \mathbb{R}^n$  and  $V$  is radially unbounded, then the system (1.13) is strongly globally **FTS**.  $V$  called a **FT** Lyapunov function. Moreover, the settling time function  $T$  is continuous for all initial conditions  $x \in \mathbb{R}^n$  (due to (1.11))<sup>8</sup>.

As seen before, researchers are interested in the so-called **FxTS** of **DI**s since they appear as regular extensions of discontinuous systems. For this reason, a Lyapunov based characterisation has been developed for **FxTS DI**s as stated in the next theorem.

**Theorem 1.6** (Polyakov et al. 2011 [72])

Suppose that there exists a continuous radially unbounded function  $V : \mathbb{R}^n \rightarrow \mathbb{R}_+$  and real numbers  $c_1, c_2 > 0, 0 < \alpha < 1$  and  $\beta > 1$  such that

$$\sup_{h \in F(x)} \langle \nabla V(x), h \rangle \leq -c_1 [V(x)]^\alpha - c_2 [V(x)]^\beta, \forall x \in \mathbb{R}^n,$$

Then the origin is a strongly **FxTS** equilibrium of (1.2) and  $T$  satisfies (1.12).

---

<sup>8</sup>Indeed (1.11) implies that  $T$  is continuous at the origin which combines with Lemma 1.1 implies continuity for all initial conditions.

**Example 1.5**

Let us consider the set valued function

$$F(x) = \begin{cases} |x|^{\frac{3}{2}} + |x|^{\frac{1}{2}} & \text{if } x < 0 \\ [-1, 1] & \text{if } x = 0 \\ -|x|^{\frac{3}{2}} - |x|^{\frac{1}{2}} & \text{if } x > 0, \end{cases}$$

and the the DI  $\dot{x} \in F(x), x \in \mathbb{R}$ . Let  $x \mapsto V(x) = \frac{1}{2}x^2$ , one gets

$$\sup_{h \in F(x)} \langle \nabla V(x), h \rangle \leq -|x|^{\frac{5}{2}} - |x|^{\frac{3}{2}} = -2^{\frac{5}{4}}V(x)^{\frac{5}{4}} - 2^{\frac{3}{4}}V(x)^{\frac{3}{4}}, \quad \forall x \in \mathbb{R}.$$

Then, the origin of  $\dot{x} \in F(x)$  is strongly globally **FxTS** and the settling time function is estimated as follows:  $T(x) \leq 2^{\frac{2}{4}}(\sqrt{2} + 1), \forall x \in \mathbb{R}$ .

Using **DI**s to investigate the rate of convergence for continuous and discontinuous systems is very common. In addition, **DI**s arise also as a regular extension of systems, which are not easy to be studied (see chapter 4 & 5). In general, these extension may not be strongly **FTS** or strongly **FxTS**. However, these properties may be held weakly in the case of **DI** (1.13). Therefore, the next definition introduces the notions of weak **FTS**, weak **FxTS** and weak nearly **FxTS** for **DI**s.

**Definition 1.7** (Polyakov et al. 2004 [78], Clarke et al. 1998 [26])

The origin of the system (1.13) is

- **weakly FTS**; (resp., weakly uniformly **FxTS**) if there exists a subset  $\hat{\mathbf{S}}$  of the set  $\mathbf{S}$  of solutions of (1.13), such that all  $x(\cdot) \in \hat{\mathbf{S}}$  are uniformly **FTS** (resp., **FxTS**) see Definitions 1.1.
- **weakly nearly FxTS**; if there exists a subset  $\hat{\mathbf{S}}$  of the set  $\mathbf{S}$  of solutions of (1.13), such that all  $x(\cdot) \in \hat{\mathbf{S}}$  are nearly **FTS** (see Definition 1.1).

Note that system (1.2) is **Lyapunov stable** (resp. **AS** or **FTS** or **FxTS**) if and only if it is uniformly **Lyapunov stable** (resp. uniformly **AS** or uniformly **FTS** or uniformly **FxTS**) (see [78, 26]).

## 1.2 Homogeneity

In control theory, homogeneity simplifies qualitative analysis of non-linear dynamic systems. So that, it allows local properties (e.g. local stability) to be extended globally using a scaling or dilation of the solutions (homogeneity is a kind of Lie symmetry). A first concept called standard homogeneity appeared for the first time with the work of Euler and his famous theorem providing a simple characterisation of homogeneous differentiable functions. To study dynamical systems, homogeneity has been used by Lasalle and Hahn in the 1940s (see for

example [39]). Moreover, homogeneity of negative degree combined with **AS** implies **FTS** for non-linear systems [14]. These facts motivate the here proposed section.

### 1.2.1 Standard Homogeneity

In this subsection, let us start with the first introduced notion of homogeneity, which goes back to Euler, i.e., *standard homogeneity* (or classical homogeneity). This definition has been mentioned in 1958 by Zubov and later by Hermes and Hahn and others (see [39, 43, 95]).

**Definition 1.8** (Hahn 1967 [39])

A mapping  $f : \mathbb{R}^n \rightarrow \mathbb{R}^m$  is said to be homogeneous of degree  $k \in \mathbb{R}$ , in the classical sense, if

$$\forall \lambda > 0, \forall x \in \mathbb{R}^n : f(\lambda x) = \lambda^k f(x).$$

The function  $f(x) = Ax$ , where  $x \in \mathbb{R}^n$  and  $A \in \mathbb{R}^{n \times n}$  i.e. a linear system, is homogeneous of degree 1 since  $f(\lambda x) = \lambda f(x)$ .

**Remark 1.4**

Another necessary and sufficient condition for homogeneity of differentiable functions is provided by Euler's Theorem on homogeneous functions: If  $f : \mathbb{R}^n \rightarrow \mathbb{R}^m$  is a differentiable mapping, then  $f$  is homogeneous with degree  $k$  if and only if for all  $i \in \{1, \dots, m\}$

$$\sum_{j=1}^n x_j \frac{\partial f_i}{\partial x_j}(x) = k f_i(x), \quad \forall x \in \mathbb{R}^n.$$

The following example shows that homogeneous functions can be non-linear or discontinuous.

**Example 1.6**

The function

$$f(x, y) = \begin{cases} \frac{x^\beta + y^\beta}{x^\alpha + y^\alpha}, & \text{if } x \neq 0 \\ 0, & \text{if } x = 0, \end{cases}$$

is homogeneous of degree  $\beta - \alpha$  and non-linear. Note that  $f$  is continuous if  $\beta > \alpha$ , and discontinuous otherwise.

For homogeneous systems, many properties that hold locally will hold immediately globally. As the next theorem shows, this includes stability.

**Theorem 1.7** (Hahn 1967 [39], Bernuau et al. 2014 [9])

Consider the homogeneous system (1.2) with a continuous vector field  $f$  and with forward uniqueness of solutions. If the origin is a locally attractive equilibrium, then the origin is globally asymptotically stable.

**Theorem 1.8** (Zubov 1964 [94])

Consider a homogeneous system  $\dot{x} = f(x)$ ,  $x \in \mathbb{R}^n$ , with a continuous  $f$ . Then, the origin is globally asymptotically stable if and only if there exists a homogeneous and continuous function  $V$ , of class  $\mathcal{C}^1$  on  $\mathbb{R}^n \setminus \{0\}$ , s.t.  $V$  and  $-\dot{V}$  are positive definite.

However, the field of standard homogeneity is very restrictive. For instance, consider the function  $x^\alpha + y$ ,  $\alpha > 1$ . Since  $x$  is at the power  $\alpha$  while  $y$  is at the power 1, this function cannot be homogeneous in the standard sense. But if one scales  $y$ ,  $\alpha$  times faster than  $x$ , this obstruction is removed. Hence, a generalization of the standard homogeneity was proposed by Zubov in 1950s [95] and developed by Hermes in the 1990s [42, 41] using different weights, leading to weighted homogeneity. Nowadays, this is the most popular definition of homogeneity. The weighted homogeneity has permitted to extend many results to a broader class of objects.

### 1.2.2 Weighted Homogeneity

*Weighted homogeneity* was introduced by V. I. Zubov in late 1950s and independently by H. Hermes in 1980s when looking at a local approximation of non-linear systems: asymptotic controllability is shown to be inherited by the original non-linear system if this property holds for the homogeneous approximation. Weighted homogeneity enlarges the concept of standard homogeneity by allowing the multiplicative factor  $\lambda$  to have different powers for each coordinate. Therefore, the dilation is different from the one used in the standard case. Let us start with the fundamental definition of this property. First, we start with the so-called *weights* (i.e.,  $r = (r_1, \dots, r_n)$  with  $r_i, i \in \{1, \dots, n\}$  positive real numbers),  $r_{\max} = \max_{1 \leq j \leq n} r_j$  and  $r_{\min} = \min_{1 \leq j \leq n} r_j$  denote the maximum and the minimum element of  $r$ , respectively. The matrix  $\Lambda_r(\lambda) = \text{diag}\{\lambda^{r_1}, \dots, \lambda^{r_n}\}$  is called the *dilation matrix* associated to the vector of weights  $r$  and is defined for all  $\lambda > 0$ . Note that for any  $x \in \mathbb{R}^n$ ,

$$\Lambda_r(\lambda)x = (\lambda^{r_1}x_1, \dots, \lambda^{r_i}x_i, \dots, \lambda^{r_n}x_n)^\top.$$

The  $r$ -homogeneous norm<sup>9</sup> is denoted for any  $x \in \mathbb{R}^n$  as  $\|x\|_{r,\rho} = (\sum_{i=1}^n |x_i|^{\rho/r_i})^{1/\rho}$  where  $\rho \geq r_{\max}$ . When the value of  $\rho$  is omitted, i.e.  $\|x\|_r$ , it means that  $\rho = \prod_{i=1}^n r_i$ . Let us introduce the following definition inspired from [6, 49].

#### Definition 1.9

A function  $V : \mathbb{R}^n \rightarrow \mathbb{R}$  is said to be  $r$ -homogeneous of degree  $k \in \mathbb{R}$  if

$$V(\Lambda_r(\lambda)x) = \lambda^k V(x), \quad \forall x \in \mathbb{R}^n, \forall \lambda > 0.$$

A vector field  $f : \mathbb{R}^n \rightarrow \mathbb{R}^n$  is said to be  $r$ -homogeneous of degree  $\nu \in \mathbb{R}$  if

$$f(\Lambda_r(\lambda)x) = \lambda^\nu \Lambda_r(\lambda)f(x), \quad \forall x \in \mathbb{R}^n, \forall \lambda > 0, \quad (1.16)$$

in other words,  $f_i$  are  $r$ -homogeneous of degree  $\nu + r_i$ , for each  $i \in \{1, \dots, n\}$ .

<sup>9</sup>In general, the homogeneous norm is not a norm in the classical sens (it does not satisfy the triangle inequality).

**Example 1.7**

Let  $k, \alpha, \beta > 0$  the function  $V(x) = x_1^\alpha + x_2^\beta$  is  $r$ -homogeneous of degree  $k$  with  $r = (\frac{k}{\alpha}, \frac{k}{\beta})$  since

$$V(\lambda^{\frac{k}{\alpha}}x_1, \lambda^{\frac{k}{\beta}}x_2) = \lambda^k V(x), \quad \forall \lambda > 0, \forall x \in \mathbb{R}^2.$$

Let us stress that the homogeneity degree and weights are not unique. Indeed, the degree  $k$  is arbitrary. Moreover, it is always possible to select  $r_1 = 1$  and scale  $k$  and  $r_2$ . Notice also that the symmetry-like property of  $V$  can be seen along the curve  $\lambda^k$ . Figure 1.4 compares the plots of the function  $V$  for  $\alpha = 3$  and  $\beta = 4$  and  $\alpha = \beta = 2$ .

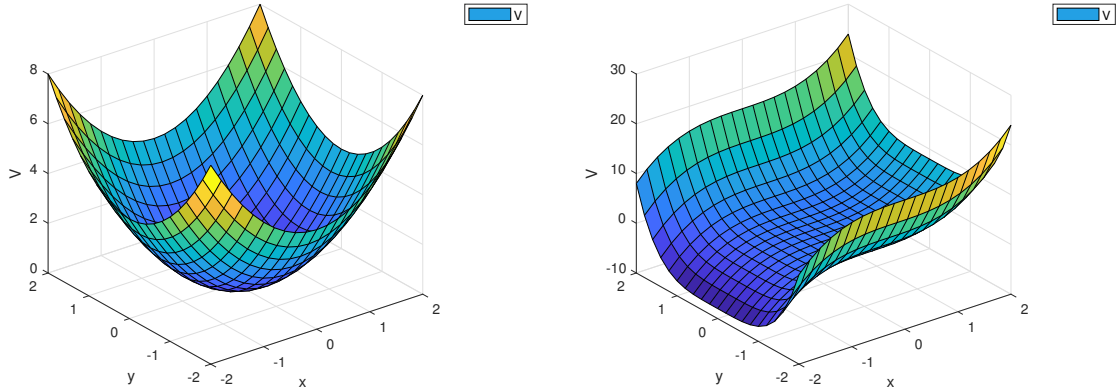

Figure 1.4: The plot of the  $r$ -homogeneous function  $V$  when  $\alpha = \beta = 2$  in the left side; for  $\alpha = 3$  and  $\beta = 4$  in right side.

*Euler's Theorem* has been generalized in [95] for weighted homogeneity. As in Remark 1.4, this result provides a necessary and sufficient condition for a differentiable function to be homogeneous with respect to a weighted dilation. Let  $f : \mathbb{R}^n \rightarrow \mathbb{R}^m$  be a differentiable mapping. Then,  $f$  is  $r$ -homogeneous with degree  $k$  if and only if for all  $i \in \{1, \dots, m\}$

$$\sum_{j=1}^n r_j x_j \frac{\partial f_i}{\partial x_j}(x) = (k + r_i) f_i(x), \quad \forall x \in \mathbb{R}^n.$$

For **AS** homogeneous system the next Lemma links **FTS** with the system's degree of homogeneity (see [12, 66] for more details).

**Lemma 1.2** (Bhat et al. 1997 [12], Nakamura et al. 2002 [66])

If the system (1.2) is  $r$ -homogeneous of degree  $\nu$  and asymptotically stable at the origin, then it is

- i) globally exponentially stable at the origin if  $\nu = 0$ ,
- ii) globally **FTS** at the origin if  $\nu < 0$ ,
- iii) globally **nearly FxTS** if  $\nu > 0$ .

**Example 1.8** (Bhat & Bernstein, 2000 [13])

Consider the second order system

$$\begin{cases} \dot{x}_1 &= x_2 \\ \dot{x}_2 &= u(x_1, x_2). \end{cases} \quad (1.17)$$

Designing the control  $u$  as

$$u(x_1, x_2) = -k_1[x_1]^{\frac{\alpha}{2-\alpha}} - k_2[x_2]^\alpha, \quad 0 < \alpha,$$

will provide the desired stability property for the closed-loop system (1.17). The right-hand-side of the system (1.17) is given by

$$f_\alpha(x_1, x_2) = (x_2, -k_1[x_1]^{\frac{\alpha}{2-\alpha}} - k_2[x_2]^\alpha)^\top.$$

► For  $\alpha = 1$ , the control  $u(x_1, x_2) = -k_1x_1 - k_2x_2$  and we get the following linear system

$$\dot{x} = Ax, \quad x = (x_1, x_2) \in \mathbb{R}^2, \quad A = \begin{pmatrix} 0 & 1 \\ -k_1 & -k_2 \end{pmatrix}. \quad (1.18)$$

We choose the gains  $k_1, k_2 > 0$  such that  $A$  is a Hurwitz matrix, then the origin of (1.18) is exponentially stable. Let us recall that system (1.18) is  $r$ -homogeneous of degree 0 with  $\Lambda_r(\lambda) = \lambda I_n$ .

► For  $0 < \alpha < 1$  the closed loop system (1.17) is **FTS** for  $k_1, k_2 > 0$ . Indeed, the fact that the  $A$  is Hurwitz implies that there exists a Lyapunov function  $V$  such that  $\langle \nabla V(x), f_1(x) \rangle$  is continuous and negative definite. Let

$$\mathcal{A} = \{x \in \mathbb{R}^2 : 0 \leq V(x) \leq 1\}.$$

In [13], the authors proved that there exists some  $\epsilon > 0$  such that the function

$$\varphi : (0, 1] \times \partial\mathcal{A} \rightarrow \mathbb{R} \quad \text{with} \quad \varphi(\alpha, x) = \langle \nabla V(x), f_\alpha(x) \rangle$$

satisfies:  $\varphi((1 - \epsilon, 1] \times \partial\mathcal{A}) \subset (-\infty, 0)$ . Then, for any  $\alpha \in (1 - \epsilon, 1)$ ,  $\varphi$  takes negative values on<sup>10</sup>  $\partial\mathcal{A}$  and therefore  $\mathcal{A}$  is a positively invariant set of  $f_\alpha$  for any  $\alpha \in (1 - \epsilon, 1)$ . The function  $f_\alpha$  is  $r_\alpha$ -homogeneous with degree of homogeneity  $\nu = \frac{\alpha-1}{2-\alpha} < 0$  and

$$\Lambda_{r_\alpha}(\lambda) = \begin{pmatrix} \lambda & 0 \\ 0 & \lambda^{\frac{1}{2-\alpha}} \end{pmatrix}.$$

Finally, using Theorem 1.2 and the fact that the degree of homogeneity of  $f_\alpha$  is negative with respect to  $r$ , we conclude that the origin of (1.17) is, furthermore, **FTS** (for some sufficiently small  $\epsilon$ ).

---

<sup>10</sup> $\partial\mathcal{A}$  denotes the boundary of  $\mathcal{A}$ .

Let us emphasize that, in this example, the authors used linear systems techniques and homogeneity property of the system to conclude **FTS** without constructing a specific complex non-linear Lyapunov function satisfying one of the previously given inequality conditions ensuring **FTS**.

Another fundamental result in the study of **FTS** has been proven by Malkin in 1952 [58] and Krasovski in 1963 [91] for standard homogeneous systems and it was generalized to weighted homogeneous systems in [12].

**Corollary 1.1** (Bhat & Bernstein. 1997 [12])

Let  $f_1, \dots, f_p$  be continuous homogeneous vector fields of degrees  $k_1 < k_2 < \dots < k_p$  and denote  $f = f_1 + \dots + f_p$ . Assume moreover that  $f(0) = 0$ . If the origin is GAS under  $f_1$  then the origin is locally asymptotically stable under  $f$ . Moreover, if the origin is **FTS** under  $f_1$  then the origin is **FTS** under  $f$ .

The next result is central and provides the existence of homogeneous Lyapunov functions for **GAS** systems:

**Theorem 1.9** (Rosier 1992 [81])

If the system (1.2) is  $r$ -homogeneous, then the origin is globally asymptotically stable if and only if there exists a homogeneous and  $C^1$  function  $V$  on  $\mathbb{R}^n \setminus \{0\}$ , s.t.

- $V(0) = 0$  and  $V(x) > 0$  for all  $x \in \mathbb{R}^n \setminus \{0\}$ ;
- $-\dot{V}$  is positive definite.

### 1.2.3 Geometric and Local Homogeneity

Nowadays, weighted homogeneity is the most popular definition of homogeneity. Nevertheless, this definition was still inconsistent with respect to a change of coordinates. Therefore, a more general definition of dilations was provided in [80, 49, 13, 52].

**Definition 1.10** (Bernuau et al. 2014 [9])

A vector field  $\chi : \mathbb{R}^n \rightarrow \mathbb{R}^n$  is said to be Euler if  $\chi$  is of class  $C^1$ , complete<sup>11</sup> and the system  $\dot{x} = -\chi(x)$  is **GAS**. We will denote  $\Lambda$  the flow of  $\dot{x} = \chi(x)$  and  $\Lambda(s, x) = \Lambda_\chi^s(x)$ .

**Definition 1.11** (Bernuau et al. 2014 [9])

Let  $\chi$  be an Euler vector field. A function  $f$  is said to be  $\Lambda_\chi^s$ -homogeneous of degree  $\nu$  if and only if for all  $s \in \mathbb{R}$  and all  $x \in \mathbb{R}^n$  we have

$$f(\Lambda_\chi^s(x)) = e^{-\nu s} f(x).$$

A vector field  $f$  is said to be  $\Lambda_\chi^s$ -homogeneous of degree  $\nu$  iff for all  $s \in \mathbb{R}$  and all  $x \in \mathbb{R}^n$  we

---

<sup>11</sup>A vector field is complete if its flow curves exist for all time.

have:

$$f(\Lambda_\chi^s(x)) = e^{\nu s} \frac{\partial \Lambda_\chi^s}{\partial x}(x) f(x).$$

Going back to the weighted homogeneity, one can see that, considering the vector field  $\chi(x) = \text{diag}\{r_1, \dots, r_n\}x$  with a  $\Lambda_\chi^s$ -homogeneous vector field  $f$ , then we get

$$f(\text{diag}\{e^{r_i s}\}x) = e^{\nu s} \text{diag}\{e^{r_i s}\}f(x).$$

Choosing  $\lambda = e^s$ , one obtains exactly the definition of the weighted homogeneity. This proves that weighted homogeneity is a particular case of the geometric homogeneity and standard one as well. To ensure the homogeneity of a function or a vector field, the following Lemma provides some sufficient conditions.

**Lemma 1.3** (Bernuau et al. 2014 [9])

Let  $\chi$  be an Euler vector field and  $f \in \mathcal{C}^1(\mathbb{R}^n, \mathbb{R}^n)$ . If  $f$  is  $\Lambda_\chi^s$ -homogeneous with degree  $\nu \in \mathbb{R}$ , then

1. for all  $t \geq 0$  we have  $x(t, \Lambda_\chi^s(x_0)) = \Lambda_\chi^s(x(e^{\nu s}t, x_0))$ ,  $\forall s \in \mathbb{R}$  and  $x_0 \in \mathbb{R}^n$ .
2.  $\chi \frac{\partial f}{\partial x} = \left( \nu + \frac{\partial \chi}{\partial x} \right) f$ .

If  $f$  is a  $\mathcal{C}^1$  function (i.e.,  $f \in \mathcal{C}^1(\mathbb{R}^n, \mathbb{R})$ ), then it is  $\Lambda_\chi^s$ -homogeneous with degree  $\nu$  if and only if  $\chi \frac{\partial f}{\partial x} = \nu f$ .

Item 1. of the above lemma is an explanation why "for homogeneous systems, local attractivity implies global asymptotic stability". For homogeneous systems (in the geometric sens), the rate of convergence can be evaluated via its degree as in Lemma 1.2 which was given for weighted homogeneity.

However, homogeneity does not cover all the systems. Therefore, homogeneity was reformulated into a local version [2]. It lead to the notion of homogeneous approximation allowing to study more general non-linear control systems (see [2] and [32] for more details).

**Definition 1.12** (Andrieu et al. 2008 [2])

A function (resp., a vector field)  $f$  is said to be homogeneous in the 0-limit with associated triple  $(\nu_0, \Lambda_{\chi_0}^s, f_0)$  if

$$\lim_{s \rightarrow -\infty} \sup_{x \in K} \|e^{-\nu_0 s} f(\Lambda_{\chi_0}^s(x)) - f_0(x)\| = 0,$$

resp., if

$$\lim_{s \rightarrow -\infty} \sup_{x \in K} \left\| e^{-\nu_0 s} \left( \frac{\partial \Lambda_{\chi_0}^s}{\partial x}(x) \right)^{-1} f(\Lambda_{\chi_0}^s(x)) - f_0(x) \right\| = 0$$

for all compact subsets  $K$  of  $\mathbb{R}^n \setminus \{0\}$ .



**Definition 1.13** (Andrieu et al. 2008 [2])

A function (resp., a vector field)  $f$  is said to be homogeneous in the  $\infty$ -limit with associated triple  $(\nu_\infty, \Lambda_{\chi_\infty}^s, f_\infty)$  if

$$\lim_{s \rightarrow +\infty} \sup_{x \in K} \|e^{-\nu_\infty s} f(\Lambda_{\chi_\infty}^s(x)) - f_\infty(x)\| = 0,$$

resp., if

$$\lim_{s \rightarrow +\infty} \sup_{x \in K} \left\| e^{-\nu_\infty s} \left( \frac{\partial \Lambda_{\chi_\infty}^s}{\partial x}(x) \right)^{-1} f(\Lambda_{\chi_\infty}^s(x)) - f_\infty(x) \right\| = 0$$

for all compact subsets  $K$  of  $\mathbb{R}^n \setminus \{0\}$ .

Note that it is sufficient to check these limits properties only on the unit sphere associated to the corresponding homogeneous norm.

**Example 1.9** (Andrieu et al. 2008 [2])

Let  $f : (x_1, x_2) \in \mathbb{R}^2 \mapsto (x_2, x_2^{1.5} + 5x_2^3)^T \in \mathbb{R}^2$ . The vector field  $f$  is homogeneous in the 0-limit with associated triple

$$(\nu_0, \Lambda_{\chi_0}^s, f_0(x)) = \left( 0.5, \begin{pmatrix} e^{0.5s} & 0 \\ 0 & e^s \end{pmatrix}, (x_2, x_2^{1.5})^T \right).$$

If a vector field fails to exhibit a global degree of homogeneity but behaves as a homogeneous vector field near infinity and/or near the origin, we say that it is *bi-/locally homogeneous*. Let us now focus on the consequences that the scaling behavior of homogeneous systems have in the study of stability and robustness of such systems.

**Proposition 1.7** (Andrieu et al. 2008 [2])

Assume that the vector field  $f$  is homogeneous in the 0-limit with associated triple  $(\nu_0, \Lambda_{\chi_0}^s, f_0)$ . If the origin of  $\dot{x} = f_0(x)$  is locally asymptotically stable, then the origin of (1.2) is locally asymptotically stable.

**Example 1.10**

Consider the non-linear system

$$\begin{cases} \dot{x}_1 = x_2 - x_1^3, \\ \dot{x}_2 = -x_1^5 + x_2^2. \end{cases} \quad (1.19)$$

Its linearized system is given by

$$\begin{cases} \dot{x}_1 = x_2, \\ \dot{x}_2 = 0. \end{cases}$$

The origin of the linearized system is not stable and we cannot infer anything about the stability of the original system (1.19). In addition, it is not possible to find real numbers  $r_1, r_2$  and  $\nu$  such that  $f$  is homogeneous. However, we can prove that  $f$  is homogeneous in the 0-limit with associated triple  $(2, \Lambda_\chi^s, f_0)$  where

$$\Lambda_\chi^s = \begin{pmatrix} e^s & 0 \\ 0 & e^{3s} \end{pmatrix} \text{ and } f_0(x_1, x_2) = \begin{pmatrix} x_2 - x_1^3 \\ -x_1^5 \end{pmatrix}.$$

Eliminating the term  $x_2^2$  produces the following homogeneous approximation of system (1.19):

$$\begin{cases} \dot{x}_1 = x_2 - x_1^3, \\ \dot{x}_2 = -x_1^5. \end{cases} \quad (1.20)$$

Using the Lyapunov function  $V(x) = \frac{1}{18}(4x_1^6 - 6x_1^3x_2 + 21x_2^2)$ , it can be easily shown that the origin of the homogeneous approximation is asymptotically stable and then the original system also is asymptotically stable. This example shows that, for some systems, homogeneous approximation captures better the system's behavior than its linearization.

Stabilization of control system is another important field of control theory which has gained attention in the recent years and it is still currently under active developments. Stabilization of nonlinear homogeneous systems started from 1995 by Kawski in [49] where some local/global stabilization of homogeneous affine systems is provided. More details have been shown later about the asymptotic, **FT** and **FxT** stabilization for nonlinear control systems [27, 59, 64]. A brief review about stabilization of control systems is presented in the next section.

#### 1.2.4 Stabilization in the light of homogeneity

Stabilizability is a control oriented version of the stability property. It has been largely studied in the case of linear systems:

$$\dot{x} = Ax + Bu,$$

where  $x \in \mathbb{R}^n$ ,  $u \in \mathbb{R}^m$ ,  $A \in \mathcal{M}_n$  and  $B \in \mathcal{M}_{n,m}$ . For this class of systems, a complete and satisfactory theory is available. Let us remind the Kalman controllability rank condition for the pair  $(A, B)$

$$\text{rank}[B, AB, A^2B, \dots, A^{n-1}B] = n. \quad (1.21)$$

If (1.21) holds, then there exists a feedback matrix  $K$  such that  $A + BK$  is Hurwitz (see [54]). Obviously, one can see that the designed control  $u(x) = Kx$  is homogeneous and it guarantees the homogeneity of the stabilized linear system (i.e.,  $\dot{x} = (A + BK)x$  is homogeneous with degree  $\nu = 0$  (in the standard sense)). However, in general, this is not the case for nonlinear systems where the problem is considerably more difficult. Systematic studies started at the end of the 70's [1, 48].

Let us consider the following nonlinear system

$$\dot{x} = f(x, u), \quad (1.22)$$

where the state is  $x \in \mathbb{R}^n$ , the control is  $u \in \mathbb{R}^m$  and the function  $f$  is of class  $\mathcal{C}^0$  in the neighborhood of  $(0, 0) \in \mathbb{R}^n \times \mathbb{R}^m$  and such that  $f(0, 0) = 0$ . The system (1.22) cannot, in general, be stabilized using a continuous closed loop control  $u(x)$ . We say that the control system (1.22) is asymptotically stabilizable by means of a continuous stationary feedback law if there exists a control  $u \in \mathcal{C}^0(\mathbb{R}^n; \mathbb{R}^m)$ , satisfying:

1.  $u(0) = 0$ ,

2.  $0 \in \mathbb{R}^n$  is a locally (or globally) asymptotically stable point, for the closed-loop system:

$$\dot{x} = f(x, u(x)). \quad (1.23)$$

The existence of such an asymptotic stabilizable control can be guaranteed if the vector field  $f$  is of class  $\mathcal{C}^1$  in a neighborhood of  $(0, 0) \in \mathbb{R}^n \times \mathbb{R}^m$  and the pair

$$\left( \frac{\partial f}{\partial x}(0, 0), \frac{\partial f}{\partial u}(0, 0) \right) \text{ is controllable,}$$

as stated in the following proposition

**Proposition 1.8** (Coron 2007 [27])

Assume that  $f$  is of class  $\mathcal{C}^1$  and the linearized control system

$$\dot{x} = \frac{\partial f}{\partial x}(0, 0)x + \frac{\partial f}{\partial u}(0, 0)u, \quad (1.24)$$

is controllable. Then there exists  $K \in \mathcal{M}_{m,n}$  such that the closed-loop system  $\dot{x} = f(x, Kx)$  is locally asymptotically stable at the origin.

The controllability of  $\left( \frac{\partial f}{\partial x}(0, 0), \frac{\partial f}{\partial u}(0, 0) \right)$  implies that there exists  $K \in \mathcal{M}_{m,n}$  such that all the eigenvalues of

$$\frac{\partial f}{\partial x}(0, 0) + \frac{\partial f}{\partial u}(0, 0)K,$$

are placed within the left complex half-plane.

Let  $g : x \in \mathbb{R}^n \mapsto g(x) = f(x, Kx) \in \mathbb{R}^n$ . Hence,  $g(0) = 0$  and  $g'(0) = \frac{\partial f}{\partial x}(0, 0) + \frac{\partial f}{\partial u}(0, 0)K$ , this implies that all the eigenvalues of  $g'(0)$  are placed within the left complex half-plane. Then,  $0 \in \mathbb{R}^n$  is locally asymptotically stable for  $\dot{x} = g(x)$ . This concludes the results of Proposition 1.8.

Proposition 1.8 shows that if the linearized control system of a given nonlinear control system is controllable, then the control system can be asymptotically stabilized (at least locally) by means of continuous stationary feedback law (i.e.,  $u(x) = Kx$ ). The choice of  $K$  is crucial in order to have a good performances for the closed-loop system  $\dot{x} = f(x, Kx)$ . In general, one desires to have robust feedback laws for uncertain linear or nonlinear control systems. There are many tools available to deal with this problem. Let us now give the following example, which shows an application of Proposition 1.8.

**Example 1.11** (Coron 2007 [27])

Let us consider the following mechanical system (i.e., the attitude of a rigid spacecraft):

$$\begin{cases} \dot{\eta} &= A(\eta)\omega, \\ J\dot{\omega} &= S(\omega)J\omega + \sum_{i=1}^m u_i b_i, \end{cases} \quad (1.25)$$

where  $\eta = (\phi, \theta, \psi)$  is the Euler angles,  $\omega = (\omega_1, \omega_2, \omega_3)$  is the angular velocity,  $J$  is the inertia matrix  $u_i \in \mathbb{R}$ ,  $1 \leq i \leq m$  are the controls,  $b_1, \dots, b_m$  are  $m$  fixed vectors in  $\mathbb{R}^3$

( $b_i u_i \in \mathbb{R}^3$ ,  $1 \leq i \leq m$  and  $S(\omega)$  is the matrix representation of the wedge-product, i.e.,

$$S(\omega) = \begin{pmatrix} 0 & \omega_3 & \omega_2 \\ -\omega_3 & 0 & \omega_1 \\ \omega_2 & \omega_1 & 0 \end{pmatrix} \text{ and } A(\eta) = \begin{pmatrix} \cos(\theta) & 0 & \sin(\theta) \\ \sin(\theta) \tan(\phi) & 1 & -\cos(\theta) \tan(\phi) \\ -\frac{\sin(\theta)}{\cos(\phi)} & 0 & \frac{\cos(\theta)}{\cos(\phi)} \end{pmatrix}.$$

$b_i$ ,  $i \in \{1, \dots, m\}$  and  $m \in \mathbb{N}$  will be considered such that the system (1.25) is controllable. Then, the linearized control system at the equilibrium  $(0, 0) \in \mathbb{R}^{6+m}$  is

$$\begin{cases} \dot{\eta} = \omega, \\ \dot{\omega} = \sum_{i=1}^m u_i J^{-1} b_i, \end{cases} \quad (1.26)$$

where  $(\eta_1, \eta_2, \eta_3, \omega_2, \omega_3)^\top \in \mathbb{R}^6$  is the state and  $(u_1, \dots, u_m) \in \mathbb{R}^m$  is the control. Hence, as it has been proven in [27] when  $m = 3$ , the control system (1.26) is controllable at the equilibrium  $(0, 0) \in \mathbb{R}^{6+m}$ . Therefore, the control system (1.25) is locally stabilizable by means of a continuous feedback law at  $(0, 0) \in \mathbb{R}^{6+m}$ .

As we have seen, Lyapunov approach is defined to describe and study the asymptotic behavior of an equilibrium point (see [6]). Moreover, this concept is also useful for the stabilization of control systems. In the framework of control systems, the Lyapunov function approach leads to the following definition.

**Definition 1.14** (Coron 2007 [27], Bacciotti et al. 2007 [6])

A function  $V \in \mathcal{C}^1(\mathbb{R}^n, \mathbb{R}_+)$  is a control Lyapunov function for the control system (1.22) if

1.  $V(0) = 0$ ,  $\lim_{\|x\| \rightarrow +\infty} V(x) = +\infty$  and  $V(x) > 0$ ,  $\forall x \in \mathbb{R}^n \setminus \{0\}$
2.  $\forall x \in \mathbb{R}^n \setminus \{0\}$ ,  $\exists u \in \mathbb{R}^m$  such that

$$\langle \nabla V(x), f(x, u) \rangle < 0.$$

Moreover,  $V$  satisfies the small control property if, for every number  $\varepsilon > 0$ , there exists  $\eta > 0$  such that, for every  $x \in \mathbb{R}^n$  with  $0 < \|x\| < \eta$ , there exists  $u \in \mathbb{R}^m$  satisfying  $\|u\| < \varepsilon$  and  $\langle \nabla V(x), f(x, u) \rangle < 0$ .

From Definition 1.14, one deduces that if the control system (1.22) is globally asymptotically stabilizable by means of continuous stationary feedback laws, then it admits a control Lyapunov function satisfying the small control property. If (1.22) is a control affine system, i.e.,

$$f(x, u) = f_0(x) + \sum_{i=1}^m u_i f_i(x), \quad \forall (x, u) \in \mathbb{R}^n \times \mathbb{R}^m,$$

$$f_0, \dots, f_m \in \mathcal{C}^\infty(\mathbb{R}^n, \mathbb{R}^n),$$

and it admits a control Lyapunov function satisfying the small control property, i.e., there exists a positive definite function  $V \in \mathcal{C}\mathcal{L}^\infty(\mathcal{V}, \mathbb{R}_+)$  such that for all  $x \in \mathcal{V} \setminus \{0\}$ :

$$\inf_{u \in \mathcal{U}} (a(x) + \langle B(x), u \rangle) < 0,$$

where  $\mathcal{U} \subset \mathbb{R}^m$ ,  $a(x) = \langle \nabla V(x), f_0(x) \rangle$ ,  $B(x) = (b_1(x), \dots, b_m(x))^\top$  with  $b_i(x) = \langle \nabla V(x), f_i(x) \rangle$  for  $i \in \{1, \dots, m\}$ . Then the control system (1.22) can be globally asymptotically stabilized by means of continuous stationary feedback laws. Eduardo Sontag in [87] gives an explicit and simple feedback laws and it has been used to prove the following theorem about stabilization via homogeneous feedback controls:

**Theorem 1.10** (Moulay et al. 2008 [59])

Assume that  $V$  is a control Lyapunov function satisfying the small control property for the control system (1.22). Then  $u = (u_1, \dots, u_m)^\top : \mathbb{R}^n \rightarrow \mathbb{R}^m$  defined by

$$u_i(x) = -\phi \left( \langle \nabla V(x), f_0(x) \rangle, \sum_{j=1}^m (\langle \nabla V(x), f_j(x) \rangle)^2 \right) \langle \nabla V(x), f_i(x) \rangle, \quad \forall i \in \{1, \dots, m\}, \quad (1.27)$$

with

$$\phi(a, b) = \begin{cases} \frac{a + \sqrt[p]{|a|^p + |b|^q}}{b} & \text{if } b \neq 0, \\ 0 & \text{if } b = 0, \end{cases}$$

where,  $p, q > 1$  are positive real numbers.  $u_i$ ,  $i \in \{1, \dots, m\}$  is continuous, vanishes at  $0 \in \mathbb{R}^n$  and globally asymptotically stabilizes the control system (1.22).

**Remark 1.5**

The function  $\phi : E = \{(a, b) \in \mathbb{R}^2 : a < 0 \text{ or } b > 0\} \rightarrow \mathbb{R}$  is continuous. Indeed,

$$\begin{aligned} \lim_{b \rightarrow 0, a < 0} \phi(a, b) &= \lim_{b \rightarrow 0, a < 0} \frac{a + \sqrt[p]{|a|^p + |b|^q}}{b} = \lim_{b \rightarrow 0, a < 0} \frac{a + |a| \sqrt[p]{1 + \frac{|b|^q}{|a|^p}}}{b} \\ &= \lim_{b \rightarrow 0, a < 0} \frac{-a|b|^q}{pb|a|^p} \\ &= \lim_{b \rightarrow 0, a < 0} \frac{|b|^{q-1}}{p|a|^{p-1}} = 0. \end{aligned}$$

This proves also the continuity of the control  $u_i$  for all  $i \in \{1, \dots, n\}$ . Moreover, (1.27) implies that:

$$\left\langle \nabla V(x), f_0(x) + \sum_{i=1}^m f_i(x)u_i(x) \right\rangle = -\sqrt[p]{a(x)^p + b(x)^q} < 0, \quad \forall x \in \mathcal{V} \setminus \{0\}.$$

Then, the control  $u = (u_1, \dots, u_m)$  stabilizes the system (1.22) asymptotically.

Constructing such a smooth Lyapunov function is sometimes difficult or simply impossible. It was shown by many authors (see Artstein [5] for the affine case, and Clarke, Ledyaev, and Stern [26] for the general case) that there is no hope for obtaining a smooth Lyapunov function in the general case of globally asymptotically controllable systems.

Moreover, control Lyapunov functions were used to stabilize an affine control system in finite-time [64]. Hence, to obtain the finite-time stabilization, an additional condition is needed. The control Lyapunov function  $V \in \mathcal{CL}^\infty(\mathcal{V}, \mathbb{R}_+)$  has to be chosen such that:

$$\inf_{u \in \mathcal{U}} (a(x) + \langle B(x), u(x) \rangle) < -c[V(x)]^\alpha, \quad \forall x \in \mathcal{V} \setminus \{0\},$$

where  $c > 0$  and  $0 < \alpha < 1$ . This inequality involves also the continuity of the settling-time function at the origin of the closed-loop system. To guarantee this inequality, the following proposition defines a sufficient Lyapunov-like condition.

**Proposition 1.9** (Moulay et al. 2005 [64])

Let  $\mathcal{V}$  be a neighborhood of the origin. If there exists a continuously differentiable control Lyapunov function  $V : \mathcal{V} \rightarrow \mathbb{R}_+$  for the control system (1.22) verifying the small control property and

$$\sqrt[p]{a(x)^p + b(x)^q} \geq c[V(x)]^\alpha, \quad \forall x \in \mathcal{V},$$

where  $p, q > 1$  are positive real numbers, and where  $c > 0$  and  $0 < \alpha < 1$  then the system (1.22) is finite time stabilizable under the continuous feedback control (1.27). The settling-time function is given by the estimation (1.11), which proves its continuity at the origin.

The next example provides a **F**T**S** stabilizable control based on such construction via control Lyapunov function.

**Example 1.12** (Moulay et al. 2005 [64])

Let us consider the following system:

$$\begin{cases} \dot{x}_1 = -|x_1|^\gamma - x_2, \\ \dot{x}_2 = |x_1|^\beta |x_2|^{1-\beta} - |x_2|^\gamma u, \end{cases}$$

with  $0 < \beta, \gamma < 1$  such that  $4(\beta + \gamma) < \beta + 1$  (for example  $\beta = \gamma = \frac{1}{8}$ ). Using the  $\mathcal{C}^1$  function  $V(x) = |x_1|^{1+\beta} + |x_2|^{1+\beta}$ , we obtain

$$\frac{a(x)}{|B(x)|} = \frac{-|x_1|^{\beta+\gamma}}{|x_2|^{\beta+\gamma}} \leq 0, \quad \forall x \neq 0,$$

where

$$\begin{aligned} a(x) &= -(\beta + 1)|x_1|^{\beta+\gamma}, \\ b(x) &= (\beta + 1)^2 |x_2|^{2(\beta+\gamma)}, \\ B(x) &= (\beta + 1)|x_2|^{\beta+\gamma}. \end{aligned}$$

Then,  $V$  satisfies the small control property and  $\inf_{u \in \mathbb{R}} (a(x) + B(x)u) < 0$ . The functions  $a$  and  $b$  satisfies the following condition

$$\begin{aligned} a(x)^4 + b(x)^2 &= (1 + \beta)^4 \left( |x_1|^{4(\beta+\gamma)} + |x_2|^{4(\beta+\gamma)} \right), \\ &\geq (1 + \beta)^4 \left( |x_1|^{\beta+1} + |x_2|^{\beta+1} \right)^{\frac{4(\beta+\gamma)}{\beta+1}}, \end{aligned}$$

$$\begin{aligned} &\geq (1 + \beta)^4 [V(x)]^{\frac{4(\beta+\gamma)}{\beta+1}}, \\ &-\sqrt[4]{a(x)^4 + b(x)^2} \leq -(1 + \beta)[V(x)]^\alpha, \end{aligned}$$

with  $0 < \alpha = \frac{(\beta+\gamma)}{\beta+1} < 1$  and  $(p, q) = (4, 2)$ . A simple calculation gives the feedback control (1.27)

$$u(x) = \frac{|x_1|^{\beta+\gamma} - \sqrt[4]{|x_1|^{4(\beta+\gamma)} + |x_2|^{4(\beta+\gamma)}}}{[x_2]^{\beta+\gamma}}.$$

Using this control, the inequality (1.10) holds. Then, the closed-loop system (1.22) with the proposed continuous control is **FTS**.

Control Lyapunov function is a very powerful tool used to design stabilizing feedback laws. But one needs to guess Lyapunov candidates. Additionally, control Lyapunov function is not the unique technique to design stabilizing feedback law for the control system (1.22). There are other tools such as backstepping [22], damping, homogeneity [80], ..., etc. In this thesis, we will focus on the notion of homogeneity property and the theory of differential inclusion to analyse the stability of nonlinear systems.

### 1.3 Applications of Finite-time stability and homogeneity

The relevance of **FTS**, in control theory, drives researchers to establish this property for different kinds of robot systems. Hence, over the last few decades, several works have shown some fulfillment of **FTS** control. These works include applications to secure network communications [70], **FT** regulation of robot manipulators [46, 29] and **FT** Consensus for Multi-Agent Networks [92]... etc. In this section we will mention two examples: one about **FT** controller for the robot manipulator and the second one is about **FT** observer.

#### 1.3.1 Finite-time stabilizing control for robot manipulators

In the paper [46], authors studied the global **FT** stabilization of robot system described by

$$M(q)\ddot{q} + C(q, \dot{q})\dot{q} + G(q) = \tau, \quad q \in \mathbb{R}^n, \quad (1.28)$$

where  $q$  is the vector of generalized coordinates and  $\tau$  is the vector of external torque representing the control input,  $M(q)$  denotes the inertia matrix,  $C(q, \dot{q})\dot{q}$  is the Coriolis and centrifugal forces, and  $G(q)$  represents gravitational force and they are all assumed to be smooth. Let us emphasize that the system (1.28) is such that  $M(q)$ ,  $C(q, \dot{q})\dot{q}$  and  $G(q)$  satisfy some specific properties, for more details we refer to the paper [46].

In [46], the following controller was proposed:

$$\tau = C(q, \dot{q})\dot{q} + G(q) - M(q) (k_1 \text{sign}(q - q^*)^{\alpha_1} + k_2 \text{sign}(\dot{q})^{\alpha_2}),$$

where  $\text{sign}(x)^\alpha = ([x_1]^\alpha, \dots, [x_n]^\alpha)^\top \in \mathbb{R}^n$ ,  $x \in \mathbb{R}^n$ . This control enforces **FTS** behaviors of the robot manipulator (e.g., Figure 1.5).



Figure 1.5: Robot Manipulator (Robot Arm).

### 1.3.2 Finite-time Observer (Chua's Oscillator)

Homogeneity has been used to investigate **FTS** of some classes of non-linear systems. A particular attention was paid for **FTS** stabilization of linear systems [72]. In [70], in the framework of secure communications, such homogeneity based technique was used to design a **FT** observer for some class of observable nonlinear systems that can be related to some linear system with a non-linear output injection term.

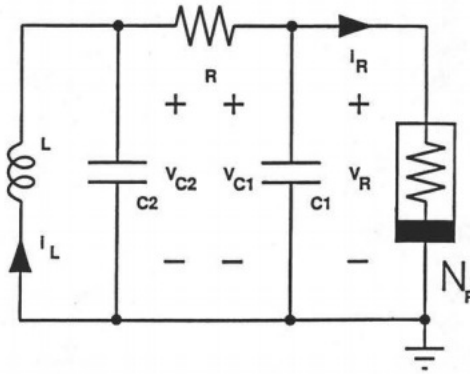

Figure 1.6: Chua's Circuit.

In [70], authors considered the Chua's oscillator given by:

$$\begin{cases} C_1 \dot{v}_{C_1} &= \frac{1}{R}(v_{C_2} - v_{C_1}) + h(v_{C_1}), \\ C_2 \dot{v}_{C_2} &= \frac{1}{R}(v_{C_1} - v_{C_2}) + i_L, \\ L \dot{i}_L &= -v_{C_2}, \end{cases} \quad (1.29)$$

where  $L$  is an inductor,  $R$  is a resistor,  $C_1$  and  $C_2$  are two capacitors,  $h$  is the piece-wise linear Chua's function and the measured output is  $y = v_{C_1}$ . Using a change of variable (see [70] for



more details), the system (1.29) is transformed into the observable canonical form:

$$\begin{cases} \dot{z} &= Az + f(y), \\ y &= Cz, \end{cases}$$

where  $z \in \mathbb{R}^3$  is the state and  $y \in \mathbb{R}$  is the measured output, and

$$A = \begin{pmatrix} 0 & 1 & 0 \\ 0 & 0 & 1 \\ 0 & 0 & 0 \end{pmatrix}, \quad C = (1, 0, 0),$$

are in a canonical representation. An observer for this system is designed as

$$\dot{\hat{z}} = A \begin{pmatrix} \hat{z}_1 \\ \hat{z}_2 \\ \hat{z}_3 \end{pmatrix} + f(y) - \begin{pmatrix} k_1 [z_1 - \hat{z}_1]^{\alpha_1} \\ k_2 [z_1 - \hat{z}_1]^{\alpha_2} \\ k_3 [z_1 - \hat{z}_1]^{\alpha_3} \end{pmatrix},$$

where  $\hat{z} \in \mathbb{R}^3$  is an estimate of  $z$ ,  $\alpha_i$  are constant powers and  $k_i$  are constant observer gain (for  $1 \leq i \leq 3$ ). The estimation error dynamics can be written as follows ( $e = z - \hat{z}$  is the error):

$$\begin{cases} \dot{e}_1 &= e_2 - k_1 [e_1]^{\alpha_1}, \\ \dot{e}_2 &= e_3 - k_2 [e_1]^{\alpha_2}, \\ \dot{e}_3 &= -k_3 [e_1]^{\alpha_3}, \end{cases} \quad (1.30)$$

To guarantee **FTS** of (3.15), the homogeneity framework is used [70] resulting in the choice  $\alpha_i = 1 + i\alpha$ ,  $1 \leq i \leq 3$  where  $\alpha > -\frac{1}{3}$  is a tuning parameter (related to the homogeneity degree of the system), for the dilation

$$\Lambda^s = \text{diag} [e^s, e^{(1+\alpha)s}, e^{(1+2\alpha)s}].$$

The gains  $k_i$ ,  $1 \leq i \leq 3$  should be selected so that  $\lambda^3 + k_1 \lambda^2 + k_2 \lambda + k_3$  is a Hurwitz polynomial.

# Problem statement and main tools

## Contents

<b>2.1</b>	<b>Introduction</b>	45
<b>2.2</b>	<b>Problem Statement</b>	46
<b>2.3</b>	<b>Preliminaries on the main mathematical tools</b>	48
2.3.1	Generalized homogeneity	48
2.3.2	Robustness, ISS, iISS, FTISS and FTiISS	54

This chapter introduces the considered classes of systems together with the problem statement (goals to be achieved in this work). In addition to that, the main required mathematical concepts are introduced and discussed.

## 2.1 Introduction

As seen in the previous chapter, **FTS** and **FxTS** properties have been investigated intensively in the last two decades (see [12, 11, 63, 62, 56]  $\dots$  etc). A large part of these works are using *Lyapunov characterization* of these properties. They require the existence of a Lyapunov function  $V$ , such that a specific inequality holds, i.e., there exists a continuously differentiable and positive definite function  $V : \mathcal{V} \rightarrow \mathbb{R}_+$  and  $r \in \mathcal{K}$  such that (1.8) is fulfilled (for example). But finding such a function satisfying precise conditions is not obvious. Therefore, these properties were investigated using also *homogeneity* property which do not necessitate constructing such a Lyapunov function (most of the time). Thus, using the *homogeneity* property, **FTS/FxTS** results were derived for nonlinear systems, **DI**s and evolution systems (for more details see [13, 62, 68, 75]). However, because of the restrictive field of *geometric homogeneity*, Andrieu in 2008 (see [2]) came out with another less restrictive technique base on the notion of *local homogeneity*. This new concept were used to establish the **FT** and **FxTS** for some class of nonlinear systems that are not homogeneous in the geometric sense. Both concepts *geometric* and *local homogeneity* do not require the existence of **FT** or **FxT** Lyapunov function. For example, an asymptotic stable homogeneous or locally homogeneous system with negative degree of homogeneity is **FTS** (see for example [2, 13, 75]).

However, these fields are still limited. Therefore, in this chapter, and in turn, in the subsequent chapters, we will consider nonlinear systems that *may not have* a homogeneous

approximation at the origin nor at infinity.

## 2.2 Problem Statement

Roughly speaking we are going to investigate **FTS** & **FxTS** properties for non-linear systems of the form

$$\begin{cases} \dot{x}(t) = f(x(t)), & t > 0, \\ x(0) = x_0, & x_0 \in \mathbb{R}^n, x(t) \in \mathbb{R}^n, \end{cases} \quad (2.1)$$

without requiring a homogeneity property and their robustness for the corresponding perturbed system

$$\dot{x}(t) = f(x(t), \delta(t)), \quad t \geq 0, \quad (2.2)$$

where  $x(t) \in \mathbb{R}^n$  is the state and  $\delta(t) \in \mathbb{R}^m$  is the external input,  $\delta \in \mathcal{L}_\infty$ .

Thus, once some conditions for robustness<sup>1</sup> will be obtained in the presence of external inputs for the systems, which are homogeneous for any fixed value of the input (in Chapter 3), we will switch to the case when our system is not homogeneous, neither globally nor locally in Chapters 4 and 5.

Let us give more details about the first problem. For that, we consider system (2.1) (which corresponds to (1.2) in Chapter 1) under the following assumptions:

### Assumption 2.1

*The vector field  $f$  is chosen such that the system (2.1) has a unique solution in forward time (for example  $f$  is assumed to be locally Lipschitz except at the origin).*

### Assumption 2.2

*The origin of system (2.1) is **GAS**.*

Under these assumptions, **FTS** and **FxTS** of (2.1) will be derived under some additional conditions:

**Q1** : Firstly, we consider the system (2.1) with  $f$  given by:

$$f(x) = \sum_{i=0}^{i=p} H_i(x) b_i(x), \quad p \in \mathbb{N}, \quad (2.3)$$

where<sup>2</sup>  $H_i : \mathbb{R}^n \rightarrow \mathcal{M}_{n,m}$ ,  $i = 0, \dots, p$  are homogeneous functions and  $b_i : \mathbb{R}^n \rightarrow \mathbb{R}^m$   $i = 0, \dots, p$  are bounded maps. For this class of systems, no result exist for **FTS**/**FxTS** without looking for a Lyapunov function. Therefore, the question of **FTS**/**FxTS** for the dynamical system (2.3) will be treated without requiring to construct a specific Lyapunov

<sup>1</sup>more precisely **FTISS** see below for a definition.

<sup>2</sup> $\mathcal{M}_{m,n}$  is the set of all  $m \times n$ -matrices over the field of real numbers. When  $m = n$  we write  $\mathcal{M}_n$  instead of  $\mathcal{M}_{n,n}$ . (Notation)

function when applying the result. More precisely, what should be the conditions on functions  $b_i$  in order to guarantee **FTS** or **FxTS** of (2.3)? Chapter 4 addresses this problem and presents a new approach called *homogeneous extensions*. This concept will be used to derive the system's rate of convergence and its **ISS** robustness in the presence of disturbances.

**Q2** : Secondly, if the vector field  $f$  is not given in the special form (2.3), then what are the conditions on  $f$  to guarantee either the **FTS** or **FxTS** of (2.1)? This is the central topic of Chapter 5, where new conditions ensuring **FTS** and **FxTS** of (2.1) will be presented using new notions of sub-and sup-homogeneity.

Now, let us give more details about the second problem concerning robustness of **FTS** with respect to perturbations (to be considered in Chapter 3). Thereby, we consider nonlinear system given by (2.2) under the following assumptions:

### Assumption 2.3

The vector field  $f : \mathbb{R}^n \times \mathbb{R}^m \rightarrow \mathbb{R}^n$  is a locally Lipschitz (or Hölder) continuous function,  $f(0,0) = 0$ . For an initial condition  $x_0 \in \mathbb{R}^n$  and input  $\delta \in \mathcal{L}_\infty$ , define the corresponding solutions by  $x(t, x_0, \delta)$  for any  $t \geq 0$  for which the solution exists.

This class of systems have been intensively studied in many works such as [4, 10, 38, 88, 89, 90]. Most of these contributions present the **ISS**, **iISS**, **FTiISS** or **FTISS** properties of (2.2) starting from the assumption that (2.2) is **AS** when  $\delta = 0$  (see [10, 59, 63, 64]). Sufficient conditions have been exhibited in [10] for **ISS**, **iISS**, **FTISS** and **FTiISS** of homogeneous systems. Moreover, another property has also been established for the system (2.2) and it is called strong **iISS** [23, 24]. But the **FT** version of this notion has not been treated yet. Additionally, the problem of **FTS** of the system (2.2) (uniformly in  $\delta$ ) has also not been considered. Therefore, in Chapter 3, we will be considering the following questions concerning robustness of **FTS** property under perturbations:

**Q3** : If the vector field  $f$  is given in the form

$$f(x, \delta) = f_1(x) + f_2(x)\delta, \quad (2.4)$$

and the origin of (2.2) is **AS** when  $\delta = 0$ , then what are the conditions on the perturbation  $\delta$  to ensure **FTS** of (2.2) when  $f_1$  and  $f_2$  are two homogeneous functions?

**Q4** : If the vector field  $f$  is locally homogeneous and its homogeneous approximation is given by (2.2). Then, is it possible to guarantee its **FTS** in the presence of disturbances?

**Q5** : Another question will also be considered in Chapter 3, which is the problem of **FTISS** of a class of interconnected systems given as follows:

$$\begin{cases} \dot{x} &= f_1(x) + f_2(x)\delta. \\ \dot{\delta} &= g(x, \delta), \end{cases}$$

with  $g$  is homogeneous.

All these robustness notions **ISS**, **iISS**, **FTISS**, **FTiISS** will be detailed in the next section but roughly speaking they are providing deviation of the asymptotic/finite-time stability property in the presence of "small" disturbances.

## 2.3 Preliminaries on the main mathematical tools

As discussed in the previous section, in order to answer the above described questions, we need to:

1. introduce and recall some results about the recently introduced notion of *generalized homogeneity*<sup>3</sup> that will be combined with some new **DI** extensions for answering questions  $Q1 - Q2$ ,
2. introduce and recall some results about these robustness notions (namely **ISS**, **iISS**, **FTISS**, **FTiISS**) to be used for answering questions  $Q3 - 5$ .

For these reasons and for the reader's benefit, we shall now list briefly the preliminary notions, which will be used in the sequel of this work. Hence, the next subsections we present the so-called *generalized linear dilation* and the robustness stability property.

### 2.3.1 Generalized homogeneity

Let us start with the notion of *generalized linear dilation*. It is a generalization of linear dilation (which includes the weighted dilation) in [74, 75, 76, 71]. As seen previously, weighted homogeneity is the most prevalent definition of homogeneity in the field of stability analysis. However, this concept is based on a precise choice of the dilation, which is coordinate-dependent.

For instance, let us start with the following example from [73]:

$$x \in \mathbb{R}^3 \mapsto f(x) = \begin{pmatrix} x_2^2 + x_3^2 \\ x_1^2 (\cos(\ln(|x_1|)) + \sin(\ln(|x_1|))) \\ x_1^2 (\cos(\ln(|x_1|)) - \sin(\ln(|x_1|))) \end{pmatrix} \in \mathbb{R}^3,$$

where  $x = (x_1, x_2, x_3)^\top \in \mathbb{R}^3$ . According to the definition of weighted homogeneity, the function  $f$  is not homogeneous with respect to a weighted dilation. But, considering the following map

$$\mathbf{d} : s \in \mathbb{R} \mapsto \mathbf{d}(s) = e^s \begin{pmatrix} 1 & 0 & 0 \\ 0 & \cos(s) & \sin(s) \\ 0 & -\sin(s) & \cos(s) \end{pmatrix} \in \mathcal{M}_3, \quad (2.5)$$

---

<sup>3</sup>Chapter 1 recalls the main well known homogeneity notions which are not used here but help to understand this quite new notion of *generalized homogeneity*.

one can see that  $f$  satisfies the following relation

$$f(\mathbf{d}(s)x) = e^s \mathbf{d}(s) f(x).$$

Hence, in order to say that  $f$  is homogeneous,  $\mathbf{d}$  has to be a dilation. Therefore, in this subsection we will give the assertions that a *generalized linear dilation* has to satisfy. To do so, let us start with the following definition (see [74, 75, 76, 71] )

### Definition 2.1

A map  $\mathbf{d} : \mathbb{R} \rightarrow \mathcal{M}_n$  is called a *generalized linear dilation* in  $\mathbb{R}^n$  if it satisfies

- **Group property:**  $\mathbf{d}(0) = I_n$ ,  $\mathbf{d}(t+s) = \mathbf{d}(t)\mathbf{d}(s)$ ,  $t, s \in \mathbb{R}$ .
- **Continuity property:**  $\mathbf{d}$  is continuous, i.e.  $\forall t > 0, \forall \varepsilon > 0, \exists \gamma > 0$  :

$$|s - t| < \gamma \Rightarrow \|\mathbf{d}(s) - \mathbf{d}(t)\|_{\mathcal{M}_n} \leq \varepsilon,$$

where  $\|\cdot\|_{\mathcal{M}_{m,n}}$  denotes the matrix norm induced by  $\|\cdot\|$ .  $\|A\|_{\mathcal{M}_{m,n}} = \sup_{x \in S} \|Ax\|$ , where  $A \in \mathcal{M}_{m,n}$  (see Notations).

- **Limit property:**  $\lim_{s \rightarrow -\infty} \|\mathbf{d}(s)x\| = 0$  and  $\lim_{s \rightarrow +\infty} \|\mathbf{d}(s)x\| = +\infty$  uniformly on the unit sphere.

### Example 2.1

Matrix (2.5) satisfies all properties of Definition 2.1. Indeed:

$$\begin{aligned} \bullet \mathbf{d}(0) &= e^0 \begin{pmatrix} 1 & 0 & 0 \\ 0 & \cos(0) & \sin(0) \\ 0 & -\sin(0) & \cos(0) \end{pmatrix} = I_3 \text{ and} \\ \mathbf{d}(t+s) &= e^{t+s} \begin{pmatrix} 1 & 0 & 0 \\ 0 & \cos(t+s) & \sin(t+s) \\ 0 & -\sin(t+s) & \cos(t+s) \end{pmatrix} \\ &= e^{t+s} \begin{pmatrix} 1 & 0 & 0 \\ 0 & \cos(t)\cos(s) - \sin(t)\sin(s) & \sin(t)\cos(s) + \sin(s)\cos(t) \\ 0 & -\sin(t)\cos(s) - \sin(s)\cos(t) & \cos(t)\cos(s) - \sin(t)\sin(s) \end{pmatrix} \\ &= \mathbf{d}(s)\mathbf{d}(t). \end{aligned}$$

This proves the **group property** of  $\mathbf{d}$ .

- **Continuity property:**

$$\lim_{s \rightarrow 0} \|\mathbf{d}(s) - I_n\|_{\mathcal{M}_n} = \lim_{s \rightarrow 0} e^s \sqrt{2(\cos(s) - 1)^2 + 2\sin^2(s)} = 0.$$

This proves the continuity of  $s \mapsto \mathbf{d}(s)$  at 0, and the group property implies the continuity of  $\mathbf{d}$  on  $\mathbb{R}$ .

• *Limit property:*

$$\lim_{s \rightarrow -\infty} \|\mathbf{d}(s)x\| = \lim_{s \rightarrow -\infty} e^s \sqrt{x_1^2 + (\cos(s)x_2 + \sin(s)x_3)^2 + (\cos(s)x_3 - \sin(s)x_2)^2} = 0,$$

$$\lim_{s \rightarrow +\infty} \|\mathbf{d}(s)x\| = \lim_{s \rightarrow +\infty} e^s \sqrt{x_1^2 + (\cos(s)x_2 + \sin(s)x_3)^2 + (\cos(s)x_3 - \sin(s)x_2)^2} = +\infty,$$

uniformly for all  $x \in S$ .

Thus,  $\mathbf{d}$  is a generalized linear dilation.

This notion of *generalized linear dilation* can be also called *geometric dilation*. They have been studied in [50, 80, 13] and they are assumed to be generated by smooth vector fields. Below we deal only with the so-called **linear geometric dilation** [74] defined as follows

$$\mathbf{d}(s) = e^{G_{\mathbf{d}}s} = \sum_{i=0}^{+\infty} \frac{s^i G_{\mathbf{d}}^i}{i!},$$

where  $G_{\mathbf{d}} \in \mathcal{M}_n$  is an anti-Hurwitz<sup>4</sup> matrix known as the generator of the dilation group  $\mathbf{d}$ . It is well known that  $\frac{d}{ds}\mathbf{d}(s) = G_{\mathbf{d}}\mathbf{d}(s) = \mathbf{d}(s)G_{\mathbf{d}}$  for all  $s \in \mathbb{R}$ . The next definition provides the definition of a monotonic (or monotone) dilation  $\mathbf{d}$  (see [75, 76, 71]).

**Definition 2.2**

The dilation  $\mathbf{d}$  is monotone in  $\mathbb{R}^n$  if  $\|\mathbf{d}(s)\|_{\mathcal{M}_n} < 1, \forall s < 0$ .

Note that the standard and weighted dilation are always monotone (see example 2.2). Definition 2.2 emphasis that, in general, *generalized linear dilation* is not monotone. Therefore, this definition is required, and this class of dilation will be used in the next chapters.

**Example 2.2**

As an example we consider the dilation  $\mathbf{d}(s) = \text{diag}\{e^{r_i s}\}_{i=1}^n, r_i > 0$ . Its norm is given by

$$\begin{aligned} \|\mathbf{d}(s)\|_{\mathcal{M}_n} &= \sup \{ \|\mathbf{d}(s)x\| : x \in \mathbb{R}^n \text{ with } \|x\| = 1 \} \\ &= \sup \{ e^{r_i s} : i = 1, \dots, n \} < 1, \forall s < 0. \end{aligned}$$

Then, the dilation  $\mathbf{d}$  is monotone.

The monotonicity property is mandatory for introducing the so-called homogeneous norm.

**Definition 2.3** (Polyakov 2020 [71])

For a monotone dilation  $\mathbf{d}$ , the continuous mapping  $x \mapsto \|x\|_{\mathbf{d}} = e^{s_x}$  where  $s_x \in \mathbb{R} : \|\mathbf{d}(-s_x)x\| = 1$ , is called the **canonical homogeneous norm**. It is

1. positive definite (i.e.,  $\forall x \in \mathbb{R}^n, \|x\|_{\mathbf{d}} \geq 0$  and  $\|x\|_{\mathbf{d}} > 0, \forall x \neq 0$ ),

---

<sup>4</sup>A matrix is anti-Hurwitz if all its eigenvalues are placed in the right-half complex plane.

2.  $\lim_{x \rightarrow 0} \|x\|_{\mathbf{d}} = 0$ ,
3.  $\mathbf{d}$ -homogeneous of degree 1 (i.e.,  $\|\mathbf{d}(s)x\|_{\mathbf{d}} = e^s \|x\|_{\mathbf{d}}$ , for all  $x \in \mathbb{R}^n \setminus \{0\}$  and  $s \in \mathbb{R}$ ).

The homogeneous unit sphere is defined as  $S_{\mathbf{d}} = \{x \in \mathbb{R}^n : \|x\|_{\mathbf{d}} = 1\}$ . Note the relation:

$$\|x\|_{\mathbf{d}} = e^{sx} = 1 \Leftrightarrow \|x\| = 1,$$

this means that  $x \in S$  ( $x \in S_{\mathbf{d}} \Leftrightarrow x \in S$ ).

Let us emphasize that the homogeneous norm is not a norm in the usual sense, since it does not satisfy the triangle inequality. The next lemma shows a relevant relation between the Euclidean norm and the  $\mathbf{d}$ -homogeneous norm (see [74, 75] for more details and proof).

### Lemma 2.1

Let  $\mathbf{d}$  be a generalized linear dilation. For any  $x \in \mathbb{R}^n$ , there exists some  $\bar{\sigma}, \underline{\sigma} \in \mathcal{K}_{\infty}$  such that  $\underline{\sigma}(\|x\|_{\mathbf{d}}) \leq \|x\| \leq \bar{\sigma}(\|x\|_{\mathbf{d}})$  holds.

### Example 2.3

Let us consider the dilation  $\mathbf{d}(s) = \text{diag}\{e^{r_i s}\}_{i=1}^n$ ,  $r_i > 0$ , the homogeneous norm is given by  $\|x\|_{\mathbf{d}} = \left(\sum_{i=1}^n |x_i|^{\frac{\rho}{r_i}}\right)^{\frac{1}{\rho}}$ , where  $\rho = \prod_{i=1}^n r_i$ . The inequality holds for  $x = 0$ . Let us consider  $x \neq 0$ . There exists  $y \in S$  such that  $x = \mathbf{d}(s)y$  with  $s = \ln(\|x\|_{\mathbf{d}})$ . If  $s \geq 0$  we have

$$\|x\| = \|\mathbf{d}(s)y\| = \left(\sum_{i=1}^n |e^{r_i s} y_i|^2\right)^{\frac{1}{2}}$$

which leads to

$$e^{r_{\min} s} \|y\| \leq \|x\| \leq e^{r_{\max} s} \|y\|,$$

which implies

$$\|x\|_{\mathbf{d}}^{r_{\min}} \leq \|x\| \leq \|x\|_{\mathbf{d}}^{r_{\max}}.$$

If  $s \leq 0$ , we get similarly

$$\|x\|_{\mathbf{d}}^{r_{\max}} \leq \|x\| \leq \|x\|_{\mathbf{d}}^{r_{\min}}.$$

Setting

$$\underline{\sigma}(s) = \begin{cases} s^{r_{\max}} & \text{if } 0 \leq s \leq 1, \\ s^{r_{\min}} & \text{if } s \geq 1, \end{cases} \quad \text{and} \quad \bar{\sigma}(s) = \begin{cases} s^{r_{\min}} & \text{if } 0 \leq s \leq 1, \\ s^{r_{\max}} & \text{if } s \geq 1, \end{cases}$$

we get

$$\underline{\sigma}(\|x\|_{\mathbf{d}}) \leq \|x\| \leq \bar{\sigma}(\|x\|_{\mathbf{d}}).$$

The notion of *generalized linear dilation* will be used to define the so called homogeneous functions, vector fields and **DI**s. In the following definition, we introduce the homogeneity for functions and vector fields with respect to a *generalized linear dilation* (for more details see [71, 74]).



**Definition 2.4**

A vector field  $f : \mathbb{R}^n \rightarrow \mathbb{R}^n$  (resp., a function  $h : \mathbb{R}^n \rightarrow \mathbb{R}$ ) is said to be  $\mathbf{d}$ -homogeneous of degree  $\nu \in \mathbb{R}$  (resp.,  $\mu \in \mathbb{R}$ ) if for all  $s \in \mathbb{R}$  and all  $x \in \mathbb{R}^n$  we have

$$e^{-\nu s} \mathbf{d}(-s)f(\mathbf{d}(s)x) = f(x),$$

(resp.,  $e^{-\mu s}h(\mathbf{d}(s)x) = h(x)$ ). We say that (2.1) is a  $\mathbf{d}$ -homogeneous system if its corresponding vector fields  $f$  is  $\mathbf{d}$ -homogeneous.

Homogeneity property was introduced also for Banach and Hilbert spaces, and it is given by a group of dilations. Let us remark that there is a key difference between a homogeneous function and a homogeneous vector field. The following lemma provides a useful comparison between homogeneous functions (see for more details [13, 71]).

**Lemma 2.2**

Suppose that  $V_1$  and  $V_2$  are continuous real-valued functions on  $\mathbb{R}^n$ ,  $\mathbf{d}$ -homogeneous of degrees  $l_1 > 0$  and  $l_2 > 0$ , respectively, and  $V_1$  is positive definite. Then, for every  $x \in \mathbb{R}^n$ , we have

$$a_1[V_1(x)]^{\frac{l_2}{l_1}} \leq V_2(x) \leq a_2[V_1(x)]^{\frac{l_2}{l_1}},$$

where  $a_1 = \min_{\{z \in \mathbb{R}^n: V_1(z)=1\}} V_2(z)$  and  $a_2 = \max_{\{z \in \mathbb{R}^n: V_1(z)=1\}} V_2(z)$ .

Let us now state a key result about invariance property of solutions for homogeneous systems and from which many interesting properties are derived (see [71, 74]).

**Theorem 2.1**

Assume that  $f : \mathbb{R}^n \rightarrow \mathbb{R}^n$  is a  $\mathbf{d}$ -homogeneous vector field of degree  $\nu$ , let  $x_0 \in \mathbb{R}^n$ . If  $x(t, x_0)$  is a solution of (2.1), then any curve of the family  $\mathbf{d}(s)x(e^{\nu s}t, x_0)$ ,  $s \in \mathbb{R}$ , is also a solution of (2.1), i.e.

$$\mathbf{d}(s)x(e^{\nu s}t, x_0) = x(t, \mathbf{d}(s)x_0), \quad \forall s \in \mathbb{R}. \quad (2.6)$$

Theorem 2.1 shows that once a solution of the system is known, a whole family of solutions, with a scaled initial condition, can be obtained. Moreover, (2.6) shows also that knowing the behavior of a solution starting from  $x_0 \in \mathbb{R}^n$  allows us to know the behavior of solutions starting from  $\mathbf{d}(s)x_0$ ,  $s \in \mathbb{R}$  [39]. In addition, by the definition of the dilation  $\mathbf{d}$ , we have: for all  $y \in \mathbb{R}^n$  there exists a unique  $s \in \mathbb{R}$  and unique  $x \in S_{\mathbf{d}}$  such that

$$s = \ln(\|y\|_{\mathbf{d}}) \text{ and } y = \mathbf{d}(s)x.$$

This implies that to study a homogeneous system can be done only on the unit sphere (and not for all initial conditions  $x_0$ ).

The existence of a homogeneous Lyapunov function for a **GAS** homogeneous system was provided in [81] and [95, in Russian] by using weighted dilation. The proof for any other kind of dilation is literally the same [73, 74, 81].

Additionally, any generalized homogeneous system is diffeomorphic to standard homogeneous one when the dilation  $\mathbf{d}$  is monotone (for more details see [73]). Moreover, for such asymptotically stable systems, it has been proven that they are also diffeomorphic to a quadratically asymptotically stable system.

**Theorem 2.2** (Polyakov 2018 [74])

Assume that the vector field  $f$  in the system (2.1) is  $\mathbf{d}$ -homogeneous with degree of homogeneity  $\nu \in \mathbb{R}$ . The next five claims are equivalent

1. The origin of (2.1) is **AS**.
2. There exists a  $\mathbf{d}$ -homogeneous  $C^\infty$  Lyapunov function  $V$  for the system (2.1).
3. The origin of the system

$$\dot{z} = \|z\|^{1+\nu} \left( \frac{(I_n - G_{\mathbf{d}})z^\top z P}{z^\top P G_{\mathbf{d}} z} + I_n \right) f \left( \frac{z}{\|z\|} \right)$$

is **AS**, where  $\|z\| = \sqrt{z^\top P z}$  with

$$P G_{\mathbf{d}} + G_{\mathbf{d}}^\top P > 0, \quad P = P^\top > 0, \quad P \in \mathcal{M}_n. \quad (2.7)$$

4. For any matrix  $P \in \mathcal{M}_n$  satisfying (2.7) there exists a  $\mathbf{d}$ -homogeneous mapping  $\Psi \in C^\infty(\mathbb{R}^n \setminus \{0\})$  with degree of homogeneity  $\nu_\Psi = 0$  such that  $\Psi$  is a diffeomorphism on  $\mathbb{R}^n \setminus \{0\}$ , a homeomorphism on  $\mathbb{R}^n$ ,  $\Psi(0) = 0$  and

$$\frac{\partial(\Psi^\top(\zeta)P\Psi(\zeta))}{\partial\zeta} f(\zeta) \quad \text{if} \quad \Psi^\top(\zeta)P\Psi(\zeta) = 1.$$

Moreover,  $\|\Psi(\cdot)\|_{\mathbf{d}} \in C^\infty(\mathbb{R}^n \setminus \{0\})$  is a  $\mathbf{d}$ -homogeneous Lyapunov function for (2.1).

5. For any matrix  $P \in \mathcal{M}_n$  satisfying (2.7) there exists a map  $\Xi \in C^\infty(\mathbb{R}^n \setminus \{0\}, \mathcal{M}_n)$  such that

$$\det(\Xi(z)) \neq 0, \quad \frac{\partial\Xi(z)}{\partial z_i} z = 0, \quad \Xi(e^s z) = \Xi(z) \quad \text{for} \quad z \in \mathbb{R}^n \setminus \{0\}, \quad s \in \mathbb{R}$$

and

$$z^\top \Xi^\top(z) P \Xi(z) \left( \frac{(I_n - G_{\mathbf{d}})z^\top z P}{z^\top P G_{\mathbf{d}} z} + I_n \right) f \left( \frac{z}{\|z\|} \right) < 0.$$

**Remark 2.1**

The claim 5. in Theorem 2.2 shows that since the property  $\frac{\partial\Xi(z)}{\partial z_i} z = 0$  holds, then the existence of a quadratic Lyapunov function for **AS** standard homogeneous system can be always guaranteed. Moreover, the fact that any generalized homogeneous system is diffeomorphic to standard homogeneous one implies that we can always find a quadratic Lyapunov function for a  $\mathbf{d}$ -homogeneous **AS** system.

**Remark 2.2**

Due to the fact that a  $\mathbf{d}$ -homogeneous system is diffeomorphic to standard homogeneous one (claim 3. in Theorem 2.2), the fundamental results of Theorem 1.7 may be generalized to  $\mathbf{d}$ -homogeneous systems (see [71] and [74]). This result, in another word, may also roughly stated as "for homogeneous systems, attractivity implies **GAS**".

Regarding non-asymptotic stability rates, stable homogeneous systems also provide a characterization based only on its homogeneity degree, this is, without relying on Lyapunov analysis (see [74, 66]): Lemma 1.2 remains true if we replace " $r$ -homogeneous" by " $\mathbf{d}$ -homogeneous".

Stabilization of homogeneous dynamical systems can, be derived using Sontag's formula (for more details see [59, 67]). Combining Sontag's formula with Theorem 2.2, Polyaklov provides a homogeneous dynamical feedback for  $\mathbf{d}$ -homogeneous systems (see [73] for more details).

Lastly, in the next chapters, we will build some differential inclusions extensions (**DI** extensions) for deriving new **FTS** / **FxTS** results regarding non-homogeneous systems. For that, the notion of  $\mathbf{d}$ -homogeneous *differential inclusions* will be needed: **DI** are recalled in Chapter 1 together with some basic properties and homogeneity for differential inculsions follows the definition of homogeneous set-valued map given below.

**Definition 2.5**

$F : \mathcal{D}(F) \subset \mathbb{R}^n \rightrightarrows \mathbb{R}^n$  is  $\mathbf{d}$ -homogeneous with degree of homogeneity  $\nu \in \mathbb{R}$  :

$$F(\mathbf{d}(s)x) = e^{\nu s} \mathbf{d}(s)F(x), \quad \forall s \in \mathbb{R}.$$

Results of Lemma 1.2 have been generalized to **DI**s (see [8]).

**2.3.2 Robustness, ISS, iISS, FTISS and FTiISS**

Robust control design has to take into account, somehow, a description of the plant uncertainty. Moreover, in control theory, an uncertain dynamical system is described by a set of models rather than a single model. For example, a system with an unknown parameter generates a set of models, one for each possible value of the parameter. Likewise for a system with an unknown disturbance (which can be a function of time as well as state variables and control inputs).

Reducing the effect of disturbances on vital dynamic systems is one of the main purposes of every feedback loop. Feedback can be used for stabilization, but inappropriately designed feedback controllers may reduce, rather than enlarge, regions of stability (more details about the stabilization tools are presented in the next section). Generally speaking, robustness is a property which guarantees the appropriate behavior for a plant in the presence of unknown parameters. During the last decade, great efforts were devoted to the study of **FTS** robustness for non-linear systems with exogenous disturbances. The class of systems considered in this orientation is given by (2.2).

Let us start with some definitions of robust stability<sup>5</sup> and its **FTS** counterpart which will be investigated for systems with disturbances:

**Definition 2.6** (Sontag 1989 [89], Hong et al. 2008 [44])

System (2.2) is said to be

- **ISS** if there exist a class  $\mathcal{KL}$  function  $\beta$  and a class  $\mathcal{K}$  function  $\gamma$  such that for any initial state  $x_0 \in \mathbb{R}^n$  and any  $\delta \in \mathcal{L}_\infty$ , the solution  $x(t, x_0, \delta)$  of (2.2) exists for all  $t \geq 0$  and satisfies

$$\|x(t, x_0, \delta)\| \leq \beta(\|x_0\|, t) + \gamma(\|\delta\|_\infty). \quad (2.8)$$

If **ISS** property holds with<sup>6</sup>  $\beta \in \mathcal{GKL}$ , then (2.2) is called **finite-time ISS (FTISS)**.

- **ISS with respect to small input** if there exist a constant  $r > 0$  such that for all  $x_0 \in \mathbb{R}^n$  and all  $t \geq 0$ , we have

$$\|\delta\|_\infty < r \implies \|x(t, x_0, \delta)\| \leq \beta(\|x_0\|, t) + \gamma(\|\delta\|_\infty). \quad (2.9)$$

If (2.8) (resp., (2.9)) holds for  $x_0 \in \mathcal{V} \subset \mathbb{R}^n$  with  $\mathcal{V}$  is a neighborhood of the origin, then the previous **ISS** properties hold locally.

#### Example 2.4

Let us consider system

$$\dot{x} = -2x - x^3 + (x^2 + 1)\delta.$$

It is **GAS** when there is no disturbance ( $\delta = 0$ , i.e.,  $\dot{x} = -2x - x^3$ ). In addition, it is **ISS**. Intuitively, for large  $x$ , the term  $x^3$  dominates the term  $(x^2 + 1)\delta$ , for all bounded disturbances  $\delta(\cdot)$ , and this prevents the state from getting too large.

**Definition 2.7** (Sontag. 1998 [88])

The system (2.2) is called **iISS**, if there are some functions  $\alpha \in \mathcal{K}_\infty$ ,  $\gamma \in \mathcal{K}$  and  $\beta \in \mathcal{KL}$  such that for any  $x_0 \in \mathbb{R}^n$  and  $\delta \in \mathcal{L}_\infty$  the following estimate holds:

$$\alpha(\|x(t, x_0, \delta)\|) \leq \beta(\|x_0\|, t) + \int_0^t \gamma(\|\delta(s)\|) ds, \quad \forall t > 0. \quad (2.10)$$

If  $\beta \in \mathcal{GKL}$ , we say that system (2.2) is **finite-time iISS (FTiISS)**.

**Definition 2.8** (Chaillet et al. 2014 [23], Chaillet et al. 2014 [24])

The system (2.2) is said to be **strongly iISS** if it is both **iISS** and **ISS with respect to small inputs**.

<sup>5</sup>For more details about its links with homogeneity see [10].

<sup>6</sup> $\beta : \mathbb{R}_+ \times \mathbb{R}_+ \rightarrow \mathbb{R}_+$  is said to be a class  $\mathcal{GKL}$  function, if  $\beta(\cdot, t) \in \mathcal{K}_\infty$  for each fixed  $t \in \mathbb{R}_+$ ,  $\beta$  is a strictly decreasing function until  $T$  in its second argument  $t \in \mathbb{R}_+$  for any fixed first argument  $s \in \mathbb{R}_+ \setminus \{0\}$  and  $\beta(s, \tau) = 0$ ,  $\forall \tau \geq T$  for each fixed  $s \in \mathbb{R}_+$  for some  $0 \leq T < +\infty$ . (See Notations).

## Lyapunov Characterization of ISS/FTISS and iISS/FTiISS

**Definition 2.9** (Sontag et al. 1995 [90] for ISS)

A smooth function  $V : \mathbb{R}^n \rightarrow \mathbb{R}_+$  is called

- an **ISS** Lyapunov function if for all  $x \in \mathbb{R}^n$ ,  $\delta \in \mathbb{R}^m$  and some functions  $\alpha_1, \alpha_2, \alpha_3 \in \mathcal{K}_\infty$  and  $\gamma \in \mathcal{K}$  :

$$\alpha_1(\|x\|) \leq V(x) \leq \alpha_2(\|x\|), \quad (2.11)$$

$$\langle \nabla V(x), f(x, \delta) \rangle \leq -\alpha_3(\|x\|) + \gamma(\|\delta\|), \quad (2.12)$$

such a function  $V$  is called **ISS** Lyapunov function with respect to  $\mathcal{A} = \{x \in \mathbb{R}^n : \|x\| \leq A\}$  for some  $A \geq 0$ , if the inequality (2.12) holds for all  $x \in \mathbb{R}^n \setminus \mathcal{A}$ ;

- an **iISS** Lyapunov function if in the above definition, the function  $\alpha_3 : \mathbb{R}_+ \rightarrow \mathbb{R}_+$  is positive definite instead of belonging to  $\mathcal{K}_\infty$ ;
- a **FTISS** or **FTiISS** Lyapunov function, if there exists  $\varepsilon > 0$  such that  $\alpha_3(\|x\|) \geq cV(x)^\alpha$  for all  $\|x\| \leq \varepsilon$  with  $c > 0$  and  $0 < \alpha < 1$ ;
- a local **ISS** Lyapunov function if there exist some functions  $\alpha_1, \alpha_2, \alpha_3 \in \mathcal{K}_\infty$ ,  $\gamma \in \mathcal{K}$  and  $r > 0$  such that the inequalities (2.11) and (2.12) hold  $\forall x \in \mathbb{R}^n$  with  $\|x\| \leq r$ ,  $\forall \delta \in \mathbb{R}^m$  with  $\|\delta\| \leq r$ .

Note that an **ISS** Lyapunov function can also satisfy the following equivalent condition for some  $\chi \in \mathcal{K}$  and  $\alpha_3 \in \mathcal{K}_\infty$  (see [90]):

$$\|x\| \geq \chi(\|\delta\|) \implies \langle \nabla V(x), f(x, \delta) \rangle \leq -\alpha_3(\|x\|). \quad (2.13)$$

**Theorem 2.3** (Sontag et al. 1995 [90])

The following properties are equivalent:

- 1) System (2.2) is **ISS** (resp., **iISS**) with  $\delta$  as input;
- 2) There is an **ISS**-Lyapunov (resp., **iISS**-Lyapunov) function  $V \in \mathcal{C}^1(\mathbb{R}^n, \mathbb{R}_+)$ .

The property 1) holds in finite-time iff there exists a **FTISS**- (resp., **FTiISS**-) Lyapunov function as mentioned in Definition 2.9.

**Theorem 2.4** (Chaillet et al. 2014 [24])

The system (2.2) is strong **iISS** if

- there exists an **iISS**-Lyapunov function  $W$  for (2.2);
- there exists an **ISS**-Lyapunov function with respect to small inputs  $V$ ; i.e., there exists a smooth function  $V : \mathbb{R}^n \rightarrow \mathbb{R}_+$  such that for all  $x \in \mathbb{R}^n$ ,  $\delta \in \mathbb{R}^m$  and some functions  $\alpha_1, \alpha_2, \alpha_3 \in \mathcal{K}_\infty$  and  $\gamma \in \mathcal{K}$  : such that (2.11) holds and

$$\|\delta\| < R \implies \langle \nabla V(x), f(x, \delta) \rangle \leq -\alpha_3(\|x\|) + \gamma(\|\delta\|), \quad R > 0.$$

**Example 2.5**

Let us consider the system

$$\dot{x} = f(x, \delta) = -(\delta + 1)|x|^\alpha, \quad 0 < \alpha < 1.$$

Using the Lyapunov function  $V(x) = \frac{1}{2}x^2$ , we get

$$\langle \nabla V(x), f(x, \delta) \rangle = -(\delta + 1)|x|^{\alpha+1} \leq -(1 - |\delta|)|x|^{\alpha+1},$$

which implies that the system  $\dot{x} = f(x, \delta)$  is

- **ISS** with respect to small inputs, i.e., if

$$0 < |\delta| < \beta < 1 \Rightarrow \langle \nabla V(x), f(x, \delta) \rangle = -(1 - \beta)|x|^{\alpha+1};$$

- **FTISS** with respect to small inputs if  $0 < \alpha < 1$ ;

- **iISS** if  $0 < \alpha < 1$ , i.e., using the Lyapunov function  $W(x) = \ln(1 + \frac{1}{2}x^2)$

$$\begin{aligned} \langle \nabla W(x), f(x, \delta) \rangle &= -(\delta + 1) \frac{2|x|^{\alpha+1}}{2 + |x|^2} \\ &\leq -\frac{2|x|^{\alpha+1}}{2 + |x|^2} + |\delta| \frac{2|x|^{\alpha+1}}{2 + |x|^2} \\ &\leq -\sigma(|x|) + 2|\delta|, \end{aligned}$$

where  $\sigma(s) = \frac{2s^{\alpha+1}}{2+s^2}$  and  $0 < \alpha < 1$ . This implies the **iISS** property.

The following theorem is about strong **iISS** under cascade interconnection.

**Theorem 2.5** (Chaillet et al. 2014 [24])

Assume that the systems  $\dot{x}_1 = f_1(x_1, u_1)$  and  $\dot{x}_2 = f_2(x_2, u_2)$  ( $f_1(0, 0) = 0, f_2(0, 0) = 0$ ) are strongly **iISS** with respect to  $u_1$  and  $u_2$  respectively. Then, the cascade system

$$\begin{cases} \dot{x}_1 &= f_1(x_1, x_2), \\ \dot{x}_2 &= f_2(x_2, u_2), \end{cases} \quad (2.14)$$

is strongly **iISS**.

As for **ISS**, homogeneous systems also possess a convenient property. If the origin is **GAS** for input zero, then the homogeneity degree will determine its robustness. Define  $\tilde{f}(x, d) = [f(x, d)^T \ 0_m^T]^T \in \mathbb{R}^{n+m}$ . It is an extended auxiliary vector field for the system (2.2), where  $0_m$  is the zero vector in  $\mathbb{R}^m$ .

**Theorem 2.6** (Bernuau et al. 2013 [10])

Let the vector field  $\tilde{f}$  be  $\mathbf{d}$ -homogeneous with

$$\mathbf{d}(s) = \text{diag}\{\mathbf{d}_r(s), \mathbf{d}_{\tilde{r}}(s)\} = \text{diag}\{e^{r_1 s}, \dots, e^{r_n s}, e^{\tilde{r}_1 s}, \dots, e^{\tilde{r}_m s}\}$$

of degree  $\nu \geq -r_{\min}$ , (i.e.,  $f(\mathbf{d}_r(s)x, \mathbf{d}_{\tilde{r}}(s)\delta) = e^{\nu s} \mathbf{d}_r(s) f(x, \delta)$  for all  $x \in \mathbb{R}^n, \delta \in \mathbb{R}^m$ ). Assume that the system (2.2) is **GAS** for  $\delta = 0$ , then the system (2.2) is

1. **ISS** if  $\tilde{r}_{\min} > 0$ ;
2. **FTISS** if it is **ISS** and  $\nu < 0$ ;
3. **iISS** if  $\tilde{r}_{\min} = 0$  and  $\nu \leq 0$ .

In the case of locally homogeneous systems, **ISS** stability can be asserted through their homogeneous approximations at 0 and at  $\infty$ .

### Example 2.6

Consider the system

$$\begin{cases} \dot{x} = y \\ \dot{y} = -\alpha x^3 - \beta |y|^{\frac{3}{2}} + \delta. \end{cases} \quad (2.15)$$

Using the Lyapunov function  $V(x) = \frac{1}{4}\alpha x^4 + \frac{1}{y}y^2$ , one can prove that the origin of system (2.15) is globally asymptotically stable when  $\delta = 0$ . Indeed, we have that

$$\langle \nabla V(x, y), f(x, y, \delta) \rangle = -\beta |y|^{\frac{5}{2}}, \quad f(x, y, \delta) = (y, -\alpha x^3 - \beta |y|^{\frac{3}{2}} + \delta)^\top.$$

Then, using LaSalle principle, one deduces that for  $\delta = 0$ , the origin of (2.15) is GAS. In general cases, it is not easy to find a strict Lyapunov function. Then, it won't be straightforward to prove the **ISS** property with respect to  $\delta$ . However, the fact that  $f$  is  $\mathbf{d}$ -homogeneous with degree  $\nu = 1$  and  $\mathbf{d}(s) = \text{diag}\{e^s, e^{2s}, e^{\frac{3}{2}s}\}$  and using Theorem 2.6 we can prove **ISS** property of the considered system. As we can see, Figure 2.1 shows the behavior of the solutions of (2.15), starting from the same initial condition (1, 4), with and without perturbations. The figure on the right side shows that the solution still bounded in the presence of bounded disturbances (i.e.,  $\delta(t) = \cos(t)$ ).

The last result connects **ISS** property with **GAS** properties of the original system together with its bi-limit homogeneous approximation (when there is no perturbation).

### Theorem 2.7 (Andrieu et al. 2008 [2])

Let the vector field  $\tilde{f}$  be continuous and

1. homogeneous in the  $\infty$ -limit with associated triple  $(\nu_\infty, \mathbf{d}_\infty, \tilde{f}_\infty)$  where

$$\mathbf{d}_\infty(s) = \text{diag}\{e^{r_{\infty,1}s}, \dots, e^{r_{\infty,n}s}, e^{\tilde{r}_{\infty,1}s}, \dots, e^{\tilde{r}_{\infty,m}s}\},$$

$$r_{\infty,1}, \dots, r_{\infty,n} > 0 \text{ and } \tilde{r}_{\infty,1}, \dots, \tilde{r}_{\infty,m} > 0.$$

2. homogeneous in the 0-limit with associated triple  $(\nu_0, \mathbf{d}_0, \tilde{f}_0)$  where

$$\mathbf{d}_0(s) = \text{diag}\{e^{r_{0,1}s}, \dots, e^{r_{0,n}s}, e^{\tilde{r}_{0,1}s}, \dots, e^{\tilde{r}_{0,m}s}\},$$

$$r_{0,1}, \dots, r_{0,n} > 0 \text{ and } \tilde{r}_{0,1}, \dots, \tilde{r}_{0,m} > 0.$$

If the origin for the systems  $\dot{x} = \tilde{f}_0(x, 0)$ ,  $\dot{x} = \tilde{f}(x, 0)$  and  $\dot{x} = \tilde{f}_\infty(x, 0)$  are GAS then the system (2.2) is **ISS**.

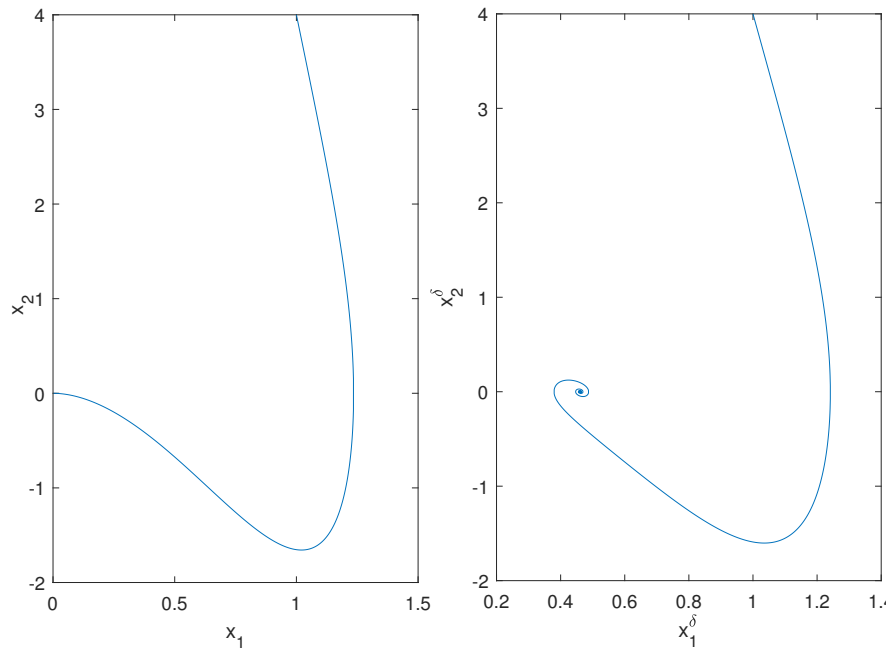

Figure 2.1: The trajectory in the left side shows the GAS behavior of (2.15) with  $\delta = 0$  and the second trajectory shows the **ISS** behavior of the system (2.15) for  $\delta(t) = \cos(t)$ .





# Robustness and finite-time stability of homogeneous systems

## Contents

<b>3.1</b>	<b>Finite-time strong iISS</b>	<b>62</b>
<b>3.2</b>	<b>Robustness analysis of a homogeneous system and interconnections</b>	<b>63</b>
3.2.1	Robustness of Finite-time Stability of Homogeneous Systems	63
3.2.2	Robustness of Locally Homogeneous Systems	68
3.2.3	Robustness of Finite-Time Stability of Cascade System	72
<b>3.3</b>	<b>Application</b>	<b>76</b>
3.3.1	Homogeneous Affine Nonlinear Dynamical System	77
3.3.2	Interconnected System	79
<b>3.4</b>	<b>Conclusion</b>	<b>79</b>

The problem of robustness analysis of nonlinear control systems is at the center of attention of researchers for many decades [89, 47, 88, 23, 4, 38, 24], etc. This property gained its importance due to the fact that all industrial plants are usually accompanied by exogenous disturbances and uncertainties. The aim of robustness analysis is to warranty the boundedness of the system's states in the presence of perturbations. As we have seen in this direction, there are many different kinds of robust stability properties (as **ISS**, **iISS**, strong **iISS**, etc.) that have been treated for linear and nonlinear systems. However, it can also be the case that the rate of convergence and stability of the origin are uniform and preserved even under influence of the disturbances.

For example, consider the following system:

$$\ddot{x}(t) = -[x(t)]^\alpha - (1 + \delta(t))[\dot{x}(t)]^\beta, \quad t \geq 0; \quad (3.1)$$

where  $x(t), \dot{x}(t) \in \mathbb{R}$  form the state and  $\delta(t) \in \mathbb{R}$  is an input,  $\alpha, \beta \in (0, 1)$ . This system is homogeneous for any constant  $\delta$  and **FTiISS** for  $0 < \beta = \frac{2\alpha}{\alpha+1} < 1$  (see [10]).

The questions that we may ask in this case are: is it possible to ensure a uniform **FTS** of generic homogeneous nonlinear dynamical systems even in the presence of disturbances? Otherwise, what robust stability properties can we guarantee?

Following [18, 17], in this chapter we are going to answer these questions and explore several robust stability concepts for a class of homogeneous systems and their interconnections. Note that the basic conditions of **ISS** and **iISS** for homogeneous systems have been established in [10], and in this part we are going to go beyond with a more evolved analysis.

To start with the thesis' problematic, this chapter investigates robustness issues and finite-time stability property for dynamical systems in the presence of sufficiently small affine inputs. It is assumed that for any constant value of the input the system is homogeneous (as (3.1)), or it admits a local homogeneous approximation at the origin or at infinity. Two cases are studied: the input is just a bounded external signal, or it is generated by another homogeneous system. The utility of the obtained results is illustrated via robustness analysis of homogeneous observer with time-varying gains.

The following stability concept will be used next in the chapter.

### 3.1 Finite-time strong iISS

Let us consider again a nonlinear system in the form (2.2), where, to recall,  $x(t) \in \mathbb{R}^n$  is the state and  $\delta(t) \in \mathbb{R}^m$  is the external input,  $\delta \in \mathcal{L}_\infty$ . The vector field  $f : \mathbb{R}^n \times \mathbb{R}^m \rightarrow \mathbb{R}^n$  is a locally Lipschitz (or Hölder) continuous function,  $f(0, 0) = 0$ .

A simple combination of previously introduced properties gives a new concept:

#### Definition 3.1

The system (2.2) is said to be **FT strongly iISS** if it is **FTiISS** and **FTISS** with respect to small input.

As it has been mentioned in the previous chapter, strong **iISS** takes an intermediate place sharing the utility of **ISS** and widespread of **iISS**. Let us now introduce a Lyapunov characterization of the **FT strong iISS**.

#### Lemma 3.1

The system (2.2) is **FT strong iISS** if and only if

1. there exists a **FTiISS** Lyapunov function  $W$  for (2.2);
2. there exists a **FTISS** Lyapunov function with respect to small inputs  $V$ , i.e., there exists a smooth function  $V : \mathbb{R}^n \rightarrow \mathbb{R}_+$  such that for all  $x \in \mathbb{R}^n$ ,  $\delta \in \mathbb{R}^m$  and some  $\alpha_1, \alpha_2, \alpha_3 \in \mathcal{K}_\infty$  and  $\gamma \in \mathcal{K}$ :

$$\alpha_1(\|x\|) \leq V(x) \leq \alpha_2(\|x\|), \quad (3.2)$$

$$\|\delta\| < R \implies \langle \nabla V(x), f(x, \delta) \rangle \leq -\alpha_3(\|x\|) + \gamma(\|\delta\|). \quad (3.3)$$

$$\exists \varepsilon > 0, \alpha_3(\|x\|) \geq cV(x)^\alpha, \forall \|x\| \leq \varepsilon$$

with  $c > 0$  and  $0 < \alpha < 1$ .

**Proof of Lemma 3.1:**

$\implies$ ) we assume that the system (2.2) is **FT** strong **iISS**. This means that (2.2) is **FTiISS** and **FTISS** with respect to small inputs. Using Theorem 2.3 one deduces the existence of a couple of Lyapunov functions such that 1. and 2. hold.

$\impliedby$ ) Let us now assume that there exist two functions  $V$  and  $W$  such that 1. and 2. are fulfilled. Then, Again by using Theorem 2.3, one gets that the system (2.2) is both **FTiISS** and **FTISS** with respect to small inputs.

This concludes the proof. ■

Below we will demonstrate that the property of **FT** strong **iISS** appears naturally for a class of homogeneous systems and nonlinear systems admitting homogeneous approximations. This concept will also allow us to study the **FTiISS** for some classes of interconnected systems.

## 3.2 Robustness analysis of a homogeneous system and interconnections

In this section, first, we will consider stable homogeneous systems, which are affine in the external perturbations, and establish the conditions of uniform (robust) stability. Next, we will analyze locally homogeneous dynamics by looking for similar properties. And finally, a cascade connection will be investigated.

### 3.2.1 Robustness of Finite-time Stability of Homogeneous Systems

In this section we will study the system (2.2) satisfying the following hypotheses:

**Assumption 3.1**

$$f(x, \delta) = f_1(x) + f_2(x)\delta, \quad \forall x \in \mathbb{R}^n, \forall \delta \in \mathbb{R}^m.$$

**Assumption 3.2**

$f_1 : \mathbb{R}^n \rightarrow \mathbb{R}^n$  and  $f_2 : \mathbb{R}^n \rightarrow \mathcal{M}_{n,m}$  are continuous and  $\mathbf{d}$ -homogeneous with degree of homogeneity  $\nu \in \mathbb{R}$  for a monotone dilation  $\mathbf{d}$ .

**Assumption 3.3**

The system (2.2) with  $\delta = 0$  (i.e.,  $\dot{x} = f(x, 0)$ ) is **GAS**.

Assumptions 3.1 and 3.2 imply that the function  $f$  is also  $\mathbf{d}$ -homogeneous with degree of homogeneity  $\nu$  for any constant  $\delta$ .

**Theorem 3.1**

Assume that the system (2.2) satisfies Assumptions 3.1, 3.2 and 3.3.

- If  $\nu \in \mathbb{R}$ , then (2.2) is uniformly **GAS** for small inputs.
- If  $\nu < 0$ , then (2.2) is
  - uniformly **GFTS** for small inputs,
  - **FT** strongly **iISS** (in the sense of Definition 3.1).

**Proof of Theorem 3.1:**

**Step I: In this step we will prove the uniform GAS of (2.2) for any  $\nu \in \mathbb{R}$  and small inputs  $\delta$ .** We assume that the system  $\dot{x} = f(x, 0)$  is **GAS** (Assumption 3.3) and  $\mathbf{d}$ -homogeneous. Then, Theorem 2.2 implies that there exists a  $\mathbf{d}$ -homogeneous positive definite Lyapunov function  $V \in \mathcal{C}^\infty(\mathbb{R}^n \setminus \{0\}, \mathbb{R}_+) \cap \mathcal{C}(\mathbb{R}^n, \mathbb{R}_+)$  with degree of homogeneity  $k > \max\{-\nu, 0\}$ , such that:

$$\langle DV(x), f(x, 0) \rangle < 0, \quad \forall x \in \mathbb{R}^n \setminus \{0\}.$$

Using Lemma 2.2 and Assumption 3.2 with  $V_1(x) = \|x\|_{\mathbf{d}}$  and  $V_2(x) = \langle DV(x), f(x, 0) \rangle$ , we get

$$\langle DV(x), f(x, 0) \rangle \leq -a\|x\|_{\mathbf{d}}^{k+\nu}, \quad \forall x \in \mathbb{R}^n, \quad (3.4)$$

where  $a = \min_{\|y\|_{\mathbf{d}}=1} [-\langle DV(y), f(y, 0) \rangle]$ . Let  $x \in \mathbb{R}^n$  and  $y \in S_{\mathbf{d}}$  be such that  $y = \mathbf{d}(-\ln(\|x\|_{\mathbf{d}}))x$ . Due to Assumptions 3.1 and 3.2, one gets

$$\begin{aligned} & \langle DV(\mathbf{d}(\ln(\|x\|_{\mathbf{d}}))y), f_2(\mathbf{d}(\ln(\|x\|_{\mathbf{d}}))y)\delta \rangle \\ &= \left\langle e^{k \ln(\|x\|_{\mathbf{d}})} \mathbf{d}(-\ln(\|x\|_{\mathbf{d}})) DV(y), e^{\nu \ln(\|x\|_{\mathbf{d}})} \mathbf{d}(\ln(\|x\|_{\mathbf{d}})) f_2(y)\delta \right\rangle \\ &= \|x\|_{\mathbf{d}}^{\nu+k} \langle DV(y), f_2(y)\delta \rangle \end{aligned}$$

by using Cauchy-Schwarz inequality and (3.4), one gets

$$\begin{aligned} \langle DV(x), f(x, \delta) \rangle &= \langle DV(x), f(x, 0) \rangle + \langle DV(\mathbf{d}(\ln(\|x\|_{\mathbf{d}}))y), f_2(\mathbf{d}(\ln(\|x\|_{\mathbf{d}}))y)\delta \rangle \\ &= \langle DV(x), f(x, 0) \rangle + \|x\|_{\mathbf{d}}^{k+\nu} \langle DV(y), f_2(y)\delta \rangle \\ &\leq -a\|x\|_{\mathbf{d}}^{k+\nu} + \|x\|_{\mathbf{d}}^{k+\nu} \langle f_2(y)^T DV(y), \delta \rangle \\ &\leq -a\|x\|_{\mathbf{d}}^{k+\nu} + c\|x\|_{\mathbf{d}}^{k+\nu} \|\delta\|, \end{aligned} \quad (3.5)$$

with  $c = \sup_{\|y\|_{\mathbf{d}}=1} \|f_2(y)^T DV(y)\|$ .

For  $\|\delta\| \leq \frac{a}{2c}$ , we have  $\langle DV(x), f(x, \delta) \rangle \leq -\frac{a}{2}\|x\|_{\mathbf{d}}^{k+\nu}$ , which implies that the system (2.2) with Assumptions 3.1, 3.2 and 3.3. is **uniformly GAS** for small inputs  $\delta$  and for every  $\nu \in \mathbb{R}$ .

**Step II:  $\nu < 0$**

1. Recall that if  $\|\delta\| \leq \frac{a}{2c}$ , then

$$\dot{V}(x(t)) = \langle DV(x(t)), f(x(t), \delta(t)) \rangle \leq -\frac{a}{2} \|x(t)\|_{\mathbf{d}}^{k+\nu}.$$

Using the homogeneity of  $V$ , there exist  $v_1 = \min_{\|x\|_{\mathbf{d}=1}} V(x)$ , and  $v_2 = \max_{\|x\|_{\mathbf{d}=1}} V(x)$  such that

$$v_1 \|x\|_{\mathbf{d}}^k \leq V(x) \leq v_2 \|x\|_{\mathbf{d}}^k. \quad (3.6)$$

Consequently,  $\dot{V}(x) = \langle DV(x), f(x, \delta) \rangle \leq -\frac{a}{2v_2^\alpha} V(x)^\alpha$ , with  $0 < \alpha = \frac{k+\nu}{k} < 1$ , for all  $x \in \mathbb{R}^n$ . This inequality implies the **finite-time rate of convergence** to the origin globally and uniformly with respect to such small inputs  $\delta$ .

2. Let the function  $W$  be defined by:

$$W(x) = \ln[1 + V(x)]. \quad (3.7)$$

It is continuously differentiable, positive definite and radially unbounded, which means that it is a Lyapunov function for (2.2) when  $\delta = 0$ . The conditions  $k + \nu > 0$  and  $\nu < 0$  give

$$\|x\|_{\mathbf{d}}^{k+\nu} \leq v(\|x\|_{\mathbf{d}}), \text{ with } v(s) = \begin{cases} 1, & \text{if } s \leq 1 \\ s^k, & \text{if } s \geq 1 \end{cases}.$$

This implies that, if  $\|x\|_{\mathbf{d}} \leq 1$ ,  $\frac{\|x\|_{\mathbf{d}}^{k+\nu}}{1+V(x)} \leq \frac{v(\|x\|_{\mathbf{d}})}{1+V(x)} \leq 1$ . If  $\|x\|_{\mathbf{d}} \geq 1$ , then

$$\frac{\|x\|_{\mathbf{d}}^{k+\nu}}{1+V(x)} \leq \frac{\|x\|_{\mathbf{d}}^k}{1+v_1\|x\|_{\mathbf{d}}^k} \leq \frac{1}{v_1}$$

using (3.6). Therefore,

$$\frac{\|x\|_{\mathbf{d}}^{k+\nu}}{1+V(x)} \leq \max \left\{ 1, \frac{1}{v_1} \right\} = v_3. \quad (3.8)$$

Combining properties (3.5) and (3.8) we obtain:

$$\begin{aligned} \langle DW(x), f(x, \delta) \rangle &\leq -a \frac{\|x\|_{\mathbf{d}}^{k+\nu}}{1+V(x)} + v_3 \|\delta\| \\ &\leq -a \frac{\|x\|_{\mathbf{d}}^{k+\nu}}{1+v_2\|x\|_{\mathbf{d}}^k} + v_3 \|\delta\|, \\ &\leq -\alpha_3(\|x\|_{\mathbf{d}}) + v_3 \|\delta\|, \end{aligned}$$

where  $\alpha_3(s) = a \frac{s^{k+\nu}}{1+v_2s^k}$  is a positive definite function. This implies the **iISS** property for the system (2.2) (Definition 2.9). Recall that  $e^W - 1 \geq W$  for any  $W \geq 0$ , select  $\varepsilon > 0$ , then

$$\begin{aligned} \|x\|_{\mathbf{d}} \leq \varepsilon &\implies a \frac{\|x\|_{\mathbf{d}}^{k+\nu}}{1+v_2\varepsilon^k} \leq a \frac{\|x\|_{\mathbf{d}}^{k+\nu}}{1+V(x)} \\ &\implies \langle DW(x), f(x, \delta) \rangle \leq -a \frac{\|x\|_{\mathbf{d}}^{k+\nu}}{1+v_2\varepsilon^k} + v_3 \|\delta\| \\ &\leq -C V(x)^{\frac{k+\nu}{k}} + v_3 \|\delta\| \\ &\leq -C W(x)^\alpha + v_3 \|\delta\|, \end{aligned}$$

with  $C = \frac{a}{v_2^{\frac{k+\nu}{k}}(1+v_2\varepsilon^k)}$ . The fact that  $0 < \alpha = \frac{k+\nu}{k} < 1$  and Definition 2.9 imply that system (2.2) is **finite-time iISS**. Combining this result with the uniform **GFTS** for small inputs proven previously (which is stronger than **FTISS** for small inputs) we substantiates that the system (2.2) is **finite-time strongly iISS**. The theorem is proven. ■

**Example 3.1**

We consider example (3.1) with  $y = \dot{x}$ , we get

$$\begin{cases} \dot{x}(t) = y(t), & t \geq 0 \\ \dot{y}(t) = -[x(t)]^\alpha - (1 + \delta(t))[y(t)]^{\frac{2\alpha}{\alpha+1}}, & 0 < \alpha < 1. \end{cases}$$

Moreover, this system can be also written in the following form

$$\dot{z} = f_1(z) + f_2(z)\delta$$

with

$$z = (x, y)^\top, \quad f_1(z) = \left( y, -[x(t)]^\alpha - [y(t)]^{\frac{2\alpha}{\alpha+1}} \right)^\top$$

$$\text{and } f_2(z) = \left( 0, -[y(t)]^{\frac{2\alpha}{\alpha+1}} \right)^\top$$

$f_1$  and  $f_2$  are **d**-homogeneous with degree of homogeneity  $\nu = \frac{\alpha-1}{2}$  where

$$d(s) = \begin{pmatrix} e^s & 0 \\ 0 & e^{\frac{\alpha+1}{2}s} \end{pmatrix}.$$

For  $0 < \alpha < 1$ , one gets that this system is **GFTS** for small inputs and **FT strong iISS** for all disturbances with bounded energy. These conclusions are illustrated in Figure 3.1.

To conclude the analysis of the system (2.2) given in this subsection, **ISS** and **FTISS** conditions are formulated for generalized homogeneous systems with exogenous disturbances (extending the result of [10]). These results will be used in the last subsection to study the interconnected homogeneous systems with different degrees of homogeneity.

**Theorem 3.2**

Consider the system (2.2) with  $f \in \mathcal{C}^0(\mathbb{R}^{n+m}, \mathbb{R}^n)$ , let  $e^{-\mu s} d_x(-s)f(d(s)(x, \delta)^T) = f(x, \delta)$  for all  $s \in \mathbb{R}$ , all  $x \in \mathbb{R}^n$  and all  $\delta \in \mathbb{R}^m$ , where  $d(s) = \text{diag}\{d_x(s), d_\delta(s)\}$  forms a generalized linear dilation and let the system (2.2) be **GAS** for  $\delta = 0$ . Then, the system (2.2) is **ISS** for all  $\mu \in \mathbb{R}$ , and **FTISS** if  $\mu < 0$ .

**Proof of Theorem 3.2.**

Using the fact that the system  $\dot{x} = f(x, 0)$  is **GAS** and homogeneous implies that there exists a homogeneous Lyapunov function  $V$  such that the inequality (3.4) is satisfied, where  $k > \max\{0, -\mu\}$  is the degree of homogeneity of  $V$  and  $a = \inf_{\|\bar{x}\|_{d_x}=1} [-\langle DV(\bar{x}), f(\bar{x}, 0) \rangle]$ . Let

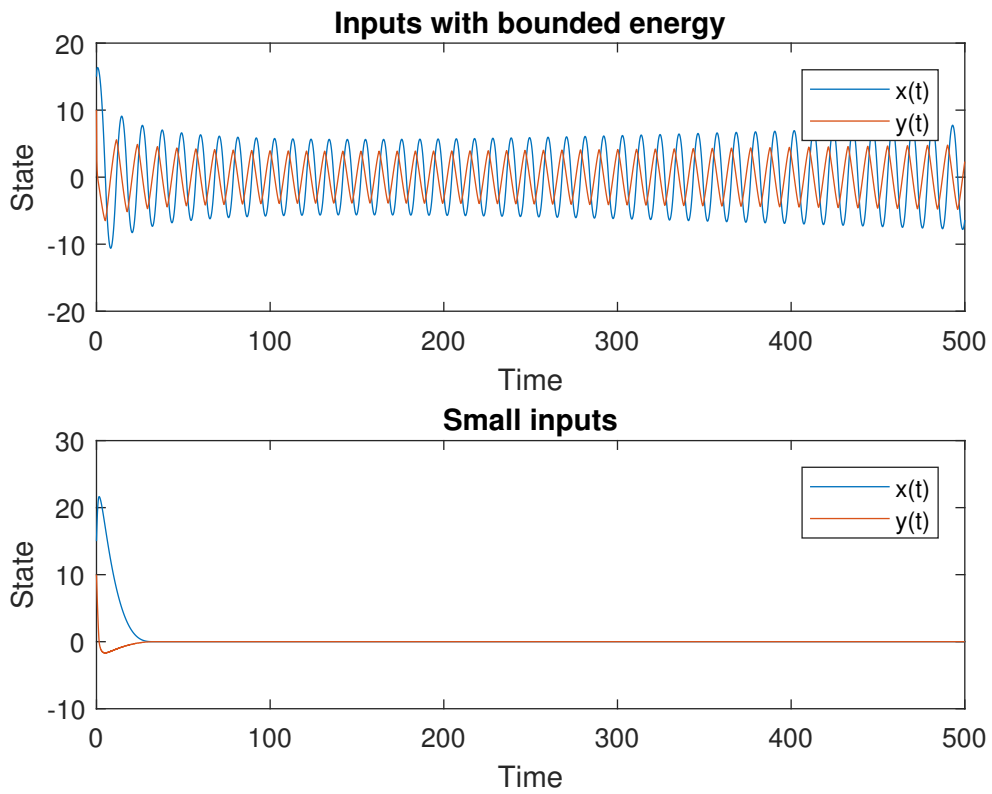

Figure 3.1: The states starting from the same initial condition  $(15, 10)$ ,  $\alpha = \frac{1}{3}$ , for small inputs (i.e.,  $\delta(t) = 0.5 \cos(t)$ ) and input with bounded energy (i.e.,  $\delta(t) = e^{-t^2}$ ).



$s = -\ln(\|x\|_{\mathbf{d}_x})$  and  $\tilde{x} = \mathbf{d}_x(s)x$ , using the inequality (3.4), we get

$$\langle DV(x), f(x, \delta) \rangle \leq \|x\|_{\mathbf{d}_x}^{\mu+\tilde{k}} \left( -a + b \sup_{\|\tilde{x}\|_{\mathbf{d}_x}=1} \|f(\tilde{x}, \mathbf{d}_\delta(s)\delta) - f(\tilde{x}, 0)\| \right),$$

with  $b = \sup_{\|\tilde{x}\|_{\mathbf{d}_x}=1} \|DV(\tilde{x})\|$ . The continuity of the function  $f$  implies that there exists a constant  $c > 0$  such that

$$\begin{aligned} \|x\|_{\mathbf{d}_x} > c^{-1}\|\delta\|_{\mathbf{d}_\delta} &\Leftrightarrow \|\mathbf{d}_\delta(s)\delta\|_{\mathbf{d}_\delta} < c \implies \sup_{\|\tilde{x}\|_{\mathbf{d}_x}=1} \|f(\tilde{x}, \mathbf{d}_\delta(s)\delta) - f(\tilde{x}, 0)\| \leq \frac{a}{2b} \\ &\implies \langle DV(x), f(x, \delta) \rangle \leq -\frac{a}{2}\|x\|_{\mathbf{d}_x}^{\mu+\tilde{k}}, \end{aligned}$$

which due to (2.13) proves the **ISS** property of the system (2.2). If  $\mu < 0$ , we deduce that the system (3.11) is globally **FTISS**. ■

### 3.2.2 Robustness of Locally Homogeneous Systems

As we have demonstrated, **FTS** can be guaranteed for a special class of nonlinear systems in the presence of disturbances. Inherited properties may also be held for some other classes of systems failing to satisfy Assumptions 3.1 and 3.2. Below, the notions of **FTS** stability and **FT** strong **iISS** will be investigated for nonlinear systems that are locally homogeneous (nonlinear dynamics, which admit a homogeneous approximation either at 0 or at  $\infty$ , and whose approximation satisfies Assumptions 3.1, 3.2 and 3.3).

#### Theorem 3.3

Assume that  $\forall \delta \in \mathbb{R}^m$ ,  $f(\cdot, \delta)$  is homogeneous in the 0-limit with associated triple  $(\nu_0, \mathbf{d}, f_0(\cdot, \delta))$  where  $f_0$  satisfies Assumptions 3.1, 3.2 and 3.3. Then,

- 1) if  $\nu_0 \in \mathbb{R}$ , the system (2.2) is uniformly **AS** for small inputs;
- 2) if  $\nu_0 < 0$ , the system (2.2) is uniformly **FTS** for small inputs.

#### Proof of Theorem 3.3:

1) We assume that the function  $f(\cdot, \delta) : \mathbb{R}^n \rightarrow \mathbb{R}^n$  has a homogeneous approximation  $f_0(\cdot, \delta)$ , i.e.,

$$\lim_{s \rightarrow -\infty} \|e^{-\nu_0 s} \mathbf{d}(-s) f(\mathbf{d}(s)x, \delta) - f_0(x, \delta)\| = 0, \quad \forall x \in S_{\mathbf{d}}, \quad \forall \delta \in \mathbb{R}^m. \quad (3.9)$$

The function  $f_0$  satisfies the Assumptions 3.1, 3.2 and 3.3. Similarly to the proof of Theorem 3.1, there exists  $\mathbf{d}$ -homogeneous Lyapunov function  $V$  of degree  $k > \max\{-\nu_0, 0\}$  and two positive constant  $a$  and  $c$  such that

$$\langle DV(x), f_0(x, \delta) \rangle \leq -a\|x\|_{\mathbf{d}}^{k+\nu_0} + c\|x\|_{\mathbf{d}}^{k+\nu_0}\|\delta\|, \quad \forall x \in \mathbb{R}^n.$$

Below we will use the coordinate transformation  $x = \mathbf{d}(s)y$  with  $s = \ln(\|x\|_{\mathbf{d}})$ , which connects any  $x \in \mathbb{R}^n \setminus \{0\}$  with corresponding point  $y \in S_{\mathbf{d}}$ , leading to

$$\begin{aligned} \langle DV(x), f(x, \delta) \rangle &= \langle DV(\mathbf{d}(s)y), f(\mathbf{d}(s)y, \delta) \rangle \\ &= \left\langle e^{ks} \mathbf{d}(-s) DV(y), f(\mathbf{d}(s)y, \delta) \right\rangle \\ &= e^{(k+\nu_0)s} \langle DV(y), e^{-\nu_0 s} \mathbf{d}(-s) f(\mathbf{d}(s)y, \delta) \rangle \\ &= e^{(k+\nu_0)s} \langle DV(y), f_0(y, \delta) \rangle \\ &\quad + e^{(k+\nu_0)s} \langle DV(y), (e^{-\nu_0 s} \mathbf{d}(-s) f(\mathbf{d}(s)y, \delta) - f_0(y, \delta)) \rangle \\ &\leq \|x\|_{\mathbf{d}}^{k+\nu_0} (-a + c\|\delta\|) + \|x\|_{\mathbf{d}}^{k+\nu_0} \langle DV(y), (e^{-\nu_0 s} \mathbf{d}(-s) f(\mathbf{d}(s)y, \delta) - f_0(y, \delta)) \rangle. \end{aligned}$$

It is clear that  $s \rightarrow -\infty$  when  $\|x\|_{\mathbf{d}} \rightarrow 0$ . The property (3.9) holds, and it implies that we can define an open set containing the origin

$$\mathcal{V} = \{x \in \mathbb{R}^n : x = \mathbf{d}(s)y, \forall y \in S_{\mathbf{d}}, \forall s < \epsilon_a\},$$

for some  $\epsilon_a \in \mathbb{R}_+$ , such that:

$$\langle DV(y), (e^{-\nu_0 s} \mathbf{d}(-s) f(\mathbf{d}(s)y, \delta) - f_0(y, \delta)) \rangle \leq \frac{a}{2}, \quad \forall y \in S_{\mathbf{d}}, \forall s < \epsilon_a.$$

Thus

$$\langle DV(x), f(x, \delta) \rangle \leq -\frac{a}{2} \|x\|_{\mathbf{d}}^{k+\nu_0} + c \|x\|_{\mathbf{d}}^{k+\nu_0} \|\delta\|, \quad \forall x \in \mathcal{V}, \quad \forall \delta \in \mathbb{R}^m.$$

Therefore, for  $\forall \delta \in \mathbb{R}^m$  such that  $\|\delta\| \leq \frac{a}{4c}$  we have

$$\langle DV(x), f(x, \delta) \rangle \leq -\frac{a}{4} \|x\|_{\mathbf{d}}^{k+\nu_0}, \quad \forall x \in \mathcal{V}.$$

This implies that the system (2.2) is **uniformly AS** with respect to small inputs and for any  $\nu_0 \in \mathbb{R}$ .

2) Note that if  $\nu_0 < 0$  and the inputs are small (i.e.,  $\forall \delta \in \mathbb{R}^m, \|\delta\| \leq \frac{a}{4c}$ ), then by using (3.6), one gets

$$\langle DV(x), f(x, \delta) \rangle \leq -\frac{a}{4} \|x\|_{\mathbf{d}}^{k+\nu_0} \leq -\frac{a}{4\nu_2^\alpha} V(x)^\alpha, \quad \forall x \in \mathcal{V},$$

with  $0 < \alpha = \frac{k+\nu_0}{k} < 1$ . Then, the system preserves a **uniform finite-time rate of convergence** to the origin locally. ■

### Example 3.2

Consider the system (2.2) with the vector field  $f$  given by

$$f((x, y), (\delta_1, \delta_2)) = \begin{pmatrix} 0 & -yx^2 \\ x^3 + y^4 & -y^3 + x^4 \end{pmatrix} \left[ \begin{pmatrix} 7 \\ 7 \end{pmatrix} + \begin{pmatrix} \delta_1 \\ \delta_2 \end{pmatrix} \right],$$

it is homogeneous in 0-limit with associated triple  $(2, \mathbf{d}, f_0)$  with

$$\mathbf{d}(s) = \begin{pmatrix} e^s & 0 \\ 0 & e^s \end{pmatrix}$$

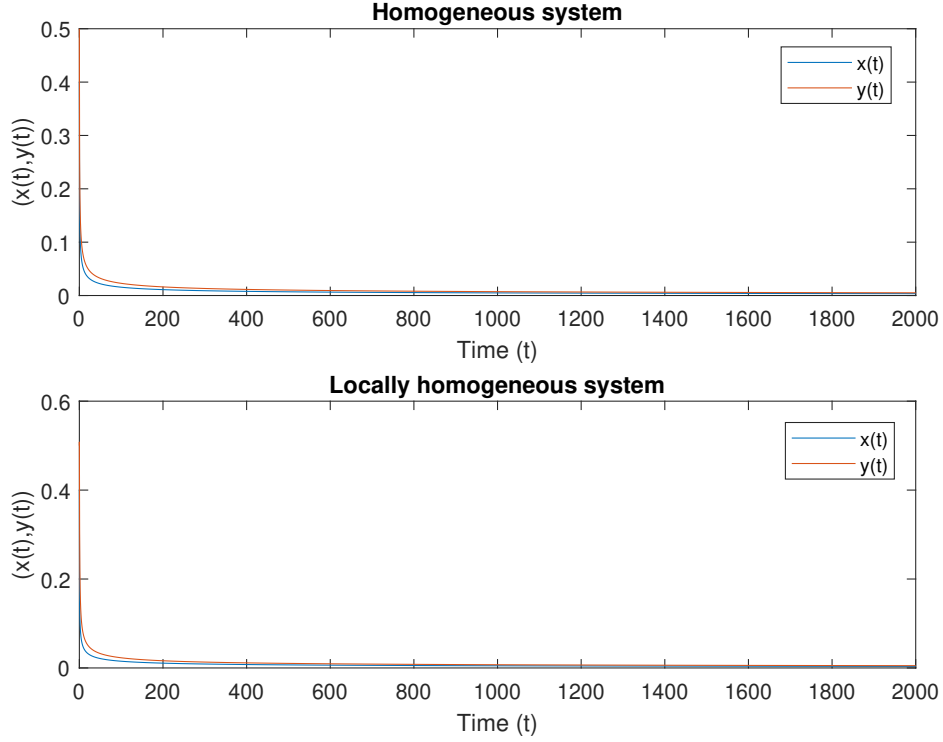

Figure 3.2: The trajectories of the systems (homogeneous and locally homogeneous one) starting from the same initial condition  $(0.4, 0.5)$  and perturbation  $(\delta_1, \delta_2) = 7(1+0.5 \cos(t), 1+0.5 \cos(t))$ .

and

$$f_0((x, y), (\delta_1, \delta_2)) = \begin{pmatrix} 0 & -yx^2 \\ x^3 & -y^3 \end{pmatrix} \left[ \begin{pmatrix} 7 \\ 7 \end{pmatrix} + \begin{pmatrix} \delta_1 \\ \delta_2 \end{pmatrix} \right].$$

For the homogeneous Lyapunov function  $V(x, y) = \frac{1}{2}x^2 + \frac{1}{2}y^2$ , we get

$$\langle DV(x, y), f_0((x, y), (0, 0)) \rangle = -7y^4.$$

It follows that the origin for the system  $(\dot{x}, \dot{y}) = f_0((x, y), (0, 0))$  is **GAS** (using Lasalle invariance principle). Then, according to Theorem 3.3, the system  $(\dot{x}, \dot{y})^T = f((x, y), (\delta_1, \delta_2))$  is uniformly **AS** for small inputs (see Figure 3.2).

### Theorem 3.4

If a function  $f(\cdot, \delta)$  is homogeneous in  $\infty$ -limit with respect to the triple  $(\nu_\infty, \mathbf{d}, f_\infty(\cdot, \delta))$ , where the function  $f_\infty$  satisfies Assumptions 3.1, 3.2 and 3.3. Then,

- 1) if  $\nu_\infty \in \mathbb{R}$ , the system (2.2) is uniformly **GFTS** with respect to  $\mathcal{A} = \{x \in \mathbb{R}^n : \|x\|_{\mathbf{d}} \leq A\}$  for some  $A > 0$  and small inputs.
- 2) if  $\nu_\infty < 0$ , the set  $\mathcal{A}$  is **iISS**.

3) if  $\nu_\infty > 0$ , the rate of convergence to the set  $\mathcal{A}$  is uniform (independent on initial conditions) for small inputs.

**Proof of Theorem 3.4:** 1) Repeating the arguments of Theorem 3.3, there is a Lyapunov function  $V$  such that

$$\begin{aligned} \langle DV(x), f(x, \delta) \rangle &\leq \|x\|_{\mathbf{d}}^{k+\nu_\infty} (-a + c\|\delta\|) \\ + \|x\|_{\mathbf{d}}^{k+\nu_\infty} \langle DV(y), (e^{-\nu_\infty s} \mathbf{d}(-s) f(\mathbf{d}(s)y, \delta) - f_\infty(y, \delta)) \rangle. \end{aligned}$$

Using the definition of  $f_\infty$  and the fact that the limit of

$$\langle DV(y), (e^{-\nu_\infty s} \mathbf{d}(-s) f(\mathbf{d}(s)y, \delta) - f_\infty(y, \delta)) \rangle$$

goes to zero when  $s$  tends to  $+\infty$ , we deduce that there exists a positive constant  $A$  such that for all  $x \in \mathbb{R}^n$  and  $\forall \delta \in \mathbb{R}^m$

$$\|x\|_{\mathbf{d}} > A, \|\delta\| \leq \frac{a}{4c} \implies \langle DV(x), f(x, \delta) \rangle \leq -\frac{a}{4} \|x\|_{\mathbf{d}}^{k+\nu_\infty}.$$

This implication substantiates that the system (2.2) is **uniformly GFTS** with respect to  $\mathcal{A} = \{x \in \mathbb{R}^n : \|x\|_{\mathbf{d}} \leq A\}$  for small inputs for all  $\nu_\infty \in \mathbb{R}$ .

2) If  $\nu_\infty < 0$ , we use the same Lyapunov function  $W(x) = \ln(1 + V(x))$  as above, and we get

$$\|x\|_{\mathbf{d}} > A \implies \langle DW(x), f(x, \delta) \rangle \leq -\frac{a\|x\|_{\mathbf{d}}^{k+\nu_\infty}}{2(1+V(x))} + \tilde{c}\|\delta\|, \quad \tilde{c} > 0.$$

Then the system (2.2) is **iISS** with respect to  $\mathcal{A} = \{x \in \mathbb{R}^n : \|x\|_{\mathbf{d}} \leq A\}$ .

3) If  $\nu_\infty > 0$ , one gets the relation:

$$\|x\|_{\mathbf{d}} > A, \|\delta\| \leq \frac{a}{4c} \implies \langle DV(x), f(x, \delta) \rangle \leq -\frac{a}{4v_2^{\frac{k}{\nu_\infty}}} V(x)^{\frac{k+\nu_\infty}{k}}.$$

Recall that in this case  $\frac{k+\nu_\infty}{k} > 1$ , denote  $V_0 = V(x(0)) \in \mathbb{R}_+$ , then we obtain the following estimate on the trajectory of  $V(x(\cdot))$ :

$$\begin{aligned} \|x\|_{\mathbf{d}} > A, \|\delta\| \leq \frac{a}{4c} \implies V(x(t)) &\leq \frac{1}{\left( V_0^{-\frac{\nu_\infty}{k}} + \frac{a}{4v_2^{\frac{k}{\nu_\infty}}} \frac{\nu_\infty}{k} t \right)^{\frac{k}{\nu_\infty}}}, \text{ for all } V_0, \\ \implies V(x(t)) &\leq \frac{1}{\left( \frac{a}{4v_2^{\frac{k}{\nu_\infty}}} \frac{\nu_\infty}{k} t \right)^{\frac{k}{\nu_\infty}}}. \end{aligned}$$

Define the ball  $\mathcal{B} = \{x \in \mathbb{R}^n : V(x) \leq v_1 A^k\}$ , which means that  $\mathcal{B} \subset \mathcal{A}$ . Obviously, for small inputs the time of convergence to the set  $\mathcal{A}$  is upper bounded by  $T = \frac{4k}{a\nu_\infty v_1^{\frac{k}{\nu_\infty}} v_2^{\frac{k}{\nu_\infty}} A^{\nu_\infty}}$  and it is uniform (independently on initial conditions). ■

Theorems 3.3 and 3.4 show that if a system has a homogeneous approximation, which satisfies Assumptions 3.1, 3.2 and 3.3, then it preserves some finite-time convergence even in the presence of exogenous inputs.

### 3.2.3 Robustness of Finite-Time Stability of Cascade System

In many cases, for analysis or design purposes, the system model can be decomposed on several blocks, which are representing physical components (actuators, sensors, process dynamics, etc.) or a part the behavior (e.g., fast-slow or modeled-unmodeled, etc.). Then the problem of analysis of stability properties of a cascade or an interconnection arises, and it is a well-known fact that cascade of (strong integral) **ISS** systems inherits the quality of the ingredients [47, 24]. In this section we will investigate the robustness of **FTISS/FTiISS** for two serially connected systems, which are homogeneous with different degrees of homogeneity:

$$\dot{x}(t) = f(x(t), y(t)), \quad (3.10)$$

$$\dot{y}(t) = g(y(t), \delta(t)), \quad (3.11)$$

where  $x(t) \in \mathbb{R}^n$ ,  $y(t) \in \mathbb{R}^m$  are the state components and  $\delta(t) \in \mathbb{R}^p$  represents an external input,  $\delta \in \mathcal{L}_\infty$ . Before studying the cascade (3.10), (3.11), we introduce the following lemma, which gives the conditions for forward existence of solutions for the system (3.10) with bounded inputs.

#### Lemma 3.2

*If the system (3.10) satisfies Assumptions 3.1, 3.2 with  $\nu \leq 0$  and the input  $y$  does not blow up in finite-time, then the solutions of the system (3.10) are well-defined for all  $t \geq 0$ .*

**Proof of Lemma 3.2:** By the imposed conditions (Assumption 3.1)  $f(x, y) = f_1(x) + f_2(x)y$  with  $\mathbf{d}$ -homogeneous vector fields  $f_1$  and  $f_2$  of degree  $\nu$ . Select any positive definite and continuously differentiable  $\mathbf{d}$ -homogeneous Lyapunov function  $V$  of degree  $k > \max\{-\nu, 0\}$ , then the relations (3.6) are satisfied. For any  $x \in \mathbb{R}^n$  define  $s = \ln(\|x\|_{\mathbf{d}})$  and  $\tilde{x} \in S_{\mathbf{d}}$  such that  $x = \mathbf{d}(s)\tilde{x}$ , then we derive the estimates:

$$-\|y\| \sup_{\|\tilde{x}\|_{\mathbf{d}}=1} \|f_2(\tilde{x})^T DV(\tilde{x})\| \leq \langle f_2(\tilde{x})^T DV(\tilde{x}), y \rangle \leq \|y\| \sup_{\|\tilde{x}\|_{\mathbf{d}}=1} \|f_2(\tilde{x})^T DV(\tilde{x})\|.$$

From this using homogeneity we obtain:

$$\begin{aligned} \langle DV(x), f(x, y) \rangle &= \langle DV(x), f_1(x) \rangle + \langle DV(x), f_2(x)y \rangle \\ &= \langle DV(\mathbf{d}(s)\tilde{x}), f_1(\mathbf{d}(s)\tilde{x}) \rangle + \langle DV(\mathbf{d}(s)\tilde{x}), f_2(\mathbf{d}(s)\tilde{x})y \rangle \\ &= e^{(\nu+k)s} \langle DV(\tilde{x}), f_1(\tilde{x}) \rangle + e^{(\nu+k)s} \langle DV(\tilde{x}), f_2(\tilde{x})y \rangle \\ &\leq \|x\|_{\mathbf{d}}^{\nu+k} \langle DV(\tilde{x}), f_1(\tilde{x}) \rangle + \|x\|_{\mathbf{d}}^{\nu+k} \langle f_2(\tilde{x})^T DV(\tilde{x}), y \rangle \\ &\leq \|x\|_{\mathbf{d}}^{\nu+k} \sup_{\|\tilde{x}\|_{\mathbf{d}}=1} \langle DV(\tilde{x}), f_1(\tilde{x}) \rangle \\ &\quad + \|x\|_{\mathbf{d}}^{\nu+k} \|y\| \sup_{\|\tilde{x}\|_{\mathbf{d}}=1} \|f_2(\tilde{x})^T DV(\tilde{x})\| \\ &= \|x\|_{\mathbf{d}}^{\nu+k} (a + c\|y\|), \end{aligned} \quad (3.12)$$

and

$$\begin{aligned}
 \langle DV(x), f(x, y) \rangle &= \|x\|_{\mathbf{d}}^{\nu+k} (\langle DV(\tilde{x}), f_1(\tilde{x}) \rangle + \langle f_2(\tilde{x})^T DV(\tilde{x}), y \rangle) \\
 &\geq \|x\|_{\mathbf{d}}^{\nu+k} \left( \inf_{\|\tilde{x}\|_{\mathbf{d}}=1} \langle DV(\tilde{x}), f_1(\tilde{x}) \rangle \right. \\
 &\quad \left. - \|y\| \sup_{\|\tilde{x}\|_{\mathbf{d}}=1} \|f_2(\tilde{x})^T DV(\tilde{x})\| \right) \\
 &= \|x\|_{\mathbf{d}}^{\nu+k} (a' - c\|y\|),
 \end{aligned} \tag{3.13}$$

where

$$\begin{aligned}
 a &= \sup_{\|\tilde{x}\|_{\mathbf{d}}=1} \langle DV(\tilde{x}), f_1(\tilde{x}) \rangle, \quad a' = \inf_{\|\tilde{x}\|_{\mathbf{d}}=1} \langle DV(\tilde{x}), f_1(\tilde{x}) \rangle, \\
 c &= \sup_{\|\tilde{x}\|_{\mathbf{d}}=1} \|f_2(\tilde{x})^T DV(\tilde{x})\|.
 \end{aligned}$$

From (3.12) and (3.13), the derivative of  $V$  for the system (3.10) satisfies the following relations:

$$\|x(t)\|_{\mathbf{d}}^{k+\nu} (a' - c\|y\|_{[0,t]}) \leq \dot{V}(t) = \langle DV(x(t)), f(x(t), y(t)) \rangle \leq \|x(t)\|_{\mathbf{d}}^{k+\nu} (a + c\|y\|_{[0,t]}),$$

on the time interval  $[0, t)$  for any finite  $t \geq 0$  for which the solution  $x(t)$  exists. Hence, if  $\nu < 0$  then an upper estimate on the behavior of  $V(x(t))$  can be obtained:

$$\dot{V}(x(\tau)) \leq (v_1^{-1}V(x(\tau)))^\alpha (a + c\|y\|_{[0,t]})$$

for all  $\tau \in [0, t)$  and for  $\alpha = \frac{k+\nu}{k}$ , or equivalently

$$V^{1-\alpha}(x(t)) \leq V^{1-\alpha}(x_0) + v_1^{-\alpha}(1 - \alpha) (a + c\|y\|_{[0,t]}) t$$

for any  $t \geq 0$  and all initial conditions  $x(0) = x_0 \in \mathbb{R}^n$ . Note that the right-hand side is bounded for all  $t \geq 0$  provided that  $\|y\|_{[0,t]}$  is finite (which is assumed in the conditions of the lemma). Therefore,  $V(t)$  is well-defined and the solutions exists for any  $t \geq 0$ . ■

Lemma 3.2 shows that if the degree of homogeneity  $\nu$  is negative, then the solutions of the system (3.10) are well-defined for all  $t \geq 0$  if the system (3.11) possesses the same property.

**Remark 3.1**

*For the system (3.10), if the degree of homogeneity  $\nu$  is positive, then its solutions may escape to infinity in finite-time for some inputs  $y$ .*

The theorem bellow fixes the conditions of robust stability of the interconnection (3.10),(3.11) when the vector field  $f$  of the system (3.10) satisfies Assumptions 3.1, 3.2 and 3.3 and  $y$  represents filtered by (3.11) perturbation  $\delta$ .

**Theorem 3.5**

*If*

- (a) *the vector field  $f$  satisfies Assumptions 3.1, 3.2, 3.3, and  $\nu < 0$ ,*

(b) the vector field  $g$  is chosen such that

$$e^{-\mu s} \mathbf{d}_y(-s)g(\mathbf{d}_y(s)y, \mathbf{d}_\delta(s)\delta) = g(y, \delta),$$

$\forall s \in \mathbb{R}, \forall y \in \mathbb{R}^m, \forall \delta \in \mathbb{R}^p$  where  $\text{diag}\{\mathbf{d}_y(s), \mathbf{d}_\delta(s)\}$  forms a generalized dilation,

(c)  $\dot{y} = g(y, 0)$  is **GAS**.

Then, the system (3.10),(3.11) is

- strongly **iISS** for every  $\mu \in \mathbb{R}$ ,
- if  $\mu < 0$  globally **FTISS** for small inputs.

**Proof of Theorem 3.5:** Since (b) and (c) are verified, by using Theorem 3.2, we conclude that (3.11) is **ISS** for every  $\mu \in \mathbb{R}$ , and if  $\mu < 0$ , then (3.11) is **FTISS**. According to (a) and using theorems 3.1 and 2.5, we deduce that the system (3.10), (3.11) is strongly **iISS**.

To prove global **FTISS** property for small inputs if  $\mu < 0$ , select any  $(x_0, y_0) \in \mathbb{R}^n \times \mathbb{R}^m$ , and denote  $z(t, z_0, \delta) = (x^T(t, x_0, y), y^T(t, y_0, \delta))^T$  the common solution of the cascade for initial conditions  $z_0 = (x_0^T, y_0^T)^T$ . Theorem 3.1 implies that for  $\nu < 0$  the system (3.10) is uniformly **GFTS** for small inputs, i.e. there exist  $m > 0$  and  $\beta_x \in \mathcal{GKL}$  such that

$$\begin{aligned} \|y\|_{[0, T_x(x_0)]} \leq m &\implies \|x(t, x_0, y)\| \leq \beta_x(\|x_0\|, t) \\ &\implies \lim_{t \rightarrow T_x(x_0)} \|x(t, x_0, y)\| = 0, \end{aligned}$$

for all  $x_0 \in \mathbb{R}^n$ , where  $T_x : \mathbb{R}^n \rightarrow \mathbb{R}_+$  is the settling-time function of the system (3.10). The system (3.11) is **FTISS** if  $\mu < 0$ , i.e. there exist  $\beta_y \in \mathcal{GKL}$  and  $\sigma \in \mathcal{K}$  such that

$$\|y(t, y_0, \delta)\| \leq \beta_y(\|y_0\|, t) + \sigma(\|\delta\|_{[0, t]}) \implies \limsup_{t \rightarrow T_y(y_0)} \|y(t, y_0, \delta)\| \leq \sigma(\|\delta\|_\infty),$$

where  $T_y : \mathbb{R}^n \rightarrow \mathbb{R}_+$  is the settling-time function of the system (3.11).

Assume that  $\|\delta\|_\infty \leq \sigma^{-1}(\frac{m}{2})$ .

**First case:** If  $\beta_y(\|y_0\|, 0) \leq \frac{m}{2}$ , this implies that  $\|y(t, y_0, \delta)\| \leq m, \forall t \geq 0$  then

$$\lim_{t \rightarrow T_x(x_0)} \|x(t, x_0, y)\| = 0.$$

Consequently,

$$\begin{aligned} \lim_{t \rightarrow \max\{T_x(x_0), T_y(y_0)\}} \|z(t, z_0, \delta)\| &\leq \lim_{t \rightarrow \max\{T_x(x_0), T_y(y_0)\}} (\|x(t, x_0, y)\| + \|y(t, y_0, \delta)\|) \\ &\leq \sigma(\|\delta\|_\infty). \end{aligned}$$

**Second case:** If  $\beta_y(\|y_0\|, 0) > \frac{m}{2}$ , since  $\beta_y \in \mathcal{GKL}$  there exists  $T_{y_0} > 0$  such that

$$t \geq T_{y_0} \implies \beta_y(\|y_0\|, t) \leq \frac{m}{2},$$

this implies that

$$\|y(t)\| \leq m, \quad \forall t \geq T_{y_0}.$$

and, consequently,  $x(t, x_0, y)$  will converges to zero provided that it is well defined for  $t \in [0, T_{y_0}]$ . Using the result of Lemma 3.2 we substantiate that the value  $x(T_{y_0}, x_0, y)$  is finite for any  $x_0 \in \mathbb{R}^n$  (see the estimate obtained in the proof), then

$$\|x(t, x(T_{y_0}), y)\| \leq \beta_x (\|x(T_{y_0})\|, t - T_{y_0}) \implies \lim_{t \rightarrow T_x(x(T_{y_0})) + T_{y_0}} \|x(t, x(T_{y_0}), y)\| = 0.$$

Which leads to

$$\begin{aligned} & \lim_{t \rightarrow \max\{T_x(x(T_{y_0})) + T_{y_0}, T_y(y_0)\}} \|z(t, z_0, \delta)\| \\ \leq & \lim_{t \rightarrow \max\{T_x(x(T_{y_0})) + T_{y_0}, T_y(y_0)\}} (\|x(t, x_0, y)\| + \|y(t, y_0, \delta)\|) \\ \leq & \sigma (\|\delta\|_\infty) \end{aligned}$$

and the finite-time convergence is proven for small inputs. Applying the same arguments the global boundedness of all trajectories can be established. Then we deduce that the system (3.10),(3.11) is **FTISS** for small inputs for the case  $\nu < 0$  and  $\mu < 0$ . ■

In the above theorem we also have shown that in the latter case the system (3.10),(3.11) is uniformly globally **FTS** for small inputs.

The following corollary extends the above stability result to the interconnected system (3.10),(3.11) when the vector field  $f$  of the system (3.10) has a homogeneous approximation.

**Corollary 3.1**

Assume that conditions (b) and (c) of Theorem 3.5 are satisfied, while the condition (a) is replaced by  $f(\cdot, y)$  is homogeneous in the 0-limit (resp.,  $\infty$ -limit) with associated triple  $(\nu_0, \mathbf{d}, f_0(\cdot, y))$  (resp.,  $(\nu_\infty, \mathbf{d}, f_\infty(\cdot, y))$ ), where  $\mathbf{d}$  is a generalized linear dilation and  $\nu_0 < 0$  (resp.,  $\nu_\infty < 0$ ) and  $f_0$  (resp.,  $f_\infty$ ) satisfies Assumptions 3.1, 3.2 and 3.3.. Then, if  $\mu < 0$  the interconnected system (3.10),(3.11) is locally **FTISS** (resp., is **FTISS** with respect to

$$\mathcal{B} = \{(x, y) \in \mathbb{R}^n \times \mathbb{R}^m : \|x\|_{\mathbf{d}_x} \leq A, y = 0\}$$

for some  $A > 0$ ) for small inputs.

**Proof of Corollary 3.1:** By using the conditions of Corollary 3.1 and Theorem 3.5 we deduce that the system (3.11) is **ISS**. If  $\nu_0 < 0$ , from Theorem 3.3, the system (3.10) is uniformly **FTS** for small inputs. By using the same method as in the **Step II** of the proof of Theorem 3.5, we substantiate that if  $\mu < 0$ , the interconnected system (3.10),(3.11) is **locally FTISS for small inputs**.

Theorem 3.4 implies that, if we choose  $A > 0$  sufficiently big, for all  $\|x_0\| > A$ , if  $\nu_\infty < 0$ , the system (3.10) is uniformly **GFTS** for small inputs to the set  $\mathcal{A} = \{x \in \mathbb{R}^n : \|x\|_{\mathbf{d}_x} \leq A\}$ .



Using the same method as in the proof of Theorem 3.5 one deduce that the set  $\mathcal{B}$  is **FTISS for small inputs** for the interconnected system (3.10),(3.11) when  $\mu < 0$ . ■

**Remark 3.2**

Assume that instead of (3.11), we have

$$\dot{y} = g(y), \quad (3.14)$$

with  $g$  is  $\mathbf{d}_y$ -homogeneous function with degree of homogeneity  $\mu$  and the system (3.14) is **GAS**. Then if  $\nu < 0$ , the dynamical system (3.10),(3.14) is **GAS** for all  $\mu \in \mathbb{R}$ . If  $\nu < 0$  and  $\mu < 0$  in the conditions of Theorem 3.5, then the system (3.10),(3.14) is **GFTS**.

In the next section, to illustrate the utility of these results we are going to analyze the robustness of a finite-time observer with respect to time variations of its gains.

### 3.3 Application

In [70] a finite-time observer is proposed for a nonlinear system in the form:

$$\begin{aligned} \dot{z} &= Az + h(o, u), \\ o &= Cz, \end{aligned}$$

where  $z \in \mathbb{R}^n$  is the state,  $u \in \mathbb{R}^m$  is the known input and  $o \in \mathbb{R}$  is the measured output, and

$$A = \begin{pmatrix} 0 & 1 & 0 & \cdots & 0 \\ 0 & 0 & 1 & \cdots & 0 \\ \vdots & \vdots & \ddots & \ddots & \vdots \\ 0 & 0 & \cdots & \ddots & 1 \\ 0 & 0 & \cdots & \cdots & 0 \end{pmatrix}, \quad C = (1, 0, \cdots, 0)$$

are in a canonical representation. An observer for this system is designed as

$$\dot{\hat{z}} = A\hat{z} + h(o, u) - \begin{pmatrix} k_1[o - \hat{z}_1]^{\alpha_1} \\ k_2[o - \hat{z}_1]^{\alpha_2} \\ \vdots \\ k_n[o - \hat{z}_1]^{\alpha_n} \end{pmatrix},$$

where  $\hat{z} \in \mathbb{R}^n$  is an estimate of  $z$ ,  $\alpha_i$  is a constant power and  $k_i$  is a constant observer gain for  $1 \leq i \leq n$ . The dynamics of the estimation error  $e = z - \hat{z}$  can be written as follows:

$$\begin{cases} \dot{e}_1 &= e_2 - k_1[e_1]^{\alpha_1} \\ \dot{e}_2 &= e_3 - k_2[e_1]^{\alpha_2} \\ \vdots & \\ \dot{e}_{n-1} &= e_{n-1} - k_{n-1}[e_1]^{\alpha_{n-1}} \\ \dot{e}_n &= -k_n[e_1]^{\alpha_n} \end{cases} \quad (3.15)$$

To guarantee **FTS** of the system (3.15), the homogeneity framework is used [70] resulting in the choice  $\alpha_i = 1 + i\alpha$ ,  $1 \leq i \leq n$  where  $\alpha > -\frac{1}{n}$  is a tuning parameter linked to the homogeneity degree of the system, for the dilation

$$\mathbf{d}_x(s) = \text{diag} \left[ e^s, e^{(1+\alpha)s}, \dots, e^{(1+(n-1)\alpha)s} \right].$$

The gains  $k_i$ ,  $1 \leq i \leq n$  should be selected to form a Hurwitz polynomial.

### 3.3.1 Homogeneous Affine Nonlinear Dynamical System

Our goal is to study the same problem with multiplicative disturbances introduced as follows:

$$\dot{\hat{z}} = A\hat{z} + h(o, u) - \begin{pmatrix} (k_1 + y_1)[o - \hat{z}_1]^{\alpha_1} \\ (k_2 + y_2)[o - \hat{z}_1]^{\alpha_2} \\ \vdots \\ (k_n + y_n)[o - \hat{z}_1]^{\alpha_n} \end{pmatrix}, \quad (3.16)$$

where all symbols keep their meaning, and  $y_i \in \mathbb{R}$ ,  $1 < i \leq n$  represent variations of the gains  $k_i$ ,  $1 \leq i \leq n$  occurred due to an additional on-line tuning (via adaptation algorithms) or due to an auxiliary measurement information (usually the values of  $k_i$  are related with the amplitude of uncertainty to compensate).

It is straightforward to verify that the error dynamics for (3.16) satisfies Assumptions 3.1 and 3.2 for  $f(e, y) = f_1(e) + f_2(e)y$  with

$$f_1(e) = \begin{pmatrix} -k_1[e_1]^{1+\alpha} + e_2 \\ -k_2[e_1]^{1+2\alpha} + e_3 \\ \vdots \\ -k_n[e_1]^{1+n\alpha} \end{pmatrix},$$

and

$$f_2(e) = -\text{diag} \left[ [e_1]^{1+\alpha}, \dots, [e_1]^{1+n\alpha} \right]$$

and the functions  $f_1$  and  $f_2$  are  $\mathbf{d}_x$ -homogeneous with the same degree of homogeneity  $\alpha$ . Using the method proposed in [70] it is possible to show that Assumption 3.3 is also verified for  $\alpha$  sufficiently close to zero (of both signs). Therefore, Theorem 3.1 allows us to conclude that the estimation error dynamics for the observer (3.16) is uniformly **GAS** for small inputs for any  $\alpha > -\frac{1}{n}$  and it is strongly finite-time **iISS** and uniformly **GFTS** for small inputs if  $\alpha \in (-\frac{1}{n}, 0)$ .

Let  $n = 3$  and select  $k_1 = 1000$ ,  $k_2 = 240$  and  $k_3 = 24$ , the figures 3.3 and 3.4 show the uniform **GAS** and **GFTS** of the state of the system (3.16) for different degree  $\alpha$  and sufficiently small inputs  $y$ .

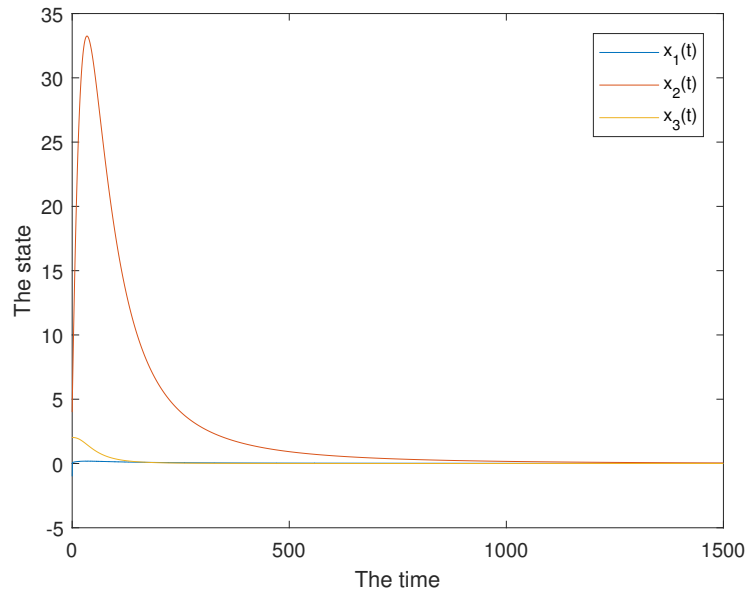

Figure 3.3: The solutions of the system (3.16) with the initial condition  $(x_{1,0}, x_{2,0}, x_{3,0}) = (-1, 2, 1)$ ,  $y(t) = (\cos(t), \frac{t}{1+t^2} + 2, 200\frac{t}{1+t^2} + \cos(1+t^2))^T$  and  $\alpha = 2$ .

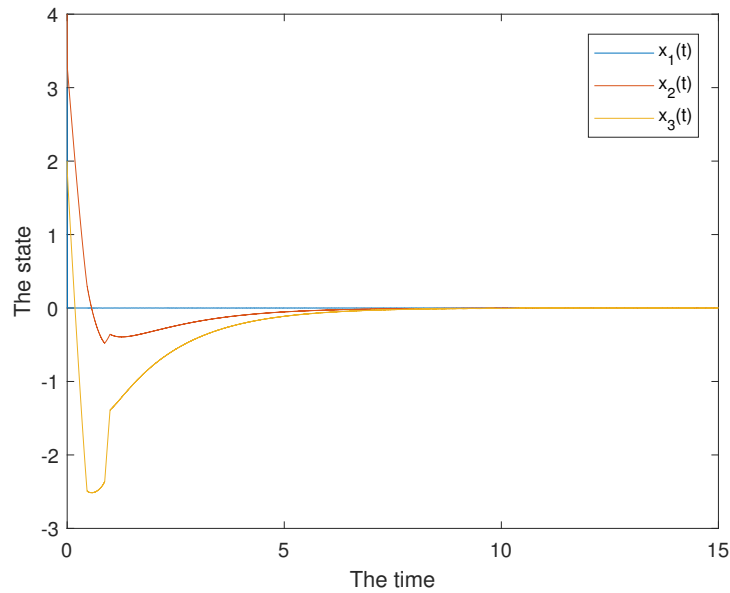

Figure 3.4: The solutions of the system (3.16) with the initial condition  $(x_{1,0}, x_{2,0}, x_{3,0}) = (-1, 2, 1)$ ,  $y(t) = (\cos(t), \frac{t}{1+t^2} + 2, 200\frac{t}{1+t^2} + \cos(1+t^2))^T$  and  $\alpha = 0.7$ .

### 3.3.2 Interconnected System

In order to illustrate the results of Theorem 3.5 we will consider also the system (3.16) in a cascade with

$$\dot{y} = g(y, \delta) \quad (3.17)$$

which may represent an adaptation algorithm influenced by a measurement noise or a disturbance  $\delta \in \mathbb{R}^p$  (a stable filter).

For simulations with  $n = 3$ , let

$$g(y, \delta) = \begin{pmatrix} y_2^{\frac{1}{3}} - [y_1]^{\frac{1}{2}} \\ y_3 - y_1 - [y_2]^{\frac{2}{3}} \\ -y_2^{\frac{1}{3}} - [y_3]^{\frac{1}{2}} + \delta \end{pmatrix},$$

where  $g : \mathbb{R}^3 \times \mathbb{R} \mapsto \mathbb{R}^3$  is continuous and  $\mathbf{d}$ -homogeneous with degree of homogeneity  $\mu = -\frac{1}{3}$ ,  $\mathbf{d}(s) = \begin{pmatrix} e^{\frac{2}{3}s} & 0 & 0 & 0 \\ 0 & e^s & 0 & 0 \\ 0 & 0 & e^{\frac{2}{3}s} & 0 \\ 0 & 0 & 0 & e^{\frac{1}{3}s} \end{pmatrix}$  and the system  $\dot{y}(t) = g(y(t), 0)$  is **GAS**. Then, if

$\frac{1}{n} < \alpha < 0$ , Theorem 3.5 implies that the system (3.16), (3.5) in cascade are finite-time **ISS** for small inputs and **FT strongly iISS**. From Figure 3.5 we see that the state is bounded when inputs are bounded.

## 3.4 Conclusion

In this chapter, we studied the robustness features of **FT** stable homogeneous dynamical systems with respect to additive perturbations. Some extensions are established for the systems admitting homogeneous approximations at the origin and at infinity. Influence on robustness of additional dynamics in the input channel is also investigated. The efficiency and practicality of the obtained conditions are demonstrated by considering a homogeneous observer with the gains dependent on functions of time, i.e., on additional measured information or adaptive tuning. Simulation results and academic examples are included for illustration.

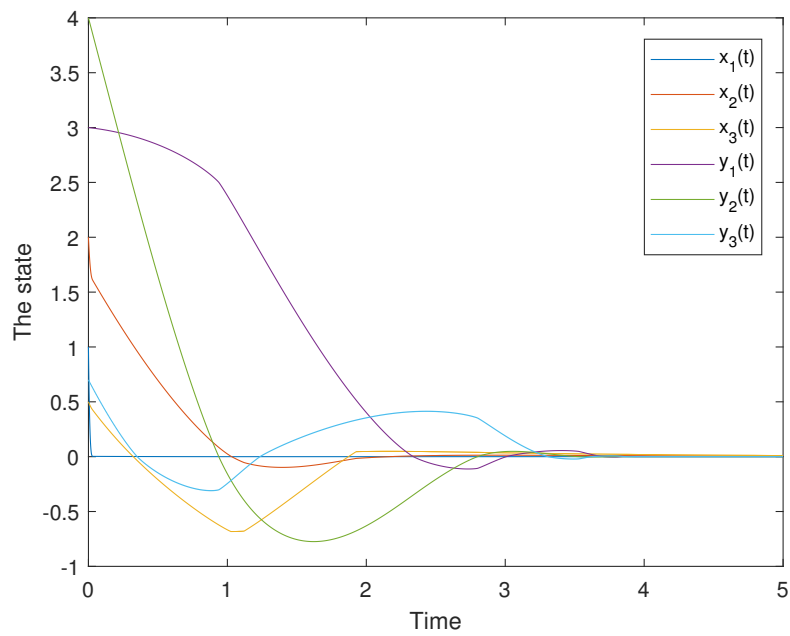

Figure 3.5: The solutions of the system (3.16) with the initial condition  $(x_{1,0}, x_{2,0}, x_{3,0}, y_{1,0}, y_{2,0}, y_{3,0}) = (1, 2, 0.5, 3, 4, 0.7)$ ,  $\delta(t) = \cos(t)$  and  $\alpha = 0.7$ .

# Finite-time stability analysis based on homogeneous extensions

## Contents

<b>4.1</b>	<b>Introduction</b>	<b>81</b>
<b>4.2</b>	<b>Homogeneous extension</b>	<b>82</b>
<b>4.3</b>	<b>On stability analysis via homogeneous extensions</b>	<b>83</b>
4.3.1	Homogeneous Lyapunov function theorem	83
4.3.2	Finite-time and near fixed-time stability	89
<b>4.4</b>	<b>A planar system example</b>	<b>90</b>
<b>4.5</b>	<b>Conclusion</b>	<b>93</b>

In this chapter, we consider the problem of finite-time and fixed-time stability analysis for a specific class of nonlinear non-homogeneous systems, which do not have homogeneous approximations at zero or at infinity, but admit the so-called homogeneous extension. It is shown that under certain conditions on the system, its asymptotic stability implies finite-time stability for negative homogeneity degree or nearly fixed-time stability for positive homogeneity degree of the extension. An example of a mechanical system is presented to illustrate the obtained results.

## 4.1 Introduction

As it is stated in Chapter 2 (see Section 2.2), we focus here on **FTS** and nearly **FxTS** analysis of non-homogeneous systems having the form:

$$\begin{cases} \dot{x} &= f(x) \\ x(0) &= x_0, \quad x_0, x \in \mathbb{R}^n \end{cases} \quad (4.1)$$

Below we assume that  $f(x) = H(x)b(x)$ , where  $H$  is homogeneous (in a certain sense) matrix-valued function and  $b$  is a bounded vector-valued function. We show that under certain conditions on the function  $b$ , the finite-time or the nearly fixed-time stability of the system can be derived from its asymptotic stability and the homogeneity of  $H$ . To simplify the corresponding analysis we use the so-called *homogeneous extensions*, which were introduced

originally for evolution systems in Banach spaces [75]. Notice that the homogeneous extension can be defined even when the homogeneous approximation [2] does not exist.

## 4.2 Homogeneous extension

Let us introduce the definition of homogeneous extension [75] which allows homogeneity-based methods of analysis to be applied for non-homogeneous systems.

### Definition 4.1

A set-valued map  $F : \mathbb{R}^n \rightrightarrows \mathbb{R}^n$  is said to be a **d**-homogeneous extension of a vector field  $f : \mathbb{R}^n \rightarrow \mathbb{R}^n$  with a degree  $\nu \in \mathbb{R}$  if  $f(x) \in F(x)$  for any  $x \in \mathbb{R}^n$  and  $F$  is **d**-homogeneous of the degree  $\nu$ .

Such extensions appear, for example, as a result of Filippov regularization of a homogeneous discontinuous vector field (see [55]). In this paper we deal with the **d**-homogeneous extensions given by [75]

$$F(x) = \bigcup_{s \in \mathbb{R}} \{e^{-\nu s} \mathbf{d}(-s) f(\mathbf{d}(s)x)\}, \quad x \in \mathbb{R}^n, \quad (4.2)$$

where  $\mathbf{d}$  is a linear dilation and  $\nu \in \mathbb{R}$ . The set-valued map  $F$  given above is, obviously, a **d**-homogeneous extension of the vector field  $f$  and

$$e^{\nu \tau} \mathbf{d}(\tau) F(x) = F(\mathbf{d}(\tau)x), \quad \tau \in \mathbb{R}, \quad x \in \mathbb{R}^n.$$

Such an extension exists even for functions which do not have a homogeneous approximation<sup>1</sup>. Therefore, to study its stability and a convergence rate, the homogeneous extension can be used. However, to use the classical methods of stability analysis such as Lyapunov functions or LaSalle invariance principle, the differential inclusion must satisfy the classical conditions [26], [30]. For example, the right-hand side of the system

$$\dot{x}(t) = - \left( 2 + \cos \left( \frac{1}{x(t)} \right) \right) x^{1/3}(t), \quad t \geq 0. \quad (4.3)$$

does not have a homogeneous approximation at zero, but it has a homogeneous extension  $\dot{x}(t) \in F(x(t)) = -x^{1/3}(t) [1, 3]$ ,  $t \geq 0$ , which allows us to study the finite-time stability using the homogeneity of set-valued mappings.

### Remark 4.1

We do not need to prove the existence of strong solutions for the differential inclusion  $\dot{x} \in F(x)$  with  $F$  given by (4.2) provided that  $f$  is a continuous vector field. Indeed, since  $f(x) \in F(x)$  then solutions of the system (4.1) belong to a set of solutions of the differential inclusion  $\dot{x} \in F(x)$ .

<sup>1</sup>We refer the reader to Chapter 1 and to [2] for more details about homogeneous approximations.

The stability definitions for differential inclusions are literary the same as for the differential equations (Definition 1.5).

## 4.3 On stability analysis via homogeneous extensions

### 4.3.1 Homogeneous Lyapunov function theorem

Let the vector field  $f : \mathbb{R}^n \rightarrow \mathbb{R}^n$  of the system (4.1) satisfy the following assumptions

#### Assumption 4.1

Let  $f$  be continuous on  $\mathbb{R}^n$  and  $f(x) = H(x)b(x)$  for all  $x \in \mathbb{R}^n$ ;

#### Assumption 4.2

The mapping  $H : \mathbb{R}^n \rightarrow \mathcal{M}_{n,m}$  is continuous and  $d$ -homogeneous of a degree  $\nu \in \mathbb{R}$  i.e.,

$$e^{-\nu s} \mathbf{d}(-s)H(\mathbf{d}(s)x) = H(x), \quad \forall x \in \mathbb{R}^n$$

and  $\forall s \in \mathbb{R}$ .

#### Assumption 4.3

The function  $b : \mathbb{R}^n \rightarrow \mathbb{R}^m$  is uniformly bounded

$$\sup_{x \in \mathbb{R}^n} \|b(x)\| < +\infty$$

and continuous on  $\mathbb{R}^n \setminus \{0\}$ .

#### Assumption 4.4

The origin of the system (4.1) is **GAS**.

The hypothesis 4.4 implies that 1)  $f(0) = 0$ ; 2)  $b(x)$  does not belong to the kernel of  $H(x)$ ,  $\forall x \in \mathbb{R}^n \setminus \{0\}$  and 3)  $H(x) = 0 \Leftrightarrow x = 0$ . Recall [6] that, in the view of Kurzweil's converse Lyapunov theorem, any globally asymptotically stable system (4.1) with a continuous vector field  $f$  admits a smooth positive definite and proper<sup>2</sup> (or, equivalently, radially unbounded [26]) Lyapunov function. We use this fact in order to derive a sufficient condition allowing an expansion of the global asymptotic stability of the system (4.1) to its homogeneous extension (1.13), (4.2).

#### Theorem 4.1

Let the system (4.1) satisfies Assumptions 4.1, 4.2, 4.3, 4.4 and there exists a positive definite proper Lyapunov function

$$V \in C^1(\mathbb{R}^n \setminus \{0\}, \mathbb{R}_+) \cap C(\mathbb{R}^n, \mathbb{R}_+)$$

---

<sup>2</sup>A continuous function  $V : \mathbb{R}^n \rightarrow \mathbb{R}$  is proper if the inverse image of any compact set is a compact set.



for the system (2.1) such that

$$\sup_{y \neq 0} \|b(y) - b(x)\| \leq -\beta \frac{\langle \nabla V(x), f(x) \rangle}{\|H^\top(x) \nabla V(x)\|}, \quad (4.4)$$

for any  $x \in \tilde{S}$  and some constant  $\beta \in (0, 1)$ , where  $\tilde{S} = \{x \in \mathbb{R}^n : V(x) = 1\}$ .

Then the differential inclusion (1.13) with  $F$  given by (4.2) is globally asymptotically stable and there exists a positive definite radially unbounded  $\mathbf{d}$ -homogeneous Lyapunov function

$$V_{\mathbf{d}} \in C^1(\mathbb{R}^n \setminus \{0\}, \mathbb{R}_+) \cap C(\mathbb{R}^n, \mathbb{R}_+)$$

of a degree 1 such that

$$\sup_{h \in F(x)} \langle \nabla V_{\mathbf{d}}(x), h \rangle \leq -W_{\mathbf{d}}(x), \quad \forall x \in \mathbb{R}^n \setminus \{0\}. \quad (4.5)$$

where the positive definite function  $W_{\mathbf{d}}: \mathbb{R}^n \rightarrow \mathbb{R}_+$  is  $\mathbf{d}$ -homogeneous of the degree  $1 + \nu$ .

**Proof of Theorem 4.1:** Assumptions 4.1, 4.2 and 4.3 imply that the homogeneous extension is defined as follows  $F(x) = \bigcup_{s \in \mathbb{R}} \{H(x)b(\mathbf{d}(s)x)\}$  and the set  $F(x)$  is bounded and

$$\sup_{h \in F(x)} \langle \nabla V(x), h \rangle < +\infty$$

for every  $x \in \mathbb{R}^n$ . Let us consider the set

$$K_{\gamma_1, \gamma_2} = \{x \in \mathbb{R}^n : \gamma_1 \leq V(x) \leq \gamma_2\}$$

and prove that for some parameters  $\gamma_1 \in [1/2, 1)$  and  $\gamma_2 \in (1, 3/2]$  sufficiently close to 1 we have

$$\sup_{h \in F(y)} \langle \nabla V(y), h \rangle \leq -c, \quad \forall y \in K_{\gamma_1, \gamma_2}$$

or, equivalently,

$$\langle \nabla V(y), H(y)b(\mathbf{d}(s)y) \rangle \leq -c, \quad \forall y \in K_{\gamma_1, \gamma_2}, \quad \forall s \in \mathbb{R},$$

where  $c := -0.5(1 - \beta) \max_{x \in \tilde{S}} \langle \nabla V(x), f(x) \rangle > 0$ . Indeed, using the Cauchy-Schwartz inequality and (4.4) we derive

$$\begin{aligned} \langle \nabla V(x), H(x)[b(z) - b(x)] \rangle &\leq \|H^\top(x) \nabla V(x)\| \|b(z) - b(x)\| \\ &\leq -\beta \langle \nabla V(x), f(x) \rangle, \end{aligned} \quad (4.6)$$

for all  $z \in \mathbb{R}^n$  and  $x \in \tilde{S}$ . Hence, for any  $x \in \tilde{S}$ , any  $s \in \mathbb{R}$  and any  $\Delta \in \mathbb{R}^n : \Delta \neq -x$  we have

$$\begin{aligned} \langle \nabla V(x + \Delta), H(x + \Delta)b(\mathbf{d}(s)(x + \Delta)) \rangle &= \langle H^\top(x + \Delta) \nabla V(x + \Delta) - H^\top(x) \nabla V(x), b(\mathbf{d}(s)(x + \Delta)) \rangle + \\ &\quad \langle \nabla V(x), f(x) \rangle + \langle \nabla V(x), H(x)[b(\mathbf{d}(s)(x + \Delta)) - b(x)] \rangle \\ &\leq \|H^\top(x + \Delta) \nabla V(x + \Delta) - H^\top(x) \nabla V(x)\| \bar{b} \\ &\quad + \langle \nabla V(x), f(x) \rangle - \beta \langle \nabla V(x), f(x) \rangle \end{aligned}$$

$$\leq -2c + \|H^\top(x + \Delta)\nabla V(x + \Delta) - H^\top(x)\nabla V(x)\|\bar{b},$$

where  $\bar{b} := \sup_{x \in \mathbb{R}^n} \|b(x)\|$ . On the one hand, since  $V$  is proper then the set  $K_{\gamma_1, \gamma_2}$  is compact.

On the other hand, since the vector field  $x \mapsto g(x) := H^\top(x)\nabla V(x)$  is continuous on  $\mathbb{R}^n \setminus \{0\}$  then by Heine-Cantor theorem it is uniformly continuous<sup>3</sup> on the compact set  $K_{1/2, 3/2}$  with some modulus of continuity  $\omega \in \mathcal{K}$ . Notice that  $g$  is uniformly continuous on  $K_{\gamma_1, \gamma_2} \subset K_{1/2, 3/2}$  with the same modulus of continuity. For any  $x \in \tilde{S}$  and any  $\Delta \in \mathbb{R}^n : x + \Delta \in K_{1/2, 3/2}$  we have

$$\|H^\top(x + \Delta)\nabla V(x + \Delta) - H^\top(x)\nabla V(x)\|\bar{b} \leq \bar{b}\omega(\|\Delta\|).$$

Let  $\delta > 0$  be such that  $\bar{b}\omega(\delta) \leq c$ . Such  $\delta > 0$  always exists due to  $\omega \in \mathcal{K}$ . Let  $\gamma_1 \in [1/2, 1)$  and  $\gamma_2 \in (1, 3/2]$  be selected sufficiently close to 1 such that

$$K_{\gamma_1, \gamma_2} \subset \left\{ x + \Delta \in \mathbb{R}^n : x \in \tilde{S} \text{ and } \|\Delta\| \leq \delta \right\}.$$

Such  $\gamma_1$  and  $\gamma_2$  always exist due to uniform continuity of the vector field  $g$  on  $K_{1/2, 3/2}$ , which implies the convergence  $K_{\gamma_1, \gamma_2} \rightarrow \tilde{S}$  as  $|1 - \gamma_1| + |\gamma_2 - 1| \rightarrow 0$  in the Hausdorff metric (see e.g. [34]).

The rest part of the proof uses the scheme suggested in [81]. We consider the  $\mathbf{d}$ -homogeneous function  $V_{\mathbf{d}} : \mathbb{R}^n \rightarrow \mathbb{R}$  defined as follows

$$V_{\mathbf{d}}(x) = \int_{-\infty}^{+\infty} e^{-s} a(V(\mathbf{d}(s)x)) ds$$

where  $a : \mathbb{R} \rightarrow \mathbb{R}$  is an arbitrary  $a \in C^\infty$  function such that  $a(\rho) = 0$  for  $\rho \leq \gamma_1$ ,  $a(\rho) = 1$  for  $\rho \geq \gamma_2$  and  $a'(\rho) > 0$  for  $\rho \in (\gamma_1, \gamma_2)$ . The function  $V_{\mathbf{d}}$  is continuous on  $\mathbb{R}^n$ , continuously differentiable on  $\mathbb{R}^n \setminus \{0\}$  and  $\mathbf{d}$ -homogeneous of the degree 1. Moreover, for any  $x \in \mathbb{R}^n \setminus \{0\}$  we have

$$\begin{aligned} \sup_{h \in F(x)} \langle \nabla V_{\mathbf{d}}(x), h \rangle &= \sup_{h \in F(x)} \int_{-\infty}^{+\infty} e^{-s} a'(V(\mathbf{d}(s)x)) \langle \nabla V(\mathbf{d}(s)x), \mathbf{d}(s)h \rangle ds \\ &\leq \int_{-\infty}^{+\infty} e^{-s} a'(V(\mathbf{d}(s)x)) \sup_{h \in F(x)} \langle \nabla V(\mathbf{d}(s)x), \mathbf{d}(s)h \rangle ds \\ &\leq \int_{-\infty}^{+\infty} e^{-s} a'(V(y)) \sup_{\tilde{h} : e^{-\nu s} \mathbf{d}(-s)\tilde{h} \in F(\mathbf{d}(-s)y)} \langle \nabla V(y), e^{-\nu s} \tilde{h} \rangle ds, \end{aligned}$$

where the following notation  $y = \mathbf{d}(s)x$  and  $\tilde{h} = e^{\nu s} \mathbf{d}(s)h$  is utilized. Since  $a'(V(y)) = 0$  for  $y \notin K_{\gamma_1, \gamma_2}$  and  $\sup_{h \in F(y)} \langle \nabla V(y), h \rangle \leq -c$  for  $y \in K_{\gamma_1, \gamma_2}$ , then using  $\mathbf{d}$ -homogeneity of  $F$  we derive

$$\begin{aligned} \sup_{h \in F(x)} \langle \nabla V_{\mathbf{d}}(x), h \rangle &\leq \int_{-\infty}^{+\infty} e^{-(\nu+1)s} a'(V(\mathbf{d}(s)x)) \sup_{\tilde{h} \in F(y)} \langle \nabla V(y), \tilde{h} \rangle ds \\ &\leq -c \int_{-\infty}^{+\infty} e^{-(\nu+1)s} a'(V(\mathbf{d}(s)x)) ds = -W_{\mathbf{d}}(x). \end{aligned}$$

<sup>3</sup>A vector field  $g : \mathbb{R}^n \rightarrow \mathbb{R}^n$  is said to be uniformly continuous on a set  $\Omega \subset \mathbb{R}^n$  if there exists the so-called modulus of continuity  $\omega \in \mathcal{K}$  such that  $\|g(x) - g(y)\| \leq \omega(\|x - y\|)$  for all  $x, y \in \Omega$ .

The function  $W_{\mathbf{d}}$  is, obviously, positive definite and  $\mathbf{d}$ -homogeneous of the degree  $\nu + 1$ . The proof is complete. ■

#### Remark 4.2

The most sophisticated condition of Theorem 4.1 is (4.4). This condition gives a maximal upper bound of the admissible deviation of  $b(\cdot)$  with respect to its values on the sphere  $\tilde{S}$ . In the right-hand side of (4.4), only the values of  $b$  from the sphere are used. Therefore, the condition (4.4) evaluates how far  $b(y)$  is varying with respect to  $b(x)$ , where  $y \in \mathbb{R}^n \setminus \{0\}$  and  $x \in \tilde{S}$ , respectively. Hence, (4.4) quantifies the variation of values of  $b(\cdot)$ . Obviously, if  $b(\cdot)$  is a constant function, then the left-hand side is zero and the condition (4.4) is always satisfied (in such a case  $f$  is a homogeneous function).

#### Remark 4.3

Theorem 4.1 proves also that if the condition (4.4) holds, then there exists a  $\mathbf{d}$ -homogeneous Lyapunov function for the system (4.1). In particular, this property holds if the function  $b$  is a constant function (i.e.  $f = Hb$  is  $\mathbf{d}$ -homogeneous) [81, 74, 73].

For a scalar-valued function  $b$  the condition (4.4) can be omitted.

#### Corollary 4.1

If the vector field  $f$  of the system (4.1) satisfies Assumptions 4.1, 4.2, 4.3 and 4.4 with  $b : \mathbb{R}^n \rightarrow \mathbb{R}$  and

$$\inf_{x \in \mathbb{R}^n} |b(x)| > 0,$$

then conclusions of Theorem 4.1 remain true.

**Proof of Corollary 4.1:** Using Assumption 4.3 and the fact that  $\frac{b(\mathbf{d}(s)y)}{b(y)} > 0$ , for  $y \in K_{\gamma_1, \gamma_2}$  we derive

$$\begin{aligned} \langle \nabla V(y), H(y)b(\mathbf{d}(s)y) \rangle &= \langle \nabla V(y), H(y)b(y) \rangle \frac{b(\mathbf{d}(s)y)}{b(y)} \\ &\leq \langle \nabla V(y), H(y)b(y) \rangle \underline{b}/\bar{b} \leq -c, \end{aligned}$$

where

$$\underline{b} := \inf_{x \in \mathbb{R}^n} |b(x)| \leq \bar{b} := \sup_{x \in \mathbb{R}^n} |b(x)| \quad \text{and} \quad c = -\underline{b}\bar{b}^{-1} \max_{y \in K_{\gamma_1, \gamma_2}} \langle \nabla V(y), f(y) \rangle.$$

All the remaining considerations literally repeat the proof of Theorem 4.1. ■

#### Example 4.1

Let us illustrate this results by the following example

$$\begin{cases} \dot{x} &= y - x^{\frac{2}{3}} \text{sign}(x), \\ \dot{y} &= -\alpha x^{\frac{1}{3}} - \beta \left( 2 - \cos \left( \frac{1}{\sqrt{x^2 + y^2}} \right) \right) |y|^{\frac{1}{2}} \text{sign}(y) \end{cases} \quad (4.7)$$

with  $\alpha, \beta > 0$ . We can write the system (4.15) as follows

$$\dot{z} = H(z)b(z), \quad z = \begin{pmatrix} x \\ y \end{pmatrix}, \quad (4.8)$$

with

$$H(x, y) = \begin{pmatrix} y - x^{\frac{2}{3}} \operatorname{sign}(x) & 0 \\ -\alpha x^{\frac{1}{3}} & -\beta |y|^{\frac{1}{2}} \operatorname{sign}(y) \end{pmatrix}$$

and

$$b(x, y) = \begin{pmatrix} 1 \\ 2 - \cos\left(\frac{1}{\sqrt{x^2+y^2}}\right) \end{pmatrix}.$$

The function  $H$  is continuous and  $\mathbf{d}$ -homogeneous of degree  $\nu = -1$ , provided that the dilation  $\mathbf{d}$  is defined as follows  $\mathbf{d}(s) = \begin{pmatrix} e^{3s} & 0 \\ 0 & e^{2s} \end{pmatrix}$ . The function  $b$  is continuous and bounded. We use the Lyapunov function

$$V(x, y) = \alpha \frac{3}{4} x^{\frac{4}{3}} + \frac{1}{2} y^2, \quad (4.9)$$

one gets  $\dot{V} = -\alpha|x| - \beta \left(2 - \cos\left(\frac{1}{\sqrt{x^2+y^2}}\right)\right) |y|^{\frac{3}{2}}$ . Then, we deduce that the origin of system (4.15) is **GAS**. The homogeneous extension of the function  $f$  is given by

$$F(z) = \bigcup_{s \in \mathbb{R}} \{H(z)b(\mathbf{d}(s)z)\}. \quad (4.10)$$

Using again the homogeneous Lyapunov function  $V$  we derive

$$\langle DV(z), H(z)b(\mathbf{d}(s)z) \rangle = -\alpha|x| - \beta \left(2 - \cos\left(\frac{1}{\sqrt{e^{6s}x^2 + e^{4s}y^2}}\right)\right) |y|^{\frac{3}{2}} < 0, \quad (4.11)$$

$\forall z \in S_{\mathbf{d}}$  and  $\forall s \in \mathbb{R}$ . This proves that the differential inclusion given by the homogeneous extension (4.10) is **GAS**, and the degree of homogeneity  $\nu = -1 < 0$ , then the theorem 4.1 implies that the origin of system (4.7) is **FTS**. The Figure 4.1 shows the solution of the system (4.7) with initial condition (3, 2) which reaches the origin in **FT**.

#### Remark 4.4

If the Assumptions 4.1, 4.2, 4.3 and 4.4 hold and in addition if the function  $b$  satisfies the condition

$$\sup_{y \neq 0} \|b(y) - b(x)\| \leq \beta \alpha^* \|b(x)\|, \quad (4.12)$$

for all  $x \in \tilde{S}$ , where  $\alpha^* = \inf_{x \in \tilde{S}} \left\langle \frac{-H^T(x)\nabla V(x)}{\|H^T(x)\nabla V(x)\|}, \frac{b(x)}{\|b(x)\|} \right\rangle$ . Then, the results of Theorem 3.4 holds.

The following result is an extension of Theorem 3.4 to the system (4.1) with  $f$  is a homogeneous vector fields with different degrees and multiplicative perturbations.

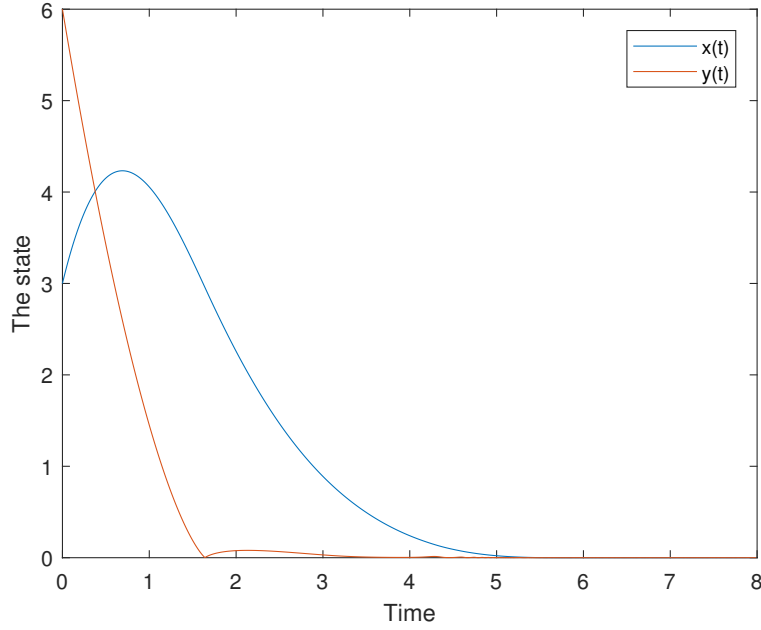

Figure 4.1: The solutions of the system (4.15) with  $\alpha = 0.5$ ,  $\beta = 2$  and the initial condition  $(x_0, y_0) = (3, 6)$ .

**Remark 4.5**

Let us assume that the system (4.1) is globally asymptotically stable and:  $f : x \in \mathbb{R}^n \rightarrow f(x) = \sum_{i=0}^p H_i(x)b_i(x) \in \mathbb{R}^n$ ,  $p \in \mathbb{N}$ , is continuous on  $\mathbb{R}^n$ , where

- the matrix-valued functions  $H_i : \mathbb{R}^n \rightarrow \mathcal{M}_{n,m_i}$  are continuous and  $\mathbf{d}$ -homogeneous of a degree  $\nu_i \in \mathbb{R}$  with  $\nu_0 \leq \nu_1 \leq \dots \leq \nu_p$ ;
- the functions  $b_i : \mathbb{R}^n \setminus \{0\} \rightarrow \mathbb{R}^{m_i}$  are continuous on  $\mathbb{R}^n \setminus \{0\}$  and there exists  $\nu \in \mathbb{R}$  such that function  $x \rightarrow b(x) := \begin{pmatrix} b_1(x) \\ \vdots \\ b_p(x) \end{pmatrix}$  satisfies the following condition

$$0 < \inf_{x \neq 0, s \in \mathbb{R}} \|\Lambda(s)b(\mathbf{d}(s)x)\| \leq \sup_{x \neq 0, s \in \mathbb{R}} \|\Lambda(s)b(\mathbf{d}(s)x)\| < +\infty,$$

$$\Lambda(s) = \begin{pmatrix} e^{(\nu_0 - \nu)s} I_{m_0} & 0 & \cdots & 0 \\ 0 & e^{(\nu_1 - \nu)s} I_{m_2} & \ddots & \vdots \\ \vdots & \ddots & \ddots & 0 \\ 0 & \cdots & 0 & e^{(\nu_p - \nu)s} I_{m_p} \end{pmatrix}.$$

If there exist a Lyapunov function  $V \in C^1(\mathbb{R}^n \setminus \{0\}, \mathbb{R}_+) \cap C(\mathbb{R}^n, \mathbb{R}_+)$  for the system (2.1) and a number  $0 < \beta < 1$  such that

$$\sup_{y \neq 0, s \in \mathbb{R}} \|\Lambda(s)b(\mathbf{d}(s)y) - b(x)\| \leq -\frac{\beta \langle \nabla V(x), f(x) \rangle}{\|H^\top(x) \nabla V(x)\|} \quad (4.13)$$

for any  $x \in \tilde{S}$ , where  $\tilde{S} = \{x \in \mathbb{R}^n : V(x) = 1\}$ . Then conclusions of Theorem 3.4 remain true.

### 4.3.2 Finite-time and near fixed-time stability

If the  $\mathbf{d}$ -homogeneous differential inclusion (1.13), (4.2) is **GAS**, then it is globally uniformly finite-time, exponentially or nearly fixed-time stable dependently of the sign of the homogeneity degree.

#### Corollary 4.2

If the system (4.1) satisfies the assumptions of Theorem 4.1 (resp. Remark 4.5), then the origin of the system (4.1) is globally

- uniformly **FTS** for  $\nu < 0$ ;
- exponentially stable for  $\nu = 0$ ;
- nearly **FxTS** for  $\nu > 0$ .

**Proof of Corollary 4.2:** From the proof of Theorem 4.1 and Lemma 2.2 we derive

$$\sup_{h \in F(x)} \langle \nabla V_{\mathbf{d}}(x), h \rangle \leq -a_1 V_{\mathbf{d}}^{1+\nu}(x), \quad \forall x \neq 0,$$

where  $a_1 = \min_{x \in \mathbb{R}^n : V_{\mathbf{d}}(x)=1} W_{\mathbf{d}}(x)$ . The latter implies that for any strong solution  $\phi_{x_0}$  of the differential inclusion (1.13), (4.2) we have

$$\frac{d}{dt} V_{\mathbf{d}}(\phi_{x_0}(t)) \stackrel{a.e.}{\leq} -a_1 V_{\mathbf{d}}^{\nu+1}(\phi_{x_0}(t)), \quad t > 0 : \phi_{x_0}(t) \neq 0.$$

Since  $V$  is differentiable on  $\mathbb{R}^n \setminus \{0\}$  and  $\phi_{x_0}$  is absolutely continuous then  $t \mapsto V_{\mathbf{d}}(\phi_{x_0}(t))$  is absolutely continuous as well. For  $\nu < 0$  the latter inequality and the positive definiteness of  $V_{\mathbf{d}}$  implies  $\|\phi_{x_0}(t)\| = 0$  for  $t \geq V_{\mathbf{d}}^{-\nu}(x_0)/(-\nu a_1)$  for any strong solution  $\phi_{x_0}(t)$  of the differential inclusion (1.13), (4.2) and, in particular, for all solutions of the system (4.1).

For  $\nu > 0$  we need to show that any neighborhood of the origin (4.1) is fixed-time time attractive. Indeed, since  $V_{\mathbf{d}}$  is positive definite and continuous at 0 then for any neighborhood  $M$  of the origin there exists  $\gamma > 0$  such that  $\{x \in \mathbb{R}^n : V_{\mathbf{d}}(x) \leq \gamma\} \subset M$ . For  $\nu > 0$  the above differential inequality implies

$$V_{\mathbf{d}}(\phi_{x_0}(t)) \leq \gamma, \quad \forall t \geq \frac{1}{a_1 \nu \gamma^{\nu}}$$

independently of  $x_0$ . For  $\nu = 0$  we derive similarly  $V_{\mathbf{d}}(\phi_{x_0}(t)) \leq e^{-a_1 t} V_{\mathbf{d}}(\phi_{x_0}(0)), t \geq 0$ . The proof is complete.

■

In the case of a scalar-valued function  $b$  the restriction to the Lyapunov function  $V$  can be omitted.

**Corollary 4.3**

Let conditions of Corollary 4.1 be fulfilled then the system (4.1) is globally uniformly **FTS** for  $\nu < 0$ , globally uniformly exponentially stable for  $\nu < 0$  and nearly **FxTS** for  $\nu > 0$ .

As a trivial example illustrating the presented corollary, the system

$$\dot{x} = - \left( 2 + \cos \left( \frac{1}{x(t)} \right) \right) x^{1/3}(t), \quad t \geq 0$$

can be considered. This system does not have a homogeneous approximation at zero, but it has a homogeneous extension that uniformly **GFTS**.

### 4.4 A planar system example

In this section, we consider the class of planar systems studied in [15, 79], which has the following form:

$$\begin{cases} \dot{q} = v, \\ \dot{v} = f(q, v) + u(q, v), \end{cases} \quad (4.14)$$

where  $q = (q_1, \dots, q_n)^T \in \mathbb{R}^n$  is the vector of generalized coordinates,  $v = (v_1, \dots, v_n)^T \in \mathbb{R}^n$  is the vector of generalized velocities while  $f(q, v) = (f_1(q, v), \dots, f_n(q, v))^T$  represents generalized forces and  $u$  is the vector of the inputs. For simplicity we consider  $n = 2$  and

$$\begin{aligned} f_1(q, v) &= -\beta_1 b_1(q, v) |v_1|^{\frac{1}{2}}, \\ f_2(q, v) &= -\beta_2 b_2(q, v) |v_2|^{\frac{1}{2}}, \end{aligned}$$

where  $\beta_2 > 0, \beta_1 > 0$ , (without loss of generality we choose  $\beta_2 \geq \beta_1 > 0$ ) and continuous functions  $b_i : \mathbb{R}^4 \setminus \{0\} \rightarrow \mathbb{R}$  satisfy the following conditions:  $\exists \underline{b} > 0$  and  $\exists \bar{b} > 0$  such that  $\underline{b} \leq b_i(q, v) \leq \bar{b}, \forall (q, v) \in \mathbb{R}^4, i = 1, 2$ . Under these conditions the system has only one equilibrium at the origin. The considered system

$$\begin{cases} \dot{q}_1 = v_1, \\ \dot{q}_2 = v_2, \\ \dot{v}_1 = -\beta_1 b_1(q, v) |v_1|^{\frac{1}{2}} + u_1(q, v), \\ \dot{v}_2 = -\beta_2 b_2(q, v) |v_2|^{\frac{1}{2}} + u_2(q, v), \end{cases} \quad (4.15)$$

can be represented as follows

$$\dot{z} = H(z)b(z),$$

with  $z = (q, v)^T$ ,

$$b(z) = (1, 1, b_1(z), b_2(z))^T$$

and

$$H(z) = \begin{pmatrix} v_1 & 0 & 0 & 0 \\ 0 & v_2 & 0 & 0 \\ u_1(q, v) & 0 & -\beta_1[v_1]^{\frac{1}{2}} & 0 \\ 0 & u_2(q, v) & 0 & -\beta_2[v_2]^{\frac{1}{2}} \end{pmatrix}.$$

The function  $b$  is uniformly bounded and it is continuous on  $\mathbb{R}^4 \setminus \{0\}$  due to imposed properties of  $b_1$  and  $b_2$ . If we define

$$(u_1, u_2)^\top = \left( -\alpha_1 q_1^{\frac{1}{3}}, -\alpha_2 q_2^{\frac{1}{3}} \right)^\top, \quad \alpha_2 \geq \alpha_1 > 0$$

then the function  $H : \mathbb{R}^4 \rightarrow \mathcal{M}_{4,4}$  is continuous and  $\mathbf{d}$ -homogeneous of the degree  $\nu = -1$ , provided that the dilation  $\mathbf{d}$  is weighted homogeneous  $\mathbf{d}(s) = \text{diag}\{e^{3s}I, e^{2s}I\}$ ,  $I \in \mathbb{R}^{2 \times 2}$ .

Consider the following Lyapunov function

$$V(z) = cU^{\frac{5}{4}}(z) + \alpha_1^{\frac{3}{4}}q_1v_1 + \alpha_2^{\frac{3}{4}}q_2v_2,$$

where  $U(z) = \frac{3}{4} \sum_{i=1}^2 \alpha_i |q_i|^{\frac{4}{3}} + \frac{1}{2} \|v\|^2$  and

$$c > \max \left\{ \frac{\alpha_2^{\frac{3}{4}} \left(1 + \beta_2 \frac{\bar{b}}{4}\right)}{\frac{5b}{4} \beta_1 \left(\frac{1}{2}\right)^{\frac{1}{4}}}, \left(\frac{4}{5}\right)^{\frac{5}{4}} \right\}. \quad (4.16)$$

Applying Young's inequality produces

$$\left( \sum_{i=1}^2 \alpha_i^{\frac{3}{4}} |q_i| |v_i| \right)^{\frac{4}{5}} \leq \sum_{i=1}^2 \left( \alpha_i^{\frac{3}{4}} |q_i| \right)^{\frac{4}{5}} |v_i|^{\frac{4}{5}} \leq \frac{3}{5} \sum_{i=1}^2 \alpha_i |q_i|^{\frac{4}{3}} + \frac{2}{5} \|v\|^2.$$

Hence,  $V$  is positive definite for  $c > \left(\frac{4}{5}\right)^{\frac{5}{4}}$ . From the definition of  $U$ , we obtain

$$\begin{aligned} \langle \nabla U(z), H(z)b(z) \rangle &= -\beta_1 b_1(z) |v_1|^{\frac{3}{2}} - \beta_2 b_2(z) |v_2|^{\frac{3}{2}} \leq \\ &= -\beta_1 \underline{b} |v_1|^{\frac{3}{2}} - \beta_2 \underline{b} |v_2|^{\frac{3}{2}} \leq -\underline{b} \beta_1 \|v\|^{\frac{3}{2}}, \end{aligned}$$

$(U(z))^{\frac{1}{4}} \geq \left(\frac{1}{2}\right)^{\frac{1}{4}} \|v\|^{\frac{1}{2}}$  and again by applying Young's inequality, we have

$$\begin{aligned} \langle \nabla V(z), H(z)b(z) \rangle &= \frac{5c}{4} \langle \nabla U(z), H(z)b(z) \rangle U^{\frac{1}{4}}(z) + \alpha_1^{\frac{3}{4}} v_1^2 + \alpha_2^{\frac{3}{4}} v_2^2 \\ &+ \alpha_1^{\frac{3}{4}} q_1 (f_1(z) + u_1(z)) + \alpha_2^{\frac{3}{4}} q_2 (f_2(z) + u_2(z)) \\ &\leq -\left(\frac{1}{2}\right)^{\frac{1}{4}} \frac{5bc}{4} \beta_1 \|v\|^2 + \alpha_2^{\frac{3}{4}} \beta_2 \frac{\bar{b}}{4} \|v\|^2 + \alpha_2^{\frac{3}{4}} \|v\|^2 \\ &- \alpha_1^{\frac{7}{4}} \sum_{i=1}^2 |q_i|^{\frac{4}{3}} + \alpha_2^{\frac{3}{4}} \beta_2 \frac{3\bar{b}}{4} \sum_{i=1}^2 |q_i|^{\frac{4}{3}} \\ &= -k_1 \|v\|^2 - k_2 \sum_{i=1}^2 |q_i|^{\frac{4}{3}}, \end{aligned}$$

with

$$k_1 = \frac{5b}{4} \beta_1 \left(\frac{1}{2}\right)^{\frac{1}{4}} c - \alpha_2^{\frac{3}{4}} \left(1 + \beta_2 \frac{\bar{b}}{4}\right),$$



and

$$k_2 = \left( \alpha_1^{\frac{7}{4}} - \alpha_2^{\frac{3}{4}} \beta_2 \frac{3\bar{b}}{4} \right).$$

By choosing  $\alpha_1^{\frac{7}{4}} > \alpha_2^{\frac{3}{4}} \beta_2 \frac{3\bar{b}}{4}$  and  $c$  such that (4.16) holds, we get  $k_1, k_2 > 0$ . This implies that the origin of the system (4.15) is **GAS**. According to Theorem 4.1 and Corollary 4.2 this system is **FTS** provided that there exists  $\beta \in (0, 1)$  such that

$$\sup_{y \neq 0} \|b(y) - b(z)\| \leq \frac{-\beta \langle \nabla V(z), H(z)b(z) \rangle}{\|H^\top(z) \nabla V(z)\|}, \quad \forall z \in \tilde{S},$$

where  $\tilde{S} = \{z \in \mathbb{R}^n : V(z) = 1\}$  (inequality (8) for this example). The latter inequality can be restricted to

$$\sqrt{2}(\bar{b} - \underline{b}) \leq -\frac{\beta \max_{z \in \tilde{S}} \langle \nabla V(z), H(z)b(z) \rangle}{\max_{z \in \tilde{S}} \|H^\top(z) \nabla V(z)\|}.$$

For  $\bar{b}$  sufficiently close to  $\underline{b}$  this condition holds and implies the finite-time stability of the system (4.15). Since

$$a_1 \|z\|_{\mathbf{d}}^5 \leq V(z) \leq a_2 \|z\|_{\mathbf{d}}^5,$$

with

$$\|z\|_{\mathbf{d}}^4 = \|v\|^2 + \sum_{i=1}^2 |q_i|^{\frac{4}{3}},$$

$$a_1 = \left( c - (4/5)^{\frac{5}{4}} \right) \min \left\{ (3\alpha_2/4)^{\frac{5}{4}}, (1/2)^{\frac{5}{4}} \right\}$$

and

$$a_2 = \left( c + (4/5)^{\frac{5}{4}} \right) \max \left\{ (3\alpha_2/4)^{\frac{5}{4}}, (1/2)^{\frac{5}{4}} \right\}.$$

We obtain

$$-\max_{z \in \tilde{S}} \langle \nabla V(z), H(z)b(z) \rangle \geq \frac{\min\{k_1, k_2\}}{a_2^{\frac{5}{4}}} = 0.3985,$$

and

$$\begin{aligned} \max_{z \in \tilde{S}} \|H^\top(z) \nabla V(z)\| &\leq \max_{z \in \tilde{S}} \left\{ m_1 \|z\|_{\mathbf{d}}^4 \right. \\ &\quad \left. + m_2 \frac{\|z\|_{\mathbf{d}}}{4} + m_2 \|z\|_{\mathbf{d}}^5 + m_3 \frac{\|z\|_{\mathbf{d}}^{\frac{9}{4}}}{4} + m_3 \|z\|_{\mathbf{d}}^{\frac{1}{2}} \right\} \\ &\leq \frac{m_1}{a_1^{\frac{4}{5}}} + m_2 \left( \frac{1}{4a_1^{\frac{5}{5}}} + \frac{1}{a_1} \right) + m_3 \left( \frac{1}{4a_1^{\frac{10}{10}}} + \frac{1}{a_1^{\frac{10}{10}}} \right) = 2.1626, \end{aligned}$$

with

$$m_1 = \max \left\{ \left( \alpha_2^{\frac{3}{4}} + \alpha_2^{\frac{5}{2}} + \alpha_2^{\frac{3}{2}} \beta_2^2 / 2 \right)^{\frac{1}{2}}, \left( \alpha_2^{\frac{7}{2}} + \alpha_2^{\frac{5}{2}} + \alpha_2^{\frac{3}{2}} \beta_2^2 / 2 \right)^{\frac{1}{2}} \right\},$$

$$m_2 = \beta_2 c \max \left\{ \frac{1}{2}, \frac{3\alpha_2^2}{4} \right\}^{\frac{1}{4}},$$

$$m_3 = \beta_2 \sqrt{c} \max \left\{ \frac{1}{2}, \frac{3\alpha_2^2}{4} \right\}^{\frac{1}{8}},$$

$\alpha_1 = 1$ ,  $\alpha_2 = 1$ ,  $\beta_1 = 0.1$ ,  $\beta_2 = 0.2$ ,  $\underline{b} = 4$ ,  $\bar{b} = 4.01$  and  $c = 17.2776$ . Then

$$\sqrt{2}(\bar{b} - \underline{b}) = 0.0141 \leq 0.0243\beta \leq -\frac{\beta \max_{z \in \tilde{S}} \langle \nabla V(z), H(z)b(z) \rangle}{\max_{z \in \tilde{S}} \|H^\top(z) \nabla V(z)\|}.$$

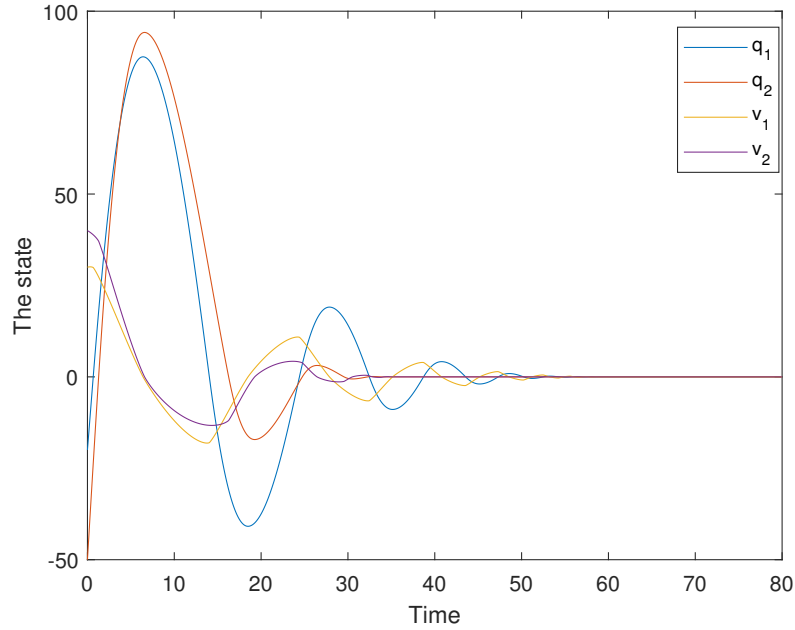

Figure 4.2: The solutions of the system (4.15) with  $(\alpha_1, \alpha_2) = (1, 1)$ ,  $(\beta_1, \beta_2) = (0.1, 0.2)$ ,  $b_1(z) = 4.005 - 0.005 \sin\left(\frac{1}{\|z\|}\right)$ ,  $b_2(z) = 4.005 - 0.005 \cos\left(\frac{1}{\|z\|}\right)$  and the initial condition  $(q_0, v_0) = (-20, -50, 30, 40)$ .

For  $0.0765 < \beta = 0.08 < 1$ , the functions  $b_1(z) = 4.005 - 0.005 \sin\left(\frac{1}{\|z\|}\right)$  and  $b_2(z) = 4.005 - 0.005 \cos\left(\frac{1}{\|z\|}\right)$  satisfy the condition (4.4). The simulation results for this case are depicted in Figure 4.2.

## 4.5 Conclusion

**FTS** and nearly **FxTS** of a class of non-homogeneous systems are investigated using the homogeneous extension and Lyapunov function method. More precisely, we presented some sufficient conditions to guarantee FT or nearly **FxTS** of a non-homogeneous ODE using homogeneity degree of a homogeneous extension of the system.



# Finite-time stability analysis based on sup- and sub-homogeneity

## Contents

<b>5.1</b>	<b>Introduction</b>	<b>95</b>
<b>5.2</b>	<b>Model description</b>	<b>96</b>
<b>5.3</b>	<b>Sub-homogeneous DI</b>	<b>96</b>
<b>5.4</b>	<b>Sup-homogeneous DI</b>	<b>103</b>
<b>5.5</b>	<b>FTS/FxTS of non-homogeneous systems</b>	<b>106</b>
5.5.1	Sub-homogeneous extension	106
5.5.2	Sup-homogeneous extension	107
<b>5.6</b>	<b>Academic example</b>	<b>107</b>
<b>5.7</b>	<b>Conclusion</b>	<b>110</b>

In this chapter, we investigate the properties of differential inclusions using the introduced notions of *sup-* and *sub-homogeneity*. These concepts allow the systems that do not admit homogeneous approximations to be analyzed using the relaxed homogeneity notions of their extensions, then finite-time stability and fixed-time stability properties can be recovered. An academic example is presented in the last section, to show that *sup-* and *sub-homogeneity* can be utilized for an analysis of non-homogeneous systems which do not admit homogeneous extensions satisfying the classical conditions.

## 5.1 Introduction

Requiring homogeneity for **FTS/FxTS** analysis is restrictive. However, many useful properties can be guaranteed for non homogeneous systems admitting homogeneous extension. The class of such dynamics is very large [19], but still limited. In this chapter we will present a new notion, which also induces the symmetry of the solutions of DIs. It is called sup/sub-homogeneity (see [16, 20]).

Sup- or sub-homogeneity is a sort of symmetry, which appears as a certain relaxation of homogeneity of **DIs**. An advantage of these concepts is that a system may do not admit a

homogeneous approximation or homogeneous extension possessing, at the same time, sup- or sub-homogeneity properties. This chapter proves that if a sup- or sub-homogeneous DI is **GAS**, then there exists a homogeneous Lyapunov function, which characterizes its behaviour. This result is a generalization of the converse Lyapunov theorem for homogeneous **DI** [65]. The property of **weak FTS/FxTS** is also investigated for this class of **DI**s. The obtained results lead to simple conditions for a nonlinear **GAS** system guarantying its **FTS/FxTS**.

The main contribution of this chapter deals with a new and simpler approach to analyze **FTS** or **FxTS** of nonlinear systems. The principal novelty is the concept of sub/sup-homogeneous extension, which can be constructed for any nonlinear system (in contrast to homogeneous approximation).

## 5.2 Model description

We consider again the system

$$\dot{x}(t) = f(x(t)), \quad (5.1)$$

In order to develop our approach and study the **FTS** and **FxTS** property of this system, we first study another class of system: differential inclusions that ( see Chapters 1 and 2). We recall it here as follows:

$$\dot{x}(t) \in F(x(t)), \quad \forall t \geq 0. \quad (5.2)$$

For this class of systems, we are going to introduce a new concept that we call sub- and sup-homogeneity that we present in the next sections.

Recall that a solutions of **DI** is an absolutely continuous functions satisfying (5.2) almost everywhere. Let us also recall some notations:

- $\mathbf{S}(x_0)$  denotes the set of all solutions of (5.2) with  $x(0) = x_0$ .
- Given  $\beta \in \mathcal{KL}$ , we denote by  $\hat{\mathbf{S}}^\beta(x_0)$  a set of weakly uniformly **GAS** solutions of (5.2) with  $x(0) = x_0$  such that  $x \in \hat{\mathbf{S}}^\beta(x_0)$  iff  $x \in \mathbf{S}(x_0)$  and  $\|x(t)\| \leq \beta(\|x_0\|, t), \forall t \geq 0$ .
- $\mathbf{S} = \bigcup_{x_0 \in \mathbb{R}^n} \mathbf{S}(x_0)$  and  $\hat{\mathbf{S}}^\beta = \bigcup_{x_0 \in \mathbb{R}^n} \hat{\mathbf{S}}^\beta(x_0)$

## 5.3 Sub-homogeneous DI

In this section, we define *sub-homogeneous* DI and we investigate its **FTS**.

### Definition 5.1

A set-valued mapping  $F : \mathbb{R}^n \rightrightarrows \mathbb{R}^n$  is said to be *d-sub-homogeneous* of degree  $\nu \in \mathbb{R}^n$ , if for

all  $x \in \mathbb{R}^n$  and  $s \geq 0$  we have

$$e^{\nu s} \mathbf{d}(s)F(x) \subseteq F(\mathbf{d}(s)x),$$

where  $\mathbf{d}$  is a linear dilation in  $\mathbb{R}^n$ .

Let us introduce the following assumptions for (5.2):

**Assumption 5.1**

$F$  is  $\mathbf{d}$ -sub-homogeneous of degree  $\nu \in \mathbb{R}$ .

Obviously, the sub-homogeneity implies the inclusion

$$F(\mathbf{d}(s)x) \subseteq e^{\nu s} \mathbf{d}(s)F(x), \quad \forall s \leq 0, \quad \forall x \in \mathbb{R}^n$$

but not the equality as in the conventional case. Below we show that such **DI**s may appear as extensions of some dynamical systems, which do not have homogeneous approximation. The sub-homogeneity simplifies the **F**TS analysis in the latter case. The following proposition ensures symmetry of solutions of *sub-homogeneous DI* (5.2)

**Proposition 5.1**

Let  $F$  satisfy Assumption 5.1. If  $t \rightarrow x(t)$  is a solution of (5.2) then for each  $s \geq 0$  the function  $t \rightarrow \mathbf{d}(s)x(e^{\nu s}t)$  is a solution of (5.2) as well.

**Proof of Proposition 5.1:** We consider a trajectory  $x(\cdot)$  of (5.2). The curve  $t \rightarrow \mathbf{d}(s)x(e^{\nu s}t)$  is continuous for all  $s \geq 0$ . Moreover, for almost all  $t \in \mathbb{R}$  we have:

$$\frac{d}{dt} [\mathbf{d}(s)x(e^{\nu s}t)] \stackrel{a.e.}{=} e^{\nu s} \mathbf{d}(s) \dot{x}(e^{\nu s}t) \stackrel{a.e.}{\in} e^{\nu s} \mathbf{d}(s)F(x(e^{\nu s}t)).$$

Since  $F$  is  $\mathbf{d}$ -sub-homogeneous with degree  $\nu$ , one gets

$$\frac{d}{dt} [\mathbf{d}(s)x(e^{\nu s}t)] \stackrel{a.e.}{\in} F(\mathbf{d}(s)x(e^{\nu s}t)),$$

i.e.  $t \rightarrow \mathbf{d}(s)x(e^{\nu s}t)$  is a solution of (5.2) for any  $s \geq 0$ . ■

The following result generalizes the Rosier's theorem [81] to sub-homogeneous **DI**.

**Theorem 5.1**

Let  $F$  satisfy Assumption 5.1 and be nonempty-, compact-, convex-valued and upper-semicontinuous. Let  $p \in \mathbb{N}$  be an arbitrary natural number. The origin of (5.2) is **GAS** if and only if there exists a pair  $(V, W)$  of continuous functions such that:

- 1)  $V \in \mathcal{C}^p(\mathbb{R}^n, \mathbb{R}_+)$ ,  $V$  is positive definite and  $\mathbf{d}$ -homogeneous with a degree  $k > 0$  i.e.,

$$V(\mathbf{d}(\tau)x) = e^{k\tau} V(x), \quad \forall \tau \in \mathbb{R}, \quad \forall x \in \mathbb{R}^n,$$

such that the matrix  $pG_{\mathbf{d}} - kI_n$  is Hurwitz

- 2)  $W \in \mathcal{C}^\infty(\mathbb{R}^n \setminus \{0\}, \mathbb{R}_+)$ ,  $W$  is positive definite and  $\mathbf{d}$ -homogeneous with degree  $k + \nu$ ;
- 3)  $\max_{h \in F(x)} \langle \nabla V(x), h \rangle \leq -W(x)$  for all  $x \neq 0$ .

**Proof of Theorem 5.1:** Let us prove the necessity, since the sufficiency is trivial. For non-homogeneous  $V_0$  and  $W_0$  the claimed result is proven in [25], i.e. there exists a pair  $(V_0, W_0)$  of continuous functions, such that:

- 1)  $V_0 \in \mathcal{C}^\infty(\mathbb{R}^n, \mathbb{R}_+)$ ,  $V_0$  is positive definite;
- 2)  $W_0 \in \mathcal{C}^\infty(\mathbb{R}^n \setminus \{0\}, \mathbb{R}_+)$ ,  $W_0$  is positive definite;
- 3)  $\max_{h \in F(x)} \langle \nabla V_0(x), h \rangle \leq -W_0(x)$  for all  $x \in \mathbb{R}^n \setminus \{0\}$ .

Since  $V_0(0) = 0$ ,  $V_0(x) \rightarrow +\infty$  as  $\|x\| \rightarrow +\infty$  and  $\mathbf{d}$  is a dilation then there exist  $\gamma > 0$  and  $0 < v_1 < v_2$  such that

$$\begin{aligned} V_0(\mathbf{d}(s)x) &\leq v_1 \text{ for any } x : \|x\| = 1 \text{ and } \forall s \leq 0, \\ V_0(\mathbf{d}(s)x) &\geq v_2 \text{ for any } x : \|x\| = 1 \text{ and } \forall s \geq \gamma. \end{aligned}$$

Following Rosier's theorem (see [81]) to build a homogeneous Lyapunov function  $V$  we consider a  $\mathcal{C}^\infty$  function  $a : [0, +\infty) \rightarrow [0, 1]$  such that

$$a(t) = \begin{cases} 0, & \text{if } t \leq v_1, \\ 1, & \text{if } t \geq v_2, \end{cases}$$

and  $\dot{a}(t) > 0$  for all  $t \in (v_1, v_2)$ . If  $k > \max\{-\nu, 0\}$  then the function

$$x \rightarrow V(x) := \int_{\mathbb{R}} e^{-ks} a \circ V_0(\mathbf{d}(s)x) ds$$

is well defined, continuous on  $\mathbb{R}^n$  and  $\mathcal{C}^\infty$  on  $\mathbb{R}^n \setminus \{0\}$ . Moreover,  $V$  is  $\mathbf{d}$ -homogeneous  $V(\mathbf{d}(\tau)x) = e^{k\tau}V(x)$ , and for any  $x : \|x\| = 1$  and any  $h \in F(x)$  we have

$$\langle \nabla V(x), h \rangle = \int_{\mathbb{R}} e^{-ks} \dot{a}(V_0(\mathbf{d}(s)x)) \langle \nabla V_0(\mathbf{d}(s)x), \mathbf{d}(s)h \rangle ds.$$

and, due to Assumption 5.1, we get

$$\begin{aligned} \max_{h \in F(x)} \langle \nabla V(x), h \rangle &= \int_{\mathbb{R}} e^{-ks} \dot{a}(V_0(\mathbf{d}(s)x)) \max_{h \in F(x)} \langle \nabla V_0(\mathbf{d}(s)x), \mathbf{d}(s)h \rangle ds \\ &\leq \int_0^\gamma e^{-ks} \dot{a}(V_0(\mathbf{d}(s)x)) \max_{h \in e^{-\nu s} \mathbf{d}(-s)F(\mathbf{d}(s)x)} \langle \nabla V_0(\mathbf{d}(s)x), \mathbf{d}(s)h \rangle ds \\ &= \int_0^\gamma e^{-(k+\nu)s} \dot{a}(V_0(\mathbf{d}(s)x)) \max_{h \in F(\mathbf{d}(s)x)} \langle \nabla V_0(\mathbf{d}(s)x), h \rangle ds \\ &\leq - \int_0^\gamma e^{-(k+\nu)s} \dot{a}(V_0(\mathbf{d}(s)x)) W_0(\mathbf{d}(s)x) ds = -W(x) \leq 0. \end{aligned}$$

These inequalities are derived by using the sub-homogeneity of  $F$ . Notice that,  $W$  is a  $\mathbf{d}$ -homogeneous positive definite function with the degree  $(\nu + k) > 0$ . This proves that  $V$  is a  $\mathbf{d}$ -homogeneous Lyapunov function for (5.2). Now, let  $k > \max\{-\nu, 0\}$  be such that the matrix  $pG_{\mathbf{d}} - kI_n$  is Hurwitz. Then for  $s \in \mathbb{R}$  and  $x : \|x\| = 1$  we have

$$\frac{d^p}{d(\mathbf{d}(s)x)^p} V(\mathbf{d}(s)x) = e^{ks} \mathbf{d}(-ps) \frac{d^p}{dx^p} V(x).$$

To guarantee that  $V \in \mathcal{C}^p(\mathbb{R}^n, \mathbb{R}_+)$  it is enough to show

$$\lim_{s \rightarrow -\infty} \left\| \frac{d^p V(\mathbf{d}(s)x)}{d(\mathbf{d}(s)x)^p} \right\| = \lim_{s \rightarrow -\infty} \left\| e^{ks} \mathbf{d}(-ps) \frac{d^p}{dx^p} V(x) \right\| = 0.$$

This is true, because the matrix  $pG_{\mathbf{d}} - kI_n$  is Hurwitz and

$$e^{ks} \mathbf{d}(-ps) = e^{s(kI_n - pG_{\mathbf{d}})}.$$

We use the same argument to prove that  $W \in \mathcal{C}^\infty(\mathbb{R}^n \setminus \{0\}, \mathbb{R}_+)$ . ■

The proposition 5.1 implies that the function  $t \rightarrow \mathbf{d}(s)x(e^{\nu s t})$  belongs to  $\mathbf{S}(\mathbf{d}(s)x_0)$  for any  $x \in \mathbf{S}(x_0)$  and any  $s \geq 0$ . Notice that this inclusion may not hold for a set of weakly uniformly **GAS** solutions. Let us introduce this as an assumption:

### Assumption 5.2

There exists  $\beta_{\mathbf{d}} \in \mathcal{KL}$  such that the function  $t \rightarrow \mathbf{d}(s)x(e^{\nu s t})$  belongs to  $\hat{\mathbf{S}}^{\beta_{\mathbf{d}}}(\mathbf{d}(s)x_0)$  for any  $x \in \hat{\mathbf{S}}^{\beta_{\mathbf{d}}}(x_0)$ , any  $x_0 \in \mathbb{R}^n$  and any  $s \geq 0$ .

The next corollary shows that the latter assumption is fulfilled under certain conditions.

### Corollary 5.1

Let  $F$  satisfy Assumption 5.1 and let  $\hat{\mathbf{S}}^\beta \subset \mathbf{S}$  be a set of **weakly uniformly GAS** solutions of (5.2) with some  $\beta \in \mathcal{KL}$ . If

$$\exists \beta_{\mathbf{d}} \in \mathcal{KL} : \beta_{\mathbf{d}}(\rho, t) \geq \sup_{s \geq 0} \|\mathbf{d}(-s)\| \beta(\|\mathbf{d}(s)\| \rho, e^{-\nu s t}), \quad (5.3)$$

for all  $t \geq 0$  and all  $\rho \geq 0$ , then there exists  $\hat{\mathbf{S}}^{\beta_{\mathbf{d}}} \subset \mathbf{S}$  satisfying the Assumption 5.2 such that  $\hat{\mathbf{S}}^\beta \subset \hat{\mathbf{S}}^{\beta_{\mathbf{d}}}$ .

**Proof of Corollary 5.1:** If

$$\hat{\mathbf{S}}^{\beta_{\mathbf{d}}}(x_0) := \bigcup_{s \geq 0} \left\{ \tilde{x} \in \mathcal{C}(\mathbb{R}_+, \mathbb{R}^n) : \tilde{x}(t) = x(e^{\nu s t}), t \geq 0, x \in \hat{\mathbf{S}}^\beta(\mathbf{d}(-s)x_0) \right\},$$

where  $\hat{\mathbf{S}}^\beta$  is the set of **weakly GAS** solutions with  $\beta \in \mathcal{KL}$ , then  $\hat{\mathbf{S}}^\beta \subset \hat{\mathbf{S}}^{\beta_{\mathbf{d}}}$  and the properties mentioned in Assumption 5.2 are fulfilled by construction. Moreover,  $\hat{\mathbf{S}}^{\beta_{\mathbf{d}}} \subset \mathbf{S}$  due to Proposition 5.1. Let us prove that  $\hat{\mathbf{S}}^{\beta_{\mathbf{d}}}$  is a set of **weakly GAS** solutions with  $\beta^{\mathbf{d}} \in \mathcal{KL}$ .

By construction, for any  $x_0 \in \mathbb{R}^n$  the inclusion  $\tilde{x} \in \hat{\mathbf{S}}^{\beta_{\mathbf{d}}}(x_0)$  means that for any  $s \geq 0$  there exists  $x \in \hat{\mathbf{S}}^\beta(\mathbf{d}(s)x_0)$  such that

$$\tilde{x}(t) = \mathbf{d}(-s)x(e^{-\nu s t}), \quad x(0) = \mathbf{d}(s)x_0.$$



Hence, we derive

$$\|\tilde{x}(t)\| = \|\mathbf{d}(-s)x(e^{-\nu s}t)\| = \|\mathbf{d}(-s)\| \cdot \|x(e^{-\nu s}t)\| \leq$$

$$\|\mathbf{d}(-s)\|\beta(\|\mathbf{d}(s)\| \cdot \|x_0\|, e^{-\nu s}t) \leq \beta_{\mathbf{d}}(\|x_0\|, t),$$

for all  $t \geq 0$ , all  $x_0 \in \mathbb{R}^n$  and all  $\tilde{x} \in \hat{\mathbf{S}}^{\beta_{\mathbf{d}}}$ . ■

Taking into account that any function  $\beta \in \mathcal{KL}$  admits the estimate [51, Lemma 7]

$$\sigma_1(\beta(\rho, t)) \leq \sigma_2(\rho)e^{-t}, \quad \sigma_1, \sigma_2 \in \mathcal{K}_{\infty},$$

the condition (5.3) can be represented as follows

$$\exists \sigma_{\mathbf{d}} \in \mathcal{K}_{\infty} \quad : \quad \sigma_{\mathbf{d}}(\rho) \geq \sup_{s \geq 0} \|\mathbf{d}(-s)\| \sigma_2(\|\mathbf{d}(s)\| \rho),$$

provided that  $\nu \leq 0$ . Indeed, since  $e^{-e^{-\nu s}t} \leq e^{-t}, \forall s \geq 0, \forall \nu \leq 0, \forall t \geq 0$  then we can select

$$\beta_{\mathbf{d}}(\rho, t) = \sigma_1^{-1}(\sigma_{\mathbf{d}}(\rho)e^{-t}), \quad \rho, t \geq 0.$$

### Theorem 5.2

If the set  $\hat{\mathbf{S}}^{\beta} \subset \mathbf{S}$  of **weakly** uniformly **GAS** solutions satisfies the Assumption 5.2 for  $\nu < 0$  then  $\hat{\mathbf{S}}^{\beta}$  is a set of **weakly** uniformly **GFTS** solutions.

**Proof of Theorem 5.2: Step I:** Let  $\hat{\mathbf{S}}^{\beta}$  be the set of solutions of (5.2) satisfying Assumption 5.2. Let  $R > 0$  be an arbitrary real number and let us define a time  $\tau_R$  for **weakly** uniformly **GAS** solutions from  $\hat{\mathbf{S}}^{\beta}$  which start from the set  $B_{\mathbf{d}}(2R)$  and converge into the set  $B_{\mathbf{d}}(R)$ :

$$\tau_R = \sup_{x \in \hat{\mathbf{S}}^{\beta}(B_{\mathbf{d}}(2R))} \inf \{T > 0 : x(t) \in B_{\mathbf{d}}(R), \forall t \geq T\}.$$

Let us denote

$$\bar{\rho}(R) = \sup_{z \in \overline{B_{\mathbf{d}}(2R)}} \|z\| \quad \text{and} \quad \underline{\rho}(R) = \inf_{z \in \mathbb{R}^n \setminus B_{\mathbf{d}}(R)} \|z\|.$$

Notice that  $\bar{\rho}(R) > 0, \underline{\rho}(R) > 0$  for any  $R > 0$  and

$$\|x(t)\| \leq \beta(\|x(0)\|, t) \leq \beta(\bar{\rho}(R), t), \quad \forall t \geq 0$$

for any  $x \in \hat{\mathbf{S}}^{\beta}(\overline{B_{\mathbf{d}}(2R)})$ , where monotonicity of  $\beta \in \mathcal{KL}$  with respect to the first argument is taken into account. Since  $\beta(\bar{\rho}(R), t)$  monotonically tends to 0 as  $t \rightarrow +\infty$  then there exists a finite number  $T_R^{\beta} > 0$  such that  $\beta(\bar{\rho}(R), t) \leq \underline{\rho}(R), \forall t \geq T_R^{\beta}$ . This means  $\tau_R < +\infty$  for any  $R > 0$ .

On the other hand, we derive

$$\begin{aligned}
\tau_{R/2} &= \sup_{x \in \hat{\mathbf{S}}^\beta(B_{\mathbf{d}}(R))} \inf \{T > 0 : x(t) \in B_{\mathbf{d}}(R/2), \forall t \geq T\} \\
&= \sup_{x \in \hat{\mathbf{S}}^\beta(B_{\mathbf{d}}(R))} \inf \{T > 0 : \mathbf{d}(\ln(2))x(t) \in B_{\mathbf{d}}(R), \forall t \geq T\} \\
&= 2^\nu \sup_{x \in \hat{\mathbf{S}}^\beta(B_{\mathbf{d}}(R))} \inf \left\{ 2^{-\nu}T > 0 : \begin{array}{l} \mathbf{d}(\ln(2))x(2^\nu t) \in B_{\mathbf{d}}(R), \\ \forall t \geq 2^{-\nu}T \end{array} \right\} \\
&\leq 2^\nu \sup_{y \in \hat{\mathbf{S}}^\beta(\mathbf{d}(\ln(2))B_{\mathbf{d}}(R))} \inf \left\{ \tilde{T} > 0 : y(t) \in B_{\mathbf{d}}(R), \forall t \geq \tilde{T} \right\} \\
&= 2^\nu \sup_{y \in \hat{\mathbf{S}}^\beta(B_{\mathbf{d}}(2R))} \inf \left\{ \tilde{T} > 0 : y(t) \in B_{\mathbf{d}}(R), \forall t \geq \tilde{T} \right\} = 2^\nu \tau_R,
\end{aligned}$$

where  $y(t) = \mathbf{d}(\ln(2))x(2^\nu t)$ .

**Step II** In this step we will prove the **FTS** of the differential inclusion (5.2) when  $\nu < 0$ . Let  $x(\cdot, x_0) \in \mathbf{S}(x_0)$ , Proposition 5.1 implies that

$$x^s(t, x_0) = \mathbf{d}(s)x(e^{\nu s}t, x_0) \in \mathbf{S}(\mathbf{d}(s)x_0)$$

$$x^s(t_0, x_0) \in B_{\mathbf{d}}(2R) \implies x^s(t, x_0) \in B_{\mathbf{d}}(R); \forall t \geq t_0 + \tau_R, t_0 \geq 0.$$

Let  $x_0 \in B_{\mathbf{d}}(R)$  and  $t_0 = 0$ , we consider the solution  $x^s(t, x_0) = \mathbf{d}(s)x(e^{\nu s}t, x_0)$ ,  $x^s(0, x_0) = \mathbf{d}(s)x_0$ , and  $s = \ln(2)$ . Let  $\tilde{t}_0 = 2^{-\nu}\tau_R$ , one has

$$\begin{aligned}
x^{\ln(2)}(\tilde{t}_0, x_0) &= \mathbf{d}(\ln(2))x(\tau_R, x_0) \in B_{\mathbf{d}}(2R) \\
&\implies x^{\ln(2)}(t, x_0) \in B_{\mathbf{d}}(R), \forall t \geq \tilde{t}_0 + \tau_R,
\end{aligned}$$

which means that for every  $t \geq \tilde{t}_0 + \tau_R$ , we have

$$\begin{aligned}
\|\mathbf{d}(-\ln(R))x^s(t, x_0)\| \leq 1 &\Leftrightarrow \|\mathbf{d}(-\ln(R))\mathbf{d}(\ln(2))x(2^\nu t, x_0)\| \leq 1, \\
&\Leftrightarrow \|\mathbf{d}(-\ln(R) + \ln(2))x(2^\nu t, x_0)\| \leq 1, \\
&\Leftrightarrow \|\mathbf{d}(-\ln(\frac{R}{2}))x(2^\nu t, x_0)\| \leq 1.
\end{aligned}$$

Then, we deduce that  $x(t, x_0) \in B_{\mathbf{d}}(\frac{R}{2})$ ,  $\forall t \geq 2^\nu[\tilde{t}_0 + \tau_R]$ . Let now  $\tilde{t}_1 = \tilde{t}_0 + \tau_R$ , then

$$x^{\ln(2)}(\tilde{t}_1, x_0) = \mathbf{d}(\ln(2))x(2^\nu[\tilde{t}_0 + \tau_R], x_0) \in B_{\mathbf{d}}(R).$$

Again, from this we have  $x^{\ln(2)}(t, x_0) \in B_{\mathbf{d}}(\frac{R}{2})$ ,  $\forall t \geq \tilde{t}_1 + \tau_{\frac{R}{2}}$ , which implies that

$$x(t, x_0) \in B_{\mathbf{d}}\left(\frac{R}{4}\right), \forall t \geq 2^\nu\left[\tilde{t}_1 + \tau_{\frac{R}{2}}\right].$$

By iterating on  $i$ , we get

$$x(t, x_0) \in B_{\mathbf{d}}\left(\frac{R}{2^{i+1}}\right); \forall t \geq 2^\nu\left[\tilde{t}_i + \tau_{\frac{R}{2^i}}\right].$$

Where the sequence  $\{\tilde{t}_i\}_{i \in \mathbb{N}}$  is given by

$$\tilde{t}_{i+1} = \tilde{t}_i + \tau_{\frac{R}{2^i}} \leq \tilde{t}_i + 2^{i\nu}\tau_R \leq 2^{-\nu}\tau_R + \tau_R \sum_{k=0}^i 2^{k\nu}.$$

The degree of homogeneity  $\nu < 0$ , then we obtain

$$\lim_{i \rightarrow +\infty} \tilde{t}_i \leq \lim_{i \rightarrow +\infty} \left( 2^{-\nu} \tau(x_0, B_R) + \tau_R \sum_{k=0}^i 2^{k\nu} \right) = \left( 2^{-\nu} + \frac{1}{1-2^\nu} \right) \tau_R < +\infty.$$

Hence, the convergence time of  $x \in \hat{\mathbf{S}}^\beta(B_d(2R))$  to zero, i.e.

$$x(t, x_0) \in \bigcap_{i=1}^{\infty} B_{\frac{R}{2^i}} = \{0\},$$

$$\text{for every } t \geq 2^{-\nu} \tau_R + \tau_R \frac{2^\nu}{1-2^\nu}$$

admits the estimate

$$\left( 2^{-\nu} + \frac{2^\nu}{1-2^\nu} \right) \tau_R < +\infty.$$

■

Theorem 5.2 generalizes the results from [68], [7] about **FTS** of homogeneous **DI** with negative degree.

Proposition 5.1 implies that Assumption 5.2 is fulfilled for the set of all solutions of (5.2) provided that (5.2) is **strongly uniformly GAS**. Therefore, **strongly uniformly GAS** sub-homogeneous **DI** (5.2) with negative degree is **strongly uniformly GFTS**. Notice that the latter theorem does ask (explicitly) any restriction to  $F$ . Under some additional restrictions on  $F$  the same conclusion can be made using Theorem 5.1.

### Corollary 5.2

Let  $F$  satisfy the hypothesis of Theorem 5.1 with  $\nu < 0$ . If (5.2) is **strongly GAS** then it is **strongly uniformly GFTS**.

**Proof of Corollary 5.2:** According to Theorem 5.1, there exists a continuous pair  $(V, W)$  such that

1.  $V \in \mathcal{C}^p(\mathbb{R}^n, \mathbb{R}_+)$ ,  $V_0$  is positive definite and  $\mathbf{d}$ -homogeneous with degree of homogeneity  $k > \max\{-\nu, 0\}$ ;
2.  $W \in \mathcal{C}^\infty(\mathbb{R}^n \setminus \{0\}, \mathbb{R}_+)$ ,  $W$  is positive definite and  $\mathbf{d}$ -homogeneous with degree of homogeneity  $k + \nu$ ;
3.  $\max_{h \in F(x)} \langle DV(x), h \rangle \leq -W(x)$  for all  $x \neq 0$ .

Let  $\tau \geq 0$ , using the homogeneity of  $V$  and the sub-homogeneity of  $F$ , we get

$$\begin{aligned} e^{(k+\nu)\tau} \max_{h \in F(x)} \langle DV(x), h \rangle &= e^{k\tau} \max_{h \in e^{\nu\tau} \mathbf{d}(\tau)F(x)} \langle DV(x), \mathbf{d}(-\tau)h \rangle \\ &\leq \max_{h \in F(\mathbf{d}(\tau)x)} \langle DV(\mathbf{d}(\tau)x), h \rangle \\ &\leq -W(\mathbf{d}(\tau)x). \end{aligned} \tag{5.4}$$

Let  $R > 0$ , for  $\tau = -\ln\left(\frac{\|x\|_{\mathbf{d}}}{R}\right) \geq 0$ , from (5.4) and due to homogeneity, we obtain

$$\max_{h \in F(x)} \langle DV(x), h \rangle \leq -\frac{\bar{W}}{aR^{k+\nu}} V(x)^{\frac{k+\nu}{k}}, \quad (5.5)$$

$\forall \|x\|_{\mathbf{d}} \leq R$ , where  $a = \left(\max_{\|y\|_{\mathbf{d}}=1} V(y)\right)^{\frac{k+\nu}{k}}$  and  $\bar{W} = \min_{\|y\|_{\mathbf{d}}=R} W(y)$ . If  $\nu < 0$ , the inequality (5.5) implies that:

$$\begin{aligned} \dot{V}(x(t)) \leq -c [V(x(t))]^\alpha &\implies \frac{\dot{V}(x(t))}{[V(x(t))]^\alpha} \leq -c \\ [V(x(t))]^{1-\alpha} &\leq \begin{cases} [V(x_0)]^{1-\alpha} - (1-\alpha)ct, & t \leq \frac{[V(x_0)]^{1-\alpha}}{(1-\alpha)c} \\ 0, & t \geq \frac{[V(x_0)]^{1-\alpha}}{(1-\alpha)c} \end{cases} \end{aligned} \quad (5.6)$$

$\forall \|x_0\|_{\mathbf{d}} \leq R$ ,  $c = \frac{\bar{W}}{aR^{k+\nu}}$  and  $0 < \alpha = \frac{k+\nu}{k} < 1$ , then from (5.6) we conclude that the origin of (5.2) is **F**TS for all initial conditions  $x_0 \in B(0, R)$ . The **G**AS property of (5.2) implies that, for any  $x_0 \in \mathbb{R}^n$  and any  $R > 0$  there exists  $T_{R, x_0} > 0$  such that  $x(t) \in B(0, R)$ ,  $\forall t \geq T_{R, x_0}$ . This implies the **G**FTS of (5.2) (settling time function is bounded by  $T(x_0) \leq \frac{[V(x(T_{R, x_0}))]^{1-\alpha}}{(1-\alpha)c} + T_{R, x_0}$ ). We complete the proof noticing that for  $F$  satisfying the hypothesis of Theorem 5.1 the strong **G**AS is equivalent to strong uniform **G**AS (see [25] for more details). ■

## 5.4 Sup-homogeneous DI

### Definition 5.2

The set-valued mapping  $F : \mathbb{R}^n \rightrightarrows \mathbb{R}^n$  is said to be  $\mathbf{d}$ -sup-homogeneous with a degree of homogeneity  $\nu \in \mathbb{R}$  if it satisfies

$$e^{\nu s} \mathbf{d}(s)F(x) \subseteq F(\mathbf{d}(s)x), \quad \forall s \leq 0, \quad \forall x \in \mathbb{R}^n,$$

where  $\mathbf{d}$  is a linear dilation in  $\mathbb{R}^n$ .

In this section we consider **DI** (5.2) satisfying the assumption:

### Assumption 5.3

$F$  is  $\mathbf{d}$ -sup-homogeneous of the degree  $\nu \in \mathbb{R}$ .

The following proposition shows the symmetry of solutions to the differential inclusion (5.2) provided that  $F$  satisfies the sup-homogeneity property.

### Proposition 5.2

Let  $F$  satisfy Assumption 5.3. If  $x(\cdot)$  is a solution of (5.2), then for any  $s \leq 0$  the function  $t \rightarrow \mathbf{d}(s)x(e^{\nu s}t)$  is a solution of (5.2).

**Proof of Proposition 5.2:** Proof of proposition uses the sup-homogeneity property and follows the same steps as the proof of Proposition 5.1. ■

The following theorem shows the existence of a homogeneous Lyapunov function for an asymptotically stable *sup-homogeneous* differential inclusion.

**Theorem 5.3**

Let  $F$  satisfy Assumption 5.3 and be nonempty-, compact-, convex-valued and upper-semi-continuous. Let  $p \in \mathbb{N}$  be an arbitrary natural number. The origin of (5.2) is **GAS** if and only if there exists a pair  $(V, W)$  of continuous functions

- 1)  $V \in \mathcal{C}^p(\mathbb{R}^n, \mathbb{R}_+)$ ,  $V$  is positive definite and  $\mathbf{d}$ -homogeneous with a degree  $k > 0$  such that the matrix  $pG_{\mathbf{d}} - kI_n$  is Hurwitz;
- 2)  $W \in \mathcal{C}^\infty(\mathbb{R}^n \setminus \{0\}, \mathbb{R}_+)$ ,  $W$  is positive definite and  $\mathbf{d}$ -homogeneous with degree of homogeneity  $k + \nu$ ;
- 3)  $\max_{h \in F(x)} \langle \nabla V(x), h \rangle \leq -W(x)$  for all  $x \in \mathbb{R}^n \setminus \{0\}$ .

**Proof of Theorem 5.3:** We follow the arguments of the proof of Theorem 5.1 and we construct the so-called cut-off function  $a$ . For any constant  $\gamma > 0$ , by the definition of the dilation  $\mathbf{d}$  and since  $V_0(0) = 0$  and  $V_0(x) \rightarrow +\infty$  as  $\|x\| \rightarrow +\infty$ , there exist two numbers  $0 < v_1 < v_2$ , such that

$$\begin{aligned} V_0(\mathbf{d}(s)x) &\leq v_1, \text{ for } \|x\| = 1 \text{ and } \forall s \leq -\gamma, \\ V_0(\mathbf{d}(s)x) &\geq v_2, \text{ for } \|x\| = 1 \text{ and } \forall s \geq 0. \end{aligned} \tag{5.7}$$

This is the difference with the proof of Theorem 5.1 (the property (5.7) holds for a different interval of  $s$ ). The cut-off function  $a$  will have the same form that we defined in the proof of Theorem 5.1, then for  $k > \max\{-\nu, 0\}$  The Lyapunov function  $V$  is given by  $V(x) = \int_{\mathbb{R}} e^{-ks} a \circ V_0(\mathbf{d}(s)x) ds$  and the function  $W(x) = \int_{\mathbb{R}} e^{-(k+\nu)s} \dot{a}(V_0(\mathbf{d}(s)x)) W_0(\mathbf{d}(s)x) ds$ . ■

Let us introduce the assumption

**Assumption 5.4**

The property given in Assumption 5.2 is fulfilled for  $s \leq 0$ .

Similarly to Corollary 5.1, it can be shown that Assumption 5.4 is fulfilled if there exists a set  $\hat{\mathbf{S}}^\beta \subset \mathbf{S}$  of **weakly** uniformly stable solutions and

$$\exists \beta_{\mathbf{d}} \in \mathcal{KL}: \beta_{\mathbf{d}}(\rho, t) \geq \sup_{s \leq 0} \|\mathbf{d}(-s)\| \beta(\|\mathbf{d}(s)\| \rho, e^{-\nu s} t), \tag{5.8}$$

for all  $\forall t \geq 0$  and all  $\rho \geq 0$ , where  $\beta \in \mathcal{KL}$  corresponds to  $\hat{\mathbf{S}}^\beta$ .

Taking into account that any function  $\beta \in \mathcal{KL}$  admits the estimate [51, Lemma 7]

$$\sigma_1(\beta(\rho, t)) \leq \sigma_2(\rho) e^{-t}, \quad \sigma_1, \sigma_2 \in \mathcal{K}_\infty,$$

the condition (5.8) can be represented as follows

$$\exists \sigma_{\mathbf{d}} \in \mathcal{K}_{\infty} \quad : \quad \sigma_{\mathbf{d}}(\rho) \geq \sup_{s \leq 0} \|\mathbf{d}(-s)\| \sigma_2(\|\mathbf{d}(s)\| \rho),$$

provided that  $\nu \geq 0$ . Indeed, since  $e^{-e^{-\nu s} t} \leq e^{-t}$ ,  $\forall s \leq 0, \forall \nu \geq 0, \forall t \geq 0$  then we can select

$$\beta_{\mathbf{d}}(\rho, t) = \sigma_1^{-1}(\sigma_{\mathbf{d}}(\rho) e^{-t}), \quad \rho, t \geq 0.$$

#### Theorem 5.4

If the set  $\hat{\mathbf{S}}^{\beta} \subset \mathcal{S}$  of *weakly uniformly GAS* solutions satisfies the Assumption 5.2 for  $\nu > 0$  then  $\hat{\mathbf{S}}^{\beta}$  is the set of *weakly globally nearly FxTS* solutions.

**Proof of Theorem 5.4:** Let  $\hat{\mathbf{S}}^{\beta}$  be the set of solutions of satisfying Assumption 5.4. For a given  $R > 0$  and let us define

$$\tau_R = \sup_{x \in \hat{\mathbf{S}}^{\beta}(B_{\mathbf{d}}(2R))} \inf \{T > 0 : x(t) \in B_{\mathbf{d}}(R), \forall t \geq T\}.$$

If  $\nu > 0$  then repeating the proof of Theorem 5.2 we derive  $\tau_{2^i R} \leq 2^{-i\nu} \tau_R$  and the time of convergence of any solution from  $\hat{\mathbf{S}}^{\beta}$  to a  $\mathbf{d}$ -homogeneous ball of the radius  $R > 0$  is finite

$$\sum_{i=0}^{+\infty} \tau_{2^i R} \leq \tau_R \sum_{i=0}^{+\infty} 2^{-i\nu} = \frac{2^{\nu} \tau_R}{2^{\nu} - 1} < +\infty$$

independently of the initial value  $x(0)$ . ■

The latter theorem guarantees that the strongly uniformly **GAS** sup-homogeneous **DI** with positive degree is **strongly globally nearly FxTS**. Under additional restrictions on  $F$  this can be proven using Theorem 5.3.

#### Corollary 5.3

Let  $F$  satisfies the hypotheses of Theorem 5.3 with  $\nu > 0$ . If (5.2) is *strongly GAS* then it is *strongly globally nearly FxTS*.

**Proof of Corollary 5.3:** Since (5.2) satisfies Assumption 5.3 and it is **strongly GAS**, then there exists a continuous pair  $(V, W)$  such that

1.  $V \in \mathcal{C}^p(\mathbb{R}^n, \mathbb{R}_+)$ ,  $V_0$  is positive definite and  $\mathbf{d}$ -homogeneous with degree of homogeneity  $k > \max\{-\nu, 0\}$ ;
2.  $W \in \mathcal{C}^{\infty}(\mathbb{R}^n \setminus \{0\}, \mathbb{R}_+)$ ,  $W$  is strictly positive definite outside the origin and  $\mathbf{d}$ -homogeneous with degree of homogeneity  $k + \nu$ ;
3.  $\max_{h \in F(x)} \langle DV(x), h \rangle \leq -W(x)$  for all  $x \neq 0$ .

Using the homogeneity of  $V$  and the sub-homogeneity of  $F$ , we get for all  $\tau \leq 0$

$$\begin{aligned} e^{(k+\nu)\tau} \max_{h \in F(x)} \langle DV(x), h \rangle &= e^{k\tau} \max_{h \in e^{\nu\tau} \mathbf{d}(\tau)F(x)} \langle DV(x), \mathbf{d}(-\tau)h \rangle \\ &\leq \max_{h \in F(\mathbf{d}(\tau)x)} \langle DV(\mathbf{d}(\tau)x), h \rangle \\ &\leq -W(\mathbf{d}(\tau)x). \end{aligned} \quad (5.9)$$

For  $\tau = -\ln\left(\frac{\|x\|_{\mathbf{d}}}{R}\right) \leq 0$ ,  $R > 0$ , we obtain

$$\dot{V}(x) = \max_{h \in F(x)} \langle DV(x), h \rangle \leq -\frac{\bar{W}}{bR^{k+\nu}} V(x)^{\frac{k+\nu}{k}}, \quad \forall \|x\|_{\mathbf{d}} \geq R, \quad (5.10)$$

where  $b = \left(\max_{\|y\|_{\mathbf{d}}=1} V(y)\right)^{\frac{k+\nu}{k}}$  and  $\bar{W} = \min_{\|y\|_{\mathbf{d}}=R} W(y)$ . For  $\nu > 0$  the latter implies the fixed-time convergence to  $\|x\| \leq R$ . ■

## 5.5 FTS/FxTS of non-homogeneous systems

In this section, we consider the dynamical systems like (5.1) which are not homogeneous but admit the **FTS** and **FxTS** analysis using sub- and sup-homogeneity.

### 5.5.1 Sub-homogeneous extension

Studying the finite-time stability of a dynamical system by construction of a strict Lyapunov function is not easy sometimes. To simplify this analysis, we consider the **DI** (5.2) with

$$F(x) = \bigcup_{s \leq 0} \{e^{-\nu s} \mathbf{d}(-s) f(\mathbf{d}(s)x)\}, \quad (5.11)$$

where  $\mathbf{d}$  is a linear dilation and  $\nu \in \mathbb{R}$ . Indeed, the set valued mapping  $F$  is  $\mathbf{d}$ -sub-homogeneous with the degree of homogeneity  $\nu \in \mathbb{R}$ . The set  $F(x)$  is nonempty for every  $x \in \mathbb{R}^n$ . Since, by construction,  $f(x) \in F(x)$  for all  $x \in \mathbb{R}^n$  then any solution of (5.1) is a solution of (5.2), (5.11). Hence, Corollary 5.2 immediately implies

#### Corollary 5.4

Let  $f$  be continuous and  $F$  given by (5.11) with some  $\nu < 0$  be nonempty, convex, compact-valued and upper-semi-continuous. If the system (5.2) is **GAS** then (5.1) is **globally uniformly FTS**.

#### Corollary 5.5

If (5.1) is uniformly **GAS** with  $\beta \in \mathcal{KL}$  satisfying the condition (5.3) for some  $\nu < 0$  then it is **globally uniformly FTS**.

**Proof of Corollary 5.5:** The set of solutions of (5.1) is a subset  $\hat{\mathbf{S}}^\beta$  of **weakly AS** solutions of (5.2) with  $F$  given (5.11). Using Corollary 5.1 we conclude that all conditions of Theorem 5.2 are fulfilled and the origin of (5.1) is **globally uniformly FTS**. ■

### 5.5.2 Sup-homogeneous extension

In this section we define the sup-homogeneous extension of a vector field  $f$  as follows

$$F(x) = \bigcup_{s \geq 0} \{e^{-\nu s} \mathbf{d}(-s) f(\mathbf{d}(s)x)\}, \quad (5.12)$$

where  $\mathbf{d}$  is a linear dilation and  $\nu \in \mathbb{R}$ .

Similarly to the previous section, the following condition of the **nearly FxTS** of the system (5.1) can be derived.

#### Corollary 5.6

Let  $f$  be continuous and  $F$  given by (5.12) with some  $\nu > 0$  be nonempty, convex, compact-valued and upper-semi-continuous. If the system (5.2) is **GAS** then (5.1) is **globally nearly FxTS**.

#### Corollary 5.7

If (5.1) is **GAS** with  $\beta \in \mathcal{KL}$  satisfying the condition (5.8) then it is **globally nearly FxTS**.

The rate of convergence of the system (5.1) is defined the sign of the homogeneity degree  $\nu$ . If the system (5.1) satisfies the conditions (5.3) and (5.8) for two different degrees  $\nu_- < 0$  and  $\nu_+ > 0$ , respectively, then one can provide **FxTS** results.

Combining the above results we derive the condition of global **FxTS**.

#### Corollary 5.8

If (5.1) is **GAS** with  $\beta \in \mathcal{KL}$  satisfying both (5.3) and (5.8) with some  $\nu_- < 0$  and  $\nu_+ > 0$ , respectively, then (5.1) is **globally FxTS**.

**Proof of Corollary 5.8:** Using Corollary 5.7 we deduce that the system (5.1) is **nearly** fixed-time stable and to a ball  $B_R$  in a fixed time  $T$ . In addition, Corollary 5.5 implies that the system (5.1) is **FTS** for all  $x_0 \in B_R$ . These two facts imply that the state of the system (5.1) converges to the origin in a fixed time (see Fig. 5.1).■

#### Corollary 5.9

If hypotheses of both corollaries 5.4 and 5.6 hold, simultaneously, then (5.1) is **globally FxTS**.

## 5.6 Academic example

Let us consider the second order system

$$\begin{cases} \dot{x}_1 = x_2, \\ \dot{x}_2 = -k_1(x_1) - k_2(x_2), \end{cases} \quad (5.13)$$



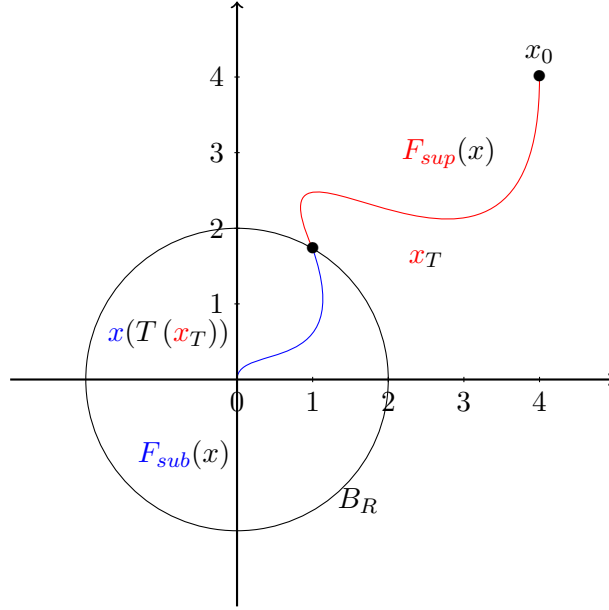

Figure 5.1: Fixed-time stable solution.

where  $x_1(t), x_2(t) \in \mathbb{R}$  are components of the state vector  $x = (x_1, x_2)^\top$  and

$$k_i \in \mathcal{C}(\mathbb{R}, \mathbb{R}), \quad k_i(\rho)\rho > 0, \quad \forall \rho \in \mathbb{R}, \quad i = 1, 2.$$

Let us denote by  $f$  the vector field, which defines the right-hand side of the considered system. It is easy to see that  $f$  is continuous on  $\mathbb{R}^2$ . The system (5.13) can be interpreted as a mechanical model with the total energy (i.e. the sum of kinetic and potential energy) given by

$$U(x) = \int_0^{x_1} k_1(\sigma) d\sigma + \frac{x_2^2}{2}.$$

The mechanical system is dissipative since

$$\langle \nabla U(x), f(x) \rangle = -k_2(x_2)x_2 < 0 \quad \text{for } x_2 \neq 0.$$

Applying LaSalle invariance principle (Barbashin-Krasovski Theorem) we conclude that the origin of the considered system is **GAS**. Its **FTS** and (**nearly**) **FxTS** can be studied using the sub/sup-homogeneous extensions. Taking

$$\mathbf{d}(s) = \text{diag}\{e^s, e^{(1+\nu)s}\}, s \in \mathbb{R}, \quad \text{and} \quad \nu > -1$$

we derive

$$g(s, x) := e^{-\nu s} \mathbf{d}(-s) f(\mathbf{d}(s)x) = \begin{pmatrix} x_2 \\ -e^{-(1+2\nu)s} (k_1(e^s x_1) + k_2(e^{(1+\nu)s} x_2)) \end{pmatrix}.$$

Let the functions  $k_1, k_2$  and the degree  $\nu$  be such that

$$e^{-(1+2\nu)s} k_1(e^s x_1) = k_1(x_1), \quad \forall s \in \mathbb{R}, \quad x_1 \in \mathbb{R}.$$

Then

$$\langle \nabla U(x), g(s, x) \rangle = -e^{-(1+2\nu)s} x_2 k_2(e^{(1+\nu)s} x_2) < 0$$

and for any sub-homogeneous extension

$$F(x) = \overline{\text{co}} \bigcup_{s \leq 0} \{g(s, x)\} \quad (5.14)$$

we have

$$\sup_{y \in F(x)} \langle \nabla U(x), y \rangle \leq 0, \quad x_2 \neq 0.$$

If

$$0 < \liminf_{s \rightarrow -\infty} e^{-(1+2\nu)s} x_2 k_2(e^{(1+\nu)s} x_2) \leq \limsup_{s \rightarrow -\infty} e^{-(1+2\nu)s} x_2 k_2(e^{(1+\nu)s} x_2) < +\infty, \quad \forall x_2 \neq 0.$$

then, obviously,  $F$  is nonempty-, compact-, convex-valued and upper-semi-continuous. Moreover, the sub-homogeneous extension (5.2), (5.11) is **strongly GAS** due LaSalle invariance principle (see Theorem 14, [30] for an extension of the LaSalle invariance principal to **DI**). Hence, from Corollary 5.4 we conclude that (5.13) is **globally uniformly FTS**. For example, if

$$k_1(x_1) = -x_1^{1/3}, \quad k_2(x_2) = -\frac{x_2}{\sqrt{|x_2|}} (1 + |x_2|(1 + \cos(1/x_2)) + 0.5 \sin(1/x_2))$$

the system (5.13) does not have an asymptotically stable **d**-homogeneous approximation at 0. Moreover, the homogeneous extension (4.2) studied in Chapter 4 is not bounded-valued, but the system is **globally FTS** since the conditions given above are fulfilled for  $\nu = -1/3$  and the sub-homogeneity allows us to apply the conventional homogeneity-based arguments for analysis of this non-homogeneous system as well.

Similarly if  $\nu > 0$  and

$$0 < \liminf_{s \rightarrow +\infty} e^{-(1+2\nu)s} x_2 k_2(e^{(1+\nu)s} x_2) \leq \limsup_{s \rightarrow +\infty} e^{-(1+2\nu)s} x_2 k_2(e^{(1+\nu)s} x_2) < +\infty, \quad \forall x_2 \neq 0$$

then the sup-homogeneous extension

$$F(x) = \overline{\text{co}} \bigcup_{s \geq 0} \{g(s, x)\} \quad (5.15)$$

is nonempty-, compact-, convex-valued and upper-semi-continuous. Moreover, the system (5.2), (5.12) is **GAS** and the origin of the system (5.13) is **globally nearly FxTS** in the view of Corollary 5.4. For example, the required conditions are fulfilled for  $k_1(x_1) = -x_1^3$  and  $k_2(x_2) = -x_2|x_2|(1 + 0.5 \sin(x))$ .

Notice that to analyze **FTS (nearly FxTS)** of (5.13) a strict Lyapunov function  $V(x) = U^\gamma(x) + \varepsilon x_1 x_2$  with  $\varepsilon, \gamma > 0$  can be utilized. However, in this case, to prove **FTS** we need to show  $\dot{V}(x) \leq -cV^{1-\alpha}(x)$  with  $\alpha \in (0, 1)$ ,  $c > 0$  at least close to the origin (to infinity, respectively). The corresponding derivations are much more cumbersome (see e.g. [79]) than the given above sub-homogeneous extension-based analysis.

## 5.7 Conclusion

The notions of sup- and sub-homogeneity were introduced. These concepts allow some systems which do not admit homogeneous approximations to be analyzed using the homogeneity technique. **FTS/FxTS** of sub/sup-homogeneous **DI**s as well as **weak FTS/FxTS** are investigated. Some sufficient conditions to a set of uniformly **GAS** solutions to guarantee its **FTS/FxTS** are derived. It is shown that non-homogeneous systems, which admit **GAS** sub/sup-homogeneous extensions, are **FTS/FxTS** for negative/positive homogeneity degree. The results are supported with academic example.

# Conclusion and perspectives

The investigations of this thesis focused on analysis of **FT** convergence rates and stability robustness for dynamical systems in control and estimation. These kinds of performance were selected due to their importance and popularity in many industrial applications. Since detailed qualitative and quantitative analysis of plant's comportment via Lyapunov function method may be quite difficult (there is no tool for selection of a Lyapunov function for a generic nonlinear dynamical system), the theory of homogeneity was considered. The advantage of homogeneity is that this property can be checked algebraically, then many features of homogeneous dynamical systems (like convergence rates and robustness, for instance) can be established by the homogeneity degree. However, the class of homogeneous systems or ones, which yield local homogeneous approximations, is still limited. That is why different relaxations of the concepts of homogeneity were proposed in this work.

The main results of the thesis are presented in chapters 3–5.

The problems of robustness and uniformity of **FTS** for nonlinear dynamical systems were considered in Chapter 3. Starting with an affine system, which is homogeneous for any constant value of the disturbance, the conditions of uniform **FTS** were derived in the presence of disturbances. These results were developed to assess the behavior of perturbed systems admitting a homogeneous approximation. Additionally, the notions of **FTISS** and strong **FTiISS** were also investigated. One section was devoted to analysis of interconnected systems. In particular, it was proven that a cascade of homogeneous affine systems with disturbances preserves either **FTS** or **FTISS** property. It was demonstrated that the key condition to check is the degree of homogeneity, *i.e.*, the concept of homogeneity showed its utility, since it allows the construction of a Lyapunov function to be avoided in applications for verification of assumptions imposed in this chapter.

In Chapter 4 the notion of homogeneous extensions was introduced. This concept provides qualitative means to study the robustness and the convergence rates of nonlinear systems that do not admit homogeneous approximation at the origin nor at infinity. It was demonstrated that a homogeneous Lyapunov function can be found for a homogeneous extension provided that it is derived for a globally asymptotically stable nonlinear system. This result allows the exact rate of convergence of dynamical systems to be established regarding only the degree of homogeneity of their homogeneous extensions.

Finally, in Chapter 5 we considered the problem of **FTS/FxTS** for nonlinear dynamical systems, which may do not admit a homogeneous extension. New relaxed "homogeneity" concepts, called sup- or sub-homogeneity, were introduced, which guarantee a sort of symmetry of solutions for admitted dynamical systems. It was shown that a sup-/sub-homogeneous system can be embedded in a homogeneous differential inclusion, which can be used to investigate **FTS** and near **FxTS** properties of the nominal dynamics. It was proven that for a **GAS** system the corresponding sup-/sub-homogeneous differential inclusion admits a homogeneous Lyapunov function. This result was used to derive the conditions of **FTS**/near **FxTS** for

these class of systems by analyzing the degree's sign of sup-/sub-homogeneity.

To summarize, the introduced notions of homogeneous extensions and sub-/sup-homogeneity allow the **FT** convergence rates and stability robustness features to be investigated for a rather general class of nonlinear dynamical systems by avoiding an explicit design of respective (*e.g.*, **FT** or **ISS**) Lyapunov functions. The efficiency of these new tools was demonstrated by several their applications to design and analysis of control and estimation algorithms.

In the light of real-world applications and their needs, some open research directions in the domain of the thesis' research are presented below:

- The problem of robust (and uniform) state observer design for nonlinear systems with uncertainty can be treated for many classes of nonlinear dynamical systems by using the techniques of sup- and sub-homogeneous extensions. An issue for designing an observer for uncertain systems is that it is difficult to use the copy of the plant's model in the estimator construction due to the presence of unknown or varying elements. However, the differential inclusions obtained for sup-/sub-homogeneous dynamical systems may hide these uncertain elements, and an observer can be designed for this differential inclusion using the conventional methodology.
- The extensions introduced in this work can also be used to draw new methods of designing **FT** or **FxT** controllers for uncertain nonlinear systems having parametric variations and time-varying components. Again, analysis of robustness or convergence rate can be simplified greatly in such a case.
- Another direction, which can be considered for a future research, is to generalize the obtained in this work results to nonlinear evolution systems. Some preliminary results can be found in [75, 76] for design of **FT** controllers for homogeneous evolution systems. Since development of the theory of Lyapunov functionals is really sophisticated in the field of partial differential equations, the sup-/sub- and homogeneous extensions can be very useful for the analysis and investigation of the rate of convergence for nonlinear evolution systems.
- The sup- and sub-homogeneous extensions can also be constructed for initially discontinuous systems. Hence, they can be used to study the existence and regularity of solutions for some class of set-valued models by using the theory of Filippov. Moreover, these extensions may be applied to design a controller, which guarantees the asymptotic, **FT** or **FxT** stability for discontinuous dynamical systems.

To conclude, the properties of homogeneity and homogeneous extensions are very useful for the stability analysis, control, observer design, and the Lyapunov function's construction. Theoretical advances in these research directions will likely further the development of more comprehensive frameworks for stability of practical applications.

# Bibliography

- [1] Dirk Aeyels. “Stabilization of a class of nonlinear systems by a smooth feedback control.” In: *Systems & Control Letters* 5.5 (1985), pp. 289–294 (cit. on p. 37).
- [2] Vincent Andrieu, Laurent Praly, and Alessandro Astolfi. “Homogeneous approximation, recursive observer design, and output feedback.” In: *SIAM Journal on Control and Optimization* 47.4 (2008), pp. 1814–1850 (cit. on pp. 35, 36, 45, 58, 82).
- [3] Daniele Angeli, Brian P Ingalls, Eduardo Sontag, and Y Wang. “Uniform global asymptotic stability of differential inclusions.” In: *Journal of Dynamical and Control Systems* 10.3 (2004), pp. 391–412 (cit. on p. 26).
- [4] Murat Arcak and Petar Kokotović. “Nonlinear observers: a circle criterion design and robustness analysis.” In: *Automatica* 37.12 (2001), pp. 1923–1930 (cit. on pp. 1, 9, 47, 61).
- [5] Zvi Artstein. “Stabilization with relaxed controls.” In: 1983 (cit. on p. 40).
- [6] Andrea Bacciotti and Lionel Rosier. *Liapunov functions and stability in control theory*. Springer Science & Business Media, 2006 (cit. on pp. 31, 39, 83).
- [7] Emmanuel Bernuau, Denis Efimov, Wilfrid Perruquetti, and Andrey Polyakov. *Homogeneity of differential inclusions*. 2015 (cit. on p. 102).
- [8] Emmanuel Bernuau, Denis Efimov, Wilfrid Perruquetti, and Andrey Polyakov. “On an extension of homogeneity notion for differential inclusions.” In: *Control Conference ECC, 2013 European*. IEEE. 2013, pp. 2204–2209 (cit. on pp. 8, 54).
- [9] Emmanuel Bernuau, Denis Efimov, Wilfrid Perruquetti, and Andrey Polyakov. “On homogeneity and its application in sliding mode control.” In: *Journal of the Franklin Institute* 351.4 (2014), pp. 1866–1901 (cit. on pp. 2, 9, 26, 27, 30, 34, 35).
- [10] Emmanuel Bernuau, Andrey Polyakov, Denis Efimov, and Wilfrid Perruquetti. “Verification of ISS, iISS and IOSS properties applying weighted homogeneity.” In: *Systems & Control Letters* 62.12 (2013), pp. 1159–1167 (cit. on pp. 2, 9, 47, 55, 57, 61, 62, 66).
- [11] Sanjay P. Bhat and Dennis S. Bernstein. “Finite-time stability of continuous autonomous systems.” In: *SIAM Journal on Control and Optimization* 38.3 (2000), pp. 751–766 (cit. on pp. 7, 14–18, 22, 23, 45).
- [12] Sanjay P. Bhat and Dennis S. Bernstein. “Finite-time stability of homogeneous systems.” In: *Proceedings of the 1997 American Control Conference (Cat. No. 97CH36041)*. Vol. 4. IEEE. 1997, pp. 2513–2514 (cit. on pp. 32, 34, 45).
- [13] Sanjay P. Bhat and Dennis S. Bernstein. “Geometric homogeneity with applications to finite-time stability.” In: *Mathematics of Control, Signals and Systems* 17.2 (2005), pp. 101–127 (cit. on pp. 7, 8, 18–20, 22, 33, 34, 45, 50, 52).
- [14] S.P. Bhat and D.S. Bernstein. “Finite-time stability of continuous autonomous systems.” In: *SIAM Journal of Control and Optimization* 38(3) (2000), pp. 751–766 (cit. on p. 30).

- [15] Benjamin Biemond, Nathan van de Wouw, and Henk Nijmeijer. “Bifurcations of equilibrium sets in mechanical systems with dry friction.” In: *Physica D: Nonlinear Phenomena* 241.22 (2012), pp. 1882–1894 (cit. on p. 90).
- [16] Youness Braidiz, Denis Efimov, Andrey Polyakov, and Wilfrid Perruquetti. “On finite-time stability of sub-homogeneous differential inclusions.” In: *IFAC 2020-21rst IFAC World Congress*. 2020 (cit. on p. 95).
- [17] Youness Braidiz, Denis Efimov, Andrey Polyakov, and Wilfrid Perruquetti. “On robustness of finite-time stability of homogeneous affine nonlinear systems and cascade interconnections.” In: *International Journal of Control* 0.ja (2020), pp. 1–22. eprint: <https://doi.org/10.1080/00207179.2020.1823017> (cit. on p. 62).
- [18] Youness Braidiz, Denis Efimov, Andrey Polyakov, and Wilfrid Perruquetti. “Robust Finite-time stability of homogeneous systems with respect to multiplicative disturbances.” In: *2019 18th European Control Conference (ECC)*. IEEE. 2019, pp. 668–673 (cit. on p. 62).
- [19] Youness Braidiz, Wilfrid Perruquetti, Andrey Polyakov, and Denis Efimov. “On finite-time stability of homogeneous systems with multiplicative bounded function.” In: *2019 18th European Control Conference (ECC)*. IEEE. 2019, pp. 645–649 (cit. on pp. 7, 95).
- [20] Youness Braidiz, Andrey Polyakov, Denis Efimov, and Wilfrid Perruquetti. “On fixed-time stability of a class of nonlinear time-varying systems.” In: *IFAC 2020-21rst IFAC World Congress*. 2020 (cit. on p. 95).
- [21] Roger W. Brockett et al. “Asymptotic stability and feedback stabilization.” In: *Differential geometric control theory* 27.1 (1983), pp. 181–191 (cit. on p. 24).
- [22] Christopher I. Byrnes and Alberto Isidori. “New results and examples in nonlinear feedback stabilization.” In: *Systems & Control Letters* 12.5 (1989), pp. 437–442 (cit. on p. 42).
- [23] Antoine Chaillet, David Angeli, and Hiroshi Ito. “Combining iISS and ISS with respect to small inputs: the Strong iISS property.” In: *IEEE Transactions on Automatic Control* 59.9 (2014), pp. 2518–2524 (cit. on pp. 47, 55, 61).
- [24] Antoine Chaillet, David Angeli, and Hiroshi Ito. “Strong iISS is preserved under cascade interconnection.” In: *Automatica* 50.9 (2014), pp. 2424–2427 (cit. on pp. 47, 55–57, 61, 72).
- [25] Francis Clarke. “Lyapunov functions and feedback in nonlinear control.” In: *Optimal control, stabilization and nonsmooth analysis*. Springer, 2004, pp. 267–282 (cit. on pp. 98, 103).
- [26] Francis Clarke, Yu S. Ledyaev, and Ronald J Stern. “Asymptotic stability and smooth Lyapunov functions.” In: *Journal of differential Equations* 149.1 (1998), pp. 69–114 (cit. on pp. 16, 20, 29, 40, 82, 83).
- [27] Jean-Michel Coron. *Control and nonlinearity*. 136. American Mathematical Soc., 2007 (cit. on pp. 37–39).

- [28] Jean-Michel Coron. “On the stabilization in finite time of locally controllable systems by means of continuous time-varying feedback law.” In: *SIAM Journal on Control and Optimization* 33.3 (1995), pp. 804–833 (cit. on p. 14).
- [29] Emmanuel Cruz-Zavala, Emmanuel Nuno, and Jaime A Moreno. “Finite-time regulation of robot manipulators: an energy shaping approach.” In: *IFAC-PapersOnLine* 50.1 (2017), pp. 9583–9588 (cit. on p. 42).
- [30] W Desch, H Logemann, EP Ryan, and ED Sontag. “Meagre functions and asymptotic behaviour of dynamical systems.” In: *Nonlinear Analysis: Theory, Methods & Applications* 44.8 (2001), pp. 1087–1109 (cit. on pp. 82, 109).
- [31] Rodney D Driver. “Methods of AM Lyapunov and their application (VI Zubov).” In: *SIAM Review* 7.4 (1965), p. 570 (cit. on p. 7).
- [32] Denis Efimov and Wilfrid Perruquetti. “On conditions of oscillations and multi-homogeneity.” In: *Mathematics of Control, Signals, and Systems* 28.1 (2016), p. 3 (cit. on p. 35).
- [33] Denis Efimov, Andrei Polyakov, Wilfrid Perruquetti, and J-P Richard. “Weighted homogeneity for time-delay systems: Finite-time and independent of delay stability.” In: *IEEE Transactions on Automatic Control* 61.1 (2015), pp. 210–215 (cit. on p. 8).
- [34] Aleksej Fedorovič Filippov. “Differential Equations with Discontinuous Righthand Sides: Control Systems.” In: *Mathematics and its Applications. Springer Netherlands* (1988) (cit. on pp. 14, 25, 85).
- [35] Aleksej Fedorovič Filippov. “Differential equations with multi-valued discontinuous right-hand side.” In: (cit. on p. 25).
- [36] Irmgard Flügge-Lotz. *Discontinuous and Optional Control*. McGraw-Hill book Company, Incorporated, 1968 (cit. on p. 14).
- [37] Alexander Fradkov. *Cybernetical physics: from control of chaos to quantum control*. Springer, 2007 (cit. on p. 7).
- [38] Randy Freeman and Petar V. Kokotovic. *Robust nonlinear control design: state-space and Lyapunov techniques*. Springer Science and Business Media, 2008 (cit. on pp. 1, 9, 47, 61).
- [39] Wolfgang Hahn. *Stability of Motion*. New York: Springer-Verlag Berlin Heidelberg, 1967 (cit. on pp. 30, 52).
- [40] V.T. Haimo. “Finite time controllers.” In: *SIAM Journal of Control and Optimization* 24(4) (1986), pp. 760–770 (cit. on pp. 7, 20, 21).
- [41] Henry Hermes. “Nilpotent and high-order approximations of vector field systems.” In: *SIAM Review* 33.2 (1991), pp. 238–264 (cit. on p. 31).
- [42] Henry Hermes. “Nilpotent approximations of control systems and distributions.” In: *SIAM Journal on Control and Optimization* 24.4 (1986), pp. 731–736 (cit. on pp. 8, 31).
- [43] Henry Hermes. “Nilpotent approximations of control systems and distributions.” In: *SIAM Journal of Control and Optimization* 24 (1986), pp. 731–736 (cit. on p. 30).



- [44] Yiguang Hong, Zhong-Ping Jiang, and Gang Feng. “Finite-time input-to-state stability and applications to finite-time control.” In: *IFAC Proceedings Volumes* 41.2 (2008), pp. 2466–2471 (cit. on p. 55).
- [45] Yiguang Hong, Zhong-Ping Jiang, and Gang Feng. “Finite-time input-to-state stability and applications to finite-time control design.” In: *SIAM Journal on Control and Optimization* 48.7 (2010), pp. 4395–4418 (cit. on p. 15).
- [46] Yiguang Hong, Yangsheng Xu, and Jie Huang. “Finite-time control for robot manipulators.” In: *Systems & control letters* 46.4 (2002), pp. 243–253 (cit. on p. 42).
- [47] Zhong-Ping Jiang, Andrew R. Teel, and Laurent Praly. “Small-gain theorem for ISS systems and applications.” In: *Mathematics of Control, Signals and Systems* 7.2 (1994), pp. 95–120 (cit. on pp. 61, 72).
- [48] Velimir Jurdjevic and John P Quinn. “Controllability and stability.” In: *Journal of differential equations* 28.3 (1978), pp. 381–389 (cit. on p. 37).
- [49] Matthias Kawski. “Geometric homogeneity and stabilization.” In: *Nonlinear Control Systems Design 1995*. Elsevier, 1995, pp. 147–152 (cit. on pp. 8, 31, 34, 37).
- [50] Matthias Kawski. “Homogeneous feedback stabilization.” In: *New trends in systems theory*. Springer, 1991, pp. 464–471 (cit. on pp. 8, 50).
- [51] Christopher M Kellett. “A compendium of comparison function results.” In: *Mathematics of Control, Signals, and Systems* 26.3 (2014), pp. 339–374 (cit. on pp. 100, 104).
- [52] V.V. Khomenyuk. “Systems of ordinary differential equations with generalized homogeneous right-hand sides.” In: *Izvestiya Vysshikh Uchebnykh Zavedenii. Matematika* 3 (1961), pp. 157–164 (cit. on pp. 8, 34).
- [53] Valerii Korobov. “A general approach to synthesis problem.” In: *Doklady Akademii Nauk SSSR* 248 (1979), pp. 1051–1063 (cit. on p. 7).
- [54] Huibert Kwakernaak and Raphael Sivan. *Linear optimal control systems*. Vol. 1. Wiley-interscience New York, 1972 (cit. on p. 37).
- [55] Arie Levant. “Homogeneity approach to high-order sliding mode design.” In: *Automatica* 41.5 (2005), pp. 823–830 (cit. on pp. 8, 82).
- [56] Francisco Lopez-Ramirez, Denis Efimov, Andrey Polyakov, and Wilfrid Perruquetti. “Conditions for fixed-time stability and stabilization of continuous autonomous systems.” In: *Systems & Control Letters* 129 (2019), pp. 26–35 (cit. on pp. 15, 24, 45).
- [57] Francisco Lopez-Ramirez, Andrey Polyakov, Denis Efimov, and Wilfrid Perruquetti. “Finite-Time and Fixed-Time Observers Design via Implicit Lyapunov Function.” In: *European Control Conference 2016*. Aalborg, Denmark, June 2016 (cit. on p. 15).
- [58] Ioël’ Gil’evich Malkin. *Theory of stability of motion*. Vol. 3352. US Atomic Energy Commission, Office of Technical Information, 1959 (cit. on p. 34).
- [59] Emmanuel Moulay. “Stabilization via homogeneous feedback controls.” In: *Automatica* 44.11 (2008), pp. 2981–2984 (cit. on pp. 37, 40, 47, 54).

- [60] Emmanuel Moulay and Wilfrid Perruquetti. “Finite time stability and stabilization of a class of continuous systems.” In: *Journal of Mathematical Analysis and Applications* 323.2 (2006), pp. 1430–1443 (cit. on p. 14).
- [61] Emmanuel Moulay and Wilfrid Perruquetti. “Finite time stability conditions for non-autonomous continuous systems.” In: *International Journal of control* 81.5 (2008), pp. 797–803 (cit. on pp. 14, 15, 21, 22).
- [62] Emmanuel Moulay and Wilfrid Perruquetti. “Finite time stability of differential inclusions.” In: *IMA Journal of Mathematical Control and Information* 22.4 (2005), pp. 465–475 (cit. on pp. 15, 25, 27, 28, 45).
- [63] Emmanuel Moulay and Wilfrid Perruquetti. “Finite time stability of nonlinear systems.” In: *Decision and Control, 2003. Proceedings. 42nd IEEE Conference on*. Vol. 4. IEEE. 2003, pp. 3641–3646 (cit. on pp. 45, 47).
- [64] Emmanuel Moulay and Wilfrid Perruquetti. “Lyapunov-based approach for finite time stability and stabilization.” In: *Decision and Control, 2005 and 2005 European Control Conference. CDC-ECC’05. 44th IEEE Conference on*. IEEE. 2005, pp. 4742–4747 (cit. on pp. 37, 41, 47).
- [65] Hisakazu Nakamura, Yuh Yamashita, and Hirokazu Nishitani. “Lyapunov functions for homogeneous differential inclusions.” In: *IFAC Proceedings Volumes* 37.13 (2004), pp. 733–738 (cit. on p. 96).
- [66] Hisakazu Nakamura, Yuh Yamashita, and Hirokazu Nishitani. “Smooth Lyapunov functions for homogeneous differential inclusions.” In: *SICE 2002. Proceedings of the 41st SICE Annual Conference*. Vol. 3. IEEE. 2002, pp. 1974–1979 (cit. on pp. 32, 54).
- [67] Nami Nakamura, Hisakazu Nakamura, Yuh Yamashita, and Hirokazu Nishitani. “Homogeneous stabilization for input affine homogeneous systems.” In: *IEEE Transactions on Automatic Control* 54.9 (2009), pp. 2271–2275 (cit. on p. 54).
- [68] Yury Orlov. “Finite time stability and robust control synthesis of uncertain switched systems.” In: *SIAM Journal on Control and Optimization* 43.4 (2004), pp. 1253–1271 (cit. on pp. 15, 25, 45, 102).
- [69] Yury Orlov. “Finite time stability and robust control synthesis of uncertain switched systems.” In: *SIAM Journal of Control and Optimization* 43(4) (2005), pp. 1253–1271 (cit. on p. 15).
- [70] Wilfrid Perruquetti, Thierry Floquet, and Emmanuel Moulay. “Finite-time observers: application to secure communication.” In: *IEEE Transactions on Automatic Control* 53.1 (2008), pp. 356–360 (cit. on pp. 15, 42–44, 76, 77).
- [71] Andrey Polyakov. *Generalized Homogeneity in Systems and Control*. Springer, 2020 (cit. on pp. 48–52, 54).
- [72] Andrey Polyakov. “Nonlinear feedback design for fixed-time stabilization of linear control systems.” In: *IEEE Transactions on Automatic Control* 57.8 (2011), pp. 2106–2110 (cit. on pp. 7, 15, 19, 23, 28, 43).
- [73] Andrey Polyakov. “Quadratic-like stability of nonlinear homogeneous systems.” In: *56th IEEE Conference on Decision and Control*. 2017 (cit. on pp. 48, 52–54, 86).

- [74] Andrey Polyakov. “Sliding mode control design using canonical homogeneous norm.” In: *International Journal of Robust and Nonlinear Control* (2018) (cit. on pp. 48–54, 86).
- [75] Andrey Polyakov, Jean-Michel Coron, and Lionel Rosier. “On Homogeneous Finite-Time Control for Linear Evolution Equation in Hilbert Space.” In: *IEEE Transactions on Automatic Control* (2018) (cit. on pp. 8, 45, 48–51, 82, 112).
- [76] Andrey Polyakov, Denis Efimov, Emilia Fridman, and Wilfrid Perruquetti. “On Homogeneous Distributed Parameter Systems.” In: *IEEE Transactions on Automatic Control* 61.11 (2016), pp. 3657–3662 (cit. on pp. 8, 48–50, 112).
- [77] Andrey Polyakov, Denis Efimov, and Wilfrid Perruquetti. “Finite-time and fixed-time stabilization: Implicit Lyapunov function approach.” In: *Automatica* 51 (2015), pp. 332–340 (cit. on p. 15).
- [78] Andrey Polyakov and Leonid Fridman. “Stability notions and Lyapunov functions for sliding mode control systems.” In: *Journal of the Franklin Institute* 351.4 (2014), pp. 1831–1865 (cit. on pp. 16, 29).
- [79] Andrey Polyakov, Yuri Orlov, Harshal Oza, and Sarah Spurgeon. “Robust finite-time stabilization and observation of a planar system revisited.” In: *2015 54th IEEE Conference on Decision and Control (CDC)*. IEEE. 2015, pp. 5689–5694 (cit. on pp. 90, 109).
- [80] Lionel Rosier. “Etude de quelques problemes de stabilisation.” PhD thesis. Cachan, Ecole normale supérieure, 1993 (cit. on pp. 8, 34, 42, 50).
- [81] Lionel Rosier. “Homogeneous Lyapunov function for homogeneous continuous vector field.” In: *Systems & Control Letters* 19.6 (1992), pp. 467–473 (cit. on pp. 8, 34, 52, 85, 86, 97, 98).
- [82] Emilio Roxin. “On finite stability in control systems.” In: *Rendiconti del Circolo Matematico di Palermo* 15.3 (1966), pp. 273–282 (cit. on pp. 7, 14).
- [83] EP Ryan. “Optimal feedback control of saturating systems.” In: *International Journal of Control* 35.3 (1982), pp. 521–534 (cit. on p. 14).
- [84] EP Ryan. “Singular optimal controls for second-order saturating systems.” In: *International Journal of Control* 30.4 (1979), pp. 549–564 (cit. on p. 25).
- [85] Tonametl Sanchez, Denis Efimov, Andrey Polyakov, Jaime Moreno, and Wilfrid Perruquetti. “On homogeneity of discrete-time systems: stability and convergence rates.” In: *International Journal of Robust and Nonlinear Control* (2019) (cit. on p. 8).
- [86] Yanjun Shen, Yuehua. Huang, and Jason Gu. “Global Finite-Time Observers for Lipschitz Nonlinear Systems.” In: *IEEE Transactions on Automatic Control* 56(2) (2011), pp. 418–424 (cit. on p. 15).
- [87] Eduardo D. Sontag. “A ‘universal’ construction of Artstein’s theorem on nonlinear stabilization.” In: *Systems & control letters* 13.2 (1989), pp. 117–123 (cit. on p. 40).
- [88] Eduardo D. Sontag. “Comments on integral variants of ISS1.” In: *Systems and Control Letters* 34.1-2 (1998), pp. 93–100 (cit. on pp. 1, 9, 47, 55, 61).

- 
- [89] Eduardo D. Sontag. “Smooth stabilization implies coprime factorization.” In: *IEEE Transactions on Automatic Control* 34.4 (1989), pp. 435–443 (cit. on pp. [1](#), [9](#), [47](#), [55](#), [61](#)).
- [90] Eduardo D. Sontag and Yuan Wang. “On characterizations of the input-to-state stability property.” In: *Systems and Control Letters* 24.5 (1995), pp. 351–359 (cit. on pp. [2](#), [9](#), [47](#), [56](#)).
- [91] G Temple. “Stability of Motion. Applications of Lyapunov’s second method to differential systems and equations with delay. By N N. Krasovskii. Translated by J L. Brenner. Standford University Press, 1963. Pp. 1–188. 48s.” In: *The Mathematical Gazette* 49.367 (1965), pp. 114–114 (cit. on p. [34](#)).
- [92] Xiaoli Wang and Yiguang Hong. “Finite-time consensus for multi-agent networks with second-order agent dynamics.” In: *IFAC Proceedings volumes* 41.2 (2008), pp. 15185–15190 (cit. on p. [42](#)).
- [93] Ali Zolghadri, David Henry, Jérôme Cieslak, Denis Efimov, and Philippe Goupil. *Fault diagnosis and fault-tolerant control and guidance for aerospace vehicles*. Springer, 2014 (cit. on p. [7](#)).
- [94] Vladimir Ivanovich Zubov. *Methods of AM Lyapunov and their Application*. P. Noordhoff, 1964 (cit. on pp. [8](#), [14](#), [16](#), [31](#)).
- [95] Vladimir Ivanovich Zubov. *On systems of ordinary differential equations with generalized homogenous right-hand sides*. *Izvestia Vuzov. Mathematica.*, 1: 80–88. 1958 (cit. on pp. [8](#), [30–32](#), [52](#)).



Dernière page

*Titre en français :* Notions d'homogénéité assouplies pour l'analyse de stabilité en temps fini et en temps fixe

*Résumé en français :* Ce manuscrit présente des nouveaux résultats sur la stabilité en temps fini et en temps fixe des systèmes non linéaires. Une nouvelle approche pour étudier la stabilité en temps fini et stabilité en temps fixe pour les systèmes non linéaires, spécialement ceux qui n'ont pas d'approximation homogène, est introduite. Les chapitres 1 et 2 se concentrent sur les outils principaux (propriétés de stabilité et de robustesse ainsi que la notion d'homogénéité), nous étudions la robustesse de la stabilité en temps fini pour les systèmes affines homogènes non linéaires (chapitre 3). Au chapitre 4, nous introduisons la notion d'extensions homogènes. Ce concept fournit des outils qualitatifs pour étudier la robustesse et le taux de convergence de systèmes non linéaires qui n'admettent pas d'approximation homogène à l'origine ni à l'infini. Enfin, dans le cinquième chapitre, le problème de la stabilité en temps fini et en temps fixe des systèmes dynamiques non linéaires, qui peuvent ne pas admettre une extension homogène, est considéré. De nouveaux concepts garantissant la symétrie des solutions pour les systèmes dynamiques, appelés sup- ou sub-homogénéité, sont introduits. Ces notions sont utilisées pour étudier la stabilité en temps fini et en temps fixe des inclusions différentielles et des systèmes dynamiques non linéaires. Ensuite, un contrôleur à temps fixe a été conçu en utilisant les résultats obtenus pour des systèmes non homogènes. De plus, un algorithme d'observation en temps et en temps fixe et sa procédure de conception pour un système de type canonique ont été obtenus.

*Mots-clefs :*

homogénéité
stabilité en temps fini
systèmes dynamiques non linéaires
inclusions différentielles
théorie de Lyapunov

*Titre en anglais* : Relaxed homogeneity notions for finite-time and fixed-time stability analysis

*Résumé en anglais* : This manuscript presents new results on the finite-time stability (FTS) of nonlinear systems. In addition, the case where the convergence time is a bounded function is studied. This property, called fixed-time stability (FxTS), is studied in the case of non-homogeneous systems. A new approach to study FTS and FxTS for nonlinear systems, especially those which do not have a homogeneous approximation, is introduced. Stability of the trajectories of the systems with respect to exogenous disturbances is also established for certain classes of nonlinear systems. Chapters 2 and 3 focus on the main tools (stability and robustness properties as well as the notion of homogeneity), we study the robustness of FTS for nonlinear homogeneous affine systems in chapter 3. In chapter 4 we introduce the notion of homogeneous extensions. This concept provides qualitative tools to study the robustness and the rate of convergence of nonlinear systems which do not admit a homogeneous approximation at the origin or at infinity. Finally, in the fifth chapter, the problem of finite-time and fixed-time stability of nonlinear dynamical systems, which may not admit a homogeneous extension, is considered. New concepts guaranteeing the symmetry of solutions for dynamical systems, called sup- or sub-homogeneity, are introduced. These notions are used to study the finite-time and near fixed-time stability of differential inclusions and nonlinear dynamic systems. Then, a fixed time controller was designed using the results obtained for nonhomogeneous systems. In addition, a finite-time observation algorithm and its design procedure for a canonical-type system were obtained.

*Mots-clefs* :

homogeneity
finite time stability
nonlinear dynamical systems
differential inclusions
lyapunov approach