



HAL
open science

Nitrous oxide and ammonia emissions from crop residue decomposition in soils

Varunesh Chandra

► **To cite this version:**

Varunesh Chandra. Nitrous oxide and ammonia emissions from crop residue decomposition in soils. Earth Sciences. Sorbonne Université, 2021. English. NNT : 2021SORUS204 . tel-03793805v2

HAL Id: tel-03793805

<https://theses.hal.science/tel-03793805v2>

Submitted on 2 Oct 2022

HAL is a multi-disciplinary open access archive for the deposit and dissemination of scientific research documents, whether they are published or not. The documents may come from teaching and research institutions in France or abroad, or from public or private research centers.

L'archive ouverte pluridisciplinaire **HAL**, est destinée au dépôt et à la diffusion de documents scientifiques de niveau recherche, publiés ou non, émanant des établissements d'enseignement et de recherche français ou étrangers, des laboratoires publics ou privés.

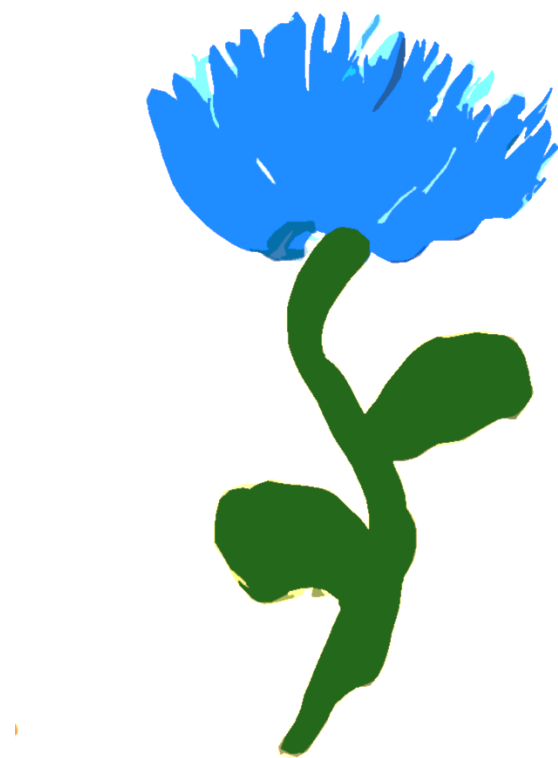

**Nitrous Oxide and Ammonia Emissions
from Crop Residue Decomposition in Soil**

Doctoral Thesis in Environmental Science (2018-2021)

Varunesh Chandra



Doctoral Scholar

Varunesh Chandra

Student Number: 3780251, Sorbonne Université, Paris (France)
Doctoral School: ED 129 *Sciences de l'Environnement*

Director of Doctoral Research

Benjamin Loubet, PhD

Director of Research, UMR ECOSYS, INRAE-AgroParisTech-Université Paris-Saclay,
Thiverval-Grignon, 78850 (France)

Co-supervisors of Doctoral Research

Gwenaëlle Lashermes, PhD

Researcher, FARE, UMR A 614, INRAE-Université de Reims Champagne-Ardenne, Reims,
51097 (France)

Raia-Silvia Massad, PhD

Researcher, UMR ECOSYS, INRAE-AgroParisTech-Université Paris-Saclay, Thiverval-
Grignon, 78850 (France)



Title of the project

Nitrous oxide and ammonia emissions from crop residue
decomposition in soils

Date of Manuscript Submission

June 2021

Funding Agencies

FACCE Era-Gas, Project *ResidueGas*
and
Department of Environment and Agronomy, INRAE

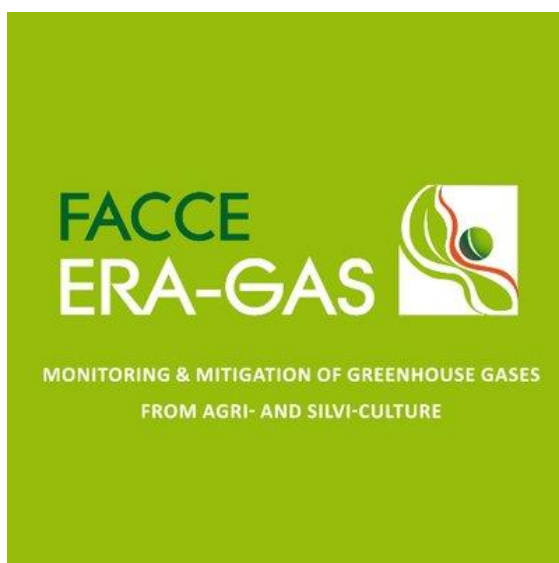

Acknowledgements

Inquisition is the cause of knowledge. The path to knowledge needs crucial guidance. Benjamin Loubet, PhD, Director of Research, UMR ECOSYS, INRAE Thiverval-Grignon provided this guidance by his illuminating discussions and advice during the course of this doctoral research. Deep gratitude is to be bestowed on him. The guidance was equally given in full strength and vigour by Raia Silvia Massad, PhD, Researcher, UMR ECOSYS, INRAE Thiverval-Grignon and Gwenaëlle Lashermes, PhD, Researcher, UMR FARE, INRAE Reims. Their constant support and energy gave life to the project and pushed it towards its fruition. Profound regards to them. Words know no bounds for the depth of gratitude to Patricia Laville, Former Research Engineer of UMR ECOSYS INRAE Thiverval-Grignon, for her invaluable contributions to planning and execution of experiments related to this work. Her social aura and deep commitment to compassion was a strong motivator. Alain Fortineau, Study Engineer, UMR ECOSYS, INRAE Thiverval-Grignon definitely receives special thanks for his constant technical supervision in engineering the project apparatus and perpetual readiness to help in whatever way possible. Thuy Dung Ngo, former intern of the same laboratory deserves an accolade for everything she brought in the project, her dedication, her hard work and her compassion. Contributions from Josiane Jean-Jacques and Olivier Fanucci from UMR ECOSYS INRAE Thiverval-Grignon are mentionworthy for their presence made all the technical shortcomings of the project vanish. Heartfelt thanks to François Lafolie, PhD, Researcher and Scientific Responsible for VSOIL Platform, UMR EMMAH INRAE Avignon for all the necessary inputs in modelling work. Had his virtual presence not there, a major part of the work would not have found its genesis. Nicolas Moitrier, Informatics Coordinator of VSOIL platform from the same laboratory receives a special mention for his technical help. Catherine Richard, Christine Collin, Sophie Formisano, Pascal Duprix, Maxime Marques, Michel Burban and others from UMR ECOSYS are appreciated for everything they did to make the research atmosphere friendly and welcoming. Respect goes to the two consecutive Directors of UMR ECOSYS, Enrique Barriuso and Sabine Huot, for their concern for laboratory and research team well-being was a guarding pillar in the research life. Special mention of

Gonzague Alavoine, Miguel Pernes, Olivier Delfosse, Pascal Thiebeau, Laurence Foulon, François Gaudard, Sylvie Millon, Frédéric Doremus and Anouck Habrant for their valuable inputs to the administrative and social aspects of research life in UMR FARE, INRAE Reims. Gratitude also goes to Bernard Kurek, Director of UMR FARE INRAE Reims for a fruitful provision of administrative supervision of the project while it was carried out in Reims.

There is ample gratitude for the members of the Doctoral Committee, Sylvie Recous, Director of Research of UMR FARE INRAE Reims, Catherine Hénault, Director of Research of INRAE Orléans, Bertrand Guenet, Researcher CNRS LSCE, Klaus Butterbach-Bahl, Division Head Biogeochemical Cycles, KIT Garmisch-Partenkirchen and Marco Carozzi UMR Agronomie INRAE Thiverval-Grignon. Their suggestions refined the project approach and outcome, leading to a successful completion of this work.

A note of acknowledgement also goes to Herve le Treut, Former President of *ED 129 Science de l'Environnement de l'Île de France* (Doctoral School 129 of Environmental Science of Île de France), Sorbonne University for his time and concern provided at the time of need. Madam Laurence Amsili Touchon, Coordinator of the same doctoral school ED 129 of Sorbonne University for immense support in administration related issues. Of course, thanks also reaches out to the entire Doctoral school for the bonhomie provided during the course of the academic parcours.

Deep gratitude is also extended to FACEE ERAGAS ResidueGas and Department of Environment and Agronomy, INRAE for co-funding this research project.

Thanks also goes to kilt and kin, and to the reality. The repository of discriminative wisdom, the perfection of insight, the strength of the adamantine, the sprightly crown of void; which, provided appropriate conditions for the success of the work and the nurture of the spirits.

Prologue

Agriculture is the cradle of human civilisation. Since antiquity, the cultural-social-academic enrichment of humanity is only possible due to stable supply of food from farming. Even roots of economics find themselves arising from system of barter frequently deployed by early human-farmers for commerce. An activity that grounds a human being to mere sheaths of reality, it can be said, its prime age came with the industrial revolution. Development of sophisticated machinery and advances in crop selection and genomics coupled with the fears of food shortages due to wars and epidemics paved way to what is commonly called industrial farming; especially in the regions worst affected by such disasters. Natural land has been meddled with so much that vast areas of landscape are now artificial. In what are known as 'developed countries', this artificialisation of land has almost reached quintessence, while 'developing countries' continue to chase this ideal. It is implicit in humanity that more human control over land use means more security and certainty in future sustenance. And why should not it be, knowledge indeed yields protection. It indeed has been a crucial factor in human evolution. Yet seeing how unchecked and unsustainable progress in human society cites biased implementations of such knowledge, it makes it inevitable to aim for a more synchronised approach between cognizance and contrivance.

Planet earth is constantly being challenged at all fronts by plethora of quandary. In modern times, that is fondly known as anthropocene, climate change gets to be the cherry on top of this cake of quandary. Climate change is driven by greenhouse effect. Greenhouse effect is being driven by both human and natural causes whose nexus converge together in land use. Land use involves agriculture. Agriculture involves crop production and animal domestication. Crop production yields depend on soil fertility. Soil fertility is enhanced with organic and chemical additions. Organic and chemical addition to soil enhances soil microbial growth and activity. Soil microbial growth and activity releases mineral chemistry elements that subsequently escape the confinement of soil particles, as famous greenhouse gases.

Contents

Chapters	Page Number
1. Introduction to nitrous oxide and ammonia emission mechanisms from crop residue decomposition in soils	9
2. A review of conventional agriculture and agroecological management impacts on nitrous oxide and ammonia emissions with two contrasting agricultural systems	22
3. Vertical Distribution of Crop Residues affects Nitrous Oxide and Ammonia Emissions from Soils	49
4. Simulating nitrous oxide and ammonia emissions from crop residue decomposition in small particled clay soil by a coupled model	77
<i>Epilogue</i>	105
<i>Addendum – Résumé en Français</i>	111
<i>References</i>	152

List of Figures and Tables

Figures	Page No.
<i>Chapter 1</i>	
Figure 1.1 Agriculture Practices and resulting greenhouse and pollutant gas emissions	11
Figure 1.2 Mechanistic description of soil decomposition processes, organic matter formation and greenhouse gas emissions	13
<i>Chapter 2</i>	
Figure 2.1 Description of agriculture management with respect to crop phenology and abiotic factors for examples of scenarios : (a) conventional agriculture and (b)agroecological practice	37
Figure 2.2. Estimate of nitrous oxide and ammonia fluxes deduced from available literature on different type of crop systems	46/47
<i>Chapter 3</i>	
Figure 3.1 Schematic showing flow circuitry of Gas Emission Detection Incubator. Red circuit represents the main measurement airflow circulation.	59
Figure 3.2 Net Cumulated Gaseous Fluxes of N ₂ O (a, b, c) and NH ₃ (d, e, f) for modalities with three soil types and three red clover residue vertical positions for 50 days of incubation.	61
Figure 3.3 Dynamics of N ₂ O (A) and NH ₃ (B) fluxes for surface, mixed, layered and control modalities as well as soil mineral N content (ammonium (C) and nitrate (D)) for the three soil types (SLU, GEXER and GICOS).	63
Figure 3.4 Dynamics of CO ₂ flux for surface, mixed, layer and control modalities for three soils – SLU, GICOS and GEXER.	64
Figure 3.5 Correlation table between cumulated gaseous fluxes and mineral nitrogen contents of all three soils resulting of gaseous fluxes and mineral N concentrations from Day 1, Day 4, Day 7, Day 14, Day 28 and last day of incubation.	70
Figure 3.6 Schematic of underlying processes that influence evolution of daily fluxes from the crop residue decomposition in three soils – SLU, GEXER and GICOS.	73
Figure 3.7 Wheat Modality Net cumulative Fluxes N ₂ O for with Gri EXER and GICOS soils on day 50	75
Figure 3.8 Wheat Modality Net cumulative Fluxes for Ammonia on day 50 with GICOS and Gri EXER soils	75
Figure 3.9 Wheat Modalities Daily Dynamic fluxes of N ₂ O and NH ₃ and time series of concentrations of NH ₄ ⁺ and NO ₃	76
<i>Chapter 4</i>	
Figure 4.1 Diagrammatic depiction of processes in CANTIS model.	83
Figure 4.2 Depiction of processes in the coupled models of CANTIS, NOE and NH ₃ volatilisation.	90
Figure 4.3 Carbon dioxide fluxes, (a)dynamic and (b)cumulative for control soil GICOS. (c)Mineral NH ₄ ⁺ (ammonium) and (d)NO ₃ ⁻ (nitrate) contents for control soil with time.	95
Figure 4.4 Carbon dioxide fluxes, (a) cumulative and (b) daily dynamic, for red-clover mixed in top 4 cm layer of GICOS soil	96
Figure 4.5 Cumulative (a) and daily dynamic (b) nitrous oxide fluxes for soil system of red-clover mixed in top 4 cm layer of soil.	97
Figure 4.6 Ammonium (a) and nitrate (b) contents of soil-residue system where red-clover is mixed in top 4 cm layer of soil.	98
Figure 4.7 Cumulated (a) and daily dynamic (b) ammonia (NH ₃) fluxes from residue-soil system with red-clover mixed in top 4 cm layer of GICOS soil.	98
Tables	
<i>Chapter 2</i>	
Table 2.1 Summary of Nitrogen Cycle Processes in Soil	28
Table 2.2 Summary of cumulative flux of nitrous oxide and ammonia and mineral nitrogen concentration values from certain studies pertaining to agriculture practices	46
<i>Chapter 3</i>	
Table 3.1 Physico-chemical characteristics of three soils – SLU, GEXER and GICOS	54
Table 3.2 Modalities with different vertical distribution of residues in soils and added KNO ₃ solution	56
<i>Chapter 4</i>	
Table 4.1 Parameter values default in CANTIS and those used in simulations	92
Table 4.2 Input values of parameters associated with soil and residue used in the simulations	92
Table 4.3 Parameter values default in NOE and those used in Simulations	93
Table 4.4 Equations of pool changes in CANTIS	100
Table 4.5 Rates of assimilation and decomposition in CANTIS	102
Table 4.6 Equations of NOE and description of variables	104

Chapter 1

Description of nitrous oxide and ammonia emission mechanisms from crop residue decomposition in soils

Human civilisation has progressed since the appearance of *homo sapiens sapiens* 503000-565000 years ago [Hajdinjak et al 2018]. This progress has changed the shape of the planet earth and transformed landscapes, from green lush river plains to dry sandy deserts; from hills and plateau to thriving concrete urbanscape. The quality of human life has increased, the life expectancy is higher and the human population is expected to cross 9 billion by mid 21st century [Engelman 2012]. In this century, one drawback of all these anthropogenic changes is climate change, whose primary reason is increased greenhouse gas emissions from human societal development activities. Burning of fossil fuels, mostly for energy and transports, is the largest sources of greenhouse gases, but land use greenhouse gas effect is too significant to be ignored. Around 24% of total greenhouse gas emissions result from agriculture, land use and forestry [IPCC report 2015]. Carbon dioxide, methane and nitrous oxide are the three major greenhouse gases resulting from agriculture activities (Figure 1.1). While methane (16% of total greenhouse gases) is mostly resultant of anaerobic decomposition in marshes and swamps or from paddy cultivation or from livestock production, nitrous oxide (6% of total greenhouse gases) is resulting from chemical fertiliser and vegetation decomposition in soils [Mosier et al 1991]. Nitrous oxide has a global warming potential in the range 265-298 while methane's global warming potential is in the range 28-36 [United States Environment Protection Agency 2020]. Nitrous oxide's sink is in stratospheric ozone depletion where it gets converted into nitrogen dioxide and nitric oxide. Nitrogen fertilisation of agriculture fields contribute upto 40% of total N₂O emissions [Tian et al 2020]. Mechanisms underlying emissions of nitrous oxide is quite complex and involves an interplay between soil biological, physical and chemical parameters, alongside the crop management practice

[Butterbach-Bahl et al 2013, Canfield et al 2010]. These processes also yield a by-product emission of ammonia, which in itself is a threatening pollutant for the environment and health [Sutton et al., 2011]. Ammonia is volatilised from soil by decomposing litters and fertilisers with its sinks in reactions with nitrites or phytochemical destruction. Mitigation of carbon dioxide has held an important priority in greenhouse gas mitigation, and increased carbon sequestration in soil through agriculture has been proposed to be an important measure in its checking such as the proposed 4 per 1000 initiative [Soussana et al 2019]. Even though increasing soil carbon stock to capture atmospheric carbon seems promising, the resulting nitrous oxide and ammonia emissions through organic matter decomposition processes may result in a feedback and hamper the impact of enhanced soil carbon storage in greenhouse gas mitigation (Figure 1). Replacement of chemical fertilisers by organic manures and crop residues is another methodical change being encouraged under the banner of agroecology. Crop residues and organic manure do enhance soil fertility by priming soil microbial activity and biodiversity, but their decomposition in soil also contributes to soil carbon stock and thus result in nitrous oxide and ammonia emissions due to microbial decomposition of the soil organic matter [Huang et al 2004]. Conventional agriculture systems where chemical products are frequently employed and soil is largely disturbed also contribute to these gas emissions. But in recent years, with shift of trends towards organic agriculture and agroecological methods, the contribution of former to nitrous oxide and ammonia emissions is decreasing, while it is increasing for the latter [FAOSTAT 2016]. It is therefore essential to determine whether the benefits of incorporating crop residues, for soil fertility and mitigating climate change, may be compensated or not by the drawbacks of increasing nitrous oxide and ammonia emissions. In the next sections we will make a quick overview on the knowledge on biochemical processes happening in soils that result in such gaseous emissions: What is happening in soil when dead organic matter is introduced? How is the introduction of organic matter affecting soil processes? How are these soil processes interrelated?

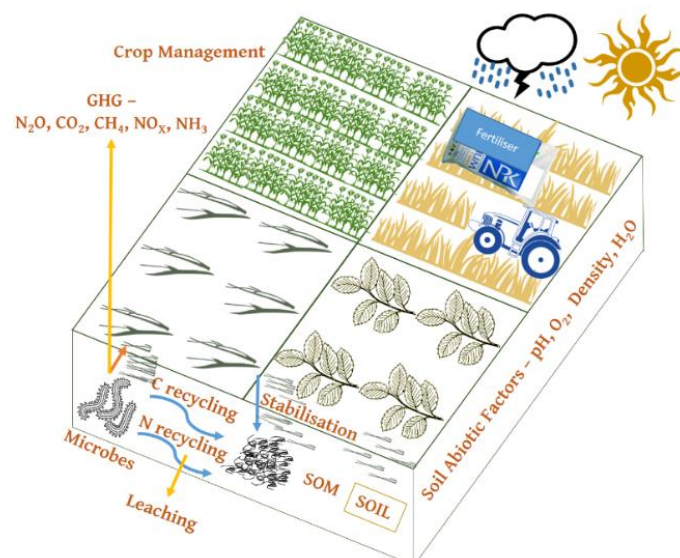

Figure 1.1 Agriculture Practices and resulting greenhouse and pollutant gas emissions. The human activity on soil primes soil microbial activity resulting in feedback gas emissions.

1. Decomposition of Organic Matter in Soil

Any dead organic matter with dysfunctional metabolism undergoes catabolism (molecular break-down) in soil. Instead of ending up accumulated as bulk wasteful remains of their living forms, this dead matter becomes food sources for simpler life forms such as mesofauna (minuscule invertebrates), fungi and microorganisms. Life continues to flourish in these fragmented species. The metabolism of these species yield release of simple molecules to the atmosphere and soil. Birth, Life, Death, Release. The cycle goes on. The process by which this molecular breakdown of dead takes place resulting in ultimate recycle is organic matter decomposition.

Any organic matter posthumously undergoes decomposition – a senescent leaf, older root, insect body, human body, dead skins, dead cells etc. Vegetation components are particularly interesting in this case. They somehow act as ‘constant’ providers of organic matter to soil owing to their immobile nature, seasonal metabolic variations (for example leaf shedding, stem senescence). Grassland and agricultural residue are important contributors too. What is interesting here is how they are safely existing with no locomotion around decomposers or detritivores (organisms inducing decomposition or organisms consuming dead matter) while their dead counterparts suffer excessive sabotage by microbial action. Living vegetation’s

possess active cells with their defence mechanisms such as constitutive defences – cell walls, barks and waxy epidermal cuticles; and inducive defences – toxic chemicals like terpenes, anti-pathogen bioenzymes and cellular suicide [Freeman et al 2008]. This prevents infectious attack of microbes and other mesofauna on their bodies. Dead vegetation on the contrary undergoes cell death (necrosis/apoptosis/oncosis/pyroptosis/autophagy) that results in cellular or tissue rupture [Fink et al 2005]. Necrosis stands for prematured cell death through auto-digestion, apoptosis stands for programmed cell death in response to a signal, oncosis is cell death with swelling, pyroptosis is lytic cell death due to infectins from intracellular pathogens and autophagy is intracellular recycling of unwanted components. These provide easy access to mesofauna and microbes. The microbes or mesofauna then utilise heterotrophic respiration to catabolise carbohydrates into sources of energy to be utilised in cellular metabolism. In prokaryotes this happens in cytoplasm via glycolysis where glucose is transformed into pyruvate ($\text{CH}_3\text{COCOO}^-$) resulting in formation of two adenosine triphosphate (ATP) molecules. This is followed by tri-carboxylic acid cycle (TCA cycle) yielding three more units of ATP thus effective energy supply in presence of oxygen. In eukaryotes, the latter process happens in mitochondria. The by-product of this heterotrophic cellular respiration is carbon dioxide [Bill, Enger and Ross 2007]. In the presence of oxygen, this is called aerobic respiration. In the absence of oxygen, glycolysis is followed by either lactate formation or ethanol production. This is called anaerobic respiration or fermentation. The by-product of ethanol production is also carbon dioxide. Microbes are osmotrophs meaning they exchange nutrients utilising active transport or osmosis. The complex nature of lignocellulose could therefore be an obstruction in the nutrient exchange pathway. Exoenzymes produced by microbes counter this obstruction. They breakdown lignocellulosic mass into simpler carbon structures easing nutrient transport for respiration and other metabolism. Vegetation litter being in direct contact with the soil forms microbial hotspots where decomposition rates are highest. This interface located at the soil surface, called detritosphere regulates organic matter formation in soil [Müller et al 2017].

Conclusively, the phenomenon of decomposition is an important facilitator of soil organic matter formation and soil respiration, successively impacting soil carbon and nitrogen cycle.

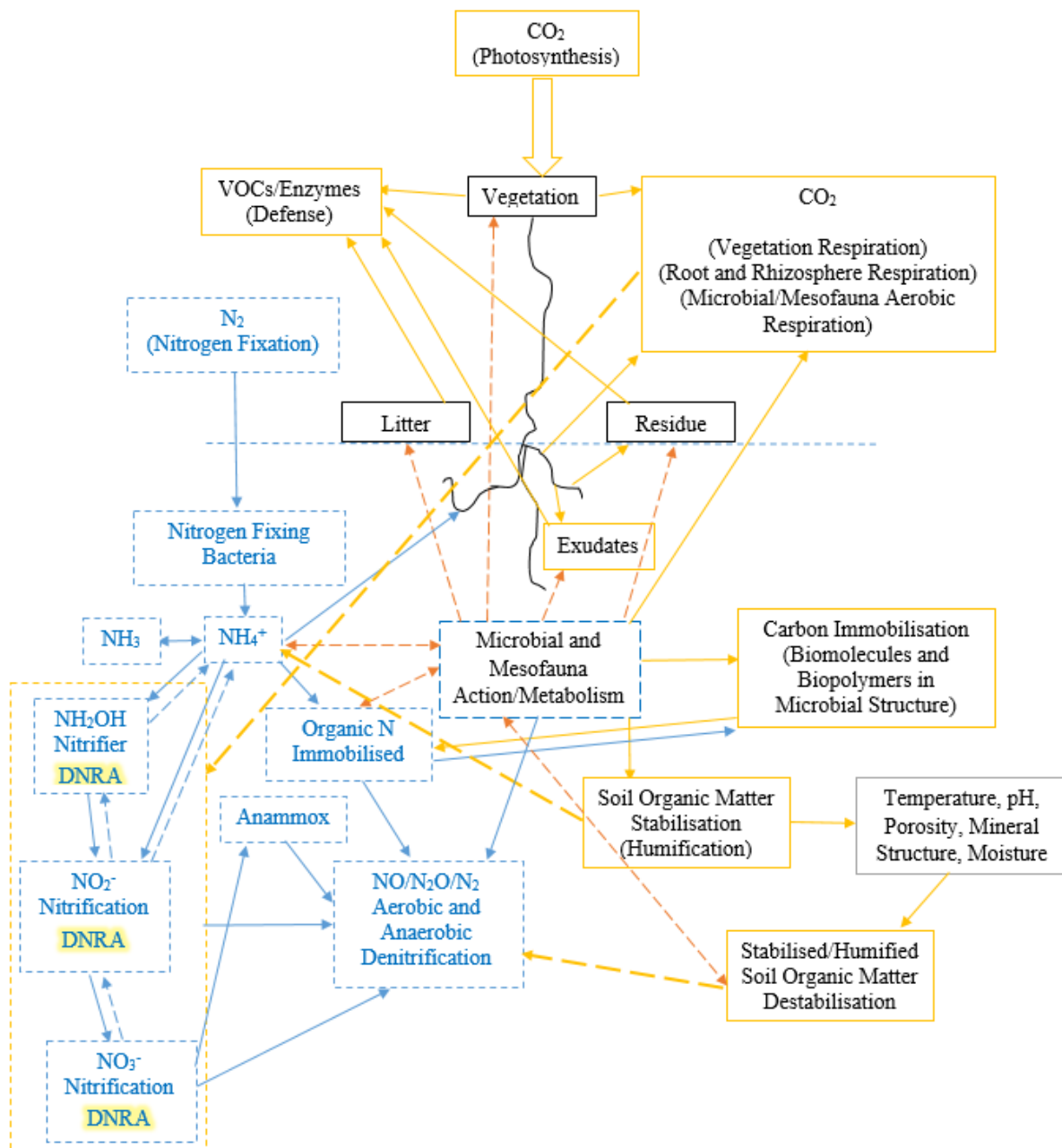

Figure 1.2 Mechanistic description of soil decomposition processes, organic matter formation and greenhouse gas emissions. Please note that the DNRA microbes are responsible for dissimilatory nitrate reduction to ammonia process. The blue colour is representing nitrogen processes and yellow is representing carbon processes in soil. The soil organic matter formation from the introduction of organic amendments is described in the carbon cycle. From this process results mineral nitrogen release in the form of ammonium ions (NH_4^+) subsequently converted to nitrite (NO_2^-) and then nitrate (NO_3^-) through nitrification and denitrification respectively. These processes release mineral nitrogen gases. Ammonia is also released by virtue of decomposition and the chemical equilibrium between its liquid and gaseous state. The nitrification and denitrification processes in reverse direction is called Dissimilatory Nitrate Reduction to Ammonia.

1.1 Organic Matter Decomposition and Soil Carbon Cycle

The starting point of soil carbon cycle, if looked from above, is the autotrophic photosynthesis by vegetation [R.E. White, 2013 4th Edition]. Atmospheric carbon is fixed as sugars used for energy provisioning and metabolism in cells. While plants grow, certain molecules such as sugars, amino acids, terpenes, mucilage, phenols, volatile organic compounds (VOCs) exudes from their roots. These molecular species, root exudates, contribute to specific microbial utilities at the root interface for nutrient regulation (through ionic forms) in addition to acting as defence mechanisms against infections [Baetz et al 2014]. Certain root exudates like flavonoids result in root-microbe interaction leading to nodulation process on roots like in legumes or mycorrhization [Bonfante et al 2009]. Others result in root-root communication as in allelopathy. Roots also outgas CO₂ to the atmosphere through respiration (known as root respiration), necessary for root-growth [Trolldenier et al 1981]. Microbial action on exudates at root-soil interface (known as rhizosphere) also results in heterotrophic respiration producing CO₂ (and water). VOCs from exudates may also get volatilised (Figure 1.2).

There are other forms of vegetation-microbiota associations. Symbiotic associations of roots with mycorrhizae for inorganic nitrogen and phosphate assimilation, nitrogen fixing bacteria (e.g. rhizobium) for nitrogen assimilation, sulphate reducing and phosphate solubilising bacteria for nutrient transfer; for their carbon needs for energy production also result in respiration [Bonfante et al 2009]. This collectively contributes to rhizosphere respiration. Rhizosphere respiration, VOC volatilisation and root respiration therefore collectively feedback a portion of carbon assimilated back to the atmosphere.

Then comes the decomposition of litter, residues and senescent bodies. As mentioned before, they are facilitated by microbial action and they use respiration to produce energy, again outgassing CO₂ (in case of aerobic respiration) or CH₄ / lactate / ethanol / VOCs (in case of anaerobic respiration through methanogenesis or fermentation or micro-aerobic fermentive processes) [Insam and Seewald 2010]. The remnants of decomposition could form aggregates by interacting with soil minerals, or could get trapped by virtue of van der waals forces within cavities, or could aggregate with each other forming energetically stable micro-aggregates, or

could remain available as simpler compounds ready to be attacked further by microorganisms [Huang et al 2004, Lehmann et al 2015]. In this context, the soil organic matter can be separated into several carbon pools depending on their stability. Variations in temperature, porosity (defining microbial access to the organic matter), pH, moisture and fertilisation influencing microbial actions on these pools are key factors of organic matter decomposition and carbon and nitrogen gaseous species release to the atmosphere [Huang et al 2004].

The process where organic matter (containing carbon and other elements such as nitrogen, sulphur, phosphorous) gets converted into an inorganic form possibly in solutions, leading to CO_2 , CH_4 , N_2O , carbonates, bicarbonates or other carbon species, is called mineralisation [White 2005]. The fixed carbon (and other elements) in soil as biomolecules in microbes or as stabilised organic matter is said to be immobilised i.e. it becomes unavailable for further breakdown or plant use [White 2013]. The stabilisation of organic matter due to soil interactions, space constraints, microbial inaccessibility, micro-aggregation and post-microbial action recalcitrant biochemical protection; yield humus and the process is conventionally called humification or stabilised organic matter formation [White 2005, Lehmann et al 2015, Six et al 2002]. Evidently soil organic matter formation and stabilisation, is limited by other elements, namely nitrogen, phosphorous, sulphur and other soil minerals at many stages. Indeed, certain microbes utilise this elemental presence for amino acid synthesis or carbon oxidation to yield energy. Presence of such microbes also facilitates symbiosis in plants and microorganisms (for example mycorrhiza). This is where nitrogen cycle, phosphorous cycle, sulphur cycle and other nutrient cycles coalesce with carbon cycle, complexing the simple appearing process into a comprehensive omni-potent system. The following section discusses the nitrogen cycle processes coexisting with organic matter decomposition and soil carbon cycle (Figure 1.2).

1.2 Organic Matter Decomposition and Soil Nitrogen Cycle

There exists a certain range of bacteria and other microbes that utilise atmospheric nitrogen to hydrolyse ATP to produce energy. These microbes therefore “fix” atmospheric nitrogen

through a process termed as nitrogen fixation. The $N \equiv N$ bond is activated by an enzyme called nitrogenase followed by its transformation to ammonium. Ammonium is then either utilised by eukaryotes or prokaryotes directly or through assimilatory NO_3^- reduction [Canfield et al 2010]. This could happen by wide array of mechanisms – Heterotrophic Fixation (by bacterial species like *Klebsiella*, *Azotobacter*, *Clostridium*, *Bacillus*), Associative Fixation (e.g. *Azospirillum* with *Poaceae* (grasses)), Symbiotic Fixation (e.g. Alder with actinomycete *Frankia* or legume root nodules with *rhizobium*) [Wagner et al 2011]. Although biological, Nitrogen Fixation constitutes the largest natural input of nitrogen to soils. Soil Organic Matter constitutes the most significant pool of nitrogen to soil. Its formation from decomposition results in incorporation NH_4^+ , amino acids, protein fragments and other nitrogen species to soil. In an industrial agriculture modern-day scenario, nitrogen fixation through chemical fertiliser incorporation is almost twice as large as the biological nitrogen fixation [Fowler et al 2013].

Some prokaryotes and eukaryotes (specific bacteria, archaea or fungi) use ammonium to power their metabolism and growth in dark. In order to do so, they end up oxidising NH_4^+ (or NH_3 in low pH conditions) in aerobic conditions. This is again carried out by virtue of enzymatic actions (ammonium oxidase), that prevalently oxidises ammonium into NO_2^- (with a probable intermediate NH_2OH that gets acted upon by enzyme hydroxylamine oxidoreductase to yield nitrite). This is then further oxidised to NO_3^- (by enzyme nitrite oxidoreductase), concluding a process called nitrification [Canfield et al 2010]. The microbes responsible are called nitrifiers. Nitrification in itself follows varied pathways and has multiple driving forces but all surmounting by microbial metabolism. Significant microbial communities which are chemolithotrophic use oxidation of reduced inorganic compound (in this case $\text{NH}_4^+/\text{NH}_3$) to produce energy by fixing CO_2 in the absence of light [Canfield et al 2010, Oren 2009]. These are primarily responsible for nitrification. But then there is heterotrophic nitrification where prokaryotic and eukaryotic microbes tend to oxidise any reduced form of nitrogen (including organic N) to its more oxidised form [Stein 2018]. This therefore results in the production of N_2 , N_2O and NO (from $\text{NO}_3^-/\text{NO}_2^-$ /amino acid fragments), in addition to NO_2^- and NO_3^- . The conversion of NO_3^- to produce nitrogen gaseous species in

oxic condition is called aerobic denitrification. When mediated by nitrifiers, then it is called nitrifier denitrification [Stein 2018]. Heterotrophic nitrifiers employ these oxidations for their defence, cellular and energy metabolism (e.g. re-oxidation of NAD(P)H under high oxygen concentration for appropriate glucose utilisation in bacteria or simultaneous oxidation of nitrate and formate in mitochondria of fungi *Fusarium Oxysporum* in endogenous respiration) [Stein 2018]. They do not employ nitrification for carbon fixation like by chemolithotrophic nitrifiers.

The NO_3^- produced is either taken up by eukaryotes (plant roots) or is undergone further microbial action. In anaerobic conditions NO_3^- is used as electron donor by microbes for respiration. NO_3^- thus gets transformed back to nitrite NO_2^- by enzyme dissimilatory nitrate reductase, successively converting to NO by nitrite reductase, then transforming into N_2O by nitric oxide reductase, to finally yield N_2 by nitrous oxide reductase [Canfield et al 2010]. NO_3^- is also transformed into ammonium directly through a process called DNRA (dissimilatory nitrate reduction to ammonia) by combined actions of nitrite reductase and nitrate reductase. Furthermore, ammonium/ammonia can be simultaneously oxidised and then reduced in anoxic conditions to yield N_2 without intermediates like NO or N_2O . This is termed as Anammox (anaerobic ammonia oxidation). Heterotrophic nitrifiers can also undergo nitrification and denitrification simultaneously as aforementioned, with the process termed simultaneous nitrification-denitrification (SND). It may also be noted that the gaseous or soluble intermediates at any stage could find an escape from the soil resulting in N_2O and NO emissions additionally. Metabolic usage of nitrogen species by microbes (as in case of nitrogen fixation) may also result in nitrogen immobilisation due to their transcription in microbial body as proteins or amino acids or even in enzymatic activities and genomics [Ladd et al 1973].

Soil Ecology and microbial biodiversity are therefore prominent factors deciding the extent of nitrogen gaseous species emissions from soil. The quality of soil organic matter, the 'food' for microbes, therefore also influences the rates of nitrification and denitrification. Furthermore, space constraints imposed by SOM and soil structure should also influence Chemolithotrophy perturbing nitrification and microbial access to nutrients. Acidity would affect the chemistry

by affecting soil microbial behaviour and growth, and stabilisation of intermediate complexes of nitrogen processes that may also promote nitrous oxide mineralisation [Qin et al 2019]. Certain processes such as symbiosis, SND, Anammox, heterotrophic nitrification and nitrifier denitrification, etc. are also limited by presence of other nutrients such as copper and iron [Reichardson et al 2009]. This could perturb microbial growth and metabolism by impacting essential genomics to code for enzymes.

Consequently, from this description of processes, it is evident that the correlation between soil nitrogen and carbon cycle is via microbial action pathways. This action happens either directly on the atmospheric sources of the elements or through the decomposition and assimilation of organic matter in soil.

1.3 Interrelation between Carbon and Nitrogen Cycle in Soil

Microbial action on residues and litters is a significant source of both immobilised and mineralised carbon and nitrogen in the soil. A phenomenon where carbon and nitrogen cycles coalesce. Litters and residue themselves comprise cellular components and structures rich in amino acids and proteins, sugars and terpenes, with elemental composition of both carbon and nitrogen (and even sulphur and phosphorous) – another point of intersection between the two cycles. Chemolithotrophic nitrification, the most significant process transforming NH_4^+ to NO_2^- and then NO_3^- chiefly uses CO_2 in soil for sugar synthesis. The CO_2 in soil is partly the product of heterotrophic respiration by microorganisms, suggesting another possible coalition between the two nutrient cycles in soil. Heterotrophic nitrification and denitrification also uses ambient nitrogen for metabolic activities in soil, such as from stabilised soil organic matter or immobilised nitrogen stocks. This immobilisation of nitrogen takes place with its bonding to carbon. The end products of this utilisation could be mineralised nitrogen in the form of gases like N_2 , NO or N_2O . It's intriguing because seeking stability in this chaotic nature, demarcating and classifying extremely entangled processes is very complex. But then at the same time attempts have been made to qualitatively and quantitatively understand their interrelation (Mosier et al 1991, Manzoni and Porporato 2007, Schulze 2000). Experimental

data and then numerical modelling provide essential tools for development of their understanding. Some key models are detailed in the following paragraphs.

1.3.1 Existing models for carbon and nitrogen cycle interplay

There have several attempts already been made to realise this understanding of mineral nitrogen and carbon emissions from soil. As apparent as it is, these emission dynamics constitute various knowledge factions ranging from environmental physics, mechanics and chemistry to ecology, biology and biochemistry. Simplistic numerical and empirical models animate one or more processes of either one or many of these knowledge factions to simulate mineral nitrogen and carbon emissions. Models like CANTIS-PASTIS [Garnier et al 2001] or ASM2d-N₂O [Massara et al 2018] use simple relationships and partial characteristic processes to simulate nitrogen pools and mineralisation. ASM2d-N₂O model gives N₂O emissions disregarding completely the influence of litter/residue decomposition influence. It uses active sludge method of an aerated chamber with sludge and microbes, typically involved in emission predictions from wetlands or wastewater treatment plants. PASTIS-CANTIS does describe effect transformation of nitrogen pools but neglect denitrification step completely. It does include a well-defined litter/residue decomposition influence on the following nitrogen recycling dynamics though. Furthermore it has described two sort of microbial biomass acting on different thermodynamically stabilised soil organic matter. Both these simplistic models are field scale models. Models like Ecosys [Metivier et al 2009] and ECOSSE [Smith et al 2010] are somewhat more complex. These models are ecosystem models and tend to have a more holistic perspective on mineral nitrogen and carbon emissions. Both of them are process-based models characterising every step in the course of residue/litter incorporation in soil to nitrification-denitrification steps. Ecosys has in fact placed microbial action as the central principle of defining these processes and uses Michaelis-Menten dynamics for simulations. It has also included a module of functional categories of microorganisms bringing in attention the variety of microbial metabolism and its influence on the constituent processes of soil organic matter stabilisation and its influence on nitrogen cycle. ECOSSE on the contrary, while describing soil organic matter stabilisation through microbial dynamics, uses first order kinetics for description of nitrogen processes. This somehow neglects the simultaneous

influence of microbial activity on both soil carbon and nitrogen cycle, thereby making it not so suitable for microsite applications. Models such as DNDC [Li 1996] and CCSM-CLM-CN-BEC-OCMIP [Thornton et al 2009] are more holistic; their objective is to simulate landscape/global scale emissions of mineral nitrogen and carbon. DNDC treats soil in discrete layers with homogeneity of properties. It has very well coupled processes of soil organic matter stabilisation and the influence of nitrogen cycling through microbial activity. Still, influence of heterotrophic respiration on nitrification has not been represented. CCSM – CLM-CN – BEC – OCMIP is a version of Community Climate Systems Model (CCSM) coupled global climate model with land module (Community Land Management – Carbon-Nitrogen), biogeochemical element cycling module (BEC) and a carbonate chemistry module called Ocean Carbon Model Intercomparison Project (OCMIP). Even when this is a global scale model, the influence of heterotrophic respiration on nitrification is ignored, just like DNDC. Additionally, in both the aforementioned models, the emissions from already stabilised soil organic matter by virtue of microbial activity is ignored too.

When looked deeper, it is clearly evident that neither of these models completely describe gaseous emissions from decomposition of litter/residue in soil. While some modules solely focus on the mechanism of soil organic matter stabilisation from microbial activities, others focus more on the elemental composition of residue in determining mineral nitrogen emissions or on mineral nitrogen emissions solely by virtue of first order kinetics and pool sizes. Therefore, there evidently is a need to conjugate microbial activity and nitrogen cycle processes to develop a holistic understanding of the process. This understanding will help in better predictability of emissions of nitrogen gases from agriculture.

1.4 Objectives of this research

This quick overview of the potential effects of soil residues incorporation on the carbon and nitrogen cycle shows the need to both; a better characterisation of the carbon stocks, nitrous oxide and ammonia fluxes resulting from this agricultural practice; and a step forward in modelling coupled carbon and nitrogen cycle. With increasing utilisation of crop residues as

fertilising agent, it has become necessary to determine their impacts on biogeochemical cycles and ultimately on nitrous oxide and ammonia emissions.

The objectives of this research is therefore to determine the effects of representative crop residues incorporation on soil nitrous oxide and ammonia emissions from different residues and different soils with diverse texture .

The manuscript is further organised in three sections explaining our research approaches and the resulting information obtained :

- The second chapter is dedicated to intercomparing the effects of conventional and agroecological practices on nitrous oxide and ammonia emissions by a review of available literature on the subject and finding what lacks in this domain of research. We are correlating the processes described in this introduction to the agriculture management practices. We are constructing two hypothetical systems to identify individual drivers in agriculture methodology influencing soil nitrogen and carbon cycles in each kind of agriculture practice.
- The third chapter is dedicated to the experimental determination of the effects of incorporation of crop residues in soil on nitrous oxide and ammonia emissions with respect to its placement in soil. Here, the key observation on the effects of residue position on ammonia and nitrous oxide emissions is further studied using laboratory incubations with red clover and wheat residues.
- The fourth chapter is dedicated to numerical modelling with coupled Carbon and Nitrogen cycles incorporating nitrous oxide and ammonia emissions, which is optimised using the data obtained from second chapter. This approach is adopted to enable an efficient digital solution for better predictability of crop residue ammonia and nitrous oxide emissions, arising from different positions of incorporation of residues in soil.

The fourth chapter is a general discussion and a conclusion summarising the research finding.

Chapter 2

A review of conventional agriculture and agroecological management impacts on nitrous oxide and ammonia emissions with two contrasting agricultural systems

Varunesh Chandra^{a,b}, Gwenaëlle Lashermes^b, Benjamin Loubet^a, Raia Silvia Massad^{a*}

^aUniversité Paris-Saclay, INRAE, AgroParisTech, UMR ECOSYS, 78850, Thiverval-Grignon, France

^bUniversité de Reims Champagne Ardenne, INRAE, FARE, UMR A 614, 51097 Reims, France

*Corresponding Author, Email : raia-silvia.massad@inrae.fr, ORCID : 0000000212961744

Abstract

In a climate change scenario sustainability of agriculture is an important question. Industry based conventional agriculture no doubt has potentials to feed the growing human population of the world but its side-effects on environment health is numerous. This has resulted in the rise of organic methods of farming or a mixture between the two. Chemical fertilisers form the basis for conventional agriculture while organic practices completely rely on crop residues and organic amendment for crop field fertilisation. Organic fertilisation has benefits to ecosystem services, although nitrous oxide (greenhouse gas) and ammonia (air pollutant) are by-products of this practice. There is still a great uncertainty about the extent to which these practices are sustainable both ecologically and economically. Here we have attempted to identify the factors decisive to these gaseous emissions from conventional and agroecological

farming systems by soliciting information about cumulative annual gas fluxes from available literature. We take a generic example of a crop cycle from each farming system to demonstrate the mechanisms that underlie these gaseous emissions and their advantages and disadvantages to climate change mitigation. Our findings showed not much of a difference between annual cumulated gaseous fluxes between conventional agriculture and agroecology. We concluded that one crucial point that may reduce greenhouse gas emissions from agroecology is the position of the incorporation of organic amendments although more experimental studies are needed to appropriately quantify their effects.

Keyword(s): crop residue, organic farming, industrial agriculture, chemical fertilisers, greenhouse effect, tillage

1. Introduction

Agriculture is the most crucial economic activity on the face of planet earth. It is accredited for being the stepping-stone to civilisation. It is also what laid the foundation of human cooperation and governance. With time, civilisations have grown more sophisticated. Human population has increased exponentially. Food demands have been perpetually increasing with a projection of 35%-165% increase between 2010 to 2100 [Bijl et al 2017]. Agriculture has become intensive with increased chemical inputs of fertilisers, pesticides and herbicides. The increasing intensity of agriculture land use is good news for food security, but it isn't as good for environment and biodiversity. For example, chemical fertilisers are renowned for their efficient nutrition supply to plants in conventional modern agriculture. These are catalysts to plant growth, their photosynthesis ability and resistance to diseases [Fertilizer 101, The Fertilizer Institute 2014]. They are crucial for increased crop yields. However they come with their fair share of problems. Nitrogen fertilisers have been proven to cause groundwater and aquifer pollution through nitrate accumulation [Zhang et al 1996]. Nitrate leaching to water bodies from fertilisers increases eutrophication threatening the local ecosystem. Fertiliser usage also contributes to air pollution through NH_3 volatilisation and greenhouse effect through nitrite/nitrate accumulation and resulting NO , NO_2 and N_2O formation [Bremner 1995, Cleemput and Samater 1995, Kumar et al 2018, Zhang et al 2018]. They are also responsible for phytotoxicity and microbial community alteration in soils [Nalewaja et al 1998, Kulikova et 2020]. Micronutrient deficiency is another problem attributed to their abundant usage [Sinclair and Edwards 2008]. Pesticides and herbicides usage has the same problems. Even though they are providing crops defense to unwanted plants and pests, they affect human and wildlife health, long term soil productivity, biodiversity, resistance of disease causing organisms [Brandsæter et al 2020, Addison et al 2019, Gotosa et al 2019, Joimel et al. 2021]. The need for increased crop yields has also pushed large scale deployment of several novel mechanical practices. Increased tillage is one of them. Excessive tillage practices, though productive to large-scale farming, are primary causes for top soil degradation and erosion. This culminates to loss of soil organic matter and fertility over time [Micucci and Taboada 2006]. Microbial biota of the soil is affected too due to tillage and so does their structure and therefore their water retention capacity [Wang et al 2020]. Deep vertical rotary tilling is another new practice which hampers soil morphology and erosion [Wang et al 2020].

Although, deep tillage on the contrary seems to be a boon to crop yields without affecting much the topsoil fertility but they seem to be highly dependent on soil structure [Schneider et al 2017]. Increased frequency of crop diseases is another problem finding its roots in excessive tillage practice [Bwala et al 2018].

Around 24% of total greenhouse emissions are resulting from agriculture, forestry and land use. A major portion of these emissions is resulting from agricultural practices and land use intensification. Agriculture is therefore expected today to work on decreasing its environmental footprint. A measure suggested today is increasing soil carbon stock through agriculture by capturing excess carbon dioxide from the atmosphere as in the initiative of 4 per 1000, where the soil carbon storage is aimed to increase to 3.4 GtC per year in the top 40 cm layer of soil [Soussana et al 2019].

Agroecological and conventional practices are considered ideal in land use carbon dioxide emission mitigation as It is effective for carbon sequestration than its conventional counterpart and has a higher CH₄ uptake by soil [Lorenz and Lal, 2016]. Although is this method of agriculture sufficient enough solely to meet the growing food demands ? Several studies suggest that is not the case. Connor (2008) argues that the yield projections for organic agriculture are highly overestimated majorly owing to the infinite natural nutrient source assumptions in these predictions. Kirchmann et al 2009 also argue that it is insufficient and almost entirely impossible to replace synthetic fertilisers from conventional agriculture with organic amendments to get similar yields. This is owed to limited availability of animal manure and leguminous plants in such large scale for fertilisation purposes. Crop residues are speculated to aid in this regard. They definitely do increase soil carbon stock and their abundance could yield lower reliance on synthetic amendments [Jensen et al 2005] . There are several initiatives to use them even in a climate change mitigation context through its catalytic activity on carbon sequestration in soil [Stella et al 2019]. Despite advantages of the usage of crop residue, there is drawback in its utility. Their decomposition in the soil has been found to be a hotspot for soil N₂O, NH₃ and other nitrogen gases. Moreover, incorporation of organic amendments with tillage have been shown to lower soil organic carbon stocks over time [Lorenz and Lal 2016]. Thus, organic agriculture, though as promising

as it sounds, comes up with its own set of challenges. Cover crops, application of organic manures and slurry under organic agriculture contribute strongly to soil nitrous oxides and ammonia emissions by priming nitrogen mineralisation in soil through decomposition of organic residues, litters and matter [Jensen et al 2005] Resultantly, under the banner of Climate Smart Agriculture, a fusion of organic and conventional agricultural methods is paving way to agroecology [Taylor 2018]. Still one crucial need of the moment is to lower organic amendment related greenhouse gas emissions, especially nitrous oxide, which has a global warming potential of 265-298 [Fifth IPCC Report 2014]. Detailed study of processes at soil level is needed for better planning for sustainability of agriculture systems in a global warming scenario. In this article we are identifying at the soil scale, the processes interplaying in nitrogen and carbon transformations, leading to nitrous oxide and ammonia emissions. We are taking two examples, one from conventional system of cropping, the other from agroecological system of cropping to illustrate the processes and their effects of nitrous oxide and ammonia emissions and we are conducting a review on the available publications pertaining to the issue. There is not a clear consensus if agroecology is performing better than conventional agriculture in greenhouse gas emissions scenario. We are also determining here if agroecology is performing better than conventional agriculture in emissions of nitrous oxide and ammonia.

1.1 Soil Carbon Storage and Agriculture Practices

In agriculture ecosystems, natural carbon recycling is disturbed by: (i) soil preparation through tillage and ploughing [Verdi et al 2016]; (ii) inputs of fertilisers in both chemical and organic forms [Addison et al 2019]; (iii) export of plant biomass post-harvest [Nett et al 2016]; (iv) restoration of grasslands [Ball et al 2014]; (v) indirectly by the application of pesticides and herbicides et cetera. The processes deployed today in conventional agriculture usually resort to the practices mentioned above to ensure high crop yields. Repeated use of these management practices in agriculture has globally caused widespread topsoil degradation and loss of soil carbon stocks [Addison et al 2019]. This has caused a major need for sustainable agriculture practices to enhance soil carbon storage. Several agricultural practices are

proposed today as a means for replenishing the lost soil carbon and additional carbon sequestration [Bilalis et al 2010, Gomiero et al 2008].

- Crop rotations with leguminous plants: this enhances soil nitrogen balance through atmospheric nitrogen fixation by leguminous plants.
- alternating grassland and croplands: This converts a conventional agriculture system into a natural ecosystem for a certain period of time thereby restoring soil functions and properties.
- incorporation of crop residues and exogenous organic matter (examples: manure, compost, slurries, litter, etc.): This provides natural fertilisation means through organic matter introduction to soil. It increases microbial population thus enhances nitrogen and carbon processes in soil.
- Cover crops and intercropping: It provides carbon to soil through stubble and shedding of litter from crops harvested in a few months from the day of sowing.

In this paper, our choice of the two cropping systems (conventional and agro-ecological, Section 3) is based on their contrasting practices especially related to soil carbon **storage** and the nitrogen cycle. The conventional crop rotation is a very widespread management practice in continental Europe today [Bergström and Kirchmann 2009] and is not very beneficial for long term soil health. Whereas the agro-ecological rotation is an encouraged practice but that has not been well evaluated for its long-term positive or negative effects on soil carbon stocks, green house gas emissions and the release of reactive nitrogen forms to the environment [Gomiero et al 2008]. We are choosing these two cropping systems to identify the effects of individual drivers of agriculture methodology on soil biogeochemical cycles and resulting ammonia and nitrous oxide emissions.

2. Soil Processes linked to Agriculture Management

Carbon, nitrogen, phosphorous and sulphur dynamics are major cycles taking place in the soil and at the soil plant interface. [Erikson et al 1998, Filippelli 2008]. All these elements are mainly present in organic forms and they are all primarily mineralised or immobilised depending on microbial dynamics [Kertesz and Mirleau 2004]. Organic matter is always present in the soil either as fresh organic matter or stabilised organic matter. The breakdown of organic matter during decomposition into particulate organic matter and/or soluble organic matter that are then metabolised by microbes for energy production, growth, reproduction, defence and cellular maintenance. Nitrogen is an important element for microorganisms as it is used in protein synthesis, and its oxides can be easily reduced in anaerobic and aerobic conditions by microbial enzymes.

Table 2.1 (below) summarises the nitrogen processes in soils with the electron transfer reactions associated to each of them. Most of these processes are nitrogen limiting, but it is found out that in the presence of high nitrogen and sulphur in soils, the processes could become carbon limiting [Kopáček et al 2013].

These pathways of reduction of nitrogen in soils are the source of soil nitrous oxide, nitrogen oxides and ammonia emissions to the atmosphere as well as the release of nitrate to the aquifers. The final product of this reduction is dinitrogen gas. These processes of the nitrogen cycle are not only dependent on microbial action, the availability of the necessary substrates they feed on (NH_4^+ and NO_3^-) as well as several abiotic factors: O_2 availability, temperature, soil texture, etc.

Process	Substrates	Products	Agents
Mineralisation	Organic N	NH_4^+	Microbial Heterotrophic Respiration
Chemolithotrophic Nitrification (I)	$\text{NH}_4^+ + \text{CO}_2$	NH_2OH	Microbial Enzyme <i>Ammonium Monooxygenase</i>
			Microbial

Chemolithotrophic Nitrification (II)	NH_2OH	NO_2^-	Enzyme <i>Hydroxylamine oxidoreductase</i>	Aerobic
Autotrophic Nitrification	NO_2^-	NO_3^-	Microbial Enzyme <i>Nitrite oxidoreductase</i>	
Nitrifier Denitrification	NH_2OH	$\text{NO} \rightarrow \text{N}_2\text{O}$	Microbial Maintenance and Defense	
Simultaneous Nitrification-Denitrification	$\text{NH}_4^+ \rightarrow \text{NH}_2\text{OH}$	$\text{NO}_2^- \rightarrow \text{NO}_3^- \rightarrow \text{N}_2\text{O} \rightarrow \text{N}_2$ or $\text{NO}_2^- \rightarrow \text{N}_2\text{O} \rightarrow \text{N}_2$	Aerobic Respiration in Microbes	
Codenitrification	Organic N	$\text{N}_2\text{O} \rightarrow \text{N}_2$	Microbial Respiration and Maintenance	Aerobic and/or Anaerobic
Nitrate Reduction and Denitrification (I)	NO_3^-	$\text{NO}_2^- \rightarrow \text{NO}$	Microbial Enzyme <i>Nitrite reductase</i>	Anaerobic
Anaerobic Denitrification (II)	NO	N_2O	Microbial Enzyme <i>Nitric oxide reductase</i>	
Anaerobic Denitrification (III)	N_2O	N_2	Microbial Enzyme <i>Nitrous Oxide reductase</i>	
Anammox	$\text{NO}_3^- \rightarrow \text{NO}_2^-$	$\text{NO} \rightarrow \text{N}_2$	Anaerobic Ammonia Oxidation	
Dissimilatory Nitrate Reduction to Ammonia	NO_3^-	$\text{NO}_2^- \rightarrow \text{NH}_4^+$	Microbial Enzyme <i>Nitrate reductase and Nitrite Reductase</i>	
Ammonia Volatilisation	NH_4^+	$\text{NH}_4^+ (\text{aq}) \leftrightarrow \text{NH}_3(\text{aq}) \leftrightarrow \text{NH}_3 (\text{g})$	Chemical Equilibrium	Abiotic Effect

Table 2.1 Summary of Nitrogen Cycle Processes in Soil in relation to aerobic and anaerobic conditions.

2.1 Substrate availability

Emissions of nitrous oxide from soils are nitrate limiting [Breitenbeck et al 1980]. The widespread source of nitrous oxide is the process of anaerobic denitrification. High concentrations of nitrate in soil makes the process of anaerobic denitrification non limiting providing for stable reduction of nitrate to nitrous oxide and other nitrogen gases.

Higher NH_4^+ concentrations in the soils are favourable for N_2O emissions from nitrifier denitrification as generally when in low concentrations, ammonia oxidising bacteria are unable to compete with heterotrophic and plant immobilisation of ammonium ions [Wrage-Mönnig et al 2018]. This competition would also imply lower nitrate content at the end of nitrification that would further impact anaerobic denitrification [Wrage-Mönnig et al 2018]. Thus in natural conditions where the concentrations of nitrate in soil is low (unlike in chemical fertiliser incorporation), nitrate concentration and thus nitrous oxide emissions depends on soil ammonium concentrations [Griffis et al 2017]. Major portion of ammonium in soil is a result of fertilisation or addition of exogeneous organic matter (EOM). Therefore the ammonium concentration in soil is also dependent on the chemical composition of organic matter as well as its physical state and ultimately its degradability [Griffis et al 2017]. Generally organic matter with low C:N ratios mineralise larger quantities of nitrogen than organic matter with high C:N [Wagger et al 1998]. Lignin and cellulose content of vegetation matter also determine their decomposability in soils and generally the higher the lignin and cellulose content the lower the decomposability [Neff and Hooper 2002].

Consequently it can be said that higher decomposability ensures higher mineralisation of nitrogen into NH_4^+ that goes on to influence subsequent nitrogen transformation processes. The chemical equilibrium between $\text{NH}_4^+/\text{NH}_3$ from the soil also shifts to right i.e. NH_3 volatilisation from soil increases with increase in NH_4^+ concentration. It is important to reiterate here the influence of abiotic factors such as temperature, precipitation and soil texture on decomposition dynamics and that mineralisation of NH_4^+ is also subjected to those influences.

2.2 Soil moisture and oxicity

The water content of soil has significant effects on nitrogen cycle processes as water content of soil can alter redox potentials, movements of ions and O₂ availability [Zhu et al 2018]. The amount of soluble organic matter or dissolved organic carbon is also influenced by the presence of water in soil leading to more colonisation of microbes around those microsites. More microbial respiration, more consumption of oxygen [Metivier et al 2009]. With higher water content in the soil, the air filled pore space would also reduce due to increase in water filled pore space. Increased anaerobicity means increased anaerobic respiration by denitrifying microbes on soil nitrate, thus increased anaerobic denitrification. The water content of soil therefore can influence soil dissolved organic matter content, soil ammonium and nitrate content and the pathway to ammonia emissions and denitrification of soil nitrogen [Zhu et al 2018]. It has been shown that their effects are not independent of soil texture. Microsites of coarse particled soil have greater access to gaseous exchanges than a fine particled soil. Therefore the oxygen availability in the microsites is higher in a coarse particled soil, leading to nitrification as the primary nitrogen transforming process and resulting in denitrification of nitrogen to N₂O through nitrifier denitrification pathway or simultaneous nitrification-denitrification pathway. The NO₃⁻ content of a coarse particled soil is therefore higher than a fine particled soil, making a coarse particled soil prone to nitrate leaching. In case there is a sudden change in porosity of microsites in these soils (as a result of precipitation or irrigation), there will also result anaerobic denitrification by denitrifiers. In fine particled soils, the microsites with soluble organic matter are higher owing to the soil's higher porosity, thus inviting a faster microbial colonisation than in a coarse particled soil. The presence of water therefore, combined with greater heterotrophic microbial respiration normally creates anaerobic conditions making anaerobic denitrification as the primary process of reduction of nitrate to nitrogen gases. Although depending on the amount of dissolved organic matter, the denitrified nitrogen will be outgassed as N₂O or NO_x or N₂. Higher amount of labile carbon would favour complete reduction of nitrate to dinitrogen gas. Studies have shown that the N₂O emissions from soil are small when the water filled pore space (WFPS) is less than 60%, this is due to presence of oxygen in the soil micropores favouring nitrification process. Nitrifier denitrification yielding N₂O emissions are shown to be taking

place in between 40% to 60% WFPS. Above the soil microsites get saturated with water and therefore anaerobic denitrification supersedes, resulting in N_2O emissions from 60% to 95% WFPS, with some studies showing highest N_2O emissions at or above 90% WFPS [Metivier et al 2009]. Rabot et al (2015) also explains the emissions of N_2O from wetting and drying due to high solubility of N_2O in water and that with increasing air filled pore space in soil while drying, the diffusivity of gas from aqueous to gaseous form is high thus causing nitrous oxide emissions.

In each soil, when organic matter decomposes, the mineral nitrogen content of the microsites would determine the extent of NH_3 volatilisation from the soil. Ammonia volatilisation is generally higher in coarse particled soil than fine particled soil as there is a low physical barrier due to larger pore size. Higher water content in the soil stabilises NH_3 in liquid water in the chemical equilibrium of NH_4^+/NH_3 as NH_3 has high diffusivity through soil pores in aqueous phase. This causes increasing ammonia emissions with increasing soil water filled pore space [Mkhabela et al 2006].

2.3 Soil acidity

Van den Heuvel et al (2011) carried out series of incubation experiments with various soils to study the impact of soil pH on nitrous oxide emissions. Their experiments revealed that in low pH conditions, in the range of pH 4-6, N_2O production was higher than for pH values of 6 and above. They also found out that the rate of NO_3^- reduction increased with pH and with it increased the reduction of intermediate nitrous oxide and other nitrogen oxide into N_2 [Hénault et al 2019]. Even though the production rate of N_2O was higher at pH of 5, they hypothesised that the presence of NO_3^- and its ongoing reduction in soil was also higher. In pH lower than 5, the higher concentration of NO_3^- acted as a diffusion barrier to the movement of N_2O within soil layers thereby impeding its reduction to other nitrogen gases and accelerating its emissions to atmosphere. There results were in concordance with other previous experimental observations [Nicol et al 2008]. Therefore it can be summarised that lower pH in soil pores facilitates for higher N_2O emission rates than pH at neutral or above [Russenes et al 2016].

For NH_3 emissions, on the contrary pH has a reverse effect. Lower pH favours the NH_4^+ ion form as compared to the aqueous ammonia form in the soil leading to lower rates of volatilisation. As the soil acidity decreases, the NH_3 emissions thus increase. The oxidation of ammonia increases in acidic soils, this also influences nitrification rates therefore reducing NH_3 volatilisation from soil while resulting in N_2O emissions from autotrophic nitrification [Nicol et al 2008]. Heterotrophic nitrification rates generally get reduced in low pH conditions [de Boer and Kowalchuk 2001]. In high acidic or basic conditions in soils the microbial activity is impacted due to hypertoxic effects resulting in almost no microbial activity and no nitrous oxide or ammonia emissions in those conditions.

2.4 Temperature

Temperature plays an important role in soil microbial activity. High rates of microbial activity in soil are observed when temperature is in the range of 25°C to 30°C [Pietikäinen et al 2005]. Although higher microbial respiration rates are observed at higher temperatures. This thermal variability of microbial action subsequently influences the decomposition of organic matter and thus resulting in carbon dioxide emissions and in the availability of substrates for other microbial or bio-physical processes (nitrification, denitrification, ammonia volatilisation etc.) depending on the environmental factors (O_2 avail, pH, etc.). The ambient temperature also effects the evapotranspiration rates therefore influencing the water availability in the soil and all consequences (part 3.2 above). Luo et al (2013) reported from a series of experiments that N_2O emissions were higher in ecosystems with warm and moist climate and with oxic-anoxic switch resulting from freeze-thaw in moist low temperature soils.

Ammonia emissions follow an exponential increase with temperature due to the equilibrium between $\text{NH}_3(\text{aq})$ and $\text{NH}_3(\text{g})$ (Sutton et al. 2013). When talking about freeze-thaw, it is important to note that NH_3 emissions from soil decrease during a freeze event and it gets accelerated during a thaw event [Ruijter et al 2010]. Ammonia emissions increase with increasing temperatures also due to loss in soil moisture that assures greater permeability through soil pores [Pagans et al 2006]. Activity of NH_3 oxidising microbiota generally increases with increasing temperature and therefore the process of nitrification is boosted in higher

temperatures [Tourna et al 2008]. This would be another reason for increase in nitrous oxide emissions in elevated ambient temperature.

2.5 Soil texture

As mentioned earlier, soil texture plays a decisive role in soil nitrous oxide and ammonia emissions by affecting movements of substrates in soil, pore size therefore water and oxygen availability as well as adsorption of ions [Barton et al 2008]. It also determines the diffusivity of gases through the soil surface [Rochette et al 2008]. Large particled sandy soils consequently would have higher nitrous oxide and ammonia emissions in comparison to small particled silty and clayey soils. Small particled soils also prove to be a natural barrier to soil water evaporation therefore keeping soil relatively more moist than large particled soil [Arya and Paris 1981]. Therefore soil particle size also plays a role in oxic-anoxic conditioning of soils while simultaneously influencing aerobic and anaerobic denitrification processes. These effects have already been documented in the previous section(s).

3. Agriculture Methodology and their effects on N₂O and NH₃ Emissions

3.1 Example of Two Contrasting Agriculture Practices

In this section the effects of two different agriculture practices i.e. conventional agriculture and agroecology on soil nitrogen cycle and resulting nitrous oxide and ammonia emissions is presented. An example of crop rotation cycle is chosen for each scenario and the soil processes are discussed in the following section with respect to management practices and crop phenology. These two hypothetical scenarios are designed to serve as a standard and a point of inflection for reference to elaborate the discourse on the effects of individual drivers in diverse agriculture methodology, on the ammonia and nitrous oxide emissions from soils. These hypothetical scenarios are culmination of various agriculture practices, common in Northern and Western Europe. They are somewhat more of idealised scenarios and it might be difficult to reproduce such a crop cycle on field in a specific geographical area. But this comparison procedure really allows to estimate a range of nitrous oxide and ammonia

emissions reported in the available scientific literature from these two broadly defined agriculture systems (Figure 2.1).

3.1.1 Conventional Agriculture System

[Red Clover - Winter Wheat - Oilseed Rape - Winter Wheat]

The first case presented here is that of a conventional farm cycle of three years, with two important annual cash crops of Europe - winter wheat (*triticum aestivum*) and oilseed rape (*brassica napus*). In order to ensure soil conservation by preventing erosion, soil nitrogen loss and carbon stock degradation, once every two years, a nitrogen rich cover crop such as red clover, alfalfa or vetch, is planted on the fields in the regions concerned. The idea is also to let the cover crop present on the fields post harvest enabling it to act as an organic fertiliser input through its decomposition in soil. This type of crop cycle is typical in Northern Europe. The advantages of growing them in the mentioned region is being owed to the abundance of silty-clay soils in the fields permitting greater seed germinability and survival rates, thus yielding better harvests.

In this particular case, the crop cycle starts with plantation of cover crop in summer and its harvest in late summer early autumn. The stubble from the harvest is left on soil while the land is ploughed using stubble tillage. Thereafter winter wheat seeds are planted and it grows all its way through winter and spring before finally maturing near summer. While there is no chemical fertilisation done during the cover crop growth season, ammonium nitrate and isotopic nitrogen fertilisers were put on fields late winter and early spring respectively. The crop is harvested mid-summer and the field is left fallow for three months until the sowing season from oilseed rape begins early autumn. The land is ploughed again through stubble tillage and winter wheat residues were left on the field. The seeds grow into small plants throughout the winter while shedding their bottom leaves. This is a mechanism of the plant to ensure enough nitrogen supply for its growth and maintenance throughout the chilly winter months. The land is fertilised with ammonium nitrate twice, first in late winter and second in early spring. Meanwhile the crop reaches maturation around mid-summer and is harvested. This is followed by another winter wheat crop cycle. After the second harvest of winter wheat,

the land is planted again with a cover crop, then a cash crop, and then again, another cash crop with in-between fallow, and the cycle keeps repeating. One important point to note here is that there is usually no need of irrigation in this cropping cycle, owing to precipitation in winter months and mid spring and early summer months.

3.1.2 Agro-ecological System

[Mustard - Winter Wheat - Winter Pea - Winter Barley]

The second case presented here is that of an agro-ecological system. The three year cycle for this example begins with cultivation of a green manure crop, followed by cereal crops and leguminous crops. Usually, the cropping cycle is three years but the range of crop rotation length in organic agriculture can go up to seven years [Peigné et al 2015]. Here we present a case of a tri-annual crop cycle, beginning with cultivation of mustard as the green manure, followed by winter wheat, winter pea and winter barley. Mustard is planted usually in late summer and harvested in late autumn. The advantages of planting mustard is of course its nitrogen rich properties making it suitable for green manure as well as its ability to provide defence to the growing plants against pests and diseases [Motici et al 2009]. Most of the time, land is tilled before the planting of mustard seeds and after its harvest in late autumn. This makes this agriculture scenario a high soil disturbance one. By early winter, winter wheat is planted on the ploughed and stubble tilled soil. The weeding frequency is high usually during the growth stage and no external chemical fertilisation of the soil is carried out. Winter wheat is then harvested around late summer, the soil is tilled with its residues and left fallow for a few weeks before plantation of a leguminous crop such as winter pea begins. In most cases, no green manure crop is planted after the harvest of the main cereal crop. The advantage of planting leguminous crop is its synergic relationship with nitrogen fixing bacteria in its root nodules that utilise nitrogenase enzymatic complex for hydrolysis of ATP (adenosine triphosphate) to fix exergonically the dinitrogen gas from the atmosphere as ammonia NH_3 [Canfield et al 2010].

Winter pea is usually planted with stubble tillage and deep non inversion ploughing. This makes it fall under the scenario of medium soil disturbance. Its importance for cultivation lies in its diverse utility as both a fodder and a grain crop. It is planted around mid autumn and it is left to grow all throughout the winter until spring, and it is harvested around early summer. Its roots are left in the soil to ensure decomposition and release of fixed nitrogen in soil for future cropping. The residue post- harvest is also left on the field as mulch. Subsequently, the last year of cropping cycle begins again in early autumn with planting of winter wheat seeds, usually in a no till fashion. It makes this a scenario of no soil disturbance. The crop is allowed to grow with mulch decomposition throughout the winter and early spring, that allows for constant carbon and nitrogen supply to growing plants. The weeding frequency during the growth stage is kept to bare minimum - usually once or twice. Furthermore, to ensure good yields, manure application takes place two times - first in late winter and second in early spring. The harvest is done around early summer. This cropping cycle then repeats itself with other combination of green manures and cereal and leguminous crops. Field irrigation is not done in organic agriculture in northern countries attributed to frequent winter and spring showers, as mentioned in the previous case.

3.2 Linking the crop management practices to soil Nitrogen and Carbon processes

When comparing the above two cropping scenarios, there are several differences in cropping methodology that can be earmarked.

3.2.1 Chemical versus organic fertiliser use

Introduction of chemical fertilisers to soil, as in the case of conventional agriculture acts as a strong catalyst to soil nitrogen processes. Incorporation of ammonium nitrate fertilisers in soils results in its hydrolysis leading to increased NH_4^+ and NO_3^- pools in the soils. This results in more NH_4^+ and NO_3^- available for plant intake but also for microbial assimilation and metabolism [Hauck 1981, Fowler et al 2013]. This primes the soil microbial processes such as chemolithotrophic nitrification and anaerobic denitrification from soils [Wrage-Mönnig et

al 2018]. The applications of chemical fertilisers early spring and late winter does avoids the problem of nitrate leaching to some extent [Fowler et al 2013], but the arrival of spring showers lead to a change in oxicity of soils, increasing the soil water drainage, resulting in further anaerobic denitrification [Butterbach-Bahl et al 2013]. Most of the experimental field studies recorded high nitrous oxide flushes during the spring season from agricultural crops [Mazzetto et al 2020, Wagner-Riddle et al 1997] probably resulting from fertlilisation events. Ammonia volatilisation is a result of chemical equilibria between ammonium ions and water. Therefore, it is natural to expect its flush from the fields right after chemical fertilisation [Scotto di Perta et al 2020, Verdi et al 2018]. N_2O and NH_3 emissions in response to N application is variable but ranges from 0.5% to 2% for N_2O and 1% to 30% for NH_3 [Akiyama et al 2004, Cowan et al 2019, Degaspari et al 2020]

In agroecological practices, seldom the chemical fertilisation is replaced with slurry and manure fertilisation. Organic fertilisation has been shown to increase soil microbial abundance and diversity while still accounting for lower nitrous oxide emissions [Tao et al 2018, Verdi et al 2018]. Ammonia emissions also result from organic fertilisation often in significant quantity in comparison to chemical fertilisation [Vilarrasa-Nogu  et al 2020, Schils et al 2008, Bourdin et al 2014]. These emissions are significant still highly dependent on physico-chemical properties of slurry such as their acidity, their water content, their time of incorporation and their mode of incorporation [Badagliacca et al 2018, Machado et al 2021]

Soil Acidity also increases due to chemical fertiliser application. This enhanced soil acidity therefore also contributes to soil nitrous oxide and ammonia emission and liming of fields every few years helps to prevent this problem, however liming causes pH increase in soil that enhances nitrous oxide and ammonia emissions from soil, reducing nitrifier denitrification and increasing anaerobic denitrification and facilitating gas-liquid equilibrium for ammonia [Mosier et al 1998, Barton et al 2013].

Slightly acidic conditions favour nitrous oxide emissions from soil, but checks ammonia emissions. Water content in slurry determines the pathway to nitrous oxide emissions - heterotrophic denitrification or anaerobic denitrification. While the time of incorporation is solely dependent on interactions between weather and soil processes, and it has been found

out that slurry incorporation before sowing results in lower nitrous oxide and ammonia emissions while not significantly affecting the yield of the crop [Viguria et al 2015].

3.2.2 Crop residues and green manure management

Another significant similarity between the two cases of agriculture systems presented above is the incorporation of crop residues. In conventional agriculture system, the frequency of incorporation is lower than that of organic agriculture system. In conventional agriculture system stubble tillage is common, that means the harvested residue is left mixed on the top surface of the soil. Seldom it is a green manure, only during the harvest of cover crop.

Incorporation of green manure in organic farms on the contrary is a common phenomenon. The question that arises then is if these two practices have different interactions with soil microbial processes. The answer to this question lies in the chemical properties of the crop residue left on the field. It is well known that residue with high nitrogen prime strongly the soil nitrogen processes and thus impact soil mineral nitrogen emissions. Residue with high carbon content have lower decomposability and thus their priming of soil microbial processes is not as significant in comparison [Jensen et al 2005]. It has been found that nitrogen mineralisation in soil is highly dependent on the initial water soluble nitrogen composition of the vegetation but after a few weeks is dependent on its total nitrogen content i.e. both organic and inorganic [Jensen et al 2005, Shan and Yan 2013]. Miller et al (2008) through experimental incubations in controlled conditions found a strong influence of nitrogen rich red clover residue on increase of soil microbial population in comparison to the influence from nitrogen deficient barley residue. Their studies also found higher nitrous oxide flush from red clover residue in the early stages of incubation than from the barley residue, although the cumulative flux of N_2O for both the residue came closer by the end of incubation (around 144th hour). This study is just another example of many where the effects of residue chemical quality is shown to describe their effects on various soil nitrogen transformation processes. The flux of nitrous oxide emission resulting with its immediate incorporation into soil is mostly an interplay between both heterotrophic nitrification and anaerobic denitrification [Yang et al 2019, Frimpong et al 2011]. Addition of green manure to the soil therefore in the beginning boosts the nitrifier denitrification process due to higher amount of water soluble nitrogen in

them, but with precipitation, loss of oxygen and higher moisture content with time results in priming of anaerobic denitrification process thus leading to high flush of nitrous oxide in the spring months, when the temperature is favourable for microbial activity and moisture content of soil is usually high owing to frequent showers in the season in the region concerned. The stubble tillage with nitrogen deficient residues such as wheat, barley or matured oilseed rape as is common with the conventional crop rotations doesn't really significantly reinforce the nitrifier denitrification at the beginning, but reaching around spring time, again due to meteorological reasons, it contributes its shares to nitrous oxide emissions [Frimpong et al 2011], even though the emissions are not as significant as from a green manure. Ammonia emissions are resulting only from nitrogen rich green manure, and that too only at the beginning of its incorporation to soil. Another important factor is the physical state of crop residue. Kravchenko et al (2018) found from their experiments on soil microcosms of two different soils one coarse with pore size of 30 μ m and another with pore size of 10 μ m, that in coarse soil there were differences in nitrous oxide flux peak between two residues incorporated – crimson clover and red clover. They found that crimson clover with higher water retention capacity than red clover had higher nitrous oxide emissions in coarse soil. In fine soil, the differences between the emissions were not significant. They also found slightly higher fluxes of nitrous oxide from crimson clover residues ground to powder than from the intact residues. For red clover their physical state did not alter the nitrous oxide fluxes. More studies are needed for studies of effects of crop residue's physical characteristics on nitrogen dynamics in soil.

3.2.3 Mode of application of plant organic matter

Another important factor to be considered while comparing green manures and harvested stubble is their mode of incorporation. In both systems stubble is mixed in top soil through tillage. However for green manures in agro-ecological systems, it is deployed in the soils in primarily three different ways - left on soil surface as mulch, mixed with topsoil through stubble tillage or buried at a certain depth in soil through deep tillage. The positioning of residue in soil is expected to affect its decomposition dynamics and the nitrogen mineralisation processes as the soil physico-chemical properties can vary in its different

layerings. Allmaras et al (1988) showed that mouldboard plough resulted in lower proportion of coarse organic matter (16%-52% of total organic matter incorporated as wheat residue) in the top 10 cm of soil, while in chisel and sweep tillage the proportion of coarse organic matter in topsoil was higher, ranging from 87% to 96%. Thus it can be surmised that decomposition of residue will be higher when the residue is mixed in the soil due to greater availability of oxygen that provides little to no limitation to heterotrophic microbial decomposition. This will prove to be a boost to ammonia mineralisation and nitrification processes. This should imply nitrifier denitrification should be the process overtaking the anaerobic denitrification in this case. Residues buried inside the soil layers would also have some nitrifier denitrification but due to lack of oxygen, anaerobic denitrification and simultaneous nitrification-denitrification seem to be the primary processes resulting in nitrous oxide flux in this case. Mutegi et al (2010) and Nett et al (2016) found out through experiments that nitrous oxide emissions were higher in conventional tillage where residues were either mixed or ploughed in fine textured soils. Emissions from mulch were significantly lower ascertained to lower contact of residue with soil microbes. Nett et al 2016 although found a high ammonia fluxes from mulch than from ploughing and conservation tillage. It is attributed to the lack of physical barrier in the volatilisation process of ammonia enhancing the diffusivity of NH_3 gas from its liquid form in soil water. If talked of carbon dioxide fluxes from these situations, it is normal for it to be highest in cases where residue is mixed or buried than when it is placed as mulch owing again to microbial contact to residue and the associated rates of decomposition.

3.2.4 Weeding

Weeding frequency between organic and conventional agricultural systems vary significantly. It is high in conventional agriculture, where herbicide application takes place frequently. In large scale organic agriculture, weeding is usually done mechanically using machinery. In mechanical weeding, the dead plant matter is usually left on the field for decomposition. It is naturally expected positive contribution to soil nitrogen and carbon pool. Steenwerth and Belina (2010) found that in vineyards, cultivation of weeds had slightly higher sequestered carbon in the soil while the soil nitrate levels increased with herbicide application. This was coupled to their observation of around 50% higher nitrous oxide emissions from herbicide

application (peaking around $4 \mu\text{g N}_2\text{O-N m}^{-2} \text{ s}^{-1}$ between 20th to 30th hour after application) than from weed cultivation in drip system (peaking at around $2 \mu\text{g N}_2\text{O-N m}^{-2} \text{ s}^{-1}$ between 20th to 30th hour after cultivation). This also puts light on the aerobic-anaerobic switching associated with drip irrigation and its impacts on nitrification and denitrification. Their assumption for lower N_2O emissions from cultivated weed is the presence of labile carbon through its decomposition that facilitates greater reduction of N_2O to N_2 . Presence of weed on the soil during the growth stage of the crop with a combination of low to no weeding frequency in organic agriculture also results in uptake of inorganic nitrogen by growing weeds, this results in lower nitrous oxide emissions from the soil than when there is little to no weed on the field [Bailey et al 2015]. For ammonia emissions, it is only mulch presence of cultivated weed residue that results in some ammonia emissions with its decomposition. From herbicide treatment there have been observations of gaseous fluxes of NO , NO_2 and NO_x . Concerning ammonia emissions, Pacheco et al (2017) found through experimental incubations that herbicides such as glyphosate or glyfosinate or paraquat applied on pearl millet and congo grass residues emitted cumulative NH_3 fluxes ranging from around 8 kg ha^{-1} to 14 kg ha^{-1} on day 14. Herbicide application can accelerate plant senescence leading to protein breakdown in leaves and thus higher ammonium concentrations thereby indirectly increasing foliage ammonia emissions [Pacheco et al 2017, Manderscheid et al 2005]. This is therefore a similar process as senescence induced ammonia emissions demonstrated by several studies [David et al 2009, Sutton et al 2009, Personne et al 2015]

3.2.5 Crop phenology

This evidently plays a huge role in determining soil nitrogen emissions. The life cycle of a crop is affected by abiotic weather related factors. Precipitation, ambient temperature and sunlight affect directly soil physical properties such as temperature, moisture, oxygen content and porosity, subsequently meddling with the soil chemical properties such as acidity/basicity, microbial biodiversity, mineralisation and immobilisation processes. Their effects on soil carbon and nitrogen dynamics are already demonstrated in the previous section 2.

With the start of cropping season post summer in continental countries, the soil is exposed to an increased phenomena of rainfall. Precipitation is an interesting case where the soil WFPS increases quickly causing an oxic-anoxic switch. With increased anaerobicity, the denitrifiers get active and release N_2O that starts to get released once the soil starts to dry off after the precipitation [Oates et al 2016]. This causes a slight delay in these significant N_2O emissions from soil after a rainfall event [Pattey et al 2007]. Furthermore, the changing soil aerobicity also results in simultaneous nitrification and denitrification in nitrifying bacteria, especially during the wet-dry weather changes. This suggests flushes of nitrogen gases from agricultural fields during this time period of crop phenology. The flush of nitrous oxide and ammonia during late summer and early autumn also depends on if the soil has crop residue in it from cover crop and if the soil was cultivated with a nitrogen fixing leguminous crop. In case of a nitrogen fixing cover crop, the atmospheric nitrogen is fixed by virtue of rhizobacteria in the root nodules of plants. Thus nitrogen fixed increases the quantity of mineral nitrogen in soil. This increase in mineral nitrogen in soil results in higher cumulative nitrous oxide emissions from soils after harvest of leguminous crops (with or without intercropping) while checking nitrate leaching from soils [Pappa et al 2011, Jeuffroy et al 2013]. In study of Pappa et al (2011), there were some flushes of nitrous oxide in the beginning of cropping season post crop rotation, slightly higher than post harvest of cereal monocrop (barley in this case). In case there is stubble or green manure present in soil during the beginning of crop cycle in early autumn, with precipitation, there is also some nitrous oxide emission during the phase of preparation of soil and sowing [Kandel et al 2019, Kandel et al 2019].

Subsequently, during the growth stage of the crop, there are no significant nitrous oxide emissions as the mineral nitrogen is taken by the plants for growth and maintenance [de Klein et al 2019] therefore no significant emissions of nitrous oxide during the period from until late winter. Although freezing and thawing could result in some flushes of nitrous oxide through anaerobic-aerobic switch during winter [Metivier et al 2009, Pappa et al 2011]. Fertiliser or manure application in late winter or early spring, and then again in mid spring also acts as precursors to nitrous oxide and ammonia emissions [Kandel et al 2019, Jeuffroy et al 2013, Pappa et al 2011].

Another factor coming into light determining the extent of nitrous oxide emission is plant rhizodeposition. Ai et al (2020) found out that wheat can induce 3.5-9.2 times increase in nitrous oxide emissions from soil in a variety of soils with variant fertility by modifying the microbial abundance of nitrifier and denitrifier in the rhizosphere. Furthermore, weather can affect strongly the rhizodeposition for example decreasing plant contribution to soil carbon through rhizodeposition while increasing nitrogen mineralisation in plants due to temperature and water quantity effects on soil microbial activity [Canarini and Dijkstra 2015]. Increased nitrogen mineralisation may increase ammonia emissions but more investigation is necessary in that regard in future.

3.3 Estimation of the range of Ammonia and Nitrous Oxide fluxes from Agroecological and Conventional Crop Cycle

After comparison of several studies deploying conventional agriculture practices and agroecological methodologies (Table 2.2, Figure 2.2), we have gathered a range of flux values for gas emissions for specific periods of measurement. We then averaged those flux values to a period of one crop year. This allowed us to draw conclusions from that annual cumulative nitrous oxide and ammonia emissions from both types of agriculture practices are not so different statistically [Ball and Nevison 2014]. The emission characteristics seem to be highly dependent on a wide array of factors already mentioned before and it appears that their interplay essentially brings the annual cumulative fluxes from both the systems to an identical range (Figure 2.2). Although in case of ammonia fluxes, the lowest point in the range for agroecology and organic agriculture practices is lower than that of the conventional agriculture that suggests that there is definitely a driver in the methodology that gives advantage to the agroecological methods. From the literature analysis it can be surmised that these low ammonia emissions happen when the residue is positioned within the soil. The same reason is applied to lower limit of nitrous oxide emissions from both the systems. Nitrous oxide emissions have been recorded lowest when the fertilising inputs and crop residues are left on the soil surface either as mulch or in a partially embedded state in the top soil.

Meanwhile most of the studies done to determine emissions of nitrous oxide and ammonia from soils are done experimentally using microcosm or mesocosm incubations. In those cases

it is challenging to regard their flux values for comparison especially when their fluxes have been cumulated only for a few days or months pertaining to incubation experiments under controlled conditions. Another challenge in this estimation is inadequate data available for annual mineral nitrogen contents of soil with respect to agroecological treatment which is crucial to understand nitrogen partitioning in the soil and the fraction of nitrogen outgassing as nitrous oxide and ammonia.

Nitrogen Species	Quantity	Unit	Crop	Reference	Cumulation Period	Tillage	Fertilisation
N ₂ O	1.296	kg N/ha	Cauliflower	Nett et al 2016	231 days	Reduced	Crop Residue
	1.033	kg N/ha	Cauliflower	Nett et al 2016	231 days	None	Crop Residue
	3.216	kg N/ha	Cauliflower	Nett et al 2016	231 days	Conventional	Crop Residue
	4.81	kg N/ha	Wheat and Maize	Drury et al 2006	1 Year	Conventional	Chemical Fertilisation
	1.72	kg N/ha	Winter Wheat and Wheat after Fava bean	Badagliacca et al 2018	2 Years	Conventional	Chemical Fertilisation
	2.98	kg N/ha	Wheat and Maize	Drury et al 2006	1 Year	Reduced	Chemical Fertilisation
	3.71	kg N/ha	Wheat and Maize	Drury et al 2006	1 Year	None	Chemical Fertilisation
	2.45	kg N/ha	Winter Wheat and Wheat after Fava bean	Badagliacca et al 2018	2 Years	None	Chemical Fertilisation
	1.6	kg N/ha	Winter Wheat	Wang et al 2019	1 Year	None	Chemical Fertilisation
	3	kg N/ha	Winter Wheat	Wang et al 2020	1 Year	Conventional	Chemical Fertilisation
	0.647 to 2.3437	kg N/ha	wheat, red clover, soyabean	Machado et al 2021	1 Year	Conventional	Crop Residue
	1.5-4.5	kg N/ha	Oat Residue	Ball and Nevison 2014	1 Year	Reduced	Crop Residue
	2.0-7.0	kg N/ha	clover grass	Ball and Nevison 2014	1 Year	Reduced	Crop Residue
	2-4.5	kg N/ha	wheat	Ball and Nevison 2014	1 Year	Reduced	Crop Residue
1.0667 to 3.1283	kg N/ha	Wheat, red clover, soyabean	Machado et al 2021	1 Year	Reduced	Crop Residue	
NH ₃	1.113	kg N/ha	Cauliflower	Nett et al 2016	231 days	Reduced	Crop Residue
	1.645	kg N/ha	Cauliflower	Nett et al 2016	231 days	None	Crop Residue
	0.836	kg N/ha	Cauliflower	Nett et al 2016	231 days	Conventional	Crop Residue
	10.0 to 16.0	kg N/ha	Winter Wheat and Wheat after Fava bean	Badagliacca et al 2018	2 Years	Conventional	Chemical Fertilisation
	5.99	kg N/ha	Winter Wheat	Yang et al 2015	1 Year	Conventional	Chemical Fertilisation
	4.9 to 5.73	kg N/ha	winter wheat	Yang et al 2015	1 Year	Reduced	Chemical Fertilisation
	10.0 to 16.0	kg N/ha	Winter Wheat and Wheat after Fava bean	Badagliacca et al 2018	2 years	None	Chemical Fertilisation
15.9	kg N/ha	Grass	Ruijter et al 2010	119 days	Reduced	Crop Residue	
NO ₃ ⁻	20-50	mg N/kg soil	Wheat and Corn	Drury et al 2006	1 year	Conventional	Chemical Fertilisation
	1.5-1.6	mg N/kg soil	Winter Wheat and Wheat after Fava bean	Badagliacca et al 2018	2 Years	Conventional	Chemical Fertilisation
	20-50	mg N/kg soil	Wheat and Maize	Drury et al 2006	1 Year	Reduced	Chemical Fertilisation
	20-50	mg N/kg soil	Wheat and Maize	Drury et al 2006	1 Year	None	Chemical Fertilisation
	1.3-1.8	mg N/kg soil	Winter Wheat and Wheat after Fava bean	Badagliacca et al 2018	2 Years	None	Chemical Fertilisation
	9.16	mg N/kg soil	Winter Wheat	Wang et al 2019	1 Year	None	Chemical Fertilisation
	10.16	mg N/kg soil	Winter Wheat	Wang et al 2019	1 Year	Conventional	Chemical Fertilisation
	14.1 to 63.5	kg N/ha	Wheat, red clover, soyabean	Machado et al 2021	1 Year	Conventional	Crop Residue
13.8 to 66.9	kg N/ha	Wheat, red clove, Soyabean	Machado et al 2021	1 Year	Reduced	Crop Residue	
NH ₄ ⁺	0.74	mg N/kg soil	Winter Wheat	Wang et al 2019	1 Year	None	Chemical Fertilisation
	0.35	mg N/kg soil	Winter Wheat	Wang et al 2019	1 Year	Conventional	Chemical Fertilisation

Table 2.2 Summary of cumulative flux of nitrous oxide and ammonia and mineral nitrogen concentration values from certain studies pertaining to diverse agriculture practices and diverse fertilising inputs.

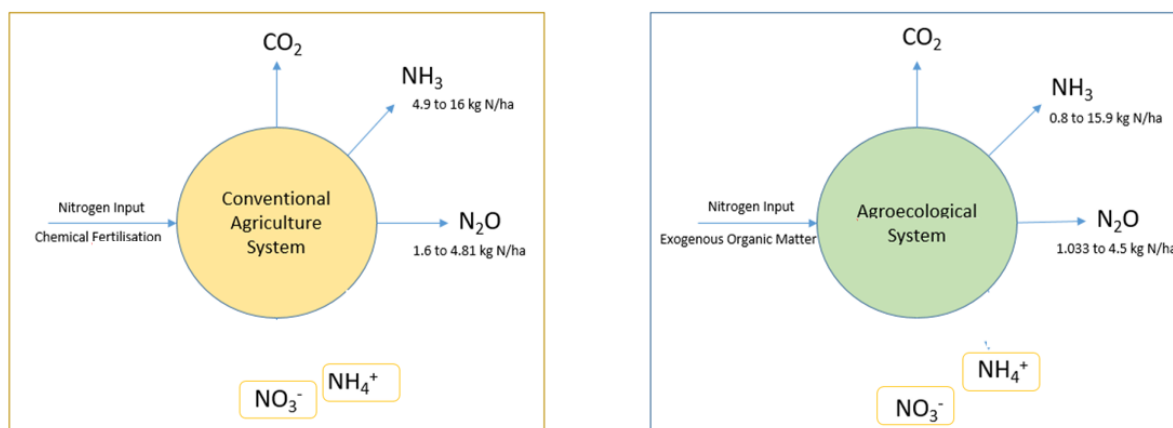

Figure 2.2. Estimates of the range of annual nitrous oxide and ammonia fluxes deduced from available literature on different type of crop systems and rotations

4. Conclusion and prospects

This study summarises differences between agroecological and conventional agriculture practices and their influences on soil carbon and nitrogen processes. While there are definitely proven benefits of deployment of agroecology over conventional agriculture, especially in relation to biodiversity, preservation of ecological services and soil conservation, in terms of land use nitrous oxide and ammonia emissions, there does not seem to be much difference in between the two systems. The rates of fluxes of these gases might differ, but when looked into the multitude of studies, it can be found that their cumulative values are in the same range. Furthermore, apart from abiotic and biological causes, the factor that seems to play a significant role in determining emission characteristics of N₂O and NH₃ from these systems is the position of incorporation of both chemical fertiliser and organic manure [Drury et al 2006, Ball and Nevison et al 2014]. While there are several studies available in literature concerning the position of application of fertilisers, slurry and manures [Fangueiro et al 2018, Duncan et al 2017, Drury et al 2006], there are not enough research on position of incorporation of crop residues in soils and the resulting nitrous oxide and ammonia emissions. Consequently, with the need to shift agriculture towards sustainability in climate change scenario, more experimental studies on incorporation depth of crop residues are needed to better quantify and mitigate agroecological greenhouse gas emissions. More experimental studies on annual

fluxes of nitrous oxide and ammonia are also needed to evaluate more precisely the impacts of agroecology and conventional agriculture system. Furthermore, crop residue incorporation also sequesters carbon in soil leading in long run, greater presence of stabilised organic matter in soils. More long term experiments are needed to have precise information on them. The cumbersome experimentation may also be replaced with predictive numerical modelling. The experimental data obtained will also act as standard for optimisation and parameterisation of models simulating these gaseous emissions from soils.

Chapter 3

Vertical Distribution of Crop Residues affects Nitrous Oxide and Ammonia Emissions from Soils

Varunesh Chandra^{a,b}, Gwenaëlle Lashermes^b, Thuy Dung Ngo^a, Alain Fortineau^a, Patricia Laville^a, Benjamin Loubet^a, Raia Silvia Massad^{a*}

^aUniversité Paris-Saclay, INRAE, AgroParisTech, UMR ECOSYS, 78850, Thiverval-Grignon, France

^bUniversité de Reims Champagne Ardenne, INRAE, FARE, UMR A 614, 51097 Reims, France

*Corresponding Author, Email : raia-silvia.massad@inrae.fr, ORCID : 0000000212961744

Abstract

Aims: Crop residue incorporation in fields provides organic carbon (C) and nitrogen (N) inputs to soil, enhancing carbon sequestration and fertility. Such addition usually primes greenhouse gas emissions due to microbial action. Surface contact between residues and soil plays a major role in these emissions. Farmer decision on agricultural practices resulting in different vertical distribution of residues influences surface contact. To understand this effect, we performed laboratory incubation of N-rich red clover residues, a common cover-crop.

Methods: Red clover was incorporated at a rate of 4000 kg dry matter ha⁻¹ in three different soils: a sandy Swedish soil (SLU), a silty French soil (GICOS) and a calcareous silty French soil (GEXER). We tested three vertical distributions: surface, mixed in top 4 cm, and layered at 4 cm depth. Soil was kept at 15°C and 60% water filled pore space. High N₂O fluxes were observed in the first five days of incubation from all vertical distributions.

Results: Mixed and layered modalities had higher N₂O cumulative fluxes than surface modalities. Significant NH₃ fluxes were measured only from surface modalities. Sandy SLU soil had higher N₂O and NH₃ fluxes than fine silty GEXER and GICOS soils. Nitrification and denitrification processes explaining differences in N₂O and NH₃ fluxes are discussed.

Conclusions: Consequently, it is found that residue mixed or layered in soil yield a significant feedback N₂O emissions, while those left on surface yield significant NH₃ emissions.

Keywords: laboratory incubations; organic matter decomposition; soil quality; litter; nitrogen mineralization; red clover; greenhouse gases; agricultural practices

Declaration

Funding

- French National Research Agency (ANR) under the ERA-NET Cofund scheme ERAGAS (Residuegas project).
- Department of Environment and Agriculture, INRAE (French National Research Institute for Agriculture, Food, and Environment).

Conflicts of interest/Competing interests

None

Availability of data and material

Data are available upon request

Code availability

Not applicable

1. Introduction

Nitrous oxide (N_2O) is a strong greenhouse gas (GHG) with a global warming potential 265 times that of carbon dioxide (CO_2). It is the third contributor to global anthropogenic radiative forcing and accounts for more than 6% of the total anthropogenic forcing (AR5 IPCC, 2014). Moreover, N_2O is a major contributor to stratospheric ozone depletion (Ravishankara et al. 2009). Agriculture is the main source of N_2O and accounted for about 75% of global N_2O emissions in 2017 (FAO Stats, 2020). Twenty nine percent of these emissions are attributed to chemical fertiliser application, the rest 71% is released from organic farming methods such as manure management and crop residue incorporation (FAO Stats, 2020). The contribution of crop residues on the contrary has increased by 0.81 % (FAO Stats, 2020) and can potentially increase in the future with more incentives on usage of organic amendments in the aim of increasing soil C storage (Rumpel et al. 2019, Smith et al. 2016). Unharvested crop residues incorporated in soil act as organic manure but also have a priming effect on soil microbial activity and therefore on greenhouse gas (especially N_2O) emissions (Nebert et al. 2011, Stewart et al. 2015). Despite offering alternatives to fertiliser usage, the long term effects of residue application on soil should be evaluated in terms of GHG emissions (Chen et al. 2013). Moreover, residue decomposition in soils potentially releases ammonia gas which is a precursor of secondary aerosol, a harmful pollutant for the environment and human health (Ruijter and Huijsmans 2012; Sutton et al. 2011). Decomposition of organic matter releases mineral nitrogen as NH_4^+ and NO_3^- . Ammonium and hydronium ions in the soil solution are in equilibrium with ammonia. Ammonia in solution is in equilibrium with ammonia gas according to Henry's law (Génermont et al. 1998). Thus depending on soil pH and temperature, ammonia can thus be volatilized from soil surface.

Ammonium ions can then go through chemolithotrophic nitrification using carbon dioxide in presence of oxygen to reduce ammonium to nitrite, which then undergoes transformation into nitrate (de Boer et al. 1991). Nitrate ions in the soils can be denitrified leading to N_2O emissions (simultaneous nitrification-denitrification). In parallel, there may be oxidation directly from NH_4^+ to N_2O (codenitrification) or from NH_4^+ to NO_2^- to N_2O (nitrifier

denitrification) (Wrage et al. 2018). Ammonium oxidation (Anammox) is another process resulting in direct conversion of ammonium with nitrite into dinitrogen (Kuenen 2008). These soil microbial processes are heavily dependent on the availability of carbon and nitrogen substrates, but also on abiotic factors such as temperature, soil water content, pH as well as soil physico-chemical properties (He et al. 2006, Loick et al. 2017, Pelster et al. 2019, Venterea and Rolston 2000).

Around 85% of total N_2O emissions in the world result from soil microbial processes of nitrification and denitrification (Skiba and Rees, 2014) and organic inputs in soil could increase this share further. Indeed, many studies report effects of climate (precipitation and temperature), soil aeration (tillage scenarios) and soil types on field N_2O emissions (Novoa and Tejeda 2006, Mutegi et al. 2010, Chen et al. 2013). It is well established that N_2O emissions increase when water filled pore space (WFPS) increases from 60% to 80% (Hénault et al. 2005, Khalil and Baggs 2005, Metivier et al. 2009). Usually soils with fine particles (high percentage of clay and silt) result in higher N_2O fluxes than the coarse-particled sandy soils. This has also been shown to be dependent on soil porosity, humidity and aeration (Balaine et al. 2013, Gaillard et al. 2016, Yu et al. 2019). Smith et al. (1998) found an exponential relationship between soil temperature and N_2O flux while Maag and Vinther (1996) showed that loamy soils, they have a high nitrification rate.

A number of studies highlight the effects of crop residue management on N_2O emissions from fields. Baggs et al. (2006) observed high N_2O flux ($2.1 \text{ g } N_2O\text{-N ha}^{-1} \text{ kg}^{-1} \text{ N applied}$) during the first two weeks after residue incorporation in the soil in Western Kenya. Akiyama et al. (2020) reported a strong increase of N_2O (peak in the range of $800\text{-}1200 \mu\text{g N m}^{-2} \text{ h}^{-1}$) fluxes from the field two weeks after cabbage residue with low C:N were left on the soil surface, a slight peak was observed right after residue incorporation. Pugesgaard et al. (2017) showed from field measurements that crop residues with low C:N (grass clover and potatoes) emitted higher N_2O fluxes than crop residues with high C:N (wheat and barley). These results are in line with a synthesis from Butterbach-Bahl et al. (2013) concluding that the addition of crop residues rich in nitrogen primes the soil processes of organic matter stabilization therefore leading to nitrous oxide emissions from such sustainable agriculture practices. Localisation of crop

residues in soils could also play an important role in N₂O emissions (Coppens et al. 2006). Residues buried in the soil offer greater microbial contact between organic matter and the soil, triggering therefore higher decomposition rates compared to residues left on the soil surface (Prescott et al. 2017, Parker 1962). With organic matter decomposition, rates directly influencing soil mineral nitrogen availability and thus N₂O production (Trinsoutrot et al., 2000).

Focusing on ammonia, several studies have tried to understand its volatilisation from soils, in scenarios of manure/slurry/fertilizer applications (Huijsmans and Schills, 2009, Singh et al. 2013, Webb et al. 2014). After incorporation of organic amendments, it has been shown that the volatilization of NH₃ may be enhanced by N mineralization (Nemitz et al. 2000, Zhang et al. 2015). NH₃ emissions are strongly sensitive to moisture conditions, soil organic carbon and texture (both determining soil moisture characteristics and the reaction of positively charged NH₄⁺ with the negatively charged cation exchange sites: Cation Exchange Capacity) (Al-Kanani and MacKenzie, 1992; Delon et al. 2017; Keller and Mengel, 1986). Rochette et al. (2013) for example demonstrated through soil mesocosm experiments with urea application that NH₃ volatilisation rates were larger when the application was on surface than when applied beneath soil surface.

The variability in N₂O emissions is extremely high as shown in meta-analyses by Chen et al. (2013) and Shan and Yan (2013), who identified both soil type and residue quality as important controls of N₂O emissions. Some studies have shown considerable differences in N₂O and NH₃ emissions of leaving cover crops undisturbed versus incorporation or harvesting (de Ruijter et al. 2010, Longlong et al. 2018; Xia et al. 2016). Laboratory experiments conducted by Huang et al. (2004) showed that tillage and the incorporation of plant residues increased N₂O and CO₂ emissions. The localisation of crop residues within the soil (on the surface, slightly buried or completely buried) has a major effect on gaseous nitrogen emissions. This vertical distribution can potentially modify key factors such as water dynamics, distribution of microbial activities, mineral nitrogen and soluble C as well as the contact surface between the residues and the soil and therefore microbial colonization (Coppens et al., 2006; Iqbal et al., 2015).

In this study we aim to quantify N₂O and NH₃ emissions from red clover with three different soil types and in different vertical distributions, in a laboratory setup under controlled conditions, over a 50-60 days period. Additionally, soil nitrogen and carbon content was measured throughout the incubation and CO₂ fluxes were recorded. Three crop residues localization were tested, mixed, layered and surface positions in soils; and three soils were used to get a wider view of the interaction between soil type and residue location.

2. Materials and Methods

2.1 Soil and Residues Used

Soils were sampled from 0-20 cm depth from three different locations to prepare soil microcosms for laboratory incubation. A first soil was collected from an experimental site in Alnarp, Sweden (55°39'28.2"N 13°04'56.1"E) (called SLU here) and stored frozen at -20°C. Two soils, one with high calcareous content and therefore high pH and the other with neutral pH were sampled from Thiverval-Grignon, France (48°50'53.4"N, 1°56'23.1"E and 48°50'37.0"N 1°57'03.6"E respectively) and stored at 0-4°C. These soils are called GEXER and GICOS respectively. All soils were sieved to 6 mm and all the vegetation fragments were removed. They were sampled for analysis of total carbon and nitrogen, pH and texture prior to its storage. Physico-chemical properties of these soils are depicted in Table 3.1.

Table 3.1 Physico-chemical characteristics of three soils – SLU, GEXER and GICOS

Soil	Units	SLU	GEXER	GICOS
Clay (< 2 μm)	g kg ⁻¹	158	214	108
Fine silt (2/20 μm)	g kg ⁻¹	122	139	287
Coarse silt (20/50 μm)	g kg ⁻¹	102	219	353

Fine sand (50/200 µm)	g kg ⁻¹	307	100	104
Coarse sand (200/2000 µm)	g kg ⁻¹	311	47	27
Organic C	g kg ⁻¹	15	18.4	20.8
Total N	g kg ⁻¹	1.49	1.79	2.11
CaCO ₃	g kg ⁻¹	<1	275	58
Organic matter	g kg ⁻¹	26	31.9	41.7
C:N	-	10.1	10.3	9.9
Water pH	-	6.18	8.29	7.6
CEC	cmol kg ⁻¹	15.5	13.6	15.5



Red clover plants (C:N = 17.9, Dry matter 2.5%, N-NO₃ ‰ = 0, N-NH₄ ‰ = 0.2, Soluble N ‰ = 2.2, Soluble C ‰ = 85) sampled from Ås, Norway (59°39'57.7"N, 0°46'06.5"E) were harvested at a reproductive stage. Different organs were separated (leaves, stems, flowers and petioles), weighed and dried for a week at 40°C and then cut to 1 cm pieces. These parts were then mixed together in proportions similar to their occurrence in the field (37% stem, 34% flowers and leaves, 29% petioles) for the incubation.

2.2 Preparing Soil Microcosms

Frozen SLU soil was thawed for one week at 5°C. All soils were preincubated for one week at 15°C in a temperature regulated chamber with aeration. SLU soil was preincubated at 35% water filled pore space (WFPS) in 1 g cm⁻³ bulk density, GEXER and GICOS at 40% WFPS in 1 g cm⁻³ bulk density. We added potassium nitrate (KNO₃ 98% pure) to preincubated soils so as to reach 100 mg NO₃⁻ N kg⁻¹ soil for SLU and GEXER soils (Table 2). GICOS was treated with 100 mg NO₃⁻ N kg⁻¹ soil.

Preincubated soils were then packed at 1.25 g cm^{-3} bulk density in incubation cylinders of 12.5 cm diameter with perforated bottom. To ensure homogeneity in the cylinders, soils were put in layers of 2 cm each until they reached 8 cm height in the cylinder. Mass of each 2 cm layer was calculated from bulk density, cylinder volume and moisture content for each soil. The WFPS of each 2 cm soil layer was adjusted to 60% before it was topped with another 2 cm layer. Prepared 1 cm cut residues were added with an amount of $0.04 \text{ g DM cm}^{-2}$ surface of soil. These residues were either on top of the 8 cm cylinder (surface modality), or after having added the first two layers (at 4cm) for the sandwich modality or by mixing them with the upper two layers of soils for the mixed modality. No residue was added to control treatments. Three repetitions of each modality and control were prepared. Similar microcosms with cylinders of perforated bases (7 cm diameter) were prepared (one per modality) at the same time with preincubated soils and residues in accordance with Table 3.2 for mineral nitrogen extraction and sampling. Each prepared microcosm was covered with a perforated film and kept at 15°C in an aerated dark room when idle from measurement. One point to note here is that there was no surface modality for GEXER soil due to lack of appropriate soil availability.

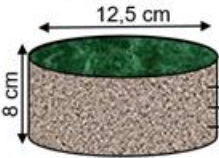
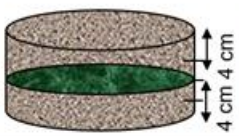
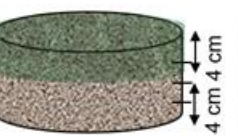
Table 3.2 Modalities with different vertical distribution of residues in soils and added mineral N as KNO_3 solution

Modalities	Surface	Sandwich	Mixed	Control
				
Soil type	GEXER SLU GICOS	GEXER SLU GICOS	SLU GICOS	GEXER SLU GICOS
Soil mineral N	100 kg/ha	100 kg/ha	100 kg/ha	100 kg/ha
WFPS	60%	60%	60%	60%

2.3 Measuring Gas Emissions from Soil Microcosms

We set up a gas incubator (Gas Emission Detection Incubator: GEDI) allowing us to measure gas fluxes from our incubation cylinders. Four different gases (N_2O , NH_3 , CO_2 and H_2O vapor) were measured with continuous airflow during 50 days everyday for the first two weeks, twice per week from day 14 till 28 and then once per week for the rest of the period.

2.3.1 Gas Emission Detection Incubator (GEDI)

GEDI (see Figure 1 for more details) is a system that allows for automatic measurements of gas exchanges in a laboratory setup. It is all setup in a temperature-controlled box (Length: 115 cm, Width: 60 cm, Height: 60 cm) with five chambers with each chamber holding one soil cylinder (12.5 cm diameter and 8 cm height). The chambers are exclusively made of glass and all tubing was Teflon PTFE made to minimize NH₃ adsorption. Chambers were also cylindrical with a headspace of 530.14 cm³. A Teflon based air deflector was used (Flura et al. 2014) for the chambers to (i) allow turbulent air flow in the head space and (ii) avoid direct air flow on the soil so that it does not dry.

All of the chambers are connected in parallel to one another through three-way solenoid valves at each inlet and outlet. Air is supplied to each of these chambers in sequence from their inlets to allow for a gas flow through the outlet. Gas flow from the outlet then reaches the different analyzers for measurement. The three-way solenoid valves are also connected to another parallel air circuit simultaneously that allows for constant airflow in the chambers not in measurement through a secondary exhaust preventing any accumulation inside those chambers. In Figure 1, the red circuit corresponds to the measurement circuit, and the green to the auxiliary circuit. The gas sampling is performed automatically following a sampling sequence controlled by a data logger (Campbell CR1000X). Air flow through the system is controlled and measured by a mass flowmeter. Fluxes are computed following a steady-state chamber approach, i.e. from the difference in air trace-gas concentrations between the outlets of a cell with treated soil-cylinder and a blank-cell, empty. The soil-headspace exchange rate of each trace-gas is a result of the mass balance between the two outlets (chamber air) concentrations assuming mass flow equilibrium conditions.

$$F_{ss} = Q/A \times (C_{out} - C_{blk})$$

where F_{ss} stands for the trace gas flux; A denotes the soil surface of the soil cylinder; Q is the headspace air flow rate. C_{blk} and C_{out} are the trace gas mixing ratios of the outflowing chamber air for the blank cell and cell with treatment respectively. Fluxes were converted to kg N (or

C) /ha /d using air temperature measurements (the atmospheric pressure was set to 1013 hPa).

The *air supplied* for measurement is 'cleaned' by filter traps connected in series at the inlet of the GEDI. Manganese dioxide based filter (Purafil Inc., Atlanta, GA, USA) to eliminate ozone and nitrogen oxides (NO_x), active charcoal filter to trap volatile organic compounds (VOCs), acetic acid based filter to capture background ammonia, a cotton-tissue based particle filter and an empty trap to obstruct entry of water to the incubator. A bubbling humidifier with ultra pure water is connected in series to these filters to maintain constant air humidity in the incubator. Temperature was kept constant at 15°C during the course of measurements. All the measurements took place in the dark. An airflow of 4.0 l min^{-1} was maintained at the entry of GEDI. A datalogger (Campbell CR1000X) was used to record measured data. Thermocouples were attached to this datalogger to record real time temperature of the incubator.

A *measurement cycle* for the five cylinders placed in the GEDI is 140 minutes. Cycle starts with a 15 minutes purge of the whole system with clean air, followed by a sequential measurement of each cylinder of 25 minutes. The 25 minutes measurement sequence is subdivided into three parts: (i) a continuous flow rate measurement where the outlet is sampled for 15 minutes and (ii) an accumulation measurement where the chamber is closed for 3 minutes and then air is purged and measured for one minute and (iii) a zero air measurement where the blank exhaust is sampled for 6 minutes.

Three *gas analysers* were connected in parallel with the GEDI outlet. A constant air-flow rate (1 L min^{-1}) was maintained at the input of each analyser by a thorpe tube flow-meter connected in series with GEDI [See *Figure 3.1* for more details]. An ammonia Cavity Ring-down Spectroscopy Analyser (PICARRO G2103) was used for measurement of ammonia (in ppb) and water (in % by mass). Infrared analyser LICOR (Li – 840A) was deployed for continuous monitoring of carbon dioxide (in ppm). It also detected water concentration in parts per

thousand (ppth). A Quantum Cascade Laser Tunable Infrared Laser Differential Absorption Spectrometer (QCL TILDAS – Aerodyne Research Inc.) analyser was used for measuring nitrous oxide (in ppb).

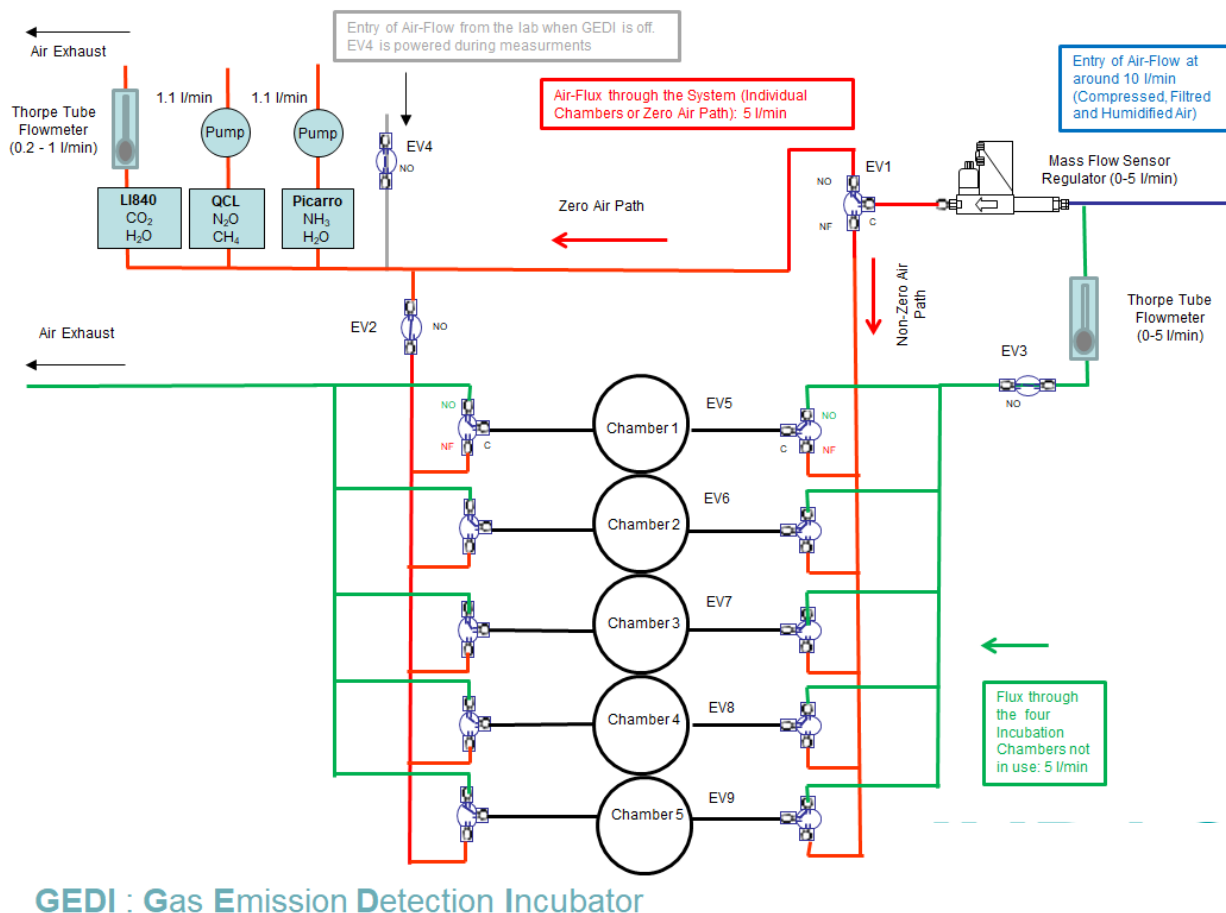

Figure 3.1 Schematic showing flow circuitry of Gas Emission Detection Incubator. Red circuit represents the main measurement airflow circulation. Green circuit represents the auxiliary “sweeping” airflow circulation. EV stands for electro valves, NO for normally open and NF for normally closed.

2.3.2 Measurement Protocol and Soil Analysis

Incubation and measurement period for each microcosm lasted 50-60 days. Gas measurements were done five days each week for first two weeks from the day of soil microcosm preparation. Then two days per week in the two successive weeks and one day per week in the last three-four weeks.

Before and after each gas measurement, masses of the soil microcosms were recorded. Water loss from microcosms during measurements were compensated by adding equivalent amounts of ultra pure water to the incubation cylinders. Since the water loss after each measurement cycle was minimal, water was added weekly during first two weeks and then once every two weeks until the end of incubation period.

The sampling of *mineral nitrogen* was done in the complementary cylinders prepared specifically for mineral nitrogen measurements at days 4, 7, 14, 28 and 50 or 60. Soil of each cylinder was mixed and packed in a labelled sachet and frozen under -20°C until extraction. For extraction, the frozen samples thawed overnight at 5°C . Airtight bags were prepared and 50 g of soil from each sample was put with 100 ml of 1 mol l^{-1} KCl (Potassium Chloride, 99% pure, Merck Chemicals) solution. They were then mixed in a rotative shaker for 30 minutes. The bags were then left standing undisturbed for 30 minutes for sedimentation. Vacuumed tubes were labelled and then used for collecting the supernatant with a syringe. The tubes were then frozen and later analysed by colorimetric method (LDAR, Laon reference: A_RS19.66-1) for mineral NH_4^+ and NO_3^- .

2.3.3 Calculation and statistical analysis

Cumulated daily fluxes were calculated until day 50 of incubation period to yield cumulative gaseous fluxes. Linear interpolation was used to fill the gaps between measurement days, by taking the mean of the daily gaseous flux between the precedent and the successive measurement day for each modality and their repetitions. *Net cumulative fluxes* were calculated by subtracting the cumulative fluxes of control modalities (without residue application) from those with residues. The means were calculated from the three repetitions of each modality. We statistically compared the cumulative gaseous fluxes obtained between different vertical distributions within each soil, a Tukey test was used. Principal component analysis was performed to determine interrelationship between different gaseous fluxes and soil nitrogen processes.

3. Results

We present here cumulative fluxes for N_2O and NH_3 exchanges as well as time series for N_2O , NH_3 fluxes and soil mineral NH_4^+ and NO_3^- contents.

3.1 Net Cumulative Fluxes of Nitrous Oxide and Ammonia

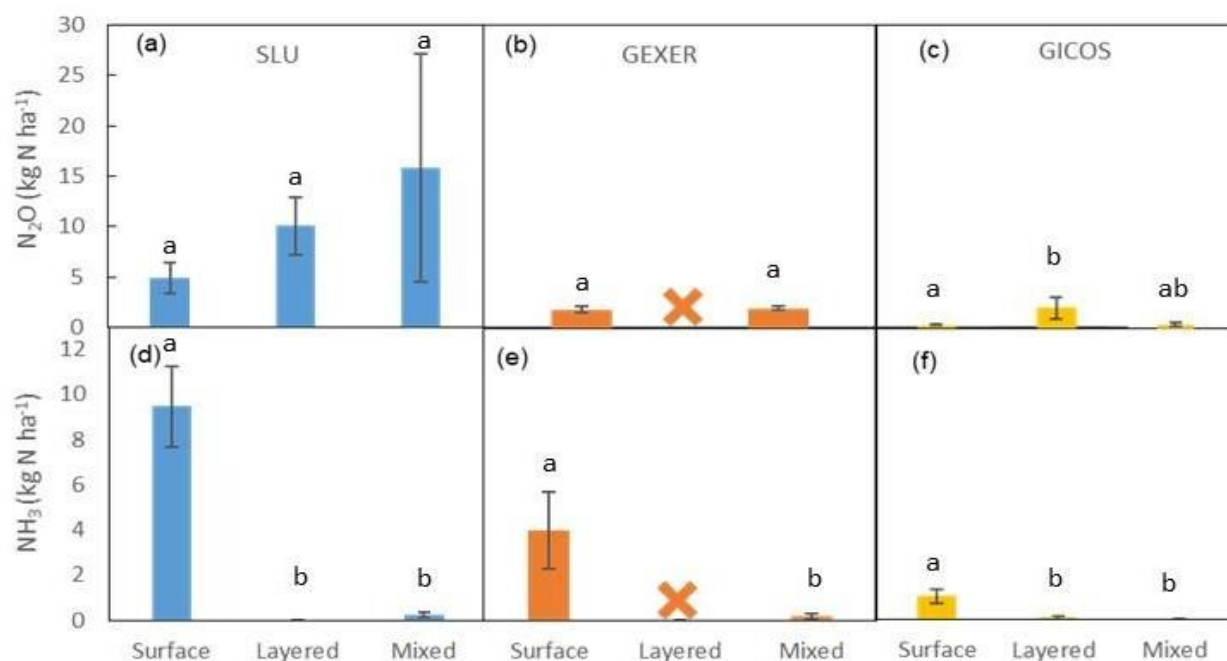

Figure 3.2 Net Cumulated Gaseous Fluxes of N_2O (a, b, c) and NH_3 (d, e, f) for modalities with three soil types and three red clover residue vertical positions for 50 days of incubation. Here SLU: Swedish soil (a and d), GEXER: Grignon Exercise French Soil (b and e), GICOS: Grignon ICOS site French Soil (c and f). Small letters represent results of the Tukey test.

Swedish soil SLU had the highest net N_2O cumulated flux for 50 days of incubation (Figure 3.2 (a)). French soils GICOS and GEXER had similar net N_2O cumulated fluxes, which did not differ statistically according to the Tukey test. Within SLU modalities, red clover mixed on the top half of soil had highest average net cumulated N_2O flux of $15.82 \text{ kg N ha}^{-1}$. Next followed layered modality with net average cumulated N_2O flux of $10.09 \text{ kg N ha}^{-1}$ and red clover on surface had the lowest average net cumulated N_2O flux of $4.90 \text{ kg N ha}^{-1}$. However taking into account the great variability of the replicates for each of the modalities, they were not

statistically different between them. In the case of GICOS soil (Fig. 3.2 (c)), layered modality recorded the highest average cumulated N_2O flux of $1.94 \text{ kg N ha}^{-1}$, mixed and surface modality subsequently recorded average net cumulative flux of $0.42 \text{ kg N ha}^{-1}$ and $0.28 \text{ kg N ha}^{-1}$. For GEXER soil (Fig. 3.2(b)), both surface and mixed microcosms had statistically similar average net cumulated N_2O fluxes of $1.91 \text{ kg N ha}^{-1}$ and $1.76 \text{ kg N ha}^{-1}$.

Significant fluxes of NH_3 were measured (Figure 3.2 (d, e, f)). Surface modalities had the highest emissions with mean net cumulative flux values of 9.5 kg N ha^{-1} , 3.7 kg N ha^{-1} and $0.95 \text{ kg N ha}^{-1}$ respectively for SLU, GEXER and GICOS soils. Mixed and layered modalities recorded near-zero net cumulated NH_3 fluxes.

3.2 Time Series of Average Dynamic Gaseous Fluxes

In order to better understand the differences between the different modalities and soil types, we analyzed the temporal sequence of the fluxes in relation with the dynamics of soil mineral nitrogen and the mineralized carbon.

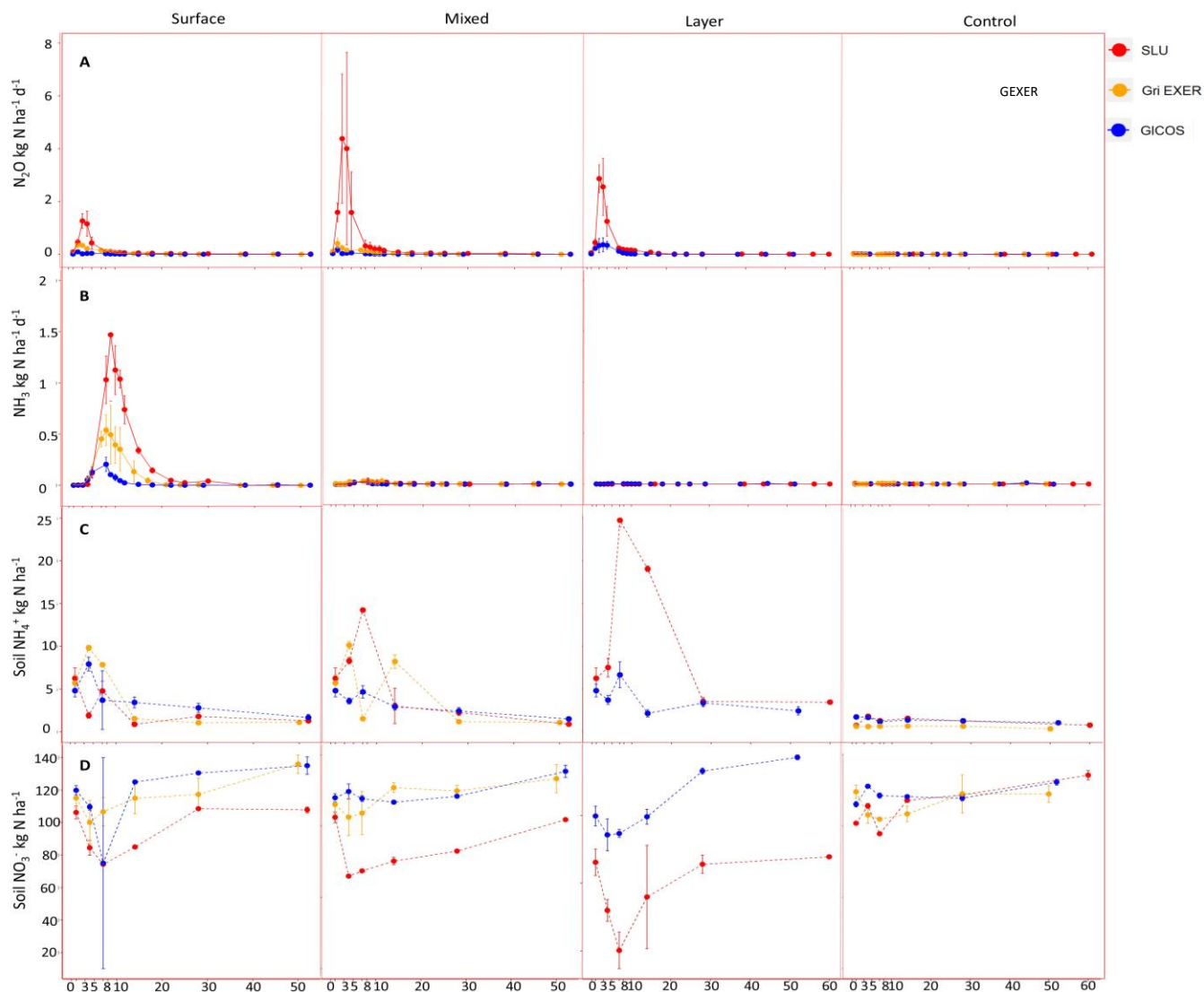

Figure 3.3 Dynamics of N_2O (A) and NH_3 (B) fluxes for surface, mixed, layered and control modalities as well as soil mineral N content (ammonium (C) and nitrate (D)) for the three soil types (SLU, GEXER and GICOS).

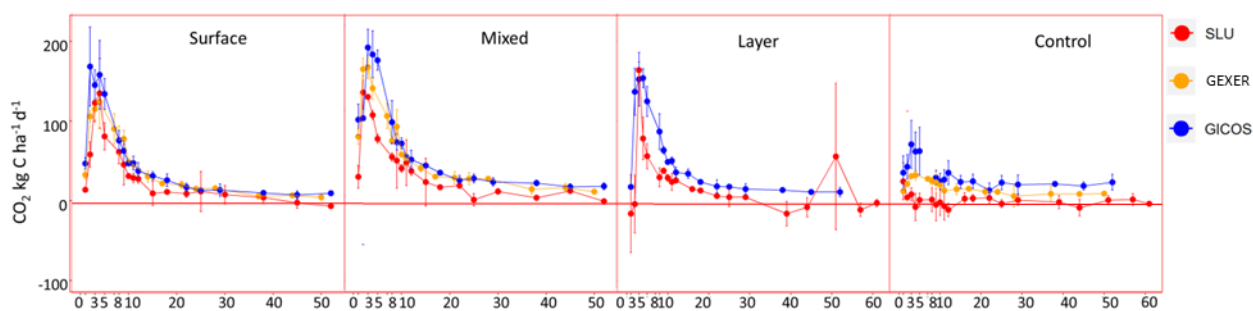

Figure 3.4 Dynamics of CO_2 flux for surface, mixed, layer and control modalities for three soils – SLU, GICOS and GEXER.

a. Surface modalities

N_2O fluxes for surface modalities reached peak values in the first five-six days of incubation (Figure 3.3(A)). The highest peak value of daily flux was recorded for SLU soil at $1.26 \text{ kg N ha}^{-1} \text{ d}^{-1}$ on day 3. GEXER soil had the intermediate peak daily N_2O flux at $0.36 \text{ kg N ha}^{-1} \text{ d}^{-1}$ on day 2, while GICOS soil had the lowest peak at $0.095 \text{ kg N ha}^{-1} \text{ d}^{-1}$ on day 2.

NH_3 flux dynamics reached peak between day five and day fourteen of the incubation period. SLU soil recorded the highest peak daily NH_3 flux at $1.47 \text{ kg N ha}^{-1} \text{ d}^{-1}$, followed by GEXER soil at $0.54 \text{ kg N ha}^{-1} \text{ d}^{-1}$ (Figure 3.3(B)). GICOS soil had the lowest NH_3 daily flux peak, at $0.205 \text{ kg N ha}^{-1} \text{ d}^{-1}$ at day 8. Post day 20 of incubation, both N_2O and NH_3 daily fluxes phased towards zero.

The NH_4^+ content in GEXER soil surface and GICOS modality had peak values in the first week of incubation at $9.82 \text{ kg N ha}^{-1}$ and at $7.93 \text{ kg N ha}^{-1}$ respectively (Figure 3.3(C)). SLU soil reached a trough after day 1, then increased to a peak value of NH_4^+ content on day 7 ($4.78 \text{ kg N ha}^{-1}$), yet there was a significant analytical variance ($= 1.121$). After day 14, the NH_4^+ contents in all the three soils phased towards zero.

Contrary to ammonium content, the NO_3^- content of GEXER soil reached minimum value in the first week of incubation at 100 kg N ha^{-1} . This is lower by 4.7 kg N ha^{-1} than the control which implies net immobilisation by microbes; and depletion in content in comparison to control. GICOS soil reached trough at $74.9 \text{ kg N ha}^{-1}$ (difference of $45.7 \text{ kg N ha}^{-1}$, with the control) (Figure 3.3(D)). The nitrate contents of these soils increased from day 7 to the end of the incubation. SLU soil in contrast, first decreased until day 7 ($106.6 \text{ kg N ha}^{-1}$, variance= 8.7) and then reached a value of $114.9 \text{ kg N ha}^{-1}$ in the second week (day 14), then increased towards the end.

Concerning CO_2 daily flux maximum was highest for GICOS at $168.2 \text{ kg C ha}^{-1} \text{ d}^{-1}$ on day 2 while SLU soil had a peak at $134.8 \text{ kg C ha}^{-1} \text{ d}^{-1}$ on day 4 (Figure 3.4). GEXER soil had the lowest peak CO_2 flux at $124 \text{ kg C ha}^{-1} \text{ d}^{-1}$ on day 4.

b. Mixed modalities

In case of mixed modalities peak values of N₂O daily fluxes (Figure 3.3(A)), were observed in the first week of incubation for all three soils, SLU soil at 4.4 kg N ha⁻¹ d⁻¹ (day 3), GEXER soil at 0.4 kg N ha⁻¹ d⁻¹ (day 2) and GICOS soil at 0.2 kg N ha⁻¹ d⁻¹ (day 2). From day five to the end of incubation, all the daily N₂O fluxes for three soils phase towards zero. There were near-zero average NH₃ fluxes for the three soils with red clover in mixed modality (Figure 3.3(B)).

The ammonium content for all three soils reached a peak in the first week of incubation. SLU soil recorded a peak value at 14.2 kg N ha⁻¹, GEXER soil had a peak at 10.1 kg N ha⁻¹ and GICOS soil reached a small trough on day 4, then a small peak at 4.7 kg N ha⁻¹ (day 7) (Figure 3.3(C)). From day 14 onwards, the ammonium content for all three soils decreased towards zero.

The NO₃⁻ content decreased for SLU soil until day 3 thereafter increasing to around 108 kg N ha⁻¹ at the end of incubation (Figure 3.3(D)). GEXER soil recorded a trough on day 4, then a peak nitrate content in the second week of incubation at 126.9 kg N ha⁻¹ (day 14) thereafter remaining more or less stable to the end of incubation period (133.2 kg N ha⁻¹ on day 50). The GICOS soil recorded little to no change in nitrate content values in first two weeks, reaching its peak in the last day of incubation period at 138.4 kg N ha⁻¹ on day 52.

For CO₂, GICOS soil had the peak emissions at 173.9 kg C ha⁻¹ d⁻¹ on day 3, GEXER soil at 150.7 kg C ha⁻¹ d⁻¹ on day 3 and SLU soil at 120.9 kg C ha⁻¹ d⁻¹ on day 2. Mixed modalities had higher peaks than the surface modalities for calcareous and silt-loamy GICOS and GEXER soils. However, surface modality has higher peak than mixed modality in sandy SLU soil. The days of these peaks of daily CO₂ flux are in slight correlation to days of N₂O daily flux peaks (Figure 3.3).

c. Layered modalities

Layered modality was similar to mixed modality with slightly lower peaks for SLU and GICOS soils concerning N₂O emissions (Figure 3.3(A)). For Layered modalities, SLU soil emitted highest daily flux of N₂O at 2.9 kg N ha⁻¹ d⁻¹ on day 3 while GICOS soil had a daily flux of 3.7

kg N ha⁻¹ d⁻¹ on day 4. Their ammonium contents reached a peak on day 7, from there decreased until the end of the incubation (Figure 3.3(C)). The nitrate content of both these soils were lowest on day 7, increasing from there to the end of incubation (Figure 3.3(D)). The peak CO₂ daily flux coincided with days 3 and 4 of incubation (Figure 3.4).

d. Control modalities

Control modalities of all the three soils had N₂O and NH₃ fluxes close to zero all throughout the incubation period (Figure 3.3 (A) and (B)). They remained constant for soil mineral NH₄⁺ content (in the range of 1-3 kg N ha⁻¹) and slightly increased for NO₃⁻ contents (from around 100 kg N ha⁻¹ to 130 kg N ha⁻¹). For CO₂ daily fluxes, the control modality of GEXER soil reached a slight peak at 23.6 kg C ha⁻¹ d⁻¹ on day 4 and GICOS control modality at 60 kg C ha⁻¹ d⁻¹ on day 3. SLU control CO₂ daily flux remained close to zero (Figure 3.4).

4. Discussion

We articulate the discussion around three major points: (i) the effects of soil biogeochemical properties on the net cumulative fluxes as well as the dynamics of gaseous fluxes, (ii) the effect of residue position on cumulative gaseous fluxes, and (iii) the evolution of daily gaseous fluxes in relation to underlying microbial processes. We try to highlight how this experiment improves our overall understanding of factors and processes influencing N₂O and NH₃ emission characteristics from the three soils with red clover residue.

4.1 Effect of soil type on N₂O and NH₃ fluxes

The net cumulative N₂O and NH₃ fluxes between the three soils – SLU, GEXER and GICOS differed significantly among themselves for each residue positioning. This highlights the effect of soil physico-chemical properties (porosity, particle size, water retention capacity, microbial biodiversity) on these gaseous fluxes.

Several experiments have shown the effects of soil texture on gaseous fluxes. Usually, fine textured soils yielded higher N₂O fluxes in conventional agricultural systems without residues

on fields (Stehfest and Bouwman 2006, van Groenigen et al. 2004) which is consistent with our results. Gaillard et al. (2016) modelled N_2O emissions from different categories of US soils using DayCent model and found that fine textured silt soils had higher fluxes than coarse-textured sandy soils. They found that in their loamy sand and sandy loam soil, around 70% of N_2O emissions resulted from nitrification, while in silty loam soils nitrification accounted for 24% of N_2O . Rochette et al. (2018) discussed this phenomenon with respect to higher WFPS in field soils with fine texture, facilitating N_2O emissions. In our experiment, the WFPS of soil cores incubated was kept constant at 60% WFPS so this factor may well be ruled out for discussion.

In the laboratory experiments done by Yu et al. (2019) in controlled conditions with cotton crop residues, coarse textured sandy loamy soil recorded higher N_2O fluxes than silty loamy soil. This suggests contrasting effects of addition of crop residues to soil. It is generally assumed that silty soils have higher N_2O emissions because of their ability for water retention and lower oxygen diffusivity leading to anaerobic denitrification. Chen et al. (2013) summarised results of N_2O fluxes from a range of crop residue amendments and found that emissions were higher in coarse-textured soils than in fine-textured soils, similar observations were recorded in several other laboratory experiments (Maag and Vinther 1996). This is potentially owing to the aerobic nitrifier denitrification phenomenon (Wrage et al. 2018). In our experiment, SLU soil, which had higher sand content had the highest net cumulative flux. GEXER and GICOS soils had similar yet low sand content (Table 1) thereby having similar values for cumulative N_2O flux. This is in conjunction with the observations of Chen et al. (2013), Maag and Vinther et al. (1996) and Yu et al. (2019). Likewise, higher N_2O emissions from sandy soil might have been the result of higher gaseous diffusivity resulting in greater oxygen availability for decomposition of organic matter, thus releasing more NH_4^+ ions than fine textured soils (in line with our observation of SLU mixed and layered modality), available for nitrification and aerobic denitrification. Fine textured soils with their low diffusivity would be slightly more oxygen deficient than coarse textured soils thus facilitating anaerobic denitrification and complete reduction of NH_4^+ to N_2 , hence leading to lower N_2O emissions, as observed in GEXER and GICOS soils. Moreover, initial pH of SLU soil is slightly acidic –

6.8, this favors accumulation of NH_4^+ , while GEXER and GICOS had higher pH, which may again explain the differences between soils. It has been demonstrated that soil with slightly acidic pH have higher N_2O flux due to nitrification and denitrification process (Boer and Kowalchuk 2001, Van den Heuvel et al. 2011).

Our results are also consistent with Han et al. (2017) who studied effects of residue incorporation and fertilizer application on nitrous oxide emissions from conventional and organic fields in the United States. They observed a peak in the N_2O daily flux a few days after residue frost seeding ($\sim 0.182 \text{ kg N ha}^{-1} \text{ d}^{-1}$) for clover-maize crop rotation in a loamy soil. Similar peaks were observed for other systems of crop rotations such as stult-clover. This maximum daily flux obtained from fields is in the same range of maximum daily fluxes observed in the loamy soils of GICOS ($0.17 \text{ kg N ha}^{-1} \text{ d}^{-1}$, mixed modality) and GEXER ($0.42 \text{ kg N ha}^{-1} \text{ d}^{-1}$, mixed modality) in our experiments. It is noteworthy that no daily peak was observed post fertiliser application in the respective fields.

Baggs et al. (2000) in similar field experiments reported cumulative N_2O fluxes from uncut grass clover, cut grass clover and italian ryegrass swards respectively at $0.24 \text{ kg N ha}^{-1}$, $0.22 \text{ kg N ha}^{-1}$ and $0.15 \text{ kg N ha}^{-1}$ on 83rd sampling day. While they do not give information about their soil types, these cumulative flux values are in the same range obtained in GICOS and GEXER soils on day 50. Nett et al. (2016) observed average cumulative N_2O flux peaks at $1.29 \text{ kg N ha}^{-1}$ for loamy sand mixed with cauliflower residue on day 41. Ploughed cauliflower residue in the same soil recorded a cumulative flux of $2.42 \text{ kg N ha}^{-1}$ on day 41. These values are in conjugation with those obtained with red clover residue in SLU soils in our experiment.

Concerning ammonia emissions from soils, studies have shown that soils with high clay contents result in lower NH_3 emissions, because NH_4^+ is trapped on clay particles by ionic adsorption (Pelster et al. 2012, Moldrup et al. 2004). With higher proportion of coarse particles in soil, lower is the adsorption of NH_4^+ on the surface, greater is the gaseous diffusivity resulting in higher ammonia volatilization. Our results are in agreement with this proposition – sandy SLU soil had the highest net NH_3 cumulative flux and the excessively silty GICOS soil

had the lowest net cumulative flux of NH_3 . Another important physico-chemical soil property that has been shown to play an important role in NH_3 emissions is soil pH (Flechard et al. 2013 and references within). We observed highest NH_3 fluxes for acidic SLU soil (Figure 3.2). Although the pH of soil microsites were not measured during the experiment therefore making it implausible to comment further on this factor.

4.2 Effect of residue position on N_2O and NH_3 fluxes

Mean net cumulated N_2O flux from mixed and layered residue positions was higher than that from the residue on soil surface (Figure 3.2 (a, b, c)). This can be partly explained by the difference in decomposition rates in different residue positions due to the effects of microbial contact (Coppens et al. 2006, 2007; Gaillard et al. 1999). Usually higher decomposition rates in soils pertains to higher release of NH_4^+ , thus priming nitrification and denitrification (Baggs et al. 2000, Muhammad et al. 2011, Mehnaz et al. 2019). This is observed in our incubations with increased ammonium content in mixed and layer modalities for SLU soil particularly coinciding with peak N_2O and CO_2 emissions (Figures 3.5). Mixed and layered positioned residues with greater contact with soil were exposed to faster microbial colonization, which stimulated residue mineralization. However, we observed no trend in cumulated CO_2 emissions concerning the different vertical distributions with no significant difference between surface, mixed and layered positioning of residues. It is important to note that large number of fungal growths were observed for SLU soil with surface residues. We think that these fungal growths intercepted extra water added to compensate for soil moisture loss, possibly creating a favorable humid zone for microbial decomposition, enhancing N_2O and CO_2 fluxes.

For GEXER soil, low N_2O fluxes were recorded for both surface and mixed modalities probably due to a strong effect of soil physico-chemical properties particularly related to the pH of the soil.

Concerning NH_3 fluxes, we only observed emissions from residues put on the surface. Unlike N_2O that is produced through microbial enzymatic action, NH_3 emissions result from physico-chemical equilibrium with labile NH_4^+ and H^+ ions. Moreover, NH_3 is a highly reactive gas,

which can be easily adsorbed or chemically reactive within the soil pores (Lovanh et al. 2010) which partly explains the observed fluxes. Mixed and layered positioned residues probably released NH_3 which got trapped within the soil layers.

These observations are consistent with results Nett et al. (2016) who measured field NH_3 fluxes from a Nitrogen rich residue (cauliflower). They noted high NH_3 emissions on day 41 from all three soils they studied – sandy loam ($2.17 \text{ kg N ha}^{-1}$), silt loam ($1.13 \text{ kg N ha}^{-1}$), sandy clay loam ($1.04 \text{ kg N ha}^{-1}$). There were some emissions from mixed residue while low emissions from ploughed (layered) residue position. These fluxes are in the same order of magnitudes as fluxes recorded from GEXER and GICOS soils. However, much higher fluxes were recorded in the SLU soil potentially due to this soil's high sand content.

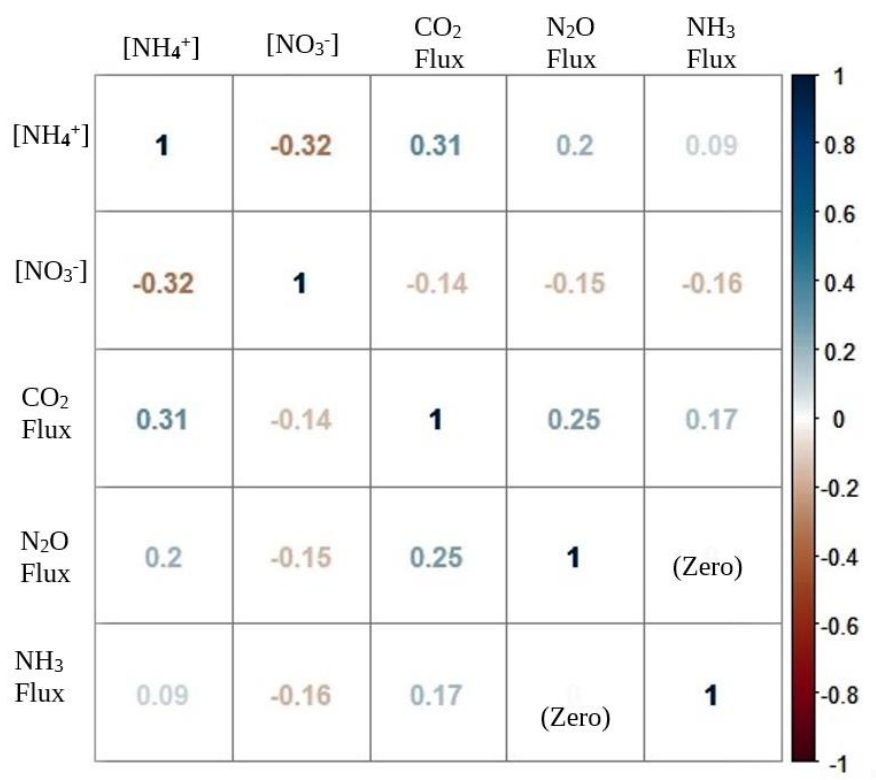

Figure 5 Correlation table between cumulated gaseous fluxes and mineral nitrogen contents of all three soils resulting of gaseous fluxes and mineral N concentrations from Day 1, Day 4, Day 7, Day 14, Day 28 and last day of incubation.

4.3 Evolution of daily gaseous fluxes in relation to underlying microbial processes

We observe that peaks of daily N_2O fluxes are in the first week of the incubation. Several other experimental studies in controlled conditions have also observed the gaseous fluxes of N_2O and NH_3 to be significant in the first two weeks of closed chamber incubation after residue addition (Frimpong et al. 2011, Miller et al. 2008, Yang et al. 2019). This is related to the high content of soluble and labile organic matter of red clover residues (cf Materials and Methods) that is decomposed. This is also supported by the peak of the CO_2 daily flux (Figure 3.4) occurring at the same time suggesting heterotrophic decomposition of crop residue, with N_2O peak observed around the same time.

Looking at soil mineral N content, (Figure 3.3), the low soil NH_4^+ content and slight increase of soil NO_3^- content for SLU soil surface modality suggests either NH_4^+ immobilisation, or nitrification resultant N_2O emission. This is consistent with the fact that sandy SLU provides for higher nitrification through increased heterotrophic activity (Figure 3.6). GICOS and GEXER surface modalities on the contrary yielded a positive contribution to soil NH_4^+ content and a lowering of NO_3^- content in week one of incubation. This suggests anaerobic denitrification as the underlying process of N_2O peak in this period (Figure 3.6). The decrease of soil nitrate in the first week of incubation for all the modalities was most probably due to nitrate immobilization by microbes during decomposition. Although these hypotheses could not be confirmed by our experiment as we did not carry out isotopic labelling to determine the partitioning between anaerobic and aerobic activities.

Another reason why the peak of daily fluxes were observed in the first two weeks of incubation could be the growth of microbial biomass. The growth of specific biota of microbes are influenced by availability of O_2 , moisture and organic matter in the soil. Each specific biota then would compete with others resulting in different microbial process, in our case – nitrification, aerobic and anaerobic denitrification.

Miller et al. (2008) showed on laboratory experiments that the modality with N-rich red clover residue addition showed high enzymatic activity and a slightly higher number of gene copies of the denitrifier biomass compared to no residue addition. According to them, residue addition to the soil, by priming the microbial decomposition also reduces the oxygen availability in soil pronouncing anaerobic denitrification. While sandy soils facilitate gaseous exchange through their pores, silty soils are generally poorly aerated with vegetation residue in them (Dörr et al. 1993, Rochette 2008).

Our observation appears to be also consistent with the results obtained through modelling by Gaillard et al. (2016) as mentioned in the previous section. In case of mixed modality, though the peaks of N_2O daily fluxes also appeared in the first week of incubation. For SLU soil, the increase in NH_4^+ content with a decrease in soil NO_3^- content suggests NO_3^- immobilisation by decomposing microbes and a higher release of NH_4^+ due to decomposition. If holding the hypothesis that nitrification is the predominant source for sandy soils in conjunction to the observation of decreased NO_3^- content, immobilisation seems to be strong in case of mixed SLU modality. The lower CO_2 daily flux in SLU when compared to GEXER and GICOS suggests lower heterotrophic activity in the sandy SLU soil than in the two other soils, which suggests chemolithotrophic nitrification as the metabolic pathway for decomposition. In GICOS mixed modality, the decrease in soil NH_4^+ content and increase in soil NO_3^- content may suggest nitrification process active throughout the incubation period.

Focusing on NH_3 daily fluxes, the peak values were obtained in the second week of incubation in all the three soil surface modalities, a delay of around 4-5 days from the peak values of N_2O flux. Other laboratory experiments in controlled conditions with slurry, manures or crop residues have also observed this delay in NH_3 daily flux peak (Chen et al. 2013, Lovanh et al. 2010). This is probably related to the rise in soil ammonium content in the first week to reach a peak in accumulation, facilitating the chemical equilibrium to shift from NH_4^+ to NH_3 gas, subsequently volatilized. This delay in NH_3 emissions could also be due to initial microbial immobilisation of NH_4^+ .

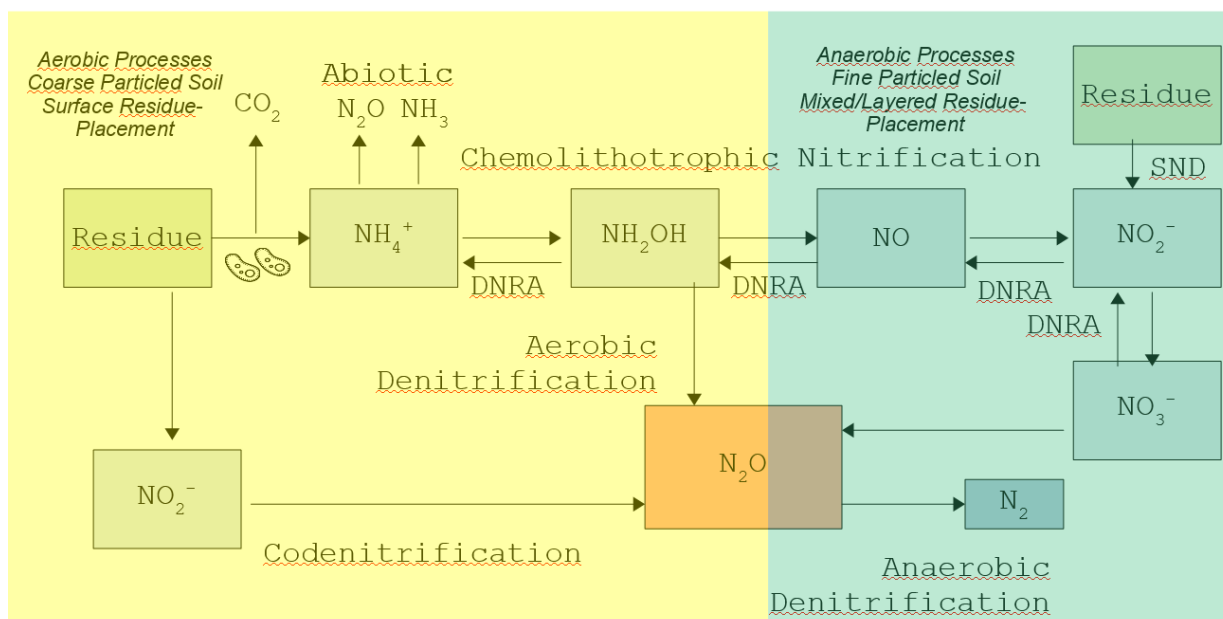

Figure 3.6 Schematic of underlying processes that influence evolution of daily fluxes from the crop residue decomposition in three soils – SLU, GEXER and GICOS. The yellow shade denotes aerobic processes in SLU soil and surface modalities of all soils while the blue shade is highlighting anaerobic processes in GEXER and GICOS soils. SND: Simultaneous Nitrification Denitrification. DNRA: Dissimilatory Nitrate Reduction to Ammonia

5. Conclusion

From these results, it is apparent that the vertical distribution of crop residues in soil plays an important role in gaseous fluxes of N_2O , NH_3 and CO_2 . Surface placement of residues contributed to higher NH_3 fluxes, while mixing residues in soil or placing it between two-soil layers increased N_2O flux. Fluxes are also dependent on the soil physico-chemical characteristics. Higher sand content had a greater impact on priming of these gaseous fluxes than the fine-particle soils and influenced microbial growth and activity. Even though the emission characteristics are same, from NH_4^+ and NO_3^- time series evolution it is apparent that different microbial processes of aerobic and anaerobic denitrification are sources of N_2O fluxes in different types of soils.

N-rich and green stage residue incorporation as organic amendment proves to be challenging in sandy soils as it is difficult to minimise greenhouse gas emissions. However, for farmers cultivating fine particled silty soils, the best option appears to be mixing the residue in top

layer uniformly to minimise both NH_3 and N_2O flux. There is definitely a priming of CO_2 flux post residue addition owing to the microbial respiration from residue breakdown.

The results and data obtained here can be used to optimize interdependency between soil organic matter stabilization and nitrous oxide flux. Further experimental analyses of microbial growth rates, genetics and microsite pH, oxygen contents as well as vertical discretization of soil mineral N content could explicitly refine the understanding of microbial processes involved in N_2O and NH_3 fluxes.

Acknowledgements

Authors acknowledge the financial support received from the French National Research Agency (ANR) under the ERA-NET Cofund scheme ERAGAS (Residuegas project). This project was also funded by the Department of Environment and Agriculture, INRAE (French National Research Institute for Agriculture, Food, and Environment). Special thanks goes to Ms J. Jean-Jacques for her supervision and advice on chemical analyses. Gratitude to Mr O. Fanucci for his constant support to ensure the operation of the measuring equipment. Thanks also goes to Mr L. Vieville and Mr M. Marques for providing aid at times of bulk experimental work. We would also like to thank Dr. B. Andrieu for his review of an earlier version of this manuscript.

Supplementary Information

Microcosm experiments were also conducted with wheat residue incorporation in Gri EXER and GICOS soils. There results were not compared with red clover owing to the very low gaseous fluxes detected in the course of incubation measurements (Figures 3.7, 3.8 and 3.9).

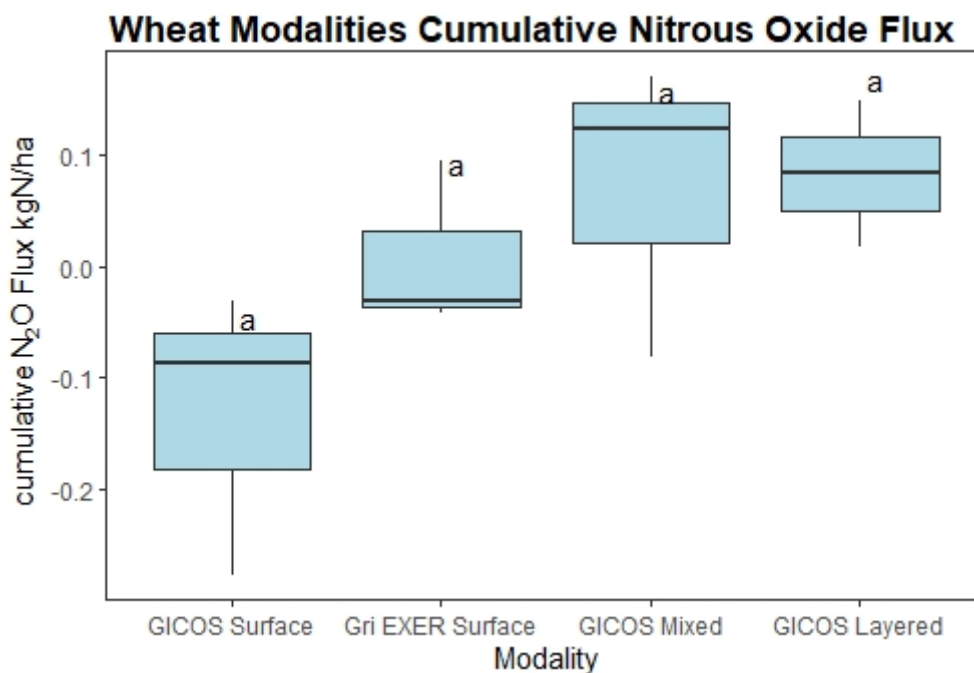

Figure 3.7 Wheat Modality Net cumulative Fluxes N₂O for with Gri EXER and GICOS soils on day 50

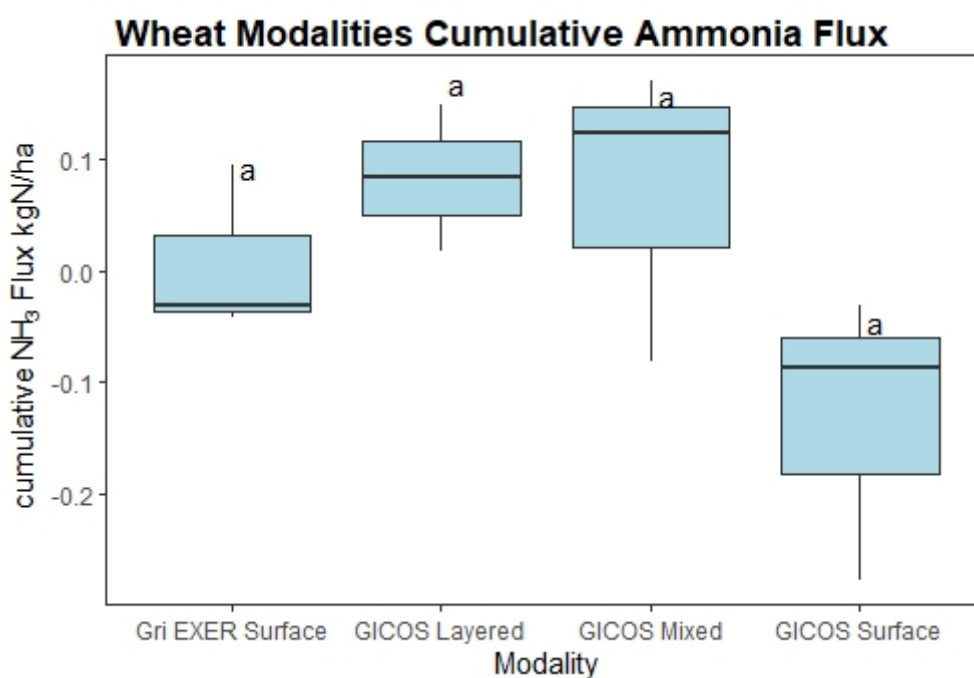

Figure 3.8 Wheat Modality Net cumulative Fluxes for Ammonia on day 50 with GICOS and Gri EXER soils

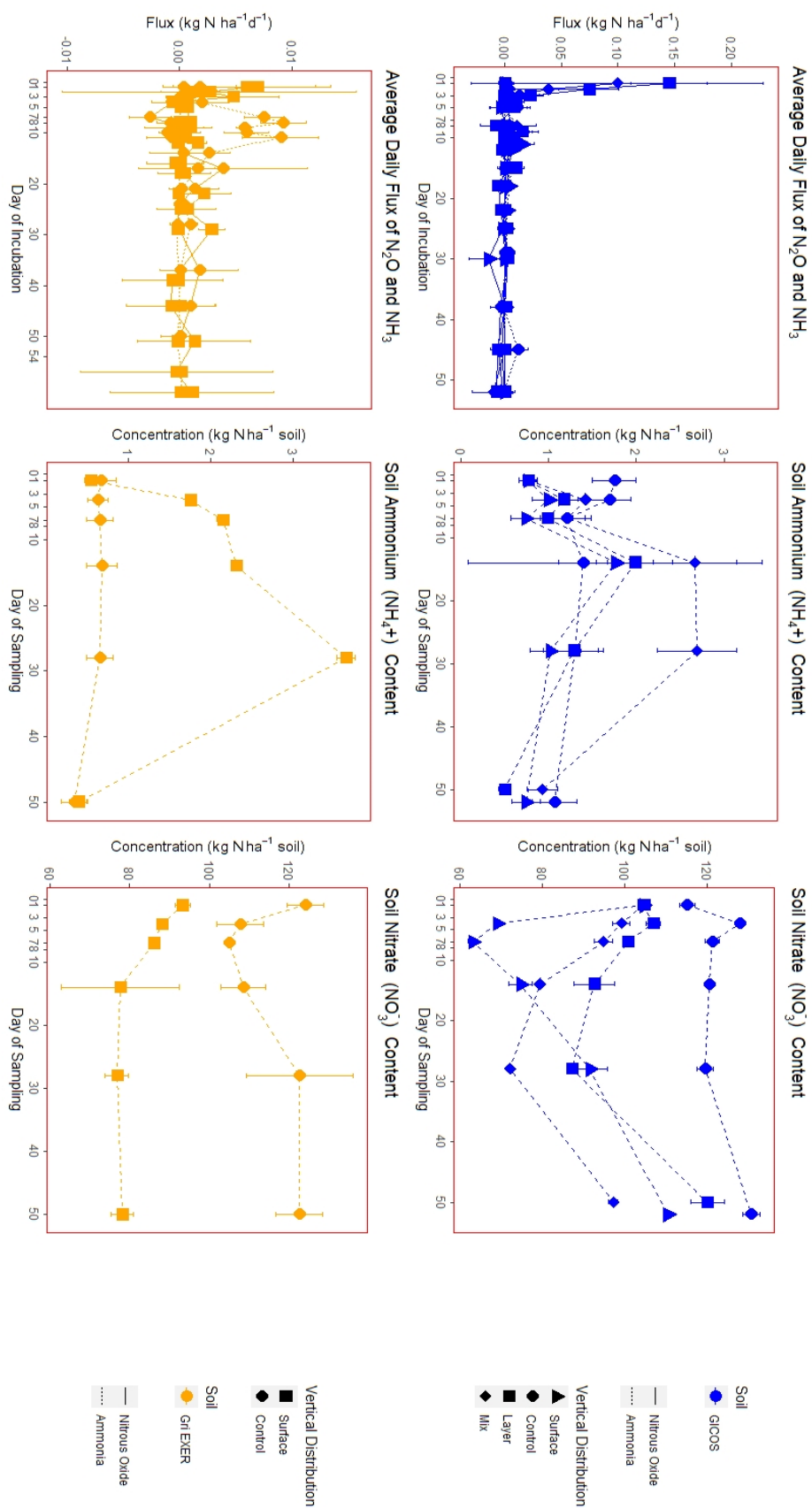

Figure 3.9 Wheat Modalities Daily Dynamic fluxes of N_2O and NH_3 and time series of concentrations of NH_4^+ and NO_3^-

Chapter 4

Simulating nitrous oxide and ammonia emissions from crop residue decomposition in a clay soil by a coupled model

Varunesh Chandra^{a,b}, Raia Silvia Massad^a, François Lafolie^c, Benjamin Loubet^a,
Gwenaëlle Lashermes^b

^aUniversité Paris-Saclay, INRAE, AgroParisTech, UMR ECOSYS, 78850 Thiverval-Grignon, France

^bUniversité de Reims Champagne Ardenne, INRAE, FARE, UMR A 614, 51097 Reims, France

^cAvignon Université, INRAE, UMR EMMAH, 84914, Avignon, France

Abstract

Crop residue decomposition in soil is an important source of greenhouse gas – nitrous oxide, and air pollutant – ammonia. Return to soil of fresh residues and their transformation into stabilised organic matter result in priming of soil microbial activity, which influences soil nitrification, denitrification and other nitrogen cycle processes resulting in these emissions. In a global warming scenario, for appropriate planning of sustainable agriculture methods, it is crucial to have important tools of understanding and ultimately prediction for these gases. Here, we attempt to construct a model based on the coupling of three existing modules to simulate nitrous oxide and ammonia emissions from a silt-clay soil with a nitrogen rich residue (red-clover) mixed in its top layer. The model parameters for soil basal functioning were optimised using the control scenario of soil with no residue. We compared cumulative

and daily dynamic fluxes obtained for carbon dioxide, nitrous oxide, and ammonia gases, as well as dynamics of ammonium and nitrate content with the experimentally obtained data to evaluate the performance of this constructed model. Experimental observations and simulated data were in quite some synchronicity for carbon dioxide and ammonia. With nitrous oxide fluxes, the simulated values obtained were in the same range with experimental measurements but lacked intravariability and underestimated the cumulative and daily fluxes. We found model outputs to be promising but there is a crucial need for experimental determination of microbial activity related soil specific data to improve this coupled model's performance.

Keyword(s) : CANTIS, NOE, soil organic matter, soil nitrogen cycle, denitrification, nitrification, NH₃ volatilisation

1. Introduction

Crop residue management is crucial for increasing soil carbon stocks and mitigating climate change due to biochemical transformation of atmospheric carbon into vegetation bodies ultimately finding their way into soil [Reicosky and Wilts, 2005]. They are also important in decreasing agricultural dependency on chemical fertilisers [Shah et al 2003, Bacenetti et al 2016, Damon et al 2014]. However, residues can be a source of N_2O and NH_3 emissions during their decay in soils [Nett et al 2016, Badagliacca et 2018]. Nitrous oxide is an ozone depleting greenhouse gas, expected to be 265-298 times stronger than carbon dioxide [AR5 IPCC, 2014] and contributions from crop residues to these emissions are increasing annually [FAO stats, 2020]. Ammonia is a secondary air pollutant and plays significant role in aerosol formation [Sutton et al 2009]. Additionally ammonia from agriculture may damage crops lying next to the source of these emissions [Van der Eeden et al 1998]. Thus it is evident how crucial it is to evaluate and predict these emissions from perpetually transforming agriculture landscape in a climate change and sustainable development scenario.

Evaluation of these emissions from several land sources involves vast experimentation. This complex especially when there are multitudes of processes and chemical compartments needing to be quantified to have a wholesome idea about the phenomenon. The compartments are envisaged for a simple representation of soil-organic material continuum's processes gathered into pools with common average characteristics. Moreover, soil characteristics are not uniform, and so does the vegetation variety, and other abiotic factors such as climate, soil characteristics, et cetera. It makes it physically impossible at present to experimentally map emissions from such widespread scale. What seems logical is to utilise generic information obtained from experiments and optimise them for predictions through numerical modelling. To understand and ultimately predict these emissions from a scenario of crop residue incorporation in soil is to conjoin mechanistically and theoretically, the two important soil phenomena – microbial degradation and nitrogen and carbon mineralisation. Whenever an organic residue is introduced to soil, microbial action commences almost instantly post

hydrolysis and mechanical breakdown of the organic material. The decomposability of this organic matter plays a crucial role in determining the biochemical by-products of microbial action. The appropriation of the carbon to nitrogen ratio (C:N) of an organic matter is a common mean of determining decomposability through the nitrogen content [Nicolardot et al 2001]. Usually, higher nitrogen availability in residue i.e. low C:N ratio enhances the rate of decomposition of organic matter in soil [Truong and Marschner 2018] but the complexity of organic carbon and nitrogen forms such as lignin, cellulose, hemicellulose is not indicated with the C:N ratio. Conclusively, a major factor of paramount importance that drives decomposition and resulting gaseous emissions from organic matter is the biochemical composition (so called 'quality') of the residue. Next comes the formation and stabilisation of organic matter in soil. It is well established that organic residue undergoes several biochemical transformations through microbial degradation ultimately feeding itself stabilised soil organic matter (SOM) (popularly known as 'Humus') [Six et al 2002]. As a matter of fact, this carbon transformation and nitrous oxide and ammonia emissions are occurring simultaneously in soils and are coupled to each other [Manzoni and Porporato 2007]. Ammonium ions (NH_4^+) are mineralised during decomposition that may further undergo transformation into NH_3 due to the chemical equilibrium; or may further get subjected to microbial action by nitrifiers and denitrifiers to release nitrate (NO_3^-), nitrous oxide and other oxides of nitrogen ultimately releasing dinitrogen gas [Chen et al 2013]. There are two significant pathways to N_2O release, one arising from nitrification and the other from anaerobic denitrification [Wrage-Mönnig et al 2018]. Meanwhile, labile organic carbon and nitrogen of residues support the initial hotspot of microbial biomass that consume (i.e., assimilate for their stoichiometric needs) available organic and mineral nitrogen, but gradually for growth and defence, they immobilise such carbon and nitrogen organic forms i.e. proteins. This microbial immobilisation, alongside other processes aforementioned, limit the gaseous fluxes of N_2O and NH_3 from residues decomposing in soils [Muhammad et al 2011]. Thus, for better predictability of these emissions the all such soil carbon and nitrogen phenomena, alongside the influences of abiotic factors such as weather, soil physico-chemical characteristics and aerobicity. Numerical modelling is a necessity here as it helps in hierarchising this complex interaction of carbon and nitrogen transformation processes. It

also helps in identification of individual drivers affecting these phenomena paving way to more appropriate experimental planning. Noteworthy is the contribution of their predictions to effective policy drafting in response to sustainable farming and climate change.

There already exists a huge plethora of gaseous emission models in the literature. To pick a few, DNDC is a model simulating soil nitrogen dynamics in quite some detail and incorporates soil aerobicity as a determining process to nitrous oxide emission [Giltrap et al 2010]. This model also includes parameters pertaining to physical resistance offered by soil during their release out of pedosphere. It also simulates NH_3 emission. The only drawback to its usage is this vast list of parameters it needs for proper functioning, and this can challenge the efficiency of producing standard outputs for a scenario. The model also simulates carbon dynamics in a general non-complex manner, that could be improved by coupling some excess microbial pools into it. The decomposition processes of freshly introduced organic matter to soil is not represented with sophisticated complexity. All in all, to run DNDC is a challenge in itself. Same things can be said for other models simulating nitrous oxide emissions, such as Ecosys [Metivier et al 2009]. This is a model that includes in its simulation of N_2O fluxes, the contribution from nitrifier denitrification in a detailed manner. The complexity of its structuration of soil nitrogen processes is breathtaking, yet like DNDC, this beautiful complexity can ultimately prove to be a challenge in producing standard outputs. NOE [Hénault et al 2005] is another model for N_2O simulation from both nitrification and denitrification, but its relatively simple empirical formulation may become heavily dependent on experimental determination of certain parameters. CANTIS [Garnier et al 2001] is another model that holistically maps organic matter formation in soil starting from the biochemical quality of residue and also simulates nitrification process in soil, but lacks coupling to nitrous oxide and ammonia emissions.

The objective of this paper is construction and test of a model that simulates soil nitrous oxide, ammonia and carbon dioxide emissions, as well as mineral ammonium and nitrate

dynamics from crop residue incorporation in soils. Three different existing models, one to simulate soil carbon dynamics and resulting CO₂ flux, nitrate and ammonium dynamics, others for calculating nitrous oxide and ammonia fluxes from residue decomposition, are selected and coupled. The outputs obtained is then compared to experimental observation.

2. Material and Methods

2.1 Selection of Models

The simulations of nitrous oxide and ammonia emissions from crop residue decomposition in soils require coupling of three models/modules. The first describes the processes relating to organic matter decomposition in soils, the subsequent ones should describe this decomposition's effects on soil nitrogen processes yielding nitrous oxide and ammonia emissions throughout the process. The model we chose for former is CANTIS [Garnier et al 2001 and 2003]. For nitrous oxide simulation, we chose NOE [Hénault et al 2005] and for ammonia emission simulations, we chose the standard volatilisation equation from Sommer et al (2003). CANTIS was chosen as it simulates the organic matter decomposition in soil with nitrification and simultaneous ammonium mineralisation, nitrification and immobilisation. For nitrous oxide emissions, it is important to have a model that describes the processes in soil resulting into these emissions holistically. Additionally, a model requiring lower number of input variables that can facilitate the coupling. NOE was chosen for this purpose as it incorporates nitrous oxide emissions from both nitrification and denitrification. Additionally, the mineralised NH₄⁺ pool coming as an output from CANTIS is coupled to input parameters of nitrification and denitrification of NOE that yields nitrous oxide emissions from both the processes. Simultaneously, NH₃ emission equation takes the NH₄⁺ output from CANTIS as an input variable for its simulations. Further details are provided in the following sections on models and their structure and functioning.

2.1.1 CANTIS Model

CANTIS i.e. *Carbon and Nitrogen Transformation in Soil*, is a mechanistic model that simulates soil organic matter carbon and nitrogen dynamics (Garnier et al. 2001, Garnier et al. 2003, Iqbal et al. 2014). The introduction of fresh organic matter to soils as crop residue, its breakdown and subsequent stabilisation by virtue of microbial activities are depicted in the model. The microbial action undertaking this decomposition and stabilisation of organic matter mineralises carbon and nitrogen. With time, the stabilisation of organic matter results in the formation of humified organic matter that is stabilized in soil but still considered as active organic matter, thus making soil a sink of carbon. The nitrogen mineralised also undergoes nitrification, i.e. the NH_4^+ mineralised transforms into NO_3^- . All these processes are subjected to the influence of temperature, water potential, contact between microorganisms and their substrate and nitrogen limitations (Figure 4.1).

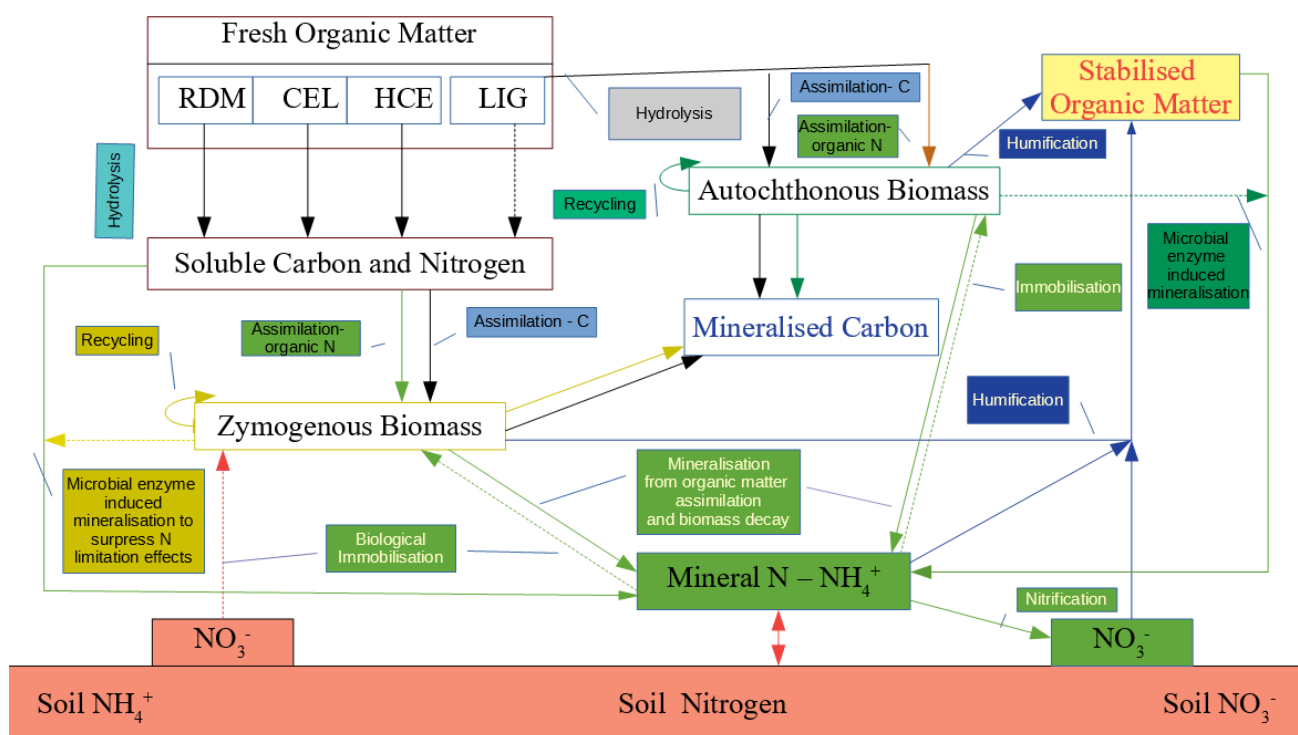

Figure 4.1 Diagrammatic depiction of processes in CANTIS model.

The model considers two different types of microbial biomass decomposing organic matter: zymogenous biomass that feeds on fresh organic matter as crop residue newly incorporated to soil, and autochthonous biomass that feeds on stabilized ('humified') soil organic matter.

The organic carbon and nitrogen of the fresh organic matter are initially distributed among the five constituent pools- soluble (SOL), Rapidly Decomposable Matter (RDM), Cellulose, (CEL) Hemicellulose (HCE) and Lignin (LIG) of decreasing degradability. It is RDM, CEL, HCE, and LIG whose hydrolysis in soil, according to the decay rate constant k , results in the soluble (SOL) carbon and nitrogen pool (refer to supplementary information).

Zymogenous biomass (ZYB) assimilates initially available soluble carbon and nitrogen (SOL) from the crop residue and from its decomposition, according to an assimilation yield Y_s . Autochthonous biomass (AUB) degrades the stabilized organic matter (mentioned as active or humified organic matter in the model).

The decomposition of fresh or soluble organic matter is assumed to follow kinetics as:

$$dC_i / dt = k_i C_i f_T f_W f_N f_B$$

where C_i is the carbon content of the organic matter pool i , k_i is the decomposition rate constant of that pool, f_T is the temperature function, f_W is the moisture function, f_N is the nitrogen limitation function, and f_B is the biomass-dependent function. The function f_B relative to the zymogenous biomass is calculated as follows:

$$f_B = BZ / (BZ + KMZ)$$

where BZ is the carbon content in the zymogenous biomass, and KMZ is an empirical factor connected to the size of the zymogenous biomass linked to the contact between the residue and the biomass.

Both these biomasses recycle themselves throughout these biogeochemical metabolic activities, according to a decay rate (k_z and k_a) and re-assimilation yield (Y_z and Y_a) respectively for zymogenous and autochthonous biomass. Over time, a part of both microbial decay fluxes, defined by, respectively, h_z and h_a parameters, is stabilized ('humify') to contribute to the pool of stabilised organic matter.

The two groups of microbes mineralise carbon as carbon dioxide with reference to the following equation:

$$dC_{\text{mineral,CO}_2}/dt = dC_{\text{ZYB, mineralisation, ZYB}}/dt + dC_{\text{SOL,mineralisation,zyb}}/dt + dC_{\text{AOM, mineralisation, AUB}}/dt + dC_{\text{AUB, mineralisation, AUB}}/dt$$

where $dC_{\text{mineral,CO}_2}/dt$ is the gross rate of mineralisation of CO_2 , $dC_{\text{ZYB, mineralisation, ZYB}}/dt$ is the rate of CO_2 mineralisation from ZYB pool being acted upon by ZYB itself, $dC_{\text{SOL,mineralisation,zyb}}/dt$ is the rate of CO_2 mineralisation from SOL pool being acted upon by ZYB, $dC_{\text{AOM, mineralisation, AUB}}/dt$ is the CO_2 mineralisation rate from AOM pool being acted upon by AUB and $dC_{\text{AUB, mineralisation, AUB}}/dt$ is the mineralisation rate of CO_2 from AUB pool being acted upon by AUB. Refer to supplementary information for further information on these mineralisation rates. Units of these rates are $\text{mg C kg}^{-1} \text{ soil d}^{-1}$.

Nitrogen is mineralised as ammonium, and immobilised either as nitrate and ammonium. Ammonium is nitrified into nitrate according to a reverse Michael-Menten equation with maximum nitrification rate V_{max} and affinity constant for ammonium for nitrifying bacteria, K_N .

The nitrification rate is expressed in the model as,

$$dN_{\text{nitrification}}/dt = V_{\text{max}} * f_N * f_W * \{[N_{\text{NH}_4^+}]/(K_N + [N_{\text{NH}_4^+}])\}$$

where V_{max} is maximal nitrification rate (in $\text{mg N kg}^{-1} \text{ d}^{-1}$), f_N and f_W are nitrogen limiting and water limiting functions (Garnier et al 2001), $[N_{\text{NH}_4^+}]$ is the concentration of NH_4^+ in soil (mg N kg^{-1}) and K_N is affinity constant between ammonium and nitrifying bacteria expressed in mg N kg^{-1} .

Gross Mineralisation rate of nitrogen as NH_4^+ is expressed in the model as

$$dN_{\text{NH}_4^+}/dt = dN_{\text{SOL, mineralisation, ZYB}}/dt + dN_{\text{ZYB, mineralisation, ZYB}}/dt + dN_{\text{AOM, mineralisation, AUB}}/dt + dN_{\text{AUB,mineralisation, AUB}}/dt - dN_{\text{NH}_4^+, immobilisation, AUB}/dt - dN_{\text{NH}_4^+, immobilisation, ZYB}/dt - dN_{\text{nitrification}}/dt - dH_{\text{NH}_4^+}/dt$$

where $dN_{\text{SOL, mineralisation, ZYB}}/dt$ is gross mineralisation rate of NH_4^+ from SOL pool acted upon by ZYB, $dN_{\text{ZYB, mineralisation, ZYB}}/dt$ is NH_4^+ mineralisation rate from ZYB pool being acted upon by ZYB, $dN_{\text{AOM, mineralisation, AUB}}/dt$ is NH_4^+ mineralisation rate from AOM pool by AUB and the last $dN_{\text{AUB,mineralisation, AUB}}/dt$ is the same rate of mineralisation as others from AUB pool by

AUB. $dN_{\text{NH}_4^+, \text{immobilisation, AUB}}/dt$, $dN_{\text{NH}_4^+, \text{immobilisation, ZYB}}/dt$ are immobilisation rates of NH_4^+ by AUB and zyb. $dN_{\text{nitrification}}/dt$ and $dH_{\text{NH}_4^+}/dt$ are nitrification rates and humification rates respectively. The units are $\text{mg N kg}^{-1} \text{ soil d}^{-1}$ (Refer to supplementary information for details).

Gross biological immobilisation rate of nitrogen is expressed as,

$$dN_{\text{immobilisation}}/dt = dN_{\text{NH}_4^+, \text{immobilisation, ZYB}}/dt + dN_{\text{NO}_3^-, \text{immobilisation, ZYB}}/dt + dN_{\text{NH}_4^+, \text{immobilisation, AUB}}/dt$$

where $dN_{\text{NH}_4^+, \text{immobilisation, ZYB}}/dt$ and $dN_{\text{NH}_4^+, \text{immobilisation, AUB}}/dt$ is the immobilisation rates of NH_4^+ by ZYB and AUB, $dN_{\text{NO}_3^-, \text{immobilisation, ZYB}}/dt$ is immobilisation rate of nitrate by ZYB. Refer to supplementary information for details. All the units are expressed in $\text{mg N kg}^{-1} \text{ soil d}^{-1}$.

The model takes into account the initial total available nitrogen in soil, characterising it as mineral nitrogen pool. The process of decomposition by microbes, subsequent mineralisation and immobilisation of nitrogen alters mineral nitrogen pool that may yield nitrogen limiting conditions. Nitrogen limiting conditions essentially apply directly only to zymogenous biomass activity. One of the following four scenarios can be chosen to account for N limitation in the model:

- i. Decomposition rates of substrates of fresh organic matter i.e. RDM, HCE, CEL and LIG are reduced.
- ii. N Recycling i.e. death rate of zymogenous biomass is increased.
- iii. N:C ratio of zymogenous biomass is reduced.
- iv. Assimilation yields of the substrates by microbes is reduced.

Therefore if nitrogen is limiting carbon decomposition, the immobilisation rates of nitrogen as ammonium and nitrate by zymogenous biomass are assumed to be maximum i.e. equal to gross immobilisation rates of ammonium and nitrate by zymogenous biomass. Initially, as the nitrogen availability for microbes depletes, the decomposition, assimilation rates of the organic soluble substrates [Craine et al. 2007], the mineral nitrogen immobilisation rates (in function of the N:C ratio of microbes) may increase certain time until finally, the metabolic activities slow down with depletion of the nutrient reaching [Riggs and Hobbie, 2016]. In case,

there is no nitrogen limitation, the decomposition rates of fresh organic matter substrates are put at their maximum, N recycling i.e. death rates of zymogenous biomass are put at their minimum and N:C ratio of zymogenous microbes are taken to be maximum (or constant). Here there could be either net immobilisation meaning that both ammonium and nitrate would be immobilised with a preference to ammonium ; or 'no net biological immobilisation' where the ammonium immobilisation yield would be exactly equal to nitrogen requirement deficit of the microbe. Here there would be no nitrate immobilisation.

The immobilisation and mineralisation rates of autochthonous biomass remains unaltered directly by this nitrogen limitation as it is assumed to be independent. Yet, the changes in nitrogen limitation function would still influence it indirectly. Autochthonous biomass either immobilises or mineralises nitrogen. Nitrate immobilisation doesn't take place by autochthonous biomass in the model. In case of our simulations, there is no nitrogen limitation as the soils in question are fertilised with 100 kg N ha⁻¹ of KNO₃.

After calculations of rates of carbon assimilation, mineralisation and immobilisation, the model computes pool sizes of organic matter and microbes, mineralisation and immobilisation rates of nitrogen. Nitrification rates and humification rates are then calculated ultimately.

CANTIS implemented in the VSOil platform (more information in the following sections) treats soil as layers and calculations take place for each of them before going ahead further layers along the depth. The calculations are performed on a daily time-step.

2.1.2 NOE Model

NOE (Nitrous Oxide Emission) model is an empirical model first described by Henault et al. (2005) that predicts N₂O emissions from soils based on nitrification and denitrification rates. Its parameters are based on experiments carried with soil cores in controlled conditions [Garrido et al 2002 ; Henault and Germon 2000]. The effect of oxygen content on N₂O

emissions have been accounted as a potential denitrification rate constant in the model that is determined experimentally. This does make it a necessity to experimentally determine values of such a function for each soil but it eases the numerical modelling process. This is in contrast to process based aerobic-anaerobic switch in models such as DNDC and ECOSYS, which are computationally and runwise quite heavy. Also, as only a part of anaerobically denitrified nitrogen gets emitted as nitrous oxide, NOE computes N_2O flux as a product of the ratio of accumulated N_2O to total denitrified nitrate and total anaerobic denitrification rate. Same thing is done for N_2O emissions from nitrification. In this model, WFPS is used as a proxy for depiction of oxygen availability in soil.

The total rate of N_2O emission is expressed in the model as

$N_2O_{Total} = N_2O_{denit} + N_2O_{nit}$ where N_2O_{denit} is N_2O emission rate from denitrification and N_2O_{nit} is N_2O emission rate from nitrification. The units are $kg\ N\ ha^{-1}\ d^{-1}$.

N_2O emission rate from denitrification process is expressed as, $N_2O_{denit} = r_{max} D_A$ where r_{max} is dimensionless constant of maximum ratio of accumulated N_2O to denitrified nitrate and D_A is rate of actual denitrification ($kg\ N\ ha^{-1}\ d^{-1}$). Here $D_A = D_P F_N F_W F_T$ where D_P is potential denitrification rate specific to a soil (in $kg\ N\ ha^{-1}\ d^{-1}$) and F_N , F_W and F_T are dimensionless nitrate, water and temperature limiting functions respectively. As mentioned earlier water function is proxy for soil aerobicity and is described as $F_W = 0$ if $WFPS < \text{or} = 0.62$; $F_W = [(WFPS - 0.62) / 0.38]^{1.74}$ if $WFPS > 0.62$. Refer to supplementary information for further details.

N_2O emission rate from nitrification is expressed as $N_2O_{nit} = z N_A$ when $WFPS < 0.62$ and $N_2O_{nit} = r_{max} z N_A$ when $WFPS > \text{or} = 0.62$. Here N_A is the rate of actual nitrification ($kg\ N\ ha^{-1}\ d^{-1}$), z (dimensionless) is the proportion of N_2O to nitrified nitrogen and r_{max} is already described above. For further details please refer to the supplementary information.

2.1.3 NH₃ Volatilisation Model

For the simulation of NH₃ volatilisation from decomposing crop residues, volatilisation equation derived from chemical equilibrium of ammonia and ammonium in liquid and gaseous phases has been chosen. The release of gaseous NH₃ from liquid form is described by the virtue of Henry's law. The equation as mentioned in Sommer et al 2003 is described as follows :

$$[\text{NH}_4^+] \xrightleftharpoons{K_N} [\text{NH}_{3,l}] + [\text{H}^+]$$

$$[\text{NH}_{3,l}] = \frac{[\text{TAN}]}{\left\{1 + \left(\frac{[\text{H}_3\text{O}^+]}{K_N}\right)\right\}}$$

$$[\text{NH}_{3,g}] = K_H \left\{ \frac{[\text{TAN}]}{\left\{1 + \left(\frac{[\text{H}_3\text{O}^+]}{K_N}\right)\right\}} \right\}$$

$$[\text{TAN}] = [\text{NH}_4^+] + [\text{NH}_{3,l}] + [\text{NH}_{3,g}]$$

where [NH₄⁺], [NH_{3,l}] and [NH_{3,g}], [H⁺] are concentrations of ammonium, liquid ammonia and gaseous ammonia, and hydronium ion in soil respectively. [TAN] is the concentration of Total Ammoniacal Nitrogen. All the concentrations are expressed in mol l⁻¹. K_N is equilibrium constant between ammonium and liquid ammonia, while K_H is Henry's constant between liquid and gaseous ammonia.

2.2 Coupling of Models

The models were coupled using open source graphic user interface platform of modelling called VSOIL (Virtual Soil, <https://www6.inrae.fr/vsoil>). The platform aims to ease soil modelling process by providing for easy interaction between soil physical, biological and chemical processes. In order to do so, the platform creates different groupings of concepts namely skeletons and processes, modules and models. The version of the platform used in our work was '=== 20210115 ==='. The principal model used for coupling was CANTIS. The

entire segment of decomposition of fresh organic matter and resulting nitrogen and carbon transformations are described by this model. Thus the CO_2 mineralisation and nitrogen mineralisation as ammonium and its conversion to nitrate by nitrification is taken from CANTIS. Hereafter, the concentration of NO_3^- is used in nitrate limiting function for calculation of actual denitrification rate in NOE. Actual nitrification rate of the NOE is directly taken as the nitrification rate from CANTIS. The total N_2O emission rate is then calculated as a sum of N_2O from both actual nitrification and denitrification rates as described in equations of NOE. The ammonia emission module was linked to ammonium pool of CANTIS simultaneously to account for ammonia volatilisation from such system of organic matter decomposition. The initial parameters for the simulations were selected from values already reported in literature. Conceptually, such a model is represented in Figure 4.2.

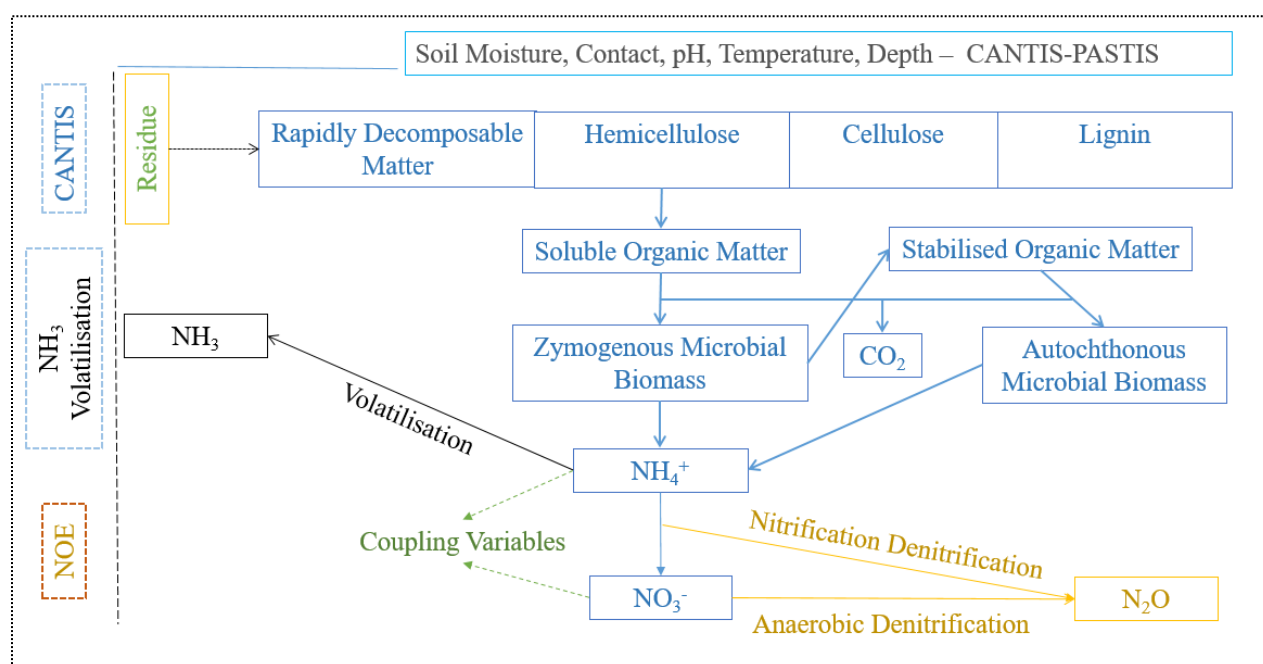

Figure 4.2 Depiction of processes in the coupled models of CANTIS, NOE and NH_3 volatilisation. Please note that blue colour depicts processes from CANTIS, yellow depicts processes from NOE and black depicts processes from NH_3 volatilisation. Green colour depicts coupling variables. Grey colour depicts abiotic influences on these processes.

2.3 Simulation Setups

A clay soil was selected to run simulations with this coupled CANTIS-NOE- NH_3 Volatilisation model. The soil used was extracted from ICOS (Integrated Carbon Observation System) site in

Thiverval-Grignon (France) and is called GICOS here. GICOS soil is small particled clayey soil. Its initial pH recorded was around 7.6 making it almost neutral. The residue chosen for simulations was nitrogen rich red clover. The ambient conditions for the soil-residue interaction was devised in accordance with the microcosm incubations reported Chandra et al (2021, submitted). The soil profile was assumed to be 8 cm in depth. The residue was assumed to be mixed on the top 4 cm layer of the profile. Residue addition rate was 0.04 g dry matter per cm² which is equivalent to 4 ton ha⁻¹, a realistic value for field residue incorporation. The simulations were carried out at 15°C soil temperature and 60% WFPS. The initial values of parameters associated with residues and soils could be found Tables 4.1, 4.2 and 4.3.

CANTIS Parameters

Parameter Description	Representation	Unit	Default Values	Simulation Value
RDM decomposition rate constant	k ₁	d ⁻¹	0.16	0.2
HCE decomposition rate constant	k ₂	d ⁻¹	0.064	0.1
CEL decomposition rate constant	k ₃	d ⁻¹	0.51	0.02
LIG decomposition rate constant	k ₄	d ⁻¹	0.00000165	0.005
SOL decomposition rate constant	k _S	d ⁻¹	1.0	1.0
ZYB decomposition rate constant	k _Z	d ⁻¹	0.076	0.07
AUB decomposition rate constant	k _A	d ⁻¹	0.0048	0.02
AOM/HOM decomposition rate	k _M	d ⁻¹	0.000115	0.001
SOL-C assimilation yield constant	Y _S	dimensionless	0.60	0.5
ZYB-C assimilation yield	Y _Z	dimensionless	0.60	0.5
AUB-C assimilation yield	Y _A	dimensionless	0.60	0.5
AOM/HOM-C assimilation yield	Y _H	dimensionless	0.60	0.5
LIG-C Humification coefficient	h _L	dimensionless	0	0
Humification coefficient of ZYB	h _Z	dimensionless	0.39	0.30
Humification coefficient of AUB	h _A	dimensionless	0.20	0.30
Maximal Nitrification Rate	V _{max}	mg N kg ⁻¹ d ⁻¹	5.0	5.92
Affinity constant between ammonium and nitrifying bacteria	K _N	mg N kg ⁻¹	3.5	5.0
Langmuir coefficient for immobilisation	Beta	dimensionless	0.045	0.05
Partition coefficient between N direct assimilation and biological immobilisation by ZYB	FNOZ	dimensionless	1	1.0
Partition coefficient between N direct assimilation and	FNOA	dimensionless	0	0

biological immobilisation by AUB				
Michaelis-Menten constant for SOL decomposition	K_{MZ}	dimensionless	0	0.000006
Michaelis-Menten constant for HOM decomposition	K_{MA}	dimensionless	0	0
Minimum size of zymogenous biomass	ZYBO	mg kg ⁻¹ soil		1
Choice for nitrogen limiting conditions	NLIMIT	dimensionless	0 to 19	3
Available mineral nitrogen in soil	AVMIN	mg N kg ⁻¹ soil	-1.e ⁻¹³	
Threshold or minimum ammonium content in soil	THRA	mg N kg ⁻¹ soil	0.20	
Threshold or minimum nitrate content in soil	THRN	mg N kg ⁻¹ soil	0.05	
Reduction factor on decomposition due to N	FRN or P(25)	dimensionless	0 or 1	0.50
Priority of nitrification over humification	NITHUM	dimensionless	0 or 1	1
Maximum N:C ratio of humified material	RH	dimensionless		0.1667

Table 4.1 Parameter values default in CANTIS and those used in simulations

Input Soil and Residue Data to the Coupled Model

(i) GICOS Soil

Parameters	Description	GICOS Initial Value	Unit
ρ	Soil Bulk Density	1250	kg m ⁻³
watercontentmobile	Mobile Water Content	0.3169	m ³ m ⁻³
NH ₄ ⁺	Ammonium Content	0.00431	kg m ⁻³
NO ₃ ⁻	Nitrate Content	2.01	kg m ⁻³
NH ₃	Ammonia Content	0.0002535	kg m ⁻³
Forced_temperature	Homogeneous Soil Temperature	288.000	K
clay_pc	Clay Content	1.0	% by mass
silt_pc	Silt Content	3.0	% by mass
organic_pc	Organic Matter Content	2.0	% by mass
textural_density	Bulk density of soil aggregates of horizon	1900	kg m ⁻³

(ii) Red Clover Residue

Parameter	Description	Red-Clover Initial Value
Pool Sizes in kg kg⁻¹		
AOM	Active Organic Matter	0.0207
AUB	Autochthonous Biomass	0.000341
CEL	Cellulose	0.000812
HCEL	Hemicellulose	0.000832
LIG	Lignin	0.00018
RDM	Rapidly Decomposable Matter	0.00191
SOL	Soluble Organic Matter	0.000704
ZYB	Zymogenous Biomass	0.000114
N:C Ratios		
AOM	Active Organic Matter	0.08583
AUB	Autochthonous Biomass	0.08407
CEL	Cellulose	0.0698
HCEL	Hemicellulose	0.0091

LIG	Lignin	0.0464
RDM	Rapidly Decomposable Matter	0.0554
SOL	Soluble Organic Matter	0.1222
ZYB	Zymogenous Biomass	0.06957

Table 4.2 Input values of parameters associated with soil and residue used in the simulations

NOE Parameters

Parameter	Description	Unit	Default Value	Simulation Value
k_{m1}	Michaelis Menten constant for denitrifier	μM	6000	22
t	Soil Temperature	°C	-	15
r_{max}	maximum ratio of accumulated N ₂ O to denitrified nitrate	-	-	0.900
WFPS	Water Filled Pore Space	-	-	0.620
a	slope of linear relationship between gravimetric water content and nitrification rate	-	-	0.04
b	ordinate intercept of linear relationship between gravimetric water content and nitrification rate	-	-	-0.04
D_p	Potential Denitrification Rate	g N ha ⁻¹ d ⁻¹	-	5.7
t_{seuil}	Threshold temperature in temperature response function	K	-	284.149999
k_{m2}	Michaelis Mente Constant for Nitrifier Dynamics	μM	714	2.6
z	proportion of N ₂ O to Total Nitrified Nitrogen	-	-	0.0006

Table 4.3 Parameter values default in NOE and those used in Simulations

2.4 Experimental data to evaluate model performance

Data from soil microcosm incubation experiments of Chandra et al (2021, submitted) were used as the standard for comparison with the simulated data. Compared output variables were daily carbon dioxide, ammonia and nitrous oxide fluxes, soil ammonium and nitrate concentrations measured on days (1, 4, 7, 14, 28 and last day of incubation). These data were obtained from incubation of open system soil microcosms with residue incorporated and non-incorporated soil at 288.15 K and 60% WFPS in Gas Emission Detection Incubator (GEDI). Fluxes were calculated from the gaseous concentrations obtained using the formula

$$F_{ss} = Q/A \times (C_{out} - C_{blk}) \quad (1)$$

where F_{ss} stood for the gas fluxes; A represented the soil surface area of the incubation cylinder; Q is the air flow rate through the cylinder. C_{blk} and C_{out} are the trace gas mixing ratios of the outflowing chamber air for the blank chamber and chamber with treatment respectively. Fluxes were converted to $\text{kg N (or C) ha}^{-1} \text{ d}^{-1}$ using air temperature measurements (the atmospheric pressure was set to 1013 hPa). Mineral nitrogen contents of such residue-soil systems were analysed post extraction with 1 mol l^{-1} KCl by colorimetric methods.

Measurements done on bare soil (without residue addition), called control here, were used to calibrate the model for parameters of autochthonous biomass. The data related to physico-chemical characteristics of soil and residue were taken from measurements done by consortium of FACCE Eragas ResidueGas project.

Once the input data to the coupled model is filled on the VSOIL platform, simulations were run for control and residue mixed in the top layer, and data was obtained for CO_2 , N_2O and NH_3 fluxes for 60 days period. Multiple simulations were run on control soil prior to simulations with residue addition. The control soil simulations allowed for the optimisation of process related parameters with the objective of approximating model outputs with experimental data.

3. Result and Discussion

Post simulation run, the data obtained as results are treated and their units converted to match the experimental data presented in Chandra et al (2021, submitted).

3.1 Model outputs for soil with no residue

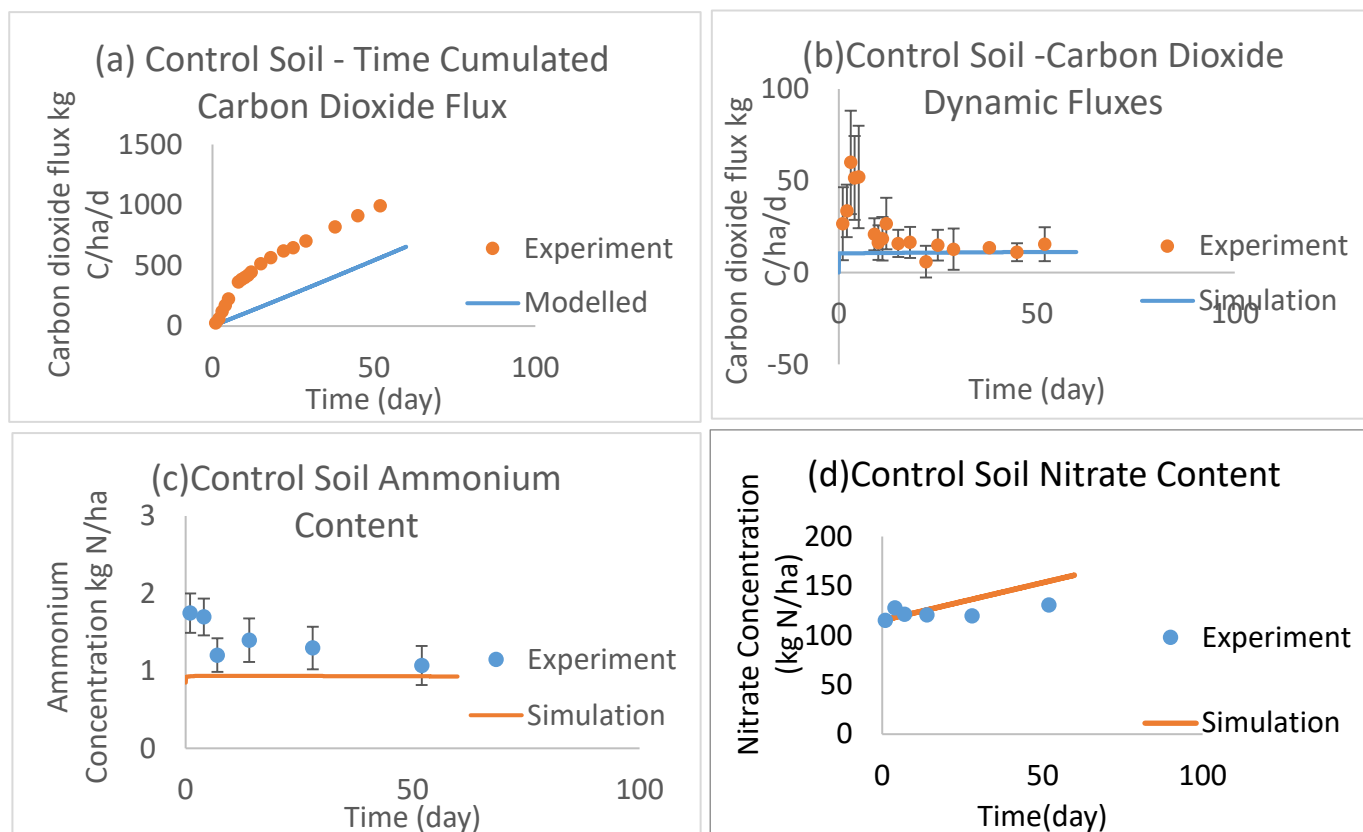

Figure 4.3 Carbon dioxide fluxes, (a)dynamic and (b)cumulative for control soil GICOS. (c)Mineral NH_4^+ (ammonium) and (d) NO_3^- (nitrate) contents for control soil with time.

From figure 4.3(b), it is evident that the modelled CO_2 dynamic fluxes are in good agreement with the CO_2 fluxes measured in the incubation experiment yet underestimated during the first two weeks of incubation. Although, the cumulative flux dynamics of CO_2 is underestimated (Figure 4.3(a)). Control soil is devoid of exogenous organic matter, we get a constant simulated curve as the temperature and humidity is kept constant throughout the incubation period. The peak in dynamic flux of CO_2 might be a result of some residual organic matter (such as roots) in soil of experiment not accounted for in the input carbon pools of the model. Moreover, the CO_2 daily flux values are not high, this is due to the absence of no crop residue in the control conditions. Obviously these fluxes are not zero as the soil already contains some stabilised organic matter and the CO_2 fluxes are resulting from microbial activity associated to them. In terms of CANTIS we can say that this is the activity of autochthonous biomass on active organic matter. However, the simulated mineral nitrogen

concentrations of soil i.e. NH_4^+ and NO_3^- (figure 4.3(c) and (d)) show close agreement with modelled data demonstrating that the coupled model is performing well in simulating these concentrations.

3.2 Model outputs for soil with red-clover residue

3.2.1 Fluxes of CO_2 from decomposition of red-clover mixed in top layer of GICOS soil

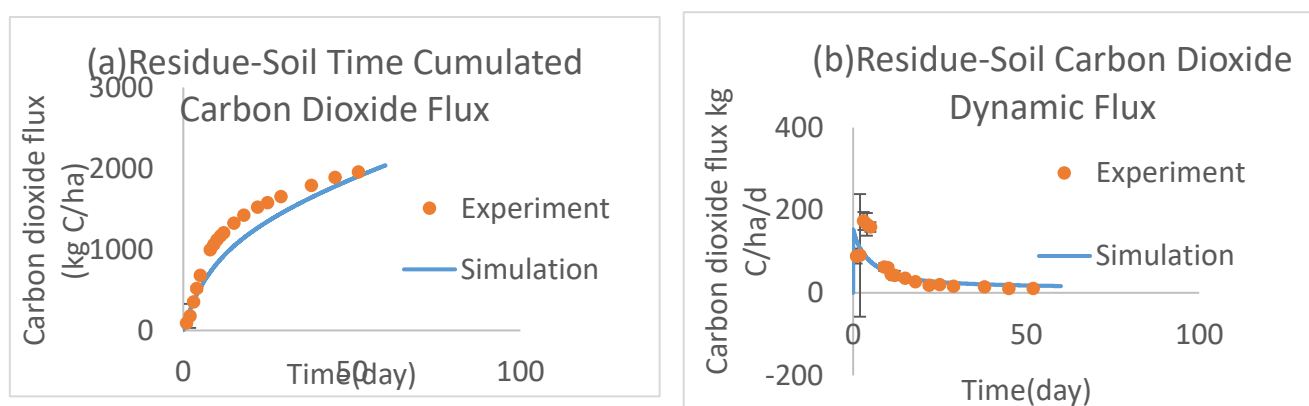

Figure 4.4 Carbon dioxide fluxes, (a) cumulative and (b) daily dynamic, for red-clover mixed in top 4 cm layer of GICOS soil

The carbon dioxide cumulative flux of red-clover soil mix system is simulated (Figure 4.4(a)) and the output dynamics are identical with the experimentally observed value. With reference to Chandra et al (2021, submitted), an important point to note here is that the cumulative fluxes of CO_2 from experiments were determined by linear interpolation between two consecutive measurements of daily dynamic fluxes. There is a point of conjunction ($\sim 46730 \text{ kg C ha}^{-1}$) between the simulated and experimental cumulative flux on day 52 i.e. last day of microcosm incubation. This is an optimistic sign pertaining to the functioning of the model. Additionally, on inspection of daily dynamic fluxes (figure 4(b)), it is clearly evident that the simulated dynamics and the experimental dynamics are following same evolution in terms of both quality and quantity. The peak in the first week of incubation during experiments is observed due to fresh addition of crop residue. It is highly encouraging to see the same effect in the model output.

3.2.2 Fluxes of N₂O from decomposition of red-clover mixed in top layer of GICOS soil

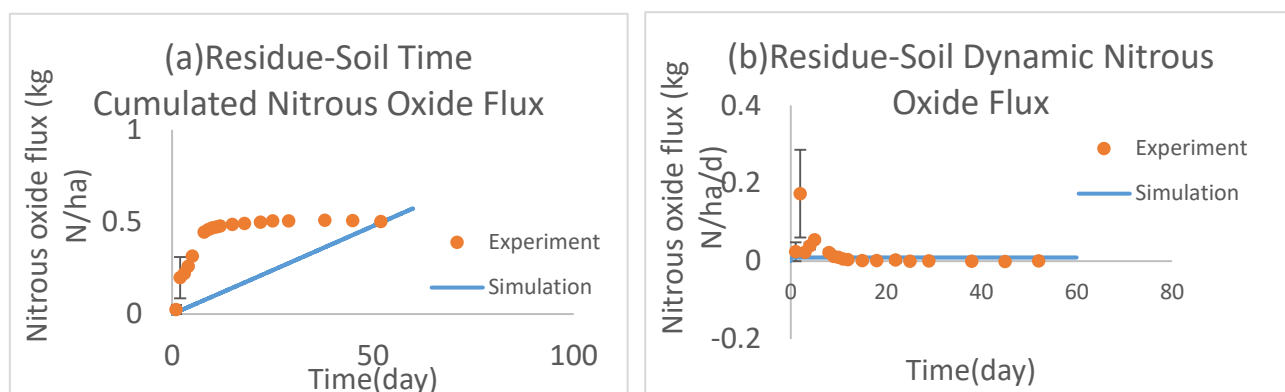

Figure 4.5 Cumulative (a) and daily dynamic (b) nitrous oxide fluxes for soil system of red-clover mixed in top 4 cm layer of soil.

On comparison of cumulative nitrous oxide emissions from red clover mixed in top layer of the GICOS soil (figure 4.5(a)), we find no difference in the dynamics and the value on day 52 i.e. last day of incubation experiment ($\sim 18 \text{ kg N ha}^{-1}$ for simulation and experiment). Although the cumulative flux dynamics simulation is not following the same trend with experiment. On speculation, the reasons for these differences can be simply due to an improperly optimised parameter in the coupled model, such as the rate constants for denitrification N₂O emission from nitrification or anaerobic denitrification. The parameters could not be optimised on the grounds of just a single experiment. Although such differences might also be resulting due to over-estimation of mineral NH₄⁺ in the first two weeks of decomposition in this model simulation (figure 4.6(a)). This over-estimation can also suggest higher rates of nitrification (from CANTIS part) during this time period with an implication that nitrification contribution to N₂O flux might have been under-estimated by the model. This under-estimation is thus originating in the NOE algorithm incorporated in this model. Evidently, on inspection of daily dynamic N₂O fluxes from simulations and experiments (figure 4.5(b)), it is clear that peak of N₂O flux in the first week of microcosm incubation is not simulated by the model. This lower N₂O flux value from simulation in the first week of incubation experiment indeed suggests for overcompensation by nitrification in the initial stages of decomposition, as seen in the increasing NO₃⁻ content in this time period (figure 4.6(b)). Another observation, that pushes the need for further refinement of this coupled model is the limited variability in daily N₂O

flux simulation (figure 4.5(b)). This calls for further evaluation of the coupled model input parameters and stresses the importance for experimental determination of certain case specific soil parameters such as potential denitrification and nitrification rates of the NOE module. The overestimation of ammonium and nitrate contents also depicts the need of verification of decomposition rate constants of microbial pools acting on organic matter through assimilation and mineralisation in the CANTIS module of the coupled model.

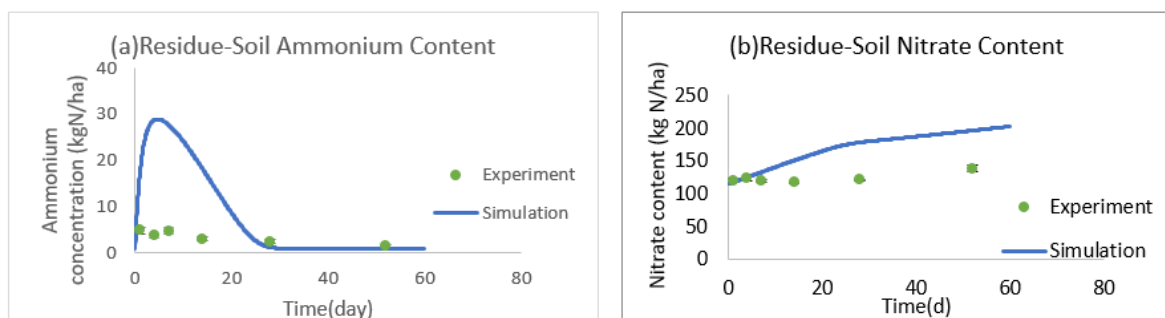

Figure 4.6 Ammonium (a) and nitrate (b) contents of soil-residue system where red-clover is mixed in top 4 cm layer of soil.

3.2.3 Fluxes of NH_3 from decomposition of red-clover mixed in top layer of GICOS soil

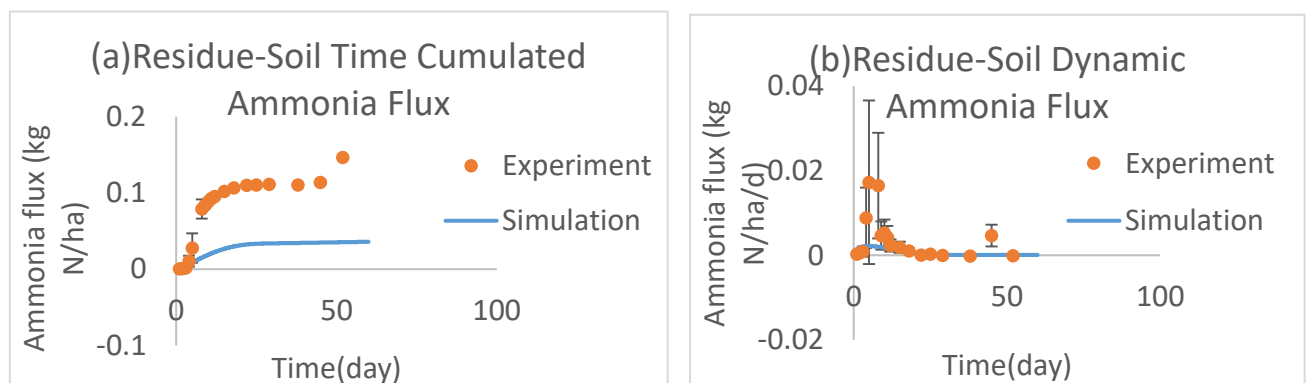

Figure 7 Cumulated (a) and daily dynamic (b) ammonia (NH_3) fluxes from residue-soil system with red-clover mixed in top 4 cm layer of GICOS soil.

Figure 4.7(a) shows the experimental and simulated cumulative ammonia emissions follow the same dynamics and are not proximate with each other. On comparison with figure 7(b), it seems that while some low to near zero daily fluxes of NH_3 were detected during experiments, simulation daily fluxes are approaching zero after day 20. The small peak observed in first

two weeks of incubation from simulation coincides with that of experiment, even though there is slight underestimation. Chandra et al (2021, submitted) argued that these observation of low fluxes might result during periodic water addition in the soil microcosms to keep the soil WFPS constant at 60%. The reason why we observe the difference in the dynamics of cumulative flux of NH_3 between the modelled and the experimental data could be attributed to overestimation of NH_4^+ ions concentration during the first two weeks of incubation (Figure 4.6(a)). The closeness of simulation and experimentally determined daily flux values in figure 4.7(b) indicates well functioning of NH_3 volatilisation component of the coupled model. The fluxes of ammonia here are in low quantities owing to physical barrier to the escape of the gas in the system where the residue is mixed in the top layer of the soil. Chandra et al (2021, submitted) argue that only surface placement of residues on soil yields significant NH_3 fluxes. Our model seems to showcase this effect in the mixed placement. Of course, more simulations are needed, especially with surface placement of residue to further establish this hypothesis. The balance between the degree of refinement and the amount of information needed to run it is quite delicate. Being able to simulate one-off events like N_2O and NH_3 flushes/pulses is complex and would require more refined representation of underlying mechanisms in soil organic matter decomposition.

4. Conclusion

Modelling of N_2O and NH_3 fluxes is crucial for enhanced predictability of these greenhouse and pollutant gas emissions from crop residues. The underlying mechanisms to these emissions are complex interplays between biological, physical and chemical factors. The models for these simulations are equally complex and usually take significant amount of time and data management to generate suitable outputs. With this pretext, we tried to construct a simple empirical model for N_2O and NH_3 emission calculations from land use, by coupling carbon and nitrogen model CANTIS, nitrous oxide emission model NOE and NH_3 volatilisation equations from Sommer et al 2003. This constructed model gave satisfactory results for CO_2 and NH_3 fluxes in a residue soil microcosm system. NH_3 cumulative fluxes are still

underestimated though probably owing to overestimation of soil NH_4^+ content by the coupled model. For N_2O fluxes, the dynamics of daily fluxes are still not well calibrated as they remained almost constant after the initial small spike in the N_2O concentration in the initial stage of fresh organic matter decomposition in soil. This can be a result of some prior residual organic matter in the soil, not taken into account as a model input and lack of certain experimental data pertaining to the soil such as soil microbial biomass population and diversity. This model can also be coupled with mulch decomposition modules, which would make it possible to simulate residue recycling situations on the soil surface. Future work is needed, in experimentation to gather case specific parameter values for the model compartments; and in modelling to evaluate of its performance over wider range of residues and soils.

• Supplementary Information

Table 4.4. Equations of pool changes in CANTIS

Name of Variable	Description of Variable	Equation	Unit
DN_{RDM}	Change in RDM nitrogen pool	$\text{DN}_{\text{RDM}} = \text{dC}_{\text{RDM}}/\text{dt} * \text{N}:\text{C}_{\text{RDM}} = \text{dN}_{\text{RDM}}/\text{dt}$	$\text{mg N kg}^{-1} \text{ soil d}^{-1}$
DC_{RDM}	Change in RDM carbon pool	$\text{DC}_{\text{RDM}} = \text{dC}_{\text{RDM}}/\text{dt}$	$\text{mg C kg}^{-1} \text{ soil d}^{-1}$
DN_{HCE}	Change in HCE nitrogen pool	$\text{DN}_{\text{HCE}} = \text{dC}_{\text{HCE}}/\text{dt} * \text{N}:\text{C}_{\text{HCE}} = \text{dN}_{\text{HCE}}/\text{dt}$	$\text{mg N kg}^{-1} \text{ soil d}^{-1}$
DC_{HCE}	Change in HCE carbon pool	$\text{DC}_{\text{HCE}} = \text{dC}_{\text{HCE}}/\text{dt}$	$\text{mg C kg}^{-1} \text{ soil d}^{-1}$
DN_{CEL}	Change in CEL nitrogen pool	$\text{DN}_{\text{CEL}} = \text{dC}_{\text{CEL}}/\text{dt} * \text{N}:\text{C}_{\text{CEL}} = \text{dN}_{\text{CEL}}/\text{dt}$	$\text{mg N kg}^{-1} \text{ soil d}^{-1}$
DC_{CEL}	Change in CEL carbon pool	$\text{DC}_{\text{CEL}} = \text{dC}_{\text{CEL}}/\text{dt}$	$\text{mg C kg}^{-1} \text{ soil d}^{-1}$
DN_{LIG}	Change in LIG nitrogen pool	$\text{DN}_{\text{LIG}} = \text{dC}_{\text{LIG}}/\text{dt} * \text{N}:\text{C}_{\text{LIG}} = \text{dN}_{\text{LIG}}/\text{dt}$	$\text{mg N kg}^{-1} \text{ soil d}^{-1}$
DC_{LIG}	Change in LIG carbon pool	$\text{DC}_{\text{LIG}} = \text{dC}_{\text{LIG}}/\text{dt}$	$\text{mg C kg}^{-1} \text{ soil d}^{-1}$
DN_{SOL}	Change in SOL nitrogen pool	$\text{DN}_{\text{SOL}} = - \text{dN}_{\text{RDM}}/\text{dt} - \text{dN}_{\text{HCE}}/\text{dt} - \text{dN}_{\text{CEL}}/\text{dt} - \text{dN}_{\text{LIG}}/\text{dt} - \{\text{dC}_{\text{SOL}}/\text{dt} * \text{N}:\text{C}_{\text{SOL}}\}$	$\text{mg N kg}^{-1} \text{ soil d}^{-1}$

DC _{SOL}	Change in SOL carbon pool	$DC_{SOL} = dC_{RDM}/dt + dC_{HCE}/dt + dC_{CEL}/dt + dC_{SOL,LIG}/dt - dC_{SOL}/dt$	mg C kg ⁻¹ soil d ⁻¹
DN _{ZYB}	Change in ZYB nitrogen pool	$DN_{ZYB} = dN_{SOL, assimilation, ZYB}/dt + dN_{NH4+, immobilisation, ZYB} + dN_{NO3-, immobilisation, ZYB} - dN_{ZYB, mineralisation, ZYB}/dt - dN_{NH4+, mineralisation, ZYB}/dt$	mg N kg ⁻¹ soil d ⁻¹
DC _{ZYB}	Change in ZYB carbon pool	$DC_{ZYB} = dC_{SOL, assimilation, ZYB}/dt + dC_{ZYB, assimilation, ZYB}/dt - dC_{ZYB}/dt$	
DN _{AUB}	Change in AUB nitrogen Pool	$DN_{AUB} = dN_{AOM, assimilation, AUB}/dt + dN_{NH4+, immobilisation, AUB}/dt - dN_{AUB, mineralisation, AUB}/dt - dN_{NH4+, mineralisation, AUB}$	mg N kg ⁻¹ soil d ⁻¹
DC _{AUB}	Change in AUB carbon pool	$DC_{AUB} = dC_{AOM, assimilation, AUB}/dt + dC_{AUB, assimilation, AUB}/dt - dC_{AUB, mineralisation, AUB}/dt$	mg C kg ⁻¹ soil d ⁻¹
DN _{AOM}	Change in AOM/HOM carbon pool	$DN_{AOM} = dH_{NH4+}/dt + dH_{NO3-}/dt - dN_{AOM, assimilation, AUB}/dt - dN_{AOM, mineralisation, AUB}/dt$	mg N kg ⁻¹ soil d ⁻¹
DC _{AOM}	Change in AOM/HOM carbon pool	$DC_{AOM} = dH_{LIG}/dt + dH_{ZYB}/dt + dH_{AUB}/dt - dC_{AOM}/dt$	mg C kg ⁻¹ soil d ⁻¹
DC _{SOL, mineralisation}	Change in mineralisation pool of SOL-C i.e. CO ₂	$DC_{SOL, mineralisation} = dC_{SOL, mineralisation, ZYB}/dt$	mg C kg ⁻¹ soil d ⁻¹
DC _{AOM, mineralisation}	Change in mineralisation pool of AOM-C i.e. CO ₂	$DC_{AOM, mineralisation} = dC_{AOM, mineralisation, AUB}/dt$	mg C kg ⁻¹ soil d ⁻¹
DC _{ZYB, mineralisation}	Change in mineralisation pool of ZYB-C i.e. CO ₂	$DC_{ZYB, mineralisation} = dC_{ZYB, mineralisation, ZYB}/dt$	mg C kg ⁻¹ soil d ⁻¹
DC _{AUB, mineralisation}	Change in mineralisation pool of AUB-C i.e. CO ₂	$DC_{AUB, mineralisation} = dC_{AUB, mineralisation, AUB}/dt$	mg C kg ⁻¹ soil d ⁻¹
DN _{NO3-}	Change in nitrate pool	$DN_{NO3-} = dN_{nitrification}/dt - dN_{NO3-, immobilisation, ZYB}/dt - dH_{NO3-}/dt$	mg N kg ⁻¹ soil d ⁻¹
DN _{mineralised, total}	Gross mineralisation of nitrogen as NH ₄ ⁺	$DN_{NH4+} = dN_{SOL, mineralisation, ZYB}/dt + dN_{ZYB, mineralisation, ZYB}/dt + dN_{AOM, mineralisation, AUB}/dt + dN_{AUB, mineralisation, AUB}/dt + dN_{NH4+, mineralisation, ZYB}/dt + dN_{NH4+, mineralisation, AUB}/dt - dN_{NH4+, immobilisation, AUB}/dt - dN_{NH4+, immobilisation, ZYB}/dt - dN_{nitrification}/dt - dH_{NH4+}/dt$	mg N kg ⁻¹ soil d ⁻¹
DN _{remineralisation, ZYB}	Remineralisation of nitrogen from ZYB	$DN_{remineralisation} = dN_{SOL, mineralisation, ZYB}/dt + dN_{ZYB, mineralisation, ZYB}/dt + dN_{NH4+, mineralisation, ZYB}/dt$	mg N kg ⁻¹ soil d ⁻¹

$DN_{\text{immobilisation, total}}$	Gross biological immobilisation of nitrogen	$DN_{\text{immobilisation, ZYB/dt}} + DN_{\text{immobilisation, ZYB/dt}} + DN_{\text{immobilisation, AUB/dt}}$	=	$dN_{\text{NH}_4^+} + dN_{\text{NO}_3^-} + dN_{\text{NH}_4^+}$	mg N kg ⁻¹ soil d ⁻¹
-------------------------------------	---	--	---	--	--

Table 4.5. Rates of Assimilation and Decomposition in CANTIS

Variable	Description	Equation	Unit
dC_{RDM}/dt	Rate of decomposition of RDM	$dC_{\text{RDM}}/dt = k_1 * f_N * f_W * f_T * [1/1 + (K_{\text{MZ}}/[C_{\text{ZYB}} - \text{ZYB}_0])]$	mg C kg ⁻¹ soil d ⁻¹
dC_{HCE}/dt	Rate of decomposition of HCE	$dC_{\text{HCE}}/dt = k_2 * f_N * f_W * f_T * [C_{\text{HCE}}] * [1/1 + (K_{\text{MZ}} / [C_{\text{ZYB}} - \text{ZYB}_0]) * \exp(3.2 * ((C_{\text{LIG}} / ((C_{\text{RDM}}) + [C_{\text{HCE}}] + [C_{\text{CEL}}] + [C_{\text{LIG}}])))]$	mg C kg ⁻¹ soil d ⁻¹
dC_{CEL}/dt	Rate of decomposition of CEL	$dC_{\text{CEL}}/dt = k_3 * f_N * f_W * f_T * [C_{\text{CEL}}] * [1/1 + (K_{\text{MZ}} / [C_{\text{ZYB}} - \text{ZYB}_0]) * \exp(3.2 * ((C_{\text{LIG}} / ((C_{\text{RDM}}) + [C_{\text{HCE}}] + [C_{\text{CEL}}] + [C_{\text{LIG}}])))]$	mg C kg ⁻¹ soil d ⁻¹
dH_{LIG}/dt	Rate of humification of LIG	$dH_{\text{LIG}}/dt = dC_{\text{LIG}}/dt * h_L$	mg C kg ⁻¹ soil d ⁻¹
dC_{LIG}/dt	Rate of Decomposition of LIG	$dC_{\text{LIG}}/dt = k_4 * f_N * f_W * f_T * [C_{\text{LIG}}] * [1/1 + (K_{\text{MZ}}/[C_{\text{ZYB}} - \text{ZYB}_0])]$	mg C kg ⁻¹ soil d ⁻¹
$dC_{\text{SOL,LIG}}/dt$	Rate of formation of SOL from LIG	$dC_{\text{SOL,LIG}}/dt = dC_{\text{LIG}}/dt * (1 - h_L)$	mg C kg ⁻¹ soil d ⁻¹
$dC_{\text{SOL,mineralisation,ZYB}}/dt$	Rate of mineralisation of SOL by ZYB	$dC_{\text{SOL, mineralisation, ZYB}}/dt = dC_{\text{SOL}}/dt * (1 - (Y_S * f_N))$	mg C kg ⁻¹ soil d ⁻¹
dC_{SOL}/dt	Rate of decomposition of SOL	$dC_{\text{SOL}}/dt = k_S * f_N * f_W * f_T * [C_{\text{SOL}}] * [1/1 + (K_{\text{MZ}}/[C_{\text{ZYB}} - \text{ZYB}_0])]$	mg C kg ⁻¹ soil d ⁻¹
$dC_{\text{SOL,assimilation,ZYB}}/dt$	Rate of assimilation of SOL by ZYB	$dC_{\text{SOL,assimilation,ZYB}}/dt = dC_{\text{SOL}}/dt * Y_S * f_N$	mg C kg ⁻¹ soil d ⁻¹
$dC_{\text{ZYB,ZYB}}/dt$	Rate of decomposition of ZYB by ZYB	$dC_{\text{ZYB}}/dt = k_Z * f_N * f_W * f_T * ([C_{\text{ZYB}}] - \text{ZYB}_0)$	mg C kg ⁻¹ soil d ⁻¹
dH_{ZYB}/dt	Rate of humification of ZYB	$dH_{\text{ZYB}}/dt = dC_{\text{ZYB}}/dt * h_Z$	mg C kg ⁻¹ soil d ⁻¹
$dC_{\text{ZYB, mineralisation, ZYB}}/dt$	Rate of mineralisation of ZYB by ZYB	$dC_{\text{ZYB, mineralisation, ZYB}}/dt = dC_{\text{ZYB}}/dt * (1 - h_Z) * (1 - Y_Z)$	mg C kg ⁻¹ soil d ⁻¹
$dC_{\text{ZYB, assimilation, ZYB}}/dt$	Rate of assimilation of ZYB by ZYB	$dC_{\text{ZYB, assimilation, ZYB}}/dt = dC_{\text{ZYB}}/dt * (1 - h_Z) * Y_Z$	mg C kg ⁻¹ soil d ⁻¹
dC_{AOM}/dt	Rate of decomposition of AOM/HOM	$dC_{\text{AOM}}/dt = k_H * [C_{\text{AOM}}] * f_T * f_W * \{[C_{\text{AUB}}] / ([C_{\text{AUB}}] + K_{\text{MA}})\}$	mg C kg ⁻¹ soil d ⁻¹
$dC_{\text{AOM, mineralisation, AUB}}/dt$	Rate of mineralisation of AOM/HOM by AUB	$dC_{\text{AOM, mineralisation, AUB}}/dt = dC_{\text{AOM}}/dt * (1 - Y_H)$	mg C kg ⁻¹ soil d ⁻¹

$dC_{AOM, \text{assimilation}, AUB}/dt$	Rate of assimilation of AOM/HOM by AUB	$dC_{AOM, \text{assimilation}, AUB}/dt = dC_{AOM}/dt * Y_H$	$mg C kg^{-1} soil d^{-1}$
dC_{AUB}/dt	Rate of decomposition of AUB	$dC_{AUB}/dt = k_A * [C_{AUB}] * f_T * f_w$	$mg C kg^{-1} soil d^{-1}$
dH_{AUB}/dt	Rate of Humification of AUB	$dH_{AUB}/dt = dC_{AUB}/dt * h_A$	$mg C kg^{-1} soil d^{-1}$
$dC_{AUB, \text{mineralisation}, AUB}/dt$	Rate of mineralisation of AUB by AUB	$dC_{AUB, \text{mineralisation}, AUB}/dt = dC_{AUB}/dt * (1 - h_A) * (1 - Y_A)$	$mg C kg^{-1} soil d^{-1}$
$dC_{AUB, \text{assimilation}, AUB}/dt$	Rate of assimilation of AUB by AUB	$dC_{AUB, \text{assimilation}, AUB}/dt = dC_{AUB}/dt * (1 - h_A) * Y_A$	$mg C kg^{-1} soil d^{-1}$
SOLS	N supply from SOL-C decomposition	$SOLS = dC_{SOL}/dt * N:C_{SOL}$	$mg N kg^{-1} soil d^{-1}$
$dN_{SOL, \text{assimilation}, ZYB}/dt$	Rate of assimilation of SOL-N by ZYB	$dN_{SOL, \text{assimilation}, ZYB}/dt = FNOZ * dC_{SOM}/dt * N:C_{SOM}$	$mg N kg^{-1} soil d^{-1}$
$dN_{SOL, \text{mineralisation}, ZYB}/dt$	Rate of mineralisation of SOL-N by ZYB	$dN_{SOL, \text{mineralisation}, ZYB}/dt = dC_{SOL}/dt * N:C_{SOL} * (1 - FNOZ)$	$mg N kg^{-1} soil d^{-1}$
ZYBS or dN_{ZYB}/dt	N supply from ZYB decomposition	$dN_{ZYB}/dt = dC_{ZYB}/dt * N:C_{ZYB}$	$mg N kg^{-1} soil d^{-1}$
$dN_{ZYB, \text{assimilation}, ZYB}/dt$	Rate of assimilation of organic ZYB-N by ZYB	$dN_{ZYB, \text{assimilation}, ZYB}/dt = dC_{ZYB, \text{assimilation}, ZYB}/dt * N:C_{ZYB}$	$mg N kg^{-1} soil d^{-1}$
$dN_{ZYB, \text{mineralisation}, ZYB}/dt$	Rate of mineralisation of ZYB-N by ZYB	$dN_{ZYB, \text{mineralisation}, ZYB}/dt = dN_{ZYB}/dt - dN_{ZYB, \text{assimilation}, ZYB}/dt$	$mg N kg^{-1} soil d^{-1}$
AOMN/ dN_{AOM}/dt	N supply from AOM/HOM decomposition	$dN_{AOM}/dt = dC_{AOM}/dt * N:C_{AOM}$	$mg N kg^{-1} soil d^{-1}$
$dN_{AOM, \text{assimilation}, AUB}/dt$	Rate of assimilation of AOM/HOM-N by AUB	$dN_{AOM, \text{assimilation}, AUB}/dt = FNOA * dN_{AOM}/dt$	$mg N kg^{-1} soil d^{-1}$
$dN_{AOM, \text{mineralisation}, AUB}/dt$	Rate of mineralisation of AOM/HOM-N by AUB	$dN_{AOM, \text{mineralisation}, AUB}/dt = dN_{AOM}/dt - dN_{AOM, \text{assimilated}, AUB}/dt$	$mg N kg^{-1} soil d^{-1}$
AUBS or dN_{AUB}/dt	N supply from AUB decomposition	$dN_{AUB}/dt = dC_{AUB}/dt * N:C_{AUB}$	$mg N kg^{-1} soil d^{-1}$
$dN_{AUB, \text{assimilation}, AUB}/dt$	Rate of assimilation of AUB-N by AUB	$dN_{AUB, \text{assimilation}, AUB}/dt = dC_{AUB, \text{assimilation}, AUB}/dt * N:C_{AUB}$	$mg N kg^{-1} soil d^{-1}$
$dN_{AUB, \text{mineralisation}, AUB}/dt$	Rate of mineralisation of AUB-N by AUB	$dN_{AUB, \text{mineralisation}, AUB}/dt = dN_{AUB}/dt - dN_{AUB, \text{assimilation}, AUB}/dt$	$mg N kg^{-1} soil d^{-1}$
$dN_{NH4, \text{Imm.}, AUB}/dt$	Rate of Immobilisation of Ammonium by AUB	$dN_{NH4+, \text{immobilisation}, AUB}/dt = [(dC_{AOM, \text{assimilation}, AUB}/dt + dC_{AUB, \text{assimilation}, AUB}/dt) * N:C_{AUB}] - dN_{AOM, \text{assimilated}, AUB}/dt + dN_{AUB, \text{assimilated}, AUB}/dt$	$mg N kg^{-1} soil d^{-1}$
$dN_{NH4, \text{mineralisation}, AUB}/dt$	Rate of mineralisation of ammonium by AUB	$dN_{NH4+, \text{mineralisation}, AUB}/dt = - [dN_{NH4+, \text{immobilisation}, AUB}/dt]$	$mg N kg^{-1} soil d^{-1}$

$dN_{NH_4^+}$, immobilisation, ZYB/dt	Immobilisation rate of ammonium by ZYB	$dN_{NH_4^+}$, immobilisation, ZYB/dt = $([N_{NH_4^+}] - THRA)/dt + DN_{NH_4^+} + dN_{SOL}$, mineralisation, ZYB/dt + dN_{ZYB} , mineralised, ZYB/dt	mg N kg ⁻¹ soil d ⁻¹
$dN_{NH_4^+}$, mineralisation ZYB/dt	Rate of mineralisation of ammonium by ZYB	$dN_{NH_4^+}$, mineralisation, ZYB/dt = - $\{ dN_{NH_4^+}$, immobilisation, ZYB/dt }	mg N kg ⁻¹ soil d ⁻¹

HUMIFN	Humification capacity to fix NH ₄ ⁺ -N	HUMIFN= $(dH_{LIG}/dt + dH_{ZYB}/dt + dH_{AUB}/dt) * RH$	mg N kg ⁻¹ soil
$dH_{NH_4^+}/dt$	Humification rate of NH ₄ ⁺ -N	$dH_{NH_4^+}/dt = ([N_{NH_4^+}] - THRA)/dt + DN_{NH_4^+}$	mg N kg ⁻¹ soil d ⁻¹
$dH_{NO_3^-}/dt$	Humification rate of NO ₃ ⁻ -N	$dH_{NO_3^-}/dt = HUMIFN - DH_{NH_4^+}/dt$	mg N kg ⁻¹ soil d ⁻¹
$dN_{nitrification}/dt$	Nitrification rate	$dN_{nitrification}/dt = V_{max} * f_N * f_W * \{ [N_{NH_4^+}] / (K_N + [N_{NH_4^+}]) \}$	mg N kg ⁻¹ soil d ⁻¹

Table 4.6. Equations of NOE and description of variables

Variable	Description	Equation	Unit
D_A	actual denitrification	$D_A = D_p F_N F_W F_T$	kg N ha ⁻¹ d ⁻¹
D_p	potential denitrification	Experimentally Determined	kg N ha ⁻¹ d ⁻¹
F_N	Nitrate Limiting Function	$F_N = [NO_3^-] / \{ K_{m1} + [NO_3^-] \}$	Dimensionless
F_W	Denitrification Water Function	$F_W = 0$ if WFPS < or = 0.62 ; $F_W = [(WFPS - 0.62) / 0.38]^{1.74}$ if WFPS > 0.62	Dimensionless
F_T	Denitrification Temperature Function	$F_T = \exp\{[(t-11)\ln(89) - 9(\ln 2.1)] / 10\}$ when $t < 11^\circ C$; $F_T = \exp\{[t - 20]\ln(2.1) / 10\}$ when $t \geq 11^\circ C$	Dimensionless
N_2O_{denit}	Anaerobic Denitrified N ₂ O	$N_2O_{denit} = r_{max} D_A$	kg N ha ⁻¹ d ⁻¹
N_A	Actual Nitrification	$N_A = 0$ if WFPS > 0.8 ; $N_A = N_W N_{NH_4} N_T$ if WFPS < 0.8	kg N ha ⁻¹ d ⁻¹
N_W	Water response to Nitrification	$N_W = a WC + b$	kg N ha ⁻¹ d ⁻¹
N_{NH_4}	Ammonium Response to Nitrification	$N_{NH_4} = [NH_4^+] / \{ km_2 + [NH_4^+] \}$	dimensionless
N_T	Temperature response to nitrification	$N_T = F_T$	dimensionless
N_2O_{nit}	N ₂ O emission from Nitrification	$N_2O_{nit} = z N_A$ when WFPS < 0.62 ; $N_2O_{nit} = r_{max} z N_A$ when WFPS > or = 0.62	kg N ha ⁻¹ d ⁻¹

Epilogue

1. Discussions

This manuscript is approaching nitrous oxide and ammonia emissions from different agriculture systems and crop residue incorporation methods in a holistic manner. The different chapters have described different facets of information and data obtained through rigorous review of scientific articles, incubation experiments and modelling nitrous oxide and ammonia emissions by parameterisation with data obtained from incubation experiments. The scientific literature review evaluated the performance of conventional agriculture and agroecology in soil nitrous oxide and ammonia emissions. We found a plenty of information regarding these for conventional agriculture system. In case of agroecology, there are not enough studies comparing the annual performances of these crop management systems to greenhouse emissions. Conventional agriculture primarily relies on technology for land preparation, chemical products for fertilisation and pest control and cash crop seeds (hybrid or indigenous). Agroecology predominantly relies on conservation agriculture with reduced tillage, organic fertilisation and pest control, and/or indigenous seeds. Major factor influencing the nitrous oxide and ammonia emissions from these systems is land fertilisation. Of course precipitation and freezing-thawing is also a natural driver for these gaseous emissions from soil but presence of mineral nitrogen in either from chemical fertilisers or from organic slurries and decomposing crop residues comprise the major part in their annual emission inventory [Wagner-Riddle et al 2017, Nett et al 2016]. Wagner-Riddle et al (2017) concludes that nitrous oxide emissions can be underestimated globally by 17-25% by neglecting the freeze-thaw effect. Adair et al 2019 experimentally found that the cumulative nitrous oxide emissions from freeze-thaw systems injected with organic manure were 2-20 times higher than that of other treatments of their soil cores on 8th day. They also had manure application as broadcasting and broadcasted with ploughing but the cumulative emissions of N₂O were higher from freeze-thaw events than manure application in regular conditions. This made them conclude that the position of manure application is an important driver in determining the extent of nitrous oxide emissions. Concluding from several other studies cited

in Chapter 2 [Hauck 1981, Mutegi et al 2010, Nett et al 2016], we also reached the same conclusion. We found that when compared annually, the ammonia and nitrous oxide emissions from a crop rotation system either conventional or agroecological emitted nitrous oxide and ammonia in the same ranges of cumulative fluxes. Tillage method and type and time of organic or chemical fertilisation influence these emissions and there is a vital need of experimental studies to testify these factors. One recurring observation we found in the studies we referred to is how the position of fertiliser (chemical or organic) affects these gaseous emissions. The objectives of our study is to understand greenhouse gas emissions from agroecological practice of crop residue incorporation. Therefore this motivated us to perform laboratory experiments on soil microcosms, in controlled conditions of temperature (288.15 K) and moisture (60% WFPS), to measure nitrous oxide and ammonia fluxes from soils with crop residues placed in three positions – surface, mixed on top half of soil and layered at a certain depth in soil. These three positions mimiced the field scenario where crop residues are incorporated either as mulch (surface) or in stubble tillage (mixed) or with deep tillage (layered). We did these experiments with two residues – nitrogen rich red clover and nitrogen deficient wheat. We also used three different soils to assess the influences of soil biochemical and physical properties on these gaseous emissions. We did not present gaseous fluxes obtained from wheat as due to its high carbon content, wheat residue did not decompose significantly during fifty day incubation and therefore very low to almost zero nitrous oxide and ammonia fluxes were emitted from the wheat incorporated soil system. On comparison of net cumulative fluxes at day 50 of incubation for nitrous oxide and ammonia emissions from red clover residues we found that they were highest from sandy soil (average 4.9 to 15.8 kg N ha⁻¹) than the alkaline clayey and silty soils (average 0.28 to 1.9 kg N ha⁻¹). Higher soil pore size of sandy soils result in an enhanced diffusion of gases from soil to atmosphere. Additionally, in case of nitrous oxide emissions, aerobic-anaerobic switch plays a significant role and water evaporation rates are higher in sandy soils than in small particled clayey silty soils. Both these effects combined results in higher fluxes of nitrous oxide and ammonia from large particled sandy soils. Amongst these, for all three soils nitrous oxide emissions were higher in mixed or layered residue positioning than when placed on surface. For NH₃ emissions though the effect was reversed for residue position and surface residue

resulted in higher net cumulative flux than the mixed or layered residue (9.5 kg N ha⁻¹ for sandy soil, 3.7 kg N ha⁻¹ and 0.95 kg N ha⁻¹ for alkaline silty clayey soil and slightly alkaline silty soil respectively). Other studies have also found similar observations especially Nett et al (2016) for NH₃ emissions from cauliflower residue where they also found that surface placed residues emitted highest ammonia cumulative flux than mixed or ploughed. For nitrous oxide emissions, several studies conclude that in a conventional tillage method of residue incorporation the cumulative fluxes of N₂O are higher [Mutegi et al 2010, Yang et al 2019]. Evidently, we wanted to ascertain properly the attribution of crop residue and/or green manures to total nitrous oxide and ammonia budget from agriculture, it is crucial to integrate information on residue positioning in soil and its effects on these gas emissions with existing soil carbon and nitrogen models. To have all the data for proper optimisation of a soil nitrogen model is a wholesome process. In our experiments we only measured N₂O, NH₃, CO₂, soil NH₄⁺ and NO₃⁻. A crucial factor determining nitrous oxide emissions as mentioned in chapters 2 and 3 is also microbial population and diversity. Measurements of pH and oxygen content in soil microsites would have given a clearer picture of the nitrogen cycle mechanisms underlying these gaseous emissions from crop residue decomposition in soils. Another important aspect to be looked into in great detail is the influence of microbial contact with organic matter and its decomposition, resulting in nitrous oxide and ammonia emissions. This will not only improve estimates of these gaseous emissions but also solidify hypotheses widely in use for modelling purposes of these gases. In our case, we have tried to couple nitrifier denitrification and anaerobic denitrification equations from NOE model to carbon model of CANTIS. To the ammonium pool of CANTIS, we have coupled NH₃ volatilisation equation from Sommer et al (2003). We did this because most of the models simulating nitrous oxide and ammonia from agriculture systems with organic manures are quite complicated and cumbersome. CANTIS describes in great detail the stabilisation and formation of soil organic matter. NOE is an empirical model highly dependent on calibration to each different kind of soil in question. Ideally each rate constant associated to denitrification processes must be determined experimentally for each soil. We did not do that due to time constraints rather we used parameter values predetermined from earlier experiments. Despite that we have found from the outputs of the coupled model that it performs quite well in simulating carbon dioxide and

ammonia emissions. The nitrous oxide simulations were in same order of magnitude as the experiments but it was underestimated. The intravariability in N₂O daily flux was constant from the initial stage of decomposition to the end, something which is not in compliance with the experimentally observed peak of N₂O daily flux in the first week of decomposition to approach zero after two weeks of microcosm incubation.

2. Conclusions and Prospects

These studies jot down some extremely crucial information regarding agricultural systems and methodologies and their effects on soil nitrous oxide and ammonia emissions. First, when looked annually through the lens of crop rotations, both conventional agriculture and agroecology performs similarly to nitrous oxide and ammonia budget in general. But on disintegrating these agriculture systems by their methodologies, diverse effects on N₂O and NH₃ emissions are observed. The effects of abiotic factors such as meteorology, soil physics and chemistry are described in great lengths but seldom they are controlled directly through human intervention. Soil chemistry and pedology can be very well changed due to tillage and introduction of fertiliser inputs but if conservation agriculture is deployed, these influences can be brought to a minimum. Chemical fertilisers are strong acidifiers of soil and their impacts on soil is pronounced, and its widespread usage makes it out from conservation agriculture. Organic manures in the form of crop residues are efficient organic green manures and their introduction to soil with or without tillage forms an integral part of agroecology and with increased pressure on conventional agriculture to transform itself into organic agriculture in light of climate change and global warming, more and more farmers are combining incorporation of crop residues in soil. It has already been proven that nitrogen rich crop residues are better fertilisers than nitrogen deficient. Our study is an addition to this discovery and it has found that it is the position of incorporation of crop residues that impacts the N₂O and NH₃ emissions. When placed in layered and/or mixed position, the N₂O emissions are significantly higher than when put on surface as a mulch in a no till scenario. Also the mineralisation of NH₄⁺ and NO₃⁻ are higher in layered and mixed position than when placed on surface thus making residue mixing and layering through ploughing and deep tillage more fertilising to soil. In case of NH₃ emissions, it's the surface residue placement that results in

higher ammonia emissions than when they are buried in soil or mixed. This puts forth a challenging scenario in front of a farmer so as to adopt an agricultural practice where its releasing air pollutant ammonia or greenhouse gas nitrous oxide. Our findings from experiments in controlled conditions suggest that in case of the soil being fine particled clayey and silty, the nitrous oxide fluxes are not as high in mixed and layered residue positions thus resulting in a situation with negligible ammonia emissions and minimum nitrous oxide emissions. Another factor that plays a role in determining these gaseous emissions is the presence of mineral nitrogen in soil at a given moment. So if these organic fertilisers are incorporated in soil during the growth phase of crop phenology, the emissions of nitrous oxides could be further less pronounced. More laboratory experimental studies are therefore needed to testify this proposition towards a more sustainable agriculture system.

Another important question that would determine the choice of agriculture methodology to the farmer is the crop yield. Not much information is available on whether agroecology is sufficient enough to meet the growing human population food demands on earth. One may even argue that the similar performance of conventional agriculture and agroecology on N_2O and NH_3 emissions budget of agriculture is not a very favourable news to agroecology in this scenario. In these moments, it has to be reuttered that an entire life cycle assessment of the fate of nitrogen – both in conventional agriculture in the form of chemical fertilisers and agroecology in the form of organic manure, is needed for a genuine intercomparison on their sustainability and potentials to greenhouse gas mitigation.

Consequently, more experimental data are needed on deployability of crop residues as organic manures and their resulting nitrous oxide and ammonia emissions to better optimise this tool of modelling we have devised through an intercouple of three different models. While crop residue incorporation is definitely an environment-friendly agriculture method, more laboratory experimental studies simulating out-in-the-field scenarios are needed on longer time scales, preferably an annual time scale to have a precise interpretation of their environmental impacts. Measurements on soil microbial population and biodiversity on these experiments would definitely enrich the quality of data to be used for modelling purposes for enhancement of predictability of greenhouse gas emissions from agriculture.

Addendum

Émissions gazeuses d'oxyde nitreux et d'ammoniac provenant de la décomposition des résidus de culture dans les sols

Candidat: Varunesh Chandra ^[1,2], Directeur: Benjamin Loubet^[1],

Co-encadrant(s): Gwenaëlle Lashermes^[2], Raia-Silvia Massad^[1]

^[1] Université Paris-Saclay, INRAE, AgroParisTech, UMR ECOSYS, 78850, Thiverval-Grignon, France

^[2] Université de Reims Champagne Ardenne, INRAE, FARE, UMR A 614, 51097 Reims, France

Résumé en Français

1. Introduction des objectifs et les processus du carbone et de l'azote dans le sol

Dans le monde moderne, les activités anthropiques entraînent un changement climatique. Le principal responsable de ce changement climatique est le réchauffement de la planète, dont la raison principale est l'augmentation des émissions de gaz à effet de serre dues aux activités de la société humaine. La combustion de combustibles fossiles, la fabrication industrielle et l'exploitation minière sont en effet les sources les plus visibles de gaz à effet de serre, mais l'effet de serre lié à l'utilisation des sols est trop important pour être ignoré. Environ 24 % des émissions totales de gaz à effet de serre proviennent de l'agriculture, de l'utilisation des terres et de la sylviculture [rapport 2015 du GIEC]. Le dioxyde de carbone, le méthane et l'oxyde nitreux, également appelé protoxyde d'azote, sont les trois principaux gaz à effet de serre résultant des activités agricoles. Alors que le méthane résulte principalement de la décomposition anaérobie dans les marais et les marécages ou de la culture du riz, l'oxyde

nitreux résulte de la transformation des engrais chimiques, la décomposition des résidus de la végétation dans les sols [Mosier et al 1991]. Les mécanismes qui sous-tendent les émissions d'oxyde nitreux sont complexes et impliquent une interaction entre les paramètres biologiques, physiques et chimiques du sol, ainsi que les pratiques de gestion des cultures qui modifient ces paramètres [Butterbach-Bahl et al 2013, Canfield et al 2010]. Ces processus produisent également un sous-produit, l'ammoniac, qui est en soi un polluant atmosphérique. L'atténuation du dioxyde de carbone a été une priorité importante dans l'atténuation des gaz à effet de serre, et l'augmentation de la séquestration du carbone dans le sol par l'agriculture a été proposée comme une mesure importante, comme l'initiative 4 pour 1000 [Soussana et al 2019]. Même si l'augmentation du stock de carbone dans le sol pour capturer le carbone atmosphérique semble prometteuse, les émissions d'oxyde nitreux et d'ammoniac résultant des processus de décomposition peuvent entraîner une rétroaction et entraver l'impact du stockage accru du carbone dans le sol dans l'atténuation des gaz à effet de serre. Le remplacement des engrais chimiques par des fumiers organiques et des résidus de culture est un autre changement dans les pratiques culturelles encouragé sous la bannière de l'agroécologie. La substitution de la fertilisation minérale par un apport accru de fertilisants sous forme organique permet de limiter les pertes par lixiviation de l'azote minéral et in fine la pollution des aquifères. La fertilisation minérale est en effet souvent apportée en trop grande quantité, lors de météo défavorable ou à un moment inapproprié du cycle des cultures. De plus le procédé de fabrication des engrais chimiques (procédé de Haber) est coûteux en énergie. Les résidus de culture et la fumure organique améliorent effectivement la fertilité des sols en stimulant l'activité microbienne et la biodiversité, mais leur décomposition dans le sol contribue également au stock de carbone du sol et entraîne donc des émissions d'oxyde nitreux et d'ammoniac [Huang et al 2004].

Dans ce projet, nous cherchons à comprendre les effets des pratiques agricoles sur les émissions d'oxyde nitreux et d'ammoniac du sol. En introduction, nous aborderons les processus biogéochimiques et qui entraînent de telles émissions gazeuses. Comment l'introduction de la matière organique résiduaire affecte-t-elle les processus du sol ? Comment ces processus du sol sont-ils couplés entre eux ? Dans le chapitre suivant, nous inter-

comparons les effets des pratiques conventionnelles et agroécologiques sur les émissions d'oxyde nitreux et d'ammoniac en passant en revue la littérature disponible sur le sujet et en identifiant les manques de connaissances dans ce domaine de recherche. Nous établissons une corrélation entre les processus décrits dans la première section et les pratiques de gestion agricole. Par la suite, nous déterminons expérimentalement les effets de l'incorporation des résidus de culture dans le sol sur les émissions d'oxyde nitreux et d'ammoniac en fonction de leur localisation à la surface du sol ou incorporés au sein du profil de sol. Nous couplons trois modules numériques pour simuler ces processus. Et enfin, nous utilisons les données obtenues de cette expérience pour optimiser le modèle créé permettant de mieux simuler ces émissions à partir des sols.

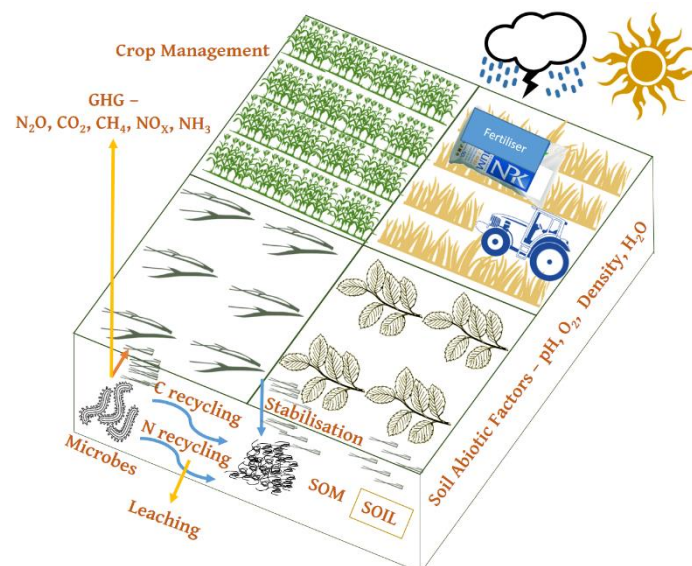

Figure 3. Pratiques agricoles et émissions de gaz à effet de serre qui en résultent

Processus du carbone et de l'azote dans le sol

Cycle du carbone dans le sol

Le début du cycle du carbone du sol est la photosynthèse autotrophe par la végétation. Le carbone atmosphérique est fixé sous forme de sucres utilisés pour l'approvisionnement en

énergie et le métabolisme des cellules. Pendant leur croissance, les plantes exsudent de leurs racines certaines molécules telles que les sucres, les acides aminés, les terpènes, les mucilages, les phénols, les composés organiques volatils (COV). Les exsudats racinaires, sont utilisés par les microorganismes à l'interface racinaire pour la régulation des nutriments (par des formes ioniques) en plus d'agir comme mécanismes de défense contre les infections [Baetz et al 2014]. Certains exsudats racinaires, comme les flavonoïdes, entraînent une interaction racine-microbe conduisant à un processus de nodulation sur les racines comme chez les légumineuses ou à une mycorhization [Bonfante et al 2009]. D'autres permettent une communication racine-racine comme dans l'allélopathie. Les racines rejettent également du CO₂ dans l'atmosphère par la respiration (appelée respiration racinaire), nécessaire à la croissance des racines [Trolldenier et al 1981]. L'action microbienne sur les exsudats à l'interface racine-sol (appelée rhizosphère) entraîne également une respiration hétérotrophe produisant du CO₂ (et de l'eau). Les COV des exsudats peuvent également être volatilisés. Les associations symbiotiques des racines avec des mycorhizes pour l'assimilation de l'azote minéral et du phosphate, des bactéries fixatrices d'azote (par exemple, le rhizobium) pour l'assimilation de l'azote, des bactéries réductrices de sulfate et solubilisatrices de phosphate pour le transfert de nutriments, pour leur fournir du carbone pour l'énergie, entraînent également une respiration [Bonfante et al 2009]. Tout cela contribue collectivement à la respiration de la rhizosphère. La respiration de la rhizosphère, la volatilisation des COV et la respiration des racines renvoient donc une partie du carbone assimilé vers l'atmosphère.

Vient ensuite la décomposition des litières, résidus et corps sénescents. Comme mentionné précédemment, elle est facilitée par l'action microbienne et utilise la respiration pour produire de l'énergie, en dégageant du CO₂ (dans le cas d'une respiration aérobie) ou du méthane (CH₄) / lactate / éthanol / COV (dans le cas d'une respiration anaérobie par méthanogénèse, fermentation ou processus de fermentation micro-aérobie) [Insam et Seewald 2010]. Les produits de décomposition peuvent former des agrégats en interagissant avec les minéraux du sol, ou peuvent être piégés par des forces de van der Waals dans les cavités, ou peuvent s'agréger les uns aux autres en formant des micro-agrégats énergétiquement stables, ou peuvent rester disponibles sous forme de composés plus simples prêts à être attaqués par les

microorganismes. Dans ce contexte, la matière organique du sol stabilisée devient un réservoir de carbone. Ce réservoir de carbone stabilisé n'est pas inerte. Les variations de température, de porosité (définissant l'accès microbien à la matière organique), de pH, d'humidité et de fertilisation influençant les actions microbiennes sur ces matières conduisent à la libération de composés gazeux carbonés et d'azotés dans l'atmosphère [Huang et al 2004].

Le processus par lequel le carbone organique (ou même d'autres éléments comme l'azote, le soufre, le phosphore) est converti en une forme minérale, éventuellement en solution, en cas de décomposition - CO₂ (également méthane, carbonates, bicarbonates ou autres composés dérivés du carbone), est appelé minéralisation [White 2005]. Le carbone (et d'autres éléments) fixé dans le sol sous forme de biomolécules dans les microorganismes ou sous forme de matière organique stabilisée est dit immobilisé, c'est-à-dire qu'il devient indisponible pour une décomposition ultérieure ou une utilisation par les plantes [White 2013]. La stabilisation de la matière organique due aux interactions du sol, aux contraintes d'espace, à l'inaccessibilité microbienne, à la micro-agrégation et à la protection biochimique récalcitrante post-microbienne produit de l'humus et le processus est conventionnellement appelé humification ou formation de matière organique stabilisée [White 2005, Lehmann et al 2015, Six et al 2002]. De toute évidence, la formation et la stabilisation de la matière organique du sol, qui font partie du cycle du carbone, sont limitées par d'autres éléments, à savoir l'azote, le phosphore, le soufre et d'autres minéraux du sol à de nombreuses étapes. Certains microorganismes utilisent cette présence d'éléments pour la synthèse d'acides aminés ou l'oxydation du carbone pour produire de l'énergie. Leur présence facilite également la symbiose entre les plantes et les microorganismes (par exemple le mycorhize). C'est là que le cycle de l'azote, le cycle du phosphore, le cycle du soufre et d'autres cycles de nutriments sont couplés avec le cycle du carbone, complexifiant le simple processus d'apparition en un système complet omnipotent.

Le cycle de l'azote dans le sol

Il existe une certaine gamme de bactéries et d'autres microorganismes qui utilisent l'azote atmosphérique pour hydrolyser l'ATP et produire de l'énergie. Ces microorganismes "fixent" donc l'azote atmosphérique par un processus appelé "fixation de l'azote". La liaison N≡N est

activée par une enzyme appelée nitrogénase, puis transformée en ammonium. L'ammonium est ensuite utilisé par les eucaryotes ou les procaryotes directement ou par réduction assimilatoire de NO_3^- [Canfield et al 2010]. Cela peut se produire par un large éventail de mécanismes - Fixation hétérotrophe (par des espèces bactériennes comme *Klebsiella*, *Azotobacter*, *Clostridium*, *Bacillus*), Fixation associative (par exemple *Azospirillum* avec *Poaceae* (graminées)), Fixation symbiotique (par exemple aulne avec l'actinomycète *Frankia* ou nodules de racines de légumineuses avec rhizobium) [Wagner et al 2011]. La fixation de l'azote constitue la première étape du cycle de l'azote dans le sol. Bien que la matière organique du sol constitue en réalité la source la plus importante d'azote dans le sol. Sa formation par décomposition entraîne l'incorporation de NH_4^+ , d'acides aminés, de fragments de protéines et d'autres composés azotés dans le sol.

Certains procaryotes et eucaryotes (bactéries, archées ou champignons spécifiques) utilisent l'ammonium pour alimenter leur métabolisme et leur croissance dans l'obscurité. Pour ce faire, ils oxydent le NH_4^+ (ou le NH_3 dans des conditions de faible pH) dans des conditions aérobies. Cette oxydation est également réalisée grâce à des actions enzymatiques (ammonium oxydase), qui oxydent principalement l'ammonium en nitrite (NO_2^-) (avec un probable intermédiaire NH_2OH qui est traité par l'enzyme hydroxylamine oxydoréductase pour donner du nitrite). Ce dernier est ensuite oxydé en NO_3^- (par l'enzyme nitrite oxydoréductase), concluant un processus appelé nitrification [Canfield et al 2010]. Les microorganismes responsables sont appelés nitrifiants. La nitrification en elle-même suit des voies variées et a de multiples forces motrices, mais elles sont toutes réalisées par un métabolisme microbien. Les communautés microbiennes importantes qui sont chimiolithotrophes utilisent l'oxydation de composés minéraux réduits (dans ce cas $\text{NH}_4^+/\text{NH}_3$) pour produire de l'énergie en fixant le CO_2 en l'absence de lumière [Canfield et al 2010, Oren 2009]. Ces derniers sont principalement responsables de la nitrification. Il y a aussi la nitrification hétérotrophe où les microorganismes procaryotes et eucaryotes oxydent toute forme réduite d'azote (y compris l'azote organique) en sa forme la plus oxydée [Stein 2018]. Cela entraîne donc la production de N_2 , N_2O et NO (à partir de fragments de $\text{NO}_3^-/\text{NO}_2^-$ /acides aminés), en plus de NO_2^- et NO_3^- . La conversion de NO_3^- pour produire des composés gazeux azotés en présence d'oxygène

est appelée dénitrification aérobie. Lorsqu'elle est réalisée par des nitrifiants, elle est appelée dénitrification par nitrification [Stein 2018]. Les nitrifiants hétérotrophes utilisent ces oxydations pour leur défense, leur métabolisme cellulaire et énergétique (par exemple, la réoxydation du NAD(P)H sous une forte concentration d'oxygène pour une utilisation appropriée du glucose chez les bactéries ou l'oxydation simultanée du nitrate et du formiate dans les mitochondries des champignons *Fusarium Oxysporum* dans la respiration endogène) [Stein 2018]. Ils n'utilisent pas la nitrification pour la fixation du carbone comme les nitrifiants chimolithotrophes.

Le NO_3^- produit est soit absorbé par les eucaryotes (racines des plantes), soit soumis à une autre action microbienne. Dans des conditions anaérobies, le NO_3^- est utilisé comme donneur d'électrons par les microorganismes pour la respiration. Le NO_3^- est alors retransformé en nitrite NO_2^- par l'enzyme nitrate réductase dissimilaire, se transformant successivement en NO par la nitrite réductase, puis en N_2O par l'oxyde nitrique réductase, pour finalement produire du N_2 par l'oxyde nitreux réductase [Canfield et al 2010]. NO_3^- est également transformé en ammonium directement par un processus appelé DNRA (réduction dissimilaire du nitrate en ammoniac) par les actions combinées de la nitrite réductase et de la nitrate réductase. En outre, l'ammonium/ammoniac peut être simultanément oxydé puis réduit dans des conditions anoxiques pour produire du N_2 sans intermédiaires tels que le monoxyde d'azote (NO) ou N_2O . Ce phénomène est appelé Anammox (oxydation anaérobie de l'ammoniac). Les nitrifiants hétérotrophes peuvent également réaliser une nitrification et une dénitrification simultanées, comme indiqué dans le paragraphe précédent, le processus étant appelé nitrification-dénitrification simultanée (SND). Il convient également de noter que les intermédiaires gazeux ou solubles peuvent, à n'importe quel stade, s'échapper du sol et entraîner des émissions supplémentaires de N_2O et de NO. L'utilisation métabolique des composés azotés par les microorganismes (comme dans le cas de la fixation de l'azote) peut également entraîner une immobilisation de l'azote en raison de leur assimilation dans le corps microbien sous forme de protéines ou d'acides aminés, voire dans les activités enzymatiques et la génomique [Ladd et al 1973].

L'écologie du sol et la biodiversité microbienne sont donc des facteurs importants qui déterminent l'ampleur des émissions de composés gazeux azotés par le sol. La qualité de la matière organique du sol, la "nourriture" des microorganismes, influence donc également les taux de nitrification et de dénitrification. En outre, les contraintes d'espace imposées par la SOM et la structure du sol devraient également influencer la chimiolithotrophie, perturbant la nitrification et l'accès microbien aux nutriments. L'acidité influence beaucoup la chimie. Certains processus tels que la symbiose, la SND, l'Anammox, la nitrification hétérotrophe et la dénitrification par les nitrifiants, etc. sont également limités par la présence d'autres nutriments. Cela pourrait perturber la croissance et le métabolisme microbiens en affectant la génomique essentielle pour coder les enzymes.

Par conséquent, à partir de cette description des processus, il est évident que la corrélation entre l'azote du sol et le cycle du carbone se fait via des voies microbiennes. Cette action se produit soit directement sur les sources atmosphériques des éléments, par la décomposition et l'assimilation de la matière organique dans le sol, soit par la transformation des sources minérales du sol.

Interrelation entre le cycle du carbone et de l'azote dans le sol

Les résidus de culture et les litières sont une source importante de carbone et d'azote minéralisés dans le sol par les microorganismes. C'est un phénomène où les cycles du carbone et de l'azote sont couplés. Les litières et les résidus sont riches en acides aminés et en protéines, en sucres et en terpènes, dont la composition élémentaire contient à la fois du carbone et de l'azote (également du soufre et du phosphore) - un autre point d'intersection entre les deux cycles. La nitrification chimiolithotrophique, le processus le plus important qui transforme le NH_4^+ en NO_2^- puis en NO_3^- , utilise principalement le CO_2 du sol pour la synthèse des sucres. Le CO_2 dans le sol est le produit de la respiration hétérotrophe des microorganismes, ce qui suggère un autre couplage entre les deux cycles des nutriments dans le sol. La nitrification et la dénitrification hétérotrophes utilisent également l'azote ambiant pour les activités métaboliques dans le sol, par exemple à partir de la matière organique stabilisée du sol ou des stocks d'azote immobilisé. Cette immobilisation de l'azote se fait par sa liaison au carbone. Les produits finaux peuvent être de l'azote minéralisé sous forme de

gaz comme N₂, NO ou N₂O. Ces processus sont très complexes, il est difficile de les classer alors qu'ils sont extrêmement enchevêtrés. Des tentatives ont été faites pour comprendre qualitativement et quantitativement leur interrelation. Les données expérimentales, puis la modélisation numérique, fournissent des outils essentiels à l'amélioration de leur compréhension.

2. Impact de l'agriculture conventionnelle et de la gestion agroécologique sur les émissions de protoxyde d'azote et d'ammoniac dans deux systèmes agricoles contrastés

Introduction

Environ 24 % des émissions totales de gaz à effet de serre proviennent de l'agriculture, de la sylviculture et de l'utilisation des terres. Une grande partie de ces émissions est due aux pratiques agricoles et à l'intensification de l'utilisation des terres. On attend donc aujourd'hui de l'agriculture qu'elle s'efforce de réduire son empreinte écologique. Une mesure suggérée aujourd'hui est l'augmentation du stock de carbone dans le sol par l'agriculture en capturant l'excès de dioxyde de carbone de l'atmosphère comme proposée dans l'initiative 4 pour 1000, où le stockage de carbone dans le sol est destiné à augmenter à 3,4 GtC par an dans la couche supérieure de 40 cm du sol [Soussana et al 2019].

Les pratiques agroécologiques et conventionnelles sont considérées comme de bonnes pratiques pour l'atténuation des émissions de dioxyde de carbone liées à l'utilisation des terres, car elles sont plus efficaces pour la séquestration du carbone que leurs homologues conventionnelles et ont une plus grande absorption du CH₄ par le sol [Lorenz et Lal, 2016].

Pour autant, cette méthode d'agriculture est-elle suffisante pour répondre à la demande alimentaire croissante ? Plusieurs études suggèrent que ce n'est pas le cas. Connor (2008) affirme que les prévisions de rendement de l'agriculture biologique sont fortement surestimées, principalement en raison de l'hypothèse d'une source infinie de nutriments dans ces prévisions. Kirchmann et al 2009 affirment également qu'il est insuffisant et presque totalement impossible de remplacer les engrais synthétiques de l'agriculture conventionnelle par des amendements biologiques pour obtenir des rendements similaires. Cela est dû à la disponibilité limitée de fumier animal et de plantes légumineuses à une telle échelle pour la fertilisation. On pense que les résidus de culture peuvent aider à cet égard. Ils augmentent incontestablement le stock de carbone dans le sol et leur abondance pourrait permettre de réduire la dépendance à l'égard des amendements synthétiques [Jensen et al 2005]. Il existe plusieurs initiatives visant à les utiliser dans un contexte d'atténuation du changement climatique grâce à leur potentiel important pour augmenter la séquestration du carbone dans le sol [Stella et al 2019]. Malgré les avantages de l'utilisation des résidus de culture, il y a des inconvénients à leur utilisation. Leur décomposition dans le sol s'est avérée une source importante d'émissions de N_2O , de NH_3 et d'autres gaz azotés. En outre, il a été démontré que l'incorporation d'amendements organiques lors du travail du sol peut diminuer les stocks de carbone organique du sol au fil du temps [Lorenz et Lal 2016]. Ainsi, l'agriculture biologique, bien qu'aussi prometteuse qu'elle puisse paraître, présente son propre lot de défis. Les cultures intermédiaires, l'application de fumier et de lisier organiques dans le cadre de l'agriculture biologique contribuent fortement aux émissions d'oxydes d'azote et d'ammoniac en amorçant la minéralisation de l'azote dans le sol par la décomposition des résidus, des litières et des matières organiques [Jensen et al 2005]. L'un des besoins cruciaux du moment est de réduire les émissions de gaz à effet de serre liées aux amendements organiques, en particulier l'oxyde nitreux, dont le potentiel de réchauffement planétaire est de 265-298. Une étude détaillée des processus au niveau du sol est nécessaire pour mieux planifier la durabilité des systèmes agricoles dans un scénario de réchauffement climatique. Ici, nous identifions à l'échelle du sol, les processus qui interagissent dans les transformations de l'azote et du carbone, conduisant aux émissions d'oxyde nitreux et d'ammoniac. Nous prenons deux exemples, l'un d'un système de culture conventionnel, l'autre d'un système de culture agro-

écologique pour illustrer les processus et leurs effets sur les émissions d'oxyde nitreux et d'ammoniac et nous effectuons une revue des publications disponibles sur le sujet.

Les systèmes agricoles et leurs effets sur les émissions de N₂O et NH₃

Exemple de système d'agriculture conventionnelle

Cycle de culture triennal [Trèfle rouge - Blé d'hiver - Colza - Blé d'hiver]

Le premier cas présenté ici est celui d'un cycle agricole conventionnel de trois ans, avec deux cultures annuelles de rente importantes en Europe - le blé d'hiver (*triticum aestivum*) et le colza (*brassica napus*). Afin d'assurer la conservation des sols en prévenant l'érosion, la perte d'azote du sol et la dégradation du stock de carbone, une fois tous les deux ans, une culture de couverture riche en azote, comme le trèfle rouge, la luzerne ou la vesce, est plantée sur les champs dans les régions concernées. L'idée est également de laisser des cultures intermédiaires sur les champs après la récolte, ce qui lui permet d'agir comme un apport d'engrais organique par sa décomposition dans le sol. Ce type de cycle de culture est typique de l'Europe du Nord. La fertilisation chimique, le désherbage fréquent et l'utilisation de pesticides et d'herbicides sont courants dans ce système d'agriculture.

Exemple de système agro-écologique

Cycle de culture triennal [Moutarde - Blé d'hiver - Pois d'hiver - Orge d'hiver]

Le deuxième cas présenté ici est celui d'un système agro-écologique. Le cycle de trois ans de cet exemple commence par la culture d'un engrais vert, suivie de cultures céréalières et de légumineuses. Habituellement, le cycle de culture est de trois ans mais la gamme de longueur de rotation des cultures en agriculture biologique peut aller jusqu'à sept ans [Peigné et al 2015]. Nous présentons ici le cas d'un cycle de culture tri-annuel, commençant par la culture de la moutarde comme engrais vert, suivie du blé d'hiver, du pois d'hiver et de l'orge d'hiver. Dans ce cas, les résidus de culture et les engrais verts sont utilisés pour la fertilisation, le

désherbage est réduit au minimum et le travail de conservation du sol est fréquemment employé.

Estimation des flux d'azote provenant du cycle de culture agroécologique et conventionnel

Après comparaison de plusieurs études déployant des pratiques agricoles conventionnelles et des méthodologies agroécologiques (tableau 1), nous pouvons conclure que les émissions annuelles cumulées d'oxyde nitreux et d'ammoniac des deux pratiques ne sont pas si différentes statistiquement parlant [Ball et Nevison 2014]. Les caractéristiques des émissions semblent dépendre fortement d'un large éventail de facteurs déjà mentionnés précédemment et il semble que leur interaction amène essentiellement les flux annuels cumulés des deux systèmes dans une fourchette identique (voir la figure 4).

La plupart des études réalisées pour déterminer les émissions d'oxyde nitreux et d'ammoniac des sols sont effectuées de manière expérimentale en utilisant des incubations en microcosme ou en mésocosme. Dans ces cas, il est difficile de considérer les valeurs de leurs flux à des fins de comparaison, surtout lorsque ces flux n'ont été cumulés que pendant quelques jours ou quelques mois dans le cadre d'expériences d'incubation dans des conditions contrôlées. Un autre défi dans cette estimation est l'insuffisance des données disponibles pour les teneurs annuelles en azote minéral du sol en fonction du traitement agro-écologique, ce qui est crucial pour comprendre la répartition de l'azote dans le sol et la fraction de l'azote qui se dégage sous forme d'oxyde nitreux et d'ammoniac.

Nitrogen Species	Quantity	Unit	Crop	Reference	Cumulation Period	Tillage	Fertilisation
N ₂ O	1.296	kg N/ha	Cauliflower	Nett et al 2016	231 days	Reduced	Crop Residue
	1.033	kg N/ha	Cauliflower	Nett et al 2016	231 days	None	Crop Residue
	3.216	kg N/ha	Cauliflower	Nett et al 2016	231 days	Conventional	Crop Residue
	4.81	kg N/ha	Wheat and Maize	Drury et al 2006	1 Year	Conventional	Chemical Fertilisation
	1.72	kg N/ha	Winter Wheat and Wheat after Fawa bean	Badagliacca et al 2018	2 Years	Conventional	Chemical Fertilisation
	2.98	kg N/ha	Wheat and Maize	Drury et al 2006	1 Year	Reduced	Chemical Fertilisation
	3.71	kg N/ha	Wheat and Maize	Drury et al 2006	1 Year	None	Chemical Fertilisation
	2.45	kg N/ha	Winter Wheat and Wheat after Fawa bean	Badagliacca et al 2018	2 Years	None	Chemical Fertilisation
	1.6	kg N/ha	Winter Wheat	Wang et al 2019	1 Year	None	Chemical Fertilisation
	3	kg N/ha	Winter Wheat	Wang et al 2020	1 Year	Conventional	Chemical Fertilisation
	0.647 to 2.3437	kg N/ha	wheat, red clover, soyabean	Machado et al 2021	1 Year	Conventional	Crop Residue
	1.5-4.5	kg N/ha	Oat Residue	Ball and Nevison 2014	1 Year	Reduced	Crop Residue
	2.0-7.0	kg N/ha	clover grass	Ball and Nevison 2014	1 Year	Reduced	Crop Residue
	2-4.5	kg N/ha	wheat	Ball and Nevison 2014	1 Year	Reduced	Crop Residue
	1.0667 to 3.1283	kg N/ha	Wheat, red clover, soyabean	Machado et al 2021	1 Year	Reduced	Crop Residue
NH ₃	1.113	kg N/ha	Cauliflower	Nett et al 2016	231 days	Reduced	Crop Residue
	1.645	kg N/ha	Cauliflower	Nett et al 2016	231 days	None	Crop Residue
	0.836	kg N/ha	Cauliflower	Nett et al 2016	231 days	Conventional	Crop Residue
	10.0 to 16.0	kg N/ha	Winter Wheat and Wheat after Fawa bean	Badagliacca et al 2018	2 Years	Conventional	Chemical Fertilisation
	5.99	kg N/ha	Winter Wheat	Yang et al 2015	1 Year	Conventional	Chemical Fertilisation
	4.9 to 5.73	kg N/ha	winter wheat	Yang et al 2015	1 Year	Reduced	Chemical Fertilisation
	10.0 to 16.0	kg N/ha	Winter Wheat and Wheat after Fawa bean	Badagliacca et al 2018	2 years	None	Chemical Fertilisation
	15.9	kg N/ha	Grass	Ruijter et al 2010	119 days	Reduced	Crop Residue
NO ₃ ⁻	20-50	mg N/kg soil	Wheat and Corn	Drury et al 2006	1 year	Conventional	Chemical Fertilisation
	1.5-1.6	mg N/kg soil	Winter Wheat and Wheat after Fawa bean	Badagliacca et al 2018	2 Years	Conventional	Chemical Fertilisation
	20-50	mg N/kg soil	Wheat and Maize	Drury et al 2006	1 Year	Reduced	Chemical Fertilisation
	20-50	mg N/kg soil	Wheat and Maize	Drury et al 2006	1 Year	None	Chemical Fertilisation
	1.3-1.8	mg N/kg soil	Winter Wheat and Wheat after Fawa bean	Badagliacca et al 2018	2 Years	None	Chemical Fertilisation
	9.16	mg N/kg soil	Winter Wheat	Wang et al 2019	1 Year	None	Chemical Fertilisation
	10.16	mg N/kg soil	Winter Wheat	Wang et al 2019	1 Year	Conventional	Chemical Fertilisation
	14.1 to 63.5	kg N/ha	Wheat, red clover, soyabean	Machado et al 2021	1 Year	Conventional	Crop Residue
	13.8 to 66.9	kg N/ha	Wheat, red clove, Soyabean	Machado et al 2021	1 Year	Reduced	Crop Residue
NH ₄ ⁺	0.74	mg N/kg soil	Winter Wheat	Wang et al 2019	1 Year	None	Chemical Fertilisation
	0.35	mg N/kg soil	Winter Wheat	Wang et al 2019	1 Year	Conventional	Chemical Fertilisation

Tableau 1. Résumé des flux cumulés d'oxyde nitreux et d'ammoniac et des valeurs de concentration d'azote minéral provenant de certaines études relatives aux pratiques agricoles

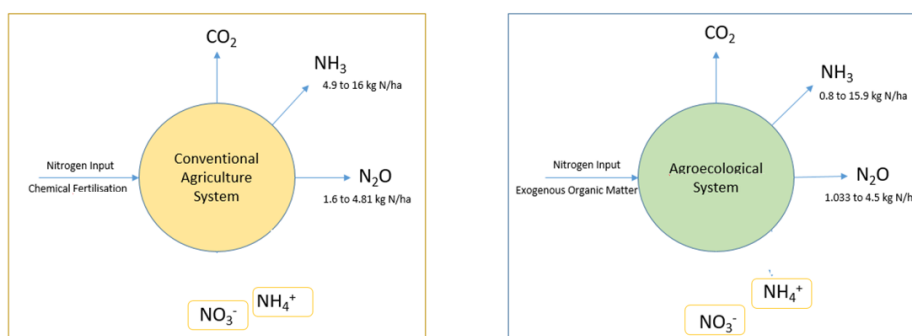

Figure 4. Estimation des flux annuels d'oxyde nitreux et d'ammoniac déduits de la littérature disponible pour différents types de systèmes de culture.

Conclusion et perspectives

Cette étude résume les différences entre les pratiques de l'agriculture agroécologique et de l'agriculture conventionnelle et leurs influences sur les processus du carbone et de l'azote dans le sol. S'il est certain que le déploiement de l'agroécologie par rapport à l'agriculture conventionnelle présente des avantages avérés, notamment en ce qui concerne la biodiversité, la préservation des services écologiques et la conservation des sols, en termes d'émissions de protoxyde d'azote et d'ammoniac liées à l'utilisation des terres, il ne semble pas y avoir beaucoup de différence entre les deux systèmes. Les taux de flux de ces gaz peuvent différer, mais si l'on examine la multitude d'études, on constate que leurs valeurs cumulées se situent dans la même fourchette. En outre, en dehors des causes abiotiques et biologiques, le facteur qui semble jouer un rôle important dans la détermination des caractéristiques d'émission de N_2O et de NH_3 de ces systèmes est la position d'incorporation des engrais chimiques et de la fumure organique [Drury et al 2006, Ball et Nevison et al 2014]. Alors que plusieurs études sont disponibles dans la littérature concernant la position d'application des engrais, du lisier et des fumiers [Fangueiro et al 2018, Duncan et al 2017, Drury et al 2006], il n'y a pas assez de recherches sur la position d'incorporation des résidus de culture dans les sols et les émissions d'oxyde nitreux et d'ammoniac qui en résultent. Par conséquent, avec la nécessité de faire évoluer l'agriculture vers la durabilité dans le scénario du changement climatique, davantage d'études expérimentales sur la profondeur d'incorporation des résidus de culture sont nécessaires pour mieux quantifier et atténuer les émissions agroécologiques de gaz à effet de serre. D'autres études expérimentales sur les flux annuels d'oxyde nitreux et d'ammoniac sont également nécessaires pour évaluer plus précisément les impacts de l'agroécologie et du système agricole conventionnel. Les données expérimentales obtenues serviront également de référence pour l'optimisation et le paramétrage des modèles simulant ces émissions gazeuses des sols.

3. La distribution verticale des résidus de culture impact les émissions d'oxyde nitreux et d'ammoniac des sols

Introduction

Vingt-neuf pour cent des émissions de N_2O sont attribuées à l'application d'engrais chimiques, les 71 % restants sont libérés par des méthodes d'agriculture biologique telles que la gestion du fumier et l'incorporation des résidus de culture (FAO Stats, 2020). La contribution des résidus de culture, au contraire, a augmenté de 0,81 % (FAO Stats, 2020) et peut potentiellement augmenter à l'avenir avec plus d'incitations à l'utilisation d'amendements organiques dans le but d'augmenter le stockage de carbone dans le sol (Rumpel et al. 2019, Smith et al. 2016). Les résidus de culture non récoltés incorporés dans le sol agissent comme une fumure organique mais ont également un effet sur les activités microbienne du sol et donc sur les émissions de gaz à effet de serre (en particulier le N_2O) (Nebert et al. 2011, Stewart et al. 2015). Bien qu'offrant des alternatives à l'utilisation d'engrais, les effets à long terme de l'application de résidus de cultures sur le sol doivent être évalués en termes d'émissions de GES (Chen et al. 2013). De plus, la décomposition des résidus dans les sols libère potentiellement de l'ammoniac qui est un précurseur d'aérosol secondaire, un polluant nocif pour l'environnement et la santé humaine (Ruijter et Huijsmans 2012 ; Sutton et al. 2011). La décomposition de la matière organique libère de l'azote minéral sous forme de NH_4^+ et NO_3^- . Les ions ammonium et les protons présents dans la solution du sol sont en équilibre avec l'ammoniac. L'ammoniac en solution est en équilibre avec le gaz ammoniac selon la loi de Henry (Génermont et al. 1998). Ainsi, en fonction du pH et de la température du sol, l'ammoniac peut donc être volatilisé depuis la surface du sol.

Environ 85 % des émissions totales de N_2O dans le monde résultent des processus microbiens de nitrification et de dénitrification du sol (Skiba et Rees, 2014) et les apports organiques dans le sol pourraient encore augmenter cette part. En effet, de nombreuses études rapportent les effets du climat (précipitations et température), de l'aération du sol (scénarios de travail du

sol) et des types de sol sur les émissions de N_2O au champ (Novoa et Tejada 2006, Mutegi et al. 2010, Chen et al. 2013). Il est bien établi que les émissions de N_2O augmentent lorsque la part de porosité occupée par l'eau (PPOE ou WFPS pour water filled pore space) passe de 60% à 80% (Hénault et al. 2005, Khalil et Baggs 2005, Metivier et al. 2009). En général, les sols à particules fines (pourcentage élevé d'argile et de limon) génèrent des flux de N_2O plus élevés que les sols sableux à grosses particules, ce qui dépend également de la porosité, de l'humidité et de l'aération du sol (Balaine et al. 2013, Gaillard et al. 2016, Yu et al. 2019). Smith et al. (1998) ont trouvé une relation exponentielle entre la température du sol et le flux de N_2O tandis que Maag et Vinther (1996) ont montré que les sols limoneux, ils ont un taux de nitrification élevé.

Un certain nombre d'études soulignent les effets de la gestion des résidus de culture sur les émissions de N_2O des champs. Baggs et al. (2006) ont observé un flux élevé de N_2O (2,1 g N_2O -N ha⁻¹ kg⁻¹ N appliqué) pendant les deux premières semaines après l'incorporation des résidus dans le sol dans l'ouest du Kenya. Akiyama et al. (2020) ont rapporté une forte augmentation des flux de N_2O (pic dans la gamme de 800-1200 $\mu\text{g N m}^{-2} \text{ h}^{-1}$) du champ deux semaines après que des résidus de choux avec un faible C:N aient été laissés sur la surface du sol, un léger pic a été observé juste après l'incorporation des résidus. Pugesgaard et al. (2017) ont montré, à partir de mesures sur le terrain, que les résidus de cultures à faible C:N (trèfle des prés et pommes de terre) émettaient des flux de N_2O plus élevés que les résidus de cultures à fort C:N (blé et orge). Ces résultats sont en accord avec une synthèse de Butterbach-Bahl et al. (2013) qui conclut que l'ajout de résidus de culture riches en azote amorce les processus de stabilisation de la matière organique dans le sol, ce qui conduit à des émissions d'oxyde nitreux par ces pratiques d'agriculture durable. La localisation des résidus de culture dans les sols pourrait également jouer un rôle important dans les émissions de N_2O (Coppens et al. 2006). Les résidus enfouis dans le sol offrent un plus grand contact microbien entre la matière organique et le sol, déclenchant ainsi des taux de décomposition plus élevés par rapport aux résidus laissés à la surface du sol (Prescott et al. 2017, Parker 1962).

En se concentrant sur l'ammoniac, plusieurs études ont essayé de comprendre sa volatilisation à partir des sols, dans des scénarios d'applications de fumier/lisier/engrais (Huijsmans et Schills, 2009, Singh et al. 2013, Webb et al. 2014). Après l'incorporation d'amendements organiques, il a été démontré que la volatilisation de NH_3 peut être renforcée par la minéralisation de l'azote (Nemitz et al. 2000, Zhang et al. 2015). Les émissions de NH_3 sont fortement sensibles aux conditions d'humidité, au carbone organique du sol et à la texture (tous deux déterminant les caractéristiques d'humidité du sol et la réaction du NH_4^+ chargé positivement avec les sites d'échange cationique chargés négativement : Capacité d'échange cationique) (Al-Kanani et MacKenzie, 1992 ; Delon et al. 2017 ; Keller et Mengel, 1986). Rochette et al. (2013) ont par exemple démontré à travers des expériences de mésocosme de sol avec l'application d'urée que les taux de volatilisation du NH_3 étaient plus importants lorsque l'application se faisait en surface que lorsqu'elle se faisait sous la surface du sol.

Dans cette étude, nous visons à quantifier les émissions de N_2O et NH_3 du trèfle rouge (résidu riche en azote) avec trois types de sol différents et dans différentes distributions verticales, dans une installation de laboratoire en conditions contrôlées, sur une période de 50-60 jours. De plus, la teneur en azote et en carbone du sol a été mesurée tout au long de l'incubation et les flux de CO_2 ont été enregistrés. Trois localisations des résidus de culture ont été testées, Imélangées dans les 4 premiers cm, en couches à 4cm de profondeurs et en surface du sol. Trois sols ont été utilisés pour avoir une vision plus large de l'interaction entre le type de sol et la localisation des résidus.

Matériel et méthodes

Sol et résidus utilisés

Des échantillons de sol ont été prélevés à une profondeur de 0 à 20 cm à trois endroits différents afin de préparer des microcosmes de sol pour l'incubation en laboratoire. Un premier sol a été collecté sur un site expérimental à Alnarp, en Suède (55°39'28.2 "N 13°04'56.1 "E) (appelé ici SLU) et stocké congelé à -20°C. Deux sols, l'un à forte teneur en

calcaire et donc à pH élevé et l'autre à pH neutre ont été échantillonnés à Thiverval-Grignon, France (48°50'53.4 "N, 1°56'23.1 "E et 48°50'37.0 "N 1°57'03.6 "E respectivement) et stockés à 0-4°C. Ces sols sont appelés GEXER et GICOS respectivement. Tous les sols ont été tamisés à 6 mm et tous les fragments de végétation ont été enlevés. Ils ont été échantillonnés pour l'analyse du carbone et de l'azote total, du pH et de la texture avant leur stockage.

Des plantes de trèfle rouge (C:N = 17,9, matière sèche 2,5%, N-NO₃ ‰ négligeable, N-NH₄ ‰ = 0,2, N soluble ‰ = 2,2, C soluble ‰ = 85) échantillonnées à Ås, Norvège (59°39'57,7 "N, 0°46'06,5 "E) ont été récoltées au stade de reproduction. Différents organes ont été séparés (feuilles, tiges, fleurs et pétioles), pesés et séchés pendant une semaine à 40°C, puis coupés en morceaux de 1 cm. Ces parties ont ensuite été mélangées dans des proportions similaires à leur présence sur le terrain (37% tige, 34% fleurs et feuilles, 29% pétioles) pour l'incubation.



Préparation des microcosmes de sol

Le sol SLU congelé a été décongelé pendant une semaine à 5°C. Tous les sols ont été préincubés pendant une semaine à 15°C dans une chambre à température régulée avec aération. Le sol SLU a été préincubé à 35% de PPOE avec 1 g cm⁻³ de densité apparente, GEXER et GICOS à 40% de PPOE et 1 g cm⁻³ de densité apparente. Nous avons ajouté du nitrate de potassium (KNO₃ pur à 98%) aux sols pré-incubés de manière à atteindre 100 mg NO₃⁻ N kg⁻¹ de sol pour les sols SLU et GEXER (Tableau 2). GICOS a été traité avec 100 mg NO₃⁻ N kg⁻¹ de sol.

Les sols préincubés ont ensuite été tassés à une densité apparente de 1,25 g cm⁻³ dans des cylindres d'incubation de 12,5 cm de diamètre à fond perforé. Le WFPS du sol est ajusté à 60%. Des résidus découpés à 1 cm ont été ajoutés avec une quantité de 0.04 g DM cm⁻² de surface de sol. Ces résidus ont été ajoutés soit sur le dessus du cylindre de 8 cm (modalité de surface), soit après avoir ajouté les deux premières couches (à 4cm) pour la modalité sandwich ou en les mélangeant avec les deux couches supérieures de sols pour la modalité mixte. Aucun résidu n'a été ajouté aux traitements de contrôle. Trois répétitions de chaque modalité et du contrôle ont été préparées. Des microcosmes similaires avec des cylindres à base perforée (7 cm de diamètre) ont été préparés (un par modalité) en même temps avec des sols et des résidus

préincubés conformément au tableau 2 pour l'extraction et l'échantillonnage de l'azote minéral. Chaque microcosme préparé a été recouvert d'un film perforé et conservé à 15°C dans une chambre noire aérée lorsqu'il n'a pas été mesuré. Un point à noter ici est qu'il n'y a pas eu de modalité de surface pour le sol GEXER en raison du manque de disponibilité de sol approprié.

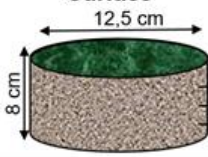
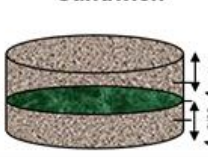
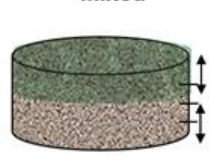
Tableau 2 Modalités avec différentes distributions verticales de résidus dans les sols et solution de KNO₃ ajoutée

Modalités	Surface	Sandwich	Mixed	Control
				
Soil type	GEXER SLU GICOS	GEXER SLU GICOS	SLU GICOS	GEXER SLU GICOS
Soil mineral N	100 kg/ha	100 kg/ha	100 kg/ha	100 kg/ha
WFPS	60%	60%	60%	60%

Mesure des émissions de gaz des microcosmes de sol

Nous avons mis en place un incubateur à gaz (Gas Emission Detection Incubator : GEDI) nous permettant de mesurer les flux de gaz à partir de nos cylindres d'incubation. Quatre gaz différents (N₂O, NH₃, CO₂ et vapeur H₂O) ont été mesurés avec un flux d'air continu tous les jours pendant les deux premières semaines, deux fois par semaine du jour 14 au jour 28, puis une fois par jusqu'au jour 50.

Incubateur de détection d'émission de gaz (GEDI)

L'incubateur GEDI (voir la figure 3 pour plus de détails) est un système qui permet de mesurer automatiquement les échanges gazeux dans un laboratoire. Il est installé dans une boîte à température contrôlée (Longueur : 115 cm, Largeur : 60 cm, Hauteur : 60 cm) avec cinq chambres, chaque chambre contenant un cylindre de sol (12,5 cm de diamètre et 8 cm de hauteur). Les chambres sont exclusivement en verre et tous les tuyaux étaient en téflon PTFE pour minimiser l'adsorption de l'NH₃. Les chambres étaient également cylindriques avec un

espace libre au dessus d'un volume de 530,14 cm³. Un déflecteur d'air à base de téflon a été utilisé (Flura et al. 2014) pour les chambres afin (i) de permettre un flux d'air turbulent dans l'espace libre au dessus et (ii) d'éviter un flux d'air direct sur le sol afin qu'il ne sèche pas.

Toutes les chambres sont connectées en parallèle les unes aux autres par des électrovannes à trois voies à chaque entrée et sortie. Le flux de gaz provenant de la sortie est dirigé ensuite vers les différents analyseurs pour être mesuré. Les électrovannes à trois voies sont également connectées simultanément à un autre circuit d'air parallèle qui permet un débit d'air constant dans les chambres qui ne sont pas en mode mesure empêchant toute accumulation à l'intérieur de ces chambres. Sur la figure 3, le circuit rouge correspond au circuit de mesure, et le vert au circuit auxiliaire. L'échantillonnage des gaz est effectué automatiquement en suivant une séquence d'échantillonnage contrôlée par un enregistreur de données (Campbell CR1000X). Le flux d'air à travers le système est contrôlé et mesuré par un débitmètre massique. Les flux sont calculés suivant une approche de chambre en régime permanent, c'est-à-dire à partir de la différence de concentration des gaz dans l'air entre les sorties d'une cellule avec un cylindre de sol traité et une cellule vide. Le taux d'échange sol-espace aérien de chaque gaz-trace est le résultat de l'équilibre de masse entre les concentrations des deux sorties (air de la chambre) en supposant des conditions d'équilibre du flux de masse.

$$F_{ss} = \frac{Q}{A} \times (C_{out} - C_{blk})$$

où F_{ss} représente le flux de gaz; A désigne la surface du sol du cylindre de sol ; Q est le débit d'air. C_{blk} et C_{out} sont les concentrations de chaque gaz à la sortie de la chambre de cellule vierge et la cellule avec traitement respectivement. Les flux ont été convertis en kg N (ou C) par hectare et par jour en utilisant les mesures de la température de l'air (la pression atmosphérique a été fixée à 1013 hPa).

L'air fourni pour la mesure est préalablement filtré avec une série de filtre : un filtre à base de dioxyde de manganèse (Purafil Inc., Atlanta, GA, USA) pour éliminer l'ozone et les oxydes d'azote (NOx), un filtre à charbon actif pour piéger les composés organiques volatils (COV), un

filtre à base d'acide acétique pour capturer l'ammoniac, un filtre à particules à base de tissu de coton et une fiole vide pour empêcher l'entrée d'eau dans l'incubateur. Un humidificateur « bulleur » est connecté en série à ces filtres pour maintenir une humidité constante de l'air dans l'incubateur. La température a été maintenue constante à 15°C au cours des mesures. Toutes les mesures ont eu lieu dans l'obscurité. Un débit d'air de 4,0 l min⁻¹ a été maintenu à l'entrée du GEDI. Un enregistreur de données (Campbell CR1000X) a été utilisé pour enregistrer les données mesurées. Des thermocouples ont été attachés à cet enregistreur de données pour enregistrer la température en temps réel.

Un cycle de mesure pour les cinq cylindres placés dans le GEDI dure 140 minutes. Le cycle commence par une purge de 15 minutes de l'ensemble du système avec de l'air propre, suivie d'une mesure séquentielle de chaque cylindre pendant 25 minutes. La séquence de mesure de 25 minutes est subdivisée en trois parties : (i) une mesure de débit continu où la sortie est échantillonnée pendant 15 minutes et (ii) une mesure d'accumulation où la chambre est fermée pendant 3 minutes, puis l'air est purgé et mesuré pendant une minute et (iii) une mesure d'air zéro où l'échappement à blanc est échantillonné pendant 6 minutes.

Trois analyseurs de gaz ont été connectés en parallèle à la sortie du GEDI. Un débit d'air constant (1 L min⁻¹) a été maintenu à l'entrée de chaque analyseur. [Voir la figure 3 pour plus de détails]. Un analyseur à spectroscopie à cavité optique (PICARRO G2103) a été utilisé pour mesurer l'ammoniac (en ppb) et l'eau (en % en masse). Un analyseur infrarouge LICOR (Li - 840A) a été déployé pour la surveillance continue du dioxyde de carbone (en ppm). Il a également détecté la concentration (ppth). Un analyseur infrarouge de type laser à cascade quantique (QCL TILDAS - Aerodyne Research Inc.) a été utilisé pour mesurer le protoxyde d'azote (en ppb).

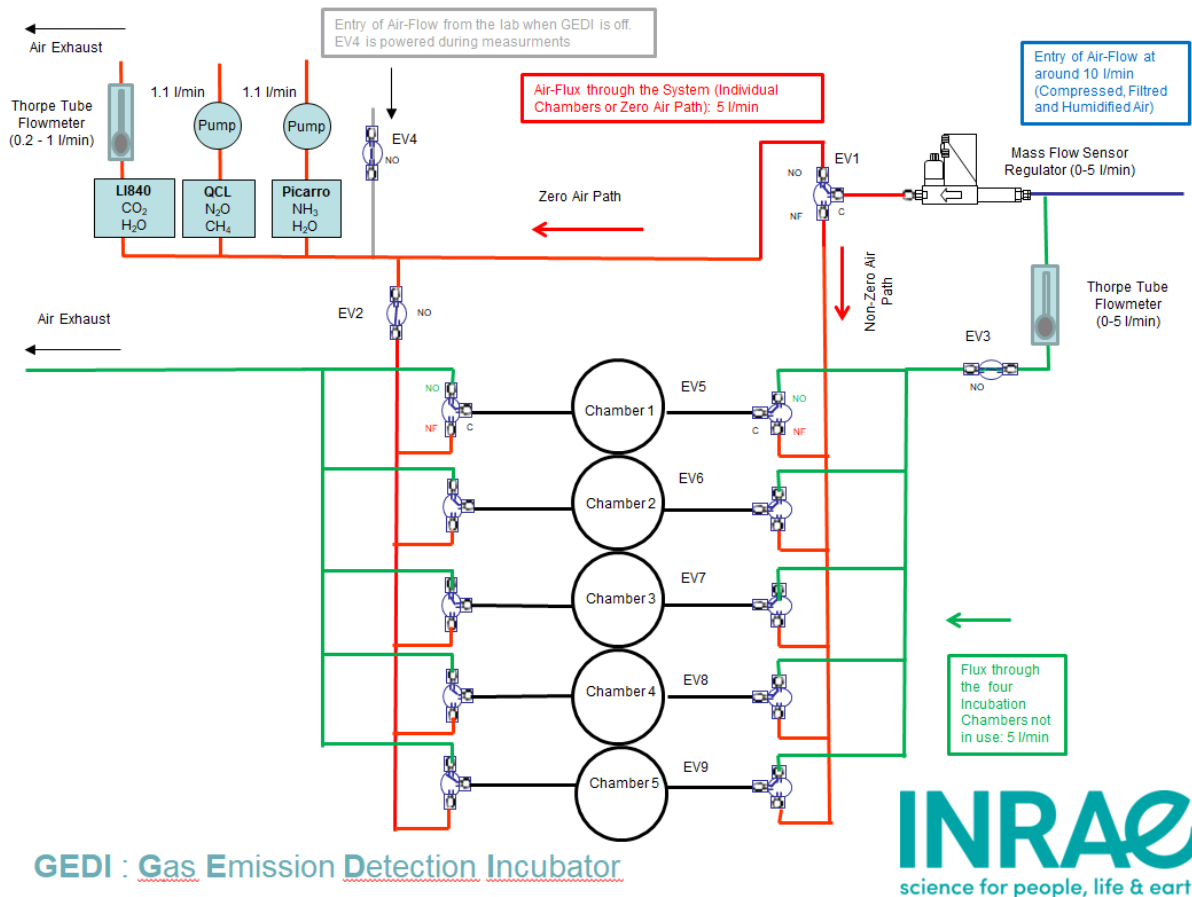

Figure 3 Schéma montrant le circuit de l'incubateur GEDI. Le circuit rouge représente la circulation du flux d'air de mesure principal. Le circuit vert représente la circulation du flux d'air auxiliaire de "balayage". EV représente les électrovannes, NO pour normalement ouvert et NF pour normalement fermé.

Protocole de mesure et analyse du sol

La période d'incubation et de mesure pour chaque microcosme a duré 50-60 jours. Les mesures de gaz ont été effectuées cinq jours par semaine pendant les deux premières semaines à partir du jour de la préparation du microcosme de sol. Puis deux jours par semaine pendant les deux semaines suivantes et un jour par semaine pendant les trois-quatre dernières semaines.

Avant et après chaque mesure de gaz, les masses des microcosmes de sol ont été enregistrées. Les pertes d'eau des microcosmes pendant les mesures ont été compensées en ajoutant des

quantités équivalentes d'eau ultra pure dans les cylindres d'incubation. Comme la perte d'eau après chaque cycle de mesure était minime, l'eau a été ajoutée une fois par semaine pendant les deux premières semaines, puis une fois toutes les deux semaines jusqu'à la fin de la période d'incubation.

L'échantillonnage de l'azote minéral a été effectué dans les cylindres complémentaires préparés spécifiquement aux jours 4, 7, 14, 28 et 50 ou 60. Le sol de chaque cylindre a été mélangé et emballé dans un sachet étiqueté et congelé à -20°C jusqu'à l'extraction. Pour l'extraction, les échantillons congelés ont été décongelés pendant la nuit à 5°C . Des sacs hermétiques ont été préparés et 50 g de sol de chaque échantillon ont été mis avec 100 ml de solution de KCl (Chlorure de Potassium, pur à 99%, Merck Chemicals) à 1 mol l^{-1} . Ils ont ensuite été mélangés dans un agitateur rotatif pendant 30 minutes. Les sacs ont ensuite été laissés debout sans être dérangés pendant 30 minutes pour la sédimentation. Les tubes sous vide ont été étiquetés et utilisés pour recueillir le surnageant à l'aide d'une seringue. Les tubes ont ensuite été congelés et analysés ultérieurement par méthode colorimétrique (LDAR, Laon référence : A_RS19.66-1) pour les minéraux NH_4^+ et NO_3^- .

Calcul et analyse statistique

Les flux quotidiens cumulés ont été calculés jusqu'au jour 50 de la période d'incubation. Une interpolation linéaire a été utilisée pour combler les écarts entre les jours de mesure, en prenant la moyenne du flux gazeux quotidien entre le jour de mesure précédent et le jour de mesure suivant pour chaque modalité et leurs répétitions. Les flux cumulés nets ont été calculés en soustrayant les flux cumulés des modalités témoins (sans application de résidus) de celles avec résidus. Les moyennes ont été calculées à partir des trois répétitions de chaque modalité. Nous avons comparé statistiquement les flux gazeux cumulés obtenus entre différentes distributions verticales au sein de chaque sol, un test de Tukey a été utilisé. Une analyse en composantes principales a été réalisée pour déterminer l'interrelation entre les différents flux gazeux et les processus d'azote du sol.

Résultats

Flux nets cumulés d'oxyde nitreux et d'ammoniac

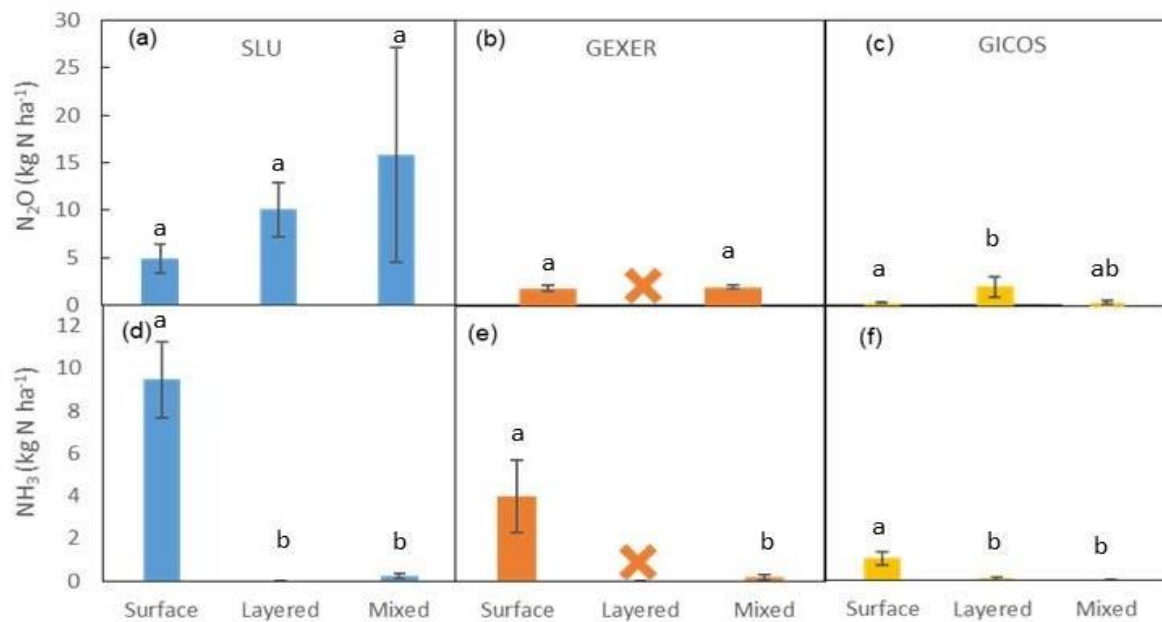

Figure 4 Flux gazeux nets cumulés de N₂O (a, b, c) et NH₃ (d, e, f) pour des modalités avec trois types de sol et trois positions verticales de résidus de trèfle rouge pendant 50 jours d'incubation. Ici SLU : Sol suédois (a et d), GEXER : Sol français de la parcelle exercice de Grignon (b et e), GICOS : sol de la parcelle ICOS à Grignon (c et f). Les petites lettres représentent les résultats du test de Tukey.

Le sol suédois SLU présentait le flux net cumulé de N₂O le plus élevé pendant 50 jours d'incubation (figure 4 (a)). Les sols français GICOS et GEXER présentaient des flux nets cumulés de N₂O similaires, qui n'était pas différent statistiquement selon le test de Tukey. Dans les modalités SLU, le trèfle rouge mélangé de la modalité mixte présentait le flux net cumulé de N₂O le plus élevé, soit 15,82 kg N ha⁻¹. Venait ensuite la modalité en sandwich avec un flux net moyen de N₂O cumulé de 10,09 kg N ha⁻¹ et le trèfle rouge en surface présentait le flux net de N₂O cumulé le plus faible, soit 4,90 kg N ha⁻¹. Cependant, compte tenu de la grande variabilité des réplicats pour chacune des modalités, ils n'étaient pas statistiquement différents entre eux. Dans le cas du sol GICOS (Figure 4 (c)), la modalité en couches a enregistré le flux moyen cumulé de N₂O le plus élevé de 1,94 kg N ha⁻¹, les modalités mixte et de surface ont ensuite enregistré des flux nets cumulés moyens de 0,42 kg

N ha⁻¹ et 0,28 kg N ha⁻¹. Pour le sol GEXER (Fig. 4(b)), les microcosmes de surface et mixtes ont eu des flux nets cumulés de N₂O statistiquement similaires de 1,91 kg N ha⁻¹ et 1,76 kg N ha⁻¹.

Des flux significatifs de NH₃ ont été mesurés (Figure 4 (d, e, f)). Les modalités de surface ont eu les émissions les plus élevées avec des valeurs moyennes de flux nets cumulés de 9,5 kg N ha⁻¹, 3,7 kg N ha⁻¹ et 0,95 kg N ha⁻¹ respectivement pour les sols SLU, GEXER et GICOS. Les modalités mixtes et en couches ont enregistré des flux nets cumulés de NH₃ proches de zéro.

Série chronologique des flux gazeux moyens

Figure 5 Dynamique des flux de N₂O (A) et de NH₃ (B) pour les modalités surface, mixte, couche et contrôle ainsi que la teneur en azote minéral du sol (ammonium (C) et nitrate (D)) pour les trois types de sol (SLU, GEXER et GICOS).

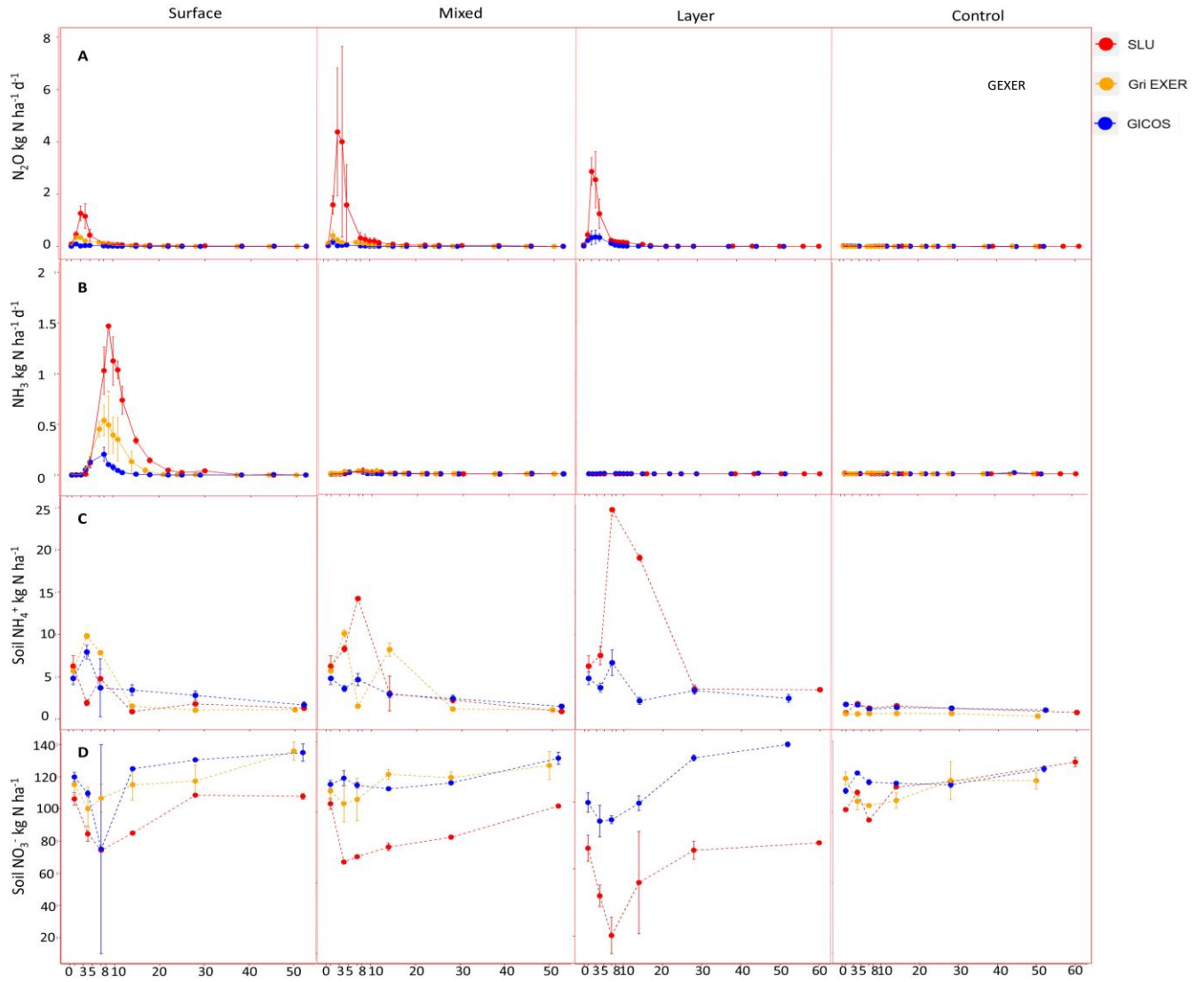
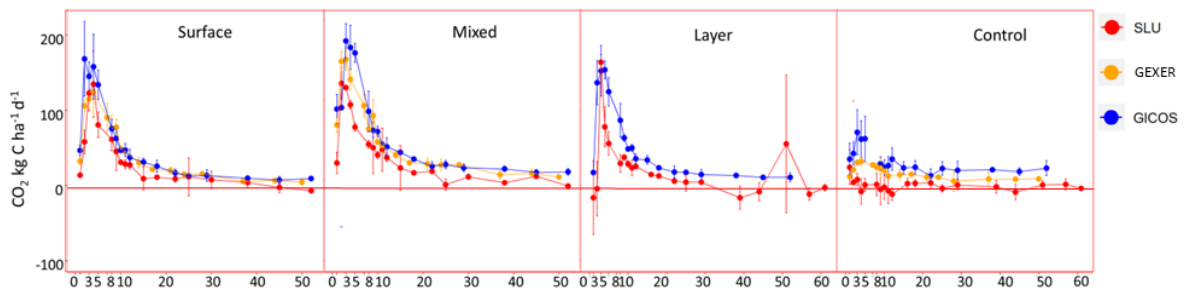

Figure 6 Dynamique du flux de CO_2 pour les modalités de surface, mixte, couche et contrôle pour trois sols - SLU, GICOS et GEXER.



Comme le montrent les figures ci-dessus, le flux quotidien atteint son maximum pour le N_2O au cours des sept premiers jours d'incubation des microcosmes de sol. Après 14 jours, le flux quotidien de N_2O s'approche essentiellement de zéro. Pour le NH_3 , seules les modalités de surface montrent un pic, mais le pic apparaît à partir du 7ème jour, et il redescend à une valeur proche de zéro vers le 25ème-30ème jour. Les flux quotidiens de CO_2 atteignent un pic au cours de la première semaine d'incubation, pour finalement se stabiliser à zéro au jour 25-30.

La teneur en ammonium varie selon les modalités, mais en général, elle atteint un pic au cours des deux premières semaines d'incubation et diminue ensuite. Les teneurs en nitrates, au contraire, atteignent un creux généralement au cours des dix premiers jours d'incubation.

Effet de la position du résidu sur les flux de N_2O et de NH_3

Le flux net moyen de N_2O cumulé provenant des positions de résidus mixtes et en couches était plus élevé que celui provenant des résidus à la surface du sol (Figure 2 (a, b, c)). Cela peut s'expliquer en partie par la différence des taux de décomposition dans les différentes positions de résidus en raison des effets du contact microbien (Coppens et al. 2006, 2007 ; Gaillard et al. 1999). Habituellement, des taux de décomposition plus élevés dans les sols correspondent à une plus grande libération de NH_4^+ , ce qui amorce la nitrification et la dénitrification (Baggs et al. 2000, Muhammad et al. 2011, Mehnaz et al. 2019). Ceci est observé dans nos incubations avec une teneur accrue en ammonium dans les modalités mixtes et en couches pour le sol SLU particulièrement coïncidant avec le pic d'émissions de N_2O et de CO_2 (Figures 5). Les résidus positionnés en mélange et en couche avec un plus grand contact avec le sol ont été exposés à une colonisation microbienne plus rapide, ce qui a stimulé la minéralisation des résidus. Cependant, nous n'avons pas observé de tendance dans les émissions cumulées de CO_2 concernant les différentes distributions verticales, sans différence significative entre le positionnement des résidus en surface, en mélange et en couche. Il est important de noter qu'un nombre important de croissances fongiques a été observées pour le sol SLU avec des résidus de surface. Nous pensons que ces croissances

fongiques ont intercepté l'eau supplémentaire ajoutée pour compenser la perte d'humidité du sol, créant éventuellement une zone humide favorable à la décomposition microbienne, augmentant les flux de N_2O et de CO_2 .

Pour le sol GEXER, de faibles flux de N_2O ont été enregistrés pour les modalités de surface et mixte, probablement en raison d'un fort effet des propriétés physico-chimiques du sol, particulièrement liées au pH du sol.

En ce qui concerne les flux de NH_3 , nous n'avons observé que les émissions des résidus déposés en surface. Contrairement au N_2O qui est produit par une action enzymatique microbienne, les émissions de NH_3 résultent d'un équilibre physico-chimique avec les ions labiles NH_4^+ et H^+ . De plus, le NH_3 est un gaz hautement réactif, qui peut être facilement adsorbé ou chimiquement réactif dans les pores du sol (Lovanh et al. 2010), ce qui explique en partie les flux observés. Les résidus positionnés en mélange et en couches ont probablement libéré du NH_3 qui a été piégé dans les couches du sol.

Ces observations sont cohérentes avec les résultats de Nett et al. (2016) qui ont mesuré les flux de NH_3 au champ à partir d'un résidu riche en azote (chou-fleur). Ils ont noté des émissions élevées de NH_3 au jour 41 dans les trois sols étudiés - limon sableux (2,17 kg N ha⁻¹), limoneux (1,13 kg N ha⁻¹), limon argileux sableux (1,04 kg N ha⁻¹). Il y a eu quelques émissions à partir de résidus mélangés alors que de faibles émissions ont été enregistrées quand les résidus sont labourés (en couches). Ces flux sont du même ordre de grandeur que les flux enregistrés dans les sols GEXER et GICOS. Cependant, des flux beaucoup plus élevés ont été enregistrés dans le sol SLU, potentiellement en raison de la teneur élevée en sable de ce sol.

Figure 7 Tableau de corrélation entre les flux gazeux cumulés et les teneurs en azote minéral des trois sols résultant des flux gazeux et des concentrations en azote minéral du jour 1, jour 4, jour 7, jour 14, jour 28 et dernier jour d'incubation.

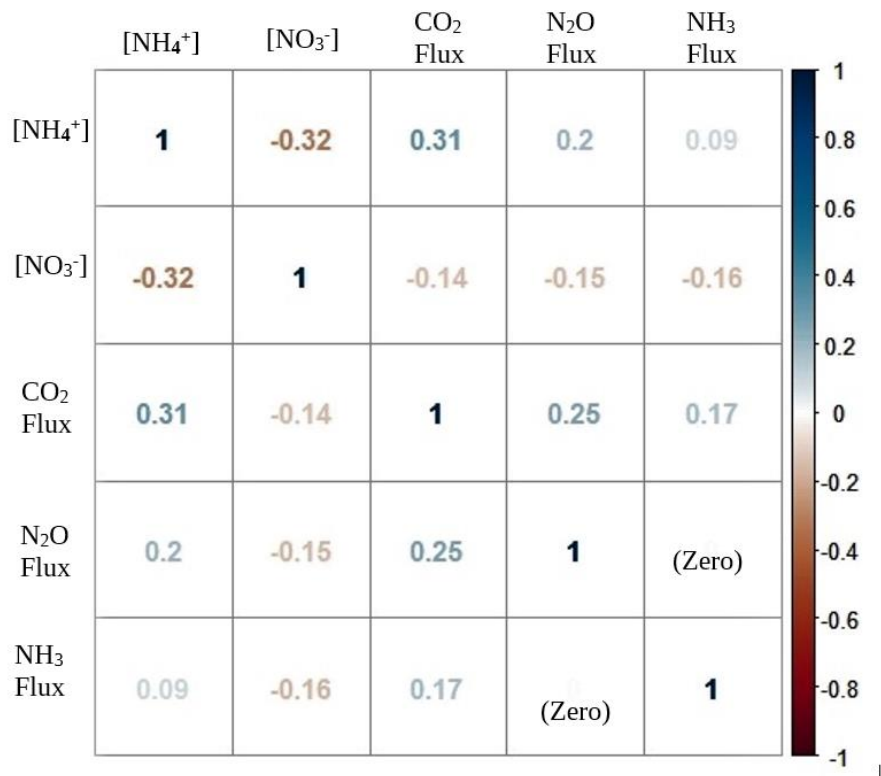

Conclusion

Ces résultats montrent que la distribution verticale des résidus de culture dans le sol joue un rôle important dans les flux gazeux de N₂O, NH₃ et CO₂. Le placement des résidus en surface a contribué à augmenter les flux de NH₃, tandis que le mélange des résidus dans le sol ou leur placement entre deux couches de sol a augmenté le flux de N₂O. Les flux dépendent également des caractéristiques physico-chimiques du sol. Une teneur plus élevée en sable a eu un impact plus important sur les flux gazeux que les sols à particules fines et a influencé la croissance et l'activité microbienne. Même si les caractéristiques d'émission sont les mêmes, l'évolution des séries temporelles de NH₄⁺ et NO₃⁻ montre que différents processus microbiens de dénitrification aérobie et anaérobie sont des sources de flux de N₂O dans différents types de sols.

L'incorporation de résidus vert riches en N en tant qu'amendement organique s'avère être un défi dans les sols sablonneux car elle stimule les émissions de gaz à effet de serre. Cependant, pour les agriculteurs cultivant des sols limoneux à fines particules, la meilleure option semble être de mélanger uniformément les résidus dans la couche supérieure afin de minimiser les

flux de NH_3 et de N_2O . Il y a définitivement une augmentation du flux de CO_2 après l'ajout de résidus en raison de la respiration microbienne et de la dégradation des résidus.

Les résultats et les données obtenus ici peuvent être utilisés pour optimiser l'interdépendance entre la stabilisation de la matière organique du sol et le flux d'oxyde nitreux. D'autres analyses expérimentales des taux de croissance microbienne, de la génétique et du pH des microsites, des teneurs en oxygène ainsi que la discrétisation verticale de la teneur en azote minéral du sol pourraient affiner explicitement la compréhension des processus microbiens impliqués dans les flux de N_2O et de NH_3 .

4. Simulation des émissions d'oxyde nitreux et d'ammoniac provenant de la décomposition des résidus de culture dans un sol argileux à l'aide d'un modèle couplé

Introduction

La décomposition des résidus de culture dans le sol est une source importante de gaz à effet de serre - le protoxyde d'azote - et de polluant atmosphérique - l'ammoniac. Les résidus en décomposition et leur transformation en matière organique fraîche du sol et en matière organique stabilisée ont pour effet d'amorcer l'activité microbienne du sol, ce qui influence la nitrification, la dénitrification du sol et d'autres processus du cycle de l'azote, d'où ces émissions. Dans un scénario de réchauffement climatique, pour une planification appropriée des méthodes d'agriculture durable, il est crucial de disposer d'outils importants de prédiction de ces gaz. Ici, nous essayons de construire un modèle couplé simple pour simuler les

émissions d'oxyde nitreux et d'ammoniac d'un sol limono-argileux à petites particules avec un résidu riche en azote (trèfle rouge) mélangé dans sa couche supérieure.

Sélection des modèles

Les simulations des émissions d'oxyde nitreux et d'ammoniac provenant de la décomposition des résidus de culture dans les sols nécessitent le couplage de trois modèles/modules dynamiques. Le premier décrit les processus relatifs à la décomposition de la matière organique dans les sols, les suivants décrivent les processus de transformation de l'azote du sol donnant lieu à des émissions d'oxyde nitreux et d'ammoniac tout au long de la décomposition. Le modèle que nous avons choisi pour simuler la décomposition des matières organiques est CANTIS [Garnier et al 2001 et 2003]. Pour la simulation du protoxyde d'azote, nous avons choisi NOE [Hénault et al 2005] et pour les simulations d'émissions d'ammoniac, nous avons choisi l'équation standard de volatilisation de Sommer et al (2003). CANTIS a été choisi car il simule la décomposition de la matière organique dans le sol en représentant simultanément les processus de nitrification, minéralisation et immobilisation de l'azote. Pour les émissions d'oxyde nitreux, il est important d'avoir un modèle qui décrit les processus dans le sol résultant en ces émissions, de manière holistique. De plus, un modèle nécessitant un nombre réduit de variables d'entrée facilite le couplage. Le modèle NOE a été choisi dans ce but car il intègre les émissions d'oxyde nitreux provenant à la fois de la nitrification et de la dénitrification. De plus, le pool de NH_4^+ minéralisé provenant de CANTIS est couplé aux paramètres d'entrée de la nitrification et de la dénitrification de NOE, ce qui simule les émissions d'oxyde nitreux des deux processus. Simultanément, l'équation d'émission de NH_3 prend la sortie NH_4^+ de CANTIS comme variable d'entrée pour ses simulations.

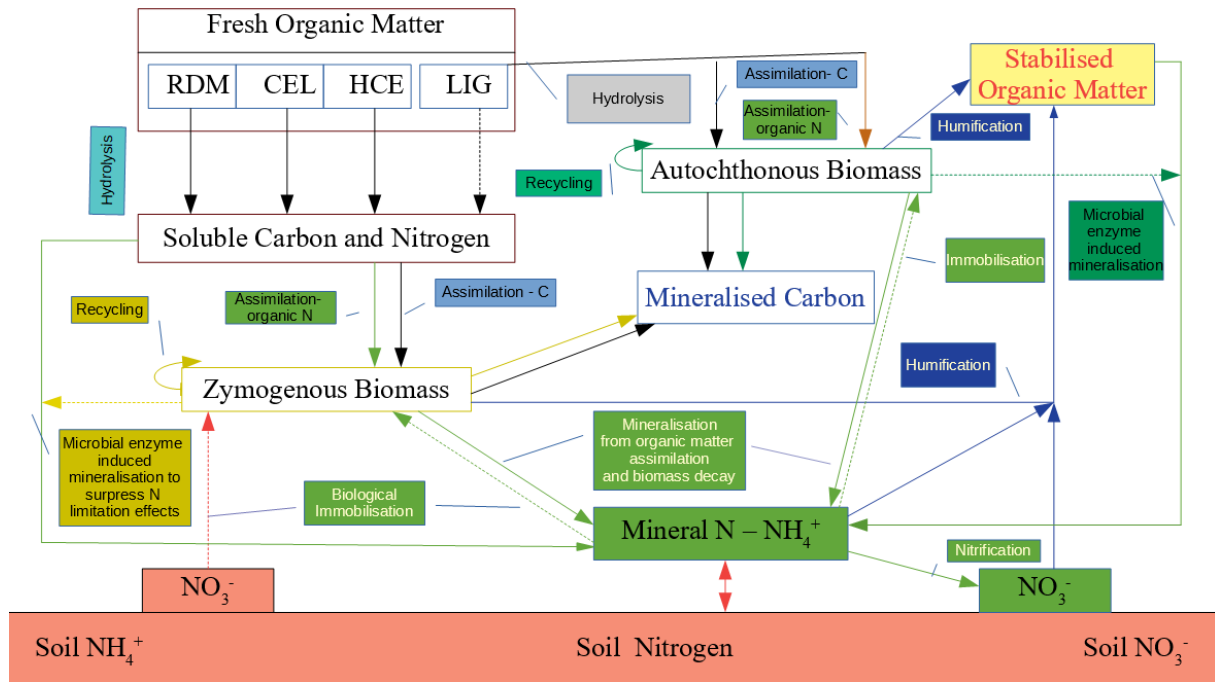

Figure 1 Représentation schématique des processus dans le modèle CANTIS.

Le taux total d'émission de N_2O est exprimé à partir du modèle NOE comme suit :

$$N_2O_{\text{Total}} = N_2O_{\text{denit}} + N_2O_{\text{nit}}$$

où N_2O_{denit} est le taux d'émission de N_2O par dénitrification et N_2O_{nit} est le taux d'émission de N_2O par nitrification. Les unités sont les $\text{kg N ha}^{-1} \text{ j}^{-1}$.

Le taux d'émission de N_2O provenant du processus de dénitrification est exprimé comme suit :

$$N_2O_{\text{denit}} = r_{\text{max}} D_A$$

où r_{max} est la constante sans dimension du rapport maximum entre N_2O accumulé et nitrate dénitrifié et D_A est le taux de dénitrification réel ($\text{kg N ha}^{-1} \text{ j}^{-1}$).

Le taux d'émission de N_2O par la nitrification est exprimé par $N_2O_{\text{nit}} = z N_A$ lorsque $WFPS < 0,62$ et $N_2O_{\text{nit}} = r_{\text{max}} z N_A$ lorsque $WFPS > \text{ou} = 0,62$. Ici N_A est le taux de nitrification réel ($\text{kg N ha}^{-1} \text{ j}^{-1}$), z (sans dimension) est la proportion de N_2O par rapport à l'azote nitrifié et r_{max} est déjà décrit ci-dessus. Pour plus de détails, veuillez vous référer aux informations supplémentaires.

Pour la simulation de la volatilisation du NH_3 à partir de résidus de culture en décomposition, l'équation de volatilisation dérivée de l'équilibre chimique de l'ammoniac et de l'ammonium

en phases liquide et gazeuse a été choisie. La libération de NH_3 gazeux à partir de la forme liquide est décrite par la vertu de la loi de Henry. L'équation mentionnée dans Sommer et al [2003] est décrite comme suit :

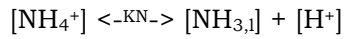

$$[\text{NH}_{3,l}] = [\text{TAN}] / \{1 + ([\text{H}_3\text{O}^+] / K_N)\}$$

$$[\text{NH}_{3,g}] = K_H \{[\text{TAN}] / (1 + ([\text{H}_3\text{O}^+] / K_N))\}$$

$$[\text{TAN}] = [\text{NH}_4^+] + [\text{NH}_{3,l}] + [\text{NH}_{3,g}]$$

Où $[\text{NH}_4^+]$, $[\text{NH}_{3,l}]$ and $[\text{NH}_{3,g}]$, $[\text{H}^+]$ sont respectivement les concentrations d'ammonium, d'ammoniac liquide et d'ammoniac gazeux, et l'ion hydronium dans le sol. $[\text{TAN}]$ est la concentration d'azote ammoniacal total. Toutes les concentrations sont exprimées en mol l^{-1} . K_N est le contant d'équilibre entre l'ammonium et l'ammoniac liquide, alors que K_H est le contant d'Henry entre l'ammoniac liquide et gazeux.

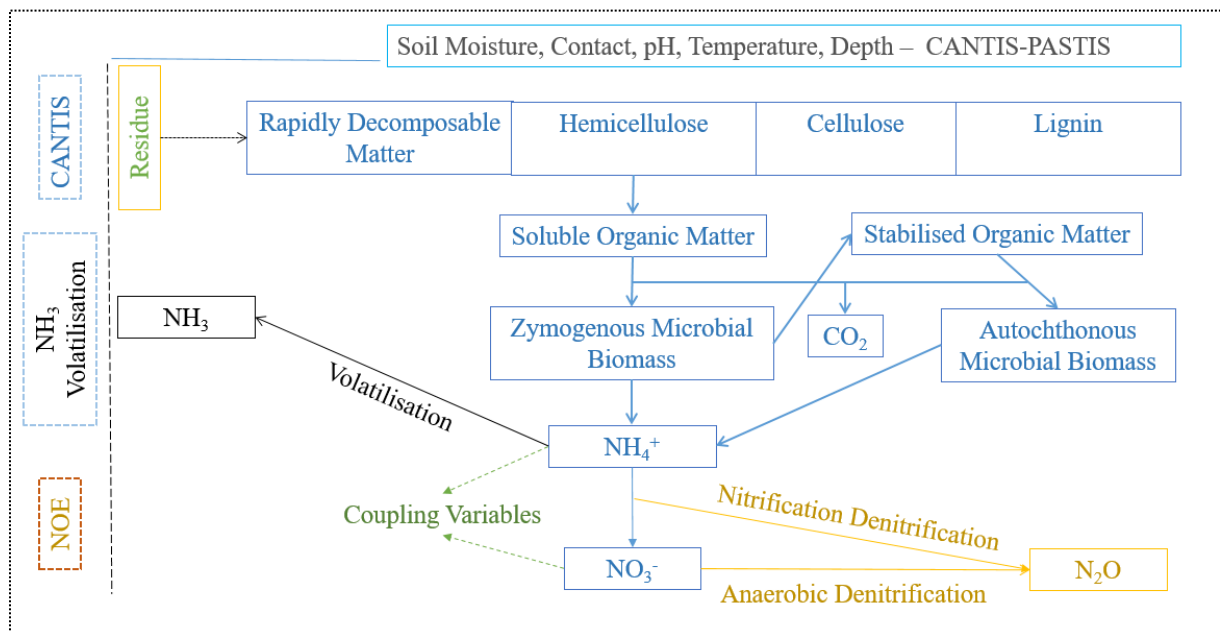

Figure 2 Représentation des processus dans les modèles couplés de CANTIS, NOE et de la volatilisaison du NH_3 . Veuillez noter que la couleur bleue représente les processus de CANTIS, la couleur jaune représente les processus de NOE et la couleur noire représente les processus de la volatilisaison du NH_3 . La couleur verte représente les variables de couplage. La couleur grise représente les influences abiotiques sur ces processus.

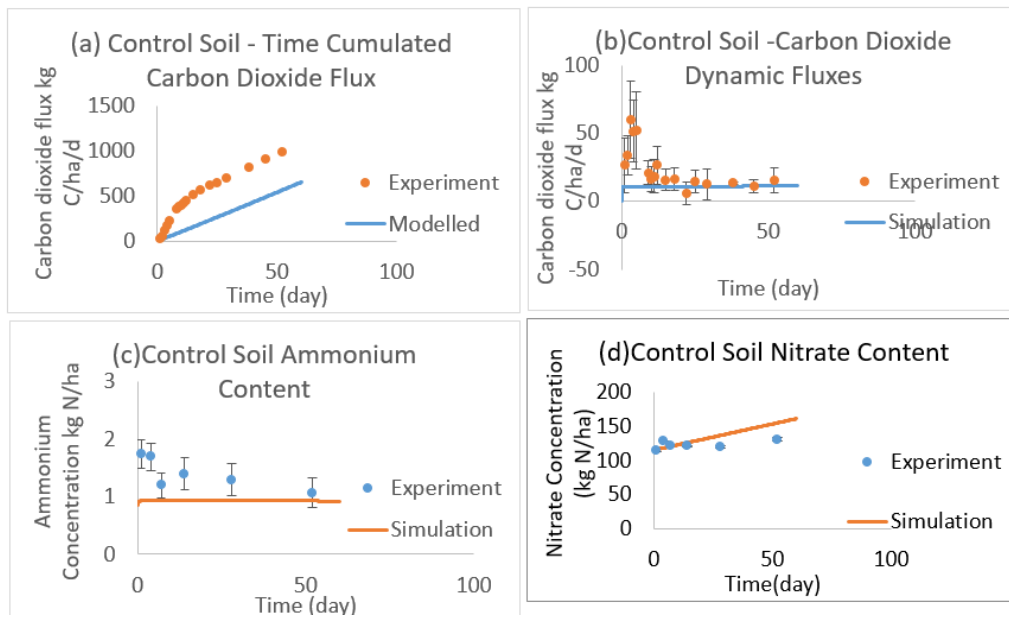

Figure 3 Flux de dioxyde de carbone, (a) dynamique et (b) cumulatif pour le sol témoin GICOS. (c) Teneurs minérales en NH_4^+ (ammonium) et (d) NO_3^- (nitrate) pour le sol témoin en fonction du temps.

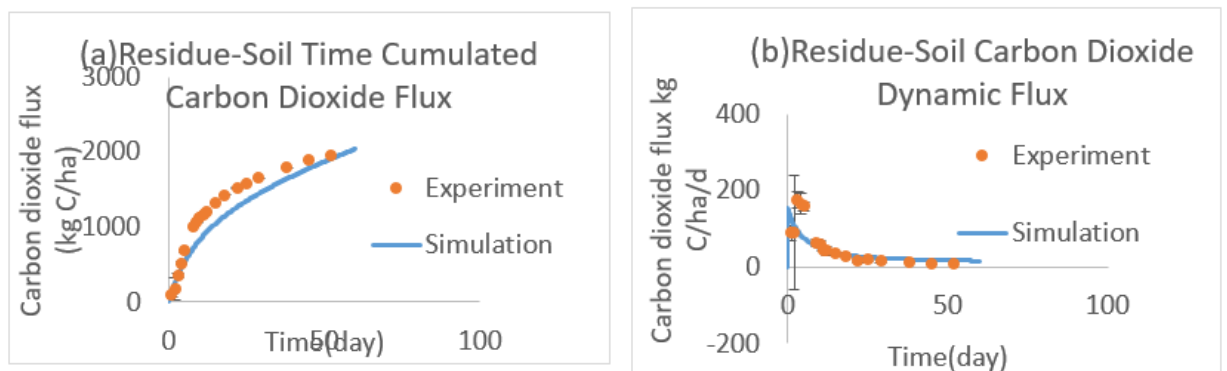

Figure 4 Flux de dioxyde de carbone, (a) cumulatif et (b) dynamique journalière, pour le trèfle rouge mélangé à la couche supérieure de 4 cm du sol GICOS.

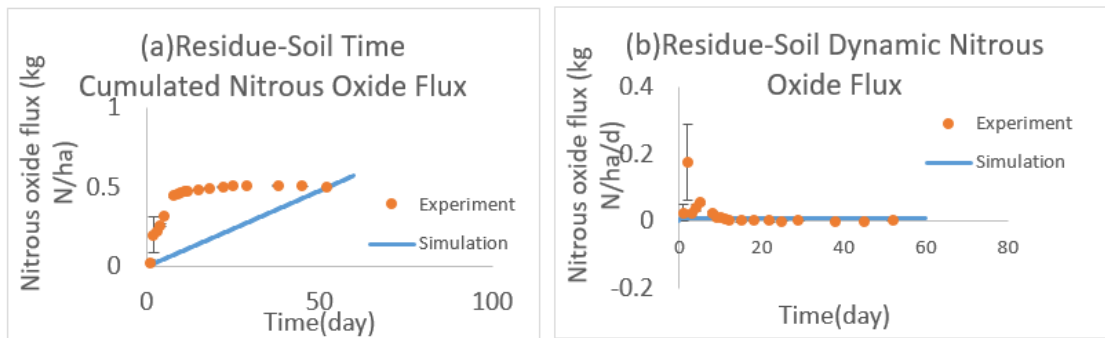

Figure 5 Flux cumulé (a) et dynamique quotidienne (b) d'oxyde nitreux pour un système de sol de trèfle rouge mélangé dans la couche supérieure de 4 cm du sol.

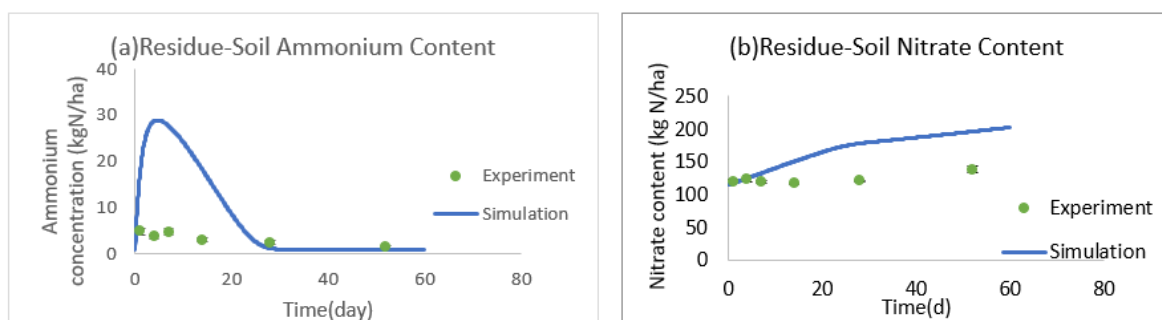

Figure 6 Teneurs en ammonium (a) et en nitrates (b) du système sol-résidu où le trèfle rouge est mélangé à la couche supérieure de 4 cm du sol.

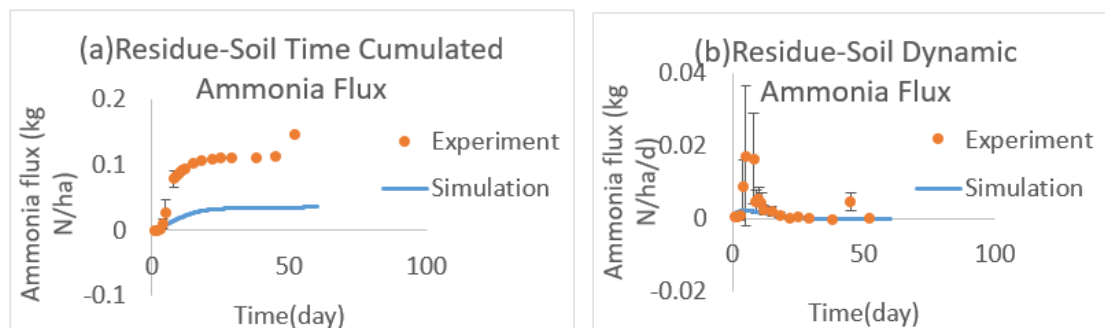

Figure 7 Flux d'ammoniac (NH_3) cumulé (a) et dynamique quotidienne (b) du système résidu-sol avec trèfle rouge mélangé dans la couche supérieure de 4 cm du sol GICOS.

Conclusions

La modélisation des flux de N_2O et de NH_3 est essentielle pour améliorer la prévisibilité de ces émissions de gaz à effet de serre et de gaz polluants provenant des résidus de culture. Les mécanismes sous-jacents à ces émissions sont des interactions complexes entre des facteurs biologiques, physiques et chimiques. Les modèles pour ces simulations sont tout aussi complexes et nécessitent généralement beaucoup de temps et de gestion de données pour générer des résultats appropriés. Pour cette raison, nous avons essayé de construire un modèle empirique simple pour le calcul des émissions de N_2O et de NH_3 provenant de l'utilisation des terres, en couplant le modèle de carbone et d'azote CANTIS, le modèle d'émission d'oxyde nitreux NOE et les équations de volatilisation du NH_3 de Sommer et al [2003]. Ce modèle construit a donné des résultats satisfaisants pour les flux de CO_2 et de NH_3 . Pour les flux de N_2O , la dynamique des flux quotidiens n'est pas encore bien calibrée car ils sont restés presque constants après le pic initial de la concentration de N_2O dans la phase initiale de décomposition de la matière organique fraîche dans le sol. Cela peut être le résultat d'une certaine matière organique résiduelle antérieure dans le sol, qui n'a pas été prise en compte en tant qu'entrée du modèle et du manque de certaines données expérimentales relatives au sol, telles que la population et la diversité de la biomasse microbienne du sol. Des travaux futurs sont nécessaires, dans l'expérimentation pour recueillir des valeurs de paramètres spécifiques au cas pour les compartiments du modèle ; et dans la modélisation pour évaluer sa performance sur une gamme plus large de résidus et de sols.

5. Epilogue

Discussions

Des études bibliographiques nous ont permis de constater que, lorsqu'elles sont comparées annuellement, les émissions d'ammoniac et d'oxyde nitreux de deux systèmes de rotation différentes l'un conventionnel et l'autre agroécologique, émettent de l'oxyde nitreux et de l'ammoniac dans les mêmes ordres de grandeurs. La méthode de travail du sol ainsi que le

type et la durée de la fertilisation organique ou chimique influencent ces émissions et il y a un besoin important d'études expérimentales pour caractériser l'influence de ces facteurs. Une observation récurrente que nous avons trouvée dans les études auxquelles nous nous sommes référés est la façon dont la position de l'engrais (chimique ou organique) affecte ces émissions gazeuses. L'objectif de notre étude est de comprendre les émissions de gaz à effet de serre issu des pratiques agroécologiques notamment en relation avec l'incorporation des résidus de culture. C'est pourquoi nous avons décidé d'effectuer des expériences en laboratoire sur des microcosmes de sol, dans des conditions contrôlées de température (288,15 K) et d'humidité (60% WFPS), afin de mesurer les flux d'oxyde nitreux et d'ammoniac des sols avec des résidus de culture placés dans trois positions - en surface, mélangés sur la moitié supérieure du sol et en couches à une profondeur de 4cm dans le sol. Ces trois positions imitent des scénarios de terrain où les résidus de culture sont incorporés soit sous forme de paillis (surface), soit dans le cadre d'un déchaumage (mixte), soit dans le cadre d'un travail profond du sol (en couches). Nous avons réalisé ces expériences avec deux résidus - trèfle rouge riche en azote et blé déficient en azote. Nous avons également utilisé trois sols différents pour évaluer l'influence des propriétés biochimiques et physiques du sol sur ces émissions gazeuses. Nous n'avons pas présenté les flux gazeux obtenus à partir du blé car, en raison de sa forte teneur en carbone, le résidu de blé ne s'est pas décomposé de manière significative au cours de l'incubation de cinquante jours et, par conséquent, les flux d'oxyde nitreux et d'ammoniac émis par le système de sol incorporé au blé étaient très faibles, voire nuls. En comparant les flux cumulatifs nets au jour 50 de l'incubation pour les émissions d'oxyde nitreux et d'ammoniac des résidus de trèfle rouge, nous avons constaté qu'ils étaient plus élevés dans les sols sableux (moyenne de 4,9 à 15,8 kg N ha⁻¹) que dans les sols argileux et limoneux alcalins (moyenne de 0,28 à 1,9 kg N ha⁻¹). La présence de pores de plus grande taille dans les sols sableux entraîne une meilleure diffusion des gaz du sol vers l'atmosphère. En outre, dans le cas des émissions d'oxyde nitreux, la présence de site aérobie et anaérobie joue un rôle important et les taux d'évaporation de l'eau sont plus élevés dans les sols sableux que dans les sols limoneux argileux à petites particules. Ces deux effets combinés entraînent des flux plus élevés d'oxyde nitreux et d'ammoniac à partir des sols sableux à grosses particules. Parmi ceux-ci, pour les trois sols, les émissions d'oxyde nitreux

étaient plus élevées lorsque les résidus étaient mélangés ou disposés en couches que lorsqu'ils étaient placés en surface. En ce qui concerne les émissions de NH_3 , l'effet était toutefois inversé pour la position du résidu et le résidu de surface entraînait un flux net cumulé plus élevé que le résidu mixte ou en couches (9,5 kg N ha⁻¹ pour le sol sableux, 3,7 kg N ha⁻¹ et 0,95 kg N ha⁻¹ pour le sol argileux limoneux alcalin et le sol limoneux légèrement alcalin respectivement). D'autres études ont également trouvé des observations similaires, en particulier Nett et al (2016) pour les émissions d' NH_3 à partir de résidus de chou-fleur, où ils ont également constaté que les résidus placés en surface émettaient des flux cumulé d'ammoniac plus élevé que les résidus mélangés ou labourés. Pour les émissions d'oxyde nitreux, plusieurs études concluent que dans une méthode conventionnelle d'incorporation des résidus, les flux cumulés de N_2O sont plus élevés [Mutegei et al 2010, Yang et al 2019]. De toute évidence, si nous voulons vérifier correctement la contribution des résidus de culture et/ou des engrais verts au budget total d'oxyde nitreux et d'ammoniac de l'agriculture, il est crucial d'intégrer les informations sur le positionnement des résidus dans le sol et leurs effets sur ces émissions de gaz aux modèles existants de carbone et d'azote du sol. Disposer de toutes les données pour optimiser correctement un modèle d'azote du sol est un processus compliqué. Dans nos expérimentations, nous n'avons mesuré que les échanges de N_2O , NH_3 , et CO_2 et les concentration d' NH_4^+ et d' NO_3^- dans la solution du sol. Un facteur déterminant pour les émissions d'oxyde nitreux, comme mentionné dans les chapitres 2 et 3, est également la population et la diversité microbienne. Des mesures du pH et de la teneur en oxygène dans les microsites du sol auraient donné une image plus claire des mécanismes du cycle de l'azote qui sous-tendent ces émissions gazeuses provenant de la décomposition des résidus de culture dans les sols. Un autre aspect important à étudier en détail est l'influence du contact microbien avec la matière organique et de sa décomposition, entraînant des émissions d'oxyde nitreux et d'ammoniac. Cela permettra non seulement d'améliorer les estimations de ces émissions gazeuses, mais aussi de consolider les hypothèses largement utilisées à des fins de modélisation de ces gaz. Dans notre cas, nous avons essayé de coupler les équations de dénitrification des nitrifiants et de dénitrification anaérobie du modèle NOE au modèle CANTIS. Au pool d'ammonium de CANTIS, nous avons couplé l'équation de volatilisation du NH_3 de Sommer et al (2003). Nous avons fait cela parce que la plupart des modèles simulant

l'oxyde nitreux et l'ammoniac des systèmes agricoles avec des fumures organiques sont assez compliqués et lourds. CANTIS décrit de manière très détaillée la stabilisation et la formation de la matière organique du sol. NOE est un modèle empirique qui dépend fortement de la calibration à chaque type de sol en question. Idéalement, chaque constante de vitesse associée aux processus de dénitrification doit être déterminée expérimentalement pour chaque sol. Nous ne l'avons pas fait en raison des contraintes de temps, nous avons plutôt utilisé des valeurs de paramètres prédéterminées à partir d'expériences antérieures.

Conclusions et perspectives

Ces études consignent des informations nouvelles concernant les systèmes et méthodologies agricoles et leurs effets sur les émissions d'oxyde nitreux et d'ammoniac à partir du sol. Tout d'abord, lorsqu'on les examine annuellement sous l'angle de la rotation des cultures, l'agriculture conventionnelle et l'agroécologie affichent des performances similaires en ce qui concerne le bilan d'oxyde nitreux et d'ammoniac en général. Mais en regardant ces systèmes agricoles plus précisément au vue de leurs méthodologies, on observe des effets divers sur les émissions de N_2O et de NH_3 . Les effets des facteurs abiotiques tels que la météorologie, la physique et la chimie du sol sont décrits en détail, mais ils sont rarement contrôlés directement par l'intervention humaine. La chimie et la pédologie du sol peuvent très bien être modifiées par le travail du sol et l'introduction d'engrais, mais si l'agriculture de conservation est déployée, ces influences peuvent être réduites au minimum. Les engrais chimiques sont des acidifiants puissants du sol et leurs impacts sur le sol sont prononcés, et leur utilisation répandue les exclut de l'agriculture de conservation. Les engrais organiques sous forme de résidus de culture sont des engrais verts organiques efficaces et leur introduction dans le sol avec ou sans travail du sol fait partie intégrante de l'agroécologie. Avec la pression croissante exercée sur l'agriculture conventionnelle pour qu'elle se transforme en agriculture biologique à la lumière du changement climatique et du réchauffement de la planète, de plus en plus d'agriculteurs combinent l'incorporation des résidus de culture dans le sol. Il a déjà été prouvé que les résidus de culture riches en azote sont de meilleurs fertilisants que ceux qui en sont déficients. Notre étude vient s'ajouter à cette découverte et a révélé que c'est la position de l'incorporation des résidus de culture qui

a un impact sur les émissions de N_2O et de NH_3 . Lorsqu'ils sont placés en couches et/ou mélangés, les émissions de N_2O sont significativement plus élevées que lorsqu'ils sont placés à la surface du sol comme un paillis dans un scénario sans labour. De même, la minéralisation de NH_4^+ et de NO_3^- est plus élevée pour les résidus placés sous une couche de sol ou mélangés que lorsqu'ils sont placés en surface, ce qui rend le mélange et la mise en couches des résidus par le labour et le travail profond plus fertilisant pour le sol. Dans le cas des émissions de NH_3 , c'est le placement des résidus en surface qui entraîne des émissions d'ammoniac les plus importantes. Il s'agit donc d'un scénario difficile pour l'agriculteur qui doit adopter une pratique agricole qui rejette de l'ammoniac, un polluant atmosphérique, ou de l'oxyde nitreux, un gaz à effet de serre. Les résultats de nos expériences dans des conditions contrôlées suggèrent que si le sol est argileux et limoneux à fines particules, les flux d'oxyde nitreux ne sont pas aussi élevés dans les positions de résidus mélangés et en couches, ce qui donne une situation avec des émissions d'ammoniac négligeables et des émissions d'oxyde nitreux minimales. Un autre facteur qui joue un rôle dans la détermination de ces émissions gazeuses est la présence d'azote minéral dans le sol à un moment donné. Ainsi, si ces engrais organiques sont incorporés dans le sol pendant la phase de croissance de la phénologie des cultures, les émissions d'oxydes d'azote pourraient être encore moins importantes. D'autres études expérimentales en laboratoire sont donc nécessaires pour confirmer cette proposition en faveur d'un système agricole plus durable.

Une autre question importante qui déterminerait le choix de la méthodologie agricole pour est le rendement des cultures. Peu d'informations sont disponibles pour savoir si l'agroécologie est suffisante pour répondre à la demande alimentaire croissante de la population humaine sur terre. On peut même dire que la performance similaire de l'agriculture conventionnelle et de l'agroécologie sur le budget des émissions de N_2O et NH_3 de l'agriculture n'est pas une nouvelle très favorable à l'agroécologie dans ce scénario. Dans ces moments, il faut réaffirmer qu'une évaluation du cycle de vie complet du devenir de l'azote - à la fois dans l'agriculture conventionnelle sous la forme d'engrais chimiques et dans l'agroécologie sous la forme de fumier organique, est nécessaire pour une véritable intercomparaison sur leur durabilité et leur potentiel de réduction des émissions de gaz à effet de serre.

Par conséquent, davantage de données expérimentales sont nécessaires sur la possibilité de déployer les résidus de culture comme engrais organiques et sur les émissions d'oxyde nitreux et d'ammoniac qui en résultent, afin de mieux optimiser l'outil de modélisation que nous avons conçu par le biais d'un couplage de trois modèles différents. Bien que l'incorporation des résidus de culture soit une méthode d'agriculture respectueuse de l'environnement, davantage d'études expérimentales en laboratoire simulant des scénarios sur le terrain sont nécessaires sur des échelles de temps plus longues, de préférence une échelle annuelle, pour avoir une interprétation précise de leurs impacts environnementaux. Des mesures de la population microbienne du sol et de la biodiversité dans le cadre de ces expériences enrichiraient certainement la qualité des données à utiliser à des fins de modélisation pour améliorer la prévisibilité des émissions de gaz à effet de serre provenant de l'agriculture.

References

- Adair, E. Carol; Barbieri, Lindsay; Schiavone, Kevin; Darby, Heather M. (2019): Manure Application Decisions Impact Nitrous Oxide and Carbon Dioxide Emissions during Non-Growing Season Thaws. In *Soil Science Society of America Journal* 83 (1), pp. 163–172. DOI: 10.2136/sssaj2018.07.0248.
- Addison, S. L.; Smaill, S. J.; Garrett, L. G.; Wakelin, S. A. (2019): Effects of forest harvest and fertiliser amendment on soil biodiversity and function can persist for decades. In *Soil Biology and Biochemistry* 135, pp. 194–205. DOI: 10.1016/j.soilbio.2019.05.006.
- Ahmad, N. (Ed.) (1996): Nitrogen Economy in Tropical Soils. Proceedings of the International Symposium on Nitrogen Economy in Tropical Soils, held in Trinidad, W.I., January 9-14, 1994. Dordrecht: Springer Netherlands.
- Ai, Chao; Zhang, Meiling; Sun, Yuanyuan; Zhang, Liyu; Zeng, Li; Liu, Yao et al. (2020): Wheat rhizodeposition stimulates soil nitrous oxide emission and denitrifiers harboring the nosZ clade I gene. In *Soil Biology and Biochemistry* 143, p. 107738. DOI: 10.1016/j.soilbio.2020.107738.
- Akiyama, Hiroko; McTaggart, Iain P.; Ball, Bruce C.; Scott, Albert (2004): N₂O, NO, and NH₃ Emissions from Soil after the Application of Organic Fertilizers, Urea and Water. In *Water, Air, & Soil Pollution* 156 (1), pp. 113–129. DOI: 10.1023/b:wate.0000036800.20599.46.
- Akiyama, Hiroko; Yamamoto, Akinori; Uchida, Yoshitaka; Hoshino, Yuko Takada; Tago, Kanako; Wang, Yong; Hayatsu, Masahito (2020): Effect of low C/N crop residue input on N₂O, NO, and CH₄ fluxes from Andosol and Fluvisol fields. In *Science of The Total Environment* 713, p. 136677. DOI: 10.1016/j.scitotenv.2020.136677.
- Al-Kanani, T., and A. F. MacKenzie, Effect of tillage practices and hay straw on ammonia volatilization from nitrogen fertilizer solutions, *Can. J. Soil Sci.*, 72, 145–157, 1992

Allmaras, R. R.; Pikul, J. L.; Wilkins, D. E.; Kraft, J. M. (1988): A Method for Measuring Incorporated Crop Residue and Associated Soil Properties. In *Soil Science Society of America Journal* 52 (4), pp. 1128–1133. DOI:

10.2136/sssaj1988.03615995005200040044x.

Alloway, Brian J. (Ed.) (2008): *Micronutrient Deficiencies in Global Crop Production*. Dordrecht: Springer Netherlands.

Arya, Lalit M.; Paris, Jack F. (1981): A Physicoempirical Model to Predict the Soil Moisture Characteristic from Particle-Size Distribution and Bulk Density Data. In *Soil Science Society of America Journal* 45 (6), pp. 1023–1030. DOI:

10.2136/sssaj1981.03615995004500060004x.

Badagliacca, Giuseppe; Benitez, Emilio; Amato, Gaetano; Badalucco, Luigi; Giambalvo, Dario; Laudicina, Vito Armando; Ruisi, Paolo (2018): Long-term effects of contrasting tillage on soil organic carbon, nitrous oxide and ammonia emissions in a Mediterranean Vertisol under different crop sequences. In *The Science of the total environment* 619-620, pp. 18–27. DOI: 10.1016/j.scitotenv.2017.11.116.

Baetz U. Et al. Root exudates, the hidden part of plant defense. *Trends in Plant Science*. [Volume 19, Issue 2](#), February 2014, Pages 90-98

Baggs, E. M.; Chebii, J.; Ndufa, J. K. (2006): A short-term investigation of trace gas emissions following tillage and no-tillage of agroforestry residues in western Kenya. In *Soil and Tillage Research* 90 (1), pp. 69–76. DOI: 10.1016/j.still.2005.08.006.

Baggs, E. M.; Rees, R. M.; Smith, K. A.; Vinten, A.J.A. (2000): Nitrous oxide emission from soils after incorporating crop residues. In *Soil Use and Management* 16 (2), pp. 82–87. DOI: 10.1111/j.1475-2743.2000.tb00179.x.

Bailey, Rebecca R.; Butts, Thomas R.; Lauer, Joseph G.; Laboski, Carrie A. M.; Kucharik, Christopher J.; Davis, Vince M. (2015): Effect of Weed Management Strategy and Row Width on Nitrous Oxide Emissions in Soybean. In *Weed sci.* 63 (4), pp. 962–971. DOI: 10.1614/WS-D-15-00010.1.

Balaine, Nimlesh; Clough, Tim J.; Beare, Mike H.; Thomas, Steve M.; Meenken, Esther D.; Ross, James G. (2013): Changes in Relative Gas Diffusivity Explain Soil Nitrous Oxide Flux Dynamics. In *Soil Science Society of America Journal* 77 (5), pp. 1496–1505. DOI: 10.2136/sssaj2013.04.0141.

Ball, Bruce C.; Griffiths, Bryan S.; Topp, Cairstiona F.E.; Wheatley, Ron; Walker, Robin L.; Rees, Robert M. et al. (2014): Seasonal nitrous oxide emissions from field soils under reduced tillage, compost application or organic farming. In *Agriculture, Ecosystems & Environment* 189, pp. 171–180. DOI: 10.1016/j.agee.2014.03.038.

Barton, L.; Gleeson, D. B.; Maccarone, L. D.; Zúñiga, L. P.; Murphy, D. V. (2013): Is liming soil a strategy for mitigating nitrous oxide emissions from semi-arid soils? In *Soil Biology and Biochemistry* 62, pp. 28–35. DOI: 10.1016/j.soilbio.2013.02.014.

BARTON, LOUISE; KIESE, RALF; GATTER, DAVID; BUTTERBACH-BAHL, KLAUS; BUCK, RENEE; HINZ, CHRISTOPH; MURPHY, DANIEL V. (2008): Nitrous oxide emissions from a cropped soil in a semi-arid climate. In *Global Change Biology* 14 (1), pp. 177–192. DOI: 10.1111/j.1365-2486.2007.01474.x.

Bergström, L.; Kirchmann, H. (Eds.) (2009): Organic crop production. Ambitions and limitations. Dordrecht, London: Springer.

Bijl, David L.; Bogaart, Patrick W.; Dekker, Stefan C.; Stehfest, Elke; Vries, Bert J.M. de; van Vuuren, Detlef P. (2017): A physically-based model of long-term food demand. In *Global Environmental Change* 45, pp. 47–62. DOI: 10.1016/j.gloenvcha.2017.04.003.

Bilalis, Dimitrios; Papastylianou, Panayiota; Konstantas, Aristidis; Patsiali, Sotiria; Karkanis, Anestis; Efthimiadou, Aspasia (2010): Weed-suppressive effects of maize–legume intercropping in organic farming. In *International Journal of Pest Management* 56 (2), pp. 173–181. DOI: 10.1080/09670870903304471.

Boer, W. de; Gunnewiek, P. J. A. Klein; Veenhuis, M.; Bock, E.; Laanbroek, H. J. (1991): Nitrification at Low pH by Aggregated Chemolithotrophic Bacteria. In *Applied and Environmental Microbiology* 57 (12), p. 3600.

Boer, W. de; Kowalchuk, G.A (2001): Nitrification in acid soils: micro-organisms and mechanisms. In *Soil Biology and Biochemistry* 33 (7-8), pp. 853–866. DOI: 10.1016/S0038-0717(00)00247-9.

Boer, W. de; Kowalchuk, G.A (2001): Nitrification in acid soils: micro-organisms and mechanisms. In *Soil Biology and Biochemistry* 33 (7), pp. 853–866. DOI: 10.1016/S0038-0717(00)00247-9.

Bonfante, P. et al. Plants, Mycorrhizal Fungi, and Bacteria: A Network of Interactions. *Annu. Rev. Microbiol.* 2009. 63:363–83

Bourdin, F.; Sakrabani, R.; Kibblewhite, M. G.; Lanigan, G. J. (2014): Effect of slurry dry matter content, application technique and timing on emissions of ammonia and greenhouse gas from cattle slurry applied to grassland soils in Ireland. In *Agriculture, Ecosystems & Environment* 188, pp. 122–133. DOI: 10.1016/j.agee.2014.02.025.

Brandsæter, Lars Olav; Mangerud, Kjell; Andersson, Lars; Børresen, Trond; Brodal, Guro; Melander, Bo (2020): Influence of mechanical weeding and fertilisation on perennial weeds, fungal diseases, soil structure and crop yield in organic spring cereals. In *Acta Agriculturae Scandinavica, Section B — Soil & Plant Science* 70 (4), pp. 318–332. DOI: 10.1080/09064710.2020.1728371.

Bremner, J. M. (1996): Recent research on problems in the use of urea as a nitrogen fertilizer. In N. Ahmad (Ed.): *Nitrogen Economy in Tropical Soils*. Proceedings of the International Symposium on Nitrogen Economy in Tropical Soils, held in Trinidad, W.I., January 9-14, 1994. Dordrecht: Springer Netherlands, pp. 321–329.

Briar, Shabeg S.; Wichman, David; Reddy, Gadi V.P. (2016): Plant-Parasitic Nematode Problems in Organic Agriculture. In Dilip Nandwani (Ed.): *Organic Farming for Sustainable Agriculture*. 1st ed. 2016. Cham: Springer International Publishing (Sustainable Development and Biodiversity, 9), pp. 107–122.

Butterbach-Bahl, Klaus; Baggs, Elizabeth M.; Dannenmann, Michael; Kiese, Ralf; Zechmeister-Boltenstern, Sophie (2013): Nitrous oxide emissions from soils: how well do we understand the processes and their controls? In *Philosophical Transactions of the*

Royal Society B: Biological Sciences 368 (1621), p. 20130122. DOI: 10.1098/rstb.2013.0122.

Canarini, Alberto; Dijkstra, Feike A. (2015): Dry-rewetting cycles regulate wheat carbon rhizodeposition, stabilization and nitrogen cycling. In *Soil Biology and Biochemistry* 81, pp. 195–203. DOI: 10.1016/j.soilbio.2014.11.014.

Canfield, Donald E.; Glazer, Alexander N.; Falkowski, Paul G. (2010): The evolution and future of Earth's nitrogen cycle. In *Science* 330 (6001), pp. 192–196. DOI: 10.1126/science.1186120.

Chen, Huaihai; Li, Xuechao; Hu, Feng; Shi, Wei (2013): Soil nitrous oxide emissions following crop residue addition: a meta-analysis. In *Glob Change Biol* 19 (10), pp. 2956–2964. DOI: 10.1111/gcb.12274.

Cleemput, Oswald; Samater, Abdullahi H. (1995): Nitrite in soils: accumulation and role in the formation of gaseous N compounds. In *Fertilizer Research* 45 (1), pp. 81–89. DOI: 10.1007/BF00749884.

Coppens, F.; Garnier, P.; Gryze, S. de; Merckx, R.; Recous, S. (2006): Soil moisture, carbon and nitrogen dynamics following incorporation and surface application of labelled crop residues in soil columns. In *European Journal of Soil Science* 57 (6), pp. 894–905. DOI: 10.1111/j.1365-2389.2006.00783.x.

Coppens, Filip; Garnier, Patricia; Findeling, Antoine; Merckx, Roel; Recous, Sylvie (2007): Decomposition of mulched versus incorporated crop residues: Modelling with PASTIS clarifies interactions between residue quality and location. In *Soil Biology and Biochemistry* 39 (9), pp. 2339–2350. DOI: 10.1016/j.soilbio.2007.04.005.

Cowan, Nicholas; Levy, Peter; Moring, Andrea; Simmons, Ivan; Bache, Colin; Stephens, Amy et al. (2019): Nitrogen use efficiency and N₂O and NH₃ losses attributed to three fertiliser types applied to an intensively managed silage crop. In *Biogeosciences* 16 (23), pp. 4731–4745. DOI: 10.5194/bg-16-4731-2019.

Craine, Joseph M.; Morrow, Carl; Fierer, Noah (2007): Microbial nitrogen limitation increases decomposition. In *Ecology* 88 (8), pp. 2105–2113. DOI: 10.1890/06-1847.1.

Dalal, R. C.; Allen, D. E.; Wang, W. J.; Reeves, S.; Gibson, I. (2011): Organic carbon and total nitrogen stocks in a Vertisol following 40 years of no-tillage, crop residue retention and nitrogen fertilisation. In *Soil and Tillage Research* 112 (2), pp. 133–139. DOI: 10.1016/j.still.2010.12.006.

Damon, Paul M.; Bowden, Bill; Rose, Terry; Rengel, Zed (2014): Crop residue contributions to phosphorus pools in agricultural soils: A review. In *Soil Biology and Biochemistry* 74, pp. 127–137. DOI: 10.1016/j.soilbio.2014.03.003.

David, M.; Loubet, B.; Cellier, P.; Mattsson, M.; Schjoerring, J. K.; Nemitz, E. et al. (2009): Ammonia sources and sinks in an intensively managed grassland canopy. In *Biogeosciences* 6 (9), pp. 1903–1915. DOI: 10.5194/bg-6-1903-2009.

Delon, C., Galy-Lacaux, C., Serça, D., Loubet, B., Camara, N., Gardrat, E., Saneh, I., Fensholt, R., Tagesson, T., Le Dantec, V., Sambou, B., Diop, C., and Mougin, E.: Soil and vegetation atmosphere exchange of NO, NH₃, and N₂O from field measurements in a semi-arid grazed ecosystem in Senegal, *Atmos. Environ.*, 156, 36–51, 2017.

Di Scotto Perta, Ester; Fiorentino, Nunzio; Carozzi, Marco; Cervelli, Elena; Pindozi, Stefania (2020): A Review of Chamber and Micrometeorological Methods to Quantify NH₃ Emissions from Fertilisers Field Application. In *International Journal of Agronomy* 2020, pp. 1–16. DOI: 10.1155/2020/8909784.

Dörr, Helmut; Katruff, Luisa; Levin, Ingeborg (1993): Soil texture parameterization of the methane uptake in aerated soils. In *Chemosphere* 26 (1), pp. 697–713. DOI: 10.1016/0045-6535(93)90454-D.

Drury, C. F.; Reynolds, W. D.; Tan, C. S.; Welacky, T. W.; Calder, W.; McLaughlin, N. B. (2006): Emissions of Nitrous Oxide and Carbon Dioxide. In *Soil Sci. Soc. Am. J.* 70 (2), pp. 570–581. DOI: 10.2136/sssaj2005.0042.

Duncan, E. W.; Dell, C. J.; Kleinman, P. J. A.; Beegle, D. B. (2017): Nitrous Oxide and Ammonia Emissions from Injected and Broadcast-Applied Dairy Slurry. In *Journal of Environmental Quality* 46 (1), pp. 36–44. DOI: 10.2134/jeq2016.05.0171.

Engelman, Robert (2012): Nine Population Strategies to Stop Short of 9 Billion. In Linda Stark (Ed.): State of the world 2012. Moving toward sustainable prosperity : a Worldwatch Institute Report on progress toward a sustainable Society. Washington: Island Press, pp. 121–128.

Entz, M. H.; Fowler, D. B. (1991): Agronomic Performance of Winter versus Spring Wheat. In *Agron.j.* 83 (3), pp. 527–532. DOI: 10.2134/agronj1991.00021962008300030002x.

Eriksen, J.; Murphy, M. D.; Schnug, E. (1998): The Soil Sulphur Cycle. In Ewald Schnug (Ed.): Sulphur in Agroecosystems. Dordrecht: Springer Netherlands, pp. 39–73.

Fangueiro, David; Pereira, José L. S.; Fraga, Irene; Surgy, Sónia; Vasconcelos, Ernesto; Coutinho, João (2018): Dataset on ammonia, nitrous oxide, methane, and carbon dioxide fluxes from two soils fertilized amended with treated and non-treated cattle slurry. In *Data in Brief* 21, pp. 1558–1567. DOI: 10.1016/j.dib.2018.10.124.

Fernandez, Adria L.; Sheaffer, Craig C.; Wyse, Donald L.; Staley, Christopher; Gould, Trevor J.; Sadowsky, Michael J. (2016): Structure of bacterial communities in soil following cover crop and organic fertilizer incorporation. In *Appl Microbiol Biotechnol* 100 (21), pp. 9331–9341. DOI: 10.1007/s00253-016-7736-9.

Fertilizer 101: The Big 3 - Nitrogen, Phosphorus and Potassium (2014). Available online at <https://www.tfi.org/the-feed/fertilizer-101-big-3-nitrogen-phosphorus-and-potassium>, updated on 10/31/2016, checked on 2/1/2021.

Figueiredo, Cícero Célio de; Oliveira, Alexsandra Duarte de; dos Santos, Isis Lima; Ferreira, Eloisa Aparecida Belleza; Malaquias, Juaci Vitoria; Sá, Marcos Aurélio Carolino de et al. (2018): Relationships between soil organic matter pools and nitrous oxide emissions of agroecosystems in the Brazilian Cerrado. In *Science of The Total Environment* 618, pp. 1572–1582. DOI: 10.1016/j.scitotenv.2017.09.333.

Filippelli, G. M. (2008): The Global Phosphorus Cycle: Past, Present, and Future. In *Elements* 4 (2), pp. 89–95. DOI: 10.2113/GSELEMENTS.4.2.89.

Fink, Susan L.; Cookson, Brad T. (2005): Apoptosis, pyroptosis, and necrosis: mechanistic description of dead and dying eukaryotic cells. In *Infection and Immunity* 73 (4), pp. 1907–1916. DOI: 10.1128/IAI.73.4.1907-1916.2005.

Flechard, C. R., Massad, R.-S., Loubet, B., Personne, E., Simpson, D., Bash, J. O., Cooter, E. J., Nemitz, E., and Sutton, M. A.: Advances in understanding, models and parameterizations of biosphere-atmosphere ammonia exchange, *Biogeosciences*, 10, 5183–5225, <https://doi.org/10.5194/bg-10-5183-2013>, 2013.

Flura, D., Masson, S., Fanucci, O., Autret, H., Lecuyer, V., Décuq, C., Générumont, S.. (2014). Characterizing ammonia volatilization from fertilized soils and organic manure applied in the field: a laboratory volatilization set-up. Open Science Conference Integreting impacts of air pollution and climate change on ecosystems, Budapest (Hongrie), 01-03/10/2014, (poster)

Fowler, D. et al. The global nitrogen cycle in the twenty-first century. *Philos. Trans. R. Soc. B-Biol. Sci.* 368, doi:10.1098/rstb.2013.0164 (2013).

Freeman, B C. et al. An Overview of Plant Defenses against Pathogens and Herbivores. *Plant Health Instructor*. 2008

Frimpong, K. A.; Yawson, D. O.; Baggs, E. M.; Agyarko, Kofi (2011): Does incorporation of cowpea-maize residue mixes influence nitrous oxide emission and mineral nitrogen release in a tropical luvisol? In *Nutrient Cycling in Agroecosystems* 91 (3), pp. 281–292. DOI: 10.1007/s10705-011-9461-1.

Fukuda, Y.; Moller, H.; Burns, B. (2011): Effects of organic farming, fencing and vegetation origin on spiders and beetles within shelterbelts on dairy farms. In *New Zealand Journal of Agricultural Research* 54 (3), pp. 155–176. DOI: 10.1080/00288233.2011.591402.

Gaillard, Richard; Duval, Benjamin D.; Osterholz, William R.; Kucharik, Christopher J. (2016): Simulated Effects of Soil Texture on Nitrous Oxide Emission Factors from Corn and Soybean Agroecosystems in Wisconsin. In *J. Environ. Qual.* 45 (5), pp. 1540–1548. DOI: 10.2134/jeq2016.03.0112.

Gaillard, V.; Chenu, C.; Recous, S.; Richard, G. (1999): Carbon, nitrogen and microbial gradients induced by plant residues decomposing in soil. In *European Journal of Soil Science* 50 (4), pp. 567–578. DOI: 10.1046/j.1365-2389.1999.00266.x.

Garnier, P.; Néel, C.; Aita, C.; Recous, S.; Lafolie, F.; Mary, B. (2003): Modelling carbon and nitrogen dynamics in a bare soil with and without straw incorporation. In *European Journal of Soil Science* 54 (3), pp. 555–568. DOI: 10.1046/j.1365-2389.2003.00499.x.

Garnier, P.; Néel, C.; Mary, B.; Lafolie, F. (2001): Evaluation of a nitrogen transport and transformation model in a bare soil. In *European Journal of Soil Science* 52 (2), pp. 253–268. DOI: 10.1046/j.1365-2389.2001.00374.x.

Garrido, F.; Hénault, C.; Gaillard, H.; Pérez, S.; Germon, J.C (2002): N₂O and NO emissions by agricultural soils with low hydraulic potentials. In *Soil Biology and Biochemistry* 34 (5), pp. 559–575. DOI: 10.1016/s0038-0717(01)00172-9.

Genermont, S.; Cellier, P.; Flura, D.; Morvan, T.; Laville, P. (1998): Measuring ammonia fluxes after slurry spreading under actual field conditions. In *Atmospheric Environment* 32 (3), pp. 279–284. DOI: 10.1016/S1352-2310(97)00007-1.

Giltrap, Donna L.; Li, Changsheng; Saggarr, Surinder (2010): DNDC: A process-based model of greenhouse gas fluxes from agricultural soils. In *Agriculture, Ecosystems & Environment* 136 (3-4), pp. 292–300. DOI: 10.1016/j.agee.2009.06.014.

Gomiero, T.; Paoletti, M. G.; Pimentel, D. (2008): Energy and Environmental Issues in Organic and Conventional Agriculture. In *Critical Reviews in Plant Sciences* 27 (4), pp. 239–254. DOI: 10.1080/07352680802225456.

Gotosa, Jephita; Kodzwa, Jefline; Nyamangara, Justice; Gwenzi, Willis (2019): Effect of Nitrogen Fertiliser Application on Maize Yield Across Agro-Ecological Regions and Soil Types in Zimbabwe: A Meta-analysis Approach. In *Int. J. Plant Prod.* 13 (3), pp. 251–266. DOI: 10.1007/s42106-019-00045-9.

Griffis, Timothy J.; Chen, Zichong; Baker, John M.; Wood, Jeffrey D.; Millet, Dylan B.; Lee, Xuhui et al. (2017): Nitrous oxide emissions are enhanced in a warmer and wetter world. In *PNAS* 114 (45), pp. 12081–12085. DOI: 10.1073/pnas.1704552114.

Hajdinjak, Mateja; Fu, Qiaomei; Hübner, Alexander; Petr, Martin; Mafessoni, Fabrizio; Grote, Steffi et al. (2018): Reconstructing the genetic history of late Neanderthals. In *Nature* 555 (7698), pp. 652–656. DOI: 10.1038/nature26151.

Han, Z., Walter, M. Todd, & Drinkwater, L. E. (2017). N₂O emissions from grain cropping systems: a meta-analysis of the impacts of fertilizer-based and ecologically-based nutrient management strategies. *Nutrient cycling in agroecosystems*, 107, 335-355. doi: 10.1007/s10705-017-9836-z.

Hauck, R. D. (1981): NITROGEN FERTILIZER EFFECTS ON NITROGEN CYCLE PROCESSES. In *Ecological Bulletins* (33), pp. 551–562. Available online at <http://www.jstor.org/stable/45128688>.

He, P. J.; Shao, L. M.; Guo, H. D.; Li, G. J.; Lee, D. J. (2006): Nitrogen removal from recycled landfill leachate by ex situ nitrification and in situ denitrification. In *Waste Management* 26 (8), pp. 838–845. DOI: 10.1016/j.wasman.2005.11.014.

Hénault, C.; Germon, J. C. (2000): NEMIS, a predictive model of denitrification on the field scale. In *European Journal of Soil Science* 51 (2), pp. 257–270. DOI: 10.1046/j.1365-2389.2000.00314.x.

Hénault, C.; Grossel, A.; Mary, B.; Roussel, M.; Léonard, J. (2012): Nitrous Oxide Emission by Agricultural Soils: A Review of Spatial and Temporal Variability for Mitigation. In *Pedosphere* 22 (4), pp. 426–433. DOI: 10.1016/S1002-0160(12)60029-0.

Hillel, Daniel (Ed.) (2005): *Encyclopedia of soils in the environment*. Amsterdam: Elsevier.

Huang, Y. et al. Nitrogen oxide emissions as influenced by amendment of plant residues with different C: N ratios. *Soil Biology and Biochemistry*. Volume 36, Issue 6, June 2004, Pages 973 - 981

Huang, Yao; Zou, Jianwen; Zheng, Xunhua; Wang, Yuesi; Xu, Xingkai (2004): Nitrous oxide emissions as influenced by amendment of plant residues with different C:N ratios. In *Soil Biology and Biochemistry* 36 (6), pp. 973–981. DOI:

10.1016/j.soilbio.2004.02.009.

Huijsmans, J.F.M.; Schils, R.L.M. (2009): Ammonia and nitrous oxide emissions following field-application of manure: state of the art measurements in the Netherlands. International Fertiliser Society. York (9780853102922).

Insam, Heribert; Seewald, Martin S. A. (2010): Volatile organic compounds (VOCs) in soils. In *Biol Fertil Soils* 46 (3), pp. 199–213. DOI: 10.1007/s00374-010-0442-3.

IPCC, 2014: *Climate Change 2014: Synthesis Report. Contribution of Working Groups I, II and III to the Fifth Assessment Report of the Intergovernmental Panel on Climate Change* [Core Writing Team, R.K. Pachauri and L.A. Meyer (eds.)]. IPCC, Geneva, Switzerland, 151 pp.

Iqbal, Akhtar; Aslam, Sohaib; Alavoine, Gonzague; Benoit, Pierre; Garnier, Patricia; Recous, Sylvie (2015): Rain regime and soil type affect the C and N dynamics in soil columns that are covered with mixed-species mulches. In *Plant and Soil* 393 (1-2), pp. 319–334. DOI: 10.1007/s11104-015-2501-x.

Iqbal, Akhtar; Garnier, Patricia; Lashermes, Gwenaëlle; Recous, Sylvie (2014): A new equation to simulate the contact between soil and maize residues of different sizes during their decomposition. In *Biol Fertil Soils* 50 (4), pp. 645–655. DOI: 10.1007/s00374-013-0876-5.

Jensen, Lars S.; Salo, Tapio; Palmason, Fridrik; Breland, Tor Arvid; Henriksen, Trond M.; Stenberg, Bo et al. (2005): Influence of biochemical quality on C and N mineralisation from a broad variety of plant materials in soil. In *Plant Soil* 273 (1-2), pp. 307–326. DOI: 10.1007/s11104-004-8128-y.

Jeuffroy, M. H.; Baranger, E.; Carrouée, B.; Chezelles, E. de; Gosme, M.; Hénault, C. et al. (2013): Nitrous oxide emissions from crop rotations including wheat, oilseed rape and dry peas. In *Biogeosciences* 10 (3), pp. 1787–1797. DOI: 10.5194/bg-10-1787-2013.

Joimel, Sophie; Cortet, Jérôme; Consalès, Jean Noël; Branchu, Philippe; Haudin, Claire-Sophie; Morel, Jean Louis; Schwartz, Christophe (2021): Contribution of chemical inputs on the trace elements concentrations of surface soils in urban allotment gardens. In *J Soils Sediments* 21 (1), pp. 328–337. DOI: 10.1007/s11368-020-02784-z.

Jungkunst, Hermann F.; Freibauer, Annette; Neufeldt, Henry; Bareth, Georg (2006): Nitrous oxide emissions from agricultural land use in Germany— a synthesis of available annual field data. In *J. Plant Nutr. Soil Sci.* 169 (3), pp. 341–351. DOI: 10.1002/jpln.200521954.

Kandel, Tanka P.; Gowda, Prasanna H.; Northup, Brian K.; Rocateli, Alexandre C. (2020): Winter wheat yield and nitrous oxide emissions in response to cowpea-based green manure and nitrogen fertilization. In *Ex. Agric.* 56 (2), pp. 239–254. DOI: 10.1017/S0014479719000334.

Keller, G. D., and D. B. Mengel, Ammonia volatilization from nitrogen fertilizers surface applied to no-till corn, *Soil Sci. Soc. Am. J.*, 50, 1060–1063, 1986.

Kertesz, Michael A.; Mirleau, Pascal (2004): The role of soil microbes in plant sulphur nutrition. In *J Exp Bot* 55 (404), pp. 1939–1945. DOI: 10.1093/jxb/erh176.

Kesenheimer, Katharina; Pandeya, Hemant Raj; Müller, Torsten; Buegger, Franz; Ruser, Reiner (2019): Nitrous oxide emissions after incorporation of winter oilseed rape (*Brassica napus* L.) residues under two different tillage treatments. In *J. Plant Nutr. Soil Sci.* 182 (1), pp. 48–59. DOI: 10.1002/jpln.201700507.

Khalil, M. I.; Baggs, E. M. (2005): CH₄ oxidation and N₂O emissions at varied soil water-filled pore spaces and headspace CH₄ concentrations. In *Soil Biology and Biochemistry* 37 (10), pp. 1785–1794. DOI: 10.1016/j.soilbio.2005.02.012.

Khanal, Ram Chandra (2009): Climate Change and Organic Agriculture. In 1 10, pp. 116–127. DOI: 10.3126/aej.v10i0.2136.

Kirchmann, Holger; Bergström, Lars; Kätterer, Thomas; Andrén, Olof; Andersson, Rune (2009): Can Organic Crop Production Feed the World? In L. Bergström, H. Kirchmann

(Eds.): Organic crop production. Ambitions and limitations. Dordrecht, London: Springer, pp. 39–72.

Klein, Cecile A. M. de; van der Weerden, Tony J.; Luo, Jiafa; Cameron, Keith C.; Di, Hong J. (2020): A review of plant options for mitigating nitrous oxide emissions from pasture-based systems. In *New Zealand Journal of Agricultural Research* 63 (1), pp. 29–43. DOI: 10.1080/00288233.2019.1614073.

Klepper, Lowell (1979): Nitric oxide (NO) and nitrogen dioxide (NO₂) emissions from herbicide-treated soybean plants. In *Atmospheric Environment (1967)* 13 (4), pp. 537–542. DOI: 10.1016/0004-6981(79)90148-3.

Kopáček, Jiří; Cosby, Bernard J.; Evans, Christopher D.; Hruška, Jakub; Moldan, Filip; Oulehle, Filip et al. (2013): Nitrogen, organic carbon and sulphur cycling in terrestrial ecosystems: linking nitrogen saturation to carbon limitation of soil microbial processes. In *Biogeochemistry* 115 (1-3), pp. 33–51. DOI: 10.1007/s10533-013-9892-7.

Kriauciūnienė, Zita; Čepulienė, Rita; Velička, Rimantas; Marcinkevičienė, Aušra; Lekavičienė, Kristina; Šarauskis, Egidijus (2018): Oilseed Rape Crop Residues: Decomposition, Properties and Allelopathic Effects. In Eric Lichtfouse (Ed.): Waste recycling and fertilisation. Cham, Switzerland: Springer (Sustainable agriculture reviews, volume 32), pp. 169–205.

Kuenen, J. Gijs (2008): Anammox bacteria: from discovery to application. In *Nature Reviews Microbiology* 6 (4), pp. 320–326. DOI: 10.1038/nrmicro1857.

Kulikova, N. A.; Zhelezova, A. D.; Voropanov, M. G.; Filippova, O. I.; Plyushchenko, I. V.; Rodin, I. A. (2020): Monoammonium Phosphate Effects on Glyphosate in Soils: Mobilization, Phytotoxicity, and Alteration of the Microbial Community. In *Eurasian Soil Sc.* 53 (6), pp. 787–797. DOI: 10.1134/S106422932006006X.

Kumar, Manoj; Trabelsi, Tarek; Francisco, Joseph S. (2018): Can Urea Be a Seed for Aerosol Particle Formation in Air? In *The journal of physical chemistry. A* 122 (12), pp. 3261–3269. DOI: 10.1021/acs.jpca.8b02189.

Ladd, J. N. et al. Changes in enzymatic activity and distribution of acid-soluble, amino acid nitrogen in soil during nitrogen immobilisation and mineralisation. *Soil Biology and Biogeochemistry*, Volume 5, 1973

Lehamann et al. The Contentious Nature of Soil Organic Matter. *Nature* volume 528, pages 60–68 (03 December 2015)

Li, Changsheng (1996): The DNDC Model. In David S. Powlson (Ed.): *Evaluation of Soil Organic Matter Models. Using Existing Long-Term Datasets*. Berlin, Heidelberg, 1996. *Advanced Research Workshop Evaluation of Soil Organic Matter Models Using Existing Long Term Datasets*. Berlin, Heidelberg: Springer Berlin Heidelberg (NATO ASI Series), pp. 263–267.

Lichtfouse, Eric (Ed.) (2018): *Waste recycling and fertilisation*. Cham, Switzerland: Springer (Sustainable agriculture reviews, volume 32).

Loick, Nadine; Dixon, Elizabeth; Abalos, Diego; Vallejo, Antonio; Matthews, Peter; McGeough, Karen et al. (2017): “Hot spots” of N and C impact nitric oxide, nitrous oxide and nitrogen gas emissions from a UK grassland soil. In *Geoderma* 305, pp. 336–345. DOI: 10.1016/j.geoderma.2017.06.007.

Long, Andrew; Heitman, Joshua; Tobias, Craig; Philips, Rebecca; Song, Bongkeun (2013): Co-Occurring Anammox, Denitrification, and Codenitrification in Agricultural Soils. In *Applied and Environmental Microbiology* 79 (1), p. 168. DOI: 10.1128/AEM.02520-12.

Lorenz, K.; Lal, R. (2016): Chapter Three - Environmental Impact of Organic Agriculture. In Donald L. Sparks (Ed.): *Advances in Agronomy*, vol. 139: Academic Press, pp. 99–152.

Lovanh, Nanh; Warren, Jason; Sistani, Karamat (2010): Determination of ammonia and greenhouse gas emissions from land application of swine slurry: A comparison of three application methods. In *Bioresource Technology* 101 (6), pp. 1662–1667. DOI: 10.1016/j.biortech.2009.09.078.

Luo, G. J.; Kiese, R.; Wolf, B.; Butterbach-Bahl, K. (2013): Effects of soil temperature and moisture on methane uptake and nitrous oxide emissions across three different

ecosystem types. In *Biogeosciences* 10 (5), pp. 3205–3219. DOI: 10.5194/bg-10-3205-2013.

M.G. Wagger; M.L. Cabrera; N.N. Ranells (1998): Nitrogen and carbon cycling in relation to cover crop residue quality. In *Journal of Soil and Water Conservation* 53 (3), pp. 214–218.

Maag, M.; Vinther, F.P (1996): Nitrous oxide emission by nitrification and denitrification in different soil types and at different soil moisture contents and temperatures. In *Applied Soil Ecology* 4 (1), pp. 5–14. DOI: 10.1016/0929-1393(96)00106-0.

Machado, Pedro Vitor Ferrari; Farrell, Richard E.; Deen, William; Voroney, R. Paul; Congreves, Katelyn A.; Wagner-Riddle, Claudia (2021): Contribution of crop residue, soil, and fertilizer nitrogen to nitrous oxide emissions varies with long-term crop rotation and tillage. In *The Science of the total environment* 767, p. 145107. DOI: 10.1016/j.scitotenv.2021.145107.

Madu Ali Bwala; Saliu Akinlabi Tihamiyu; Alhaji Yanda Kolo (2018): Analysis of land tillage practices and related problems among rice farmers in the tropic of sub-saharan Africa. In *1 16* (1), pp. 98–103.

Manzoni, Stefano; Porporato, Amilcare (2007): A theoretical analysis of nonlinearities and feedbacks in soil carbon and nitrogen cycles. In *Soil Biology and Biochemistry* 39 (7), pp. 1542–1556. DOI: 10.1016/j.soilbio.2007.01.006.

Massara, Theoni Maria; Solís, Borja; Guisasola, Albert; Katsou, Evina; Baeza, Juan Antonio (2018): Development of an ASM2d-N₂O model to describe nitrous oxide emissions in municipal WWTPs under dynamic conditions. In *Chemical Engineering Journal* 335, pp. 185–196. DOI: 10.1016/j.cej.2017.10.119.

Mathew, Reji P.; Feng, Yucheng; Githinji, Leonard; Ankumah, Ramble; Balkcom, Kipling S. (2012): Impact of No-Tillage and Conventional Tillage Systems on Soil Microbial Communities. In *Applied and Environmental Soil Science* 2012, pp. 1–10. DOI: 10.1155/2012/548620.

- Mazzetto, Andre M.; Styles, David; Gibbons, James; Arndt, Claudia; Misselbrook, T.; Chadwick, Dave (2020): Region-specific emission factors for Brazil increase the estimate of nitrous oxide emissions from nitrogen fertiliser application by 21%. In *Atmospheric Environment* 230, p. 117506. DOI: 10.1016/j.atmosenv.2020.117506.
- Mehnaz, Kazi R.; Corneo, Paola E.; Keitel, Claudia; Dijkstra, Feike A. (2019): Carbon and phosphorus addition effects on microbial carbon use efficiency, soil organic matter priming, gross nitrogen mineralization and nitrous oxide emission from soil. In *Soil Biology and Biochemistry* 134, pp. 175–186. DOI: 10.1016/j.soilbio.2019.04.003.
- Metivier, K. A.; Pattey, E.; Grant, R. F. (2009): Using the ecosys mathematical model to simulate temporal variability of nitrous oxide emissions from a fertilized agricultural soil. In *Soil Biology and Biochemistry* 41 (12), pp. 2370–2386. DOI: 10.1016/j.soilbio.2009.03.007.
- Metivier, K. A.; Pattey, E.; Grant, R. F. (2009): Using the ecosys mathematical model to simulate temporal variability of nitrous oxide emissions from a fertilized agricultural soil. In *Soil Biology and Biochemistry* 41 (12), pp. 2370–2386. DOI: 10.1016/j.soilbio.2009.03.007.
- Micucci, Federico G.; Taboada, Miguel A. (2006): Soil physical properties and soybean (*Glycine max*, Merrill) root abundance in conventionally- and zero-tilled soils in the humid Pampas of Argentina. In *Soil and Tillage Research* 86 (2), pp. 152–162. DOI: 10.1016/j.still.2005.02.004.
- Migliorini, Paola; Wezel, Alexander (2017): Converging and diverging principles and practices of organic agriculture regulations and agroecology. A review. In *Agron. Sustain. Dev.* 37 (6). DOI: 10.1007/s13593-017-0472-4.
- Miller, M. N.; Zebarth, B. J.; Dandie, C. E.; Burton, D. L.; Goyer, C.; Trevors, J. T. (2008): Crop residue influence on denitrification, N₂O emissions and denitrifier community abundance in soil. In *Soil Biology and Biochemistry* 40 (10), pp. 2553–2562. DOI: 10.1016/j.soilbio.2008.06.024.

Mkhabela, M. S.; Gordon, R.; Burton, D.; Madani, A.; Hart, W. (2006): Effect of lime, dicyandiamide and soil water content on ammonia and nitrous oxide emissions following application of liquid hog manure to a marshland soil. In *Plant Soil* 284 (1-2), pp. 351–361. DOI: 10.1007/s11104-006-0056-6.

Moldrup, Per; Olesen, Torben; Yoshikawa, Seiko; Komatsu, Toshiko; Rolston, Dennis E. (2004): Three-Porosity Model for Predicting the Gas Diffusion Coefficient in Undisturbed Soil. In *Soil Science Society of America Journal* 68 (3), pp. 750–759. DOI: 10.2136/sssaj2004.7500.

Mosier, A. R.; Delgado, J. A.; Keller, M. (1998): Methane and nitrous oxide fluxes in an acid Oxisol in western Puerto Rico: effects of tillage, liming and fertilization. In *Soil Biology and Biochemistry* 30 (14), pp. 2087–2098. DOI: 10.1016/S0038-0717(98)00085-6.

Mosier, A.; Schimel, D.; Valentine, D.; Bronson, K.; Parton, W. (1991): Methane and nitrous oxide fluxes in native, fertilized and cultivated grasslands. In *Nature* 350 (6316), pp. 330–332. DOI: 10.1038/350330a0.

Muhammad, Wisal; Vaughan, Sarah M.; Dalal, Ram C.; Menzies, Neal W. (2011): Crop residues and fertilizer nitrogen influence residue decomposition and nitrous oxide emission from a Vertisol. In *Biology and Fertility of Soils* 47 (1), pp. 15–23. DOI: 10.1007/s00374-010-0497-1.

Muhammad, Wisal; Vaughan, Sarah M.; Dalal, Ram C.; Menzies, Neal W. (2011): Crop residues and fertilizer nitrogen influence residue decomposition and nitrous oxide emission from a Vertisol. In *Biol Fertil Soils* 47 (1), pp. 15–23. DOI: 10.1007/s00374-010-0497-1.

Müller, Karolin; Marhan, Sven; Kandeler, Ellen; Poll, Christian (2017): Carbon flow from litter through soil microorganisms: From incorporation rates to mean residence times in bacteria and fungi. In *Soil Biology and Biochemistry* 115, pp. 187–196. DOI: 10.1016/j.soilbio.2017.08.017.

Mutegi, James K.; Munkholm, Lars J.; Petersen, Bjørn M.; Hansen, Elly M.; Petersen, Søren O. (2010): Nitrous oxide emissions and controls as influenced by tillage and crop residue management strategy. In *Soil Biology and Biochemistry* 42 (10), pp. 1701–1711. DOI: 10.1016/j.soilbio.2010.06.004.

Mutegi, James K.; Munkholm, Lars J.; Petersen, Bjørn M.; Hansen, Elly M.; Petersen, Søren O. (2010): Nitrous oxide emissions and controls as influenced by tillage and crop residue management strategy. In *Soil Biology and Biochemistry* 42 (10), pp. 1701–1711. DOI: 10.1016/j.soilbio.2010.06.004.

Nalewaja, John D.; Tadeusz Praczyk; Robert Matysiak (1998): Nitrogen Fertilizer, Oil, and Surfactant Adjuvants with Nicosulfuron. In *Weed Technology* 12 (4), pp. 585–589. Available online at <http://www.jstor.org/stable/3989074>.

Nandwani, Dilip (Ed.) (2016): *Organic Farming for Sustainable Agriculture*. 1st ed. 2016. Cham: Springer International Publishing (Sustainable Development and Biodiversity, 9).

Nebert, Lucas D.; Bloem, Jaap; Lubbers, Ingrid M.; van Groenigen, Jan Willem (2011): Association of Earthworm-Denitrifier Interactions with Increased Emission of Nitrous Oxide from Soil Mesocosms Amended with Crop Residue. In *Applied and Environmental Microbiology* 77 (12), p. 4097. DOI: 10.1128/AEM.00033-11.

Neff, Jason C.; Hooper, David U. (2002): Vegetation and climate controls on potential CO₂, DOC and DON production in northern latitude soils. In *Global Change Biology* 8 (9), pp. 872–884. DOI: 10.1046/j.1365-2486.2002.00517.x.

Nemitz, Eiko; Sutton, Mark A.; Gut, Andreas; San José, Roberto; Husted, Søren; Schjoerring, Jan K. (2000): Sources and sinks of ammonia within an oilseed rape canopy. In *Agricultural and Forest Meteorology* 105 (4), pp. 385–404. DOI: 10.1016/S0168-1923(00)00205-7.

Nett, Leif; Sradnick, André; Fuß, Roland; Flessa, Heinz; Fink, Matthias (2016): Emissions of nitrous oxide and ammonia after cauliflower harvest are influenced by soil type and crop residue management. In *Fertilizer Research* 106 (2), pp. 217–231. DOI: 10.1007/s10705-016-9801-2.

Nett, Leif; Sradnick, André; Fuß, Roland; Flessa, Heinz; Fink, Matthias (2016): Emissions of nitrous oxide and ammonia after cauliflower harvest are influenced by soil type and crop residue management. In *Nutrient Cycling in Agroecosystems* 106 (2), pp. 217–231. DOI: 10.1007/s10705-016-9801-2.

Nett, Leif; Sradnick, André; Fuß, Roland; Flessa, Heinz; Fink, Matthias (2016): Emissions of nitrous oxide and ammonia after cauliflower harvest are influenced by soil type and crop residue management. In *Nutr Cycl Agroecosyst* 106 (2), pp. 217–231. DOI: 10.1007/s10705-016-9801-2.

Nett, Leif; Sradnick, André; Fuß, Roland; Flessa, Heinz; Fink, Matthias (2016): Emissions of nitrous oxide and ammonia after cauliflower harvest are influenced by soil type and crop residue management. Springer. Available online at <https://link.springer.com/article/10.1007/s10705-016-9801-2>, updated on 3/25/2021, checked on 3/25/2021.

Nicol, Graeme W.; Leininger, Sven; Schleper, Christa; Prosser, James I. (2008): The influence of soil pH on the diversity, abundance and transcriptional activity of ammonia oxidizing archaea and bacteria. In *Environmental Microbiology* 10 (11), pp. 2966–2978. DOI: 10.1111/j.1462-2920.2008.01701.x.

Nitrogen fertilizer effects on nitrogen cycle processes (1981). Available online at <https://www.jstor.org/stable/45128688>.

Novoa, Rafael S.A.; Tejeda, Hernan R. (2006): Evaluation of the N₂O emissions from N in plant residues as affected by environmental and management factors. In *Nutrient Cycling in Agroecosystems* 75 (1), pp. 29–46. DOI: 10.1007/s10705-006-9009-y.

Oates, Lawrence G.; Duncan, David S.; Gelfand, Ilya; Millar, Neville; Robertson, G. Philip; Jackson, Randall D. (2016): Nitrous oxide emissions during establishment of eight alternative cellulosic bioenergy cropping systems in the North Central United States. In *GCB Bioenergy* 8 (3), pp. 539–549. DOI: 10.1111/gcbb.12268.

O'Callaghan, M.; Glare, T. R. (2001): Impacts of transgenic plants and microorganisms on soil biota. In *NZPP* 54, pp. 105–110. DOI: 10.30843/nzpp.2001.54.3725.

Oren, Aharon (2009): Chemolithotrophy: American Cancer Society (eLS).

Pacheco, L. C. P. S.; Damin, V.; Pelosi, A. P.; Ferreira, K. R. S.; Trivelin, P. C. O. (2017): Herbicides Increase Emission of Ammonia by Pearl Millet and Congo Grass. In *Agronomy Journal* 109 (4), pp. 1232–1239. DOI: 10.2134/agronj2016.04.0242.

Pagans, Estela; Barrena, Raquel; Font, Xavier; Sánchez, Antoni (2006): Ammonia emissions from the composting of different organic wastes. Dependency on process temperature. In *Chemosphere* 62 (9), pp. 1534–1542. DOI: 10.1016/j.chemosphere.2005.06.044.

Pappa, Valentini A.; Rees, Robert M.; Walker, Robin L.; Baddeley, John A.; Watson, Christine A. (2011): Nitrous oxide emissions and nitrate leaching in an arable rotation resulting from the presence of an intercrop. In *Agriculture, Ecosystems & Environment* 141 (1-2), pp. 153–161. DOI: 10.1016/j.agee.2011.02.025.

Parker, D. T. (1962): Decomposition in the Field of Buried and Surface-Applied Cornstalk Residue. In *Soil Science Society of America Journal* 26 (6), pp. 559–562. DOI: 10.2136/sssaj1962.03615995002600060014x.

Pattey, E.; Edwards, G. C.; Desjardins, R. L.; Pennock, D. J.; Smith, W.; Grant, B.; MacPherson, J. I. (2007): Tools for quantifying N₂O emissions from agroecosystems. In *Agricultural and Forest Meteorology* 142 (2-4), pp. 103–119. DOI: 10.1016/j.agrformet.2006.05.013.

Peigné, Joséphine; Casagrande, Marion; Payet, Vincent; David, Christophe; Sans, F. Xavier; Blanco-Moreno, José M. et al. (2016): How organic farmers practice conservation agriculture in Europe. In *Renew. Agric. Food Syst.* 31 (1), pp. 72–85. DOI: 10.1017/S1742170514000477.

Pelster, David E.; Chantigny, Martin H.; Rochette, Philippe; Angers, Denis A.; Rieux, Christine; Vanasse, Anne (2012): Nitrous Oxide Emissions Respond Differently to Mineral and Organic Nitrogen Sources in Contrasting Soil Types. In *J. Environ. Qual.* 41 (2), pp. 427–435. DOI: 10.2134/jeq2011.0261.

Personne, Erwan; Tardy, Florence; Générmont, Sophie; Decuq, Céline; Gueudet, Jean-Christophe; Mascher, Nicolas et al. (2015): Investigating sources and sinks for ammonia exchanges between the atmosphere and a wheat canopy following slurry application with trailing hose. In *Agricultural and Forest Meteorology* 207, pp. 11–23. DOI: 10.1016/j.agrformet.2015.03.002.

Pietikäinen, Janna; Pettersson, Marie; Bååth, Erland (2005): Comparison of temperature effects on soil respiration and bacterial and fungal growth rates. In *FEMS Microbiol Ecol* 52 (1), pp. 49–58. DOI: 10.1016/j.femsec.2004.10.002.

Powlson, David S. (Ed.) (1996): *Evaluation of Soil Organic Matter Models. Using Existing Long-Term Datasets*. Berlin, Heidelberg, 1996. Advanced Research Workshop Evaluation of Soil Organic Matter Models Using Existing Long Term Datasets. Berlin, Heidelberg: Springer Berlin Heidelberg (NATO ASI Series).

Prescott, Cindy E.; Reid, Anya; Wu, Shu Yao; Nilsson, Marie-Charlotte (2017): Decomposition rates of surface and buried forest-floor material. In *Canadian Journal of Forest Research* 47 (8), pp. 1140–1144. DOI: 10.1139/cjfr-2016-0533.

Principles and Practices of Soil Science, the soil as a natural resource (4th edition), R.E. White, 2013

Pugesgaard, Siri; Petersen, Søren O.; Chirinda, Ngonidzashe; Olesen, Jørgen E. (2017): Crop residues as driver for N₂O emissions from a sandy loam soil. In *Agricultural and Forest Meteorology* 233, pp. 45–54. DOI: 10.1016/j.agrformet.2016.11.007.

Qin, Hongling; Xing, Xiaoyi; Tang, Yafang; Hou, Haijun; Yang, Jie; Shen, Rong et al. (2019): Linking soil N₂O emissions with soil microbial community abundance and structure related to nitrogen cycle in two acid forest soils. In *Plant Soil* 435 (1-2), pp. 95–109. DOI: 10.1007/s11104-018-3863-7.

Rabot, E.; Cousin, I.; Hénault, C. (2015): A modeling approach of the relationship between nitrous oxide fluxes from soils and the water-filled pore space. In *Biogeochemistry* 122 (2-3), pp. 395–408. DOI: 10.1007/s10533-014-0048-1.

- Ravishankara, A. R.; Daniel, John S.; Portmann, Robert W. (2009): Nitrous Oxide (N_2O): The Dominant Ozone-Depleting Substance Emitted in the 21st Century. In *Science* 326 (5949), p. 123. DOI: 10.1126/science.1176985.
- Reicosky, D. C.; Wilts, A. R. (2005): CROP-RESIDUE MANAGEMENT. In Daniel Hillel (Ed.): *Encyclopedia of soils in the environment*. Amsterdam: Elsevier, pp. 334–338.
- Richardson, David; Felgate, Heather; Watmough, Nick; Thomson, Andrew; Baggs, Elizabeth (2009): Mitigating release of the potent greenhouse gas N_2O from the nitrogen cycle - could enzymic regulation hold the key? In *Trends in Biotechnology* 27 (7), pp. 388–397. DOI: 10.1016/j.tibtech.2009.03.009.
- Riggs, Charlotte E.; Hobbie, Sarah E. (2016): Mechanisms driving the soil organic matter decomposition response to nitrogen enrichment in grassland soils. In *Soil Biology and Biochemistry* 99, pp. 54–65. DOI: 10.1016/j.soilbio.2016.04.023.
- Rochette, Philippe (2008): No-till only increases N_2O emissions in poorly-aerated soils. In *Soil and Tillage Research* 101 (1), pp. 97–100. DOI: 10.1016/j.still.2008.07.011.
- Rochette, Philippe; Angers, Denis A.; Chantigny, Martin H.; Bertrand, Normand (2008): Nitrous Oxide Emissions Respond Differently to No-Till in a Loam and a Heavy Clay Soil. In *Soil Sci. Soc. Am. J.* 72 (5), pp. 1363–1369. DOI: 10.2136/sssaj2007.0371.
- Rochette, Philippe; Angers, Denis A.; Chantigny, Martin H.; Gasser, Marc-Olivier; MacDonald, J. Douglas; Pelster, David E.; Bertrand, Normand (2013): NH_3 volatilization, soil concentration and soil pH following subsurface banding of urea at increasing rates. In *Canadian Journal of Soil Science* 93 (2), pp. 261–268. DOI: 10.4141/cjss2012-095.
- Ruijter, F. J. de; Huijsmans, J.F.M. (2012): Ammonia emission from crop residues : quantification of ammonia volatilization based on crop residue properties. Plant Research International. Wageningen. Available online at <https://edepot.wur.nl/213704>.
- Ruijter, F. J. de; Huijsmans, J.F.M.; Rutgers, B. (2010): Ammonia volatilization from crop residues and frozen green manure crops. In *Atmospheric Environment* 44 (28), pp. 3362–3368. DOI: 10.1016/j.atmosenv.2010.06.019.

Rumpel, C., Amiraslani, F., Chenu, C. *et al.* The 4p1000 initiative: Opportunities, limitations and challenges for implementing soil organic carbon sequestration as a sustainable development strategy. *Ambio* 49, 350–360 (2020).

<https://doi.org/10.1007/s13280-019-01165-2>

Russenes, Aina Lundon; Korsæth, Audun; Bakken, Lars R.; Dörsch, Peter (2016): Spatial variation in soil pH controls off-season N₂O emission in an agricultural soil. In *Soil Biology and Biochemistry* 99, pp. 36–46. DOI: 10.1016/j.soilbio.2016.04.019.

Schils, R. L. M.; van Groenigen, J. W.; Velthof, G. L.; Kuikman, P. J. (2008): Nitrous oxide emissions from multiple combined applications of fertiliser and cattle slurry to grassland. In *Plant Soil* 310 (1-2), pp. 89–101. DOI: 10.1007/s11104-008-9632-2.

Schneider, Florian; Don, Axel; Hennings, Inga; Schmittmann, Oliver; Seidel, Sabine J. (2017): The effect of deep tillage on crop yield – What do we really know? In *Soil and Tillage Research* 174, pp. 193–204. DOI: 10.1016/j.still.2017.07.005.

Schnug, Ewald (Ed.) (1998): Sulphur in Agroecosystems. Dordrecht: Springer Netherlands.

Schulze, E.-D (Ed.) (2000): Carbon and nitrogen cycling in European forest ecosystems. Berlin: Springer (Ecological studies, 142).

Shah, Z.; Shah, S. H.; Peoples, M. B.; Schwenke, G. D.; Herridge, D. F. (2003): Crop residue and fertiliser N effects on nitrogen fixation and yields of legume–cereal rotations and soil organic fertility. In *Field Crops Research* 83 (1), pp. 1–11. DOI: 10.1016/s0378-4290(03)00005-4.

Shan, J. and Yan, X., 2013. Effects of crop residue returning on nitrous oxide emissions in agricultural soils. *Atmospheric Environment*, 71, pp.170-175.

Sheehy, Jatta; Six, Johan; Alakukku, Laura; Regina, Kristiina (2013): Fluxes of nitrous oxide in tilled and no-tilled boreal arable soils. In *Agriculture, Ecosystems & Environment* 164, pp. 190–199. DOI: 10.1016/j.agee.2012.10.007.

Shijia WANG; Daihua JIANG; Wenguo ZHU; Rongrong ZHANG; Junwei LI; Benhui WEI: Effect of Deep Vertical Rotary Tillage on Aggregate Structure in Farmland of Lateritic Red Soil. In *Acta Pedol Sin* 57 (2), pp. 326–335. DOI: 10.11766/trxb201902110023.

Simulation of C and N mineralisation during crop residue decomposition: a simple dynamic model based on the C: N ratio of the residues (2001). Available online at <https://link.springer.com/article/10.1023/a:1004813801728>.

Sinclair, Alex H.; Edwards, Anthony C. (2008): Micronutrient Deficiency Problems in Agricultural Crops in Europe. In Brian J. Alloway (Ed.): *Micronutrient Deficiencies in Global Crop Production*. Dordrecht: Springer Netherlands, pp. 225–244.

Singh, Jagrati; Kunhikrishnan, A.; Bolan, N. S.; Saggar, S. (2013): Impact of urease inhibitor on ammonia and nitrous oxide emissions from temperate pasture soil cores receiving urea fertilizer and cattle urine. In *Science of The Total Environment* 465, pp. 56–63. DOI: 10.1016/j.scitotenv.2013.02.018.

Six, J., Conant, R.T., Paul, E.A., Paustian K. (2002) Stabilization mechanisms of soil organic matter: implications for C-saturation of soils. *Plant and Soil* (2002) 241: 155

Skiba, U. M.; Rees, R. M. (2014): Nitrous oxide, climate change and agriculture. CAB Reviews. With assistance of FAO of the UN: CABI (CAB Reviews, 9). Available online at <http://sites.cabi.org/review/20143160036>.

Smith, J.; Gottschalk, P.; Bellarby, J.; Chapman, S.; Lilly, A.; Towers, W. et al. (2010): Estimating changes in Scottish soil carbon stocks using ECOSSE. I. Model description and uncertainties. In *Clim. Res.* 45, pp. 179–192. DOI: 10.3354/cr00899.

Smith, K.A; Thomson, P.E; Clayton, H.; Mctaggart, I.P; Conen, F. (1998): Effects of temperature, water content and nitrogen fertilisation on emissions of nitrous oxide by soils. In *Atmospheric Environment* 32 (19), pp. 3301–3309. DOI: 10.1016/S1352-2310(97)00492-5.

Smith, P., S.J. Davis, F. Creutzig, S. Fuss, J. Minx, B. Gabrielle, et al. 2016. Biophysical and economic limits to negative CO₂ emissions. *Nature Climate Change* 6: 42–50.

Sokolowski, Ana Clara; Prack McCormick, Barbara; Grazia, Javier de; Wolski, José E.; Rodríguez, Hernán A.; Rodríguez-Frers, Eric P. et al. (2020): Tillage and no-tillage effects on physical and chemical properties of an Argiaquoll soil under long-term crop rotation in Buenos Aires, Argentina. In *International Soil and Water Conservation Research* 8 (2), pp. 185–194. DOI: 10.1016/j.iswcr.2020.02.002.

Sommer, S. G.; Géniermont, S.; Cellier, P.; Hutchings, N. J.; Olesen, J. E.; Morvan, T. (2003): Processes controlling ammonia emission from livestock slurry in the field. In *European Journal of Agronomy* 19 (4), pp. 465–486. DOI: 10.1016/s1161-0301(03)00037-6.

Soussana, J. F.; Allard, V.; Pilegaard, K.; Ambus, P.; Amman, C.; Campbell, C. et al. (2007): Full accounting of the greenhouse gas (CO₂, N₂O, CH₄) budget of nine European grassland sites. In *Agriculture, Ecosystems & Environment* 121 (1-2), pp. 121–134. DOI: 10.1016/j.agee.2006.12.022.

Soussana, Jean-François; Lutfalla, Suzanne; Ehrhardt, Fiona; Rosenstock, Todd; Lamanna, Christine; Havlík, Petr et al. (2019): Matching policy and science: Rationale for the '4 per 1000 - soils for food security and climate' initiative. In *Soil and Tillage Research* 188, pp. 3–15. DOI: 10.1016/j.still.2017.12.002.

Sparks, Donald L. (Ed.) (2016): *Advances in Agronomy*: Academic Press.

Stabilization mechanisms of soil organic matter: implications for C-saturation of soils (2002). Available online at <https://link.springer.com/article/10.1023/a:1016125726789>.

Stark, Linda (Ed.) (2012): *State of the world 2012. Moving toward sustainable prosperity : a Worldwatch Institute Report on progress toward a sustainable Society*. Washington: Island Press.

Stefan Frank, P Havlik, JF Soussana (2017): Reducing greenhouse gas emissions in agriculture without compromising food security? *Environ. Res. Lett.* 12 105004.

Stehfest, Elke; Bouwman, Lex (2006): N₂O and NO emission from agricultural fields and soils under natural vegetation: summarizing available measurement data and modeling of global annual emissions. In *Nutrient Cycling in Agroecosystems* 74 (3), pp. 207–228. DOI: 10.1007/s10705-006-9000-7.

Stein, L. Y. Heterotrophic Nitrification and Nitrifier Denitrification. 2018

Stella, Tommaso; Mouratiadou, Ioanna; Gaiser, Thomas; Berg-Mohanicke, Michael; Wallor, Evelyn; Ewert, Frank; Nendel, Claas (2019): Estimating the contribution of crop residues to soil organic carbon conservation. In *Environ. Res. Lett.* 14 (9), p. 94008. DOI: 10.1088/1748-9326/ab395c.

Stewart, Catherine E.; Moturi, Pratibha; Follett, Ronald F.; Halvorson, Ardell D. (2015): Lignin biochemistry and soil N determine crop residue decomposition and soil priming. In *Biogeochemistry* 124 (1), pp. 335–351. DOI: 10.1007/s10533-015-0101-8.

Sutton, M. A.; Nemitz, E.; Theobald, M. R.; Milford, C.; Dorsey, J. R.; Gallagher, M. W. et al. (2009): Dynamics of ammonia exchange with cut grassland: strategy and implementation of the GRAMINAE Integrated Experiment. In *Biogeosciences* 6 (3), pp. 309–331. DOI: 10.5194/bg-6-309-2009.

Sutton, Mark A.; Oenema, Oene; Erisman, Jan Willem; Leip, Adrian; van Grinsven, Hans; Winiwarter, Wilfried (2011): Too much of a good thing. In *Nature* 472 (7342), pp. 159–161. DOI: 10.1038/472159a.

Sutton, Mark A.; Reis, Stefan; Baker, Samantha M. H. (Eds.) (2009): Atmospheric ammonia. Detecting emission changes and environmental impacts : results of an expert workshop under the Convention on Long-Range Transboundary Air Pollution. Dordrecht, London: Springer.

Tao, Rui; Wakelin, Steven A.; Liang, Yongchao; Hu, Baowei; Chu, Guixin (2018): Nitrous oxide emission and denitrifier communities in drip-irrigated calcareous soil as affected by chemical and organic fertilizers. In *The Science of the total environment* 612, pp. 739–749. DOI: 10.1016/j.scitotenv.2017.08.258.

Taylor, Marcus (2018): Climate-smart agriculture: what is it good for? In *The Journal of Peasant Studies* 45 (1), pp. 89–107. DOI: 10.1080/03066150.2017.1312355.

Thornton, P. E.; Doney, S. C.; Lindsay, K.; Moore, J. K.; Mahowald, N.; Randerson, J. T. et al. (2009): Carbon-nitrogen interactions regulate climate-carbon cycle feedbacks: results from an atmosphere-ocean general circulation model. In *Biogeosciences* 6 (10), pp. 2099–2120. DOI: 10.5194/bg-6-2099-2009.

Tian, Hanqin; Xu, Rongting; Canadell, Josep G.; Thompson, Rona L.; Winiwarter, Wilfried; Suntharalingam, Parvatha et al. (2020): A comprehensive quantification of global nitrous oxide sources and sinks. In *Nature* 586 (7828), pp. 248–256. DOI: 10.1038/s41586-020-2780-0.

Tillery, Bill W.; Enger, Eldon D.; Ross, Frederick C. (2007): *Integrated science*. 3rd ed. Boston: McGraw-Hill Higher Education. Available online at <https://cds.cern.ch/record/898304>.

Tourna, Maria; Freitag, Thomas E.; Nicol, Graeme W.; Prosser, James I. (2008): Growth, activity and temperature responses of ammonia-oxidizing archaea and bacteria in soil microcosms. In *Environmental Microbiology* 10 (5), pp. 1357–1364. DOI: 10.1111/j.1462-2920.2007.01563.x.

Trinsoutrot, I., Recous, S., Bentz, B., Linères, M., Chèneby, D. and Nicolardot, B. (2000), Biochemical Quality of Crop Residues and Carbon and Nitrogen Mineralization Kinetics under Nonlimiting Nitrogen Conditions. *Soil Sci. Soc. Am. J.*, 64: 918-926.

doi:[10.2136/sssaj2000.643918x](https://doi.org/10.2136/sssaj2000.643918x)

Trolldenier G. Et al. *Z. Pflanzenernaehr. Bodenk.* 144, 366-377 (1981)

Truong, Thi Hoang Ha; Marschner, Petra (2018): Respiration, available N and microbial biomass N in soil amended with mixes of organic materials differing in C/N ratio and decomposition stage. In *Geoderma* 319, pp. 167–174. DOI: 10.1016/j.geoderma.2018.01.012.

van den Heuvel, R. N.; Bakker, S. E.; Jetten, M. S. M.; Hefting, M. M. (2011): Decreased N₂O reduction by low soil pH causes high N₂O emissions in a riparian ecosystem. In *Geobiology* 9 (3), pp. 294–300. DOI: 10.1111/j.1472-4669.2011.00276.x.

van den Heuvel, R. N.; Bakker, S. E.; Jetten, M. S. M.; Hefting, M. M. (2011): Decreased N₂O Reduction By Low soil pH causes high N₂O emissions in a riparian ecosystem. In *Geobiology* 9 (3), pp. 294–300. DOI: 10.1111/j.1472-4669.2011.00276.x.

van der Eerden, L.J.M.; Visser, P.H.B. de; van Dijk, C. J. (1998): Risk of damage to crops in the direct neighbourhood of ammonia sources. In *Environmental Pollution* 102 (1), pp. 49–53. DOI: 10.1016/s0269-7491(98)80014-6.

van Groenigen, J. W.; Kasper, G. J.; Velthof, G. L.; van den Pol-van Dasselaar, A.; Kuikman, P. J. (2004): Nitrous oxide emissions from silage maize fields under different mineral nitrogen fertilizer and slurry applications. In *Plant and Soil* 263 (1), pp. 101–111. DOI: 10.1023/B:PLSO.0000047729.43185.46.

Venterea, Rodney T.; Rolston, Dennis E. (2000): Nitric and nitrous oxide emissions following fertilizer application to agricultural soil: Biotic and abiotic mechanisms and kinetics. In *J. Geophys. Res.* 105 (D12), pp. 15117–15129. DOI: 10.1029/2000JD900025.

Verdi, Leonardo; Mancini, Marco; Ljubojevic, Mirjana; Orlandini, Simone; Dalla Marta, Anna (2016): Greenhouse gas and ammonia emissions from soil: the effect of organic matter and fertilisation method. In *1 11* (3), pp. 260–266. DOI: 10.4081/ija.2018.1124.

Viguria, Maialen; Sanz-Cobeña, Alberto; López, Diana María; Arriaga, Haritz; Merino, Pilar (2015): Ammonia and greenhouse gases emission from impermeable covered storage and land application of cattle slurry to bare soil. In *Agriculture, Ecosystems & Environment* 199, pp. 261–271. DOI: 10.1016/j.agee.2014.09.016.

Vilarrasa-Nogué, M.; Teira-Esmatges, M. R.; González-Llinàs, E.; Domingo-Olivé, F.; Villar, J. M. (2020): Ammonia volatilisation from pig slurry and ANS with DMPP applied to Westerwold ryegrass (*Lolium multiflorum* Lam., cv. Trinova) under Mediterranean

conditions. In *The Science of the total environment* 724, p. 137918. DOI:
10.1016/j.scitotenv.2020.137918.

Wagner, S. C. (2011) Biological Nitrogen Fixation. *Nature Education Knowledge* 3(10):15

Wagner-Riddle, C.; Thurtell, G. W.; Kidd, G. K.; Beauchamp, E. G.; Sweetman, R. (1997):
Estimates of nitrous oxide emissions from agricultural fields over 28 months. In *Can. J.
Soil. Sci.* 77 (2), pp. 135–144. DOI: 10.4141/S96-103.

Wagner-Riddle, Claudia; Congreves, Katelyn A.; Abalos, Diego; Berg, Aaron A.; Brown,
Shannon E.; Ambadan, Jaison Thomas et al. (2017): Globally important nitrous oxide
emissions from croplands induced by freeze–thaw cycles. In *Nature Geosci* 10 (4),
pp. 279–283. DOI: 10.1038/ngeo2907.

Walker, Travis S.; Bais, Harsh Pal; Grotewold, Erich; Vivanco, Jorge M. (2003): Root
exudation and rhizosphere biology. In *Plant Physiology* 132 (1), pp. 44–51. DOI:
10.1104/pp.102.019661.

Webb, J.; Thorman, R. E.; Fernanda-Aller, M.; Jackson, D. R. (2014): Emission factors
for ammonia and nitrous oxide emissions following immediate manure incorporation on
two contrasting soil types. In *Atmospheric Environment* 82, pp. 280–287. DOI:
10.1016/j.atmosenv.2013.10.043.

White, Robert E. (October 2005). [Principles and Practice of Soil Science: The Soil as a
Natural Resource](#) (4th ed.). Blackwell Publishing

Wrage-Mönnig, Nicole; Horn, Marcus A.; Well, Reinhard; Müller, Christoph; Velthof,
Gerard; Oenema, Oene (2018): The role of nitrifier denitrification in the production of
nitrous oxide revisited. In *Soil Biology and Biochemistry* 123, A3-A16. DOI:
10.1016/j.soilbio.2018.03.020.

Xia, L, Lam, SK, Wolf, B, Kiese, R, Chen, D, Butterbach-Bahl, K. Trade-offs between soil
carbon sequestration and reactive nitrogen losses under straw return in global
agroecosystems. *Glob Change
Biol.* 2018; 24: 5919– 5932. <https://doi.org/10.1111/gcb.14466>

Xia, L., Xia, Y., Ma, S., Wang, J., Wang, S., Zhou, W., and Yan, X.: Greenhouse gas

emissions and reactive nitrogen releases from rice production with simultaneous incorporation of wheat straw and nitrogen fertilizer, *Biogeosciences*, 13, 4569–4579, <https://doi.org/10.5194/bg-13-4569-2016>, 2016.

Yang, Tong; Li, Fengbo; Zhou, Xiyue; Xu, ChunChun; Feng, Jinfei; Fang, Fuping (2019): Impact of nitrogen fertilizer, greenhouse, and crop species on yield-scaled nitrous oxide emission from vegetable crops: A meta-analysis. In *Ecological Indicators* 105, pp. 717–726. DOI: 10.1016/j.ecolind.2019.02.001.

Yu, Yongxiang; Zhao, Chengyi; Zheng, Ningguo; Jia, Hongtao; Yao, Huaiying (2019): Interactive effects of soil texture and salinity on nitrous oxide emissions following crop residue amendment. In *Geoderma* 337, pp. 1146–1154. DOI: 10.1016/j.geoderma.2018.11.012.

Zhang X, Wang Q, Xu J, Gilliam FS, Tremblay N, Li C (2015) In Situ Nitrogen Mineralization, Nitrification, and Ammonia Volatilization in Maize Field Fertilized with Urea in Huanghuaihai Region of Northern China. *PLoS ONE* 10(1): e0115649. doi:10.1371/journal.pone.0115649

Zhang, Lu; Yan, Chengxi; Guo, Qing; Zhang, Junbiao; Ruiz-Menjivar, Jorge (2018): The impact of agricultural chemical inputs on environment: global evidence from informetrics analysis and visualization. In *Int J Low-Carbon Tech* 13 (4), pp. 338–352. DOI: 10.1093/ijlct/cty039.

Zhang, W. L.; Tian, Z. X.; Zhang, N.; Li, X. Q. (1996): Nitrate pollution of groundwater in northern China. In *Agriculture, Ecosystems & Environment* 59 (3), pp. 223–231. DOI: 10.1016/0167-8809(96)01052-3.

Zhao, Xin; Liu, Sheng-Li; Pu, Chao; Zhang, Xiang-Qian; Xue, Jian-Fu; Zhang, Ran et al. (2016): Methane and nitrous oxide emissions under no-till farming in China: a meta-analysis. In *Global Change Biology* 22 (4), pp. 1372–1384. DOI: 10.1111/gcb.13185.

Zhu, Qing; Castellano, Michael J.; Yang, Guishan (2018): Coupling soil water processes and the nitrogen cycle across spatial scales: Potentials, bottlenecks and solutions. In *Earth-Science Reviews* 187, pp. 248–258. DOI: 10.1016/j.earscirev.2018.10.005.

The cover page is designed by author and is subjected to copyright.

The manuscript is printed on 28 June 2021.

