



**HAL**  
open science

# Study and design of a new PHY/MAC Cross-Layer architecture for Wireless Sensor Networks Dedicated to Healthcare

Prasaja Wikanta

► **To cite this version:**

Prasaja Wikanta. Study and design of a new PHY/MAC Cross-Layer architecture for Wireless Sensor Networks Dedicated to Healthcare. Micro and nanotechnologies/Microelectronics. Université Polytechnique Hauts-de-France, 2021. English. NNT : 2021UPHF0014 . tel-03824930

**HAL Id: tel-03824930**

**<https://theses.hal.science/tel-03824930v1>**

Submitted on 21 Oct 2022

**HAL** is a multi-disciplinary open access archive for the deposit and dissemination of scientific research documents, whether they are published or not. The documents may come from teaching and research institutions in France or abroad, or from public or private research centers.

L'archive ouverte pluridisciplinaire **HAL**, est destinée au dépôt et à la diffusion de documents scientifiques de niveau recherche, publiés ou non, émanant des établissements d'enseignement et de recherche français ou étrangers, des laboratoires publics ou privés.



Thèse de doctorat

Pour obtenir le grade de Docteur Sciences et Technologie

UNIVERSITE POLYTECHNIQUE HAUTS-DE-FRANCE

Discipline, specialite selon la liste des specialites pour lesquelles l'Ecole Doctorale est accreditee:

**Electronique, Microelectronique et Nanotechnologie**

Présentée et soutenue par **Prasaja WIKANTA**

Le 25/03/2021, à Valenciennes

**Ecole doctorale:**

Sciences Pour l'Ingénieur (SPI)

**Equipe de recherche, Laboratoire:**

Laboratoire d'IEMN/DOAE

**Etude et conception d'une nouvelle architecture transversale  
PHY/MAC pour les réseaux de capteurs sans fils dédiés à la  
télémédecine**

**(Study and Design of a new PHY/MAC Cross-Layer Architecture  
for Wireless Sensor Networks Dedicated to Healthcare)**

**JURY :**

***Rapporteurs***

- M. Basuki Rachmatul ALAM - Professeur, Institut Teknologi Bandung  
M. Hongwu LI - Professeur, Université de Nantes (Président du jury)

***Examineurs:***

- Mme. Nji Raden POESPAWATI - Professeur Universitas Indonesia, Jakarta  
M. Rabah ATTIA - Professeur, Ecole Polytechnique de Tunis  
Mme. Lynda CHEHAMI - Maître de Conférence, UPHF, Valenciennes

***Directeur de Thèse:***

- M. Iyad DAYOUB - Professeur, UPHF, Valenciennes

***Co-Directeur:***

- M. El Hadj DOGHECHE - Professeur, UPHF, Valenciennes



Doctoral thesis

To obtain the degree of Doctor Science and Technology

UNIVERSITE POLYTECHNIQUE HAUTS-DE-FRANCE

Discipline, specialty according to the list of specialties for which the Doctoral School is accredited:

**Electronique, Microelectronique et Nanotechnologie**

Presented and defended by **Prasaja WIKANTA**

At 25/03/2021, in Valenciennes

**Doctoral School:**

Sciences for the Engineer (SPI)

**Research team, Laboratory:**

Laboratory of IEMN/DOAE

**Study and Design of a new PHY/MAC Cross-Layer Architecture**

**for Wireless Sensor Networks Dedicated to Healthcare**

**(Etude et conception d'une nouvelle architecture transversale**

**PHY/MAC pour les réseaux de capteurs sans fils dédiés à la**

**télémédecine)**

**JURY :**

***Reviewers***

Mr. Basuki Rachmatul ALAM - Professor, Institut Teknologi Bandung

Mr. Hongwu LI - Professor, Université de Nantes

***Examiners:***

Mrs. Nji Raden POESPAWATI - Professor Universitas Indonesia, Jakarta

Mr. Rabah ATTIA - Professor, Ecole Polytechnique de Tunis

Mrs. Lynda CHEHAMI - Associate Professor, UPHF, Valenciennes

***Supervisor:***

Mr. Iyad DAYOUB - Professor, UPHF, Valenciennes

***Co-Supervisor:***

Mr. El Hadj DOGHECHE - Professor, UPHF, Valenciennes

# Contents

<b>Acronyms</b>	<b>11</b>
<b>1 Introduction</b>	<b>15</b>
1.1 Healthcare and Telemedicine . . . . .	15
1.2 Wireless Sensors Network . . . . .	18
1.3 Internet of Things . . . . .	18
1.3.1 SmartHome . . . . .	19
1.3.2 SmartCity . . . . .	19
1.3.3 SmartGrid . . . . .	21
1.3.4 SmartFactory . . . . .	22
1.3.5 Healthcare . . . . .	23
1.4 Context and Motivation . . . . .	27
1.5 Contribution and Outline . . . . .	28
<b>2 Internet of Things</b>	<b>29</b>
2.1 Wireless Technologies for IoT . . . . .	29
2.1.1 802.15.4 ZigBee . . . . .	29
2.1.2 Bluetooth . . . . .	30
2.1.3 LoRA and SigFox . . . . .	32
2.1.4 802.11 WiFi . . . . .	35
2.1.5 802.15.6 WBAN . . . . .	37
2.1.6 802.11ah HaLow . . . . .	38
2.2 Summary . . . . .	48
<b>3 Challenge of IoT for Healthcare</b>	<b>51</b>
3.1 Introduction of Network Architecture of 802.11ah . . . . .	51
3.2 Data Security and Privacy . . . . .	53

3.3	Interoperability . . . . .	54
3.4	Impact of Body Pathloss on Wearable Sensor . . . . .	54
3.4.1	Body Pathloss Model . . . . .	54
3.4.2	Result and Discussion . . . . .	57
<b>4</b>	<b>PHY/MAC Cross-Layer Performance With the Aid of Beacon</b>	<b>61</b>
4.1	Cross-Layer Design and Analysis . . . . .	61
4.2	Packet Error Rate and Throughput of Body Pathloss . . . . .	67
4.2.1	Research About Effect of Body Pathloss . . . . .	67
4.2.2	PER Performance with PHY/MAC Cross-Layer: Analysis and Simulation	69
4.2.3	Throughput Performance with PHY/MAC Cross-Layer: Analysis and Simulation . . . . .	71
<b>5</b>	<b>Prototyping PHY/MAC Cross-Layer Devices</b>	<b>81</b>
5.1	SDR for Experimentation of 802.11ah . . . . .	81
5.1.1	USRP . . . . .	83
5.1.2	GnuRadio . . . . .	84
5.2	Data Flow and Data Format . . . . .	85
5.3	System Design and Programming . . . . .	88
5.3.1	MAC Cross-Layer Protocol Algorithm and Programming . . . . .	90
5.3.2	PHY Layer GnuRadio Programming . . . . .	98
5.3.3	Application Layer and Database Design . . . . .	100
5.4	Evaluation of Prototype . . . . .	100
<b>6</b>	<b>Conclusion</b>	<b>113</b>

# List of Figures

1.1	Smarthome diagram. . . . .	20
1.2	Smartcity diagram. . . . .	20
1.3	Smartgrid diagram. Photo by Portland General Electric / CC BY . . . . .	21
1.4	Market of IoT. . . . .	25
1.5	Cross Layer Architecture. . . . .	26
1.6	Territorial zones of Indonesia (Yellow: West, Green: Mid, Blue: East). . . . .	27
2.1	Topology of LR-WPAN. [1] . . . . .	30
2.2	LoRa and LoRaWAN Architecture [2]. . . . .	33
2.3	SigFox Architecture [3]. . . . .	34
2.4	IEEE 802.11 family. . . . .	36
2.5	Wireless Local Area Network. . . . .	38
2.6	Simplex Point to Point OFDM. . . . .	40
2.7	Subcarrier. . . . .	42
2.8	S1G_SHORT format. . . . .	43
2.9	S1G_LONG format. . . . .	44
2.10	S1G_1M format. . . . .	44
2.11	Frequencies of IEEE 802.11ah. . . . .	46
2.12	MAC format of IEEE 802.11ah. . . . .	47
2.13	Diagram System. . . . .	49
3.1	Mesh Topology. . . . .	52
3.2	Point to Point Topology. . . . .	52
3.3	Range of 802.11ah using outdoor pathloss. . . . .	56
3.4	Pathloss of outdoor model and body model. . . . .	58
3.5	Range of 802.11ah using outdoor pathloss and body pathloss. . . . .	59
4.1	Unit step approximation PER of fading channel model. . . . .	63

4.2	PER Performance of 802.11ah. . . . .	64
4.3	DCF Model. . . . .	65
4.4	Throughput vs Payload size for 802.11ah. . . . .	66
4.5	PER Performance of 802.11ah with body pathloss. . . . .	69
4.6	PER Analysis. . . . .	70
4.7	PER Analysis with $p_{body}$ 7%. . . . .	71
4.8	Curve of Throughput vs Distance. . . . .	72
4.9	Throughput Analysis. . . . .	73
4.10	PER Simulation for $p_{body} = 5\%$ . . . . .	74
4.11	Throughput Simulation for $p_{body} = 5\%$ . . . . .	75
4.12	PER Simulation for $p_{body} = 7\%$ . . . . .	76
4.13	Throughput Simulation for $p_{body} = 7\%$ . . . . .	77
4.14	PER Simulation for $p_{body} = 10\%$ . . . . .	78
4.15	Throughput Simulation for $p_{body} = 10\%$ . . . . .	79
5.1	Simple SDR illustration. . . . .	82
5.2	USR P B200, one of the product of Ettus. . . . .	83
5.3	Outdoor experiment. . . . .	84
5.4	Indoor experiment. . . . .	84
5.5	Interconnection of PHY layer and MAC layer. . . . .	85
5.6	Example of state of MAC layer buffer before transmission. . . . .	86
5.7	Data format for Analysis. . . . .	87
5.8	Configuration of Arduino with sensor. . . . .	89
5.9	Configuration of Arduino with sensor. . . . .	89
5.10	Structure table of Data Sensor. . . . .	90
5.11	Diagram of connection of web server and web client. . . . .	91
5.12	Algorithm of Server receiving request from web client. . . . .	91
5.13	Algorithm of original 802.11. . . . .	93
5.14	Cross Layer algorithm. . . . .	94
5.15	Example of state of MAC layer buffer after transmission. . . . .	95
5.16	Design of Transceiver in GNURadio. . . . .	96
5.17	Screen Capture of Wireshark. . . . .	99
5.18	Gnuradio 802.11ah Transmitter. . . . .	100
5.19	Gnuradio 802.11ah Receiver. . . . .	101
5.20	Constellation diagram of receiver. . . . .	102

5.21 Spectrum in 900 MHz. . . . .	103
5.22 Spectrum in 940 MHz. . . . .	103
5.23 Power measurement configuration. . . . .	104
5.24 Generate single tone signal with frequency 902.5MHz. . . . .	105
5.25 Spectrum of frequency 902.5MHz. . . . .	105
5.26 SNR as Function of Distance in Outdoor Measurement. . . . .	106
5.27 Packet Loss Ratio as Function of Distance in Outdoor Measurement. . . . .	107
5.28 Indoor experiment . . . . .	108
5.29 Illustration of Hallway Measurement . . . . .	109
5.30 Screenshot of interface to sensor. . . . .	111





# List of Tables

2.1	Bluetooth Frequency Channels. . . . .	31
2.2	IEEE 802.11ah Physical Layer Parameters . . . . .	41
2.3	IEEE 802.11ah Pilot Position . . . . .	43
2.4	S1G PPDU Field. . . . .	45
2.5	IEEE 802.11ah MCS for 2MHz Bandwidth Channels . . . . .	46
2.6	Comparison of 802.15.1, 802.15.4, 802.15.6 and 802.11ah. . . . .	48
4.1	Parameters used in simulation. . . . .	67
5.1	Outdoor Experiment Parameters . . . . .	104
5.2	Comparison temperature between database and serial monitoring. . . . .	110



# Acronyms

ACK	Acknowledge
ADC	Analog to Digital Converter
AID	Association Identifier
AP	Access Point
API	Application Programming Interface
BER	Bit Error Rate
BLE	Bluetooth Low Energy
BPSK	Binary Phase Shift Keying
BSS	Basic Service Set
BSSID	Basic Service Set Identifier
COFDM	Coded OFDM
COPD	Chronic Obstructive Pulmonary Disease
CP	Cyclic Prefix
CSMA/CA	Carrier Sense Multiple Access with Collision Avoidance
CSS	Chirp Spread Spectrum
CW	Contention Window
DA	Destination Address
DAC	Digital to Analog Converter
DC	Direct Current
DCF	Distributed Coordination Function
DFT	Discrete Fourier Transform
DIFS	DCF Interframe Spaces
DL MU-MIMO	Downlink Multi-User MIMO
DSP	Digital Signal Processing

DSSS	Direct-Sequence Spread Spectrum
ECG	Electrocardiogram
EEG	Electroencephalogram
EU	Europe Union
FCS	Frame Check Sequence
FEC	Forward Error Correction
FFD	Full-Function Device
FFT	Fast Fourier Transform
FHSS	Frequency Hopping Spread Spectrum
FIFO	First In First Out
FPGA	Field Programmable Gate Arrays
GI	Guard Interval
GMSK	Gaussian Minimum Shift Keying
GPP	General Purpose Processors
HRQoL	Health-related Quality of Life
HTTP	Hypertext Transfer Protocol
I/Q	Phase/Quadrature
IC	Integrated Circuit
ICI	Inter Carrier Interference
ICT	Information and Communications Technology
ICU	Intensive Care Unit
IDFT	Inverse Discrete Fourier Transform
IEEE	Institute of Electrical and Electronics Engineers
IoT	Internet of Things
IP	Internet Protocol
ISI	Inter Symbol Interference
ISM	Industrial, Scientific and Medical
JSON	JavaScript Object Notation
KEMDIKBUD	Indonesian Ministry for Education and Culture
KEMENRISTEK	Indonesian Ministry for Research and Technology

LAN	Local Area Network
LoS	Line of Sight
LPWAN	Low Power Wide Area Network
LR-WPAN	Low-Rate Wireless Personal Area Network
MAC	Medium Access Control
MAN	Metropolitan Area Networks
MCS	Modulation and Coding Schemes
MIMO	Multiple Input Multiple Output
MRI	Magnetic Resonance Imaging
MU	Multiple Users
NAV	Network Allocation Vector
NDP	Null Data Packet
NTP	Network Time Protocol
O-QPSK	Offset-Quadrature Phase Shift Keying
OFDM	Orthogonal Frequency Division Multiplexing
PC	Personal Computer
PDU	Protocol Data Unit
PER	Packet Error Rate
PHC	Partenariat Hubert Curien
PHY	Physical
PLR	Packet Loss Ratio
PPDU	Physical layer Protocol Data Unit
PSK	Phase Shift Keying
QoS	Quality of Services
QPSK	Quadrature Phase Shift Keying
RA	receiving STA address
RAW	Restricted Access Window
RF	Radio Frequency
RFD	Reduced-Function Device
RPS	RAW Parameter Set
RTS/CTS	Request To Send/Clear To Send
Rx	Receiver
SA	Source Address

SC	Sub Channel
SDR	Software Defined Radio
SER	Symbol Error Rate
SIFS	Short Interframe Spaces
SISO	Single Input Single Output
SNR	Signal to Noise Ratio
SoC	System on Chip
SQL	Standard Query Language
STA	station
SU	Single User
TA	transmitting STA address
TBTT	Target Beacon Transmission Time
TCP/IP	Transmission Control Protocol/Internet Protocol
TDOA	Time Difference of Arrival
TGah	IEEE 802.11ah Task Group
Tx	Transmitter
UDP	User Datagram Protocol
UHD	USRP Hardware Driver
UHF	Ultra High Frequency
USB	Universal Serial Bus
USG	Ultrasonography
USRP	Universal Software Radio Peripheral
VHF	Very High Frequency
VHT	Very High Throughput
WBAN	Wireless Body Area Network
WLAN	Wireless Local Area Network
WSN	Wireless Sensor Network

# Chapter 1

## Introduction

### 1.1 Healthcare and Telemedicine

Nowadays the demand for health is very high. All people are aware and proactive to know their health condition at any time. How can people manage their illness? By knowing the condition of his health, a person can know his illness earlier and take preventive measures. Especially for those who have chronic diseases, that need to be managed properly.

They need to check their health condition regularly and long-term treatment. If it is not managed, it will result in increased treatment costs. To be able to manage their illness, patients need to know their body condition, such as blood pressure, weight, body temperature, and so on. Self-evaluation of health is called Health-related Quality of Life (HRQoL).

HRQoL has been characterized as the assessment made by the individual with respect to their wellbeing and level of working in everyday exercises, including physical, mental, and social capacity; general view of wellbeing; movement; and emotional health. HRQoL has become a basic idea for thorough consideration of the patient with chronic diseases [4].

That management is classified as healthcare, although, Healthcare definition is very broad. All action to have good health is considered as healthcare, like prevention and diagnosis of disease, injury, or medication of illness. In this manuscript, we emphasize health monitoring as healthcare.

Measurement of the health conditions, ranging from the simplest such as measuring body weight, height, blood pressure, heart rate to more sophisticated devices like Electroencephalogram (EEG) or Magnetic Resonance Imaging (MRI) brain scanning, is generally done in clinics or hospitals. Patients could also do the medical checkup at that places. Though, for a medical checkup at the clinics or hospital, it needs an appointment and spends time on the trip, which



certainly feels grave for someone who is sick.

The development of technology allows us to easily know the condition of the body, using portable medical devices, which previously had to be operated by competent staff in the hospital. But sometimes, self-check-up requires a cumbersome device, and the data must be submitted to the doctor or nurse through physical or electronic means. With routine measurements, patients can detect symptoms of the disease.

In the hospitals, the patients, especially those who are in the intensive care, need continuous monitoring and close attention so as to react to the possible crisis and save lives. These monitoring systems employ sensors to collect physiological information which is analyzed and stored on the cloud and health staff could analyze it. Many health professionals collaborate together and then examine the patients according to each one's specialty, by analyzing the flow of data collected by the sensors. Then the identification of the emergency condition for risky patients (Urgent or emergent surgery patient, cardiac patients et cetera.) will be an easy task.

Remote monitoring is an important paradigm for many real-world applications. Nowadays, all over the world, there are many people whose health might suffer due to a lack of effective healthcare monitoring. Elderly, children or chronically ill people need to be examined almost daily. Because of their critical status, sometimes their health goes unnoticed until the diseases develop into a crisis stage. Remote access sensor helps the caregivers to have pre-diagnosis and earlier intervention before things go wrong.

Many patients who suffer from chronic illnesses such as cardiopulmonary disease, Asthma, and Heart failure are located far away from the medical care facilities. The real-time monitoring of such patients through wireless monitoring systems is the most promising application. Some of the real-time healthcare monitoring systems are remote patient tracking and monitoring system, remote monitoring of cardiac patients, and heartbeat monitoring system. The real-time monitoring system consists of a remote medical monitoring unit and the monitoring center. It analyses the information from the sensor based on real-time analysis and a warning sign will emerge for emergency and diagnosis.

The signals from the body sensor are taken to the corresponding medical center through a wired or wireless telecommunication system, hence it is called Telemedicine. For Merriam Webster dictionary, Telemedicine is medical care provided remotely to a patient in a separate location using two-way voice and visual communication (as by computer or cell phone) [5]. As a result, this real-time monitoring system provides information about patient's health conditions, and it may also reduce more complications and provide treatment at the earliest. Thus, it provides an accurate and real-time monitoring system in the healthcare sector. It also helps for faster detection of input sensors and saves a life.

In Europe, there are several projects for monitoring health using the internet. As the internet is a means of telecommunication, then this is included in Telemedicine. For example eLECTOR, telemedicine for eHealth in rheumatology project funded by the European Union, 2015-2018 [6].

Patients in the home, will do a self-blood test and answering an online questionnaire, and submit the result to the internet. The information will be viewed by the doctor, and the doctor will be available for online consultation. Regarding their published paper [7], a relevant result for this proposal is: some patients had difficulties connecting to the Information and Communications Technology (ICT) platform (internet) for the first time because it needs configuration, and others got confused by the short message service (SMS) text messages for the reminder.

Another telemedicine application was implemented in Denmark in 2012 [8]. Odense University Hospital created a briefcase for the patient with Chronic Obstructive Pulmonary Disease (COPD). This "patient briefcase" is filled with instruction and medical tools to collect data about lung and the level of oxygen in the blood, so that the patient could be hospitalized at home and connect to the internet for telemonitoring and teleconsulting. A technician will be needed to assist the patient for the first time to install the briefcase.

A new project for telemedicine, which has an end date of 30 June 2021 is THALEA II. THALEA II is Telemonitoring and Telemedicine for Hospitals Assisted by ICT for Life-saving co-morbid patients in Europe as part of a Patient personalized care program of the European Union (EU) [9]. The main usefulness of THALEA II arrangement is to furnish Tele-ICU focuses with an extra observation and warning for regional Intensive Care Unit (ICU). Notwithstanding, the neighborhood doctor remains in charge of the patient and is responsible for the treatment. The THALEA II arrangement will show the actual status and important treatments of patients situated in various regional ICUs in a dense view, giving an outline of bigger numbers (100 - 150 per workplace) of patients. The graphical portrayal will empower medical staff in the tele-ICU focus to separate patients as far as physiological strength or precariousness, such as advancing organ dysfunction.

There is also FORTO, a Europe project in 2020 [10]. FORTO's targets are building up an easy-to-understand gadget and supporting framework for self-evaluation of muscle fatigability in old people. Early changes in health are hard to survey as estimations that as of now exist are less sensitive for changes. FORTO permits to recognize little changes. FORTO can be utilized for an assortment of utilizations like going about as an early notice framework for the weakening of the overall health status some time BEFORE it tends to be recognized by different techniques. FORTO can likewise be applied to monitor and distinguish postponed recuperation in aging patients when returning to home.

FORTO comprises an elastic bulb that can be remotely associated with a cell phone. The framework will permit self-assessment of muscle fatigue by estimating the greatest power old person can apply and support until their handgrip strength drops to half of its most extreme. Proficient follow-up is acknowledged distantly through an application utilizing the cell phone of the old person, which simultaneously makes the framework less expensive and very easy to use.

All those sensors actually can be connected together to create a wireless sensor network. Hence, we could monitor all sensors at once, without cable, in a central monitoring device.

## 1.2 Wireless Sensors Network

The development of telecommunications technology has spawned a network called the Wireless Sensor Network (WSN). WSN allows us to provide effective and economical solutions in close or remote wireless monitoring. These networks can be used for various monitoring applications covering various areas such as health, home automation, industry, farms, and forests. WSN gained increased attention because of some of its current applications and potential future.

A wireless sensor network consists of wireless devices that have a sensor(s) to obtain information from the environment. This device is called a sensor node. The sensors are varied according to the information that we want to get. Then the information will be collected into a data collector called the master station. Sensor nodes communicate using radio signals.

Some sensor nodes can make a direct connection from the sensor node to the master station, or others must go through several routers before it gets to the coordinator node. Usually, the router nodes and master stations have a higher ability than the sensor nodes. Sensor nodes have limitations in battery life, memory, and processing. Sensor nodes are generally operated with non-rechargeable batteries. We have IoT by connecting this WSN to the internet.

Usage of energy is the main challenge of WSN. As explained before, sensor nodes have limited battery life, it has used energy efficiently. Hence, this also is our main concern when we design our solution.

## 1.3 Internet of Things

Many people want all things to run automatically, the goal is certainly to facilitate our lives. Starting from the field of manufacturing industry, making goods, electronic devices, cars and so on, until now it goes into our daily lives. For example the use of sensors to automate watering

plants, heating devices, and air conditioning. We can determine the parameters for automation based on sensor data. We can also find out the history of sensor readings by storing them in a database. The connection of these sensors with the internet will result in an Internet of Things (IoT) devices.

IoT is the recent technological term, which is a collection of devices or sensors that have connectivity to the internet. Here, the Internet does not have to be a global connection; indeed, a Local Area Network (LAN) is also possible as long as it supports Transmission Control Protocol/Internet Protocol (TCP/IP). Most IoT devices use wireless connections to ensure mobility and portability. However, wireless devices have some fundamental issues such as energy consumption, noise, and interference of wireless communication.

When we want to control the conditions/parameters for the system via the internet, then a technique appears to control and send reading data over the internet, and store data in the cloud. So that the system can be controlled or read remotely anytime, anywhere. IoT happens.

Pervasive cellular connectivity, miniaturization of sensor devices, and lowering costs of hardware and connectivity are driving IoT development. IoT enables remote sensing and control of objects over a communication network. Creation of direct integration of the physical world into computerized systems. IoT has proven useful for different industries, each with different needs and conditions. There are several important IoT implementations, which will be explained below:

### 1.3.1 SmartHome

The first implementation is Smarthome, which collects all home monitoring systems and controls home devices in accordance with data from the monitoring system. While sensors can detect changes in temperature, the air conditioning system can be monitored. A home security camera can capture intruders and send alerts to homeowners via the mobile application. Figure 1.1 shown devices of Smarthome.

### 1.3.2 SmartCity

Another implementation is a smart city, which makes it easy for city governments to oversee public services, as well as to monitor traffic jams, air quality, schools, and even the condition of trash cans can also be monitored by utilizing IoT. The efficiency of using street lighting can also be increased, even further, by monitoring the grid, the city can monitor its energy consumption. Taking decisions by the city council will be easier with the help of data from IoT devices. Figure 1.2 shown the diagram of Smartcity.

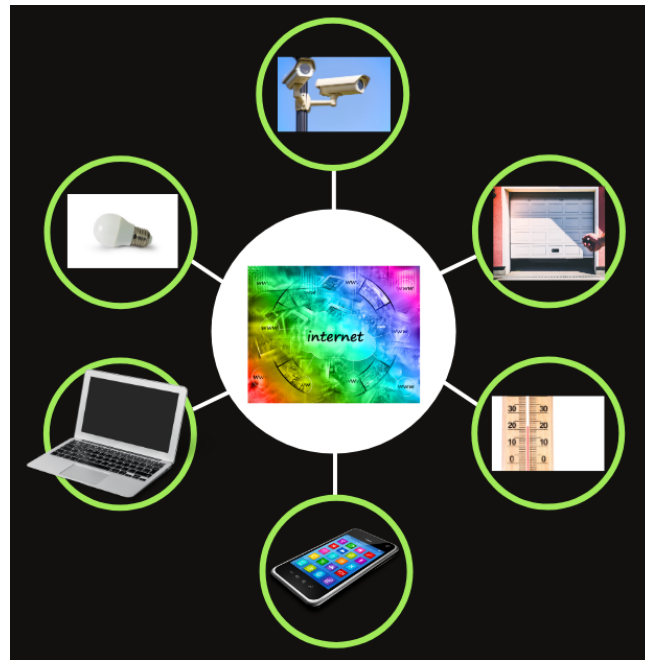

Figure 1.1: Smarthome diagram.

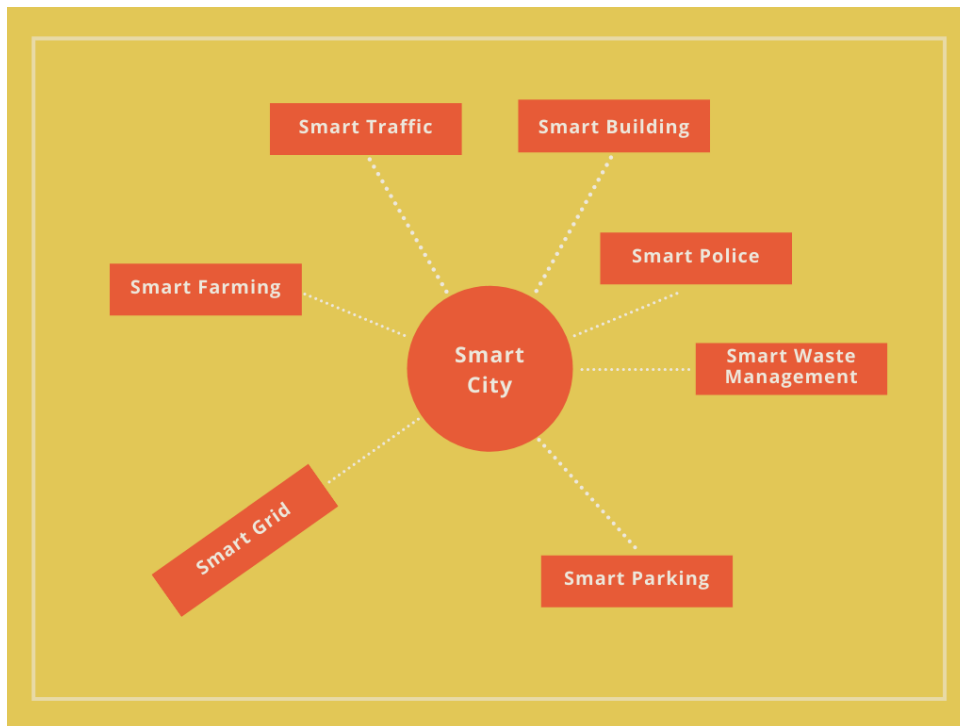

Figure 1.2: Smartcity diagram.

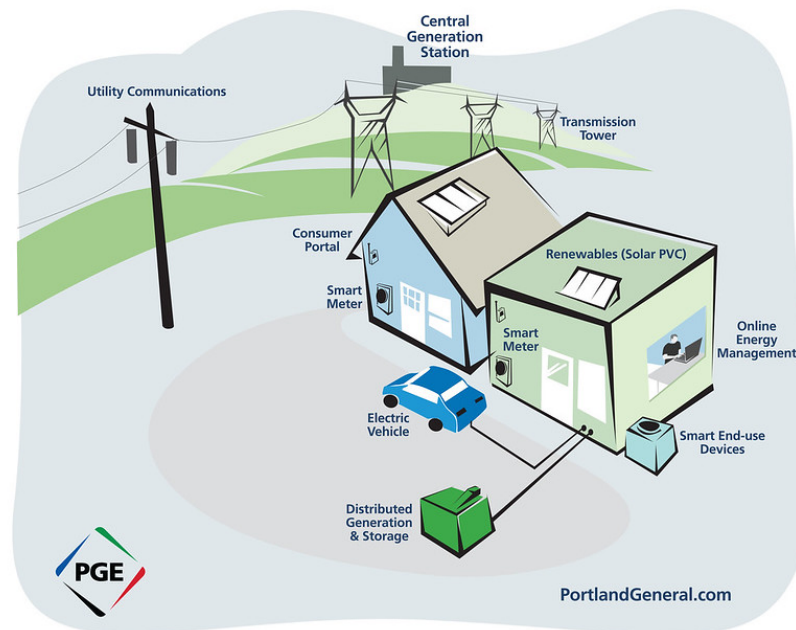

Figure 1.3: Smartgrid diagram. Photo by Portland General Electric / CC BY

If the data of IoT monitoring are opened to the public, the city residents will also get the benefit. Eg. congestion. By avoiding congestion, motorized vehicle users can reduce time losses and fuel losses. Another example is air quality data. Sportsmen, runners, cyclists can avoid areas that have high pollution.

### 1.3.3 SmartGrid

A smart grid could also get an advantage from IoT. Traditional and centrally controlled power distribution systems are used for long days. This is usually called the power grid. Due to electricity consumption, the global power grid has a similar structure, dynamics, and principles even as technology advances. This traditional energy network only focuses on a few main functions such as power generation, distribution, and control [11].

The power grid in its current form is unreliable, has high transmission losses, is of poor power quality, is prone to interruptions and interruptions, provides insufficient power, and hinders the integration of distributed energy sources. Traditional non-intelligent systems lack real-time monitoring and control, which is a challenging opportunity for smart networks to function as a real-time solution.

To solve this problem, the energy supply structure had to be completely revised. The

advantages of electricity are not only driving the introduction of the smart grid concept, but also environmental aspects. The electric industry is making the transformation from a centralized, producer-controlled network to a less centralized and more consumer-interactive one as shown in figure 1.3. Smart houses could supply energy also and interconnected directly to other suppliers and consumers. Energy efficiency and dependence on renewable resources will also help reduce society's carbon footprint.

The smart grid will make an entire change to all consumers of electric power. Wireless sensor networks enable smart grid utilities and customers to transfer, monitor, predict, and manage energy usage effectively. They are widely applied in wireless automatic meter reading systems. Based on those sensors, energy usage information such as frequency, phase angle and voltage values can be read in real-time. Therefore, managing electricity demand can be done by utility companies efficiently.

Smart grid technology offers solutions for better power generation and an efficient way to transfer and distribute that energy. Its flexibility makes it easier to install and takes up less space than traditional networks. The smart network design concept focuses on monitoring the network, creating control over the system, improving the performance and security of energy systems, and in particular the economic aspects of operation, maintenance, and planning. Therefore, smart grid technology is also considered usable at the microgrid level, which will eventually be linked to all other microgrids to form a large smart grid network. These smart grids have great potential and can be a reliable solution for energy transmission and distribution in developing countries that do not yet have the infrastructure.

### 1.3.4 SmartFactory

Another implementation of IoT is in smart factories. Osterrieder [12] describes a smart factory as a production environment where people and production processes are supported by an intelligent computer-assisted system and offer a smooth and sustainable production flow for higher productivity and quality.

In some cases, intelligent factories always have machines with sensors and actors that can collect, send, receive, process and act accordingly. These machines communicate with each other to perform assigned tasks and the mechanical systems are set up and configured to achieve the same goals. In this way, the system is monitored by a higher object, namely the basic software model, a person, or a combination of both, and follows the directions of a complex computer program. As other scientists have determined, the production facility can no longer be viewed as a level of activity but rather broken down into four separate layers. These are the physical,

data, cloud, and intelligence, and control layers. They assign all machines, entire warehouses, and actions actually performed to physical shifts.

The data layer includes the process of transferring data from the machine (sensors) to the cloud and back, while the software controls what data is sent/received (data types and variations) and at speed (speed and volume). The data is then at least temporarily stored in the cloud, where it can be processed through complex analysis. The top layer is monitored. Here, the basic program for controlling smart factories can be adapted through human intervention if necessary. This process could be done in IoT.

### 1.3.5 Healthcare

Also, there is the implementation of IoT in healthcare. Yet another potential of IoT on health is enabling doctor/nurse to perform retrieval of data in real-time and immediately perform diagnostics on the spot, without preoccupied with the installation of conventional medical devices. This will speed up diagnosis and give a positive impact on the health of the patient.

In the hospitals, the patients, especially those who are in the intensive care, need continuous monitoring and close attention so as to react to the possible crisis and save lives. These monitoring systems employ sensors to collect physiological information which is analyzed and stored on the cloud and health staff could analyze it. Many health professionals collaborate together and then examine the patients according to each one's specialty, by analyzing the flow of data collected by the sensors. Then the identification of the emergency condition for risky patients (Urgent or emergent surgery patient, cardiac patients et cetera.) will be an easy task.

Remote monitoring is an important paradigm for many real-world applications. Nowadays, all over the world, there are many people whose health might suffer due to a lack of effective healthcare monitoring. Elderly, children or chronically ill people need to be examined almost daily. Because of their critical status, sometimes their health goes unnoticed until the diseases develop into a crisis stage. Remote access sensor helps the caregivers to have pre-diagnosis and earlier intervention before things go wrong.

Many patients who suffer from chronic illnesses such as cardiopulmonary disease, Asthma, and Heart failure are located far away from the medical care facilities. The real-time monitoring of such patients through wireless monitoring systems is the most promising application. Some of the real-time healthcare monitoring systems are remote patient tracking and monitoring system, remote monitoring of cardiac patients, and heartbeat monitoring system. The real-time monitoring system consists of a remote medical monitoring unit and the monitoring center. It analyses the information from the sensor based on real-time analysis and a warning sign will



emerge for emergency and diagnosis.

The signals from the body sensor are taken to the corresponding medical center through the Wireless Local Area Network (WLAN) system. As a result, this real-time monitoring system provides information about patient's health conditions, and it may also reduce more complications and provide treatment at the earliest. Thus, it provides an accurate and real-time monitoring system in the healthcare sector. It also helps for faster detection of input sensors and saves a life.

IoT system in the health sector has several advantages over conventional cable systems such as ease of use, reducing the risk of infection, reduce the risk of failure, reducing user discomfort, increase mobility, improve the efficiency of hospital care, and lower installation costs.

There are two incentives to promote IoT solutions that lead to fewer doctor visits and improved self-management in the health care system: First, reducing costs for health and social care workers. Second, these choices are closely linked to improving the quality of life for everyone. IoT devices will make it easier for patients to connect automatically to the internet.

When viewed from the market, IoT in healthcare is taking the biggest niche [13]. Gartner analytics said that Healthcare shares 15 percent of the market, equal to the manufacture field, as shown in figure 1.4.

Today, sensor nodes have changed into small, unobtrusive, and powerful devices, which can be easily accommodated into wearable devices such as smartwatches, bracelets, gloves, or buttons. Thus, it gives a more convenient way to collect the health condition data of patients using wearable sensors and then send, analyzed, and stored the data in the cloud. For example, by using heart rate sensors, the conditions of the patients such as heart attacks, anxiety, and stress can be continuously monitored.

Another potential of using IoT in health sectors is the telemedicine field. It is enabling doctors/nurses to perform retrieval of data in real-time and immediately perform diagnostics on the spot. Without preoccupied with the installation of conventional medical devices. This will speed up diagnosis and give a positive impact on the health of the patient.

Indeed, deploying IoT systems in the health sector has several advantages over conventional wired systems such as ease of use, reducing the risk of infection, reducing the risk of failure, reducing user discomfort, increasing mobility, improving the efficiency of hospital care, and lower installation costs. However, providing robust transmission in wireless communication is a challenge in the healthcare domain, because continuously updated health data is very important for the treatment of the patients.

Sensors for the patient must close to the body, it can be implanted to the body, or just patch it to the skin on the wearable gadget. However, there are problems with wearable IoT sensors,

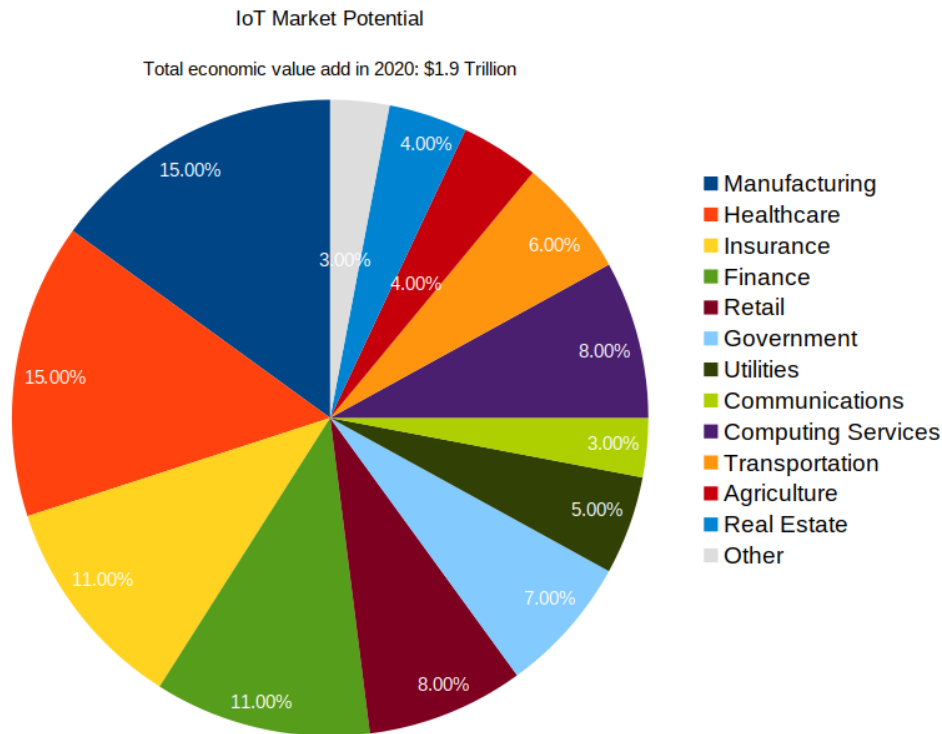

Figure 1.4: Market of IoT.

that degrade their robustness, which is body pathloss. Pathloss is caused by the attenuation of power transmitted, and one of the causes is body absorption. Body pathloss will attenuate signal more than free space pathloss, hence it will impact the effectiveness and efficiency of the signal transmitted.

One of the techniques to increase the effectiveness of wireless transmission is the cross-layer method. Cross-layer, which uses the relationship between the communication layers for determining the next step action, is one of the adopted techniques to improve the communication network [14]. We choose cross-layer method to solve the body pathloss problem.

Cross-layer design refers to sharing data between layers for productive utilization of information in each layer and accomplishing high efficiency. In cross-layer configuration, each layer is described by a couple of parameters. These parameters are passed to different layers to assist them with deciding the best variation rules for their control handles as to the current network status. Cross-layer configuration is normally detailed as an enhancement issue, with optimization factors and requirements from numerous layers. Cross-layer design is particularly engaging in wireless networks for the accompanying reasons. Dissimilar to wired networks, where resources are plentiful, the need is convincing in wireless networks to investigate a bigger enhancement space, including multiple layers to make the best of restricted resources. Second,

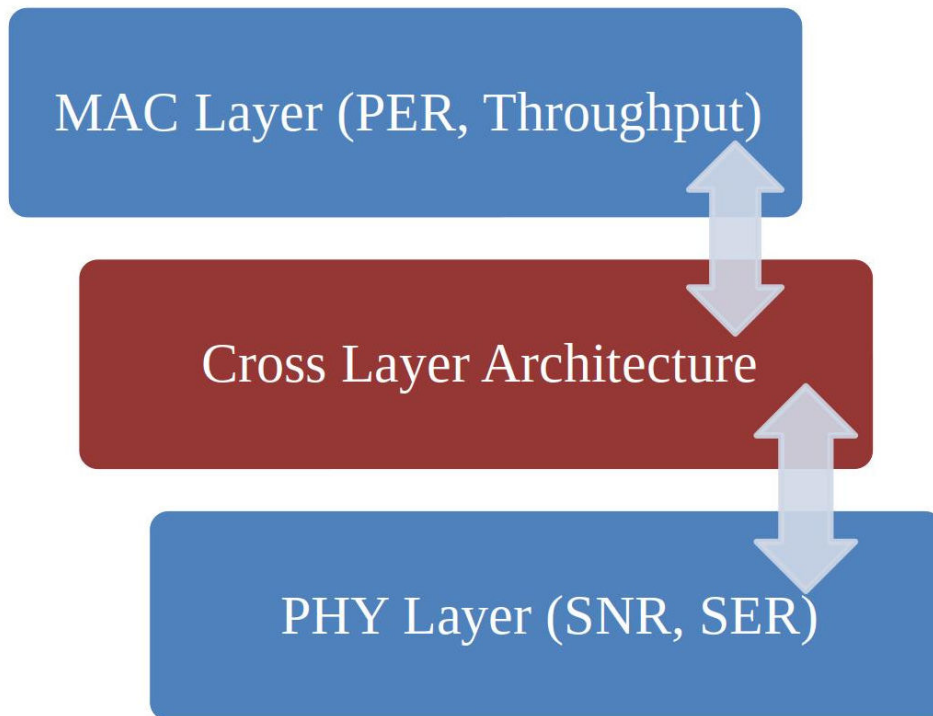

Figure 1.5: Cross Layer Architecture.

the current protocol stack is characterized in view of wired networks. It may not be appropriate for wireless networks that are on a very basic level distinctive in numerous perspectives. For instance, the idea of "link" is entirely different at this point. A network between two hubs generally relies upon the distance between them and their transmit powers. The remarkable attributes of wireless networks require joint parameters that recently situated in different layers.

IoT system could work from application layer to Physical (PHY) layer. Hence we may design a cross-layer on every layer, one of them is data link layer and physical layer. Inside data link layer, there are logical link layer and Medium Access Control (MAC), each will interface with its upper and lower layer. Performance of MAC layer can be stated by Packet Error Rate (PER) and throughput. PER is a ratio of a packet that is not successfully received to the number of packets transmitted.

Whereas, parameter of PHY layer are Signal to Noise Ratio (SNR), Bit Error Rate (BER) and Symbol Error Rate (SER). BER is a ratio of the number of bits in error to the total number of bits transmitted. By combining every parameter, we have cross-layer design, as shown in figure 1.5.



Figure 1.6: Territorial zones of Indonesia (Yellow: West, Green: Mid, Blue: East).

## 1.4 Context and Motivation

Improving access and quality of public health services in Indonesia is still a big challenge. Geographic obstacles, shortage, and maldistribution of specialists/doctors especially in rural areas are some of the challenges to be answered. Indonesia has 24688 doctors in the west part, 5187 doctors in the mid part, and 803 doctors in the east part [15]. Figure 1.6 show part of Indonesia. The yellow one is west part, the green one is mid part and the blue one is east part.

Hospital/clinic also not equal, Indonesia has 2281 hospitals in the west part, 456 hospitals in the mid part, and 109 hospitals in the east part. Hence, the west part enjoys 80 percent of hospital distribution, and also 80 percent of doctors distribution. Of course, telemedicine could be one of the solutions to make healthcare access easier for citizens in the mid part and the east part.

There is some solution for telemedicine in Indonesia, one of them is Dottorota. In 2016, the city council of Makassar Indonesia (east part) has developed a telemedicine system called "home care" to overcome those challenges. They created a mobile healthcare vehicle called "Dottorota" that gives healthcare services 24 hours/day to the community. This vehicle is equipped with Electrocardiogram (ECG), Ultrasonography (USG) and other standard medical equipment. When patients call this service, a team consisting of doctors, nurses and drivers will move to the patient's location and gives a proper treatment [16].

In part of our doctorate project, we propose IoT implementation in Indonesia by submitting to Partenariat Hubert Curien (PHC) Nusantara. Program Nusantara is a joint initiative between the governments of France and Indonesia, it aims to encourage collaboration on research and innovation while strengthening connections that will lead to greater collaboration in the

future. This program is managed by the French Ministry for Europe and Foreign Affairs, the French Ministry of Higher Education, Research and Innovation, the Indonesian Ministry for Research and Technology (KEMENRISTEK), and the Indonesian Ministry for Education and Culture (KEMDIKBUD).

This proposal is dedicated to solving the aforementioned problems in the domain of wireless communications using IoT devices for healthcare applications. Our main objective is to increase the safety and the robustness of transmitted health data of the patients to hospitalizing data center. We will design, develop and implement an IoT healthcare device prototype using Software Defined Radio (SDR), which will gather data from the sensors of patients.

## 1.5 Contribution and Outline

We explain and compare the wireless communication standards that can be used in IoT. Until recently, there were quite a number of wireless standards emerging, such as 802.11, Bluetooth, LoRA, Sigfox, ZigBee et cetera. Some of them can be used as Radio Frequency (RF) part of IoT. This topic will be discussed in chapter 2.

We analyze and explain the problems of implementing 802.11ah in the field of healthcare, especially the problem of body path loss that interferes with data transmission from wearable sensors to the access point. We propose a new body pathloss model for the use of sub-gigahertz frequencies in the body. The interference from the body will affect and change the pathloss of the system. This topic will be discussed in chapter 3.

As mentioned before, interference from the body will affect and change the pathloss of the system. We propose a cross-layer method to overcome these disturbances. From the analysis and simulation results, we show that the proposed cross-layer method can improve system performance, especially for Packet Error Rate (PER), while keeping the throughput stable. This topic will be discussed in chapter 4.

Finally, We show how to implement 802.11ah using Software Defined Radio (SDR). Lack of product of the shelf for the new technology of 802.11ah, making us have to develop our own prototype for 802.11ah. The hardware we use is Universal Software Radio Peripheral (USRP) B200 from Ettus Research. For software development, we use GNURadio. The combination of both hardware and software, assists us to give proof of concept of 802.11ah implementation and the cross-layer solution. This topic will be discussed in chapter 5.

# Chapter 2

## Internet of Things

### 2.1 Wireless Technologies for IoT

In wireless communications, there are several standards issued by IEEE, such as 802.15.1, 802.15.4, 802.15.6, and 802.11ah. Development in some sections of the standards still can be done to improve the performance of wireless communication in IoT systems, especially in the health sector.

#### 2.1.1 802.15.4 ZigBee

A Low-Rate Wireless Personal Area Network (LR-WPAN) is a simple, low-cost communication network that allows wireless connectivity in applications with limited power and relaxed throughput requirements [1]. The fundamental targets of a LR-WPAN are simplicity of establishment, dependable information transfer, very minimal cost, and sensible battery life while keeping a straightforward and adaptable protocol.

There are two types of device in 802.15.4: a Full-Function Device (FFD) and a Reduced-Function Device (RFD). FFD is a device to manage the personal area network, it could be a master station or a router. RFD on contrary, is just a sensor node, without the ability to manage the network. RFD send a small amount of data and connect to a single FFD, so RFD only using small resources and memory. FFD could connect to several FFD and numerous RFD.

There are also two types of topology, which can be used in 802.15.4 network, depending on the application requirements: the star topology or the peer-to-peer topology. Both are shown in Figure 2.1, which is taken from Institute of Electrical and Electronics Engineers (IEEE) 802.15.4-2015 standard.

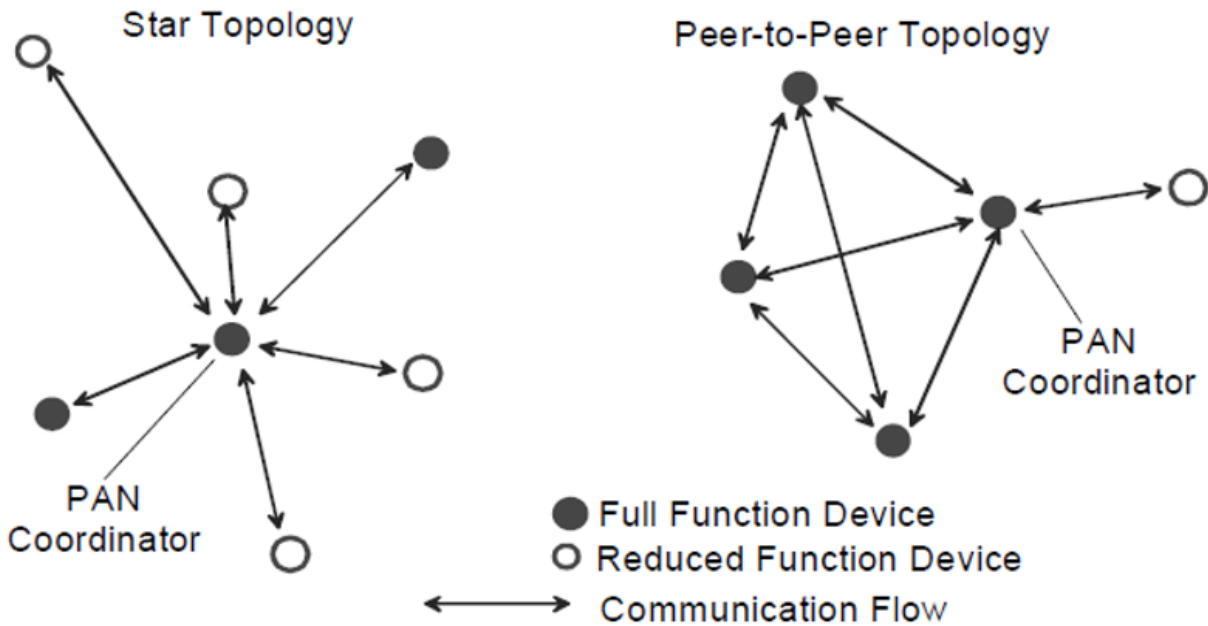

Figure 2.1: Topology of LR-WPAN. [1]

ZigBee operate in frequency 868 MHz, 965 MHz and 2450 MHz. Modulation employ for frequency 868 MHz and 965 MHz is Binary Phase Shift Keying (BPSK). ZigBee use Offset-Quadrature Phase Shift Keying (O-QPSK) for frequency 2450 MHz [17].

LR-WPAN is possible to be used for WSN in the health sector. In fact, the majority of WSN implementations are using LR-WPAN standards. 802.15.4 has become a de facto standard for WSN. The problem for 802.15.4 is short-range and limited mobility of the patient.

### 2.1.2 Bluetooth

Bluetooth version 4.0 is the version that could be used in healthcare WSN. It is also known as Bluetooth Low Energy (BLE) or smart Bluetooth [18]. In addition to healthcare applications, BLE could be used in entertainment and security. BLE itself uses standard Bluetooth protocols with the addition of energy efficiency. BLE adds the sleep cycle when the node is not active. But under the burst peak, it could consume a relatively high current.

Bluetooth use Frequency Hopping Spread Spectrum (FHSS) as radio technology. BLE uses the same frequency as other standards, i.e. in the 2.4 GHz Frequency Hopping Spread Spectrum (FHSS) band with 40 channels (3 for broadcast, 37 for communication) as shown in table 2.1. Bluetooth advertiser channel is for broadcast, and find another device for connection. Once it is connected, it will use the data channel for communication.

Table 2.1: Bluetooth Frequency Channels.

Frequency (MHz)	Channel Number	Channel Type
2402	37	Advertiser Channel
2404	0	Data Channel
2406	1	Data Channel
2408	2	Data Channel
2410	3	Data Channel
2412	4	Data Channel
2414	5	Data Channel
2416	6	Data Channel
2418	7	Data Channel
2420	8	Data Channel
2422	9	Data Channel
2424	10	Data Channel
2426	38	Advertiser Channel
2428	11	Data Channel
2430	12	Data Channel
2432	13	Data Channel
.	.	.
.	.	.
.	.	.
2474	34	Data Channel
2476	35	Data Channel
2478	36	Data Channel
2480	39	Advertiser Channel

BLE can be used to connect body sensors directly to smartphones. Smartwatch and smart-wrist for example, can sense heart rate and deliver it to a smartphone using a Bluetooth connection. However, Bluetooth has several disadvantages, its origin is a point-to-point connection. It is difficult to create a network for several nodes with Bluetooth.



### 2.1.3 LoRA and SigFox

Low Power Wide Area Network (LPWAN) is gaining popularity in the industrial and research communities due to its low power, long-distance, and low-cost communication capabilities. It provides long-term communications of up to 10-40 km in rural areas and 1-5 km in urban areas [19]. Therefore, it could be used for IoT applications.

Much of the LPWAN technology comes from both licensed and unlicensed bandwidth. Among them, LoRa and Sigfox are the leading new technologies today, which have many technical differences. LoRa was first developed in 2009 by Cycleo (in Grenoble, France) and purchased three years later by Semtech (USA). In 2015 LoRa was standardized by the LoRa Alliance. The Sigfox technology was developed in 2010 by the Sigfox start-up (in Toulouse, France), which is a company and operator of the LPWAN network. Sigfox operates and markets its own IoT solutions in 31 countries and continues to grow worldwide thanks to partnerships with various network operators.

LoRa is a physical layer innovation that modulates the signals in the sub-GHZ ISM band utilizing a restrictive spread range procedure. LoRa utilizes unlicensed ISM groups, i.e., 868 MHz in Europe, 915 MHz in North America, and 433 MHz in Asia. The bidirectional correspondence is given by the Chirp Spread Spectrum (CSS) tweak that spreads a thin band signal over a more extensive channel transmission capacity. The subsequent sign has low noise levels, empowering high interference blocking, and is hard to distinguish or jammed [20].

LoRa utilizes six spreading factors (SF7 to SF12) to adjust the information rate and range tradeoff. Higher spreading factor permits longer range but tradeoff with lower information rate, and the other way around. The LoRa information rate is between 300 bps and 50 kbps relying upon spreading variable and channel bandwidth. Further, messages sent utilizing diverse spreading elements can be received at the same time by LoRa base stations. The greatest payload length for each message is 243 bytes.

Communication Protocol based on LoRa which is called LoRaWAN was standardized by LoRa-Alliance (first form in 2015). The architecture of LoRaWAN is shown in figure 2.2, where End Device, Node, Mote is an object with an embedded low-power communication device. Gateway is an antenna that receives broadcasts from End Devices and sends data back to End Devices. Network Server is servers that route messages from End Devices to the right Application, and back. And Application is a piece of software, running on a server.

Utilizing LoRaWAN, each message communicated by an end device is received by all the base stations in the range. By exploiting this excess reception, LoRaWAN improves the ratio of the successfully received messages. But, accomplishing this element requires various base

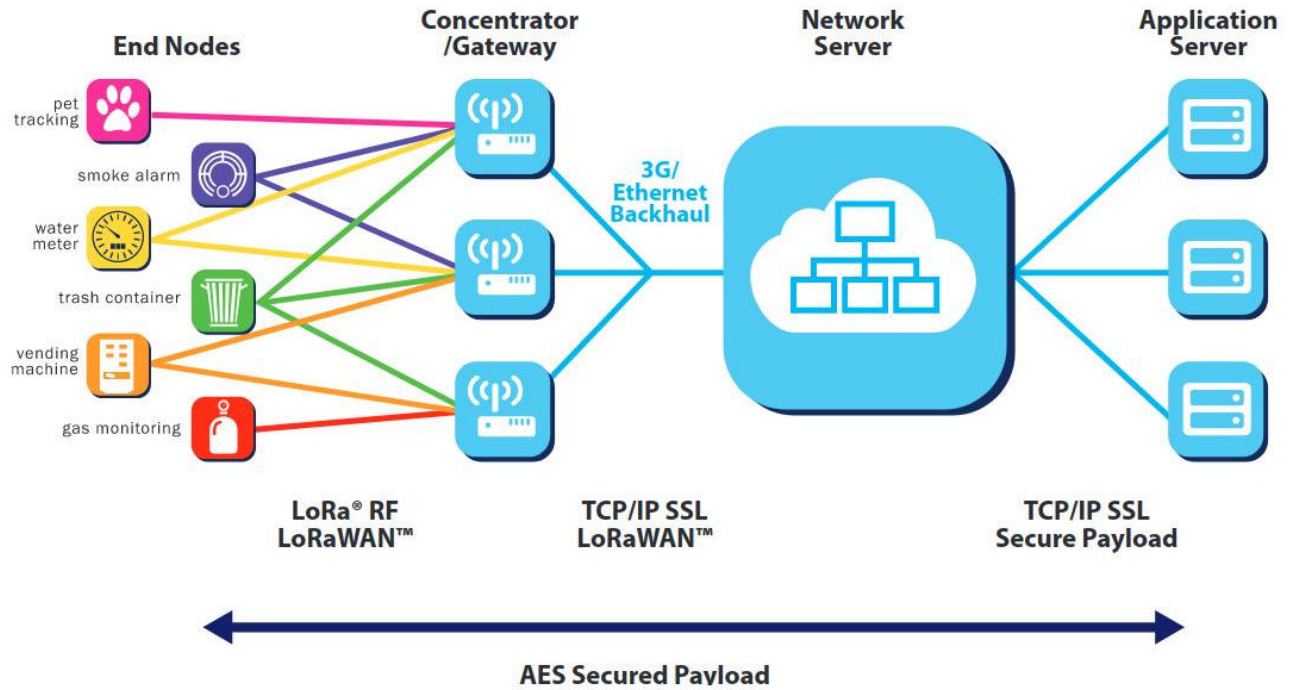

Figure 2.2: LoRa and LoRaWAN Architecture [2].

stations in the area, which may expand the organization's operation cost. The subsequent copy is separated in the backend framework (network server) that likewise has the necessary insight for checking security, sending Acknowledge (ACK) to the end device, and sending the message to the relating application server.

Further, numerous reception of similar messages by various base stations is used by LoRaWAN for searching the location of end devices. For this reason, the Time Difference of Arrival (TDOA) - based localization procedure upheld by extremely precise time synchronization between various base stations is utilized. In addition, numerous gatherings of similar messages at various base stations could remove the handover need in LoRaWAN network.

Sigfox is an LPWAN network operator that offers a complete IoT connectivity solution based on its proprietary technology. Sigfox uses its own transmitter, is equipped with cognitive software-defined radio, and connects it to a server on the back via an Internet Protocol (IP)-based network.

Figure 2.3 shown SigFox network architecture. Object/Devices connected to SigFox gateway or Base Station, which is connected via Binary Phase Shift Keying (BPSK) modulation in a very narrow range (100 Hz) sub-GHZ-Industrial, Scientific and Medical (ISM) carrier band. SigFox objects are connected with Gateway using star topology. There is a direct secure point-to-point link between SigFox gateways and SigFox cloud.

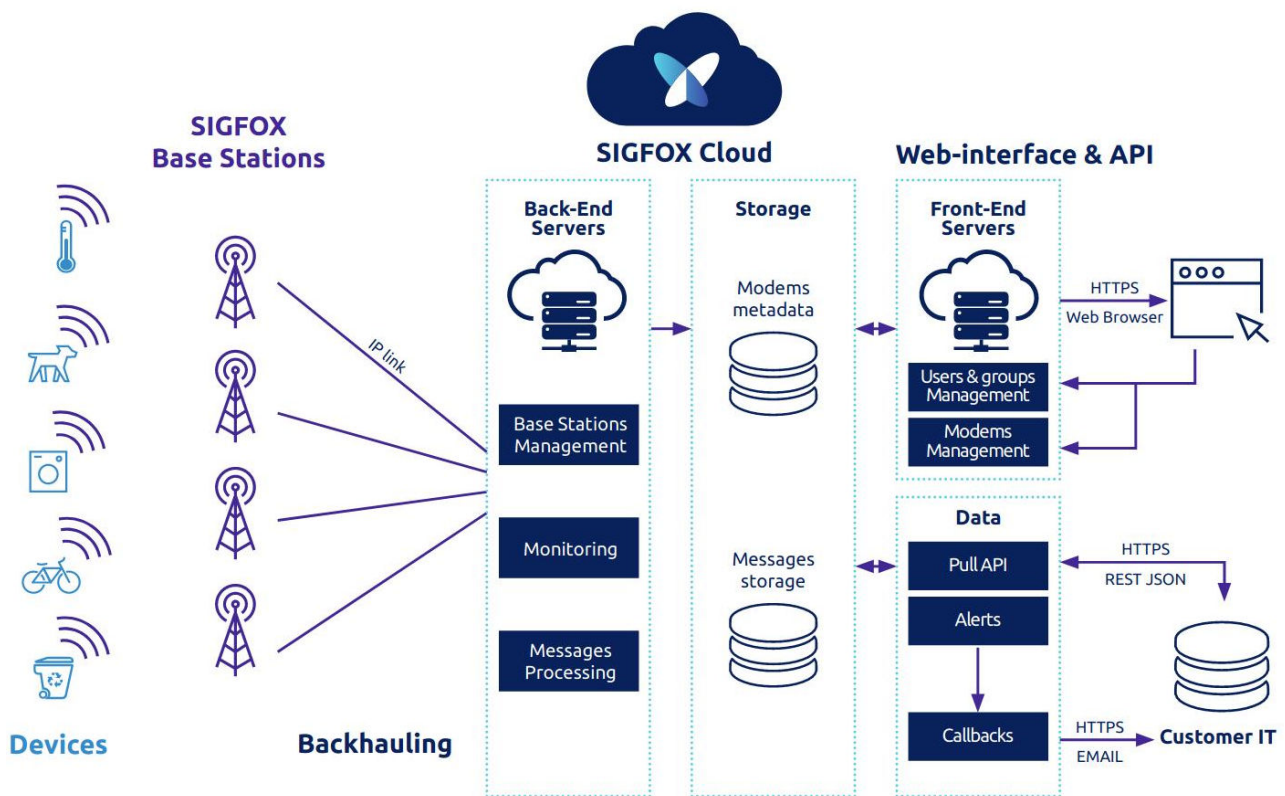

Figure 2.3: SigFox Architecture [3].

SigFox uses unlicensed ISM bands such as 868 MHz in Europe, 915 MHz in North America, and 433 MHz in Asia. With its ultra-narrowband, SigFox uses bandwidth efficiently and has a very low noise level, which results in very low power consumption, high receiver sensitivity, and an inexpensive antenna design with a maximum bandwidth of only 100 bit / s.

Initially, SigFox only supported uplinks, but later became a two-way technology with significant link asymmetry. Communication is cut off, that is. Data from the base station to the terminal can only occur after upward communication. The number of messages via the uplink is limited to 140 messages per day. The maximum user data length for each message is 12 bytes. However, the number of downlink messages is limited to four messages per day, which means acknowledgment of individual uplink messages is not supported.

The maximum user data length for each message is 8 bytes. Without adequate recognition support, uplink reliability is ensured through the use of time and frequency diversity and transmission duplication. Each message in the terminal is sent multiple times (three by default) on a different frequency channel.

For this purpose, for example, in Europe, the band between 868,180 MHz and 868,220 MHz is divided into 400 orthogonal 100 Hz channels (40 of which are reserved and unused) [21]. Since the transmitter can receive messages on all channels at the same time, the terminals can randomly select the frequency channel to send their message to. This simplifies terminal design and reduces costs.

#### 2.1.4 802.11 WiFi

IEEE 802.11 family is a progression of the standard of physical and MAC layer, fundamentally for wireless local area networks communications, which is made and kept up by IEEE LAN and Metropolitan Area Networks (MAN)) standards committee. The IEEE 802.11 was the first one to be delivered in June 1997.

In this way, numerous arrangements of standards for different working frequencies have been proposed, for example, IEEE 802.11a, IEEE 802.11b, IEEE 802.11g, IEEE 802.11n, IEEE 802.11ac, IEEE 802.11ad, IEEE 802.11af, and IEEE 802.11ah for different applications with different transmission ranges under 54 MHz to 60 GHz frequency band. Figure 2.4 shows different IEEE 802.11 standards comparable to the operation frequency and most farther transmission distance.

The working frequency for IEEE 802.11b and IEEE 802.11g is the 2.4 GHz Industrial Scientific Medical (ISM) band. Because of the frequency band, IEEE 802.11b and IEEE 802.11g hardware may sometimes experience interference from microwaves, cordless phones, and Blue-

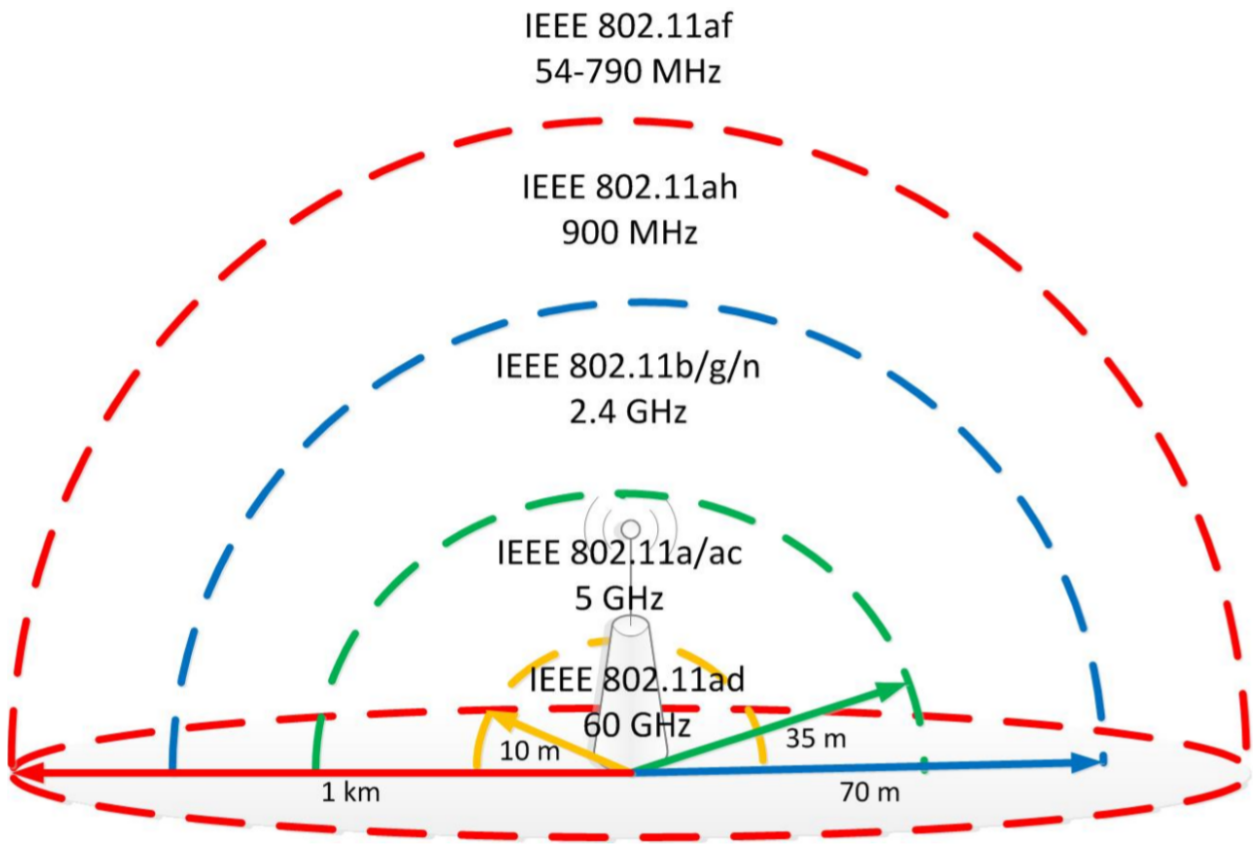

Figure 2.4: IEEE 802.11 family.

tooth devices. To address this issue, Direct-Sequence Spread Spectrum (DSSS) and Orthogonal Frequency Division Multiplexing (OFDM) modulation are utilized to control interference in IEEE 802.11b and IEEE 802.11g.

The IEEE 802.11n standard is another standard working at 2.4 GHz, where Multiple Input Multiple Output (MIMO) is applied to expand the range and throughput for wireless networks. The IEEE 802.11a standard works at 5 GHz, which gives minimal 23 non-overlap channels instead of the 2.4 GHz ISM frequency band with overlap channels.

IEEE 802.11ac uses a frequency of 5 GHz with less possibility for interference when contrasted with IEEE 802.11b and g. For IEEE 802.11n, there is more interference if working with 2.4 GHz, while less interference if working with 5 GHz, which is like IEEE 802.11ac standard. IEEE 802.11ad works in the 60 GHz millimetre wave spectrum, where it comprises four channels as each 2.16 GHz wide with centre frequencies of 58.32, 60.48, 62.64, and 64.80 GHz.

IEEE 802.11af permits Wireless Local Area Network (WLAN) activity in TV void area spectrum in the Very High Frequency (VHF) and Ultra High Frequency (UHF) groups by cognitive radio innovation to communicate on unused TV channels, with the maximal effort to restrict interference for main users, for example, digital and analogue TV or wireless mic.

Actually, Wi-Fi is the infrastructure of WLAN. Figure 2.5 shows a WLAN interfacing with a wired network. The WLAN consists of a wireless network interface card, known as station (STA), and a wireless bridge referred to as an Access Point (AP). The AP interfaces the wireless network with the wired network (e.g., Ethernet LAN). The connection between STA and AP could use Wi-Fi.

### 2.1.5 802.15.6 WBAN

IEEE working group has issued a standard Physical (PHY) layer and data link layer (Medium Access Control (MAC)) for Wireless Body Area Network (WBAN). WBAN supports a data rate of 971.4 Kbps with 79 channels. This is a wireless standard for low power short-range communication around or through the human body, although it is possible also for other living creature [22]. Modulation for WBAN are Binary Phase Shift Keying (BPSK), Quadrature Phase Shift Keying (QPSK) and Gaussian Minimum Shift Keying (GMSK). WBAN could use frequency of 400 MHz, 800 MHz, 900 MHz and 2.4 GHz.

WBAN can use Industrial, Scientific and Medical (ISM) bands like other wireless technology and also other specific frequency bands for medical purpose that issued by government. WBAN support for Quality of Services (QoS) and maintain low power transmission to eliminate interference. This standard considers the effect of radiation on a person, so an antenna must

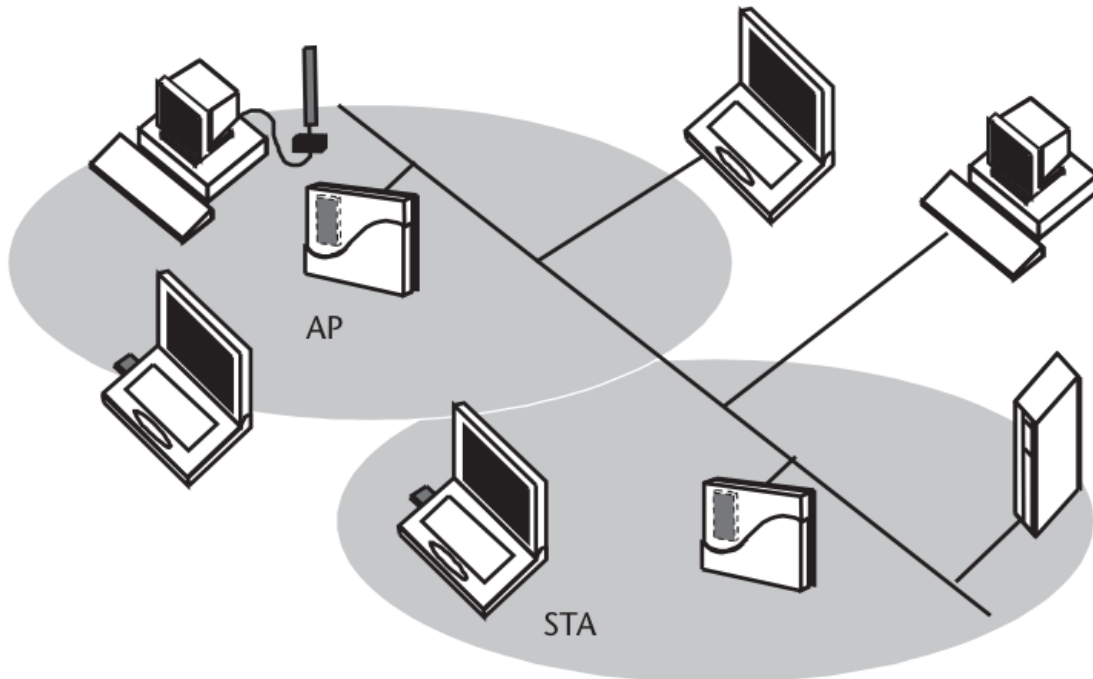

Figure 2.5: Wireless Local Area Network.

carefully design to minimize the effect. WBAN is different from LR-WPAN in the medical context, such as proximity to human tissue.

WBAN is designed for patient's mobility due to portable wearable or implanted sensors. And the patient is also independent of the location of monitoring, whether in a hospital, in a clinic or in a home. But WBAN has a drawback for its short range. It will be difficult to connect to the master station afar from the patient.

### 2.1.6 802.11ah HaLow

IEEE 802.11ah is a Wireless Local Area Network (WLAN) standard with system operation at sub 1 GHz [23]. Other WLAN standards, like 802.11a/b/g/n, use ISM band 2,4GHz or 5GHz. Because it is using low frequency, 802.11ah can improve its range, longer than conventional 802.11. But its bandwidth will be lower, which will result in a lower data rate. Because it is WLAN standard, 802.11ah using the same topology with other WLAN standards, it comprises of Access Point (AP) and station (STA). Since one of the objectives of IEEE IEEE 802.11ah Task Group (TGah) is to offer a standard that, aside from fulfilling these recently referenced prerequisites, limits the progressions as for the widely accepted IEEE 802.11. In that sense,

the proposed physical and MAC layers depend on the IEEE 802.11ac standard and attempt to accomplish an advantage by decreasing some control frame and the MAC header length.

The intention of 802.11ah is not for internet multimedia. It has already served by 802.11a-/b/g/n/ac. 802.11ah will be used for large scale wireless sensor networks, which only need a low data rate. This innovation is visualized to be utilized in the smart grid, consumer electronics and healthcare. The highlights of Low Power Wi-Fi incorporates the procedure utilized in target wake time to educate devices when to wake up and header overhead decreases.

To save bandwidth, 802.11ah will not use lengthy MAC addresses and Null Data Packet (NDP). Instead, it will use Association Identifier (AID) number to communicate with STAs. Root AP assign AID, which will save the overhead of sending long control frames [23].

The IEEE 802.11ah physical layer is acquired from IEEE 802.11ac and use to access sub-1 GHz bandwidth. The channel utilized in IEEE 802.11ah is ten times smaller than those in IEEE 802.11ac: 1, 2, 4, 8 and 16 MHz, of which just 1 and 2 MHz channels are obligatory. Advancements like OFDM, MIMO and Downlink Multi-User MIMO (DL MU-MIMO) which was initially presented in the IEEE 802.11ac, are likewise utilized by the IEEE 802.11ah framework.

Single-stream transmission is substantially simpler than multi-stream operation. When a device transmits multiple spatial streams, significant computational resources combine multiple spatial streams into one transmission. With only one spatial stream, however, the Digital Signal Processing (DSP) work is not needed. Eliminating the DSP requirement also reduces power consumption, which is why many small battery-operated devices are single-stream only. Hence, our implementation for 802.11ah will use Single Input Single Output (SISO).

The 802.11ah's standard use OFDM like its siblings to transmit the information with BPSK, QPSK, 16QAM and 64QAM modulation.

OFDM is a parallel transmission scheme in which a high-speed serial data stream is divided into a set of low-speed sub-streams, each of which is modulated into a separate Sub Channel (SC). In this way, the SC bandwidth is small compared to the channel coherence bandwidth; That is, the individual SC experiences a flat fading, allowing easy alignment. This indicates that the sub-stream symbol period is longer than the time channel delay.

A high spectral efficiency is obtained by selecting a special set of carrier frequencies (orthogonal) because the SC spectrum overlaps while mutual interference between the SCs can be avoided. Derivation of the system model shows that the introduction of Cyclic Prefix (CP) (Guard Interval (GI)) can maintain orthogonality along the dispersion channel.

Figure 2.6 shows block diagram of OFDM from transmit to receive. Inverse Discrete Fourier Transform (IDFT) and Discrete Fourier Transform (DFT) are used to modulate and demodulate orthogonal SC data constellations. This signal processing algorithm replaces the bank of



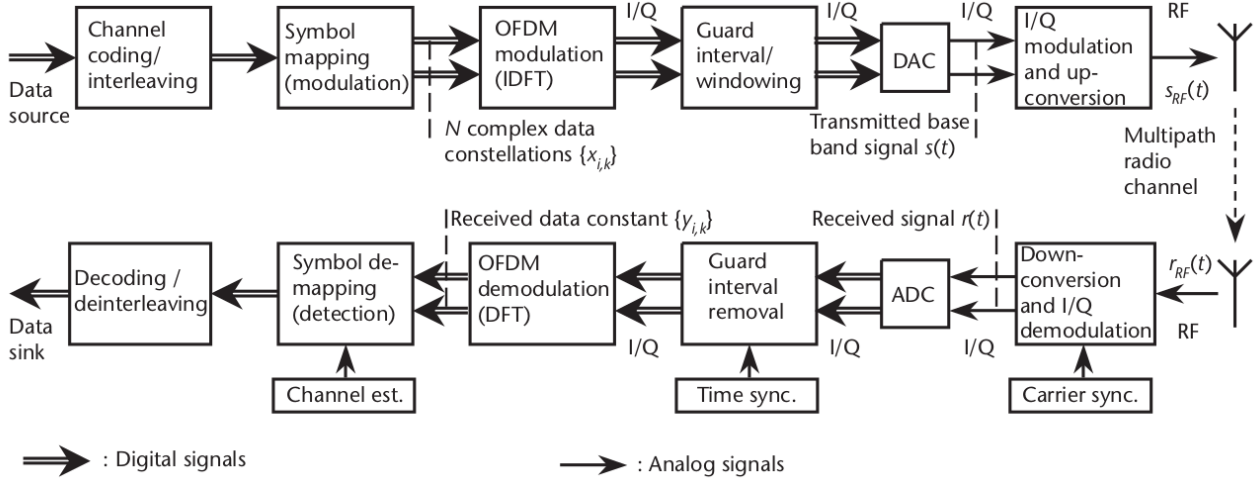

Figure 2.6: Simplex Point to Point OFDM.

modulator and demodulator Phase/Quadrature (I/Q) that would otherwise be required.

Note that in the data constellation  $x_{i,k}$ , there are  $N$  points in the IDFT input, where  $N$  is the number of DFT points. ( $i$  is the SC index;  $k$  is the OFDM symbol index). These constellations can be recorded according to phase manipulation (Phase Shift Keying (PSK)) or a set of QAM (character mapping) signals. The IDFT  $N$  output sample at TD forms a baseband signal carrying data symbols from an SC orthogonal  $N$  set.

Typically,  $N$  is used as a squared integer, which allows the use of a very efficient (reverse) Fast Fourier Transform (FFT) algorithm for modulation and demodulation. The second fundamental principle is the introduction of cyclic prefixes such as GI, whose length must exceed the maximum channel delay, which is unnecessary for multipath propagation. Due to the cyclic prefix, the transmitted signal becomes periodic, and the time-spread multipath channel effect becomes equivalent to the cyclic winding rejecting GI in the receiver.

Due to the nature of the cyclic winding, the multipath channel effect is limited to the point multiplication of the data constellation transmitted from the IR channel's TF or FT channel. That is, SC remains orthogonal. The only drawback of this principle is a slight loss of adequate transmission power because the excess GI must be transmitted. Usually, GI is chosen so that it has a length of one-tenth to a quarter of the symbol period, which results in a Signal to Noise Ratio (SNR) loss of 0.5 to 1 dB.

The alignment (character mapping) required to recognize constellation data is the multiplication of the DFT element by the inverse of the channel's TF prediction (channel estimate). In a phase modulation scheme, multiplication can be done by multiplying it by the approximate conjugate of the complex channel. Differential detection can also be used, in which the

symbol constellations of the neighbouring SC or subsequent OFDM data recovery symbols are compared.

Forward Error Correction (FEC) coding and (FD) interleaving is the third important idea. The frequency selectable radio channel can severely attenuate the data symbol sent to one or more SCs, causing bit errors. By assigning the encoded bits along with the frequency band of the transmitter system, an efficient coding scheme can correct incorrect bits and thereby take advantage of the frequency diversity of the broadband channel.

OFDM systems that use error correction coding are often referred to as Coded OFDM (COFDM) systems. The complex equivalent baseband signal generated by digital signal processing is phase/quadrature (I / Q) modulated and upward-converted for transmission over RF media. The recipient takes the opposite step.

Synchronization is a major issue when designing powerful OFDM receivers. Time and frequency synchronization are essential for identifying the OFDM symbol's initiation and aligning the local oscillator frequency of the modulator and demodulator. If one of these synchronization tasks is not performed with sufficient accuracy, the orthogonality of the SC is (partially) lost. That is, Inter Symbol Interference (ISI) and Inter Carrier Interference (ICI) are introduced.

802.11ah's signal is a burst signal. A single OFDM symbol with a 2 MHz bandwidth of 802.11ah contains 52 SCs, and 12 null carriers to have FFT Size = 64. 52 SCs divided into 48 SCs for data and 4 SCs for the pilot. For different bandwidth, we have different subcarrier and pilot, as shown in the table 2.2:

Table 2.2: IEEE 802.11ah Physical Layer Parameters

Parameter	Value
FFT Size	32/64/128/256/512
Pilot subcarriers	2/4/6/8/16
Data subcarriers	24/52/108/234/468
Channel Bandwidth	1/2/4/8/16
Subcarriers spacing	31.25kHz
OFDM Symbol Duration	40/36 microseconds
Guard Interval	4/8/16 microseconds
Preamble durations	320 microsec untuk BW 1M/160us
Modulation	BPSK/QPSK/16QAM/64QAM/256QAM

802.11ah has normal guard interval 8 microseconds as shown in table 2.2. However, it has

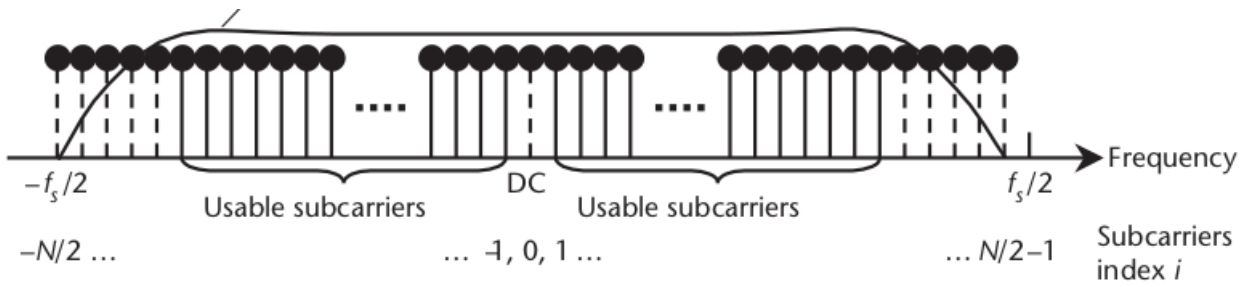

Figure 2.7: Subcarrier.

also a double guard interval of 16 microseconds and a short guard interval of 4 microseconds. Hence, the duration of the OFDM symbol will depend on the guard interval used. OFDM symbol duration will be 40 microseconds for normal guard interval, and it will be 36 microseconds for short guard interval.

The location of data subcarriers should be in the centre. Because in the edge, it will be filtered. Figure 2.7 show the filter that will attenuate the signal.

For a 1 MHz S1G PPDU transmission, the 1 MHz is divided into 32 subcarriers. The signal is transmitted on subcarriers  $-13$  to  $-1$  and  $1$  to  $13$ , with  $0$  being the centre (Direct Current (DC)) subcarrier. The pilot position is on subcarriers  $-7, 7$ . For a 2 MHz S1G PPDU transmission, the 2 MHz is divided into 64 subcarriers. The signal is transmitted on subcarriers  $-28$  to  $-1$  and  $1$  to  $28$ , with  $0$  being the centre (DC) subcarrier. The pilot position is on subcarriers  $-21, -7, 7, 21$ . For a 4 MHz S1G PPDU transmission, the 4 MHz is divided into 128 subcarriers. The signal is transmitted on subcarriers  $-58$  to  $-2$  and  $2$  to  $58$ . Pilot position is on subcarriers  $-53, -25, -11, 11, 25, 53$ . For an 8 MHz S1G PPDU transmission, the 8 MHz is divided into 256 subcarriers. The signal is transmitted on subcarriers  $-122$  to  $-2$  and  $2$  to  $122$ . Pilot position is on subcarriers  $-103, -75, -39, -11, 11, 39, 75, 103$ . For a 16 MHz S1G PPDU transmission, the 16 MHz is divided into 512 subcarriers. The signal is transmitted on subcarriers  $-250$  to  $-130, -126$  to  $-6, 6$  to  $126$ , and  $130$  to  $250$ . Pilot position is on subcarriers  $-231, -203, -167, -139, -117, -89, -53, -25, 25, 53, 89, 117, 139, 167, 203, 231$ . Pilot position summary could be looked on table 2.3:

All data carriers use the same modulation format in a particular burst. However, the modulation format may vary from series to series. Possible formats for subcarrier modulation are BPSK, QPSK, 16QAM and 64QAM. Pilot subcarriers are always modulated with BPSK and a specific size and phase.

Each OFDM subcarrier carries a single modulated data symbol or "constellation point" along with size and phase information. This means that the size and phase vary for each

Table 2.3: IEEE 802.11ah Pilot Position

Bandwidth	Subcarrier number
1	-7, 7
2	-21,-7,7,21
4	-53, -25, -11, 11, 25, 53
8	-103, -75, -39, -11, 11, 39, 75, 103
16	-231, -203, -167, -139, -117, -89, -53, -25, 25, 53, 89, 117, 139, 167, 203, 231

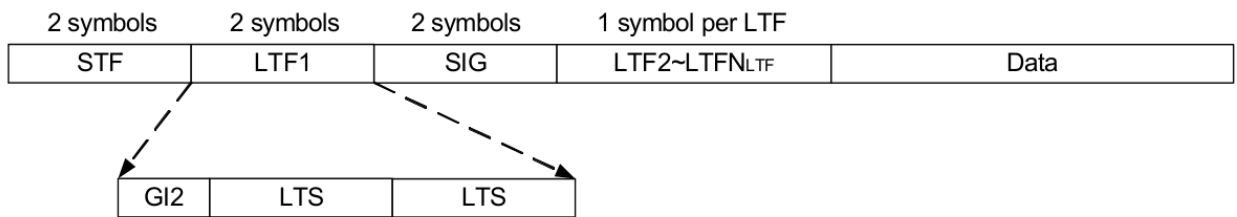

Figure 2.8: S1G\_SHORT format.

subcarrier and each OFDM symbol in the transmitted packet.

The basic frame format structure for 802.11ah burst contains a preamble, signal and data symbols. Each data symbol contains  $N$  subcarriers that  $N$  is FFT Size, and it depends on Channel Bandwidth. In the PHY layer, there are three modes:

- The 1 MHz mode (S1G\_1M) is intended for low data rate applications. This mode features an extended preamble and a new modulation and coding scheme, MCS10, to improve robustness.
- The more than 2 MHz long preamble mode (S1G\_LONG) is used for single or multi-user transmissions with a 2, 4, 8, or 16 MHz channel bandwidth. The Physical layer Protocol Data Unit (PPDU) is similar to a 802.11ac Very High Throughput (VHT) PPDU.
- The more than 2 MHz short preamble mode (S1G\_SHORT) is used for single-user transmissions with a 2, 4, 8, or 16 MHz channel bandwidth.

The general structure for S1G\_SHORT is defined as in Figure 2.8. This format is used for Single User (SU) transmission using 2 MHz, 4 MHz, 8 MHz, and 16 MHz PPDUs.

The preamble is for synchronization. It has two parts: Short training field and long training field. The short training field and long training field consist of a sequence of 12 OFDM symbols

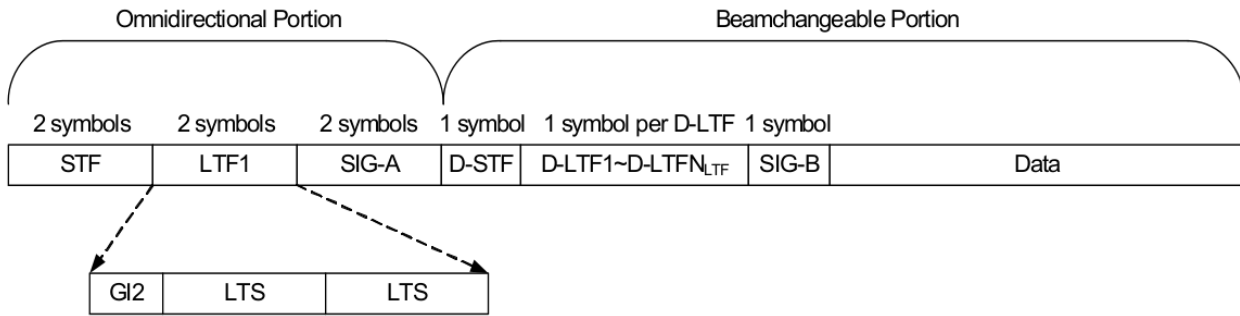

Figure 2.9: S1G\_LONG format.

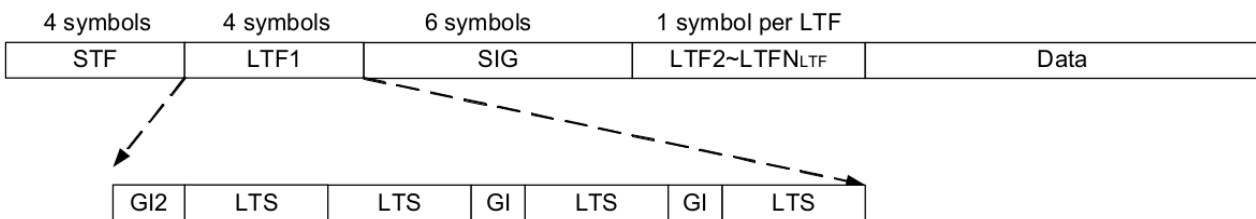

Figure 2.10: S1G\_1M format.

that are used to assist the receiver in identifying that an 802.11 frame is about to start, synchronizing timers, and selecting an antenna. The Signal field is used by 802.11 to describe the data rate and length (in bytes) of the frame used by receivers to calculate the time duration of the frame's transmission.

The general structure for S1G\_LONG is defined as in Figure 2.9. This frame format can be used for Multiple Users (MU) and SU beamformed transmissions using 2 MHz, 4 MHz, 8 MHz, and 16 MHz PPDUs.

The general structure for S1G\_1M is defined as in Figure 2.10. This frame format is used for S1G\_1M PDU SU transmission.

The fields of the S1G PDU formats are summarized in Table 2.4.

To decrease collision probability in networks with thousands of devices and improve power efficiency, TGah has developed RAW. The key idea of RAW is to limit the number of devices contending within the window that consists of equal time slots.

By broadcasting in beacons special RAW Parameter Set (RPS) i.e., the AP allocates one or more restricted channel access intervals as Restricted Access Window (RAW). All devices in this network listen at the beginning of the beacon frame called Target Beacon Transmission Time (TBTT) to obtain scheduling information that indicates which RAW they belong to. Subsequently, devices would fall into sleep mode until turning to their allocated RAW to

Table 2.4: S1G PPDU Field.

Field	Description
STF	Short Training field
LTF	Long Training field
SIG	SIGNAL field
SIG-A	Signal A field
D-STF	Short Training field for the beam changeable portion
D-LTF	Long Training field for the beam changeable portion
SIG-B	Signal B field
Data	The Data field carries the PSDU(s)
GI	Guard interval
GI2	Double guard interval
LTS	Long training symbol

attempt to access. During RAW, only a set of devices determined by the lowest and the highest AIDs, both from the same page, can access the channel.

Each RAW consists of equal time slots corresponding to various devices. Due to the frame format, if the number of slots in one window is less than 8, each slot may reach 246.14 ms. Otherwise, the slot duration is limited to 31.1 ms. During RAW, each device is forbidden to access the channel before its slot.

Periodically, AP broadcast control/management frames, which is called beacon frames. Beacon frame will aid STA to operate and remain synchronized with AP within Basic Service Set (BSS). AP and its connected STA(s) form a BSS. BSS can use different frequencies and different channel, depending on the country, as shown in figure 2.11.

AP is also setting up a new connection with STA, who want to connect with the BSS. AP response to uplink data with Acknowledge (ACK), and send data to STA in the downlink. AP will transmit more frequently because it will send data to several STAs.

Because of the scarcity of the available spectrum, sub-1 GHz does not allow using wide bands, especially  $\geq 20$  MHz wide bands introduced in IEEE 802.11n and ac. 802.11ah uses a clocked down version of 802.11ac, like its bandwidth ten times lower: 1, 2, 4, 8, and 16 MHz, respectively. 802.11ah's transmission is frame-based, with each frame consisting of multiple OFDM symbols. Modulation and Coding Schemes (MCS) of 802.11ah is shown in table 2.5.

MAC frame consists of a set of fields that occur in a fixed order. The general MAC frame

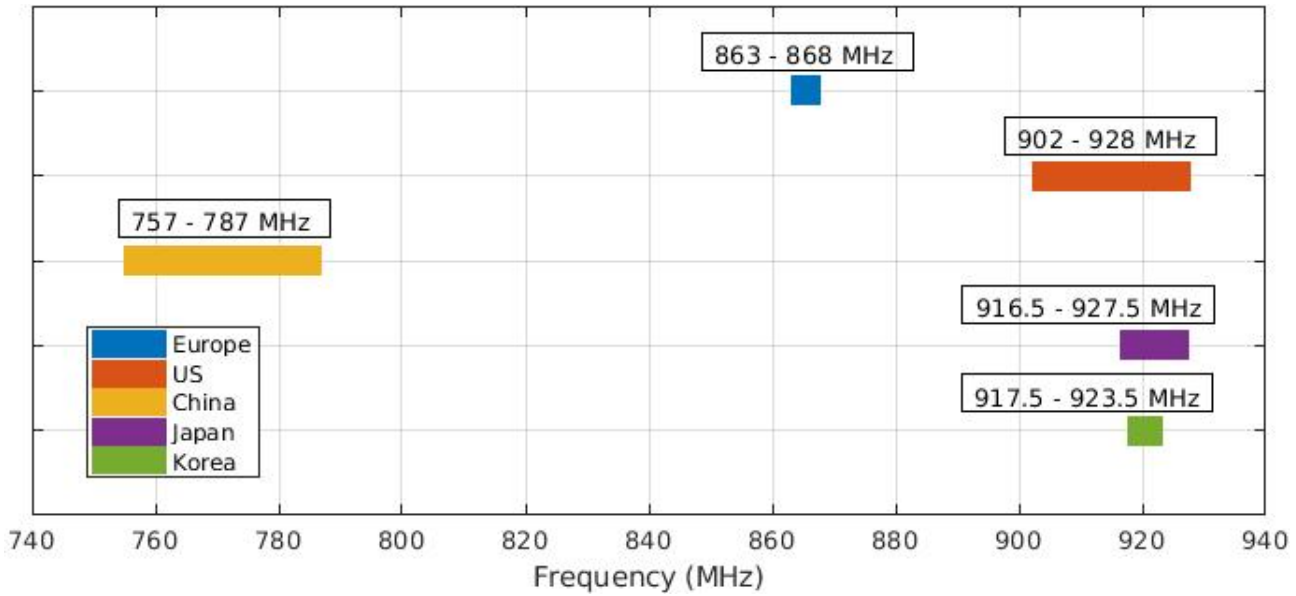

Figure 2.11: Frequencies of IEEE 802.11ah.

Table 2.5: IEEE 802.11ah MCS for 2MHz Bandwidth Channels

MCS Index	Tabulation	Code Rate	Data Rate normal GI (Mbps)	Data Rate short GI (Mbps)
0	BPSK	1/2	0.65	0.72
1	QPSK	1/2	1.3	1.44
2	QPSK	3/4	1.95	2.17
3	16-QAM	1/2	3.9	2.89
4	16-QAM	3/4	5.2	2.89
5	64-QAM	2/3	5.85	2.89
6	64-QAM	3/4	2.6	2.89
7	64-QAM	5/6	2.6	2.89
8	256-QAM	3/4	2.6	2.89
9	256-QAM	5/6	2.6	2.89

format for 802.11 is depicted in Figure 2.12. The maximum size is 7991 bytes. The first three fields (Frame Control, Duration/ID, and Address 1) and the last field (Frame Check Sequence (FCS)) are present in all frames. The other fields are present only in certain frame types and subtypes.

802.11ah using BPSK, QPSK modulation as mandatory, and 16QAM, 64QAM, 256QAM

Bytes: 2	2	6	0 or 6	0 or 6	0 or 2	0 or 6	0 or 2	0 or 4	0-7959	4
Frame Control	Duration /ID	Address 1	Address 2	Address 3	Sequence Control	Address 4	QoS Control	HT Control	Frame Body	FCS

Figure 2.12: MAC format of IEEE 802.11ah.

modulation is optional. Modulation involves changing some of the periodic wave properties with an external high-frequency signal. It is used to send information bearer signals over long distances. These high-frequency carrier signals can travel through the transmitted path or through the air and cover great distances. The carrier signal can be electric current, radio frequency or microwave, or light.

The taking of information at the receiving end is called demodulation. The carrier signal's characteristics (amplitude, frequency or phase) are changed according to the information carrier signal. This information-carrying signal is also referred to as a modulation signal. This modulated signal is a slowly changing signal as opposed to a rapidly changing carrier frequency.

Each frame is divided into three parts: a MAC header, a variable-length frame body, and an FCS containing an IEEE 32-bit CRC for error detection. The MAC header comprises several fields:

- **Frame Control:** consists of several subfields. The type of frame defines which subfields should be included in frame control. Frame control contains information about the frame type, fragmentation, power management and etcetera.
- **Duration/ID:** varies with frame type, but it is usually set to the time (in microseconds) required to complete the current transmission. It can also carry the AID of the STA that transmitted the frame [3].
- **Address Fields:** used to identify the Basic Service Set Identifier (BSSID), Source Address (SA), Destination Address (DA), transmitting STA address (TA) and receiving STA address (RA).
- **Sequence Control:** indicates the sequence number of the frame. Sequence numbers are used for duplicate detection and recovery.
- **QoS Control:** determines the QoS policies desired for the corresponding frame transmitted by QoS-enabled STAs.



- HT Control: gives information about link adaptation, used MCS, and antenna selection in MIMO.

## 2.2 Summary

One obvious advantage of HaLow is longer distance and higher throughput if we compare with previous standards like BLE, LR-WPAN and WBAN. We could effectively install one access point to cover a house or a small clinic. Although its power consumption is higher than previous standards, it is still comparable.

In table 2.6, we compare aforementioned standards with data rate, channel, and range. Considering data rate, 802.15.4 is lower as written in its name, Low Rate Wireless Personal Area Network. HaLow has the highest data rate. Even using 16-QAM, it could have a data rate of 2.6 Mbps.

Table 2.6: Comparison of 802.15.1, 802.15.4, 802.15.6 and 802.11ah.

Standard	Data Rate	Channel	Range
802.15.1	1 Mbps	37	100 m
802.15.4	250 kbps	16	10 m
802.15.6	971.4 kbps	79	2 m
802.11ah	8.67 Mbps	10	1 km

Because WBAN has many channels, it can have many devices communicate together without interference. Just choose the unused channel. Also, if it operates in a dense ISM band, it could easily find an empty channel. HaLow's channels depend on bandwidth. If it uses 1MHz bandwidth in US frequency, it could have 26 channel. With the lowest data rate, 802.11ah could reach 1 km, which is the longest compared to other standards. Because WBAN only works around the body, it just needs to communicate within 2 m range, as long as human height. WBAN has a drawback for its short range. It will be challenging to connect to the master station afar from the patient.

802.11ah uses the same topology like other WLAN standards such as 802.11a/b/g/n,. This topology is composed of AP and STA (STAtion), for infrastructure mode. Analysis and simulations from [24], [25] and [26] are done only for standard pathloss described in [27]. If we use body pathloss proposed by [28], with frequency correction for S1G (sub 1 GHz), the performance will be lower.

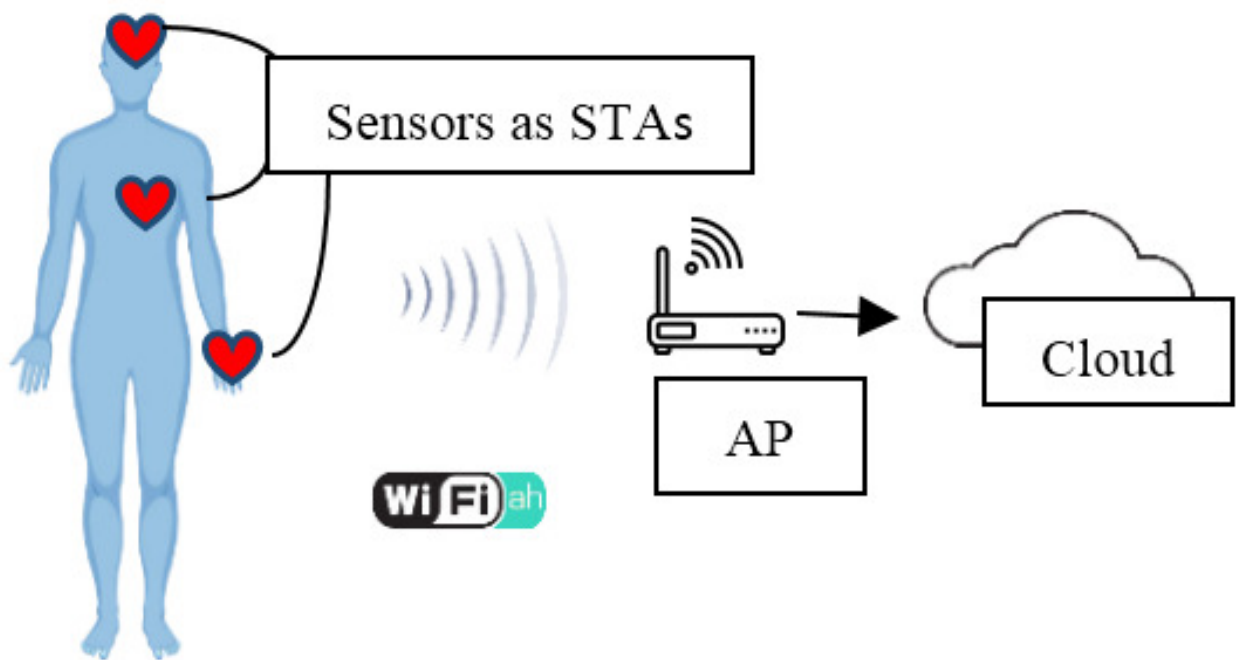

Figure 2.13: Diagram System.

There is WBAN (Wireless Body Area Network) that is developed particularly for body network, yet we must use a coordinator that is carried by the patient [29]. Using 802.11ah, we can expect sensor nodes to directly communicate with the access point without the need for a relay station. Fig. 2.13 show the diagram of the system.



# Chapter 3

## Challenge of IoT for Healthcare

### 3.1 Introduction of Network Architecture of 802.11ah

IoT network topology shares common network topology, i.e., star topology, mesh topology and point-to-point network. Ring topology is not suitable for IoT network because it is a wired network. IoT needs to be portable so that it could give an advantage to a system.

Most of Low Power Wide Area Network (LPWAN) technology, notwithstanding WiFi and cellular, utilize a star network topology. A star network topology has an access point in the centre that interfaces with all the terminals or station.

The benefit of star topology is that the access point handles all the network complexity, so all different stations require to transmit signal in their time or frequency space. The essential hindrance of star topology is that the radio connection between the access point and station can be long, implying that the further a station is, the more energy it needs to hand off a message from the access point.

A mesh topology is a network setup where each access point and sensor device is interconnected. Figure 3.1 show the mesh network. There is no hierarchy, uniform pattern and interdependency between nodes in this topology and connections between nodes randomly occur.

Point to Point topology is the simplest topology that connects two nodes directly together with a common link as shown in figure 3.2. The entire bandwidth of the common link is reserved for transmission between those two nodes. The point-to-point connections use an actual length of wire or cable to connect the two ends, but other options, such as satellite links, or microwaves are also possible.

The advantage of point-to-point network topology is that it is much simpler than mesh or

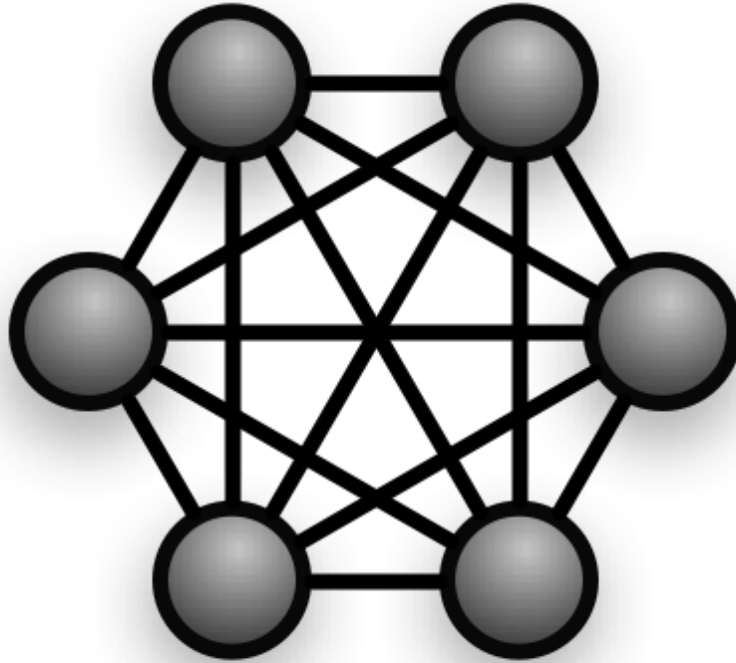

Figure 3.1: Mesh Topology.

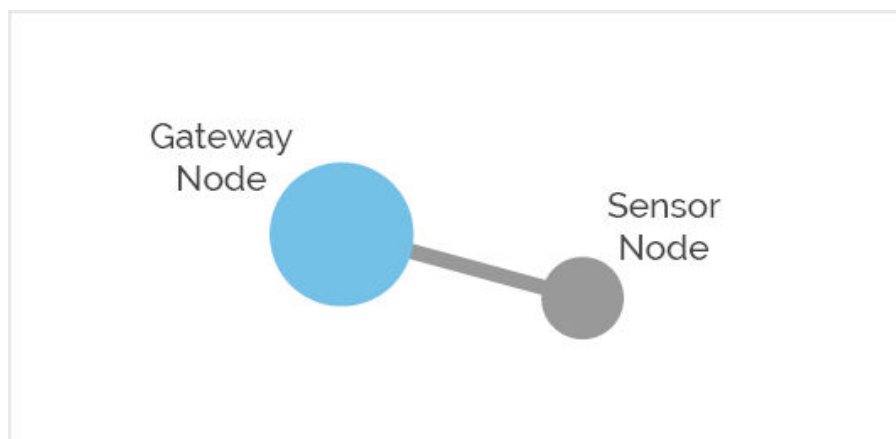

Figure 3.2: Point to Point Topology.

star. The topology tunnels a flow of data either unidirectionally or bidirectionally between two points.

## 3.2 Data Security and Privacy

One of the challenges that have received particular attention is data security and privacy in healthcare IoT. Namely, devices used in healthcare collect and transmit sensitive personal data. It can be misused by hackers to compromise the patient's medical record. Since connected medical devices collect patient's vital parameters, it is of utmost importance to ensure their performance and reliability.

The main priority for healthcare is to ensure patients and their data safe. This priority implies more exhaustive work with equipment and programming designers on security and protection issues with IoT in medical services.

When sending data to the emergency clinic's IoT framework, classified information capture attempts are dangerous. To acquire it through a flood of unprotected traffic, the hacker should be indeed near it or plant a device like a gadget that would read the clinical information with sensors and send it to the server.

Validation and approval ought to be introduced at all phases of collaboration to guarantee assurance against hacking endeavours. The two of them are required when the gadget contacts the information transmitter and connects with the wireless network. The system should be ensured at the information move level to keep any entrance from outside.

Cryptography can be executed to neutralize information block attempts in the IoT system on both the application and physical layers. In any case, on account of the last mentioned, it will be significantly more challenging. Generally, lightweight cryptography is utilized as cryptography strategies for sensor nodes in IoT. Among the sorts of lightweight cryptography methods, we can utilize asymmetric and symmetric ones:

asymmetric — utilizes two keys for encryption. The public key is available to all, and the owner has the subsequent private key. Generally, asymmetric encryption is utilized uniquely to set up a handshake, the alleged key exchange, during which public and private keys are traded between the sender and the recipient. At that point, symmetric encryption assumes control over the actual work.

Symmetric — the least complex encryption strategy. It utilized one secret key (i.e. number, word, character set, or even images not accessible on the console format) and made it during the meeting, after the handshake. The sender and receiver should know the key to decrypt. However, cryptography uses high resources of processing, and it will drain the battery fast.

### 3.3 Interoperability

Another challenge present in the whole IoT ecosystem, and not only in the healthcare sector, is interoperability. It can be defined as the ability of an ICT system to operate with parts of other systems. Later on, many IoT medical devices will exist, which is slowly expanding as time passes, coming about into a bunch of many devices associated with the healthcare IoT. However, these devices are regularly described by a high level of heterogeneity, delivering tremendous health information measures in various formats.

Many medical services manufacturers challenge extracting information from various healthcare devices, whether for patient care or the clinical report. Nevertheless, every one of these medical services manufacturers is confronting numerous challenges in dealing with every one of these immense information measures, fundamentally lacking standard data of healthcare information.

To exchange information with any IoT medical devices, interoperability is the only way to let systems interact with each other. It is considered a need in the electronic medical care frameworks for settling information heterogeneity issues.

### 3.4 Impact of Body Pathloss on Wearable Sensor

#### 3.4.1 Body Pathloss Model

802.11ah is developed for general IoT, and its standard declares that it could be implemented in the healthcare area. However, as far as we know, there is no research about 802.11ah in the healthcare environment, only introduce the required data rate for e-Health applications [30]. Suppose we want to develop for healthcare specifically. In that case, it should have the ability to solve the specific problem of body network, for example, to recognize packet error caused by human body pathloss.

Pathloss is caused by the attenuation of power transmitted, and one of the causes is body absorption. If the human body causes pathloss, then normal retransmission mode will be not beneficial. It will consume more energy.

Original outdoor path loss model of 802.11ah used by article [24] [26] is derived from TGah model as shown in equation 3.1. It assumed the height of the antenna is 15 meters from the rooftop.

$$L = 8 + 37.6 \log_{10}(d) \quad (3.1)$$

Where  $L$  is pathloss in dB,  $d$  is the distance in meters, and frequency is 900 MHz. Domaze-

tovic et. al. [25] did a performance analysis of 802.11ah. They use pathloss of TGah model and assume all of the other parameters is the same. The result is shown in figure 3.3 as we reproduced.

A couple of various cases were considered in the recreation model. Correspondence range is determined for various numbers of transmission powers (10mW, 200mW and 1000mW), characterized for various topographical territories, just as for various numbers receiver minimum input sensitivity by utilized MCS (from the standard page 488). The transmission power parameter depends on which country regulates. In Europe, the maximum transmits power is 10 mW. In Japan, maximum power transmit 250 mW, and in the United States, it is 1 W.

From the figure 3.3, theoretically, the maximum distance of 802.11ah transmission is less than 500 meters for transmission power of 10 mW. It can reach more than 1500 mW with a transmission power of 100 mW. However, a different result will be obtained with the body pathloss model. There is model for body pathloss in S1G (under 1 GHz). We should carefully analyze the model for other frequency and derived it for S1G.

T. Kikuzuki et al. [28] proposed body propagation loss model using frequency 2,4 GHz. They combined two propagation channels, which are on-body and free space channel. Their pathloss model is shown in equation 3.2.

$$L = 10(n - 2)\log_{10}(d_1) + 20\log_{10}(d) + S + C \quad (3.2)$$

Where C is system loss constant, d1 is the distance within the body, d is air distance. S is body shadow constant, and its value is 0 if there is not body shadow. To get the n, S, and C parameters, they experimented using a Zigbee development kit with the frequency of 2,4GHz. After several experiment, they got  $n = 3$ ,  $S = 8,68$  and  $C = 64,7$  which are reasonable value from their perspective.

To use this path loss on 802.11ah, we have to correct its frequency used. By assuming free space propagation, we could derive a formula with frequency 900 MHz consideration. We start with pathloss in equation 3.3.

$$L = 10n \log_{10}(d) + C \quad (3.3)$$

Where d is distance, and C is constant for system losses. For free space,  $n = 2$ . Equation 3.4 is free space path loss.

$$L = 20\log_{10}\left(\frac{4\pi df_c}{c}\right) \quad (3.4)$$

If we compare equation 3.3 and equation 3.4, we got equation 3.5.

$$C = C_1 = 20\log_{10}\left(\frac{4\pi}{c}\right) + 20\log_{10}(f_{2.4}) + D \quad (3.5)$$



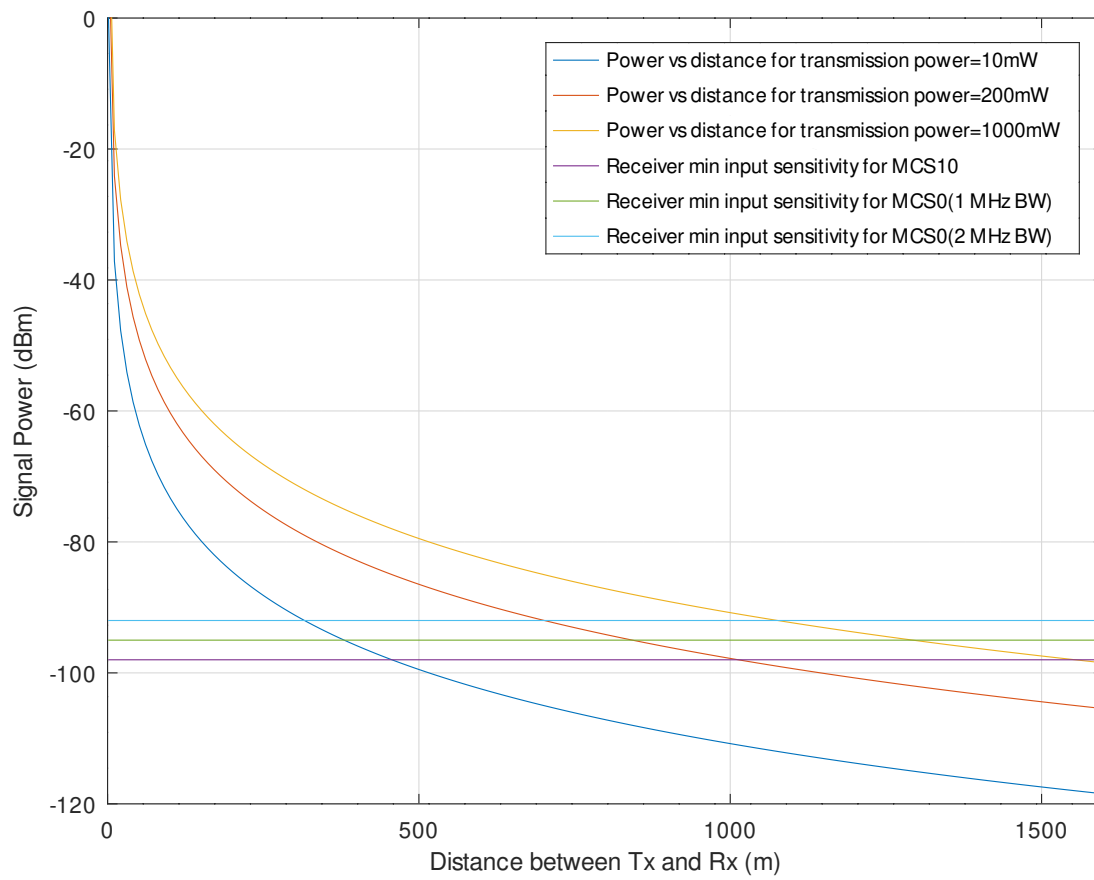

Figure 3.3: Range of 802.11ah using outdoor pathloss.

$C_1$  is another symbol to distinguish with later  $C$ .  $D$  is constant for system losses after subtracted by wavelength loss. The experiment did by T. Kikuzuki [28] was using carrier frequency  $f_c = 2.405$  GHz, so I will write it as  $f_{2.4}$ . Hence we have equation 3.6.

$$D = C_1 - 20\log_{10}\left(\frac{4\pi}{c}\right) - 20\log_{10}(f_{2.4}) \quad (3.6)$$

On the other hand, for frequency 900 MHz ( $f_{0.9}$ ) that is used by 802.11ah, we will have equation 3.7.

$$C = C_2 = 20\log_{10}\left(\frac{4\pi}{c}\right) + 20\log_{10}(f_{0.9}) + D \quad (3.7)$$

By combining equation 3.5 and 3.7,

$$C_2 = C_1 + 20\log_{10}\left(\frac{f_{0.9}}{f_{2.4}}\right) \quad (3.8)$$

To adjust for frequency 900 MHz, I add equation 3.2 with frequency correction from equation 3.8,

$$L = 10(n - 2)\log_{10}(d_1) + 20\log_{10}(d) + S + C + 20\log_{10}\left(\frac{f_{0.9}}{f_{2.4}}\right) \quad (3.9)$$

Equation 3.9 will be used for channel model of body pathloss.

### 3.4.2 Result and Discussion

Figure 3.4 show comparison between body pathloss with original pathloss from IEEE 802.11ah Task Group (TGah). Body pathloss is higher than standard pathloss from TGah. The difference is about 20 dB. Then by drawing a line for recommended receiving sensitivity from the standard, we know the maximum range of 802.11ah with body pathloss as shown in figure 3.5. It assumed all other parameter is the same and without fading. Theoretically, the maximum distance is around 100 meters, with MCS0, BPSK and bandwidth 2 MHz.

This body pathloss model will be used to analyse PER and throughput of the system.

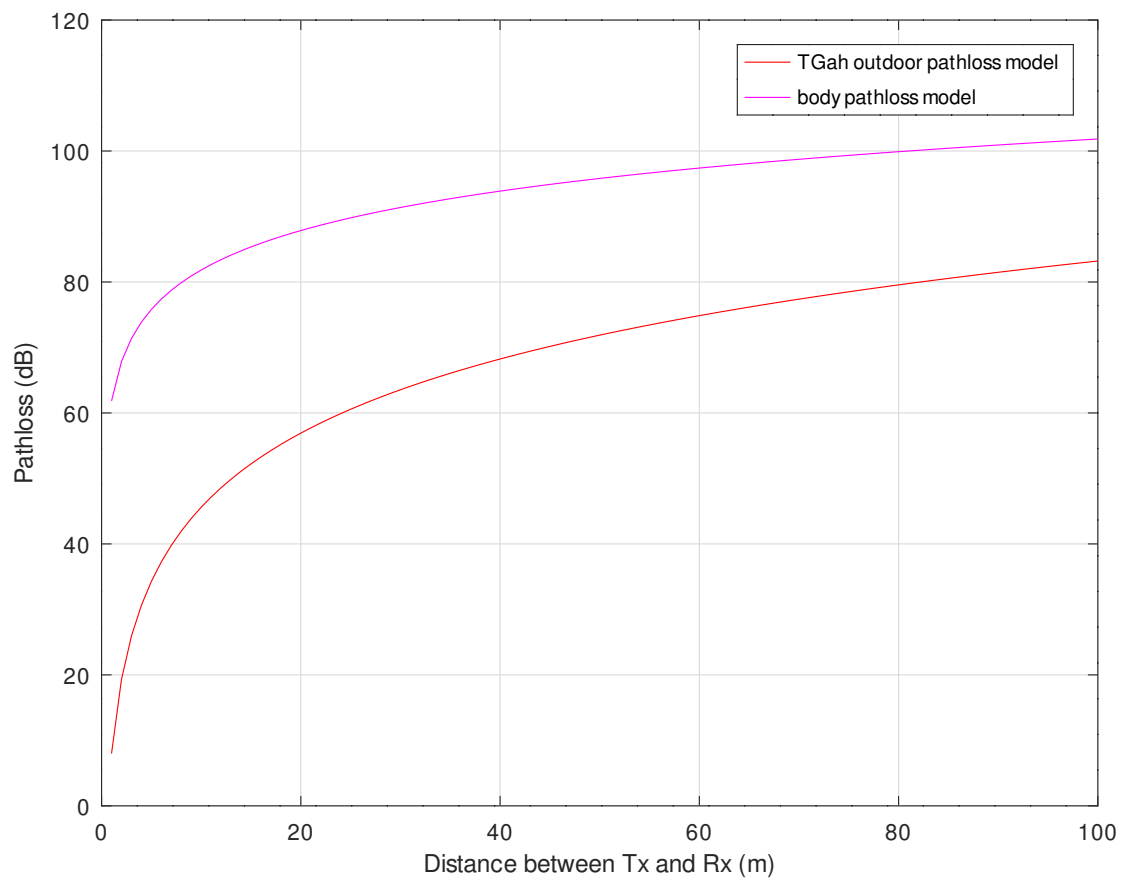

Figure 3.4: Pathloss of outdoor model and body model.

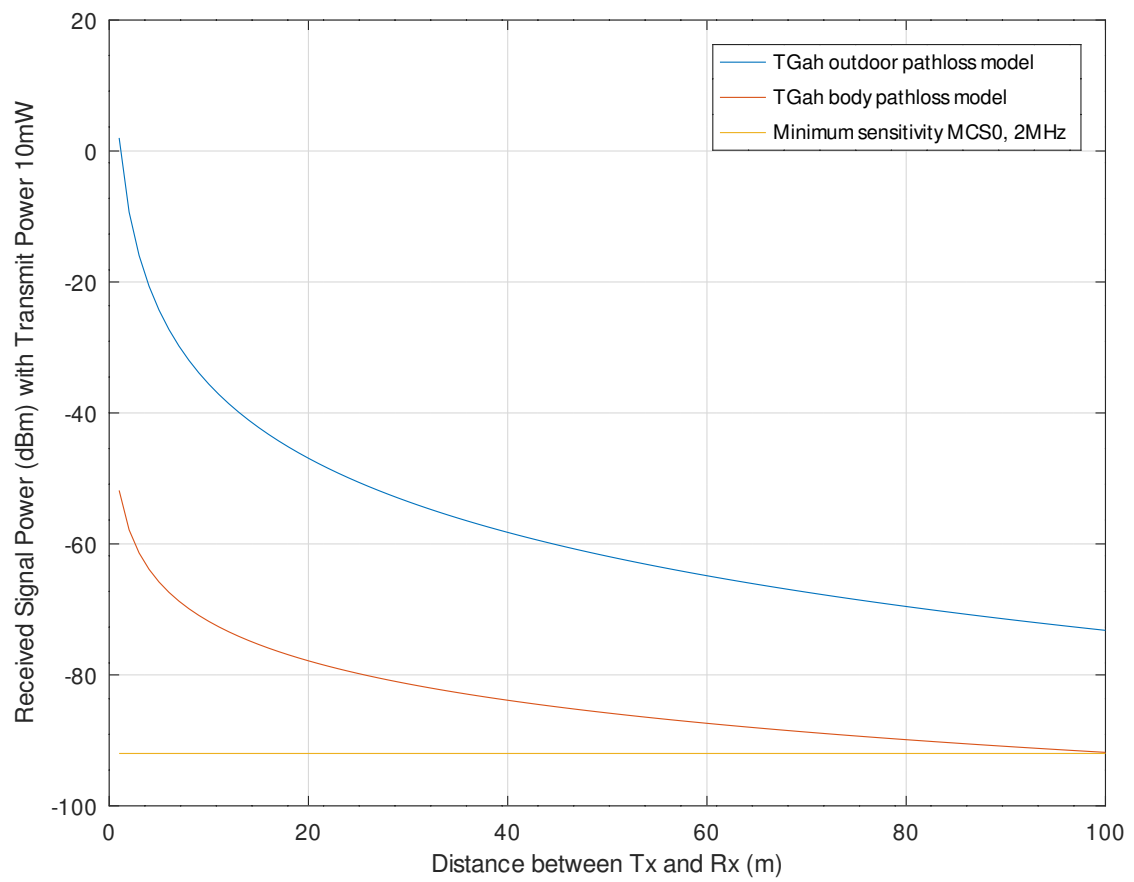

Figure 3.5: Range of 802.11ah using outdoor pathloss and body pathloss.



# Chapter 4

## PHY/MAC Cross-Layer Performance With the Aid of Beacon

### 4.1 Cross-Layer Design and Analysis

Sensor nodes are scattered or carefully distributed in a sensing field without fixed infrastructure. Sooner or later, sensor nodes will die from lack of power, physical damage or impairment of the environment. So it needs an IoT protocol that is simple, energy-efficient and adapts to various environmental conditions.

In general, the component which consumes the highest power is the radio communication unit of the sensor node that takes information from the sensor and then submitting its data to the master station or the next-hop router. Therefore, it is interesting to develop a method or protocol that can reduce the transmission power of sensor nodes [31].

The energy consumption of sensor nodes become dominant criteria in assessing the performance of IoT. Many studies are offered to keep energy efficiency at every layer protocol by developing new algorithms and protocols to solve this problem. However, the separation layer is a constraint in the evolvement of IoT. Thus, the cooperation of multiple layers can be developed so that the advancement process can continue.

One way to improve energy efficiency is to use a cross-layer which utilizing the relationship between the communication layers for determining the following step action [32]. In designing protocols that use a cross-layer approach, information on a layer can be used by a protocol in the other layers. For example, information received about signal strength from the adjacent node (meaning information on the physical layer) can assist routing protocols (in the network layer) determine the next hop in the route. If the signal is weak or the node is far, it should

not be used as a candidate next hop in the routing.

Our cross-layer approach is using information from Physical (PHY) to decide the next move of Medium Access Control (MAC). The information used from PHY is the Signal to Noise Ratio (SNR) of the received beacon signal from Access Point (AP). MAC protocol of sensor nodes (station (STA)) will decide whether transmit on postponing its data based on that information. To find out its performance, we analyze Packet Error Rate (PER) and Throughput.

Article [33] has approximation of block fading rayleigh which is used by article [26] to approximate PER on 802.11ah. The average block PER for rayleigh channel is shown in equation 4.1 [33].

$$\overline{PER} = 1 - \exp\left(-\frac{\gamma_{th}}{\bar{\gamma}}\right) \quad (4.1)$$

where gamma threshold is SNR threshold. For uncoded modulation system, SNR threshold is shown in equation 4.2 [33].

$$(1 - SER(\gamma_{th}))^N = \frac{1}{2} \quad (4.2)$$

where N is number of symbols per packet and SER is symbol error rate. Figure 4.1 try to reproduce curve of this approximation from Ferrand Et. Al.[33] with N = 312 for Rayleigh and Rice fading channel model. For small SNR, PER is almost 1, which mean high probability of error. And as SNR is increasing, PER will improve.

If the approximation of PER is combined with outdoor pathloss of TGah, then we obtain figure 4.2. Figure 4.2 is the reproduction of [26]. It has a variety of packet size and transmission power. The transmission power parameter depends on which country regulates. In Europe, the maximum transmits power is 10 mW. In Japan, maximum power transmit 250 mW, and in the United States, it is 1 W. PER will rise with the expansion of packet size. However, PER is decreasing with higher transmission power.

To calculate throughput, we need to know the MAC mechanism in 802.11ah. MAC is a protocol that is responsible for regulating access to the media. The MAC for 802.11ah inherits the standard from MAC 802.11 mechanism, namely Distributed Coordination Function (DCF), which is based on Carrier Sense Multiple Access with Collision Avoidance (CSMA/CA) [34]. DCF has two schemes, namely basic access and Request To Send/Clear To Send (RTS/CTS).

For basic access, the STA waits for idle channels throughout DCF Interframe Spaces (DIFS) time added with random back-off times. If the channel continues to idle, then the STA will send the data. Random back-off time is calculated from the time slot multiplied by the Contention Window (CW). CW is a random integer number between [0, CWmin]. CW will decrease one by one each time the STA finds an empty time slot. However, if the time slot is not idle, then CW will not decrease. If CW reaches 0, the STA will send data.

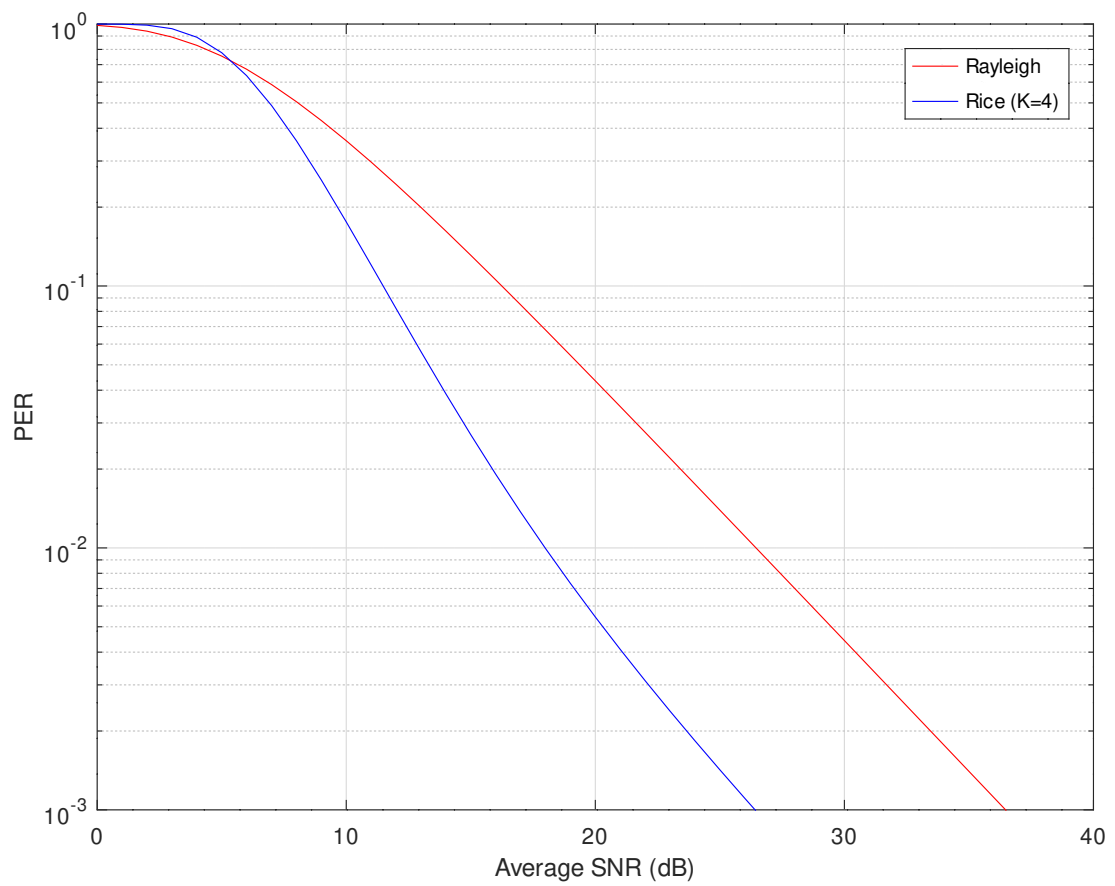

Figure 4.1: Unit step approximation PER of fading channel model.



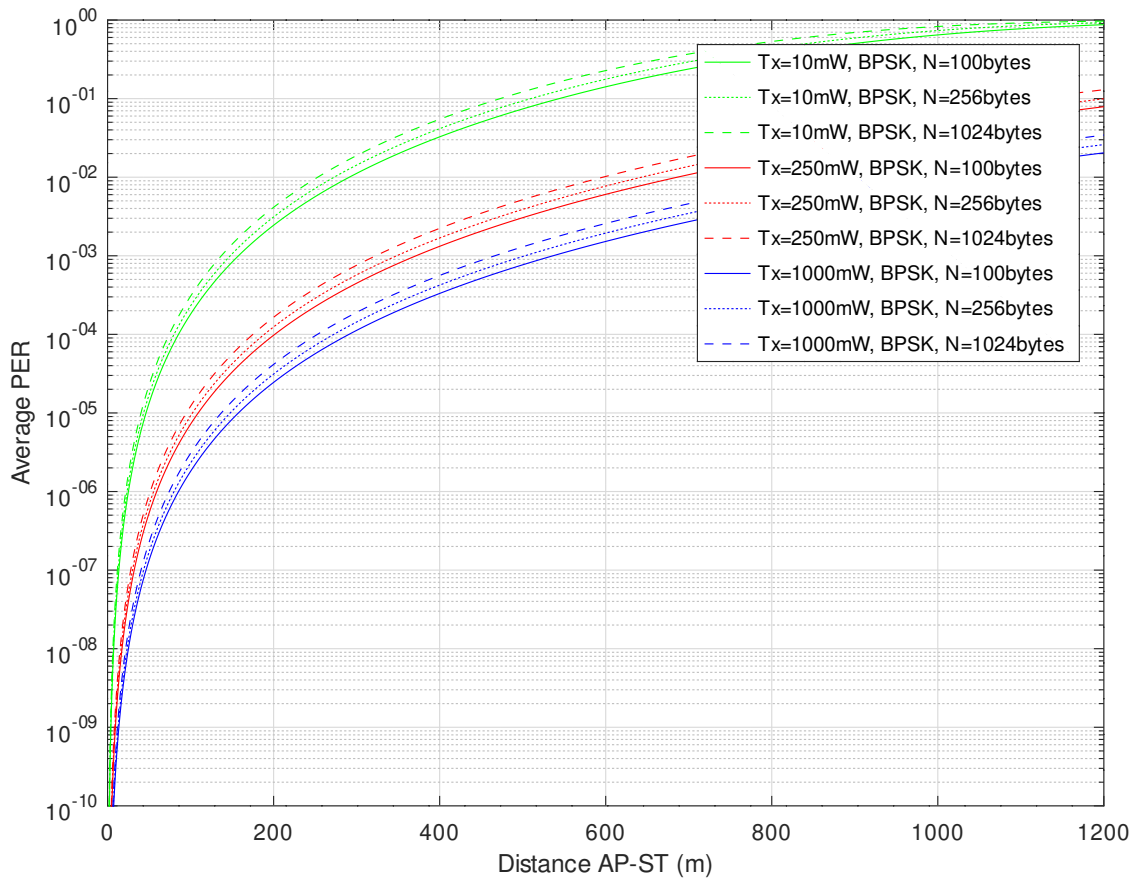

Figure 4.2: PER Performance of 802.11ah.

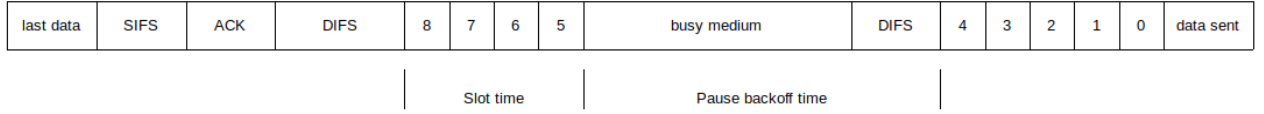

Figure 4.3: DCF Model.

To find out whether the AP has received the data, the AP will send the ACK to the STA after Short Interframe Spaces (SIFS) time. If the Acknowledge (ACK) is not received by the STA within a specified time (ACK timeout), the STA will assume a collision or data sent in error. STA will retransmit with an exponentially greater upper limit of CW, as long as it does not exceed CWmax.

Figure 4.3 explained the mechanism. For example, after received ACK, STA wants to send another data. STA will wait for DIFS added with CW. Here CW is 8. Every idle Time slot, CW will decrease one by one. When CW reach 5, the Time slot is not idle. So it will wait for the Time slot to idle, then continues to decrease CW again. When CW equal zero, STA will transmit data.

Changes in the 802.11ah standard that are important in the header are a 4 bytes reduction in MAC addressing. If legacy 802.11 uses 6 bytes for MAC addresses, 802.11ah uses 2 bytes of Association Identifier (AID), which can reduce overhead.

To calculate throughput of DCF, we could use equation 4.3 [26].

$$S = \frac{8 L_{data}}{T_{message}} \quad (4.3)$$

where  $L_{data}$  is payload size in bytes, and  $T_{message}$  is described in equation 4.4.

$$T_{message} = DIFS + T_{data} + SIFS + T_{ACK} + T_{BACKOFF} + 2\delta \quad (4.4)$$

DIFS and SIFS are given in table 4.1.  $T_{data}$ ,  $T_{ACK}$  and  $T_{BACKOFF}$  are transmission time of DATA, ACK and BACKOFF respectively.  $\delta$  is propagation delay.

The equation 4.4 above is for the ideal condition, where there is no error. Because there is no error, the contention window (CW) size does not increase exponentially. However, for real-world condition, we must consider a scenario with an error by multiplying throughput with PER. Also, PER will introduce retransmission, and CW will increase exponentially. Hence it will be the function of PER as shown in equation 4.5 [26].

$$T_{BACKOFF} = \sum_{i=0}^{\infty} PDR(i) T_{backoff}(i) \quad (4.5)$$

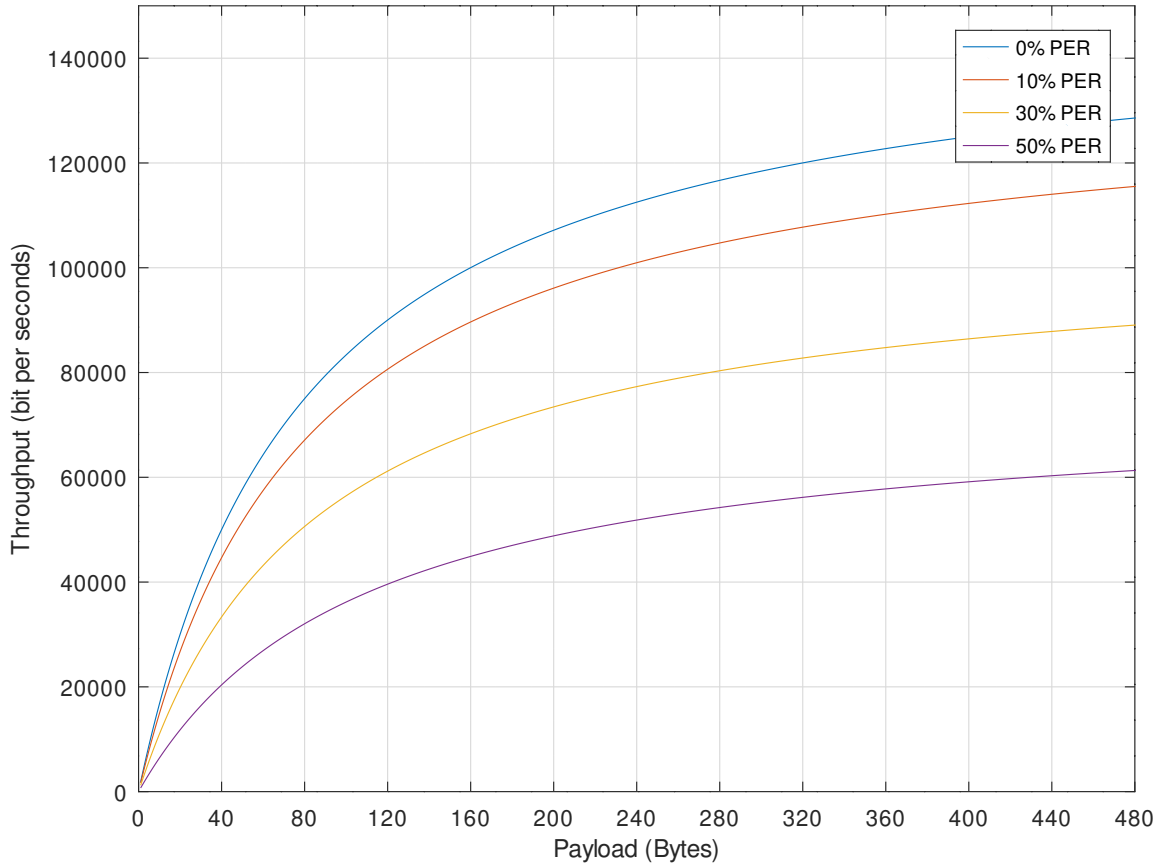

Figure 4.4: Throughput vs Payload size for 802.11ah.

where,

$$PDR(i) = (1 - PER)PER^{(i-1)} \quad (4.6)$$

and,

$$T_{backoff}(i) = \begin{cases} \frac{2^{(i-1)}(CW_{min}+1)-1}{2} T_{Slot} & , 1 \leq i < m \\ \frac{CW_{max}}{2} T_{Slot} & , i \geq m \end{cases} \quad (4.7)$$

where  $m$  is maximum number of exponential of back-off, which is 6.

Figure 4.4 show curve of the throughput results as a function of payload size. Figure 4.4 is a reproduce of [24].

By using equation 3.1, 3.9, 4.1, 4.3, we could compare outdoor path loss model of 802.11ah standard (TGah) with pathloss model of body.

## 4.2 Packet Error Rate and Throughput of Body Pathloss

### 4.2.1 Research About Effect of Body Pathloss

To counter loss from body pathloss, we propose a cross-layer method. As mentioned in the standard, 802.11ah AP transmits beacon periodically. By measuring the received power of the beacon at the PHY layer in sensor nodes (STA), the MAC layer of the sensor node could use this information to decide whether it will transmit or not. Here we assume signal attenuation only caused by body pathloss.

Table 4.1: Parameters used in simulation.

Parameter	Values
MCS	0
N	100
DIFS	264 us
SIFS	160 us
$CW_{min}$	15
$CW_{max}$	1023
Time slot	52 us
Body Shadow Probability ( $p_{body}$ )	ECG: 7% Glucose Monitor: 5% Blood Pressure: 10%

Body pathloss does not happen all the time. There is a probability it happens, as discussed in [35] [36], and we can see it in table 4.1. The parameters are from 802.11ah standard [23], except for body shadow probability. We use information from article [36] for probability of body shadow. The probability of body attenuation in ECG, glucose monitor, and blood pressure is different because sensor nodes' location is different.

The attenuation rate will change continually following physical activity. Sometimes it is high, and sometimes it is low. Measurements from [35] have shown that attenuation can be greater than 70 dB. In this work, we assume that when it is high, there is body pathloss, and when it is low, there is not body pathloss. In the absence of body pathloss, we use TGah pathloss model from [27].

Cross-layer, which uses the relationship between the communication layers for determining the following step action, is one of the adopted techniques to improve the communication

network [14]. Hence, we propose a cross-layer protocol PHY/MAC to solve the problem of retransmission in 802.11ah caused by body pathloss and a solution to manage the energy consumption.

Our algorithm for the cross-layer is explained next. STA will measure the received power ( $P_{rx}$ ) of a beacon. If received power is smaller than the threshold, we assume body movement, which will raise body pathloss. STA will defer its transmission because it is no use to transmit data with high PER. It will result in higher packet loss. When STA receives a bigger power than the threshold, we are sure that the signal will have a high probability of arriving at AP. STA will resume its transmission.

Several situations cause smaller power received other than body shadowing. They may be collision or STA move away from AP. Because our proposed protocol only measures beacon, it is assumed that a beacon cannot have a collision [23] since the beacon use BPSK. Furthermore, if STA moves away from AP, there is no sudden decline of power received. The power received will decrease gradually.

Threshold will decrease gradually also, keeping pace with power received. If there is a sudden decline of power received, then we assume there is body shadowing. From the algorithm, we also could see that if there is no sudden decline of received power, the power saved ( $P_{saved}$ ) will actively follow the condition of the environment.

For analysis, we use probability to differentiate whether there is the body pathloss or not during the transmission. If  $p_{body}$  is probability an AP sends data under body pathloss, then the average PER ( $PER_{avg}$ ) is:

$$PER_{avg} = (PER_{BPL} \times p_{body}) + (PER_{SPL} \times (1 - p_{body})) \quad (4.8)$$

$PER_{BPL}$  (PER of Body Pathloss) is the PER of the system when there is body pathloss. PER is calculated from the approximation of Block rayleigh described in [33], this is a function of Symbol Error Rate (SER) and SNR. Noise temperature, noise figure and gain in the receiver are -145.22 dB, +5 dB and +3 dB respectively [26]. Because body pathloss is bigger than standard pathloss,  $PER_{BPL}$  is higher than  $PER_{SPL}$  (PER of Standard Pathloss). Therefore, with higher  $p_{body}$ ,  $PER_{avg}$  will be higher.

In addition to the PER, the throughput of the MAC layer between AP and STA is also used to evaluate the performance of the cross-layer solution adopted in this paper. The throughput could be defined as the number of data sent (in bits) per time needed to send those data [24]. Because packet size in bytes, then it is multiplied by 8 to represent it in bits. To take account of packet loss, it is multiplied by  $1 - PER_{avg}$ . However, as cross-layer method delay the number of packets to send, there will be a decrease in throughput accordingly. We have to multiply

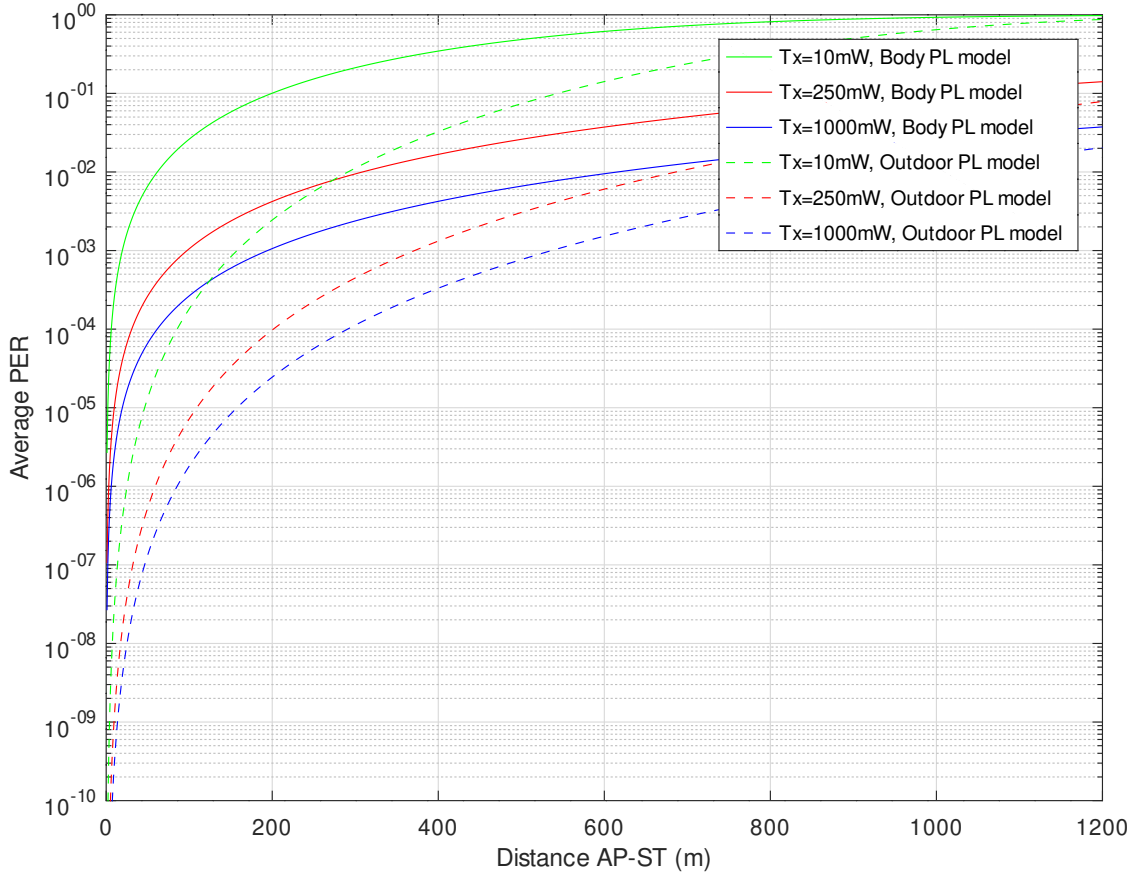

Figure 4.5: PER Performance of 802.11ah with body pathloss.

throughput with  $(1 - p_{body})$ . So the throughput  $S$  could calculate by:

$$S = \frac{8 L_{data}}{T_{message}} (1 - PER_{avg}) (1 - p_{body}) \quad (4.9)$$

#### 4.2.2 PER Performance with PHY/MAC Cross-Layer: Analysis and Simulation

Figure 4.5 show comparison PER of TGah outdoor pathloss model with body pathloss model as a function of distance. It is safe to say that the average PER of the body pathloss model is worse than the TGah outdoor pathloss model. The difference is about  $10^{-1}$  for transmission power 10 mW and  $N=100$ . Higher PER will result in data loss. STA (sensor node) will try to retransmit the loss data, which will use additional battery energy to transmit data.

Figure 4.6 shows the average PER as a function of the distance between AP and STA. It compares the cross-layer method to the non-cross layer method with several  $p_{body}$ . We could

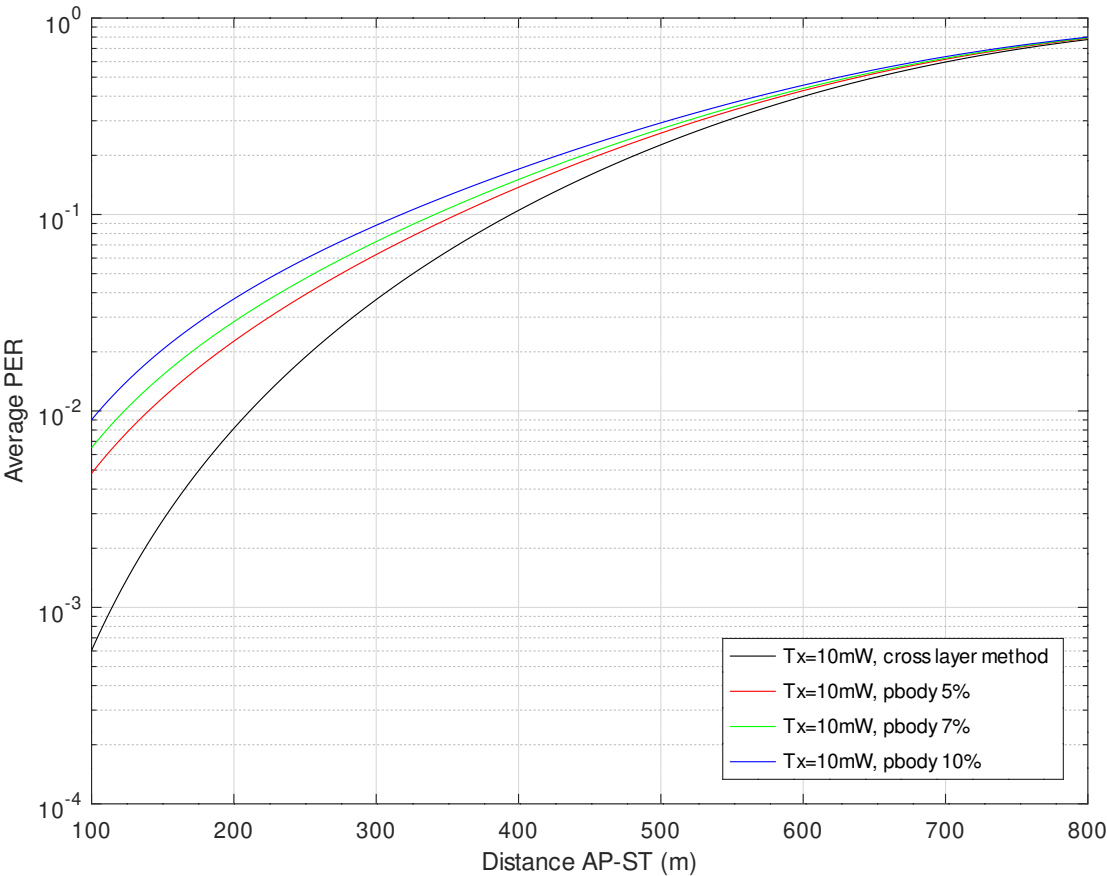

Figure 4.6: PER Analysis.

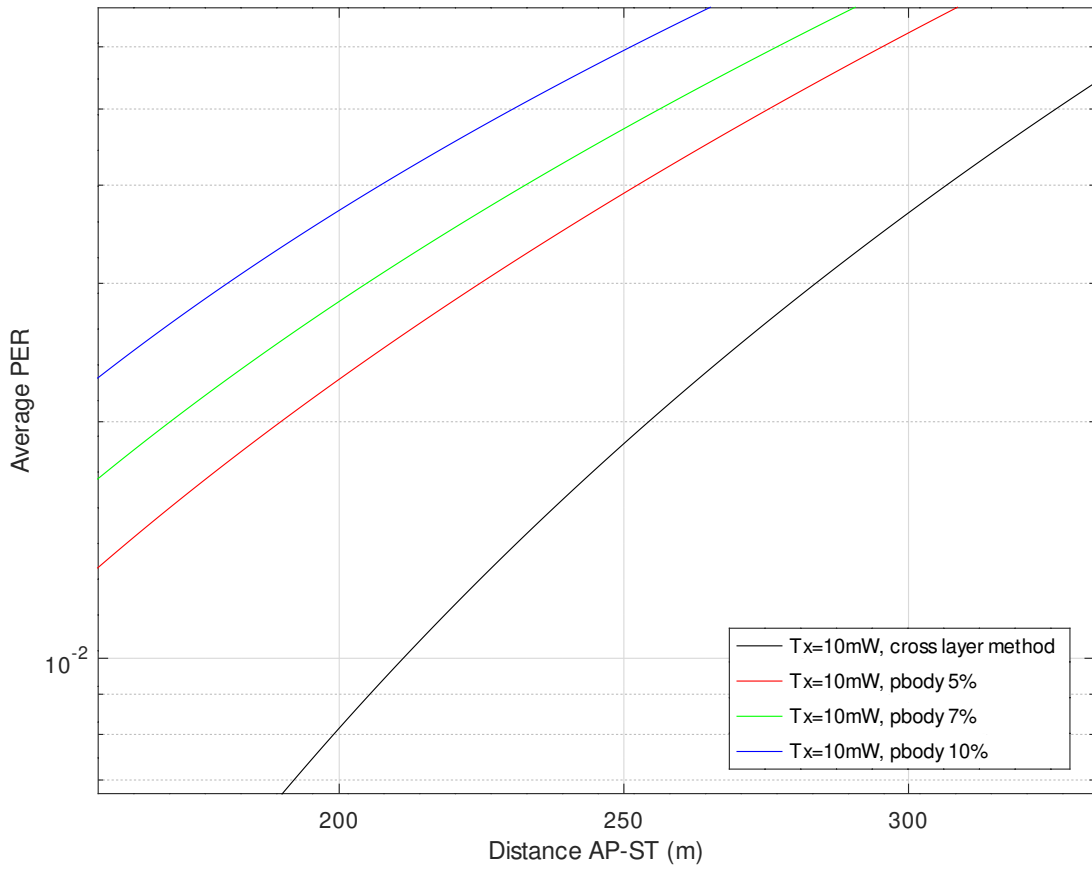

Figure 4.7: PER Analysis with  $p_{body}$  7%.

see that the proposed cross-layer method could improve PER. For example, at a distance of 200 meters, with the probability of body pathloss 7%, PER could reduce by 63%, as shown in figure 4.7. This condition happens because the cross-layer method will not transmit data when there is a high probability of packet error.

### 4.2.3 Throughput Performance with PHY/MAC Cross-Layer: Analysis and Simulation

Figure 4.8 show comparison of throughput of 802.11ah pathloss model with body pathloss model as function of distance. For figure 4.8, we use packet size 475 bytes. We could see that throughput of the 802.11ah pathloss model is lower than the body pathloss model on any transmission power. This is because body pathloss add another loss for the signal transmitted to the receiver.



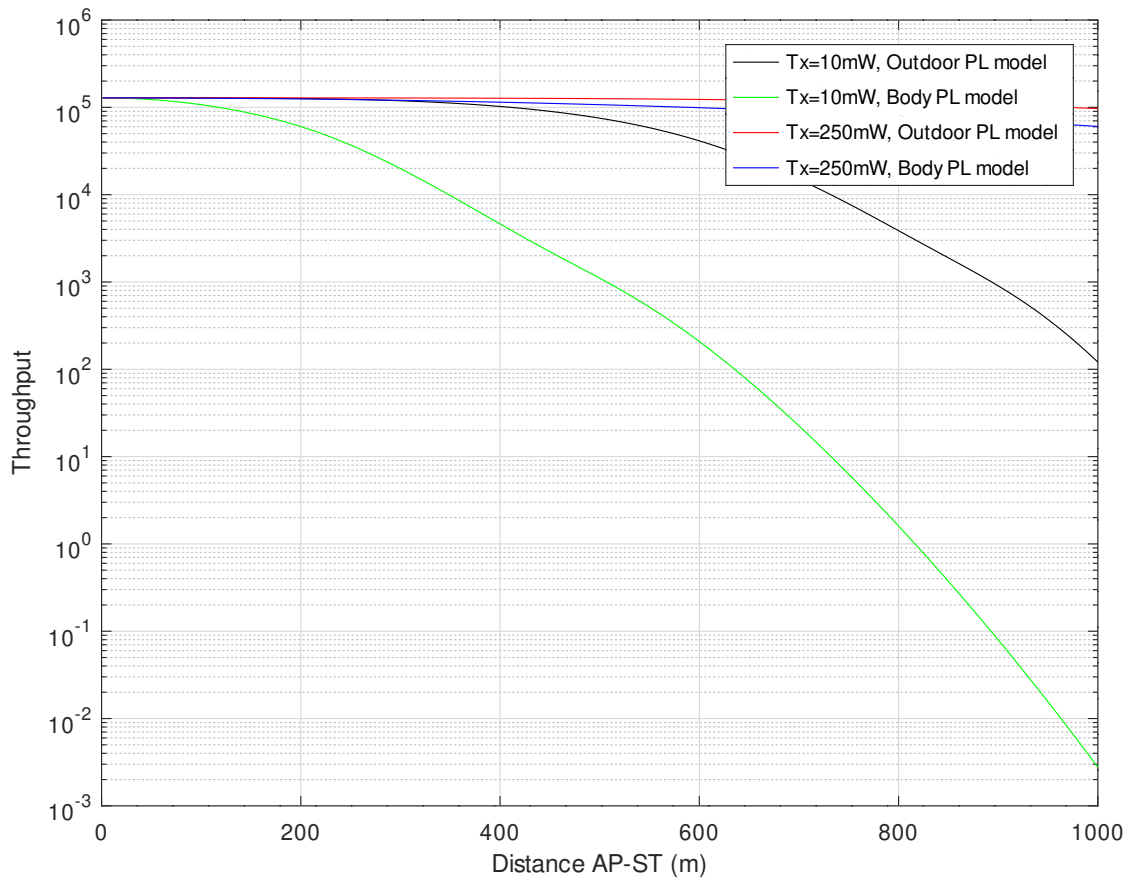

Figure 4.8: Curve of Throughput vs Distance.

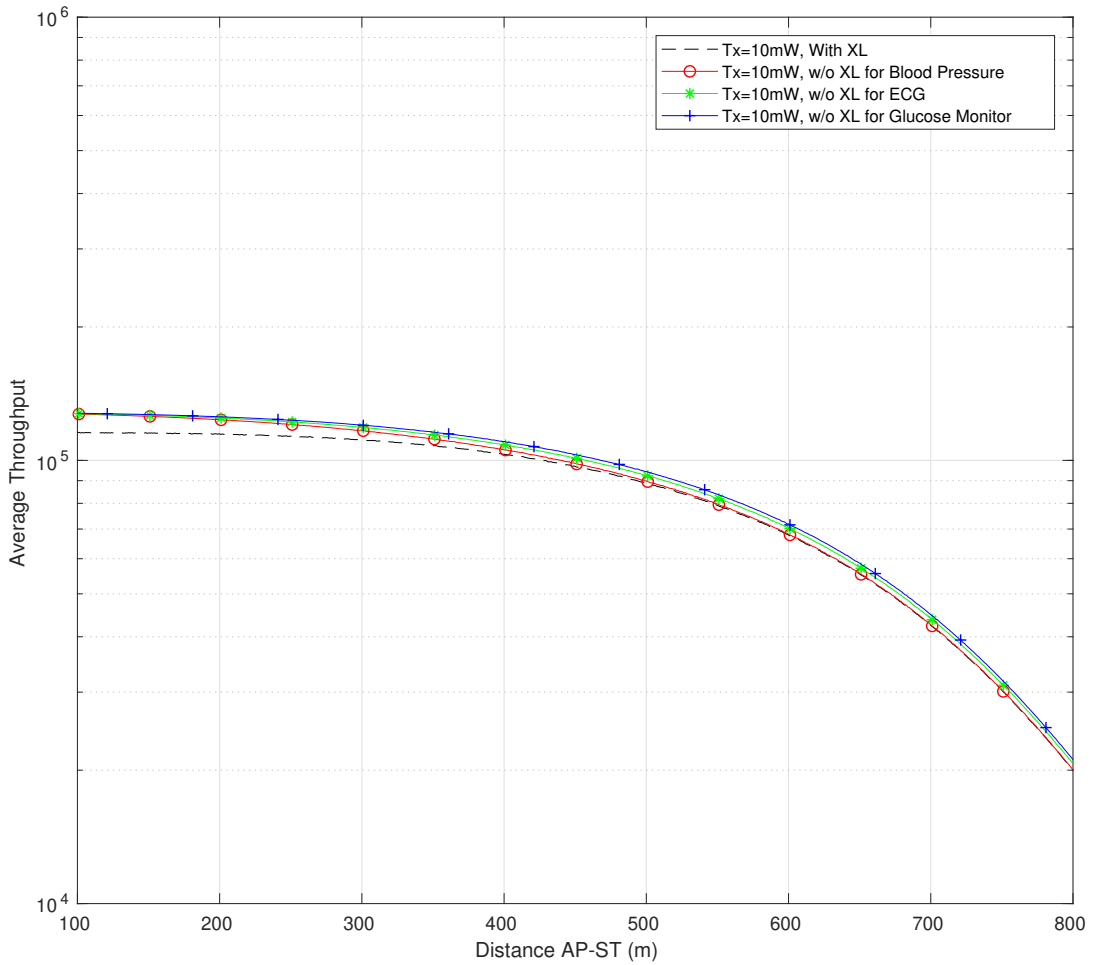

Figure 4.9: Throughput Analysis.

As mentioned before, the reduction of PER is at the cost of reduction of throughput. However, Figure 4.9 shows that decrements of throughput for sensor ECG are not significant. For example, at a distance of 200 meters, with the probability of body pathloss 7%, throughput is reduced only by 5%. This condition happens because although data transmitted is less in the cross-layer method, it is guaranteed that it will have a lower PER. The typical method will transmit more packet than the cross-layer method, but its packet loss is higher with a higher PER. Overall, the data received in AP is almost the same.

For other sensors, the results are similar. For example, for a distance of 200 meters, in the case of the Glucose Monitor sensor and Blood Pressure sensor, throughput is reduced by 3.9% and 7% while improving PER by 67.7% and 80% respectively. The farther the distance, the

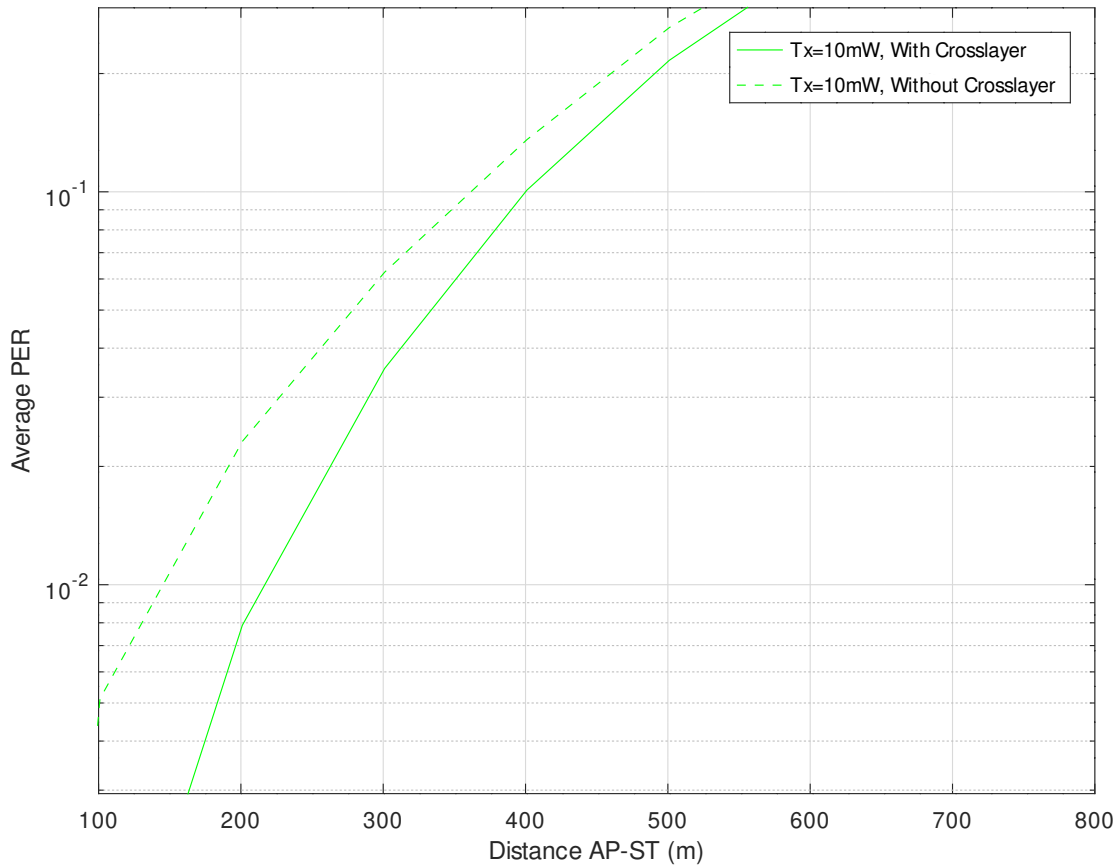

Figure 4.10: PER Simulation for  $p_{body} = 5\%$ .

average PER will converge.

For simulations, we use Matlab with the parameters done in table I. We consider that the AP will transmit a beacon every 10 milliseconds. Simulation time is 1000 seconds. We decide whether it is body attenuation or not using the probability of body pathloss.

We calculate PER and Throughput every beacon interval per distance (in meter). Then we average the results. We interchange pathloss between body pathloss and regular pathloss, depending on the results of random probability. Figure 4.10 show the result of simulation for average PER as a function of distance. This simulation use  $p_{body} = 5\%$ . We could see some improvement of about 65% for distance 200 meters. However, this improvement will cost with a reduction of throughput. Figure show throughput simulation for  $p_{body} = 5\%$ . Throughput is reduced by 3.7% for a distance of 200 meters.

Another simulation in Figure 4.12 shows a comparison between analysis and simulations for the probability of body pathloss 7%.

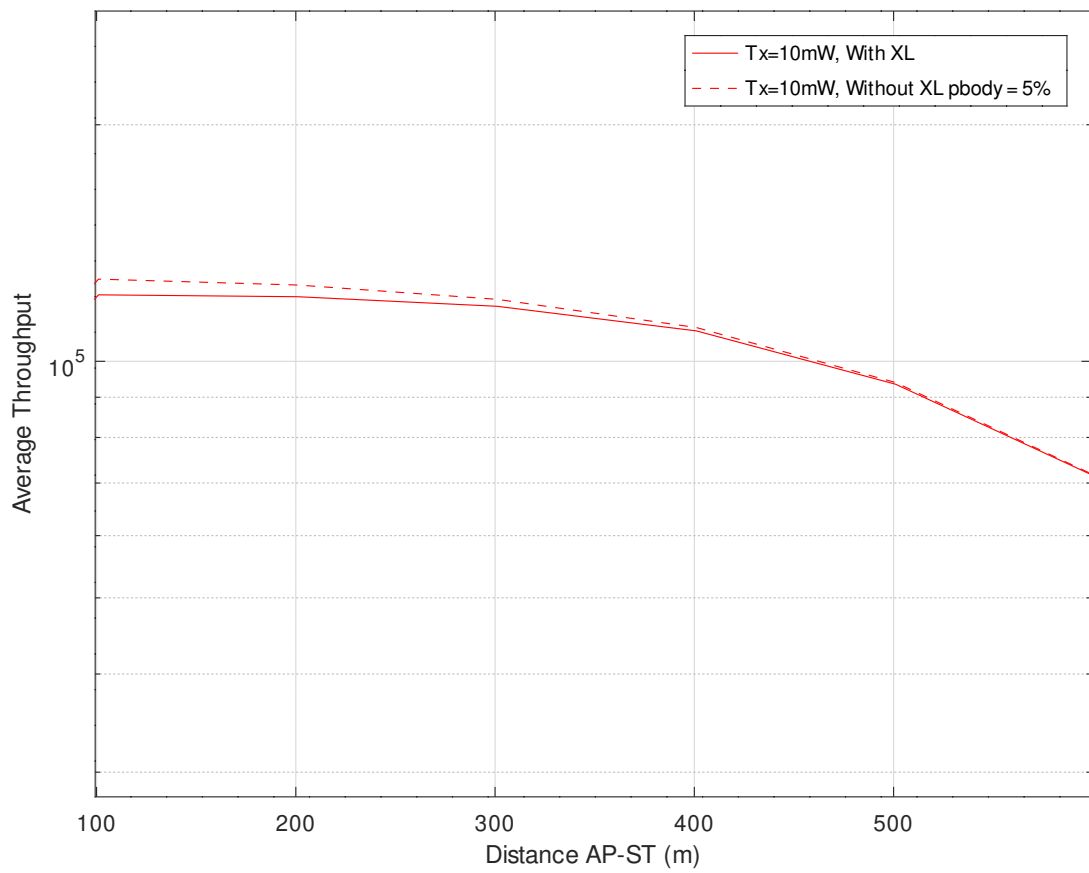

Figure 4.11: Throughput Simulation for  $p_{body} = 5\%$ .

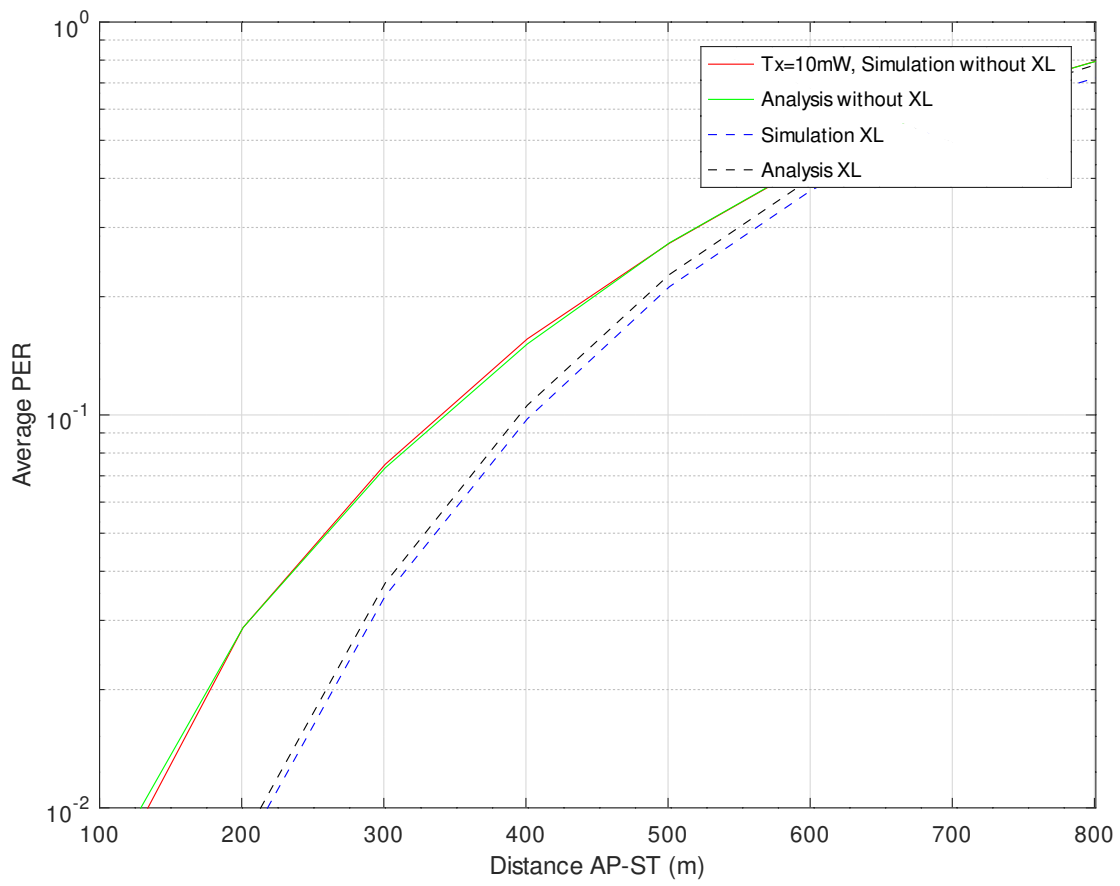

Figure 4.12: PER Simulation for  $p_{body} = 7\%$ .

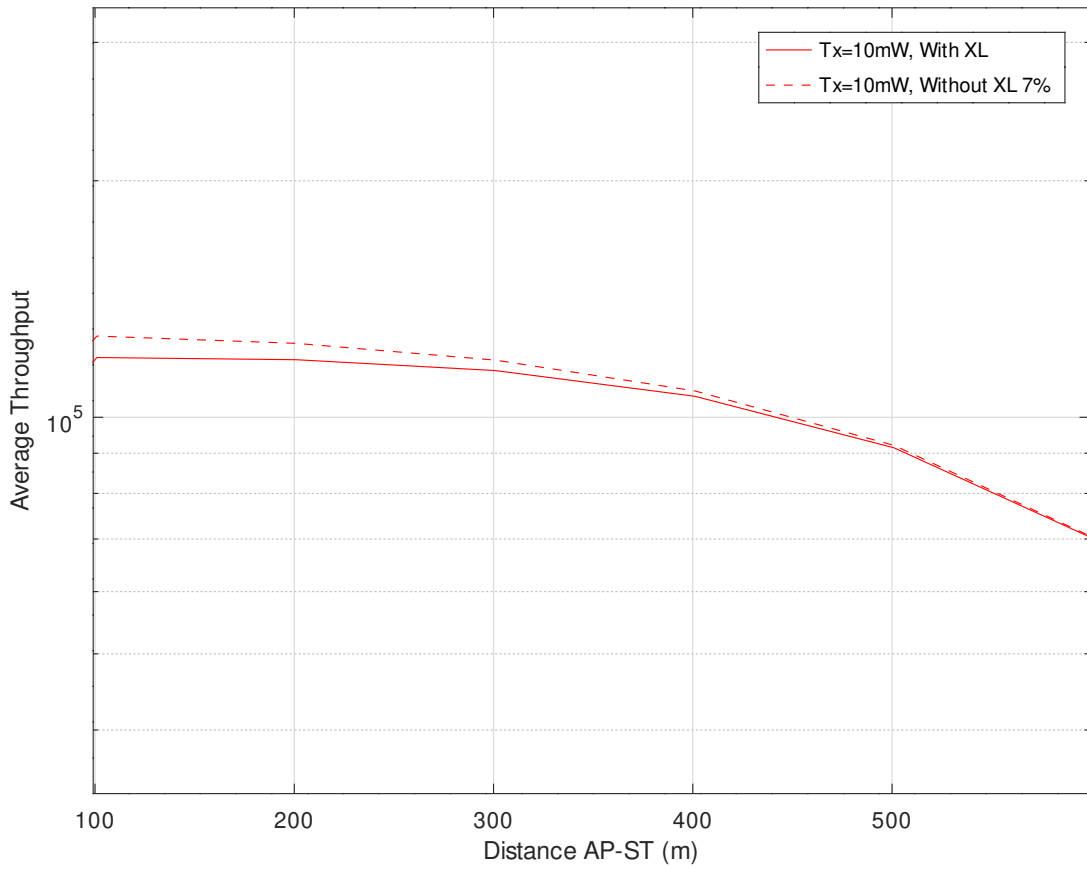

Figure 4.13: Throughput Simulation for  $p_{body} = 7\%$ .

Here, the trend of the curve with the analysis is the same. However, at great distances, greater than 700 meters, the difference between simulations and analysis results slightly grows, but it is still acceptable. This condition happened because the step function approximation is accurate for high SNR, as explained in [33]. Therefore it will make less accurate if the distance is farther. Similar to PER, the throughput of analytical and simulation result remains the same as shown in Fig. 4.13.

Similar result happen with probability of body pathloss 10%. Figure 4.14 show that cross layer design could reduce PER about 79% in the distance 200 meter. In the same time, throughput decrease by 9% as shown in figure 4.15.

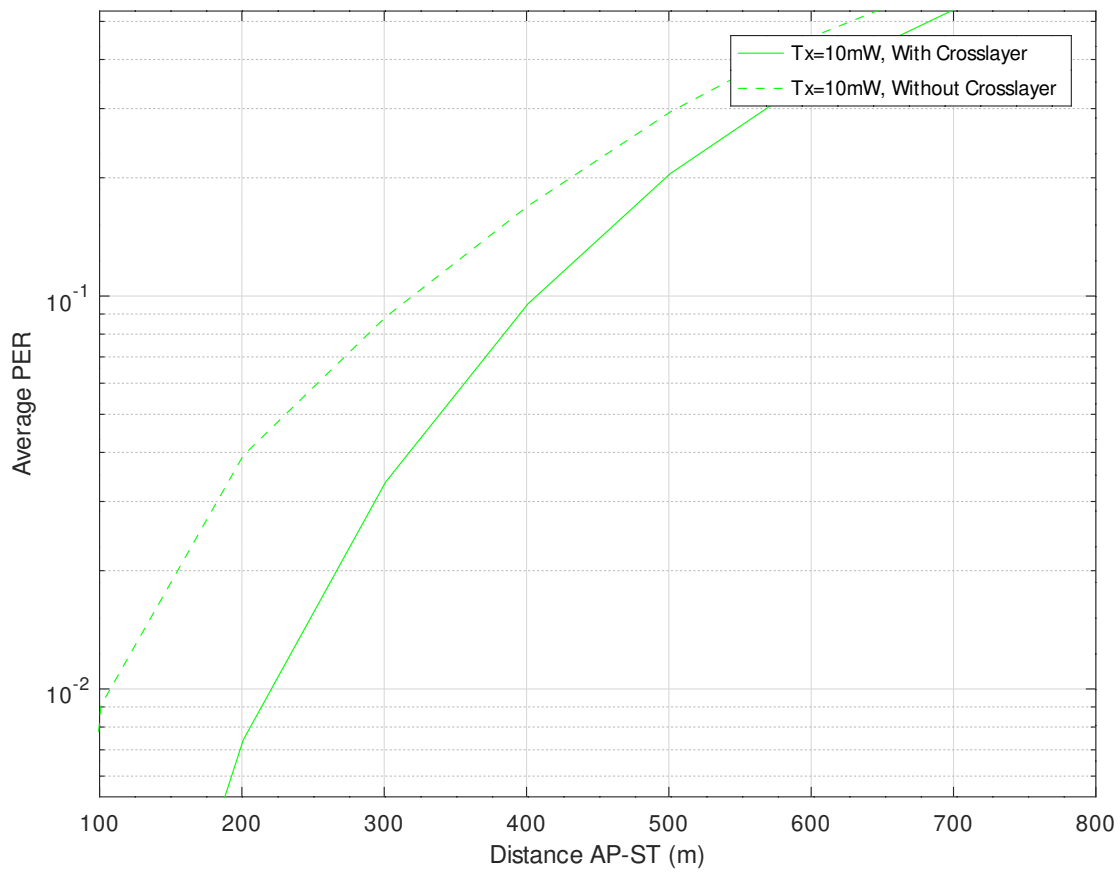
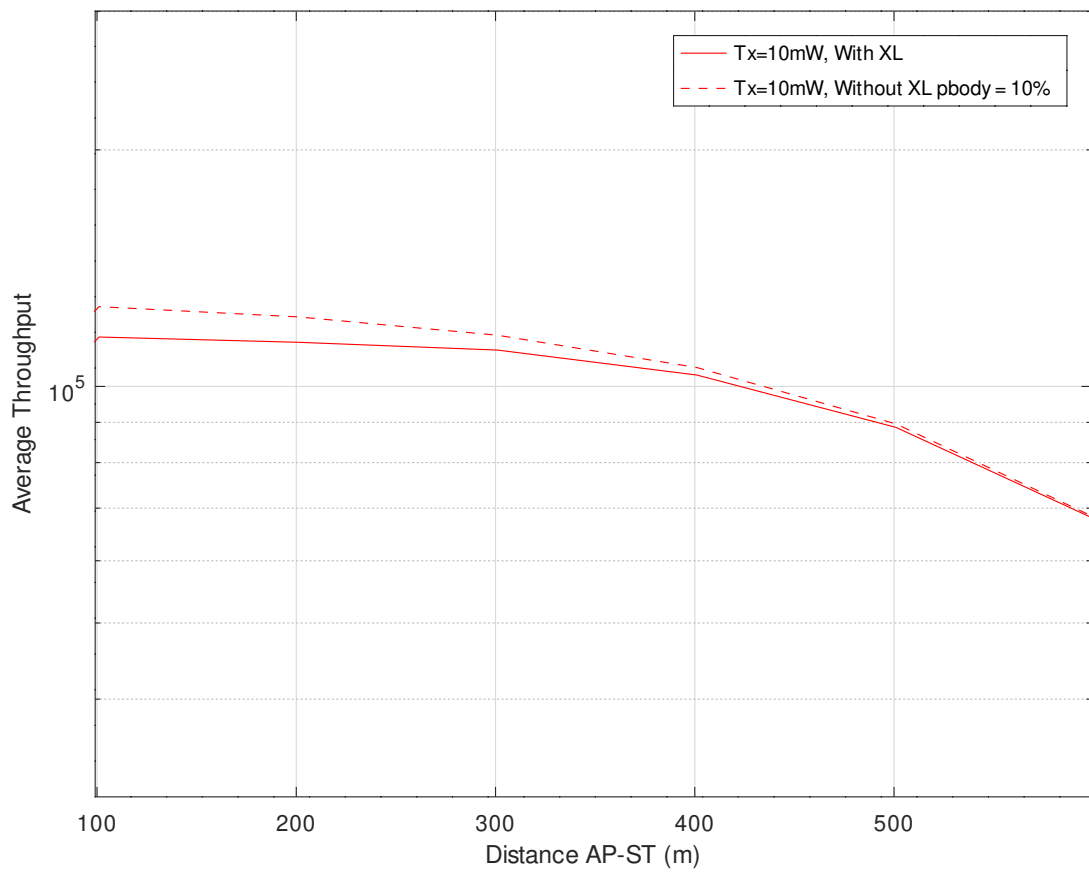

Figure 4.14: PER Simulation for  $p_{body} = 10\%$ .

Figure 4.15: Throughput Simulation for  $p_{body} = 10\%$ .





# Chapter 5

## Prototyping PHY/MAC Cross-Layer Devices

### 5.1 SDR for Experimentation of 802.11ah

Comparing the standard 802.11ah with the cross-layer version requires implementation of the hardware. However, there is no commercial off-the-shelf product of 802.11ah. Fortunately, there is SDR (Software Defined Radio) which could be used to implement 802.11ah.

From [37], Wireless Innovation Forum with IEEE, define Software Defined Radio as: "Radio in which some or all of the physical layer functions are software defined".

SDR is the best wireless innovation that joins two principle advancements: digital RF and PCs Programming. On account of advanced RF, the more significant part of the signal handling happens in the computerized space, where it is kept up close to the RF front end. Parts ordinarily installed in hardware (filter, modulators/demodulators, amplifier, mixer) are actualized utilizing programming or, actually, programmable equipment.

SDR characterizes an assortment of equipment and programming innovations. A few or the entirety of the radio's working capacities (additionally alluded to as physical layer preparing) are actualized through modifiable programming or firmware working on programmable processing technologies.

In principle, typical relevant hardware serves as an interface among the baseband and the RF. The waveform of a transmitted signal is all generated via a software program. The received signal is also all processed and demodulated inside software algorithms.

A significant advantage for everyday use is changing the modulation scheme, bandwidth, frequency only with a changement of software. The utilization of these innovations permits

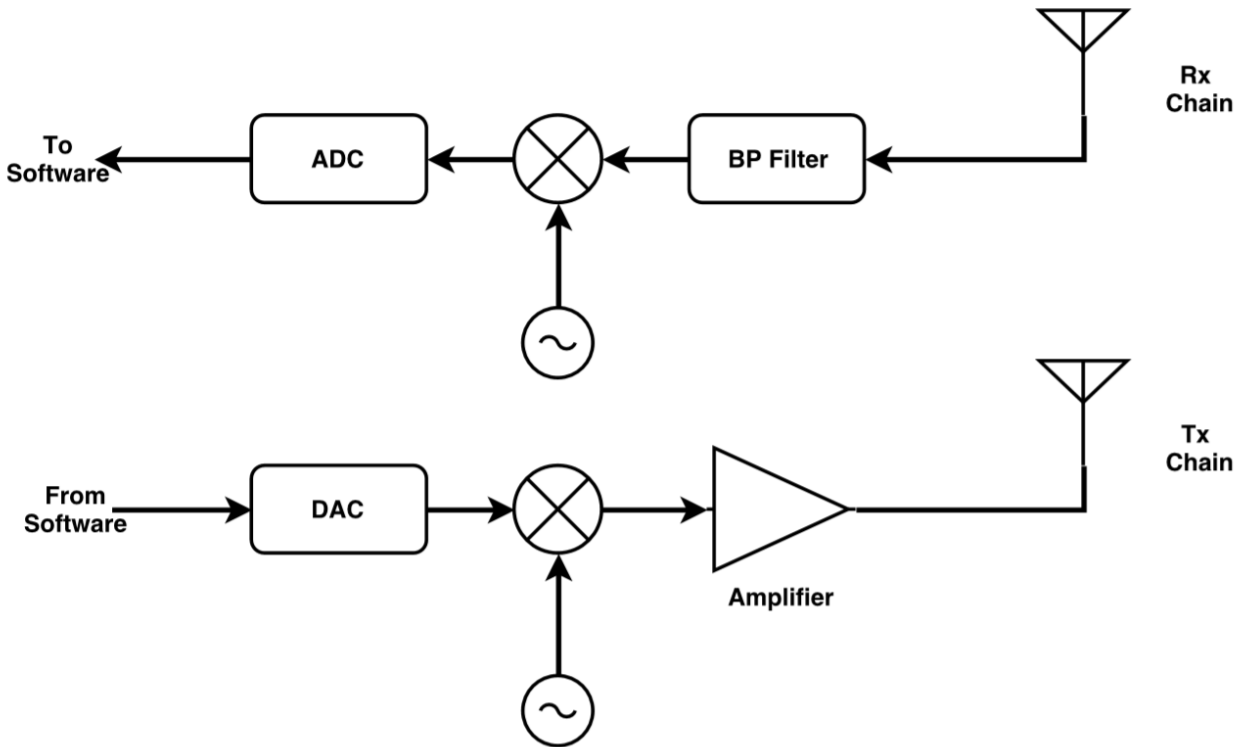

Figure 5.1: Simple SDR illustration.

new wireless features and abilities to be added to existing radio frameworks without requiring new equipment. We could change the parameters of radio gadgets by physically adjust the device hardware. It will be troublesome and costly to updates the hardware. Utilizing SDR will be progressively adaptable to change the modulation, data transmission, and different radio parameters. This additionally spares expenses and time for new advancements.

These devices incorporate Field Programmable Gate Arrays (FPGA), Digital Signal Processing (DSP), General Purpose Processors (GPP), programmable System on Chip (SoC) or other application specific programmable processors. Together with Analog to Digital Converter (ADC)/Digital to Analog Converter (DAC) and RF component, they build the main component of SDR, as shown in figure 5.1.

Since the carrier frequency for many protocols is much higher than hundreds of mega hertz, the signal received by the receiver chain antenna has a very high bandwidth which cannot be directly converted to digital. Thus, a mixer would have to bring the received signal to baseband domain before being sampled by ADC. Similarly, in the transmitter chain, the signal after DAC is in the baseband and is brought to the required carrier frequency by an analog mixer.

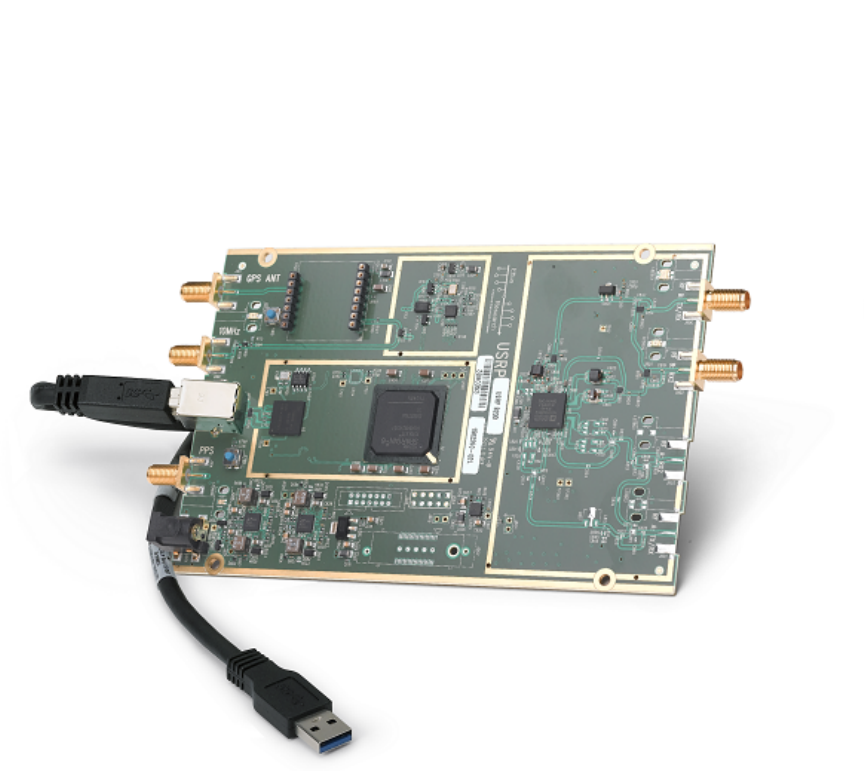

Figure 5.2: USRP B200, one of the product of Ettus.

### 5.1.1 USRP

There are several providers for Hardware of SDR, like Ettus and Analog Devices. Universal Software Radio Peripheral (USRP) is a famous SDR hardware by Ettus Research. USRPs have a motherboard, shown in figure 5.2 with very accurate and high-speed ADC and DAC, together with an FPGA for signal processing purposes. The USRP's goal itself is to facilitate the development of inexpensive wireless software. This association permits the software to control the USRP and set the signal for sending and getting information.

In typical applications, the FPGA on USRP adjusts the sampling rate of incoming and outgoing sample streams. Digital samples are transmitted to and received from a host computer using a LAN cable or Universal Serial Bus (USB). The FPGA is open to be programmed for high speed and low latency operations that cannot tolerate the delay of communicating with a host computer.



Figure 5.3: Outdoor experiment.



Figure 5.4: Indoor experiment.

Our experiment was done in two places, which are indoor and outdoor. For outdoor measurement, we did in the street of our campus as shown in figure 5.3. We use a car to move the receiver at certain distances. The indoor experiment did in the hallway of our laboratory to have a longer distance compared to the inside of the room. We use a trolley to move the receiver at certain distances as shown in figure 5.4.

### 5.1.2 GnuRadio

USRP devices come with USRP Hardware Driver (UHD)) to be installed on an ordinary computer. Using UHD, one can work with USRPs on MATLAB, Simulink, GNURadio or by writing software that is directly communicating with the UHD Application Programming Interface (API).

There are a few noted developers engaged with a product for creating SDR applications,

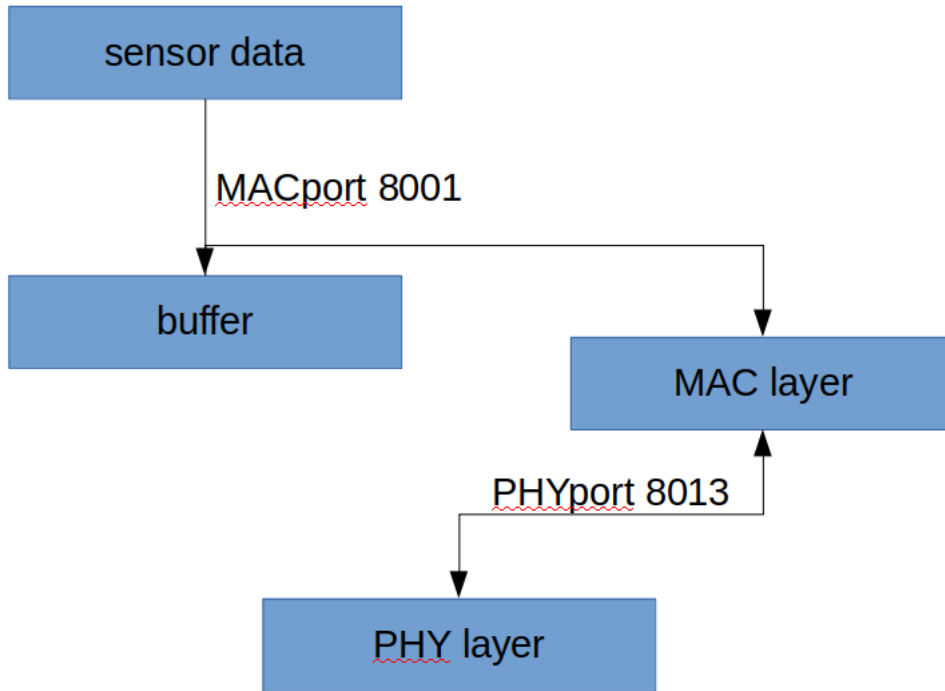

Figure 5.5: Interconnection of PHY layer and MAC layer.

yet GNU Radio [38] is the most well known SDR Toolbox. GNU Radio is a free software for creating open-source programming that provides several modules to develop software radio.

It can be used to either run pure simulations or interact with external hardware like USRP for SDR purposes. A user can implement arbitrary protocols by connecting different blocks and creating a flow graph for digital samples to be processed. GNURadio comes with many built-in blocks for modulation, coding, and many other signal processing functions. A user can also implement and add its blocks to the platform.

Thus, in this experiment, we will use USRP combined with GNU Radio.

## 5.2 Data Flow and Data Format

Buffer Program will store data to transmit and data received. Buffer Program will listen on port 8001 by default. However, we could change the port. PHY Program will also have a node number to identify the USRP card. This node number will be used by MAC Program to generate the MAC address. To interface between the PHY layer and MAC layer, we use a port. Diagram in figure 5.5 show the interconnection between the PHY layer and MAC layer and the default ports of each program.

```

antok@antok-LIFEBOOK-SH771:~/Documents/source_code/gr-ieee802-11/wifi_mac_edit$ ./ul_buffer.py
-----
Upper layer running ...
(ctrl + c) to exit
-----

== Statistics 1582049195.87 ==
===== TX Buffer =====
['56 bpm']
===== RX Buffer =====
[]
== Statistics 1582049195.89 ==
===== TX Buffer =====
['57 bpm', '56 bpm']
===== RX Buffer =====
[]
== Statistics 1582049195.91 ==
===== TX Buffer =====
['56 bpm', '57 bpm', '56 bpm']
===== RX Buffer =====
[]
== Statistics 1582049195.93 ==
===== TX Buffer =====
['56 bpm', '56 bpm', '57 bpm', '56 bpm']
===== RX Buffer =====
[]
== Statistics 1582049195.95 ==
===== TX Buffer =====
['60 bpm', '56 bpm', '56 bpm', '57 bpm', '56 bpm']
===== RX Buffer =====
[]

```

Figure 5.6: Example of state of MAC layer buffer before transmission.

Buffer Program will create a buffer to store generated traffic. Here for the experiment, we will use the string “56 bpm”, “57 bpm”, “58 bpm”, “59 bpm”, and “60 bpm” to represent the simulated heartbeat data. Bpm means “beats per minute”. The generated data from Sensor Data Program will be chosen randomly from the strings above. Figure 5.6 shows the state of buffer. For example, we generate 5 packets from the upper layer. Each packet has an interval of 0,2 seconds. A packet of Transmitter (Tx) Buffer will increase one by one, with random data selected from the strings above. The next code is the snippet to generate traffic:

```

1 num = random.randint(0, 4)
2 if num == 0:
3     pkt = mac.create_packet("PAYLOAD", "56 bpm")
4 elif num == 1:
5     pkt = mac.create_packet("PAYLOAD", "57 bpm")
6 elif num == 2:
7     pkt = mac.create_packet("PAYLOAD", "58 bpm")
8 elif num == 3:
9     pkt = mac.create_packet("PAYLOAD", "59 bpm")
10 elif num == 4:
11     pkt = mac.create_packet("PAYLOAD", "60 bpm")

```

We will save the dataset of SNR, throughput and packet error ratio for a different distance and analyze it for the experiment. To obtain throughput data, we infuse payload with a

```

3| beacon| 1610682597.042887| 9.50| False| 1610682597.008740
4| beacon| 1610682597.137474| 12.53| False| 1610682597.159987
5| beacon| 1610682597.242758| 5.42| False| 1610682597.261828
6| beacon| 1610682597.338112| 9.75| False| 1610682597.354054
8| beacon| 1610682597.539372| 13.68| False| 1610682597.558401
10| beacon| 1610682597.741393| 2.33| False| 1610682597.763308
11| beacon| 1610682597.846822| 13.01| False| 1610682597.867237
12| beacon| 1610682597.94247| 9.52| False| 1610682597.959325
13| beacon| 1610682598.04819| 10.15| False| 1610682598.071541
14| beacon| 1610682598.144075| 10.33| False| 1610682598.165901
15| beacon| 1610682598.240275| 9.52| False| 1610682598.257250
16| beacon| 1610682598.346587| 13.07| False| 1610682598.369489
19| beacon| 1610682598.64378| 5.64| False| 1610682598.666767
20| beacon| 1610682598.750288| 9.51| False| 1610682598.768612
22| beacon| 1610682598.942817| 4.64| False| 1610682598.970755
23| beacon| 1610682599.048856| 6.78| False| 1610682599.067592
25| beacon| 1610682599.249942| 11.40| False| 1610682599.276715
27| beacon| 1610682599.451398| 12.21| False| 1610682599.471569
31| beacon| 1610682599.847556| 8.61| False| 1610682599.871506
32| beacon| 1610682599.953246| 3.78| False| 1610682599.974142
33| beacon| 1610682600.048191| 13.17| False| 1610682600.065709
35| beacon| 1610682600.249274| 13.35| False| 1610682600.270320
36| beacon| 1610682600.354382| 12.03| False| 1610682600.372501
37| beacon| 1610682600.450041| -0.45| True| 1610682600.475207
38| beacon| 1610682600.545893| 10.70| False| 1610682600.567063
39| beacon| 1610682600.651293| 11.89| False| 1610682600.669568
42| beacon| 1610682600.947933| 11.10| False| 1610682600.964428
43| beacon| 1610682601.053223| -1.74| True| 1610682601.077502

```

Figure 5.7: Data format for Analysis.

timestamp. In the receiver, we subtract the time received with time transmitted to get time delta. Then by the ratio of data size per time delta, we get throughput. Whilst PER, we observe the sequence number of packet received. If any number missing, then we assume that packet is lost. The following code is a snippet of payload infusing:

```

1 transmitting_time = time.time()
2 PAYLOAD = PAYLOAD + "|" + repr(transmitting_time)

```

We use the symbol '|' to separate payload and timestamp. The purpose is to facilitate the analysis of data. Figure 5.7 is screenshot of data format in MAC layer. By separating with the symbol '|' on a spreadsheet, we could analyse the data easily.

The problem arises when the time of one PC is different from another PC. We need to synchronize both PC. Fortunately, there is a protocol to sync time between PC, and it is



called Network Time Protocol (NTP). NTP is a protocol designed to synchronize the clocks of computers over a network.

### 5.3 System Design and Programming

To create a complete implementation of the IoT system, we added data from actual sensors and sent it to the internet. To develop a system of IoT, we need comprehensive knowledge from end to end communications.

The architecture of the system consists of several sections. The first sections are the sensor node. It is responsible for acquiring data, which is temperature data. However, for general IoT system, it is not limited to the temperature. We could use any sensors. For example, in a smartfarm, the IoT system will sense the humidity of soil. Or for smart city, the IoT system sense traffic of car circulation.

This sensor, infrared sensor Melexis MLX MLX90614, will connect to Arduino because B200 does not have an I/O pin for the sensor. Arduino in turn will connect to Personal Computer (PC), which have USB3.0 connection to B200. Figure 5.8 show the configuration.

First of all, Arduino makes a timer. This timer function so that the sensor node does not continuously take data and transmit data. This will make the battery usage wasteful, not economical. Body temperature does not change too extreme, so there is no need for continuous data transmission. Arduino will send all the data to the PC.

From PC, data will be put as Protocol Data Unit (PDU) for the MAC layer. Stream data of sensor will occupy MAC buffer for Tx. As the MAC layer program continues, this data from the buffer will be picked and sent to the access point using the 802.11ah network.

On the other end, USRP B200 act as an access point. It receives a data sensor from another USRP B200 using an 802.11ah network and forwards it to the internet. On the internet, we must have a server to save data. There are several parts of a web server. The first part is as a receiver of sensor data. The web server will receive requests from sensor nodes, in this case, is sensor reading data. If data is received, then the webserver extracts the data from Hypertext Transfer Protocol (HTTP) protocol and save it to the database with SQL command. The algorithm in the first part of this can be seen in the figure 5.9.

The database table structure can be seen in figure 5.10. The table consists of 4 columns, namely the id column, iddevice column, date column, parameter column, and value column. The id column functions as the primary key to differentiate between one data and another.

The Iddevice column is to distinguish between one device and another. This separation is essential so that data from each sensor node is not confusing. The Date column is to record the

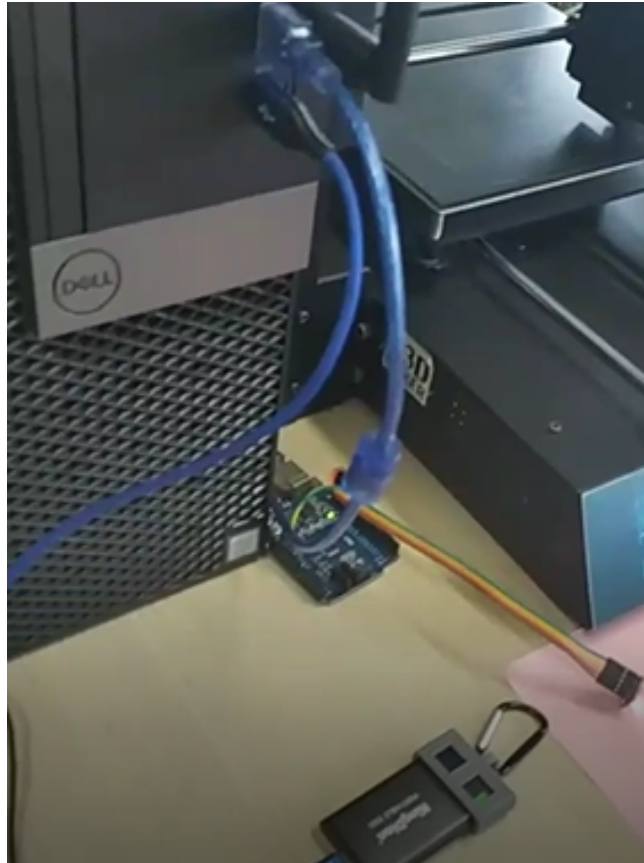

Figure 5.8: Configuration of Arduino with sensor.

1. Create database connection.
2. Read GET request.
3. For every parameters of GET request do:
4.   Insert into table: datetime, id device, parameter and value
5. Close database connection.

Figure 5.9: Configuration of Arduino with sensor.

data	
id	int
id_device	int
time	timestamp
parameter	varchar
value	float

Figure 5.10: Structure table of Data Sensor.

time of sensor data collection. So that temperature conditions can be monitored from time to time. The Parameters and Value fields contain what parameter to measure and at what value.

This parameter column is for development in the subsequent research. We will not only measure temperature but can also heart rate, oxygen content and many others. Nevertheless, for now, the parameter will contain temperature.

The second part of the webserver is to receive requests from the web client. Its function is to act as the user interface to medical staff and family. From the browser or later from the mobile apps, we can see previous temperature data and real-time measurement of temperature. We can analyze the history of patient temperature according to the time and date of the data input from the sensor node.

In this second part, there are two more subsections, namely HTML files and PHP files. Html file to present data, so it is more convenient to view, and PHP file provides data with JavaScript Object Notation (JSON) format. The diagram of the second part of the webserver can be seen in the figure 5.11. And algorithm of second part is shown in figure 5.12. The server will receive continuous ajax request from javascript of HTML file and respond with JSON format data.

### 5.3.1 MAC Cross-Layer Protocol Algorithm and Programming

For the MAC layer, we modified MAC implementation from [39] by adding cross-layer ability. We still preserve channel access by using CSMA/CA. Figure 5.13 and figure 5.14 show original

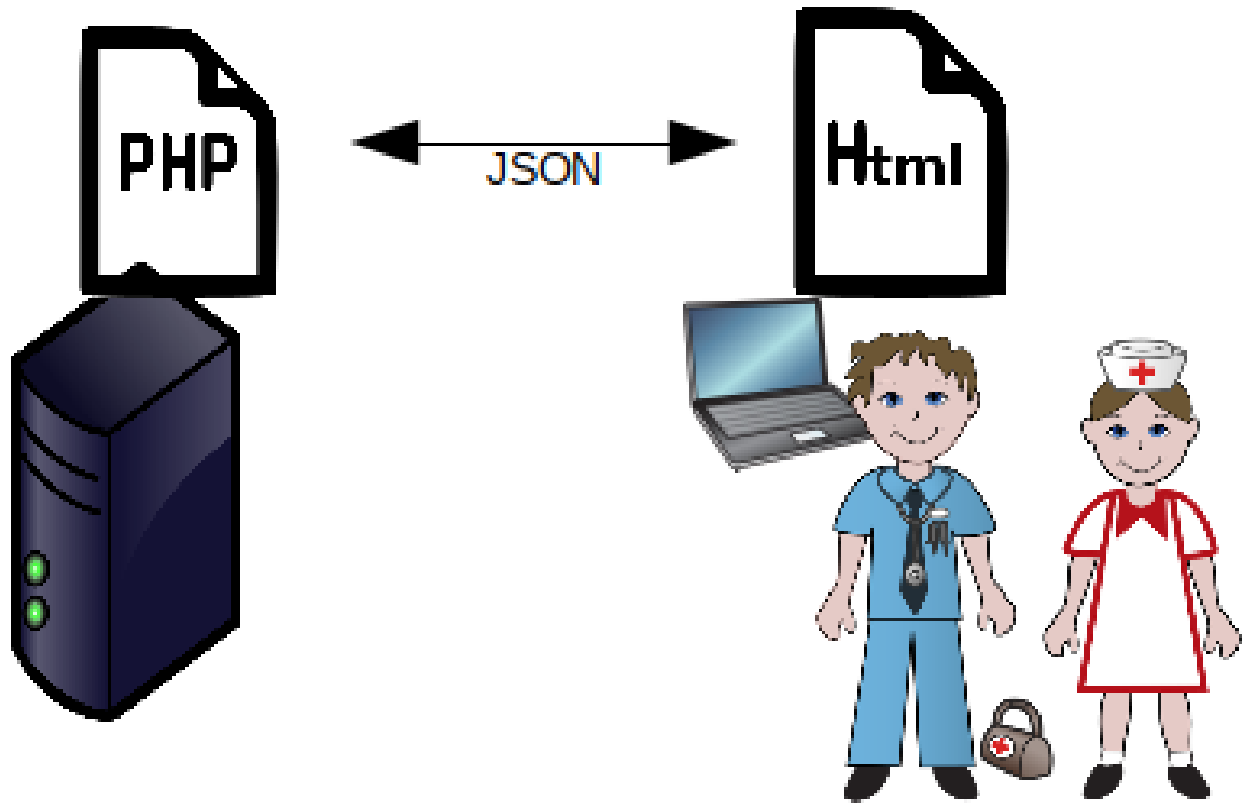

Figure 5.11: Diagram of connection of web server and web client.

1. Wait for request
2. If receive GET request:
3. Query for 10 last data.
4. Format data to JSON.
5. Send response.

Figure 5.12: Algorithm of Server receiving request from web client.

implementation of MAC layer in general and our modification.

In the original MAC protocol, The MAC process is starting in an idling position. Then the process moves to the receive position. MAC will access the PHY layer buffer to look for any data received. If it found data, then the data will be saved to MAC layer Receiver (Rx) buffer and transmit ACK. We need a buffer because data from the sensor will stream continuously, but the wireless transmission could not be sent continuously because it must consider the channel availability.

After that process, the system will return to the idle position and repeat the cycle. MAC will move to the receive position. If MAC did not find any data in the PHY layer buffer, MAC would search for data to send in his Tx buffer. Data in the Tx buffer is from the layer above, like PDU from the network layer, transport layer or application layer.

If there are no data in the MAC Tx buffer or PHY Rx buffer, the system will return to the idle position again to repeat the cycle. If MAC has data to transmit, the MAC will start the protocol of CSMA/CA.

First, the system will wait for Network Allocation Vector (NAV) and DIFS for several microseconds. Then sense the channel. The reason for waiting NAV and DIFS is to preserve energy. Because if MAC directly senses the channel, it will encounter the channel busy during NAV and DIFS time. The sensing uses more power since it involves the RF section.

If the channel is busy after NAV dan DIFS time, the system will return to the idle position to prevent a signal collision. Moreover, the system will repeat the cycle from the beginning. However, MAC will wait for random backoff time to anticipate if other nodes send data simultaneously and initiate a collision if the channel is not busy.

After waiting for random backoff time, the system listens to the channel again, whether exist another transmission or not. If the channel is not busy, data will be transmitted, or the system will return to the beginning of the cycle.

Figure 5.15 show the buffer after the MAC layer is running. We could see the first data will be fetched and sent to the PHY layer, followed by the next data and so on, until the buffer is empty. It implement the First In First Out (FIFO) concept.

In figure 5.14, our cross-layer modification introduces if-else selection before checking for MAC Tx buffer for transmission. MAC will check the data of power of the last beacon transmission. If it is higher than a certain threshold, then it might continue the process. Otherwise, the system will return to the idle position.

For cross-layer implementation, we combined the transmitter with the receiver as a transceiver. The main GNURadio module is Wifi Physical Hierarchy, and it will both receive data from MAC and receive from other transmitting station/access point. Figure 5.16 is design of the transceiver

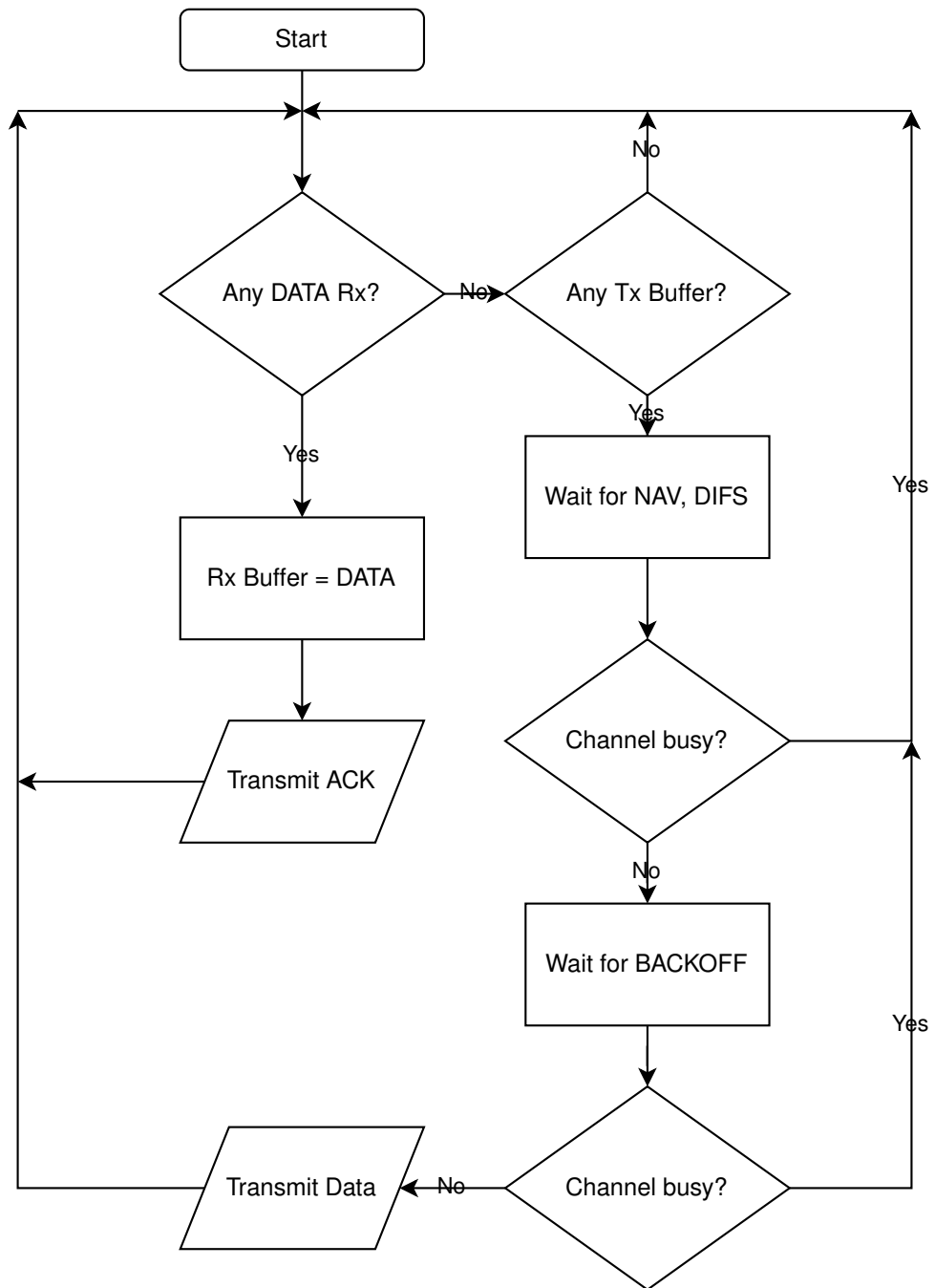

Figure 5.13: Algorithm of original 802.11.

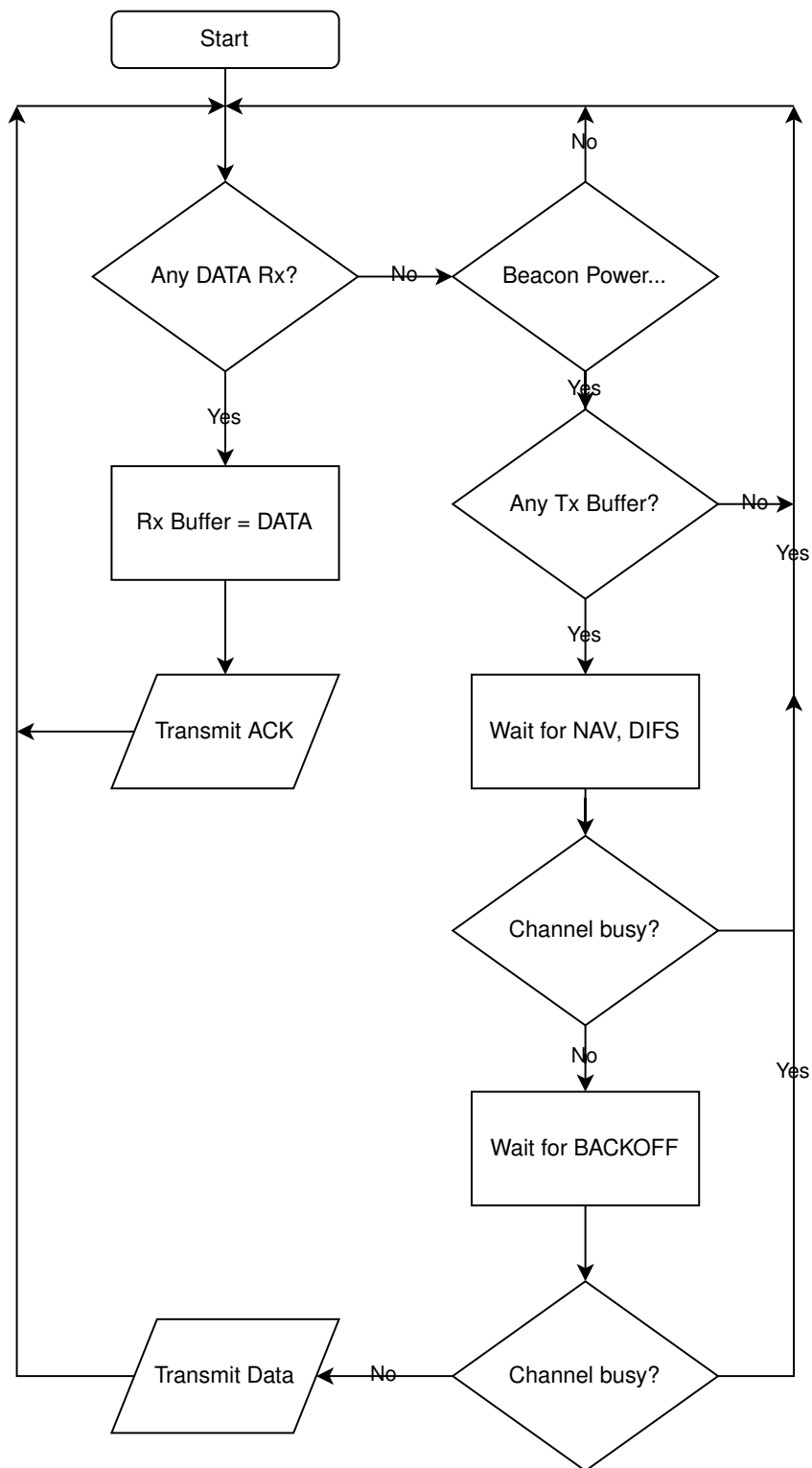

Figure 5.14: Cross Layer algorithm.

```
===== RX Buffer =====  
[ ]  
Buffer has a DATA to send.....  
== Statistics 1583314686.33 ==  
===== TX Buffer =====  
['57 bpm', '60 bpm', '58 bpm', '56 bpm']  
===== RX Buffer =====  
[ ]  
Buffer has a DATA to send.....  
== Statistics 1583314686.91 ==  
===== TX Buffer =====  
['57 bpm', '60 bpm', '58 bpm']  
===== RX Buffer =====  
[ ]  
Buffer has a DATA to send.....  
== Statistics 1583314687.48 ==  
===== TX Buffer =====  
['57 bpm', '60 bpm']  
===== RX Buffer =====  
[ ]  
Buffer has a DATA to send.....  
== Statistics 1583314688.06 ==  
===== TX Buffer =====  
['57 bpm']  
===== RX Buffer =====  
[ ]  
Buffer has a DATA to send.....  
== Statistics 1583314688.64 ==  
===== TX Buffer =====  
[ ]  
===== RX Buffer =====  
[ ]  
[ ]
```

Figure 5.15: Example of state of MAC layer buffer after transmission.



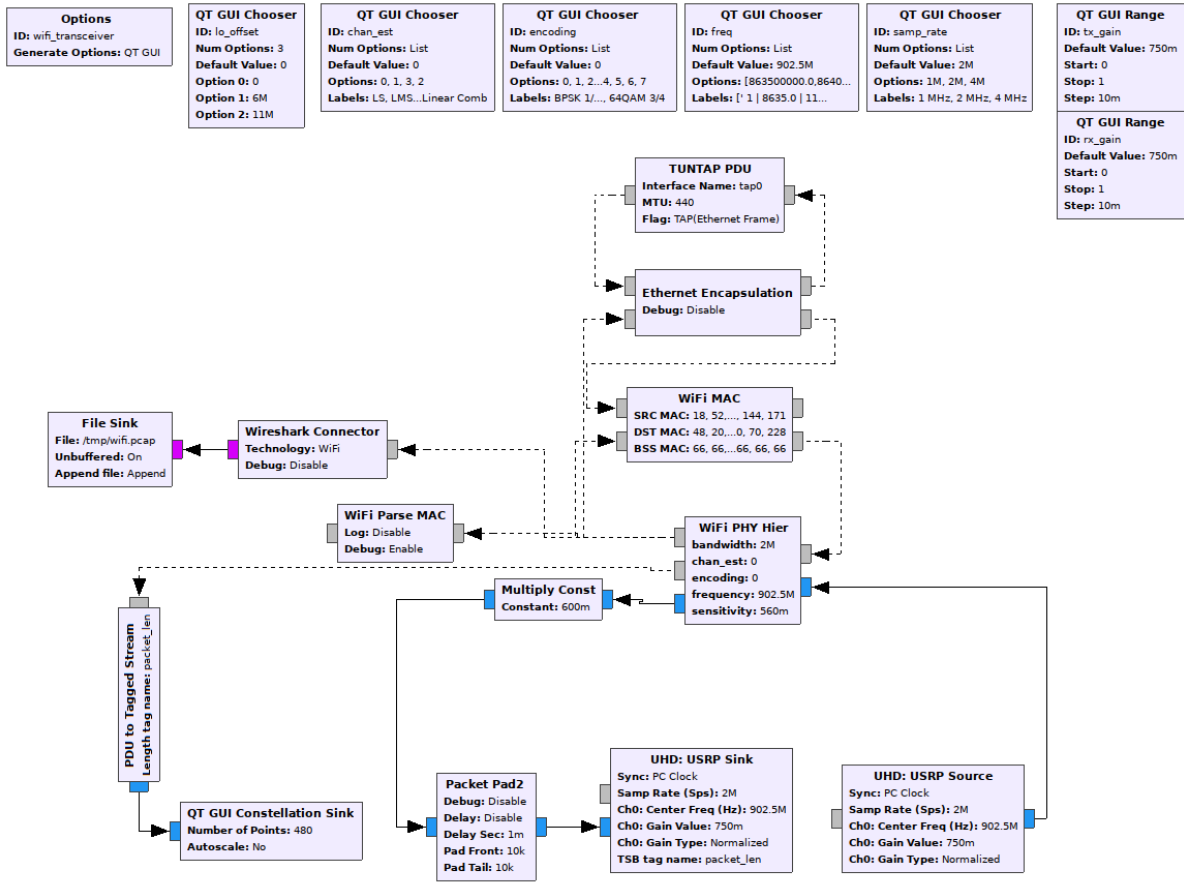

Figure 5.16: Design of Transceiver in GNURadio.

from [40], and we modified its frequency, encoding and sample rate to match 802.11ah standard.

For frequency, as explained in chapter 2, is below 1 GHz. Every region has their frequency range. The following code is a snippet of frequencies used by 802.11ah for all region:

```

1 self._freq_options =
  [863500000.0,864000000.0,864500000.0,865500000.0,866000000.0,866500000.0,
  867500000.0, 902500000.0,903000000.0,903500000.0, 904500000.0,905000000.0,
  905500000.0, 906000000.0, 906500000.0,907000000.0, 907500000.0,908000000.0,
  908500000.0, 909000000.0, 909500000.0, 910000000.0,910500000.0,911000000.0,
  911500000.0, 912500000.0, 913000000.0, 913500000.0, 914000000.0,914500000.0,
  915000000.0, 915500000.0, 916000000.0, 916500000.0,
  917000000.0,917500000.0,918000000.0, 918500000.0, 919000000.0, 919500000.0,
  920000000.0,920500000.0,921000000.0, 921500000.0, 922000000.0, 922500000.0,
  923000000.0,923500000.0,924000000.0, 924500000.0, 925000000.0, 925500000.0,
  926000000.0, 926500000.0,927000000.0, 927500000.0]
2 self._freq_labels = [ ' 1 | 8635.0 | 11ah', ' 2 | 8640.0 | 11ah', ' 3 |
  8645.0 | 11ah', ' 4 | 8655.0 | 11ah', ' 5 | 8660.0 | 11ah', ' 6 | 8665.0 | 11

```

```

ah', ' 7 | 8675.0 | 11ah', ' 8 | 9025.0 | 11ah', ' 9 | 9030.0 | 11ah', ' 10 |
9035.0 | 11ah', ' 11 | 9045.0 | 11ah', ' 12 | 9050.0 | 11ah', ' 13 | 9055.0
| 11ah', ' 14 | 9060.0 | 11ah', ' 15 | 9065.0 | 11ah', ' 16 | 9070.0 | 11ah',
' 17 | 9075.0 | 11ah', ' 18 | 9080.0 | 11ah', ' 19 | 9085.0 | 11ah', ' 20 |
9090.0 | 11ah', ' 21 | 9095.0 | 11ah', ' 22 | 9100.0 | 11ah', ' 23 | 9105.0 |
11ah', ' 24 | 9110.0 | 11ah', ' 25 | 9115.0 | 11ah', ' 26 | 9125.0 | 11ah',
' 27 | 9130.0 | 11ah', ' 28 | 9135.0 | 11ah', ' 29 | 9140.0 | 11ah', ' 30 |
9145.0 | 11ah', ' 31 | 9150.0 | 11ah', ' 32 | 9155.0 | 11ah', ' 33 | 9160.0 |
11ah', ' 34 | 9165.0 | 11ah', ' 35 | 9170.0 | 11ah', ' 36 | 9175.0 | 11ah',
' 37 | 9180.0 | 11ah', ' 38 | 9185.0 | 11ah', ' 39 | 9190.0 | 11ah', ' 40 |
9195.0 | 11ah', ' 41 | 9200.0 | 11ah', ' 42 | 9205.0 | 11ah', ' 43 | 9210.0 |
11ah', ' 44 | 9215.0 | 11ah', ' 45 | 9220.0 | 11ah', ' 46 | 9225.0 | 11ah',
' 47 | 9230.0 | 11ah', ' 48 | 9235.0 | 11ah', ' 49 | 9240.0 | 11ah', ' 50 |
9245.0 | 11ah', ' 51 | 9250.0 | 11ah', ' 52 | 9255.0 | 11ah', ' 53 | 9260.0 |
11ah', ' 54 | 9265.0 | 11ah', ' 55 | 9270.0 | 11ah', ' 56 | 9275.0 | 11ah']

```

From the beginning of the 802.11 standards, it always uses a sample rate from 10 MHz in 802.11a to 160MHz in 802.11ax standard. 802.11ah use a smaller sample rate, 1 MHz to 2 MHz. The following code is a snippet of the sample rate which we use, 1 MHz and 2 MHz:

```

1 self._samp_rate_options = [1e6, 2e6]
2 self._samp_rate_labels = ["1 MHz", "2 MHz"]

```

We also modified the MAC layer procedure from [39]. The procedure is for 802.11 standards. We add cross-layer capabilities to the program. The following code is a snippet of reading SNR from beacon data and save the time of beacon arrived:

```

1 last_beacon_time = time.time()
2 if data_pkt["snr"] < snr_threshold:
3     allowed_to_send_data = False
4 else:
5     allowed_to_send_data = True

```

We need to save the time of the beacon because we want to know when the last time to receive the beacon. Sometimes, when the interference is severe, the beacon signal is lost. Hence, the station will be timing from the last beacon time received. If it exceeds the threshold of time, we assume that there is a high interference in the channel, and the program will defer its transmission if it has any. The following code is a snippet of transmission requirement:

```

1 if (time.time() - last_beacon_time) > time_threshold:
2     allowed_to_send_data = False
3 if not allowed_to_send_data:
4     state = "IDLE"
5     continue

```

### 5.3.2 PHY Layer GnuRadio Programming

We use source code from Bastian [40] which is basic wifi 802.11/a/g/p and use OFDM. To make it follow the standard of 802.11ah, we make some modification.

1. Frequency are: [863500000.0, 864000000.0, 864500000.0, 865500000.0, 866000000.0, 866500000.0, 867500000.0, 902500000.0, 903000000.0, 903500000.0, 904500000.0, 905000000.0, 905500000.0, 906000000.0, 906500000.0, 907000000.0, 907500000.0, 908000000.0, 908500000.0, 909000000.0, 909500000.0, 910000000.0, 910500000.0, 911000000.0, 911500000.0, 912500000.0, 913000000.0, 913500000.0, 914000000.0, 914500000.0, 915000000.0, 915500000.0, 916000000.0, 916500000.0, 917000000.0, 917500000.0, 918000000.0, 918500000.0, 919000000.0, 919500000.0, 920000000.0, 920500000.0, 921000000.0, 921500000.0, 922000000.0, 922500000.0, 923000000.0, 923500000.0, 924000000.0, 924500000.0, 925000000.0, 925500000.0, 926000000.0, 926500000.0, 927000000.0, 927500000.0].

This frequency correspond with bandwidth channel 1 MHz, 2 MHz, 4 MHz in Europe. ([  
 1 — 8635.0 — 11ah', ' 2 — 8640.0 — 11ah', ' 3 — 8645.0 — 11ah', ' 4 — 8655.0 — 11ah', ' 5  
 — 8660.0 — 11ah', ' 6 — 8665.0 — 11ah', ' 7 — 8675.0 — 11ah', ' 8 — 9025.0 — 11ah', ' 9 —  
 9030.0 — 11ah', ' 10 — 9035.0 — 11ah', ' 11 — 9045.0 — 11ah', ' 12 — 9050.0 — 11ah', ' 13  
 — 9055.0 — 11ah', ' 14 — 9060.0 — 11ah', ' 15 — 9065.0 — 11ah', ' 16 — 9070.0 — 11ah', '  
 17 — 9075.0 — 11ah', ' 18 — 9080.0 — 11ah', ' 19 — 9085.0 — 11ah', ' 20 — 9090.0 — 11ah', '  
 21 — 9095.0 — 11ah', ' 22 — 9100.0 — 11ah', ' 23 — 9105.0 — 11ah', ' 24 — 9110.0 — 11ah',  
 ' 25 — 9115.0 — 11ah', ' 26 — 9125.0 — 11ah', ' 27 — 9130.0 — 11ah', ' 28 — 9135.0 —  
 11ah', ' 29 — 9140.0 — 11ah', ' 30 — 9145.0 — 11ah', ' 31 — 9150.0 — 11ah', ' 32 — 9155.0  
 — 11ah', ' 33 — 9160.0 — 11ah', ' 34 — 9165.0 — 11ah', ' 35 — 9170.0 — 11ah', ' 36 —  
 9175.0 — 11ah', ' 37 — 9180.0 — 11ah', ' 38 — 9185.0 — 11ah', ' 39 — 9190.0 — 11ah', ' 40  
 — 9195.0 — 11ah', ' 41 — 9200.0 — 11ah', ' 42 — 9205.0 — 11ah', ' 43 — 9210.0 — 11ah', '  
 44 — 9215.0 — 11ah', ' 45 — 9220.0 — 11ah', ' 46 — 9225.0 — 11ah', ' 47 — 9230.0 — 11ah',  
 ' 48 — 9235.0 — 11ah', ' 49 — 9240.0 — 11ah', ' 50 — 9245.0 — 11ah', ' 51 — 9250.0 —  
 11ah', ' 52 — 9255.0 — 11ah', ' 53 — 9260.0 — 11ah', ' 54 — 9265.0 — 11ah', ' 55 — 9270.0  
 — 11ah', ' 56 — 9275.0 — 11ah']]).

2. Bandwidth are 1 MHz, 2 MHz and 4 MHz. Although 1 MHz and 4 MHz is optional. The mandatory bandwidth is 2 MHz.

3. For the transmitter, we need to modify the source code also. Because for MCS1, it is different. If 802.11a/g/p use BPSK 3/4, then for 802.11ah, it uses QPSK 1/2. Because we only use MCS0 and MCS1, then we did not implement QAM, although it is possible.

To get the data of SNR, we use an additional block from gr-rftap in the receiver. This

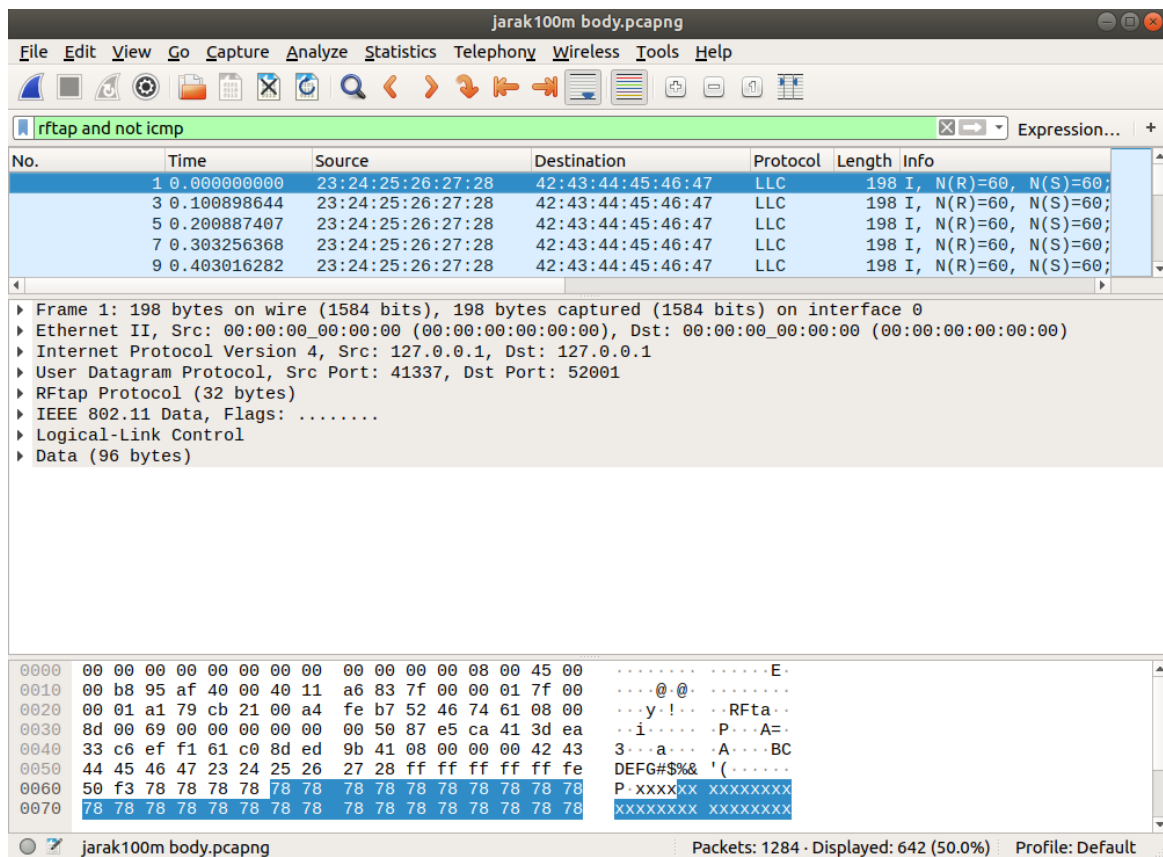

Figure 5.17: Screen Capture of Wireshark.

block will stream information from the PHY layer (frequency, frequency offset, SNR) to User Datagram Protocol (UDP) client, which will forward it to Wireshark. Figure 5.17 shown a screen capture of Wireshark with some data.

Complete design of Transmitter is shown in figure 5.18.

We send data from strobe to analyze the SNR. Socket PDU can be used to transmit data from other devices connected to the PC.

Complete design of Receiver is shown in figure 5.19. Furthermore, when we run the program, we have the constellation diagram as shown in figure 5.20. In that figure, the modulation of the signal transmitted is BPSK.

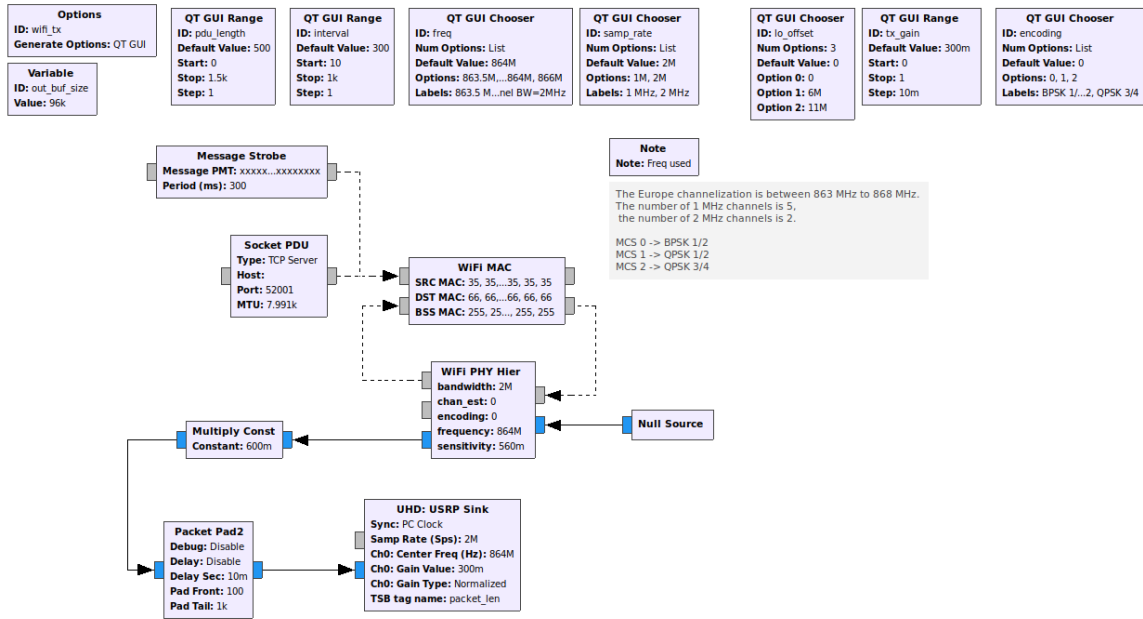

Figure 5.18: Gnuradio 802.11ah Transmitter.

### 5.3.3 Application Layer and Database Design

## 5.4 Evaluation of Prototype

802.11ah use range frequency from 863.5 MHz to 927.5 MHz, although the application varies within countries. Many groups use this sub-GHz frequency. The most notable is for the cellular system. It is also allocated for amateur radio.

To have a smooth experiment, we choose the frequency range, which is "quiet". We do not want another signal that interferes with our signal. We sweep the spectrum to search for a "quiet" channel. Because B200 have a maximum bandwidth of 56MHz, we used 50MHz step, from 850MHz to 900MHz. In the lab, we found that frequency 900MHz is less crowded, as shown in figure 5.21.

If we compare with the hectic spectrum around 940MHz, shown in figure 5.22, then 900MHz is better. Hence we will use this frequency for the experiment. However, in the standard of 802.11ah, there is no channel for frequency 900MHz. The closest channel for frequency 900MHz is channel number 8, with a frequency 902.5MHz.

We measure the power maximum transmitted from USRP B200. To transmit maximum power, we use GNURadio design as shown in figure 5.24. The design is transmitting a sinusoidal signal with amplitude gain 1 (normalized). This design means USRP will use maximum power.

The output of USRP is connected with the spectrum analyzer's input using a cable to

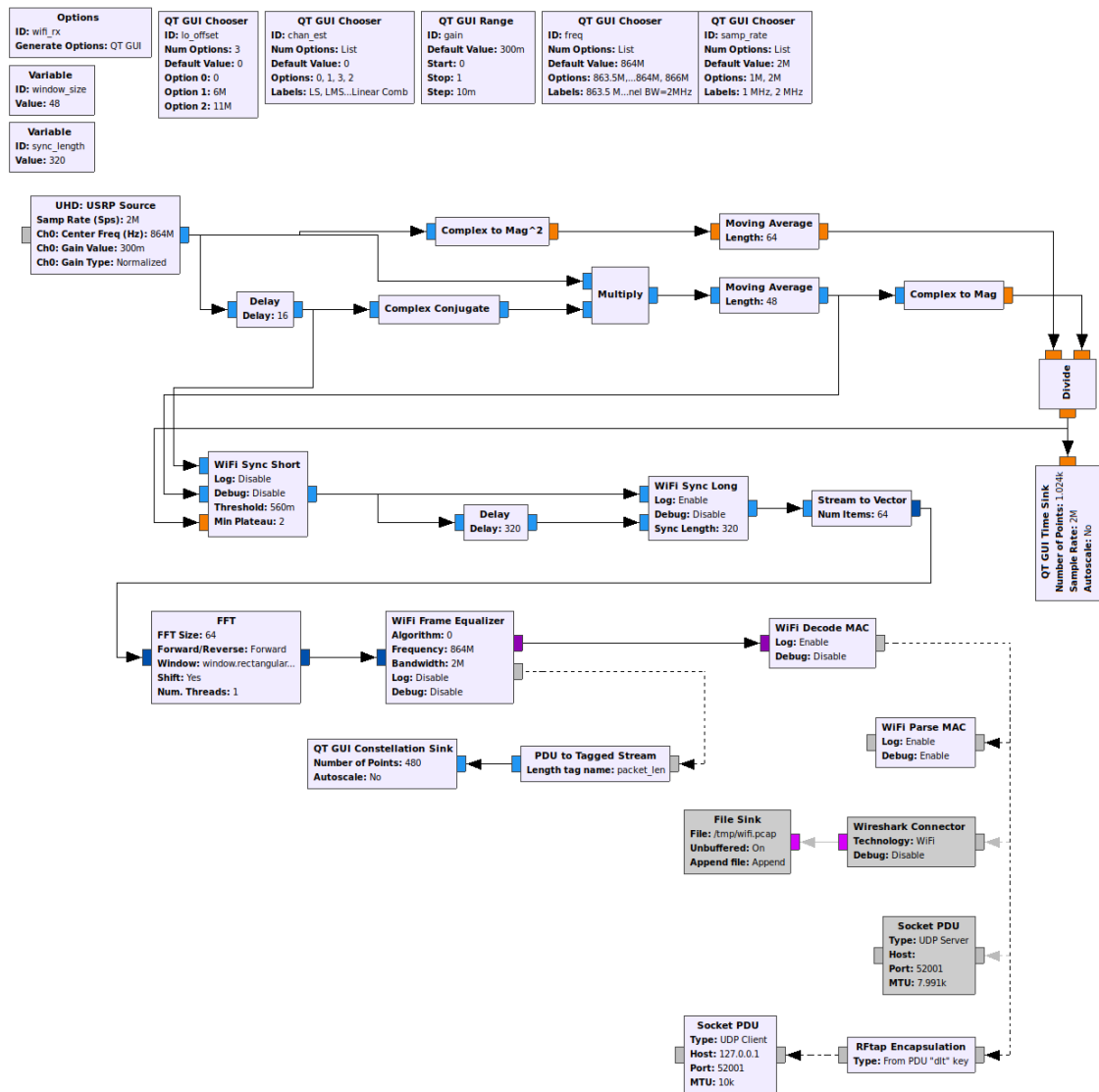

Figure 5.19: Gnuradio 802.11ah Receiver.

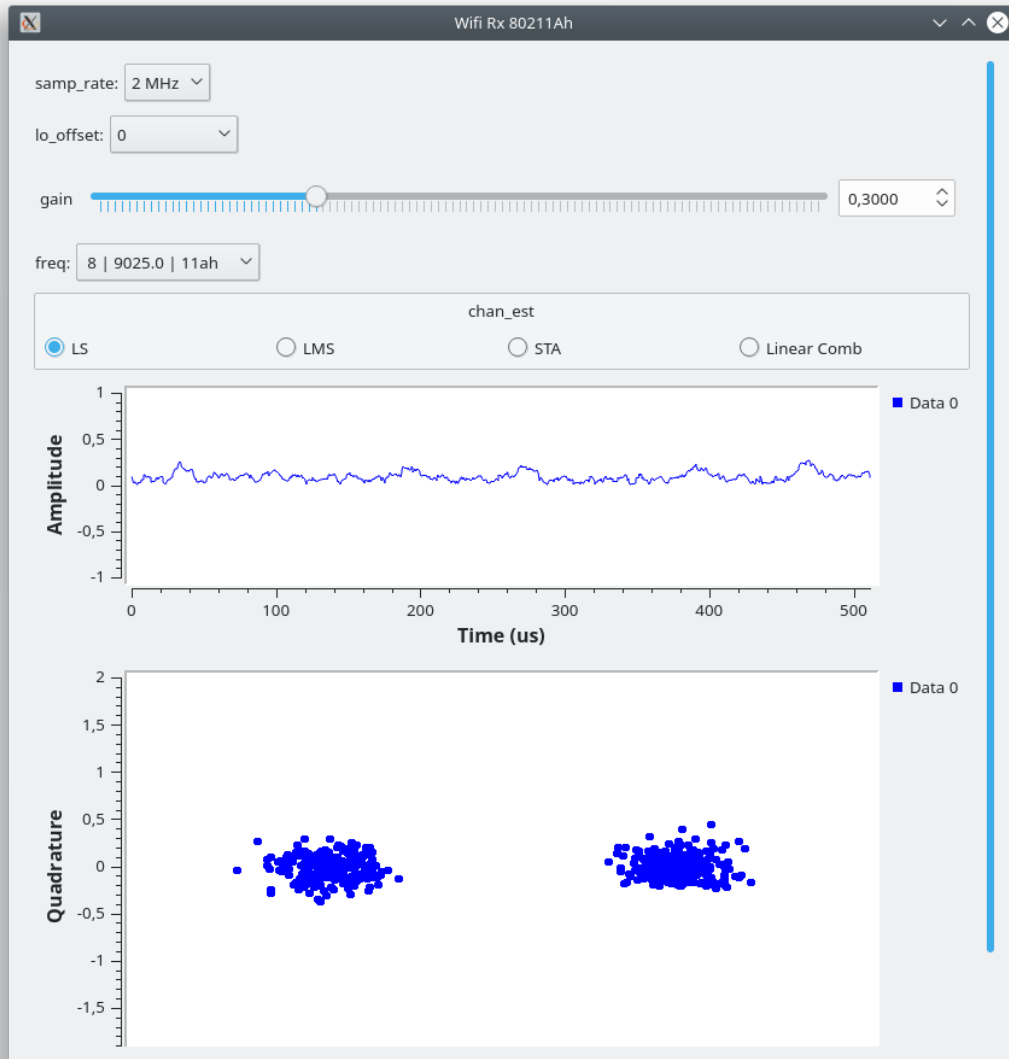

Figure 5.20: Constellation diagram of receiver.

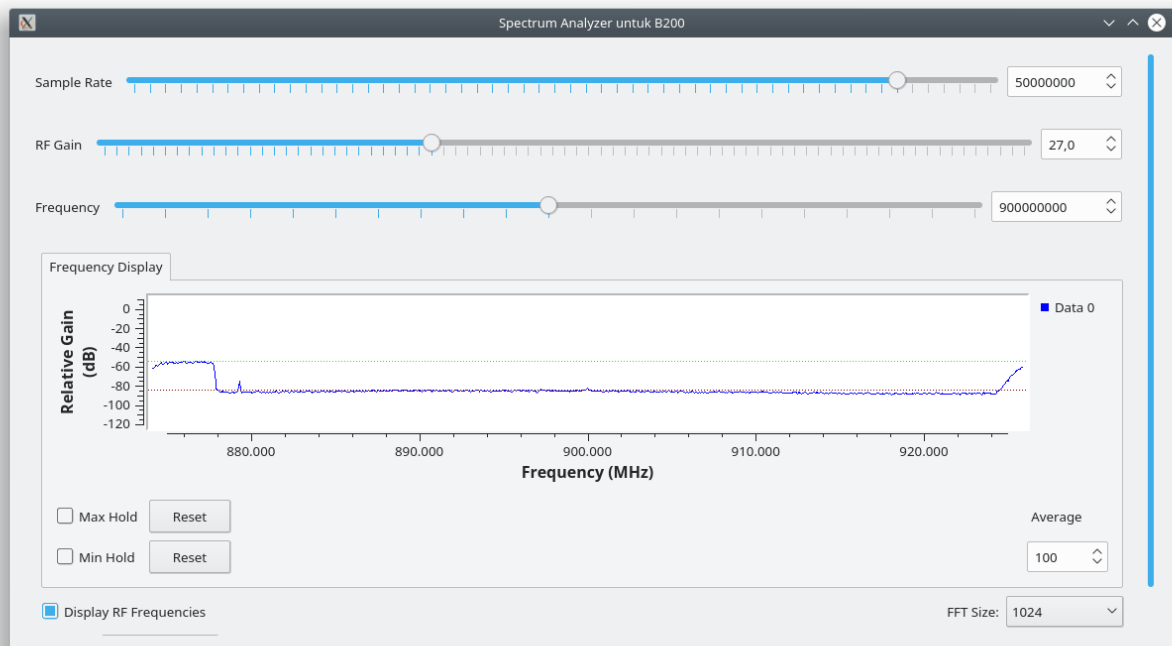

Figure 5.21: Spectrum in 900 MHz.

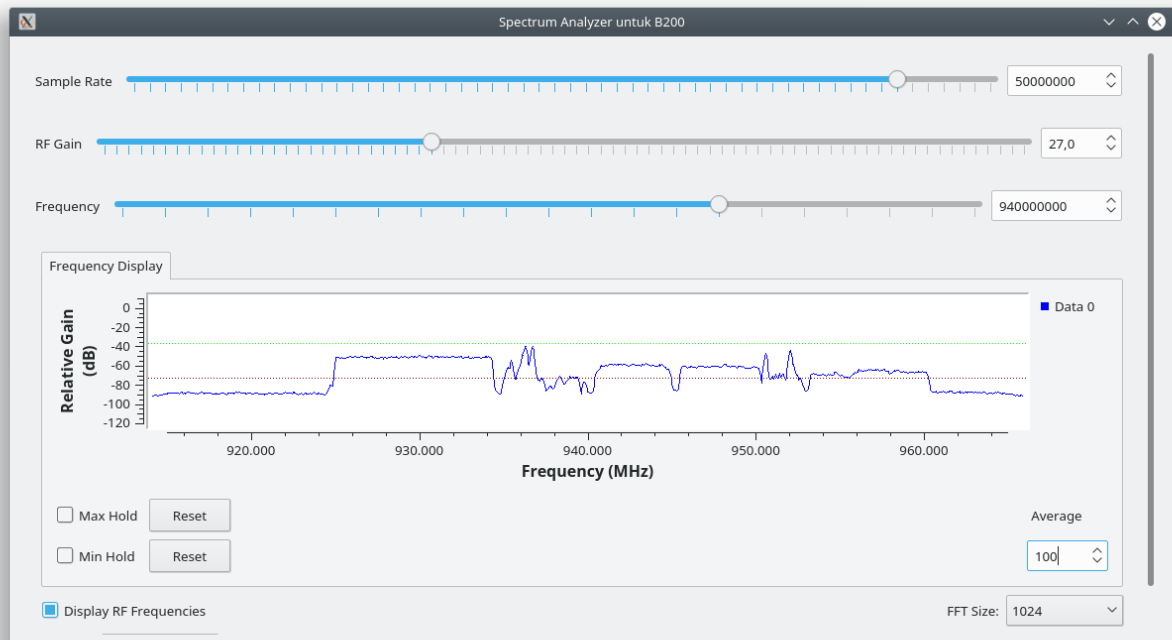

Figure 5.22: Spectrum in 940 MHz.



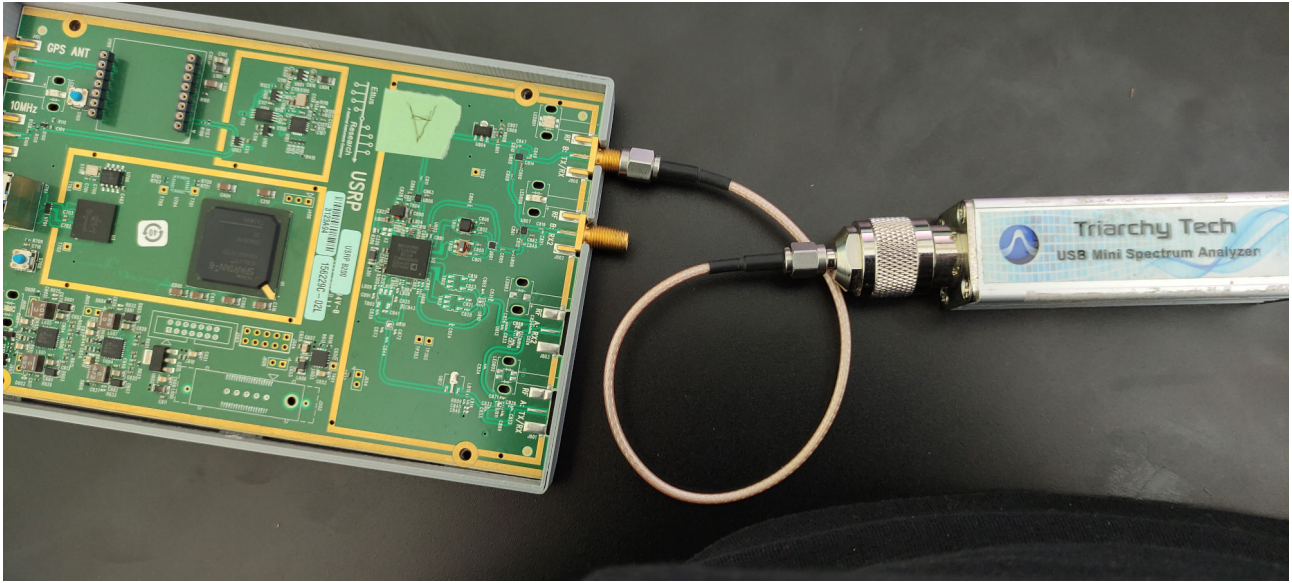

Figure 5.23: Power measurement configuration.

prevent loss from the air channel. Hence we could get truly maximum power without loss. The configuration is shown on figure 5.23. We use a spectrum analyzer from Triarchy.

Figure 5.25 show the spectrum of signal received. Here we have maximum power received is 20 dBm which is confirmed with datasheet of USRP B200 from Ettus.

Therefore, the first procedure before each experiment is always to check the spectrum around 900 MHz, whether there are other transmissions or not. Also, we need to check room temperature in the lab to have valid result regarding temperature noise.

For outdoor, we have different parameters as shown in table 5.1. The experiment is to measure outdoor SNR with a range from 40 to 100 meters. Complete parameter is shown in table 5.1. We walk back and forth in front of the receiver to test whether our body affects the transmission.

Table 5.1: Outdoor Experiment Parameters

Parameter	Value
Modulation	BPSK
Frequency	902.5 MHz
Bandwidth	2 MHz
Packetrate	5 packet/second
PDU size	200 bytes

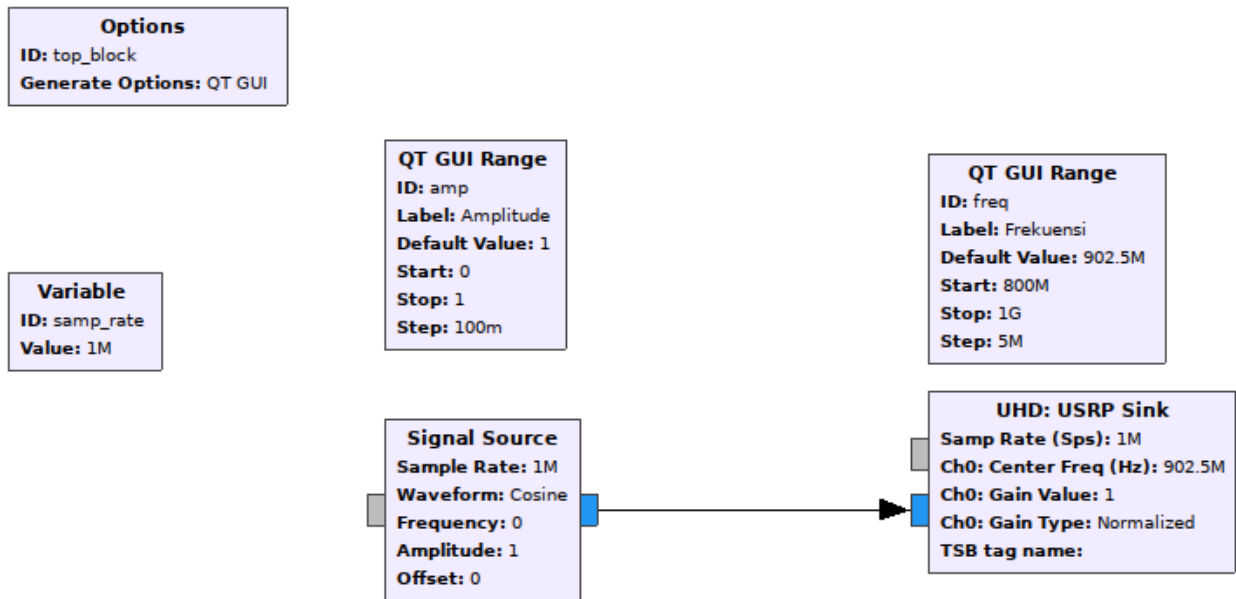

Figure 5.24: Generate single tone signal with frequency 902.5MHz.

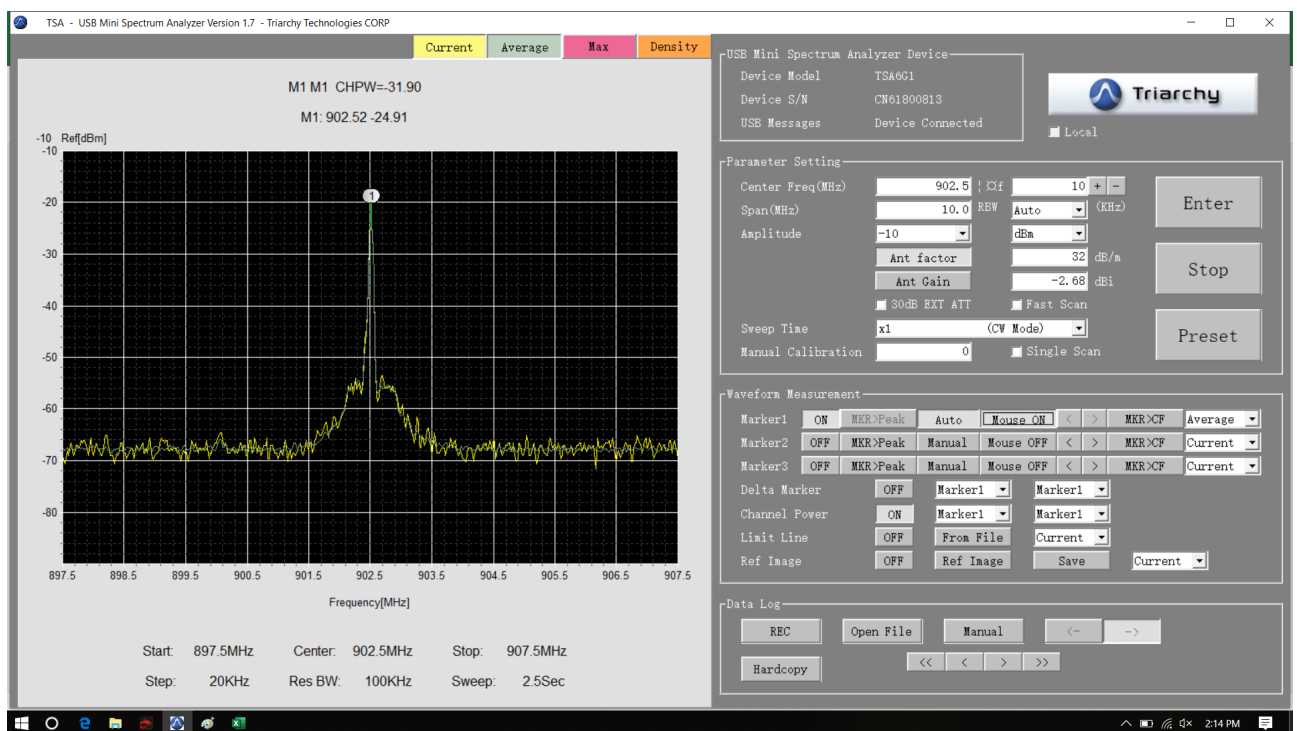

Figure 5.25: Spectrum of frequency 902.5MHz.

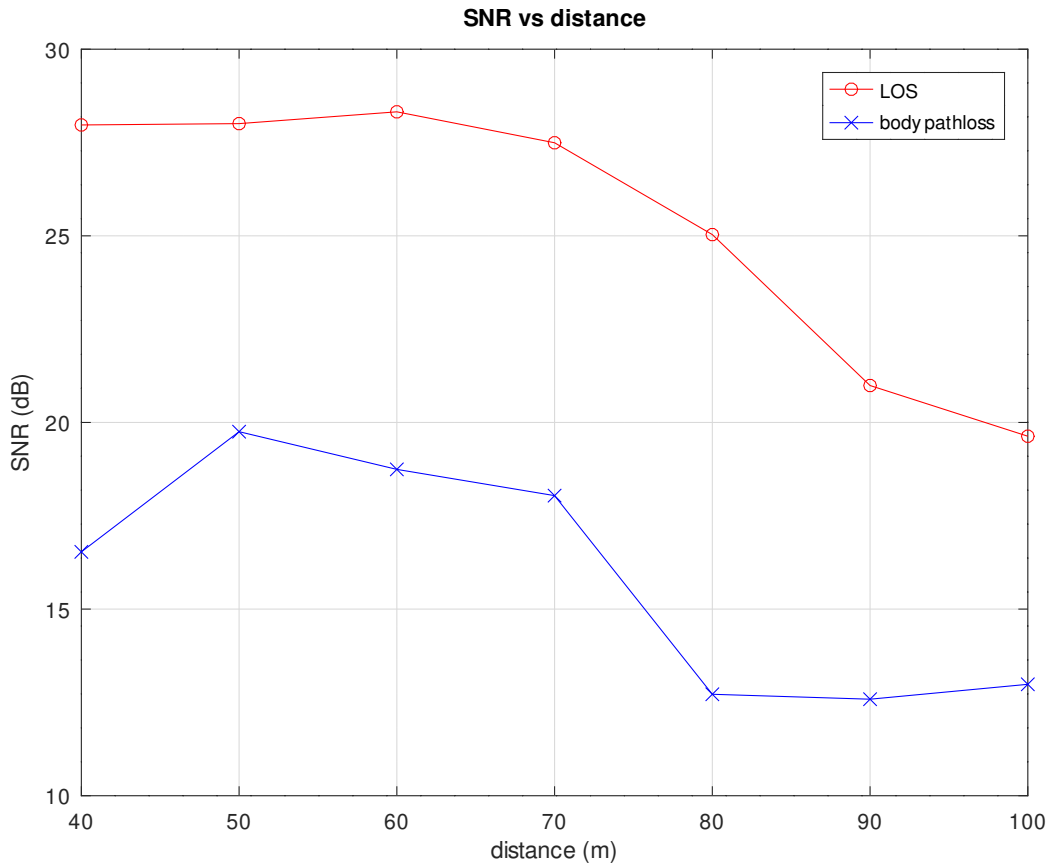

Figure 5.26: SNR as Function of Distance in Outdoor Measurement.

The result is shown in Figure 5.26. The result shows that body pathloss has higher loss than free space pathloss by 37 percent in the range of 40-100m. (red: without body pathloss/LOS. Blue: with body pathloss).

We also calculate packet loss from this experiment. Packet Loss Ratio (PLR) is a ratio between packet loss and packet sent. Packet loss ratio is a function of distance.

To measure the packet loss ratio, we extract the time of received data. Because we sent data every 200ms, the received data should have the exact timing. If not, we assume the data is lost.

Within a short distance, the packet loss ratio should be small, as shown in figure 5.27. With high SNR, practically, there is no packet loss. However, with body pathloss, we have high packet loss in the range of 90 - 100 meters. The longer the distance, the packet loss should be higher.

We did the indoor experiment in the corridor of our lab. Figure 5.28 is the result of measurement. In general, SNR for Line of Sight (LoS) will decrease as distance increases.

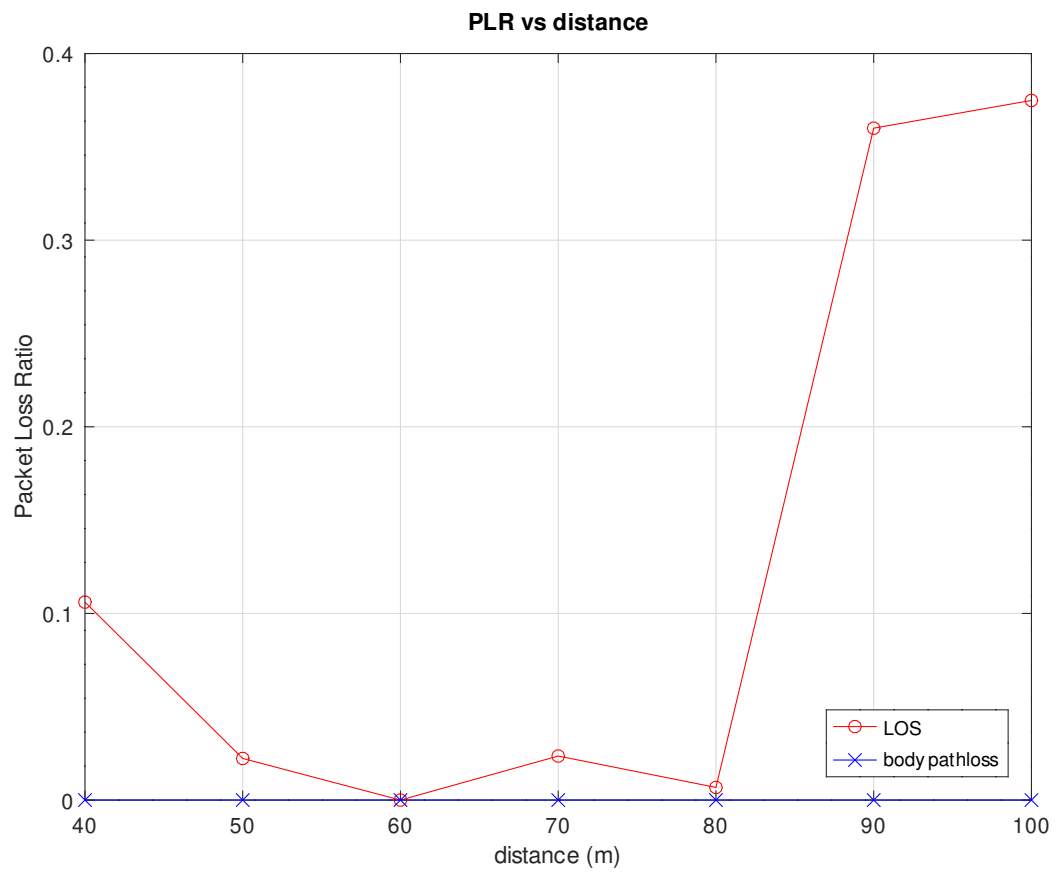

Figure 5.27: Packet Loss Ratio as Function of Distance in Outdoor Measurement.

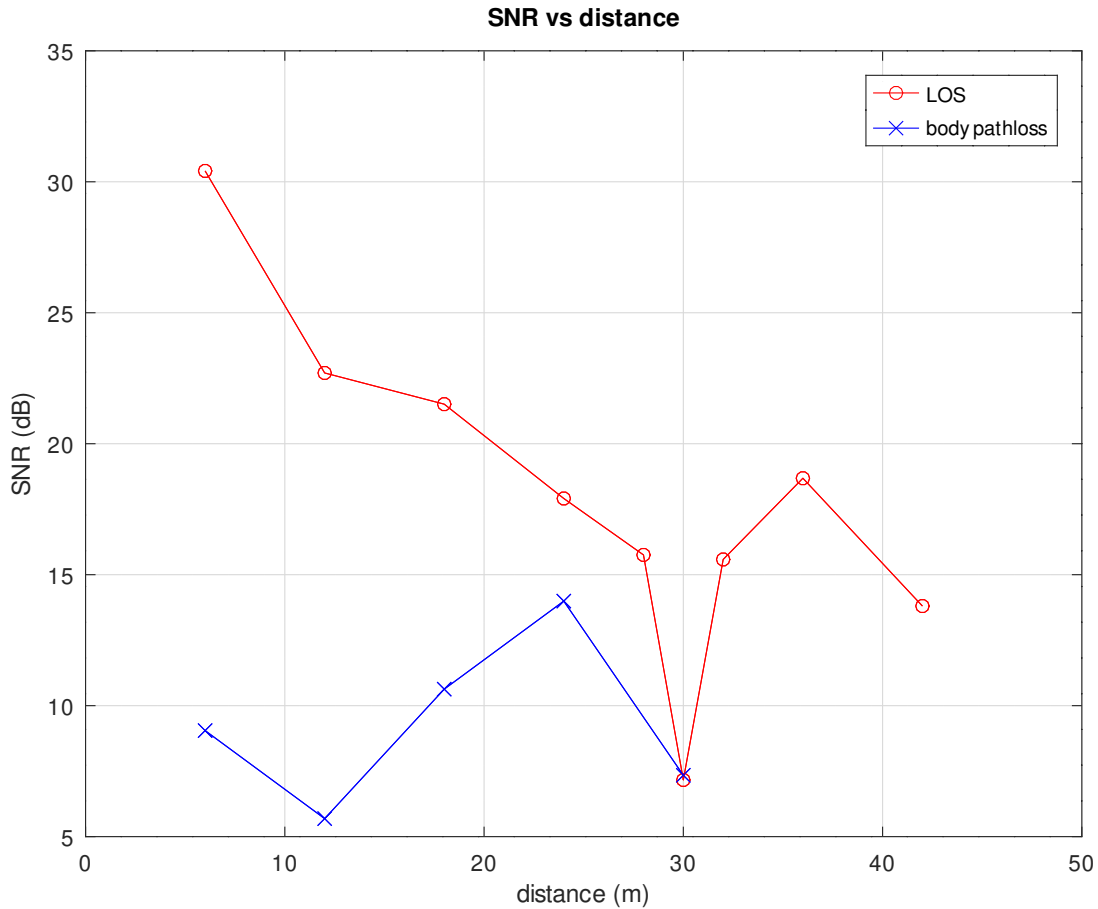

Figure 5.28: Indoor experiment

However, there is an anomaly for a distance of 30 meters. We believe it is because of large interference at those specific distance. It is a hallway without windows and door.

For body pathloss, it starts with small SNR and increases as distance goes by, although at a distance of 30 meters, it encounters the same interference with LOS. The difference between LOS and body pathloss is around 15dB. It is caused by body absorption.

The interesting part is: in the short distance, SNR is lower compare to the longer distance. It is because of the multipath signal. In a short distance, there is no chance for the bounced signal to arrive at the receiver. However, for a longer distance, the bounced signal will enhance the gain of the signal. Figure 5.29 show the illustration.

After confirming that the sensor data is accurate enough, the sensor data is sent to the server. The data sent will be compared with the data in the database. The 5.2 table shows a comparison of the sensor data sent with the data stored in the database. Data is taken from the database and serial monitoring, which displays the sensor readings directly before sending

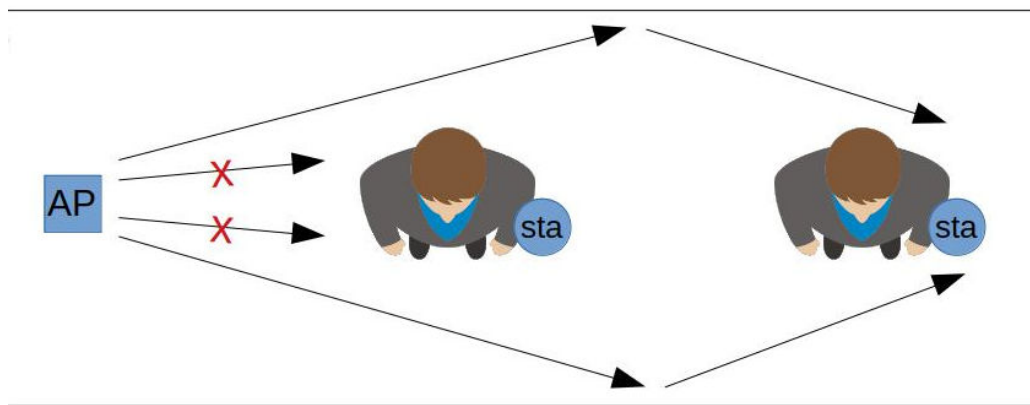

Figure 5.29: Illustration of Hallway Measurement

via B200. It can be seen that the values are the same.

Finally, we have data from a wearable sensor in the cloud. We could access data from anywhere as long as we connect to the internet. Figure 5.30 is screenshot of sensor data in the internet.

Table 5.2: Comparison temperature between database and serial monitoring.

	<b>value</b>	
<b>date</b>	<b>database</b>	<b>serial mon.</b>
2020-12-04 11:26:05	27.15	27.15
2020-12-04 11:26:10	27.23	27.23
2020-12-04 11:26:15	27.17	27.17
2020-12-04 11:26:20	27.25	27.25
2020-12-04 11:26:25	27.29	27.29
2020-12-04 11:26:30	27.21	27.21
2020-12-04 11:26:35	27.15	27.15
2020-12-04 11:26:40	27.09	27.09
2020-12-04 11:26:45	27.11	27.11
2020-12-04 11:26:50	27.09	27.09
2020-12-04 11:26:55	27.17	27.17
2020-12-04 11:27:00	27.15	27.15
2020-12-04 11:27:05	27.21	27.21
2020-12-04 11:27:10	27.35	27.35
2020-12-04 11:27:15	27.37	27.37
2020-12-04 11:27:20	27.37	27.37
2020-12-04 11:27:25	27.35	27.35

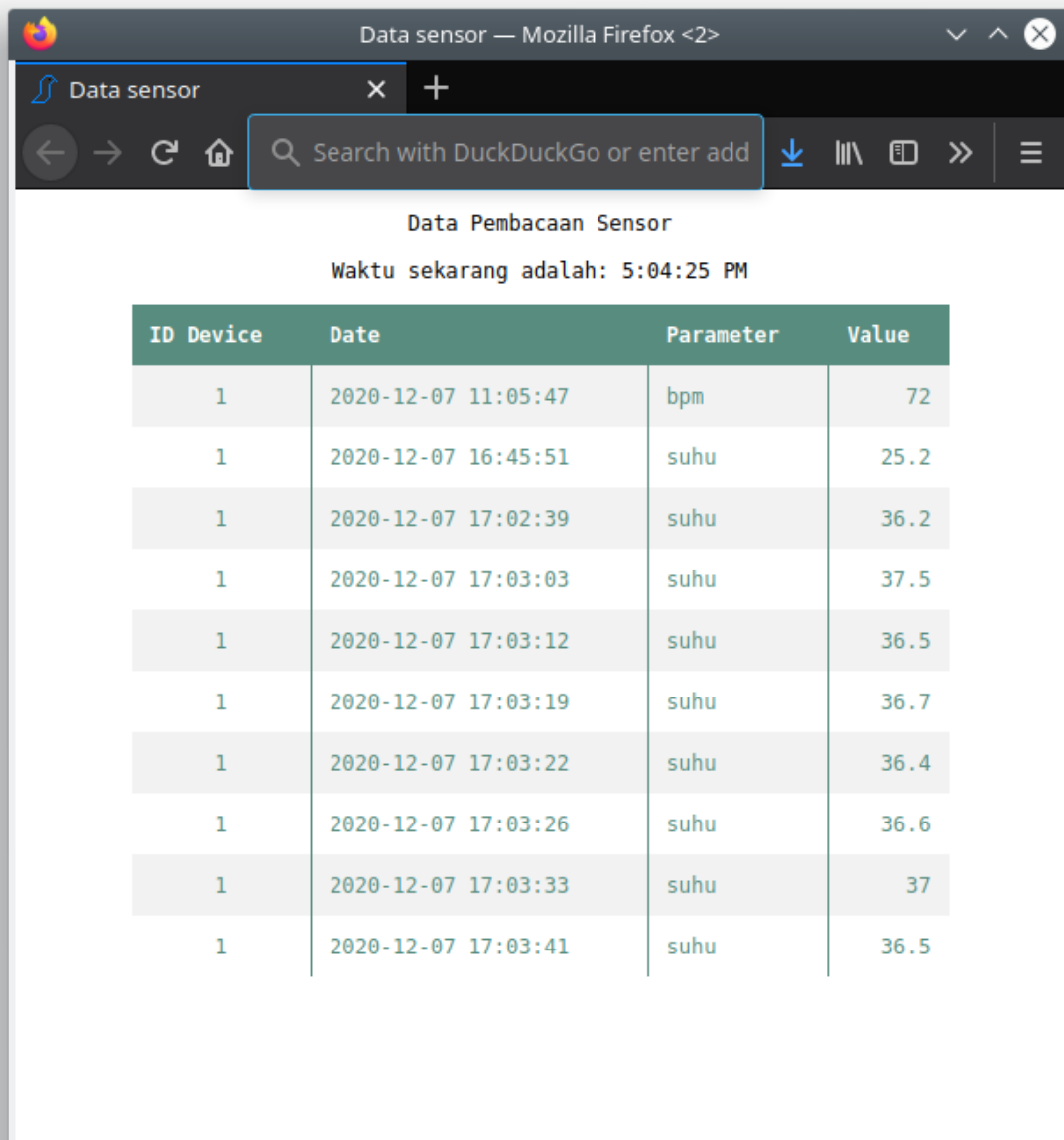

Data Pembacaan Sensor

Waktu sekarang adalah: 5:04:25 PM

ID Device	Date	Parameter	Value
1	2020-12-07 11:05:47	bpm	72
1	2020-12-07 16:45:51	suhu	25.2
1	2020-12-07 17:02:39	suhu	36.2
1	2020-12-07 17:03:03	suhu	37.5
1	2020-12-07 17:03:12	suhu	36.5
1	2020-12-07 17:03:19	suhu	36.7
1	2020-12-07 17:03:22	suhu	36.4
1	2020-12-07 17:03:26	suhu	36.6
1	2020-12-07 17:03:33	suhu	37
1	2020-12-07 17:03:41	suhu	36.5

Figure 5.30: Screenshot of interface to sensor.





# Chapter 6

## Conclusion

The evaluation of the cross-layer protocols developed for wireless networks is essential before deploying them, whether in indoor or outdoor environments. This evaluation is necessary both to verify that the protocol works correctly in various scenarios and to validate its system architecture. Above all, to measure its performance, compare it with existing protocols and improve it with new mechanisms and features.

In this work, the aim is to evaluate the performance of 802.11ah with body pathloss in the indoor and outdoor propagation channel. Certain aspects can be the subject of theoretical analyzes, simulation and experiment.

In this paper, we analytically show the effect of body pathloss on the 802.11ah network. We compare the standard pathloss of 802.11ah with body pathloss. Particular attention has been paid to PER and throughput that are exploited by each of these pathloss. We analytically show that body pathloss increase PER and decrease throughput. This comparative study emerges that body pathloss increases PER and decreases throughput because the body absorbs electromagnetic signal.

We also propose a cross-layer algorithm to counter the effect of body pathloss. The idea is to defer the transmission of the data if there is a high probability of body shadow by detecting the received power of the beacon. Of course, because the cross-layer protocol defers the transmission, the transmitted data of the cross-layer method will be lower than without the cross-layer method. Our analysis corresponds to that.

To assess the robustness of the cross-layer algorithm, simulation models have been developed. A model was built in the environment MATLAB, which allows to simulate the cross-layer. Our simulation shows that the reduction of average throughput between the cross-layer method and without the cross-layer method is not significant. However, the PER of the cross-layer method surpasses the non-cross-layer method while maintaining the throughput. This means

that our cross-layer method is more efficient compare to the non-cross-layer method. Also, the results obtained by simulation are well correlated with the analysis.

Experimental tests in LOS and body pathloss were carried out indoors in a hallway of our laboratory and outdoor on the road of our campus. Since there is no off-the-shelf product of 802.11ah, we contribute to creating PHY/MAC of 802.11ah in SDR by adding the bandwidth and frequency used by the standard. We also validated the attenuation from body pathloss.

To create a complete IoT environment system, we implemented a proof of concept of our technique using SDR, sensors, microcontroller and server on the internet. We successfully could observe the data of sensors on the internet.

For the perspective, there are more works to do. We will research about varying packet size, beacon interval and transmission power. We want to know how they affect the performance of 802.11ah. Also, in this paper, the network is assumed point-to-point. The nature of 802.11ah is a multi-user network. We will modify our cross-layer algorithm to accommodate multi nodes.

This is PHY/MAC cross-layer analysis. Enhancement of the cross-layer to another layer may increase throughput and PER efficiency, such as prioritized important packet from the application layer in the access control layer/physical layer.

Future research in this area may analyze the effect of hidden terminal problems with RTS/CTS activated. The hidden terminal problem is a transmission problem that arises when two or more stations that are out of range of each other transmit simultaneously to a common recipient. This is prevalent in decentralized systems with no entity for controlling transmissions, like 802.11ah networks. This occurs when a station is visible from a wireless access point (AP) but is hidden from other stations that communicate with the AP.

Reduced PER could lead to reduced energy use since the transmitter does not waste packet data. It saves energy by not transmitting a packet, which is sure to be an error. This has been our hypothesis from the beginning. However, further research is needed to validate this reduction of energy consumption.

Security and privacy enhancement of the cross-layer method are also important. MAC layer could postpone transmission when PHY layer detects hacker listen to network illegally. Hacker needs much data to crack the key. Hence when the MAC layer defers data transmission, it will reduce data collected by the hacker.

To have a commercial prototype, our subsequent work is to tap out the program in SDR and implement it in FPGA to create a tiny Integrated Circuit (IC) modem of cross-layered 802.11ah. This cross-layer 802.11ah modem will be connected to the microcontroller and sensor to collect data and send it to AP and the internet.

In the Covid-19 pandemic, real-time monitoring of patient condition could be life-saving.

For example, implementing IoT healthcare with a SpO<sub>2</sub> sensor attached to a patient of Covid-19. SpO<sub>2</sub> is the level of oxygen in the blood as a percentage. People who have lung issues such as COPD, asthma, or pneumonia or people who temporarily stop breathing during sleep (sleep apnea) may be more likely to have lower SpO<sub>2</sub> levels, likewise people with Covid-19. With the subsequent research on cross-layer 802.11ah healthcare IoT, we could have a better position in the fight against Covid-19.



# Bibliography

- [1] IEEE. *IEEE Std 802.15.4<sup>TM</sup>-2015, IEEE Standard for Low-Rate Wireless Networks*. IEEE, 2015.
- [2] Technical Marketing Workgroup. Technical Overview of LoRa and LoRaWAN, November 2015.
- [3] Sigfox Foundation. Sigfox Technical Overview, January 2018.
- [4] Carmen M. Perales Montilla, Stefan Duschek, and Gustavo A. Reyes del Paso. Health-related quality of life in chronic kidney disease: Predictive relevance of mood and somatic symptoms. *Nefrología (English Edition)*, 36(3):275–282, May 2016.
- [5] telemedicine. <https://www.merriam-webster.com/dictionary/telemedicine>. Accessed: 13 February 2021.
- [6] Elector ehealth in rheumatology. <http://www.elector.eu/>. Accessed: 25 September 2018.
- [7] Anne Lee, Marianne Sandvei, Hans Christian Asmussen, Marie Skougaard, Joanne Macdonald, Jakub Zavada, Henning Bliddal, Peter C Taylor, and Henrik Gudbergesen. The development of complex digital health solutions: Formative evaluation combining different methodologies. *JMIR Res Protoc*, 7(7):e165, July 2018.
- [8] Chronic obstructive pulmonary disease (copd) briefcase. <http://www.telemedicine-momentum.eu/copd-suitcase-dk/>. Accessed: 25 September 2018.
- [9] Thalea ii. <https://cordis.europa.eu/project/id/689041>. Accessed: 13 February 2021.
- [10] Forto. <https://forto-aal.eu/>. Accessed: 13 February 2021.

- [11] Osama Majeed Butt, Muhammad Zulqarnain, and Tallal Majeed Butt. Recent advancement in smart grid technology: Future prospects in the electrical power network. *Ain Shams Engineering Journal*, page S2090447920301064, July 2020.
- [12] Philipp Osterrieder, Lukas Budde, and Thomas Friedli. The smart factory as a key construct of industry 4.0: A systematic literature review. *International Journal of Production Economics*, 221:107476, March 2020.
- [13] Gartner: Internet of things plus big data transforming the world. [https://www.datanami.com/2013/10/09/gartner\\_internet\\_of\\_things\\_plus\\_big\\_data\\_transforming\\_the\\_world/](https://www.datanami.com/2013/10/09/gartner_internet_of_things_plus_big_data_transforming_the_world/). Accessed: 18 August 2017.
- [14] A. Triwinarko, I. Dayoub, and P. Wikanta. Using MIMO and cross layer design for VANETs: A review. In *2017 International Conference on Signals and Systems (ICSigSys)*, pages 13–18, May 2017.
- [15] Rekapitulasi sdm kesehatan yang didayagunakan di rumah sakit di indonesia. [http://bppsdmk.kemkes.go.id/info\\_sdmk/info/distribusi\\_sdmk\\_rs](http://bppsdmk.kemkes.go.id/info_sdmk/info/distribusi_sdmk_rs). Accessed: 13 February 2021.
- [16] Berkat home care, puskesmas kassi-kassi dekat di hati. <https://www.kemkes.go.id/article/view/17012000003/berkat-home-care-puskesmas-kassi-kassi-dekat-di-hati.html>. Accessed: 21 September 2018.
- [17] Sinem Coleri Ergen. ZigBee/IEEE 802.15.4 Summary. *University of California, Berkeley*, September 2004.
- [18] Ahmed Salem and Tamer Nadeem. Exposing Bluetooth lower layers for IoT communication. In *2016 IEEE 3rd World Forum on Internet of Things (WF-IoT)*, pages 147–152, Reston, VA, USA, December 2016. IEEE.
- [19] Kais Mekki, Eddy Bajic, Frederic Chaxel, and Fernand Meyer. A comparative study of LPWAN technologies for large-scale IoT deployment. *ICT Express*, 5(1):1–7, March 2019.
- [20] Ismail Butun, Nuno Pereira, and Mikael Gidlund. Security Risk Analysis of LoRaWAN and Future Directions. *Future Internet*, 11(1):3, December 2018.
- [21] Usman Raza, Parag Kulkarni, and Mahesh Sooriyabandara. Low Power Wide Area Networks: An Overview. *IEEE Communications Surveys & Tutorials*, 19(2):855–873, 2017.

- [22] IEEE. *IEEE Std 802.15.6-2012, IEEE Standard for Local and metropolitan area networks—Part 15.6: Wireless Body Area Networks*. IEEE, 2012.
- [23] IEEE. *IEEE Std 802.11ah-2016 (Amendment to IEEE Std 802.11-2016, as amended by IEEE Std 802.11ai-2016): IEEE Standard for Information technology—Telecommunications and information exchange between systems - Local and metropolitan area networks—Specific require*. IEEE, S.l., 2017. OCLC: 1012468995.
- [24] Victor Baños-Gonzalez, Shahwaiz Afaqui, Elena Lopez-Aguilera, and Eduard Garcia-Villegas. Throughput and Range Characterization of IEEE 802.11ah. *IEEE Latin America Transactions*, 15, April 2016.
- [25] Bojan Domazetovic, Enis Kocan, and Albena Mihovska. Performance evaluation of IEEE 802.11ah systems. In *Performance evaluation of IEEE 802.11ah systems*, pages 1–4, Belgrade, Serbia, November 2016. IEEE.
- [26] Bojan Domazetovic and Enis Kocan. Packet error rate in IEEE 802.11ah use case scenarios. In *Packet error rate in IEEE 802.11ah use case scenarios*, pages 1–4, Belgrade, Serbia, November 2017. IEEE.
- [27] R. Porat, SK. Yong, and K. Doppler. TGah Channel Model. *Available online: <https://mentor.ieee.org/802.11/dcn/11/11-11-0968-04-00ah-channel-model-text.docx> (accessed on 13 May 2019).*, 2015.
- [28] T. Kikuzuki, A. S. Andrenko, and M. G. S. Hossain. A Simple Path Loss Model for Body Area Network in the Bed Side Monitoring Applications. In *A Simple Path Loss Model for Body Area Network in the Bed Side Monitoring Applications*, pages 765–768, 2011.
- [29] Yu Zhang, Bing Zhang, and Shi Zhang. A Lifetime Maximization Relay Selection Scheme in Wireless Body Area Networks. *Sensors*, 17(6):1267, June 2017.
- [30] Victor Baños-Gonzalez, M. Shahwaiz Afaqui, Elena Lopez-Aguilera, and Eduard Garcia-Villegas. IEEE 802.11ah: A Technology to Face the IoT Challenge. *Sensors*, 16(11):1960, November 2016.
- [31] Javad Haghghat and Walaa Hamouda. A Power-Efficient Scheme for Wireless Sensor Networks Based on Transmission of Good Bits and Threshold Optimization. *IEEE Transactions on Communications*, 64(8):3520–3533, August 2016.



- [32] Sachin Gajjar, Mohanchur Sarkar, and Kankar Dasgupta. FAMACROW: Fuzzy and ant colony optimization based combined mac, routing, and unequal clustering cross-layer protocol for wireless sensor networks. *Applied Soft Computing*, 43:235–247, June 2016.
- [33] Paul Ferrand, Jean-Marie Gorce, and Claire Goursaud. Approximations of the packet error rate under slow fading in direct and relayed links. *RESEARCH REPORT No 8316, INRIA*, page 23, 2013.
- [34] G. Bianchi. Performance analysis of the IEEE 802.11 distributed coordination function. *IEEE Journal on Selected Areas in Communications*, 18(3):535–547, March 2000.
- [35] A. Boulis, D. Smith, D. Miniutti, L. Libman, and Y. Tselishchev. Challenges in body area networks for healthcare: the MAC. *IEEE Communications Magazine*, 50(5):100–106, May 2012.
- [36] H. W. Tseng, R. Y. Wu, and Y. Z. Wu. An Efficient Cross-Layer Reliable Retransmission Scheme for the Human Body Shadowing in IEEE 802.15.6-Based Wireless Body Area Networks. *IEEE Sensors Journal*, 16(9):3282–3292, May 2016.
- [37] Introduction to SDR. [https://www.wirelessinnovation.org/Introduction\\\_to\\\_SDR](https://www.wirelessinnovation.org/Introduction\_to\_SDR). Accessed: 31 August 2020.
- [38] Gnuradio. <https://www.gnuradio.org/>. Accessed: 31 August 2020.
- [39] Haoyang Lu and Wei Gao. Scheduling dynamic wireless networks with limited operations. In *2016 IEEE 24th International Conference on Network Protocols (ICNP)*, pages 1–10, Singapore, November 2016. IEEE.
- [40] Bastian Bloessl, Michele Segata, Christoph Sommer, and Falko Dressler. Performance Assessment of IEEE 802.11p with an Open Source SDR-based Prototype. *IEEE Transactions on Mobile Computing*, 17(5):1162–1175, May 2018.