



HAL
open science

Consequences of artificial light at night on a diurnal insect (*Venturia canescens*): behavioural and physiological responses

Elisa Gomes

► **To cite this version:**

Elisa Gomes. Consequences of artificial light at night on a diurnal insect (*Venturia canescens*): behavioural and physiological responses. Populations and Evolution [q-bio.PE]. Université de Lyon, 2021. English. NNT: 2021LYSE1055 . tel-03826927

HAL Id: tel-03826927

<https://theses.hal.science/tel-03826927v1>

Submitted on 24 Oct 2022

HAL is a multi-disciplinary open access archive for the deposit and dissemination of scientific research documents, whether they are published or not. The documents may come from teaching and research institutions in France or abroad, or from public or private research centers.

L'archive ouverte pluridisciplinaire **HAL**, est destinée au dépôt et à la diffusion de documents scientifiques de niveau recherche, publiés ou non, émanant des établissements d'enseignement et de recherche français ou étrangers, des laboratoires publics ou privés.



N° d'ordre NNT : 2021LYSE1055

THESE de DOCTORAT DE L'UNIVERSITE DE LYON

opérée au sein de

l'Université Claude Bernard Lyon 1

Ecole Doctorale N° 342

Evolution, Ecosystèmes Microbiologie Modélisation

Spécialité de doctorat : Biologie Evolutive

Soutenue publiquement le 24/03/2021 par :

Elisa Gomes

**Consequences of artificial light at night on a diurnal insect
(*Venturia canescens*): behavioural and physiological
responses**

Devant le jury composé de :

Gibert Patricia, DR HDR, CNRS UMR 5558

Jones Thérèse, Senior lecturer, University of Melbourne

Renault David, PU, Université Rennes 1

Louâpre Philippe, MCU, Université de Bourgogne

Desouhant Emmanuel, PU, Université Lyon 1

Amat Isabelle, MCU, Université Lyon 1

Présidente

Rapporteure

Rapporteur

Examineur

Directeur de thèse

Co-directrice de thèse

Université Claude Bernard – LYON 1

Administrateur provisoire de l'Université	M. Frédéric FLEURY
Président du Conseil Académique	M. Hamda BEN HADID
Vice-Président du Conseil d'Administration	M. Didier REVEL
Vice-Président du Conseil des Etudes et de la Vie Universitaire	M. Philippe CHEVALLIER
Vice-Président de la Commission de Recherche	M. Jean-François MORNEX
Directeur Général des Services	M. Pierre ROLLAND

COMPOSANTES SANTE

Département de Formation et Centre de Recherche en Biologie Humaine	Directrice : Mme Anne-Marie SCHOTT
Faculté d'Odontologie	Doyenne : Mme Dominique SEUX
Faculté de Médecine et Maïeutique Lyon Sud – Charles Mérieux	Doyenne : Mme Carole BURILLON
Faculté de Médecine Lyon-Est	Doyen : M. Gilles RODE
Institut des Sciences et Techniques de la Réadaptation (ISTR)	Directeur : M. Xavier PERROT
Institut des Sciences Pharmaceutiques et Biologiques (ISBP)	Directrice : Mme Christine VINCIGUERRA

COMPOSANTES & DEPARTEMENTS DE SCIENCES & TECHNOLOGIE

Département Génie Electrique et des Procédés (GEP)	Directrice : Mme Rosaria FERRIGNO
Département Informatique	Directeur : M. Behzad SHARIAT
Département Mécanique	Directeur : M. Marc BUFFAT
Ecole Supérieure de Chimie, Physique, Electronique (CPE Lyon)	Directeur : Gérard PIGNAULT
Institut de Science Financière et d'Assurances (ISFA)	Directeur : M. Nicolas LEBOISNE
Institut National du Professorat et de l'Education	Administrateur provisoire : M. Pierre CHAREYRON
Institut Universitaire de Technologie de Lyon 1	Directeur : M. Christophe VITON
Observatoire de Lyon	Directrice : Mme Isabelle DANIEL
Polytechnique Lyon	Directeur : Emmanuel PERRIN
UFR Biosciences	Administratrice provisoire : Mme Kathrin GIESELER
UFR des Sciences et Techniques des Activités Physiques et Sportives (STAPS)	Directeur : M. Yannick VANPOULLE
UFR Faculté des Sciences	Directeur : M. Bruno ANDRIOLETTI

Abstract

Light pollution, defined as the alteration of night natural lighting levels by artificial light sources, is a widespread anthropogenic disturbance that affects almost every ecosystem on Earth. It mainly comes from direct illumination due to public street lighting, but can also take the form of skyglow (*i.e.* the scattering of upwardly-emitted light into the atmosphere) which extends over hundreds of kilometres around urbanised areas. For a long time, light pollution had received less attention than other types of anthropogenic disturbances such as climate change. However, a growing number of studies have highlighted its numerous biological consequences on a large number of organisms, and at all levels of biological organisation (individuals, populations, ecosystems). Light pollution is therefore now considered as an important driver of global change and a major concern for human health and biodiversity.

Studies on light pollution have mainly focused on nocturnal organisms, which are more likely to be disturbed by the presence of light at night. This is particularly true for insect, as evidenced by numerous studies that investigated the attractiveness of artificial light sources on moths or the modification of flashing activities in fireflies exposed to light pollution. On the contrary, very little is known about consequences of light pollution on diurnal insects.

The aim of my thesis was therefore to investigate experimentally the changes induced by light pollution in a diurnal parasitoid, the wasp *Venturia canescens*. To do this, I studied behavioural, life-history and physiological traits of female wasps exposed to various intensities of light pollution. My work was divided in two parts.

The first part dealt with changes in behavioural traits related to parasitic efficiency and lifetime reproductive success, in relation to energy reserves, at the intra- and trans-generational levels. I demonstrated that light pollution led diurnal wasps to become active and search for food and hosts at night. In addition, I showed that light at night, depending on its intensity, also modified wasps' daytime foraging behaviour, but without affecting their energy reserves. Indeed, there was an increased preference for host searching in wasps exposed to low intensity light pollution. However, light at night does not seem to have a strong effect on the lifetime reproductive success of *Venturia canescens*. Finally, light pollution also acted at trans-generational level, influencing offspring feeding behaviour and development time.

In the second part of my work, I focused on a physiological trait, the production of melatonin. Melatonin is a key hormone involved in the regulation of circadian rhythm in organisms. It is also known to be strongly impacted by the presence of light at night. This hormone is therefore

likely to play a major role in the phenotypic changes observed in organisms exposed to light pollution. Melatonin has been well studied in vertebrates, especially mammals, but knowledge of its synthesis and circadian rhythm in insect is scarce. I therefore developed two methods for quantifying melatonin in *Venturia canescens*, in order to describe its dynamics over a 24-hour cycle in the absence of light pollution. This work could thus serve as a basis for future studies to experimentally test the effect of light pollution on melatonin synthesis in *Venturia canescens*.

Keywords: nocturnal light pollution; parasitoid wasp; foraging behaviour; life history traits; reproductive success; melatonin; gene expression

Résumé

La pollution lumineuse, définie comme la modification des niveaux naturels de lumière nocturne par des sources lumineuses artificielles, est une perturbation anthropique très répandue qui touche quasiment tous les écosystèmes sur Terre. Elle provient principalement de l'éclairage public, mais peut également prendre la forme du « skyglow », un halo lumineux dû à la diffusion de la lumière émise vers le ciel par les particules présentes dans l'atmosphère, et qui s'étend sur des centaines de kilomètres autour des zones urbanisées. Pendant longtemps, la pollution lumineuse a été moins étudiée que d'autres types de perturbations anthropiques telles que le changement climatique. Cependant, un nombre croissant d'études a mis en évidence ses nombreuses conséquences biologiques sur un grand nombre d'organismes, et à tous les niveaux d'organisation biologique (individus, populations, écosystèmes). La pollution lumineuse est donc désormais considérée comme un acteur important du changement global, et représente une préoccupation majeure pour la santé humaine et la biodiversité.

Les études sur la pollution lumineuse se sont majoritairement intéressées aux organismes nocturnes, plus susceptibles d'être perturbés par la présence de lumière pendant la nuit. Ce constat est particulièrement vrai pour les insectes, comme l'attestent de nombreuses études s'intéressant à l'attractivité des lumières artificielles sur les papillons de nuit ou à la modification du comportement de signalisation par flash lumineux chez les lucioles en présence de pollution lumineuse. Au contraire, les conséquences de la pollution lumineuse sur les insectes diurnes sont très peu connues.

L'objectif de ma thèse était donc d'étudier expérimentalement les changements causés par la pollution lumineuse chez un parasitoïde diurne, la guêpe *Venturia canescens*. Pour cela, je me suis intéressée à différents traits comportementaux, d'histoire de vie et physiologiques de femelles exposées à différentes intensités de pollution lumineuse. Mon travail se divise en deux parties.

La première partie porte sur les modifications de traits comportementaux liés à l'efficacité parasitaire et au succès reproducteur, en lien avec les réserves énergétiques, aux niveaux intra et transgénérationnels. J'ai démontré que la pollution lumineuse conduisait les femelles à être actives et à chercher de la nourriture et des hôtes la nuit. De plus, j'ai montré que la lumière nocturne, selon son intensité, modifiait également le comportement d'approvisionnement des femelles parasitoïdes pendant la journée, sans affecter leurs réserves énergétiques. En effet, une préférence accrue pour la recherche d'hôtes a été constatée chez les femelles exposées à une pollution lumineuse de faible intensité. Cependant, la pollution lumineuse ne semble pas avoir

un fort effet sur le succès reproducteur de *Venturia canescens*. Enfin, la pollution lumineuse agit également au niveau transgénérationnel, en influençant le comportement alimentaire ainsi que le temps de développement des descendants.

Dans la seconde partie de mon travail, je me suis intéressée à un trait physiologique, la production de mélatonine. La mélatonine est une hormone clé, principalement impliquée dans la régulation du rythme circadien des organismes. On sait de plus qu'elle est fortement influencée par la présence de lumière pendant la nuit. Cette hormone est donc susceptible de jouer un rôle majeur dans les changements phénotypiques observés chez les organismes soumis à la pollution lumineuse. La mélatonine a été bien étudiée chez les vertébrés, en particulier les mammifères, mais les connaissances sur sa synthèse et son rythme circadien chez les insectes sont rares. J'ai donc développé deux méthodes de quantification de la mélatonine chez *Venturia canescens*, afin de décrire sa dynamique sur un cycle de 24 heures en l'absence de pollution lumineuse. Ces travaux pourront ainsi servir de base à de futures études souhaitant tester expérimentalement l'effet de la pollution lumineuse sur la synthèse de mélatonine chez *Venturia canescens*.

Mots-clés : pollution lumineuse nocturne ; guêpe parasitoïde ; comportement d'approvisionnement ; traits d'histoire de vie ; succès reproducteur ; mélatonine ; expression de gènes

Table of contents

PART I – GENERAL INTRODUCTION.....	17
1. Chapter 1: Artificial light at night: historical background, sources and characterization of a human disturbance.....	19
1.1. Brightly illuminated nights: a recent feature in human history.....	20
1.2. Units of light measurement.....	23
1.3. Artificial light at night comes from various sources.....	25
1.4. What is the current situation worldwide with regard to light at night?.....	28
2. Chapter 2: Review on mechanistic, ecological and evolutionary consequences of artificial light at night for insects.....	33
3. Chapter 3: The hymenopteran parasitoid <i>Venturia canescens</i>: a relevant biological model to study the effects of artificial light at night.....	56
3.1. Biological description of <i>Venturia canescens</i>	57
3.2. A relevant biological model to study the effects of artificial light at night.....	59
4. Chapter 4: Thesis objectives.....	61
PART II – CONSEQUENCES OF ARTIFICIAL LIGHT AT NIGHT FROM A BEHAVIOURAL PERSPECTIVE.....	66
5. Chapter 5: Consequences of artificial light at night on decision-making in <i>Venturia canescens</i> at intra- and trans-generational levels: focus on foraging behaviour.....	68
5.1. Introduction.....	69
5.1.1. Disruption of foraging behaviours by artificial light at night in nocturnal organisms.....	69
5.1.2. Can night-time artificial lighting impact behaviours and physiology during the day? The specific case of diurnal species.....	70
5.1.2.1. Daily activity patterns.....	70
5.1.2.2. Can exposure to artificial light at night alter foraging and reproductive behaviours during the day?.....	72
5.1.2.3. Physiological consequences of artificial light at night in diurnal species: a focus on energy reserves.....	73

5.2. Dealing with host and food searching in a diurnal parasitoid: consequences of light at night at intra- and trans-generational levels (published in <i>Insect Conservation and Diversity</i> in 2021).....	76
5.3. Does the choice between parasitizing high- or low-quality hosts depends on artificial light at night in <i>Venturia canescens</i> ?.....	108
5.3.1. Superparasitism behaviour in <i>Venturia canescens</i>	108
5.3.2. Methods.....	109
5.3.3. Results and conclusion.....	113
5.4. Conclusion.....	115
6. Chapter 6: Fitness consequences of artificial light at night: impacts on lifetime reproductive success and senescence.....	117
6.1. Artificial light and foraging at night in a diurnal insect: consequences of lifetime reproductive success and senescence (in preparation).....	118
6.2. Conclusion.....	148
PART III – MELATONIN: A KEY MECHANISM THAT COULD UNDERLIE BEHAVIOURAL RESPONSES TO ARTIFICIAL LIGHT AT NIGHT.....	149
7. Chapter 7: Mini-review on melatonin biosynthesis, roles and relationship to artificial light at night.....	150
7.1. Melatonin biosynthesis and regulation in vertebrates and insects.....	151
7.2. Melatonin: a ubiquitous molecule that plays many roles	153
7.3. Why focusing on melatonin when studying consequences of artificial light at night on living organisms?.....	156
7.3.1. Artificial light at night disrupts melatonin synthesis during the night.....	156
7.3.2. Is there evidence linking artificial light at night, melatonin synthesis and changes in biological traits?.....	157
8. Chapter 8: Melatonin dynamics over a 24-hour period in a parasitoid wasp: methodological developments and application.....	161
8.1. Methodological developments: how to quantify melatonin in a parasitoid insect?.....	163
8.1.1. Quantitative analysis by enzyme-linked immunosorbent assay (ELISA).....	163
8.1.1.1. Principle of the ELISA method.....	163
8.1.1.2. Assay protocol.....	164

8.1.1.3.	Calculation of melatonin quantities.....	165
8.1.2.	A molecular approach: quantitative analysis of gene expression (quantitative PCR).....	165
8.1.2.1.	Principle of quantitative PCR.....	165
8.1.2.2.	Gene selection and identification in <i>V. canescens</i>	167
8.1.2.3.	Primers.....	170
8.1.2.4.	Extraction of total RNAs.....	171
8.1.2.5.	Synthesis of cDNA.....	172
8.1.2.6.	Optimization of qPCR conditions.....	172
8.2.	Practical application: are melatonin synthesis and expression of two melatonin-related genes correlated during a 24-hour period?.....	174
8.2.1.	Experimental design.....	174
8.2.2.	Data analysis.....	175
8.2.2.1.	Analysis of qPCR data.....	175
8.2.2.2.	Statistical analysis.....	175
8.2.3.	Results.....	176
8.3.	Discussion.....	179
PART IV – GENERAL DISCUSSION.....		183
9.	Chapter 9: General discussion.....	185
9.1.	Summary of results.....	186
9.2.	Spatial variation of nocturnal light pollution levels: consequences on the biological responses of organisms.....	188
9.2.1.	What are the levels of artificial light at night experienced by organisms in their natural environment?.....	189
9.2.2.	Is there evidence of local adaptation to nocturnal light pollution?.....	190
9.3.	Interaction between artificial light at night and daylength: studying nocturnal light pollution at various latitudes.....	192
9.4.	Does nocturnal light pollution interact with other human-induced disturbances?.....	193
9.5.	Conclusion.....	197

PART V – APPENDIX 1.....	198
PART VI – APPENDIX 2.....	199
PART VII – APPENDIX 3.....	207
PART VIII – REFERENCES.....	209

Figures

Figure 1 The Nightmare (1781), oil painting by Henry Fuseli..	21
Figure 2 Night (Painting IV; 1736 – 1738), oil painting by William Hogarth..	22
Figure 3 Variation of illuminance levels depending on the horizontal and vertical distance from a typical street lamp (from Bennie et al., 2016).	26
Figure 4 Skyglow above the city of Los Angeles (photo by P. Gomes).	27
Figure 5 Spectral composition of the main lighting types used in artificial lighting (modified from Gaston et al., 2013).	28
Figure 6 World map of artificial night sky brightness (from Falchi et al., 2016).	29
Figure 7 World map of the annual rate of changes (calculated over the period between 2012 and 2016) in (A) surface of lit area and (B) radiance of previously lit areas (from Kyba et al., 2017).	29
Figure 8 Change in lighting technology in Milan, Italy (from Kyba et al., 2017).	31
Figure 9 Movement at different stages of the egg-laying process in <i>Venturia canescens</i> . The position of the egg is showed at each stage (from Rogers, 1972).	58
Figure 10 Diagram of a host patch after being parasitized by 5 wasps for 2.5h. The patch contains 37 host larvae, of which 16 are already parasitized (black circles) and 21 are healthy (white circles).	111
Figure 11 Effect of body size (estimated by tibia length) on patch residence time in the control and low artificial light at night (ALAN) conditions.	114
Figure 12 Effect of body size (estimated by tibia length) on the time spent antennating in the control and low artificial light at night (ALAN) conditions.	114
Figure 13 Simplified pathway of melatonin biosynthesis in vertebrates. Enzymes are shown in italics. HIOMT is now called acetylserotonin O-methyltransferase (ASMT). β R and NA are β -adrenergic receptors (from Jones et al., 2015).	151
Figure 14 Schema describing the three steps of a PCR cycle (denaturation, annealing, extension).	165
Figure 15 Theoretical PCR amplification curve.	166
Figure 16 Result of total RNAs ran on a non-denaturing 1% agarose gel.	172
Figure 17 Sampling scheme of the wasps used to describe the dynamics of melatonin over a 24-hour period.	174
Figure 18 Melatonin content in samples made up of 10 heads of <i>V. canescens</i> over a 24-hour cycle (quantification by ELISA method).	176
Figure 19 Boxplots representing the variability in Ct values for the four genes analysed by qPCR.	177
Figure 20 Relative expression levels for A) <i>Vcan_aanat</i> and B) <i>Vcan_asmt</i> over a 24-hour cycle.	178
Figure 21 Cross-correlograms of the cross-correlation functions between <i>Vcan_aanat</i> expression level, <i>Vcan_asmt</i> expression level and melatonin content.	179

Tables

Table 1 Examples of illuminance levels (in lux) of various artificial sources of light at night. Data are taken from Rich & Longcore (2006), Gaston et al. (2013), Bennie et al. (2016).....	25
Table 2 Results of tBLASTn searches against the transcriptome of <i>V. canescens</i> for the gene <i>aanat</i>	168
Table 3 Results of tBLASTn searches against the transcriptome of <i>V. canescens</i> for the gene <i>asmt</i>	168
Table 4 Final sequences for the genes <i>aanat</i> and <i>asmt</i> in <i>V. canescens</i>	170
Table 5 Primer sequences used to amplify and quantify the expression of the two focal genes (<i>Vcan_aanat</i> & <i>Vcan_asmt</i>) and the two reference genes (<i>Vcan_gapdh</i> & <i>Vcan_rpl32</i>).....	171
Table 6 Optimal annealing temperatures for qPCR assays for each pair of primers	173
Table 7 Serial dilutions used to generate the standard curves for the four target sequences .	173

Remerciements

Je remercie tout d'abord les membres de mon jury, Thérèse Jones, Patricia Gibert, Philippe Louâpre et David Renault, d'avoir accepté de lire et d'évaluer mon travail. Je tiens également à remercier les membres de mon comité de pilotage, Nathalie Mondy, Samuel Caro, François-Xavier Dechaume-Moncharmont et Marc Théry pour leur accompagnement et leurs conseils au cours de ces 3 années.

Je ne pourrais jamais assez remercier mes encadrants, Manu et Isa. C'est grâce à vous que j'ai pu mettre un pied dans la recherche dès la L3 et découvrir ce super modèle qu'est *Venturia canescens*, que je n'ai plus quitté depuis ! Merci de m'avoir fait confiance en M2, puis pendant cette chouette aventure de la thèse. Merci d'avoir été aussi présents, que ce soit pour m'aider lors des manips, qu'elles aient lieu le week-end ou même en plein milieu de la nuit (!), pour vos relectures toujours attentives et rapides de mon travail, pour votre aide lorsque je devais préparer des présentations orales. Toujours disponibles lorsque j'en avais besoin, vous m'avez en même temps laissé de la liberté et de l'autonomie, et c'était aussi appréciable ! Merci pour votre gentillesse, vos encouragements, de m'avoir toujours poussée à avoir confiance en moi (ce n'est pas encore tout à fait gagné, mais j'y travaille !). Bref, je n'aurais pas pu rêver meilleur encadrement ! Ces trois années ont été une belle expérience, et c'est en grande partie grâce à vous.

Cette thèse, c'est surtout et avant tout des manips ! C'est pourquoi je souhaite adresser un grand merci à tous les membres du pôle biotechnologique, sans qui ma thèse ne serait pas allée très loin ! Merci à toutes les techniciennes qui se sont succédées pour chouchouter nos chers petits insectes : Elsa, Camille A., Inessa, Valentina, Camille. Merci à François d'avoir donné corps à toutes nos idées de dispositifs expérimentaux et de m'avoir aidée avec tous les aspects techniques ; merci aussi de m'avoir accompagnée dans mes « expéditions polaires » de dissection d'insectes à -20°C ! Un grand grand merci tout particulier à Valentina, qui m'a si bien épaulée pendant ma dernière manip de thèse, dans des conditions si particulières entre COVID et travaux. J'ai énormément apprécié travailler avec toi, ton implication, ta rigueur et ta constante bonne humeur ont été précieuses pendant ces derniers mois. Merci pour les conversations sur la nourriture, la découverte de la musique sud-américaine, les leçons d'allemand en fond sonore, bref tout ce qui a rendu bien moins monotones les longues journées passées assises à nos bureaux dans la canicule lyonnaise ! Et j'espère sincèrement ne pas t'avoir traumatisée avec toutes ces larves à trier...

Un grand merci à Sonia, Nelly et Corinne, que j'ai souvent embêtées avec mes fréquentes demandes de matériel au magasin et qui ont toujours été disponibles. Merci à Hélène et David d'avoir répondu à toutes mes questions sur la qPCR, et pour toutes les infos sur la biomol en général. Merci à Benjamin de m'avoir fait découvrir la biochimie et de m'avoir permis de devenir une pro (enfin j'aime à le penser) du pipetage et du remplissage de plaque 96 puits. Ça a été un sacré travail, mais je me suis bien amusée ! Merci aussi pour ta relecture attentive de mon travail, ça a été un vrai plaisir de collaborer avec toi.

Parce que mes expériences se sont un peu étendues hors du LBBE, je voudrais remercier Nathalie Mondy, Morgane et Adeline au LEHNA, grâce à qui j'ai pu mener à bien tout un chapitre de ma thèse. Un grand merci d'avoir partagé vos connaissances précieuses sur la pollution lumineuse et la mélatonine et d'avoir consacré de votre temps à me former et à superviser mes expériences de dosage de mélatonine.

Merci à tous les membres du pôle administratif : Nathalie, Odile, Laetitia, Aurélie pour votre travail et votre accompagnement quotidien, indispensable pour s'y retrouver dans les méandres de l'administration. Merci également à tous les membres du pôle informatique.

Merci à tous les chercheurs avec qui j'ai pu échanger et interagir au laboratoire pendant ces 3 années. Merci aux membres de l'équipe Evolution, Adaptation & Comportement pour nos échanges et pour avoir été présents aux différentes présentations que j'ai pu faire pendant les réunions d'équipe. Une pensée toute particulière pour Aurore, qui a été ma collègue de bureau pendant un bon bout de temps, et qui m'a initiée au monde mystérieux de la qPCR en répondant patiemment à toutes mes questions de novice. Merci d'avoir relu mon travail avec attention et d'avoir apporté ton expertise pour mon dernier chapitre de thèse. Enfin, merci également à Jeff d'avoir répondu à mes questions et donné de précieux conseils pour les analyses de sénescence. Ces 3 années de thèse ont aussi été une super expérience humaine, grâce aux nombreux doctorants et post-doctorants du laboratoire. Je ne suis pas la personne la plus expansive du monde, mais je tiens vraiment à souligner que si cette thèse s'est aussi bien passée, c'est grâce à l'accueil chaleureux et à la gentillesse de tous les doctorants que j'ai pu côtoyer depuis mon arrivée au labo. À ceux déjà présents à mon arrivée : Salomé, Valentine, Laura, Eliane, Nicolas, Thibault, Jennifer, Mickaël, Sylvie, Elodie, Morgane, Célia, Pierre, Gabriel, Sébastien, Timothée (j'espère n'avoir oublié personne !). Merci de m'avoir permis de me sentir à l'aise et à ma place dès le début de ma thèse. Je pense aussi à tous ceux qui n'ont pas encore terminé leur thèse (ou qui approchent de la fin), et à qui je souhaite beaucoup de courage dans cette période un peu difficile : Kamal, Alexis, Vincent M., Florentin, Florian, Aïssa, Lucie, Mary, Blandine, Thibault, Emilie. Merci Seb, Gabriel et Kamal pour ces soirées d'escalade, j'espère

qu'on pourra se retrouver un de ces jours pour grimper de nouveau ensemble ! Aïssa, Lucie, Mary, j'ai été très contente de partager un bureau avec vous, même si ça a été trop rapidement écourté à mon goût... Merci à Blandine et Vincent L. d'avoir partagé les joies et les peines de l'expérimentation avec ces chères Venturia (courage Blandine, ne te laisse pas marcher sur les pieds par ces petites bêtes !). Enfin, une mention toute particulière à Elise, que j'ai la chance de connaître et avec qui j'ai la chance de travailler depuis la L3 (ça commence à dater !). Merci pour ces nombreuses séances de cinéma (avec plus ou moins de bonheur dans le choix des films parfois, n'est-ce pas...mais vivement qu'on puisse y retourner !), pour tout ce que tu as fait pour la vie des doctorants au laboratoire, et de m'avoir permis de sortir un peu du labo pour t'accompagner à la recherche des chevreuils dans la nuit et le froid entre deux confinements! J'admire ta force de travail, ton engagement et ton implication dans tout ce que tu fais, ta persévérance malgré les coups durs que tu as rencontrés dans ta thèse. J'espère de tout cœur que tu pourras accomplir toutes tes envies de chercheuse, en tout cas le monde de la recherche a besoin de gens comme toi ! Une pensée aussi pour Juliette S-F, là-bas à Chambéry, qui va être la première de nous trois à soutenir !

Cette thèse a été une belle expérience aussi grâce à mon entourage hors du laboratoire et de l'université. Merci à Lynda et Océane, je suis heureuse de vous avoir à mes côtés depuis tant d'années ; merci de vous être toujours intéressées à ce que je faisais, même si ça n'est parfois pas facile à appréhender ! Votre présence et votre soutien comptent beaucoup pour moi. Un grand merci à Adèle pour nos longues discussions, les week-ends à Strasbourg et les échanges sur les galères de la vie d'étudiante en médecine et de doctorante (beaucoup de points communs !). Et promis, je ne t'en veux plus de dire que j'étudie des mouches... !

Merci à Thierry, Isa, Zoë et Mad, de leur présence bienveillante à mes côtés depuis si longtemps.

Merci à mes grands-parents ; Grand-Père & Grand-mère, Mamie, je vous aime très fort. Merci à Kiki, Momo, Hippolyte et Roman, Nathalie et Michel pour les voyages, les festivals de photo à Montier-en-Der, les moments de rigolade depuis toutes ces années. J'espère qu'on pourra bientôt se retrouver tous ensemble, comme avant !

Un grand grand merci à ma chère cousine, Juliette je ne sais pas ce que je serai sans toi ! On commence chacune un nouveau chapitre de notre existence, mais on ne sera jamais bien loin l'une de l'autre. Et vivement qu'on le fasse, ce voyage en Ecosse !

Papa, Maman, merci pour tout. Merci de votre amour, de votre soutien indéfectible, d'avoir toujours été fiers de moi, c'est inestimable quand on a parfois du mal à avoir confiance en soi.

Papa, ne désespère pas, un jour peut-être, j'étudierai des grosses bêtes en Afrique et tu pourras m'accompagner sur le terrain pour t'occuper pendant ta retraite !

PART I

GENERAL INTRODUCTION

Foremost

The first chapter of this general introduction describes in details the history of the development of artificial light at night, as well as its features and extent on a global scale nowadays. The second chapter is a review on mechanistic, ecological and evolutionary consequences of artificial light at night for insects, published in *Entomologia Experimentalis et Applicata* in 2019. The final chapter describes the biology of *Venturia canescens*, the insect species that I studied during my thesis work.

Chapter 1

Artificial light at night: historical background, sources and characterization of a human disturbance

1. Brightly illuminated nights: a recent feature in human history

*“Fine vapors escape from whatever is doing the living.
The night is cold and delicate and full of angels
Pounding down the living.”
The Ecclesiast, John Ashbery*

This section describing briefly the history of artificial illumination in European cities is based on the book “At Day’s Close: Night in Times Past” by A. Roger Ekirch (2006, W. W. Norton & Company).

For thousands of years, humans have been afraid of night and darkness. This ancient aversion, which is likely to have an evolutionary cause (Marks & Nesse, 1994), has been found in many civilizations all around the world (*e.g.* Ancient Rome, Ancient Egypt, Christian Europe, but also in African and Oceanian cultures) and has been reinforced culturally throughout human history. Anxiety bred by darkness is illustrated in religion, arts (Figure 1) or popular legends and folklore (*e.g.* the diversity of imaginary creatures associated with nighttime such as witches, vampires or ghosts). In addition to superstitious beliefs, there were also more rational reasons for fearing the nighttime. In rural areas, absence of light increased the risk of accident due to natural hazards concealed by darkness, and the dark streets of preindustrial cities were the place where many criminal acts occurred (*e.g.* mugging, robberies, assaults and even murders).



Figure 1 *The Nightmare* (1781), oil painting by Henry Fuseli. It depicts a sleeping woman surmounted by an ape-like figure and a horse, that refer to folkloric beliefs of evil spirits tormenting humans at night.

If at first the Moon and the stars were the only sources of light at night, humans rapidly developed techniques to ward off darkness. Indeed, remains of primitive lamps from the late Palaeolithic period were found near the Lascaux cave. In the 15th century in Europe, the only sources of light in the streets were those from households and pedestrians (as can be seen in the painting in Figure 2). Lanterns outside private homes were made mandatory in metropolitan centres such as London and Paris, and people walking in the streets has to carry torches or lanterns. Nevertheless, city streets remained rather dark, and such measures did not apply to smaller towns or rural areas. By the second half of the 17th century, public policies were implemented in major urban centres to enhance lighting on the most important streets, facilitated by technological innovations such as oil lamps with reflectors that magnified light. The main objective of the city leaders was to reduce insecurity and criminality, but the development of street lighting also accompanied the increase of opportunities for entertainment, such as drinking or gaming houses. By 1700, many major European cities had some form of public lighting, consisting of oil lamps and lanterns lit with candles. Paris was the first example of this in 1667.



Figure 2 *Night* (Painting IV; 1736 – 1738), oil painting by William Hogarth. The scene depicts the activities of a London street at night.

Industrial revolution and the beginning of consumerism led to the extension of human activity into the night hours (*e.g.* shops staying open later and later in the evening) and technological innovations. This resulted in a significant improvement in urban lighting, and in the 19th century, street lamps burning coal gas appeared in city streets. Such lamps produced a light 10 to 12 times more powerful than that of a candle or an oil lamp. As a result, gas lighting rapidly spread across every European city, causing tremendous changes in people’s life and habits. Shift work became more common in factories, and social life as well as leisure activities were increasingly taking place in the evening or at night (*e.g.* theatres, cafés; Figure 2). If rural areas remained rather protected from artificial lighting during the 19th century, electric lighting soon became dominant, leading to the gradual elimination of nighttime darkness. In Paris for instance, the first electric streetlights were installed in 1878, and the technology improved throughout the 20th century. Low pressure sodium lamps were introduced in Europe in the 1930s, followed by the development of high-pressure sodium lamps from the 1960s onwards. The most recent innovation is the apparition of light-emitted diodes (hereafter “LEDs”) that are rapidly replacing older technologies in a growing number of cities (Zissis & Bertoldi, 2018).

Artificial illumination profoundly changed the relationship of humans to the night, which became less and less synonymous with fear and danger. This has led to changes in many aspects of human life, in particular in the relationship between humans and their environment. A good example is given by a blackout that occurred in Los Angeles in 1994. On 17 January, before dawn, an earthquake knocked out the power in the entire city and woke up its inhabitants, who went out in the darkened streets. At that moment, emergency centres received numerous calls from people anxious about a large silvery cloud visible above the city. It was simply the Milky Way, which the people of Los Angeles had never seen before because it was erased from urban skies by the glare of electric lights. Nowadays, more than one-third of humanity cannot see the Milky Way because the sky is too brightly illuminated (Falchi *et al.*, 2016).

The development of artificial light at night calls for an assessment of its consequences on ecosystems, which requires a reliable quantification of the levels of night lighting in the environment.

2. Units of light measurement

This section is partly based on the book “Introduction to radiometry and photometry” by W. R. McCluney (2014, Artech House).

The word “light” refers to the narrow range of electromagnetic radiations that can be perceived by the human eye (wavelengths between 360 and 800 nm). The visible portion of the electromagnetic spectrum is surrounded by the spectral regions of ultraviolet radiations (wavelengths between 100 and 360 nm) and infrared radiations (wavelengths between 800 nm and 1mm). Light can be measured using two different approaches which have their own terms and measurement units. Radiometry deals with electromagnetic radiations at all wavelengths while photometry deals with the visible portion of the electromagnetic spectrum only (*i.e.* light in the strict sense) and therefore describes quantities related to the sensitivity of the human eye. Although ultraviolet and infrared radiations can be of interest when studying the effects of artificial light at night on organisms other than humans (*e.g.* insects that have receptors sensitive to ultraviolet radiations, Briscoe & Chittka, 2001), photometric quantities and units are more

frequent in the literature on biological consequences of light at night. It is therefore these that will be presented in this section.

There are four fundamental photometric quantities (luminous flux, luminous intensity, illuminance and luminance), which are based on radiant flux. Radiant flux is a radiometric quantity defined as the total power of radiation emitted by a source transferring through a surface or a region of space per unit time. Luminous flux (measured in lumens) is the photometric quantity equivalent to the radiant flux, but weighted by the sensitivity of the human eye to wavelengths in the visible electromagnetic spectrum. Luminous intensity, in candela, gives the luminous flux emanating from a source in a certain direction. Illuminance is defined as the amount of luminous flux falling upon unit area of a surface. Its unit is in lumens per square meter, also called lux. Finally, luminance, in candela per meter squared, is defined as the luminous flux emitted or reflected from a light source. It therefore describes the photometric brightness of a certain location on a surface when viewed from a certain direction, and is the equivalent of the radiometric radiance.

Because they are based on the perception of light by the human eye and focus on the visible spectrum of electromagnetic radiation, photometric light measurements may lead to missing important information when studying the biological effects of light at night. It does not take into account the differences in spectral signature between different types of lamps, which can affect the way organisms respond to light (*e.g.* Lewanzik & Voigt, 2016). However, the variety of terminology and units used to measure light can be confusing and make communication between lighting manufacturers, scientists and policy makers difficult. Illuminance is the quantity measured by most of light meters, and lux is the standard unit used to describe light pollution levels in many studies (*e.g.* Bennie *et al.*, 2016; Rich & Longcore, 2006) as well as to define government lighting regulations (*e.g.* French government report by Conseil général de l'Environnement et du Développement Durable, 2018). Consequently, despite their drawbacks, light measurements in lux are the most commonly used in the studies studying the ecological consequences of artificial light at night (Longcore & Rich, 2004).

3. Artificial light at night comes from various sources

The presence of artificial light at night is commonly called (nocturnal) light pollution, which is defined as the alteration of night natural lighting levels by anthropogenic sources of light. The most studied type of light pollution is the one that comes from direct illumination by one or several light sources. Many lighting devices contribute to direct illumination of the environment: public street lighting (the most dominant source of artificial light at night), but also internal and external lightings of buildings and houses, illuminated advertising panels or recreational areas (*e.g.* sport fields) (Gaston *et al.*, 2014). All these light sources are responsible for rather persistent illumination throughout the night, with various intensities (Table 1). On the contrary, vehicle headlights represent a highly temporally variable source of light at night whose intensity can be strong (Table 1). The number of circulating vehicles is high in many countries (*e.g.* 38.2 million of cars in 2020 in France, Service de la donnée et des études statistiques (SDES), 2020) but it is very difficult to know what proportion of these vehicles travel at night. The importance of road traffic in terms of light pollution has therefore been little studied up to now (Lyytimäki *et al.*, 2012).

Table 1 Examples of illuminance levels (in lux) of various artificial sources of light at night. Data are taken from Rich & Longcore (2006), Gaston *et al.* (2013), Bennie *et al.* (2016).

Light source	Illuminance (lux)
Main road street lighting (average street level illumination)	15
Residential road street lighting (average street level illumination)	5
Most homes	100 - 300
Vehicle headlights	Up to 1500
Skyglow	Up to 0.5

Another feature of light pollution due to direct illumination is its spatial heterogeneity (Gaston *et al.*, 2012). It is generally assumed that the average level of illuminance in an area is that experienced by organisms in that zone. However, for example, illuminance at ground level decreases rapidly as the distance to the light source increases (Figure 3). Direct illuminance can also carry over long distances with decreasing intensity when emitted in the horizontal plane,

such as car headlights. Moreover, vegetation (trees, bushes, hedgerows...) and human-made structures can create zones partially or totally protected from artificial light (Gaston *et al.*, 2012). All this can therefore modify what light pollution is actually experienced by organisms in the natural environment, which is not yet very well known (Gaston *et al.*, 2015).

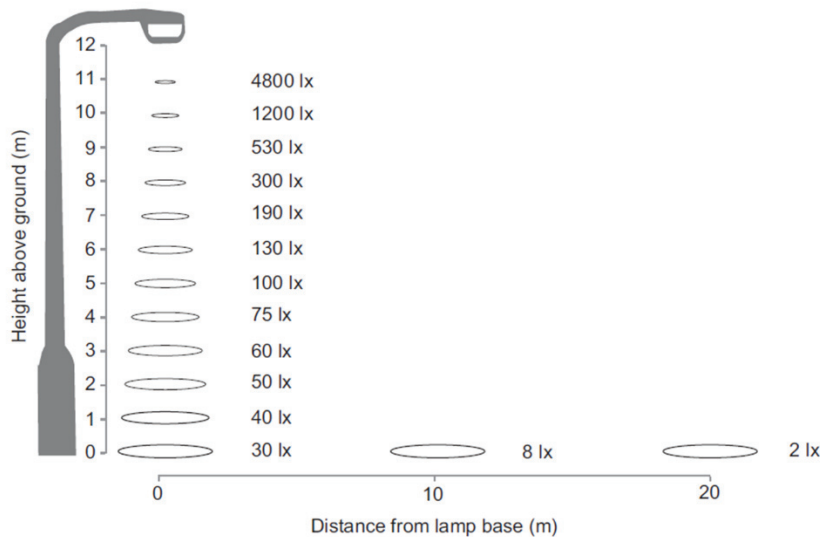

Figure 3 Variation of illuminance levels depending on the horizontal and vertical distance from a typical street lamp (from Bennie *et al.*, 2016).

In addition to direct illumination, the second type of light pollution is skyglow, which is responsible for the “light dome” often observed over cities at night (Figure 4). It occurs when artificial light emitted or reflected upwards is scattered into the atmosphere by clouds, aerosols or gas molecules. Skyglow intensity is lower than that of other artificial sources of light (Table 1), however it can extend over large distances (up to hundreds of kilometres) from urban areas (Luginbuhl *et al.*, 2014) and sometimes exceed natural moonlight levels (*e.g.* 0.3 lux, which is full moon under optimal atmospheric conditions, Kyba *et al.*, 2017). It is particularly the case under overcast conditions, because cloud coverage has a strong amplification effect on skyglow. A study found that sky luminance over Berlin was 10.1 times brighter on overcast nights than on clear moonless nights, and that the clouds still brightened the night sky by a factor of 2.8 at 32 km from the city centre (Kyba *et al.*, 2011). Skyglow can therefore extend light pollution far beyond urban areas, in natural environments with little direct illumination and which are thought to be protected from light pollution.



Figure 4 Skyglow above the city of Los Angeles (photo by P. Gomes).

Light pollution does not only change the intensity levels of light at night and its spatial distribution. Introduction of artificial light sources also modified the spectral composition of the night sky. Each type of lighting technology has its own emission spectrum, with some lighting devices emitting light over a narrow range of wavelengths (*e.g.* low-pressure sodium) and others over a wide range of wavelengths (*e.g.* LEDs) (Figure 5). However, as the use of mercury vapour lamps and some sodium lamps is gradually being banned or restricted (European directive of 21 October 2009, French government report by Conseil général de l’Environnement et du Développement Durable, 2018), LEDs are increasingly replacing other lamp types all over the world. In France for example, a report from the ‘Syndicat français de l’éclairage’ (French lighting union; 2018) estimated that the number of LED lamps sold between 2016 and 2017 increased by 46%. LEDs lamps are popular for a number of reasons (efficiency, low cost, production of aesthetically pleasing “white” light), but LED-based white lighting has a broad emission spectrum with a peak in blue wavelengths (Figure 5). This feature, in addition to its many biological consequences (Davies & Smyth, 2018), may increase skyglow because short-wavelength light is more scattered by the atmosphere (Aubé, 2015), and therefore worsen light pollution.

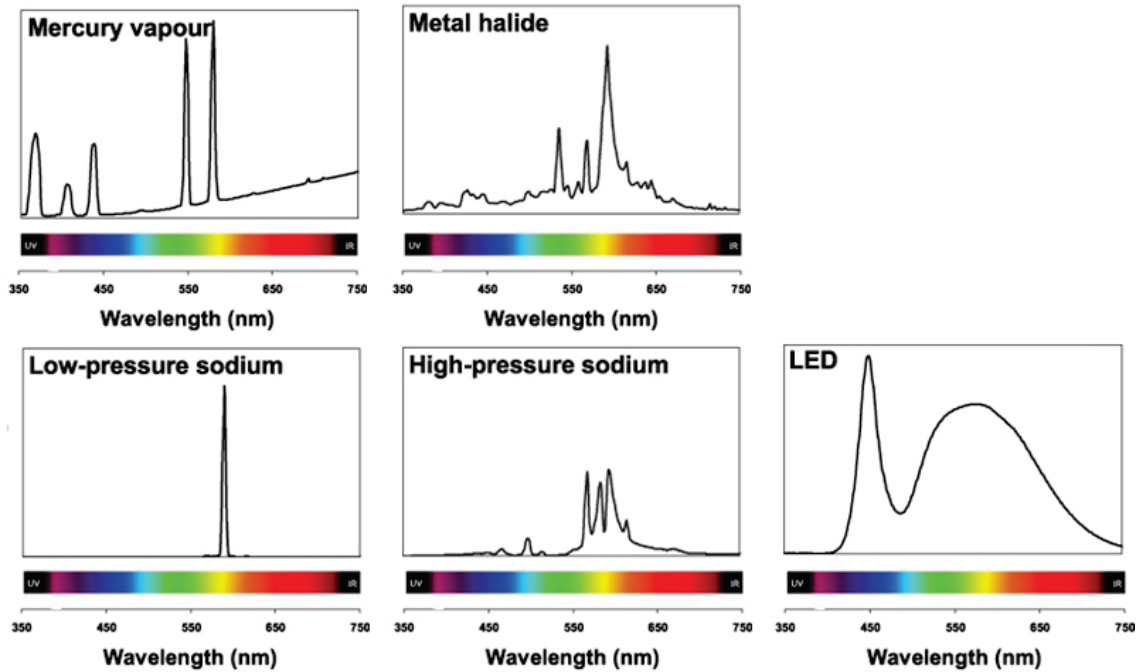

Figure 5 Spectral composition of the main lighting types used in artificial lighting (modified from Gaston *et al.*, 2013).

4. What is the current situation worldwide with regard to light at night?

Artificial light at night is a pervasive anthropogenic disturbance on a global scale. It is, of course, particularly strong in wealthy and industrialised countries where street lighting is common. For example, 88% of Europe and 50% of the United States land surfaces experience modified light-dark cycles due to artificial illumination (Falchi *et al.*, 2016). But this light pollution also affects the entire Earth's surface, to a greater or a lesser extent (Figure 6). Worldwide, it has been estimated that 23% of the land surfaces experience nocturnal light pollution, which lead 83% of the world's human population to live under light-polluted skies (Falchi *et al.*, 2016).

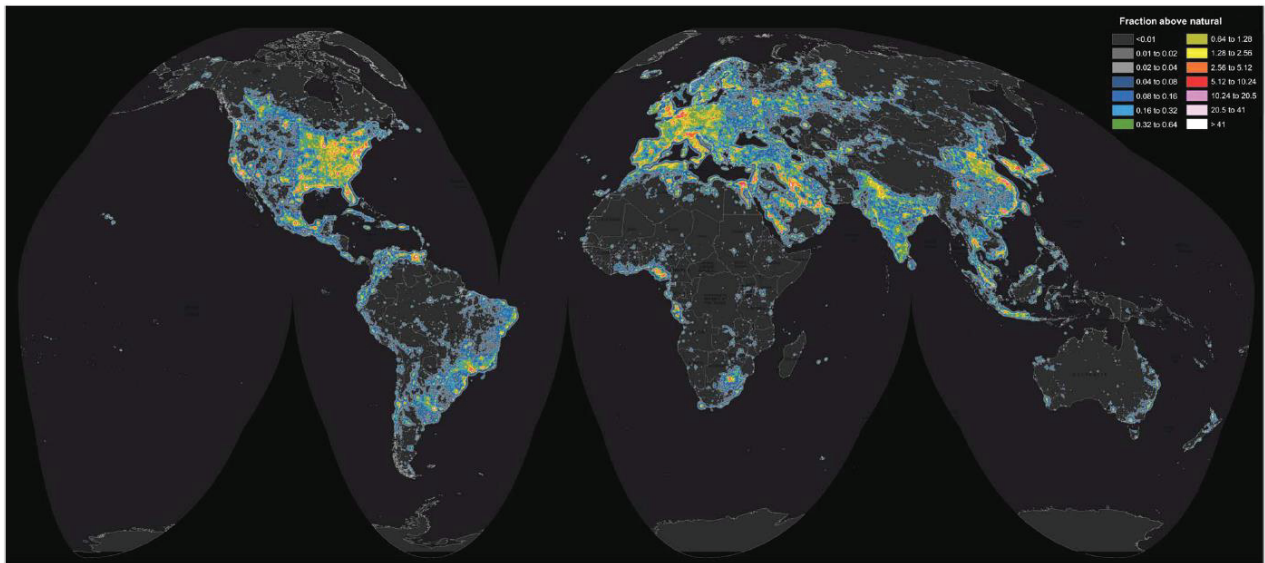

Figure 6 World map of artificial night sky brightness (from Falchi *et al.*, 2016). The colours show the artificial sky brightness as a ratio to the natural sky brightness. The artificial sky brightness extends along a gradient, with black and white representing the lowest and highest ratio values, respectively.

Moreover, the extent of light pollution on a global scale evolves constantly. From 2012 to 2016, a study estimated that not only the artificially lit areas increased by an average of 2.2% per year, but the brightness in the visible spectrum of previously lit areas also increased by an average of 2.2% per year (Kyba *et al.*, 2017). In most countries, either one or both of these variables exhibited an increase (Figure 7).

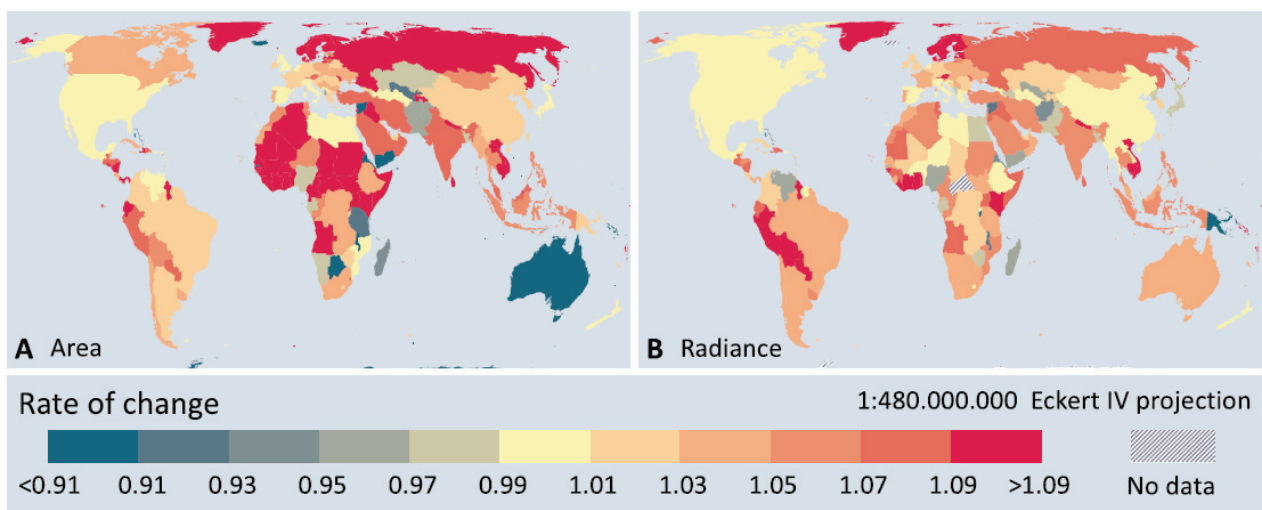

Figure 7 World map of the annual rate of changes (calculated over the period between 2012 and 2016) in (A) surface of lit area and (B) radiance of previously lit areas (from Kyba *et al.*, 2017).

If urbanised areas or their surroundings are obviously among the first to be exposed to artificial light at night, it also reaches areas further away from direct human influence mainly through

skyglow. Recent studies showed that key biodiversity areas (hereafter “KBAs”), and among them protected areas, are not preserved from artificial lighting. Garrett and colleagues (2020) showed that only 27% of KBAs total surface (KBAs being defined as sites that contribute significantly to the global persistence of biodiversity by supporting, for example, viable populations of species) are not exposed to nocturnal light pollution. The probability of experiencing pristine dark sky nevertheless increased when the KBA was fully protected (Garrett *et al.*, 2020). However, even if protected areas are less exposed to artificial light at night than non-protected areas, their surroundings experience a high intensity of nighttime illumination (Guetté *et al.*, 2018) which leads to the protected areas becoming increasingly isolated. Artificial light, by fragmenting the nighttime landscape, can therefore also impact conservation issues.

Light pollution is therefore a worldwide phenomenon of ever-increasing intensity. Despite a growing awareness of the (mainly negative) effects of artificial light at night in a wide variety of fields (*e.g.* biological and ecological changes, Sanders *et al.*, 2020; human health, Navara & Nelson, 2007; Touitou *et al.*, 2017; impacts on astronomical observations and human culture, Smith, 2009), light pollution is unlikely to decrease in the short term. The development of more efficient and less costly lighting technologies such as LEDs, originally intended to reduce energy consumption, is likely to lead to greater use of outdoor lighting which is called the “rebound effect” (Hölker, Moss, *et al.*, 2010). The transition of street lighting from older lamp types (*e.g.* sodium vapor) to LEDs can locally decrease the radiance in city centres (Figure 8). However, it can be outweighed by an increase in radiance in outlying areas, as lower lighting costs make it possible to install additional lighting where the use of light was previously moderate (Kyba *et al.*, 2017).

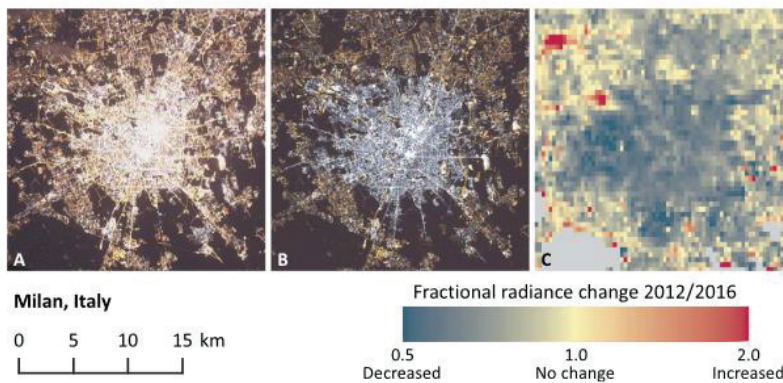

Figure 8 Change in lighting technology in Milan, Italy (from Kyba *et al.*, 2017). Photographs of (A) the city centre in 2012, when sodium vapor lamps were used as street lighting, and (B) the city centre in 2015, when the older lamps were replaced with LEDs. (C) shows the change in radiance, used to model sky brightness, between 2012 and 2016.

There are also places, mainly in economically developing countries, where the use of street lighting is still less frequent than in wealthy parts of the world such as Europe or North America. Some studies found a positive correlation between light pollution and national gross domestic product (GDP) (*e.g.* Garrett *et al.*, 2020), although the relationship is not necessarily linear (Kyba *et al.*, 2017). The night sky may therefore become increasingly lit as developing countries grow economically, further eroding remaining areas that, until now, experienced relatively natural day-night light cycles. From this perspective, it is interesting to note that the strongest changes in both the surface exposed to artificial lighting and the brightness of previously lit areas occur mainly in South America, Africa and Asia (Figure 7, Kyba *et al.*, 2017).

Citizens and governments are beginning to acknowledge the serious threat posed by light pollution and solutions are being proposed to deal with it (Gaston *et al.*, 2012). In France, for example, there are discussions between scientists and policy makers to create a network of “dark” ecological corridors to reduce the negative effects of artificial light at night on wildlife (“Trame noire”). However, it will take time to develop lighting strategies that minimise the ecological impacts of light at night while fulfilling human needs in terms of activities, comfort and security at night.

In the previous chapter, I described the origins, characteristics and worldwide importance of artificial light at night. This anthropogenic disturbance has many biological and ecological consequences on various organisms (for a recent meta-analysis of the magnitude and strength of these impacts, see Sanders *et al.*, 2020). The next chapter reviews these consequences on insects at several biological levels. It also provides research perspectives that should be developed to fully understand the effects of artificial light at night on species that are involved in major ecological functions, as well as in health and economic processes.

Chapter 2

Review on mechanistic, ecological and evolutionary consequences of artificial light at night for insects

Mechanistic, ecological, and evolutionary consequences of artificial light at night for insects: review and prospective

Emmanuel Desouhant^{1*} , Elisa Gomes¹, Nathalie Mondy² & Isabelle Amat¹ 

¹UMR 5558, Laboratoire de Biométrie et Biologie Evolutive, CNRS, Université Claude Bernard Lyon 1, F-69622

Villeurbanne, France, and ²UMR5023 LEHNA, ENTPE, CNRS, Université Claude Bernard Lyon 1, F-69622 Villeurbanne, France

Accepted: 11 December 2018

Key words: anthropogenic pollution, eco-physiology, fitness traits, population, community, ALAN, disruption, preservation, ecosystem service

Abstract

The alternation of light and dark periods on a daily or seasonal time scale is of utmost importance for the synchronization of physiological and behavioral processes in the environment. For the last 2 decades, artificial light at night (ALAN) has strongly increased worldwide, disrupting the photoperiod and its related physiological processes, and impacting the survival and reproduction of wild animals. ALAN is now considered as a major concern for biodiversity and human health. Here, we present why insects are relevant biological models to investigate the impact of ALAN. First the phenotypic responses to ALAN and their underpinning mechanisms are reviewed. The consequences for population dynamics, and the community composition and functioning are described in the second part. Because ALAN provides new and widespread selective pressure, we inventory evolutionary changes in response to this anthropogenic change. Finally, we identify promising future avenues, focusing on the necessity of understanding evolutionary processes that could help stakeholders consider darkness as a resource to preserve biodiversity as well as numerous ecosystem services in which insects are involved.

Introduction

Human-induced rapid environmental changes (HIREC; Sih et al., 2011), such as climate change, habitat loss or fragmentation, and pollution, represent threats to living organisms (Candolin & Wong, 2012; van Baaren & Candolin, 2018). Whereas the effects of chemical pollution on human health and biodiversity have been thoroughly studied for decades, the investigation of the effects of light during nighttime is still in its infancy. Artificial light at night (ALAN) results mainly from street lights and road networks and is amplified by skyglow, i.e., reflection of light in the atmosphere, particularly from clouds (Aubé et al., 2015). Skyglow increases light level over dozens of kilometers, exposing areas beyond urbanized ones (Kyba et al.,

2011; Secondi et al., 2017). ALAN is a widespread phenomenon of continuous expansion due to urbanization increases: each year, 6% more of the earth's surface is contaminated, and 80% of the human world's population lives under light-polluted skies (Falchi et al., 2016). ALAN is now considered a major concern for biodiversity and human health (Davies & Smyth, 2018; Gaston, 2018). Nighttime lighting is responsible for changes in natural rhythms, such as diel, lunar, and seasonal rhythms (Gaston et al., 2017), and has negative consequences for animals and plants at all biological organization levels, from molecular to community and ecosystem levels (Gaston et al., 2013, 2015; Russart & Nelson, 2018a). In humans, ALAN is suspected to induce hormonal deregulation, leading to physiological disorders and diseases (e.g., obesity, depression, and breast cancer; Lunn et al., 2017; Russart & Nelson, 2018b).

In the first major review of the effects of ALAN on animals, Longcore & Rich (2004) mentioned only a few examples concerning insects, and these examples

*Correspondence: Emmanuel Desouhant, UMR 5558, Laboratoire de Biométrie et Biologie Evolutive, CNRS, Université Claude Bernard Lyon 1, F-69622 Villeurbanne, France.
E-mail: emmanuel.desouhant@univ-lyon1.fr

focused exclusively on nocturnal insects. Since then, an exponentially growing number of papers has been published, and the bias in the number of studies toward vertebrates was reduced (Davies & Smyth, 2018; Grubisic et al., 2018; Owens et al., 2018). We thus believe it is timely to review the large literature dealing with ALAN effects on insects. The first reason for studying insects is that they represent a good opportunity to test how ALAN affects organisms in all ecosystems. Indeed, the Insecta class contains the largest number of species in Animalia (Stork, 2018), and it has colonized all terrestrial ecosystems (covering a large gradient of urbanization, latitude, ...). The second reason for studying insects is that their visual system makes them sensitive to a wide spectrum of wavelengths. Some species of butterflies and Hymenoptera cover visual ranges that are among the broadest of all animals – from <300 nm (i.e., in infra-red) to >700 nm (i.e., in UV) (Briscoe & Chittka, 2001). As a consequence, insects may be affected by all types of artificial light to which they are subjected. In addition, insects are easy to rear, which makes them relevant biological models for running laboratory experiments. Their generally short generation time allows the conduct of transgenerational experiments to simulate biological evolution and thus study evolutionary changes in response to this novel anthropogenic stressor. Finally, insects disappear at a high speed (Conrad et al., 2006). For instance, an approximately 80% decline in total biomass of flying insects was recorded between 1989 and 2016 in German protected areas (Hallmann et al., 2017). Assessing whether ALAN is one of the causes of extinction is of utmost importance as insects are major ecological factors involved in ecosystem services (e.g., pollination, biological control) and have a direct impact on human well-being (e.g., disease vectors).

Here, we aim to review the potential and realized effects of ALAN on all the levels of biological organization in nocturnal and diurnal insects and to identify questions for the future (Figure 1). In the first part, we review the effects of artificial lighting on organisms, describing the mechanisms and the life-history and behavioral traits that are altered. We then make an inventory of consequences of light pollution for populations, as well as community composition and functioning. Because ALAN is a widespread selective pressure, we present and discuss, in a third part, the experimental evidence of ALAN's evolutionary impact on insects. In a last prospective section, we identify open questions and gaps in experimental data to provide an exhaustive understanding of ALAN effects. We review all the effects of artificial lighting, irrespective of the intensity (from <0.1 lux that mimics full moon light to >20 lux

that corresponds to urban area lighting; Kyba et al., 2017), wavelength, and ecological relevance.

Life history and behavioral responses to ALAN and their underpinning mechanisms

At first glance, one expects that disruptive effects of ALAN should be different between diurnal and nocturnal species that represent two-thirds of described insect species. Among nocturnal species, moths are particularly studied (Macgregor et al., 2015; Owens & Lewis, 2018). However, an integrative overview of phenotypic responses to ALAN in insects is still lacking. In the following section, we review the recent literature and illustrate ALAN effects on behavioral and life-history traits, and the physiology and genetics in diurnal or nocturnal species.

ALAN affects insect movement at multiple spatial scales

Attraction of insects by lights is an old topic of interest in entomology (Jones et al., 1972). Because of the phototactics of nocturnal insects, spots of artificial light represent traps for numerous species and modify spatial dispersal and distribution of individuals. The disrupting effects of artificial lights on spatial dispersal are well known at small spatial scales (Merckx & Slade, 2014). For instance, the attractiveness of a single 70-W high-pressure sodium lamp (96 lm W^{-1}) is approximately 20 m away from the light source (Degen et al., 2016). Attraction to light sources has been described in terrestrial insect species (e.g., moths: Altermatt et al., 2009; beetles: Wakefield et al., 2016; de Medeiros et al., 2017). This 'flight-to-light' behavior varies, however, according to sex, mating status, type of lighting, or species. In nocturnal insects, males are generally more attracted by light than females. For instance, this is the case in males of spruce budworm, *Choristoneura fumiferana* Clemens (Rhainds & Heard, 2015), and male moths of *Yponomeuta cagnagella* (Hübner) and *Ligdia adustata* (Denis & Schiffermüller) (Altermatt et al., 2009). However, in the moth *Spodoptera exigua* (Hübner), mated females are more captured by light traps in the first half of the night whereas males are more attracted by light during the second half of the night (Cheng et al., 2016). In this species, unmated females respond less to light stimuli. The strength of attraction to light also depends on the type of lamp used (i.e., the emission spectrum; Somers-Yeates et al., 2013; Longcore et al., 2015; Donners et al., 2018; Wakefield et al., 2018). Light-emitting diodes (LEDs), in general, seem less attractive than mercury vapor lamps (van Grunsven et al., 2014) or compact fluorescent lamps (Longcore et al., 2015) for a given insect species. However, because of the broad wavelength

spectrum of LEDs simulating daylight (with a peak in blue), they attract a larger range of insect species than conventional lamps, such as high-pressure sodium or metal halide (e.g., van Langevelde et al., 2011; Pawson & Bader, 2013; Wakefield et al., 2016; de Medeiros et al., 2017). Finally, the attractiveness of light sources varies according to insect orders (van Grunsven et al., 2014). In field experiments, in areas with similar insect species richness, Trichoptera represented 21% of the insects caught with mercury vapor light sources, but only 1% of those were caught with LEDs. Furthermore, ceramic metal halide lamps trapped a greater proportion of Hemiptera than low-pressure sodium light (van Grunsven et al., 2014). Noctuidae moths were more attracted to short-wavelength lights, whereas Geometridae were equally attracted by short- or long-wavelength lights (Somers-Yeates et al., 2013). Variability in spectral sensitivity among taxa could be an explanation for such differences (Briscoe & Chittka, 2001).

On larger (landscape) scales, ALAN has spectacular effects. Dung beetles, *Scarabaeus satyrus* Boheman, use the Milky Way for orientation; they transport their dung balls along straight paths under a starlit sky, but they are disoriented when the Milky Way is not visible (Dacke et al., 2013), which happens when the sky is light polluted. The disrupting effects of ALAN on large scales have also been shown in aquatic insects, for which dispersal across the terrestrial landscape is crucial in colonizing restored habitats (Perkin et al., 2014), as well as on the exchanges between aquatic and terrestrial habitats in riparian areas (Meyer & Sullivan, 2013; Manfrin et al., 2017).

ALAN modifies foraging behavior

Most studies about light-at-night effects on behavior have been conducted on nocturnal insects. In 1972, the mosquito *Anopheles gambiae* Giles was found to exhibit a burst of flight activity upon exposure to artificial light (even at low intensities of 0.3 lux) instead of the flight inhibition expected in nocturnal species (Jones et al., 1972). In contrast, light at night (especially green wavelengths) suppresses locomotor and cleaning activity in the tea green leafhopper, *Empoasca onukii* Matsuda (Shi et al., 2017). These modifications of locomotor activity may be associated with alterations of feeding behavior. In four species of moths, from the families Noctuidae, Geometridae, and Erebidae, feeding probability was higher when individuals were in darkness than when exposed to ALAN of various spectral compositions (red, white, or green light), reducing the feeding time by 58–82% (van Langevelde et al., 2017). Finally, ALAN generates avoidance of artificially lit areas in the New Zealand weta [*Hemideima thoracica* (White)]. Males are less frequently observed at illuminated sites

(Farnworth et al., 2018). This type of behavior is usually observed under a full moon and, although this behavior is probably an anti-predator response, the authors suggest that it could interfere with other activities, such as feeding or mating.

Artificial light at night is also assumed to impact the behavior of diurnal species by increasing the photophase and thus potentially the activity and metabolism of insects. This potential effect has been less studied in insects up to now. However, another arthropod, the diurnal jumping spider *Platycryptus undatus* (De Geer) exploits artificial light to hunt insects during the night (Frank, 2009). Before concluding whether this extension of foraging activities into the night in artificially lit areas is adaptive, we need to assess the consequences for energy allocation and life-history traits over lifetime.

ALAN interferes with mate finding and mate choice

Finding and choosing a mate requires the utilization of (a combination of) signals or cues (Candolin, 2003; Metzger et al., 2010) that can be affected by ALAN at each step of the communication process (i.e., signal production, transmission, and detection). Visual signals are particularly affected by light pollution. Indeed, some insect species communicate through bioluminescent flashes used in courtship displays to find and attract mates. With flashing occurring late in the day when ambient light declines, ALAN can impede reproduction by reducing the efficiency of the bioluminescent signals. Emblematic species such as fireflies and glow worms are thus obvious targets for light pollution. Adding artificial nighttime lighting experimentally modifies abundances and total flashing activity of fireflies and thus also modifies courtship behavior and mating between tethered females and free-flying males. Light pollution reduces flashing activities in a dark-active firefly species, *Photuris versicolor* Fabricius, by about 70% as well as courtship behavior and mating success in a twilight-active species, *Photinus pyralis* (L.) (Firebaugh & Haynes, 2016). Dim light (approximately $0.107 \mu\text{mol m}^{-2} \text{s}^{-1}$) also reduces the frequency of flash signals (but increases their intensity) in the Taiwanese firefly *Aquatica ficta* (Olivier), but brighter intensity ($10\times$ higher) suppresses signaling activity in half of the males tested (Owens et al., 2018). However, for some species, these effects may depend on the characteristics of artificial light used. Male *A. ficta* fireflies are sensitive to short and mid wavelengths ($<597 \text{ nm}$) but not to long wavelengths, likely because they cannot perceive them (Owens et al., 2018).

There is no experimental proof that acoustic signals, used for sexual communication in some insect species, are

affected by light-at-night. In the crepuscular and nocturnal black field cricket, *Teleogryllus commodus* (Walker), males emit courtship calls to attract females. In the laboratory, lighting regimes (0, 1, 10, and 100 lux) did not modify acoustic signals – neither the number of courtship calls, nor the time spent calling or the courtship call structure (Botha et al., 2017).

Beyond visual and acoustical information, insects communicate mostly via chemical cues which are subjected to increasing anthropogenic disturbances (Henneken & Jones, 2017). The potential effects of ALAN on these chemical signals are nevertheless not utterly understood. Male winter moths, *Operophtera brumata* (L.), thriving in lit areas are less attracted by female sex pheromones which may be due to a chemical disruption of the pheromone induced by ALAN (van Geffen et al., 2015). In the black field cricket, the highest levels of lighting increased the probability of mating and disrupted pre-copulatory mating behavior in a sex-specific way (Botha et al., 2017). In crickets, females assess mate discrimination by mounting the males, which partly determines the success of mating. When females were exposed to bright artificial light, they engaged in less mountings, revealing a decrease in their capacity to discriminate and choose their mate. However, when male crickets were exposed to bright ALAN, they were mounted more often (i.e., rejected more often by females) before mating. One of the potential mechanisms explaining this change in mounting behavior in females could be a variation in cuticular hydrocarbons in males exposed to ALAN, molecules that females use to assess males after calling (Botha et al., 2017). However, this hypothesis needs further investigation.

ALAN affects offspring developmental time and number

Developmental time and number of eggs laid are traits usually used as proxies of fitness. Effects of ALAN on these traits were tested experimentally without any clear consensus. In the tropical fruit fly *Drosophila jambulina* Parshad & Paika, ALAN modifies circadian rhythm of pupal eclosion. Whereas light at night of 0.5 lux (ca. moonlight) does not impact the pattern of eclosion, greater intensities (5 and 50 lux) reduced the eclosion rate, and the eclosion events became arrhythmic (Thakurdas et al., 2009). The advancement of the eclosion peak, which usually occurs at dawn when conditions are optimal for the emerged flies, may have a negative impact on fitness-related traits and consequences for the population.

Nighttime lighting also disrupts prolonged developmental time (diapause), considered as an adaptive response to environmental variability with strong influence on fitness (Moreau et al., 2017). In the nocturnal

moth *Mamestra brassicae* (L.), larvae exposed to white and green lights emerge earlier from pupae than larvae in dark conditions (van Geffen et al., 2014). Moreover, male larvae exposed to white and green lights initiate their pupation earlier. Thus, ALAN interferes with natural light-dark cycles, which are the main environmental cue used by caterpillars to initiate pupal diapause, leading to a reduced larval developmental time. This phenomenon is likely due to the suppression of diapause initiation in larvae in light-polluted conditions (van Geffen et al., 2014).

McLay et al. (2017) showed convincingly that ALAN has negative consequences for reproductive success by investigating the effects of chronic exposure to various nighttime lighting intensities on growth, reproduction, and survival traits in the diurnal *Drosophila melanogaster* Meigen. After three generations of rearing with ALAN, the probability to start ovipositing (i.e., laying at least one egg) and the number of eggs laid per female were reduced by 20% even when the females were exposed to dim ALAN (1 lux). Adult survival was also affected, but a decrease was observed only for light intensities above 10 lux (i.e., average street lighting). On the contrary, in *T. commodus*, egg hatching, adult survival, probability to mate, and number of eggs laid were not affected by light-at-night (Durrant et al., 2018).

ALAN disrupts melatonin synthesis and related physiological processes

Artificial light at night affects many physiological pathways via a disruption of melatonin synthesis, a key hormone involved in the overall circadian regulation (review in Gaston et al., 2015). Melatonin (N-acetyl-5-methoxy-tryptamine) is principally found in the head, eyes, optic lobe, and brain of insects (Vivien-Roels & Pévet, 1993; Hardeland & Poeggeler, 2003). In a large range of species, the synthesis and release of melatonin occurs in darkness and is suppressed during daylight hours (Hardeland & Poeggeler, 2003; Bembenek et al., 2005; Subala & Shivakumar, 2018). However, this pattern can be more complex. In the honey bee, *Apis mellifera* L., circulating melatonin exhibits multiple daily peaks at the beginning and end of the night (Yang et al., 2007). Sometimes, temporal patterns of melatonin concentration are divergent among organs, such as in the two-spotted cricket, *Gryllus bimaculatus* De Geer (Itoh et al., 1995). Additional evidence for the presence, timing, and role of melatonin has also been obtained from assays of enzymes involved in its biosynthesis: arylalkylamine N-acetyltransferase (AA-NAT) and hydroxyindole O-methyltransferase (Hardeland & Poeggeler, 2003; Bembenek et al., 2005).

Although few studies have investigated the physiological effects of nighttime lighting in insects (Durrant et al.,

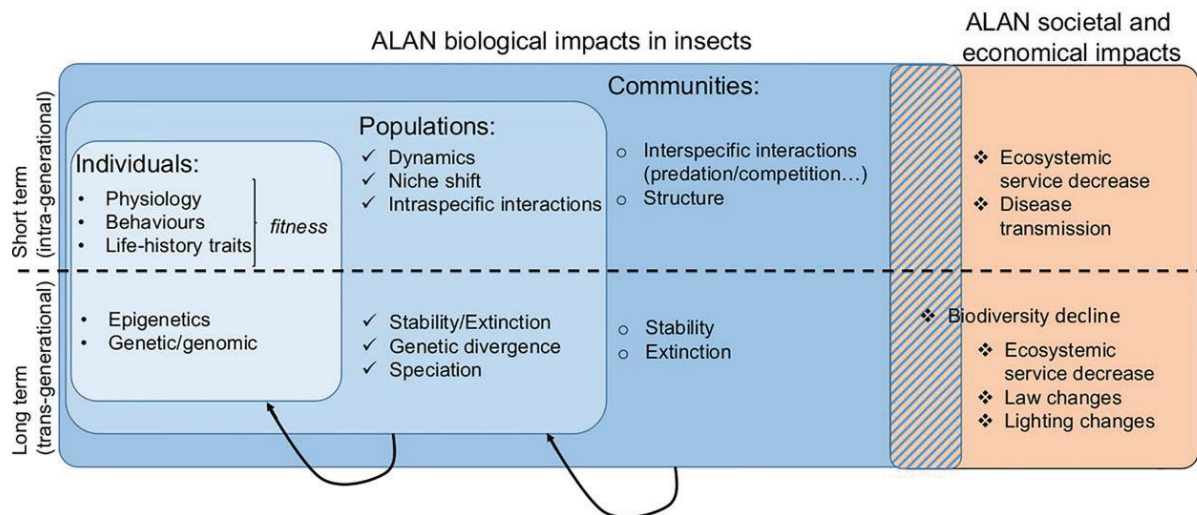

Figure 1 Summary of potential artificial light at night (ALAN) effects in insects at various levels of biological organization and their societal and economical impacts. On the left ('biological impacts') individuals are within populations which are within communities which symbolize that ALAN effects on individuals may have consequences on higher levels of biological organization. Feedback effects are represented by black arrows (e.g., density-dependence process influencing life-history traits). The hatching symbolizes that biological and societal impacts are not separated (e.g., 'Biodiversity decline' can be studied as a biological and a societal impact of ALAN). On the right ('societal and economical impacts'), disease transmission refers to the potential changes of behavior in insect vectors of diseases. Law and lighting changes are discussed in the 'Conclusions and next challenges' section. Above the dashed line are short-term effects of ALAN, below the dashed line are long-term effects.

2015; Haim & Zubidat, 2015; Honnen et al., 2016), those concerning impact of photoperiod changes provide information on the potential effects of ALAN (Figure 2). Suppression or alteration of melatonin synthesis due to ALAN may affect, through cascading effects, several post-embryonic processes such as molting or metamorphosis. Melatonin stimulates the release of prothoracicotrophic hormone, as demonstrated in the American cockroach, *Periplaneta americana* (L.) (Richter et al., 2000). Prothoracicotrophic hormone controls the biosynthesis of ecdysteroids (molting hormone) by prothoracic glands in larvae (Gade et al., 1997). As a consequence, ALAN could lead to an increase of immature growth period. However, the influence of ALAN on development times was uncertain, either ALAN reduced this trait value (van Geffen et al., 2014) or ALAN increased it (Durrant et al., 2018). Another important role of melatonin is its antioxidant capacity. This hormone protects lipid, protein, and DNA molecules against damage caused by free radicals by acting as a direct scavenger to detoxify reactive oxygen and nitrogen species (Reiter et al., 2013). Reactive oxygen species (ROS) are mainly produced by mitochondria (oxidative phosphorylation) during ATP production (e.g., Monaghan et al., 2009; Mondy et al., 2012). Although low levels of ROS play a role in cell signaling and induction of defense genes, an excessive

release of ROS induces oxidative stress that leads to loss of cell functions and programmed cell death. In *Drosophila*, oxidative damage to proteins was diminished by administration of melatonin (Coto-Montes & Hardeland, 1999). Variations of melatonin level induced by different photoperiod regimes are correlated with the antioxidant enzyme activities in the cotton leafworm, *Spodoptera litura* (Fabricius) (Subala & Shivakumar, 2018). In the same way, incorporation of melatonin in the feeding medium of *D. melanogaster* improved the resistance to paraquat – a ROS generator – and extended lifespan (by 13.5%), suggesting an effect on the rate of ageing. The efficiency in life extension driven by melatonin was particularly obvious in short-lived flies (Izmaylov & Obukhova, 1999).

Exposure to ALAN could also have a negative impact on immune function, as shown in vertebrates (e.g., Calvo et al., 2013; Carrillo-Vico et al., 2013). The suppression of melatonin in response to ALAN could be a general mechanism underpinning changes in immune function (review in Durrant et al., 2015; Jones et al., 2015). In the black field cricket (*T. commodus*), exposure to constant illumination decreased the activity of two of the three immune functions (haemocyte concentration and lytic activity, but not phenol oxidase activity) (Durrant et al., 2015). In the same species, when *T. commodus* adults exposed to

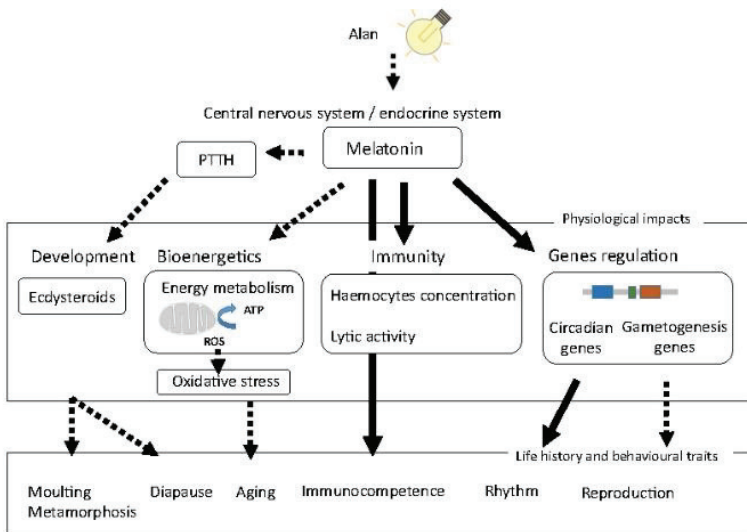

Figure 2 A simplified schematic of a physiological mechanism network involved in response to artificial light at night (ALAN) in insects. Solid arrows indicate effects from studies on ALAN, dotted arrows indicate results from studies on light or photoperiod modification. In both compartments ('Physiological impacts' and 'Life history and behavioural traits') the elements can interact [e.g., reactive oxygen species (ROS) production acts on oxidative stress but also on immunity]. See text for details.

constant illumination were provided with melatonin in drinking water, the hormone was partially able to mitigate the detrimental effects of ALAN; melatonin did not improve survival, fecundity, or phenol oxidase activity, but it had a dose-dependent positive effect on haemocyte concentration and lysozyme-like activity (Jones et al., 2015).

Finally, investigations on effects of ALAN at molecular level remain limited. Light-at-night may disrupt the molecular clock of insects, as shown in vertebrates (Smolensky et al., 2015). In insects, the genes of the circadian clock are expected to be affected by ALAN via the blue light receptor cryptochrome-1 – an extra-retinal photoreceptor – that receives the environmental light cues used in clock synchronization (Stanewsky et al., 1998). Genes of the circadian clock are well described, especially in *D. melanogaster* (Goto, 2013). The impact of 3 h of ALAN (300 lux) per day during 3 days on the expression of these clock genes has been shown in mosquitoes using a transcriptomic approach. The expression patterns of circadian genes of *Culex pipiens* L. males exposed to ALAN did not differ significantly compared to control males (i.e., without ALAN) (Honnen et al., 2016). However, at the same time, exposed males had a reduced expression of gametogenesis-related genes compared to control males (Honnen et al., 2016). These results confirm that physiological processes, even if they are not under direct circadian control, may be influenced by ALAN.

It is clearly premature to address a general pattern of the consequences of ALAN in terms of fitness in insects. Till now, most experimental studies provide a plot view of the changes in physiological and life-history traits for individuals under nighttime lighting, independently of the

trade-offs in which they are involved. Whether ALAN has negative or positive impact in lifetime reproductive success needs to be investigated thoroughly.

Population and community consequences of ALAN

Artificial light at night may impact population dynamics, as well as community composition and functioning via four non-exclusive pathways. First, as explained in the section 'ALAN affects insect movement at multiple spatial scales', ALAN acts as an attractor/repellent of individuals, thereby changing community composition locally, according to the relative strength of attraction to/repulsion from the light sources for each species involved (Longcore et al., 2015; Wakefield et al., 2016). Second, ALAN disturbs the timing of various biological events due to a mismatch between internal clock and natural dark-light cycles, which may desynchronize ecological interactions (Gaston et al., 2017). As a consequence of these two pathways, any change in nighttime lighting may change the risks (predation, competition) and opportunities (feeding, mating) that individuals are exposed to (review for animals in Kronfeld-Schor et al., 2017). Third, through the abovementioned impact of ALAN on physiological, behavioral, and life-history traits, the main demographical parameters (migration, birth, death) may be impacted, with consequences for population dynamics (Gaston & Bennie, 2014). Finally, beyond the impact on the species composing the community, ALAN can change the link between them (Sanders & Gaston, 2018). A better understanding of these four pathways would improve our ability to predict the effects of ALAN on community functioning. In the following paragraphs, we first review

evidence from insects about these pathways, and then we focus on the effects of ALAN on ecosystem services and biodiversity conservation issues.

ALAN affects population dynamics, species interactions, and community composition and functioning

The effects of light on interspecific interactions were first described before ALAN emerged as a major cause of concern and resulted from attraction to light and the associated increased direct mortality and predation risks. Depending on the intensity and spectral composition of lighting and the response curve of organisms (their spectral sensitivity and radius of attraction), some groups of insects may be more impacted. For instance, the rate of predation of Lepidoptera by vespid wasps was increased in the vicinity of ultraviolet light (Warren, 1990). Increased predation of insects near artificial light may result from changes in foraging behavior of their predators. The nocturnal orb-web spider *Larinioides sclopetarius* (Clerck) evolved a foraging behavior that consisted of constructing their webs in lit areas, where they captured more insects (mainly chironomids) (Heiling, 1999). In riparian areas, ALAN interferes with aquatic–terrestrial fluxes of insect prey and it is linked to species and seasonal specific changes in predator and scavenger diets (Manfrin et al., 2018). By inducing increased prey abundance near street lights, ALAN also impacts bat–insect interactions (Stone et al., 2015). Beyond its impact on spatial distribution, ALAN may also modify the daily temporal distribution of species and their interactions by increasing the photoperiod duration. Nocturnal species may compete with diurnal species for resources, where such interactions were inexistent in unlit areas during the night.

The first empirical study addressing whether the effects of ALAN on organisms have consequences on higher levels of biological organization in insects was conducted by Davies et al. (2012). These authors showed that communities of ground-dwelling invertebrates are affected by the proximity of street lighting (high-pressure-sodium lights). The light pollution had a more permanent effect on the composition of the community than simply attracting some species to street lights at night. This pioneer study was completed by a 3-year field study to assess the impact of modern lighting with LEDs on the composition of ground-dwelling invertebrate assemblages (Davies et al., 2017). As with classic lighting, LEDs lead to predator aggregation in lit areas and we expect that they increase prey mortality.

After offering a constant number of prey (the greater wax moth, *Galleria mellonella* L.) to invertebrate predators (ants, wasps, and other arthropods) in lit vs. unlit areas, Grenis et al. (2015) suggested that

light pollution does not affect the predation pressure on lepidopteran larvae during the day or night. Conversely, the strength of predator–prey interactions between ladybirds and aphids has been shown to be influenced by exposure to ALAN (Miller et al., 2017). More studies on the behavioral responses of predators to light pollution are required to clarify the impact of ALAN on the functional and numeric responses of predators, a key element of predator–prey dynamics.

ALAN changes ecosystem services and conservation issues

The previous examples suggest the implications ALAN could have on ecosystem services, i.e., benefits for humans. Studies by Macgregor et al. (2015, 2017) indicated that nocturnal pollinators (moths) are negatively impacted by ALAN, with cascading effects on species with which they interact, notably diurnal pollinators. This result suggests a reduction in pollen transport and pollination under ALAN conditions. In an elegant field study investigating multiple trophic levels, Knop et al. (2017) demonstrated that ALAN has combined effects on nocturnal and diurnal pollinator networks and that the reduction of flower visits by insects under lit areas yields to a decrease of plant reproductive success.

Artificial light at night also affects the diurnal network of insects with intricate relationships, e.g., pest–biocontrol agent networks. In an outdoor mesocosm experiment, the dynamics of host–parasitoid interactions under ALAN was followed over several generations (Sanders et al., 2015). After five generations of light treatment (cool white LED, approximately 30 lux), host abundance (aphids) was, on average, reduced by 20%. This result most likely stems from cascading bottom-up effects of the reduction in resource availability for these herbivores, due to reduced bean plant biomass and quality under artificial light. ALAN treatment did not have the same effect on the various host species; it ranged from no effect to a strong effect. As predicted, the population size of the three parasitoid species under study decreased, mainly as a consequence of the reduced host population, but direct effects of ALAN on parasitoids (e.g., on fecundity or attack rate) were not excluded. By studying the cascading effects of ALAN on plant–aphid–predatory ground beetle networks, Bennie et al. (2015) also described bottom-up effects, where exposure to light decreased the flowering of the leguminous food plant, thereby reducing population size of pea aphids. More recently, mesocosm field experiment of plant–aphid–parasitoid food webs under ALAN revealed reduced aphid densities in lit areas due to an increase in parasitoid efficiency (Sanders et al., 2018). It is noteworthy that the higher impact was observed at low light intensities (0.1–5 lux).

The effects of artificial light could also favor the spread of various vector-borne diseases. Indeed, several insect vector species such as *Aedes* and *Culex* spp. mosquitoes are attracted by artificial light. Although disease transmission under ALAN was not quantified, Pacheco-Tucuch et al. (2012) showed that house infestation by the blood-sucking bug *Triatoma dimidiata* (Latreille), one of the primary vectors of Chagas disease, increases near public street lights in Mexico.

Because ALAN affects several life-history and behavioral traits, ecologists assume that it could be responsible for widespread population losses and species extinction. However, quantifying the population-level impact of ALAN remains one of the most important and challenging problems facing ecologists interested in ALAN consequences. To date, there is little evidence of a negative effect of ALAN on population size. Using a 30-year (1985–2015) database of moth fauna presence in The Netherlands in regions with high ALAN levels, van Langevelde et al. (2018) suggest that ALAN is an important factor in explaining the observed decline in moth populations (see also Wilson et al., 2018). Indeed, among the 11 relevant ecological traits of each of the 481 moth species under study, the two that are strongly correlated to population decline are nocturnal/diurnal activity and phototactics, i.e., the two traits related to light. Nocturnal species with positive phototactics suffer the highest decline during the covered period. However, adaptations to light conditions, such as reduced flight-to-light behavior (see below), can partly compromise density estimations, leading to lower catching probabilities of light traps and lower observed population densities over time. This drawback highlights the urgency to combine short-period studies of ALAN effects on organisms/populations with studies of evolutionary impact of ALAN for a better understanding of the consequences for ecosystems.

Evolutionary impact of ALAN: scarce empirical evidence

Changes in natural light regimes and wavelengths to which animals and plants are subjected are unprecedented over evolutionary timescales and represent a new selective pressure (Hopkins et al., 2018). Under such anthropogenic conditions, the plasticity level of phenotypic responses might be insufficient, and the behavioral responses should be maladaptive on a short time scale (Caro & Sherman, 2011). However, on time scales of several generations, and under the hypothesis that behavioral traits covary with underlying genotypes and that organisms possess sufficient genetic variance, genetic changes are expected.

However, experimental evidence of evolutionary changes due to ALAN remain scarce.

The first experimental study demonstrating that ALAN is an agent of selection was performed by Altermatt & Ebert (2016). They show that selection favors less pronounced phototaxis in prey insects living in lit areas. They compared flight toward artificial light in adults of the small ermine moth, *Y. cagnagella*, from populations occurring in areas with different levels of light pollution. Individuals from populations experiencing high light pollution for many generations had a lower propensity to fly to light. This adaptive response causes a reduction in mortality risk in the moths from lit populations (direct mortality and predation) in comparison to those from unlit populations.

This result raises questions concerning the mechanisms underpinning behavioral responses to ALAN, which are addressed directly and indirectly in recent studies. In the nocturnal moth *Helicoverpa armigera* (Hübner), three genes (*IMFamide*, *leucokinin*, *SNPF*) involved in hormonal regulation display differential expression between individuals under lit or unlit conditions (Wang et al., 2018). These genes complete the list of candidate genes established through the ‘dark fly’ project that provided indirect evidence of the selection pressures exerted by lighting (Izutsu et al., 2016). In this project, a *D. melanogaster* line was maintained in constant dark conditions for more than 60 years, to compete ‘dark fly’ and wild-type lines under dark or light conditions. In darkness, ‘dark fly’ dominated their wild-type counterparts. Through a genome-wide analysis, Izutsu et al. (2016) identified single nucleotide polymorphisms and 100 candidate genes associated with the adaptive advantage of the ‘dark fly’ line. Some of these genes are expressed in a circadian oscillatory manner and should be sensitive to any disruption of light/dark cycles due to ALAN.

Note that an exhaustive list of potential micro- and macro-evolutionary effects of ALAN on animals is presented in two recent reviews (Swaddle et al., 2015; Tierney et al., 2017). However, we wish to focus on the opportunity offered by the ‘omics’ approach combined with experimental evolution (e.g., ‘dark fly’ project; Fuse, 2017) to clearly identify the traits under selection, as well as the molecular mechanisms underpinning these traits and the potential mutations due to ALAN (see also Schell, 2018). These transgenerational experiments will also allow quantification of heritability of the phenotypic response to this novel anthropogenic stressor.

Conclusions and next challenges

The past decade has witnessed improved efforts to describe and test ALAN effects on insect biology. Our review

Table 1 Summary of the experimental studies dealing with behavioural and life-history, physiological, population or community, and evolutionary responses to artificial light at night (ALAN) in insects. We distinguished species (or orders) according to their period of activity (diurnal/nocturnal/crepuscular) and the stage affected by light (adult/immature). We also added information concerning the light used – type of light [light-emitting diode (LED), sodium (Na) lamp, fluorescent tube, . . .], wavelength spectrum (nm), the intensity of lighting – and the traits under study in experiments (field/laboratory). If different lights were used in a given study, they are indicated by letters. In several studies the range of wavelengths was represented by a graph. We used this graph to determine the wavelength spectrum range and we indicated the wavelength of the main peak of this spectrum in parentheses. In studies dealing with a community, we only indicated the main orders. NA: data not available. Traits affected by light exposition in each reference are described in the main text.

Responses to ALAN	Species	Order	Diurnal/ nocturnal/ crepuscular	Adult/ immature	Type of light	Wavelength spectrum		Intensity (units)	Traits under study	Field/ laboratory	Reference
						Fluorescent tube	(main wavelength peak, nm)				
Behavioural and life-history	<i>Yponomeuta cognatella</i> , <i>Ligdia adustata</i> <i>Y. cognatella</i>	Lepidoptera	Nocturnal	Adult	Fluorescent tube	NA	NA	NA	Movement	Laboratory	Altermatt et al. (2009)
	<i>Teleoglyptus commodus</i>	Lepidoptera	Nocturnal	Immature	NA	NA	NA	<3 vs. >20 ($\times 10^{-9}$ W cm $^{-2}$ sr $^{-1}$)	Movement	Field	Altermatt & Ebert (2016)
	Group of species (137) <i>T. commodus</i>	Orthoptera	Crepuscular and nocturnal	Adult	LED	NA	NA	1, 10, or 100 (lux)	Mate finding, mate choice	Laboratory	Botha et al. (2017)
		Lepidoptera	Nocturnal	Adult	High-pressure Na lamp	NA	NA	96 (lm W $^{-1}$)	Movement	Field	Degen et al. (2016)
		Orthoptera	Nocturnal	Larvae	LED	NA	NA	0.1, 10, or 100 (lux)	Larval development, larval survival, size	Laboratory	Durrant et al. (2018)
	<i>Hemideina floricola</i> , Rhopidophoridae (i.e. <i>Platoplectron diversum</i> , <i>Gymnoplectron</i> sp., <i>Neonetus</i> sp., and <i>Pachylammia</i> sp.) <i>Photinus pyralis</i> , <i>Photuris versicolor</i> <i>Operophtera brumata</i>	Orthoptera	Nocturnal	Adult	LED	NA	NA	1000 (lux)	Movement, foraging	Field	Farmworth et al. (2018)
		Coleoptera	Nocturnal	Adult	LED	NA	NA	301.24 \pm 89.07 (lux)	Mate finding	Field	Firebaugh & Haynes (2016)
		Lepidoptera	Nocturnal	Adult	a. LED white; b. LED green; c. LED red	a. [415;780] (610); b. [396;690] (543); c. [425;720] (623)	10 (lux)		Mate finding, mating	Field	van Geffen et al. (2015)
	<i>Manestra brassicae</i>	Lepidoptera	Nocturnal	Immature	a. LED white; b. LED green; c. LED red	a. [380;775] (611); b. [380;780] (666); c. [380;780] (641)	7 (lux)		Larval development, diapause	Laboratory	van Geffen et al. (2014)

Table 1. Continued

Responses to ALAN	Species	Order	Diurnal/ nocturnal/ crepuscular	Adult/ immature	Type of flight	Wavelength spectrum (main wavelength peak, nm)	Intensity (units)	Traits under study	Field/ laboratory	Reference
	Group of species	Diptera, Lepidoptera, Trichoptera, Hymenoptera, Coleoptera, Hemiptera	Nocturnal and diurnal	Adult	a. High-pressure mercury b. LED; c. ceramic metalhalide; d. low-pressure Na; e. induction blue; f. induction red	a. [307;710] (545); b. [427;780] (608); c. [348;780] (590); d. [566;780] (591); e. [401;585] (436); f. [310;718] (611)	a. 3.598; b. 3.836; c. 4.086; d. 3.134; e. 3.259; f. 3.757 (lm)	Movement	Field	van Ganssven et al. (2014)
	<i>Anopheles gambiae</i>	Diptera	Crepuscular and nocturnal	Adult	Tungsten bulbs	NA	70 (lux)	Movement	Laboratory	Jones et al. (1972)
	<i>M. brassicae</i> , <i>Rivula sericealis</i> , <i>Idaea bisulata</i> , <i>Dystrota truncata</i>	Lepidoptera	Nocturnal	Adult	a. LED white; b. LED green; c. LED red	a. [420;780] (626); b. [440;680] (516); c. [380;780] (634)	15 (lux)	Foraging	Laboratory	van Langevelde et al. (2017)
	Group of species (112)	Lepidoptera	Nocturnal	Adult	NA	Means: a. 381.8; b. 534.3; c. 554.0; d. 597.1; e. 616.6; f. 617.6	a. 2.2; b. 293; c. 297; d. 162; e. 153; f. 143 (lm)	Movement	Field	van Langevelde et al. (2011)
	Group of species	Diptera, Lepidoptera, others	Nocturnal and diurnal	Adult	a. Custom LED; b. custom LEDs; c. commercial LEDs; d. compact fluorescent lamps (CFL) LED cool white	a. [380;750] (631); b. [380;750] (633); c. [350;750] (596); d. [350;750] (610)	a. 1.675; b. 1.145 and 1.830; c. 2.75 and 656; d. 253 and 525 (lux)	Movement	Field	Longcore et al. (2015)
	<i>Drosophila melanogaster</i>	Diptera	Diurnal and crepuscular	Both	LED cool white	[405;760] (445)	0, 1, 10, or 100 (lux)	Offspring number	Laboratory	McLay et al. (2017)

Table 1. Continued

Responses to ALAN	Species	Order	Diurnal/ nocturnal/ crepuscular	Adult/ immature	Type of light	Wavelength spectrum (main wavelength peak, nm)	Intensity (units)	Traits under study	Field/ laboratory	Reference
	Group of species (266)	Coleoptera	NA	Adult	a. Mercury vapor bulb; b. high-pressure Na vapor bulb; c. Na vapor bulb + UV filter	Means: a. 531; b. 607; c. 609	NA	Movement	Field	deMedeiros et al. (2017)
	Group of species (44)	Lepidoptera	Crepuscular and nocturnal	Adult	Actinic tube	NA	NA	Movement	Field	Merckx & Slade (2014)
	Group of species (aquatic and terrestrial arthropods)	NA	NA	Adult	LED	NA	10–12 (lux)	Movement	Field	Meyer & Sullivan (2013)
	<i>Aquatica fiza</i>	Coleoptera	Nocturnal	Adult	LED	Eight wavelengths: 444, 463, 488, 515, 533, 597, 628, 663	0.107 ± 0.02 (dim intensity), 1.075 ± 0.212 (bright intensity) ($\mu\text{mol m}^{-2} \text{s}^{-1}$)	Mate finding	Field (mesocosm)	Owens et al. (2018)
	<i>Triatoma dimidiata</i>	Hemiptera	Nocturnal	Both	Street lights in the field and LED in the lab	Field: NA; laboratory: [400;750 (white), 450 (blue), 500 (green), 590 (yellow), and 630 (red)]	Field: 22 ± 1 (lux); laboratory: NA	Movement	Field and laboratory	Pacheco-Turuch et al. (2012)

Table 1. Continued

Responses to ALAN	Species	Group of species	Order	Diurnal/ nocturnal/ crepuscular	Adult/ immature	Type of flight	Wavelength spectrum (main wavelength peak, nm)	Intensity (units)	Traits under study	Field/ laboratory	Reference
			Diptera, Trichoptera, Coleoptera, Hymenoptera, Hemiptera, Ephemeroptera, Lepidoptera, Neuroptera, Thysanoptera, Plecoptera, Isoptera, Orthoptera, Blattodea, Psocoptera, Mantodea	Nocturnal and diurnal	Adult	a. LED; b. high-pressure Na; c. LED 2700 K; d. LED 3000 K; e. LED 3500 K; f. LED 4000 K; g. LED 5000 K; h. LED 6500 K	a. [400;700] (589); b. [400;700] (580); c. [400;700] (600); d. [400;700] (593); e. [400;700] (552,592); f. [400;700] (545); g. [400;700] (454); h. [400;700] (545)	NA	Movement	Field	Pawson & Badler (2014)
			Diptera, Ephemeroptera, Trichoptera, Coleoptera, Hemiptera, Lepidoptera, Hymenoptera, Thysanoptera, Orthoptera, Psocoptera Hemiptera	Nocturnal and diurnal	Adult	High-pressure Na lamps	[350;850] (820)	5600 (lm)	Movement	Field	Perkin et al. (2014)
	<i>Empoasca onukii</i>			Nocturnal	Adult	a. Quartz lamps b. LED yellow; c. LED green	a. [350;800] (800); b. [350;800] (545); c. [437;695] (502)	2000 (lux)	Movement	Laboratory	Shi et al. (2017)
			Lepidoptera	Crepuscular and nocturnal	Adult	a. High-pressure Na lamp; b. metal halide lamp	a. [350;1050] (820); b. [350;1050] (590)	a. 15000; b. 12000 (lm)	Movement	Field	Somers-Yeates et al. (2013)

Table 1. Continued

Responses to ALAN	Species	Order	Diurnal/ nocturnal/ crepuscular	Adult/ immature	Type of light	Wavelength spectrum (main wavelength peak, nm)	Intensity (units)	Traits under study	Field/ laboratory	Reference
	<i>Drosophila janbulina</i>	Diptera	Diurnal	Both	NA (field experiment); LED white (laboratory experiment)	NA	Field: 0.004–0.45; laboratory: 0.5–5.50 (lux)	Developmental time, offspring number	Field and laboratory	Thakurdas et al. (2009)
	Group of species	Diptera, Coleoptera, Lepidoptera, Hemiptera, Hymenoptera, Psocoptera, Neuroptera, Ephemeroptera, Trichoptera, Thysanoptera	Nocturnal and diurnal	Adult	a. Metal halide lamp; b. high-pressure Na lamp; c. LED	a. [350;800] (592); b. [350;800] (594); c. [350;800] (453)	a. 300; b. 168; c. 181 (lux)	Movement	Field	Wakefield et al. (2018)
	Group of species	Coleoptera, Dermaptera, Diptera, Ephemeroptera, Hemiptera, Hymenoptera, Lepidoptera, Neuroptera, Psocoptera, Trichoptera	Nocturnal and diurnal	Adult	a. Compact fluorescent lamp; b. tungsten filament; c. LED cool-white; d. LED warm-white	a. [350;800] (611); b. [350;800] (800); c. [401;775] (450); d. [425;800] (613)	a. 1100; b. 970; c. 1130; d. 1060 (lm)	Movement	Field	Wakefield et al. (2016)
Physiological	<i>T. commodus</i>	Orthoptera	Nocturnal	Adult	Fluorescent tube	NA	0–4000 (lux)	Immunity	Laboratory	Durrant et al. (2015)
	<i>T. commodus</i>	Orthoptera	Nocturnal	Larvae	LED	NA	0, 1, 10, or 100 (lux)	Larval development, gametogenesis	Laboratory	Durrant et al. (2018)
	<i>M. brassicae</i>	Lepidoptera	Nocturnal	Immature	a. LED white; b. LED green; c. LED red	a. [380;775] (611); b. [380;780] (466); c. [380;780] (641)	7 (lux)	Larval development, weight	Laboratory	van Geffen et al. (2014)
	<i>Culex pipiens</i>	Diptera	Nocturnal	Adult	LED white	NA	300 (lux)	Gametogenesis, metabolism, immunity	Laboratory	Honnen et al. (2016)

Table 1. Continued

Responses to ALAN	Species	Order	Diurnal/ nocturnal/ crepuscular	Adult/ immature	Type of flight	Wavelength spectrum (main wavelength peak, nm)	Intensity (units)	Traits under study	Field/ laboratory	Reference
Population or community	<i>Aorythosphion pisum</i> predated by <i>Adalia bipunctata</i> and <i>Pterostichus melanarius</i>	Homoptera, Coleoptera	Nocturnal and diurnal	Both (long-term study)	LED	a. [400;750] (445); b. 588	a. b. 10-15 (lux)	Dynamics of tri-trophic food web	Field (mesocosm)	Bennie et al. (2015)
	Group of species	Orthoptera, Coleoptera, Hymenoptera	Nocturnal and diurnal	NA	High pressure Na street lights	NA	3.02 ± 0.14 or 19.29 ± 1.31 (lux)	Community composition	Field	Davies et al. (2012)
	Group of species	Coleoptera	Nocturnal and diurnal	Adult	LED	a-c. Cool white; d. amber: 588	a. 29.6 ± 1.2; b. 14.6 ± 0.3; c. 14.4 ± 0.8; d. 18.2 ± 1.3 (lux)	Community composition	Field	Davies et al. (2017)
	Generalist invertebrate predators of <i>Galleria mellonella</i> larvae	Dermoptera, Hymenoptera	Nocturnal and diurnal	Adult	NA	NA	NA	Predation rate	Field	Grenis et al. (2015)
	Group of pollinator species	Coleoptera, Dermaptera, Diptera, Hemiptera, Orthoptera, Hymenoptera, Lepidoptera, Neuroptera	Nocturnal and diurnal	Both (long-term study)	LED white	NA	From 3.9 ± 0.4 to 52.0 ± 4.2 (lux) according to distance from light source	Pollination network	Field	Knop et al. (2017)
	Group of species	Lepidoptera	Nocturnal and diurnal	Both (long-term study)	NA	NA	NA	Population dynamics	Field	van Langevalde et al. (2018)
	Exhaustive sample	Lepidoptera	Nocturnal	Both (long-term study)	High-pressure Na	NA	Median 2.3 (range 0.2-12.1) (lux)	Pollination network	Field	Macgregor et al. (2017)

Table 1. Continued

Responses to ALAN	Species	Order	Diurnal/ nocturnal/ crepuscular	Adult/ immature	Type of light	Wavelength spectrum (main wavelength peak, nm)	Intensity (units)	Traits under study	Field/ laboratory	Reference
	Exhaustive sample	Blattoptera, Coleoptera, Diptera, Ephemeroptera, Hemiptera, Lepidoptera, Mecoptera, Megaloptera, Neuroptera, Odonata, Orthoptera, Psocoptera, Siphonaptera, Thysanoptera, Trichoptera	Nocturnal and diurnal	Both (long-term study)	Streetlights + high-pressure Na	[400;760] (580-600)	1-50 (lux)	Community composition	Field	Manfin et al. (2017)
	<i>A. pisum</i> predated by <i>Coccinella septempunctata</i> and <i>Coleomegilla maculata</i>	Homoptera, Coleoptera	NA	Adult	LED	NA	1500 (nW cm ⁻²)	Predation	Field (mesocosm)	Miller et al. (2017)
	3 host/parasitoid systems: <i>Aphis fabae</i> / <i>Lysiphilus fabarum</i> , <i>A. pisum</i> / <i>Aphidius ervi</i> , and <i>Megoura viciae</i> / <i>Aphidius mesogaurae</i>	Hemiptera, Hymenoptera	NA	Both (long-term study)	LED	[400;750] (445)	30 (lux)	Dynamics of tritrophic food web	Field (mesocosm)	Sanders et al. (2015)

Table 1. Continued

Responses to ALAN	Species	Order	Diurnal/ nocturnal/ crepuscular	Adult/ immature	Type of flight	Wavelength spectrum (main wavelength peak, nm)	Intensity (units)	Traits under study	Field/ laboratory	Reference
	Plant (<i>Vicia faba</i> or <i>Hordeum vulgare</i>)/aphid (<i>Megoura viciae</i> , <i>A. pisum</i> , or <i>A. fabae</i>)/ parasitoid (<i>A. ervi</i> , <i>L. fabarum</i> , or <i>A. megourae</i>) food webs	Hemiptera, Hymenoptera	NA	Both	LED	[400;750] (445)	0.1, 1, 5, 10, 20, 50, and 100 (lux)	Dynamics of trophic food web	Field (mesocosm)	Sanders et al. (2018)
	Group of species	Diptera, Coleoptera, Lepidoptera, Hemiptera, Hymenoptera, Psocoptera, Neuroptera, Ephemeroptera, Tricoptera, Thysanoptera	Nocturnal and diurnal	Adult	a. Metal halide lamp; b. high-pressure Na lamp; c. LED	a. [350;800] (592); b. [350;800] (594); c. [350;800] (453)	a. 300; b. 168; c. 181 (lux)	Community composition	Field	Wakefield et al. (2018)
	Group of species	Coleoptera, Dermaptera, Diptera, Ephemeroptera, Hemiptera, Hymenoptera, Lepidoptera, Neuroptera, Psocoptera, Trichoptera	Nocturnal and diurnal	Adult	a. Compact fluorescent lamp; b. tungsten filament; c. LED cool-white; d. LED warm-white	a. [350;800] (611); b. [350;800] (800); c. [401;775] (450); d. [425;800] (613)	a. 1100; b. 970; c. 1130; d. 1060 (lm)	Community composition	Field	Wakefield et al. (2016)

Table 1. Continued

Responses to ALAN	Species	Order	Diurnal/ nocturnal/ crepuscular	Adult/ immature	Type of flight	Wavelength spectrum (main wavelength peak, nm)	Intensity (units)	Traits under study	Field/ laboratory	Reference
	<i>Nepheleodes minians</i> , <i>Pseudaletia unipuncta</i> , <i>Heliothis zea</i> , <i>Trichoplusia ni</i> , and <i>Catocala faust</i> predated by <i>Vespula</i> <i>penisylvanica</i> Group of species	Lepidoptera, Hymenoptera	Nocturnal	Adult	NA	Ultraviolet	NA	Predation	Field	Warren (1990)
		Lepidoptera	NA	Both (long-term study)	NA	NA	Low, medium, and high (image satellites)	Population dynamics	Field	Wilson et al. (2018)
Evolutionary	<i>X. cognatella</i>	Lepidoptera	Nocturnal	Immature	NA	NA	[0.253] vs. >20 ($\times 10^{-9}$ W cm ⁻² sr ⁻¹)	Evolutionary response	Field	Altamir & Ebert (2016)
	<i>Helicoverpa armigera</i>	Lepidoptera	Nocturnal	Adult	LED UVA	[365]	400 (μ W cm ⁻²)	Gene expression	Laboratory	Wang et al. (2018)

highlights that lighting impacts all levels of biological organizations, from the organism (hormones, genes, and traits) to community and ecosystem functioning and thus has consequences for human well-being. Obviously scientific questions are still unexplored or need multi-disciplinary research in the next years to elaborate a complete view of the increasing impact of ALAN. We identified some of these questions.

Methodological challenges for ecologically relevant measures of ALAN impact

A crucial point is to test ecologically relevant levels of light at night in animals. Indeed, numerous studies have investigated the effects of light without paying attention to the ecological relevance of light intensity. This issue requires the development of an apparatus (Jechow et al., 2017, 2018) to quantify the spatial and temporal dynamics of ALAN and the intensity of lighting to which the animals are subjected in natural conditions. In addition, the use of common units to measure lighting (Table 1) would ease the reading and comparisons of ALAN studies. Applying ecologically relevant light intensities and duration should allow addressing mechanistic questions more efficiently (Figure 2). For instance, although the physiological effects of ALAN on vertebrates are well known (Acuña-castroviejo et al., 2007), there is no experimental evidence how, in insects, ALAN affects melatonin synthesis, the main driver of circadian rhythms.

ALAN in the global change perspective: a major actor?

Artificial light at night is not solely responsible for insect physiological and phenotypical perturbations or declines (Biesmeijer, 2006; van Langevelde et al., 2018). As stated in the introduction, HIRECs are numerous (Candolin & Wong, 2012) and should now be studied in combination, as suggested by Swaddle et al. (2015), to test whether these various types of anthropogenic changes act additively or synergistically. In ectotherms, we expect that ALAN strongly covaries or interacts with climate change (Miller et al., 2017) and with noise induced by human activity (Swaddle et al., 2015). Disentangling the relative impact of the various HIRECs is a promising avenue.

'Nothing makes sense [in ALAN studies] except in the light of evolution'

Much of our understanding of organismal responses to light is restricted to short-term behavioral responses. As a consequence, there is still a lack of studies that document long-term effects of ALAN. Is this widespread pollution responsible for directional selection? What are the adaptations in response to this potential selective pressure?

Insects, with their short generation times, provide an excellent opportunity to face the challenge of testing ecological and evolutionary processes. Trans-generational experiments and, especially, experimental evolution should inform the process under selection and how insects should evolve when facing different ALAN regimes. Only studies with fitness measures over several generations will inform us on the negative or positive impacts of ALAN on insects. These studies are urgent to assess, for instance, the impact of ALAN relative to other HIRECs on insect declines observed in numerous countries (Grubisic et al., 2018).

Scientists should also take advantage of the widespread distribution of insects to compare populations thriving in areas with different ALAN regimes (as done in Altermatt & Ebert, 2016). Sampling across a large geographical scale (e.g., latitude) coupled with phylogeny for comparative analysis would provide a test of the prediction that tropical species should be more sensitive to alterations in natural dark-light cycles because of the minimal seasonal variations in diel patterns under these latitudes.

ALAN studies in the framework of evolutionary ecology: a valuable support for stakeholders

Beyond basic research, ALAN concerns should also be considered by lawyers and stakeholders. Indeed, public light is also a question of public order (security, public tranquility). Insects are at the base of the trophic chain and should be considered sentinel species to calibrate lighting. Insects are relevant biological models to establish dose-responses to wavelengths and intensity. This aspect should provide solutions to mitigate the effects of ALAN (e.g., Egri et al., 2017) and to test the relevance of LEDs vs. other lamps for lighting (Longcore et al., 2015; Wakefield et al., 2018). From an applied point of view, experimental evolution should allow testing the effects of various types of nighttime lighting on entomological diversity and thus lead to the adoption of lighting laws to protect fauna.

We hope that this review will pave the road for future studies on ALAN and that their results will have strong influence on scientists and public policy about lighting to preserve darkness as a resource.

Acknowledgments

We thank Marc Rhainds for inviting us and giving us the opportunity to write this review. We also thank Xavier Fauvergue and an anonymous referee for their relevant comments and suggestions. The authors are grateful to IDEX Lyon.

References

- Acuña-castroviejo D, Acuna-castroviejo D, Escames G, Rodríguez MI & López LC (2007) Melatonin role in the mitochondrial function. *Frontiers in Bioscience* 12: 947–963.
- Altermatt F & Ebert D (2016) Reduced flight-to-light behaviour of moth populations exposed to long-term urban light pollution. *Biology Letters* 12: 1–4.
- Altermatt F, Baumeier A & Ebert D (2009) Experimental evidence for male biased flight-to-light behavior in two moth species. *Entomologia Experimentalis et Applicata* 130: 259–265.
- Aubé M, Kocifaj M, Zamorano J, Solano Lamphar HA & Sanchez de Miguel A (2015) The spectral amplification effect of clouds to the night sky radiance in Madrid. *Journal of Quantitative Spectroscopy and Radiative Transfer* 181: 11–23.
- van Baaren J & Candolin U (2018) Plasticity in a changing world: behavioural responses to human perturbations. *Current Opinion in Insect Science* 27: 21–25.
- Bembenek J, Sehadova H, Ichihara N & Takeda M (2005) Day/night fluctuations in melatonin content, arylalkylamine N-acetyltransferase activity and NAT mRNA expression in the CNS, peripheral tissues and hemolymph of the cockroach, *Periplaneta americana*. *Comparative Biochemistry and Physiology B* 140: 27–36.
- Bennie J, Davies TW, Cruse D, Inger R & Gaston KJ (2015) Cascading effects of artificial light at night: resource-mediated control of herbivores in a grassland ecosystem. *Philosophical Transactions of the Royal Society B* 370: 20140131.
- Biesmeijer JC (2006) Parallel declines in pollinators and insect-pollinated plants in Britain and the Netherlands. *Science* 313: 351–354.
- Botha LM, Jones TM & Hopkins GR (2017) Effects of lifetime exposure to artificial light at night on cricket (*Teleogryllus commodus*) courtship and mating behaviour. *Animal Behaviour* 129: 181–188.
- Briscoe A & Chittka L (2001) The evolution of color vision in insects. *Annual Review of Entomology* 46: 471–510.
- Calvo JR, Gonzalez-Yanes C & Maldonado MD (2013) The role of melatonin in the cells of the innate immunity: a review. *Journal of Pineal Research* 55: 103–120.
- Candolin U (2003) The use of multiple cues in mate choice. *Biological Reviews* 78: 575–595.
- Candolin U & Wong BBM (2012) Behavioural Responses to a Changing World – Mechanisms & Consequences. Oxford University Press, Oxford, UK.
- Caro T & Sherman PW (2011) Endangered species and a threatened discipline: behavioural ecology. *Trends in Ecology and Evolution* 26: 111–118.
- Carrillo-Vico A, Lardone PJ, Álvarez-Sánchez N, Rodríguez-Rodríguez A & Guerrero JM (2013) Melatonin: buffering the immune system. *International Journal of Molecular Sciences* 14: 8638–8683.
- Cheng W-J, Zheng X-L, Wang P, Zhou Z-L, Si S-Y & Wang X-P (2016) Male-biased capture in light traps in *Spodoptera exigua* (Lepidoptera: Noctuidae): results from the studies of reproductive activities. *Journal of Insect Behavior* 29: 368–378.
- Conrad KF, Warren MS, Fox R, Parsons MS & Woiwod IP (2006) Rapid declines of common, widespread British moths provide evidence of an insect biodiversity crisis. *Biological Conservation* 132: 279–291.
- Coto-Montes A & Hardeland R (1999) Antioxidative effects of melatonin in *Drosophila melanogaster* antagonization of damage induced by the inhibition of catalase. *Journal of Pineal Research* 27: 154–158.
- Dacke M, Baird E, Byrne M, Scholtz CH & Warrant EJ (2013) Dung beetles use the milky way for orientation. *Current Biology* 23: 298–300.
- Davies TW & Smyth T (2018) Why artificial light at night should be a focus for global change research in the 21st century. *Global Change Biology* 24: 872–882.
- Davies TW, Bennie J & Gaston KJ (2012) Street lighting changes the composition of invertebrate communities. *Biology Letters* 8: 764–767.
- Davies TW, Bennie J, Cruse D, Blumgart D, Inger R & Gaston KJ (2017) Multiple night-time light-emitting diode lighting strategies impact grassland invertebrate assemblages. *Global Change Biology* 23: 2641–2648.
- Degen T, Mitesser O, Perkin EK, Weiß NS, Oehlert M et al. (2016) Street lighting: sex-independent impacts on moth movement. *Journal of Animal Ecology* 85: 1352–1360.
- Donners M, van Grunsven RHA, Groenendijk D, van Langevelde F, Bikker JW et al. (2018) Colors of attraction: modeling insect flight to light behavior. *Journal of Experimental Zoology A* 329: 434–440.
- Durrant J, Michaelides EB, Rupasinghe T, Tull D, Green MP & Jones TM (2015) Constant illumination reduces circulating melatonin and impairs immune function in the cricket *Teleogryllus commodus*. *PeerJ* 3: e1075.
- Durrant J, Botha LM, Green MP & Jones TM (2018) Artificial light at night prolongs juvenile development time in the black field cricket, *Teleogryllus commodus*. *Journal of Experimental Zoology B* 330: 225–233.
- Egri Á, Száz D, Farkas A, Pereszlényi Á, Horváth G & Kriska G (2017) Method to improve the survival of night-swarming mayflies near bridges in areas of distracting light pollution. *Royal Society Open Science* 4: 171166.
- Falchi F, Cinzano P, Duriscoe D, Kyba CCM, Elvidge CD et al. (2016) The new world atlas of artificial night sky brightness. *Science Advances* 2: e1600377.
- Farnworth B, Innes J, Kelly C, Littler R & Waas JR (2018) Photons and foraging: artificial light at night generates avoidance behaviour in male, but not female, New Zealand weta. *Environmental Pollution* 236: 82–90.
- Firebaugh A & Haynes KJ (2016) Experimental tests of light-pollution impacts on nocturnal insect courtship and dispersal. *Oecologia* 182: 1203–1211.
- Frank KD (2009) The Daschner guide to in-hospital antibiotic therapy. *Peckhamia* 78: 1–3.
- Fuse N (2017) Genome research elucidating environmental adaptation: dark-fly project as a case study. *Current Opinion in Genetics and Development* 45: 97–102.
- Gade G, Hoffmann KH & Spring JH (1997) Hormonal regulation in insects: facts, gaps, and future directions. *Physiological Reviews* 77: 963–1032.

- Gaston KJ (2018) Lighting up the nighttime. *Science* 362: 744–746.
- Gaston KJ & Bennie J (2014) Demographic effects of artificial nighttime lighting on animal populations. *Environmental Reviews* 22: 323–330.
- Gaston KJ, Bennie J, Davies TW & Hopkins J (2013) The ecological impacts of nighttime light pollution: a mechanistic appraisal. *Biological Reviews* 88: 912–927.
- Gaston KJ, Visser ME & Hölker F (2015) The biological impacts of artificial light at night: the research challenge. *Philosophical transactions of the Royal Society B* 370: 20140133.
- Gaston KJ, Davies TW, Nedelec SL & Holt LA (2017) Impacts of artificial light at night on biological timings. *Annual Review of Ecology, Evolution, and Systematics* 48: 49–68.
- van Geffen KG, van Grunsven RHA, van Ruijven J, Berendse F & Veenendaal EM (2014) Artificial light at night causes diapause inhibition and sex-specific life history changes in a moth. *Ecology and Evolution* 4: 2082–2089.
- van Geffen KG, van Eck E, de Boer RA, van Grunsven RHA, Salis L et al. (2015) Artificial light at night inhibits mating in a geometrid moth. *Insect Conservation and Diversity* 8: 282–287.
- Goto SG (2013) Roles of circadian clock genes in insect photoperiodism. *Entomological Science* 16: 1–16.
- Grenis K, Tjossem B & Murphy SM (2015) Predation of larval Lepidoptera in habitat fragments varies spatially and temporally but is not affected by light pollution. *Journal of Insect Conservation* 19: 559–566.
- Grubisic M, van Grunsven RHA, Kyba CCM, Manfrin A & Hölker F (2018) Insect declines and agroecosystems: does light pollution matter? *Annals of Applied Biology* 173: 180–189.
- van Grunsven RHA, Lham D, van Geffen KG & Veenendaal EM (2014) Range of attraction of a 6-W moth light trap. *Entomologia Experimentalis et Applicata* 152: 87–90.
- Haim A & Zubidat AE (2015) Artificial light at night: melatonin as a mediator between the environment and epigenome. *Philosophical transactions of the Royal Society B* 370: 912–927.
- Hallmann CA, Sorg M, Jongejans E, Siepel H, Hofland N et al. (2017) More than 75 percent decline over 27 years in total flying insect biomass in protected areas. *PLoS ONE* 12: e0185809.
- Hardeland R & Poeggeler B (2003) Non-vertebrate melatonin. *Journal of Pineal Research* 34: 233–241.
- Heiling AM (1999) Why do nocturnal orb-web spiders (Araneidae) search for light? *Behavioral Ecology and Sociobiology* 46: 43–49.
- Henneken J & Jones TM (2017) Pheromones-based sexual selection in a rapidly changing world. *Current Opinion in Insect Science* 24: 84–88.
- Honnen AC, Johnston PR & Monaghan MT (2016) Sex-specific gene expression in the mosquito *Culex pipiens f. molestus* in response to artificial light at night. *BMC Genomics* 17: 1–10.
- Hopkins GR, Gaston KJ, Visser ME, Elgar MA & Jones TM (2018) Artificial light at night as a driver of evolution across urban–rural landscapes. *Frontiers in Ecology and the Environment* 16: 472–479.
- Itoh MT, Hattori A, Sumi Y & Suzuki T (1995) Day-night changes in melatonin levels in different organs of the cricket (*Gryllus bimaculatus*). *Journal of Pineal Research* 18: 165–169.
- Izmaylov DM & Obukhova LK (1999) Geroprotector effectiveness of melatonin: investigation of lifespan of *Drosophila melanogaster*. *Mechanisms of Ageing and Development* 106: 233–240.
- Izutsu M, Toyoda A, Fujiyama A, Agata K & Fuse N (2016) Dynamics of dark-fly genome under environmental selections. *G3: Genes, Genomes, Genetics* 6: 365–376.
- Jechow A, Kolláth Z, Ribas SJ, Spoelstra H, Hölker F & Kyba CCM (2017) Imaging and mapping the impact of clouds on skyglow with all-sky photometry. *Scientific Reports* 7: 1–10.
- Jechow A, Ribas SJ, Domingo RC, Hölker F, Kolláth Z & Kyba CCM (2018) Tracking the dynamics of skyglow with differential photometry using a digital camera with fisheye lens. *Journal of Quantitative Spectroscopy and Radiative Transfer* 209: 212–223.
- Jones MDR, Cubbin CM & Marsh D (1972) The circadian rhythm of flight activity of the mosquito *Anopheles gambiae*: the light-response rhythm. *Journal of Experimental Biology* 57: 337–346.
- Jones TM, Durrant J, Michaelides EB & Green MP (2015) Melatonin: a possible link between the presence of artificial light at night and reductions in biological fitness. *Philosophical Transactions of the Royal Society B* 370: 20140122.
- Knop E, Zoller L, Ryser R, Gerpe C, Hörler M & Fontaine C (2017) Artificial light at night as a new threat to pollination. *Nature* 548: 206–209.
- Kronfeld-Schor N, Visser ME, Salis L & van Gils JA (2017) Chronobiology of interspecific interactions in a changing world. *Philosophical Transactions of the Royal Society B* 372: 20160248.
- Kyba C, Mohar A & Posch T (2017) How bright is moonlight? *A&G Astronomy and Geophysics* 58: 1.31–1.32.
- Kyba CCM, Ruhtz T, Fischer J & Hölker F (2011) Cloud coverage acts as an amplifier for ecological light pollution in urban ecosystems. *PLoS ONE* 6: e17307.
- van Langevelde F, Ettema JA, Donners M, WallisDeVries MF & Groenendijk D (2011) Effect of spectral composition of artificial light on the attraction of moths. *Biological Conservation* 144: 2274–2281.
- van Langevelde F, van Grunsven RHA, Veenendaal EM & Fijen TPM (2017) Artificial night lighting inhibits feeding in moths. *Biology Letters* 13: 20160874.
- van Langevelde F, Braamburg-Annegarn M, Huigens ME, Groenendijk R, Poitevin O et al. (2018) Declines in moth populations stress the need for conserving dark nights. *Global Change Biology* 24: 925–932.
- Longcore T & Rich C (2004) Ecological light pollution. *Frontiers in Ecology and the Environment* 2: 191–198.
- Longcore T, Aldern HL, Eggers JF, Flores S, Franco L et al. (2015) Tuning the white light spectrum of light emitting diode lamps to reduce attraction of nocturnal arthropods. *Philosophical Transactions of the Royal Society B* 370: 20140125.
- Lunn RM, Blask DE, Coogan AN, Figueiro MG, Gorman MR et al. (2017) Health consequences of electric lighting practices

- in the modern world: a report on the National Toxicology Program's workshop on shift work at night, artificial light at night, and circadian disruption. *Science of the Total Environment* 607(608): 1073–1084.
- Macgregor CJ, Pocock MJO, Fox R & Evans DM (2015) Pollination by nocturnal Lepidoptera, and the effects of light pollution: a review. *Ecological Entomology* 40: 187–198.
- Macgregor CJ, Evans DM, Fox R & Pocock MJO (2017) The dark side of street lighting: impacts on moths and evidence for the disruption of nocturnal pollen transport. *Global Change Biology* 23: 697–707.
- Manfrin A, Singer G, Larsen S, Weiß N, van Grunsven RHA et al. (2017) Artificial light at night affects organism flux across ecosystem boundaries and drives community structure in the recipient ecosystem. *Frontiers in Environmental Science* 5: 61.
- Manfrin A, Lehmann D, van Grunsven RHA, Larsen S, Syväranta J et al. (2018) Dietary changes in predators and scavengers in a nocturnally illuminated riparian ecosystem. *Oikos* 127: 960–969.
- McLay LK, Green MP & Jones TM (2017) Chronic exposure to dim artificial light at night decreases fecundity and adult survival in *Drosophila melanogaster*. *Journal of Insect Physiology* 100: 15–20.
- de Medeiros BAS, Barghini A & Vanin SA (2017) Streetlights attract a broad array of beetle species. *Revista Brasileira de Entomologia* 61: 74–79.
- Merckx T & Slade EM (2014) Macro-moth families differ in their attraction to light: implications for light-trap monitoring programmes. *Insect Conservation and Diversity* 7: 453–461.
- Metzger M, Fischbein D, Auguste A, Fauvergue X, Bernstein C & Desouhant E (2010) Synergy in information use for mate finding: demonstration in a parasitoid wasp. *Animal Behaviour* 79: 1307–1315.
- Meyer LA & Sullivan MP (2013) Bright lights, big city: influences of ecological light pollution on reciprocal stream – riparian invertebrate fluxes. *Ecological Applications* 23: 1322–1330.
- Miller CR, Barton BT, Zhu L, Radeloff VC, Oliver KM et al. (2017) Combined effects of night warming and light pollution on predator-prey interactions. *Proceedings of the Royal Society B* 284: 20171195.
- Monaghan P, Metcalfe NB & Torres R (2009) Oxidative stress as a mediator of life history trade-offs: mechanisms, measurements and interpretation. *Ecology Letters* 12: 75–92.
- Mondy N, Rey B & Voituron Y (2012) The proximal costs of case construction in caddisflies: antioxidant and life history responses. *Journal of Experimental Biology* 215: 3453–3458.
- Moreau J, Desouhant E, Louâpre P, Goubault M, Rajon E et al. (2017) How host plant and fluctuating environments affect insect reproductive strategies? *Advances in Botanical Research* 81: 259–287.
- Owens AC & Lewis SM (2018) The impact of artificial light at night on nocturnal insects: a review and synthesis. *Ecology & Evolution* 8: 11337–11358.
- Owens ACS, Meyer-Rochow VB & Yang EC (2018) Short- and mid-wavelength artificial light influences the flash signals of *Aquaticia ficta* fireflies (Coleoptera: Lampyridae). *PLoS ONE* 13: 1–14.
- Pacheco-Tucuch FS, Ramirez-Sierra MJ, Gourbière S & Dumonteil E (2012) Public street lights increase house infestation by the chagas disease vector *Triatoma dimidiata*. *PLoS ONE* 7: 3–9.
- Pawson SM & Bader BK-F (2013) LED lighting increases the ecological impact of light pollution irrespective of color temperature. *Ecological Applications* 23: 515–522.
- Pawson SM & Bader MK-F (2014) LED lighting increases the ecological impact of light pollution irrespective of color temperature. *Ecological Applications* 24: 1561–1568.
- Perkin EK, Hölker F & Tockner K (2014) The effects of artificial lighting on adult aquatic and terrestrial insects. *Freshwater Biology* 59: 368–377.
- Reiter RJ, Tan DX, Rosales-Corral S & Manchester LC (2013) The universal nature, unequal distribution and antioxidant functions of melatonin and its derivatives. *Mini Reviews in Medicinal Chemistry* 13: 373–384.
- Rhainds M & Heard SB (2015) Sampling procedures and adult sex ratios in spruce budworm. *Entomologia Experimentalis et Applicata* 154: 91–101.
- Richter K, Peschke E & Peschke D (2000) A neuroendocrine releasing effect of melatonin in the brain of an insect, *Periplaneta americana* (L.). *Journal of Pineal Research* 28: 129–135.
- Russart KLG & Nelson RJ (2018a) Artificial light at night alters behavior in laboratory and wild animals. *Journal of Experimental Zoology A* 329: 401–408.
- Russart KLG & Nelson RJ (2018b) Light at night as an environmental endocrine disruptor. *Physiology and Behavior* 190: 82–89.
- Sanders D & Gaston KJ (2018) How ecological communities respond to artificial light at night. *Journal of Experimental Zoology A* 329: 394–400.
- Sanders D, Kehoe R, Tiley K, Bennie J, Cruse D et al. (2015) Artificial nighttime light changes aphid-parasitoid population dynamics. *Scientific Reports* 5: 15232.
- Sanders D, Kehoe R, Cruse D, van Veen FJF & Gaston KJ (2018) Low levels of artificial light at night strengthen top-down control in insect food web. *Current Biology* 28: 2474–2478.
- Schell CJ (2018) Urban evolutionary ecology and the potential benefits of implementing genomics. *Journal of Heredity* 109: 138–151.
- Secondi J, Dupont V, Davranche A, Mondy N, Lengagne T & Théry M (2017) Variability of surface and underwater nocturnal spectral irradiance with the presence of clouds in urban and peri-urban wetlands. *PLoS ONE* 12: 9–11.
- Shi L, Vasseur L, Huang H, Zeng Z, Hu G et al. (2017) Adult tea green leafhoppers, *Empoasca onukii* (Matsuda), change behaviors under varying light conditions. *PLoS ONE* 12: 1–17.
- Sih A, Ferrari MCO & Harris DJ (2011) Evolution and behavioural responses to human-induced rapid environmental change. *Evolutionary Applications* 4: 367–387.
- Smolensky MH, Sackett-Lundeen LL & Portaluppi F (2015) Nocturnal light pollution and underexposure to daytime sunlight: complementary mechanisms of circadian disruption and related diseases. *Chronobiology International* 32: 1029–1048.
- Somers-Yeates R, Hodgson D, Mcgregor PK, Spalding A & French-Constant RH (2013) Shedding light on moths: shorter

This chapter gave a global vision of the known consequences of artificial light at night on insect species, and research perspectives that should be developed in the coming years. The following chapter presents the biological model on which I worked during my thesis, and why it is a relevant species to study the biological consequences of nocturnal light pollution.

Chapter 3

The hymenopteran parasitoid *Venturia canescens*: a relevant biological model to study the effects of artificial light at night

1. Biological description of *Venturia canescens*

Parasitoids are holometabolous insects that are parasitic during their juvenile stages and become free-ranging as adults by killing their host. *Venturia canescens* Gravenhorst is an endoparasitoid wasp (Hymenoptera: Ichneumonidae) that lays its eggs in lepidopteran larvae in their second to fifth instar (Harvey & Thompson, 1995). Host species belong mainly to the Pyralidae family but *V. canescens* can also parasitise a great variety of species from other lepidopteran families (Salt, 1975, 1976). These hosts live concealed in substrates such as dried fruits (*e.g.* carob or fig), husks of almonds or stored products (*e.g.* grain or flour), some are therefore considered as agricultural pests (*e.g.* *Ephestia kuehniella* Zeller or *Plodia interpunctella* Hübner). Parasitoid females locate their hosts using kairomone, a mandibular gland secretion released by lepidopteran larvae when feeding (Castelo *et al.*, 2003; Corbet, 1971), then search for them by probing the substrate with their ovipositor. A successful oviposition is followed by a specific movement of the abdomen, called “cocking” (Figure 9), by which the female places a new egg in the tip of its ovipositor for the next oviposition (Rogers, 1972). Hosts continue to grow when parasitized (koinobiont parasitoid, Corbet, 1968) and at most one egg per host can develop into an adult (solitary parasitoid). In this species, development from egg to adult lasts about 21 days at 25°C. *V. canescens* females are synovigenic (Jervis *et al.*, 2001) which means that they emerge with a certain amount of mature eggs but continue to produce additional eggs throughout their adult stage. These eggs are hydropic, which means they are yolk-deficient and do not contain energy reserves (Le Ralec, 1995). They therefore absorb nutrients from the host’s haemolymph.

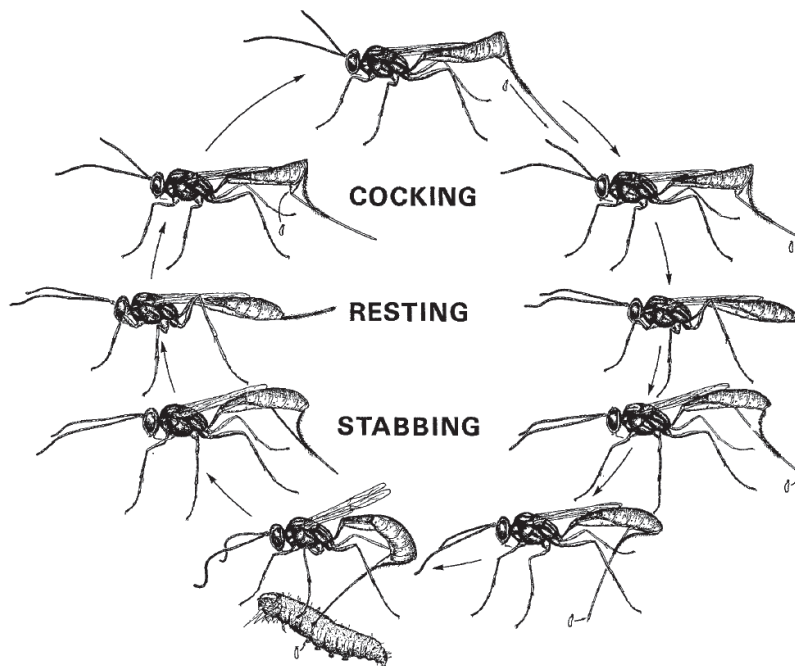

Figure 9 Movement at different stages of the egg-laying process in *Venturia canescens*. The position of the egg is shown at each stage (from Rogers, 1972).

In natural conditions, *V. canescens* feeds on sugary sources such as nectar or honeydew (Casas *et al.*, 2003; Desouhant *et al.*, 2010). In laboratory conditions, diluted honey or sucrose solution are very frequently used to feed the insects in rearing cages or during experiments.

There are two reproductive modes in *V. canescens*. On one hand, arrhenotokous populations have both male and female individuals that reproduce sexually, following the haplodiploid mechanism classically found in hymenopterans. On the other hand, thelytokous populations have only females that reproduce asexually by automictic parthenogenesis, which maintains a certain degree of heterozygosity for loci near the centromere (obligate thelytoky without endosymbiont influence, Beukeboom & Pijnacker, 2000). Offspring of thelytokous females can therefore be slightly genetically different from their mother and from each other (Beukeboom & Pijnacker, 2000). Arrhenotokous and thelytokous populations coexist in the same geographical areas but thrive in distinct habitats with different features resource and environmental variability (Pelosse *et al.*, 2007; Schneider *et al.*, 2002). Arrhenotokous individuals live exclusively in natural habitats such as orchards while thelytokous individuals prefer the anthropogenic environment of buildings with stored products such as mills or granaries (although thelytokous wasps can sometimes be found in natural environment; Amat, 2004). The two reproductive modes also differ in various life-history and behavioural traits that are adaptive responses to the environmental conditions they encounter (Amat *et al.*, 2017). This

ecological differentiation seems to be the main reason for the coexistence of the sexual and asexual forms in *V. canescens* (Amat *et al.*, 2017). As my thesis work was the first study on the effects of light pollution in *V. canescens*, I worked exclusively on thelytokous females. Thelytokous wasps live mainly in anthropogenic environments, which are more likely to be exposed to strong artificial light at night. However, because they are sometimes found in natural habitats, thelytokous individuals can also experience low intensity light pollution through skyglow. Moreover, since we did not plan to study light pollution effects on behaviours related to mate choice, using thelytokous strain allowed us to work on larger sample sizes than if we had used individuals from a sexual strain.

2. A relevant biological model to study the effects of artificial light at night

Venturia canescens has many advantages when it comes to investigating the consequences of artificial light at night on insects.

More than 60% of all invertebrates are nocturnal (Hölker, Wolter, *et al.*, 2010), which led scientists studying light pollution effects on insects to focus almost exclusively on nocturnal species such as moths (Langevelde *et al.*, 2018; Macgregor *et al.*, 2015; Wakefield *et al.*, 2018). Daytime and nighttime responses of diurnal insects to light at night are therefore not well known. *V. canescens* is considered to be diurnal because it shows no nocturnal activity in the dark (E. Desouhant and L. Froissart personal observation, confirmed by Gomes *et al.*, 2021). However, individuals are attracted to light during the day (Gomes *et al.*, 2019). At night, this positive phototaxis may thus attract resting wasps out of potential dark refuges and expose them to strong intensities of artificial light. Moreover, their hosts live concealed in the substrate, which protects them from artificial light at night (at the larval stage at least). In experimental laboratory conditions, it therefore allows to test the effects of light at night on parasitoid wasps while excluding the potential interaction with the host responses to light at night.

Since the 1970s, *V. canescens* has been extensively used for a range of behavioural studies on, among others, foraging (Desouhant *et al.*, 2005, 2010; Driessen & Bernstein, 1999), responses to environmental variables such as temperature (Amat *et al.*, 2006; Foray *et al.*, 2014), cognition (Amat *et al.*, 2009; Froissart *et al.*, 2017) or associative learning (Arthur, 1971; Lucchetta *et al.*, 2008). This species has also been studied from a physiological perspective, with a focus on energy allocation and dynamics (Amat *et al.*, 2012; Casas *et al.*, 2003) and methodological

developments to estimate energy reserves (Foray *et al.*, 2012). The behavioural repertoire of *V. canescens* is therefore well described, such as the behavioural sequence leading to egg laying (Rogers, 1972; Figure 9). Thanks to their relatively large size (between 0.7 and 1 cm), individuals are easy to observe and manipulate, which enables the design of various behavioural tests (*e.g.* Gomes *et al.*, 2019; Castelo *et al.*, 2003). As in other parasitoids, the biological characteristics of *V. canescens* allow also the measure of major life-history traits. For example, estimating the selective value of an individual requires measuring both its longevity and reproductive success. These two components can be accessed relatively easily in *V. canescens* in laboratory experiments. When fed regularly, *V. canescens* can live up to two or three weeks in the lab (Desouhant *et al.*, 2005), which allows monitoring precisely the lifespan of individuals. Reproductive success can also be estimated in different ways. Females can be presented with patches containing a defined number of hosts in which they can lay eggs, and the number of adult parasitoids produced from these hosts subsequently recorded. This method has been used by numerous studies to compare the reproductive success between different experimental conditions (*e.g.* Pelosse *et al.*, 2011) or to estimate the lifetime reproductive success of females monitored throughout their lives (Harvey *et al.*, 2001). The number of observed “cocking” movements may also be used as a proxy of parasitism rate, because it is considered a reliable signal of a successful oviposition (Amat *et al.*, 2003).

Finally, in chapter 2, we highlighted a lack of knowledge about the evolutionary consequences of light artificial light at night on insects. Easy to breed and with a short generation time, *V. canescens*, especially from arrhenotokous strains, would be of great interest to study the long-term effects of nocturnal light pollution by means of trans-generational or experimental evolution experiments. Arrhenotokous strains could also be used to investigate the consequences of artificial light at night on behaviours related to sexual selection.

Venturia canescens is a relevant model to investigate the consequences of artificial light at night on diurnal species. Indeed, its numerous biological characteristics and the existence of asexual and sexual strains make it possible to address various questions, from behavioural modifications to effects of light at night over one or several generations. Moreover, parasitoids being one of the most important group of insects used in biological control of agricultural pests (Wajnberg *et al.*, 2008), studying their responses to light pollution in terms of parasitic efficiency or fitness can also be important from an economic perspective.

Chapter 4

Thesis objectives

This thesis takes place in the growing body of work tackling the multiple and various consequences of light pollution on organisms. A recent meta-analysis by Sanders *et al.* (2020) showed that modifications due to light pollution are widespread, affecting from microbial communities to vertebrates, as well as plants. They identified a broad array of biological consequences on these organisms (for instance on physiology, life history traits or populations and communities), with strong effect sizes for most of them. The breadth and strength of these biological impacts highlights the fact that artificial light at night can be as important a driver of global change as global warming, and need to be considered as such.

Despite this growing awareness about impacts of light pollution on our environment, there is still a bias regarding which taxa are studied. Indeed, the aforementioned meta-analysis included 746 effect sizes for vertebrates, and only 388 for invertebrates (Sanders *et al.*, 2020). Although insect responses to ALAN are being studied increasingly at several biological levels (Desouhant *et al.*, 2019), insect's diversity and major ecological roles require more in-depth knowledge about how these organisms can be impacted by such an anthropogenic disturbance. Moreover, many studies still focus on nocturnal species (*e.g.* moths Macgregor *et al.*, 2015), even though ALAN effects on diurnal species can also be significant (Sanders *et al.*, 2020). Therefore, less is known about consequences of light at night on the activity, behaviours and life-history traits of diurnal insects.

Within this context, the main goal of my thesis is to tackle the question of ALAN-induced modifications in a diurnal parasitoid, the wasp *Venturia canescens* (Hym. Ichneumonidae). We took an integrative approach by experimentally studying changes in behavioural, life-history and physiological traits under various light pollution regimes. To do so, my work was divided in two parts.

Part II focuses on the effects of ALAN on behavioural traits related to parasitic efficiency and lifetime reproductive success measures, linked to potential underlying physiological mechanism. In this part, we aimed to answer the following questions:

1. Does ALAN influence decision-making linked to foraging for hosts or food in *V. canescens*, at both intra- and inter-generational levels? (Chapter 5)

A frequent hypothesis is that light pollution increases the duration of activity in diurnal species, which may have repercussions on individual traits such as body condition. In *V. canescens*, the trade-off between current and future reproduction depends on the choice made by the wasps between searching for hosts (*i.e.* reproduce immediately), or searching for food (*i.e.* increasing their probability to lay eggs in the future). How to allocate time between the two behaviours is thus crucial for a wasp's fitness. In this species, this decision is underlain by physiological state (Desouhant *et al.*, 2005). We made the hypothesis that ALAN, by modifying the activity pattern of wasps, could affect their physiological condition and therefore their decision-making process during the day. We tested that hypothesis experimentally, combining behavioural tests (activity, choice, egg-laying) and biochemical assay of energy budget on wasps either exposed to two intensities of light at night or in the dark at night. Taking advantage of the short generation time of our study species, we also tested if ALAN can act at the trans-generational level. To do so, we examined body condition and behaviour of wasps whose mother were exposed to light at night.

In addition to choosing between foraging for hosts or food, fitness of *V. canescens* also depends on the quality of hosts in which females lay their eggs. The decision whether to parasitize a healthy host (high quality) or an already parasitized one (low quality), which is called superparasitism, is also state-dependent (Sirot *et al.*, 1997). We therefore made the hypothesis that, if ALAN influences the wasps' physiological state, it would increase their tendency to superparasitize during the day. We tested this experimentally on wasps exposed or not to light at night.

This chapter is composed of an introduction that reviews the effects of light pollution on activity patterns, foraging behaviour and reproductive traits, with a focus on the responses of diurnal species. The results on nocturnal activity and decision-making between hosts and food are then presented in the form of an article, which has been published in *Insect Conservation and Diversity* in 2021. It is followed by a section describing the context and results of the experiment on superparasitism.

2. Does ALAN impact the lifetime reproductive success of *V. canescens*? (Chapter 6)

This chapter results directly from the previous one, and aims to deepen our understanding of the fitness consequences of ALAN. Indeed, we determined that ALAN elicited nocturnal movement in *V. canescens*, but we do not know if the wasps can indeed take advantage of this extended period of activity in a way that influence their fitness. Presence of illuminated night may be beneficial for diurnal species, that could use the so called “night-time niche” to gain resources (food or reproduction opportunities for instance). It has been demonstrated in some occasions (Frank, 2009; Maurer *et al.*, 2019), but the actual consequences on individual fitness have not been truly tested yet.

With this in mind, we created an experimental design to assess the feeding and patch exploitation behaviours of *V. canescens* both during the day and at night. The wasps were either in the dark at night, or exposed to two intensities of light at night. By following the wasps until their death, we quantified the effect of ALAN on longevity and lifetime reproductive success, the two components of fitness. Such longitudinal study also allowed us to tackle the question of difference in rates of senescence between various night-time lighting conditions.

This chapter presents the results in the form of an article entitle ‘Artificial light and foraging at night in a diurnal insect: consequences on lifetime reproductive success and senescence’, which is in preparation.

Part III focuses on a physiological trait, melatonin, which is a key hormone mainly involved in the regulation of circadian rhythm in organisms. This hormone is strongly impacted by the presence of light at night, and is likely to play a part in the phenotypic changes observed in organisms exposed to light pollution (Jones *et al.*, 2015). Chapter 7 reviews the biosynthesis and roles of melatonin, both in vertebrates and invertebrates, as well as what we know about ALAN consequences on this hormone production and its link with other traits. Whereas the dynamics of melatonin is well-known in vertebrates, there is no clear and conserved pattern between insect species. To ascertain if and how melatonin production in *V. canescens* is affected by ALAN, it is thus fundamental to describe its baseline dynamics. Therefore, I aimed to answer to the following question:

3. How does melatonin level vary over a 24-hour cycle in *V. canescens* in the absence of ALAN? (Chapter 8)

This chapter describes the methodological developments that I carried out to measure melatonin over a 24-hour period in *V. canescens*. I developed two methods to quantify melatonin in our study species: a direct quantification through biochemical analysis, and an indirect quantification by measuring the expression of two genes coding for enzymes involved in the melatonin biosynthesis pathway. These two methods were then applied on biological samples, consisting of heads of wasps raised in absence of light at night and collected at regular intervals over a 24-hour period, in order to describe the dynamics of melatonin from different perspectives. This work is exploratory, and was planned to be followed by further studies. A foreword thus precedes Chapter 8, to explain how describing the dynamics of melatonin in *V. canescens* was supposed to fit in a broader aim.

This chapter 8 consists of 3 parts: the first describes the two methods developed to quantify melatonin in *V. canescens*, the second presents the implementation of these methods to determine the dynamics of melatonin over a 24-hour period and the third compares the results with what is known about melatonin quantification and variation in insect species.

PART II

CONSEQUENCES OF ARTIFICIAL LIGHT AT NIGHT FROM A BEHAVIOURAL PERSPECTIVE

Foremost

This second part focuses on the consequences of artificial light at night on behavioural and life-history traits influencing parasitic efficiency in the parasitoid wasp *Venturia canescens*. It is composed of two chapters.

Chapter 5 is built around an article published in *Insect Conservation and Diversity* in 2021, which investigates the influence of ALAN on decision-making between foraging for hosts or food in *Venturia canescens* at intra- and trans-generational levels. This article is followed by a sub-section focusing on the consequences of artificial light at night in terms of choice between parasitizing high- or low-quality hosts.

Chapter 6 is built around an article in preparation, which tackles the question of the fitness consequences of artificial light at night by investigating its consequences on the lifetime reproductive success of *Venturia canescens*.

Chapter 5

Consequences of artificial light at night on decision-making in *Venturia canescens* at intra- and inter-generational levels: focus on foraging behaviour

1. Introduction

1.1. Disruption of foraging behaviours by artificial light at night in nocturnal organisms

Consequences of light pollution have been extensively studied in nocturnal species because they represent a large part of biodiversity. Around 30% of vertebrates, and among them 70% of mammals (Bennie *et al.*, 2014), and more than 60% of invertebrates are nocturnal (Hölker, Wolter, *et al.*, 2010). In these species, artificial light at night has many consequences (reviewed in Desouhant *et al.*, 2019; Owens & Lewis, 2018; Russart & Nelson, 2018) and can, in particular, strongly influence foraging and reproductive behaviours, as illustrated below with some examples.

Artificial light at night can reduce foraging behaviour in vertebrate and invertebrate nocturnal species. The Santa Rosa beach mouse (*Peromyscus polionotus leucocephalus*) exploited fewer food patches, and less intensively, when artificial lighting was present in natural conditions (Bird *et al.*, 2004). A similar result was found in an invertebrate, the amphipod *Orchestoidea tuberculata*, whose feeding activity was reduced under high intensity of light at night (Luarte *et al.*, 2016). In insects, males of two weta species (*Hemideina thoracica* and *Rhaphidophoridae*) avoided illuminated sites at night (Farnworth *et al.*, 2018) and night-time feeding behaviour was reduced in several species of moths exposed to light pollution (Langevelde *et al.*, 2017). In addition to modifications in foraging behaviour intensity, studies on nocturnal rodents also demonstrated that artificial light at night could shift the timing of feeding from night-time to daytime (Fonken *et al.*, 2013, 2010).

Artificial light at night also influences reproductive behaviours in nocturnal organisms. One of its most well-known consequences is the impact on fireflies and glow worms signalling behaviour, with for instance a reduction in bioluminescent flashing activity used in courtship behaviour (Firebaugh & Haynes, 2016). Night-time lighting has also been shown to disrupt reproductive behaviours in amphibians, such as the common toad (*Bufo bufo*) in which low intensities of artificial light at night affected the ability of males to pair with females and reduced their fertilisation rate (Touzot *et al.*, 2020), or in reptiles, with numerous studies on the effect of light pollution on sea turtles breeding behaviour (*e.g.* choice of nest site, spawning) for example (Falcón *et al.*, 2020).

Evidence that nocturnal organisms are strongly affected by the presence of artificial light at night is abundant, and the negative impact of this anthropogenic disturbance has been highlighted by a recent meta-analysis (Sanders *et al.*, 2020). However, nocturnal species could also benefit from illuminated nights, as has been shown in some urban exploiters bats that hunt around light sources attracting insects (Bolliger *et al.*, 2020; Rydell, 1992) or in estuarine birds that increase the intensity of their nocturnal foraging behaviour in illuminated intertidal areas (Santos *et al.*, 2010). For a long time, diurnal organisms thought to be less affected by artificial light at night than nocturnal ones, because their usual activities take place in presence of light. However, studies on the (beneficial or adverse) effects of light at night are more frequent and highlight the fact that light pollution can, indeed, alter biological functions/traits in diurnal species (Sanders *et al.*, 2020).

1.2. Can night-time artificial lighting impact behaviours and physiology during the day?

The specific case of diurnal species

1.2.1. Daily activity patterns

In diurnal organisms, one of the best-known consequences of the presence of artificial light at night is the modification of the locomotor activity patterns. This phenomenon has mainly been studied in birds. During the breeding season in the common swift (*Apus apus*) for example, very high intensity of artificial light at night promoted locomotor activity throughout the night while individuals exposed to low ALAN ceased activity and joined their nest at sunset, which is the classical behaviour in this species in absence of light at night (Amichai & Kronfeld-Schor, 2019). However, this observation is rather original because in many bird species, the most reported consequence of light at night is an advanced onset of activity (*i.e.* individuals start their locomotor activity before dawn; *e.g.* Kempnaers *et al.*, 2010). In sites exposed to low intensity of ALAN, the locomotor activity of male European blackbirds (*Turdus merula*) started up to 1 hour earlier in the morning than in a site without light pollution (Dominoni *et al.*, 2014). In the great tit (*Parus major*), the effect of light at night on the timing of daily activity was also strong in the morning, and increased with ALAN intensity (de Jong *et al.*, 2016). Birds exposed to 0.5 lux of light at night became active half an hour before dawn, while the onset of activity could be advanced by more than 5 hours in birds exposed to 5 lux of light at night (de Jong *et al.*,

2016). To a lesser extent, this species also modified its activity pattern after dusk in response to light at night. Individuals stayed active longer at the end of the day, therefore increasing the part of their active period that took place during the night. However, a higher amount activity during the night led to a lower amount during the day, because there was no increase in the total amount of activity during a 24-hour cycle (de Jong et al., 2016). Finally, the timing to which birds are exposed to light at night can influence their response to this perturbation. A study on Indian weaver birds (*Ploceus philippinus*) showed that presence of artificial light throughout the night or for 4 hours at the end of the night led to an earlier onset of activity (Kumar et al., 2018). However, when birds were exposed to ALAN for 4 hours at the beginning of the night, they extended their daytime activity into the night, delaying their offset of activity (Kumar et al., 2018). Nevertheless, in bird species, these changes in activity pattern are likely to depend on the time of the year. In *T. merula*, a strong seasonal effect was detected, with more pronounced modifications in the early breeding season (Dominoni et al., 2014).

Patterns of locomotor activity under ALAN have also been studied, less extensively, in other diurnal vertebrates but with less consistent results. In rodents, Nile grass rats (*Arvicanthis niloticus*) exposed to dim light at night maintained a diurnal locomotor activity pattern, without differences in onset or offset of activity due to night-time light exposure (Fonken et al., 2012). The same type of result was found in the diurnal golden spiny mouse (*Acomys russatus*), which did not extend its locomotor activity into the night when exposed to artificial light (Rotics et al., 2011). However, the absence of effect of light at night may be due to the presence of a nocturnal competitors (the spiny mouse *Acomys cahirinus*) (Rotics et al., 2011). On the contrary, a study on two diurnal lizard species (*Anolis leachii* and *Anolis wattsi*) showed that individuals exposed to artificial light at night were active at night, with an activity peak in early morning hours (Maurer et al., 2019).

Daily activity patterns have been particularly well-studied in relation with light at night for diurnal vertebrate species. However, whether exposure to artificial lighting at night could also have consequences on daytime behaviours is an issue that has been less frequently studied in diurnal species.

1.2.2. Can exposure to artificial light at night alter foraging and reproductive behaviours during the day?

Evidence of daytime consequences of artificial light at night come mainly from birds, with a seemingly strong effect on timing of reproductive physiology in these species. Photoperiod is a crucial environmental cue timing the start of egg-laying in birds (Lambrechts *et al.*, 1997). A common hypothesis is therefore that artificial light at night can influence the birds' decision on when to lay eggs because it interferes with photoperiod by altering the perception of day length. Earlier egg-laying dates in presence of artificial lighting have been observed in several bird species. Blue tits (*Cyanistes caeruleus*) living near street lights laid eggs 1.5 days earlier than their counterparts living in dark areas (Kempnaers *et al.*, 2010), whereas light intensity of 1 lux at night advanced egg-laying by 6 days in the European blackbird *T. merula* (Russ *et al.*, 2017). Another study on blackbirds exposed to 0.3 lux of artificial light at night for 2 years showed that in the first year, egg-laying, but also gonadal growth, were advanced by 1 month (Dominoni, Quetting, *et al.*, 2013a). In addition, in the second reproductive cycle, birds showed no sign of reproductive activity throughout the entire breeding season because of an absence of gonadal development (Dominoni, Quetting, *et al.*, 2013b). Light at night also altered other traits related to reproduction in birds, such as nest site selection (Russ *et al.*, 2017) or nest building (Holveck *et al.*, 2019). Birds built thinner nests when exposed to artificial light from lampposts, which would be beneficial because they are less costly to build and could provide better protection against predation (Holveck *et al.*, 2019). However, many of these studies are conducted in the field, comparing natural versus urbanised habitats. Urbanization is characterised by a strong presence of artificial lighting, but other factors (such as chemical pollution) could also participate in the behavioural changes observed in the reproductive biology of birds (Russ *et al.*, 2015). Nevertheless, continuous exposure to artificial light at night is highly likely to have a great impact on reproduction in diurnal vertebrate species. Studies on insects are less frequent. In *Drosophila melanogaster*, mating occurs during daylight hours (Sakai & Ishida, 2001). A recent study showed that rather low intensity of light at night (10 lux) modified the flies' mating behaviour during the day (McLay *et al.*, 2018). Exposed individuals increased their time spent courting, however the probability to copulate and duration of copulation were not affected by light at night (McLay *et al.*, 2018). Physiological mechanisms underlying these behavioural changes have yet to be identified, but a potential and often cited

candidate is the relationship between light at night and melatonin secretion (Dominoni, Quetting, *et al.*, 2013a; Durrant *et al.*, 2015; Russ *et al.*, 2017; see also Chapter 7 of this thesis). Evidence of daytime modifications in foraging behaviour due to the presence of light at night are scarce. In great tits for example, although artificial light at night did not influence the onset, offset or duration of daily activity in breeding adults, the latter increased the feeding rate of their offspring during the day (Titulaer *et al.*, 2012). The authors made two hypotheses to explain this behavioural modification. First, presence of light at night could alter the perception of the season by breeding birds, leading them to increase their foraging activity to provide offspring with enough food and improve their survival probability (Titulaer *et al.*, 2012). Second, night-time lighting may influence the parents' foraging behaviour indirectly by increasing the begging behaviour of offspring (Titulaer *et al.*, 2012). Foraging behaviour of diurnal insects exposed to artificial light at night does not appear to have been studied yet.

1.2.3. Physiological consequences of artificial light at night in diurnal species: a focus on energy reserves

As presented in the previous section, light pollution has behavioural consequences on diurnal species by altering their daily activity patterns or the timing of some fitness-related behaviours. This disturbance can also have various physiological consequences, such as effects on energy reserves and metabolism which have been mainly studied in humans and nocturnal rodents. Light at night is thought to be involved in the development of obesity and metabolism disorders in night-shift workers (Nelson & Chbeir, 2018) or weight gain in mice (Fonken *et al.*, 2010). Some studies also investigate the influence of light at night on physiological mechanisms such as metabolism in diurnal species, whether in laboratory or more natural conditions. A hypothesis about diurnal species is that additional activity induced by artificial light at night may lead to a greater energy expenditure and impact energy reserves of individuals. The rockfish *Girella laevis*, which exhibits a diurnal peak of activity under 12h:12h light/dark cycle, had increased activity level and higher oxygen consumption increase when exposed to high intensity of light at night (Pulgar *et al.*, 2019). On the contrary, great tits (*Parus major*) breeding in natural areas did not show an increase of their daily energy expenditure under ALAN conditions (Welbers *et al.*, 2017). Individuals exposed to light at night had lower daily energy expenditure than control ones, which was not expected because birds can have higher

activity levels, during the day and at night, in presence of light pollution (Alaasam *et al.*, 2018; Titulaer *et al.*, 2012). The authors suggested several hypotheses to explain this result, and the most likely is that artificial light at night increased food availability by impacting caterpillar biomass in the study sites (Welbers *et al.*, 2017). Artificial light at night could therefore have an indirect effect on energy metabolism by influencing food availability and consumption. By being active at unusual times during a 24-hour cycle, individuals exposed to light pollution could have access to new food resources and experience changes in body condition. There is mixed evidence that artificial light at night increases food intake in diurnal species. Several studies showed that body condition of individuals exposed to light at night was not modified (*e.g.* in the diurnal toad *Melanophryniscus rubriventris*, (Gastón *et al.*, 2019) or in the brown anole *Anolis sagrei*, (Thawley & Kolbe, 2020), although an increase in growth rate could sometimes be observed (Thawley & Kolbe, 2020). In the zebra finch (*Taeniopygia guttata*), which is usually active in the light phase under light/dark conditions, individuals exposed to low intensity of artificial light at night (0.3 lux) were active throughout the night but did not increase their food consumption and did not lose body mass (Alaasam *et al.*, 2018). Another study on zebra finches showed modifications in the feeding pattern of birds exposed to 5-lux artificial light at night (Batra *et al.*, 2019). They had a greater number of feeding bouts and increased feeding duration during the night compared to control birds, and also exhibited a higher body mass gain (Batra *et al.*, 2019). However, the total food intake was not different between control and light-polluted individuals. The authors suggest that this result may be due to the birds feeding at an unusual time of the day (*i.e.* at night for a diurnal species), as it has been observed in nocturnal species feeding during the day (Fonken *et al.*, 2010). Similarly, in a diurnal rodent (*Arvicanthis ansorgei*), light at night did not modify the amount of food consumed by the individuals (Masís-Vargas *et al.*, 2019). However, artificial light increased the sugar intake of individuals during the night (depending on the diet provided) (Masís-Vargas *et al.*, 2019).

Artificial light at night therefore seems to impact energy metabolism in diurnal vertebrates, although the exact mechanisms underlying these changes have not been identified yet. Such studies do not seem to have been conducted on insects, although some behaviours are known to be state-dependent in these species (Bodin *et al.*, 2009; Desouhant *et al.*, 2005). Therefore, knowing whether light pollution affects the physiological status of individuals in terms of

metabolism and energy reserves may be important to understand their behavioural response to this artificial light at night.

- 2. Dealing with host and food searching in a diurnal parasitoid:
consequences of light at night at intra- and trans-generational levels**
(published in *Insect Conservation and Diversity* in 2021)

**Dealing with host and food searching in a diurnal
parasitoid: consequences of light at night at
intra and trans-generational levels**

Light pollution alters foraging in wasps

Gomes Elisa¹, Rey Benjamin¹, Débias François¹, Amat Isabelle¹,
Desouhant Emmanuel¹

¹ Univ. Lyon, Université Lyon 1, CNRS, UMR 5558, Laboratoire de Biométrie et Biologie
Evolutive (LBBE), Villeurbanne, France

Corresponding author:

Gomes Elisa, Biométrie et Biologie Evolutive, UMR CNRS 5558, Université Claude Bernard
Lyon1, Bât. Gregor Mendel, 43 bd du 11 novembre 1918, F-69622 Villeurbanne cedex,
France

E-mail address: elisa.gomes@univ-lyon1.fr

Abstract

1. Light pollution is a widespread phenomenon with major consequences on nocturnal organisms from individual to community. However, its effects on diurnal organisms are still scarcely studied.
2. We exposed diurnal parasitoid wasps (*Venturia canescens*) to low (0.7 lux) or high (20 lux) artificial light for two to eight consecutive nights, and quantified its consequences on their physiology and daytime behaviour compared to a control group (0 lux). We next considered potential trans-generational effects on offspring whose mothers were exposed to light pollution.
3. While in the dark night the wasps showed no activity, exposure to artificial light triggered nocturnal activity and altered diurnal behaviours related to foraging. Wasps exposed to light at night had a greater propensity to choose hosts rather than food compared to controls. They also spent more time feeding when exposed to 0.7 lux of light at night. However, these behavioural modifications were not related to changes in individual energy reserves.
4. Light pollution effects persisted at trans-generational level: offspring development time and latency before feeding increased when mothers were exposed to 0.7-lux light at night.
5. Even at low intensity, light pollution alters foraging behaviour of a diurnal insect. Searching for hosts or food being essential for fitness, light pollution is likely to have long-term repercussions on insect populations.
6. Light pollution caused behavioural modifications potentially beneficial for *V. canescens* in the short term. However, longer term studies (*e.g.* on lifetime reproductive success) are needed to fully understand its consequences on insects.

Key-words: Artificial light at night; *Venturia canescens*; foraging behaviour; population conservation; life history traits; energy reserves

Graphical Abstract:

Daytime and nighttime behavioural modifications in the parasitoid
Venturia canescens due to artificial light at night

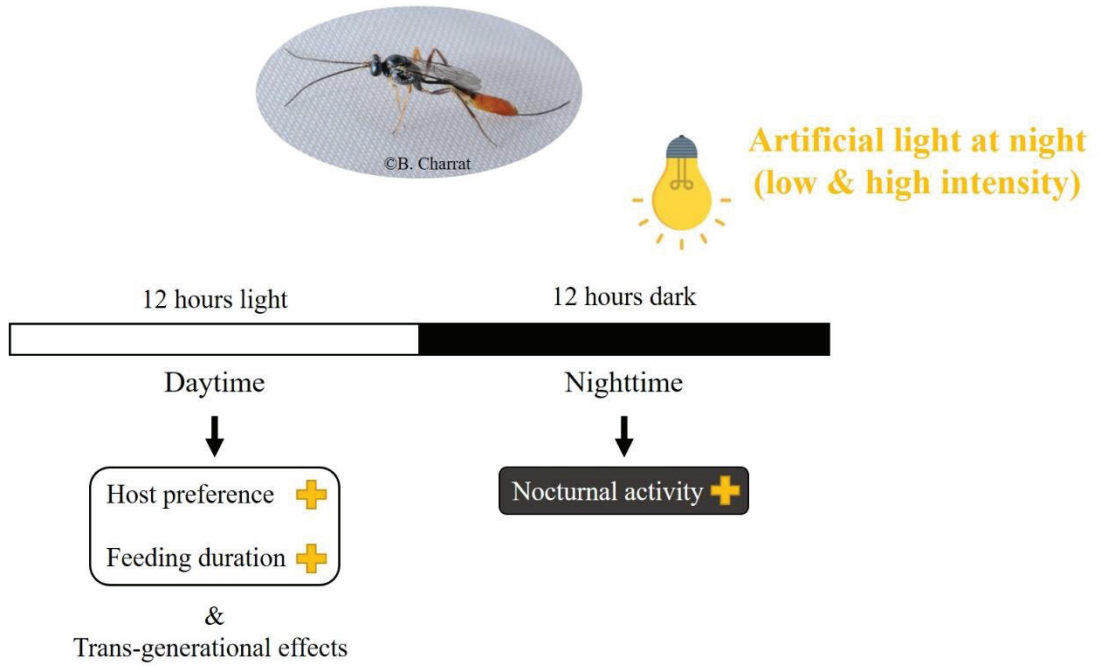

INTRODUCTION

Ecosystems are mostly studied during the daytime without considering the ecological differences between daytime and nighttime in terms of ambient temperatures, species assemblages or light intensity (Gaston, 2019). Before the development of urban areas and the intensification of artificial lighting, daily light cycles remained rather invariant at a given time of the year. They represent a key clue shaping the timing of major biological events, such as the synchronization of zooplankton diel movement or singing patterns in birds (Gaston *et al.*, 2017). However, in the recent decades, they have been affected by the outbreak of artificial light at night, also called light pollution, a major anthropogenic disturbance.

Light pollution comes from anthropogenic sources of light that disrupt the natural patterns of light and dark and the lighting levels at night in the ecosystems (Longcore & Rich, 2004), either directly because of street lighting or car headlights, or indirectly through skyglow. The latter represents the artificial light scattered into the atmosphere by clouds, aerosols or gas molecules and that spreads over hundreds of kilometres (Luginbuhl *et al.*, 2014). Light pollution is thus a widespread phenomenon that affects not only urban areas but most ecosystems, including protected areas (Guetté *et al.*, 2018). Indeed, 23% of the Earth's land surfaces are exposed to artificial light at night and this number increases steadily by 6% per year (Falchi *et al.*, 2016). Until recently, light pollution had received less attention as a component of global change than other phenomena such as global warming, but a growing number of studies have now revealed the numerous and negative biological consequences of this light at night on many organisms (Bennie *et al.*, 2016; Gaston *et al.*, 2014; Hölker *et al.*, 2010). Insects seem particularly affected by artificial light at night, which has consequences at individual, population and ecosystem levels (Boyes *et al.*, 2020; Desouhant *et al.*, 2019). Artificial light at night has also been identified as a factor that could drive the decline of insect populations (Langevelde *et al.*, 2018), raising questions about their conservation. Given that many insect species are involved in ecosystemic services, light pollution could thus lead to serious environmental and economic consequences (*e.g.* effects of artificial light at night on pollination, Knop *et al.*, 2017).

So far, most studies have been conducted on nocturnal insect species (*e.g.* Macgregor *et al.*, 2015; Wakefield *et al.*, 2018), in which artificial light at night causes direct behavioural changes, such as reduced feeding activities in moths (Langevelde *et al.*, 2017) or flashing activity in fireflies in the context of sexual selection (Firebaugh & Haynes, 2016), but also modifications in species interactions (Miller *et al.*, 2017). Artificial light at night can also have

an impact on diurnal species by extending the photophase and modifying their diel partition time (as shown in vertebrates such as birds, Lebbin *et al.*, 2007, or lizards, Maurer *et al.*, 2019). We thus proposed that a longer photophase could extend the activity of diurnal insects during the night and allow them to exploit new resources, but likely at the cost of greater energy expenditure. Given that decision-making may be state-dependent in insects (*e.g.* the haematophagous bug *Rhodnius prolixus*, Bodin *et al.*, 2009, or the parasitoid wasp *Venturia canescens*, Desouhant *et al.*, 2005), increasing night-time activity could lead to daytime modifications of behaviours such as foraging. Changes in foraging activities under artificial light at night have rarely been investigated in diurnal insects, but one study showed that a diurnal arthropod, the spider *Platycrypus undatus*, hunts at night in artificially lit areas (Frank, 2009). Therefore, more knowledge is needed on the extension of foraging activity into the lit night, and its potential consequences on energy and fitness for diurnal insects (but see McLay *et al.*, 2017, 2018, for consequences of artificial light at night on life history traits in the diurnal *Drosophila melanogaster*).

Beyond immediate phenotypic responses on organisms, environmental stressors can also have long-lasting consequences on the phenotype of subsequent generations through trans-generational effects. These occur when environmental conditions experienced by parents affect the phenotype of their offspring without alteration of the DNA nucleotide sequence (Bonduriansky & Day, 2009). Trans-generational effects are well documented in response to multiple environmental stresses. In insects, they are known to occur in response to predation risk (Keiser & Mondor, 2013) or mild heat stress (Ismaeil *et al.*, 2013). However, to the best of our knowledge, the question of whether or not artificial light at night can cause phenotypic modifications transmissible to the offspring remains unanswered.

The aim of this study was to investigate the effects of artificial light at night on the physiology and behaviour of a diurnal parasitoid wasp, *Venturia canescens*, at both intra and trans-generational levels. We exposed wasps to three controlled experimental conditions: no light at night (control), low (0.7 lux) or high (20 lux) artificial light at night, and focused on foraging behaviours related to fitness. Indeed, previous studies have determined that female fitness depends on its decision-making between searching for hosts to lay eggs (*i.e.* current reproduction) or searching for food to increase its survival probability (*i.e.* future reproduction), and that this decision-making is underpinned by the individual energy reserves and is involved in a trade-off (Desouhant *et al.*, 2005). At the intra-generational level, we first tested

experimentally whether artificial light at night extends the activity of *V. canescens* at night. We expected the wasps in the control group (*i.e.* no light during the night) to show no movement at night, because *V. canescens* is known to be inactive in the dark (E. Desouhant & L. Froissart, personal obs.), whereas we predicted the wasps to move during the night when exposed to artificial light. Then, we conducted a second set of experiments to assess whether artificial light at night had consequences on energy reserves, feeding behaviour and choice between host and food, along with effects on longevity and a proxy of reproductive success. We also aimed to determine whether the duration of exposure to artificial light at night had an impact by comparing the responses of wasps exposed to the three light conditions during 2 and 8 consecutive nights. In our experimental set-up, wasps had limited access to food (30 min per day, see Methods section). Therefore, we expected that artificial light at night, by extending the activity of wasps at night, would lead to a greater metabolic consumption and thus a decrease in the different energy reserve compartments. Since there is no lipogenesis in *V. canescens* (Casas *et al.*, 2003), we predicted that the amount of lipids would decrease as the wasps aged, and that this decrease would be stronger under artificial light at night. Regarding sugars, we had two alternative predictions. On one hand, wasps could compensate for a higher energy consumption by increasing food intake, thus maintaining a constant energy level (as shown in the field, Casas *et al.*, 2003) in the control and artificial light at night conditions. On the other hand, food availability being limited, the amount of sugar should decrease throughout life, with a steeper decrease for light-polluted wasps. Regarding behaviours, it is known that unfed wasps prioritise the search for food while well-fed wasps prefer to search for hosts (Desouhant *et al.*, 2005). Because of the expected decrease in energy reserves, and given that wasps did not have access to food during the night, we predicted that light-polluted wasps would spend more time feeding during the daytime than control ones. We also predicted that, when given the choice, light-polluted wasps would prefer to search for food while control wasps would prefer to search for hosts. However, if wasps could compensate for the effects of light pollution by increasing daytime food intake, then we would expect control wasps and those exposed to artificial light at night to behave similarly.

At the trans-generational level, we compared body size and development time of offspring whose mothers were exposed to light pollution to those of control condition. We also quantified the offspring body energy reserves and tested their feeding behaviour to detect any trans-generational effect of artificial light at night.

METHODS

Biological model and rearing conditions

Venturia canescens (Gravenhorst) is a solitary endoparasitoid hymenopteran (Ichneumonidae). It attacks lepidopteran larvae, mainly Pyralidae (Salt, 1975), in their second to fifth instar (Harvey & Thompson, 1995). Parasitoid females use a mandibular gland secretion, called kairomone, released by host larvae when feeding, to locate them (Castelo *et al.*, 2003). *V. canescens* is a diurnal species (Desouhant *et al.*, 2003), which shows no activity in the dark (E. Desouhant and L. Froissart, personal obs.) but exhibits a positive phototaxis during the day (Gomes *et al.*, 2019; Lucchetta *et al.*, 2008).

We used thelytokous females of a strain established from about 70 wild females trapped near Valence (southern France) during the summer of 2016. The strain was maintained under controlled conditions (25±1°C, 60±5% relative humidity, 12:12 light:dark) in boxes containing larvae of *Ephestia kuehniella* (Lepidoptera: Pyralidae) as hosts and organic wheat semolina as feeding medium for the host larvae. The adult wasps were fed *ad libitum* with honey diluted 1:1 with distilled water, because in natural conditions *V. canescens* use nectar or honeydew as food sources (Desouhant *et al.*, 2010).

Light conditions

We have created three experimental groups of wasps differing in their intensity of exposure to light at night. The wasps were kept in two thermostated chambers (SANYO Electric Co., Ltd, model number: MLR-351H) providing a temperature of 25°C and a relative humidity of 60%. Light cycle (12:12 h light:dark) and daytime light intensity (3500 lux) provided by neon tubes were similar in both chambers. In the first chamber, the wasps were not exposed to light at night (0 lux, total darkness) and served as a control. The second chamber was equipped with white LED lights (ribbon of LED SMD 5050, 6000-6500K, Sysled) on the ceiling to provide light at night, and was divided with an opaque horizontal panel made of black Gore-Tex[®] fabric to dim the light underneath. This set-up allowed to create two artificial light conditions: a “high artificial light at night” condition (20 lux, equivalent to the intensity of a street lamp) above the panel, and a “low artificial light at night” condition (0.7 lux, equivalent to the intensity of a city skyglow) (Bennie *et al.*, 2016; Rich & Longcore, 2006) below the panel. We measured light intensities to the nearest 0.01 lux with an illuminance meter (T-10MA, Konica Minolta[®]). Light

measurements were performed inside the transparent plastic vials (7 x 3 cm) subsequently used in the experiments, at several locations (every six cm) in the climatic chambers to ensure homogeneity of light intensity within each condition (mean light intensity \pm SE: 19.9 ± 1.2 and 0.69 ± 0.04 lux for high artificial light at night and low artificial light at night conditions, respectively). The presence of the Gore-Tex[®] panel did not affect the temperature and relative humidity in the climatic chamber ($N = 900$ successive measurements, one per min, over time; mean temperature \pm SE: 24.8 ± 0.2 and 25.4 ± 0.2 °C below and above the panel, respectively; mean relative humidity: 57.6 ± 0.9 and 57.0 ± 0.9 % below and above the panel, respectively). There was also no effect of the Gore-Tex[®] panel and no effect of the climatic chamber on insect longevity and activity (data not shown).

Exp 1- Does artificial light at night trigger nocturnal activity in *V. canescens*?

To test whether *V. canescens* prolongs its activity during the night when exposed to artificial light, we used custom-made 3D-printed tubes divided in two compartments by a funnel (C1 in front of the funnel and C2 behind the funnel; see Figure S1 in the Supplementary Data). This design allows an active wasp to move from C1 to C2 through the funnel, but not the passage in the opposite direction (pers. obs. on 27 wasps during daytime). When the wasps are positioned in C1, the movement towards C2 thus reveals their activity. The tubes were closed by foam plugs at both ends.

For each light condition, we took newly emerged wasps and kept them individually in plastic vials (7 x 3 cm) under controlled conditions in the climatic chambers (25 ± 1 °C, 60% relative humidity, 12:12 h light:dark). On the same day, 2 hours before the end of the photophase, each wasp was individually transferred into a tube, in the compartment before the funnel (C1). A Plexiglas[®] partition was used to obstruct the funnel exit, preventing the wasp to go from C1 to C2 during daytime. Thirty minutes after the end of the photophase, we carefully removed the Plexiglas[®] partition to allow the wasps to move through the entire set-up during the night.

The next morning, just before the photophase, we checked the position of the wasps in their tube; they could be either in C1 (they did not move during the night, *i.e.* “no nocturnal activity”) or in C2 (they moved during the night, *i.e.* “nocturnal activity”).

We tested 36, 37 and 37 wasps in the control, low and high artificial light at night conditions, respectively.

Exp 2- Physiological and behavioural effects of artificial light at night: experimental design

We followed the same experimental design for the three light conditions (control, low artificial light at night, high artificial light at night). The wasps had access to 4 µl of 40% sucrose solution for 30 minutes each day and to 20 µl of demineralised water every two days. This protocol keeps the wasps alive for several days after their emergence (Desouhant *et al.*, 2005) and allows us to assess the effects of artificial light after up to 8 nights.

We conducted experiments at both intra and trans-generational levels (Figure 1). To test the intra-generational effects of artificial light at night, wasps were isolated at emergence, placed individually in plastic vials (7 x 3 cm) in the thermostated chambers and exposed to either the control condition or one of the two artificial light at night conditions for 2 days or 8 days. After 2 or 8 days, the wasps were randomly assigned to one of the different experiments (see Figure 1 and below for a detailed description): measure of body energy reserves, choice trial between food and host and measure of a proxy of reproductive success (see below). Moreover, we kept a batch of wasps from emergence to death to assess their longevity. Finally, we evaluated the feeding behaviour and quantified the energy reserves of the offspring of wasps exposed to the three light conditions for 2 or 8 days (see Figure 1) to assess the trans-generational effects of artificial light at night.

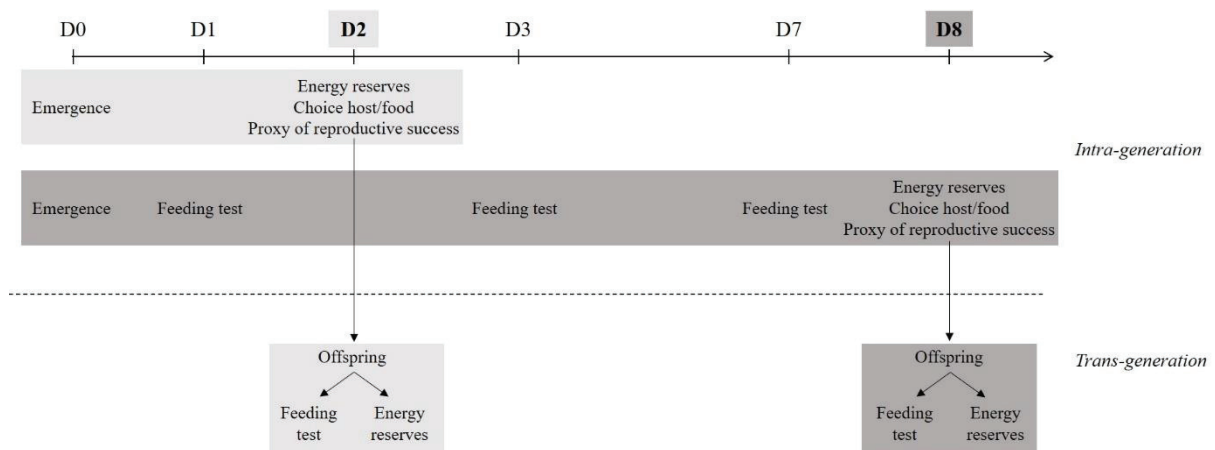

Figure 1 Sequence of experiments in a data collection session (from day 0 ‘D0’ to day 8 ‘D8’).

In order to take into account a potential size effect in the analyses (see statistical analyses section below), we determined tibia length as a proxy of body size, as commonly done in this species (Harvey & Vet, 1997). For each individual, we took a picture of the left hind tibia under

a binocular magnifier coupled with a camera and measured its length to the nearest 0.01 mm with the software Motic Image Plus 2.0 (Motic, Hong Kong).

Except when stated in the text, the number of wasps tested in each experiment is given in Table 1.

Table 1 Sample size in each sub-experiment (except test of artificial light at night, hereafter ALAN, on feeding behaviour) of Experiment 2 “Physiological and behavioural effects of artificial light at night”.

	Control		Low ALAN		High ALAN	
	2 days	8 days	2 days	8 days	2 days	8 days
Intra-generational effects of ALAN						
Energy reserves						
<i>Proteins - Glycogen - Neutral lipids</i>	28	26	29	22	28	25
<i>Free sugars</i>	28	26	29	21	28	24
Choice experiment	19	22	17	17	20	16
Proxy of reproductive success	22	17	21	22	20	17
Trans-generational effects of ALAN						
Offspring energy reserves	9	7	9	12	13	11
Offspring feeding behaviour	5	7	11	8	9	10

For “Intra-generational effects of ALAN”, “Control”, “Low ALAN” and “High ALAN” are the light treatments the insects were subjected to for 2 days or 8 days. For “Trans-generational effects of ALAN”, “Control”, “Low ALAN” and “High ALAN” are the light treatments the insect mothers were subjected to, for 2 days or 8 days.

Intra-generational effects of artificial light at night

Artificial light at night and individual energy reserves

We applied the method developed by Foray *et al.* (2012) to quantify the energy reserves of *V. canescens*. This protocol made it possible to individually quantify the four nutrients that are the main sources of energy for insects: proteins, free sugars, glycogen and neutral lipids. Briefly, we extracted the soluble proteins with an aqueous lysis buffer and determined the protein content using Bradford reagent. Then, after an extraction with a chloroform: methanol (1:2 v/v) solution, we quantified the amount of neutral lipids using Vanillin reagent and the carbohydrate (soluble carbohydrates and glycogen) content using Anthrone reagent (for details, see Foray *et al.*, 2012). We conducted the assays in 96-well microplates, with 2 technical replicates per individual (mean coefficients of variation are 12.0%, 8.1%, 7.4% and 13.2% for proteins, free sugars, glycogen and neutral lipids, respectively). We also duplicated the standard curves in each microplate to take into account the variability between and within microplates.

The overall energy content of individuals was calculated by summing the energy content of each nutrient converted to Joules using the following conversion factors: proteins 16.0 J.g⁻¹; carbohydrates 16.0 J.g⁻¹; lipids 37.5 J.g⁻¹ (Giron & Casas, 2003).

Artificial light at night and feeding behaviour

We studied the feeding behaviour of wasps thrice during the experiment: on day 1, then on days 3 and 7. We monitored the feeding behaviour of the wasps for 20 minutes, during which we recorded the latency before the first feeding bout and the total time spent feeding using an event recorder (JWatcher v1.0). We recorded the feeding behaviour of 78, 81 and 79 wasps in the control, low and high artificial light at night conditions, respectively.

Artificial light at night and choice between hosts and food

We individually placed the wasps in Plexiglas boxes (34 x 18 cm and 12 cm high) and recorded their choice between two odour sources: food or host kairomones. A food patch consisted of 5 ml of honey diluted 1:1 with distilled water in a Petri[®] dish (diameter 55 mm) covered by a piece of organza (10x10 cm, hereafter ‘a veil’). We used a kairomone solution to mimic host odour (Castelo *et al.*, 2003). This was obtained by mixing 250 g of 1-month-old host contaminated semolina with 500 ml of an acetone-ethanol (1:1 v/v) solution, then filtering the mix after 2.5h. A veil was soaked with 500 µl of kairomone solution and dried under a hood for 15 min to evaporate the solvents.

We put the odour patches in the box in a standardized way and we alternated their position between each trial. We introduced the wasps at equal distance between the two patches. Once in the box, we monitored the wasp and registered its choice. We considered a choice was made when the wasp arrived on one of the two patches. If the wasp did not make a choice within 10 min, we stopped the observation and excluded the individual from the analysis (see the Statistical Analyses section).

Reproductive success

We measured a proxy of the reproductive success of wasps exposed to control and artificial light at night conditions for 2 or 8 days (Figure 1). From this experiment, we also obtained offspring on which we examined the trans-generational effects of the artificial light at night conditions (see Figure 1 and below).

We individually put wasps in round plastic boxes (diameter 80 mm, height 60 mm), each containing a host patch. The host patches were prepared 8 days before the test, and were made of 10 third-instar host larvae in a Petri dish (diameter 35 mm) filled with semolina and covered by a veil. We allowed the wasps to exploit a patch and lay eggs for 3 hours. We then kept the host patches in the rearing room and checked them daily for offspring emergence. The hosts were not exposed to artificial light at night during their life cycle.

Trans-generational effects of artificial light at night

We recorded the date of emergence of all the offspring (checked once a day), and collected only the first two to emerge, in order to monitor their feeding behaviour or measure their energy reserves. For a given patch, if the first offspring was used in the feeding experiment, the second one was frozen dry at -20°C for the assay of energy reserves, and vice versa. For the two experiments, we followed the protocols previously described in the paragraph “Intra-generational effects of artificial light at night”.

Exp 3- Does exposure to artificial light at night impact longevity of *V. canescens*?

For the control and the two artificial light at night conditions, we kept newly emerged wasps in plastic vials in the thermostated chambers and checked them thrice a day (at 09:00, 11:00 and 17:00 h) to record the time of death of the wasps. On weekends, we checked the wasps only once a day (at midday). The feeding conditions were similar to those in Experiment 2. We ended the experiment on the 26th July 2019, and the few wasps still alive at that time were considered censored in the survival analysis ($N = 14$). These censored observations are taken into account in the survival analysis because they provide partial information on the longevity of the individual.

We measured the longevity of 22, 21 and 20 wasps in the control, low artificial light at night and high artificial light at night conditions, respectively.

Statistical analyses

We performed the statistical analyses with R 3.6.1 (R Core Team, 2019). We used the packages *lme4* (Bates *et al.*, 2014) and *nlme* (Pinheiro *et al.*, 2019) to build linear and generalized linear models (GLMs), as well as linear mixed models (LMMs). In each model described below, we included tibia length, light condition (factor with three modalities, ‘control’, ‘low artificial light

at night’, ‘high artificial light at night’) and age of the individual (factor with two modalities, ‘2 days’, ‘8 days’), as well as their two by two interactions, as explanatory variables. From the full models, we used a backward model selection approach to select the best model. We compared nested models and removed all non-significant interactions and variables. When needed, we computed post hoc comparisons between factor modalities using the package *emmeans* (Lenth, 2020). Cohen’s *h* was computed to estimate effect sizes between proportions, using the *pwr* package (Champely, 2020).

To assess whether wasps are active during the night (Experiment 1), we fitted a binomial GLM with the binary variable ‘Nocturnal activity’ (‘Yes’ or ‘No’) as response variable.

For the analysis of proteins, free sugars, glycogen, neutral lipids and energy content (Experiment 2), we built linear models with the quantity of nutrient per individual (mean between the two technical replicates), or the energy content per individual, as response variable. We included the additional explanatory variable “microplate” as random effect to take into account the variability of measures between the microplates used during the experiments. This random effect was retained in the models when significant, which occurred only for neutral lipids. We followed the procedure described in Zuur *et al.* (2009) to deal with heterogeneity in the residuals for the free sugar model. During the experiment measuring glycogen, we had to prepare an additional solution of sulphuric acid. We thus fitted a linear mixed model (LMM) with an additional explanatory variable called Solution (factor with two modalities ‘Sol1’ and ‘Sol2’) as a random effect.

We performed the same statistical analyses for each nutrient at the trans-generational level, keeping microplate as a random effect only for proteins.

Because we recorded the feeding behaviour of each individual several times, we built LMMs by adding the wasp identity as random factor for both total time spent feeding and latency before the first feeding bout. For the total time spent feeding, we followed the procedure described in Zuur *et al.* (2009) to deal with heterogeneity in the residuals. We then tested the statistical significance of explanatory variables with likelihood ratio tests (LRTs) based on the χ^2 statistic. For the latency before feeding, we log-transformed the data to meet the assumption of normality. The statistical significance of fixed effects was based on the *F* statistic, with adjusted degrees of freedom (following Kenward & Roger, 1997).

At the trans-generational level, for both total time spent feeding and latency before feeding, we fitted gamma GLMs (log link) including offspring tibia length, mother's light at night condition, mother's age and their two by two interactions as explanatory variables.

Concerning the choice between host and food, the proportion of indecisive individuals was similar between the control, low and high artificial light at night conditions (0.31, 0.34 and 0.27, respectively; $\chi^2 = 0.33$, $df = 2$, $P = 0.85$). We thus discarded these indecisive individuals from the analysis ($N = 49$ out of 161). We built a binomial GLM (logit link) with the binary variable 'Choice' ('host' or 'food') as response.

We computed the proxy of reproductive success as the proportion of wasps among the total number of adult insects (wasps and *E. kuehniella*) emerging from the 10 hosts provided to each mother. In this way, we could estimate the number of egg-laying events that occurred during the experiment, while taking into account the extrinsic host mortality. We then analysed the effect of artificial light at night on this proportion by fitting a binomial GLM (logit link). We also investigated the consequences of mother's light condition on the development time of their offspring by building a linear mixed model with mother's identity as a random factor, and mother's light condition, mother's age and their interaction as explanatory variables. We log-transformed the data to meet the assumption of normality. The size of the offspring was analysed by building a LMM with the same explanatory variables.

Finally, longevity was analysed using a Cox proportional hazards model (package *survival* Therneau, 2015) with light condition, tibia length and their interaction as explanatory variables.

RESULTS

Exp 1- Does artificial light at night trigger nocturnal activity in *Venturia canescens*?

The wasps exposed to light pollution showed a significantly higher proportion of nocturnal activity compared to controls ($\chi^2 = 32.3$, $df = 2$, $P < 0.001$), an effect that was all the more pronounced as the intensity of light pollution was high (post hoc test of difference between low and high artificial light at night: $z = 2.6$, $P = 0.03$). The proportion of nocturnally active wasps in control, low artificial light at night and high artificial light at night conditions was 5.6%, 32.4% and 62.2%, respectively (Figure 2). There thus was a 27% increase of nocturnally active wasps between control and low artificial light at night conditions (effect size Cohen's $h = 0.74$),

and a 30% increase of nocturnally active wasps between low and high artificial light at night conditions (effect size Cohen’s $h = 0.60$).

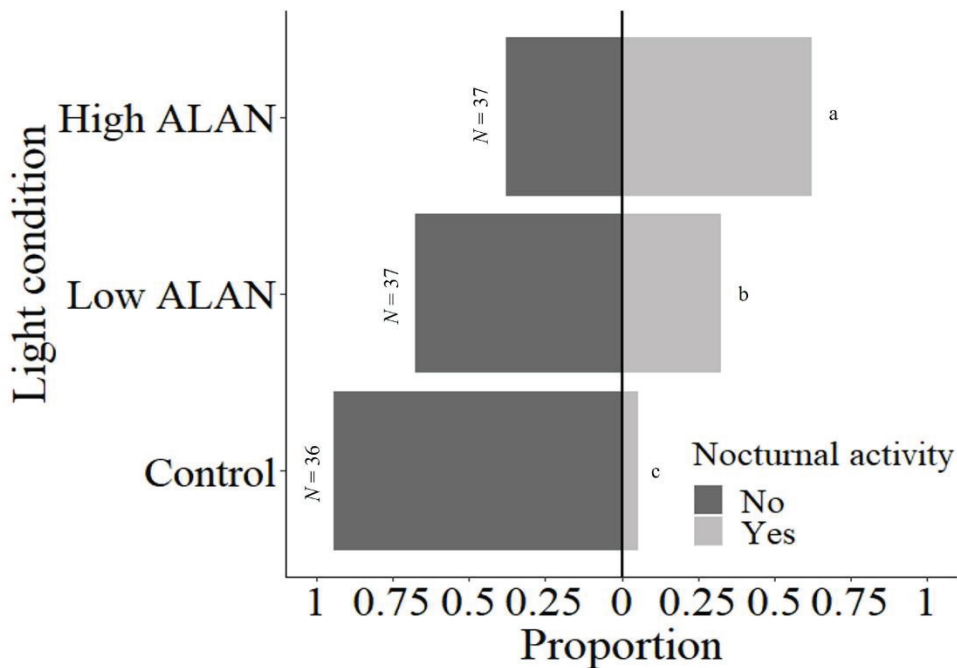

Figure 2 Proportion of individuals with (light grey) or without (dark grey) nocturnal activity for the control and artificial light at night (ALAN) conditions. Different letters indicate a significant statistical difference at the 0.05 level.

Exp 2- Intra-generational effects of artificial light at night

Energy reserves

Artificial light at night conditions had no effect on any of the energy compartment, nor on the overall level of energy reserves of the wasps compared to controls (Table 2). However, there was a significant effect of the wasps’ age and body size (tibia length). For free sugars and glycogen, these effects were additive: larger individuals had higher contents of free sugars and glycogen, and these contents decreased with the age of the individuals. For proteins and neutral lipids, there was an interaction between the two variables (Table 2): protein and neutral lipid contents decreased with age, and this was more pronounced for large individuals than for small individuals.

Table 2 Effect of artificial light at night (ALAN) conditions, age and body size (tibia length, TL) on the different energy compartments. Significance was set at $p < 0.05$, 'NS' indicates no significance during the model selection process.

	Protein content			Free sugar content			Glycogen content			Neutral lipid content		
	<i>F</i>	<i>df</i>	<i>P</i>	<i>F</i>	<i>df</i>	<i>P</i>	<i>F</i>	<i>df</i>	<i>P</i>	<i>F</i>	<i>df</i>	<i>P</i>
ALAN condition (AC)			NS			NS			NS			NS
Age	42.2	1, 154	<0.001	18.1	1, 153	<0.001	26.3	1, 154.0	<0.001	223.2	1, 149.4	<0.001
Tibia length (TL)	114.1	1, 154	<0.001	9.9	1, 153	0.002	12.2	1, 154.1	<0.001	26.9	1, 149.4	0.001
Age * TL	6.2	1, 154	0.01			NS			NS	7.5	1, 149.4	0.02
Age * AC			NS			NS			NS			NS
AC * TL			NS			NS			NS			NS
<hr/>												
Total energy content												
	<i>F</i>	<i>df</i>	<i>P</i>									
ALAN condition (AC)			NS									
Age	57	1, 153	<0.001									
Tibia length (TL)	32.1	1, 153	<0.001									
Age * TL			NS									
Age * AC			NS									
AC * TL			NS									

The overall energy reserves of wasps were also affected by the age of the individual and body size (see Table 2 and Figure 3).

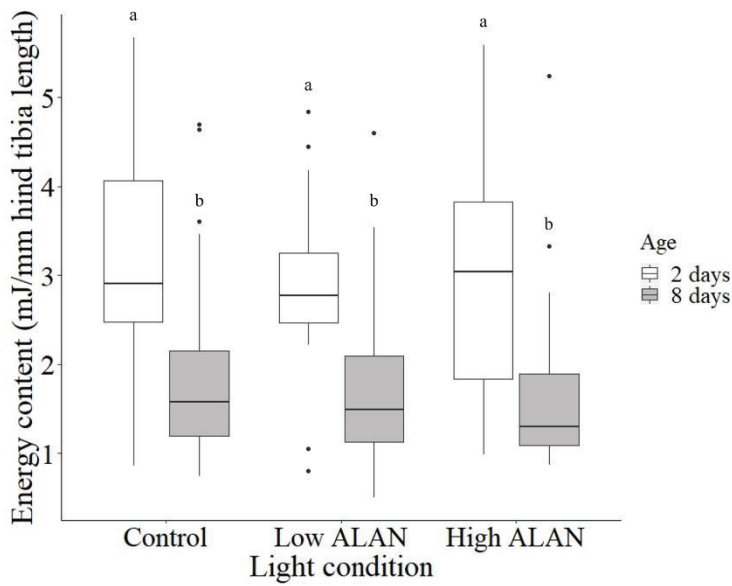

Figure 3 Energy content (in $\text{mJ}\cdot\text{mm}^{-1}$ tibia length) in wasps exposed to the control and the two artificial light at night conditions for 2 or 8 days. Different letters indicate significant statistical difference at the 0.05 level.

Feeding behaviour

We found a significant effect of artificial light at night on the latency before the first feeding bout (Table 3). Light-polluted wasps, for both low and high artificial light intensities, started feeding later than controls (mean duration before starting feeding: 72.3 ± 11.4 , 105.8 ± 16.7 and 143.2 ± 19.7 s for control, low and high artificial light at night intensities, respectively). As could be expected, there was also an effect of age of the individuals (Table 3), with wasps older than one day starting to feed earlier regardless of light condition (mean duration before starting feeding: 196.9 ± 20.5 , 44.0 ± 6.4 and 50.7 ± 11.0 s when the wasps were one day old, three days old and seven days old, respectively).

Artificial light at night also had a significant effect on feeding duration (Table 3).

Table 3 Effect of artificial light at night (ALAN) treatment on two components of feeding behaviour, age and body size (tibia length, TL).

	Latency before feeding			Total feeding duration		
	<i>F</i>	<i>df</i>	<i>P</i>	χ^2	<i>df</i>	<i>P</i>
ALAN condition (AC)	4.9	2, 220.5	0.008	10.8	2	0.004
Age	46.7	2, 415.3	< 0.001	44.7	2	< 0.001
Tibia length (TL)		NS			NS	
Age * TL		NS			NS	
Age * AC		NS			NS	
AC * TL		NS			NS	

Significance was set at $p < 0.05$, ‘NS’ indicates no significance during the model selection process.

Wasps exposed to low intensity artificial light at night spent more time feeding in the daytime than wasps exposed to high intensity or no artificial light at night (Figure 4). Feeding duration was also affected by age of the individuals (Table 3). The time spent feeding increased as the wasps got older (Figure 4).

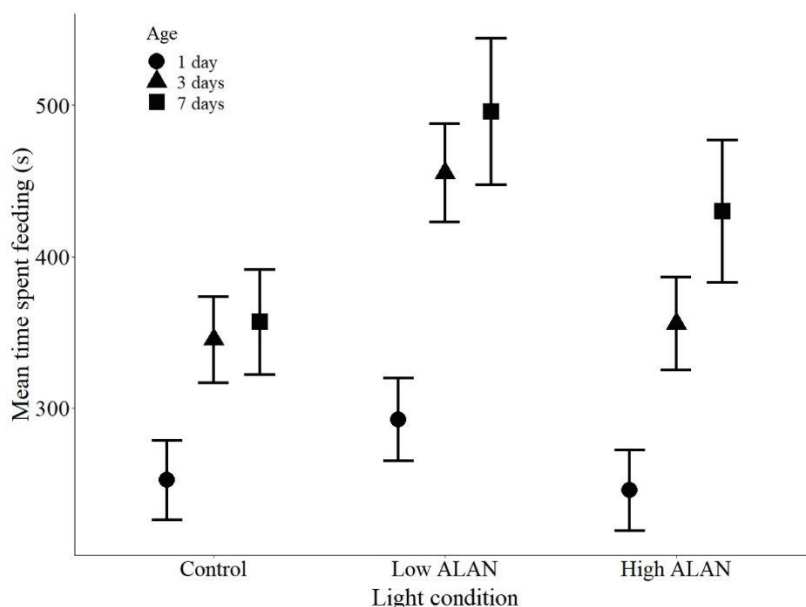

Figure 4 Effect of low artificial light at night (ALAN) (0.7 lux) and high ALAN (20 lux) conditions compared to controls (0 lux) on mean time spent feeding in one, three- and seven-day old wasps. Symbols represents means \pm SE.

Choice between hosts and food

Among all the explanatory variables tested, the presence of artificial light at night was the only one affecting the decision of wasps to choose hosts or food ($\chi^2 = 8.5$, $df = 2$, $P = 0.01$). A

significantly higher proportion of wasps exposed to low and high artificial light at night conditions chose hosts over food compared to controls (effect sizes were $h = 0.70$ between control and low artificial light at night condition, and $h = 0.45$ between control and high artificial light at night condition), but there was no difference between low and high artificial light at night (Figure 5).

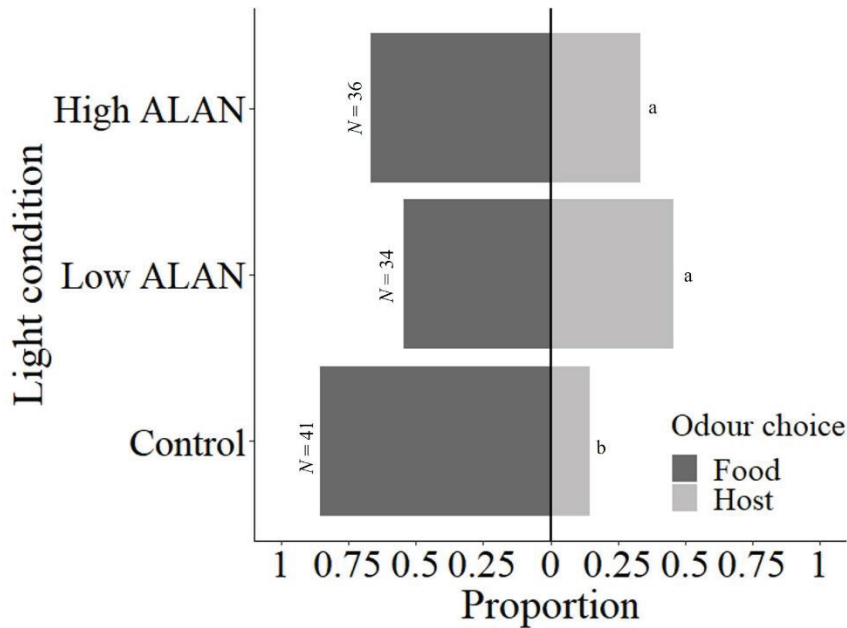

Figure 5 Proportion of wasps that chose host odour (light grey) or food odour (dark grey) for the control and the two artificial light at night (ALAN) conditions. Different letters indicate a significant statistical difference at the 0.05 level.

Reproductive success

Wasps under both low and high artificial light intensity at night tended to have a higher proxy of reproductive success than controls ($F = 2.901$, $df = 2, 115$, $P = 0.06$). The mean proportion of offspring were 0.24, 0.34 and 0.37 for control, low and high artificial light at night conditions, respectively. The effect sizes indicate that the biological difference between control and low artificial light at night conditions (Cohen's $h = 0.23$) as well as between control and high artificial light at night conditions (Cohen's $h = 0.29$), are small.

Exp 2- Trans-generational effects of artificial light at night

Wasp exposure to artificial light at night had no effect on the energy reserves (see Table S1 in the Supplementary data) or on the feeding duration ($\chi^2 = 1.08$, $df = 2$, $P = 0.411$) of their offspring. However, artificial light at night had a trans-generational effect on the latency before the first feeding bout ($\chi^2 = 10.27$, $df = 2$, $P = 0.007$). The offspring of mothers exposed to low artificial light at night started feeding later than those of mothers exposed to high artificial light at night or no artificial light at night at all (Figure 6).

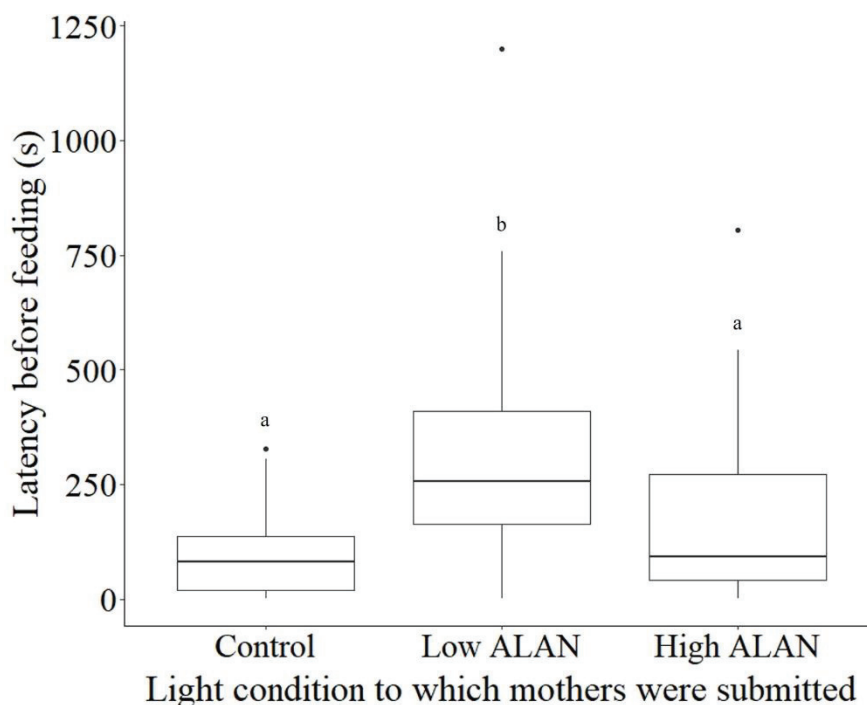

Figure 6 Box plot representation of the latency before feeding in wasps whose mothers were exposed to control condition (0 lux), or low (0.7 lux) or high (20 lux) artificial light at night (ALAN). Different letters indicate significant statistical difference at the 0.05 level.

Mother's light condition, in interaction with mother's age, influenced the offspring's development time ($F = 3.3$, $df = 2$, 144.4 , $P = 0.04$). Mother's age was positively correlated with offspring development time only for wasps exposed to low artificial light at night (post hoc comparison, $t = -3.6$, $P = 0.0005$). In this condition, offspring of eight-day-old mothers took longer to develop into adult wasps than offspring of two-day-old mothers (Figure 7). However, the offspring size remained similar regardless of the mother's age ($F = 1.17$, $df = 1$, 67.6 , $P = 0.28$) or light condition ($F = 0.53$, $df = 2$, 68.9 , $P = 0.59$).

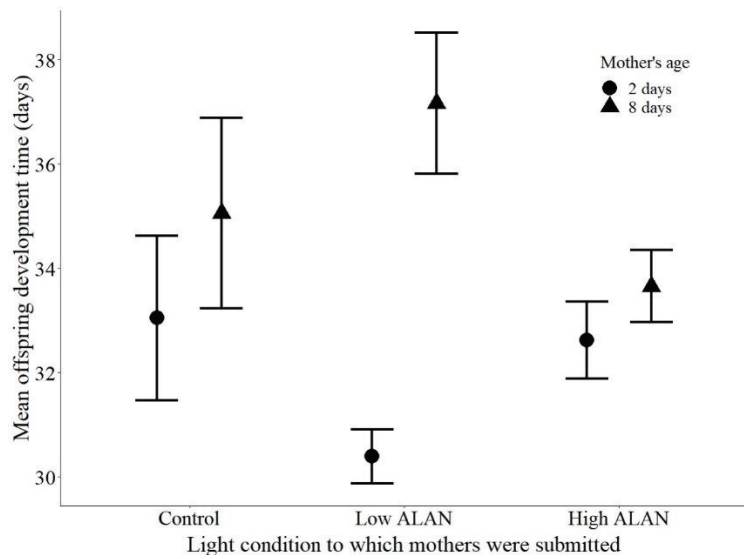

Figure 7 Development time of offspring whose mothers were exposed to low (0.7 lux), high (20 lux) or no (control, 0 lux) artificial light at night (ALAN) and were 2 days or 8 days old. Symbols represent mean \pm SE.

Exp 3- Does exposure to artificial light at night impact longevity of *V. canescens*?

We found no effect of artificial light at night on the longevity of wasps ($N = 63$, $\chi^2 = 0.79$, $df = 2$, $P = 0.673$) but a significant effect of body size ($\chi^2 = 4.94$, $df = 1$, $P = 0.026$), with smaller wasps dying earlier than large ones.

DISCUSSION

Using an experimental approach, we showed that, in the diurnal wasp *V. canescens*, exposure to artificial light at night prompts nocturnal activity and alters diurnal behaviours related to feeding and egg-laying, two main components of fitness. In a context where wasps had access to food each day, those exposed to artificial light at night started feeding later than controls, regardless of light intensity, and only those exposed to low artificial light intensity at night spent more time feeding. Light pollution at night also altered the wasps' choice between host and food, with those exposed to artificial light at night showing a greater preference for hosts than controls. Finally, we detected a tendency for wasps to have a higher reproductive success when exposed to artificial light at night. Light pollution at night thus seems to modify the way wasps manage the trade-off between immediate and future reproduction. Surprisingly, these behavioural changes were not driven by modifications in the levels of energy reserves, as there

were no differences in nutrient contents between the control and two artificial light at night conditions.

V. canescens is inactive at night, but in presence of artificial light the extension of the photophase results in locomotor activity during the night-time. Modifications of diel activity patterns has been found in few diurnal spiders (Frank, 2009), birds (Amichai & Kronfeld-Schor, 2019) and lizards (Maurer *et al.*, 2019) species. Very often linked to foraging activities, the extension of activity at night is likely to be costly to organisms, due to increased risk of predation, competition for resources with nocturnal species and higher energy expenditure. However, it has rarely been investigated whether daily energy expenditure is influenced by light pollution (but see de Jong *et al.*, 2016, for an example in great tits). Contrary to our predictions, night-time activity did not seem to affect the energy reserves of wasps. We observed a decrease with age for all the nutrients tested, which has already been found for lipids in *V. canescens* because lipogenesis does not occur in these parasitoids (Casas *et al.*, 2003). However, the total energy budget remained similar in wasps from the control and the two artificial light at night conditions. This may be due to easy, albeit limited, access to food in a lab-environment with stable and favourable temperature and humidity. Indeed, the wasps exposed to artificial light at night spent more time feeding than controls, which may indicate that they could compensate for higher daily energy expenditure by increasing their feeding behaviour. In natural conditions, a far more complex environment than the laboratory, *V. canescens* is known to maintain a constant level of energy by gaining food, and more precisely sugars, available in its environment (Casas *et al.*, 2003). Therefore, wasps would probably be able to compensate for higher energy expenditure when exposed to artificial light at night in the wild, albeit with more associated costs than in our experimental set-up. We also observed that wasps exposed to low artificial light at night started feeding later than controls, although the ecological implications of such behavioural modification remain unclear. The absence of effect of artificial light at night on energy reserves is consistent with the lack of differences in longevity between control and artificial light at night conditions.

Despite no differences in energy state, we found behavioural modifications due to artificial light at night in *V. canescens*. Being exposed to light at night affects how the wasps manage the trade-off between current and future reproduction. Artificial light at night conditions increased wasp preference towards hosts during daytime activity, along with a tendency to lay more eggs.

Artificial light at night thus seems to promote immediate reproduction, but independently of the wasps' energetic status. Wasps exposed to artificial light at night seem to behave as time-limited insects; when there is a reduction in life expectancy (*i.e.* a higher risk of death before exhaustion of egg supply), time-limitation leads to an intensification of oviposition rate (Adamo, 1999; Javoš & Tammaru, 2004). Experimental studies have demonstrated that intensive host patch exploitation in parasitoid species can be elicited by environmental conditions, such as drop in atmospheric pressure (Roitberg *et al.*, 1993) or temperature changes (Amat *et al.*, 2006, in *V. canescens*). Altering the perception of time limitation can have major ecological and evolutionary consequences for parasitoid wasps. We hypothesize that artificial light at night should stimulate investment in exploitation of host patches, which is highly energy-consuming behaviour. In a natural environment, this could be accompanied by lower survival rate and thus affect the population dynamics. Moreover, time-limited wasps have a higher tendency to superparasitize (Sirot *et al.*, 1997), which can induce fitness cost because only a single adult wasp can emerge from a host larva. Light pollution could thus have an impact the lifetime reproductive success of parasitoids in a way that needs to be determined. However, it should be noted that conditions of total darkness at night, such as those in the control group, are probably not always encountered by wasps in the natural environment, even in the absence of light pollution. The night can be illuminated by natural sources of light such as the stars or the moon, with variations in intensity during the lunar cycle. The typical intensity of moonlight is about 0.1 lux, although it can exceptionally reach intensity of 0.3 lux (Kyba *et al.*, 2017). In the absence of light pollution, moonlight could therefore also affect the behaviour and physiology of *V. canescens* in its natural environment, as observed in other taxa (Kronfeld-Schor *et al.*, 2013).

Whether light pollution can cause phenotypic changes that persist in subsequent generations is a question that has yet to be answered. Here, we showed that artificial light at night had trans-generational consequences in addition to intra-generational effects on daytime behaviours. First, exposure to artificial light at night affected the development time of offspring, in interaction with mother's age. The offspring of eight-day old wasps exposed to low artificial light at night took longer to reach adult developmental stage, but there was no difference in offspring size, which is consistent with previous studies that showed that *V. canescens* prioritizes offspring size over development time (Harvey & Strand, 2002). Even if this species lays its eggs in concealed hosts that are thus relatively well protected against predation, longer

development times can increase the risk of external mortality for the host, hence impacting the parasitoid fitness. We also found a trans-generational effect of artificial light at night on the feeding behaviour of the offspring. Offspring whose mothers were exposed to low artificial light at night started feeding later than those whose mothers were exposed to control or high artificial light at night conditions. Although it is not yet clear how this behavioural response could impact parasitoid fitness, it could be interpreted in the perspective of time limitation. Offspring of light-polluted wasps may, as soon as they emerge, invest more in reproduction rather than survival. This result may be due to a maternal effect, although not through energy reserves. Indeed, contrary to some parasitoid species where maternal effects have been found to influence offspring nutrient contents (Muller *et al.*, 2017), we did not observe any trans-generational effects on energy reserves. The explanation may lie in the fact that *V. canescens* females produce yolk-deficient hydropic eggs (Le Ralec, 1995) that contain very little energy but whose embryonic development depends mainly on the availability of resources in the host. Studying trans-generational effects of light pollution over several generations would be of great value to understand the mechanisms underlying the behavioural responses we have observed after one generation, and their adaptive value.

For some traits, at both intra- and trans-generational levels, we found an effect of low intensity artificial light at night only. Low intensity of light pollution, sometimes even lower than the light emitted by a full moon, can disrupt fitness related behaviours. For instance, common toad males exposed to 0.1 lux at night took longer (three-fold increase in latency) before achieving successful amplexus (copulation) than those exposed to 5 lux (1.5-fold increase in latency) (Touzot *et al.*, 2020). Although the difference between responses at 0.1 and 5 lux is not statistically significant in the common toad study, it suggests an interesting quadratic pattern of response to light pollution similar to the one observed in our study. The stronger response to low artificial light intensity at night for some traits can evoke a non-monotone dose-response relationship, where the effect of artificial light at night on the parasitoid traits increases up to a certain artificial light intensity, and then decreases past this threshold. Such pattern is classically observed for physiological variables whose responses to light exposure is nonlinear (Yang *et al.*, 2018, 2016) and may imply hormonal response (Homma *et al.*, 1967). Artificial light at night is indeed closely associated with melatonin, a key hormone involved in the regulation of circadian rhythms, whose synthesis can be altered by light pollution (*e.g.* Durrant *et al.*, 2015) with potential resulting behavioural changes (Jones *et al.*, 2015). Thereby, our results on time

spent feeding at intra-generational level, and latency before feeding and offspring development time at trans-generational level, might be explained by the effect of artificial light at night on the pattern of melatonin secretion. Further studies are nevertheless needed to investigate this hypothesis and, more generally, the role of melatonin in the behavioural modifications due to light pollution.

While most of the studies conclude to deleterious effects of light pollution on nocturnal organisms (e.g. Langevelde *et al.*, 2018), effects on diurnal insects may be more mixed. On one hand, we showed that artificial light at night disrupted the management of the trade-off between current and future reproduction in *V. canescens*. On the other hand, artificial light at night could have positive outcomes such as a greater short-term egg-laying activity (proxy of reproductive success). Longer timescale observations are needed to robustly determine the effects of light pollution on the lifetime reproductive success of *V. canescens* and whether those are transmittable over several generations. Finally, determining the extent to which low-intensity light pollution affects the fitness and population dynamics of other diurnal insect species requires more in-depth studies at large spatial and temporal scales.

ACKNOWLEDGEMENTS

This work was partly funded by Scientific Breakthrough Program, IDEX LYON. We thank Marc Théry for lending us the luxmeter and Thierry Lengagne, Nathalie Mondy and Morgane Touzot for scientific discussion on our data.

REFERENCES

- Adamo, S.A. (1999). Evidence for adaptive changes in egg laying in crickets exposed to bacteria and parasites. *Animal Behaviour*. 57(1), 117–124.
- Amat, I., Castelo, M., Desouhant, E. & Bernstein, C. (2006) The influence of temperature and host availability on the host exploitation strategies of sexual and asexual parasitic wasps of the same species. *Oecologia*. 148(1), 153–161.
- Amichai, E. & Kronfeld-Schor, N. (2019) Artificial Light at Night Promotes Activity Throughout the Night in Nesting Common Swifts (*Apus apus*). *Scientific Reports*. 9(1), 11052.
- Bates, D., Mächler, M., Bolker, B. & Walker, S. (2014) Fitting Linear Mixed-Effects Models using lme4. *Journal of Statistical Software*. 67(1), 1-48. doi:10.18637/jss.v067.i01.
- Bennie, J., Davies, T.W., Cruse, D. & Gaston, K.J. (2016) Ecological effects of artificial light at night on wild plants. *Journal of Ecology*. 104(3), 611–620.
- Bodin, A., Vinauger, C. & Lazzari, C.R. (2009) Behavioural and physiological state dependency of host seeking in the blood-sucking insect *Rhodnius prolixus*. *Journal of Experimental Biology*. 212(15), 2386–2393.
- Bonduriansky, R. & Day, T. (2009) Nongenetic Inheritance and Its Evolutionary Implications. *Annual Review of Ecology, Evolution, and Systematics*. 40(1), 103–125.
- Boyes, D.H., Evans, D.M., Fox, R., Parsons, M.S. & Pocock, M.J.O. (2020) Is light pollution driving moth population declines? A review of causal mechanisms across the life cycle. *Insect Conservation and Diversity*.
- Casas, J., Driessen, G., Mandon, N., Wielaard, S., Desouhant, E., ... Bernstein, C. (2003) Energy dynamics in a parasitoid foraging in the wild. *Journal of Animal Ecology*. 72(4), 691–697.
- Castelo, M.K., Corley, J.C. & Desouhant, E. (2003) Conspecific Avoidance During Foraging in *Venturia canescens* (Hymenoptera: Ichneumonidae): The Roles of Host Presence and Conspecific Densities. *Journal of Insect Behavior*. 16(2), 307–318.
- Champely, S. (2020) pwr: Basic Functions for Power Analysis. R package version 1.3-0. <https://CRAN.R-project.org/package=pwr>
- Desouhant, E., Gomes, E., Mondy, N. & Amat, I. (2019) Mechanistic, ecological, and evolutionary consequences of artificial light at night for insects: review and prospective. *Entomologia Experimentalis et Applicata*. 167(1), 37–58.
- Desouhant, E., Driessen, G., Lapchin, L., Wielaard, S. & Bernstein, C. (2003) Dispersal between host populations in field conditions: navigation rules in the parasitoid *Venturia canescens*. *Ecological Entomology*. 28(3), 257–267.

- Desouhant, E., Driessen, G., Amat, I. & Bernstein, C. (2005) Host and food searching in a parasitic wasp *Venturia canescens*: A trade-off between current and future reproduction? *Animal Behaviour*. 70(1), 145–152.
- Desouhant, E., Lucchetta, P., Giron, D. & Bernstein, C. (2010) Feeding activity pattern in a parasitic wasp when foraging in the field. *Ecological Research*. 25(2), 419–428.
- Durrant, J., Michaelides, E.B., Rupasinghe, T., Tull, D., Green, M.P. & Jones, T.M. (2015) Constant illumination reduces circulating melatonin and impairs immune function in the cricket *Teleogryllus commodus*. *PeerJ*. 3, e1075.
- Falchi, F., Cinzano, P., Duriscoe, D., Kyba, C.C.M., Elvidge, C.D., ... Furgoni, R. (2016) The new world atlas of artificial night sky brightness. *Science Advances*. 2(6), e1600377.
- Firebaugh, A. & Haynes, K.J. (2016) Experimental tests of light-pollution impacts on nocturnal insect courtship and dispersal. *Oecologia*. 182(4), 1203–1211.
- Foray, V., Pelisson, P.-F., Bel-Venner, M.-C., Desouhant, E., Venner, S., ... Rey, B. (2012) A handbook for uncovering the complete energetic budget in insects: the van Handel's method (1985) revisited. *Physiological Entomology*. 37(3), 295–302.
- Frank, K. (2009) Exploitation of artificial light at night by a diurnal jumping spider. *Peckhamia*. 78(1), 1–3.
- Gaston, K.J. (2019) Nighttime Ecology: The “Nocturnal Problem” Revisited. *The American Naturalist*. 193(4), 481–502.
- Gaston, K.J., Duffy, J.P., Gaston, S., Bennie, J. & Davies, T.W. (2014) Human alteration of natural light cycles: causes and ecological consequences. *Oecologia*. 176(4), 917–931.
- Gaston, K.J., Davies, T.W., Nedelec, S.L. & Holt, L.A. (2017) Impacts of Artificial Light at Night on Biological Timings. *Annual Review of Ecology, Evolution, and Systematics*. 48(1), 49–68.
- Giron, D. & Casas, J. (2003) Mothers reduce egg provisioning with age. *Ecology Letters*. 6(4), 273–277.
- Gomes, E., Desouhant, E. & Amat, I. (2019) Evidence for risk-taking behavioural types and potential effects on resource acquisition in a parasitoid wasp. *Animal Behaviour*. 154, 17–28.
- Guetté, A., Godet, L., Juigner, M. & Robin, M. (2018) Worldwide increase in Artificial Light At Night around protected areas and within biodiversity hotspots. *Biological Conservation*. 223, 97–103.
- Harvey, J.A. & Strand, M.R. (2002) The Developmental Strategies of Endoparasitoid Wasps Vary with Host Feeding Ecology. *Ecology*. 83(9), 2439–2451.
- Harvey, J.A. & Thompson, D.J. (1995) Developmental interactions between the solitary endoparasitoid *Venturia canescens* (Hymenoptera: Ichneumonidae), and two of its

- hosts, *Plodia interpunctella* and *Corcyra cephalonica* (Lepidoptera: Pyralidae). *European Journal of Entomology*. 92(2), 427–435.
- Harvey, J.A. & Vet, L.E.M. (1997) *Venturia canescens* parasitizing *Galleria mellonella* and *Anagasta kuehniella*: differing suitability of two hosts with highly variable growth potential. *Entomologia Experimentalis et Applicata*. 84(1), 93–100.
- Hölker, F., Wolter, C., Perkin, E.K. & Tockner, K. (2010) Light pollution as a biodiversity threat. *Trends in Ecology & Evolution*. 25(12), 681–682.
- Homma, K., McFarland, L.Z. & Wilson, W.O. (1967) Response of the Reproductive Organs of the Japanese Quail to Pinealectomy and Melatonin Injections. *Poultry Science*. 46(2), 314–319.
- Ismaeil, I., Doury, G., Desouhant, E., Dubois, F., Prevost, G. & Couty, A. (2013) Trans-Generational Effects of Mild Heat Stress on the Life History Traits of an Aphid Parasitoid. *PLOS ONE*. 8(2), e54306.
- Javoiš, J. & Tammaru, T. (2004) Reproductive decisions are sensitive to cues of life expectancy: the case of a moth. *Animal Behaviour*. 68(2), 249–255.
- Jones, T.M., Durrant, J., Michaelides, E.B. & Green, M.P. (2015) Melatonin: a possible link between the presence of artificial light at night and reductions in biological fitness. *Philosophical Transactions of the Royal Society B: Biological Sciences*. 370(1667), 20140122.
- de Jong, M., Jeninga, L., Ouyang, J.Q., van Oers, K., Spoelstra, K. & Visser, M.E. (2016) Dose-dependent responses of avian daily rhythms to artificial light at night. *Physiology & Behavior*. 155, 172–179.
- Keiser, C.N. & Mondor, E.B. (2013) Transgenerational Behavioral Plasticity in a Parthenogenetic Insect in Response to Increased Predation Risk. *Journal of Insect Behavior*. 26(4), 603–613.
- Kenward, M.G. & Roger, J.H. (1997) Small Sample Inference for Fixed Effects from Restricted Maximum Likelihood. *Biometrics*. 53(3), 983–997.
- Knop, E., Zoller, L., Ryser, R., Gerpe, C., Hörler, M. & Fontaine, C. (2017) Artificial light at night as a new threat to pollination. *Nature*. 548(7666), 206–209.
- Kronfeld-Schor, N., Dominoni, D., De la Iglesia, H., Levy, O., Herzog, E. D., Dayan, T. & Helfrich-Forster, C. (2013) Chronobiology by moonlight. *Proceedings of the Royal Society B: Biological Sciences*. 280(1765), 20123088.
- Kyba, C., Mohar, A. & Posch, T. (2017) How bright is moonlight? *Astronomy & Geophysics*. 58, 31–32.
- Langevelde, F. van, Grunsven, R.H.A. van, Veenendaal, E.M. & Fijen, T.P.M. (2017) Artificial night lighting inhibits feeding in moths. *Biology Letters*. 13(3), 20160874.

- Langevelde, F. van, Braamburg-Annegarn, M., Huigens, M.E., Groendijk, R., Poitevin, O., ... WallisDeVries, M.F. (2018) Declines in moth populations stress the need for conserving dark nights. *Global Change Biology*. 24(3), 925–932.
- Le Ralec, A. (1995) Egg contents in relation to host-feeding in some parasitic hymenoptera. *Entomophaga*. 40(1), 87–93.
- Lebbin, D.J., Harvey, M.G., Lenz, T.C., Andersen, M.J. & Ellis, J.M. (2007) Nocturnal Migrants Foraging at Night by Artificial Light. *The Wilson Journal of Ornithology*. 119(3), 506–508.
- Lenth, R. (2020) emmeans: Estimated Marginal Means, aka Least-Squares Means. R package version 1.5.1. <https://CRAN.R-project.org/package=emmeans>
- Longcore, T. & Rich, C. (2004) Ecological light pollution. *Frontiers in Ecology and the Environment*. 2(4), 191–198.
- Lucchetta, P., Bernstein, C., Théry, M., Lazzari, C. & Desouhant, E. (2008) Foraging and associative learning of visual signals in a parasitic wasp. *Animal Cognition*. 11(3), 525–533.
- Luginbuhl, C.B., Boley, P.A. & Davis, D.R. (2014) The impact of light source spectral power distribution on sky glow. *Journal of Quantitative Spectroscopy and Radiative Transfer*. 139, 21–26.
- Macgregor, C.J., Pocock, M.J.O., Fox, R. & Evans, D.M. (2015) Pollination by nocturnal Lepidoptera, and the effects of light pollution: a review. *Ecological Entomology*. 40(3), 187–198.
- Maurer, A., Thawley, C., Fireman, A., Giery, S. & Stroud, J. (2019) Nocturnal activity of Antigua lizards under artificial light. *Herpetological Conservation and Biology*. 14, 105–110.
- McLay, L.K., Green, M.P. & Jones, T.M. (2017) Chronic exposure to dim artificial light at night decreases fecundity and adult survival in *Drosophila melanogaster*. *Journal of Insect Physiology*. 100(Supplement C), 15–20.
- McLay, L.K., Nagarajan-Radha, V., Green, M.P. & Jones, T.M. (2018) Dim artificial light at night affects mating, reproductive output, and reactive oxygen species in *Drosophila melanogaster*. *Journal of Experimental Zoology Part A: Ecological and Integrative Physiology*. 329(8–9), 419–428.
- Miller, C.R., Barton, B.T., Zhu, L., Radeloff, V.C., Oliver, K.M., ... Ives, A.R. (2017) Combined effects of night warming and light pollution on predator–prey interactions. *Proceedings of the Royal Society B: Biological Sciences*. 284(1864), 20171195.
- Muller, D., Giron, D., Desouhant, E., Rey, B., Casas, J., ... Visser, B. (2017) Maternal age affects offspring nutrient dynamics. *Journal of Insect Physiology*. 101, 123–131.

- Pinheiro, J., Bates, D., DebRoy, S., Sarkar, D. & R Core Team. (2019) nlme: Linear and Nonlinear Mixed Effects Models. R package version 3.1-141. <https://CRAN.R-project.org/package=nlme>.
- R Core Team. (2019) R: A language and environment for statistical computing. *R Foundation for Statistical Computing, Vienna, Austria*. <https://www.R-project.org/>.
- Rich, C. & Longcore, T. (2006) *Ecological Consequences of Artificial Night Lighting*. Island Press, Washington, USA.
- Roitberg, B.D., Sircom, J., Roitberg, C.A., Alphen, J.J.M. van & Mangel, M. (1993) Life expectancy and reproduction. *Nature*. 364(6433), 108–108.
- Salt, G. (1975) The fate of an internal parasitoid, *Nemeritis canescens*, in a variety of insects. *Transactions of the Royal Entomological Society of London*. 127(2), 141–161.
- Siro, E., Ploye, H. & Bernstein, C. (1997) State dependent superparasitism in a solitary parasitoid: egg load and survival. *Behavioral Ecology*. 8(2), 226–232.
- Therneau, T. (2015) A Package for Survival Analysis in S. R package version 2.37-7. <http://CRAN.R-project.org/package=survival>.
- Touzot, M., Lengagne, T., Secondi, J., Desouhant, E., Théry, M., ... Mondy, N. (2020) Artificial light at night alters the sexual behaviour and fertilisation success of the common toad. *Environmental Pollution*. 259, 113883.
- Wakefield, A., Broyles, M., Stone, E.L., Harris, S. & Jones, G. (2018) Quantifying the attractiveness of broad-spectrum street lights to aerial nocturnal insects. *Journal of Applied Ecology*. 55(2), 714–722.
- Yang, Y., Yu, Y., Yang, B., Zhou, H. & Pan, J. (2016) Physiological responses to daily light exposure. *Scientific Reports*. 6(1), 24808.
- Yang, Y., Pan, C., Zhong, R. & Pan, J. (2018) Artificial light and biological responses of broiler chickens: dose-response. *Journal of Animal Science*. 96(1), 98–107.
- Zuur, A.F., Ieno, E.N., Walker, N.J., Saveliev, A.A. & Smith, G.M. (2009) *Mixed Effects Models and Extensions in Ecology with R*. Springer, New York, NY.

SUPPLEMENTARY DATA

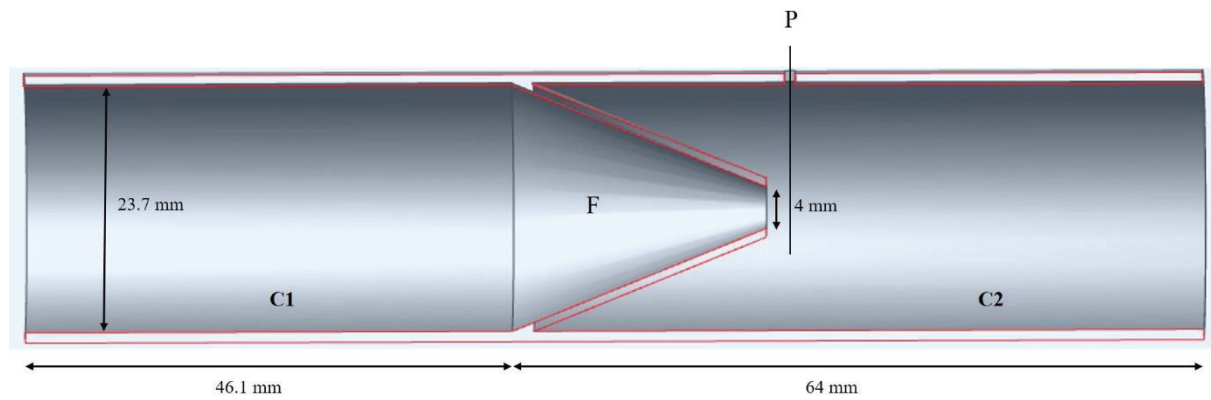

Figure S1 Schema of the experimental device used to assess the nocturnal activity of *V. canescens* (cross-section view). The device consisted in a 3D-printed tube separated in two compartments (C1 and C2) by a funnel (F). The tube is closed at both ends by foam plugs. We prevented the insects from passing through the funnel before the nighttime by obstructing the funnel exit with a Plexiglas partition (P).

Table S1 Relationships between offspring energy reserves and their mother’s light condition, their mother’s age and their body size (tibia length, TL), at the trans-generational level. ALAN means “Artificial light at night”

	Protein content			Free sugar content			Glycogen content			Neutral lipid content		
	<i>F</i>	<i>df</i>	<i>P</i>	<i>F</i>	<i>df</i>	<i>P</i>	<i>F</i>	<i>df</i>	<i>P</i>	<i>F</i>	<i>df</i>	<i>P</i>
ALAN condition (AC)		NS			NS			NS			NS	
Age		NS			NS			NS			NS	
Tibia length (TL)	48.33	1, 56.2	<0.001	20.53	1, 59	0.001	4.10	1, 58	0.05	21.1	1, 55.5	0.001
Age * TL		NS			NS			NS			NS	
Age * AC		NS			NS			NS			NS	
AC * TL		NS			NS			NS			NS	

We labelled ‘NS’ the variables and interactions which turned out to be non-significant at the 0.05 level during the model selection process.

3. Does the choice between parasitizing high- or low-quality hosts depends on artificial light at night in *Venturia canescens*?

3.1. Superparasitism behaviour in *Venturia canescens*

Venturia canescens is a solitary parasitoid, which means that at most one egg per host can develop into an adult. Female parasitoids can encounter two types of hosts in their environment: healthy hosts and hosts that have already been parasitized. When several eggs are laid in the same host, the outcome of the competition between parasitoid larvae can depend on several factors, such as their competitive abilities (e.g. larvae can physically attack each other, Marris & Casperd, 1996) or the delay between ovipositions (Sirot, 1996). In *V. canescens* for example, when the interval between two ovipositions in the same host is more than 3 days, the second larva always lost the competition which drastically reduces the pay-off of superparasitism (Sirot, 1996). The decision whether to reject or to oviposit in an already parasitized host, which is called superparasitism, is therefore of utmost importance for the fitness of female parasitoids. Avoiding superparasitism by selecting a healthy host instead of a parasitized one depends on the wasps' ability to discriminate them. Several studies demonstrated that thelytokous *V. canescens* can detect already parasitized hosts thanks to chemical marks deposited inside the host during oviposition (Hubbard *et al.*, 1987). When exploiting a host patch, wasps also deposit a chemical marker on its surface, which can influence the time spent searching for hosts on this patch by subsequent females (Bernstein & Driessen, 1996). Since female parasitoids are able to discriminate parasitized hosts and therefore avoid superparasitism, its common occurrence in nature has first been considered as the consequence of mistakes made by the wasps when allocating their eggs. However, studies rapidly highlighted that superparasitism can be considered as an adaptative reproductive strategy (van Alphen & Visser, 1990). For example, if hosts are scarce, female wasps can be subject to time-limitation (*i.e.* death before total exhaustion of egg supply). In this context, it could therefore be beneficial for wasps to oviposit in an already parasitized host larva instead of avoiding superparasitism. It has also been shown that unfed *V. canescens* females with reduced life expectancy always superparasitized, and wasps with higher life expectancy superparasitized when they had a large egg load (Sirot *et al.*, 1997).

The aim of this study was to determine whether artificial light at night modified the tendency to superparasitise in *Venturia canescens*. We exposed thelytokous wasps to two light conditions for two nights: a control condition (total darkness) and a low ALAN condition (0.7 lux), and then assessed their host searching behaviour on a patch containing both healthy and parasitized hosts. This was carried out in parallel with the experiment investigating the consequences of light at night on host and food searching (see the previous section “Dealing with host and food searching in a diurnal parasitoid: consequences of light at night at intra- and trans-generational levels”). *V. canescens* being a diurnal species, we hypothesized that presence of light at night could make wasps active at night, as sometimes observed in other diurnal species such as birds (Amichai & Kronfeld-Schor, 2019). Moreover, wasps had access to food only during the day for a limited period of time. We therefore made the hypothesis that artificial light at night, by extending the activity of *V. canescens* into the night, would impact the physiological state of the wasps and increase their tendency to superparasitise compared to wasps in the control condition. We also expected wasps not exposed to light at night to avoid attacking already parasitized hosts.

3.2. Methods

Biological model and rearing conditions

We used thelytokous females of a strain established from about 70 wild females trapped near Valence (southern France) during the summer of 2016. The strain was maintained under controlled conditions ($25\pm 1^\circ\text{C}$, $60\pm 5\%$ relative humidity, 12:12 light:dark) in boxes containing larvae of *Ephestia kuehniella* (Lepidoptera: Pyralidae) as hosts and organic wheat semolina as feeding medium for the host larvae. The adult wasps were fed *ad libitum* with honey diluted 1:1 with distilled water, because in natural conditions *V. canescens* use nectar or honeydew as food sources (Desouhant *et al.*, 2010).

Light conditions

We used the same lighting conditions as in Gomes *et al.* (2021) (see ‘Methods’ in section 2, ‘Dealing with host and food searching in a diurnal parasitoid: consequences of light at night at intra and trans-generational levels’, of this chapter for a complete description).

Experimental procedure

The aim of this experiment was to compare superparasitism rates between the control and low ALAN conditions. For this purpose, wasps were presented with host patches containing two types of host larvae: healthy larvae or already parasitized larvae. We partly followed the protocol described in Amat *et al.* (2009).

Preparation of partially parasitized host patches

Host patches were made of Plexiglas discs (14 cm diameter, 1 cm thick) carved with 69 cells (8 mm diameter, 2 mm deep). Cells were evenly spaced and arranged in 9 rows (Figure 10). On each row, one cell out of two was filled with semolina and contained a single third-instar host larva (Figure 10). Each disc therefore contained 37 host larvae. The discs were covered by a piece of organza to prevent the wasps from leaving their cell. The host patches were prepared 9 days before the day of the experiment to allow the semolina to become impregnated with host kairomones.

One day before the experiment, for each host patch, one out of every two rows of cells (*i.e.* 4 rows per patch) were covered with strips of paper to protect the larvae from wasps' attacks. Host patches were then individually placed in a round Petri dish (diameter 19 cm) with five one-day-old females that have not been exposed to artificial light at night. Host patches were removed after 2.5h, a period of time after which all the unprotected larvae were considered marked and/or parasitized. Strips of paper were also removed, and the larvae that were underneath were not parasitized (hereafter 'healthy').

Each host patch therefore had alternate rows of parasitized and healthy host larvae (Figure 10). There was 16 parasitized larvae and 21 healthy larvae.

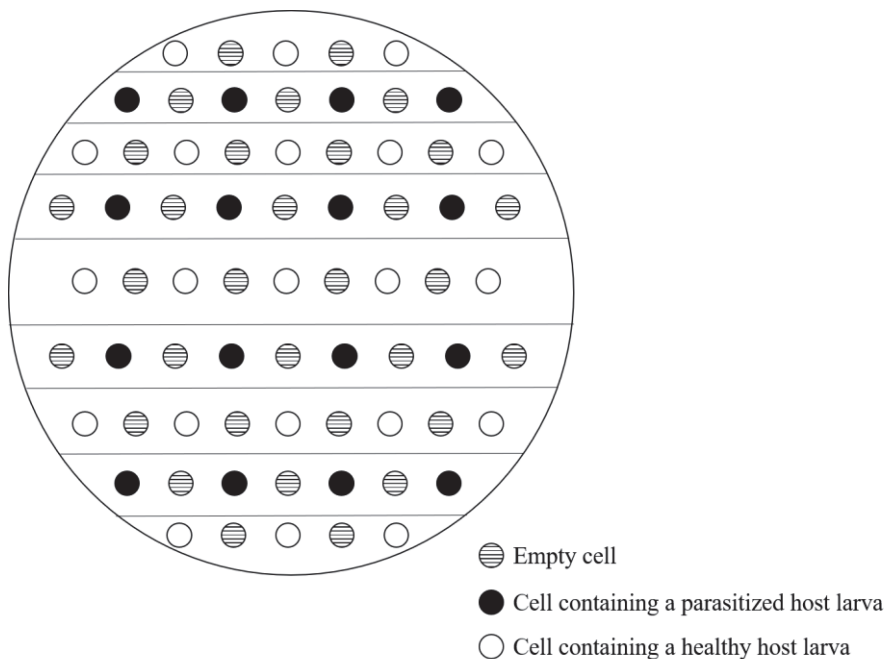

Figure 10 Diagram of a host patch after being parasitized by 5 wasps for 2.5h. The patch contains 37 host larvae, of which 16 are already parasitized (black circles) and 21 are healthy (white circles).

Exploitation of partially parasitized host patches

Newly emerged wasps were kept individually in plastic vials (7 x 3 cm) in control or low ALAN conditions for two days before the behavioural test, that took place on the third day. Wasps were fed every day with 4 μ l of 40% sucrose solution, and were given 20 μ l of demineralised water the first day only.

The behavioural test took place on the third day after wasps' emergence. A host patch was placed in a round Petri dish (diameter 20 cm) and the surrounding space was filled with clean semolina. The patch was then placed in a Plexiglas box (30 x 25 cm and 9 cm high) under a camera connected to a computer. The trial began just after a wasp was carefully placed on the central cell of the host patch, and lasted a maximum of 30 minutes. We recorded three behaviours through an event recorder (Ethovision, Noldus Technology, Wageningen, The Netherlands): antennating (*i.e.* tapping of the substrate with the antennae), probing (*i.e.* searching for hosts in the substrate with the ovipositor) and cocking (*i.e.* positioning of an egg in the ovipositor by an abdominal movement, (Rogers, 1972)). The event recorder differentiated when the behaviours were performed on cells containing healthy or already parasitized hosts. The wasps were frozen dry at -20°C right after the behavioural test. In order to take into account a potential effect of wasp size in the analyses, we determined tibia length as a proxy of body

size, as commonly done in this species (Harvey & Vet, 1997). For each wasp, we took a picture of the left hind tibia under a binocular magnifier coupled with a camera and measured its length to the nearest 0.01 mm with the software Motic Image Plus 2.0 (Motic, Hong Kong).

We tested 23 and 24 wasps in the control and low ALAN conditions, respectively.

Statistical analyses

For each wasp, we computed the time spent on the host patch (patch residence time), as well as the time spent antennating and the time spent probing in healthy and already parasitized hosts. Probing followed by a cocking indicated a successful oviposition in the last larvae attacked (Amat *et al.*, 2003). We therefore also computed the number of cocking events in each type of host. The host patches did not have the same proportion of healthy (57%) and already parasitized (43%) hosts. We therefore accounted for this difference in the availability of each type of host in the analyses.

We also estimated a superparasitism index (*SP*) for each wasp that measured its tendency to superparasitize (Amat *et al.*, 2009; Sirot *et al.*, 1997). *SP* is defined by equation (1), in which p_{para} designates the number of ovipositions in already parasitized hosts and t_{para} the time spent probing in cells containing already parasitized hosts, and $p_{healthy}$ and $t_{healthy}$ designated the same variables but in cells containing healthy hosts.

$$SP = \frac{p_{para}/t_{para}}{p_{healthy}/t_{healthy}} \quad (1)$$

Assuming that healthy hosts are always accepted by the females, $p_{healthy}/t_{healthy}$ measures the ability of a wasp to successfully parasitize a host. *SP* therefore measures the willingness of the wasp to lay an egg in an already parasitized host.

When the wasps do not discriminate between healthy and already parasitized hosts, *SP* is equal to 1. *SP* lower than 1 indicates that the wasps tend to avoid laying eggs in already parasitized hosts. On the contrary, *SP* higher than 1 means that already parasitized host are more frequently attacked than healthy hosts. Finally, when *SP* is equal to zero, it indicates that wasps do not superparasitize at all.

We performed statistical analyses with R 3.6.1 (R Core Team, 2019). We fitted all the models with body size, light condition (factor with two modalities, ‘Control’ and ‘Low ALAN’) and their interaction as explanatory variables. From the full models, we used a backward model selection approach to select the best model. We compared nested models and removed all non-significant interactions and variables.

We first considered behaviours related to patch exploitation (*i.e.* patch residence time, antennating, probing and cocking) separately. We therefore built two Gamma (log link) generalized linear models (GLMs) with the patch residence time, time spent antennating and time spent probing as response variables. We also built a linear model with the number of cocking events as response variable. For these models, we added host type (factor with two modalities, ‘Healthy’ and ‘Parasitized’), and its two-way interactions with body size and light condition, as explanatory variables.

We then analysed the *SP* index in two steps. First, to determine whether the light condition influenced the proportion of wasps that did not superparasitize at all (*i.e.* with $SP = 0$), we fitted a binomial GLM with the binary variable ‘Superparasitism’ (factor with two modalities, ‘No when *SP* was equal to 0 and ‘Yes’ when the *SP* was different than 0). In a second step, we focused on wasps with *SP* strictly higher than 0 to analyse the influence of light condition on the tendency to lay eggs in already parasitized hosts. We therefore fitted a Gamma (log link) GLM with *SP* as response variable. The analysis was weighted by the total number of ovipositions among which *SP* was calculated (Amat *et al.*, 2009).

3.3. Results and conclusion

Patch residence time was influenced by light condition in interaction with wasps’ body size ($\chi^2 = 5.74$, $df = 1$, $P = 0.02$). Larger wasps had a longer patch residence time in the control condition than in the low ALAN condition, and conversely for smaller wasps (Figure 11).

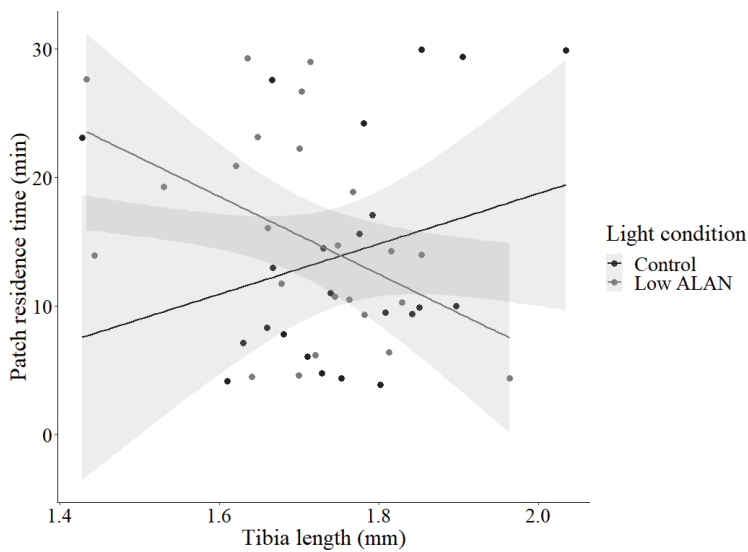

Figure 11 Effect of body size (estimated by tibia length) on patch residence time in the control and low artificial light at night (ALAN) conditions.

Light condition did not influence the time spent probing (mean values in seconds: 74.3 ± 9.7 and 81.1 ± 9.0 in the control and low ALAN conditions, respectively; $\chi^2 = 0.07$, $df = 1$, $P = 0.79$) or the number of cocking events (mean number of cocking events: 2.4 ± 0.3 and 2.8 ± 0.3 in the control and low ALAN conditions, respectively; $F = 1.09$, $df = 1, 88$, $P = 0.30$). However, time spent antennating was influenced by light condition, in interaction with wasps' body size ($\chi^2 = 5.57$, $df = 1$, $P = 0.02$). Larger wasps spent more time antennating than smaller wasps in the control condition, and conversely in low ALAN condition (Figure 12).

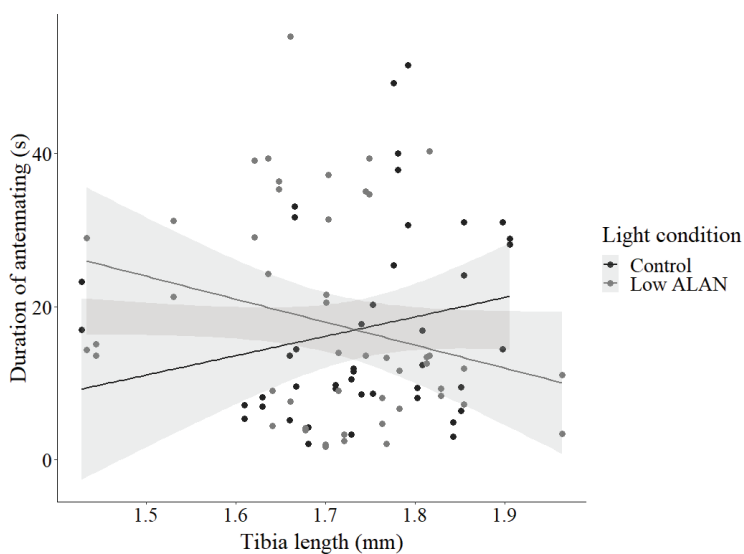

Figure 12 Effect of body size (estimated by tibia length) on the time spent antennating in the control and low artificial light at night (ALAN) conditions.

The proportion of wasps that did not superparasitize (*i.e.* $SP = 0$) was not different between the light conditions (19% and 25% in the control and low ALAN conditions, respectively; $\chi^2 = 0.13$, $df = 1$, $P = 0.72$). Similarly, the propensity of wasps to superparasitize (estimated with SP) did not differ between light condition ($\chi^2 = 0.05$, $df = 1$, $P = 0.82$).

Finally, the wasps did not discriminate between healthy and already parasitized hosts ($SP = 0.91$ was not statistically different from 1: Wilcoxon's signed-rank test $V = 446$, $P = 0.42$).

We found that no matter what light conditions the wasps were exposed to at night, they did not discriminate between healthy and parasitized hosts (or did not base their decision whether or not to lay eggs on the status of the host larvae). The absence of difference in superparasitism behaviour between no ALAN and low ALAN may be due to the fact that, with the same feeding protocol, light at night did not modify wasps' energy reserves (Gomes *et al.*, 2021). The physiological state of females was therefore equal in the two light conditions, which did not cause light-polluted wasps to accept superparasitism more, contrary to our initial hypothesis. However, the fact that healthy and parasitized hosts were not discriminated is a surprising result, especially in the control condition. Indeed, it has been shown that well-fed thelytokous wasps can cope with superparasitism by avoiding attacking already parasitized hosts (Amat *et al.*, 2009). A potential explanation may be that not all the unprotected larvae on the host patches were parasitized the day before the experiment, although it seems unlikely because patch exploitation behaviour was visually monitored at the start of the 2.5h period (*pers. obs.*). A lack of statistical power because of the low number of ovipositions (the average number of eggs laid was 2.5 and 3 in the control and light conditions, respectively) may also have prevented the detection of an effect of artificial light at night on the superparasitism behaviour in *Venturia canescens*.

4. Conclusion

In this chapter, we demonstrated that artificial light at night induced movement at night in a diurnal insect species, but also altered daytime behaviours related to feeding and host searching. Wasps exposed to low intensity of light at night spent more time feeding and, in a choice experiment, showed a greater preference for hosts. Artificial light at night, however, did not affect their decision to superparasitize. These behavioural changes were not driven by effects

of ALAN on energy reserves. Finally, we also detected that wasps tended to have a higher number of offspring when exposed to light at night.

Venturia canescens became active at night in presence of light. The next step was therefore to test whether light-polluted wasps were able to take advantage of this extended period of activity to feed and search for hosts. It is indeed a frequent, but rarely tested, assumption that diurnal species could benefit from foraging opportunities offered by what is called the ‘night-light niche’. However, becoming active at night is likely to also be accompanied by costs that would negatively affect the wasps’ fitness. Therefore, we also aimed to determine the potential fitness consequences of light pollution by quantifying the lifetime reproductive success of wasps exposed to different intensities of light at night.

Chapter 6

Fitness consequences of artificial light at night: impacts on lifetime reproductive success and senescence

1. Artificial light and foraging at night in a diurnal insect: consequences on lifetime reproductive success and senescence (in preparation)

**Artificial light and foraging at night in a diurnal insect:
consequences on lifetime reproductive success and
senescence**

Gomes Elisa¹, Lemaître Jean-François¹, Rodriguez-Rada Valentina¹, Débias François¹,
Desouhant Emmanuel¹, Amat Isabelle¹

¹ Univ. Lyon, Université Lyon 1, CNRS, UMR 5558, Laboratoire de Biométrie et Biologie
Evolutive (LBBE), Villeurbanne, France

In preparation

INTRODUCTION

Among human-induced rapid environmental changes (HIRECs) such as habitat loss, chemical pollution or climate change (Sih *et al.*, 2011), artificial light at night (ALAN) is an unprecedented phenomenon from an evolutionary perspective (Davies & Smyth, 2018; Swaddle *et al.*, 2015). The rise of artificial light at night during the 19th century and its strong increase with the development of electric lighting profoundly altered natural light cycles. Daily and seasonal cycles of light and dark, as well as lunar light cycles, are predictable environmental variations that act as major environmental cues for organisms (Gaston *et al.*, 2017; Kronfeld-Schor *et al.*, 2013). Their disruption by artificial light at night has therefore many biological impacts in multitude species (Sanders *et al.*, 2020).

Initially, studies solely focused on nocturnal organisms, such as bats, moths or fireflies, which were more likely to have their behaviours disturbed by light at night (Firebaugh & Haynes, 2016; Langevelde *et al.*, 2017; Russo *et al.*, 2017). However, diurnal organisms are also impacted by these illuminated nights. Indeed, artificial lighting creates new opportunities for diurnal species to forage or display reproductive behaviours at night ('night-light' niche, Longcore & Rich, 2004). Evidence of the use of the 'night-light niche' come mostly from vertebrate species. Studies highlighted modifications in activity patterns in diurnal animals under ALAN, such as birds with an advanced onset of activity (Dominoni *et al.*, 2014; de Jong *et al.*, 2016) or an increase in night-time activity (Ouyang *et al.*, 2017). In the common swift *Apus apus*, high intensity of light at night during the breeding season led birds to be active throughout the night instead of joining their nest (Amichai & Kronfeld-Schor, 2019). In the European blackbird (*Turdus merula*), individuals exposed to rather dim levels of ALAN (about 0.15 lux) extended their foraging activity in the evening compared to individuals in darker areas (Russ *et al.*, 2015). Observations also showed that diurnal vertebrates can take advantage of light sources, which attract arthropods, to forage during the night (*e.g.* several bird species, Lebbin *et al.*, 2007, or two lizard species, *Anolis leachii* and *Anolis wattsi*, Maurer *et al.*, 2019). However, studies in arthropods are scarce. The diurnal jumping spider (*Platycryptus undatus*) changed its hunting habits under ALAN conditions, by preying on insects around light sources at night (Frank, 2009). Artificial light at night can also thoroughly change interactions between arthropod species. A mesocosm study suggested that some parasitoid species may extend their parasitism activity into the night when exposed to low levels of ALAN (Sanders *et al.*, 2018). However, the ecological and evolutionary consequences of such 'additional' activities, either

beneficial or detrimental, are still largely unknown. For example, diurnal insects becoming active under light at night could be exposed to predators against which they lack anti-predator behavioural responses, contrary to nocturnal insect species (Wakefield *et al.*, 2015). Testing explicitly the impact of artificial lighting on fitness-related traits at night and during the day is therefore necessary to fully understand the evolutionary consequences of light pollution on diurnal organisms.

Lifetime reproductive success ('LRS'), defined as the number of offspring produced during an individual's lifespan, is a keystone variable to estimate fitness of organisms (Clutton-Brock, 1988) and therefore a relevant proxy to study evolutionary consequences of artificial light at night. Lifetime reproductive success depends on survival and reproductive success, two biological traits exhibiting age-related changes (*i.e.* senescence) in both laboratory and wild populations (Nussey *et al.*, 2013). Senescence patterns can differ between species (Lemaître *et al.*, 2020) and also according to environmental conditions (Nussey *et al.*, 2013). For example, in the wild snake *Vipera ursinii*, actuarial senescence (*i.e.* increase in mortality hazard with age) patterns differed between sub-populations living in different habitats, shifting from negligible senescence in the optimal habitat to strong senescence in the sub-optimal habitat exposed to human disturbance (Tully *et al.*, 2020). Some studies suggested a potential link between artificial light at night and age-related changes in biological traits, potentially through the action of light at night on oxidative stress (El-Bakry *et al.*, 2018; Vinogradova *et al.*, 2009) but evidence is still scarce and indirect. Long-term studies, monitoring individuals from birth to death, are therefore needed to estimate their fitness, and represent also an opportunity to investigate the existence of age-related changes in reproductive performance and survival that affect lifetime reproductive success (Clutton-Brock & Sheldon, 2010).

The aim of this study was to test whether artificial light at night, by potentially allowing the wasps to forage at night, affected the lifetime reproductive success and senescence patterns of a diurnal parasitoid wasp, *Venturia canescens*. A previous study showed that females exposed to ALAN altered their diurnal behaviours. First, night-time lighting induced nocturnal activity while wasps kept in the dark did not move (Gomes *et al.*, 2021). Moreover, wasps exposed to light at night preferred to search for hosts than for food during the day, and had a tendency to produce more offspring when given a single occasion to parasitize a host aggregate (Gomes *et al.*, 2021). This species is therefore a relevant biological model to determine whether diurnal

insects can exploit the night-light niche (*i.e.* by feeding and exploiting host patches) when exposed to artificial light at night, and what the consequences are in terms of lifetime reproductive success. We exposed female wasps to three controlled experimental conditions: no light at night (control), low ALAN (0.7 lux) or high ALAN (20 lux). Their feeding and reproductive behaviours were monitored daily, both during the day and at night, until their death.

METHODS

Biological model and rearing conditions

Venturia canescens (Gravenhorst) is a solitary endoparasitoid hymenopteran (Ichneumonidae). It attacks lepidopteran larvae, mainly Pyralidae (Salt, 1975), in their second to fifth instar (Harvey & Thompson, 1995). Parasitoid females use a mandibular gland secretion, called kairomone, released by host larvae when feeding, to locate them (Castelo *et al.*, 2003). *V. canescens* is a synovigenic species (Jervis *et al.*, 2001), which means that the females emerge with an initial load of mature eggs and additional eggs are produced throughout their adult life. The eggs are hydropic (*i.e.* yolk-deficient) which means that they do not store nutrients (Le Ralec, 1995). Eggs are therefore not energetically costly to produce (Pelosse *et al.*, 2011) and the lifetime reproductive success of *V. canescens* will depend on longevity and host availability. Feeding influencing longevity, it should therefore increase the fecundity of *V. canescens* by giving females more opportunities to parasitize hosts (Harvey *et al.*, 2001). *V. canescens* is a diurnal species showing no activity in the dark (Gomes *et al.*, 2021). However, females exposed to ALAN became active during the night (Gomes *et al.*, 2021).

We used thelytokous females of a strain established from about 70 wild females trapped near Valence (southern France) during the summer of 2016. The strain was maintained under controlled conditions (25±1°C, 60±5% relative humidity, 12:12 light:dark) in boxes containing larvae of *Ephestia kuehniella* (Lepidoptera: Pyralidae) as hosts and organic wheat semolina as feeding medium for the host larvae. The adult wasps were fed *ad libitum* with honey diluted 1:1 with distilled water, because in natural conditions *V. canescens* has frequently access to nectar or honeydew as food sources (Desouhant, Lucchetta, *et al.*, 2010).

Light conditions

We have created three experimental groups of wasps differing in their intensity of exposure to light at night. The wasps were kept in three thermostated chambers (SANYO Electric Co., Ltd, model number: MLR-351H) providing a temperature of 25°C and a relative humidity of 60%. Light cycle (12:12 h light:dark) and daytime light intensity (3500 lux) provided by neon tubes were similar in all three chambers. Each chamber was equipped with white LED lights (ribbon of LED SMD 5050, 6000-6500K, Sysled) on the ceiling to provide either a high intensity of light at night (20 lux, equivalent to the intensity of a street lamp; hereafter ‘high ALAN’ condition) or a low intensity of light at night (0.7 lux, equivalent to the intensity of a city skyglow, Bennie *et al.*, 2016); hereafter ‘low ALAN’ condition). These lighting systems were switched on in two of the three chambers, the third being used for the ‘control’ condition (0 lux, total darkness at night). We measured light intensities to the nearest 0.01 lux with an illuminance meter (T-10MA, Konica Minolta®) before the experiment, and checked light intensity every time we switched light conditions between thermostated chambers (see below). Light measurements in the chambers were performed inside the clear plastic boxes containing the insects and subsequently used in the experiments. We alternated the light conditions between chambers every two weeks to prevent any “chamber effect”.

Experimental set-up

We aimed to quantify the daily number of offspring produced by the wasps (exploiting host patches during the day and at night), as well as their feeding behaviour. We therefore designed an experimental set-up that made it possible to control when the wasps could feed and lay eggs, day and night. Host and food patches (see below) were placed on a Plexiglas® plate in a standardised way (“bottom plate” in Figure S1 (A) in the Supplementary data). Right above, the wasps were individually kept in clear plastic boxes on a white Plexiglas® plate (“superior plate” in Figure S1 (B) in the Supplementary Data), which was drilled with holes whose size and position coincide with the location of the host and food patches on the bottom plate. That superior plate could be lowered to allow the wasps to access the patches through the holes or lifted to prevent them to do so (Figure S2 (B) and (A) in the Supplementary Data). Lifting the superior plate also enabled to replace host patches with new ones when needed (see “Description of patch replacement” in Supplementary Data). A coarse mesh was stretched under the superior plate to prevent the wasps from escaping through the holes when the superior

plate was lifted (see Figure S2 in the Supplementary Data). That mesh had no effect on the wasp ability to lay eggs or acquire food (pers. obs. on 10 wasps, data not shown).

Preparation of host and food patches

Host patches consisted of 15 third-instar larvae in a Petri[®] dish (55 mm diameter) filled with semolina and covered by a piece of organza. They were prepared from 7 to 10 days before they were used to allow the semolina to become impregnated with host kairomones.

Food patches were prepared by soaking cotton wools with 8 ml of sucrose solution (40%) in a Petri[®] dish (35 mm diameter). The sucrose solution was dyed blue with food dyed (1% v/v), so we could easily determine if the insects ate or not by looking at the colour of their abdomen (see also in Desouhant *et al.*, 2005). Food patches were prepared daily, just before their use in the experiment.

Effect of ALAN on night-time feeding behaviour

Under the three night-time light conditions, the wasps had access to food either during the day or at night, alternately, followed by a 24-hour period without food (see Table). This experimental design aimed to test whether the wasps fed during the night when exposed to light. The day without food was planned to prevent a state of satiety that would have prevented the wasps from feeding on the following days.

Table 1 Schedule of the periods when the wasps were allowed to feed during a two-week experimental session. “∅” meant that food was not available. This sequence of feeding (D0-D3) was repeated until day 13.

Day	Daytime (8 a.m. to 8 p.m.)	Night-time (8:20 p.m. to 8 a.m.)
Day 0	Food	∅
Day 1	∅	Food
Day 2	∅	∅
Day 3	Food	∅

Effect of ALAN on lifetime reproductive success and senescence

Our experimental design consisted of three two-week experimental sessions, during which we compared the lifetime reproductive success and senescence patterns of 76 wasps exposed to the

three night-time lighting conditions ($N = 26$, 26 and 24 in the control, low ALAN and high ALAN conditions, respectively).

For every experimental session, we took newly emerged wasps, and individually provided them with a new host patch every day (from 8 a.m. to 8 p.m.) and every night (8:20 p.m. to 8 a.m. the next day) until death. Host larvae were concealed in the substrate (here, semolina) and each host patch was exposed to artificial light for 12 hours. It was therefore highly unlikely that artificial light at night had consequences on hosts in our experiment. Age of death was recorded for each wasp, and those who were not yet dead after two weeks were considered as censored in the survival analysis (there was 3, 2 and 7 censored wasps in the control, low ALAN and high ALAN conditions, respectively; $N = 12$ out of 76 wasps in total). Wasps were then kept at -20°C to measure their body size and egg load (see the paragraph “Body size and egg load measurements”). Each potentially parasitized host patch was kept in the rearing room (12:12 h light:dark, without light at night) and offspring emergences were counted for seven weeks (see the section ‘Dynamics of offspring production’ for a more detailed description). Classically, the development from egg to adult lasts 21 days in *V. canescens*. However, we extended the monitoring period because we observed that mother’s night-time light condition, in interaction with mother’s age, prolonged offspring development time up to 60 days (Gomes *et al.*, 2021).

In conclusion, our experimental design allowed to measure the daily reproductive success of each wasp, distinguishing between daytime and night-time egg-laying. It also enabled to quantify the potential age-related changes in wasps’ mortality rate (*i.e.* actuarial senescence) and reproductive traits (*i.e.* reproductive senescence).

Dynamics of offspring production

All host patches were monitored twice a week to count the total number of offspring per wasp.

In addition, we also wanted to determine whether the dynamics of offspring emergence changed over the life of the wasps, and whether these dynamics depended on the night-time lighting conditions to which wasps had been exposed. For this purpose, we monitored the development time of offspring emerging from host patches parasitized by one- four-, seven- and ten-day-old wasps. We monitored the patches parasitized during both daytime and night-time. Offspring emerging from these patches were frozen dry at -20°C to measure their body size (see protocol below).

Body size and egg load measurements

Body size can influence longevity and reproductive success in *V. canescens* (Pelosse *et al.*, 2011). We therefore estimated body size of the wasps in the three light conditions, as well as the size of selected offspring as described in the previous section, to account for size difference between individuals when assessing the effect of artificial light at night on longevity and actuarial senescence, and lifetime reproductive success and reproductive senescence.

We determined the tibia length as a proxy of body size as commonly done in this species (Harvey & Vet, 1997). For each wasp, we took a picture of the left hind tibia under a binocular magnifier coupled with a camera and measured its length to the nearest 0.01 mm with the software Motic Image Plus 2.0 (Motic, Hong Kong).

We measured the egg load at death of the mothers only (*i.e.* the wasps that were exposed to one of the three light conditions). The frozen wasps were immersed in Ringer solution for 2 hours to rehydrate. Their ovaries were then removed and the eggs counted under a microscope. There was no difference in egg load at death between light conditions (data not shown). We therefore used only body size to control for difference between individuals in subsequent analyses.

Statistical analysis

We performed the statistical analyses with R 4.0.2 (R Core Team, 2020). We used the packages *lme4* (Bates *et al.*, 2014) and *nlme* (Pinheiro *et al.*, 2019) to build linear and generalized linear models (GLMs), as well as linear mixed models (LMMs) and generalized linear mixed models (GLMMs). In the majority of models, unless otherwise specified, we included body size, light condition (factor with three modalities, ‘control’, ‘low ALAN’ and ‘high ALAN’) and thermostated chamber (factor with three modalities, ‘Chamber1’, ‘Chamber2’ and ‘Chamber3’), as well as their two by two interactions, as explanatory variables. From the full models, we used, unless otherwise stated, a backward model selection approach to select the best model. When needed, we computed post hoc comparisons between factor modalities using the package *emmeans* (Lenth, 2020). Cohen’s *h* (Cohen, 1992) was computed to estimate effect sizes between proportions, using the *pwr* package (Champely, 2020). Magnitude of effect sizes was assessed according to the following thresholds: $|x| < 0.2$: negligible; $0.2 \leq |x| < 0.5$: small; $0.5 \leq |x| < 0.8$: medium; $|x| \geq 0.8$: large (Cohen, 1992).

Night-time behaviours

We first focused on the consequences of ALAN on the wasps' feeding and egg-laying behaviours at night.

To assess whether light condition influenced the wasps' night-time feeding behaviour, we fitted binomial GLMs (logit link) with two different response variables. The first one was the binary variable 'Night-time feeding' ('Yes' or 'No'). Second, for each wasp that fed at night, we computed the proportion of night-time feeding events weighted by the total number of nights the individual had access to food. This variable therefore took into account the wasp's longevity.

With regard to the egg-laying behaviour, we analysed the proportion of wasp that exploited host patches at night depending on light condition by fitting a binomial GLM with the binary variable 'Patch exploitation behaviour at night' ('Yes' or 'No') as response variable.

Effect of ALAN on lifetime reproductive success ('LRS')

Night-time reproductive success was defined as the total number of offspring that emerged from all the host patches exploited during the night throughout a wasp's life. This response variable was analysed by fitting a negative binomial GLM (log link) to account for overdispersion in the data.

LRS was estimated by pooling the number of offspring produced from daytime and night-time host patches. We then fitted a negative binomial GLM (log link), to account for overdispersion in the data, with this count as response variable.

We also investigated the correlation between the total number of offspring from daytime and night-time host patches, and whether this relationship depended on light condition. To do this, we built a negative binomial GLM (log link) with the total number of offspring from daytime host patches as a response variable, and the total number of offspring from night-time host patches, body size, light condition and thermostated chamber, as well as their two by two interactions, as explanatory variables.

Effect of ALAN on senescence

We investigated the effect of light condition on age-specific mortality hazard using survival analysis (package *survival* (Therneau, 2015)). To determine whether light condition affected lifespan in *V. canescens*, we fitted Cox proportional hazards model.

To determine the shape of actuarial senescence in *V. canescens* and its characteristics (onset and rate of senescence), we used accelerated failure time (AFT) models that allow the definition of the distribution followed by survival times (Cowpertwait & Metcalfe, 2009). Within each light condition, we compared AFT models in which survival times were modelled using four distributions: exponential, Weibull, Gompertz and log-logistic. The AFT models included the same covariates as the selected Cox model. For both Cox and AFT models, we selected the best model based on the Akaike Information Criterion (AIC). When models had a ΔAIC (*i.e.* difference between their AIC and the AIC of the best model) lower than 2, we selected the simplest model to satisfy parsimony rules.

We investigated reproductive senescence in *V. canescens* by focusing on three traits: the daily reproductive success (*i.e.* number of offspring produced from daytime and night-time host patches), offspring quality, estimated by their body size, and offspring development time. Age-related changes in reproductive success were assessed by building LMMs with the daily number of offspring as response variable and age and light condition, as well as their interaction, as explanatory variables. Individual identity was included as a random effect to account for individual heterogeneity (van de Pol & Verhulst, 2006). Individual longevity was also included as a fixed effect to control for selective disappearance (*i.e.* the fact that ‘low-quality’ individuals die younger, causing older age classes to be composed of ‘high-quality’ individuals in a non-random way) (Nussey *et al.*, 2008). Three types of age function were compared: linear, quadratic and threshold. For the threshold function, the threshold value was determined by fitting a piecewise regression over a range of values between 1 and 14 days of age and selecting the value that gives the lowest residual deviance (Crawley, 2007). The selected threshold was set at 5 days.

The effect of mother’s age on offspring quality was analysed by fitting a LMM with offspring body size as response variable and mother’s age, light condition and their interaction as explanatory variables. We also tested the influence of mother’s age on offspring development time by fitting a negative binomial GLMM (log link) with. Mother’s identity was included as a

random effect. The number of offspring for each mother's age and light condition is given in Table 3, as well as the number of females by which these offspring were produced.

We tested the same age functions as for daily reproductive success. In both cases, the model selection procedure was based on AIC.

RESULTS

Night-time behaviours

Light conditions influenced the proportion of wasps that fed at night: 64%, 38% and 82% in the control, low ALAN and high ALAN conditions, respectively ($\chi^2 = 10.55$, $df = 2$, $P = 0.005$; Figure 1). The difference between low and high ALAN conditions was statistically significant (post-hoc test: $z = 2.99$, $P = 0.009$) and corresponded to a large biological effect (effect size Cohen's $h = 0.96$). On the other hand, the biological differences between control and low ALAN conditions and control and high ALAN conditions are considered as medium (effect sizes: Cohen's $h = 0.54$, Cohen's $h = 0.43$, respectively) (Figure 1).

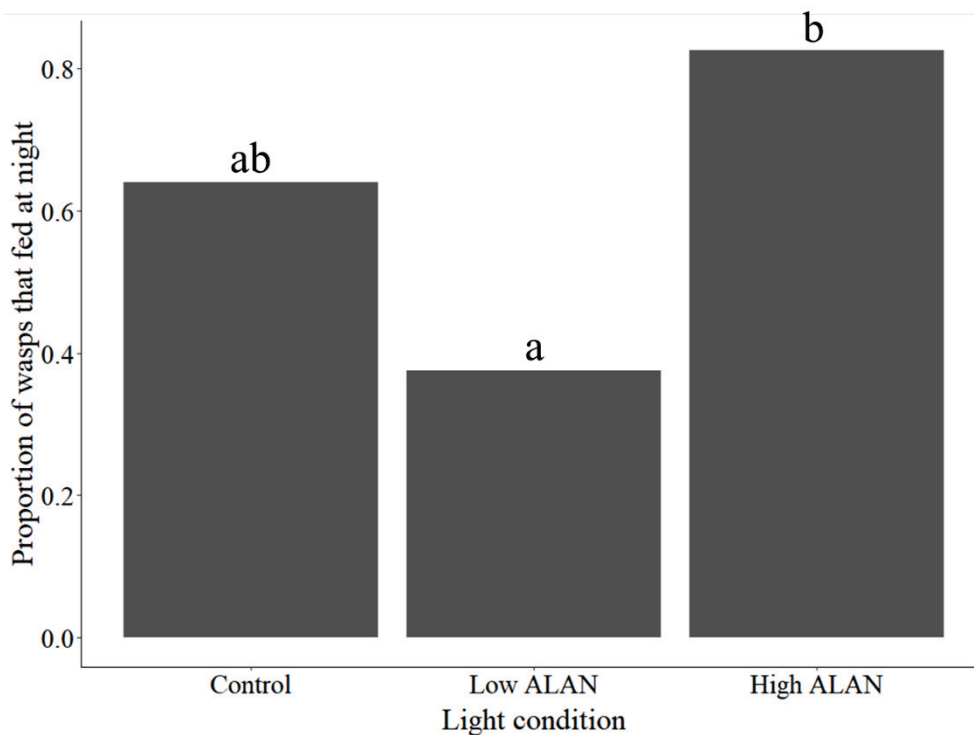

Figure 1 Proportion of wasps that fed at night for the control and artificial light at night (ALAN) conditions. Different letters show a significant statistical difference at the 0.05 level.

Among the wasps that fed at night, about 3/4 of the wasps fed on the first night that food was available regardless of the light condition (75%, 77% and 74% in the control, low ALAN and high ALAN conditions, respectively). Light conditions influenced the proportion of night-time feeding events (weighted by the number of night-time feeding opportunities): 63%, 51% and 81% in the control, low and high ALAN conditions, respectively ($\chi^2 = 8.81$, $df = 2$, $P = 0.01$; Figure 2). Post-hoc tests showed that the only significant difference was between low and high ALAN conditions ($z = 2.80$, $P = 0.02$) with a biological difference considered as medium (effect size: Cohen's $h = 0.65$) (Figure 2). However, the effect size between control and high ALAN conditions (Cohen's $h = 0.43$) suggested that the difference, albeit non statistically significant, was also moderately biologically relevant.

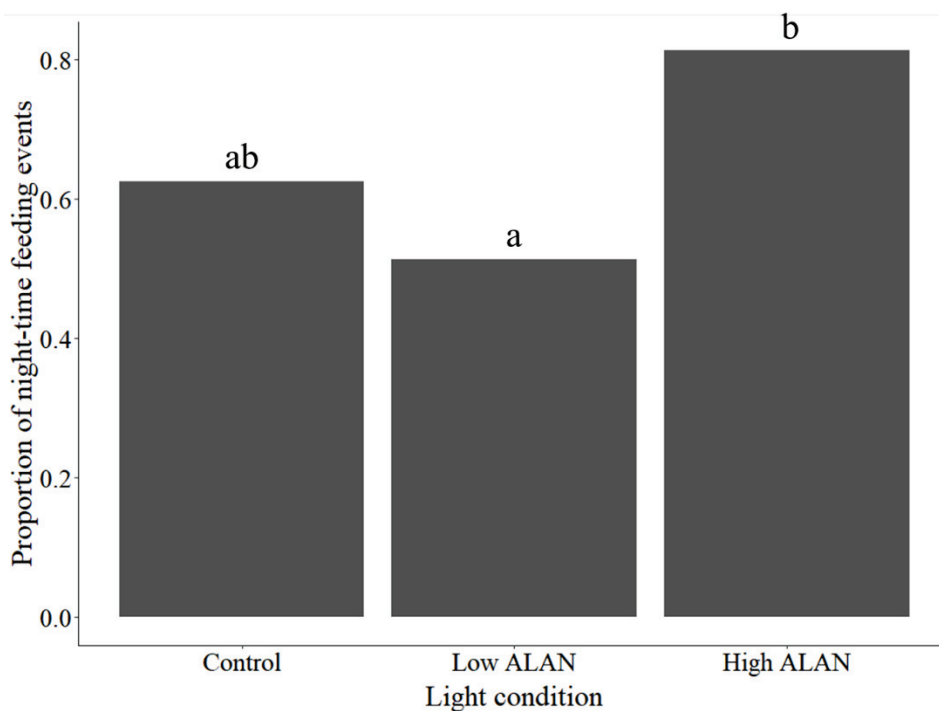

Figure 2 Proportion of night-time feeding events (weighted by the number of night-time feeding opportunities) for the control and artificial light at night (ALAN) conditions. Different letters show a significant statistical difference at the 0.05 level.

With regard to the night-time egg-laying behaviour, light condition influenced the proportion of wasps that exploited (*i.e.* that have had offspring) host patches at night: 75%, 80% and 100% in the control, low and high ALAN conditions, respectively ($\chi^2 = 10.0$, $df = 2$, $P = 0.007$). Effect sizes suggested a strong effect of high ALAN condition compared to control (Cohen's $h = 1$)

and low ALAN (Cohen's $h = 0.93$) conditions. 44%, 45% and 75% of wasps began to exploit host patches from the first night onwards in the control, low ALAN and high ALAN conditions, respectively.

Effect of ALAN on lifetime reproductive success

There was a tendency for light condition to influence the night-time reproductive success ($\chi^2 = 5.46$, $df = 2$, $P = 0.06$) (Figure 3). The mean night-time reproductive success almost doubled between control and high ALAN conditions (3.95 and 7.75 offspring in average, respectively), and between low and high ALAN conditions (3.96 and 7.75 offspring in average, respectively). Body size also had a tendency to be positively correlated with the total number of offspring emerging from host patches exploited at night (estimate \pm SE = 1.83 ± 0.94 ; $\chi^2 = 3.21$, $df = 1$, $P = 0.07$).

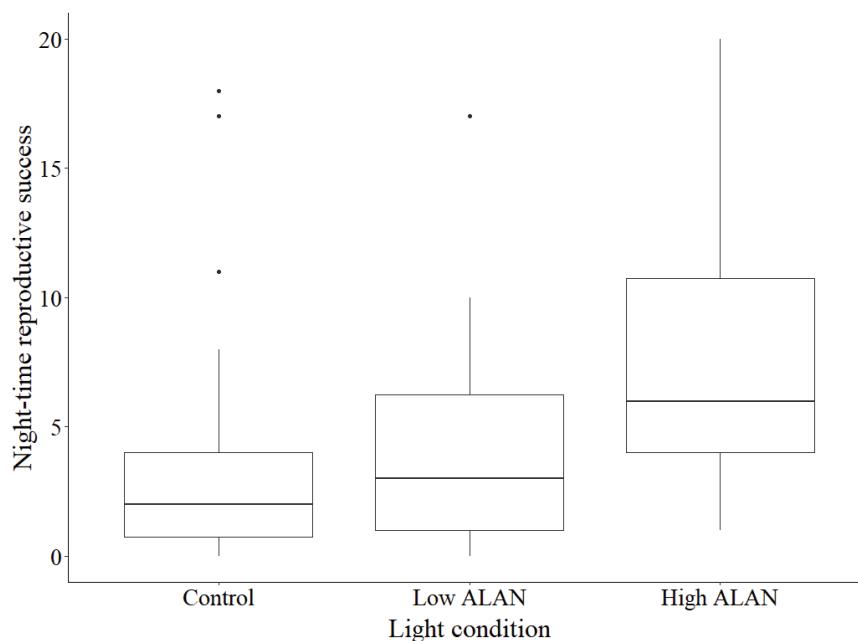

Figure 3 Effect of night-time lighting on the night-time reproductive success (estimated by the total number of offspring emerging from the host patches exploited at night throughout the life of the wasps).

When considering the overall lifetime reproductive success, body size had a positive effect on the total number of offspring produced throughout a wasp's life ($\chi^2 = 4.98$, $df = 1$, $P = 0.03$), but no influence of light condition was detected ($\chi^2 = 2.03$, $df = 2$, $P = 0.36$). Multivariate analysis of variance also failed to detect a significant effect of light condition on the bivariate response variable combining total number of offspring and longevity ($F = 1.27$, $df = 4, 134$, $P = 0.29$). Finally, there was a positive relationship between night-time and daytime reproductive

success (estimate \pm SE = 0.05 ± 0.02 ; $\chi^2 = 10.90$, $df = 1$, $P < 0.001$), but it was independent from the light condition ($\chi^2 = 1.60$, $df = 2$, $P = 0.45$) (Figure 4). Figure 4 also gives an illustration of the respective contribution of daytime and night-time reproductive success to lifetime reproductive success. Offspring coming from host patches exploited during night-time represented 24%, 28% and 37% of the total number of offspring in the control, low ALAN and high ALAN conditions, respectively.

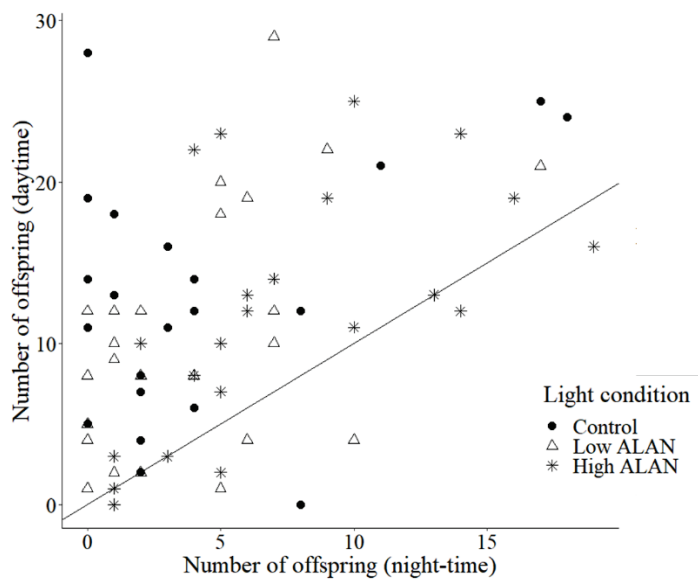

Figure 4 Relationship between night-time and daytime reproductive success depending on the light condition (control, low artificial light at night (ALAN) and high ALAN). The line represents what should be observed if wasps had the same egg-laying behaviour during the day and at night.

Effect of ALAN on senescence

Actuarial senescence - Light condition did not influence the lifespan in *V. canescens*. The selected Cox model included body size and light condition as explanatory variables, but only body size had a significant effect on the wasp longevity, with large wasps living longer than small ones (Table 2).

Table 2 Semi-parametric Cox proportional hazards (PH) model selected for the longevity data. The best model was selected based on Akaike Information Criterion (AIC).

Type	Best model	Age function	Variable	Coefficient ± SE (hazard ratio)	z-value	P
Semi-parametric Cox PH	Size + Light condition	–	Body size	-4.89 ± 1.3 (0.008)	-3.8	<0.01
			Light condition (Low ALAN)	0.47 ± 0.3 (1.60)	1.5	0.13
			Light condition (High ALAN)	-0.35 ± 0.3 (0.70)	-1.1	0.3

Age-related changes in mortality hazard were best represented by a logistic model in control, low ALAN and high ALAN conditions. The onset of actuarial senescence was equivalent between the three light conditions and started at the age at first reproduction (Figure 5). Light condition also influenced the effect of age on mortality rate ($\chi^2 = 6.63$, $df = 2$, $P = 0.04$), with the decrease in survival probability being less steep for wasps in the high ALAN condition (Figure 5).

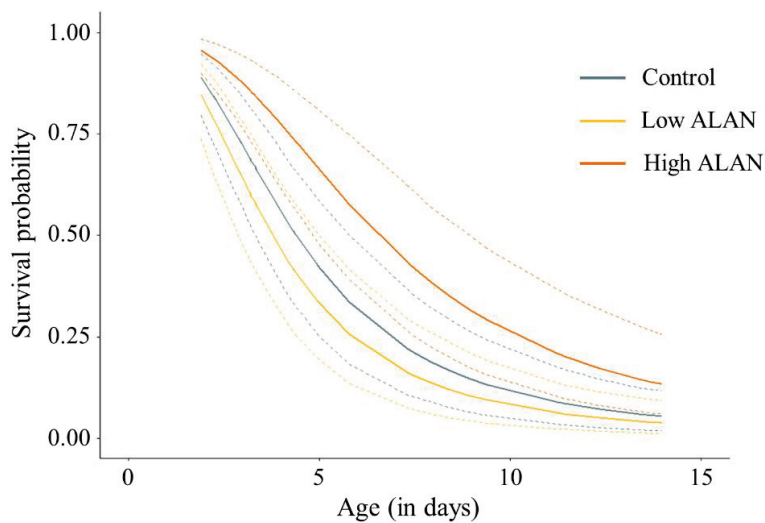

Figure 5 Age-related survival probabilities in the control, low artificial light at night (ALAN) and high ALAN conditions.

Reproductive senescence - The best model selected to describe the evolution of daily reproductive success with age included only Age (linear function) as explanatory variable ($F = 92.04$, $df = 1$, 413.51 , $P < 0.01$). Daily reproductive success decreased linearly with age (estimate \pm SE = -0.38 ± 0.04) (Figure 6).

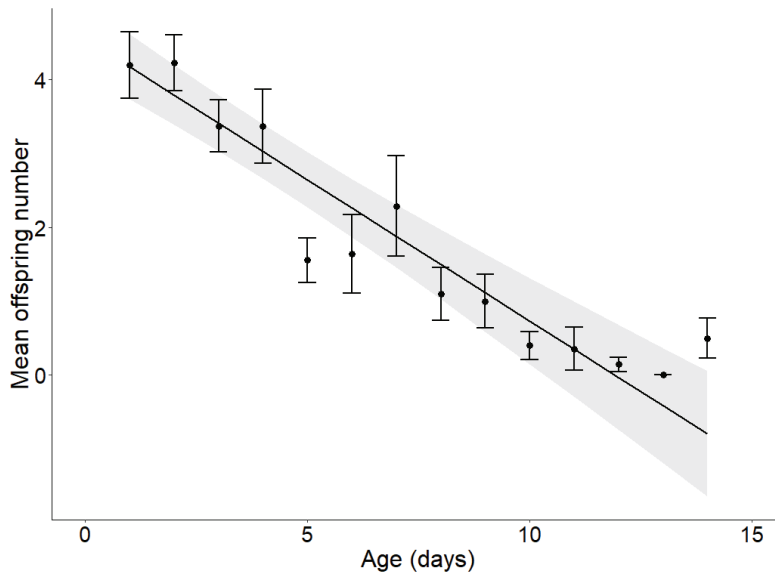

Figure 6 Age-related changes in overall reproductive success in *Venturia canescens*. The points represent the average number of offspring produced per age and the bars correspond to Standard Error. The line represents prediction from the best selected model (linear effect of age) and the shaded area the 95% CI.

As with the daily reproductive success, the best model that described the evolution of offspring size with age of their mother included only Age (linear function) as explanatory variable. However, the effect of mother's age was marginally significant ($F = 3.03$, $df = 1$, 354.45 , $P = 0.08$). There was therefore a tendency for the offspring quality to decrease linearly with their mother's age (estimate \pm SE = -0.008 ± 0.004). Finally, offspring development time depended on the interaction between mother's age (linear function) and light condition ($F = 9.55$, $df = 2$, 365.93 , $P < 0.001$). In the control condition, offspring development time increased with mother's age, whereas offspring from old mothers took less time to develop into adults than offspring from young mothers in the two artificial light at night conditions (Figure 7). The number of offspring produced by wasps at the three ages tested and in each light condition is given in Table 3.

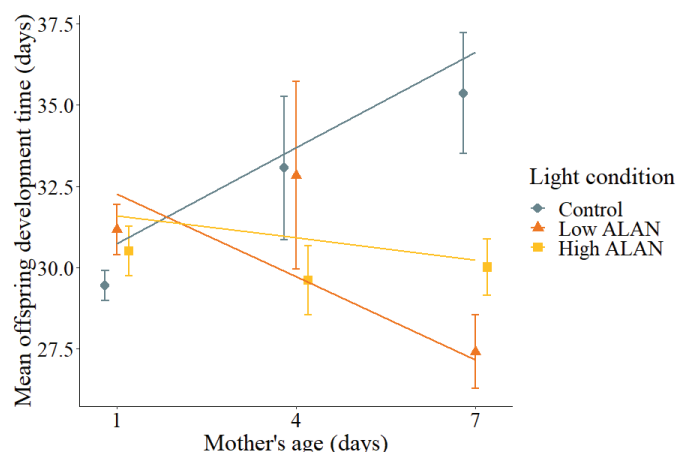

Figure 7 Effect of mother’s age on offspring development time in the control, low artificial light at night (ALAN) and high ALAN conditions. Individuals older than 7 days of age were pooled in the “7+” class. Symbols represent mean ± SE. Lines represent predictions from the selected model.

Table 3 Number of offspring in each cross-modality of artificial light at night (ALAN) condition and mother’s age. The number of mothers is written in brackets in the table.

		Mother’s age		
		<i>1 day</i>	<i>4 days</i>	<i>[7 – 10] days</i>
Light condition	<i>Control</i>	121 (22)	17 (5)	12 (4)
	<i>Low ALAN</i>	98 (26)	12 (9)	10 (2)
	<i>High ALAN</i>	100 (21)	31 (12)	9 (5)

DISCUSSION

Artificial light at night influenced night-time foraging behaviours in *Venturia canescens*. A high intensity of artificial light increased the proportion of wasps that fed at night. Among those night-time feeding wasps, almost all started feeding at the first opportunity, but wasps exposed to high level of artificial light fed more often at night than wasps exposed to low or no artificial light at night. Artificial light increased the proportion of wasps that lay eggs at night, and wasps also tended to lay more eggs at night when exposed to high intensity of artificial light. The number of eggs laid at night was nevertheless lower than during the day. However, night-time activity induced by artificial light did not affect the wasps’ lifetime reproductive success. Wasps

in the three light conditions had equivalent lifespan and did not differ in the total number of offspring produced throughout their lives. Finally, we detected both actuarial and reproductive senescence in *Venturia canescens*. Age-related changes in mortality indicated that mortality rate followed an exponential increase at young ages, and then the rate of increase decreased with age. Rate of actuarial senescence was influenced by artificial light at night. Reproductive traits (LRS, offspring body size and offspring development time) decreased linearly with age since the age of first reproduction. However, while this variation with age was independent of the presence of artificial light at night for LRS and offspring body size, our results showed that ALAN affected the senescence pattern for offspring development time. When mothers had been exposed to artificial light at night, offspring development time was negatively correlated with mother's age.

Our experiment showed that presence of artificial light at night led *V. canescens* females to use the 'night-light niche', although their egg-laying activity was weaker than during the day. This phenomenon has rarely been reported and quantified in insect species. A recent study by Sanders and colleagues (2018) showed that parasitism rate of an aphid parasitoid, *Aphidius megourae*, almost doubled when individuals were exposed to low levels of light at night (between 0.1 and 5 lux). They showed that *A. megourae* did not attack hosts during the night in absence of light pollution, but did not differentiate between daytime and night-time parasitism activity in the light-polluted conditions. Even though we showed that *V. canescens* did not move in the dark (Gomes *et al.*, 2021), in our experiment wasps fed and laid eggs during the night despite the absence of light. An explanation may be the easy access to both food and hosts in our experimental set-up. In the lab, wasps did not have to search intensely for resources. On the contrary, in field conditions, resources may be more difficult to reach. Thelytokous wasps live mostly in anthropogenic habitats where food is absent (Pelosse *et al.*, 2007), but are also found in natural habitats (Amat, 2004) where they can acquire food. In the natural environment, food sources are relatively frequent (Casas *et al.*, 2003) and nectar can be produced at night (Antoń *et al.*, 2017; Wolff *et al.*, 2006). However, it has been shown that visual cues are involved in host and food searching in *V. canescens*, with wasps being able of associative learning between colour cues and a food or host reward (Desouhant, Navel, *et al.*, 2010; Lucchetta *et al.*, 2008). Such visual cues probably increase the efficiency of females for finding hosts or food, but their use in absence of light might be less efficient. Night-time foraging activity without light at night

may therefore be less likely to occur in a natural environment more complex than the laboratory setting we created.

Artificial light at night has short-term impacts on key biological traits in both nocturnal and diurnal species (Sanders *et al.*, 2020), which are likely to influence lifetime reproductive success and therefore fitness of individuals. Assessing the fitness differences under various regimes of light at night have been conducted in laboratory, with various outcomes. In *Drosophila melanogaster*, a species that has an optimal oviposition behaviour at dusk or early night, chronic exposure to dim light at night reduced significantly (by 20%) the proportion of ovipositing females and the number of eggs laid (McLay *et al.*, 2017). Artificial light at night also reduced the lifespan of adults by 12%. A subsequent study showed that these negative consequences of light at night persisted as females aged (McLay *et al.*, 2018), confirming the probable fitness costs of light pollution in this species. However, some species seem to benefit from the presence of light at night, such as the diurnal lizard *Anolis sagrei*. In this species often found in urbanized habitats, females exposed to artificial light at night increased their reproductive output by laying more eggs at a higher rate (Thawley & Kolbe, 2020). Moreover, light at night did not affect offspring quality (Thawley & Kolbe, 2020). Fitness consequences of light pollution have also been estimated, although less frequently, in natural conditions. A study on two free-living bird species, the great tit *Parus major* and the pied flycatcher *Ficedula hypoleuca*, monitored for two years demonstrated that artificial light emitted by street lamps did not affect the birds' breeding success (number and mass of fledglings) (de Jong *et al.*, 2015). Survival rates also seemed to be unaffected by light at night (de Jong *et al.*, 2015). In *Venturia canescens*, global lifetime reproductive success was not affected by artificial light at night, despite the intensification of night-time egg-laying behaviour or changes in feeding behaviour. This absence of difference was not due to a decrease in daytime reproductive success or to differences in longevity between light conditions (although we cannot exclude a lack of statistical power). However, estimating lifetime reproductive success as a one-time measure at the end of an individual's life may not be enough to understand the impact of light at night on its fitness. Indeed, lifetime reproductive success depends on offspring production and survival, two traits that can exhibit age-related changes characterized by their onset (*i.e.* the age at which the studied trait begins to decline) and their rate (*i.e.* the intensity of decline). Artificial light at night could therefore act on these two parameters while yielding the same overall lifetime reproductive success.

We detected senescence in *Venturia canescens* for both survival and reproductive traits, with an impact of artificial light at night on actuarial senescence and on age-related changes in offspring development time. Mortality rates followed a logistic function, which means that the senescence rate first increases exponentially and then decreases (or even reach a plateau phase) at old ages. This pattern of mortality rate has been found in humans, but also in some other insect species (e.g. medflies, Carey *et al.*, 1992; Wilson, 1994, or beetles, Šešlija *et al.*, 2008). It can reflect heterogeneity in mortality rates, resulting in a higher proportion of ‘high-quality’ individuals as the population ages (Vaupel & Yashin, 1985). Increasing the sample size, in order to have more individuals reaching oldest ages, would allow a better estimation of the decrease of senescence rate at late age. It may also give more statistical power to detect differences in actuarial senescence rates in presence of artificial light at night. Changes of reproductive performance with age have been detected in a number of insect species (e.g. cockroach *Nauphoeta cinerea*, Moore & Moore, 2001, or fruit flies, Carey & Molleman, 2010). In our study, offspring development time was negatively correlated with mother’s age for mothers who had been exposed to (low and high) artificial light at night. In a previous study we had already found an interaction between mother’s age and mother’s light condition on offspring development time (Gomes *et al.*, 2021). However, the effect of the interaction was the opposite; offspring development time increased with mother’s age when mothers were exposed to low ALAN (Gomes *et al.*, 2021). A way to have a more precise knowledge of age-related changes in offspring development time, in relation with ALAN, would be to monitor mothers from more diverse ages. Nevertheless, evidence of relationship between light at night and reproductive senescence are rare. A study on *D. melanogaster* found that exposition to light at night influenced (non-linear) age-related declines in the propensity to lay eggs and the number of eggs produced by females (McLay *et al.*, 2018). A potential mechanism by which artificial light at night could act on ageing is melatonin production and its relationship with oxidative stress (El-Bakry *et al.*, 2018; Verma *et al.*, 2020). However, more studies are needed to determine precisely relationships between light at night, senescence and potential underlying mechanisms.

The experimental conditions in which the wasps were maintained could have influence the results we obtained about consequences of light at night on reproductive success and senescence. Indeed, evidence suggests sharp differences in age-related changes in phenotypic traits between laboratory and natural environments. A comparison between genetically similar

cohorts of the fly *Telostylinus angusticollis* maintained either in laboratory or in the wild showed that individuals in natural conditions had more rapid senescence than laboratory individuals (Kawasaki *et al.*, 2015). Factors such as food composition and availability could also have a non-negligible influence (Zajitschek *et al.*, 2020). Absence of some energetically costly behaviours, such as flight, or selective pressures, such as risk of predation, competition or temperature variations, in our experimental design may hide potential effects of light at night. Studies in natural conditions are therefore necessary to fully determine the consequences of artificial light at night on the fitness of organisms and hence its ecological and evolutionary impacts on insect populations.

ACKNOWLEDGMENTS

We thank Marc Théry for lending the illuminance meter. The research was partly funded by IDEXLyon (Scientific Breakthrough project).

REFERENCES

- Amat, I. 2004. Coexistence de la reproduction sexuée et asexuée chez l’hyménoptère parasitoïde *Venturia canescens* : aspects comportementaux et écologiques. Lyon 1. (These de doctorat). <https://www.theses.fr/2004LYO10140> Date of access: 25 Jan. 2021.
- Amichai, E. & Kronfeld-Schor, N. 2019. Artificial Light at Night Promotes Activity Throughout the Night in Nesting Common Swifts (*Apus apus*). *Scientific Reports*. 9(1):11052.
- Antoń, S., Komoń-Janczara, E. & Denisow, B. 2017. Floral nectary, nectar production dynamics and chemical composition in five nocturnal *Oenothera* species (Onagraceae) in relation to floral visitors. *Planta*. 246(6):1051–1067.
- Bates, D., Mächler, M., Bolker, B. & Walker, S. 2014. Fitting Linear Mixed-Effects Models using lme4. *arXiv:1406.5823 [stat]*. (June, 23). <http://arxiv.org/abs/1406.5823> Date of access: 04 May 2017.
- Bennie, J., Davies, T.W., Cruse, D. & Gaston, K.J. 2016. Ecological effects of artificial light at night on wild plants. *Journal of Ecology*. 104(3):611–620.
- Carey, J.R. & Molleman, F. 2010. Reproductive aging in tephritid fruit flies. *Annals of the New York Academy of Sciences*. 1204:139–148.
- Carey, J.R., Liedo, P., Orozco, D. & Vaupel, J.W. 1992. Slowing of Mortality Rates at Older Ages in Large Medfly Cohorts. *Science*. 258(5081):457–461.
- Casas, J., Driessen, G., Mandon, N., Wielaard, S., Desouhant, E., ... Bernstein, C. 2003. Energy dynamics in a parasitoid foraging in the wild. *Journal of Animal Ecology*. 72(4):691–697.
- Castelo, M.K., Corley, J.C. & Desouhant, E. 2003. Conspecific Avoidance During Foraging in *Venturia canescens* (Hymenoptera: Ichneumonidae): The Roles of Host Presence and Conspecific Densities. *Journal of Insect Behavior*. 16(2):307–318.
- Champely, S. 2020. pwr: Basic Functions for Power Analysis. R package version 1.3-0. <https://CRAN.R-project.org/package=pwr>
- Clutton-Brock, T.H. 1988. *Reproductive Success: Studies of Individual Variation in Contrasting Breeding Systems*. University of Chicago Press.
- Clutton-Brock, T. & Sheldon, B.C. 2010. Individuals and populations: the role of long-term, individual-based studies of animals in ecology and evolutionary biology. *Trends in Ecology & Evolution*. 25(10):562–573.
- Cohen, J. 1992. A power primer. *Psychological Bulletin*. 112:155–159.
- Conseil Général de l’Environnement et du Développement Durable. 2018. *A la reconquête de la nuit. La pollution lumineuse: état des lieux et propositions*.

https://cgedd.documentation.developpement-durable.gouv.fr/documents/Affaires-0010973/012301-01_rapport-publie.pdf;jsessionid=48977A21461B208F635E1473537EC421.

- Cowpertwait, P.S.P. & Metcalfe, A.V. 2009. *Introductory Time Series with R*. Springer Science & Business Media.
- Crawley, M., J. 2007. *The R Book*. Chichester (UK): John Wiley & Sons.
- Davies, T.W. & Smyth, T. 2018. Why artificial light at night should be a focus for global change research in the 21st century. *Global Change Biology*. 24(3):872–882.
- Desouhant, E., Driessen, G., Amat, I. & Bernstein, C. 2005. Host and food searching in a parasitic wasp *Venturia canescens*: A trade-off between current and future reproduction? *Animal Behaviour*. 70(1):145–152.
- Desouhant, E., Lucchetta, P., Giron, D. & Bernstein, C. 2010. Feeding activity pattern in a parasitic wasp when foraging in the field. *Ecological Research*. 25(2):419–428.
- Desouhant, E., Navel, S., Foubert, E., Fischbein, D., Théry, M. & Bernstein, C. 2010. What matters in the associative learning of visual cues in foraging parasitoid wasps: colour or brightness? *Animal Cognition*. 13(3):535–543.
- Directive 2009/125/CE of 21 October 2009, European Parliament.
- Dominoni, D.M., Carmona-Wagner, E.O., Hofmann, M., Kranstauber, B. & Partecke, J. 2014. Individual-based measurements of light intensity provide new insights into the effects of artificial light at night on daily rhythms of urban-dwelling songbirds. *Journal of Animal Ecology*. 83(3):681–692.
- Ekirch, A. R. 2006. *At Day's Close: Night in Times Past*. W. W. Norton & Company (447p).
- El-Bakry, H.A., Ismail, I.A. & Soliman, S.S. 2018. Immunosenescence-like state is accelerated by constant light exposure and counteracted by melatonin or turmeric administration through DJ-1/Nrf2 and P53/Bax pathways. *Journal of Photochemistry and Photobiology B: Biology*. 186:69–80.
- Firebaugh, A. & Haynes, K.J. 2016. Experimental tests of light-pollution impacts on nocturnal insect courtship and dispersal. *Oecologia*. 182(4):1203–1211.
- Frank, K. 2009. Exploitation of artificial light at night by a diurnal jumping spider. *Peckhamia*. 78(1):1–3.
- Gaston, K.J., Davies, T.W., Nedelec, S.L. & Holt, L.A. 2017. Impacts of Artificial Light at Night on Biological Timings. *Annual Review of Ecology, Evolution, and Systematics*. 48(1):49–68.

- Gomes, E., Rey, B., Débias, F., Amat, I., Desouhant, E. 2021. Dealing with host and food searching in a diurnal parasitoid: consequences of light at night at intra and trans-generational levels. *Insect Conservation and Diversity*.
- Harvey, J.A. & Thompson, D.J. 1995. Developmental interactions between the solitary endoparasitoid *Venturia canescens* (Hymenoptera: Ichneumonidae), and two of its hosts, *Plodia interpunctella* and *Corcyra cephalonica* (Lepidoptera: Pyralidae). *European Journal of Entomology*. 92(2):427–435.
- Harvey, J.A. & Vet, L.E.M. 1997. *Venturia canescens* parasitizing *Galleria mellonella* and *Anagasta kuehniella*: differing suitability of two hosts with highly variable growth potential. *Entomologia Experimentalis et Applicata*. 84(1):93–100.
- Harvey, J.A., Harvey, I.F. & Thompson, D.J. 2001. Lifetime reproductive success in the solitary endoparasitoid, *Venturia canescens*. *Journal of Insect Behavior*. 14(5):573–593.
- Jervis, M.A., Heimpel, G.E., Ferns, P.N., Harvey, J.A. & Kidd, N.A.C. 2001. Life-history strategies in parasitoid wasps: a comparative analysis of ‘ovigeny’. *Journal of Animal Ecology*. 70(3):442–458.
- de Jong, M., Ouyang, J.Q., Da Silva, A., van Grunsven, R.H.A., Kempenaers, B., ... Spoelstra, K. 2015. Effects of nocturnal illumination on life-history decisions and fitness in two wild songbird species. *Philosophical Transactions of the Royal Society B: Biological Sciences*. 370(1667):20140128.
- de Jong, M., Jeninga, L., Ouyang, J.Q., van Oers, K., Spoelstra, K. & Visser, M.E. 2016. Dose-dependent responses of avian daily rhythms to artificial light at night. *Physiology & Behavior*. 155:172–179.
- Kawasaki, N., E. Brassil, C., C. Brooks, R. & Bonduriansky, R. 2015. Environmental Effects on the Expression of Life Span and Aging: An Extreme Contrast between Wild and Captive Cohorts of *Telostylinus angusticollis* (Diptera: Neriidae). *The American Naturalist*. (July, 17).
- Kronfeld-Schor, N., Dominoni, D., de la Iglesia, H., Levy, O., Herzog, E.D., ... Helfrich-Forster, C. 2013. Chronobiology by moonlight. *Proceedings of the Royal Society B: Biological Sciences*. 280(1765):20123088.
- Langevelde, F. van, Grunsven, R.H.A. van, Veenendaal, E.M. & Fijen, T.P.M. 2017. Artificial night lighting inhibits feeding in moths. *Biology Letters*. 13(3):20160874.
- Le Ralec, A. 1995. Egg contents in relation to host-feeding in some parasitic hymenoptera. *Entomophaga*. 40(1):87–93.
- Lebbin, D.J., Harvey, M.G., Lenz, T.C., Andersen, M.J. & Ellis, J.M. 2007. Nocturnal Migrants Foraging at Night by Artificial Light. *The Wilson Journal of Ornithology*. 119(3):506–508.

- Lemaître, J.-F., Ronget, V. & Gaillard, J.-M. 2020. Female reproductive senescence across mammals: A high diversity of patterns modulated by life history and mating traits. *Mechanisms of Ageing and Development*. 192:111377.
- Lenth, R. 2020. emmeans: Estimated Marginal Means, aka Least-Squares Means. R package version 1.5.2-1. <https://CRAN.R-project.org/package=emmeans>
- Longcore, T. & Rich, C. 2004. Ecological light pollution. *Frontiers in Ecology and the Environment*. 2(4):191–198.
- Lucchetta, P., Bernstein, C., Théry, M., Lazzari, C. & Desouhant, E. 2008. Foraging and associative learning of visual signals in a parasitic wasp. *Animal Cognition*. 11(3):525–533.
- Maurer, A., Thawley, C., Fireman, A., Giery, S. & Stroud, J. 2019. Nocturnal activity of Antigua lizards under artificial light. *Herpetological Conservation and Biology*. 14:105–110.
- McCluney, W. R. 2014. *Introduction to radiometry and photometry*. Artech House (2nd edition; 480p).
- McLay, L.K., Green, M.P. & Jones, T.M. 2017. Chronic exposure to dim artificial light at night decreases fecundity and adult survival in *Drosophila melanogaster*. *Journal of Insect Physiology*. 100(Supplement C):15–20.
- McLay, L.K., Nagarajan-Radha, V., Green, M.P. & Jones, T.M. 2018. Dim artificial light at night affects mating, reproductive output, and reactive oxygen species in *Drosophila melanogaster*. *Journal of Experimental Zoology Part A: Ecological and Integrative Physiology*. 329(8–9):419–428.
- Moore, P.J. & Moore, A.J. 2001. Reproductive aging and mating: The ticking of the biological clock in female cockroaches. *Proceedings of the National Academy of Sciences*. 98(16):9171–9176.
- Nussey, D.H., Froy, H., Lemaître, J.-F., Gaillard, J.-M. & Austad, S.N. 2013. Senescence in natural populations of animals: Widespread evidence and its implications for biogerontology. *Ageing Research Reviews*. 12(1):214–225.
- Nussey, D.H., Coulson, T., Festa-Bianchet, M. & Gaillard, J.-M. 2008. Measuring Senescence in Wild Animal Populations: Towards a Longitudinal Approach. *Functional Ecology*. 22(3):393–406.
- Ouyang, J.Q., Jong, M. de, Grunsvan, R.H.A. van, Matson, K.D., Haussmann, M.F., ... Spoelstra, K. 2017. Restless roosts: Light pollution affects behavior, sleep, and physiology in a free-living songbird. *Global Change Biology*. 23(11):4987–4994.
- Pelosse, P., Bernstein, C. & Desouhant, E. 2007. Differential energy allocation as an adaptation to different habitats in the parasitic wasp *Venturia canescens*. *Evolutionary Ecology*. 21(5):669–685.

- Pelosse, P., Jervis, M.A., Bernstein, C. & Desouhant, E. 2011. Does synovigeny confer reproductive plasticity upon a parasitoid wasp that is faced with variability in habitat richness? *Biological Journal of the Linnean Society*. 104(3):621–632.
- Pinheiro, J., Bates, D., DebRoy, S., Sarkar, D. & R Core Team. 2019. nlme: Linear and Nonlinear Mixed Effects Models. <https://CRAN.R-project.org/package=nlme>.
- van de Pol, M. & Verhulst, S. 2006. Age-Dependent Traits: A New Statistical Model to Separate Within- and Between-Individual Effects. *The American Naturalist*. 167(5):766–773.
- R Core Team. 2020. R: A language and environment for statistical computing. *R Foundation for Statistical Computing, Vienna, Austria*. <https://www.R-project.org/>.
- Russ, A., Rüger, A. & Klenke, R. 2015. Seize the night: European Blackbirds (*Turdus merula*) extend their foraging activity under artificial illumination. *Journal of Ornithology*. 156(1):123–131.
- Russo, D., Cistrone, L., Libralato, N., Korine, C., Jones, G. & Ancillotto, L. 2017. Adverse effects of artificial illumination on bat drinking activity. *Animal Conservation*. 20(6):492–501.
- Salt, G. 1975. The fate of an internal parasitoid, *Nemeritis canescens*, in a variety of insects. *Transactions of the Royal Entomological Society of London*. 127(2):141–161.
- Sanders, D., Kehoe, R., Cruse, D., van Veen, F.J.F. & Gaston, K.J. 2018. Low Levels of Artificial Light at Night Strengthen Top-Down Control in Insect Food Web. *Current Biology*. 28(15):2474-2478.e3.
- Sanders, D., Frago, E., Kehoe, R., Patterson, C. & Gaston, K.J. 2020. A meta-analysis of biological impacts of artificial light at night. *Nature Ecology & Evolution*. (November, 2):1–8.
- Šešlija, D., Marečko, I. & Tucić, N. 2008. Sexual selection and senescence: do seed beetle males (*Acanthoscelides obtectus*, Bruchidae, Coleoptera) shape the longevity of their mates? *Journal of Zoological Systematics and Evolutionary Research*. 46(4):323–330.
- Sih, A., Ferrari, M.C.O. & Harris, D.J. 2011. Evolution and behavioural responses to human-induced rapid environmental change. *Evolutionary Applications*. 4(2):367–387.
- Swaddle, J.P., Francis, C.D., Barber, J.R., Cooper, C.B., Kyba, C.C.M., ... Longcore, T. 2015. A framework to assess evolutionary responses to anthropogenic light and sound. *Trends in Ecology & Evolution*. 30(9):550–560.
- Thawley, C.J. & Kolbe, J.J. 2020. Artificial light at night increases growth and reproductive output in *Anolis* lizards. *Proceedings of the Royal Society B: Biological Sciences*. 287(1919):20191682.
- Therneau, T. 2015. A Package for Survival Analysis in S. R package version 2.37-7. 2014. URL <http://CRAN.R-project.org/package=survival>.

- Tully, T., Galliard, J.-F.L. & Baron, J.-P. 2020. Micro-geographic shift between negligible and actuarial senescence in a wild snake. *Journal of Animal Ecology*. 89(11):2704–2716.
- Vaupel, J.W. & Yashin, A.I. 1985. Heterogeneity's Ruses: Some Surprising Effects of Selection on Population Dynamics. *The American Statistician*. 39(3):176–185.
- Verma, A.K., Singh, S. & Rizvi, S.I. 2020. Age-dependent altered redox homeostasis in the chronodisrupted rat model and moderation by melatonin administration. *Chronobiology International*. 0(0):1–11.
- Vinogradova, I.A., Anisimov, V.N., Bukalev, A.V., Semenchenko, A.V. & Zabezhinski, M.A. 2009. Circadian disruption induced by light-at-night accelerates aging and promotes tumorigenesis in rats. *Aging (Albany NY)*. 1(10):855–865.
- Wakefield, A., Stone, E.L., Jones, G. & Harris, S. 2015. Light-emitting diode street lights reduce last-ditch evasive manoeuvres by moths to bat echolocation calls. *Royal Society Open Science*. 2(8):150291.
- Wilson, D.L. 1994. The analysis of survival (mortality) data: Fitting Gompertz, Weibull, and logistic functions. *Mechanisms of Ageing and Development*. 74(1–2):15–33.
- Wolff, D., Witt, T., Jürgens, A. & Gottsberger, G. 2006. Nectar dynamics and reproductive success in *Saponaria officinalis* (Caryophyllaceae) in southern Germany. *Flora - Morphology, Distribution, Functional Ecology of Plants*. 201(5):353–364.
- Zajitschek, F., Zajitschek, S. & Bonduriansky, R. 2020. Senescence in wild insects: Key questions and challenges. *Functional Ecology*. 34(1):26–37.

SUPPLEMENTARY DATA

(A)

Bottom plate (top view)

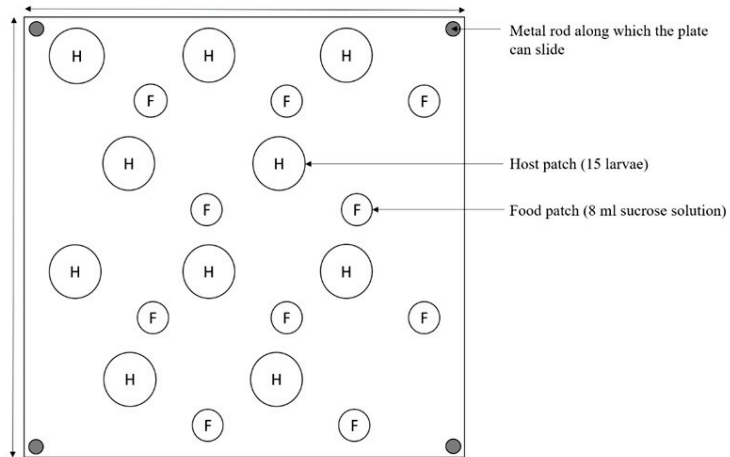

(B)

Superior plate (top view)

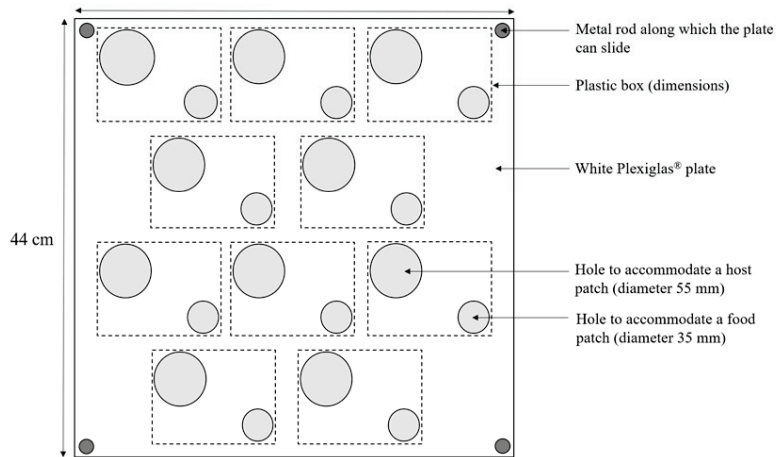
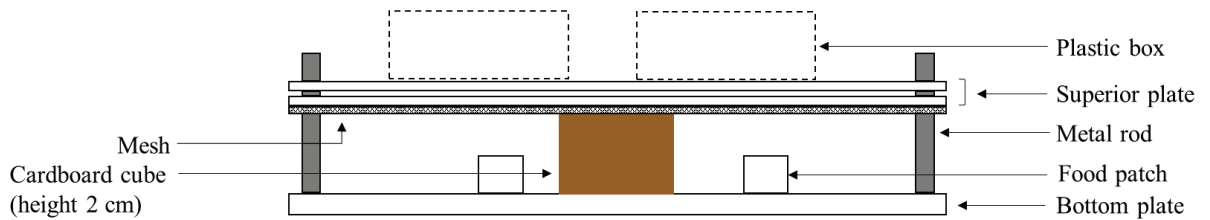

Figure S1 Diagram of the experimental set-up designed to measure the lifetime reproductive success of *V. canescens* (top view). (A) represents the bottom plate. (B) represents the superior plate, grey areas indicating empty zones (*i.e.* holes).

(A) Experimental set-up (side view, lifted)



(B) Experimental set-up (side view, lowered)

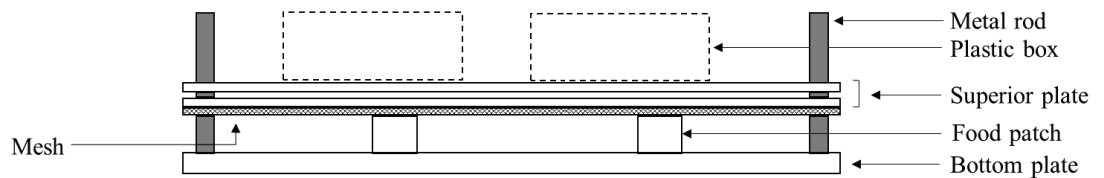

Figure S2 Diagram of the experimental set-up designed to measure the lifetime reproductive success in *V. canescens* (side view). (A) represents the superior plate in lifted position, which prevents the wasps to access the food and host patches. (B) represents the superior plate in lowered position, which enables the wasps to feed and parasitize host patches (not shown on the diagram).

Description of patch replacement:

In the evening, before the end of the photophase, the superior plates were lifted to stop the wasps from accessing the patches. Host patches were replaced with new ones, and food patches were provided or removed, depending on the day (see Table 1). The mesh under the superior plate was also changed to remove any odour deposited by the wasps during the day or kairomone and food residues. Twenty minutes after the end of the photophase, the superior plates were gently lowered so that the wasps could start feeding and exploiting host patches. In the morning, access to host and food was prevented just before the onset of the photophase by lifting the superior plate again. The host patches and the mesh were replaced by new ones, and food patches were provided or removed, depending on the day. We checked if the wasps fed during the night by looking at the colour of their abdomen. Host and food were made available again for the wasps at the same time in each light condition.

2. Conclusion

Artificial light at night did not seem to strongly impact the fitness of *Venturia canescens* under laboratory conditions. However, easy access to food and host resources, as well as absence of environmental fluctuations in temperature for example, may have hidden potential costs due to nocturnal light pollution. It would therefore be interesting to measure the lifetime reproductive success of wasps exposed to various intensities of light at night under more ecologically realistic conditions, using for example mesocosm experiments. In this type of setting, wasps would have to search for hosts and food more thoroughly, with also the possibility to fly, which is known to be an energetically costly behaviour in insects (Amat *et al.*, 2012). Moreover, it would allow to determine whether wasps under dark conditions are really able to forage at night in a more complex environment.

We showed that artificial light at night altered both daytime and night-time behaviours in *Venturia canescens*. Such behavioural changes were not related to changes in physiological status in terms of energy reserves. However, another physiological mechanism could underlie behavioural modifications due to nocturnal pollution: melatonin production.

PART III

MELATONIN, A KEY MECHANISM THAT COULD UNDERLIE BEHAVIOURAL RESPONSES TO ARTIFICIAL LIGHT AT NIGHT

Chapter 7

Mini-review on melatonin biosynthesis, roles and relationship to artificial light at night

1. Melatonin biosynthesis and regulation in vertebrates and insects

Melatonin (N-acetyl-5-methoxytryptamine) is a molecule/hormone found in a wide range of living organisms as diverse as bacteria, plants, animals (both vertebrates and invertebrates) (Zhao *et al.*, 2019). It is synthesized from the amino acid tryptophan, which is transformed through the action of four enzymes (Figure 13). The biosynthetic pathway of melatonin is well-known in vertebrates, and particularly mammals. In this taxon, melatonin synthesis occurs mainly in the pineal gland, although it has also been detected in other organs (such as the gut, the retina or reproductive organs, Huether, 1993; Reiter *et al.*, 2013; Tan *et al.*, 2010), and the molecule is released in the blood to act as a hormone. Melatonin secretion follows a daily pattern that is well conserved in vertebrates, with the highest concentrations of melatonin occurring during the (dark) night and the lowest concentrations during the day (Amaral & Cipolla-Neto, 2018).

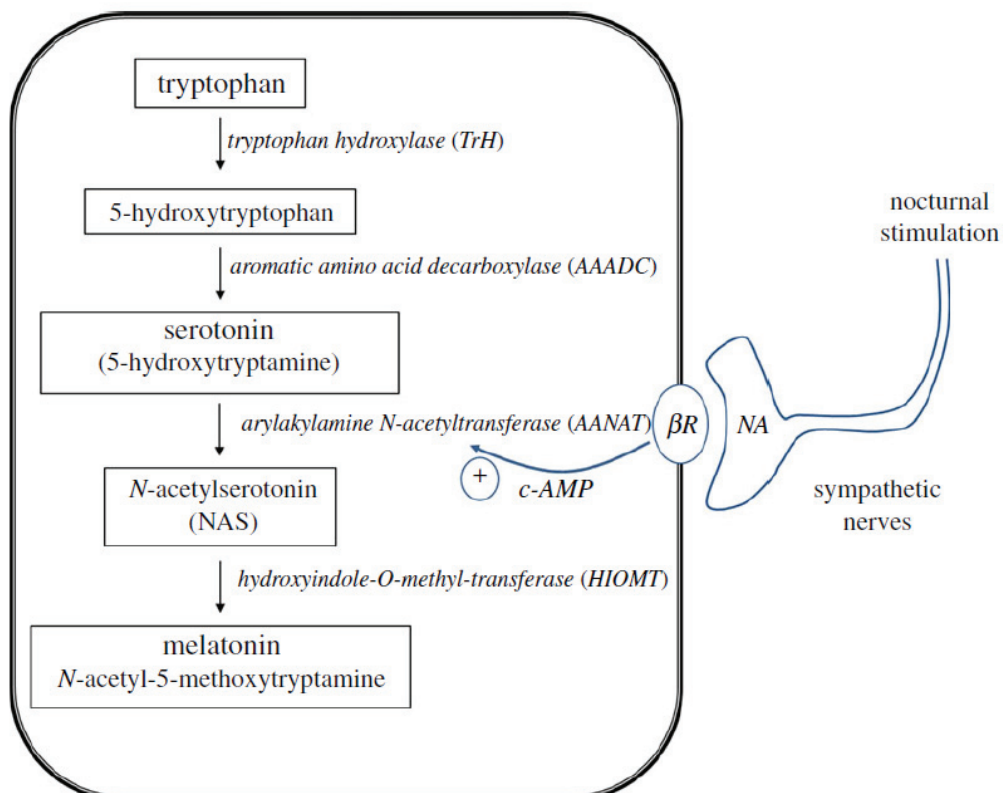

Figure 13 Simplified pathway of melatonin biosynthesis in vertebrates. Enzymes are shown in italics. *HIOMT* is now called *acetylserotonin O-methyltransferase (ASMT)*. βR and *NA* are β -adrenergic receptors (from Jones *et al.*, 2015).

One enzyme is particularly important for the production of melatonin in the vertebrate pineal gland: arylalkylamine N-acetyltransferase (AANAT), also known as the “Timezyme” (Klein, 2007). Indeed, AANAT controls the rhythmic production of melatonin in the pineal gland, with a 10- to 100-fold increase in activity during the night, and is also considered to be the rate-limiting enzyme for melatonin synthesis (Klein & Weller, 1970). The regulation of AANAT activity depends on two mechanisms. The first one is the circadian clock, an endogenous timer located in the suprachiasmatic nucleus of the hypothalamus (hereafter “SCN”) and entrained by light. The photic signal is perceived by photoreceptors in the retina and the information then reaches the SCN through the retinohypothalamic tract. This allows the circadian clock to synchronize with the day/night cycle in the environment (Reppert & Weaver, 2002). The second system which controls AANAT activity is a photic turnoff mechanism (Klein, 2007). The light stimulus activates retinal photoreceptor cells which lead to the reduction of cAMP levels (Figure 13) and inactivation of AANAT, thus resulting in inhibition of melatonin synthesis (Amaral & Cipolla-Neto, 2018). Therefore, light has a rapid suppressive effect on AANAT activity. Indeed, after a transition from night to light, the enzyme activity in the rat pineal gland is reduced by half in 3.5 minutes (Klein & Weller, 1972). The second enzymatic reaction that catalyses melatonin production involves the acetylserotonin O-methyltransferase (“ASMT”), formerly known as hydroxyindole-O-methyltransferase (“HIOMT”) (Figure 13). Because of the focus on AANAT, ASMT has been less studied when it comes to the regulation of melatonin synthesis. However, the enzyme may also determine melatonin production at night in a rate-limiting way (Liu & Borjigin, 2005).

Melatonin has been found in numerous insect species and appears to be mainly produced in the brain and eyes, although it has been found in other organs as in vertebrates (Itoh, Hattori, Sumi, *et al.*, 1995). Its biosynthetic pathway has long been assumed to be similar to that of vertebrates (Vivien-Roels & Pévet, 1993), but this assumption has not been fully demonstrated yet, especially regarding the transformation of serotonin into *N*-acetylserotonin catalysed by AANAT. Indeed, AANAT found in insects (iAANAT) belongs to the same superfamily (GCN5-related *N*-acetyltransferase) as vertebrate AANAT (vAANAT) but forms a clade distinct from vAANAT in the phylogeny (Hiragaki *et al.*, 2015). Moreover, their sequences are not very well conserved between insect species (Hiragaki *et al.*, 2015). iAANAT is involved in several processes such as cuticular sclerotization or pigmentation (Hiragaki *et al.*, 2015), but there is more and more evidence that iAANAT is also involved in melatonin synthesis.

Transcripts for two iAANAT genes and melatonin were co-localized in the central nervous system of the aphid *Acyrtosiphon pisum* (Barberà *et al.*, 2020), and iAANAT activity and melatonin content correlate in some tissues in *Bombyx mori*, *Oedipoda caerulescens* and *Ischnura graellsii* (Itoh, Hattori, Nomura, *et al.*, 1995; Vieira *et al.*, 2005). How melatonin and iAANAT are regulated is, however, still unclear. Melatonin follows a circadian rhythm with higher levels at night in some insect species (*e.g.* the nocturnal moth *Antheraea pernyi*, (Mohamed *et al.*, 2014) or the diurnal damselfly *Ischnura graellsii*, (Vieira *et al.*, 2005). However, there are some exceptions, with a diurnal peak of melatonin in the diurnal/crepuscular *Drosophila melanogaster* (Hintermann *et al.*, 1996) or no melatonin variation throughout a 24-hour cycle in the aphid *A. pisum* (Barberà *et al.*, 2020). In addition, it is still debated whether iAANAT gene expression and enzymatic activity are regulated by a circadian clock as in vertebrates, although some recent studies support this hypothesis. A direct link was found between a circadian transcription factor (CLK/CYC) and the transcription of *aanat* in *A. pernyi* (Mohamed *et al.*, 2014), and regulatory elements usually present in the promoter region of genes under the control of the circadian clock were found in genes encoding AANAT in *A. pisum* (Barberà *et al.*, 2020).

Regarding the influence of ASMT in melatonin synthesis, information is as scarce in insects as it is in vertebrates. A study detected a circadian rhythm of ASMT-like activity in the head of *Bombyx mori* (Itoh *et al.*, 1997), and melatonin and ASMT were co-localized in the brain of *A. pernyi* (Mohamed *et al.*, 2014).

In conclusion, melatonin biosynthesis pathway in insects is not as well described as in vertebrates, but evidence regarding their similarities are growing and confirm the major role played by the enzyme AANAT, and probably ASMT, in it.

2. Melatonin: a ubiquitous molecule that plays many roles

Biological functions of melatonin are diverse. This molecule has been identified in a wide variety of living organisms, but I will describe only the best known and most important functions in mammals and insects in this part.

Melatonin is famously known as the hormone that gives the signal of darkness in mammals. As described in the former part, pineal melatonin is produced in a circadian manner, with a typical nocturnal peak and basal daytime level. Increase of circulating melatonin thus conveys a signal

that provides information about the day/night cycle to the whole organism and that helps to synchronise it with the environment (Amaral & Cipolla-Neto, 2018). Through this function of dark signal conveyance, melatonin plays an important role in timing seasonal biological events (Gorman, 2020). Indeed, the duration of melatonin secretion is inversely correlated with day length, long winter nights yielding longer duration of melatonin secretion and short summer nights yielding shorter duration of melatonin secretion. For instance, melatonin has been shown to regulate changes in reproductive physiology in rodents or sheep (Badness *et al.*, 1993; Reiter, 1973), to synchronize reproduction with suitable environmental conditions. In insects, the role of melatonin as a signal of darkness is less obvious, because of the diversity of melatonin rhythm between species (mostly nocturnal peaks, but also diurnal peaks or arrhythmicity; Hintermann *et al.*, 1996; Vivien-Roels *et al.*, 1984; Yang *et al.*, 2007). A study nevertheless showed that melatonin in the drinking water reduced the variability in locomotor activity in the house cricket (*Acheta domesticus*) with an increase in the night activity to total activity ratio (Yamano *et al.*, 2001). It also synchronized night activity in free-running individuals. With regard to photoperiodism in insects, two recent studies highlighted the link between melatonin, diapause termination and photoperiodism in *A. pernyi* (Mohamed *et al.*, 2014), and in photoperiodic response in the pea aphid *A. pisum* (Barberà *et al.*, 2020). In the latter, melatonin was measured under short-day (SD) and long-day (LD) conditions in two aphid strains (a ‘photoperiodic’ one that had a seasonal response with sexual morphs being produced under short photoperiods, and a ‘non-photoperiodic’ one in which only parthenogenesis was observed independently of photoperiodic conditions). The authors found differences in melatonin content in the photoperiodic strain only, with a higher level in insects reared under SD condition than under LD condition.

A second major role of melatonin is its radical scavenging action that can limit oxidative stress (Tan *et al.*, 2010; Zhao *et al.*, 2019). Antioxidant activity has been proposed to be an evolutionary early function of melatonin (Hardeland *et al.*, 1995). Due to its molecular structure and properties, melatonin can neutralize reactive oxygen species (ROS) and reactive nitrogen species (RNS), but also bind heavy metals. It can also have an indirect effect on the organism oxidative status by stimulating antioxidative enzymes and controlling the activity of enzymes that produce free radicals (Reiter *et al.*, 2016). All these actions thus help to reduce oxidative damage in the organism. Numerous studies demonstrated this antioxidant capacity of melatonin in mammals, including humans (Bejarano *et al.*, 2014; Chuffa *et al.*, 2011; Loren *et al.*, 2017;

Reiter *et al.*, 2016). Protection against oxidative stress by melatonin has also been shown in insects. In *Drosophila melanogaster*, melatonin-enriched food increased resistance to paraquat, a ROS generator (Bonilla *et al.*, 2002), and prevented the increase of oxidative damage due to inhibition of catalase (Coto-Montes & Hardeland, 1999). Such protective effect has also been highlighted in another insect, the cotton leafworm *Spodoptera litura*, against the oxidative stress caused by an insecticide (Karthi & Shivakumar, 2015).

Melatonin can also have indirect antioxidant effects on other physiological processes, such as immune response. The numerous effects of melatonin on the immune system have been well studied in vertebrates (Carrillo-Vico *et al.*, 2005). There is also evidence of a relationship between seasonality (*i.e.* photoperiod) and immune function, regulated by melatonin (Martin *et al.*, 2008). This question has nevertheless not been addressed much in insects (with a few exceptions related to light which will be presented in the following part of this chapter). However, the fact that melatonin in particular plays a role in vertebrate innate immunity (Calvo *et al.*, 2013) suggests that it could also be the case in insects. Indeed, innate immune system is the only one present in insects, and it shares characteristics with that of vertebrates (Jones *et al.*, 2015). Finally, the influence of melatonin on age-related process and its anti-aging properties are beginning to be well studied in vertebrates, including humans. A recent paper reviewed the mechanisms by which melatonin can act on ageing, such as influence on metabolism, protection against mitochondrial dysfunction, and actions on the nervous system or cardiovascular system (Majidinia *et al.*, 2018). In particular, several studies have demonstrated a relationship between melatonin and longevity. Indeed, melatonin administration increased lifespan in many species, both mammals and insects, although it may depend on when melatonin is provided (Tan *et al.*, 2010). In *D. melanogaster*, for example, melatonin in the nutrient medium extended the lifespan of individuals by 13.5% (Bonilla *et al.*, 2002).

Melatonin, because of its pleiotropic functions, is a crucial molecule for the proper functioning of living organisms. It could also be a potential driver of biological change if impacted by anthropogenic disturbance, as has been assumed in the case of light pollution (Jones *et al.*, 2015). In the next part, I will describe the impact of artificial light at night on melatonin synthesis, and what are the consequences known so far on biological traits.

3. Why focusing on melatonin when studying consequences of artificial light at night on living organisms?

3.1. Artificial light at night disrupts melatonin synthesis during the night

As described in part 1 of this chapter, light is a key factor that can control the production of melatonin, mainly through its action on AANAT activity (Klein, 2007 & Figure 13). Exposition to light at night almost always alters, even suppresses, melatonin secretion in animals. It is well known in humans, where it has been studied mostly from a medical point of view and primarily in relationship with shift work (Touitou *et al.*, 2017). Depending on the timing of light at night exposition, the consequences can differ. Melatonin secretion is completely suppressed when light exposure occurs in the middle of the night, whereas the peak of secretion occurs earlier than in control condition when there is exposure to ALAN in the morning (Touitou *et al.*, 2017). The suppressive effect of ALAN on melatonin is also observed in other vertebrates, such as birds, fishes or rodents (reviewed in Grubisic *et al.*, 2019). There are, however, a few exceptions to this general pattern. The western scrub-jay (*Aphelocoma californica*) is the only bird studied so far for which melatonin levels increased under light at night (Schoech *et al.*, 2013), and there seems to be no effect of light at night on melatonin levels in reptiles (considering however that there is a lack of studies on this point) (Grubisic *et al.*, 2019). Regarding the effect of ALAN on melatonin secretion in insects, information is scarce. Studies on the Australian black field cricket *Teleogryllus commodus* showed that individuals under constant illumination had lower melatonin concentrations than individuals reared under a 12h day 12h night photoperiod (Durrant *et al.*, 2015; Jones *et al.*, 2015). However, these studies exposed the insects to high light intensities, which does not provide information on the potential consequences of ecologically realistic light pollution levels (for intensities of artificial light sources, see Table 1 in Chapter 1).

Early studies found that the minimum intensity of light at night needed to suppress melatonin in humans ranged from 300 lux to 2500 lux (Aoki *et al.*, 1998; Lewy *et al.*, 1980; Rollag & Niswender, 1976). However, recent work on other species showed that an intensity as low as 0.2/0.3 lux can reduce melatonin levels in birds or rodents (*e.g.* Dominoni, Goymann, *et al.*, 2013; Xiang *et al.*, 2015), although this minimum value probably varies between species (Grubisic *et al.*, 2019). Moreover, the relationship between light intensity and melatonin

decrease is not necessarily linear (de Jong *et al.*, 2016). Finally, the light spectrum plays an important part in the disruption of melatonin synthesis. There is a consensus on the stronger suppressive effect of short wavelengths (corresponding to blue light, which can be emitted by white-light LEDs for example) on melatonin synthesis, in a wide range of species (Ouyang *et al.*, 2018).

3.2. Is there evidence linking artificial light at night, melatonin synthesis and changes in biological traits?

Exposure of light at night thus impacts melatonin secretion, and through this could result in a variety of biological modifications in organisms. However, the functional consequences of relationship between ALAN, melatonin levels and behaviour or physiology are still not fully understood, especially in insects.

In humans, the knowledge comes mostly from health studies, that established a link between light at night, melatonin secretion and cancer risk, obesity or depression-like syndromes (Bedrosian & Nelson, 2013; Touitou *et al.*, 2017). Among other vertebrates, there is evidence that ALAN acts on locomotor activity through melatonin, as reviewed in Jones *et al.* (2015). In the fish *Tinca tinca*, light pulses of low intensity during the night lowered melatonin plasma concentration and suppressed locomotor activity (Vera *et al.*, 2005). In the European blackbird *Turdus merula*, the change in plasma melatonin concentration between midnight and morning was negatively correlated with morning locomotor activity in birds raised under ALAN (Dominoni, Goymann, *et al.*, 2013). In the house lemur *Microcebus murinus*, which exhibit seasonal rhythms, ALAN reduced locomotor activity by shortening the active period at night. Moreover, male lemurs typically show sexual rest during short-day period, but the presence of light at night led to a decrease in melatonin levels and an activation of reproduction functions, characteristic of a long-day period (Le Tallec *et al.*, 2016). Studies about the immune response also provide evidence of the role played by melatonin in biological changes observed under light pollution. Most of these studies have been conducted on bird species (Kernbach *et al.*, 2020; Malek & Haim, 2019; Mishra *et al.*, 2019). For instance, in the house sparrow *Passer domesticus*, 5-lux broad spectrum light at night affected both melatonin concentration and West Nile virus-induced mortality, with individuals exposed to ALAN dying from the infection at lower viral burdens (Kernbach *et al.*, 2020). This question has also been tackled, albeit less

frequently, in insect species such as the cricket *T. commodus*. In this species, constant illumination (light of high intensity) reduced melatonin level and negatively affected components of the insect immune response (Durrant *et al.*, 2015).

However, all the above studies are only correlative and do not demonstrate a causal relationship between melatonin and changes in biological traits under light pollution. Experiments of supplementation with melatonin could help to test this hypothesis. In the Japanese quail *Coturnix coturnix japonica*, an experiment comparing light/dark and light/light photoperiods showed that melatonin provided in drinking water was immune-enhancing for birds maintained under the light/light condition, whose immune function was reduced in absence of night darkness (Moore & Siopes, 2000). This type of melatonin supplementation has also been conducted in *T. commodus*, in which presence of light at night correlates with reduced immune function and lowered melatonin concentrations (Jones *et al.*, 2015). As in the Japanese quail, dietary melatonin increased some of the immune measures in crickets exposed to constant illumination (Jones *et al.*, 2015).

Melatonin is a ubiquitous and pleiotropic molecule that play major roles in a wide variety of living organisms. There is clearly strong links between artificial light at night and melatonin, with potential biological consequences that still remain to determine and test experimentally, especially in insect species.

Foremost

The next chapter presents the work that I conducted on melatonin synthesis in *Venturia canescens*, which was initially intended to be part of a larger project. In this preface, I will thus describe what was the purpose of studying melatonin in the context of this thesis.

Melatonin is a hormone strongly influenced by the presence of artificial light at night, and could thus be a key mechanism underlying behavioural changes observed in organisms exposed to this disturbance. The first step of this part of my thesis was to find a method capable of accurately detecting and quantifying melatonin in an insect as small as *Venturia canescens*, without the need for too much biological material. We chose to quantify melatonin in two ways; on the one hand directly with a method of biochemical quantification targeting melatonin itself, and on the other hand indirectly with a molecular biology method targeting the expression of melatonin-related genes. We wanted to determine whether the results obtained by the two methods were correlated, so that we could then only use the molecular method to study variation of melatonin production in *V. canescens*. Measuring gene expression is indeed easier to implement routinely and potentially requires less biological material or even allows individual measurements to be considered. The other aim of this step was to describe the reference dynamics of melatonin during a 24-hour cycle in *V. canescens*, because day/night variations of melatonin are not necessarily consistent between insect species, contrary to vertebrates.

Once the reference melatonin dynamics described, the second step was to determine if, and how, melatonin synthesis was affected by ALAN in *V. canescens*. We planned to expose wasps to different light at night intensities and measure the resulting modifications in melatonin content at key points (*e.g.* peak(s) of secretion) throughout the day/night cycle. As is the case in many species, we expected ALAN to reduce, or even suppress, the peak of melatonin production during the night in *V. canescens*.

The long-term goal of this work was to create an integrative view of how light pollution affects an arthropod species. To do so, we wanted to be able to correlate behavioural and physiological changes in melatonin secretion at the individual level in *V. canescens*. Indeed, contrary to large insect species, such as bugs or cockroaches (Bembenek *et al.*, 2005; Gorbet & Steel, 2003), melatonin in small insects is always quantified with pooled individuals (*e.g.* pea aphids; Escrivá *et al.*, 2016). Only with individual measurements will we be able to determine the precise mechanisms by which ALAN affects insects.

However, due to some methodological difficulties that led to experimental delays, I could only begin to address this overall issue. In the following chapter, I thus present the methodological

development that I carried out to quantify melatonin, both directly and indirectly, and the results about the variation of melatonin secretion and expression of melatonin-related genes throughout a 24-hour cycle in *V. canescens*.

Chapter 8

Melatonin dynamics over a 24-hour period in a parasitoid wasp: methodological developments and application

ABBREVIATIONS AND ACRONYMS USED IN CHAPTER 8

AANAT: arylalkylamine N-acetyltransferase

aanat: gene encoding the enzyme AANAT

Ct: threshold cycle

DNA: deoxyribonucleic acid

cDNA: complementary deoxyribonucleic acid

ELISA: enzyme-linked immunosorbent assay

ASMT: acetylserotonin O-methyltransferase

asmt: gene encoding the enzyme ASMT

PCR: polymerase chain reaction

qPCR: quantitative polymerase chain reaction

RNA: ribonucleic acid

RT: reverse transcriptase

RT-qPCR: quantitative reverse transcription PCR

ZT: zeitgeber time

1. Methodological developments: how to quantify melatonin in a parasitoid insect?

We followed two distinct approaches to quantify melatonin in *Venturia canescens*. On one hand, we quantified the hormone directly in groups of heads using enzyme-linked immunosorbent assay (hereafter “ELISA”). This method and the resulting experiments were developed in collaboration with Nathalie Mondy, Adeline Dumet and Morgane Touzot at “Laboratoire d’Ecologie des Hydrosystèmes Naturels et Anthropisés” (University of Lyon). Simultaneously, we attempted to measure the production of melatonin by quantifying the expression of two genes involved in its biosynthesis pathway. We hoped that the molecular method would require less biological material than quantification by ELISA and even, in the end, allow to study the relationship between behaviour and melatonin variation at the individual level. This part was developed with the help of Aurore Gallot, H el ene Henri and David Lepetit at “Laboratoire de Biologie et Biom etrie Evolutive” (University of Lyon).

In both cases, we used only the heads of parasitoid because this is where tissues involved in melatonin biosynthesis (*e.g.* eyes, optic lobes) are primarily found (Vieira *et al.*, 2019; Vivien-Roels & P evet, 1993). Melatonin biosynthesis has also been detected in other organs, but sometimes with different rhythmicity than in the brain or the eyes (Itoh, Hattori, Sumi, *et al.*, 1995). Carry out measurements on the whole body could thus hide the melatonin dynamics of interest to this study.

1.1. Quantitative analysis by enzyme-linked immunosorbent assay (ELISA)

1.1.1. Principle of the ELISA method

ELISA is a technique that allows the detection and quantification of soluble molecules. There are several types of ELISAs, but they follow the same basic principle. A target molecule (hereafter “sample antigen”) is detected and immobilized by an antibody thanks to highly specific antibody-antigen interactions. The sample antigen is then detected by an antibody conjugated with a molecule easy to track down, such as a fluorophore.

In this study, we used the “Melatonin ELISA kit NB-44-BTBA-E-3300” from NeoBiotech™ that follows the principle of competitive ELISA. It relies on the competition between the sample antigen, here melatonin extracted from the wasp heads, and a labelled antigen, here biotinylated melatonin, for a fixed number of antibody binding sites. When the system is in equilibrium, the amount of labelled melatonin bound to the antibodies is quantified by adding an enzyme and a substrate that elicit a colorimetric reaction. The more sample antigen, the less labelled antigen is detected, hence weaker is the signal. The signal is therefore inversely proportional to the concentration of sample antigen. Quantity of sample antigen is then determined by comparison to a reference curve prepared by using known melatonin standards.

1.1.2. Assay protocol

The kit we used was designed for the quantitative determination of melatonin in human serum and plasma (limit of detection: 1.6 pg/ml). We followed the manufacturer’s protocol for the most part, with some modifications to adapt it to our study species.

In order to have enough biological material, we assayed the amount of melatonin in samples consisting of pools of 10 female heads. Each sample was crushed in 250 μ L of wash buffer solution, sonicated and centrifuged. 200 μ L of supernatant was then collected to be extracted, along with standards, through extraction columns. Extraction was carried out with methanol. Methanol was evaporated to dryness by using an evaporator centrifuge, and the samples were reconstituted with 150 μ L of distilled water.

50 μ L of extracted samples (undiluted) and standards were then transferred into a 96-well microplate, together with biotin and melatonin antiserum, and incubated for 17 hours at 4°C. The samples were determined in duplicates to identify potential technical errors. After washing the plate with wash buffer, enzyme conjugate was added into each well and the plate was incubated 2 hours at room temperature. After another washing step, substrate solution was added into each well and the plate was incubated for 20 minutes. Without delay, the optical density of samples and standards was measured at 405 nm with a photometer.

The complete and detailed protocol can be found in Appendix 1.

1.1.3. Calculation of melatonin quantities

To determine the melatonin concentration in our samples, their optical densities (OD) were compared with those of the standard curve. The standard curve was built from six standards of known concentration (0, 3.7, 9, 27, 100 and 275 pg/mL). Their percentage of coloration (defined as $OD/OD_{max} \times 100$) were plotted against these concentrations (logarithmic), which then allowed us to calculate the samples' concentrations from their own values of OD.

1.2. A molecular approach: quantitative analysis of gene expression (quantitative PCR)

1.2.1. Principle of quantitative PCR

Quantitative PCR (hereafter “qPCR”) is a molecular biology technique that allows the detection and quantification of nucleic acids. It is based on Polymerase Chain Reaction (PCR), a process that amplifies a target DNA sequence (also called template), using a pair of primers specific to the target and a polymerase to elongate these primers and generate copies of the template. A cycle of PCR is composed of three steps: denaturation, annealing and extension (Figure 14).

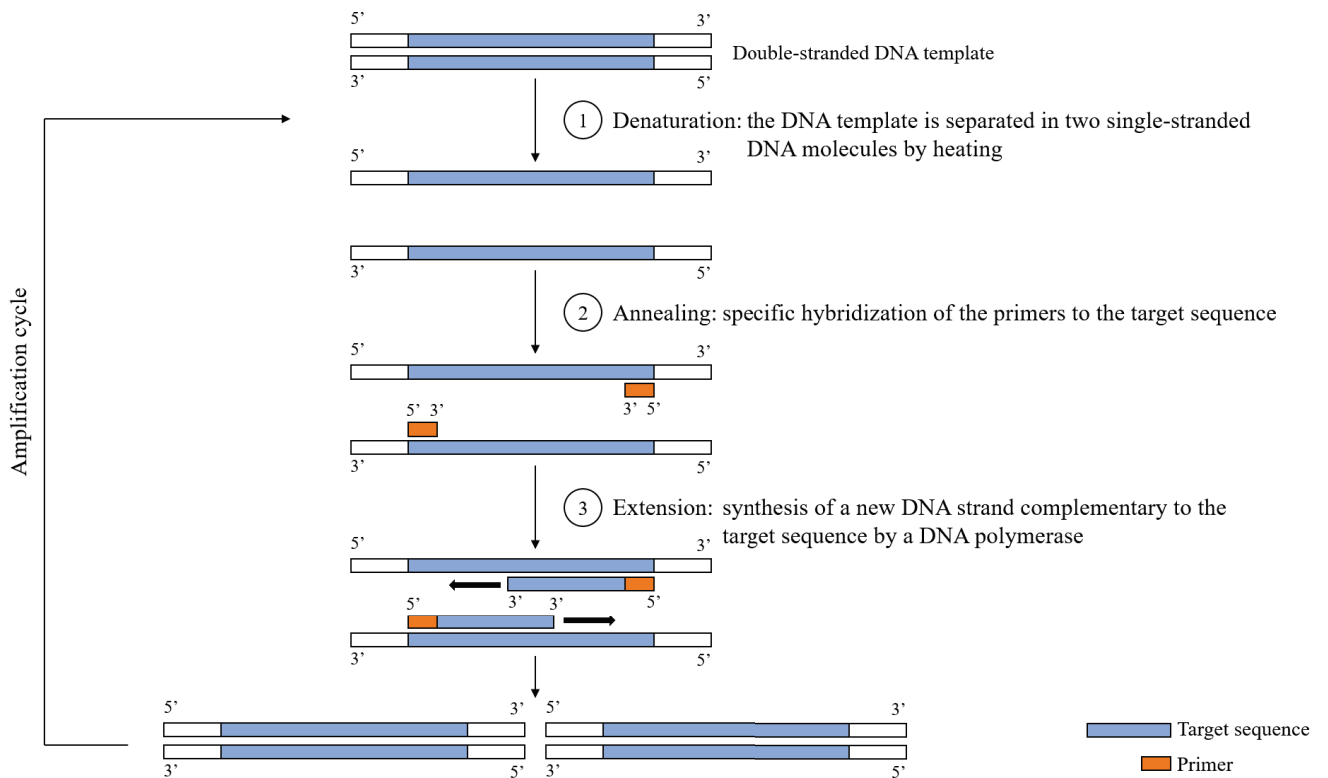

Figure 14 Schema describing the three steps of a PCR cycle (denaturation, annealing, extension).

Theoretically, the number of template molecules doubles with each amplification cycle, which leads to an exponential increase in the amount of template. The amount of PCR product at the end of a cycle correlates with the amount of starting target sequence. Classically, amplification lasts up to 40 PCR cycles maximum. Over 40 cycles, PCR efficiency is lowered and, in the end, amplification stops and reaches a plateau phase (Figure 15). In practice, exponential increase does not happen in the first amplification cycles because there are not enough template molecules, nor in the last amplification cycles because of reagent exhaustion or polymerase saturation. Quantification is therefore only possible in the phase of exponential growth, where the relationship between the number of cycles and the amount of DNA template is linear.

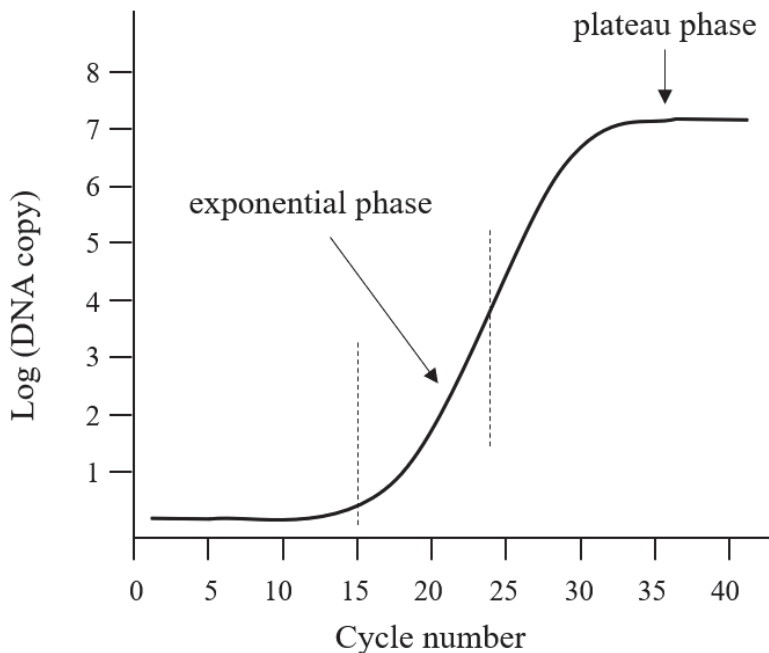

Figure 15 Theoretical PCR amplification curve.

While only the final result of amplification is observed in classic PCR, qPCR monitors the amount of PCR product generated at each cycle. One of the most common technique is to use a fluorescent dye (such as SYBR[®] Green) that binds to DNA and emits fluorescence when intercalated into double-stranded DNA at the extension phase. As more copies of the target sequence are created during the amplification process, the number of dye molecules incorporated into DNA increases. Therefore, the fluorescent signal increases in direct proportion to the amount of PCR product generated, and is also linked to the original amount of target sequence.

Fluorescence is measured at the end of each cycle. By plotting fluorescence against the number of cycles, we obtain the amplification curve of the reaction (Figure 2). The amplification curve is used to extract the threshold cycle (hereafter “Ct”) value, which represents the number of cycles from which the exponential phase starts. Ct values are then used to quantify the initial amount of target sequence in the sample. These two values are inversely proportional; a high Ct value signals a low level of RNAs in the sample and therefore a low level of gene expression, and vice versa. Most of the time, relative quantification is chosen rather than absolute quantification, to account for variability within and between samples. Relative quantification normalises the expression level of the target gene with one or several reference gene(s) whose expression is constant between all samples. The changes in gene expression are then compared between samples, by choosing one sample as the calibrator. The expression of the target gene in all other samples is therefore expressed as an increase or decrease relative to the calibrator. In this study, we used more specifically Reverse Transcription qPCR (RT-qPCR) because we were interested in measuring the level of expression of genes. The starting material was thus RNA instead of DNA. Before qPCR, the total RNAs are transcribed into complementary DNA (cDNA) by reverse transcriptase (RT), and these cDNAs are then used as template for the qPCR reaction.

1.2.2. Gene selection and identification in *V. canescens*

We chose to study the expression of the genes *aanat* and *asmt*, that encode the enzymes AANAT and ASMT in the melatonin biosynthetic pathway. As described in more detail in Chapter 7 (“Mini-review on melatonin biosynthesis, roles and relationship to artificial light at night”), AANAT is crucial for melatonin synthesis, because it catalyses the limiting step in the synthesis of melatonin (Klein, 2007). ASMT, although less studied than AANAT, seems to also regulate the production of melatonin (Itoh *et al.*, 1997). AANAT activity is regulated by light/dark cycles in vertebrates (Klein, 2007), as well as in some invertebrate species (*e.g.* the orthoptera *Oedipoda caerulescens*, Vieira *et al.*, 2019; the lepidoptera *Antheraea pernyi*, Mohamed *et al.*, 2014). Moreover, AANAT activity is rapidly suppressed by light (Klein, 2007). All these characteristics show that the identification and study of *aanat* and *asmt* are particularly relevant when addressing the responses to ALAN in terms of melatonin production and dynamics.

To identify the gene *aanat* in *V. canescens*, we performed a tBLASTn search on the *V. canescens* head transcriptome (NCBI Gene Expression Omnibus, accession number GSE124129). Insects lack vertebrate-like AANAT orthologous genes (Coon & Klein, 2006), but arylalkylamine-N-acetyltransferases belonging to a separate family have been found in insect species such as *Drosophila melanogaster* (Amherd *et al.*, 2000; Hintermann *et al.*, 1996). We used the *D. melanogaster* dopamine-N-acetyltransferase 1 protein sequence and the *Apis mellifera* N-acetyltransferase domain-containing protein as queries (see Table 1 in Appendix 2 for more details). We identified 2 alternative transcripts from the same gene for both query sequences (Table 2). We designed primers for *aanat* on sequence regions common to both transcripts.

Table 2 Results of tBLASTn searches against the transcriptome of *V. canescens* for the gene *aanat*.

Query		Best hit in <i>V. canescens</i> genome			tBlastn statistics	
Species	Accession number	Gene	Transcript	Transcript length	% identity	e-value
<i>D. melanogaster</i>	Q94521 DNAT_DROME	XLOC_014680	TCONS_00030426	1557	62%	1.00E-43
<i>A. mellifera</i>	A0A088AHR1_APIME	XLOC_014680	TCONS_00030425	2263	76%	3.00E-90

Regarding the gene *asmt*, we performed a tBLASTn search using three query sequences from *D. melanogaster*, *Apis cerana cerana* and *Bombis impatiens* (see Table 2 in Appendix 2 for more details). We identified two transcripts from the same gene regardless the query used (Table 3). We designed primers for *asmt* on sequence regions common to both transcripts.

Table 3 Results of tBLASTn searches against the transcriptome of *V. canescens* for the gene *asmt*.

Query		Best hits in <i>V. canescens</i> genome			Blastn statistics	
Species	Accession number	Gene	Transcript	Transcript length	% identity	e-value
<i>D. melanogaster</i>	Q86BM0_DROME	XLOC_008116	TCONS_00016683	1099	69%	6.00E-55
		XLOC_008116	TCONS_00016682	961	68%	1.00E-43
<i>A. cerana cerana</i>	A0A2A3EH61_APICC	XLOC_008116	TCONS_00016683	1099	82%	5.00E-91
		XLOC_008116	TCONS_00016682	961	81%	2.00E-77
<i>B. impatiens</i>	XP_003490036.1	XLOC_008116	TCONS_00016683	1099	81%	5.00E-91
		XLOC_008116	TCONS_00016682	961	81%	6.00E-79

We applied the method of reciprocal best hits to confirm the orthology between *aanat* and *asmt* genes and the sequences identified in *V. canescens*. The AANAT sequence found in *V. canescens* was used to perform tBLASTn searches on the *D. melanogaster* and *A. mellifera* genomes. The two best hits corresponded to the AANAT sequences in these species (*D. melanogaster*: Identity = 39%, E-value = $7e^{-38}$; *A. mellifera*: Identity = 62%, E-value = $2e^{-95}$). The ASMT sequence found in *V. canescens* was used to perform tBLASTn searches on the genomes of *D. melanogaster*, *A. cerana cerana* and *B. impatiens*. The best hits corresponded to the ASMT sequence in *D. melanogaster* (Identity = 47%, E-value = $3e^{-63}$) and *B. impatiens* (Identity = 68%, E-value = $5e^{-92}$). However, no match was found for the tBLASTn search on the genome of *A. cerana cerana*. These results provided confidence on the orthologous status of the genes *aanat* and *asmt* identified in *V. canescens*. These genes are subsequently named *Vcan_aanat* and *Vcan_asmt* in the text.

The transcripts (TCONS_00030425 and TCONS_00030426 for *Vcan_aanat*; TCONS_00016683 and TCONS_00016682 for *Vcan_asmt*) were aligned with several coding DNA and mRNA sequences (presented in Appendix 2, Table 3) using SeaView (Gouy *et al.*, 2010), to identify the regions that were the most conserved and thus the most suitable to design primers for quantitative PCR. For each gene, we then selected sequence regions common to both transcripts to design primers.

The final nucleotidic sequences for *Vcan_aanat* and *Vcan_asmt* are given in Table 4.

Table 4 Final sequences for the genes *aanat* and *asmt* in *V. canescens*.

Gene	Final sequence
<i>Vcan_aanat</i>	ATGGATTATAACATTCAACTTACTTGCAAAGAGGACAAACCAAGGGTCCTCAAGTTCTTGA GACGCTTTTTTCTTCCGTGACGAGCCCCTTAATCACAGTATCGAGCTCATAACCGGAAGGCGA AGACAGTACGTGCCTCGAACTCGAGGAGTACAGCCTTTCGGCCCTTATGGATAATCTTAGC TTGATGGCGGTCTCCTCGAACGGTTCGATCATCGGTGTTCAACTCAACGGTAAAATGGAAG CAGCACCGGATGAGGGCGAGCCCGAATACATAACCAATTGCAAGAATCCAAAATTCGGAAA AATTTTAAGGCTGCTTCATCACGTGACAAAAAAGTTGACATCCCCTCGAGATATCCGAAA AAAAAGATTGCAAGAATCCAAAATTCGAAAAATTTTAAGGCTGCTTCATCACGTGACAAA AAAAGTTGACATCCCCTCGAGATATCCGAAAAAAAAGGTTCTTGAAATAAGGATCATATCG GTTGACAGTAACTGGCGCGGACAAGGAGTAGCCGGAGCTCTCATCGAAAAAACCATAGAAA TTGCCCGCGAGTTGGGTTTTCACTTGATCCGATCGGATTGCACGTCTCTGTTTTCCGGCAA ACTTTGCAAGAGATACGGTTTTCGAACCGGTTTATGAGCTCAGATACGCGGACTACGTGAT GAAAATGGTAAACCGATATTCACACCGGCCAAACCCACGACGCCGTTATGACTTACGTCA AATTATTG
<i>Vcan_asmt</i>	CGAGTTATTCTGGCTAGTTCTTCACCGAGACGACAGGAAATCATTGAAATTTGGGAATCA ATGCTGAGTGTATAACCGTCGAGTTATGACGAGAATCTCGACAGAAACAAATATTCAAACCA TGGCGAATACGTTCAAGATTTGGCTTATTACAAAGTGCAGGAAGTGTGGGAACGTGTTTCCAG AAAGATGAACCACCTCCAGTACTCGTAATTGGAGCTGACACGGTCGTTACAATGGACGATA AAATATATGGAAAACCAAAGACGAGTCGGATGCATTTTCGCATTCTTTCTTGTTTTAGCCAA AAAAAATCATACGGTTTACACTGGAGTATGTTTGAAAACCTCCCAAATCGGAAATAAAATTT TATGAGAGTACAACAGTCCAGTTTGGTGATATATCCGAGGAACAAATTAAGCTTATATCA AAACCTGGAGAACCTTTGGACAAGGCAGGGGTTATGGAATTC AAGGCGTGGGTGGATGTCT GATTGAAAAAATTGATGGAGATTATTACACCGTGATGGGAATGCCACTCTACTCGTTGATT AGGCATTTGAACAAGCTGTTT

1.2.3. Primers

We used the software Primer3 (version 4.1.0) to design primers for *Vcan_aanat* and *Vcan_asmt* from their final sequences. For each gene, we obtained three pairs of primers that we tested to keep only the best pair, that is the most specific and efficient for the subsequent qPCR analysis. The reference genes selected were *Vcan_gapdh* (encoding the enzyme glyceraldehyde-3-phosphate dehydrogenase, GAPDH) and *Vcan_rpl32* (encoding the 60S ribosomal protein L32). These two genes were considered to have the most stable expression between different samples among the six genes tested, and are currently used as reference genes in qPCR

experiments with *V. canescens* (Gallot *et al.*, in prep.). The sequences of the four pairs of primers used for the subsequent qPCR analysis are presented in Table 5.

Table 5 Primer sequences used to amplify and quantify the expression of the two focal genes (*Vcan_aanat* & *Vcan_asmt*) and the two reference genes (*Vcan_gapdh* & *Vcan_rpl32*).

Gene	Primer sequences (5' to 3')	Amplicon size (pb)
<i>Vcan_aanat</i>	GATGGCGGTCTCCTCGAAC (forward)	109
	TGGATTCTTGCAATTGGTTATGT (reverse)	
<i>Vcan_asmt</i>	CAGGAAGTGTGGGAACGTGT (forward)	95
	GCATCCGACTCGTCTTTTGG (reverse)	
<i>Vcan_gapdh</i>	TGTGTCCGGATGTACCTGAGT (forward)	149
	TTAAATACACGCTCGGTCTCG (reverse)	
<i>Vcan_rpl32</i>	GCGTTTCAAGGGTCAGTTCT (forward)	159
	AGCGATCTCTGCACAGAATTT (reverse)	

1.2.4. Extraction of total RNAs

Total RNAs were extracted from pools of 5 female heads. The heads were crushed dry with steel beads and Tissue Lyser (25 hertz, 45 seconds, Qiagen). The extraction was then performed using QIAzol[®] lysis reagent and chloroform. After extraction, total RNAs were purified using the RNeasy Mini Kit[®] from QIAGEN. We also made sure to remove all residual DNA that could interfere with subsequent qPCR adding a DNase (Invitrogen[™] Ambion[™] Turbo DNA-free, Fisher Scientific) in our samples.

DNA quality and quantity were assessed by spectrophotometry using a NanoDrop. We double-checked the RNAs integrity visually, by running 1 µL sample aliquots on a non-denaturing 1% agarose gel. If RNAs are of good quality, a strong band should appear on the gel, corresponding to 18S and 28S ribosomal RNAs. However, the more the RNAs are degraded, the more a smear will appear (Figure 16).

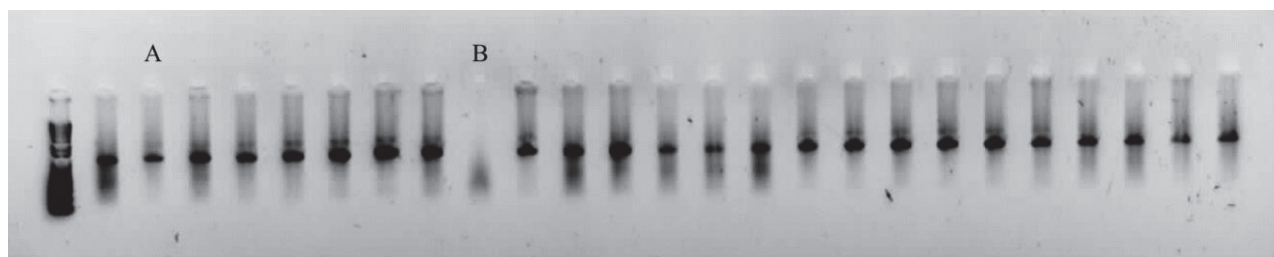

Figure 16 Result of total RNAs ran on a non-denaturing 1% agarose gel. “A” shows a good quality (*i.e.* intact RNA) sample, while “B” shows degraded RNAs that thus appears as a smear.

1.2.5. Synthesis of cDNA

cDNAs were synthesised from 0.5 µg of extracted RNAs using the kit “SuperScript III First-Strand Synthesis System” (Invitrogen™) using the manufacturer protocol. For each sample, a negative control was prepared without adding the reverse transcriptase enzyme. These samples containing only RNAs were then used as negative controls in qPCR plates. Samples were stored at -20°C before being used to perform qPCR.

1.2.6. Optimization of qPCR conditions

Before performing qPCR on valuable samples, we searched for the ideal qPCR conditions that would allow efficient and specific amplification of our target sequences.

A key point of a qPCR assay is the annealing temperature, because reaction specificity depends on it. Setting the annealing temperature too low may lead to amplification of sequences other than the target, but setting the annealing temperature too high may lead to an overly stringent amplification and thus a reduced yield. The optimal annealing temperature for each pair of primers was determined by testing a range of temperatures in a thermal gradient, and choosing the one leading to the optimal amplification (Table 6).

Table 6 Optimal annealing temperatures for qPCR assays for each pair of primers

Gene	Thermal gradient tested	Optimal annealing temperature
<i>Vcan_aanat</i>	4 temperatures ranging from 57°C to 60°C	60°C
<i>Vcan_asmt</i>	4 temperatures ranging from 58°C to 61°C	58°C
<i>Vcan_gapdh</i>	8 temperatures ranging from 54°C to 67°C	60°C
<i>Vcan_rpl32</i>	8 temperatures ranging from 54°C to 67°C	59°C

It is also important to determine which dilution is optimal for the samples of interest. By diluting our samples, we also dilute potential reaction inhibitors that can reduce the yield, or even prevent, amplification. However, excessive dilution of the samples reduces the initial number of target gene copies, that could therefore become undetectable. Regarding our samples, a dilution of 1:16 gave the best result.

Finally, a standard curve for each target sequence was needed to determine the efficiency of our qPCR assays. To do so, the four target sequences were amplified from cDNAs by means of simple PCR, with the annealing temperatures given in Table 4. PCR products were purified with the QIAquick PCR Purification kit (QIAGEN) and their precise DNA concentration was measured with Qubit® dsDNA HS Assay kit and Qubit® fluorometer. Serial dilutions were then made, that span the expected concentrations of the test samples (Table 7).

Table 7 Serial dilutions used to generate the standard curves for the four target sequences

Genes	Serial dilution (number of DNA copies)
<i>Vcan_aanat</i> & <i>Vcan_asmt</i>	$10^5 - 10^4 - 10^3 - 10^2 - 50 - 10 - 5 - 1$
<i>Vcan_gapdh</i> & <i>Vcan_rpl32</i>	$10^7 - 10^6 - 10^5 - 10^4 - 10^3 - 10^2 - 10 - 1$

The quantitative PCR assays were performed using a CFX Connect Real-Time PCR System (Bio-Rad) with SsoAdvanced™ Universal SYBR® Green Supermix (Bio-Rad) in a 96 well format, from 1 µL of cDNA. Each sample was analysed in triplicate to control for technical variability.

2. Practical application: are melatonin synthesis and expression of two melatonin-related genes correlated during a 24-hour period?

2.1. Experimental design

Newly emerged female wasps were kept individually in plastic vials (7 x 3 cm) under controlled conditions in a climatic chambers ($25 \pm 1^\circ\text{C}$, 60% relative humidity, 12:12 h light:dark) for 72 hours. During this time, the wasps were fed with 20 μL of honey diluted 1:1 with distilled water. After 72 hours, wasps were sampled randomly at nine different moments along the day-night cycle, starting at the moment when the lights were switched on (Zeitgeber Time 0, hereafter “ZT0”) and taken at 3-hour intervals (Figure 17). At night, sampling was done in the dark. Once out of the climatic chamber, they were immediately killed and stored at -80°C to block any process that could influence melatonin or gene expression levels in the wasps at this time.

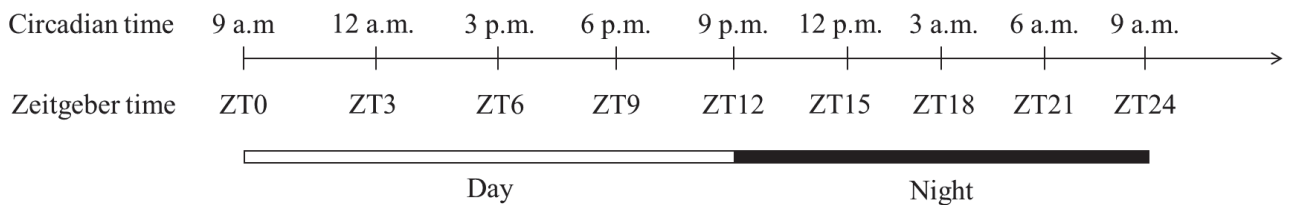

Figure 17 Sampling scheme of the wasps used to describe the dynamics of melatonin over a 24-hour period. “ZT0” represents the moment when the lights are switched on, and “ZT12” represents the moment when the lights are switched off.

The wasp heads were then dissected at -20°C with minimum light, to minimize the potential degradation of RNA or melatonin. For each sampling time point, we made biological samples of ten and five heads for the ELISA and qPCR experiments, respectively. For the ELISA experiment, there was only 1 biological sample per time point. For the qPCR experiment, there were 3 biological samples per time point, except for ZT12 where there were only 2.

2.2. Data analysis

2.2.1. Analysis of qPCR data

First, we used the Bio-Rad CFX Manager™ software (3.0) to perform an analysis on the raw qPCR data we obtained.

For each replicate, the software calculated the Ct value using the regression method as Ct determination mode. Each biological sample had three technical replicates to account for potential technical errors (e.g. pipetting). As is customary, we suppressed a technical replicate from the data set when there was a standard deviation greater than 0.5 Ct with the other replicates from the same biological sample. This accounted for 19%, 4% and 7% of the technical replicates for genes *Vcan_aanat*, *Vcan_asmt* and *Vcan_gapdh*, respectively. After this sorting step, we calculated the mean Ct value between the technical replicates per biological sample. We also calculated the amplification efficiencies for the four genes tested from their standard curves ($E_{Vcan_aanat} = 121\%$; $E_{Vcan_asmt} = 129\%$; $E_{Vcan_gapdh} = 116\%$; $E_{Vcan_rpl32} = 141\%$).

We continued the analyses with the *pcr* package (Ahmed & Kim, 2018) in R version 4.2.0 (R Core Team, 2020). We chose the standard curve method (Yuan *et al.*, 2006) to calculate the relative expression of *Vcan_aanat* and *Vcan_asmt* because this method takes account of the amplification efficiencies and is recommended when these values deviate from 100%.

2.2.2. Statistical analysis

We used the ANOVA method provided with the *pcr* package to test if there was a statistically significant effect of the sampling time point on the expression levels of *Vcan_aanat* and *Vcan_asmt*.

Our aim was then to determine if the three dynamics that we established over a 24-hour cycle (*Vcan_aanat* expression, *Vcan_asmt* expression and melatonin levels) were correlated, and whether gene expression leads the melatonin production (and with what time delay). To quantify these potential relationships, we transformed our data in time series objects and used the cross-correlation function (hereafter “*ccf*”) in R version 4.2.0 (R Core Team, 2020). Cross-correlation function estimates the correlation between two time series x and y at different time lags. More precisely, it calculates the correlation between x_{t+k} and y_t , with the lag value k which

can be positive or negative (Cowpertwait & Metcalfe, 2009). Lag unit is defined by the duration between two sampling points, which is 3 hours in our study.

2.3. Results

Over a day/night cycle, melatonin content in *V. canescens* varied between about 30 pg and 50 pg. There seemed to be two peaks in melatonin content: one at the end of the night (ZT21, *i.e.* 6 a.m.) and one during the day (ZT6, *i.e.* 3 p.m.) (Figure 18). These two highest values were similar, and represented a 1.5-fold increase compared to the lowest value (ZT0/ZT24 and ZT12).

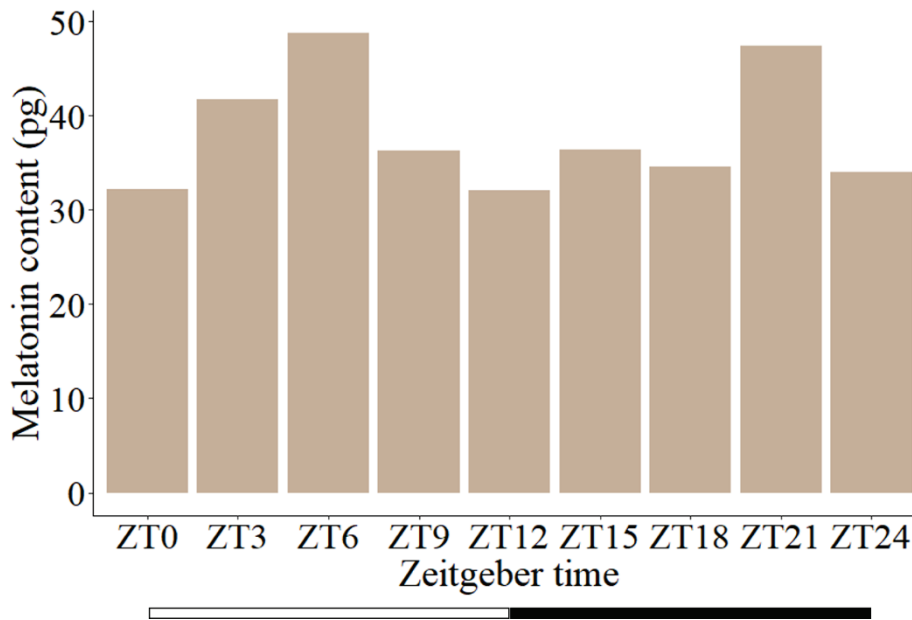

Figure 18 Melatonin content in samples made up of 10 heads of *V. canescens* over a 24-hour cycle (quantification by ELISA method). There was only one sample per time point. Zeitgeber time 0 (ZT0) represents the moment when the lights went on, and zeitgeber time 12 (ZT12) the moment when the lights went off. White and black rectangles represent day time and night time, respectively.

gapdh and *rpl32* were selected to be used as reference genes in the qPCR data analysis. Ideally, reference genes should show a stronger expression level (*i.e.* lower Ct values) and less variation than the genes of interest. In our study, *Vcan_gapdh* and *Vcan_rpl32* have higher levels of expression than *Vcan_asmt* but not *Vcan_aanat* (Figure 19). Moreover, variance differences

were not statistically significant between the four genes (Bartlett test: $B = 2.98$, $df = 3$, $P = 0.40$).

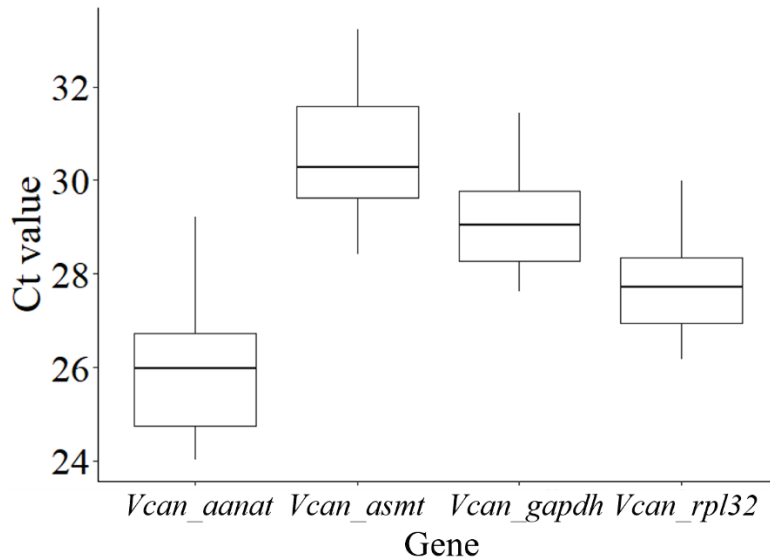

Figure 19 Boxplots representing the variability in Ct values for the four genes analysed by qPCR.

Normalisation by either *Vcan_gapdh* or *Vcan_rpl32* did not yield highly similar results (see Figure 1 in the Appendix 3). We therefore chose to use *Vcan_rpl32* as reference gene in our analysis, because its expression level was higher than that of *Vcan_gapdh*.

The relative expression levels of *Vcan_aanat* and *Vcan_asmt* (normalised by *Vcan_rpl32*) were calculated in relation to the beginning of the photophase (ZT0 used as the calibrator samples with expression level set to 1) (Figure 20). ZT15 had only one biological sample because there was RNA degradation in 2 of the 3 RNA extractions for this sampling point. We must therefore be cautious drawing conclusions from this time point for gene expression levels.

Excluding ZT15, the highest expression level was found at ZT12 (*i.e.* 9 p.m.) for *Vcan_aanat* and at ZT18 (*i.e.* 3 a.m.) for *Vcan_asmt* (Figure 20). However, there were no significant differences in expression levels between the 9 sampling points, either for *Vcan_aanat* or *Vcan_asmt*.

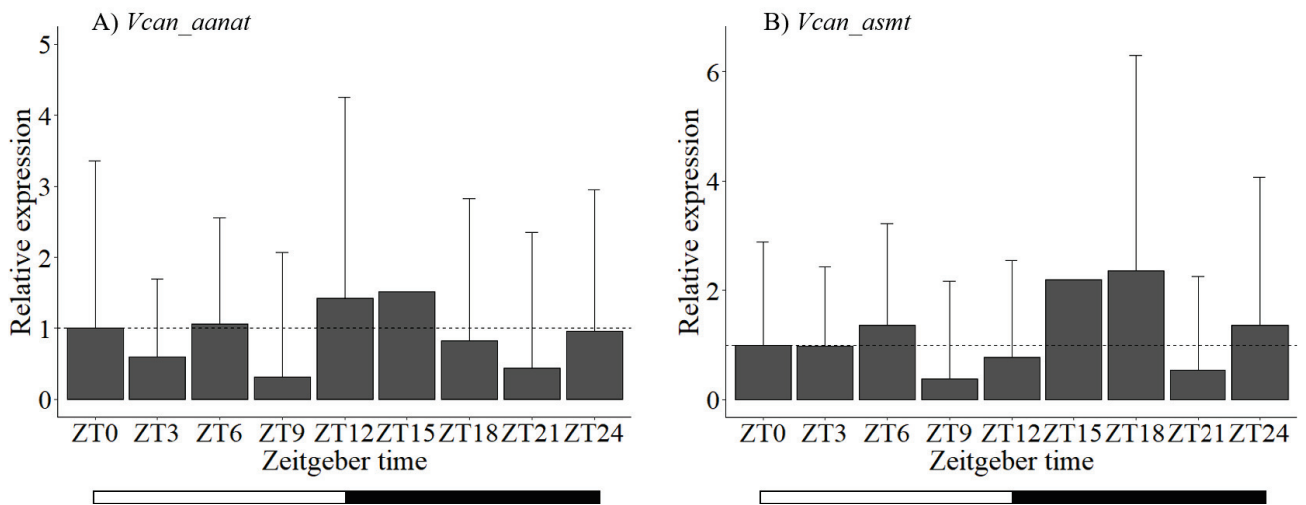

Figure 20 Relative expression levels for A) *Vcan_aanat* and B) *Vcan_asmt* over a 24-hour cycle. Bars represent the standard deviation associated with each time point. Zeitgeber time 0 (ZT0) represents the moment when the lights went on, and zeitgeber time 12 (ZT12) the moment when the lights went off. White and black rectangles represent day time and night time, respectively.

Despite the absence of significant differences in gene expression levels over a 24-hour cycle, we tested the relationships between the dynamics with cross-correlation functions. We did not detect any significant relationship between *Vcan_aanat* and *Vcan_asmt* expression levels, nor between melatonin content and *asmt* expression levels (Figure 21). However, there was a significant positive correlation between *Vcan_aanat* expression level and melatonin content at lag 3 (0.711; Figure 21). It means that melatonin content at time t is positively correlated with *Vcan_aanat* expression level at time $t + 9$ hours (lag unit being 3 hours in our study). In other words, melatonin content followed *Vcan_aanat* expression level with a 15-hour delay.

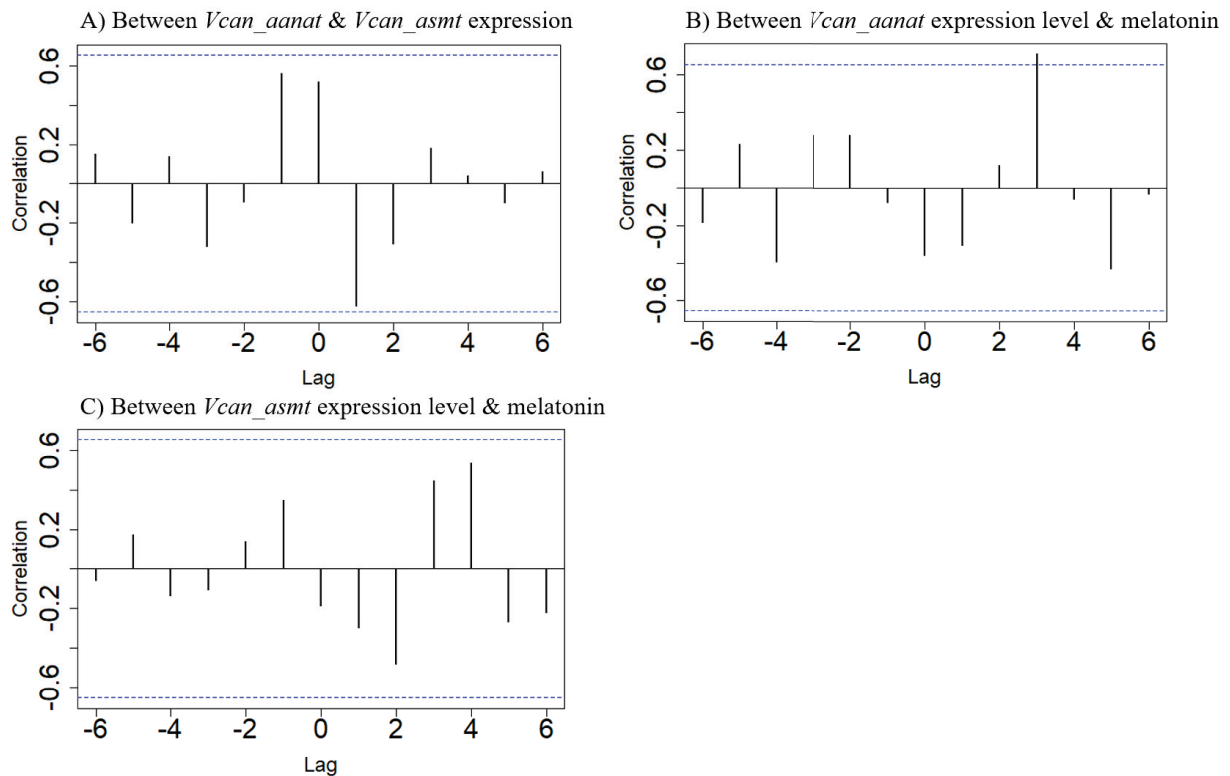

Figure 21 Cross-correlograms of the cross-correlation functions between *Vcan_aanat* expression level, *Vcan_asmt* expression level and melatonin content. The dashed blue lines represent the values beyond which the correlation between the two time-series is significantly different from zero.

3. Discussion

In vertebrates, melatonin exhibits a strong circadian variation with a peak of secretion during the dark phase of the day (Arendt & Skene, 2005). Moreover, this pattern of variation is well conserved between species. Conversely, studies monitoring melatonin levels throughout a 24-hour cycle in insects reflected a variety of relationships between melatonin concentration and circadian rhythm. In some insect species, melatonin reaches its highest concentration at night as in vertebrates. For example, the moth *Antheraea pernyi* exhibits a peak in melatonin content four hours after the lights went off (Mohamed *et al.*, 2014), and later peaks of melatonin were detected around 4 a.m. in the grasshopper *Oedipoda caerulescens* (Vieira *et al.*, 2019) and in the damselfly *Ischnura graellsii* (Vieira *et al.*, 2005). Other insect species exhibit high melatonin levels at night (*e.g.* the cricket *Gryllus bimaculatus*, (Itoh, Hattori, Sumi, *et al.*, 1995); the bug *Rhodnius prolixus*, (Gorbet & Steel, 2003); the cockroach *Periplaneta americana*, (Bembenek *et al.*, 2005), but all these studies compared only two time points (one

at day and one at night) and therefore probably missed information on melatonin circadian variation. However, nocturnal secretion of melatonin is not the only pattern found in insects. A diurnal peak of melatonin (at midday) was found in *Drosophila melanogaster* (Hintermann *et al.*, 1996). In *Apis mellifera*, melatonin showed a daily rhythm with two peaks at ZT0 and ZT12, which corresponds to the beginning and the end of the photophase (Yang *et al.*, 2007). The variation of melatonin content in *V. canescens*, with potentially two peaks (one diurnal and one nocturnal) thus represents a new pattern compared to what is known in insects up to now. It is also worth noticing that, although *V. canescens* and *A. mellifera* are phylogenetically close, their patterns of melatonin variation are exactly the opposite. When looking at the intensity of variation between peaks and baseline levels, our results are at the lower end of the range of values found in the literature. Indeed, most of the species studied showed 3-fold to 7-fold variation between the lowest and the highest melatonin content (*e.g.* Itoh, Hattori, Nomura, *et al.*, 1995; Vieira *et al.*, 2019; Yang *et al.*, 2007). With a maximum 1.5-fold variation during a day/night cycle, *V. canescens* compares with what was observed in *D. melanogaster* (Hintermann *et al.*, 1996). Our experimental design gave us a basic idea of the daily melatonin variation in *V. canescens*. The amount of biological material per sample (10 wasp heads), as well as the use of technical replicates in the ELISA test, should give rather reliable values. Nevertheless, as in other studies on melatonin circadian variation, additional biological replicates are needed to account for variation between individuals and between time points, and to test the existence of significant differences in melatonin content over 24 hours.

Knowledge on circadian variations in the expression of melatonin-related genes is rarer. A few studies quantified the variation of *aanat* expression level in insect over a day/night cycle. The expression level of *Dmel_aanat* in heads of *D. melanogaster* did not significantly vary during 24 hours (Hintermann *et al.*, 1996), as did the expression of the four *Apisum_aanat* genes identified in *Acyrtosiphon pisum* (Barberà *et al.*, 2013). Concentrations of *Pame_aanat* mRNA were also similar between night and day in the brain of the cockroach *P. americana* (Bembenek *et al.*, 2005), although it is worth noticing that *aanat* expression was the lowest in this organ compared to other tissues. *aanat* expression was found to fluctuate in a circadian manner only in *A. pernyi*, with a peak at the end of the photophase when the lights went off (Mohamed *et al.*, 2014). Information about the circadian rhythm of *asmt* is much rarer, or even non-existent in insects. Indeed, only one study measured the enzymatic activity of ASMT in

the head of the silkworm *Bombyx mori*, and found that this activity showed a circadian variation with high levels at night (Itoh *et al.*, 1997).

Our results seem to confirm that the pattern of expression of genes related to melatonin biosynthesis is diverse in insects. In *V. canescens*, although the differences between time points were not significant, we found one potential peak of gene expression at night for both *Vcan_aanat* and *Vcan_asmt* (expression level at ZT15 was not considered because of the absence of biological replicate). However, our data showed a great variability, which may be due to the relatively small number of biological samples at each zeitgeber time (three maximum). By increasing the number of samples to a minimum of five per time point, which is classically used in qPCR studies, we would probably obtain more precise values of gene expression and thus have more power to detect a potential daily rhythm of variation. We should also test other potential reference genes. *gapdh* and *rpl32* have been found to be good reference genes in *V. canescens* and consequently used in several studies on this species (Gallot *et al.*, in prep.). However, our results showed that their overall range of variation is equivalent to that of the genes of interest. This may be explained by the fact that *aanat* and *asmt* show little variation in their levels of expression. However, we cannot rule out potential circadian variation in the expression of *Vcan_gapdh* and *Vcan_rpl32* that could affect the normalisation of our qPCR data and maybe mask the circadian variation of *Vcan_aanat* and *Vcan_asmt*. Having more biological samples and choosing more suitable reference genes might therefore allow us to detect significant variations in *Vcan_aanat* and *Vcan_asmt* expression according to circadian rhythm, as there seems to be a hint in our results.

In this chapter, we aimed to relate genetic expression and melatonin levels in the head of *V. canescens*. In the literature investigating melatonin synthesis and variation, studies often try and link AANAT activity and melatonin (Bembenek *et al.*, 2005; Vieira *et al.*, 2005; Vieira *et al.*, 2019), but rarer are the studies quantifying both variation of gene expression and melatonin content in order to explicitly correlate them over time (but see Hintermann *et al.*, 1996 and Mohamed *et al.*, 2014 for examples of measurements over the same timespan). A recent paper by Barberà and colleagues (2020) co-localized melatonin and *Apisum_aanat* transcripts in the central nervous system of *A. pisum* and found that the expression of some of the *aanat* genes paralleled melatonin content. Yet, they compared these variables between short-day and long-day photoperiods, and not between different times of the day/night cycle. Although still a distant goal, using gene expression as a proxy to monitor melatonin variation would have significant

benefits. Here, we demonstrated that we were able to quantify *aanat* and *hiomt* expression with half as much biological material as for the detection of melatonin by ELISA (pools of 5 heads versus pools of 10 heads). With qPCR, it might even be possible to perform individual measurements, which would be more difficult on insects as small as *V. canescens* with ELISA or other methods frequently used to quantify melatonin in organisms (e.g. radioimmunoassay or high-performance liquid chromatography). Moreover, qPCR, which is relatively faster and cheaper than ELISA, is now commonly performed in many laboratories.

Despite growing evidence, direct or indirect (e.g. Barberà *et al.*, 2020), that *aanat* is indeed involved in the regulation of melatonin biosynthesis in insects, work is still needed to build a clear pathway linking daily rhythms of *aanat* and *asmt* expression, AANAT and ASMT activity and melatonin synthesis. To this end, an important step would be to find a gene encoding a receptor to melatonin in the transcriptome of *V. canescens*. A melatonin receptor-type gene has been found in *Apis cerana cerana* in the context of the cold stress response (Li *et al.*, 2018), but we failed to characterize such gene in *V. canescens* yet.

PART IV

GENERAL DISCUSSION

Foremost

This general discussion aims to put into perspective the results obtained during my thesis with some emerging issues concerning the biological consequences of artificial light at night, and to propose ideas for future work on these questions. First, I will sum up the main results of my thesis. Second, I will discuss how spatial variation in nocturnal light pollution levels may influence the biological responses of organisms, with a focus on local adaptations. Then, I will discuss how the consequences of artificial light at night can depend on latitude. Finally, I will consider the likely interactions between nocturnal light pollution and other anthropogenic disturbances, and their potential impact for organisms and biodiversity.

Chapter 9

General discussion

1. Summary of results

The aim of my thesis was to investigate the consequences of nocturnal light pollution on a diurnal insect (*Venturia canescens*) in an integrative way. For this purpose, we experimentally studied both behavioural and physiological responses to the presence of light at night. We investigated short-term but also longer-term responses to artificial light at night, by monitoring its consequences on lifetime reproductive success and its potential trans-generational effects. The light intensities we created (using LEDs) were equivalent to the intensity of a city skyglow ('low artificial light at night') or a streetlight ('high artificial light at night') in order to correspond as closely as possible to the lighting conditions that organisms may experience in nature in terms of intensity and spectrum.

First, we showed that artificial light at night had consequences on the nocturnal behaviour of *Venturia canescens*. Wasps exposed to artificial light became active (*i.e.* moved) at night. Moreover, they were able to exploit the 'night-light niche', that is foraging for hosts and food during the night in presence of artificial light. When exposed to high intensity of light at night, a higher proportion of wasps fed at night, and those wasps fed at night more often than wasps exposed to low or no artificial light at night. There was also a higher proportion of wasps that laid eggs at night, accompanied by a tendency to lay more eggs.

In addition, night-time lighting altered daytime behaviours in *V. canescens*. Artificial light at night increased the amount of time the wasps spent feeding during the day, and modified their decision-making behaviour between searching for hosts or food, leading to a greater propensity to choose hosts over food. We also observed that, when given a single occasion to parasitize a patch containing several hosts, wasps exposed to light at night tended to lay more eggs. This observation, associated with the modification of trade-off between spending time searching for food or spending time searching for hosts, suggested that nocturnal light pollution may promote immediate reproduction in this diurnal species. It therefore led us to investigate the fitness consequences of artificial light at night in *Venturia canescens*.

We conducted an experiment in which we quantified the daily reproductive success of wasps until they died. This daily monitoring also allowed to investigate whether actuarial and reproductive senescence (*i.e.* age-related changes in survival and reproductive traits that can affect lifetime reproductive success) were impacted by artificial light at night. Presence of light at night did not affect the lifetime reproductive success of *Venturia canescens*. We detected

actuarial senescence in our study species, with a mortality rate following an exponential increase at young ages and then decreasing at old ages. Moreover, the rate of senescence was slower in wasps exposed to high intensity of light at night. Reproductive senescence also occurred in *Venturia canescens*, with reproductive traits, such as the number of eggs laid or offspring body size, decreasing linearly with age since the age of first reproduction, but without influence of artificial light at night. Offspring development time was the only trait for which the senescence pattern was influenced by artificial light at night. However, this relationship between mother's age, offspring development time and artificial light at night would deserve further investigation, because opposite effects of light at night were found in two of our experiments.

Finally, we highlighted some trans-generational effects of artificial light at night. As said before, light at night influenced offspring development time in interaction with mother's age. Moreover, offspring whose mothers had been exposed to low artificial light at night took longer to start feeding at emergence.

We investigated two potential mechanisms that could underlie these behavioural changes under ALAN. Our results showed that the observed behavioural changes were not related to the physiological status of *Venturia canescens* in terms of energy reserves. However, melatonin synthesis is another physiological mechanism which is very likely to underly phenotypic changes in response to light at night. Melatonin is involved in the regulation of circadian rhythm and has been shown to be strongly impacted by presence of light at night in vertebrates (Grubisic *et al.*, 2019). Contrary to mammals in which the circadian rhythm of melatonin is well-known (Amaral & Cipolla-Neto, 2018), there is a lot of variability in secretion patterns between insect species (Jones *et al.*, 2015). We therefore conducted an experiment to describe the dynamics of melatonin synthesis in *Venturia canescens* throughout a 24-hour cycle, under 12h:12h light/dark photoperiod. We quantified melatonin directly, with enzyme-linked immunosorbent assay, and indirectly, by measuring expression levels of two genes (*Vcan_aanat* and *Vcan_asmt*) involved in melatonin biosynthesis. We succeeded in measuring melatonin with both methods, using relatively small amount of biological material. We detected two peaks of melatonin secretion, one during the day and one at night. Expression of *Vcan_aanat* and *Vcan_asmt* also seemed to reach their highest level at night, although the differences in gene expression levels were not statistically significant over a 24-hour cycle. This preliminary work is promising for future research on the consequences of presence of light at

night on melatonin production in *V. canescens*. The continuation of this work should focus on gathering additional data to describe more precisely the dynamics of melatonin secretion in absence of light at night. This would also allow to have more statistical power to test whether there is a correlation between the variation in melatonin synthesis and the variation in the expression of *Vcan_aanat* and *Vcan_asmt*. Should such a correlation prove to be strong, we could then rely on the indirect method (measure of gene expression), easier to be implemented routinely in the laboratory, to evaluate the influence of artificial light at night on melatonin dynamics in *Venturia canescens*.

Our experimental work focused on a given population. This is clearly a limitation preventing us to draw general conclusions about the consequences of nocturnal light pollution for this species. It would have been relevant, albeit more difficult from an experimental point of view, to conduct experiments on several populations in order to take into account, for example, the variation in nocturnal light pollution levels at different spatial scales.

2. Spatial variation of nocturnal light pollution levels: consequences on the biological responses of organisms

Studies on the biological consequences of artificial light at night were, and still are, often conducted in laboratory environments (*e.g.* Sanders *et al.*, 2020). In these settings, lighting conditions are therefore created either by mimicking the intensity of specific light sources (*e.g.* street lamp or urban skyglow) as we did in our experiments, or by setting a light intensity equivalent to the average light level present in the natural environment of the studied species (*e.g.* Dominoni, Goymann, *et al.*, 2013). This is notably the case for studies using wild-captured animals that are then tested in semi-natural or laboratory conditions (Luarte *et al.*, 2016; Taufique *et al.*, 2018). In field experiments, it is also common that the average level of artificial light measured in the study area is that to which the individuals are considered to be exposed (*e.g.* Rowse *et al.*, 2018). However, levels of artificial light at night in nature can be quite heterogeneous, even at small spatial scale. Indeed, it has been shown that light intensity can vary greatly depending on the distance from an artificial light source (Bennie *et al.*, 2016) (see Figure 3 in Chapter 1). Moreover, the presence of human-made items (*e.g.* buildings) or natural

landscape features (*e.g.* rocks, foliage) could provide dark refuges for organisms, especially for small species such as insects, and allow them to avoid exposure to nocturnal light pollution. It is therefore a challenge to accurately determine the amount of artificial light that organisms receive at night, because it requires both localized light measurements in the field and a precise knowledge of the nocturnal behaviour of animals in their natural environment.

2.1. What are the levels of artificial light at night experienced by organisms in their natural environment?

The intensity of artificial light at night that organisms truly experience in the wild is still largely unknown. In humans, individual monitoring devices capable of measuring visible, and sometimes blue, light exposure have been recently developed (Arguelles-Prieto *et al.*, 2019), and studies are beginning to use these light sensors, placed on wristbands for example, to quantify the intensity and timing of people's light exposure in the course of their daily activities (Huss *et al.*, 2019; Lee *et al.*, 2020). In free-living animals, similar devices have been used on some bird species such as great tits or European blackbirds (Dominoni, Quetting, *et al.*, 2013a; Dominoni *et al.*, 2014; Dominoni & Partecke, 2015; Jong *et al.*, 2016). This type of study has, for example, allowed to estimate differences in daylength perception for individuals exposed or not exposed to light at night (Dominoni & Partecke, 2015). It also showed that birds seem to be able to avoid being exposed to light at night by choosing roosting places with reduced light intensity (*e.g.* away from light sources, or hiding behind tree trunks, Jong *et al.*, 2016). A study on the European blackbird showed that birds living in urban sites were indeed exposed to higher light levels than those living in rural sites (Dominoni *et al.*, 2014). However, the light intensity experienced by these individuals was 20-fold lower than that measured around a light source in the studied urban site (Dominoni *et al.*, 2014). Such result shows how important it would be to have precise information on individual light exposure to accurately quantify the biological consequences of nocturnal light pollution. Regarding *Venturia canescens*, its nocturnal behaviour is not known in the field. Wasps might be able to reduce or avoid light exposure by resting under leaves or into the vegetation. Although small insects can be recaptured in a natural environment, which is the case of *Venturia canescens* (Desouhant *et al.*, 2003), their size would require important technological developments to allow the use of individual light-measuring devices in studies on nocturnal light pollution. A possibility in small species such as *V.*

canescens would be to try to observe and monitor the behaviour of focal individuals in semi-natural conditions (e.g. cages or mesocosms) illuminated with artificial light. However, the fact that using low levels of artificial light at night is particularly pertinent when studying biological consequences of light pollution (e.g. de Jong *et al.*, 2016, Gomes *et al.*, 2021) raises the question of the possibility, for a human observer, to successfully record behaviours under dim light intensity.

2.2. Is there evidence of local adaptation to nocturnal light pollution?

Nocturnal light pollution is also heterogeneous at a large spatial scale, and in rapid expansion (Falchi *et al.*, 2016; Gaston, 2019). As a result, some areas (e.g. urbanized) have been exposed to artificial light at night for longer than others (e.g. rural), leading to potential local adaptation(s) to light exposure for animal populations. There is evidence of local adaptation to light at night, although such studies are uncommon. In the spider *Steatoda triangulosa*, eggs were collected at several urban and rural locations differing, in particular, in their night-time lighting levels and the web-building behaviour of spiderlings was investigated in laboratory conditions (Czaczkes *et al.*, 2018). At emergence, the spiderlings coming from rural habitats avoided building their webs in lit areas, whereas spiderlings from urban habitats (*i.e.* exposed to nocturnal light pollution) chose lit and dark areas indifferently (Czaczkes *et al.*, 2018). The authors explain the reduction in light avoidance for spiders coming from light-polluted populations by changes in selective pressures (Czaczkes *et al.*, 2018), however the existence of non-genetic trans-generational effects of artificial light at night cannot be excluded, as we also showed in one of our experiment (see ‘Dealing with host and food searching in a diurnal parasitoid: effects of ALAN at intra and trans-generational levels’ in Chapter 5). Behavioural differences between urban and rural populations have been found in another insect species, the moth *Ypomoneuta cagnagella* (Altermatt & Ebert, 2016). Larvae were collected in areas exposed to either very low (considered as control condition) or strong nocturnal light pollution for decades, and then raised in the laboratory until the adult stage when their flight-to-light behaviour was tested. Individuals from populations exposed to high level of light at night were less attracted by artificial light sources than those from control populations (Altermatt & Ebert, 2016). In the diurnal mosquito *Aedes albopictus*, the ability to enter diapause is crucial for winter survival, and higher rates of diapause have been found under short daylength. A recent

study investigated the effects of nocturnal light pollution on diapause incidence in this species (Westby & Medley, 2020). The authors predicted that light at night would reduce diapause incidence, but that this reduction would be smaller in mosquitoes from urban populations because of local adaptation. However, in this species, no difference in diapause incidence has been found between individuals coming from rural and light-polluted urban populations (Westby & Medley, 2020). Mosquitoes from both populations were exposed to low artificial light at night in semi-natural conditions (garden experiments), but the proportion of eggs in diapause was the same regardless of nocturnal light pollution in the population of origin (Westby & Medley, 2020).

For our experiments, we used wasps from a single population located in the South of France, near the city of Valence (44°98'N, 4°93'E, INRA, Gotheron). Moreover, we studied exclusively thelytokous wasps, which are known to thrive mainly in anthropogenic environments (Pelosse *et al.*, 2007), and are consequently more likely to be exposed to light at night than natural conditions. The strain we studied could therefore already be adapted to a certain intensity of light at night, causing the wasps to exhibit weaker responses to artificial lighting than wasps from strains living in an environment free of nocturnal light pollution. To test this hypothesis, a first step would be to conduct localized field measurements of artificial lighting in the area where these wasps live. Indeed, although satellite-based maps of light pollution show that Valence and its surroundings are located in a region of high night-time lighting levels (Falchi *et al.*, 2016), we lack measurements at smaller spatial scale. A second step would be to identify and sample parasitoid populations living along a gradient of night-time lighting intensity, and then test experimentally the effect of different levels of artificial light at night on these insects. Comparing different parasitoid populations in controlled conditions (common garden) would allow to demonstrate potential local adaptation to light at night while avoiding the potentially confounding effects of other environmental variables associated with urbanization (*e.g.* noise or temperature, see section 4 'Does nocturnal light pollution interact with other human-induced disturbances?' of this chapter).

Experimental evolution could also give meaningful insight about the evolutionary consequences of artificial light at night. Nocturnal light pollution is a new selective pressure that has a great potential to influence evolutionary process through its effect on various mechanisms such as gene flow, genetic drift or reproductive isolation (Hopkins *et al.*, 2018; Swaddle *et al.*, 2015). However, evidence of its action as a selective agent over several

generations are rare. *Venturia canescens* would be a suitable model in studies of experimental evolution, in order to identify behavioural traits evolving under artificial light at night, but also potential physiological mechanisms that could underlie them. Wasps could be maintained under different intensities of light at night over several generations in the lab quite easily, in cages for example, with individuals being sampled after different numbers of generations for behavioural tests and measures of life-history traits. It would also be a good opportunity to investigate the effect of artificial light at night on melatonin synthesis in *V. canescens*, and determine how this effect, whether it is a reduction in melatonin content or a temporal shift in the secretion peak(s), evolves over time.

3. Interaction between artificial light at night and daylength: studying nocturnal light pollution at various latitudes

Nocturnal light pollution modifies the natural cycles of light and dark, and can interact with the photoperiod under which organisms live by altering the perception of daylength (Dominoni & Partecke, 2015). Photoperiod changes strongly along a latitudinal gradient, with annual variation in daylength increasing with latitude (Secondi *et al.*, 2020). Near the Equator, duration of light and dark periods is stable all year round, whereas organisms at northern latitudes can experience almost continuous daylight or darkness depending on the time of the year. Variation in daylength is also known to be accompanied by phenotypic variation in important biological traits (*e.g.* migration, reproduction, diapause) (Secondi *et al.*, 2020). Artificial light at night is present on Earth at a global scale, affecting almost every ecosystem (Falchi *et al.*, 2016; Garrett *et al.*, 2020). However, the daily number of artificially-lit hours is likely to change with latitude, ranging from constant at low latitudes (near the Equator) to much higher during the winter months (*i.e.* short daylength) at higher latitudes (Secondi *et al.*, 2020). An emerging issue in the study of nocturnal light pollution is therefore whether populations' responses to the presence of artificial light at night vary with latitude. However, the majority of studies on nocturnal light pollution focuses on temperate regions and tropical areas are largely overlooked, although the effects of light at night is predicted to be strong at these latitudes because organisms are adapted to low variation in photoperiod (Sanders *et al.*, 2020; Secondi *et al.*, 2020). Few studies tested the effect of artificial light at night on biological traits at different latitudes. The timing of dawn singing in response to the presence of light at night has been investigated on five passerine bird

species in three regions at different latitudes (in Spain, Germany and Finland) (Silva & Kempenaers, 2017). The authors showed that robins (*Eurithacus rubecula*) and blackbirds (*Turdus merula*) started singing earlier as the season progressed only in Finland (*i.e.* higher latitude). Moreover, in these two species, artificial light at night advanced the onset of dawn singing at low latitudes (Spain, Germany) but not high latitudes (Finland) (Silva & Kempenaers, 2017). However, in three other species (the great tit *Parus major*, the blue tit *Cyanistes caeruleus* and the chaffinch *Fringilla coelebs*), artificial light at night advanced the onset of singing in a similar way at all latitudes (Silva & Kempenaers, 2017). The seasonal increase in light levels at high latitudes could therefore mask the effect of artificial light at night in some species. In insects, a study investigated the interaction between varying daylength and artificial light at night in a laboratory experiment on a diurnal parasitoid, *Aphidius megourae* (Kehoe *et al.*, 2020). It showed that artificial light at night and longer daylength both increased parasitism rate, but that the positive effect of light at night was stronger under short daylength (Kehoe *et al.*, 2020). Knowledge about the interaction between latitude and nocturnal light pollution is therefore still in its infancy and remains an important perspective for future research on the biological impacts of light at night, because range shifts in species distributions are observed due to climate change (Pecl *et al.*, 2017). Some species, moving to find better thermal conditions, may therefore be exposed to new conditions in terms of light (both natural and artificial), with biological and ecological consequences difficult to predict at the moment. This point clearly pleads in favour of the study of artificial light at night in combination with various anthropogenic stressors.

4. Does nocturnal light pollution interact with other human-induced disturbances?

Nocturnal light pollution is a major anthropogenic pressure that can be placed in the category of human-induced rapid environmental changes (HIREC) (Sih *et al.*, 2011). Indeed, the rapid, steep and relatively recent increase of artificial light at night on Earth put organisms into evolutionary novel environmental conditions, with multiple biological consequences. Besides nocturnal light pollution, other HIREC include, for example, habitat loss, chemical pollution or climate change (Sih *et al.*, 2011). Often studied in isolation, several of these anthropogenic stressors can nevertheless impact natural environments at the same time and therefore interact

with each other, having additive, synergistic or antagonistic effects on organisms. Surprisingly, the combined consequences of artificial light at night and other human-induced disturbances are still little studied.

Modification in temperatures is one of the main features of climate change that could interact with modifications in natural light-dark cycles due to artificial night-time lighting. Indeed, many life-history events such as reproduction or migration are seasonal and depend on specific ecological conditions (*e.g.* food availability), with photoperiod (*i.e.* daylength) being used by many organisms to predict and anticipate the occurrence of favourable climatic conditions (Walker *et al.*, 2019). Under stable photoperiod, increase in temperatures due to climate change has been shown to desynchronize seasonal events and favourable ecological conditions (Walker *et al.*, 2019). For example, the migration of the Greenland caribou (*Rangifer tarandus*), cued by photoperiod, is usually timed to coincide with the time of the year when trophic resources are the highest, in order to favour offspring production and rearing. However, due to climate change, plant growth occurs in advance of caribou migration, creating a mismatch between offspring production and resource availability over the years and therefore leading to a reduction in reproductive success (Post & Forchhammer, 2008). The presence of artificial light at night is therefore likely to influence the species responses to climate change, in a way that still needs to be fully understood. It has been shown, for example, that spring temperature can modulate the timing of egg-laying under artificial light at night in great tits (*P. major*) (Dominoni, Kjellberg Jensen, *et al.*, 2020). Difference in egg-laying date between light-polluted and control birds was greater when spring temperatures were cold, but the authors did not detect any fitness consequences of this interaction in their study (Dominoni, Kjellberg Jensen, *et al.*, 2020). The interplay between light exposure and temperature should be particularly important for insects which, as ectotherms, are highly influenced by temperatures. For example, the parasitism rate of *A. megourae* increased when individuals were exposed to artificial light at night, but this increase was weaker when temperature were lower at night (Kehoe *et al.*, 2020). Moreover, a drop in night-time temperatures did not affect parasitism rate in absence of light at night (Kehoe *et al.*, 2020). Based on these results, the authors suggest that one could expect a stronger effect of artificial light at night in urban environments, where temperatures are higher due to the urban heat island phenomenon. The effect of night-time lighting and temperature on parasitism rate also interacted with daylength, highlighting the complexity of biological responses to nocturnal light pollution and global warming in wild species. Another study

investigated the effect of both nocturnal light pollution and night-time warming on the interaction between pea aphids (*Acyrtosiphon pisum*) and two nocturnal predators, the ladybeetle species *Coccinella septempunctata* and *Coleomegilla maculata* (Miller *et al.*, 2017). The authors showed that, in the USA, night temperatures and artificial light at night correlate positively in the field, confirming the relevance of studying their combined effects. Moreover, they demonstrated a non-additive effect of these two factors on the aphid predation by *C. septempunctata*. Without light at night, high night-time temperatures decreased predation by *C. septempunctata*; however, adding artificial lighting increased greatly the number of aphids consumed by this predator (Miller *et al.*, 2017). Conversely, *C. maculata* was not affected by either light at night, night-time warming or their combination. The difference of response between species, likely due to their different biological traits (both species increase their foraging activity with temperature, but only *C. septempunctata* relies on visual cues to forage), and the non-additive effect of light at night and temperature show that accurately predicting the ecological consequences of anthropogenic pressures is an important but complex issue. One effect of global warming being a greater increase in night-time temperatures than daytime temperatures (Davy *et al.*, 2017), it is also likely that diurnal species respond differently to the combination of light at night and temperature changes.

The interaction between temperature and night-time illumination could be tackled in *Venturia canescens* with individuals in cages placed in natural conditions (*i.e.* submitted to environmental fluctuations in temperature) in lit and dark areas, or in mesocosm experiments with controlled temperature variations. Studying interaction between nocturnal light pollution and temperature would be particularly interesting in *Venturia canescens* because, in this species, two types of strategy co-occur in response to temperature fluctuations. Wasps from thelytokous strains (*i.e.* ‘asexual’ individuals) are thermal specialists that maximize their reproductive success for a narrow range of temperatures wasps, whereas arrhenotokous wasps (*i.e.* ‘sexual’ individuals) are thermal generalists that able to reproduce over a wider range of temperatures (Foray *et al.*, 2014, 2011). Because higher light pollution levels often correlate with higher temperatures, arrhenotokous individuals might therefore suffer greater effects from light at night because they would be less likely to migrate than thelytokous individuals to reach natural habitats with more optimal temperature.

Nocturnal light pollution is typically associated with urbanization, which is also characterized by high levels of noise and chemical pollution. These three types of anthropogenic pressures are grouped under the term of ‘sensory pollutants’, because they are stimuli that interfere with the sensory capacities of organisms (Halfwerk & Slabbekoorn, 2015). Each sensory pollutant can act on sensory systems by masking environmental stimuli, distracting an animal from its usual tasks, or misleading organisms by being detected as a natural cue and yielding an inappropriate response (Dominoni, Halfwerk, *et al.*, 2020). Artificial light at night, noise and chemical pollution are often studied in isolation, but studies are needed to investigate how their combination alter the behaviour and physiology of organisms (Halfwerk & Slabbekoorn, 2015). Studying the interaction between light and chemical pollution would be particularly interesting for insect species, which are likely to be exposed to these two types of anthropogenic pressures, in agroecosystems or through the use of insecticides to control some vector species for example. Such studies, however, are still scarce. For example, it has been shown that the combined effect of UV light and polycyclic aromatic hydrocarbons (PAHs), a widespread family of pollutants, increased the tolerance of the yellow fever mosquito (*Aedes aegypti*), both at larval and adult stages, to chemical insecticides (Tetreau *et al.*, 2014).

Developing studies considering multiple environmental stressors is therefore a crucial issue and a research challenge to fully understand the ecological and evolutionary consequences of human activities on populations and ecosystems (Swaddle *et al.*, 2015). Moreover, being able to determine the importance of each anthropogenic stressor involved in these interactions is also important for policy-makers and conservation issues. Indeed, some sensory pollutants are more difficult to mitigate than others (Dominoni, Halfwerk, *et al.*, 2020). Deciding on which anthropogenic stressor to act on as a priority to preserve biodiversity is therefore important, because resources allocated to conservation are very often limited. Finally, the existence of interactions between anthropogenic stressors, whose effects are very likely to depend on the ecosystem and the species considered, illustrates the complexity of implementing mitigation measures.

5. Conclusion

During my PhD thesis, I showed experimentally that artificial light at night impacts behavioural and life-history traits in a diurnal insect species. Our experiments did not detect strong effects of light at night on the fitness of the individuals, nor on the physiology of *Venturia canescens*. Nonetheless, our results suggest a tendency towards a positive effect of the presence of artificial light at night in this diurnal species (no reduction in longevity, preference towards immediate reproduction). This is an important first step, because historically diurnal insects have been less studied than nocturnal ones when it comes to the consequences of nocturnal light pollution. However, experimental laboratory conditions are usually favourable and can mask costs that organisms encounter in their natural environment. In order to have a better understanding of the biological consequences of light at night on this diurnal parasitoid, the continuation of this work would therefore be to extend our experiments outside the laboratory to capture more ecologically realistic conditions.

Whether the effects of light at night are positive or negative on diurnal species, nocturnal light pollution will influence interactions between species. The use of the night-light niche can induce competition between diurnal and nocturnal species (Rotics *et al.*, 2011), and artificial light at night has been shown to influence predator-prey interactions (Bennie *et al.*, 2018; Wakefield *et al.*, 2015) or interaction between parasitoids and their hosts (Kehoe *et al.*, 2020). In *Venturia canescens*, we can be pretty confident that hosts are protected from light at night at the larval stage because they live concealed in the substrate (*e.g.* flour, grain, desiccated fruits) (Driessen & Bernstein, 1999; Salt, 1976). However, effect on the hosts at the adult stage cannot be ruled out. The effects of nocturnal light pollution on *Venturia canescens*, and its potential and as yet unknown impacts on their hosts, are therefore likely to interact to influence the response to light at night at population and community levels. Studies on communities are thus crucial to fully apprehend the consequences of nocturnal light pollution on biodiversity.

PART V
APPENDIX 1

Quantification of melatonin by enzyme linked-immunosorbent assay (ELISA)

Kit used: Melatonin ELISA kit NB-44-BTBA-E-3300”, NeoBiotech™

1. Sample preparation

A sample was composed of 10 heads of Venturia canescens.

- Add 250 μ L of wash buffer to per sample.
- Crush samples with a steel bead and Tissue Lyser (50 hertz, 2 min).
- Complete tissue lysis with sonication (2 min).
- Centrifuge for 10 min at 1000 x g (4°C).
- Transfer supernatant in 1.5 mL tube and centrifuge again for 5 min at 1000 x g.
- Transfer 200 μ L supernatant (minimum) in a new tube.

2. Column conditioning

- Place the extraction columns into glass tubes (12 x 75 mm).
- Add 1 mL of methanol (undiluted) to the columns. Let the solvent pass through the column by centrifugation for 1 min at 120 x g. Discard eluate.
- Add 1 mL of bidist. water to the columns. Let the solvent pass through the column by centrifugation for 1 min at 120 x g. Discard eluate.
- Proceed with sample application without delay to avoid the columns getting dry.

3. Sample Application

- Place the extraction columns into correspondingly marked glass tubes (12 x 75 mm).
- Add 500 μ L of Standards and Controls, or 200 μ L of samples to the columns.
- Add qsp 1000 μ L bidist water to the columns. Let the solvent pass through the column by centrifugation for 5 min at 120 x g. Discard eluate.

4. Washing

- Add 1 mL of 10% methanol in bidist. water (v/v) to the columns. Let the solvent pass through the column by centrifugation for 5 min at 120 x g. Discard eluate.
- Repeat the previous step.

5. Elution of extract

- Place the extraction columns into new correspondingly marked glass tubes (12 x 75 mm).
- Add 1 mL of methanol (undiluted) to the columns. Let the solvent pass through the column by centrifugation for 5 min at 120 x g. DO NOT discard eluate.
- Remove columns from the tubes. Avoid drops to be left at the columns. Use columns for extraction of the next samples or store at 2 – 8 °C protected from dust. Extraction columns may be re-used up to 4 times.

6. Evaporation and reconstitution of extract

- Evaporate the methanol to dryness by use of evaporator centrifuge (about 2h30).
- The dried extracts (after evaporation of methanol) may be stored at $\leq -20^{\circ}\text{C}$ for up to 24h. Close the tubes carefully with parafilm to avoid humidity.*
- Reconstitute samples with 150 μL of bidist. water.
 - Vortex at least 1 min and assay immediately.

7. Test procedure

Allow reagents to reach room temperature (18 – 25°C) before use. Do not open the pouch until it reaches room temperature to avoid humidity in the coated wells. It is recommended to use an 8-channel micropipettor for pipetting of solutions into wells.

- Pipette 50 μL of each extracted standard, extracted control and extracted sample into the respective wells of the microtiter plate.
- Pipette 50 μL of Melatonin Biotin into each well.
- Pipette 50 μL of Melatonin Antiserum into each well.
- Cover plate with adhesive foil. Shake plate carefully. Incubate 17h at 4°C.
- Remove adhesive foil. Discard incubation solution with a pipettor. Wash plate 3 times with 250 μL of diluted Wash buffer into each well. Remove excess solution by tapping the inverted plate on a paper towel.
- Pipette 150 μL of freshly prepared Enzyme Conjugate into each well.
- Cover plate with new adhesive foil. Incubate 120 min at room temperature (18 – 25°C) on an orbital shaker (500 rpm).
- Remove adhesive foil. Discard incubation solution with a pipettor. Wash plate 3 times with 250 μL of diluted Wash buffer into each well. Remove excess solution by tapping the inverted plate on a paper towel.

- Pipette 200 μL of PNPP Substrate Solution into each well. Use positive displacement and avoid formation of air bubbles.

- Wrap plate into aluminium foil and incubate 40 min at room temperature (18 – 25°C) on an orbital shaker (500 rpm).

- Stop the substrate reaction by adding 50 μL of PNPP Stop Solution into each well. Briefly mix contents by gently shaking the plate.

- Measure optical density with a photometer at 405 nm.

We recommend a first measure of optical density after a 20-min incubation, because optical density can exceed the optimal range of values before 40 min of incubation.

PART VI
APPENDIX 2

Identification of *aanat* and *hiomt* in *Venturia canescens*

Table 1 Details about the protein sequences used as queries for identifying the gene *aanat* in the transcriptome of *V. canescens*

Protein name	Organism	Identification number (UniProtKB)	Sequence
Dopamine N-acetyltransferase	<i>Drosophila melanogaster</i>	Q94521 (DNAT_DROME)	MEVQKLPDQSLISSMMLDSRCGLNDLYPIARLTQKMEDALTVSG KPAACPVDQDCPYTIELIQPEDGEAVIAMLKTFFFKDEPLNTFL DLGECKELEKYSLKPLPDNCSYKAVNKKGEIIGVFLNGLMRRPS PDDVPEKAADSCEHPKFKKILSLMDHVEEQFNIFDVYPDEELIL DGKILSVDNTNYRGLGIAGRLTERAYEYMRGENINVYHVLCSSEHY SARVMEKLGFEHVFRMQFADYKPKQGEVVFKAAPHVGIQVMAKE VGPAKAAQTKL
N-acetyltransferase domain-containing protein	<i>Apis mellifera</i>	A0A088AHR1_APIME	METALSTNMDNSALIDVAKSQTNFAKKMPKMKVYTLADSANDER IGMDYHIQMITKDDKLRILKFLRRFFFRDEPLNHSIELIPESED STCLELEEYCSMSSFENNLSLMAVSTNGAIIIGVILNGKMDPPND EEPEYITTCENAKFKKILRLLNYVDRNVNRDGGFRGLNILEIRI MSVDSNWRGKGVAKALVEKTLEIGKEKGLHICRVDCSSYFSGKL CARLGFEQIYELNYADYVDEEDGNPIFSPALPHTAIVTYIKKL

Table 2 Details about the protein sequences used as queries for identifying the gene *asmt* in the transcriptome of *V. canescens*

Protein name	Organism	Identification number	Sequence
CG9515 isoform A	<i>Drosophila melanogaster</i>	Q86BM0_DROME (UniProtKB)	MLAPIKHLLGNRYRIVLASGSPRRQELVKMLGLNAELCPST FEENLNLEDFKEFSYIEATALGKAAEVYSRLRSTGDSKN LIVIAADTMVTLGKEIYGKPKDPADAIRMLTNLSGTSNRV FTGVVLKHANGIRKFTDTADVDFGDLLEPEIQSYVDSGDP LDKAGAYGVQGPAGALIHRI DGDYFCVMGLPLHRLCCELNKLFLLEDLSS
N-acetylserotonin O-methyltransferase protein	<i>Apis cerana cerana</i>	A0A2A3EH61_APICC (UniProtKB)	MLEQTIQALTTSRVILASASPRRYEIMKQLGINVEIVPSM YDENLDRSIYKNYGEYVQDLAKYKVDVYNRLQDVIPFPL IIGADTIVTMGNIYGKPKNKHHAFEILSSLANKEHIVYT GVCLKTSKKEVNFYESTKVKFGDISEEQIWTYIKSGEPLD KAGGYGVQGLGGCLIEKIDG DFYTVMGMPYLSLTKQLNEMFNNN
N-acetylserotonin O-methyltransferase-like protein	<i>Bombis impatiens</i>	XP_003490036.1 (RefSeq)	MFEQVVQVLTAGRVVLASGSPRRYEIMKQLGINIEVVSST YDENLDRSAYKNSGDYVQDLAKYKQEVYDRLKEDVTPPS LIIGADTLVMTGDVIYGKPKNNLHAFEMLSLANKEHIVY TGVCLKTPKKEVNFYESTKVKFGDISEEQIWAYIKSGEPL DKAGGYGVQGLGGCLIEKIDGDYFVTVMGMPYLSLTKRLNE MFGNN

Table 3 Sequences used in the Seaview alignment for *Vcan_aanat* and *Vcan_asmt* transcripts.

Sequence type	Gene	Organism	Sequence
Coding DNA sequence	<i>aanat</i>	<i>Drosophila melanogaster</i>	<p>ATGGAAGTGCAGAAGCTGCCGGACCAGTCGCTGATATCCAGCATGAT GTTGGACTCCCGATGTGGGCTGAACGACTTGTATCCGATCGCCCGGC TGACACAGAAAATGGAGGACGCATTGACCGTCTCTGGGAAGCCAGCC GCATGCCCCGTCGACCAGGACTGCCCTACACCATCGAACTGATCCA GCCGGAGGATGGGGAGGCGGTGATAGCCATGCTCAAGACCTTTTTTCT TCAAGGATGAACCGCTGAACACCTTCTCGACCTTGGCGAGTGCAAG GAGCTGGAGAAGTACTCCCTGAAACCGCTACCCGACAACCTGCTCCTA CAAGGCGGTCAACAAGAAGGGCGAGATTATCGGTGTGTTCTAAATG GACTTATGAGGCGTCCGTCCCCGATGATGTGCCCGAAAAGGCGGCC GACTCCTGTGAACATCCCAAATCAAGAAGATCCTCTCGCTGATGGA CCACGTGGAGGAGCAGTTCAACATCTTCGACGTGTATCCCGACGAGG AGCTCATCCTGGACGGCAAGATCCTGTCCGGTGGACACCAACTACCGG GGCCTGGGCATCGCAGGCCGCTGACGGAGAGGGCGTACGAGTACAT GCGGGAGAACGGCATCAATGTGTACCACGTGCTCTGCTCCAGCCACT ACTCCGCCCGGGTGTGAGGAGAAGCTGGGCTTCCACGAGGTGTTCCGC ATGCAGTTCGCCGACTACAAGCCTCAGGGAGAGGTGGTCTTCAAGCC GGCGGCCCCGCACGTGGGCATACAGGTGATGGCCAAGGAAGTGGGTG CCGCGAAGGCGGCGCAGACCAAGCTGTAG</p>
Dopamine N-acetyltransferase mRNA	<i>aanat</i>	<i>Apis mellifera</i>	<p>ATATAACTACATGTGAAAATGCAAAATTTAAAATTCCTAAGATTATTA AATTACGTAGATCGAAATGTAAATCGCGATGGAAAATTTTCGAGGATT AAATATTTTGGAAATCAGAATAATGTCTGTAGATTCAAATTTGGCGCG GTAAAGGAGTTGCCAAAGCGCTTGTAGAAAAAACACTTGAAATTGGA AAAGAAAAAGGCTTGCATATTTGTCGTGTCGACTGTTTCATCCTATTT TTCCGAAAACTTTTCGCGCGACTTGGTTTTTGAACAAATATATGA ACTTAATTATGCAGATTATGTAGATGAAGATGGTAATCCTATATTTT CTCCAGCACTTCCACATACAGCAATTGTTACGTACATTAAGAAATTG TGAACACGATAGATATAGAATCAAGAGTACCTGTTTATAGAGAATTG AAAATGATTTTTTAAAAACGCACCTTCTACATTTATATTTTATTTTTCT TTTTCGAATTTACGAAAATGTTGTACAGTTATTTTTTTCTAATGTTT CTTTAATTTATTTATTACTTTTTGTACAAATTTAAAATGTAATATGG TTATAATACAATTATTTGCTCGTGACATTACATTAATAACGAATCGT GCCAAAATGCTAGCAATAATATTTTAATATATAACGCGCACGTTAAT AAATATGATTGCATTAAACTATAAATGAATATTGCATTATTAGAAAT GTAAACATATATATGAGTTACATGTTTTTGTCTTTGTTGGATATTTCT AAAATATATATGAATTTATTTATTTATCTATGTAATTTATACACGAAA ATAAAGATAGCATGATT</p>
Coding DNA sequence	<i>asmt</i>	<i>Drosophila melanogaster</i>	<p>ATGTTGGCGCCAATTAAGCACTTATTAGGGAATTATCGCATAGTCTT AGCCAGCGGCTCTCCACGGCGACAGGAAGTGGTCAAGATGTTGGGAC</p>

	<p>TAAATGCCGAATTGTGTCCTTCGACTTTTGAGGAGAATTTAAACTTG GAGGACTTTAAGGAGTTCTCGGATTATATTGAAGCCACTGCTCTGGG AAAAGCCGAGGAGGTCTACTCGAGATTGAGGTCCACGGGGGACTCTA AAAACTAATTGTCATAGCCGCAGATACGATGGTCACCTTGGGAAAG GAGATCTATGGAAAACCCAAGGATCCTGCGGATGCTATACGCATGCT AACCAATCTCTCTGGAACCTCCAATCGCGTTTTTACCGGCGTTGTCC TGAAACATGCCAACGGTATTGAAAATTTACGGACACAGCGGACGTA TACTTTGGCGATCTGCTGCCAGAACAAATTCAGAGCTATGTGGACTC TGGAGATCCCCTAGATAAAGCTGGTGCTTATGGCGTTCAAGGACCTG CAGGCGCGCTCATCCACCGAATCGATGGGGACTTTTACTGTGTCATG GGTCTGCCCCTGCATCGACTGTGCTGTGAACTAAATAAGCTTTTCCT AGAGGATCTATCCTCGTAA</p>
<p>Coding DNA sequence</p>	<p><i>asmt</i></p> <p><i>Bombus impatiens</i></p> <p>ATGTTTGAACAAGTAGTGCAAGTCTTGACAGCAGGTAGAGTTGTATT AGCCAGTGGATCTCCTAGACGATATGAAATAATGAAGCAATTGGGTA TAAATATAGAAGTAGTATCATCTACGTATGATGAAAATTTAGATAGA TCGGCATATAAAAAATCTGGTGACTATGTACAAGACTTGGCAAATA TAAAGTGCAAGAAGTATATGATAGATTTAAAGGAAGATGTAACACCAC CTTCCTTAATAAATGGTGCAGATACTTTGGTTACAATGGGTGATGTC ATTTATGGTAAACCAAAGAATAACTTACATGCATTTGAAATGTTATC AAGTTTAGCAAATAAGGAACACATAGTTTATACCGGAGTATGTTTAA AAACGCCAAAGAAAGAAGTCAATTTTTATGAATCTACAAAAGTAAAA TTTGGTGACATATCGGAAGAACAATATGGGCATATATAAAATCAGG GGAACCACTAGATAAAGCTGGAGGTTACGGCGTACAAGGTCTTGGCG GTTGTTTAATTGAAAAAATAGACGGTGATTTTTATACAGTAATGGGC TTGCCATTGTATTTCATTGACAAAACGATTAACGAAATGTTTGGTAA TAACTAA</p>

PART VII
APPENDIX 3

Choice of a reference gene for the analysis of qPCR data

Figure 1 Comparison of calibrated gene expression of A) *Vcan_aanat* and B) *Vcan_asmt* when either *Vcan_gapdh* or *Vcan_rpl32* were used as reference gene.

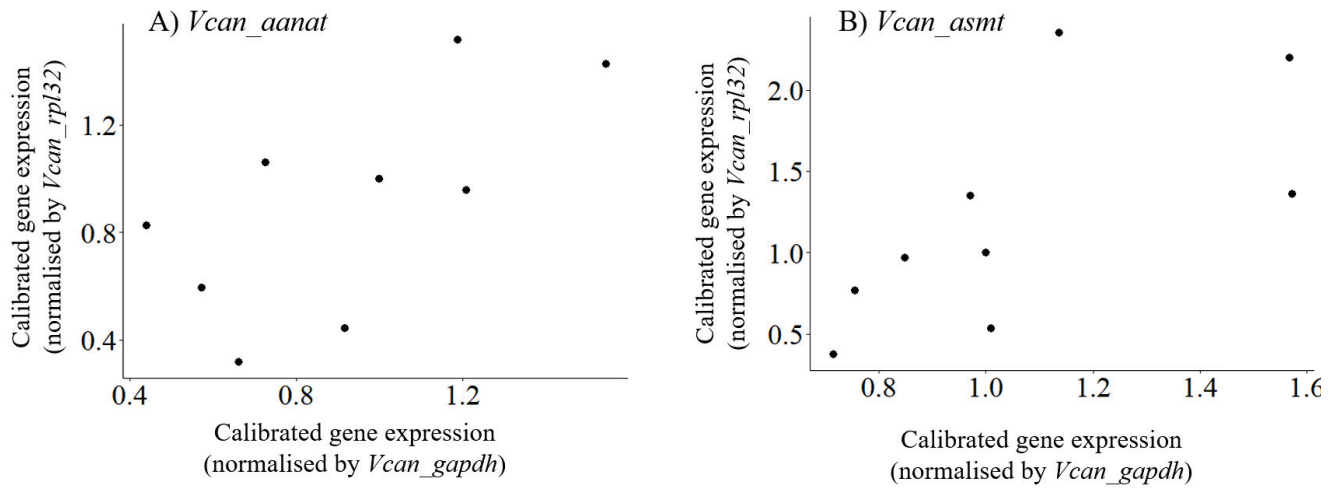

PART VIII

REFERENCES

- Ahmed, M. & Kim, D.R. 2018. pcr: an R package for quality assessment, analysis and testing of qPCR data. *PeerJ*. 6:e4473.
- Alaasam, V.J., Duncan, R., Casagrande, S., Davies, S., Sidher, A., ... Ouyang, J.Q. 2018. Light at night disrupts nocturnal rest and elevates glucocorticoids at cool color temperatures. *Journal of Experimental Zoology Part A: Ecological and Integrative Physiology*. 329(8–9):465–472.
- van Alphen, J.J.M. & Visser, M.E. 1990. Superparasitism as an Adaptive Strategy for Insect Parasitoids. *Annual Review of Entomology*. (35):59–79.
- Altermatt, F. & Ebert, D. 2016. Reduced flight-to-light behaviour of moth populations exposed to long-term urban light pollution. *Biology Letters*. 12(4):20160111.
- Amaral, F.G. do & Cipolla-Neto, J. 2018. A brief review about melatonin, a pineal hormone. *Archives of Endocrinology and Metabolism*. 62(4):472–479.
- Amat, I. 2004. Coexistence de la reproduction sexuée et asexuée chez l’hyménoptère parasitoïde *Venturia canescens* : aspects comportementaux et écologiques. Lyon 1. (These de doctorat). <https://www.theses.fr/2004LYO10140> Date of access: 25 Jan. 2021.
- Amat, I., Bernstein, C. & van Alphen, J.J.M. 2003. Does a deletion in a virus-like particle protein have pleiotropic effects on the reproductive biology of a parasitoid wasp? *Journal of Insect Physiology*. 49(12):1183–1188.
- Amat, I., Castelo, M., Desouhant, E. & Bernstein, C. 2006. The influence of temperature and host availability on the host exploitation strategies of sexual and asexual parasitic wasps of the same species. *Oecologia*. 148(1):153–161.
- Amat, I., Desouhant, E. & Bernstein, C. 2009. Differential use of conspecific-derived information by sexual and asexual parasitic wasps exploiting partially depleted host patches. *ResearchGate*. 63(4):563–572.
- Amat, I., Alphen, J.J.M. van, Kacelnik, A., Desouhant, E. & Bernstein, C. 2017. Adaptations to different habitats in sexual and asexual populations of parasitoid wasps: a meta-analysis. *PeerJ*. 5:e3699.
- Amat, I., Besnard, S., Foray, V., Pelosse, P., Bernstein, C. & Desouhant, E. 2012. Fuelling flight in a parasitic wasp: which energetic substrate to use? *Ecological Entomology*. 37(6):480–489.
- Amherd, R., Hintermann, E., Walz, D., Affolter, M. & Meyer, U.A. 2000. Purification, Cloning, and Characterization of a Second Arylalkylamine N-Acetyltransferase from *Drosophila melanogaster*. *DNA and Cell Biology*. 19(11):697–705.
- Amichai, E. & Kronfeld-Schor, N. 2019. Artificial Light at Night Promotes Activity Throughout the Night in Nesting Common Swifts (*Apus apus*). *Scientific Reports*. 9(1):11052.

- Aoki, H., Yamada, N., Ozeki, Y., Yamane, H. & Kato, N. 1998. Minimum light intensity required to suppress nocturnal melatonin concentration in human saliva. *Neuroscience Letters*. 252(2):91–94.
- Arendt, J. & Skene, D.J. 2005. Melatonin as a chronobiotic. *Sleep Medicine Reviews*. 9(1):25–39.
- Arguelles-Prieto, R., Bonmati-Carrion, M.-A., Rol, M.A. & Madrid, J.A. 2019. Determining Light Intensity, Timing and Type of Visible and Circadian Light From an Ambulatory Circadian Monitoring Device. *Frontiers in Physiology*. 10.
- Arthur, A.P. 1971. ASSOCIATIVE LEARNING BY NEMERITIS CANESCENS (HYMENOPTERA: ICHNEUMONIDAE). *The Canadian Entomologist*. 103(8):1137–1141.
- Aubé, M. 2015. Physical behaviour of anthropogenic light propagation into the nocturnal environment. *Philosophical Transactions of the Royal Society B: Biological Sciences*. 370(1667):20140117.
- Badness, T.J., Powers, J.B., Hastings, M.H., Bittman, E.L. & Goldman, B.D. 1993. The timed infusion paradigm for melatonin delivery: What has it taught us about the melatonin signal, its reception, and the photoperiodic control of seasonal responses? *Journal of Pineal Research*. 15(4):161–190.
- Barberà, M., Mengual, B., Collantes-Alegre, J.M., Cortés, T., González, A. & Martínez-Torres, D. 2013. Identification, characterization and analysis of expression of genes encoding arylalkylamine N-acetyltransferases in the pea aphid *Acyrtosiphon pisum*. *Insect Molecular Biology*. 22(6):623–634.
- Barberà, M., Escrivá, L., Collantes-Alegre, J.M., Meca, G., Rosato, E. & Martínez-Torres, D. 2020. Melatonin in the seasonal response of the aphid *Acyrtosiphon pisum*. *Insect Science*. 27(2):224–238.
- Batra, T., Malik, I. & Kumar, V. 2019. Illuminated night alters behaviour and negatively affects physiology and metabolism in diurnal zebra finches. *Environmental Pollution*. 254:112916.
- Bedrosian, T.A. & Nelson, R.J. 2013. Influence of the modern light environment on mood. *Molecular Psychiatry*. 18(7):751–757.
- Bejarano, I., Monllor, F., Marchena, A.M., Ortiz, A., Lozano, G., ... Espino, J. 2014. Exogenous melatonin supplementation prevents oxidative stress-evoked DNA damage in human spermatozoa. *Journal of Pineal Research*. 57(3):333–339.
- Bembenek, J., Sehadova, H., Ichihara, N. & Takeda, M. 2005. Day/night fluctuations in melatonin content, arylalkylamine N-acetyltransferase activity and NAT mRNA expression in the CNS, peripheral tissues and hemolymph of the cockroach, *Periplaneta americana*. *Comparative Biochemistry and Physiology Part B: Biochemistry and Molecular Biology*. 140(1):27–36.
- Bennie, J., Davies, T.W., Cruse, D. & Gaston, K.J. 2016. Ecological effects of artificial light at night on wild plants. *Journal of Ecology*. 104(3):611–620.

- Bennie, J., Davies, T.W., Cruse, D., Inger, R. & Gaston, K.J. 2018. Artificial light at night causes top-down and bottom-up trophic effects on invertebrate populations. *Journal of Applied Ecology*. 55(6):2698–2706.
- Bennie, J.J., Duffy, J.P., Inger, R. & Gaston, K.J. 2014. Biogeography of time partitioning in mammals. *Proceedings of the National Academy of Sciences*. 111(38):13727–13732.
- Bernstein, C. & Driessen, G. 1996. Patch-Marking and Optimal Search Patterns in the Parasitoid *Venturia canescens*. *Journal of Animal Ecology*. 65(2):211–219.
- Beukeboom, L.W. & Pijnacker, L.P. 2000. Automictic parthenogenesis in the parasitoid *Venturia canescens* (Hymenoptera: Ichneumonidae) revisited. *Genome*. 43(6):939–944.
- Bird, B.L., Branch, L.C. & Miller, D.L. 2004. Effects of Coastal Lighting on Foraging Behavior of Beach Mice. *Conservation Biology*. 18(5):1435–1439.
- Bodin, A., Vinauger, C. & Lazzari, C.R. 2009. Behavioural and physiological state dependency of host seeking in the blood-sucking insect *Rhodnius prolixus*. *Journal of Experimental Biology*. 212(15):2386–2393.
- Bolliger, J., Hennet, T., Wermelinger, B., Bösch, R., Pazur, R., ... Obrist, M.K. 2020. Effects of traffic-regulated street lighting on nocturnal insect abundance and bat activity. *Basic and Applied Ecology*. 47:44–56.
- Bonilla, E., Medina-Leendertz, S. & Díaz, S. 2002. Extension of life span and stress resistance of *Drosophila melanogaster* by long-term supplementation with melatonin. *Experimental Gerontology*. 37(5):629–638.
- Briscoe, A.D. & Chittka, L. 2001. The Evolution of Color Vision in Insects. *Annual Review of Entomology*. 46(1):471–510.
- Calvo, J.R., González-Yanes, C. & Maldonado, M.D. 2013. The role of melatonin in the cells of the innate immunity: a review. *Journal of Pineal Research*. 55(2):103–120.
- Carrillo-Vico, A., Guerrero, J.M., Lardone, P.J. & Reiter, R.J. 2005. A review of the multiple actions of melatonin on the immune system. *Endocrine*. 27(2):189–200.
- Casas, J., Driessen, G., Mandon, N., Wielaard, S., Desouhant, E., ... Bernstein, C. 2003. Energy dynamics in a parasitoid foraging in the wild. *Journal of Animal Ecology*. 72(4):691–697.
- Castelo, M.K., Corley, J.C. & Desouhant, E. 2003. Conspecific Avoidance During Foraging in *Venturia canescens* (Hymenoptera: Ichneumonidae): The Roles of Host Presence and Conspecific Densities. *Journal of Insect Behavior*. 16(2):307–318.
- Chuffa, L.G.A., Amorim, J.P.A., Teixeira, G.R., Mendes, L.O., Fioruci, B.A., ... Martinez, F.E. 2011. Long-term melatonin treatment reduces ovarian mass and enhances tissue antioxidant defenses during ovulation in the rat. *Brazilian Journal of Medical and Biological Research*. 44(3):217–223.

- Coon, S.L. & Klein, D.C. 2006. Evolution of arylalkylamine N-acetyltransferase: Emergence and divergence. *Molecular and Cellular Endocrinology*. 252(1):2–10.
- Corbet, S.A. 1968. The Influence of *Ephestia kuehniella* on the Development of its Parasite *Nemeritis Canescens*. *Journal of Experimental Biology*. 48(2):291–304.
- Corbet, S.A. 1971. Mandibular Gland Secretion of Larvae of the Flour Moth, *Anagasta kuehniella*, contains an Epideictic Pheromone and elicits Oviposition Movements in a Hymenopteran Parasite. *Nature*. 232(5311):481–484.
- Coto-Montes, A. & Hardeland, R. 1999. Antioxidative effects of melatonin in *Drosophila melanogaster*: Antagonization of damage induced by the inhibition of catalase. *Journal of Pineal Research*. 27(3):154–158.
- Cowpertwait, P.S.P. & Metcalfe, A.V. 2009. *Introductory Time Series with R*. Springer Science & Business Media.
- Czaczkas, T.J., Bastidas-Urrutia, A.M., Ghislandi, P. & Tunì, C. 2018. Reduced light avoidance in spiders from populations in light-polluted urban environments. *The Science of Nature*. 105(11):64.
- Davies, T.W. & Smyth, T. 2018. Why artificial light at night should be a focus for global change research in the 21st century. *Global Change Biology*. 24(3):872–882.
- Davy, R., Esau, I., Chernokulsky, A., Outten, S. & Zilitinkevich, S. 2017. Diurnal asymmetry to the observed global warming. *International Journal of Climatology*. 37(1):79–93.
- Desouhant, E., Gomes, E., Mondy, N. & Amat, I. 2019. Mechanistic, ecological, and evolutionary consequences of artificial light at night for insects: review and prospective. *Entomologia Experimentalis et Applicata*. 167(1):37–58.
- Desouhant, E., Driessen, G., Lapchin, L., Wielaard, S. & Bernstein, C. 2003. Dispersal between host populations in field conditions: navigation rules in the parasitoid *Venturia canescens*. *Ecological Entomology*. 28(3):257–267.
- Desouhant, E., Driessen, G., Amat, I. & Bernstein, C. 2005. Host and food searching in a parasitic wasp *Venturia canescens*: A trade-off between current and future reproduction? *Animal Behaviour*. 70(1):145–152.
- Desouhant, E., Lucchetta, P., Giron, D. & Bernstein, C. 2010. Feeding activity pattern in a parasitic wasp when foraging in the field. *Ecological Research*. 25(2):419–428.
- Dominoni, D.M. & Partecke, J. 2015. Does light pollution alter daylength? A test using light loggers on free-ranging European blackbirds (*Turdus merula*). *Philosophical Transactions of the Royal Society B: Biological Sciences*. 370(1667):20140118.
- Dominoni, D., Quetting, M. & Partecke, J. 2013a. Artificial light at night advances avian reproductive physiology. *Proceedings of the Royal Society B: Biological Sciences*. 280(1756):20123017.

- Dominoni, D.M., Halfwerk, W., Baird, E., Buxton, R.T., Fernández-Juricic, E., ... Barber, J.R. 2020. Why conservation biology can benefit from sensory ecology. *Nature Ecology & Evolution*. 4(4):502–511.
- Dominoni, D.M., Quetting, M. & Partecke, J. 2013b. Long-Term Effects of Chronic Light Pollution on Seasonal Functions of European Blackbirds (*Turdus merula*). *PLoS ONE*. 8(12).
- Dominoni, D.M., Goymann, W., Helm, B. & Partecke, J. 2013. Urban-like night illumination reduces melatonin release in European blackbirds (*Turdus merula*): implications of city life for biological time-keeping of songbirds. *Frontiers in Zoology*. 10(1):60.
- Dominoni, D.M., Carmona-Wagner, E.O., Hofmann, M., Kranstauber, B. & Partecke, J. 2014. Individual-based measurements of light intensity provide new insights into the effects of artificial light at night on daily rhythms of urban-dwelling songbirds. *Journal of Animal Ecology*. 83(3):681–692.
- Dominoni, D.M., Kjellberg Jensen, J., Jong, M., Visser, M.E. & Spoelstra, K. 2020. Artificial light at night, in interaction with spring temperature, modulates timing of reproduction in a passerine bird. *Ecological Applications*. 30(3).
- Driessen, G. & Bernstein, C. 1999. Patch departure mechanisms and optimal host exploitation in an insect parasitoid. *Journal of Animal Ecology*. 68(3):445–459.
- Durrant, J., Michaelides, E.B., Rupasinghe, T., Tull, D., Green, M.P. & Jones, T.M. 2015. Constant illumination reduces circulating melatonin and impairs immune function in the cricket *Teleogryllus commodus*. *PeerJ*. 3:e1075.
- Escrivá, L., Manyes, L., Barberà, M., Martínez-Torres, D. & Meca, G. 2016. Determination of melatonin in *Acyrtosiphon pisum* aphids by liquid chromatography–tandem mass spectrometry. *Journal of Insect Physiology*. 86:48–53.
- Falchi, F., Cinzano, P., Duriscoe, D., Kyba, C.C.M., Elvidge, C.D., ... Furgoni, R. 2016. The new world atlas of artificial night sky brightness. *Science Advances*. 2(6):e1600377.
- Falcón, J., Torriglia, A., Attia, D., Viénot, F., Gronfier, C., ... Hicks, D. 2020. Exposure to Artificial Light at Night and the Consequences for Flora, Fauna, and Ecosystems. *Frontiers in Neuroscience*. 14:1183.
- Farnworth, B., Innes, J., Kelly, C., Littler, R. & Waas, J.R. 2018. Photons and foraging: Artificial light at night generates avoidance behaviour in male, but not female, New Zealand weta. *Environmental pollution (Barking, Essex : 1987)*. 236:82–90.
- Firebaugh, A. & Haynes, K.J. 2016. Experimental tests of light-pollution impacts on nocturnal insect courtship and dispersal. *Oecologia*. 182(4):1203–1211.
- Fonken, L.K., Workman, J.L., Walton, J.C., Weil, Z.M., Morris, J.S., ... Nelson, R.J. 2010. Light at night increases body mass by shifting the time of food intake. *Proceedings of the National Academy of Sciences*. 107(43):18664–18669.

- Fonken, L.K., Kitsmiller, E., Smale, L. & Nelson, R.J. 2012. Dim Nighttime Light Impairs Cognition and Provokes Depressive-Like Responses in a Diurnal Rodent. *Journal of Biological Rhythms*. 27(4):319–327.
- Fonken, L.K., Aubrecht, T.G., Meléndez-Fernández, O.H., Weil, Z.M. & Nelson, R.J. 2013. Dim Light at Night Disrupts Molecular Circadian Rhythms and Affects Metabolism. *Journal of biological rhythms*. 28(4):262–271.
- Foray, V., Gibert, P. & Desouhant, E. 2011. Differential thermal performance curves in response to different habitats in the parasitoid *Venturia canescens*. *Die Naturwissenschaften*. 98:683–91.
- Foray, V., Desouhant, E. & Gibert, P. 2014. The impact of thermal fluctuations on reaction norms in specialist and generalist parasitic wasps. *Functional Ecology*. 28(2):411–423.
- Foray, V., Pelisson, P.-F., Bel-Venner, M.-C., Desouhant, E., Venner, S., ... Rey, B. 2012. A handbook for uncovering the complete energetic budget in insects: the van Handel's method (1985) revisited. *Physiological Entomology*. 37(3):295–302.
- Frank, K. 2009. Exploitation of artificial light at night by a diurnal jumping spider. *Peckhamia*. 78(1):1–3.
- Froissart, L., Giurfa, M., Sauzet, S. & Desouhant, E. 2017. Cognitive adaptation in asexual and sexual wasps living in contrasted environments. *PLOS ONE*. 12(5):e0177581.
- Gallot, A., Amat, I., Desouhant, E. Foraging gene as one of the drivers of foraging behaviour variations in a parasitic wasp. In preparation.
- Garrett, J.K., Donald, P.F. & Gaston, K.J. 2020. Skyglow extends into the world's Key Biodiversity Areas. *Animal Conservation*. 23(2):153–159.
- Gaston, K.J. 2019. Nighttime Ecology: The “Nocturnal Problem” Revisited. *The American Naturalist*. 193(4):481–502.
- Gaston, K.J., Duffy, J.P., Gaston, S., Bennie, J. & Davies, T.W. 2014. Human alteration of natural light cycles: causes and ecological consequences. *Oecologia*. 176(4):917–931.
- Gaston, K.J., Visser, M.E. & Hölker, F. 2015. The biological impacts of artificial light at night: the research challenge. *Philosophical Transactions of the Royal Society B: Biological Sciences*. 370(1667).
- Gaston, K.J., Davies, T.W., Bennie, J. & Hopkins, J. 2012. REVIEW: Reducing the ecological consequences of night-time light pollution: options and developments. *Journal of Applied Ecology*. 49(6):1256–1266.
- Gaston, K.J., Bennie, J., Davies, T.W. & Hopkins, J. 2013. The ecological impacts of nighttime light pollution: a mechanistic appraisal. *Biological Reviews*. 88(4):912–927.
- Gastón, M.S., Pereyra, L.C. & Vaira, M. 2019. Artificial light at night and captivity induces differential effects on leukocyte profile, body condition, and erythrocyte size of a diurnal toad. *Journal of Experimental Zoology Part A: Ecological and Integrative Physiology*. 331(2):93–102.

- Gomes, E., Rey, B., Débias, F., Amat, I., Desouhant, E. 2021. Dealing with host and food searching in a diurnal parasitoid: consequences of light at night at intra and trans-generational levels. *Insect Conservation and Diversity*.
- Gomes, E., Desouhant, E. & Amat, I. 2019. Evidence for risk-taking behavioural types and potential effects on resource acquisition in a parasitoid wasp. *Animal Behaviour*. 154:17–28.
- Gorbet, D.J. & Steel, C.G.H. 2003. A miniature radioimmunoassay for melatonin for use with small samples from invertebrates. *General and Comparative Endocrinology*. 134(2):193–197.
- Gorman, M.R. 2020. Temporal organization of pineal melatonin signaling in mammals. *Molecular and Cellular Endocrinology*. 503:110687.
- Gouy, M., Guindon, S. & Gascuel, O. 2010. SeaView Version 4: A Multiplatform Graphical User Interface for Sequence Alignment and Phylogenetic Tree Building. *Molecular Biology and Evolution*. 27(2):221–224.
- Grubisic, M., Haim, A., Bhusal, P., Dominoni, D.M., Gabriel, K.M.A., ... Hölker, F. 2019. Light Pollution, Circadian Photoreception, and Melatonin in Vertebrates. *Sustainability*. 11(22):6400.
- Guetté, A., Godet, L., Juigner, M. & Robin, M. 2018. Worldwide increase in Artificial Light At Night around protected areas and within biodiversity hotspots. *Biological Conservation*. 223:97–103.
- Halfwerk, W. & Slabbekoorn, H. 2015. Pollution going multimodal: the complex impact of the human-altered sensory environment on animal perception and performance. *Biology Letters*. 11(4):20141051.
- Hardeland, R., Balzer, I., Poeggeler, B., Fuhrberg, B., Una, H., ... Reiter, R.J. 1995. On the primary functions of melatonin in evolution: Mediation of photoperiodic signals in a unicell, photooxidation, and scavenging of free radicals*. *Journal of Pineal Research*. 18(2):104–111.
- Harvey, J.A. & Thompson, D.J. 1995. Developmental interactions between the solitary endoparasitoid *Venturia canescens* (Hymenoptera: Ichneumonidae), and two of its hosts, *Plodia interpunctella* and *Corcyra cephalonica* (Lepidoptera: Pyralidae). *European Journal of Entomology*. 92(2):427–435.
- Harvey, J.A. & Vet, L.E.M. 1997. *Venturia canescens* parasitizing *Galleria mellonella* and *Anagasta kuehniella*: differing suitability of two hosts with highly variable growth potential. *Entomologia Experimentalis et Applicata*. 84(1):93–100.
- Harvey, J.A., Harvey, I.F. & Thompson, D.J. 2001. Lifetime reproductive success in the solitary endoparasitoid, *Venturia canescens*. *Journal of Insect Behavior*. 14(5):573–593.
- Hintermann, E., GRIEDERT, N.C., Amherd, R., Brodbeck, D. & Meyer, U.A. 1996. Cloning of an arylalkylamine N-acetyltransferase (aaNATI) from *Drosophila melanogaster* expressed in the nervous system and the gut. *Proc. Natl. Acad. Sci. USA*. 6.

- Hiragaki, S., Suzuki, T., Mohamed, A.A.M. & Takeda, M. 2015. Structures and functions of insect arylalkylamine N-acetyltransferase (iaaNAT); a key enzyme for physiological and behavioral switch in arthropods. *Frontiers in Physiology*. 6.
- Hölker, F., Moss, T., Griefahn, B., Kloas, W., Voigt, C.C., ... Tockner, K. 2010. The Dark Side of Light: A Transdisciplinary Research Agenda for Light Pollution Policy. <https://www.goedoc.uni-goettingen.de/goescholar/handle/1/7268> Date of access: 17 Jun. 2017.
- Hölker, F., Wolter, C., Perkin, E.K. & Tockner, K. 2010. Light pollution as a biodiversity threat. *Trends in Ecology & Evolution*. 25(12):681–682.
- Holveck, M.-J., Grégoire, A., Doutrelant, C. & Lambrechts, M.M. 2019. Nest height is affected by lamppost lighting proximity in addition to nestbox size in urban great tits. *Journal of Avian Biology*. 50(1).
- Hopkins, G.R., Gaston, K.J., Visser, M.E., Elgar, M.A. & Jones, T.M. 2018. Artificial light at night as a driver of evolution across urban–rural landscapes. *Frontiers in Ecology and the Environment*. 16(8):472–479.
- Hubbard, S.F., Marris, G., Reynolds, A. & Rowe, G.W. 1987. Adaptive Patterns in the Avoidance of Superparasitism by Solitary Parasitic Wasps. *Journal of Animal Ecology*. 56(2):387–401.
- Huether, G. 1993. The contribution of extrapineal sites of melatonin synthesis to circulating melatonin levels in higher vertebrates. *Experientia*. 49(8):665–670.
- Huss, A., van Wel, L., Bogaards, L., Vrijkkotte, T., Wolf, L., ... Vermeulen, R. 2019. Shedding Some Light in the Dark—A Comparison of Personal Measurements with Satellite-Based Estimates of Exposure to Light at Night among Children in the Netherlands. *Environmental Health Perspectives*. 127(6).
- Itoh, M.T., Nomura, T. & Sumi, Y. 1997. Hydroxyindole-O-methyltransferase activity in the silkworm *Bombyx mori*. 6.
- Itoh, M.T., Hattori, A., Sumi, Y. & Suzuki, T. 1995. Day-night changes in melatonin levels in different organs of the cricket (*Gryllus bimaculatus*). *Journal of Pineal Research*. 18(3):165–169.
- Itoh, M.T., Hattori, A., Nomura, T., Sumi, Y. & Suzuki, T. 1995. Melatonin and arylalkylamine N-acetyltransferase activity in the silkworm, *Bombyx mori*. *Molecular and Cellular Endocrinology*. 115(1):59–64.
- Jervis, M.A., Heimpel, G.E., Ferns, P.N., Harvey, J.A. & Kidd, N.A.C. 2001. Life-history strategies in parasitoid wasps: a comparative analysis of ‘ovigeny’. *Journal of Animal Ecology*. 70(3):442–458.
- Jones, T.M., Durrant, J., Michaelides, E.B. & Green, M.P. 2015. Melatonin: a possible link between the presence of artificial light at night and reductions in biological fitness. *Phil. Trans. R. Soc. B*. 370(1667):20140122.

- Jong, M. de, Ouyang, J.Q., Grunsven, R.H.A. van, Visser, M.E. & Spoelstra, K. 2016. Do Wild Great Tits Avoid Exposure to Light at Night? *PLOS ONE*. 11(6):e0157357.
- de Jong, M., Jeninga, L., Ouyang, J.Q., van Oers, K., Spoelstra, K. & Visser, M.E. 2016. Dose-dependent responses of avian daily rhythms to artificial light at night. *Physiology & Behavior*. 155:172–179.
- Karthi, S. & Shivakumar, M.S. 2015. The protective effect of melatonin against cypermethrin-induced oxidative stress damage in *Spodoptera litura* (Lepidoptera: Noctuidae). *Biological Rhythm Research*. 46(1):1–12.
- Kehoe, R., Sanders, D., Cruse, D., Silk, M., Gaston, K.J., ... Veen, F. 2020. Longer photoperiods through range shifts and artificial light lead to a destabilizing increase in host–parasitoid interaction strength. *Journal of Animal Ecology*. 89(11):2508–2516.
- Kempnaers, B., Borgström, P., Loës, P., Schlicht, E. & Valcu, M. 2010. Artificial Night Lighting Affects Dawn Song, Extra-Pair Siring Success, and Lay Date in Songbirds. *Current Biology*. 20(19):1735–1739.
- Kernbach, M.E., Cassone, V.M., Unnasch, T.R. & Martin, L.B. 2020. Broad-spectrum light pollution suppresses melatonin and increases West Nile virus–induced mortality in House Sparrows (*Passer domesticus*). *The Condor*. 122(3).
- Klein, D.C. 2007. Arylalkylamine N-Acetyltransferase: “the Timezyme”. *Journal of Biological Chemistry*. 282(7):4233–4237.
- Klein, D.C. & Weller, J.L. 1970. Indole Metabolism in the Pineal Gland: A Circadian Rhythm in N-Acetyltransferase. *Science*. 169(3950):1093–1095.
- Kyba, C.C.M., Kuester, T., Sánchez de Miguel, A., Baugh, K., Jechow, A., ... Guanter, L. 2017. Artificially lit surface of Earth at night increasing in radiance and extent. *Science Advances*. 3(11):e1701528.
- Kyba, C.C.M., Ruhtz, T., Fischer, J. & Hölker, F. 2011. Cloud Coverage Acts as an Amplifier for Ecological Light Pollution in Urban Ecosystems. *PLoS ONE*. 6(3).
- Lambrechts, M.M., Blondel, J., Maistre, M. & Perret, P. 1997. A single response mechanism is responsible for evolutionary adaptive variation in a bird’s laying date. *Proceedings of the National Academy of Sciences*. 94(10):5153–5155.
- Langevelde, F. van, Grunsven, R.H.A. van, Veenendaal, E.M. & Fijen, T.P.M. 2017. Artificial night lighting inhibits feeding in moths. *Biology Letters*. 13(3):20160874.
- Langevelde, F. van, Braamburg-Annegarn, M., Huigens, M.E., Groendijk, R., Poitevin, O., ... WallisDeVries, M.F. 2018. Declines in moth populations stress the need for conserving dark nights. *Global Change Biology*. 24(3):925–932.
- Le Ralec, A. 1995. Egg contents in relation to host-feeding in some parasitic hymenoptera. *Entomophaga*. 40(1):87–93.

- Le Tallec, T., Théry, M. & Perret, M. 2016. Melatonin concentrations and timing of seasonal reproduction in male mouse lemurs (*Microcebus murinus*) exposed to light pollution. *Journal of Mammalogy*. 97(3):753–760.
- Lee, E.E., Amritwar, A., Hong, L.E., Mohyuddin, I., Brown, T. & Postolache, T.T. 2020. Daily and Seasonal Variation in Light Exposure among the Old Order Amish. *International Journal of Environmental Research and Public Health*. 17(12):4460.
- Lewanzik, D. & Voigt, C.C. 2016. Transition from conventional to light-emitting diode street lighting changes activity of urban bats. *Journal of Applied Ecology*. 54(1):264–271.
- Lewy, A.J., Wehr, T.A., Goodwin, F.K., Newsome, D.A. & Markey, S.P. 1980. Light suppresses melatonin secretion in humans. *Science*. 210(4475):1267–1269.
- Li, G., Zhang, Y., Ni, Y., Wang, Y., Xu, B. & Guo, X. 2018. Identification of a melatonin receptor type 1A gene (*AccMTNR1A*) in *Apis cerana cerana* and its possible involvement in the response to low temperature stress. *The Science of Nature*. 105(3):24.
- Liu, T. & Borjigin, J. 2005. N-acetyltransferase is not the rate-limiting enzyme of melatonin synthesis at night. *Journal of Pineal Research*. 39(1):91–96.
- Longcore, T. & Rich, C. 2004. Ecological light pollution. *Frontiers in Ecology and the Environment*. 2(4):191–198.
- Loren, P., Sánchez, R., Arias, M.-E., Felmer, R., Risopatrón, J. & Cheuquemán, C. 2017. Melatonin Scavenger Properties against Oxidative and Nitrosative Stress: Impact on Gamete Handling and In Vitro Embryo Production in Humans and Other Mammals. *International Journal of Molecular Sciences*. 18(6):1119.
- Luarte, T., Bonta, C.C., Silva-Rodriguez, E.A., Quijón, P.A., Miranda, C., ... Duarte, C. 2016. Light pollution reduces activity, food consumption and growth rates in a sandy beach invertebrate. *Environmental Pollution*. 218(Supplement C):1147–1153.
- Lucchetta, P., Bernstein, C., Théry, M., Lazzari, C. & Desouhant, E. 2008. Foraging and associative learning of visual signals in a parasitic wasp. *Animal Cognition*. 11(3):525–533.
- Luginbuhl, C.B., Boley, P.A. & Davis, D.R. 2014. The impact of light source spectral power distribution on sky glow. *Journal of Quantitative Spectroscopy and Radiative Transfer*. 139:21–26.
- Lyytimäki, J., Tapio, P. & Assmuth, T. 2012. Unawareness in environmental protection: The case of light pollution from traffic. *Land Use Policy*. 29(3):598–604.
- Macgregor, C.J., Pocock, M.J.O., Fox, R. & Evans, D.M. 2015. Pollination by nocturnal Lepidoptera, and the effects of light pollution: a review. *Ecological Entomology*. 40(3):187–198.
- Majidinia, M., Reiter, R.J., Shakouri, S.K. & Yousefi, B. 2018. The role of melatonin, a multitasking molecule, in retarding the processes of ageing. *Ageing Research Reviews*. 47:198–213.

- Malek, I. & Haim, A. 2019. Bright artificial light at night is associated with increased body mass, poor reproductive success and compromised disease tolerance in Australian budgerigars (*Melopsittacus undulatus*). *Integrative Zoology*. 14(6):589–603.
- Marks, I. & Nesse, R.M. 1994. Fear and fitness: An evolutionary analysis of anxiety disorders. *Ethology and Sociobiology*. 15(5–6):247–261.
- Marris, G.C. & Casperd, J. 1996. The relationship between conspecific superparasitism and the outcome of in vitro contests staged between different larval instars of the solitary endoparasitoid *Venturia canescens*. *Behavioral Ecology and Sociobiology*. 39(1):61–69.
- Martin, L.B., Weil, Z.M. & Nelson, R.J. 2008. Seasonal changes in vertebrate immune activity: mediation by physiological trade-offs. *Philosophical Transactions of the Royal Society B: Biological Sciences*. 363(1490):321–339.
- Masís-Vargas, A., Hicks, D., Kalsbeek, A. & Mendoza, J. 2019. Blue light at night acutely impairs glucose tolerance and increases sugar intake in the diurnal rodent *Arvicanthis ansorgei* in a sex-dependent manner. *Physiological Reports*. 7(20):e14257.
- Maurer, A., Thawley, C., Fireman, A., Giery, S. & Stroud, J. 2019. Nocturnal activity of Antigua lizards under artificial light. *Herpetological Conservation and Biology*. 14:105–110.
- McLay, L.K., Nagarajan-Radha, V., Green, M.P. & Jones, T.M. 2018. Dim artificial light at night affects mating, reproductive output, and reactive oxygen species in *Drosophila melanogaster*. *Journal of Experimental Zoology Part A: Ecological and Integrative Physiology*. 329(8–9):419–428.
- Miller, C.R., Barton, B.T., Zhu, L., Radeloff, V.C., Oliver, K.M., ... Ives, A.R. 2017. Combined effects of night warming and light pollution on predator–prey interactions. *Proc. R. Soc. B*. 284(1864):20171195.
- Mishra, I., Knerr, R.M., Stewart, A.A., Payette, W.I., Richter, M.M. & Ashley, N.T. 2019. Light at night disrupts diel patterns of cytokine gene expression and endocrine profiles in zebra finch (*Taeniopygia guttata*). *Scientific Reports*. 9(1):15833.
- Mohamed, A.A.M., Wang, Q., Bembenek, J., Ichihara, N., Hiragaki, S., ... Takeda, M. 2014. N-acetyltransferase (*nat*) Is a Critical Conjoint of Photoperiodism between the Circadian System and Endocrine Axis in *Antheraea pernyi*. *PLOS ONE*. 9(3):e92680.
- Moore, C.B. & Siopes, T.D. 2000. Effects of Lighting Conditions and Melatonin Supplementation on the Cellular and Humoral Immune Responses in Japanese Quail *Coturnix coturnix japonica*. *General and Comparative Endocrinology*. 119(1):95–104.
- Navara, K.J. & Nelson, R.J. 2007. The dark side of light at night: physiological, epidemiological, and ecological consequences. *Journal of Pineal Research*. 43(3):215–224.
- Nelson, R.J. & Chbeir, S. 2018. Dark matters: effects of light at night on metabolism. *Proceedings of the Nutrition Society*. 77(3):223–229.

- Ouyang, J.Q., Davies, S. & Dominoni, D. 2018. Hormonally mediated effects of artificial light at night on behavior and fitness: linking endocrine mechanisms with function. *Journal of Experimental Biology*. 221(6):jeb156893.
- Owens, A.C.S. & Lewis, S.M. 2018. The impact of artificial light at night on nocturnal insects: A review and synthesis. *Ecology and Evolution*. 8(22):11337–11358.
- Pecl, G.T., Araújo, M.B., Bell, J.D., Blanchard, J., Bonebrake, T.C., ... Williams, S.E. 2017. Biodiversity redistribution under climate change: Impacts on ecosystems and human well-being. *Science*. 355(6332).
- Pelosse, P., Bernstein, C. & Desouhant, E. 2007. Differential energy allocation as an adaptation to different habitats in the parasitic wasp *Venturia canescens*. *Evolutionary Ecology*. 21(5):669–685.
- Pelosse, P., Jervis, M.A., Bernstein, C. & Desouhant, E. 2011. Does synovigeny confer reproductive plasticity upon a parasitoid wasp that is faced with variability in habitat richness? *Biological Journal of the Linnean Society*. 104(3):621–632.
- Post, E. & Forchhammer, M.C. 2008. Climate change reduces reproductive success of an Arctic herbivore through trophic mismatch. *Philosophical Transactions of the Royal Society B: Biological Sciences*. 363(1501):2369–2375.
- Pulgar, J., Zeballos, D., Vargas, J., Aldana, M., Manriquez, P.H., ... Duarte, C. 2019. Endogenous cycles, activity patterns and energy expenditure of an intertidal fish is modified by artificial light pollution at night (ALAN). *Environmental Pollution*. 244:361–366.
- R Core Team. 2020. R: A language and environment for statistical computing. R Foundation for Statistical Computing, Vienna, Austria. <https://www.R-project.org/>.
- R Core Team. 2019. R: A language and environment for statistical computing. R Foundation for Statistical Computing, Vienna, Austria. <https://www.R-project.org/>.
- Reiter, R.J. 1973. Pineal Control of a Seasonal Reproductive Rhythm in Male Golden Hamsters Exposed to Natural Daylight and Temperature. *Endocrinology*. 92(2):423–430.
- Reiter, R.J., Mayo, J.C., Tan, D.-X., Sainz, R.M., Alatorre-Jimenez, M. & Qin, L. 2016. Melatonin as an antioxidant: under promises but over delivers. *Journal of Pineal Research*. 61(3):253–278.
- Reiter, R.J., Rosales-Corral, S.A., Manchester, L.C. & Tan, D.-X. 2013. Peripheral Reproductive Organ Health and Melatonin: Ready for Prime Time. *International Journal of Molecular Sciences*. 14(4):7231–7272.
- Reppert, S.M. & Weaver, D.R. 2002. Coordination of circadian timing in mammals. *Nature*. 418(6901):935–941.
- Rich, C. & Longcore, T. 2006. Ecological Consequences of Artificial Night Lighting. In: *Ecological Consequences of Artificial Night Lighting*. Island Press.

- Rogers, D. 1972. The Ichneumon Wasp *Venturia Canescens*: Oviposition and Avoidance of Superparasitism. *Entomologia Experimentalis et Applicata*. 15(2):190–194.
- Rollag, M.D. & Niswender, G.D. 1976. Radioimmunoassay of Serum Concentrations of Melatonin in Sheep Exposed to Different Lighting Regimens. *Endocrinology*. 98(2):482–489.
- Rotics, S., Dayan, T. & Kronfeld-Schor, N. 2011. Effect of artificial night lighting on temporally partitioned spiny mice. *Journal of Mammalogy*. 92(1):159–168.
- Rowse, E.G., Harris, S. & Jones, G. 2018. Effects of dimming light-emitting diode street lights on light-opportunistic and light-averse bats in suburban habitats. *Royal Society Open Science*. 5(6):180205.
- Russ, A., Reitemeier, S., Weissmann, A., Gottschalk, J., Einspanier, A. & Klenke, R. 2015. Seasonal and urban effects on the endocrinology of a wild passerine. *Ecology and Evolution*. 5(23):5698–5710.
- Russ, A., Lučeničová, T. & Klenke, R. 2017. Altered breeding biology of the European blackbird under artificial light at night. *Journal of Avian Biology*. 48(8):1114–1125.
- Russart, K.L.G. & Nelson, R.J. 2018. Artificial light at night alters behavior in laboratory and wild animals. *Journal of Experimental Zoology Part A: Ecological and Integrative Physiology*. 329(8–9):401–408.
- Rydell, J. 1992. Exploitation of Insects around Streetlamps by Bats in Sweden. *Functional Ecology*. 6(6):744–750.
- Sakai, T. & Ishida, N. 2001. Circadian rhythms of female mating activity governed by clock genes in *Drosophila*. *Proceedings of the National Academy of Sciences*. 98(16):9221–9225.
- Salt, G. 1975. The fate of an internal parasitoid, *Nemeritis canescens*, in a variety of insects. *Transactions of the Royal Entomological Society of London*. 127(2):141–161.
- Salt, G. 1976. The hosts of *Nemeritis canescens* a problem in the host specificity of insect parasitoids. *Ecological Entomology*. 1(1):63–67.
- Sanders, D., Frago, E., Kehoe, R., Patterson, C. & Gaston, K.J. 2020. A meta-analysis of biological impacts of artificial light at night. *Nature Ecology & Evolution*. (November, 2):1–8.
- Santos, C.D., Miranda, A.C., Granadeiro, J.P., Lourenço, P.M., Saraiva, S. & Palmeirim, J.M. 2010. Effects of artificial illumination on the nocturnal foraging of waders. *Acta Oecologica*. 36(2):166–172.
- Schneider, M.V., Beukeboom, L.W., Driessen, G., Lapchin, L., Bernstein, C. & Alphen, J.J.M.V. 2002. Geographical distribution and genetic relatedness of sympatrical thelytokous and arrhenotokous populations of the parasitoid *Venturia canescens* (Hymenoptera). *Journal of Evolutionary Biology*. 15(2):191–200.

- Schoech, S.J., Bowman, R., Hahn, T.P., Goymann, W., Schwabl, I. & Bridge, E.S. 2013. The effects of low levels of light at night upon the endocrine physiology of western scrub-jays (*Aphelocoma californica*). *Journal of Experimental Zoology Part A: Ecological Genetics and Physiology*. 319(9):527–538.
- Secondi, J., Davranche, A., Théry, M., Mondy, N. & Lengagne, T. 2020. Assessing the effects of artificial light at night on biodiversity across latitude – Current knowledge gaps. *Global Ecology and Biogeography*. 29(3):404–419.
- Sih, A., Ferrari, M.C.O. & Harris, D.J. 2011. Evolution and behavioural responses to human-induced rapid environmental change. *Evolutionary Applications*. 4(2):367–387.
- Silva, A.D. & Kempnaers, B. 2017. Singing from North to South: Latitudinal variation in timing of dawn singing under natural and artificial light conditions. *Journal of Animal Ecology*. 86(6):1286–1297.
- Sirot, E. 1996. The pay-off from superparasitism in the solitary parasitoid *Venturia canescens*. *Ecological Entomology*. 21(3):305–307.
- Sirot, E., Ploye, H. & Bernstein, C. 1997. State dependent superparasitism in a solitary parasitoid: egg load and survival. *Behavioral Ecology*. 8(2):226–232.
- Smith, M. 2009. Time to turn off the lights. *Nature*. 457(7225):27–27.
- Swaddle, J.P., Francis, C.D., Barber, J.R., Cooper, C.B., Kyba, C.C.M., ... Longcore, T. 2015. A framework to assess evolutionary responses to anthropogenic light and sound. *Trends in Ecology & Evolution*. 30(9):550–560.
- Tan, D.-X., Hardeland, R., Manchester, L.C., Paredes, S.D., Korkmaz, A., ... Reiter, R.J. 2010. The changing biological roles of melatonin during evolution: from an antioxidant to signals of darkness, sexual selection and fitness. *Biological Reviews*. 85(3):607–623.
- Taufique, S.K.T., Prabhat, A. & Kumar, V. 2018. Illuminated night alters hippocampal gene expressions and induces depressive-like responses in diurnal corvids. *European Journal of Neuroscience*. 48(9):3005–3018.
- Tetreau, G., Chandor-Proust, A., Faucon, F., Stalinski, R., Akhouayri, I., ... Reynaud, S. 2014. UV light and urban pollution: Bad cocktail for mosquitoes? *Aquatic Toxicology*. 146:52–60.
- Thawley, C.J. & Kolbe, J.J. 2020. Artificial light at night increases growth and reproductive output in *Anolis* lizards. *Proceedings of the Royal Society B: Biological Sciences*. 287(1919):20191682.
- Titulaer, M., Spoelstra, K., Lange, C.Y.M.J.G. & Visser, M.E. 2012. Activity Patterns during Food Provisioning Are Affected by Artificial Light in Free Living Great Tits (*Parus major*). *PLOS ONE*. 7(5):e37377.
- Touitou, Y., Reinberg, A. & Touitou, D. 2017. Association between light at night, melatonin secretion, sleep deprivation, and the internal clock: Health impacts and mechanisms of circadian disruption. *Life Sciences*. 173:94–106.

- Touzot, M., Lengagne, T., Secondi, J., Desouhant, E., Théry, M., ... Mondy, N. 2020. Artificial light at night alters the sexual behaviour and fertilisation success of the common toad. *Environmental Pollution*. 259:113883.
- Vera, L.M., López-Olmeda, J.F., Bayarri, M.J., Madrid, J.A. & Sánchez-Vázquez, F.J. 2005. Influence of Light Intensity on Plasma Melatonin and Locomotor Activity Rhythms in Tench. *Chronobiology International*. 22(1):67–78.
- Vieira, R., Míguez, J.M. & Aldegunde, M. 2005. GABA modulates day–night variation in melatonin levels in the cerebral ganglia of the damselfly *Ischnura graellsii* and the grasshopper *Oedipoda caerulescens*. *Neuroscience Letters*. 376(2):111–115.
- Vieira, R., Mancebo, M.J., Pérez-Maceira, J.J. & Aldegunde, M. 2019. Melatonin synthesis in the optic lobes and midbrain of the grasshopper *Oedipoda caerulescens*. *Archives of Insect Biochemistry and Physiology*. 102(4):e21605.
- Vivien-Roels, B. & Pévet, P. 1993. Melatonin: presence and formation in invertebrates. *Experientia*. 49(8):642–647.
- Vivien-Roels, B., Pevet, P. & Beck, O. 1984. IDENTIFICATION OF MELATONIN IN THE COMPOUND EYES OF AN INSECT, THE LOCUST (*LOCUST.4 MIGRA TORIA*), BY RADIOIMMUNO- ASSAY AND GAS CHROMATOGRAPHY-MASS SPECTROMETRY. 5.
- Wajnberg, E., Bernstein, C. & Alphen, J. van. 2008. *Behavioral Ecology of Insect Parasitoids: From Theoretical Approaches to Field Applications*. John Wiley & Sons.
- Wakefield, A., Stone, E.L., Jones, G. & Harris, S. 2015. Light-emitting diode street lights reduce last-ditch evasive manoeuvres by moths to bat echolocation calls. *Royal Society Open Science*. 2(8):150291.
- Wakefield, A., Broyles, M., Stone, E.L., Harris, S. & Jones, G. 2018. Quantifying the attractiveness of broad-spectrum street lights to aerial nocturnal insects. *Journal of Applied Ecology*. 55(2):714–722.
- Walker, W.H., Meléndez-Fernández, O.H., Nelson, R.J. & Reiter, R.J. 2019. Global climate change and invariable photoperiods: A mismatch that jeopardizes animal fitness. *Ecology and Evolution*. 9(17):10044–10054.
- Welbers, A.A.M.H., Dis, V., E, N., Kolvoort, A.M., Ouyang, J., ... Dominoni, D.M. 2017. Artificial Light at Night Reduces Daily Energy Expenditure in Breeding Great Tits (*Parus major*). *Frontiers in Ecology and Evolution*. 5.
- Westby, K.M. & Medley, K.A. 2020. Cold Nights, City Lights: Artificial Light at Night Reduces Photoperiodically Induced Diapause in Urban and Rural Populations of *Aedes albopictus* (Diptera: Culicidae). *Journal of Medical Entomology*. 57(6):1694–1699.
- Xiang, S., Dauchy, R.T., Hauch, A., Mao, L., Yuan, L., ... Hill, S.M. 2015. Doxorubicin resistance in breast cancer is driven by light at night-induced disruption of the circadian melatonin signal. *Journal of Pineal Research*. 59(1):60–69.

- Yamano, H., Watari, Y., Arai, T. & Takeda, M. 2001. Melatonin in drinking water influences a circadian rhythm of locomotor activity in the house cricket, *Acheta domesticus*. *Journal of Insect Physiology*. 47(8):943–949.
- Yang, L., Qin, Y., Li, X., Song, D. & Qi, M. 2007. Brain melatonin content and polyethism in adult workers of *Apis mellifera* and *Apis cerana* (Hym., Apidae). *Journal of Applied Entomology*. 131(9–10):734–739.
- Yuan, J.S., Reed, A., Chen, F. & Stewart, C.N. 2006. Statistical analysis of real-time PCR data. *BMC Bioinformatics*. 7(1):85.
- Zhao, D., Yu, Y., Shen, Y., Liu, Q., Zhao, Z., ... Reiter, R.J. 2019. Melatonin Synthesis and Function: Evolutionary History in Animals and Plants. *Frontiers in Endocrinology*. 10:249.