



HAL
open science

Morse theory and higher algebra of A-infinity algebras

Thibaut Mazuir

► **To cite this version:**

Thibaut Mazuir. Morse theory and higher algebra of A-infinity algebras. Algebraic Topology [math.AT]. Sorbonne Université, 2022. English. NNT : 2022SORUS181 . tel-03828262

HAL Id: tel-03828262

<https://theses.hal.science/tel-03828262>

Submitted on 25 Oct 2022

HAL is a multi-disciplinary open access archive for the deposit and dissemination of scientific research documents, whether they are published or not. The documents may come from teaching and research institutions in France or abroad, or from public or private research centers.

L'archive ouverte pluridisciplinaire **HAL**, est destinée au dépôt et à la diffusion de documents scientifiques de niveau recherche, publiés ou non, émanant des établissements d'enseignement et de recherche français ou étrangers, des laboratoires publics ou privés.

Sorbonne Université



École doctorale de sciences mathématiques de Paris centre

THÈSE DE DOCTORAT

Discipline : Mathématiques

présentée par

Thibaut MAZUIR

Théorie de Morse et algèbre supérieure des A_∞ -algèbres

dirigée par Alexandru OANCEA

Soutenue le 21 juin 2022 devant le jury composé de :

M. Mohammed ABOUZAIID	Université de Columbia	rapporteur
M. Frédéric BOURGEOIS	Université Paris-Saclay	examineur
M. David CHATAUR	Université de Picardie Jules Vernes	rapporteur
M. Ilia ITENBERG	Sorbonne Université	examineur
M. Alexandru OANCEA	Sorbonne Université	directeur
M. Bruno VALLETTE	Université Sorbonne Paris Nord	examineur
M ^{me} Nathalie WAHL	Université de Copenhague	examinatrice

Institut de mathématiques de Jussieu-
Paris Rive gauche. UMR 7586.
Boîte courrier 247
4 place Jussieu
75 252 Paris Cedex 05

Sorbonne Université.
École doctorale de sciences
mathématiques de Paris centre.
Boîte courrier 290
4 place Jussieu
75 252 Paris Cedex 05

Résumé

Étant donnée une fonction de Morse sur une variété fermée orientée, nous nous inspirons de travaux d'Abouzaid et de Mescher pour munir son complexe de cochaînes de Morse d'une structure de ΩBAs -algèbre définie par un comptage d'arbres de gradient de Morse perturbé. Nous définissons également la notion de ΩBAs -morphisme entre deux ΩBAs -algèbres et construisons des ΩBAs -morphisms géométriques entre complexes de cochaînes de Morse par un comptage d'arbres de gradient perturbé 2-colorés. Nous utilisons des réalisations explicites des associaèdres et des multiplièdres en tant que polytopes et en tant qu'espaces de modules d'arbres métriques pour montrer qu'un ΩBAs -morphisme entre ΩBAs -algèbres induit naturellement un A_∞ -morphisme entre A_∞ -algèbres. Nous définissons ensuite la notion de n -morphisms entre A_∞ -algèbres et de n -morphisms entre ΩBAs -algèbres. L'ensemble des morphisms supérieurs entre deux A_∞ -algèbres définit alors un ensemble simplicial qui a la propriété d'être un complexe de Kan et dont nous calculons les groupes d'homotopie simpliciaux de manière explicite. Les n -morphisms sont de plus encodés par de nouvelles familles de polytopes que nous appelons les n -multiplièdres et qui généralisent les multiplièdres standard. Nous construisons dans un second temps des $n - \Omega BAs$ -morphisms géométriques entre complexes de cochaînes de Morse en comptant des arbres de gradient perturbé associés à des simplexes de données de perturbation admissibles. Nous prouvons en particulier que l'ensemble simplicial des morphisms supérieurs définis par un comptage d'arbres de gradient perturbé est un complexe de Kan qui est contractile. Cela donne une formulation rigoureuse en algèbre supérieure de l'unicité à homotopie près des morphisms de continuation en théorie de Morse. Nous comparons ensuite nos constructions aux structures supérieures définies en topologie symplectique par des comptages de courbes cousues pseudo-holomorphes. Nous décrivons finalement nos avancées sur deux projets de recherche : la définition d'une structure de catégorie symétrique monoïdale à homotopie près sur la catégorie des A_∞ -algèbres et des A_∞ -morphisms et la construction d'une structure de V_∞ -algèbre sur les chaînes symplectiques d'une variété de Liouville.

Mots-clefs. Théorie de Morse, théorie des opérades, algèbre supérieure, théorie de l'homotopie, infini-catégories, polytopes, topologie symplectique, théorie de Floer

Abstract

Elaborating on work by Abouzaid and Mescher, we prove that the Morse cochain complex of a Morse function can be endowed with an ΩBAs -algebra structure by counting perturbed Morse gradient trees. We then introduce the notion of an ΩBAs -morphism between two ΩBAs -algebras and construct geometric ΩBAs -morphisms between Morse cochain complexes by counting two-colored perturbed Morse gradient trees. We use explicit realizations of the associahedra and the multiplihedra as polytopes and moduli spaces of metric trees to show that an ΩBAs -morphism between ΩBAs -algebras naturally induces an A_∞ -morphism between A_∞ -algebras. We then introduce the notion of a n -morphism between A_∞ -algebras and of a n -morphism between ΩBAs -algebras. The set of higher morphisms between two A_∞ -algebras defines in fact a simplicial set which is a Kan complex and we explicitly compute its simplicial homotopy groups. The n -morphisms are moreover encoded by new families of polytopes that we call the n -multiplihedra and which generalize the standard multiplihedra. We then construct geometric $n - \Omega BAs$ -morphisms between Morse cochain complexes by counting perturbed Morse gradient trees associated to admissible simplices of perturbation data. We show in particular that the simplicial set consisting of higher morphisms defined by a count of perturbed Morse gradient trees is a Kan complex which is contractible. This gives a higher categorical meaning to the fact that continuation morphisms in Morse theory are well-defined up to homotopy at chain level. We subsequently compare our constructions to the higher structures defined by counts of pseudo-holomorphic quilts in symplectic topology. We finally describe two research projects on which we are currently working : the definition of a homotopy symmetric monoidal category structure on the category of A_∞ -algebras with A_∞ -morphisms between them and the construction of a V_∞ -algebra structure on the symplectic chains of a Liouville manifold.

Keywords. Morse theory, algebraic operads, higher algebra, homotopy theory, infinity-categories, polytopes, symplectic topology, Floer theory

Table des matières

Résumé	3
Abstract	5
Remerciements	9
Introduction	11
Chapitre 1. Présentation du contexte	13
1. Théorie des opérades	13
2. Topologie symplectique	15
3. Théorie de Morse	16
4. Point de départ des travaux de thèse	18
Chapitre 2. Contenu du manuscrit	21
1. Higher algebra of A_∞ and ΩBAs -algebras in Morse theory I	21
2. Higher algebra of A_∞ and ΩBAs -algebras in Morse theory II	25
3. Développements et pistes de recherche futures	30
partie 1. Higher algebra of A_∞ and ΩBAs-algebras in Morse theory I	35
partie 2. Higher algebra of A_∞ and ΩBAs-algebras in Morse theory II	131
partie 3. Further developments	213
Chapitre 1. Higher algebra from multi-gauged trees and quilted curves	215
1. Moduli spaces of bigauged metric trees	215
2. Higher algebra from moduli spaces of quilted disks	219
3. Towards the $(A_\infty, 2)$ -category Symp	225
4. Towards the homotopy 2-functor $\text{Symp} \rightarrow A_\infty - \text{Cat}$	228
Chapitre 2. Tensor products of A_∞ -algebras and A_∞ -morphisms	231
1. Diagonals on the associahedra and the multiplihedra	231
2. Tensor products in symplectic topology	232
Chapitre 3. New algebraic structures on the symplectic and Rabinowitz-Floer chains	235
1. The V_∞ -algebra structure on the symplectic chains	235
2. Further directions	240
Bibliographie	243

Remerciements

Mes premiers remerciements s'adressent à mon directeur Alexandru Oancea. Je m'estime profondément chanceux d'avoir eu l'opportunité de travailler à ses côtés pendant quatre ans. Les passionnants échanges scientifiques que nous avons partagés, ses conseils toujours avisés, sa bienveillance, sa disponibilité, son humanité et son inoxydable bonne humeur ont constitué le socle fondamental de mon doctorat. C'est avant tout grâce à son encadrement exemplaire, tant sur le plan humain que scientifique, que les quatre années de thèse qui s'achèvent ont été pour moi si heureuses et stimulantes. Je souhaite pour cela lui témoigner mon estime et ma plus sincère reconnaissance. J'aimerais également exprimer toute ma gratitude à Bruno Vallette. Les nombreuses discussions que nous avons eu l'occasion d'échanger, tant sur le plan scientifique que sur le plan privé, ont façonné de manière profonde et déterminante l'établissement de ce manuscrit. Je remercie ensuite mes deux rapporteurs, Mohammed Abouzaid et David Chataur, d'avoir accepté de prêter leur expertise à la relecture attentive de mon travail de thèse. J'adresse pareillement ma gratitude aux trois autres membres de mon jury : Frédéric Bourgeois, Ilia Itenberg et Nathalie Wahl. Ce travail est aussi le fruit de l'ensemble de mes interactions avec tous les chercheurs que j'ai eu la joie de rencontrer au fil de ma thèse : Guillem Cazassus, Damien Calaque, Ricardo Campos, Geoffroy Horel, Nate Bottman, Brice Le Grignou, Baptiste Chantraine, Muriel Livernet, François Laudénbach, Robert Lipshitz et Lino Amorim. Ma reconnaissance va enfin à Chris Wendl, qui a soutenu ma candidature à une bourse de postdoctorat de la Berlin Mathematical School, et que j'aurai la chance de côtoyer au cours des deux années à venir à l'université de Humboldt à Berlin.

Mes années de thèse sont indissociables de toutes les personnes que j'ai eu le bonheur de rencontrer, au gré de mes voyages en conférences et durant ma vie quotidienne dans les couloirs de l'IMJ-PRG. Ma première pensée s'adresse évidemment à mes collègues du couloir des doctorants. Merci à petit Thomas, mon ami et fidèle camarade de pause en salle de convivialité, de rigolade, de drama, et d'après-midis ensoleillées au parc de Vincennes. À mes quatre collègues de bureau que j'adore : Christina, la plus avisée des conseillères pâtisseries de Paris, Jean-Michel, génial théoricien de l'homotopie, grand Thomas, meilleur ouvrier de France section poterie, et Raphaël. À Mahya, Perla et Chiara, éternelles sources de bonne humeur du laboratoire. Merci également à Anna F., la meilleure d'entre nous, à Nelson, mon malade préféré, à Anna R.S., à Christophe, à Grace, à Haowen, à Vadim, à Mathieu, à Eva, à Thiago, à Jacques et à Raphaël. Je n'oublie pas non plus les plus anciens, Alexandre, Benoît, Sudarshan, Mathieu et Sylvain. C'est dans le couloir des doctorants que j'ai aussi eu la chance de rencontrer mon collaborateur et très grand ami Guillaume. Nos échanges ont joué un rôle déterminant dans mon travail de thèse et j'espère que nous serons amenés à écrire ensemble de longues années durant. J'ai également été très heureux de rencontrer Florian lors de la conférence d'analyse microlocale organisée au CRM de Montréal. Pendant un mois nous avons partagé apprentissage du go et des infini-catégories, dégustation de panini poulet-pesto et de théorie microlocale des faisceaux, et visites touristiques des gratte-ciels de Montréal et des catégories de Tamarkin. Je n'oublie pas non plus le reste de mes camarades symplecticiens, Amiel, Pierre-Alexandre, Côme, Noémie, Ella, Thomas, ni mes amis opératchiks, Victor, Coline, Hugo, Maxime, ainsi que les membres du séminaire Roberta.

Merci enfin aux membres de l'équipe administrative de l'IMJ-PRG que j'ai pu rencontrer au cours de ma thèse : Emilie Jacquemot, Sakina Madel-Kawami, Evariste Ciret, Julienne Passave, Gaëlle Callouard, Cyril Bourcier-Kadi, Corentin Lacombe et Sitti Mchinda. Je vous adresse mon amitié et toute ma gratitude pour m'avoir fourni un excellent environnement de travail durant ces quatre années.

Parmi tous les amis que j'ai pu côtoyer au cours de ma thèse, je tiens maintenant à remercier individuellement chacun des membres du Filtre. David, pour toutes les sorties sportives et festives à Paris, et les vacances rando, ski et vélo à la montagne. Rémy, pour les après-midis FIFA, les discussions Signal tard dans la nuit, les omelettes soufflées et pour m'avoir fait rencontrer Messi, Mbappé et Neymar. Marc, meilleur organisateur de soirées à Paris et à Lille, guide hors classe sur la route de chez Colin-Maçon et premier libanais dans mon coeur. Ulysse et Simon, mes deux anciens colocs avec lesquels j'ai partagé toutes mes joies et mes peines pendant une année dans notre belle maison du Kremlin-Bicêtre. Cyril, pour m'avoir initié au rock et que je suis heureux d'avoir vu revenir en vie du Mont Ventoux. Enfin Jean et Seginus, que j'ai malheureusement peu eu l'occasion de recroiser depuis ma sortie de l'ENS, mais avec qui j'ai partagé un excellent week-end de l'Ascension cette année. Je ne saurais bien sûr oublier de remercier tous les autres amis que j'ai eu l'occasion de rencontrer au cours de mes années à l'ENS. Merci à Tony, volleyeur et ami d'exception, dessinateur hors pair et futur Challenger. À Matteo, mon coéquipier préféré de tournois de volley et qui m'a fait découvrir la côte Adriatique et les paysages de Toscane. À Benjamin, pour les poulets-patates du dimanche et pour avoir si bien géré le club volley durant mes absences. À Marion et Vadim, mes habitants du sixième arrondissement favoris, cuisiniers remarquables et fidèles partenaires de virée au restaurant malgré leurs agendas de ministres. Merci à Adele, de m'avoir accueilli à San Niccolò et m'avoir fait découvrir la beauté de l'Ombrie, à Quentin, réservoir intarissable d'histoires comiques, ainsi qu'à Alia, Lucky et May, fidèles partenaires de brunch tardifs le dimanche. J'ai enfin eu la joie de jouer pendant quatre ans au club de volleyball de Dunois. Merci à Diego, pour avoir été un coach, un entraîneur et un formateur exceptionnel. Merci aussi à tous mes coéquipiers géniaux : captain Hadri, Jérém, Léo, Romain, Antho, Séb, Coco, Michele, Alain, Pako, Benoît, Micka, Guillaume, Damien, Julien et Marius. Courage les gars, la montée c'est pour l'année prochaine !

Je pense finalement à mes parents et à ma sœur Auriane, qui m'ont toujours soutenu depuis le début de mes études en classes préparatoires à Strasbourg et tout au long de mon parcours à l'ENS puis en thèse à Jussieu. Merci également à ma grand-mère Marthe, mon grand-père Alfred qui s'inquiète encore de ma réussite malgré sa maladie, mon grand-père Gérard et ma grand-mère Nicole. Mes derniers mots vont à toi Souraya. Les moments partagés depuis notre rencontre ont tous été baignés d'un bonheur tendre et évident. Merci pour ton amour, pour ta complicité, pour ton sens de l'humour et ta bienveillance.

بِحُبِّكَ بالصيف و بحُبِّكَ بالشتي

Introduction

Présentation du contexte

1. Théorie des opérades

Le paradigme de la théorie des opérades consiste à concevoir l'ensemble des opérations encodant une structure algébrique, ainsi que les relations qu'elles satisfont entre elles, comme une entité algébrique à part entière que l'on peut étudier de manière systématique : cette entité algébrique est appelée *opérade*. Dit autrement, une opérade P encode une catégorie de P -algèbres. Les algèbres associatives sont ainsi encodées par l'opérade As , engendrée par une unique opération Υ qui satisfait la relation d'associativité

$$\begin{array}{c} \Upsilon \\ \Upsilon \end{array} = \begin{array}{c} \Upsilon \\ \Upsilon \end{array} .$$

Le point de vue opéradique permet donc d'étudier différentes propriétés de la catégorie des P -algèbres en manipulant directement l'opérade P . Initialement développée au cours des années 60 pour l'étude de différents problèmes de topologie algébrique, la théorie des opérades a connu des développements impressionnants à partir des années 90 et irrigue depuis de nombreux domaines des mathématiques modernes : déformation par quantification, topologie des cordes, géométrie algébrique, théorie des nœuds, ainsi que la théorie de Morse et la topologie symplectique sur lesquelles nous revenons en détails plus bas. Nous renvoyons à [MSS02] pour une introduction historique détaillée du domaine.

La théorie de la dualité de Koszul des opérades et son application à l'étude de la théorie de l'homotopie des P -algèbres sont deux exemples frappants de la puissance du paradigme opéradique. Étant donnée une dg-opérade P (où dg est l'abréviation que nous utiliserons pour *différentielle graduée* dans la suite de ce manuscrit) on souhaiterait en effet formuler une notion de P -algèbre à homotopie près qui serait invariante sous la relation d'équivalence d'homotopie des dg-modules sous-jacents. La théorie de l'homotopie des dg-opérades montre que, pour une résolution cofibrante $Q \rightarrow P$, la structure de Q -algèbre fournit bien une telle notion de P -algèbre à homotopie près. On dispose en particulier dans ce cas d'un théorème de transfert homotopique qui s'exprime comme suit. Considérons un diagramme de rétracte par déformation

$$h \begin{array}{c} \curvearrowright \\ \curvearrowleft \end{array} (A, \partial_A) \begin{array}{c} \xrightarrow{p} \\ \xleftarrow{i} \end{array} (H, \partial_H) ,$$

où $\text{id}_A - ip = [\partial, h]$ et A est une P -algèbre. Alors, la structure de P -algèbre sur A se transfère naturellement en une structure de Q -algèbre sur H . Ce théorème est appelé le *théorème de transfert homotopique*. Nous renvoyons à [MSS02] pour une preuve générale de ce théorème ainsi qu'à l'article [Mar06] qui démontre le théorème de transfert homotopique dans le cas particulier de la résolution $A_\infty \rightarrow As$ que nous rencontrerons plus bas.

Il s'avère que la théorie de la dualité de Koszul des opérades permet de construire de telles résolutions. De manière sommaire, à tout opérade dite *quadratique* (c'est-à-dire correspondant à la donnée d'une collection d'opérations génératrices satisfaisant des relations quadratiques entre elles), on peut associer une nouvelle opérade $P_\infty := \Omega P^i$. Ici P^i est une coopérade construite à

partir de la donnée quadratique de P et Ω désigne la construction cobar opéradique, transformant une coopérade Q en une opérade quasi-libre ΩQ . Si l'opérade P a en plus la propriété d'être de Koszul, alors $P_\infty \rightarrow P$ est une résolution cofibrante de P . C'est par exemple le cas des opérades As , Com et Lie encodant respectivement les dg-algèbres associatives, commutatives et de Lie. Nous renvoyons à [Val20] pour plus de détails sur la théorie de l'homotopie des algèbres encodées par une opérade de Koszul. Mentionnons également que tout opérade P admet une résolution cofibrante universelle $\Omega BP \rightarrow P$, où B est la construction bar opéradique transformant une opérade en coopérade quasi-libre. La notion de ΩBP -algèbre fournit alors en particulier une autre notion de P -algèbre à homotopie près.

On peut spécialiser la discussion ci-dessus à l'étude de la théorie de l'homotopie des dg-algèbres. Étant donnée une résolution cofibrante Q de l'opérade As encodant les dg-algèbres (associatives), on appellera Q -algèbre une *algèbre fortement associative à homotopie près*. La dualité de Koszul donne une première résolution cofibrante $A_\infty \rightarrow As$. Une structure de A_∞ -algèbre sur un dg-module A correspond à la donnée d'une collection d'opérations $m_n : A^{\otimes n} \rightarrow A$ de degré $2 - n$ pour $n \geq 2$, satisfaisant les équations

$$[\partial_A, m_n] = \sum_{\substack{i_1+i_2+i_3=n \\ 2 \leq i_2 \leq n-1}} (-1)^{i_1+i_2 i_3} m_{i_1+1+i_3} (\text{id}^{\otimes i_1} \otimes m_{i_2} \otimes \text{id}^{\otimes i_3}).$$

En représentant m_n comme une corolle d'arité n , ces équations se représentent comme suit

$$[\partial_A, \text{corolla}(n)] = \sum_{\substack{h+k=n+1 \\ 2 \leq h \leq n-1 \\ 1 \leq i \leq k}} \pm 1 \cdot \text{corolla}(h, i, k).$$

Autrement dit, A_∞ est l'opérade quasi-libre engendrée en arité n par une corolle m_n d'arité n , et dont la différentielle est donnée par la somme des arbres obtenus par l'éclatement de l'unique sommet de m_n . L'équation d'arité 2 implique que le produit m_2 est compatible avec la différentielle ∂_A , tandis que l'équation d'arité 3 exhibe m_3 comme l'homotopie encodant le défaut d'associativité de m_2 : l'opération m_2 induit en particulier une structure d'algèbre graduée (associative) sur la cohomologie $H^*(A)$. Les opérations m_n d'arité supérieure peuvent être interprétées comme la famille cohérente d'homotopies supérieures encodant le défaut d'associativité de m_2 .

L'opérade A_∞ est en fait encodée par une famille de polytopes, appelés *associaèdres*. Ces polytopes définis pour la première fois dans l'article fondateur de Stasheff [Sta63] sur les H-espaces, sont depuis apparus dans de nombreux champs de recherche des mathématiques modernes : en topologie symplectique (cf. plus bas), en combinatoire ou dans l'étude des variétés toriques par exemple. Mentionnons également ici que la résolution cofibrante universelle de As , l'opérade ΩBAs , fournit un modèle alternatif d'algèbre associative à homotopie près. L'opérade ΩBAs peut alors être décrite comme l'opérade quasi-libre engendrée par tous les types d'arbres enrubannés t ,

$$\Omega BAs := \mathcal{F}(\Upsilon, \Psi, \Upsilon, \Upsilon, \dots, SRT_n, \dots),$$

où SRT_n désigne l'ensemble des types d'arbres enrubannés t . Le bord d'une opération m_t est donné par la somme des arbres obtenus en contractant exactement une arête de l'arbre t ou en brisant exactement une de ses arêtes.

2. Topologie symplectique

Une variété symplectique correspond à la donnée d'une variété lisse M munie d'une 2-forme fermée non-dégénérée ω . Un des objectifs de la *topologie symplectique* est l'étude des propriétés géométriques des variétés symplectiques (M, ω) , ainsi que de la manière dont elles sont préservées par des transformations lisses préservant la structure symplectique. Le paradigme de la topologie algébrique, qui associe des invariants algébriques aux espaces topologiques afin de les distinguer et de comprendre certaines de leurs propriétés, peut être appliqué à l'étude des variétés symplectiques. L'implémentation des outils de la topologie algébrique en topologie symplectique a été propulsée par les articles fondateurs de Gromov sur les espaces de modules de courbes pseudo-holomorphes [Gro85] et de Floer sur l'homologie de Floer lagrangienne [Flo88]. Le travail de Gromov implique que le comptage de points d'espaces de modules de courbes pseudo-holomorphes de dimension 0 définis dans la variété symplectique (M, ω) permet de définir des invariants algébriques rendant compte de la géométrie de (M, ω) . Floer associe quant à lui à deux sous-variétés lagrangiennes $L_0, L_1 \subset M$ s'intersectant transversalement un complexe de chaînes définissant l'homologie de Floer lagrangienne $FH_*(L_0, L_1)$. Ces groupes d'homologie permettent de comprendre la théorie de l'intersection des lagrangiennes L_0 et L_1 .

La construction de la catégorie de Fukaya $\text{Fuk}(M, \omega)$ d'une variété symplectique (M, ω) poursuit cette lignée d'idées. C'est une A_∞ -catégorie, c'est-à-dire une catégorie dont la composition a été relaxée à homotopie près au moyen d'une suite d'homotopies encodées par l'opérade A_∞ , contenant une grande quantité d'informations sur la théorie de l'intersection des sous-variétés lagrangiennes de (M, ω) , dont les groupes d'homologie $FH_*(L_0, L_1)$. Ses objets sont les sous-variétés lagrangiennes de M et ses compositions supérieures m_n sont définies par des comptages de disques à $n+1$ points marqués sur leur bord et satisfaisant une condition au bord lagrangienne (voir le schéma 1). Nous renvoyons aux excellents articles de Auroux [Aur14] et Smith [Smi15] pour une introduction plus détaillée sur les catégories de Fukaya, et mentionnons également les ouvrages fondateurs de Seidel [Sei08] et Fukaya, Oh, Ota et Ono [FOOO09a] et [FOOO09b].

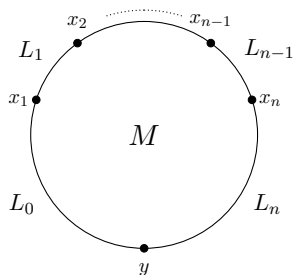
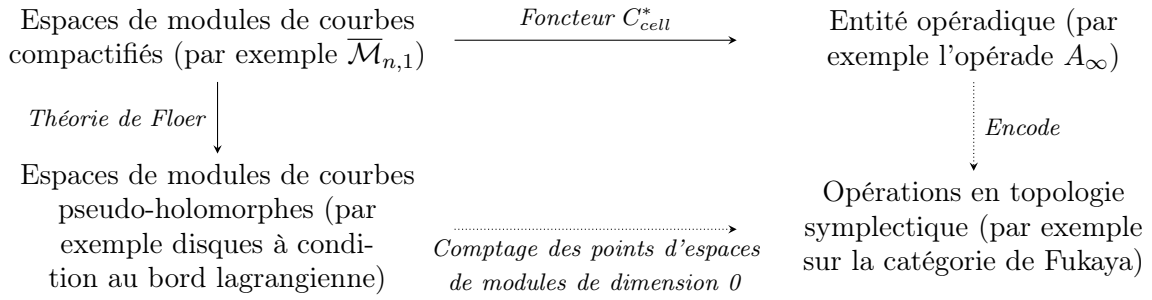

FIGURE 1 – Un exemple de disque pseudo-holomorphe à condition au bord sur les lagrangiennes L_0, \dots, L_n avec $n+1$ points marqués qui s'envoient sur les points y, x_1, \dots, x_n dans M

Il y a en fait un lien étroit entre la théorie des opérades et les structures algébriques définies en topologie symplectique. Prenons en pour exemple la structure de A_∞ -catégorie sur la catégorie de Fukaya. Ses opérations d'arité n sont définies en réalisant en topologie symplectique l'espace de modules $\mathcal{M}_{n,1}$, qui est l'espace de modules de disques à $n+1$ points marqués sur leur bord, dont n points sont vus comme entrants et 1 est vu comme sortant. Cet espace de modules peut alors être compactifié et muni d'une topologie de sorte à ce que sa compactification soit isomorphe à l'associaèdre, comme le démontre par exemple Seidel dans [Sei08]. Autrement dit, les espaces de modules de disques compactifiés $\overline{\mathcal{M}}_{n,1}$ réalisent l'opérade A_∞ . Nous résumons cela dans le diagramme ci-dessous. La grande diversité de structures algébriques pouvant être observées sur

des complexes de Floer en topologie symplectique s'explique également par le lien étroit entre la topologie symplectique et la topologie des cordes, qui a joué un rôle prépondérant dans le développement de la théorie des opérades. Viterbo montre ainsi par exemple dans [Vit98] que la cohomologie symplectique du cotangent d'une variété M à coefficients dans $\mathbb{Z}/2\mathbb{Z}$ est isomorphe à l'homologie de son espace de lacets libres, $SH^{-*}(T^*M) \simeq H_*(\mathcal{LM})$. Ses travaux ont ensuite été complétés par ceux de Salamon et Weber [SW06], Abbondandolo et Schwarz [AS06], Abouzaid [Abo15] et Kragh [Kra18]. Abouzaid construit dans [Abo15] une structure de BV-algèbre sur la cohomologie symplectique $SH^{-*}(T^*M)$ telle que l'isomorphisme précédent soit un isomorphisme de BV-algèbre en munissant $H_*(\mathcal{LM})$ de sa structure de BV-algèbre construite dans [CS99]. Cieliebak, Hingston et Oancea ont également démontré des résultats de dualité de Poincaré pour les espaces de lacets en utilisant l'homologie de Rabinowitz Floer dans [CHO20].



Citons enfin le travail de Bottman, qui réalise parfaitement la philosophie du diagramme ci-haut. Il cherche actuellement à trouver un modèle algébrique pour la notion de $(A_\infty, 2)$ -catégorie, qui serait encodée par les espaces de modules de *witch curves*. Si l'on comprend une A_∞ -catégorie comme une catégorie dont la composition a été relaxée à homotopie près, une $(A_\infty, 2)$ -catégorie représenterait alors une 2-catégorie dont les opérations auraient été relaxées à homotopie près. Son objectif ultime est de montrer qu'il existe une $(A_\infty, 2)$ -catégorie Symp dont les objets seraient des variétés symplectiques fermées et dont la A_∞ -catégorie de morphismes entre deux variétés symplectiques M et N serait la catégorie de Fukaya $\text{Symp}(M, N) := \text{Fuk}(M^- \times N)$. Nous renvoyons à deux de ses articles récents [Bot19b] et [BC21] ainsi qu'à la section 3 de la partie 3 de ce manuscrit pour plus de détails à ce sujet.

3. Théorie de Morse

La théorie de Morse correspond à l'étude des variétés munies d'une fonction de Morse, c'est-à-dire une fonction dont les points critiques sont non-dégénérés. Considérons une variété M , munie d'une fonction de Morse $f : M \rightarrow \mathbb{R}$ ainsi que d'une métrique riemannienne g . Pour une métrique générique g on peut alors associer à (M, f) un dg-module, appelé *complexe de Morse*. Celui-ci est librement engendré en degré k par l'ensemble des points critiques d'indice k de la fonction f

$$C^k(f) := \bigoplus_{\substack{x \in \text{Crit}(f) \\ |x|=k}} \mathbb{Z} \cdot x,$$

où l'indice de x est défini comme $|x| := \dim(W^S(x))$ et $W^S(x)$ est la variété stable de x pour le champ de vecteurs $-\nabla_g f$. Notons

$$\mathcal{T}(y; x) := W^S(y) \cap W^U(x) / \mathbb{R}$$

l'espace de modules des trajectoires de gradient négatif de f reliant un point critique x à un point critique y , avec $x \neq y$. Sous l'hypothèse générique dite de Morse-Smale sur la métrique g , cet espace de modules est une variété de dimension $\dim(\mathcal{T}(y; x)) = |y| - |x| - 1$.

La différentielle de Morse ∂_{Morse} est alors définie par un comptage d'éléments d'espaces de modules de trajectoires de gradient négatif de dimension 0

$$\partial_{Morse}(x) := \sum_{|y|=|x|+1} \#\mathcal{T}(y; x) \cdot y .$$

En notant $C^*(f)$ le complexe de cochaînes ainsi défini, on appelle cohomologie de Morse sa cohomologie. Cette cohomologie est en fait exactement la cohomologie singulière de la variété M sous-jacente $H_{sing}^*(M) \simeq H^*(f)$, comme le montre par exemple Salamon dans [Sal90]. La donnée d'une fonction de Morse sur la variété M contient en fait bien plus d'informations que l'homologie singulière de la variété M . L'analyse des ensembles de niveaux de la fonction f montre qu'elle permet de reconstruire M par une suite de recollements d'anse associés à chaque point critique de f . Nous renvoyons au livre [Mil13] de Milnor pour plus de détails à ce sujet.

La topologie symplectique peut en fait être interprétée comme une quantification de la topologie différentielle, comme l'expliquent Fukaya et Oh dans [FO97] : la théorie des courbes pseudo-holomorphes correspond alors à la quantification de la théorie de Morse. L'homologie de Floer lagrangienne peut en effet être interprétée comme une homologie de Morse en dimension infinie où la variété M est remplacée par l'espace des chemins $\mathcal{P}(L_0, L_1)$ reliant L_0 à L_1 et la fonction de Morse $f : M \rightarrow \mathbb{R}$ par une fonctionnelle sur $\mathcal{P}(L_0, L_1)$ que nous ne détaillons pas. Ces points critiques sont alors en bijection avec les points d'intersection de L_0 et L_1 et sa différentielle est définie par un comptage de bandes pseudo-holomorphes reliant deux points d'intersection x et y dans $L_0 \cap L_1$ (voir [Flo88] pour plus de détails).

Dans cette veine, Fukaya et Oh utilisent la théorie de Morse pour associer à une variété M une A_∞ -catégorie Morse(M) dans [Fuk97], [Fuk93] et [FO97]. Les objets de cette catégorie sont des fonctions $f_i : M \rightarrow \mathbb{R}$ et les espaces de morphismes entre deux fonctions f_i et f_j (telles que $f_i - f_j$ soit de Morse) sont les cochaînes de Morse $C^*(f_i - f_j)$. Les multiplications supérieures de Morse(M) sont alors définies en comptant des arbres de gradient dont les arêtes sont des trajectoires de gradient négatif des fonctions de Morse $f_i - f_j$. Nous représentons sur le schéma 2 l'espace de modules définissant la composition m_2 . On parle en fait d'une A_∞ -catégorie topologique, car les objets sont les points d'un espace topologique X (l'espace des fonctions $f : M \rightarrow \mathbb{R}$) et les espaces de morphismes et leurs compositions supérieures sont définis uniquement pour des n -uplets d'objets dans un sous-ensemble de Baire de X (ce qui signifie ici qu'ils sont définis en prenant des conditions génériques sur les fonctions f_i).

À toute variété M correspond maintenant une variété symplectique, son cotangent T^*M , et à toute fonction $f : M \rightarrow \mathbb{R}$ la lagrangienne $\Lambda_f \subset T^*M$ définie comme le graphe de la différentielle de la fonction f , $\Lambda_f := \{(p, df_p), p \in M\}$. Posons de plus $\Lambda_f^\varepsilon := \{(p, \varepsilon df_p), p \in M\}$. Fukaya et Oh montrent par un argument de limite adiabatique dans [FO97] que, pour ε assez petit, les espaces de modules définissant les compositions supérieures de la catégorie de Fukaya $\text{Fuk}(M, \varepsilon)$ formée par les lagrangiennes de la forme Λ_f^ε coïncident avec les espaces de modules définissant les compositions supérieures de la A_∞ -catégorie Morse(M). En particulier, $\text{Morse}(M) \simeq \text{Fuk}^\#(M, \varepsilon)$. Mentionnons également le travail plus récent de Ekholm [Ekh07] qui démontre l'équivalence entre courbes pseudo-holomorphes et arbres de gradient pour une legendrienne de la variété de contact des 1-jets $T^*M \times \mathbb{R}$.

Notons de plus que l'opération d'arité 2 de Morse(M) représentée sur le schéma 2, réalise exactement le produit cup sur la cohomologie singulière. Nous renvoyons également vers l'article

de Betz et Cohen [Coh06], qui associe en général à tout graphe planaire Γ un élément

$$q(\Gamma, M) \in \bigotimes_{i=1}^{n_1} H^*(M) \otimes \bigotimes_{j=1}^{n_2} H_*(M)$$

défini en réalisant le graphe Γ en théorie de Morse. Ils recouvrent de la sorte plusieurs opérations et invariants de topologie algébrique classique, dont la classe d'Euler ou la classe fondamentale de M par exemple.

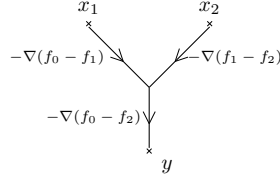

FIGURE 2 – L'arbre de gradient d'arité 2 dont le comptage réalise la composition $m_2 : C^*(f_0 - f_1) \otimes C^*(f_1 - f_2) \rightarrow C^*(f_0 - f_2)$.

4. Point de départ des travaux de thèse

Fukaya et Oh affirment dans [FO97] qu'il faut en fait penser à la A_∞ -catégorie Morse(M) comme à une A_∞ -algèbre. Cette interprétation est réalisée plus tard par Abouzaid dans [Abo11]. Étant donnée une fonction de Morse $f : M \rightarrow \mathbb{R}$, il définit une structure de A_∞ -algèbre sur les cochaînes de Morse $C^*(f)$ en comptant des arbres de gradient perturbé. De manière sommaire, étant donné que l'on travaille désormais avec une unique fonction de Morse, on ne peut plus considérer des arbres de gradient dont toutes les arêtes correspondent au gradient négatif $-\nabla f$. En effet, les seuls espaces de modules non vides seraient ceux dont les arêtes entrantes sont toutes issues du même point critique, étant donné que deux trajectoires de gradient issues de deux points critiques différents ne peuvent s'intersecter. Ces espaces de modules non vides ne satisferaient en fait alors même pas d'hypothèses de transversalité. Abouzaid règle cette question en choisissant de perturber l'équation satisfaite par la trajectoire de gradient au voisinage de chaque sommet de l'arbre. Nous représentons cela sur le schéma 3. Son travail a ensuite été repris par Mescher

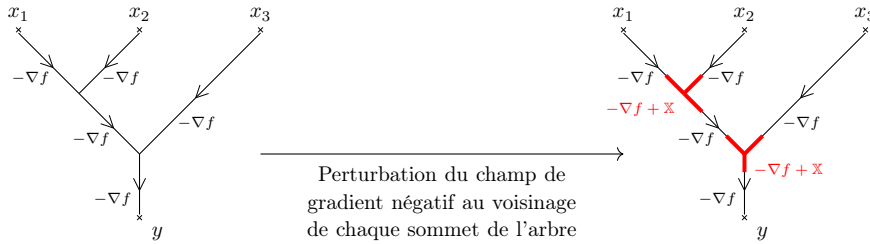

FIGURE 3

dans [Mes18]. Mentionnons également l'article très récent [AL21] de Abbaspour et Laudenchbach qui construisent la structure de A_∞ -algèbre sur $C^*(f)$ par une méthode différente.

La construction d'Abouzaid peut en fait être expliquée à la lumière du théorème de transfert homotopique rappelé au début de cette introduction. La cohomologie de Morse est non seulement isomorphe à la cohomologie singulière de la variété M , mais les cochaînes de Morse $C^*(f)$ forment en fait un rétracte par déformation des cochaînes singulières comme le montre Hutchings dans [Hut08]

$$h \begin{array}{c} \curvearrowright \\ \curvearrowleft \end{array} (C_{sing}^*(M), \partial_{sing}) \begin{array}{c} \xrightarrow{p} \\ \xleftarrow{i} \end{array} (C^*(f), \partial_{Morse}) .$$

Le cup produit munit de plus les cochaînes singulières d'une structure de dg-algèbre. On peut donc la transférer en une structure de A_∞ -algèbre sur $C^*(f)$ au moyen de ce diagramme de rétracte par déformation. Cette structure de A_∞ -algèbre n'est toutefois alors obtenue que par un théorème algébrique abstrait mais n'est pas d'essence géométrique, c'est-à-dire ne résulte pas comme la différentielle de Morse d'un comptage des points d'espaces de modules de dimension 0. Le travail d'Abouzaid peut donc être interprété comme une construction géométrique de la structure de A_∞ -algèbre sur $C^*(f)$, dont on a exhibé l'existence par des arguments purement algébriques. Abouzaid définit en fait aussi un quasi-isomorphisme de A_∞ -algèbres $C^*(f) \rightarrow C_{sing}^*(M)$ de manière géométrique, ce qui implique en particulier que la structure "géométrique" et la structure "algébrique" de A_∞ -algèbre sur $C^*(f)$ sont bien quasi-isomorphes.

Deux problématiques majeures découlent de cette interprétation du travail d'Abouzaid. La première est de savoir si, étant données deux fonctions de Morse f et g , il est toujours possible de construire un A_∞ -morphisme de $C^*(f)$ vers $C^*(g)$ par un comptage des points d'espaces de modules géométriques de dimension 0. La deuxième est de formuler ensuite rigoureusement, en algèbre supérieure, l'unicité à homotopie près de tels morphismes géométriques. Il s'agit en particulier d'exhiber à chaque fois des espaces de modules encodant les structures algébriques étudiées et pouvant se réaliser en théorie de Morse. Ces deux problématiques constituent le point de départ des travaux de ce manuscrit de thèse.

Contenu du manuscrit

Ce manuscrit de thèse se découpe en trois grandes parties. Les parties 1 et 2 sont formées du collage des deux articles *Higher algebra of A_∞ and ΩBAs -algebras in Morse theory I-II* [Maz21a] [Maz21b] qui ont pour objectif de répondre aux questions découlant de l'article d'Abouzaid [Abo11] que nous avons exposées plus haut. Dans la partie 3 nous décrivons plusieurs pistes de réflexion découlant des constructions de ces deux articles et exposons également des résultats préliminaires obtenus dans le cadre de deux projets de recherche en cours. Le contenu de chacun de ces chapitres est résumé en détails dans les sections qui suivent. La numérotation des énoncés prend pour référence celle de l'article dont ils sont tirés.

1. Higher algebra of A_∞ and ΩBAs -algebras in Morse theory I

Ce premier article est disponible sur arXiv (2102.06654, 93 pages) et soumis pour publication. La numérotation des pages que nous utiliserons dans sa reproduction dans la partie 1 est celle de l'article original. Il est constitué de trois grandes parties : Algèbre, Géométrie et Perspectives.

1.1. Algèbre.

1.1.1. *Algèbre opéradique et A_∞ -algèbres.* Nous rappelons dans la section 1 des éléments de base du langage opéradique qui seront utiles tout au long de notre diptyque d'articles, les définitions de A_∞ -algèbre et de A_∞ -morphisme du point de vue de la construction bar et du point de vue opéradique, ainsi que deux résultats majeurs sur leur théorie de l'homotopie. Nous définissons de plus le bimodule opéradique $A_\infty - \text{Morph}$, qui est l'objet opéradique encodant la notion de A_∞ -morphisme .

1.1.2. *Associaèdres et multiplièdres.* Nous débutons la section 2 en rappelant la définition de la catégorie monoïdale Poly de [MTTV21], dont les objets sont des polytopes. Sa structure monoïdale permet en particulier de définir des opérades et bimodules opéradiques en polytopes. Nous décrivons alors deux collections de polytopes : les associaèdres K_n et les multiplièdres J_n . La collection des associaèdres est munie dans [MTTV21] d'une structure d'opérade dans la catégorie Poly réalisant l'opérade A_∞ sous le foncteur monoïdal des chaînes cellulaires. De la même manière, nous prouvons dans [LAM] que la collection des multiplièdres peut être munie d'une structure de bimodule opéradique réalisant le bimodule opéradique $A_\infty - \text{Morph}$ encodant la notion de A_∞ -morphisme.

1.1.3. *Les espaces de modules d'arbres métriques enrubannés et leurs décompositions cellulaires.* Nous définissons dans la section 3 deux collections d'espaces de modules d'arbres métriques. D'abord, les espaces de modules d'arbres métriques enrubannés d'arité n , que l'on note \mathcal{T}_n . Ces espaces de modules se compactifient en autorisant les longueurs des arêtes internes à tendre vers l'infini. L'espace de modules compactifié $\overline{\mathcal{T}}_n$ est alors isomorphe à l'associaèdre K_n . Ces espaces de modules peuvent en fait être munis de deux décompositions cellulaires. La première, dite grossière, est celle donnant l'isomorphisme avec l'associaèdre K_n . La seconde, dite

fine, est déduite de la décomposition de \mathcal{T}_n comme union des espaces de modules d'arbres métriques $\mathcal{T}_n(t)$ modélisés sur un arbre enrubanné t . Voir le schéma 1 pour les deux décompositions de K_4 . L'image de cette décomposition fine sous le foncteur des chaînes cellulaires réalise alors l'opérade ΩBAs . C'est l'opérade quasi-libre engendrée en arité n par les arbres enrubannés t d'arité n , là où A_∞ est l'opérade quasi-libre engendrée en arité n par une unique corolle d'arité n . Cette opérade, qui peut être également construite comme image de l'opérade As sous les foncteurs opéradiques bar B et cobar Ω , donne un modèle alternatif pour la notion d'algèbre fortement associative à homotopie près.

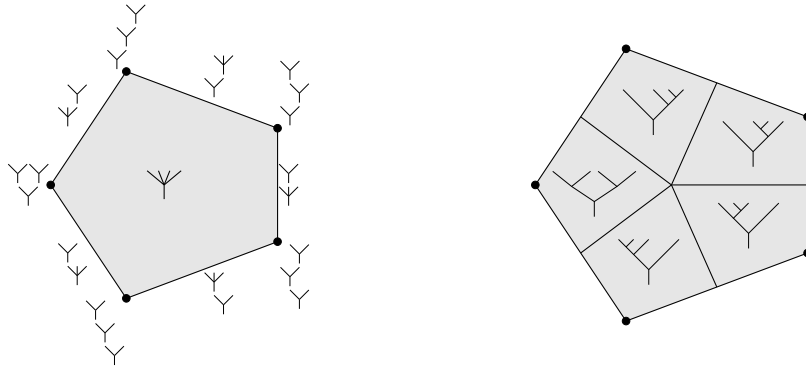

FIGURE 1 – L'associaèdre K_4 muni de sa décomposition A_∞ à gauche et de sa décomposition ΩBAs à droite

1.1.4. *Les espaces de modules d'arbres métriques jaugés et enrubannés et leurs décompositions cellulaires.* Nous définissons ensuite les espaces de modules d'arbres métriques enrubannés et jaugés d'arité n , également appelé arbres métriques 2-colorés enrubannés, et que l'on note \mathcal{CT}_n . Ces espaces de modules admettent également une compactification naturelle en autorisant les longueurs des arêtes internes à tendre vers l'infini, en tenant cette fois compte des relations sur les longueurs imposées par les couleurs de l'arbre 2-coloré sous-jacent. Sa compactification $\overline{\mathcal{CT}}_n$ est alors isomorphe au multiplièdre J_n . Il peut à son tour être muni de deux décompositions cellulaires. La première est à nouveau appelée grossière et est déduite de l'isomorphisme avec le multiplièdre J_n . La deuxième, appelée fine, est celle découlant de la décomposition de \mathcal{CT}_n comme union des espaces de modules d'arbres métriques $\mathcal{CT}_n(t_c)$ modélisés sur un arbre 2-coloré enrubanné t_c . Nous renvoyons au schéma 2 pour une illustration des deux décompositions de J_3 . L'image de cette décomposition fine sous le foncteur des chaînes cellulaires définit cette fois un nouveau bimodule opéradique : le bimodule opéradique $\Omega BAs - \text{Morph}$ qui encode la notion nouvelle d'un ΩBAs -morphisme entre ΩBAs -algèbres.

DÉFINITION 16. Un ΩBAs -morphisme correspond à la donnée d'une opération pour chaque type d'arbre 2-coloré enrubanné, et dont la différentielle est modélée sur le bord de codimension 1 de l'espace de module $\mathcal{CT}_n(t_c)$ dans $\overline{\mathcal{CT}}_n$. Nous notons $\Omega BAs - \text{Morph}$ le bimodule opéradique encodant cette notion.

1.1.5. *Signes et étude détaillée des espaces de modules et des polytopes.* Dans les sections 4 et 5, nous nous attelons à une étude détaillée des signes apparaissant dans les équations des A_∞ et ΩBAs -algèbres et des A_∞ et ΩBAs -morphisms. Nous donnons en particulier des réalisations explicites des associaèdres K_n et des multiplièdres J_n , reprises de [MTTV21] et [LAM], et montrons que les conventions de signes pour les A_∞ -algèbres et A_∞ -morphisms que nous utilisons dans cet article sont dictées par la structure du bord de ces polytopes. Nous rappelons également la définition de l'opérade ΩBAs utilisée dans [MS06], et recourons au

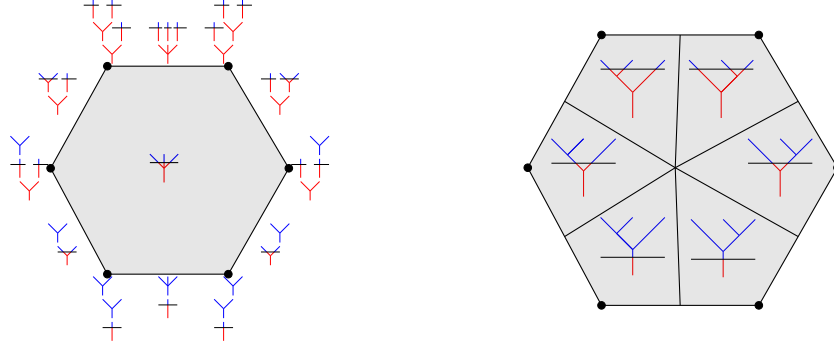

FIGURE 2 – Le multiplièdre J_3 muni de sa décomposition A_∞ à gauche et de sa décomposition ΩBAs à droite

langage de cet article pour définir rigoureusement le bimodule opéradique $\Omega BAs - \text{Morph}$. La majeure partie de la section 5 est consacrée à l'étude détaillée des signes apparaissant dans le bord des espaces de modules compactifiés $\overline{\mathcal{CT}}_n$. Nous utilisons enfin les réalisations explicites de K_n et de J_n pour donner une preuve géométrique de la proposition suivante.

PROPOSITIONS 2 ET 3. *Il existe un morphisme d'opérades $A_\infty \rightarrow \Omega BAs$ et un morphisme de bimodules opéradiques $A_\infty - \text{Morph} \rightarrow \Omega BAs - \text{Morph}$. En particulier, une structure de ΩBAs -algèbre induit naturellement une structure de A_∞ -algèbre et un ΩBAs -morphisme entre ΩBAs -algèbres induit naturellement un A_∞ -morphisme entre A_∞ -algèbres.*

1.2. Géométrie. La partie 2 est consacrée à la réalisation en théorie de Morse des espaces de modules d'arbres métriques \mathcal{T}_n et \mathcal{CT}_n comme espaces de modules d'arbres de gradient perturbé. Nous travaillons dans cette partie avec une fonction de Morse f définie sur une variété riemannienne fermée et orientée M et satisfaisant la condition de Morse-Smale.

1.2.1. *La structure de ΩBAs -algèbre sur les cochaînes de Morse.* Nous rappelons dans la section 1 la notion d'arbre de gradient (perturbé) associé à une donnée de perturbation sur un arbre métrique enrubanné telle que définie dans [Abo11]. La langage que nous utilisons pour décrire ces données de perturbation est tiré de [Mes18]. Étant donné un type d'arbre enrubanné t d'arité n , ainsi qu'une collection de points critiques x_1, \dots, x_n, y de la fonction f , nous définissons l'espace de modules

$$\mathcal{T}_t^{\mathbb{X}_t}(y; x_1, \dots, x_n)$$

des arbres de gradient modélés sur t , associés à un choix de données de perturbation \mathbb{X}_t sur l'espace $\mathcal{T}_n(t)$, et reliant les points critiques x_1, \dots, x_n au point critique y . Sous une hypothèse satisfaite génériquement sur les données de perturbation \mathbb{X}_t , ces espaces de modules sont des variétés orientables dont la dimension dépend de l'indice des points critiques et de l'arbre t . Sous de nouvelles hypothèses dites *admissibles* sur les données de perturbation \mathbb{X} , les espaces de modules d'arbres de gradient de dimension 1 admettent alors une compactification en une variété à bord de dimension 1 et dont le bord est modélé sur le bord des espaces de modules $\mathcal{T}_n(t)$. Nous prouvons alors les deux théorèmes suivants.

THÉORÈME 7. *Il existe un choix de données de perturbation admissible sur la collection des espaces de modules \mathcal{T}_n .*

THÉORÈME 9. Soit \mathbb{X} un choix de données de perturbation admissible sur les espaces de modules \mathcal{T}_n . On définit pour tout arbre enrubanné t d'arité n l'opération m_t comme

$$m_t : C^*(f) \otimes \cdots \otimes C^*(f) \longrightarrow C^*(f)$$

$$x_1 \otimes \cdots \otimes x_n \longmapsto \sum_{|y|=\sum_{i=1}^n |x_i|-e(t)} \#\mathcal{T}_t^{\mathbb{X}}(y; x_1, \dots, x_n) \cdot y .$$

Cette collection d'opérations définit alors une structure de ΩBAs -algèbre sur les cochaînes de Morse $C^*(f)$.

Cette structure de ΩBAs -algèbre sur $C^*(f)$ est plus canonique que la structure de A_∞ -algèbre de [Abo11], car elle résulte du choix de décomposition cellulaire des espaces de modules \mathcal{T}_n qui s'impose naturellement lorsqu'on souhaite les réaliser en théorie de Morse. Notons également que l'on retrouve la structure de A_∞ -algèbre sur $C^*(f)$ en appliquant la Proposition 2.

1.2.2. *ΩBAs -morphisms entre cochaînes de Morse.* Soient f et g deux fonctions de Morse sur M . Choisissons deux données de perturbation admissibles \mathbb{X}_f et \mathbb{X}_g définissant une structure de ΩBAs -algèbre respectivement sur $C^*(f)$ et $C^*(g)$. Nous construisons dans la section 2 un ΩBAs -morphisme de $C^*(f)$ vers $C^*(g)$, en réalisant cette fois les espaces de modules \mathcal{CT}_n comme espaces de modules d'arbres de gradient : pour un arbre 2-coloré t_c , les arêtes situées au-dessus de la jauge correspondent alors à des trajectoires de gradient perturbé de f , et celles en-dessous de la jauge à des trajectoires de gradient perturbé de g . Pour un choix de données de perturbation \mathbb{Y}_{t_c} sur $\mathcal{CT}_n(t_c)$ on note ces espaces de modules

$$\mathcal{CT}_{t_c}^{\mathbb{Y}}(y; x_1, \dots, x_n)$$

où $x_1, \dots, x_n \in \text{Crit}(f)$ et $y \in \text{Crit}(g)$. On dispose alors des mêmes résultats que précédemment. Sous de nouvelles hypothèses d'admissibilité sur les données de perturbation \mathbb{Y} sur les espaces de modules \mathcal{CT}_n , les espaces de modules d'arbres de gradient 2-colorés de dimension 1 admettent alors une compactification en une variété à bord de dimension 1 et dont le bord est modelé sur le bord des espaces de modules $\mathcal{CT}_n(t_c)$. On portera toutefois attention au fait que les choix de données de perturbation sur \mathcal{CT}_n doivent en plus être compatibles avec \mathbb{X}_f et \mathbb{X}_g .

THÉORÈME 10. Il existe un choix de donnée de perturbations admissible sur les espaces de modules \mathcal{CT}_n qui est compatible avec les données de perturbation \mathbb{X}_f et \mathbb{X}_g .

THÉORÈME 12. Soit \mathbb{Y} un tel choix de données de perturbation admissible sur \mathcal{CT}_n . On définit pour tout arbre enrubanné t_c d'arité n l'opération μ_{t_c} comme

$$\mu_{t_c}^{\mathbb{Y}} : C^*(f) \otimes \cdots \otimes C^*(f) \longrightarrow C^*(g)$$

$$x_1 \otimes \cdots \otimes x_n \longmapsto \sum_{|y|=\sum_{i=1}^n |x_i|+|t_c|} \#\mathcal{CT}_{t_c}^{\mathbb{Y}}(y; x_1, \dots, x_n) \cdot y .$$

Ces opérations définissent alors un ΩBAs -morphisme $\mu^{\mathbb{Y}} : (C^*(f), m_t^{\mathbb{X}^f}) \rightarrow (C^*(g), m_t^{\mathbb{X}^g})$.

En munissant $C^*(f)$ et $C^*(g)$ de leurs structures de A_∞ -algèbre induites, le Théorème 12 couplé à la Proposition 3 fournit en particulier un A_∞ -morphisme de $C^*(f)$ vers $C^*(g)$.

1.2.3. *Transversalité, orientations et signes.* Les sections 3 et 4 sont consacrées à la preuve des propositions et théorèmes des sections 1 et 2. Dans la section 3, on montre l'existence de données de perturbation admissibles en utilisant un argument de Taubes tiré de [MS12]. On traite la question des signes apparaissant dans les équations ΩBAs des Théorèmes 9 et 12 dans la section 4. Cela implique de comprendre les orientations définies sur les espaces de modules d'arbres de gradient utilisés dans la définition des opérations ΩBAs . Nous utilisons à cet effet le langage idoine des suites exactes courtes signées de fibrés vectoriels. Nous prouvons en particulier

un lemme technique permettant de construire des applications de recollement pour ces espaces de modules. Nous montrons de plus que les opérations définies dans les Théorèmes 9 et 12 satisfont bien les équations ΩBAs , au détail près qu'il est nécessaire de modifier par un signe la différentielle apparaissant dans $[\partial_{Morse}, m_t]$ et $[\partial_{Morse}, \mu_{t_c}]$.

1.3. Perspectives. Nous montrons dans la section 1 de la partie 3 la proposition suivante :

PROPOSITION 20. *Le ΩBAs -morphisme $\mu^{\mathbb{Y}} : (C^*(f), m_t^{\mathbb{X}^f}) \rightarrow (C^*(g), m_t^{\mathbb{X}^g})$ construit dans le Théorème 12 est un quasi-isomorphisme.*

La section 2 est consacrée à une suite de remarques sur l'équivalence des points de vue A_∞ et ΩBAs comme modèles pour les algèbres fortement associatives à homotopie près et leurs morphismes préservant le produit à homotopie près. La section 3 explique de manière concise comment les structures A_∞ apparaissent plus généralement en topologie symplectique. Nous donnons en fait de plus amples détails à ce sujet dans le chapitre 1 de la partie 3 de ce manuscrit. On détaille finalement dans la section 4 deux problématiques majeures découlant naturellement des constructions effectuées dans cet article.

2. Higher algebra of A_∞ and ΩBAs -algebras in Morse theory II

Ce deuxième article est également disponible sur arXiv (2102.08996, 79 pages) et soumis pour publication. La numérotation des pages que nous utiliserons dans sa reproduction dans la partie 2 est celle de l'article original. La première problématique formulée à la fin de [Maz21b] constitue son point de départ et se formule de la manière suivante. Soient f, g deux fonctions de Morse, \mathbb{X}^f et \mathbb{X}^g deux choix de données de perturbation sur \mathcal{T}_n et \mathbb{Y} et \mathbb{Y}' deux choix de données de perturbation sur \mathcal{CT}_n compatibles à \mathbb{X}^f et \mathbb{X}^g . Le morphisme $\mu^{\mathbb{Y}}$ est-il toujours homotope au morphisme $\mu^{\mathbb{Y}'}$ au sens des A_∞ -morphisms ou des ΩBAs -morphisms? Autrement dit, est-il toujours possible de remplir le diagramme suivant (au sens A_∞ ou ΩBAs)

$$\begin{array}{ccc} & \mu^{\mathbb{Y}} & \\ \curvearrowright & \Downarrow & \curvearrowleft \\ C^*(f) & & C^*(g) \quad ? \\ \curvearrowleft & \mu^{\mathbb{Y}'} & \end{array}$$

Comment se formule alors rigoureusement, en algèbre supérieure, l'unicité à homotopie près de tels morphismes géométriques ?

2.1. Morphismes supérieurs entre A_∞ et ΩBAs -algèbres.

2.1.1. *Définition des morphismes supérieurs entre A_∞ -algèbres.* Nous débutons la partie 1 en définissant dans la section 1 une notion satisfaisante de A_∞ -homotopie entre A_∞ -morphisms, et plus généralement de *morphismes supérieurs* (ou *homotopies supérieures*) entre A_∞ -algèbres. Nous commençons à cet effet par rappeler la définition d'une A_∞ -homotopie donnée dans [LH02] et ses différentes formulations équivalentes en terme de construction bar et d'opérations. L'argument crucial est que l'on peut voir la catégorie des A_∞ -algèbres avec les A_∞ -morphisms comme une sous-catégorie pleine de la catégorie des dg-cogèbres $\mathbf{A}_\infty - \mathbf{alg} \subset \mathbf{dg} - \mathbf{Cog}$. Nous définissons ensuite la dg-cogèbre cosimpliciale Δ^n , munie du coproduit de Alexander-Whitney. Nous rappelons également le langage des partitions chevauchantes d'un simplexe de [MS03], qui apparaît naturellement dans la combinatoire du coproduit de Alexander-Whitney.

DÉFINITION 6. Soient A et B deux A_∞ -algèbres. Un n -morphisme de A vers B est défini comme un morphisme de dg-cogèbres

$$F : \Delta^n \otimes \overline{T}(sA) \longrightarrow \overline{T}(sB) .$$

En utilisant la propriété universelle de la construction bar, cette définition se reformule bien en termes opéradiques :

DÉFINITION 7. Soient A et B deux A_∞ -algèbres. Un n -morphisme de A vers B correspond de manière équivalente à la donnée d'une collection d'applications $f_I^{(m)} : A^{\otimes m} \longrightarrow B$ de degrés respectifs $1 - m + |I|$ pour $I \subset \Delta^n$ et $m \geq 1$, et qui satisfont les équations suivantes,

$$[\partial, \text{ }_I \text{ } \text{ }] = \sum_{j=0}^{\dim(I)} (-1)^j \text{ }_{\partial_j^{\text{in}} I} \text{ } + \sum_{I_1 \cup \dots \cup I_s = I} \pm \text{ }_{I_1} \text{ } \dots \text{ }_{I_s} \text{ } + \sum \pm \text{ }_I \text{ } ,$$

où les opérations m_n^B sont représentées par les corolles rouges $\text{ } \text{ }$, les opérations m_n^A par les corolles bleues $\text{ } \text{ }$ et les opérations $f_I^{(m)}$ par les corolles 2-colorées $\text{ }_I \text{ } \text{ }$.

Les A_∞ -morphisms correspondent alors bien aux 0-morphisms et les A_∞ -homotopies correspondent bien aux 1-morphisms. Nous formulons une troisième définition équivalente de la notion de n -morphisme dans la Proposition 2 :

PROPOSITION 2. Soient A et B deux A_∞ -algèbres. Un n -morphisme de A vers B se définit de manière équivalente comme un A_∞ -morphisme $A \rightarrow \Delta_n \otimes B$.

Dans cette proposition, Δ_n est la dg-algèbre duale de Δ^n et $\Delta_n \otimes B$ est muni de la structure de A_∞ -algèbre déduite des structures de dg-algèbre sur Δ_n et de A_∞ -algèbre sur B .

2.1.2. *Les n -multiplièdres.* L'objectif de la section 2 est de construire une famille de polytopes $n - J_m$ appelés n -multiplièdres et encodant la notion de n -morphisme entre A_∞ -algèbres, de la même manière que les associaèdres encodent la structure de A_∞ -algèbre et les multiplièdres encodent la notion de A_∞ -morphisme. Nous commençons à cet effet par rappeler le relèvement du coproduit de Alexander-Whitney en une application polytopale $AW : \Delta^n \rightarrow \Delta^n \times \Delta^n$ défini dans [MTTV21]. Nous montrons alors dans la Proposition 6 que les applications $AW^{os} := (\text{id}^{\times(s-1)} \times AW) \circ \dots \circ (\text{id} \times AW) \circ AW$ induisent un raffinement de la décomposition polytopale de Δ^n , dont les faces de dimension maximale sont en correspondance bijective avec les partitions chevauchantes de Δ^n . Nous définissons enfin des applications polytopales $AW_{\mathbf{a}}$ généralisant les itérées AW^{os} et induisant une décomposition polytopale de Δ^n identique à celle décrite pour les applications AW^{os} . Nous pouvons alors définir les n -multiplièdres $n - J_m$ comme suit :

DÉFINITION 12. Le n -multiplièdre $n - J_m$ est défini comme le polytope $\Delta^n \times J_m$ muni d'une décomposition polytopale plus fine construite à l'aide des subdivisions de Δ^n induites par les applications $AW_{\mathbf{a}}$. Il modèlè la combinatoire des équations A_∞ pour les n -morphisms.

Le 1-multiplièdre $1 - J_3$ est représenté sur le schéma 3.

2.1.3. *Morphisms supérieurs entre ΩBAs -algèbres.* Dans la section 3, nous définissons de manière similaire la notion d'un n -morphisme entre ΩBAs -algèbres.

DÉFINITION 13. Un n -morphisme entre ΩBAs -algèbres est encodé par le bimodule opéradique quasi-libre engendré par les paires (face $I \subset \Delta^n$, arbre 2-coloré enrubanné),

$$n - \Omega BAs - \text{Morph} := \mathcal{F}^{\Omega BAs, \Omega BAs}(\text{ }_I \text{ } , \text{ }_I \text{ } , \text{ }_I \text{ } , \text{ }_I \text{ } , \dots , (I, \text{SCRT}_n), \dots ; I \subset \Delta^n) ,$$

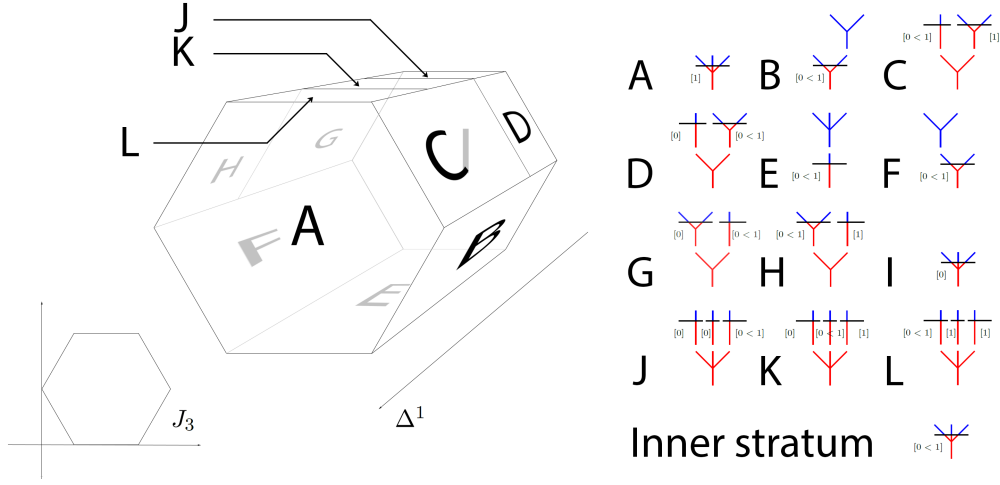
 FIGURE 3 – Le 1-multiplièdre $\Delta^1 \times J_3$

où $SCRT_n$ désigne l'ensemble des types d'arbres 2-colorés enrubannés t_c . Une opération $t_{I,c} := (I, t_c)$ est de degré $|t_{I,c}| := |I| + |t_c|$. Sa différentielle est donnée par la règle prescrite par le bord de l'espace de modules compactifié $\overline{\mathcal{CT}}_m(t_c)$ que l'on combine à la combinatoire des partitions chevauchantes, et à laquelle on ajoute la différentielle simpliciale de I . Autrement dit,

$$\partial t_{I,c} = t_{\partial \text{sing } I,c} + \pm (\partial \overline{\mathcal{CT}}_m t_c)_I .$$

Ces morphismes supérieurs entre ΩBAs -algèbres sont encodés par les n -multiplièdres $n - J_m$ munis d'une décomposition polytopale plus fine : le facteur J_m de $\Delta^n \times J_m$ est cette fois muni de sa décomposition ΩBAs et non plus de sa décomposition A_∞ . Les n -multiplièdres encodent la notion de n -morphisme entre A_∞ -algèbres lorsqu'ils sont munis de leur décomposition A_∞ , et la notion de n -morphisme entre ΩBAs -algèbres lorsqu'ils sont munis de leur décomposition ΩBAs . On en déduit donc la proposition suivante.

PROPOSITION 9. *Un n -morphisme entre ΩBAs -algèbres induit naturellement un n -morphisme entre A_∞ -algèbres.*

2.1.4. Signes pour les morphismes supérieurs. Nous détaillons dans la section 4 les conventions de signe des équations A_∞ pour les morphismes supérieurs. Ces conventions de signe sont en particulier dictées par le bord de réalisations explicites des n -multiplièdres. Nous définissons finalement la notion de n -morphisme entre ΩBAs -algèbres dans de plus grands détails, en prêtant de nouveau une attention particulière aux calculs de signes.

2.2. Les ensembles simpliciaux $\text{HOM}_{A_\infty\text{-Alg}}(A, B)_\bullet$. La collection des dg-cogèbres Δ^n formant une dg-cogèbre cosimpliciale, les morphismes supérieurs entre deux A_∞ -algèbres A et B s'agencent naturellement en un ensemble simplicial

$$\text{HOM}_{A_\infty\text{-Alg}}(A, B)_\bullet := \text{Hom}_{\text{dg-Cog}}(\Delta^\bullet \otimes \overline{T}(sA), \overline{T}(sB)) .$$

La partie 2 a pour but d'étudier les propriétés de cet ensemble simplicial.

2.2.1. ∞ -catégories, complexes de Kan et résolutions cosimpliciales. Nous rappelons à cet effet dans la section 1 quelques notions de base sur les ∞ -catégories. Une ∞ -catégorie est un ensemble simplicial X admettant la propriété de relèvement à gauche pour toutes les inclusions de cornets internes $\Lambda_n^k \rightarrow \Delta^n$, où $n \geq 2$ et $0 < k < n$. La notion d'une ∞ -catégorie fournit un modèle alternatif à celui d'une A_∞ -catégorie pour la notion de "catégorie dont la composition est

associative à homotopie près". Si X admet également la propriété de relèvement à gauche pour toutes les inclusions de cornets externes $\Lambda_n^k \rightarrow \Delta^n$, où $n \geq 2$ et $k = 0, n$, on parle alors d'un *complexe de Kan*. Nous rappelons également un lemme de [Hir03] sur les résolutions cosimpliciales dans les catégories de modèles, qui sera crucial dans la preuve du Théorème 1.

2.2.2. *Le complexe de Kan $\mathrm{HOM}_{A_\infty\text{-Alg}}(A, B)_\bullet$.* Nous formulons l'un des théorèmes principaux de cet article dans la section 2.

THÉORÈME 1. *Si A et B sont deux A_∞ -algèbres, alors l'ensemble simplicial $\mathrm{HOM}_{A_\infty}(A, B)_\bullet$ est un complexe de Kan.*

Si l'on s'intéresse uniquement à la structure de ∞ -catégorie de $\mathrm{HOM}_{A_\infty\text{-Alg}}(A, B)_\bullet$, on peut en fait entièrement décrire les remplissages de cornets internes $\Lambda_n^k \rightarrow \Delta^n$.

PROPOSITION 11. *Soit $\Lambda_n^k \subset \Delta^n$ un cornet interne de Δ^n . On dispose alors d'une correspondance bijective entre les remplissages*

$$\begin{array}{ccc} \Lambda_n^k & \longrightarrow & \mathrm{HOM}_{A_\infty}(A, B)_\bullet \\ \downarrow & \nearrow & \\ \Delta^n & & \end{array}$$

et les familles de morphismes $f_{\Delta^n}^{(m)} : A^{\otimes m} \rightarrow B$ de degré $1 - m - n$ où $m \geq 1$. Dit autrement, le complexe de Kan $\mathrm{HOM}_{A_\infty}(A, B)_\bullet$ est en particulier une ∞ -catégorie algébrique.

Tandis que la preuve du Théorème 1 utilise le lemme de [Hir03] sur les résolutions cosimpliciales dans la catégorie de modèles $\mathbf{dg}\text{-Cogc}$ des dg-cogèbres cocomplètes, la Proposition 11 admet une preuve purement combinatoire en utilisant la définition des n -morphisms du point de vue opéradique. Nous calculons ensuite de manière explicite tous les groupes d'homotopie simpliciaux du complexe de Kan $\mathrm{HOM}_{A_\infty\text{-Alg}}(A, B)_\bullet$ ainsi que leur loi de composition dans le Théorème 2.

2.2.3. *n - A_∞ -foncteurs et pré-transformations naturelles entre A_∞ -catégories.* Dans la section 3, nous commençons par généraliser la notion d'un n -morphisme entre A_∞ -algèbres à celle d'un n -foncteur entre A_∞ -catégories. Les 0-foncteurs correspondent alors toujours aux A_∞ -foncteurs et les 1-foncteurs correspondent aux A_∞ -homotopies entre A_∞ -foncteurs. Nous définissons également l'ensemble simplicial $\mathrm{HOM}_{A_\infty\text{-Cat}}(\mathcal{A}, \mathcal{B})_\bullet$ formé des foncteurs supérieurs entre les A_∞ -catégories \mathcal{A} et \mathcal{B} . Nous nous attendons à ce que cet ensemble simplicial soit à nouveau un complexe de Kan, en adaptant la preuve du Théorème 1 au cadre de la théorie de l'homotopie des dg-cocatégories.

Nous comparons ensuite l'ensemble simplicial $\mathrm{HOM}_{A_\infty\text{-Cat}}(\mathcal{A}, \mathcal{B})_\bullet$ à la A_∞ -catégorie des A_∞ -foncteurs $\mathrm{Func}_{\mathcal{A}, \mathcal{B}}$ définie par Fukaya dans [Fuk02]. En appliquant à cette A_∞ -catégorie le nerf simplicial N_{A_∞} défini par Faonte dans [Fao17], on obtient en effet un nouvel ensemble simplicial $N_{A_\infty}(\mathrm{Func}_{\mathcal{A}, \mathcal{B}})$ qui a la propriété d'être une ∞ -catégorie. Nous en explicitons en particulier les n -simplexes. Nous expliquons ensuite pourquoi les ensembles simpliciaux $\mathrm{HOM}_{A_\infty\text{-Cat}}(\mathcal{A}, \mathcal{B})_\bullet$ et $N_{A_\infty}(\mathrm{Func}_{\mathcal{A}, \mathcal{B}})$ diffèrent fondamentalement l'un de l'autre. Les simplexes de $\mathrm{HOM}_{A_\infty\text{-Cat}}(\mathcal{A}, \mathcal{B})_\bullet$ correspondent à des homotopies supérieures, tandis que les simplexes de $N_{A_\infty}(\mathrm{Func}_{\mathcal{A}, \mathcal{B}})$ doivent être interprétés comme des transformations naturelles supérieures entre les A_∞ -catégories \mathcal{A} et \mathcal{B} . L'ensemble simplicial $\mathrm{HOM}_{A_\infty\text{-Cat}}(\mathcal{A}, \mathcal{B})_\bullet$ est donc un complexe de Kan car une homotopie est toujours inversible à homotopie près, tandis que l'ensemble simplicial $N_{A_\infty}(\mathrm{Func}_{\mathcal{A}, \mathcal{B}})$ est une ∞ -catégorie car un A_∞ -foncteur n'est pas nécessairement toujours inversible à homotopie près.

2.2.4. *La ∞ -catégorie des A_∞ -algèbres ?* Dans la section 4, nous nous intéressons au problème du relèvement de la composition des A_∞ -morphisms aux $n - A_\infty$ -morphisms. L'objectif est ici de montrer que les ensembles simpliciaux $\text{HOM}_{A_\infty\text{-alg}}(A, B)_\bullet$ forment en fait un enrichissement simplicial de la catégorie $A_\infty\text{-alg}$. Nous détaillons à cet effet deux approches. La première utilise la formulation $\Delta^n \otimes \overline{T}(sA) \rightarrow \overline{T}(sB)$ pour les n -morphisms. Nous montrons que du fait que le coproduit de Alexander-Whitney vu comme morphisme de la dg-cogèbre Δ^n vers la dg-cogèbre $\Delta^n \otimes \Delta^n$ n'est pas compatible aux coproduits, l'approche naturelle pour composer les morphisms supérieurs en utilisant cette définition ne peut aboutir. On peut toutefois montrer que le morphisme de Alexander-Whitney s'étend en fait en un A_∞ -morphisme de la dg-cogèbre Δ^n vers la dg-cogèbre $\Delta^n \otimes \Delta^n$. La deuxième approche consiste à utiliser la Proposition 2 et à définir un n -morphisme comme un A_∞ -morphisme $A \rightarrow \Delta_n \otimes B$. En utilisant la donnée d'une diagonale sur le multiplèdre (voir par exemple [LAM]), il est alors possible de relever la composition sur les A_∞ -morphisms à une composition sur les morphisms supérieurs. Savoir si cette composition respecte bien les faces et dégénérescences simpliciales et si elle est associative demeure toutefois une question ouverte que nous comptons étudier dans le futur. S'en suit finalement une discussion sur les travaux de Faonte, Lyubashenko, Fukaya et Bottman traitant de la preuve d'un résultat de nature similaire utilisant les A_∞ -catégories $\text{Func}_{A,B}$. Nous renvoyons au chapitre 1 de la partie 3 de ce manuscrit pour plus de détails au sujet de leurs travaux.

2.3. Morphismes supérieurs en théorie de Morse.

2.3.1. *Construction de morphismes supérieurs entre ΩBAs -algèbres en théorie de Morse.* Dans la section 1, nous réalisons en théorie de Morse cette algèbre supérieure des ΩBAs -algèbres. Dit autrement, nous construisons des morphismes supérieurs géométriques entre les ΩBAs -algèbres de deux fonctions de Morse $(C^*(f), m_t^{\mathbb{X}^f})$ et $(C^*(g), m_t^{\mathbb{X}^g})$. Nous définissons à cet effet la notion de n -simplexe de données de perturbation $\mathbb{Y}_{\Delta^n, t_c}$ sur les espaces de modules $\mathcal{CT}(t_c)$. Soient x_1, \dots, x_m des points critiques de la fonction de Morse f et y un point critique de g . On peut alors définir l'espace de modules

$$\mathcal{CT}_{\Delta^n, t_c}^{\mathbb{Y}_{\Delta^n, t_c}}(y; x_1, \dots, x_m) := \bigcup_{\delta \in \hat{\Delta}^n} \mathcal{CT}_{t_c}^{\mathbb{Y}_{\delta, t_c}}(y; x_1, \dots, x_m).$$

Sous certaines hypothèses génériques sur $\mathbb{Y}_{\Delta^n, t_c}$, cet espace de modules est une variété orientable dont la dimension dépend de t_c , n et des indices de x_1, \dots, x_m et y . Nous détaillons alors des conditions de compatibilité pour le recollement sur les n -simplexes de données de perturbations : elles sont choisies de sorte à ce qu'un espace de modules $\mathcal{CT}_{\Delta^n, t_c}(y; x_1, \dots, x_m)$ de dimension 1 se compactifie en une variété orientable dont le bord est modelé sur les équations ΩBAs pour les n -morphisms. La formulation de ces conditions de recollement utilise en particulier le relèvement du coproduit de Alexander-Whitney au niveau des polytopes AW que nous avons utilisé pour définir les n -multiplèdres. Un n -simplexe de données de perturbation vérifiant ces conditions est dit *admissible*.

THÉORÈME 4. *Il existe un n -simplexe de données de perturbations admissible et compatible avec les données de perturbation \mathbb{X}^f et \mathbb{X}^g .*

THÉORÈME 6. *Soit $(\mathbb{Y}_{I,m})_{I \subset \Delta^n}^{m \geq 1}$ un n -simplexe de données de perturbation admissible. On définit pour tout arbre 2-coloré t_c et tout $I \subset \Delta^n$ l'opération μ_{I, t_c} comme*

$$\begin{aligned} \mu_{I, t_c} : C^*(f) \otimes \cdots \otimes C^*(f) &\longrightarrow C^*(g) \\ x_1 \otimes \cdots \otimes x_m &\longmapsto \sum_{|y| = \sum_{i=1}^m |x_i| + |t_{I,c}|} \#\mathcal{CT}_{I, t_c}^{\mathbb{Y}_{I, t_c}}(y; x_1, \dots, x_m) \cdot y. \end{aligned}$$

Ces opérations définissent alors un n -morphisme entre les ΩBAs -algèbres des cochaînes de Morse $(C^*(f), m_t^{\mathbb{X}^f})$ et $(C^*(g), m_t^{\mathbb{X}^g})$.

Il apparaît de plus clair qu'étant donné deux variétés symplectiques M et N , cette construction en théorie de Morse devrait pouvoir s'adapter en théorie de Floer pour définir des n -foncteurs géométriques entre les catégories de Fukaya $\text{Fuk}(M)$ et $\text{Fuk}(N)$. Ces n -foncteurs seraient définis par des comptages de disques cousus pseudo-holomorphes dont la couture s'envoie sur une correspondance lagrangienne de M_0 vers M_1 . L'étude de tels espaces de modules fait l'objet de l'article [MWW18] et nous renvoyons à la sous-section 2.1 de la partie 3 de ce manuscrit pour plus de détails à ce sujet.

2.3.2. *Propriétés de remplissage pour les morphismes supérieurs géométriques.* Définissons pour tout $n \geq 0$,

$$\text{HOM}_{\Omega BAs}^{\text{geom}}(C^*(f), C^*(g))_n \subset \text{HOM}_{\Omega BAs}(C^*(f), C^*(g))_n$$

le sous-ensemble des n -morphismes μ de $C^*(f)$ vers $C^*(g)$ pour lesquels il existe un n -simplexe de données de perturbation \mathbb{Y}_{Δ^n} tel que $\mu = \mu^{\mathbb{Y}_{\Delta^n}}$. On dispose alors des propriétés de remplissage suivantes.

THÉORÈMES 7 ET 8. *Pour tout choix de données de perturbations admissibles \mathbb{Y}_S paramétré par un sous-complexe simplicial $S \subset \Delta^n$, il existe un n -simplexe admissible de données de perturbation \mathbb{Y}_{Δ^n} qui étend \mathbb{Y}_S . Par conséquent, l'ensemble $\text{HOM}_{\Omega BAs}^{\text{geom}}(C^*(f), C^*(g))_n$ définit bien un ensemble simplicial qui est un sous-ensemble simplicial de $\text{HOM}_{\Omega BAs}(C^*(f), C^*(g))_{\bullet}$. L'ensemble simplicial $\text{HOM}_{\Omega BAs}^{\text{geom}}(C^*(f), C^*(g))_{\bullet}$ est de plus alors un complexe de Kan qui est contractile.*

En corollaire direct de ce théorème se trouve la réponse à la problématique ayant initialement motivé cet article.

COROLLAIRE 1. *Soient \mathbb{Y} et \mathbb{Y}' deux choix de données de perturbation admissibles sur les espaces de modules \mathcal{CT}_m . Alors les morphismes $\mu^{\mathbb{Y}}$ et $\mu^{\mathbb{Y}'}$ sont toujours homotopes en tant que ΩBAs -morphisms,*

$$\begin{array}{ccc} C^*(f) & \xrightarrow{\mu^{\mathbb{Y}}} & C^*(g) \\ & \Downarrow & \\ C^*(f) & \xrightarrow{\mu^{\mathbb{Y}'}} & C^*(g) \end{array} \quad .$$

Suit finalement la section 2 contenant les détails techniques sur les arguments de transversalité, les orientations des espaces de modules et les signes, et les preuves des Théorèmes 4 et 7. Les arguments analytiques invoqués sont en particulier de même nature que ceux utilisés dans notre premier article.

3. Développements et pistes de recherche futures

3.1. Algèbre supérieure des arbres multi-jagés et des surfaces cousues. Commençons par formuler la deuxième problématique découlant de notre premier article. Considérons trois fonctions de Morse f_0, f_1, f_2 , des données de perturbation admissibles \mathbb{X}^i et des données de perturbation admissibles \mathbb{Y}^{ij} définissant trois ΩBAs -morphisms

$$\begin{aligned} \mu^{\mathbb{Y}^{01}} &: (C^*(f_0), m_t^{\mathbb{X}^0}) \longrightarrow (C^*(f_1), m_t^{\mathbb{X}^1}) , \\ \mu^{\mathbb{Y}^{12}} &: (C^*(f_1), m_t^{\mathbb{X}^1}) \longrightarrow (C^*(f_2), m_t^{\mathbb{X}^2}) , \\ \mu^{\mathbb{Y}^{02}} &: (C^*(f_0), m_t^{\mathbb{X}^0}) \longrightarrow (C^*(f_2), m_t^{\mathbb{X}^2}) . \end{aligned}$$

Est-il possible de construire une ΩBAs -homotopie telle que $\mu^{\mathbb{Y}02} \simeq \mu^{\mathbb{Y}12} \circ \mu^{\mathbb{Y}01}$? Ce premier chapitre est consacré à la résolution de cette question ainsi qu'à une série de développements et d'idées autour de l'algèbre supérieure encodée par les espaces de modules d'arbres multi-jaugés et les espaces de modules de surfaces cousues.

3.1.1. *Espaces de modules d'arbres bijaugés métriques.* Nous débutons la section 1 par la définition d'une composition associative pour les ΩBAs -morphisms induisant la composition standard de ΩBAs -morphisms sous le morphisme de bimodules opéradiques $A_\infty - \text{Morph} \rightarrow \Omega BAs - \text{Morph}$. Nous décrivons ensuite les espaces de modules d'arbres métriques bijaugés $2\mathcal{GT}_m$ ainsi que leur compactification. Nous montrons alors que l'intuition première de réaliser une ΩBAs -homotopie entre les ΩBAs -morphisms $\mu^{\mathbb{Y}02}$ et $\mu^{\mathbb{Y}12} \circ \mu^{\mathbb{Y}01}$ en comptant des arbres de gradient bijaugés ne peut se réaliser de manière immédiate. La description des strates de bord des espaces de modules compactifiés $\overline{2\mathcal{GT}_m}$ ne correspond en effet pas à la combinatoire attendue d'une telle ΩBAs -homotopie, et certaines de ces strates sont de plus identifiées à des produits fibrés, donc ne se comportent pas de manière satisfaisante sous le foncteur des chaînes cellulaires. Si l'on souhaite produire une ΩBAs -homotopie $\mu^{\mathbb{Y}02} \simeq \mu^{\mathbb{Y}12} \circ \mu^{\mathbb{Y}01}$ il est donc nécessaire de trouver un argument supplémentaire s'appliquant directement au niveau de la théorie de Morse.

3.1.2. *Espaces de modules de disques cousus.* Mau, Wehrheim et Woodward rencontrent un problème de nature similaire dans [MWW18], en étudiant la composition de A_∞ -foncteurs géométriques entre catégories de Fukaya. Nous rappelons deux résultats majeurs de leurs travaux dans la section 2.

Nous décrivons dans un premier temps la construction de [MWW18] d'un A_∞ -foncteur $\phi_{\mathcal{L}01} : \text{Fuk}(M_0) \rightarrow \text{Fuk}(M_1)$ associé à une correspondance lagrangienne $\mathcal{L}01$ entre deux variétés symplectiques (fermées monotones) M_0 et M_1 . Ses opérations d'arité n sont définies par un comptage de disques cousus pseudo-holomorphes, dont le bord contient n points marqués et s'envoie sur des lagrangiennes de M_0 , et dont la couture s'envoie sur la correspondance lagrangienne $\mathcal{L}01$. Nous expliquons alors comment Mau, Wehrheim et Woodward parviennent à construire une A_∞ -homotopie $\phi_{\mathcal{L}01 \circ \mathcal{L}12} \simeq \phi_{\mathcal{L}12} \circ \phi_{\mathcal{L}01}$ où $\mathcal{L}01 \circ \mathcal{L}12$ désigne la composition géométrique de deux correspondances lagrangiennes $\mathcal{L}01$ et $\mathcal{L}12$, à travers un comptage de disques bicousus pseudo-holomorphes à points marqués sur leur bord et dont la première couture s'envoie sur $\mathcal{L}01$ et la deuxième sur $\mathcal{L}12$. Il est clair que leurs arguments devraient également s'appliquer dans le cas des ΩBAs -morphisms entre cochaînes de Morse, résolvant la question initiale de la section 1.

Nous décrivons ensuite leur construction d'un A_∞ -foncteur de catégorification

$$\text{Fuk}(M_0^- \times M_1) \longrightarrow \text{Func}(\text{Fuk}(M_0), \text{Fuk}(M_1))$$

défini par un comptage de disques cousus pseudo-holomorphes à points marqués sur leur bord et leur couture, et où $\text{Func}(\text{Fuk}(M_0), \text{Fuk}(M_1))$ désigne la A_∞ -catégorie des A_∞ -foncteurs de $\text{Fuk}(M_0)$ vers $\text{Fuk}(M_1)$. Il relève en fait au niveau dg le foncteur de 2-catégories $\text{Floer} \rightarrow \text{Cat}$ construit dans [WW10a], où Floer désigne la 2-catégorie dont les objets sont des variétés symplectiques et dont les catégories de morphismes sont les catégories de Donaldson $\text{Don}(M_0^- \times M_1)$.

3.1.3. *Vers la définition de la $(A_\infty, 2)$ -catégorie Symp .* La première question découlant naturellement du travail de [WW10a] est de savoir s'il est possible de relever leur construction au niveau dg, c'est-à-dire de remplacer les catégories de Donaldson $\text{Don}(M_0^- \times M_1)$ par des catégories de Fukaya $\text{Fuk}(M_0^- \times M_1)$. Tandis qu'une 2-catégorie peut être définie comme une catégorie enrichie en catégories, il n'existe toutefois pas pour le moment de notion satisfaisante d'une catégorie qui serait enrichie en A_∞ -catégories. Nous décrivons dans la section 3 les avancées de Bottman dans cette direction, qui se propose de définir une $(A_\infty, 2)$ -catégorie dont les objets seraient des variétés symplectiques fermées monotones M et les A_∞ -catégories de morphismes les catégories de Fukaya $\text{Fuk}(M_0^- \times M_1)$. Il conjecture que les espaces de modules $2\mathcal{M}_n$ de *witch*

curves, qui sont des sphères multi-cousues dont les coutures se rencontrent en un unique point, devraient encoder la notion recherchée d'une telle catégorie enrichie en A_∞ -catégories. Il montre de plus dans [Bot19b] que la compactification des espaces de modules $2\mathcal{M}_n$ admet une stratification qui se décrit de manière ad hoc par des polytope abstraits, appelés les *2-associaèdres* et définis dans [Bot19a]. Ces compactifications font toutefois de nouveau apparaître des produits fibrés dans leurs strates de bord, ce qui rend leur réalisation au niveau dg problématique.

Nous concluons cette section en formulant un ensemble de conjectures autour des liens entre les 2-associaèdres de [Bot19b] et les n -multiplièdres définis [Maz21b]. De manière sommaire, nous conjecturons que

- (i) Le polytope $[0, 1] \times J_m$ peut être muni d'une décomposition polytopale raffinée, contenant à la fois la décomposition polytopale du 2-associaèdre $2\overline{QD}_{m,1}$ et celle du 1-multiplièdre $1 - J_m$.
- (ii) Les espaces de modules compactifiés de disques à n coutures et $m + 1$ points marqués sur leur bord $n\overline{QD}_{m,1}$ devraient permettre de définir des diagrammes de $(n - 1) - A_\infty$ foncteurs entre catégories de Fukaya.

Ces deux conjectures sont illustrées dans le schéma 4. On représente à gauche la décomposition polytopale sur $[0, 1] \times J_3$ raffinant celles du 2-associaèdre $2\overline{QD}_{3,1}$ et du 1-multiplièdre $1 - J_3$. Le diagramme de droite correspond à un diagramme dont les sommets sont des A_∞ -foncteurs, les 1-flèches de A_∞ -homotopies et les 2-flèches des $2 - A_\infty$ -foncteurs, qui serait déduit d'un comptage de disques tricousus pseudo-holomorphes à points marqués sur leur bord et donc la i -ème couture s'envoie sur la correspondance lagrangienne $\mathcal{L}_{i-1,i}$.

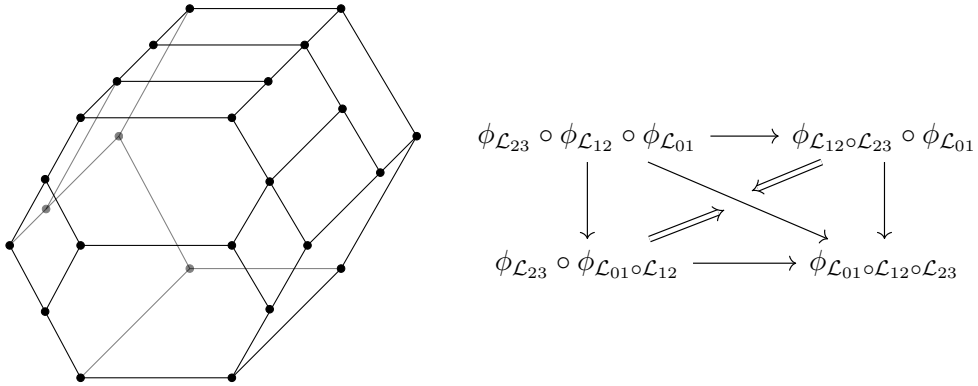

FIGURE 4

3.1.4. *Le "2-foncteur" $\text{Symp} \rightarrow A_\infty - \text{Cat}$.* Nous décrivons finalement dans la section 4 plusieurs constructions réalisées par Fukaya dans [Fuk17], dans l'optique de définir un "2-foncteur" $\text{Symp} \rightarrow A_\infty - \text{Cat}$ entre les "2-catégories" Symp et $A_\infty - \text{Cat}$.

3.2. Produits tensoriels de A_∞ -algèbres et de A_∞ -morphisms. Nous exposons dans la section 1 les premiers résultats d'une collaboration en cours avec Guillaume Laplante-Anfossi autour de la définition d'une structure de catégorie symétrique monoidale à homotopie près sur la catégorie $A_\infty - \text{alg}$. Nous rappelons en premier lieu que la donnée d'un morphisme d'opérades $A_\infty \rightarrow A_\infty \otimes A_\infty$ permet de définir de manière naturelle une structure de A_∞ -algèbre sur le produit tensoriel $A \otimes B$ de deux A_∞ -algèbres A et B . Une telle *diagonale pour l'opérade* A_∞ est définie dans [MS06], puis relevée au niveau des polytopes comme une famille d'applications polytopales $\Delta_{K_n} : K_n \rightarrow K_n \times K_n$ dans [MTTV21].

Guillaume Laplante-Anfossi et moi-même adaptons dans [LAM] les méthodes de [MTTV21] afin de définir une diagonale $\Delta_{J_n} : J_n \rightarrow J_n \times J_n$ sur les multiplièdres. En posant $M_\infty := A_\infty - \text{Morph}$, on en déduit alors un morphisme de bimodules opéradiques $M_\infty \rightarrow M_\infty \otimes M_\infty$ compatible à la diagonale de [MS06] sur l'opérade A_∞ , dont nous calculons en particulier une formule explicite. La donnée de cette diagonale sur M_∞ nous permet finalement de définir le produit tensoriel de deux A_∞ -morphisms $F_1 : A_1 \rightarrow B_1$ et $F_2 : A_2 \rightarrow B_2$, que nous notons $F_1 \otimes_\infty F_2 : A_1 \otimes_\infty B_1 \rightarrow A_2 \otimes_\infty B_2$.

Un certain nombre de résultats prouvés dans [MSS02] et [MS06] suggèrent que la structure induite sur la catégorie $A_\infty - \text{alg}$ par la donnée d'une diagonale sur A_∞ et d'une diagonale sur M_∞ , serait celle d'une structure de catégorie symétrique monoïdale à homotopie près. Dans l'optique de parvenir à la définition d'une telle structure sur $A_\infty - \text{alg}$, nous nous proposons comme première étape de comprendre quelles homotopies supérieures découlent au niveau des polytopes du défaut de coassociativité de la diagonale définie sur les associaèdres K_n dans [MTTV21].

Nous décrivons finalement deux applications possibles à la définition du produit tensoriel de A_∞ -algèbres et de A_∞ -morphisms. La première est un résultat d'Amorim qui démontre dans [Amo17] une formule de Künneth pour l'algèbre de Fukaya d'une lagrangienne : la A_∞ -algèbre de Fukaya $\mathcal{F}(L_1 \times L_2)$ d'une lagrangienne produit $L_1 \times L_2$ est A_∞ -quasi-isomorphe au produit tensoriel des algèbres de Fukaya des lagrangiennes $\mathcal{F}(L_1 \times L_2) \simeq \mathcal{F}(L_1) \otimes_\infty \mathcal{F}(L_2)$. Ce résultat est en fait adapté au niveau des catégories de Fukaya dans [Fuk17], et est en lien avec les constructions décrites sur Symp dans le chapitre 1. La deuxième application est un travail en cours de Lipshitz, Oszváth et Thurston en homologie de Heegaard Floer, dont l'article [LOT21] constitue la première étape.

3.3. Nouvelles structures algébriques sur les chaînes symplectiques et sur les chaînes de Rabinowitz-Floer. L'objectif de ce dernier chapitre est de décrire les grandes lignes d'un travail en cours sur la construction de nouvelles opérations sur les chaînes symplectiques $SC_*(W)$ et les chaînes de Rabinowitz-Floer $SC_*(\partial W)$, qui sont deux dg-modules associés à une variété de Liouville W et dont la différentielle est définie en théorie de Floer. Le point de départ de ce projet est la série d'articles en cours [CHO20], [CO20] et [CHOb] de Cieliebak, Hingston et Oancea sur un théorème de dualité de Poincaré pour l'homologie de Rabinowitz-Floer.

Nous décrivons dans la section 1 un programme en plusieurs étapes dont l'objectif final est la réalisation d'une structure de V_∞ -algèbre au sens de [TZ07a] sur les chaînes symplectiques $SC_*(W)$ d'une variété de Liouville W . De manière sommaire, une structure de V_∞ -algèbre sur un dg-module A correspond à la donnée d'opérations à m entrées et k sorties définies sur A , telles que $m + k \geq 2$ et $k \geq 1$ et qui peuvent être représentées par des disques avec m pointes positives et k pointes négatives sur leur bord. La différentielle d'une telle opération est alors définie par une certaine somme de disques nodaux avec des pointes sur leur bord, tels que le disque marqué obtenu par recollement au niveau de leur unique noeud soit exactement le disque étiquetant l'opération considérée. La structure de V_∞ -algèbre est en fait encodée par une diopérade, appelée la diopérade V_∞ . Poirier et Tradler montre dans [PT19] que cette diopérade fournit exactement une résolution cofibrante $V_\infty := \Omega V^i \rightarrow V$ dans le cadre de la dualité de Koszul des diopérades de [Gan03], où V est la diopérade encodant la structure d'algèbre associative munie d'un coproduit interne symétrique et invariant.

La structure de V_∞ -algèbre est encodée par une famille de polytopes, appelés *associpaèdres* et que Poirier et Tradler construisent dans [PT18]. Ils montrent en fait que les associpaèdres sont les polytopes $\Delta^n \times K_m$ munis d'une décomposition polytopale plus fine. Tandis que leur construction des associpaèdres s'appuie sur la méthode *secondary polytope* de [GKZ94], nous prévoyons de montrer que ces polytopes s'obtiennent en fait de manière similaire aux n -multiplièdres, en

raffinant directement la subdivision de Δ^n selon chaque face de K_m . L'objectif suivant serait alors de montrer qu'il est possible de réaliser ces polytopes de manière géométrique, comme espaces de modules de disques à $m + 1$ points marqués sur leur bord et munis d'une famille de 1-formes paramétrée par Δ^n . La règle de compactification pour ces espaces de modules découlerait de la description des subdivisions de Δ^n définies par l'opérade V_∞ . De tels espaces de modules se réaliseraient finalement sur les chaînes symplectiques $SC_*(W)$ d'une variété de Liouville, en utilisant les techniques de courbes pseudo-holomorphes de [CO20].

Il serait également intéressant de définir la notion d'un V_∞ -morphisme entre V_∞ -algèbres, de manière à définir la catégorie $V_\infty\text{-alg}$ des V_∞ -algèbres avec V_∞ -morphisms. Une telle définition de V_∞ -morphisme devrait en particulier s'inscrire dans un théorème de transfert homotopique pour les V_∞ -algèbres. Une piste serait de comprendre le cadre de la dualité de Koszul de [Gan03] afin d'associer un analogue de la construction bar classique à une V_∞ -algèbre, qui permettrait une définition naturelle de la notion des V_∞ -morphisme et de leur composition. Nous mentionnons que nous sommes tout de même déjà parvenus à définir la notion de V_2 -morphisme entre V_2 -algèbres, en recourant au point de vue de [TZ07b].

Nous donnons enfin dans la section 2 plusieurs pistes de réflexion à explorer une fois cette première étape réalisée. Nous souhaiterions en premier lieu comprendre quelle structure serait induite sur les chaînes de Rabinowitz-Floer par la structure de V_∞ -algèbre sur les chaînes symplectiques. D'après [Ven18] et [CO18], l'homologie de Rabinowitz-Floer peut en effet être construite comme le cône d'une application de chaînes $SC^{-*}(W) \rightarrow SC_*(W)$ qui est canonique à homotopie près. Dans cette direction, Cieliebak, Hingston et Oancea montrent également dans [CHO20] que la cohomologie de Rabinowitz-Floer d'une variété de Liouville peut être munie d'une structure de bigèbre de coFrobenius involutive et biunitaire. Un objectif à plus long terme serait également de parvenir à construire de nouvelles opérations en topologie des cordes à partir des nouvelles structures ainsi obtenues, en mettant en pratique la devise générale que *toute structure sur les chaînes symplectiques du cotangent T^*M d'une variété M devrait avoir une contrepartie sur les chaînes singulières de l'espace de lacets libres \mathcal{LM} de M .*

Première partie

Higher algebra of A_∞ and ΩBAs -algebras in
Morse theory I

HIGHER ALGEBRA OF A_∞ AND ΩBAs -ALGEBRAS IN MORSE THEORY I

THIBAUT MAZUIR

ABSTRACT. Elaborating on works by Abouzaid and Mescher, we prove that for a Morse function on a smooth compact manifold, its Morse cochain complex can be endowed with an ΩBAs -algebra structure by counting moduli spaces of perturbed Morse gradient trees. This rich structure descends to its already known A_∞ -algebra structure. We then introduce the notion of ΩBAs -morphism between two ΩBAs -algebras and prove that given two Morse functions, one can construct an ΩBAs -morphism between their associated ΩBAs -algebras by counting moduli spaces of two-colored perturbed Morse gradient trees. This morphism induces a standard A_∞ -morphism between the induced A_∞ -algebras. We work with integer coefficients, and provide to this extent a detailed account on the sign conventions for A_∞ (resp. ΩBAs)-algebras and A_∞ (resp. ΩBAs)-morphisms, using polytopes (resp. moduli spaces) which explicitly realize the dg-operadic objects encoding them. Our proofs also involve showing at the level of polytopes that an ΩBAs -morphism between ΩBAs -algebras naturally induces an A_∞ -morphism between A_∞ -algebras. This paper is adressed to people acquainted with either differential topology or algebraic operads, and written in a way to be hopefully understood by both communities. It comes in particular with a short survey on operads, A_∞ -algebras and A_∞ -morphisms, the associahedra and the multiplihedra. All the details on transversality, gluing maps, signs and orientations for the moduli spaces defining the algebraic structures on the Morse cochains are thoroughly carried out. It moreover lays the basis for a second article in which we solve the problem of finding a satisfactory homotopic notion of higher morphisms between A_∞ -algebras and between ΩBAs -algebras, and show how this higher algebra of A_∞ and ΩBAs -algebras naturally arises in the context of Morse theory.

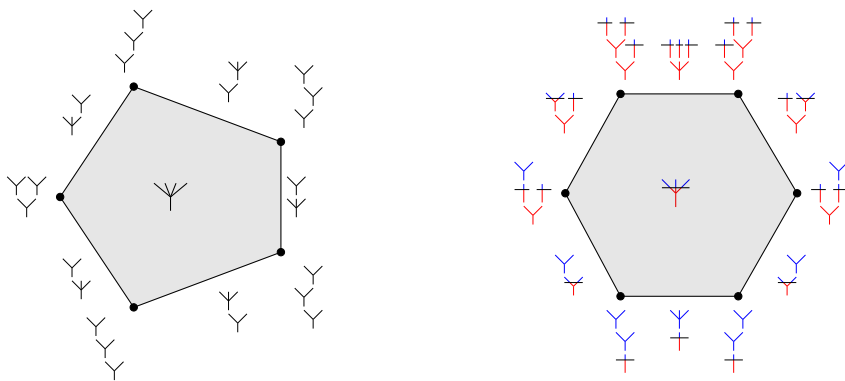

The associahedron K_4 and the multiplihedron $J_3 \dots$

CONTENTS

1 Algebra	7
1. Operadic algebra	7
2. Operads in polytopes	13
3. Moduli spaces of metric trees	16
4. Signs and polytopes for A_∞ -algebras and A_∞ -morphisms	26
5. Signs and moduli spaces for ΩBAs -algebras and ΩBAs -morphisms	37
2 Geometry	54
1. A_∞ and ΩBAs -algebra structures on the Morse cochains	54
2. A_∞ and ΩBAs -morphisms between the Morse cochains	61
3. Transversality	68
4. Signs, orientations and gluing	71
3 Further developments	87
1. The map $\mu^{\mathbb{Y}}$ is a quasi-isomorphism	87
2. More on the ΩBAs viewpoint	89
3. A_∞ -structures in symplectic topology	89
4. Towards higher algebra	91
References	92

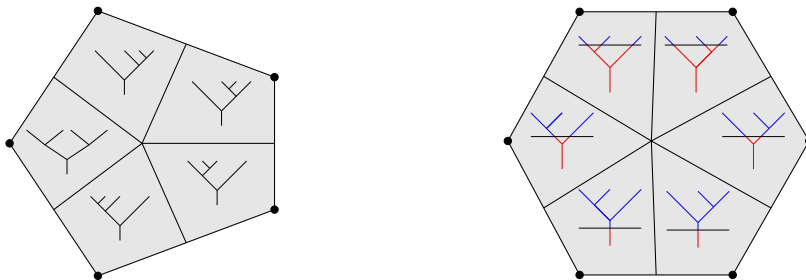

... and their ΩBAs -cell decompositions

Introduction

Outline of the paper and main results. — Our first part begins with concise and self-contained recollections on the theory of algebraic (non-symmetric) operads, that we subsequently specialize to the case of A_∞ -algebras, A_∞ -morphisms between them and their homotopy theory. We introduce in particular the convenient setting of operadic bimodules to define the operadic bimodule $A_\infty - \text{Morph}$ encoding A_∞ -morphisms between A_∞ -algebras. We then recall how the operad A_∞ (resp. the operadic bimodule $A_\infty - \text{Morph}$) can be realized using families of polytopes, known as the associahedra (resp. multiplihedra). The associahedra can themselves be realized as geometric moduli spaces : the compactified moduli spaces of metric stable ribbon trees $\overline{\mathcal{T}}_n$. These moduli spaces come with a refined cell decomposition encoding the operad ΩBAs . Likewise, the multiplihedra can be realized as the compactified moduli spaces of two-colored metric stable ribbon trees $\overline{\mathcal{CT}}_n$. Endowing these moduli spaces with a refined cell decomposition, we introduce a new operadic bimodule : the operadic bimodule $\Omega BAs - \text{Morph}$, encoding ΩBAs -morphisms between ΩBAs -algebras.

Definition 16. The operadic bimodule $\Omega BAs - \text{Morph}$ is the quasi-free $(\Omega BAs, \Omega BAs)$ -operadic bimodule generated by the set of two-colored stable ribbon trees

$$\Omega BAs - \text{Morph} := \mathcal{F}^{\Omega BAs, \Omega BAs}(\uparrow, \downarrow, \swarrow, \searrow, \dots),$$

where a two-colored stable ribbon tree t_g with $e(t)$ internal edges and whose gauge crosses j vertices has degree $|t_g| := j - e(t) - 1$. The differential of a two-colored stable ribbon tree t_g is given by the signed sum of all two-colored stable ribbon trees obtained from t_g under the rule prescribed by the top dimensional strata in the boundary of $\overline{\mathcal{CT}}_n(t_g)$.

The ΩBAs framework provides another template to study algebras which are homotopy-associative, together with morphisms between them which preserve the product up to homotopy. This is followed by a comprehensive study on the A_∞ and ΩBAs sign conventions. In the A_∞ case, we show how the two usual sign conventions for A_∞ -algebras and A_∞ -morphisms are naturally induced by the shifted bar construction viewpoint. Using the Loday realizations of the associahedra [MTTV19] and the Forcey-Loday realizations of the multiplihedra [MMV], we give a complete proof of the following two folklore propositions :

Propositions 4 and 5. *The Loday realizations of the associahedra and the Forcey-Loday realizations of the multiplihedra determine the usual sign conventions for A_∞ -algebras and A_∞ -morphisms between them.*

On the ΩBAs side, we start by recalling the formulation of the operad ΩBAs by Markl and Shnider [MS06]. We then proceed to study the moduli spaces of stable two-colored metric ribbon trees $\mathcal{CT}_n(t_g)$ and compute the signs arising in the top dimensional strata of their boundary in Propositions 8 to 12. This allows us to complete our definition of the operadic bimodule $\Omega BAs - \text{Morph}$ by making explicit the signs for the action-composition maps and the differential. We finally give an alternative and more geometric construction of the morphism of operads $A_\infty \rightarrow \Omega BAs$ defined in [MS06], using the realizations of the associahedra as geometric moduli spaces. We then build an explicit morphism of operadic bimodules $A_\infty - \text{Morph} \rightarrow \Omega BAs - \text{Morph}$ applying the same ideas to the moduli spaces realizing the multiplihedra.

Propositions 2 and 3. *There exist a geometric morphism of operads $A_\infty \rightarrow \Omega BAs$ and a geometric morphism of operadic bimodules $A_\infty - \text{Morph} \rightarrow \Omega BAs - \text{Morph}$.*

Morse theory corresponds to the study of manifolds endowed with a *Morse function*, i.e. a function whose critical points are non-degenerate. Given a smooth compact manifold M , Fukaya constructed in [Fuk97] an A_∞ -category whose objects are functions f_i on M , whose spaces of morphisms between two functions f_i and f_j (such that $f_i - f_j$ is Morse) are the Morse cochain complexes $C^*(f_i - f_j)$, and whose higher multiplications are defined by counting moduli spaces of Morse ribbon trees. Adapting this construction to the case of a single Morse function f on M , Abouzaid defines in [Abo11] an A_∞ -algebra structure on the Morse cochains $C^*(f)$ by counting moduli spaces of *perturbed Morse gradient ribbon trees*. His work was subsequently continued by Mescher in [Mes18].

In the second part of this paper, we adapt the constructions of Abouzaid [Abo11], using the terminology of Mescher [Mes18], to perform two constructions on the Morse cochains $C^*(f)$. Firstly, we introduce the notion of smooth choices of perturbation data \mathbb{X}_n on the moduli spaces \mathcal{T}_n that we use to define the moduli spaces of perturbed Morse gradient trees $\mathcal{T}_t^{\mathbb{X}_t}(y; x_1, \dots, x_n)$ modeled on a stable ribbon tree type t .

Theorems 7 and 8. *Under some generic assumptions on the choice of perturbation data $\{\mathbb{X}_n\}_{n \geq 2}$, the moduli spaces $\mathcal{T}_t^{\mathbb{X}_t}(y; x_1, \dots, x_n)$ are orientable manifolds. If they have dimension 0, they are compact. If they have dimension 1, they can be compactified to compact manifolds with boundary, whose boundary is modeled on the boundary of the moduli spaces $\mathcal{T}_n(t)$.*

We then show that under a generic choice of perturbation data $\{\mathbb{X}_n\}_{n \geq 2}$ the Morse cochains $C^*(f)$ can be endowed with an ΩBAs -algebra structure, by counting 0-dimensional moduli spaces of Morse gradient ribbon trees.

Theorem 9. *Defining for every n and every stable ribbon tree type t of arity n the operation m_t as*

$$m_t : C^*(f) \otimes \cdots \otimes C^*(f) \longrightarrow C^*(f)$$

$$x_1 \otimes \cdots \otimes x_n \longmapsto \sum_{|y| = \sum_{i=1}^n |x_i| - e(t)} \# \mathcal{T}_t^{\mathbb{X}_t}(y; x_1, \dots, x_n) \cdot y ,$$

these operations endow the Morse cochains $C^(f)$ with an ΩBAs -algebra structure.*

This ΩBAs -algebra structure is more canonical than the A_∞ -algebra structure of Abouzaid, as the ΩBAs -cell decomposition of the associahedra is the natural cell decomposition arising when realizing the moduli spaces of stable metric ribbon trees in Morse theory. This cell decomposition is also more appropriate for a rigorous proof of Theorem 7, than the A_∞ -cell decomposition used in [Abo11]. We recover the A_∞ -algebra structure of Abouzaid using the morphism $A_\infty \rightarrow \Omega BAs$ of Proposition 2.

Given now two Morse functions f and g , we can perform the same constructions in Morse theory using this time the moduli spaces \mathcal{CT}_n as blueprints. The counterparts of Theorems 7 and 8 still hold. Moreover, given two generic choices of perturbation data \mathbb{X}^f and \mathbb{X}^g , we construct an ΩBAs -morphism between the ΩBAs -algebras $C^*(f)$ and $C^*(g)$ by counting 0-dimensional moduli spaces of two-colored Morse gradient trees. This construction provides a first geometric and explicit instance of the newly defined notion of ΩBAs -morphism.

Theorem 12. *Let $(\mathbb{Y}_n)_{n \geq 1}$ be a generic choice of perturbation data on the moduli spaces \mathcal{CT}_n . Defining for every n and every two-colored stable ribbon tree type t_g of arity n the operations μ_{t_g} as*

$$\begin{aligned} \mu_{t_g}^{\mathbb{Y}} : C^*(f) \otimes \cdots \otimes C^*(f) &\longrightarrow C^*(g) \\ x_1 \otimes \cdots \otimes x_n &\longmapsto \sum_{|y| = \sum_{i=1}^n |x_i| + |t_g|} \# \mathcal{CT}_{t_g}^{\mathbb{Y}}(y; x_1, \dots, x_n) \cdot y . \end{aligned}$$

these operations fit into an ΩBAs -morphism $\mu^{\mathbb{Y}} : (C^(f), m_t^{\mathbb{X}^f}) \rightarrow (C^*(g), m_t^{\mathbb{X}^g})$.*

This ΩBAs -morphism yields in particular an A_∞ -morphism between two A_∞ -algebras, using the morphism of Proposition 3. These constructions are followed by a section dedicated to a comprehensive proof of Theorems 7 and 10, which clarifies and completes the constructions of [Abo11]. Our last section on signs and orientations is dedicated to a thorough sign check for Theorems 9 and 12. We show that we have in fact defined a twisted ΩBAs -algebra structure on the Morse cochains, and a twisted ΩBAs -morphism between two Morse cochains complexes : when the manifold M is odd-dimensional, the word "twisted" can be dropped.

Definition 39. A *twisted A_∞ -algebra* is a dg- \mathbb{Z} -module A endowed with two different differentials ∂_1 and ∂_2 , and a sequence of degree $2 - n$ operations $m_n : A^{\otimes n} \rightarrow A$ such that

$$[\partial, m_n] = - \sum_{\substack{i_1+i_2+i_3=n \\ 2 \leq i_2 \leq n-1}} (-1)^{i_1+i_2 i_3} m_{i_1+1+i_3}(\text{id}^{\otimes i_1} \otimes m_{i_2} \otimes \text{id}^{\otimes i_3}) ,$$

where $[\partial, \cdot]$ denotes the bracket for the maps $(A^{\otimes n}, \partial_1) \rightarrow (A, \partial_2)$. A *twisted ΩBAs -algebra* and a *twisted ΩBAs -morphism* are defined similarly.

Our computations are performed using the convenient viewpoint of signed short exact sequences of vector bundles. This last section also gives us the opportunity to recall in detail the basic method to compute the relations satisfied by algebraic operations defined in the context of Morse theory or symplectic topology : counting the points on the boundary of an oriented 1-dimensional manifold. We moreover pay a particular attention to the construction of explicit gluing maps for the 1-dimensional moduli spaces of perturbed Morse gradient trees.

Finally, the third and last part is composed of a series of developments on the algebraic and geometric constructions performed in the first two parts. We show in particular that :

Proposition 20. *The twisted ΩBAs -morphism $\mu^{\mathbb{Y}} : (C^*(f), m_t^{\mathbb{X}^f}) \longrightarrow (C^*(g), m_t^{\mathbb{X}^g})$ constructed in Theorem 12 is a quasi-isomorphism.*

We also give a brief overview on the A_∞ -structures appearing in symplectic topology through Floer theory, which is sometimes presented as an infinite-dimensional analogue of Morse theory. In the last section we formulate two problems naturally arising from our constructions. Problem 1 is solved in our second article [Maz21] while Problem 2 is still a work in progress.

Towards article II. — This article completes the existing works on strongly homotopy associative structures arising from Morse theory and clarifies the analytical and algebraic technicalities that they involve. It moreover lays the ground for a second article [Maz21] dealing with two questions. First, understand and define a suitable homotopic notion of higher morphisms between A_∞ -algebras, which would give a satisfactory description of the higher algebra of A_∞ -algebras. Secondly, elaborating on

the work of Abouzaid and Mescher on perturbed Morse gradient trees, realize these higher morphisms through moduli spaces in Morse theory.

Acknowledgements. My first thanks go to my advisor Alexandru Oancea, for his continuous help and support through the settling of this series of papers. I also express my gratitude to Bruno Vallette for his constant reachability and his suggestions and ideas on the algebra underlying this work. I specially thank Jean-Michel Fischer and Guillaume Laplante-Anfossi who repeatedly took the time to offer explanations on higher algebra and ∞ -categories. I finally adress my thanks to Florian Bertuol, Thomas Massoni, Amiel Peiffer-Smadja and Victor Roca Lucio for useful discussions.

Part 1

Algebra

1. OPERADIC ALGEBRA

Our first section is devoted to some basic recollections on operadic algebra, and the particular case of the operad A_∞ . The specialist already acquainted with these notions will only have to read sections 1.3 and 1.5, which introduce the *operadic bimodule* viewpoint on A_∞ -morphisms through the (A_∞, A_∞) -operadic bimodule $A_\infty - \text{Morph}$. All the signs of this section are worked out in section 4.2, and will temporarily be written \pm here.

We let in the rest of this section \mathcal{C} be one the following two monoidal categories : the category of differential graded \mathbb{Z} -modules with cohomological convention $(\mathbf{dg} - \mathbb{Z} - \mathbf{mod}, \otimes)$ and the category of polytopes (\mathbf{Poly}, \times) , introduced in detail in subsection 2.1.2. We will write \otimes for the tensor product on \mathcal{C} , and I for its identity element. Sections 1.1 and 1.2 are derived from [LV12]. Apart from the operadic bimodule viewpoint, most of the material presented in sections 1.4 and 1.5 is inspired from [LV12] and [Val14].

1.1. Operads.

1.1.1. Definition.

Definition 1. A (*non-symmetric*) \mathcal{C} -operad P consists in the data of a collection of objects $\{P_n\}_{n \geq 1}$ of \mathcal{C} together with a unit element $e \in P_1$ and with compositions

$$P_k \otimes P_{i_1} \otimes \cdots \otimes P_{i_k} \xrightarrow{c_{i_1, \dots, i_k}} P_{i_1 + \dots + i_k}$$

which are unital and associative. The objects P_n are to be thought as spaces encoding arity n operations while the compositions c_{i_1, \dots, i_k} define how to compose these operations together.

Operads can be defined in an equivalent fashion using partial compositions instead of total compositions. An operad is then the data of a collection of objects $\{P_n\}_{n \geq 1}$ together with a unit element $e \in P_1$ and with partial composition maps

$$\circ_i : P_k \otimes P_h \longrightarrow P_{h+k-1}, \quad 1 \leq i \leq k$$

which are unital and associative. Finally a morphism of operads $P \rightarrow Q$ is a sequence of maps $P_n \rightarrow Q_n$ compatible with the compositions and preserving the identity.

1.1.2. *Schur functors.* There is a third equivalent definition of operads using the notion of Schur functors. Call any collection $P = \{P_n\}$ of objects of \mathcal{C} a \mathbb{N} -module. To each \mathbb{N} -module one can associate its *Schur functor*, which is the endofunctor $S_P : \mathcal{C} \rightarrow \mathcal{C}$ defined as

$$C \longmapsto \bigoplus_{n=1}^{\infty} P_n \otimes C^{\otimes n}.$$

Given two \mathbb{N} -modules P and Q , composing their Schur functors gives the following formula

$$S_P \circ S_Q : \mathcal{C} \longrightarrow \bigoplus_{n=1}^{\infty} \left(\bigoplus_{i_1+\dots+i_k=n} P_k \otimes Q_{i_1} \otimes \dots \otimes Q_{i_k} \right) \otimes \mathcal{C}^{\otimes n} .$$

In other words, there is a \mathbb{N} -module associated to the composition of the Schur functors of two \mathbb{N} -modules, and it is given by

$$P \circ Q = \left\{ \bigoplus_{i_1+\dots+i_k=n} P_k \otimes Q_{i_1} \otimes \dots \otimes Q_{i_k} \right\}_{n \geq 1} .$$

The category $(\text{End}(\mathcal{C}), \circ, \text{Id}_{\mathcal{C}})$, endowed with composition of endofunctors, is a monoidal category. In particular, there is a well-defined notion of monoid in $\text{End}(\mathcal{C})$. A monoid structure on an endofunctor $F : \mathcal{C} \rightarrow \mathcal{C}$ is the data of natural transformations $\mu_F : F \circ F \rightarrow F$ and $e : \text{Id}_{\mathcal{C}} \rightarrow F$, which satisfy the usual commutative diagrams for monoids. This viewpoint yields the following equivalent definition of an operad. Albeit tedious, it will prove useful in the following section when considering operadic modules.

Definition 2. A \mathcal{C} -operad is the data of a \mathbb{N} -module $P = \{P_n\}$ of \mathcal{C} together with a monoid structure on its Schur functor S_P .

1.2. P -algebras. Let A be a dg- \mathbb{Z} -module and $n \geq 1$. Define the graded \mathbb{Z} -module $\text{Hom}(A^{\otimes n}, A)^i$ of i -graded maps $A^{\otimes n} \rightarrow A$, and endow it with the differential $[\partial, f] = \partial f - (-1)^{|f|} f \partial$. The \mathbb{N} -module $\text{End}_A(n) := \text{Hom}(A^{\otimes n}, A)$ in dg- \mathbb{Z} -modules can then naturally be endowed with an operad structure, where composition maps are defined as one expects. Let P be a $(\text{dg} - \mathbb{Z} - \text{mod})$ -operad. A *structure of P -algebra* on A is defined to be the datum of a morphism of operads

$$P \longrightarrow \text{End}_A ,$$

in other words the datum of a way to interpret each operation of P_n in $\text{Hom}(A^{\otimes n}, A)$, such that abstract composition in P coincides with actual composition in End_A .

A morphism of P -algebras between A and B is then simply a dg-map $f : A \rightarrow B$, which commutes with every operation of P_n interpreted in A and B . In other words, for every $m_n \in P_n$,

$$m_n^B \circ f^{\otimes n} = f \circ m_n^A .$$

1.3. Operadic bimodules.

1.3.1. Definition with Schur functors. Let now $(\mathcal{D}, \otimes_{\mathcal{D}}, I)$ be any monoidal category, and (A, μ_A) and (B, μ_B) be two monoids in \mathcal{D} . Reproducing the diagrams of usual algebra, one can define the notion of an (A, B) -bimodule in \mathcal{D} . It is simply the data of an object R of \mathcal{D} , together with action maps $\lambda : A \otimes R \rightarrow R$ and $\mu : R \otimes B \rightarrow R$ which are compatible with the product on A and B , act trivially under their identity elements and satisfy the obvious associativity conditions.

Take for instance \mathcal{D} to be the category $\text{dg} - \mathbb{Z} - \text{mod}$. A monoid in \mathcal{D} is then a unital associative differential graded algebra, and the notion of bimodules in the previous paragraph then coincides with the usual notion of bimodules over dg-algebras.

Definition 3. Given P and Q two operads seen as their Schur functors S_P and S_Q , let $R = \{R_n\}$ be a \mathbb{N} -module of \mathcal{C} seen as its Schur functor S_R . A (P, Q) -operadic bimodule structure on R is a (S_P, S_Q) -bimodule structure $\lambda : S_P \circ S_R \rightarrow S_R$ and $\mu : S_R \circ S_Q \rightarrow S_R$ on S_R in $(\text{End}(\mathcal{C}), \circ, \text{Id}_{\mathcal{C}})$.

1.3.2. *Operadic bimodules with operations.* This definition is of course of no use for actual computations. Unraveling the definitions, we get an equivalent definition for (P, Q) -operadic bimodules.

Definition 4. A (P, Q) -operadic bimodule structure on R is the data of action-composition maps

$$\begin{aligned} R_k \otimes Q_{i_1} \otimes \cdots \otimes Q_{i_k} &\xrightarrow{\mu_{i_1, \dots, i_k}} R_{i_1 + \dots + i_k}, \\ P_h \otimes R_{j_1} \otimes \cdots \otimes R_{j_h} &\xrightarrow{\lambda_{j_1, \dots, j_h}} R_{j_1 + \dots + j_h}, \end{aligned}$$

which are compatible with one another, with identities, and with compositions in P and Q .

Note that the action of Q on R can be reduced to partial action-composition maps

$$\circ_i : R_k \otimes Q_h \longrightarrow R_{h+k-1} \quad 1 \leq i \leq k,$$

as Q has an identity. This cannot be done for the action of P on R , as R does not necessarily have an identity.

1.3.3. *The $(\text{End}_B, \text{End}_A)$ -operadic bimodule $\text{Hom}(A, B)$.* Let A and B be two dg- \mathbb{Z} -modules. We have seen that they each determine an operad, End_A and End_B respectively. Then the \mathbb{N} -module $\text{Hom}(A, B) := \{\text{Hom}(A^{\otimes n}, B)\}_{n \geq 1}$ in dg- \mathbb{Z} -modules is a $(\text{End}_B, \text{End}_A)$ -operadic bimodule where the action-composition maps are defined as one could expect.

1.4. The operad A_∞ .

1.4.1. *Suspension of a dg- \mathbb{Z} -module.* Let A be a graded \mathbb{Z} -module. We define sA to be the graded \mathbb{Z} -module $(sA)^i := A^{i-1}$. In other words, $|sa| = |a| - 1$. It is merely a notation that gives a convenient way to handle certain degrees. Note for instance that a degree $2 - n$ map $A^{\otimes n} \rightarrow A$ is simply a degree $+1$ map $(sA)^{\otimes n} \rightarrow sA$. This will be used thoroughly in the rest of this part.

1.4.2. *A_∞ -algebras.* Let A be a dg- \mathbb{Z} -module with differential m_1 . Recall that we are working in the cohomological framework hence m_1 has degree $+1$. A structure of A_∞ -algebra on A is the data of a collection of degree $2 - n$ maps

$$m_n : A^{\otimes n} \longrightarrow A, \quad n \geq 1,$$

extending m_1 and which satisfy the following equations, called the A_∞ -equations

$$[m_1, m_n] = \sum_{\substack{i_1+i_2+i_3=n \\ 2 \leq i_2 \leq n-1}} \pm m_{i_1+1+i_3}(\text{id}^{\otimes i_1} \otimes m_{i_2} \otimes \text{id}^{\otimes i_3}).$$

We refer to section 4.2 for the signs. Representing m_n as $\begin{matrix} 1 & 2 & n \\ & \vee & \\ & & \end{matrix}$, this equation reads as

$$[m_1, \begin{matrix} 1 & 2 & n \\ & \vee & \\ & & \end{matrix}] = \sum_{\substack{h+k=n+1 \\ 2 \leq h \leq n-1 \\ 1 \leq i \leq k}} \pm 1 \begin{matrix} 1 & h \\ & \vee & \\ & & i \\ & & \vee & \\ & & & k \end{matrix}.$$

We have in particular that

$$\begin{aligned} [m_1, m_2] &= 0 , \\ [m_1, m_3] &= m_2(\text{id} \otimes m_2 - m_2 \otimes \text{id}) . \end{aligned}$$

Defining $H^*(A)$ to be the cohomology of A relative to m_1 , the last two equations show that m_2 descends to an associative product on $H^*(A)$. An A_∞ -algebra is simply a correct notion of a dg-algebra whose product is associative up to homotopy. Indeed to define such a notion, we have to keep track of all the higher homotopies coming with the fact that the product is associative up to homotopy : these higher homotopies are exactly the m_n .

1.4.3. *The operad A_∞ .* The A_∞ -algebra structure defined previously is actually governed by the following operad :

Definition 5. The operad A_∞ is the quasi-free $\mathbf{dg} - \mathbb{Z} - \mathbf{mod}$ -operad generated in arity $n \geq 2$ by one operation m_n of degree $2 - n$ and whose differential is defined by

$$\partial(m_n) = \sum_{\substack{i_1+i_2+i_3=n \\ 2 \leq i_2 \leq n-1}} \pm m_{i_1+1+i_3}(\text{id}^{\otimes i_1} \otimes m_{i_2} \otimes \text{id}^{\otimes i_3}) .$$

This is often written as $A_\infty = \mathcal{F}(\Upsilon, \Psi, \Psi, \dots)$ where

$$\partial\left(\begin{array}{c} 1 \ 2 \quad n \\ \Upsilon \\ \end{array}\right) = \sum_{\substack{h+k=n+1 \\ 2 \leq h \leq n-1 \\ 1 \leq i \leq k}} \pm 1 \begin{array}{c} 1 \quad h \\ \Upsilon \\ \dots \\ i \\ \Upsilon \\ \dots \\ k \end{array} .$$

Recall that quasi-free means that the operad is freely generated by the operations $\begin{array}{c} 1 \ 2 \quad n \\ \Upsilon \\ \end{array}$ as a graded object, with the additional datum of a differential on its generating operations that is non-canonical. We then check that an A_∞ -algebra structure on a dg- \mathbb{Z} -module A amounts simply to a morphism of operads $A_\infty \rightarrow \text{End}_A$.

1.4.4. *The bar construction.* A_∞ -algebras can also be defined using the *bar construction*. Define the reduced tensor coalgebra of a graded \mathbb{Z} -module V to be

$$\overline{TV} := V \oplus V^{\otimes 2} \oplus \dots$$

endowed with the coassociative comultiplication

$$\Delta_{\overline{TV}}(v_1 \dots v_n) := \sum_{i=1}^{n-1} v_1 \dots v_i \otimes v_{i+1} \dots v_n .$$

Then, we have a correspondence

$$\left\{ \begin{array}{l} \text{collections of morphisms of degree } 2 - n \\ m_n : A^{\otimes n} \rightarrow A , n \geq 1 \end{array} \right\} \longleftrightarrow \left\{ \begin{array}{l} \text{collections of morphisms of degree } +1 \\ b_n : (sA)^{\otimes n} \rightarrow sA , n \geq 1 \end{array} \right\} .$$

\updownarrow

$$\left\{ \text{coderivations } D \text{ of degree } +1 \text{ of } \overline{T}(sA) \right\}$$

Indeed, to each family of maps $b_n : (sA)^{\otimes n} \rightarrow sA$ of degree $+1$ one can associate a map $D : \overline{T}(sA) \rightarrow \overline{T}(sA)$ of degree $+1$ whose restriction to the $(sA)^{\otimes n}$ summand is given by

$$\sum_{i_1+i_2+i_3=n} \pm \text{id}^{\otimes i_1} \otimes b_{i_2} \otimes \text{id}^{\otimes i_3} .$$

Then the map D is a coderivation of $\overline{T}(sA)$.

There is a second correspondence

$$\left\{ \begin{array}{l} \text{collections of morphisms of degree } 2-n \\ m_n : A^{\otimes n} \rightarrow A, \ n \geq 1, \\ \text{satisfying the } A_\infty\text{-equations} \end{array} \right\} \longleftrightarrow \left\{ \begin{array}{l} \text{coderivations } D \text{ of degree } +1 \text{ of } \overline{T}(sA) \\ \text{such that } D^2 = 0 \end{array} \right\} .$$

Hence, the following proposition

Proposition 1. *There is a one-to-one correspondence between A_∞ -algebra structures on A and coderivations $D : \overline{T}(sA) \rightarrow \overline{T}(sA)$ of degree $+1$ which square to 0.*

1.5. A_∞ -morphisms.

1.5.1. *dg-morphisms between A_∞ -algebras.* Using the definition of section 1.2, a morphism between two A_∞ -algebras A and B is simply a dg-morphism $f : A \rightarrow B$ which is compatible with all the m_n . This notion of morphism is however not satisfactory from an homotopy-theoretic point of view. Indeed, an A_∞ -algebra being an algebra whose product is associative up to homotopy, the correct homotopy notion of a morphism between two A_∞ -algebras would be that of a map which preserves the product m_2 up to homotopy, i.e. of a dg-morphism $f_1 : A \rightarrow B$ together with higher coherent homotopies, the first one satisfying

$$[\partial, f_2] = f_1 m_2^A - m_2^B(f_1 \otimes f_1) .$$

1.5.2. A_∞ -morphisms.

Definition 6. An A_∞ -morphism between two A_∞ -algebras A and B is a dg-coalgebra morphism $F : (\overline{T}(sA), D_A) \rightarrow (\overline{T}(sB), D_B)$ between their bar constructions.

As previously, we have a one-to-one correspondence

$$\left\{ \begin{array}{l} \text{collections of morphisms of degree } 1-n \\ f_n : A^{\otimes n} \rightarrow B, \ n \geq 1, \end{array} \right\} \longleftrightarrow \left\{ \begin{array}{l} \text{morphisms of graded coalgebras} \\ F : \overline{T}(sA) \rightarrow \overline{T}(sB) \end{array} \right\} .$$

The component of F mapping $(sA)^{\otimes n}$ to $(sB)^{\otimes s}$ is given by

$$\sum_{i_1+\dots+i_s=n} \pm f_{i_1} \otimes \dots \otimes f_{i_s} .$$

A coalgebra morphism preserves the differentials if and only if for all $n \geq 1$,

$$(\star) \quad \sum_{i_1+i_2+i_3=n} \pm f_{i_1+1+i_3}(\text{id}^{\otimes i_1} \otimes m_{i_2}^A \otimes \text{id}^{\otimes i_3}) = \sum_{i_1+\dots+i_s=n} \pm m_s^B(f_{i_1} \otimes \dots \otimes f_{i_s}) .$$

These equations can be rewritten as

$$(\star) \quad [m_1, f_n] = \sum_{\substack{i_1+i_2+i_3=n \\ i_2 \geq 2}} \pm f_{i_1+1+i_3}(\text{id}^{\otimes i_1} \otimes m_{i_2}^A \otimes \text{id}^{\otimes i_3}) + \sum_{\substack{i_1+\dots+i_s=n \\ s \geq 2}} \pm m_s^B(f_{i_1} \otimes \dots \otimes f_{i_s}) .$$

This yields the following equivalent definition :

Definition 7. An A_∞ -morphism between two A_∞ -algebras A and B is a family of maps $f_n : A^{\otimes n} \rightarrow B$ of degree $1 - n$ satisfying equations \star .

See section 4.2 for signs. We check that we recover in particular $[\partial, f_2] = f_1 m_2^A - m_2^B(f_1 \otimes f_1)$. As a result, an A_∞ -morphism of A_∞ -algebras induces a morphism of associative algebras on the level of cohomology. An A_∞ -quasi-isomorphism is then defined to be an A_∞ -morphism inducing an isomorphism in cohomology.

1.5.3. *Composing A_∞ -morphisms.* Given two coalgebra morphisms $F : \overline{TV} \rightarrow \overline{TW}$ and $G : \overline{TW} \rightarrow \overline{TZ}$, the family of morphisms associated to $G \circ F$ is given by

$$(G \circ F)_n := \sum_{i_1 + \dots + i_s = n} \pm g_s(f_{i_1} \otimes \dots \otimes f_{i_s}).$$

Hence, the composition of two A_∞ -morphisms $f : A \rightarrow B$ and $g : B \rightarrow C$ is defined to be

$$(g \circ f)_n := \sum_{i_1 + \dots + i_s = n} \pm g_s(f_{i_1} \otimes \dots \otimes f_{i_s}).$$

In particular one can define $\mathbf{A}_\infty\text{-alg}$, the category of A_∞ -algebras with A_∞ -morphisms between them, whose composition is defined by the previous formula.

1.5.4. *The (A_∞, A_∞) -operadic bimodule encoding A_∞ -morphisms.* In fact there is an (A_∞, A_∞) -operadic bimodule encoding the notion of A_∞ -morphisms of A_∞ -algebras.

Definition 8. The operadic bimodule $A_\infty\text{-Morph}$ is the quasi-free (A_∞, A_∞) -operadic bimodule generated in arity $n \geq 1$ by one operation f_n of degree $1 - n$ and whose differential is defined by

$$\partial(f_n) = \sum_{\substack{i_1 + i_2 + i_3 = n \\ i_2 \geq 2}} \pm f_{i_1 + 1 + i_3}(\text{id}^{\otimes i_1} \otimes m_{i_2} \otimes \text{id}^{\otimes i_3}) + \sum_{\substack{i_1 + \dots + i_s = n \\ s \geq 2}} \pm m_s(f_{i_1} \otimes \dots \otimes f_{i_s}).$$

Representing the generating operations of the operad A_∞ acting on the right in blue $\begin{matrix} 12 \\ \vee \\ n \end{matrix}$ and the ones of the operad A_∞ acting on the left in red $\begin{matrix} 12 \\ \wedge \\ n \end{matrix}$, we represent f_n by $\begin{matrix} 12 \\ \vee \\ n \\ \wedge \\ 12 \\ n \end{matrix}$. This operadic bimodule can then be written as

$$A_\infty\text{-Morph} = \mathcal{F}^{A_\infty, A_\infty}(\begin{matrix} + \\ \vee \\ \wedge \\ \vee \\ \wedge \\ \dots \end{matrix}, \dots),$$

with differential defined as

$$\partial\left(\begin{matrix} 12 \\ \vee \\ n \\ \wedge \\ 12 \\ n \end{matrix}\right) = \sum_{\substack{h+k=n+1 \\ 1 \leq i \leq k \\ h \geq 2}} \pm \begin{matrix} 1 & h \\ \vee & \\ & \vdots \\ & i \\ \wedge & \\ & \vdots \\ & k \end{matrix} + \sum_{\substack{i_1 + \dots + i_s = n \\ s \geq 2}} \pm \begin{matrix} 1 & i_1 & & & 1 & i_s \\ \vee & & & & \vee & \\ & \vdots & & & & \vdots \\ & & & & & \\ \wedge & & & & \wedge & \end{matrix}.$$

Consider A and B two A_∞ -algebras, which we can see as two morphisms of operads $A_\infty \rightarrow \text{End}_A$ and $A_\infty \rightarrow \text{End}_B$. Recall from subsection 1.3.3 that $\text{Hom}(A, B)$ is a $(\text{End}_B, \text{End}_A)$ -operadic bimodule. The previous two morphisms of operads make $\text{Hom}(A, B)$ into an (A_∞, A_∞) -operadic

bimodule. An A_∞ -morphism between A and B is then simply a morphism of (A_∞, A_∞) -operadic bimodules

$$A_\infty - \text{Morph} \longrightarrow \text{Hom}(A, B) .$$

It is in that sense that $A_\infty - \text{Morph}$ is the (A_∞, A_∞) -operadic bimodule encoding the notion of A_∞ -morphisms of A_∞ -algebras.

1.5.5. *The framework of two-colored operads.* In fact, our choice of notation $\overset{12}{\underset{n}{\frown}}$ reveals that the natural framework to work with the operad A_∞ and the operadic bimodule $A_\infty - \text{Morph}$ is provided by the quasi-free two-colored operad

$$A_\infty^2 := \mathcal{F}(\underset{\text{red}}{\frown}, \underset{\text{red}}{\frown}, \underset{\text{red}}{\frown}, \dots, \underset{\text{blue}}{\frown}, \underset{\text{blue}}{\frown}, \underset{\text{blue}}{\frown}, \dots, \text{+}, \underset{\text{red}}{\frown}, \underset{\text{red}}{\frown}, \underset{\text{red}}{\frown}, \dots) ,$$

where the differential on the generating operations is given by the previous formulae. A two-colored operad can be roughly defined as an operad whose operations have entries and output labeled either in red or in blue, and whose operations can only be composed along the same color. See [Yau16] for a complete definition.

1.6. **Homotopy theory of A_∞ -algebras.** A_∞ -algebras with A_∞ -morphisms between them provide a suitable framework to study homotopy theory of dg-associative algebras. This is because the two-colored operad A_∞^2 is a resolution

$$A_\infty^2 \xrightarrow{\sim} As^2 ,$$

of the two-colored operad encoding associative algebras with morphisms of algebras, and a fibrant-cofibrant object in the model category of two-colored operads in dg- \mathbb{Z} -modules. See [Mar02]. We illustrate these statements with two fundamental theorems. We refer moreover to [Mar06] for a more general version of Theorem 1.

Theorem 1 (Homotopy transfer theorem [Kad80]). *Let (A, ∂_A) and (H, ∂_H) be two cochain complexes. Suppose that H is a deformation retract of A , that is that they fit into a diagram*

$$h \begin{array}{c} \circlearrowleft \\ \longrightarrow \end{array} (A, \partial_A) \begin{array}{c} \xrightarrow{p} \\ \xleftarrow{i} \end{array} (H, \partial_H) ,$$

where $\text{id}_A - ip = [\partial, h]$. Then if (A, ∂_A) is endowed with an associative algebra structure, H can be made into an A_∞ -algebra such that i and p extend to A_∞ -morphisms.

Theorem 2 (Fundamental theorem of A_∞ -quasi-isomorphisms [LH02]). *For every A_∞ -quasi-isomorphism $f : A \rightarrow B$ there exists an A_∞ -quasi-isomorphism $B \rightarrow A$ which inverts f on the level of cohomology.*

2. OPERADS IN POLYTOPES

We recall in the first section the monoidal category Poly defined in [MTTV19], which yields a good framework to handle operadic calculus in a category whose objects are polytopes. We then introduce in sections 2.2 and 2.3 the two main combinatorial objects of this article : the *associahedra* and the *multiplihedra*, which are polytopes that respectively encode A_∞ -algebras and A_∞ -morphisms between them. Explicit realizations of the associahedra and the multiplihedra will be given in sections 4.3 and 4.4.

2.1. Three monoidal categories and their operadic algebra.

2.1.1. *Differential graded \mathbb{Z} -modules and CW-complexes.* Consider $\mathbf{dg} - \mathbb{Z} - \mathbf{mod}$ to be the category with objects differential graded \mathbb{Z} -modules with cohomological convention, and morphisms the morphisms of dg- \mathbb{Z} -modules. It is a monoidal category with the classical tensor product of dg- \mathbb{Z} -modules and unit the underlying field seen as a dg- \mathbb{Z} -module concentrated in degree 0.

Likewise, define \mathbf{CW} to be the category whose objects are finite CW-complexes and whose morphisms are CW-maps between CW-complexes. This category is again a monoidal category with product the usual cartesian product and unit the point $*$. The cellular chain functor $C_*^{cell} : \mathbf{CW} \rightarrow \mathbf{dg} - \mathbb{Z} - \mathbf{mod}$ is then strong monoidal, i.e. it satisfies

$$C_*^{cell}(P \times Q) = C_*^{cell}(P) \otimes C_*^{cell}(Q) .$$

To be consistent with the cohomological degree convention on A_∞ -algebras, we will actually work with the strong monoidal functor

$$C_{-*}^{cell} : \mathbf{CW} \longrightarrow \mathbf{dg} - \mathbb{Z} - \mathbf{mod} ,$$

where $C_{-*}^{cell}(P)$ is simply the \mathbb{Z} -module $C_*^{cell}(P)$ taken with its opposite grading.

2.1.2. *The category of polytopes* ([MTTV19]). Define a *polytope* to be the convex hull of a finite number of points in a Euclidean space \mathbb{R}^n . A *polytopal complex* is then a finite collection \mathcal{P} of polytopes satisfying three conditions :

- (i) $\emptyset \in \mathcal{P}$,
- (ii) if $P \in \mathcal{P}$ then all the faces of P are also in \mathcal{P} ,
- (iii) if P and Q are two polytopes of \mathcal{P} then the intersection $P \cap Q$ belongs to \mathcal{P} .

The realisation of a polytopal complex is simply

$$|\mathcal{P}| := \bigcup_{P \in \mathcal{P}} P .$$

Given P a polytope, we say in particular that a polytopal complex \mathcal{Q} is a polytopal subdivision of P if $|\mathcal{Q}| = P$. Every polytope P comes with a polytopal complex $\mathcal{L}(P)$ consisting of all its faces, which realizes a polytopal subdivision of P .

Following [MTTV19], we then define the category \mathbf{Poly} as :

Objects. Polytopes.

Morphisms. A continuous map $f : P \rightarrow Q$ which is a homeomorphism $P \rightarrow |\mathcal{D}|$ where \mathcal{D} is a polytopal subcomplex of $\mathcal{L}(Q)$ and $f^{-1}(\mathcal{D})$ is a polytopal subdivision of P . Such a map will be called a *polytopal map*.

This is a monoidal category with product the usual cartesian product and unit the polytope reduced to a point $*$. It is in fact a monoidal subcategory of \mathbf{CW} .

2.1.3. *From operadic algebra in \mathbf{Poly} to operadic algebra in $\mathbf{dg} - \mathbb{Z} - \mathbf{mod}$.* Let $\{X_n\}$ be a \mathbf{Poly} -operad, that is a collection of polytopes X_n together with polytopal maps

$$\circ_i : X_k \times X_h \longrightarrow X_{h+k-1} ,$$

satisfying the compatibility conditions of partial compositions. Then, the functor C_{-*}^{cell} yields a new $\mathbf{dg} - \mathbb{Z} - \mathbf{mod}$ -operad $\{P_n\}$ defined by $P_n := C_{-*}^{cell}(X_n)$ and whose partial compositions are

$$\circ_i : C_{-*}^{cell}(X_k) \otimes C_{-*}^{cell}(X_h) \xrightarrow{\sim} C_{-*}^{cell}(X_k \times X_h) \xrightarrow{C_{-*}^{cell}(\circ_i)} C_{-*}^{cell}(X_{h+k-1}) .$$

In the same way, let $\{X_n\}$ and $\{Y_n\}$ be two \mathbf{Poly} -operads, and $\{Z_n\}$ be a $(\{X_n\}, \{Y_n\})$ -operadic bimodule, that is a collection of polytopes $\{Z_n\}$ together with polytopal action-composition maps

$$\begin{aligned} X_s \times Z_{i_1} \times \cdots \times Z_{i_s} &\xrightarrow{\mu} Z_{i_1+\cdots+i_s} , \\ Z_k \times Y_h &\xrightarrow{\circ_i} Z_{h+k-1} , \end{aligned}$$

which are compatible with the composition maps of $\{X_n\}$ and $\{Y_n\}$. Then, the functor C_{-*}^{cell} yields a new operadic-bimodule in $\mathbf{dg} - \mathbb{Z} - \mathbf{mod}$ as follows. Denote $P_n = C_{-*}^{cell}(X_n)$ and $Q_n = C_{-*}^{cell}(Y_n)$. These are both operads in $\mathbf{dg} - \mathbb{Z} - \mathbf{mod}$. Defining $R_n := C_{-*}^{cell}(Z_n)$, this is a (P, Q) -operadic bimodule with action-composition maps defined by

$$\begin{aligned} C_{-*}^{cell}(X_s) \otimes C_{-*}^{cell}(Z_{i_1}) \otimes \cdots \otimes C_{-*}^{cell}(Z_{i_s}) &\xrightarrow{\sim} C_{-*}^{cell}(X_s \times Z_{i_1} \times \cdots \times Z_{i_s}) \xrightarrow{C_{-*}^{cell}(\mu)} C_{-*}^{cell}(Z_{i_1+\cdots+i_s}) , \\ C_{-*}^{cell}(Z_k) \otimes C_{-*}^{cell}(Y_h) &\xrightarrow{\sim} C_{-*}^{cell}(Z_k \times Y_h) \xrightarrow{C_{-*}^{cell}(\circ_i)} C_{-*}^{cell}(Z_{h+k-1}) . \end{aligned}$$

2.2. The associahedra. The $\mathbf{dg} - \mathbb{Z} - \mathbf{mod}$ -operad A_∞ actually stems from a \mathbf{Poly} -operad :

Theorem 3 ([MTTV19]). *There exists a collection of polytopes, called the associahedra and denoted $\{K_n\}$, endowed with a structure of operad in the category \mathbf{Poly} and whose image under the functor C_{-*}^{cell} yields the operad A_∞ .*

We refer to section 4.3 in the appendix for a detailed construction and a proof that $A_\infty(n) = C_{-*}^{cell}(K_n)$, and only list noteworthy properties of these polytopes in the following paragraphs.

As $A_\infty(n) = C_{-*}^{cell}(K_n)$, we know that K_n has to have a unique cell $[K_n]$ of dimension $n - 2$ whose image under ∂_{cell} is the A_∞ -equation, that is such that

$$\partial_{cell}[K_n] = \sum \pm \circ_i ([K_k] \otimes [K_h]) .$$

In fact, these polytopes are constructed such that the boundary of K_n is exactly

$$\partial K_n = \bigcup_{\substack{h+k=n+1 \\ 2 \leq h \leq n-1}} \bigcup_{1 \leq i \leq k} K_k \times_i K_h ,$$

where \times_i is in fact the standard \times cartesian product, and such that partial compositions are then simply polytopal inclusions of $K_k \times K_h$ in the boundary of K_{h+k-1} .

The first three associahedra K_2 , K_3 and K_4 are represented in figure 3, labeling their cells by the operations they define in A_∞ when seen in $C_{-*}^{cell}(K_n)$.

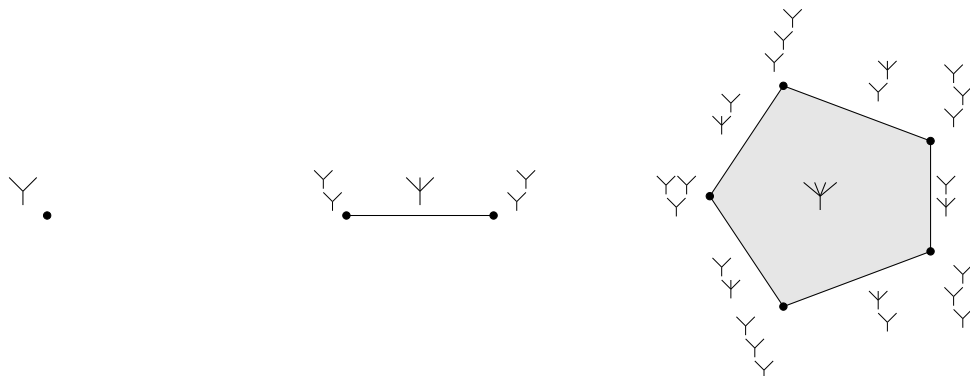
FIGURE 3. The associahedra K_2 , K_3 and K_4

2.3. The multiplihedra. Just like the operad A_∞ , the $\mathbf{dg} - \mathbb{Z} - \mathbf{mod}$ -operadic bimodule $A_\infty - \mathbf{Morph}$ is the image under the functor C_{-*}^{cell} of a **Poly**-operadic bimodule :

Theorem 4 ([MMV]). *There exists a collection of polytopes, called the multiplihedra and denoted $\{J_n\}$, endowed with a structure of $(\{K_n\}, \{K_n\})$ -operadic bimodule, i.e. with polytopal action-composition maps*

$$\begin{aligned} K_s \times J_{i_1} \times \cdots \times J_{i_s} &\xrightarrow{\mu} J_{i_1+\cdots+i_s} , \\ J_k \times K_h &\xrightarrow[\circ_i]{} J_{h+k-1} , \end{aligned}$$

whose image under the functor C_{-*}^{cell} yields the (A_∞, A_∞) -operadic bimodule $A_\infty - \mathbf{Morph}$.

We refer this time to section 4.4 for details and conclude again by listing the main noteworthy properties of the J_n . Knowing that $A_\infty - \mathbf{Morph}(n) = C_{-*}^{cell}(J_n)$, we know that J_n has to have a unique $n - 1$ -dimensional cell $[J_n]$ whose image under ∂_{cell} is the A_∞ -equation for A_∞ -morphisms, that is such that

$$\partial_{cell}[J_n] = \sum \pm \circ_i ([J_k] \otimes [K_h]) + \sum \pm \mu([K_s] \otimes [J_{i_1}] \otimes \cdots \otimes [J_{i_s}]) .$$

In fact, the polytopes J_n have the following properties

(i) the boundary of J_n is exactly

$$\partial J_n = \bigcup_{\substack{h+k=n+1 \\ h \geq 2}} \bigcup_{1 \leq i \leq k} J_k \times_i K_h \cup \bigcup_{\substack{i_1+\cdots+i_s=n \\ s \geq 2}} K_s \times J_{i_1} \times \cdots \times J_{i_s} ,$$

where \times_k is the standard cartesian product \times ,

(ii) action-compositions are polytopal inclusions of faces in the boundary of J_n .

The first three polytopes J_1 , J_2 and J_3 are represented in figure 4, labeling their cells by the operations they define in $A_\infty - \mathbf{Morph}$.

3. MODULI SPACES OF METRIC TREES

The associahedra and the multiplihedra are the polytopes governing the structures of A_∞ -algebras and A_∞ -morphisms between them. We show in this section that these polytopes can in fact be

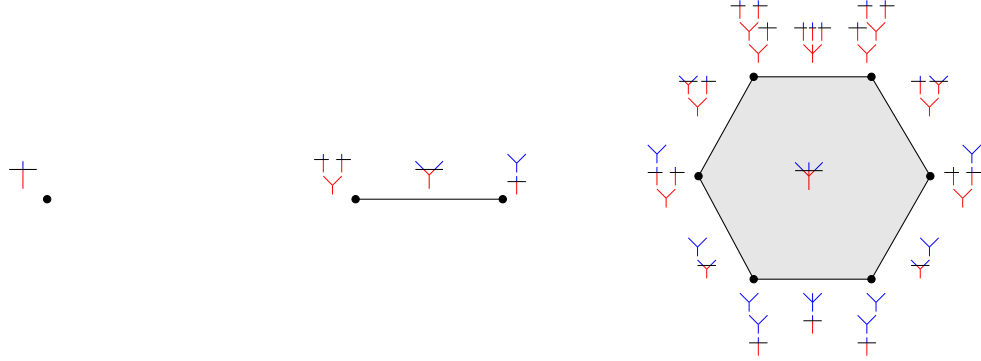

FIGURE 4. The multiplihedra J_1 , J_2 and J_3

realized as geometric moduli spaces : the associahedra are the compactified moduli spaces of stable metric ribbon trees $\overline{\mathcal{T}}_n$, while the multiplihedra are the compactified moduli spaces of stable two-colored metric ribbon trees $\overline{\mathcal{CT}}_n$.

These moduli spaces will come with two cell decompositions : their A_∞ -cell decomposition, corresponding to the cell decomposition of the associahedra (resp. multiplihedra), and a refined decomposition, called the ΩBAs -cell decomposition. This second cell decomposition recovers the operad ΩBAs in the case of $\overline{\mathcal{T}}_n$, and an $(\Omega BAs, \Omega BAs)$ -operadic bimodule denoted $\Omega BAs - \text{Morph}$ in the case of $\overline{\mathcal{CT}}_n$. They are respectively related to the operad A_∞ and the operadic bimodule $A_\infty - \text{Morph}$ by a morphism of operads $A_\infty \rightarrow \Omega BAs$ and a morphism of operadic bimodules $A_\infty - \text{Morph} \rightarrow \Omega BAs - \text{Morph}$ (Propositions 2 and 3).

3.1. The associahedra and metric ribbon trees. We refer to section 2 of [MW10] and section 7 of [Abo11] for the moduli space viewpoint on the associahedra.

3.1.1. Definitions. We begin by giving the definitions of the trees we will need in the rest of the section. The best way to understand them is with the examples depicted in figure 5.

- Definition 9.**
- (i) A *(rooted) ribbon tree*, is the data of a tree together with a cyclic ordering on the edges at each vertex of the tree and a distinguished vertex adjacent to an external edge called the *root*. This external edge is then called the *outgoing edge*, while all the other external edges are called the *incoming edges*. For a ribbon tree t , we will write $E(t)$ for the set of its internal edges, $\overline{E}(t)$ for the set of all its edges, and $e(t)$ for its number of internal edges.
 - (ii) A *metric ribbon tree* is the data of a ribbon tree, together with a length $l_e \in]0, +\infty[$ for each of its internal edges e . The external edges are thought as having length equal to $+\infty$.
 - (iii) A ribbon tree is called *stable* if all its inner vertices are at least trivalent. It is called *binary* if all its inner vertices are trivalent. We denote SRT_n the set of all stable ribbon trees, and BRT_n the set of all binary ribbon trees. Note in particular that for a binary tree $t \in BRT_n$ we have that $e(t) = n - 2$.

3.1.2. Moduli spaces of stable metric ribbon trees.

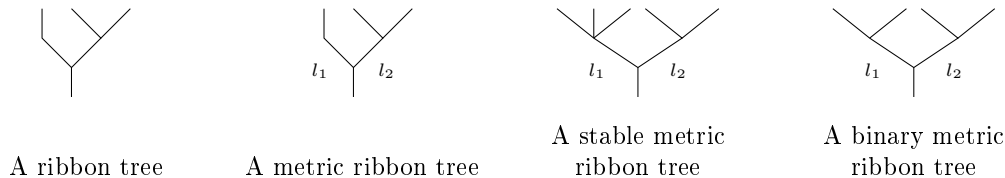

FIGURE 5

Definition 10. Define \mathcal{T}_n to be *moduli space of stable metric ribbon trees with n incoming edges*. For each stable ribbon tree type t , we define moreover $\mathcal{T}_n(t) \subset \mathcal{T}_n$ to be the moduli space

$$\mathcal{T}_n(t) := \{\text{stable metric ribbon trees of type } t\} .$$

We then have that

$$\mathcal{T}_n = \bigcup_{t \in SRT_n} \mathcal{T}_n(t) .$$

Writing $e(t)$ the number of internal edges for a ribbon tree of type t , each $\mathcal{T}_n(t)$ is naturally topologized as $]0, +\infty[^{e(t)}$, and they form a stratification of \mathcal{T}_n . This is illustrated in figures 6 and 7.

Interpreting a length in $]0, +\infty[^{e(t)}$ which goes towards 0 as the contraction of the corresponding edge of t , the strata $\mathcal{T}_n(t)$ can in fact be consistently glued together. With this observation, one can prove that the space \mathcal{T}_n is in fact itself homeomorphic to \mathbb{R}^{n-2} . Allowing lengths of internal edges to go to $+\infty$, this moduli space can be compactified into a $(n-2)$ -dimensional CW-complex $\overline{\mathcal{T}}_n$, where \mathcal{T}_n is seen as its unique $(n-2)$ -dimensional stratum. The codimension 1 stratum of this CW-complex is given by

$$\bigcup_{\substack{h+k=n+1 \\ 2 \leq h \leq n-1}} \bigcup_{1 \leq i \leq k} \mathcal{T}_k \times_i \mathcal{T}_h ,$$

where \times_i is the standard cartesian product \times , and the i means that the outgoing edge of a tree in \mathcal{T}_h connects to the i -th incoming edge of a tree in \mathcal{T}_k . It corresponds to metric trees with one internal edge of infinite length. More generally, the codimension m stratum is given by metric trees with m internal edges of infinite lengths. This cell decomposition of $\overline{\mathcal{T}}_n$ will be called its *A_∞ -cell decomposition*.

Theorem 5. *The moduli space $\overline{\mathcal{T}}_n$ endowed with its A_∞ -cell decomposition is isomorphic as a CW-complex to the associahedron K_n .*

This was first noticed in section 1.4. of Boardman-Vogt [BV73]. See two examples on figure 7.

3.1.3. The second cell decomposition of $\overline{\mathcal{T}}_n$. In fact the previous compactification can be obtained by first compactifying each cell $\mathcal{T}_n(t)$ individually and then gluing consistently all compactifications together. For $t \in RT_n$, the stratum $\mathcal{T}_n(t)$ is homeomorphic to $]0, +\infty[^{e(t)}$ and its compactification in $\overline{\mathcal{T}}_n$ is homeomorphic to $[0, +\infty]^{e(t)}$. A length equal to 0 simply corresponds to collapsing one edge of t and a length equal to $+\infty$ is interpreted as breaking this edge. This is illustrated in the instance of a cell of $\mathcal{T}_4(t)$ in figure 6.

Definition 11. A *broken ribbon tree* is a ribbon tree some of whose internal edges may be broken. Equivalently, it is the datum of a finite collection of (unbroken) ribbon trees together with a way

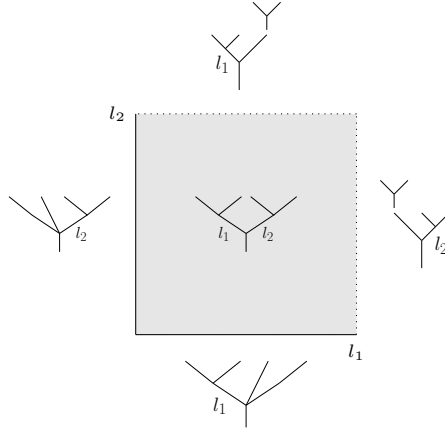

FIGURE 6. Compactification of a stratum of \mathcal{T}_4

of arranging this collection into a new tree (with broken edges). A broken ribbon tree is said to be *stable* if every unbroken ribbon tree forming it is stable.

The viewpoint introduced in the previous paragraph yields a new cell decomposition of $\overline{\mathcal{T}}_n$, an example of which is given in figure 7. Its cells are indexed by broken stable ribbon trees, a broken stable ribbon tree with i finite internal edges labeling an i -dimensional cell.

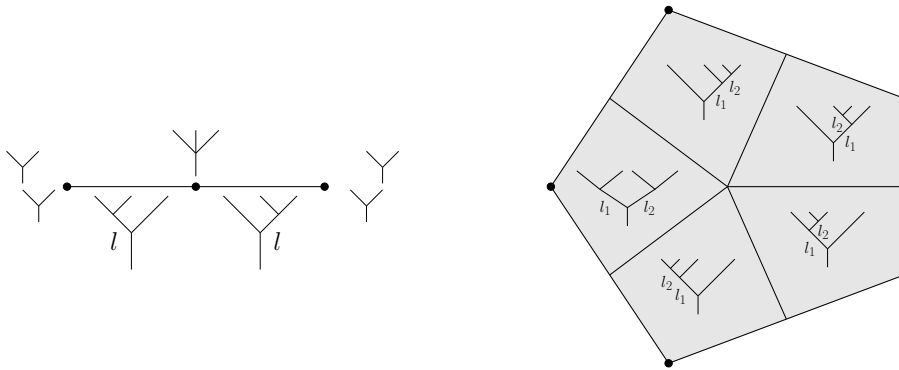

FIGURE 7. The compactified moduli spaces $\overline{\mathcal{T}}_3$ and $\overline{\mathcal{T}}_4$ with their cell decomposition by broken stable ribbon tree type

3.1.4. *The operad ΩBAs .* Endowing the $\overline{\mathcal{T}}_n$ with this new cell decomposition, the maps

$$\overline{\mathcal{T}}_k \times \overline{\mathcal{T}}_h \xrightarrow{\circ_i} \overline{\mathcal{T}}_{h+k-1}$$

are then cellular maps, and hence form a new operad in \mathbf{CW} . Taking its image under the functor C_{-*}^{cell} yields an operad in $\mathbf{dg} - \mathbb{Z} - \mathbf{mod}$: *the operad ΩBAs* . We refer to section 5.1 for a complete description of this operad and its sign conventions.

Definition 12. The *operad* ΩBAs is the quasi-free operad generated by the set of stable ribbon trees, where a stable ribbon tree t has degree $|t| := -e(t)$. Its differential on a stable ribbon tree t is given by the signed sum of all stable ribbon trees obtained from t by breaking or collapsing exactly one of its internal edges.

In other words, it is the quasi-free operad

$$\Omega BAs := \mathcal{F}(\vee, \Upsilon, \Upsilon, \Upsilon, \dots, SRT_n, \dots)$$

where for instance

$$\begin{aligned} |\vee| &= -2, \\ \partial(\vee) &= \pm \Upsilon \pm \Upsilon \pm \vee \pm \vee. \end{aligned}$$

As the choice of notation ΩBAs suggests, this $\mathbf{dg} - \mathbb{Z} - \mathbf{mod}$ -operad is in fact the bar-cobar construction of the operad As , usually denoted ΩBAs . To put it shortly, the classical cobar-bar adjunction for standard algebras and coalgebras

$$\Omega : \mathbf{conilpotent\ dg - coalgebras} \rightleftharpoons \mathbf{augmented\ dg - algebras} : B,$$

admits a counterpart in the realm of operads and cooperads

$$\Omega : \mathbf{coaugmented\ dg - cooperads} \rightleftharpoons \mathbf{augmented\ dg - operads} : B,$$

and the previously obtained operad is exactly equal to ΩBAs . We refer the curious reader to section 6.5 in Loday-Vallette [LV12], for more details on that matter.

3.1.5. *From the operad A_∞ to the operad ΩBAs .* The $\mathbf{dg} - \mathbb{Z} - \mathbf{mod}$ -operads A_∞ and ΩBAs are in fact related by the following proposition :

Proposition 2. *There exists a morphism of operads $A_\infty \rightarrow \Omega BAs$ given on the generating operations of A_∞ by*

$$m_n \mapsto \sum_{t \in BRT_n} \pm m_t.$$

This morphism stems from the image under the functor C_{-*}^{cell} of the identity map $\text{id} : (\overline{\mathcal{T}}_n)_{A_\infty} \rightarrow (\overline{\mathcal{T}}_n)_{\Omega BAs}$ refining the cell decomposition on $\overline{\mathcal{T}}_n$. The formula on m_n then simply corresponds to associating to the $n - 2$ -dimensional cell of $\overline{\mathcal{T}}_n$ with the A_∞ -cell decomposition, the signed sum of all $n - 2$ -dimensional cells of $\overline{\mathcal{T}}_n$ with the ΩBAs -cell decomposition.

This geometric construction of the morphism $A_\infty \rightarrow \Omega BAs$ is an adaptation of the algebraic construction by Markl and Shnider in [MS06] and is detailed in subsection 5.1.4. Proposition 2 dates in fact back to [GJ94], and is built in the theory of Koszul duality, as explained in sections 7 and 9 of [LV12]. We moreover point out that the morphism $A_\infty \rightarrow \Omega BAs$ will be crucial in the rest of this paper. It implies indeed that in order to construct a structure of A_∞ -algebra on a cochain complex, it is enough to endow it with a structure of ΩBAs -algebra.

3.2. The multiplihedra and two-colored metric ribbon trees. We have seen in the previous section that the polytopes K_n can be realized as the compactified moduli spaces of stable metric ribbon trees. So can the polytopes J_n : they are the compactified moduli spaces of stable two-colored metric ribbon trees.

3.2.1. *Two-colored metric ribbon trees.*

Definition 13. A *stable two-colored metric ribbon tree* or *stable gauged metric ribbon tree* is defined to be a stable metric ribbon tree together with a length $\lambda \in \mathbb{R}$. This length is to be thought of as a gauge drawn over the metric tree, at distance λ from its root, where the positive direction is pointing down.

The gauge divides the tree into two parts, each of which we think of as being colored in a different color. See an instance on figure 8. This definition, despite being visual, will prove difficult to manipulate when trying to compactify moduli spaces of stable two-colored metric ribbon trees. We thus proceed to give an equivalent definition, which will provide a natural way of compactifying these moduli spaces. The equivalence between the two definitions is depicted on an example in figure 8.

- Definition 14.**
- (i) A *two-colored ribbon tree* is defined to be a ribbon tree together with a distinguished subset of vertices $E_{col}(T)$ called the *colored vertices*. This set is such that, either there is exactly one colored vertex in every non-self crossing path from an incoming edge to the root and none in the path from the outgoing edge to the root, or there is no colored vertex in any non-self crossing path from an incoming edge to the root and exactly one in the path from the outgoing edge to the root. These colored vertices are to be thought as the intersection points of the gauge with the ribbon tree.
 - (ii) A two-colored ribbon tree is called *stable* if all its non-colored vertices are at least trivalent. We denote $SCRT_n$ the set of all stable two-colored ribbon trees, and $CBRT_n$ the set of all two-colored binary ribbon trees whose gauge does not cross any vertex of the underlying binary ribbon tree.
 - (iii) A *two-colored metric ribbon tree* is the data of a length for all internal edges $l_e \in]0, +\infty[$, such that the lengths of all non self-crossing paths from a colored vertex to the root are all equal.

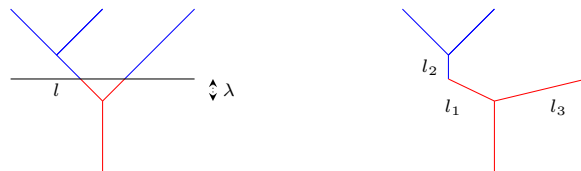

FIGURE 8. An example of a stable two-colored metric ribbon tree with the two definitions : here $l_1 = l_3 = -\lambda$ and $l = l_1 + l_2$

These two definitions of two-colored metric ribbon trees are easily seen to be equivalent, by viewing the colored vertices as the intersection points between the gauge and the edges. In the rest of the paper, the notations t_c and t_g will both stand for a two-colored stable ribbon tree, seen respectively from the colored vertices and from the gauged viewpoint. The symbol t will then denote the underlying stable ribbon tree.

3.2.2. *Moduli spaces of stable two-colored metric ribbon trees.* The results presented in this subsection can be found in section 7 of Mau-Woodward [MW10], where they are formulated in the two-colored viewpoint.

Definition 15. For $n \geq 2$, we define \mathcal{CT}_n to be the *moduli space of stable two-colored metric ribbon trees*. It has a cell decomposition by stable two-colored ribbon tree type,

$$\mathcal{CT}_n = \bigcup_{t_c \in SCRT_n} \mathcal{CT}_n(t_c).$$

We also denote $\mathcal{CT}_1 := \{+\}$ the space whose only element is the unique two-colored ribbon tree of arity 1.

The space \mathcal{CT}_n is homeomorphic to \mathbb{R}^{n-1} : \mathcal{T}_n is homeomorphic to \mathbb{R}^{n-2} and, using the gauge description, the datum of a gauge adds a factor \mathbb{R} . Allowing again internal edges of metric trees to go to $+\infty$ by using the second definition for two-colored metric ribbon trees, this moduli space \mathcal{CT}_n can be compactified into a $(n-1)$ -dimensional CW-complex $\overline{\mathcal{CT}}_n$. It has one $n-1$ dimensional stratum given by \mathcal{CT}_n . Its codimension 1 stratum is given by

$$\bigcup_{i_1 + \dots + i_s = n} \mathcal{T}_s \times \mathcal{CT}_{i_1} \times \dots \times \mathcal{CT}_{i_s} \cup \bigcup_{i_1 + i_2 + i_3 = n} \mathcal{CT}_{i_1+1+i_3} \times \mathcal{T}_{i_2}.$$

This cell decomposition of $\overline{\mathcal{CT}}_n$ will be called its *A_∞ -cell decomposition*. Two sequences of stable two-colored metric ribbon trees converging in the compactification $\overline{\mathcal{CT}}_3$ are represented in figure 9.

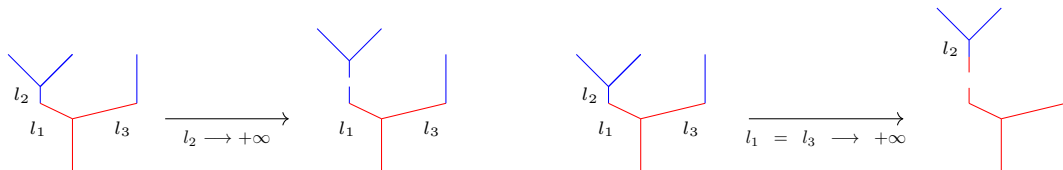

FIGURE 9. Two sequences of stable two-colored metric ribbon trees converging in the compactification $\overline{\mathcal{CT}}_3$

Theorem 6 ([MW10]). *The moduli space $\overline{\mathcal{CT}}_n$ endowed with its A_∞ -cell decomposition is isomorphic as a CW-complex to the multiplihedron J_n .*

This theorem is illustrated in figure 11.

3.2.3. The second cell decomposition of $\overline{\mathcal{CT}}_n$. As for $\overline{\mathcal{T}}_n$, the compactified moduli space $\overline{\mathcal{CT}}_n$ can be endowed with a refined cell decomposition. This subsection sums up some of the main results of section 5.2, where we provide an extensive study of the strata of this refined cell decomposition.

Let t_g be a gauged stable ribbon tree. Writing again $e(t)$ for the number of internal edges of the underlying stable ribbon tree, the stratum $\mathcal{CT}_n(t_g)$ is a polyhedral cone in $\mathbb{R}^{e(t)+1}$. For instance,

$$\mathcal{CT}_4(\text{diagram}) = \{(\lambda, l_1, l_2) \text{ such that } l_1 > 0 ; l_2 > 0 ; 0 < -\lambda < l_1, l_2\}.$$

Denote j the number of vertices v of t crossed by the gauge as depicted below

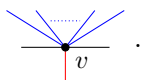

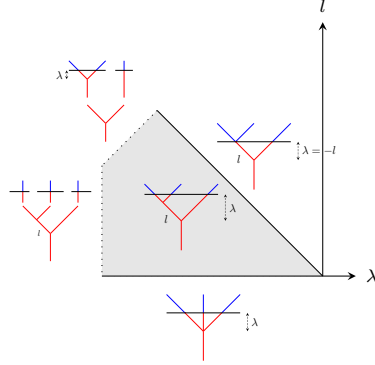

FIGURE 10. Compactification of a stratum of \mathcal{CT}_3

There is for instance one vertex intersected by the gauge in $\begin{array}{c} \diagup \\ \diagdown \end{array}$. The stratum $\mathcal{CT}_n(t_g)$ then has dimension $e(t) + 1 - j$, but is not naturally isomorphic to $]0, +\infty[^{e(t)+1-j}$, in the sense that its compactification will not coincide with a $(e(t) + 1 - j)$ -dimensional cube.

Switching now to the colored vertices viewpoint, the polyhedral cones $\mathcal{CT}_n(t_c)$ can be compactified, by allowing lengths of internal edges to go towards 0 or $+\infty$. The compactification $\overline{\mathcal{CT}}_n$ is simply obtained by gluing the previous compactifications. See an instance of the compactification of $\mathcal{CT}_3(\begin{array}{c} \diagup \\ \diagdown \end{array}) = \{(\lambda, l) \text{ such that } l > 0 ; -\lambda > l\}$ in figure 10.

This yields a new cell decomposition of $\overline{\mathcal{CT}}_n$, where each cell is labeled by a broken two-colored stable ribbon tree. A two-colored stable ribbon tree t_g with $e(t)$ internal edges and whose gauge crosses j vertices labels a $e(t) + 1 - j$ -dimensional cell. The dimension of a cell labeled by a broken two-colored tree can then simply be obtained by adding the dimensions associated to each of the pieces of the broken tree. The cell decompositions for $\overline{\mathcal{CT}}_2$ and $\overline{\mathcal{CT}}_3$ are represented in figure 11.

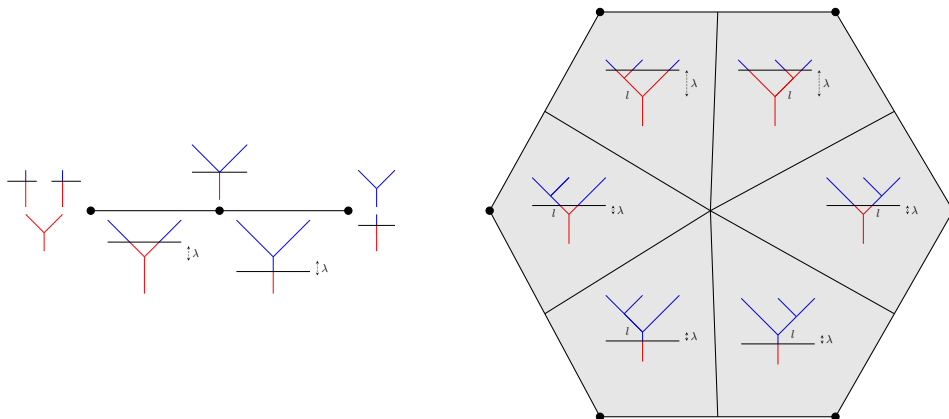

FIGURE 11. The compactified moduli spaces $\overline{\mathcal{CT}}_2$ and $\overline{\mathcal{CT}}_3$ with their cell decomposition by stable two-colored ribbon tree type

Endowing the moduli spaces $\overline{\mathcal{T}}_n$ with their ΩBAs -cell decomposition and the moduli spaces $\overline{\mathcal{CT}}_n$ with this new cell decomposition, the maps







$$\begin{aligned} \overline{\mathcal{T}}_s \times \overline{\mathcal{CT}}_{i_1} \times \cdots \times \overline{\mathcal{CT}}_{i_s} &\longrightarrow \overline{\mathcal{CT}}_{i_1+\dots+i_s}, \\ \overline{\mathcal{CT}}_k \times \overline{\mathcal{T}}_h &\xrightarrow[\circ_i]{} \overline{\mathcal{CT}}_{h+k-1}, \end{aligned}$$

are cellular : the \mathbb{N} -module $\{\overline{\mathcal{CT}}_n\}$ is a $(\{\overline{\mathcal{T}}_n\}, \{\overline{\mathcal{T}}_n\})$ -operadic bimodule for this new cell decomposition.

3.2.4. The operadic bimodule $\Omega BAs - \text{Morph}$. The functor C_{-*}^{cell} sends the previous operadic bimodule in \mathbf{CW} to an $(\Omega BAs, \Omega BAs)$ -operadic bimodule in $\mathbf{dg} - \mathbb{Z} - \mathbf{mod}$, that we will denote $\Omega BAs - \text{Morph}$. We refer to section 5.3 for a complete description of $\Omega BAs - \text{Morph}$ and explicit sign computations.

Definition 16. The operadic bimodule $\Omega BAs - \text{Morph}$ is the quasi-free $(\Omega BAs, \Omega BAs)$ -operadic bimodule generated by the set of two-colored stable ribbon trees. A two-colored stable ribbon tree t_g with $e(t)$ internal edges and whose gauge crosses j vertices has degree $|t_g| := j - e(t) - 1$. The differential of a two-colored stable ribbon tree t_c is given by the signed sum of all two-colored stable ribbon trees obtained from t_c under the rule prescribed by the top dimensional strata in the boundary of $\overline{\mathcal{CT}}_n(t_c)$.

Before giving tedious written details for the differential rule, we refer the reader to figure 10 and to the upcoming example. Consider the following two-colored stable ribbon tree . Which codimension 1 phenomena can happen ?

- (i) The gauge can be moved to cross exactly one vertex of  : these situations are given by ,  and .
- (ii) An internal edge can break above the gauge :  and .
- (iii) Both internal edges can break below the gauge : .

Note that unlike for $\mathcal{CT}_3(\overline{\mathcal{T}}_3)$, no internal edge can collapse in this example : that would be a codimension 2 phenomenon. These two examples list all four possible codimension 1 phenomena that can happen : the gauge moves to cross exactly one additional vertex of the underlying stable ribbon tree (gauge-vertex) ; an internal edge located above the gauge or intersecting it breaks or, when the gauge is below the root, the outgoing edge breaks between the gauge and the root (above-break) ; edges (internal or incoming) that are possibly intersecting the gauge, break below it, such that there is exactly one edge breaking in each non-self crossing path from an incoming edge to the root (below-break) ; an internal edge that does not intersect the gauge collapses (int-collapse).

In other words, we constructed the quasi-free $(\Omega BAs, \Omega BAs)$ -operadic bimodule

$$\Omega BAs - \text{Morph} := \mathcal{F}^{\Omega BAs, \Omega BAs}(\overline{\mathcal{T}}_1, \overline{\mathcal{T}}_2, \overline{\mathcal{T}}_3, \overline{\mathcal{T}}_4, \dots, \mathcal{S CRT}_n, \dots),$$

where for instance

$$| \begin{array}{c} \text{---} \\ \diagup \quad \diagdown \\ \text{---} \\ \text{---} \\ \diagdown \quad \diagup \\ \text{---} \end{array} | = -3 ,$$

$$\partial \left(\begin{array}{c} \text{---} \\ \diagup \quad \diagdown \\ \text{---} \\ \text{---} \\ \diagdown \quad \diagup \\ \text{---} \end{array} \right) = \pm \begin{array}{c} \text{---} \\ \diagup \quad \diagdown \\ \text{---} \\ \text{---} \\ \diagdown \quad \diagup \\ \text{---} \end{array} \pm \begin{array}{c} \text{---} \\ \diagup \quad \diagdown \\ \text{---} \\ \text{---} \\ \diagdown \quad \diagup \\ \text{---} \end{array} \pm \begin{array}{c} \text{---} \\ \diagup \quad \diagdown \\ \text{---} \\ \text{---} \\ \diagdown \quad \diagup \\ \text{---} \end{array} \pm \begin{array}{c} \text{---} \\ \diagup \quad \diagdown \\ \text{---} \\ \text{---} \\ \diagdown \quad \diagup \\ \text{---} \end{array} \pm \begin{array}{c} \text{---} \\ \diagup \quad \diagdown \\ \text{---} \\ \text{---} \\ \diagdown \quad \diagup \\ \text{---} \end{array} \pm \begin{array}{c} \text{---} \\ \diagup \quad \diagdown \\ \text{---} \\ \text{---} \\ \diagdown \quad \diagup \\ \text{---} \end{array} \pm \begin{array}{c} \text{---} \\ \diagup \quad \diagdown \\ \text{---} \\ \text{---} \\ \diagdown \quad \diagup \\ \text{---} \end{array} .$$

Note that the symbol $\begin{array}{c} \text{---} \\ \diagup \quad \diagdown \\ \text{---} \\ \text{---} \\ \diagdown \quad \diagup \\ \text{---} \end{array}$ used here is the same as the one used for the only arity 2 generating operation of $A_\infty - \text{Morph}$. It will however be clear from the context what $\begin{array}{c} \text{---} \\ \diagup \quad \diagdown \\ \text{---} \\ \text{---} \\ \diagdown \quad \diagup \\ \text{---} \end{array}$ stands for in the rest of this paper.

Consider A and B two ΩBAs -algebras, which we can see as two morphisms of operads $\Omega BAs \rightarrow \text{End}_A$ and $\Omega BAs \rightarrow \text{End}_B$. We then define an ΩBAs -morphism $A \rightarrow B$ to be a morphism of $(\Omega BAs, \Omega BAs)$ -operadic bimodules $\Omega BAs - \text{Morph} \rightarrow \text{Hom}(A, B)$. It is equivalent to a collection of operations $\mu_{t_g} : A^{\otimes n} \rightarrow B$, $t_g \in SCRT_n$, satisfying the equations prescribed by the differential on $\Omega BAs - \text{Morph}$. Note that in order to define the category $\Omega BAs - \text{alg}$ of ΩBAs -algebras with ΩBAs -morphisms between them, it remains to define the composition of two ΩBAs -morphisms. This question will be explored in an upcoming article.

3.2.5. *From $A_\infty - \text{Morph}$ to $\Omega BAs - \text{Morph}$.* The morphism of operads $A_\infty \rightarrow \Omega BAs$ makes the $(\Omega BAs, \Omega BAs)$ -operadic bimodule $\Omega BAs - \text{Morph}$ into an (A_∞, A_∞) -operadic bimodule.

Proposition 3. *There exists a morphism of (A_∞, A_∞) -operadic bimodules $A_\infty - \text{Morph} \rightarrow \Omega BAs - \text{Morph}$ given on the generating operations of $A_\infty - \text{Morph}$ by*

$$f_n \mapsto \sum_{t_g \in CBRT_n} \pm f_{t_g} .$$

As a result, to construct an A_∞ -morphism between two A_∞ -algebras whose A_∞ -algebra structure comes from an ΩBAs -algebra structure, it is enough to construct an ΩBAs -morphism between them. As in subsection 3.1.5, this morphism stems again from the image under the functor C_{-*}^{cell} of the identity morphism on \overline{CT}_n refining its cell decomposition. The formula for f_n is obtained by sending the $n - 1$ -dimensional cell of \overline{CT}_n appearing in the A_∞ -cell decomposition, to the signed sum of all $n - 1$ -dimensional cells \overline{CT}_n appearing in the ΩBAs -cell decomposition. We refer to subsection 5.3.5 for a complete proof and the details on signs.

3.3. **Résumé.** The moduli space of stable metric ribbon trees \mathcal{T}_n can be compactified by allowing lengths of internal edges to go towards $+\infty$. This compactification comes with two cell decompositions. The first one, by considering the moduli spaces \mathcal{T}_n as $(n - 2)$ -dimensional strata, yields a CW-complex isomorphic to the associahedron K_n . Its realization under the functor C_{-*}^{cell} then yields the operad A_∞ . The second one is obtained by considering the stratification of \mathcal{T}_n by strata labeled by stable ribbon tree types. It is sent under the functor C_{-*}^{cell} to the operad ΩBAs . These two operads in $\mathbf{dg} - \mathbb{Z} - \mathbf{mod}$ are then related by a morphism of operads $A_\infty \rightarrow \Omega BAs$.

The moduli space of stable two-colored metric ribbon trees \mathcal{CT}_n can be compactified by allowing lengths to go towards $+\infty$. There are again two cell decompositions for this compactification. Considering the moduli spaces \mathcal{CT}_n as $(n - 1)$ -dimensional strata yields a first CW-complex isomorphic to the multiplihedron J_n . Its image under C_{-*}^{cell} is the (A_∞, A_∞) -operadic bimodule $A_\infty - \text{Morph}$. Likewise, considering the stratification of \mathcal{CT}_n by strata labeled by two-colored stable ribbon tree types, we obtain a second cell decomposition. The functor C_{-*}^{cell} sends it to the $(\Omega BAs, \Omega BAs)$ -operadic

bimodule $\Omega BAs - \text{Morph}$. The morphism of operads $A_\infty \rightarrow \Omega BAs$ makes $\Omega BAs - \text{Morph}$ into a (A_∞, A_∞) -operadic bimodule. It is related to $A_\infty - \text{Morph}$ by a morphism of operadic bimodules $A_\infty - \text{Morph} \rightarrow \Omega BAs - \text{Morph}$.

4. SIGNS AND POLYTOPES FOR A_∞ -ALGEBRAS AND A_∞ -MORPHISMS

The goal of this section is twofold : work out all the signs written as \pm in the A_∞ -equations in section 1 and provide explicit realizations for the associahedra and multiplihedra as polytopes. We begin by introducing the basic Koszul sign rules to work in a graded algebraic framework, and explain how to compute signs by comparing orientations on the boundary of a manifold with boundary. We then recall two equivalent sign conventions for A_∞ -algebras and A_∞ -morphisms and show how they naturally ensue from the bar construction viewpoint. We subsequently detail explicit polytopal realizations of the associahedra and the multiplihedra, introduced in [MTTV19] and [MMV], and conclude by showing that these polytopes determine indeed the A_∞ -sign conventions previously defined.

4.1. Basic conventions for signs and orientations.

4.1.1. *Koszul sign rule.* All formulae in this section will be written using the Koszul sign rule that we briefly recall. We will work exclusively with cohomological conventions.

Given A and B two dg \mathbb{Z} -modules, the differential on $A \otimes B$ is defined as

$$\partial_{A \otimes B}(a \otimes b) = \partial_A a \otimes b + (-1)^{|a|} a \otimes \partial_B b .$$

Given A and B two dg \mathbb{Z} -modules, we consider the graded \mathbb{Z} -module $\text{Hom}(A, B)$ whose degree r component is given by all maps $A \rightarrow B$ of degree r . We endow it with the differential

$$\partial_{\text{Hom}(A, B)}(f) := \partial_B \circ f - (-1)^{|f|} f \circ \partial_A =: [\partial, f] .$$

Given $f : A \rightarrow A'$ and $g : B \rightarrow B'$ two graded maps between dg- \mathbb{Z} -modules, we set

$$(f \otimes g)(a \otimes b) = (-1)^{|g||a|} f(a) \otimes g(b) .$$

Finally, given $f : A \rightarrow A'$, $f' : A' \rightarrow A''$, $g : B \rightarrow B'$ and $g' : B' \rightarrow B''$, we define

$$(f' \otimes g') \circ (f \otimes g) = (-1)^{|g'||f|} (f' \circ f) \otimes (g' \circ g) .$$

We check in particular that with this sign rule, the differential on a tensor product $A_1 \otimes \cdots \otimes A_n$ is given by

$$\partial_{A_1 \otimes \cdots \otimes A_n} = \sum_{i=1}^n \text{id}_{A_1} \otimes \cdots \otimes \partial_{A_i} \otimes \cdots \otimes \text{id}_{A_n} .$$

4.1.2. *Orientation of the boundary of a manifold with boundary.* Let $(M, \partial M)$ be an oriented n -manifold with boundary. We choose to orient its boundary ∂M as follows : given $x \in \partial M$, a basis e_1, \dots, e_{n-1} of $T_x(\partial M)$, and an outward pointing vector $\nu \in T_x M$, the basis e_1, \dots, e_{n-1} is positively oriented if and only if the basis ν, e_1, \dots, e_{n-1} is a positively oriented basis of $T_x M$. Note that in the particular case when the manifold with boundary is a half-space inside the Euclidean space \mathbb{R}^n , defined by an inequality

$$\sum_{i=1}^n a_i x_i \leq C ,$$

the vector (a_1, \dots, a_n) is outward-pointing.

We recover under this convention the classical singular and cubical differentials. Take X a topological space. Given a singular simplex $\sigma : \Delta^n \rightarrow X$, its differential is classically defined as

$$\partial_{sing}(\sigma) := \sum_{i=0}^n (-1)^i \sigma_i ,$$

where σ_i stands for the restriction $[0 < \dots < \hat{i} < \dots < n] \hookrightarrow \Delta^n \rightarrow X$. Realizing Δ^n as a polytope in \mathbb{R}^n and orienting it with the canonical orientation of \mathbb{R}^n , we check that its boundary reads exactly as

$$\partial \Delta^n = \bigcup_{i=0}^n (-1)^i \Delta_i^{n-1} ,$$

where Δ_i^{n-1} is the $(n-1)$ -simplex corresponding to the face $[0 < \dots < \hat{i} < \dots < n]$. The sign $(-1)^i$ means that the orientation of Δ_i^{n-1} induced by its canonical identification with Δ^{n-1} and its orientation as the boundary of Δ^n , differ by a $(-1)^i$ sign.

Similarly, given a singular cube $\sigma : I^n \rightarrow X$, its differential is

$$\partial_{cub} \sigma := \sum_{i=1}^n (-1)^i (\sigma_{i,0} - \sigma_{i,1}) ,$$

where $\sigma_{i,0}$ denotes the singular cube $I^{n-1} \rightarrow X$ obtained from σ by setting its i -th entry to 0, and $\sigma_{i,1}$ is defined similarly. We check again that considering $I^n \subset \mathbb{R}^n$ as a polytope of \mathbb{R}^n , its boundary reads as

$$\partial I^n = \bigcup_{i=1}^n (-1)^i (I_{i,0}^{n-1} \cup -I_{i,1}^{n-1}) ,$$

where $I_{i,0}^{n-1}$ is the face of I^n obtained by setting the i -th coordinate equal to 0, and $I_{i,1}^{n-1}$ is defined likewise.

4.1.3. Coorientations. Our convention for orienting the boundary of an oriented manifold with boundary $(M, \partial M)$ can in fact be rephrased as follows : the boundary ∂M is cooriented by the outward pointing vector field ν .

More generally consider an oriented manifold N and a submanifold $S \subset N$. A coorientation of S is defined to be an orientation of the normal bundle to S . Given any complement bundle ν_S to TS in $TN|_S$,

$$TN|_S = \nu_S \oplus TS ,$$

this orientation induces in turn an orientation on ν_S , the normal bundle being canonically isomorphic to ν_S . The manifold S is then orientable if and only if it is coorientable. This can be proven using the first Stiefel-Whitney class for instance. Given a coorientation for S , the induced orientation on S is set to be the one whose concatenation with that of ν_S , in the order (ν_S, TS) , gives the orientation on $TN|_S$.

4.2. Signs for A_∞ -algebras and A_∞ -morphisms using the bar construction. There exist various conventions on signs for A_∞ -algebras and A_∞ -morphisms between them, which can seem inexplicable when met out of context. The goal of this section is twofold : to give a comprehensive account of the two sign conventions coming from the bar construction, and to state our choice of signs for the rest of the paper. The eager reader can straightaway jump to subsection 4.2.4, where our choice of signs is given.

4.2.1. *A_∞ -algebras.* We will first be interested in the following two sign conventions for A_∞ -algebras :

$$(A) \quad [m_1, m_n] = - \sum_{\substack{i_1+i_2+i_3=n \\ 2 \leq i_2 \leq n-1}} (-1)^{i_1 i_2 + i_3} m_{i_1+1+i_3} (\text{id}^{\otimes i_1} \otimes m_{i_2} \otimes \text{id}^{\otimes i_3}) ,$$

$$(B) \quad [m_1, m_n] = - \sum_{\substack{i_1+i_2+i_3=n \\ 2 \leq i_2 \leq n-1}} (-1)^{i_1+i_2 i_3} m_{i_1+1+i_3} (\text{id}^{\otimes i_1} \otimes m_{i_2} \otimes \text{id}^{\otimes i_3}) ,$$

which can be rewritten as

$$(A) \quad \sum_{i_1+i_2+i_3=n} (-1)^{i_1 i_2 + i_3} m_{i_1+1+i_3} (\text{id}^{\otimes i_1} \otimes m_{i_2} \otimes \text{id}^{\otimes i_3}) = 0 ,$$

$$(B) \quad \sum_{i_1+i_2+i_3=n} (-1)^{i_1+i_2 i_3} m_{i_1+1+i_3} (\text{id}^{\otimes i_1} \otimes m_{i_2} \otimes \text{id}^{\otimes i_3}) = 0 .$$

First, note that these two sign conventions are equivalent in the following sense : given a sequence of operations $m_n : A^{\otimes n} \rightarrow A$ satisfying equations (A), we check that the operations $m'_n := (-1)^{\binom{n}{2}} m_n$ satisfy equations (B). This sign change does not come out of the blue, and appears in the following proof that these equations come indeed from the bar construction.

Introduce the suspension and desuspension maps

$$\begin{array}{ccc} s : A \longrightarrow sA & & w : sA \rightarrow A \\ a \longmapsto sa & & sa \longmapsto a , \end{array}$$

which are respectively of degree -1 and $+1$. We check that with the Koszul sign rule,

$$w^{\otimes n} \circ s^{\otimes n} = (-1)^{\binom{n}{2}} \text{id}_{A^{\otimes n}} .$$

Then, note that a degree $2-n$ map $m_n : A^{\otimes n} \rightarrow A$ yields a degree $+1$ map $b_n := sm_n w^{\otimes n} : (sA)^{\otimes n} \rightarrow sA$. Consider now a collection of degree $2-n$ maps $m_n : A^{\otimes n} \rightarrow A$, and the associated degree $+1$ maps $b_n : (sA)^{\otimes n} \rightarrow sA$. Denoting D the unique coderivation on $\overline{T}(sA)$ associated to the b_n , the equation $D^2 = 0$ is then equivalent to the equations

$$\sum_{i_1+i_2+i_3=n} b_{i_1+1+i_3} (\text{id}^{\otimes i_1} \otimes b_{i_2} \otimes \text{id}^{\otimes i_3}) = 0 .$$

There are now two ways to unravel the signs from these equations.

The first way consists in simply replacing the b_i by their definition. It leads to the (A) sign conventions :

$$\begin{aligned}
& \sum_{i_1+i_2+i_3=n} b_{i_1+1+i_3}(\text{id}^{\otimes i_1} \otimes b_{i_2} \otimes \text{id}^{\otimes i_3}) \\
= & \sum_{i_1+i_2+i_3=n} sm_{i_1+1+i_3}(w^{\otimes i_1} \otimes w \otimes w^{\otimes i_3})(\text{id}^{\otimes i_1} \otimes sm_{i_2} w^{\otimes i_2} \otimes \text{id}^{\otimes i_3}) \\
= & \sum_{i_1+i_2+i_3=n} (-1)^{i_3} sm_{i_1+1+i_3}(w^{\otimes i_1} \otimes m_{i_2} w^{\otimes i_2} \otimes w^{\otimes i_3}) \\
= & \sum_{i_1+i_2+i_3=n} (-1)^{i_3+i_1 i_2} sm_{i_1+1+i_3}(\text{id}^{\otimes i_1} \otimes m_{i_2} \otimes \text{id}^{\otimes i_3})(w^{\otimes i_1} \otimes w^{\otimes i_2} \otimes w^{\otimes i_3}) \\
= & s \left(\sum_{i_1+i_2+i_3=n} (-1)^{i_1 i_2+i_3} m_{i_1+1+i_3}(\text{id}^{\otimes i_1} \otimes m_{i_2} \otimes \text{id}^{\otimes i_3}) \right) w^{\otimes n} .
\end{aligned}$$

The second way consists in first composing and post-composing by w and $s^{\otimes n}$ and then replacing the b_i by their definition. It leads to the (B) sign conventions and makes the $(-1)^{\binom{n}{2}}$ sign change appear:

$$\begin{aligned}
& \sum_{i_1+i_2+i_3=n} w b_{i_1+1+i_3}(\text{id}^{\otimes i_1} \otimes b_{i_2} \otimes \text{id}^{\otimes i_3}) s^{\otimes n} \\
= & \sum_{i_1+i_2+i_3=n} w b_{i_1+1+i_3}(\text{id}^{\otimes i_1} \otimes b_{i_2} \otimes \text{id}^{\otimes i_3})(s^{\otimes i_1} \otimes s^{\otimes i_2} \otimes s^{\otimes i_3}) \\
= & \sum_{i_1+i_2+i_3=n} (-1)^{i_1} w b_{i_1+1+i_3}(s^{\otimes i_1} \otimes b_{i_2} s^{\otimes i_2} \otimes s^{\otimes i_3}) \\
= & \sum_{i_1+i_2+i_3=n} (-1)^{i_1} w sm_{i_1+1+i_3} w^{\otimes i_1+1+i_3}(s^{\otimes i_1} \otimes sm_{i_2} w^{\otimes i_2} s^{\otimes i_2} \otimes s^{\otimes i_3}) \\
= & \sum_{i_1+i_2+i_3=n} (-1)^{i_1} m_{i_1+1+i_3} w^{\otimes i_1+1+i_3} (s^{\otimes i_1} \otimes (-1)^{\binom{i_2}{2}} sm_{i_2} \otimes s^{\otimes i_3}) \\
= & \sum_{i_1+i_2+i_3=n} (-1)^{i_1+i_2 i_3} m_{i_1+1+i_3} w^{\otimes i_1+1+i_3} s^{\otimes i_1+1+i_3} (\text{id}^{\otimes i_1} \otimes (-1)^{\binom{i_2}{2}} m_{i_2} \otimes \text{id}^{\otimes i_3}) \\
= & \sum_{i_1+i_2+i_3=n} (-1)^{i_1+i_2 i_3} (-1)^{\binom{i_1+1+i_3}{2}} m_{i_1+1+i_3}(\text{id}^{\otimes i_1} \otimes (-1)^{\binom{i_2}{2}} m_{i_2} \otimes \text{id}^{\otimes i_3}) .
\end{aligned}$$

4.2.2. *A_∞-morphisms.* We now dwell into the two sign conventions for A_∞-morphisms that are coming with the bar construction viewpoint. They are as follows :

$$\begin{aligned}
\text{(A)} \quad [m_1, f_n] &= \sum_{\substack{i_1+i_2+i_3=n \\ i_2 \geq 2}} (-1)^{i_1 i_2 + i_3} f_{i_1+1+i_3}(\text{id}^{\otimes i_1} \otimes m_{i_2} \otimes \text{id}^{\otimes i_3}) \\
&\quad - \sum_{\substack{i_1+\dots+i_s=n \\ s \geq 2}} (-1)^{\epsilon_A} m_s(f_{i_1} \otimes \dots \otimes f_{i_s}), \\
\text{(B)} \quad [m_1, f_n] &= \sum_{\substack{i_1+i_2+i_3=n \\ i_2 \geq 2}} (-1)^{i_1+i_2 i_3} f_{i_1+1+i_3}(\text{id}^{\otimes i_1} \otimes m_{i_2} \otimes \text{id}^{\otimes i_3}) \\
&\quad - \sum_{\substack{i_1+\dots+i_s=n \\ s \geq 2}} (-1)^{\epsilon_B} m_s(f_{i_1} \otimes \dots \otimes f_{i_s}),
\end{aligned}$$

which can be rewritten as

$$\begin{aligned}
\text{(A)} \quad \sum_{i_1+i_2+i_3=n} (-1)^{i_1 i_2 + i_3} f_{i_1+1+i_3}(\text{id}^{\otimes i_1} \otimes m_{i_2} \otimes \text{id}^{\otimes i_3}) &= \sum_{i_1+\dots+i_s=n} (-1)^{\epsilon_A} m_s(f_{i_1} \otimes \dots \otimes f_{i_s}), \\
\text{(B)} \quad \sum_{i_1+i_2+i_3=n} (-1)^{i_1+i_2 i_3} f_{i_1+1+i_3}(\text{id}^{\otimes i_1} \otimes m_{i_2} \otimes \text{id}^{\otimes i_3}) &= \sum_{i_1+\dots+i_s=n} (-1)^{\epsilon_B} m_s(f_{i_1} \otimes \dots \otimes f_{i_s}),
\end{aligned}$$

where

$$\epsilon_A = \sum_{u=1}^s i_u \left(\sum_{u < t \leq s} (1 - i_t) \right), \quad \epsilon_B = \sum_{u=1}^s (s - u)(1 - i_u).$$

These two sign conventions are again equivalent : given a sequence of operations m_n and f_n satisfying equations (A), we check that the operations $m'_n := (-1)^{\binom{n}{2}} m_n$ and $f'_n := (-1)^{\binom{n}{2}} f_n$ satisfy equations (B). The $(-1)^{\binom{n}{2}}$ twist will again appear in the following proof, from the formula $w^{\otimes n} \circ s^{\otimes n} = (-1)^{\binom{n}{2}} \text{id}_{A^{\otimes n}}$.

Consider now two dg-modules A and B , together with a collection of degree $2 - n$ maps $m_n : A^{\otimes n} \rightarrow A$ and $m_n : B^{\otimes n} \rightarrow B$ (we use the same notation for sake of readability), and a collection of degree $1 - n$ maps $f_n : A^{\otimes n} \rightarrow B$. We associate again to the m_n the degree $+1$ maps b_n , and also associate to the f_n the degree 0 maps $F_n := s f_n w^{\otimes n} : (sA)^{\otimes n} \rightarrow sB$. We denote D_A and D_B the unique coderivations acting respectively on $\overline{T}(sA)$ and $\overline{T}(sB)$, and $F : \overline{T}(sA) \rightarrow \overline{T}(sB)$ the unique coalgebra morphism associated to the F_n . The equation $FD_A = D_B F$ is then equivalent to the equations

$$\sum_{i_1+i_2+i_3=n} F_{i_1+1+i_3}(\text{id}^{\otimes i_1} \otimes b_{i_2} \otimes \text{id}^{\otimes i_3}) = \sum_{i_1+\dots+i_s=n} b_s(F_{i_1} \otimes \dots \otimes F_{i_s}).$$

There are again two ways to unravel the signs from these equations, which will lead to conventions (A) and (B). The proofs proceed exactly as in subsection 4.2.1.

4.2.3. *Composition of A_∞ -morphisms.* Let $f_n : A^{\otimes n} \rightarrow B$ and $g_n : B^{\otimes n} \rightarrow C$ be two A_∞ -morphisms under conventions (A). The arity n component of their composition $g \circ f$ is defined as

$$(A) \quad \sum_{i_1 + \dots + i_s = n} (-1)^{\epsilon_A} g_s(f_{i_1} \otimes \dots \otimes f_{i_s}),$$

where ϵ_A is as previously.

Let $f_n : A^{\otimes n} \rightarrow B$ and $g_n : B^{\otimes n} \rightarrow C$ be two A_∞ -morphisms under conventions (B). The arity n component of their composition $g \circ f$ is this time defined as

$$(B) \quad \sum_{i_1 + \dots + i_s = n} (-1)^{\epsilon_B} g_s(f_{i_1} \otimes \dots \otimes f_{i_s}),$$

where ϵ_B is as previously.

We check that in each case, this newly defined morphism satisfies the A_∞ -equations, respectively under the sign conventions (A) and (B). This can again be proven using the bar construction and applying the previous transformations.

4.2.4. *Choice of convention in this paper.* We will work in the rest of this paper under the set of conventions (B). The operations m_n of an A_∞ -algebra will satisfy equations

$$[m_1, m_n] = - \sum_{\substack{i_1 + i_2 + i_3 = n \\ 2 \leq i_2 \leq n-1}} (-1)^{i_1 + i_2 i_3} m_{i_1 + 1 + i_3}(\text{id}^{\otimes i_1} \otimes m_{i_2} \otimes \text{id}^{\otimes i_3}),$$

an A_∞ -morphism between two A_∞ -algebras will satisfy equations

$$[m_1, f_n] = \sum_{\substack{i_1 + i_2 + i_3 = n \\ i_2 \geq 2}} (-1)^{i_1 + i_2 i_3} f_{i_1 + 1 + i_3}(\text{id}^{\otimes i_1} \otimes m_{i_2} \otimes \text{id}^{\otimes i_3}) - \sum_{\substack{i_1 + \dots + i_s = n \\ s \geq 2}} (-1)^{\epsilon_B} m_s(f_{i_1} \otimes \dots \otimes f_{i_s}),$$

and two A_∞ -morphisms will be composed as

$$\sum_{i_1 + \dots + i_s = n} (-1)^{\epsilon_B} g_s(f_{i_1} \otimes \dots \otimes f_{i_s}),$$

where $\epsilon_B = \sum_{u=1}^s (s-u)(1-i_u)$.

This choice of conventions will be accounted for in the next two sections : the signs are the ones which arise naturally from the realizations of the associahedra and the multiplihedra à la Loday. We also point out that a choice of convention for the signs on A_∞ -algebras completely determines the conventions on A_∞ -morphisms and their composition.

4.3. Loday associahedra and signs. A_∞ -structures were introduced for the first time in two seminal papers by Stasheff on homotopy associative H-spaces [Sta63]. In the first paper of the series, he defined cell complexes $K_n \subset I^{n-2}$ which govern A_n -structures on topological spaces, and hence realize the associahedra as cell complexes. The associahedra were later realized as polytopes by Haiman in [Hai84], Lee in [Lee89] or Loday in [Lod04]. They were recently endowed with an operad structure in the category \mathbf{Poly} by Masuda, Thomas, Tonks and Vallette in [MTTV19], using the notion of weighted Loday realizations.

Following [MTTV19], we explain the construction of these realizations. We then show that the sign convention (B) for A_∞ -algebras is determined by these realizations : this gives a more geometric

explanation of these signs, which does not come from a $(-1)^{\binom{n}{2}}$ twist after reading the signs on the bar construction. This also provides an explicit proof with signs of the statement in [MTTV19], that these polytopes are sent to the operad A_∞ by the functor C_{-*}^{cell} (Proposition 4). These realizations moreover achieve the first step towards constructing the morphism of operads of Markl-Shnider $A_\infty \rightarrow \Omega BAs$.

4.3.1. Realizations of the associahedra à la Loday.

Definition 17 ([MTTV19]). Given $n \geq 1$, define a weight ω to be a list of n positive integers $(\omega_1, \dots, \omega_n)$. The *Loday realization of weight ω* of K_n is defined as the common intersection in \mathbb{R}^{n-1} of the hyperplane of equation

$$H_\omega : \sum_{i=1}^{n-1} x_i = \sum_{1 \leq k < l \leq n} \omega_k \omega_l$$

and of the half-spaces of equation

$$D_{i_1, i_2, i_3} : x_{i_1+1} + \dots + x_{i_1+i_2-1} \geq \sum_{i_1+1 \leq k < l \leq i_1+i_2} \omega_k \omega_l,$$

for all $i_1 + i_2 + i_3 = n$ and $2 \leq i_2 \leq n-1$. This polytope is denoted K_ω .

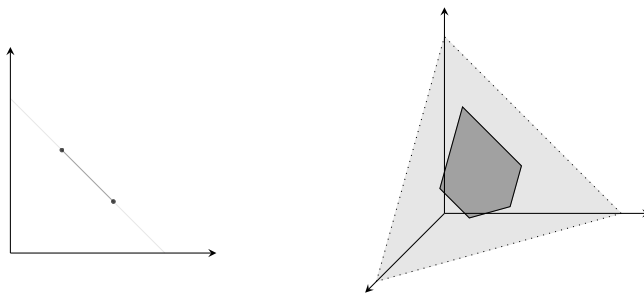

FIGURE 12. The Loday realizations $K_{(1,1)}$ and $K_{(1,1,1)}$: the lighter grey depicts H_ω , while the darker grey stands for K_ω .

The Loday realizations $K_{(1,1)}$ and $K_{(1,1,1)}$ are represented in figure 12. The polytope K_ω being defined as an intersection of half-spaces inside the $(n-2)$ -dimensional space H_ω , it has dimension $n-2$. In fact, denoting $\mathbf{1}_n$ the weight of length n whose entries are all equal to 1, it is one of the main results of [MTTV19] that the collection of polytopes $(K_{\mathbf{1}_n})_{n \geq 1}$ can be made into an operad in the category \mathbf{Poly} . The goal of this section is to show the following proposition :

Proposition 4. *The Loday associahedra determine the sign conventions (B) for A_∞ -algebras.*

That is, after orienting each polytope $K_n := K_{\mathbf{1}_n}$ the boundary of K_n reads as

$$\partial K_n = - \bigcup_{\substack{i_1+i_2+i_3=n \\ 2 \leq i_2 \leq n-1}} (-1)^{i_1+i_2i_3} K_{i_1+1+i_3} \times K_{i_2},$$

where $K_{i_1+1+i_3} \times K_{i_2}$ is sent to $m_{i_1+1+i_3}(\text{id}^{\otimes i_1} \otimes m_{i_2} \otimes \text{id}^{\otimes i_3})$ under the functor C_{-*}^{cell} . The signs mean that after comparing the product orientation on $K_{i_1+1+i_3} \times K_{i_2}$ induced by the orientations

of $K_{i_1+1+i_3}$ and K_{i_2} , to the orientation of the boundary of K_n , they differ by the sign $-(-1)^{i_1+i_2i_3}$. We explain now how to obtain the set-theoretic decomposition of the boundary

$$\partial K_n = \bigcup_{\substack{i_1+i_2+i_3=n \\ 2 \leq i_2 \leq n-1}} K_{i_1+1+i_3} \times K_{i_2} ,$$

and inspect the signs in the next section.

The top dimensional strata in the boundary of some K_ω are obtained by allowing exactly one of the inequalities

$$x_{i_1+1} + \cdots + x_{i_1+i_2-1} \geq \sum_{i_1+1 \leq k < l \leq i_1+i_2} \omega_k \omega_l ,$$

to become an equality. We write H_{i_1, i_2, i_3} for these hyperplanes. Defining two new weights

$$\begin{aligned} \bar{\omega} &:= (\omega_1, \dots, \omega_{i_1}, \omega_{i_1+1} + \cdots + \omega_{i_1+i_2}, \omega_{i_1+i_2+1}, \dots, \omega_n) , \\ \tilde{\omega} &:= (\omega_{i_1+1}, \dots, \omega_{i_1+i_2}) , \end{aligned}$$

the map

$$\begin{aligned} \theta : \mathbb{R}^{i_1+i_3} \times \mathbb{R}^{i_2-1} &\longrightarrow \mathbb{R}^{n-1} \\ (x_1, \dots, x_{i_1+i_3}) \times (y_1, \dots, y_{i_2-1}) &\longmapsto (x_1, \dots, x_{i_1}, y_1, \dots, y_{i_2-1}, x_{i_1+1}, \dots, x_{i_1+i_3}) \end{aligned}$$

induces a bijection between $K_{\bar{\omega}} \times K_{\tilde{\omega}}$ and the codimension 1 face of K_ω corresponding to the intersection with H_{i_1, i_2, i_3} .

4.3.2. Recovering signs from these realizations. The directing hyperplane \bar{H}_ω of the affine hyperplane H_ω has basis

$$e_j^\omega = (1, 0, \dots, 0, -1_{j+1}, 0, \dots, 0) ,$$

where -1 is in the $j+1$ -th spot, and we add a superscript ω for later use. We choose this basis as a positively oriented basis for \bar{H}_ω : this defines our orientation of K_ω . Choosing any $(a_1, \dots, a_{n-1}) \in H_\omega$, the basis e_j^ω parametrizes H_ω under the map

$$(y_1, \dots, y_{n-2}) \longmapsto \left(\sum_{j=1}^{n-2} y_j + a_1, -y_1 + a_2, \dots, -y_{n-2} + a_{n-1} \right) .$$

Hence in the coordinates of the basis e_j^ω , the half-space $H_\omega \cap D_{i_1, i_2, i_3}$ reads as

$$\begin{aligned} \text{when } i_1 = 0 : & \quad -y_{i_2-1} - \cdots - y_{n-2} \leq C , \\ \text{when } i_1 \geq 1 : & \quad y_{i_1} + \cdots + y_{i_1+i_2-2} \leq C , \end{aligned}$$

where C denotes some constant that we are not interested in. Hence, in the basis e_j^ω , an outward pointing vector for the boundary $H_\omega \cap H_{i_1, i_2, i_3}$ is

$$\begin{aligned} \text{when } i_1 = 0 : & \quad \nu := (0, \dots, 0, -1_{i_2-1}, \dots, -1_{n-2}) , \\ \text{when } i_1 \geq 1 : & \quad \nu := (0, \dots, 0, 1_{i_1}, \dots, 1_{i_1+i_2-2}, 0, \dots, 0) . \end{aligned}$$

We have chosen orienting bases for the directing hyperplanes \bar{H}_ω , and computed all outward pointing vectors for the boundaries in these bases. It only remains to study the image of these bases under the maps θ . We write $e_j^{\bar{\omega}}$ for the orienting basis of $K_{\bar{\omega}}$ and $e_j^{\tilde{\omega}}$ for the one of $K_{\tilde{\omega}}$. We distinguish two cases.

When $i_1 = 0$, the map θ reads as

$$\theta(x_1, \dots, x_{i_3}, y_1, \dots, y_{i_2-1}) = (y_1, \dots, y_{i_2-1}, x_1, \dots, x_{i_3}),$$

and we compute that :

$$\theta(e_j^{\bar{\omega}}) = -e_{i_2-1}^{\omega} + e_{j+i_2-1}^{\omega} \qquad \theta(e_j^{\tilde{\omega}}) = e_j^{\omega}.$$

The determinant then has value

$$\det_{e_j^{\omega}} \left(\nu, \theta(e_j^{\bar{\omega}}), \theta(e_j^{\tilde{\omega}}) \right) = -i_3(-1)^{i_2 i_3}.$$

Thus, we recover the $-(-1)^{i_1+i_2 i_3} K_{i_1+1+i_3} \times K_{i_2}$ oriented component of the boundary.

When $i_1 \geq 1$, the map θ now reads as

$$\theta(x_1, \dots, x_{i_3}, y_1, \dots, y_{i_2-1}) = (x_1, \dots, x_{i_1}, y_1, \dots, y_{i_2-1}, x_{i_1+1}, \dots, x_{i_1+i_3}),$$

and we compute that :

$$j \leq i_1 - 1, \theta(e_j^{\bar{\omega}}) = e_j^{\omega} \qquad j \geq i_1, \theta(e_j^{\bar{\omega}}) = e_{j+i_2-1}^{\omega} \qquad \theta(e_j^{\tilde{\omega}}) = e_{j+i_1}^{\omega} - e_{i_1}^{\omega}.$$

This time,

$$\det_{e_j^{\omega}} \left(\nu, \theta(e_j^{\bar{\omega}}), \theta(e_j^{\tilde{\omega}}) \right) = -(i_2 - 1)(-1)^{i_1+i_2 i_3}.$$

We find again the $-(-1)^{i_1+i_2 i_3} K_{i_1+1+i_3} \times K_{i_2}$ oriented component of the boundary, which concludes the proof of Proposition 4.

4.4. Forcey-Loday multiplihedra and signs. Iwase and Mimura realized the multiplihedra as cell complexes in [IM89] following the hints of Stasheff in [Sta63]. The multiplihedra were later realized as polytopes in [For08]. This will be adapted in an upcoming paper by Masuda, Vallette and the author [MMV], which uses again the notion of weighted Loday realizations.

The goal of this section is to show that the sign convention (B) for A_∞ -morphisms is naturally determined by the weighted Loday realizations of [MMV]. In this regard, we lay out the explicit construction of [MMV], and follow the same lines of proof as in the previous section. This also provides a proof with signs that these polytopes are sent to the operadic bimodule $A_\infty - \text{Morph}$ by the functor C_{-*}^{cell} (Proposition 5).

4.4.1. Forcey-Loday realizations of the multiplihedra.

Definition 18 ([MMV]). Given $n \geq 1$, choose a weight $\omega = (\omega_1, \dots, \omega_n)$. The *Forcey-Loday realization* of weight ω of J_n is defined as the intersection in \mathbb{R}^{n-1} of the half-spaces of equation

$$D_{i_1, i_2, i_3} : x_{i_1+1} + \dots + x_{i_1+i_2-1} \geq \sum_{i_1+1 \leq k < l \leq i_1+i_2} \omega_k \omega_l,$$

for all $i_1 + i_2 + i_3 = n$ and $i_2 \geq 2$, with the half-spaces of equation

$$D^{i_1, \dots, i_s} : x_{i_1} + x_{i_1+i_2} + \dots + x_{i_1+\dots+i_{s-1}} \leq 2 \sum_{1 \leq t < u \leq s} \Omega_t \Omega_u$$

for all $i_1 + \dots + i_s = n$, with each $i_t \geq 1$ and $s \geq 2$, and where $\Omega_t := \sum_{a=1}^{i_t} \omega_{i_1+\dots+i_{t-1}+a}$. This polytope is denoted J_ω .

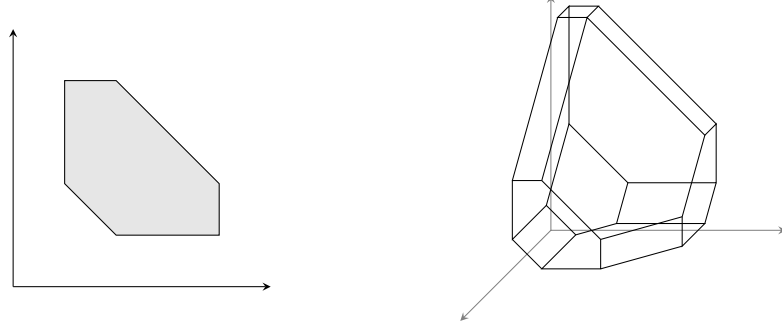
 FIGURE 13. The Forcey-Loday realizations $J_{(1,1,1)}$ and $J_{(1,1,1,1)}$

The Forcey-Loday realizations $J_{(1,1,1)}$ and $J_{(1,1,1,1)}$ are depicted in figure 13. The polytope J_ω being an intersection of half-spaces in \mathbb{R}^{n-1} , it has dimension $n - 1$. Setting $J_n := J_{\mathbf{1}_n}$, it is proven in [MMV] that the collection of polytopes $\{J_n\}_{n \geq 1}$ can be made into a $(\{K_n\}, \{K_n\})$ -operadic bimodule in the category \mathbf{Poly} .

Proposition 5. *The Forcey-Loday realizations determine the sign conventions (B) for A_∞ -morphisms.*

More precisely our goal is to prove that, after orienting the K_n as before and choosing an orientation for the J_n , the boundary of J_n reads as

$$\partial J_n = \bigcup_{\substack{i_1+i_2+i_3=n \\ i_2 \geq 2}} (-1)^{i_1+i_2 i_3} J_{i_1+1+i_3} \times K_{i_2} \cup - \bigcup_{\substack{i_1+\dots+i_s=n \\ s \geq 2}} (-1)^{\epsilon_B} K_s \times J_{i_1} \times \dots \times J_{i_s} ,$$

where ϵ_B is as in subsection 4.2.4 ; $K_{i_1+1+i_3} \times K_{i_2}$ is sent to $f_{i_1+1+i_3}(\text{id}^{\otimes i_1} \otimes m_{i_2} \otimes \text{id}^{\otimes i_3})$ while $K_s \times J_{i_1} \times \dots \times J_{i_s}$ is sent to $m_s(f_{i_1} \otimes \dots \otimes f_{i_s})$ by the functor C_{-*}^{cell} .

We conclude this section with a proof of the set-theoretic equality for the boundary

$$\partial J_n = \bigcup_{\substack{i_1+i_2+i_3=n \\ i_2 \geq 2}} J_{i_1+1+i_3} \times K_{i_2} \cup \bigcup_{\substack{i_1+\dots+i_s=n \\ s \geq 2}} K_s \times J_{i_1} \times \dots \times J_{i_s} ,$$

and postpone the processing of signs to the next subsection. The top dimensional strata in the boundary of a J_ω are obtained by allowing exactly one of the inequalities

$$\begin{aligned} x_{i_1+1} + \dots + x_{i_1+i_2-1} &\geq \sum_{i_1+1 \leq k < l \leq i_1+i_2} \omega_k \omega_l , \\ x_{i_1} + x_{i_1+i_2} + \dots + x_{i_1+\dots+i_{s-1}} &\leq 2 \sum_{1 \leq t < u \leq s} \Omega_t \Omega_u , \end{aligned}$$

to become an equality. We write H_{i_1, i_2, i_3} and H^{i_1, \dots, i_s} for these hyperplanes.

Begin with the H_{i_1, i_2, i_3} component. Defining two new weights

$$\begin{aligned} \bar{\omega} &:= (\omega_1, \dots, \omega_{i_1}, \omega_{i_1+1} + \dots + \omega_{i_1+i_2}, \omega_{i_1+i_2+1}, \dots, \omega_n) , \\ \tilde{\omega} &:= (\omega_{i_1+1}, \dots, \omega_{i_1+i_2}) , \end{aligned}$$

the map

$$\begin{aligned} \theta : \mathbb{R}^{i_1+i_3} \times \mathbb{R}^{i_2-1} &\longrightarrow \mathbb{R}^{n-1} \\ (x_1, \dots, x_{i_1+i_3}) \times (y_1, \dots, y_{i_2-1}) &\longmapsto (x_1, \dots, x_{i_1}, y_1, \dots, y_{i_2-1}, x_{i_1+1}, \dots, x_{i_1+i_3}) \end{aligned}$$

induces a bijection between $J_{\bar{\omega}} \times K_{\bar{\omega}}$ and the codimension 1 face of J_{ω} corresponding to the intersection with H_{i_1, i_2, i_3} .

In the case of the H^{i_1, \dots, i_s} component, we define the weights

$$\begin{aligned} \bar{\omega} &:= (\sqrt{2}\Omega_1, \dots, \sqrt{2}\Omega_s), \\ \tilde{\omega}_t &:= (\omega_{i_1+\dots+i_{t-1}+1}, \dots, \omega_{i_1+\dots+i_{t-1}+i_t}), \quad 1 \leq t \leq s. \end{aligned}$$

This time, the map

$$\theta : \mathbb{R}^{s-1} \times \mathbb{R}^{i_1-1} \times \dots \times \mathbb{R}^{i_s-1} \longrightarrow \mathbb{R}^{n-1}$$

sends an element $(x_1, \dots, x_{s-1}) \times (y_1^1, \dots, y_{i_1-1}^1) \times \dots \times (y_1^s, \dots, y_{i_s-1}^s)$ to

$$(y_1^1, \dots, y_{i_1-1}^1, x_1, y_1^2, \dots, y_{i_2-1}^2, x_2, y_1^3, \dots, x_{s-1}, y_1^s, \dots, y_{i_s-1}^s).$$

It induces a bijection between $K_{\bar{\omega}} \times J_{\tilde{\omega}_1} \times \dots \times J_{\tilde{\omega}_s}$ and the codimension 1 face of J_{ω} corresponding to the intersection with H^{i_1, \dots, i_s} .

4.4.2. *Processing the signs for these realizations.* We set the orientation on \mathbb{R}^{n-1} , and hence on J_{ω} , to be such that the vectors

$$f_j^{\omega} := (0, 0, \dots, 0, -1_j, 0, \dots, 0),$$

define a positively oriented basis of \mathbb{R}^{n-1} . In the coordinates of the basis f_j^{ω} , the half-space D_{i_1, i_2, i_3} reads as

$$z_{i_1+1} + \dots + z_{i_1+i_2-1} \leq - \sum_{i_1+1 \leq k < l \leq i_1+i_2} \omega_k \omega_l,$$

and the half-space D^{i_1, \dots, i_s} as

$$-z_{i_1} - z_{i_1+i_2} - \dots - z_{i_1+\dots+i_{s-1}} \leq 2 \sum_{1 \leq t < u \leq s} \Omega_t \Omega_u$$

In this basis, an outward pointing vector for the boundary H_{i_1, i_2, i_3} is then

$$\nu := (0, \dots, 0, 1_{i_1+1}, \dots, 1_{i_1+i_2-1}, 0, \dots, 0),$$

while an outward pointing vector for the boundary H^{i_1, \dots, i_s} is

$$\nu := (0, \dots, 0, -1_{i_1}, 0, \dots, 0, -1_{i_1+i_2}, 0, \dots, 0, -1_{i_1+i_2+\dots+i_{s-1}}, 0, \dots, 0).$$

Now that we have chosen positively oriented bases for the J_{ω} , and chosen outward pointing vectors for each component of their boundaries, we conclude again by computing the image of these bases under the maps θ .

In the case of a boundary component H_{i_1, i_2, i_3} ,

$$j \leq i_1, \quad \theta(f_j^{\bar{\omega}}) = f_j^{\omega} \quad j \geq i_1 + 1, \quad \theta(f_j^{\bar{\omega}}) = f_{j+i_2-1}^{\omega} \quad \theta(e_j^{\tilde{\omega}}) = -f_{i_1+1}^{\omega} + f_{i_1+j+1}^{\omega}.$$

The determinant against the basis f_j^{ω} then has value

$$\det_{f_j^{\omega}} \left(\nu, \theta(f_j^{\bar{\omega}}), \theta(e_j^{\tilde{\omega}}) \right) = (i_2 - 1)(-1)^{i_1+i_2+i_3}.$$

Thus, we recover the $(-1)^{i_1+i_2+i_3} J_{i_1+1+i_3} \times K_{i_2}$ oriented component of the boundary.

Finally, in the case of a boundary component H^{i_1, \dots, i_s} , we compute that

$$\theta(\overline{e_j^\omega}) = -f_{i_1}^\omega + f_{i_1 + \dots + i_{j+1}}^\omega \qquad \theta(f_j^{\tilde{\omega}_t}) = f_{j+i_1 + \dots + i_{t-1}}^\omega .$$

This time,

$$\det_{f_j^\omega} \left(\nu, \theta(\overline{e_j^\omega}), \theta(f_j^{\tilde{\omega}_1}), \dots, \theta(f_j^{\tilde{\omega}_s}) \right) = -(s-1)(-1)^{\epsilon_B} .$$

We find again the $-(-1)^{\epsilon_B} K_s \times J_{i_1} \times \dots \times J_{i_s}$ oriented component of the boundary, which concludes the proof of Proposition 5.

5. SIGNS AND MODULI SPACES FOR ΩBAs -ALGEBRAS AND ΩBAs -MORPHISMS

This section completes section 3 by explicitly describing the two families of moduli spaces of metric trees $\mathcal{T}_n(t)$ and $\mathcal{CT}_n(t_g)$, working out the induced signs for ΩBAs -algebras and ΩBAs -morphisms and eventually constructing the morphisms of Propositions 2 and 3.

More precisely, we begin by recalling the definition of the operad ΩBAs from Markl-Shnider, using the formalism of orientations on broken stable ribbon trees. This establishes a direct link to the moduli spaces $\mathcal{T}_n(t)$. Using the fact that the dual decomposition on the associahedron coincides with its ΩBAs decomposition, we give a new proof of the morphism of operads $A_\infty \rightarrow \Omega BAs$, that relies uniquely on polytopes and not on sign computations. We then attend to the definition of the operadic bimodule $\Omega BAs - \text{Morph}$. This goes through a long and comprehensive study of the signs ensuing from orientations of the codimension 1 strata of the compactified moduli spaces $\overline{\mathcal{CT}}_n(t_g)$. We finally define the morphism of operadic bimodules $A_\infty - \text{Morph} \rightarrow \Omega BAs - \text{Morph}$, using again solely the realizations of the multiplihedra from [MMV]. This is an opportunity to state a MacLane's coherence theorem encoded by the multiplihedra, while the classical MacLane's coherence theorem on monoidal categories is encoded by the associahedra (see subsection 5.3.4).

5.1. The operad ΩBAs .

5.1.1. *Definition of the operad ΩBAs .* The definition of the operad ΩBAs that we now lay out is the one given by Markl and Shnider in [MS06]. We only expose the material necessary to our construction, and refer to their paper for further details and proofs. In the rest of the section, the notation t stands for a stable ribbon tree, and the notation t_{br} denotes a broken stable ribbon tree. Observe that a stable ribbon tree is a broken stable ribbon tree with 0 broken edge. As a result, all constructions performed for broken stable ribbon trees in the upcoming subsections will hold in particular for stable ribbon trees.

Definition 19 ([MS06]). Given a broken stable ribbon tree t_{br} , an *ordering* of t_{br} is defined to be an ordering of its i finite internal edges e_1, \dots, e_i . Two orderings are said to be equivalent if one passes from one ordering to the other by an even permutation. An *orientation* of t_{br} is then defined to be an equivalence class of orderings, and written $\omega := e_1 \wedge \dots \wedge e_i$. Each tree t_{br} has exactly two orientations. Given an orientation ω of t_{br} we will write $-\omega$ for the second orientation on t_{br} , called its *opposite orientation*.

Definition 20 ([MS06]). Consider the \mathbb{Z} -module freely generated by the pairs (t_{br}, ω) where t_{br} is a broken stable ribbon tree and ω an orientation of t_{br} . We define the arity n space of operations $\Omega BAs(n)_*$ to be the quotient of this \mathbb{Z} -module under the relation

$$(t_{br}, -\omega) = -(t_{br}, \omega) .$$

A pair (t_{br}, ω) where t_{br} has i finite internal edges, is defined to have degree $-i$. The partial compositions are then

$$(t_{br}, \omega) \circ_k (t'_{br}, \omega') = (t_{br} \circ_k t'_{br}, \omega \wedge \omega') ,$$

where the tree $t_{br} \circ_k t'_{br}$ is the broken ribbon tree obtained by grafting t'_{br} to the k -th incoming edge of t_{br} , and the edge resulting from the grafting is broken. The differential $\partial_{\Omega BAs}$ on $\Omega BAs(n)_*$ is finally set to send an element $(t_{br}, e_1 \wedge \cdots \wedge e_i)$ to

$$\sum_{j=1}^i (-1)^j ((t_{br}/e_j, e_1 \wedge \cdots \wedge \hat{e}_j \wedge \cdots \wedge e_i) - ((t_{br})_j, e_1 \wedge \cdots \wedge \hat{e}_j \wedge \cdots \wedge e_i)) ,$$

where t_{br}/e_j is the tree obtained from t by collapsing the edge e_j and $(t_{br})_j$ is the tree obtained from t_{br} by breaking the edge e_j . It can be checked that the collection of dg- \mathbb{Z} -modules $\Omega BAs(n)_*$ defines indeed an operad in $\mathbf{dg} - \mathbb{Z} - \mathbf{mod}$.

Choosing a distinguished orientation for every stable ribbon tree $t \in SRT$, this definition of the operad ΩBAs yields the definition as the quasi-free operad

$$\mathcal{F}(\Upsilon, \Psi, \Upsilon, \Psi, \dots, SRT_n, \dots) ,$$

given in subsection 3.1.4. Our definition with the pairs (t, ω) , albeit more tedious at first sight, allows however for easier computations of signs.

5.1.2. *Canonical orientations for the binary ribbon trees* ([MS06]). For a fixed $n \geq 2$, the set of binary ribbon trees BRT_n can be endowed with a partial order that Tamari introduced in his thesis [Tam54].

Definition 21. The *Tamari order* on BRT_n is the partial order generated by the covering relations

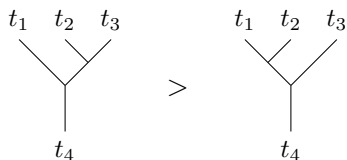

where t_1, t_2, t_3 and t_4 are binary ribbon trees.

The left-hand side in the above covering relation will be called a *right-leaning configuration*, and the right-hand side a *left-leaning configuration*. Hence given two trees t and t' in BRT_n , the inequality $t \geq t'$ holds if and only one can pass from t to t' by successive transformations of a right-leaning configuration into a left-leaning configuration. For example in the case of BRT_4 , we obtain the Hasse diagram in figure 14.

The Tamari poset has a unique maximal element and a unique minimal element, respectively given by the right-leaning and left-leaning combs, denoted t_{max} and t_{min} . Given moreover a binary ribbon tree t , its immediate neighbours are by definition the trees obtained from t by either transforming exactly one right-leaning configuration of t into a left-leaning configuration, or transforming exactly one left-leaning configuration of t into a right-leaning configuration.

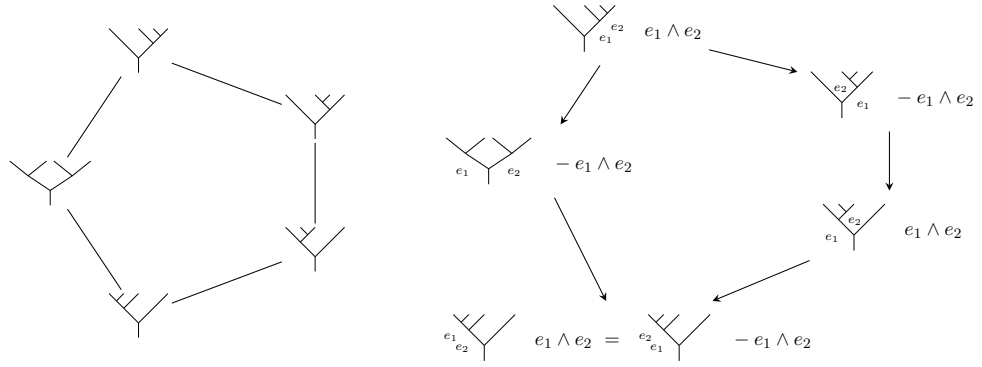

FIGURE 14. On the left, the Hasse diagram of the Tamari poset, where the maximal element is written at the top. On the right, all the canonical orientations for BRT_4 computed going down the Tamari poset.

The canonical orientation on the maximal binary tree is defined as

$$\omega_{can} := e_1 \wedge \cdots \wedge e_{n-2} .$$

Using the Tamari order, we can now build inductively canonical orientations on all binary trees. We start at the maximal binary ribbon tree, and use the following rule on the covering relations

$$\omega = \cdots \wedge e \wedge \cdots \longrightarrow -\omega = \cdots \wedge (-e) \wedge \cdots ,$$

to define the orientations of its immediate neighbours. We then repeat this rule while going down the Tamari poset until the minimal binary tree is reached. This process is consistent (see subsection 5.3.4), i.e. it does not depend on the path taken in the Tamari poset from the maximal binary tree to the binary tree whose orientation is being defined. A full example for BRT_4 is illustrated in figure 14.

Definition 22 ([MS06]). The orientations obtained under this process are called the *canonical orientations* and written ω_{can} .

5.1.3. *The moduli spaces $\overline{\mathcal{T}}_n$ realize the operad ΩBAs .* We explained in subsection 3.1.3 that the compactified moduli space $\overline{\mathcal{T}}_n$ comes with a fine cell decomposition, which is labeled by all broken stable ribbon trees with n incoming edges. Consider then a cell $\overline{\mathcal{T}}_n(t_{br}) \subset \overline{\mathcal{T}}_n$, where t_{br} is a broken stable ribbon tree. An ordering of its finite internal edges e_1, \dots, e_i induces an isomorphism

$$\overline{\mathcal{T}}_n(t_{br}) \xrightarrow{\sim} [0, +\infty]^i ,$$

where the length l_{e_j} is seen as the j -th coordinate in $[0, +\infty]^i$. This ordering induces in particular an orientation on $\overline{\mathcal{T}}_n(t_{br})$, by taking the image of the canonical orientation of $]0, +\infty[^i$ under the

isomorphism. We check that two orderings of t_{br} define the same orientation on $\mathcal{T}_n(t_{br})$ if and only if they are equivalent : in other words, an orientation of t_{br} amounts to an orientation of $\mathcal{T}_n(t_{br})$.

Consider now the \mathbb{Z} -module freely generated by the pairs

$$(\overline{\mathcal{T}}_n(t_{br}), \text{choice of orientation } \omega \text{ on the cell } \overline{\mathcal{T}}_n(t_{br})) ,$$

where t_{br} is a broken stable ribbon tree. The complex $C_{-*}^{cell}(\overline{\mathcal{T}}_n)$ can simply be defined to be the quotient of this \mathbb{Z} -module under the relation

$$-(\overline{\mathcal{T}}_n(t_{br}), \omega) = (\overline{\mathcal{T}}_n(t_{br}), -\omega) .$$

The differential of an element $(\overline{\mathcal{T}}_n(t_{br}), \omega)$ is moreover given by the classical cubical differential on $[0, +\infty]^i$. Defining the cell chain complex in this way, it becomes tautological that :

Proposition 6. *The functor C_{-*}^{cell} sends the operad $\overline{\mathcal{T}}_n$ to the operad ΩBAs .*

What's more, it can be easily seen that given a binary ribbon tree t , the cells labeled by the immediate neighbours to the tree t in the Tamari order are exactly the cells having a codimension 1 stratum in common with the cell $\overline{\mathcal{T}}_n(t)$.

5.1.4. *The morphism of operads $A_\infty \rightarrow \Omega BAs$.* The moduli space $\overline{\mathcal{T}}_n$ endowed with its A_∞ -cell decomposition is isomorphic to the Loday realization K_n of the associahedron. In fact, tedious computations show that under this isomorphism, the ΩBAs -decomposition is sent to the dual subdivision of K_n . See appendix C of [LV12] and an illustration in figure 7 for instance. The goal of this section is to prove the following proposition :

Proposition 7. *The map $\text{id} : (\overline{\mathcal{T}}_n)_{A_\infty} \rightarrow (\overline{\mathcal{T}}_n)_{\Omega BAs}$ is sent under the functor C_{-*}^{cell} to the morphism of operads $A_\infty \rightarrow \Omega BAs$ acting as*

$$m_n \longmapsto \sum_{t \in BRT_n} (t, \omega_{can}) .$$

For this purpose, we will work with the Loday realizations of the associahedra. We will show that taking the restriction of the orientation of K_n chosen in section 4.3 to the top dimensional cells of its dual subdivision yields the canonical orientations on these cells in the $\overline{\mathcal{T}}_n$ viewpoint.

We begin by proving this statement for the cell labeled by the right-leaning comb t_{max} . Consider the orientation on the cell $\overline{\mathcal{T}}_n(t_{max})$ induced by the canonical ordering e_1, \dots, e_{n-2} under the isomorphism

$$\overline{\mathcal{T}}_n(t_{max}) \xrightarrow{\sim} [0, +\infty]^{n-2} .$$

The face of $\overline{\mathcal{T}}_n(t_{max})$ associated to the breaking of the i -th edge corresponds to the face $H_{i, n-i, 0}$ when seen in the Loday polytope. An outward-pointing vector for the face $H_{i, n-i, 0}$ is moreover

$$\nu_i := (0, \dots, 0, 1_i, \dots, 1_{n-2}) ,$$

where coordinates are taken in the basis e_j^ω . The orientation defined by the canonical basis of $[0, +\infty]^{n-2}$ being exactly the one defined by the ordered list of the outwarding-point vectors to the $+\infty$ boundary, it is sent to the orientation of the basis $(\nu_1, \dots, \nu_{n-2})$ in the Loday polytope. We then check that

$$\det_{e_j^\omega}(\nu_j) = 1 .$$

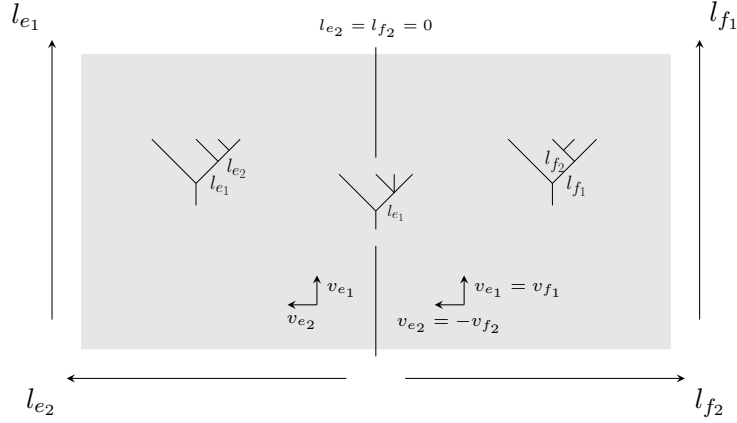

FIGURE 15. Gluing the cells $\overline{\mathcal{T}}_n(t_{max})$ and $\overline{\mathcal{T}}_n(t)$ along their common boundary : on this diagram, a vector of the form v_e is the vector orienting the axis associated to the length l_e

Hence the orientation of K_n and the one induced by the canonical orientation are the same for the cell $\overline{\mathcal{T}}_n(t_{max})$.

As explained in the previous subsection, the cells labeled by the immediate neighbours of the right-leaning comb t_{max} in the Tamari order are exactly the cells having a codimension 1 stratum in common with this cell. Choose an immediate neighbour t , and write e for the edge that has been collapsed to obtain the common codimension 1 stratum. We detail the process to obtain the induced orientation on $\overline{\mathcal{T}}_n(t)$ following figure 15. Gluing the cells $\overline{\mathcal{T}}_n(t_{max})$ and $\overline{\mathcal{T}}_n(t)$ along their common boundary, we obtain a new copy of $[0, +\infty]^{n-2}$ which can be divided into two halves t_{max} and t . We then orient the total space $[0, +\infty]^{n-2}$ as the t_{max} half. Reading the induced orientation on the t half, it is the one obtained from the t_{max} half by reversing the axis associated to the edge e . By construction, this orientation is exactly the one obtained by restricting the global orientation on K_n to an orientation on $\mathcal{T}_n(t)$.

Finally, going down the Tamari order, we can read the induced orientation on the top dimensional cells one immediate neighbour after another. And the rule to do this step-by-step process is exactly the one given in 5.1.2 on the covering relations. Hence, by construction, the global orientation on K_n restricts to the canonical orientations on binary trees, which concludes the proof of Proposition 2.

5.2. The moduli spaces $\mathcal{CT}_n(t_{br,g})$. We give a detailed definition of the moduli spaces of gauged stable metric ribbon trees $\mathcal{CT}_n(t_g)$, introduced in part 3.2. Building on these explicit realizations, we then thoroughly compute the signs appearing in the codimension 1 strata of the compactified moduli spaces $\overline{\mathcal{CT}}_n(t_g)$. This yields in particular the signs which will appear in subsection 5.3.1, in the definition of the differential on the operadic bimodule $\Omega BAs - Morph$.

5.2.1. Definition. In the rest of the section, we will write $t_{br,g}$ for a broken gauged stable ribbon tree, and t_g for an unbroken gauged stable ribbon tree.

Definition 23. We set \dagger to be the unique stable gauged tree of arity 1, and will call it the *trivial gauged tree*. We define the underlying broken stable ribbon tree t_{br} of a $t_{br,g}$ to be the ribbon tree

obtained by first deleting all the \vdash in $t_{br,g}$, and then forgetting all the remaining gauges of $t_{br,g}$. We refer moreover to a gauge in $t_{br,g}$ which is associated to a non-trivial gauged tree, as a *non-trivial gauge* of $t_{br,g}$.

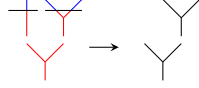

FIGURE 16. An instance of association $t_{br,g} \mapsto t_{br}$

We now define the moduli spaces $\mathcal{CT}_n(t_{br,g})$ in three steps. Consider a gauged stable ribbon tree t_g whose gauge does not intersect any of its vertices. Locally at any vertex directly adjacent to the gauge, the intersection between the gauge and the edges of t corresponds to one of the following two cases



Write r for the root, the unique vertex adjacent to the outgoing edge. For a vertex v , we denote $d(r, v)$ the distance separating it from the root : the sum of the lengths of the edges appearing in the unique non self-crossing path going from r to v . Associating lengths $l_e > 0$ to all edges of t , we then associate the following inequalities to the two above cases

$$-\lambda > d(r, v) \qquad -\lambda < d(r, v') .$$

Note that this set of inequalities amounts to seeing the gauge as going towards $-\infty$ when going up, and towards $+\infty$ as going down. The moduli space $\mathcal{CT}_n(t_g)$ is then defined as

$$\mathcal{CT}_n(t_g) := \{(\lambda, \{l_e\}_{e \in E(t)}), \lambda \in \mathbb{R}, l_e > 0, -\lambda > d(r, v), -\lambda < d(r, v')\} ,$$

where the set of inequalities on λ is prescribed by the gauged tree t_g .

Consider now a gauged stable ribbon tree t_g whose gauge may intersect some of its vertices. To the two previous local pictures, one has to add the case

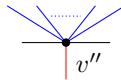

to which we associate the equality

$$-\lambda = d(r, v'') .$$

The moduli space $\mathcal{CT}_n(t_g)$ is this time defined as

$$\mathcal{CT}_n(t_g) := \{(\lambda, \{l_e\}_{e \in E(t)}), \lambda \in \mathbb{R}, l_e > 0, -\lambda > d(r, v), -\lambda < d(r, v'), -\lambda = d(r, v'')\} ,$$

where the set of equalities and inequalities on λ is prescribed by the gauged tree t_g .

Finally, consider a gauged broken stable ribbon tree $t_{br,g}$, whose gauges may intersect some of its vertices. We order the non-trivial unbroken gauged ribbon trees appearing in $t_{br,g}$ from left to right, as

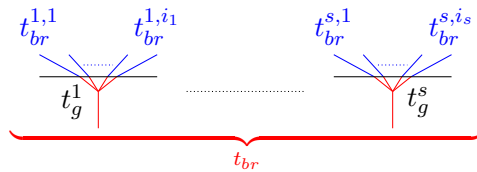

where $t_{br}^{1,1}, \dots, t_{br}^{1,i_1}, \dots, t_{br}^{s,1}, \dots, t_{br}^{s,i_s}$ and t_{br} are broken stable ribbon trees, and the non-trivial unbroken gauged ribbon trees are represented in the picture as gauged corollae t_g^1, \dots, t_g^s for the sake of readability. We write moreover r_1, \dots, r_s and $\lambda_1, \dots, \lambda_s$ for their respective roots and gauges. The moduli space $\mathcal{CT}_n(t_{br,g})$ is this time defined as

$$\mathcal{CT}_n(t_{br,g}) := \left\{ \begin{array}{l} (\lambda_1, \dots, \lambda_s, \{l_e\}_{e \in E(t_{br})}), \lambda_i \in \mathbb{R}, l_e > 0, \\ -\lambda_i > d(r_i, v), -\lambda_i < d(r_i, v'), -\lambda_i = d(r_i, v'') \end{array} \right\},$$

where the set of equalities and inequalities on λ_i is prescribed by the unbroken gauged tree t_g^i .

5.2.2. Orienting the moduli spaces $\mathcal{CT}_n(t_{br,g})$.

Definition 24. Define an *orientation* on a broken gauged stable ribbon tree $t_{br,g}$, to be an orientation $e_1 \wedge \dots \wedge e_i$ on t_{br} .

We now explain how to orient the moduli spaces $\mathcal{CT}_n(t_{br,g})$, following the previous three steps approach. Begin with a gauged stable ribbon tree t_g whose gauge does not intersect any of its vertices. An orientation ω on t_g identifies $\mathcal{CT}_n(t_g)$ with a polyhedral cone

$$\mathcal{CT}_n(t_g) \subset] -\infty, +\infty[\times]0, +\infty[^{e(t)},$$

defined by the inequalities $-\lambda > d(r, v)$ and $-\lambda < d(r, v')$. This polyhedral cone has dimension $e(t) + 1$, and we choose to orient it as an open subset of $] -\infty, +\infty[\times]0, +\infty[^{e(t)}$ endowed with its canonical orientation.

Consider now a gauged stable ribbon tree t_g whose gauge may intersect some of its vertices. This time, an orientation ω on t_g identifies $\mathcal{CT}_n(t_g)$ with a polyhedral cone

$$\mathcal{CT}_n(t_g) \subset] -\infty, +\infty[\times]0, +\infty[^{e(t)},$$

defined by the inequalities $-\lambda > d(r, v)$ and $-\lambda < d(r, v')$, to which we add the equalities $-\lambda = d(r, v'')$. If there are exactly j gauge-vertex intersections in the gauged tree t_g , this polyhedral cone has dimension $e(t) + 1 - j$. Order now the j intersections from left to right



and consider the tree t'_g obtained by replacing these intersections by



One can see t_g as lying in the boundary of t'_g , by allowing the inequalities $-\lambda > d(r, v_k)$ to become equalities $-\lambda = d(r, v_k)$ for $k = 1, \dots, j$. This determines in particular j vectors ν_k corresponding to the outward-pointing vectors to the boundary of the half-space $-\lambda \geq d(r, v_k)$. We finally choose to coorient (and hence orient) $\mathcal{CT}_n(t_g)$ inside $] -\infty, +\infty[\times]0, +\infty[^{e(t)}$ with the vectors (ν_1, \dots, ν_j) .

Lastly, consider a gauged broken stable ribbon tree $t_{br,g}$, whose gauges may intersect some of its vertices. Suppose there are exactly s non-trivial unbroken gauged trees t_g^1, \dots, t_g^s appearing in $t_{br,g}$, which are ordered from left to right as previously. Suppose also that in each tree t_g^i , there are j_i gauge-vertex intersections. An orientation ω on $t_{br,g}$ identifies $\mathcal{CT}_n(t_{br,g})$ with a polyhedral cone

$$\mathcal{CT}_n(t_{br,g}) \subset] -\infty, +\infty[\times]0, +\infty[^{e(t_{br})},$$

defined by the set of equalities and inequalities on the λ_i , and where the factor $] - \infty, +\infty[^s$ corresponds to $(\lambda_1, \dots, \lambda_s)$. This polyhedral cone has dimension $e(t_{br}) + s - \sum_{i=1}^s j_i$. Now, as in the previous paragraph, order all gauge-vertex intersections from left to right in every tree t_g^i , and construct a new tree $t'_{br,g}$. Seeing $\mathcal{CT}_n(t_{br,g})$ as lying in the boundary of $\mathcal{CT}_n(t'_{br,g})$, this determines again a collection of outward-pointing vectors $\nu_{i,1}, \dots, \nu_{i,j_i}$ for $i = 1, \dots, s$. We then coorient $\mathcal{CT}_n(t_{br,g})$ inside $] - \infty, +\infty[^s \times]0, +\infty[^{e(t_{br})}$ with the vectors $(\nu_{1,1}, \dots, \nu_{1,j_1}, \dots, \nu_{s,1}, \dots, \nu_{s,j_s})$.

Definition 25. We define $\mathcal{CT}_n(t_{br,g}, \omega)$ to be the moduli space $\mathcal{CT}_n(t_{br,g})$ endowed with the previous orientation.

We moreover insist on the fact that for a given broken stable ribbon tree type t_{br} all gauged trees $t_{br,g}$ whose underlying ribbon tree is t_{br} form polyhedral cones $] - \infty, +\infty[^s \times]0, +\infty[^{e(t_{br})}$, and the collection of these polyhedral cones is a partition of $] - \infty, +\infty[^s \times]0, +\infty[^{e(t_{br})}$. This is illustrated in figure 17.

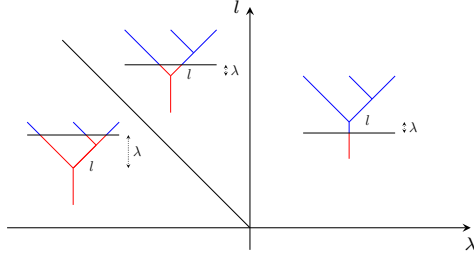

FIGURE 17

5.2.3. Compactification. Recall from section 3.2 that each broken gauged ribbon tree $t_{br,g}$ can be seen as a broken two-colored ribbon tree $t_{br,c}$. Using the two-colored metric trees viewpoint, the compactification of $\mathcal{CT}_n(t_{br,c})$ is defined by allowing lengths of internal edges to go towards 0 or $+\infty$, where combinatorics are induced by the equalities defined by the colored vertices. The compactification rule for gauged metric trees is then simply defined by transporting the compactification rule from the two-colored viewpoint to the gauged viewpoint. We do not give further details here, as we won't need them in our upcoming computations.

For a gauged stable ribbon tree t_g , the compactified moduli space $\overline{\mathcal{CT}}_n(t_g)$ has codimension 1 strata given by the four components (int-collapse), (gauge-vertex), (above-break) and (below-break). Choose an orientation ω for t_g . As for the moduli spaces $\mathcal{T}_n(t, \omega)$, the question is now to determine which signs appear in the boundary of the compactification of the oriented moduli space $\mathcal{CT}_n(t_g, \omega)$. We will inspect this matter in the four upcoming sections, computing the signs for each boundary component. Note that this time the compactification is much more elaborate than the cubical compactification of the $\mathcal{T}_n(t, \omega)$, and as a result we will not be able to write nice and elegant formulae. We will rather give recipes to compute the signs in each case.

5.2.4. The (int-collapse) boundary component. Consider a gauged stable ribbon tree t_g . The (int-collapse) boundary corresponds to the collapsing of an internal edge that does not intersect the gauge of the tree t . Choosing an ordering $\omega = e_1 \wedge \dots \wedge e_i$, suppose that it is the p -th edge of t which

collapses. Write moreover $(t/e_p)_g$ for the resulting gauged tree, and $\omega_p := e_1 \wedge \cdots \wedge \widehat{e_p} \wedge \cdots \wedge e_i$ for the induced ordering on the edges of t/e_p .

We begin by considering the case of a gauged tree t_g whose gauge does not intersect any of its vertices. Suppose first that the collapsing edge is located above the gauge. A neighborhood of the boundary can then be parametrized as

$$\begin{aligned}] - 1, 0] \times \mathcal{CT}_n((t/e_p)_g, \omega_p) &\longrightarrow \overline{\mathcal{CT}}_n(t_g, \omega) \\ (\delta, \lambda, l_1, \dots, \widehat{l_p}, \dots, l_i) &\longmapsto (\lambda, l_1, \dots, l_p := -\delta, \dots, l_i) . \end{aligned}$$

This map has sign $(-1)^{p+1}$, and the component $\mathcal{CT}_n((t/e_p)_g, \omega_p)$ consequently bears a $(-1)^{p+1}$ sign in the boundary of $\overline{\mathcal{CT}}_n(t_g, \omega)$.

Suppose next that the collapsing edge is located below the gauge. We define a parametrization of a neighborhood of the boundary

$$] - 1, 0] \times \mathcal{CT}_n((t/e_p)_g, \omega_p) \longrightarrow \overline{\mathcal{CT}}_n(t_g, \omega)$$

as follows : λ is sent to $\lambda + \delta$; if the edge e_q is located directly below a gauge-edge intersection

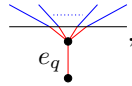

then we send l_q to $l_q - \delta$; for all the other edges e_q of (t/e_p) , we send l_q to l_q ; finally, we set $l_p := -\delta$. We check again that this map has sign $(-1)^{p+1}$. Hence, in general, for a gauged tree t_g whose gauge does not intersect any of its vertices, the component $\mathcal{CT}_n((t/e_p)_g, \omega_p)$ bears a $(-1)^{p+1}$ sign in the boundary of $\overline{\mathcal{CT}}_n(t_g, \omega)$.

Move on to the case of a gauged stable ribbon tree t_g whose gauge may intersect some of its vertices. Order the j gauge-vertex intersections from left to right as depicted in subsection 5.2.2. We are going to distinguish three cases, but will eventually end up with the same sign in each case. Suppose to begin with that the collapsing edge e_p is located above the gauge, and is not adjacent to a gauge-vertex intersection. Then, denoting $(t/e_p)'_g$ the tree obtained via the same process as t'_g , we check that the first parametrization introduced in this section

$$\Phi :] - 1, 0] \times \mathcal{CT}_n((t/e_p)'_g, \omega_p) \longrightarrow \overline{\mathcal{CT}}_n(t'_g, \omega) ,$$

restricts to a parametrization of a neighborhood of the boundary

$$\phi :] - 1, 0] \times \mathcal{CT}_n((t/e_p)_g, \omega_p) \longrightarrow \overline{\mathcal{CT}}_n(t_g, \omega) .$$

We also check that Φ sends the outward-pointing vectors $\nu_k^{(t/e_p)}$ associated to the gauge-vertex intersections in $(t/e_p)_g$, to the outward-pointing vectors ν_k^t associated to the gauge-vertex intersections in t_g . Computing the sign of ϕ amounts to computing the sign of Φ and then exchanging the direction δ with the outward-pointing vectors ν_1^t, \dots, ν_j^t . The total sign is hence $(-1)^{p+1+j}$.

Suppose, as second case, that the collapsing edge e_p is located above the gauge, and directly adjacent to a gauge-vertex intersection.

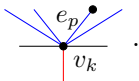

We cannot use the trees $(t/e_p)'_g$ and t'_g as in the last paragraph, as the gauge would then cut the edge e_p in the gauged tree t'_g . A small change is required. We form the tree t''_g as the tree t'_g , but instead

of moving the gauge up at the vertex v_k , we move it down. The tree $(t/e_p)''_g$ is defined similarly. Applying the same argument as previously, we compute again a $(-1)^{p+1+j}$ sign for the boundary.

Finally, suppose that the collapsing edge e_p is located below the gauge. It may this time be directly adjacent to a gauge-vertex intersection. Introducing again the trees $(t/e_p)'_g$ and t'_g , and using this time the second parametrization introduced in this section, we find a $(-1)^{p+1+j}$ sign for the boundary. Note that there is a small adjustment to make in the proof for the outward-pointing vectors. Indeed, the outward-pointing vector $\nu_k^{(t/e_p)}$ gets again sent to the outward-pointing vector ν_k^t , except if the edge e_p is located in the non-self crossing path going from the vertex v_k intersected by the gauge to the root. For such an intersection, the vector $\nu_k^{(t/e_p)}$ is sent to $\nu_k^t - e_p$ by the map Φ , where e_p is the positive direction for the length l_p . Though the vector $\nu_k^t - e_p$ is not equal to ν_k^t , it is still outward-pointing to the half-space $-\lambda \geq d(r, v_k)$. As a result, $\Phi(\nu_1^{(t/e_p)}), \dots, \Phi(\nu_j^{(t/e_p)})$ defines indeed the same coorientation of $\mathcal{CT}_n(t_g, \omega)$ as ν_1^t, \dots, ν_j^t .

Proposition 8. *For a gauged stable ribbon tree t_g whose gauge intersects j vertices, the boundary component $\mathcal{CT}_n((t/e_p)_g, \omega_p)$ corresponding to the collapsing of the p -th edge of t bears a $(-1)^{p+1+j}$ sign in the boundary of $\overline{\mathcal{CT}}_n(t_g, \omega)$.*

5.2.5. *The (gauge-vertex) boundary component.* Consider a gauged stable ribbon tree t_g whose gauge may intersect some of its vertices. We order the gauge-vertex intersections from left to right as depicted in subsection 5.2.2. The (gauge-vertex) boundary corresponds to the gauge crossing exactly one additional vertex of t . We suppose that this intersection takes place between the k -th and $k+1$ -th intersections of t_g . We write moreover t_g^0 for the resulting gauged tree, and introduce again the tree t'_g of subsection 5.2.2.

Proposition 9. *Suppose the crossing results from a move*



Then the boundary component $\mathcal{CT}_n(t_g^0, \omega)$ has sign $(-1)^{j+k}$ in the boundary of $\overline{\mathcal{CT}}_n(t_g, \omega)$.

Indeed the orientation induced on $\mathcal{CT}_n(t_g^0, \omega)$ in the boundary of $\overline{\mathcal{CT}}_n(t_g, \omega)$, is defined by the coorientation $(\nu_1, \dots, \nu_k, \widehat{\nu}, \nu_{k+1}, \dots, \nu_j, \nu)$ inside $\mathcal{CT}_n(t_g^0, \omega)$. The orientation defined by ω on $\mathcal{CT}_n(t_g^0, \omega)$, is the one defined by the coorientation $(\nu_1, \dots, \nu_k, \nu, \nu_{k+1}, \dots, \nu_j)$ inside $\mathcal{CT}_n(t'_g, \omega)$. Hence, these two orientations differ by a $(-1)^{j+k}$ sign.

Proposition 10. *Suppose the crossing results from a move*



Then the boundary component $\mathcal{CT}_n(t_g^0, \omega)$ has sign $(-1)^{j+k+1}$ in the boundary of $\overline{\mathcal{CT}}_n(t_g, \omega)$.

Again the orientation induced on $\mathcal{CT}_n(t_g^0, \omega)$ in the boundary of $\overline{\mathcal{CT}}_n(t_g, \omega)$, is defined by the coorientation $(\nu_1, \dots, \nu_k, \widehat{\nu}, \nu_{k+1}, \dots, \nu_j, -\nu)$ inside $\mathcal{CT}_n(t_g^0, \omega)$. The orientation defined by ω on $\mathcal{CT}_n(t_g^0, \omega)$, is the one defined by the coorientation $(\nu_1, \dots, \nu_k, \nu, \nu_{k+1}, \dots, \nu_j)$ inside $\mathcal{CT}_n(t'_g, \omega)$. Hence, these two orientations differ by a $(-1)^{j+k+1}$ sign.

5.2.6. *The (above-break) boundary component.* The (above-break) boundary corresponds either to the breaking of an internal edge of t , that is located above the gauge or intersects the gauge, or, when the gauge is below the root, to the outgoing edge breaking between the gauge and the root. Choosing an ordering $\omega = e_1 \wedge \cdots \wedge e_i$, suppose that it is the p -th edge of t which breaks and write moreover $(t_p)_g$ for the resulting broken gauged tree.

We begin by considering the case of a gauged tree t_g whose gauge does not intersect any of its vertices. Suppose first that the breaking edge does not intersect the gauge. A neighborhood of the boundary can then be parametrized as

$$\begin{aligned}]0, +\infty] \times \mathcal{CT}_n((t_p)_g, \omega_p) &\longrightarrow \overline{\mathcal{CT}}_n(t_g, \omega) \\ (\delta, \lambda, l_1, \dots, \widehat{l}_p, \dots, l_i) &\longmapsto (\lambda, l_1, \dots, l_p := \delta, \dots, l_i) . \end{aligned}$$

This map has sign $(-1)^p$. In the case when the breaking edge does intersect the gauge, a neighborhood of the boundary can be parametrized as

$$\begin{aligned}]0, +\infty] \times \mathcal{CT}_n((t_p)_g, \omega_p) &\longrightarrow \overline{\mathcal{CT}}_n(t_g, \omega) \\ (\delta, \lambda, l_1, \dots, \widehat{l}_p, \dots, l_i) &\longmapsto (\lambda, l_1, \dots, l_p := \delta - \lambda, \dots, l_i) , \end{aligned}$$

where we set this time $l_p := \delta - \lambda$ in order for the inequality $-\lambda < d(r, v')$ to hold in this case. This parametrization again has sign $(-1)^p$.

The case of a gauged tree t_g whose gauge may intersect some of its vertices is treated as in subsection 5.2.4. We check again that the parametrization maps Φ introduced in the previous paragraph, restrict to parametrizations of a neighborhood of the boundary

$$]0, +\infty] \times \mathcal{CT}_n((t_p)_g, \omega_p) \longrightarrow \overline{\mathcal{CT}}_n(t_g, \omega) ,$$

and that Φ sends moreover the coorientation of $\mathcal{CT}_n((t_p)_g, \omega_p)$ to the coorientation of $\mathcal{CT}_n(t_g, \omega)$. These coorientations introduce as previously an additional $(-1)^j$ sign.

Finally, suppose that the gauge of t_g intersects its outgoing edge and compute the sign of the (above-break) boundary component corresponding to the gauge going towards $+\infty$. A parametrization of a neighborhood of the boundary is simply given by

$$\begin{aligned}]0, +\infty] \times \mathcal{CT}_n((t_0)_g, \omega_p) &\longrightarrow \overline{\mathcal{CT}}_n(t_g, \omega) \\ (\delta, l_1, \dots, l_i) &\longmapsto (\lambda := \delta, l_1, \dots, l_i) . \end{aligned}$$

This map has sign 1.

Proposition 11. *For a gauged stable ribbon tree t_g whose gauge intersects j vertices, the boundary component $\mathcal{CT}_n((t_p)_g, \omega_p)$ corresponding to the breaking of the p -th edge of t bears a $(-1)^{p+j}$ sign in the boundary of $\overline{\mathcal{CT}}_n(t_g, \omega)$, where we set e_0 for the outgoing edge of t .*

5.2.7. *The (below-break) boundary component.* The (below-break) boundary corresponds to the breaking of edges of t that are located below the gauge or intersect it, such that there is exactly one edge breaking in each non-self crossing path from an incoming edge to the root. Write $(t_{br})_g$ for the resulting broken gauged tree. Consider now an ordering $\omega = e_1 \wedge \cdots \wedge e_i$ of t_g . We order again from left to right the s non-trivial unbroken gauged trees t_g^1, \dots, t_g^s of $(t_{br})_g$, and denote moreover e_{j_1}, \dots, e_{j_s} the internal edges of t whose breaking produce the trees t_g^1, \dots, t_g^s . Beware that we do not necessarily have that $j_1 < \cdots < j_s$. We assume in the next paragraphs that $j_1 = 1, \dots, j_s = s$,

and will explain how to deal with the general case at the end of this section. We set to this extent $\omega_{br} := e_{s+1} \wedge \cdots \wedge e_i$.

We introduce two more pieces of notation. We will denote \mathcal{E}_∞ the set of incoming edges of t which are crossed by the gauge and correspond to the trivial gauged trees in $(t_{br})_g$. In other words, the set of edges which are breaking in the (below-break) boundary component associated to $(t_{br})_g$ is $\mathcal{E}_\infty \cup \{e_{j_1}, \dots, e_{j_s}\}$. For an edge e , internal or external, we will moreover write w_e for the vertex adjacent to e which is closest to the root r of t , and set $w_u := w_{e_u}$ for $u = 1, \dots, s$.

Start by considering the case of a gauged tree t_g whose gauge does not intersect any of its vertices. Suppose first that among the breaking internal edges, none of them intersects the gauge. We define a parametrization of a neighbourhood of the boundary

$$]0, +\infty] \times \mathcal{CT}_n((t_{br})_g, \omega_{br}) \longrightarrow \overline{\mathcal{CT}}_n(t_g, \omega)$$

by sending $(\delta, \lambda_1, \dots, \lambda_s, l_{s+1}, \dots, l_i)$ to the element of $\mathcal{CT}_n(t_g, \omega)$ whose entries are defined as

$$\begin{aligned} \lambda &:= -\delta + \sum_{u=1}^s (\lambda_u - d(r, w_u)) - \sum_{e \in \mathcal{E}_\infty} d(r, w_e) , \\ l_v &:= \delta + \sum_{\substack{u=1, \dots, s \\ u \neq v}} (-\lambda_u + d(r, w_u)) + \sum_{e \in \mathcal{E}_\infty} d(r, w_e) && \text{for } v = e_1, \dots, e_s , \\ l_k &:= l_k && \text{for } k = s+1, \dots, i . \end{aligned}$$

We compute that this map has sign -1 .

Suppose now that among the breaking internal edges of t_g , some of them may intersect the gauge. We denote $\mathcal{N}_\cap \subset \{1, \dots, s\}$ for the set of indices corresponding to the breaking internal edges which intersect the gauge, and $\mathcal{N}_\emptyset \subset \{1, \dots, s\}$ for the set of indices corresponding to the breaking of internal edges which do not intersect the gauge. We define this time a parametrization of a neighbourhood of the boundary

$$]0, +\infty] \times \mathcal{CT}_n((t_{br})_g, \omega_{br}) \longrightarrow \overline{\mathcal{CT}}_n(t_g, \omega)$$

by sending $(\delta, \lambda_1, \dots, \lambda_s, l_{s+1}, \dots, l_i)$ to the element of $\mathcal{CT}_n(t_g, \omega)$ whose entries are set to be

$$\begin{aligned} \lambda &:= -\delta + \sum_{u \in \mathcal{N}_\emptyset} (\lambda_u - d(r, w_u)) - \sum_{u \in \mathcal{N}_\cap} d(r, w_u) - \sum_{e \in \mathcal{E}_\infty} d(r, w_e) , \\ l_v &:= \delta + \sum_{\substack{u \in \mathcal{N}_\emptyset \\ u \neq v}} (-\lambda_u + d(r, w_u)) + \sum_{u \in \mathcal{N}_\cap} d(r, w_u) + \sum_{e \in \mathcal{E}_\infty} d(r, w_e) && \text{for } v \in \mathcal{N}_\emptyset , \\ l_v &:= \delta + \lambda_v + \sum_{u \in \mathcal{N}_\emptyset} (-\lambda_u + d(r, w_u)) + \sum_{\substack{u \in \mathcal{N}_\cap \\ u \neq v}} d(r, w_u) + \sum_{e \in \mathcal{E}_\infty} d(r, w_e) && \text{for } v \in \mathcal{N}_\cap , \\ l_k &:= l_k && \text{for } k = s+1, \dots, i . \end{aligned}$$

We compute that this map has again sign -1 .

Consider now the case of a gauged tree t_g whose gauge intersects j of its vertices. We check as in the previous sections that the parametrization maps introduced in the previous paragraphs, restrict

to parametrizations of a neighborhood of the boundary

$$]0, +\infty] \times \mathcal{CT}_n((t_{br})_g, \omega_{br}) \longrightarrow \overline{\mathcal{CT}}_n(t_g, \omega) ,$$

and that these maps send moreover the coorientation of $\mathcal{CT}_n((t_{br})_g, \omega_{br})$ to the coorientation of $\mathcal{CT}_n(t_g, \omega)$. These coorientations introduce an additional $(-1)^j$ sign.

We have thus computed the sign of the (below-break) boundary when $j_1 = 1, \dots, j_s = s$. Now, consider the general case where we do not necessarily have that $j_1 = 1, \dots, j_s = s$. We denote $\varepsilon(j_1, \dots, j_s; \omega)$ the sign obtained after modifying ω by moving e_{j_k} to the k -th spot in ω , and write ω_0 for the newly obtained orientation on t_g . Twisting the orientation on $\mathcal{CT}_n(t_g, \omega)$ by $(-1)^{\varepsilon(j_1, \dots, j_s; \omega)}$ amounts to identifying it with $\mathcal{CT}_n(t_g, \omega_0)$. We can apply the previous constructions and find the desired sign for the associated (below-break) component.

Proposition 12. *For a gauged stable ribbon tree t_g whose gauge intersects j vertices, the boundary component $\mathcal{CT}_n((t_{br})_g, \omega_{br})$ corresponding to the breaking of the internal edges e_{j_1}, \dots, e_{j_s} of t bears a $(-1)^{\varepsilon(j_1, \dots, j_s; \omega) + 1 + j}$ sign in the boundary of $\overline{\mathcal{CT}}_n(t_g, \omega)$.*

5.3. The operadic bimodule Ω BA s – Morph.

5.3.1. *Definition of the operadic bimodule Ω BA s – Morph.* We choose to define the operadic bimodule Ω BA s – Morph with the formalism of orientations on gauged trees, so that it be compatible with the definition of Markl-Shnider for the operad Ω BA s . As before, $t_{br,g}$ will stand for a broken gauged stable ribbon tree, while t_g will denote an unbroken gauged stable ribbon tree. We also respectively write t_{br} and t for the underlying stable ribbon trees.

Definition 26 (Spaces of operations and action-composition maps). Consider the \mathbb{Z} -module freely generated by the pairs $(t_{br,g}, \omega)$. We define the arity n space of operations Ω BA s – Morph $(n)_*$ to be the quotient of this \mathbb{Z} -module under the relation

$$(t_{br,g}, -\omega) = -(t_{br,g}, \omega) .$$

An element $(t_{br,g}, \omega)$ where $t_{br,g}$ has $e(t_{br})$ finite internal edges and g non-trivial gauges which intersect j vertices of t_{br} is defined to have degree $j - (e(t_{br}) + g)$. The operad Ω BA s then acts on Ω BA s – Morph as follows

$$\begin{aligned} (t_{br,g}, \omega) \circ_i (t'_{br}, \omega') &= (t_{br,g} \circ_i t'_{br}, \omega \wedge \omega') , \\ \mu((t_{br}, \omega), (t_{br,g}^1, \omega_1), \dots, (t_{br,g}^s, \omega_s)) &= (-1)^\dagger (\mu(t_{br}, t_{br,g}^1 \dots, t_{br,g}^s), \omega \wedge \omega_1 \wedge \dots \wedge \omega_s) , \end{aligned}$$

where the tree $t_{br,g} \circ_i t'_{br}$ is the gauged broken ribbon tree obtained by grafting t'_{br} to the i -th incoming edge of $t_{br,g}$ and $\mu(t_{br}, t_{br,g}^1 \dots, t_{br,g}^s)$ is the gauged broken ribbon tree defined by grafting each $t_{br,g}^j$ to the j -th incoming edge of t_{br} . Writing g_i for the number of non-trivial gauges and j_i for the number of gauge-vertex intersections of $t_{br,g}^i$, $i = 1, \dots, s$, and setting $t_{br}^0 := t_{br}$ and $g_0 = j_0 = 0$,

$$\dagger := \sum_{i=1}^s g_i \sum_{l=0}^{i-1} e(t_{br}^l) + \sum_{i=1}^s j_i \sum_{l=0}^{i-1} (e(t_{br}^l) + g_l - j_l) ,$$

or equivalently

$$\dagger = \sum_{i=1}^s g_i \left(|t_{br}| + \sum_{l=1}^{i-1} |t_{br}^l| \right) + \sum_{i=1}^s j_i \left(|t_{br}| + \sum_{l=1}^{i-1} |t_{br,g}^l| \right) .$$

Choosing a distinguished orientation for every gauged stable ribbon tree $t_g \in SCRT$, this definition of the operadic bimodule $\Omega BAs - \text{Morph}$ amounts to defining it as the free operadic bimodule in graded \mathbb{Z} -modules

$$\mathcal{F}^{\Omega BAs, \Omega BAs}(\uparrow, \downarrow, \downarrow, \downarrow, \dots, SCRT_n, \dots) .$$

It remains to define a differential on the generating operations (t_g, ω) to recover the definition given in subsection 3.2.4.

Definition 27 (Differential). The differential of a gauged stable ribbon tree (t_g, ω) is defined as the signed sum of all codimension 1 contributions

$$\partial(t_g, \omega) = \sum \pm(\text{int} - \text{collapse}) + \sum \pm(\text{gauge} - \text{vertex}) + \sum \pm(\text{above} - \text{break}) + \sum \pm(\text{below} - \text{break}) ,$$

where the signs are as computed in Propositions 8 to 12.

For instance, choosing the ordering $e_1 \wedge e_2$ on

$$\frac{\downarrow \downarrow \downarrow}{e_1 \downarrow e_2} ,$$

the signs in the computation of subsection 3.2.4 are

$$\begin{aligned} \partial \left(\frac{\downarrow \downarrow \downarrow}{\downarrow}, e_1 \wedge e_2 \right) &= \left(\frac{\downarrow \downarrow \downarrow}{\downarrow}, e_1 \wedge e_2 \right) - \left(\frac{\downarrow \downarrow \downarrow}{\downarrow}, e_1 \wedge e_2 \right) - \left(\frac{\downarrow \downarrow \downarrow}{\downarrow}, e_1 \wedge e_2 \right) \\ &\quad + \left(\frac{\downarrow \downarrow \downarrow}{\downarrow}, e_1 \right) - \left(\frac{\downarrow \downarrow \downarrow}{\downarrow}, e_2 \right) - \left(\frac{\downarrow \downarrow \downarrow}{\downarrow}, \emptyset \right) . \end{aligned}$$

5.3.2. *The moduli spaces $\overline{\mathcal{CT}}_n$ realize the operadic bimodule $\Omega BAs - \text{Morph}$.* We only have to check that the signs for the action-composition maps of $\Omega BAs - \text{Morph}$ are indeed the ones determined by the moduli spaces $\overline{\mathcal{CT}}_n$, to conclude that the moduli spaces $\overline{\mathcal{CT}}_n$ endowed with their fine cell decomposition realize the operadic bimodule $\Omega BAs - \text{Morph}$ under the functor C_{-*}^{cell} .

The computation for \circ_i is straightforward. Consider now the map

$$\begin{aligned} \mu : \mathcal{T}(t_{br}, \omega) \times \mathcal{CT}(t_{br,g}^1, \omega_1) \times \dots \times \mathcal{CT}(t_{br,g}^s, \omega_s) &\longrightarrow \mathcal{CT}(\mu(t_{br}, t_{br,g}^1, \dots, t_{br,g}^s), \omega \wedge \omega_1 \wedge \dots \wedge \omega_s) \\ (L_\omega, (\Lambda_1, L_{\omega_1}), \dots, (\Lambda_s, L_{\omega_s})) &\longmapsto (\Lambda_1, \dots, \Lambda_s, L_\omega, L_{\omega_1}, \dots, L_{\omega_s}) , \end{aligned}$$

where L_{ω_i} stands for the list of lengths of t_{br}^i according to the ordering ω_i , and $\Lambda_i := (\lambda_{i,1}, \dots, \lambda_{i,g_i})$ stands for the list of non-trivial gauges of $t_{br,g}^i$. We compute that, in the absence of gauge vertex intersections, this map has sign

$$(-1)^{\sum_{i=1}^s g_i \sum_{l=0}^{i-1} e(t_{br}^l)} .$$

Assuming that there are some gauge-vertex intersections, the combinatorics of coorientations introduce an additional sign

$$(-1)^{\sum_{i=1}^s j_i \sum_{l=0}^{i-1} (e(t_{br}^l) + g_l - j_l)} .$$

In total, we recover the sign $(-1)^\dagger$, which concludes the proof.

5.3.3. *Canonical orientations for the gauged binary ribbon trees.* For a fixed $n \geq 2$, the set of gauged binary ribbon trees $CBRT_n$ can be endowed with a partial order, inspired by the Tamari order on BRT_n . It is introduced in [MMV].

Definition 28 ([MMV]). The *Tamari order on $CBRT_n$* is the partial order generated by the covering relations

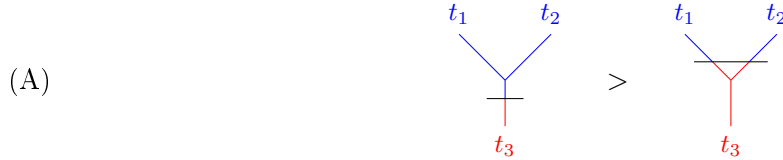

where t_1, t_2 and t_3 are binary ribbon trees,

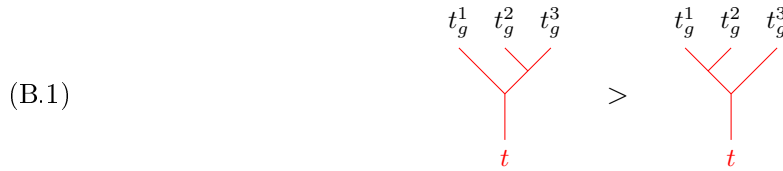

where t_g^1, t_g^2, t_g^3 are gauged binary ribbon trees and t is a binary ribbon tree, and

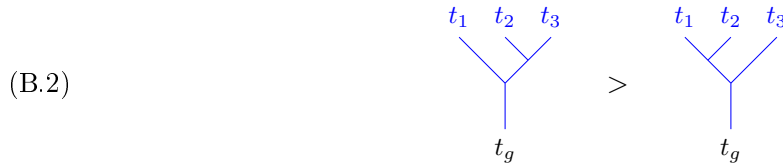

where t_1, t_2, t_3 are binary ribbon trees and t_g is a gauged binary ribbon tree.

For example in the case of $CBRT_4$, we obtain the Hasse diagram in figure 18. This Tamari-like poset has a unique maximal element and a unique minimal element, respectively given by the right-leaning comb whose gauge intersects the outgoing edge, and the left-leaning comb whose gauge intersects all incoming edges.

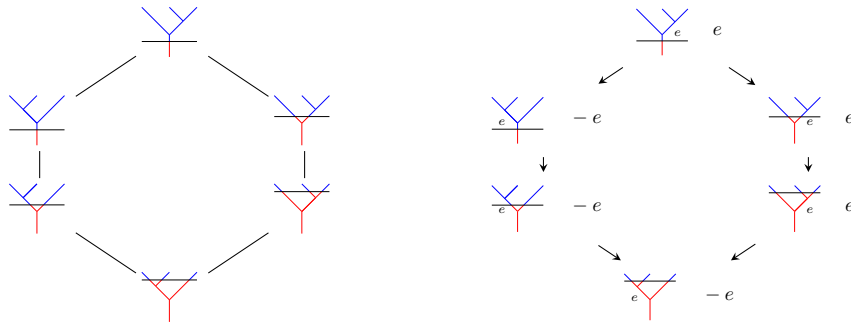
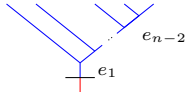

FIGURE 18. On the left, the Hasse diagram of the poset $CBRT_3$, where the maximal element is written at the top. On the right, all the canonical orientations for $CBRT_3$ computed going down the poset.

The canonical orientation on the maximal gauged binary tree is defined as



The diagram shows a binary tree structure with blue edges. The root node has a left child (edge e_1) and a right child. The right child has a left child (edge e_{n-2}) and a right child. The tree is oriented downwards.

$$\omega_{can} := e_1 \wedge \cdots \wedge e_{n-2} .$$

Using this Tamari-like order, we can now build inductively canonical orientations on all gauged binary trees. We start at the maximal gauged binary tree, and transport the orientation ω_{can} to its immediate neighbours as follows : the immediate neighbours of t_g^{max} obtained under the covering relation (A) are endowed with the orientation ω_{can} , while the ones obtained under the covering relations (B) are endowed with the orientation $-\omega_{can}$. We then repeat this operation while going down the poset until the minimal gauged binary tree is reached. This process is consistent (see next section), i.e. it does not depend on the path taken in the poset from t_g^{max} to the gauged binary tree whose orientation is being defined. A full example for $CBRT_3$ is illustrated in figure 18.

Definition 29. The such obtained orientations will again be called the *canonical orientations* and written ω_{can} . They coincide in fact with the canonical orientations on the underlying binary trees.

5.3.4. *MacLane's coherence.* We stated in subsections 5.1.2 and 5.3.3 that our process of transforming orientations is consistent, i.e. it does not depend on the path taken in the Tamari poset from the maximal tree to the tree whose orientation is being defined. In fact, our rules to transform orientations under the covering relations enable us to transport the orientation ω of any (gauged) tree $t_{(g)}$ to any (gauged) tree $t'_{(g)}$, along a path in the Tamari poset. The following result then holds : for a given oriented (gauged) tree $(t_{(g)}, \omega)$, any two paths in the Tamari poset from $t_{(g)}$ to $t'_{(g)}$ yield the same orientation on $t'_{(g)}$.

As pointed out by Markl and Shnider in [MS06], an adaptation of the proof of MacLane's coherence theorem shows that it is enough to prove that the diagram described by K_4 commutes to conclude that this statement holds for BRT_n . And this is the case as shown in figure 14. In the case of $CBRT_n$, an adaptation of these arguments shows this time that it is enough to prove that the diagrams described by K_4 and J_3 commute in order to conclude. This is again the case.

A conceptual explanation for these two "coherence theorems" can be given as follows. In the case of BRT_n , a path between two trees t and t' in the Tamari poset corresponds to a path in the 1-skeleton of K_n . The faces of the 2-skeleton of K_n consist moreover of the products

$$K_2 \times \cdots \times K_2 \times K_3 \times K_2 \times \cdots \times K_2 \times K_3 \times K_2 \times \cdots \times K_2 ,$$

$$K_2 \times \cdots \times K_2 \times K_4 \times K_2 \times \cdots \times K_2 .$$

The first type of face corresponds to a square diagram that tautologically commutes, while the second type of face corresponds to the K_4 diagram. Given now two paths from t to t' , they delineate a family of faces in the 2-skeleton of K_n . Translating this into algebra, as all faces translate into commuting diagrams, the two paths produce the same orientation.

5.3.5. *The morphism of operadic bimodules $A_\infty - \text{Morph} \rightarrow \Omega BAs - \text{Morph}$.* The moduli space \overline{CT}_n endowed with its A_∞ -cell decomposition is isomorphic to the Forcey-Loday realization J_n of the multiplihedron. Forcey shows in [For08] that under this isomorphism, the ΩBAs -decomposition is sent to the dual subdivision of J_n . This is illustrated on figure 11 for instance. The goal of this section is again to show that :

Proposition 13. *The map $\text{id} : (\overline{\mathcal{CT}}_n)_{A_\infty} \rightarrow (\overline{\mathcal{CT}}_n)_{\Omega BAs}$ is sent under the functor C_{-*}^{cell} to the morphism of operadic bimodules $A_\infty - \text{Morph} \rightarrow \Omega BAs - \text{Morph}$ acting as*

$$f_n \mapsto \sum_{t_g \in CBRT_n} (t_g, \omega_{\text{can}}) .$$

We prove that taking the restriction of the orientation of J_n chosen in section 4.4 to the top dimensional cells of its dual subdivision, yields the canonical orientations on these cells in the $\overline{\mathcal{CT}}_n$ viewpoint. We follow in this regard the exact same line of proof as in subsection 5.1.4.

This statement is at first shown for the maximal gauged binary tree t_g^{max} , the right-leaning comb whose gauge crosses the outgoing edge. The orientation on the cell $\overline{\mathcal{CT}}_n(t_g^{\text{max}})$ induced by the canonical orientation $e_1 \wedge \cdots \wedge e_{n-2}$ defines an isomorphism

$$\overline{\mathcal{CT}}_n(t_g^{\text{max}}) \xrightarrow{\sim} [0, +\infty] \times [0, +\infty]^{n-2} ,$$

where the factor $[0, +\infty]$ corresponds to the gauge λ , and the factor $[0, +\infty]^{n-2}$ to the lengths of the inner edges. The face of $\overline{\mathcal{CT}}_n(t_g^{\text{max}})$ associated to the gauge going to $+\infty$ corresponds to the face $H_{0,n,0}$ when seen in the Forcey-Loday polytope, while the face associated to the breaking of the i -th edge corresponds to the face $H_{i,n-i,0}$. An outward-pointing vector for the face $H_{i,n-i,0}$ is moreover

$$\nu_i := (0, \dots, 0, 1_{i+1}, \dots, 1_{n-1}) ,$$

where coordinates are taken in the basis f_j^ω . The orientation defined by the canonical basis of $[0, +\infty] \times [0, +\infty]^{n-2}$ is exactly the one defined by the ordered list of the outward-pointing vectors to the $+\infty$ boundary. This orientation is thus sent to the orientation defined by the basis $(\nu_0, \dots, \nu_{n-2})$ in the Forcey-Loday polytope. It remains to check that

$$\det_{f_j^\omega}(\nu_j) = 1 .$$

As a result, the orientation induced by J_n and the one defined by the canonical orientation coincide for the cell $\overline{\mathcal{CT}}_n(t_g^{\text{max}})$.

The rest of the proof is a mere adaptation of the proof of subsection 5.1.4. The cells labeled by the gauged binary trees which are immediate neighbours of the maximal gauged binary tree, are exactly the ones having a codimension 1 stratum in common with $\overline{\mathcal{CT}}_n(t_g^{\text{max}})$. Choosing one such tree t_g , and gluing the cells $\overline{\mathcal{CT}}_n(t_g)$ and $\overline{\mathcal{CT}}_n(t_g^{\text{max}})$ along their common boundary, one can read the induced orientation on $\overline{\mathcal{CT}}_n(t_g)$. In the case when the immediate neighbour t_g is obtained under the covering relation (A), the cells $\overline{\mathcal{CT}}_n(t_g)$ and $\overline{\mathcal{CT}}_n(t_g^{\text{max}})$ are in fact both oriented as subspaces of $] - \infty, +\infty[\times]0, +\infty[^{n-2}$. In the case when the immediate neighbour t_g is obtained under the covering relations (B), we send the reader back to subsection 5.1.4 for explanations on why a -1 twist of the orientation has to be introduced. In each case, the induced orientation is exactly the canonical orientation on $\overline{\mathcal{CT}}_n(t_g)$. This argument can now be repeated going down the poset, and the induced orientation will always coincide with the canonical orientation on the cell, which concludes the proof of Proposition 3.

Part 2

Geometry

1. A_∞ AND ΩBAs -ALGEBRA STRUCTURES ON THE MORSE COCHAINS

Let M be an oriented closed Riemannian manifold endowed with a Morse function f together with a Morse-Smale metric. Following [Hut08], the Morse cochains $C^*(f)$ form a deformation retract of the singular cochains on M . The cup product naturally endows the singular cochains $C_{sing}^*(M)$ with a dg-algebra structure. The homotopy transfer theorem then ensures that it can be transferred to an A_∞ -algebra structure on the Morse cochains $C^*(f)$. The following question then naturally arises. The differential on the Morse cochains is defined by a count of moduli spaces of gradient trajectories connecting critical points of f . Is it possible to define higher multiplications m_n on $C^*(f)$ by a count of moduli spaces such that they fit in a structure of A_∞ -algebra ?

We have seen in the previous part that the polytopes encoding the operad A_∞ are the associahedra and that they can be realized as the compactified moduli spaces of stable metric ribbon trees. A natural candidate would thus be an interpretation of metric ribbon trees in Morse theory. A naive approach would be to define trees each edge of which corresponds to a Morse gradient trajectory as in figure 19. These moduli spaces are however not well defined, as two trajectories coming from two distinct critical points cannot intersect. A second problem is that moduli spaces of trajectories issued from the same critical point do not intersect transversely. In his article [Abo11], Abouzaid bypasses this problem by perturbing the equation around each vertex, so that a transverse intersection can be achieved. See also [Mes18]. This is illustrated in figure 19.

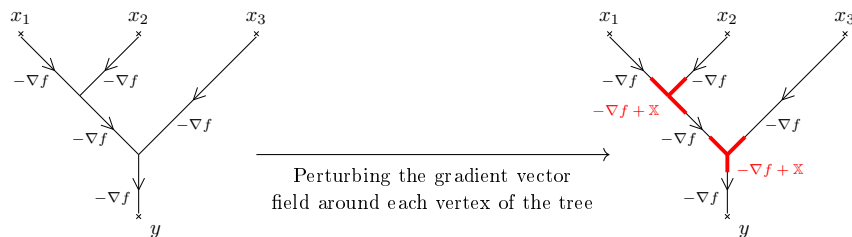

FIGURE 19

Trees obtained in this way will be called *perturbed Morse gradient trees*. Let t be a stable ribbon tree type and y, x_1, \dots, x_n a collection of critical points of the Morse function f . We prove in this section that for a generic choice of perturbation data \mathbb{X}_t on the moduli space $\mathcal{T}_n(t)$, the moduli space of perturbed Morse gradient trees modeled on t and connecting x_1, \dots, x_n to y , denoted $\mathcal{T}_t(y; x_1, \dots, x_n)$, is an orientable manifold (Proposition 15). Under some additional generic assumptions on the choices of perturbation data \mathbb{X}_t , these moduli spaces are compact in the 0-dimensional case, and can be compactified to compact manifolds with boundary in the 1-dimensional case (Theorems 7 and 8). We are finally able to define operations on the Morse cochains $C^*(f)$ by counting

the 0-dimensional moduli spaces of Morse gradient trees : these operations define an ΩBAs -algebra structure on $C^*(f)$ (Theorem 9). Our constructions are carried out using the formalism introduced in [Abo11] and some terminology of [Mes18]. Technical details are moreover postponed to sections 3 and 4.

Note that in Floer theory, A_∞ -structures arise from the fact that moduli spaces of closed pointed disks naturally yield the A_∞ -cell decompositions of the associahedra. This is not the case in our situation, where it is the ΩBAs -cell decompositions that naturally arise.

1.1. Conventions. We refer to section 4.2 for additional details on the moduli spaces introduced in this section. We will study Morse theory of the Morse function $f : M \rightarrow \mathbb{R}$ using its negative gradient vector field $-\nabla f$. Denote d the dimension of the manifold M and ϕ^s the flow of $-\nabla f$. For a critical point x define its unstable and stable manifolds

$$W^U(x) := \{z \in M, \lim_{s \rightarrow -\infty} \phi^s(z) = x\}$$

$$W^S(x) := \{z \in M, \lim_{s \rightarrow +\infty} \phi^s(z) = x\} .$$

Their dimensions are such that $\dim(W^U(x)) + \dim(W^S(x)) = d$. We then define the *degree of a critical point* x to be $|x| := \dim(W^S(x))$. This degree is often referred to as the *coindex of x* in the literature.

We will moreover work with Morse cochains. For two critical point $x \neq y$, define

$$\mathcal{T}(y; x) := W^S(y) \cap W^U(x) / \mathbb{R}$$

to be the moduli space of negative gradient trajectories connecting x to y . Denote moreover $\mathcal{T}(x; x) = \emptyset$. Under the Morse-Smale assumption on f and the Riemannian metric on M , for $x \neq y$ the moduli space $\mathcal{T}(y; x)$ has dimension $\dim(\mathcal{T}(y; x)) = |y| - |x| - 1$. The Morse differential $\partial_{Morse} : C^*(f) \rightarrow C^*(f)$ is then defined to count descending negative gradient trajectories

$$\partial_{Morse}(x) := \sum_{|y|=|x|+1} \#\mathcal{T}(y; x) \cdot y .$$

1.2. Perturbed Morse gradient trees.

Definition 30 ([Abo11]). Let $T := (t, \{l_e\}_{e \in E(t)})$ be a metric tree, where $\{l_e\}_{e \in E(t)}$ are the lengths of its internal edges. A *choice of perturbation data* on T consists of the following data :

(i) a vector field

$$[0, l_e] \times M \xrightarrow{\mathbb{X}_e} TM ,$$

that vanishes on $[1, l_e - 1]$, for every internal edge e of t ;

(ii) a vector field

$$[0, +\infty[\times M \xrightarrow{\mathbb{X}_{e_0}} TM ,$$

that vanishes away from $[0, 1]$, for the outgoing edge e_0 of t ;

(iii) a vector field

$$]-\infty, 0] \times M \xrightarrow{\mathbb{X}_{e_i}} TM ,$$

that vanishes away from $[-1, 0]$, for every incoming edge e_i ($1 \leq i \leq n$) of t .

Note that when $l_e \leq 2$, the vanishing condition on $[1, l_e - 1]$ is empty, that is we do not require any specific vanishing property for \mathbb{X}_e . For brevity's sake we will write D_e for all segments $[0, l_e]$ as well as for all semi-infinite segments $]-\infty, 0]$ and $[0, +\infty[$ in the rest of the paper.

Definition 31 ([Abo11]). A *perturbed Morse gradient tree* T^{Morse} associated to (T, \mathbb{X}) is the data for each edge e of t of a smooth map $\gamma_e : D_e \rightarrow M$ such that γ_e is a trajectory of the perturbed negative gradient $-\nabla f + \mathbb{X}_e$, i.e.

$$\dot{\gamma}_e(s) = -\nabla f(\gamma_e(s)) + \mathbb{X}_e(s, \gamma_e(s)) ,$$

and such that the endpoints of these trajectories coincide as prescribed by the edges of the tree T .

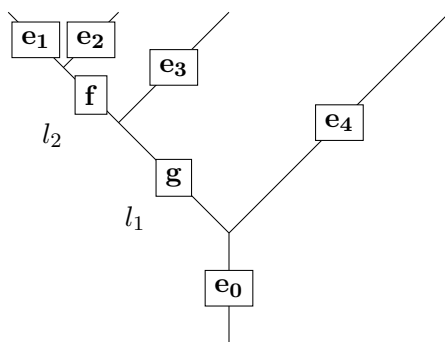

FIGURE 20. Choosing perturbation data \mathbb{X} for this metric tree, we have that $\phi_{1, \mathbb{X}} = \phi_{g, \mathbb{X}}^{l_1} \circ \phi_{f, \mathbb{X}}^{l_2} \circ \phi_{e_1, \mathbb{X}}^1$, $\phi_{2, \mathbb{X}} = \phi_{g, \mathbb{X}}^{l_1} \circ \phi_{f, \mathbb{X}}^{l_2} \circ \phi_{e_2, \mathbb{X}}^1$, $\phi_{3, \mathbb{X}} = \phi_{g, \mathbb{X}}^{l_1} \circ \phi_{e_3, \mathbb{X}}^1$ and $\phi_{4, \mathbb{X}} = \phi_{e_4, \mathbb{X}}^1$

A perturbed Morse gradient tree T^{Morse} associated to (T, \mathbb{X}) is determined by the data of the time -1 points on its incoming edges plus the time 1 point on its outgoing edge. Indeed, for each edge e of t , we write $\phi_{e, \mathbb{X}}$ for the flow of $-\nabla f + \mathbb{X}_e$. We moreover define for every incoming edge e_i ($1 \leq i \leq n$) of T , the diffeomorphism $\phi_{i, \mathbb{X}}$ to be the composition of all flows obtained by following the time -1 point of the metric tree on e_i along the only non-self crossing path connecting it to the root. We also set $\phi_{0, \mathbb{X}}$ for the flow of $\phi_{e_0, \mathbb{X}}$ at time -1, where e_0 is the outgoing edge of t . This is depicted on figure 20. Setting

$$\Phi_{T, \mathbb{X}} : M \times \cdots \times M \xrightarrow{\phi_{0, \mathbb{X}} \times \cdots \times \phi_{n, \mathbb{X}}} M \times \cdots \times M ,$$

and Δ for the thin diagonal of $M \times \cdots \times M$, it is then clear that :

Proposition 14 ([Abo11]). *There is a one-to-one correspondence*

$$\left\{ \begin{array}{l} \text{perturbed Morse gradient trees} \\ \text{associated to } (T, \mathbb{X}) \end{array} \right\} \longleftrightarrow (\Phi_{T, \mathbb{X}})^{-1}(\Delta) .$$

The vector fields on the external edges are equal to $-\nabla f$ away from a length 1 segment, hence the trajectories associated to these edges all converge to critical points of the function f . For critical points y and x_1, \dots, x_n , the map $\Phi_{T, \mathbb{X}}$ can be restricted to

$$W^S(y) \times W^U(x_1) \times \cdots \times W^U(x_n) ,$$

such that the inverse image of the diagonal yields all perturbed Morse gradient trees associated to (T, \mathbb{X}) connecting x_1, \dots, x_n to y .

1.3. Moduli spaces of perturbed Morse gradient trees. Recall that $E(t)$ stands for the set of internal edges of t , and $\overline{E}(t)$ for the set of all its edges. We previously saw that a choice of perturbation data on a metric ribbon tree $T := (t, \{l_e\}_{e \in E(t)})$ is the data of maps $\mathbb{X}_{T,f} : D_f \times M \rightarrow TM$, for every edge $f \in \overline{E}(t)$ of t . Define the cone $C_f \subset \mathcal{T}_n(t) \times \mathbb{R} \simeq \mathbb{R}^{e(t)+1}$ to be

- (i) $\{((l_e)_{e \in E(t)}, s) \text{ such that } 0 \leq s \leq l_f\}$ if f is an internal edge ;
- (ii) $\{((l_e)_{e \in E(t)}, s) \text{ such that } s \leq 0\}$ if f is an incoming edge ;
- (iii) $\{((l_e)_{e \in E(t)}, s) \text{ such that } s \geq 0\}$ if f is the outgoing edge.

Then a choice of perturbation data for every metric ribbon tree in $\mathcal{T}_n(t)$ yields a map

$$\mathbb{X}_{t,f} : C_f \times M \rightarrow TM ,$$

for every edge f of t . This choice of perturbation data is said to be *smooth* if all these maps are smooth.

Definition 32. Let \mathbb{X}_t be a smooth choice of perturbation data on $\mathcal{T}_n(t)$. For critical points y and x_1, \dots, x_n , we define the moduli space

$$\mathcal{T}_t^{\mathbb{X}_t}(y; x_1, \dots, x_n) := \left\{ \begin{array}{l} \text{perturbed Morse gradient trees associated to } (T, \mathbb{X}_T) \\ \text{and connecting } x_1, \dots, x_n \text{ to } y, \text{ for } T \in \mathcal{T}_n(t) \end{array} \right\} .$$

Introduce now the map

$$\phi_{\mathbb{X}_t} : \mathcal{T}_n(t) \times W^S(y) \times W^U(x_1) \times \dots \times W^U(x_n) \rightarrow M^{\times n+1} ,$$

whose restriction to every $T \in \mathcal{T}_n(t)$ is as defined previously :

Proposition 15. (i) *The moduli space $\mathcal{T}_t^{\mathbb{X}_t}(y; x_1, \dots, x_n)$ can be rewritten as*

$$\mathcal{T}_t^{\mathbb{X}_t}(y; x_1, \dots, x_n) = \phi_{\mathbb{X}_t}^{-1}(\Delta) ,$$

where Δ is the thin diagonal of $M^{\times n+1}$.

(ii) *Given a choice of perturbation data \mathbb{X}_t making $\phi_{\mathbb{X}_t}$ transverse to the diagonal Δ , the moduli space $\mathcal{T}_t^{\mathbb{X}_t}(y; x_1, \dots, x_n)$ is an orientable manifold of dimension*

$$\dim(\mathcal{T}_t(y; x_1, \dots, x_n)) = e(t) + |y| - \sum_{i=1}^n |x_i| .$$

(iii) *Choices of perturbation data \mathbb{X}_t such that $\phi_{\mathbb{X}_t}$ is transverse to Δ exist.*

Item (i) is straightforward and item (ii) stems from the fact that if $\phi_{\mathbb{X}_t}$ transverse to Δ , the moduli spaces $\mathcal{T}_t^{\mathbb{X}_t}(y; x_1, \dots, x_n)$ are manifolds of codimension

$$\text{codim}(\mathcal{T}_t(y; x_1, \dots, x_n)) = \text{codim}_{M^{\times n+1}}(\Delta) = nd ,$$

where $d := \dim(M)$. Note that we have chosen to grade the Morse cochains using the coindex in order for this convenient dimension formula to hold. We refer to sections 3 for details on item (iii).

1.4. Compactifications. We now would like to compactify the moduli spaces $\mathcal{T}_t^{\mathbb{X}_t}(y; x_1, \dots, x_n)$ that have dimension 1 to 1-dimensional manifolds with boundary. They are defined as the inverse image in $\mathcal{T}_n(t) \times W^S(y) \times W^U(x_1) \times \dots \times W^U(x_n)$ of the diagonal Δ under $\phi_{\mathbb{X}_t}$. The boundary components in the compactification should hence come from those of $\mathcal{T}_n(t)$, of the $W^U(x_i)$, and of $W^S(y)$: that is they will respectively come from internal edges of the perturbed Morse gradient tree collapsing, or breaking at a critical point (boundary of $\mathcal{T}_n(t)$), its semi-infinite incoming edges breaking at a critical point (boundary of $W^U(x_i)$) and its semi-infinite outgoing edge breaking at a critical point (boundary of $W^S(y)$). Some of these phenomena are represented on figure 21.



FIGURE 21. Two examples of perturbed Morse gradient trees breaking at a critical point

Choose smooth perturbation data \mathbb{X}_t for all $t \in SRT_i$, $2 \leq i \leq n$. We denote $\mathbb{X}_n := (\mathbb{X}_t)_{t \in SRT_n}$ and call it a *choice of perturbation data on the moduli space \mathcal{T}_n* . We construct the boundary of the compactification of the moduli space $\mathcal{T}_t^{\mathbb{X}_t}(y; x_1, \dots, x_n)$ by using the perturbation data $(\mathbb{X}_t)_{1 \leq i \leq n}$. It is given by the spaces

- (i) corresponding to an internal edge collapsing (int-collapse) :

$$\mathcal{T}_{t'}^{\mathbb{X}_{t'}}(y; x_1, \dots, x_n)$$

where $t' \in SRT_n$ are all the trees obtained by collapsing exactly one internal edge of t ;

- (ii) corresponding to an internal edge breaking (int-break) :

$$\mathcal{T}_{t_1}^{\mathbb{X}_{t_1}}(y; x_1, \dots, x_{i_1}, z, x_{i_1+i_2+1}, \dots, x_n) \times \mathcal{T}_{t_2}^{\mathbb{X}_{t_2}}(z; x_{i_1+1}, \dots, x_{i_1+i_2}),$$

where t_2 is seen to lie above the $i_1 + 1$ -incoming edge of t_1 ;

- (iii) corresponding to an external edge breaking (Morse) :

$$\mathcal{T}(y; z) \times \mathcal{T}_t^{\mathbb{X}_t}(z; x_1, \dots, x_n) \quad \text{and} \quad \mathcal{T}_t^{\mathbb{X}_t}(y; x_1, \dots, z, \dots, x_n) \times \mathcal{T}(z; x_i) .$$

While the (Morse) boundary simply comes from the fact that external edges are Morse trajectories away from a length 1 segment, the analysis for the (int-collapse) and (int-break) boundaries requires to refine our definitions of perturbation data. It namely appears here why we had to choose more perturbation data than \mathbb{X}_t , as they will appear in the boundary of the compactified moduli space.

We begin by tackling the conditions coming with the (int-collapse) boundary. Let t be a stable ribbon tree type and consider a choice of perturbation data on $\mathcal{T}_n(t)$: it is a choice of perturbation data \mathbb{X}_T for every $T \in \mathcal{T}_n(t) \simeq]0, +\infty[^{e(t)}$. Denote $coll(t) \subset SRT_n$ the set of all trees obtained by collapsing internal edges of t . A choice of perturbation data $(\mathbb{X}_{t'})_{t' \in coll(t)}$ then corresponds to a choice of perturbation data \mathbb{X}_T for every $T \in [0, +\infty[^{e(t)}$. Following section 1.3, such a choice of

perturbation data is equivalent to a map

$$\tilde{\mathbb{X}}_{t,f} : \tilde{C}_f \times M \longrightarrow TM ,$$

for every edge f of t , where $\tilde{C}_f \subset [0, +\infty[^{e(t)} \times \mathbb{R}$ is defined in a similar fashion to C_f .

Definition 33. A choice of perturbation data $(\mathbb{X}_{t'})_{t' \in \text{coll}(t)}$ is said to be *smooth* if all maps $\tilde{\mathbb{X}}_{t,f}$ are smooth. A choice of perturbation data \mathbb{X}_n is said to be *smooth* if for every $t \in SRT_n$, the choice of perturbation data $(\mathbb{X}_{t'})_{t' \in \text{coll}(t)}$ is smooth.

We now tackle the conditions coming with the (int-break) boundary. We work again with a fixed stable ribbon tree type t . Consider a choice of perturbation data $\mathbb{X}_t = (\mathbb{X}_{t,e})_{e \in \bar{E}(t)}$ on $\mathcal{T}_n(t)$. We have to specify what happens on the $\mathbb{X}_{t,e}$ when the length of an internal edge f of t , denoted l_f , goes towards $+\infty$. Write t_1 and t_2 for the trees obtained by breaking t at the edge f .

- (i) For $e \in \bar{E}(t)$ and $e \neq f$, assuming for instance that $e \in t_1$, we require that

$$\lim_{l_f \rightarrow +\infty} \mathbb{X}_{t,e} = \mathbb{X}_{t_1,e} .$$

- (ii) For $f = e$, $\mathbb{X}_{t,f}$ yields two parts when $l_f \rightarrow +\infty$: the part corresponding to the infinite edge in t_1 and the part corresponding to the infinite edge in t_2 . We then require that they coincide respectively with $\mathbb{X}_{t_1,f}$ and $\mathbb{X}_{t_2,f}$.

Two examples illustrating these two cases are detailed in the following paragraphs.

Begin with an example of the first case, where $e \neq f$. This is represented on figure 22. We only represent the perturbation \mathbb{X}_{t,f_3} on this figure for clarity's sake. The perturbation datum $\mathbb{X}_{t,f_3}^\infty$ could a priori depend on l_{f_1} : the requirement $\mathbb{X}_{t,f_3}^\infty = \mathbb{X}_{t_1,f_3}$ says in particular that it is independent of l_{f_1} .

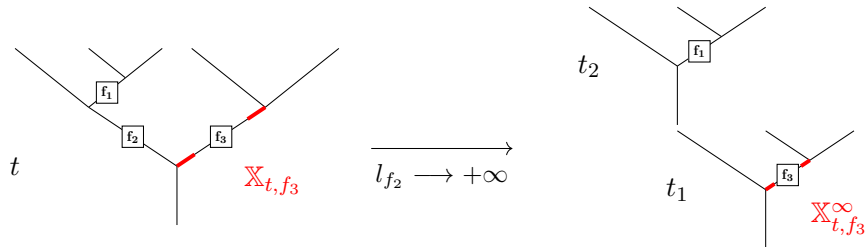

FIGURE 22

Similarly, we illustrate the second case, where $e = f$, on figure 23. A priori, \mathbb{X}_{t,f_2}^+ and \mathbb{X}_{t,f_2}^- can depend on both l_{f_1} and l_{f_3} : the requirement $\mathbb{X}_{t,f_2}^+ = \mathbb{X}_{t_2,f_2}$ says exactly that \mathbb{X}_{t,f_2}^+ is independent of l_{f_3} , and similarly for $\mathbb{X}_{t,f_2}^- = \mathbb{X}_{t_1,f_2}$ with respect to l_{f_1} .

Definition 34. A choice of perturbation data $(\mathbb{X}_i)_{2 \leq i \leq n}$ is said to be *gluing-compatible* if it satisfies conditions (i) and (ii) for lengths of edges going toward $+\infty$. A choice of perturbation data $(\mathbb{X}_n)_{n \geq 2}$ being both smooth and gluing-compatible, and such that all maps $\phi_{\mathbb{X}_t}$ are transverse to Δ , is said to be *admissible*.

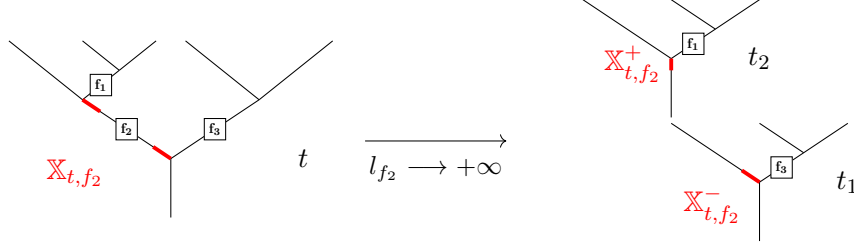

FIGURE 23

Theorem 7. *Admissible choices of perturbation data on the moduli spaces \mathcal{T}_n exist.*

Theorem 8. *Let $(\mathbb{X}_n)_{n \geq 2}$ be an admissible choice of perturbation data. The 0-dimensional moduli spaces $\mathcal{T}_t^{\mathbb{X}_t}(y; x_1, \dots, x_n)$ are compact. The 1-dimensional moduli spaces $\mathcal{T}_t^{\mathbb{X}_t}(y; x_1, \dots, x_n)$ can be compactified to 1-dimensional manifolds with boundary $\overline{\mathcal{T}}_t^{\mathbb{X}_t}(y; x_1, \dots, x_n)$, whose boundary is described at the beginning of this section.*

We refer to section 3 for a proof of Theorem 7. Theorem 8 is proven in chapter 6 of [Mes18]. Using the results of [Weh12], we could in fact try to prove that all moduli spaces $\mathcal{T}_t^{\mathbb{X}_t}(y; x_1, \dots, x_n)$ can be compactified to compact manifolds with corners. The analysis involved therein goes however beyond the scope of this paper.

Consider now a stable ribbon tree t together with an internal edge $f \in E(t)$ and write t_1 and t_2 for the trees obtained by breaking t at the edge f , where t_2 is seen to lie above t_1 . Given critical points y, z, x_1, \dots, x_n suppose moreover that the moduli spaces $\mathcal{T}_{t_1}(y; x_1, \dots, x_{i_1}, z, x_{i_1+i_2+1}, \dots, x_n)$ and $\mathcal{T}_{t_2}(z; x_{i_1+1}, \dots, x_{i_1+i_2})$ are 0-dimensional. Let T_1^{Morse} and T_2^{Morse} be two perturbed Morse gradient trees which belong respectively to the former and the latter moduli spaces. Theorem 8 implies in particular that there exists $R > 0$ and an embedding

$$\#_{T_1^{Morse}, T_2^{Morse}} : [R, +\infty] \longrightarrow \overline{\mathcal{T}}_t(y; x_1, \dots, x_n)$$

parametrizing a neighborhood of the boundary $\{T_1^{Morse}\} \times \{T_2^{Morse}\} \subset \partial \overline{\mathcal{T}}_t^{Morse}$, i.e. sending $+\infty$ to $(T_1^{Morse}, T_2^{Morse}) \in \partial \overline{\mathcal{T}}_t^{Morse}$. Such a map is called a *gluing map* for T_1^{Morse} and T_2^{Morse} . Explicit gluing maps are constructed in subsection 4.4.3.

1.5. ΩBAs -algebra structure on the Morse cochains. We now have all the necessary material to define an ΩBAs -algebra structure on the Morse cochains $C^*(f)$.

Theorem 9. *Let $\mathbb{X} := (\mathbb{X}_n)_{n \geq 2}$ be an admissible choice of perturbation data. Defining for every n and $t \in SRT_n$ the operations m_t as*

$$m_t : C^*(f) \otimes \cdots \otimes C^*(f) \longrightarrow C^*(f)$$

$$x_1 \otimes \cdots \otimes x_n \longmapsto \sum_{|y| = \sum_{i=1}^n |x_i| - e(t)} \# \mathcal{T}_t^{\mathbb{X}}(y; x_1, \dots, x_n) \cdot y,$$

they endow the Morse cochains $C^(f)$ with an ΩBAs -algebra structure.*

The proof of this theorem is detailed in section 4.4. Putting it shortly, counting the boundary points of the 1-dimensional orientable compactified moduli spaces $\overline{\mathcal{T}}_t^{\mathbb{X}}(y; x_1, \dots, x_n)$ whose boundary is described in the previous section yields the ΩBAs -equations

$$[\partial_{Morse}, m_t] = \sum_{t' \in coll(t)} \pm m_{t'} + \sum_{t_1 \#_i t_2 = t} \pm m_{t_1} \circ_i m_{t_2} .$$

In fact, the collection of operations $\{m_t\}$ does not exactly define an ΩBAs -algebra structure : one of the two differentials ∂_{Morse} appearing in the bracket $[\partial_{Morse}, \cdot]$ has to be twisted by a specific sign for the ΩBAs -equations to hold. We will speak about a *twisted ΩBAs -algebra structure*. In the case when M is odd-dimensional, this twisted ΩBAs -algebra is exactly an ΩBAs -algebra.

If we want to recover an A_∞ -algebra structure on the Morse cochains, it suffices to apply the morphism of operads $A_\infty \rightarrow \Omega BAs$ described in section 3.1.5. In his paper [Abo11], Abouzaid constructs a geometric A_∞ -morphism $C_{sing}^*(M) \rightarrow C^*(f)$, where the Morse cochains are endowed with the A_∞ -algebra structure constructed in this subsection. This A_∞ -morphism is in fact a quasi-isomorphism. This implies in particular that the Morse cochains $C^*(f)$ endowed with the A_∞ -algebra structure constructed in this subsection are quasi-isomorphic as an A_∞ -algebra to the Morse cochains endowed with the A_∞ -algebra structure induced by the homotopy transfer theorem. His construction of the A_∞ -morphism $C_{sing}^*(M) \rightarrow C^*(f)$ could be adapted to our present framework, and lifted to an ΩBAs -morphism. We will however not give more details on that matter.

2. A_∞ AND ΩBAs -MORPHISMS BETWEEN THE MORSE COCHAINS

Let M be an oriented closed Riemannian manifold endowed with a Morse function f together with a Morse-Smale metric. We have proven in the previous section that, upon choosing admissible perturbation data on the moduli spaces of stable metric ribbon trees $\mathcal{T}_n(t)$, we can define moduli spaces of perturbed Morse gradient trees, whose count will define the operations m_t , $t \in SRT$, of an ΩBAs -algebra structure on the Morse cochains $C^*(f)$.

Consider now another Morse function g on M . Apply again the homotopy transfer theorem to $C^*(f)$ and $C^*(g)$, which are deformation retracts of the singular cochains on M . Endowing them with their induced A_∞ -algebra structures, the theorem yields a diagram

$$(C^*(f), m_n^{ind}) \xrightarrow{\sim} (C_{sing}^*(M), \cup) \xrightarrow{\sim} (C^*(g), m_n^{ind}) ,$$

where each arrow is an A_∞ -quasi-isomorphism, hence an A_∞ -quasi-isomorphism $(C^*(f), m_n^{ind}) \rightarrow (C^*(g), m_n^{ind})$. Let \mathbb{X}^g be an admissible perturbation data for g . This motivates the following question : endowing $C^*(f)$ and $C^*(g)$ with their ΩBAs -algebra structures, can we construct an ΩBAs -morphism

$$(C^*(f), m_t^{\mathbb{X}^f}) \longrightarrow (C^*(g), m_t^{\mathbb{X}^g}) ?$$

While stable metric ribbon trees control ΩBAs -algebra structures, we have seen that two-colored stable metric ribbon trees control ΩBAs -morphisms. The answer to the previous question is then of course positive, and the morphism will be constructed using moduli spaces of *two-colored perturbed Morse gradient trees*. As in section 1, two-colored Morse gradient trees will be defined by perturbing Morse gradient equations around each vertex of the tree, where the Morse gradient is $-\nabla f$ above the gauge, and $-\nabla g$ below the gauge. This is illustrated in figure 24. The figure is incorrect, because

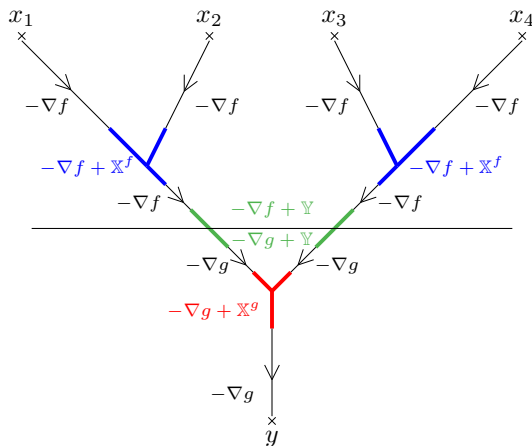

FIGURE 24. An example of a perturbed two-colored Morse gradient tree, where the x_i are critical points of f and y is a critical point of g

we won't choose the perturbation to be equal to \mathbb{X}^f above the gauge and to \mathbb{X}^g below, but gives the correct intuition on the construction we unfold in this section.

The structure of this section follows the same lines as the previous section, and the only difficulty will consist in adapting properly our arguments to the combinatorics of two-colored ribbon trees. Under a generic choice of perturbation data on the moduli spaces \mathcal{CT}_n , the moduli spaces of two-colored perturbed Morse gradient trees connecting $x_1, \dots, x_n \in \text{Crit}(f)$ to $y \in \text{Crit}(g)$, that we denote $\mathcal{CT}_{t_g}(y; x_1, \dots, x_n)$, are orientable manifolds. They are moreover compact when 0-dimensional and can be compactified to compact manifolds with boundary when 1-dimensional (Theorems 10 and 11). Counting 0-dimensional moduli spaces of two-colored Morse gradient trees then defines an ΩBAs -morphism from $C^*(f)$ to $C^*(g)$ (Theorem 12).

2.1. Notation. A two-colored ribbon tree will be written t_g using the gauge viewpoint, and t_c using the colored vertices viewpoint. The tree t_g then comes with an underlying stable ribbon tree t , while the tree t_c is already a ribbon tree (though not necessarily stable because of its colored vertices).

A two-colored stable metric ribbon tree T will be written $(t_g, (l_e)_{e \in E(t)}, \lambda)$ using the gauge viewpoint. The lengths associated to the underlying metric ribbon tree with colored vertices will then be written $L_{f_c}((l_e)_{e \in E(t)}, \lambda)$ where $f_c \in E(t_c)$. For instance, on figure 8,

$$L_1 = -\lambda \qquad L_2 = l + \lambda \qquad L_3 = -\lambda .$$

For the sake of readability, we do not write the dependence on $((l_e)_{e \in E(t)}, \lambda)$ in the sequel.

2.2. Perturbed two-colored Morse gradient trees.

Definition 35. Let $T_g = (t_g, (l_e)_{e \in E(t)}, \lambda)$ be a two-colored metric ribbon tree. A *choice of perturbation data* \mathbb{Y} on T_g is defined to be a choice of perturbation data on the associated metric ribbon tree (t_c, L_{f_c}) in the sense of section 1.2.

Definition 36. A *two-colored perturbed Morse gradient tree* T_g^{Morse} associated to a pair two-colored metric ribbon tree and perturbation data (T_g, \mathbb{Y}) is the data

(i) for each edge f_c of t_c which is above the gauge, of a smooth map

$$D_{f_c} \xrightarrow{\gamma_{f_c}} M ,$$

such that γ_{f_c} is a trajectory of the perturbed negative gradient $-\nabla f + \mathbb{Y}_{f_c}$,

(ii) for each edge f_c of t_c which is below the gauge, of a smooth map

$$D_{f_c} \xrightarrow{\gamma_{f_c}} M ,$$

such that γ_{f_c} is a trajectory of the perturbed negative gradient $-\nabla g + \mathbb{Y}_{f_c}$,

and such that the endpoints of these trajectories coincide as prescribed by the edges of the tree t_c .

Note that the above definitions still work for \dagger . A choice of perturbation data for \dagger is the data of vector fields

$$\begin{aligned} [0, +\infty[\times M &\xrightarrow{\mathbb{Y}_+} TM , \\] -\infty, 0] \times M &\xrightarrow{\mathbb{Y}_-} TM , \end{aligned}$$

which vanish away from a length 1 segment, and a two-colored perturbed Morse gradient tree associated to (\dagger, \mathbb{Y}) is then simply the data of two smooth maps

$$\begin{aligned}] -\infty, 0] &\xrightarrow{\gamma_-} M , \\ [0, +\infty[&\xrightarrow{\gamma_+} M , \end{aligned}$$

such that γ_- is a trajectory of $-\nabla f + \mathbb{Y}_-$ and γ_+ is a trajectory of $-\nabla g + \mathbb{Y}_+$.

There is also an equivalent formulation for two-colored perturbed Morse gradient trees, by following the flows of $-\nabla f + \mathbb{Y}$ and $-\nabla g + \mathbb{Y}$ along the the metric ribbon tree (t_c, L_{f_c}) . That is, a two-colored perturbed Morse gradient tree is determined by the data of the time -1 points on its incoming edges plus the time 1 point on its outgoing edge. Introduce again the map

$$\Phi_{T_g, \mathbb{Y}} : M \times \cdots \times M \xrightarrow{\phi_{0, \mathbb{Y}} \times \cdots \times \phi_{n, \mathbb{Y}}} M \times \cdots \times M ,$$

defined as before, and set Δ for the diagonal of $M^{\times n+1}$

Proposition 16. *There is a one-to-one correspondence*

$$\left\{ \begin{array}{l} \text{two-colored perturbed Morse gradient trees} \\ \text{associated to } (T_g, \mathbb{Y}) \end{array} \right\} \longleftrightarrow (\Phi_{T_g, \mathbb{Y}})^{-1}(\Delta) .$$

The vector fields on the incoming edges are equal to $-\nabla f$ away from a length 1 segment, hence the trajectories associated to these edges all converge to critical points of the function f , while the vector field on the outgoing edge is equal to $-\nabla g$ away from a length 1 segment, hence the trajectory associated to these edge converges to a critical point of the function g . For critical points y of the function g and x_1, \dots, x_n of the function f , the map $\Phi_{T, \mathbb{Y}}$ can be restricted to

$$W_g^S(y) \times W_f^U(x_1) \times \cdots \times W_f^U(x_n) ,$$

such that the inverse image of the diagonal yields all two-colored perturbed Morse gradient trees associated to (T, \mathbb{Y}) connecting x_1, \dots, x_n to y .

2.3. Moduli spaces of two-colored perturbed Morse gradient trees. Choose a two-colored stable ribbon tree $t_g \in SCRT_n$ whose underlying stable ribbon tree is t and whose associated ribbon tree with colored vertices is t_c . We write $(*)_{t_g}$ for the set of inequalities and equalities on $\{l_e\}_{e \in E(t)}$ and λ , which define the polyedral cone $\mathcal{CT}_n(t_g) \subset \mathbb{R}^{e(t)+1}$. See part 1 section 5.2 for more details. Define for all $f_c \in \overline{E}(t_c)$, the cone $C_{f_c} \subset \mathcal{CT}_n(t_g) \times \mathbb{R} \subset \mathbb{R}^{e(t)+1} \times \mathbb{R}$ to be

- (i) $\{((l_e)_{e \in E(T)}, \lambda, s) \text{ such that } (*)_{t_g}, 0 \leq s \leq L_{f_c}((l_e)_{e \in E(T)}, \lambda)\}$ if f_c is an internal edge ;
- (ii) $\{((l_e)_{e \in E(T)}, \lambda, s) \text{ such that } (*)_{t_g}, s \leq 0\}$ if f_c is an incoming edge ;
- (iii) $\{((l_e)_{e \in E(T)}, \lambda, s) \text{ such that } (*)_{t_g}, s \geq 0\}$ if f_c is the outgoing edge.

Then a choice of perturbation data for every two-colored metric ribbon tree in $\mathcal{CT}_n(t_g)$, yields maps $\mathbb{Y}_{t_g, f_c} : C_{f_c} \times M \rightarrow TM$ for every edge f_c of t_c . These perturbation data are said to be *smooth* if all these maps are smooth.

Definition 37. Let \mathbb{Y}_{t_g} be a smooth choice of perturbation data on the stratum $\mathcal{CT}_n(t_g)$. Given $y \in \text{Crit}(g)$ and $x_1, \dots, x_n \in \text{Crit}(f)$, we define the moduli spaces

$$\mathcal{CT}_{t_g}^{\mathbb{Y}_{t_g}}(y; x_1, \dots, x_n) := \left\{ \begin{array}{l} \text{two-colored perturbed Morse gradient trees associated to } (T_g, \mathbb{Y}_{T_g}) \\ \text{and connecting } x_1, \dots, x_n \text{ to } y \text{ for } T_g \in \mathcal{CT}_n(t_g) \end{array} \right\}.$$

Using the smooth map

$$\phi_{\mathbb{Y}_{t_g}} : \mathcal{CT}_n(t_g) \times W^S(y) \times W^U(x_1) \times \dots \times W^U(x_n) \rightarrow M^{\times n+1},$$

this moduli space can be rewritten as

$$\mathcal{CT}_{t_g}^{\mathbb{Y}_{t_g}}(y; x_1, \dots, x_n) = \phi_{\mathbb{Y}_{t_g}}^{-1}(\Delta).$$

Proposition 17. (i) *Given a choice of perturbation data \mathbb{Y}_{t_g} making $\phi_{\mathbb{Y}_{t_g}}$ transverse to the diagonal $\Delta \subset M^{\times n+1}$, the moduli spaces $\mathcal{CT}_{t_g}^{\mathbb{Y}_{t_g}}(y; x_1, \dots, x_n)$ are orientable manifolds of dimension*

$$\dim(\mathcal{CT}_{t_g}(y; x_1, \dots, x_n)) = +|y| - \sum_{i=1}^n |x_i| - |t_g|.$$

(ii) *Choices of perturbation data \mathbb{Y}_{t_g} such that $\phi_{\mathbb{Y}_{t_g}}$ is transverse to the diagonal Δ exist.*

The proof of this proposition is again postponed to section 3.

2.4. Compactifications. We finally proceed to compactify the moduli spaces $\mathcal{CT}_{t_g}^{\mathbb{Y}_{t_g}}(y; x_1, \dots, x_n)$ that have dimension 1 to 1-dimensional manifolds with boundary. Their boundary components are going to be given by those coming from the compactification of $\mathcal{CT}_n(t_g)$, and the compactifications of the $W^U(x_i)$ and of $W^S(y)$.

Choose admissible perturbation data \mathbb{X}^f and \mathbb{X}^g for the functions f and g . Choose moreover smooth perturbation data \mathbb{Y}_{t_g} for all $t_g \in SCRT_i$, $1 \leq i \leq n$. We will again denote $\mathbb{Y}_n := (\mathbb{Y}_{t_g})_{t_g \in SCRT_n}$, and call it a choice of perturbation data on \mathcal{CT}_n . Fixing a two-colored stable ribbon tree $t_g \in SCRT_n$ we would like to compactify the 1-dimensional moduli space $\mathcal{CT}_{t_g}^{\mathbb{Y}_{t_g}}(y; x_1, \dots, x_n)$ using the perturbation data \mathbb{X}^f , \mathbb{X}^g and $(\mathbb{Y}_i)_{1 \leq i \leq n}$. Its boundary will be given by the following phenomena

- (i) an external edge breaks at a critical point (Morse) :

$$\mathcal{T}(y; z) \times \mathcal{CT}_{t_g}^{\mathbb{Y}_{t_g}}(z; x_1, \dots, x_n) \quad \text{and} \quad \mathcal{CT}_{t_g}^{\mathbb{Y}_{t_g}}(y; x_1, \dots, z, \dots, x_n) \times \mathcal{T}(z; x_i) ;$$

- (ii) an internal edge of the tree t collapses (int-collapse) :

$$\mathcal{CT}_{t'_g}^{\mathbb{Y}_{t'_g}}(y; x_1, \dots, x_n)$$

where $t'_g \in SCRT_n$ are all the two-colored trees obtained by collapsing exactly one internal edge, which does not cross the gauge ;

- (iii) the gauge moves to cross exactly one additional vertex of the underlying stable ribbon tree (gauge-vertex) :

$$\mathcal{CT}_{t'_g}^{\mathbb{Y}_{t'_g}}(y; x_1, \dots, x_n)$$

where $t'_g \in SCRT_n$ are all the two-colored trees obtained by moving the gauge to cross exactly one additional vertex of t ;

- (iv) an internal edge located above the gauge or intersecting it breaks or, when the gauge is below the root, the outgoing edge breaks between the gauge and the root (above-break) :

$$\mathcal{CT}_{t'_g}^{\mathbb{Y}_{t'_g}}(y; x_1, \dots, x_{i_1}, z, x_{i_1+i_2+1}, \dots, x_n) \times \mathcal{T}_{t^2}^{\mathbb{X}_{t^2}^f}(z; x_{i_1+1}, \dots, x_{i_1+i_2}) ;$$

- (v) edges (internal or incoming) that are possibly intersecting the gauge, break below it, such that there is exactly one edge breaking in each non-self crossing path from an incoming edge to the root (below-break) :

$$\mathcal{T}_{t^1}^{\mathbb{X}_{t^1}^g}(y; y_1, \dots, y_s) \times \mathcal{CT}_{t^1_g}^{\mathbb{Y}_{t^1_g}}(y_1; x_1, \dots) \times \dots \times \mathcal{CT}_{t^s_g}^{\mathbb{Y}_{t^s_g}}(y_s; \dots, x_n) .$$

The (Morse) boundaries are again a simple consequence of the fact that external edges are Morse trajectories away from a length 1 segment. Perturbation data that behave well with respect to the (int-collapse) and (gauge-vertex) boundaries are defined using simple adjustments of the discussion in section 1.4. Hence, it only remains to specify the required behaviours under the breaking of edges.

We begin with the (above-break) boundary. Writing t_c for the two-colored ribbon tree associated to t_g , it corresponds to the breaking of an internal edge f_c of t_c situated above the set of colored vertices. Denote t_c^1 and t_c^2 the trees obtained by breaking t_c at the edge f_c , where t_c^2 is seen to lie above t_c^1 . We have to specify, for each edge $e_c \in \overline{E}(t_c)$, what happens to the perturbation $\mathbb{Y}_{t_c, e}$ at the limit.

- (i) For $e_c \in \overline{E}(t_c^2)$ and $\neq f_c$, we require that

$$\lim \mathbb{Y}_{t_c, e_c} = \mathbb{X}_{t_c^2, e_c}^f .$$

- (ii) For $e_c \in \overline{E}(t_c^1)$ and $\neq f_c$, we require that

$$\lim \mathbb{Y}_{t_c, e_c} = \mathbb{Y}_{t_c^1, e_c} .$$

- (iii) For $f_c = e_c$, \mathbb{Y}_{t_c, f_c} yields two parts at the limit : the part corresponding to the outgoing edge of t_c^1 and the part corresponding to the incoming edge of t_c^2 . We then require that they coincide respectively with the perturbation $\mathbb{X}_{t_c^2, e_c}^f$ and $\mathbb{Y}_{t_c^1, e_c}$.

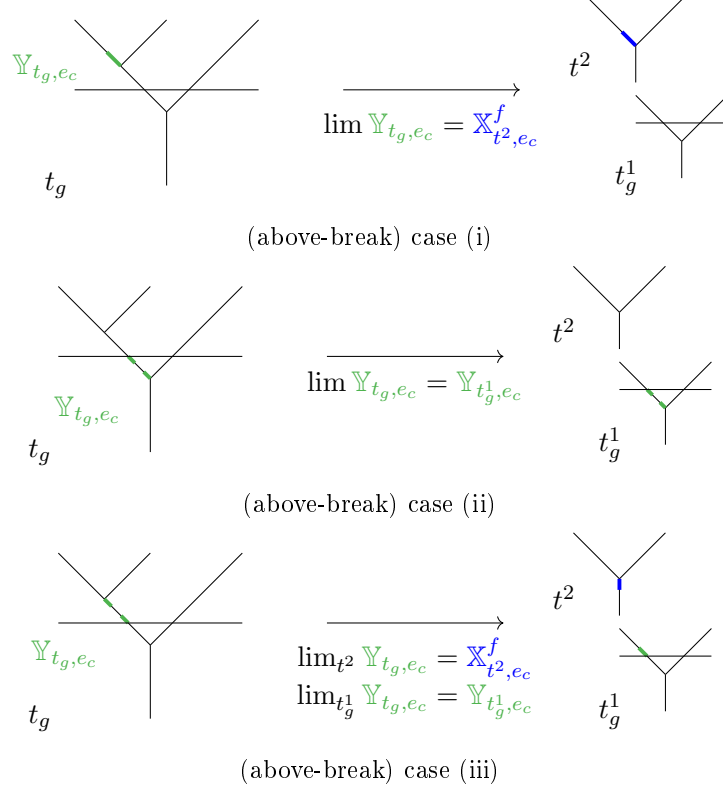

FIGURE 25

Leaving the notations aside, an example of each case is illustrated in figure 25.

We conclude with the (below-break) boundary. Denote t_g^1, \dots, t_g^s and t^0 the trees obtained by the chosen breaking of t_g below the gauge, where t_g^1, \dots, t_g^s are seen to lie above t^0 .

- (i) For $e_c \in \overline{E}(t_c^i)$ and not among the breaking edges, we require that

$$\lim \mathbb{Y}_{t_c, e_c} = \mathbb{Y}_{t_c^i, e_c} .$$

- (ii) For $e_c \in \overline{E}(t^1)$ and not among the breaking edges, we require that

$$\lim \mathbb{Y}_{t_c, e_c} = \mathbb{X}_{t^0, e_c}^g .$$

- (iii) For f_c among the breaking edges, \mathbb{Y}_{t_c, f_c} yields two parts at the limit : the part corresponding to the outgoing edge of a t_c^j and the part corresponding to the incoming edge of t^0 . We then require that they coincide respectively with the perturbation $\mathbb{Y}_{t_c^j}$ and $\mathbb{X}_{t^0}^g$.

This is again illustrated on figure 26.

Definition 38. A choice of perturbation data \mathbb{Y} on the moduli spaces \mathcal{CT}_n is said to be *smooth* if it is compatible with the (int-collapse) and (gauge-vertex) boundaries. A smooth choice of perturbation data is said to be *gluing-compatible w.r.t. \mathbb{X}^f and \mathbb{X}^g* if it satisfies the (above-break) and (below-break) conditions described in this section. Smooth and consistent choices of perturbation data

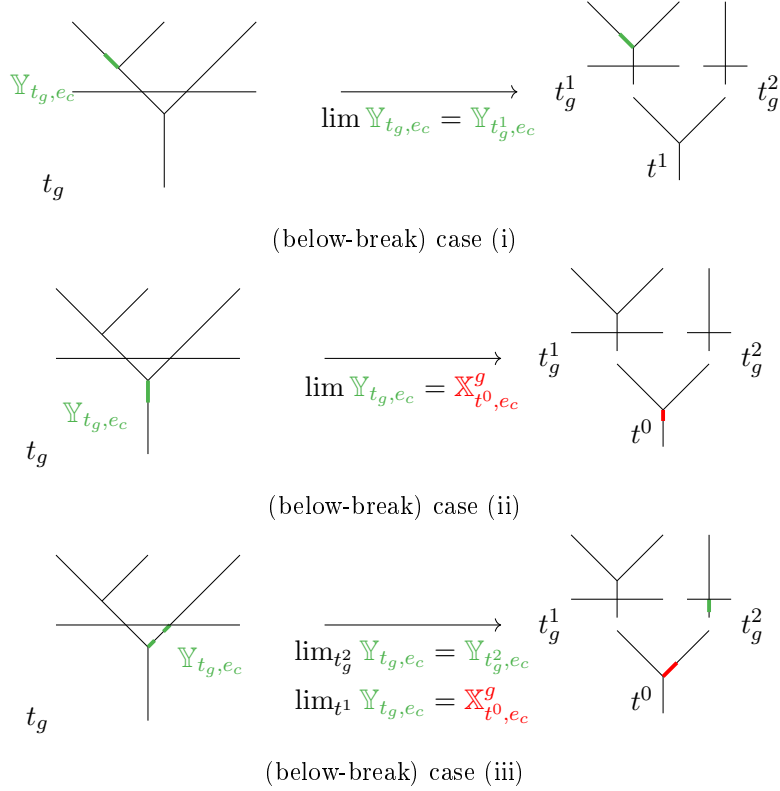

FIGURE 26

$(\mathbb{Y}_n)_{n \geq 1}$ such that all maps $\phi_{\mathbb{Y}_{t_g}}$ are transverse to the diagonal Δ are called *admissible w.r.t. \mathbb{X}^f and \mathbb{X}^g* or simply *admissible*.

Theorem 10. *Given admissible choices of perturbation data \mathbb{X}^f and \mathbb{X}^g on the moduli spaces \mathcal{T}_n , choices of perturbation data on the moduli spaces \mathcal{CT}_n that are admissible w.r.t. \mathbb{X}^f and \mathbb{X}^g exist.*

Theorem 11. *Let $(\mathbb{Y}_n)_{n \geq 1}$ be an admissible choice of perturbation data on the moduli spaces \mathcal{CT}_n . The 0-dimensional moduli spaces $\mathcal{CT}_{t_g}^{\mathbb{Y}_{t_g}}(y; x_1, \dots, x_n)$ are compact. The 1-dimensional moduli spaces $\mathcal{CT}_{t_g}^{\mathbb{Y}_{t_g}}(y; x_1, \dots, x_n)$ can be compactified to 1-dimensional manifolds with boundary, whose boundary is described at the beginning of this section..*

Theorem 10 is proven in section 3. Theorem 11 is a consequence of the results in chapter 6 of [Mes18]. We moreover point out that Theorem 11 implies in particular the existence of gluing maps

$$\begin{aligned} \#_{T_g^1, Morse, T_g^2, Morse}^{above-break} &: [R, +\infty] \longrightarrow \overline{\mathcal{CT}}_{t_g}(y; x_1, \dots, x_n) \\ \#_{T^0, Morse, T_g^1, Morse, \dots, T_g^s, Morse}^{below-break} &: [R, +\infty] \longrightarrow \overline{\mathcal{CT}}_{t_g}(y; x_1, \dots, x_n) \end{aligned}$$

where notations are as in section 1.4. Such gluing maps are constructed in subsection 4.5.4.

2.5. The Ω BAAs-morphism between Morse cochains. Let \mathbb{X}^f and \mathbb{X}^g be admissible choices of perturbation data for the Morse functions f and g . Denote $(C^*(f), m_t^{\mathbb{X}^f})$ and $(C^*(g), m_t^{\mathbb{X}^g})$ the Ω BAAs-algebras constructed in section 1.5.

Theorem 12. *Let $(\mathbb{Y}_n)_{n \geq 1}$ be a choice of perturbation on the moduli spaces \mathcal{CT}_n that is admissible w.r.t. \mathbb{X}^f and \mathbb{X}^g . Defining for every n and $t_g \in \text{SCRT}_n$ the operations μ_{t_g} as*

$$\begin{aligned} \mu_{t_g}^{\mathbb{Y}} : C^*(f) \otimes \cdots \otimes C^*(f) &\longrightarrow C^*(g) \\ x_1 \otimes \cdots \otimes x_n &\longmapsto \sum_{|y| = \sum_{i=1}^n |x_i| + |t_g|} \#\mathcal{CT}_{t_g}^{\mathbb{Y}}(y; x_1, \dots, x_n) \cdot y . \end{aligned}$$

they fit into an Ω BAAs-morphism $\mu^{\mathbb{Y}} : (C^*(f), m_t^{\mathbb{X}^f}) \rightarrow (C^*(g), m_t^{\mathbb{X}^g})$.

Again, the collection of operations $\{\mu_{t_g}\}$ does not exactly define an Ω BAAs-morphism but rather a *twisted Ω BAAs-morphism*. In the case when M is odd-dimensional, this twisted Ω BAAs-morphism is exactly an Ω BAAs-morphism between two Ω BAAs-algebras. All sign computations are detailed in section 4. If we want to go back to the more classical algebraic framework of A_∞ -algebras, an A_∞ -morphism between the induced A_∞ -algebra structures on the Morse cochains is simply obtained under the morphism of operadic bimodules $A_\infty - \text{Morph} \rightarrow \Omega\text{BAAs} - \text{Morph}$.

3. TRANSVERSALITY

The goal of this section is to prove Theorems 7 and 10. In this regard, we recall at first the parametric transversality lemma and then build an admissible choice of perturbation data $(\mathbb{X}_n)_{n \geq 2}$ on the moduli spaces \mathcal{T}_n , proceeding by induction on the number of internal edges $e(t)$ of a stable ribbon tree t . It moreover appears in our construction that all arguments adapt nicely to the framework of two-colored trees and admissible choices of perturbation data $(\mathbb{Y}_n)_{n \geq 1}$ on the moduli spaces \mathcal{CT}_n .

3.1. Parametric transversality lemma. We begin by recalling Smale's generalization of the classical Sard theorem. See [Sma65] or [MS12] for a detailed proof :

Theorem 13 (Sard-Smale theorem). *Let X and Y be separable Banach manifolds. Suppose that $f : X \rightarrow Y$ is a Fredholm map of class C^l with $l \geq \max(1, \text{ind}(f) + 1)$. Then the set $Y_{\text{reg}}(f)$ of regular values of f is residual in Y in the sense of Baire.*

This theorem implies in particular the following corollary in transversality theory, that will constitute the cornerstone of our proof of Theorem 7 :

Corollary 1 (Parametric transversality lemma). *Let \mathfrak{X} be a Banach space, M and N two finite-dimensional manifolds and $S \subset N$ a submanifold of N . Suppose that $f : \mathfrak{X} \times M \rightarrow N$ is a map of class C^l with $l \geq \max(1, \dim(M) + \dim(S) - \dim(N) + 1)$ and that it is transverse to S . Then the set*

$$\mathfrak{X}_{\pitchfork S} := \{\mathbb{X} \in \mathfrak{X} \text{ such that } f_{\mathbb{X}} \pitchfork S\}$$

is residual in \mathfrak{X} in the sense of Baire.

Proof. The map f being transverse to S , the inverse image $f^{-1}(S)$ is a Banach submanifold of $\mathfrak{X} \times M$. Consider the standard projection $p_{\mathfrak{X}} : \mathfrak{X} \times M \rightarrow \mathfrak{X}$ and denote $\pi := p_{\mathfrak{X}}|_{f^{-1}(S)}$. Following Lemma 19.2 in [AR67], this map is Fredholm and has index $\dim(M) + \dim(S) - \dim(N)$. Moreover, drawing from an argument in section 3.2. of [MS12], there is an equality $\mathfrak{X}_{reg}(\pi) = \mathfrak{X}_{\natural S}$. One can then conclude by applying the Sard-Smale theorem to the map π . \square

3.2. Proof of theorem 7.

3.2.1. *The case $e(t) = 0$.* If $e(t) = 0$, the tree t is a corolla. Fix an integer l such that

$$l \geq \max \left(1, e(t) + |y| - \sum_{i=1}^n |x_i| + 1 \right).$$

We define C^l -choices of perturbation data in a similar fashion to smooth choices of perturbation data. A C^l -choice of perturbation data \mathbb{X}_t on $\mathcal{T}_n(t)$ then simply corresponds to a C^l -choice of perturbation datum on each external edge of t . Define the parametrization space

$$\mathfrak{X}_t^l := \{C^l\text{-perturbation data } \mathbb{X}_t \text{ on the moduli space } \mathcal{T}_n(t)\}.$$

This parametrization space is a Banach space. The linear combination of choices of perturbation data is simply defined as the linear combination of each perturbation datum $\mathbb{X}_{t,e}$ with e an external edge of t . The vector space \mathfrak{X}_t^l is moreover Banach as each perturbation datum $\mathbb{X}_{t,e}$ vanishes away from a length 1 segment in D_e .

Given critical points y and x_1, \dots, x_n , introduce the C^l -map

$$\phi_t : \mathfrak{X}_t^l \times \mathcal{T}_n(t) \times W^S(y) \times W^U(x_1) \times \dots \times W^U(x_n) \longrightarrow M^{\times n+1},$$

such that for every $\mathbb{X}_t \in \mathfrak{X}_t^l$, $\phi_t(\mathbb{X}_t, \cdot) = \phi_{\mathbb{X}_t}$. Note that we should in fact write $\phi_t^{y, x_1, \dots, x_n}$ as the domain of ϕ_t depends on y, x_1, \dots, x_n . The map ϕ_t is then a submersion. This is proven in Lemma 7.3. of [Abo11] and Abouzaid explains it informally in the following terms : "[this lemma] is the infinitesimal version of the fact that perturbing the gradient flow equation on a bounded subset of an edge integrates to an essentially arbitrary diffeomorphism".

In particular the map ϕ_t is transverse to the diagonal $\Delta \subset M^{\times n+1}$. Applying the parametric transversality theorem of subsection 3.1, there exists a residual set $\mathfrak{Y}_t^{l; y, x_1, \dots, x_n} \subset \mathfrak{X}_t^l$ such that for every choice of perturbation data $\mathbb{X}_t \in \mathfrak{Y}_t^{l; y, x_1, \dots, x_n}$ the map $\phi_{\mathbb{X}_t}$ is transverse to the diagonal $\Delta \subset M^{\times n+1}$. Considering the intersection

$$\mathfrak{Y}_t^l := \bigcap_{y, x_1, \dots, x_n} \mathfrak{Y}_t^{l; y, x_1, \dots, x_n} \subset \mathfrak{X}_t^l$$

which is again residual, any $\mathbb{X}_t \in \mathfrak{Y}_t^l$ yields a C^l -choice of perturbation data on $\mathcal{T}_n(t)$ such that all the maps $\phi_{\mathbb{X}_t}$ are transverse to the diagonal $\Delta \subset M^{\times n+1}$. It remains to prove this statement in the smooth case.

3.2.2. *Achieving smoothness à la Taubes.* Using an argument drawn from section 3.2. of [MS12] and attributed to Taubes, we now prove that the set

$$\mathfrak{Y}_t := \left\{ \begin{array}{l} \text{smooth choices of perturbation data } \mathbb{X}_t \text{ on } \mathcal{T}_n(t) \text{ such that} \\ \text{all the maps } \phi_{\mathbb{X}_t} \text{ are transverse to the diagonal } \Delta \subset M^{\times n+1} \end{array} \right\}$$

is residual in the Fréchet space

$$\mathfrak{X}_t := \{\text{smooth choices of perturbation data } \mathbb{X}_t \text{ on } \mathcal{T}_n(t)\} .$$

Choose an exhaustion by compact sets $L_0 \subset L_1 \subset L_2 \subset \dots$ of the space $\mathcal{T}_n(t) \times W^S(y) \times W^U(x_1) \times \dots \times W^U(x_n)$. Define

$$\mathfrak{Y}_{t,L_m} := \left\{ \begin{array}{l} \text{smooth choices of perturbation data } \mathbb{X}_t \text{ on } \mathcal{T}_n(t) \text{ such that} \\ \text{all maps } \phi_{\mathbb{X}_t} \text{ are transverse on } L_m \text{ to the diagonal of } M^{\times n+1} \end{array} \right\}$$

and note that

$$\mathfrak{Y}_t = \bigcap_{m=0}^{+\infty} \mathfrak{Y}_{t,L_m} .$$

We will prove that each $\mathfrak{Y}_{t,L_m} \subset \mathfrak{Y}_t$ is open and dense in \mathfrak{X}_t to conclude that \mathfrak{Y}_t is indeed residual.

Fix $m \geq 0$. To prove that the set \mathfrak{Y}_{t,L_m} is open in \mathfrak{X}_t it suffices to prove that for every l , the set \mathfrak{Y}_{t,L_m}^l is open in \mathfrak{X}_t^l , where \mathfrak{Y}_{t,L_m}^l is defined by replacing "smooth" by " C^l " in the definition of \mathfrak{Y}_{t,L_m} . This last result is a simple consequence of the fact that "being transverse on a compact subset" is an open property : if the map $\phi_{\mathbb{X}_t^0}$ is transverse on L_m to the diagonal $\Delta \subset M^{\times n+1}$ then for $\mathbb{X}_t \in \mathfrak{X}_t^l$ sufficiently close to \mathbb{X}_t^0 the map $\phi_{\mathbb{X}_t}$ is again transverse on L_m to the diagonal on L_m .

Let now $\mathbb{X}_t \in \mathfrak{X}_t$. As $\mathbb{X}_t \in \mathfrak{X}_t^l$ and the set \mathfrak{Y}_t^l is dense in \mathfrak{X}_t^l , there exists a sequence $\mathbb{X}_t^l \in \mathfrak{Y}_t^l$ such that for all l

$$\|\mathbb{X}_t - \mathbb{X}_t^l\|_{C^l} \leq 2^{-l} .$$

Note that $\mathbb{X}_t^l \in \mathfrak{Y}_{t,L_m}^l$. Now since the set \mathfrak{Y}_{t,L_m}^l is open in \mathfrak{X}_t^l for the C^l -topology, there exists $\varepsilon_l > 0$ such that for all $\mathbb{X}_t^l \in \mathfrak{X}_t^l$ if

$$\|\mathbb{X}_t^l - \mathbb{X}_t^l\|_{C^l} \leq \min(2^{-l}, \varepsilon_l) ,$$

then $\mathbb{X}_t^l \in \mathfrak{Y}_{t,L_m}^l$. Choosing \mathbb{X}_t^l to be smooth, this yields a sequence of smooth choices of perturbation data lying in \mathfrak{Y}_{t,L_m} and converging to \mathbb{X}_t , which concludes the proof.

3.2.3. Induction step and conclusion. Let $k \geq 0$ and suppose that we have constructed an admissible choice of perturbation data $(\mathbb{X}_t^0)_{e(t) \leq k}$. This notation should not be confused with the notation $(\mathbb{X}_i)_{i \leq k}$: the former corresponds to a choice of perturbation data on the strata $\mathcal{T}(t)$ of dimension $\leq k$ while the latter corresponds to a choice of perturbation data on the moduli spaces \mathcal{T}_i with $i \leq k$. Let t be a stable ribbon tree with $e(t) = k + 1$. We want to construct a choice of perturbation data \mathbb{X}_t on $\mathcal{T}_n(t)$ which is smooth, gluing-compatible and such that each map $\phi_{\mathbb{X}_t}$ is transverse to the diagonal $\Delta \subset M^{\times n+1}$.

Under a choice of identification $\overline{\mathcal{T}}_n(t) \simeq [0, +\infty]^{e(t)}$, define $\underline{\mathcal{T}}_n(t) \subset \overline{\mathcal{T}}_n(t)$ as the inverse image of $[0, +\infty]^{e(t)}$. Introduce the parametrization space

$$\mathfrak{X}_t^l := \left\{ \begin{array}{l} C^l\text{-perturbation data } \mathbb{X}_t \text{ on } \underline{\mathcal{T}}_n(t) \text{ such that} \\ \mathbb{X}_t|_{\mathcal{T}(t')} = \mathbb{X}_{t'}^0 \text{ for all } t' \in \text{coll}(\underline{\mathcal{T}}_n(t)) \text{ and such that} \\ \lim_{l_e \rightarrow +\infty} \mathbb{X}_t = \mathbb{X}_{t_1}^0 \#_e \mathbb{X}_{t_2}^0 \text{ for all } e \in E(t) \end{array} \right\} ,$$

where $t_1 \#_e t_2 = t$, and $\lim_{l_e \rightarrow +\infty} \mathbb{X}_t = \mathbb{X}_{t_1}^0 \#_e \mathbb{X}_{t_2}^0$ denotes the gluing-compatibility condition described in section 1.4. Following [Mes18] this parametrization space is an affine space which is Banach. One can indeed show that the $l_e \rightarrow +\infty$ conditions imply that each $\mathbb{X}_t \in \mathfrak{X}_t^l$ is bounded in the C^l -norm, and that the C^l -norm is thus well defined on \mathfrak{X}_t^l although $\underline{\mathcal{T}}_n(t)$ is not compact.

Consider the C^l -map

$$\phi_t : \mathfrak{X}_t^l \times \mathcal{T}_n(t) \times W^S(y) \times W^U(x_1) \times \cdots \times W^U(x_n) \longrightarrow M^{\times n+1} .$$

Using the same argument as in subsection 3.2.1, the map ϕ_t is again transverse to the diagonal $\Delta \subset M^{\times n+1}$. Applying the parametric transversality theorem and proceeding as in the case $e(t) = 0$, there exists a residual set $\mathfrak{Y}_t^l \subset \mathfrak{X}_t^l$ such that for every choice of perturbation data $\mathbb{X}_t \in \mathfrak{Y}_t^l$ the map $\phi_{\mathbb{X}_t}$ is transverse to the diagonal $\Delta \subset M^{\times n+1}$. Using the previous argument à la Taubes, we can moreover prove the same statement in the smooth context. By definition of the parametrization spaces \mathfrak{X}_t this construction yields indeed an admissible choice of perturbation data $(\mathbb{X}_t)_{e(t) \leq k+1}$, which concludes the proof of Theorem 7 by induction.

4. SIGNS, ORIENTATIONS AND GLUING

We now complete and conclude the proofs of Theorems 9 and 12, by expliciting all orientations conventions on the moduli spaces of Morse gradient trees and computing the signs involved therein. We use to this extent the ad hoc formalism of signed short exact sequences of vector bundles. Particular attention will be paid to the behaviour of orientations under gluing in our proof.

4.1. More on signs and orientations.

4.1.1. *Additional tools for orientations.* Consider a short exact sequence of vector spaces

$$0 \longrightarrow V_2 \longrightarrow W \longrightarrow V_1 \longrightarrow 0 .$$

It induces a direct sum decomposition $W = V_1 \oplus V_2$. Suppose that the vector spaces W , V_1 and V_2 are oriented. We denote $(-1)^\varepsilon$ the sign obtained by comparing the orientation on W to the one induced by the direct sum $V_1 \oplus V_2$. We will then say that the short exact sequence has sign $(-1)^\varepsilon$. In particular, when $(-1)^\varepsilon = 1$, we will say that the short exact sequence is *positive*.

Now, consider two short exact sequences

$$0 \longrightarrow V_2 \longrightarrow W \longrightarrow V_1 \longrightarrow 0 \quad \text{and} \quad 0 \longrightarrow V_2' \longrightarrow W' \longrightarrow V_1' \longrightarrow 0 ,$$

of respective signs $(-1)^\varepsilon$ and $(-1)^{\varepsilon'}$. Then the short exact sequence obtained by summing them

$$0 \longrightarrow V_2 \oplus V_2' \longrightarrow W \oplus W' \longrightarrow V_1 \oplus V_1' \longrightarrow 0 ,$$

has sign $(-1)^{\varepsilon+\varepsilon'+\dim(V_1)\dim(V_2)}$. Indeed, the direct sum decomposition writes as

$$W \oplus W' = (-1)^\varepsilon(V_1 \oplus V_2) \oplus (-1)^{\varepsilon'}(V_1' \oplus V_2') \simeq (-1)^{\varepsilon+\varepsilon'+\dim(V_1)\dim(V_2)}V_1 \oplus V_1' \oplus V_2 \oplus V_2' .$$

4.1.2. *Orientation and transversality.* Given two manifolds M, N , a codimension k submanifold $S \subset N$ and a smooth map

$$\phi : M \longrightarrow N$$

which is transverse to S , the inverse image $\phi^{-1}(S)$ is a codimension k submanifold of M . Moreover, choosing a complementary ν_S to TS , the transversality assumption yields the following short exact sequence of vector bundles

$$0 \longrightarrow T\phi^{-1}(S) \longrightarrow TM|_{\phi^{-1}(S)} \xrightarrow{d\phi} \nu_S \longrightarrow 0 .$$

Suppose now that M , N and S are oriented. The orientations on N and S induce an orientation on ν_S . The submanifold $\phi^{-1}(S)$ is then oriented by requiring that the previous short exact sequence be positive. We will refer to this choice of orientation as the *natural orientation on $\phi^{-1}(S)$* .

In the particular case of two submanifolds S and R of M which intersect transversely, we will use the inclusion map $S \hookrightarrow M$, which is transverse to $R \subset M$, to define the intersection $S \cap R$. The orientation will then be defined using the positive short exact sequence

$$0 \longrightarrow T(S \cap R) \longrightarrow TS|_{S \cap R} \longrightarrow \nu_R \longrightarrow 0 ,$$

or equivalently with the direct sum decomposition

$$TS = \nu_R \oplus T(S \cap R) .$$

The intersection $R \cap S$ (in contrast to $S \cap R$) is oriented by interchanging S and R in the above discussion. The two orientations on the intersection differ then by a $(-1)^{\text{codim}(S)\text{codim}(R)}$ sign.

4.2. Basic moduli spaces in Morse theory and their orientations.

4.2.1. *Orienting the unstable and stable manifolds.* Recall that for a critical point x of a Morse function f , its unstable and stable manifolds are respectively defined as

$$\begin{aligned} W^U(x) &:= \{z \in M, \lim_{s \rightarrow -\infty} \phi^s(z) = x\} \\ W^S(x) &:= \{z \in M, \lim_{s \rightarrow +\infty} \phi^s(z) = x\} , \end{aligned}$$

where we denote ϕ^s the flow of $-\nabla f$, and its degree is defined as $|x| := \dim(W^S(x))$.

The unstable and stable manifolds are respectively diffeomorphic to a $(d - |x|)$ -dimensional ball and a $|x|$ -dimensional ball. They are hence orientable. They intersect moreover transversely in a unique point, which is x . Assume now that the manifold M is orientable and oriented. We choose for the rest of this section an arbitrary orientation on $W^U(x)$, and endow $W^S(x)$ with the unique orientation such that the concatenation of orientations $or_{W^U(x)} \wedge or_{W^S(x)}$ at x coincides with the orientation or_M .

4.2.2. *Orienting the moduli spaces $\mathcal{T}(y; x)$.* For two critical points $x \neq y$, the moduli spaces of negative gradient trajectories $\mathcal{T}(y; x)$ can be defined in two ways. The first point of view hinges on the fact that \mathbb{R} acts on $W^S(y) \cap W^U(x)$, by defining $s \cdot p = \phi^s(p)$ for $s \in \mathbb{R}$ and $p \in W^S(y) \cap W^U(x)$. The moduli space $\mathcal{T}(y; x)$ is then defined by considering the quotient associated to this action, i.e. by defining $\mathcal{T}(y; x) := W^S(y) \cap W^U(x) / \mathbb{R}$. The second point of view is to consider the transverse intersection with the level set of a regular value a ,

$$\mathcal{T}(y; x) := W^S(y) \cap W^U(x) \cap f^{-1}(a) .$$

Using this description, and coorienting the level set $f^{-1}(a)$ with $-\nabla f$, the spaces $\mathcal{T}(y; x)$ can easily be oriented with the formalism of section 4.1.2 on transverse intersections :

$$TW^S(y) \simeq TW^S(x) \oplus T(W^S(y) \cap W^U(x)) \simeq TW^S(x) \oplus -\nabla f \oplus T\mathcal{T}(y; x) .$$

Note that the space $W^S(y) \cap W^U(x)$ consists in a union of negative gradient trajectories $\gamma : \mathbb{R} \rightarrow M$. We will therefore use the notation $\dot{\gamma}$ for $-\nabla f$, which will become handy in the next section.

We point out that the moduli spaces $\mathcal{T}(y; x)$ are constructed in a different way than the moduli spaces $\mathcal{T}_t(y; x_1, \dots, x_n)$: they cannot naturally be viewed as an arity 1 case of the moduli spaces of gradient trees. This observation will be of importance in our upcoming discussion on signs for the ΩBAs -algebra structure on the Morse cochains.

Finally, the moduli spaces $\mathcal{T}(y; x)$ are manifolds of dimension

$$\dim(\mathcal{T}(y; x)) = |y| - |x| - 1 ,$$

which can be compactified to manifolds with corners $\overline{\mathcal{T}}(y; x)$, by allowing convergence towards broken negative gradient trajectories. See for instance [Weh12]. In the case where they are 1-dimensional, their boundary is given by the signed union

$$\partial \overline{\mathcal{T}}(y; x) = \bigcup_{z \in \text{Crit}(f)} -\mathcal{T}(y; z) \times \mathcal{T}(z; x) .$$

We moreover recall from section 1.1 that we work under the convention $\mathcal{T}(x; x) = \emptyset$.

4.2.3. Compactifications of the unstable and stable manifolds. Using the moduli spaces $\mathcal{T}(y; x)$, we can now compactify the manifolds $W^S(y)$ and $W^U(x)$ to compact manifolds with corners $\overline{W^S}(y)$ and $\overline{W^U}(x)$. See [Hut08] for instance. With our choices of orientations detailed in the previous section, the top dimensional strata in their boundary are given by

$$\begin{aligned} \partial \overline{W^S}(y) &= \bigcup_{z \in \text{Crit}(f)} (-1)^{|z|+1} W^S(z) \times \mathcal{T}(y; z) , \\ \partial \overline{W^U}(x) &= \bigcup_{z \in \text{Crit}(f)} (-1)^{(d-|z|)(|x|+1)} W^U(z) \times \mathcal{T}(z; x) , \end{aligned}$$

where d is the dimension of the ambient manifold M .

The pictures in the neighborhood of the critical point z are represented in figure 27. For instance, in the case of $\partial \overline{W^S}(y)$, an element of $W^S(y)$ is seen as lying on a negative semi-infinite trajectory converging to y , and an outward-pointing vector to the boundary is given by $-\dot{\gamma}$. We hence have that

$$-\dot{\gamma} \oplus TW^S(z) \oplus T\mathcal{T}(y; z) = (-1)^{|z|} TW^S(z) \oplus -\dot{\gamma} \oplus T\mathcal{T}(y; z) = (-1)^{|z|+1} TW^S(y) .$$

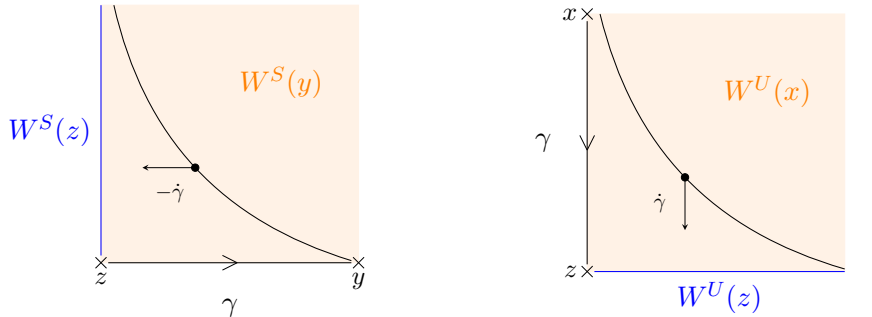

FIGURE 27

4.2.4. *Euclidean neighborhood of a critical point.* Following [Weh12], we will assume in the rest of this part that the pair (Morse function, metric) on the manifold M is Euclidean. Denote $B_\delta^k := \{x \in \mathbb{R}^k, |x| < \delta\}$. Such a pair is said to be *Euclidean* if it is Morse-Smale and is such that for each critical point $z \in \text{Crit}(f)$ there exists a local chart $\phi : B_\delta^{d-|z|} \times B_\delta^{|z|} \xrightarrow{\sim} U_z \subset M$, such that $\phi(0) = z$ and such that the function f and the metric g read as

$$f(x_1, \dots, x_{n-|z|}, y_1, \dots, y_{|z|}) = f(p) - \frac{1}{2}(x_1^2 + \dots + x_{n-|z|}^2) + \frac{1}{2}(y_1^2 + \dots + y_{|z|}^2)$$

$$g = \sum_{i=1}^{n-|z|} dx_i \otimes dx_i + \sum_{i=1}^{|z|} dy_i \otimes dy_i$$

in the chart ϕ . In this chart, we then have that

$$W^U(z) := \{y_1 = \dots = y_{|z|} = 0\}$$

$$W^S(z) := \{x_1 = \dots = x_{n-|z|} = 0\},$$

and $M = W^U(z) \times W^S(z)$. Hence any point of U_z can be uniquely written as a sum $x + y$ where $x \in W^U(z)$ and $y \in W^S(z)$. Choosing now $s \in \mathbb{R}$ such that the the image of $x + y$ under the Morse flow map ϕ^s still lies in U_z , we have that

$$\phi^s(x + y) = e^s x + e^{-s} y.$$

These observations will reveal crucial in the proof of subsection 4.4.3.

4.3. Preliminaries for section 4.4.

4.3.1. *Counting the points on the boundary of an oriented 1-dimensional manifold.* Consider an oriented 1-dimensional manifold with boundary. Then its boundary ∂M is oriented. Assume it can be written set-theoretically as a disjoint union

$$\partial M = \bigsqcup_i N_i.$$

Suppose now that each N_i comes with its own orientation, and write $(-1)^{\dagger i}$ for the sign obtained by comparing this orientation to the boundary orientation. As oriented manifolds, the union writes as

$$\partial M = \bigsqcup_i (-1)^{\dagger i} N_i.$$

The N_i being 0-dimensional, they can be seen as collections of points each coming with a + or - sign. Noticing that an orientable 1-dimensional manifold with boundary is either a segment or a circle, and writing $\#N_i$ for the signed count of points of N_i , the previous equality finally implies that

$$\sum (-1)^{\dagger i} \#N_i = 0.$$

This basic observation is key to constructing most algebraic structures arising in symplectic topology (and in particular Morse theory).

For instance, for a critical point x , counting the boundary points of the 1-dimensional manifolds $\overline{\mathcal{T}}(y; x)$ proves that

$$\partial^{Morse} \circ \partial^{Morse}(x) = \sum_{\substack{y \in \text{Crit}(f) \\ |y|=|x|+2}} \sum_{\substack{z \in \text{Crit}(f) \\ |z|=|x|+1}} \#\mathcal{T}(y; z) \#\mathcal{T}(z; x) \cdot y = 0 .$$

The equations for ΩBAs -algebras and ΩBAs -morphisms will be proven using this method in the following two subsections.

4.3.2. Reformulating the ΩBAs -equations. We fix for each $t \in SRT_n$ an orientation ω_t . Given a $t \in SRT_n$ the orientation ω_t defines an orientation of the moduli space $\mathcal{T}_n(t)$, and we write moreover m_t for the operations (t, ω) . The ΩBAs -equations for an ΩBAs -algebra then read as

$$[\partial, m_t] = \sum_{t' \in \text{coll}(t)} (-1)^{\dagger_{\Omega BAs}} m_{t'} + \sum_{t_1 \#_i t_2 = t} (-1)^{\dagger_{\Omega BAs}} m_{t_1} \circ_i m_{t_2} ,$$

where the notations for trees are as defined previously. The signs $(-1)^{\dagger_{\Omega BAs}}$ are obtained as in section 5.1, by computing the signs of $\mathcal{T}_n(t')$ and $\mathcal{T}_{i_1+1+i_3}(t_1) \times_i \mathcal{T}_{i_2}(t_2)$ in the boundary of $\mathcal{T}_n(t)$. We will not need to compute their explicit value, and will hence keep this useful notation $(-1)^{\Omega BAs}$ to refer to them.

4.3.3. Twisted A_∞ -algebras and twisted ΩBAs -algebras. It is clear using this counting method, that the operations m_t of section 1.5 will endow the Morse cochains $C^*(f)$ with a structure of ΩBAs -algebra over $\mathbb{Z}/2$. Working over integers will prove more difficult, and we will prove a weaker result in this case. We introduce to this extent the notion of twisted A_∞ -algebras and twisted ΩBAs -algebras.

Definition 39. A *twisted A_∞ -algebra* is a dg- \mathbb{Z} -module A endowed with two different differentials ∂_1 and ∂_2 , and a sequence of degree $2 - n$ operations $m_n : A^{\otimes n} \rightarrow A$ such that

$$[\partial, m_n] = - \sum_{\substack{i_1+i_2+i_3=n \\ 2 \leq i_2 \leq n-1}} (-1)^{i_1+i_2 i_3} m_{i_1+1+i_3}(\text{id}^{\otimes i_1} \otimes m_{i_2} \otimes \text{id}^{\otimes i_3}) ,$$

where $[\partial, \cdot]$ denotes the bracket for the maps $(A^{\otimes n}, \partial_1) \rightarrow (A, \partial_2)$. A *twisted ΩBAs -algebra* is defined similarly.

We make explicit the formulae obtained by evaluating the ΩBAs -equations on $A^{\otimes n}$, as we will need them in our next proof :

$$\begin{aligned} & - \partial_2 m_t(a_1, \dots, a_n) + (-1)^{|t| + \sum_{j=1}^{i-1} |a_j|} m_t(a_1, \dots, a_{i-1}, \partial_1 a_i, a_{i+1}, \dots, a_n) \\ & + \sum_{t_1 \#_i t_2 = t} (-1)^{\dagger_{\Omega BAs} + |t_2| \sum_{j=1}^{i_1} |a_j|} m_{t_1}(a_1, \dots, a_{i_1}, m_{t_2}(a_{i_1+1}, \dots, a_{i_1+i_2}), a_{i_1+i_2+1}, \dots, a_n) \\ & + \sum_{t' \in \text{coll}(t)} (-1)^{\dagger_{\Omega BAs}} m_{t'}(a_1, \dots, a_n) \\ & = 0 . \end{aligned}$$

We refer to them as "twisted", as these algebras will occur in the upcoming lines by setting $\partial_2 := (-1)^\sigma \partial_1$, that is by simply twisting the differential ∂_1 by a specific sign.

Note that these two definitions cannot be phrased in terms of operads, as $\text{Hom}((A, \partial_1), (A, \partial_2))$ is an $(\text{End}_{(A, \partial_1)}, \text{End}_{(A, \partial_2)})$ -operadic bimodule but is NOT an operad : the composition maps on $\text{Hom}((A, \partial_1), (A, \partial_2))$ are associative, but they fail to be compatible with the differential $[\partial, \cdot]$. As a result, a twisted A_∞ -algebra cannot be described as a morphism of operads from A_∞ to $\text{Hom}((A, \partial_1), (A, \partial_2))$. However, a twisted ΩBAs -algebra structure always transfers to a twisted A_∞ -algebra structure. Indeed, while the functorial proof of 3.1.5 does not work anymore, we point out that the morphism of operads $A_\infty \rightarrow \Omega BAs$ still contains the proof that a sequence of operations m_t defining a twisted ΩBAs -algebra structure on A can always be arranged in a sequence of operations m_n defining a twisted A_∞ -algebra structure on A .

4.3.4. *The maps ψ_{e_i, \mathbb{X}_t} .* Consider again a stable ribbon tree t and order its external edges clockwise, starting with e_0 at the outgoing edge. Given a choice of perturbation data \mathbb{X}_t , we illustrate in figure 28 a mean to visualize the map

$$\phi_{\mathbb{X}_t} : \mathcal{T}_n(t) \times W^S(y) \times W^U(x_1) \times \cdots \times W^U(x_n) \longrightarrow M^{\times n+1}$$

defined in section 1.3. We introduce a family of maps defined in a similar fashion. Consider e_i an incoming edge of t . Define the map

$$\psi_{e_i, \mathbb{X}_t} : \mathcal{T}_n(t) \times W^S(y) \times W^U(x_1) \times \cdots \times \widehat{W^U(x_i)} \times \cdots \times W^U(x_n) \longrightarrow M^{\times n}$$

to be the map which for a fixed metric tree T takes a point of a $W^U(x_j)$ for $j \neq i$ to the point in M obtained by following the only non-self crossing path from the time -1 point on e_j to the time -1 point on e_i in T through the perturbed gradient flow maps associated to \mathbb{X}_T , and which takes a point of $W^S(y)$ to the point in M obtained by following the only non-self crossing path from the time 1 point on e_0 to the time -1 point on e_i in T through the perturbed gradient flow maps associated to \mathbb{X}_T . The map ψ_{e_0, \mathbb{X}_t} is defined similarly for the outgoing edge e_0 . These two definitions are to be understood as depicted on two examples in figure 28.

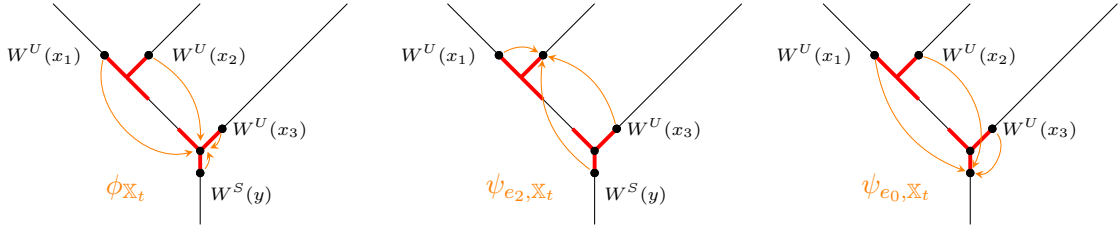

FIGURE 28. Representations of a map $\phi_{\mathbb{X}_t}$, a map ψ_{e_2, \mathbb{X}_t} and a map ψ_{e_0, \mathbb{X}_t}

4.4. The twisted ΩBAs -algebra structure on the Morse cochains.

4.4.1. Summary of the proof of Theorem 9.

Definition 40. (i) We define $\widetilde{\mathcal{T}}_t^{\mathbb{X}}(y; x_1, \dots, x_n)$ to be the oriented manifold $\mathcal{T}_t^{\mathbb{X}}(y; x_1, \dots, x_n)$ whose natural orientation has been twisted by a sign of parity

$$\sigma(t; y; x_1, \dots, x_n) := dn(1 + |y| + |t|) + |t||y| + d \sum_{i=1}^n |x_i|(n - i) .$$

- (ii) Similarly, we define $\widetilde{\mathcal{T}}(y; x)$ to be the oriented manifold $\mathcal{T}(y; x)$ whose natural orientation has been twisted by a sign of parity

$$\sigma(y; x) := 1 .$$

The operations m_t and the differential on $C^*(f)$ are then defined as

$$\begin{aligned} m_t(x_1, \dots, x_n) &= \sum_{|y|=\sum_{i=1}^n |x_i|+|t|} \# \widetilde{\mathcal{T}}_t^{\times}(y; x_1, \dots, x_n) \cdot y , \\ \partial_{Morse}(x) &= \sum_{|y|=|x|+1} \# \widetilde{\mathcal{T}}(y; x) \cdot y . \end{aligned}$$

Proposition 18. *If $\widetilde{\mathcal{T}}_t(y; x_1, \dots, x_n)$ is 1-dimensional, its boundary decomposes as the disjoint union of the following components*

- (i) $(-1)^{|y|+\dagger_{\Omega BAs}+|t|\sum_{i=1}^{i_1}|x_i|} \widetilde{\mathcal{T}}_{t_1}(y; x_1, \dots, x_{i_1}, z, x_{i_1+i_2+1}, \dots, x_n) \times \widetilde{\mathcal{T}}_{t_2}(z; x_{i_1+1}, \dots, x_{i_1+i_2})$;
- (ii) $(-1)^{|y|+\dagger_{\Omega BAs}} \widetilde{\mathcal{T}}_{t'}(y; x_1, \dots, x_n)$ for $t' \in \text{coll}(t)$;
- (iii) $(-1)^{|y|+\dagger_{Koszul}+(d+1)|x_i|} \widetilde{\mathcal{T}}_t(y; x_1, \dots, z, \dots, x_n) \times \widetilde{\mathcal{T}}(z; x_i)$ where $\dagger_{Koszul} = |t| + \sum_{j=1}^{i-1} |x_j|$;
- (iv) $(-1)^{|y|+1} \widetilde{\mathcal{T}}(y; z) \times \widetilde{\mathcal{T}}_t(z; x_1, \dots, x_n)$.

Applying the method of subsection 4.3.1 finally proves that :

Theorem 9. *The operations m_t define a twisted ΩBAs -algebra structure on $(C^*(f), \partial_{Morse}^{Tw}, \partial_{Morse})$, where*

$$(\partial_{Morse}^{Tw})^k = (-1)^{(d+1)k} \partial_{Morse}^k .$$

4.4.2. *Signs for the (int-break) boundary.* We resort to the formalism of short exact sequences of vector bundles to handle orientations in this section. For the sake of readability, we will write N rather than TN for the tangent bundle of a manifold N in the upcoming computations.

The moduli space $\mathcal{T}_t(y; x_1, \dots, x_n)$ is defined as the inverse image of the diagonal $\Delta \subset M^{\times n+1}$ under the map

$$\phi_{\mathbb{X}_t} : \mathcal{T}_n(t) \times W^S(y) \times W^U(x_1) \times \dots \times W^U(x_n) \longrightarrow M^{\times n+1} ,$$

where the factors of $M^{\times n+1}$ are labeled in the order $M_y \times M_{x_1} \times \dots \times M_{x_n}$. Orienting the domain and codomain of $\phi_{\mathbb{X}_t}$ by taking the product orientations, and orienting Δ as M , defines the natural orientation on $\mathcal{T}_t(y; x_1, \dots, x_n)$ as in subsection 4.1.2. Choose $M^{\times n}$ labeled by x_1, \dots, x_n as complementary to Δ . Then the orientation induced on $M^{\times n}$ by the orientations on $M^{\times n+1}$ and on Δ , differs by a $(-1)^{d^2 n}$ sign from the product orientation of $M^{\times n}$. In the language of short exact sequences, $\mathcal{T}_t(y; x_1, \dots, x_n)$ is oriented by the short exact sequence

$$0 \longrightarrow \mathcal{T}_t(y; x_1, \dots, x_n) \longrightarrow \mathcal{T}_n(t) \times W^S(y) \times \prod_{i=1}^n W^U(x_i) \longrightarrow M^{\times n} \longrightarrow 0 ,$$

which has a sign of parity

$$(A) \quad dn .$$

In the case of $\mathcal{T}_{t_1}^{Morse} := \mathcal{T}_{t_1}(y; x_1, \dots, x_{i_1}, z, x_{i_1+i_2+1}, \dots, x_n)$, we choose $M^{\times i_1+1+i_3}$ labeled by $y, x_1, \dots, x_{i_1}, x_{i_1+i_2+1}, \dots, x_n$ as complementary to Δ . The orientation induced on $M^{\times i_1+1+i_3}$, by

the orientations on $M^{\times i_1+2+i_3}$ and on Δ , differs by a $(-1)^{d^2 i_3}$ sign from the product orientation of $M^{\times i_1+1+i_3}$. Hence the short exact sequence

$$0 \longrightarrow \mathcal{T}_{t_1}^{Morse} \longrightarrow \mathcal{T}_{i_1+1+i_3}(t_1) \times W^S(y) \times \prod_{i=1}^{i_1} W^U(x_i) \times W^U(z) \times \prod_{i=i_1+i_2+1}^n W^U(x_i) \longrightarrow M^{\times i_1+1+i_3} \rightarrow 0 ,$$

has a sign of parity

$$(B) \quad di_3 .$$

In the case of $\mathcal{T}_{t_2}^{Morse} := \mathcal{T}_{t_2}(z; x_{i_1+1}, \dots, x_{i_1+i_2})$, we choose $M^{\times i_2}$ labeled by $x_{i_1+1}, \dots, x_{i_1+i_2}$ as complementary to Δ . The orientation induced on $M^{\times i_2}$ differs this time by a $(-1)^{d^2 i_2}$ sign from the product orientation. The short exact sequence

$$0 \longrightarrow \mathcal{T}_{t_2}^{Morse} \longrightarrow \mathcal{T}_{i_2}(t_2) \times W^S(z) \times \prod_{i=i_1+1}^{i_1+i_2} W^U(x_i) \longrightarrow M^{\times i_2} \rightarrow 0 ,$$

has now a sign given by the parity of

$$(C) \quad di_2 .$$

Following the convention of subsection 4.1.1, taking the product

$$0 \longrightarrow \mathcal{T}_{t_1}^{Morse} \times \mathcal{T}_{t_2}^{Morse} \longrightarrow \mathcal{T}_{i_1+1+i_3}(t_1) \times W^S(y) \times \prod_{i=1}^{i_1} W^U(x_i) \times W^U(z) \times \prod_{i=i_1+i_2+1}^n W^U(x_i) \times \mathcal{T}_{i_2}(t_2) \times W^S(z) \times \prod_{i=i_1+1}^{i_1+i_2} W^U(x_i) \\ \longrightarrow M^{\times i_1+1+i_3} \times M^{\times i_2} \rightarrow 0$$

doesn't introduce a sign, as $\mathcal{T}_{t_1}^{Morse}$ and $\mathcal{T}_{t_2}^{Morse}$ are 0-dimensional.

In the previous short exact sequence, $M^{\times i_1+1+i_3} \times M^{\times i_2}$ is labeled by

$$y, x_1, \dots, x_{i_1}, x_{i_1+i_2+1}, \dots, x_n, x_{i_1+1}, \dots, x_{i_1+i_2} .$$

We rearrange this labeling into

$$y, x_1, \dots, x_n ,$$

which induces a sign given by the parity of

$$(D) \quad di_2 i_3 .$$

We also rearrange the expression

$$\mathcal{T}_{i_1+1+i_3}(t_1) \times W^S(y) \times \prod_{i=1}^{i_1} W^U(x_i) \times W^U(z) \times \prod_{i=i_1+i_2+1}^n W^U(x_i) \times \mathcal{T}_{i_2}(t_2) \times W^S(z) \times \prod_{i=i_1+1}^{i_1+i_2} W^U(x_i) ,$$

into

$$W^U(z) \times W^S(z) \times \mathcal{T}_{i_1+1+i_3}(t_1) \times \mathcal{T}_{i_2}(t_2) \times W^S(y) \times \prod_{i=1}^n W^U(x_i) .$$

The parity of the produced sign is that of

$$(E) \quad |z| \left(|t_2| + \sum_{i=i_1+i_2+1}^n (d - |x_i|) \right) + m \left(|t_1| + |y| + \sum_{i=1}^{i_1} (d - |x_i|) \right) \\ + |t_2| \left(|y| + \sum_{i=1}^{i_1} (d - |x_i|) + \sum_{i=i_1+i_2+1}^n (d - |x_i|) \right) + \left(\sum_{i=i_1+1}^{i_1+i_2} (d - |x_i|) \right) \left(\sum_{i=i_1+i_2+1}^n (d - |x_i|) \right) .$$

Introduce now the factor $[L, +\infty[$, corresponding to the length l_e increasing towards $+\infty$, where e is the edge of t whose breaking produces t_1 and t_2 . Following convention 4.1.2, the short exact sequence

$$0 \longrightarrow [L, +\infty[\times \mathcal{T}_{t_1}^{Morse} \times \mathcal{T}_{t_2}^{Morse} \longrightarrow [L, +\infty[\times W^U(z) \times W^S(z) \times \mathcal{T}(t_1) \times \mathcal{T}(t_2) \times W^S(y) \times \prod_{i=1}^n W^U(x_i) \longrightarrow M^{\times n+1} \longrightarrow 0 ,$$

induces a sign change whose parity is given by

$$(F) \quad d(n+1) .$$

Define the map

$$\psi : M \times \mathcal{T}_n(t) \times W^S(y) \times \prod_{i=1}^n W^U(x_i) \longrightarrow M \times M^{\times n+1} ,$$

which is defined on the factors $\mathcal{T}_n(t) \times W^S(y) \times \prod_{i=1}^n W^U(x_i)$ as ϕ and is defined on $M \times \mathcal{T}_n(t)$ by seeing M as the point lying in the middle of the edge e in t . This map is depicted on figure 29. The inverse image of the diagonal of $M \times M^{\times n+1}$ is exactly $\mathcal{T}_t(y, x_1, \dots, x_n)$. Fix now a sufficiently great $L > 0$. We prove in subsection 4.4.3 that orienting $[L, +\infty[\times \mathcal{T}_{t_1}^{Morse} \times \mathcal{T}_{t_2}^{Morse}$ with the previous short exact sequence, the orientation induced on \mathcal{T}_t^{Morse} by gluing is the exactly the one given by the short exact sequence

$$0 \longrightarrow \mathcal{T}_t^{Morse} \longrightarrow [L, +\infty[\times M \times \mathcal{T}(t_1) \times \mathcal{T}(t_2) \times W^S(y) \times \prod_{i=1}^n W^U(x_i) \xrightarrow{d\psi} M^{\times n+1} \longrightarrow 0 ,$$

where our convention on orientations for the unstable and stable manifolds of z implies that $W^U(z) \times W^S(z)$ yields indeed the orientation of M , and $M^{\times n+1}$ is labeled by y, x_1, \dots, x_n .

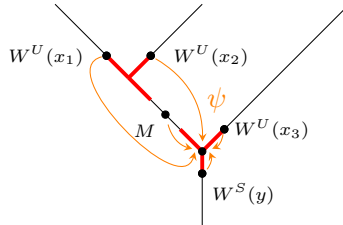

FIGURE 29. Representation of the map ψ

Transform the coorientation labeled by y, x_1, \dots, x_n into the coorientation labeled by M, x_1, \dots, x_n and rearrange the factors $[L, +\infty[\times M \times \mathcal{T}(t_1) \times \mathcal{T}(t_2) \times \dots$ into $M \times [L, +\infty[\times \mathcal{T}(t_1) \times \mathcal{T}(t_2) \times \dots$

This produces a sign change of parity

$$(G) \quad d + d \equiv 0 .$$

We can moreover now delete the two M factors associated to the label M to obtain the short exact sequence

$$0 \longrightarrow \mathcal{T}_t(y; x_1, \dots, x_n) \longrightarrow [L, +\infty[\times \mathcal{T}(t_1) \times \mathcal{T}(t_2) \times W^S(y) \times \prod_{i=1}^n W^U(x_i) \longrightarrow M^{\times n} \longrightarrow 0 ,$$

where $M^{\times n} = M_{x_1} \times \dots \times M_{x_n}$.

Transforming finally $[L, +\infty[\times \mathcal{T}(t_1) \times \mathcal{T}(t_2)$ into $\mathcal{T}_n(t)$ gives a sign of parity

$$(H) \quad \dagger_{\Omega BAs} .$$

In closing, the short exact sequence

$$0 \longrightarrow \mathcal{T}_t(y; x_1, \dots, x_n) \longrightarrow \mathcal{T}_n(t) \times W^S(y) \times \prod_{i=1}^n W^U(x_i) \longrightarrow M^{\times n} \longrightarrow 0 ,$$

has sign given by the parity of A when \mathcal{T}_t^{Morse} is endowed with its natural orientation. It has sign given by the parity of $B + C + D + E + F + G + H$ when \mathcal{T}_t^{Morse} is endowed with the orientation induced by $[L, +\infty[\times \mathcal{T}_{t_1}^{Morse} \times \mathcal{T}_{t_2}^{Morse}$, where the first factor is the length l_e and determines the outward-pointing direction ν_e to the boundary component $\mathcal{T}_{t_1}^{Morse} \times \mathcal{T}_{t_2}^{Morse}$.

We thus obtain that with our choice of orientation on the moduli spaces \mathcal{T}_t^{Morse} , the sign of $\mathcal{T}_{t_1}(y; x_1, \dots, x_{i_1}, z, x_{i_1+i_2+1}, \dots, x_n) \times \mathcal{T}_{t_2}(z; x_{i_1+1}, \dots, x_{i_1+i_2})$ in the boundary of the 1-dimensional moduli space $\mathcal{T}_t(y; x_1, \dots, x_n)$ is given by the parity of

$$(*) \quad A + B + C + D + E + F + G + H$$

$$= |z||t_2| + d|y| + d|t_1| + (n+1)d + \sum_{i=1}^{i_1} d|x_i| + |t_2||y| + di_1|t_2| + di_2 \sum_{i=i_1+i_2+1}^n |x_i| + \dagger_{\Omega BAs} + |t_2| \sum_{i=1}^{i_1} |x_i| .$$

Hence the sign of $\widetilde{\mathcal{T}}_{t_1}(y; x_1, \dots, x_{i_1}, z, x_{i_1+i_2+1}, \dots, x_n) \times \widetilde{\mathcal{T}}_{t_2}(z; x_{i_1+1}, \dots, x_{i_1+i_2})$ in the boundary of the 1-dimensional moduli space $\widetilde{\mathcal{T}}_t(y; x_1, \dots, x_n)$ is given by the parity of

$$\begin{aligned} & \sigma(t; y; x_1, \dots, x_n) + \sigma(t_1; y; x_1, \dots, x_{i_1}, z, x_{i_1+i_2+1}, \dots, x_n) + \sigma(t_2; z; x_{i_1+1}, \dots, x_{i_1+i_2}) + (*) \\ &= |y| + \dagger_{\Omega BAs} + |t_2| \sum_{i=1}^{i_1} |x_i| . \end{aligned}$$

4.4.3. Gluing and orientations. We prove in this subsection that after orienting $[L, +\infty[\times \mathcal{T}_{t_1}^{Morse} \times \mathcal{T}_{t_2}^{Morse}$ with the short exact sequence

$$0 \longrightarrow [L, +\infty[\times \mathcal{T}_{t_1}^{Morse} \times \mathcal{T}_{t_2}^{Morse} \longrightarrow [L, +\infty[\times W^U(z) \times W^S(z) \times \mathcal{T}(t_1) \times \mathcal{T}(t_2) \times W^S(y) \times \prod_{i=1}^n W^U(x_i) \longrightarrow M^{\times n+1} \longrightarrow 0 ,$$

the orientation induced on \mathcal{T}_t^{Morse} by gluing is the one given by the short exact sequence

$$0 \longrightarrow \mathcal{T}_t^{Morse} \longrightarrow [L, +\infty[\times M \times \mathcal{T}(t_1) \times \mathcal{T}(t_2) \times W^S(y) \times \prod_{i=1}^n W^U(x_i) \xrightarrow{d\psi} M^{\times n+1} \longrightarrow 0 .$$

The proof boils down to the following lemma.

Lemma 1. *Let M and N be manifolds and $S \subset N$ a submanifold of N . Suppose that M , N and S are orientable and oriented. Let $f : [0, 1] \times M \rightarrow N$ be a smooth map such that $f_1 := f(1, \cdot) : M \rightarrow N$ is transverse to S . Let $x \in f_1^{-1}(S)$. Then there exist an open subset V of M containing x and $0 \leq t_1 < 1$ such that*

- (i) *The map $f|_{[t_1, 1] \times V} : [t_1, 1] \times V \rightarrow N$ is transverse to S . In particular the inverse image $f|_{[t_1, 1] \times V}^{-1}(S)$ is then a submanifold of $[t_1, 1] \times V$.*
- (ii) *There exists an orientation-preserving embedding*

$$f|_{[t_1, 1] \times V}^{-1}(S) \longrightarrow [t_1, 1] \times f_1^{-1}(S)$$

equal to the identity on $f_1|_V^{-1}(S)$ and preserving the t coordinate, where we orient $[t_1, 1] \times f_1^{-1}(S)$ with the short exact sequence

$$0 \longrightarrow [t_1, 1] \times f_1^{-1}(S) \longrightarrow [0, 1] \times M \longrightarrow \nu_S \longrightarrow 0$$

and we orient $f|_{[t_1, 1] \times V}^{-1}(S)$ with the short exact sequence

$$0 \longrightarrow f|_{[t_1, 1] \times V}^{-1}(S) \longrightarrow [0, 1] \times M \longrightarrow \nu_S \longrightarrow 0 .$$

Proof. Choose an adapted chart for S around $f_1(x)$, i.e. a chart $\phi : U' \subset N \rightarrow \mathbb{R}^n$ such that

$$\phi(U' \cap S) = \{(y_1, \dots, y_{n-s}, x_1, \dots, x_s) \in \mathbb{R}^n, y_1 = \dots = y_{n-s} = 0\} ,$$

where n and s respectively denote the dimensions of N and S . Using the local normal form theorem for submersions, there exists a local chart $\psi : U \subset M \rightarrow \mathbb{R}^m$ around x such that the map f_1 reads as

$$(y_1, \dots, y_{n-s}, x_1, \dots, x_{m+s-n}) \longmapsto (y_1, \dots, y_{n-s}, F_1(\vec{y}, \vec{x}), \dots, F_s(\vec{y}, \vec{x}))$$

in the local charts ψ and ϕ , where the F_i are smooth maps and $\vec{y} := y_1, \dots, y_{n-s}$, $\vec{x} := x_1, \dots, x_{m+s-n}$ and $m := \dim(M)$. In these local charts,

$$U \cap f_1^{-1}(U' \cap S) = \{(y_1, \dots, y_{n-s}, x_1, \dots, x_{m+s-n}) \in \mathbb{R}^m, y_1 = \dots = y_{n-s} = 0\} .$$

The property "being transverse to S " being open, there exists a neighborhood W of x in M and $t_0 \in [0, 1[$ such that the map $f|_{[t_0, 1] \times W} : [t_0, 1] \times W \rightarrow N$ is transverse to S . Suppose $W \subset U$ and consider now the projection $\pi : \mathbb{R}^m \rightarrow \mathbb{R}^{m+s-n}$ given by

$$(y_1, \dots, y_{n-s}, x_1, \dots, x_{m+s-n}) \longmapsto (x_1, \dots, x_{m+s-n})$$

and define the smooth map

$$\iota := \text{id}_t \times \pi : f|_{[t_0, 1] \times W}^{-1}(S) \longrightarrow [0, 1] \times f_1^{-1}(S)$$

in the local charts ϕ and ψ . The differential of this map is invertible at $(1, x)$. The inverse function theorem then ensures that there exists $t_1 \in [t_0, 1[$ and a neighborhood $V \subset W$ of x such that the map

$$\iota : f|_{[t_1, 1] \times V}^{-1}(S) \longrightarrow [0, 1] \times f_1^{-1}(S)$$

is a diffeomorphism on its image.

Orient now $[0, 1] \times f_1^{-1}(S)$ and $f|_{[t_1, 1] \times V}^{-1}(S)$ with the previous short exact sequences. It remains to show that the map ι is orientation-preserving. The proof of this result can be reduced to a proof

in linear algebra, i.e. by considering a smooth family of linear maps $f : [0, 1] \times \mathbb{R}^m \rightarrow \mathbb{R}^n$ such that f_1 reads as

$$(y_1, \dots, y_{n-s}, x_1, \dots, x_{m+s-n}) \mapsto (y_1, \dots, y_{n-s}, F_1(\vec{y}, \vec{x}), \dots, F_s(\vec{y}, \vec{x})) ,$$

and the linear subspace $S = \{0\} \times \mathbb{R}^s \subset \mathbb{R}^n$. Then there exists $t_0 \in [0, 1]$ such that $f|_{[t_0, 1] \times \mathbb{R}^m}$ is transverse to S , and we can consider the smooth map

$$\iota := \text{id}_t \times \pi : f|_{[t_0, 1] \times \mathbb{R}^m}^{-1}(S) \longrightarrow [0, 1] \times f_1^{-1}(S)$$

which is a diffeomorphism on its image. Basic computations finally show that the map ι is indeed orientation-preserving. \square

We now go back to our initial problem. Let $T_1^{Morse} \in \mathcal{T}_1^{Morse}$ and $T_2^{Morse} \in \mathcal{T}_2^{Morse}$, where we refer to subsection 4.4.2 for notations. Consider a local Euclidean chart $\phi_z : U_z \rightarrow \mathbb{R}^d$ for the critical point z as in subsection 4.2.4. Introduce the map $ev : [0, +\infty] \times U_z \rightarrow U_z \times U_z$ reading as

$$(\delta, x + y) \mapsto (e^{-2\delta}x + y, x + e^{-2\delta}y)$$

in the chart ϕ_z . The pair $ev(\delta, x + y)$ corresponds to the two endpoints of the unique finite Morse trajectory parametrized by $[-\delta, \delta]$ and meeting $e^{-\delta}x + e^{-\delta}y$ at time 0.

Consider the trajectory $\gamma_{e,1} :]-\infty, 0] \rightarrow M$ and the trajectory $\gamma_{e,2} : [0, +\infty[\rightarrow M$, respectively associated to the incoming edge of T_1^{Morse} and to the outgoing edge of T_2^{Morse} which result from the breaking of the edge e in t . Choose L large enough such that $\gamma_{e,1}(-L)$ and $\gamma_{e,2}(L)$ belong to U_z . Introduce the map $f := ev \times (\phi^{-(L-1)})^{\times i_1 + i_3} \circ \psi_{e, \mathbb{X}_{t_1}} \times (\phi^{L-1})^{\times i_2} \circ \psi_{e, \mathbb{X}_{t_2}}$ acting as

$$\begin{aligned} [0, +\infty] \times U_z \times \mathcal{T}_{i_1 + i_3}(t_1) \times W^S(y) \times \prod_{i=1}^{i_1} W^U(x_i) \times \prod_{i=i_1 + i_2 + 1}^n W^U(x_i) \times \mathcal{T}_{i_2}(t_2) \times \prod_{i=i_1 + 1}^{i_1 + i_2} W^U(x_i) \\ \longrightarrow M^{\times 2} \times M^{\times i_1 + i_3} \times M^{\times i_2} , \end{aligned}$$

where ϕ^{L-1} stands for the time $L-1$ Morse flow and the maps $\psi_{e, \mathbb{X}_{t_2}}$ and $\psi_{e, \mathbb{X}_{t_1}}$ have been introduced in subsection 4.2.4. This map is depicted in figure 30.

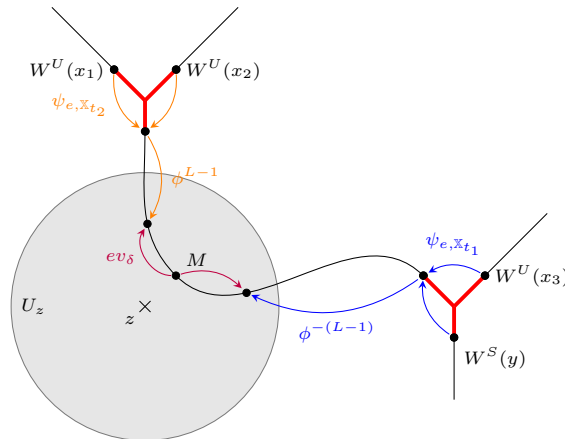

FIGURE 30. Representation of the map f . The label M corresponds to the point $e^{-\delta}x + e^{-\delta}y$ and not to the point $x + y$.

Define the $2d$ -dimensional submanifold $\Lambda \subset M^{\times 2} \times M^{\times i_1+1+i_3} \times M^{\times i_2}$ to be

$$\Lambda := \left\{ \begin{array}{l} (m_z^1, m_z^2, m_y, m_1, \dots, m_{i_1}, m_{i_1+1+i_2}, \dots, m_n, m_{i_1+1}, \dots, m_{i_1+i_2}) \\ \text{such that } m_z^1 = m_{i_1+1} = \dots = m_{i_1+i_2} \quad \text{and} \\ m_z^2 = m_y = m_1 = \dots = m_{i_1} = m_{i_1+1+i_2} = \dots = m_n \end{array} \right\} .$$

The pair $(T_1^{Morse}, T_2^{Morse})$ then belongs to the inverse image $f_{+\infty}^{-1}(\Lambda)$. By assumption on the choice of perturbation data $(\mathbb{X}_n)_{n \geq 2}$, the map $f_{+\infty}$ is moreover transverse to Λ . Applying Lemma 1 to the map f at the point $(T_1^{Morse}, T_2^{Morse})$, there exists $R > 0$ and an embedding

$$\#_{T_1^{Morse}, T_2^{Morse}} : [R, +\infty] \longrightarrow \overline{\mathcal{T}}_t(y; x_1, \dots, x_n) .$$

Note that the parameter δ corresponds to an edge of length $2L + 2\delta$ in the resulting glued tree. Upon reordering the factors of the domain of f , it is finally easy to check that this lemma also implies the result on orientations stated at the beginning of this subsection.

4.4.4. Signs for the (int-collapse) and (Morse) boundary. Repeating the beginning of the previous section, for the moduli spaces $\mathcal{T}_{t'}(y; x_1, \dots, x_n)$, where $t' \in \text{coll}(t)$, and $\overline{\mathcal{T}}_t(y; x_1, \dots, x_n)$, we choose $M^{\times n}$ labeled by x_1, \dots, x_n as complementary to the diagonal $\Delta \subset M^{\times n+1}$. The parity of the total sign change coming from these coorientation choices is

$$(A) \quad dn + dn = 0 .$$

Introduce the factor $]0, L]$, corresponding to the length l_e going towards 0, where e is the edge of t whose collapsing produces t' . Applying again Lemma 1 and following convention 4.1.1, the short exact sequence

$$0 \longrightarrow \mathcal{T}_t(y; x_1, \dots, x_n) =]0, L] \times \mathcal{T}_{t'}(y; x_1, \dots, x_n) \longrightarrow]0, L] \times \mathcal{T}_n(t') \times W^S(y) \times \prod_{i=1}^n W^U(x_i) \longrightarrow M^{\times n} \longrightarrow 0 ,$$

introduces a sign change whose parity is given by

$$(B) \quad dn .$$

Transforming finally $]0, L] \times \mathcal{T}_n(t')$ into $\mathcal{T}_n(t)$ gives a sign of parity

$$(C) \quad \dagger_{\Omega BAs} .$$

Adding these contributions, we obtain that the sign of $\mathcal{T}_{t'}(y; x_1, \dots, x_n)$ in the boundary of the 1-dimensional moduli space $\overline{\mathcal{T}}_t(y; x_1, \dots, x_n)$ is given by the parity of

$$(*) \quad A + B + C = dn + \dagger_{\Omega BAs} .$$

The sign of $\widetilde{\mathcal{T}}_{t'}(y; x_1, \dots, x_n)$ in the boundary of the 1-dimensional moduli space $\widetilde{\mathcal{T}}_t(y; x_1, \dots, x_n)$ is hence given by the parity of

$$\sigma(t; y; x_1, \dots, x_n) + \sigma(t'; y; x_1, \dots, x_n) + (*) = |y| + \dagger_{\Omega BAs} .$$

Finally, the signs for the (Morse) boundary can be computed following the exact same lines of the two previous proofs.

4.5. The twisted ΩBAs -morphism between the Morse cochains.

4.5.1. *Reformulating the ΩBAs -equations.* We set again for the rest of this section an orientation ω for each $t_g \in SCRT_n$, which endows each moduli space $\mathcal{CT}_n(t_g)$ with an orientation, and write moreover μ_{t_g} for the operations (t_g, ω) of ΩBAs – Morph. The ΩBAs -equations for an ΩBAs -morphism then read as

$$\begin{aligned} [\partial, \mu_{t_g}] = & \sum_{t'_g \in \text{coll}(t_g)} (-1)^{\dagger \Omega BAs} \mu_{t'_g} + \sum_{t'_g \in g\text{-vert}(t_g)} (-1)^{\dagger \Omega BAs} \mu_{t'_g} + \sum_{t_g^1 \#_i t_g^2 = t_g} (-1)^{\dagger \Omega BAs} \mu_{t_g^1} \circ_i m_{t_g^2} \\ & + \sum_{t^0 \# (t_g^1, \dots, t_g^s) = t_g} (-1)^{\dagger \Omega BAs} m_{t^0} \circ (\mu_{t_g^1} \otimes \dots \otimes \mu_{t_g^s}), \end{aligned}$$

where the notations for trees are transparent. The signs $(-1)^{\dagger \Omega BAs}$ are obtained as in subsection 4.3.2.

4.5.2. *Twisted A_∞ -morphisms and twisted ΩBAs -morphisms.* Again, it is clear using the counting method of 4.3.1 that if we work over $\mathbb{Z}/2$, the operations μ_{t_g} of 2.5 define an ΩBAs -morphism. We will prove a weaker result in the case of integers, introducing for this matter the notion of twisted A_∞ -morphisms and twisted ΩBAs -morphisms.

Definition 41. Let $(A, \partial_1, \partial_2, m_n)$ and $(B, \partial_1, \partial_2, m_n)$ be two twisted A_∞ -algebras. A *twisted A_∞ -morphism* from A to B is defined to be a sequence of degree $1 - n$ operations $f_n : A^{\otimes n} \rightarrow B$ such that

$$[\partial, f_n] = \sum_{\substack{i_1+i_2+i_3=n \\ i_2 \geq 2}} (-1)^{i_1+i_2 i_3} f_{i_1+i_2+i_3}(\text{id}^{\otimes i_1} \otimes m_{i_2} \otimes \text{id}^{\otimes i_3}) - \sum_{\substack{i_1+\dots+i_s=n \\ s \geq 2}} (-1)^{\epsilon_B} m_s(f_{i_1} \otimes \dots \otimes f_{i_s}),$$

where $[\partial, \cdot]$ denotes the bracket for the maps $(A^{\otimes n}, \partial_1) \rightarrow (B, \partial_2)$. A *twisted ΩBAs -morphism* between twisted ΩBAs -algebras is defined similarly.

The formulae obtained by evaluating the ΩBAs -equations on $A^{\otimes n}$ then become

$$\begin{aligned} & - \partial_2 \mu_{t_g}(a_1, \dots, a_n) + (-1)^{|t_g| + \sum_{j=1}^{i-1} |a_j|} \mu_{t_g}(a_1, \dots, a_{i-1}, \partial_1 a_i, a_{i+1}, \dots, a_n) \\ & + \sum_{t_g^1 \# t_g^2 = t_g} (-1)^{\dagger \Omega BAs + |t_g^2| \sum_{j=1}^{i_1} |a_j|} \mu_{t_g^1}(a_1, \dots, a_{i_1}, m_{t_g^2}(a_{i_1+1}, \dots, a_{i_1+i_2}), a_{i_1+i_2+1}, \dots, a_n) \\ & + \sum_{t^1 \# (t_g^1, \dots, t_g^s) = t_g} (-1)^{\dagger \Omega BAs + \dagger_{Koszul}} m_{t^0}(\mu_{t_g^1}(a_1, \dots, a_{i_1}), \dots, \mu_{t_g^s}(a_{i_1+\dots+i_{s-1}+1}, \dots, a_n)) \\ & + \sum_{t'_g \in \text{coll}(t_g)} (-1)^{\dagger \Omega BAs} \mu_{t'_g}(a_1, \dots, a_n) + \sum_{t'_g \in g\text{-vert}(t_g)} (-1)^{\dagger \Omega BAs} \mu_{t'_g}(a_1, \dots, a_n) \\ & = 0, \end{aligned}$$

where

$$\dagger_{Koszul} = \sum_{r=1}^s |t_g^r| \left(\sum_{t=1}^{r-1} \sum_{j=1}^{i_t} |a_{i_1+\dots+i_{t-1}+j}| \right).$$

Again these two definitions cannot be phrased using an operadic viewpoint. However, a twisted ΩBAs -morphism between twisted ΩBAs -algebras always descends to a twisted A_∞ -morphism between twisted A_∞ -algebras, for the same reason as in subsection 4.3.3.

4.5.3. *Summary of the proof of Theorem 12.* Let \mathbb{X}^f and \mathbb{X}^g be admissible choices of perturbation data on the moduli spaces \mathcal{T}_n for the Morse functions f and g , and \mathbb{Y} be a choice of perturbation data on the moduli spaces \mathcal{CT}_n that is admissible w.r.t. \mathbb{X}^f and \mathbb{X}^g .

Definition 42. We define $\widetilde{\mathcal{CT}}_{t_g}^{\mathbb{Y}}(y; x_1, \dots, x_n)$ to be the oriented manifold $\mathcal{CT}_{t_g}^{\mathbb{Y}}(y; x_1, \dots, x_n)$ whose natural orientation has been twisted by a sign of parity

$$\sigma(t_g; y; x_1, \dots, x_n) := dn(1 + |y| + |t_g|) + |t_g||y| + d \sum_{i=1}^n |x_i|(n - i).$$

The moduli spaces $\widetilde{\mathcal{T}}(y; x)$ and $\widetilde{\mathcal{T}}_t(y; x_1, \dots, x_n)$ are moreover defined as in section 4.4. We define the operations $\mu_{t_g} : C^*(f)^{\otimes n} \rightarrow C^*(g)$ as

$$\mu_{t_g}(x_1, \dots, x_n) = \sum_{|y| = \sum_{i=1}^n |x_i| + |t_g|} \# \widetilde{\mathcal{CT}}_{t_g}^{\mathbb{Y}}(y; x_1, \dots, x_n) \cdot y.$$

Proposition 19. *If $\widetilde{\mathcal{CT}}_{t_g}(y; x_1, \dots, x_n)$ is 1-dimensional, its boundary decomposes as the disjoint union of the following components*

- (i) $(-1)^{|y| + \dagger_{\Omega BAs} + |t^2| \sum_{i=1}^{i_1} |x_i|} \widetilde{\mathcal{CT}}_{t'_g}(y; x_1, \dots, x_{i_1}, z, x_{i_1+i_2+1}, \dots, x_n) \times \widetilde{\mathcal{T}}_{t^2}(z; x_{i_1+1}, \dots, x_{i_1+i_2})$;
- (ii) $(-1)^{|y| + \dagger_{\Omega BAs} + \dagger_{Koszul}} \widetilde{\mathcal{T}}_{t^1}(y; y_1, \dots, y_s) \times \widetilde{\mathcal{CT}}_{t'_g}(y_1; x_1, \dots) \times \dots \times \widetilde{\mathcal{CT}}_{t'_g}(y_s; \dots, x_n)$;
- (iii) $(-1)^{|y| + \dagger_{\Omega BAs}} \widetilde{\mathcal{CT}}_{t'_g}(y; x_1, \dots, x_n)$ for $t' \in \text{coll}(t)$;
- (iv) $(-1)^{|y| + \dagger_{\Omega BAs}} \widetilde{\mathcal{CT}}_{t'_g}(y; x_1, \dots, x_n)$ for $t' \in g - \text{vert}(t)$;
- (v) $(-1)^{|y| + \dagger_{Koszul} + (m+1)|x_i|} \widetilde{\mathcal{CT}}_{t_g}(y; x_1, \dots, z, \dots, x_n) \times \widetilde{\mathcal{T}}(z; x_i)$ where $\dagger_{Koszul} = |t_g| + \sum_{j=1}^{i-1} |x_j|$;
- (vi) $(-1)^{|y|+1} \widetilde{\mathcal{T}}(y; z) \times \widetilde{\mathcal{CT}}_{t_g}(z; x_1, \dots, x_n)$.

Applying the method of subsection 4.3.1 again finally proves that :

Theorem 12. *The operations μ_{t_g} define a twisted Ω BAs-morphism between the Morse cochains $(C^*(f), \partial_{Morse}^{Tw}, \partial_{Morse})$ and $(C^*(g), \partial_{Morse}^{Tw}, \partial_{Morse})$.*

4.5.4. *Gluing.* We construct explicit gluing maps in the two-colored framework using Lemma 1. Gluing maps for the (above-break) boundary components are built as in subsection 4.4.3. In the (below-break) case, consider critical points $y, y_1, \dots, y_s \in \text{Crit}(g)$ and $x_1, \dots, x_n \in \text{Crit}(f)$ such that the moduli spaces $\mathcal{T}_{t^0}(y; y_1, \dots, y_s)$ and $\mathcal{CT}_{t'_g}(y_r; x_{i_1+\dots+i_{r-1}+1}, \dots, x_{i_1+\dots+i_r})$ are 0-dimensional. Let $T^{0, Morse} \in \mathcal{T}_{t^0}^{Morse}$ and $T_g^{r, Morse} \in \mathcal{CT}_{t'_g}^{Morse}$. Fix moreover an Euclidean neighborhood U_{z_r} of each critical point z_r and choose L large enough such that for $r = 1, \dots, s$, $\gamma_{e_r, T^{0, Morse}}(-L)$ and $\gamma_{e_0, T_g^{r, Morse}}(L)$ belong to U_{z_r} . Define finally the map $\sigma_{e_0, \mathbb{X}_{t^0}} : M \rightarrow M^{\times s}$ in a similar fashion to the maps ψ_{e_i, \mathbb{X}_t} , as depicted for instance in figure 31. Gluing maps for the perturbed Morse trees $T^{0, Morse}$ and $T_g^{r, Morse}$ can then be defined by applying Lemma 1 to the map

$$[0, +\infty) \times \prod_{r=1}^s U_{z_r} \times \mathcal{T}_s(t^0) \times W^S(y) \times \prod_{r=1}^s \left(\mathcal{CT}_{t'_g}(y_r) \times \prod_{i=i_1+\dots+i_{r-1}+1}^{i_1+\dots+i_r} W^U(x_i) \right) \longrightarrow M^{\times 2s} \times M^{\times s} \times \prod_{r=1}^s M^{\times i_r}.$$

defined as follows :

- (i) the factor $\mathcal{T}_s(t^0) \times W^S(y)$ is sent to $M^{\times s}$ under the map $(\phi^{-(L-1)})^{\times s} \circ \sigma_{e_0, t^0}$;
- (ii) the factor $\mathcal{CT}_{i_r}(t_g^r) \times \prod W^U(x_i)$ is sent to $M^{\times i_r}$ under the map $(\phi^{(L-1)})^{\times i_r} \circ \sigma_{e_0, t_g^r}$;
- (iii) the factor $[0, +\infty] \times \prod_{r=1}^s U_{z_r}$ is sent to $M^{\times 2s}$ under the map $ev_{l_\delta^1}^{U_{z_1}} \times \cdots \times ev_{l_\delta^s}^{U_{z_s}}$ where δ denotes the parameter in $[0, +\infty]$ and the lengths l_δ^r are defined as in subsection 5.2.7 of part 1 in order for them to define a two-colored metric ribbon tree. In particular, we have explicit formulae depending on δ for the resulting edges in the glued tree.

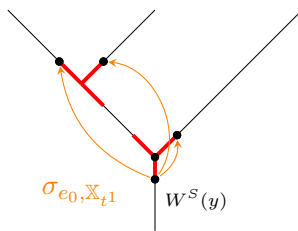

FIGURE 31. Representation of the map $\sigma_{e_0, \mathbb{X}_{t^1}}$.

4.6. On these twisted structures. Note first that if we work with coefficients in $\mathbb{Z}/2$, the operations m_t define of course an ΩBAs -algebra structure on the Morse cochains. The operations μ_{t_g} then define an ΩBAs -morphism between two ΩBAs -algebras. We will say that the structure we defined are *untwisted*. We hence work now over the integers \mathbb{Z} . It appears from the definition of ∂_{Morse}^{Tw} that when M is odd-dimensional, the structures we define are untwisted. In the even-dimensional case, the structures are twisted, and it remains to be proven that all the operations m_t could be twisted in order to get an untwisted structure.

We also point out that the twisted structures arise from the two incompatible orientation conventions on an intersection $R \cap S$ and $S \cap R$ detailed in 4.1.2. Indeed, we decided to orient $\mathcal{T}(y; x)$ inside the intersection $W^S(y) \cap W^U(x)$. The signs then compute nicely for the boundary component $\tilde{\mathcal{T}}(y; z) \times \tilde{\mathcal{CT}}_{t_g}(z; x_1, \dots, x_n)$, and the twist in ∂_{Morse}^{Tw} arises in $\tilde{\mathcal{CT}}_{t_g}(y; x_1, \dots, z, \dots, x_n) \times \tilde{\mathcal{T}}(z; x_i)$.

Orienting $\mathcal{T}(y; x)$ inside the intersection $W^U(x) \cap W^S(y)$ makes these two boundary components switch roles. In that case, redefining the twist on the orientation of the moduli space $\mathcal{T}(y; x)$ as given by the parity of

$$\sigma(y; x) := 1 + |x| ,$$

we check that the operations m_t define a twisted ΩBAs -algebra structure on $(C^*(f), \partial_{Morse}, \partial_{Morse}^{Tw})$. The operations μ_{t_g} on their side define a twisted ΩBAs -morphism between $(C^*(f), \partial_{Morse}, \partial_{Morse}^{Tw})$ and $(C^*(g), \partial_{Morse}, \partial_{Morse}^{Tw})$.

Part 3

Further developments

1. THE MAP $\mu^{\mathbb{Y}}$ IS A QUASI-ISOMORPHISM

The goal of this section is to prove the following proposition :

Proposition 20. *The twisted ΩBAs -morphism $\mu^{\mathbb{Y}} : (C^*(f), m_t^{\mathbb{X}^f}) \longrightarrow (C^*(g), m_t^{\mathbb{X}^g})$ constructed in Theorem 12 is a quasi-isomorphism.*

In other words we want to prove that the arity 1 component $\mu_+^{\mathbb{Y}} : C^*(f) \rightarrow C^*(g)$ is a map which induces an isomorphism in cohomology. The map $\mu_+^{\mathbb{Y}}$ is a dg-map $(C^*(f), \partial_{Morse}^{Tw}) \rightarrow (C^*(g), \partial_{Morse})$, but the cohomologies defined by the differentials ∂_{Morse}^{Tw} and ∂_{Morse} are equal.

In this regard, we will prove that given three perturbation data on $\mathcal{CT}_1 := \{+\}, \mathbb{Y}_+^{fg}, \mathbb{Y}_+^{gf}$ and \mathbb{Y}_+^{ff} , defining dg-maps

$$\mu_+^{\mathbb{Y}^{ij}} : (C^*(i), \partial_{Morse}^{Tw}) \longrightarrow (C^*(j), \partial_{Morse}) ,$$

we can construct a homotopy $h : C^*(f) \rightarrow C^*(f)$ such that

$$(-1)^d \mu_+^{\mathbb{Y}^{gf}} \circ \mu_+^{\mathbb{Y}^{fg}} - \mu_+^{\mathbb{Y}^{ff}} = \partial_{Morse} h + h \partial_{Morse}^{Tw} .$$

Specializing to the case where \mathbb{Y}_+^{ff} is null, $\mu_+^{\mathbb{Y}^{ff}} = \text{id}$ and this yields the desired result. For the sake of readability, we will write $\mathbb{Y}^{ij} := \mathbb{Y}_+^{ij}$ in the rest of this section. Note also that the choice of perturbation data \mathbb{X}^f and \mathbb{X}^g are not necessary for this construction.

In the last paragraph of subsection 1.5 of part 2, we explained that given any Morse function f together with an admissible choice of perturbation data \mathbb{X}^f , the Morse cochains $C^*(f)$ and the singular cochains $C_{sing}^*(M)$ are quasi-isomorphic as twisted ΩBAs -algebras. In particular, given another Morse function g together with an admissible choice of perturbation data \mathbb{X}^g , the Morse cochains $C^*(f)$ and $C^*(g)$ are quasi-isomorphic as twisted ΩBAs -algebras. Proposition 20 show that the twisted ΩBAs -morphism $\mu^{\mathbb{Y}}$ realizes such a quasi-isomorphism explicitly.

1.1. The moduli space $\mathcal{H}(y; x)$. Begin by considering the moduli space of metric trees \mathcal{H} , represented in two equivalent ways in figure 32. Adapting the discussions of section 1.2, we infer without difficulty the notion of *smooth choice of perturbation data on \mathcal{H}* . Given such a choice of perturbation data \mathbb{W} , we then say that it is consistent with the \mathbb{Y}^{ij} if it is such that, when $l \rightarrow 0$, $\lim(\mathbb{W}) = \mathbb{Y}^{ff}$, and when $l \rightarrow +\infty$, the limit $\lim(\mathbb{W})$ on the above part of the broken tree is \mathbb{Y}^{fg} and the limit $\lim(\mathbb{W})$ on the bottom part of the broken tree is \mathbb{Y}^{gf} .

For x and y critical points of the function f , introduce now the moduli space $\mathcal{H}^{\mathbb{W}}(y; x)$ consisting of perturbed Morse gradient trees modeled on \dagger , and such that the two external edges correspond to perturbed Morse equations for f , and the internal edge corresponds to a perturbed Morse equation



FIGURE 32

for g . We then check that a generic choice of perturbation data \mathbb{W} makes them into orientable manifolds of dimension

$$\dim(\mathcal{H}^{\mathbb{W}}(y; x)) = |y| - |x| + 1 .$$

The 1-dimensional moduli spaces $\mathcal{H}(y; x)$ can be compactified into compact manifolds with boundary $\overline{\mathcal{H}}(y; x)$, whose boundary is given by the three following phenomena :

- (i) an external edge breaks at a critical point of f (Morse) ;
- (ii) the length of the internal edge tends towards 0 : this yields the moduli spaces

$$\mathcal{CT}^{\mathbb{Y}^{ff}}(y; x) ;$$

- (iii) the internal edge breaks at a critical point of g : this yields the moduli spaces

$$\bigcup_{z \in \text{Crit}(g)} \mathcal{CT}^{\mathbb{Y}^{gf}}(y; z) \times \mathcal{CT}^{\mathbb{Y}^{fg}}(z; x) .$$

Defining the map $h : C^*(f) \rightarrow C^*(f)$ as $h(x) := \sum_{|y|=|x|-1} \#\mathcal{H}^{\mathbb{W}}(y; x) \cdot y$, a signed count of the boundary points of the 1-dimensional compactified moduli spaces $\overline{\mathcal{H}}^{\mathbb{W}}(y; x)$ then proves that :

Proposition 21. *The map h defines an homotopy between $(-1)^d \mu^{\mathbb{Y}^{gf}} \circ \mu^{\mathbb{Y}^{fg}}$ and $\mu^{\mathbb{Y}^{ff}}$ i.e. is such that*

$$(-1)^d \mu^{\mathbb{Y}^{gf}} \circ \mu^{\mathbb{Y}^{fg}} - \mu^{\mathbb{Y}^{ff}} = \partial_{\text{Morse}} h + h \partial_{\text{Morse}}^{\text{Tw}} .$$

Proposition 20 is then a simple corollary to this proposition.

1.2. Proof of Propositions 20 and 21. We define the moduli space $\mathcal{H}(y; x)$ as before, by introducing the map

$$\phi_{\mathbb{W}} : \mathcal{H} \times W^S(y) \times W^U(x) \longrightarrow M \times M ,$$

and setting $\mathcal{H}(y; x) := \phi^{-1}(\Delta)$ where Δ is the diagonal of $M \times M$. We recall moreover that $\sigma(+; y; x) = d(1 + |y|)$, $\sigma(y; x) = 1$ and that

$$\mu^{\mathbb{Y}^{ij}}(x) = \sum_{|y|=|x|} \#\widetilde{\mathcal{CT}}_+^{\mathbb{Y}^{ij}}(y; x) \cdot y \qquad \partial_{\text{Morse}}(x) = \sum_{|y|=|x|+1} \#\widetilde{\mathcal{T}}(y; x) \cdot y .$$

We then set

$$\sigma(\ddagger; y; x) = (d + 1)|y| ,$$

and write $\widetilde{\mathcal{H}}(y; x)$ for the moduli space $\mathcal{H}(y; x)$ endowed with the orientation obtained by twisting its natural orientation by a sign of parity $\sigma(\ddagger; y; x)$. We can now define the map $h : C^*(f) \rightarrow C^*(f)$ by

$$h(x) := \sum_{|y|=|x|-1} \#\widetilde{\mathcal{H}}(y; x) \cdot y .$$

If $\widetilde{\mathcal{H}}(y; x)$ is 1-dimensional, its boundary decomposes as the disjoint union of the following four types of components

$$\begin{aligned} (-1)^{|y|+d} \widetilde{\mathcal{C}\mathcal{T}}^{\mathbb{Y}^{gf}}(y; z) \times \widetilde{\mathcal{C}\mathcal{T}}^{\mathbb{Y}^{fg}}(z; x) & & (-1)^{|y|+1} \widetilde{\mathcal{C}\mathcal{T}}^{\mathbb{Y}^{ff}}(y; x) \\ (-1)^{|y|+1} \widetilde{\mathcal{T}}(y; z) \times \widetilde{\mathcal{H}}(z; x) & & (-1)^{|y|+1+(d+1)|x|} \widetilde{\mathcal{H}}(y; z) \times \widetilde{\mathcal{T}}(z; x) . \end{aligned}$$

Counting the boundary points of these 1-dimensional moduli spaces implies that

$$(-1)^d \mu^{\mathbb{Y}^{gf}} \circ \mu^{\mathbb{Y}^{fg}} - \mu^{\mathbb{Y}^{ff}} = \partial_{Morse} h + h \partial_{Morse}^{Tw} .$$

To prove Proposition 20, it remains to note that this relation descends in cohomology to the relation

$$(-1)^d [\mu^{\mathbb{Y}^{gf}}] \circ [\mu^{\mathbb{Y}^{fg}}] = [\mu^{\mathbb{Y}^{ff}}] .$$

2. MORE ON THE ΩBAs VIEWPOINT

We stated in section 1.6 that because the two-colored operad A_∞^2 is a fibrant-cofibrant replacement of As^2 in the model category of two-colored operads, the category of A_∞ -algebras with A_∞ -morphisms between them yields a nice homotopic framework to study the notion of "dg-algebras which are associative up to homotopy". In fact, most classical theorems for A_∞ -algebras can be proven using the machinery of model categories, on the model category of two-colored operads in dg- \mathbb{Z} -modules. We can thus similarly introduce the two-colored operad ΩBAs^2 , which is again a fibrant-cofibrant replacement of As^2 in the model category of two-colored operads. The category of ΩBAs -algebras with ΩBAs -morphisms between them yields another satisfactory homotopic framework to study "dg-algebras which are associative up to homotopy", in which most classical theorems for A_∞ -algebras still hold.

We also point out that while there exists a morphism of operads $A_\infty \rightarrow \Omega BAs$ which is canonically given by refining the cell decompositions on the associahedra, Markl and Shnider constructed in [MS06] an explicit non-canonical morphism of operads $\Omega BAs \rightarrow A_\infty$. The operads ΩBAs and A_∞ being fibrant-cofibrant replacements of As , model category theory tells us that there necessarily exist two morphisms $A_\infty \rightarrow \Omega BAs$ and $\Omega BAs \rightarrow A_\infty$. Hence the noteworthy property of these two morphisms is *not that they exist, but that they are explicit and computable*.

Switching to the two-colored operadic viewpoint, model category theory tells us again that there necessarily exist two morphisms $A_\infty^2 \rightarrow \Omega BAs^2$ and $\Omega BAs^2 \rightarrow A_\infty^2$. We have already introduced the necessary material to define an explicit and computable morphism of two-colored operads $A_\infty^2 \rightarrow \Omega BAs^2$. To render explicit a morphism $\Omega BAs^2 \rightarrow A_\infty^2$ it would be enough to construct a morphism of operadic bimodules $\Omega BAs\text{-Morph} \rightarrow A_\infty\text{-Morph}$. To our knowledge, this has not yet been done, but we conjecture that the construction of Markl-Shnider should adapt nicely to the multiplihedra to define such a morphism.

3. A_∞ -STRUCTURES IN SYMPLECTIC TOPOLOGY

We explained in this article how the associahedra can be realized as compactified moduli spaces of stable metric ribbon trees. In fact, writing $\mathcal{D}_{n,1}$ for the moduli space of stable disks with $n+1$ marked points on their boundary, where n points are seen as incoming, and 1 as outgoing, the moduli space $\mathcal{D}_{n,1}$ can be compactified and topologized in such a way that it is isomorphic as a CW-complex to the associahedron K_n . See [Sei08] for instance. Mau-Woodward also prove in [MW10] that the

multiplihedra J_n can be realized as the compactified moduli spaces of stable quilted disks $\overline{\mathcal{QD}}_{n,1}$. The objects of $\mathcal{QD}_{n,1}$ are disks with $n + 1$ points z_0, z_1, \dots, z_n marked on the boundary, with an additional interior disk passing through the point z_0 . An instance is depicted in figure 33. These families of moduli spaces however only contain the A_∞ -cell decompositions of the associahedra resp. multiplihedra, and do not contain their ΩBAs -cell decompositions.

A *symplectic manifold* corresponds to the data of a smooth manifold M together with a closed non-degenerate 2-form ω on M . The purpose of *symplectic topology* is the study of the geometrical properties of symplectic manifolds (M, ω) , and of the way they are preserved under smooth transformations preserving the symplectic structure. As algebraic topology seeks to associate algebraic invariants to topological spaces, in the hope of distinguishing them and understanding some of their topological properties, the same *modus operandi* can be applied to the study of symplectic manifolds. This point view was prompted by the seminal work of Gromov [Gro85] on *moduli spaces of pseudo-holomorphic curves*. By counting the points of 0-dimensional moduli spaces of pseudo-holomorphic curves, one will be able to define algebraic operations stemming from the geometry of the underlying symplectic manifolds.

The most famous example is that of the *Fukaya category* $\text{Fuk}(M)$ of a symplectic manifold M (with additional technical assumptions). It is an A_∞ -category whose higher multiplications are defined by counting moduli spaces of pseudo-holomorphic disks with Lagrangian boundary conditions and $n + 1$ marked points on their boundary, in other words by realizing the moduli spaces $\mathcal{D}_{n,1}$ in symplectic topology. We refer for instance to [Smi15] and [Aur14] for introductions to the subject. The moduli spaces of quilted disks can be similarly realized as pseudo-holomorphic curves in symplectic topology as in [MWW18], to construct A_∞ -functors between Fukaya categories.

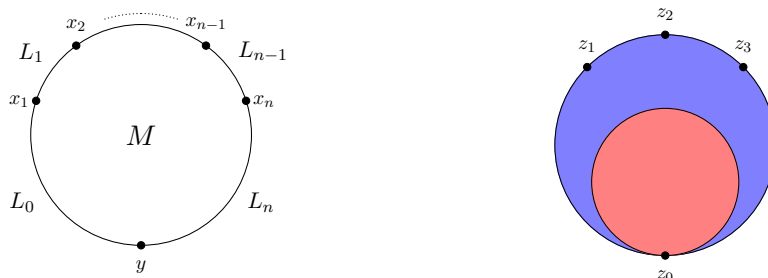

FIGURE 33. On the left, an example of a pseudo-holomorphic disk with Lagrangian boundary conditions on the Lagrangian submanifolds L_0, \dots, L_n whose $n + 1$ marked points are sent to the points y, x_1, \dots, x_n in M . On the right, an example of a quilted disk in $\mathcal{QD}_{3,1}$.

It is also worth mentioning the work of Bottman on that matter. He is currently developing an algebraic model for the notion of $(A_\infty, 2)$ -categories, using moduli spaces of witch curves. The goal is to prove that one can then define an $(A_\infty, 2)$ -category \mathbf{Symp} whose objects would be symplectic manifolds (with suitable technical assumptions), and such that the space of morphisms between two symplectic manifolds M and N would be the Fukaya category $\text{Fuk}(M^- \times N)$. We refer to his recent papers [Bot19a] and [Bot19b] for more details.

4. TOWARDS HIGHER ALGEBRA

In closing, two questions naturally arise from this construction. They will respectively represent the starting points to the parts II and III to this article.

Problem 1. Given two Morse functions f, g , choices of perturbation data \mathbb{X}^f and \mathbb{X}^g , and choices of perturbation data \mathbb{Y} and \mathbb{Y}' , is $\mu^{\mathbb{Y}}$ always A_∞ -homotopic (resp. ΩBAs -homotopic) to $\mu^{\mathbb{Y}'}$? I.e., when can the following diagram be filled in the A_∞ (resp. ΩBAs) world

$$\begin{array}{ccc}
 & \mu^{\mathbb{Y}} & \\
 \curvearrowright & & \curvearrowleft \\
 C^*(f) & \Downarrow & C^*(g) \quad ? \\
 \curvearrowleft & & \curvearrowright \\
 & \mu^{\mathbb{Y}'} &
 \end{array}$$

In which sense, with which notion of homotopy can it be filled ? And in general, which notion of higher operadic algebra naturally encodes this type of problem ?

Problem 2. Given three Morse functions f_0, f_1, f_2 , choices of perturbation data \mathbb{X}^i , and choices of perturbation data \mathbb{Y}^{ij} defining morphisms

$$\begin{aligned}
 \mu^{\mathbb{Y}^{01}} &: (C^*(f_0), m_t^{\mathbb{X}^0}) \longrightarrow (C^*(f_1), m_t^{\mathbb{X}^1}) , \\
 \mu^{\mathbb{Y}^{12}} &: (C^*(f_1), m_t^{\mathbb{X}^1}) \longrightarrow (C^*(f_2), m_t^{\mathbb{X}^2}) , \\
 \mu^{\mathbb{Y}^{02}} &: (C^*(f_0), m_t^{\mathbb{X}^0}) \longrightarrow (C^*(f_2), m_t^{\mathbb{X}^2}) ,
 \end{aligned}$$

can we construct an A_∞ -homotopy (or an ΩBAs -homotopy), such that $\mu^{\mathbb{Y}^{12}} \circ \mu^{\mathbb{Y}^{01}} \simeq \mu^{\mathbb{Y}^{02}}$ through this homotopy ? That is, can the following cone be filled in the A_∞ (resp. ΩBAs) world

$$\begin{array}{ccc}
 C^*(f_0) & \xrightarrow{\mu^{\mathbb{Y}^{01}}} & C^*(f_1) \\
 & \searrow \mu^{\mathbb{Y}^{02}} & \swarrow \mu^{\mathbb{Y}^{12}} \\
 & & C^*(f_2) \quad ?
 \end{array}$$

Which higher operadic algebra naturally arises from this basic question ? Note that the construction of section 1 solves the arity 1 step of this problem.

Problem 1 is solved in [Maz21] by introducing the notions of $n - A_\infty$ -morphisms and $n - \Omega BAs$ -morphisms. Problem 2 will be adressed in an upcoming paper, in which it will appear that the higher algebra of $n - A_\infty$ -morphisms provides a natural framework to solve this problem.

REFERENCES

- [Abo11] Mohammed Abouzaid. A topological model for the Fukaya categories of plumbings. *J. Differential Geom.*, 87(1):1–80, 2011.
- [AR67] Ralph Abraham and Joel Robbin. *Transversal mappings and flows*. An appendix by Al Kelley. W. A. Benjamin, Inc., New York-Amsterdam, 1967.
- [Aur14] Denis Auroux. A beginner’s introduction to Fukaya categories. In *Contact and symplectic topology*, volume 26 of *Bolyai Soc. Math. Stud.*, pages 85–136. János Bolyai Math. Soc., Budapest, 2014.
- [Bot19a] Nathaniel Bottman. 2-associahedra. *Algebr. Geom. Topol.*, 19(2):743–806, 2019.
- [Bot19b] Nathaniel Bottman. Moduli spaces of witch curves topologically realize the 2-associahedra. *J. Symplectic Geom.*, 17(6):1649–1682, 2019.
- [BV73] J. M. Boardman and R. M. Vogt. *Homotopy invariant algebraic structures on topological spaces*. Lecture Notes in Mathematics, Vol. 347. Springer-Verlag, Berlin-New York, 1973.
- [For08] Stefan Forcey. Convex hull realizations of the multiplihedra. *Topology Appl.*, 156(2):326–347, 2008.
- [Fuk97] Kenji Fukaya. Morse homotopy and its quantization. In *Geometric topology (Athens, GA, 1993)*, volume 2 of *AMS/IP Stud. Adv. Math.*, pages 409–440. Amer. Math. Soc., Providence, RI, 1997.
- [GJ94] Ezra Getzler and John DS Jones. Operads, homotopy algebra and iterated integrals for double loop spaces. *hep-th/9403055*, 1994.
- [Gro85] M. Gromov. Pseudo holomorphic curves in symplectic manifolds. *Invent. Math.*, 82(2):307–347, 1985.
- [Hai84] M. Haiman. Constructing the associahedron, 1984. available for download at <http://math.berkeley.edu/mhaiman/ftp/assoc/manuscript.pdf>.
- [Hut08] Michael Hutchings. Floer homology of families. I. *Algebr. Geom. Topol.*, 8(1):435–492, 2008.
- [IM89] Norio Iwase and Mamoru Mimura. Higher homotopy associativity. In *Algebraic topology (Arcata, CA, 1986)*, volume 1370 of *Lecture Notes in Math.*, pages 193–220. Springer, Berlin, 1989.
- [Kad80] T. V. Kadeišvili. On the theory of homology of fiber spaces. *Uspekhi Mat. Nauk*, 35(3(213)):183–188, 1980. International Topology Conference (Moscow State Univ., Moscow, 1979).
- [Lee89] Carl W. Lee. The associahedron and triangulations of the n -gon. *European J. Combin.*, 10(6):551–560, 1989.
- [LH02] Kenji Lefevre-Hasegawa. *Sur les A_∞ -catégories*. PhD thesis, Ph. D. thesis, Université Paris 7, UFR de Mathématiques, 2003, math. CT/0310337, 2002.
- [Lod04] Jean-Louis Loday. Realization of the Stasheff polytope. *Arch. Math. (Basel)*, 83(3):267–278, 2004.
- [LV12] Jean-Louis Loday and Bruno Vallette. *Algebraic operads*, volume 346 of *Grundlehren der Mathematischen Wissenschaften [Fundamental Principles of Mathematical Sciences]*. Springer, Heidelberg, 2012.
- [Mar02] Martin Markl. Homotopy diagrams of algebras. In *Proceedings of the 21st Winter School “Geometry and Physics” (Srni, 2001)*, number 69, pages 161–180, 2002.
- [Mar06] Martin Markl. Transferring A_∞ (strongly homotopy associative) structures. *Rend. Circ. Mat. Palermo (2) Suppl.*, (79):139–151, 2006.
- [Maz21] Thibaut Mazuir. Higher algebra of A_∞ and ΩBAs -algebras in Morse theory II. arXiv:2102.08996, 2021.
- [Mes18] Stephan Mescher. *Perturbed gradient flow trees and A_∞ -algebra structures in Morse cohomology*, volume 6 of *Atlantis Studies in Dynamical Systems*. Atlantis Press, [Paris]; Springer, Cham, 2018.
- [MMV] Naruki Masuda, Thibaut Mazuir, and Bruno Vallette. The diagonal of the multiplihedra and the product of A_∞ -categories. In preparation.
- [MS06] Martin Markl and Steve Shnider. Associahedra, cellular W -construction and products of A_∞ -algebras. *Trans. Amer. Math. Soc.*, 358(6):2353–2372, 2006.
- [MS12] Dusa McDuff and Dietmar Salamon. *J-holomorphic curves and symplectic topology*, volume 52 of *American Mathematical Society Colloquium Publications*. American Mathematical Society, Providence, RI, second edition, 2012.
- [MSS02] Martin Markl, Steve Shnider, and Jim Stasheff. *Operads in algebra, topology and physics*, volume 96 of *Mathematical Surveys and Monographs*. American Mathematical Society, Providence, RI, 2002.
- [MTTV19] Naruki Masuda, Hugh Thomas, Andy Tonks, and Bruno Vallette. The diagonal of the associahedra. arXiv:1902.08059, 2019.
- [MW10] S. Ma’u and C. Woodward. Geometric realizations of the multiplihedra. *Compos. Math.*, 146(4):1002–1028, 2010.

- [MWW18] S. Ma'u, K. Wehrheim, and C. Woodward. A_∞ functors for Lagrangian correspondences. *Selecta Math. (N.S.)*, 24(3):1913–2002, 2018.
- [Sei08] Paul Seidel. *Fukaya categories and Picard-Lefschetz theory*. Zurich Lectures in Advanced Mathematics. European Mathematical Society (EMS), Zürich, 2008.
- [Sma65] S. Smale. An infinite dimensional version of Sard's theorem. *Amer. J. Math.*, 87:861–866, 1965.
- [Smi15] Ivan Smith. A symplectic prolegomenon. *Bull. Amer. Math. Soc. (N.S.)*, 52(3):415–464, 2015.
- [Sta63] James Dillon Stasheff. Homotopy associativity of H -spaces. I, II. *Trans. Amer. Math. Soc.* 108 (1963), 275-292; *ibid.*, 108:293–312, 1963.
- [Tam54] Dov Tamari. Monoïdes préordonnés et chaînes de Malcev. *Bulletin de la Société mathématique de France*, 82:53–96, 1954.
- [Val14] Bruno Vallette. Algebra + homotopy = operad. In *Symplectic, Poisson, and noncommutative geometry*, volume 62 of *Math. Sci. Res. Inst. Publ.*, pages 229–290. Cambridge Univ. Press, New York, 2014.
- [Weh12] Katrin Wehrheim. Smooth structures on Morse trajectory spaces, featuring finite ends and associative gluing. In *Proceedings of the Freedman Fest*, volume 18 of *Geom. Topol. Monogr.*, pages 369–450. Geom. Topol. Publ., Coventry, 2012.
- [Yau16] Donald Yau. *Colored operads*, volume 170 of *Graduate Studies in Mathematics*. American Mathematical Society, Providence, RI, 2016.

Deuxième partie

Higher algebra of A_∞ and ΩBAs -algebras in
Morse theory II

HIGHER ALGEBRA OF A_∞ AND ΩBAs -ALGEBRAS IN MORSE THEORY II

THIBAUT MAZUIR

ABSTRACT. This paper introduces the notion of n -morphisms between two A_∞ -algebras, such that 0-morphisms correspond to standard A_∞ -morphisms and 1-morphisms correspond to A_∞ -homotopies between A_∞ -morphisms. The set of higher morphisms between two A_∞ -algebras then defines a simplicial set which has the property of being a Kan complex, whose simplicial homotopy groups can be explicitly computed. The operadic structure of $n - A_\infty$ -morphisms is also encoded by new families of polytopes, which we call the n -multiplihedra and which generalize the standard multiplihedra. These are constructed from the standard simplices and multiplihedra by lifting the Alexander-Whitney map to the level of simplices. Rich combinatorics arise in this context, as conveniently described in terms of overlapping partitions. Shifting from the A_∞ to the ΩBAs framework, we define the analogous notion of n -morphisms between ΩBAs -algebras, which are again encoded by the n -multiplihedra, endowed with a refined cell decomposition by stable gauged ribbon tree type. We then realize this higher algebra of A_∞ and ΩBAs -algebras in Morse theory. Given two Morse functions f and g , we construct $n - \Omega BAs$ -morphisms between their respective Morse cochain complexes endowed with their ΩBAs -algebra structures, by counting perturbed Morse gradient trees associated to an admissible simplex of perturbation data. We moreover show that the simplicial set consisting of higher morphisms defined by a count of perturbed Morse gradient trees is a contractible Kan complex.

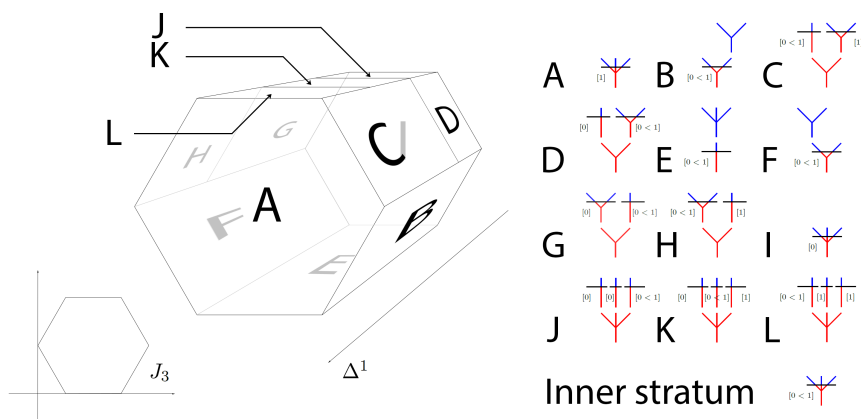

The 1-multiplihedron $\Delta^1 \times J_3 \dots$

CONTENTS

1	Higher morphisms between A_∞ and ΩBAs-algebras	10
1.	$n - A_\infty$ -morphisms	10
2.	The n -multiplihedra	17
3.	$n - \Omega BAs$ -morphisms	26
4.	Signs for n -morphisms	30
2	The simplicial sets $\text{HOM}_{A_\infty\text{-Alg}}(A, B)$	44
1.	∞ -categories, Kan complexes and cosimplicial resolutions	44
2.	The HOM-simplicial sets $\text{HOM}_{A_\infty\text{-Alg}}(A, B)$	46
3.	Higher functors and pre-natural transformations between A_∞ -categories	55
4.	The ∞ -category of A_∞ -algebras ?	58
3	Higher morphisms in Morse theory	62
1.	n -morphisms in Morse theory	62
2.	Transversality, signs and orientations	71
3.	Towards the problem of the composition	76
	References	78

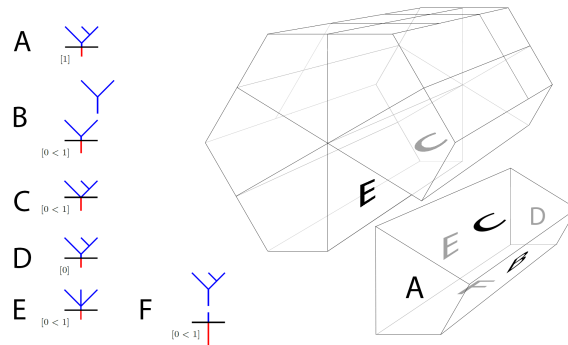

... and its ΩBAs -cell decomposition

Introduction

Summary and results of article I. This article is the direct sequel to [Maz21]. We thus begin by summarizing our first article, after which we outline the main results and constructions carried out in the present paper.

The structure of strong homotopy associative algebra, or equivalently A_∞ -algebra, was introduced in the seminal paper of Stasheff [Sta63]. It provides an operadic model for the notion of differential graded algebra whose product is associative up to homotopy. It is defined as the datum of a set of operations $\{m_m : A^{\otimes m} \rightarrow A\}_{m \geq 2}$ of degree $2 - m$ on a dg- \mathbb{Z} -module (A, ∂) , which satisfy the sequence of equations

$$[\partial, m_m] = \sum_{\substack{i_1+i_2+i_3=m \\ 2 \leq i_2 \leq m-1}} \pm m_{i_1+1+i_3}(\text{id}^{\otimes i_1} \otimes m_{i_2} \otimes \text{id}^{\otimes i_3}).$$

The first two equations respectively ensure that m_2 is compatible with ∂ and that it is associative up to the homotopy m_3 . This algebraic structure is encoded by an operad in dg- \mathbb{Z} -modules, called the operad A_∞ . As shown in [MTTV21], this operad stems in fact from an operad in the category of polytopes, whose arity m space of operations is defined to be the $(m - 2)$ -dimensional associahedron K_m .

Similarly, the notion of A_∞ -morphism between two A_∞ -algebras A and B offers an operadic model for the notion of morphism of strong homotopy associative algebras which preserves the product up to homotopy. It is defined as the datum of a set of operations $\{f_m : A^{\otimes m} \rightarrow B\}_{m \geq 1}$ of degree $1 - m$ which satisfy the sequence of equations

$$[\partial, f_m] = \sum_{\substack{i_1+i_2+i_3=m \\ i_2 \geq 2}} \pm f_{i_1+1+i_3}(\text{id}^{\otimes i_1} \otimes m_{i_2} \otimes \text{id}^{\otimes i_3}) + \sum_{\substack{i_1+\dots+i_s=m \\ s \geq 2}} \pm m_s(f_{i_1} \otimes \dots \otimes f_{i_s}).$$

The first two equations show this time that f_1 commutes with the differentials and that it preserves the product up to the homotopy f_2 . From the point of view of operadic algebra, A_∞ -morphisms are encoded by an operadic bimodule in dg- \mathbb{Z} -modules : the operadic bimodule $A_\infty - \text{Morph}$. It occurs from an operadic bimodule in polytopes, whose arity m space of operations is the $(m - 1)$ -dimensional multiplihedron J_m as shown in [LAM].

A_∞ -algebras and A_∞ -morphisms between them provide a satisfactory framework for homotopy theory. The most famous instance of this statement is the homotopy transfer theorem : given (A, ∂_A) and (H, ∂_H) two cochain complexes and a homotopy retract diagram

$$h \begin{array}{c} \curvearrowright \\ \text{---} \end{array} (A, d_A) \begin{array}{c} \xrightarrow{p} \\ \xleftarrow{i} \end{array} (H, d_H),$$

if (A, ∂_A) is endowed with an A_∞ -algebra structure, then H can be made into an A_∞ -algebra such that i and p extend to A_∞ -morphisms. See also [Val20] and [LH02] for an extensive study on the homotopy theory of A_∞ -algebras.

The associahedra and multiplihedra, respectively encoding the operad A_∞ and the operadic bimodule $A_\infty\text{-Morph}$, can in fact be both realized as moduli spaces of metric trees. The associahedron K_m is isomorphic as a CW-complex to the compactified moduli space of stable metric ribbon trees $\overline{\mathcal{T}}_m$ as first pointed out in [BV73]. The multiplihedron J_m is isomorphic as a CW-complex to the compactified moduli space of stable gauged metric ribbon trees $\overline{\mathcal{CT}}_m$ as shown in [For08] and [MW10]. These moduli spaces come in fact with refined cell decompositions, called their ΩBAs -cell decompositions : the cell decomposition by stable ribbon tree type for $\overline{\mathcal{T}}_m$, and the cell decomposition by stable gauged ribbon tree type for $\overline{\mathcal{CT}}_m$. These refined decompositions provide another operadic model for strong homotopy associative algebras with morphisms preserving the product up to homotopy between them : the standard operad ΩBAs and the operadic bimodule $\Omega BAs\text{-Morph}$ introduced in [Maz21]. We show moreover in [Maz21] that one can naturally shift from the ΩBAs to the A_∞ framework via a geometric morphism of operads $A_\infty \rightarrow \Omega BAs$ and a geometric morphism of operadic bimodules $A_\infty\text{-Morph} \rightarrow \Omega BAs\text{-Morph}$.

Consider now a Morse function f on a closed oriented Riemannian manifold M together with a Morse-Smale metric. Following [Hut08], the Morse cochain complex $C^*(f)$ is a homotopy retract of the singular cochain complex $C_{sing}^*(M)$ which is a dg-algebra with respect to the standard cup product. The dg-algebra structure on $C_{sing}^*(M)$ can thus be transferred to an A_∞ -algebra structure on $C^*(f)$ using the homotopy transfer theorem. We show in [Maz21] that one can in fact directly define an ΩBAs -algebra structure on the Morse cochains $C^*(f)$ by realizing the moduli spaces of stable metric ribbon trees \mathcal{T}_m in Morse theory. Given a choice of perturbation data $\{\mathbb{X}_m\}_{m \geq 2}$ on the moduli spaces \mathcal{T}_m as introduced by Abouzaid in [Abo11] and further studied by Mescher in [Mes18], we define the moduli spaces of perturbed Morse gradient trees modeled on a stable ribbon tree type t and connecting the critical points $x_1, \dots, x_m \in \text{Crit}(f)$ to the critical point $y \in \text{Crit}(f)$, denoted $\mathcal{T}_t^{\mathbb{X}}(y; x_1, \dots, x_m)$. We prove in [Maz21] that under generic assumptions on the choice of perturbation data, these moduli spaces are in fact orientable manifolds of finite dimension. If they have dimension 1, they can moreover be compactified to 1-dimensional manifolds with boundary, whose boundary is modeled on the top dimensional strata in the boundary of the compactified moduli space $\overline{\mathcal{T}}_m$. The ΩBAs -algebra structure on the Morse cochains $C^*(f)$ is finally defined by counting the points of the 0-dimensional moduli spaces $\mathcal{T}_t^{\mathbb{X}}(y; x_1, \dots, x_m)$. The induced geometric A_∞ -algebra structure on $C^*(f)$ is then quasi-isomorphic to the A_∞ -algebra structure on $C^*(f)$ given by the homotopy transfer theorem.

Consider now two Morse functions f and g on M together with generic choices of perturbation data \mathbb{X}_f and \mathbb{X}_g . Endow the Morse cochains $C^*(f)$ and $C^*(g)$ with their associated ΩBAs -algebra structures. We prove in [Maz21] that one can adapt the construction of the previous paragraph, to define an ΩBAs -morphism from the ΩBAs -algebra $C^*(f)$ to the ΩBAs -algebra $C^*(g)$. We count this time 0-dimensional moduli spaces of perturbed Morse stable gauged trees modeled on a stable gauged ribbon tree type t_g and connecting the critical points $x_1, \dots, x_m \in \text{Crit}(f)$ to the critical point $y \in \text{Crit}(g)$, denoted $\mathcal{CT}_{t_g}^{\mathbb{Y}}(y; x_1, \dots, x_m)$, after making a generic choice of perturbation data \mathbb{Y} on the moduli spaces \mathcal{CT}_m .

Motivational question. Let \mathbb{Y} and \mathbb{Y}' be two admissible choices of perturbations data on the moduli spaces \mathcal{CT}_m . Writing $\mu^{\mathbb{Y}}$ resp. $\mu^{\mathbb{Y}'}$ for the ΩBAs -morphisms they define, the question which

motivates this paper is to know whether $\mu^{\mathbb{Y}}$ and $\mu^{\mathbb{Y}'}$ are always homotopic or not

$$C^*(f) \begin{array}{c} \xrightarrow{\mu^{\mathbb{Y}}} \\ \Downarrow \\ \xrightarrow{\mu^{\mathbb{Y}'}} \end{array} C^*(g) .$$

In particular, one needs to determine what is the correct notion of a homotopy between two ΩBAs -morphisms.

Outline of the present paper and main results. The first step towards answering this problem is carried out on the algebraic side in part 1, where we define the notion of n -morphisms between A_∞ -algebras and n -morphisms between ΩBAs -algebras. In section 1, we recall at first the suspended bar construction point of view on A_∞ -algebras and the definition of an A_∞ -homotopy between A_∞ -morphisms from [LH02]. After introducing the cosimplicial dg-coalgebra Δ^n together with the language of overlapping partitions, we can finally define a n -morphism between two A_∞ -algebras A and B :

Definition 6. Let A and B be two A_∞ -algebras. A n -morphism from A to B is defined to be a morphism of dg-coalgebras

$$F : \Delta^n \otimes \overline{T}(sA) \longrightarrow \overline{T}(sB) ,$$

where $\overline{T}(sA)$ denotes the suspended bar construction of A (see subsection 1.1).

Using the universal property of the bar construction, this definition is equivalent to the following one in terms of operations :

Definition 7. Let A and B be two A_∞ -algebras. A n -morphism from A to B is defined to be a collection of maps $f_I^{(m)} : A^{\otimes m} \longrightarrow B$ of degree $1 - m - \dim(I)$ for $I \subset \Delta^n$ and $m \geq 1$, that satisfy

$$\left[\partial, f_I^{(m)} \right] = \sum_{j=0}^{\dim(I)} (-1)^j f_{\partial_j I}^{(m)} + (-1)^{|I|} \sum_{\substack{i_1+i_2+i_3=m \\ i_2 \geq 2}} \pm f_I^{(i_1+1+i_3)} (\text{id}^{\otimes i_1} \otimes m_{i_2} \otimes \text{id}^{\otimes i_3}) + \sum_{\substack{i_1+\dots+i_s=m \\ I_1 \cup \dots \cup I_s = I \\ s \geq 2}} \pm m_s (f_{I_1}^{(i_1)} \otimes \dots \otimes f_{I_s}^{(i_s)}) .$$

We show in Proposition 2 that the datum of a n -morphism is also equivalent to the datum of a morphism of A_∞ -algebras $A \rightarrow \Delta_n \otimes B$, where Δ_n is the dg-algebra dual to the dg-coalgebra Δ^n . While the operad A_∞ stems from the associahedra K_m and the operadic bimodule $A_\infty - \text{Morph}$ stems from the multiplihedra J_m , we introduce in section 2 a family of polytopes encoding the A_∞ -equations for n -morphisms : *the n -multiplihedra $n - J_m$* . In this regard, we begin by introducing a lift of the Alexander-Whitney coproduct AW at the level of the polytopes Δ^n , following [MTTV21]. The map $\text{AW}^{\text{os}} := (\text{id}^{\times(s-1)} \times \text{AW}) \circ \dots \circ (\text{id} \times \text{AW}) \circ \text{AW}$ then induces a refined polytopal subdivision of Δ^n , whose top dimensional cells can be labeled by all overlapping $(s+1)$ -partitions of Δ^n . After introducing the maps $\text{AW}_{\mathbf{a}}$, which generalize the maps AW^{os} and still induce the previous subdivisions on the simplices Δ^n , we construct a refined polytopal subdivision of the polytopes $\Delta^n \times J_m$:

Definition 12. The polytopes $\Delta^n \times J_m$ endowed with the polytopal subdivisions induced by the maps $\text{AW}_{\mathbf{a}}$ will be called the *n -multiplihedra* and denoted $n - J_m$.

The boundaries of the n -multiplihedra $n - J_m$ yield the $n - A_\infty$ -equations :

Proposition 8. *The boundary of the top dimensional cell $[n - J_m]$ of the n -multiplihedron $n - J_m$ is given by*

$$\partial^{sing}[n - J_m] \cup \bigcup_{\substack{h+k=m+1 \\ 1 \leq i \leq k \\ h \geq 2}} [n - J_k] \times_i [K_h] \cup \bigcup_{\substack{i_1 + \dots + i_s = m \\ I_1 \cup \dots \cup I_s = \Delta^n \\ s \geq 2}} [K_{i_1}] \times [\dim(I_1) - J_{i_1}] \times \dots \times [\dim(I_s) - J_{i_s}] ,$$

where $I_1 \cup \dots \cup I_s = \Delta^n$ is an overlapping partition of Δ^n . In other words, the n -multiplihedra encode the A_∞ -equations for n -morphisms.

We then show in section 3 that these constructions can be transported from the A_∞ to the ΩBAs realm. We define n -morphisms between ΩBAs -algebras as follows :

Definition 13. $n - \Omega BAs$ -morphisms are the higher morphisms between ΩBAs -algebras encoded by the quasi-free operadic bimodule generated by all pairs (face $I \subset \Delta^n$, two-colored stable ribbon tree),

$$n - \Omega BAs - \text{Morph} := \mathcal{F}^{\Omega BAs, \Omega BAs}(\text{diagrams}, \dots; I \subset \Delta^n) .$$

An operation $t_{I,g} := (I, t_g)$, whose underlying stable ribbon tree t has $e(t)$ inner edges, and such that its gauge crosses j vertices of t , is defined to have degree $|t_{I,g}| := j - 1 - e(t) - \dim(I) = |I| + |t_g|$. The differential of $t_{I,g}$ is given by the rule prescribed by the top dimensional strata in the boundary of $\overline{\mathcal{CT}}_m(t_g)$ combined with the algebraic combinatorics of overlapping partitions, added to the simplicial differential of I , i.e.

$$\partial t_{I,g} = t_{\partial^{sing} I, g} + \pm (\partial^{\overline{\mathcal{CT}}_m} t_g)_I .$$

We show that the $n - \Omega BAs$ -equations are also encoded by the n -multiplihedra, endowed this time with a refined cell decomposition taking the ΩBAs -decomposition of the multiplihedra J_m into account. What's more, a n -morphism between ΩBAs -algebras naturally yields a n -morphism between A_∞ -algebras :

Proposition 9. *There exists a morphism of (A_∞, A_∞) -operadic bimodules $n - A_\infty - \text{Morph} \rightarrow n - \Omega BAs - \text{Morph}$.*

Using the same tools as in [Maz21], we finally unravel all sign conventions in section 4.

In part 2, we study the simplicial set $\text{HOM}_{A_\infty - \text{Alg}}(A, B)_\bullet$ of higher morphisms from A to B , whose n -simplices are the n -morphisms from A to B . We recall at first basic results on ∞ -categories and Kan complexes, which are simplicial sets having the left-lifting property with respect to the inner horn inclusions resp. to all horn inclusions $\Lambda_n^k \subset \Delta^n$. We also introduce the convenient setting of cosimplicial resolutions in model categories, following [Hir03]. We can then prove the following theorem in section 2 :

Theorem 1. *For A and B two A_∞ -algebras, the simplicial set $\text{HOM}_{A_\infty}(A, B)_\bullet$ is a Kan complex.*

This Kan complex is in particular an algebraic ∞ -category as explained in Proposition 11. Fix now $F : A \rightarrow B$ an A_∞ -morphism, i.e. a point of the simplicial set $\text{HOM}_{A_\infty}(A, B)_\bullet$. We proceed to compute the simplicial homotopy groups with basepoint F of this Kan complex in subsection 2.4 :

Theorem 2. (i) For $n \geq 1$, the set $\pi_n(\mathrm{HOM}_{A_\infty\text{-Alg}}(A, B)_\bullet, F)$ consists of the equivalence classes of collections of degree $-n$ maps $F_{\Delta^n}^{(m)} : (sA)^{\otimes m} \rightarrow sB$ satisfying the following equations

$$\begin{aligned} & (-1)^n \sum_{i_1+i_2+i_3=m} F_{\Delta^n}^{(i_1+1+i_3)} (\mathrm{id}^{\otimes i_1} \otimes b_{i_2} \otimes \mathrm{id}^{\otimes i_3}) \\ &= \sum_{\substack{i_1+\dots+i_s+l \\ +j_1+\dots+j_t=m}} b_{s+1+t} \left(F^{(i_1)} \otimes \dots \otimes F^{(i_s)} \otimes F_{\Delta^n}^{(l)} \otimes F^{(j_1)} \otimes \dots \otimes F^{(j_t)} \right), \end{aligned}$$

where two such collections of maps $(F_{\Delta^n}^{(m)})^{m \geq 1}$ and $(G_{\Delta^n}^{(m)})^{m \geq 1}$ are equivalent if and only if there exists a collection of degree $-(n+1)$ maps $H^{(m)} : (sA)^{\otimes m} \rightarrow sB$ such that

$$\begin{aligned} & G_{\Delta^n}^{(m)} - F_{\Delta^n}^{(m)} + (-1)^{n+1} \sum_{i_1+i_2+i_3=m} H^{(i_1+1+i_3)} (\mathrm{id}^{\otimes i_1} \otimes b_{i_2} \otimes \mathrm{id}^{\otimes i_3}) \\ &= \sum_{\substack{i_1+\dots+i_s+l \\ +j_1+\dots+j_t=m}} b_{s+1+t} (F^{(i_1)} \otimes \dots \otimes F^{(i_s)} \otimes H^{(l)} \otimes F^{(j_1)} \otimes \dots \otimes F^{(j_t)}). \end{aligned}$$

(ii) If $n = 1$, given two such collection of maps $(F_{\Delta^1}^{(m)})^{m \geq 1}$ and $(G_{\Delta^1}^{(m)})^{m \geq 1}$, the composition law on $\pi_1(\mathrm{HOM}_{A_\infty\text{-Alg}}(A, B)_\bullet, F)$ is given by the formula

$$G_{\Delta^1}^{(m)} + F_{\Delta^1}^{(m)} - \sum_{\substack{i_1+\dots+i_s+l_1 \\ +j_1+\dots+j_t+l_2 \\ +k_1+\dots+k_u=m}} b_{s+t+u+2} (F^{(i_1)} \otimes \dots \otimes F^{(i_s)} \otimes F_{\Delta^1}^{(l_1)} \otimes F^{(j_1)} \otimes \dots \otimes F^{(j_t)} \otimes G_{\Delta^1}^{(l_2)} \otimes F^{(k_1)} \otimes \dots \otimes F^{(k_u)}).$$

(iii) If $n \geq 2$, given two such collection of maps $(F_{\Delta^n}^{(m)})^{m \geq 1}$ and $(G_{\Delta^n}^{(m)})^{m \geq 1}$, the composition law on $\pi_n(\mathrm{HOM}_{A_\infty\text{-Alg}}(A, B)_\bullet, F)$ is given by the formula

$$G_{\Delta^n}^{(m)} + F_{\Delta^n}^{(m)}.$$

In section 3, we begin by generalizing the notion of a n -morphism between A_∞ -algebras to that of a n -functor between A_∞ -categories. We define the simplicial set $\mathrm{HOM}_{A_\infty\text{-Cat}}(\mathcal{A}, \mathcal{B})_\bullet$ of higher functors between two A_∞ -categories, which we expect to also be a Kan complex. We then recall the definition of the A_∞ -category of A_∞ -functors $\mathrm{Func}_{\mathcal{A}, \mathcal{B}}$ of [Fuk02], as well as the simplicial nerve functor N_{A_∞} of [Fao17b]. These constructions yield a new simplicial set $N_{A_\infty}(\mathrm{Func}_{\mathcal{A}, \mathcal{B}})$ which has the property of being an ∞ -category. Although the simplicial sets $\mathrm{HOM}_{A_\infty\text{-Cat}}(\mathcal{A}, \mathcal{B})_\bullet$ and $N_{A_\infty}(\mathrm{Func}_{\mathcal{A}, \mathcal{B}})$ bear many similarities, they actually differ fundamentally : while the simplices of $\mathrm{HOM}_{A_\infty\text{-Cat}}(\mathcal{A}, \mathcal{B})_\bullet$ correspond to higher homotopies between A_∞ -functors, the simplices of $N_{A_\infty}(\mathrm{Func}_{\mathcal{A}, \mathcal{B}})$ correspond to higher natural transformations between A_∞ -functors $\mathcal{A} \rightarrow \mathcal{B}$. Heuristically, the simplicial set $N_{A_\infty}(\mathrm{Func}_{\mathcal{A}, \mathcal{B}})$ has thereby no reason to be a Kan complex, as homotopies are reversible whether functors are not. Nevertheless, the Kan complex $\mathrm{HOM}_{A_\infty\text{-Cat}}(\mathcal{A}, \mathcal{B})_\bullet$ and the A_∞ -category $\mathrm{Func}_{\mathcal{A}, \mathcal{B}}$ each define a notion of homotopy between A_∞ -functors, that we compare when the A_∞ -category \mathcal{B} is unital by recalling a proposition of [Fuk17]. In section 4, we finally explore two approaches to lift the composition of A_∞ -morphisms to a composition between $n - A_\infty$ -morphisms. We fall however short of defining a natural simplicial enrichment of the category $A_\infty - \mathrm{Alg}$. We also discuss the results of Faonte, Lyubashenko, Fukaya and Bottman concerning a statement of a similar nature involving the A_∞ -categories $\mathrm{Func}_{\mathcal{A}, \mathcal{B}}$.

In part 3 we illustrate how n -morphisms naturally arise in geometry, here in the context of Morse theory, solving our motivational question at the same time. In section 1 we detail the construction of n -morphisms between ΩBAs -algebras in Morse theory. Given two Morse functions f and g on a closed oriented manifold M , endow their Morse cochains with their ΩBAs -algebra structure coming from a choice of perturbation data on the moduli spaces \mathcal{T}_m . A n -morphism between $C^*(f)$ and $C^*(g)$ can be constructed by adapting the techniques of [Abo11] and [Mes18] that we used in [Maz21] for moduli spaces of perturbed Morse gradient trees. We define to this extent the notion of n -simplices of perturbation data \mathbb{Y}_{Δ^n} :

Definition 22. A n -simplex of perturbation data for a gauged metric stable ribbon tree T_g is defined to be a choice of perturbation data \mathbb{Y}_{δ, T_g} for T_g for every $\delta \in \overset{\circ}{\Delta}^n$.

Given a smooth n -simplex of perturbation data $\mathbb{Y}_{\Delta^n, t_g}$ on the moduli space $\mathcal{CT}_m(t_g)$, we introduce the following moduli spaces of perturbed Morse gradient trees :

Definition 24. Let $y \in \text{Crit}(g)$ and $x_1, \dots, x_m \in \text{Crit}(f)$, we define the moduli spaces

$$\mathcal{CT}_{\Delta^n, t_g}^{\mathbb{Y}_{\Delta^n, t_g}}(y; x_1, \dots, x_m) := \bigcup_{\delta \in \overset{\circ}{\Delta}^n} \mathcal{CT}_{t_g}^{\mathbb{Y}_{\delta, t_g}}(y; x_1, \dots, x_m) .$$

As in [Maz21], these moduli spaces are orientable manifolds under some generic transversality assumptions on the perturbation data :

Theorems 4 and 5. *Under some generic assumptions on the choice of perturbation data $(\mathbb{Y}_{I, m})_{I \subset \Delta^n}^{m \geq 1}$, the moduli spaces $\mathcal{CT}_{I, t_g}(y; x_1, \dots, x_m)$ are orientable manifolds. If they have dimension 0 they are moreover compact. If they have dimension 1 they can be compactified to 1-dimensional manifolds with boundary, whose boundary is modeled on the boundary of the n -multiplihedron $n - J_m$ endowed with its $n - \Omega BAs$ -cell decomposition.*

Perturbation data $(\mathbb{Y}_{I, m})_{I \subset \Delta^n}^{m \geq 1}$ satisfying the generic assumptions under which Theorems 4 and 5 hold will be called admissible. Given admissible choices of perturbation data \mathbb{X}^f and \mathbb{X}^g , we construct a $n - \Omega BAs$ -morphism between the ΩBAs -algebras $C^*(f)$ and $C^*(g)$ by counting 0-dimensional moduli spaces of Morse gradient trees :

Theorem 6. *Let $(\mathbb{Y}_{I, m})_{I \subset \Delta^n}^{m \geq 1}$ be an admissible choice of perturbation data. For every m and $t_g \in SCRT_m$, and every $I \subset \Delta^n$ we define the operation μ_{I, t_g} as*

$$\begin{aligned} \mu_{I, t_g} : C^*(f) \otimes \cdots \otimes C^*(f) &\longrightarrow C^*(g) \\ x_1 \otimes \cdots \otimes x_m &\longmapsto \sum_{|y| = \sum_{i=1}^m |x_i| + |t_{I, g}|} \#\mathcal{CT}_{I, t_g}^{\mathbb{Y}_{I, t_g}}(y; x_1, \dots, x_m) \cdot y . \end{aligned}$$

This set of operations then defines a $n - \Omega BAs$ -morphism $(C^(f), m_t^{\mathbb{X}^f}) \rightarrow (C^*(g), m_t^{\mathbb{X}^g})$.*

This n -morphism is in fact a twisted n -morphism as defined in [Maz21]. We subsequently prove a filling theorem for simplicial complexes of perturbation data :

Theorem 7. *For every admissible choice of perturbation data \mathbb{Y}_S parametrized by a simplicial sub-complex $S \subset \Delta^n$, there exists an admissible n -simplex of perturbation data \mathbb{Y}_{Δ^n} extending \mathbb{Y}_S .*

Defining $\text{HOM}_{\Omega BAs}^{geom}(C^*(f), C^*(g))_\bullet$ to be the simplicial subset of $\text{HOM}_{\Omega BAs}(C^*(f), C^*(g))_\bullet$ consisting of higher morphisms defined by a count of perturbed Morse gradient trees, we prove that Theorem 7 implies the following theorem :

Theorem 8. *The simplicial set $\text{HOM}_{\Omega BAs}^{geom}(C^*(f), C^*(g))_\bullet$ is a Kan complex which is contractible.*

This solves in particular the motivational question to this paper. It is quite clear that given two compact symplectic manifolds M and N , one should be able to construct n -functors between their Fukaya categories $\text{Fuk}(M)$ and $\text{Fuk}(N)$ by counting pseudo-holomorphic quilted disks with Lagrangian correspondence seam condition, as suggested by the construction of geometric A_∞ -functors between Fukaya categories in [MWW18].

All transversality arguments and sign computations are performed in section 2 : they are mere adaptations of the analogous constructions in [Maz21]. We finally recall the second question stated at the end of [Maz21] in section 3, which is going to be tackled in an upcoming article.

Acknowledgements. My first thanks go to my advisor Alexandru Oancea, for his continuous help and support through the settling of this series of papers. I also express my gratitude to Bruno Vallette for his constant reachability and his suggestions and ideas on the algebra underlying this work. I specially thank Jean-Michel Fischer and Guillaume Laplante-Anfossi who repeatedly took the time to offer explanations on higher algebra and ∞ -categories. I finally adress my thanks to Florian Bertuol, Thomas Massoni, Amiel Peiffer-Smadja, Victor Roca Lucio, Geoffroy Horel, Brice Le Grignou, Nate Bottman and the members of the Roberta seminar for useful discussions.

Part 1

Higher morphisms between A_∞ and ΩBAs -algebras

1. $n - A_\infty$ -MORPHISMS

This section is dedicated to the study of the *higher algebra of A_∞ -algebras*. Our starting point is the study of homotopy theory in the category of A_∞ -algebras. Putting it simply, considering two A_∞ -morphisms F, G between A_∞ -algebras, we would like to determine which notion would give a satisfactory meaning to the sentence " F and G are homotopic". This question is solved in section 1.2 following [LH02], where we define the notion of an A_∞ -homotopy.

Studying higher algebra of A_∞ -algebras means that we will be concerned with the higher homotopy theory of A_∞ -algebras. Typically, the questions arising are the following ones. Homotopies being defined, what is now a good notion of a homotopy between homotopies? And of a homotopy between two homotopies between homotopies? And so on. Higher algebra is a general term standing for all problems that involve defining coherent sets of *higher homotopies* (also called *n -morphisms*) when starting from a basic homotopy setting.

The sections following the definition of A_∞ -homotopies will then be concerned with defining a good notion of n -morphisms between A_∞ -algebras, i.e. such that A_∞ -morphisms correspond to 0-morphisms and A_∞ -homotopies to 1-morphisms. This will be done using the viewpoint of section 1.1, which defines the category of A_∞ -algebras as a full subcategory of the category of dg-coalgebras. Sections 1.3 and 1.4 consist in a pedestrian approach to the construction of these n -morphisms, and section 1.6 sums it all up. In section 1.5 we moreover introduce an equivalent definition of n -morphisms, that we will need in section 4.3 of part 2. We postpone all sign computations to section 4.2.

1.1. Recollections and definitions. Let A be a graded \mathbb{Z} -module. We introduce its suspension sA defined as the graded \mathbb{Z} -module $(sA)^i := A^{i+1}$. In other words, $|sa| = |a| - 1$. This is merely a notation that gives a convenient way to handle certain degrees. Note for instance that a degree $2 - n$ map $A^{\otimes n} \rightarrow A$ is simply a degree $+1$ map $(sA)^{\otimes n} \rightarrow sA$.

Our main category of interest will be the category whose objects are A_∞ -algebras and whose morphisms are A_∞ -morphisms. It will be written as $A_\infty - \text{Alg}$. Recall that a structure of A_∞ -algebra on a dg- \mathbb{Z} -module A can equivalently be defined as a collection of operations $m_n : A^{\otimes n} \rightarrow A$ satisfying the A_∞ -equations, or as a codifferential D_A on its shifted bar construction $\overline{T}(sA)$. Similarly, an A_∞ -morphism is equivalently defined as a collection of operations $f_n : A^{\otimes n} \rightarrow B$ satisfying the A_∞ -equations, or as a morphism of dg-coalgebras $(\overline{T}(sA), D_A) \rightarrow (\overline{T}(sB), D_B)$. We refer to the first article of this series [Maz21] for a detailed discussion on these results.

As a consequence, the shifted bar construction functor identifies the category $A_\infty - \text{Alg}$ with a full subcategory of the category of dg-coalgebras $\text{dg} - \text{Cog}$, that is

$$A_\infty - \text{Alg} \subset \text{dg} - \text{Cog} .$$

This basic idea is the key to our first construction of n -morphisms in this section. We will perform some natural constructions in the category $\text{dg} - \text{Cog}$, and then specialize them to the category $A_\infty - \text{Alg}$ using the above inclusion. As before, these natural constructions will then admit an interpretation in terms of operations $A^{\otimes n} \rightarrow B$, using the universal property of the bar construction.

1.2. A_∞ -homotopies. The material presented in this section is taken from the thesis of Lefèvre-Hasegawa [LH02].

1.2.1. Homotopies between morphisms of dg-coalgebras.

Definition 1 ([LH02]). Let C and C' be two dg-coalgebras. Let F and G be morphisms $C \rightarrow C'$ of dg-coalgebras. A (F, G) -coderivation is defined to be a map $H : C \rightarrow C'$ such that

$$\Delta_{C'} H = (F \otimes H + H \otimes G) \Delta_C .$$

The morphisms F and G are then said to be *homotopic* if there exists a (F, G) -coderivation H of degree -1 such that

$$[\partial, H] = G - F .$$

Introduce the dg-coalgebra

$$\mathbf{\Delta}^1 := \mathbb{Z}[0] \oplus \mathbb{Z}[1] \oplus \mathbb{Z}[0 < 1] .$$

Its differential is the singular differential ∂^{sing}

$$\partial^{sing}([0 < 1]) = [1] - [0] \quad \partial^{sing}([0]) = 0 \quad \partial^{sing}([1]) = 0 ,$$

its coproduct is the Alexander-Whitney coproduct

$$\Delta_{\mathbf{\Delta}^1}([0 < 1]) = [0] \otimes [0 < 1] + [0 < 1] \otimes [1] \quad \Delta_{\mathbf{\Delta}^1}([0]) = [0] \otimes [0] \quad \Delta_{\mathbf{\Delta}^1}([1]) = [1] \otimes [1] ,$$

the elements $[0]$ and $[1]$ have degree 0, and the element $[0 < 1]$ has degree -1 . We refer to subsection 1.3.1 for a broader interpretation of $\mathbf{\Delta}^1$.

Proposition 1 ([LH02]). *There is a one-to-one correspondence between (F, G) -coderivations and morphisms of dg-coalgebras $\mathbf{\Delta}^1 \otimes C \rightarrow C'$.*

Proof. One checks indeed that :

- (i) F and G are the restrictions to the summands $\mathbb{Z}[0] \otimes C$ and $\mathbb{Z}[1] \otimes C$, H is the restriction to the summand $\mathbb{Z}[0 < 1] \otimes C$;
- (ii) the coderivation relation is given by the compatibility with the coproduct ;
- (iii) the homotopy relation is given by the compatibility with the differential.

□

1.2.2. A_∞ -homotopies. Using the inclusion $A_\infty - \text{Alg} \subset \text{dg} - \text{Cog}$, this yields a notion of homotopy between two A_∞ -morphisms, which we call a A_∞ -homotopy :

Definition 2 ([LH02]). Let $(\overline{T}(sA), D_A)$ and $(\overline{T}(sB), D_B)$ be two A_∞ -algebras. Given two A_∞ -morphisms $F, G : (\overline{T}(sA), D_A) \rightarrow (\overline{T}(sB), D_B)$, an A_∞ -homotopy from F to G is defined to be a morphism of dg-coalgebras

$$H : \Delta^1 \otimes \overline{T}(sA) \longrightarrow \overline{T}(sB) ,$$

whose restriction to the $[0]$ summand is F and whose restriction to the $[1]$ summand is G .

An alternative and equivalent definition ensues then as follows (see subsection 1.4.2 for a more general proof of the equivalence between the two definitions) :

Definition 3 ([LH02]). An A_∞ -homotopy between two A_∞ -morphisms $(f_n)_{n \geq 1}$ and $(g_n)_{n \geq 1}$ of A_∞ -algebras A and B is defined to be a collection of maps

$$h_n : A^{\otimes n} \longrightarrow B ,$$

of degree $-n$, which satisfy the equations

$$\begin{aligned} [\partial, h_n] = & g_n - f_n + \sum_{\substack{i_1+i_2+i_3=n \\ i_2 \geq 2}} \pm h_{i_1+1+i_3}(\text{id}^{\otimes i_1} \otimes m_{i_2} \otimes \text{id}^{\otimes i_3}) \\ & + \sum_{\substack{i_1+\dots+i_s+l \\ +j_1+\dots+j_t=n \\ s+1+t \geq 2}} \pm m_{s+1+t}(f_{i_1} \otimes \dots \otimes f_{i_s} \otimes h_l \otimes g_{j_1} \otimes \dots \otimes g_{j_t}) . \end{aligned}$$

The signs will be made explicit in section 4.2. Using the same symbolic formalism as in [Maz21], this can be represented as

$$[\partial, \text{[0 < 1]}] = \text{[1]} - \text{[0]} + \sum \pm \text{[0 < 1]} + \sum \pm \text{[0] [0 < 1] [1] [1]} ,$$

where we denote [0] , [0 < 1] and [1] respectively for the f_n , the h_n and the g_n .

1.2.3. *On this notion of homotopy.* The relation *being A_∞ -homotopic* on the class of A_∞ -morphisms is in fact an equivalence relation. It is moreover stable under composition. These results cannot be proven using naive tools, and are obtained through considerations of model categories. We refer to Lefèvre-Hasegawa [LH02] for the reader interested in the proof of these two results.

1.3. Some definitions.

1.3.1. The cosimplicial dg-coalgebra Δ^n .

Definition 4. Define Δ^n to be the graded \mathbb{Z} -module generated by the faces of the standard n -simplex Δ^n ,

$$\Delta^n = \bigoplus_{0 \leq i_0 < \dots < i_k \leq n} \mathbb{Z}[i_0 < \dots < i_k] ,$$

where the grading is $|I| := -\dim(I)$ for I a face of Δ^n . We endow this graded \mathbb{Z} -module with a dg-coalgebra structure, whose differential is the simplicial differential

$$\partial_{\Delta^n}([i_0 < \cdots < i_k]) := \sum_{j=0}^k (-1)^j [i_0 < \cdots < \widehat{i_j} < \cdots < i_k],$$

and whose coproduct is the Alexander-Whitney coproduct

$$\Delta_{\Delta^n}([i_0 < \cdots < i_k]) := \sum_{j=0}^k [i_0 < \cdots < i_j] \otimes [i_j < \cdots < i_k].$$

These dg-coalgebras are to be seen as the realizations of the simplices Δ^n in the world of dg-coalgebras. The collection of dg-coalgebras $\mathbf{\Delta}^\bullet := \{\Delta^n\}_{n \geq 0}$ is then naturally a cosimplicial dg-coalgebra. The coface map

$$\delta_i : \Delta^{n-1} \longrightarrow \Delta^n, 0 \leq i \leq n,$$

is obtained by seeing the simplex Δ^{n-1} as the i -th face of the simplex Δ^n . The codegeneracy map

$$\sigma_i : \Delta^{n+1} \longrightarrow \Delta^n, 0 \leq i \leq n,$$

is defined as

$$\begin{aligned} [j_0 < \cdots < j_r < \widehat{i} < j_{r+1} < \cdots < j_s] &\longmapsto [j_0 < \cdots < j_r < j_{r+1} - 1 < \cdots < j_s - 1], \\ [j_0 < \cdots < j_r < \widehat{i+1} < j_{r+1} < \cdots < j_s] &\longmapsto [j_0 < \cdots < j_r < j_{r+1} - 1 < \cdots < j_s - 1], \\ [j_0 < \cdots < j_s] &\longmapsto 0 \quad \text{if } [i < i+1] \subset [j_0 < \cdots < j_s]. \end{aligned}$$

In other words, the face $[0 < \cdots < \widehat{i} < \cdots < n+1]$ and its subfaces are identified with Δ^n and its subfaces. The same goes for $[0 < \cdots < \widehat{i+1} < \cdots < n+1]$ and its subfaces. All faces of Δ^{n+1} that contain $[i < i+1]$ are taken to 0.

Heuristically, the coface and codegeneracy maps are obtained by applying the functor

$$C_{-*}^{sing} : \mathbf{Spaces} \longrightarrow \mathbf{dg - Cog}$$

to the cosimplicial space Δ^n , and then quotienting out each $C_{-*}^{sing}(\Delta^n)$ by the subcomplex generated by all degenerate singular simplices. For instance, the codegeneracy map $\sigma_i : \Delta^{n+1} \rightarrow \Delta^n$ is obtained by contracting the edge $[i < i+1]$ of Δ^{n+1} , which yields the above codegeneracy map $\sigma_i : \Delta^{n+1} \rightarrow \Delta^n$. We refer to [GJ09] for more details on the matter.

1.3.2. Overlapping partitions.

Definition 5 ([MS03]). Let I be a face of Δ^n . An *overlapping partition* of I is defined to be a sequence of faces $(I_\ell)_{1 \leq \ell \leq s}$ of I such that

- (i) the union of this sequence of faces is I , i.e. $\cup_{1 \leq \ell \leq s} I_\ell = I$;
- (ii) for all $1 \leq \ell < s$, $\max(I_\ell) = \min(I_{\ell+1})$.

These two requirements then imply in particular that $\min(I_1) = \min(I)$ and $\max(I_s) = \max(I)$. If the overlapping partition has s components I_ℓ , we will refer to it as an *overlapping s -partition*. These sequences of faces are those which naturally arise when applying several times the Alexander-Whitney coproduct to a face I . For instance, the Alexander-Whitney coproduct corresponds to the

sum of all overlapping 2-partitions of I . Iterating n times the Alexander-Whitney coproduct, we get the sum of all overlapping $(n + 1)$ -partitions of I . An overlapping 6-partition for $[0 < 1 < 2]$ is for instance

$$[0 < 1 < 2] = [0] \cup [0] \cup [0 < 1] \cup [1] \cup [1 < 2] \cup [2] .$$

1.4. n -morphisms between A_∞ -algebras. We now want to define a notion of *higher homotopies*, or *n -morphisms*, between A_∞ -algebras, such that 0-morphisms are A_∞ -morphisms and 1-morphisms are A_∞ -homotopies. Since A_∞ -morphisms correspond to the set

$$\mathrm{Hom}_{\mathrm{dg}\text{-}\mathrm{Cog}}(\overline{T}(sA), \overline{T}(sB))$$

and A_∞ -homotopies correspond to the set

$$\mathrm{Hom}_{\mathrm{dg}\text{-}\mathrm{Cog}}(\Delta^1 \otimes \overline{T}(sA), \overline{T}(sB)) ,$$

a natural candidate for the set of n -morphisms is

$$\mathrm{HOM}_{A_\infty\text{-}\mathrm{Alg}}(A, B)_n := \mathrm{Hom}_{\mathrm{dg}\text{-}\mathrm{Cog}}(\Delta^n \otimes \overline{T}(sA), \overline{T}(sB)) .$$

1.4.1. n -morphisms between dg-coalgebras. We begin by making explicit the n -simplices of the HOM -simplicial sets

$$\mathrm{HOM}_{\mathrm{dg}\text{-}\mathrm{Cog}}(C, C')_n := \mathrm{Hom}_{\mathrm{dg}\text{-}\mathrm{Cog}}(\Delta^n \otimes C, C') .$$

Take a morphism of dg-coalgebras

$$f : \Delta^n \otimes C \longrightarrow C' .$$

Write $f_{[i_0 < \dots < i_k]} : C \rightarrow C'$ for its restriction to the $\mathbb{Z}[i_0 < \dots < i_k] \otimes C$ summand. Then the property that f is a morphism of dg- \mathbb{Z} -modules is equivalent to the system of equations

$$(1.1) \quad [\partial, f_{[i_0 < \dots < i_k]}] = \sum_{j=0}^k (-1)^j f_{[i_0 < \dots < \widehat{i_j} < \dots < i_k]} ,$$

while the property that f is a morphism of coalgebras is equivalent to the system of equations

$$(1.2) \quad \Delta_{C'} f_{[i_0 < \dots < i_k]} = \sum_{j=0}^k (f_{[i_0 < \dots < i_j]} \otimes f_{[i_j < \dots < i_k]}) \Delta_C .$$

These two sets of equations of morphisms hence characterize the n -simplices of the HOM -simplicial sets $\mathrm{HOM}_{\mathrm{dg}\text{-}\mathrm{Cog}}(C, C')_\bullet$, i.e. the n -morphisms between the dg-coalgebras C and C' .

1.4.2. n -morphisms between A_∞ -algebras. We now use the previous characterization of n -morphisms between dg-coalgebras to obtain a simpler definition for n -morphisms between two A_∞ -algebras :

Definition 6. Let A and B be two A_∞ -algebras. A *n -morphism* from A to B is defined to be a morphism of dg-coalgebras

$$F : \Delta^n \otimes \overline{T}(sA) \longrightarrow \overline{T}(sB) .$$

We will write b_n for the degree +1 maps associated to the A_∞ -operations m_n , which define the codifferentials on $\overline{T}(sA)$ and $\overline{T}(sB)$. The property of being a morphism of coalgebras is equivalent to the property of satisfying equations 1.2. Using the universal property of the bar construction, this is equivalent to saying that the n -morphism is given by a collection of maps of degree $|I|$,

$$F_I^{(m)} : (sA)^{\otimes m} \longrightarrow sB ,$$

where I is a face of Δ^n and $m \geq 1$. The restriction of the map $F_I : \overline{T}(sA) \rightarrow \overline{T}(sB)$ to $(sA)^{\otimes m}$ is then given by

$$F_I^{(m)} + \sum_{\substack{i_1+i_2=m \\ I_1 \cup I_2 = I}} F_{I_1}^{(i_1)} \otimes F_{I_2}^{(i_2)} + \cdots + \sum_{\substack{i_1+\cdots+i_s=m \\ I_1 \cup \cdots \cup I_s = I}} F_{I_1}^{(i_1)} \otimes \cdots \otimes F_{I_s}^{(i_s)} + \cdots + \sum_{I_1 \cup \cdots \cup I_m = I} F_{I_1}^{(1)} \otimes \cdots \otimes F_{I_m}^{(1)},$$

where $I_1 \cup \cdots \cup I_s = I$ stands for an overlapping partition of I . Corestricting to $B^{\otimes s}$ yields the morphism

$$\sum_{\substack{i_1+\cdots+i_s=m \\ I_1 \cup \cdots \cup I_s = I}} F_{I_1}^{(i_1)} \otimes \cdots \otimes F_{I_s}^{(i_s)} : (sA)^{\otimes m} \longrightarrow (sB)^{\otimes s}.$$

The property of being compatible with the differentials is equivalent to the property of satisfying equations 1.1. This is itself equivalent to the fact that the collection of morphisms $F_I^{(m)}$ satisfies the following family of equations involving morphisms $(sA)^{\otimes m} \rightarrow sB$,

$$\sum_{j=0}^{\dim(I)} (-1)^j F_{\partial_j I}^{(m)} + (-1)^{|I|} \sum_{i_1+i_2+i_3=m} F_I^{(i_1+1+i_3)} (\text{id}^{\otimes i_1} \otimes b_{i_2} \otimes \text{id}^{\otimes i_3}) = \sum_{\substack{i_1+\cdots+i_s=m \\ I_1 \cup \cdots \cup I_s = I}} b_s(F_{I_1}^{(i_1)} \otimes \cdots \otimes F_{I_s}^{(i_s)}).$$

We unwind the signs obtained by changing the b_n into the m_n and the degree $|I|$ maps $F_I^{(m)} : (sA)^{\otimes m} \rightarrow sB$ into degree $1 - m + |I|$ maps $f_I^{(m)} : A^{\otimes m} \rightarrow B$ in subsection 4.2.3. The final equations read as

$$\begin{aligned} (\star) \quad \left[\partial, f_I^{(m)} \right] &= \sum_{j=0}^{\dim(I)} (-1)^j f_{\partial_j I}^{(m)} + (-1)^{|I|} \sum_{\substack{i_1+i_2+i_3=m \\ i_2 \geq 2}} \pm f_I^{(i_1+1+i_3)} (\text{id}^{\otimes i_1} \otimes m_{i_2} \otimes \text{id}^{\otimes i_3}) \\ &\quad + \sum_{\substack{i_1+\cdots+i_s=m \\ I_1 \cup \cdots \cup I_s = I \\ s \geq 2}} \pm m_s(f_{I_1}^{(i_1)} \otimes \cdots \otimes f_{I_s}^{(i_s)}), \end{aligned}$$

or equivalently and more visually,

$$\left[\partial, \begin{array}{c} \text{---} \\ \diagup \quad \diagdown \\ \text{---} \end{array} \right] = \sum_{j=0}^{\dim(I)} (-1)^j \begin{array}{c} \text{---} \\ \diagup \quad \text{---} \quad \diagdown \\ \text{---} \end{array} + \sum_{I_1 \cup \cdots \cup I_s = I} \pm \begin{array}{c} \text{---} \quad \text{---} \\ \diagup \quad \text{---} \quad \diagdown \\ \text{---} \end{array} + \sum \pm \begin{array}{c} \text{---} \\ \diagup \quad \text{---} \quad \diagdown \\ \text{---} \end{array}.$$

Definition 7. Let A and B be two A_∞ -algebras. A n -morphism from A to B is defined to be a collection of maps $f_I^{(m)} : A^{\otimes m} \rightarrow B$ of degree $1 - m + |I|$ for $I \subset \Delta^n$ and $m \geq 1$, that satisfy equations \star .

1.5. An equivalent definition for n -morphisms. We show in this section that given A and B two A_∞ -algebras, the datum of a n -morphism from A to B is equivalent to the datum of a morphism of A_∞ -algebras $A \rightarrow \mathbf{\Delta}_n \otimes B$.

Consider first C a dg-algebra and B an A_∞ -algebra. Then the tensor product $C \otimes B$ can be naturally endowed with an A_∞ -algebra structure by defining $m_n : (A \otimes B)^{\otimes n} \rightarrow A \otimes B$ as

$$m_n := ((m_2^A)^{\otimes n-1} \otimes m_n^B) \circ \tau_n,$$

where τ_n denotes the map rearranging an element $a_1 b_1 \dots a_n b_n$ of $(A \otimes B)^{\otimes n}$ into an element $a_1 \dots a_n b_1 \dots b_n$ of $A^{\otimes n} \otimes B^{\otimes n}$ and $(m_2^A)^{\circ n-1} : A^{\otimes n} \rightarrow A$ denotes the $(n-1)$ -th iterate of the multiplication m_2^A on A . We moreover define Δ_n to be the simplicial dg-algebra $\Delta_n := \text{Hom}(\Delta^n, \mathbb{Z})$ dual to the cosimplicial dg-coalgebra Δ^n . Its underlying graded module is in particular

$$\Delta_n = \bigoplus_{0 \leq i_0 < \dots < i_k \leq n} \mathbb{Z}[i_0 < \dots < i_k]$$

where the grading is $|I|_{\Delta_n} := \dim(I)$ for I a face of Δ^n . It is endowed with the standard cup product.

An A_∞ -morphism $F : A \rightarrow \Delta_n \otimes B$ then corresponds to a collection of degree $1 - m$ maps $F^{(m)} : A^{\otimes m} \rightarrow \Delta_n \otimes B$ which can be rewritten as a collection of degree $1 - m - \dim(I)$ maps $f_I^{(m)} : A^{\otimes m} \rightarrow B$ such that

$$F^{(m)} = \bigoplus_{I \subset \Delta^n} I \otimes f_I^{(m)} .$$

We denote $\pi_I : \Delta_n \rightarrow \mathbb{Z} \cdot I$ the projection from Δ_n to its summand labeled by I . Then, the A_∞ -equations for the A_∞ -morphism $F : A \rightarrow \Delta_n \otimes B$ read as

$$[\partial, F^{(m)}] = \sum_{\substack{i_1+i_2+i_3=m \\ i_2 \geq 2}} \pm F^{(i_1+1+i_3)}(\text{id}^{\otimes i_1} \otimes m_{i_2}^A \otimes \text{id}^{\otimes i_3}) + \sum_{\substack{i_1+\dots+i_s=m \\ s \geq 2}} \pm m_s^{\Delta_n \otimes B}(F^{(i_1)} \otimes \dots \otimes F^{(i_s)}) ,$$

and their images under the map π_I yield exactly the A_∞ -equations \star for the collection of morphisms $f_I^{(m)}$.

Proposition 2. *Let A and B be two A_∞ -algebras. A n -morphism from A to B can be equivalently defined as an A_∞ -morphism $A \rightarrow \Delta_n \otimes B$.*

We will only need this equivalent definition of n -morphisms in subsection 4.3 of part 2, and will stick to the definition $\Delta^n \otimes \overline{T}(sA) \rightarrow \overline{T}(sB)$ and to the definition in terms of operations in the rest of this paper. We moreover point out that the natural sign convention for n -morphisms arising from this new definition differs slightly from the one arising from the two previous definitions, as we explain in subsection 4.2.4.

1.6. Résumé. Given A and B two A_∞ -algebras, we define a n -morphism between A and B to be an element of the simplicial set

$$\text{HOM}_{A_\infty\text{-Alg}}(A, B)_n := \text{Hom}_{\text{dg-Cog}}(\Delta^n \otimes \overline{T}(sA), \overline{T}(sB)) ,$$

or equivalently a collection of operations $\overline{\text{Y}}_I : A^{\otimes m} \rightarrow B$ of degree $1 - m - \dim(I)$ for all faces I of Δ^n and all $m \geq 1$, satisfying the A_∞ -equations

$$[\partial, \overline{\text{Y}}_I] = \sum_{j=0}^{\dim(I)} (-1)^j \overline{\text{Y}}_{\partial_j^{\text{sign}} I} + \sum_{I_1 \cup \dots \cup I_s = I} \pm \overline{\text{Y}}_{I_1} \dots \overline{\text{Y}}_{I_s} + \sum \pm \overline{\text{Y}}_I ,$$

where we refer to subsection 4.2.3 for signs.

2. THE n -MULTIPLIHEDRA

Recall from [Maz21] that, in the language of operadic algebra, A_∞ -algebras are governed by the operad A_∞ , and A_∞ -morphisms are governed by the (A_∞, A_∞) -operadic bimodule $A_\infty - \text{Morph}$. These two operadic objects actually stem from collections of polytopes. Under the functor C_{-*}^{cell} the associahedra $\{K_m\}$ realise the operad A_∞ , while the multiplihedra $\{J_m\}$ form a $(\{K_m\}, \{K_m\})$ -operadic bimodule realising $A_\infty - \text{Morph}$.

The first section shows that the operadic bimodule formalism for A_∞ -morphisms can be generalised to the setting of $n - A_\infty$ -morphisms : for each $n \geq 0$ there exists an (A_∞, A_∞) -operadic bimodule $n - A_\infty - \text{Morph}$, which encodes n -morphisms between A_∞ -algebras. In fact, they fit into a cosimplicial operadic bimodule $\{n - A_\infty - \text{Morph}\}_{n \geq 0}$. Reproducing the previous progression, we would like to realise the combinatorics of n -morphisms at the level of polytopes. The first step in this direction is performed in section 2.2 : we explain how to lift the Alexander-Whitney coproduct to the level of the standard simplices Δ^n and study the rich combinatorics that arise in this problem. Section 2.3 subsequently introduces the n -multiplihedra $n - J_m$, which are the polytopes $\Delta^n \times J_m$ endowed with a refined polytopal subdivision. These polytopes do not form a $(\{K_m\}, \{K_m\})$ -operadic bimodule, but they suffice to recover all the combinatorics of n -morphisms.

 2.1. The cosimplicial (A_∞, A_∞) -operadic bimodule encoding higher morphisms.

2.1.1. *The (A_∞, A_∞) -operadic bimodules $n - A_\infty - \text{Morph}$.* The (A_∞, A_∞) -operadic bimodule encoding A_∞ -morphisms is the quasi-free (A_∞, A_∞) -operadic bimodule generated in arity n by one operation $\begin{array}{c} \color{red}{\vee} \\ \color{blue}{\vee} \end{array}$ of degree $1 - n$,

$$A_\infty - \text{Morph} = \mathcal{F}^{A_\infty, A_\infty}(\color{red}{\vee}, \begin{array}{c} \color{red}{\vee} \\ \color{blue}{\vee} \end{array}, \begin{array}{c} \color{blue}{\vee} \\ \color{red}{\vee} \end{array}, \begin{array}{c} \color{blue}{\vee} \\ \color{blue}{\vee} \end{array}, \dots).$$

Representing the generating operations of the operad A_∞ acting on the right in blue $\begin{array}{c} \color{blue}{\vee} \\ \color{red}{\vee} \end{array}$ and the ones of the operad A_∞ acting on the left in red $\begin{array}{c} \color{red}{\vee} \\ \color{blue}{\vee} \end{array}$, its differential is defined by

$$\partial(\begin{array}{c} \color{red}{\vee} \\ \color{blue}{\vee} \end{array}) = \sum_{\substack{h+k=m+1 \\ 1 \leq i \leq k \\ h \geq 2}} \pm \begin{array}{c} \color{red}{\vee} \\ \color{blue}{\vee} \end{array} + \sum_{\substack{i_1 + \dots + i_s = m \\ s \geq 2}} \pm \begin{array}{c} \color{red}{\vee} \\ \color{blue}{\vee} \end{array}.$$

Definition 8. The (A_∞, A_∞) -operadic bimodule encoding $n - A_\infty$ -morphisms is the quasi-free (A_∞, A_∞) -operadic bimodule generated in arity m by the operations $f_I^{(m)}$ of degree $1 - m + |I|$, for all faces I of Δ^n , and whose differential is defined by

$$\partial(f_I^{(m)}) = \sum_{j=0}^{\dim I} (-1)^j f_{\partial_j^{sing} I}^{(m)} + \sum_{\substack{i_1+i_2+i_3=m \\ i_2 \geq 2}} \pm f_I^{(i_1+i_3)}(\text{id}^{\otimes i_1} \otimes m_{i_2} \otimes \text{id}^{\otimes i_3}) + \sum_{\substack{i_1+\dots+i_s=m \\ I_1 \cup \dots \cup I_s = I \\ s \geq 2}} \pm m_s(f_{I_1}^{(i_1)} \otimes \dots \otimes f_{I_s}^{(i_s)}).$$

Representing the operations $f_I^{(m)}$ as $\begin{array}{c} \color{red}{\vee} \\ \color{blue}{\vee} \end{array}$, this can be rewritten as

$$n - A_\infty - \text{Morph} = \mathcal{F}^{A_\infty, A_\infty}(\color{red}{\vee}, \begin{array}{c} \color{red}{\vee} \\ \color{blue}{\vee} \end{array}, \begin{array}{c} \color{blue}{\vee} \\ \color{red}{\vee} \end{array}, \begin{array}{c} \color{blue}{\vee} \\ \color{blue}{\vee} \end{array}, \dots; I \subset \Delta^n).$$

where

$$\partial(\text{tree}) = \sum_{j=0}^{\dim I} (-1)^j \text{tree}_{\partial_j^{\text{ins}} I} + \sum_{I_1 \cup \dots \cup I_s = I} \pm \text{tree}_{I_1, \dots, I_s} + \sum \pm \text{tree}_I .$$

The collection of (A_∞, A_∞) -operadic bimodules $\{n - A_\infty - \text{Morph}\}_{n \geq 0}$ forms a cosimplicial (A_∞, A_∞) -operadic bimodule whose coface and codegeneracy maps are built out of those of section 1.3. Given two A_∞ -algebras $A_\infty \rightarrow \text{Hom}(A)$ and $A_\infty \rightarrow \text{Hom}(B)$, the set of n -morphisms is then simply given by

$$\text{HOM}_{A_\infty\text{-Alg}}(A, B)_n = \text{Hom}_{(A_\infty, A_\infty)\text{-op.bimod.}}(n - A_\infty - \text{Morph}, \text{Hom}(A, B)) .$$

2.1.2. *The two-colored operadic viewpoint.* Recall that A_∞ -algebras and A_∞ -morphisms between them are naturally encoded by the quasi-free two-colored operad

$$A_\infty^2 := \mathcal{F}(\text{tree}_1, \text{tree}_2, \text{tree}_3, \dots, \text{tree}_4, \text{tree}_5, \text{tree}_6, \dots, \text{tree}_7, \text{tree}_8, \text{tree}_9, \dots) ,$$

with differential given by the A_∞ -algebra relations on the one-colored operations, and the A_∞ -morphism relations on the two-colored operations.

Similarly, A_∞ -algebras and $n - A_\infty$ -morphisms between them are naturally encoded by the quasi-free two-colored operad

$$n - A_\infty^2 := \mathcal{F}(\text{tree}_1, \text{tree}_2, \text{tree}_3, \dots, \text{tree}_4, \text{tree}_5, \text{tree}_6, \dots, (\text{tree}_7, \text{tree}_8, \text{tree}_9, \text{tree}_{10}, \dots; I \subset \Delta^n)) ,$$

with differential given by the A_∞ -algebra relations on the one-colored operations, and the $n - A_\infty$ -morphism relations on the two-colored operations. The collection of two-colored operads $\{n - A_\infty^2\}_{n \geq 0}$ constitutes again a cosimplicial two-colored operad.

2.2. **Polytopal subdivisions on Δ^n induced by the Alexander-Whitney coproduct.** One way of interpreting the Alexander-Whitney coproduct

$$\Delta_{\Delta^n} : \Delta^n \longrightarrow \Delta^n \otimes \Delta^n$$

is to say that it is a diagonal on the dg- \mathbb{Z} -module Δ^n . The following natural question then arises. *Does there exist a diagonal (i.e. a polytopal map that is homotopic to the usual diagonal - the usual diagonal map failing to be polytopal in general) on the standard n -simplex Δ^n ,*

$$\text{AW} : \Delta^n \longrightarrow \Delta^n \times \Delta^n ,$$

such that its image under the functor C_{-*}^{cell} is $\text{AW}_{-*} = \Delta_{\Delta^n}$?

The answer to this question is positive, and contains rich combinatorics that we now lay out.

2.2.1. *The map AW.* We recall in this section the construction of a diagonal on the standard simplices explained in [MTTV21] (example 1 of section 2.3.).

Definition 9 ([MTTV21]). Consider the realizations of the standard n -simplices

$$\Delta^n := \text{conv}\{(1, \dots, 1, 0, \dots, 0) \in \mathbb{R}^n\} = \{(z_1, \dots, z_n) \in \mathbb{R}^n \mid 1 \geq z_1 \geq \dots \geq z_n \geq 0\} .$$

We define the map AW by the formula

$$\text{AW}(z_1, \dots, z_n) = ((2z_1 - 1, \dots, 2z_i - 1, 0, \dots, 0), (1, \dots, 1, 2z_{i+1}, \dots, 2z_n)) ,$$

for $1 \geq z_1 \geq \dots \geq z_i \geq 1/2 \geq z_{i+1} \geq \dots \geq z_n \geq 0$.

In particular, the map AW comes with a refined polytopal subdivision of Δ^n , whose $n + 1$ top dimensional strata are given by the subsets

$$\{(z_1, \dots, z_n) \in \mathbb{R}^n | 1 > z_1 > \dots > z_i > 1/2 > z_{i+1} > \dots > z_n > 0\} \subset \Delta^n,$$

and whose i -codimensional strata are simply obtained by replacing i symbols " $>$ " by a symbol " $=$ " in the previous sequence of inequalities. This refined subdivision is represented on the figures 1, 2 and 3, together with the value of AW on each stratum of the subdivision.

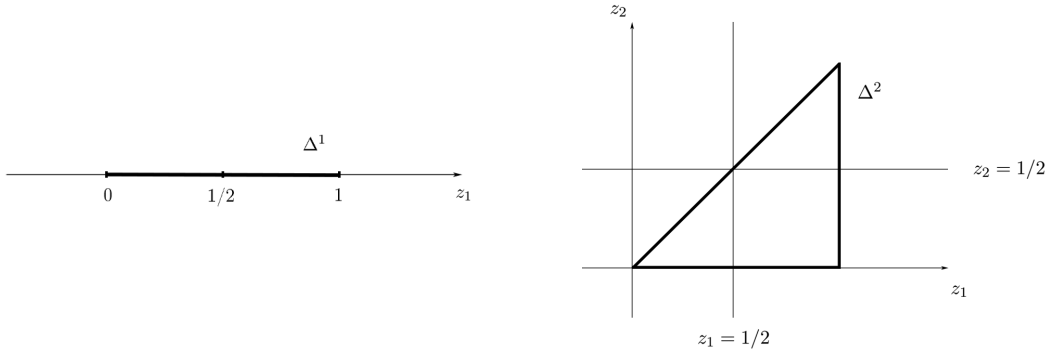

FIGURE 1. The AW-subdivision of Δ^1 and Δ^2

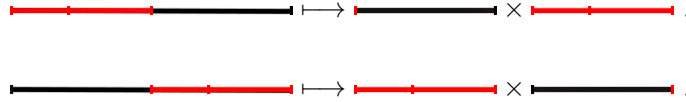

FIGURE 2. Values of AW on Δ^1 : the stratum to which AW is applied is colored in red

2.2.2. *The polytopal map AW is not coassociative.* The Alexander-Whitney coproduct Δ_{Δ^n} on the dg-level is coassociative. However, the diagonal map AW is not ! This can be checked for the 1-simplex Δ^1 :

$$\begin{aligned} (AW \times \text{id}) \circ AW(2/5) &= AW \times \text{id}(0, 4/5) = (0, 0, 4/5) \\ (\text{id} \times AW) \circ AW(2/5) &= \text{id} \times AW(0, 4/5) = (0, 3/5, 1) . \end{aligned}$$

Proposition 3. *The polytopal map AW is not coassociative.*

The polytopal subdivisions that the polytopal maps

$$\begin{aligned} (AW \times \text{id}) \circ AW &: \Delta^n \longrightarrow \Delta^n \times \Delta^n \times \Delta^n, \\ (\text{id} \times AW) \circ AW &: \Delta^n \longrightarrow \Delta^n \times \Delta^n \times \Delta^n \end{aligned}$$

induce on Δ^n are also different. See an instance on figure 4.

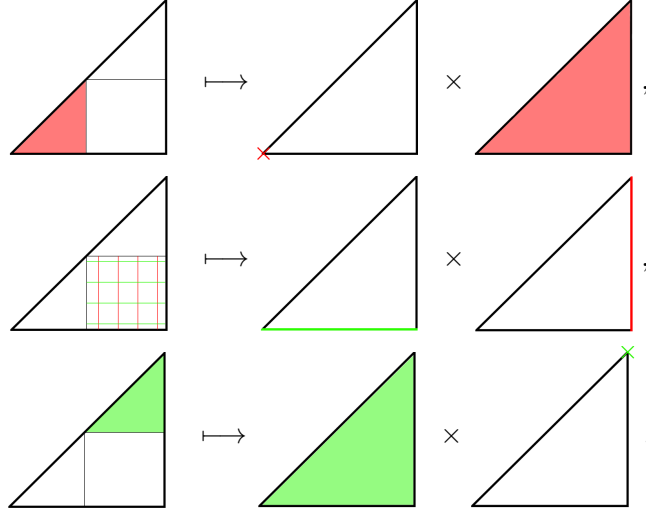
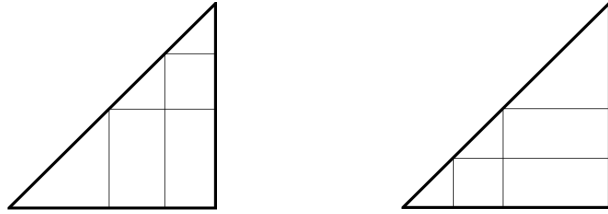
FIGURE 3. Values of AW on Δ^2 FIGURE 4. The $(AW \times \text{id}) \circ AW$ -subdivision and the $(\text{id} \times AW) \circ AW$ -subdivision of Δ^2

2.2.3. *i-overlapping s-partitions.* We defined in subsection 1.3.2 the notion of an overlapping s -partition of a face I of Δ^n . We refine it now :

Definition 10. An *i-overlapping s-partition* of I is a sequence of faces $(I_\ell)_{1 \leq \ell \leq s}$ of I such that

- (i) the union of this sequence of faces is I , i.e. $\cup_{1 \leq \ell \leq s} I_\ell = I$;
- (ii) there are exactly i integers ℓ such that $1 \leq \ell < s$ and $\max(I_\ell) = \min(I_{\ell+1})$.

An overlapping s -partition as defined in definition 5 is then simply a $(s-1)$ -overlapping s -partition. A 1-overlapping 3-partition for $[0 < 1 < 2]$ is for instance

$$[0 < 1 < 2] = [0] \cup [0] \cup [1 < 2] .$$

2.2.4. *Polytopal subdivisions of Δ^n induced by iterations of AW.*

Definition 11. Define the s -th right iterate of the map AW as

$$AW^{\circ s} := (\text{id}^{\times(s-1)} \times AW) \circ \dots \circ (\text{id} \times AW) \circ AW : \Delta^n \longrightarrow (\Delta^n)^{\times s+1} .$$

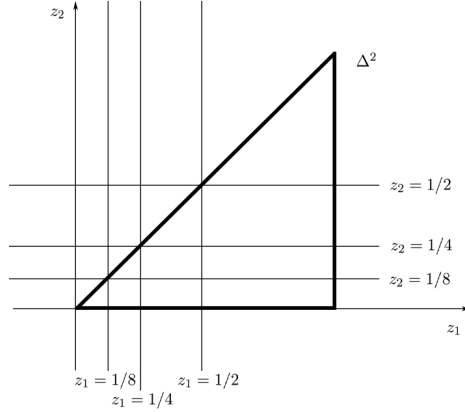
 FIGURE 5. The first three subdivisions of Δ^2

For each $s \geq 1$, the map AW^{os} induces a refined polytopal subdivision of Δ^n . These subdivisions will be called the AW^{os} -subdivisions of Δ^n . They can be described rather simply. While the AW-subdivision is obtained by dividing Δ^n into pieces using all hyperplanes $z_i = 1/2$ for $1 \leq i \leq n$, the AW^{os} -subdivision can be constructed as follows :

Proposition 4. *The AW^{os} -subdivision of Δ^n is the subdivision obtained by dividing Δ^n using all hyperplanes $z_i = (1/2)^k$, for $1 \leq i \leq n$ and $1 \leq k \leq s$.*

The first three subdivisions of Δ^2 are represented in figure 5. Note that a different choice for AW^{os} , for instance $\text{AW}^{\text{os}2} = (\text{AW} \times \text{id}) \circ \text{AW}$, would have yielded a different subdivision of Δ^n . Choices have to be made, because AW is not coassociative.

The n -dimensional cells of Δ^n endowed with its AW^{os} -subdivision are then defined by inequalities

$$\cdots \geq z_{i_k} \geq (1/2)^k \geq z_{i_{k+1}} \geq \cdots$$

for $1 \leq k \leq s$. We write C^{i_1, \dots, i_s} for such a cell. An explicit formula for the map $\text{AW}^{\text{os}} : \Delta^n \rightarrow (\Delta^n)^{\times s+1}$ can then be computed as follows. Its projection on the k -th factor Δ^n of $(\Delta^n)^{\times s+1}$ restricted to $C^{i_1, \dots, i_s} \subset \Delta^n$ is

$$(z_1, \dots, z_n) \mapsto (1, \dots, 1, 2^k z_{i_{k-1}+1} - 1, \dots, 2^k z_{i_k} - 1, 0, \dots, 0) \text{ for } 1 \leq k \leq s,$$

$$(z_1, \dots, z_n) \mapsto (1, \dots, 1, 2^s z_{i_s+1}, \dots, 2^s z_n) \text{ for } k = s + 1.$$

This explicit formula for the map AW^{os} implies the following proposition :

Proposition 5. *The map AW^{os} sends the cell $C^{i_1, \dots, i_s} \subset \Delta^n$ homeomorphically to the face*

$$[0 < \cdots < i_1] \times [i_1 < \cdots < i_2] \times \cdots \times [i_s < \cdots < n] \subset (\Delta^n)^{\times s+1} .$$

Hence not only does the map AW^{os} determine a subdivision of the simplex Δ^n but it also determines a labeling of its strata. They are labeled by the term of $(\Delta^n)^{\otimes s+1}$ which they determine after taking the image of AW^{os} under the functor C_{-*}^{cell} . Proposition 5 implies that the top-dimensional strata defined by the inequalities

$$\cdots > z_{i_k} > (1/2)^k > z_{i_{k+1}} > \cdots$$

are labeled by

$$[0 < \cdots < i_1] \otimes [i_1 < \cdots < i_2] \otimes \cdots \otimes [i_s < \cdots < n] .$$

Proposition 6. (i) *The codimension i strata of the $\text{AW}^{\circ s}$ -subdivision of Δ^n lying in the interior of Δ^n are in one-to-one correspondence with the $(s-i)$ -overlapping $(s+1)$ -partitions of Δ^n . More generally, given a face $I \subset \Delta^n$, the strata of the $\text{AW}^{\circ s}$ -subdivision of Δ^n which are lying in the interior of I and have codimension i w.r.t. the dimension of I are in one-to-one correspondence with the $(s-i)$ -overlapping $(s+1)$ -partitions of I .*

(ii) *Consider a codimension i stratum of the $\text{AW}^{\circ s}$ -subdivision of Δ^n lying in the interior of Δ^n . This stratum is defined by $s-i$ inequalities of the form*

$$\cdots > z_{i_k} > (1/2)^k > z_{i_k+1} > \cdots ,$$

and i equalities of the form

$$\cdots > z_{i_k} = (1/2)^k > z_{i_k+1} > \cdots .$$

The labeling of this stratum can then be obtained under the following simple transformation rules :

$$\begin{aligned} \cdots > z_{i_k} > (1/2)^k > z_{i_k+1} > \cdots &\mapsto \cdots < i_k] \otimes [i_k < \cdots , \\ \cdots > z_{i_k} = (1/2)^k > z_{i_k+1} > \cdots &\mapsto \cdots < i_k - 1] \otimes [i_k < \cdots . \end{aligned}$$

This recipe easily carries over to the case of strata lying in the boundary of Δ^n . The AW and $\text{AW}^{\circ 2}$ subdivisions of Δ^2 are represented in figure 6.

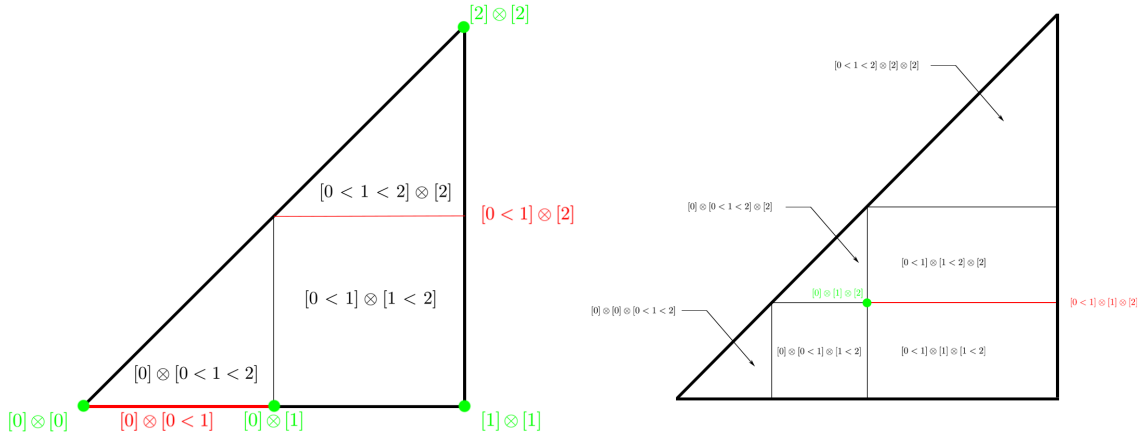

FIGURE 6. The AW and $\text{AW}^{\circ 2}$ subdivisions of Δ^2

2.2.5. *The $\text{AW}_{\mathbf{a}}$ -subdivisions of Δ^n .* Let now \mathbf{a} be a sequence of real numbers $1 > a_1 > \cdots > a_s > 0$, where we denote $|\mathbf{a}| := s$ the length of \mathbf{a} . We call such a sequence a *dividing sequence*. We define the $\text{AW}_{\mathbf{a}}$ -subdivision of Δ^n to be the subdivision obtained after dividing Δ^n by all hyperplanes $z_i = a_k$, for $1 \leq i \leq n$ and $1 \leq k \leq |\mathbf{a}|$. We denote $\Delta_{\mathbf{a}}^n$ for Δ^n endowed with its $\text{AW}_{\mathbf{a}}$ -subdivision. The cells $C_{\mathbf{a}}^{i_1, \dots, i_s}$ of $\Delta_{\mathbf{a}}^n$ are again defined by the inequalities

$$\cdots \geq z_{i_k} \geq a_k \geq z_{i_k+1} \geq \cdots ,$$

for $1 \leq k \leq |\mathbf{a}|$. We define moreover the map $AW_{\mathbf{a}} : \Delta^n \rightarrow (\Delta^n)^{\times |\mathbf{a}|+1}$ as follows. Its projection on the k -th factor Δ^n of $(\Delta^n)^{\times |\mathbf{a}|+1}$ restricted to the cell $C_{\mathbf{a}}^{i_1, \dots, i_s} \subset \Delta_{\mathbf{a}}^n$ is defined by the formula

$$\begin{aligned} (z_1, \dots, z_n) &\longmapsto (1, \dots, 1, \frac{(z_{i_{k-1}} - a_k)}{a_{k-1} - a_k}, \dots, \frac{(z_{i_k} - a_k)}{a_{k-1} - a_k}, 0, \dots, 0) \text{ for } 1 \leq k \leq |\mathbf{a}|, \\ (z_1, \dots, z_n) &\longmapsto (1, \dots, 1, z_{i_{|\mathbf{a}|+1}}/a_{|\mathbf{a}|}, \dots, z_n/a_{|\mathbf{a}|}) \text{ for } k = |\mathbf{a}| + 1, \end{aligned}$$

where we have set $a_0 := 1$. We check in particular that for $\mathbf{a} = 1/2 > \dots > (1/2)^s$ we have $AW_{\mathbf{a}} := AW^{\text{os}}$. The maps $AW_{\mathbf{a}}$ are to be understood as generalizations of the maps AW^{os} , that still realize the $|\mathbf{a}|$ -th iterate of the Alexander-Whitney coproduct under the functor C_{-*}^{cell} . In particular, the analogous statements of Propositions 3, 5 and 6 still hold for the maps $AW_{\mathbf{a}}$.

We can now state a coassociativity-like property that the maps $AW_{\mathbf{a}}$ satisfy, which did not hold when only using the map AW as proven in Proposition 3. For two dividing sequences \mathbf{a} and \mathbf{b} , we write $\mathbf{a} > \mathbf{b}$ if $a_{|\mathbf{a}|} > b_1$, and we then denote $\mathbf{a} \cdot \mathbf{b}$ the concatenation $a_1 > \dots > a_{|\mathbf{a}|} > b_1 > \dots > b_{|\mathbf{b}|}$.

Proposition 7. *Let \mathbf{a} , \mathbf{b} and \mathbf{c} be three dividing sequences such that $\mathbf{a} > \mathbf{b} > \mathbf{c}$. Then,*

$$AW_{\mathbf{a} \cdot \mathbf{b} \cdot \mathbf{c}} = (\text{id}^{\times |\mathbf{a}|} \times AW_{\mathbf{b}'} \times \text{id}^{\times |\mathbf{c}|}) \circ AW_{\mathbf{a} \cdot \mathbf{c}},$$

where \mathbf{b}' is the dividing sequence $1 > (b_1 - c_1)/(a_{\mathbf{a}} - c_1) > \dots > (b_{|\mathbf{b}|} - c_1)/(a_{\mathbf{a}} - c_1) > 0$ which is obtained from \mathbf{b} by shifting by c_1 and then rescaling by $1/(a_{\mathbf{a}} - c_1)$.

This proposition will be used in subsection 1.4.4 of part 3. We illustrate it on the simplex Δ^2 in figure 7, where $\mathbf{a} := 6/7, 5/7$, $\mathbf{b} := 4/7, 3/7$ and $\mathbf{c} := 2/7, 1/7$, which implies that $\mathbf{b}' := 2/3, 1/3$. On the left is represented the $AW_{\mathbf{a} \cdot \mathbf{b} \cdot \mathbf{c}}$ -subdivision of Δ^2 , in the middle its $AW_{\mathbf{a} \cdot \mathbf{c}}$ -subdivision and on the right the subdivision induced by the map $(\text{id}^{\times |\mathbf{a}|} \times AW_{\mathbf{b}'} \times \text{id}^{\times |\mathbf{c}|}) \circ AW_{\mathbf{a} \cdot \mathbf{c}}$, where the red lines represent the subdivision induced by $AW_{\mathbf{b}'}$. The left and right subdivisions then coincide.

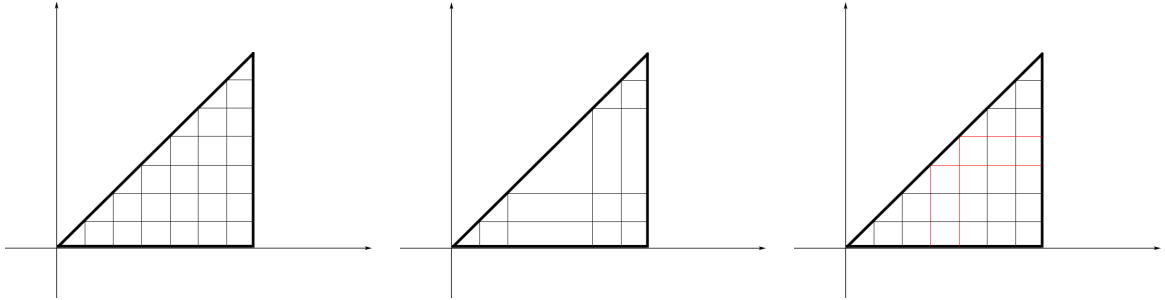

FIGURE 7

2.3. The n -multiplihedra $n - J_m$.

2.3.1. The multiplihedra. The polytopes encoding A_∞ -morphisms between A_∞ -algebras are the multiplihedra J_m , $m \geq 1$: they form a collection $\{J_m\}_{m \geq 1}$ which is a $(\{K_m\}, \{K_m\})$ -operadic bimodule whose image under the functor C_{-*}^{cell} is the (A_∞, A_∞) -operadic bimodule $A_\infty - \text{Morph}$. The faces of codimension i of J_m are labeled by all possible broken two-colored trees obtained by blowing-up i times the two-colored m -corolla. See for instance [Maz21] for pictures of the multiplihedra J_1, J_2 and

J_3 . The multiplihedra J_m can moreover be realized as the compactifications of moduli spaces of stable two-colored metric ribbon trees $\overline{\mathcal{CT}}_m$, where each \mathcal{CT}_m is seen as the unique $(m-1)$ -dimensional stratum of $\overline{\mathcal{CT}}_m$.

2.3.2. *The n -multiplihedra $n - J_m$.* Consider the polytope $\Delta^n \times J_m$ for $n \geq 0$ and $m \geq 1$. It is the most natural candidate for a polytope encoding n -morphisms between A_∞ -algebras. However, it does not fulfill that property as it is. Indeed, its faces correspond to the data of a face of Δ^n , that is of some $I \subset \Delta^n$, and of a face of J_m , that is of a broken two-colored tree obtained by blowing-up several times the two-colored m -corolla. This labeling is too coarse, as it does not contain the following trees, that appear in the A_∞ -equations for n -morphisms

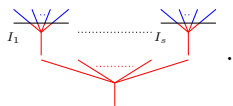

We resolve this issue by constructing a refined polytopal subdivision of $\Delta^n \times J_m$. Consider a face F of J_m labeled by a broken two-colored tree $t_{br,c}$ such that exactly s unbroken two-colored trees t_c^i for $r = 1, \dots, s$ appear in $t_{br,c}$. We see the trees t_c^r as ordered from left to right in $t_{br,c}$, write i_r for the number of incoming edges of t_c^{br} located above t_c^r in $t_{br,c}$, and recall that $t_{br,c}$ has arity m . We have in particular that $i_1 + \dots + i_s = m$. Define the dividing sequence $\mathbf{a}_{t_{br,c}}$ of length $s-1$ as

$$\frac{i_1 + \dots + i_{s-1}}{m} > \frac{i_1 + \dots + i_{s-2}}{m} > \dots > \frac{i_1}{m} .$$

We then refine the polytopal subdivision of $\Delta^n \times F$ into $\Delta_{\mathbf{a}_{t_{br,c}}}^n \times F$, where $\Delta_{\mathbf{a}_{t_{br,c}}}^n$ denotes Δ^n endowed with its $\text{AW}_{\mathbf{a}_{t_{br,c}}}$ -subdivision. This refinement process is moreover consistent : for two faces $F' \subset F$, the subdivision on Δ^n defined by the face F' is a refinement of the subdivision on Δ^n defined by the face F .

Definition 12. The n -multiplihedra are defined to be the polytopes $\Delta^n \times J_m$ endowed with the previous polytopal subdivision. We denote them $n - J_m$.

See some examples in figures 8, 9 and 10. We illustrate definition 12 with the construction of the 2-multiplihedron $\Delta^2 \times J_2$ depicted on figure 9. The polytope Δ^2 has one 2-dimensional face labeled by $[0 < 1 < 2]$ and three 1-dimensional faces labeled by $[0 < 1]$, $[1 < 2]$ and $[0 < 2]$. The polytope J_2 has one 1-dimensional face labeled by Y and has two 0-dimensional faces labeled by + and ++ . Consider now the product polytope $\Delta^2 \times J_2$. Its has one unique 3-dimensional face labeled by $[0 < 1 < 2] \times \text{Y}$ and five 2-dimensional faces. The faces $[0 < 1] \times \text{Y}$, $[1 < 2] \times \text{Y}$, $[0 < 2] \times \text{Y}$ and $[0 < 1 < 2] \times \text{+}$ that are left unchanged under the construction of the previous paragraph, as they each feature only 1 unbroken two-colored tree. They respectively correspond to the faces A, B, F and G on figure 9. The fifth face is the face $[0 < 1 < 2] \times \text{++}$. It features 2 unbroken two-colored trees : we thus have to refine the polytopal subdivision of $\Delta^2 \times \text{++}$ into $\Delta_{\text{AW}}^2 \times \text{++}$. This refinement produces the strata $([0] \otimes [0 < 1 < 2]) \times \text{++}$, $([0 < 1] \otimes [1 < 2]) \times \text{++}$ and $([0 < 1 < 2] \otimes [2]) \times \text{++}$, which respectively correspond to the labels C, D and E on figure 9. This concludes the construction of the 2-multiplihedron $\Delta^2 \times J_2$.

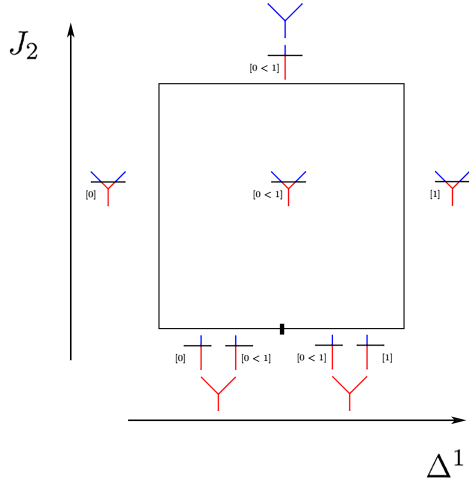

FIGURE 8. The 1-multiplihedron $\Delta^1 \times J_2$

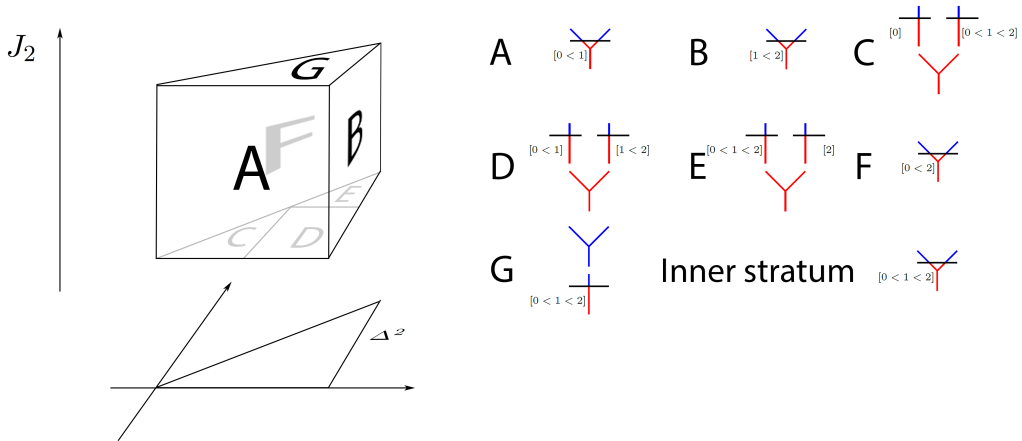
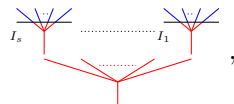
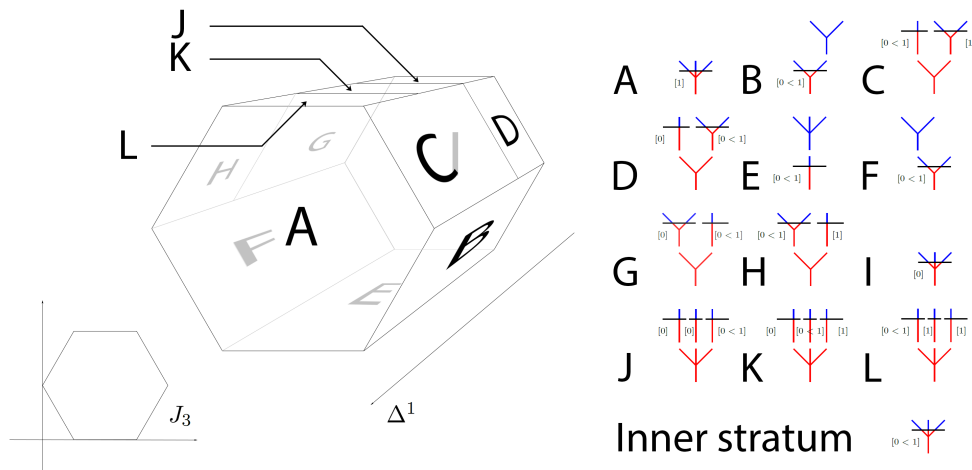

FIGURE 9. The 2-multiplihedron $\Delta^2 \times J_2$

2.3.3. *The n -multiplihedra encode $n - A_\infty$ -morphisms.* Now in which sense do these polytopes encode $n - A_\infty$ -morphisms? Note first that the collection $\{n - J_m\}_{m \geq 1}$ is not a $(\{K_m\}, \{K_m\})$ -operadic bimodule! Indeed, a $(\{K_m\}, \{K_m\})$ -operadic bimodule structure would for instance make appear a stratum labeled by



where $I_1 \cup \dots \cup I_s = \Delta^n$ is an overlapping partition of Δ^n . This stratum does not appear in the polytopal subdivision of $n - J_m$. Hence these polytopes do not recover the (A_∞, A_∞) -operadic bimodule $n - A_\infty - \text{Morph}$.

FIGURE 10. The 1-multiplihedron $\Delta^1 \times J_3$

However, the polytopal subdivision of $n - J_m$ still contains enough combinatorics to recover a n -morphism. This polytope has a unique $(n + m - 1)$ -dimensional cell $[n - J_m]$, which is labeled by $\Delta^n \begin{array}{c} \text{red} \\ \text{blue} \end{array}$. By construction :

Proposition 8. *The boundary of the cell $[n - J_m]$ is given by*

$$\partial^{\text{sing}}[n - J_m] \cup \bigcup_{\substack{h+k=m+1 \\ 1 \leq i \leq k \\ h \geq 2}} [n - J_k] \times_i [K_h] \cup \bigcup_{\substack{i_1 + \dots + i_s = m \\ I_1 \cup \dots \cup I_s = \Delta^n \\ s \geq 2}} [K_s] \times [\dim(I_1) - J_{i_1}] \times \dots \times [\dim(I_s) - J_{i_s}] ,$$

where $I_1 \cup \dots \cup I_s = \Delta^n$ is an overlapping partition of Δ^n .

Details on the orientation of the top dimensional strata in this boundary are worked out in section 4.3. Note moreover that the collection $\{n - J_m\}_{n \geq 0}$ is a cosimplicial polytope. This implies that the image of each cell $[\dim(I) - J_m]$ under the functor C_{-*}^{cell} yields an element whose boundary is exactly given by the A_∞ -equations for n -morphisms. It is in that sense that the $n - J_m$ encode n -morphisms. The previous boundary formula also implies that the $n - J_m$ will constitute a good parametrizing space for constructing moduli spaces in symplectic topology, whose count should give rise to n -morphisms between Floer complexes.

3. $n - \Omega BAs$ -MORPHISMS

The multiplihedra J_m can be realized by compactifying the moduli spaces of stable two-colored metric ribbon trees $\overline{\mathcal{CT}}_m$ and come with two cell decompositions. The first one consists in considering each \mathcal{CT}_m as a $(m - 1)$ -dimensional stratum and encodes the operadic bimodule $A_\infty - \text{Morph}$. The second one is obtained by considering the stratification of the moduli spaces \mathcal{CT}_m by two-colored stable ribbon tree types, and encodes the operadic bimodule $\Omega BAs - \text{Morph}$. The ΩBAs -cell decomposition is moreover a refinement of the A_∞ -cell decomposition. As a consequence, there exists a morphism of operadic bimodules $A_\infty - \text{Morph} \rightarrow \Omega BAs - \text{Morph}$, as shown in [Maz21]. It

is hence sufficient to construct an ΩBAs -morphism between ΩBAs -algebras to then naturally get an A_∞ -morphism between A_∞ -algebras.

We define in this section n - ΩBAs -morphisms between ΩBAs -algebras. Building on the viewpoint of the previous paragraph, we then explain how, by refining the cell decomposition of the polytope $n - J_m$, we get a new cell decomposition encoding $n - \Omega BAs$ -morphisms. This construction yields in particular a morphism of operadic bimodules $n - A_\infty - \text{Morph} \rightarrow n - \Omega BAs - \text{Morph}$. All sign computations are moreover postponed to section 4.4.

3.1. $n - \Omega BAs$ -morphisms.

3.1.1. *Recollections on ΩBAs -morphisms.* ΩBAs -morphisms are the morphisms between ΩBAs -algebras encoded by the quasi-free operadic bimodule generated by all two-colored stable ribbon trees

$$\Omega BAs - \text{Morph} := \mathcal{F}^{\Omega BAs, \Omega BAs}(\begin{array}{c} \vdash \\ \text{---} \\ \text{---} \end{array}, \begin{array}{c} \text{---} \\ \text{---} \\ \text{---} \end{array}, \begin{array}{c} \text{---} \\ \text{---} \\ \text{---} \end{array}, \begin{array}{c} \text{---} \\ \text{---} \\ \text{---} \end{array}, \dots, SCRT_n, \dots).$$

A two-colored stable ribbon tree t_g whose underlying stable ribbon tree t has $e(t)$ inner edges, and such that its gauge crosses j vertices of t , has degree $|t_g| := j - 1 - e(t)$.

The differential of a two-colored stable ribbon tree t_g is given by the signed sum of all two-colored stable ribbon trees obtained from t_g under the rule prescribed by the top dimensional strata in the boundary of $\overline{\mathcal{CT}}_n(t_g)$: the gauge moves to cross exactly one additional vertex of the underlying stable ribbon tree (gauge-vertex); an internal edge located above the gauge or intersecting it breaks or, when the gauge is below the root, the outgoing edge breaks between the gauge and the root (above-break); edges (internal or incoming) that are possibly intersecting the gauge, break below it, such that there is exactly one edge breaking in each non-self crossing path from an incoming edge to the root (below-break); an internal edge that does not intersect the gauge collapses (int-collapse).

3.1.2. $n - \Omega BAs$ -morphisms.

Definition 13. $n - \Omega BAs$ -morphisms are the higher morphisms between ΩBAs -algebras encoded by the quasi-free operadic bimodule generated by all pairs (face $I \subset \Delta^n$, two-colored stable ribbon tree),

$$n - \Omega BAs - \text{Morph} := \mathcal{F}^{\Omega BAs, \Omega BAs}(\begin{array}{c} \vdash \\ \text{---} \\ \text{---} \end{array}, \begin{array}{c} \text{---} \\ \text{---} \\ \text{---} \end{array}, \begin{array}{c} \text{---} \\ \text{---} \\ \text{---} \end{array}, \begin{array}{c} \text{---} \\ \text{---} \\ \text{---} \end{array}, \dots, (I, SCRT_n), \dots; I \subset \Delta^n).$$

An operation $t_{I,g} := (I, t_g)$ is defined to have degree $|t_{I,g}| := |I| + |t_g|$. The differential of $t_{I,g}$ is given by the rule prescribed by the top dimensional strata in the boundary of $\overline{\mathcal{CT}}_m(t_g)$ combined with the algebraic combinatorics of overlapping partitions, added to the simplicial differential of I , i.e.

$$\partial t_{I,g} = t_{\partial \text{sing } I, g} + \pm (\partial^{\overline{\mathcal{CT}}_m} t_g)_I.$$

We refer to section 4.4 for a more complete definition and sign conventions. The sign computations are in particular more involved, as we did not describe an ad hoc construction analogous to the shifted bar construction as in the A_∞ case. We also point out that the symbol $\begin{array}{c} \text{---} \\ \text{---} \\ \text{---} \end{array}$ used here is the same as the one used for the arity 2 generating operation of $n - A_\infty - \text{Morph}$. It will however be clear from

the context what $\overline{\Upsilon}$ stands for in the rest of this paper. We moreover compute the differential in the following instance

$$\begin{aligned} \left| \overline{\Upsilon}_{[0 < 1 < 2]} \right| &= -5, \\ \partial(\overline{\Upsilon}_{[0 < 1 < 2]}) &= \pm \overline{\Upsilon}_{[1 < 2]} \pm \overline{\Upsilon}_{[0 < 2]} \pm \overline{\Upsilon}_{[0 < 1]} \\ &\pm \overline{\Upsilon}_{[0 < 1 < 2]} \pm \overline{\Upsilon}_{[0 < 1 < 2]} \pm \overline{\Upsilon}_{[0 < 1 < 2]} \pm \overline{\Upsilon}_{[0 < 1 < 2]} \pm \overline{\Upsilon}_{[0 < 1 < 2]} \\ &\pm \overline{\Upsilon}_{[0] \overline{\Upsilon}_{[0 < 1 < 2]}} \pm \overline{\Upsilon}_{[0 < 1] \overline{\Upsilon}_{[1 < 2]}} \pm \overline{\Upsilon}_{[0 < 1 < 2] \overline{\Upsilon}_{[2]}}. \end{aligned}$$

3.1.3. *From $n - \Omega BAs$ -morphisms to $n - A_\infty$ -morphisms.* A $n - \Omega BAs$ -morphism between two ΩBAs -algebras naturally yields a $n - A_\infty$ -morphism between the induced A_∞ -algebras :

Proposition 9. *There exists a morphism of (A_∞, A_∞) -operadic bimodules $n - A_\infty - \text{Morph} \rightarrow n - \Omega BAs - \text{Morph}$ given on the generating operations of $n - A_\infty - \text{Morph}$ by*

$$f_{I,m} \longmapsto \sum_{t_g \in CBRT_m} \pm f_{I,t_g},$$

where $CBRT_m$ denotes the set of two-colored binary ribbon trees of arity m .

This proposition is proven in subsection 4.4.7. Note that the collection of operadic bimodules $\{n - \Omega BAs - \text{Morph}\}_{n \geq 0}$ is once again a cosimplicial operadic bimodule, where the cofaces and codegeneracies are as in subsection 1.3.1. This sequence of morphisms of operadic bimodules defines then in fact a morphism of cosimplicial operadic bimodules

$$\{n - A_\infty - \text{Morph}\}_{n \geq 0} \longrightarrow \{n - \Omega BAs - \text{Morph}\}_{n \geq 0}.$$

3.2. The n -multiplihedra encode $n - \Omega BAs$ -morphisms.

3.2.1. *The $n - \Omega BAs$ -cell decomposition of $\Delta^n \times \overline{\mathcal{CT}}_m$.* The polytopes encoding $n - A_\infty$ -morphisms have been defined to be the polytopes $\Delta^n \times J_m$ endowed with a refined polytopal subdivision induced by the maps $AW_{\mathbf{a}}$. These refined subdivisions incorporate the combinatorics of i -overlapping s -partitions in the boundary of the polytopes $\Delta^n \times J_m$. Consider now the multiplihedra $J_m = \overline{\mathcal{CT}}_m$ endowed with its ΩBAs -cell decomposition, i.e. its cell decomposition by broken stable two-colored ribbon tree type. We can define a refined cell decomposition on the product CW-complex $\Delta^n \times \overline{\mathcal{CT}}_m$ following the construction of subsection 2.3.2. Each stratum $\mathcal{CT}_m(t_{br,c})$ of the moduli space $\overline{\mathcal{CT}}_m$ determines again a dividing sequence $\mathbf{a}_{t_{br,c}}$ obtained from the unbroken two-colored trees of the two-colored tree $t_{br,c}$ labeling it. We then refine the cell decomposition of $\Delta^n \times \mathcal{CT}_m(t_{br,c})$ into $\Delta_{\mathbf{a}_{t_{br,c}}}^n \times \mathcal{CT}_m(t_{br,c})$. This refinement process can again be done consistently in order to obtain a refined cell decomposition of $\Delta^n \times \overline{\mathcal{CT}}_m$.

Definition 14. We define the $n - \Omega BAs$ -cell decomposition of the n -multiplihedron $\Delta^n \times \overline{\mathcal{CT}}_m$ to be the cell decomposition described in the previous paragraph.

See some examples in figures 11 and 12. By construction, the $n - \Omega BAs$ -cell decomposition of $\Delta^n \times \overline{\mathcal{CT}}_m$ is moreover a refinement of the $n - A_\infty$ -cell decomposition of $\Delta^n \times \overline{\mathcal{CT}}_m$.

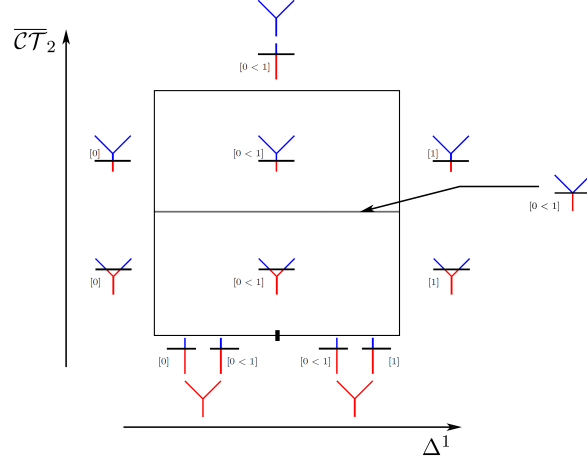

FIGURE 11. The 1 – ΩBAs -cell decomposition of $\Delta^1 \times \overline{\mathcal{CT}}_2$

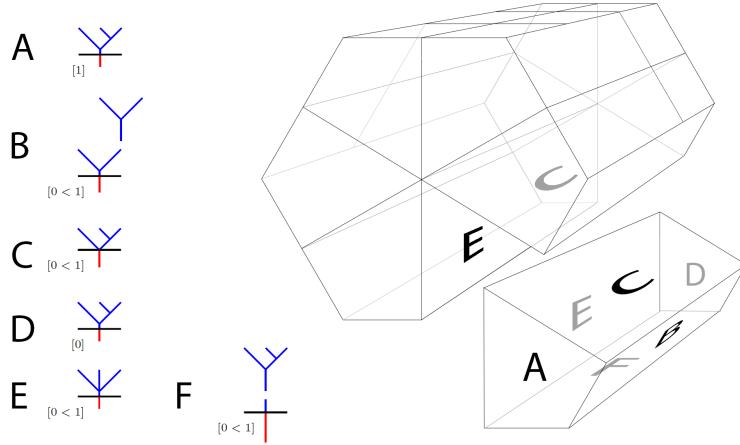

FIGURE 12. The 1 – ΩBAs -cell decomposition of $\Delta^1 \times \overline{\mathcal{CT}}_3$

3.2.2. *These CW-complexes encode n – ΩBAs -morphisms.* Consider the associahedra $K_m = \overline{\mathcal{T}}_m$ endowed with their ΩBAs -cell decompositions. We endow moreover the spaces $\Delta^n \times \overline{\mathcal{CT}}_m$ with their n – ΩBAs -cell decompositions. As in the A_∞ case, the collection of CW-complexes $\{\Delta^n \times \overline{\mathcal{CT}}_m\}_{m \geq 1}$ is not a $(\{\overline{\mathcal{T}}_m\}, \{\overline{\mathcal{T}}_m\})$ -operadic bimodule. Carrying over the details of subsection 2.3.3, it contains however enough combinatorics to recover a n – ΩBAs -morphism. What’s more, the collection $\{\Delta^n \times \overline{\mathcal{CT}}_m\}_{n \geq 0}$ is again a cosimplicial CW-complex.

3.3. **Résumé.** The higher homotopies or n -morphisms extending the notion of A_∞ -morphisms and A_∞ -homotopies between A_∞ -algebras are defined to be the morphisms of dg-coalgebras

$$\Delta^n \otimes T(sA) \longrightarrow T(sB) .$$

From an operadic viewpoint, they are naturally encoded by the operadic bimodule,

$$n - A_\infty - \text{Morph} = \mathcal{F}^{A_\infty, A_\infty} (\begin{array}{c} \text{---} \\ | \\ \text{---} \end{array}, \begin{array}{c} \text{---} \\ \diagdown \diagup \\ \text{---} \end{array}, \begin{array}{c} \text{---} \\ \diagup \diagdown \\ \text{---} \end{array}, \begin{array}{c} \text{---} \\ \diagdown \diagup \\ \text{---} \\ \diagup \diagdown \\ \text{---} \end{array}, \dots ; I \subset \Delta^n) .$$

where the differential is defined as

$$[\partial, \begin{array}{c} \text{---} \\ | \\ \text{---} \end{array}] = \sum_{j=0}^{\dim(I)} (-1)^j \begin{array}{c} \text{---} \\ \text{---} \\ \text{---} \\ \text{---} \\ | \\ \text{---} \end{array} + \sum_{I_1 \cup \dots \cup I_s = I} \pm \begin{array}{c} \begin{array}{c} \text{---} \\ \diagdown \diagup \\ \text{---} \end{array} \quad \dots \quad \begin{array}{c} \text{---} \\ \diagdown \diagup \\ \text{---} \end{array} \\ \text{---} \end{array} + \sum \pm \begin{array}{c} \begin{array}{c} \text{---} \\ \diagdown \diagup \\ \text{---} \end{array} \\ \text{---} \end{array} .$$

The combinatorics of this differential are encoded by new families of polytopes called the n -multiplihedra, which are the data of the polytopes $\Delta^n \times J_m$ together with a polytopal subdivision induced by the maps $\text{AW}_{\mathbf{a}}$. They will constitute a good parametrizing space for constructing moduli spaces in symplectic topology, whose count should recover a n -morphism between Floer complexes.

On the other side, the natural n -morphisms extending the notion of ΩBAs -morphisms are defined by adapting the operadic viewpoint on $n - A_\infty$ -morphisms. They are naturally encoded by the operadic bimodule,

$$n - \Omega BAs - \text{Morph} = \mathcal{F}^{\Omega BAs, \Omega BAs} (\begin{array}{c} \text{---} \\ | \\ \text{---} \end{array}, \begin{array}{c} \text{---} \\ \diagdown \diagup \\ \text{---} \end{array}, \begin{array}{c} \text{---} \\ \diagup \diagdown \\ \text{---} \end{array}, \begin{array}{c} \text{---} \\ \diagdown \diagup \\ \text{---} \\ \diagup \diagdown \\ \text{---} \end{array}, \dots, (I, \text{SCRT}_m), \dots ; I \subset \Delta^n) ,$$

where the differential is again defined as a signed sum prescribed by a rule on two-colored trees combinatorics combined with the algebraic combinatorics of overlapping partitions, added to the simplicial differential. This differential is encoded in the data of the polytopes $\Delta^n \times J_m$ endowed with a refined cell decomposition induced by two-colored stable ribbon tree types and the maps $\text{AW}_{\mathbf{a}}$. It is moreover sufficient to construct a $n - \Omega BAs$ -morphism between ΩBAs -algebras in order to recover a $n - A_\infty$ -morphism between the induced A_∞ -algebras, thanks to the morphism of operadic bimodules

$$n - A_\infty - \text{Morph} \longrightarrow n - \Omega BAs - \text{Morph} .$$

We show in part 3 that the previous CW-complexes constitute a good parametrizing space for moduli spaces in Morse theory, whose count will recover a $n - \Omega BAs$ -morphism between Morse cochain complexes.

4. SIGNS FOR n -MORPHISMS

We now work out all the signs left uncomputed in the previous sections of this part. These computations will be done resorting to the basic conventions on signs and orientations that we were already using in [Maz21], and that we briefly recall in the first section. In the next two sections, we display and explain the two natural sign conventions for $n - A_\infty$ -morphisms ensuing from the bar construction viewpoint, and then show that one of these conventions is in fact contained in the polytopes $n - J_m$. We finally give a complete definition of the operadic bimodule $n - \Omega BAs - \text{Morph}$ and build the morphism of operadic bimodules $n - A_\infty - \text{Morph} \rightarrow n - \Omega BAs - \text{Morph}$ of Proposition 9.

4.1. Conventions for signs and orientations.

4.1.1. *Koszul sign rule.* The formulae in this section will be written using the Koszul sign rule. We will moreover work exclusively with cohomological conventions.

Given A and B two dg \mathbb{Z} -modules, the differential on $A \otimes B$ is defined as

$$\partial_{A \otimes B}(a \otimes b) = \partial_A a \otimes b + (-1)^{|a|} a \otimes \partial_B b .$$

Given A and B two dg \mathbb{Z} -modules, we consider the graded \mathbb{Z} -module $\text{Hom}(A, B)$ whose degree r component is given by all maps $A \rightarrow B$ of degree r . We endow it with the differential

$$\partial_{\text{Hom}(A, B)}(f) := \partial_B \circ f - (-1)^{|f|} f \circ \partial_A =: [\partial, f] .$$

Given $f : A \rightarrow A'$ and $g : B \rightarrow B'$ two graded maps between dg- \mathbb{Z} -modules, we set

$$(f \otimes g)(a \otimes b) = (-1)^{|g||a|} f(a) \otimes g(b) .$$

Finally, given $f : A \rightarrow A'$, $f' : A' \rightarrow A''$, $g : B \rightarrow B'$ and $g' : B' \rightarrow B''$, we define

$$(f' \otimes g') \circ (f \otimes g) = (-1)^{|g'||f|} (f' \circ f) \otimes (g' \circ g) .$$

We check in particular that with this sign rule, the differential on a tensor product $A_1 \otimes \cdots \otimes A_n$ is given by

$$\partial_{A_1 \otimes \cdots \otimes A_n} = \sum_{i=1}^n \text{id}_{A_1} \otimes \cdots \otimes \partial_{A_i} \otimes \cdots \otimes \text{id}_{A_n} .$$

4.1.2. *Tensor product of dg-coalgebras.* Given A and B two dg \mathbb{Z} -modules, define the twist map $\tau : A \otimes B \rightarrow B \otimes A$,

$$\tau(a \otimes b) = (-1)^{|a||b|} b \otimes a .$$

Suppose now that A and B are dg-coalgebras, with respective coproducts Δ_A and Δ_B . The tensor product $A \otimes B$ can then be endowed with a structure of dg-coalgebra whose coproduct is defined as

$$\Delta_{A \otimes B} := A \otimes B \xrightarrow{\Delta_A \otimes \Delta_B} A \otimes A \otimes B \otimes B \xrightarrow{\text{id}_A \otimes \tau \otimes \text{id}_B} (A \otimes B) \otimes (A \otimes B) ,$$

and whose differential is the product differential

$$\partial_{A \otimes B} = \partial_A \otimes \text{id}_B + \text{id}_A \otimes \partial_B .$$

4.1.3. *Orientation of the boundary of a manifold with boundary.* Let $(M, \partial M)$ be an oriented n -manifold with boundary. We choose to orient its boundary ∂M as follows : given $x \in \partial M$, a basis e_1, \dots, e_{n-1} of $T_x(\partial M)$, and an outward pointing vector $\nu \in T_x M$, the basis e_1, \dots, e_{n-1} is positively oriented if and only if the basis ν, e_1, \dots, e_{n-1} is a positively oriented basis of $T_x M$.

Under this convention, given two manifolds with boundary K and L , the boundary of the product manifold $K \times L$ is then

$$\partial(K \times L) = \partial K \times L \cup (-1)^{\dim(K)} K \times \partial L ,$$

where the $(-1)^{\dim(K)}$ sign means that the product orientation of $K \times \partial L$ differs from its orientation as the boundary of $K \times L$ by a $(-1)^{\dim(K)}$ sign. This convention also recovers the classical singular and cubical differentials as detailed in [Maz21] :

$$\partial \Delta^n = \bigcup_{i=0}^n (-1)^i \Delta_i^{n-1} \quad \text{and} \quad \partial I^n = \bigcup_{i=1}^n (-1)^i (I_{i,0}^{n-1} \cup -I_{i,1}^{n-1}) .$$

4.2. Signs for $n - A_\infty$ -morphisms. We now work out the signs in the A_∞ -equations for $n - A_\infty$ -morphisms, thus completing definition 7. More precisely, we will unwind two sign conventions using the bar construction viewpoint. The impatient reader can straightaway jump to subsection 4.2.3 where the signs used in the rest of this paper are made explicit.

4.2.1. Recollections on the bar construction and A_∞ -algebras. Let A be a dg- \mathbb{Z} -module. Define the suspension and desuspension maps

$$\begin{array}{ccc} s : A \longrightarrow sA & & w : sA \rightarrow A \\ a \longmapsto sa & & sa \longmapsto a , \end{array}$$

which are respectively of degree -1 and $+1$. We verify that with the Koszul sign rule,

$$w^{\otimes m} \circ s^{\otimes m} = (-1)^{\binom{m}{2}} \text{id}_{A^{\otimes m}} .$$

Then, note for instance that a degree $2 - m$ map $m_m : A^{\otimes m} \rightarrow A$ yields a degree $+1$ map $b_m := sm_m w^{\otimes m} : (sA)^{\otimes m} \rightarrow sA$.

To the set of operations b_m one can associate a unique coderivation D on $\overline{T}(sA)$. We proved in [Maz21] using this viewpoint that the equation $D^2 = 0$ yields two sign conventions for the A_∞ -equations

$$(A) \quad [m_1, m_m] = - \sum_{\substack{i_1+i_2+i_3=m \\ 2 \leq i_2 \leq n-1}} (-1)^{i_1 i_2 + i_3} m_{i_1+1+i_3} (\text{id}^{\otimes i_1} \otimes m_{i_2} \otimes \text{id}^{\otimes i_3}) ,$$

$$(B) \quad [m_1, m_m] = - \sum_{\substack{i_1+i_2+i_3=m \\ 2 \leq i_2 \leq n-1}} (-1)^{i_1+i_2 i_3} m_{i_1+1+i_3} (\text{id}^{\otimes i_1} \otimes m_{i_2} \otimes \text{id}^{\otimes i_3}) ,$$

and that these conventions are related by a $(-1)^{\binom{m}{2}}$ twist applied to the operation m_m , which comes from the formula $w^{\otimes m} \circ s^{\otimes m} = (-1)^{\binom{m}{2}} \text{id}_{A^{\otimes m}}$.

We will adopt the exact same approach to work out two sign conventions for $n - A_\infty$ -morphisms in the following subsection : first by writing A_∞ -equations without signs using the viewpoint of a morphism between bar constructions $F : \Delta^n \otimes \overline{T}(sA) \rightarrow \overline{T}(sB)$, and secondly by unfolding the signs coming from the suspension and desuspension maps.

4.2.2. *The two conventions coming from the bar construction.* The two conventions for the A_∞ -equations for $n - A_\infty$ -morphisms are

$$(A) \quad \left[m_1, f_I^{(m)} \right] = \sum_{j=0}^{\dim(I)} (-1)^j f_{\partial_j I}^{(m)} + (-1)^{|I|} \sum_{\substack{i_1+i_2+i_3=m \\ i_2 \geq 2}} (-1)^{i_1 i_2 + i_3} f_I^{(i_1+1+i_3)} (\text{id}^{\otimes i_1} \otimes m_{i_2} \otimes \text{id}^{\otimes i_3}) \\ - \sum_{\substack{i_1+\dots+i_s=m \\ I_1 \cup \dots \cup I_s = I \\ s \geq 2}} (-1)^{\epsilon_A} m_s (f_{I_1}^{(i_1)} \otimes \dots \otimes f_{I_s}^{(i_s)}),$$

$$(B) \quad \left[m_1, f_I^{(m)} \right] = \sum_{j=0}^{\dim(I)} (-1)^j f_{\partial_j I}^{(m)} + (-1)^{|I|} \sum_{\substack{i_1+i_2+i_3=m \\ i_2 \geq 2}} (-1)^{i_1+i_2 i_3} f_I^{(i_1+1+i_3)} (\text{id}^{\otimes i_1} \otimes m_{i_2} \otimes \text{id}^{\otimes i_3}) \\ - \sum_{\substack{i_1+\dots+i_s=m \\ I_1 \cup \dots \cup I_s = I \\ s \geq 2}} (-1)^{\epsilon_B} m_s (f_{I_1}^{(i_1)} \otimes \dots \otimes f_{I_s}^{(i_s)}),$$

which can be rewritten as

$$(A) \quad \sum_{j=0}^{\dim(I)} (-1)^j f_{\partial_j I}^{(m)} + (-1)^{|I|} \sum_{i_1+i_2+i_3=m} (-1)^{i_1 i_2 + i_3} f_I^{(i_1+1+i_3)} (\text{id}^{\otimes i_1} \otimes m_{i_2} \otimes \text{id}^{\otimes i_3}) \\ = \sum_{\substack{i_1+\dots+i_s=m \\ I_1 \cup \dots \cup I_s = I}} (-1)^{\epsilon_A} m_s (f_{I_1}^{(i_1)} \otimes \dots \otimes f_{I_s}^{(i_s)}),$$

$$(B) \quad \sum_{j=0}^{\dim(I)} (-1)^j f_{\partial_j I}^{(m)} + (-1)^{|I|} \sum_{i_1+i_2+i_3=m} (-1)^{i_1+i_2 i_3} f_I^{(i_1+1+i_3)} (\text{id}^{\otimes i_1} \otimes m_{i_2} \otimes \text{id}^{\otimes i_3}) \\ = \sum_{\substack{i_1+\dots+i_s=m \\ I_1 \cup \dots \cup I_s = I}} (-1)^{\epsilon_B} m_s (f_{I_1}^{(i_1)} \otimes \dots \otimes f_{I_s}^{(i_s)}),$$

where

$$\epsilon_A = \sum_{j=1}^s (s-j)|I_j| + \sum_{j=1}^s i_j \left(\sum_{k=j+1}^s (1 - i_k - |I_k|) \right),$$

$$\epsilon_B = \sum_{j=1}^s \left(i_j \sum_{k=j+1}^s |I_k| \right) + \sum_{j=1}^s (s-j)(1 - i_j - |I_j|).$$

These two sign conventions are equivalent : given a sequence of operations m_m and $f_I^{(m)}$ satisfying equations (A), we check that the operations $m'_m := (-1)^{\binom{m}{2}} m_m$ and $f'_I^{(m)} := (-1)^{\binom{m}{2}} f_I^{(m)}$ satisfy equations (B).

Consider now two dg- \mathbb{Z} -modules A and B , together with a collection of degree $2 - m$ maps $m_m : A^{\otimes m} \rightarrow A$ and $m_m : B^{\otimes m} \rightarrow B$ (we use the same notation for sake of readability), and a

collection of degree $1 - m + |I|$ maps $f_I^{(m)} : A^{\otimes m} \rightarrow B$. We associate to the maps m_m the degree $+1$ maps $b_m := sm_m w^{\otimes m}$, and also associate to the maps $f_I^{(m)}$ the degree $|I|$ maps $F_I^{(m)} := sf_I^{(m)} w^{\otimes m} : (sA)^{\otimes m} \rightarrow sB$. We denote D_A and D_B the unique coderivations coming from the maps b_m acting respectively on $\overline{T}(sA)$ and $\overline{T}(sB)$, and $F : \Delta^n \otimes \overline{T}(sA) \rightarrow \overline{T}(sB)$ the unique morphism of coalgebras associated to the maps $F_I^{(m)}$. The equation

$$F(\partial_{sing} \otimes \text{id}_{\overline{T}(sA)} + \text{id}_{\Delta^n} \otimes D_A) = D_B F$$

is then equivalent to the equations

$$\sum_{j=0}^{\dim(I)} (-1)^j F_{\partial_j I}^{(m)} + (-1)^{|I|} \sum_{i_1+i_2+i_3=m} F_I^{(i_1+1+i_3)} (\text{id}^{\otimes i_1} \otimes b_{i_2} \otimes \text{id}^{\otimes i_3}) = \sum_{\substack{i_1+\dots+i_s=m \\ I_1 \cup \dots \cup I_s = I}} b_s(F_{I_1}^{(i_1)} \otimes \dots \otimes F_{I_s}^{(i_s)}).$$

There are now two ways to unravel the signs from these equations, which will lead to conventions (A) and (B).

The first way consists in simply replacing the b_m and the $F_I^{(m)}$ by their definition. It yields sign conventions (A). The left-hand side transforms as

$$\begin{aligned} & \sum_{j=0}^{\dim(I)} (-1)^j F_{\partial_j I}^{(m)} + (-1)^{|I|} \sum_{i_1+i_2+i_3=m} F_I^{(i_1+1+i_3)} (\text{id}^{\otimes i_1} \otimes b_{i_2} \otimes \text{id}^{\otimes i_3}) \\ &= \sum_{j=0}^{\dim(I)} (-1)^j sf_{\partial_j I}^{(m)} w^{\otimes m} + (-1)^{|I|} \sum_{i_1+i_2+i_3=m} sf_I^{(i_1+1+i_3)} w^{\otimes i_1+1+i_3} (\text{id}^{\otimes i_1} \otimes sm_{i_2} w^{\otimes i_2} \otimes \text{id}^{\otimes i_3}) \\ &= \sum_{j=0}^{\dim(I)} (-1)^j sf_{\partial_j I}^{(m)} w^{\otimes m} + (-1)^{|I|} \sum_{i_1+i_2+i_3=m} (-1)^{i_3} sf_I^{(i_1+1+i_3)} (w^{\otimes i_1} \otimes wsm_{i_2} w^{\otimes i_2} \otimes w^{\otimes i_3}) \\ &= \sum_{j=0}^{\dim(I)} (-1)^j sf_{\partial_j I}^{(m)} w^{\otimes m} + (-1)^{|I|} \sum_{i_1+i_2+i_3=m} (-1)^{i_1 i_2 + i_3} sf_I^{(i_1+1+i_3)} (\text{id}^{\otimes i_1} \otimes m_{i_2} \otimes \text{id}^{\otimes i_3}) (w^{\otimes i_1} \otimes w^{\otimes i_2} \otimes w^{\otimes i_3}) \\ &= s \left(\sum_{j=0}^{\dim(I)} (-1)^j sf_{\partial_j I}^{(m)} + (-1)^{|I|} \sum_{i_1+i_2+i_3=m} (-1)^{i_1 i_2 + i_3} sf_I^{(i_1+1+i_3)} (\text{id}^{\otimes i_1} \otimes m_{i_2} \otimes \text{id}^{\otimes i_3}) \right) w^{\otimes m}, \end{aligned}$$

while the right-hand side transforms as

$$\begin{aligned}
& \sum_{\substack{i_1+\dots+i_s=m \\ I_1\cup\dots\cup I_s=I}} b_s(F_{I_1}^{(i_1)} \otimes \dots \otimes F_{I_s}^{(i_s)}) \\
&= \sum_{\substack{i_1+\dots+i_s=m \\ I_1\cup\dots\cup I_s=I}} sm_s w^{\otimes s} (sf_{I_1}^{(i_1)} w^{\otimes i_1} \otimes \dots \otimes sf_{I_s}^{(i_s)} w^{\otimes i_s}) \\
&= \sum_{\substack{i_1+\dots+i_s=m \\ I_1\cup\dots\cup I_s=I}} (-1)^{\sum_{j=1}^s (s-j)|I_j|} sm_s (wsf_{I_1}^{(i_1)} w^{\otimes i_1} \otimes \dots \otimes wsf_{I_s}^{(i_s)} w^{\otimes i_s}) \\
&= s \left(\sum_{\substack{i_1+\dots+i_s=m \\ I_1\cup\dots\cup I_s=I}} (-1)^{\epsilon_A} m_s (f_{I_1}^{(i_1)} \otimes \dots \otimes f_{I_s}^{(i_s)}) \right) w^{\otimes m},
\end{aligned}$$

where $\epsilon_A = \sum_{j=1}^s (s-j)|I_j| + \sum_{j=1}^s i_j \left(\sum_{k=j+1}^s (1-i_k - |I_k|) \right)$.

The second way consists in first composing and post-composing by w and $s^{\otimes m}$ and then replacing the b_m and $F_I^{(m)}$ by their definition. It yields the (B) sign conventions. We will denote $m'_m := (-1)^{\binom{m}{2}} m_m$ and $f'_I{}^{(m)} := (-1)^{\binom{m}{2}} f_I^{(m)}$. The left-hand side then transforms as

$$\begin{aligned}
& \sum_{j=0}^{\dim(I)} (-1)^j w F_{\partial_j I}^{(m)} s^{\otimes m} + (-1)^{|I|} \sum_{i_1+i_2+i_3=m} w F_I^{(i_1+1+i_3)} (\text{id}^{\otimes i_1} \otimes b_{i_2} \otimes \text{id}^{\otimes i_3}) s^{\otimes m} \\
&= \sum_{j=0}^{\dim(I)} (-1)^j f'_{\partial_j I}{}^{(m)} + (-1)^{|I|} \sum_{i_1+i_2+i_3=m} (-1)^{i_1} f_I^{(i_1+1+i_3)} w^{\otimes i_1+1+i_3} (s^{\otimes i_1} \otimes sm_{i_2} w^{\otimes i_2} s^{\otimes i_2} \otimes s^{\otimes i_3}) \\
&= \sum_{j=0}^{\dim(I)} (-1)^j f'_{\partial_j I}{}^{(m)} + (-1)^{|I|} \sum_{i_1+i_2+i_3=m} (-1)^{i_1+i_2i_3} f_I^{(i_1+1+i_3)} w^{\otimes i_1+1+i_3} s^{\otimes i_1+1+i_3} (\text{id}^{\otimes i_1} \otimes m'_{i_2} \otimes \text{id}^{\otimes i_3}) \\
&= \sum_{j=0}^{\dim(I)} (-1)^j f'_{\partial_j I}{}^{(m)} + (-1)^{|I|} \sum_{i_1+i_2+i_3=m} (-1)^{i_1+i_2i_3} f'_I{}^{(i_1+1+i_3)} (\text{id}^{\otimes i_1} \otimes m'_{i_2} \otimes \text{id}^{\otimes i_3}),
\end{aligned}$$

while the right-hand side transforms as

$$\begin{aligned}
& \sum_{\substack{i_1+\dots+i_s=m \\ I_1\cup\dots\cup I_s=I}} wb_s(F_{I_1}^{(i_1)} \otimes \dots \otimes F_{I_s}^{(i_s)}) s^{\otimes m} \\
&= \sum_{\substack{i_1+\dots+i_s=m \\ I_1\cup\dots\cup I_s=I}} m_s w^{\otimes s} (sf_{I_1}^{(i_1)} w^{\otimes i_1} \otimes \dots \otimes sf_{I_s}^{(i_s)} w^{\otimes i_s}) s^{\otimes m} \\
&= \sum_{\substack{i_1+\dots+i_s=m \\ I_1\cup\dots\cup I_s=I}} (-1)^{\sum_{j=1}^s (i_j \sum_{k=j+1}^s |I_k|)} m_s w^{\otimes s} (sf_{I_1}^{(i_1)} w^{\otimes i_1} s^{\otimes i_1} \otimes \dots \otimes sf_{I_s}^{(i_s)} w^{\otimes i_s} s^{\otimes i_s}) \\
&= \sum_{\substack{i_1+\dots+i_s=m \\ I_1\cup\dots\cup I_s=I}} (-1)^{\epsilon_B} m_s w^{\otimes s} s^{\otimes s} (f'_{I_1}{}^{(i_1)} \otimes \dots \otimes f'_{I_s}{}^{(i_s)}) \\
&= \sum_{\substack{i_1+\dots+i_s=m \\ I_1\cup\dots\cup I_s=I}} (-1)^{\epsilon_B} m'_s (f'_{I_1}{}^{(i_1)} \otimes \dots \otimes f'_{I_s}{}^{(i_s)}),
\end{aligned}$$

where $\epsilon_B = \sum_{j=1}^s (i_j \sum_{k=j+1}^s |I_k|) + \sum_{j=1}^s (s-j)(1-i_j-|I_j|)$.

4.2.3. *Choice of convention in this paper.* We will work in the rest of this paper with the set of conventions (B). The operations m_m of an A_∞ -algebra will satisfy equations

$$[\partial, m_m] = - \sum_{\substack{i_1+i_2+i_3=m \\ 2 \leq i_2 \leq n-1}} (-1)^{i_1+i_2 i_3} m_{i_1+1+i_3} (\text{id}^{\otimes i_1} \otimes m_{i_2} \otimes \text{id}^{\otimes i_3}),$$

and a $n - A_\infty$ -morphism between two A_∞ -algebras will satisfy equations

$$\begin{aligned}
[\partial, f_I^{(m)}] &= \sum_{j=0}^{\dim(I)} (-1)^j f_{\partial_j I}^{(m)} + (-1)^{|I|} \sum_{\substack{i_1+i_2+i_3=n \\ i_2 \geq 2}} (-1)^{i_1+i_2 i_3} f_I^{(i_1+1+i_3)} (\text{id}^{\otimes i_1} \otimes m_{i_2} \otimes \text{id}^{\otimes i_3}) \\
&\quad - \sum_{\substack{i_1+\dots+i_s=m \\ I_1\cup\dots\cup I_s=I \\ s \geq 2}} (-1)^{\epsilon_B} m_s (f'_{I_1}{}^{(i_1)} \otimes \dots \otimes f'_{I_s}{}^{(i_s)}),
\end{aligned}$$

where $\epsilon_B = \sum_{j=1}^s (i_j \sum_{k=j+1}^s |I_k|) + \sum_{j=1}^s (s-j)(1-i_j-|I_j|)$.

In [Maz21] we had chosen conventions (B) for A_∞ -algebras and A_∞ -morphisms because they were the ones naturally arising in the realizations of the associahedra and the multiplihedra à la Loday. We prove a similar result in the following section : these sign conventions are contained in the polytopes $n - J_m = \Delta^n \times J_m$ where J_m is a Forcey-Loday realization of the multiplihedron.

4.2.4. *The sign conventions coming from Proposition 2.* We proved in Proposition 2 that the datum of a n -morphism from A to B is equivalent to the datum of an A_∞ -morphism $A \rightarrow \Delta_n \otimes B$. In fact, the two sign conventions arising from this equivalent definition differ slightly from the two conventions (A) and (B) for n -morphisms computed from the bar construction formulation.

Indeed, we can check that if we work with convention (A) (resp. (B)) for A_∞ -morphisms (not higher morphisms !) and if we write as in subsection 1.5 the A_∞ -morphism $F : A \rightarrow \Delta_n \otimes B$ as

$$F^{(m)} = \bigoplus_{I \subset \Delta^n} I \otimes f_I^{(m)},$$

then the signs for the A_∞ -equations for F read exactly as the signs for the A_∞ -equations for n -morphisms computed in the previous subsection, apart from the simplicial differential terms which read this time as

$$\sum_{j=0}^{\dim(I)} (-1)^{j+|I|+1} f_{\partial_j I}^{(m)}.$$

4.3. Signs and the polytopes $n - J_m$.

4.3.1. *Loday associahedra and Forcey-Loday multiplihedra.* In [Maz21] we introduced explicit polytopal realizations of the associahedra and the multiplihedra : the weighted Loday realizations K_ω of the associahedra from [MTTV21] and the weighted Forcey-Loday realizations J_ω of the multiplihedra from [LAM]. We then proved using basic considerations on affine geometry that, under the convention of section 4.1, their boundaries were equal to

$$\begin{aligned} \partial K_\omega &= - \bigcup_{\substack{i_1+i_2+i_3=n \\ 2 \leq i_2 \leq n-1}} (-1)^{i_1+i_2 i_3} K_{\bar{\omega}} \times K_{\tilde{\omega}}, \\ \partial J_\omega &= \bigcup_{\substack{i_1+i_2+i_3=n \\ i_2 \geq 2}} (-1)^{i_1+i_2 i_3} J_{\bar{\omega}} \times K_{\tilde{\omega}} \cup - \bigcup_{\substack{i_1+\dots+i_s=m \\ s \geq 2}} (-1)^{\varepsilon_B} K_{\bar{\omega}} \times J_{\tilde{\omega}_1} \times \dots \times J_{\tilde{\omega}_s} \end{aligned}$$

where the weights $\bar{\omega}$, $\tilde{\omega}$ and $\tilde{\omega}_t$ are derived from the weights ω , and

$$\varepsilon_B = \sum_{j=1}^s (s-j)(1-i_j).$$

In particular, these polytopes contain sign conventions (B) for A_∞ -algebras and A_∞ -morphisms.

4.3.2. *The boundary of $n - J_m$.* Consider now a n -multiplihedron $\Delta^n \times J_\omega$, where J_ω is a Forcey-Loday realization of the multiplihedron J_m . Forgetting for now about its refined polytopal subdivision, its boundary reads as

$$\partial(\Delta^n \times J_\omega) = \partial\Delta^n \times J_\omega \cup (-1)^n \Delta^n \times \partial J_\omega.$$

Recall moreover that given any dividing sequence \mathbf{a} of length s , each top dimensional cell in the $AW_{\mathbf{a}}$ -polytopal subdivision of Δ^n labeled by an overlapping partition $I_1 \cup \dots \cup I_{s+1} = \Delta^n$ is in fact isomorphic to the product $I_1 \times \dots \times I_{s+1}$. We write this as

$$\Delta_{\mathbf{a}}^n = \bigcup_{I_1 \cup \dots \cup I_s = \Delta^n} I_1 \times \dots \times I_s.$$

Proposition 10. *The n -multiplihedra $\Delta^n \times J_\omega$ endowed with their $n - A_\infty$ -polytopal subdivision contain sign conventions (B) for $n - A_\infty$ -morphisms.*

Proof. The first component of the boundary of $\Delta^n \times J_\omega$ is given by

$$\partial\Delta^n \times J_\omega = \bigcup_{i=0}^n (-1)^i \Delta_i^{n-1} \times J_\omega .$$

The second, by the first part of the boundary of ∂J_ω ,

$$(-1)^n \bigcup_{\substack{i_1+i_2+i_3=m \\ i_2 \geq 2}} (-1)^{i_1+i_2i_3} (\Delta^n \times J_{\bar{\omega}}) \times K_{\tilde{\omega}} .$$

The third and last component transforms as follows :

$$\begin{aligned} & (-1)^n \Delta^n \times (-1) \bigcup_{\substack{i_1+\dots+i_s=m \\ s \geq 2}} (-1)^{\varepsilon_B} K_{\bar{\omega}} \times J_{\tilde{\omega}_1} \times \dots \times J_{\tilde{\omega}_s} \\ = & (-1)^{n+1} \bigcup_{\substack{i_1+\dots+i_s=m \\ s \geq 2}} (-1)^{\varepsilon_B} \Delta^n \times K_{\bar{\omega}} \times J_{\tilde{\omega}_1} \times \dots \times J_{\tilde{\omega}_s} \\ = & (-1)^{n+1} \bigcup_{\substack{i_1+\dots+i_s=m \\ s \geq 2}} (-1)^{\varepsilon_B} \bigcup_{I_1 \cup \dots \cup I_s = \Delta^n} I_1 \times \dots \times I_s \times K_{\bar{\omega}} \times J_{\tilde{\omega}_1} \times \dots \times J_{\tilde{\omega}_s} \\ = & (-1)^{n+1} \bigcup_{\substack{i_1+\dots+i_s=m \\ s \geq 2}} \bigcup_{I_1 \cup \dots \cup I_s = \Delta^n} (-1)^{\varepsilon_B + s \sum_{j=1}^s |I_j|} K_{\bar{\omega}} \times I_1 \times \dots \times I_s \times J_{\tilde{\omega}_1} \times \dots \times J_{\tilde{\omega}_s} \\ = & - (-1)^n \bigcup_{\substack{i_1+\dots+i_s=m \\ I_1 \cup \dots \cup I_s = \Delta^n \\ s \geq 2}} (-1)^{\varepsilon_B + sn + \sum_{j=1}^s (i_j - 1) (\sum_{k=j+1}^s |I_k|)} K_{\bar{\omega}} \times (I_1 \times J_{\tilde{\omega}_1}) \times \dots \times (I_s \times J_{\tilde{\omega}_s}) . \end{aligned}$$

We then check that $\varepsilon_B = n + \varepsilon_B + sn + \sum_{j=1}^s (i_j - 1) \left(\sum_{k=j+1}^s |I_k| \right)$ modulo 2. Hence, the polytopes $n - J_m$ contain indeed sign conventions (B) for $n - A_\infty$ -morphisms. \square

4.4. The operadic bimodule $n - \Omega BAs - \text{Morph}$. In [Maz21], we computed the signs for ΩBAs -morphisms as follows. Endowing the compactified moduli spaces $\overline{\mathcal{CT}}_m$ with their ΩBAs -cell decompositions, we define the operadic bimodule $\Omega BAs - \text{Morph}$ to be the realization under the functor C_{-*}^{cell} of the operadic bimodule $\{\overline{\mathcal{CT}}_m\}_{m \geq 1}$. The signs in the differential are then computed as the signs arising in the top dimensional strata in the boundary of the moduli spaces $\overline{\mathcal{CT}}_m(t_g)$. The signs for the action-composition maps are the signs ensuing from the image under the functor C_{-*}^{cell} of the action-composition maps for the moduli spaces $\overline{\mathcal{CT}}_m(t_g)$.

The goal of this section is to completely state definition 13, with explicit signs and formulae. We have however seen in subsection 3.2.2 that there is no operadic bimodule in compactified moduli spaces whose image under the functor C_{-*}^{cell} could realize the operadic bimodule $n - \Omega BAs - \text{Morph}$. We will still compute the signs for the action-composition maps by introducing some suitable spaces of metric trees, which do not define an operadic bimodule but will however carry enough structure for our computations. The differential will simply be defined by reading the signs arising in the top dimensional strata of the boundary of the CW-complex $\Delta^n \times \overline{\mathcal{CT}}_m$ endowed with its $n - \Omega BAs$ -cell decomposition.

4.4.1. *Notation.* As in [Maz21], we choose to use the formalism of orientations on trees to define the operadic bimodule $n - \Omega BAs - \text{Morph}$. Recall that this formalism originates from [MS06].

Definition 15. Given a broken stable ribbon tree t_{br} , an *ordering* of t_{br} is defined to be an ordering of its i finite internal edges e_1, \dots, e_i . Two orderings are said to be *equivalent* if one passes from one ordering to the other by an even permutation. An *orientation* of t_{br} is then defined to be an equivalence class of orderings, and written $\omega := e_1 \wedge \dots \wedge e_i$. Each tree t_{br} has exactly two orientations. Given an orientation ω of t_{br} we will write $-\omega$ for the second orientation on t_{br} , called its *opposite orientation*.

In this section, we write $t_{br,g}$ for a broken gauged stable ribbon tree, and t_g for an unbroken gauged stable ribbon tree.

Definition 16. We set \dagger to be the unique stable gauged tree of arity 1 and call it the *trivial gauged tree*. We define the *underlying broken stable ribbon tree* t_{br} of a $t_{br,g}$ to be the ribbon tree obtained by first deleting all the \dagger in $t_{br,g}$, and then forgetting all the remaining gauges of $t_{br,g}$. We will moreover refer to a gauge in $t_{br,g}$ which is associated to a non-trivial gauged tree, as a *non-trivial gauge* of $t_{br,g}$. An *orientation* on a broken gauged stable ribbon tree $t_{br,g}$ is then defined to be an orientation ω on t_{br} .

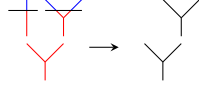

An instance of association $t_{br,g} \mapsto t_{br}$

Definition 17. Consider a gauged tree $t_{br,g}$ which has b gauges, trivial or not. A list $\mathbb{I} := (I_1, \dots, I_b)$ of faces $I_a \subset \Delta^n$ will be called a Δ^n -*labeling* of $t_{br,g}$. The tree $t_{br,g}$ endowed with its labeling will be written $(\mathbb{I}, t_{br,g})$.

We think of $(\mathbb{I}, t_{br,g})$ as depicted in the figure below, where trees are represented as corollae for the sake of readability.

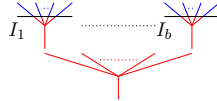

4.4.2. *Definition of the spaces of operations.*

Definition 18 (Spaces of operations). Consider the \mathbb{Z} -module freely generated by the pairs $(\mathbb{I}, t_{br,g}, \omega)$, where ω is an orientation on $t_{br,g}$ and \mathbb{I} is a Δ^n -labeling of $t_{br,g}$. We define the arity m space of operations $n - \Omega BAs - \text{Morph}(m)_*$ to be the quotient of this \mathbb{Z} -module under the relation

$$(\mathbb{I}, t_{br,g}, -\omega) = -(\mathbb{I}, t_{br,g}, \omega) .$$

Introducing the notation $|\mathbb{I}| := \sum_{a=1}^b |I_a|$, a pair $(\mathbb{I}, t_{br,g}, \omega)$ is then defined to have degree

$$|(\mathbb{I}, t_{br,g}, \omega)| := |\mathbb{I}| + |t_{br,g}| .$$

4.4.3. *The oriented spaces $\mathcal{CT}_m(\mathbb{I}, t_{br,g}, \omega)$.* Consider a Δ^n -labeled gauged tree $(\mathbb{I}, t_{br,g})$, together with a choice of orientation ω on $t_{br,g}$. We define the spaces

$$\mathcal{CT}_m(\mathbb{I}, t_{br,g}, \omega) := I_1 \times \cdots \times I_b \times \mathcal{CT}_m(t_{br,g}, \omega) .$$

An element of $\mathcal{CT}_m(\mathbb{I}, t_{br,g}, \omega)$ is thus of the form

$$(\delta_1, \dots, \delta_b, \lambda_1, \dots, \lambda_g, l_{e_1}, \dots, l_{e(t_{br})}) \in I_1 \times \cdots \times I_b \times]-\infty, +\infty[^g \times]0, +\infty[^{e(t_{br})} ,$$

where the λ_i are the non-trivial gauges of $t_{br,g}$ ordered from left to right, and the l_{e_i} are the lengths of the finite internal edges of t_{br} ordered according to ω . These spaces are then simply oriented by taking the product orientation of their factors.

4.4.4. *Definition of the action-compositions maps.* We may now introduce the "action-composition" maps on the spaces $\mathcal{CT}_m(\mathbb{I}, t_{br,g})$, that we will use to define the signs of the action-composition maps for $n - \Omega BAs - \text{Morph}$. Define the maps

$$\begin{aligned} O_i : \mathcal{CT}(\mathbb{I}, t_{br,g}, \omega) \times \mathcal{T}(t'_{br}, \omega') &= \mathbb{I} \times \mathcal{CT}(t_{br,g}, \omega) \times \mathcal{T}(t'_{br}, \omega') \\ &\longrightarrow \mathbb{I} \times \mathcal{CT}(t_{br,g} \circ_i t'_{br}, \omega \wedge \omega') = \mathcal{CT}(\mathbb{I}, t_{br,g} \circ_i t'_{br}, \omega \wedge \omega') \end{aligned}$$

where \mathbb{I} stands for the product $I_1 \times \cdots \times I_b$, and the arrow corresponds to the action-composition map

$$\mathcal{CT}(t_{br,g}, \omega) \times \mathcal{T}(t'_{br}, \omega') \longrightarrow \mathcal{CT}(t_{br,g} \circ_i t'_{br}, \omega \wedge \omega') ,$$

of the operadic bimodule $\{\mathcal{CT}_m\}_{m \geq 1}$. Define also the maps

$$\begin{aligned} M : \mathcal{T}(t_{br}, \omega) \times \mathcal{CT}(\mathbb{I}_1, t_{br,g}^1, \omega_1) \times \cdots \times \mathcal{CT}(\mathbb{I}_s, t_{br,g}^s, \omega_s) \\ \longrightarrow \mathbb{I}_1 \times \cdots \times \mathbb{I}_s \times \mathcal{T}(t_{br}, \omega) \times \mathcal{CT}(t_{br,g}^1, \omega_1) \times \cdots \times \mathcal{CT}(t_{br,g}^s, \omega_s) \\ \longrightarrow \mathcal{CT}(\mathbb{I}_1 \cup \cdots \cup \mathbb{I}_s, \mu(t_{br}, t_{br,g}^1, \dots, t_{br,g}^s), \omega \wedge \omega_1 \wedge \cdots \wedge \omega_s) \end{aligned}$$

where the second arrow corresponds to the action-composition map

$$\mathcal{T}(t_{br}, \omega) \times \mathcal{CT}(t_{br,g}^1, \omega_1) \times \cdots \times \mathcal{CT}(t_{br,g}^s, \omega_s) \longrightarrow \mathcal{CT}(\mu(t_{br}, t_{br,g}^1, \dots, t_{br,g}^s), \omega \wedge \omega_1 \wedge \cdots \wedge \omega_s) .$$

The maps O_i have sign $+1$. The maps M have sign $(-1)^\dagger$, where \dagger is defined as follows. Writing g_i for the number of non-trivial gauges and j_i for the number of gauge-vertex intersections of $t_{br,g}^i$, $i = 1, \dots, s$, and setting $t_{br}^0 := t_{br}$ and $g_0 = j_0 = \dim(\mathbb{I}_0) = 0$,

$$\dagger := \sum_{i=1}^s |\mathbb{I}_i| \left(|t_{br}| + \sum_{l=1}^{i-1} |t_{br,g}^l| \right) + \sum_{i=1}^s g_i \left(|t_{br}| + \sum_{l=1}^{i-1} |t_{br}^l| \right) + \sum_{i=1}^s j_i \left(|t_{br}| + \sum_{l=1}^{i-1} |t_{br,g}^l| \right) .$$

Definition 19 (Action-composition maps). The action of the operad ΩBAs on $n - \Omega BAs - \text{Morph}$ is defined as

$$\begin{aligned} (\mathbb{I}, t_{br,g}, \omega) \circ_i (t'_{br}, \omega') &= (\mathbb{I}, t_{br,g} \circ_i t'_{br}, \omega \wedge \omega') , \\ \mu((t_{br}, \omega), (\mathbb{I}_1, t_{br,g}^1, \omega_1), \dots, (\mathbb{I}_s, t_{br,g}^s, \omega_s)) &= (-1)^\dagger (\mathbb{I}_1 \cup \cdots \cup \mathbb{I}_s, \mu(t_{br}, t_{br,g}^1, \dots, t_{br,g}^s), \omega \wedge \omega_1 \wedge \cdots \wedge \omega_s) . \end{aligned}$$

Using for instance the maps O_i and M , and remembering the Koszul sign rules, we can check that these action-composition maps satisfy indeed all the associativity conditions for an operadic bimodule. What's more, choosing a distinguished orientation for every gauged stable ribbon tree

$t_g \in SCRT$, this definition of the operadic bimodule $n - \Omega BAs - \text{Morph}$ amounts to defining it as the free operadic bimodule in graded \mathbb{Z} -modules

$$n - \Omega BAs - \text{Morph} = \mathcal{F}^{\Omega BAs, \Omega BAs}(\overset{\curvearrowright}{\underset{\curvearrowright}{|}}, \overset{\curvearrowright}{\underset{\curvearrowright}{\curvearrowright}}, \overset{\curvearrowright}{\underset{\curvearrowright}{\curvearrowright}}, \overset{\curvearrowright}{\underset{\curvearrowright}{\curvearrowright}}, \dots, (I, SCRT_m), \dots; I \subset \Delta^n).$$

It remains to define a differential on the generating operations (I, t_g, ω) to recover definition 13.

4.4.5. *The boundary of the compactified moduli spaces $\overline{\mathcal{CT}}_m(t_g)$.* Before defining the differential on the operadic bimodule $n - \Omega BAs - \text{Morph}$, we recall the signs for the top dimensional strata in the boundary of the compactified moduli spaces $\overline{\mathcal{CT}}_m(t_g)$ that were computed in section I.5.2 in [Maz21].

We fix for the rest of this subsection a gauged stable ribbon tree t_g whose gauge intersects j of its vertices. We also choose an orientation $e_1 \wedge \dots \wedge e_i$ on t_g and order the j gauge-vertex intersections from left to right



The (int-collapse) boundary corresponds to the collapsing of an internal edge that does not intersect the gauge of the tree t . Suppose that it is the p -th edge e_p of t which collapses. Write moreover $(t/e_p)_g$ for the resulting gauged tree and $\omega_p := e_1 \wedge \dots \wedge \widehat{e_p} \wedge \dots \wedge e_i$ for the induced orientation on the edges of t/e_p . The boundary component $\mathcal{CT}_m((t/e_p)_g, \omega_p)$ bears a sign

$$(int\text{-collapse}) \quad (-1)^{p+1+j}$$

in the boundary of $\overline{\mathcal{CT}}_m(t_g, \omega)$.

The (gauge-vertex) boundary corresponds to the gauge crossing exactly one additional vertex of t . We suppose that this intersection takes place between the k -th and $(k+1)$ -th intersections of t_g and write t_g^0 for the resulting gauged tree. If the crossing results from a move



the boundary component $\mathcal{CT}_m(t_g^0, \omega)$ has sign

$$(gauge\text{-vertex } A) \quad (-1)^{j+k}$$

in the boundary of $\overline{\mathcal{CT}}_m(t_g, \omega)$. If the crossing results from a move



the boundary component $\mathcal{CT}_m(t_g^0, \omega)$ has sign

$$(gauge\text{-vertex } B) \quad (-1)^{j+k+1}$$

in the boundary of $\overline{\mathcal{CT}}_m(t_g, \omega)$.

The (above-break) boundary corresponds either to the breaking of an internal edge of t , that is located above the gauge or intersects the gauge, or, when the gauge is below the root, to the outgoing edge breaking between the gauge and the root. Denote e_0 the outgoing edge of t . Suppose that it

is the p -th edge e_p of t which breaks and write moreover $(t_p)_g$ for the resulting broken gauged tree. The boundary component $\mathcal{CT}_m((t_p)_g, \omega_p)$ bears a sign

$$(above\text{-}break) \quad (-1)^{p+j}$$

in the boundary of $\overline{\mathcal{CT}}_m(t_g, \omega)$.

The (below-break) boundary corresponds to the breaking of edges of t that are located below the gauge or intersect it, such that there is exactly one edge breaking in each non-self crossing path from an incoming edge to the root. Write $(t_{br})_g$ for the resulting broken gauged tree. We order from left to right the s non-trivial unbroken gauged trees t_g^1, \dots, t_g^s of $(t_{br})_g$ and denote e_{j_1}, \dots, e_{j_s} the internal edges of t whose breaking produces the trees t_g^1, \dots, t_g^s . Beware that we do not necessarily have that $j_1 < \dots < j_s$. To this extent, we denote $\varepsilon(j_1, \dots, j_s; \omega)$ the sign obtained after modifying ω by moving e_{j_k} to the k -th spot in ω . We write ω_{br} for the induced orientation on $(t_{br})_g$, which is obtained by deleting the edges e_{j_k} in ω . The boundary component $\mathcal{CT}_m((t_{br})_g, \omega_{br})$ has sign

$$(below\text{-}break) \quad (-1)^{\varepsilon(j_1, \dots, j_s; \omega) + 1 + j}$$

in the boundary of $\overline{\mathcal{CT}}_m(t_g, \omega)$.

4.4.6. Definition of the differential.

Definition 20 (Differential). The differential of a generating operation (I, t_g, ω) is defined by reading the signs of the top dimensional strata in the boundary of the space $I \times \overline{\mathcal{CT}}_m(t_g, \omega)$, endowed with its $\dim(I) - \Omega BAs$ cell decomposition. It reads as

$$\begin{aligned} \partial(I, t_g, \omega) := & \sum_{l=0}^{\dim(I)} (-1)^l (\partial_l^{sing} I, t_g, \omega) + (-1)^{|I|} \sum (-1)^{\dagger \Omega BAs} (I, \text{int} - \text{collapse}(t_g, \omega)) \\ & + (-1)^{|I|} \sum (-1)^{\dagger \Omega BAs} (I, \text{gauge} - \text{vertex}(t_g, \omega)) + (-1)^{|I|} \sum (-1)^{\dagger \Omega BAs} (I, \text{above} - \text{break}(t_g, \omega)) \\ & + (-1)^{|I|} \sum_{I_1 \cup \dots \cup I_b = I} (-1)^{\dagger \Omega BAs} ((I_1, \dots, I_b), \text{below} - \text{break}(t_g, \omega)), \end{aligned}$$

where b denotes the number of gauges of below - break(t_g) and the signs $(-1)^{\dagger \Omega BAs}$ denote the ΩBAs - Morph signs listed in the previous subsection.

For instance, choosing the orientation $e_1 \wedge e_2$ on

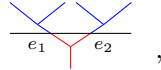

the signs in the computation of subsection 3.1.2 are

$$\begin{aligned} \partial \left(\left(\begin{array}{c} \text{Diagram} \\ \hline [0 < 1 < 2] \end{array}, e_1 \wedge e_2 \right) \right) = & \left(\begin{array}{c} \text{Diagram} \\ \hline [1 < 2] \end{array}, e_1 \wedge e_2 \right) - \left(\begin{array}{c} \text{Diagram} \\ \hline [0 < 2] \end{array}, e_1 \wedge e_2 \right) + \left(\begin{array}{c} \text{Diagram} \\ \hline [0 < 1] \end{array}, e_1 \wedge e_2 \right) \\ & - \left(\begin{array}{c} \text{Diagram} \\ \hline [0 < 1 < 2] \end{array}, e_1 \wedge e_2 \right) - \left(\begin{array}{c} \text{Diagram} \\ \hline [0 < 1 < 2] \end{array}, e_1 \wedge e_2 \right) + \left(\begin{array}{c} \text{Diagram} \\ \hline [0 < 1 < 2] \end{array}, e_1 \wedge e_2 \right) \\ & - \left(\begin{array}{c} \text{Diagram} \\ \hline [0] \end{array}, [0 < 1 < 2] \right) - \left(\begin{array}{c} \text{Diagram} \\ \hline [0 < 1] \end{array}, [1 < 2] \right) - \left(\begin{array}{c} \text{Diagram} \\ \hline [0 < 1 < 2] \end{array}, [2] \right) \\ & + \left(\begin{array}{c} \text{Diagram} \\ \hline [0 < 1 < 2] \end{array}, e_1 \right) - \left(\begin{array}{c} \text{Diagram} \\ \hline [0 < 1 < 2] \end{array}, e_2 \right). \end{aligned}$$

This concludes the construction of the operadic bimodule $n - \Omega BAs - \text{Morph}$.

4.4.7. *The morphism of operadic bimodules $n - A_\infty - \text{Morph} \rightarrow n - \Omega BAs - \text{Morph}$.* To conclude, it remains to define the morphism of operadic bimodules $n - A_\infty - \text{Morph} \rightarrow n - \Omega BAs - \text{Morph}$. It is enough to define this morphism on the generating operations of $n - A_\infty - \text{Morph}$ and to check that it is compatible with the differentials.

Proposition 9. *The map $n - A_\infty - \text{Morph} \rightarrow n - \Omega BAs - \text{Morph}$ defined on the generating operations of $n - A_\infty - \text{Morph}$ as*

$$f_{I,m} \mapsto \sum_{t_g \in CBRT_m} (I, t_g, \omega_{can})$$

is a morphism of (A_∞, A_∞) -operadic bimodules.

We refer to section I.5.3 of [Maz21] for the definition of the canonical orientations ω_{can} . It is easy to check that this map is indeed compatible with the differentials : either making explicit signs computations, or noting that this morphism corresponds to the refinement of the $n - A_\infty$ -cell decomposition of $n - J_m$ to its $n - \Omega BAs$ -cell decomposition.

Part 2

The simplicial sets $\mathrm{HOM}_{A_\infty\text{-Alg}}(A, B)$.

1. ∞ -CATEGORIES, KAN COMPLEXES AND COSIMPLICIAL RESOLUTIONS

1.1. ∞ -categories and Kan complexes.

1.1.1. *Motivation.* The operads A_∞ and ΩBAs provide two equivalent frameworks to study the notion of "dg-algebras which are associative up to homotopy". See section III.2 of [Maz21] for a detailed account on the matter. In fact, the operad A_∞ can also be used to define the notion of "dg-categories whose composition is associative up to homotopy": these categories are called A_∞ -categories. We recall their definition in subsection 3.1. They are of prime interest in symplectic topology for instance, where they appear as the Fukaya categories of symplectic manifolds. The notion of ΩBAs -categories could be defined similarly, but it has never appeared in the litterature to the author's knowledge.

A_∞ -categories are thus "categories" which are endowed with a collection of operations corresponding to all the higher coherent homotopies arising from the associativity up to homotopy of their composition. They are thus *operadic in essence*. The notion of ∞ -category that we are going to define below, provides another framework to study "categories whose composition is associative up to homotopy" but is, on the other hand, not operadic: it does not come with a specific set of operations encoding rigidly all the higher coherent homotopies.

1.1.2. *Intuition.* A category can be seen as the data of a set of points, its objects, together with a set of arrows between them, the morphisms. The composition is then simply an operation which produces from two arrows $A \rightarrow B$ and $B \rightarrow C$ a new arrow $A \rightarrow C$.

Part of the data of an ∞ -category will also consist in a set of objects and arrows between them. The difference will lie in the notion of composition. Given two arrows $u : A \rightarrow B$ and $v : B \rightarrow C$, an ∞ -category will have the property that there always exists a new arrow $A \rightarrow C$, which can be called a *composition* of u and v . But this arrow is not necessarily unique, and above all, it results from a property of the "category" and is not produced by an operation of composition. It is in this sense that an ∞ -category is not operadic.

1.1.3. *Definition.* The correct framework to formulate this paradigm is the one of simplicial sets. We write Δ^n for the simplicial set naturally realizing the standard n -simplex Δ^n , and Λ_n^k for the simplicial set realizing the simplicial subcomplex obtained from Δ^n by removing the faces $[0 < \dots < n]$ and $[0 < \dots < \widehat{k} < \dots < n]$. The simplicial set Λ_n^k is called a *horn*, if $0 < k < n$ it is called an *inner horn*, and if $k = 0$ or $k = n$ it is called an *outer horn*.

An ∞ -category is then defined to be a simplicial set X which has the left-lifting property with respect to all inner horn inclusions $\Lambda_n^k \rightarrow \Delta^n$: for each $n \geq 2$ and each $0 < k < n$, every simplicial

map $u : \Lambda_n^k \rightarrow X$ extends to a simplicial map $\bar{u} : \Delta^n \rightarrow X$ whose restriction to Λ_n^k is u . This is illustrated in the diagram below.

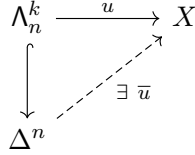

The vertices of X are then to be seen as objects, while its edges correspond to morphisms. An ∞ -groupoid, also called *Kan complex*, is defined to be a simplicial set X which has the left-lifting property with respect to all horn inclusions.

For an ∞ -category, the left-lifting property with respect to $\Lambda_2^1 \rightarrow \Delta^2$ ensures that the following diagram can always be filled by the dashed arrows

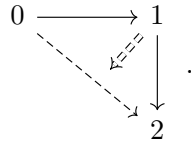

The $[0 < 2]$ edge will represent a composition of the morphisms associated to $[0 < 1]$ and $[1 < 2]$. For an ∞ -groupoid, the left-lifting property with respect to the outer horns $\Lambda_2^0 \rightarrow \Delta^2$ and $\Lambda_2^2 \rightarrow \Delta^2$ ensures that every morphism is invertible up to homotopy (hence the name *∞ -groupoid*). The intuition of subsection 1.1.2 is thus realized, and gives rise to a wide range of higher homotopies controlled by the combinatorics of simplicial algebra.

1.1.4. *Simplicial homotopy groups of a Kan complex* ([GJ99]). Let $\mathbf{X} := \{X_n\}_{n \geq 0}$ be a simplicial set. It is straightforward to define its *set of path components* $\pi_0(\mathbf{X})$. We define a *simplicial homotopy* between two simplicial maps $f, g : \Delta^n \rightarrow X$ to be a simplicial map $h : \Delta^1 \times \Delta^n \rightarrow X$ such that $h \circ (\text{id} \times d_1) = g$ and $h \circ (\text{id} \times d_0) = f$, i.e. such that the following diagram commutes

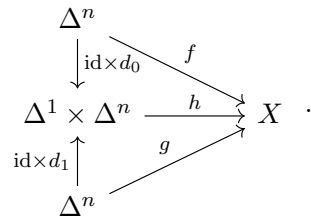

Suppose now that \mathbf{X} is a Kan complex and choose a vertex $x \in X_0$. One can associate to the pair (\mathbf{X}, x) a sequence of groups called its *simplicial homotopy groups*. For $n \geq 1$, consider the set of simplicial maps $\Delta^n \rightarrow \mathbf{X}$ taking $\partial\Delta^n$ to x . We say that two such maps $f, g : \Delta^n \rightarrow \mathbf{X}$ are equivalent if there exists a simplicial homotopy h from f to g , that maps $\Delta^1 \times \partial\Delta^n$ to x . We define $\pi_n(\mathbf{X}, x)$ to be the set of equivalence classes of such maps under this equivalence relation. It can be endowed with a composition law as follows. Given two representatives f and g in $\pi_n(\mathbf{X}, x)$, define the inner horn $\phi_{f,g} : \Lambda_{n+1}^n \rightarrow \mathbf{X}$ to send the i -th face to x for $i = 0, \dots, n - 2$, the $(n - 1)$ -th face to f and the $(n + 1)$ -th face to g . The simplicial set \mathbf{X} being a Kan complex, this horn can be filled to a $(n + 1)$ -simplex $\Phi : \Delta^{n+1} \rightarrow \mathbf{X}$. We then define $[f] \cdot [g] \in \pi_n(\mathbf{X}, x)$ to be the equivalence class of the n -th face of Φ .

The assumption that \mathbf{X} is a Kan complex then ensures that this composition law is well-defined, and that the set $\pi_n(X, x)$ endowed with this composition law is indeed a group, called the n -th (simplicial) homotopy group of \mathbf{X} at x . This group is abelian when $n \geq 2$. Moreover, it is naturally isomorphic to the classical homotopy group $\pi_n(|\mathbf{X}|, x)$ of the geometric realization $|\mathbf{X}|$ of \mathbf{X} .

1.2. Cosimplicial resolutions in model categories. One way to produce Kan complexes is through *cosimplicial resolutions* in model categories. All the results stated in this section are drawn from [Hir03]. We refer to chapters 7 and 8 for basics on model categories, and will only list the technical details that we will need in the proof of Theorem 1.

We define the simplex category Δ to be the category whose objects are nonnegative integers $[n]$ and whose sets of morphisms $\Delta([n], [m])$ consists of the increasing maps from $\{0, \dots, n\}$ to $\{0, \dots, m\}$. This is the category encoding cosimplicial objects : a cosimplicial object in a category \mathcal{C} corresponds to a functor $\Delta \rightarrow \mathcal{C}$. We denote \mathcal{C}^Δ the category of cosimplicial objects, whose morphisms are the morphisms of cosimplicial objects, i.e. the natural transformations between the associated functors $\Delta \rightarrow \mathcal{C}$. For an object $C \in \mathcal{C}$ we denote moreover const^*C the constant cosimplicial object whose cofaces and codegeneracies are the identity maps of C .

Let now \mathcal{C} be a model category. The category of cosimplicial objects \mathcal{C}^Δ can then also be endowed with a model category structure, called its *Reedy model category structure*. Its weak equivalences are the maps of cosimplicial objects that are level-wise weak equivalences in \mathcal{C} . Its cofibrant objects are the cosimplicial objects $\mathbf{C} := \{C^n\}$ such that the latching maps $L_n\mathbf{C} \rightarrow C^n$ are cofibrations in \mathcal{C} . We refer to chapters 15 and 16 of [Hir03] for a definition of latching objects and latching maps, together with a complete description of the Reedy model category structure on \mathcal{C}^Δ .

Let $C \in \mathcal{C}$. A *cosimplicial resolution* of C is defined to be a cofibrant approximation \mathbf{C} of const^*C in the model category \mathcal{C}^Δ . In other words, it is the data of a cosimplicial object $\mathbf{C} := \{C^n\}_{n \geq 0}$ of \mathcal{C} together with a cosimplicial morphism $\mathbf{C} \rightarrow \text{const}^*C$, such that the maps $C^n \rightarrow C$ are weak equivalences in \mathcal{C} and the latching maps $L_n\mathbf{C} \rightarrow C^n$ are cofibrations in \mathcal{C} .

Lemma 1 (Lemma 16.5.3 of [Hir03]). *If $\mathbf{C} \rightarrow \text{const}^*C$ is a cosimplicial resolution in \mathcal{C} and D is a fibrant object of \mathcal{C} , then the simplicial set $\mathcal{C}(\mathbf{C}, D)$ is a Kan complex.*

Following [DK80], the simplicial set $\mathcal{C}(\mathbf{C}, D)$ is called a *function complex* or *homotopy function complex* from C to D , and its homotopy type is sometimes called the *derived hom space* from C to D .

2. THE HOM-SIMPLICIAL SETS $\text{HOM}_{A_\infty\text{-Alg}}(A, B)_\bullet$

2.1. The HOM-simplicial set $\text{HOM}_{A_\infty}(A, B)_\bullet$ is a Kan complex. The HOM-simplicial sets $\text{HOM}_{A_\infty\text{-Alg}}(A, B)_\bullet$ provide a satisfactory framework to study the higher algebra of A_∞ -algebras thanks to the following theorem :

Theorem 1. *For A and B two A_∞ -algebras, the simplicial set $\text{HOM}_{A_\infty}(A, B)_\bullet$ is a Kan complex.*

The simplicial homotopy groups of this Kan complex are computed in subsection 2.4. In fact, we can moreover give an explicit description of all inner horn fillers :

Proposition 11. *For every inner horn $\Lambda_n^k \subset \Delta^n$, there is a one-to-one correspondence*

$$\left\{ \begin{array}{ccc} \Lambda_n^k & \longrightarrow & \text{HOM}_{A_\infty}(A, B)_\bullet \\ \downarrow & \nearrow & \\ \Delta^n & & \end{array} \right\} \longleftrightarrow \left\{ \begin{array}{l} \text{families of maps of degree } -n \\ F_{\Delta^n}^{(m)} : (sA)^{\otimes m} \rightarrow sB, m \geq 1 \end{array} \right\} .$$

In other words, the Kan complex $\text{HOM}_{A_\infty}(A, B)_\bullet$ is in particular an algebraic ∞ -category.

Note that our choice of terminology *algebraic ∞ -category* is borrowed from [RNV20].

One aspect of this construction needs however to be clarified. The points of these ∞ -groupoids are the A_∞ -morphisms, and the arrows between them are the A_∞ -homotopies. This can be misleading at first sight, but *the points are the morphisms and NOT the algebras and the arrows are the homotopies and NOT the morphisms.*

2.2. Proof of Theorem 1.

2.2.1. *The model category structure on $\text{dg} - \text{Cogc}$.* Let C be a dg-coalgebra. Define for every $n \geq 2$,

$$\begin{aligned} \Delta^{(n)} &:= (\text{id}^{\otimes n-2} \otimes \Delta) \circ (\text{id}^{\otimes n-3} \otimes \Delta) \circ \cdots \circ \Delta \\ F_n C &:= \text{Ker}(\Delta^{(n+1)}) . \end{aligned}$$

We say that C is cocomplete if $C = \cup_{n \geq 1} F_n C$. Every tensor coalgebra \overline{TV} is cocomplete. Given any coalgebra C and any cocomplete coalgebra D , their tensor product $C \otimes D$ is also a cocomplete dg-coalgebra.

We denote $\text{dg} - \text{Cogc} \subset \text{dg} - \text{Cog}$ the full subcategory of cocomplete dg-coalgebras. We introduce moreover $\text{dg} - \text{Alg}$, the category of dg-algebras with morphisms of dg-algebras between them. These two categories can then be related through the classical bar-cobar adjunction

$$\Omega : \text{dg} - \text{Cogc} \xrightleftharpoons[\perp]{} \text{dg} - \text{Alg} : B .$$

Theorem 1.3.1.2 of [LH02] states that the category $\text{dg} - \text{Cogc}$ can be made into a model category with the three following classes of morphisms :

- (i) the class of *weak equivalences* is the class of morphisms $f : C \rightarrow C'$ such that $\Omega f : \Omega C \rightarrow \Omega C'$ is a quasi-isomorphism ;
- (ii) the class of *cofibrations* is the class of morphisms which are monomorphisms when seen as standard morphisms between cochain complexes ;
- (iii) the class of *fibrations* is the class of morphisms which admit the right-lifting property with respect to trivial cofibrations.

We point out that a weak equivalence between cocomplete dg-coalgebras is always a quasi-isomorphism, but the converse is not true. We list in Lemma 2 some noteworthy properties of this model category structure on $\text{dg} - \text{Cogc}$ that we will need in our upcoming proof of Theorem 1. They can all be found in section 1.3 of [LH02].

Let C be a dg- \mathbb{Z} -module. A *filtration* of C is defined to be a sequence of sub-dg- \mathbb{Z} -modules $C_i \subset C$ such that

$$C_0 \subset C_1 \subset \cdots \subset C_i \subset C_{i+1} \subset \cdots .$$

It is *admissible* if $\text{colim}(C_i) = C$ and $C_0 = 0$. Given two filtered dg- \mathbb{Z} -modules C and C' , one can then define a *filtered morphism* $f : C \rightarrow C'$ to be a dg-morphism such that $\forall i, f(C_i) \subset C'_i$. It is defined to be a *filtered quasi-isomorphism* if $\forall i$, the induced morphism

$$f_i : C_i/C_{i-1} \longrightarrow C'_i/C'_{i-1}$$

is a quasi-isomorphism. A *filtered dg-coalgebra* is then defined to be a coalgebra in the category of filtered dg- \mathbb{Z} -modules, in other words a dg-coalgebra together with a filtration C_i on its underlying dg- \mathbb{Z} -module and whose coproduct satisfies

$$\Delta_C(C_i) \subset \bigoplus_{p+q=i} C_p \otimes C_q \quad \forall i .$$

Lemma 2 ([LH02]). (1) *Every dg-coalgebra in $\mathbf{dg-Cogc}$ is cofibrant.*

(2) *A dg-coalgebra in $\mathbf{dg-Cogc}$ is fibrant if and only if it is isomorphic as a graded coalgebra to a tensor coalgebra \overline{TV} .*

(3) *Filtered quasi-isomorphisms between admissible filtered cocomplete dg-coalgebras are weak equivalences.*

2.2.2. *Proof of Theorem 1.* Recall that the simplicial set $\text{HOM}_{\mathbf{A}_\infty\text{-Alg}}(A, B)_\bullet$ is defined as

$$\text{HOM}_{\mathbf{A}_\infty\text{-Alg}}(A, B)_n = \text{Hom}_{\mathbf{dg-Cogc}}(\Delta^n \otimes \overline{T}(sA), \overline{T}(sB)) .$$

Following Lemma 2, the cocomplete dg-coalgebra $\overline{T}(sB)$ is fibrant. It is thus enough to prove that the cosimplicial cocomplete dg-coalgebra $\mathbf{C} := \{\Delta^n \otimes \overline{T}(sA)\}_{n \geq 0}$ is a cosimplicial replacement of $\overline{T}(sA)$ and then apply Lemma 1 in the model category $\mathbf{dg-Cogc}$, to conclude that $\text{HOM}_{\mathbf{A}_\infty\text{-Alg}}(A, B)_\bullet$ is a Kan complex. Following subsection 1.2, we have to prove that :

- (i) the latching maps $L_n \mathbf{C} \rightarrow C^n = \Delta^n \otimes \overline{T}(sA)$ are cofibrations, i.e. they are injective ;
- (ii) the maps $p \otimes \text{Id}_{\overline{T}(sA)} : \Delta^n \otimes \overline{T}(sA) \rightarrow \Delta^0 \otimes \overline{T}(sA) = \overline{T}(sA)$ are weak equivalences in the model category $\mathbf{dg-Cogc}$, where $p : \Delta^n \rightarrow \Delta^0$ is the map collapsing the simplex Δ^n on one of its vertices.

The latching map $L_n \mathbf{C} \rightarrow C^n$ simply corresponds to the inclusion $\partial \Delta^n \otimes \overline{T}(sA) \hookrightarrow \Delta^n \otimes \overline{T}(sA)$, hence is injective. See chapters 15 and 16 of [Hir03] for details on how to compute $L_n \mathbf{C}$. This proves point (i).

To prove point (ii), Lemma 2 states that it is enough to show that $p \otimes \text{Id}_{\overline{T}(sA)}$ is in fact a filtered quasi-isomorphism. Endow $\Delta^n \otimes \overline{T}(sA)$ with the filtration

$$F_i(\Delta^n \otimes \overline{T}(sA)) := \Delta^n \otimes \bigoplus_{j=1}^i (sA)^{\otimes j} .$$

This filtration is admissible. To prove that $p \otimes \text{Id}_{\overline{T}(sA)}$ is a filtered quasi-isomorphism of admissible filtered dg-coalgebras, we have to prove that the maps

$$p \otimes \text{Id}_{(sA)^{\otimes i}} : \Delta^n \otimes (sA)^{\otimes i} \longrightarrow (sA)^{\otimes i}$$

are quasi-isomorphisms. This is a simple consequence of the fact that the dg-module Δ^n is a deformation retract of Δ^0 . Indeed, defining the degree 0 dg-morphism $i : \Delta^0 \rightarrow \Delta^n$ as $[0] \rightarrow [0]$ and the degree -1 map $h : \Delta^n \rightarrow \Delta^0$ as

$$\begin{aligned} [i_0 < \cdots < i_k] &\longmapsto 0 && \text{if } i_0 = 0, \\ [i_0 < \cdots < i_k] &\longmapsto [0 < i_0 < \cdots < i_k] && \text{if } i_0 \neq 0, \end{aligned}$$

we check that $pi = \text{Id}$ and $\text{Id} - ip = [\partial, h]$. This concludes the proof of Theorem 1.

2.3. Proof of Proposition 11.

2.3.1. *Proof of Proposition 11.* Let A and B be two A_∞ -algebras. We now prove Proposition 11, using the shifted bar construction framework, that is by defining an A_∞ -algebra to be a set of degree +1 operations $b_n : (sA)^{\otimes n} \rightarrow sA$ satisfying equations

$$\sum_{i_1+i_2+i_3=n} b_{i_1+1+i_3}(\text{id}^{\otimes i_1} \otimes b_{i_2} \otimes \text{id}^{\otimes i_3}) = 0.$$

The proof will mainly consist of easy but tedious combinatorics. We recommend reading it in two steps : first ignoring the signs ; then adding them at the second reading stage and referring to section 4.2 for the sign conventions on the shifted A_∞ -equations.

Consider an inner horn $\Lambda_n^k \rightarrow \text{HOM}_{A_\infty}(A, B)_\bullet$, where $0 < k < n$. It corresponds to a collection of degree $-\dim(I)$ morphisms

$$F_I^{(m)} : (sA)^{\otimes m} \longrightarrow sB$$

for $I \subset \Lambda_n^k$, which satisfy the A_∞ -equations

$$\sum_{j=0}^{\dim(I)} (-1)^j F_{\partial_j I}^{(m)} + (-1)^{|I|} \sum_{i_1+i_2+i_3=m} F_I^{(i_1+1+i_3)}(\text{id}^{\otimes i_1} \otimes b_{i_2} \otimes \text{id}^{\otimes i_3}) = \sum_{\substack{i_1+\dots+i_s=m \\ I_1 \cup \dots \cup I_s = I}} b_s(F_{I_1}^{(i_1)} \otimes \dots \otimes F_{I_s}^{(i_s)}).$$

Filling this horn amounts then to defining a collection of operations

$$F_{[0 < \dots < \widehat{k} < \dots < n]}^{(m)} : (sA)^{\otimes m} \longrightarrow sB \text{ and } F_{\Delta^n}^{(m)} : (sA)^{\otimes m} \longrightarrow sB,$$

of respective degree $-(n-1)$ and $-n$, and respectively satisfying the equations

$$\begin{aligned} \sum_{l=0}^{n-1} (-1)^l F_{\partial_l [0 < \dots < \widehat{k} < \dots < n]}^{(m)} + (-1)^{n-1} \sum_{i_1+i_2+i_3=m} F_{[0 < \dots < \widehat{k} < \dots < n]}^{(i_1+1+i_3)}(\text{id}^{\otimes i_1} \otimes b_{i_2} \otimes \text{id}^{\otimes i_3}) \\ \text{(i)} \qquad \qquad \qquad = \sum_{\substack{i_1+\dots+i_s=m \\ I_1 \cup \dots \cup I_s = [0 < \dots < \widehat{k} < \dots < n]}} b_s(F_{I_1}^{(i_1)} \otimes \dots \otimes F_{I_s}^{(i_s)}), \end{aligned}$$

and

$$\begin{aligned} \sum_{j=0}^n (-1)^j F_{\partial_j \Delta^n}^{(m)} + (-1)^n \sum_{i_1+i_2+i_3=m} F_{\Delta^n}^{(i_1+1+i_3)}(\text{id}^{\otimes i_1} \otimes b_{i_2} \otimes \text{id}^{\otimes i_3}) \\ \text{(ii)} \qquad \qquad \qquad = \sum_{\substack{i_1+\dots+i_s=m \\ I_1 \cup \dots \cup I_s = \Delta^n}} b_s(F_{I_1}^{(i_1)} \otimes \dots \otimes F_{I_s}^{(i_s)}). \end{aligned}$$

We begin by pointing out that the operations $F_{\Delta^n}^{(m)}$ indeed completely determine the maps $F_{[0 < \dots < \widehat{k} < \dots < n]}^{(m)}$ under the formula

$$F_{[0 < \dots < \widehat{k} < \dots < n]}^{(m)} = (-1)^k \left(\sum_{\substack{j=0 \\ j \neq k}}^n (-1)^{j+1} F_{[0 < \dots < \widehat{j} < \dots < n]}^{(m)} + \sum_{\substack{i_1 + \dots + i_s = m \\ I_1 \cup \dots \cup I_s = \Delta^n}} b_s(F_{I_1}^{(i_1)} \otimes \dots \otimes F_{I_s}^{(i_s)}) \right. \\ \left. + (-1)^{n+1} \sum_{i_1 + i_2 + i_3 = m} F_{\Delta^n}^{(i_1+1+i_3)}(\text{id}^{\otimes i_1} \otimes b_{i_2} \otimes \text{id}^{\otimes i_3}) \right).$$

To prove Proposition 11, it remains to show that for any collection of operations $(F_{\Delta^n}^{(m)})_{m \geq 1}$, we can fill the inner horn $\Lambda_n^k \rightarrow \text{HOM}_{A_\infty}(A, B)_\bullet$ by defining the operations $F_{[0 < \dots < \widehat{k} < \dots < n]}^{(m)}$ as above. Note that the $F_{[0 < \dots < \widehat{k} < \dots < n]}^{(m)}$ are well-defined as all the morphisms $F_I^{(m)}$ appearing in their definition correspond to faces of the horn Λ_n^k or to the $F_{\Delta^n}^{(m)}$.

It is clear that this choice of filler satisfies equations (ii), and we have now to verify that equations (i) are satisfied. For the sake of readability, we will only carry out the details of the proof in the case where $F_{\Delta^n}^{(m)} = 0$ for all m . In this regard, we will list one by one the terms of the left-hand side and right-hand side of this equality with their signs, and use the A_∞ -equations for the b_i and the $F_I^{(m)}$ where $I \subset \Lambda_n^k$, in order to show that the two sides are indeed equal.

The left-hand side consists of the following terms :

$$(A) \quad (-1)^l F_{\partial_l [0 < \dots < \widehat{k} < \dots < n]}^{(m)}$$

for $l = 0, \dots, n-1$;

$$(B) \quad (-1)^{n+k+j} F_{[0 < \dots < \widehat{j} < \dots < n]}^{(i_1+1+i_3)}(\text{id}^{\otimes i_1} \otimes b_{i_2} \otimes \text{id}^{\otimes i_3})$$

for $i_1 + i_2 + i_3 = m$ and $j = 0, \dots, \widehat{k}, \dots, m$;

$$(C) \quad (-1)^{n-1+k} b_s(F_{I_1}^{(j_1)} \otimes \dots \otimes F_{I_s}^{(j_s)})(\text{id}^{\otimes i_1} \otimes b_{i_2} \otimes \text{id}^{\otimes i_3})$$

for $i_1 + i_2 + i_3 = m$, $j_1 + \dots + j_s = i_1 + 1 + i_3$ and $I_1 \cup \dots \cup I_s = \Delta^n$ with $I_u \neq \Delta^n$ for all u .

The right-hand side has the following terms :

$$(D) \quad b_s(F_{I_1}^{(i_1)} \otimes \dots \otimes F_{I_s}^{(i_s)})$$

for $i_1 + \dots + i_s = m$ and $I_1 \cup \dots \cup I_s = [0 < \dots < \widehat{k} < \dots < n]$ with $I_u \neq [0 < \dots < \widehat{k} < \dots < n]$ for all u ;

$$(E) \quad (-1)^k b_s(F_{I_1}^{(i_1)} \otimes \dots \otimes F_{I_{t-1}}^{(i_{t-1})} \otimes b_q(F_{J_1}^{(j_1)} \otimes \dots \otimes F_{J_q}^{(j_q)}) \otimes F_{I_{t+1}}^{(i_{t+1})} \otimes \dots \otimes F_{I_s}^{(i_s)})$$

where, setting $I_t = J_1 \cup \dots \cup J_q$, $i_t = j_1 + \dots + j_q$, $i_1 + \dots + i_s = m$ and $I_1 \cup \dots \cup I_s = \Delta^n$, with $I_t = \Delta^n$ and $J_r \neq \Delta^n$ for all r ;

$$(F) \quad (-1)^{j+k+1} b_s(F_{I_1}^{(i_1)} \otimes \dots \otimes F_{I_t}^{(i_t)} \otimes \dots \otimes F_{I_s}^{(i_s)})$$

for $j = 0, \dots, \widehat{k}, \dots, n$, where $i_1 + \dots + i_s = m$ and $I_1 \cup \dots \cup I_s = [0 < \dots < \widehat{j} < \dots < n]$ with $I_t = [0 < \dots < \widehat{j} < \dots < n]$.

Our goal is to prove that $A + B + C = D + E + F$ or equivalently, that

$$A + B + C - D - E - F = 0 .$$

Applying the A_∞ -equations for the $F_{[0 < \dots < \widehat{j} < \dots < n]}^{(m)}$, $j \neq k$, we have that

$$A + B - F = G ,$$

the terms of the sum G being of the form

$$(G) \quad (-1)^{j+k+1} b_s(F_{I_1}^{(i_1)} \otimes \dots \otimes F_{I_s}^{(i_s)})$$

where $j = 0, \dots, \widehat{k}, \dots, n$, $i_1 + \dots + i_s = m$ and $I_1 \cup \dots \cup I_s = [0 < \dots < \widehat{j} < \dots < n]$ with $I_u \neq [0 < \dots < \widehat{j} < \dots < n]$ for all u .

Applying now the A_∞ -equations for the $F_{I_u}^{(i_u)}$, where $I_u \neq \Delta^n$, yields the equality

$$C - D + G = H ,$$

the terms of the sum H having the form

$$(H) \quad (-1)^{n-1+k+\sum_{u=t}^s |I_u|} b_s(F_{I_1}^{(i_1)} \otimes \dots \otimes F_{I_{t-1}}^{(i_{t-1})} \otimes b_q(F_{J_1}^{(j_1)} \otimes \dots \otimes F_{J_q}^{(j_q)}) \otimes F_{I_{t+1}}^{(i_{t+1})} \otimes \dots \otimes F_{I_s}^{(i_s)})$$

where, setting $I_t = J_1 \cup \dots \cup J_q$ and $i_t = j_1 + \dots + j_q$, $i_1 + \dots + i_s = m$ and $I_1 \cup \dots \cup I_s = \Delta^n$ with $I_u \neq \Delta^n$ for all u .

Finally, applying the A_∞ -equations for the b_i proves the equality

$$-E + H = 0 ,$$

which concludes the proof.

2.3.2. Remark on the proof. We point out that this proof does not adapt to the more general case of a HOM-simplicial set $\text{HOM}_{\text{dg-Cog}}(C, C')_\bullet$. Indeed, while we can always solve the equation

$$[\partial, f_{\Delta^n}] = \sum_{j=0}^n (-1)^j f_{[0 < \dots < \widehat{j} < \dots < n]} ,$$

by setting $f_{\Delta^n} = 0$ and $f_{[0 < \dots < \widehat{k} < \dots < n]} = (-1)^k \sum_{j=0, \neq k}^n (-1)^{j+1} f_{[0 < \dots < \widehat{j} < \dots < n]}$, this choice of morphisms falls short to satisfy the equation

$$\Delta_{C'} f_{\Delta^n} = \sum_{I_1 \cup I_2 = \Delta^n} (f_{I_1} \otimes f_{I_2}) \Delta_C .$$

2.4. Homotopy groups. The simplicial set $\text{HOM}_{A_\infty\text{-Alg}}(A, B)_\bullet$ being a Kan complex, we can in particular compute its simplicial homotopy groups. We fix throughout the rest of this subsection an A_∞ -morphism F from A to B , i.e. a point of $\text{HOM}_{A_\infty\text{-Alg}}(A, B)_\bullet$. We will moreover work with the suspended definition of n -morphisms that we already used in subsection 2.3.1.

Proposition 12. *The set of path components $\pi_0(\text{HOM}_{A_\infty\text{-Alg}}(A, B)_\bullet)$ corresponds to the set of equivalence classes of A_∞ -morphisms from A to B under the equivalence relation "being A_∞ -homotopic".*

A simplicial map $\Delta^n \rightarrow \mathrm{HOM}_{\mathbf{A}_\infty\text{-Alg}}(A, B)_\bullet$ taking $\partial\Delta^n$ to F corresponds to a n -morphism $(F_I^{(m)})_{I \subset \Delta^n}^{m \geq 1}$ such that $F_I^{(m)} = F^{(m)}$ for all I such that $\dim(I) = 0$ and $F_I^{(m)} = 0$ for all I such that $0 < \dim(I) < n$. In other words, this simplicial map simply corresponds to the data of maps $F_{\Delta^n}^{(m)} : (sA)^{\otimes m} \rightarrow sB$ of degree $-n$ such that

$$\begin{aligned} & (-1)^n \sum_{i_1+i_2+i_3=m} F_{\Delta^n}^{(i_1+1+i_3)} (\mathrm{id}^{\otimes i_1} \otimes b_{i_2} \otimes \mathrm{id}^{\otimes i_3}) \\ (\star) \quad & = \sum_{\substack{i_1+\dots+i_s+l \\ +j_1+\dots+j_t=m}} b_{s+1+t} \left(F^{(i_1)} \otimes \dots \otimes F^{(i_s)} \otimes F_{\Delta^n}^{(l)} \otimes F^{(j_1)} \otimes \dots \otimes F^{(j_t)} \right). \end{aligned}$$

Proposition 13. *Let $\mathcal{F}, \mathcal{G} : \Delta^n \rightarrow \mathrm{HOM}_{\mathbf{A}_\infty\text{-Alg}}(A, B)_\bullet$ be two simplicial maps taking $\partial\Delta^n$ to F , that we will respectively denote $(F_{\Delta^n}^{(m)})$ and $(G_{\Delta^n}^{(m)})$. Two such maps are then equivalent under the simplicial homotopy relation if and only if there exists a collection of maps $H^{(m)} : (sA)^{\otimes m} \rightarrow sB$ of degree $-(n+1)$ such that*

$$\begin{aligned} & G_{\Delta^n}^{(m)} - F_{\Delta^n}^{(m)} + (-1)^{n+1} \sum_{i_1+i_2+i_3=m} H^{(i_1+1+i_3)} (\mathrm{id}^{\otimes i_1} \otimes b_{i_2} \otimes \mathrm{id}^{\otimes i_3}) \\ & = \sum_{\substack{i_1+\dots+i_s+l \\ +j_1+\dots+j_t=m}} b_{s+1+t} (F^{(i_1)} \otimes \dots \otimes F^{(i_s)} \otimes H^{(l)} \otimes F^{(j_1)} \otimes \dots \otimes F^{(j_t)}). \end{aligned}$$

Proof. Recall from subsection 1.1.4 that a simplicial homotopy from \mathcal{F} to \mathcal{G} is defined to be a simplicial map $\mathcal{H} : \Delta^1 \times \Delta^n \rightarrow \mathrm{HOM}_{\mathbf{A}_\infty\text{-Alg}}(A, B)_\bullet$ such that $\mathcal{H}|_{[0] \times \Delta^n} = \mathcal{F}$, $\mathcal{H}|_{[1] \times \Delta^n} = \mathcal{G}$ and that maps $\Delta^1 \times \partial\Delta^n$ to F . Beware that the datum of a simplicial map $\mathcal{H} : \Delta^1 \times \Delta^n \rightarrow \mathrm{HOM}_{\mathbf{A}_\infty\text{-Alg}}(A, B)_\bullet$ is in general NOT equivalent to a morphism of dg-coalgebras $\Delta^1 \otimes \Delta^n \otimes \overline{T}(sA) \rightarrow \overline{T}(sB)$. To understand the map \mathcal{H} , we first have to make explicit the non-degenerate simplices of the simplicial set $\Delta^1 \times \Delta^n$.

Recall that the k -simplices of the simplicial set Δ^m are the monotone sequences of integers bounded by 0 and m

$$\left(i_0 \ i_1 \ \dots \ i_k \right) \text{ where } 0 \leq i_0 \leq i_1 \leq \dots \leq i_k \leq m.$$

Following [Mil57], the non-degenerate k -simplices of the simplicial set $\Delta^1 \times \Delta^n$ are then labeled by all pairs composed of a k -simplex σ of Δ^1 and a k -simplex σ' of Δ^n such that there does not exist $0 \leq j < k$ such that $\sigma_j = \sigma_{j+1}$ and $\sigma'_j = \sigma'_{j+1}$. For instance, the following two pairs of sequences label non-degenerate 3-simplices of $\Delta^1 \times \Delta^3$

$$\left(\begin{array}{cccc} 0 & 0 & 0 & 1 \\ 0 & 1 & 2 & 3 \end{array} \right) \qquad \left(\begin{array}{cccc} 0 & 0 & 1 & 1 \\ 0 & 1 & 1 & 2 \end{array} \right),$$

while the following pair of sequences is a degenerate 3-simplex of $\Delta^1 \times \Delta^3$

$$\left(\begin{array}{cccc} 0 & 0 & 0 & 1 \\ 0 & 1 & 1 & 3 \end{array} \right).$$

We will use the following properties of the non-degenerate simplices of the simplicial set $\Delta^1 \times \Delta^n$ in our proof of proposition 13 :

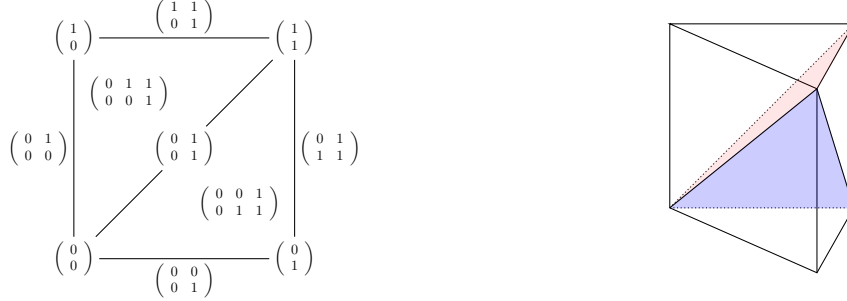

FIGURE 13. On the left, the labeling of the non-degenerate simplices of $\Delta^1 \times \Delta^1$. On the right, the (unlabeled) non-degenerate simplices of $\Delta^1 \times \Delta^2$. The two inner non-degenerate 2-simplices of $\Delta^1 \times \Delta^2$ are colored in red and in blue.

- (i) There are exactly $n + 1$ non-degenerate $(n + 1)$ -simplices, labeled by the pairs of sequences

$$\begin{pmatrix} 0 & 0 & 0 & \cdots & 0 & 1 & 1 & \cdots & 1 \\ 0 & 1 & 2 & \cdots & k & k & k + 1 & \cdots & n \end{pmatrix}.$$

The non-degenerate $(n + 1)$ -simplex labeled by the above pair of sequences will be called the k -th non-degenerate $(n + 1)$ -simplex of $\Delta^1 \times \Delta^n$.

- (ii) All non-degenerate simplices of dimension $\leq n - 1$ lie in $\Delta^1 \times \partial\Delta^n$.
 (iii) All simplices of dimension $\geq n + 2$ are degenerate.
 (iv) There are exactly n non-degenerate n -simplices lying in the interior of $\Delta^1 \times \Delta^n$. They are labeled by the pairs of sequences

$$\begin{pmatrix} 0 & 0 & \cdots & 0 & 1 & 1 & \cdots & 1 \\ 0 & 1 & \cdots & k - 1 & k & k + 1 & \cdots & n \end{pmatrix} \text{ for } 1 \leq k \leq n.$$

The non-degenerate n -simplex labeled by the above pair of sequences will be called the k -th inner non-degenerate n -simplex of $\Delta^1 \times \Delta^n$.

We point out that taking the l -th face of a simplex of $\Delta^1 \times \Delta^n$ simply corresponds to deleting the l -th column of the array labeling it. For instance,

$$\partial_1 \begin{pmatrix} 0 & 0 & 1 & 1 \\ 0 & 1 & 1 & 2 \end{pmatrix} = \begin{pmatrix} 0 & 1 & 1 \\ 0 & 1 & 2 \end{pmatrix} \quad \partial_3 \begin{pmatrix} 0 & 0 & 1 & 1 \\ 0 & 1 & 1 & 2 \end{pmatrix} = \begin{pmatrix} 0 & 0 & 1 \\ 0 & 1 & 1 \end{pmatrix}.$$

A simplicial homotopy $\mathcal{H} : \Delta^1 \times \Delta^n \rightarrow \text{HOM}_{A_\infty\text{-Alg}}(A, B)_\bullet$ is equivalent to the data of maps $H_K^{(m)} : (sA)^{\otimes m} \rightarrow sB$ for every non-degenerate simplex K of $\Delta^1 \times \Delta^n$, which moreover satisfy the A_∞ -equations for higher morphisms. According to the previous description of the non-degenerate simplices of $\Delta^1 \times \Delta^n$:

- (i) The condition $\Delta^1 \times \partial\Delta^n \mapsto F$ implies that for every non-degenerate simplex K of dimension $1 \leq \dim(K) \leq n - 1$, $H_K^{(m)} = 0$, and for every vertex v of $\Delta^1 \times \Delta^n$, $H_v^{(m)} = F^{(m)}$. This also implies that all non-degenerate n -simplices K lying in $\Delta^1 \times \partial\Delta^n$ are such that $H_K^{(m)} = 0$.
 (ii) The condition $\mathcal{H}|_{[0] \times \Delta^n} = \mathcal{F}$, $\mathcal{H}|_{[1] \times \Delta^n} = \mathcal{G}$ implies that the non-degenerate n -simplices $[0] \times \Delta^n$ and $[1] \times \Delta^n$ are respectively sent to the $F_{\Delta^n}^{(m)}$ and the $G_{\Delta^n}^{(m)}$.

- (iii) For K the k -th inner non-degenerate n -simplex, we will write $L_k^{(m)} := H_K^{(m)}$. For a fixed k , the maps $L_k^{(m)}$ satisfy the same A_∞ -equations (\star) as $F_{\Delta^n}^{(m)}$ and $G_{\Delta^n}^{(m)}$. We moreover set $L_{n+1}^{(m)} := F_{\Delta^n}^{(m)}$ and $L_0^{(m)} := G_{\Delta^n}^{(m)}$.
- (iv) Finally, we denote $H_k^{(m)}$ for the collection of maps associated to the k -th $(n+1)$ -simplex. It satisfies the following A_∞ -equations

$$\begin{aligned} & (-1)^{k+1} L_{k+1}^{(m)} + (-1)^k L_k^{(m)} + (-1)^{n+1} \sum_{i_1+i_2+i_3=m} H_k^{(i_1+1+i_3)}(\text{id}^{\otimes i_1} \otimes b_{i_2} \otimes \text{id}^{\otimes i_3}) \\ = & \sum_{\substack{i_1+\dots+i_s+l \\ +j_1+\dots+j_t=m}} b_{s+1+t}(F^{(i_1)} \otimes \dots \otimes F^{(i_s)} \otimes H_k^{(l)} \otimes F^{(j_1)} \otimes \dots \otimes F^{(j_t)}). \end{aligned}$$

Using this characterization of a simplicial homotopy from \mathcal{F} to \mathcal{G} , we check that the collection of degree $-(n+1)$ maps

$$H^{(m)} := \sum_{k=0}^n (-1)^k H_k^{(m)}$$

is such that

$$\begin{aligned} & G_{\Delta^n}^{(m)} - F_{\Delta^n}^{(m)} + (-1)^{n+1} \sum_{i_1+i_2+i_3=m} H^{(i_1+1+i_3)}(\text{id}^{\otimes i_1} \otimes b_{i_2} \otimes \text{id}^{\otimes i_3}) \\ = & \sum_{\substack{i_1+\dots+i_s+l \\ +j_1+\dots+j_t=m}} b_{s+1+t}(F^{(i_1)} \otimes \dots \otimes F^{(i_s)} \otimes H^{(l)} \otimes F^{(j_1)} \otimes \dots \otimes F^{(j_t)}). \end{aligned}$$

Conversely, we check that such a collection of maps can be arranged into a simplicial homotopy from \mathcal{F} to \mathcal{G} , by defining $L_0^{(m)} := G_{\Delta^n}^{(m)}$, $L_k^{(m)} := F_{\Delta^n}^{(m)}$ for $k \geq 1$, $H_0^{(m)} := H^{(m)}$ and $H_k^{(m)} := 0$ for $k \geq 1$. This concludes the proof of the proposition. \square

We finally make explicit the composition law on these simplicial homotopy groups. Consider $(F_{\Delta^n}^{(m)})^{m \geq 1}$ and $(G_{\Delta^n}^{(m)})^{m \geq 1}$ two representatives in $\pi_n(\text{HOM}_{\mathbf{A}_\infty\text{-Alg}}(A, B)_\bullet, F)$. Filling the cone $\phi_{F_{\Delta^n}, G_{\Delta^n}} : \Lambda_{n+1}^n \rightarrow \text{HOM}_{\mathbf{A}_\infty\text{-Alg}}(A, B)_\bullet$ defined in subsection 1.1.4 with $\phi_{\Delta_{n+1}}^{(m)} = 0$ as in the proof of Proposition 11, we get that a representative for $[\mathcal{F}] \cdot [\mathcal{G}]$ is

$$G_{\Delta^1}^{(m)} + F_{\Delta^1}^{(m)} - \sum_{\substack{i_1+\dots+i_s+l_1 \\ +j_1+\dots+j_t+l_2 \\ +k_1+\dots+k_u=m}} b_{s+t+u+2}(F^{(i_1)} \otimes \dots \otimes F^{(i_s)} \otimes F_{\Delta^1}^{(l_1)} \otimes F^{(j_1)} \otimes \dots \otimes F^{(j_t)} \otimes G_{\Delta^1}^{(l_2)} \otimes F^{(k_1)} \otimes \dots \otimes F^{(k_u)}).$$

in the $n = 1$ case, and

$$G_{\Delta^n}^{(m)} + F_{\Delta^n}^{(m)}$$

if $n \geq 2$. We get in particular that this composition law is indeed abelian when $n \geq 2$. All of our computations are summarized in the following theorem :

Theorem 2. *(i) For $n \geq 1$, the set $\pi_n(\text{HOM}_{\mathbf{A}_\infty\text{-Alg}}(A, B)_\bullet, F)$ corresponds to the equivalence classes of collections of degree $-n$ maps $F_{\Delta^n}^{(m)} : (sA)^{\otimes m} \rightarrow sB$ satisfying equations \star , where two such collections of maps $(F_{\Delta^n}^{(m)})^{m \geq 1}$ and $(G_{\Delta^n}^{(m)})^{m \geq 1}$ are equivalent if and only if there*

exists a collection of degree $-(n+1)$ maps $H^{(m)} : (sA)^{\otimes m} \rightarrow sB$ such that

$$\begin{aligned} & G_{\Delta^n}^{(m)} - F_{\Delta^n}^{(m)} + (-1)^{n+1} \sum_{i_1+i_2+i_3=m} H^{(i_1+1+i_3)}(\text{id}^{\otimes i_1} \otimes b_{i_2} \otimes \text{id}^{\otimes i_3}) \\ &= \sum_{\substack{i_1+\dots+i_s+l \\ +j_1+\dots+j_t=m}} b_{s+1+t}(F^{(i_1)} \otimes \dots \otimes F^{(i_s)} \otimes H^{(l)} \otimes F^{(j_1)} \otimes \dots \otimes F^{(j_t)}) . \end{aligned}$$

(ii) The composition law on $\pi_1(\text{HOM}_{A_\infty\text{-Alg}}(A, B)_\bullet, F)$ is given by the formula

$$G_{\Delta^1}^{(m)} + F_{\Delta^1}^{(m)} - \sum_{\substack{i_1+\dots+i_s+l_1 \\ +j_1+\dots+j_t+l_2 \\ +k_1+\dots+k_u=m}} b_{s+t+u+2}(F^{(i_1)} \otimes \dots \otimes F^{(i_s)} \otimes F_{\Delta^1}^{(l_1)} \otimes F^{(j_1)} \otimes \dots \otimes F^{(j_t)} \otimes G_{\Delta^1}^{(l_2)} \otimes F^{(k_1)} \otimes \dots \otimes F^{(k_u)}) .$$

(iii) If $n \geq 2$, the composition law on $\pi_n(\text{HOM}_{A_\infty\text{-Alg}}(A, B)_\bullet, F)$ is given by the formula

$$G_{\Delta^n}^{(m)} + F_{\Delta^n}^{(m)} .$$

2.5. A conjecture on the HOM-simplicial sets $\text{HOM}_{\Omega BAs\text{-Alg}}(A, B)_\bullet$. Given A and B two ΩBAs -algebras, we define the HOM-simplicial set

$$\text{HOM}_{\Omega BAs\text{-Alg}}(A, B)_n := \text{Hom}_{(\Omega BAs, \Omega BAs)\text{-op.bimod.}}(n - \Omega BAs - \text{Morph}, \text{Hom}(A, B)) .$$

Drawing from Theorem 1, we conjecture the following result :

Conjecture 1. *The simplicial sets $\text{HOM}_{\Omega BAs\text{-Alg}}(A, B)_\bullet$ are ∞ -categories.*

The proof without signs should follow the same lines as the proof without signs of Theorem 1, working this time with stable ribbon trees and gauged stable ribbon trees instead of corollae. The sign computations will however be much more complicated, as we did not describe a construction analogous to the shifted bar construction which would yield ad hoc sign conventions.

3. HIGHER FUNCTORS AND PRE-NATURAL TRANSFORMATIONS BETWEEN A_∞ -CATEGORIES

3.1. n -functors between A_∞ -categories. Recall that an A_∞ -category \mathcal{A} is defined to be the data

- (i) of a collection of objects $\text{Ob}(\mathcal{A})$;
- (ii) for every $A_0, A_1 \in \text{Ob}(\mathcal{A})$ of a dg-module $\mathcal{A}(A_0, A_1)$;
- (iii) for every $A_0, \dots, A_n \in \text{Ob}(\mathcal{A})$ of a degree $2-n$ map

$$m_n : \mathcal{A}(A_0, A_1) \otimes \dots \otimes \mathcal{A}(A_{n-1}, A_n) \longrightarrow \mathcal{A}(A_0, A_n) ,$$

such that the maps m_n satisfy a categorical version of the A_∞ -equations for A_∞ -algebras.

The maps m_n are called the *higher compositions* of \mathcal{A} and are to be thought of as the higher homotopies encoding the lack of associativity of the composition maps m_2 . In particular, an A_∞ -category \mathcal{A} induces an ordinary category $H^*(\mathcal{A})$ in cohomology. We refer to subsection 3.3 for a discussion of the existence of identity morphisms in $H^*(\mathcal{A})$.

An A_∞ -functor between two A_∞ -categories $\mathcal{F} : \mathcal{A} \rightarrow \mathcal{B}$ is then defined to be the data

- (i) of a map $\mathcal{F} : \text{Ob}(\mathcal{A}) \rightarrow \text{Ob}(\mathcal{B})$;

(ii) for every $A_0, \dots, A_n \in \text{Ob}(\mathcal{A})$ of a degree $1 - n$ map

$$f_n : \mathcal{A}(A_0, A_1) \otimes \cdots \otimes \mathcal{A}(A_{n-1}, A_n) \longrightarrow \mathcal{B}(\mathcal{F}(A_0), \mathcal{F}(A_n)) ,$$

such that the maps f_n satisfy a categorical version of the A_∞ -equations for A_∞ -morphisms.

A_∞ -functors correspond to functors between A_∞ -categories that preserve the composition up to higher coherent homotopies, and induce ordinary functors $H^*(\mathcal{F}) : H^*(\mathcal{A}) \rightarrow H^*(\mathcal{B})$ between the cohomological categories.

One can then similarly define a categorical generalization of n -morphisms between A_∞ -algebras given by n -functors between A_∞ -categories. The sets of n -functors between two A_∞ -categories \mathcal{A} and \mathcal{B} then fit into a simplicial set

$$\text{HOM}_{A_\infty\text{-Cat}}(\mathcal{A}, \mathcal{B})_\bullet .$$

It is straightforward from the proof of subsection 2.3.1 that these simplicial sets are again algebraic ∞ -categories. In analogy with Theorem 1, we expect that these simplicial sets are Kan complexes. The proof of this statement would rely on working out the homotopy theory of dg-cocategories.

3.2. The A_∞ -category of A_∞ -functors $\text{Func}_{\mathcal{A}, \mathcal{B}}$ and the simplicial nerve functor. Given two A_∞ -categories \mathcal{A} and \mathcal{B} , Fukaya constructed in [Fuk02] an A_∞ -category $\text{Func}_{\mathcal{A}, \mathcal{B}}$ whose objects are A_∞ -functors from \mathcal{A} to \mathcal{B} . See also [LH02] and [Sei08]. The goal of this section is to compare the construction of [Fuk02] to the Kan complex $\text{HOM}_{A_\infty\text{-Cat}}(\mathcal{A}, \mathcal{B})_\bullet$.

We begin by defining the A_∞ -category $\text{Func}_{\mathcal{A}, \mathcal{B}}$. The objects of $\text{Func}_{\mathcal{A}, \mathcal{B}}$ are A_∞ -functors $\mathcal{A} \rightarrow \mathcal{B}$. Given two A_∞ -functors $\mathcal{F}_0 = \{f_0^{(m)}\}$ and $\mathcal{F}_1 = \{f_1^{(m)}\}$, an element $\mathcal{F}_{01} \in \text{Func}_{\mathcal{A}, \mathcal{B}}(\mathcal{F}_0, \mathcal{F}_1)$ is called a *pre-natural transformation* and consists of a collection of morphisms

$$f_{01}^{(m)} : \mathcal{A}(A_0, A_1) \otimes \cdots \otimes \mathcal{A}(A_{n-1}, A_n) \longrightarrow \mathcal{B}(\mathcal{F}_0(A_0), \mathcal{F}_1(A_n))$$

for $m \geq 0$, where $f_{01}^{(0)}$ corresponds to an element of $\mathcal{B}(\mathcal{F}_0(A), \mathcal{F}_1(A))$ for all $A \in \mathcal{A}$. A pre-natural transformation has degree r if each morphism $f_{01}^{(m)}$ has degree $r - m$. The differential m_1 on $\text{Func}_{\mathcal{A}, \mathcal{B}}(\mathcal{F}_0, \mathcal{F}_1)$ is then defined as

$$(m_1(\mathcal{F}_{01}))^{(m)} := \sum_{i_1+i_2+i_3=m} \pm f_{01}^{(i_1+i_1+i_3)}(\text{id}^{\otimes i_1} \otimes m_{i_2} \otimes \text{id}^{\otimes i_3}) + \sum_{|\mathbf{i}_0|+l+|\mathbf{i}_1|=m} \pm m_s(\mathbf{f}_0^{\mathbf{i}_0} \otimes f_{01}^{(l)} \otimes \mathbf{f}_1^{\mathbf{i}_1}) ,$$

where for a list $\mathbf{i}_0 := (i_0^1, \dots, i_0^{k_0})$ of indices, we denote

$$|\mathbf{i}_0| := \sum_{j=1}^{k_0} i_0^j \quad l(\mathbf{i}_0) := k_0 \quad \mathbf{f}_0^{\mathbf{i}_0} := f_0^{(i_0^1)} \otimes \cdots \otimes f_0^{(i_0^{k_0})} ,$$

and where $s := l(\mathbf{i}_0) + 1 + l(\mathbf{i}_1)$ in the second sum. The A_∞ -operation

$$m_n := \text{Func}_{\mathcal{A}, \mathcal{B}}(\mathcal{F}_0, \mathcal{F}_1) \otimes \cdots \otimes \text{Func}_{\mathcal{A}, \mathcal{B}}(\mathcal{F}_{n-1}, \mathcal{F}_n) \rightarrow \text{Func}_{\mathcal{A}, \mathcal{B}}(\mathcal{F}_0, \mathcal{F}_n)$$

evaluated on an element $\mathcal{F}_{01} \otimes \cdots \otimes \mathcal{F}_{n-1, n}$ is defined as

$$(m_n(\mathcal{F}_{01}, \dots, \mathcal{F}_{n-1, n}))^{(m)} := \sum_{\sum_{r=0}^n |\mathbf{i}_r| + \sum_{r=0}^{n-1} l_{r, r+1} = m} \pm m_s(\mathbf{f}_0^{\mathbf{i}_0} \otimes f_{01}^{(l_{01})} \otimes \mathbf{f}_1^{\mathbf{i}_1} \otimes \cdots \otimes f_{n-1, n}^{(l_{n-1, n})} \otimes \mathbf{f}_n^{\mathbf{i}_n}) ,$$

where $s := n + \sum_{r=0}^s l(\mathbf{i}_r)$.

In [Fao17b], Faonte defines the simplicial nerve N_{A_∞} of an A_∞ -category. Given an A_∞ -category \mathcal{C} , the simplicial nerve N_{A_∞} of \mathcal{C} is a simplicial set $N_{A_\infty}(\mathcal{C})$ which has the property of being an ∞ -category. A n -simplex in this simplicial set corresponds to the data for every $0 \leq i \leq n$ of an object $f_i \in \mathcal{C}$ and for every $0 \leq i_0 < \dots < i_k \leq n$ with $k \geq 1$ of an element $f_{i_0 \dots i_k} \in \mathcal{C}(f_{i_0}, f_{i_k})$ of degree $1 - k$, such that

$$m_1(f_{i_0 \dots i_k}) = \sum_{j=1}^{k-1} (-1)^j f_{i_0 \dots \hat{i}_j \dots i_k} + \sum_{\substack{0 < j_1 < \dots < j_{s-1} < k \\ s \geq 2}} \pm m_s(f_{i_0 \dots i_{j_1}}, \dots, f_{i_{j_{s-1}} \dots i_k}).$$

One can thereby consider the simplicial set $N_{A_\infty}(\text{Func}_{\mathcal{A}, \mathcal{B}})$, which is an ∞ -category. Its n -simplices correspond to the data of

- (i) an A_∞ -functor $\mathcal{F}_{[i]} = (f_{[i]}^{(m)})_{m \geq 1}$ from \mathcal{A} to \mathcal{B} for every $0 \leq i \leq n$,
- (ii) and of a pre-natural transformation $\mathcal{F}_I = (f_I^{(m)})_{m \geq 0}$ of degree $1 - m + |I|$ for every $I \subset \Delta^n$ such that $\dim(I) \geq 1$,

which satisfy the following equations

$$\left[\partial, f_I^{(m)} \right] = \sum_{j=1}^{\dim(I)-1} (-1)^j f_{\partial_j I}^{(m)} + \sum_{\substack{i_1+i_2+i_3=m \\ i_2 \geq 2}} \pm f_I^{(i_1+1+i_3)} (\text{id}^{\otimes i_1} \otimes m_{i_2} \otimes \text{id}^{\otimes i_3}) + \sum_{\substack{i_1+\dots+i_s=m \\ I_1 \cup \dots \cup I_s = I \\ s \geq 2}} \pm m_s(f_{I_1}^{(i_1)} \otimes \dots \otimes f_{I_s}^{(i_s)}).$$

These equations are almost but not exactly identical to the A_∞ -equations for n -functors defined in this article. Indeed, the sum for the simplicial differential now runs over $j = 1, \dots, \dim(I) - 1$ and the operations $f_I^{(m)}$ defining the n -simplex can have arity 0 when $\dim(I) \geq 1$. These seemingly minor differences account for the fact that the simplicial sets $\text{HOM}_{A_\infty\text{-Cat}}(\mathcal{A}, \mathcal{B})_\bullet$ and $N_{A_\infty}(\text{Func}_{\mathcal{A}, \mathcal{B}})$ differ fundamentally. Indeed, the 1-simplices of the simplicial set $\text{HOM}_{A_\infty\text{-Cat}}(\mathcal{A}, \mathcal{B})_\bullet$ correspond to A_∞ -homotopies between two A_∞ -functors and its higher simplices are to be understood as the higher coherent homotopies generalizing A_∞ -homotopies. The simplices of the simplicial set $N_{A_\infty}(\text{Func}_{\mathcal{A}, \mathcal{B}})$ are to be interpreted differently. The equations computed in the previous paragraph show that a 1-simplex \mathcal{F}_{01} of $N_{A_\infty}(\text{Func}_{\mathcal{A}, \mathcal{B}})$ corresponds exactly to an A_∞ -natural transformation between two A_∞ -functors \mathcal{F}_0 and \mathcal{F}_1 . A 1-simplex \mathcal{F}_{01} corresponds indeed to a collection of operations from the A_∞ -category \mathcal{A} to the A_∞ -category \mathcal{B} , and the arity 0 and 1 part of the equations they satisfy show that \mathcal{F}_{01} descends to an ordinary natural transformation $H^*(\mathcal{F}_{01}) : H^*(\mathcal{F}_0) \Rightarrow H^*(\mathcal{F}_1)$. This is also the reason why the morphisms of the A_∞ -category $\text{Func}_{\mathcal{A}, \mathcal{B}}$ are called pre-natural transformations. The n -simplices of $N_{A_\infty}(\text{Func}_{\mathcal{A}, \mathcal{B}})$ are then to be understood as *higher A_∞ -natural transformations* between A_∞ -functors. This interpretation explains in particular why the simplicial set $\text{HOM}_{A_\infty\text{-Cat}}(\mathcal{A}, \mathcal{B})_\bullet$ is a Kan complex while $N_{A_\infty}(\text{Func}_{\mathcal{A}, \mathcal{B}})$ is an ∞ -category but not necessarily a Kan complex : homotopies should always be invertible (up to homotopy), but this has no reason to hold in general for natural transformations.

3.3. Two notions of homotopies between A_∞ -functors. The A_∞ -category $\text{Func}_{\mathcal{A}, \mathcal{B}}$ provides in fact an alternative framework to define a *homotopy equivalence* relation between A_∞ -functors. Following [Fuk17], we compare in this subsection this homotopy equivalence relation to our equivalence relation induced by A_∞ -homotopies between A_∞ -functors.

Define a unital A_∞ -algebra B to be an A_∞ -algebra B together with an element $e \in B$ such that $\partial e = 0$, $m_2(e, \cdot) = m_2(\cdot, e) = \text{id}$ and $m_n(\cdots, e, \cdots) = 0$ when $n \geq 3$. A unital A_∞ -algebra yields in particular a unital algebra $H^*(B)$ in cohomology. One defines the notion of a unital A_∞ -category \mathcal{B} in a similar fashion. A unital A_∞ -category yields in fact an ordinary category $H^*(\mathcal{B})$ whose identity morphisms correspond to the cohomology classes of its unit morphisms. For two A_∞ -categories \mathcal{A} and \mathcal{B} such that \mathcal{B} is unital, one can moreover check that the A_∞ -category $\text{Func}_{\mathcal{A}, \mathcal{B}}$ is again unital.

We suppose in the rest of this subsection that the A_∞ -category \mathcal{B} is unital. Following [Fuk17], define a *homotopy equivalence* between two A_∞ -functors \mathcal{F} and \mathcal{G} to be a degree 0 pre-natural transformation $\mathcal{T} \in \text{Func}_{\mathcal{A}, \mathcal{B}}(\mathcal{F}, \mathcal{G})$ for which there exists a degree 0 pre-natural transformation $\mathcal{T}' \in \text{Func}_{\mathcal{A}, \mathcal{B}}(\mathcal{G}, \mathcal{F})$ such that

- (i) $m_1(\mathcal{T}) = 0$ and $m_1(\mathcal{T}') = 0$, i.e. the pre-natural transformations \mathcal{T} and \mathcal{T}' are A_∞ -natural transformations as defined in the previous subsection ;
- (ii) $m_2(\mathcal{T}, \mathcal{T}') - \text{Id}_{\mathcal{F}} \in \text{Im}(m_1)$ and $m_2(\mathcal{T}', \mathcal{T}) - \text{Id}_{\mathcal{G}} \in \text{Im}(m_1)$, where $\text{Id}_{\mathcal{F}}$ denotes the unit of $\text{Func}_{\mathcal{A}, \mathcal{B}}(\mathcal{F}, \mathcal{F})$.

Two A_∞ -functors \mathcal{F} and \mathcal{G} are said to be *homotopy equivalent* if there exists a homotopy equivalence between them. The A_∞ -natural transformations \mathcal{T} and \mathcal{T}' then induce natural equivalences $H^*(\mathcal{T}) : H^*(\mathcal{F}) \Rightarrow H^*(\mathcal{G})$ and $H^*(\mathcal{T}') : H^*(\mathcal{G}) \Rightarrow H^*(\mathcal{F})$ which are inverse to one another. In particular, if \mathcal{F} and \mathcal{G} are homotopy equivalent then $H^*(\mathcal{T}) \circ H^*(\mathcal{F}) \circ H^*(\mathcal{T}')^{-1} = H^*(\mathcal{G})$.

We say that two A_∞ -functors \mathcal{F} and \mathcal{G} are *homotopic* if there exists an A_∞ -homotopy between them. Two homotopic A_∞ -functors \mathcal{F} and \mathcal{G} define in particular the same functor $H^*(\mathcal{F}) = H^*(\mathcal{G})$ in cohomology. These two notions of homotopy on A_∞ -functors are related by the following proposition proven by Fukaya in [Fuk17] :

Proposition 14. *Let \mathcal{B} be a unital A_∞ -category and $\mathcal{F}, \mathcal{G} : \mathcal{A} \rightarrow \mathcal{B}$ be two A_∞ -functors. If \mathcal{F} and \mathcal{G} are homotopic then they are homotopy equivalent.*

The converse is however not true in general.

4. THE ∞ -CATEGORY OF A_∞ -ALGEBRAS ?

Given three A_∞ -algebras A , B and C together with two n -morphisms going respectively from A to B and from B to C , we have not yet defined a way to compose them. In other words, we have not defined a simplicial enrichment of the category $\mathbf{A}_\infty - \text{Alg}$.

4.1. Simplicially enriched categories. A *simplicially enriched category* \mathbf{D} , or *simplicial category* for short, is the data of

- (i) a collection of objects $\text{Ob}(\mathbf{D})$;
- (ii) for every two objects A and B a simplicial set of morphisms between A and B , that we write $\text{HOM}_{\mathbf{D}}(A, B)_n$;
- (iii) simplicial composition maps

$$\text{HOM}_{\mathbf{D}}(A, B)_n \times \text{HOM}_{\mathbf{D}}(B, C)_n \longrightarrow \text{HOM}_{\mathbf{D}}(A, C)_n ;$$

which satisfy the standard axioms of an ordinary category. Defining a *simplicial enrichment* of an ordinary category \mathbf{C} consists then in defining a simplicial category \mathbf{C}_Δ having the same objects as \mathbf{C}

and such that the sets of vertices of its HOM-simplicial sets are exactly the sets of morphisms of \mathcal{C} , in other words

$$\mathrm{HOM}_{\mathcal{C}_\Delta}(A, B)_0 = \mathrm{Hom}_{\mathcal{C}}(A, B) \text{ for each } n.$$

In the particular case of the category $\mathcal{C} := A_\infty - \mathbf{Alg}$ we have already constructed the HOM-simplicial sets, and we would now like to define simplicial composition maps

$$\mathrm{HOM}_{A_\infty - \mathbf{Alg}}(A, B)_n \times \mathrm{HOM}_{A_\infty - \mathbf{Alg}}(B, C)_n \longrightarrow \mathrm{HOM}_{A_\infty - \mathbf{Alg}}(A, C)_n .$$

It is enough to construct these simplicial maps for $\mathrm{dg} - \mathbf{Cog}$, i.e. to define simplicial composition maps

$$\mathrm{HOM}_{\mathrm{dg} - \mathbf{Cog}}(A, B)_n \times \mathrm{HOM}_{\mathrm{dg} - \mathbf{Cog}}(B, C)_n \longrightarrow \mathrm{HOM}_{\mathrm{dg} - \mathbf{Cog}}(A, C)_n ,$$

which are associative, preserve the identity and lift the composition on $\mathrm{HOM}_0 = \mathrm{Hom}$.

4.2. A natural candidate that fails to preserve the coproduct. Let $F : \Delta^n \otimes C \rightarrow C'$ and $G : \Delta^n \otimes C' \rightarrow C''$ be two morphisms of dg-coalgebras. The only natural candidate to construct a composition is the Alexander-Whitney coproduct Δ_{Δ^n} , i.e. we define $G \circ F$ to be the following composite of maps

$$\Delta^n \otimes C \xrightarrow{\Delta_{\Delta^n} \otimes \mathrm{id}_C} \Delta^n \otimes \Delta^n \otimes C \xrightarrow{\mathrm{id}_{\Delta^n} \otimes F} \Delta^n \otimes C' \xrightarrow{G} C'' .$$

Note that we use the word "map" and not "morphism" because we have yet to check that this composite is indeed a morphism of dg-coalgebras.

Before moving on, we point out that for the composition of continuous maps of topological spaces $\Delta^n \times X \rightarrow Y$ we use the diagonal map of Δ^n ,

$$\Delta^n \times X \xrightarrow{\quad} \Delta^n \times \Delta^n \times X \xrightarrow{\quad} \Delta^n \times Y \xrightarrow{G} Z .$$

$\downarrow \mathrm{diag}_{\Delta^n} \times \mathrm{id}_X \qquad \downarrow \mathrm{id}_{\Delta^n} \times F$

This construction cannot be reproduced in our case, as the diagonal map $\Delta^n \rightarrow \Delta^n \otimes \Delta^n$ does not respect the gradings, nor does it respect the differentials.

Set $\Delta_1^n := \Delta^n$, $\Delta_2^n := \Delta^n$ and write $\Delta_{\Delta^n} : \Delta^n \rightarrow \Delta_1^n \otimes \Delta_2^n$ for the Alexander-Whitney map seen as a map from the dg-coalgebra Δ^n to the product dg-coalgebra $\Delta_1^n \otimes \Delta_2^n$. In the previous composition, it is sufficient to prove that $\Delta_{\Delta^n} : \Delta^n \rightarrow \Delta_1^n \otimes \Delta_2^n$ is a morphism of dg-coalgebras to prove that $G \circ F$ is a morphism of dg-coalgebras. This map does preserve the differential, but it does not preserve the coproduct ! Indeed, consider the following diagram

$$\begin{array}{ccc} \Delta^n & \xrightarrow{\Delta_{\Delta^n}} & \Delta_1^n \otimes \Delta_2^n \xrightarrow{\Delta_{\Delta_1^n} \otimes \Delta_{\Delta_2^n}} \Delta_1^n \otimes \Delta_1^n \otimes \Delta_2^n \otimes \Delta_2^n \\ \downarrow \Delta_{\Delta^n} & & \downarrow \mathrm{id} \otimes \tau \otimes \mathrm{id} \\ \Delta^n \otimes \Delta^n & \xrightarrow{\Delta_{\Delta^n} \otimes \Delta_{\Delta^n}} & (\Delta_1^n \otimes \Delta_2^n) \otimes (\Delta_1^n \otimes \Delta_2^n) \end{array} .$$

Up to specifying the correct signs, the upper composite path of the square is the map

$$I \longmapsto \sum_{I_1 \cup I_2 \cup I_3 \cup I_4 = I} I_1 \otimes I_3 \otimes I_2 \otimes I_4 ,$$

where $I_1 \cup I_2 \cup I_3 \cup I_4$ denotes an overlapping partition of the face $I \subset \Delta^n$, while the lower composite path of the square is the map

$$I \longmapsto \sum_{I_1 \cup I_2 \cup I_3 \cup I_4 = I} I_1 \otimes I_2 \otimes I_3 \otimes I_4 .$$

These two maps are not equal, the square does not commute. The map $G \circ F$ is in particular not a morphism of dg-coalgebras, and as a result does not belong to $\text{HOM}_{\text{dg-coalg}}(A, C)_n$. It ensues that the composition fails to be lifted to higher morphisms with this naive approach.

Still, something more can be said about the previous non-commutative square. Again, up to computing the correct signs, the map

$$\begin{aligned} \Delta^n &\longrightarrow (\Delta_1^n \otimes \Delta_2^n) \otimes (\Delta_1^n \otimes \Delta_2^n) \\ I &\longmapsto \sum_{I_1 \cup I_2 \cup I_3 \cup I_4 \cup I_5 = I} I_1 \otimes I_3 \otimes (I_2 \cup I_4) \otimes I_5, \end{aligned}$$

defines a homotopy between the upper composite path and the lower composite path of the square : it fills the square to make it homotopy-commutative. In the language introduced in [MS03], the upper composite path is equal to 1324, the lower one is equal to 1234, and the filler is equal to 13234. Using the results of [MS03], the author proves in [Maz] that :

Theorem 3. *The Alexander-Whitney coproduct can be lifted to an A_∞ -morphism between the dg-coalgebras Δ^n and $\Delta_1^n \otimes \Delta_2^n$, whose first higher homotopy is the map 13234.*

4.3. A second approach using the tensor product of A_∞ -morphisms. We proved in subsection 1.5 of part 1 that a n -morphism from A to B can equivalently be defined as a morphism of A_∞ -algebras $A \rightarrow \Delta_n \otimes B$. Using this definition, we can construct the composition of two n -morphisms $A \rightarrow \Delta_n \otimes B$ and $B \rightarrow \Delta_n \otimes C$ as

$$G \circ F := A \xrightarrow{F} \Delta_n \otimes B \xrightarrow[\text{id}_{\Delta_n} \otimes G]{} \Delta_n \otimes \Delta_n \otimes C \xrightarrow[\cup \otimes \text{id}_C]{} \Delta_n \otimes C.$$

In this composition, we write tensor products of A_∞ -morphisms $\text{id}_{\Delta_n} \otimes G$ and $\cup \otimes \text{id}_C$ between tensor A_∞ -algebras. This requires some further explanations.

Given two A_∞ -algebras A and B , it is not straightforward to define an A_∞ -algebra structure on the tensor dg-module $A \otimes B$. Indeed, if we define naively the operations $m_n^{A \otimes B}$ as

$$m_n^{A \otimes B}(a_1 \otimes b_1, \dots, a_n \otimes b_n) := \pm m_n^A(a_1, \dots, a_n) \otimes m_n^B(b_1, \dots, b_n),$$

they fail to satisfy the A_∞ -equations and do not even have the right degree. As explained in [MS06], the definition of a natural tensor product of A_∞ -algebras can be done by constructing a morphism of operads $A_\infty \rightarrow A_\infty \otimes A_\infty$, where $A_\infty \otimes A_\infty(n) := A_\infty(n) \otimes A_\infty(n)$ denotes the Hadamard product of operads. In [MTTV21], the authors construct such a morphism of operads by constructing a polytopal diagonal on the associahedra K_m and recover the formula originally computed on the dg-level by Markl and Shnider in [MS06]. In the particular case of a dg-algebra A and an A_∞ -algebra B , the A_∞ -structure on $A \otimes B$ deduced from a diagonal on the operad A_∞ is moreover exactly the one described at the beginning of subsection 1.5 of part 1. The A_∞ -algebras appearing in the definition of the A_∞ -morphism $G \circ F : A \rightarrow \Delta_n \otimes C$ are all of this form.

Given two A_∞ -morphisms $f^A : A_1 \rightarrow A_2$ and $f^B : B_1 \rightarrow B_2$, we would also like to define a morphism $f^A \otimes f^B : A_1 \otimes B_1 \rightarrow A_2 \otimes B_2$ between the tensor A_∞ -algebras $A_1 \otimes B_1$ and $A_2 \otimes B_2$. This involves defining this time a morphism of operadic bimodules $A_\infty - \text{Morph} \rightarrow A_\infty - \text{Morph} \otimes A_\infty - \text{Morph}$, compatible with the morphism of operads $A_\infty \rightarrow A_\infty \otimes A_\infty$ introduced in the previous paragraph. Guillaume Laplante-Anfossi together with the author define such a morphism in an upcoming article [LAM], following the method of [MTTV21] by constructing an explicit polytopal diagonal on the multiplihedra J_m . See also the work of Lipshitz, Ozsváth and Thurston in [LOT21].

In the particular case when the A_∞ -algebras A_1 and A_2 are dg-algebras and the morphism f_A is a morphism of dg-algebras, the datum of a diagonal on $A_\infty - \text{Morph}$ is not necessary to define the A_∞ -morphism $f^A \otimes f^B$. It can indeed simply be defined as

$$(f_A \otimes f_B)_m(a_1 \otimes b_1, \dots, a_m \otimes b_m) := \pm f_1^A(a_1 \cdots a_m) \otimes f_m^B(b_1, \dots, b_m),$$

where $a_1 \cdots a_m$ denotes the product of the elements a_1, \dots, a_m . The map $\text{id}_{\Delta_n} \otimes G$ in the composition $G \circ F$ is of this form. However, such a diagonal is necessary to define the tensor A_∞ -morphism $\cup \otimes \text{id}_C$, as the map \cup is this time an A_∞ -morphism and not a mere morphism between dg-algebras. Here the map \cup denotes indeed the A_∞ -morphism between the dg-algebras $\Delta_n \otimes \Delta_n$ and Δ_n , deduced from the A_∞ -morphism between the dg-coalgebras Δ^n and $\Delta^n \otimes \Delta^n$ of theorem 3.

Hence, the datum of a diagonal on the operadic bimodule $A_\infty - \text{Morph}$, as constructed in [LAM] or [LOT21], allows us to define the composition of two n -morphisms $A \rightarrow \Delta_n \otimes B$ and $B \rightarrow \Delta_n \otimes C$. It is however not immediately clear that this composition defines a map of simplicial sets

$$\text{HOM}_{A_\infty}(A, B)_n \times \text{HOM}_{A_\infty}(B, C)_n \longrightarrow \text{HOM}_{A_\infty}(A, C)_\bullet,$$

nor that this composition is associative. It is thereby still an open question to know whether these HOM -simplicial sets could fit into a simplicial enrichment of the category $A_\infty - \text{Alg}$. This would then endow $A_\infty - \text{Alg}$ with a structure of ∞ -category, following Proposition 1.1.5.10. of [Lur09]. The author plans to inspect these questions in an upcoming paper.

4.4. Enriching $A_\infty - \text{Cat}$ using the A_∞ -categories $\text{Func}_{\mathcal{A}, \mathcal{B}}$. In [Fao17a], Faonte claims that the simplicial sets $N_{A_\infty}(\text{Func}_{\mathcal{A}, \mathcal{B}})$ enhance the category $A_\infty - \text{Cat}$ of A_∞ -categories with A_∞ -functors between them to an $(\infty, 2)$ -category. The same difficulties that were tackled in this section and section 4.2 seem however to arise when lifting the composition of A_∞ -functors to the level of the simplicial sets $N_{A_\infty}(\text{Func}_{\mathcal{A}, \mathcal{B}})$.

In the same vein, Lyubashenko constructs in [Lyu03] an A_∞ -bifunctor

$$\text{Func}_{\mathcal{A}, \mathcal{B}} \times \text{Func}_{\mathcal{B}, \mathcal{C}} \longrightarrow \text{Func}_{\mathcal{A}, \mathcal{C}}$$

defined as the composition of A_∞ -functors on objects. We refer to his paper for a definition of an A_∞ -bifunctor and simply stress here that the notation $\text{Func}_{\mathcal{A}, \mathcal{B}} \times \text{Func}_{\mathcal{B}, \mathcal{C}}$ is a mere notation and does not refer to the tensor product of the A_∞ -categories $\text{Func}_{\mathcal{A}, \mathcal{B}}$ and $\text{Func}_{\mathcal{B}, \mathcal{C}}$. Fukaya then proves in [Fuk17] that this composition A_∞ -bifunctor is associative up to homotopy equivalence.

This suggests that the A_∞ -categories $\text{Func}_{\mathcal{A}, \mathcal{B}}$ should fit into an enrichment in A_∞ -categories of the category $A_\infty - \text{Cat}$. This enrichment should in particular induce in cohomology the 2-category structure on the category Cat , whose objects are ordinary categories, whose 1-morphisms are functors and whose 2-morphisms are natural transformations. The structure of a category enriched in A_∞ -categories has however not been defined to this day. Bottman is currently working on such a definition, which he calls an $(A_\infty, 2)$ -category structure. See for instance [BC21]. The A_∞ -categories $\text{Func}_{\mathcal{A}, \mathcal{B}}$ and the problem of defining the notion of a category enriched in A_∞ -categories arise in fact naturally in symplectic topology when considering moduli spaces of pseudo-holomorphic quilts defining operations on Fukaya categories $\text{Fuk}(M)$ of symplectic manifolds M . See for instance [MWW18], [Fuk17], [Bot20] and [Bot19] for more details on the subject.

Part 3

Higher morphisms in Morse theory

1. n -MORPHISMS IN MORSE THEORY

Let M be a closed oriented Riemannian manifold endowed with a Morse function f together with a Morse-Smale metric. In [Maz21], we explored how to realize the moduli spaces of stable metric ribbon trees \mathcal{T}_m and the moduli spaces of stable two-colored metric ribbon trees \mathcal{CT}_m in Morse theory. It was proven that, upon choosing admissible perturbation data \mathbb{X}^f on the moduli spaces \mathcal{T}_m for the function f , the Morse cochains $C^*(f)$ can be endowed with an ΩBAs -algebra structure whose operations m_t for $t \in SRT_m$ are defined by counting 0-dimensional moduli spaces $\mathcal{T}_t^{\mathbb{X}^f}(y; x_1, \dots, x_m)$. Similarly, choose an additional Morse function g together with admissible perturbation data \mathbb{X}^g on the moduli spaces \mathcal{T}_m , and admissible perturbation data \mathbb{Y} on the moduli spaces \mathcal{CT}_m which are compatible with \mathbb{X}^f and \mathbb{X}^g . We can then define an ΩBAs -morphism $\mu^{\mathbb{Y}} : (C^*(f), m_t^{\mathbb{X}^f}) \rightarrow (C^*(g), m_t^{\mathbb{X}^g})$, whose operations $\mu_{t_g}^{\mathbb{Y}}$ for $t_g \in SCRT_m$ are defined by counting the 0-dimensional moduli spaces $\mathcal{CT}_{t_g}^{\mathbb{Y}}(y; x_1, \dots, x_m)$.

The goal of this section is to realize the n -multiplihedra $n - J_m$ endowed with their $n - \Omega BAs$ -cell decomposition in Morse theory. We first introduce the notion of n -simplices of perturbation data on the moduli spaces \mathcal{CT}_m (definitions 22 and 23), generalizing the notion of perturbation data on these moduli spaces defined in [Maz21]. We then use n -simplices of perturbation data to define the moduli spaces $\mathcal{CT}_{I, t_g}(y; x_1, \dots, x_m)$, $I \subset \Delta^n$. Under generic assumptions on the simplices of perturbation data, these moduli spaces are orientable manifolds (Proposition 15). Requiring some additional compatibilities involving the maps $AW_{\mathbf{a}}$ on the simplices of perturbation data, the 1-dimensional moduli spaces $\mathcal{CT}_{I, t_g}(y; x_1, \dots, x_m)$ can be compactified to 1-dimensional manifolds with boundary, whose boundary is modeled on the boundary of $\Delta^n \times \overline{\mathcal{CT}}_m$ endowed with its $n - \Omega BAs$ -cell decomposition (Theorems 4 and 5). We construct as a result a $n - \Omega BAs$ -morphism between the Morse cochains $C^*(f)$ and $C^*(g)$ (Theorem 6), by counting the signed points of the 0-dimensional oriented manifolds $\mathcal{CT}_{I, t_g}(y; x_1, \dots, x_m)$. We finally prove a filling theorem for perturbation data parametrized by a simplicial subcomplex $S \subset \Delta^n$ (Theorem 7), solving as a corollary the question that initially motivated this paper (corollary 1).

1.1. Conventions. We will study Morse theory of the Morse function $f : M \rightarrow \mathbb{R}$ using its negative gradient vector field $-\nabla f$. Denote d the dimension of the manifold M and ϕ^s the flow of $-\nabla f$. For a critical point x define its unstable and stable manifolds

$$W^U(x) := \{z \in M, \lim_{s \rightarrow -\infty} \phi^s(z) = x\}$$

$$W^S(x) := \{z \in M, \lim_{s \rightarrow +\infty} \phi^s(z) = x\}.$$

Their dimensions are such that $\dim(W^U(x)) + \dim(W^S(x)) = d$. We then define the *degree of a critical point* x to be $|x| := \dim(W^S(x))$. This degree is often referred to as the *coindex of x* in the literature.

We will moreover work with Morse cochains. For two critical point $x \neq y$, define

$$\mathcal{T}(y; x) := W^S(y) \cap W^U(x) / \mathbb{R}$$

to be the moduli space of negative gradient trajectories connecting x to y . Denote moreover $\mathcal{T}(x; x) = \emptyset$. Under the Morse-Smale assumption on f and the Riemannian metric on M , for $x \neq y$ the moduli space $\mathcal{T}(y; x)$ has dimension $\dim(\mathcal{T}(y; x)) = |y| - |x| - 1$. The Morse differential $\partial_{Morse} : C^*(f) \rightarrow C^*(f)$ is then defined to count descending negative gradient trajectories

$$\partial_{Morse}(x) := \sum_{|y|=|x|+1} \#\mathcal{T}(y; x) \cdot y .$$

1.2. n -simplices of perturbation data on a stratum $\mathcal{CT}_m(t_g)$. Fix a gauged stable metric ribbon tree $T_g = (t_g, \lambda, \{l_e\}_{e \in E(t)})$. Let $T_c = (t_c, L_{f_c})$ be its associated two-colored metric ribbon tree, $\overline{E}(t_c)$ the set of all edges of t_c and $E(t_c) \subset \overline{E}(t_c)$ the set of internal edges of t_c . We point out that L_{f_c} is a linear combination of the parameters $\lambda, \{l_e\}_{e \in E(t)}$ and that we should in fact write $L_{f_c}(\lambda, \{l_e\}_{e \in E(t)})$. Recall from [Maz21] that :

Definition 21 ([Maz21]). A choice of perturbation data on T_g consists of the following data :

(i) a vector field

$$[0, L_{f_c}] \times M \xrightarrow{\mathbb{X}_{f_c}} TM ,$$

that vanishes on $[1, L_{f_c} - 1]$, for every internal edge f_c of t_c ;

(ii) a vector field

$$[0, +\infty[\times M \xrightarrow{\mathbb{X}_{f_0}} TM ,$$

that vanishes away from $[0, 1]$, for the outgoing edge f_0 of t_c ;

(iii) a vector field

$$]-\infty, 0] \times M \xrightarrow{\mathbb{X}_{f_i}} TM ,$$

that vanishes away from $[-1, 0]$, for every incoming edge f_i ($1 \leq i \leq n$) of t_c .

In the rest of the paper, we will moreover write D_{f_c} for all segments $[0, L_{f_c}]$, as well as for all semi-infinite segments $]-\infty, 0]$ and $[0, +\infty[$.

Definition 22. A n -simplex of perturbation data for T_g is defined to be a choice of perturbation data \mathbb{Y}_{δ, T_g} for every $\delta \in \mathring{\Delta}^n$. Equivalently, it is the datum of a vector field

$$\mathring{\Delta}^n \times D_{f_c} \times M \xrightarrow{\mathbb{Y}_{\Delta^n, T_g, f_c}} TM$$

for every edge $f_c \in \overline{E}(t_c)$, abiding by the previous vanishing conditions on D_{f_c} . We will denote it as $\mathbb{Y}_{\Delta^n, T_g} := \{\mathbb{Y}_{\delta, T_g}\}_{\delta \in \mathring{\Delta}^n}$.

Introduce the cone $C_{f_c} \subset \mathcal{CT}_m(t_g) \times \mathbb{R}$ defined as

- (i) $\{((\lambda, \{l_e\}_{e \in E(t)}), s) \text{ such that } (\lambda, \{l_e\}_{e \in E(t)}) \in \mathcal{CT}_m(t_g) \text{ and } 0 \leq s \leq L_{f_c}\}$ if f_c is an internal edge ;
- (ii) $\{((\lambda, \{l_e\}_{e \in E(t)}), s) \text{ such that } (\lambda, \{l_e\}_{e \in E(t)}) \in \mathcal{CT}_m(t_g) \text{ and } s \leq 0\}$ if f_c is an incoming edge ;
- (iii) $\{((\lambda, \{l_e\}_{e \in E(t)}), s) \text{ such that } (\lambda, \{l_e\}_{e \in E(t)}) \in \mathcal{CT}_m(t_g) \text{ and } s \geq 0\}$ if f_c is the outgoing edge.

Definition 23. A n -simplex of perturbation data on $\mathcal{CT}_m(t_g)$, or choice of perturbation data on $\mathcal{CT}_m(t_g)$ parametrized by Δ^n , is defined to be the data of a n -simplex of perturbation data $\mathbb{Y}_{\Delta^n, T_g}$ for every $T_g \in \mathcal{CT}_m(t_g)$. A n -simplex of perturbation data $\mathbb{Y}_{\Delta^n, t_g}$ defines maps

$$\mathbb{Y}_{\Delta^n, t_g, f_c} : \mathring{\Delta}^n \times D_{f_c} \times M \longrightarrow TM ,$$

for every edge f_c of t_c . It is said to be *smooth* if all these maps are smooth.

1.3. The moduli spaces $\mathcal{CT}_{I, t_g}(y; x_1, \dots, x_m)$. Recall from [Maz21] that given an admissible choice of perturbation data \mathbb{Y} on the moduli spaces \mathcal{CT}_m , the moduli spaces $\mathcal{CT}_{t_g}^{\mathbb{Y}}(y; x_1, \dots, x_m)$ are defined as the inverse image of the thin diagonal $\Delta \subset M^{\times m+1}$ under the flow map

$$\phi_{\mathbb{Y}_{t_g}} : \mathcal{CT}_m(t_g) \times W^S(y) \times W^U(x_1) \times \dots \times W^U(x_m) \longrightarrow M^{\times m+1} .$$

Definition 24. Let $\mathbb{Y}_{\Delta^n, t_g}$ be a smooth n -simplex of perturbation data on $\mathcal{CT}_m(t_g)$. Given $y \in \text{Crit}(g)$ and $x_1, \dots, x_m \in \text{Crit}(f)$, we define the moduli spaces

$$\begin{aligned} \mathcal{CT}_{\Delta^n, t_g}^{\mathbb{Y}_{\Delta^n, t_g}}(y; x_1, \dots, x_m) &:= \bigcup_{\delta \in \mathring{\Delta}^n} \mathcal{CT}_{t_g}^{\mathbb{Y}_{\delta, t_g}}(y; x_1, \dots, x_m) \\ &= \left\{ (\delta, \text{two-colored perturbed Morse gradient tree associated to } (T_g, \mathbb{Y}_{\delta, T_g}) \right. \\ &\quad \left. \text{which connects } x_1, \dots, x_m \text{ to } y), \text{ for } T_g \in \mathcal{CT}_m(t_g) \text{ and } \delta \in \mathring{\Delta}^n \right\} . \end{aligned}$$

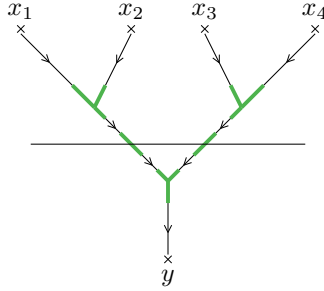

FIGURE 14. An example of a perturbed two-colored Morse gradient tree associated to the perturbation data \mathbb{Y}_{δ} for a $\delta \in \mathring{\Delta}^n$. The black segments above the gauge correspond to $-\nabla f$ and the green ones to $-\nabla f + \mathbb{Y}_{\delta}$. As for the segments below the gauge, replace f by g in these formulae.

An example of a perturbed two-colored Morse gradient tree associated to the perturbation data \mathbb{Y}_{δ} for a $\delta \in \mathring{\Delta}^n$ is represented on figure 14. Introduce the flow map

$$\phi_{\mathbb{Y}_{\Delta^n, t_g}} : \mathring{\Delta}^n \times \mathcal{CT}_m(t_g) \times W^S(y) \times W^U(x_1) \times \dots \times W^U(x_m) \longrightarrow M^{\times m+1} ,$$

whose restriction to every $\delta \in \mathring{\Delta}^n$ is

$$\phi_{\mathbb{Y}_{\delta, t_g}} : \mathcal{CT}_m(t_g) \times W^S(y) \times W^U(x_1) \times \dots \times W^U(x_m) \longrightarrow M^{\times m+1} .$$

Proposition 15. (i) The moduli space $\mathcal{CT}_{\Delta^n, t_g}^{\mathbb{Y}_{\Delta^n, t_g}}(y; x_1, \dots, x_m)$ can be rewritten as

$$\mathcal{CT}_{\Delta^n, t_g}^{\mathbb{Y}_{\Delta^n, t_g}}(y; x_1, \dots, x_m) = \phi_{\mathbb{Y}_{\Delta^n, t_g}}^{-1}(\Delta) ,$$

where $\Delta \subset M^{\times m+1}$ is the thin diagonal of $M^{\times m+1}$.

(ii) Given a n -simplex of perturbation data $\mathbb{Y}_{\Delta^n, t_g}$ making $\phi_{\mathbb{Y}_{\Delta^n, t_g}}$ transverse to Δ , the moduli space $\mathcal{CT}_{\Delta^n, t_g}(y; x_1, \dots, x_m)$ is an orientable manifold of dimension

$$\dim(\mathcal{CT}_{\Delta^n, t_g}(y; x_1, \dots, x_m)) = -|t_{\Delta^n, g}| + |y| - \sum_{i=1}^m |x_i|.$$

(iii) n -simplices of perturbation data $\mathbb{Y}_{\Delta^n, t_g}$ such that $\phi_{\mathbb{Y}_{\Delta^n, t_g}}$ is transverse to Δ exist.

Replacing Δ^n by any face $I \subset \Delta^n$, the moduli spaces $\mathcal{CT}_{I, t_g}^{\mathbb{Y}_{I, t_g}}(y; x_1, \dots, x_m)$ can be defined in the same way and made into orientable manifolds of dimension

$$\dim(\mathcal{CT}_{I, t_g}(y; x_1, \dots, x_m)) = -|t_{I, g}| + |y| - \sum_{i=1}^m |x_i|.$$

We refer to section 2 for the details on transversality and orientability.

1.4. Compactifications.

1.4.1. *The compactified moduli spaces $\overline{\mathcal{CT}}_{I, t_g}(y; x_1, \dots, x_m)$.* We now would like to compactify the 1-dimensional moduli spaces $\mathcal{CT}_{I, t_g}(y; x_1, \dots, x_m)$ to 1-dimensional manifolds with boundary. They are defined as the inverse image in $I \times \mathcal{CT}_m(t_g) \times W^S(y) \times W^U(x_1) \times \dots \times W^U(x_m)$ of the thin diagonal $\Delta \subset M^{\times m+1}$ under the flow map $\phi_{\mathbb{Y}_{I, t_g}}$. The boundary components in the compactification should come from those of $W^S(y)$, of the $W^U(x_i)$ and of $\mathring{I} \times \mathcal{CT}_m(t_g)$. However, rather than considering the boundary components coming from the separate compactifications of \mathring{I} and $\mathcal{CT}_m(t_g)$, we will consider the n - ΩBAs -decomposition of $I \times \overline{\mathcal{CT}}_m(t_g)$ and model the remaining boundary components on this decomposition.

Choose admissible perturbation data \mathbb{X}^f and \mathbb{X}^g for the functions f and g . Choose moreover smooth simplices of perturbation data \mathbb{Y}_{I, t_g} for all $t_g \in SCRT_i$, $1 \leq i \leq m$ and $I \subset \Delta^n$. We denote $(\mathbb{Y}_{I, m})_{I \subset \Delta^n} := (\mathbb{Y}_{I, t_g})_{I \subset \Delta^n}^{t_g \in SCRT_m}$, and call it a choice of perturbation data on \mathcal{CT}_m parametrized by Δ^n . Fixing a two-colored stable ribbon tree type $t_g \in SCRT_m$ and $I \subset \Delta^n$ we want to compactify the moduli space $\mathcal{CT}_{I, t_g}^{\mathbb{Y}_{I, t_g}}(y; x_1, \dots, x_m)$ using the perturbation data \mathbb{X}^f , \mathbb{X}^g and $(\mathbb{Y}_{I, k})_{I \subset \Delta^n}^{k \leq m}$. The boundary will be described by the following phenomena :

- (i) the parameter $\delta \in I$ tends towards the codimension 1 boundary of I ($\partial^{sing} I$) ;
- (ii) an external edge breaks at a critical point (Morse) ;
- (iii) an internal edge of the tree t collapses (int-collapse) :

$$\mathcal{CT}_{I, t'_g}^{\mathbb{Y}_{I, t'_g}}(y; x_1, \dots, x_m)$$

where $t'_g \in SCRT_n$ are all the two-colored trees obtained by collapsing exactly one internal edge, which does not cross the gauge ;

- (iv) the gauge moves to cross exactly one additional vertex of the underlying stable ribbon tree (gauge-vertex) :

$$\mathcal{CT}_{I, t'_g}^{\mathbb{Y}_{I, t'_g}}(y; x_1, \dots, x_m)$$

where $t'_g \in SCRT_n$ are all the two-colored trees obtained by moving the gauge to cross exactly one additional vertex of t ;

- (v) an internal edge located above the gauge or intersecting it breaks or, when the gauge is below the root, the outgoing edge breaks between the gauge and the root (above-break) :

$$\mathcal{CT}_{I,t_g^1}^{\mathbb{Y}}(y; x_1, \dots, x_{i_1}, z, x_{i_1+i_2+1}, \dots, x_m) \times \mathcal{T}_{t^2}^{\mathbb{X}^f}(z; x_{i_1+1}, \dots, x_{i_1+i_2}) ,$$

where the tree resulting from grafting the outgoing edge of t^2 to the $i_1 + 1$ -th incoming edge of t_g^1 is t_g ;

- (vi) edges (internal or incoming) that are possibly intersecting the gauge, break below it, such that there is exactly one edge breaking in each non-self crossing path from an incoming edge to the root (below-break) ; the simplex of perturbation data \mathbb{Y}_{I,t_g} then "breaks" according to the combinatorics of the Alexander-Whitney coproduct :

$$\mathcal{T}_{t^0}^{\mathbb{X}^g}(y; y_1, \dots, y_s) \times \mathcal{CT}_{I_1,t_g^1}^{\mathbb{Y}}(y_1; x_1, \dots) \times \dots \times \mathcal{CT}_{I_s,t_g^s}^{\mathbb{Y}}(y_s; \dots, x_m)$$

where the tree resulting from grafting for each r the outgoing edge of t_g^r to the r -th incoming edge of t^0 is t_g , and $I_1 \cup \dots \cup I_s = I$ is an overlapping partition of I .

Note that the (Morse) boundaries are a simple consequence of the fact that external edges are Morse trajectories away from a length 1 segment.

1.4.2. *Smooth choice of perturbation data $\mathbb{Y}_{I \subset \Delta^n, m}$.* We begin by tackling the conditions coming with the $(\partial^{\text{sing}}I)$, (int-collapse) and (gauge-vertex) boundaries. Let $t_g \in \text{SCRT}_m$ and denote $\text{coll} \cup g - v(t_g) \subset \text{SCRT}_m$ the set consisting of all stable gauged trees obtained by collapsing internal edges of t and/or moving the gauge to cross additional vertices of t . In particular, $t_g \in \text{coll} \cup g - v(t_g)$. We define

$$\underline{\mathcal{CT}}_m(t_g) := \bigcup_{t'_g \in \text{coll} \cup g - v(t_g)} \mathcal{CT}_m(t'_g)$$

for the stratum $\mathcal{CT}_m(t_g) \subset \underline{\mathcal{CT}}_m$ together with its inner boundary components. A choice of perturbation data $(\mathbb{Y}_{I,t'_g})_{t'_g \in \text{coll} \cup g - v(t_g)}$ for a fixed $I \subset \Delta^n$ corresponds to a $\dim(I)$ -simplex of perturbation data on $\underline{\mathcal{CT}}_m(t_g)$. Following section 1.2, such a choice of perturbation data is equivalent to a map

$$\tilde{\mathbb{Y}}_{I,t_g,f_c} : \mathring{I} \times \tilde{C}_{f_c} \times M \longrightarrow TM ,$$

for every edge f_c of t_c , where $\tilde{C}_{f_c} \subset \underline{\mathcal{CT}}_m(t_g) \times \mathbb{R}$ is defined in a similar fashion to C_{f_c} .

Definition 25. A choice of perturbation data $(\mathbb{Y}_{I,m})_{I \subset \Delta^n}$ is said to be *smooth* if all maps

$$\tilde{\mathbb{Y}}_{\Delta^n,t_g,f_c} : \Delta^n \times \tilde{C}_{f_c} \times M \longrightarrow TM ,$$

are smooth, where we extended $\mathring{\Delta}^n$ to Δ^n by defining $\tilde{\mathbb{Y}}_{\Delta^n,t_g,f_c} := \tilde{\mathbb{Y}}_{I,t_g,f_c}$ on a face $I \subset \Delta^n$.

1.4.3. *The (above-break) boundary.* The (above-break) conditions are tackled as in [Maz21]. Write t_c for the two-colored ribbon tree associated to t_g . The (above-break) boundary corresponds to the breaking of an internal edge f_c of t_c located above the set of colored vertices. Denote t_c^1 and t^2 the trees obtained by breaking t_c at the edge f_c , where t^2 is seen to lie above t_c^1 . We have to specify for each edge $e_c \in \overline{E}(t_c)$ and each $\delta \in \mathring{I}$, what happens to the perturbation $\mathbb{Y}_{\delta,t_c,e_c}$ at the limit.

- (i) For $e_c \in \overline{E}(t^2)$ and $\neq f_c$, we require that

$$\lim \mathbb{Y}_{\delta,t_c,e_c} = \mathbb{X}_{t^2,e_c}^f .$$

(ii) For $e_c \in \overline{E}(t_c^1)$ and $\neq f_c$, we require that

$$\lim \mathbb{Y}_{\delta, t_c, e_c} = \mathbb{Y}_{\delta, t_c^1, e_c} .$$

(iii) For $f_c = e_c$, $\mathbb{Y}_{\delta, t_c, f_c}$ yields two parts at the limit : the part corresponding to the outgoing edge of t^2 and the part corresponding to the incoming edge of t_c^1 . We then require that they coincide respectively with the perturbation $\mathbb{X}_{t^2}^f$ and $\mathbb{Y}_{\delta, t_c^1}$.

An example of each case is illustrated in figure 15.

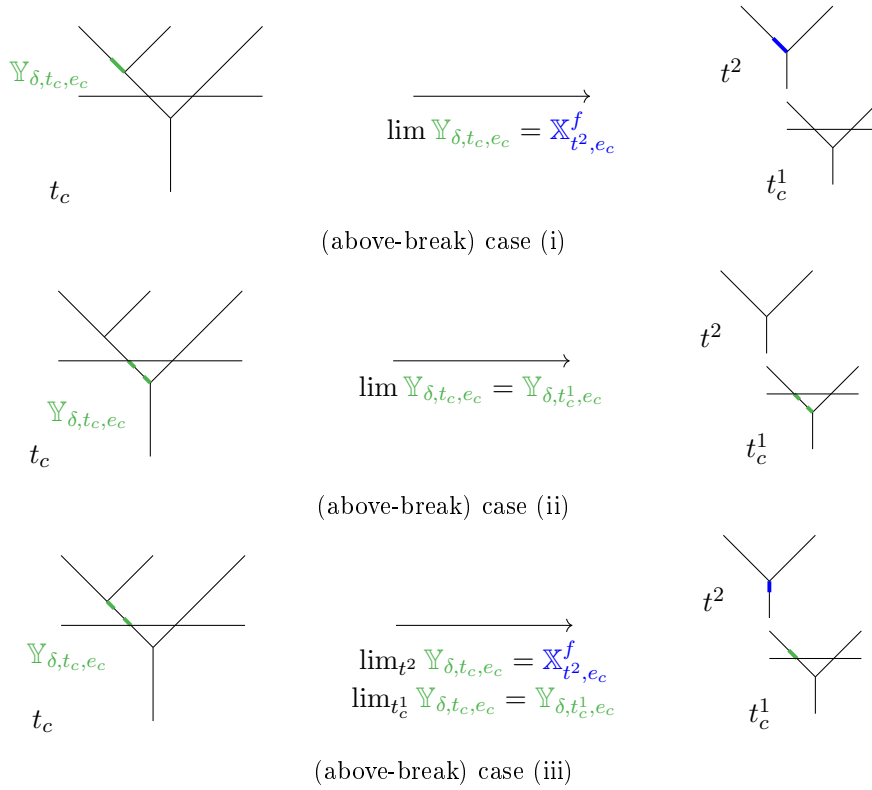

FIGURE 15

1.4.4. *The (below-break) boundary.* Denote t_c^1, \dots, t_c^s and t^0 the trees obtained by breaking t_c below the gauge, where the trees t_c^r for $r = 1, \dots, s$ are seen to lie above t^0 and are ordered from left to right. We write i_r for the arity of t_c^r and introduce the dividing sequence \mathbf{a} defined as

$$\frac{i_1 + \dots + i_{s-1}}{m} > \frac{i_1 + \dots + i_{s-2}}{m} > \dots > \frac{i_1}{m} ,$$

as in subsection 2.3.2 of part 1. Consider now the map $\text{AW}_{\mathbf{a}} : I \rightarrow I^s$. It comes with s maps

$$\text{pr}_r \circ \text{AW}_{\mathbf{a}} : I \rightarrow I$$

for $1 \leq r \leq s$ corresponding to the projection on the r -th factor of I^s . For the sake of readability we will simply denote them pr_r .

We have to specify for each edge $e_c \in \overline{E}(t_c)$ and each $\delta \in \overset{\circ}{I}$, what happens to the perturbation $\mathbb{Y}_{\delta, t_c, e_c}$ at the limit. The maps pr_r will allow us to produce the overlapping partitions combinatorics on the parameter δ .

(i) For $e_c \in \overline{E}(t_c^r)$ and not among the breaking edges, we require that

$$\lim \mathbb{Y}_{\delta, t_c, e_c} = \mathbb{Y}_{\text{pr}_r(\delta), t_c^r, e_c}.$$

(ii) For $e_c \in \overline{E}(t^0)$ and not among the breaking edges, we require that

$$\lim \mathbb{Y}_{\delta, t_c, e_c} = \mathbb{X}_{t^0, e_c}^g.$$

(iii) For f_c among the breaking edges, $\mathbb{Y}_{\delta, t_c, f_c}$ yields two parts at the limit : the part corresponding to the outgoing edge of t_c^r and the part corresponding to the incoming edge of t^0 . We then require that they coincide respectively with the perturbations $\mathbb{Y}_{\text{pr}_r(\delta), t_c^r, e_c}$ and \mathbb{X}_{t^0, e_c}^g .

This is again illustrated in figure 16. We also point out that Proposition 7 ensures that the limit condition (iii) on the perturbation $\mathbb{Y}_{\delta, t_c, e_c}$ is consistent.

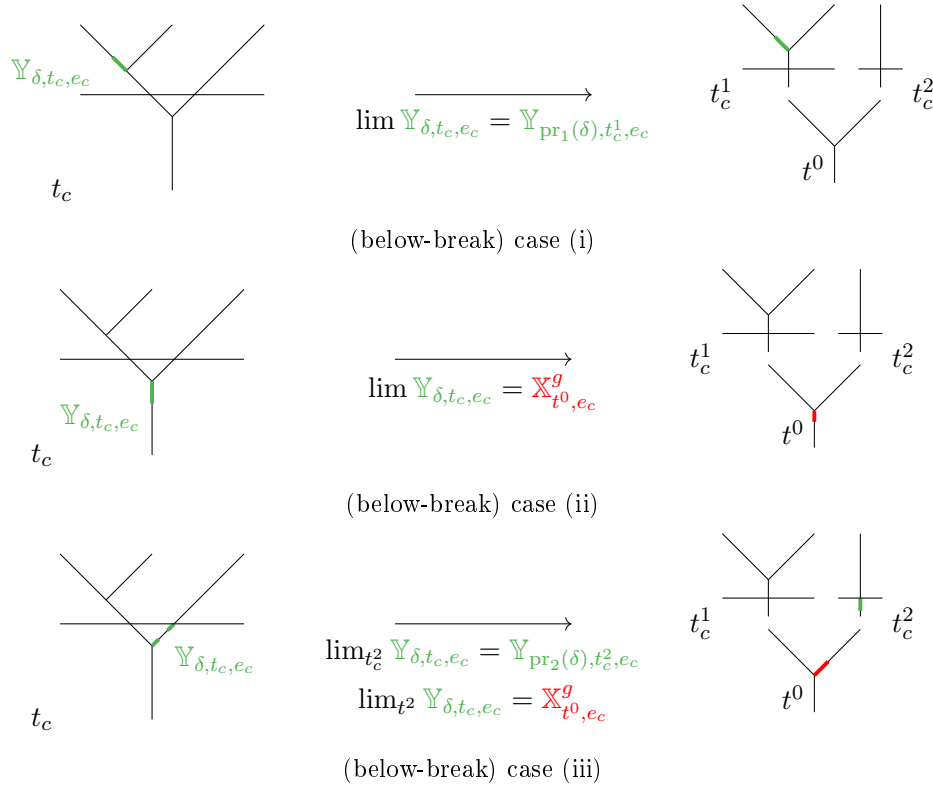

FIGURE 16

1.4.5. Admissible n -simplices of perturbation data.

Definition 26. A smooth choice of perturbation data $(\mathbb{Y}_{I,m})_{I \subset \Delta^n}^{m \geq 1}$ is said to be *gluing-compatible* w.r.t. \mathbb{X}^f and \mathbb{X}^g if it satisfies the (above-break) and (below-break) conditions described in subsections 1.4.3 and 1.4.4. Smooth and gluing-compatible perturbation data $(\mathbb{Y}_{I,m})_{I \subset \Delta^n}^{m \geq 1}$ such that all maps $\phi_{\mathbb{Y}_{I,t_g}}$ are transverse to the diagonal Δ are called *admissible w.r.t. \mathbb{X}^f and \mathbb{X}^g* or simply *admissible*.

Theorem 4. *Admissible choices of perturbation data $(\mathbb{Y}_{I,m})_{I \subset \Delta^n}^{m \geq 1}$ exist.*

Theorem 5. *Let $(\mathbb{Y}_{I,m})_{I \subset \Delta^n}^{m \geq 1}$ be an admissible choice of perturbation data. The 0-dimensional moduli spaces $\mathcal{CT}_{I,t_g}(y; x_1, \dots, x_m)$ are compact. The 1-dimensional moduli spaces $\mathcal{CT}_{I,t_g}(y; x_1, \dots, x_m)$ can be compactified to 1-dimensional manifolds with boundary $\overline{\mathcal{CT}}_{I,t_g}(y; x_1, \dots, x_m)$, whose boundary is described in subsection 1.4.1.*

The proof of Theorem 4 is postponed to subsection 2.1.1 and will proceed as in [Maz21]. Theorem 5 is a direct consequence of the analysis carried out in chapter 6 of [Mes18]. For this reason, we will not give details of its proof. We only point out that all spaces

$$\mathcal{T}_{t_0}^{\mathbb{X}^g}(y; y_1, \dots, y_s) \times \mathcal{CT}_{I_1, t_g^1}^{\mathbb{Y}_{I_1, t_g^1}}(y_1; x_1, \dots) \times \dots \times \mathcal{CT}_{I_s, t_g^s}^{\mathbb{Y}_{I_s, t_g^s}}(y_s; \dots, x_m)$$

where $I_1 \cup \dots \cup I_s = I$ is an i -overlapping s -partition of I , could a priori appear in the boundary of $\mathcal{CT}_{I,t_g}(y; x_1, \dots, x_m)$. The assumption that our choice of perturbation data is admissible ensures however in particular that whenever $I_1 \cup \dots \cup I_s = I$ is not an $(s-1)$ -overlapping s -partition of I the previous space is empty, as at least one of its factors then has negative dimension.

Theorem 5 implies moreover the existence of gluing maps

$$\begin{aligned} \#_{T_{I,g}^{1,Morse}, T_{I,g}^{2,Morse}}^{\text{above-break}} : [R, +\infty] &\longrightarrow \overline{\mathcal{CT}}_{I,t_g}(y; x_1, \dots, x_n), \\ \#_{T_{I,g}^{0,Morse}, T_{I,g}^{1,Morse}, \dots, T_{I,g}^{s,Morse}}^{\text{below-break}} : [R, +\infty] &\longrightarrow \overline{\mathcal{CT}}_{I,t_g}(y; x_1, \dots, x_n), \end{aligned}$$

whenever the perturbed Morse trees $T_{I,g}^{1,Morse}$, $T_{I,g}^{2,Morse}$ and $T_{I,g}^{0,Morse}$, $T_{I,g}^{1,Morse}$, \dots , $T_{I,g}^{s,Morse}$ respectively lie in a 0-dimensional moduli space, and where notations are as in items (v) and (vi) of subsection 1.4.1. The constructions of explicit gluing maps in subsections II.4.4.3 and II.4.5.4 of [Maz21] in the case of the moduli spaces $\mathcal{CT}_{t_g}(y_1; x_1, \dots, x_n)$ can be adapted without problems to the present setting.

1.5. $n - \Omega BAs$ -morphisms between Morse cochains. Let \mathbb{X}^f and \mathbb{X}^g be admissible choices of perturbation data for the Morse functions f and g . Denote $(C^*(f), m_t^{\mathbb{X}^f})$ and $(C^*(g), m_t^{\mathbb{X}^g})$ the Morse cochains endowed with their ΩBAs -algebra structures constructed in [Maz21].

Theorem 6. *Let $(\mathbb{Y}_{I,m})_{I \subset \Delta^n}^{m \geq 1}$ be a choice of perturbation that is admissible w.r.t. \mathbb{X}^f and \mathbb{X}^g . Defining for every m and $t_g \in SCRT_m$, and every $I \subset \Delta^n$ the operations μ_{I,t_g} as*

$$\begin{aligned} \mu_{I,t_g} : C^*(f) \otimes \dots \otimes C^*(f) &\longrightarrow C^*(g) \\ x_1 \otimes \dots \otimes x_m &\longmapsto \sum_{|y| = \sum_{i=1}^m |x_i| + |t_{I,g}|} \# \mathcal{CT}_{I,t_g}^{\mathbb{Y}_{I,t_g}}(y; x_1, \dots, x_m) \cdot y, \end{aligned}$$

they fit into a $n - \Omega BAs$ -morphism $(C^*(f), m_t^{\mathbb{X}^f}) \rightarrow (C^*(g), m_t^{\mathbb{X}^g})$

The proof is postponed to section 2.4. It boils down to counting the boundary points of the 1-dimensional oriented compactified moduli spaces $\overline{\mathcal{CT}}_{I,t_g}^{\mathbb{Y}}(y; x_1, \dots, x_m)$ whose boundary is described in the subsection 1.4.1. As a matter of fact, the set of operations $\{\mu_{I,t_g}\}$ does not exactly define a $n - \Omega BAs$ -morphism. One of the two differentials ∂_{Morse} in the bracket $[\partial_{Morse}, \mu_{I,t_g}]$ appearing in the $n - \Omega BAs$ -equations has to be twisted by a specific sign for the $n - \Omega BAs$ -equations to hold. We will speak about a *twisted $n - \Omega BAs$ -morphism* between twisted ΩBAs -algebras. In the case where M is odd-dimensional, this twisted $n - \Omega BAs$ -morphism is a standard $n - \Omega BAs$ -morphism.

As explained in subsection 3.1.3 of part 1, if we want moreover to go back to the algebraic framework of A_∞ -algebras, a $n - A_\infty$ -morphism between the induced A_∞ -algebra structures on the Morse cochains can simply be obtained under the morphism of operadic bimodules $n - A_\infty - \text{Morph} \rightarrow n - \Omega BAs - \text{Morph}$.

1.6. Filling properties in Morse theory. Consider a simplicial subcomplex $S \subset \Delta^n$. Definitions 23 and 26 can be straightforwardly extended to define an *admissible choice of perturbation data parametrized by S* on the moduli spaces \mathcal{CT}_m , that we will denote $\mathbb{Y}_S := (\mathbb{Y}_{I,m})_{I \subset S}^{m \geq 1}$. The following theorem is proven in section 2.1 :

Theorem 7. *For every admissible choice of perturbation data \mathbb{Y}_S parametrized by a simplicial subcomplex $S \subset \Delta^n$, there exists an admissible n -simplex of perturbation data \mathbb{Y}_{Δ^n} extending \mathbb{Y}_S .*

We define for every $n \geq 0$,

$$\text{HOM}_{\Omega BAs}^{\text{geom}}(C^*(f), C^*(g))_n \subset \text{HOM}_{\Omega BAs}(C^*(f), C^*(g))_n$$

to be the set of $n - \Omega BAs$ -morphisms μ from $C^*(f)$ to $C^*(g)$ for which there exists an admissible n -simplex of perturbation data \mathbb{Y}_{Δ^n} such that $\mu = \mu^{\mathbb{Y}_{\Delta^n}}$.

Theorem 8. *The sets $\text{HOM}_{\Omega BAs}^{\text{geom}}(C^*(f), C^*(g))_n$ define a simplicial subset of the simplicial set $\text{HOM}_{\Omega BAs}(C^*(f), C^*(g))_\bullet$. The simplicial set $\text{HOM}_{\Omega BAs}^{\text{geom}}(C^*(f), C^*(g))_\bullet$ has the property of being a Kan complex which is contractible.*

Proof. We first prove that the face and degeneracy maps of $\text{HOM}_{\Omega BAs}(C^*(f), C^*(g))_\bullet$ preserve the sets $\text{HOM}_{\Omega BAs}^{\text{geom}}(C^*(f), C^*(g))_\bullet$. This is clear for the face maps. Consider a n -simplex $\mu^{\mathbb{Y}_{\Delta^n}} \in \text{HOM}_{\Omega BAs}^{\text{geom}}(C^*(f), C^*(g))_n$ and a degeneracy map

$$\sigma_i : \text{HOM}_{\Omega BAs}(C^*(f), C^*(g))_n \longrightarrow \text{HOM}_{\Omega BAs}(C^*(f), C^*(g))_{n+1}, \quad 1 \leq i \leq n+1.$$

We have to construct an admissible $(n+1)$ -simplex of perturbation data \mathbb{Y}' such that $\sigma_i(\mu^{\mathbb{Y}_{\Delta^n}}) = \mu^{\mathbb{Y}'}$. Using the realizations

$$\Delta^n = \{(z_1, \dots, z_n) \in \mathbb{R}^n \mid 1 \geq z_1 \geq \dots \geq z_n \geq 0\},$$

we define $s_i : \Delta^{n+1} \rightarrow \Delta^n$ as $s_i(z_1, \dots, z_{n+1}) := (z_1, \dots, \hat{z}_i, \dots, z_{n+1})$. The $(n+1)$ -simplex of perturbation data defined as $\mathbb{Y}'_\delta := (\mathbb{Y}_{\Delta^n})_{s_i(\delta)}$ for $\delta \in \Delta^{n+1}$ is then an admissible simplex of perturbation data which has the desired property.

It is clear from Theorem 7 that the simplicial set $\text{HOM}_{\Omega BAs}^{\text{geom}}(C^*(f), C^*(g))_\bullet$ is a Kan complex. A Kan complex is contractible if and only if all its simplicial homotopy groups are trivial. One can moreover check on the definition of the homotopy relation in subsection 1.1.4 of part 1 that if a Kan complex X_\bullet has the property that each simplicial subcomplex $S \subset \Delta^n$ can be filled in X_\bullet , then its

homotopy groups are trivial. In particular, Theorem 7 implies that $\text{HOM}_{\Omega BAs}^{geom}(C^*(f), C^*(g))_\bullet$ has trivial homotopy groups hence is contractible. \square

Shifting from the ΩBAs to the A_∞ viewpoint, we can define in a similar fashion the simplicial subset

$$\text{HOM}_{A_\infty}^{geom}(C^*(f), C^*(g))_\bullet \subset \text{HOM}_{A_\infty}(C^*(f), C^*(g))_\bullet .$$

The simplicial set $\text{HOM}_{A_\infty}^{geom}(C^*(f), C^*(g))_\bullet$ is then again a Kan complex which is contractible. Given an admissible horn of perturbation data $\mathbb{Y}_{\Lambda_n^k}$, Theorem 1 implies that the induced horn $\Lambda_n^k \rightarrow \text{HOM}_{A_\infty}(C^*(f), C^*(g))_\bullet$ can always be filled algebraically. The fact that $\text{HOM}_{A_\infty}^{geom}(C^*(f), C^*(g))_\bullet$ is a Kan complex implies something stronger : this horn can not only be filled algebraically, but also geometrically. We moreover point out that we should in fact work with twisted $n - A_\infty$ and $n - \Omega BAs$ -morphisms, as explained in section 2.4. However, the constructions of this section still hold in that context.

The following proposition is a direct corollary to Theorem 8 and solves the motivational question formulated in the introduction :

Corollary 1. *Let \mathbb{Y} and \mathbb{Y}' be two admissible choices of perturbation data on the moduli spaces \mathcal{CT}_m . The ΩBAs -morphisms $\mu^\mathbb{Y}$ and $\mu^{\mathbb{Y}'}$ are then ΩBAs -homotopic*

$$C^*(f) \begin{array}{c} \xrightarrow{\mu^\mathbb{Y}} \\ \Downarrow \\ \xrightarrow{\mu^{\mathbb{Y}'}} \end{array} C^*(g) .$$

2. TRANSVERSALITY, SIGNS AND ORIENTATIONS

2.1. Proof of theorems 4 and 7.

2.1.1. *Proof of theorem 4.* We detailed in section II.3. of [Maz21] how to build an admissible choice of perturbation data $(\mathbb{X}_n)_{n \geq 2}$ on the moduli spaces \mathcal{T}_m . Drawing from this construction, we provide a sketch of the proof of Theorem 4 in this subsection : admissible n -simplices of perturbation data $(\mathbb{Y}_{I,m})_{I \subset \Delta^n}^{m \geq 1}$ on the moduli spaces $\mathcal{CT}(t_g)$ exist. The proof proceeds again by induction on the integer $N = \dim(\mathcal{CT}(t_g)) + \dim(I)$.

If $N = 0$, $\dim(I) = 0$ and the gauged tree t_g is a corolla whose gauge intersects its root. Let $y \in \text{Crit}(g)$ and $x_1, \dots, x_m \in \text{Crit}(f)$ and fix an integer l such that

$$l \geq \max \left(1, |y| - \sum_{i=1}^m |x_i| + 1 \right) .$$

Define the parametrization space

$$\mathfrak{X}_{t_g}^l := \{C^l\text{-perturbation data } \mathbb{Y}_{t_g} \text{ on } \mathcal{CT}_m(t_g)\} ,$$

and introduce the C^l -map

$$\phi_{t_g} : \mathfrak{X}_{t_g}^l \times \mathcal{CT}_m(t_g) \times W^S(y) \times W^U(x_1) \times \dots \times W^U(x_m) \longrightarrow M^{\times m+1} ,$$

such that for every $\mathbb{Y}_{t_g} \in \mathfrak{X}_{t_g}^l$, $\phi_{t_g}(\mathbb{Y}_{t_g}, \cdot) = \phi_{\mathbb{Y}_{t_g}}$. Note that we should in fact write $\phi_{t_g}^{y, x_1, \dots, x_m}$ as the domain of ϕ_{t_g} depends on y, x_1, \dots, x_m . The space $\mathfrak{X}_{t_g}^l$ is then a Banach space and the map ϕ_{t_g} is a

submersion. The map ϕ_{t_g} is in particular transverse to the diagonal $\Delta \subset M^{\times m+1}$. The parametric transversality lemma implies that there exists a subset $\mathfrak{Y}_{t_g}^{l;y,x_1,\dots,x_m} \subset \mathfrak{X}_{t_g}^l$ which is residual in the sense of Baire, and such that for every choice of perturbation data $\mathbb{Y}_{t_g} \in \mathfrak{Y}_{t_g}^{l;y,x_1,\dots,x_m}$ the map $\phi_{\mathbb{Y}_{t_g}}$ is transverse to the diagonal $\Delta \subset M^{\times m+1}$. Any \mathbb{Y}_{t_g} in the intersection

$$\mathfrak{Y}_{t_g}^l := \bigcap_{y,x_1,\dots,x_m} \mathfrak{Y}_{t_g}^{l;y,x_1,\dots,x_m} \subset \mathfrak{X}_{t_g}$$

then yields a C^l -choice of perturbation data on $\mathcal{CT}(t_g)$ such that all maps $\phi_{\mathbb{Y}_{t_g}}$ are transverse to the diagonal $\Delta \subset M^{\times m+1}$. Using an argument à la Taubes we prove that one can in fact construct a residual set $\mathfrak{Y}_{t_g} \subset \mathfrak{X}_{t_g}$, where \mathfrak{X}_{t_g} is the Fréchet space defined by replacing " C^l " by "smooth" in the definition of $\mathfrak{X}_{t_g}^l$, and such that any $\mathbb{Y}_{t_g} \in \mathfrak{Y}_{t_g}$ yields a smooth choice of perturbation data such that all maps $\phi_{\mathbb{Y}_{t_g}}$ are transverse to the diagonal $\Delta \subset M^{\times m+1}$. See subsection II.3.2.2 of [Maz21] for more details on that last point. This wraps up the first step of the induction.

Let $N \geq 0$ and suppose that we have constructed an admissible choice of perturbation data (\mathbb{Y}_{I,t_g}^0) , where $I \subset \Delta^n$ and $t_g \in \mathit{SCRT}_m$ are such that $\dim(\mathcal{CT}(t_g)) + \dim(I) \leq N$. Let $I \subset \Delta^n$ and $t_g \in \mathit{SCRT}_m$ be such that $\dim(\mathcal{CT}(t_g)) + \dim(I) = N + 1$. Let $y \in \text{Crit}(g)$ and $x_1, \dots, x_m \in \text{Crit}(f)$ and fix an integer l such that

$$l \geq \max \left(1, |y| - \sum_{i=1}^m |x_i| - |t_{I,g}| + 1 \right) .$$

We introduce the parametrization space

$$\mathfrak{X}_{I,t_g}^l := \left\{ \begin{array}{l} \dim(I)\text{-simplices of perturbation data } \mathbb{Y}_{I,t_g} \text{ on } \mathcal{CT}_m(t_g) \text{ such that the perturbation} \\ \text{data } \{\mathbb{Y}_{I,t_g}\} \cup (\mathbb{Y}_{J,t'_g}^0)_{J \subset I}^{t'_g \in \text{coll} \cup g^{-v}(t_g)} \text{ are of class } C^l \text{ in the sense of definition 25,} \\ \text{and such that } \mathbb{Y}_{I,t_g} \text{ is gluing-compatible w.r.t. the perturbation data } (\mathbb{Y}_{I,t_g}^0) \end{array} \right\} .$$

This parametrization space is a Banach affine space. Define again the C^l -map

$$\phi_{I,t_g} : \mathfrak{X}_{I,t_g}^l \times \mathring{I} \times \mathcal{CT}_m(t_g) \times W^S(y) \times W^U(x_1) \times \dots \times W^U(x_m) \longrightarrow M^{\times m+1} .$$

The map ϕ_{I,t_g} is then transverse to the diagonal $\Delta \subset M^{\times m+1}$. Applying the parametric transversality theorem and proceeding as in the case $N = 0$, there exists a residual set $\mathfrak{Y}_{I,t_g}^l \subset \mathfrak{X}_{I,t_g}^l$ such that for every choice of perturbation data $\mathbb{Y}_{I,t_g} \in \mathfrak{Y}_{I,t_g}^l$ the map $\phi_{\mathbb{Y}_{I,t_g}}$ is transverse to the diagonal $\Delta \subset M^{\times m+1}$. Resorting again to an argument à la Taubes, we can prove the same statement in the smooth context. By definition of the parametrization spaces \mathfrak{X}_{I,t_g} this construction yields an admissible choice of perturbation data (\mathbb{Y}_{I,t_g}) , where the indices I and t_g are such that $\dim(\mathcal{CT}(t_g)) + \dim(I) \leq N + 1$. This concludes the proof of Theorem 4 by induction.

2.1.2. Proof of theorem 7. The proof of Theorem 7 proceeds exactly as the previous proof, by replacing the requirements in the definition of \mathfrak{X}_{I,t_g}^l by the conditions prescribed by the simplicial subcomplex $S \subset \Delta^n$.

2.2. Orientation and transversality.

2.2.1. *Signed short exact sequences.* Consider a short exact sequence of vector spaces

$$0 \longrightarrow V_2 \longrightarrow W \longrightarrow V_1 \longrightarrow 0 .$$

It induces a direct sum decomposition $W = V_1 \oplus V_2$. Suppose that the vector spaces W , V_1 and V_2 are oriented. We denote $(-1)^\varepsilon$ the sign obtained by comparing the orientation on W to the one induced by the direct sum $V_1 \oplus V_2$. We will then say that the short exact sequence has sign $(-1)^\varepsilon$. In particular, when $(-1)^\varepsilon = 1$, we will say that the short exact sequence is *positive*.

2.2.2. *Orientation and transversality.* Given now two manifolds M, N , a codimension k submanifold $S \subset N$ and a smooth map

$$\phi : M \longrightarrow N$$

which is tranverse to S , the inverse image $\phi^{-1}(S)$ is a codimension k submanifold of M . Moreover, choosing a complementary ν_S to TS , the transversality assumption yields the following short exact sequence of vector bundles

$$0 \longrightarrow T\phi^{-1}(S) \longrightarrow TM|_{\phi^{-1}(S)} \xrightarrow{d\phi} \nu_S \longrightarrow 0 .$$

Suppose now that M, N and S are oriented. The orientations on N and S induce an orientation on ν_S . The submanifold $\phi^{-1}(S)$ is then oriented by requiring that the previous short exact sequence be positive. We will refer to this choice of orientation as the *natural orientation on $\phi^{-1}(S)$* .

For instance, the moduli space $\mathcal{T}_t^{\mathbb{X}}(y; x_1, \dots, x_m)$ is defined as the inverse image of the diagonal $\Delta \subset M^{\times m+1}$ under the map

$$\phi_{\mathbb{X}_t} : \mathcal{T}_m(t) \times W^S(y) \times W^U(x_1) \times \dots \times W^U(x_m) \longrightarrow M^{\times m+1} .$$

Orienting the domain and codomain of $\phi_{\mathbb{X}_t}$ by taking the product orientation, and orienting the diagonal $\Delta \subset M^{\times m+1}$ as M , defines a natural orientation on $\mathcal{T}_t(y; x_1, \dots, x_m)$.

2.3. Algebraic preliminaries.

2.3.1. *Reformulating the $n - \Omega BAs$ -equations.* We set for the rest of this section an orientation ω for each $t_g \in SCRT_n$, which endows each moduli space $\mathcal{CT}_n(t_g)$ with an orientation. We write moreover μ_{I, t_g} for the operations (I, t_g, ω) of $n - \Omega BAs - \text{Morph}$. The ΩBAs -equations for a $n - \Omega BAs$ -morphism then read as

$$[\partial, \mu_{I, t_g}] = \sum_{l=0}^{\dim(I)} (-1)^l \mu_{\partial_l^{sing} I, t_g} + (-1)^{|I|} \left(\sum_{\substack{t^0 \# (t_g^1, \dots, t_g^s) = t_g \\ I_1 \cup \dots \cup I_s = I}} (-1)^{\dagger \Omega BAs} m_{t^0} \circ (\mu_{I_1, t_g^1} \otimes \dots \otimes \mu_{I_s, t_g^s}) \right. \\ \left. + \sum_{t'_g \in coll(t_g)} (-1)^{\dagger \Omega BAs} \mu_{I, t'_g} + \sum_{t'_g \in g\text{-vert}(t_g)} (-1)^{\dagger \Omega BAs} \mu_{I, t'_g} + \sum_{t'_g \# i t^2 = t_g} (-1)^{\dagger \Omega BAs} \mu_{I, t'_g} \circ_i m_{t^2} \right) .$$

The signs $(-1)^{\dagger \Omega BAs}$ need not be made explicit, but can be computed as in section I.5.2 of [Maz21].

2.3.2. Twisted $n - A_\infty$ -morphisms and twisted $n - \Omega BAs$ -morphisms.

Definition 27. (i) A *twisted A_∞ -algebra* is a dg- \mathbb{Z} -module A endowed with two different differentials ∂_1 and ∂_2 , and a collection of degree $2 - m$ operations $m_m : A^{\otimes m} \rightarrow A$ such that

$$[\partial, m_m] = - \sum_{\substack{i_1+i_2+i_3=m \\ 2 \leq i_2 \leq m-1}} (-1)^{i_1+i_2 i_3} m_{i_1+1+i_3} (\text{id}^{\otimes i_1} \otimes m_{i_2} \otimes \text{id}^{\otimes i_3}),$$

where $[\partial, \cdot]$ denotes the bracket for the maps $(A^{\otimes m}, \partial_1) \rightarrow (A, \partial_2)$.

(ii) Let $(A, \partial_1, \partial_2, m_m)$ and $(B, \partial_1, \partial_2, m_m)$ be two twisted A_∞ -algebras. A *twisted $n - A_\infty$ -morphism* from A to B is defined to be a sequence of degree $1 - m + |I|$ operations $f_I^{(m)} : A^{\otimes m} \rightarrow B$ such that

$$\begin{aligned} [\partial, f_I^{(m)}] &= \sum_{j=0}^{\dim(I)} (-1)^j f_{\partial_j I}^{(m)} + (-1)^{|I|} \sum_{\substack{i_1+i_2+i_3=n \\ i_2 \geq 2}} (-1)^{i_1+i_2 i_3} f_I^{(i_1+1+i_3)} (\text{id}^{\otimes i_1} \otimes m_{i_2} \otimes \text{id}^{\otimes i_3}) \\ &\quad - \sum_{\substack{i_1+\dots+i_s=m \\ I_1 \cup \dots \cup I_s = I \\ s \geq 2}} (-1)^{\epsilon_B} m_s (f_{I_1}^{(i_1)} \otimes \dots \otimes f_{I_s}^{(i_s)}), \end{aligned}$$

where $[\partial, \cdot]$ denotes the bracket for the maps $(A^{\otimes m}, \partial_1) \rightarrow (B, \partial_2)$.

(iii) A *twisted ΩBAs -algebra* and a *twisted $n - \Omega BAs$ -morphism* between twisted ΩBAs -algebras are defined similarly.

The explicit formulae obtained by evaluating the $n - \Omega BAs$ -equations of a twisted $n - \Omega BAs$ -morphism on $A^{\otimes m}$ then read as follows :

$$\begin{aligned} & - \partial_2 \mu_{I, t_g}(a_1, \dots, a_m) + (-1)^{|I|+|t_g|+\sum_{j=1}^{i-1} |a_j|} \mu_{I, t_g}(a_1, \dots, a_{i-1}, \partial_1 a_i, a_{i+1}, \dots, a_m) \\ & + \sum_{t_g^\# t^2 = t} (-1)^{|I|+\dagger \Omega BAs + |t^2| \sum_{j=1}^{i_1} |a_j|} \mu_{I, t_g^1}(a_1, \dots, a_{i_1}, m_{t^2}(a_{i_1+1}, \dots, a_{i_1+i_2}), a_{i_1+i_2+1}, \dots, a_m) \\ & + \sum_{\substack{t^0 \# (t_g^1, \dots, t_g^s) = t_g \\ I_1 \cup \dots \cup I_s = I}} (-1)^{|I|+\dagger \Omega BAs + \dagger Koszul} m_{t^0}(\mu_{I_1, t_g^1}(a_1, \dots, a_{i_1}), \dots, \mu_{I_s, t_g^s}(a_{i_1+\dots+i_{s-1}+1}, \dots, a_m)) \\ & + \sum_{t'_g \in \text{coll}(t_g)} (-1)^{|I|+\dagger \Omega BAs} \mu_{I, t'_g}(a_1, \dots, a_m) + \sum_{t'_g \in g\text{-vert}(t_g)} (-1)^{|I|+\dagger \Omega BAs} \mu_{I, t'_g}(a_1, \dots, a_m) \\ & + \sum_{l=0}^{\dim(I)} (-1)^l \mu_{\partial_i^{sing} I, t_g}(a_1, \dots, a_m) = 0, \end{aligned}$$

where

$$\dagger Koszul = \sum_{r=1}^s (|I_r| + |t_g^r|) \left(\sum_{t=1}^{r-1} \sum_{j=1}^{i_t} |a_{i_1+\dots+a_{i_{t-1}}+j}| \right).$$

As explained in [Maz21], these definitions cannot be phrased using an operadic viewpoint. However, a twisted $n - \Omega BAs$ -morphism between twisted ΩBAs -algebras still always descends to a twisted $n - A_\infty$ -morphism between twisted A_∞ -algebras.

2.4. Proof of Theorem 6.

2.4.1. *Recollections on twisted ΩBAs -algebra structures on the Morse cochains.* We prove in [Maz21] that given a Morse function f and an admissible choice of perturbation data \mathbb{X} on the moduli spaces \mathcal{T}_m , the Morse cochains $C^*(f)$ can be endowed with a twisted ΩBAs -algebra structure by counting the 0-dimensional moduli spaces $\mathcal{T}_t^{\mathbb{X}}(y; x_1, \dots, x_n)$.

We twist to this end the natural orientation on the moduli spaces $\mathcal{T}_t^{\mathbb{X}}(y; x_1, \dots, x_m)$ defined in subsection 2.2.2, by a sign of parity

$$\sigma(t; y; x_1, \dots, x_m) := dm(1 + |y| + |t|) + |t||y| + d \sum_{i=1}^m |x_i|(m - i) ,$$

and the orientation on the moduli spaces $\mathcal{T}(y; x)$ by a sign of parity

$$\sigma(y; x) := 1 ,$$

where d denotes the dimension of the manifold M . The moduli spaces $\mathcal{T}_t^{\mathbb{X}}(y; x_1, \dots, x_m)$ and $\mathcal{T}(y; x)$ endowed with these new orientations are then respectively written $\tilde{\mathcal{T}}_t^{\mathbb{X}}(y; x_1, \dots, x_m)$ and $\tilde{\mathcal{T}}(y; x)$.

The operations m_t and the differential on $C^*(f)$ are then defined as

$$\begin{aligned} m_t(x_1, \dots, x_m) &= \sum_{|y|=\sum_{i=1}^m |x_i|+|t|} \# \tilde{\mathcal{T}}_t^{\mathbb{X}}(y; x_1, \dots, x_m) \cdot y , \\ \partial_{Morse}(x) &= \sum_{|y|=|x|+1} \# \tilde{\mathcal{T}}(y; x) \cdot y . \end{aligned}$$

Counting the signed points in the boundary of the oriented 1-dimensional manifolds $\tilde{\mathcal{T}}_t^{\mathbb{X}}(y; x_1, \dots, x_m)$ proves that the operations m_t define a twisted ΩBAs -algebra structure on $(C^*(f), \partial_{Morse}^{Tw}, \partial_{Morse})$, where

$$(\partial_{Morse}^{Tw})^k = (-1)^{(d+1)k} \partial_{Morse}^k .$$

In particular, either working with coefficients in $\mathbb{Z}/2$, or with coefficients in \mathbb{Z} and an odd-dimensional manifold M , the operations m_t define an ΩBAs -algebra structure on the Morse cochains.

2.4.2. *Twisted $n - \Omega BAs$ -morphisms between the Morse cochains.* Let \mathbb{X}^f and \mathbb{X}^g be admissible choices of perturbation data for the Morse functions f and g . Denote $(C^*(f), m_t^{\mathbb{X}^f})$ and $(C^*(g), m_t^{\mathbb{X}^g})$ the Morse cochains endowed with their ΩBAs -algebra structures. Given an admissible n -simplex of perturbation data $(\mathbb{Y}_{I,m})_{I \subset \Delta^n}^{m \geq 1}$, we now construct a twisted $n - \Omega BAs$ -morphism

$$\mu_{I,t_g} : (C^*(f), \partial_{Morse}^{Tw}, \partial_{Morse}) \longrightarrow (C^*(g), \partial_{Morse}^{Tw}, \partial_{Morse}) , \quad I \subset \Delta^n , \quad t_g \in SCRT ,$$

which completes the proof of Theorem 6.

The moduli space $\mathcal{CT}_{I,t_g}^{\mathbb{Y}_{I,t_g}}(y; x_1, \dots, x_m)$ is defined as the inverse image of the diagonal $\Delta \subset M^{\times m+1}$ under the map

$$\phi_{\mathbb{Y}_{I,t_g}} : \mathring{I} \times \mathcal{CT}_m(t_g) \times W^S(y) \times W^U(x_1) \times \dots \times W^U(x_m) \longrightarrow M^{\times m+1} .$$

Orienting the domain and codomain of $\phi_{\mathbb{Y}_{I,t_g}}$ with the product orientation, and orienting the diagonal $\Delta \subset M^{\times m+1}$ as M , defines a natural orientation on $\mathcal{CT}_{I,t_g}(y; x_1, \dots, x_m)$ as explained in subsection 2.2.2.

Definition 28. We define $\widetilde{\mathcal{CT}}_{I,t_g}^{\mathbb{Y}}(y; x_1, \dots, x_m)$ to be the oriented manifold $\mathcal{CT}_{I,t_g}^{\mathbb{Y}}(y; x_1, \dots, x_m)$ whose natural orientation has been twisted by a sign of parity

$$\sigma(t_{I,g}; y; x_1, \dots, x_m) := dm(1 + |y| + |t_{I,g}|) + |t_{I,g}||y| + d \sum_{i=1}^m |x_i|(m - i) .$$

Proposition 16. *If the moduli space $\widetilde{\mathcal{CT}}_{I,t_g}(y; x_1, \dots, x_m)$ is 1-dimensional, its boundary decomposes as the disjoint union of the following components*

- (i) $(-1)^{|y|+|I|+\dagger_{\Omega BAs}+|t^2|\sum_{i=1}^{i_1}|x_i|} \widetilde{\mathcal{CT}}_{I,t_g^1}(y; x_1, \dots, x_{i_1}, z, x_{i_1+i_2+1}, \dots, x_m) \times \widetilde{\mathcal{T}}_t(z; x_{i_1+1}, \dots, x_{i_1+i_2})$;
- (ii) $(-1)^{|y|+|I|+\dagger_{\Omega BAs}+\dagger_{Koszul}} \widetilde{\mathcal{T}}_t(y; y_1, \dots, y_s) \times \widetilde{\mathcal{CT}}_{I_1,t_g^1}(y_1; x_1, \dots) \times \dots \times \widetilde{\mathcal{CT}}_{I_s,t_g^s}(y_s; \dots, x_m)$;
- (iii) $(-1)^{|y|+|I|+\dagger_{\Omega BAs}} \widetilde{\mathcal{CT}}_{I,t_g'}(y; x_1, \dots, x_m)$ for $t_g' \in \text{coll}(t)$;
- (iv) $(-1)^{|y|+|I|+\dagger_{\Omega BAs}} \widetilde{\mathcal{CT}}_{I,t_g'}(y; x_1, \dots, x_m)$ for $t_g' \in g - \text{vert}(t)$;
- (v) $(-1)^{|y|+\dagger_{Koszul}+(m+1)|x_i|} \widetilde{\mathcal{CT}}_{I,t_g}(y; x_1, \dots, z, \dots, x_m) \times \widetilde{\mathcal{T}}(z; x_i)$ where we have set $\dagger_{Koszul} = |I| + |t_g| + \sum_{j=1}^{i-1} |x_j|$;
- (vi) $(-1)^{|y|+1} \widetilde{\mathcal{T}}(y; z) \times \widetilde{\mathcal{CT}}_{I,t_g}(z; x_1, \dots, x_m)$;
- (vii) $(-1)^{|y|+l} \widetilde{\mathcal{CT}}_{\partial_i^{\text{sing}} I,t_g}(y; x_1, \dots, x_m)$.

Define the operations $\mu_{I,t_g} : C^*(f)^{\otimes m} \rightarrow C^*(g)$ as

$$\mu_{I,t_g}(x_1, \dots, x_m) = \sum_{|y|=\sum_{i=1}^m |x_i|+|t_{I,g}|} \# \widetilde{\mathcal{CT}}_{I,t_g}^{\mathbb{Y}}(y; x_1, \dots, x_m) \cdot y .$$

Counting the points in the boundary of the oriented 1-dimensional manifolds $\widetilde{\mathcal{CT}}_{I,t_g}(y; x_1, \dots, x_m)$ finally proves that :

Theorem 6. *The operations μ_{I,t_g} define a twisted $n - \Omega BAs$ -morphism between the Morse cochains $(C^*(f), \partial_{Morse}^{Tw}, \partial_{Morse})$ and $(C^*(g), \partial_{Morse}^{Tw}, \partial_{Morse})$.*

We send the reader back to [Maz21] for the complete check of signs in the case of the operations m_t , which easily transports to the case of the operations μ_{I,t_g} . Again, either working with coefficients in $\mathbb{Z}/2$, or with coefficients in \mathbb{Z} and an odd-dimensional manifold M , the operations μ_{I,t_g} fit into a standard $n - \Omega BAs$ -morphism between ΩBAs -algebras.

3. TOWARDS THE PROBLEM OF THE COMPOSITION

At the end of [Maz21] we stated two main questions. The first was the motivational question solved in this article and the second one came as follows :

Problem 2. Given three Morse functions f_0, f_1, f_2 , choices of perturbation data \mathbb{X}^i , and choices of perturbation data \mathbb{Y}^{ij} defining morphisms

$$\begin{aligned} \mu^{\mathbb{Y}^{01}} &: (C^*(f_0), m_t^{\mathbb{X}^0}) \longrightarrow (C^*(f_1), m_t^{\mathbb{X}^1}) , \\ \mu^{\mathbb{Y}^{12}} &: (C^*(f_1), m_t^{\mathbb{X}^1}) \longrightarrow (C^*(f_2), m_t^{\mathbb{X}^2}) , \\ \mu^{\mathbb{Y}^{02}} &: (C^*(f_0), m_t^{\mathbb{X}^0}) \longrightarrow (C^*(f_2), m_t^{\mathbb{X}^2}) , \end{aligned}$$

can we construct an ΩBAs -homotopy such that $\mu^{\mathbb{Y}^{12}} \circ \mu^{\mathbb{Y}^{01}} \simeq \mu^{\mathbb{Y}^{02}}$ through this homotopy? That is, can the following cone be filled in the ΩBAs realm

$$\begin{array}{ccc}
 C^*(f_0) & \xrightarrow{\mu^{\mathbb{Y}^{01}}} & C^*(f_1) \\
 & \searrow \mu^{\mathbb{Y}^{02}} & \downarrow \mu^{\mathbb{Y}^{12}} \text{ ?} \\
 & & C^*(f_2)
 \end{array}$$

The author plans to prove in an upcoming article that the answer to this question is positive. This simple problem will in fact again generalize to a wider range of constructions in Morse theory, involving the n -morphisms introduced in this article as well as some new interesting combinatorics.

REFERENCES

- [Abo11] Mohammed Abouzaid. A topological model for the Fukaya categories of plumbings. *J. Differential Geom.*, 87(1):1–80, 2011.
- [BC21] Nathaniel Bottman and Shachar Carmeli. $(A_\infty, 2)$ -categories and relative 2-operads. *High. Struct.*, 5(1):401–421, 2021.
- [Bot19] Nathaniel Bottman. Moduli spaces of witch curves topologically realize the 2-associahedra. *J. Symplectic Geom.*, 17(6):1649–1682, 2019.
- [Bot20] Nathaniel Bottman. Pseudoholomorphic quilts with figure eight singularity. *J. Symplectic Geom.*, 18(1):1–55, 2020.
- [BV73] J. M. Boardman and R. M. Vogt. *Homotopy invariant algebraic structures on topological spaces*. Lecture Notes in Mathematics, Vol. 347. Springer-Verlag, Berlin-New York, 1973.
- [DK80] W. G. Dwyer and D. M. Kan. Function complexes in homotopical algebra. *Topology*, 19(4):427–440, 1980.
- [Fao17a] Giovanni Faonte. A_∞ -functors and homotopy theory of dg-categories. *J. Noncommut. Geom.*, 11(3):957–1000, 2017.
- [Fao17b] Giovanni Faonte. Simplicial nerve of an A_∞ -category. *Theory Appl. Categ.*, 32:Paper No. 2, 31–52, 2017.
- [For08] Stefan Forcey. Convex hull realizations of the multiplihedra. *Topology Appl.*, 156(2):326–347, 2008.
- [Fuk02] Kenji Fukaya. Floer homology and mirror symmetry. II. In *Minimal surfaces, geometric analysis and symplectic geometry. Based on the lectures of the workshop and conference, Johns Hopkins University, Baltimore, MD, USA, March 16–21, 1999*, pages 31–127. Tokyo: Mathematical Society of Japan, 2002.
- [Fuk17] Kenji Fukaya. Unobstructed immersed lagrangian correspondence and filtered A_∞ functor, 2017. arXiv:1706.02131.
- [GJ99] Paul G. Goerss and John F. Jardine. *Simplicial homotopy theory*, volume 174 of *Progress in Mathematics*. Birkhäuser Verlag, Basel, 1999.
- [GJ09] Paul G. Goerss and John F. Jardine. *Simplicial homotopy theory*. Modern Birkhäuser Classics. Birkhäuser Verlag, Basel, 2009. Reprint of the 1999 edition [MR1711612].
- [Hir03] Philip S. Hirschhorn. *Model categories and their localizations*, volume 99 of *Mathematical Surveys and Monographs*. American Mathematical Society, Providence, RI, 2003.
- [Hut08] Michael Hutchings. Floer homology of families. I. *Algebr. Geom. Topol.*, 8(1):435–492, 2008.
- [LAM] Guillaume Laplante-Anfossi and Thibaut Mazuir. The diagonal of the multiplihedra and the product of A_∞ -categories. In preparation.
- [LH02] Kenji Lefevre-Hasegawa. *Sur les A_∞ -catégories*. PhD thesis, Ph. D. thesis, Université Paris 7, UFR de Mathématiques, 2003. math. CT/0310337, 2002.
- [LOT21] Robert Lipshitz, Peter Ozsváth, and Dylan Thurston. Diagonals and A-infinity tensor products, 2021.
- [Lur09] Jacob Lurie. *Higher topos theory*, volume 170 of *Annals of Mathematics Studies*. Princeton University Press, Princeton, NJ, 2009.
- [Lyu03] Volodymyr Lyubashenko. Category of A_∞ -categories. *Homology Homotopy Appl.*, 5(1):1–48, 2003.
- [Maz] Thibaut Mazuir. The Alexander-Whitney coproduct extends to an A_∞ -morphism. In preparation.
- [Maz21] Thibaut Mazuir. Higher algebra of A_∞ and ΩBAs -algebras in Morse theory I, 2021. arXiv:2102.06654.
- [Mes18] Stephan Mescher. *Perturbed gradient flow trees and A_∞ -algebra structures in Morse cohomology*, volume 6 of *Atlantis Studies in Dynamical Systems*. Atlantis Press, [Paris]; Springer, Cham, 2018.
- [Mil57] John Milnor. The geometric realization of a semi-simplicial complex. *Ann. of Math. (2)*, 65:357–362, 1957.
- [MS03] James E. McClure and Jeffrey H. Smith. Multivariable cochain operations and little n -cubes. *J. Amer. Math. Soc.*, 16(3):681–704, 2003.
- [MS06] Martin Markl and Steve Shnider. Associahedra, cellular W -construction and products of A_∞ -algebras. *Trans. Amer. Math. Soc.*, 358(6):2353–2372, 2006.
- [MTTV21] Naruki Masuda, Hugh Thomas, Andy Tonks, and Bruno Vallette. The diagonal of the associahedra. *J. Éc. polytech. Math.*, 8:121–146, 2021.
- [MW10] S. Ma'u and C. Woodward. Geometric realizations of the multiplihedra. *Compos. Math.*, 146(4):1002–1028, 2010.
- [MWW18] S. Ma'u, K. Wehrheim, and C. Woodward. A_∞ functors for Lagrangian correspondences. *Selecta Math. (N.S.)*, 24(3):1913–2002, 2018.
- [RNV20] Daniel Robert-Nicoud and Bruno Vallette. Higher Lie theory, 2020. arXiv:2010.10485.

- [Sei08] Paul Seidel. *Fukaya categories and Picard-Lefschetz theory*. Zurich Lectures in Advanced Mathematics. European Mathematical Society (EMS), Zürich, 2008.
- [Sta63] James Dillon Stasheff. Homotopy associativity of H -spaces. I, II. *Trans. Amer. Math. Soc.* 108 (1963), 275-292; *ibid.*, 108:293-312, 1963.
- [Val20] Bruno Vallette. Homotopy theory of homotopy algebras. *Ann. Inst. Fourier (Grenoble)*, 70(2):683-738, 2020.

Troisième partie

Further developments

Higher algebra from multi-gauged trees and quilted curves

1. Moduli spaces of bigauged metric trees

At the end of [Maz21a], we stated two main questions. The first question was the starting point of [Maz21b]. The second one was formulated as follows. Given three Morse functions f_0, f_1, f_2 , choices of perturbation data \mathbb{X}^i , and choices of perturbation data \mathbb{Y}^{ij} defining morphisms

$$\begin{aligned}\mu^{\mathbb{Y}^{01}} &: (C^*(f_0), m_t^{\mathbb{X}^0}) \longrightarrow (C^*(f_1), m_t^{\mathbb{X}^1}), \\ \mu^{\mathbb{Y}^{12}} &: (C^*(f_1), m_t^{\mathbb{X}^1}) \longrightarrow (C^*(f_2), m_t^{\mathbb{X}^2}), \\ \mu^{\mathbb{Y}^{02}} &: (C^*(f_0), m_t^{\mathbb{X}^0}) \longrightarrow (C^*(f_2), m_t^{\mathbb{X}^2}),\end{aligned}$$

can we construct an ΩBAs -homotopy such that

$$\mu^{\mathbb{Y}^{02}} \simeq \mu^{\mathbb{Y}^{12}} \circ \mu^{\mathbb{Y}^{01}} ?$$

More generally, which higher operadic algebra naturally arises in this context ?

1.1. Composing ΩBAs -morphisms. While we have introduced a satisfactory notion of a ΩBAs -homotopy between ΩBAs -morphisms, we have yet to define how to compose two ΩBAs -morphisms. Using the bar construction viewpoint in the A_∞ context, the composition of two A_∞ -morphisms $F : \bar{T}(sA) \rightarrow \bar{T}(sB)$ and $G : \bar{T}(sB) \rightarrow \bar{T}(sC)$ is defined as the standard composition of morphisms of dg-coalgebras $G \circ F$. This reads on the level of operations as

$$(G \circ F)_n := \sum_{i_1 + \dots + i_s = n} \pm g_s(f_{i_1} \otimes \dots \otimes f_{i_s}).$$

This composition can be defined on the operadic level as a morphism of (A_∞, A_∞) -operadic bimodules

$$A_\infty - \text{Morph} \longrightarrow A_\infty - \text{Morph} \circ_{A_\infty} A_\infty - \text{Morph}.$$

Starting from this formula, it is clear how to define the unsigned composition of ΩBAs -morphisms. Given two ΩBAs -morphisms $\{f_{t_g} : A^{\otimes m} \rightarrow B\}$ and $\{g_{t_g} : B^{\otimes m} \rightarrow C\}$ between ΩBAs -algebras A, B and C , we define their composition $g \circ f$ as

$$(g \circ f)_{t_g} := \sum g_{t_g}^r(f_{t_g}^1 \otimes \dots \otimes f_{t_g}^s),$$

where the sum runs over gauged trees $t_g^r \in sCRT_s$ and $t_g^r \in sCRT_{i_r}$ such that

- (i) the gauged tree obtained by grafting each underlying ribbon tree t^r of t_g^r to the r -th incoming edge of t_g^r is equal to t_g , i.e. $t_g^r \#(t^1, \dots, t^s) = t_g$,
- (ii) and the gauge of the gauged tree t_g^r does not intersect the vertices of t^r for $r = 1, \dots, s$.

It can be checked that this formula indeed defines a morphism satisfying the ΩBAs -equations, and that the composition defined in this way is moreover associative. For instance,

$$(g \circ f)_{\mathbb{Y}} = g_{\mathbb{Y}} \circ f_{\mathbb{Y}} + g_{\mathbb{Y}} \circ f_{\mathbb{Y}} + g_{\mathbb{Y}}(f_{\mathbb{Y}} \otimes f_{\mathbb{Y}}).$$

The morphism of $(\Omega BAs, \Omega BAs)$ -operadic bimodules induced by this unsigned composition

$$\circ : \Omega BAs - \text{Morph} \longrightarrow \Omega BAs - \text{Morph} \circ_{\Omega BAs} \Omega BAs - \text{Morph}$$

then fits into a commutative diagram of morphisms of (A_∞, A_∞) -operadic bimodules

$$\begin{array}{ccc} A_\infty - \text{Morph} & \longrightarrow & A_\infty - \text{Morph} \circ_{A_\infty} A_\infty - \text{Morph} \\ \downarrow & & \downarrow \\ \Omega BAs - \text{Morph} & \longrightarrow & \Omega BAs - \text{Morph} \circ_{\Omega BAs} \Omega BAs - \text{Morph} \end{array} .$$

More concretely, consider f and g two ΩBAs -morphisms and compose them to form a new ΩBAs -morphism $g \circ f$. Write \tilde{f} , \tilde{g} and $\widetilde{g \circ f}$ for the induced A_∞ -morphisms. Then $\tilde{g} \circ \tilde{f} = \widetilde{g \circ f}$, where the \circ on the left-hand side denotes the composition of A_∞ -morphisms.

Hence the difficulty in defining the composition of ΩBAs -morphisms does not lie in working out the trees combinatorics, but in working out the proper signs for these combinatorics. Indeed notice that the operad ΩBAs and the operadic bimodule $\Omega BAs - \text{Morph}$ in $\mathbf{dg} - \mathbf{Vect}$ have been defined using the moduli spaces $\mathcal{T}_m(t)$ and $\mathcal{CT}_m(t_g)$, but not using an intrinsic algebraic formalism as in the A_∞ context. We do not know yet how to solve this difficulty and will thereby work over $\mathbb{Z}/2\mathbb{Z}$ in the rest of this subsection.

We also point out that the composition of ΩBAs -morphisms could have been defined by replacing conditions (i) and (ii) by

- (i ') the gauged tree obtained by grafting each gauged tree t'_g to the r -th incoming edge of the underlying ribbon tree t' of t'_g is equal to t_g , i.e. $t' \#(t_g^1, \dots, t_g^s) = t_g$,
- (ii ') and the gauge of the gauged tree t'_g does not intersect the vertices of t' .

The composition \circ' for ΩBAs -morphisms would then still be associative and compatible with the composition of A_∞ -morphisms. We expect in fact that the composition morphisms \circ and \circ' could be proven to be homotopy equivalent in some sense. We will work in the rest of this chapter with the composition \circ .

1.2. Moduli spaces of bigauged metric trees. The naive intuition to construct a homotopy between the ΩBAs -morphisms $\mu^{\mathbb{Y}^{02}}$ and $\mu^{\mathbb{Y}^{12}} \circ \mu^{\mathbb{Y}^{01}}$ would be to introduce moduli spaces of bigauged stable metric ribbon trees and realize them in Morse theory as moduli spaces of bigauged perturbed Morse gradient trees. Define a *bigauged stable metric ribbon tree* to be a stable metric ribbon tree together with two lengths λ_1 and λ_2 in \mathbb{R} , such that $\lambda_2 < \lambda_1$. We think of these lengths as gauges drawn over the metric tree, at distance λ_i from its root, where the positive direction is pointing down. The two gauges moreover divide the tree into three parts, each of which we imagine being painted in a different color. Two instances of bigauged stable metric ribbon trees are represented in figure 1. We will refer to the gauge associated to the length λ_i as the i -th gauge. We moreover define the *inter-gauge gap* as $\delta := \lambda_1 - \lambda_2 \in]0, +\infty[$. We finally point out that, as for metric trees with a single gauge, there is a definition of bigauged metric trees as three-colored metric trees, which we will not write down.

For $m \geq 1$, denote $2\mathcal{GT}_m$ the *moduli space of bigauged stable metric ribbon trees*. This space is homeomorphic to \mathbb{R}^m : the moduli space of stable metric ribbon trees \mathcal{T}_m is homeomorphic to \mathbb{R}^{m-2} and the datum of the two gauges adds the factor $\{(\lambda_1, \lambda_2) , \lambda_2 < \lambda_1\} \subset \mathbb{R}^2$. This moduli space admits moreover a cell decomposition by bigauged stable ribbon tree type, that we will not describe for the sake of concision. We set in the rest of this section $\mathcal{GT}_m := \mathcal{CT}_m$ for the moduli spaces of metric gauged ribbon trees, in order to be consistent with the notation $2\mathcal{GT}_m$.

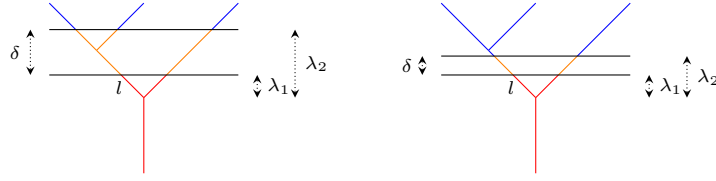

FIGURE 1 – Two instances of bigauged stable metric ribbon trees

The moduli space $2\mathcal{GT}_m$ comes with a natural compactification $\overline{2\mathcal{GT}_m}$ defined by allowing length of internal edges towards $+\infty$ and taking the two gauges into account in the process. We describe the phenomena producing the codimension 1 boundary strata of $\overline{2\mathcal{GT}_m}$:

- (i) the two gauges meet to produce a single-gauged metric tree. The corresponding boundary stratum is canonically identified with

$$\mathcal{GT}_m ;$$

- (ii) an internal edge located above the second gauge or intersecting it breaks or, when the two gauges are below the root, the outgoing edge breaks between the second gauge and the root. The corresponding boundary stratum is canonically identified with

$$2\mathcal{GT}_{i_1+i_3} \times \mathcal{T}_{i_2} ,$$

where $i_1 + i_2 + i_3 = m$;

- (iii) edges (internal or incoming) that are located below the first gauge and possibly intersecting it, break below it, such that there is exactly one edge breaking in each non-self crossing path from an incoming edge to the root, and such that the inter-gauge gaps of bigauged stable ribbon trees obtained in this way are equal. The corresponding boundary stratum can be described as a fiber product

$$\mathcal{T}_s \times (2\mathcal{GT}_{i_1} \times]0, +\infty[\cdots \times]0, +\infty[2\mathcal{GT}_{i_s}) ,$$

where $i_1 + \cdots + i_s = m$ and the fiber product is taken over the inter-gauge gap maps $\delta_r : 2\mathcal{GT}_{i_r} \rightarrow]0, +\infty[$;

- (iv) edges (internal or incoming) that are located between the two gauges and possibly intersecting them, break between the two gauges, such that there is exactly one edge breaking in each non-self crossing path from an incoming edge to the root. This boundary stratum can be described as

$$\mathcal{GT}_s \times \mathcal{GT}_{i_1} \times \cdots \times \mathcal{GT}_{i_s} ,$$

where $i_1 + \cdots + i_s = m$.

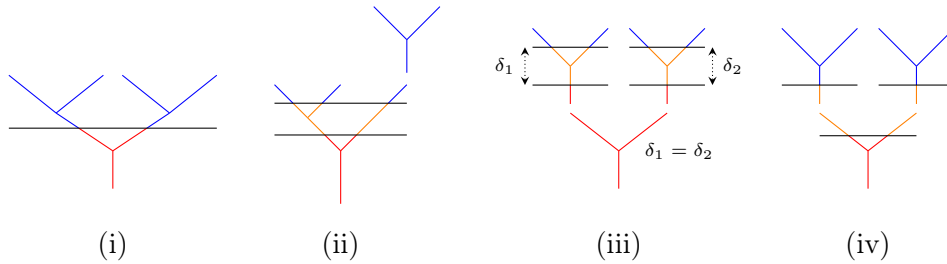

FIGURE 2 – Examples of configurations of metric trees in the codimension 1 boundary of $2\mathcal{GT}_4$. We only represent the inter-gauge gaps in (iii), in order to illustrate the fiber product description of this boundary stratum.

Examples of elements lying in these boundary strata are depicted in figure 2, following the previous labeling. Considering the compactification of a cell $2\mathcal{GT}_m(t_{g_1, g_2}) \subset 2\mathcal{GT}_m$ inside $\overline{2\mathcal{GT}_m}$, where t_{g_1, g_2} is a bigauged stable ribbon tree type, would simply add boundary strata of type (gauge-vertex) and (int-collapse). We refer to subsection 3.2.4 in part 1 of [Maz21a] for a description of these two boundary strata.

We return now to the question formulated at the beginning of this section. We would like to construct an ΩBAs -homotopy between the ΩBAs -morphisms $\mu^{\mathbb{Y}02}$ and $\mu^{\mathbb{Y}12} \circ \mu^{\mathbb{Y}01}$ by counting the points of 0-dimensional moduli spaces of bigauged perturbed Morse gradient trees

$$2\mathcal{GT}_{t_{g_1, g_2}}(y; x_1, \dots, x_m) .$$

To prove that the operations associated to these counts define an ΩBAs -homotopy, we have to inspect the boundary of the 1-dimensional compactified moduli spaces $2\mathcal{GT}_{t_{g_1, g_2}}(y; x_1, \dots, x_m)$. A boundary will again decompose as the disjoint union of the (Morse) boundary components and the $(\overline{2\mathcal{GT}_m})$ boundary components. This is where we encounter a serious obstacle.

Indeed, until now we had described moduli spaces of metric trees encoding *universally* the algebraic structures we were interested in. Said differently, we described moduli spaces whose images under the functor C_{-*}^{cell} model these algebraic structure. This is not the case for the compactification of $2\mathcal{GT}_m$. The first reason is that in general fiber products do not behave well under the functor C_{-*}^{cell} . The second reason is that, in order for the moduli spaces $2\mathcal{GT}_{t_{g_1, g_2}}(y; x_1, \dots, x_m)$ to encode a homotopy between $\mu^{\mathbb{Y}02}$ and $\mu^{\mathbb{Y}12} \circ \mu^{\mathbb{Y}01}$, we would need the boundary strata

$$\mathcal{T}_s \times (2\mathcal{GT}_{i_1} \times_{]0, +\infty[} \cdots \times_{]0, +\infty[} 2\mathcal{GT}_{i_s})$$

to be replaced by the boundary strata

$$\mathcal{T}_{s+1+t} \times \left(\mathcal{GT}_{i_1} \times \cdots \times \mathcal{GT}_{i_s} \times 2\mathcal{GT}_l \times (\mathcal{GT}_{j_1} \times (\mathcal{GT}_{m_1^1} \times \cdots \times \mathcal{GT}_{m_{j_1}^1})) \times \cdots \times (\mathcal{GT}_{j_t} \times (\mathcal{GT}_{m_1^t} \times \cdots \times \mathcal{GT}_{m_{j_t}^t})) \right) ,$$

where

$$l + \sum_{r=1}^s i_r + \sum_{r=1}^t \sum_{i=1}^{j_r} m_i^r .$$

We would then recover the following term in the ΩBAs -equations

$$\sum_{\substack{i_1 + \cdots + i_s + l \\ + k_1 + \cdots + k_t = m \\ s+1+t \geq 2}} \pm m_{s+1+t} \left(\mu_{i_1}^{\mathbb{Y}02} \otimes \cdots \otimes \mu_{i_s}^{\mathbb{Y}02} \otimes h_l \otimes (\mu^{\mathbb{Y}12} \circ \mu^{\mathbb{Y}01})_{k_1} \otimes \cdots \otimes (\mu^{\mathbb{Y}12} \circ \mu^{\mathbb{Y}01})_{k_t} \right) ,$$

which we have written here in the A_∞ -context for the sake of readability.

As a result, we can state that the moduli spaces $2\mathcal{GT}_m$ cannot universally encode ΩBAs -homotopies between an *indivisible* ΩBAs -morphism and the composite of two ΩBAs -morphisms (we should in fact write A_∞ instead of ΩBAs here, as we do not consider the cells $2\mathcal{GT}_m(t_{g_1, g_2})$ but the full moduli space $2\mathcal{GT}_m$). So in order to produce out of the moduli spaces

$$2\mathcal{GT}_{t_{g_1, g_2}}(y; x_1, \dots, x_m)$$

a homotopy between $\mu^{\mathbb{Y}02}$ and $\mu^{\mathbb{Y}12} \circ \mu^{\mathbb{Y}01}$, we have to come up with an argument living directly at the level of Morse theory. A solution to this problem will be explained at the end of subsection 2.2.

2. Higher algebra from moduli spaces of quilted disks

As a matter of fact, Mau, Wehrheim and Woodward encounter in [MWW18] the exact same type of problem formulated at the end of subsection 1.2, when studying geometric A_∞ -functors between Fukaya categories. The goal of this section is to provide an exposition to the moduli spaces and algebraic structures appearing in their article. We describe in subsection 2.1 the moduli spaces of quilted disks involved in the definition of geometric A_∞ -functors between Fukaya categories, and explain in subsection 2.2 how Mau, Wehrheim and Woodward solve the problem of the comparison between algebraic and geometric composition in that framework. We expect that their method should in particular be applicable to a Morse theoretic setup and solve the motivational question to section 1. We then explain their construction of a categorification A_∞ -functor $\text{Fuk}(M_0^- \times M_1) \rightarrow \text{Func}(\text{Fuk}(M_0), \text{Fuk}(M_1))$ in [MWW18] and of a 2-functor $\text{Floer} \rightarrow \text{Cat}$ in [WW10a], where Floer denotes the 2-category whose objects are closed monotone symplectic manifolds and whose categories of morphisms are the Donaldson categories $\text{Don}(M_0^- \times M_1)$. We moreover point out that their constructions take place in the context of quilted Floer cohomology, as explained in subsection 2.5.

2.1. A_∞ -functors associated to Lagrangian correspondences. Consider a closed monotone symplectic manifold (M, ω) . The *Fukaya category* $\text{Fuk}(M, \omega)$ is an A_∞ -category which is defined as follows. The objects of $\text{Fuk}(M)$ are the closed monotone and graded Lagrangians $L \subset M$. The space of morphisms from a Lagrangian L_0 to a Lagrangian L_1 is the \mathbb{Z} -module $CF^*(L_0, L_1)$ freely generated by the points of $L_0 \cap L_1$ and graded using the Maslov index. For $x_1 \in L_0 \cap L_1, \dots, x_n \in L_{n-1} \cap L_n$ and $y \in L_0 \cap L_n$, introduce the moduli space of pseudo-holomorphic disks with Lagrangian boundary conditions on the L_i , $n + 1$ marked boundary points that are clockwise sent to the x_i and y , and that solve a Cauchy-Riemann equation with suitable Hamiltonian perturbation, as depicted in figure 3. We denote it as

$$\mathcal{D}_{n,1}(y; x_1, \dots, x_n),$$

where the $n, 1$ simply means that we see the pseudo-holomorphic disks with n entries x_1, \dots, x_n and one exit y . The higher compositions of $\text{Fuk}(M, \omega)$ are then defined by counting the points of the 0-dimensional moduli spaces $\mathcal{D}_{n,1}(y; x_1, \dots, x_n)$.

We are well-aware that the assumptions made in the previous paragraph are insufficient to rigorously define the Fukaya category of a symplectic manifold. However, as our main goal is to put the emphasis on the algebraic constructions arising from Fukaya categories, we will keep the same level of details in the rest of this chapter in order not to obscure our algebraic statements. We refer for instance to [Aur14] and [Sei08] for more details on the technicalities necessary to define a Fukaya category.

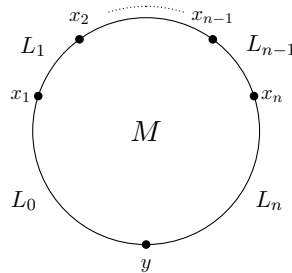

FIGURE 3 – A pseudo-holomorphic disk with Lagrangian boundary conditions on the L_i and $n + 1$ marked boundary points

One would now like to construct geometric A_∞ -functors between two Fukaya categories $\text{Fuk}(M_0)$ and $\text{Fuk}(M_1)$. Following Weinstein [Wei81], a Lagrangian $\mathcal{L}_{01} \subset M_0^- \times M_1$ can be interpreted as a morphism from M_0 to M_1 , where $M_0^- \times M_1$ denotes the symplectic manifold $(M_0 \times M_1, -\omega_0 \oplus \omega_1)$. These Lagrangians will be called *Lagrangian correspondences* from M_0 to M_1 . Lagrangian correspondences generalize the notion of symplectomorphism, as every symplectomorphism $\psi : M_0 \rightarrow M_1$ defines a Lagrangian correspondence $\{(x, \psi(x)), x \in M_0\} \subset M_0^- \times M_1$. Following this idea, Mau, Wehrheim and Woodward associate to a Lagrangian correspondence $\mathcal{L}_{01} \subset M_0^- \times M_1$ an A_∞ -functor $\phi_{\mathcal{L}_{01}} : \text{Fuk}(M_0) \rightarrow \text{Fuk}(M_1)$ in [MWW18]. Their construction goes as follows.

We define a *quilted disk* with $n + 1$ marked boundary points to be the data of a disk $D \subset \mathbb{C}$, distinct points z_0, z_1, \dots, z_n ordered clockwise on ∂D , and a circle $C \subset D$ such that $0 < \text{radius}(C) < \text{radius}(D)$, and which is tangent to z_0 . The circle C is called the *seam* of the quilt, and divides the interior of D into two components, called the *patches*. An example of a quilted disk with four marked boundary points is depicted in figure 4. Mau and Woodward provide an extensive study of the moduli spaces of quilted disks in [MW10] and show in particular that the moduli spaces $\mathcal{QD}_{n,1}$ provide another realization of the multiplihedra in the realm of geometry.

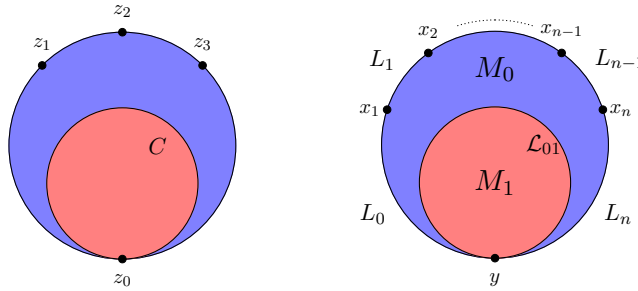

FIGURE 4 – On the left, a quilted disk in $\mathcal{QD}_{3,1}$. On the right, a pseudo-holomorphic quilted disk with Lagrangian boundary conditions on the L_i , seam condition on \mathcal{L}_{01} and $n + 1$ marked boundary points

The A_∞ -functor $\phi_{\mathcal{L}_{01}}$ of [MWW18] is defined on objects as

$$\phi_{\mathcal{L}_{01}}(L_0) := \pi_{M_1}(L_0 \times_{M_0} \mathcal{L}_{01}) ,$$

where π_{M_1} denotes the projection $M_0 \times M_0^- \times M_1 \rightarrow M_1$ and \times_{M_0} is the fiber product over M_0 . See subsection 2.5 for more details on the definition of $\phi_{\mathcal{L}_{01}}(L_0)$. Let L_0, \dots, L_n be Lagrangian submanifolds of M_0 . For $x_1 \in L_0 \cap L_1, \dots, x_n \in L_{n-1} \cap L_n$ and $y \in \phi_{\mathcal{L}_{01}}(L_0) \cap \phi_{\mathcal{L}_{01}}(L_n)$, introduce the moduli space of pseudo-holomorphic quilted disks with Lagrangian boundary conditions on the L_i , seam condition on \mathcal{L}_{01} and $n + 1$ marked boundary points that are clockwise sent to the x_i and y , as depicted in figure 4. The labelings M_0 and M_1 mean that each patch comes with a map u_i from this patch to M_i , while the seam condition means that the map (u_0, u_1) which is defined on the seam takes its values in \mathcal{L}_{01} . We denote this moduli space as

$$\mathcal{QD}_{n,1}^{\mathcal{L}_{01}}(y; x_1, \dots, x_n) .$$

The operations of the A_∞ -functor

$$\phi_{\mathcal{L}_{01}} : \text{Fuk}(M_0) \longrightarrow \text{Fuk}(M_1)$$

can then finally be defined by counting pseudo-holomorphic quilted disks of this form.

2.2. Algebraic composition versus geometric composition. We now consider three monotone symplectic manifolds (M_0, ω_0) , (M_1, ω_1) and (M_2, ω_2) and two Lagrangian correspondences $\mathcal{L}_{01} \subset M_0^- \times M_1$ and $\mathcal{L}_{12} \subset M_1^- \times M_2$. They can be composed into a third Lagrangian correspondence

$$\mathcal{L}_{01} \circ \mathcal{L}_{12} \subset M_0^- \times M_2 ,$$

by defining $\mathcal{L}_{01} \circ \mathcal{L}_{12} := \pi_{M_0 \times M_2}(\mathcal{L}_{01} \times_{M_1} \mathcal{L}_{12})$. We assume from now on that this Lagrangian correspondence is smooth and embedded in $M_0 \times M_2$. Consider the three A_∞ -functors $\phi_{\mathcal{L}_{01}}$, $\phi_{\mathcal{L}_{12}}$ and $\phi_{\mathcal{L}_{01} \circ \mathcal{L}_{12}}$. The first main result of [MWW18] is the construction of an A_∞ -homotopy between the two A_∞ -functors

$$\phi_{\mathcal{L}_{01} \circ \mathcal{L}_{12}} \simeq \phi_{\mathcal{L}_{12}} \circ \phi_{\mathcal{L}_{01}} .$$

The natural approach they follow is to introduce moduli spaces of biquilted disks and their pseudo-holomorphic counterparts.

We define a *biquilted disk* with $n + 1$ marked boundary points to be the data of a disk $D \subset \mathbb{C}$, distinct points z_0, z_1, \dots, z_n ordered clockwise on ∂D , and two circles $C_1, C_2 \subset D$ such that $0 < \text{radius}(C_1) < \text{radius}(C_2) < \text{radius}(D)$, and which are tangent to z_0 . The circle C_i is called the *i-th seam* of the quilt, and the two seams divide the interior of D into three patches. We moreover define the *radii ratio* as $\rho := \text{radius}(C_2)/\text{radius}(C_1) - 1$: it lies in $]0, +\infty[$. An instance of a biquilted disk with four marked boundary points is illustrated in figure 5.

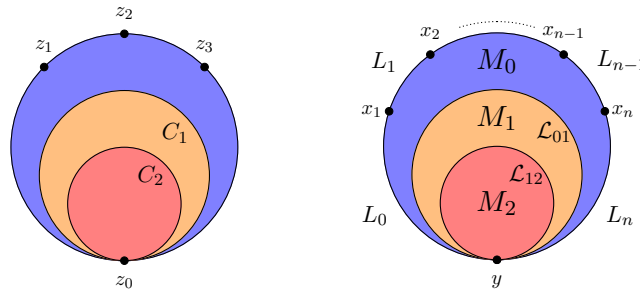

FIGURE 5 – On the left, a biquilted disk in $2\mathcal{QD}_{3,1}$. On the right, a pseudo-holomorphic biquilted disk with Lagrangian boundary conditions on the L_i , seam conditions on \mathcal{L}_{01} and \mathcal{L}_{12} , and $n + 1$ marked boundary points

For $n \geq 1$, denote $2\mathcal{QD}_{n,1}$ the moduli space of biquilted disks with $n + 1$ marked points on their boundary. These moduli spaces can be topologized and compactified in such a way that the codimension 1 boundary of $2\mathcal{QD}_{n,1}$ reads exactly as the one of $2\mathcal{GT}_n$. As a result, the same problem formulated at the end of section 1.2 arises from the boundary strata

$$\mathcal{D}_{s,1} \times (2\mathcal{QD}_{i_1,1} \times_{]0,+\infty[} \cdots \times_{]0,+\infty[} 2\mathcal{QD}_{i_s,1}) ,$$

where the fiber product is defined over the radii ratio maps $\rho_r : 2\mathcal{QD}_{i_r} \rightarrow]0, +\infty[$.

Let L_0, \dots, L_n be Lagrangian submanifolds of M_0 . For $x_1 \in L_0 \cap L_1, \dots, x_n \in L_{n-1} \cap L_n$ and $y \in \phi_{\mathcal{L}_{01} \circ \mathcal{L}_{12}}(L_0) \cap \phi_{\mathcal{L}_{01} \circ \mathcal{L}_{12}}(L_n)$, define

$$2\mathcal{QD}_{n,1}^{\mathcal{L}_{01}, \mathcal{L}_{12}}(y; x_1, \dots, x_n)$$

to be the moduli space of pseudo-holomorphic biquilted disks with Lagrangian boundary conditions on the L_i , seam conditions on \mathcal{L}_{01} and \mathcal{L}_{12} , and $n + 1$ marked boundary points that are clockwise sent to the x_i and y , as represented in figure 5.

As explained in subsection 1.2, we cannot naively count the points of these 0-dimensional moduli spaces in order to produce an A_∞ -homotopy $\phi_{\mathcal{L}_{01} \circ \mathcal{L}_{12}} \simeq \phi_{\mathcal{L}_{12}} \circ \phi_{\mathcal{L}_{01}}$. We have to come

up with an argument living directly at the level of the pseudo-holomorphic biquilted disks. Mau, Wehrheim and Woodward show that, under some generic assumptions, the moduli spaces $2\mathcal{QD}_{n,1}(y; x_1, \dots, x_n)$ can be used to produce a sequence of A_∞ -functors F_i and A_∞ -homotopies $H_{i,i+1}$ between them,

$$\phi_{\mathcal{L}_{01} \circ \mathcal{L}_{12}} = \mathcal{F}_0 \xrightarrow{\mathcal{H}_{0,1}} \mathcal{F}_1 \xrightarrow{\mathcal{H}_{1,2}} \dots \xrightarrow{\mathcal{H}_{n-1,n}} \mathcal{F}_n = \phi_{\mathcal{L}_{12}} \circ \phi_{\mathcal{L}_{01}} .$$

Composing these A_∞ -homotopies finally produces an A_∞ -homotopy

$$\phi_{\mathcal{L}_{01} \circ \mathcal{L}_{12}} \simeq \phi_{\mathcal{L}_{12}} \circ \phi_{\mathcal{L}_{01}} .$$

As a matter of fact, the previous sequence of A_∞ -homotopies is not finite in general, but the A_∞ -homotopy can nevertheless always be defined using an inductive limit argument.

The details of their proof go beyond the scope of this section. We only warn the reader that their construction does not consist in transforming the boundary strata of the moduli spaces of pseudo-holomorphic biquilted disks

$$\mathcal{D}_{s,1} \times (2\mathcal{QD}_{i_1,1} \times_{]0,+\infty[} \dots \times_{]0,+\infty[} 2\mathcal{QD}_{i_s,1})$$

into strata

$$\mathcal{D}_{s+1+t} \times \left(\mathcal{QD}_{i_1} \times \dots \times \mathcal{QD}_{i_s} \times 2\mathcal{QD}_l \times (\mathcal{QD}_{j_1} \times (\mathcal{QD}_{m_1^t} \times \dots \times \mathcal{QD}_{m_{j_1}^t})) \times \dots \times (\mathcal{QD}_{j_t} \times (\mathcal{QD}_{m_1^t} \times \dots \times \mathcal{QD}_{m_{j_t}^t})) \right) ,$$

where we omit to write the $(y; x_1, \dots, x_n)$ and replace the notation $D_{s+1+t,1}$ by D_{s+1+t} in the second formula for the sake of readability. The proof comes however with a detailed analysis of these fiber products, in order to produce the sequence of A_∞ -functors and A_∞ -homotopies. We also mention that their proof crucially depends on an adiabatic limit type argument relying on strip-shrinking analysis, and which is explained in [WW12].

We expect that the proof of [MWW18] should apply to the Morse-theoretic setup described in section 1. Counting the points of 0-dimensional moduli spaces of perturbed Morse bigauged trees should exhibit a ΩBAs -homotopy $\mu^{\mathbb{Y}^{02}} \simeq \mu^{\mathbb{Y}^{12}} \circ \mu^{\mathbb{Y}^{01}}$. The proof of this statement would in fact again involve working out the tree combinatorics arising from the decomposition of the moduli spaces $2\mathcal{GT}_m$ by bigauged ribbon tree types.

2.3. The categorification A_∞ -functor. The second main result of [MWW18] is the construction of an A_∞ -functor

$$(\star) \quad \text{Fuk}(M_0^- \times M_1) \longrightarrow \text{Func}(\text{Fuk}(M_0), \text{Fuk}(M_1))$$

where M_0 and M_1 are two closed monotone symplectic manifolds, and $\text{Func}(\text{Fuk}(M_0), \text{Fuk}(M_1))$ denotes the A_∞ -category whose objects are A_∞ -functors from $\text{Fuk}(M_0)$ to $\text{Fuk}(M_1)$ and morphisms are pre-natural transformations from $\text{Fuk}(M_0)$ to $\text{Fuk}(M_1)$. We describe this A_∞ -category thoroughly in subsection 3.2 of part 2 in [Maz21b], drawing from [Sei08]. The A_∞ -functor (\star) is referred to as a *categorification A_∞ -functor* in [MWW18] and [WW10a].

The categorification A_∞ -functor is constructed as follows. It is defined on objects as $\mathcal{L} \rightarrow \phi_{\mathcal{L}}$, where $\phi_{\mathcal{L}}$ is the A_∞ -functor $\text{Fuk}(M_0) \rightarrow \text{Fuk}(M_1)$ constructed in subsection 2.1. Let $\mathcal{L}_0, \dots, \mathcal{L}_m$ be Lagrangian correspondences in $M_0^- \times M_1$ and L_0, \dots, L_n be Lagrangian submanifolds of M_0 . Let $x_1 \in L_0 \cap L_1, \dots, x_n \in L_{n-1} \cap L_n, y_1 \in \mathcal{L}_0 \cap \mathcal{L}_1, \dots, y_m \in \mathcal{L}_{m-1} \cap \mathcal{L}_m$ and $z \in \phi_{\mathcal{L}_0}(L_0) \cap \phi_{\mathcal{L}_m}(L_n)$. Introduce the moduli space of pseudo-holomorphic quilted disks with Lagrangian boundary conditions on the L_i and $n + 1$ marked boundary points that are clockwise sent to the x_i and z , and seam conditions on the \mathcal{L}_j with m marked seam points that are clockwise sent to the y_j . An example of such a quilted disk is depicted in figure 6. We denote these moduli spaces as

$$\mathcal{QD}_{n,m,1}(z; y_1, \dots, y_m; x_1, \dots, x_n) .$$

The operations of the categorification A_∞ -functor are then defined by counting pseudo-holomorphic quilted disks of the previous form : a sequence of intersection points $y_1 \in \mathcal{L}_0 \cap \mathcal{L}_1, \dots, y_m \in \mathcal{L}_{m-1} \cap \mathcal{L}_m$ is sent to the pre-natural transformation whose n -ary operations are defined as

$$CF^*(L_0, L_1) \otimes \cdots \otimes CF^*(L_{n-1}, L_n) \longrightarrow CF^*(\phi_{\mathcal{L}_0}(L_0), \phi_{\mathcal{L}_m}(L_n))$$

$$x_1 \otimes \cdots \otimes x_n \longmapsto \sum \# \mathcal{QD}_{n,m,1}(z; y_1, \dots, y_m; x_1, \dots, x_n) \cdot z .$$

We point out that there are four type of moduli spaces arising in the construction of the categorification A_∞ -functor :

- (i) The moduli spaces of disks with marked boundary points, encoding the operations of the A_∞ -categories $\text{Fuk}(M_0)$ and $\text{Fuk}(M_1)$.
- (ii) The moduli spaces of quilted spheres with marked seam points, encoding the operations of the A_∞ -category $\text{Fuk}(M_0^- \times M_1)$. The crucial point here is that quilted spheres with two patches can be identified with disks mapping to the product, and that the moduli spaces of quilted spheres with marked seam points realize the associahedra.
- (iii) The moduli spaces of quilted disks with marked boundary points, encoding the operations of the A_∞ -functors $\phi_{\mathcal{L}} : \text{Fuk}(M_0) \rightarrow \text{Fuk}(M_1)$.
- (iv) The moduli spaces of quilted disks with marked seam points and marked boundary points, encoding the operations of the categorification A_∞ -functor itself.

A careful analysis of the boundary of the compactification of the 1-dimensional moduli spaces $\mathcal{QD}_{n,m,1}(z; y_1, \dots, y_m; x_1, \dots, x_m)$ then shows that it features combinations of these four moduli spaces of pseudo-holomorphic curves and that it is exactly modeled on the A_∞ -equations that the categorification A_∞ -functor has to satisfy.

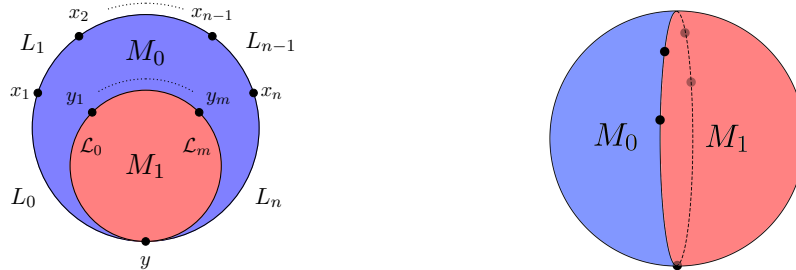

FIGURE 6 – On the left, a biquilted disk with Lagrangian boundary conditions and Lagrangian correspondence seam conditions. On the right, an example of a quilted sphere with 4 marked seam points.

2.4. The 2-category Floer. Define a 2-category \mathcal{C} to be the data of

- (i) a set of objects $\text{Ob}(\mathcal{C})$;
- (ii) for every $X, Y \in \text{Ob}(\mathcal{C})$ of a category $\mathcal{C}(X, Y)$, together with an identity morphism if $X = Y$;
- (iii) for every $X, Y, Z \in \text{Ob}(\mathcal{C})$ of a bifunctor

$$\mathcal{C}(X, Y) \times \mathcal{C}(Y, Z) \rightarrow \mathcal{C}(X, Z) .$$

In other words, a 2-category is simply a category enriched in categories. The objects of $\mathcal{C}(X, Y)$ are called the 1-morphisms of \mathcal{C} and their morphisms its 2-morphisms. The category Cat of categories together with functors as 1-morphisms and natural transformations as 2-morphisms defines in particular a 2-category. We moreover define a 2-functor $\mathcal{F} : \mathcal{C} \rightarrow \mathcal{D}$ between 2-categories to be

a functor between categories enriched in categories, i.e. the data of a map $\mathcal{F} : \text{Ob}(\mathcal{C}) \rightarrow \text{Ob}(\mathcal{D})$ and of functors $\mathcal{C}(X, Y) \rightarrow \mathcal{D}(\mathcal{F}(X), \mathcal{F}(Y))$ respecting the composition and the identities.

In [WW10a], Wehrheim and Woodward define a *Weinstein-Floer 2-category Floer* whose objects are (closed monotone) symplectic manifolds as follows. For M_0 and M_1 two symplectic manifolds, we define

$$\text{Floer}(M_0, M_1) := \text{Don}(M_0^- \times M_1) ,$$

where the category $\text{Don}(M)$ is the category whose objects are Lagrangian submanifolds of M and whose morphism spaces are the Floer cohomology groups of M , i.e. $\text{Don}(M) := H^*(\text{Fuk}(M))$. Its composition bifunctor

$$\text{Don}(M_0^- \times M_1) \times \text{Don}(M_1^- \times M_2) \longrightarrow \text{Don}(M_0^- \times M_2)$$

is defined on objects as $(\mathcal{L}_{01}, \mathcal{L}_{12}) \mapsto \mathcal{L}_{01} \circ \mathcal{L}_{12}$ (see subsection 2.5 for more details on that notation) and on the categories of morphisms by counting pseudo-holomorphic quilted pair of pants as represented in figure 7. The categorification A_∞ -functor for Fukaya categories constructed in subsection 2.3 then defines a *categorification 2-functor*

$$\text{Floer} \longrightarrow \text{Cat} ,$$

defined on objects as $M \mapsto \text{Don}(M)$ and on the categories of morphisms as

$$\text{Floer}(M_0, M_1) = \text{Don}(M_0^- \times M_1) \longrightarrow \text{Fun}(\text{Don}(M_0), \text{Don}(M_1)) .$$

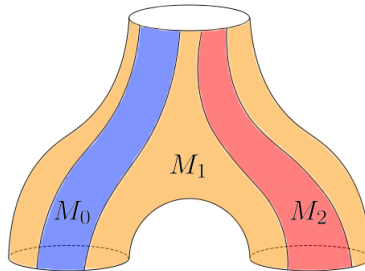

FIGURE 7 – An example of a pseudo-holomorphic quilted pair of pants

2.5. Quilted Floer cohomology and technical assumptions. This section was written without any technical assumptions, as our main focus was to give an overview of the algebraic constructions in [MWW18] and [WW10a] without dwelling into technical details. We refer the reader interested in the exact technical assumptions on the symplectic manifolds and their Lagrangians to these two papers.

There is however an important part of these constructions that we have eluded until now. They do not take place in the framework of ordinary Lagrangian Floer cohomology, but of *quilted Floer cohomology*. To put it shortly, the A_∞ -categories $\text{Fuk}(M^- \times N)$ have to be replaced by A_∞ -categories $\text{Fuk}^\#(M, N)$ which are defined as follows. Their objects are *generalized Lagrangian correspondences*, which are defined as sequences of Lagrangian correspondences

$$\underline{\mathcal{L}} : M = M_0 \xrightarrow{\mathcal{L}_{01}} M_1 \xrightarrow{\mathcal{L}_{12}} \cdots \xrightarrow{\mathcal{L}_{n-1,n}} M_n = N$$

where an arrow $\mathcal{L}_{i,i+1} : M_i \rightarrow M_{i+1}$ denotes a Lagrangian correspondence $\mathcal{L}_{i,i+1} \subset M_i^- \times M_{i+1}$. Their morphism spaces $CF^*(\underline{\mathcal{L}}, \underline{\mathcal{L}}')$ are then defined in a similar way to Lagrangian Floer cohomology, replacing pseudo-holomorphic strips by pseudo-holomorphic quilted strips with seam conditions on the Lagrangian correspondences of $\underline{\mathcal{L}}$ and $\underline{\mathcal{L}}'$. We refer to [WW10b] for more details on the definition of the quilted Floer cohomology groups. In the same fashion, the moduli

spaces of pseudo-holomorphic disks with Lagrangian boundary conditions can be adapted to the quilted framework in order to define the operations of the A_∞ -category $\text{Fuk}^\#(M, N)$. The Fukaya categories $\text{Fuk}(M)$ and the Donaldson categories $\text{Don}(M)$ and $\text{Don}(M^- \times N)$ then also have to be replaced by their enlargement $\text{Fuk}^\#(M) := \text{Fuk}^\#(\text{pt}, M)$, $\text{Don}^\#(M)$ and $\text{Don}^\#(M^- \times N)$.

3. Towards the $(A_\infty, 2)$ -category *Symp*

In subsection 2.4 we recalled the construction in [WW10a] of a 2-category Floer whose objects are closed manifolds M and morphism spaces are the Donaldson categories $\text{Don}(M_0^- \times M_1)$. A natural question to ask is whether this 2-category can be lifted to the dg-level, by defining a homotopy 2-category whose objects are symplectic manifolds and morphism spaces the Fukaya categories $\text{Fuk}(M_0^- \times M_1)$. In other words, a category enriched in A_∞ -categories. This expected category is referred to as the $(A_\infty, 2)$ -category *Symp* by Bottman, and we will expose in the subsections 3.1 and 3.2 his current progress towards its definition. We will then expose in subsection 3.3 a series of conjectures that relates the work of Bottman and our work in [Maz21b].

3.1. Pseudo-holomorphic quilts with figure eight singularity. In order to define the category *Symp*, we would first like to define an A_∞ -bifunctor

$$\text{Fuk}(M_0^- \times M_1) \times \text{Fuk}(M_1^- \times M_2) \longrightarrow \text{Fuk}(M_0^- \times M_2) ,$$

i.e. a collection of operations

$$\begin{aligned} \phi_{k,l} : CF^*(\mathcal{L}_{01}^0, \mathcal{L}_{01}^1) \otimes \cdots \otimes CF^*(\mathcal{L}_{01}^{k-1}, \mathcal{L}_{01}^k) \otimes CF^*(\mathcal{L}_{12}^0, \mathcal{L}_{12}^1) \otimes \cdots \otimes CF^*(\mathcal{L}_{12}^{l-1}, \mathcal{L}_{12}^l) \\ \longrightarrow CF^*(\mathcal{L}_{01}^0 \circ \mathcal{L}_{12}^0, \mathcal{L}_{01}^k \circ \mathcal{L}_{12}^l) \end{aligned}$$

such that

$$\begin{aligned} [\partial, \phi_{k,l}] = & \sum_{k_1+k_2+k_3=k} \phi_{k_1+1+k_3,l}(\text{id}^{\otimes k_1} \otimes m_{k_2}^{01} \otimes \text{id}^{\otimes k_3} \otimes \text{id}^{\otimes l}) \\ & + \sum_{l_1+l_2+l_3=l} \phi_{k,l_1+1+l_3}(\text{id}^{\otimes k} \otimes \text{id}^{\otimes l_1} \otimes m_{l_2}^{12} \otimes \text{id}^{\otimes l_3}) \\ & + \sum_{\substack{k_1+\dots+k_s=k \\ l_1+\dots+l_s=l}} m_s^{02}(\phi_{k_1,l_1}, \dots, \phi_{k_s,l_s}) . \end{aligned}$$

Beware that $\text{Fuk}(M_0^- \times M_1) \times \text{Fuk}(M_1^- \times M_2)$ is a mere notation, and we do not think of it as a tensor product of A_∞ -categories. We refer however to section 2 for more details on the tensor product of Fukaya categories.

In order to define an A_∞ -bifunctor of this form, Bottman studies in [Bot20] the moduli spaces of pseudo-holomorphic quilts with marked points on their seams and figure eight singularity. An example of such a pseudo-holomorphic quilt is depicted in figure 8. He expects that counting the points of 0-dimensional moduli spaces of pseudo-holomorphic quilts of this form should define the A_∞ -bifunctor sketched in the previous paragraph. Here one of the crucial argument is again that quilted spheres with two patches can be identified with disks mapping to the product.

We moreover point out that such a bifunctor would recover the categorification A_∞ -functor of [MWW18]. Indeed, setting $M_0 := \{\text{pt}\}$ it would yield an A_∞ -bifunctor

$$\text{Fuk}(M_1) \times \text{Fuk}(M_1^- \times M_2) \longrightarrow \text{Fuk}(M_2) ,$$

which can be shown to yield an A_∞ -functor

$$\text{Fuk}(M_1^- \times M_2) \longrightarrow \text{Func}(\text{Fuk}(M_1), \text{Fuk}(M_2)) .$$

This A_∞ -functor is the categorification A_∞ -functor of [MWW18], as moduli spaces of pseudo-holomorphic quilts with marked seam points whose left patch is sent to a point correspond exactly to moduli spaces of quilted disks with marked boundary and seam points.

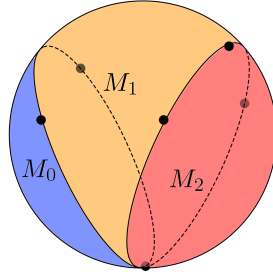

FIGURE 8 – An example of a pseudo-holomorphic quilt with figure eight singularity

3.2. Moduli spaces of witch curves, 2-associahedra and the $(A_\infty, 2)$ -category Symp.

Bottman suggests that the higher operations of Symp should then be encoded by generalizing the pseudo-holomorphic quilts of the previous subsection and allowing for more than three patches (and still requiring that the seams all intersect at a single common point). He calls these moduli spaces the *moduli spaces of witch curves* and denotes them $2\mathcal{M}_n$. They are studied in [Bot19b]. The stratification of the compactified moduli spaces of witch curves $2\overline{\mathcal{M}}_n$ can in fact be described by a family of abstract polytopes, called the *2-associahedra* and studied in [Bot19a]. The moduli spaces of witch curves with more than four patches feature unfortunately yet again fiber products in their boundary, hence do not naturally encode a dg-operadic object. In [BC21], Bottman and Carmeli however bypass this issue by defining a relative 2-operad structure on the moduli spaces of witch curves. More precisely, they prove that the 2-associahedra $2\overline{\mathcal{M}}_n$ form a 2-operad in topological spaces relative to the associahedra $\overline{\mathcal{M}}_r$. Using this formalism, they then manage to provide an explicit definition of an $(A_\infty, 2)$ -category on the dg-level, using the notion of a linear category over a relative 2-operad in topological spaces. Beware however that the relative 2-operad in topological spaces $(2\overline{\mathcal{M}}_n, \overline{\mathcal{M}}_r)$ still does not yield a relative 2-operad in dg-modules under the image of the cellular chains functor. In other words, the relative 2-operadic viewpoint does not yield a dg-model for the 2-associahedra.

3.3. Conjectures on the 2-associahedra and the n -multiplihedra.

We have seen in subsection 2.2 that the moduli spaces of biquilted disks $2\mathcal{QD}_{m,1}$ with $m+1$ marked points on their boundary can be represented in Floer theory to define an A_∞ -homotopy between algebraic and geometric composition of A_∞ -functors associated to Lagrangian correspondences. The moduli space of biquilted disks $2\mathcal{QD}_{m,1}$ is in fact isomorphic to $]0, +\infty[\times \mathcal{QD}_{m,1}$ where the $]0, +\infty[$ factor corresponds to the radii ratio value. The compactified moduli space of biquilted disks $2\overline{\mathcal{QD}}_{m,1}$ then fibers over $[0, +\infty]$ and its fibers can be described as follows :

- (i) The fiber over any $\delta \in [0, +\infty[$ corresponds to a copy of the multiplihedron J_m , where the two-colored corollae labeling the top dimensional stratum of J_m can be seen as labeled by a biquilted disk with fixed radii ratio δ .
- (ii) The fiber over $+\infty$ corresponds to a CW-complex whose top dimensional strata can be consistently labeled by all three-colored trees arising in the definition of the composition of two A_∞ -morphisms.

We conjecture in fact that

- (i) There exists a refined polytopal decomposition of J_m which can be consistently labeled by all three-colored trees arising in the definition of the composition of two A_∞ -morphisms. This decomposition is illustrated in the case of J_3 in figure 9 and will be called the \circ_{A_∞} -polytopal decomposition of J_m .
- (ii) The compactified moduli space $\overline{2\mathcal{QD}}_{m,1}$ is then isomorphic as a CW-complex to the polytope $[0, 1] \times J_m$, whose face $\{1\} \times J_m$ is endowed with its \circ_{A_∞} -polytopal decomposition.

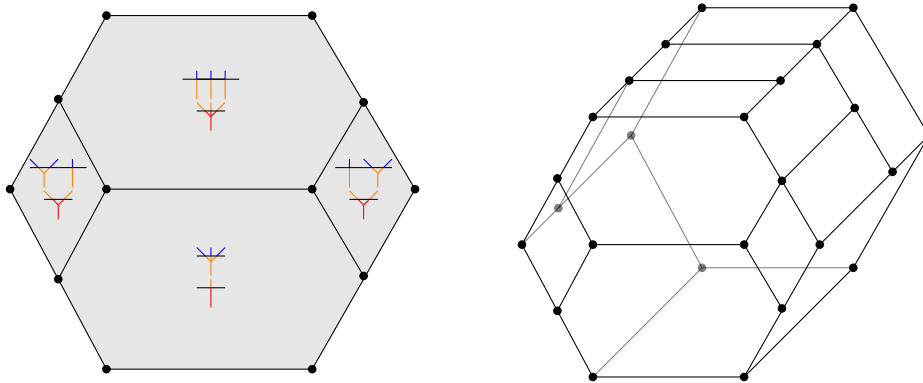

FIGURE 9 – The \circ_{A_∞} -polytopal decomposition on J_3 on the left, and the polytopal decomposition on $[0, 1] \times J_3$ refining the 1-multiplihedron and the \circ_{A_∞} polytopal decompositions on the right

The 1-multiplihedra $1 - J_m$ that we defined in [Maz21b] and which encode A_∞ -homotopies between A_∞ -morphisms, were in fact also defined by refining the polytopal decomposition on $[0, 1] \times J_m$. We suspect in fact that there should exist a polytopal decomposition on $[0, 1] \times J_m$ that refines simultaneously its 1-multiplihedron and its \circ_{A_∞} -decompositions. This decomposition is represented on figure 9 in the case of $[0, 1] \times J_3$. It would then be interesting to know whether one could endow the moduli spaces $2\mathcal{QD}_{m,1}$ with a refined compactification rule, such that their boundary reads exactly as the boundary of this newly defined refined polytopal decomposition of $[0, 1] \times J_m$.

More generally, moduli spaces of n -quilted disks $n\mathcal{QD}_m$ with marked boundary points could be expected to produce $(n-1)$ -morphisms between Fukaya categories. A first step in that direction would be to understand how exactly they are linked to the n -multiplihedra $n - J_m$ that we introduced in [Maz21b]. We think for instance that moduli spaces of 3-quilted disks with marked boundary points should give rise to the following diagram of A_∞ -functors, A_∞ -homotopies and 2 - A_∞ -functors between Fukaya categories defined by Lagrangian correspondences

$$\begin{array}{ccc}
 \phi_{\mathcal{L}_{23}} \circ \phi_{\mathcal{L}_{12}} \circ \phi_{\mathcal{L}_{01}} & \longrightarrow & \phi_{\mathcal{L}_{12} \circ \mathcal{L}_{23}} \circ \phi_{\mathcal{L}_{01}} \\
 \downarrow & \searrow & \downarrow \\
 \phi_{\mathcal{L}_{23}} \circ \phi_{\mathcal{L}_{01} \circ \mathcal{L}_{12}} & \longrightarrow & \phi_{\mathcal{L}_{01} \circ \mathcal{L}_{12} \circ \mathcal{L}_{23}}
 \end{array}$$

The combinatorics of the moduli spaces of witch curves could then be expected to be governed at the same time by the combinatorics of higher functors between A_∞ -categories as defined in [Maz21b] and by the combinatorics of pre-natural transformations between A_∞ -categories, which would respectively arise from the number of seams of the quilted sphere and from the marked points on these seams.

4. Towards the homotopy 2-functor $\mathbf{Simp} \rightarrow A_\infty - \mathbf{Cat}$

Fukaya tackles in [Fuk17] the issue of the construction of a homotopy 2-functor $\mathbf{Simp} \rightarrow A_\infty - \mathbf{Cat}$, where \mathbf{Simp} and $A_\infty - \mathbf{Cat}$ are informally defined as the homotopy 2-category whose objects are closed symplectic manifolds and A_∞ -categories of morphisms are the Fukaya categories $\mathbf{Fuk}(M_0^- \times M_1)$ resp. whose objects are A_∞ -categories and A_∞ -categories of morphisms are the A_∞ -categories $\mathbf{Func}(\mathcal{A}, \mathcal{B})$. This informal homotopy 2-functor is defined on objects as $M \mapsto \mathbf{Fuk}(M)$ and on morphisms as $\mathbf{Fuk}(M_0^- \times M_1) \mapsto \mathbf{Func}(\mathbf{Fuk}(M_0), \mathbf{Fuk}(M_1))$. We point out that he however does not exhibit an explicit satisfactory definition of a homotopy 2-category to consider in that context. The notion of an $(A_\infty, 2)$ -category that Bottman is currently trying to define could provide a well-suited definition for his construction.

4.1. Results. Let M_0, M_1 and M_2 be three closed symplectic manifolds. Fukaya constructs to begin with a composition A_∞ -bifunctor between Fukaya categories

$$\mathbf{Fuk}(M_0^- \times M_1) \times \mathbf{Fuk}(M_1^- \times M_2) \longrightarrow \mathbf{Fuk}(M_0^- \times M_2) ,$$

by counting pseudo-holomorphic quilts. This A_∞ -bifunctor is then *homotopy associative*, meaning that the diagram

$$\begin{array}{ccc} \mathbf{Fuk}(M_0^- \times M_1) \times \mathbf{Fuk}(M_1^- \times M_2) \times \mathbf{Fuk}(M_2^- \times M_3) & \longrightarrow & \mathbf{Fuk}(M_0^- \times M_2) \times \mathbf{Fuk}(M_2^- \times M_3) \\ \downarrow & & \downarrow \\ \mathbf{Fuk}(M_0^- \times M_1) \times \mathbf{Fuk}(M_1^- \times M_3) & \longrightarrow & \mathbf{Fuk}(M_0^- \times M_3) \end{array}$$

commutes up to homotopy equivalence. The notion of a homotopy equivalence has been recalled in subsection 3.3. of part 2 in [Maz21b]. Given three A_∞ -categories $\mathcal{A}_0, \mathcal{A}_1, \mathcal{A}_2$ it is also possible to define a composition A_∞ -bifunctor

$$\mathbf{Func}(\mathcal{A}_0, \mathcal{A}_1) \times \mathbf{Func}(\mathcal{A}_1, \mathcal{A}_2) \longrightarrow \mathbf{Func}(\mathcal{A}_0, \mathcal{A}_2) ,$$

following [Lyu03]. Fukaya proves that this composition A_∞ -bifunctor is again homotopy associative, meaning that the diagram

$$\begin{array}{ccc} \mathbf{Func}(\mathcal{A}_0, \mathcal{A}_1) \times \mathbf{Func}(\mathcal{A}_1, \mathcal{A}_2) \times \mathbf{Func}(\mathcal{A}_2, \mathcal{A}_3) & \longrightarrow & \mathbf{Func}(\mathcal{A}_0, \mathcal{A}_2) \times \mathbf{Func}(\mathcal{A}_2, \mathcal{A}_3) \\ \downarrow & & \downarrow \\ \mathbf{Func}(\mathcal{A}_0, \mathcal{A}_1) \times \mathbf{Func}(\mathcal{A}_1, \mathcal{A}_3) & \longrightarrow & \mathbf{Func}(\mathcal{A}_0, \mathcal{A}_3) \end{array}$$

commutes up to homotopy equivalence.

As explained at the end of subsection 3.1, a categorification A_∞ -functor

$$\mathbf{Fuk}(M_0^- \times M_1) \longrightarrow \mathbf{Func}(\mathbf{Fuk}(M_0), \mathbf{Fuk}(M_1)) ,$$

can then simply be deduced by setting $M_2 = \{\text{pt}\}$. Fukaya finally proves that this categorification A_∞ -functor has the property that the following diagram is homotopy commutative

$$\begin{array}{ccc} \mathbf{Fuk}(M_0^- \times M_1) \times \mathbf{Fuk}(M_1^- \times M_2) & \longrightarrow & \mathbf{Fuk}(M_0^- \times M_2) \\ \downarrow & & \downarrow \\ \mathbf{Func}(\mathbf{Fuk}(M_0), \mathbf{Fuk}(M_1)) \times \mathbf{Func}(\mathbf{Fuk}(M_1), \mathbf{Fuk}(M_2)) & \longrightarrow & \mathbf{Func}(\mathbf{Fuk}(M_0), \mathbf{Fuk}(M_2)) . \end{array}$$

We point out that Fukaya however does not work out the full set of higher coherent homotopies that should arise from the homotopy commutativity property of the three previous diagrams.

4.2. Technical assumptions and relation to the work of Mau, Wehrheim and Woodward. The symplectic manifolds considered in [Fuk17] are only required to be closed, while they were also required to be monotone in [MWW18] and [WW10a]. The Lagrangian submanifolds are moreover required to be immersed but not necessarily embedded. His results are thereby stated in a greater generality than those of [MWW18]. This however implies several adjustments in the definition of the Fukaya category $\text{Fuk}(M)$.

The objects of $\text{Fuk}(M)$ are this time Lagrangian submanifolds endowed with a bounding cochain. The datum of a bounding cochain is indeed necessary in order to define Lagrangian Floer cohomology groups without the monotonicity assumption. See [FOOO09a] and [AJ10] for instance. We point out that in general, bounding cochains do not exist for all Lagrangian submanifolds. Lagrangian submanifolds that admit bounding cochains are in particular said to be *unobstructed*. However, under the monotonicity assumptions of [MWW18], all Lagrangian submanifolds were unobstructed. The A_∞ -category $\text{Fuk}(M)$ of [Fuk17] is moreover a *curved filtered unital* A_∞ -category. *Filtered* refers to the fact that this A_∞ -category is defined over the Novikov ring Λ_0 , *curved* to the fact that it features nonzero arity 0 operations $m_0^L \in CF^*(L, L)$ for all Lagrangians and *unital* was defined in subsection 3.3. of part 2 in [Maz21b].

As Fukaya works with unobstructed Lagrangians, it is necessary to know whether unobstructedness is preserved under the constructions described in the previous subsection. The answer to this problem is positive and is in fact one of the main results of [Fuk17]. He proves that the composition $\mathcal{L}_{01} \circ \mathcal{L}_{12}$ of two unobstructed immersed Lagrangian correspondences \mathcal{L}_{01} and \mathcal{L}_{12} remains unobstructed, and that if $L \subset M_0$ and $\mathcal{L}_{01} \subset M_0^- \times M_1$ are unobstructed, then the immersed Lagrangian $\phi_{\mathcal{L}_{01}}(L)$ is also unobstructed. We point out that he choses to work with immersed but not embedded Lagrangians, as the geometric composition of two generic embedded Lagrangians is immersed but not embedded in general. We finally mention that while the work of Mau, Wehrheim, Woodward and Bottman relies on the analysis of strip-shrinking and figure eight bubbling, the work of Fukaya is based on an argument of Lekili and Lipyanskiy in [LL13] and on an extensive use of Yoneda functors and homological algebra in the A_∞ setting.

Tensor products of A_∞ -algebras and A_∞ -morphisms

1. Diagonals on the associahedra and the multiplihedra

1.1. Polytopal diagonals on the associahedra and the multiplihedra. We write $\mathbf{A}_\infty - \mathbf{alg}$ for the category of A_∞ -algebras with A_∞ -morphisms between them. Given A and B two A_∞ -algebras, we would like to define an A_∞ -algebra structure on the tensor product $A \otimes B$. The naive approach to define the A_∞ -operations on $A \otimes B$ would be to set $m_n^{A \otimes B} := (m_n^A \otimes m_n^B) \circ \tau$, where τ denotes the map rearranging an element of $(A \otimes B)^{\otimes n}$ into an element of $A^{\otimes n} \otimes B^{\otimes n}$. One can however check that these maps do not satisfy the A_∞ -equations and in fact do not even have the correct degree.

Define a *diagonal on the operad* A_∞ to be the datum of a morphism of operads $A_\infty \rightarrow A_\infty \otimes A_\infty$, where $P \otimes Q(n) := P(n) \otimes Q(n)$ denotes the Hadamard product of two operads P and Q . Recall moreover that an A_∞ -algebra structure on A corresponds to a morphism of operads $A_\infty \rightarrow \text{End}_A$. Using this viewpoint and given a diagonal on the operad A_∞ , one can define an A_∞ -algebra structure on $A \otimes B$ as

$$A_\infty \longrightarrow A_\infty \otimes A_\infty \longrightarrow \text{End}_A \otimes \text{End}_B \longrightarrow \text{End}_{A \otimes B},$$

where it is straightforward to define the map of operads $\text{End}_A \otimes \text{End}_B \rightarrow \text{End}_{A \otimes B}$.

An explicit formula for a diagonal on the operad A_∞ was computed for the first time in [MS06]. Using the general theory of positively oriented polytopes and fiber polytopes, Masuda, Thomas, Tonks and Vallette then constructed in [MTTV21] a family of polytopal maps $\Delta_{K_n} : K_n \rightarrow K_n \times K_n$ which fit into a morphism of operads in polytopes, and whose image under the cellular chains functor recovers exactly the diagonal $A_\infty \rightarrow A_\infty \otimes A_\infty$ of [MS06]. The problem of the definition of a diagonal on the associahedra was also studied in [SU04] and [Lod11].

For the sake of readability, we set from now on $M_\infty := A_\infty - \text{Morph}$. In [LAM], Laplante-Anfossi and myself adapt the method of [MTTV21] in order to define a diagonal on the multiplihedra $\Delta_{J_n} : J_n \rightarrow J_n \times J_n$ compatible with both the $\{K_n\}$ -operadic bimodule structure on the polytopes J_n and the diagonal Δ_{K_n} constructed in [MTTV21]. The image of this polytopal diagonal under the cellular chains functors then yields on the dg-level a morphism of operadic bimodules $M_\infty \rightarrow M_\infty \otimes M_\infty$, which is compatible with the morphism of operads $A_\infty \rightarrow A_\infty \otimes A_\infty$ and that we explicitly compute. The datum of this *diagonal on* M_∞ finally allows us to define the tensor product of two A_∞ -morphisms $F_1 : A_1 \rightarrow B_1$ and $F_2 : A_2 \rightarrow B_2$, that we denote $F_1 \otimes_\infty F_2 : A_1 \otimes_\infty B_1 \rightarrow A_2 \otimes_\infty B_2$, where $A \otimes_\infty B$ stands for the dg-module $A \otimes B$ endowed with the tensor A_∞ -algebra structure defined by the diagonal on A_∞ .

1.2. The homotopy monoidal category structure on $\mathbf{A}_\infty - \mathbf{alg}$? We would now like to know if the tensor product \otimes_∞ defined using the diagonal Δ_{A_∞} introduced in [MS06] and the diagonal Δ_{M_∞} that we construct in [LAM], endows the category $\mathbf{A}_\infty - \mathbf{alg}$ with a symmetric monoidal category structure, where \mathbb{Z} is taken to be the identity object. More precisely, we have to prove that there exist functorial isomorphisms $\alpha_{A,B,C} : A \otimes_\infty (B \otimes_\infty C) \rightarrow (A \otimes_\infty B) \otimes_\infty C$ and $\tau_{A,B} : A \otimes_\infty B \rightarrow B \otimes_\infty A$ that fit into the usual diagrams for a monoidal category, and that

this tensor product is functorial i.e. that given A_∞ -morphisms $F_i : A_i \rightarrow B_i$ and $G_i : B_i \rightarrow C_i$ for $i = 1, 2$, the following identity is satisfied

$$(G_1 \circ F_1) \otimes_\infty (G_2 \circ F_2) = (G_1 \otimes_\infty G_2) \circ (F_1 \otimes_\infty F_2) .$$

We refer to [Mac98] for the complete definition of a symmetric monoidal category structure.

Applying the theory of Hopf operads and minimal models to the Hopf operad Ass endowed with the obvious diagonal and its minimal model $A_\infty \rightarrow Ass$, it is proven in [MSS02] and [MS06] that there exists a homotopy of morphisms of operads between $(\Delta_{A_\infty} \otimes \text{id}) \circ \Delta_{A_\infty}$ and $(\text{id} \otimes \Delta_{A_\infty}) \circ \Delta_{A_\infty}$. Following for instance [Fuk10], this means that there exists a quasi-isotopy between the A_∞ -algebras $A \otimes_\infty (B \otimes_\infty C)$ and $(A \otimes_\infty B) \otimes_\infty C$ whose underlying dg-module is $A \otimes B \otimes C$, thus in particular that there exists an A_∞ -quasi-isomorphism between them. A similar method also shows that $A \otimes_\infty B \simeq B \otimes_\infty A$. It is however unclear why these collections of quasi-isomorphisms should fit into natural transformations α and τ defining the associator and the symmetry of a symmetric monoidal category structure on $\mathbf{A}_\infty - \mathbf{alg}$. It is moreover proven in [MS06] that a diagonal on A_∞ can in fact never be coassociative, i.e. that for any morphism of operads $\Delta_{A_\infty} : A_\infty \rightarrow A_\infty \otimes A_\infty$ we have that

$$(\Delta_{A_\infty} \otimes \text{id}) \circ \Delta_{A_\infty} \neq (\text{id} \otimes \Delta_{A_\infty}) \circ \Delta_{A_\infty} .$$

We also prove in [LAM] that a diagonal on M_∞ can never be functorial.

It is thus impossible to endow the category $\mathbf{A}_\infty - \mathbf{alg}$ with a symmetric monoidal category structure from the perspective of diagonals on the operad A_∞ and the operadic bimodule M_∞ . Guillaume Laplante-Anfossi and myself therefore plan to inspect in which sense this data would endow $\mathbf{A}_\infty - \mathbf{alg}$ with a "homotopy" monoidal category structure. It is not yet clear to us which explicit model for such a category one would have to choose. Understanding which higher coherent homotopies arise from the lack of associativity of Δ_{K_n} and Δ_{J_n} on the level of polytopes could for instance be a first step towards solving that problem. Given two diagonals $\Delta_{A_\infty}^i$ and $\Delta_{M_\infty}^i$ for $i = 1, 2$, it would also be interesting to know how the two "homotopy" monoidal category structures defined on $\mathbf{A}_\infty - \mathbf{alg}$ would then be related. A first result in that direction is again given in [MS06]. Two diagonals $\Delta_{A_\infty}^1$ and $\Delta_{A_\infty}^2$ on the operad A_∞ are always homotopic as morphisms of operads, which implies that the A_∞ -algebras $A \otimes_{\infty_1} B$ and $A \otimes_{\infty_2} B$ are always quasi-isomorphic. We finally point out that such a homotopy monoidal category structure on $\mathbf{A}_\infty - \mathbf{alg}$ could then be easily adapted to define a homotopy monoidal category structure on the category of A_∞ -categories with A_∞ -functors.

2. Tensor products in symplectic topology

2.1. A Künneth theorem in Lagrangian Floer theory. Let M be a closed symplectic manifold and $L \subset M$ a closed spin Lagrangian submanifold. Using Lagrangian Floer theory and pseudo-holomorphic disks curves with Lagrangian boundary conditions, Fukaya constructs in [Fuk10] a unital A_∞ -algebra $\mathcal{F}(L)$ associated to the Lagrangian L , called the *Fukaya algebra of L* . In [Amo17], Amorim shows that given two symplectic manifolds M_1 and M_2 together with Lagrangians $L_i \subset M_i$, the Fukaya algebra of the product Lagrangian $L_1 \times L_2$ is quasi-isomorphic to the tensor product of their Fukaya algebras, i.e. $\mathcal{F}(L_1 \times L_2) \simeq \mathcal{F}(L_1) \otimes_\infty \mathcal{F}(L_2)$. His proof relies on a theorem that he proves in [Amo16], giving a criterion for an A_∞ -algebra C to be quasi-isomorphic to the tensor product $A \otimes_\infty B$ of two commuting A_∞ -subalgebras $A \subset C$ and $B \subset C$, which he then applies to the two A_∞ -subalgebras $\mathcal{F}(L_1) \subset \mathcal{F}(L_1 \times L_2)$ and $\mathcal{F}(L_2) \subset \mathcal{F}(L_1 \times L_2)$.

Fukaya generalizes this result in [Fuk17], working this time on the level of Fukaya categories. He proves that for two closed symplectic manifolds M_0 and M_1 there exists a unital A_∞ -functor

$$\text{Fuk}(M_0) \otimes \text{Fuk}(M_1) \longrightarrow \text{Fuk}(M_0^- \times M_1)$$

which is a homotopy equivalence to its image. This A_∞ -functor and the categorification A_∞ -functor then fit into a diagram

$$(\star) \quad \text{Fuk}(M_0) \otimes \text{Fuk}(M_1) \longrightarrow \text{Fuk}(M_0^- \times M_1) \longrightarrow \text{Func}(\text{Fuk}(M_0), \text{Fuk}(M_1)) .$$

It would in fact be interesting to know when the A_∞ -functors in (\star) become homotopy equivalences. Given \mathcal{A} and \mathcal{B} two A_∞ -categories, one could also ask whether there exists a purely algebraic A_∞ -functor

$$\mathcal{A} \otimes \mathcal{B} \longrightarrow \text{Func}(\mathcal{A}, \mathcal{B}) ,$$

such that the previous composition is homotopy equivalent to this A_∞ -functor when $\mathcal{A} := \text{Fuk}(M_0)$ and $\mathcal{B} := \text{Fuk}(M_1)$. A third question of interest could finally be to understand how the tensor product of A_∞ -functors could be realized in symplectic topology, using Lagrangian correspondences.

2.2. The work of Lipshitz, Oszv ath and Thurston. In [LOT21], Lipshitz, Oszv ath and Thurston also study diagonals on the operad A_∞ and on the operadic bimodule M_∞ . They however work exclusively on the dg-level, constructing abstract diagonals by using the fact that A_∞ and M_∞ are contractible. They show in particular that one can construct a trigonal $M_\infty \rightarrow M_\infty^{\otimes 3}$ in order to produce a natural quasi-isomorphism

$$A_0 \otimes_\infty (A_2 \otimes_\infty A_3) \simeq (A_1 \otimes_\infty A_2) \otimes_\infty A_3 .$$

This provides an alternative construction for a quasi-isomorphism of this form, which has already been constructed in subsection 1.2 using the theory of Hopf operads and minimal models.

The goal of their work is to study bordered Heegaard Floer homology of 3-manifolds. Given a 3-manifold Y with two boundary components, they are working to construct a *bimodule twisted complex* $CFDD^-(Y)$, also called a *type DD-bimodule*. The definition of such an object uses a diagonal on A_∞ . A diagonal on M_∞ is then needed in order to relate the categories of bimodules defined with different diagonals on A_∞ , which in turn is needed for properties like associativity of tensor products. The authors also expect that diagonals on M_∞ could be needed in a distant future to define A_∞ -morphisms between bimodule twisted complexes arising from a cobordism between two 3-manifolds Y_1 and Y_2 .

The previous paragraph is drawn from a private communication with Robert Lipshitz and remains very vague as their work on Heegaard Floer homology relying on [LOT21] is still in progress. We however insist that their construction differs greatly from the one explained in subsection 2.1. Amorim and Fukaya use a diagonal on A_∞ in order to respectively prove a K unneth theorem for Fukaya algebras and Fukaya categories, while Lipshitz, Oszv ath and Thurston resort to diagonals on A_∞ and M_∞ in order to define and study the properties of the bimodule twisted complex $CFDD^-(Y)$.

New algebraic structures on the symplectic and Rabinowitz-Floer chains

Let W be a Liouville domain, i.e. an exact symplectic manifold with convex boundary ∂W . There are several Floer-type (co)homologies associated to W . Among them are the Rabinowitz-Floer homology $SH_*(\partial W)$ and the symplectic homology $SH_*(W)$ and cohomology $SH^*(W)$. We refer to [CO18] for their definition. Rabinowitz-Floer homology can in fact be computed as the homology of a cone, defined by a canonical up to homotopy chain map $SC^{-*}(W) \rightarrow SC_*(W)$ relating the chain complexes that respectively define symplectic cohomology $SH^{-*}(W)$ and symplectic homology $SH_*(W)$, as proven in [Ven18] and [CO18].

In [CHO20], [CO20] and [CHOb], it is proven that Rabinowitz-Floer homology $SH_*(\partial W)$ can be endowed with a biunital involutive coFrobenius bialgebra structure in the sense of [CHOa]. In this regard, Cieliebak and Oancea are brought to study the following algebraic question. Given two dg-modules A and M and a chain map $c : M \rightarrow A$, what is the structure on the pair (M, A) that defines an A_∞ -algebra structure on $Cone(c)$? More specifically, which structure to define on A in order to get an A_∞ -algebra structure on the cone associated to a pair of the form (A^\vee, A) . The arity 2 case is studied in [CO20] but the higher arity cases are left unsolved. This problem is the starting point to a series of projects that we are currently working on and that we will describe in this section.

1. The V_∞ -algebra structure on the symplectic chains

1.1. V_∞ -algebras. Some preliminary (unsigned) computations that we performed suggest that the correct structure to consider on A in the previous problem would be that of a V_∞ -algebra as defined in [TZ07a].



FIGURE 1 – Two operations represented as disks with marked boundary points. From left to right, one operation with n inputs and 1 output and one operation in $A^{\otimes 2} \otimes (A^\vee)^{\otimes 2} \otimes A \otimes A^\vee \otimes A \otimes A^\vee$.

Throughout this section we will consider operations with multiple inputs and outputs $A^{\otimes m} \rightarrow A^{\otimes k}$. For the sake of readability, we will write these operations as elements of

$$A \otimes (A^\vee)^{\otimes i_1} \otimes \dots \otimes A \otimes (A^\vee)^{\otimes i_k} ,$$

where $\sum_{j=1}^k i_j = m$, even when the dg-module A is not finite-dimensional. These operations will be represented as disks with marked points on their boundary : the inputs will be labeled with $+$ while the outputs will be labeled with $-$. See figure 1 for two illustrations of these notations. In this formalism, the unsigned A_∞ -equation of arity 3 for A_∞ -algebras then reads for instance as

where we have represented the equivalent equation in terms of trees on the right-hand side.

Following [TZ07a], we define a V_∞ -algebra structure on a dg-module A as follows. It is the datum for each $k \geq 1$ and $i_1, \dots, i_k \geq 0$ of operations

$$m_{i_1, \dots, i_k} \in A \otimes (A^\vee)^{\otimes i_1} \otimes \dots \otimes A \otimes (A^\vee)^{\otimes i_k}$$

where we require that $m_1 = \partial$ and $k + \sum_{j=1}^k i_j \geq 2$. An operation m_{i_1, \dots, i_k} is then defined to have degree $4 - \sum_{j=1}^k i_j - 2k$. These operations have to satisfy the following symmetry condition : writing τ for the map rearranging an element of $A \otimes (A^\vee)^{\otimes i_1} \otimes \dots \otimes A \otimes (A^\vee)^{\otimes i_k}$ into an element of $A \otimes (A^\vee)^{\otimes i_2} \otimes \dots \otimes A \otimes (A^\vee)^{\otimes i_k} \otimes A \otimes (A^\vee)^{\otimes i_1}$ and ε for the sign of τ , we require that

$$m_{i_2, \dots, i_k, i_1} = (-1)^\varepsilon \tau m_{i_1, i_2, \dots, i_k} .$$

As explained in the previous paragraph, we can now denote an operation m_{i_1, \dots, i_k} as a disk with $k + \sum_{j=1}^k i_j$ marked boundary points, whose boundary points are labeled by going around the boundary circle following the factors $A \otimes (A^\vee)^{\otimes i_1} \otimes \dots \otimes A \otimes (A^\vee)^{\otimes i_k}$ and replacing A by $-$ and A^\vee by $+$. Notice that the conditions on k and the i_j mean that we consider operations associated to all possible labelings of disks with at least two marked boundary points and at least one output. The symmetry condition implies moreover that writing these operations as disks with marked boundary points is indeed consistent, as the symmetry of the notation carries the same symmetry as these operations.

The V_∞ -equation for the operation m_{i_1, \dots, i_k} seen as a disk with marked boundary points is then defined to be the signed sum of all nodal disks with exactly one node such that :

- (i) The disk with marked boundary points obtained by gluing the nodal disk along the node is exactly m_{i_1, \dots, i_k} .
- (ii) Each of the two disks composing the nodal disk has at least two marked boundary points and at least one output.
- (iii) The common marked point of the two disks composing the nodal disk cannot be simultaneously labeled with $+$ or simultaneously labeled with $-$.

The V_∞ -equations for the operations $A \rightarrow A^{\otimes 2}$ and $A \rightarrow A^{\otimes 3}$ write for instance respectively as

$$\begin{aligned}
 [\partial, \text{disk}_{+}^-] &= -\text{disk}_{-+}^- + \text{disk}_{+-}^- , \\
 [\partial, \text{disk}_{+}^-] &= -\text{disk}_{-+}^- + \text{disk}_{-+}^- + \text{disk}_{-+}^- + \text{disk}_{-+}^- \\
 &\quad + \text{disk}_{-+}^- + \text{disk}_{-+}^- + \text{disk}_{-+}^- + \text{disk}_{-+}^- .
 \end{aligned}$$

Tradler and Zeinalian also define the notion of a V_k -algebra to be a collection of operations m_{i_1, \dots, i_h} for all $1 \leq h \leq k$ that satisfy the previous degree, symmetry and boundary conditions. A V_1 -algebra structure on A then corresponds exactly to an A_∞ -algebra structure on A . Notice however that the collection of operations with exactly 1 input do not fit into an A_∞ -coalgebra structure on A . The operation $A \rightarrow A^{\otimes 2}$ indeed has degree -1 and is not even compatible with the differential, as illustrated in the previous example. The only operations that are compatible with the differential are in fact the product $m_2 : A^{\otimes 2} \rightarrow A$ and the element $c \in A \otimes A$, hence are the only ones that induce operations in cohomology. They moreover both have degree 0.

The structure of a V_∞ -algebra is in fact encoded by a *dioperad*, as proven in [PT19]. We refer to it as the *dioperad* V_∞ . Roughly speaking, a dioperad is nothing more than an operad whose operations are allowed to have multiple outputs using the partial compositions viewpoint. We point out that a dioperad is the simplest operadic object that can be expected to encode V_∞ -algebras, as their definition features operations with multiple outputs and partial compositions in the V_∞ -equations. Define a symmetric and invariant co-inner product on an associative algebra A to be the datum of an element $c := c_1 \otimes c_2 \in A \otimes A$ such that

$$c_1 \otimes c_2 = (-1)^{|c_2||c_1|} c_2 \otimes c_1 \quad (a \cdot c_1) \otimes c_2 = (-1)^{|a|(|c_1|+|c_2|)} c_1 \otimes (c_2 \cdot a) ,$$

where $c := c_1 \otimes c_2$ are Sweedler's notations. Define moreover V to be the dioperad encoding the structure of an associative algebra with symmetric and invariant co-inner product. In [PT19], Poirier and Tradler use the Koszul duality theory for dioperads of [Gan03] to show that the dioperad V_∞ is Koszul auto-dual and that the dioperad V_∞ then corresponds exactly to the resolution $V_\infty := \Omega V^i \rightarrow V$. In particular, a structure of V_∞ -algebra on A induces a structure of associative algebra with symmetric and invariant co-inner product on $H^*(A)$, whose product is $[m_2]$ and whose co-inner product is $[c]$.

1.2. The associpahedra. The combinatorics of the dioperad V_∞ is in fact governed by families of polytopes called the *associpahedra*, that were introduced by Poirier and Tradler in [PT18]. They perform their constructions by seeing operations of V_∞ as encoded by trees rather than disks. They work thereby in their article with the viewpoint of directed planar trees, which are all the trees that can be obtained under partial compositions in the dioperad V_∞ , rather than the equivalent viewpoint of nodal disks with marked boundary points that we used in the previous subsections. We choose to adopt their point of view in order to describe the associpahedra in the following paragraph.

Poirier and Tradler construct more precisely in [PT18] a cell complex whose cells can be labeled by all directed planar trees. In particular, the codimension 1 strata of this cell complex encode exactly the V_∞ -equations. The choice of denomination *associpahedra* was inspired from the associahedra : while the former encodes a homotopy version of associ(ative) algebras, the latter encodes a homotopy version of asso(ciative algebras with) co-i(nner) p(roduct). Beware however that they do not construct a dioperad in Poly realizing the dioperad V_∞ as in [MTTV21]. They show moreover that the associpahedron whose inner cell is labeled by an operation m_{i_1, \dots, i_k} corresponds to the polytope $K_{i_1 + \dots + i_k + k - 1} \times \Delta^{k-1}$ endowed with a refined polytopal decomposition. The projection to the factor $K_{i_1 + \dots + i_k + k - 1}$ is defined by mapping a directed planar tree to the planar tree obtained after distinguishing one output and forgetting all its edge directions, while the factor Δ^{k-1} keeps track of all possible edge expansion directions. We refer for instance to figure 2 for a representation of the associpahedron associated to the operation $A \rightarrow A^{\otimes 3}$.

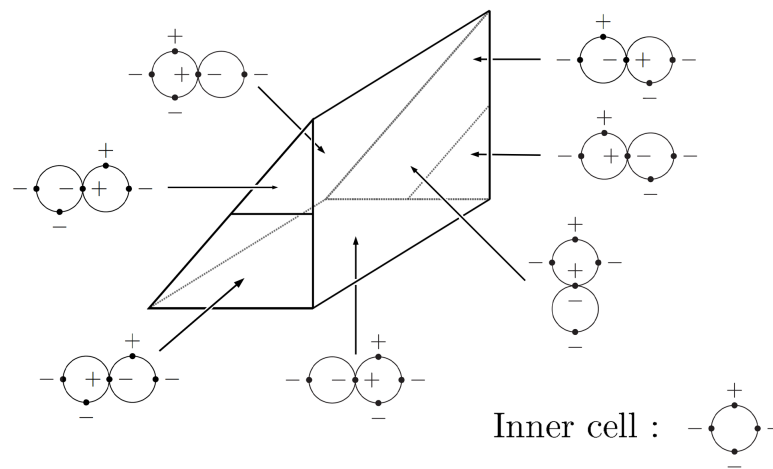

FIGURE 2 – The associpahedron associated to the operation $A \rightarrow A^{\otimes 3}$

Poirier and Tradler construct in fact the associpahedra as convex hulls of some particular sets of points in the Euclidean spaces obtained by using the secondary polytope method of [GKZ94]. They also mention that an alternative convex hull realization of the associpahedra could be expected by applying the same method as Loday in [Lod04]. We conjecture that the associpahedra can be constructed in a third way, by refining directly the polytopal decomposition on Δ^{k-1} for each face of $K_{i_1 + \dots + i_k + k - 1}$. The hyperplanes refining the decomposition of the simplex

$$\Delta^{k-1} := \{(z_1, \dots, z_{k-1}) \in \mathbb{R}^{k-1}, 0 \leq z_1 \leq \dots \leq z_{k-1} \leq 1\}$$

would be defined by equations of the form $z_j = z_i + a$ for $0 \leq i < j \leq k - 1$ and $0 < a < 1$, where we set $z_0 := 1$. We stress that albeit the constructions of the n -multiplihedra and the associpahedra are similar in appearance, the structures they encode do not arise in the same algebraic context.

1.3. Geometric realizations of the associpahedra and the V_∞ -algebra structure on the symplectic chains. We also conjecture that the associpahedra can be realized as moduli spaces of curves whose points should correspond to the datum of a disk with $m + 1$ marked boundary points on its boundary and equipped with a family of 1-forms parametrized by Δ^n . The compactification rule defined on these moduli spaces would model the combinatorics of the dioperad V_∞ on the family of 1-forms using the new realizations of the associpahedra defined in the previous subsection. This compactification would in particular correspond to a geometric

refinement of the cell decomposition on $\overline{\mathcal{D}}_{m,1} \times \Delta^n$, where $\overline{\mathcal{D}}_{m,1}$ denotes the compactified moduli space of disks with $m + 1$ marked points on their boundary. We then plan to realize these moduli spaces as moduli spaces of pseudo-holomorphic curves in symplectic topology in order to define a V_∞ -algebra structure on the Floer chains $SC_*(W)$ defining symplectic homology $SH_*(W)$. These V_∞ -operations would in particular extend the operations of arity 1, 2 and 3 described in [CO20], that are defined using moduli spaces of pseudo-holomorphic curves of the previous form.

1.4. The category of V_∞ -algebras? We also plan to inspect how to define the category $V_\infty - \text{alg}$ of V_∞ -algebras. While its objects have already been defined, it remains to define the notion of a morphism which preserves the product and the co-inner product up to homotopy and a way to compose such morphisms, which we will call V_∞ -morphisms. This is where we encounter a serious obstacle. Indeed, A_∞ -morphisms and their composition were straightforward to define in the case of the category $A_\infty - \text{alg}$ by using the bar construction viewpoint. Such a well-suited formulation is unfortunately currently lacking in the case of V_∞ -algebras. We would in particular like to have a notion of V_∞ -morphism that behaves well with respect to a homotopy transfer theorem for V_∞ -algebras.

While V_1 -morphisms between V_1 -algebras correspond exactly to A_∞ -morphisms between A_∞ -algebras, we can define the notion of V_2 -morphisms between V_2 -algebras as follows. Given an A_∞ -algebra A , one can endow its dual A^\vee with the structure of an A_∞ -bimodule over the A_∞ -algebra A by setting

$$(a_1 \otimes \cdots \otimes a_n) \otimes \phi \otimes (a_{n+1} \otimes \cdots \otimes a_{n+m}) \mapsto (a \mapsto \phi(m_{n+m+1}(a_{n+1}, \dots, a_{n+m}, a, a_1, \dots, a_n))) ,$$

where $a_k \in A$ and $\phi \in A^\vee$. The A_∞ -algebra A carries moreover naturally the structure of an A_∞ -bimodule over itself. As proven in [TZ07b], a V_2 -algebra can then equivalently be defined as the data of an A_∞ -algebra A together with a morphism of A_∞ -bimodules $A^\vee \rightarrow A$. The operations of this A_∞ -bimodule morphism correspond indeed to maps $A^{\otimes i_1} \otimes A^\vee \otimes A^{\otimes i_2} \rightarrow A$, thus can be rewritten as elements $m_{i_1, i_2} \in (A^\vee)^{\otimes i_1} \otimes A \otimes (A^\vee)^{\otimes i_2} \otimes A$. The A_∞ -equations for the A_∞ -bimodule morphism $A^\vee \rightarrow A$ then yield exactly the V_2 -equations for the maps m_{i_1, i_2} . A V_2 -algebra was in fact referred to as an A_∞ -algebra with homotopy co-inner product in [TZ07b] and motivated later on the introduction of the notion of a V_∞ -algebra in [TZ07a].

Let now A and B be two V_2 -algebras. To begin with, a V_2 -morphism $A \rightarrow B$ should contain the datum of an A_∞ -morphism $A \rightarrow B$. Using the datum of such an A_∞ -morphism one can endow B and B^\vee with A_∞ -bimodule structures over A . Consider then the following diagram of morphisms of A_∞ -bimodules over A

$$\begin{array}{ccc} B^\vee & \longrightarrow & A^\vee \\ \downarrow & & \downarrow \\ B & \longleftarrow & A . \end{array}$$

where the horizontal arrows are to be interpreted as the A_∞ -analogue of pre-composition and post-composition by the A_∞ -morphism $A \rightarrow B$. We can define two distinct notions of a V_2 -morphism from A to B using this diagram :

- (i) Either it corresponds to the datum of an A_∞ -morphism $A \rightarrow B$ such that the previous diagram commutes. In other words, a V_2 -morphism is an A_∞ -morphism which is "compatible" with the m_{i_1, i_2} operations of A and B . The composition of V_2 -morphisms is then simply defined as the composition of A_∞ -morphisms.
- (ii) Or we can also require that this diagram commutes up to homotopy of morphisms of A_∞ -bimodules over A . Homotopies of morphisms of A_∞ -bimodules can be defined in a similar fashion to A_∞ -homotopies for A_∞ -morphisms. In that case, it would amount to a

collection of operations $f_{i_1, i_2} \in (A^\vee)^{\otimes i_1} \otimes B \otimes (A^\vee)^{\otimes i_2} \otimes B$ satisfying an equation encoding the lack of compatibility of the A_∞ -morphism $A \rightarrow B$ with the m_{i_1, i_2} operations of A and B . The composition of V_2 -morphisms can then be defined as the composition of A_∞ -morphisms together with the homotopy obtained by composing the two homotopies in the following diagram

$$\begin{array}{ccccc}
 C^\vee & \longrightarrow & B^\vee & \longrightarrow & A^\vee \\
 \downarrow & & \downarrow & & \downarrow \\
 C & \longleftarrow & B & \longleftarrow & A.
 \end{array}$$

We expect that the correct homotopy notion a V_2 -morphism is given by definition (ii), and will refer to a V_2 -morphism using this definition in the following paragraph.

In general, such a nice algebraic description of the structure of a V_k -algebra in terms of morphisms of A_∞ -bimodules is unfortunately not possible for $k \geq 3$. Heuristically this stems from the fact that extending a V_2 -algebra structure to a V_k -algebra structure for $k \geq 3$ does not add cohomologically meaningful operations to the V_2 -operations : the only operations compatible with the differential are $c \in A \otimes A$ and $m_2 : A \otimes A \rightarrow A$ and all the other operations should be interpreted as the higher coherent homotopies encoding the structure of a homotopy associative algebra with symmetric and invariant co-inner product. While we manage to understand how to generalize the notion of a V_2 -morphism to that of V_k -morphism by writing down the explicit V_2 -equations for V_2 -morphisms in terms of operations, we do not understand yet the combinatorics involved in the definition of the composition of V_k -morphisms for $k \geq 3$.

We plan thereby on inspecting how Koszul duality for dioperads as defined in [Gan03] might be applied to the dioperads V and V_∞ in order to define a well-suited framework for the notion of V_∞ -algebras and V_∞ -morphisms together with a way to compose them. Understanding the homotopy theory of dioperadic bimodules (and in fact defining the notion of a dioperadic bimodule first) and their cofibrant replacements might also be of interest for that question.

2. Further directions

2.1. Algebraic structures on the symplectic and Rabinowitz-Floer cochains. Once these questions have been solved, we first plan to clarify which exact structure is induced on the cone associated to the pair (A^\vee, A) by a V_∞ -algebra structure on A . Venkatesh as well as Cieliebak and Oancea prove indeed respectively in [Ven18] and [CO18] that Rabinowitz-Floer homology $SH_*(\partial W)$ can be computed as the homology of a cone defined by a canonical up to homotopy chain map $SC^{-*}(W) \rightarrow SC_*(W)$. It is moreover shown in [CHOb] that Rabinowitz-Floer homology $SH_*(\partial W)$ carries the structure of a biunital involutive coFrobenius bialgebra, not only that of an associative algebra induced by the V_∞ -algebra structure on $SC_*(W)$. A comprehensive study of the V_∞ -operations on $SC_*(W)$ may show that some of them are in fact null, exhibiting stronger relations satisfied in the particular case of $SH_*(\partial W)$.

In [Abo15], Abouzaid defines a BV-algebra structure on the symplectic homology of a co-tangent bundle T^*M using moduli spaces of curves with asymptotic markers. Bottman defines in [Bot21] a simplicial version of the Fulton-MacPherson operad and states that he expects that this operad in topological spaces could be used to lift the BV-algebra structure to a homotopy BV-algebra structure on the symplectic chains of T^*M . It would therefore be interesting to clarify if the V_∞ -algebra structure and the expected homotopy BV-algebra structure on $SC_*(T^*M)$ could fit into a satisfactory common operadic framework. This problem may feature operations similar to the algebraic string operations introduced in [TZ07a].

2.2. Towards string topology. It is finally a general motto that given a smooth manifold M , algebraic structures on Floer-type (co)chain complexes of the Liouville domain T^*M always have a counterpart in string topology, as algebraic structures on the singular (co)chains of the free loop space $\mathcal{L}M$. The seminal result on that matter is Viterbo's isomorphism relating symplectic cohomology $SH^*(T^*M)$ of the Liouville domain T^*M and the ordinary homology of the free loop space $H_*(\mathcal{L}M)$, which is thoroughly explained in [Abo15]. Further work in that direction is also carried out in [CHO20] in relation with the Sullivan-Goresky-Hingston coproduct defined in [Sul04] and [GH09]. We thus plan to investigate how the algebraic structures defined on symplectic and Rabinowitz-Floer chain complexes in the previous problems incarnate in the world of string topology. As proven in [Nae21], the Goresky-Hingston coproduct in string topology is not homotopy invariant. Our hope is that these full chain level structures in string topology would in fact allow to detect properties of the underlying manifold M beyond its homotopy type.

Bibliographie

- [Abo11] Mohammed Abouzaid. A topological model for the Fukaya categories of plumbings. *J. Differential Geom.*, 87(1) :1–80, 2011.
- [Abo15] Mohammed Abouzaid. Symplectic cohomology and Viterbo’s theorem. In *Free loop spaces in geometry and topology. Including the monograph Symplectic cohomology and Viterbo’s theorem by Mohammed Abouzaid*, pages 271–485. Zürich : European Mathematical Society (EMS), 2015.
- [AJ10] Manabu Akaho and Dominic Joyce. Immersed Lagrangian Floer theory. *J. Differ. Geom.*, 86(3) :381–500, 2010.
- [AL21] Hossein Abbaspour and Francois Laudenbach. Morse complexes and multiplicative structures. *Mathematische Zeitschrift*, pages 1–42, 2021.
- [Amo16] Lino Amorim. Tensor product of filtered A_∞ -algebras. *J. Pure Appl. Algebra*, 220(12) :3984–4016, 2016.
- [Amo17] Lino Amorim. The Künneth theorem for the Fukaya algebra of a product of Lagrangians. *Int. J. Math.*, 28(4) :38, 2017. Id/No 1750026.
- [AS06] Alberto Abbondandolo and Matthias Schwarz. On the Floer homology of cotangent bundles. *Commun. Pure Appl. Math.*, 59(2) :254–316, 2006.
- [Aur14] Denis Auroux. A beginner’s introduction to Fukaya categories. In *Contact and symplectic topology. Proceedings of the CAST summer schools and conferences, Nantes, France, June 2011 and Budapest, Hungary, July 2012*, pages 85–136. Cham : Springer ; Budapest : János Bolyai Mathematical Society, 2014.
- [BC21] Nathaniel Bottman and Shachar Carmeli. $(A_\infty, 2)$ -categories and relative 2-operads. *High. Struct.*, 5(1) :401–421, 2021.
- [Bot19a] Nathaniel Bottman. 2-associahedra. *Algebr. Geom. Topol.*, 19(2) :743–806, 2019.
- [Bot19b] Nathaniel Bottman. Moduli spaces of witch curves topologically realize the 2-associahedra. *J. Symplectic Geom.*, 17(6) :1649–1682, 2019.
- [Bot20] Nathaniel Bottman. Pseudoholomorphic quilts with figure eight singularity. *J. Symplectic Geom.*, 18(1) :1–55, 2020.
- [Bot21] Nathaniel Bottman. A simplicial version of the 2-dimensional Fulton-MacPherson operad, 2021. arXiv :2101.03211.
- [CHOa] Kai Cieliebak, Nancy Hingston, and Alexandru Oancea. Algebra for Poincaré duality. In preparation.
- [CHOb] Kai Cieliebak, Nancy Hingston, and Alexandru Oancea. Sullivan’s relation for Rabinowitz Floer homology. In preparation.
- [CHO20] Kai Cieliebak, Nancy Hingston, and Alexandru Oancea. Poincaré duality for loop spaces, 2020. arXiv :2008.13161.
- [CO18] Kai Cieliebak and Alexandru Oancea. Symplectic homology and the Eilenberg-Steenrod axioms. *Algebr. Geom. Topol.*, 18(4) :1953–2130, 2018. Appendix written jointly with Peter Albers.
- [CO20] Kai Cieliebak and Alexandru Oancea. Multiplicative structures on cones and duality, 2020. arXiv :2008.13165.
- [Coh06] Ralph L. Cohen. Morse theory, graphs, and string topology. In *Morse theoretic methods in nonlinear analysis and in symplectic topology. Proceedings of the NATO Advanced Study Institute, Montréal, Canada, July 2004*, pages 149–184. Dordrecht : Springer, 2006.
- [CS99] Moira Chas and Dennis Sullivan. String topology, 1999. arXiv :math/9911159.
- [Ekh07] Tobias Ekholm. Morse flow trees and Legendrian contact homology in 1-jet spaces. *Geom. Topol.*, 11 :1083–1224, 2007.

- [Fao17] Giovanni Faonte. Simplicial nerve of an A_∞ -category. *Theory Appl. Categ.*, 32 :Paper No. 2, 31–52, 2017.
- [Flo88] Andreas Floer. Morse theory for Lagrangian intersections. *J. Differ. Geom.*, 28(3) :513–547, 1988.
- [FO97] Kenji Fukaya and Yong-Geun Oh. Zero-loop open strings in the cotangent bundle and Morse homotopy. *Asian J. Math.*, 1(1) :96–180, 1997.
- [FOOO09a] Kenji Fukaya, Yong-Geun Oh, Hiroshi Ohta, and Kaoru Ono. *Lagrangian intersection Floer theory. Anomaly and obstruction. I*, volume 46. Providence, RI : American Mathematical Society (AMS); Somerville, MA : International Press, 2009.
- [FOOO09b] Kenji Fukaya, Yong-Geun Oh, Hiroshi Ohta, and Kaoru Ono. *Lagrangian intersection Floer theory. Anomaly and obstruction. II*, volume 46. Providence, RI : American Mathematical Society (AMS); Somerville, MA : International Press, 2009.
- [Fuk93] Kenji Fukaya. Morse homotopy, A_∞ -category, and Floer homologies. In *Proceedings of the GARC workshop on geometry and topology '93 held at the Seoul National University, Seoul, Korea, July 1993*, pages 1–102. Seoul : Seoul National University, 1993.
- [Fuk97] Kenji Fukaya. Morse homotopy and its quantization. In *Geometric topology. 1993 Georgia international topology conference, August 2–13, 1993, Athens, GA, USA*, pages 409–440. Providence, RI : American Mathematical Society; Cambridge, MA : International Press, 1997.
- [Fuk02] Kenji Fukaya. Floer homology and mirror symmetry. II. In *Minimal surfaces, geometric analysis and symplectic geometry. Based on the lectures of the workshop and conference, Johns Hopkins University, Baltimore, MD, USA, March 16–21, 1999*, pages 31–127. Tokyo : Mathematical Society of Japan, 2002.
- [Fuk10] Kenji Fukaya. Cyclic symmetry and adic convergence in Lagrangian Floer theory. *Kyoto J. Math.*, 50(3) :521–590, 2010.
- [Fuk17] Kenji Fukaya. Unobstructed immersed Lagrangian correspondence and filtered A_∞ functor, 2017. arXiv :1706.02131.
- [Gan03] Wee Liang Gan. Koszul duality for dioperads. *Math. Res. Lett.*, 10(1) :109–124, 2003.
- [GH09] Mark Goresky and Nancy Hingston. Loop products and closed geodesics. *Duke Math. J.*, 150(1) :117–209, 2009.
- [GKZ94] I. M. Gelfand, M. M. Kapranov, and A. V. Zelevinsky. *Discriminants, resultants, and multidimensional determinants*. Boston, MA : Birkhäuser, 1994.
- [Gro85] M. Gromov. Pseudo holomorphic curves in symplectic manifolds. *Invent. Math.*, 82(2) :307–347, 1985.
- [Hir03] Philip S. Hirschhorn. *Model categories and their localizations*, volume 99 of *Mathematical Surveys and Monographs*. American Mathematical Society, Providence, RI, 2003.
- [Hut08] Michael Hutchings. Floer homology of families. I. *Algebr. Geom. Topol.*, 8(1) :435–492, 2008.
- [Kra18] Thomas Kragh. The Viterbo transfer as a map of spectra. *J. Symplectic Geom.*, 16(1) :85–226, 2018.
- [LAM] Guillaume Laplante-Anfossi and Thibaut Mazuir. The diagonal of the multiplihedra and the product of A_∞ -categories. In preparation.
- [LH02] Kenji Lefevre-Hasegawa. *Sur les A_∞ -catégories*. PhD thesis, Ph. D. thesis, Université Paris 7, UFR de Mathématiques, 2003, math. CT/0310337, 2002.
- [LL13] Yankı Lekili and Max Lipyanskiy. Geometric composition in quilted Floer theory. *Adv. Math.*, 236 :1–23, 2013.
- [Lod04] Jean-Louis Loday. Realization of the Stasheff polytope. *Arch. Math.*, 83(3) :267–278, 2004.
- [Lod11] Jean-Louis Loday. The diagonal of the Stasheff polytope. In *Higher structures in geometry and physics. In honor of Murray Gerstenhaber and Jim Stasheff*, pages 269–292. Basel : Birkhäuser, 2011.
- [LOT21] Robert Lipshitz, Peter Ozsváth, and Dylan Thurston. Diagonals and A-infinity tensor products, 2021. arXiv :2009.05222.
- [Lyu03] Volodymyr Lyubashenko. Category of A_∞ -categories. *Homology Homotopy Appl.*, 5(1) :1–48, 2003.
- [Mac98] Saunders Mac Lane. *Categories for the working mathematician.*, volume 5. New York, NY : Springer, 1998.
- [Mar06] Martin Markl. Transferring A_∞ (strongly homotopy associative) structures. *Rend. Circ. Mat. Palermo (2) Suppl.*, (79) :139–151, 2006.

- [Maz21a] Thibaut Mazuir. Higher algebra of A_∞ and ΩBAs -algebras in Morse theory I, 2021. arXiv :2102.06654.
- [Maz21b] Thibaut Mazuir. Higher algebra of A_∞ and ΩBAs -algebras in Morse theory II. arXiv :2102.08996, 2021.
- [Mes18] Stephan Mescher. *Perturbed gradient flow trees and A_∞ -algebra structures in Morse cohomology*, volume 6 of *Atlantis Studies in Dynamical Systems*. Atlantis Press, [Paris]; Springer, Cham, 2018.
- [Mil13] John W. Milnor. *Morse theory. Based on lecture notes by M. Spivak and R. Wells*, volume 66. New Delhi : Hindustan Book Agency, 2013.
- [MS03] James E. McClure and Jeffrey H. Smith. Multivariable cochain operations and little n -cubes. *J. Amer. Math. Soc.*, 16(3) :681–704, 2003.
- [MS06] Martin Markl and Steve Shnider. Associahedra, cellular W -construction and products of A_∞ -algebras. *Trans. Amer. Math. Soc.*, 358(6) :2353–2372, 2006.
- [MS12] Dusa McDuff and Dietmar Salamon. *J-holomorphic curves and symplectic topology*, volume 52 of *American Mathematical Society Colloquium Publications*. American Mathematical Society, Providence, RI, second edition, 2012.
- [MSS02] Martin Markl, Steve Shnider, and Jim Stasheff. *Operads in algebra, topology and physics*, volume 96. Providence, RI : American Mathematical Society (AMS), 2002.
- [MTTV21] Naruki Masuda, Hugh Thomas, Andy Tonks, and Bruno Vallette. The diagonal of the associahedra. *J. Éc. polytech. Math.*, 8 :121–146, 2021.
- [MW10] S. Ma'u and C. Woodward. Geometric realizations of the multiplihedra. *Compos. Math.*, 146(4) :1002–1028, 2010.
- [MWW18] S. Ma'u, K. Wehrheim, and C. Woodward. A_∞ functors for Lagrangian correspondences. *Selecta Math. (N.S.)*, 24(3) :1913–2002, 2018.
- [Nae21] Florian Naef. The string coproduct "knows" Reidemeister/Whitehead torsion, 2021. arXiv :2106.11307.
- [PT18] Kate Poirier and Thomas Tradler. The combinatorics of directed planar trees. *J. Combin. Theory Ser. A*, 160 :31–61, 2018.
- [PT19] Kate Poirier and Thomas Tradler. Koszuality of the $\mathcal{V}^{(d)}$ dioperad. *J. Homotopy Relat. Struct.*, 14(2) :477–507, 2019.
- [Sal90] Dietmar Salamon. Morse theory, the Conley index and Floer homology. *Bull. Lond. Math. Soc.*, 22(2) :113–140, 1990.
- [Sei08] Paul Seidel. *Fukaya categories and Picard-Lefschetz theory*. Zürich : European Mathematical Society (EMS), 2008.
- [Smi15] Ivan Smith. A symplectic prolegomenon. *Bull. Amer. Math. Soc. (N.S.)*, 52(3) :415–464, 2015.
- [Sta63] James Dillon Stasheff. Homotopy associativity of H -spaces. I, II. *Trans. Amer. Math. Soc.* 108 (1963), 275–292; *ibid.*, 108 :293–312, 1963.
- [SU04] Samson Sanedidze and Ronald Umble. Diagonals on the permutahedra, multiplihedra and associahedra. *Homology Homotopy Appl.*, 6(1) :363–411, 2004.
- [Sul04] Dennis Sullivan. Open and closed string field theory interpreted in classical algebraic topology. In *Topology, geometry and quantum field theory. Proceedings of the 2002 Oxford symposium in honour of the 60th birthday of Graeme Segal, Oxford, UK, June 24–29, 2002*, pages 344–357. Cambridge : Cambridge University Press, 2004.
- [SW06] D. A. Salamon and J. Weber. Floer homology and the heat flow. *Geom. Funct. Anal.*, 16(5) :1050–1138, 2006.
- [TZ07a] Thomas Tradler and Mahmoud Zeinalian. Algebraic string operations. *K-Theory*, 38(1) :59–82, 2007.
- [TZ07b] Thomas Tradler and Mahmoud Zeinalian. Infinity structure of Poincaré duality spaces. With an appendix by Dennis Sullivan. *Algebr. Geom. Topol.*, 7 :233–260, 2007.
- [Val20] Bruno Vallette. Homotopy theory of homotopy algebras. *Ann. Inst. Fourier (Grenoble)*, 70(2) :683–738, 2020.
- [Ven18] Sara Venkatesh. Rabinowitz Floer homology and mirror symmetry. *J. Topol.*, 11(1) :144–179, 2018.
- [Vit98] Claude Viterbo. Functors and computations in Floer homology with applications Part II. *Prépublication Orsay 98-15*, 1998.

- [Wei81] Alan Weinstein. Symplectic geometry. *Bull. Am. Math. Soc., New Ser.*, 5 :1–13, 1981.
- [WW10a] Katrin Wehrheim and Chris T. Woodward. Functoriality for Lagrangian correspondences in Floer theory. *Quantum Topol.*, 1(2) :129–170, 2010.
- [WW10b] Katrin Wehrheim and Chris T. Woodward. Quilted Floer cohomology. *Geom. Topol.*, 14(2) :833–902, 2010.
- [WW12] Katrin Wehrheim and Chris T. Woodward. Floer cohomology and geometric composition of Lagrangian correspondences. *Adv. Math.*, 230(1) :177–228, 2012.